

COMMUNITY EMERGENCY RESPONSE TEAM

Basic Training Instructor Guide

Developed For:

**National CERT Program
Federal Emergency Management Agency
Department of Homeland Security
Washington, D.C.**

Developed By:

**PerformTech Inc.
Alexandria, Virginia**

January 2011

COMMUNITY EMERGENCY RESPONSE TEAM
INTRODUCTION AND OVERVIEW

ACKNOWLEDGEMENTS

The Community Emergency Response Team (CERT) concept was developed and implemented by the City of Los Angeles Fire Department (LAFD) in 1985. They recognized that citizens would very likely be on their own during the early stages of a catastrophic disaster. Accordingly, LAFD decided that some basic training in disaster survival and rescue skills would improve the ability of citizens to survive and to safely help others until responders or other assistance could arrive.

The training model that the LAFD initiated was adopted by other fire departments around the country, including communities where the major threat is hurricanes rather than earthquakes. Building on this development, in 1994 the Federal Emergency Management Agency (FEMA) expanded the CERT materials to make them applicable to all hazards and made the program available to communities nationwide. Since that time, thousands of dedicated trainers, organizations, and citizens have embraced the responsibility to learn new skills and become prepared to execute safe and effective emergency response. We salute you.

The National CERT Program and the Individual and Community Preparedness Division in FEMA would like to thank the following people who participated in a focus group to review and update the *CERT Basic Training* material:

Lt. Joe Geleta
New Jersey State Police

Pam Harris
Hernando County (FL) Emergency Management

Erin Hausauer
Stearns County (MN) Emergency Management

Capt. Joel Kasprzak
Portland (OR) Fire & Rescue

Cynthia L. Kellams
Arlington County (VA) CERT Program

Janet E. Lindquist
Millard County (UT) CERT Program

Don Lynch
Shawnee Pottawatomie County (OK) Emergency Management

COMMUNITY EMERGENCY RESPONSE TEAM
INTRODUCTION AND OVERVIEW

Mayor Dave Nichols
Mississippi State Citizen Corps Council

Lt. Brad Smith
Dearborn (MI) Emergency Management

Kimberly H. Spill
Pompano Beach (FL) Fire Rescue

Firefighter Jarvis Willis
Los Angeles (CA) Fire Department

We would also like to thank those many individuals from local and State CERT programs who reviewed the draft of the updated *CERT Basic Training* material.

COMMUNITY EMERGENCY RESPONSE TEAM

INTRODUCTION AND OVERVIEW

COMMUNITY PREPAREDNESS

Following the events of September 11, 2001, Citizen Corps was launched as a grassroots strategy to strengthen community safety and preparedness through increased civic participation. Since then, the importance of preparedness education, training, and involving the whole community has become increasingly recognized as critical to successful community preparedness and resilience.

Citizen Corps is administered by the Federal Emergency Management Agency, within the Department of Homeland Security, but is implemented locally. Communities across the country have created Citizen Corps Councils as effective partnerships between government and community leaders to focus on the following objectives: engaging the whole community in collaborative community planning and capacity building; integration of community resources; outreach and localized preparedness education and training; emergency communications to all population segments; drills and exercises; and, volunteer programs.

CERT is a critical program in the effort to engage everyone in America in making their communities safer, more prepared, and more resilient when incidents occur.

Community-based preparedness planning allows us all to prepare for and respond to anticipated disruptions and potential hazards following a disaster. As individuals, we can prepare our homes and families to cope during that critical period. Through pre-event planning, neighborhoods and worksites can also work together to help reduce injuries, loss of lives, and property damage. Neighborhood preparedness will enhance the ability of individuals and neighborhoods to reduce their emergency needs and to manage their existing resources until professional assistance becomes available.

Studies of behavior following disasters have shown that groups working together in the disaster period perform more effectively if there has been prior planning and training for disaster response. These studies also show that organized grassroots efforts may be more successful if they are woven into the social and political fabric of the community — neighborhood associations, schools, workplaces, places of worship, and other existing organizations.

Effective response therefore requires comprehensive planning and coordination of all who will be involved — government, volunteer groups, private businesses, schools, and community organizations. With training and information, individuals and community groups can be prepared to serve as a crucial resource capable of performing many of the emergency functions needed in the immediate post-disaster period. The CERT Program is designed to train individuals to be assets to help communities prepare for effective disaster response.

COMMUNITY EMERGENCY RESPONSE TEAM

INTRODUCTION AND OVERVIEW

WHEN DISASTER STRIKES

The damage caused by natural disasters, such as earthquakes, hurricanes, tornadoes, and flooding, or from manmade/technological events such as explosions or hazardous materials accidents can affect all aspects of a community, from government services to private enterprise to civic activities. These events:

- Severely restrict or overwhelm our response resources, communications, transportation, and utilities
- Leave many individuals and neighborhoods cut off from outside support

Damaged roads and disrupted communications systems may restrict the access of emergency response agencies into critically affected areas. Thus, for the initial period immediately following a disaster — often up to 3 days or longer — individuals, households, and neighborhoods may need to rely on their own resources for:

- Food
- Water
- First aid
- Shelter

Individual preparedness, planning, survival skills, and mutual aid within neighborhoods and worksites during this initial period are essential measures in coping with the aftermath of a disaster. What you do today will have a critical impact on the quality of your survival and your ability to help others safely and effectively. By learning about the likely hazards in your community and your community's plans and protocols, understanding hazard-specific protective actions and response skills, assembling important emergency supplies, and mitigating potential hazards in your home, you will be more resilient to any disruptive event. You will be an important asset to your family, neighbors, and other members of your community.

ABOUT COMMUNITY EMERGENCY RESPONSE TEAM (CERT) BASIC TRAINING

If available, emergency services personnel are the best trained and equipped to handle emergencies. Following a catastrophic disaster, however, you and the community may be on your own for a period of time because of the size of the area affected, lost communications, and unpassable roads.

CERT Basic Training is designed to prepare you to help yourself and to help others in the event of a catastrophic disaster. Because emergency services personnel will not be able to help everyone immediately, you can make a difference by using your CERT training to save lives and protect property.

COMMUNITY EMERGENCY RESPONSE TEAM

INTRODUCTION AND OVERVIEW

ABOUT COMMUNITY EMERGENCY RESPONSE TEAM (CERT) BASIC TRAINING (CONTINUED)

This training covers basic skills that are important to know in a disaster when emergency services are not available. With training and practice, and by working as a team, you will be able to protect yourself and do the greatest good for the greatest number after a disaster.

HOW CERTS OPERATE

As each CERT is organized and trained in accordance with standard operating procedures developed by the sponsoring agency, its members select an Incident Commander/Team Leader (IC/TL) and an alternate and identify a meeting location, or *staging area*, to be used in the event of a disaster.

The staging area is where the fire department and other services will interact with CERTs. Having a centralized contact point makes it possible to communicate damage assessments and allocate volunteer resources more effectively. This is true for all CERTs, whether active in a neighborhood, workplace, school, college/university campus, or other venue.

Damage from disasters may vary considerably from one location to another. In an actual disaster, CERTs are deployed progressively and as needs dictate. Members are taught to assess their own needs and the needs of those in their immediate environment first.

CERT members who encounter no need in their immediate area then report to their staging area, where they take on assigned roles based on overall area needs. Members who find themselves in a heavily affected location send runners to staging areas to get help from available resources. Ham and other radio links also may be used to increase communication capabilities and coordination.

The CERT Program can provide an effective first-response capability. Acting as individuals first, then later as members of teams, trained CERT volunteers can fan out within their assigned areas, extinguishing small fires, turning off natural gas at damaged homes, performing light search and rescue, and rendering basic medical treatment. CERTs also act as effective “eyes and ears” for uniformed emergency responders. Trained volunteers also offer an important potential workforce to service organizations in non-hazardous functions such as shelter support, crowd control, and evacuation.

COMMUNITY EMERGENCY RESPONSE TEAM

INTRODUCTION AND OVERVIEW

COURSE OVERVIEW AND OBJECTIVES

The purpose of the *Community Emergency Response Team (CERT) Basic Training* is to provide the individuals who complete this course with the basic skills that they will need to respond to their community's immediate needs in the aftermath of a disaster, when emergency services are not immediately available. By working together, CERT members can assist in saving lives and protecting property using the basic techniques in this course. The target audience for this course is individuals who desire the skills and knowledge required to prepare for and respond to a disaster.

Overall Course Objectives

Upon completing this course, the participants should be able to:

1. Describe the types of hazards that are most likely to affect their homes, workplaces, and neighborhoods.
2. Take steps to prepare themselves and their families for a disaster.
3. Describe the functions of CERTs and their role in immediate response.
4. Identify and reduce potential fire hazards in their homes, workplaces, and neighborhoods.
5. Work as a team to apply basic fire suppression strategies, resources, and safety measures to extinguish a pan fire.
6. Apply techniques for opening airways, controlling excessive bleeding, and treating for shock.
7. Conduct triage under simulated disaster conditions.
8. Perform head-to-toe patient assessments.
9. Select and set up a treatment area.
10. Employ basic treatments for various injuries and apply splints to suspected fractures and sprains.
11. Identify planning and sizeup requirements for potential search and rescue situations.
12. Describe the most common techniques for searching a structure.
13. Work as a team to apply safe techniques for debris removal and victim extrication.
14. Describe ways to protect rescuers during search and rescue operations.
15. Describe the post-disaster emotional environment and the steps that rescuers can take to relieve their own stressors and those of disaster survivors.
16. Describe CERT organization and documentation requirements.

In addition to the overall course objectives listed above, each unit has specific objectives.

COMMUNITY EMERGENCY RESPONSE TEAM

INTRODUCTION AND OVERVIEW

COURSE AGENDA

The agenda for this course is shown below and continued on the following pages. Please note that some adjustments to the agenda may be required to allow discussion of hazards specific to a community and — depending on class size — to allow all participants to take part in the exercise portions of this course.

Unit	Topics
1	Disaster Preparedness <ul style="list-style-type: none">▪ Introductions and Overview▪ Community Preparedness: Roles and Responsibilities▪ Hazards and Their Potential Impact▪ Impact on the Infrastructure▪ Home and Workplace Preparedness▪ Reducing the Impact of Hazards Through Mitigation▪ CERT Disaster Response▪ Protection for Disaster Workers▪ Additional Training for CERTs▪ Unit Summary
2	Fire Safety and Utility Controls <ul style="list-style-type: none">▪ Introduction and Unit Overview▪ Fire Chemistry▪ Fire and Utility Hazards▪ CERT Sizeup▪ Fire Sizeup Considerations▪ Firefighting Resources▪ Fire Suppression Safety▪ Hazardous Materials▪ Exercise: Suppressing Small Fires▪ Unit Summary

COMMUNITY EMERGENCY RESPONSE TEAM
INTRODUCTION AND OVERVIEW

Unit	Topics
3	Disaster Medical Operations — Part 1 <ul style="list-style-type: none">▪ Introduction and Unit Overview▪ Treating Life-Threatening Conditions▪ Triage▪ Unit Summary
4	Disaster Medical Operations — Part 2 <ul style="list-style-type: none">▪ Introduction and Unit Overview▪ Public Health Considerations▪ Functions of Disaster Medical Operations▪ Establishing Medical Treatment Areas▪ Conducting Head-to-Toe Assessments▪ Treating Burns▪ Wound Care▪ Treating Fractures, Dislocations, Sprains, and Strains▪ Nasal Injuries▪ Treating Cold-Related Injuries▪ Treating Heat-Related Injuries▪ Bites and Stings▪ Unit Summary
5	Light Search and Rescue Operations <ul style="list-style-type: none">▪ Introduction and Unit Overview▪ Safety During Search and Rescue Operations▪ Conducting Interior and Exterior Search Operations▪ Conducting Rescue Operations▪ Unit Summary
6	CERT Organization <ul style="list-style-type: none">▪ Introduction and Unit Overview▪ CERT Organization▪ CERT Mobilization

COMMUNITY EMERGENCY RESPONSE TEAM
INTRODUCTION AND OVERVIEW

Unit	Topics
	<ul style="list-style-type: none"> ▪ Documentation ▪ Activity: ICS Functions ▪ Activity: Tabletop Exercise ▪ Unit Summary
7	<p>Disaster Psychology</p> <ul style="list-style-type: none"> ▪ Introduction and Unit Overview ▪ Disaster Trauma ▪ Team Well-Being ▪ Working with Survivors' Trauma ▪ Unit Summary
8	<p>Terrorism and CERT</p> <ul style="list-style-type: none"> ▪ Introduction and Unit Overview ▪ What Is Terrorism? ▪ Terrorist Targets ▪ Terrorist Weapons ▪ CBRNE Indicators ▪ Preparing at Home, Work, and in Your Neighborhood ▪ CERTs and Terrorist Incidents ▪ Activity: Applying CERT Principles to a Suspected Terrorist Incident ▪ Unit Summary
9	<p>Course Review, Final Exam, and Disaster Simulation</p> <ul style="list-style-type: none"> ▪ Introduction and Unit Overview ▪ Course Review ▪ Final Exam ▪ Disaster Simulation ▪ Exercise Critique and Summary

COMMUNITY EMERGENCY RESPONSE TEAM
INTRODUCTION AND OVERVIEW

AFTER CERT BASIC TRAINING

Upon completion of the *CERT Basic Training* course, participants will receive a certificate. Your community may also provide additional documents that will identify each participant as an emergency response team member during disaster response.

CERT members should maintain their own CERT safety equipment, such as goggles, gloves, and basic first aid supplies, and have them available for use during a disaster. Training in disaster response should not be a one-time event. Awareness, commitment, and skills must be reinforced through followup training and repeated practice to maintain the edge necessary for effective response in the face of a disaster.

To maintain their skill level and continually improve performance, CERT members should participate in continuing supplemental training when offered in your area. Working through practice disaster scenarios with other teams will provide opportunities not only for extended practice but also for valuable networking with teams in the local area.

COMMUNITY EMERGENCY RESPONSE TEAM

INTRODUCTION AND OVERVIEW

INSTRUCTOR RESPONSIBILITIES

INSTRUCTOR QUALIFICATIONS

Instructors will be recruited and selected to conduct this course based on their working knowledge of the content and skills required for each session. It is recommended that at least two instructors jointly conduct each session. Because Sessions 3 and 4 address disaster medical operations, it is recommended that these sessions be conducted by licensed or certified:

- Paramedics or Emergency Medical Technicians
- Nurses

It is recommended that *all other sessions be conducted by skilled fire and rescue instructors who have completed the CERT Train-the-Trainer course.*

Instructors should also be knowledgeable about:

- The CERT model
- The types of hazards (natural, technological, and manmade) that present the greatest risk to the community
- Local building structures that present the greatest hazard in the event of a disaster
- The community's emergency operation plan

PREPARING TO TRAIN

The preparation and conduct of the Instructor has a definite impact on the effectiveness of the training. This introductory section provides guidelines for preparing for this course. Use the following steps when you prepare for training:

- Thoroughly read both the Instructor Guide and the Participant Manual.
- Conduct a walk-through of all exercises and be prepared to answer any questions that the participants ask while completing the exercises themselves.
- Tailor each session to your local community. Wherever possible, use local photographs of common fire hazards, local buildings, etc. Using local information will add a personal meaning for the participants and will help them to “buy into” the CERT concept.
- Draft your own notes in the white space around the margins of this book. Include information that is specific to the community. Indicate points where you want to include additional local photographs.
- Identify sessions that require you to prepare information or materials that relate specifically to your community (see “Preparation” at the beginning of each unit). Prepare these items in advance of the session.

COMMUNITY EMERGENCY RESPONSE TEAM

INTRODUCTION AND OVERVIEW

PREPARING TO TRAIN (CONTINUED)

- Be certain you are aware of any cultural sensitivities for the community in which you will be training. It is important to understand how to best deliver the content so as to engage the participants. Because of the differences in individual cultures, it is essential that you get to know the culture. You will need to work with members of that culture to understand any topics in the training that may be culturally sensitive and to resolve any potential issues.
 - In advance of the training, meet with a community representative involved in emergency preparedness to discuss the different topics covered in the training. Together, try to identify any culturally sensitive issues, such as physical contact, medical response, or disaster psychology. Discuss ways to present these topics in the most appropriate way for the participants.
 - During the training, don't pretend to be an expert on cultural issues, and invite participants to discuss such topics. If possible, a member of the community in which you are training should co-teach the class.
 - Bear in mind several points regarding communities and cultures. First, when coming into a new community, members of that community may not accept you immediately. This is one reason to request information and seek the guidance and advice of community representatives regarding cultural issues. Additionally, remember that not all members of a community may have the same cultural background. Avoid making assumptions about the beliefs or attitudes of the participants.
- Draft or copy any supplemental materials from which you feel the participants will benefit. Many supplemental materials may be available from local emergency management personnel or from such Federal agencies as the National Fire Academy, Emergency Management Institute, or National Severe Weather Center. If you use copyrighted materials, be sure to obtain copyright releases.
- Instructors are encouraged to add pertinent information to the course, but topics should not be deleted.

COMMUNITY EMERGENCY RESPONSE TEAM
INTRODUCTION AND OVERVIEW

PREPARING THE CLASSROOM

As an Instructor, you are responsible for:

- The equipment that you need for the course

For each session, you will need:

- A computer with PowerPoint software (PowerPoint 97 or more recent)
- A computer projector and screen
- Chart paper, easel, and markers
- Masking tape
- Pens and pencils

Session-specific equipment and materials are listed at the beginning of the Instructor Notes for each unit.

- The room arrangement

This is your choice and, depending on the number of participants, you may opt for different arrangements. Regardless of the room arrangement you select, the training room must be large enough to accommodate the exercises for each session.

[This page intentionally left blank]

**COMMUNITY EMERGENCY RESPONSE TEAM
BASIC TRAINING COURSE
TABLE OF CONTENTS**

	PAGE
Introduction and Overview	
Acknowledgements.....	1
Community Preparedness.....	3
When Disaster Strikes.....	4
About Community Emergency Response Team (CERT) Training	4
How CERTs Operate	5
Course Overview and Objectives	6
Course Agenda.....	7
After <i>CERT Basic Training</i>	10
Instructor Responsibilities	11
 Unit 1: Disaster Preparedness	
Introductions and Overview.....	1-4
Community Preparedness: Roles and Responsibilities	1-12
Hazards and Their Potential Impact	1-16
Impact on the Infrastructure	1-18
Home and Workplace Preparedness.....	1-24
Reducing the Impact of Hazards Through Mitigation.....	1-44
CERT Disaster Response	1-50
Protection for Disaster Workers	1-56
Additional Training for CERTs.....	1-58
Unit Summary	1-60
Additional Materials	
Appendix 1-A: Hazard Lesson Plans	
 Unit 2: Fire Safety	
Introduction and Unit Overview	2-6
Fire Chemistry.....	2-11
Fire and Utility Hazards.....	2-14
CERT Sizeup	2-22
Fire Sizeup Considerations	2-27
Firefighting Resources	2-28
Fire Suppression Safety.....	2-42
Hazardous Materials	2-48
Exercise: Suppressing Small Fires.....	2-54
Unit Summary	2-58

**COMMUNITY EMERGENCY RESPONSE TEAM
 BASIC TRAINING COURSE
 TABLE OF CONTENTS**

	PAGE
 Unit 3: Disaster Medical Operations—Part 1	
Introduction and Unit Overview	3-5
Treating Life-Threatening Conditions	3-12
Triage	3-37
Unit Summary	3-53
 Unit 4: Disaster Medical Operations—Part 2	
Introduction and Unit Overview	4-5
Public Health Considerations	4-9
Functions of Disaster Medical Operations	4-12
Establishing Medical Treatment Areas	4-14
Conducting Head-to-Toe Assessments	4-23
Treating Burns	4-33
Wound Care.....	4-41
Treating Fractures, Dislocations, Sprains, and Strains	4-45
Nasal Injuries	4-56
Treating Cold-Related Injuries.....	4-57
Treating Heat-Related Injuries	4-61
Bites and Stings.....	4-63
Unit Summary	4-65
 Unit 5: Light Search and Rescue Operations	
Introduction and Unit Overview	5-5
Safety During Search and Rescue Operations.....	5-11
Conducting Interior and Exterior Search Operations	5-38
Conducting Rescue Operations	5-46
Unit Summary	5-58
 Unit 6: CERT Organization	
Introduction and Unit Overview	6-5
CERT Organization	6-9
CERT Mobilization	6-21
Documentation.....	6-27
Activity: ICS Functions	6-45
Activity: Tabletop Exercise	6-48
Unit Summary	6-50

**COMMUNITY EMERGENCY RESPONSE TEAM
BASIC TRAINING COURSE
TABLE OF CONTENTS**

	PAGE
Unit 7: Disaster Psychology	
Introduction and Unit Overview	7-4
Disaster Trauma	7-8
Team Well-Being	7-10
Working with Survivors' Trauma.....	7-14
Unit Summary	7-21
Unit 8: Terrorism and CERT	
Introduction and Unit Overview	8-4
What is Terrorism?.....	8-8
Terrorist Targets	8-9
Terrorist Weapons	8-10
CBRNE Indicators.....	8-20
Preparing at Home, Work, and in Your Neighborhood.....	8-22
CERTs and Terrorist Incidents	8-25
Activity: Applying CERT Principles to a Suspected Terrorist Incident	8-32
Unit Summary	8-35
Unit 9: Course Review and Disaster Simulation	
Introduction and Unit Overview	9-8
Course Review.....	9-8
Final Exam	9-13
Disaster Simulation	9-27
Exercise Critique and Summary	9-29
Graduation	9-29

[This page intentionally left blank]

UNIT 1: DISASTER PREPAREDNESS

In this unit you will learn about:

- **Roles and Responsibilities for Community Preparedness:** How everyone in a community has a role in disaster preparedness and response.
- **Elements of Disasters and Their Impact on the Infrastructure:** The potential effect of extreme emergencies and disasters on transportation; electrical service; telephone communication; availability of food, water, shelter and fuel; and emergency services.
- **Personal and Organizational Preparedness:** How you can prepare in advance to improve the quality of your survival and to reduce the damage from hazards.
- **Role of CERTs:** CERT organization, disaster and non-disaster roles, and laws that protect disaster workers from liability.

[This page intentionally left blank]

**COMMUNITY EMERGENCY RESPONSE TEAM
UNIT 1: DISASTER PREPAREDNESS**

OBJECTIVES	<p>At the conclusion of this unit, the participants will be able to:</p> <ul style="list-style-type: none">▪ Identify the roles and responsibilities for community preparedness, to include government, community leaders from all sectors, and the public.▪ Describe the types of hazards most likely to affect their community and their potential impact on people, health, and infrastructure.▪ Undertake personal and organizational preparedness actions.▪ Describe the functions of CERTs and their role as a CERT member.
SCOPE	<p>The topics that will be discussed in this unit are:</p> <ul style="list-style-type: none">▪ Introductions and Overview▪ Community Preparedness: Roles and Responsibilities▪ Hazards and Their Potential Impact▪ Impact on the Infrastructure▪ Home and Workplace Preparedness▪ Reducing the Impact of Hazards Through Mitigation▪ CERT Disaster Response▪ Protection for Disaster Workers▪ Additional Training for CERTs▪ Unit Summary
ESTIMATED COMPLETION TIME	<p>2 hours 30 minutes</p>
TRAINING METHODS	<p>The lead instructor will begin by welcoming the participants to the course, introducing himself or herself and the other instructor(s), and making any necessary administrative announcements. The instructor will then briefly review a major disaster that recently affected the area or the State, stressing its aftermath, lessons learned (including the importance of preparedness), and the role that CERTs might have had in that disaster.</p> <p>Next, the instructor will briefly explain the course objectives and discuss the topics to be covered in the course.</p>

COMMUNITY EMERGENCY RESPONSE TEAM
UNIT 1: DISASTER PREPAREDNESS

**TRAINING METHODS
(CONTINUED)**

The instructor will then give a brief overview of the nature of disasters and extreme emergencies, stressing how CERTs fit into the response and recovery picture.

Then the instructor will begin an introductory exercise. The purpose of this exercise is to introduce the participants to each other and illustrate the types of skills and abilities that CERTs require.

During this exercise, each participant will introduce himself or herself and provide a brief description of:

- Why he or she is attending the course
- Where he or she lives or works in the community

Following the introductions, the instructor will review the collective distribution of participants and facilitate a brief discussion of how the skills demonstrated in the introductory activity might be useful in the immediate aftermath of a disaster. During the discussion, the instructor will stress the importance of communication, trust, and teamwork (the whole being greater than the sum of the parts) as critical elements of effective CERTs.

Next, the instructor will lead a discussion of the chief threat(s) for the community and the impact that the threat(s) is (are) likely to have on the community's infrastructure and emergency services.

The instructor will then lead a discussion of the types of structural and non-structural hazards that the participants may face in the different types of structures located within the community and how those hazards can be mitigated through individual and community preparedness efforts both at home and in the workplace.

Finally, the instructor will summarize the key points of the session while creating the linkage that, as CERT members, the participants will play a vital role in response.

Please be advised that, as a general rule, the instructor is encouraged to add pertinent local information to this unit, but should never subtract material.

**RESOURCES
REQUIRED**

- *Community Emergency Response Team Instructor Guide*
- *Community Emergency Response Team Participant Manual*
- PowerPoint Slides 1-0 through 1-35
- PowerPoint Slides from hazard modules selected

**COMMUNITY EMERGENCY RESPONSE TEAM
UNIT 1: DISASTER PREPAREDNESS**

EQUIPMENT

The following additional equipment is required for this unit:

- A computer with PowerPoint software
- A computer projector and screen
- Scissors (1 for every 5 participants)
- Tape (1 roll for every 5 participants)
- Two pieces of cardboard, approximately 8 by 10 inches (1 set for every 5 participants)
- Forty pieces of construction paper, 8.5 by 11 inches (1 set for every 5 participants)

PREPARATION

- Prepare information on State and local laws that protect CERT members in your area. Enter the information in the table on p. 1-37 of the Participant Manual before making copies.
- Carefully review this unit and the hazard modules that are included as annexes to this unit. Select the hazards that present the greatest threat to your community and incorporate them into the unit. If possible, tailor the hazard materials by including local examples and photographs.
- Working with a representative of the community in which you will be conducting training, identify any potentially culturally sensitive topics in this module. Develop strategies for presenting any such topics in ways that will be engaging and appropriate for the participants.

For example, some cultures dislike the term “disaster preparedness,” because it can imply an invitation to disaster. In this case, an alternate concept such as “community readiness” could be helpful.

**COMMUNITY EMERGENCY RESPONSE TEAM
UNIT 1: DISASTER PREPAREDNESS**

NOTES

A suggested time plan for this unit is as follows:

Introductions and Overview.....	20 minutes
Community Preparedness: Roles and Responsibilities.....	10 minutes
Hazards and Their Potential Impact.....	10 minutes
Impact on the Infrastructure	30 minutes
Home and Workplace Preparedness	30 minutes
Reducing the Impact of Hazards Through Mitigation	15 minutes
CERT Disaster Response	15 minutes
Protection for Disaster Workers	10 minutes
Additional Training for CERTS	5 minutes
Unit Summary	5 minutes



Total Time: 2 hours 30 minutes

REMARKS

This unit includes information on a variety of hazards, some of which, but not all, may affect your community. Review this unit and the additional materials carefully before training to identify hazards that pose a threat to your community.

After determining which hazard presentations you wish to include, you will want to add the PowerPoint slides into the main file for Unit 1.

1. To merge the slide presentations:

1. Open the PowerPoint file for Unit 1.
2. Open the PowerPoint file for the hazard you wish to include.
3. While in the hazard presentation, click “Slide Sorter View” () at the bottom left corner of the screen.
4. Click “Edit” at the top of the screen.
5. Click “Select All” from the edit pull-down menu.
6. Click “Window” at the top of the screen and select the Unit 1 presentation.
7. Click “Slide Sorter View” ().
8. Place the cursor where the hazard insert should be by clicking between the slides at the appropriate place in the Unit 1 presentation.
9. Right click, and select “Paste” to pull in the hazard slides.
10. Repeat Steps 2 through 8 for each hazard presentation that you wish to include in this unit.

Unit 1: Disaster Preparedness

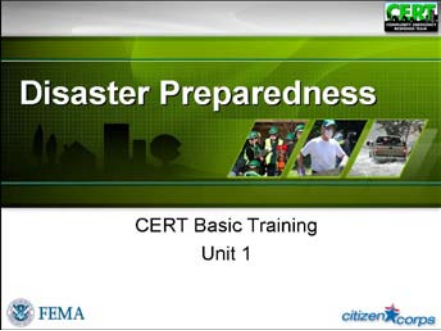
INSTRUCTOR GUIDANCE	CONTENT
 <p>Display Slide 1-0</p>	<p>Check-In</p> <p>As the participants are arriving, develop a class roster by passing around a sheet of paper, or ask them to be sure to check in on the class roster if it has already been developed. Ask the participants to confirm their name, address, phone number, and e-mail address.</p> <hr/> <p><i>Introductions and Overview</i></p> <p>Welcome</p> <p>Welcome the participants to <i>Community Emergency Response Team Basic Training</i>.</p> <p>Introduce yourselves and provide some background information about your past experiences in emergency response.</p> <p>Make any administrative announcements that are necessary at this time. Include information about:</p> <ul style="list-style-type: none">▪ The times for this and future sessions▪ Materials required▪ Building disaster preparedness kits▪ Emergency exits▪ Restroom locations, smoking policy, etc.▪ Course completion requirements

**COMMUNITY EMERGENCY RESPONSE TEAM
UNIT 1: DISASTER PREPAREDNESS**

INSTRUCTOR GUIDANCE	CONTENT
 <p>Display Slide 1-1</p>	<p>Setting the Stage</p> <p>Open by telling the participants that the damage caused by natural disasters and manmade events can be extensive.</p> <p>While emergency services personnel are the best trained and equipped to handle emergencies, they may not be immediately available in a catastrophic disaster. In such a situation, members of the community may be on their own for several days or longer. They may have to rely on their own resources for food, water, first aid, and shelter, and neighbors or coworkers may have to provide immediate assistance to those who are hurt or need other help.</p> <p>Point out that Community Emergency Response Teams (CERTs) respond in the period immediately after a disaster when response resources are overwhelmed or delayed.</p> <p>Explain that CERTs:</p> <ul style="list-style-type: none">▪ Assist first responders when requested in accordance with standard operating procedures developed by the sponsoring agency and by area of training▪ Assume many of the same functions as response personnel following a disaster <p>While CERTs are a valuable asset in emergency response, CERTs are not trained to perform all of the functions or respond to the same degree as professional responders. CERTs are a bridge to professional responders until they are able to arrive.</p> <p>This training covers basic skills that are important to know in a disaster when emergency services are not immediately available. By learning how to work as a team, neighbors and coworkers will be able to do the greatest good for the greatest number after a disaster.</p>

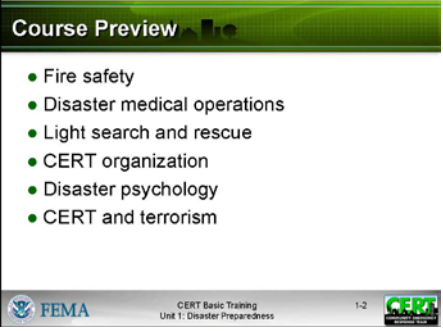

**COMMUNITY EMERGENCY RESPONSE TEAM
UNIT 1: DISASTER PREPAREDNESS**

INSTRUCTOR GUIDANCE	CONTENT
 <p>Display Slide 1-2</p> <p>If desired, provide the participants with a different activity that highlights similar skills: the ability to work together successfully with limited resources and under time pressure.</p>	<p>Course Preview</p> <p>Explain that this unit will provide an overview of the course by establishing a context for CERTs within the specific hazards faced by the community.</p> <p>Tell the group that later units will cover:</p> <ul style="list-style-type: none">▪ Fire safety▪ Disaster medical operations▪ Light search and rescue▪ CERT organization▪ Disaster psychology▪ CERT and terrorism <p>Exercise: Building a Tower</p> <p>Introduce the exercise to the participants by explaining that they will now work in small groups. Each group will work together to accomplish the same task — building a tower.</p> <p>Instructions: Follow the steps below to conduct this exercise:</p> <ol style="list-style-type: none">1. Assign the participants to groups of five.2. Distribute the following materials to each group:<ul style="list-style-type: none">▪ One pair of scissors▪ One roll of scotch tape▪ Two pieces of cardboard (approximately 8 by 10 inches)▪ Forty pieces of construction paper (8.5 by 11 inches)3. Tell the groups that they will spend the next 10

**COMMUNITY EMERGENCY RESPONSE TEAM
UNIT 1: DISASTER PREPAREDNESS**

INSTRUCTOR GUIDANCE	CONTENT
	<p>minutes planning and designing a freestanding tower that stands at least 5 feet tall from the bottom of the structure to the top. Explain that you will tell the groups when to begin and that they will have 5 minutes from that point to construct the tower. Emphasize that the first 5 minutes is for planning only.</p> <ol style="list-style-type: none">4. Tell the groups when to begin their work and when to end.5. At the end of the allotted time, facilitate a group discussion of what the groups have learned through the exercise. Be sure to cover the following points:<ul style="list-style-type: none">▪ Unfamiliar people. . .▪ Can work on an unfamiliar problem. . .▪ Using unfamiliar tools. . .▪ In unfamiliar surroundings. . .▪ In a time-compressed environment. . .▪ <u>To reach a common goal</u>6. Stress that the skills and abilities that the groups used during the exercise are the same skills that they will use as CERT members.

**COMMUNITY EMERGENCY RESPONSE TEAM
UNIT 1: DISASTER PREPAREDNESS**

INSTRUCTOR GUIDANCE	CONTENT
<div data-bbox="237 369 675 422">Unit Objectives</div> <ul data-bbox="261 436 626 646" style="list-style-type: none">● Identify roles and responsibilities for community preparedness● Describe types of hazards that affect community, people, health, and infrastructure● Undertake personal and organizational preparedness actions● Describe functions of CERTs <div data-bbox="237 659 675 697"> CERT Basic Training Unit 1: Disaster Preparedness 1-3 </div> <p data-bbox="237 716 492 751">Display Slide 1-3</p>	<p data-bbox="704 369 938 405">Unit Objectives</p> <p data-bbox="704 464 1500 499">At the end of this unit, the participants should be able to:</p> <ul data-bbox="704 516 1500 919" style="list-style-type: none">▪ Identify the roles and responsibilities for community preparedness, to include government, community leaders from all sectors, and the public.▪ Describe the types of hazards most likely to affect their community and their potential impact on people, health, and infrastructure.▪ Undertake personal and organizational preparedness actions.▪ Describe the functions of CERTs and their role as a CERT member.

COMMUNITY EMERGENCY RESPONSE TEAM
UNIT 1: DISASTER PREPAREDNESS

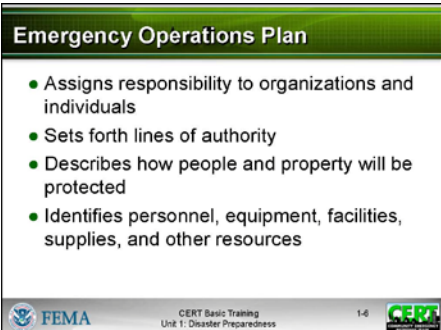
INSTRUCTOR GUIDANCE	CONTENT
 <p>Emergency Operations Plan</p> <ul style="list-style-type: none">• Assigns responsibility to organizations and individuals• Sets forth lines of authority• Describes how people and property will be protected• Identifies personnel, equipment, facilities, supplies, and other resources <p>FEMA CERT Basic Training Unit 1: Disaster Preparedness 1-6</p> <p>Display Slide 1-6</p> <p>Your local agency may use a different term for the Emergency Operations Plan. Use the term used in your jurisdiction.</p> <p>Depending on where you live, there may also be a hazard mitigation plan and/or evacuation plan. Briefly describe these if applicable.</p>	<p>Tell participants that government emergency service providers include:</p> <ul style="list-style-type: none">▪ Emergency Management▪ Law Enforcement▪ Fire and Rescue▪ Emergency Medical Services▪ Public Health Services▪ Public Works▪ Human Services <p>The Emergency Operations Plan (EOP)</p> <p>Tell participants that all government agencies with a role in disaster response work to organize and coordinate their agencies' activities before an emergency or disaster. The product of their work is the Emergency Operations Plan or "EOP" for that community.</p> <p>Explain that the EOP is a document that:</p> <ul style="list-style-type: none">▪ <u>Assigns responsibility</u> to organizations and individuals for carrying out specific actions at projected times and places in an emergency that exceeds the capability or routine responsibility of any one agency (e.g., the fire department)▪ <u>Sets forth lines of authority</u> and organizational relationships and shows how all actions will be coordinated▪ <u>Describes how people and property will be protected</u> in emergencies and disasters

**COMMUNITY EMERGENCY RESPONSE TEAM
UNIT 1: DISASTER PREPAREDNESS**

INSTRUCTOR GUIDANCE	CONTENT
<div data-bbox="235 737 675 1066" data-label="Image"> </div> <p data-bbox="235 1083 493 1119">Display Slide 1-7</p>	<ul style="list-style-type: none"> <li data-bbox="711 365 1474 541">▪ <u>Identifies personnel, equipment, facilities, supplies, and other resources</u> available — within the jurisdiction or by agreement with other jurisdictions — for use during response and recovery operations <p data-bbox="711 583 1435 653">In short, the EOP describes how the community will function in an emergency.</p> <p data-bbox="711 747 1013 783">Community Leaders</p> <p data-bbox="711 852 1435 993">Explain to participants that community leaders from the private and civic sectors have a responsibility to participate in community preparedness. Their responsibilities include:</p> <ul style="list-style-type: none"> <li data-bbox="711 1020 1463 1266">▪ Participating on the local collaborative planning council to provide insights and perspectives reflecting their industry or the constituency they service, for example, people with disabilities, local schools, communities with language or cultural differences, small businesses, the economically disadvantaged, communities of faith <li data-bbox="711 1293 1442 1362">▪ Identifying and integrating appropriate resources into government plans <li data-bbox="711 1377 1386 1482">▪ Ensuring facilities, staff, and customers or population served are prepared, trained, and practiced in preparedness actions

**COMMUNITY EMERGENCY RESPONSE TEAM
UNIT 1: DISASTER PREPAREDNESS**

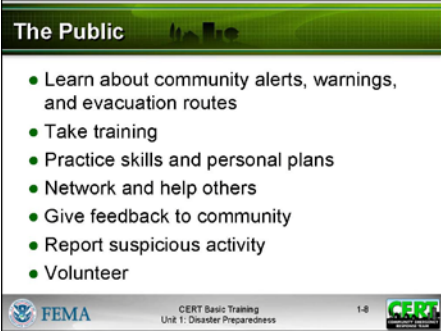
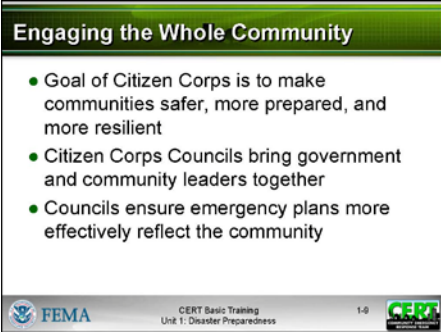
INSTRUCTOR GUIDANCE	CONTENT
 <p>The Public</p> <ul style="list-style-type: none"> ● Learn about community alerts, warnings, and evacuation routes ● Take training ● Practice skills and personal plans ● Network and help others ● Give feedback to community ● Report suspicious activity ● Volunteer <p>FEMA CERT Basic Training Unit 1: Disaster Preparedness 1-8</p> <p>Display Slide 1-8</p>	<p>The Public</p> <p>Remind participants that the public also has a responsibility for preparedness. All members of the community should:</p> <ul style="list-style-type: none"> ▪ Learn about community alerts and warnings, evacuation routes, and how to get critical information ▪ Take training in preparedness, first aid, and response skills ▪ Practice skills and personal plans through periodic drills in multiple settings ▪ Network and be able to help others ▪ Participate in community feedback opportunities ▪ Report suspicious activity ▪ Volunteer
 <p>Engaging the Whole Community</p> <ul style="list-style-type: none"> ● Goal of Citizen Corps is to make communities safer, more prepared, and more resilient ● Citizen Corps Councils bring government and community leaders together ● Councils ensure emergency plans more effectively reflect the community <p>FEMA CERT Basic Training Unit 1: Disaster Preparedness 1-9</p> <p>Display Slide 1-9</p> <p>Explain to participants that some communities may have a Citizen Corps Council (CCC) or other entity such as a Local Emergency Planning Committee (LEPC) that acts as a CCC.</p>	<p>Engaging the Whole Community</p> <p>Citizen Corps is the grassroots movement to strengthen community safety and preparedness through increased engagement of all sectors of the community. Citizen Corps is administered by the Federal Emergency Management Agency but implemented locally. The goal of Citizen Corps is to make communities safer, more prepared, and more resilient when incidents occur.</p> <p>Despite advances in technology, a functioning community is based on complex and interdependent systems driven by human forces. Citizen Corps Councils bring government and community leaders together to ensure emergency plans more effectively reflect the community, including the population composition, the hazard profile, and the infrastructure.</p>

**COMMUNITY EMERGENCY RESPONSE TEAM
UNIT 1: DISASTER PREPAREDNESS**

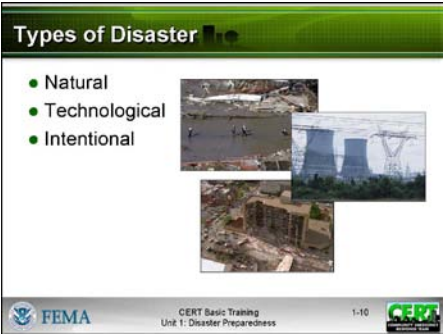
INSTRUCTOR GUIDANCE	CONTENT
 <p>Display Slide 1-10</p>	<p>The goals of the Councils are to:</p> <ul style="list-style-type: none">▪ Tailor activities to engage all sectors of the community▪ Identify and build on existing strengths▪ Increase collaboration between government and the whole community▪ Expand integration of community resources into plans and protocols▪ Encourage personal and organizational preparedness through outreach, training, and exercises▪ Promote volunteer opportunities for ongoing community safety and surge capacity in disasters <p><i>Hazards and Their Potential Impact</i></p> <p>Types of Disasters</p> <p>Explain that disasters can be:</p> <ul style="list-style-type: none">▪ Natural (e.g., earthquakes, wildfires, floods, extreme heat, hurricanes, landslides, thunderstorms, tornadoes, tsunamis, volcanic eruptions, winter storms)▪ Technological (e. g., hazardous material spill, nuclear power plant accident)▪ Intentional (terrorism using chemical, biological, radiological, nuclear, or explosive weapons)

COMMUNITY EMERGENCY RESPONSE TEAM
UNIT 1: DISASTER PREPAREDNESS

INSTRUCTOR GUIDANCE	CONTENT
---------------------	---------

Key Disaster Elements

- They are relatively unexpected
- Emergency personnel may be overwhelmed
- Lives, health, and the environment are endangered



FEMA CERT Basic Training Unit 1: Disaster Preparedness 1-11

Display Slide 1-11

Local Hazard Vulnerability

- Identify most common disasters that occur
- Identify possible hazards with most severe impact
- Consider recent or historical impacts
- Identify susceptible locations in the community for specific hazards
- Consider what to expect from disruption of services

FEMA CERT Basic Training Unit 1: Disaster Preparedness 1-12

Display Slide 1-12

Key Elements of Disasters

Explain that, regardless of the event, disasters have several key elements in common:

- They are relatively unexpected, with little or no warning or opportunity to prepare.
- Available personnel and emergency services may be overwhelmed initially by demands for their services.
- Lives, health, and the environment are endangered.

Stress that, in the immediate aftermath of a disaster, needs are often greater than professional emergency services personnel can provide. In these instances, CERTs become a vital link in the emergency service chain.

Understanding Local Hazard Vulnerability

Assessing your community's vulnerability to hazards allows the community to prioritize preparedness measures and to target effective actions for the appropriate hazard. To assess your community's vulnerability to hazards, it is useful to:

- Identify the most common disasters that occur
- Identify possible hazards with most severe impact
- Consider recent and/or historical impacts
- Identify susceptible locations in the community for specific hazards: people, buildings, infrastructure
- Consider what to expect for disruption of services and length of restoration

COMMUNITY EMERGENCY RESPONSE TEAM
UNIT 1: DISASTER PREPAREDNESS





INSTRUCTOR GUIDANCE	CONTENT
 <p>Keep a close eye on the clock. Try to limit the discussion to 10-15 minutes.</p> <p>PM, P. 1-9</p>	<p><i>Impact on the Infrastructure</i></p> <p>How many of you have been caught in a(n) [insert the type of event that is most common for your area]?</p> <p>What types of problems did you experience with such things as utilities and transportation?</p> <p>Refer the participants to the chart titled <i>Possible Impact of Damage on Infrastructure</i> in their Participant Manuals. Summarize the participants' responses to the discussion question by listing some of the effects on the infrastructure.</p>

**COMMUNITY EMERGENCY RESPONSE TEAM
UNIT 1: DISASTER PREPAREDNESS**

PM, P. 1-9	Examples of Possible Impact of Damage on Infrastructure
-------------------	--

Damage to . . .	Possible Effects
Transportation	▪ Inability to assess damage accurately
	▪ Ambulances prevented from reaching victims
	▪ Police prevented from reaching areas of civil unrest
	▪ Fire departments prevented from getting to fires
	▪ Flow of needed supplies (food, water, etc.) is interrupted
	▪ Roads are closed and/or impassable
Structures	▪ Damaged critical facilities (e.g., hospitals, fire stations, police precincts, airports) unable to function normally
	▪ Increased risk of damage from falling debris
Communication Systems	▪ Victims unable to call for help
	▪ Coordination of services is hampered
	▪ Families and friends cannot communicate
Utilities	▪ Loss of service
	▪ Increased risk of fire or electrical shock
	▪ Limited access to fuel, e.g., pumps that may not work
	▪ Loss of contact between victims and service providers
Water Service	▪ Medical facilities hampered
	▪ Inadequate water flow, which results in notice to boil water and hampered firefighting capabilities
	▪ Increased risk to public health
Fuel Supplies	▪ Increased risk of fire or explosion from fuel line rupture
	▪ Risk of asphyxiation
Financial Services	▪ ATM machines do not work
	▪ Credit card systems inoperable



**COMMUNITY EMERGENCY RESPONSE TEAM
UNIT 1: DISASTER PREPAREDNESS**

INSTRUCTOR GUIDANCE	CONTENT
<p data-bbox="240 449 673 485">Results of Damage to Infrastructure</p> <ul data-bbox="261 499 646 657" style="list-style-type: none">● Police: address incidences of <u>grave</u> public safety● Firefighters: suppress <u>major</u> fires● EMS personnel: handle <u>life-threatening</u> injuries● Lower priority needs met in other ways <p data-bbox="240 730 673 762"> CERT Basic Training Unit 1: Disaster Preparedness 1-13 </p> <p data-bbox="240 800 511 835">Display Slide 1-13</p>	<p data-bbox="706 401 1307 436">Results of Damage to the Infrastructure</p> <p data-bbox="706 474 1507 579">Draw the correlation that each instance of damage to the infrastructure may severely restrict the abilities of police, fire, and emergency medical services in that disaster.</p> <p data-bbox="706 621 1474 762">Point out that, because emergency services personnel are likely to have inadequate resources to meet the public's needs, those resources must be applied according to the highest priority need.</p> <ul data-bbox="706 783 1495 1031" style="list-style-type: none">▪ Police will address incidences of <u>grave</u> public safety.▪ Firefighters will suppress <u>major</u> fires.▪ EMS personnel will handle <u>life-threatening</u> injuries. (Stress, however, that CERTs will also handle life-threatening injuries until EMS units become available.) <p data-bbox="706 1052 1474 1087">Lower priority needs will have to be met in other ways.</p>
<p data-bbox="240 1184 673 1220">Hazards Related to Structure Type</p> <ul data-bbox="261 1234 646 1434" style="list-style-type: none">● You may not have opportunity to select type of structure when a disaster occurs● Engineered buildings have performed well in most types of disasters● Types of damage vary by structure● Differences in hazards and mitigation between single-family homes and multiple-unit dwellings <p data-bbox="240 1465 673 1497"> CERT Basic Training Unit 1: Disaster Preparedness 1-14 </p> <p data-bbox="240 1514 511 1549">Display Slide 1-14</p>	<p data-bbox="706 1163 1226 1199">Hazards Related to Structure Type</p> <p data-bbox="706 1236 1507 1413">Remind the participants that they might not have an opportunity to select the type of structure that they are in when a disaster occurs. It is important to know what type of damage to expect from the main types of structures in the community.</p>

**COMMUNITY EMERGENCY RESPONSE TEAM
UNIT 1: DISASTER PREPAREDNESS**

INSTRUCTOR GUIDANCE	CONTENT
	<p>Tell the participants that engineered buildings, such as most high-rise buildings, have performed well in most types of disasters.</p> <p>Stress that, during earthquakes and high-wind events (e.g., tornadoes, hurricanes), older high-rise buildings, however, are more susceptible to damage from:</p> <ul style="list-style-type: none">▪ Broken glass▪ Falling panels▪ Collapsing walkways and stairways <p>How many of you live in single-family homes?</p> <p>Do you know what types of damage to expect?</p> <p>If not mentioned by the group, tell them that age, type of construction, and type of disaster are major factors in potential damage to detached homes and garages.</p> <ul style="list-style-type: none">▪ Homes built before 1940 generally were not bolted to the foundation, making them subject to being shaken, blown, or floated off their foundations.▪ Older homes constructed of non-reinforced brick are less stable than newer construction. <p>Remind the participants that:</p> <ul style="list-style-type: none">▪ Tornado and hurricane damage to single homes can range from little damage to total destruction.▪ Following an event in which a structure has been damaged, there is a threat of additional damage, such as fire from ruptured gas lines.▪ They should be aware that they will encounter multiple-unit dwellings and that such dwellings should be approached in a different manner than a single family home. (Utility control will be covered in more depth in Unit 2 of the training.)

COMMUNITY EMERGENCY RESPONSE TEAM
UNIT 1: DISASTER PREPAREDNESS

INSTRUCTOR GUIDANCE	CONTENT
 	<p>How many of you live in mobile homes?</p> <p>Do you know what type of damage you can expect if a high-risk hazard occurs?</p> <p>If not mentioned by the group, stress that mobile homes are most susceptible to damage because they are easily displaced. When displacement occurs, structural integrity becomes questionable and utility connections are easily damaged, increasing the risk of fire and electric shock.</p> <p>How many of you live in multiple-unit dwellings?</p> <p>Do you understand how the hazards and mitigation approaches differ from those of single-family homes?</p> <p>Remind participants that others in the building may be affected even if it appears that there is limited damage to the part of the building that is visible.</p> <p>Utility shutoffs are often arranged differently in multiple-unit dwellings than is typical in single-family homes. There is often a main utility shutoff for the entire building, as well as a shutoff located within each individual unit. Depending on the situation at hand, one or the other or both may need to be used. Be mindful of the effects and consequences of using each.</p> <p>Multiple-Use Buildings</p> <p>Explain that buildings such as malls, sports arenas, airports, places of worship, and other buildings with oversized roof spans pose particular hazards in a disaster:</p> <ul style="list-style-type: none">▪ Strip shopping centers pose a threat from collapse and broken glass.▪ Warehouse-type structures may also collapse.

**COMMUNITY EMERGENCY RESPONSE TEAM
UNIT 1: DISASTER PREPAREDNESS**

INSTRUCTOR GUIDANCE	CONTENT
<div data-bbox="237 470 315 543" data-label="Image"> </div> <div data-bbox="237 867 675 1194" data-label="Complex-Block"> <p>Hazards from Home Fixtures</p> <ul style="list-style-type: none"> ● Gas line ruptures <ul style="list-style-type: none"> ▪ Displaced water heaters or ranges ● Damage <ul style="list-style-type: none"> ▪ From falling books, dishes, other cabinet contents ● Electric shock or injury <ul style="list-style-type: none"> ▪ From displaced appliances, office equipment ● Fire <ul style="list-style-type: none"> ▪ From faulty wiring, overloaded plugs, or frayed electric cords <p><small>FEMA CERT Basic Training Unit 1: Disaster Preparedness 1-15</small></p> </div> <div data-bbox="232 1228 511 1268" data-label="Text"> <p>Display Slide 1-15</p> </div>	<p>Add that there is also a risk in all types of structures from non-structural hazards.</p> <p>How many of you are aware of non-structural hazards in your own neighborhoods, homes, or workplaces?</p> <p>If not mentioned by the group, stress that, in addition to structural hazards, everyone has non-structural hazards in their neighborhood, homes, or workplaces. Fixtures and items within a home, garage, or workplace can pose a hazard during or after a disaster.</p> <p>Hazards from Home Fixtures</p> <p>Some of the hazards include:</p> <ul style="list-style-type: none"> ▪ Gas line ruptures from water heaters or ranges displaced by shaking, water, or wind ▪ Damage from falling books, dishes, or other cabinet contents ▪ Risk of injury or electric shock from displaced appliances and office equipment ▪ Fire from faulty wiring, overloaded plugs, frayed electrical cords <p>Emphasize the importance of reducing hazards as part of personal preparedness. Stress that there are several relatively simple measures that individuals can take to alleviate many home and workplace hazards. These will be covered later under home and workplace preparedness. It is also important to know how and when to turn off utilities safely. Utility shutoffs will be covered in Unit 2 – Fire Safety and Utility Control.</p>

COMMUNITY EMERGENCY RESPONSE TEAM
UNIT 1: DISASTER PREPAREDNESS



INSTRUCTOR GUIDANCE	CONTENT
 <p>Display Slide 1-16</p>	<p><i>Home and Workplace Preparedness</i></p> <p>Tell participants that FEMA conducts a national household survey to measure the public's attitudes, perceptions, and actions taken for personal preparedness. Research findings provide some interesting insights on public expectations and beliefs. Data for the 2009 survey include:</p> <ul style="list-style-type: none">▪ Only 50% of the public is familiar with the alerts and warning systems in their community.▪ Importance of family and community members in the first 72 hours of a disaster: 70% of people report an expectation to rely on household members, and 49% say they will rely on people in their neighborhood.▪ Nearly 30% indicate that a primary reason they have not taken steps to prepare is the expectation that fire, police, or other emergency personnel will help them.▪ Only 40% of people nationwide think there is a likelihood of a natural disaster <u>ever</u> occurring in their community.▪ Fifty-three percent indicate confidence in ability to respond in the first 5 minutes of a sudden natural disaster, but only 20% report confidence in ability to respond to a terrorist attack.▪ Preparedness differs according to age, education, income, language and culture, disabilities and abilities, experience, and other factors.

**COMMUNITY EMERGENCY RESPONSE TEAM
UNIT 1: DISASTER PREPAREDNESS**

PM, P. 1-15	Web Sites of Interest
--------------------	------------------------------

URL	Description
www.ready.gov/	FEMA's national Web site for disaster preparedness. Excellent general advice and a good place to start.
www.fema.gov/areyouready/	<i>Are You Ready?</i> is a 200-page FEMA publication that provides a step-by-step approach to disaster preparedness and specific information by disaster type.
www.redcross.org	The American Red Cross has a Web site full of excellent tips and information related to most of the natural disasters that occur, including a few topics not covered at FEMA's www.ready.gov Web site.
www.pandemicflu.gov	The Centers for Disease Control and Prevention (CDC) established this Web site as a hub for national information on pandemic influenza.

**COMMUNITY EMERGENCY RESPONSE TEAM
UNIT 1: DISASTER PREPAREDNESS**

INSTRUCTOR GUIDANCE	CONTENT
<div data-bbox="240 407 675 464">Protective Actions</div> <ul data-bbox="261 474 626 684" style="list-style-type: none">● Assess situation● Decide to stay or change locations<ul style="list-style-type: none">▪ Critical early decision in disasters● Seek clean air and protect breathing passages● Protect from debris and signal if trapped● Remove contaminants● Practice good hygiene <div data-bbox="240 695 675 732"> CERT Basic Training Unit 1: Disaster Preparedness 1-18 </div> <p data-bbox="240 747 509 785">Display Slide 1-18</p>	<h3 data-bbox="706 415 987 449">Protective Actions</h3> <p data-bbox="706 520 1479 957">Explain to participants that because many disasters occur with little or no warning, individuals need to have the knowledge and skills to take immediate protective actions in the first critical moments after a disaster has occurred, before they have instruction from authorities. While the specific action to take is based on the disaster type, the amount of warning, whether they are inside, outside, or driving, and the amount of training they have, the following list provides a good overview of the protective actions you should be familiar with. These should be their objectives in assessing their post-event environment.</p> <ul data-bbox="706 978 1471 1608" style="list-style-type: none">▪ Assess situation. When something occurs without notice, it is important to take a few seconds to assess the situation to determine their most effective next steps. This includes identifying the type of event and whether air or a building structure has been compromised.▪ Decide to stay or change locations. In some instances they should stay where they are (if they are inside and an event has occurred outside, they may need to stay inside) and in other circumstances they should change location (if they are inside and the event is inside, they may need to evacuate the building). All disasters have unique attributes, so it is important for them to realize that they may need to evaluate the circumstances to determine the best course of action.

**COMMUNITY EMERGENCY RESPONSE TEAM
UNIT 1: DISASTER PREPAREDNESS**

INSTRUCTOR GUIDANCE	CONTENT
	<ul style="list-style-type: none"><li data-bbox="706 380 1469 884">▪ Staying or changing location is a critical early decision in disasters. If they are not in immediate danger, they should stay where they are and get more information before taking their next steps. Thinking through the likely hazards in their community and where they might be when an event occurs may help them visualize their response. While they may need to make the first, immediate decision to stay inside or go outside, or to shelter in place by sealing a room without authoritative instruction, it is important that they listen to local authorities when that information is provided. If experts tell them to evacuate from their location, LEAVE!<li data-bbox="706 947 1469 1230">▪ Seek clean air and protect breathing passages. Regardless of the type of disaster, clean air is a critical need. Actions to protect their breathing passages and seek clean air may include covering their mouth with a cloth or mask, vacating the building, or sheltering in place by sealing an internal room while the airborne contaminant dissipates.<li data-bbox="706 1293 1469 1503">▪ Protect themselves from debris and signal rescuers if trapped. Protecting themselves from falling or precarious debris is a critical protective action. If they become trapped, protect their airways, bang on an object, or blow a whistle. Yelling should be a last resort.<li data-bbox="706 1566 1469 1818">▪ Remove contaminants. If contaminants have been released into the area or they have made contact with liquid or solid contaminants, it is critical that they remove the contaminants as quickly as possible. Remove contaminated clothing and wash with soap and water starting at the head and working toward the feet.

COMMUNITY EMERGENCY RESPONSE TEAM
UNIT 1: DISASTER PREPAREDNESS

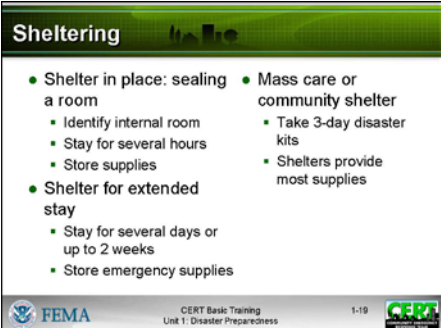
INSTRUCTOR GUIDANCE	CONTENT
 <p>Display Slide 1-19</p>	<ul style="list-style-type: none">Practice good hygiene. Good hygiene is a preventive measure for spreading disease, and it's important to be mindful of hygiene in a post-disaster environment. Clean drinking water and sanitation are important protective actions. <p>Sheltering</p> <p>There are different types of sheltering, and different types are appropriate for different disasters.</p> <ul style="list-style-type: none">Shelter in place: sealing a room. Sealing a room is a way to protect themselves from contaminants in the air for a short period of time until the contaminants dissipate. They should identify an internal room in their home, at work, or other locations where they spend a great deal of time. If sheltering-in-place is needed, they will be in this room for only a few hours, but it is important that they be able to seal the room quickly. Storing specific items in the room is helpful. They should have snacks and water; a battery-operated radio, a flashlight, and pre-cut plastic sheeting and duct tape to seal off vents and door and window openings.Shelter for extended stay. Sheltering for an extended stay means that they would stay where they are for several days or, in the case of a pandemic, they may be asked to limit their time outside the home for up to 2 weeks. It is important to store emergency supplies for these possibilities.

**COMMUNITY EMERGENCY RESPONSE TEAM
UNIT 1: DISASTER PREPAREDNESS**

INSTRUCTOR GUIDANCE	CONTENT
<div data-bbox="235 772 673 1102" data-label="Image"> <p>Develop a Disaster Plan</p> <ul style="list-style-type: none"> • Where will you meet family members? • Who is your out-of-State "check-in" contact? • Will you have an extended stay? Shelter in place? Evacuate? • How will you escape your home? Workplace? School? Place of worship? • What route (and several alternates) will you use to evacuate your neighborhood? • Do you have transportation? • Did you practice your plan? <p>FEMA CERT Basic Training Unit 1: Disaster Preparedness 1-20</p> </div> <p>Display Slide 1-20</p> <p>Explain that the answers to these questions may be different depending on the hazard and the participants probably will not be able to plan for every event that could happen. But stress that, by playing "What if?" with high-risk hazards, they will be better prepared for any hazard that might strike.</p>	<ul style="list-style-type: none"> ▪ Mass care/community shelter. These are congregate care facilities that house many people in one location. These shelters often provide water, food, medicine, and basic sanitary facilities but, if possible, they should take their 3-day disaster supplies kit with them so that they will be sure to have the supplies they require. <p>Developing a Disaster Plan</p> <p>Point out to participants that in addition to knowing immediate protective actions that they may need to take, an emergency plan can mean the difference between life and death in a disaster. For example:</p> <ul style="list-style-type: none"> ▪ Where will you meet family members? You should have a location outside the house and another location outside the neighborhood. ▪ Identify an out-of-state "check-in contact." ▪ Plan for all possibilities: extended stay, shelter in place, or evacuation. ▪ How will you escape buildings where you spend time: your home, workplace, school, place of worship? ▪ What route (and several alternatives) will you use to evacuate? Do you have transportation?

**COMMUNITY EMERGENCY RESPONSE TEAM
UNIT 1: DISASTER PREPAREDNESS**

INSTRUCTOR GUIDANCE	CONTENT
<p>Remind the participants to see www.ready.gov for additional information.</p> <p>PM, P. 1-19</p>	<p>Remind participants that, as always, family safety is the most important factor when disaster strikes. In an effort to make the best decision regarding their family's safety, the participants should always first consider what is best given the situation. It is also essential that they practice their plan with their family — evacuating the home and contacting all family members using their “check-in contact.”</p> <p>Emphasize to participants that practicing their plan now will improve their performance when it matters most.</p> <p>Direct the participants to a handout provided in their Participant Manual, <i>Creating a Family Disaster Plan</i>.</p>

**COMMUNITY EMERGENCY RESPONSE TEAM
UNIT 1: DISASTER PREPAREDNESS**

PM, P. 1-19

Creating a Family Disaster Plan

To get started . . .

- **Contact your local emergency management office and your local chapter of the American Red Cross.**
 - Find out which disasters are most likely to happen in your community.
 - Ask how you would be warned.
 - Find out how to prepare for each type of disaster.
- **Meet with your family.**
 - Discuss the types of disasters that could occur.
 - Explain how to prepare and respond.
 - Discuss what to do if advised to evacuate.
 - Practice what you have discussed.
- **Plan how your family will stay in contact if separated by disaster.**
 - Pick two meeting places:
 - A location a safe distance from your home in case of fire
 - A place outside your neighborhood in case you can't return home
 - Choose an out-of-State friend as a "check-in contact" for everyone to call.
 - Make sure that the person selected understands that they are your out-of-State contact in case of emergency and what you would expect of them should such an emergency arise.
 - Give your "check-in contact" person a list of pertinent people to contact. Be sure to include phone numbers!
 - Periodically practice using your local and out-of-State contacts as if it were an emergency situation.
- **Complete the following steps.**
 - Post emergency telephone numbers by every phone.
 - Show responsible family members how and when to shut off water, gas, and electricity at main switches.
 - Install a smoke alarm on each level of your home, especially near bedrooms; test them monthly and change the batteries two times each year. (Change batteries when you change your clocks in the spring and fall.)
- **Contact your local fire department to learn about home fire hazards.**
 - Learn first aid and CPR. Contact your local chapter of the American Red Cross for information and training.
- **Meet with your neighbors.**
 - Plan how the neighborhood could work together after a disaster. Know your neighbors' skills (medical, technical).
 - Consider how you could help neighbors who have special needs, such as elderly or disabled persons.
 - Make plans for child care in case parents can't get home.

**COMMUNITY EMERGENCY RESPONSE TEAM
UNIT 1: DISASTER PREPAREDNESS**

INSTRUCTOR GUIDANCE	CONTENT
	<p>Activity: Evacuate!</p> <p>Instructions: Follow the steps below to conduct this exercise:</p> <ol style="list-style-type: none">1. Describe a disaster (hurricane, earthquake, etc.) and instruct the participants that they have 5 minutes to evacuate their home in this disaster scenario.2. Ask participants to come up with a list of items they would bring with them and/or what they would do in that window of time.3. For added urgency, end the exercise after 4 minutes.4. Ask volunteers to share their information and explain their choices. <p>Debrief by explaining that the answer to this question may be different depending on the hazard. Participants probably will not be able to plan for every event that could happen.</p> <p>Stress that, by playing “What if?” with high-risk hazards, they will be better prepared for any hazard that might strike.</p>

**COMMUNITY EMERGENCY RESPONSE TEAM
UNIT 1: DISASTER PREPAREDNESS**

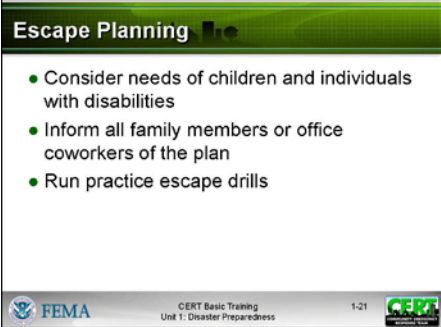
INSTRUCTOR GUIDANCE	CONTENT
  <p>Display Slide 1-21</p> <p>PM, P. 1-21</p>	<p>Escape Planning</p> <p>How many of you have developed escape plans for your homes or workplaces?</p> <p>Emphasize the importance of having an escape plan that:</p> <ul style="list-style-type: none">▪ Includes escape from every room of the house or every area of the workplace▪ Considers the needs of children and individuals with disabilities <p>Explain that all family members or office coworkers should be informed about the plan.</p> <p>Explain the <i>Escape Planning</i> plan. Tell the participants that a sample escape plan is in the Participant Manual. Explain that, in most cases, homeowners won't have smoke alarms in every room, but it is important to have a smoke alarm at least on every level of the house.</p> <p>Urge the participants to practice their plans after they develop them. Suggest that they conduct family fire drills, follow the local evacuation routes, and locate the nearest shelter to ensure that, when a disaster occurs, they know what to do.</p> <p>An example of an escape plan is shown in the figure that follows.</p>

COMMUNITY EMERGENCY RESPONSE TEAM
UNIT 1: DISASTER PREPAREDNESS

PM, P. 1-21	Escape Planning
-------------	-----------------

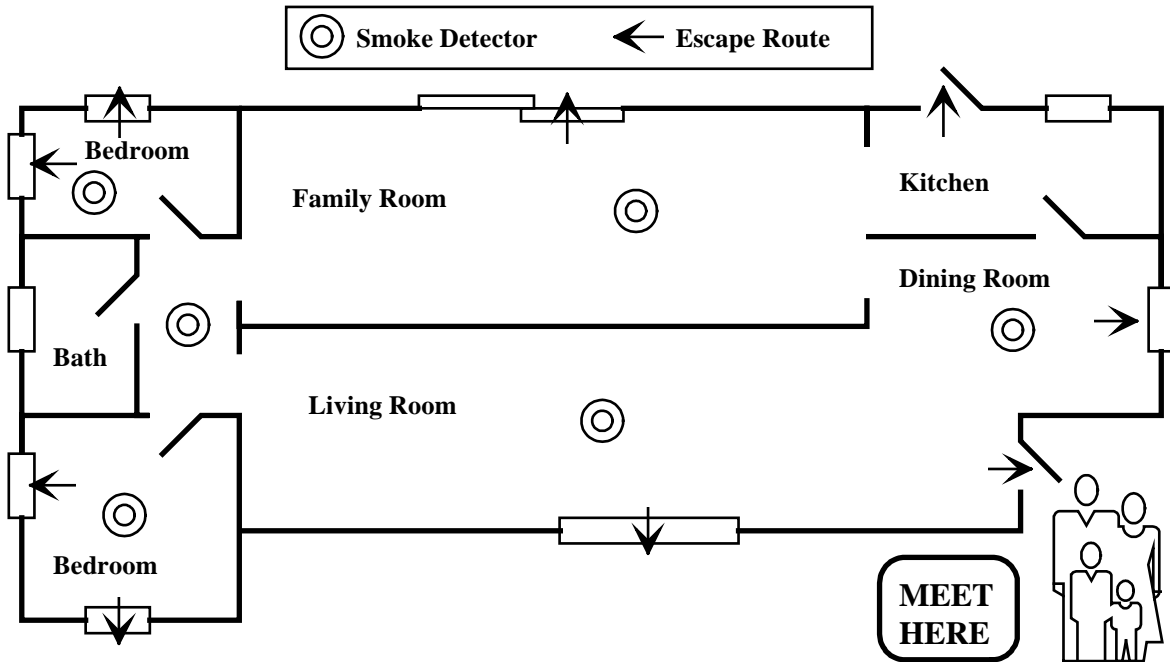

Sample family escape plan with arrows showing an escape route from every room in the home and a family meeting place outside the home

**COMMUNITY EMERGENCY RESPONSE TEAM
UNIT 1: DISASTER PREPAREDNESS**

INSTRUCTOR GUIDANCE	CONTENT
<p>PM, PP. 1-22 through 1-27</p> <p>Consider asking participants to take one or two steps (that you define) in assembling their household kit.</p> 	<p>Refer the participants to <i>Assembling and Storing a Disaster Supply Kit</i> in the Participant Manual. Tell the group that the list includes all disaster supplies recommended by FEMA.</p> <p>Point out that the disaster supplies included on this list are fairly complete. Suggest that the participants determine the supplies that they will need for evacuation, those that they will need to shelter in place, and those that they will need for both.</p> <p>Remind the participants that there are special considerations for those with special needs, children, and pets.</p> <p>Do you have any questions about home and workplace preparations?</p>

**COMMUNITY EMERGENCY RESPONSE TEAM
UNIT 1: DISASTER PREPAREDNESS**

INSTRUCTOR GUIDANCE	CONTENT
PM, PP. 1-22 through 1-27	Assembling and Storing a Disaster Supply Kit

You can cope best by preparing for disaster before it strikes. One way to prepare is by assembling a Disaster Supply Kit. After disaster strikes, you won't have time to shop or search for supplies. But if you've gathered supplies in advance, you and your family can endure an evacuation or home confinement.

To Prepare Your Kit

1. Review the checklist on the next few pages.
2. Gather the supplies from the list. Remember that many households already have many of the items needed for their kits. These items can be assembled in appropriate locations for quick access in an emergency, but used under normal circumstances whenever needed. For example, keep a wrench in your kit to shut off gas at the meter in an emergency, but use the wrench for everyday tasks, too. Just be sure to return it to the emergency kit.
3. **Place the supplies you're apt to need for an evacuation in an easy-to-carry container. These supplies are listed with an asterisk (*).**

COMMUNITY EMERGENCY RESPONSE TEAM
UNIT 1: DISASTER PREPAREDNESS

Water

Store water in plastic containers such as soft drink bottles.

- Look for the triangular recycling symbol with a number 1 on the bottom of the bottle as those are best for water storage. Avoid using containers that will decompose or break, such as plastic milk jugs or glass bottles.
- Wash the bottle with soap and warm water, fill with water from your tap, and store in a cool, dark area away from direct sunlight.
- Replace your emergency water every 6 months by repeating the process; like food and batteries, water does expire!

Keep in mind that a normally active person needs to drink at least 2 quarts of water each day. Hot environments and intense physical activity can double that requirement. Children, nursing mothers, and ill people will need more.

- Store 1 gallon of water per person per day (2 quarts for drinking, 2 quarts for food preparation and sanitation).*
- Keep at least a 3-day supply of water for each person in your household.

**COMMUNITY EMERGENCY RESPONSE TEAM
UNIT 1: DISASTER PREPAREDNESS**

PM, PP. 1-22 through 1-27	Assembling and Storing a Disaster Supply Kit
--------------------------------------	---

If you have questions about the quality of the water, purify it before drinking. You can heat water to a rolling boil for 1 minute or use commercial purification tablets to purify the water. You can also use regular household liquid chlorine bleach if it is pure 5.25% sodium hypochlorite. (Do not use perfumed bleach!) To purify water, use the table below as a guide:

Ratios for Purifying Water with Bleach

Water Quantity	Bleach Added
1 Quart	2 Drops
1 Gallon	8 Drops
5 Gallons	1/2 Teaspoon

Note: If water is cloudy, double the recommended dosage of bleach.

After adding bleach, shake or stir the water container and let it stand 30 minutes before drinking.

Food

Store at least a 3-day supply of nonperishable food. Select foods that require no refrigeration, preparation, or cooking and little or no water. If you must heat food, pack a can of Sterno[®]. Select food items that are compact and lightweight. Avoid salty foods if possible as they increase thirst. Include a selection of the following foods in your disaster supply kit. Check food and water expiration dates biannually.

- Ready-to-eat canned meats, fruits, and vegetables
- Canned juices, milk, soup (if powdered, store extra water)
- Staples — sugar, salt, pepper
- High-energy foods — peanut butter, jelly, crackers, granola bars, trail mix
- Foods for infants, elderly persons, or persons on special diets
- Comfort and stress foods — cookies, hard candy, sweetened cereals, lollipops, instant coffee, tea bags

**COMMUNITY EMERGENCY RESPONSE TEAM
UNIT 1: DISASTER PREPAREDNESS**

**PM, PP. 1-22 through
1-27**

Assembling and Storing a Disaster Supply Kit

Kitchen Items

- Manual can opener
- Mess kits or paper cups, plates, and plastic utensils
- All-purpose knife
- Household liquid bleach to treat drinking water
- Aluminum foil and plastic wrap
- Re-sealing plastic bags
- If food must be cooked, small cooking stove and a can of cooking fuel

First Aid Kit*

Assemble a first aid kit for your home and one for each car. (Note: This kit is not intended to supplement or replace a CERT member supply kit!) A first aid kit should include:

- First aid manual
- Sterile adhesive bandages in assorted sizes
- Two-inch sterile gauze pads (4-6)
- Four-inch sterile gauze pads (4-6)
- Hypoallergenic adhesive tape
- Triangular bandages (3)
- Needle
- Moistened towelettes
- Antibacterial ointment
- Thermometer
- Tongue blades (2)
- Tube of petroleum jelly or other lubricant
- Assorted sizes of safety pins
- Cleaning agent/soap
- Non-latex exam gloves (2 pairs)
- Cotton balls
- Sunscreen
- Three-inch sterile roller bandages (3 rolls)
- Four-inch sterile roller bandages (3 rolls)
- Scissors
- Tweezers
- Hot and cold compress

**COMMUNITY EMERGENCY RESPONSE TEAM
UNIT 1: DISASTER PREPAREDNESS**

**PM, PP. 1-22 through
1-27**

Assembling and Storing a Disaster Supply Kit

First Aid Kit* (contd.)

Nonprescription Drugs

- Aspirin or nonaspirin pain reliever
- Antidiarrhea medication
- Antacid (for stomach upset)
- Allergy medication and, if necessary, epinephrine
- Laxative
- Vitamins
- Activated charcoal (used if advised by the Poison Control Centers)

Tools and Supplies

- Emergency preparedness manual*
- Battery-operated weather radio and extra batteries*
- Flashlight and extra batteries*
- Fire extinguisher: small canister, ABC type
- Tube tent
- Pliers
- Duct tape
- Compass*
- Matches in a waterproof container
- Aluminum foil
- Plastic storage containers
- Signal flare(s)*
- Paper, pencil*
- Needles, thread
- Work gloves
- Medicine dropper
- Non-sparking shutoff wrench to turn off household gas and water
- Whistle
- Plastic sheeting
- Landline telephone
- Fuel for vehicle and generator

Sanitation

- Toilet paper, towelettes*
- Soap, liquid detergent*
- Feminine supplies*
- Personal hygiene items*
- Plastic garbage bags, ties (for personal sanitation uses)
- Plastic bucket with tight lid
- Disinfectant
- Liquid hand sanitizer
- Household chlorine bleach

**COMMUNITY EMERGENCY RESPONSE TEAM
UNIT 1: DISASTER PREPAREDNESS**

PM, PP. 1-22 through 1-27	Assembling and Storing a Disaster Supply Kit
--------------------------------------	---

Pet Supplies

- Medications and medical records (stored in a waterproof container) and a first aid kit
- Current photos of your pets in case they get lost
- Information on feeding schedules, medical conditions, behavior problems, and the name and number of your veterinarian in case you have to foster or board your pets
- Sturdy leashes, harnesses, and/or carriers to transport pets safely and ensure that your animals can't escape
- Food, potable water, bowls, cat litter and pan, and can opener
- Pet beds and toys, if easily transportable

Clothing and Bedding

Include at least one complete change of clothing and footwear per person (and remember to change for the different seasons!).

- Sturdy shoes or boots*
- Rain gear*
- Blankets or sleeping bags*
- Hat and gloves*
- Thermal underwear*
- Sunglasses*

**COMMUNITY EMERGENCY RESPONSE TEAM
UNIT 1: DISASTER PREPAREDNESS**

PM, PP. 1-22 through 1-27	Assembling and Storing a Disaster Supply Kit
--------------------------------------	---

Household Documents and Contact Numbers*

- Personal identification, cash (including change) or traveler’s checks, and a credit card
- Copies of important documents: birth certificates, marriage certificate, driver’s license, Social Security cards, passport, wills, deeds, inventory of household goods, insurance papers, contracts, immunization records, bank and credit card account numbers, stocks and bonds. Be sure to store these in a watertight container.
- Emergency contact list and other important phone numbers
- Map of the area and phone numbers of places you could go
- An extra set of car keys and house keys
- Copies of prescriptions and/or original prescription bottles

Special Items

Remember family members with special needs, such as infants and elderly or those with disabilities.

For Baby*

- Formula
- Diapers
- Bottles
- Powdered milk
- Medications

For All Family Members



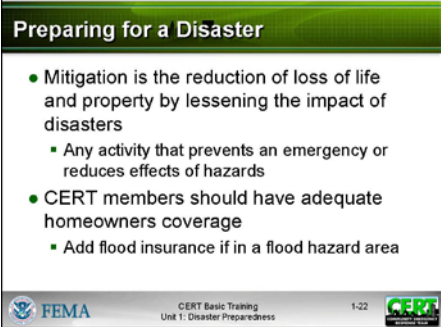

- Heart and high blood pressure medication*
- Insulin*
- Other prescription drugs*
- Denture needs*
- Contact lenses and supplies*
- Extra eye glasses*
- Entertainment — games and books

*Items marked with an asterisk are recommended for evacuation.

COMMUNITY EMERGENCY RESPONSE TEAM
UNIT 1: DISASTER PREPAREDNESS

INSTRUCTOR GUIDANCE	CONTENT
 <p>Display Slide 1-22</p>	<p><i>Reducing the Impact of Hazards Through Mitigation</i></p> <p>Preparing for a Disaster</p> <p>Tell participants that in addition to managing the impact that a disaster would have on them and their families by assembling disaster supplies, mitigation will also help. Mitigation is the reduction of loss of life and property by lessening the impact of disasters. Mitigation includes any activities that prevent an emergency, reduce the likelihood of occurrence, or reduce the damaging effects of unavoidable hazards. Mitigation can include non-structural measures, structural changes, and purchasing appropriate insurance.</p> <p>Explain that CERT members should ensure that their homeowner’s policy provides adequate coverage and covers appropriate hazards in their area. In addition, homeowners insurance does not cover damage caused by flooding, so it is important to know whether they are in a flood hazard area and to purchase flood insurance if so. Visit the National Flood Insurance Program Web site, www.floodsmart.gov, to learn more.</p>

COMMUNITY EMERGENCY RESPONSE TEAM
UNIT 1: DISASTER PREPAREDNESS

INSTRUCTOR GUIDANCE	CONTENT
<p>Non-structural Hazard Mitigation</p> <ul style="list-style-type: none">● Anchor heavy furniture● Secure appliances and office equipment● Install hurricane storm shutters● Childproof cabinet doors● Locate and label gas, electricity, and water shutoffs● Secure water heaters and have flexible gas lines installed <p> CERT Basic Training Unit 1: Disaster Preparedness 1-23 </p> <p>Display Slide 1-23</p> <p>Pay particular attention to the precautions that are common and necessary in your locality. Whenever possible, bring in samples of materials used (e.g., industrial-strength Velcro®), and demonstrate their use.</p>	<p>Explain that non-structural hazard mitigation includes relatively simple actions participants can take to prevent home furnishings and appliances from causing damage or injuries during any event that might cause them to shift. Examples of non-structural hazard mitigation include:</p> <ul style="list-style-type: none">▪ Anchor heavy furniture.▪ Secure appliances and office equipment.▪ Install hurricane storm shutters.▪ Secure cabinet doors with childproof fasteners.▪ Locate and label gas, electricity, and water shutoffs.▪ Secure water heaters and have flexible gas lines installed.
<p>Other Mitigation Measures</p> <ul style="list-style-type: none">● Bolt houses to foundations● Install trusses or hurricane straps to reinforce roof● Strap propane tanks and chimneys● Strap mobile homes to their slabs● Raise utilities● Build a safe room <p> CERT Basic Training Unit 1: Disaster Preparedness 1-24 </p> <p>Display Slide 1-24</p> <p>Research the types of structural hazards in your area, and modify these hazard mitigation measures to make them appropriate to your area.</p>	<p>Some mitigation measures require a bigger investment to address structural changes to reduce the impact of disasters. Depending on the likely hazards in each area, these may include:</p> <ul style="list-style-type: none">▪ Bolt house to foundations.▪ Install trusses or hurricane straps to reinforce the roof.▪ Strap propane tanks and chimneys.▪ Strap mobile homes to their slabs.▪ Raise utilities (above the level of flood risk).▪ Build a safe room.

**COMMUNITY EMERGENCY RESPONSE TEAM
UNIT 1: DISASTER PREPAREDNESS**

INSTRUCTOR GUIDANCE	CONTENT
<p>PM, P. 1-30</p>	<p>Emphasize that a safe room is NOT the same as a shelter-in-place location. A safe room requires significant fortification in order for the room to provide protection against extremely high winds. More information is available at www.fema.gov/plan/prevent/saferoom/index.shtm</p> <p>Tell participants that sheltering-in-place is done to protect against contaminants in the air. To shelter in place, they do not need to alter the structure of the room. Participants are simply sealing the room with plastic sheeting and duct tape for a short period of time while the contaminants in the air dissipate.</p> <p>Refer the participants to <i>Fortifying Your Home</i> in the Participant Manual.</p>

**COMMUNITY EMERGENCY RESPONSE TEAM
UNIT 1: DISASTER PREPAREDNESS**

PM, P. 1-30	Fortifying Your Home
--------------------	-----------------------------

Type of Hazard	Sample Precautions
Structural	<ul style="list-style-type: none">▪ Bolt older houses to the foundation.▪ Install trusses or hurricane straps to reinforce the roof.▪ Strap propane tanks and chimneys.▪ Strap mobile homes to their concrete pads.▪ Raise utilities (above the level of flood risk).▪ Ask a professional to check the foundation, roof connectors, chimney, etc.
Non-Structural	<ul style="list-style-type: none">▪ Anchor such furniture as bookshelves, hutches, and grandfather clocks to the wall.▪ Secure appliances and office equipment in place with industrial-strength Velcro[®].▪ Install hurricane storm shutters to protect windows.▪ Secure cabinet doors with childproof fasteners.▪ Locate and label shutoffs for gas, electricity, and water before disasters occur. After a disaster, shut off the utilities as needed to prevent fires and other risks. Store a non-sparking shutoff wrench where it will be immediately available.▪ Teach all home occupants, including children who are old enough to handle the responsibility, when and how to shut off the important utilities.▪ Secure water heaters to the wall to safeguard against a ruptured gas line or loose electrical wires.

COMMUNITY EMERGENCY RESPONSE TEAM
UNIT 1: DISASTER PREPAREDNESS

INSTRUCTOR GUIDANCE	CONTENT
 <p>Fortifying Your Home</p> <ul style="list-style-type: none">• Different non-structural hazards to fortify against:<ul style="list-style-type: none">▪ Home fires▪ Landslides or mudslides▪ Wildfires <p>FEMA CERT Basic Training Unit 1: Disaster Preparedness 1-25</p> <p>Display Slide 1-25</p>	<h3>Fortifying Your Home</h3> <p>Remind participants that different non-structural hazards pose different threats, depending on the disaster. A few examples are provided below.</p> <ul style="list-style-type: none">▪ Home Fires: Make sure that burglar bars and locks on outside window entries are easy to open from the inside.▪ Landslides and Mudslides: Install flexible pipe fittings to avoid gas or water leaks. Flexible fittings are more resistant to breakage.▪ Wildfires:<ul style="list-style-type: none">• Avoid using wooden shakes and shingles for roofing.• Clear all flammable vegetation at least 30 feet from the home. Remove vines from the walls of the home.• Place propane tanks at least 30 feet from the home or other structures.• Stack firewood at least 30 feet away and uphill from the home. <p>For more information: “Learn About the Different Types of Disasters and Hazards” at www.fema.gov/hazard/index.shtm</p>

**COMMUNITY EMERGENCY RESPONSE TEAM
UNIT 1: DISASTER PREPAREDNESS**

INSTRUCTOR GUIDANCE	CONTENT
---------------------	---------

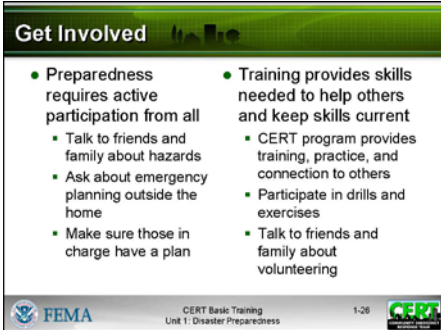

Display Slide 1-26

Get Involved

Explain that preparedness requires active participation from all. Participants should:

- Start the process by talking to their friends and family about the hazards in their area and what steps they all need to take to be able to help each other in a crisis — large or small
- Ask about emergency planning at their workplace, their schools, their place of worship, and other social settings
- Make sure that those in charge have a plan and are connected to community authorities on emergency management and planning

Emphasize that they should take training to acquire the skills they need to help others and to keep their skills current through refresher training and practice.

- Their participation in the CERT Program will provide training, practice, and the connection with others to develop teams.
- Plan also to participate in drills and exercises with their family and neighbors and at their workplace, school, place of worship, and community-organized events. The more they practice, the better prepared they will be to take effective action when a disaster happens.
- Talk to their friends and family about volunteering, too. Volunteering to help their community through CERT and other activities is a great experience to share!

**COMMUNITY EMERGENCY RESPONSE TEAM
UNIT 1: DISASTER PREPAREDNESS**

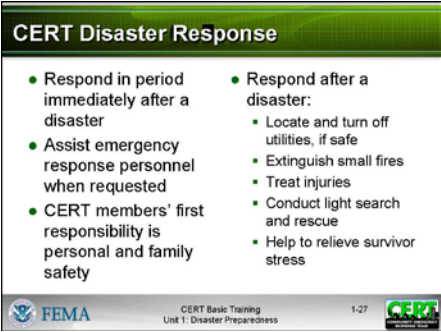

INSTRUCTOR GUIDANCE	CONTENT
 <p>CERT Disaster Response</p> <ul style="list-style-type: none">• Respond in period immediately after a disaster• Assist emergency response personnel when requested• CERT members' first responsibility is personal and family safety• Respond after a disaster:<ul style="list-style-type: none">▪ Locate and turn off utilities, if safe▪ Extinguish small fires▪ Treat injuries▪ Conduct light search and rescue▪ Help to relieve survivor stress <p>FEMA CERT Basic Training Unit 1: Disaster Preparedness 1-27</p>	<p style="text-align: center;"><i>CERT Disaster Response</i></p> <p>Explain that, as described earlier in this unit, CERTs respond in the period immediately after a disaster when response resources are overwhelmed or delayed.</p> <p>CERTs assist emergency response personnel when requested in accordance with standard operating procedures developed by the sponsoring agency. Working as a team, members assume some of the same functions as emergency response personnel.</p> <p>Remind participants that, while CERTs are a valuable asset in emergency response, CERTs are not trained to perform all of the functions or respond to the same degree as professional responders. CERTs are a bridge to professional responders until they are able to arrive.</p> <p>CERTs respond after a disaster by:</p> <ul style="list-style-type: none">▪ Locating and turning off utilities, if safe to do so▪ Extinguishing small fires▪ Treating life-threatening injuries until professional assistance can be obtained▪ Conducting light search and rescue operations▪ Helping disaster survivors cope with their emotional stressors <p>There is a distinction between how a CERT member responds to a disaster as an individual and how that member responds as part of a team.</p> <p><u>A CERT member's first responsibility is personal and family safety.</u> For many participants, that is the central reason for attending this training.</p>

Display Slide 1-27

**COMMUNITY EMERGENCY RESPONSE TEAM
UNIT 1: DISASTER PREPAREDNESS**

INSTRUCTOR GUIDANCE	CONTENT
	<p>Only after personal and family safety is secured is it possible and pertinent to respond in a group capacity to do what is necessary for the community as a whole.</p> <p>How that group response is orchestrated is defined by the sponsoring agency. In general, the team members select a leader (and alternate) and define the meeting location — or staging area — to be used in the event of disaster.</p> <p>CERT members gather at the pre-established staging area to organize and receive tasking assignments. Runners may be identified to serve as a communication link between the staging area and CERT members working in the field.</p> <p>In this way, CERT members can provide first for their own well-being and that of their family and, once appropriate, serve as part of the CERT responding to the disaster in the community.</p> <p>In some cases, CERT members also provide a well-trained workforce for such duties as shelter support, crowd and traffic management, and evacuation.</p> <p>In all instances, it is critical that CERT members stay within the limits of their training when providing disaster relief.</p> <p>CERT organization and operations will be covered in depth in Unit 6 of the training.</p>

COMMUNITY EMERGENCY RESPONSE TEAM
UNIT 1: DISASTER PREPAREDNESS

INSTRUCTOR GUIDANCE	CONTENT
<p data-bbox="237 394 675 726"></p> <p data-bbox="237 762 509 795">Display Slide 1-28</p> <p data-bbox="237 835 407 869">PM, P. 1-34</p> <p data-bbox="237 909 618 978">Clearly explain to whom CERTs report in your area.</p> <p data-bbox="237 1018 652 1194">Explain also that this is a snapshot of how CERTs operate. CERT organization and operation will be covered in detail Unit 6.</p> <p data-bbox="237 1329 313 1402"></p>	<p data-bbox="706 369 997 403">CERT Organization</p> <p data-bbox="706 474 1463 615">Refer the participants to the chart titled <i>CERT Organization</i> in the Participant Manual. Point out that they will learn more about the major CERT functional areas in Unit 6.</p> <p data-bbox="706 636 1422 737">Emphasize that, no matter which function CERT members are assigned to, effective CERTs require <u>teamwork</u>.</p> <p data-bbox="706 758 1435 898">Remind the participants that while CERT members play a vital role in disaster response, they are NOT trained or expected to perform all of the functions of professional responders.</p> <p data-bbox="706 919 1487 1020">Tell the group that there are checklists in the <i>Additional Materials</i> section at the back of Unit 1 in the Participant Manual that will help in:</p> <ul data-bbox="706 1041 1430 1129" style="list-style-type: none">▪ Planning and organizing a CERT▪ Assembling equipment and supplies for a CERT <p data-bbox="706 1150 1479 1251">Be sure to emphasize that many details included in the checklists for <i>Team Organization</i> will be discussed in later modules of the training.</p> <p data-bbox="706 1329 1393 1398">Do you have any questions about community preparations?</p>

COMMUNITY EMERGENCY RESPONSE TEAM
UNIT 1: DISASTER PREPAREDNESS

PM, P. 1-34	CERT Organization
-------------	-------------------

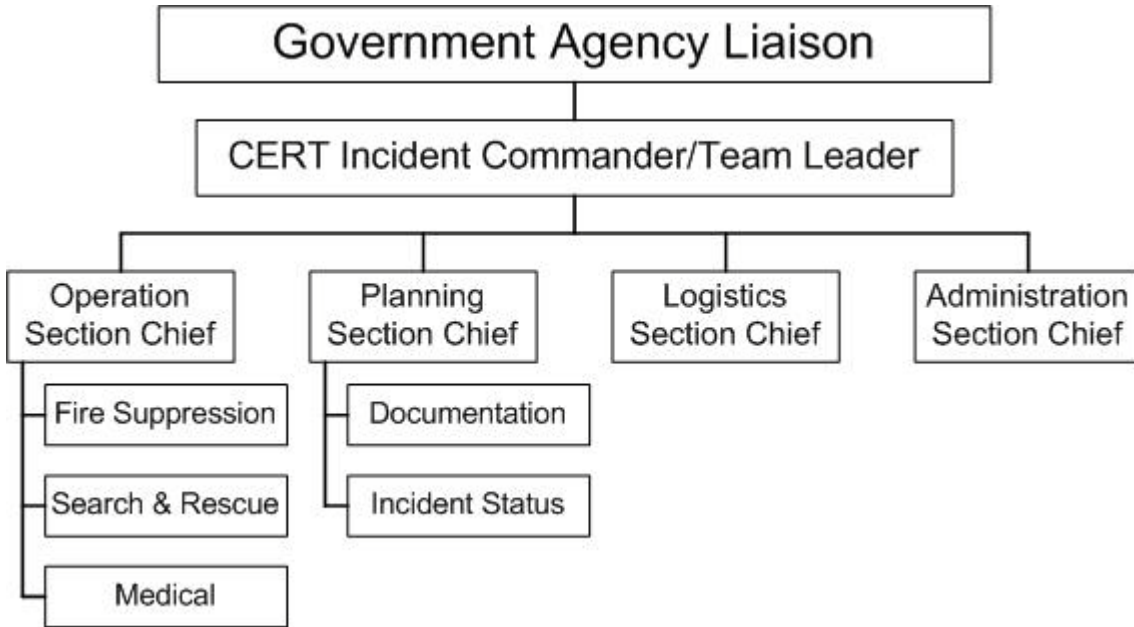



CERT organization showing the government agency liaison at the top.

Underneath is the CERT Incident Commander/Team Leader who directs the activities of four sections: Operations, Planning, Logistics, and Administration.

Underneath the Operations section are three response teams: Fire Suppression, Search and Rescue, and Medical.

Underneath the Planning section are two sections: Documentation and Incident Status.

**COMMUNITY EMERGENCY RESPONSE TEAM
UNIT 1: DISASTER PREPAREDNESS**

INSTRUCTOR GUIDANCE	CONTENT
<p data-bbox="228 709 675 1045">Personal Protective Equipment</p> <ul data-bbox="253 779 415 961" style="list-style-type: none">● Helmet● Goggles● N95 Mask● Gloves (work and non-latex)● Sturdy shoes or work boots  <p data-bbox="228 1010 675 1045">FEMA CERT Basic Training Unit 1: Disaster Preparedness 1-29</p> <p data-bbox="228 1062 500 1094">Display Slide 1-29</p> <p data-bbox="228 1146 659 1247">Briefly demonstrate the proper equipment by putting on your own PPE.</p> <p data-bbox="228 1314 675 1650">CERT in Action</p>  <p data-bbox="228 1614 675 1650">FEMA CERT Basic Training Unit 1: Disaster Preparedness 1-30</p> <p data-bbox="228 1667 480 1698">Display Slide 1-30</p>	<p data-bbox="706 369 1179 401">Personal Protective Equipment</p> <p data-bbox="706 468 1455 646">Emphasize to participants that while CERT members play a vital role in disaster response, they are NOT trained or expected to perform all of the functions of professional responders. Also emphasize that, at all times, <u>a CERT member's first job is to stay safe.</u></p> <p data-bbox="706 714 1479 821">Remind the participants of the central importance of wearing the appropriate personal protective equipment (PPE). CERT members are required to wear:</p> <ul data-bbox="706 842 1240 1083" style="list-style-type: none">▪ Helmet▪ Goggles▪ N95 Mask▪ Gloves (work and non-latex exam)▪ Sturdy shoes or boots <p data-bbox="706 1325 938 1356">CERT in Action</p> <p data-bbox="706 1430 1479 1608">Explain that, across the country, CERTs continue to be activated in a wide range of disaster and emergency support operations. For these efforts, CERT members and teams are receiving Federal, State, and local recognition for their response assistance.</p> <p data-bbox="706 1629 1479 1808">For brief profiles of how CERTs have assisted in actual emergencies all over the country, visit "CERT in Action!" at the national CERT Web site, www.citizencorps.gov/cert. Click on the link "CERT in Action!"</p>

**COMMUNITY EMERGENCY RESPONSE TEAM
UNIT 1: DISASTER PREPAREDNESS**

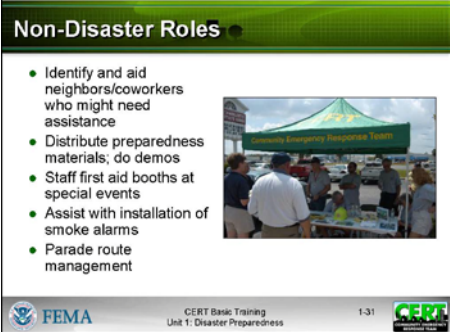
INSTRUCTOR GUIDANCE	CONTENT
<p data-bbox="228 401 675 730"><p>Non-Disaster Roles</p><ul style="list-style-type: none">• Identify and aid neighbors/coworkers who might need assistance• Distribute preparedness materials; do demos• Staff first aid booths at special events• Assist with installation of smoke alarms• Parade route management<p><small>FEMA CERT Basic Training Unit 1: Disaster Preparedness 1-31</small></p></p>	

COMMUNITY EMERGENCY RESPONSE TEAM
UNIT 1: DISASTER PREPAREDNESS

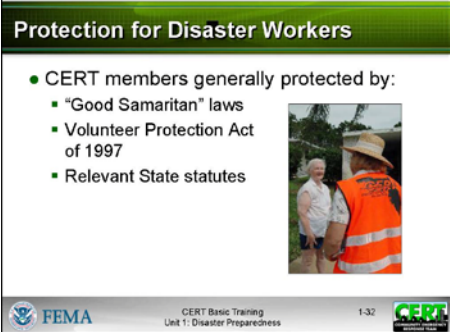
INSTRUCTOR GUIDANCE	CONTENT
<p data-bbox="228 443 675 772"></p> <p data-bbox="228 806 503 840">Display Slide 1-32</p> <p data-bbox="228 873 670 1325">Please remember to cover all State laws that apply to both rescuers and victims. If pertinent information has been entered on the page, tell participants to turn to p. 1-37 in their Participant Manuals for applicable laws. Direct participants to the following Web site for additional information: http://nonprofitrisk.org/library/state-liability.shtml</p>	<p data-bbox="706 365 1269 399"><i>Protection for Disaster Workers</i></p> <p data-bbox="706 443 1479 583">Explain that, as volunteers engaging in CERT, members are generally protected by “Good Samaritan” laws that protect people who provide care <u>in a prudent and reasonable manner</u>.</p> <p data-bbox="706 621 1468 793">Point out that, in a disaster, CERT members are also protected by the Volunteer Protection Act of 1997, a Federal law that protects volunteers from liability as long as they are acting in accordance with the training that they have received.</p> <p data-bbox="706 831 1446 972">CERT members may also have protection under relevant State statutes where they live. Remind participants that these laws vary from State to State, and emphasize the laws that apply in their area.</p>

**COMMUNITY EMERGENCY RESPONSE TEAM
UNIT 1: DISASTER PREPAREDNESS**

PM, P. 1-37	Applicable Laws and Key Points
--------------------	---------------------------------------

Applicable Laws	Key Points

COMMUNITY EMERGENCY RESPONSE TEAM
UNIT 1: DISASTER PREPAREDNESS

INSTRUCTOR GUIDANCE	CONTENT
<p data-bbox="228 401 675 453">Additional Training for CERTs</p> <ul data-bbox="253 468 643 674" style="list-style-type: none">• Advanced first aid• Animal issues in disasters• Automated External Defibrillator (AED) use• Community relations• CPR skills• Debris removal• Donations management• Shelter management• Special needs concerns• Traffic/crowd control• Utilities control• Online courses  <p data-bbox="228 768 500 804">Display Slide 1-33</p> <p data-bbox="228 842 633 1020">Indicate that these are some examples and specify any additional training that your program offers to CERT members.</p> <p data-bbox="228 1062 633 1205">Recommend the CERT Web site for online training for a range of topics: www.citizencorps.gov/cert/</p>	<p data-bbox="706 363 1240 401"><i>Additional Training for CERTs</i></p> <p data-bbox="706 443 1463 657">After completing initial CERT training, many CERT members seek to expand and improve their skills — through continuing CERT modules offered locally, courses offered through the American Red Cross, or programs from other sources. Some CERT members have sought additional training opportunities in:</p> <ul data-bbox="706 699 1360 1461" style="list-style-type: none">▪ Advanced first aid▪ Animal issues in disasters▪ Automated External Defibrillator (AED) use▪ Community relations▪ CPR skills▪ Debris removal▪ Donations management▪ Shelter management▪ Special needs concerns▪ Traffic and crowd control▪ Utilities control

**COMMUNITY EMERGENCY RESPONSE TEAM
UNIT 1: DISASTER PREPAREDNESS**

INSTRUCTOR GUIDANCE	CONTENT
	<p>There are also Independent Study (IS) courses available online from the Federal Emergency Management Agency (FEMA) that will of interest to CERT members. Some of these include:</p> <ul style="list-style-type: none">IS-100.a Introduction to Incident Command SystemIS-200.a ICS for Single Resources and Initial Action IncidentsIS-700.a National Incident Management System (NIMS), An IntroductionIS-800.b National Response Framework, An Introduction <p>For a complete listing and access to FEMA Independent Study courses, visit www.training.fema.gov/IS/. Click on the “ISP Course List” link.</p>

**COMMUNITY EMERGENCY RESPONSE TEAM
UNIT 1: DISASTER PREPAREDNESS**

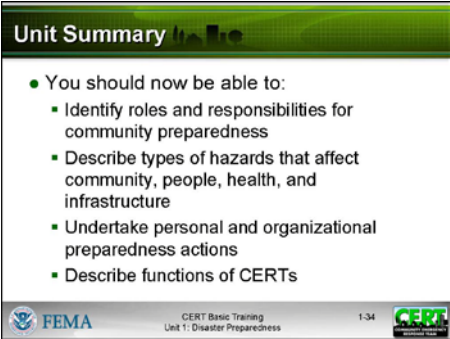
INSTRUCTOR GUIDANCE	CONTENT
<div data-bbox="228 464 675 800"></div> <p data-bbox="228 835 503 871">Display Slide 1-34</p>	<p data-bbox="711 369 966 409"><i>Unit Summary</i></p> <p data-bbox="711 468 1425 504">Summarize the unit by making the following points:</p> <ul data-bbox="711 520 1474 1402" style="list-style-type: none">▪ Everyone in the community has the ability and the responsibility to prepare for disasters.▪ Citizen Corps is the grassroots movement to strengthen community safety and preparedness through increased civic participation. CERTs are a key partner with Citizen Corps.▪ Government leaders have the responsibility to engage the whole community in the process of community planning and in testing and evaluating those plans.▪ Community leaders have the responsibility to ensure their employees and constituent groups are prepared and to participate on coordinating planning councils.▪ The public has the responsibility to learn about community hazards and plans, and to prepare, train, practice, and volunteer.▪ There are three kinds of disasters: natural, technological, and intentional. Most hazards occur with little or no notice, may cause emergency personnel to be overwhelmed, and are a danger to lives, health, and the environment.

**COMMUNITY EMERGENCY RESPONSE TEAM
UNIT 1: DISASTER PREPAREDNESS**

INSTRUCTOR GUIDANCE	CONTENT
	<ul style="list-style-type: none">▪ Personal preparedness should be tailored to the hazards in your community, but should include:<ul style="list-style-type: none">• Learning about community alerts, warnings, and plans• Learning about appropriate protective actions• Developing household plans and conducting drills to practice• Assembling disaster supplies in multiple locations• Reducing hazards in the home• Encouraging others to prepare and volunteering to help your community ▪ CERTs are among a variety of agencies and personnel who cooperate to provide assistance in the aftermath of a disaster. The keys to CERT effectiveness are in:<ul style="list-style-type: none">• Familiarity with the types of events that are high risk for the area and the types of damage that can occur as a result• Adequate preparation for each event and its aftermath• Training in the functional areas to which CERTs are assigned• Practice through refreshers and simulations ▪ CERTs have proven themselves invaluable in the areas in which they were tested. They can be invaluable in this community as well. <p>Do you have any questions about anything covered in this unit?</p>



**COMMUNITY EMERGENCY RESPONSE TEAM
UNIT 1: DISASTER PREPAREDNESS**

INSTRUCTOR GUIDANCE	CONTENT
<div data-bbox="228 501 675 835"><p>Homework Assignment</p><ol style="list-style-type: none">1. Review detailed information for Unit 12. Read unit to be covered in next session3. Bring necessary supplies and wear appropriate clothes for next session4. Discuss preparedness with family and friends5. Assemble supplies in multiple locations6. Examine homes for hazards<p><small>FEMA CERT Basic Training Unit 1: Disaster Preparedness 1-35</small></p></div> <p data-bbox="228 873 500 909">Display Slide 1-35</p>	<p data-bbox="706 371 1122 411"><i>Homework Assignment</i></p> <p data-bbox="706 468 1446 573">Tell the group that the next unit will cover fire safety. Then remind the group that, before the next session, they should:</p> <ol style="list-style-type: none"><li data-bbox="706 615 1414 684">1. Review the detailed information in Unit 1 of the Participant Manual<li data-bbox="706 726 1479 795">2. Read and familiarize themselves with Unit 2: Fire Safety and Utility Controls in the Participant Manual<li data-bbox="706 837 1471 1089">3. Bring a pair of leather gloves and safety goggles to use in the fire suppression unit and to serve as a starting point for their disaster supply kits. Tell the group to wear appropriate clothes to the next session (no shorts or open-toed shoes) because they will practice putting out a small fire with an extinguisher.<li data-bbox="706 1131 1455 1236">4. Discuss preparedness with family and friends and make a communications plan, including an out-of-State “check-in contact”<li data-bbox="706 1278 1430 1314">5. Begin to assemble supplies in multiple locations<li data-bbox="706 1356 1471 1425">6. Examine their homes for hazards and identify ways to prevent potential injury <p data-bbox="706 1493 1390 1528">Thank the participants for attending this session.</p>

UNIT 1: ADDITIONAL MATERIALS

[This page intentionally left blank]

**COMMUNITY EMERGENCY RESPONSE TEAM
UNIT 1: DISASTER PREPAREDNESS**

COMMUNITY EMERGENCY RESPONSE TEAM CHECKLIST

Instructions: This checklist will help guide you in the setup of your CERT as well as emergency preparedness at home.

<i>Personal Preparedness</i>	<i>Check if Completed</i>	<i>Date Checked</i>
▪ Food	<input type="checkbox"/>	
▪ Water	<input type="checkbox"/>	
▪ Out-of-State Check-In Contact	<input type="checkbox"/>	
▪ Mitigation Measures		
• Water heater	<input type="checkbox"/>	
• Utilities	<input type="checkbox"/>	
• Cabinets, etc.	<input type="checkbox"/>	
• Other: _____	<input type="checkbox"/>	
 <i>Team Organization</i>		
▪ Leadership		
• Incident Commander/Team Leader	<input type="checkbox"/>	
• Group leaders	<input type="checkbox"/>	
▪ Membership		
• Roster	<input type="checkbox"/>	
• Phone list	<input type="checkbox"/>	
• Skills inventory	<input type="checkbox"/>	
▪ Communications		
• Telephone tree	<input type="checkbox"/>	
• Newsletter	<input type="checkbox"/>	
• Amateur radio	<input type="checkbox"/>	
• Runners	<input type="checkbox"/>	

**COMMUNITY EMERGENCY RESPONSE TEAM
UNIT 1: DISASTER PREPAREDNESS**

COMMUNITY EMERGENCY RESPONSE TEAM CHECKLIST (CONTINUED)

<i>Team Organization</i>	<i>Check if Completed</i>	<i>Date Checked</i>
▪ Resources		
• Personnel	<input type="checkbox"/>	
• Equipment	<input type="checkbox"/>	
• Supplies	<input type="checkbox"/>	
• Personal CERT kit	<input type="checkbox"/>	
▪ Area Surveys and Locations		
• Evacuation plans	<input type="checkbox"/>	
• Staging area/command post	<input type="checkbox"/>	
• Medical treatment area	<input type="checkbox"/>	
• Specific hazard areas	<input type="checkbox"/>	
• Area maps	<input type="checkbox"/>	
▪ Response Plan		
• Response criteria	<input type="checkbox"/>	
• Communications and notifications	<input type="checkbox"/>	
• Staging area/command post	<input type="checkbox"/>	
▪ Teamwork		
• Meetings	<input type="checkbox"/>	
• Drills and exercises	<input type="checkbox"/>	
• Training		
First aid	<input type="checkbox"/>	
CPR	<input type="checkbox"/>	
Other: _____	<input type="checkbox"/>	

**COMMUNITY EMERGENCY RESPONSE TEAM
UNIT 1: DISASTER PREPAREDNESS**

RECOMMENDED PERSONAL PROTECTION EQUIPMENT (PPE)

The following items are minimum safety equipment for all CERT members.

- Hard hat
- Protective eyewear (safety goggles)
- Leather work gloves
- Long-sleeved shirt
- N95 mask
- Reflective vest
- Sturdy shoes or boots
- Long pants

**COMMUNITY EMERGENCY RESPONSE TEAM
UNIT 1: DISASTER PREPAREDNESS**

RECOMMENDED CERT EQUIPMENT AND SUPPLIES

The following equipment and supplies are recommended as minimum kit items for each CERT member. These guidelines are recommended in addition to team supplies.

<i>Equipment and Supplies</i>	<i>Date Obtained</i>	<i>Quantity</i>	<i>Date Checked</i>
<ul style="list-style-type: none"> ▪ Nylon or canvas bag with shoulder strap ▪ Water (two canteens or bottles per search and rescue team) ▪ Dehydrated foods ▪ Water purification tablets ▪ Work gloves (leather) ▪ Non-latex exam gloves (10 pair min.) ▪ Goggles ▪ N95 masks ▪ Flashlight or miner's lamp ▪ Batteries and extra bulbs ▪ Secondary flashlight ▪ Cyalume sticks (12-hour omni glow) ▪ Voltage tick meter ▪ Pea-less whistle ▪ Utility knife ▪ Note pads ▪ Markers: <ul style="list-style-type: none"> • Thin point • Thick point ▪ Pens ▪ Duct tape ▪ Masking tape (2 inch) ▪ Scissors (EMT shears) 			

**COMMUNITY EMERGENCY RESPONSE TEAM
UNIT 1: DISASTER PREPAREDNESS**

<i>Equipment and Supplies</i>	<i>Date Obtained</i>	<i>Quantity</i>	<i>Date Checked</i>
<ul style="list-style-type: none">▪ Non-sparking crescent wrench▪ First aid pouch containing:<ul style="list-style-type: none">• 4- by 4-inch gauze dressings (6)• Abdominal pads (4)• Triangular bandages (4)• Band-Aids• Roller bandage• Any personal medications that a CERT member may need during deployment			

[This page intentionally left blank]

UNIT 2: FIRE SAFETY AND UTILITY CONTROLS

In this unit you will learn about:

- **Fire Chemistry:** How fire occurs, classes of fire, and choosing the correct means to extinguish each type of fire.
- **Fire and Utility Hazards:** Potential fire and utility hazards in the home and workplace, and fire prevention strategies
- **CERT Sizeup:** How to conduct the continual data-gathering and evaluation process at the scene of a disaster or emergency
- **Fire Sizeup Considerations:** How to evaluate fires, assess firefighting resources, and determine a course of action
- **Portable Fire Extinguishers:** Types of portable fire extinguishers and how to operate them
- **Fire Suppression Safety:** How to decide if you should attempt to extinguish a fire; how to approach and extinguish a fire safely
- **Hazardous Materials:** How to identify potentially dangerous materials in storage, in transit, and in your home

[This page intentionally left blank]

COMMUNITY EMERGENCY RESPONSE TEAM
UNIT 2: FIRE SAFETY AND UTILITY CONTROLS

OBJECTIVES	<p>At the conclusion of this unit, the participants should be able to:</p> <ul style="list-style-type: none">▪ Explain the role of CERTs in fire safety.▪ Identify and reduce potential fire and utility risks in the home and workplace.▪ Know the nine steps of the CERT sizeup process.▪ Conduct a basic sizeup for a fire emergency.▪ Operate a portable fire extinguisher correctly.▪ Understand minimum safety precautions, including safety equipment, utility control, buddy system, and backup teams.▪ Identify the locations of hazardous materials in the community and home and reduce the risk from hazardous materials in the home.▪ Extinguish small fires using a fire extinguisher.
-------------------	---

SCOPE	<p>The topics that will be discussed in this unit are:</p> <ul style="list-style-type: none">▪ Introduction and Unit Overview▪ Fire Chemistry▪ Fire and Utility Hazards▪ CERT Sizeup▪ Fire Sizeup Considerations▪ Firefighting Resources▪ Fire Suppression Safety▪ Hazardous Materials▪ Exercise: Suppressing Small Fires▪ Unit Summary
--------------	--

ESTIMATED COMPLETION TIME	2 hours 30 minutes
--	--------------------

COMMUNITY EMERGENCY RESPONSE TEAM
UNIT 2: FIRE SAFETY AND UTILITY CONTROLS

**TRAINING
METHODS**

As an introduction to fire safety, the instructor will describe fire chemistry and the classes of fire, emphasizing the importance of selecting the correct methods or agent for fire safety.

Then, the instructor will present an overview of hazards in the home and workplace, including electrical hazards, natural gas hazards, and flammable and combustible liquids, and lead a discussion of hazard mitigation and preparedness.

The instructor will then describe CERT strategies for assessing disaster or emergency situations using the continual, 9-step sizeup process. Participants will learn fire sizeup considerations and how to use the fire sizeup checklist when conducting a sizeup for a situation involving fire.

The next topic will be a discussion of firefighting resources, including portable fire extinguishers and creative resources such as pools, dirt or sand, and a garden hose. Emphasis will be placed on portable fire extinguishers because they will be the most common resource available to CERTs. Discussion of portable fire extinguishers will include types, extinguisher components, deciding to use a fire extinguisher, and correct extinguisher operation.

Fire suppression safety will be the next topic. The instructor will introduce the use of fire safety equipment and will place special emphasis on firefighter safety rules, including the 5-second rule, using the buddy system and a backup team, and techniques for fighting fires (e.g., confine the fire, stay low to the ground, identify a second exit route, etc.).

The instructor may choose to show a video at this point to reinforce the presentation on fire safety and fire extinguishers. (Video resources are included in the Equipment section below.)

Next, the instructor will lead an interactive discussion of hazardous materials, including where they are found, placarding, storage, and defensive strategies for hazardous materials accidents.

Finally, the unit will end with an exercise in which the participants will operate in teams of two and use a portable fire extinguisher to extinguish a gas fire.

COMMUNITY EMERGENCY RESPONSE TEAM
UNIT 2: FIRE SAFETY AND UTILITY CONTROLS

RESOURCES REQUIRED	<ul style="list-style-type: none">▪ <i>Community Emergency Response Team Instructor Guide</i>▪ <i>Community Emergency Response Team Participant Manual</i>▪ PowerPoint Slides 2-0 through 2-32
-------------------------------	--

OTHER RESOURCES	<p>If time permits, the 18-minute video <i>Fire Safety: The CERT Member's Role</i> is recommended for this unit. The video provides information on how to size up the fire and select the right extinguisher, as well as how to use extinguishers correctly. The video is available for download at the national CERT Web site, www.citizencorps.gov/cert/.</p>
----------------------------	---

EQUIPMENT	<p>In addition to the equipment listed at the front of this Instructor Guide, you will need the following equipment for this unit:</p> <ul style="list-style-type: none">▪ A computer with PowerPoint software▪ A computer projector and screen▪ Samples of NFPA 704 Diamond and other hazardous materials placards, if possible▪ One roll of cotton swabbing▪ One Pyrex[®] jar with lid▪ One box of wooden kitchen matches▪ One water fire extinguisher▪ One dry chemical fire extinguisher▪ Portable Class A:B:C fire extinguishers (1 for every 5 participants)▪ Fire Pan (see page 2-5)▪ Road flares and a long pole
------------------	---

COMMUNITY EMERGENCY RESPONSE TEAM
UNIT 2: FIRE SAFETY AND UTILITY CONTROLS

NOTES

A suggested time plan for this unit is as follows:

Introduction and Unit Overview.....	10 minutes
Fire Chemistry	10 minutes
Fire and Utility Hazards	15 minutes
CERT Sizeup.....	5 minutes
Fire Sizeup Considerations.....	5 minutes
Firefighting Resources.....	20 minutes
Fire Suppression Safety	10 minutes
Hazardous Materials.....	10 minutes
Exercise: Suppressing Small Fires	60 minutes
Unit Summary.....	5 minutes

Total Time: 2 hours 30 minutes

REMARKS

Most fire extinguisher service companies will provide Class A:B:C portable extinguishers for the final activity in this unit. Contact local companies for support.

COMMUNITY EMERGENCY RESPONSE TEAM
UNIT 2: FIRE SAFETY AND UTILITY CONTROLS

REMARKS
(CONTINUED)

One method for setting up this exercise is shown below. Consult your local fire department for any additional assistance required in building and operating the fire pan. Check with your State fire marshal about guidelines for open burning.

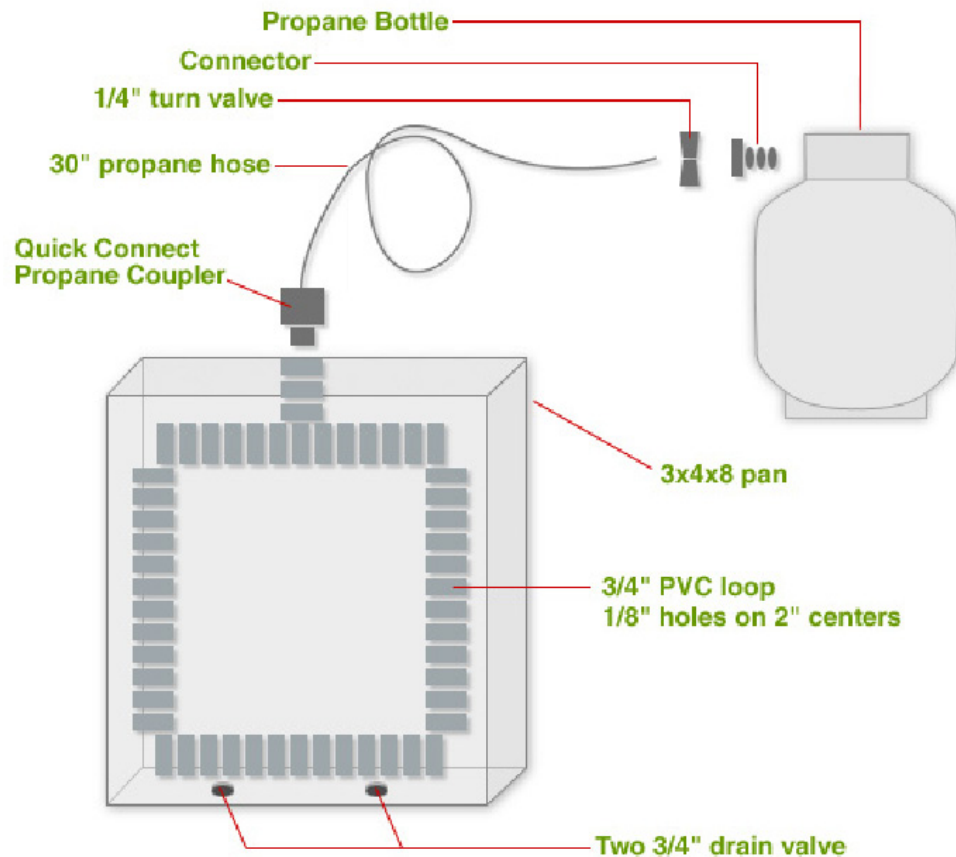

Unit 2: Fire Safety and Utility Controls

INSTRUCTOR GUIDANCE	CONTENT
---------------------	---------



Display Slide 2-0



Correct response:
Themselves.



Correct responses:

- Families
- Homes
- Neighborhoods

Introduction and Unit Overview

Welcome

Introduce this unit by welcoming the participants to Unit 2 of the *CERT Basic Training*.

Introduce any new instructors who will be assisting with this session.

Briefly review Unit 1.

Whom do CERT members take care of first?

After that, whom do CERT members take care of?

COMMUNITY EMERGENCY RESPONSE TEAM
UNIT 2: FIRE SAFETY AND UTILITY CONTROLS

INSTRUCTOR GUIDANCE	CONTENT
<p></p> <p>Correct responses:</p> <p>Damage to transportation, structures, communications, utilities, water service, fuel supply, financial services</p> <p></p> <p>Discuss responses.</p> <p></p> <p>Discuss.</p> <p></p> <p>This is a gentle reminder to participants that they should be doing these things.</p>	<p>How might a disaster impact a community's infrastructure?</p> <p>Did you look for potential structural and non-structural hazards?</p> <p>What did you find?</p> <p>How might you mitigate those hazards?</p> <p>Have you started to prepare a disaster supply kit?</p> <p>Have you started to work on a disaster plan?</p> <p>Introduce fire and utility safety by telling the participants that during and immediately following a severe emergency, the first priorities of professional fire services are life safety and extinguishing <i>major</i> fires.</p> <p>They may be hampered by impassable roads, weather conditions, inadequate water supply, and other inadequate resources.</p>

COMMUNITY EMERGENCY RESPONSE TEAM
UNIT 2: FIRE SAFETY AND UTILITY CONTROLS

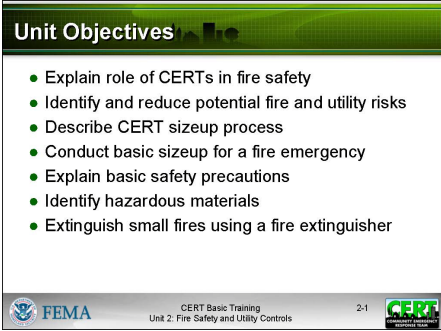
INSTRUCTOR GUIDANCE	CONTENT
<div data-bbox="188 436 626 764"><p>Unit Objectives</p><ul style="list-style-type: none">• Explain role of CERTs in fire safety• Identify and reduce potential fire and utility risks• Describe CERT sizeup process• Conduct basic sizeup for a fire emergency• Explain basic safety precautions• Identify hazardous materials• Extinguish small fires using a fire extinguisher<p>FEMA CERT Basic Training Unit 2: Fire Safety and Utility Controls 2-1</p></div> <p data-bbox="188 800 441 835">Display Slide 2-1</p>	<p data-bbox="657 405 889 441">Unit Objectives</p> <p data-bbox="657 493 1380 562">Tell the participants that at the end of this unit, they should be able to:</p> <ul data-bbox="657 577 1469 1249" style="list-style-type: none">▪ Explain the role that CERTs play in fire safety.▪ Identify and reduce potential fire and utility risks in the home and workplace.▪ Describe the 9-step CERT sizeup process.▪ Conduct a basic sizeup for a fire emergency▪ Explain minimum safety precautions, including:<ul data-bbox="706 861 1006 1060" style="list-style-type: none">• Safety equipment• Utility control• Buddy system• Backup teams▪ Identify locations of hazardous materials in the community and the home and reduce the risk from hazardous materials in the home▪ Extinguish small fires using a fire extinguisher

COMMUNITY EMERGENCY RESPONSE TEAM
UNIT 2: FIRE SAFETY AND UTILITY CONTROLS

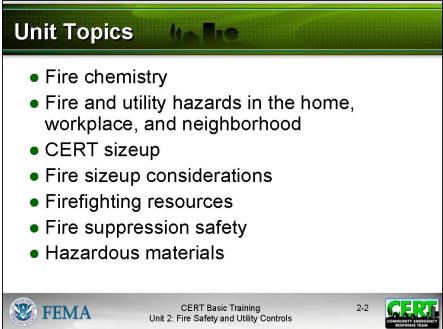
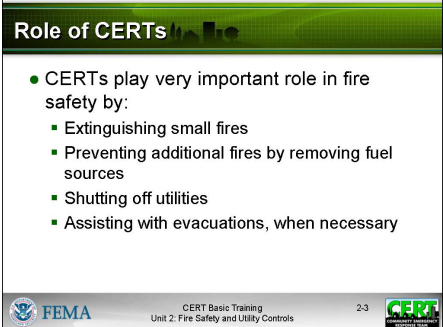
INSTRUCTOR GUIDANCE	CONTENT
 <p>Unit Topics</p> <ul style="list-style-type: none">• Fire chemistry• Fire and utility hazards in the home, workplace, and neighborhood• CERT sizeup• Fire sizeup considerations• Firefighting resources• Fire suppression safety• Hazardous materials <p>FEMA CERT Basic Training Unit 2: Fire Safety and Utility Controls 2-2</p> <p>Display Slide 2-2</p>	<p>Unit Topics</p> <p>Preview the unit topics by telling the group that the unit will provide them with the knowledge and skills that they will need to reduce or eliminate fire hazards and extinguish small fires.</p> <p>The areas that they will learn about include:</p> <ul style="list-style-type: none">▪ Fire chemistry▪ Fire and utility hazards in the home, workplace, and neighborhood▪ CERT sizeup▪ Fire sizeup considerations▪ Firefighting resources▪ Fire suppression safety▪ Hazardous materials <p>Tell the group that, at the end of the unit, they will have an opportunity to use a portable extinguisher to put out a fire.</p>
 <p>Role of CERTs</p> <ul style="list-style-type: none">• CERTs play very important role in fire safety by:<ul style="list-style-type: none">▪ Extinguishing small fires▪ Preventing additional fires by removing fuel sources▪ Shutting off utilities▪ Assisting with evacuations, when necessary <p>FEMA CERT Basic Training Unit 2: Fire Safety and Utility Controls 2-3</p> <p>Display Slide 2-3</p>	<p>Role of CERTs</p> <p>Emphasize that CERTs play a very important role in fire and utility safety by:</p> <ul style="list-style-type: none">▪ <u>Extinguishing small fires</u> before they become major fires<ul style="list-style-type: none">• This unit will provide training on how to use an extinguisher to put out small fires and how to recognize when a fire is too big to handle. As a general rule, if you can't put out a fire in 5 seconds, it is already too big to handle and you should leave the premises immediately.

COMMUNITY EMERGENCY RESPONSE TEAM
UNIT 2: FIRE SAFETY AND UTILITY CONTROLS

INSTRUCTOR GUIDANCE	CONTENT
<p>Although CERTs assist with evacuations, the procedures for conducting evacuations are not covered in this course. It is recommended that evacuation be covered in supplemental training.</p> <div data-bbox="188 1129 626 1459" data-label="Image"> </div> <p>Display Slide 2-4</p>	<ul style="list-style-type: none"> ▪ <u>Preventing additional fires by removing fuel sources</u> <ul style="list-style-type: none"> • This unit will also describe how to ensure that a fire, once extinguished, is completely extinguished and stays extinguished. This process is called overhaul. ▪ <u>Shutting off utilities</u> when necessary and safe to do so <ul style="list-style-type: none"> • This unit will review utility shutoff procedures taught in Unit 1. ▪ <u>Assisting with evacuations</u> where necessary <ul style="list-style-type: none"> • When a fire is beyond the ability of CERTs to extinguish, CERT members need to protect lives by evacuating the area and establishing a perimeter. <p>CERT Priorities</p> <p>Stress the important role that CERTs play in neighborhood and workplace fire and utility safety. CERT members help in fire- and utility-related emergencies before professional responders arrive. When responding, CERT members should keep in mind the following CERT standards:</p> <ul style="list-style-type: none"> ▪ Rescuer safety is <u>always</u> the number one priority. Therefore, CERT members always: <ul style="list-style-type: none"> • Work with a buddy • Wear safety equipment (gloves, helmet, goggles, N95 mask, and sturdy shoes or boots) ▪ The CERT goal is to do the greatest good for the greatest number.

COMMUNITY EMERGENCY RESPONSE TEAM
UNIT 2: FIRE SAFETY AND UTILITY CONTROLS

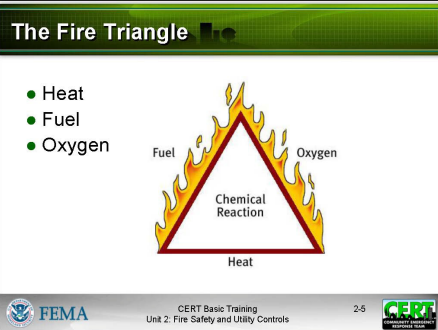
INSTRUCTOR GUIDANCE	CONTENT
<p data-bbox="191 514 267 583"></p> <p data-bbox="191 655 626 982"></p> <p data-bbox="191 1020 444 1056">Display Slide 2-5</p> <p data-bbox="191 1325 331 1360">PM, P. 2-4</p>	<p data-bbox="659 415 922 451"><i>Fire Chemistry</i></p> <p data-bbox="659 510 1422 546">Does anyone know what it takes for a fire to burn?</p> <p data-bbox="659 625 915 661">The Fire Triangle</p> <p data-bbox="659 695 1390 766">If not mentioned by the participants, explain that fire requires three elements to exist:</p> <ul data-bbox="659 783 1458 1129" style="list-style-type: none">▪ Heat: Heat is required to elevate the temperature of a material to its ignition point.▪ Fuel: The fuel for a fire may be a solid, liquid, or gas. The type and quantity of the fuel will determine which method should be used to extinguish the fire.▪ Oxygen: Most fires will burn vigorously in any atmosphere of at least 20 % oxygen. Without oxygen, most fuels could be heated until entirely vaporized, yet would not burn. <p data-bbox="659 1146 1390 1249">Explain that working together, these three elements, called the <i>fire triangle</i>, create a chemical exothermic reaction, which is fire.</p> <p data-bbox="659 1293 1414 1360">Refer the participants to the <i>Fire Triangle</i> figure in the Participant Manual.</p> <p data-bbox="659 1402 1458 1470">Stress that if <u>any</u> of these elements is missing or if any is taken away, fire will not occur or will extinguish.</p>

COMMUNITY EMERGENCY RESPONSE TEAM
UNIT 2: FIRE SAFETY AND UTILITY CONTROLS

PM, P. 2-4	Fire Triangle
-------------------	----------------------

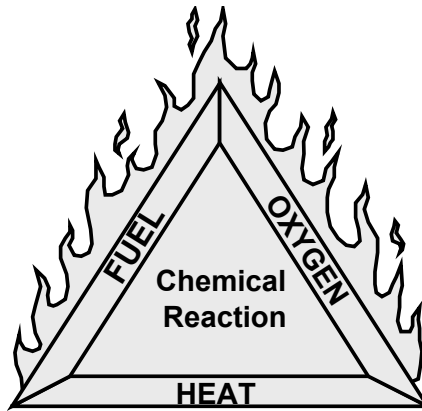



Fire Triangle: Fuel, oxygen, and heat create a chemical reaction, which causes fire.

INSTRUCTOR GUIDANCE	CONTENT
<p>Use the following steps to demonstrate the concept:</p> <ol style="list-style-type: none"> 1. Ignite a rolled-up piece of cotton, place it inside a Pyrex[®] jar, and cover it tightly. 2. Wait until the flame goes out. 3. Remove the material from the jar and blow on it to demonstrate that, unless the fire is completely out and overhauled, adding oxygen may complete the fire triangle and rekindle the fire. 	<p>Demonstrating the Fire Triangle</p> <p>Tell the group that you will now demonstrate the concept of the fire triangle by removing the oxygen from burning cotton.</p> <p>Emphasize the need to ensure that every piece of burning material is completely extinguished. Tell the participants to think of Smokey the Bear and campfires to remember this point.</p>

COMMUNITY EMERGENCY RESPONSE TEAM
UNIT 2: FIRE SAFETY AND UTILITY CONTROLS

INSTRUCTOR GUIDANCE	CONTENT
<div data-bbox="188 478 626 804" data-label="Image"> </div> <p data-bbox="188 842 444 877">Display Slide 2-6</p> <p data-bbox="188 953 613 1131">Reemphasize the need to overhaul Class A fires (i.e., ensure that every piece of burning material is <u>completely</u> extinguished).</p> <div data-bbox="188 1423 266 1499" data-label="Image"> </div>	<p data-bbox="656 407 883 443">Classes of Fire</p> <p data-bbox="656 478 1422 583">Tell the participants that, to aid in extinguishing fires, fires are categorized into classes based on the type of fuel that is burning:</p> <ul data-bbox="656 621 1463 1245" style="list-style-type: none"> ▪ <u>Class A Fires</u>: Ordinary combustibles such as paper, cloth, wood, rubber, and many plastics ▪ <u>Class B Fires</u>: Flammable liquids (e.g., oils, gasoline) and combustible liquids (e.g., charcoal lighter fluid, kerosene). These fuels burn only at the surface because oxygen cannot penetrate the depth of the fluid. Only the vapor burns when ignited. ▪ <u>Class C Fires</u>: Energized electrical equipment (e.g., wiring, motors). When the electricity is turned off, the fire becomes a Class A fire. ▪ <u>Class D Fires</u>: Combustible metals (e.g., aluminum, magnesium, titanium) ▪ <u>Class K Fires</u>: Cooking oils (e.g., vegetable oils, animal oils, fats) <p data-bbox="656 1283 1458 1381">Stress that it is <u>extremely</u> important to identify the type of fuel feeding the fire to select the correct method and agent for extinguishing the fire.</p> <p data-bbox="656 1423 1317 1493">Does anyone have any questions about fire chemistry?</p>

COMMUNITY EMERGENCY RESPONSE TEAM
UNIT 2: FIRE SAFETY AND UTILITY CONTROLS

INSTRUCTOR GUIDANCE	CONTENT
	<p data-bbox="657 415 1073 453"><i>Fire and Utility Hazards</i></p> <p data-bbox="657 506 1398 606">Explain that this section will deal with identifying and preventing fire and utility hazards in the home and workplace.</p> <p data-bbox="191 659 266 730"></p> <p data-bbox="657 646 1430 716">What are potential fire and utility hazards in homes or workplaces?</p> <p data-bbox="657 785 1458 854">Allow the group time to respond. Provide suggestions of additional potential fire and utility hazards.</p> <p data-bbox="191 898 266 970"></p> <p data-bbox="657 894 1344 963">What measures have you taken to mitigate or prevent the hazards?</p> <p data-bbox="657 1010 1409 1079">Use the participants' responses to make the following points:</p> <ul data-bbox="657 1094 1422 1373" style="list-style-type: none"><li data-bbox="657 1094 1422 1163">▪ Each of us has some type of fire or utility hazard in our home and workplace.<li data-bbox="657 1178 1422 1373">▪ Most of these hazards fall into three categories:<ul data-bbox="704 1234 1227 1373" style="list-style-type: none"><li data-bbox="704 1234 1005 1268">• Electrical hazards<li data-bbox="704 1283 1040 1316">• Natural gas hazards<li data-bbox="704 1331 1227 1373">• Flammable or combustible liquids <p data-bbox="657 1430 1455 1610">Point out that homes and workplaces can and do have other hazards, including incompatible materials stored in close proximity to each other, such as flammables/combustibles, corrosives, compressed gases, and explosives.</p>

COMMUNITY EMERGENCY RESPONSE TEAM
UNIT 2: FIRE SAFETY AND UTILITY CONTROLS

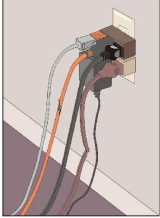
INSTRUCTOR GUIDANCE	CONTENT
<p data-bbox="196 772 496 802">Reducing Electrical Hazards</p> <ul data-bbox="212 825 406 1024" style="list-style-type: none">● Avoid the “electrical octopus”● Don’t run cords under carpets● Check for and replace broken or frayed cords● Maintain appliances  <p data-bbox="196 1052 626 1083">FEMA CERT Basic Training Unit 2: Fire Safety and Utility Controls 2-7</p> <p data-bbox="188 1123 443 1157">Display Slide 2-7</p>	<p data-bbox="657 407 1406 474">Explain that simple fire prevention measures will help reduce the likelihood of fires:</p> <ul data-bbox="657 495 1406 615" style="list-style-type: none">▪ First, <i>locate</i> potential sources of ignition.▪ Then, do what you can to <i>reduce or eliminate</i> the hazards. <p data-bbox="657 726 932 760">Electrical Hazards</p> <p data-bbox="657 800 1422 905">Provide the group with examples of common electrical hazards and simple ways that they can be reduced or eliminated:</p> <ul data-bbox="657 926 1422 1262" style="list-style-type: none">▪ Avoid the “electrical octopus.” Eliminate tangles of electrical cords. Don’t overload electrical outlets. Don’t plug power strips into other power strips.▪ Don’t run electrical cords under carpets.▪ Check for and replace broken or frayed cords immediately.▪ Maintain electrical appliances properly. Repair or replace malfunctioning appliances.

COMMUNITY EMERGENCY RESPONSE TEAM
UNIT 2: FIRE SAFETY AND UTILITY CONTROLS

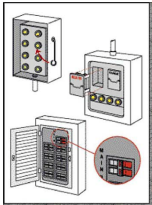
INSTRUCTOR GUIDANCE	CONTENT
<div data-bbox="188 436 626 762"><p>Electrical Emergencies</p><ul style="list-style-type: none">• Know where power shutoffs are for:<ul style="list-style-type: none">▪ Appliances▪ Circuit breakers▪ Fuses• Post shutoff directions next to all utilities• Know procedures for turning power back on</div> <div data-bbox="188 800 444 837"><p>Display Slide 2-8</p></div> <div data-bbox="183 867 628 1125"><p>Check with a representative from the local utility company regarding local utility protocols. Obtain or develop training models of fuse and breaker boxes to allow demonstrations and hands-on practice.</p></div> <div data-bbox="183 1161 615 1270"><p>Depending on your location, you may also choose to cover propane gas shutoffs.</p></div> <div data-bbox="183 1306 344 1346"><p>PM, P. 2-8</p></div> <div data-bbox="188 1417 626 1747"><div data-bbox="188 1417 626 1747"><p>Shutoff Procedures</p><ul style="list-style-type: none">• Fuse box with shutoff• Circuit box with shutoff</div></div> <div data-bbox="183 1778 444 1818"><p>Display Slide 2-9</p></div>	<p>Responding to Electrical Emergencies</p> <p>Point out that electrical emergencies sometimes occur despite our best efforts. Every member of the household should be aware of the following procedures in the event of an electrical emergency:</p> <ul style="list-style-type: none">▪ Locate the circuit breakers or fuses, and know how to shut off the power. Post shutoff instructions next to the breaker box or fuse box.▪ Unscrew individual fuses or switch off smaller breakers first, then pull the main switch or breaker.▪ When turning the power back on, turn on the main switch or breaker first, then screw in the fuses or switch on the smaller breakers, one at a time. <p>Stress that the participants should <u>not</u> enter a flooded basement or standing water to shut off the electrical supply because water conducts electricity.</p> <p>Refer the participants to the figures <i>Circuit Box and Fuse Box</i> in the Participant Manual.</p>

COMMUNITY EMERGENCY RESPONSE TEAM
UNIT 2: FIRE SAFETY AND UTILITY CONTROLS

PM, P. 2-8	Circuit Box and Fuse Box
------------	--------------------------

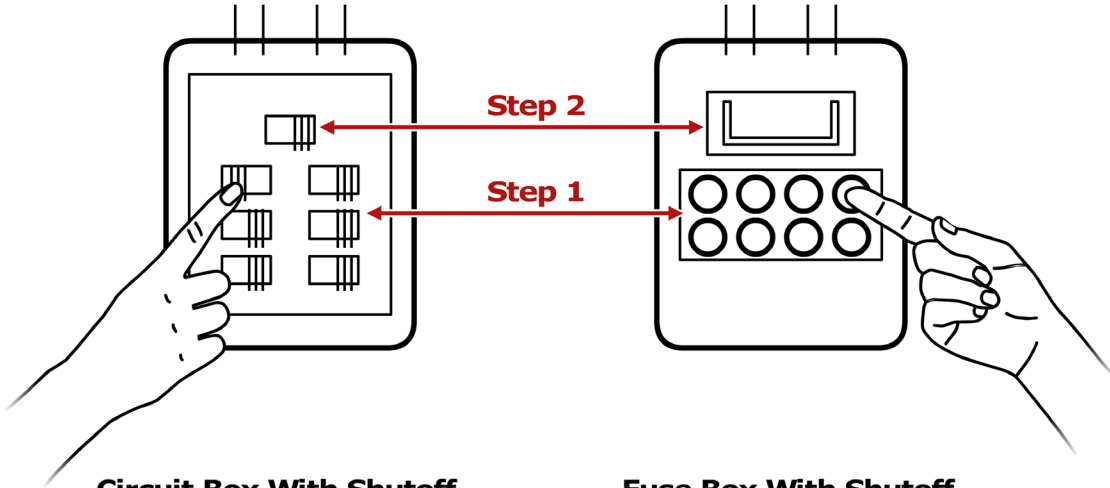

Circuit Box With Shutoff
Circuit box showing shutoff steps.
Step 1: Shut off individual breakers.
Step 2: Shut off main breaker.

Fuse Box With Shutoff
Fuse box showing shutoff steps.
Step 1: Pull out individual fuses.
Step 2: Pull out main fuse.

COMMUNITY EMERGENCY RESPONSE TEAM
UNIT 2: FIRE SAFETY AND UTILITY CONTROLS

INSTRUCTOR GUIDANCE	CONTENT
<div data-bbox="188 436 617 758"><p>Natural Gas Hazards</p><ul style="list-style-type: none">● Asphyxiant<ul style="list-style-type: none">▪ Robs body of oxygen● Explosive<ul style="list-style-type: none">▪ Can easily ignite</div> <p data-bbox="188 793 461 827">Display Slide 2-10</p> <div data-bbox="188 898 617 1220"><p>Natural Gas Hazard Awareness</p><ul style="list-style-type: none">● Install natural gas detector● Install carbon monoxide detector in home● Test batteries for natural gas and carbon monoxide detectors every month<ul style="list-style-type: none">▪ Change batteries every 6 months● Locate and label gas shutoffs<ul style="list-style-type: none">▪ Have proper non-sparking tool</div> <p data-bbox="188 1255 461 1289">Display Slide 2-11</p> <p data-bbox="188 1774 358 1808">PM, P. 2-10</p>	<p data-bbox="646 407 959 441">Natural Gas Hazards</p> <p data-bbox="646 478 1422 548">Explain that natural gas presents two types of hazards. It is an:</p> <ul data-bbox="646 569 1263 657" style="list-style-type: none">▪ <u>Asphyxiant</u> that robs the body of oxygen▪ <u>Explosive</u> that can easily ignite <p data-bbox="646 869 1118 903">Natural Gas Hazard Awareness</p> <p data-bbox="646 940 1352 1010">Provide the participants with several examples for monitoring natural gas hazards:</p> <ul data-bbox="646 1031 1438 1717" style="list-style-type: none">▪ As with smoke alarms that need to be strategically placed in your home, e.g., on every level of the home and near all sleeping areas, install a natural gas detector near the furnace, hot water tank, and gas appliances such as clothes dryer or stove. Test the detector monthly to ensure that it works.▪ Install a carbon monoxide detector near the sleeping area. Additional detectors may be installed on every level of the home and in every bedroom. Detectors should not be placed within 15 feet of heating or cooking appliances or in or near very humid areas such as bathrooms. Test the detector monthly to ensure that it works.▪ Locate and label the gas shutoff valve(s). (There may be multiple valves inside a home in addition to the main shutoff.) Know how to shut off the gas and have the proper non-sparking tool for shutting off the gas. <p data-bbox="646 1774 1401 1843">Refer the participants to the figure <i>Natural Gas Meter with Shutoff</i> in the Participant Manual.</p>

COMMUNITY EMERGENCY RESPONSE TEAM
UNIT 2: FIRE SAFETY AND UTILITY CONTROLS

PM, P. 2-10

Natural Gas Meter with Shutoff

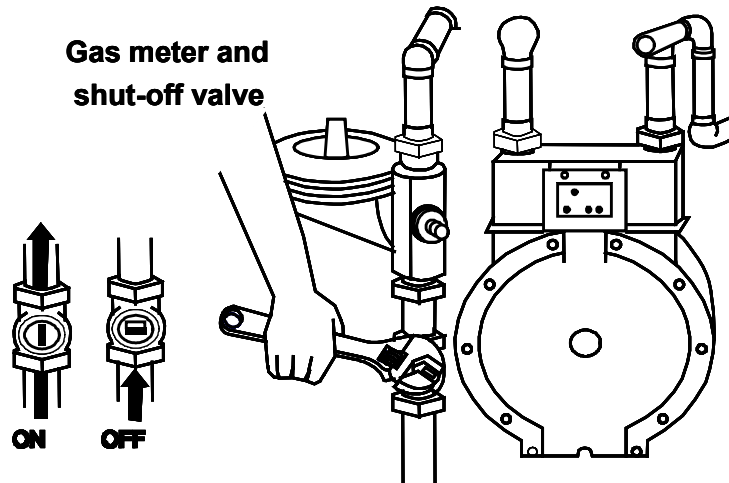

The gas meter shutoff diagram indicates the shutoff valve location on the pipe that comes out of the ground. To turn off the valve, use a non-sparking wrench to turn the valve clockwise one-quarter turn. Remember that, in all cases, natural gas flow should only be turned on by a licensed technician.

Please note: Some gas meters have automatic shutoff valves that restrict the flow of gas during an earthquake or other emergency. These are installed by a licensed plumber, downstream of the utility point of delivery. If you are unsure whether your home has this shutoff device, contact your gas service company. If this shutoff device is closed, only a qualified professional should restore it.

COMMUNITY EMERGENCY RESPONSE TEAM
UNIT 2: FIRE SAFETY AND UTILITY CONTROLS

INSTRUCTOR GUIDANCE	CONTENT
<div data-bbox="188 415 626 741"><p>Gas Shutoff</p><ul style="list-style-type: none">• Locate and label gas shutoff valves• If not automatic, know procedures for shutting off gas</div> <p>Display Slide 2-12</p> <p>Consult with a local utility representative to determine protocols and, if possible, create a model gas meter to demonstrate and allow practice with the procedure for shutting off the gas.</p>	<p>Gas Shutoff</p> <p><u>Gas meter inside the home</u></p> <p>Explain that if the gas meter is located inside the home, participants should only shut off the gas flow when instructed to by local authorities. Emphasize that if they smell gas or see the dials on the meter showing gas is flowing even though appliances are turned off, they should evacuate the premises and call 911. Tell them that they should not attempt to shut off the gas from inside the building if gas may be in the air.</p> <p><u>Gas meter outside the home</u></p> <p>Tell participants that they should turn off the meter from outside the building if they smell gas or see dials on the meter showing gas is flowing even though appliances are turned off. Stress that if there is a fire that they cannot extinguish, they should call 911 and turn off the gas only if it is safe to do so.</p> <p>Explain that if participants are unsure of the proper procedures, they should not attempt to turn the utilities on again by themselves, particularly in multiple-unit dwellings. They should always follow the local fire department's guidelines.</p> <p>Stress that after the gas flow is turned off, <u>it can be restored only by a trained technician.</u></p> <p>Note that some gas meters have automatic shutoff valves that restrict the flow of gas during an earthquake or other emergency. Explain that these should be installed by a licensed plumber, downstream of the utility point of delivery. Tell participants that if they are unsure whether their home has this shutoff device, they should contact their gas service company. Stress that if this shutoff device is closed, only a qualified professional should restore it.</p> <p>Warn the participants never to enter the basement of a structure that is on fire to turn off any utility.</p>

COMMUNITY EMERGENCY RESPONSE TEAM
UNIT 2: FIRE SAFETY AND UTILITY CONTROLS

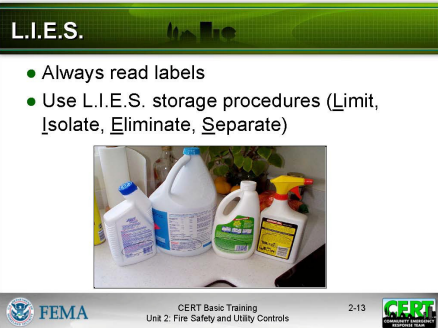
INSTRUCTOR GUIDANCE	CONTENT
<p data-bbox="191 632 626 957">A presentation slide titled "L.I.E.S." with a green header. It lists two bullet points: "Always read labels" and "Use L.I.E.S. storage procedures (Limit, Isolate, Eliminate, Separate)". Below the text is a photograph of several household cleaning products on a counter. At the bottom of the slide are logos for FEMA and CERT, along with the text "CERT Basic Training Unit 2: Fire Safety and Utility Controls 2-13".</p> <p data-bbox="191 999 461 1031">Display Slide 2-13</p> <p data-bbox="191 1073 586 1136">L.I.E.S. stands for Limit, Isolate, Eliminate, Separate.</p> <p data-bbox="191 1182 505 1325">Provide the group with information about safe disposal of hazardous materials in your area.</p>	<p data-bbox="659 384 1419 485">Explain that they should use a flashlight, not a candle, if an additional light source is needed to locate and shut off the gas valve.</p> <p data-bbox="659 562 1062 594">Flammable Liquid Hazards</p> <p data-bbox="659 653 1398 716">Provide several examples for reducing hazards from flammable liquids:</p> <ul data-bbox="659 741 1365 863" style="list-style-type: none">▪ Read labels to identify flammable products.▪ Store them properly, using the L.I.E.S. method (Limit, Isolate, Eliminate, Separate). <p data-bbox="659 884 1360 989">Stress that participants should only extinguish a flammable liquid using a portable fire extinguisher rated for Class B fires.</p> <p data-bbox="659 1182 1425 1325">Tell the group that they should extinguish a flammable liquid using a portable fire extinguisher rated for that class of fire. Explain that ratings for portable extinguishers will be addressed later in this unit.</p>

COMMUNITY EMERGENCY RESPONSE TEAM
UNIT 2: FIRE SAFETY AND UTILITY CONTROLS

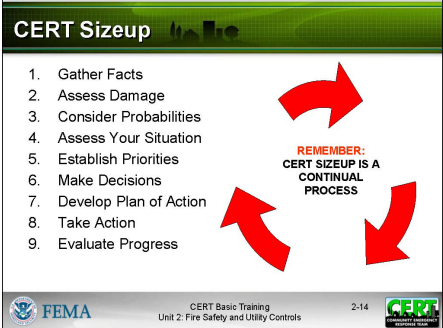
INSTRUCTOR GUIDANCE	CONTENT
 <p>CERT Sizeup</p> <ol style="list-style-type: none">1. Gather Facts2. Assess Damage3. Consider Probabilities4. Assess Your Situation5. Establish Priorities6. Make Decisions7. Develop Plan of Action8. Take Action9. Evaluate Progress <p style="text-align: center;">REMEMBER: CERT SIZEUP IS A CONTINUAL PROCESS</p> <p>FEMA CERT Basic Training Unit 2: Fire Safety and Utility Controls 2-14</p> <p>Display Slide 2-14</p> <p>PM, PP. 2-13 to 2-15</p> <p>Point out that, while sizeup is a fire department term, the process has been tailored for CERTs and will be used again in other areas of CERT responsibility.</p> <p>Provide several examples to illustrate the differences between fire department sizeup and CERT sizeup.</p>	<p>CERT Sizeup</p> <p>Introduce this topic by explaining to the group that sizeup is a continual process that enables professional responders to make decisions and respond appropriately in the areas of greatest need. CERT sizeup consists of 9 steps and should be used in any emergency situation.</p> <p>Refer the participants to <i>CERT Fire Sizeup</i> in the Participant Manual. Point out that, although the checklist is not exhaustive, it does include many of the questions that CERT members should ask when sizing up a fire situation.</p> <p>Explain that you will now discuss fire sizeup considerations and review the checklist with the group.</p> <p>CERT Sizeup Steps</p> <p>Explain that the 9 steps of CERT sizeup are:</p> <ol style="list-style-type: none">1. <u>Gather facts</u>. What has happened? How many people appear to be involved? What is the current situation?2. <u>Assess and communicate the damage</u>. Try to determine what has happened, what is happening now, and how bad things can really get.3. <u>Consider probabilities</u>. What is likely to happen? What could happen through cascading events?4. <u>Assess your own situation</u>. Are you in immediate danger? Have you been trained to handle the situation? Do you have the equipment that you need?5. <u>Establish priorities</u>. Are lives at risk? Can you help? <u>Remember, life safety is the first priority!</u>

COMMUNITY EMERGENCY RESPONSE TEAM
UNIT 2: FIRE SAFETY AND UTILITY CONTROLS

INSTRUCTOR GUIDANCE	CONTENT
	<ol style="list-style-type: none"><li data-bbox="659 401 1393 506">6. <u>Make decisions</u>. Base your decisions on the answers to Steps 1 through 5 and in accordance with the priorities that you established.<li data-bbox="659 527 1406 667">7. <u>Develop a plan of action</u>. Develop a plan that will help you accomplish your priorities. Simple plans may be verbal, but more complex plans should always be written.<li data-bbox="659 688 1398 793">8. <u>Take action</u>. Execute your plan, documenting deviations and status changes so that you can report the situation accurately to first responders.<li data-bbox="659 814 1435 989">9. <u>Evaluate progress</u>. At intervals, evaluate your progress in accomplishing the objectives in the plan of action to determine what is working and what changes you may have to make to stabilize the situation.

COMMUNITY EMERGENCY RESPONSE TEAM
UNIT 2: FIRE SAFETY AND UTILITY CONTROLS

PM, PP. 2-13 TO 2-15	CERT Fire Sizeup
-----------------------------	-------------------------

	Yes	No
Step 1: Gather Facts		
<i>Time</i>		
<ul style="list-style-type: none"> ▪ Does the time of day or week affect fire suppression efforts? How? 	<input type="checkbox"/>	<input type="checkbox"/>
<i>Weather</i>		
<ul style="list-style-type: none"> ▪ Are there weather conditions that affect your safety? If yes, how will your safety be affected? 	<input type="checkbox"/>	<input type="checkbox"/>
<ul style="list-style-type: none"> ▪ Will weather conditions affect the fire situation? If yes, how will the fire situation be affected? 	<input type="checkbox"/>	<input type="checkbox"/>
<i>Type of Construction</i>		
<ul style="list-style-type: none"> ▪ What type(s) of structure(s) are involved? 		
<ul style="list-style-type: none"> ▪ What type(s) of construction are involved? 		
<i>Occupancy</i>		
<ul style="list-style-type: none"> ▪ Are the structures occupied? If yes, how many people are likely to be affected? 	<input type="checkbox"/>	<input type="checkbox"/>
<ul style="list-style-type: none"> ▪ Are there special considerations (e.g., children, elderly, pets, people with disabilities)? 	<input type="checkbox"/>	<input type="checkbox"/>

COMMUNITY EMERGENCY RESPONSE TEAM
UNIT 2: FIRE SAFETY AND UTILITY CONTROLS

	Yes	No
<i>Hazards</i>		
<ul style="list-style-type: none"> ▪ Are hazardous materials evident? 	<input type="checkbox"/>	<input type="checkbox"/>
<ul style="list-style-type: none"> ▪ Are any other types of hazards present? If yes, what other hazards? 	<input type="checkbox"/>	<input type="checkbox"/>
Step 2: Assess and Communicate the Damage		
<ul style="list-style-type: none"> ▪ Survey all sides of the building. Is the danger beyond the CERT's capability? 	<input type="checkbox"/>	<input type="checkbox"/>
<ul style="list-style-type: none"> ▪ Have the facts and the initial damage assessment been communicated to the appropriate person(s)? 	<input type="checkbox"/>	<input type="checkbox"/>
Step 3: Consider Probabilities		
<i>Life Hazards</i>		
<ul style="list-style-type: none"> ▪ Are there potentially life-threatening hazards? If yes, what are the hazards? 	<input type="checkbox"/>	<input type="checkbox"/>
<i>Path of Fire</i>		
<ul style="list-style-type: none"> ▪ Does the fire's path jeopardize other areas? If yes, what other areas may be jeopardized? 	<input type="checkbox"/>	<input type="checkbox"/>
<i>Additional Damage</i>		
<ul style="list-style-type: none"> ▪ Is there a high potential for more disaster activity that will impact personal safety? If yes, what are the known risks? 	<input type="checkbox"/>	<input type="checkbox"/>

COMMUNITY EMERGENCY RESPONSE TEAM
UNIT 2: FIRE SAFETY AND UTILITY CONTROLS

	Yes	No
Step 4: Assess Your Own Situation		
<ul style="list-style-type: none"> ▪ What equipment is available to help suppress the fire? 		
<ul style="list-style-type: none"> ▪ What other resources are available? 		
<ul style="list-style-type: none"> ▪ Can fire suppression be <i>safely</i> attempted by CERT members? <u>If not, do <i>not</i> attempt suppression.</u> 	<input type="checkbox"/>	<input type="checkbox"/>
Step 5: Establish Priorities		
<ul style="list-style-type: none"> ▪ Are there other, more pressing needs at the moment? If yes, list. 	<input type="checkbox"/>	<input type="checkbox"/>
Step 6: Make Decisions		
<ul style="list-style-type: none"> ▪ Where will resources do the most good while maintaining an adequate margin of safety? 		
Step 7: Develop a Plan of Action		
<ul style="list-style-type: none"> ▪ Determine how personnel and other resources should be used. 		
Step 8: Take Action		
<ul style="list-style-type: none"> ▪ Put the plan into effect. 		
Step 9: Evaluate Progress		
<ul style="list-style-type: none"> ▪ Continually size up the situation to identify changes in the: <ul style="list-style-type: none"> • Scope of the problem • Safety risks • Resource availability 		
<ul style="list-style-type: none"> ▪ Adjust strategies as required. 		

COMMUNITY EMERGENCY RESPONSE TEAM
UNIT 2: FIRE SAFETY AND UTILITY CONTROLS

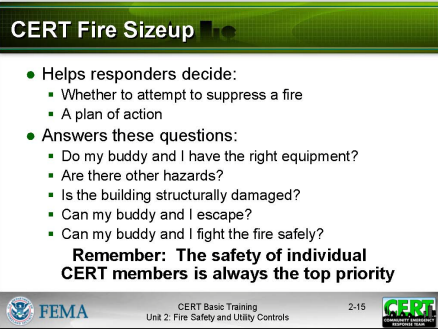
INSTRUCTOR GUIDANCE	CONTENT
  <p>Display Slide 2-15</p>	<p>Emphasize that sizeup is a continuous process.</p> <p>Evaluation of progress — Step 9 — may require you to go back and gather more facts.</p> <p>Does anyone have any questions about CERT fire sizeup?</p> <p><i>Fire Sizeup Considerations</i></p> <p>Explain that a sizeup of a situation involving a fire will dictate whether to attempt fire suppression and will help you plan for extinguishing the fire.</p> <p>Point out that CERT sizeup is a continual 9-step process that enables one to make decisions and respond appropriately in the areas of greatest need.</p> <p>Emphasize that the safety of individual CERT members is always the top priority. Say that effective fire sizeup will allow participants to answer all of the following questions:</p> <ul style="list-style-type: none">▪ Do my buddy and I have the right equipment?▪ Are there other hazards?▪ Is the building structurally damaged?▪ Can my buddy and I escape?▪ Can my buddy and I fight the fire safely? <p>Remind participants that the safety of individual CERT members is always the top priority.</p>

**COMMUNITY EMERGENCY RESPONSE TEAM
UNIT 2: FIRE SAFETY AND UTILITY CONTROLS**





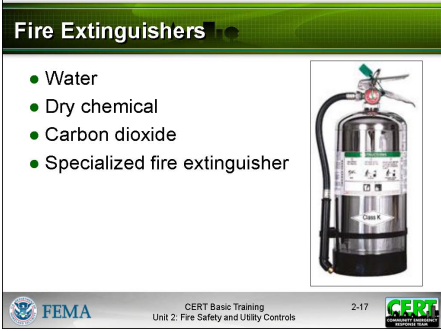





INSTRUCTOR GUIDANCE	CONTENT
<div data-bbox="188 506 266 577"></div> <div data-bbox="188 653 626 982"><p>Firefighting Resources</p><ul style="list-style-type: none">• Portable fire extinguishers• Wet standpipes• Confinement• “Creative” resources<p>FEMA CERT Basic Training Unit 2: Fire Safety and Utility Controls 2-16</p></div> <p data-bbox="188 1016 461 1052">Display Slide 2-16</p>	<p data-bbox="659 407 1065 443"><i>Firefighting Resources</i></p> <p data-bbox="659 501 1308 569">What comes to mind when you think about firefighting resources?</p> <p data-bbox="659 625 1414 693">If not mentioned, tell the group that the most common firefighting resources are:</p> <ul data-bbox="659 711 1073 793" style="list-style-type: none">▪ Portable fire extinguishers▪ Interior wet standpipes <p data-bbox="659 814 1373 882">Other resources include confinement and “creative resources.”</p> <p data-bbox="659 1094 935 1129">Fire Extinguishers</p> <p data-bbox="659 1163 1453 1331">Remind the participants that portable fire extinguishers are invaluable for putting out small fires. A well-prepared home or workplace will have at least two portable fire extinguishers of the appropriate type for the location.</p> <p data-bbox="659 1367 1360 1434">Emphasize that the type of fuel that is burning will determine which resources to select to fight a fire.</p> <p data-bbox="659 1478 1430 1545">Because portable fire extinguishers are most common, this section will focus on them.</p>

COMMUNITY EMERGENCY RESPONSE TEAM
UNIT 2: FIRE SAFETY AND UTILITY CONTROLS

INSTRUCTOR GUIDANCE	CONTENT
<div data-bbox="188 430 626 758"><p>Fire Extinguishers</p><ul style="list-style-type: none">• Water• Dry chemical• Carbon dioxide• Specialized fire extinguisher<p>FEMA CERT Basic Training Unit 2: Fire Safety and Utility Controls 2-17</p></div> <p>Display Slide 2-17</p> <p>PM, P. 2-18</p>	<p>Types of Fire Extinguishers</p> <p>Tell the group that there are four types of extinguishers:</p> <ul style="list-style-type: none">▪ Water▪ Dry chemical▪ Carbon dioxide▪ Specialized fire extinguishers <p>Explain that the next section will briefly describe the characteristics of each type of fire extinguisher. Refer the participants to the <i>Fire Types, Extinguishing Agents, and Methods</i> chart in the Participant Manual for an overview of this information.</p> <p>Review the types of fires and extinguishing methods with the group.</p>

COMMUNITY EMERGENCY RESPONSE TEAM
UNIT 2: FIRE SAFETY AND UTILITY CONTROLS

PM, P. 2-17	Fire Types, Extinguishing Agents, and Methods
--------------------	--

FIRE TYPE	EXTINGUISHING AGENT	EXTINGUISHING METHOD
Ordinary Solid Materials  	Water Foam Dry chemical	Removes heat Removes air and heat Breaks chain reaction
Flammable Liquids  	Foam CO ₂ Dry chemical	Removes air Breaks chain reaction
Electrical Equipment  	CO ₂ Dry chemical	Removes air Breaks chain reaction
Combustible Metals  	Special agents	Usually remove air
Kitchen Oils  	Chemical	Usually removes air

COMMUNITY EMERGENCY RESPONSE TEAM
UNIT 2: FIRE SAFETY AND UTILITY CONTROLS

INSTRUCTOR GUIDANCE	CONTENT
<div data-bbox="188 415 626 741"><p>Extinguisher Rating/Labeling</p><ul style="list-style-type: none">● Labels show types of fires that extinguisher is used for:<ul style="list-style-type: none">▪ Class A fire ratings: 1A to 40A▪ Class B fire ratings: 1B to 640B● Higher number on label = greater amount of extinguishing agent<p><small>FEMA CERT Basic Training Unit 2: Fire Safety and Utility Controls 2-18</small></p></div> <p data-bbox="188 772 461 810">Display Slide 2-18</p>	<p data-bbox="657 380 1166 417">Extinguisher Rating and Labeling</p> <p data-bbox="657 453 1427 705">Tell the group that portable fire extinguishers must be rated and approved by the State fire marshal and Underwriters Laboratories (an organization that sets safety standards for manufactured goods). They are rated according to their effectiveness on the different classes of fire. Their strength and capability must also be labeled by the manufacturer.</p> <p data-bbox="657 743 1406 852">Explain that the label contains vital information about the type(s) of fire for which the extinguisher is appropriate.</p> <p data-bbox="657 890 1382 999">Extinguishers that are appropriate for Class A fires have a rating from 1A to 40A, with a higher number indicating a higher volume of extinguishing agent.</p> <p data-bbox="657 1037 1370 1108">Extinguishers that are appropriate for Class B fires have a rating from 1B to 640B.</p> <p data-bbox="657 1146 1409 1218">No number accompanies an extinguisher rated Class C, D, or K.</p> <p data-bbox="657 1255 1419 1327">The C on the label indicates only that the extinguisher is safe to use on electrical fires.</p> <p data-bbox="657 1365 1424 1545">Extinguishers for Class D fires must match the type of metal that is burning and are labeled with a list detailing the metals that match the unit's extinguishing agent. These extinguishers also do not use numerical ratings.</p> <p data-bbox="657 1583 1417 1801">Extinguishers for Class K fires are designed to supplement fire suppression systems in commercial kitchens. They spray an alkaline mixture that, when combined with the fatty acid of the burning cooking oil or fat, creates soapy foam to hold in the vapors and extinguish the fire.</p>

**COMMUNITY EMERGENCY RESPONSE TEAM
UNIT 2: FIRE SAFETY AND UTILITY CONTROLS**

INSTRUCTOR GUIDANCE	CONTENT
<p>Examples of Labels</p>  <p>Display Slide 2-19</p> <p>PM, P. 2-20</p>	<p>Describe some of the different types of fire extinguisher labels that participants might encounter.</p> <p>Refer the participants to the <i>Manufacturer's Label</i> illustration in the Participant Manual.</p>

PM, P. 2-20	Manufacturer's Label Illustration
--------------------	--

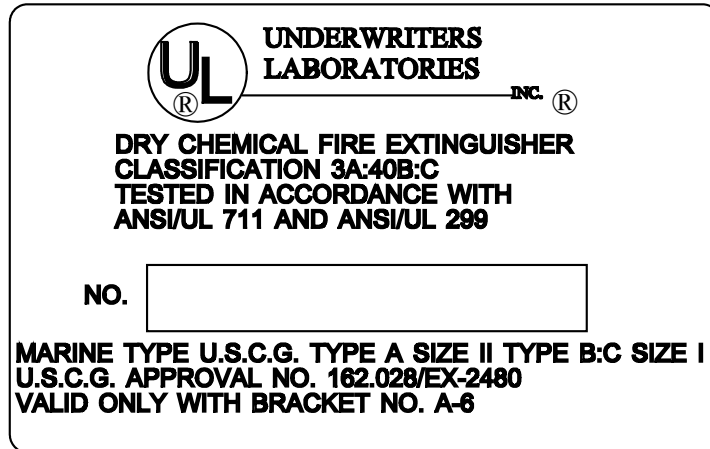

Sample manufacturer's label for a fire extinguisher, showing the Underwriters Laboratories symbol at the top, the type and classification of fire extinguisher, testing procedures used, and serial number. At the bottom of the label is marine information, including the U.S. Coast Guard approval number.

COMMUNITY EMERGENCY RESPONSE TEAM
UNIT 2: FIRE SAFETY AND UTILITY CONTROLS

INSTRUCTOR GUIDANCE	CONTENT
Display a water extinguisher.	<p>Review the types of fires and appropriate extinguishing methods with the group, noting the capacity, range, and pressure of each type of extinguisher.</p> <p>Water Extinguishers</p> <p>Tell the group that common characteristics of water extinguishers include:</p> <ul style="list-style-type: none">▪ <u>Capacity</u>. Standard size is 2.5 gallons.▪ <u>Range</u>. Standard range is 30-40 feet.▪ <u>Pressure</u>. Standard pressure is 110 pounds per square inch (psi). <p>Warn the group to use extreme caution when using a water extinguisher to ensure that the water, which is under pressure, does not scatter lightweight materials and spread the fire.</p>
Display a chemical extinguisher.	<p>Chemical Extinguishers</p> <p>Tell the participants that <u>dry chemical extinguishers</u> are most common.</p> <ul style="list-style-type: none">▪ Dry chemical extinguishers have a sodium bicarbonate base and are effective on Class B and C fires.▪ Multipurpose dry chemical extinguishers have a monoammonium phosphate base and are effective for Class A, B, and C fires.

COMMUNITY EMERGENCY RESPONSE TEAM
UNIT 2: FIRE SAFETY AND UTILITY CONTROLS

INSTRUCTOR GUIDANCE	CONTENT
<p>If discussing or demonstrating how to use a carbon dioxide extinguisher indoors, note the need for caution, as these extinguishers remove oxygen from the room.</p> <p>PM, P 2-23</p>	<p>Common characteristics of dry chemical extinguishers include:</p> <ul style="list-style-type: none">▪ <u>Capacity</u>. Approximately 10-20 seconds discharge time▪ <u>Range</u>. Standard range is 8-12 feet.▪ <u>Pressure</u>. Standard pressure is 175-250 psi. <p>Explain that, while still in use, <u>carbon dioxide</u> and <u>other specialized extinguishers</u> are becoming less common.</p> <p>Deciding to Use a Fire Extinguisher</p> <p>Tell the participants that there is a series of questions that they should ask themselves before attempting to fight a fire with a fire extinguisher.</p> <p>Refer the group to the chart titled <i>Deciding to Use a Fire Extinguisher</i> in the Participant Manual, and review the questions and decisions with the group:</p> <ul style="list-style-type: none">▪ Are there two ways to exit the area quickly and safely if I attempt to extinguish the fire? (The first priority for you and your buddy is safety.)▪ Do I have the right type of extinguisher for the type of fire?▪ Is the extinguisher large enough for the fire?▪ Is the area free from other dangers, such as hazardous materials and falling debris? <p>Stress that if the participants answer “NO” to <u>any</u> of these questions, or if they have been unable to put out the fire in 5 seconds using the extinguisher, they should:</p> <ul style="list-style-type: none">▪ Leave the building immediately.▪ Shut all doors as they leave to slow the spread of the fire.

COMMUNITY EMERGENCY RESPONSE TEAM
UNIT 2: FIRE SAFETY AND UTILITY CONTROLS



INSTRUCTOR GUIDANCE	CONTENT
	<p>Tell the participants that if they answer “YES” to <u>all</u> of these questions, they may attempt to extinguish the fire. Emphasize that, even if they answer “YES” to all of the questions but feel unable to extinguish the fire, they should leave immediately. Reemphasize the 5-second rule.</p> <p>Overhauling the Fire</p> <p>Explain that, if the fire is extinguished in 5 seconds and the area is safe, CERT members should stay and overhaul the fire. Overhauling is the process of searching a fire scene for hidden fire or sparks in an effort to prevent the fire from rekindling. Tell the participants how to overhaul a fire by remembering “cool, soak, and separate.”</p>

COMMUNITY EMERGENCY RESPONSE TEAM
UNIT 2: FIRE SAFETY AND UTILITY CONTROLS

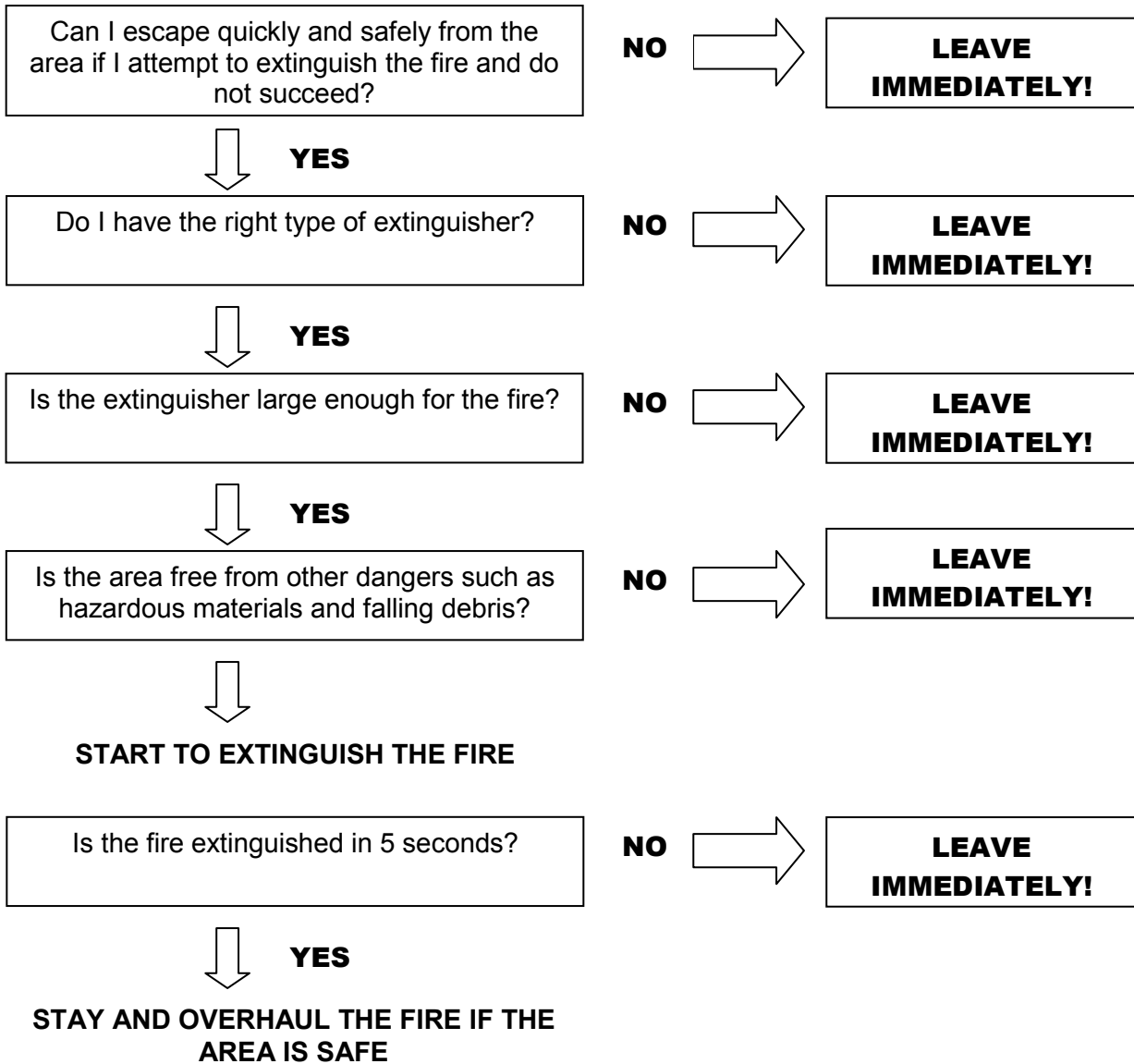
PM, P. 2-23	Deciding to Use a Fire Extinguisher
--------------------	--



COMMUNITY EMERGENCY RESPONSE TEAM
UNIT 2: FIRE SAFETY AND UTILITY CONTROLS

INSTRUCTOR GUIDANCE	CONTENT
  Demonstrate how to use a portable extinguisher. PM, P. 2-24	<p>Does anyone have any questions about how to use the decision-making flowchart?</p> <p>Operating a Fire Extinguisher</p> <p>How many of you have operated a portable fire extinguisher?</p> <p>After a show of hands, ask a few participants to share their results. Use their comments to elaborate on the topic.</p> <p>Explain that you will demonstrate how to use a portable fire extinguisher.</p> <p>Refer the participants to the diagram titled <i>Components of a Portable Fire Extinguisher</i> in the Participant Manual. Explain that a portable fire extinguisher includes four components:</p> <ul style="list-style-type: none">▪ A pressure gauge▪ A hose▪ A cylinder▪ A carrying handle with trigger <p>Tell the group that they should always operate portable fire extinguishers in an upright position.</p>

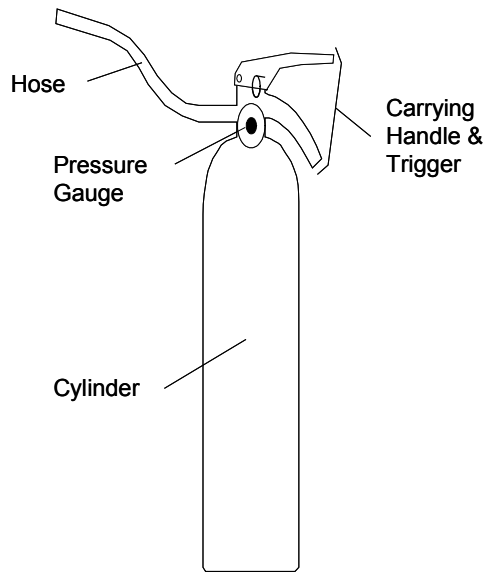

COMMUNITY EMERGENCY RESPONSE TEAM
UNIT 2: FIRE SAFETY AND UTILITY CONTROLS

PM, P. 2-24	Components of a Portable Fire Extinguisher
--------------------	---

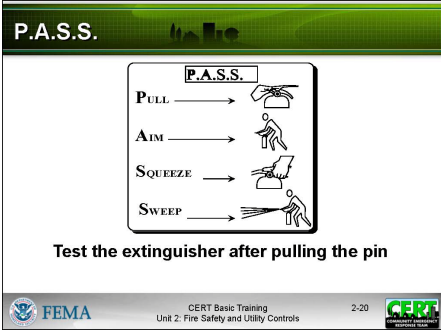

Components of a portable fire extinguisher: Hose, carrying handle and trigger, pressure gauge, cylinder

COMMUNITY EMERGENCY RESPONSE TEAM
UNIT 2: FIRE SAFETY AND UTILITY CONTROLS

INSTRUCTOR GUIDANCE	CONTENT
<div data-bbox="188 476 626 804"><p>P.A.S.S.</p><p>PULL → [Illustration of pulling the pin]</p><p>AIM → [Illustration of aiming the nozzle]</p><p>SQUEEZE → [Illustration of squeezing the handle]</p><p>SWEEP → [Illustration of sweeping the nozzle across the fire]</p><p>Test the extinguisher after pulling the pin</p><p><small>FEMA CERT Basic Training Unit 2: Fire Safety and Utility Controls 2-20</small></p></div> <p>Display Slide 2-20</p> <p>Demonstrate P.A.S.S.</p> <p>PM, P. 2-25</p> <div data-bbox="188 1423 267 1501"></div>	<p>P.A.S.S.</p> <p>Explain that the acronym for operating a fire extinguisher is P.A.S.S.:</p> <ul style="list-style-type: none">▪ <u>P</u>ull (Test the extinguisher after pulling the pin)▪ <u>A</u>im▪ <u>S</u>queeze▪ <u>S</u>weep <p>To ensure that the extinguisher is working properly, test it before approaching any fire.</p> <p>Refer the participants to the <i>PASS</i> diagram in the Participant Manual.</p> <p>Emphasize the need to <u>aim at the base</u> of the fire. Explain that each participant will have the opportunity to practice this technique near the end of the session.</p> <p>Explain that, once used, fire extinguishers that have been completely depleted should be laid down and stored on their side so no attempt will be made to use them until recharged.</p> <p>Does anyone have any questions about portable fire extinguishers or their operation?</p>

COMMUNITY EMERGENCY RESPONSE TEAM
UNIT 2: FIRE SAFETY AND UTILITY CONTROLS

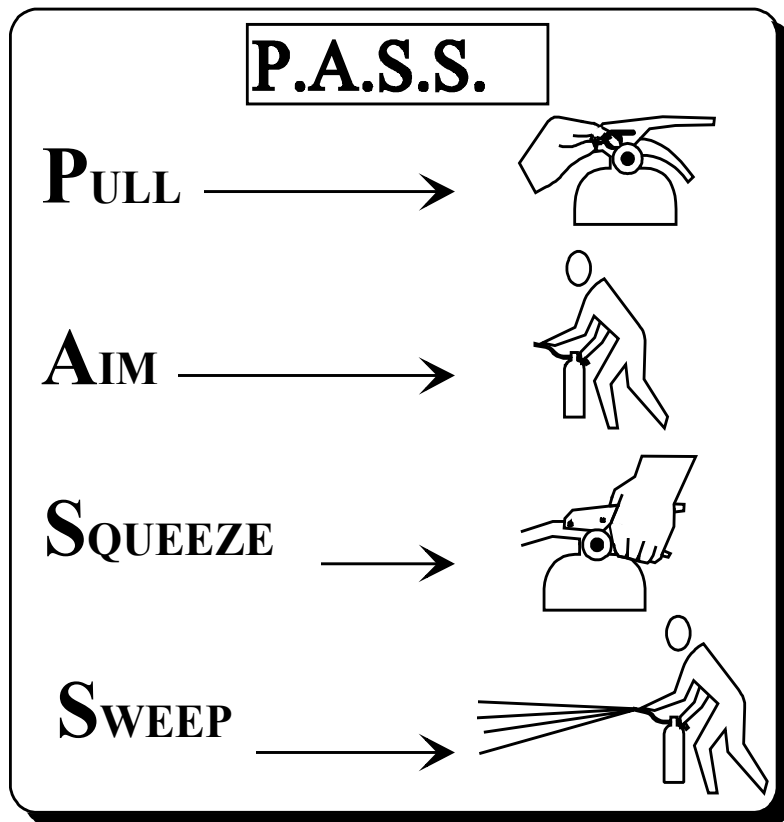

PM, P. 2-25	P.A.S.S
-------------	---------



COMMUNITY EMERGENCY RESPONSE TEAM
UNIT 2: FIRE SAFETY AND UTILITY CONTROLS

INSTRUCTOR GUIDANCE	CONTENT
<div data-bbox="188 436 626 764"><p>Interior Wet Standpipes</p><ul style="list-style-type: none">• Usually in commercial buildings or apartments• Work in two-person teams when using wet standpipes<p>FEMA CERT Basic Training Unit 2: Fire Safety and Utility Controls 2-21</p></div> <p>Display Slide 2-21</p>	<p>Interior Wet Standpipes</p> <p>Explain that interior wet standpipes are usually in commercial and apartment buildings and consist of 100 feet of 1.5-inch jacketed hose with an adjustable spray nozzle. They deliver up to 125 gallons of water per minute.</p> <p>Caution the group always to work in two-person teams when using an interior wet standpipe.</p> <p>Team Member 1: Removes the hose from the cabinet and makes sure that hose is free of kinks and bends in the line. When ready, gives the go-ahead to Team Member 2 to open the water valve.</p> <p>Team Member 2: After Team Member 1 gives the go-ahead, opens the water valve. Team Member 2 will then back up Team Member 1 at the nozzle.</p> <p>Explain that, due to the dryness of the hose fabric, water may seep through the hose fabric until the hose is saturated. This may last for approximately 1 minute.</p> <p>Confinement</p> <p>In interior spaces, it is possible to <i>confine</i> a fire and restrict the spread of smoke and heat by closing doors, interior and exterior.</p>

**COMMUNITY EMERGENCY RESPONSE TEAM
UNIT 2: FIRE SAFETY AND UTILITY CONTROLS**

INSTRUCTOR GUIDANCE	CONTENT
<p data-bbox="191 436 266 510"></p> <p data-bbox="191 548 553 615">If not mentioned, suggest these:</p> <ul data-bbox="191 638 581 810" style="list-style-type: none">▪ Swimming pool or spa water and buckets▪ Sand or dirt and shovels▪ A garden hose <div data-bbox="191 898 626 1226"></div> <p data-bbox="191 1262 461 1293">Display Slide 2-22</p> <p data-bbox="191 1367 407 1398">PM, P. 2-27-28</p>	<p data-bbox="659 405 1049 436">Other Creative Resources</p> <p data-bbox="659 478 1373 546">What other resources might be handy to fight a fire?</p> <p data-bbox="659 877 1084 909"><i>Fire Suppression Safety</i></p> <p data-bbox="659 968 1430 1220">Introduce this topic by reminding the participants that, as CERT members, small fire suppression may be one of their roles. Emphasize, however, that — even following a disaster — their personal safety must always be their number one concern. Stress that they will be unable to help anyone if they are injured through careless sizeup or unsafe acts.</p> <p data-bbox="659 1335 1406 1402">Refer the group to the list of <i>Fire Suppression Safety Rules</i> in the Participant Manual.</p> <p data-bbox="659 1461 919 1493">Fire Safety Rules</p> <p data-bbox="659 1514 1414 1581">Stress the importance of following <u>all</u> fire suppression safety rules.</p> <ul data-bbox="659 1608 1406 1745" style="list-style-type: none">▪ <u>Use safety equipment</u> at all times. Wear your helmet, goggles, dust mask, leather gloves, and sturdy shoes or boots. If you are not equipped to protect your personal safety, <u>leave the building</u>.

COMMUNITY EMERGENCY RESPONSE TEAM
UNIT 2: FIRE SAFETY AND UTILITY CONTROLS

INSTRUCTOR GUIDANCE	CONTENT
	<ul style="list-style-type: none">▪ <u>Work with a buddy.</u> Buddies serve an important purpose. They protect your safety. Don't ever try to fight a fire alone.▪ <u>Have a backup team, whenever possible.</u> A backup team just makes good sense. A backup team can support your fire suppression efforts and can provide help if you need it.▪ <u>Always have two ways to exit the fire area.</u> Fires spread much faster than you might think. Always have a backup escape plan in case your main escape route becomes blocked.▪ <u>Look at the door.</u> If air is being sucked under the door or smoke is coming out the top of the door, do <u>not</u> touch the door.▪ <u>Feel closed doors with the back of the hand,</u> working from the bottom of the door up. Do <u>not</u> touch the door handle before feeling the door. If the door is hot, there is fire behind it. Do not enter! Opening the door will feed additional oxygen to the fire.▪ <u>Confine the fire,</u> whenever possible, by closing doors and keeping them closed.▪ <u>Stay low to the ground.</u> Smoke will naturally rise. Keeping low to the ground will provide you with fresher air to breathe.▪ <u>Maintain a safe distance.</u> Remember the effective range of your fire extinguisher. Don't get closer than necessary to extinguish the fire.▪ <u>Never turn your back on a fire when backing out.</u>▪ <u>Overhaul the fire</u> to be sure that it is extinguished – and stays extinguished.

COMMUNITY EMERGENCY RESPONSE TEAM
UNIT 2: FIRE SAFETY AND UTILITY CONTROLS

INSTRUCTOR GUIDANCE	CONTENT
<div data-bbox="188 432 626 758" data-label="Image"> </div> <p data-bbox="188 793 461 829">Display Slide 2-23</p> <p data-bbox="188 877 621 949">Explain that a small fire, unlike a large fire:</p> <ul data-bbox="188 1003 594 1150" style="list-style-type: none"> ▪ Is about the size of a wastepaper can ▪ Can be extinguished with one fire extinguisher <p data-bbox="188 1186 586 1360">Remind the group of the earlier demonstration (using burning cotton in the Pyrex[®] jar) to stress the need for overhauling.</p>	<p data-bbox="657 405 1404 476">Stress that what CERTs <u>don't</u> do when suppressing fires is as important as what they should do. <u>DON'T</u>:</p> <ul data-bbox="657 493 1437 976" style="list-style-type: none"> ▪ <u>Get too close</u>. Stay near the outer range of your extinguisher. If you feel the heat, you are too close. ▪ <u>Try to fight a fire alone</u>. Remember that your first priority is your personal safety. Don't put it at risk. ▪ <u>Try to suppress large fires</u>. Learn the capability of your equipment, and do not try to suppress a fire that is clearly too large for the equipment at hand (i.e., a fire that is larger than the combined ratings of available fire extinguishers). ▪ <u>Enter smoke-filled areas</u>. Suppressing fires in smoke-filled areas requires equipment that CERTs don't have.

COMMUNITY EMERGENCY RESPONSE TEAM
UNIT 2: FIRE SAFETY AND UTILITY CONTROLS

PM, P. 2-27	Fire Suppression Safety Rules
--------------------	--------------------------------------

- Use safety equipment at all times. Wear your helmet, goggles, dust mask, leather gloves, and sturdy shoes or boots. If you are not equipped to protect your personal safety, leave the building.
- Work with a buddy. Buddies serve an important purpose. They protect your safety. Don't ever try to fight a fire alone.
- Have a backup team, whenever possible. A backup team just makes good sense. A backup team can support your fire suppression efforts and can provide help if you need it.
- Always have two ways to exit the fire area. Fires spread much faster than you might think. Always have a backup escape plan in case your main escape route becomes blocked.
- Look at the door. If air is being sucked under the door or smoke is coming out of the top of the door, do not touch the door.
- Feel closed doors with the back of the hand, working from the bottom of the door up. Do not touch the door handle before feeling the door. If the door is hot, there is fire behind it. Do not enter! Opening the door will feed additional oxygen to the fire.
- Confine the fire, whenever possible, by keeping doors closed.
- Maintain a safe distance. Remember the effective range of your fire extinguisher. Don't get closer than necessary to extinguish the fire.
- Overhaul the fire to be sure that it is extinguished — and stays extinguished.

What CERTs don't do when suppressing fires is as important as what they should do.
DON'T:

- Get too close. Stay near the outer range of your extinguisher. If you feel the heat, you are too close.
- Try to fight a fire alone. Remember that your first priority is your personal safety. Don't put yourself at risk.
- Try to suppress large fires. Learn the capability of your equipment, and do not try to suppress a fire that is clearly too large for the equipment at hand (i.e., a fire that is larger than the combined ratings of available fire extinguishers).
- Enter smoke-filled areas. Fire suppression in smoke-filled areas requires equipment that CERTs don't have.

COMMUNITY EMERGENCY RESPONSE TEAM
UNIT 2: FIRE SAFETY AND UTILITY CONTROLS

INSTRUCTOR GUIDANCE	CONTENT
	<p>Does anyone have any questions about fire suppression safety?</p> <p>Tell the group that next they are going to learn about identifying hazardous materials.</p>

**COMMUNITY EMERGENCY RESPONSE TEAM
UNIT 2: FIRE SAFETY AND UTILITY CONTROLS**

INSTRUCTOR GUIDANCE	CONTENT
<div data-bbox="188 485 267 560"></div> <p data-bbox="188 590 516 657">Allow the group time to respond.</p> <div data-bbox="188 726 626 1052"><p>Hazardous Materials</p><ul style="list-style-type: none">• Corrode other materials• Explode or are easily ignited• React strongly with water• Are unstable when exposed to heat or shock• Are otherwise toxic to humans, animals, or the environment through absorption, inhalation, injection, or ingestion<p><small>FEMA CERT Basic Training Unit 2: Fire Safety and Utility Controls 2-24</small></p></div> <p data-bbox="188 1087 462 1123">Display Slide 2-24</p>	<p data-bbox="659 388 1023 424"><i>Hazardous Materials</i></p> <p data-bbox="659 485 1339 520">How do you know if a material is hazardous?</p> <p data-bbox="659 699 1437 766">Explain that materials are considered hazardous if they have <u>any</u> of the characteristics listed on the slide:</p> <ul data-bbox="659 785 1364 1087" style="list-style-type: none">▪ Corrode other materials▪ Explode or are easily ignited▪ React strongly with water▪ Are unstable when exposed to heat or shock▪ Are otherwise toxic to humans, animals, or the environment through absorption, inhalation, injection, or ingestion <p data-bbox="659 1163 1404 1230">Explain that hazardous materials include, but are not limited to:</p> <ul data-bbox="659 1249 1128 1585" style="list-style-type: none">▪ Explosives▪ Flammable gases and liquids▪ Poisons and poisonous gases▪ Corrosives▪ Nonflammable gases▪ Oxidizers▪ Radioactive materials



COMMUNITY EMERGENCY RESPONSE TEAM
UNIT 2: FIRE SAFETY AND UTILITY CONTROLS

INSTRUCTOR GUIDANCE	CONTENT
 <p>Acknowledge the participants' responses.</p>	<p>Why is it important to know if hazardous materials are present?</p> <p>If not mentioned by the group, explain that knowledge that hazardous materials are present helps to protect CERT members' safety and is valuable sizeup information for all first responders.</p> <p>Identifying Hazardous Materials Locations</p> <p>Explain that there are several ways to identify locations where hazardous materials are stored, used, or in transit:</p> <ul style="list-style-type: none">▪ Location and type of occupancy▪ Placards▪ Sights, sounds, and smells <p><u>Location and Type of Occupancy</u></p> <p>Explain that hazardous materials are commonplace throughout every community. They are used in many commercial processes and sold in many retail outlets. While these hazards are managed under normal circumstances, accidents and disasters can cause these materials to be released into the environment.</p> <p>Provide some common locations in the community:</p> <ul style="list-style-type: none">▪ Industrial locations (e.g., warehouse, rail yard, shipyard)▪ Dry cleaner▪ Funeral home▪ Home supply store▪ Big box store▪ Delivery van (UPS, FedEx)

COMMUNITY EMERGENCY RESPONSE TEAM
UNIT 2: FIRE SAFETY AND UTILITY CONTROLS

INSTRUCTOR GUIDANCE	CONTENT
<p data-bbox="191 447 266 516"></p> <p data-bbox="191 600 626 921"></p> <p data-bbox="191 957 461 989">Display Slide 2-25</p>	<p data-bbox="659 380 784 411"><u>Placards</u></p> <p data-bbox="659 453 1406 558">Has anyone ever seen the symbol in the slide or one similar to it? Does anyone know what it is or what it means?</p> <p data-bbox="659 600 1422 852">If not mentioned by the group, explain that the placard is an <u>NFPA 704 Diamond</u>— the identification system instituted by the National Fire Protection Association. The NFPA 704 Diamond is a concise system for identifying the hazards associated with specific materials. This placard would be found on a fixed facility.</p> <p data-bbox="659 894 1438 1073">Tell the participants that the diamond is divided into four colored quadrants, each with a rating number inside of it, and that the number indicates the degree of risk associated with the material. Numbers range from 1 to 4. The higher the number the higher the risk!</p> <p data-bbox="659 1115 837 1146">Explain that:</p> <ul data-bbox="659 1167 1308 1346" style="list-style-type: none"><li data-bbox="659 1167 1308 1241">▪ The <u>red</u> quadrant describes the material's <u>flammability</u>.<li data-bbox="659 1251 1308 1293">▪ The <u>blue</u> quadrant indicates <u>health hazard</u>.<li data-bbox="659 1304 1308 1346">▪ The <u>yellow</u> quadrant indicates <u>reactivity</u>.

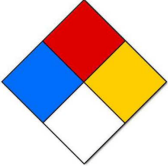
COMMUNITY EMERGENCY RESPONSE TEAM
UNIT 2: FIRE SAFETY AND UTILITY CONTROLS

INSTRUCTOR GUIDANCE	CONTENT
<p data-bbox="196 426 423 453">The White Quadrant</p> <ul data-bbox="212 472 407 600" style="list-style-type: none">• NFPA 704 Diamond White Quadrant:<ul style="list-style-type: none">▪ W: Shows unusual reactivity with water▪ OX: Possesses oxidizing properties  <p data-bbox="196 701 626 730">FEMA CERT Basic Training Unit 2: Fire Safety and Utility Controls 2-26</p> <p data-bbox="188 766 461 800">Display Slide 2-26</p>	<p data-bbox="657 380 1398 485">Point out that the <u>white</u> quadrant indicates <u>special precautions</u>. There are two symbols specified in the National Fire Codes, section 704.</p> <ul data-bbox="657 506 1414 810" style="list-style-type: none">▪ W indicates a material that displays unusual reactivity with water (i.e., should never be mixed with water or have water sprayed on it). <u>Magnesium metal</u> is an example of a material that is reactive to water.▪ OX indicates a material that possesses oxidizing properties. <u>Ammonium nitrate</u> is an example of a material with oxidizing properties. <p data-bbox="657 831 1398 898">Explain that materials that are oxidizers increase the potential for explosion or fire.</p> <p data-bbox="657 957 1430 1062">Tell participants that in addition to the above symbols that are specified under the National Fire Codes, some NFPA 704 Diamonds will include additional symbols:</p> <ul data-bbox="657 1083 1325 1283" style="list-style-type: none">▪ <u>ACID</u> indicates that the material is an acid.▪ <u>ALK</u> indicates that the material is a base.▪ <u>COR</u> indicates that the material is corrosive.▪  indicates that the material is radioactive.
<p data-bbox="196 1388 269 1415">STOP!</p>  <p data-bbox="196 1667 626 1696">FEMA CERT Basic Training Unit 2: Fire Safety and Utility Controls 2-27</p> <p data-bbox="188 1732 461 1766">Display Slide 2-27</p>	<p data-bbox="657 1346 1430 1486">Stress that the numbers within the NFPA 704 Diamond are used to assist professional firefighters in responding to accidents or fires. <u>CERT members should consider these placards a “stop sign.”</u></p> <p data-bbox="657 1524 1430 1665">The only action CERT members should take is to evacuate persons who are downwind, as necessary, to an uphill or upwind location. Do not enter the building in an attempt to evacuate persons inside.</p>

COMMUNITY EMERGENCY RESPONSE TEAM
UNIT 2: FIRE SAFETY AND UTILITY CONTROLS

INSTRUCTOR GUIDANCE	CONTENT
---------------------	---------

Mention or use slides to illustrate local transportation hazards and any facilities that use the NFPA 704 Diamond, to provide more relevance to the discussion.

If possible, show the group an actual 704 placard to improve recognition.

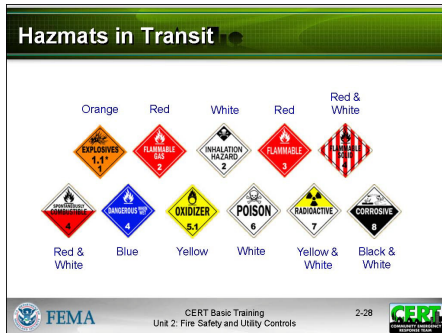

Display Slide 2-28



The NA placarding system is being phased out but is still occasionally used, usually on hazardous materials being transported from Canada.

Identifying Hazardous Materials in Transit

Does anyone recognize the placards in the slide?

If not mentioned by the group, explain that they are Department of Transportation (DOT) placards.

Explain that the DOT placard is one of three ways that hazardous materials are marked and identified while in transit. The other two ways are:

- The United Nations (UN) system
- The North American (NA) warning placards

COMMUNITY EMERGENCY RESPONSE TEAM
UNIT 2: FIRE SAFETY AND UTILITY CONTROLS

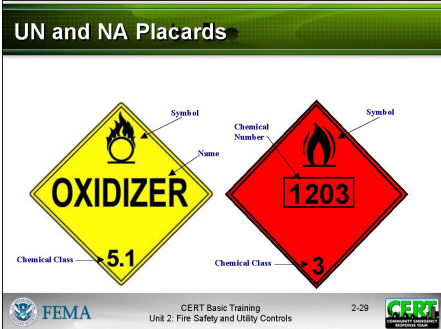
INSTRUCTOR GUIDANCE	CONTENT
<p>If anyone asks, hazardous materials that require placarding in any quantity include poisonous gases that present an inhalation hazard (DOT Class 2.3), poisonous liquids that present an inhalation hazard (DOT Class 6.1), and radioactive materials (DOT Class 7).</p> <p>PM, P. 2-33</p>  <p>Display Slide 2-29</p> <p>If possible, show the participants actual DOT placards to improve recognition.</p>	<p>Point out that these placards can be on any vehicle, not only tankers. Also, emphasize that:</p> <ul style="list-style-type: none"> ▪ No placard is required for less than 1,000 pounds of many hazardous materials. ▪ Certain hazardous materials (e.g., anhydrous ammonia) are placarded as a nonflammable gas for domestic transport but as a flammable gas for international transport. (<u>Anhydrous ammonia is a flammable gas!</u>) ▪ Sometimes drivers forget to change the placard when they change their cargo. CERT members should use extreme caution when approaching any vehicle in an accident. <p>Refer the participants to the <i>DOT Placard Warning</i> illustrations in the Participant Manual.</p> <p>Tell the group that this slide shows examples of the UN and NA systems. The UN and NA systems are displayed mainly on tank cars, cargo tanks, rail cars, and portable tanks.</p> <p>Explain that, like the NFPA 704 Diamond, the DOT, UN, and NA placards should be a “stop sign” for CERT members. CERT members should always err on the side of safety. They should <i>not</i> assume that, because there is no placard, no hazardous materials are present. Treat any unknown situation as a hazardous materials incident.</p>



COMMUNITY EMERGENCY RESPONSE TEAM
UNIT 2: FIRE SAFETY AND UTILITY CONTROLS

INSTRUCTOR GUIDANCE	CONTENT
---------------------	---------

Greater Than 1? 



Remember!
All hazardous material placards are
a stop sign for CERTs

 CERT Basic Training Unit 2: Fire Safety
and Utility Controls  2-30

Display Slide 2-30



As a general rule of thumb, if you see a number in the NFPA 704 Diamond that is greater than one, stay away.

Sights, Sounds, and Smells

Explain that hazardous materials are all around us and may be present regardless of the location or whether there are placards or other posted warnings. While hazardous materials often smell, sound, or look unusual, participants may not be able recognize something toxic. Participants should stay away from any unidentifiable substance and alert building managers or authorities.

Does anyone have any questions about hazardous materials or how they are identified in storage or transport?

Exercise: Suppressing Small Fires

Purpose: This exercise will provide the participants with experience in two key areas of fire suppression:

- Using a portable fire extinguisher to suppress a small fire
- Applying teamwork to fire suppression

Ensure that all of the participants are dressed properly and wear safety equipment for this exercise. Dress for this exercise may be casual. However, shorts and open-toed shoes should not be permitted.

COMMUNITY EMERGENCY RESPONSE TEAM
UNIT 2: FIRE SAFETY AND UTILITY CONTROLS

INSTRUCTOR GUIDANCE	CONTENT
<p>It is advisable to demonstrate critical steps (e.g., the “ready” position) before allowing the participants to complete this exercise.</p>	<p>Prepare a propane gas fire source outside in an area with at least 40 feet of open space upwind of the fire source. Provide Class A:B:C portable extinguishers.</p> <p>This exercise requires two instructors: Instructor 1 will lead the exercise. Instructor 2 will observe and serve as the exercise Safety Officer.</p> <p>Instructions: Follow the steps below to conduct this exercise. Coach the participants through the exercise using the instructions shown in bold type.</p> <ol style="list-style-type: none">1. Assign the participants to two-person teams. Stress that participants must communicate with each other. The emphasis is on safety and teamwork.2. Taking one team at a time, provide each team member with a portable fire extinguisher.3. Instructor 2 will light the fire, using a road flare mounted on a long pole, when Instructor 1 indicates that the participants are ready to begin the exercise.4. Before allowing the participants to begin this exercise, Instructor 1 should ask them:<ul style="list-style-type: none">▪ What their exit routes are▪ From which direction the wind is blowing▪ Whether the fire is spreading and where it would be in the next 30 seconds

**COMMUNITY EMERGENCY RESPONSE TEAM
UNIT 2: FIRE SAFETY AND UTILITY CONTROLS**

INSTRUCTOR GUIDANCE	CONTENT
	<p>5. Ask Team Member 1 to assume the “ready” position, with pin pulled, extinguisher aimed and upright, approximately 20 to 25 feet from the fire.</p> <p>When ready to approach the fire, Team Member 1 should say, “Ready.” Team Member 2 should repeat, “Ready.”</p> <p>As Team Member 1 begins to move forward, he or she should say, “Going in.” Team Member 2 should repeat the command and place his or her hand on Team Member 1’s shoulder and stay within reach of Team Member 1.</p> <p>6. Ask Team Member 2 to act as backup, assuming the “ready” position at an arm’s distance from Team Member 1.</p> <div style="text-align: center;"> <p>The diagram illustrates the layout for a fire safety drill. At the top center is a fire labeled "Flammable Liquid Fire". To its right is an upward-pointing arrow labeled "Wind". Below the fire, from left to right, are "Participant No. 1" and "Instructor No. 1", both holding fire extinguishers. To the left of them is "Participant No. 2 (Back-Up)", also holding an extinguisher. At the top left is "Instructor No. 2 (Safety Officer)". At the bottom center is a group of six "Observers".</p> </div>

COMMUNITY EMERGENCY RESPONSE TEAM
UNIT 2: FIRE SAFETY AND UTILITY CONTROLS

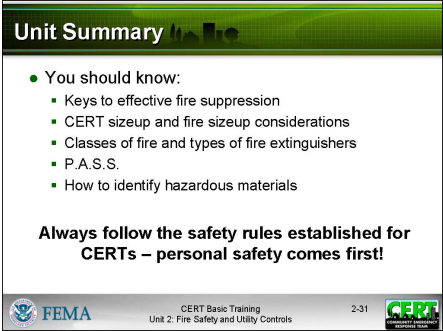

INSTRUCTOR GUIDANCE	CONTENT
	<p>7. Position Instructor 1 between the participants and the fire at all times.</p> <p>Both team members should walk toward the fire. Team Member 1 should watch the fire and Team Member 2 should stay close to Team Member 1, keeping his or her hand on Team Member 1's shoulder. Team Member 2's job is to protect Team Member 1.</p> <p>8. Ask Team Member 1 to approach the fire from the windward side (i.e., with the wind to the participant's back). When approximately 10 feet from the fire, Team Member 1 should begin to discharge the extinguisher at the base of the fire, continuing the approach until the range for the extinguisher is optimal.</p> <p>9. Team Member 1 should sweep the base of the fire until it is extinguished.</p> <p>When Team Member 1 is ready to exit the fire area, he or she should say, "Backing out." Team Member 2 should repeat the command. Team Member 2 should guide Team Member 1 from the area with his or her hands as Team Member 1 continues facing the fire and looking for other hazards.</p> <p>After the fire is extinguished, ask the participants to trade positions and repeat the exercise. If time permits, allow each participant to use the extinguisher twice, to provide added practice.</p> <p>Repeat this exercise with the other teams until all participants have had the opportunity to extinguish the fire.</p>

COMMUNITY EMERGENCY RESPONSE TEAM
UNIT 2: FIRE SAFETY AND UTILITY CONTROLS

INSTRUCTOR GUIDANCE	CONTENT
 <p>Unit Summary</p> <ul style="list-style-type: none">You should know:<ul style="list-style-type: none">Keys to effective fire suppressionCERT sizeup and fire sizeup considerationsClasses of fire and types of fire extinguishersP.A.S.S.How to identify hazardous materials <p>Always follow the safety rules established for CERTs – personal safety comes first!</p> <p>FEMA CERT Basic Training Unit 2: Fire Safety and Utility Controls 2-31</p>	<p><i>Unit Summary</i></p> <p>Summarize the key points of this unit:</p> <p>Effective fire suppression depends on an understanding of:</p> <ul style="list-style-type: none">The elements required for fire to existThe type of fuel involvedThe class of fireThe resources required and available to extinguish each type of fireEffective fire suppression techniques <p>Fire requires heat, fuel, and oxygen to exist.</p> <p>There are five types, or classes, of fire:</p> <ul style="list-style-type: none">Class A: Ordinary combustiblesClass B: Flammable liquidsClass C: Energized electrical equipmentClass D: Combustible metalsClass K: Cooking oils <p>It is extremely important to identify the class of fire to use the proper extinguisher for the class.</p> <p>Portable fire extinguishers are most frequently used for suppressing small fires. Their labels tell the types of fires for which they are effective and the area that they can suppress.</p> <p>When using portable fire extinguishers, remember P.A.S.S.: Pull, Aim, Squeeze, and Sweep. Always test the extinguisher after pulling the pin.</p> <p>When suppressing a fire, <u>always</u> follow the safety rules established for CERTs.</p>

Display Slide 2-31

COMMUNITY EMERGENCY RESPONSE TEAM
UNIT 2: FIRE SAFETY AND UTILITY CONTROLS

INSTRUCTOR GUIDANCE	CONTENT
<div data-bbox="188 648 626 976"><p>Homework Assignment</p><ol style="list-style-type: none">1. Read unit to be covered in next session2. Bring necessary supplies to next session3. Wear appropriate clothes to next session<p> CERT Basic Training Unit 2: Fire Safety and Utility Controls 2-32 </p></div> <p>Display Slide 2-32</p>	<p>To help understand the types of materials, there are several methods of placarding hazardous materials being stored or transported, including NFPA, DOT, UN, and NA. When faced with accidents involving materials that are placarded as hazardous — or when the material is unknown — <u>keep away and call for professional help immediately.</u></p> <p>Homework Assignment</p> <p>Remind the participants that, before the next session, they should:</p> <ul style="list-style-type: none">▪ Read and familiarize themselves with Unit 3: Disaster Medical Operations — Part I in the Participant Manual.▪ Obtain and bring to the session:<ul style="list-style-type: none">• One box of 4- by 4-inch bandages• One roll of gauze• One medical mask (N95)• One pair of examination gloves• One blanket <p>Ask the participants to wear comfortable clothes for the next session because they will be practicing medical techniques.</p> <p>Thank the participants for attending the session. Remind them of the date and time for the next session if necessary.</p>

[This page intentionally left blank]

UNIT 3: DISASTER MEDICAL OPERATIONS — PART 1

In this unit you will learn about:

- **Life-Threatening Conditions:** How to recognize and treat an airway obstruction, bleeding, and shock.
- **Triage:** Principles of triage and how to conduct triage evaluations.

[This page intentionally left blank]

COMMUNITY EMERGENCY RESPONSE TEAM
UNIT 3: DISASTER MEDICAL OPERATIONS — PART 1

OBJECTIVES	<p>At the conclusion of this unit, the participants should be able to:</p> <ul style="list-style-type: none">▪ Identify the “killers.”▪ Apply techniques for opening airways, controlling bleeding, and treating for shock.▪ Conduct triage under simulated disaster conditions.
SCOPE	<p>The scope of this unit will include:</p> <ul style="list-style-type: none">▪ Introduction and Unit Overview▪ Treating Life-Threatening Conditions▪ Triage▪ Unit Summary
ESTIMATED COMPLETION TIME	<p>2 hours 30 minutes</p>
TRAINING METHODS	<p>The lead instructor will begin this session by welcoming the participants to Unit 3: Disaster Medical Operations — Part 1, and will introduce the instructors for the session. The instructor will then provide an overview of the topics included in the unit: Treatment of life-threatening conditions that may be encountered (airway obstruction, bleeding, and shock) and conducting triage.</p> <p>Next, the instructor will discuss and demonstrate the immediate procedures required for opening the airway, controlling bleeding, and treating for shock. The participants will have the opportunity to practice techniques for treating each of these conditions. During this period, some discussion will take place about the differences between disaster medical operations and the participants’ image of everyday first aid. (For example, mouth-to-mouth resuscitation and cardiopulmonary resuscitation [CPR] lose some of their importance in disaster situations when there are multiple casualties needing immediate attention and limited resources.)</p> <p>The next topic of this session will deal with triage. The instructor will open with a discussion of what triage is, when it is used, and the four categories into which victims are sorted. The instructor then explains the 6 steps of using triage in a disaster environment.</p>

COMMUNITY EMERGENCY RESPONSE TEAM
UNIT 3: DISASTER MEDICAL OPERATIONS — PART 1

**TRAINING
METHODS
(CONTINUED)**

Finally, the participants will practice triage evaluation and immediate treatment in a multi-casualty exercise. This exercise will illustrate the need to conduct triage effectively and expeditiously under pressure and to focus on rescuer safety.

**RESOURCES
REQUIRED**

- *Community Emergency Response Team Instructor Guide*
- *Community Emergency Response Team Participant Manual*
- PowerPoint slides 3-0 through 3-27

**OTHER
RESOURCES**

If time permits, the 23-minute video, *CERT Triage: Handling Mass Casualty Situations*, is recommended for this unit. The video portrays triage procedures and treatment of obstructed airway, uncontrolled bleeding, and shock, as well as sizeup and rescuer safety. The video is available for download at the national CERT Web site: www.citizencorps.gov/cert/

EQUIPMENT

In addition to the equipment listed at the front of this instructor Guide, you will need the following equipment for this unit:

- A computer with PowerPoint software
- A computer projector and screen
- One mannequin
- Non-latex examination gloves (1 pair for each participant)
- One can of shaving cream
- 4- by 4-inch dressings (1 dressing for every 2 students)
- Note cards, markers, and masking tape

PREPARATION

Triage Exercise

The triage exercise near the end of this session requires materials prepared in advance of the activity.

Before the session, prepare victim status cards, each documenting the status of one disaster victim. Create at least 1 victim description for every 3 participants in the group (e.g., 7 different descriptions for a group of 21 participants). Make three sets of the victim status cards.

COMMUNITY EMERGENCY RESPONSE TEAM
UNIT 3: DISASTER MEDICAL OPERATIONS — PART 1

**PREPARATION
(CONTINUED)**

Sample victim status descriptions

- Victim #1: Ambulatory — responds to voice triage
Minor bleeding
Normal blanch
- Victim #2: Bleeding extremity
Unconscious
After two attempts to open airway, still not breathing
- Victim #3: Standing, but does not respond to voice commands
- Victim #4: No signs of bleeding
Unconscious
Blanch takes 5 seconds
- Victim #5: No bleeding
Conscious
Doesn't squeeze hand when asked
- Victim #6: Minor bleeding
Conscious but disoriented
Breathing rate is 40 per minute

Culturally Sensitive Topics

Working with a representative of the community in which you will be teaching, identify any potentially culturally sensitive topics in this module. This module features a variety of topics that may require care in how they are presented, including the prioritization of injury required to conduct triage. Some content in this unit discusses touching victims (also featured in the end-of-unit role-playing activity), an activity that may be uncomfortable to some cultures or individuals.

Develop strategies for presenting any such topics in ways that will engage, rather than offend, participants.

COMMUNITY EMERGENCY RESPONSE TEAM
UNIT 3: DISASTER MEDICAL OPERATIONS — PART 1

NOTES

A suggested time plan for this unit is as follows:



Introduction and Unit Overview 10 minutes
Treating Life-Threatening Conditions 90 minutes
Triage 45 minutes
Unit Summary 5 minutes

Total Time: 2 hours 30 minutes

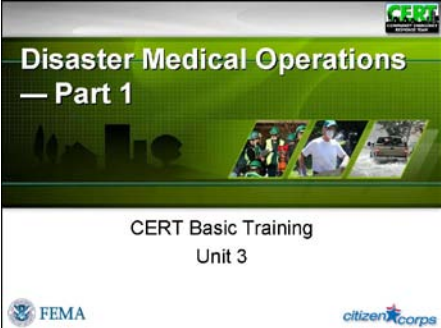

REMARKS

Be sure to emphasize throughout the session the importance of rescuer safety (e.g., using safety equipment, working with a buddy, and doing a thorough sizeup). These points cannot be made too often or too strongly. CERT members cannot help anyone if they become victims.





Unit 3: Disaster Medical Operations – Part I

INSTRUCTOR GUIDANCE	CONTENT
 <p>Display Slide 3-0</p>  <p>Correct responses:</p> <ul style="list-style-type: none">▪ Class A Fires: Ordinary combustibles such as paper, cloth, wood, rubber, and many plastics▪ Class B Fires: Flammable liquids (e.g., oils, gasoline) and combustible liquids (e.g., charcoal lighter fluid, kerosene)▪ Class C Fires: Energized electrical equipment (e.g., wiring, motors) .	<p><i>Introduction and Overview</i></p> <p>Welcome</p> <p>Introduce this unit by welcoming the participants to Unit 3 of the <i>CERT Basic Training</i>.</p> <p>Introduce the new instructors for this unit and ask each to describe briefly his or her experience in medical operations.</p> <p>Briefly review the fire safety lesson.</p> <p>What are the five classes of fire?</p>

COMMUNITY EMERGENCY RESPONSE TEAM
UNIT 3: DISASTER MEDICAL OPERATIONS — PART 1

INSTRUCTOR GUIDANCE	CONTENT
 <p>Correct responses:</p> <ul style="list-style-type: none">▪ Can I escape quickly and safely from the area if I attempt to extinguish the fire? (The first priority for you and your buddy is safety.)▪ Do I have the right type of extinguisher?▪ Is the extinguisher large enough for the fire?▪ Is the area free from other dangers, such as hazardous materials and falling debris?▪ Is the fire extinguished in 5 seconds?	<p>There are some questions we need to ask to decide whether to extinguish a fire. What are they?</p>
 <p>Correct response: As a stop sign</p>	<p>How should CERT members treat a hazardous material placard?</p> <p>Answer any questions that the students may have about fire safety. Then continue with the session.</p>

COMMUNITY EMERGENCY RESPONSE TEAM
UNIT 3: DISASTER MEDICAL OPERATIONS — PART 1

INSTRUCTOR GUIDANCE	CONTENT
<p data-bbox="245 415 472 449">Assumptions</p> <ul data-bbox="261 468 649 667" style="list-style-type: none">● Need for CERT members to learn disaster medical operations is based on two assumptions:<ul style="list-style-type: none">■ Number of victims could exceed local capacity for treatment■ Survivors will assist others<ul style="list-style-type: none">– They will do whatever they know how to do– They need to know lifesaving first aid or post-disaster survival techniques <p data-bbox="245 699 673 730"> CERT Basic Training Unit 3: Disaster Medical Operations — Part 1 3-1 </p> <p data-bbox="237 768 488 802">Display Slide 3-1</p> <p data-bbox="245 856 537 890">Importance of Quick Action</p> <ul data-bbox="261 909 639 1056" style="list-style-type: none">● Phase 1: Death within minutes, result of severe trauma● Phase 2: Death within several hours, result of excessive bleeding● Phase 3: Death in several days or weeks, result of infection <p data-bbox="245 1136 673 1167"> CERT Basic Training Unit 3: Disaster Medical Operations — Part 1 3-2 </p> <p data-bbox="237 1205 493 1239">Display Slide 3-2</p>	<p data-bbox="704 405 1406 510">Explain that the need for CERT members to learn disaster medical operations is based on two assumptions:</p> <ul data-bbox="704 531 1430 726" style="list-style-type: none">■ The number of victims could exceed the local capacity for treatment.■ Survivors will attempt to assist others. CERT members will need to know lifesaving first aid or post-disaster survival techniques. <p data-bbox="704 846 1458 915">Emphasize the need for CERT medical operations by describing the phases of death from trauma:</p> <ol data-bbox="753 936 1479 1255" style="list-style-type: none">1. Phase 1: Death within minutes as a result of overwhelming and irreversible damage to vital organs2. Phase 2: Death within several hours as a result of excessive bleeding3. Phase 3: Death in several days or weeks as a result of infection or multiple-organ failure (i.e., complications from an injury) <p data-bbox="704 1314 1474 1493">Explain that these phases underlie <u>why</u> disaster medical operations are conducted as they are (by identifying those with the most serious injuries as soon as possible and treating those with life-threatening injuries first).</p> <p data-bbox="704 1535 1468 1640">Point out that some disaster victims in the second and third phases of death could be saved by providing simple medical care.</p>

COMMUNITY EMERGENCY RESPONSE TEAM
UNIT 3: DISASTER MEDICAL OPERATIONS — PART 1

INSTRUCTOR GUIDANCE	CONTENT
 <p>CERT Training</p> <ul style="list-style-type: none"> • Treatment for life-threatening conditions <ul style="list-style-type: none"> ▪ Airway obstruction, bleeding, shock • Treatment for other, less urgent conditions <p><i>Provide greatest good for greatest number by conducting simple triage and rapid treatment</i></p> <p>FEMA CERT Basic Training Unit 3: Disaster Medical Operations — Part 1 3-3</p> <p>Display Slide 3-3</p>	<p>Add that in a disaster, there may be more victims than rescuers, and assistance from medical professionals may not be immediately available. CERT personnel are trained to be part of disaster medical operations and to provide:</p> <ul style="list-style-type: none"> ▪ Treatment for life-threatening conditions — airway obstruction, bleeding, and shock — and for other, less urgent conditions ▪ The greatest good for the greatest number of people by conducting simple triage and rapid treatment <p>START</p>
 <p>START</p> <ul style="list-style-type: none"> • Start = Simple Triage <ul style="list-style-type: none"> ▪ Victims sorted based on priority of treatment • stART = And Rapid Treatment <ul style="list-style-type: none"> ▪ Rapid treatment of injuries assessed and prioritized in first phase <p>FEMA CERT Basic Training Unit 3: Disaster Medical Operations — Part 1 3-4</p> <p>Display Slide 3-4</p>	<p>Explain that Simple Triage And Rapid Treatment (START) is a critical concept for initially dealing with casualties in a disaster.</p> <p>History has proven that 40% of disaster victims can be saved with simple (rapid!) medical care. START is based on the premise that a simple medical assessment and rapid treatment based on that assessment will yield positive — often lifesaving — results.</p> <p><u>S</u>tart = Simple Triage: The first phase of START is the process by which victims are sorted based on injury and priority of treatment.</p> <p><u>st</u>ART = And Rapid Treatment: The second phase of START consists of rapid treatment of the injuries assessed and prioritized in the first phase.</p> <p>Poll the group to see how many have taken first aid courses.</p>

COMMUNITY EMERGENCY RESPONSE TEAM
UNIT 3: DISASTER MEDICAL OPERATIONS — PART 1

INSTRUCTOR GUIDANCE	CONTENT
<div data-bbox="237 810 675 1142" data-label="Image"> </div> <p data-bbox="237 1178 492 1213">Display Slide 3-5</p>	<p data-bbox="704 407 1468 730">Explain that all CERT participants are encouraged to take basic first aid and CPR training; however, those who have taken first aid courses will need to understand that CERT covers disaster medical operations where time is critical to conduct triage and treat many victims. CPR is not taught in this course because it is labor intensive and not appropriate when there are many victims and professional help will be delayed.</p> <p data-bbox="704 814 938 850">Unit Objectives</p> <p data-bbox="704 905 1446 972">Tell the group that at the end of this unit, they should be able to:</p> <ul style="list-style-type: none"> <li data-bbox="704 995 1029 1026">▪ Identify the “killers.” <li data-bbox="704 1047 1360 1115">▪ Apply techniques for opening the airway, controlling bleeding, and treating for shock. <li data-bbox="704 1136 1317 1203">▪ Conduct triage under simulated disaster conditions. <p data-bbox="704 1226 1463 1402">Stress once more that the goal of disaster medical operations is to do the greatest good for the greatest number. In a disaster with many victims, time will be critical. CERT members will need to work quickly and efficiently to help as many victims as possible.</p>

COMMUNITY EMERGENCY RESPONSE TEAM
UNIT 3: DISASTER MEDICAL OPERATIONS — PART 1

INSTRUCTOR GUIDANCE	CONTENT
 <p>The slide is titled "Unit Topics" and lists two bullet points: "Treating life threatening injuries" and "Triage". To the right of the text is a photograph of a simulated disaster scene with several people wearing green and yellow vests, some attending to a person on a stretcher. At the bottom of the slide, there is a FEMA logo, the text "CERT Basic Training Unit 3: Disaster Medical Operations — Part 1", the slide number "3-6", and another FEMA logo.</p>	<p>Unit Topics</p> <p>Reiterate that this session will introduce the participants to the principles of triage, including treating the “three killers”: airway obstruction, excessive bleeding, and shock.</p> <p>Tell the group that, throughout the unit, they will have opportunities to practice the treatment techniques and, at the end of the unit, they will have the opportunity to conduct triage evaluations in a simulated disaster.</p>

Display Slide 3-6

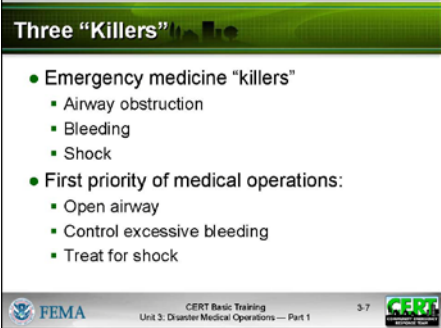

COMMUNITY EMERGENCY RESPONSE TEAM
UNIT 3: DISASTER MEDICAL OPERATIONS — PART 1

INSTRUCTOR GUIDANCE	CONTENT
 <p>Display Slide 3-7</p>	<p><i>Treating Life-Threatening Conditions</i></p> <p>Introduce this section by telling the group that, in emergency medicine, airway obstruction, bleeding, and shock are “killers” because without treatment they will lead to death. The first priority of medical operations is to attend to those potential killers by:</p> <ul style="list-style-type: none">▪ Opening the airway▪ Controlling excessive bleeding▪ Treating for shock <p>Explain that this section will train the group to recognize the “killers” by recognizing their symptoms and their effects on the body.</p> <p>Approaching the Victim</p> <p>Discuss some general guidelines on how to approach a victim.</p> <p>Emphasize that rescuers must first ensure that they are wearing safety equipment:</p> <ul style="list-style-type: none">▪ Helmet▪ Goggles▪ Gloves▪ N95 mask▪ Sturdy shoes or boots▪ Non-latex exam gloves

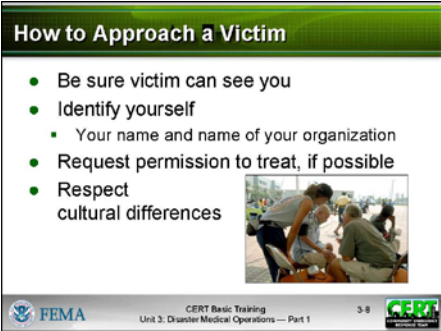
COMMUNITY EMERGENCY RESPONSE TEAM
UNIT 3: DISASTER MEDICAL OPERATIONS — PART 1

INSTRUCTOR GUIDANCE	CONTENT
 <p>Display Slide 3-8</p>	<p>Tell them that a time-saving technique is to wear non-latex exam gloves under their work gloves. Then, when they find a victim, they can remove their work gloves and are ready to work with the victim.</p> <p>Remind participants to use non-latex exam gloves to prevent potential reaction by individuals who are allergic to latex.</p> <p>Explain to the group that there are several steps to take when approaching a victim. When ready to approach a victim:</p> <ol style="list-style-type: none">1. If the victim is conscious, be sure he or she can see you.2. Identify yourself by giving your name and indicating the organization with which you are affiliated.3. ALWAYS request permission to treat an individual. If the individual is unconscious, he or she is assumed to have given “implied consent,” and you may treat him or her. Ask a parent or guardian for permission to treat a child, if possible.4. Whenever possible, respect cultural differences. For example, in some Muslim traditions it is customary to address the male when requesting permission to treat a female member of his family.5. Remember, all medical patients are legally entitled to confidentiality (HIPAA). When dealing with victims, always be mindful and respectful of the privacy of their medical condition.

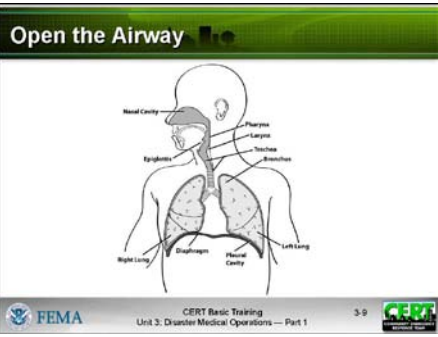
COMMUNITY EMERGENCY RESPONSE TEAM
UNIT 3: DISASTER MEDICAL OPERATIONS — PART 1

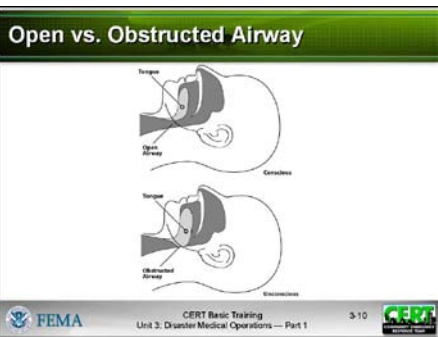
INSTRUCTOR GUIDANCE	CONTENT
	<p>Opening the Airway</p> <p>Explain that the respiratory system includes the following components:</p> <ul style="list-style-type: none"> ▪ Lung ▪ Bronchus ▪ Larynx ▪ Pharynx ▪ Nasal Cavity ▪ Trachea
<p>Display Slide 3-9</p>	<p>Does anyone know what the most common airway obstruction is?</p>
	<p>If not mentioned, tell the group that the most common airway obstruction is the tongue.</p>
	<p>Explain that, in an unconscious or semiconscious victim, especially one positioned on his or her back, the most common airway obstruction is the tongue. The tongue — which is a muscle — may relax and block the airway. A victim with a suspected airway obstruction must be checked immediately for breathing and, if necessary, the airway must be opened.</p>
<p>Display Slide 3-10</p>	<p>Refer the participants to the illustration titled <i>Airway Obstructed by the Tongue</i> in the Participant Manual.</p>
<p>PM, P. 3-6</p>	

COMMUNITY EMERGENCY RESPONSE TEAM
UNIT 3: DISASTER MEDICAL OPERATIONS — PART 1

PM, P. 3-6	Airway Obstructed by the Tongue
------------	---------------------------------

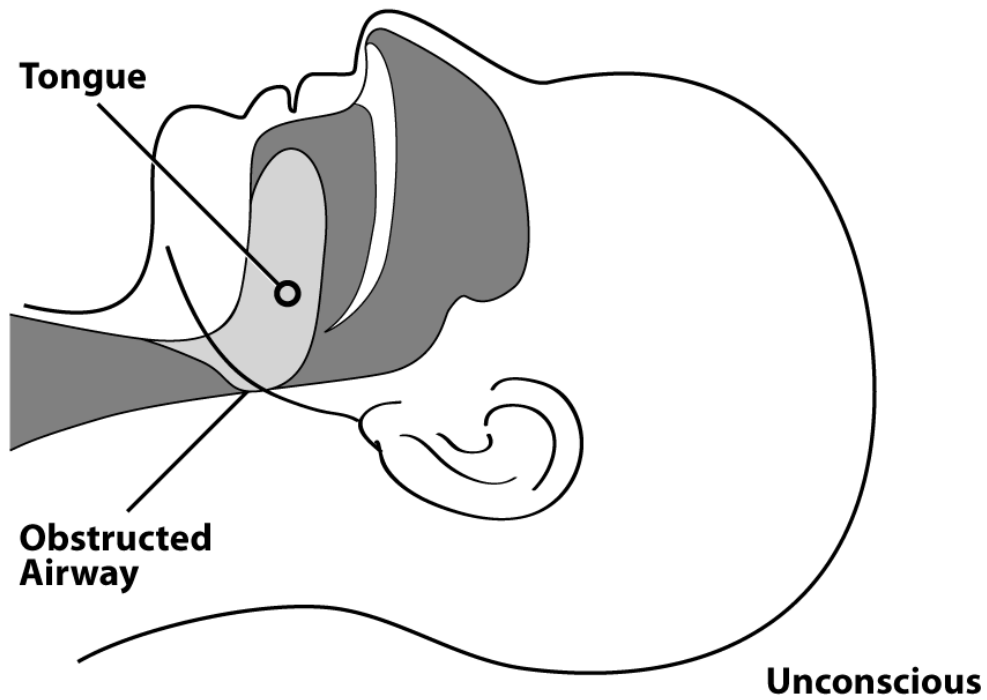
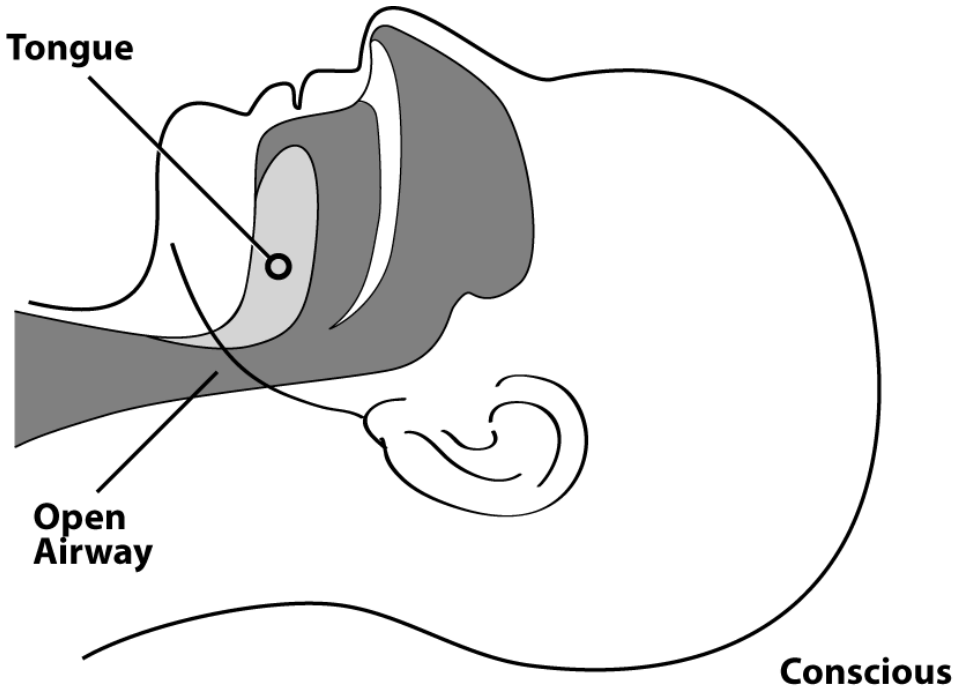

COMMUNITY EMERGENCY RESPONSE TEAM
UNIT 3: DISASTER MEDICAL OPERATIONS — PART 1

INSTRUCTOR GUIDANCE	CONTENT
<p data-bbox="240 420 673 745"></p> <p data-bbox="240 787 511 819">Display Slide 3-11</p> <p data-bbox="240 882 389 913">PM, P. 3-7</p> <p data-bbox="240 1113 665 1323">Demonstrate each step slowly using an instructor or participant as the victim. Be sure to wear gloves to reinforce the need for protective equipment.</p>	<p data-bbox="706 409 1169 441">The Head-Tilt/Chin-Lift Method</p> <p data-bbox="706 472 1469 619">Explain that, when an airway obstruction is suspected, because a victim is unconscious or semiconscious, CERT members should clear the airway using the Head-Tilt/Chin-Lift method.</p> <p data-bbox="706 661 1469 766">Refer the participants to the table titled <i>Head-Tilt/Chin-Lift Method for Opening an Airway</i> in the Participant Manual.</p> <p data-bbox="706 808 1469 913">Explain that in addition to opening the airway, this method causes little or no cervical-spine manipulation because only the head is manipulated.</p> <p data-bbox="706 955 1469 1060">Mention that the proper technique is important in opening an airway, but so is speed if there are multiple victims.</p> <p data-bbox="706 1102 1307 1134">This method involves the following 7 steps:</p> <ul data-bbox="706 1176 1469 1795" style="list-style-type: none"><li data-bbox="706 1176 1469 1281">▪ <u>Step 1</u>: Positioning oneself at an arm’s distance, make contact with the victim and ask, “Can you hear me?” Speak loudly but do not yell.<li data-bbox="706 1323 1469 1428">▪ <u>Step 2</u>: If the victim does not or cannot respond, place the palm of one hand on the victim’s forehead.<li data-bbox="706 1470 1469 1575">▪ <u>Step 3</u>: Place two fingers of the other hand under the chin and tilt the jaw upward while tilting the head backward slightly.<li data-bbox="706 1617 1469 1722">▪ <u>Step 4</u>: Place your ear close to the victim’s mouth, looking toward the victim’s feet, and place a hand on the victim’s abdomen.<li data-bbox="706 1764 1469 1795">▪ <u>Step 5</u>: Look for chest rise.

COMMUNITY EMERGENCY RESPONSE TEAM
UNIT 3: DISASTER MEDICAL OPERATIONS — PART 1

INSTRUCTOR GUIDANCE	CONTENT
<p>If possible, demonstrate “abnormal” lung sounds.</p>	<ul style="list-style-type: none">▪ <u>Step 6</u>: Listen for air exchange.<ul style="list-style-type: none">• Indicate that when listening for air exchange, a CERT member should document abnormal lung sounds (wheezing, gasping, gurgling, etc).• Appearance of any sound that is not normal raises the victim’s status to “I.” Remind the participants that it is NOT their duty to diagnose based on those signs.▪ <u>Step 7</u>: Feel for abdominal movement.▪ <u>Step 8</u>: If breathing has been restored, the clear airway must be maintained by keeping the head tilted back. If breathing has not been restored, repeat steps 2-7.

COMMUNITY EMERGENCY RESPONSE TEAM
UNIT 3: DISASTER MEDICAL OPERATIONS — PART 1

PM, P. 3-7	Head-Tilt/Chin-Lift Method for Opening an Airway
-------------------	---

Step	Action
1	At an arm's distance, make contact with the victim by touching the shoulder and asking, "Can you hear me?" Speak loudly, but do not yell.
2	If the victim does not or cannot respond, place the palm of one hand on the forehead.
3	Place two fingers of the other hand under the chin and tilt the jaw upward while tilting the head back slightly.
4	Place your ear close to the victim's mouth, looking toward the victim's feet, and place a hand on the victim's abdomen.
5	<i>Look</i> for chest rise.
6	<i>Listen</i> for air exchange. <ul style="list-style-type: none">▪ Document abnormal lung sounds (wheezing, gasping, gurgling, etc.).
7	<i>Feel</i> for abdominal movement.

COMMUNITY EMERGENCY RESPONSE TEAM
UNIT 3: DISASTER MEDICAL OPERATIONS — PART 1

INSTRUCTOR GUIDANCE	CONTENT
<p>Teach this skill in accordance with your local protocols.</p> <p>It is important to have other instructors who can help observe. Make sure that you all agree on the proper procedure.</p>	<p>Exercise: Opening the Airway</p> <p>Procedure: Explain that this exercise allows the participants in pairs to practice using the Head-Tilt/Chin-Lift method on each other.</p> <p>After all of the participants have had the opportunity to be the rescuer, discuss any problems or incorrect techniques that were observed. Explain how to avoid these problems in the future.</p> <p>Instructions: Follow the steps below to conduct this exercise:</p> <ol style="list-style-type: none">1. Assign the group to work in pairs.2. Ask the person on the right to be the victim and the person on the left to be the rescuer.3. Ask the victims to lie on the floor on their backs and close their eyes.4. Ask the rescuer to use the Head-Tilt/Chin-Lift method on the victim to open the airway.5. After the rescuer has made two or three attempts at using the Head-Tilt/Chin-Lift method, ask the victim and the rescuer to change roles.6. Allow each rescuer two or three observed attempts to use the Head-Tilt/Chin-Lift method. <p>Observe each pair and correct improper technique.</p> <p>After all of the participants have had the opportunity to be the rescuer, discuss any problems or incorrect techniques that were observed. Explain how to avoid these problems in the future.</p>

COMMUNITY EMERGENCY RESPONSE TEAM
UNIT 3: DISASTER MEDICAL OPERATIONS — PART 1

INSTRUCTOR GUIDANCE	CONTENT
<p>Demonstrate both techniques.</p> <p>Explain that “head injury” refers to concussion, not head or facial cuts, although these may be indicators of head injury.</p> 	<p>Maintaining the Airway</p> <p>Tell the group that, if breathing has been restored, the clear airway still must be maintained. One option is to ask another person to hold the head in place; even another victim with minor injuries could do this. The airway also can be maintained by placing soft objects under the victim’s shoulders to elevate the shoulders slightly and keep the airway open.</p> <p>Remind the participants that part of their mission is to do the greatest good for the greatest number of people. For that reason, if breathing is not restored on the first try using the Head-Tilt/Chin-Lift method, CERT members should try again using the same method. If breathing cannot be restored on the second try, CERT members must move on to the next victim.</p> <p>Tell the group that they should always be concerned with head, neck, or spinal injuries (all of which are common in structural collapses). Used properly, the Head-Tilt/Chin-Lift method for opening an airway causes little spinal manipulation because the head pivots on the spine.</p> <p>Remind the group of the importance of opening the airway as quickly as possible. Emphasize that, in treating the three killers, checking for airway obstruction is <u>always</u> first.</p> <p>Does anyone have any questions about recognizing and clearing airway obstructions?</p> <p>Tell the participants that in the next section, they will learn to recognize and treat uncontrolled bleeding.</p>

COMMUNITY EMERGENCY RESPONSE TEAM
UNIT 3: DISASTER MEDICAL OPERATIONS — PART 1

INSTRUCTOR GUIDANCE	CONTENT
<p>Show the class a 1-liter bottle to illustrate this learning point.</p> <div data-bbox="237 791 675 1119"> <p>Types of Bleeding - 1</p> <ul style="list-style-type: none"> • Arterial bleeding <ul style="list-style-type: none"> ▪ Bleeding from artery spurts • Venous bleeding <ul style="list-style-type: none"> ▪ Bleeding from vein flows • Capillary bleeding <ul style="list-style-type: none"> ▪ Bleeding from capillaries oozes <p><small>FEMA CERT Basic Training Unit 3: Disaster Medical Operations — Part 1 3-12</small></p> </div> <div data-bbox="237 1184 675 1512"> <p>Types of Bleeding - 2</p>  <p><small>FEMA CERT Basic Training Unit 3: Disaster Medical Operations — Part 1 3-13</small></p> </div> <p>Display Slides 3-12 and 3-13</p>	<p>Controlling Bleeding</p> <p>Introduce this section by telling the group that uncontrolled bleeding initially causes weakness. If bleeding is not controlled, the victim will go into shock within a short period of time and finally will die. An adult has about 5 liters of blood. Losing 1 liter can result in death.</p> <p>Explain to the group that there are three types of bleeding and the type can usually be identified by how fast the blood flows:</p> <ul style="list-style-type: none"> ▪ <u>Arterial bleeding</u>. Arteries transport blood under high pressure. Blood coming from an artery will <u>spurt</u>. ▪ <u>Venous bleeding</u>. Veins transport blood under low pressure. Blood coming from a vein will <u>flow</u>. ▪ <u>Capillary bleeding</u>. Capillaries also carry blood under low pressure. Blood coming from capillaries will <u>ooze</u>.

COMMUNITY EMERGENCY RESPONSE TEAM
UNIT 3: DISASTER MEDICAL OPERATIONS — PART 1

PM, P. 3-10	Procedures for Controlling Bleeding
--------------------	--

Method	Procedures
Direct Pressure	<ul style="list-style-type: none">▪ Place direct pressure over the wound by putting a clean dressing over the wound and pressing firmly.▪ Maintain pressure on the dressing over the wound by wrapping the wound <u>firmly</u> with a pressure bandage and tying with a bow.
Elevation	<ul style="list-style-type: none">▪ Elevate the wound above the level of the heart.
Pressure Points	<ul style="list-style-type: none">▪ Put pressure on the nearest pressure point to slow the flow of blood to the wound. Use the:<ul style="list-style-type: none">• Brachial point for bleeding in the arm• Femoral point for bleeding in the leg• Popliteal point for bleeding in the lower leg

COMMUNITY EMERGENCY RESPONSE TEAM
UNIT 3: DISASTER MEDICAL OPERATIONS — PART 1

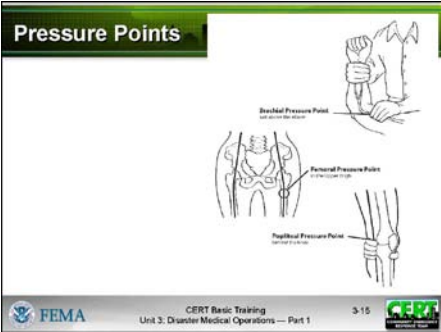
INSTRUCTOR GUIDANCE	CONTENT
<p>Demonstrate why elevation works by asking the participants to put their arms straight up in the air over their heads. Have them hold this position for 20-30 seconds.</p> <p>Ask them how their fingers, hands and arms feel. They should feel cold, tingly, numb, etc.</p>  <p>Display Slide 3-15</p> <p>Demonstrate use of the brachial pressure point by applying pressure to your own arm. Explain that this technique requires the application of strong pressure. Then, have the participants apply pressure to their own arms so that they can feel the effect of this method.</p>	<p>Emphasize that the body has great difficulty pumping blood against gravity; therefore, elevating a wound above the heart will decrease blood flow and loss of blood through the wound.</p> <p><i>Pressure Points</i></p> <p>Tell the participants that there are also pressure points that can be used to stem the flow of bleeding.</p> <p>Demonstrate where to find the pressure points. The pressure points most often used are the:</p> <ul style="list-style-type: none"> ▪ Brachial point in the arm ▪ Femoral point in the leg ▪ Pressure point behind the knee <p>Explain that the pressure point to be used depends on the location of the wound. The correct pressure point will be between the wound and the heart.</p>

COMMUNITY EMERGENCY RESPONSE TEAM
UNIT 3: DISASTER MEDICAL OPERATIONS — PART 1

INSTRUCTOR GUIDANCE	CONTENT
<p data-bbox="237 464 407 495">PM, P. 3-12</p> 	<p data-bbox="704 407 1386 512">Refer the participants to the illustrations of these pressure points and the figure titled <i>Methods for Controlling Bleeding</i> in the Participant Manual.</p> <p data-bbox="704 554 1451 659">Encourage the participants to get victims to help themselves whenever possible by using any of these methods to control bleeding.</p> <p data-bbox="704 701 1305 774">Does anyone have any questions about controlling bleeding?</p>

COMMUNITY EMERGENCY RESPONSE TEAM
UNIT 3: DISASTER MEDICAL OPERATIONS — PART 1

PM, P. 3-12

Methods for Controlling Bleeding

Brachial Pressure Point
just above the elbow

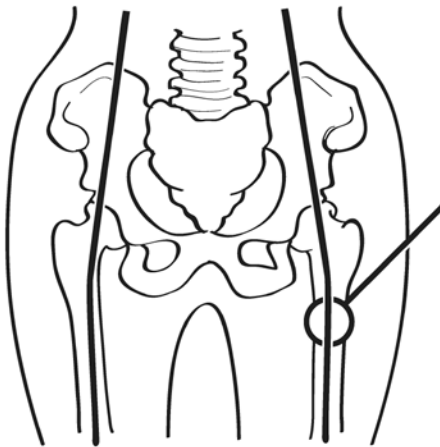
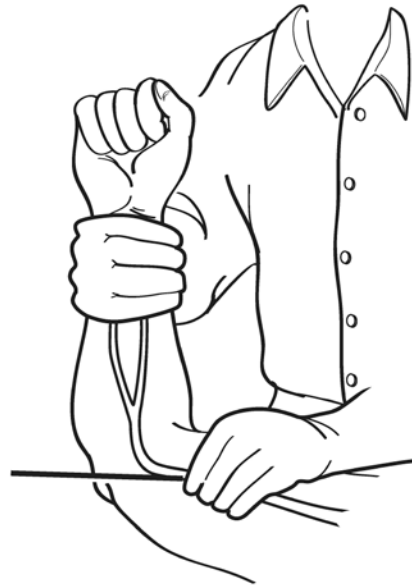

Femoral Pressure Point
in the Upper thigh

Popliteal Pressure Point
behind the knee

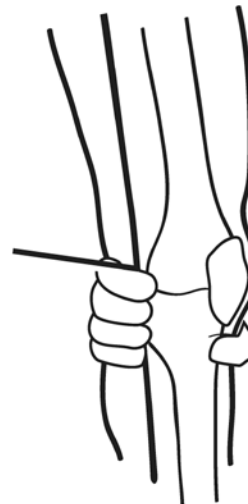

COMMUNITY EMERGENCY RESPONSE TEAM
UNIT 3: DISASTER MEDICAL OPERATIONS — PART 1

INSTRUCTOR GUIDANCE	CONTENT
	<p>Exercise: Controlling Bleeding</p> <p>Procedure: Explain that this exercise allows the participants to practice the techniques for controlling bleeding on each other.</p> <p>The participants will be divided into pairs. Each member of the pair will practice applying a pressure bandage and elevation.</p> <p>Instructions: Follow the steps below to conduct this exercise:</p> <ol style="list-style-type: none">1. Assign the group to pairs.2. Identify one person to be the victim and one person to be the rescuer.3. Ask the victims to lie on the floor on their backs and close their eyes.4. Ask the rescuer to use direct pressure to control bleeding from a simulated wound on the right forearm just below the elbow. Have the rescuer:<ul style="list-style-type: none">▪ Apply a pressure bandage▪ Elevate the arm▪ Repeat these two steps▪ Repeat the two steps for speed5. After the rescuer has made at least three attempts at using each technique, ask the victim and the rescuer to change roles. (Note: The three attempts should emphasize a progression of slow to fast in applying the skill.)6. Observe each group and correct any improper techniques. Common errors include bandages that are too loose, tying a knot instead of a bow, or elevation that cannot be maintained with comfort. <p>Allow each rescuer at least one observed attempt to use each technique.</p>

COMMUNITY EMERGENCY RESPONSE TEAM
UNIT 3: DISASTER MEDICAL OPERATIONS — PART 1

INSTRUCTOR GUIDANCE	CONTENT
<p>Note: This section on tourniquets is optional and can be added at the instructor's discretion.</p>	<p>Tourniquets (Optional)</p> <p>Explain that CERTs will use direct pressure on pressure points and elevation to manage most bleeding. However, if bleeding cannot be stopped using these methods and professionals are delayed in responding, a tourniquet may be a viable option to save a person from bleeding to death. However, a tourniquet is absolutely a last resort (life or limb) when other preferred means have failed to control bleeding in an arm or a leg.</p> <p>While the use of a tourniquet is extremely rare, it may have a use when part of an extremity is amputated or crushed and bleeding cannot be stopped by any other preferred means.</p> <p>Explain the proper use of a tourniquet and demonstrate its application, making the following points.</p> <ul style="list-style-type: none">▪ A tourniquet is a bandage which, when placed around a limb and tightened, cuts off the blood supply to the part of the limb beyond it.▪ A tourniquet can do harm to the limb, but it can halt severe blood loss when all other means have failed and professional help will not arrive in time to help stop the bleeding before the person dies.▪ Use any long, flat, soft material (bandage, neck tie, belt, or stocking). Do not use materials like rope, wire, or string that can cut into the patient's flesh.

COMMUNITY EMERGENCY RESPONSE TEAM
UNIT 3: DISASTER MEDICAL OPERATIONS — PART 1

INSTRUCTOR GUIDANCE	CONTENT
	<ul style="list-style-type: none">▪ To tie a tourniquet:<ol style="list-style-type: none">1. Place the tourniquet between the wound and the heart (for example, if the wound is on the wrist, you would tie the tourniquet around the forearm).2. Tie the piece of material around the limb.3. Place a stick, pen, ruler, or other sturdy item against the material and tie a knot around the item, so that the item is knotted against the limb.4. Use the stick or other item as a lever to twist the knot more tightly against the limb, tightening the bandage until the bleeding stops.5. Tie one or both ends of the lever against the limb to secure it and maintain pressure.6. Mark the patient in an obvious way that indicates that a tourniquet was used and include the time it was applied.7. Do not loosen a tourniquet once it has been applied.8. Only proper medical authorities should remove a tourniquet. <p>Review</p> <p>Reiterate the three main ways to control excessive bleeding:</p> <ul style="list-style-type: none">▪ Direct pressure▪ Elevation▪ Pressure points <p>Stress that bleeding must be controlled as quickly as possible so as not to endanger the victim's life from blood loss. Remind the group that they should always wear their non-latex exam gloves, goggles, and an N95 mask as a protection against blood-borne pathogens, such as hepatitis and HIV.</p>

COMMUNITY EMERGENCY RESPONSE TEAM
UNIT 3: DISASTER MEDICAL OPERATIONS — PART 1

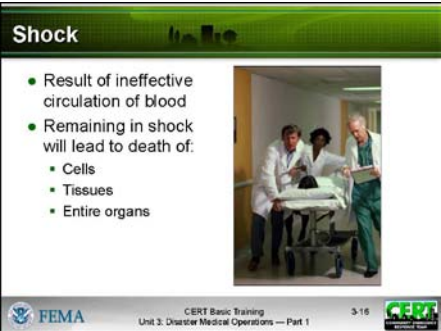
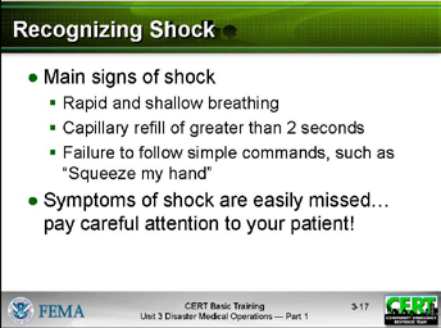
INSTRUCTOR GUIDANCE	CONTENT
  <p>Display Slide 3-16</p>  <p>Display Slide 3-17</p>	<p>Does anyone have any questions about controlling excessive bleeding?</p> <p>Tell the group that the next section will deal with recognizing and treating shock.</p> <p>Recognizing and Treating Shock</p> <p>Introduce this section by explaining that shock is a condition that occurs when the body is not getting enough blood flow. When blood doesn't circulate, oxygen and other nutrients are not carried to tissues and organs. Blood vessels begin to close and organs are damaged and, if left untreated, will shut down completely. Shock can worsen very rapidly.</p> <p>Remaining in shock will lead to the death of:</p> <ul style="list-style-type: none"> ▪ Cells ▪ Tissues ▪ Entire organs <p>Tell the group that the main signs of shock that CERT members should look for are:</p> <ul style="list-style-type: none"> ▪ Rapid and shallow breathing ▪ Capillary refill of greater than 2 seconds ▪ Failure to follow simple commands, such as "Squeeze my hand"

COMMUNITY EMERGENCY RESPONSE TEAM
UNIT 3: DISASTER MEDICAL OPERATIONS — PART 1

INSTRUCTOR GUIDANCE	CONTENT
<p>To demonstrate rapid, shallow breathing, ask two participants to come to the front of the room. Tell one to breathe normally. Tell the other to “pant” (i.e., 30 or more breaths per minute). Point out the audible difference to the class. Make sure that the participant who is “panting” is sitting during the demonstration.</p> <p>Ask the participants to check their own capillary refill by pushing down on the palm of their hand and then releasing. Tell them to watch what happens. Ask one of the participants to explain.</p> <p>Emphasize that capillary refill should occur within 2 seconds.</p> <p>Ask participants to perform a radial pulse test by placing middle and ring finger over the interior of their wrist where the thumb meets the arm</p> <p>Note that a normal pulse rate is 60-100 beats per minute.</p>	<p><i>Evaluate Breathing</i></p> <p>Demonstrate rapid, shallow breathing.</p> <p><i>Evaluate Circulation</i></p> <p>Demonstrate capillary refill. Tell the group that this is referred to as the “blanch test.” A good place to do this is on the palm of the hand. The nail beds are sometimes used.</p> <p>Explain that the blanch test is not valid in children, and that mental status should be used instead as the main indicator.</p> <p>Explain that another way to check for circulation is the radial pulse test. Explain that this is an alternative to the blanch test and can be used in the dark or where it is cold.</p> <p>Demonstrate how to find a radial pulse.</p>

COMMUNITY EMERGENCY RESPONSE TEAM
UNIT 3: DISASTER MEDICAL OPERATIONS — PART 1

INSTRUCTOR GUIDANCE	CONTENT
<p>PM P. 3-17</p>	<p><i>Evaluate Mental Status</i></p> <p>Explain that there are several ways to evaluate mental status.</p> <ul style="list-style-type: none">▪ Ask, “Are you okay?”▪ Give a simple command such as “Squeeze my hand.”▪ If you are concerned that there might be a language barrier or hearing impairment, reach out with both hands and squeeze one of the victim’s hands. The person will squeeze back if they can. <p><i>Treating for Shock</i></p> <p>Remind the group that the body will initially compensate for blood loss and mask the symptoms of shock; therefore, shock is often difficult to diagnose. It is possible — and, in fact, common — for an individual suffering from shock to be fully coherent and not complaining of pain. Pay attention to subtle clues, as failure to recognize shock will have serious consequences.</p> <p>Discuss the procedure for treating victims of shock. Refer the participants to the chart titled <i>Procedures for Controlling Shock</i> in the Participant Manual.</p> <ul style="list-style-type: none">▪ <u>Step 1</u>: Maintain an open airway.▪ <u>Step 2</u>: Control excessive bleeding.▪ <u>Step 3</u>: Maintain body temperature.

COMMUNITY EMERGENCY RESPONSE TEAM
UNIT 3: DISASTER MEDICAL OPERATIONS — PART 1

INSTRUCTOR GUIDANCE	CONTENT
	<p>Remind participants to avoid rough or excessive handling. Stress the importance of maintaining the victim's body temperature. If necessary, place a blanket or other material under and/or over the victim to provide protection from extreme ground temperatures (hot or cold). Position the victim on his or her back and elevate the feet 6 to 10 inches above the level of the heart to assist in bringing blood to the vital organs.</p> <p>Emphasize that, although victims who are suffering from shock may be thirsty, they should <u>not</u> eat or drink anything initially because they may also be nauseated.</p> <p>Does anyone have a question about the signs or treatment of shock?</p>

PM, P. 3-17	Procedures for Controlling Shock
-------------	---

Step	Action
1	<ul style="list-style-type: none"> ▪ Maintain an open airway.
2	<ul style="list-style-type: none"> ▪ Control obvious bleeding.
3	<ul style="list-style-type: none"> ▪ Maintain body temperature (e.g., cover the ground and the victim with a blanket if necessary).
Notes	<ul style="list-style-type: none"> ▪ Avoid rough or excessive handling. ▪ Do not provide food or drink.

COMMUNITY EMERGENCY RESPONSE TEAM
UNIT 3: DISASTER MEDICAL OPERATIONS — PART 1

INSTRUCTOR GUIDANCE	CONTENT
	<p>Exercise: Treating Shock</p> <p><u>Procedure:</u> Explain that this exercise allows the participants in pairs to practice the steps for treating shock on each other.</p> <p>Reiterate the key points about recognizing and treating shock:</p> <ul style="list-style-type: none">▪ A victim may display one or more signs of shock.▪ If there is any reason to suspect shock, apply immediate treatment. <p><u>Instructions:</u> Follow the steps below to conduct this exercise:</p> <ol style="list-style-type: none">1. Assign the group to the same pairs as in the previous exercises.2. Ask those who were the rescuers first in the last exercise to be the victims first.3. Ask the victims to lie on the floor on their backs and close their eyes.4. Explain the following scenario to the rescuers:<ul style="list-style-type: none">▪ You have come upon an unconscious victim who has been bleeding profusely from a wound of the upper arm for an undetermined period of time. You have controlled the bleeding.▪ What do you need to do next?5. Ask the rescuer to treat the victim.6. Observe each rescuer as he or she treats for shock. Do not let the students put a blanket under the victim's feet. Blankets are scarce during a disaster response and should not be used for nonessential purposes.

COMMUNITY EMERGENCY RESPONSE TEAM
UNIT 3: DISASTER MEDICAL OPERATIONS — PART 1

INSTRUCTOR GUIDANCE	CONTENT
	<p>When each rescuer has been observed treating for shock, ask the victim and the rescuer to switch roles.</p> <p>When all of the rescuers have had the opportunity to treat their victims, lead a discussion about any incorrect techniques observed and how to correct them in the future.</p> <p>Does anyone have a question about the signs of shock or its treatment?</p> <p>Tell the group that, in a disaster scenario, they may have many victims requiring attention and few resources to use. The next section will use the skills just learned for prioritizing victim treatment. This is called triage.</p>

COMMUNITY EMERGENCY RESPONSE TEAM
UNIT 3: DISASTER MEDICAL OPERATIONS — PART 1

INSTRUCTOR GUIDANCE	CONTENT
---------------------	---------

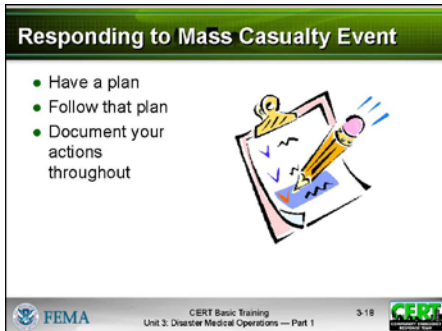

Display Slide 3-18

Examples might be from a recent news story or imagining what the emergency room would be like after an explosion at a shopping mall or sports event.

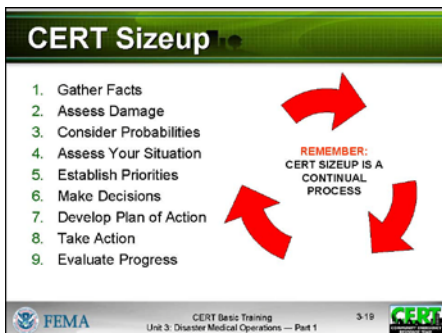

Display Slide 3-19

Triage

Introduce this topic by getting participants thinking about a mass casualty event and how medical personnel handle it.

Emphasize the importance of sizeup by reviewing the 9 steps to properly size up a situation. Remind the participants that sizeup is a continual process; it never stops.

COMMUNITY EMERGENCY RESPONSE TEAM
UNIT 3: DISASTER MEDICAL OPERATIONS — PART 1

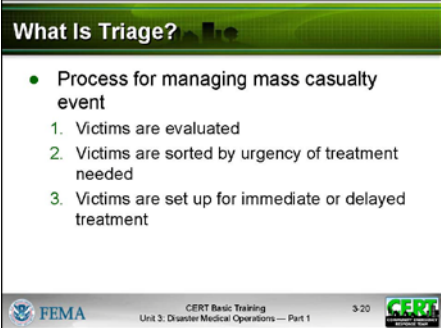
INSTRUCTOR GUIDANCE	CONTENT
<p>The point of this discussion is to get the participants thinking about multiple casualties.</p>  <p>Display Slide 3-20</p>	<p>In mass casualty events, medical personnel:</p> <ul style="list-style-type: none">▪ Identify the dead and those who are too severely injured to be saved▪ Send those with relatively minor injuries and wounds to a holding area to await treatment▪ Identify those who would die from life-threatening injuries and treat them immediately <p>Tell the participants that these scenes showed medical personnel conducting <u>triage</u> — a French term meaning “to sort.”</p> <p>What Is Triage?</p> <p>Explain that during medical triage, victims are evaluated, sorted by the urgency of the treatment needed, and set up for immediate or delayed treatment.</p> <p>Explain further that triage was, in fact, initiated by the military and that experience has shown that triage is an effective strategy in situations where:</p> <ul style="list-style-type: none">▪ There are many more victims than rescuers▪ There are limited resources▪ Time is critical <p>Point out that triage occurs as quickly as possible after victims are located or rescued.</p>

COMMUNITY EMERGENCY RESPONSE TEAM
UNIT 3: DISASTER MEDICAL OPERATIONS — PART 1

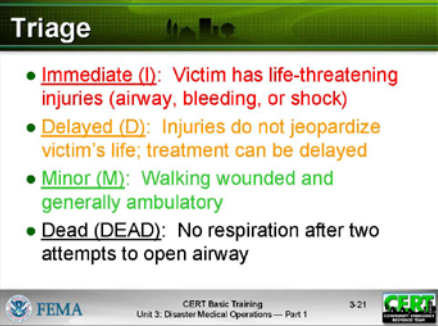
INSTRUCTOR GUIDANCE	CONTENT
 <p>Display Slide 3-21</p> <p>When discussing triage, be sure to highlight how triage is organized and conducted in your area. Specify what materials the CERTs use to mark triaged victims, e.g., tags, tape, etc.</p> <p>Some participants may respond negatively to not performing CPR. CPR is a maintenance therapy that requires time and rescuers that may not be available when dealing with multiple casualties. In a situation without multiple casualties, CPR may be administered by available trained personnel.</p> <p>Explain any State laws about moving the dead that may apply to CERTs.</p>	<p>During medical triage, victims' conditions are evaluated and the victims are prioritized into four categories:</p> <ul style="list-style-type: none"> ▪ Immediate (I): The victim has life-threatening injuries (airway, bleeding, or shock) that demand immediate attention to save his or her life; rapid, lifesaving treatment is urgent. These victims are marked with a red tag or labeled "I." ▪ Delayed (D): Injuries do not jeopardize the victim's life. The victim may require professional care, but treatment can be delayed. These victims are marked with a yellow tag or labeled "D." ▪ Minor (M): Walking wounded and generally ambulatory. These victims are marked with a green tag or labeled "M." ▪ Dead (DEAD): No respiration after two attempts to open the airway. Because CPR is one-on-one care and is labor intensive, CPR is not performed when there are many more victims than rescuers. These victims are marked with a black tag or labeled "DEAD." <p>Remind the group that the CERT goal is to do the greatest good for the greatest number.</p> <p>Explain that, from triage, victims are taken to the designated medical treatment area (immediate care, delayed care, or the morgue).</p> <p>Remind the participants that CERT members do not rescue those tagged DEAD. If the scene is deemed safe and it is appropriate to do so, CERT members may move the DEAD to the morgue.</p>

COMMUNITY EMERGENCY RESPONSE TEAM
UNIT 3: DISASTER MEDICAL OPERATIONS — PART 1

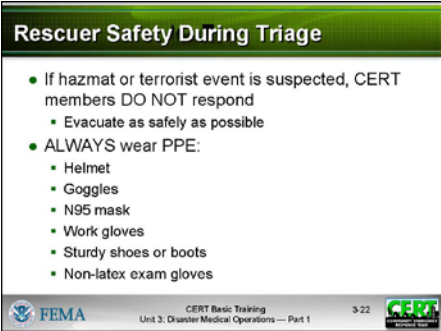
INSTRUCTOR GUIDANCE	CONTENT
 <p>Display Slide 3-22</p> <p>Emphasize these points.</p> <p>Demonstrate the methods for changing non-latex exam gloves without contaminating oneself by pinching the glove at the top and rolling it off while turning it inside out as it comes off. To remove the second glove, tuck two fingers inside the glove and roll the glove off, being careful not to touch the outside.</p>	<p>It is crucial to the physical and mental well-being of disaster survivors that the morgue be placed away from the other groups. Traditionally, blue tarps are used to identify and conceal the morgue area.</p> <p>Note that the setup of medical treatment areas will be covered in the next unit.</p> <p>Rescuer Safety During Triage</p> <p>Remind the group that, if hazardous materials are present, rescuer safety is paramount. CERT members should leave the scene to avoid harm to themselves and to reduce the risk of spreading the contamination.</p> <p>Emphasize the need for rescuer safety during triage. Rescuers must wear all safety equipment, including non-latex exam gloves, goggles, a helmet, and an N95 mask when examining victims and should try to change gloves between victims. Because of limited supplies, it may not be possible to use a new pair of gloves for every victim. If this is the case, gloves may be sterilized between treating victims using 1 part bleach to 10 parts water. Tell the group that their disaster kits should have a box of non-latex exam gloves. Bleach and potable water should also be available at the CERT's medical treatment area.</p>

COMMUNITY EMERGENCY RESPONSE TEAM
UNIT 3: DISASTER MEDICAL OPERATIONS — PART 1

INSTRUCTOR GUIDANCE	CONTENT
	<p>Exercise: Removing Exam Gloves</p> <p><u>Procedure:</u> Explain that this exercise allows the participants to practice the proper technique for removing soiled exam gloves without spreading contaminants.</p> <p><u>Instructions:</u> Follow the steps below to conduct this exercise:</p> <ol style="list-style-type: none">1. Ask the participants to put on a pair of non-latex exam gloves.2. Walk around the room and give each participant a small dollop of shaving cream and ask them to rub their hands together as if washing.3. Demonstrate the procedure for removing gloves again with shaving cream on your gloves.4. Ask the participants to remove their gloves without touching or splattering any shaving cream. <p>Repeat until all participants are able to complete the technique quickly and comfortably.</p>

COMMUNITY EMERGENCY RESPONSE TEAM
UNIT 3: DISASTER MEDICAL OPERATIONS — PART 1

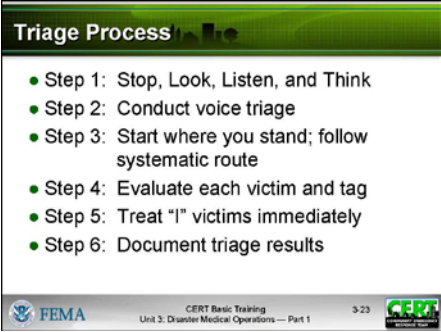
INSTRUCTOR GUIDANCE	CONTENT
 <p>Display Slide 3-23 Emphasize this first step.</p> <p>Discuss questions you should ask to gather facts about the situation.</p>	<h3>Triage in a Disaster Environment</h3> <p>Introduce this section by explaining the general procedure for CERTs to conduct triage:</p> <ul style="list-style-type: none">▪ <u>Step 1: Stop, Look, Listen, and Think.</u> Before your team starts, stop and size up the situation by looking around and listening. Think about your safety, capability, and limitations, and decide if you will approach the situation. If you decide to proceed, quickly make a plan about your approach that all members understand. ▪ <u>Step 2: Conduct voice triage.</u> Begin by calling out, “Community Emergency Response Team. If you can walk, come to the sound of my voice.” Speak loudly and firmly. If there are survivors who are ambulatory, tag them M and direct them to a designated location. If rescuers need assistance and there are ambulatory survivors, then these survivors should be asked to provide assistance. These persons may also provide useful information about the location of the victims. Note that, during triage, these individuals must be tagged “M.” ▪ <u>Step 3: Start where you stand, and follow a systematic route.</u> Start with the closest victims and work outward in a systematic fashion.

COMMUNITY EMERGENCY RESPONSE TEAM
UNIT 3: DISASTER MEDICAL OPERATIONS — PART 1

INSTRUCTOR GUIDANCE	CONTENT
	<ul style="list-style-type: none">▪ <u>Step 4: Evaluate each victim and tag them “I” (immediate), “D” (delayed), “M” (minor), or DEAD.</u> Remember to evaluate the walking wounded. Remember to ASK for permission to treat if the individual is conscious. <u>Say that you will explain more about how to do a triage evaluation in a minute.</u> ▪ <u>Step 5: Treat I victims immediately.</u> Initiate airway management, bleeding control, and/or treatment for shock for Category I victims. ▪ <u>Step 6: Document triage results</u> for:<ul style="list-style-type: none">• Effective deployment of resources• Information on the victims’ locations• A quick record of the number of casualties by degree of severity <p>Emphasize that the rescuer’s safety is paramount during triage. Stress the importance of wearing proper protective equipment to avoid endangering personal health.</p>

COMMUNITY EMERGENCY RESPONSE TEAM
UNIT 3: DISASTER MEDICAL OPERATIONS — PART 1

INSTRUCTOR GUIDANCE	CONTENT
<p>This section puts together the pieces that have been covered so far in the unit.</p> <div data-bbox="237 583 675 911"><p>Step 4: Triage Evaluation</p><ul style="list-style-type: none">• Check airway and breathing• Check circulation and bleeding• Check mental status<p><small>FEMA CERT Basic Training Unit 3: Disaster Medical Operations — Part 1 3-24</small></p></div> <p>Display Slide 3-24 PM, P. 3-22</p> <p>Demonstrate as you explain the steps.</p>	<p>Evaluating a Victim During Triage</p> <p>Remind participants that the goal of triage is to identify and treat victims who need immediate care as rapidly as possible. As an expansion of Step 4 on the previous page, explain that there is a certain order for doing a triage evaluation. Every evaluation should be done in this order.</p> <p>Refer the participants to the table titled <i>Evaluating a Victim During Triage</i> in the Participant Manual.</p> <p>Explain that when conducting a triage evaluation they should:</p> <ul style="list-style-type: none">▪ <u>Start with the airway.</u> At an arm's distance, make contact with the victim and speak loudly. If the victim does not respond, then:<ul style="list-style-type: none">• Position the airway.• Look, listen, and feel.• Check breathing rate. Abnormally rapid respiration (above 30 per minute) indicates shock. Maintain the airway and treat for shock and tag "I."• If the victim is not breathing after two attempts to open the airway, then tag the victim "DEAD."

COMMUNITY EMERGENCY RESPONSE TEAM
UNIT 3: DISASTER MEDICAL OPERATIONS — PART 1

INSTRUCTOR GUIDANCE	CONTENT
	<ul style="list-style-type: none">▪ <u>Second, check for bleeding.</u><ul style="list-style-type: none">• Stop uncontrolled bleeding.• Perform blanch test for capillary refill (greater than 2 seconds should be marked “I”).• Or perform a radial pulse test.<ul style="list-style-type: none">• If pulse present, continue to assessment of mental status. Note abnormal pulse.• If pulse absent or abnormal, elevate status to “I” and treat for bleeding and shock. ▪ Third, <u>check mental status.</u> If no response, the victim’s status is “I.” <p>If the victim passes all tests, his or her status is “D.” If the victim fails one test, status is “I.” Remember that <u>everyone gets a tag.</u></p>

COMMUNITY EMERGENCY RESPONSE TEAM
UNIT 3: DISASTER MEDICAL OPERATIONS — PART 1

PM, P. 3-22	Evaluating a Victim During Triage
--------------------	--

Step	Procedures
1	<p>Check airway/breathing. At an arm’s distance, make contact with the victim and speak loudly. If the victim does not respond:</p> <ul style="list-style-type: none"> ▪ Position the airway. ▪ Look, listen, and feel. ▪ Check breathing rate. Abnormally rapid respiration (above 30 per minute) indicates shock. Maintain the airway and treat for shock and tag “I.” ▪ If below 30 per minute, then move to Step 2. ▪ If the victim is not breathing after two attempts to open airway, then tag “DEAD.”
2	<p>Check circulation/bleeding.</p> <ul style="list-style-type: none"> ▪ Take immediate action to control severe bleeding. ▪ Check circulation using the blanch test (for capillary refill) or a radial pulse test. <ul style="list-style-type: none"> • Press on an area of skin until normal skin color is gone. Time how long it takes for normal color to return. Treat for shock if normal color takes longer than 2 seconds to return, and tag “I.” • Or check the radial pulse. <ul style="list-style-type: none"> • If present, continue to step 3. • Note if the pulse is abnormal (rapid, thready, weak, etc.) • If absent, tag “I” and treat for bleeding and shock.
3	<p>Check mental status. Inability to respond indicates that immediate treatment for shock is necessary. Treat for shock and tag “I.”</p>

COMMUNITY EMERGENCY RESPONSE TEAM
UNIT 3: DISASTER MEDICAL OPERATIONS — PART 1

INSTRUCTOR GUIDANCE	CONTENT
<p>Ask participants to work individually to learn the steps:</p> <ol style="list-style-type: none">1. Read through the first step.2. Perform the motions of the step.3. Repeat the process for steps 2 and 3.4. Finally, perform the motions of the entire triage evaluation without looking at the chart. <p>Suggest that participants do mental and physical walk-throughs of the triage evaluations at least three times a day until the next session.</p> <p>PM, P. 3-23</p>	<p>Tell participants that they need to get very good at doing a triage evaluation rapidly. The goal should be to do it within 15-30 seconds.</p> <p>Documenting Triage</p> <p>Refer the participants to the <i>Sample Triage Documentation</i> figure in the Participant Manual.</p> <p>Explain how to document victims during triage (the number of people tagged “Immediate,” “Delayed,” “Minor,” and “Dead”) and their location. Also explain to the group how useful such information can be to professional responders.</p>

COMMUNITY EMERGENCY RESPONSE TEAM
UNIT 3: DISASTER MEDICAL OPERATIONS — PART 1

PM, P. 3-23	Sample Triage Documentation
--------------------	------------------------------------

Status	Location			
	A	B	C	D
I	1	2	0	1
D	0	2	5	3
M	10	11	7	15
Dead	3	7	1	0

COMMUNITY EMERGENCY RESPONSE TEAM
UNIT 3: DISASTER MEDICAL OPERATIONS — PART 1

PM, P. 3-25	Triage Decision Flowchart
--------------------	----------------------------------

Triage Decision Flowchart

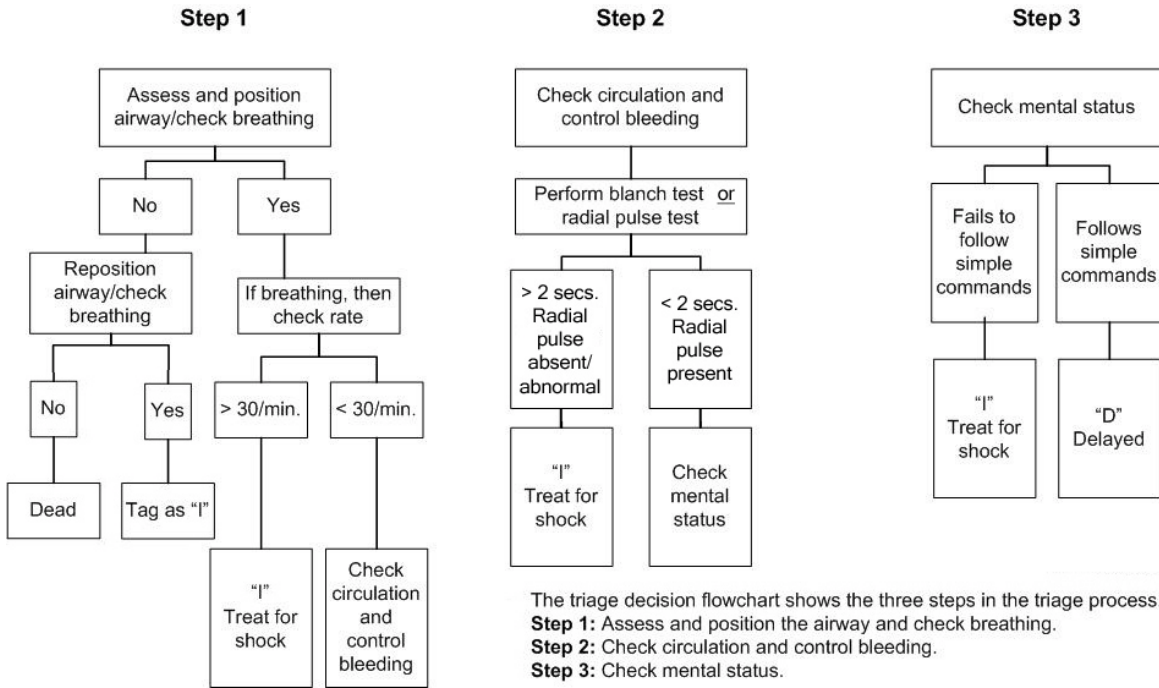

COMMUNITY EMERGENCY RESPONSE TEAM
UNIT 3: DISASTER MEDICAL OPERATIONS — PART 1

INSTRUCTOR GUIDANCE	CONTENT
<p>Before the session, prepare victim status cards, each documenting the status of one disaster victim. See Preparation at the beginning of this unit for instructions on how to complete the victim status cards.</p>	<p>Exercise: Conducting Triage</p> <p>Purpose: Explain that this exercise will allow the participants to practice conducting triage in a high-pressure situation.</p> <p>Participants will divide into three groups. Each participant will be given a card describing their medical status to tape to their shirt. The members of the group will take turns triaging.</p> <p>Explain to the participants that there will be three rounds of the exercise to give each person a chance to practice triage. In each round, one group will be the rescuers and the other groups will be victims. Each participant has a chance to be a rescuer once. The rescuers will have a limited amount of time to:</p> <ul style="list-style-type: none">▪ Size up the situation and develop a plan of action▪ Conduct triage and tag each victim for treatment▪ Document the number of victims in each category of triage (Immediate, Delayed, Minor, Dead) <p>Remind the participants to bring their blankets to the disaster area.</p> <p>Instructions: Follow the steps below to conduct this exercise:</p> <ol style="list-style-type: none">1. In the classroom, divide the participants into three groups. Provide one set of the victim status cards to each group. Each participant will get one card.2. In Round 1, Groups 2 and 3 are victims and remain in the classroom. Each person should tape his or her victim status card to their shirt. One instructor remains in the classroom to work with the victims to arrange themselves.

COMMUNITY EMERGENCY RESPONSE TEAM
UNIT 3: DISASTER MEDICAL OPERATIONS — PART 1

INSTRUCTOR GUIDANCE	CONTENT
<p data-bbox="237 1507 315 1579"></p> <p data-bbox="237 1633 675 1766">Be sensitive to the participants and the difficulty of these decisions during a catastrophic event.</p>	<p data-bbox="704 422 1484 600">3. In Round 1, Group 1 will be the rescuers. While Groups 2 and 3 set up the scene in the classroom, Group 1 goes outside the room to quickly develop a plan of action. A second instructor should observe the rescuers' brief planning session.</p> <p data-bbox="704 621 1484 762">4. After no more than 2 minutes, Group 1 enters the classroom to triage the victims. (They will tag each by writing "I," "D," "M," or "Dead" on the victim status card.)</p> <p data-bbox="704 783 1484 852">5. Allow the rescuers 5 minutes to complete their triage. Observe the rescuers as they conduct triage.</p> <p data-bbox="704 873 1321 905">6. In Round 2, Group 2 will be the rescuers.</p> <p data-bbox="704 926 1321 957">7. In Round 3, Group 3 will be the rescuers.</p> <p data-bbox="704 1014 1468 1121">Debrief: After all three groups have had a chance to practice triage, call the groups together and conduct a discussion on the results of the triage exercise:</p> <ul data-bbox="704 1142 1500 1262" style="list-style-type: none"> ▪ Problems that the rescuers encountered during triage ▪ How it felt to be under pressure to conduct triage within such a short period of time <p data-bbox="704 1318 1500 1455">Relate the rescuers' feelings about their time constraints to the pressure they will feel under actual conditions. Explain that they will learn ways to control some of their stresses in a later session.</p> <p data-bbox="704 1507 1354 1539">Does anyone have questions about triage?</p> <p data-bbox="704 1633 1500 1734">Emphasize that planning and organization are necessary to do the greatest good for the greatest number of victims.</p>

COMMUNITY EMERGENCY RESPONSE TEAM
UNIT 3: DISASTER MEDICAL OPERATIONS — PART 1

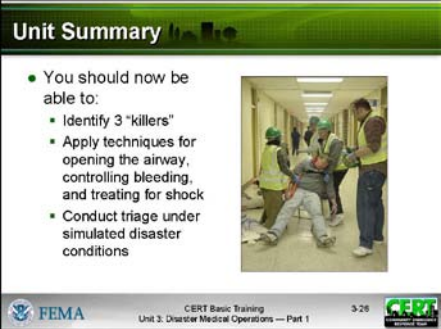
INSTRUCTOR GUIDANCE	CONTENT
 <p>Unit Summary</p> <ul style="list-style-type: none">You should now be able to:<ul style="list-style-type: none">Identify 3 "killers"Apply techniques for opening the airway, controlling bleeding, and treating for shockConduct triage under simulated disaster conditions <p>FEMA CERT Basic Training Unit 3: Disaster Medical Operations — Part 1 3-26</p>	<p>Unit Summary</p> <p>Summarize the key points from this unit:</p> <ul style="list-style-type: none">CERT members' ability to open airways, control bleeding, and treat shock is critical to saving lives.<ul style="list-style-type: none">Use the Head-Tilt/Chin-Lift method for opening airways.Control bleeding using direct pressure, elevation, and/or pressure points.If there is a question about whether a victim is in shock, treat for shock as a precaution.Triage is a system for rapidly evaluating victims' injuries and prioritizing them for treatment.<ul style="list-style-type: none">There are four triage categories:<ol style="list-style-type: none">ImmediateDelayedMinorDeadTriage in a disaster environment consists of 6 important steps:<ol style="list-style-type: none">Stop, Look, Listen and Think, and make a quick plan.Conduct voice triage.Begin where you stand, and work systematically.Evaluate and tag all victims.Treat those tagged "I" immediately.Document your findings.

Display Slide 3-26

COMMUNITY EMERGENCY RESPONSE TEAM
UNIT 3: DISASTER MEDICAL OPERATIONS — PART 1

INSTRUCTOR GUIDANCE	CONTENT
<div data-bbox="237 911 675 1241" data-label="Complex-Block"> <p>Homework Assignment</p> <ol style="list-style-type: none"> 1. Read unit to be covered in next session 2. Bring necessary supplies for the next session 3. Wear appropriate clothes for the next session <p>FEMA CERT Basic Training Unit 3: Disaster Medical Operations — Part 1 3-27 CERT</p> </div> <p>Display Slide 3-27</p>	<ul style="list-style-type: none"> ▪ The procedure for conducting triage evaluations involves checking: <ul style="list-style-type: none"> • The airway and breathing rate • Circulation and bleeding • Mental status <p>Remind the participants that disaster medical operations require careful planning, teamwork, and practice. Urge them to take advantage of community-wide disaster exercises whenever they are scheduled.</p> <p>Homework Assignment</p> <p>Ask the participants to read and become familiar with Unit 4: Disaster Medical Operations — Part 2 before the next session.</p> <p>Remind the participants to bring a blanket, roller gauze, adhesive tape, duct tape, and cardboard to the next session.</p> <p>Thank everyone for attending this session.</p>

UNIT 4: DISASTER MEDICAL OPERATIONS

— PART 2

In this unit you will learn about:

- **Public Health Considerations:** How to maintain hygiene and sanitation.
- **Functions of Disaster Medical Operations:** What the five major functions of disaster medical operations are and how they are set up.
- **Disaster Medical Treatment Areas:** How to establish them and what their functions are.
- **Patient Evaluation:** How to perform a head-to-toe assessment to identify and treat injuries.
- **Basic Treatment — How to:**
 - Treat burns
 - Dress and bandage wounds
 - Treat fractures, dislocations, sprains, and strains
 - Treat hypothermia
 - Treat heat-related injuries
 - Control nasal bleeding
 - Treat bites and stings

[This page intentionally left blank]

**COMMUNITY EMERGENCY RESPONSE TEAM
UNIT 4: DISASTER MEDICAL OPERATIONS — PART 2**

OBJECTIVES	<p>At the conclusion of this unit, the participants should be able to:</p> <ul style="list-style-type: none">▪ Take appropriate sanitation measures to help protect public health.▪ Perform head-to-toe patient assessments.▪ Establish a treatment area.▪ Apply splints to suspected fractures and sprains and employ basic treatments for other injuries.
SCOPE	<p>The scope of this unit will include:</p> <ul style="list-style-type: none">▪ Introduction and Unit Overview▪ Public Health Considerations▪ Functions of Disaster Medical Operations▪ Establishing Medical Treatment Areas▪ Conducting Head-to-Toe Assessments▪ Treating Burns▪ Wound Care▪ Treating Fractures, Dislocations, Sprains, and Strains▪ Nasal Injuries▪ Treating Cold-Related Injuries▪ Treating Heat-Related Injuries▪ Bites and Stings▪ Unit Summary
ESTIMATED COMPLETION TIME	<p>3 hours</p>
TRAINING METHODS	<p>The lead instructor will begin this session by welcoming the participants to Unit 4: Disaster Medical Operations — Part 2, and will introduce the instructors for the session. The instructor will then present a brief review of Disaster Medical Operations — Part 1, covering the “killers” and triage procedures. Next, the instructor will present a brief overview of the unit topics. This section will end with a presentation of the unit learning objectives.</p>

COMMUNITY EMERGENCY RESPONSE TEAM
UNIT 4: DISASTER MEDICAL OPERATIONS — PART 2

**TRAINING
METHODS
(CONTINUED)**

Then, the instructor will present the public health considerations for disaster medical operations, including sanitation, hygiene, and water purification.

Then, the instructor will present an overview of how disaster medical operations are organized and the responsibilities of each operational function.

The instructor will then discuss where to establish a treatment area and how the treatment area should be organized.

Next, the instructor will explain and demonstrate the procedures for conducting head-to-toe patient assessments using another instructor, a participant, or a mannequin. The participants will then be assigned into pairs so that they can practice head-to-toe patient assessments under observation. The instructors will observe the participants to ensure that they are performing the skills as taught.

Next, the instructor will describe the treatment of burns and the care of wounds to avoid infections. Topics will include the difference between bandages and dressings and bandaging techniques. The instructor will demonstrate using dressings to control bleeding and bandaging techniques using the mannequin.

The next section will deal with the treatment of fractures, sprains, and strains. An exercise will give the participants the opportunity to practice applying splints. The exercise will be followed by segments on nasal injuries, how to diagnose and treat hypothermia, heat-related injuries, and insect bites and stings. The unit will conclude with a summary.

**RESOURCES
REQUIRED**

- *Community Emergency Response Team Instructor Guide*
- *Community Emergency Response Team Participant Manual*
- PowerPoint slides 4-0 through 4-57

COMMUNITY EMERGENCY RESPONSE TEAM
UNIT 4: DISASTER MEDICAL OPERATIONS — PART 2

EQUIPMENT

In addition to the equipment listed at the front of this Instructor Guide, you will need the following equipment for this unit:

- A computer with PowerPoint software
- A computer projector and screen
- One mannequin (optional)
- One stretcher
- Non-latex examination gloves (1 pair per participant)
- 4- by 4-inch dressings (1 for each participant)
- One triangular bandage per participant
- Splinting material (cardboard, magazines, pieces of lath, pillows, towels, etc.)
- Note cards
- Duct tape

PREPARATION

Working with a representative of the community in which you will be teaching, identify any potentially culturally sensitive topics in this module. Develop strategies for presenting such topics in ways that will be engaging and appropriate for the participants.

For example, in some cultures, discussing death is taboo. Physical contact is another potentially sensitive topic that participants will encounter in this module with the *head-to-toe assessment* activity.

Prepare participants by introducing such topics gradually and with an awareness of the sensitivity of the audience. Avoid making jokes or being flippant regarding such topics.

**COMMUNITY EMERGENCY RESPONSE TEAM
UNIT 4: DISASTER MEDICAL OPERATIONS — PART 2**

NOTES

A suggested time plan for this unit is as follows:



Introduction and Unit Overview.....	15 minutes
Public Health Considerations.....	5 minutes
Functions of Disaster Medical Operations	5 minutes
Establishing Medical Treatment Areas	15 minutes
Conducting Head-to-Toe Assessments	25 minutes
Treating Burns	20 minutes
Wound Care	20 minutes
Treating Fractures, Dislocations, Sprains, and Strains.....	40 minutes
Nasal Injuries.....	10 minutes
Treating Cold-Related Injuries	5 minutes
Treating Heat-Related Injuries.....	5 minutes
Insect Bites and Stings	5 minutes
Unit Summary.....	5 minutes

Total Time: 3 hours

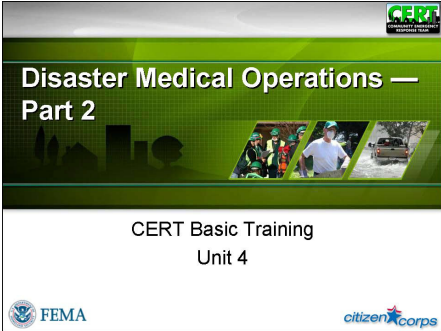
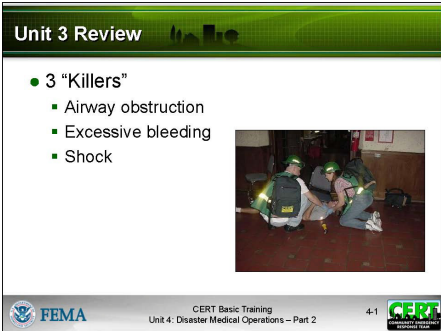

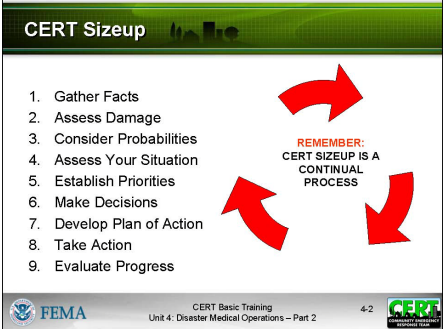

Unit 4: Disaster Medical Operations — Part 2

INSTRUCTOR GUIDANCE	CONTENT
<p data-bbox="188 556 626 884"></p> <p data-bbox="188 921 443 957">Display Slide 4-0</p> <p data-bbox="188 995 626 1323"></p> <p data-bbox="188 1360 443 1396">Display Slide 4-1</p>	<p data-bbox="657 531 1232 567"><i>Introductions and Unit Overview</i></p> <p data-bbox="657 642 797 674">Welcome</p> <p data-bbox="657 695 1438 764">Introduce this unit by welcoming the participants to Unit 4 of the <i>CERT Basic Training</i>.</p> <p data-bbox="657 806 1401 909">Introduce the instructors for this session and ask any new instructors to describe briefly their experience in medical operations.</p> <p data-bbox="657 999 1159 1035">Review the main points from Unit 3:</p> <p data-bbox="657 1073 1422 1176">Airway obstruction, excessive bleeding, and shock are “killers.” Victims with signs of these life-threatening conditions must receive <u>immediate</u> treatment.</p>



**COMMUNITY EMERGENCY RESPONSE TEAM
UNIT 4: DISASTER MEDICAL OPERATIONS — PART 2**

INSTRUCTOR GUIDANCE	CONTENT
<div data-bbox="188 361 628 688"><p>CERT Sizeup</p><ol style="list-style-type: none">1. Gather Facts2. Assess Damage3. Consider Probabilities4. Assess Your Situation5. Establish Priorities6. Make Decisions7. Develop Plan of Action8. Take Action9. Evaluate Progress<p>REMEMBER: CERT SIZEUP IS A CONTINUAL PROCESS</p><p>FEMA CERT Basic Training Unit 4: Disaster Medical Operations – Part 2 4-2</p></div> <p>Display Slide 4-2</p> <div data-bbox="188 1220 266 1289"></div> <p>Correct response: Head-Tilt/Chin-Lift</p> <div data-bbox="188 1478 266 1547"></div> <p>Correct response: Survey the area.</p>	<p>Triage has proven to be an effective way to evaluate and prioritize the treatment of mass casualties in a disaster situation.</p> <p>Remind the participants that, as always, sizeup is a critical component of any disaster operation:</p> <ul style="list-style-type: none">▪ Gather Facts▪ Assess and Communicate▪ Consider Probabilities▪ Assess Your Own Situation▪ Establish Priorities▪ Make Decisions▪ Develop Plan of Action▪ Take Action▪ Evaluate Progress <p>Briefly review Disaster Medical Operations — Part 1.</p> <p>What method is used to open the airway of a victim?</p> <p>What is the first action to take when approaching a victim?</p>

**COMMUNITY EMERGENCY RESPONSE TEAM
UNIT 4: DISASTER MEDICAL OPERATIONS — PART 2**

INSTRUCTOR GUIDANCE	CONTENT
	What techniques are available to aid in the control of bleeding?
<p>Correct responses:</p> <ul style="list-style-type: none">▪ Direct pressure▪ Elevation▪ Pressure points	
	When approaching a victim, you should always do three things before treatment. What should you do?
<p>Correct response:</p> <ul style="list-style-type: none">▪ Introduce yourself.▪ Name your affiliation.▪ Ask permission to treat.	
	What safety equipment should CERT members ALWAYS wear?
<p>Correct responses:</p> <ul style="list-style-type: none">▪ Helmet▪ Goggles▪ Gloves (work and non-latex exam)▪ N95 mask▪ Sturdy shoes or boots	
	Does anyone have questions about the information presented in the previous unit?

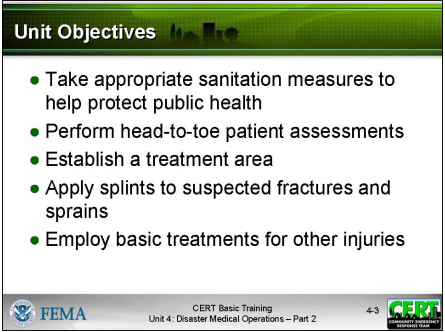
**COMMUNITY EMERGENCY RESPONSE TEAM
UNIT 4: DISASTER MEDICAL OPERATIONS — PART 2**

INSTRUCTOR GUIDANCE	CONTENT
 <p>Unit Objectives</p> <ul style="list-style-type: none">• Take appropriate sanitation measures to help protect public health• Perform head-to-toe patient assessments• Establish a treatment area• Apply splints to suspected fractures and sprains• Employ basic treatments for other injuries <p>FEMA CERT Basic Training Unit 4: Disaster Medical Operations – Part 2 4-3</p>	<p>Unit Objectives</p> <p>Tell the group that at the end of this unit, they should be able to:</p> <ul style="list-style-type: none">▪ Take appropriate sanitation measures to help protect public health.▪ Perform head-to-toe patient assessments.▪ Establish a treatment area.▪ Apply splints to suspected fractures and sprains.▪ Employ basic treatments for other injuries. <p>Unit Topics</p> <p>Introduce the unit topics by telling the participants that this unit will provide them with the information for performing treatment, setting up a medical treatment area, and transporting victims.</p>
 <p>Unit Topics</p> <ul style="list-style-type: none">• Public Health Considerations• Functions of Disaster Medical Operations• Establishing Medical Treatment Areas• Conducting Head-to-Toe Assessments• Treating Burns• Wound Care• Treating Fractures, Dislocations, Sprains, and Strains• Nasal Injuries• Treating Cold-Related Injuries• Treating Heat-Related Injuries• Bites and Stings <p>FEMA CERT Basic Training Unit 4: Disaster Medical Operations – Part 2 4-4</p>	<p>Explain that the unit topics are:</p> <ul style="list-style-type: none">▪ Public Health Considerations▪ Functions of Disaster Medical Operations▪ Establishing Medical Treatment Areas▪ Conducting Head-to-Toe Assessments▪ Treating Burns▪ Wound Care▪ Treating Fractures, Dislocations, Sprains, and Strains▪ Nasal Injuries▪ Treating Cold-Related Injuries▪ Treating Heat-Related Injuries▪ Bites and Stings

COMMUNITY EMERGENCY RESPONSE TEAM
UNIT 4: DISASTER MEDICAL OPERATIONS — PART 2

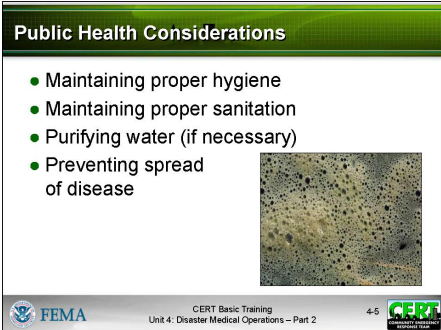
INSTRUCTOR GUIDANCE	CONTENT
  <p>Display Slide 4-5</p>	<p>Emphasize the need for practice by telling the participants that they will have the opportunity to practice many of the treatment techniques that they will learn.</p> <p>Does anyone have any questions about what will be covered in this unit?</p> <p><i>Public Health Considerations</i></p> <p>Introduce this topic by reminding the group that, when disaster victims are sheltered together for treatment, public health becomes a concern. Measures must be taken, both by individual CERT members and CERT programs, to avoid the spread of disease.</p> <p>Explain that the primary public health measures include:</p> <ul style="list-style-type: none">▪ Maintaining proper hygiene▪ Maintaining proper sanitation▪ Purifying water (if necessary)▪ Preventing the spread of disease

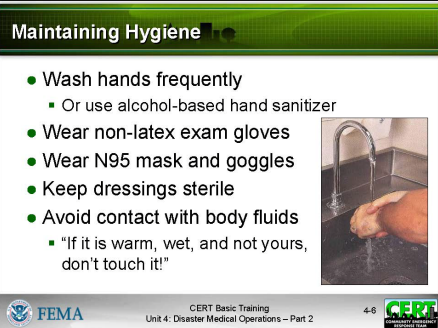

**COMMUNITY EMERGENCY RESPONSE TEAM
UNIT 4: DISASTER MEDICAL OPERATIONS — PART 2**

INSTRUCTOR GUIDANCE	CONTENT
<p data-bbox="191 464 626 789"></p> <p data-bbox="191 831 444 863">Display Slide 4-6</p>	<p data-bbox="659 363 967 394">Maintaining Hygiene</p> <p data-bbox="659 459 1438 558">Introduce hygiene by telling the group that maintenance of proper personal hygiene is critical even under makeshift conditions.</p> <p data-bbox="659 596 1409 663">Tell the group that some steps that individuals should take to maintain hygiene are to:</p> <ul data-bbox="659 684 1438 1688" style="list-style-type: none"><li data-bbox="659 684 1438 821">▪ <u>Wash hands frequently</u> using soap and water. Hand washing should be thorough (at least 15 to 20 seconds of vigorous rubbing on all surfaces of the hand).<li data-bbox="708 842 1438 1146">• Alcohol-based hand sanitizers — which don't require water — are a good alternative to hand washing. The Centers for Disease Control (CDC) recommends products that are at least 60% alcohol. To use an alcohol-based hand sanitizer, apply about ½ teaspoon of the product to the palm of your hand. Rub your hands together, covering all surfaces, until hands are dry.<li data-bbox="659 1188 1438 1398">▪ <u>Wear non-latex exam gloves at all times</u>. Change or disinfect gloves after examining and/or treating each patient. As explained earlier, under field conditions, individuals can use rubber gloves that are sterilized between treating victims using bleach and water (one part bleach to 10 parts water).<li data-bbox="659 1419 1166 1451">▪ <u>Wear an N95 mask and goggles</u>.<li data-bbox="659 1472 1406 1566">▪ <u>Keep dressings sterile</u>. Do not remove the overwrap from dressings until use. After opening, use the entire package of dressing, if possible.<li data-bbox="659 1587 1438 1688">▪ <u>Thoroughly wash areas that come in contact with body fluids</u> with soap and water or diluted bleach as soon as possible. <p data-bbox="659 1766 1373 1833">Stress the importance of practicing proper hygiene techniques even during exercises.</p>

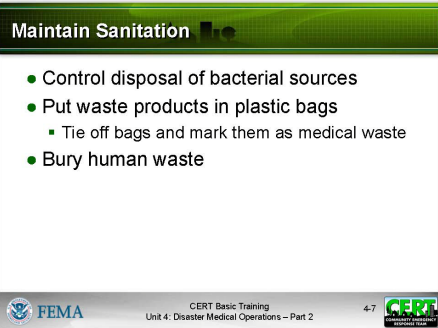
**COMMUNITY EMERGENCY RESPONSE TEAM
UNIT 4: DISASTER MEDICAL OPERATIONS — PART 2**

INSTRUCTOR GUIDANCE	CONTENT
<p data-bbox="191 573 626 898"><p>Maintain Sanitation</p><ul style="list-style-type: none">● Control disposal of bacterial sources● Put waste products in plastic bags<ul style="list-style-type: none">▪ Tie off bags and mark them as medical waste● Bury human waste<p>FEMA CERT Basic Training Unit 4: Disaster Medical Operations – Part 2 4-7</p></p>	

**COMMUNITY EMERGENCY RESPONSE TEAM
UNIT 4: DISASTER MEDICAL OPERATIONS — PART 2**

INSTRUCTOR GUIDANCE	CONTENT
<p data-bbox="191 856 266 930"></p> <p data-bbox="191 1129 626 1455"></p> <p data-bbox="191 1493 444 1528">Display Slide 4-9</p>	<p data-bbox="657 363 1437 499">Also tell the participants that rescuers should not put anything on wounds other than purified water. The use of other solutions (e.g., hydrogen peroxide) on wounds must be the decision of trained medical personnel.</p> <p data-bbox="657 573 1166 606">Preventing the Spread of Disease</p> <p data-bbox="657 667 1414 804">Stress that CERT members <u>must use non-latex exam gloves, goggles, and an N95 mask during all medical operations</u> and that they must cover all open wounds as a way of preventing the spread of infection.</p> <p data-bbox="657 846 1417 947">Does anyone have any questions about the public health considerations related to disaster medical operations?</p> <p data-bbox="657 1035 1393 1068"><i>Functions of Disaster Medical Operations</i></p> <p data-bbox="657 1129 1422 1192">Point out that there are five major functions of disaster medical operations:</p> <ul data-bbox="657 1213 1437 1728" style="list-style-type: none">▪ <u>Triage</u>: The initial assessment and sorting of victims for treatment based on the severity of their injuries▪ <u>Treatment</u>: The disaster medical services provided to victims▪ <u>Transport</u>: The movement of victims from incident location to the treatment area▪ <u>Morgue</u>: The temporary holding area for victims who have died at the treatment area. Those who are tagged as “Dead” during triage are not removed from the incident site.▪ <u>Supply</u>: The hub for crucial supply procurement and distribution

**COMMUNITY EMERGENCY RESPONSE TEAM
UNIT 4: DISASTER MEDICAL OPERATIONS — PART 2**

INSTRUCTOR GUIDANCE	CONTENT
<p>PM, P. 4-5</p>	<p>Refer the participants to the <i>Disaster Medical Operations Organization</i> chart in the Participant Manual.</p> <p>Explain that triage and transport are functions of both search and rescue operations and medical operations.</p>
<p>PM, P. 4-5</p>	<p align="center">Disaster Medical Operations Organization</p>

Disaster Medical Operations Organization

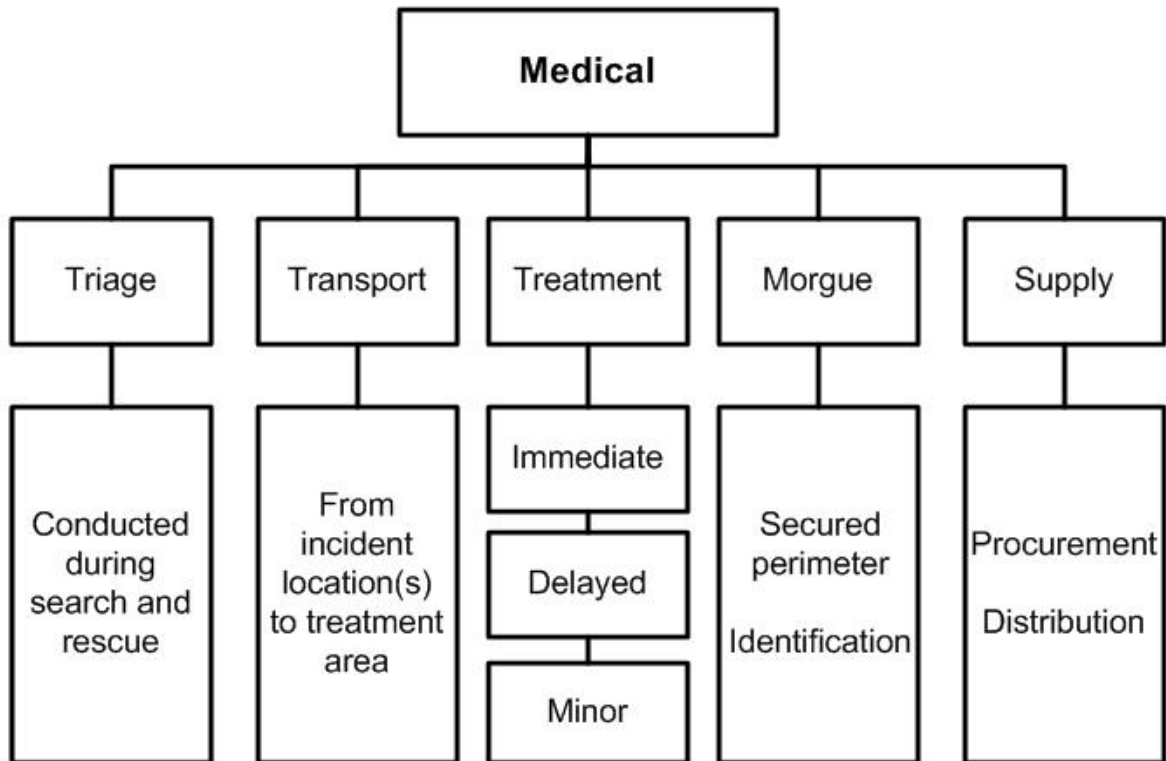

Disaster Medical Operations Organization showing the functions of disaster medical operations: Triage, Transport, Treatment, Morgue, and Supply

**COMMUNITY EMERGENCY RESPONSE TEAM
UNIT 4: DISASTER MEDICAL OPERATIONS — PART 2**

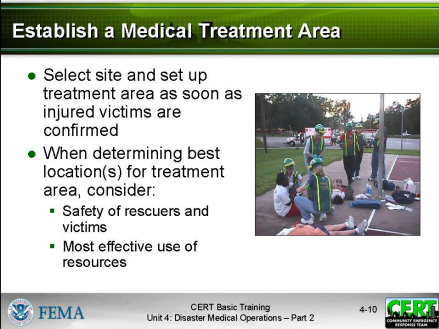
INSTRUCTOR GUIDANCE	CONTENT
<p data-bbox="196 491 626 800"></p> <p data-bbox="190 842 461 873">Display Slide 4-10</p> <p data-bbox="190 1024 626 1163">Present some “what-if” situations to illustrate the principles demonstrated by the graphic.</p>	<p data-bbox="659 373 1328 407"><i>Establishing Medical Treatment Areas</i></p> <p data-bbox="659 485 1438 617">Tell participants that because time is critical when CERTs activate, CERT medical operations personnel will need to select a site and set up a treatment area as soon as injured victims are confirmed.</p> <p data-bbox="659 642 1365 743">Determining the best location(s) for the CERT treatment area should include the following overall considerations:</p> <ul data-bbox="659 768 1341 884" style="list-style-type: none">▪ Safety for rescuers and victims▪ Most effective use of resources, e.g., CERT members themselves, time, medical supplies <p data-bbox="659 993 1146 1026">Safety for Rescuers and Victims</p> <p data-bbox="659 1066 1438 1314">Explain that as victims are located, rescued, and triaged, they are moved to a location where they can be treated. The severity of the damage and the safety of the immediate environment determine where the initial CERT treatment area should be located. Remind participants that in all cases their individual safety is the number one priority.</p> <ul data-bbox="659 1339 1438 1751" style="list-style-type: none">▪ In structures with light damage, CERT members triage the victims as they are located. Further medical treatment is performed in a safe location inside the structure where victims are organized according to the extent of their injuries.▪ In structures with moderate damage, CERT members also triage the victims as they are located; however, victims are sent to a medical treatment location that is a safe distance from the incident location. Victims are organized according to the extent of their injuries.

**COMMUNITY EMERGENCY RESPONSE TEAM
UNIT 4: DISASTER MEDICAL OPERATIONS — PART 2**

INSTRUCTOR GUIDANCE	CONTENT
<p>PM, P. 4-7</p>	<p>Tell participants that whether the treatment area is set up inside or a safe distance from the structure, a morgue may need to be set up as a temporary holding area for victims who die at the treatment area.</p> <p>Refer the participants to the <i>Flow of Patients</i> chart in the Participant Manual.</p>
<p>PM, P. 4-7</p>	<p align="center">Flow of Patients</p>

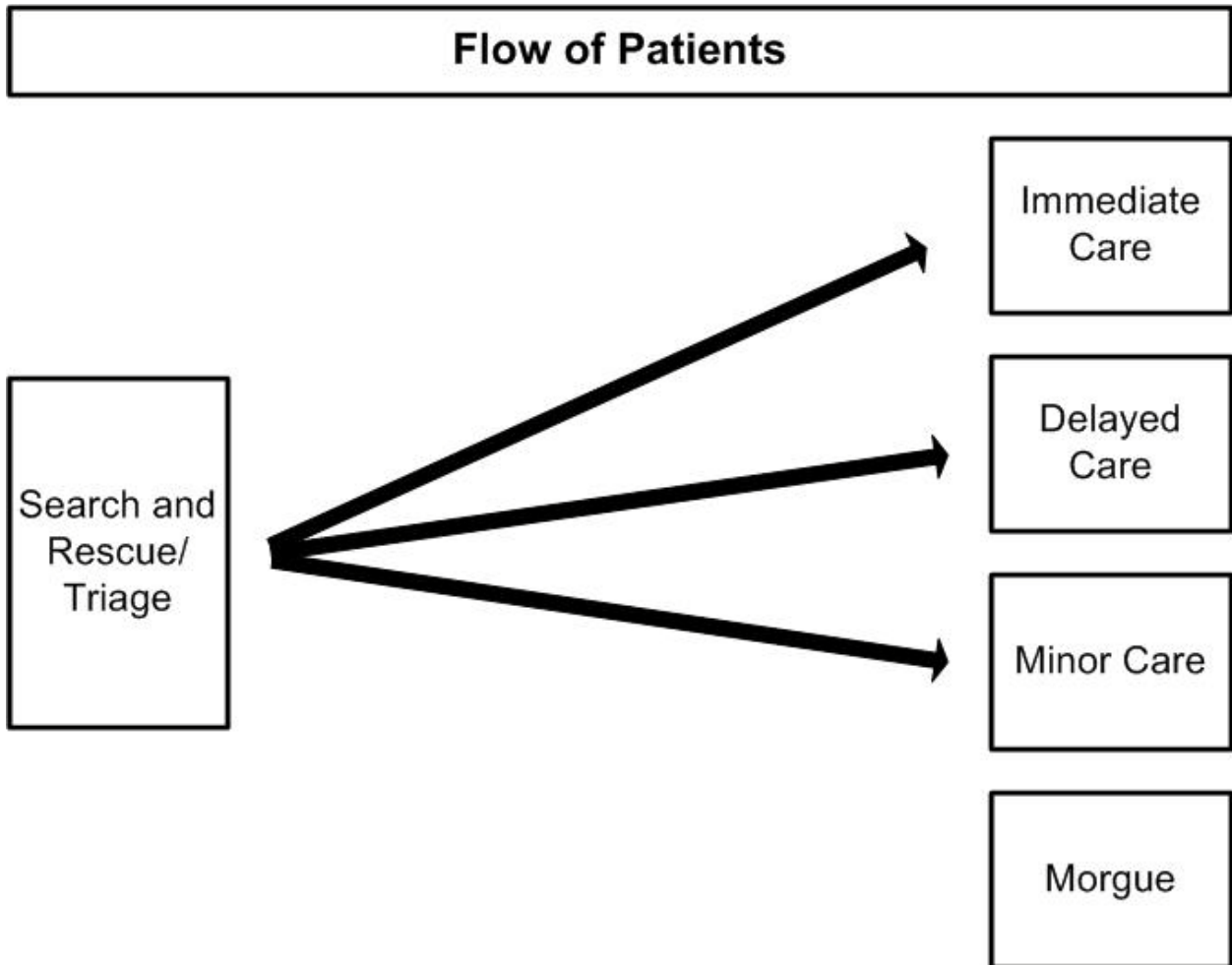

**COMMUNITY EMERGENCY RESPONSE TEAM
UNIT 4: DISASTER MEDICAL OPERATIONS — PART 2**

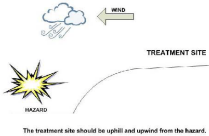
INSTRUCTOR GUIDANCE	CONTENT
<p>Treatment Area Site Selection</p> <ul style="list-style-type: none">• The site selected should be:<ul style="list-style-type: none">▪ In a safe area, free of hazards and debris▪ Upwind, uphill, and upstream (if possible) from hazard zone(s)▪ Accessible by transportation vehicles▪ Expandable  <p>FEMA CERT Basic Training Unit 4: Disaster Medical Operations – Part 2 4-11</p>	<p>Explain that in addition to the severity of the damage to the structure where victims are found, there are two other important safety considerations:</p> <ul style="list-style-type: none">▪ The treatment area itself must be free of hazards and debris.▪ The site should be close to but uphill and upwind from the hazard zone.
<p>Display Slide 4-11</p> <p>Most Effective Use of CERT Resources</p> <ul style="list-style-type: none">• To help meet the challenge of limited resources, CERT may need to establish:<ul style="list-style-type: none">▪ Decentralized medical treatment location (more than one location)▪ Centralized medical treatment location (one location) <p>FEMA CERT Basic Training Unit 4: Disaster Medical Operations – Part 2 4-12</p>	<p>Most Effective Use of CERT Resources</p> <p>Explain that, in addition to the safety of rescuers and victims, a second overall consideration for setting up treatment areas is how to make the best use of CERT resources, e.g., CERT members themselves, time, medical supplies, and equipment.</p>
<p>Display Slide 4-12</p>	<p>Tell participants that, to help meet the challenge of limited resources, particularly if initial treatment operations will continue for some time, CERT may need decentralized treatment locations and/or may establish one central medical treatment location, depending on the circumstances.</p>

**COMMUNITY EMERGENCY RESPONSE TEAM
UNIT 4: DISASTER MEDICAL OPERATIONS — PART 2**

INSTRUCTOR GUIDANCE	CONTENT
	<p>The CERT may need to include one or both in their medical operations plan:</p> <ul style="list-style-type: none">▪ Decentralized Treatment Sites: In a widespread event with many injured, it is sometimes necessary to set up and maintain more than one medical treatment location, especially when a central treatment location would be a considerable distance from the initial treatment site.<ul style="list-style-type: none">• A medical treatment location would be set up close to, but a safe distance from, each of the damage sites. Each of the treatment locations would include areas for Immediate, Delayed, and Minor victims and a morgue.• Victims remain under treatment at the location until they can be transported to a location for professional medical care or to the CERT's main treatment area. ▪ Centralized Treatment Site: In an event with one or a few injured victims at each of a number of sites, the CERT may need to establish <u>one central medical treatment location</u>. A centralized location may need to be set up even when there are decentralized sites established.<ul style="list-style-type: none">• The location would include treatment areas for Immediate, Delayed, and Minor victims, and a morgue.• Victims are moved from where they were rescued, triaged, and initially treated to the central location, and remain under treatment there until they can be transported to a location for professional medical treatment.• A central medical treatment location allows for effective use of resources since a limited number of CERT medical operation personnel in one location can take care of a greater number of victims.

**COMMUNITY EMERGENCY RESPONSE TEAM
UNIT 4: DISASTER MEDICAL OPERATIONS — PART 2**

INSTRUCTOR GUIDANCE	CONTENT
<p>PM, P. 4-10</p>	<ul style="list-style-type: none"> • EMS or other medical professionals will generally be able to transport the injured more efficiently from one central location than from multiple decentralized locations. ▪ Whether a treatment site is centralized or one of a number of decentralized sites, the location(s) selected should be: <ul style="list-style-type: none"> • Accessible by transportation vehicles (ambulances, trucks, helicopters, etc.) • Expandable <p>Refer the participants to the <i>Treatment Area Site Selection</i> diagram in the Participant Manual.</p>

PM, P. 4-10	Treatment Area Site Selection
--------------------	--------------------------------------

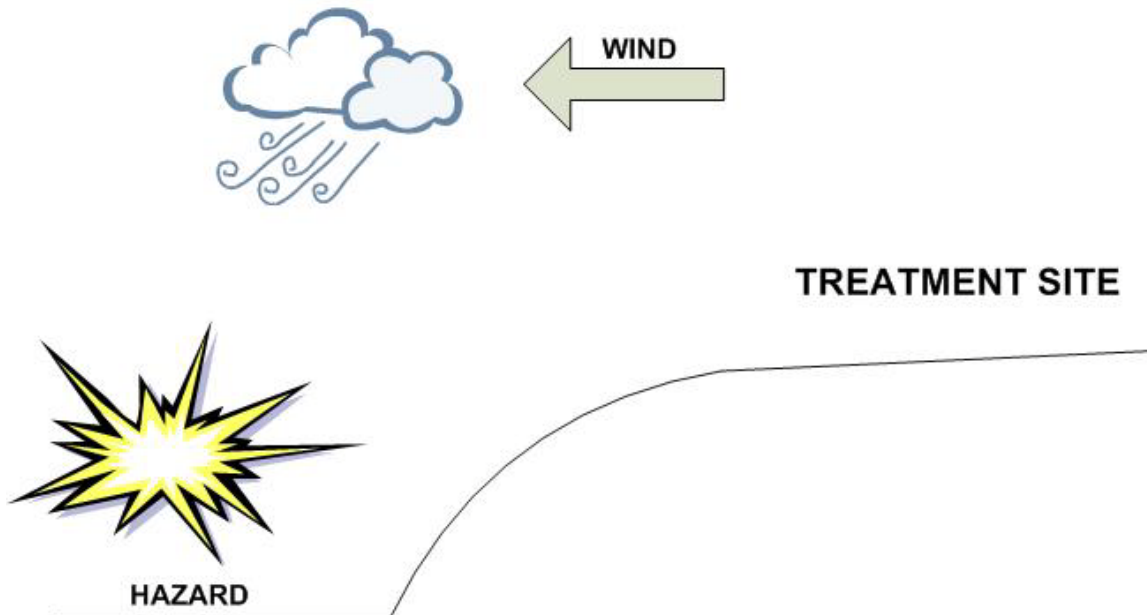

The treatment site should be uphill and upwind from the hazard.

**COMMUNITY EMERGENCY RESPONSE TEAM
UNIT 4: DISASTER MEDICAL OPERATIONS — PART 2**

INSTRUCTOR GUIDANCE	CONTENT
---------------------	---------



Display Slide 4-13

If your program uses colored tarps to delineate medical treatment areas, explain the use of the tarps.

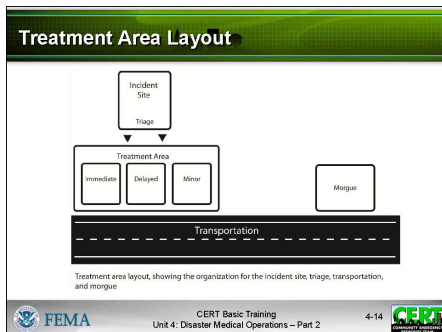

Display Slide 4-14

Treatment Area Layout

Introduce this section by stressing that the treatment area must be protected and clearly delineated. Signs should be used to identify the subdivisions of the area:

- “I” for Immediate care
- “D” for Delayed care
- “M” for Minor injuries/walking wounded
- “DEAD” for the morgue

Point out that a clearly marked treatment area will help in placing victims in the correct location.

Explain that the “I” and “D” areas should be relatively close to each other to allow:

- Verbal communication between workers in the treatment areas
- Shared access to medical supplies (which should be cached in a central location)
- Easy transfer of patients whose status has changed

Emphasize that victims who have been identified with minor injuries may choose to stay at the treatment area or leave. If they stay, they can assist CERT personnel. If they leave, it should be documented.

Explain that patients in the treatment area should be positioned in a head-to-toe configuration, with 2 to 3 feet between victims.

Stress to the participants that the morgue site should be secure, away from and not visible from the treatment area.

**COMMUNITY EMERGENCY RESPONSE TEAM
UNIT 4: DISASTER MEDICAL OPERATIONS — PART 2**

INSTRUCTOR GUIDANCE	CONTENT
<p>PM, P. 4-12</p>	<p>Finally, explain that this system will provide:</p> <ul style="list-style-type: none">▪ Effective use of space▪ Effective use of available personnel. As a worker finishes one head-to-toe assessment, he or she turns around and finds the head of the next patient. <p>Refer the participants to the <i>Treatment Area Layout</i> diagram in the Participant Manual.</p> <p>Note that the distance shown between the Incident Site/Triage and the Treatment Area will depend on whether or not the treatment location is site specific or more centralized in the CERT's service area.</p>

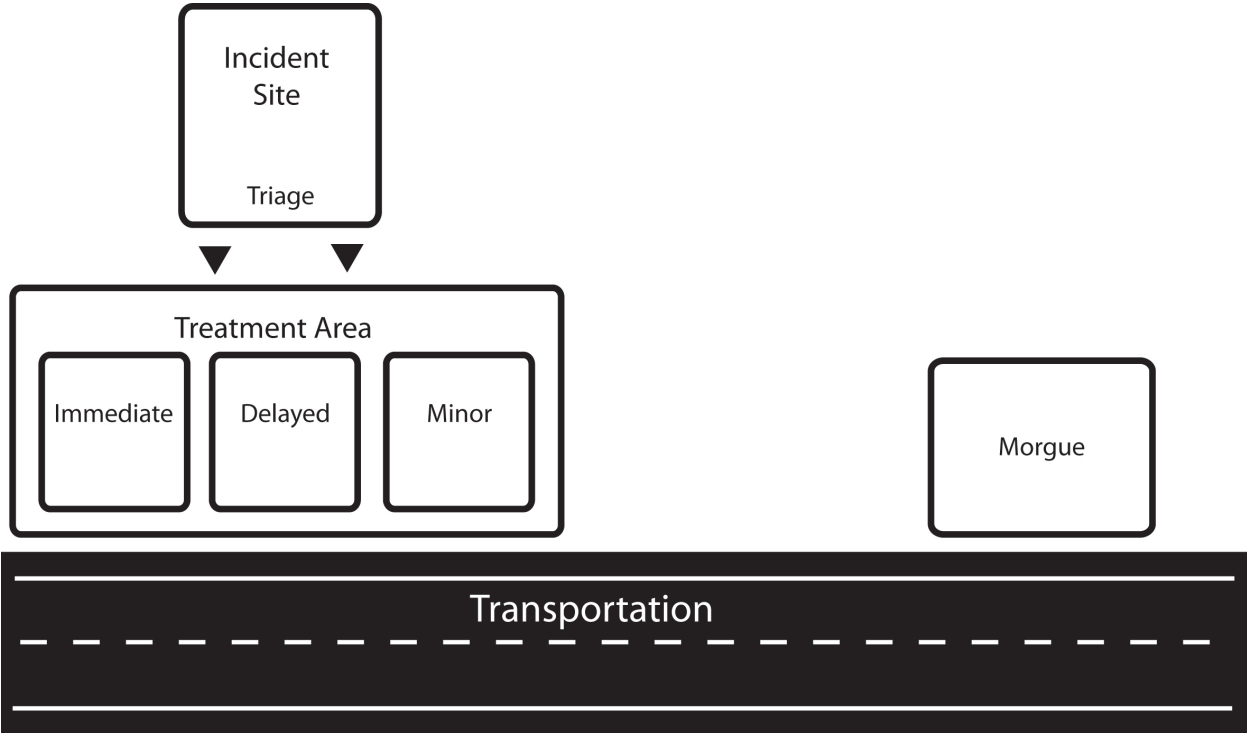

COMMUNITY EMERGENCY RESPONSE TEAM
UNIT 4: DISASTER MEDICAL OPERATIONS — PART 2

PM, P. 4-12	Treatment Area Site Layout
-------------	----------------------------



Treatment area layout, showing the organization for the incident site, triage, transportation, and morgue

**COMMUNITY EMERGENCY RESPONSE TEAM
UNIT 4: DISASTER MEDICAL OPERATIONS — PART 2**

INSTRUCTOR GUIDANCE	CONTENT
<p data-bbox="196 737 626 1066"></p> <p data-bbox="190 1081 461 1115">Display Slide 4-15</p> <p data-bbox="190 1360 266 1434"></p>	<p data-bbox="659 363 1094 396">Treatment Area Organization</p> <p data-bbox="659 432 1430 533">Introduce this section by telling the participants that the CERT must assign leaders to maintain control in each of the medical treatment areas. These leaders will:</p> <ul data-bbox="659 554 1268 674" style="list-style-type: none">▪ Ensure orderly victim placement▪ Direct assistants to conduct head-to-toe assessments <p data-bbox="659 730 1382 800">Emphasize the need for thorough documentation of victims in the treatment area, including:</p> <ul data-bbox="659 821 1430 1100" style="list-style-type: none">▪ Available identifying information▪ Description (age, sex, body build, estimated height)▪ Clothing▪ Injuries▪ Treatment▪ Transfer location <p data-bbox="659 1171 1409 1310">Recommend strongly that the participants take part in practice exercises so that they can develop a good operational plan and practice rapid treatment area setup.</p> <p data-bbox="659 1352 1409 1421">Does anyone have any questions about treatment area site selection or organization?</p> <p data-bbox="659 1486 1354 1556">Tell the participants that next they will learn about head-to-toe assessments.</p> <p data-bbox="659 1598 1354 1705">Explain that the last unit dealt with the procedures conducted in triage and that this unit will focus on treatment of triaged victims.</p>

**COMMUNITY EMERGENCY RESPONSE TEAM
UNIT 4: DISASTER MEDICAL OPERATIONS — PART 2**

INSTRUCTOR GUIDANCE	CONTENT
	<p data-bbox="659 373 1341 411"><i>Conducting Head-to-Toe Assessments</i></p> <p data-bbox="659 470 1427 716">Introduce this topic by telling the group that the first steps that they will take when working with a victim will be to conduct triage and rapid treatment. After all victims in an area have been triaged and moved to a medical treatment area, CERT members will begin a thorough head-to-toe assessment of the victim's condition.</p> <p data-bbox="659 762 1433 827">Note that techniques for moving victims will be covered in Unit 5.</p> <p data-bbox="659 873 1395 938">Remind the group that, during triage, they looked for "the killers."</p> <ul data-bbox="659 961 979 1094" style="list-style-type: none">▪ Airway obstruction▪ Excessive bleeding▪ Signs of shock <p data-bbox="659 1150 1433 1283">Stress that a head-to-toe assessment goes beyond the "killers" to try to gain more information to determine the nature of the victim's injury. The entire assessment must be performed before initiating treatment.</p>

**COMMUNITY EMERGENCY RESPONSE TEAM
UNIT 4: DISASTER MEDICAL OPERATIONS — PART 2**

INSTRUCTOR GUIDANCE	CONTENT
<div data-bbox="188 369 626 695" data-label="Complex-Block"><p>Head-to-Toe Assessment</p><ul style="list-style-type: none">● Objectives of head-to-toe assessment:<ul style="list-style-type: none">▪ Determine extent of injuries▪ Determine type of treatment needed▪ Document injuries<p><small>FEMA CERT Basic Training Unit 4: Disaster Medical Operations – Part 2 4-16 CERT</small></p></div> <p>Display Slide 4-16</p> <p>(Field Conditions) If you wish, suggest that, if the medical team runs out of non-latex exam gloves, they can use rubber gloves and clean them between treating victims in a bucket of bleach-and-water solution (1 part bleach to 10 parts water) to reduce the risk of cross contamination.</p>	<p>Objectives of Head-to-Toe Assessments</p> <p>Explain that the objectives of a head-to-toe assessment are to:</p> <ul style="list-style-type: none">▪ Determine, as clearly as possible, the extent of injuries▪ Determine what type of treatment is needed▪ Document injuries <p>Stress the importance of wearing safety equipment when conducting head-to-toe assessments.</p>

**COMMUNITY EMERGENCY RESPONSE TEAM
UNIT 4: DISASTER MEDICAL OPERATIONS — PART 2**

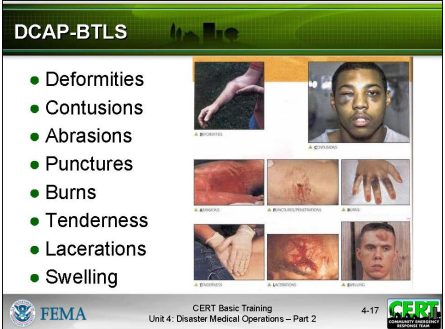
INSTRUCTOR GUIDANCE	CONTENT
 <p>Display Slide 4-17</p>	<h3>What to Look for in Head-to-Toe Assessments</h3> <p>Tell the participants that the medical community uses the acronym DCAP-BTLS to remember what to look for when conducting a rapid assessment. DCAP-BTLS stands for the following:</p> <ul style="list-style-type: none">▪ Deformities▪ Contusions (bruising)▪ Abrasions▪ Punctures▪ Burns▪ Tenderness▪ Lacerations▪ Swelling <p>Explain that, when conducting a head-to-toe assessment, CERT members should look for DCAP-BTLS in all parts of the body.</p> <p>Remind the participants to provide IMMEDIATE treatment for life-threatening injuries.</p> <p>Emphasize that the participants should pay careful attention to how people have been hurt (the mechanism of injury) because it provides insight to probable injuries suffered.</p>

**COMMUNITY EMERGENCY RESPONSE TEAM
UNIT 4: DISASTER MEDICAL OPERATIONS — PART 2**

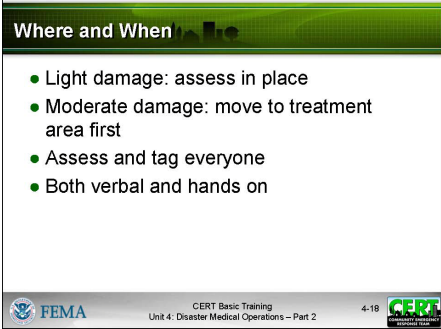
INSTRUCTOR GUIDANCE	CONTENT
<div data-bbox="188 478 626 804"></div> <p data-bbox="188 821 461 856">Display Slide 4-18</p> <p data-bbox="188 873 599 982">Tell the students that you will discuss light, moderate, and heavy damage in Unit 5.</p>	<p data-bbox="656 363 1317 428">Where and When to Conduct a Head-to-Toe Assessment</p> <p data-bbox="656 472 1422 648">Explain that a head-to-toe assessment can be done in place in a lightly damaged building. If the building is moderately damaged, the victim should be moved to a safe zone or to the treatment area for the head-to-toe assessment.</p> <p data-bbox="656 1037 1321 1073">How to Conduct a Head-to-Toe Assessment</p> <p data-bbox="656 1106 1430 1314">Tell the participants that, whenever possible, they should ask the person about any injuries, pain, bleeding, or other symptoms. Stress that, if the victim is conscious, CERT members should always ask permission to conduct the assessment. The victim has the right to refuse treatment.</p> <p data-bbox="656 1356 1442 1423">Emphasize the importance of talking with the conscious patient to reduce anxiety.</p> <p data-bbox="656 1465 1349 1501">Explain that head-to-toe assessments should be:</p> <ul data-bbox="656 1518 1419 1717" style="list-style-type: none">▪ Conducted on all victims, even those who seem all right▪ Verbal (if the patient is able to speak)▪ Hands-on. Do not be afraid to remove clothing to look.

**COMMUNITY EMERGENCY RESPONSE TEAM
UNIT 4: DISASTER MEDICAL OPERATIONS — PART 2**

INSTRUCTOR GUIDANCE	CONTENT
<p data-bbox="191 373 626 422">Conducting Head-to-Toe Assessment</p> <ul data-bbox="212 436 561 625" style="list-style-type: none">● Pay careful attention● Look, listen, and feel● Check own hands for patient bleeding● If you suspect a spinal injury in unconscious victims, treat accordingly● Check PMS in all extremities● Look for medical identification <p data-bbox="191 663 626 695">FEMA CERT Basic Training Unit 4 Disaster Medical Operations – Part 2 4-19</p> <p data-bbox="191 716 461 747">Display Slide 4-19</p> <p data-bbox="191 831 626 879">Order of Assessment</p> <ol data-bbox="212 894 334 1098" style="list-style-type: none">1. Head2. Neck3. Shoulders4. Chest5. Arms6. Abdomen7. Pelvis8. Legs  <p data-bbox="191 1125 626 1157">FEMA CERT Basic Training Unit 4 Disaster Medical Operations – Part 2 4-20</p> <p data-bbox="191 1192 461 1224">Display Slide 4-20</p>	<p data-bbox="659 363 1385 499">Stress the need for conducting head-to-toe assessments systematically; doing so will make the procedure quicker and more accurate with each assessment. Remember to:</p> <ul data-bbox="659 520 1393 695" style="list-style-type: none">▪ Pay careful attention▪ Look, listen, and feel for anything unusual▪ Suspect a spinal injury in all unconscious victims and treat accordingly <p data-bbox="659 709 1425 779">Remind the group to check their own hands for patient bleeding as they perform the head-to-toe assessment.</p> <p data-bbox="659 831 1369 936">Check body parts from the top to the bottom for continuity of bones and soft tissue injuries (DCAP-BTLS) in the following order:</p> <ol data-bbox="659 951 849 1339" style="list-style-type: none">1. Head2. Neck3. Shoulders4. Chest5. Arms6. Abdomen7. Pelvis8. Legs <p data-bbox="659 1402 1442 1472">Tell the participants that while conducting a head-to-toe assessment, CERT members should always check for:</p> <ul data-bbox="659 1486 1406 1608" style="list-style-type: none">▪ PMS (Pulse, Movement, Sensation) in all extremities▪ Medical ID emblems on bracelet or on neck chain

**COMMUNITY EMERGENCY RESPONSE TEAM
UNIT 4: DISASTER MEDICAL OPERATIONS — PART 2**

INSTRUCTOR GUIDANCE	CONTENT
<div data-bbox="191 369 626 695"><p>Closed-Head, Neck, Spinal Injuries</p><ul style="list-style-type: none">• Do no harm<ul style="list-style-type: none">▪ Minimize movement of head and neck• Keep spine in straight line• Stabilize head</div> <div data-bbox="191 663 626 695"><p>FEMA CERT Basic Training Unit 4: Disaster Medical Operations – Part 2 4-21 CERT</p></div> <p>Display Slide 4-21</p>	<h3>Closed-Head, Neck, and Spinal Injuries</h3> <p>Introduce this section by explaining that when conducting head-to-toe assessments, rescuers may come across victims who have or may have suffered closed-head, neck, or spinal injuries.</p> <p>Define a closed-head injury for the participants as a concussion-type injury, as opposed to a laceration, although lacerations can be an indication that the victim has suffered a closed-head injury.</p> <p>Tell the group that the main objective when CERT members encounter suspected injuries to the head or spine is to <u>do no harm</u>. They should minimize movement of the head and spine while treating any other life-threatening conditions.</p> <p>Tell the group to keep the spine in a straight line when doing the head-to-toe assessment.</p> <p>Tell the participants that the signs of a closed-head, neck, or spinal injury most often include:</p> <ul style="list-style-type: none">▪ Change in consciousness▪ Inability to move one or more body parts▪ Severe pain or pressure in head, neck, or back▪ Tingling or numbness in extremities▪ Difficulty breathing or seeing▪ Heavy bleeding, bruising, or deformity of the head or spine▪ Blood or fluid in the nose or ears▪ Bruising behind the ear▪ “Raccoon” eyes (bruising around eyes)

**COMMUNITY EMERGENCY RESPONSE TEAM
UNIT 4: DISASTER MEDICAL OPERATIONS — PART 2**

INSTRUCTOR GUIDANCE	CONTENT
<p>PM, P. 4-18</p>	<ul style="list-style-type: none">▪ “Uneven” pupils▪ Seizures▪ Nausea or vomiting▪ Victim found under collapsed building material or heavy debris <p>Stress that if the victim is exhibiting any of these signs, he or she should be treated as having a closed-head, neck, or spinal injury.</p> <p>Refer the participants to the list of signs in the Participant Manual.</p>

PM, P. 4-18

Signs of a Closed-Head, Neck, or Spinal Injury

The signs of a closed-head, neck, or spinal injury most often include:

- Change in consciousness
- Inability to move one or more body parts
- Severe pain or pressure in the head, neck, or back
- Tingling or numbness in extremities
- Difficulty breathing or seeing
- Heavy bleeding, bruising, or deformity of the head or spine
- Blood or fluid in the nose or ears
- Bruising behind the ear
- “Raccoon” eyes (bruising around eyes)
- “Uneven” pupils
- Seizures
- Nausea or vomiting
- Victim found under collapsed building material or heavy debris

**COMMUNITY EMERGENCY RESPONSE TEAM
UNIT 4: DISASTER MEDICAL OPERATIONS — PART 2**

INSTRUCTOR GUIDANCE	CONTENT
 <p>This exercise should be completed as many times as possible with different “victims.”</p> <p>Observe each pair and correct improper techniques.</p>	<p>Emphasize the importance of doing the procedure in the same order on every victim.</p> <p>Does anyone have any questions about the head-to-toe assessment?</p> <p>Tell the group that they will now practice the procedure.</p> <p>Exercise: Conducting Head-to-Toe Assessments</p> <p><u>Purpose:</u> This exercise allows the participants to practice conducting head-to-toe assessments on each other.</p> <p><u>Instructions:</u> Follow the steps below to facilitate this exercise:</p> <ol style="list-style-type: none">1. Assign the group to work in pairs. Attempt to pair each participant with someone with whom he or she is relatively unfamiliar. This helps to simulate a head-to-toe assessment in a disaster environment.2. Ask the person on the right to be the victim and the person on the left to be the rescuer.3. Ask the victims to lie on the floor on their backs and close their eyes.4. Ask the rescuer to conduct a head-to-toe assessment on the victim, following the procedure demonstrated earlier. Have the rescuer repeat the head-to-toe assessment.5. After the rescuer has made at least two observed head-to-toe assessments, ask the victim and rescuer to change roles.

**COMMUNITY EMERGENCY RESPONSE TEAM
UNIT 4: DISASTER MEDICAL OPERATIONS — PART 2**

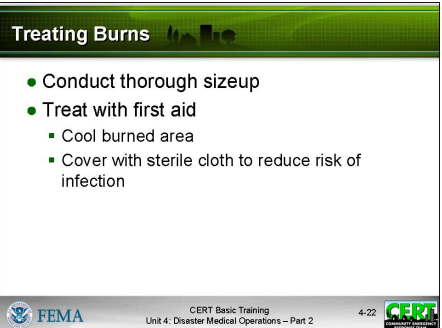
INSTRUCTOR GUIDANCE	CONTENT
<p data-bbox="191 688 267 760"></p> <div data-bbox="191 1056 630 1381"><p>Treating Burns</p><ul style="list-style-type: none">• Conduct thorough sizeup• Treat with first aid<ul style="list-style-type: none">▪ Cool burned area▪ Cover with sterile cloth to reduce risk of infection<p>FEMA CERT Basic Training Unit 4: Disaster Medical Operations – Part 2 4-22</p></div> <p data-bbox="191 1402 462 1438">Display Slide 4-22</p>	<p data-bbox="659 363 1442 619">6. Allow each new rescuer at least two observed head-to-toe assessments.</p> <p data-bbox="659 447 1442 619">7. After all of the participants have had the opportunity to be the rescuer, discuss any problems or incorrect techniques that may have been demonstrated initially. Explain how to avoid the problems during emergencies.</p> <p data-bbox="659 678 1421 745">Does anyone have any additional questions about conducting head-to-toe assessments?</p> <p data-bbox="659 814 1399 882">Tell the group that the remainder of this unit will deal with the treatment of injuries.</p> <p data-bbox="659 955 922 997"><i>Treating Burns</i></p> <p data-bbox="659 1056 1442 1123">Remind the participants that, as always, the first step in treating burns is to conduct a thorough sizeup.</p> <p data-bbox="659 1161 1442 1228">A few examples of burn-related sizeup questions to ask are:</p> <ul data-bbox="659 1245 1120 1375" style="list-style-type: none">▪ What caused the burn?▪ Is the danger still present?▪ When did the burning cease? <p data-bbox="659 1476 1412 1543">Tell the group that the objectives of first aid treatment for burns are to:</p> <ul data-bbox="659 1560 1344 1690" style="list-style-type: none">▪ Cool the burned area▪ Cover with a sterile cloth to reduce the risk of infection (by keeping fluids in and germs out)

COMMUNITY EMERGENCY RESPONSE TEAM
UNIT 4: DISASTER MEDICAL OPERATIONS — PART 2

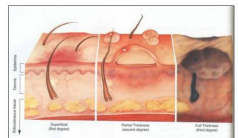
INSTRUCTOR GUIDANCE	CONTENT
<p>Burn Severity</p> <ul style="list-style-type: none">● Factors that affect burn severity:<ul style="list-style-type: none">■ Temperature of burning agent■ Period of time victim exposed■ Area of body affected■ Size of area burned■ Depth of burn  <p>FEMA CERT Basic Training Unit 4: Disaster Medical Operations – Part 2 4-23</p>	<p>Explain that burns may be caused by heat, chemicals, electrical current, and radiation. The severity of a burn depends on the:</p> <ul style="list-style-type: none">■ Temperature of the burning agent■ Period of time that the victim was exposed■ Area of the body that was affected■ Size of the area burned■ Depth of the burn
<p>Display Slide 4-23</p>	<p>Tell the group to exercise extreme caution around victims who appear to have burns when there is no obvious cause for the burns. These burns may indicate chemical burns, which present a risk to the rescuer.</p>
<p>Burn Classifications</p> <ul style="list-style-type: none">● Superficial: epidermis● Partial Thickness: dermis and epidermis● Full Thickness: subcutaneous layer and all layers above  <p>FEMA CERT Basic Training Unit 4: Disaster Medical Operations – Part 2 4-24</p>	<p>Burn Classifications</p> <p>Explain that the skin has three layers:</p> <ul style="list-style-type: none">■ The <u>epidermis</u>, or outer layer of skin, contains nerve endings and is penetrated by hairs.■ The <u>dermis</u>, or middle layer of skin, contains blood vessels, oil glands, hair follicles, and sweat glands.■ The <u>subcutaneous layer</u>, or innermost layer, contains blood vessels and overlies the muscles.
<p>Display Slide 4-24</p> <p>PM, P. 4-21</p>	<p>Depending on the severity, burns may affect all three layers of skin.</p> <p>Refer the participants to the chart titled <i>Burn Classification</i>, in the Participant Manual. Tell the group that burns are classified as superficial, partial thickness, and full thickness depending on their severity.</p>

**COMMUNITY EMERGENCY RESPONSE TEAM
UNIT 4: DISASTER MEDICAL OPERATIONS — PART 2**

INSTRUCTOR GUIDANCE	CONTENT
PM, P. 4-22	Refer the group to the <i>List of Guidelines for Treating Burns</i> in the Participant Manual. Review the guidelines with the group.

PM, P. 4-21	Burn Classification
--------------------	----------------------------

Classification	Skin Layers Affected	Signs
Superficial	<ul style="list-style-type: none"> ▪ Epidermis 	<ul style="list-style-type: none"> ▪ Reddened, dry skin ▪ Pain ▪ Swelling (possible)
Partial Thickness	<ul style="list-style-type: none"> ▪ Epidermis ▪ Partial destruction of dermis 	<ul style="list-style-type: none"> ▪ Reddened, blistered skin ▪ Wet appearance ▪ Pain ▪ Swelling (possible)
Full Thickness	<ul style="list-style-type: none"> ▪ Complete destruction of epidermis and dermis ▪ Possible subcutaneous damage (destroys all layers of skin and some or all underlying structures) 	<ul style="list-style-type: none"> ▪ Whitened, leathery, or charred (brown or black) ▪ Painful or relatively painless

**COMMUNITY EMERGENCY RESPONSE TEAM
UNIT 4: DISASTER MEDICAL OPERATIONS — PART 2**

PM, P. 22

List of Guidelines for Treating Burns

- Remove the victim from the burning source. Put out any flames and remove smoldering clothing unless it is stuck to the skin.
- Cool skin or clothing, if they are still hot, by immersing them in cool water for not more than 1 minute or covering with clean compresses that have been soaked in cool water and wrung out. Cooling sources include water from the bathroom or kitchen; garden hose; and soaked towels, sheets, or other cloths. Treat all victims of full thickness burns for shock.

Infants, young children, and older persons, and persons with severe burns, are more susceptible to hypothermia. Therefore, rescuers should use caution when applying cool dressings on such persons. A rule of thumb is do not cool more than 15% of the body surface area (the size of one arm) at once, to reduce the chances of hypothermia.

- Cover loosely with dry, sterile dressings to keep air out, reduce pain, and prevent infection.
- Wrap fingers and toes loosely and individually when treating severe burns to the hands and feet.
- Loosen clothing near the affected area. Remove jewelry if necessary, taking care to document what was removed, when, and to whom it was given.
- Elevate burned extremities higher than the heart.
- Do not use ice. Ice causes vessel constriction.
- Do not apply antiseptics, ointments, or other remedies.
- Do not remove shreds of tissue, break blisters, or remove adhered particles of clothing. (Cut burned-in clothing around the burn.)



**COMMUNITY EMERGENCY RESPONSE TEAM
UNIT 4: DISASTER MEDICAL OPERATIONS — PART 2**

INSTRUCTOR GUIDANCE	CONTENT
<div data-bbox="188 464 626 793"><p>Burn Treatment: DOs</p><ul style="list-style-type: none">When treating a burn victim, DO:<ul style="list-style-type: none">Cool skin or clothing if they are still hotCover burn loosely with dry, sterile dressings to keep air out, reduce pain, and prevent infectionElevate burned extremities<p>FEMA CERT Basic Training Unit 4: Disaster Medical Operations – Part 2 4-25</p></div> <p>Display Slide 4-25</p> <div data-bbox="188 905 626 1234"><p>Burn Treatment: DON'Ts</p><ul style="list-style-type: none">When treating a burn victim, DO NOT:<ul style="list-style-type: none">Use iceApply antiseptics, ointments, or other remediesRemove shreds of tissue, break blisters, or remove adhered particles of clothing<p>FEMA CERT Basic Training Unit 4: Disaster Medical Operations – Part 2 4-26</p></div> <p>Display Slide 4-26</p> <p>Debunk the myth about using any ointment or salve on a burn. Salve will hold heat in the burn area and later have to be scrubbed off.</p>	<p>DOs and DON'Ts of Burn Treatment</p> <p>When treating a burn victim, DO:</p> <ul style="list-style-type: none">Cool skin or clothing if they are still hot.Cover loosely with dry, sterile dressings to keep air out, reduce pain, and prevent infection.Elevate burned extremities higher than the heart. <p>When treating a burn victim:</p> <ul style="list-style-type: none">Do NOT use ice. Ice causes vessel constriction.Do NOT apply antiseptics, ointments, or other remedies.Do NOT remove shreds of tissue, break blisters, or remove adhered particles of clothing. (Cut burned-in clothing around the burn.) <p>Caution the group that infants, young children, and older persons, and persons with severe burns, are more susceptible to hypothermia. Therefore, rescuers should use caution when applying cool dressings on such persons. A rule of thumb is do not cool more than 15% of the body surface area (the size of one arm) at once, to prevent hypothermia.</p>

**COMMUNITY EMERGENCY RESPONSE TEAM
UNIT 4: DISASTER MEDICAL OPERATIONS — PART 2**

INSTRUCTOR GUIDANCE	CONTENT
<div data-bbox="188 722 626 1050"><p>Treatment for Chemical Burns</p><ul style="list-style-type: none">● Remove cause of burn + affected clothing/jewelry● If irritant is dry, gently brush away as much as possible<ul style="list-style-type: none">▪ Always brush away from eyes, victim, and you● Flush with lots of cool running water● Apply cool, wet compress to relieve pain● Cover wound loosely with dry, sterile or clean dressing● Treat for shock if appropriate<p>FEMA CERT Basic Training Unit 4: Disaster Medical Operations – Part 2 4-27</p></div> <p>Display Slide 4-27</p>	<p>Guidelines for Treating Chemical and Inhalation Burns</p> <p>State that chemical and inhalation burns vary from traditional heat-related burns in their origin and treatment. Keep in mind that suspicion of either chemical or inhalation burns elevates the victim’s status to “I.”</p> <p><i>Chemical Burns</i></p> <p>Explain that unlike more traditional burns, chemical burns do not result from extreme heat, and therefore treatment differs greatly.</p> <p>Tell the participants that such burns are not always obvious. They should consider chemical burns as a possibility if the victim’s skin is burning and there is no sign of a fire. If chemical burns are suspected:</p> <ol style="list-style-type: none">1. Protect yourself from contact with the substance. Use your protective gear — especially goggles, mask, and gloves.2. Ensure that any affected clothing or jewelry is removed.3. If the irritant is dry, gently brush away as much as possible. Always brush away from the eyes and away from the victim and you.4. Use lots of cool running water to flush the chemical from the skin for 15 minutes until emergency help arrives. The running water will dilute the chemical fast enough to prevent the injury from getting worse.5. Apply cool, wet compress to relieve pain.6. Cover the wound very loosely with a dry, sterile or clean cloth so that the cloth will not stick to the wound.7. Treat for shock if appropriate.

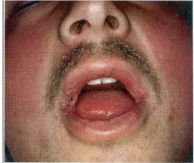

**COMMUNITY EMERGENCY RESPONSE TEAM
UNIT 4: DISASTER MEDICAL OPERATIONS — PART 2**

INSTRUCTOR GUIDANCE	CONTENT
<div data-bbox="188 369 626 695"><p>Inhalation Burns Signs and Symptoms</p><ul style="list-style-type: none">• Sudden loss of consciousness• Evidence of respiratory distress or upper airway obstruction• Soot around mouth or nose• Singed facial hair• Burns around face or neck<p><small>Figure 27-26 A singed mustache and burns to the tip of the tongue signal danger of airway burns or burns to the eyes.</small></p><p>FEMA CERT Basic Training Unit 4: Disaster Medical Operations – Part 2 4-28</p></div> <p data-bbox="188 716 461 747">Display Slide 4-28</p> 	<p data-bbox="657 363 889 394"><i>Inhalation Burns</i></p> <p data-bbox="657 432 1425 604">Remind the group that 60 to 80% of fire fatalities are the result of smoke inhalation. Whenever fire and/or smoke is present, CERT members should assess victims for signs and symptoms of smoke inhalation. These are indicators that an inhalation burn is present:</p> <ul data-bbox="657 625 1382 890" style="list-style-type: none">▪ Sudden loss of consciousness▪ Evidence of respiratory distress or upper airway obstruction▪ Soot around the mouth or nose▪ Singed facial hair▪ Burns around the face or neck <p data-bbox="657 947 1438 1119">Emphasize that the patient may not present these signs and symptoms until hours (sometimes up to a full 24 hours) after the injury occurred, and such symptoms may be overlooked when treating more obvious signs of trauma.</p> <p data-bbox="657 1157 1438 1329">Reiterate that smoke inhalation is the number one fire-related cause of death. If CERT members have reason to suspect smoke inhalation, be sure the airway is maintained, and alert a medical professional as soon as possible.</p> <p data-bbox="657 1367 1414 1440">Does anyone have a question about the treatment for burns?</p>

**COMMUNITY EMERGENCY RESPONSE TEAM
UNIT 4: DISASTER MEDICAL OPERATIONS — PART 2**

INSTRUCTOR GUIDANCE	CONTENT
	<p>Explain that in the next section, the participants will learn to treat other injuries that are common after disasters:</p> <ul style="list-style-type: none">▪ Lacerations▪ Amputations and impaled objects▪ Fractures, dislocations, sprains, and strains▪ Nasal injuries▪ Cold-related injuries▪ Heat-related injuries▪ Insect bites/stings

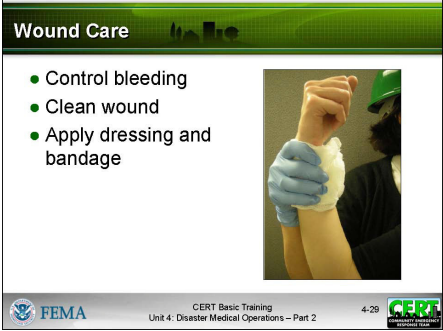

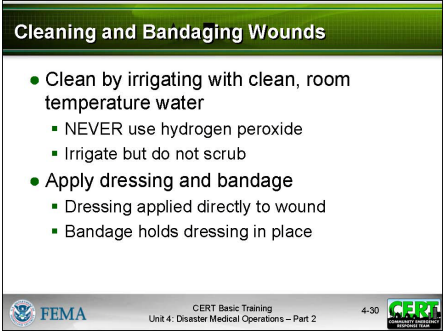
**COMMUNITY EMERGENCY RESPONSE TEAM
UNIT 4: DISASTER MEDICAL OPERATIONS — PART 2**

INSTRUCTOR GUIDANCE	CONTENT
 <p>Wound Care</p> <ul style="list-style-type: none">• Control bleeding• Clean wound• Apply dressing and bandage  <p>FEMA CERT Basic Training Unit 4: Disaster Medical Operations – Part 2 4-29</p>	<p>Wound Care</p> <p>This section will focus on cleaning and bandaging to control infection.</p> <p>Tell the group that the main treatment for wounds includes:</p> <ul style="list-style-type: none">▪ Control bleeding▪ Clean the wound▪ Apply dressing and bandage <p>Add the reminder that treatment for controlling bleeding was covered during the last session. Explain that the focus of this section is on cleaning and bandaging, which will help to prevent secondary infection.</p>
 <p>Cleaning and Bandaging Wounds</p> <ul style="list-style-type: none">• Clean by irrigating with clean, room temperature water<ul style="list-style-type: none">▪ NEVER use hydrogen peroxide▪ Irrigate but do not scrub• Apply dressing and bandage<ul style="list-style-type: none">▪ Dressing applied directly to wound▪ Bandage holds dressing in place <p>FEMA CERT Basic Training Unit 4: Disaster Medical Operations – Part 2 4-30</p>	<p>Cleaning and Bandaging Wounds</p> <p>Explain that wounds should be cleaned by irrigating with clean, room temperature water.</p> <p>NEVER use hydrogen peroxide to irrigate the wound.</p>

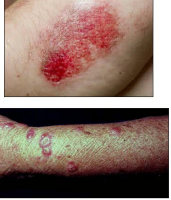
**COMMUNITY EMERGENCY RESPONSE TEAM
UNIT 4: DISASTER MEDICAL OPERATIONS — PART 2**

INSTRUCTOR GUIDANCE	CONTENT
<p data-bbox="196 386 427 415">Signs of Infection</p> <ul data-bbox="212 436 399 596" style="list-style-type: none">● Signs of possible infection<ul style="list-style-type: none">▪ Swelling around wound site▪ Discoloration▪ Discharge from wound▪ Red striations from wound site  <p data-bbox="196 667 626 695">FEMA CERT Basic Training Unit 4: Disaster Medical Operations – Part 2 4-32</p>	<p data-bbox="659 363 1146 394">Signs of possible infection include:</p> <ul data-bbox="659 415 1187 596" style="list-style-type: none">▪ Swelling around the wound site▪ Discoloration▪ Discharge from the wound▪ Red striations from the wound site <p data-bbox="659 617 1422 711">If necessary and based on reassessment and signs of infection, change the treatment priority (e.g., from Delayed to Immediate).</p> <p data-bbox="659 806 854 837">Amputations</p> <p data-bbox="659 905 1438 999">Emphasize that the main treatments for an amputation (the traumatic severing of a limb or other body part) are to:</p> <ul data-bbox="659 1020 935 1104" style="list-style-type: none">▪ Control bleeding▪ Treat shock
<p data-bbox="196 1184 427 1213">Amputations</p> <ul data-bbox="212 1234 586 1394" style="list-style-type: none">● Control bleeding; treat shock● If amputated body part is found:<ul style="list-style-type: none">▪ Save tissue parts, wrapped in clean material and placed in plastic bag▪ Keep tissue parts cool, but NOT directly on ice▪ Keep severed part with victim <p data-bbox="196 1465 626 1493">FEMA CERT Basic Training Unit 4: Disaster Medical Operations – Part 2 4-33</p>	<p data-bbox="659 1163 1438 1226">Stress that when the severed body part can be located, CERT members should:</p> <ul data-bbox="659 1247 1438 1478" style="list-style-type: none">▪ Save tissue parts, wrapped in clean material and placed in a plastic bag, if available. Label them with the date, time, and victim's name.▪ Keep the tissue parts cool, but NOT in direct contact with ice▪ Keep the severed part with the victim

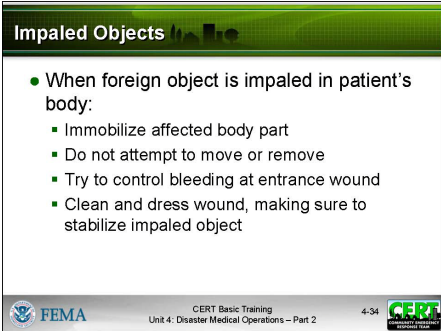
**COMMUNITY EMERGENCY RESPONSE TEAM
UNIT 4: DISASTER MEDICAL OPERATIONS — PART 2**

INSTRUCTOR GUIDANCE	CONTENT
<div data-bbox="188 640 626 968"></div> <p data-bbox="188 982 461 1020">Display Slide 4-34</p> <div data-bbox="188 1150 266 1222"></div>	<p data-bbox="657 361 906 396">Impaled Objects</p> <p data-bbox="657 457 1430 594">Tell the group that they may also encounter some victims who have foreign objects lodged in their bodies — usually as the result of flying debris during the disaster.</p> <p data-bbox="657 634 1357 703">Explain that, when a foreign object is impaled in a patient's body, the participants should:</p> <ul data-bbox="657 720 1437 1083" style="list-style-type: none">▪ Immobilize the affected body part▪ <u>Not</u> attempt to move or remove the object, unless it is obstructing the airway▪ Try to control bleeding at the entrance wound without placing undue pressure on the foreign object▪ Clean and dress the wound making sure to stabilize the impaled object. Wrap bulky dressings around the object to keep it from moving. <p data-bbox="657 1136 1398 1171">Does anyone have questions about wound care?</p> <p data-bbox="657 1276 1370 1381">Tell the participants that the next topic will address treatment for fractures, dislocations, sprains, and strains.</p>

COMMUNITY EMERGENCY RESPONSE TEAM
UNIT 4: DISASTER MEDICAL OPERATIONS — PART 2

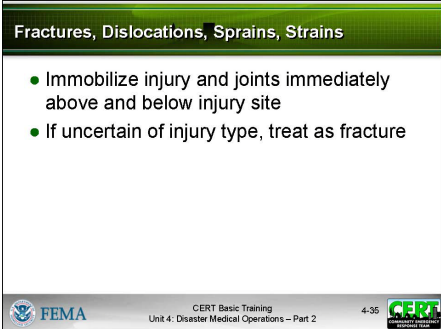
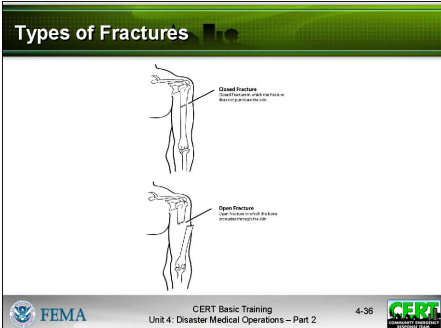
INSTRUCTOR GUIDANCE	CONTENT
<p data-bbox="196 516 626 842"></p> <p data-bbox="188 858 461 894">Display Slide 4-35</p> <p data-bbox="188 1041 354 1077">PM, P. 4-28</p> <p data-bbox="188 1262 626 1587"></p> <p data-bbox="188 1604 461 1640">Display Slide 4-36</p>	<p data-bbox="657 371 1393 449"><i>Treating Fractures, Dislocations, Sprains, and Strains</i></p> <p data-bbox="657 510 1438 646">Tell the group that the objective when treating a suspected fracture, sprain, or strain is to immobilize the injury and the joints immediately above and below the injury site.</p> <p data-bbox="657 682 1438 819">Point out that because it is difficult to distinguish among fractures, sprains, or strains, if uncertain of the type of injury, CERT members should treat the injury as a fracture.</p> <p data-bbox="657 936 802 972">Fractures</p> <p data-bbox="657 1037 1438 1215">Introduce this section by explaining that a fracture is a complete break, a chip, or a crack in a bone. There are several types of fractures (refer the participants to the illustrations titled <i>Closed and Open Fractures</i> in the Participant Manual):</p> <ul data-bbox="657 1272 1438 1493" style="list-style-type: none">▪ A <u>closed fracture</u> is a broken bone with no associated wound. First aid treatment for closed fractures may require only splinting.▪ An <u>open fracture</u> is a broken bone with some kind of wound that allows contaminants to enter into or around the fracture site.

PM, P. 4-28

Closed and Open Fractures



Closed Fracture

Closed Fracture in which the fracture does not puncture the skin.



Open Fracture

Open Fracture in which the bone protrudes through the skin.

COMMUNITY EMERGENCY RESPONSE TEAM
UNIT 4: DISASTER MEDICAL OPERATIONS — PART 2

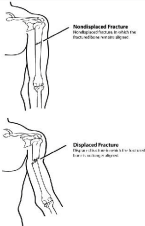
INSTRUCTOR GUIDANCE	CONTENT
<p data-bbox="199 653 428 678">Treating Open Fractures</p> <ul data-bbox="215 699 597 863" style="list-style-type: none">• Do not draw exposed bone ends back into tissue• Do not irrigate wound• Cover wound with sterile dressing• Splint fracture without disturbing wound• Place moist dressing over bone end <p data-bbox="191 932 626 961">FEMA CERT Basic Training Unit 4: Disaster Medical Operations – Part 2 4-37</p> <p data-bbox="191 982 461 1014">Display Slide 4-37</p> <p data-bbox="191 1394 354 1425">PM, P. 4-30</p> <p data-bbox="199 1535 561 1560">Displaced and Nondisplaced Fractures</p>  <p data-bbox="191 1814 626 1843">FEMA CERT Basic Training Unit 4: Disaster Medical Operations – Part 2 4-38</p> <p data-bbox="191 1864 461 1896">Display Slide 4-38</p>	<p data-bbox="659 363 1057 394">Treating an Open Fracture</p> <p data-bbox="659 432 1438 573">Explain that open fractures are more dangerous than closed fractures because they pose a significant risk of severe bleeding and infection. Therefore, they are a higher priority and need to be checked more frequently.</p> <p data-bbox="659 646 1260 678">Stress that when treating an open fracture:</p> <ul data-bbox="659 699 1409 821" style="list-style-type: none">▪ Do <u>not</u> draw the exposed bone ends back into the tissue.▪ Do <u>not</u> irrigate the wound. <p data-bbox="659 1052 1308 1083">Continue by telling the group that they <u>should</u>:</p> <ul data-bbox="659 1104 1398 1276" style="list-style-type: none">▪ Cover the wound with a sterile dressing▪ Splint the fracture without disturbing the wound▪ Place a moist 4 by 4-inch dressing over the bone end to keep it from drying out <p data-bbox="659 1297 1430 1367">Tell the group that splinting procedures will be covered later in this unit.</p> <p data-bbox="659 1388 1292 1493">Refer the participants to the illustrations titled <i>Displaced and Nondisplaced Fractures</i> in the Participant Manual.</p> <p data-bbox="659 1524 1438 1671">Explain that if the limb is angled, then there is a <u>displaced fracture</u>. Explain that displaced fractures may be described by the degree of displacement of the bone fragments.</p> <p data-bbox="659 1692 1398 1871">Explain that <u>nondisplaced fractures</u> are difficult to identify, with the main signs being pain and swelling. Stress that the participants should treat a suspected fracture as a fracture until professional treatment is available.</p>

COMMUNITY EMERGENCY RESPONSE TEAM
UNIT 4: DISASTER MEDICAL OPERATIONS — PART 2

PM, P. 4-30

Displaced and Nondisplaced Fractures

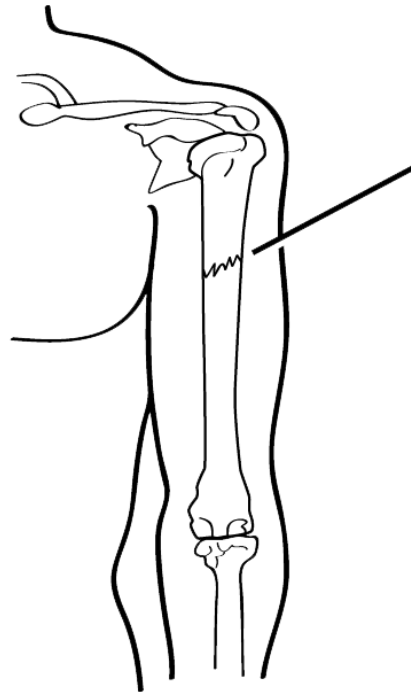

Nondisplaced Fracture

Nondisplaced Fracture in which the fractured bone remains aligned.

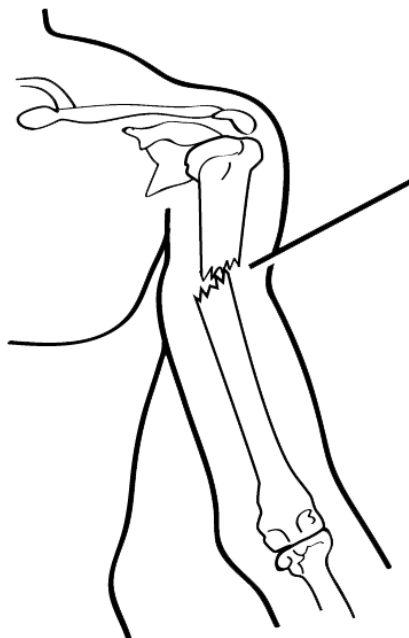



Displaced Fracture

Displaced Fracture in which the fractured bone is no longer aligned.

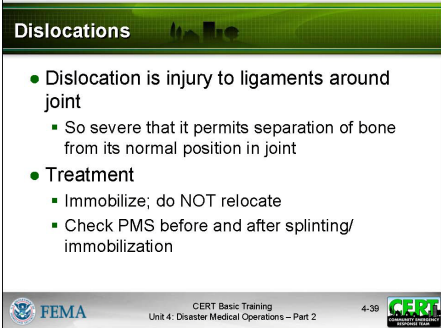
**COMMUNITY EMERGENCY RESPONSE TEAM
UNIT 4: DISASTER MEDICAL OPERATIONS — PART 2**

INSTRUCTOR GUIDANCE	CONTENT
<div data-bbox="188 470 626 795"><p>Dislocations</p><ul style="list-style-type: none">● Dislocation is injury to ligaments around joint<ul style="list-style-type: none">▪ So severe that it permits separation of bone from its normal position in joint● Treatment<ul style="list-style-type: none">▪ Immobilize; do NOT relocate▪ Check PMS before and after splinting/immobilization<p>FEMA CERT Basic Training Unit 4: Disaster Medical Operations – Part 2 4-39</p></div> <p>Display Slide 4-39</p>	<p>Dislocations</p> <p>Introduce this section by telling the group that dislocations are another common injury in emergencies.</p> <p>Explain that a dislocation is an injury to the ligaments around a joint that is so severe that it permits a separation of the bone from its normal position in a joint.</p> <p>Tell the participants that the signs of a dislocation are similar to those of a fracture and that a suspected dislocation should be treated like a fracture.</p> <p>Emphasize that, if dislocation is suspected, be sure to assess PMS (Pulse, Movement, Sensation) in the affected limb before and after splinting/immobilization. If PMS is compromised, the patient’s treatment priority is elevated to “I.”</p> <p>Stress that the participants should <u>not</u> try to relocate a suspected dislocation. They should immobilize the joint until professional medical help is available.</p> <p>Sprains and Strains</p> <p>Introduce this section by explaining that a sprain involves a stretching or tearing of ligaments at a joint and is usually caused by stretching or extending the joint beyond its normal limits.</p> <p>Point out that a <u>sprain</u> is considered a partial dislocation, although the bone either remains in place or is able to fall back into place after the injury.</p>

COMMUNITY EMERGENCY RESPONSE TEAM
UNIT 4: DISASTER MEDICAL OPERATIONS — PART 2

INSTRUCTOR GUIDANCE	CONTENT
<p data-bbox="191 367 626 695"></p> <p data-bbox="191 716 461 747">Display Slide 4-40</p> <p data-bbox="191 1304 266 1377"></p>	<p data-bbox="659 367 1419 428">Tell the group that the most common signs of a sprain are:</p> <ul data-bbox="659 449 1195 583" style="list-style-type: none">▪ Tenderness at the site of the injury▪ Swelling and/or bruising▪ Restricted use or loss of use <p data-bbox="659 806 1419 940">Remind the group that the signs of a sprain are similar to those of a nondisplaced fracture. Therefore, they should <u>not</u> try to treat the injury other than by immobilization and elevation.</p> <p data-bbox="659 978 1419 1081">Tell the group that a <u>strain</u> involves a stretching and/or tearing of muscles or tendons. Strains most often involve the muscles in the neck, back, thigh, or calf.</p> <p data-bbox="659 1119 1419 1253">Point out that in some cases, strains may be difficult to distinguish from sprains or fractures. Whether an injury is a strain, sprain, or fracture, treat the injury as if it is a fracture.</p> <p data-bbox="659 1291 1419 1362">Does anyone have any questions about fractures, dislocations, sprains, or strains?</p>

COMMUNITY EMERGENCY RESPONSE TEAM
UNIT 4: DISASTER MEDICAL OPERATIONS — PART 2

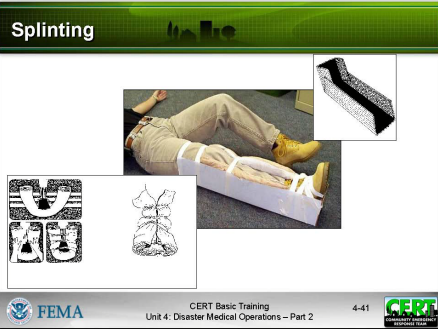
INSTRUCTOR GUIDANCE	CONTENT
 <p>Display Slide 4-41</p> <p>Remind the participants to be creative when looking for splinting materials. For example, consider using the victim's t-shirt as a makeshift sling. Remove the shirt and cut the lower portion of the shirt from armpit to armpit. Use the remaining band of fabric as a sling by placing one end under the injured arm and the other end over the victim's head.</p>	<h3>Splinting</h3> <p>Introduce this topic by explaining that splinting is the most common procedure for immobilizing an injury.</p> <p>Point out that cardboard is the material typically used for makeshift splints but a variety of materials can be used, including:</p> <ul style="list-style-type: none">▪ <u>Soft materials</u>. Towels, blankets, or pillows, tied with bandaging materials or soft cloths▪ <u>Rigid materials</u>. A board, metal strip, folded magazine or newspaper, or other rigid item <p>Add that <u>anatomical splints</u> may also be created by securing a fractured bone to an adjacent unfractured bone. Anatomical splints are usually reserved for fingers and toes, but, in an emergency, legs may also be splinted together.</p> <p>Soft materials should be used to fill the gap between the splinting material and the body part.</p>

**COMMUNITY EMERGENCY RESPONSE TEAM
UNIT 4: DISASTER MEDICAL OPERATIONS — PART 2**

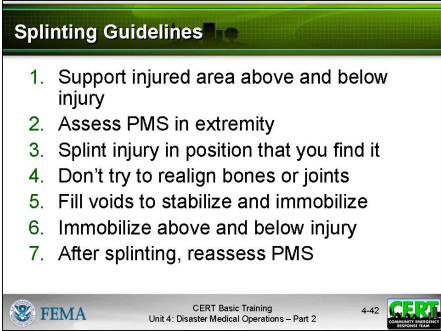
INSTRUCTOR GUIDANCE	CONTENT
<p>Demonstrate the correct procedures for splinting the upper and lower leg.</p>  <p>Display Slide 4-42</p> <p>PM, PP. 4-33 AND 4-34</p>	<p>During the demonstration, be sure to point out the guidelines for splinting:</p> <ol style="list-style-type: none">1. Support the injured area above and below the site of the injury, including the joints.2. Assess PMS in the extremity before initiating the splint.3. If possible, splint the injury in the position that you find it.4. Don't try to realign bones or joints.5. Fill the voids to further stabilize and immobilize the injury.6. Immobilize above and below the injury.7. After splinting, reassess PMS and evaluate against initial PMS assessment. <p>Tell the participants that, with this type of injury, there will be swelling. They should remove restrictive clothing, shoes, and jewelry when necessary to prevent these items from acting as unintended tourniquets.</p> <p>Refer the participants to the pages titled <i>Splint Illustrations</i> in the Participant Manual.</p>

PM, PP. 4-33 and 4-34

Splint Illustrations

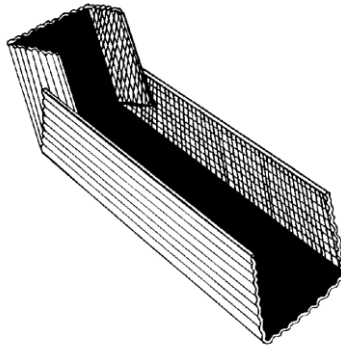

Cardboard Splint

Cardboard Splint in which the edges of the cardboard are turned up to form a “mold” in which the injured limb can rest.

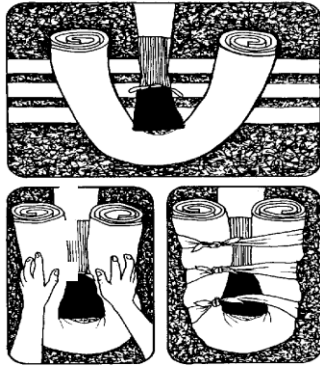

Splinting Using a Towel

Splinting using a towel, in which the towel is rolled up and wrapped around the limb, then tied in place.

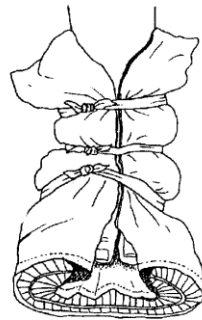

Pillow splint

Pillow splint, in which the pillow is wrapped around the limb and tied.

PM, PP. 4-33 and 4-34

Splint Illustrations

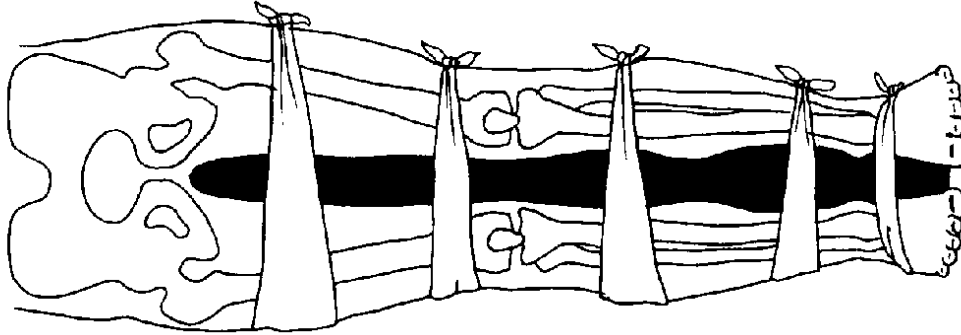

Anatomical Splint

Anatomical splint in which the injured leg is tied at intervals to the non-injured leg, using a blanket as padding between the legs.

COMMUNITY EMERGENCY RESPONSE TEAM
UNIT 4: DISASTER MEDICAL OPERATIONS — PART 2

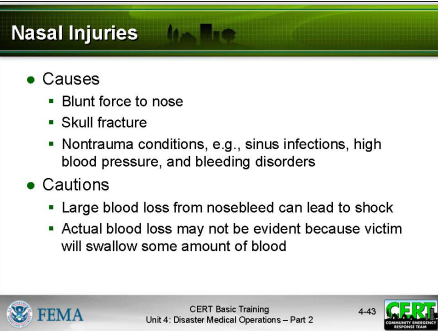
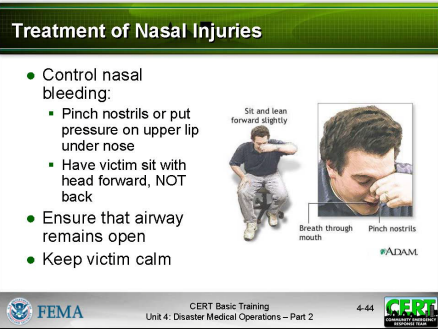
INSTRUCTOR GUIDANCE	CONTENT
<p data-bbox="191 472 626 800"></p> <p data-bbox="191 821 461 852">Display Slide 4-43</p> <p data-bbox="191 1230 623 1299">Demonstrate the correct procedures on the mannequin.</p> <p data-bbox="191 1455 626 1782"></p> <p data-bbox="191 1797 461 1829">Display Slide 4-44</p>	<p data-bbox="659 373 902 405"><i>Nasal Injuries</i></p> <p data-bbox="659 468 1430 537">Introduce this section by telling the group that bleeding from the nose can have several causes.</p> <p data-bbox="659 569 1425 600">Explain that bleeding from the nose can be caused by:</p> <ul data-bbox="659 621 1341 821" style="list-style-type: none">▪ Blunt force to the nose▪ Skull fracture▪ Nontrauma-related conditions such as sinus infections, high blood pressure, and bleeding disorders <p data-bbox="659 894 984 926">Caution the group that:</p> <ul data-bbox="659 947 1409 1094" style="list-style-type: none">▪ A large blood loss from a nosebleed can lead to shock▪ Actual blood loss may not be evident because the victim will swallow some amount of blood <p data-bbox="659 1115 1409 1184">Point out that those who have swallowed large amounts of blood may become nauseated and vomit.</p> <p data-bbox="659 1226 1312 1295">Demonstrate the methods for controlling nasal bleeding:</p> <ul data-bbox="659 1316 1398 1386" style="list-style-type: none">▪ Pinch the nostrils together▪ Put pressure on the upper lip just under the nose <p data-bbox="659 1449 1430 1518">Tell the participants that, while treating for nosebleeds, they should:</p> <ul data-bbox="659 1539 1430 1770" style="list-style-type: none">▪ Have the victim sit with the head slightly forward so that blood trickling down the throat will not be breathed into the lungs. Do not put the head back.▪ Ensure that the victim's airway remains open▪ Keep the victim quiet. Anxiety will increase blood flow.

COMMUNITY EMERGENCY RESPONSE TEAM
UNIT 4: DISASTER MEDICAL OPERATIONS — PART 2

INSTRUCTOR GUIDANCE	CONTENT
<p data-bbox="191 373 266 445"></p> <div data-bbox="188 743 626 1073"><p>Cold-Related Injuries</p><ul style="list-style-type: none">● Hypothermia :<ul style="list-style-type: none">▪ Occurs when body's temperature drops below normal● Frostbite:<ul style="list-style-type: none">▪ Occurs when extreme cold shuts down blood flow to extremities, causing tissue death</div> <p data-bbox="188 1073 626 1108">FEMA CERT Basic Training Unit 4: Disaster Medical Operations – Part 2 4-45</p> <p data-bbox="188 1073 461 1108">Display Slide 4-45</p> <div data-bbox="188 1398 626 1728"><p>Symptoms of Hypothermia</p><ul style="list-style-type: none">● Body temperature of 95° F or lower● Redness or blueness of skin● Numbness and shivering● Slurred speech● Unpredictable behavior● Listlessness</div> <p data-bbox="188 1728 626 1764">FEMA CERT Basic Training Unit 4: Disaster Medical Operations – Part 2 4-46</p> <p data-bbox="188 1728 461 1764">Display Slide 4-46</p>	<p data-bbox="659 363 1417 432">Does anyone have any questions about any of the injuries covered to this point in the unit?</p> <p data-bbox="659 499 1325 569">Tell the group that the next section will address treatment for cold-related injuries.</p> <p data-bbox="659 653 1187 688"><i>Treating Cold-Related Injuries</i></p> <p data-bbox="659 747 1357 816">Introduce this topic by explaining that cold-related injuries include:</p> <ul data-bbox="659 835 1430 1020" style="list-style-type: none">▪ <u>Hypothermia</u>, which is a condition that occurs when the body's temperature drops below normal▪ <u>Frostbite</u>, which occurs when extreme cold shuts down blood flow to extremities, causing tissue death <p data-bbox="659 1150 854 1186">Hypothermia</p> <p data-bbox="659 1226 1377 1362">Tell the group that hypothermia may be caused by exposure to cold air or water or by inadequate food combined with inadequate clothing and/or heat, especially in older people.</p> <p data-bbox="659 1402 1349 1472">Point out that the primary signs and symptoms of hypothermia are:</p> <ul data-bbox="659 1491 1341 1627" style="list-style-type: none">▪ A body temperature of 95° F (37° C) or lower▪ Redness or blueness of the skin▪ Numbness accompanied by shivering

**COMMUNITY EMERGENCY RESPONSE TEAM
UNIT 4: DISASTER MEDICAL OPERATIONS — PART 2**



INSTRUCTOR GUIDANCE	CONTENT
<div data-bbox="191 638 626 961"><p>Hypothermia Treatment</p><ul style="list-style-type: none">• Remove wet clothing• Wrap victim in blanket• Protect victim from weather• Provide food and drink to conscious victims• Do not attempt to massage to warm body• Place unconscious victim in recovery position• Place victim in warm bath<p><small>FEMA CERT Basic Training Unit 4: Disaster Medical Operations – Part 2 4-47</small></p></div> <p>Display Slide 4-47</p>	<p>Add that, in later stages, hypothermia will be accompanied by:</p> <ul style="list-style-type: none">▪ Slurred speech▪ Unpredictable behavior▪ Listlessness <p>Explain that because hypothermia can set in within only a few minutes, participants should treat victims who have been rescued from cold air or water environments.</p> <ul style="list-style-type: none">▪ Remove wet clothing.▪ Wrap the victim in a blanket or sleeping bag and cover the head and neck.▪ Protect the victim against the weather.▪ Provide warm, sweet drinks and food to conscious victims. <u>Do not offer alcohol.</u>▪ Do not attempt to use massage to warm affected body parts.▪ Place an unconscious victim in the recovery position:<ol style="list-style-type: none">1. Place the victim’s arm that is nearest to you at a right angle against the ground, with the palm facing up.2. Move the victim’s other arm across his or her chest and neck, with the back of the victim’s hand resting against his or her cheek.3. Grab a hold of the knee furthest from you and pull it up until the knee is bent and the foot is flat on the floor.4. Pull the knee toward you and over the victim’s body while holding the victim’s hand in place against his or her cheek.5. Position the victim’s leg at a right angle against the floor so that the victim is lying on his or her side.

**COMMUNITY EMERGENCY RESPONSE TEAM
UNIT 4: DISASTER MEDICAL OPERATIONS — PART 2**

INSTRUCTOR GUIDANCE	CONTENT
<p data-bbox="196 1157 418 1184">Symptoms of Frostbite</p> <ul data-bbox="215 1207 492 1285" style="list-style-type: none">● Skin discoloration● Burning or tingling sensation● Partial or complete numbness  <p data-bbox="306 1381 493 1421"><small>FIGURE 29-8 Edema and blister formation 24 hours after frostbite injury in an area covered by a tightly fitted boot. (From Auerbach PS. Wilderness medicine, ed 4, St Louis, 2001, Mosby)</small></p> <p data-bbox="196 1440 626 1465"><small>FEMA CERT Basic Training Unit 4: Disaster Medical Operations – Part 2 4-48</small></p>	<ul data-bbox="659 380 1357 443" style="list-style-type: none">▪ If the victim is conscious, place him or her in a warm bath. <p data-bbox="659 464 1425 604">Tell the participants not to allow the victim to walk around even when he or she appears to be fully recovered. If the victim must be moved outdoors, they should cover the victim's head and face.</p> <p data-bbox="659 680 797 711">Frostbite</p> <p data-bbox="659 756 1425 1100">Explain to the group that a person's blood vessels constrict in cold weather in an effort to preserve body heat. In extreme cold, the body will further constrict blood vessels in the extremities in an effort to shunt blood toward the core organs (heart, lungs, intestines, etc.). The combination of inadequate circulation and extreme temperatures will cause tissue in these extremities to freeze, and, in some cases, tissue death will result. Frostbite is most common in the hands, nose, ears, and feet.</p> <p data-bbox="659 1142 1386 1205">Tell the participants that there are several key signs and symptoms of frostbite:</p> <ul data-bbox="659 1226 1425 1394" style="list-style-type: none">▪ Skin discoloration (red, white, purple, black)▪ Burning or tingling sensation, at times not localized to the injury site▪ Partial or complete numbness

Display Slide 4-48

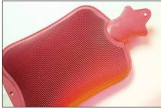
COMMUNITY EMERGENCY RESPONSE TEAM
UNIT 4: DISASTER MEDICAL OPERATIONS — PART 2

INSTRUCTOR GUIDANCE	CONTENT
<p data-bbox="196 373 626 407">Frostbite Treatment</p> <ul data-bbox="215 428 586 632" style="list-style-type: none">● Immerse injured area in warm (NOT hot) water<ul data-bbox="235 478 354 499" style="list-style-type: none">■ Warm slowly!● Do NOT allow part to re-freeze● Do NOT attempt to use massage● Wrap affected body parts in dry, sterile dressing  <p data-bbox="196 657 626 688">FEMA CERT Basic Training Unit 4: Disaster Medical Operations – Part 2 4-49</p> <p data-bbox="188 726 461 760">Display Slide 4-49</p> 	<p data-bbox="659 363 1422 499">Explain to the participants that a patient suffering from frostbite must be warmed slowly! Thawing the frozen extremity too rapidly can cause chilled blood to flow to the heart, shocking and potentially stopping it.</p> <ul data-bbox="659 520 1422 760" style="list-style-type: none">■ Immerse injured area in warm (NOT hot) water, approximately 107.6° F.■ Do NOT allow the body part to re-freeze as this will exacerbate the injury.■ Do NOT attempt to use massage to warm affected body parts. <p data-bbox="659 779 1438 947">Tell the participants to wrap affected body parts in dry, sterile dressing. Again, it is vital this task be completed carefully. Frostbite results in the formation of ice crystals in the tissue; rubbing could potentially cause a great deal of damage!</p> <p data-bbox="659 989 1341 1052">Does anyone have any questions about cold-related injuries?</p> <p data-bbox="659 1104 1390 1167">Explain that heat-related injuries will be discussed in the next section.</p>

COMMUNITY EMERGENCY RESPONSE TEAM
UNIT 4: DISASTER MEDICAL OPERATIONS — PART 2

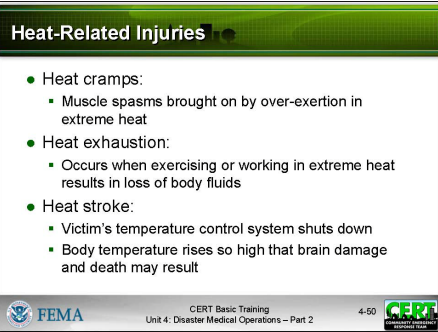
INSTRUCTOR GUIDANCE	CONTENT
<p data-bbox="191 464 626 793">Heat-Related Injuries<ul style="list-style-type: none">Heat cramps:<ul style="list-style-type: none">Muscle spasms brought on by over-exertion in extreme heatHeat exhaustion:<ul style="list-style-type: none">Occurs when exercising or working in extreme heat results in loss of body fluidsHeat stroke:<ul style="list-style-type: none">Victim's temperature control system shuts downBody temperature rises so high that brain damage and death may result<p>FEMA CERT Basic Training Unit 4: Disaster Medical Operations – Part 2 4-50</p></p>	<p data-bbox="659 373 1187 411"><i>Treating Heat-Related Injuries</i></p> <p data-bbox="659 468 1369 569">Tell the participants that there are several types of heat-related injuries that they may encounter in a disaster scenario:</p> <ul data-bbox="659 590 1438 1035" style="list-style-type: none"><u>Heat cramps</u> are muscle spasms brought on by over-exertion in extreme heat.<u>Heat exhaustion</u> occurs when an individual exercises or works in extreme heat, resulting in loss of body fluids through heavy sweating. Blood flow to the skin increases, causing blood flow to decrease to the vital organs. This results in a mild form of shock.<u>Heat stroke</u> is life threatening. The victim's temperature control system shuts down, and body temperature can rise so high that brain damage and death may result. <p data-bbox="659 1089 911 1121">Heat Exhaustion</p> <p data-bbox="659 1161 1438 1226">Explain to the group that the following are symptoms of heat exhaustion:</p> <ul data-bbox="659 1247 1167 1528" style="list-style-type: none">Cool, moist, pale, or flushed skinHeavy sweatingHeadacheNausea or vomitingDizzinessExhaustion <p data-bbox="659 1549 1382 1650">A patient suffering heat exhaustion will have a near normal body temperature. If left untreated, heat exhaustion will develop into heat stroke.</p>

Display Slide 4-50

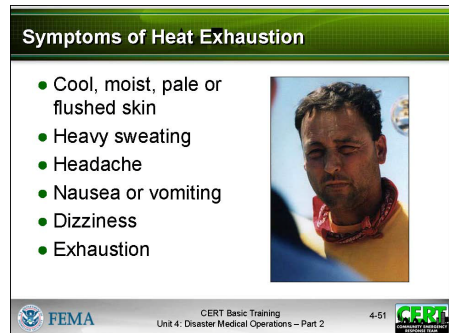

Display Slide 4-51



**COMMUNITY EMERGENCY RESPONSE TEAM
UNIT 4: DISASTER MEDICAL OPERATIONS — PART 2**

INSTRUCTOR GUIDANCE	CONTENT
<p>Symptoms of Heat Stroke</p> <ul style="list-style-type: none">• Hot, red skin• Lack of perspiration• Changes in consciousness• Rapid, weak pulse and rapid, shallow breathing <p><small>FEMA CERT Basic Training Unit 4: Disaster Medical Operations – Part 2 4-52</small></p>	<h3>Heat Stroke</h3> <p>Tell the participants that heat stroke is characterized by some or all of the following symptoms:</p> <ul style="list-style-type: none">▪ Hot, red skin▪ Lack of perspiration▪ Changes in consciousness▪ Rapid, weak pulse and rapid, shallow breathing
<p>Display Slide 4-52</p>	<p>In a heat stroke victim, body temperature can be very high — as high as 105° F. If an individual suffering from heat stroke is not treated, death can result!</p>
<p>Treatment of Heat-Related Injuries</p> <ul style="list-style-type: none">• Remove from heat to cool environment• Cool body slowly• Have the victim drink water, SLOWLY• No food or drink if victim is experiencing vomiting, cramping, or is losing consciousness <p><small>FEMA CERT Basic Training Unit 4: Disaster Medical Operations – Part 2 4-53</small></p>	<h3>Treatment</h3> <p>Explain that treatment is similar for both heat exhaustion and heat stroke.</p> <ol style="list-style-type: none">1. Take the victim out of the heat and place in a cool environment.2. Cool the body slowly with cool, wet towels or sheets. If possible, put the victim in a cool bath.3. Have the victim drink water, SLOWLY, at the rate of approximately half a glass of water every 15 minutes. Consuming too much water too quickly will cause nausea and vomiting in a victim of heat sickness.4. If the victim is experiencing vomiting, cramping, or is losing consciousness, DO NOT administer food or drink. Alert a medical professional as soon as possible, and keep a close watch on the individual until professional help is available.
<p>Display Slide 4-53</p> 	<p>Does anyone have any questions about any of the heat-related injuries covered in this section?</p> <p>Tell the group that the next section will address treatment for insect bites and stings.</p>

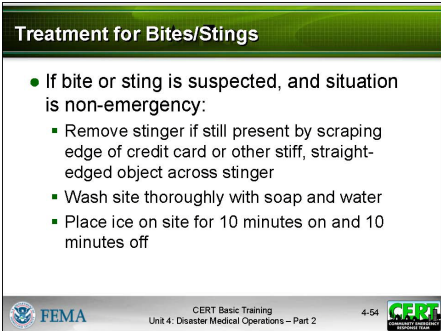
**COMMUNITY EMERGENCY RESPONSE TEAM
UNIT 4: DISASTER MEDICAL OPERATIONS — PART 2**

INSTRUCTOR GUIDANCE	CONTENT
<p>Discuss insects and/or animals that pose a particular threat to your locality.</p> <div data-bbox="188 957 626 1285"></div> <p>Display Slide 4-54</p>	<p><i>Bites and Stings</i></p> <p>Remind the participants that in a disaster environment, everything is shaken from normalcy, including insects and animals. In this time of chaos, insect bites and stings may be more common than is typical as these creatures, like people, are under additional stress.</p> <p>Tell the group that, when conducting a head-to-toe assessment, they should look for signs of insect bites and stings. The specific symptoms vary depending on the type of creature, but, generally, bites and stings will be accompanied by redness and itching, tingling or burning at the site of the injury, and often a welt on the skin at the site.</p> <p>Explain that, in general, treatment for insect bites and stings follows these steps:</p> <ol style="list-style-type: none">1. Remove the stinger if still present by scraping the edge of a credit card or other stiff, straight-edged object across the stinger. Do not use tweezers; these may squeeze the venom sac and increase the amount of venom released.2. Wash the site thoroughly with soap and water.3. Place ice (wrapped in a washcloth) on the site of the sting for 10 minutes and then off for 10 minutes. Repeat this process. <p>Tell the participants that they may help the victim take his or her own allergy medicine (Benadryl, etc.), but that they may NOT dispense medications.</p>

**COMMUNITY EMERGENCY RESPONSE TEAM
UNIT 4: DISASTER MEDICAL OPERATIONS — PART 2**

INSTRUCTOR GUIDANCE	CONTENT
<div data-bbox="188 436 626 762"><p>Anaphylaxis</p><ul style="list-style-type: none">• Check airway and breathing• Calm individual• Remove constrictive clothing and jewelry• Find and help administer victim's Epi-pen• Watch for signs of shock and treat appropriately<p>FEMA CERT Basic Training Unit 4: Disaster Medical Operations – Part 2 4-55</p></div> <p>Display Slide 4-55</p> <p>Demonstrate how to administer an Epi-pen. If possible, pass one around the room to familiarize the group with it.</p> <p>Emphasize that CERT members do not administer medications, including over-the-counter products such as aspirin. CERT members can assist victims in administering their own medications (e.g., Epi-pen).</p> 	<p>Bites and Stings and Allergic Reactions</p> <p>Tell the participants that the greatest concern with any insect bite or sting is a severe allergic reaction, or anaphylaxis. Anaphylaxis occurs when an allergic reaction becomes so severe that the airway is compromised. If you suspect anaphylaxis:</p> <ol style="list-style-type: none">1. Check airway and breathing.2. Calm the individual.3. Remove constrictive clothing and jewelry as the body often swells in response to the allergen.4. If possible, find and help administer a victim's Epi-pen. Many severe allergy sufferers carry one at all times.<ol style="list-style-type: none">a. DO NOT administer medicine aside from the Epi-pen. This includes pain relievers, allergy medicine, etc.5. Watch for signs of shock and treat appropriately. <p>Remind the participants to keep a close watch on the individual's airway and breathing. Seek professional medical help as soon as possible.</p> <p>Does anyone have any questions about any of the injuries covered in this section?</p>

**COMMUNITY EMERGENCY RESPONSE TEAM
UNIT 4: DISASTER MEDICAL OPERATIONS — PART 2**

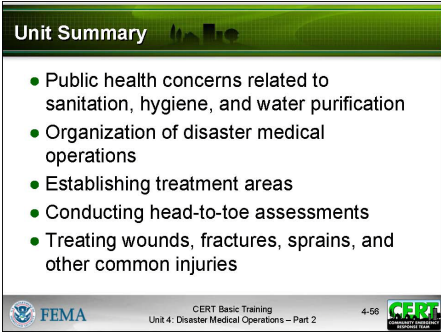
INSTRUCTOR GUIDANCE	CONTENT
<div data-bbox="188 464 626 793">A thumbnail of a presentation slide titled "Unit Summary". The slide lists five bullet points: Public health concerns related to sanitation, hygiene, and water purification; Organization of disaster medical operations; Establishing treatment areas; Conducting head-to-toe assessments; and Treating wounds, fractures, sprains, and other common injuries. The slide footer includes the FEMA logo, "CERT Basic Training", "Unit 4: Disaster Medical Operations - Part 2", the slide number "4-56", and the CERT logo.<p>Unit Summary</p><ul style="list-style-type: none">• Public health concerns related to sanitation, hygiene, and water purification• Organization of disaster medical operations• Establishing treatment areas• Conducting head-to-toe assessments• Treating wounds, fractures, sprains, and other common injuries<p>FEMA CERT Basic Training Unit 4: Disaster Medical Operations - Part 2 4-56 CERT</p></div> <p>Display Slide 4-56</p>	<p><i>Unit Summary</i></p> <p>Begin the summary by first congratulating the group on completing the disaster medical operations sessions. Remind them that they have learned an enormous amount about how to recognize and treat life-threatening and other common disaster-related injuries — and that they have proven their knowledge and skills in high-pressure exercises.</p> <p>Summarize the key points of this unit:</p> <ul style="list-style-type: none">▪ To safeguard public health, take measures to maintain proper hygiene and sanitation, and purify water if necessary. All public health measures should be planned in advance and practiced during exercises.▪ Disaster medical operations include five functions:<ul style="list-style-type: none">• Triage• Treatment• Transport• Morgue• Supply▪ Treatment areas must be established as soon as casualties are confirmed. Treatment areas should be:<ul style="list-style-type: none">• In a safe area that is close to, but uphill, upwind, and, if possible, upstream from the hazard area• Accessible by transportation vehicles• Expandable

**COMMUNITY EMERGENCY RESPONSE TEAM
UNIT 4: DISASTER MEDICAL OPERATIONS — PART 2**

INSTRUCTOR GUIDANCE	CONTENT
	<p>Depending on the circumstances, a CERT may establish a central medical treatment location and/or treatment locations at incident sites where many victims have been injured.</p> <ul style="list-style-type: none">▪ Head-to-toe assessments should be verbal and hands-on. Always conduct head-to-toe assessments in the same way — beginning with the head and moving toward the feet. If injuries to the head, neck, or spine are suspected, the main objective is to not cause additional injury. Use in-line stabilization and a backboard if the victim must be moved.▪ Burns are classified as superficial, partial thickness, or full thickness depending on severity and the depth of skin layers involved. Treatment for burns involves removing the source of the burn, cooling the burn, and covering it. For full thickness burns, always treat for shock.▪ The main first aid treatment for wounds consists of:<ul style="list-style-type: none">• Controlling bleeding• Cleaning• Dressing and bandaging▪ In the absence of active bleeding, dressings must be removed and the wound checked for infection at least every 4 to 6 hours. If there is active bleeding, a new dressing should be placed <u>over</u> the existing dressing.▪ Fractures, dislocations, sprains, and strains may have similar signs. Treat all suspected fractures, sprains, and strains by immobilizing the affected area using a splint.▪ The key to treatment of cold-related injuries such as hypothermia and frostbite is to warm the victim slowly.

**COMMUNITY EMERGENCY RESPONSE TEAM
UNIT 4: DISASTER MEDICAL OPERATIONS — PART 2**

INSTRUCTOR GUIDANCE	CONTENT
	<ul style="list-style-type: none">▪ Anaphylaxis is the most critical concern when an insect bite is suspected. Be prepared to assist the victim in using an Epi-pen and make sure to monitor the victim's airway until professional help arrives. <p>Remind the group that there is much more to learn about medical operations than could possibly be presented in two 2- to 3-hour sessions. Recommend strongly that the participants attend additional training that is offered through the American Red Cross or through community colleges.</p> <p>Remind the group also that disaster medical operations is a team effort and that, like all teams, they must practice together so that they can function as a team under pressure. Encourage the participants to attend exercise simulations whenever they are offered locally.</p>

**COMMUNITY EMERGENCY RESPONSE TEAM
UNIT 4: DISASTER MEDICAL OPERATIONS — PART 2**

INSTRUCTOR GUIDANCE	CONTENT
<p data-bbox="196 457 418 485">Homework Assignment</p> <ul data-bbox="212 506 591 701" style="list-style-type: none">● Read unit to be covered in next session● Bring necessary supplies for next session● Wear appropriate clothes for next session● Practice complete head-to-toe assessment on friend or family member  <p data-bbox="196 730 626 762">FEMA CERT Basic Training Unit 4: Disaster Medical Operations – Part 2 4-57</p> <p data-bbox="188 804 459 835">Display Slide 4-57</p>	<p data-bbox="659 363 1016 394">Homework Assignment</p> <p data-bbox="659 443 1442 506">Ask the group to read and become familiar with the unit that will be covered in the next session.</p> <p data-bbox="659 548 1442 642">Tell them to try practicing a rapid head-to-toe assessment on a friend or family member. Don't forget to document!</p> <p data-bbox="659 877 1414 972">Thank all of the participants for attending the session and remind the group of the date and time of the next session, if necessary.</p>

UNIT 5: LIGHT SEARCH AND RESCUE OPERATIONS

In this unit you will learn about:

- **Search and Rescue Sizeup:** How to size up the situation in which the search and rescue teams will operate.
- **Conducting Interior and Exterior Search Operations:** How to search systematically for disaster victims.
- **Conducting Rescue Operations:** Safe techniques for lifting, leveraging, cribbing, and victim removal.

COMMUNITY EMERGENCY RESPONSE TEAM
UNIT 5: LIGHT SEARCH AND RESCUE OPERATIONS

OBJECTIVES	<p>At the conclusion of this unit, the participants should be able to:</p> <ul style="list-style-type: none">▪ Identify sizeup requirements for potential search and rescue situations.▪ Describe the most common techniques for searching, both interior and exterior.▪ Use safe techniques for debris removal and victim extrication.▪ Describe ways to protect rescuers during search and rescue.
-------------------	---

SCOPE	<p>The topics that will be discussed in this unit are:</p> <ul style="list-style-type: none">▪ Introduction and Unit Overview▪ Safety During Search and Rescue Operations▪ Conducting Interior and Exterior Search Operations▪ Conducting Rescue Operations▪ Unit Summary
--------------	---

ESTIMATED COMPLETION TIME	2 hours 30 minutes
--	--------------------

TRAINING METHODS	<p>The lead instructor will begin this session by welcoming the participants to Unit 5: Light Search and Rescue Operations, and will introduce the instructors for the unit. The instructor will then present a brief overview of this unit, including making the distinction between search and rescue, the goals of search and rescue, search and rescue priorities, and the steps involved in effective search and rescue for both interior and exterior areas.</p> <p>Next, the instructor will review the sizeup process as it applies to search and rescue. At this time, the instructor will emphasize the most dangerous construction-related hazards. The instructor will emphasize the importance of rescuer safety in all sizeup decisions. Participants will complete a sizeup exercise using either the scenarios provided or locally prepared scenarios.</p>
-----------------------------	--

COMMUNITY EMERGENCY RESPONSE TEAM
UNIT 5: LIGHT SEARCH AND RESCUE OPERATIONS

**TRAINING
METHODS
(CONTINUED)**

The next section will deal with search techniques for locating potential victims. The instructor will identify the types of voids and collapses that CERT members should avoid and the methods that searchers can use for locating victims and documenting their positions within lightly or moderately damaged structures.

Finally, the instructor will describe rescue techniques and methods for lifting, debris removal, and finally, victim removal. The instructors will demonstrate leveraging and cribbing. The instructors will also demonstrate using lifts and drags as victim removal techniques, and the participants will practice those techniques under instructor observation. At the end of this section, the group will participate in a simulation involving both debris removal and victim removal.

**RESOURCES
REQUIRED**

- *Community Emergency Response Team Instructor Guide*
- *Community Emergency Response Team Participant Manual*
- PowerPoint slides 5-0 through 5-48

**OTHER
RESOURCES**

If time permits, all or portions of the 32-minute video *CERT Training: Safety in the Post-Disaster Environment* are recommended for this unit. The video provides an overview of safety considerations for CERT responders and is available for download at the national CERT Web site: www.citizencorps.gov/cert.

COMMUNITY EMERGENCY RESPONSE TEAM
UNIT 5: LIGHT SEARCH AND RESCUE OPERATIONS

EQUIPMENT

In addition to the equipment listed at the front of this Instructor Guide, you will need the following equipment for this session. The number of each item needed for practicing victim extrication and carries will depend on the number of groups practicing these skills at the same time.

- A computer with PowerPoint software
- A computer projector and screen
- Mannequin(s) or rescue dummy(ies) for extrication
- Blankets for victim carries
- Appropriate chairs for victim carries
- Large, flat objects (e.g., table) and pieces of wood for leveraging and cribbing
- Pry bars or long 2" x 4" pieces of lumber

PREPARATION

For the exercise titled *Gathering Facts*, a scenario has already been developed. The scenario appears in the Participant Manual and on page 5-18 in this Instructor Guide. You should feel free to alter the scenario to reflect the community's needs.

The exercise titled *Search and Rescue Sizeup* requires the preparation of scenarios that are realistic for your community. This exercise appears in the Participant Manual and on page 5-35 in this Instructor Guide. Be sure to prepare the scenarios in advance of the session and have copies for each participant. Include the following types of information in the scenarios:

- Type of event
- Intensity, severity, and duration
- Occupancy affected
- Current and forecast weather conditions
- Time of day and week
- Other factors that may affect search and rescue operations

COMMUNITY EMERGENCY RESPONSE TEAM
UNIT 5: LIGHT SEARCH AND RESCUE OPERATIONS

**PREPARATION
(CONTINUED)**

Information that is provided about assessment of probable damage in relation to types of construction focuses primarily on earthquake damage. For other types of disasters (e.g., tornadoes, hurricanes, or floods) likely to occur in your area, obtain and add information about their probable impact on various types of construction.

NOTES

Remember as you work through this unit with the group to stress the role of the CERT in search and rescue. The participants must come away from the training with an understanding of their limitations and the attitude that their safety is paramount, even above that of the victims.

A suggested time plan for this unit is as follows:

Introduction and Unit Overview.....	5 minutes
Safety During Search and Rescue Operations	45 minutes
Conducting Interior and Exterior Search Operations	35 minutes
Conducting Rescue Operations.....	60 minutes
Unit Summary	5 minutes



Total Time: 2 hours 30 minutes

For the purposes of time and comprehension, this unit may be divided into two units and taught separately. Should you choose to do this, you are advised to teach through “Conducting Interior and Exterior Search Operations” in the first session and resume with “Conducting Rescue Operations” in the second session.

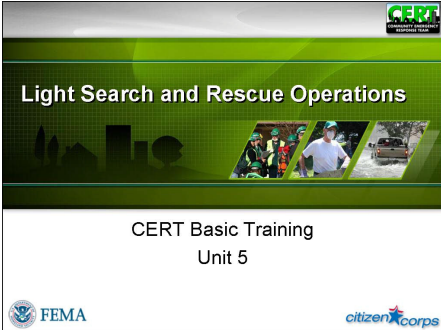

REMARKS

Search and rescue sizeup is based on the model introduced in Unit 2: Fire Safety and Utility Controls. Review the sizeup section carefully and develop examples of damage levels based on the hazards faced and the types of structures that are common to your community. Provide these examples at appropriate points in the instruction to illustrate important learning points.

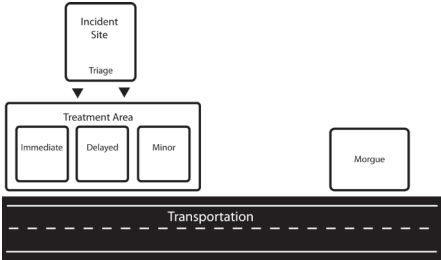
Unit 5: Light Search and Rescue Operations

INSTRUCTOR GUIDANCE	CONTENT
<div data-bbox="188 630 626 957">  </div> <p data-bbox="188 993 443 1029">Display Slide 5-0</p> <div data-bbox="188 1230 266 1304">  </div> <p data-bbox="188 1339 443 1375">Correct response:</p> <div data-bbox="188 1409 626 1667">  </div> <p data-bbox="188 1675 605 1705"><small>Treatment area layout, showing the organization for the incident site, triage, transportation, and morgue</small></p>	<p data-bbox="659 663 1153 699"><i>Introductions and Overview</i></p> <p data-bbox="659 764 800 800">Welcome</p> <p data-bbox="659 821 1393 888">Introduce this session by welcoming the participants to Unit 5 of the <i>CERT Basic Training</i>.</p> <p data-bbox="659 930 1403 1035">Introduce the instructors for this session and ask any new instructors to describe briefly their experience with search and rescue operations.</p> <p data-bbox="659 1136 1157 1171">Briefly review the fire safety lesson.</p> <p data-bbox="659 1230 1403 1335">Who can explain or diagram a good arrangement for the treatment area in relation to the incident site and transportation availability?</p>

COMMUNITY EMERGENCY RESPONSE TEAM
UNIT 5: LIGHT SEARCH AND RESCUE OPERATIONS

INSTRUCTOR GUIDANCE	CONTENT
 <p>Correct response:</p> <ul style="list-style-type: none">▪ Deformities▪ Contusions (bruising)▪ Abrasions▪ Punctures▪ Burns▪ Tenderness▪ Lacerations▪ Swelling	<p>What are you looking for in a head-to-toe assessment?</p>
 <p>Correct response:</p> <ul style="list-style-type: none">▪ Cool the burned area.▪ Cover with a sterile cloth to reduce the risk of infection (to keep fluids in and germs out).	<p>What are your objectives when treating burns?</p>
 <p>Correct response:</p> <p>Redress <u>over</u> the existing dressing and maintain pressure and elevation to control bleeding.</p>	<p>How do you dress a wound when there is active bleeding?</p>



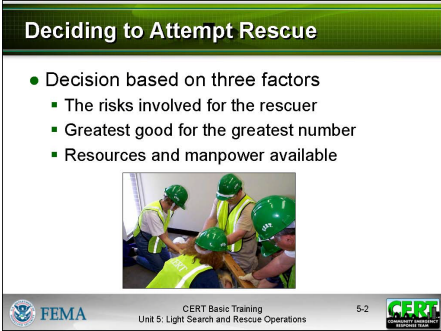

COMMUNITY EMERGENCY RESPONSE TEAM
UNIT 5: LIGHT SEARCH AND RESCUE OPERATIONS

INSTRUCTOR GUIDANCE	CONTENT
<div data-bbox="188 407 267 480" data-label="Image"> </div> <p data-bbox="188 516 444 548">Correct response:</p> <p data-bbox="188 590 591 657">Immobilize the affected area using a splint.</p> <div data-bbox="188 730 626 1056" data-label="Image"> </div> <p data-bbox="188 1094 441 1125">Display Slide 5-1</p> <p data-bbox="188 1167 571 1308">If not already discussed, explain that documentation will be covered more in a later unit.</p>	<p data-bbox="657 407 1352 474">If you are not sure whether it is a fracture or a sprain, what should you do?</p> <p data-bbox="657 705 870 737">Unit Overview</p> <p data-bbox="657 758 1336 825">Explain that search and rescue consists of three separate operations:</p> <ul data-bbox="657 852 1409 1129" style="list-style-type: none"> ▪ <u>Sizeup</u> involves assessing the situation and determining a safe action plan (using the 9-step sizeup model). ▪ <u>Search</u> involves locating victims and documenting their location. ▪ <u>Rescue</u> involves the procedures and methods required to extricate the victims. <p data-bbox="657 1157 1409 1329">Point out that previous disasters have shown that the first response to trapped victims immediately after almost every disaster is by spontaneous, untrained, and well-intentioned persons who rush to the site of a collapse in an attempt to free the victims.</p>





COMMUNITY EMERGENCY RESPONSE TEAM
UNIT 5: LIGHT SEARCH AND RESCUE OPERATIONS

INSTRUCTOR GUIDANCE	CONTENT
<p>Use the example from the earthquake in Mexico City, where spontaneous efforts saved 700 lives — but cost the lives of more than 100 people — to add emphasis to this discussion.</p> <p>Point out that the Mexico City example is not isolated, but is part of a larger pattern of behavior in emergencies, ranging from accidental drowning in which the would-be rescuer also drowns, to the massive influx of often untrained volunteers following major disasters.</p> <div data-bbox="188 1125 626 1453"></div> <p>Display Slide 5-2</p>	<p>Emphasize that, more often than not, these spontaneous rescue efforts result in serious injuries and compounded problems.</p> <p>Point out that rescue efforts should be planned and practiced in advance. People, including rescuers, have died when the rescuers weren't prepared and trained.</p> <p>Deciding to Attempt Rescue</p> <p>Explain that the decision to attempt a rescue should be based on three factors:</p> <ul style="list-style-type: none">▪ The risks involved to the rescuer▪ The overall goal of doing the greatest good for the greatest number of people▪ Resources and manpower available

COMMUNITY EMERGENCY RESPONSE TEAM
UNIT 5: LIGHT SEARCH AND RESCUE OPERATIONS

INSTRUCTOR GUIDANCE	CONTENT
<p data-bbox="191 443 626 772">Goals of Search and Rescue</p> <ul style="list-style-type: none">● Rescue greatest number in shortest amount of time● Get walking wounded out first● Rescue lightly trapped victims next● Keep the rescuer safe <p data-bbox="191 737 626 772"> CERT Basic Training Unit 5: Light Search and Rescue Operations 5-3 </p> <p data-bbox="191 810 444 846">Display Slide 5-3</p> <p data-bbox="191 926 626 1255">Effective Search and Rescue</p> <ul style="list-style-type: none">● Depends on:<ul style="list-style-type: none">■ Effective sizeup■ Rescuer safety■ Victim safety <p data-bbox="383 1016 613 1188"></p> <p data-bbox="191 1220 626 1255"> CERT Basic Training Unit 5: Light Search and Rescue Operations 5-4 </p> <p data-bbox="191 1287 444 1323">Display Slide 5-4</p>	<p data-bbox="659 405 1089 441">Goals of Search and Rescue</p> <p data-bbox="659 478 1430 548">Explain that the goals of search and rescue operations are to:</p> <ul style="list-style-type: none">■ Rescue the greatest number of people in the shortest amount of time■ Get the walking wounded and ambulatory victims out first■ Rescue lightly trapped victims next■ Keep the rescuer safe <p data-bbox="659 926 1094 961">Effective Search and Rescue</p> <p data-bbox="659 999 1382 1068">Explain that effective search and rescue operations hinge on:</p> <ul style="list-style-type: none">■ Effective sizeup■ Rescuer safety■ Victim safety <p data-bbox="659 1245 1382 1423">Tell the participants that this unit will focus on the components of an effective search and rescue operation — sizeup, search, and rescue — and the methods and techniques that rescuers can use to locate and safely remove victims.</p>

COMMUNITY EMERGENCY RESPONSE TEAM
UNIT 5: LIGHT SEARCH AND RESCUE OPERATIONS

INSTRUCTOR GUIDANCE	CONTENT
<p>Unit Objectives</p> <ul style="list-style-type: none">● Identify sizeup requirements● Describe most common search techniques● Use safe techniques for debris removal● Use safe techniques for victim extrication● Describe ways to protect rescuers <p> CERT Basic Training Unit 5: Light Search and Rescue Operations 5-5 </p> <p>Display Slide 5-5</p>	<p>Unit Objectives</p> <p>Tell the participants that at the end of this unit, they should be able to:</p> <ul style="list-style-type: none">▪ Identify sizeup requirements for potential search and rescue situations▪ Describe the most common techniques for searching, both interior and exterior▪ Use safe techniques for debris removal and victim extrication▪ Describe ways to protect rescuers during search and rescue operations
<p>Unit Topics</p> <ul style="list-style-type: none">● Safety During Search and Rescue Operations● Conducting Interior and Exterior Searches● Conducting Rescue Operations <p> CERT Basic Training Unit 5: Light Search and Rescue Operations 5-6 </p> <p>Display Slide 5-6</p> <p></p>	<p>Unit Topics</p> <p>Preview the unit topics by telling the group that the unit will provide them with the knowledge and skills that they will need:</p> <ul style="list-style-type: none">▪ Safety During Search and Rescue Operations▪ Conducting Interior and Exterior Searches▪ Conducting Rescue Operations <p>Does anyone have any questions about what will be covered in this unit?</p>

COMMUNITY EMERGENCY RESPONSE TEAM
UNIT 5: LIGHT SEARCH AND RESCUE OPERATIONS

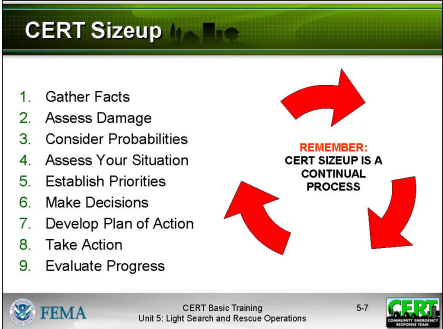
INSTRUCTOR GUIDANCE	CONTENT
 <p>Display Slide 5-7</p> <p>If you have not yet taught Unit 2, you will have to explain the 9 steps of sizeup in more depth now.</p>	<h3><i>Safety During Search and Rescue Operations</i></h3> <p>Introduce search and rescue techniques by re-emphasizing the importance of CERT safety measures, including appropriate PPE, use of the buddy system, and knowing your limitations.</p> <h3>CERT Search and Rescue Sizeup</h3> <p>Remind the participants that, like every other CERT operation, search and rescue requires sizeup at the beginning of the operation and continually as long as the operation continues.</p> <p>Review the 9 steps of the continual sizeup process that was presented in Unit 2.</p> <ol style="list-style-type: none">1. Gather facts2. Assess damage3. Consider probabilities4. Assess your situation5. Establish priorities6. Make decisions7. Develop a plan of action8. Take action9. Evaluate progress <p>Stress the need for a Safety Officer if the decision is made to take action.</p>

COMMUNITY EMERGENCY RESPONSE TEAM
UNIT 5: LIGHT SEARCH AND RESCUE OPERATIONS

INSTRUCTOR GUIDANCE	CONTENT
PM, P. 5-5 through 5-7	<p>Refer the participants to the <i>CERT Search and Rescue Sizeup Checklist</i> in the Participant Manual, and review the steps briefly.</p> <p>Tell the group that this section will focus on sizeup as it relates to both interior and exterior search and rescue operations.</p>

COMMUNITY EMERGENCY RESPONSE TEAM
UNIT 5: LIGHT SEARCH AND RESCUE OPERATIONS

PM, P. 5-5 through 5-7	CERT Search and Rescue Sizeup Checklist
------------------------	--

Step 1: Gather Facts		
<i>Time</i>		
<ul style="list-style-type: none"> ▪ Does the time of day or week affect search and rescue efforts? <p style="margin-left: 20px;">How?</p>	Yes <input type="checkbox"/>	No <input type="checkbox"/>
<i>Type of Construction and Terrain</i>		
<ul style="list-style-type: none"> ▪ What type(s) of structure(s) is (are) involved? ▪ What type(s) of construction is (are) involved? ▪ What type(s) of terrain is (are) involved? 		
<i>Occupancy</i>		
<ul style="list-style-type: none"> ▪ Are the structures occupied? <p style="margin-left: 20px;">If yes, how many people are likely to be affected?</p>	Yes <input type="checkbox"/>	No <input type="checkbox"/>
<ul style="list-style-type: none"> ▪ Are there special considerations (e.g., children, elderly)? <p style="margin-left: 20px;">If yes, what are the special considerations?</p>	Yes <input type="checkbox"/>	No <input type="checkbox"/>
<i>Weather</i>		
<ul style="list-style-type: none"> ▪ Will weather conditions affect your safety? <p style="margin-left: 20px;">If yes, how will your safety be affected?</p>	Yes <input type="checkbox"/>	No <input type="checkbox"/>

COMMUNITY EMERGENCY RESPONSE TEAM
UNIT 5: LIGHT SEARCH AND RESCUE OPERATIONS

<ul style="list-style-type: none"> ▪ Will weather conditions affect the search and rescue situation? If yes, how will the search and rescue situation be affected? 	Yes <input type="checkbox"/>	No <input type="checkbox"/>
<i>Hazards</i>		
<ul style="list-style-type: none"> ▪ Are hazardous materials involved? If yes, at what location? 	Yes <input type="checkbox"/>	No <input type="checkbox"/>
<ul style="list-style-type: none"> ▪ Are any other types of hazards involved? If yes, what other hazards? 	Yes <input type="checkbox"/>	No <input type="checkbox"/>
Step 2: Assess and Communicate the Damage		
<ul style="list-style-type: none"> ▪ For structural searches, take a lap around the building. Is the damage beyond the CERT's capability? If yes, what special requirements or qualifications are required? 	Yes <input type="checkbox"/>	No <input type="checkbox"/>
<ul style="list-style-type: none"> ▪ Have the facts and the initial damage assessment been communicated to the appropriate person(s)? 	Yes <input type="checkbox"/>	No <input type="checkbox"/>
Step 3: Consider Probabilities		
<ul style="list-style-type: none"> ▪ Is the situation stable? 	Yes <input type="checkbox"/>	No <input type="checkbox"/>
<ul style="list-style-type: none"> ▪ Is there great risk or potential for more disaster activity that will impact personal safety? If yes, what are the known risks? 	Yes <input type="checkbox"/>	No <input type="checkbox"/>

COMMUNITY EMERGENCY RESPONSE TEAM
UNIT 5: LIGHT SEARCH AND RESCUE OPERATIONS

<ul style="list-style-type: none"> ▪ What else could go wrong? 		
Step 4: Assess Your Own Situation		
<ul style="list-style-type: none"> ▪ What resources are available with which you can attempt the search and rescue? 		
<ul style="list-style-type: none"> ▪ What equipment is available? 		
Step 5: Establish Priorities		
<ul style="list-style-type: none"> ▪ Can a search and rescue be <i>safely</i> attempted by CERT members? <p>If no, do <i>not</i> attempt a search and rescue.</p>	Yes <input type="checkbox"/>	No <input type="checkbox"/>
<ul style="list-style-type: none"> ▪ Are there other, more pressing needs at the moment? <p>If yes, list.</p>	Yes <input type="checkbox"/>	No <input type="checkbox"/>
Step 6: Make Decisions		
<ul style="list-style-type: none"> ▪ Where will deployment of available resources do the most good while maintaining an adequate margin of safety? 		
Step 7: Develop Plan of Action		
<ul style="list-style-type: none"> • Determine how personnel and other resources should be deployed. 		
Step 8: Take Action		
<ul style="list-style-type: none"> ▪ Put the plan into effect. 		

COMMUNITY EMERGENCY RESPONSE TEAM
UNIT 5: LIGHT SEARCH AND RESCUE OPERATIONS

Step 9: Evaluate Progress	
<ul style="list-style-type: none">▪ Continually size up the situation to identify changes in the:<ul style="list-style-type: none">• Scope of the problem• Safety risks• Resource availability	

COMMUNITY EMERGENCY RESPONSE TEAM
UNIT 5: LIGHT SEARCH AND RESCUE OPERATIONS

INSTRUCTOR GUIDANCE	CONTENT
<p data-bbox="203 422 427 449">Sizeup: Step 1</p> <div data-bbox="191 405 626 730"><p data-bbox="235 474 380 499"><u>Gather Facts</u></p><ul data-bbox="215 506 380 663" style="list-style-type: none">● Time of event and day of the week● Construction type/terrain● Occupancy● Weather● Hazards</div> <p data-bbox="191 701 626 730">FEMA CERT Basic Training Unit 5: Light Search and Rescue Operations 5-8</p> <p data-bbox="191 768 444 804">Display Slide 5-8</p> <p data-bbox="191 846 626 1020">Provide and discuss locally relevant examples of planning factors to develop an understanding of the effects of each factor.</p> <p data-bbox="191 1062 626 1239">Mention that the amount of damage likely to be found in different types of construction will be covered in a few minutes.</p>	<p data-bbox="659 405 979 441">Step 1: Gather Facts</p> <p data-bbox="659 474 1401 579">Introduce Step 1 by telling the group that the facts of the situation must guide their search and rescue efforts.</p> <p data-bbox="659 621 1325 684">When gathering facts, CERT members need to consider:</p> <ul data-bbox="659 705 1422 1829" style="list-style-type: none">▪ <u>The time of the event and day of the week.</u> At night, more people will be in their homes, so the greatest need for search and rescue will be in residential settings. Conversely, during the day, people will be at work, so the need will be in commercial buildings. Search and rescue operations may also be affected by where people are located in their homes and the amount of daylight available.▪ <u>Construction type and terrain.</u> Some types of construction are more susceptible to damage than others. The type of terrain will affect how the search is conducted.▪ <u>Occupancy.</u> The purpose for which the structure was designed may indicate the likely number of victims and their location.▪ <u>Weather.</u> Severe weather will have an effect on victims and rescuers alike and will certainly hamper rescue efforts. Forecasts of severe weather should be considered as a limiting factor on the time period during which search and rescue can occur.▪ <u>Hazards.</u> Knowledge of other potential hazards in the general and immediate areas is important to search and rescue efforts. For example, if a gas leak is suspected, taking the time to locate and shut off the gas can have a big impact in terms of loss of life.

COMMUNITY EMERGENCY RESPONSE TEAM
UNIT 5: LIGHT SEARCH AND RESCUE OPERATIONS

INSTRUCTOR GUIDANCE	CONTENT
<p>PM, P. 5-9</p> <p>Use the following steps to facilitate this exercise, keeping in mind that this scenario is only an example and may be changed to fit your community's needs.</p>	<p>Refer the group to <i>Scenario</i> in the Participant Manual and introduce the <i>Gathering Facts</i> exercise.</p> <p>Exercise: Gathering Facts</p> <p>Purpose: Explain that this exercise is an interactive activity to give the participants the opportunity to consider some of the facts that CERT search and rescue teams will need to gather during sizeup.</p> <p>Instructions:</p> <ol style="list-style-type: none">1. Refer the participants to <i>Scenario</i> in the Participant Manual.2. Ask the group to brainstorm the following questions:<ul style="list-style-type: none">▪ What does this scenario tell you about the probable density for the affected area?▪ What does this scenario tell you about the facts that must be gathered?▪ What impact could these facts have on search and rescue operations?▪ What kinds of search and rescue operations are probable?▪ What, if any, are the constraints that search and rescue personnel may face in this scenario?▪ Can these constraints be overcome within the established CERT mission? If so, how?3. Record the group's responses on chart paper.4. Discuss the group's responses and provide feedback regarding strengths and possible improvements in their planning.

COMMUNITY EMERGENCY RESPONSE TEAM
UNIT 5: LIGHT SEARCH AND RESCUE OPERATIONS

PM, P. 5-9	Scenario
-------------------	-----------------

At 2:30 p.m. on Tuesday, August 9, a squall line passed through your town. Because of the difference in barometric pressure on either side of the front, the squall line was preceded by a “gust front” with straight-line winds of more than 70 miles per hour. The gust front was followed by continued strong winds and extremely heavy rain. Electricity was knocked out throughout the town.

You activate in accordance with your CERT program’s standard operating procedures (SOPs). On the way to the staging area at the local high school, you notice considerable damage, including felled trees and utility lines. Many streets are impassable, making you take a roundabout route to the high school. As you make your way to the staging area, you see that the roof has blown off of a large portion of a local strip shopping center and that the exterior wall on the west end of the structure has collapsed.

After reaching the staging area, you check in with the Logistics Team Leader, who assigns you to Search and Rescue Team 2. Although CERT members cannot venture into the section of the shopping center that has collapsed, Search and Rescue Team 2 will be searching near the collapsed area to see if there are victims in that area.



COMMUNITY EMERGENCY RESPONSE TEAM
UNIT 5: LIGHT SEARCH AND RESCUE OPERATIONS

INSTRUCTOR GUIDANCE	CONTENT
<div data-bbox="188 405 626 730" data-label="Image"> <p>Sizeup: Step 2</p> <p><u>Assess and Communicate Damage</u></p> <p>The CERT mission changes if:</p> <ul style="list-style-type: none"> ▪ Damage is light ▪ Damage is moderate ▪ Damage is heavy <p>FEMA CERT Basic Training Unit 5: Light Search and Rescue Operations 5-9</p> </div> <p>Display Slide 5-9</p> <p>The following information on probable damage and the table titled <i>Probable Severity and Type of Earthquake Damage Based on Construction Type</i> on page 5-14 in the Participant Manual relate to earthquakes.</p> <p>If other types of disasters (e.g., tornadoes, hurricanes, or floods) are likely in your area, add information about the probable impact on various types of construction and what you would consider light, moderate, and heavy damage to structures.</p>	<p>Step 2: Assess and Communicate Damage</p> <p>Introduce Step 2 by pointing out that there are general guidelines for assessing damage in interior searches and exterior searches. When in doubt about the condition of a building, CERT members should always use the more cautious assessment. If unsure about whether a building is moderately or heavily damaged, CERTs should assume heavy damage.</p> <p>Emphasize, however, that the CERT mission changes depending on the amount of structural damage.</p>

COMMUNITY EMERGENCY RESPONSE TEAM
UNIT 5: LIGHT SEARCH AND RESCUE OPERATIONS

INSTRUCTOR GUIDANCE	CONTENT
	<p><i>CERT Mission and Types of Damage</i></p> <p>Explain how the CERT mission for interior searches changes if:</p> <ul style="list-style-type: none">▪ <u>Damage is light</u> (superficial or cosmetic damage, superficial cracks or breaks in the wall surface, minor damage to the interior contents) <p>The CERT mission is to locate; triage; treat airway, major bleeding, and shock; continue sizeup; and document.</p> <ul style="list-style-type: none">• <u>Damage is moderate</u> (visible signs of damage, decorative work damaged or fallen, many visible cracks in the wall surface, major damage to interior content, building is on its foundation) <p>The CERT mission is to locate; treat airway, major bleeding, and shock; evacuate; warn others; continue sizeup while <u>minimizing the number of rescuers and time spent inside the structure.</u></p> <ul style="list-style-type: none">• <u>Damage is heavy</u> (partial or total collapse, tilting, obvious structural instability, building off its foundation, heavy smoke or fire, hazardous materials inside, gas leaks, rising or moving water) <p>The CERT mission is to secure the building perimeter and warn others of the danger in entering the building.</p> <p>Explain that CERT members are not to enter a building with heavy damage under any circumstances.</p>

COMMUNITY EMERGENCY RESPONSE TEAM
UNIT 5: LIGHT SEARCH AND RESCUE OPERATIONS

INSTRUCTOR GUIDANCE	CONTENT
<p>Light Damage</p> <ul style="list-style-type: none"> ● Superficial ● Broken windows ● Superficial cracks or breaks in wall surface ● Minor damage to the interior contents ● Safe to enter and remain  <p style="font-size: small;">FEMA CERT Basic Training Unit 5: Light Search and Rescue Operations 5-10</p>	<p><i>Light Damage</i></p> <p>Explain that the damage shown in the slide constitutes light damage.</p> <ul style="list-style-type: none"> ▪ Superficial damage ▪ Broken windows ▪ Superficial cracks or breaks in the wall surface, for example, fallen or cracked plaster ▪ Minor damage to the interior contents
<p>Moderate Damage</p> <ul style="list-style-type: none"> ● Visible signs of damage ● Decorative work damaged or fallen ● Many visible cracks or breaks in wall ● Major damage to interior contents ● Building still on foundation ● Enter only to save lives  <p style="font-size: small;">FEMA CERT Basic Training Unit 5: Light Search and Rescue Operations 5-11</p>	<p><i>Moderate Damage</i></p> <p>Explain that the damage shown in the slide constitutes moderate damage.</p> <ul style="list-style-type: none"> ▪ Visible signs of damage ▪ Decorative work damaged or fallen ▪ Many visible cracks or breaks in the wall surface ▪ Major damage to interior contents ▪ Building still on foundation
<p>Heavy Damage</p> <ul style="list-style-type: none"> ● Partial or total collapse ● Tilting ● Obvious structural instability ● Building off foundation  <p style="font-size: small;">Do not enter a building with heavy damage under any circumstances</p> <p style="font-size: small;">FEMA CERT Basic Training Unit 5: Light Search and Rescue Operations 5-12</p>	<p><i>Heavy Damage</i></p> <p>Explain that the damage shown in the slide constitutes heavy damage.</p> <ul style="list-style-type: none"> ▪ Partial or total collapse ▪ Tilting ▪ Obvious structural instability ▪ Building off foundation <p>Reemphasize that CERT members must not enter a building with heavy damage <u>under any circumstances</u>.</p>

COMMUNITY EMERGENCY RESPONSE TEAM
UNIT 5: LIGHT SEARCH AND RESCUE OPERATIONS

INSTRUCTOR GUIDANCE	CONTENT
<p>Mention that, later in this session, the participants will learn more about formulating rescue strategies based on the damage assessment.</p> <p>PM, P. 5-13</p> <p>More detailed search methodology will be discussed later in this unit.</p>	<p><i>Assessing Damage</i></p> <p>Explain that assessing damage of a building or structure will require an examination from all sides. Urge participants to do an initial "lap around."</p> <p>Explain that, in assessing damage, CERT personnel must consider probable levels of damage based on the type and age of construction. In addition to a visual assessment, rescuers should also "listen" to damaged structures. If a building is creaking or "groaning," it is unstable and should not be entered.</p> <p>Refer the participants to <i>Probable Severity and Type of Earthquake Damage Based on Construction Type</i> in the Participant Manual.</p> <p>Tell the participants that, in some instances, an exterior search is required and a grid search should be employed.</p> <p><i>Communicating Damage</i></p> <p>Tell participants to describe different locations within and around the structure by using the ABCD standard, with A corresponding to the front of the building and B, C, and D representing the sides of the building moving clockwise from A.</p>

COMMUNITY EMERGENCY RESPONSE TEAM
UNIT 5: LIGHT SEARCH AND RESCUE OPERATIONS



INSTRUCTOR GUIDANCE	CONTENT
	<p>Using this system, the area inside of a structure can be further broken down by quadrants to facilitate communication. For instance, a hazard or victim located closest to the A and B sides of the structure is in the A/B quadrant.</p> <p>Stress that the participants must communicate their findings to the CERT command post or responding agencies.</p>

COMMUNITY EMERGENCY RESPONSE TEAM
UNIT 5: LIGHT SEARCH AND RESCUE OPERATIONS

PM, P. 5-13	Probable Severity and Type of Earthquake Damage Based on Construction Type
--------------------	---

Construction Type	Description	Probable Damage Areas	Severity
Single-Family Dwelling	<ul style="list-style-type: none"> ▪ Wood frame 	<ul style="list-style-type: none"> ▪ Masonry chimney ▪ Utilities 	Light
	<ul style="list-style-type: none"> ▪ Pre-1933 	<ul style="list-style-type: none"> ▪ Foundation movement ▪ Utilities ▪ Porches 	Moderate
	<ul style="list-style-type: none"> ▪ Hillside 	<ul style="list-style-type: none"> ▪ Unique hazards ▪ Ground failure 	Heavy
Multiple-Family Dwelling	<ul style="list-style-type: none"> ▪ Up-and-down and/or side-by-side living units 	<ul style="list-style-type: none"> ▪ Soft first floor ▪ Utilities 	Moderate
Unreinforced Brick	<ul style="list-style-type: none"> ▪ Pre-1933 construction ▪ Lime or sand mortar ▪ “King Row” or “Soldier Row” (bricks turned on end every 5-7 rows) ▪ Reinforcing plates ▪ Arched windows and doors ▪ Recessed windows and doors 	<ul style="list-style-type: none"> ▪ Walls collapse, then roof 	Heavy
Tilt-Up	<ul style="list-style-type: none"> ▪ Large warehouses and plants ▪ Concrete slabs lifted into place ▪ Walls inset approximately 6-8 inches ▪ Lightweight roof construction 	<ul style="list-style-type: none"> ▪ Roof collapses, then walls 	Heavy
High-Rise	<ul style="list-style-type: none"> ▪ Steel reinforced 	<ul style="list-style-type: none"> ▪ Broken glass ▪ Content movement ▪ Exterior trim and fascia 	Light

COMMUNITY EMERGENCY RESPONSE TEAM
UNIT 5: LIGHT SEARCH AND RESCUE OPERATIONS

INSTRUCTOR GUIDANCE	CONTENT
<p data-bbox="207 415 430 447">Sizeup: Step 3</p> <p data-bbox="289 472 527 499"><u>Consider Probabilities</u></p> <ul data-bbox="215 506 560 604" style="list-style-type: none">• How stable is the situation?• What else could go wrong?• What does it mean for the search and rescue? <p data-bbox="196 699 625 730"> <small>CERT Basic Training Unit 5: Light Search and Rescue Operations</small> 5-13 </p> <p data-bbox="191 766 462 798">Display Slide 5-13</p>	<p data-bbox="657 405 1120 436">Step 3: Consider Probabilities</p> <p data-bbox="657 478 1421 693">Stress that, because the CERTs will be working in such close proximity to the dangerous situation, considering what <u>will probably happen</u> and what <u>could happen</u> are of critical importance. Urge the participants to identify potentially life-threatening hazards and ask:</p> <ul data-bbox="657 751 1421 1617" style="list-style-type: none">▪ <u>How stable is the situation?</u> Even within a structure that appears from the outside to have only minimal or moderate damage, nonstructural damage or instability <u>inside</u> the structure can pose real danger to the rescue team. CERT members should think about what they already know about the structure that's been damaged. Are lawn chemicals, paints, or other potentially hazardous materials stored within the structure? How are they stored? Where are they? It won't take CERT members much time to answer these types of questions, but the answers could make a huge difference in how they approach the search.▪ <u>What else could go wrong?</u> Based on the information gathered during Steps 1 and 2 of the sizeup, CERT members should take a few moments to play "What if?" to try to identify additional risks that they may face. What if the electricity fails during the search? What if a wall that appears stable shifts and collapses? Applying "Murphy's Law" to the situation could save CERT members' lives.

COMMUNITY EMERGENCY RESPONSE TEAM
UNIT 5: LIGHT SEARCH AND RESCUE OPERATIONS

INSTRUCTOR GUIDANCE	CONTENT
<div data-bbox="188 873 626 1201" data-label="Image"> </div> <p data-bbox="188 1241 461 1276">Display Slide 5-14</p> <div data-bbox="188 1528 266 1602" data-label="Image"> </div>	<ul style="list-style-type: none"> <li data-bbox="659 422 1425 821"> <p>▪ <u>What does it all mean for the search and rescue?</u> Based on the probabilities, CERTs should think about what they can do to reduce the risks associated with the probabilities that they have identified. Is a spotter necessary to look for movement that could indicate a possible collapse and warn the rescue team? Is some remedial action required to stabilize nonstructural hazards before beginning the search? CERT search and rescue teams must remember that their own safety is the first priority.</p> <p data-bbox="659 877 1122 913">Step 4: Assess Your Situation</p> <p data-bbox="659 951 1404 1203">Remind the participants that sizeup is a building process, with each step building upon the previous steps until the decision is made to begin the search and rescue operation (or that the situation is unsafe). Then, urge the group to draw on everything they've learned from Steps 1 through 3 to assess their situation to determine:</p> <ul style="list-style-type: none"> <li data-bbox="659 1224 1390 1255">▪ Whether the situation is safe enough to continue <li data-bbox="659 1276 1377 1308">▪ The risks that rescuers will face if they continue <li data-bbox="659 1329 1409 1398">▪ What resources will be needed to conduct the operation safely and what resources are available <p data-bbox="659 1419 1328 1488">Point out that assessing resources is extremely important to search and rescue operations.</p> <p data-bbox="659 1528 1377 1598">When you talk about “resources,” what are you referring to?</p> <p data-bbox="659 1644 1425 1749">Acknowledge the group's responses. If not mentioned by the participants, say that search and rescue resources include personnel, tools, and equipment.</p>

COMMUNITY EMERGENCY RESPONSE TEAM
UNIT 5: LIGHT SEARCH AND RESCUE OPERATIONS

INSTRUCTOR GUIDANCE	CONTENT
PM, P. 5-15	Refer the participants to the table titled <i>Search and Rescue Resource Planning Questions</i> in the Participant Manual.

PM, P. 5-15	Search and Rescue Resource Planning Questions
--------------------	--

Resource	Planning Questions
Personnel	<ul style="list-style-type: none"> ▪ How many trained CERT members are available for this operation? ▪ Who lives and/or works in the area? ▪ During which hours are these people most likely to be available? ▪ What skills or hobbies do they have that might be useful in search and rescue operations? ▪ What might be the most effective means of mobilizing their efforts?
Equipment	<ul style="list-style-type: none"> ▪ What equipment is available locally that might be useful for search and rescue? ▪ Where is it located? ▪ How can it be accessed? ▪ On which structures (or types of structures) might it be most effective?
Tools	<ul style="list-style-type: none"> ▪ What tools are available that might be useful for lifting, moving, or cutting disaster debris?

COMMUNITY EMERGENCY RESPONSE TEAM
UNIT 5: LIGHT SEARCH AND RESCUE OPERATIONS

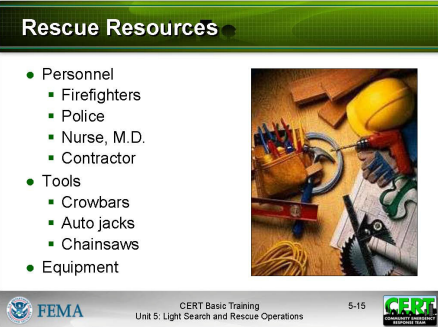
INSTRUCTOR GUIDANCE	CONTENT
<p data-bbox="191 394 626 718"></p> <p data-bbox="191 737 589 957">Display Slide 5-15 Provide the participants with examples of tools and equipment that they might need for search and rescue operations.</p>	<p data-bbox="659 394 930 426"><i>Rescue Resources</i></p> <p data-bbox="659 470 1336 537">Tell the group that search and rescue resources include:</p> <ul data-bbox="659 560 1419 936" style="list-style-type: none">▪ <u>Personnel</u><ul data-bbox="704 615 1419 936" style="list-style-type: none">• How many CERT members are available for this operation?• In addition, who lives and/or works in the area?• When are they likely to be available?• Do they have skills that might be useful in search and rescue operations?• How can their efforts be mobilized? <p data-bbox="704 957 1403 1136">Drawing on personnel resources that may be available, even if only to watch the situation and free CERT resources for tasks requiring specialized training, can make search and rescue operations more efficient.</p> <ul data-bbox="659 1209 1430 1734" style="list-style-type: none">• <u>Equipment</u><ul data-bbox="704 1264 1430 1535" style="list-style-type: none">• What equipment is available that might be useful for search and rescue?• Where is it located?• How can it be accessed?• On which structures (or types of structures) might it be most effective?▪ <u>Tools</u><ul data-bbox="704 1661 1430 1734" style="list-style-type: none">• What tools are available that might be useful for lifting, moving, or cutting debris? <p data-bbox="659 1787 1419 1860">Point out that considering each of these questions will facilitate action planning.</p>

COMMUNITY EMERGENCY RESPONSE TEAM
UNIT 5: LIGHT SEARCH AND RESCUE OPERATIONS

INSTRUCTOR GUIDANCE	CONTENT
<p>Sizeup: Step 5</p> <p><u>Establish Priorities</u></p> <ul style="list-style-type: none">● What should be done?● In what order?● How to rescue the greatest number in the shortest amount of time?  <p>FEMA CERT CERT Basic Training Unit 5: Light Search and Rescue Operations 5-16</p>	<p>Step 5: Establish Priorities</p> <p>Introduce this step by telling the group that, after evaluating the situation and keeping in mind that the safety of the CERT member is always the top priority, the next step is to determine:</p> <ul style="list-style-type: none">▪ What should be done?▪ In what order? <p>Remind participants of the goal: to rescue the greatest number in the shortest amount of time.</p> <p>Remind the group that the safety of CERT members is always the first priority and will dictate some of the other priorities. For example, removing or mitigating known hazards must be completed before teams begin to search. Urge the participants to think through the situation logically to determine how they should approach the operation.</p>
<p>Sizeup: Step 6</p> <p><u>Make Decisions</u></p> <ul style="list-style-type: none">● Keep in mind:<ul style="list-style-type: none">▪ Safety of CERT members▪ Life safety for victims and others▪ Protection of the environment▪ Protection of property <p>FEMA CERT CERT Basic Training Unit 5: Light Search and Rescue Operations 5-17</p>	<p>Step 6: Make Decisions</p> <p>Tell the group that they are at the point in the sizeup where they will make decisions about where to deploy their resources to do the most good while maintaining an adequate margin of safety. Suggest that many of their decisions will be based on the priorities established during Step 5 and remind them that those priorities are based on:</p> <ul style="list-style-type: none">▪ The safety of CERT members▪ Life safety for victims and others▪ Protection of the environment▪ Protection of property <p>Remind the group that the CERT mission in search and rescue operations changes depending on the amount of structural damage.</p>



Display Slide 5-16

Display Slide 5-17

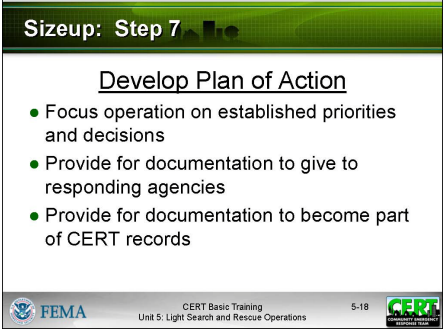
COMMUNITY EMERGENCY RESPONSE TEAM
UNIT 5: LIGHT SEARCH AND RESCUE OPERATIONS

INSTRUCTOR GUIDANCE	CONTENT
 <p>Sizeup: Step 7</p> <p><u>Develop Plan of Action</u></p> <ul style="list-style-type: none">● Focus operation on established priorities and decisions● Provide for documentation to give to responding agencies● Provide for documentation to become part of CERT records <p><small>FEMA CERT Basic Training Unit 5: Light Search and Rescue Operations 5-18</small></p> <p>Display Slide 5-18</p>	<p>Step 7: Develop Plan of Action</p> <p>Tell the group that Step 7 is where all of the information they have about the situation comes together. During Step 7, the CERT Incident Commander/Team Leader (IC/TL) will decide specifically how the team will conduct its operation, considering the highest priority tasks first.</p> <p>Remind the participants that an action plan does not need to be written, but suggest that, when search and rescue operations are required, the situation is probably complex enough that a written plan of some type will be important.</p> <p>Point out that a plan should:</p> <ul style="list-style-type: none">▪ Help focus the operation on established priorities and decisions▪ Provide for documentation to be given to responding agencies when they arrive on scene▪ Provide for documentation that will become part of the record of the CERT's overall operation <p>Urge the participants to keep a notebook for jotting notes when developing an action plan. Any changes made to the initial plan based on new information that comes in should also be documented.</p>

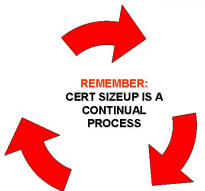
COMMUNITY EMERGENCY RESPONSE TEAM
UNIT 5: LIGHT SEARCH AND RESCUE OPERATIONS

INSTRUCTOR GUIDANCE	CONTENT
<p>Sizeup: Step 8</p> <p><u>Take Action</u></p> <ul style="list-style-type: none">Based on plan developed during Step 7  <p>FEMA CERT Basic Training Unit 5: Light Search and Rescue Operations 5-19</p>	<p>Step 8: Take Action</p> <p>Explain that the next step is to put the plan developed in Step 7 into action.</p>
<p>Display Slide 5-19</p> <p>Sizeup: Step 9</p> <p><u>Evaluate Progress</u></p> <ul style="list-style-type: none">Most critical stepMonitor plan's effectiveness and safety  <p>FEMA CERT Basic Training Unit 5: Light Search and Rescue Operations 5-20</p>	<p>Step 9: Evaluate Progress</p> <p>Emphasize that Step 9, Evaluate Progress, is the most critical, not only in terms of evaluating whether the plan works, but also from a safety standpoint.</p> <p>Remind the group that sizeup is ongoing and that information gained during Step 9 needs to be fed back into the decision-making process for possible revision of priorities and updated action planning.</p>
<p>Display Slide 5-20</p> <p>Specific Safety Considerations</p>  <ul style="list-style-type: none">Make rescuer safety primary concernUse a buddy systemBe alert for hazardsUse safety equipmentRotate teams <p>FEMA CERT Basic Training Unit 5: Light Search and Rescue Operations 5-21</p>	<p>Specific Safety Considerations</p> <p>Tell the group that regardless of the severity of structural damage, rescuer safety must be the primary concern.</p> <p>Point out that the two most frequent causes of rescuer deaths are:</p> <ul style="list-style-type: none">DisorientationSecondary collapse
<p>Display Slide 5-21</p> <p>Emphasize this point.</p>	<p>Be prepared and make rescuer safety your top priority.</p>

COMMUNITY EMERGENCY RESPONSE TEAM
UNIT 5: LIGHT SEARCH AND RESCUE OPERATIONS

INSTRUCTOR GUIDANCE	CONTENT
PM, P. 5-19	<p>Refer the participants to <i>Specific Safety Considerations</i> in the Participant Manual. Caution the participants that they must follow these guidelines during all search and rescue operations:</p> <ul style="list-style-type: none">▪ <u>Use a buddy system.</u> Successful search and rescue depends on teamwork.▪ <u>Be alert for hazards</u> (e.g., power lines, natural gas leaks, hazardous materials, sharp objects, overhead objects that could fall, etc.). Never attempt to search an area where water is rising.▪ <u>Use safety equipment.</u> Wearing gloves and a helmet will protect a rescuer's hands and head. Also, tell the group that the primary cause of rescuer problems after working in a structural collapse is breathing dust, so an N95 mask is essential. <p>Tell the group that dust masks will not filter chemicals or biological agents. Stress that, if the use of chemical or biological agents is suspected, CERTs <u>must</u> evacuate to an upwind location and notify professional responders.</p> <ul style="list-style-type: none">▪ <u>Have backup teams available</u> to allow rotating of teams, prevent fatigue, and ensure help if a team gets into trouble. Have teams drink fluids and eat to keep themselves fresh.

COMMUNITY EMERGENCY RESPONSE TEAM
UNIT 5: LIGHT SEARCH AND RESCUE OPERATIONS

PM, P. 5-19

Specific Safety Considerations

Regardless of the severity of structural damage, rescuer safety must be the primary concern.

The two most frequent causes of rescuer deaths are:

- Disorientation
- Secondary collapse

Follow these guidelines during all search and rescue operations:

- Use a buddy system. Always work in pairs, with a third person acting as a runner.
- Be alert for hazards (e.g., power lines, natural gas leaks, hazardous materials, sharp objects, etc.).

You should never attempt to search an area where water is rising.

- Use safety equipment. Wearing gloves and a helmet will protect a rescuer's hands and head. Also, the primary cause of rescuer problems after working in a structural collapse is breathing dust, so a dust mask is essential. However, a dust mask will not filter out all harmful materials. If the presence of chemical or biological agents is suspected, CERTs must evacuate to an upwind location and notify professional responders.
- Have backup teams available to allow rotating of teams, prevent fatigue, and ensure help if a team gets into trouble. Have teams drink fluids and eat to keep themselves fresh.

COMMUNITY EMERGENCY RESPONSE TEAM
UNIT 5: LIGHT SEARCH AND RESCUE OPERATIONS

INSTRUCTOR GUIDANCE	CONTENT
<p>Use the following steps to facilitate this exercise. The exercise will be based on several different types of <u>local</u> buildings (one for each small group) for the most probable type of disaster that the community will face.</p> <p>PM, P. 5-20</p>	<p>Exercise: Search and Rescue Sizeup</p> <p>Purpose: Explain that this exercise is an interactive activity to give the participants an opportunity to practice some of the thinking processes involved in planning and search and rescue sizeup.</p> <p>The brainstorming required will help the participants to begin to assess their neighborhoods or workplaces in terms of building structures, hazardous materials, safety precautions that need to be taken, etc.</p> <p>Instructions:</p> <ol style="list-style-type: none">1. Assign the participants to groups of four or five.2. Provide each group with a local scenario (with slides, if possible) describing a local building in a disaster event that is realistic for the community.3. Ask the groups to designate a recorder and, given the disaster and the specific building, answer the following questions:<ul style="list-style-type: none">▪ What are the pertinent facts that must be gathered?▪ What kind of prediction can you make regarding damage, based on the incident and the building construction?▪ What probable search and rescue problems can you identify?▪ What specific safety considerations can you identify?4. Ask each group to select a spokesperson to present the group's responses to the class.5. Discuss each group's responses and provide feedback about how their search and rescue sizeup might be improved.

COMMUNITY EMERGENCY RESPONSE TEAM
UNIT 5: LIGHT SEARCH AND RESCUE OPERATIONS

INSTRUCTOR GUIDANCE	CONTENT
	<p>Does anyone have any questions about anything covered to this point?</p> <p>Explain that the next section will deal with how to conduct search operations.</p>

COMMUNITY EMERGENCY RESPONSE TEAM
UNIT 5: LIGHT SEARCH AND RESCUE OPERATIONS

PM, P. 5-20	Search and Rescue Sizeup
--------------------	---------------------------------

Purpose: This exercise is an interactive activity that will provide an opportunity to practice some of the thinking processes involved in planning and search and rescue sizeup.

The brainstorming required will help you to begin to assess your neighborhoods or workplaces in terms of building structures, hazardous materials, safety precautions that need to be taken, etc.



Instructions:

1. Assemble in groups of four or five.
2. Read the scenario given to you by the instructor.
3. Designate a recorder and, given the disaster and the specific building, answer the following questions:
 - What are the pertinent facts that must be gathered?
 - What kind of prediction can you make regarding damage, based on the incident and the building construction?
 - What probable search and rescue problems can you identify?
 - What specific safety considerations can you identify?
4. Select a spokesperson to present the group's responses to the class.
5. Discuss each group's responses and provide feedback about how their search and rescue sizeup might be improved.

COMMUNITY EMERGENCY RESPONSE TEAM
UNIT 5: LIGHT SEARCH AND RESCUE OPERATIONS

INSTRUCTOR GUIDANCE	CONTENT
<p>Provide examples of how to use the information gathered to find out more information about areas of entrapment.</p>	<p><i>Conducting Interior and Exterior Search Operations</i></p> <p>Tell the participants that, when the decision is made to initiate search operations, CERT members will inspect the area assigned by the CERT Incident Commander/Team Leader (IC/TL).</p> <p>Explain that the search operation involves two processes:</p> <ol style="list-style-type: none">1. Employing search techniques based on the sizeup2. Locating any victims <p>Point out that by using these processes, search operations will be more efficient, thorough, and safe. They will also facilitate later rescue operations. Explain that, although the processes are related, this section will address them one at a time. Interior search operations are the most common and will be discussed first; exterior search operations will be discussed later in this unit.</p> <p>Locating Potential Victims in a Structure</p> <p>Tell the participants that the first step in locating potential victims in a structure is to conduct a sizeup of the interior of the building to gather more precise information about damage and to develop priorities and plans.</p> <p>Explain by saying that the data gathered will provide more information about possible areas of entrapment — or <u>voids</u>.</p>

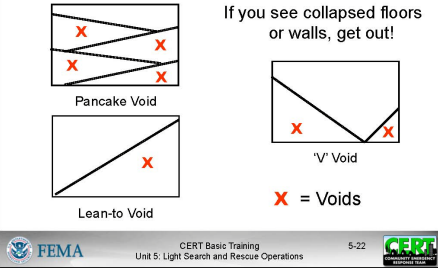
COMMUNITY EMERGENCY RESPONSE TEAM
UNIT 5: LIGHT SEARCH AND RESCUE OPERATIONS

INSTRUCTOR GUIDANCE	CONTENT
<p data-bbox="191 436 626 485">Structural Voids</p>  <p data-bbox="191 804 461 835">Display Slide 5-22</p>  <p data-bbox="191 989 626 1037">Individual Voids</p> <ul data-bbox="215 1058 602 1203" style="list-style-type: none">• Spaces where victims may seek protection<ul style="list-style-type: none">▪ Bathtubs▪ Underneath desks▪ Inside cabinets▪ Under/next to beds▪ Inside closets <p data-bbox="191 1356 461 1388">Display Slide 5-23</p>	<p data-bbox="659 407 906 438">Structural Voids</p> <p data-bbox="659 478 1305 510">Point out that there are several types of voids.</p> <p data-bbox="659 550 1393 653">Emphasize that, if CERT members see collapsed floors or walls, they should leave the premises immediately.</p> <p data-bbox="659 877 1406 947">Does anyone have any questions about the types of structural voids?</p> <p data-bbox="659 993 902 1024">Individual Voids</p> <p data-bbox="659 1064 1419 1245">Explain that individual voids are spaces into which the victim may have crawled for protection. Examples of individual voids include bathtubs and the space underneath desks. Children may seek shelter in smaller places like cabinets.</p> <p data-bbox="659 1285 1419 1354">Tell the group that, after identifying the possible areas of entrapment, CERT members must:</p> <ul data-bbox="659 1373 1370 1461" style="list-style-type: none">▪ Determine the potential number of victims▪ Identify the most probable areas of entrapment



COMMUNITY EMERGENCY RESPONSE TEAM
UNIT 5: LIGHT SEARCH AND RESCUE OPERATIONS

INSTRUCTOR GUIDANCE	CONTENT
	<p>Point out that some of this information may be known through assessment, but CERT members may need to get some information by talking to bystanders or those who are familiar with the structure.</p> <p>Explain that CERT members should ask questions when talking with these individuals, including:</p> <ul style="list-style-type: none">▪ How many people live (or work) in the building?▪ Where would they be at this time?▪ What is the building layout?▪ What have you seen or heard?▪ Has anyone come out?▪ What are the normal exit routes from the building? <p>Caution the group that bystanders may be confused by the event. They may tend to exaggerate potential numbers or may not even remember the event accurately. Tell the group to gather as much information as they can, though, because it will be useful for planning search priorities and implementing the search.</p> <p>Search Methodology</p> <p>Introduce this section by telling the group that an effective search methodology:</p> <ul style="list-style-type: none">▪ Indicates rescuer location▪ Locates victims as quickly and safely as possible▪ Prevents duplication of effort

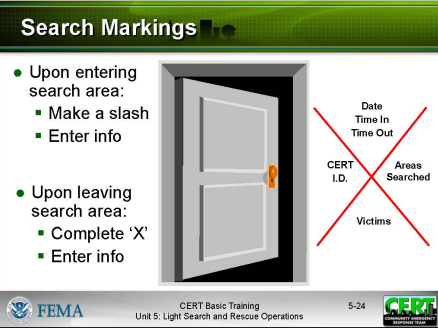
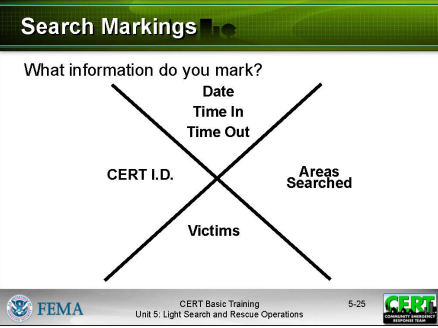



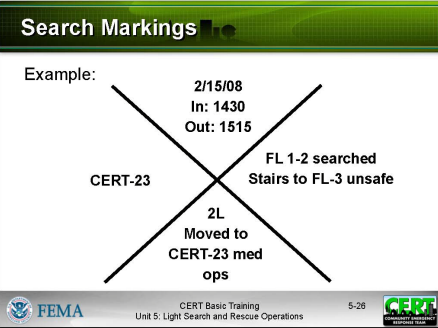

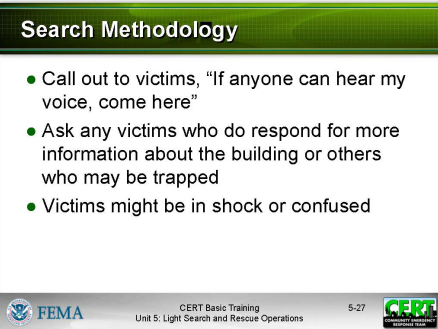
COMMUNITY EMERGENCY RESPONSE TEAM
UNIT 5: LIGHT SEARCH AND RESCUE OPERATIONS

INSTRUCTOR GUIDANCE	CONTENT
<p data-bbox="191 405 626 730"></p> <p data-bbox="191 768 461 804">Display Slide 5-24</p> <p data-bbox="191 842 618 1094">The slide above is animated. Click on the slide 3 times to show each step during the marking process. The slide below provides more detail about the information included in a marking.</p> <p data-bbox="191 1136 626 1461"></p> <p data-bbox="191 1499 461 1535">Display Slide 5-25</p>	<p data-bbox="659 405 899 441"><i>Search Markings</i></p> <p data-bbox="659 478 1422 659">Tell the group that experienced search and rescue personnel use the following system. The same system will be used by CERTs. This will save fellow CERT members and other responders time during the search and continual sizeup of the structure.</p> <ol data-bbox="659 716 1430 1766" style="list-style-type: none"><li data-bbox="659 716 1430 968">1. <u>Upon entering a search area</u>, you will make a mark next to the door to indicate that you are entering. Do not make the mark on the door or on the wall where the door swings. Make a single slash and write the agency or group ID at the “9 o’clock” position. Then write the date and “time in” at the “12 o’clock” position.<li data-bbox="659 1150 1430 1766">2. <u>Upon exiting the search area</u>, make another slash to form an “X” (the agency or group ID will be in the left quadrant). Enter the search “time out” in the top quadrant.<ul data-bbox="708 1314 1422 1766" style="list-style-type: none"><li data-bbox="708 1314 1422 1419">▪ <u>Right quadrant:</u> Enter the areas of the structure searched and any specific information about hazards.<li data-bbox="708 1440 1422 1766">▪ <u>Lower quadrant:</u> Enter information about the victims found in the search area. “L” represents living victims, while “D” represents dead victims. The search marking on the front of a structure or building should contain the total number of victims, whereas search markings inside the structure or building will include victim totals for specific search areas. Also indicate where victims have been taken.

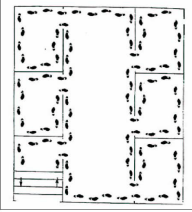
COMMUNITY EMERGENCY RESPONSE TEAM
UNIT 5: LIGHT SEARCH AND RESCUE OPERATIONS

INSTRUCTOR GUIDANCE	CONTENT
<p data-bbox="191 405 626 730"></p> <p data-bbox="191 768 461 804">Display Slide 5-26</p> <p data-bbox="191 846 266 919"></p> <p data-bbox="191 957 626 1283"></p> <p data-bbox="191 1323 461 1358">Display Slide 5-27</p>	<p data-bbox="659 405 1425 478">Review the example of the completed search marking, quadrant by quadrant.</p> <p data-bbox="659 516 1386 625">Explain what type(s) of markers the CERTs should use (e.g., lumber crayons, chalk, etc.) and suggest where to purchase markers if they are not provided.</p> <p data-bbox="659 846 1370 919">Does anyone have any questions about search markings?</p> <p data-bbox="659 957 954 993"><i>Search Methodology</i></p> <ol data-bbox="659 1031 1425 1323" style="list-style-type: none">1. Upon entering each space or room, <u>call out to victims</u>. Shout something like, "If anyone can hear my voice, come here." If any victims come to you, ask them for any information that they may have about the building or others who may be trapped, then give them further directions such as, "Stay here" or "Wait outside" (depending on the condition of the building). <p data-bbox="704 1360 1406 1541">Remember that even those who are able to get to you may be in shock and confused. When giving directions to victims, CERT members should look directly at the victims, speak in short sentences, and keep their directions simple.</p>

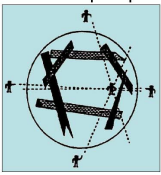
COMMUNITY EMERGENCY RESPONSE TEAM
UNIT 5: LIGHT SEARCH AND RESCUE OPERATIONS

INSTRUCTOR GUIDANCE	CONTENT
<div style="border: 1px solid black; padding: 5px;"> <p style="background-color: #4F81BD; color: white; padding: 2px;">Search Methodology</p> <ul style="list-style-type: none"> ● Bottom-up/top-down for a multi-story building ● Right wall/left wall for a single floor ● Stop frequently to listen  <p style="font-size: small; margin-top: 5px;">   CERT Basic Training Unit 5: Light Search and Rescue Operations 5-28 </p> </div> <p>Display Slide 5-28</p> <div style="border: 1px solid black; padding: 5px; margin-top: 10px;"> <p style="background-color: #4F81BD; color: white; padding: 2px;">Search Methodology</p> <ul style="list-style-type: none"> ● Stop frequently to listen for: <ul style="list-style-type: none"> ■ Tapping ■ Movement ■ Voices <p style="font-size: small; margin-top: 5px;">   CERT Basic Training Unit 5: Light Search and Rescue Operations 5-29 </p> </div> <p>Display Slide 5-29</p> <div style="border: 1px solid black; padding: 5px; margin-top: 10px;"> <p style="background-color: #4F81BD; color: white; padding: 2px;">Search Methodology</p> <ul style="list-style-type: none"> ● Triangulation allows rescuers to view a location from several perspectives  <p style="font-size: small; margin-top: 5px;">   CERT Basic Training Unit 5: Light Search and Rescue Operations 5-30 </p> </div> <p>Display Slide 5-30</p>	<p>2. <u>Use a systematic search pattern.</u> Ensure that all areas of the building are covered. Examples of systematic search patterns to use include:</p> <ul style="list-style-type: none"> ● Bottom-up/top-down ● Right wall/left wall <p>Emphasize that every interior space has six sides — including the floor and ceiling. Rescuers must check all six sides especially to locate hazards such as fixtures that may be hanging from the ceiling.</p> <p>3. <u>Stop frequently to listen.</u> Listen for tapping, movement, or voices.</p> <p>4. <u>Triangulate.</u> Triangulation can be used when a potential victim's location is obscured. If access permits, three rescuers, guided by victim sounds, form a triangle around the area and direct flashlights into the area. The light shining from different directions will eliminate shadows that could otherwise hide victims.</p> <p>Emphasize that triangulation should not be used as an initial search method.</p>



COMMUNITY EMERGENCY RESPONSE TEAM
UNIT 5: LIGHT SEARCH AND RESCUE OPERATIONS

INSTRUCTOR GUIDANCE	CONTENT
<p>Following this review of search methods, the instructor(s) should demonstrate how to conduct a search in a room, including search patterns (e.g., right wall/left wall) and marking next to doors. The demonstration can be done in any room. Tables, chairs, and other items can be used to simulate debris.</p> <div data-bbox="188 842 626 1171"> </div> <p>Display Slide 5-31</p> <div data-bbox="188 1278 626 1608"> </div> <p>Display Slide 5-32</p>	<p>5. <u>Report results.</u> Keep complete records both of removed victims and of victims who remain trapped or are dead. Report this information to emergency services personnel when they reach the scene.</p> <p><i>Exterior Search</i></p> <p>In addition to searching inside a structure, CERT members might also be required to search open areas outside of buildings.</p> <p>Conducting an effective search in open areas requires that searchers work methodically and follow standard procedures established by those in charge of the search operation. This is true in all cases, and especially if the area to be searched is a crime scene where all potential evidence must be protected.</p>





COMMUNITY EMERGENCY RESPONSE TEAM
UNIT 5: LIGHT SEARCH AND RESCUE OPERATIONS

INSTRUCTOR GUIDANCE	CONTENT
	<p>When searchers are needed, they assemble in a central staging area and sign in. Authorities will brief the searchers on what they will be looking for, what areas they are responsible for searching, the pattern of the search, and what they should do if they discover the missing person, evidence, or related information.</p> <p>Exterior search patterns include grid, line, quadrant or zone, and spiral. A grid pattern is typically used in large open areas or small areas when a hands-and-knees search is conducted.</p> <p>Tell participants that these guidelines should be followed in a grid search.</p> <ul style="list-style-type: none">▪ The area to be searched is viewed as a grid, with searchers initially positioned at one side of the grid.▪ The distance between the searchers should be set according to visibility and debris. In all cases, searchers must remain within line of sight and voice contact with searchers on either side of them. <p>It is also critical that the area to be covered by each searcher overlaps that of the searchers on either side of them.</p> <ul style="list-style-type: none">▪ The searchers proceed, maintaining as straight a line as possible across the entire search area. As each searcher moves across the area, they conduct a thorough search for victims within their designated row of the grid.▪ In order to ensure full coverage, CERTs must record each area that has been searched. <p>Explain that a grid search might be particularly useful following a tornado or hurricane.</p>

COMMUNITY EMERGENCY RESPONSE TEAM
UNIT 5: LIGHT SEARCH AND RESCUE OPERATIONS

INSTRUCTOR GUIDANCE	CONTENT
<p data-bbox="191 411 266 478"></p> <div data-bbox="188 699 626 1024"><p data-bbox="207 716 412 741">Rescue Operations</p><ul data-bbox="207 764 399 919" style="list-style-type: none">• Remove objects and debris to free victims and create safe rescue environment• Triage victims• Remove victims• Remove debris<p data-bbox="196 995 626 1024">FEMA CERT Basic Training Unit 5: Light Search and Rescue Operations 5-33</p></div> <p data-bbox="188 1066 461 1100">Display Slide 5-33</p>	<p data-bbox="659 411 1354 512">Are there any questions about planning and conducting search operations or the methods involved in an effective search?</p> <p data-bbox="659 554 1419 625">Tell the participants that the next section will deal with conducting rescue operations.</p> <p data-bbox="659 709 1214 751"><i>Conducting Rescue Operations</i></p> <p data-bbox="659 802 1354 873">Introduce this topic by telling the participants that rescues involve three primary functions:</p> <ul data-bbox="659 894 1406 1138" style="list-style-type: none">▪ <u>Moving objects and debris</u> to free victims and to create a safe rescue environment▪ <u>Triaging victims</u> by checking for the “three killers,” airway obstruction, major bleeding, and shock▪ <u>Removing victims</u> as safely and as quickly as possible <p data-bbox="659 1159 1377 1192">Stress that rescuer safety is always the top priority.</p> <p data-bbox="659 1234 1403 1306">Explain that the three primary functions of rescue will be addressed separately.</p>

COMMUNITY EMERGENCY RESPONSE TEAM
UNIT 5: LIGHT SEARCH AND RESCUE OPERATIONS

INSTRUCTOR GUIDANCE	CONTENT
<p data-bbox="207 415 516 447">Creating a Safe Environment</p> <ul data-bbox="215 470 594 579" style="list-style-type: none">● Maintain rescuer safety● Triage in lightly and moderately damaged buildings● Evacuate victims as quickly as possible <p data-bbox="196 699 626 730"> CERT Basic Training Unit 5: Light Search and Rescue Operations 5-34 </p> <p data-bbox="188 764 440 798">Display Slide 5-34</p>	<p data-bbox="659 422 1097 455">Creating a Safe Environment</p> <p data-bbox="659 474 1256 543">Tell participants that there are three safety considerations for all rescue operations:</p> <ul data-bbox="659 564 1382 810" style="list-style-type: none">▪ To maintain rescuer safety▪ To triage in lightly and moderately damaged buildings▪ To evacuate victims as quickly as possible from moderately damaged buildings while minimizing additional injury <p data-bbox="659 831 1390 1005">Emphasize that none of these can be achieved without creating as safe an environment as possible before attempting rescue. There are, therefore, certain precautions that rescuers must take to minimize risk.</p>
<p data-bbox="207 1136 516 1167">Precautions to Minimize Risk</p> <ul data-bbox="215 1190 464 1320" style="list-style-type: none">● Know your limitations● Follow safety procedures● Remove debris by:<ul data-bbox="237 1272 339 1320" style="list-style-type: none">▪ Leveraging▪ Cribbing <p data-bbox="196 1419 626 1451"> CERT Basic Training Unit 5: Light Search and Rescue Operations 5-35 </p> <p data-bbox="188 1484 464 1518">Display Slide 5-35</p>	<p data-bbox="659 1089 1097 1123">Precautions to Minimize Risk</p> <p data-bbox="659 1163 1419 1272">Stress that there are certain precautions that rescuers must take to minimize risk and increase their chances of achieving their rescue goals.</p> <ul data-bbox="659 1325 1425 1541" style="list-style-type: none">▪ <u>Know your limitations.</u> Many volunteers have been injured or killed during rescue operations because they did not pay attention to their own physical and mental limitations. CERT rescuers should take the time to eat, drink fluids, rest, and relax so that they can return with a clear mind and improved energy.

COMMUNITY EMERGENCY RESPONSE TEAM
UNIT 5: LIGHT SEARCH AND RESCUE OPERATIONS

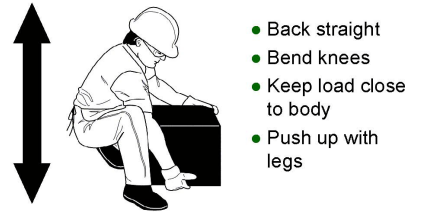
INSTRUCTOR GUIDANCE	CONTENT
<p data-bbox="207 415 626 457">Proper Lifting Procedures</p>  <ul style="list-style-type: none">● Back straight● Bend knees● Keep load close to body● Push up with legs <p data-bbox="207 699 626 730">FEMA CERT Basic Training Unit 5: Light Search and Rescue Operations 5-36</p> <p data-bbox="191 766 462 802">Display Slide 5-36</p> <p data-bbox="191 1245 360 1281">PM, P. 5-28</p>	<ul style="list-style-type: none">▪ <u>Follow safety procedures.</u> CERT members should always use the proper safety equipment required for the situation and follow established procedures, including:<ul style="list-style-type: none">• Work in pairs.• Triage and treat only in lightly damaged buildings.• In moderately damaged buildings, triage only and remove victims as quickly as possible.• Never enter an unstable structure.• Lift by bending the knees, keeping the back straight, and pushing up with the legs.• Carry the load close to the body.• Lift and carry no more than is reasonable.▪ <u>Remove debris.</u> Remove debris as needed to minimize risk to rescuers and to free entrapped victims. <p data-bbox="659 1207 1377 1276">Refer the participants to the diagram titled <i>Proper Body Positions for Lifting</i> in the Participant Manual.</p>

COMMUNITY EMERGENCY RESPONSE TEAM
UNIT 5: LIGHT SEARCH AND RESCUE OPERATIONS

PM, P. 5-28

Proper Body Position for Lifting

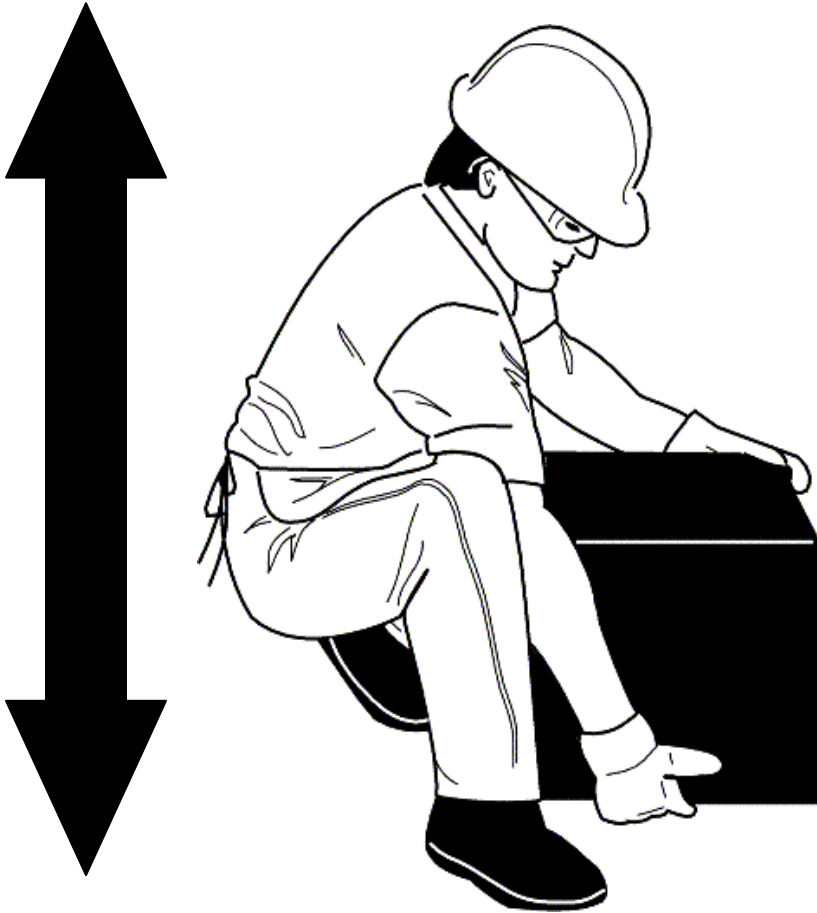

Proper body position for lifting showing the back straight and lifting with the knees



COMMUNITY EMERGENCY RESPONSE TEAM
UNIT 5: LIGHT SEARCH AND RESCUE OPERATIONS

INSTRUCTOR GUIDANCE	CONTENT
<div data-bbox="186 695 626 1024" data-label="Image"> </div> <p>Display Slide 5-37</p> <p>PM, PP. 5-31 through 5-33</p> <p>Demonstrate leveraging and cribbing for the group. Show box cribbing and “unboxed” cribbing.</p>	<p>Leveraging and Cribbing</p> <p>Tell the participants that they may encounter situations in which debris needs to be moved to free victims. In these situations, CERT rescuers should consider leveraging and cribbing to move and stabilize the debris until the rescue is complete.</p> <ul style="list-style-type: none"> ▪ <u>Leveraging</u> is accomplished by wedging a lever under the object that needs to be moved, with a stationary object underneath it to act as a fulcrum. When the lever is forced down over the fulcrum, the far end of the lever will lift the object. ▪ A <u>crib</u> is a wooden framework used for support or strengthening. <u>Box cribbing</u> means arranging pairs of wood pieces alternately to form a stable rectangle. <p>Refer the participants to the section titled <i>Leveraging and Cribbing</i> in the Participant Manual, for a description of a leveraging and cribbing operation and an illustration of procedures for cribbing.</p> <p>Explain that leveraging and cribbing are used together by alternately lifting the object and placing cribbing materials underneath the lifted edge to stabilize it.</p> <p>Safety is number one: "Lift an inch; crib an inch." Caution that leveraging and cribbing should be gradual — both for stability and to make the job easier.</p>

COMMUNITY EMERGENCY RESPONSE TEAM
UNIT 5: LIGHT SEARCH AND RESCUE OPERATIONS

INSTRUCTOR GUIDANCE	CONTENT
	<p>It may also be necessary to use leveraging and cribbing at more than one location (e.g., front and back) to ensure stability. Emphasize that leveraging and cribbing at opposite ends should <u>never</u> be done at the same time because doing so will increase the instability of the debris. Suggest that, if leveraging is required at both ends, the participants should lift and crib at one end, then repeat the process at the other end.</p> <p>Explain that positioning the pry tool and the fulcrum correctly is critical for safe operations. The fulcrum and pry tool must be perpendicular (90 degrees) to the edge of the object being lifted. Also, attempting to leverage a heavy object using too sharp an angle is inefficient and can result in back injury.</p> <p>Caution the group that box cribbing is stable, but it requires pieces of cribbing material of relatively uniform size. When such material is not available, “unboxed” cribbing can also work effectively to support and stabilize the heavy object.</p> <p>Tell the participants that a variety of cribbing materials may be used for these procedures and provide suggestions (e.g., tires or structural debris). Emphasize the importance of improvising, and encourage them not to put form over function.</p> <p>Warn the participants that when they are able to achieve sufficient lift, they should remove the victim and reverse the leveraging and cribbing procedure to lower the object. Stress that they should never leave an unsafe condition, unless the structure or building is obviously compromised.</p>

COMMUNITY EMERGENCY RESPONSE TEAM
UNIT 5: LIGHT SEARCH AND RESCUE OPERATIONS

INSTRUCTOR GUIDANCE	CONTENT
<p data-bbox="188 772 266 848"></p> <p data-bbox="188 884 626 1024">When asking the questions, set up a brief scenario and ask what the participants would do in that situation.</p> <p data-bbox="188 1066 266 1142"></p>	<p data-bbox="657 407 1409 583">Tell the group that when they must remove debris to locate victims, they should set up a human chain and pass the debris from one person to the next. Caution them, however, to set up the chain in a position that will not interfere with rescue operations.</p> <p data-bbox="657 625 1417 730">Remind them to wear their PPE to protect themselves at all times. Note that kneepads can be an important addition to their PPE during rescue operations.</p> <p data-bbox="657 772 1417 842">Ask the group several "What would you do if?" questions to ensure that they understand the material.</p> <p data-bbox="657 1066 1382 1171">Does anyone have any questions about safety precautions and leveraging and cribbing during rescue operations?</p> <p data-bbox="657 1213 1385 1318">When it is clear that the participants understand the concepts, tell them that the next section will cover moving victims.</p>

COMMUNITY EMERGENCY RESPONSE TEAM
UNIT 5: LIGHT SEARCH AND RESCUE OPERATIONS

PM, P. 5-31 through 5-33

Leveraging and Cribbing

1. Conduct a sizeup of the scene: Gather facts, identify hazards, and establish priorities.
2. Have one person in charge and formulate a plan of action, based upon the information you have received, to identify how and where to lift and crib and how the victim will be removed from underneath the debris.
3. Gather necessary materials for lifting/cribbing operations: Lever, fulcrum, cribbing blocks, spacers/wedges. During an actual emergency, you may have to use creative, substitute materials.
4. Use cribbing materials to stabilize the object prior to lifting.
5. Distribute cribbing materials as necessary to be readily accessible during the lifting operation.
6. Prepare to lift the object: Assemble the lever and fulcrum at the previously identified location.
7. Assign a person to monitor and be ready to remove the victim as soon as possible.
8. Initiate the lift, using the lever and fulcrum for mechanical advantage.
9. As the object is lifted, add cribbing as needed, one layer at a time.
10. When the object is adequately supported, remove the lever and fulcrum. The victim may then be removed.
11. Unless the structure is obviously compromised and you need to evacuate immediately, reinitiate the lift and begin removing cribbing materials, reversing the process by which the crib was built.
12. Progressively lower the object to the ground. Always return the heavy object to a stable position unless you have to evacuate immediately.
13. Before you leave, remember to collect the lifting/cribbing supplies to be available for additional operations.

COMMUNITY EMERGENCY RESPONSE TEAM
UNIT 5: LIGHT SEARCH AND RESCUE OPERATIONS

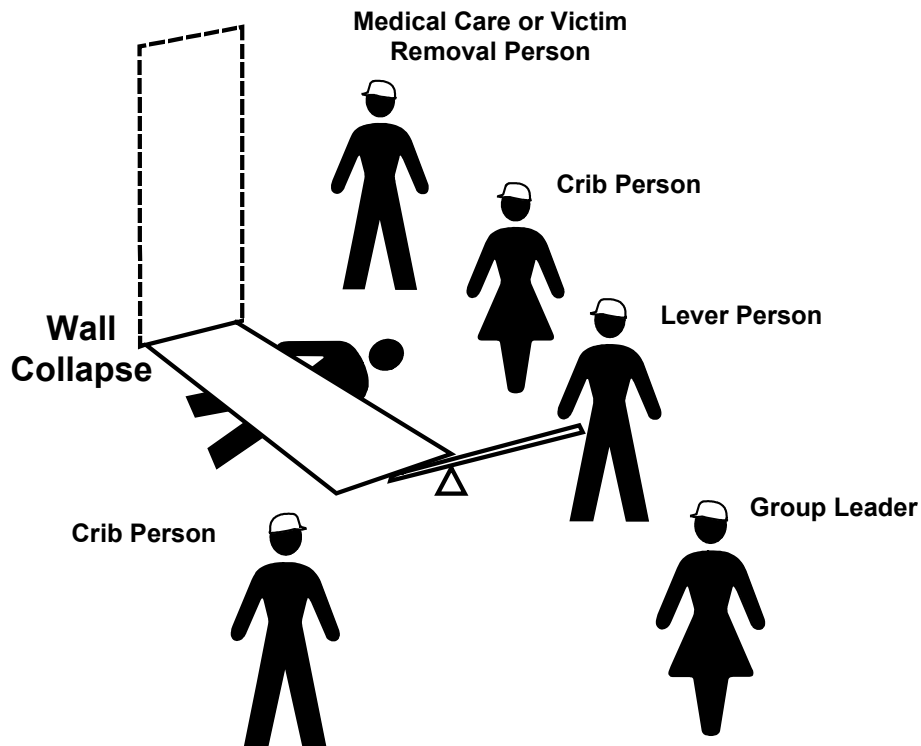

Team organization for leveraging/cribbing operation, showing the victim underneath a collapsed wall and the CERT members at the following locations:

- **Group Leader:** In front of collapse, positioned so that he or she can view the entire operation while remaining out of the rescuers' way
- **Lever Person:** At the front edge of the collapsed wall and positioned so that he or she can position a fulcrum and lever under the wall
- **Crib Persons:** On either side of the collapsed wall and positioned to enable the placement of cribbing as the wall is raised with the lever
- **Medical Care/Victim Removal Person:** Next to the Crib Person who is closest to the victim's head

COMMUNITY EMERGENCY RESPONSE TEAM
UNIT 5: LIGHT SEARCH AND RESCUE OPERATIONS

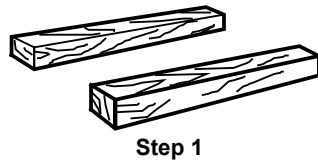
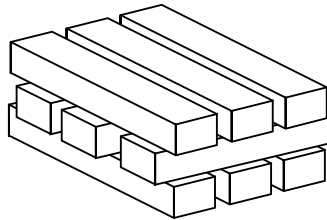

Step 1

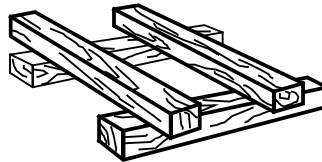

Step 2

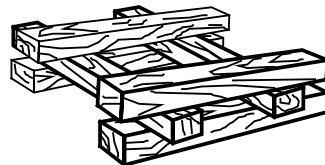

Step 3

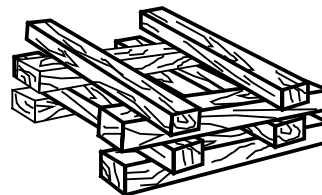

Step 4



Four steps for building box cribbing:

Step 1: Position two pieces of wood parallel to each other on either side of the collapse.

Step 2: Place two pieces of wood perpendicularly across the base pieces.

Steps 3 and 4: Add additional layers of wood, with each perpendicular to the previous level.

COMMUNITY EMERGENCY RESPONSE TEAM
UNIT 5: LIGHT SEARCH AND RESCUE OPERATIONS

INSTRUCTOR GUIDANCE	CONTENT
<p data-bbox="207 415 446 447">Two Types of Removal</p> <ul data-bbox="212 468 349 537" style="list-style-type: none">• Self removal or assist• Lifts and drags  <p data-bbox="196 699 626 730">FEMA CERT Basic Training Unit 5: Light Search and Rescue Operations 5-38</p> <p data-bbox="188 768 461 804">Display Slide 5-38</p>	<p data-bbox="659 405 935 441">Removing Victims</p> <p data-bbox="659 478 1414 548">Introduce this section by explaining that there are two basic types of victim removal:</p> <ul data-bbox="659 569 1016 653" style="list-style-type: none">▪ Self-removal or assist▪ Lifts and drags <p data-bbox="659 674 1414 888">Explain that it is usually best to allow an ambulatory victim to extricate him- or herself. Caution the group, however, that sometimes ambulatory victims are not as strong and uninjured as they think they are. When victims become free from entrapment, they may need assistance to exit the structure.</p>
<p data-bbox="207 978 496 1010">Which Extrication Method?</p> <ul data-bbox="212 1031 375 1224" style="list-style-type: none">• General stability of the immediate environment• Number of rescuers available• Strength and ability of the rescuers• Condition of victim  <p data-bbox="196 1262 626 1293">FEMA CERT Basic Training Unit 5: Light Search and Rescue Operations 5-39</p> <p data-bbox="188 1325 461 1360">Display Slide 5-39</p>	<p data-bbox="659 968 927 1003"><i>Extrication Method</i></p> <p data-bbox="659 1041 1382 1110">Explain that the type of extrication method selected should depend on the:</p> <ul data-bbox="659 1131 1365 1320" style="list-style-type: none">▪ General stability of the immediate environment▪ Number of rescuers available▪ Strength and ability of the rescuers▪ Condition of the victim
<p data-bbox="188 1482 618 1556">Review the symptoms of head and spinal injury if necessary.</p>	<p data-bbox="659 1335 1406 1446">Explain that the participants will learn the basic types of victim removal and will have the opportunity to practice some of the techniques.</p> <p data-bbox="659 1482 1422 1808">Caution the participants that, if safety and time permit, <u>they should not use lifts and drags to remove victims when closed-head or spinal injury is suspected</u>. In such cases, the spine must be stabilized using a backboard. Doors, tables, and similar materials can be used as improvised backboards. Stress that the backboard must be able to carry the person and that proper lifting techniques must be used. The log rolling technique will be covered later in this section.</p> <p data-bbox="659 1850 1390 1885">When moving victims, rescuers must use teamwork</p>

COMMUNITY EMERGENCY RESPONSE TEAM
UNIT 5: LIGHT SEARCH AND RESCUE OPERATIONS

INSTRUCTOR GUIDANCE	CONTENT
<p>PM, PP. 5-38 and 5-39</p> <p>Demonstrate these carries. Then, have all participants who are physically able pair up and practice the carries themselves. Give permission for participants to opt out of any carry with which they don't feel comfortable. Remind the participants that CERT members' safety is the number one priority.</p> <div data-bbox="188 1062 626 1390" data-label="Image"> </div> <p>Display Slide 5-40</p>	<p>and communication and keep the victim's spine in a straight line. Remember, rescuer safety and the condition of the building will dictate the approach.</p> <p>Point out that there are several types of lifts and carries. Refer the participants to the illustrations titled <i>Types of Lifts and Carries</i> in the Participant Manual.</p> <p><i>One-Person Arm Carry</i></p> <p>For example, if some participants are physically able and the victim is <u>small</u>, they may use the one-person arm carry to lift and carry the victim themselves by:</p> <ul style="list-style-type: none"> ▪ Reaching around the victim's back and under the knees ▪ Lifting the victim while keeping the rescuer's back straight and lifting with the legs <p>Consider the size of the victim and the distance he or she needs to be carried before using this carry.</p>



COMMUNITY EMERGENCY RESPONSE TEAM
UNIT 5: LIGHT SEARCH AND RESCUE OPERATIONS

INSTRUCTOR GUIDANCE	CONTENT
<p data-bbox="191 422 626 472">Pack-Strap Carry</p>  <p data-bbox="191 762 459 800">Display Slide 5-41</p>	<p data-bbox="659 405 906 443"><i>Pack-Strap Carry</i></p> <p data-bbox="659 478 1344 621">Tell the participants that another way for a single rescuer to lift a victim safely is by using the one-person pack-strap carry. Using this method, the rescuer should:</p> <ul data-bbox="659 642 1414 890" style="list-style-type: none">▪ <u>Step 1</u>: Stand with his or her back to the victim.▪ <u>Step 2</u>: Place the victim's arms over the rescuer's shoulders and grab the hands in front of the rescuer's chest.▪ <u>Step 3</u>: Hoist the victim by bending forward slightly, until the victim's feet just clear the floor. <p data-bbox="659 909 1414 978">Note: The pack-strap carry is most effective for quick removal of a victim over a short distance.</p>

COMMUNITY EMERGENCY RESPONSE TEAM
UNIT 5: LIGHT SEARCH AND RESCUE OPERATIONS

INSTRUCTOR GUIDANCE	CONTENT
<p data-bbox="191 405 625 457">Two-Person Carry</p>  <p data-bbox="191 768 462 804">Display Slide 5-42</p> <p data-bbox="191 842 625 1203">Demonstrate this lift using a participant volunteer as the victim. Allow all participants who are physically able to practice the lift: Assign the participants into groups of three (two rescuers and one victim), and rotate roles so that each person has a chance to try the two rescuer positions.</p>	<p data-bbox="659 405 922 441"><i>Two-Person Carry</i></p> <p data-bbox="659 478 1390 621">Explain that the victim's upper body will weigh more than his or her lower body; therefore, rescuers with greater body strength should be positioned at the victim's upper body.</p> <p data-bbox="659 659 1390 768">Explain that victim removal is easier when multiple rescuers are available. With two rescuers, a victim may be removed using a two-person carry.</p> <ul data-bbox="659 785 1419 1440" style="list-style-type: none">▪ <u>Rescuer 1</u>: Squat at the victim's head and grasp the victim from behind around the midsection. Reach under the arms and grasp the victim's left wrist with rescuer's right hand, and vice versa. Crossing the wrists creates a more secure hold on the victim and also pulls the victim's arms and elbows closer to their body. This will be helpful if the victim is carried through any narrow passages.▪ <u>Rescuer 2</u>: Squat between the victim's knees, facing either toward or away from the victim. Note that, if the rescuers will carry the victim over uneven areas such as stairs, the rescuers will need to face each other. Grasp the outside of the victim's legs at the knees.▪ <u>Both rescuers</u>: Rise to a standing position simultaneously, keeping backs straight and lifting with the legs. Walk the victim to safety.

COMMUNITY EMERGENCY RESPONSE TEAM
UNIT 5: LIGHT SEARCH AND RESCUE OPERATIONS

INSTRUCTOR GUIDANCE	CONTENT
<p data-bbox="207 415 332 445">Chair Carry</p>  <p data-bbox="196 699 625 730">FEMA CERT Basic Training Unit 5: Light Search and Rescue Operations 5-43</p> <p data-bbox="188 768 461 802">Display Slide 5-43</p> <p data-bbox="188 842 594 1020">Using a sturdy, non-swivel chair, demonstrate this carry using two instructors as rescuers and a volunteer participant as a victim.</p> <p data-bbox="188 1060 625 1203">Then, have all participants who are physically able practice the carry, working in the same three-person groups.</p>	<p data-bbox="659 405 824 438"><i>Chair Carry</i></p> <p data-bbox="659 478 1365 548">Demonstrate that two rescuers can also remove a victim by seating him or her on a chair:</p> <ul data-bbox="659 569 1393 814" style="list-style-type: none">▪ <u>Rescuer 1</u>: Cross the victim's arms in his or her lap. Facing the back of the chair, grasp the back upright.▪ <u>Rescuer 2</u>: Grasp the two front legs of the chair.▪ <u>Both rescuers</u>: Tilt the chair back, lift simultaneously, and walk out. <p data-bbox="659 835 1419 905">Explain that it is best to use a sturdy, non-swivel chair for this lift.</p> <p data-bbox="659 945 1419 1050">Note that, if rescuers will need to carry the victim over uneven surfaces such as stairs, the rescuers must face each other.</p>
<p data-bbox="207 1262 354 1291">Blanket Carry</p>  <p data-bbox="196 1539 625 1570">FEMA CERT Basic Training Unit 5: Light Search and Rescue Operations 5-44</p> <p data-bbox="188 1610 461 1644">Display Slide 5-44</p>	<p data-bbox="659 1245 854 1278"><i>Blanket Carry</i></p> <p data-bbox="659 1318 1425 1535">Tell the participants that they can use the blanket carry for victims who cannot be removed by other means. Caution the participants that the blanket carry requires four to six rescuers to ensure stability for the victim and that one rescuer must be designated the lead person:</p> <ul data-bbox="659 1556 1425 1822" style="list-style-type: none">▪ <u>Step 1</u>: Position a blanket next to the victim, ensuring that the blanket will extend under the victim's head.▪ <u>Step 2</u>: Tuck the blanket under the victim, and assist the victim in moving to the center of the blanket. If necessary, use the log rolling technique to position them on the blanket.

COMMUNITY EMERGENCY RESPONSE TEAM
UNIT 5: LIGHT SEARCH AND RESCUE OPERATIONS

INSTRUCTOR GUIDANCE	CONTENT
<p>Ask participants to volunteer to demonstrate log rolling and the blanket carry. Make sure that all participants have an opportunity to practice using the carry.</p>  <p>Display Slide 5-45</p>	<ul style="list-style-type: none"> ▪ <u>Step 3</u>: With three rescuers squatting on each side, roll up the edges of the blanket against the victim to grasp a “handle.” The lead person checks the team for even weight distribution and correct lifting position. ▪ <u>Step 4</u>: The lead person calls out, “Ready to lift on the count of three: One, two, three, <i>lift</i>.” ▪ <u>Step 5</u>: The team lifts and stands in unison — keeping the victim level — and carries the victim feet first. <p>Point out that the team must also lower the victim together, using the following steps:</p> <ul style="list-style-type: none"> ▪ <u>Step 1</u>: The lead person calls out, “Ready to lower on the count of three: One, two, three, <i>lower</i>.” ▪ <u>Step 2</u>: The team lowers the victim in unison, exercising caution to keep the victim level. <p>Explain that a variety of materials — such as blankets, carpets, and folded tables — can be used as improvised stretchers.</p> <p><i>Log Rolling</i></p> <p>Explain that log rolling should be used to move victims with a <u>suspected</u> or confirmed cervical spine injury. If the victim is unconscious, assume he or she has a cervical spine injury. The rescuer at a victim’s head should give commands as fellow rescuers roll the victim as a single unit onto the blanket, backboard, or other support.</p>

COMMUNITY EMERGENCY RESPONSE TEAM
UNIT 5: LIGHT SEARCH AND RESCUE OPERATIONS

PM, P.5-38 and 5-39

Types of Lifts and Carries

One-Person Arm Carry

One-Person Arm Carry, with the rescuer holding the victim around the victim's back and under the knees.



One-Person Pack-Strap Carry

One-Person Pack-Strap Carry in which the rescuer places the victim's arms over his or her shoulders and grabs the victim's wrists over his or her chest, then hoists the victim by bending over slightly.



COMMUNITY EMERGENCY RESPONSE TEAM
UNIT 5: LIGHT SEARCH AND RESCUE OPERATIONS

Two-Person Carry

Two-Person Carry in which Rescuer 1 squats at the victim's head and grasps the victim from behind at the midsection. Rescuer 1 should use his right hand to grab the victim's left wrist, and vice versa. Rescuer 2 squats between the victim's knees, grasping the outside of the knees. Both rescuers rise to a standing position."





Chair Carry

Chair Carry in which the victim is placed in a sturdy, non-swivel chair and tilted backward as rescuers lift the victim. This carry requires two rescuers. If possible, secure victim to the chair.

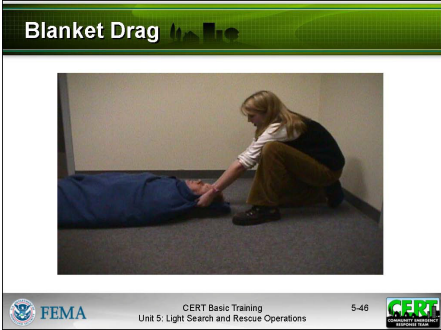

Note that, if rescuers will need to carry victim over uneven surfaces, such as stairs, the rescuers must face each other.

COMMUNITY EMERGENCY RESPONSE TEAM
UNIT 5: LIGHT SEARCH AND RESCUE OPERATIONS

INSTRUCTOR GUIDANCE	CONTENT
<p>PM, P. 5-41</p>  <p>Display Slide 5-46</p> 	<p>Point out that rescuers can also drag a victim out of a confined area by grasping either under the arms or the feet and pulling across the floor. Refer the participants to the diagram titled <i>Correct Drag Techniques</i> in the Participant Manual for an illustration. Caution the participants, however, that unless there is no other way to remove the victim and the victim's removal is time critical, they should not use this drag when debris may cause additional injury.</p> <p><i>Blanket Drag</i></p> <p>Explain that, when necessary, one rescuer can use the blanket drag by following these steps:</p> <ul style="list-style-type: none">▪ <u>Step 1</u>: Wrap the victim in a blanket.▪ <u>Step 2</u>: Squat down and grasp an edge of the blanket.▪ <u>Step 3</u>: Drag the victim across the floor. <p>Does anyone have any questions about rescue operations or victim removal?</p> <p>Explain that the participants will now have an opportunity to practice some of the victim removal techniques.</p>

COMMUNITY EMERGENCY RESPONSE TEAM
UNIT 5: LIGHT SEARCH AND RESCUE OPERATIONS

PM, P.5-41

Correct Drag Techniques

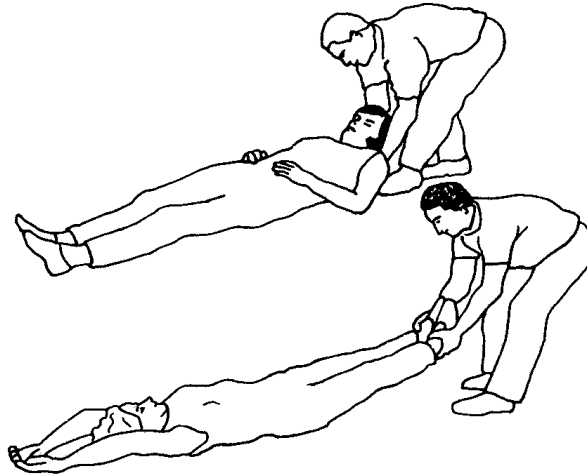

Correct Drag Technique

Correct drag technique, showing the rescuer grasping the victim by either the feet or shoulders and dragging him or her clear of the hazard

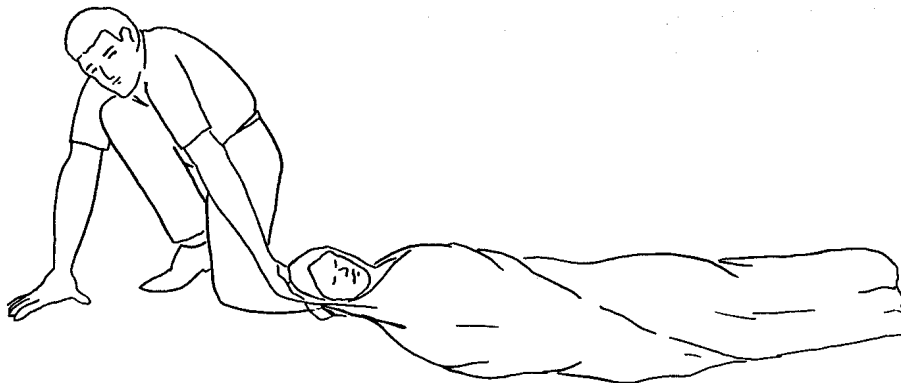

Blanket Drag

Blanket drag, showing the victim wrapped in a blanket with the rescuer squatting at the victim's head. The rescuer grasps the blanket behind the victim's head and drags him or her clear of the hazard.

COMMUNITY EMERGENCY RESPONSE TEAM
UNIT 5: LIGHT SEARCH AND RESCUE OPERATIONS

INSTRUCTOR GUIDANCE	CONTENT
<p>Instructor(s) should move from team to team and offer coaching as needed.</p> <p>Ask the teams to stay together for the next activity of the class, the Victim Extrication exercise.</p>	<p>Exercise: Victim Carries</p> <p>Purpose: Explain that this exercise will provide participants with an opportunity to practice different drags and carries to safely move victims.</p> <p>Instructions:</p> <ol style="list-style-type: none">1. Break the class into teams of seven.2. Tell all teams to practice each of the carries.<ul style="list-style-type: none">▪ Tell class that members of each team will volunteer to be “victims.”▪ Explain that the “victims” and “rescuers” must trade off roles so that everyone on the team has an opportunity to practice the drags and carries as a “rescuer.”▪ Emphasize that each person must pay attention to their own limitations. Each person should attempt only those drags or carries that will be safe for them to perform.3. Provide blankets, chairs, and back boards, if available, and encourage students to use each item as they practice performing drags and carries.4. Make sure teams trade off “victim” and “rescuer” roles so that everyone on each team has a chance to practice the drags and carries.5. Emphasize that participants know their own limits! Tell participants not to attempt any lift or carry that will not be safe for the rescuer and the victim.

COMMUNITY EMERGENCY RESPONSE TEAM
UNIT 5: LIGHT SEARCH AND RESCUE OPERATIONS

INSTRUCTOR GUIDANCE	CONTENT
<p>This exercise is best conducted by two instructors. Instructors should provide guidance to each team as they perform their extrication.</p> <p>A more realistic scenario can be created by using two or three rooms simultaneously, so that there are several "rescues" occurring at once.</p> <p>Mannequins or rescue dummies should be used as the entrapped victims at the "collapse sites," allowing all members of the group to practice as rescuers.</p> <p>If there are more groups of seven then there are "collapse sites," have one group observe while another conducts extrication at one site. When groups rotate, observers and rescuers will switch.</p> <p>Instructors should observe each group and correct errors that they see.</p>	<p>Exercise: Victim Extrication</p> <p>Purpose: Explain that this exercise will provide the participants with an opportunity to practice the removal of entrapped victims from a damage site, using leveraging/cribbing and drags and carries. Participants will be assigned to groups and told to do a room search, locate victims, and remove the victims.</p> <p>Instructions:</p> <ol style="list-style-type: none"> 1. Assign the participants to groups of seven. 2. Arrange the victims at the "collapse site(s)," using desks, shelves, etc., to represent debris. Place other items haphazardly around the victims. Make sure that there are items available that can serve as levers (e.g., 2 by 4s), fulcrums, and cribbing material. 3. Instruct the groups to: <ol style="list-style-type: none"> a. Enter their respective "collapse site" rooms b. Do a room search c. Locate the victims and use leveraging and cribbing procedures to free them d. Use appropriate lifts and drags to remove the victims from the room (and, if possible, from the building) 4. Rearrange the victims and "debris," and repeat the exercise until each participant has had an opportunity to practice being a rescuer and each team has practiced at two "collapse sites." <p>Discuss the exercise with the entire group, focusing on any differences between the teams' techniques and experiences.</p>



COMMUNITY EMERGENCY RESPONSE TEAM
UNIT 5: LIGHT SEARCH AND RESCUE OPERATIONS

INSTRUCTOR GUIDANCE	CONTENT
<div data-bbox="188 405 626 730"><p>Unit Summary</p><ul style="list-style-type: none">● You should know:<ul style="list-style-type: none">■ How to decide whether to attempt rescue■ The objectives of interior and exterior search and rescue■ How to perform search and rescue sizeup■ Building markings■ Rescue functions■ How to remove debris■ How to extricate victims<p>FEMA CERT Basic Training Unit 5: Light Search and Rescue Operations 5-47</p></div> <p data-bbox="188 768 459 804">Display Slide 5-47</p>	<p data-bbox="659 411 914 453"><i>Unit Summary</i></p> <p data-bbox="659 506 1187 541">Summarize the key points in this unit:</p> <ul style="list-style-type: none">■ The decision to attempt a rescue should be based on:<ul style="list-style-type: none">● The risks involved● Achievement of the overall goal of doing the greatest good for the greatest number■ The objectives of interior and exterior search and rescue are to:<ul style="list-style-type: none">● Maintain rescuer safety at all times● Rescue the greatest number of people in the shortest amount of time● Get the walking wounded and ambulatory victims out first● Rescue the lightly trapped victims next■ Remind the participants that CERTs are restricted to <i>light search and rescue</i>. Their mission when dealing with heavily damaged structures or situations that are clearly unsafe (e.g., rising or swiftly moving water) is to warn others.■ Search and rescue sizeup follows the same process as sizeup for other CERT operations. <u>Sizeup continues throughout search and rescue efforts</u> and provides information about how to proceed. Should sizeup indicate that evacuation of the team is necessary, the CERT mission is to ensure safety and organization during the evacuation.

COMMUNITY EMERGENCY RESPONSE TEAM
UNIT 5: LIGHT SEARCH AND RESCUE OPERATIONS

INSTRUCTOR GUIDANCE	CONTENT
	<ul style="list-style-type: none">▪ When the decision to begin search operations is made, CERT searchers must:<ul style="list-style-type: none">• Employ appropriate search techniques• Locate any victims and check for the “three killers” ▪ Locating victims means completing a sizeup of the building interior to identify areas of entrapment, then conducting a search that:<ul style="list-style-type: none">• Is systematic and thorough• Avoids unnecessary duplication of effort• Documents results ▪ Rescue involves three main functions:<ul style="list-style-type: none">• Creating a safe environment• Triaging or stabilizing victims• Removing victims based on the sizeup <p>Rescue operations hinge on maintaining rescuer safety, which requires CERT members to recognize their own limitations. CERT members should <i>never</i> attempt anything that exceeds their limitations <i>at that point in time</i>.</p> <p>Leveraging and cribbing may be used to lift heavy debris and give access to trapped victims.</p>

COMMUNITY EMERGENCY RESPONSE TEAM
UNIT 5: LIGHT SEARCH AND RESCUE OPERATIONS

INSTRUCTOR GUIDANCE	CONTENT
<div style="text-align: center; margin-bottom: 20px;">  </div> <div style="border: 1px solid black; padding: 5px; margin-bottom: 20px;"> <p style="background-color: #4F81BD; color: white; padding: 2px;">Homework Assignment</p> <ol style="list-style-type: none"> 1. Read unit to be covered in next session 2. Bring necessary supplies to next session 3. Wear appropriate clothes to next session </div> <div style="font-size: small; margin-bottom: 20px;">  CERT Basic Training Unit 5: Light Search and Rescue Operations 5-48  </div> <p>Display Slide 5-48</p>	<p>Victims can be removed in a number of ways, depending on:</p> <ul style="list-style-type: none"> ▪ Their condition ▪ The number of rescuers available ▪ The strength and ability of the rescuers ▪ The stability of the environment <p>Remind the participants of the lifts and drags that they found easier to accomplish and suggest that they use those drags and carries when circumstances permit.</p> <p>If the building's condition allows, victims with suspected head or spinal injury should be stabilized on some type of backboard before being removed. When possible, these removals should be deferred to trained EMS personnel.</p> <p>Does anyone have any questions about anything covered in this unit?</p> <p>Homework Assignment</p> <p>Ask the group to read and become familiar with the unit that will be covered in the next session.</p> <p>Thank the participants for attending the session. Remind them of the time and location of the next session, if necessary.</p>

UNIT 6: CERT ORGANIZATION

In this unit you will learn about:

- **CERT Organization:** How to organize and deploy CERT resources according to CERT organizational principles.
- **Rescuer Safety:** How to protect your own safety and your buddy's during search and rescue.
- **Documentation:** Strategies for documenting situation and resource status.
- **Team Organization:** A tabletop exercise to apply your knowledge of team organization.

[This page intentionally left blank]

COMMUNITY EMERGENCY RESPONSE TEAM

UNIT 6: CERT ORGANIZATION

OBJECTIVES	<p>At the conclusion of this unit, the participants should be able to:</p> <ul style="list-style-type: none">▪ Describe the CERT structure.▪ Identify how CERTs interrelate with the Incident Command System (ICS).▪ Explain documentation requirements.
SCOPE	<p>The topics that will be discussed in this unit are:</p> <ul style="list-style-type: none">▪ Introduction and Unit Overview▪ CERT Organization▪ CERT Mobilization▪ Documentation▪ Activity: ICS Functions▪ Tabletop Exercise▪ Unit Summary
ESTIMATED COMPLETION TIME	1 hour 45 minutes
TRAINING METHODS	<p>The lead instructor will begin this session by welcoming the participants to Unit 6: CERT Organization, and will introduce the instructors for the session. The instructor will then present a brief overview of this session.</p> <p>Next, the instructor will introduce the concept of the CERT organization — its objectives, history, and characteristics — and how CERT efforts fit into the overall Incident Command System (ICS).</p> <p>Next, the instructor will review how CERTs mobilize in a disaster situation. The instructor will introduce CERT decision-making, emphasizing the primary concern for rescuer safety. This discussion will include how CERT strategies are affected by the severity of structural damage.</p> <p>Then, the instructor will describe CERT documentation requirements. The emphasis will be on the importance of CERT documentation. The instructor will introduce some of the forms that CERTs can use to document different types of information.</p>

C COMMUNITY EMERGENCY RESPONSE TEAM

UNIT 6: CERT ORGANIZATION

TRAINING METHODS (CONTINUED)

Next, the instructor will conduct a brief activity during which the participants will match the five ICS functions with situations that could arise during a CERT deployment.

After all of the material is presented and discussed, the participants will take part in a tabletop exercise that will provide experience in CERT planning and tactics. The plan developed during the tabletop exercise will form the basis for the full-scale exercise in which the groups will participate during the final session.

RESOURCES REQUIRED

- *Community Emergency Response Team Instructor Guide*
 - *Community Emergency Response Team Participant Manual*
 - PowerPoint Slides 6-0 through 6-21
-

OTHER RESOURCES

If time permits, the 19-minute video *CERT in Action* is recommended for this unit. The video portrays a CERT activating and setting up an ICS immediately following a major storm and conducting search, rescue, and medical operations according to CERT protocols. The video is available for download at the national CERT Web site, www.citizencorps.gov/CERT/.

EQUIPMENT

The following additional equipment is required for this unit:

- A computer with PowerPoint software
 - A computer projector and screen
-

PREPARATION

Crime scene protocols. Consider whether or not you want to include basic crime scene protocols in this unit. If so, arrange for that information to be delivered.

Forms. A set of CERT documentation forms is included in the Instructor Guide and in the Participant Manual. Other options may also be used. If your local program decides to use any of the forms listed below, before conducting this unit replace the forms in this unit of the Instructor Guide and the Participant Manual. It is useful to include a blank form and an example of the same form with information filled in.

- Some local CERT programs develop their own CERT documentation forms and/or adapt forms used by the agency that sponsors the CERT program.
-

COMMUNITY EMERGENCY RESPONSE TEAM

UNIT 6: CERT ORGANIZATION

PREPARATION (CONTINUED)

- Other CERT programs use forms originally developed by the Los Angeles CERT Program. These samples and other forms are available at www.cert-la.com/forms/forms.htm. The forms should be adapted to fit your program needs.
- The National Incident Management System (NIMS) requires adoption of the Incident Command System (ICS). If your department's NIMS compliance plan includes the use of ICS forms, some of these forms could be considered for CERTs as well. All of the ICS forms are available at www.fs.fed.us/fire/planning/nist/ics_forms.htm.

Tabletop exercise. For the tabletop exercise at the end of this unit, choose a situation that might occur in your community and to which your CERT would be deployed. Select and integrate into the exercise the hazards that your CERT members would face in the event. Select an actual location in your community and create maps of the scene to make the scenario more realistic.

As part of the exercise, you may wish to develop a list of potential situations that could occur in your community and ask the participants to prioritize their responses based on the goal of doing the greatest good for the greatest number.

Culturally Sensitive Topics. Working with a representative of the community in which you will be teaching, identify any potentially culturally sensitive topics in this module. Develop strategies for presenting any such topics in ways that will engage, rather than offend, participants.

In particular, look at ways to make the end-of-unit tabletop exercise culturally appropriate to the target audience. Consider how participants may react to discussions of leadership and other ICS roles. Some audiences may find the chain-of-command structure to be rigid and uncomfortable. Be sure to explain the critical importance of all ICS roles, and point out that the incident commander role is no more or less important than any other role. Focus on the concept of teamwork and the importance of team structure in a disaster.

C COMMUNITY EMERGENCY RESPONSE TEAM

UNIT 6: CERT ORGANIZATION

NOTES

A suggested time plan for this unit is as follows:

Introduction and Unit Overview.....	5 minutes
CERT Organization.....	20 minutes
CERT Mobilization.....	10 minutes
Documentation.....	10 minutes
Activity: ICS Functions.....	10 minutes
Activity: Tabletop Exercise.....	45 minutes
Unit Summary.....	5 minutes



Total Time: 1 hour 45 minutes

Unit 6: CERT Organization

INSTRUCTOR GUIDANCE	CONTENT
 <p>Display Slide 6-0</p>	<p><i>Introductions and Unit Overview</i></p> <p>Welcome</p> <p>Welcome the participants to Unit 6 of the <i>CERT Basic Training</i>.</p> <p>Introduce the instructors for this unit and ask any new instructors to describe briefly their experience with CERT organization.</p> <p>Remind the participants that in previous units they learned specific strategies and tasks to use in specific situations. Tell them that in this session they will use that knowledge in a team environment, using the CERT organization as a foundation.</p> <p>Remind the group that they recently learned about teamwork during medical triage and search and rescue operations. Point out that team organization concepts can help them both operationally and psychologically. Working together and looking out for each other are important aspects of successful teams.</p>



C COMMUNITY EMERGENCY RESPONSE TEAM

UNIT 6: CERT ORGANIZATION

INSTRUCTOR GUIDANCE	CONTENT
<p></p> <p>Correct response:</p> <ul style="list-style-type: none">▪ Maintain rescuer safety at all times.▪ Rescue the greatest number of people in the shortest amount of time.▪ Get the walking wounded and ambulatory victims out first.▪ Rescue the lightly trapped victims next. <p></p> <p>Correct response:</p> <p>Secure the perimeter and warn others.</p>	<p>Briefly review Light Search and Rescue Operations.</p> <p>What is one of the objectives of interior and exterior searches?</p> <p>What is the CERT mission for an interior search if the damage to the building is heavy?</p>



COMMUNITY EMERGENCY RESPONSE TEAM

UNIT 6: CERT ORGANIZATION

INSTRUCTOR GUIDANCE	CONTENT
 <p>Correct response:</p> <ul style="list-style-type: none">▪ When you enter a space or room, call out to victims.▪ Use a systematic search pattern.▪ Check six sides.▪ Stop frequently to listen.▪ Triangulate.▪ Document and report.	<p>There are some specific techniques to follow when conducting an interior search. What are they?</p>
 <p>Correct response:</p> <p>Leveraging and cribbing</p>	<p>What is one way to remove debris and get access to trapped victims?</p>
 <p>Correct response:</p> <p>As a team, use the log rolling technique to roll the victim as a single unit onto a blanket, backboard, or other support, e.g., door or table.</p>	<p>There are several ways to remove a victim who can't walk on his or her own. How should you move a victim with a suspected cervical spine injury?</p>

C COMMUNITY EMERGENCY RESPONSE TEAM

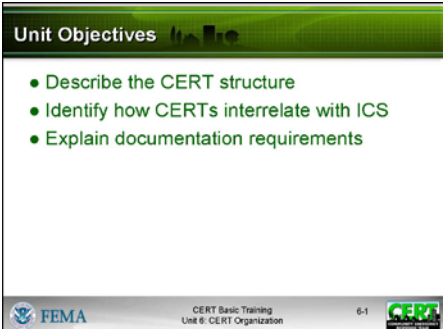
UNIT 6: CERT ORGANIZATION

INSTRUCTOR GUIDANCE	CONTENT
<div data-bbox="170 409 609 735"><p>Unit Objectives</p><ul style="list-style-type: none">• Describe the CERT structure• Identify how CERTs interrelate with ICS• Explain documentation requirements<p>FEMA CERT Basic Training Unit 6: CERT Organization 6-1</p></div> <p data-bbox="170 745 422 787">Display Slide 6-1</p> <div data-bbox="170 850 609 1186"><p>Unit Topics</p><ul style="list-style-type: none">• CERT Organization• Mobilization• Documentation<p>FEMA CERT Basic Training Unit 6: CERT Organization 6-2</p></div> <p data-bbox="170 1197 422 1239">Display Slide 6-2</p>	<p data-bbox="641 409 876 451">Unit Objectives</p> <p data-bbox="641 462 1364 535">Tell the participants that at the end of this unit, they should be able to:</p> <ul data-bbox="641 546 1364 735" style="list-style-type: none">▪ Describe the CERT structure.▪ Identify how CERTs interrelate with the Incident Command System (ICS).▪ Explain documentation requirements. <p data-bbox="641 850 812 892">Unit Topics</p> <p data-bbox="641 903 1380 1018">Preview the unit topics by telling the group that this unit will provide them with a thorough understanding of CERT organization and policy.</p> <ul data-bbox="641 1029 974 1176" style="list-style-type: none">▪ CERT Organization▪ CERT Mobilization▪ Documentation <p data-bbox="641 1186 1380 1302">Note that effective CERT operations, like all aspects of emergency response, rely on effective communication.</p> <p data-bbox="641 1312 1388 1428">Ask the group to note how frequently effective communication underlies the operational guidance to be covered in this unit.</p>

COMMUNITY EMERGENCY RESPONSE TEAM

UNIT 6: CERT ORGANIZATION

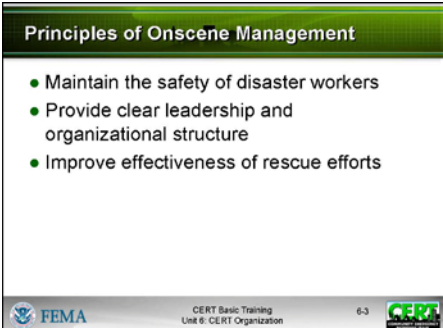
INSTRUCTOR GUIDANCE	CONTENT
 <p>Principles of Onscene Management</p> <ul style="list-style-type: none">• Maintain the safety of disaster workers• Provide clear leadership and organizational structure• Improve effectiveness of rescue efforts <p>FEMA CERT Basic Training Unit 6: CERT Organization 6-3</p> <p>Display Slide 6-3</p>	<h3><i>CERT Organization</i></h3> <h4>Principles of Onscene Management</h4> <p>Explain to the participants that onscene management in a disaster situation has three primary goals:</p> <ul style="list-style-type: none">▪ <u>Maintain the safety of disaster workers.</u> The CERT Incident Commander/Team Leader (IC/TL) must continually prioritize response activities based on the team’s capability and training and the principle that rescuer safety is the number one concern. CERT functional leadership assigns activities and accounts for team members. CERT members work in the buddy system and respond based on their sizeup of the situations that they encounter.▪ <u>Provide clear leadership and organizational structure</u> by developing a chain of command and roles that are known by all team members. Each CERT member has only one person that he or she takes direction from and responds to.▪ <u>Improve the effectiveness of rescue efforts.</u> Disaster information is collected and responses are prioritized based on rescuer safety and doing the greatest good for the greatest number according to the team’s capabilities and training. <p>Point out that the CERT organization is based on the Incident Command System (ICS), which is a proven management system used by emergency responders.</p>

C COMMUNITY EMERGENCY RESPONSE TEAM

UNIT 6: CERT ORGANIZATION

INSTRUCTOR GUIDANCE	CONTENT
<p data-bbox="186 409 609 451">CERT Onscene Management</p> <ul data-bbox="186 462 609 661" style="list-style-type: none">• Well-defined management structure• Manageable span of control• Common terminology• Effective communication• Consolidated action plans• Comprehensive resource management• Accountability  <p data-bbox="170 756 609 798">Display Slide 6-4</p> <p data-bbox="170 808 609 1039">You may want to review some of the key terminology used by CERT (e.g., delayed, immediate, minor, dead; light, moderate, and heavy damage, etc.).</p>	<p data-bbox="641 409 1079 451">CERT Onscene Management</p> <p data-bbox="641 462 1299 535">Tell the participants that the specific CERT organizational structure and protocols provide:</p> <ul data-bbox="641 546 1421 1270" style="list-style-type: none">▪ A well-defined management structure (e.g., leadership, functional areas, reporting chain, working in teams)▪ A manageable span of control that provides for a desirable rescuer-to-supervisor ratio of between three and seven rescuers per supervisor▪ Common terminology that contributes to effective communication and shared understanding▪ Effective communication among team members and with professional responders, including the use of radios▪ Consolidated action plans that coordinate strategic goals, tactical objectives, and support activities▪ Comprehensive resource management that facilitates application of available resources to the incident in a timely manner▪ Accountability

COMMUNITY EMERGENCY RESPONSE TEAM

UNIT 6: CERT ORGANIZATION

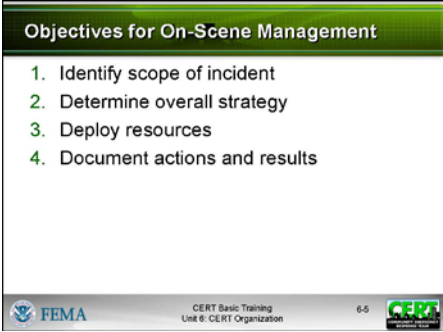
INSTRUCTOR GUIDANCE	CONTENT
 <p>Objectives for On-Scene Management</p> <ol style="list-style-type: none">1. Identify scope of incident2. Determine overall strategy3. Deploy resources4. Document actions and results <p>FEMA CERT Basic Training Unit 6: CERT Organization 6-5</p> <p>Display Slide 6-5</p>	<p>Objectives for CERT Onscene Management</p> <p>Tell the group that, in a disaster situation, the CERT:</p> <ul style="list-style-type: none">▪ Identifies the scope of the incident (What is the problem?)▪ Determines an overall strategy (What can we do, and how will we do it?)▪ Deploys teams and resources (Who is going to do what?)▪ Documents actions and results <p>Stress that disasters create a dynamic, ever-changing environment. The CERT organizational framework is flexible so that it can expand or contract depending on the ongoing assessment priorities determined by the CERT Incident Commander/Team Leader (IC/TL), and people and resources available. This expansion and contraction helps ensure:</p> <ul style="list-style-type: none">▪ Rescuer safety▪ Doing the greatest good for the greatest number▪ A manageable span of control▪ Accountability of CERT members

C COMMUNITY EMERGENCY RESPONSE TEAM

UNIT 6: CERT ORGANIZATION

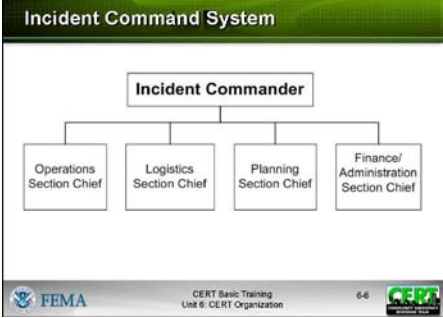
INSTRUCTOR GUIDANCE	CONTENT
<p data-bbox="170 409 609 724"><p data-bbox="170 756 430 798">Display Slide 6-6</p><p data-bbox="170 1480 324 1522">PM, P. 6-5</p></p>	<p data-bbox="641 409 1047 451">Incident Command System</p> <p data-bbox="641 462 1364 609">Tell the group that the Incident Command System (ICS) is the system used by emergency response agencies to manage emergency operations. When CERTs activate, they become part of that system.</p> <p data-bbox="641 619 1396 913">Explain that the basic ICS structure for CERT is established by the person who arrives first on the scene. This person becomes the Incident Commander/Team Leader (IC/TL). Initially, the IC/TL may handle all of the command positions of ICS but, as the incident evolves, he or she may assign personnel as needed to the four ICS Command Functions:</p> <ul data-bbox="641 934 1218 1123" style="list-style-type: none">▪ Operations Section Chief▪ Logistics Section Chief▪ Planning Section Chief▪ Finance/Administration Section Chief <p data-bbox="641 1197 1388 1417">Emphasize to participants that through an effective ICS, all CERT members report through a chain of command to the IC/TL. The IC/TL reports to the first fire or law enforcement official at their location and takes direction from that person until otherwise directed or until the CERT is relieved.</p> <p data-bbox="641 1480 1372 1627">Refer the participants to the organization chart <i>ICS Command Function Organization Chart</i> in the Participant Manual and on the following page in the Instructor Guide.</p>

COMMUNITY EMERGENCY RESPONSE TEAM

UNIT 6: CERT ORGANIZATION

PM, P. 6-5	ICS Command Function Organization Chart
------------	---

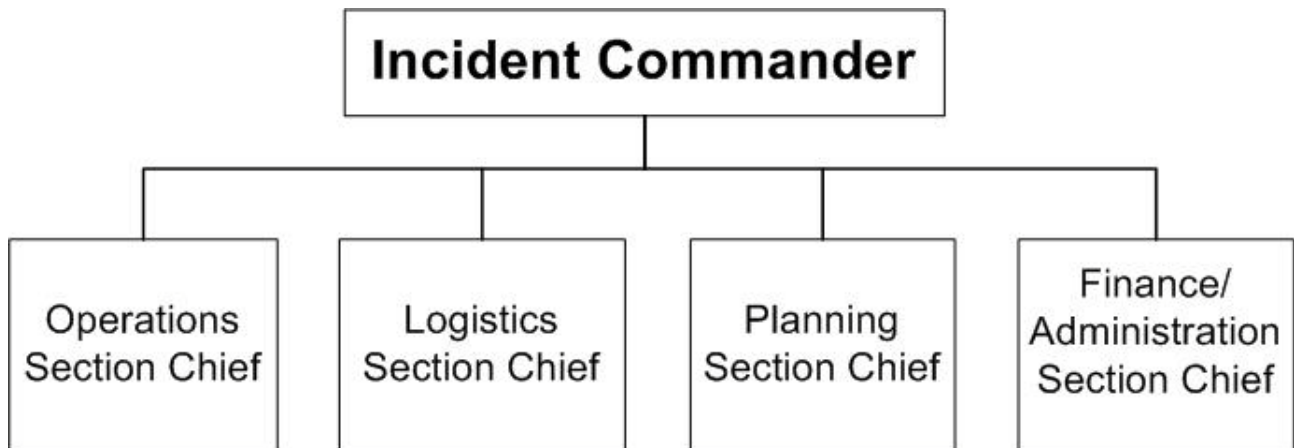

C COMMUNITY EMERGENCY RESPONSE TEAM

UNIT 6: CERT ORGANIZATION

INSTRUCTOR GUIDANCE	CONTENT
Emphasize this point.	<p>Emphasize that CERTs will typically require the Operations, Planning, and Logistics functions. The CERT Incident Commander/Team Leader (IC/TL) is responsible for handling or delegating each function.</p> <p>Say that, as the incident expands, it may be necessary to assign other personnel in each section to handle specific aspects of the response while maintaining an effective span of control.</p> <p>Explain <u>briefly</u> the responsibilities of each standard ICS function. Be sure to emphasize that, though there are a number of detailed responsibilities under each ICS function, the system itself is straightforward.</p> <p><u>CERT Incident Commander/Team Leader</u></p> <ul style="list-style-type: none">▪ Provides overall leadership for incident response▪ Ensures incident safety▪ Establishes incident objectives▪ Is responsible for all functions until delegated▪ Delegates authority to others▪ Provides information to internal and external parties▪ Establishes and maintains liaison with other responders (e.g., fire, law enforcement, public works, other CERTs)▪ Takes direction from agency official <p><u>Operations Section</u></p> <ul style="list-style-type: none">▪ Directs and coordinates all incident tactical operations▪ Is typically one of the first functions to be assigned

COMMUNITY EMERGENCY RESPONSE TEAM

UNIT 6: CERT ORGANIZATION

INSTRUCTOR GUIDANCE	CONTENT
	<p><u>Planning Section</u></p> <ul style="list-style-type: none">▪ Tracks resource status (e. g., number of CERT members who have “reported for duty”)▪ Tracks situation status▪ Prepares the Team’s action plan▪ Develops alternative strategies▪ Provides documentation services <p><u>Logistics Section</u></p> <ul style="list-style-type: none">▪ Provides communications▪ Provides food and medical support to Team members▪ Manages supplies and facilities <p><u>Finance and Administration Section</u></p> <ul style="list-style-type: none">▪ Contract negotiation and monitoring▪ Timekeeping▪ Cost analysis▪ Compensation for injury or damage to property <p>Explain that Finance and Administration is a function in the formal Incident Command System; however, CERTs will have very limited need, if any, for this function.</p>

C COMMUNITY EMERGENCY RESPONSE TEAM

UNIT 6: CERT ORGANIZATION

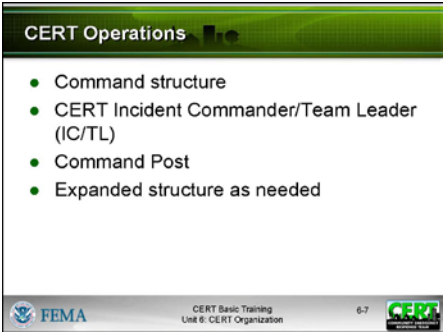
INSTRUCTOR GUIDANCE	CONTENT
 <p>CERT Operations</p> <ul style="list-style-type: none">• Command structure• CERT Incident Commander/Team Leader (IC/TL)• Command Post• Expanded structure as needed <p>FEMA CERT Basic Training Unit 6: CERT Organization 6-7</p> <p>Display Slide 6-7</p>	<h3>CERT Operations</h3> <p>Explain to the group the following points about the principles of ICS and how CERTs follow these protocols:</p> <ul style="list-style-type: none">▪ Each CERT must establish a command structure.▪ The CERT Incident Commander/Team Leader (IC/TL) directs team activities. During activation for a disaster, the first person at a predesignated staging area assumes this responsibility. The initial IC/TL may hand off this role to a predesignated leader when that person arrives.▪ The location established by the CERT IC/TL as the central point for command and control of the incident is called the <u>Command Post</u> for the CERT. The IC/TL stays in the Command Post. If the IC/TL has to leave, the responsibility of IC/TL must be delegated to someone in the Command Post.▪ Using the ICS structure, CERT members are assigned to assist with a range of functions:<ul style="list-style-type: none">• Logistics — managing resources, services, and supplies• Planning/Intelligence — collecting and displaying information; collecting and compiling documentation▪ Operations — conducting fire suppression, medical operations, search and rescue

COMMUNITY EMERGENCY RESPONSE TEAM

UNIT 6: CERT ORGANIZATION

INSTRUCTOR GUIDANCE	CONTENT
<p>PM, P. 6-9</p>	<ul style="list-style-type: none">▪ In all situations, each unit assigned <u>must have an identified leader</u> to supervise tasks being performed, to account for team members, and to report information to his or her designated leader. In all situations, a manageable span of control is three to seven team members reporting to their designated leader. <p>Refer the participants to the diagram <i>Expanded CERT Operations Structure</i> in the Participant Manual and on the following page of the Instructor Guide.</p>

PM, P. 6-9	Expanded CERT Operations Structure
------------	------------------------------------

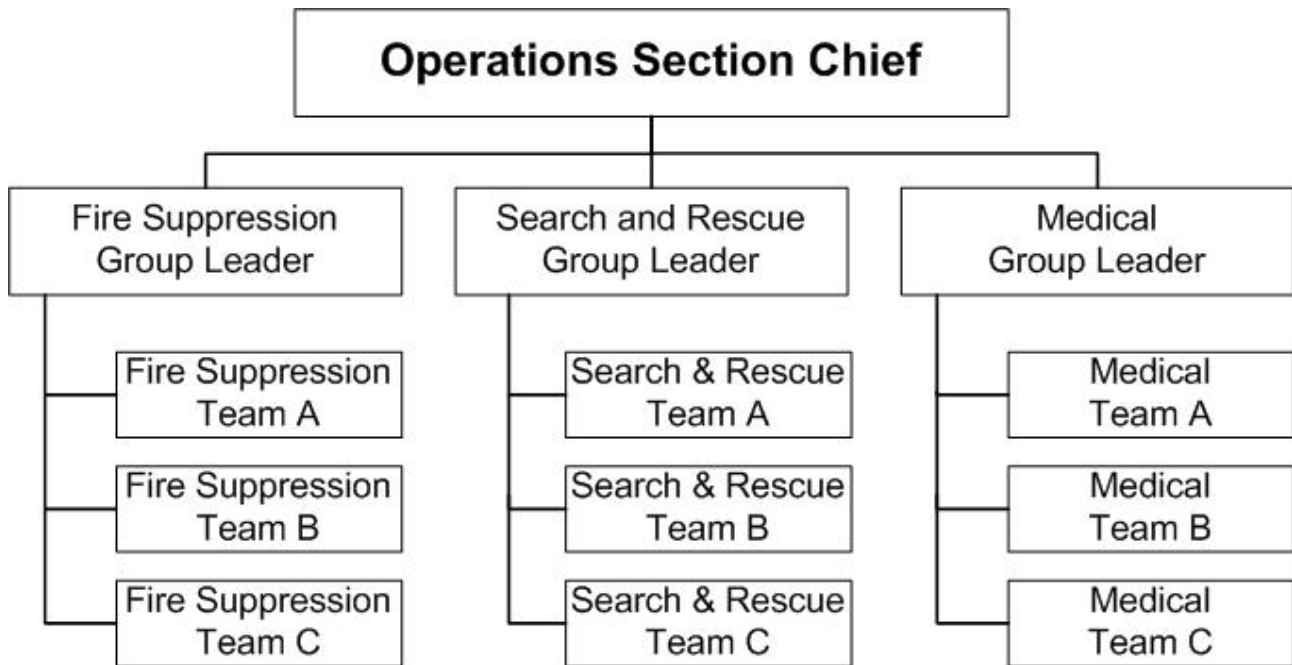

CERT operations section structure, showing the Operations Section Chief at the top and the three Group Leaders underneath

COMMUNITY EMERGENCY RESPONSE TEAM

UNIT 6: CERT ORGANIZATION

INSTRUCTOR GUIDANCE	CONTENT
<p data-bbox="186 409 609 451">Dealing with the Media</p> <ul data-bbox="186 462 365 640" style="list-style-type: none">• Refer media inquiries to CERT IC/TL• Do not let media inhibit CERT goals• Be careful about information released  <p data-bbox="170 682 609 724">FEMA CERT Basic Training Unit 6: CERT Organization 6-8</p> <p data-bbox="170 756 430 798">Display Slide 6-8</p> <p data-bbox="170 1249 584 1396">If your CERT has basic protocols for how to handle a crime scene, discuss those here.</p> 	<p data-bbox="641 409 982 451">Dealing with the Media</p> <p data-bbox="641 462 1380 598">Explain that CERT members should refer any media inquiries to the CERT IC/TL. The IC/TL should then refer the media inquiries to the Public Information Officer of the CERTs' sponsoring organization.</p> <p data-bbox="641 619 1421 756">If the Public Information Officer of the sponsoring organization refers media to the CERT IC/TL or otherwise authorizes them to speak with the media, the IC/TL should:</p> <ul data-bbox="641 766 1421 1186" style="list-style-type: none">▪ Refrain from addressing the media until doing so will no longer inhibit or delay the team's ability to do the greatest good for the greatest number in the shortest amount of time▪ Establish an area for briefing the media if necessary▪ Be careful about the information he or she releases, making sure it is both accurate and approved for release, while also keeping in mind victims' right to privacy▪ Not feel compelled to answer every question asked <p data-bbox="641 1470 1339 1543">Does anyone have any questions about CERT structure or ICS?</p>

C COMMUNITY EMERGENCY RESPONSE TEAM

UNIT 6: CERT ORGANIZATION

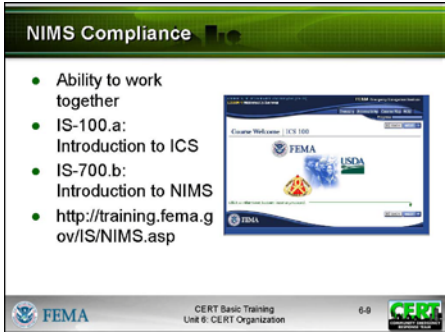
INSTRUCTOR GUIDANCE	CONTENT
<div data-bbox="168 394 609 724"></div> <p data-bbox="168 758 427 793">Display Slide 6-9</p> <p data-bbox="168 835 586 1121">Encourage participants to complete both IS-100 and IS-700. Remind them if your program requires CERT participants to complete IS-100 or 700 before they are considered official CERT members.</p>	<h3 data-bbox="639 415 911 451">NIMS Compliance</h3> <p data-bbox="639 468 1422 716">Conclude the discussion of ICS by noting that the Incident Command System is part of the National Incident Management System (NIMS). NIMS provides a consistent, comprehensive approach to incident management. It applies at all jurisdictional levels and across all emergency management functions and types of incidents.</p> <p data-bbox="639 737 1414 879">Explain that NIMS was established so that first responders, including CERT members, from different jurisdictions and disciplines can work together better to respond to disasters and emergencies.</p> <ul data-bbox="639 900 1419 1205" style="list-style-type: none"><li data-bbox="639 900 1419 1079">▪ To meet NIMS standards, CERT members must complete both the IS-100.a (<i>Introduction to Incident Command System</i>) and IS-700.b (<i>Introduction to National Incident Management System [NIMS]</i>) courses.<li data-bbox="639 1100 1419 1205">▪ Both independent study courses are available online from FEMA at http://training.fema.gov/IS/NIMS.asp. <p data-bbox="639 1278 1370 1346">Tell the participants that the next topic will be CERT mobilization.</p> <p data-bbox="639 1367 1414 1472">Explain that some of the information will be a review of topics covered in Unit 5: Light Search and Rescue Operations.</p>

COMMUNITY EMERGENCY RESPONSE TEAM

UNIT 6: CERT ORGANIZATION

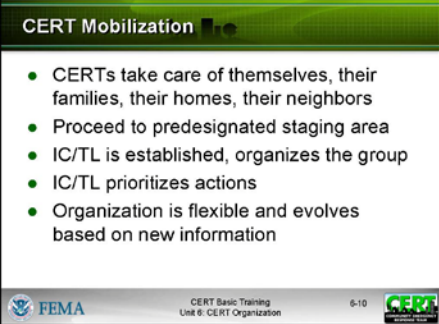
INSTRUCTOR GUIDANCE	CONTENT
 <p>CERT Mobilization</p> <ul style="list-style-type: none">• CERTs take care of themselves, their families, their homes, their neighbors• Proceed to predesignated staging area• IC/TL is established, organizes the group• IC/TL prioritizes actions• Organization is flexible and evolves based on new information <p>FEMA CERT Basic Training Unit 6: CERT Organization 6-10</p> <p>Display Slide 6-10</p> <p>This description provides an explanation for CERT deployment based on the concept of a response to a catastrophic disaster. Each community needs to develop its unique standard operating procedure for CERT.</p>	<h3><i>CERT Mobilization</i></h3> <p>Introduce CERT mobilization by pointing out how CERTs mobilize when an incident occurs. Immediately following the incident, CERT members take care of themselves, their families, their homes, and their neighbors.</p> <ul style="list-style-type: none">▪ If the standard operating procedure (SOP) calls for self-activation, CERT members proceed to the predesignated staging area with their disaster supplies. Along the way, they make damage assessments that would be helpful for the CERT IC/TL's decision-making.▪ The first CERT member at the staging area becomes the initial IC/TL for the response. As other CERT members arrive, the CERT IC/TL may pass leadership to someone else. The CERT IC/TL establishes operations to ensure effective communication, to maintain span of control, to maintain accountability, and to do the greatest good for the greatest number without placing CERT members in harm's way.▪ One of the CERT IC/TL's first decisions will be to locate the team's command post. The staging area may become the command post; however, if another location would be safer or otherwise better, the command post should be set up there.▪ As intelligence is collected and assessed, the IC/TL must prioritize actions and work with the Section Chiefs or leaders. The CERT organization is flexible and evolves based on new information.

C COMMUNITY EMERGENCY RESPONSE TEAM

UNIT 6: CERT ORGANIZATION

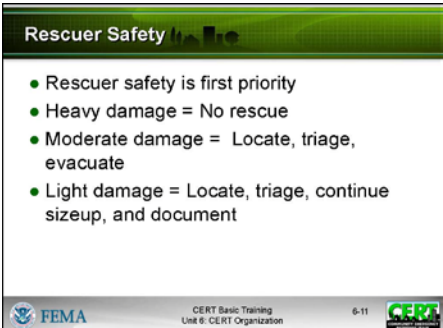
INSTRUCTOR GUIDANCE	CONTENT
 <p>Display Slide 6-11</p>	<p>Remind the group that, following an incident, information — and, therefore, priorities — may be changing rapidly. Communication between the CERT IC/TL and response teams ensures that CERTs do not overextend their resources or supplies.</p> <p>Rescuer Safety</p> <p>Introduce rescuer safety by telling the participants that effective emergency scene management requires the formulation and communication of strategic goals and tactical objectives to do the most good for the greatest number while maintaining the safety of rescue personnel.</p> <p>Remind the group that <u>rescuer safety is paramount</u>. The first question to ask is, “Is it safe for the CERT members to attempt the rescue?”</p> <p>Emphasize that the answer to this question is based mainly on the degree of damage:</p> <ul style="list-style-type: none">▪ <u>If the damage is heavy</u>: No rescue should be attempted. Use tape around the area or mark the area as heavy damage. CERT members do not have any legal authority to stop or restrict someone who wants to enter an area. At best, CERT members can warn others about the danger and inform the CERT IC/TL immediately if it is known that people are in the building.

COMMUNITY EMERGENCY RESPONSE TEAM

UNIT 6: CERT ORGANIZATION

INSTRUCTOR GUIDANCE	CONTENT
<p>PM, P. 6-12</p>	<ul style="list-style-type: none">▪ <u>If the damage is moderate</u>: Locate, triage (quickly evaluate, and treat Immediates for airway obstruction, bleeding, and shock), and immediately evacuate victims to a safe area while minimizing both the number of rescuers inside the building and the amount of time that they remain inside.▪ <u>If the damage is light</u>: Locate, triage, continue sizeup, and document. <p>Refer the participants to the chart <i>CERT Rescue Efforts Based on Degree of Damage</i> in the Participant Manual and on the following page in the Instructor Guide. Specific strategies are identified for rescue efforts based on degree of damage. Review the strategies listed in the chart.</p> <p>Explain to the group that the extent of involvement for the various CERT functional teams varies depending on the level of damage encountered.</p>

C COMMUNITY EMERGENCY RESPONSE TEAM

UNIT 6: CERT ORGANIZATION

PM, P. 6-12	CERT Rescue Efforts Based on Degree of Damage
--------------------	--

Degree of Damage	Should Rescue Be Attempted?
Heavy	No. Too dangerous to enter. Warn people to stay away. Inform the CERT Incident Commander/Team Leader (IC/TL) immediately if it is known that people are in the building.
Moderate	Yes, but perform only quick and safe removals; limit onsite medical care to checking for breathing, stopping major bleeding, and treating for shock. Minimize the number of rescuers inside the building.
Light	Yes. Locate, triage, continue sizeup, and document.

COMMUNITY EMERGENCY RESPONSE TEAM

UNIT 6: CERT ORGANIZATION

INSTRUCTOR GUIDANCE	CONTENT
PM, P. 6-13	Refer the participants to the figure titled <i>CERT Tasks Based on Damage Level</i> in the Participant Manual and on the following page in the Instructor Guide.

PM, P. 6-13	CERT Tasks Based on Damage Level
--------------------	---

Light Damage Site

Fire	Search & Rescue	Medical (on site)	Medical (off site)
<ul style="list-style-type: none"> - Shut off utilities as needed - Extinguish small fires - Document 	<ul style="list-style-type: none"> - Locate - Triage - Treat airway/major bleeding - Continue sizeup - Document 	<ul style="list-style-type: none"> - Triage again - Move to treatment area - Head-to-toe assessment - Treatment - Facilitate transport as needed - Document 	<ul style="list-style-type: none"> - Triage again - Head-to-toe assessment - Treatment - Facilitate transport as needed - Document

Moderate Damage Site

Fire	Search & Rescue	Medical (nearby)	Medical (off site)
<ul style="list-style-type: none"> - Shut off utilities if safe - Extinguish small fires - Document 	<ul style="list-style-type: none"> - Locate - Triage - Treat airway/major bleeding - Evacuate - Warn others - Continue sizeup - Document 	<ul style="list-style-type: none"> - Triage again - Move to treatment area (nearby safe location) - Head-to-toe assessment - Treatment - Facilitate transport as needed - Document 	<ul style="list-style-type: none"> - Triage again - Head-to-toe assessment - Treatment - Facilitate transport as needed - Document



Heavy Damage Site

Fire	Exterior Search & Rescue Only
<ul style="list-style-type: none"> - Shut off utilities if safe - Document 	<ul style="list-style-type: none"> - Mark area for heavy damage - Warn others - Gather information - Inform CERT IC/TL immediately - Document

Tasks required of Fire, Search and Rescue, Medical, and Treatment Area teams based on the degree of damage to the structure.



C COMMUNITY EMERGENCY RESPONSE TEAM

UNIT 6: CERT ORGANIZATION

INSTRUCTOR GUIDANCE	CONTENT
<p data-bbox="170 667 248 743"></p> <p data-bbox="170 814 597 953">Record the participants' responses on chart paper and conduct a brief discussion based on their remarks.</p> <p data-bbox="170 1031 248 1106"></p>	<p data-bbox="639 415 1393 596">Describe several hypothetical rescue situations, including the type of disaster, type of structure, and visible or probable damage. After each situation, use the following two questions to get the participants to identify rescue strategies that are appropriate.</p> <p data-bbox="639 667 1172 756">What is your primary mission? How would you respond, and why?</p> <p data-bbox="639 1031 1398 1136">Does anyone have any questions about how the CERT's mission and strategies are affected by the severity of damage?</p> <p data-bbox="639 1209 1377 1314">Tell the group that the next topic that will be covered will be documentation requirements for CERT members.</p>

COMMUNITY EMERGENCY RESPONSE TEAM

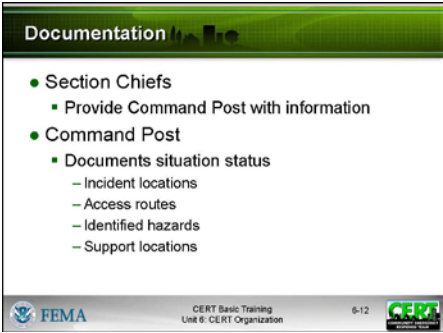
UNIT 6: CERT ORGANIZATION

INSTRUCTOR GUIDANCE	CONTENT
<div data-bbox="170 394 609 724"></div> <p data-bbox="170 756 446 793">Display Slide 6-12</p> <div data-bbox="170 850 251 924"></div> <p data-bbox="170 997 592 1144">Record the participants' responses on chart paper and conduct a brief discussion based on their remarks.</p>	<h3 data-bbox="641 409 917 451"><i>Documentation</i></h3> <p data-bbox="641 514 1372 630">Introduce the need to document by emphasizing the importance of documentation and communication about the disaster situation and resource status.</p> <p data-bbox="641 640 1388 787">Stress that efficient flow of information makes it possible for resources to be deployed effectively and for professional emergency services to be applied appropriately.</p> <h3 data-bbox="641 861 1404 934">Why do you need to document what happens in an incident?</h3> <p data-bbox="641 997 1258 1081">Recap the discussion by explaining that documentation can serve several purposes:</p> <ul data-bbox="641 1092 1404 1627" style="list-style-type: none"><li data-bbox="641 1092 1339 1165">▪ The CERT IC/TL will know what is happening throughout the incident.<li data-bbox="641 1176 1404 1291">▪ The CERT IC/TL will have written information to pass on to the professional responders when they arrive.<li data-bbox="641 1302 1323 1417">▪ The CERT will be able to show how many volunteer hours it provided to the sponsoring agency or entity.<li data-bbox="641 1428 1234 1470">▪ Liability exposure will be documented.<li data-bbox="641 1480 1161 1627">▪ Communication will be improved:<ul data-bbox="690 1533 1161 1627" style="list-style-type: none"><li data-bbox="690 1533 1161 1575">• Between the functional areas<li data-bbox="690 1585 1161 1627">• Between shifts

C COMMUNITY EMERGENCY RESPONSE TEAM

UNIT 6: CERT ORGANIZATION

INSTRUCTOR GUIDANCE	CONTENT
	<p>Explain that, under the CERT structure, each level of organization has documentation responsibilities:</p> <ul style="list-style-type: none">▪ Section Chiefs are responsible for providing the Command Post with ongoing information about damage assessment, group status, and ongoing needs.▪ The Command Post is responsible for documenting the situation status, including:<ul style="list-style-type: none">• Incident locations• Access routes• Identified hazards• Support locations <p>Note that support locations include:</p> <ul style="list-style-type: none">▪ A staging area▪ A medical treatment and triage area▪ A morgue, if there are fatalities <p>Stress that this information is vital for tracking the overall situation and that the CERT IC/TL must be ready to provide the documentation to the first professional responders on the scene.</p>

COMMUNITY EMERGENCY RESPONSE TEAM

UNIT 6: CERT ORGANIZATION

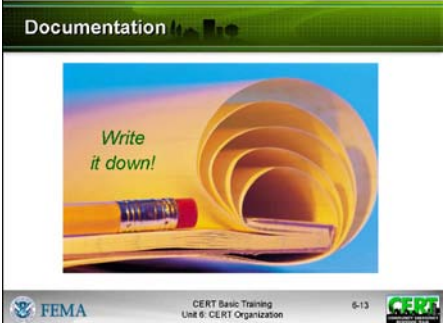
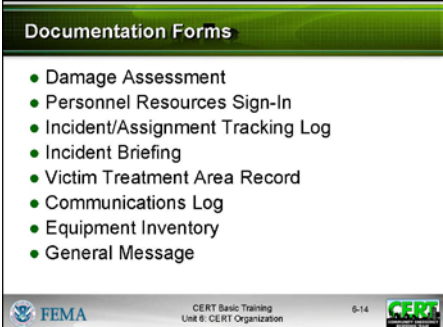
INSTRUCTOR GUIDANCE	CONTENT
 <p>Display Slide 6-13</p>	<p>Explain that the most important thing to do is to write down what happened. The information can be written down on the sample forms provided in this unit or it can be written down on a piece of paper.</p> <p>Say that every entity such as a functional team or staging location must have a scribe to record everything. The IC/TL typically designates the scribe and provides some simple instructions.</p>
 <p>Display Slide 6-14</p>	<p>Documentation Forms</p> <p>Explain that there are eight standard forms that can be used to facilitate documentation and information flow. The forms are functionally consistent with Incident Command System (ICS) forms and are designed to be NIMS compliant.</p> <p>The CERT forms are:</p> <ul style="list-style-type: none">▪ Damage Assessment▪ Personnel Resources Sign-In▪ Incident/Assignment Tracking Log▪ Briefing Assignment▪ Victim Treatment Area Record▪ Communications Log▪ Equipment Inventory▪ General Message

C COMMUNITY EMERGENCY RESPONSE TEAM

UNIT 6: CERT ORGANIZATION

INSTRUCTOR GUIDANCE	CONTENT
<p>PM, P. 6-16 and 6-17</p>	<p>Reinforce with participants that scribes can produce useful, high-quality documentation without using the forms as long as they take detailed notes of all activities.</p> <p>Refer the participants to the table <i>Forms Used for Response Documentation</i> in the Participant Manual and on the following pages of the Instructor Guide for examples.</p>

COMMUNITY EMERGENCY RESPONSE TEAM

UNIT 6: CERT ORGANIZATION

PM, P. 6-16 AND 6-17	Forms Used for Response Documentation
----------------------	---------------------------------------

Form	Purpose
Damage Assessment [CERT Form #1]	<ul style="list-style-type: none">▪ Completed by CERT members as they travel through the area to the CERT's staging location, then given to the CERT IC/TL; provides a summary of overall hazards in selected areas, including:<ul style="list-style-type: none">• Fires• Utility hazards• Structural damage• Injuries and casualties• Available access▪ Essential for prioritizing and formulating action plans
Personnel Resources Sign-In [CERT Form #2]	<ul style="list-style-type: none">▪ Used to sign in CERT members as they arrive at the staging location; provides information about:<ul style="list-style-type: none">• Who is on site• When they arrived• When they were assigned• Their special skills▪ Used by staging personnel to track personnel availability
Incident/Assignment Tracking Log [CERT Form #3]	<ul style="list-style-type: none">▪ Used by the Command Post for keeping abreast of situation status; contains essential information for tracking the overall situation
Briefing Assignment [CERT Form #4.a-b]	<ul style="list-style-type: none">▪ Used by the Command Post to provide instructions to functional teams; used by teams to log their actions and report new damage assessment information
Victim Treatment Area Record [CERT Form #5]	<ul style="list-style-type: none">▪ Completed by medical treatment area personnel to record victims entering the treatment area, their condition, and their status

C COMMUNITY EMERGENCY RESPONSE TEAM

UNIT 6: CERT ORGANIZATION

Form	Purpose
Communications Log [CERT Form #6 (based on ICS 309)]	▪ Completed by the radio operator; used to log incoming and outgoing transmissions
Equipment Inventory [CERT Form #7 (based on ICS 303)]	▪ Used to check out and check in CERT-managed equipment
General Message [CERT Form #8 (ICS 213)]	▪ Used for sending messages between command levels and groups; messages should be clear and concise and should focus on such key issues as: <ul style="list-style-type: none">• Assignment completion• Additional resources required• Special information• Status update

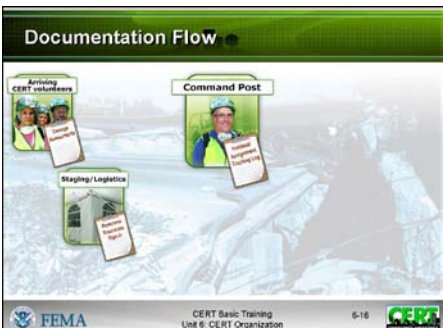

COMMUNITY EMERGENCY RESPONSE TEAM

UNIT 6: CERT ORGANIZATION

INSTRUCTOR GUIDANCE	CONTENT
<p>Display Slides 6-15 through 6-19</p> <p>Displaying these five slides in sequence will allow you to “build” a diagram that demonstrates who owns which document and how that document is used in an event.</p>   <p>The first image is a slide titled 'Documentation Flow' showing a 'Command Post' with a person holding a sign. The second image is a slide titled 'Documentation Flow' showing 'Arriving CERT volunteers', 'Command Post', and 'Register/Logistics'.</p>	<p>Documentation Flow</p> <p>Explain how a CERT would use these standard documents within the context of an event. Remind participants that, even if the forms are not used, this should give them an idea of the preferred information that needs to be collected and communicated between groups.</p> <ul style="list-style-type: none">▪ The <u>Damage Assessment Form</u> is completed by CERT members as they travel through the area to the CERT’s staging location. The form is then given to the CERT IC/TL. The form provides a summary of overall hazards in selected areas. The information is used for prioritizing and formulating activities.▪ The CERT IC/TL assembles teams and makes assignments based on the damage assessment information. This person keeps the <u>Incident/Assignment Tracking Log</u>, which is the most important tool for recording the activities of the functional teams and overall situation status.▪ A scribe at the staging location signs in each volunteer using the <u>Personnel Resources Sign-In Form</u>, noting any particular preferred team assignments or skills. This information needs to be passed on to the Command Post.

C COMMUNITY EMERGENCY RESPONSE TEAM

UNIT 6: CERT ORGANIZATION

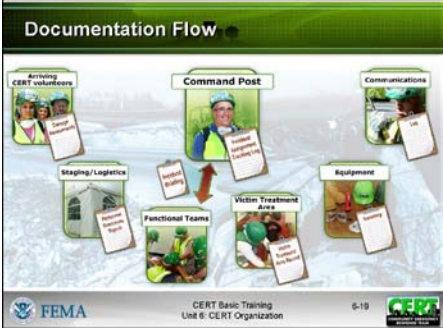
INSTRUCTOR GUIDANCE	CONTENT
 <p>The diagram shows a flow of documentation forms. 'Arriving CERT volunteers' and 'Staging/Logistics' lead to 'Command Post'. 'Command Post' leads to 'Functional Teams'. 'Functional Teams' leads to 'Victim Treatment Area'. The forms are labeled: 'Arriving CERT volunteers', 'Staging/Logistics', 'Command Post', 'Functional Teams', and 'Victim Treatment Area'. FEMA logo and 'CERT Basic Training Unit 6: CERT Organization 6-17' are at the bottom.</p>	<ul style="list-style-type: none">▪ The <u>Briefing Assignment Form</u> is shared by the Command Post and the functional team. The CERT IC/TL uses the front side of the form to communicate instructions about an incident such as address, incident type, and team objectives. The scribe of the functional team uses the back side (blank side) of the form to log team actions. The form is returned to the Command Post when the team checks in.
 <p>The diagram shows a flow of documentation forms. 'Arriving CERT volunteers' and 'Staging/Logistics' lead to 'Command Post'. 'Command Post' leads to 'Functional Teams'. 'Functional Teams' leads to 'Victim Treatment Area'. The forms are labeled: 'Arriving CERT volunteers', 'Staging/Logistics', 'Command Post', 'Functional Teams', and 'Victim Treatment Area'. FEMA logo and 'CERT Basic Training Unit 6: CERT Organization 6-18' are at the bottom.</p>	<ul style="list-style-type: none">▪ The <u>Victim Treatment Area Record</u> is used to document each person brought into the treatment area and his or her condition (Immediate, Delayed, or Minor).
 <p>The diagram shows a flow of documentation forms. 'Arriving CERT volunteers' and 'Staging/Logistics' lead to 'Command Post'. 'Command Post' leads to 'Functional Teams'. 'Functional Teams' leads to 'Victim Treatment Area'. 'Victim Treatment Area' leads to 'Equipment'. The forms are labeled: 'Arriving CERT volunteers', 'Staging/Logistics', 'Command Post', 'Functional Teams', 'Victim Treatment Area', and 'Equipment'. FEMA logo and 'CERT Basic Training Unit 6: CERT Organization 6-19' are at the bottom.</p>	<ul style="list-style-type: none">▪ The <u>Communications Log</u> is used to log incoming and outgoing transmissions; it is typically kept by the radio operator.▪ The <u>Equipment Inventory</u> is kept in the area or vehicle in which equipment is stored.

COMMUNITY EMERGENCY RESPONSE TEAM

UNIT 6: CERT ORGANIZATION

INSTRUCTOR GUIDANCE	CONTENT
<p>PM, P. 6-20 through 6-28</p> <p>Emphasize this point.</p>	<ul style="list-style-type: none">▪ The <u>General Message</u> form is used for sending messages between any command levels and groups. The messages must be clear and concise. <p>Refer the participants to the documentation forms in the Participant Manual and on the following pages in the Instructor Guide. For many of the forms, one section is filled out as an example.</p> <p>Review each form briefly and describe the types of information that each should include.</p> <p>Note that area maps, site maps, and building plans are also very useful for tracking response activities.</p> <p>Explain to the participants that the forms will assist them in collecting and organizing critical information during CERT operations. However, information needs to be recorded even if the correct form is not available. That is one reason why all members need a small notebook and a pen in their personal CERT kit.</p>

C COMMUNITY EMERGENCY RESPONSE TEAM

UNIT 6: CERT ORGANIZATION

PM, P. 6-20 THROUGH 6-28	Forms Used for Response Documentation
---------------------------------	--

DAMAGE ASSESSMENT FORM						CERT WILSONVILLE				DATE ## / ## / ##					
LOCATION SE CORNER 16 TH AND OAK															
SIZE UP (check if applicable)															
FIRES		HAZARDS				STRUCTURE		PEOPLE			ROADS		ANIMALS		
BURNING	OUT	GAS LEAK	H2O LEAK	ELECTRIC	CHEMICAL	DAMAGED	COLLAPSED	INJURED	TRAPPED	DEAD	ACCESS	NO ACCESS	INJURED	TRAPPED	ROAMING
						x		x			x				
OBSERVATIONS															
<p>HIGH SCHOOL GYM DAMAGED BY TORNADO, PARTICULARLY WEST END.</p> <p>MAY BE PEOPLE TRAPPED INSIDE.</p> <p>ROAD UP TO THE SCHOOL IS CLEAR.</p>															
CERT MEMBER SUSAN ADAMS										PAGE <u> 1 </u> OF <u> 1 </u>					

CERT FORM #1

COMMUNITY EMERGENCY RESPONSE TEAM

UNIT 6: CERT ORGANIZATION

BRIEFING ASSIGNMENT	CERT <i>WILSONVILLE</i>	DATE <i>## / ## / ##</i>													
COMMAND POST CONTACT #	<i>(212) 555-1212</i>	TIME OUT <i>9:50 AM</i>	TIME BACK <i>10:36 AM</i>												
INSTRUCTIONS TO TEAM															
TEAM NAME <i>Medical 2</i>	LOCATION <i>Delmonico's Italian Restaurant, 810 King Street</i>														
OBJECTIVES <i>To conduct medical sizeup of any victims found.</i>															
EQUIPMENT ALLOCATED															
REPORT FROM RESPONSE TEAM															
FIRES		HAZARDS			STRUCTURE		PEOPLE		ROADS		ANIMALS				
BURNING	OUT	GAS LEAK	H2O LEAK	ELECTRIC	CHEMICAL	DAMAGED	COLLAPSED	INJURED	TRAPPED	DEAD	ACCESS	NO ACCESS	INJURED	TRAPPED	ROAMING
								<i>w</i>			<i>✓</i>				

CERT FORM #4.a

C COMMUNITY EMERGENCY RESPONSE TEAM

UNIT 6: CERT ORGANIZATION

TEAM ACTION LOG (time stamp each action; draw map if needed)	
10:52	Team arrived at the restaurant. Made our way through the debris to victim #1, Bill Baker. Conscious and in pain. Ankle was trapped under a heavy bookcase. Extricated him. Two team members carried him to treatment area.
10:54	Victim #2, Carol Loughney. Bleeding on head from falling ceiling. Walked her to treatment area.
10:55	Victim #3. Found in kitchen. Unconscious but breathing. May have broken leg. Splinted leg. Moved by stretcher to treatment area.
SCRIBE	<i>Sam Arton</i>

CERT FORM #4.b

COMMUNITY EMERGENCY RESPONSE TEAM

UNIT 6: CERT ORGANIZATION

VICTIM TREATMENT AREA RECORD		CERT	WILSONVILLE	DATE	## / ## / ##
TREATMENT AREA LOCATION		RIDGEMOUNT PARK			
TIME IN	NAME OR DESCRIPTION	TRIAGE TAG (circle)	CONDITION/TREATMENT (update as needed)	MOVED TO	TIME OUT
10:24 AM	Stephen Edmondson, 35 yo, very tall	IMMED DELAY MINOR	10:30 Heavy bleeding from cut at right temple—bandaged 10:45 Complained of dizziness and nausea	Sibley Hospital	12:15 PM
		IMMED DELAY MINOR			
		IMMED DELAY MINOR			
SCRIBE(S)		REGGIE OSBORN		PAGE 2 OF 2	

CERT FORM #5

C COMMUNITY EMERGENCY RESPONSE TEAM

UNIT 6: CERT ORGANIZATION

GENERAL MESSAGE			
TO		POSITION	
FROM		POSITION	
SUBJECT	DATE	TIME	
MESSAGE			
SIGNATURE		POSITION	
REPLY			
DATE	TIME	SIGNATURE/POSITION	

CERT FORM #8 (ICS 213)

GENERAL MESSAGE			
TO		POSITION	
FROM		POSITION	
SUBJECT	DATE	TIME	
MESSAGE			
SIGNATURE		POSITION	
REPLY			
DATE	TIME	SIGNATURE/POSITION	

CERT FORM #8 (ICS 213)

COMMUNITY EMERGENCY RESPONSE TEAM

UNIT 6: CERT ORGANIZATION

INSTRUCTOR GUIDANCE	CONTENT
 <p>Use the following steps to conduct this activity.</p> <p>PM, P. 6-30 and 6-31</p>	<p>Does anyone have any questions about CERT documentation requirements?</p> <p>Tell the participants that next they will work in small groups to complete an ICS review.</p> <p>Activity: ICS Functions</p> <p>Purpose: This activity will give the participants an opportunity to relate the ICS functions to specific situations.</p> <p>Instructions:</p> <ol style="list-style-type: none">1. Assign the participants to small table groups.2. Explain that this exercise will provide the group with the opportunity to decide under which ICS functions the listed activities will fall.3. Tell the group to review the list of activities and use the initials, "IC/TL," "O," "P," or "L" to indicate which ICS function would cover each activity.4. When the groups have finished, ask a spokesperson from each group to provide the group's answers to the class. <p>Remind participants that while Finance/Administration is a part of ICS, it is generally not used by CERTs.</p>

C COMMUNITY EMERGENCY RESPONSE TEAM

UNIT 6: CERT ORGANIZATION

PM, P. 6-30 and 6-31	Activity: ICS Functions
-----------------------------	--------------------------------

Instructions:

Using your knowledge about the five ICS functions, decide under which function the following CERT activities would fall. Some activities may involve more than one function to be completed.

Use the following key to fill in the blanks before each activity:

IC/TL = Incident Commander/Team Leader

O = Operations

P = Planning

L = Logistics

L	1. It's dark, all the lights are out, you need additional flashlights to continue your response.
L	2. The designated first aid site has a downed power line.
O	3. A neighbor reports the smell of gas in his house, but he cannot shut off the gas at the meter.
L	4. The batteries for the portable radio are dead.
P & IC/TL	5. The city wants to know the overall status of your neighborhood.
O	6. Several of your neighbors have minor injuries and need first aid.
P	7. Fire from another neighborhood is moving toward your neighborhood.
O	8. There is a pit bull-type dog seen wandering near the first aid station.
IC/TL	9. A news crew has arrived with a camera to film your activities.

COMMUNITY EMERGENCY RESPONSE TEAM

UNIT 6: CERT ORGANIZATION

P & O	10. Two hysterical neighbors are demanding help. One cannot find her adolescent child who was playing outside when the disaster struck. The other wants help moving a bookcase off of his wife. He says she's bleeding from a wound on the head.
L	11. It's starting to rain. Your command post and the first aid area are not under shelter.
P	12. Too many people are coming to the Incident Commander to ask questions. The IC/TL asks for someone to act as a "gatekeeper."
O	13. There is a great increase of car and foot traffic through your neighborhood because other roadways are blocked.
P	14. The IC/TL is very tired and is going to hand over responsibilities to someone else. He or she wants a report on the status of the neighborhood before doing so.
L/O	15. Many neighborhood residents have come to volunteer their help.
IC/TL	16. Reports have come in of damage and injuries in the next block. Teams must be assigned to assess the situation.
IC/TL	17. A professional responder has arrived at the scene and would like a briefing on situation status.

C COMMUNITY EMERGENCY RESPONSE TEAM

UNIT 6: CERT ORGANIZATION

INSTRUCTOR GUIDANCE	CONTENT
<p>Use the following steps to conduct this exercise.</p>	<p>Activity: Tabletop Exercise</p> <p>Tell the group that the remainder of the unit consists of a tabletop exercise. The exercise will give the participants the opportunity to apply much of the knowledge that they have gained in this course to an actual disaster scenario.</p> <p>Introduce the “Rules of Engagement.” Stress the need for following directions, communicating, and making safe decisions.</p> <p>Purpose: This exercise is an interactive tabletop activity that gives the participants an opportunity to apply what they have learned about ICS for CERT activation.</p> <p>Instructions:</p> <ol style="list-style-type: none">1. Assign the participants to small table groups.2. Distribute the <i>CERT Tabletop Exercise</i> that you have developed, and explain the objectives of the exercise.3. Explain that this exercise will provide the group with experience in command decision-making. <p>Remind the group that CERT command objectives are to:</p> <ul style="list-style-type: none">▪ Identify the scope of the incident▪ Determine an overall CERT strategy▪ Set priorities and deploy resources

COMMUNITY EMERGENCY RESPONSE TEAM

UNIT 6: CERT ORGANIZATION

INSTRUCTOR GUIDANCE	CONTENT
	<ol style="list-style-type: none">4. Review the participants' roles in the exercise and advise them that they will have 30 minutes to complete the exercise.5. At the end of the exercise, reconvene the participants into a large group to discuss the exercise results and answer any questions that the participants may have.



C COMMUNITY EMERGENCY RESPONSE TEAM

UNIT 6: CERT ORGANIZATION

INSTRUCTOR GUIDANCE	CONTENT
<div data-bbox="168 438 609 768"><p>Unit Summary</p><ul style="list-style-type: none">• ICS provides flexible means of organization• "Is it safe to attempt the rescue?"• Document and communicate information to all CERT levels• Provide Command Post with ongoing information about damage assessment, group status, and needs• Command Post documents and tracks situation status<p>FEMA CERT Basic Training Unit 6: CERT Organization 6-20</p></div> <p data-bbox="168 806 443 842">Display Slide 6-20</p> 	<h3 data-bbox="643 438 894 474"><i>Unit Summary</i></h3> <p data-bbox="643 548 1206 583">Summarize the key points from this unit:</p> <ul style="list-style-type: none">▪ The ICS is the system used by emergency response agencies and CERT to manage emergency operations. ICS provides a flexible means of managing personnel, facilities, equipment, and communication and can be expanded as necessary.▪ The key question that CERT Incident Commanders/Team Leaders must always ask is: <i>"Is it safe for CERT members to attempt the rescue?"</i> Whether or not to attempt a rescue depends on the degree of damage to the structure involved. Remind the participants that CERT members' safety is the number one priority.▪ It is vital to document and communicate information about situation and resource status to all CERT levels.<ul style="list-style-type: none">• Sections, Groups, and Teams <i>must provide the Command Post with ongoing information</i> about damage assessment, incident status, and ongoing needs.• The command post must document the situation status so that the overall disaster situation can be tracked and reported to emergency response agencies. <p data-bbox="643 1608 1382 1675">Does anyone have any questions about anything covered in this unit?</p>

COMMUNITY EMERGENCY RESPONSE TEAM

UNIT 6: CERT ORGANIZATION

INSTRUCTOR GUIDANCE	CONTENT
<p data-bbox="207 422 430 447">Homework Assignment</p> <ol data-bbox="212 472 597 550" style="list-style-type: none">1. Read unit to be covered in next session2. Bring necessary supplies to next session3. Wear appropriate clothes to next session  <p data-bbox="365 701 467 726">CERT Basic Training Unit 6: CERT Organization</p> <p data-bbox="537 701 553 716">6-21</p>  <p data-bbox="188 768 456 806">Display Slide 6-21</p>	<p data-bbox="659 422 1013 459">Homework Assignment</p> <p data-bbox="659 512 1378 579">Ask the group to read and become familiar with the unit that will be covered in the next session.</p> <p data-bbox="659 600 1346 705">Thank the participants for attending the session. Remind them of the time and location of the next session, if necessary.</p>

[This page intentionally left blank]

UNIT 6: ADDITIONAL MATERIALS

[This page intentionally left blank]

DAMAGE ASSESSMENT FORM	CERT	DATE
-------------------------------	------	------

LOCATION

SIZE UP
(check if applicable)

FIRES		HAZARDS				STRUCTURE		PEOPLE			ROADS		ANIMALS		
BURNING	OUT	GAS LEAK	H2O LEAK	ELECTRIC	CHEMICAL	DAMAGED	COLLAPSED	INJURED	TRAPPED	DEAD	ACCESS	NO ACCESS	INJURED	TRAPPED	ROAMING

OBSERVATIONS

CERT MEMBER	PAGE ____ OF ____
-------------	-------------------

ASSIGNMENT TRACKING LOG		CERT		DATE			
ASSIGNMENT		ASSIGNMENT		ASSIGNMENT		ASSIGNMENT	
LOCATION		LOCATION		LOCATION		LOCATION	
TEAM		TEAM		TEAM		TEAM	
TEAM LEADER/CONTACT #		TEAM LEADER/CONTACT #		TEAM LEADER/CONTACT #		TEAM LEADER/CONTACT #	
START TIME	END TIME	START TIME	END TIME	START TIME	END TIME	START TIME	END TIME
1		1		1		1	
2		2		2		2	
3		3		3		3	
4		4		4		4	
5		5		5		5	
OBJECTIVES		OBJECTIVES		OBJECTIVES		OBJECTIVES	
RESULTS		RESULTS		RESULTS		RESULTS	
CERT LEADER/ INCIDENT COMMANDER						PAGE ___ OF ___	
SCRIBE(S)							

BRIEFING ASSIGNMENT		CERT				DATE									
COMMAND POST CONTACT #						TIME OUT			TIME BACK						
INSTRUCTIONS TO TEAM															
TEAM NAME				LOCATION											
OBJECTIVES															
EQUIPMENT ALLOCATED															
REPORT FROM RESPONSE TEAM															
FIRES		HAZARDS				STRUCTURE		PEOPLE			ROADS		ANIMALS		
BURNING	OUT	GAS LEAK	H2O LEAK	ELECTRIC	CHEMICAL	DAMAGED	COLLAPSED	INJURED	TRAPPED	DEAD	ACCESS	NO ACCESS	INJURED	TRAPPED	ROAMING

TEAM ACTION LOG

(time stamp each action; draw map if needed)

SCRIBE

VICTIM TREATMENT AREA RECORD		CERT	DATE		
TREATMENT AREA LOCATION					
TIME IN	NAME OR DESCRIPTION	TRIAGE TAG (circle)	CONDITION/TREATMENT (update as needed)	MOVED TO	TIME OUT
		IMMED DELAY MINOR			
		IMMED DELAY MINOR			
		IMMED DELAY MINOR			
SCRIBE(S)				PAGE ___ OF ___	

EQUIPMENT INVENTORY		CERT				DATE		
ASSET #	ITEM DESCRIPTION	OWNER	ISSUED TO		QTY	TIME	INITIALS	COMMENTS
				ISSUED				
				RETURNED				
				ISSUED				
				RETURNED				
				ISSUED				
				RETURNED				
				ISSUED				
				RETURNED				
				ISSUED				
				RETURNED				
				ISSUED				
				RETURNED				
				ISSUED				
				RETURNED				
				ISSUED				
				RETURNED				
SCRIBE(S)						PAGE ___ OF ___		

GENERAL MESSAGE		
TO	POSITION	
FROM	POSITION	
SUBJECT	DAT	TIME
MESSAGE		
SIGNATURE	POSITION	
REPLY		
DATE	TIME	SIGNATURE/POSITION

CERT FORM #8 (ICS 213)

GENERAL MESSAGE		
TO	POSITION	
FROM	POSITION	
SUBJECT	DAT	TIME
MESSAGE		
SIGNATURE	POSITION	
REPLY		
DATE	TIME	SIGNATURE/POSITION

CERT FORM #8 (ICS 213)

UNIT 7: DISASTER PSYCHOLOGY

In this unit you will learn about:

- **Disaster Psychology:** The psychological impact of a disaster on rescuers and victims and how to provide “psychological first aid.”
- **Caring for Yourself, Your Buddy, and Victims:** Steps one can take individually and as part of a CERT before, immediately following, and after a disaster.

[This page intentionally left blank]

COMMUNITY EMERGENCY RESPONSE TEAM

UNIT 7: DISASTER PSYCHOLOGY

OBJECTIVES	<p>At the conclusion of this unit, the participants should be able to:</p> <ul style="list-style-type: none">▪ Describe the disaster and post-disaster emotional environment for victims and rescuers.▪ Describe the steps that rescuers can take to relieve their own stress and that of other disaster survivors.
SCOPE	<p>The topics that will be discussed in this unit are:</p> <ul style="list-style-type: none">▪ Introduction and Unit Overview▪ Disaster Trauma▪ Team Well-Being▪ Working with Survivors' Trauma▪ Unit Summary
ESTIMATED COMPLETION TIME	<p>45 minutes (This time does not include the video.)</p> <p>Please note that the estimated time depends on how much of the video you choose to show the participants. You may show as little or as much of the video as you think is appropriate. If you use the video in its entirety, the lesson will run approximately 1 hour and 15 minutes. Please note that the video should not be used in place of teaching the unit.</p>
TRAINING METHODS	<p>The lead instructor will begin this unit by welcoming the participants to Unit 7: Disaster Psychology, and will introduce the instructors for the session. The instructor will then present a brief overview of this session.</p> <p>Next, the instructor will explain the importance of having an understanding of the disaster and post-disaster emotional environment and the impact that the emotional crisis may have on CERT members as well as victims. The instructor will present the psychological and physiological symptoms that victims and rescue personnel may exhibit and provide some suggestions for how CERT members can help survivors cope with disaster trauma and control their own stress.</p>
RESOURCES REQUIRED	<ul style="list-style-type: none">▪ <i>Community Emergency Response Team Instructor Guide</i>▪ <i>Community Emergency Response Team Participant Manual</i>▪ Visuals 7-0 through 7-21

COMMUNITY EMERGENCY RESPONSE TEAM

UNIT 7: DISASTER PSYCHOLOGY

OTHER RESOURCES

If time permits, all or portions of the 43-minute video *CERT Training: Disaster Psychology* are recommended for this unit. The video describes the physical, emotional, and psychological reactions to a disaster and techniques for CERT members to take care of themselves and assist others in coping with the stress. The video is available for download at the national CERT Web site: www.citizencorps.gov/cert/.

EQUIPMENT

The following equipment is required for this unit:

- A computer with PowerPoint software
- Computer projector and screen

PREPARATION

Working with a representative of the community in which you will be teaching, identify any potentially culturally sensitive topics in this module. Develop strategies for presenting any such topics in ways that will be engaging and appropriate for participants.

It is particularly important in this unit to be aware of how your target audience may feel about topics such as trauma or coping with stressors. Encourage participants to discuss ways that people within their community may cope with psychological trauma. Avoid forcing your own coping mechanisms onto others.

In particular, look closely at the topic on *What Not to Say*. Make specific note of phrases that might be culturally inappropriate to the target audience. In the topic, *Managing a Death Scene*, ensure that you understand culturally appropriate ways of dealing with death. Treat this topic with reverence and respect participants' cultural backgrounds.

COMMUNITY EMERGENCY RESPONSE TEAM

UNIT 7: DISASTER PSYCHOLOGY

NOTES

A suggested time plan for this unit is as follows:



Introduction and Unit Overview	5 minutes
Disaster Trauma	5 minutes
Team Well-Being	10 minutes
Working with Survivors' Trauma	20 minutes
Unit Summary	5 minutes

Total Time: 45 minutes

ACKNOWLEDGEMENT



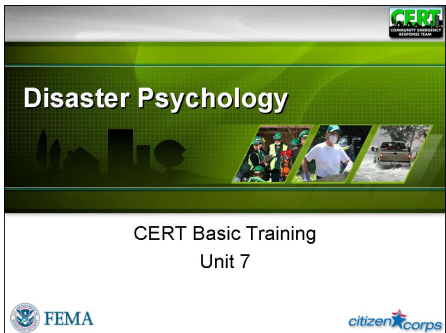

The information from this unit has been provided by Victor Welzant, Psy.D. and George Everly, Jr., Ph.D. of the International Critical Incident Stress Foundation; and Joanne Tortorici Luna, Ph.D., California State University, Long Beach, and Culver City, California, CERT. The Federal Emergency Management Agency wishes to thank them for their assistance.

Unit 7: Disaster Psychology

INSTRUCTOR GUIDANCE	CONTENT
<div data-bbox="168 512 610 842">  </div> <p data-bbox="168 856 427 894">Display Slide 7-0</p> <div data-bbox="168 1003 248 1077">  </div> <p data-bbox="168 1144 427 1182">Correct response:</p> <p data-bbox="168 1199 505 1268">The Incident Command System (ICS)</p> <div data-bbox="168 1304 248 1377">  </div> <p data-bbox="168 1444 427 1482">Correct response:</p> <ol data-bbox="168 1499 610 1661" style="list-style-type: none"> 1. The first person to arrive on the scene 2. Establishes the basic ICS structure for the incident 	<p data-bbox="636 516 1214 554"><i>Introductions and Unit Overview</i></p> <p data-bbox="636 625 781 659">Welcome</p> <p data-bbox="636 676 1154 711">Introduce the instructors for this unit.</p> <p data-bbox="636 728 1308 804">Ask any new instructors to briefly describe their experience with disaster psychology.</p> <p data-bbox="636 930 1232 966">Briefly review Unit 6: CERT Organization.</p> <p data-bbox="636 999 1317 1108">The CERT organization is based on a proven management system used by emergency responders. What is it called?</p> <p data-bbox="636 1302 1427 1373">Who becomes the CERT Incident Commander/Team Leader (IC/TL)?</p> <p data-bbox="636 1390 1050 1425">What does that person do?</p>

COMMUNITY EMERGENCY RESPONSE TEAM

UNIT 7: DISASTER PSYCHOLOGY

INSTRUCTOR GUIDANCE	CONTENT
 Correct response: The Command Post	What is the place called where the IC/TL stays?
 Correct response: <i>“Is it safe for CERT members to attempt the rescue?”</i>	What is the key question that CERT Incident Commanders/Team Leaders must always ask?
 Correct response: <ul style="list-style-type: none">▪ Damage assessment▪ Status of personnel resources▪ Communications between command levels and groups▪ Incident status▪ Victim treatment provided	Documentation is an essential part of the CERT’s job. What kinds of information should a CERT document?
 Correct response: The IC/TL	Who handles media inquiries?

COMMUNITY EMERGENCY RESPONSE TEAM

UNIT 7: DISASTER PSYCHOLOGY

INSTRUCTOR GUIDANCE	CONTENT
 <p>Discuss the participants' responses. Probe for both physical and emotional situations.</p>	<p>Explain that CERT members might see and hear things during a disaster that are unpleasant and uncomfortable.</p> <p>Has anyone ever been involved in a large-scale emergency or disaster?</p> <p>How were you impacted?</p> <p>Stress the need for CERT members to prepare themselves for their role during and following a disaster by learning about the possible impact of disasters on them and others, emotionally and physically. This knowledge will help CERT members understand and manage their reactions to the event and to work better with others.</p> <p>Remind the group that they recently learned about team organization. Point out that team organization concepts can help them both operationally and psychologically. Working together and looking out for each other are important aspects of successful teams.</p> <p>Tell the group that this unit will address basic techniques for providing psychological first aid and “field expedient” trauma intervention.</p> <p>Stress that psychological first aid is not therapy; rather, it is a set of techniques to provide emotional intervention during field operations. The techniques to be covered in this unit will help manage one’s personal situation so that the needs of all survivors, including victims and CERT members, can be met.</p>



COMMUNITY EMERGENCY RESPONSE TEAM

UNIT 7: DISASTER PSYCHOLOGY

INSTRUCTOR GUIDANCE	CONTENT
<p data-bbox="170 415 609 464">Unit Objectives</p> <ul data-bbox="191 472 592 619" style="list-style-type: none">• Describe disaster and post-disaster emotional environment for victims and rescuers• Describe steps rescuers can take to relieve their own stress and that of other survivors <p data-bbox="170 703 609 735">FEMA CERT Basic Training Unit 7: Disaster Psychology 7-1</p> <p data-bbox="170 751 422 787">Display Slide 7-1</p> <p data-bbox="170 829 609 877">Unit Topics</p> <ul data-bbox="191 886 373 997" style="list-style-type: none">• Disaster Trauma• Team Well-Being• Working with Survivors' Trauma  <p data-bbox="170 1117 609 1148">FEMA CERT Basic Training Unit 7: Disaster Psychology 7-2</p> <p data-bbox="170 1165 422 1201">Display Slide 7-2</p>	<p data-bbox="638 409 868 445">Unit Objectives</p> <p data-bbox="638 462 1360 529">Tell the participants that at the end of this unit, they should be able to:</p> <ul data-bbox="638 550 1412 709" style="list-style-type: none">▪ Describe the disaster and post-disaster emotional environment for victims and rescuers.▪ Describe the steps that rescuers can take to relieve their own stress and that of other disaster survivors. <p data-bbox="638 823 812 858">Unit Topics</p> <p data-bbox="638 875 1416 980">Preview the unit topics by telling the group that the unit will provide them with an understanding of the following components of psychological first aid:</p> <ul data-bbox="638 997 1136 1136" style="list-style-type: none">▪ Disaster Trauma▪ Team Well-being▪ Working with Survivors' Trauma





COMMUNITY EMERGENCY RESPONSE TEAM

UNIT 7: DISASTER PSYCHOLOGY

INSTRUCTOR GUIDANCE	CONTENT
<p data-bbox="175 422 415 449">Psychological Trauma</p> <ul data-bbox="191 474 574 611" style="list-style-type: none">• Your own personal losses• Working in your neighborhood• Assisting neighbors, friends, coworkers who have also been injured• Not feeling safe and secure <p data-bbox="175 705 607 730"> CERT Basic Training Unit 7: Disaster Psychology 7-3 </p> <p data-bbox="168 751 423 785">Display Slide 7-3</p>	<p data-bbox="639 422 932 457"><i>Disaster Trauma</i></p> <p data-bbox="639 485 1425 590">Introduce this section by telling the participants that, during a disaster, they may see and hear things that will be extremely unpleasant.</p> <p data-bbox="639 611 1284 642">Direct psychological trauma could result from:</p> <ul data-bbox="639 663 1386 890" style="list-style-type: none">▪ Your own personal losses▪ Working in your neighborhood▪ Assisting neighbors, friends, coworkers who have been injured▪ Not feeling safe and secure <p data-bbox="639 926 1446 1136">Explain that vicarious trauma, which is also referred to as compassion fatigue or secondary victimization, is a natural reaction to exposure to a survivor’s trauma. A person who identifies too strongly with a survivor may take on that survivor’s feelings. Explain that vicarious trauma is an “occupational hazard” for helpers.</p> <p data-bbox="639 1178 1425 1430">Warn the participants against over-identifying with the survivors. Caution them against taking on the survivors’ feelings as their own as it can affect their ability to do their job as rescuers and can also have longer term impact. Advise the group members that taking ownership of others’ problems will compound their own stress and impact the CERT’s overall effectiveness.</p> <p data-bbox="639 1472 1430 1608">Explain that CERT members need to be alert to signs of disaster trauma in themselves, as well as in disaster victims and other survivors, so that they can take steps to alleviate stress.</p>

COMMUNITY EMERGENCY RESPONSE TEAM

UNIT 7: DISASTER PSYCHOLOGY

INSTRUCTOR GUIDANCE	CONTENT
<p data-bbox="175 422 604 457">Psychological Symptoms of Trauma</p> <ul data-bbox="191 472 584 661" style="list-style-type: none">• Irritability or anger• Self-blame or blaming others• Isolation and withdrawal• Fear of recurrence• Feeling stunned, numb, overwhelmed• Feeling helpless• Mood swings• Sadness, depression, grief• Denial• Concentration and memory problems• Relationship problems/marital discord <p data-bbox="175 703 604 735"> CERT Basic Training Unit 7: Disaster Psychology 7-4 </p> <p data-bbox="175 751 422 787">Display Slide 7-4</p>	<p data-bbox="643 411 1166 447">Possible Psychological Symptoms</p> <p data-bbox="643 464 1430 569">Give examples of the types of disaster-related psychological and physiological responses that you may experience or observe others experiencing.</p> <ul data-bbox="643 590 1258 1144" style="list-style-type: none">▪ Irritability or anger▪ Self-blame or the blaming of others▪ Isolation and withdrawal▪ Fear of recurrence▪ Feeling stunned, numb, or overwhelmed▪ Feeling helpless▪ Mood swings▪ Sadness, depression, and grief▪ Denial▪ Concentration and memory problems▪ Relationship conflicts/marital discord
<p data-bbox="175 1249 604 1285">Physiological Symptoms of Trauma</p> <ul data-bbox="191 1299 516 1501" style="list-style-type: none">• Loss of appetite• Headaches or chest pain• Diarrhea, stomach pain, or nausea• Hyperactivity• Increase in drug consumption• Nightmares• Insomnia• Fatigue <p data-bbox="175 1522 604 1554"> CERT Basic Training Unit 7: Disaster Psychology 7-5 </p> <p data-bbox="175 1570 422 1606">Display Slide 7-5</p>	<p data-bbox="643 1234 1079 1270">Possible Physical Symptoms</p> <ul data-bbox="643 1287 1258 1690" style="list-style-type: none">▪ Loss of appetite▪ Headaches or chest pain▪ Diarrhea, stomach pain, or nausea▪ Hyperactivity▪ Increase in alcohol or drug consumption▪ Nightmares▪ The inability to sleep▪ Fatigue or low energy



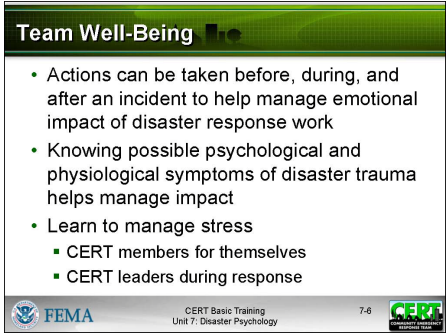
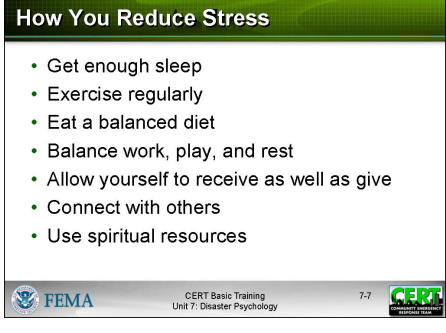

COMMUNITY EMERGENCY RESPONSE TEAM

UNIT 7: DISASTER PSYCHOLOGY

INSTRUCTOR GUIDANCE	CONTENT
 <p>Team Well-Being</p> <ul style="list-style-type: none">• Actions can be taken before, during, and after an incident to help manage emotional impact of disaster response work• Knowing possible psychological and physiological symptoms of disaster trauma helps manage impact• Learn to manage stress<ul style="list-style-type: none">▪ CERT members for themselves▪ CERT leaders during response <p>FEMA CERT Basic Training Unit 7: Disaster Psychology 7-6</p>	<h3><i>Team Well-Being</i></h3> <p>Introduce team well-being by explaining that there is a range of actions that can be taken before, during, and after an incident to help manage the emotional impact of disaster response work.</p> <p>Explain that knowing in advance the possible psychological and physiological symptoms of disaster trauma that were just covered in this unit is one step in managing the impact.</p> <p>Some other aspects of stress management for CERT responders include actions that CERT members can take for themselves and actions that CERT leaders can take during a response.</p>
 <p>How You Reduce Stress</p> <ul style="list-style-type: none">• Get enough sleep• Exercise regularly• Eat a balanced diet• Balance work, play, and rest• Allow yourself to receive as well as give• Connect with others• Use spiritual resources <p>FEMA CERT Basic Training Unit 7: Disaster Psychology 7-7</p>	<h3>How You Reduce Stress</h3> <p>Remind the participant that they should spend some time thinking about other ways to reduce stress personally.</p> <p>Emphasize that only they know what makes them able to reduce stress within themselves and that expending the effort required to find personal stress reducers is worthwhile <u>before</u> an incident occurs.</p> <p>Remind the participants that they can take the following preventive steps in their everyday lives:</p> <ul style="list-style-type: none">▪ Get enough sleep.▪ Exercise regularly.▪ Eat a balanced diet.▪ Balance work, play, and rest.▪ Allow themselves to receive as well as give; they should remember that their identity is broader than that of a helper.▪ Connect with others.▪ Use spiritual resources.

COMMUNITY EMERGENCY RESPONSE TEAM

UNIT 7: DISASTER PSYCHOLOGY

INSTRUCTOR GUIDANCE	CONTENT
<p>Take Care of Yourself</p> <ul style="list-style-type: none">• Be aware of trauma that can follow a disaster• Explain to family members and friends what you need:<ul style="list-style-type: none">▪ Listen when you want to talk▪ Don't force you to talk <p> <small>CERT Basic Training Unit 7: Disaster Psychology</small> 7-8 </p> <p>Display Slide 7-8</p>	<p>Explain that, in addition to preventive steps, participants should also be aware of trauma that can follow a disaster. They should explain to their family members and friends how to support them when they return from a disaster area. Family and friends should:</p> <ul style="list-style-type: none">▪ Listen when you want to talk.▪ Don't force you to talk if you don't want to. <p>Participants might also want to share with their loved ones and friends the information on possible disaster-related psychological and physiological symptoms that were discussed earlier in the unit.</p> <p>Point out that experienced rescue workers find these steps helpful in controlling their stress levels, but that, in some cases, it might be necessary to seek help from mental health professionals.</p>
<p>How Team Leaders Reduce Stress</p> <ul style="list-style-type: none">• Brief CERT personnel beforehand• Remember CERT is a team• Rest and regroup• Take breaks away• Eat properly, stay hydrated• Arrange for debriefing• Rotate teams and duties• Phase out workers gradually <p> <small>CERT Basic Training Unit 7: Disaster Psychology</small> 7-9 </p> <p>Display Slide 7-9</p>	<p>How Team Leaders Reduce Stress During the Incident</p> <p>Explain that there are steps that CERT leaders can take to reduce the stress on rescue workers before, during, and after an incident:</p> <ul style="list-style-type: none">▪ <u>Brief CERT personnel before the effort begins</u> on what they can expect to see and what they can expect in terms of emotional response in the survivors and themselves.▪ <u>Emphasize that the CERT is a team.</u> Sharing the workload and emotional load can help defuse pent-up emotions.▪ <u>Encourage rescuers to rest and regroup</u> so that they can avoid becoming overtired.▪ <u>Direct rescuers to take breaks</u> away from the incident area, to get relief from the stressors of the effort.

COMMUNITY EMERGENCY RESPONSE TEAM

UNIT 7: DISASTER PSYCHOLOGY

INSTRUCTOR GUIDANCE	CONTENT
<p>This will be discussed in more detail later in the unit.</p> <div data-bbox="168 1367 609 1701"><p>Critical Incident Stress Debriefing</p><ol style="list-style-type: none">1. Introductions and description2. Review of factual material3. Sharing of initial thoughts and feelings4. Sharing of emotional reactions to incident5. Instruction about normal stress reactions6. Review of symptoms7. Closing and further needs assessment<p>FEMA CERT Basic Training Unit 7: Disaster Psychology 7-10</p></div> <p>Display Slide 7-10</p>	<ul style="list-style-type: none">▪ <u>Encourage rescuers to eat properly and maintain fluid intake</u> throughout the operation. Explain that they should drink water or other electrolyte-replacing fluids and avoid drinks with caffeine or refined sugar.▪ <u>Arrange for a debriefing 1 to 3 days after the event</u> in which workers describe what they encountered and express their feelings about it in a more indepth way.▪ <u>Rotate teams</u> for breaks or new duties (i.e., from high-stress to low-stress jobs). Encourage team members to talk with each other about their experiences. This is very important for their psychological health.▪ <u>Phase out workers gradually.</u> Gradually phase them from high- to low-stress areas of the incident. For example, do not stand down and send home a team member that has just completed a high-stress operation; instead, assign them a low-stress responsibility so they can decompress gradually.▪ <u>Conduct a brief discussion</u> (defusing) with rescue workers after their shift during which they can describe what they encountered and express their feelings about it. <p>Critical Incident Stress Debriefing (CISD)</p> <p>Point out that a critical incident stress debriefing or CISD is one type of intervention that may be helpful for a CERT. CISD is one of several components of critical incident stress management (CISM).</p>

COMMUNITY EMERGENCY RESPONSE TEAM

UNIT 7: DISASTER PSYCHOLOGY

INSTRUCTOR GUIDANCE	CONTENT
	<p>CERT leaders may invite a mental health professional trained in critical incident stress management (CISM) to conduct a critical incident stress debriefing (CISD). CISM is a short term healing process that focuses on helping people deal with their trauma one incident at a time. It is intended to lessen the chance of someone experiencing post-traumatic stress disorder and get them back to their daily lives as quickly as possible.</p> <p>Explain that a CISD is a formal group process held between 1 to 3 days after the event. It is designed to help emergency services personnel and volunteers cope with a traumatic event.</p> <p>Explain that CISD would <u>not</u> be used as a stand-alone intervention but would be used in conjunction with other types of intervention, such as defusing, debriefing, and following up with the individual.</p> <p>Explain that a CISD has seven phases:</p> <ol style="list-style-type: none">1. <u>Introductions and a description</u> of the process, including assurance of confidentiality2. <u>Review of the factual material</u> about the incident3. <u>Sharing of initial thoughts and feelings</u> about the incident4. <u>Sharing of emotional reactions</u> to the incident5. <u>Review of the symptoms</u> of stress experienced by the participants6. <u>Instruction about normal stress reactions</u>7. <u>Closing and further needs assessment</u> <p>Emphasize that participation in a CISD should be voluntary.</p> <p>Say that, as the CERT program sponsor, an agency may assist in arranging CISD services for the CERTs. If so, explain how participants should access those services.</p>

COMMUNITY EMERGENCY RESPONSE TEAM

UNIT 7: DISASTER PSYCHOLOGY

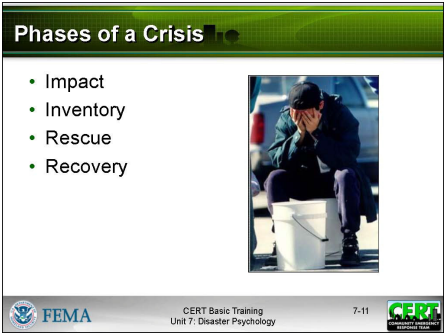
INSTRUCTOR GUIDANCE	CONTENT
 <p>Display Slide 7-11</p>	<p>If a CISD is unavailable in the agency, suggest that participants contact the Red Cross or a community mental health agency to schedule a CISD.</p> <p>Emphasize that, while it may be beneficial, pastoral counseling is not a substitute for disaster counseling from a professional.</p> <p>Explain that the next section will deal with how to handle survivors' trauma.</p> <p><i>Working with Survivors' Trauma</i></p> <p>Identify the emotional phases of a crisis survivors go through and whom and what rescuers might encounter at each phase.</p> <ul style="list-style-type: none">▪ In the <u>impact phase</u>, survivors generally do not panic and may, in fact, show no emotion.▪ In the <u>inventory phase</u>, which immediately follows the event, survivors assess damage and try to locate other survivors. During this phase, routine social ties tend to be discarded in favor of the more functional relationships required for initial response activities (e.g., search and rescue).▪ In the <u>rescue phase</u>, as emergency services personnel (including CERTs) respond, survivors are willing to take direction from these groups without protest. This is why CERT identification (helmets, vests, etc.) is important. <p>Survivors are likely to be very helpful and compliant during the rescue phase.</p>

COMMUNITY EMERGENCY RESPONSE TEAM

UNIT 7: DISASTER PSYCHOLOGY

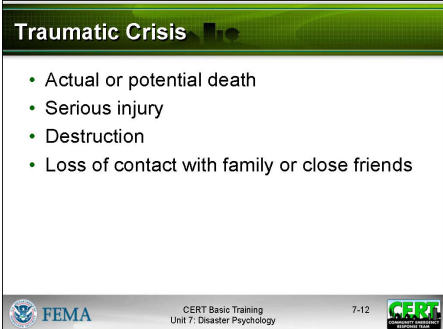
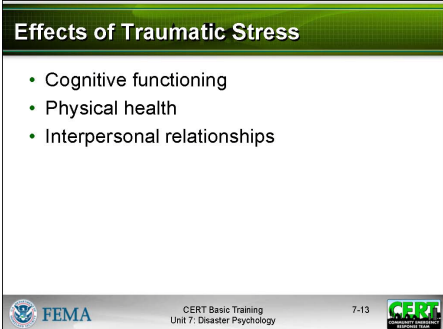
INSTRUCTOR GUIDANCE	CONTENT
 <p>Traumatic Crisis</p> <ul style="list-style-type: none">• Actual or potential death• Serious injury• Destruction• Loss of contact with family or close friends <p>FEMA CERT Basic Training Unit 7: Disaster Psychology 7-12</p> <p>Display Slide 7-12</p>  <p>Effects of Traumatic Stress</p> <ul style="list-style-type: none">• Cognitive functioning• Physical health• Interpersonal relationships <p>FEMA CERT Basic Training Unit 7: Disaster Psychology 7-13</p> <p>Display Slide 7-13</p>	<ul style="list-style-type: none">▪ In the <u>recovery phase</u>, the survivors appear to pull together <u>against</u> their rescuers, the emergency services personnel.<ul style="list-style-type: none">• Survivors may express anger or blame to the rescuers as they transition to the recovery phase. <p>Tell the participants that they should expect that survivors will show psychological effects from the disaster — and that they should expect that some of the reaction will be directed toward them.</p> <p>Traumatic Crisis</p> <p>Introduce this section by defining a crisis as an event that is experienced or witnessed in which people’s ability to cope is overwhelmed:</p> <ul style="list-style-type: none">▪ Actual or potential death or injury to self or others▪ Serious injury▪ Destruction of their homes, neighborhood, or valued possessions▪ Loss of contact with family members or close friends <p>Traumatic stress may affect:</p> <ul style="list-style-type: none">▪ <u>Cognitive functioning</u>. Those who have suffered traumatic stress may act irrationally, in ways that are out of character for them, and have difficulty making decisions. They may have difficulty sharing or retrieving memories.▪ <u>Physical health</u>. Traumatic stress can cause a range of physical symptoms — from exhaustion to health problems.▪ <u>Interpersonal relationships</u>. Those who survive traumatic stress may undergo temporary or long-term personality changes that make interpersonal relationships difficult.

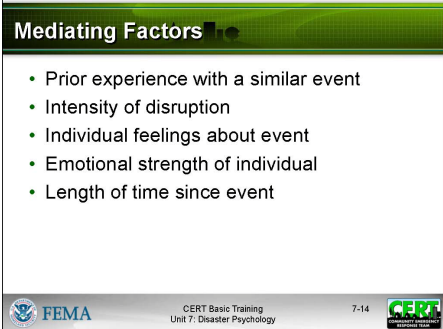

COMMUNITY EMERGENCY RESPONSE TEAM

UNIT 7: DISASTER PSYCHOLOGY

INSTRUCTOR GUIDANCE	CONTENT
 <p>Mediating Factors</p> <ul style="list-style-type: none">• Prior experience with a similar event• Intensity of disruption• Individual feelings about event• Emotional strength of individual• Length of time since event <p>FEMA CERT Basic Training Unit 7: Disaster Psychology 7-14</p> <p>Display Slide 7-14</p>	<h3>Mediating Factors</h3> <p>Explain that the strength and type of personal reaction to trauma vary depending on:</p> <ul style="list-style-type: none">▪ <u>The person's prior experience</u> with the same or a similar event; the emotional effect of multiple events can be cumulative, leading to greater stress reactions.▪ <u>The intensity of the disruption</u> in the survivors' lives; the more the survivors' lives are disrupted, the greater their psychological and physiological reactions may become.▪ <u>The meaning of the event to the individual</u>; the more catastrophic the victim perceives the event to be to him or her personally, the more intense his or her stress reaction will be.▪ <u>The emotional well-being of the individual</u> and the resources (especially social) that he or she has to cope; people who have had other recent traumas may not cope with additional stresses.▪ <u>The length of time that has elapsed</u> between the event's occurrence and the present; the reality of the event takes time to "sink in." <p>CERT members can't know — and should never assume to know — what someone is thinking or feeling. Keep the phases in mind.</p> <p>Caution the group, however, that they should not take the survivors' surface attitudes personally. Rescuers may expect to see a range of responses that will vary from person to person, but the responses they see will be part of the psychological impact of the event — and probably will not relate to anything that the CERTs have or have not done.</p>



COMMUNITY EMERGENCY RESPONSE TEAM

UNIT 7: DISASTER PSYCHOLOGY

INSTRUCTOR GUIDANCE	CONTENT
<div data-bbox="175 422 407 453">Stabilizing Victims</div> <ul data-bbox="196 474 521 653" style="list-style-type: none">• Assess survivors for injury or shock• Get uninjured people to help• Provide support by:<ul style="list-style-type: none">▪ Listening▪ Empathizing• Help survivors connect with natural support systems <div data-bbox="175 705 607 737"> CERT Basic Training Unit 7: Disaster Psychology 7-15 </div> <p data-bbox="175 753 443 789">Display Slide 7-15</p>	<h3 data-bbox="639 411 922 447">Stabilizing Victims</h3> <p data-bbox="639 464 1422 680">Explain that the goal of onscene psychological intervention on the part of CERT members should be to <u>stabilize the incident scene by stabilizing individuals</u>. While any medical needs must be addressed first, you can provide psychological intervention. Suggest that they do this in the following ways:</p> <ul data-bbox="639 699 1450 1455" style="list-style-type: none">▪ <u>Observe individuals</u> to determine their level of responsiveness and whether they pose a danger to themselves or to others.▪ <u>Get uninjured people involved in helping</u>. Engaging survivors in focused activity helps them cope, so give them constructive jobs to do such as organizing supplies. This strategy is especially effective for survivors who are being disruptive.▪ Help survivors connect to natural support systems, such as family, friends, or clergy.▪ Provide support by:<ul style="list-style-type: none">• Listening to them talk about their feelings and their physical needs. Victims often need to talk about what they've been through — and they want someone to listen to them.• Empathizing. Caring responses show victims that someone else shares their feelings of pain and grief.

COMMUNITY EMERGENCY RESPONSE TEAM

UNIT 7: DISASTER PSYCHOLOGY

INSTRUCTOR GUIDANCE	CONTENT
<p data-bbox="175 422 604 457">How to Be an Empathetic Listener</p> <ul data-bbox="191 474 581 583" style="list-style-type: none">• Put yourself in the speaker's shoes• Listen for meaning, not just words• Pay attention to nonverbal communication• Paraphrase the speaker <p data-bbox="175 705 604 737"> CERT Basic Training Unit 7: Disaster Psychology 7-16 </p> <p data-bbox="175 751 441 787">Display Slide 7-16</p>	<p data-bbox="639 411 1058 447"><i>Being an Empathetic Listener</i></p> <p data-bbox="639 464 1399 569">Explain that being an empathetic listener requires the listener to listen and let the victim talk. Good listeners will:</p> <ul data-bbox="639 590 1442 1167" style="list-style-type: none">▪ Put him- or herself in the speaker's shoes in order to better understand the speaker's point of view. Draw upon past experiences, or try to imagine how the speaker is feeling. In order to limit the effects of vicarious trauma, be careful not to completely take on the speaker's feelings.▪ Listen for meaning, not just words, and pay close attention to the speaker's nonverbal communication, such as body language, facial expressions, and tone of voice.▪ Paraphrase the speaker periodically to make sure that he or she has fully understood what the speaker has said and to indicate to the speaker that he or she is listening. This reinforces the communication process. <p data-bbox="639 1199 1377 1377">Stress that survivors that show evidence of being suicidal, psychotic, or unable to care for themselves should be referred to mental health professionals for support. (This will be infrequent in most groups of survivors.)</p>





COMMUNITY EMERGENCY RESPONSE TEAM

UNIT 7: DISASTER PSYCHOLOGY

INSTRUCTOR GUIDANCE	CONTENT
A slide titled "Avoid Saying..." with a green header. It lists seven phrases to avoid: "I understand", "Don't feel bad", "You're strong" or "You'll get through this", "Don't cry", "It's God's will", "It could be worse", "At least you still have...", and "Everything will be okay". The slide includes FEMA and CERT logos and the text "CERT Basic Training Unit 7: Disaster Psychology 7-17". <p>Display Slide 7-17</p>	<h3><i>What Not to Say</i></h3> <p>Tell the participants that, when providing support, they should avoid saying the following phrases. On the surface, these phrases are meant to comfort the survivors, but they can be misinterpreted.</p> <ul style="list-style-type: none">▪ <u>"I understand."</u> In most situations we cannot understand unless we have had the same experience.▪ <u>"Don't feel bad."</u> The survivor has a right to feel bad and will need time to feel differently.▪ <u>"You're strong" or "You'll get through this."</u> Many survivors do not feel strong and question if they will recover from the loss.▪ <u>"Don't cry."</u> It is okay to cry.▪ <u>"It's God's will."</u> With a person you do not know, giving religious meaning to an event may insult or anger the person.▪ <u>"It could be worse," "At least you still have ...", or "Everything will be okay."</u> It is up to the individual to decide whether things could be worse or if everything can be okay. <p>Emphasize that these types of responses, rather than provide comfort, could elicit a strong <u>negative</u> response or distance the survivor from the listener.</p> <p>Point out that it is okay to apologize if the survivor reacts negatively to something that was said.</p>

COMMUNITY EMERGENCY RESPONSE TEAM

UNIT 7: DISASTER PSYCHOLOGY

INSTRUCTOR GUIDANCE	CONTENT
<p data-bbox="175 422 462 453">Managing the Death Scene</p> <ul data-bbox="191 474 529 583" style="list-style-type: none">• Cover the body; treat it with respect• Move the body to temporary morgue• Follow local laws and protocols• Talk with local authorities <p data-bbox="175 705 607 730"> CERT Basic Training Unit 7: Disaster Psychology 7-18 </p> <p data-bbox="168 751 443 787">Display Slide 7-18</p>	<p data-bbox="636 407 1045 443">Managing the Death Scene</p> <p data-bbox="636 464 1430 638">Explain that one unpleasant task that CERT members may face is dealing with a victim who dies while under the team’s care. The guidelines below (T.W. Dietz, 2001; J.M. Tortorici Luna, 2002) are for dealing with this situation:</p> <ul data-bbox="636 659 1451 1035" style="list-style-type: none">▪ Cover the body; treat it with respect. Wrap mutilated bodies tightly.▪ If the person has died while at the treatment area, move the body to your team’s temporary morgue. (If the person was tagged as “dead” during triage, do not remove from the incident area.)▪ Follow local laws and protocols for handling the deceased.▪ Talk with local authorities to determine the plan.
<p data-bbox="175 1136 558 1167">Informing Family/Friends of a Death</p> <ul data-bbox="191 1188 583 1346" style="list-style-type: none">• Separate the family member(s) or friend(s)• Have the person(s) sit down• Make eye contact• “I’m sorry, but your family member has died. I am so sorry.”• Let the family and friends grieve <p data-bbox="175 1415 607 1440"> CERT Basic Training Unit 7: Disaster Psychology 7-19 </p> <p data-bbox="168 1461 443 1497">Display Slide 7-19</p>	<p data-bbox="636 1136 1305 1171">Informing the Family and Friends of a Death</p> <p data-bbox="636 1192 1442 1325">In some cases, family members or friends may not know of the death of their loved one, and CERT members may have to tell them. Suggest that, in this situation, CERT members should:</p> <ul data-bbox="636 1346 1451 1776" style="list-style-type: none">▪ <u>Separate the family members and friends</u> from others in a quiet, private place.▪ <u>Have the person(s) sit down</u>, if possible.▪ <u>Make eye contact</u> and use a calm, kind voice.▪ Use the following words to <u>tell the family members and friends</u> about the death: “I’m sorry, but your family member has died. I am so sorry.” It is okay to reference the deceased person’s name or their relation to the survivor if you know it.▪ Let the family and friends grieve.

COMMUNITY EMERGENCY RESPONSE TEAM

UNIT 7: DISASTER PSYCHOLOGY

INSTRUCTOR GUIDANCE	CONTENT
<p data-bbox="170 415 248 485"></p> <p data-bbox="170 636 589 846">After answering all of the participants' questions, pose some "What would you do if ..." questions to ensure that they understand the concepts of this section.</p> <p data-bbox="170 884 589 1056">For example, ask the participants, "What would you do if you were attempting to rescue a victim and the victim became hysterical?"</p> <div data-bbox="170 1094 609 1419"><p>Unit Summary</p><ul style="list-style-type: none">• Rescues may be unpleasant or uncomfortable• Psychological and physiological symptoms of trauma• Take steps to reduce stress• CISD is one intervention• Four emotional phases of a disaster• Stress affects cognition, health, and interactions• Stabilize individuals• Be an empathetic listener<p>FEMA CERT Basic Training Unit 7: Disaster Psychology 7-20</p></div> <p data-bbox="170 1440 443 1476">Display Slide 7-20</p>	<p data-bbox="638 422 1442 527">Does anyone have any questions about the types of emotional and physiological responses that they can expect to see during and following a disaster?</p> <p data-bbox="638 1108 894 1150">Unit Summary</p> <ul style="list-style-type: none">▪ During a disaster, rescuers may be exposed to things that are extremely unpleasant or uncomfortable. These experiences will be stressful and may be traumatic.<ul style="list-style-type: none">• Over-identifying with survivors may subject rescuers to vicarious trauma.• There are both psychological and physiological symptoms of trauma that may be observed in victims and rescuers after a disaster.• CERT leaders can take steps to reduce stress on rescue workers before, during, and after an incident.• CERT members can take steps to personally reduce stress.

COMMUNITY EMERGENCY RESPONSE TEAM



UNIT 7: DISASTER PSYCHOLOGY

INSTRUCTOR GUIDANCE	CONTENT
	<ul style="list-style-type: none">▪ The critical incident stress debriefing (CISD) is one component of critical incident stress management. CISD has seven phases and is an intervention for dealing with trauma.▪ Research shows that survivors go through distinct emotional phases following a disaster.<ul style="list-style-type: none">• Impact phase• Inventory phase• Rescue phase• Recovery phase▪ Traumatic stress may affect cognitive functioning, physical health, and interpersonal reactions.<ul style="list-style-type: none">• Different people react differently to traumatic stress based on a variety of mediating factors.• A traumatic crisis occurs when a person's ability to cope is overwhelmed.▪ The goal of onscene psychological intervention is to stabilize the incident by stabilizing individuals.▪ Provide support for survivors by being an empathetic listener. <p>Does anyone have any questions about anything covered in this unit?</p>



COMMUNITY EMERGENCY RESPONSE TEAM

UNIT 7: DISASTER PSYCHOLOGY

INSTRUCTOR GUIDANCE	CONTENT
<p data-bbox="175 422 430 453">Homework Assignment</p> <ol data-bbox="191 506 578 583" style="list-style-type: none">1. Read unit to be covered in next session2. Bring necessary supplies to next session3. Wear appropriate clothes to next session <p data-bbox="175 705 609 737"> CERT Basic Training Unit 7: Disaster Psychology 7-21 </p> <p data-bbox="175 753 440 789">Display Slide 7-21</p>	<p data-bbox="639 422 992 457">Homework Assignment</p> <p data-bbox="639 527 1422 594">Ask the group to read and become familiar with the unit that will be covered in the next session.</p> <p data-bbox="639 667 1446 772">Thank the participants for attending the session. Remind them of the time and location of the next session, if necessary.</p>

[This page intentionally left blank]

UNIT 8: TERRORISM AND CERT

In this unit you will learn about:

- **What Terrorism Is:** The definition of terrorism and terrorist goals.
- **Terrorist Targets:** How terrorists choose their targets.
- **Terrorist Weapons:** The weapons that terrorists are known or are suspected to have and the risk posed by various terrorist weapons.
- **CBRNE Indicators:** Cues that help to identify when a terrorist attack may have occurred or may be imminent.
- **Preparing at Home, Work, and in Your Neighborhood:** Ways to prepare for a terrorist incident.
- **CERTs and Terrorist Incidents:** CERT protocols for terrorist incidents and protective action following an event.

[This page intentionally left blank]

COMMUNITY EMERGENCY RESPONSE TEAM

UNIT 8: TERRORISM AND CERT

OBJECTIVES	<p>At the conclusion of this unit, the participants should be able to:</p> <ul style="list-style-type: none">▪ Define terrorism.▪ Identify potential targets in the community.▪ Identify the eight signs of terrorism.▪ Identify CERT operating procedures for a terrorist incident.▪ Describe the actions to take following a suspected terrorist incident.
SCOPE	<p>The topics of this unit will include:</p> <ul style="list-style-type: none">▪ Introduction and Unit Overview▪ What Is Terrorism?▪ Terrorist Targets▪ Terrorist Weapons▪ CBRNE Indicators▪ Preparing at Home, Work, and in Your Neighborhood▪ CERTs and Terrorist Incidents▪ Exercise: Applying CERT Principles to a Suspected Terrorist Incident▪ Unit Summary
ESTIMATED COMPLETION TIME	2 hours 30 minutes
TRAINING METHODS	<p>The instructor will introduce this unit by defining terrorism using the Department of Justice definition and providing several examples of terrorist attacks within the United States. Then, the instructor will describe the terrorists' goals.</p>

COMMUNITY EMERGENCY RESPONSE TEAM

UNIT 8: TERRORISM AND CERT

TRAINING METHODS (CONTINUED)

Next, the instructor will describe the main categories of weapons that terrorists are known to have or are suspected of having. During this discussion, the instructor will introduce the acronym CBRNE (chemical, biological, radiological, nuclear, high-yield explosives) as a way of remembering each category of weapons. The instructor will describe each type of weapon briefly, including the types of damage or injury that they can cause and, in the case of biological and chemical weapons, routes of exposure. At the end of this discussion, the instructor will present a graphic that describes the FBI's assessment of the risk posed by and the impact that could be expected from each type of weapon.

Following this topic, the instructor will cover steps to take to prepare for a terrorist incident and steps to take if an incident has occurred, including shelter-in-place procedures and emergency decontamination procedures.

In the next topic, the instructor will describe the environmental and physical indicators that serve as cues that a terrorist attack has occurred or may be imminent. Then he or she will link these cues to CERT protocols for terrorist incidents, emphasizing personal safety as the first priority. This discussion will include measures that CERT members can take to increase their safety levels (e.g., time, distance, and shielding; immediate decontamination; and not treating those who may have been contaminated), what they can do to protect others, and what to expect when professional responders arrive.

At the end of this unit, the participants will work in teams to apply CERT principles to a suspected terrorist incident.

RESOURCES REQUIRED

- *Community Emergency Response Team Instructor Guide*
- *Community Emergency Response Team Participant Manual*
- PowerPoint Slides 8-1 through 8-28

EQUIPMENT

The following additional equipment is required for this unit:

- A computer with PowerPoint software
 - A computer projector and screen
-

COMMUNITY EMERGENCY RESPONSE TEAM

UNIT 8: TERRORISM AND CERT

NOTES

A suggested time plan for this unit is as follows:

Introduction and Unit Overview	10 minutes
What Is Terrorism?.....	10 minutes
Terrorist Targets.....	10 minutes
Terrorist Weapons.....	30 minutes
CBRNE Indicators	20 minutes
Preparing at Home, Work, and in Your Neighborhood	20 minutes
CERTs and Terrorist Incidents	20 minutes
Activity: Applying CERT Principles to a Suspected Terrorist Incident	25 minutes
Unit Summary	5 minutes

Total Time: 2 hours 30 minutes

REMARKS



It is not possible to present comprehensive information about terrorists or their weapons in the timeframe provided for this unit. Refer the participants to *Are You Ready?* (www.ready.gov) for more information about possible terrorist attacks and how to prepare for them.

Unit 8: Terrorism and CERT

INSTRUCTOR GUIDANCE	CONTENT
<div data-bbox="235 583 678 919" data-label="Image"> </div> <p data-bbox="235 934 495 976">Display Slide 8-0</p> <div data-bbox="235 1071 316 1150" data-label="Image"> </div> <p data-bbox="235 1218 495 1249">Correct response:</p> <ul data-bbox="235 1270 673 1648" style="list-style-type: none"> ▪ Psychological symptoms: e.g., anger, grief, withdrawal, self-blame, memory or concentration problems ▪ Physiological symptoms: e.g., loss of appetite, sleep problems, low energy, headaches, increase in alcohol/drug consumption 	<p data-bbox="706 556 1258 598"><i>Introduction and Unit Overview</i></p> <p data-bbox="706 609 1477 682">Introduce yourself and welcome the participants to this session, Terrorism and CERT.</p> <p data-bbox="706 703 1477 808">Introduce the instructors for this unit and ask any new instructors to briefly describe their experience with terrorism planning.</p> <p data-bbox="706 997 1315 1039">Briefly review Unit 7: Disaster Psychology.</p> <p data-bbox="706 1071 1396 1176">What kinds of symptoms might you see in someone who is having trouble coping with a disaster?</p>

COMMUNITY EMERGENCY RESPONSE TEAM

UNIT 8: TERRORISM AND CERT

INSTRUCTOR GUIDANCE	CONTENT
 <p>Correct response: When a person identifies too strongly with a survivor and takes on that survivor's feelings</p>	<p>What is vicarious trauma?</p>
 <p>Correct response: Let them talk and be an empathetic listener</p>	<p>What is the best way to provide support to survivors?</p>
 <p>Correct response:</p> <ul style="list-style-type: none">▪ Get enough sleep.▪ Exercise regularly.▪ Eat a balanced diet.▪ Connect with others.▪ Ask for help if they need it.▪ Tell family and friends how to support them.	<p>What can a CERT member do to take care of himself or herself after a disaster?</p>

COMMUNITY EMERGENCY RESPONSE TEAM

UNIT 8: TERRORISM AND CERT

INSTRUCTOR GUIDANCE	CONTENT
<div data-bbox="235 520 675 850"><p>Unit Objectives</p><ul style="list-style-type: none">• Define terrorism• Identify potential targets in the community• Identify the eight signs of terrorism• Identify CERT operating procedures for a terrorist incident• Describe the actions to take following a suspected terrorist incident<p>FEMA CERT Basic Training Unit 8: Terrorism and CERT 8-1</p></div> <p>Display Slide 8-1</p> <div data-bbox="235 1066 675 1396"><p>Unit Topics</p><ul style="list-style-type: none">• What Is Terrorism?• Terrorist Targets• Terrorist Weapons• CBRNE Indicators• Preparing at Home, Work, and in Your Neighborhood• CERTs and Terrorist Incidents<p>FEMA CERT Basic Training Unit 8: Terrorism and CERT 8-2</p></div> <p>Display Slide 8-2</p>	<p>Review the unit's objectives and topics.</p> <p>Unit Objectives</p> <p>Tell the participants that at the end of this unit, they should be able to:</p> <ul style="list-style-type: none">▪ Define terrorism.▪ Identify potential targets in the community.▪ Identify the eight signs of terrorism.▪ Identify CERT operating procedures for a terrorist incident.▪ Describe the actions to take following a suspected terrorist incident. <p>Unit Topics</p> <p>Tell the participants that this unit will cover the following topics:</p> <ul style="list-style-type: none">▪ What Is Terrorism?▪ Terrorist Targets▪ Terrorist Weapons▪ CBRNE Indicators▪ Preparing at Home, Work, and in Your Neighborhood▪ CERTs and Terrorist Incidents <p>Explain that the first section will provide a definition of terrorism and give examples of terrorist incidents.</p>



COMMUNITY EMERGENCY RESPONSE TEAM

UNIT 8: TERRORISM AND CERT

INSTRUCTOR GUIDANCE	CONTENT
<p data-bbox="240 449 673 506">What Is Terrorism?</p> <p data-bbox="293 541 630 684">The unlawful use of force or violence against persons or property to intimidate or coerce a government, the civilian population, or any segment thereof, in furtherance of political or social objectives</p> <p data-bbox="240 743 673 779">FEMA CERT Basic Training Unit 8: Terrorism and CERT 8-3</p> <p data-bbox="240 793 493 829">Display Slide 8-3</p>	<p data-bbox="706 426 1045 462"><i>What Is Terrorism?</i></p> <p data-bbox="706 537 1455 606">Introduce this topic by providing the U.S. Department of Justice’s definition of terrorism:</p> <ul data-bbox="706 625 1474 806" style="list-style-type: none">▪ The unlawful use of force or violence against persons or property to intimidate or coerce a government, the civilian population, or any segment thereof, in furtherance of political or social objectives <p data-bbox="706 900 1463 970">Stress that terrorism may be perpetrated by foreign or domestic individuals or groups.</p>
<p data-bbox="240 953 673 989">Terrorism in the Past</p>  <p data-bbox="240 1241 673 1276">FEMA CERT Basic Training Unit 8: Terrorism and CERT 8-4</p> <p data-bbox="240 1291 493 1327">Display Slide 8-4</p>	<p data-bbox="706 993 1455 1098">Point out that, while the United States has not had as many terrorist incidents as some other countries, we have had several serious attacks, including:</p> <ul data-bbox="706 1117 1474 1560" style="list-style-type: none">▪ The bombing of the World Trade Center (1993)▪ The bombing of the Alfred P. Murrah Federal Building in Oklahoma City (1995)▪ The bombing at the Atlanta Olympic Games (1996)▪ Bombings at family planning clinics and gay bars in the Atlanta area (1996 and 1997)▪ The destruction of the World Trade Center and a portion of the Pentagon (2001)▪ The sending of anthrax through the U.S. mail (2001)
<p data-bbox="240 1341 646 1411">Provide and emphasize local examples if possible.</p>	<p data-bbox="706 1593 1474 1698">Explain that each of these incidents demonstrates that we live with the possibility of additional terrorist attacks on our own soil.</p>



COMMUNITY EMERGENCY RESPONSE TEAM

UNIT 8: TERRORISM AND CERT

INSTRUCTOR GUIDANCE	CONTENT
<div data-bbox="235 453 675 781"></div> <p data-bbox="235 800 492 835">Display Slide 8-5</p> <div data-bbox="235 1444 315 1520"></div> <p data-bbox="235 1535 563 1602">Allow the group time to respond.</p>	<p data-bbox="704 411 935 445">Terrorist Goals</p> <p data-bbox="704 464 1461 569">Explain that terrorist attacks can occur with or without warning. Because of the nature of terrorist attacks, they can — and are often intended to — result in:</p> <ul data-bbox="704 590 1125 831" style="list-style-type: none">▪ Mass casualties▪ Loss of critical resources▪ Disruption of vital services▪ Disruption of the economy▪ Heightened fear <p data-bbox="704 947 1003 980"><i>Terrorist Targets</i></p> <p data-bbox="704 1001 1461 1287">Tell the group that terrorists choose their targets to meet specific goals. For example, the Oklahoma City bombing was a strike against the Federal Government. The September 11, 2001, attacks targeted both our economic center and our military establishment while raising casualty levels to new heights and changing the way Americans think about their safety.</p> <p data-bbox="704 1325 1437 1392">Point out that terrorists may select “soft” or lightly protected targets over “hard” or very secure targets.</p> <p data-bbox="704 1444 1474 1549">Based on what you know about terrorists and their goals, what do you think would be likely targets in this area?</p>

COMMUNITY EMERGENCY RESPONSE TEAM

UNIT 8: TERRORISM AND CERT

INSTRUCTOR GUIDANCE	CONTENT
<p data-bbox="245 422 472 451">Terrorist Targets</p>  <ul data-bbox="461 474 646 678" style="list-style-type: none">• Seats of government• Key industries• Bridges, subways, tunnels, and other key transportation facilities• Water supplies and utilities <p data-bbox="245 705 675 732">FEMA CERT Basic Training Unit 8: Terrorism and CERT 8-6</p> <p data-bbox="237 751 492 787">Display Slide 8-6</p>	<p data-bbox="704 411 1365 483">Summarize their responses by suggesting that potential terrorist targets might include:</p> <ul data-bbox="704 501 1338 781" style="list-style-type: none">▪ Seats of government▪ Key industries▪ Bridges, subways, tunnels, and other key transportation facilities▪ Water supplies and utilities▪ Places of historical significance <p data-bbox="704 821 1468 1001">Remind the group that terrorists may also be drawn to major events such as parades or athletic and entertainment events. Remind them that, because of this, participants may see increased security measures to help deter and prevent terrorism.</p>
<p data-bbox="245 1100 472 1129">Terrorist Weapons</p> <ol data-bbox="261 1152 386 1310" style="list-style-type: none">1. Chemical2. Biological3. Radiological4. Nuclear5. High-yield Explosives  <p data-bbox="245 1377 675 1404">FEMA CERT Basic Training Unit 8: Terrorism and CERT 8-7</p> <p data-bbox="237 1428 492 1463">Display Slide 8-7</p>	<p data-bbox="704 1104 1036 1140"><i>Terrorist Weapons</i></p> <p data-bbox="704 1163 1468 1304">Tell the group that experts generally agree that there are five categories of possible terrorist weapons. The acronym CBRNE will help the participants remember the five categories.</p> <ol data-bbox="753 1325 1101 1570" style="list-style-type: none">1. Chemical2. Biological3. Radiological4. Nuclear5. High-yield explosives
	<p data-bbox="704 1656 1458 1837">Remind participants that while this unit focuses on terrorism, it is important to remember that CBRNE incidents may occur accidentally (such as a chlorine tanker truck accident) or naturally (such as pandemic influenza).</p>

COMMUNITY EMERGENCY RESPONSE TEAM

UNIT 8: TERRORISM AND CERT

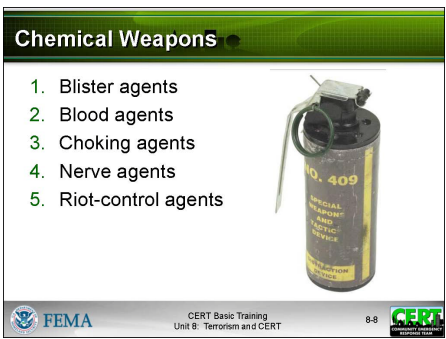
INSTRUCTOR GUIDANCE	CONTENT
 <p>Chemical Weapons</p> <ol style="list-style-type: none">1. Blister agents2. Blood agents3. Choking agents4. Nerve agents5. Riot-control agents <p>FEMA CERT Basic Training Unit 8: Terrorism and CERT 8-8</p> <p>Display Slide 8-8</p>	<p>Tell participants that another type of terrorist weapon is deliberate, large-scale disruption of computer networks. This is known as cyberterrorism. To help guard against cyberterrorism, it is important that computer users implement appropriate security measures.</p> <h3>Chemical Weapons</h3> <ol style="list-style-type: none">1. Chemical agents. Unlike biological agents or nuclear materials, which are difficult to produce or purchase, the ingredients used to produce chemical weapons are found in common products and petrochemicals. Terrorists can turn these common products into lethal weapons. <p>There are five categories of chemical weapons.</p> <ul style="list-style-type: none">▪ Blister agents cause blisters, burns, and other tissue damage. Exposure may be made through liquid or vapor contact with any exposed skin, inhalation, or ingestion. Blister agents include several families of chemicals, including mustard and lewisite. The effects of blister agents may be similar to those experienced with riot-control agents like “tear” gas but do not clear upon movement into fresh air. In fact, the effects of most blister agents increase with time and may not reach their full impact for 12 to 18 hours.

COMMUNITY EMERGENCY RESPONSE TEAM

UNIT 8: TERRORISM AND CERT

INSTRUCTOR GUIDANCE	CONTENT
	<ul style="list-style-type: none">▪ <u>Blood agents</u> are absorbed into the bloodstream and deprive blood cells of oxygen. Exposure may be made through liquid or vapor contact with any exposed skin, inhalation, or ingestion. Blood agents include two main families of chemicals, including hydrogen cyanide and cyanogen chloride. Those who are affected by blood agents may appear “bluish” across the nose and cheeks and around the mouth. As the symptoms of blood agents progress, the victim will convulse and lose consciousness.▪ <u>Choking agents</u> attack the lungs. Following exposure through inhalation, the lungs fill with fluid, which prevents oxygen from being absorbed by, and carbon dioxide from being removed from, the blood. Death results from lack of oxygen and is similar to drowning. Two common examples of choking agents are phosgene and chlorine.▪ <u>Nerve agents</u> affect the central nervous system. These agents act most quickly and are the most lethal of all chemical agents, acting within seconds of exposure. Victims of nerve agents experience constricted pupils, runny nose, shortness of breath, convulsions, and cessation of breathing. Sarin is an example of a nerve agent.▪ <u>Riot-control agents</u> cause respiratory distress and tearing and are designed to incapacitate rather than kill. Riot-control agents cause intense pain, especially when in contact with mucus membrane in areas such as the eyes, nose, and mouth. Common riot-control agents include “tear” gas and capsicum (also called pepper spray). <p>Remind the participants that the onset of symptoms that result from chemical weapons can range from immediate to 18 hours following exposure. Chemical weapons are considered a moderate risk.</p>

COMMUNITY EMERGENCY RESPONSE TEAM

UNIT 8: TERRORISM AND CERT

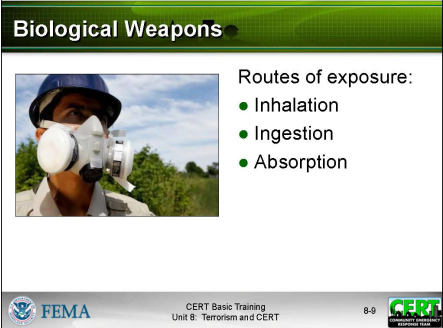
INSTRUCTOR GUIDANCE	CONTENT
<p>Although not a biological attack, the Severe Acute Respiratory Syndrome epidemic is an example of how a biological agent can be spread far from its point of origin.</p>  <p>Display Slide 8-9</p>	<p>Biological Weapons</p> <p>2. Biological weapons. Biological agents are found in nature and can also be manufactured. It is possible to weaponize biological agents so that they can be disseminated to affect broad segments of the population, animal populations, or crops.</p> <p>Some biological agents are contagious, but many are not. Routes of exposure for biological weapons are:</p> <ul style="list-style-type: none">▪ Inhalation▪ Ingestion▪ Absorption <p>Many, but not all, biological agents take days or even weeks for their symptoms to appear. It is possible for a biological attack to occur and remain unnoticed for some time. Consequently, more people may be affected before it is clear that an attack has occurred.</p> <p>It is also possible for contagious biological agents to spread far beyond their initial point of contamination as the daily routines of affected individuals broaden the reach of the agent far beyond the initial contamination area. Therefore biological weapons are considered a high risk.</p>

COMMUNITY EMERGENCY RESPONSE TEAM

UNIT 8: TERRORISM AND CERT

INSTRUCTOR GUIDANCE	CONTENT
<p data-bbox="245 491 487 520">Radiological Weapons</p> <ul data-bbox="261 541 592 590" style="list-style-type: none">• Considered a higher threat because components are easy to obtain  <p data-bbox="245 772 675 800">FEMA CERT Basic Training Unit 8: Terrorism and CERT 8-10</p> <p data-bbox="237 821 509 850">Display Slide 8-10</p>	<p data-bbox="704 411 1045 441">Radiological Weapons</p> <p data-bbox="704 478 1451 766">Radiation is energy in the form of waves or particles given off during radioactive decay or as a consequence of certain physical processes that we can control. Examples of these are x-ray machines and particle accelerators. Radiation cannot be seen, smelled, or otherwise detected by normal senses. High doses or prolonged exposure to radiation can cause radiation sickness and possibly death.</p> <p data-bbox="704 890 1479 1396">3. <u>Radiation dispersal devices</u> (RDDs) may be improvised explosive devices, also called "dirty bombs," but can include non-explosive devices that could be used to spread radioactive material as well. It is not necessary to use a bomb to disperse radioactive materials; these materials come in solids, liquids, and powdered forms, which can be spread covertly. The major impact of a dirty bomb is produced by the blast. RDDs are considered to be a much higher threat because radiological materials are much easier to obtain than enriched nuclear materials, and the technology required to detonate an RDD is similar to that involved in detonating conventional explosives.</p> <p data-bbox="704 1457 1446 1745">Radiological materials are readily available in hospitals and other medical facilities, in university science laboratories, and in many products with commercial uses. Terrorists who would attack using an RDD would need relatively small amounts of radioactive material to make an effective device. As such, radiological weapons are considered a moderate to high risk.</p>

COMMUNITY EMERGENCY RESPONSE TEAM

UNIT 8: TERRORISM AND CERT

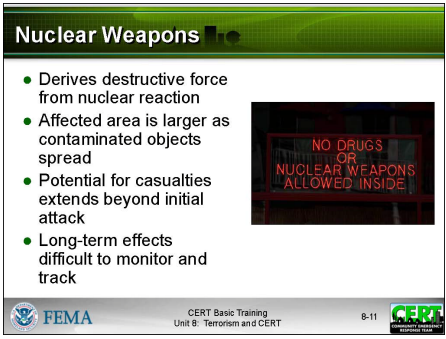
INSTRUCTOR GUIDANCE	CONTENT
<div data-bbox="235 472 678 808"></div> <p data-bbox="235 819 511 850">Display Slide 8-11</p>	<h3 data-bbox="706 409 974 441">Nuclear Weapons</h3> <p data-bbox="706 472 1469 766">A nuclear weapon is an explosive device that derives its destructive force from nuclear reaction. All nuclear devices cause deadly effects when exploded, including blinding light, intense heat, initial nuclear radiation, blast, fires started by the heat pulse, secondary fires caused by the destruction, and widespread radioactive material that can contaminate the air, water, and ground surfaces for miles around.</p> <p data-bbox="706 829 1429 1197">A nuclear device can range from a weapon carried by an intercontinental missile launched by a hostile nation or terrorist organization, to a small portable nuclear device transported by an individual. Terrorists seeking to use nuclear weapons may try to obtain a nuclear warhead from within a country known to possess nuclear weapons or they may acquire fissile material in order to make a much smaller nuclear bomb, known as an improvised nuclear device.</p> <p data-bbox="706 1228 1469 1344">4. <u>Nuclear weapons</u>. A terrorist attack with a nuclear weapon would be much different from an attack with a conventional explosive device.</p> <ul data-bbox="755 1354 1469 1764" style="list-style-type: none">• The affected area would be much larger than in a conventional explosion, and debris and other usually harmless items would be contaminated.• Due to radioactive contamination, there would be potential for physical injury and death to persons who were not injured in the initial attack. People may also become injured in the resulting damaged environment.• The long-term health effects would be more difficult to ascertain and manage.

COMMUNITY EMERGENCY RESPONSE TEAM

UNIT 8: TERRORISM AND CERT

INSTRUCTOR GUIDANCE	CONTENT
<div data-bbox="235 772 675 1104"><p>High-Yield Explosives</p><ul style="list-style-type: none">● Weapon of choice for terrorists<ul style="list-style-type: none">■ Used in 80% of attacks● Military munitions: grenades, mortars, surface-to-air missiles● Newer explosives called improvised explosive devices or IEDs<ul style="list-style-type: none">■ Any device created in an improvised manner used to destroy, disfigure, distract, or harass<p>FEMA CERT Basic Training Unit 8: Terrorism and CERT 8-12</p></div> <p>Display Slide 8-12</p>	<ul style="list-style-type: none">● Experts believe that the complexities of a terrorist group's obtaining a nuclear weapon and maintaining the tolerances that are required for the weapon to function make the use of nuclear weapons by terrorist groups a low risk. <p>High-Yield Explosives</p> <p>5. <u>High-yield Explosives</u> are the most commonly used terrorist weapons because they are easy to get, easy to hide and activate, and they can cause extensive damage. While terrorists have used military munitions such as grenades, mortars, and shoulder-fired surface-to-air missiles, experts rate high-yield explosives in the form of improvised explosive devices as a greater threat.</p> <p>Improvised explosive devices (IEDs) include any device that is created in an improvised manner, incorporating explosives or other materials designed to destroy, disfigure, distract, or harass. Most bombs used by terrorists are improvised. The raw materials required for many explosives can be purchased commercially (e.g., ammonium nitrate, which is also used as fertilizer), purchased from commercial blasting supply companies, or developed using readily available household ingredients. An IED may also contain chemicals as a means of increasing its damage potential.</p> <p>High-yield explosives are considered the highest risk when dealing with a potential terrorist attack.</p>

COMMUNITY EMERGENCY RESPONSE TEAM

UNIT 8: TERRORISM AND CERT

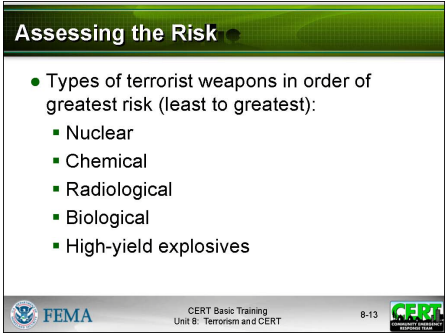
INSTRUCTOR GUIDANCE	CONTENT
<div data-bbox="235 472 678 802"><p>Assessing the Risk</p><ul style="list-style-type: none">• Types of terrorist weapons in order of greatest risk (least to greatest):<ul style="list-style-type: none">▪ Nuclear▪ Chemical▪ Radiological▪ Biological▪ High-yield explosives<p>FEMA CERT Basic Training Unit 8: Terrorism and CERT 8-13 CERT</p></div> <p data-bbox="235 814 511 850">Display Slide 8-13</p>	<p data-bbox="706 399 998 436">Assessing the Risk</p> <p data-bbox="706 472 1477 583">Tell the participants that this slide illustrates the impact versus the likelihood of the various types of terrorist weapons.</p> <p data-bbox="706 598 901 634">Point out that:</p> <ul data-bbox="706 651 1477 1270" style="list-style-type: none">▪ Although nuclear weapons present the highest impact, they are considered the lowest risk because of the difficulty in obtaining enough weapons-grade material and the technical complexity of developing and maintaining the tolerances required for a nuclear device to detonate.▪ Chemical and high-yield explosive devices are considered higher risk but lower impact weapons.▪ Biological weapons are considered both high-risk and high-impact weapons — but only for diseases that are highly contagious. Other types of biological weapons (i.e., those requiring dispersal devices) are considered a lower risk because of the sensitivity of the biological agents to heat, light, and shock.

COMMUNITY EMERGENCY RESPONSE TEAM

UNIT 8: TERRORISM AND CERT

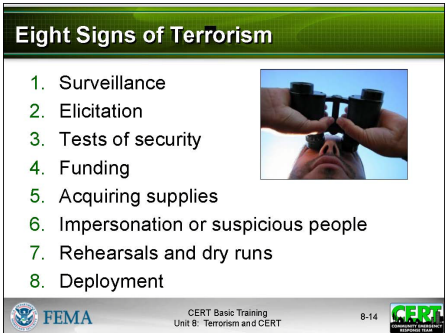
INSTRUCTOR GUIDANCE	CONTENT
<div data-bbox="235 472 678 802"><p>Eight Signs of Terrorism</p><ol style="list-style-type: none">1. Surveillance2. Elicitation3. Tests of security4. Funding5. Acquiring supplies6. Impersonation or suspicious people7. Rehearsals and dry runs8. Deployment<p>FEMA CERT Basic Training Unit 8: Terrorism and CERT 8-14</p></div> <p data-bbox="235 819 511 850">Display Slide 8-14</p> <p data-bbox="235 871 641 1039">Remind the participants that profiling is unacceptable. Watch for suspicious behaviors, not cultural or ethnic characteristics.</p>	<h3 data-bbox="706 409 1079 441">Eight Signs of Terrorism</h3> <p data-bbox="706 472 1477 840">Tell the participants that we all have a responsibility to play an active role in keeping the country safe. Everyone should report to authorities anything they see that seems suspicious or out of place. The phrase “If you see something, say something” took on additional power after the foiled Times Square bomb plot in New York City. On May 1, 2010, street vendors in Times Square noticed a smoking SUV with its blinkers on, engine running, and no one inside. They decided to say something to a police officer.</p> <p data-bbox="706 861 1477 934">Thousands of people were cleared from the area while the bomb was dismantled.</p> <p data-bbox="706 945 1477 1165">Tell the participants that through funding from DHS, the Center for Empowered Learning and Living (the CELL) produced a video outlining the eight warning signs that terrorist activity may be forthcoming (www.thecell.org). These signs are exhibited by potential terrorists (often in this order) and include:</p> <ol data-bbox="706 1186 1477 1743" style="list-style-type: none">1. <u>Surveillance</u>: The targeted area is watched and studied carefully. This may include recording or monitoring activities.2. <u>Elicitation</u>: Information is gathered that is specific to the intended target. This may be by mail, phone, or in person.3. <u>Tests of security</u>: Local security measures are tested and analyzed, including measuring reaction times to security breaches or attempts to penetrate security.4. <u>Funding</u>: Raising, transferring, spending money, which may include selling drugs or stolen merchandise, funneling money through businesses or charities

COMMUNITY EMERGENCY RESPONSE TEAM

UNIT 8: TERRORISM AND CERT

INSTRUCTOR GUIDANCE	CONTENT
	<ol style="list-style-type: none">5. <u>Acquiring supplies</u>: Necessary supplies are gathered to prepare the attack, including weapons and weapon components, transportation, and communications. Supplies may be purchased with cash only.6. <u>Impersonation or suspicious people who don't belong</u>: People impersonating roles to gain access or information and people who don't fit in or don't seem to belong in the location7. <u>Rehearsals and dry runs</u>: Groups or individuals will often operate test runs before the actual attack.8. <u>Deployment</u>: The final and most urgent phase when terrorists are deploying assets and getting into position. Attack is imminent. <p>Explain that the presence of even a few of these signs may indicate the possibility of a terrorist attack.</p> <p>Tell the group that, although it is not the mission of CERT members to keep constant watch for these eight signs, everyone should be alert to changes in their environment as a clue to a possible terrorist attack and report suspicious activities to appropriate authorities.</p>





COMMUNITY EMERGENCY RESPONSE TEAM

UNIT 8: TERRORISM AND CERT

INSTRUCTOR GUIDANCE	CONTENT
<p data-bbox="245 678 634 705">Attack Has Occurred or Is Underway</p> <ul data-bbox="261 730 488 940" style="list-style-type: none">● Vapor clouds or mists● Unscheduled spraying● Materials or equipment unusual for the area● Unusual odors or tastes● Out of place and unattended packages● Leaking packages  <p data-bbox="245 957 675 989">FEMA CERT Basic Training Unit 8: Terrorism and CERT 8-15</p> <p data-bbox="237 1010 509 1041">Display Slide 8-15</p>	<p data-bbox="708 426 1024 457"><i>CBRNE Indicators</i></p> <p data-bbox="708 485 1425 552">Stress the need to be alert to changes in the environment as a clue to a possible terrorist attack.</p> <p data-bbox="708 600 1466 632">Indicators an Attack Has Occurred or Is Underway</p> <p data-bbox="708 667 1479 846">Explain that while bombs and explosions have obvious immediate effects, biological or chemical attacks may not be as immediately noticeable. Indicators that a biological or chemical attack has occurred or is underway could include:</p> <ul data-bbox="708 867 1471 1801" style="list-style-type: none">▪ <u>Vapor clouds or mists</u> that are unusual for the area or for the time of day. Although many biological and chemical agents cannot be seen with the naked eye, the substances in which they are suspended when dispersed may be visible for a period of time after an attack.▪ <u>Unscheduled spraying</u> or abandoned spray devices. Several September 11, 2001, terrorists are known to have made inquiries into purchasing and learning to fly crop duster airplanes. Many other types of agricultural sprayers can be used to disperse biological and (more likely) chemical agents.▪ <u>Materials or equipment that are unusual for the area.</u> Dispersal devices, lab equipment, or quantities of hazardous materials that are not typically located in the area may indicate that a terrorist attack is occurring or is about to occur.▪ <u>Unusual odors or tastes</u>▪ <u>Out of place and unattended packages, boxes, or vehicles.</u> Items that are out of place and unattended could signal a possible terrorist attack. This could include chemical or biological agents as well as explosives.

COMMUNITY EMERGENCY RESPONSE TEAM

UNIT 8: TERRORISM AND CERT

INSTRUCTOR GUIDANCE	CONTENT
<p data-bbox="240 657 673 982">See CBRNE Indicators?</p> <ul data-bbox="261 722 651 842" style="list-style-type: none">● If you observe any indications of a terrorist incident you should:<ul data-bbox="282 772 565 842" style="list-style-type: none">▪ Not touch it▪ Move away from object or area▪ Report it to authorities immediately <p data-bbox="240 953 673 982"> CERT Basic Training Unit 8: Terrorism and CERT 8-16 </p> <p data-bbox="240 1003 509 1037">Display Slide 8-16</p> <p data-bbox="240 1077 542 1110">Emphasize this point.</p> <p data-bbox="240 1140 673 1455">Physical Signs of Chemical-Biological Attack</p> <ul data-bbox="261 1192 532 1392" style="list-style-type: none">● Sick or dead animals, fish, or birds● Large number of persons seeking medical attention● Multiple victims exhibiting similar symptoms● Multiple casualties without obvious signs of trauma  <p data-bbox="240 1423 673 1455"> CERT Basic Training Unit 8: Terrorism and CERT 8-17 </p> <p data-bbox="240 1472 509 1505">Display Slide 8-17</p>	<ul data-bbox="706 411 1455 625" style="list-style-type: none">▪ <u>Packages that are leaking</u> may be harmless, but they may also signal a terrorist incident. The terrorists who released sarin in the Tokyo subway system (Aum Shinrikyo) merely poked holes in bags containing sarin, then left the area as the poison leaked out. <p data-bbox="706 657 1414 726">If you observe any of these indicators of a terrorist incident, you should:</p> <ul data-bbox="706 747 1243 884" style="list-style-type: none">▪ <u>Not</u> touch it!▪ Move away from the object or area▪ Report it to authorities immediately <p data-bbox="706 898 1425 1045">Remember: Cellular phones and two-way radios create static electricity and may detonate explosive devices. CERT members should always report suspected explosive devices via landline.</p> <p data-bbox="706 1077 1438 1182">Tell participants that the physical effects on people and animals may also indicate that a chemical or biological attack has occurred. These may include:</p> <ul data-bbox="706 1203 1479 1766" style="list-style-type: none">▪ Numerous <u>sick or dead animals, fish, or birds</u>. Wildlife is often more sensitive to chemical or biological agents than humans. The absence of wildlife or insects that are common for the area or animals, fish, or birds that are obviously sick, dying, or dead may indicate the presence of a biological or chemical attack.▪ <u>Large numbers of persons seeking medical attention</u> with similar symptoms that are not characteristic of the season. The symptoms of many biological agents mimic the flu or other common illnesses. An unusually large number of persons seeking medical attention for the flu in July could indicate that a biological attack has taken place.

COMMUNITY EMERGENCY RESPONSE TEAM

UNIT 8: TERRORISM AND CERT

INSTRUCTOR GUIDANCE	CONTENT
<p data-bbox="240 976 630 1003">Preparing at Home, Work, Neighborhood</p> <ul data-bbox="261 1024 472 1245" style="list-style-type: none">• Personal and family safety is first priority!• CERT members are NOT equipped or trained to respond to terrorist incidents• Terrorism incident scenes are also crime scenes  <p data-bbox="240 1255 673 1285">FEMA CERT Basic Training Unit 8: Terrorism and CERT 8-18</p> <p data-bbox="240 1304 509 1339">Display Slide 8-18</p>	<ul data-bbox="708 411 1471 751" style="list-style-type: none">▪ <u>Multiple victims who are exhibiting similar symptoms.</u> Symptoms may range from difficulty breathing to skin necrosis to uncontrolled salivating, uncontrolled muscle twitching, convulsions, or seizure activity. All of these symptoms indicate that a chemical attack may have taken place.▪ <u>Multiple casualties without obvious signs of trauma</u> may indicate a biological or chemical attack. <p data-bbox="708 856 1377 936"><i>Preparing at Home, Work, and in Your Neighborhood</i></p> <p data-bbox="708 961 1471 1213">Stress that, because personal safety is the first priority, as with hazardous materials, CERT members should treat possible terrorist incidents as a stop sign. CERTs are not equipped or trained to respond to terrorist incidents. Professional responders will need specialized equipment and personnel to respond to a terrorist incident.</p> <p data-bbox="708 1234 1446 1377">In addition, it is important to remember that terrorism incident scenes are also crime scenes. CERT members should avoid taking any action that may disturb potential evidence.</p>

COMMUNITY EMERGENCY RESPONSE TEAM

UNIT 8: TERRORISM AND CERT

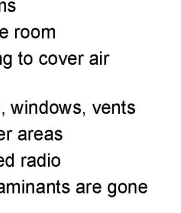
INSTRUCTOR GUIDANCE	CONTENT
<p data-bbox="245 489 675 541">Prepare for Terrorist Activity</p> <ul data-bbox="245 552 675 762" style="list-style-type: none">• CBRNE events are survivable• Preparing for terrorist incidents similar to preparing for natural hazards• Review Unit 1 guidelines• Certain actions more relevant to CBRNE  <p data-bbox="240 783 675 814">FEMA CERT Basic Training Unit 8: Terrorism and CERT 8-19</p> <p data-bbox="240 835 675 867">Display Slide 8-19</p> <p data-bbox="240 888 675 1056">Direct the participants to the Web site, www.ready.gov, for additional information and more detail on how to prepare for a terrorist incident.</p>	<p data-bbox="706 411 1474 443">Prepare for Terrorist Activity</p> <p data-bbox="706 495 1474 705">Tell participants that there are ways they can prepare for a terrorist incident. The CBRNE events covered in this unit are survivable and what they learn and do now may impact the quality of their survival. Many of the steps for preparing for a terrorist incident are the same as for natural hazards.</p> <p data-bbox="706 779 1474 1104">They should review Unit 1: Disaster Preparedness on the importance of learning about community alerts and warnings, having household plans, and assembling supplies in multiple locations. This unit will focus on some of the preparedness actions and protective measures that are particularly relevant for CBRNE events. These include: sheltering-in-place; understanding the concepts of time, distance, and shielding; and decontamination.</p>
<p data-bbox="245 1266 675 1318">Shelter-in-Place Procedures</p> <ul data-bbox="245 1329 675 1539" style="list-style-type: none">• Shut off ventilation systems• Go to your shelter-in-place room• Use precut plastic sheeting to cover air openings• Tape sheeting over doors, windows, vents• Use duct tape to seal other areas• Listen to a battery-powered radio• Ventilate room once contaminants are gone  <p data-bbox="240 1560 675 1591">FEMA CERT Basic Training Unit 8: Terrorism and CERT 8-20</p> <p data-bbox="240 1612 675 1644">Display Slide 8-20</p> <p data-bbox="240 1665 675 1791">Acknowledge that the media have created negative publicity concerning plastic sheeting and duct tape.</p>	<p data-bbox="706 1192 1474 1224">Shelter-in-Place Procedures</p> <p data-bbox="706 1266 1474 1329">Procedures for sheltering-in-place during a chemical or biological attack include:</p> <ul data-bbox="706 1350 1474 1812" style="list-style-type: none">▪ <u>Shut off the ventilation system</u> and latch all doors and windows to reduce airflow from the outside.▪ <u>Go to your shelter-in-place room (where your precut plastic, duct tape, radio, and other supplies should be stored).</u>▪ <u>Use precut plastic sheeting to cover openings where air can enter the room, including doors, windows, vents, electrical outlets, and telephone outlets.</u> When cut, the sheeting should extend several inches beyond the dimensions of the door or window to allow room to duct tape the sheeting to the walls and floor.



COMMUNITY EMERGENCY RESPONSE TEAM

UNIT 8: TERRORISM AND CERT

INSTRUCTOR GUIDANCE	CONTENT
<p>Point out that studies have shown that sheltering-in-place using plastic sheeting and duct tape reduces exposure to chemical agents by 35 percent (in mobile homes) to more than 90 percent (in office buildings).</p>	<ul style="list-style-type: none">▪ <u>Tape the plastic sheeting around all doors and windows</u> using duct tape to ensure a good seal.▪ <u>Seal with duct tape other areas where air can come in</u>, such as under doors and areas where pipes enter the home. Air can be blocked by placing towels or other soft objects in areas where air could enter, then securing them with duct tape.▪ <u>Listen to a battery-powered radio</u> for the all clear. Chemicals used in an attack will be carried on the wind and will dissipate over time. You will generally not need to stay in a sealed room for more than a few hours. Listen to Emergency Alert System broadcasts to know when it is safe to leave the safe room.▪ <u>After contaminants have cleared</u>, open windows and vents and turn on fans to provide ventilation. <p>To be able to execute these procedures during an actual event requires that you:</p> <ul style="list-style-type: none">▪ Store precut plastic sheeting in your identified shelter-in-place room▪ Assemble and store food, water, and a battery-operated radio in the shelter-in-place room▪ Practice sealing the room▪ Establish shelter-in-place procedures wherever you spend significant amounts of time at home, at work, at school <p>As a rule of thumb, 10 square feet of floor space per person will provide sufficient air to prevent carbon dioxide buildup for up to 5 hours, assuming a normal breathing rate while resting.</p>

COMMUNITY EMERGENCY RESPONSE TEAM

UNIT 8: TERRORISM AND CERT

INSTRUCTOR GUIDANCE	CONTENT
<div data-bbox="235 562 675 890"><p>Protection from Radioactive Fallout</p><ul style="list-style-type: none">• Go deep inside a building (distance/shielding)• Stay inside (time)• Stay tuned<p> <small>CERT Basic Training Unit 8: Terrorism and CERT</small> <small>8-21</small> </p></div> <p>Display Slide 8-21</p> <p>As a rule of thumb, if you can see any of the incident when you hold up your thumb, you're too close!</p>	<p><i>CERTs and Terrorist Incidents</i></p> <p>Protection from Radioactive Fallout</p> <p>There are three factors that significantly affect safety after an incident that involves radiation, such as a dirty bomb or a nuclear device. They are distance, shielding, and time. A critical protective action in a radiological or nuclear event is to get inside as quickly as possible, stay inside, and stay tuned to local radio or television stations.</p> <ul style="list-style-type: none">▪ <u>Go deep Inside (distance/shielding):</u> It is important to find adequate shelter quickly to avoid radioactive fallout resulting from the explosion. Get inside as soon as possible and go to the farthest interior room or to a basement. Flat roofs collect fallout particles so the top floor is not a good choice, nor is a floor adjacent to a neighboring flat roof. The more distance between you and the fallout particles, the better. <p>If you are outside when the event occurs, do not look at the flash or fire ball. It can blind you. Take cover behind anything that will offer protection, lie flat, and cover your head. If the explosion is some distance away, it could take 30 seconds or more for the blast wave to hit. Get inside as soon as you can. If you are not able to get inside, maintain as great a distance as possible from the incident and shield yourself with any available resources: earth, concrete, bricks, books.</p>

COMMUNITY EMERGENCY RESPONSE TEAM

UNIT 8: TERRORISM AND CERT

INSTRUCTOR GUIDANCE	CONTENT
<p data-bbox="246 1100 620 1125">Basic Decontamination Procedures</p> <ul data-bbox="263 1150 532 1356" style="list-style-type: none">• Leave the contaminated area• Take decontamination action<ul data-bbox="289 1205 461 1302" style="list-style-type: none">▪ Remove everything▪ Wash hands▪ Flush the entire body▪ Blot dry• Report for decontamination• Food safety  <p data-bbox="246 1381 673 1411">FEMA CERT Basic Training Unit 8: Terrorism and CERT 8-22</p> <p data-bbox="240 1432 509 1461">Display Slide 8-22</p>	<ul data-bbox="706 411 1474 978" style="list-style-type: none">▪ <u>Stay Inside (time)</u>: Limiting the amount of time in the area of an incident is important to limit exposure to avoid radioactive fallout resulting from the explosion. Stay inside unless threatened by fire, building collapse, medical necessity, or other immediate threats. Remain inside until you receive notification from authorities that it is safe to leave the building. Be prepared to shelter inside for up to 2 to 3 days.▪ <u>Stay Tuned</u>: Radiation levels outside will gradually drop and authorities will tell you when it is safe to go outside, bearing in mind that the explosion will have caused significant damage to buildings and infrastructure. <p data-bbox="706 1016 1243 1045">Basic Decontamination Procedures</p> <p data-bbox="706 1087 1474 1192">The objective of decontamination is to remove harmful chemicals or particles of radioactive dirt or dust that have come in contact with the skin or clothes.</p> <p data-bbox="706 1213 1269 1243">Be sure to make the points listed below:</p> <ul data-bbox="706 1268 1474 1444" style="list-style-type: none">▪ <u>Leave the contaminated area</u> immediately. Depending on the circumstances, go inside, go outside, or go upwind, uphill, or upstream from the contaminant. (Seek a distance of at least 1,000 to 1,500 feet.)

COMMUNITY EMERGENCY RESPONSE TEAM

UNIT 8: TERRORISM AND CERT

INSTRUCTOR GUIDANCE	CONTENT
	<ul style="list-style-type: none">▪ <u>Take decontamination action.</u> Seconds count! The goal is to limit the time that the agent is in contact with the skin.• <u>Remove everything</u> from the body, including jewelry. Cut off clothing that would normally be removed over the head to reduce the probability of inhaling or ingesting the agent. Seal your clothes in a plastic bag.• <u>Wash hands</u> before using them to shower. If no shower is available, improvise with water from faucets or bottled water.• <u>Flush the entire body</u>, including the eyes, underarms, and groin area, with copious amounts of <u>cool</u> water. Hot water opens the pores of the skin and can promote absorption of the contaminant. Using copious amounts of water is important because some chemicals react to small amounts of water. <p>If soap is immediately available, mix the soap with water for decontamination. Avoid scrubbing with soap because scrubbing can rub the chemical into the skin rather than remove it.</p> <p>Wash hair with soap or shampoo or rinse with water if soap is not available. Do not use conditioner as that can bind radioactive materials to your hair and make it difficult to remove.</p> <p>If hosing someone else off or pouring water from a container, avoid both physical contact with the person and with the runoff.</p> <p>The water used for decontamination must be contained and covered or drained outside of the shelter area to avoid shelter contamination.</p>

COMMUNITY EMERGENCY RESPONSE TEAM

UNIT 8: TERRORISM AND CERT

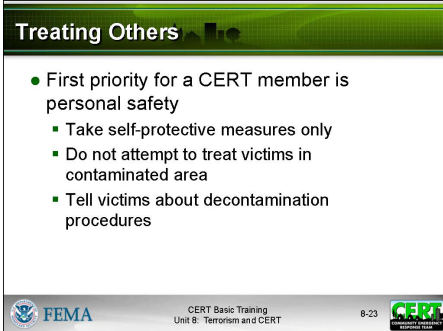
INSTRUCTOR GUIDANCE	CONTENT
 <p>Display Slide 8-23</p>	<ul style="list-style-type: none">• <u>Blot dry</u> using an absorbent cloth. <u>Do not rub</u> the skin! Put on clean clothes.▪ <u>As soon as possible, emergency responders will set up mass decontamination capabilities.</u> For radiological events, stations for radiation monitoring and blood tests will also be set up to determine levels of exposure and what next steps to take to protect health.▪ <u>Food Safety.</u> Radioactive particles in food or water may be harmful if consumed. Food in tightly covered containers (cans, bottles, plastic, and boxes) will be safe to eat or drink if you dust or wipe off the containers. Be sure to wash fruit and vegetables and peel them carefully. Water will be safe if it is in covered containers or if it has come from covered wells or from undamaged and uncontaminated water systems. <p>Treating Others</p> <p>Tell participants to remember that the first priority for CERTs is personal safety.</p> <ul style="list-style-type: none">▪ CERT members should take <u>self-protective</u> measures only.▪ They should <u>not</u> attempt to treat the injuries of victims in the contaminated area.▪ CERT members can tell people who are leaving the area about using basic decontamination procedures and waiting for responders.

COMMUNITY EMERGENCY RESPONSE TEAM

UNIT 8: TERRORISM AND CERT

INSTRUCTOR GUIDANCE	CONTENT
<p>Emphasize that individual and family safety is any CERT member's primary concern.</p>	<p>Remember that, as with professional responders, CERT members may have difficulty dealing with the idea that they should not try to help others, even partners, who are injured but may have been contaminated. To help the participants deal with the potential of having to make a decision to deny assistance, stress that:</p> <ol style="list-style-type: none">1. They have a responsibility to themselves, to other CERT members, and to their families to operate safely.2. They are neither trained nor equipped to deal with contaminated victims.3. They cannot help anyone if they become victims. In fact, they may make matters considerably worse if they spread the contamination. <p>Emphasize that CERT members must make the best decisions possible with the information that they have at hand. Even if an incident turns out not to be terrorist related, they have made the right decision if they have done the most good for the greatest number and have not become a victim themselves.</p>

COMMUNITY EMERGENCY RESPONSE TEAM

UNIT 8: TERRORISM AND CERT

INSTRUCTOR GUIDANCE	CONTENT
<div data-bbox="235 478 678 808"><p>What Professional Responders Will Do</p><ul style="list-style-type: none">● Follow sizeup steps:<ul style="list-style-type: none">▪ What is going on▪ How bad the situation is and how much worse it could get▪ What measures can be taken to control the incident safely▪ What resources will be needed</div> <p data-bbox="235 823 511 856">Display Slide 8-24</p>	<p data-bbox="701 407 1295 441">What Professional Responders Will Do</p> <p data-bbox="701 483 1469 588">Tell the group that there are several measures that they can expect professional responders to take when they arrive at the scene of a terrorist incident.</p> <p data-bbox="701 609 803 642"><i>Sizeup</i></p> <p data-bbox="701 661 1469 808">Explain that the first step that professional responders will take when they arrive at the scene is to conduct a thorough sizeup. They will follow steps that are very similar to those that CERTs take to determine:</p> <ul data-bbox="701 829 1429 1081" style="list-style-type: none">▪ What is going on▪ How bad the situation is and how much worse it could get▪ What measures can be taken to control the incident safely▪ What resources will be needed <p data-bbox="701 1165 933 1199"><i>Establish Zones</i></p> <p data-bbox="701 1249 1469 1459">CERTs can expect professional responders to treat terrorist incidents much the same as hazardous materials incidents. As such, the next step that they will take is to establish three incident zones to minimize the risk of spreading contamination from the incident site.</p> <ul data-bbox="701 1480 1453 1627" style="list-style-type: none">▪ The <u>Hot</u> Zone includes the incident scene and the contaminated area around the scene. If the incident is outdoors, the Hot Zone will spread downwind, taking wind speed into consideration.

COMMUNITY EMERGENCY RESPONSE TEAM

UNIT 8: TERRORISM AND CERT

INSTRUCTOR GUIDANCE	CONTENT
<p>Tell the group that zone information will help them to know what to expect from professional responders. Caution the group not to try to establish zones themselves.</p>	<ul style="list-style-type: none">▪ The <u>Warm Zone</u> is <u>upwind</u> (and upstream if the contaminant is waterborne) from the Hot Zone and is used to isolate victims during decontamination. It is called the Warm Zone because the evacuees can carry or spread a contaminant into this area. Professional responders will hold those who require decontamination in the Warm Zone until decontamination is complete so that contaminants do not spread.▪ The <u>Cold Zone</u> is located upwind and beyond the Warm Zone. Those who are not contaminated or who have been decontaminated will be evacuated to the Cold Zone <u>and kept there</u> until professional responders authorize them to leave.

COMMUNITY EMERGENCY RESPONSE TEAM

UNIT 8: TERRORISM AND CERT

INSTRUCTOR GUIDANCE	CONTENT
PM, P. 8-18	<p>Activity: Applying CERT Principles to a Suspected Terrorist Incident</p> <p>Purpose: The purpose of this activity is to ensure that the participants can apply their CERT protocols to what they've learned about suspected terrorist incidents.</p> <p>Instructions: Follow the steps below to conduct this activity.</p> <ol style="list-style-type: none">1. Assign the class to table groups of eight. Assign Scenario 1 to half of the groups and Scenario 2 to the other half.2. Explain the situation to the groups: The participants have completed CERT training and are part of a neighborhood team. Being prepared, each team member has CERT gear and a disaster supply kit in the car. Each team member also has a cell phone.3. Ask each group to read its assigned scenario and determine <u>as a team</u> what actions they should take.4. Tell the groups that they will have 10 minutes to read and discuss their scenarios.5. At the end of the allotted time, ask each group to select a spokesperson to present the team's response.6. Facilitate a large-group discussion of each team's responses. Solicit input from the class about whether the responses are in line with the CERT goal and protocols for terrorist incidents. Be prepared to answer questions and clarify points that the teams have about what is appropriate for the situation.

COMMUNITY EMERGENCY RESPONSE TEAM

UNIT 8: TERRORISM AND CERT

PM, P. 8-18	Activity: Applying CERT Principles to a Suspected Terrorist Incident
--------------------	---

Purpose: The purpose of this activity is to enable you to apply CERT protocols to a suspected terrorist incident.

Instructions: Follow the steps below to complete this activity:

1. Assume that you are a CERT graduate and have been assigned to a team.
 2. Working in your table group, read the scenario assigned to your group and determine as a team what actions to take.
 3. You will have 10 minutes to read and discuss your scenarios.
 4. Select a spokesperson to present the team's response to the class.
-

Scenario 1:

It is a bright, sunny spring day. You are stopping at the Post Office on your way home from work. As you enter the parking lot, you are shaken by an explosion and see glass from the Post Office windows fly through the air across the parking lot. Although it takes you a few seconds, you realize that there has been an explosion inside the Post Office.

Answer: You should suspect that this is a terrorist incident. The steps that you should take are:

1. **Move at least 1,000 to 1,500 feet upwind and uphill.**
2. **Use a landline to call information into 9-1-1.**
3. **Warn others of the possible danger.**
4. **Tell victims who try to leave the area to wait for professional responders.**

COMMUNITY EMERGENCY RESPONSE TEAM

UNIT 8: TERRORISM AND CERT

Scenario 2:

It is a bright, sunny day with light wind. You are stopping at the Post Office on your way home from work. As you enter the parking lot, you see several people exiting the building. All seem to be disoriented. Some are clutching their chests and rubbing their eyes. One has fallen to the ground and seems to be having some sort of convulsion.

Answer: You should suspect that this is a terrorist incident, and it appears from the victims' symptoms that a chemical agent has been used. The steps that you should take are:

1. Move at least 1,000 to 1,500 feet upwind and uphill.
2. Decontaminate if you think there is a chance that you might be contaminated.
3. Call 9-1-1 to report as much information as possible about the incident.
4. Warn others of the danger.

COMMUNITY EMERGENCY RESPONSE TEAM

UNIT 8: TERRORISM AND CERT

INSTRUCTOR GUIDANCE	CONTENT
<p>Unit Summary</p> <ul style="list-style-type: none">• Terrorists attack to:<ul style="list-style-type: none">▪ Intimidate the government or the civilian population▪ Further their objectives• Their goals are to:<ul style="list-style-type: none">▪ Create mass casualties▪ Disrupt critical resources, vital services, and the economy▪ Cause fear <p>FEMA CERT Basic Training Unit 8: Terrorism and CERT 8-25</p> <p>Display Slide 8-25</p>	<p>Unit Summary</p> <p>Summarize this unit by making the key points below.</p> <p>Terrorism may be perpetrated by foreign or domestic individuals or groups. Terrorists attack to:</p> <ul style="list-style-type: none">▪ Intimidate the government or the civilian population▪ Further their objectives <p>When terrorists attack, their goals are to:</p> <ul style="list-style-type: none">▪ Create mass casualties▪ Disrupt critical resources, vital services, and the economy▪ Cause fear
<p>Unit Summary (cont'd)</p> <p>Terrorist Weapons</p> <ol style="list-style-type: none">1. Chemical2. Biological3. Radiological4. Nuclear5. High-yield Explosives  <p>FEMA CERT Basic Training Unit 8: Terrorism and CERT 8-26</p> <p>Display Slide 8-26</p>	<p>The acronym CBRNE helps to remember the types of weapons that terrorists might be expected to use: chemical, biological, radiological, nuclear, high-yield explosives.</p> <p>There are a range of environmental and physical indicators for terrorist attacks. Paying attention to what is <u>not</u> present in the environment that should be is as important as what <u>is</u> present that should not be.</p>
<p>Unit Summary (cont'd)</p> <p>CERT Protocol for Terrorist Incidents</p> <ul style="list-style-type: none">• Terrorist incidents are a stop sign!• Do not proceed if you suspect terrorist activity• Simple guidelines:<ul style="list-style-type: none">▪ Do not touch▪ Move away from object or area▪ Report it to authorities immediately <p>FEMA CERT Basic Training Unit 8: Terrorism and CERT 8-27</p> <p>Display Slide 8-27</p>	<p>CERT members should treat possible terrorist incidents the same as they would HazMat incidents — as a stop sign. If they observe indicators of a possible terrorist incident, they should:</p> <ul style="list-style-type: none">▪ Not touch it!▪ Move away from the object or area▪ Report it to authorities immediately

COMMUNITY EMERGENCY RESPONSE TEAM

UNIT 8: TERRORISM AND CERT

INSTRUCTOR GUIDANCE	CONTENT
	<p>CERTs can help limit their exposure to the harmful effects of terrorist weapons by:</p> <ul style="list-style-type: none">▪ Moving quickly to limit their exposure time▪ Evacuating the area as quickly as possible, being sure to move perpendicular to or upwind of an airborne plume, and upstream if contaminants are waterborne▪ Using the protection of a sturdy building as shielding, going inside if contaminant is outside and going outside if contaminant is inside. If the event includes radioactive fallout, it is important to go quickly deep inside a building for protection.▪ Safely decontaminating themselves when necessary <p>CERT members should take immediate action to protect themselves and, if exposed, follow basic decontamination procedures immediately. Because the safety of CERT members is the number one priority, CERT members should <u>not</u> attempt to treat anyone who has been contaminated or perform decontamination procedures for them.</p> <p>Stress that terrorist incident scenes are also crime scenes. CERT members should avoid taking any action that may disturb potential evidence.</p> <p>Does anyone have any questions about CERTs and their role in terrorist incidents?</p>

COMMUNITY EMERGENCY RESPONSE TEAM

UNIT 8: TERRORISM AND CERT

INSTRUCTOR GUIDANCE	CONTENT
<p data-bbox="245 520 496 548">Homework Assignment</p> <ul data-bbox="261 569 451 716" style="list-style-type: none">• Review the materials from the previous units• Wear appropriate clothing for disaster simulation exercise  <p data-bbox="245 800 675 827">FEMA CERT Basic Training Unit 8: Terrorism and CERT 8-28</p> <p data-bbox="237 848 509 884">Display Slide 8-28</p>	<p data-bbox="704 447 1122 485"><i>Homework Assignment</i></p> <p data-bbox="704 512 1446 617">Remind the participants to read the materials for the next session. Give a brief description of the material to be covered.</p> <p data-bbox="704 638 1312 709">Tell them to be sure to wear clothing that is comfortable and appropriate.</p>

[This page intentionally left blank]

UNIT 9: COURSE REVIEW, FINAL EXAM, AND DISASTER SIMULATION

This unit includes:

- **A Review of Key Points from the Course**
- **A Final Exam**
- **A Final Exercise**

[This page intentionally left blank]

COMMUNITY EMERGENCY RESPONSE TEAM

Unit 9: Course Review, Final Exam, and Disaster Simulation

OBJECTIVES	At the conclusion of this unit, the participants should be able to apply the skills and knowledge learned in Units 1 through 8 to a simulated disaster situation.
SCOPE	<p>The topics of this unit will include:</p> <ul style="list-style-type: none">▪ Introduction and Unit Overview▪ Course Review▪ Final Exam▪ Disaster Simulation▪ Exercise Critique and Summary
ESTIMATED COMPLETION TIME	2 hours 30 minutes
TRAINING METHODS	<p>The lead instructor will begin this unit by welcoming the participants to Unit 9: Course Review, Final Exam, and Disaster Simulation, and will introduce the instructors for the unit. The instructor will then explain that this unit is the culmination of all that the participants have learned and practiced over the last eight units. The instructor will briefly review how the unit will proceed.</p> <p>The instructor will provide a brief review of the key concepts that were covered in earlier sessions and answer questions as necessary.</p> <p>After answering all questions, the instructor will administer and collect the final exam.</p> <p>The instructor will then explain how the disaster simulation will be run and point out that the intent of the simulation is to give the participants a practical perspective on overall team operations while further improving their skills. The instructor will emphasize CERT team strategies and will set the stage for conducting the exercise in either a light damage or moderate damage scenario.</p> <p>Throughout the simulation, the instructors at each station should stress that the participants must treat the exercise as if it were real and train as if lives were depending on it. The instructors will reinforce that mistakes made during training are lessons learned — lessons that may someday save lives and prevent injuries.</p>

COMMUNITY EMERGENCY RESPONSE TEAM

Unit 9: Course Review, Final Exam, and Disaster Simulation

TRAINING METHODS (CONTINUED)	<p>The instructors should, therefore, encourage leadership, decisive actions, and assertive behavior during the exercise to maximize the learning experience.</p> <p>At the end of the simulation, the instructor will lead an interactive discussion about the lessons learned and the difficulties encountered during the exercise.</p>
RESOURCES REQUIRED	<ul style="list-style-type: none">▪ <i>Community Emergency Response Team Instructor Guide</i>▪ <i>Community Emergency Response Team Participant Manual</i>▪ Certificate of Completion (to be developed locally)
OTHER RESOURCES	<p>“Victims” will be needed for the triage and treatment simulation and for the victim extrication simulation. Live “victims” are recommended for the triage and treatment simulation.</p>
EQUIPMENT	<p>In addition to the equipment listed at the front of this Instructor Guide, you will need the following equipment for this unit:</p> <ul style="list-style-type: none">▪ A computer with PowerPoint software▪ Computer projector and screen▪ Safety equipment▪ Pieces of wood, furniture, or other items to simulate debris▪ Two or more poles▪ Moulage (used to simulate injuries)▪ Other equipment items, which may be available from earlier units that may add to the realism of the simulation
GENERAL PREPARATION	<p>If you believe a PowerPoint presentation will be helpful to the participants, you may pull slides from the presentations that accompany the previous units.</p> <p>The final exam is included in the Participant Manual. Within this unit is a copy of the exam with the correct responses.</p> <p>You will need to make a copy of your agency’s CERT Certificate of Completion for each participant who will complete the training.</p>

COMMUNITY EMERGENCY RESPONSE TEAM

Unit 9: Course Review, Final Exam, and Disaster Simulation

PREPARATION FOR THE DISASTER SIMULATION

This exercise will allow the participants to use the skills and knowledge that they have learned throughout their CERT training. A great deal of preparation is required before beginning this exercise.

1. Develop a disaster scenario.

Before the session begins, develop a scenario based on a potential disaster in your community. A sample disaster scenario is included on pages 9-6 and 9-7 so that you can see the type of exercise that will be required. Note: Participant Manual includes a copy of the map for the sample disaster scenario on PM 9-19.

2. Identify four areas — three indoors and one outdoors (weather permitting) — to serve as exercise stations.

- At Station 1, the participants will receive the disaster simulation scenario. Based on that scenario, the participants will:
 - Determine the extent of damage
 - Establish team priorities
 - Determine the resources needed
 - Identify potential hazards

The participants will also select a CERT leader who will establish a CERT organization based on resources available and established priorities. Note: To help ensure that as many participants as possible have the opportunity to serve as team leader during the exercise, each group will select a different CERT leader at Station 1, Station 3 (triage and treatment), and Station 4 (victim extrication).

- At Station 2, the participants will be required to:
 - Evaluate a fire situation
 - Select the proper extinguisher
 - Extinguish a fire

NOTE: Each participant will extinguish the fire.

- At Station 3, the participants will be required to conduct triage and treat victims with the medical supplies available.
- At Station 4, the participants will perform leveraging and cribbing to extricate victims who are trapped by debris.

COMMUNITY EMERGENCY RESPONSE TEAM

Unit 9: Course Review, Final Exam, and Disaster Simulation

PREPARATION FOR THE DISASTER SIMULATION (CONTINUED)

3. Select four assistant instructors to help with the disaster simulation.

The instructors will serve at the following stations:

- Two assistants at Station 2 to conduct the fire suppression exercise
- One assistant at Station 3 to monitor victim triage and treatment
- One assistant at Station 4 to monitor victim extrication

4. Set up the four exercise stations.

The instructors at each station will oversee the station setup, monitor safety during the exercise, provide feedback to the participants, and oversee station teardown.

Setup for each station is as follows:

- Station 1: Station 1 should include one table with chairs. Place one copy of the disaster scenario on the table at each chair.
- Station 2: Set up Station 2 in the same manner as for the fire suppression exercise in Unit 2. Provide multiple types and sizes of extinguishers so that participants must select the proper type of extinguisher for the fire.
- Station 3: Before the session begins, identify several types of injuries that would be common as a result of the disaster described in the simulation. The instructors at Station 3 will apply moulage to the “victims” to simulate injuries that would be common for the disaster scenario. They should then place the “victims” in sitting or lying positions around the station. It may be desirable to *not* have all “victims” in clear view or easy reach of the participants.
- Station 4: Use pieces of wood, furniture, or other items (to simulate debris) to “trap” the victims. Provide additional materials that can be used in a leverage and cribbing operation as well as blankets and other items that could be used if necessary to lift or otherwise move the victim from his or her place of entrapment.

COMMUNITY EMERGENCY RESPONSE TEAM

Unit 9: Course Review, Final Exam, and Disaster Simulation

NOTES

A suggested time plan for this unit is as follows:

Introduction and Overview..... 5 minutes

Course Review..... 15 minutes

Final Exam..... 15 minutes

Disaster Simulation..... 90 minutes

Exercise Critique and Summary..... 25 minutes

Total Time: 2 hours 30 minutes

COMMUNITY EMERGENCY RESPONSE TEAM

Unit 9: Course Review, Final Exam, and Disaster Simulation

SAMPLE DISASTER SCENARIO

Apple Valley is a rural community with a population of 13,000. Located in Apple County, the town is located between Dawson and Sparkville.

South Lawn Retirement Home is a privately owned geriatric facility, located at the end of 7th Street (see the map on the next page). Although a new access road is under construction, 7th Street is currently the only access route to South Lawn. Because South Lawn is located across the main line of the Southeast Railroad from the remainder of Apple Valley and could be isolated in the event of a major incident, the South Lawn administrator jumped at the opportunity to organize a CERT. CERT training ended just 2 weeks ago.

You are an employee at the retirement home and a member of the CERT.

It has been a hot, muggy June day — the kind of day that usually spawns thunderstorms. Early in the day, the National Weather Service issued a severe thunderstorm watch for the afternoon and early evening hours. As the afternoon continued, the temperature rose into the high 80s. Building storms were very visible to the southwest.

While on your dinner break, you turned on the Weather Channel™ to check the latest forecast. It didn't surprise you to see that the National Weather Service had upgraded the watch to a warning for your county. After finishing your dinner, you went back to work on the second floor of the nursing home. As you work, you hear thunder off in the distance.

A while later, you hear the outdoor warning siren begin to sound. Although you immediately begin following the home's established procedures for a tornado warning, there is just no time. Before you can get even the first patient wheeled toward the hallway, you hear glass breaking at the other end of the hallway. The tornado (which would later be determined to be an F-3) struck the northwest corner of the building, tearing away the roof, throwing glass everywhere, and causing a partial collapse at that corner.

As the tornado passes, you realize that you and the residents assigned to you are safe. But you can tell from a quick look down the hall and the screams coming from that area that there have been injuries. Although the situation is confused, you also think you can smell smoke.

COMMUNITY EMERGENCY RESPONSE TEAM

Unit 9: Course Review, Final Exam, and Disaster Simulation

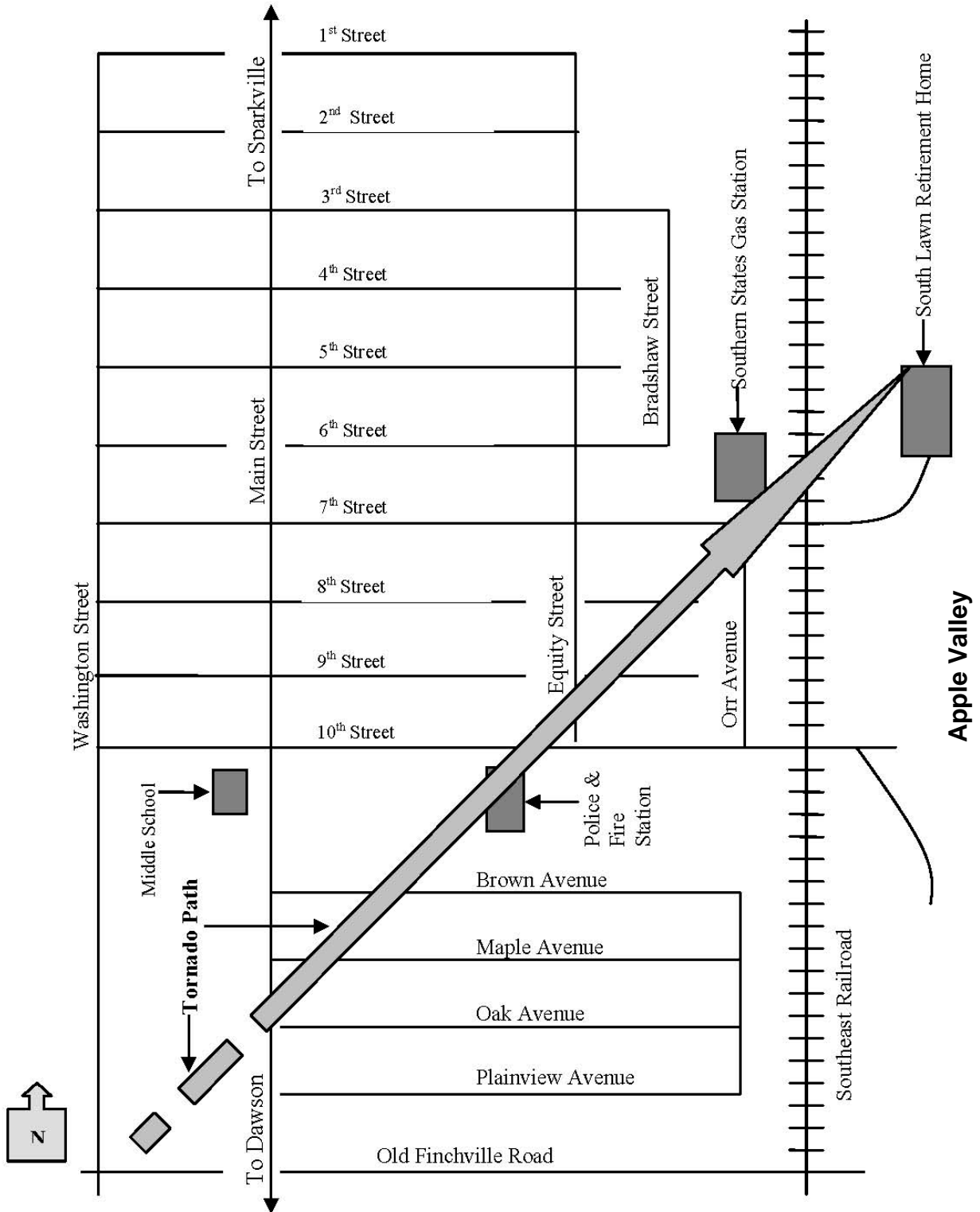

Unit 9: Course Review, Final Exam, and Disaster Simulation

INSTRUCTOR GUIDANCE	CONTENT
<p>Spend 2-3 minutes reviewing the key points from each unit.</p>	<p><i>Introduction and Overview</i></p> <p>Welcome the participants to Unit 9 of the <i>CERT Basic Training</i> course. Introduce the instructors for this session.</p> <p>Begin by telling the participants that this unit is the culmination of all that they have learned throughout the course. Tell them that, after a brief review of the key points of the course, they will take a final exam. They will then use their skills and knowledge of CERT organization and operations in a simulated disaster exercise.</p> <p>Make any administrative announcements that may be required at this time (e.g., make-up classes).</p> <p><i>Course Review</i></p> <p>Cover the following points from the disaster preparedness unit:</p> <ul style="list-style-type: none"> ▪ <u>Home and workplace preparedness</u>: <ul style="list-style-type: none"> • Assembling a disaster supply kit • Developing a disaster plan • Developing a safe room • Evacuation versus sheltering-in-place ▪ <u>Specific preparedness measures for local high-risk hazards</u> (including terrorism)

COMMUNITY EMERGENCY RESPONSE TEAM

Unit 9: Course Review, Final Exam, and Disaster Simulation

INSTRUCTOR GUIDANCE	CONTENT
	<p>Cover the following points from the fire safety and utility controls unit:</p> <ul style="list-style-type: none">▪ <u>Hazardous materials</u>:<ul style="list-style-type: none">• Identification• Defensive strategies▪ <u>Utility control</u>:<ul style="list-style-type: none">• Gas• Electric• Water▪ <u>Sizeup</u>: Stress the importance of CERT sizeup and the steps in the sizeup process.▪ <u>Firefighting resources</u>:<ul style="list-style-type: none">• General resources available• Interior wet standpipes, including operation and limitations (if applicable)• Portable fire extinguishers, their capabilities and limitations▪ <u>Safety considerations</u>:<ul style="list-style-type: none">• Safety equipment must be used at all times.• CERT members must always use the buddy system.• Fire suppression group leaders should always have a backup team available.

COMMUNITY EMERGENCY RESPONSE TEAM

Unit 9: Course Review, Final Exam, and Disaster Simulation

INSTRUCTOR GUIDANCE	CONTENT
	<p>Cover the following points for disaster medical operations (two units):</p> <ul style="list-style-type: none">▪ The "three <u>killers</u>"▪ <u>Head-Tilt/Chin-Lift method of opening an airway</u>▪ <u>Methods for controlling bleeding</u>:<ul style="list-style-type: none">• Direct pressure• Elevation• Pressure points▪ <u>Treatment for shock</u>:<ul style="list-style-type: none">• Patient position• Maintenance of body temperature• No food or drink▪ <u>Conducting triage</u>▪ <u>Head-to-toe assessments</u>▪ <u>Wound care</u>▪ <u>Special considerations when head, neck, or spinal injuries are suspected</u>▪ <u>Treatment area considerations</u>▪ <u>Splinting and bandaging</u>▪ <u>Basic treatment for various injuries</u>

COMMUNITY EMERGENCY RESPONSE TEAM

Unit 9: Course Review, Final Exam, and Disaster Simulation

INSTRUCTOR GUIDANCE	CONTENT
	<p>Cover the following points for light search and rescue:</p> <ul style="list-style-type: none">▪ <u>Search and rescue are really two functions.</u>▪ <u>Goals of search and rescue:</u><ul style="list-style-type: none">• Rescuing the greatest number of people in the shortest amount of time• Rescuing the lightly trapped victims first▪ <u>Sizeup:</u><ul style="list-style-type: none">• Construction types• Related hazards▪ <u>Structural damage:</u><ul style="list-style-type: none">• Light damage• Moderate damage• Heavy damage▪ <u>Search techniques:</u><ul style="list-style-type: none">• Be systematic and thorough• Mark areas searched• Document search results▪ <u>Rescue techniques:</u><ul style="list-style-type: none">• Victim carries• Leverage and cribbing• Lifts and drags

COMMUNITY EMERGENCY RESPONSE TEAM

Unit 9: Course Review, Final Exam, and Disaster Simulation

INSTRUCTOR GUIDANCE	CONTENT
	<p>Cover the following points for CERT organization:</p> <ul style="list-style-type: none">▪ <u>Organizational structure</u>:<ul style="list-style-type: none">• Well-defined management structure• Effective communications among agency personnel• Accountability▪ <u>Command objectives</u>:<ul style="list-style-type: none">• Identify the scope of the incident through damage assessment• Determine an overall strategy and logistical requirements• Deploy resources efficiently but safely <p>Cover the following points for disaster psychology:</p> <ul style="list-style-type: none">▪ In the aftermath of disasters, survivors and disaster workers can experience <u>psychological and physiological symptoms of stress</u>.▪ The <u>steps</u> CERT leaders should take to <u>reduce stress</u> on team members▪ The steps CERT members can take to reduce their own stress levels▪ <u>Strategies for helping survivors</u> work through their trauma <p>Cover the following points for terrorism:</p> <ul style="list-style-type: none">▪ <u>CBRNE indicators</u>▪ <u>CERT protocols</u> for terrorist incidents▪ <u>Protective actions</u> following a terrorist incident

COMMUNITY EMERGENCY RESPONSE TEAM

Unit 9: Course Review, Final Exam, and Disaster Simulation

INSTRUCTOR GUIDANCE	CONTENT
<p>The instructor's copy of the final exam is on the following pages of the Instructor Guide. The response in bold is the correct response.</p>	<p>Final Exam</p> <p>Tell participants that they will now take the final exam for <i>CERT Basic Training</i>.</p> <p>The final exam is on pp. 9-5 through 9-17 in the Participant Manual.</p>

COMMUNITY EMERGENCY RESPONSE TEAM

Unit 9: Course Review, Final Exam, and Disaster Simulation

CERT Basic Training Final Exam

Unit 1: Disaster Preparedness

1. When a disaster occurs, a CERT member's first responsibility is to:
 - A. Join the CERT in disaster response efforts
 - B. Help professional responders
 - C. Ensure personal and family safety**
 - D. Do the greatest good for the greatest number of people

2. CERT members volunteer to fill non-disaster roles. An example of a non-disaster function of CERTs is:
 - A. Staffing parades, health fairs, and other special events**
 - B. Monitoring the news for potential disaster threats
 - C. Petitioning local officials for more local emergency response funding
 - D. Distributing political pamphlets and other materials

3. There are three types of disasters. They are natural, intentional, and _____.
 - A. Mechanical
 - B. Biological
 - C. Chemical
 - D. Technological**

4. Which of the following is **NOT** a hazard associated with home fixtures?
 - A. Gas line ruptures
 - B. Hazardous material spill**
 - C. Injury or electric shock
 - D. Fire from faulty wiring

5. One of the steps in preparing for a disaster is to develop a disaster supply kit. Where should you keep separate disaster supply kits?
 - A. Home and work
 - B. Every room in the house
 - C. Vehicle
 - D. Home, work, and vehicle**

COMMUNITY EMERGENCY RESPONSE TEAM

Unit 9: Course Review, Final Exam, and Disaster Simulation

Unit 2: Fire Safety and Utility Controls

While searching a lightly damaged structure following a destructive storm, you and fellow CERT members locate a fire.

1. As you conduct your fire sizeup, which of the following is the least important question to consider:
 - A. Can my buddy and I fight the fire safely?
 - B. Do my buddy and I have the right equipment?
 - C. How many people are in the building?**
 - D. Can my buddy and I escape?

From your sizeup, you determine that the fire can be put out with a portable fire extinguisher. You and your buddy quickly retrieve a portable fire extinguisher, which you have determined is the right type of extinguisher to fight this fire.

2. What should you do before approaching the fire?
 - A. Test the extinguisher after pulling the pin**
 - B. Wait for the fire department to arrive
 - C. Tell your buddy to wait at the door for you
 - D. Make sure the house's water supply is shut off

Following the correct CERT procedure (P.A.S.S.), you discharge the extinguisher.

3. What should you do if the fire continues to burn 5 seconds after you start to extinguish it?
 - A. Check the label on the extinguisher
 - B. Look for creative resources to fight the fire
 - C. Leave immediately**
 - D. Back out and signal for your buddy to attempt to suppress the fire
4. The fire has spread to other areas by the time the fire department arrives. What's your next course of action?
 - A. Attempt to suppress the fire again with a new extinguisher
 - B. Communicate what you know to one of the firefighters**
 - C. Overhaul the fire
 - D. Send in a backup team to fight the fire

COMMUNITY EMERGENCY RESPONSE TEAM

Unit 9: Course Review, Final Exam, and Disaster Simulation

5. If the chief officer asks you and your fellow CERT members to remain outside at a safe distance, how should you respond?
- A. Continue to conduct a sizeup from a safe distance outside of the building**
 - B. Leave the premises
 - C. Enter the house after the firefighters
 - D. Call in more CERT members for backup

While the fire department manages to suppress most of the fire inside the building, a small fire has started to spread through the yard. You notice a nearby shed is posted with an NFPA 704 Diamond featuring the numbers 1, 1, and 2.

6. What should you do?
- A. Suppress and overhaul the fire because the numbers in the Diamond are small and indicate that little risk is present
 - B. Leave the area and communicate the information to one of the professional firefighters on the scene if they are accessible**
 - C. Suppress and overhaul the fire only if the number in the blue quadrant is less than 2
 - D. Make sure you are using the correct type of fire extinguisher

Unit 3: Disaster Medical Operations — Part 1

In the aftermath of a magnitude 7.7 earthquake, you have ensured your safety and your family's safety and you grab your CERT kit and PPE. As you are making your way to your CERT's established meeting point, you come across a woman lying by the side of the road. You call out your name and affiliation and ask, "Are you okay?" There is no response.

1. Based on what you know thus far, how should you proceed?
- A. Assume the woman is dead and continue to the CERT meeting point
 - B. Call 9-1-1 on your cell phone immediately
 - C. Assess for airway, bleeding, and signs of shock**
 - D. Make a note of the woman's location and go for help

COMMUNITY EMERGENCY RESPONSE TEAM

Unit 9: Course Review, Final Exam, and Disaster Simulation

You move closer to the victim. Once again, you ask, “Can you hear me? Are you okay?” As you approach, you hear a very faint “help me,” and now that you are closer, you notice that the victim is bleeding heavily from a laceration on her thigh. You immediately attempt to call 9-1-1 on your cell phone but the system is down.

2. You know this woman is seriously injured. How would you help her?
 - A. Assess for the “three killers” systematically, starting with the airway
 - B. Focus immediately on the most critical threat, the heavy bleeding**
 - C. Get blankets from your supply kit because this woman is clearly in shock
 - D. Keep the woman company until more help arrives

3. You notice that the blood is spurting from the laceration on the victim’s inner thigh. What type of bleeding is this?
 - A. Arterial**
 - B. Venous
 - C. Capillary
 - D. Mortal

4. What will you do to stop the bleeding?
 - A. Apply a tourniquet
 - B. Wrap the wound with the first piece of cloth you can find
 - C. Elevate the victim’s heart above the wound by having the woman sit up
 - D. Using the sterile dressings in your supply kit, apply pressure directly to the wound**

After a few moments, the bleeding slows considerably. You ask the woman, “Are you okay? Squeeze my hand if you can hear me.” She is only able to groan unintelligibly in response. You notice that her fingers are cold — despite soaring temperatures — when she tries to squeeze your hand.

5. The signs and symptoms that you witness tell you that this woman is suffering from what?
 - A. Low blood sugar
 - B. Shock due to inadequate blood flow**
 - C. Malnourishment
 - D. Shock due to the extreme stress of the situation

COMMUNITY EMERGENCY RESPONSE TEAM

Unit 9: Course Review, Final Exam, and Disaster Simulation

6. How would you treat the woman based on your findings?
- A. Wrap her in something warm**
 - B. Tell her to go to sleep
 - C. Ask her to hold the dressing in place while you search for help
 - D. Give her food and water
7. If asked to triage the woman, how would you tag her?
- A. With a tag signifying "Immediate"**
 - B. With a tag signifying "Delayed"
 - C. With a tag signifying "Minor"
 - D. With a tag signifying "Dead"

Unit 4: Disaster Medical Operations — Part 2

A Category 4 hurricane has just struck your town. You are assigned by your Incident Commander/Team Leader to help conduct triage operations in an area of the neighborhood that has sustained damage. Arriving at the treatment area, you notice sections marked "I," "D," and "M" where victims are already being placed for treatment.

1. What do the section markers indicate?
- A. Dead, dying, and healthy
 - B. Minor, immediate, and dead
 - C. Stop, yield, and go
 - D. Immediate, delayed, and minor**

You are directed to help with the "Immediate" victims. A fellow team member asks you to get some clean water to wash soiled gloves. You know the supply team is on its way, but could be several hours away. Grabbing a bucket, you run to a nearby stream for water.

2. What should you do to sterilize the water for medical use?
- A. Mix 1 part bleach with 10 parts water**
 - B. Mix in 8 drops of non-perfumed chlorine bleach per gallon of water and wait for 30 minutes
 - C. Take the bucket and find a place to boil the water, since you assume that one of the buildings must have a functional kitchen
 - D. Mix in 8 tablespoons of non-perfumed chlorine bleach and wait for 30 seconds

COMMUNITY EMERGENCY RESPONSE TEAM

Unit 9: Course Review, Final Exam, and Disaster Simulation

Once you arrive back at the “Immediate” treatment area with the water, the team leader explains that a victim has died. The team leader puts you in charge of establishing the morgue.

3. How and where will you set up the morgue?
- A. Near the immediate treatment area
 - B. Near the delayed treatment area
 - C. Away from all three treatment areas**
 - D. Near the triage area

A few hours later, you return to the “Immediate” area and ask your Incident Commander/Team Leader for a new assignment. She quickly explains that the area is overflowing with victims and asks you to help perform rapid head-to-toe assessments. While performing your first assessment on a young adult male, you notice swelling and deformity in the victim’s upper left arm. After you have finished your head-to-toe assessment, you try to feel for signs of a fracture, but the victim cries out in pain before you get too far.

4. Though it is impossible to be sure out in the field, you should assume that:
- A. The victim’s arm is broken**
 - B. The victim is bleeding internally
 - C. The victim will die unless you find a medical professional
 - D. The victim has a very badly bruised arm
5. You know that you need to splint the injury to prevent further damage. How would you proceed with the splint?
- A. Attempt to realign the fracture, splint, and then assess PMS
 - B. Assess PMS and then splint the injury as it lies
 - C. Attempt to realign the fracture, and splint
 - D. Splint the injury as it lies, assessing PMS before and after the splint**

COMMUNITY EMERGENCY RESPONSE TEAM

Unit 9: Course Review, Final Exam, and Disaster Simulation

Just as you are finishing up the splint on your young adult male victim, a woman runs into the “Immediate” treatment area holding a little boy and frantically calling out, “Someone please help my son, he’s turning blue! I don’t think he can breathe!” You turn and run to help the woman. You ask her to put her son down so you can help.

6. What is the first thing that you should do?
- A. Conduct a head-to-toe assessment
 - B. Have another volunteer lead the mother away
 - C. Assess for airway, bleeding, and signs of shock**
 - D. Perform CPR

While listening for lung sounds, you notice that the boy is wheezing and his lips are blue. You cannot find anything obvious obstructing his airway. As you glance down quickly at the rest of the boy’s body, you notice an angry red welt on his inner arm.

7. You have reason to suspect that this boy is suffering from:
- A. Anaphylaxis**
 - B. An unknown blood-borne disease
 - C. Hypertension
 - D. Hypothermia

Unit 5: Light Search and Rescue Operations

After a tornado ravages a nearby community, you and your fellow CERT members volunteer to help with the search and rescue operations. You arrive on the scene to discover collapsed houses, cars swept up into trees, and various debris strewn everywhere.

1. As you begin the CERT sizeup process, what is the first thing you should do?
- A. Gather facts**
 - B. Assess and communicate damage
 - C. Establish priorities
 - D. Consider probabilities

COMMUNITY EMERGENCY RESPONSE TEAM

Unit 9: Course Review, Final Exam, and Disaster Simulation

You and three other CERT members begin searching the local library, a large brick building where many people in the community were instructed to take cover before the storm. A sizeup of the building reveals superficial damage, including broken windows and cracked plaster.

2. How would you classify the damage to the building?

- A. Heavy damage
- B. Moderate damage
- C. Light damage**
- D. Slight damage

As you continue your search of the library, you make a single slash next to the doorway of the first room you enter.

3. What information do you write in what will become the left quadrant of this search marking?

- A. Information about hazards and collapses
- B. The number of victims in the room
- C. Your agency or group ID**
- D. The room number

While stopping frequently to listen, you hear a faint cry for help from the corner of the room. You walk over to find a young boy who has glass shards in his leg and is unable to walk.

4. Keeping in mind that you are searching the room with only two other CERT members, which of the following is not a recommended way of moving the boy?

- A. Blanket carry**
- B. Pack-strap carry
- C. Chair carry
- D. One-person arm carry

COMMUNITY EMERGENCY RESPONSE TEAM

Unit 9: Course Review, Final Exam, and Disaster Simulation

Upon completing your search and rescue in the library, you enter a house where the second floor has collapsed, creating a lean-to void.

5. How should you proceed?

- A. Leave the premises immediately and mark the structure as unsound**
- B. Quickly search the ground floor
- C. Use an axe or similar tool to knock down the floor and clear the void
- D. Call for backup

Unit 6: CERT Organization

Following an earthquake, you and your fellow CERT members mobilize and meet at a disaster scene, where fire and law enforcement officials have already arrived. Before taking action, you work with the professional responders to get organized.

1. What is the name of the system used by emergency response agencies to manage emergency responses?

- A. Incident Command System (ICS)**
- B. Strategic Planning Unit (SPU)
- C. Search and Rescue System (SRS)
- D. Rescue Command System (RCS)

2. In the CERT command structure, how is the CERT leader established?

- A. By being the first person to arrive on the scene**
- B. By seniority
- C. By department
- D. By the local police chief

You are the CERT Incident Commander/Team Leader and therefore responsible for directing team activities. You establish a Command Post for your CERT.

3. What should you do if you have to leave the Command Post for whatever reason?

- A. Ask a law enforcement official to take over while you're gone
- B. Designate CERT Incident Commander/Team Leader status to someone else in the Command Post**
- C. Leave without delegating any of your CERT Incident Commander/Team Leader responsibilities
- D. You may never leave the Command Post under any circumstances

COMMUNITY EMERGENCY RESPONSE TEAM

Unit 9: Course Review, Final Exam, and Disaster Simulation

4. CERT members should always be assigned to teams of at least how many people?
- A. Six
 - B. Three**
 - C. Two
 - D. Four
5. A woman comes up to a disaster scene that you have determined is unsafe to enter. What should you do?
- A. Warn her that the situation is unsafe**
 - B. Threaten to call the police if she attempts to enter
 - C. Physically restrain her from entering
 - D. Nothing; you should let her be
6. To whom should you give documentation?
- A. The first professional responders on the scene**
 - B. Your local CERT leader
 - C. Keep it for your own records
 - D. The National CERT Program Office
7. Which of the following forms contains essential information for tracking the overall situation?
- A. Victim Treatment Area Record
 - B. Incident/Assignment Tracking Log**
 - C. Message form
 - D. Equipment Resources form

COMMUNITY EMERGENCY RESPONSE TEAM

Unit 9: Course Review, Final Exam, and Disaster Simulation

Unit 7: Disaster Psychology

You and your fellow CERT members arrive at a neighboring community following a devastating tornado. Survivors have been sifting through debris and have found six bodies. They tell you about what it was like to find the bodies. One of your fellow CERT members starts feeling nauseated. He is obviously overwhelmed.

1. Which of the following is not an example of a physiological symptom of trauma?
 - A. Hyperactivity
 - B. Denial**
 - C. Headaches
 - D. Loss of appetite

Some of the survivors you rescue exhibit signs of trauma, and you've warned your team ahead of time that they should expect some of the psychological effects will be directed toward them. In order to help your team better understand what the survivors are going through, you've also explained the four phases of a crisis following a disaster.

2. During which phase do survivors attempt to assess the damage and locate other survivors?
 - A. Impact phase
 - B. Inventory phase**
 - C. Recovery phase
 - D. Rescue phase

The goal of onscene psychological intervention by CERT members is to stabilize the incident scene by stabilizing individuals. You come across a man who is in shock and bleeding from his chest.

3. What should you do first?
 - A. Listen empathetically
 - B. Attempt to locate the man's family or friends to provide natural support
 - C. Say, "You'll get through this"
 - D. Address the man's medical needs**

COMMUNITY EMERGENCY RESPONSE TEAM

Unit 9: Course Review, Final Exam, and Disaster Simulation

In order to help your team cope with the trauma experienced during the search and rescue, you invite a mental health professional trained in critical incident stress management to conduct a voluntary critical incident stress debriefing 2 days later.

4. What is the first step of the critical incident stress debriefing?
 - A. Review of symptoms
 - B. Review of the factual material
 - C. Sharing of initial thoughts and feelings
 - D. Description of the process, including assurance of confidentiality**

5. Which of the following is not a step that your team's members should take in the future to personally reduce stress?
 - A. Eat a balanced diet
 - B. Get enough sleep
 - C. Take antidepressants**
 - D. Connect with others

Unit 8: Terrorism and CERT

You are having a business lunch downtown when you hear a loud explosion. You follow others outside to find what caused the noise. In the distance you can see heavy smoke rising from the electrical plant, the very same electrical plant used to power your town and several major cities in the area and that you saw on the news last night cited as a potential target for a recently uncovered terrorist plot. All around you, people are speculating that the plot was successful.

1. What should you do?
 - A. Gather your CERT equipment and report for duty
 - B. Locate your family and evacuate to safety
 - C. Call the Federal Government to alert it about a terrorist attack
 - D. Initially monitor the situation from a safe place**

COMMUNITY EMERGENCY RESPONSE TEAM

Unit 9: Course Review, Final Exam, and Disaster Simulation

You remember from the news report that the potential plot was uncovered when an electrical plant security guard noticed the same black van parked outside for over a week. Worried that someone was watching the building, he alerted local authorities.

2. Which of the eight signs of a terrorist attack did the security guard notice?

- A. **Surveillance**
- B. Tests of security
- C. Acquiring supplies
- D. Dry runs

A friend runs over to you, a little frantic, and asks why you are not headed to the disaster site to help. After all, he says, you are a trained CERT member.

3. How do you respond to your friend?

- A. "Yes. You're right. I'm heading in that direction now."
- B. "I am a CERT member, but I have to wait for an official to declare a disaster before I can activate."
- C. "I'm not part of the Terrorist Response Team."
- D. **"You're right. I am a CERT member, but CERT members must not respond to a potential terrorist incident."**

COMMUNITY EMERGENCY RESPONSE TEAM

Unit 9: Course Review, Final Exam, and Disaster Simulation

INSTRUCTOR GUIDANCE	CONTENT
<p>PM p. 9-18</p>	<p><i>Disaster Simulation</i></p> <p>Conduct the simulated disaster exercise. Participants will find instructions for the simulation in the Participant Manual.</p> <ol style="list-style-type: none">1. Assign the participants to four groups.2. Explain that the simulation will provide each group with the opportunity to apply many of the skills that they learned during the earlier sessions.3. Elaborate by telling the participants that the disaster simulation will be conducted at four stations.4. At Station 1, each group will receive the disaster simulation. Based on that scenario, the participants will:<ul style="list-style-type: none">• Determine the extent of damage• Establish team priorities• Determine the resources needed• Identify potential hazardsExplain that, while at Station 1, the participants will select a CERT Incident Commander/Team Leader who will establish a CERT organization based on resources available and established priorities. Note that the map for the sample disaster scenario is on PM p. 9-19.5. At Station 2, the participants will be required to:<ul style="list-style-type: none">• Evaluate a fire situation• Select the proper extinguisher for the situation• Extinguish the fireTell the participants that <u>each</u> of them will be required to extinguish the fire.

COMMUNITY EMERGENCY RESPONSE TEAM

Unit 9: Course Review, Final Exam, and Disaster Simulation

INSTRUCTOR GUIDANCE	CONTENT
	<ol style="list-style-type: none">6. At Station 3, the participants will be required to conduct triage and treat victims with the medical supplies available.7. At Station 4, the participants will perform leveraging and cribbing to extricate victims who are trapped by debris.8. Explain that the participants will have approximately 15 minutes at each station. After 10 minutes, the instructors will provide feedback.9. Point out that at the end of the exercise, all of the groups will meet for feedback and a question-and-answer session. <p>Ask the participants to assemble in their four teams.</p> <p>Give each team a number and explain that each team will begin the rotation at the station that has the same number as the team.</p> <p>Instruct all of the teams to select a different person to act as leader at Station 3 and Station 4.</p> <p>Ask if there are any questions before the teams proceed to their initial stations.</p>

INSTRUCTOR GUIDANCE	CONTENT
<p>If you have any refresher or supplemental training scheduled for CERT members, provide the details.</p>	<p><i>Exercise Critique and Summary</i></p> <p>At the end of the exercise, conduct an interactive discussion on the points learned and the difficulties encountered during the exercise.</p> <p>Provide the participants with feedback on their performance, including:</p> <ul style="list-style-type: none">▪ Overall operations▪ Communications▪ Safety▪ Teamwork <p>Answer any comments or questions about the exercise.</p> <p>Stress the importance of continuing education and training to maintain and improve the participants' skills and knowledge. Suggest that the participants attend:</p> <ul style="list-style-type: none">▪ Periodic refresher training that is offered locally▪ Standard and advanced first aid courses that are offered through organizations such as the American Red Cross▪ Cardiopulmonary resuscitation classes that are offered through the American Red Cross or the American Heart Association <p>Thank all of the participants for attending the CERT training.</p> <p><i>Graduation</i></p> <p>Distribute a certificate of completion to each participant and thank each personally for attending the course.</p>

[This page intentionally left blank]