

NATIONAL TRANSPORTATION SAFETY BOARD

HIGHWAY ACCIDENT REPORT

HOPPY'S OIL SERVICE, INC.,
TRUCK OVERTURN AND FIRE,
STATE ROUTE 128,
BRAintree, MASSACHUSETTS

OCTOBER 18, 1973

FOR RELEASE:
6:30 PM EST NOV 14 1974



NATIONAL TRANSPORTATION SAFETY BOARD
Washington, D.C. 20591
REPORT NUMBER: NTSB-HAR-74-4

SS-H-31

HIGHWAY ACCIDENT REPORT

**HOPPY'S OIL SERVICE, INC.,
TRUCK OVERTURN AND FIRE,
STATE ROUTE 128,
BRAINTREE, MASSACHUSETTS**

OCTOBER 18, 1973

ADOPTED: OCTOBER 2, 1974

**NATIONAL TRANSPORTATION SAFETY BOARD
Washington, D.C. 20591
REPORT NUMBER: NTSB-HAR-74-4**

TECHNICAL REPORT STANDARD TITLE PAGE

1. Report No. NTSB-HAR-74-4		2. Government Accession No.		3. Recipient's Catalog No.	
4. Title and Subtitle Highway Accident Report - Hoppy's Oil Service, Inc., Truck Overturn and Fire, State Route 128, Braintree, Massachusetts, October 18, 1973				5. Report Date October 2, 1974	
				6. Performing Organization Code	
7. Author(s)				8. Performing Organization Report No.	
9. Performing Organization Name and Address National Transportation Safety Board Bureau of Surface Transportation Safety Washington, D. C. 20591				10. Work Unit No. 1250-A	
				11. Contract or Grant No.	
12. Sponsoring Agency Name and Address NATIONAL TRANSPORTATION SAFETY BOARD Washington, D. C. 20591				13. Type of Report and Period Covered Highway Accident Report October 18, 1973	
				14. Sponsoring Agency Code	
15. Supplementary Notes This report contains safety recommendations H-74-31 thru H-74-34.					
16. Abstract This report describes and analyzes the left side tractor-tandem equalizer beam failure and the subsequent overturn of the tractor-semitrailer (tank) carrying gasoline on Massachusetts State Route 128 in Braintree, Massachusetts, on October 18, 1973. After failure of the equalizer beam, the vehicle veered to the right and struck a guardrail which redirected the truck back into the roadway. However, the semitrailer overturned onto the guardrail, which punctured the tank shell and permitted gasoline to escape. The overturned vehicle slid on its side back into the roadway, abrading holes in the tank shell permitting further escape of gasoline. The gasoline ignited, killing the truck driver. The National Transportation Safety Board determines that the cause of loss of control and subsequent overturn of the truck was the failure of the left rear equalizer beam end of the tractor-tandem suspension. The failure was precipitated by the increased dynamic loading imposed on the equalizer beam as the truck traversed a depression in the roadway. Contributing causes of failure of the equalizer beam were (1) the inappropriate maintenance and repair procedures used in the removal of worn bushings and sleeves from the beam, (2) the overweight cargo, and (3) the presence of the minor depression in the road surface. The report contains recommendations to various Federal, State, and industry authorities intended to prevent the recurrence of this type of accident.					
17. Key Words Tractor-semitrailer overturn, fire, equalizer beam, equalizer beam failure, hazardous material, gasoline, overweight, highway repair, repaving, cutting torch, cavities, heat induced cavities, puncture, abrasion, overturn, guardrail, guardrail posts, W-beam guardrail, suspension failure, component failure, Braintree, Mass.				18. Distribution Statement This document is available to the public through the National Technical Information Service, Springfield, Va. 22151.	
19. Security Classification (of this report) UNCLASSIFIED		20. Security Classification (of this page) UNCLASSIFIED		21. No. of Pages 41	
22. Price					

NTSB Form 1765.2 (11/70)

FOREWORD

The accident described in this report has been designated as a major accident by the National Transportation Safety Board under the criteria established in the Safety Board's regulations.

This report is based on facts obtained from an investigation conducted by the Safety Board and information supplied by the Bureau of Motor Carrier Safety (Federal Highway Administration), the Registry of Motor Vehicles (Commonwealth of Massachusetts), the Massachusetts State Police, and the Massachusetts Department of Public Works.

The conclusions, the determination of probable cause, and the recommendations herein are those of the Safety Board.

TABLE OF CONTENTS

	<u>Page</u>
SYNOPSIS	1
FACTS	1
The Accident	1
Accident Site	7
The Truck	7
Truck Damage	8
The Truckdriver	10
Metallurgical Analysis of Failure	10
Dunstable Accident	11
Applicable Regulations and Manuals	11
ANALYSIS	12
Vehicle Kinematics	12
Equalizer Beam Failure	14
Crashworthiness of Truck	15
CONCLUSIONS	15
PROBABLE CAUSE	16
RECOMMENDATIONS	17
APPENDICES:	
Appendix A - NTSB Metallurgical Report No. 74-21	19
Appendix B - Summary of Accident at Dunstable, Massachusetts	25
Appendix C - Excerpt from International Harvester Motor Truck Service Manual	28
Appendix D - Excerpt from Hendrickson Manufacturing, Co., Service Manual	31
Appendix E - NTSB Safety Recommendations H-74-1 thru 3	35

NATIONAL TRANSPORTATION SAFETY BOARD
WASHINGTON, D. C. 20591

HIGHWAY ACCIDENT REPORT

Adopted: October 2, 1974

Hoppy's Oil Service, Inc., Truck Overturn and Fire,
State Route 128, Braintree, Massachusetts
October 18, 1973

SYNOPSIS

At 5:30 a.m., on October 18, 1973, an overweight tractor-semitrailer (tank) carrying gasoline was traveling west on State Route 128 in Braintree, Mass., at about 55 mph. As the truck traversed a minor depression in the road at a repaving project, the rear end of the left equalizer beam on the tractor tandem suspension failed and dropped onto the road surface. This permitted the left end of the rear tractor tandem axle to pivot rearward, which caused the vehicle to steer right and the driver to lose control. The truck veered to the right across the outside traffic lane and shoulder and struck the guardrail on the right side of the road. As the trailer overturned onto the guardrail and slid along the rail, the cargo tank shell punctured and the gasoline cargo escaped. The truck then slid back onto the roadway, which abraded through the tank and permitted further escape of the cargo. The truck came to rest on the roadway and burst into flames. The truckdriver died in the fire.

The National Transportation Safety Board determines that the cause of loss of control and subsequent overturn of the truck was the failure of the rear end of the left equalizer beam of the tractor tandem suspension. The failure was precipitated by the increased dynamic loading imposed on the equalizer beam as the truck traversed a depression in the road. Contributing to the failure of the equalizer beam were: (1) Inappropriate maintenance and repair procedures used to remove worn bushings and sleeves from the beam, (2) the overweight cargo, and (3) the presence of the minor depression in the road.

FACTS

The Accident

Sequence of events. At 5:30 a.m. on October 18, 1973, a tractor-semitrailer (tank) exited State Route 3 in Braintree, Mass., passed through a full-directional interchange, and entered the westbound lanes of State Route 128. The truck, with a gross vehicle weight of 77,535 pounds carrying 8,700 gallons (52,625 pounds) of gasoline cargo, was 4,535 pounds overweight. Because of a resurfacing project, the speed limit for the section of Route 128 which the truck entered had been reduced to 50 mph.

The truck, traveling in the second lane from the right, was traveling at a speed of 55 mph.

As the truck approached an overpass which carried Route 128 over State Route 37, the truck traversed a depression, 20 feet long and 1 to 1½ inches deep, which extended across the width of the roadway. As the truck crossed the depression, the rear end of the left equalizer beam of the tractor tandem suspension failed and dropped onto the roadway; the left end of the rear tractor tandem axle then pivoted rearward, which caused the vehicle to steer to the right. At that time, the truckdriver lost control of the vehicle.

Out of control, the truck veered across the outermost westbound lane and the paved shoulder of the highway, and struck the right-side guardrail at an angle of about 10°. As the truck slid 121 feet along the guardrail, the semitrailer overturned onto the guardrail and posts. (See Figure 1.) The cargo tank was punctured, and some of the gasoline cargo escaped. (See Figure 2(a) and (b).) The truck then slid, on its right side, back onto the roadway. During this slide, the tank shell was abraded through, and more gasoline escaped. (See Figure 2(a), (c), and (d).)

The truck came to rest on its right side about 186 feet west of the point of initial contact with the guardrail. Fire began almost immediately in the vicinity of the cargo tank. Flames quickly engulfed the entire truck and then spread to the surrounding area, generally following the downslope of the roadway and a nearby exit ramp. The truckdriver, who did not escape from the tractor, died of massive burns and multiple fractures.

At the time of the accident, the road surface was dry, and the temperature was about 45° F. Although it was still dark, the roadway was illuminated by elevated lights. Traffic was light.

Two motorists, both in the third lane from the right, witnessed the accident. One motorist was about to overtake the truck and the other was a short distance to the rear. Both reported seeing the truck bounce as it traversed the depression east of the overpass and saw sparks fly from beneath the truck as it crossed the overpass and veered across the outermost lanes and paved shoulder into the guardrail. One of the witnesses saw an object, later identified as a portion of the left rear equalizer beam end, fall from under the truck. He recovered the object after the accident.

A postaccident examination of the road revealed gouge, tire scuff, and scrape marks which began in the second traffic lane in the depression east of the Route 128 overpass bridge. (See Figure 3.) Two patterns of tire marks were observed on the roadway. The first included four parallel marks, the spacing of which were consistent with the width between tires

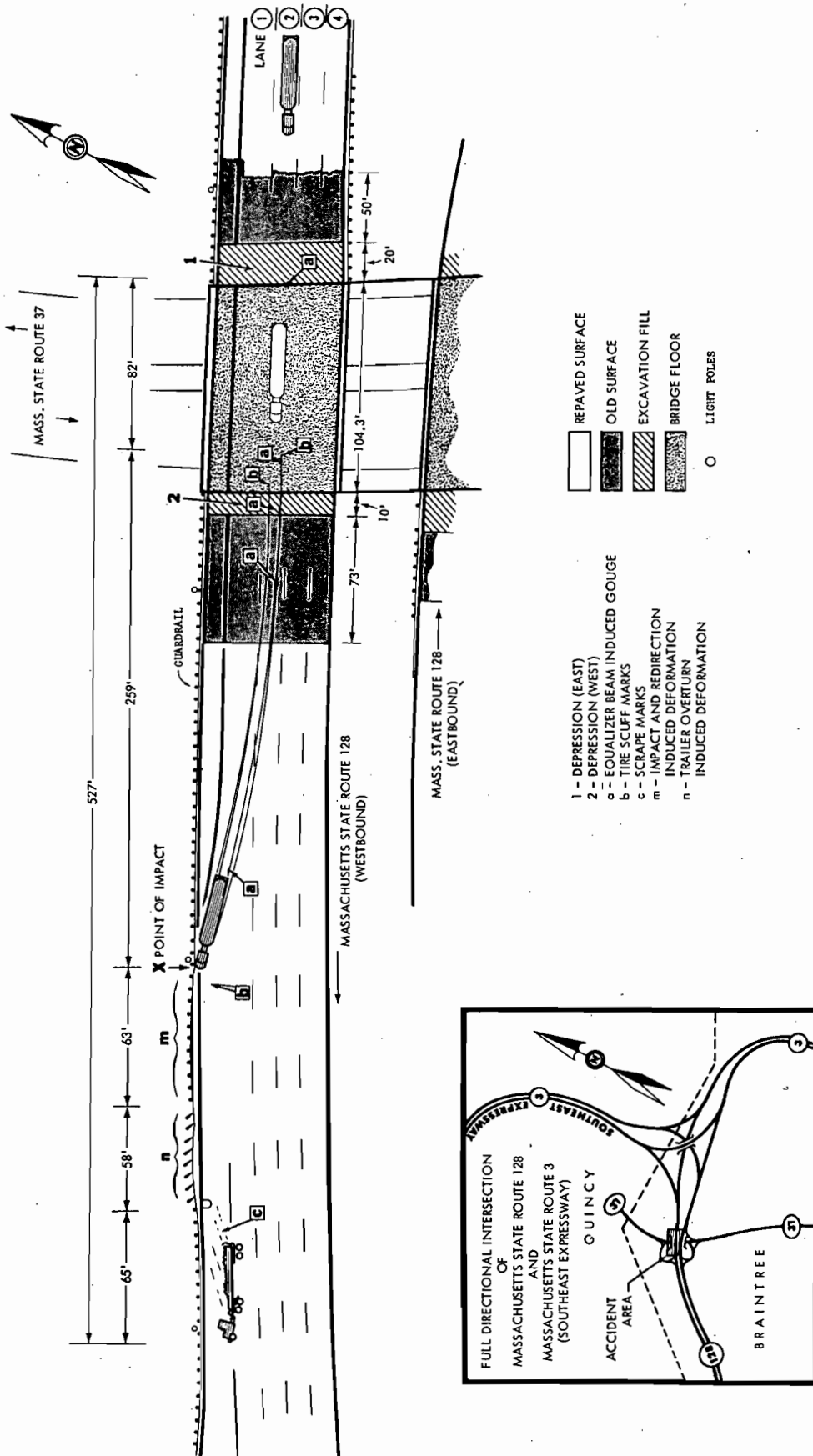
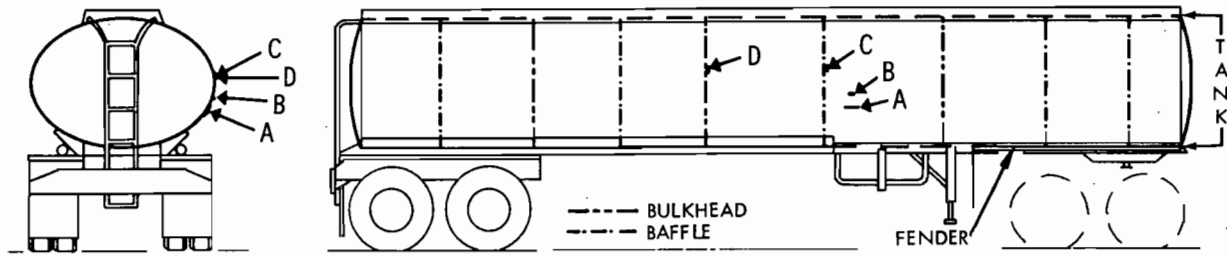
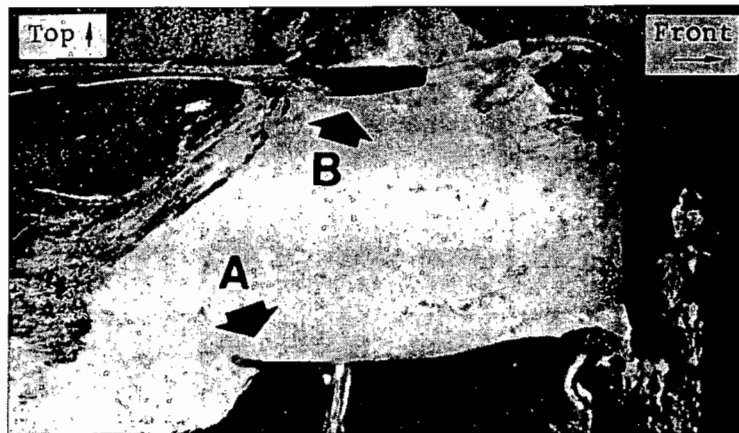

Figure 1. Accident Site.



a. TRAILER DIAGRAM. LOCATION OF PUNCTURES A AND B, AND ABRASION HOLES C AND D. FENDER WAS TORN OFF DURING INITIAL PHASE OF TRAILER OVERTURN ONTO GUARDRAIL.



b. Punctures in cargo tank caused by guardrail posts.

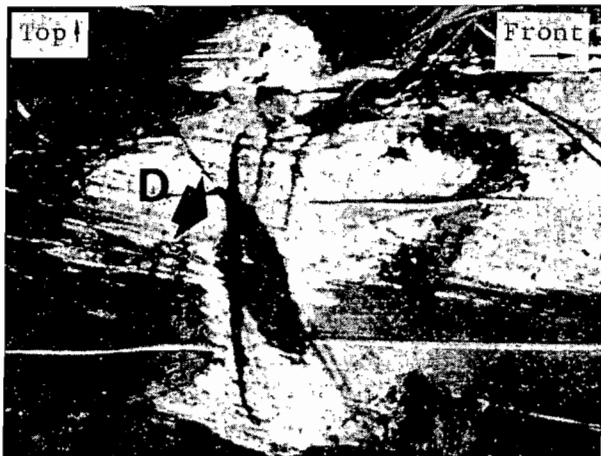

c. Abrasion failure caused by slide on roadway.



d. Abrasion failure caused by slide on roadway.

Figure 2. Cargo tank shell material failures.

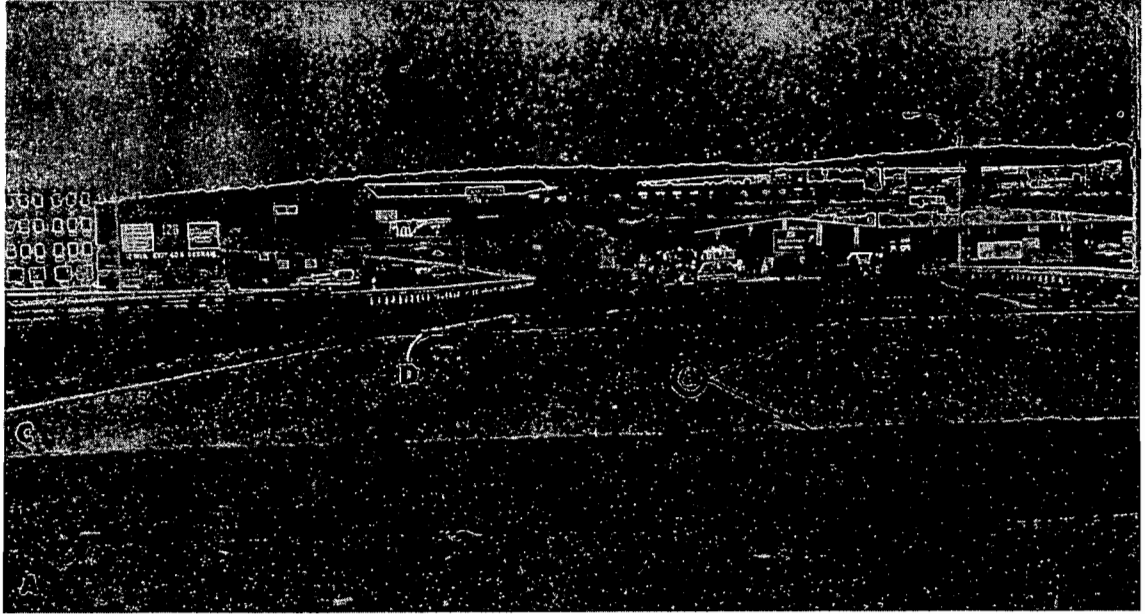

Figure 3. Westbound lanes of State Route 128 east of overpass bridge.
A - old road surface. B - east depression. C - overpass floor.
D - west depression. E - old road surface. F - first course of repaving.
ⓐ First and second gouges from failed equalizer beam.



Figure 4. Westbound lanes of State Road 128.
C - overpass floor. D - west depression.
E - old road surface. F - first course of repaving.
ⓐ equalizer beam induced gouges
ⓑ beginning of tire scuff marks

on the tractor or trailer axle. These marks, 259 feet long, started in a straight line at the edge of the overpass and then arced toward the guardrail (See Figure 4.) The second pattern consisted of four parallel sets of black rubber transfers and scuff marks which were wider than the normal tire footprint and showed crosswise striations.

Rubber and paint transfers and scrape and gouge marks showed that the truck slid along the guardrail 121 feet. (See Figure 5.) Also, scrape marks showed that the truck slid 15 feet across the highway shoulder and 50 feet on the roadway before it came to rest. Fire damage to the roadway and guardrail extended 500 feet along the north edge of the highway and exit ramp as well as onto the grass and shrubs adjacent to the highway.

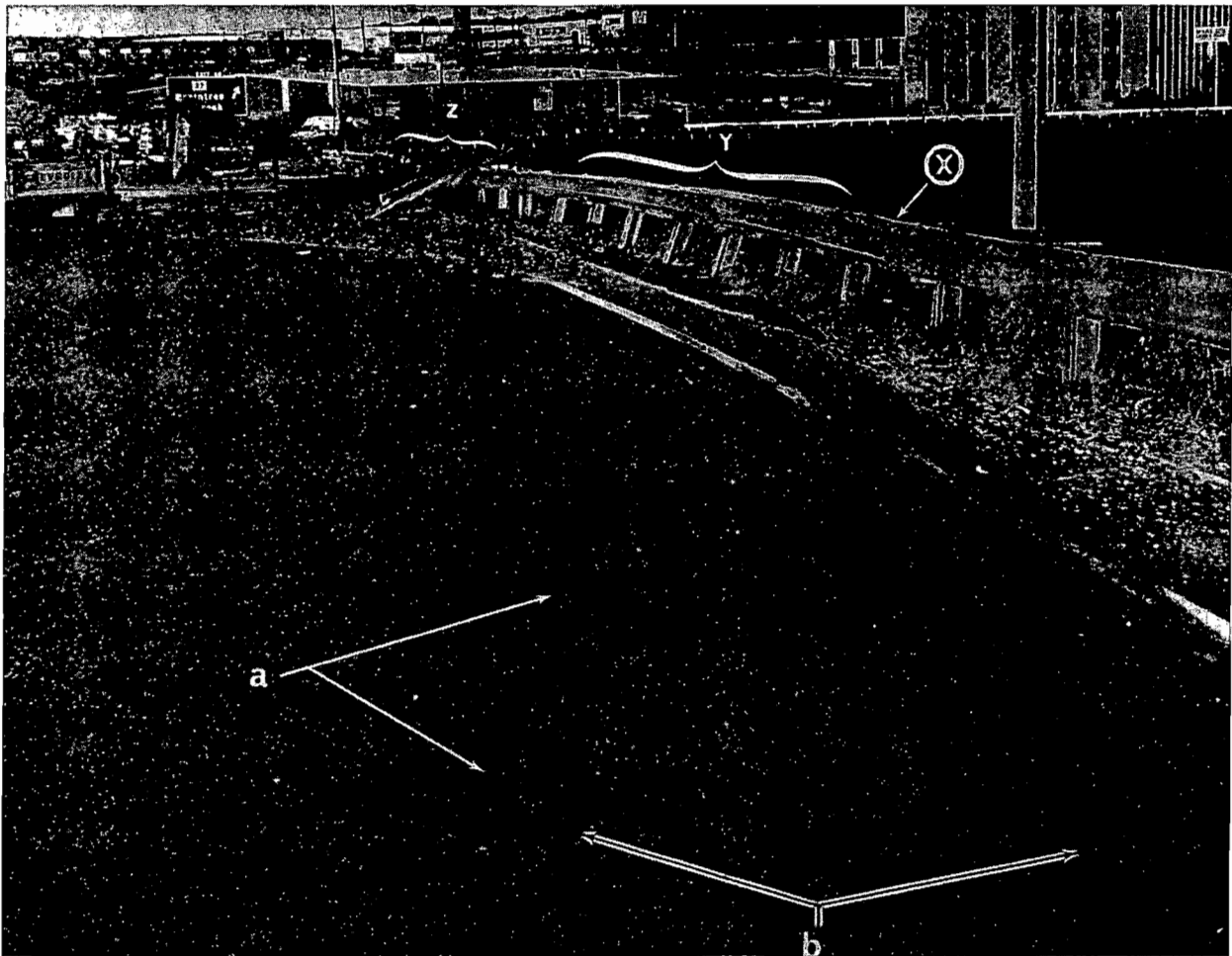

Figure 5. ① equalizer beam induced gouges. ② tire scuff marks.
⊗ impact point. ③ rubber and paint transfers and truck
redirection deformation to guardrail. ④ trailer overturn
deformation to guardrail.

Accident Site

State Route 128, a by-pass around Boston, is an 8-lane, controlled access, divided highway. The highway traverses gentle rolling terrain in the northwest outskirts of Braintree. At the accident site, the westbound and eastbound lanes were separated by a 40-foot-wide grass median. The four westbound lanes were separated by 4-inch-wide, broken white lines. The outermost westbound lane was 17.5 feet wide, and the inner three were 12.5 feet wide. A 4-inch wide, solid, white edge line was painted on the outer edges of the pavement.

East of the overpass, 2.5-foot-high steel W-beam guardrails were on both sides of the westbound roadway. West of the overpass, a similar guardrail continued on the right side of the westbound roadway only.

A mandatory speed-limit sign about 1.1 miles east of the accident site restricted the speed of all vehicles to 55 mph. The repaving project was posted with traffic control signs and devices conforming to those in the Manual on Traffic Control Devices, ^{1/} which was adopted by the Commonwealth of Massachusetts. A "ROAD CONSTRUCTION AHEAD" sign with an accompanying 50-mph advisory maximum-recommended-speed sign was posted 0.5 mile east of the accident site within the intersection of Route 3 with Route 128.

Highway repair activities. The resurfacing project on Route 128 started approximately 0.35 mile east of the overpass and continued several miles westward. The first course of a two-course overlay had been applied to the old road surface from the start of the project to a point 70 feet east of the east end of the overpass, then began again 83 feet west of the west end of the overpass, and continued through the accident site. (See Figure 1.) These overlays were feathered to the old road surface.

On the day before the accident, 9-inch-deep excavations were dug in the old road surface across the full width of the highway at both ends of the overpass. The excavation at the east end of the overpass was 20 feet long, and at the west end, 10 feet long. These excavations were filled with asphalt concrete, which was compacted to the level of the old road surface and the overpass floor with a mechanical roller. Traffic further compacted this material and caused a depression in the roadway, which averaged from 1 to 1½ inches in depth.

The Truck

The tractor-semitrailer (tank) was owned and operated by Hoppy's Oil Service, Inc., of Brockton, Mass. The weight of the truck and cargo was calculated to have been 77,535 pounds, 4,535 pounds over the gross weight permitted by Massachusetts law.

^{1/} Federal Highway Administration, Manual on Uniform Traffic Control Devices for Streets and Highways, p 267-320.

Tractor. The tractor was a 1970 International Harvester Model DCF-400-104, equipped with a diesel engine, air brakes, and a Hendrickson RT-series tandem axle rear suspension. (See Figure 6.) The equalizer beam end mountings were the adapter, draw bolt, and lock-washer type. The weight of the tractor was approximately 15,580 pounds.

Trailer. The semitrailer (tank) was a 1970 Heil Company Challenger (MC-306), Model PC-821-4, equipped with a tandem axle suspension. The four-compartment tank was equipped with transverse baffles, two in the forward compartment, and one each in the remaining three compartments. The physical characteristics of the trailer were as follows:

Empty weight	9,330 pounds
Volumetric capacity	8,755 gallons
Trailer length (overall)	443 inches
Trailer height (overall)	122 inches
Trailer width (overall)	95.75 inches
Tank length	416 inches
Tank diameter (elliptical)	95.75 inches x 65 inches
Tank shell material	0.156 inch thick, 5454H32 aluminum alloy. (Ultimate ten- sile strength 40,000 p.s.i.)

The cargo tank was within 55 gallons of being full. The center of gravity of the trailer, as loaded, was calculated to have been 84 inches above the ground. The center of gravity of the vehicle combination and load was calculated to have been 71.7 inches above the ground.

Truck Damage

The tractor and semitrailer were damaged beyond repair, and the cargo was destroyed in the ensuing fire.

Tractor. The damage sustained by the tractor during impact with the guardrail and the subsequent overturn and slide along the roadway did not contribute further to the final consequences of this accident.

A series of cavities and pits, in groovelike alignment, were observed on the inside-diameter surfaces of the equalizer beam bushing holes, roughly parallel to the axis of the bushing holes. The bottom outside-diameter surface of the rear end of the left side equalizer beam was worn down approximately 0.25 inch. A section slightly less than half the circumference of the bushing hole of the rear end of the left side equalizer beam was broken out. (See Figure 6.)

Maintenance records for the truck revealed that the equalizer beam bushings were replaced only once, on March 21, 1973. Hoppy's maintenance shop foreman stated that the bushings were replaced at A. F. Gorman, Co., Inc.,

ACCIDENT
FAILURE

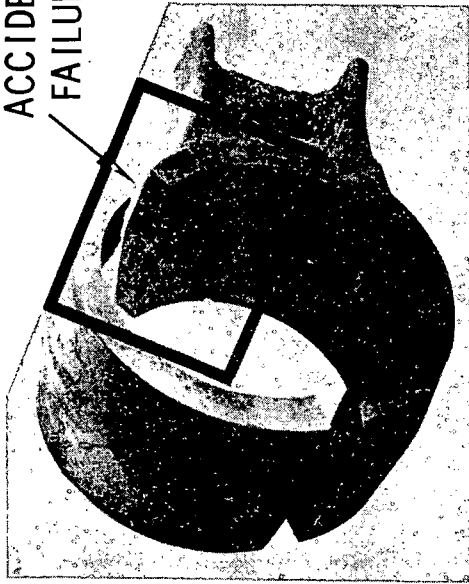

b. Failed equalizer beam end.

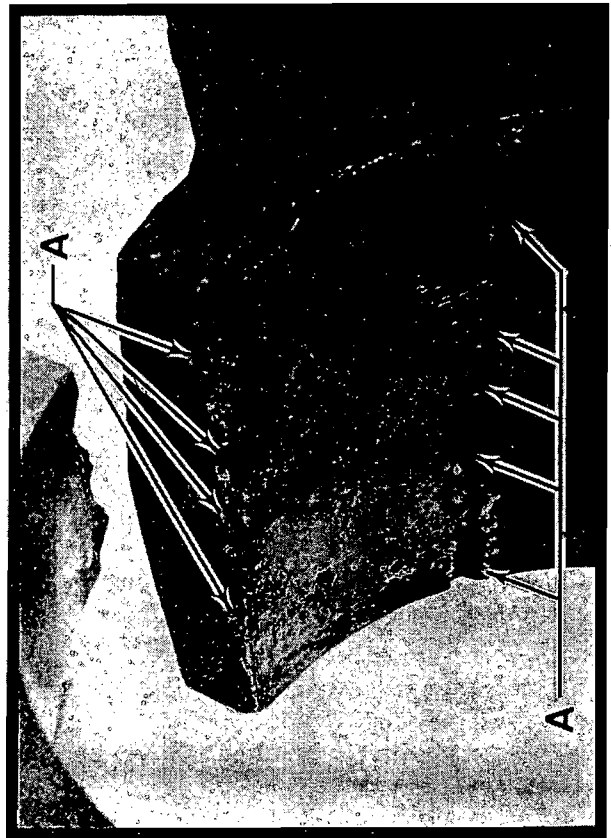

c. "A" - Cutting torch induced cavities.
(Insert from Figure 8-b.)

a. Typical left-side equalizer beam installation with center mounted torque rods.

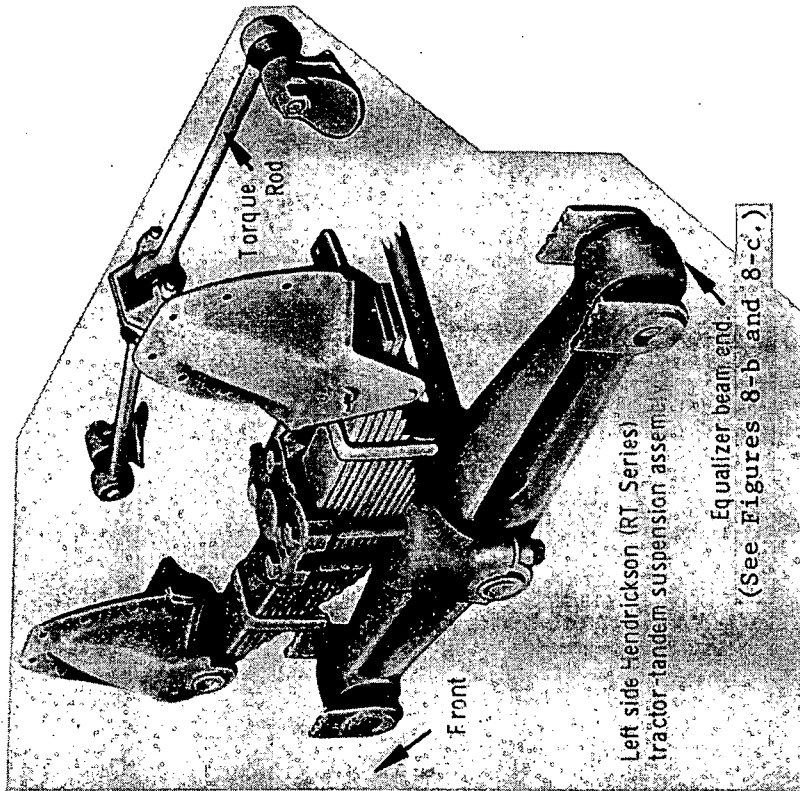

Figure 6. Failure due to use of cutting torch to remove bushings and sleeves from equalizer beam.

a local machine shop. He stated that the equalizer beams had been removed from the tractor tandem suspension and taken to German with the worn bushings still in the beams and that he did not remove the bushings.

The German shop foreman stated that German had discontinued pressing out old equalizer beam bushings several years ago because the pressures required exceeded the pressure at which the German equipment could be safely operated. Further, he stated that German required that the customer remove old bushings before new ones would be pressed in. From the evidence available, including the German work order and invoice for the job, the Safety Board could not determine who removed the bushings from the equalizer beams.

Trailer. The right side trailer-mounted tractor tandem suspension fender was torn from the trailer during impact with the guardrail. Two longitudinal punctures and two transverse abrasion holes were found in the remaining section of the right side of the tank shell. (See Figure 2.) One puncture, about 20 inches above the bottom of the tank, was about 8 inches long and about 0.25 inch wide. The second, about 25 inches above the bottom of the tank was about 2.75 inches long and about 0.50 inch wide. Both punctures were about 14 feet from the front of the tank. Two abrasion holes, 4 to 5 inches long and 0.125 to 0.25 inch wide, were about 36 inches above the bottom of the tank, with one about 15 feet and the other about 20 feet from the front of the tank. At least 3/4 of the aluminum alloy tank shell melted away in the fire. (See Figure 7.)

The Truckdriver

The truckdriver, 45 years old, had been employed by Hoppy's Oil Service, Inc., as a truckdriver since October 21, 1969. He had been a commercial driver for 20 years. At the time of the accident, the truckdriver was not certified as medically qualified to drive in interstate or intrastate (hazardous materials) commerce. He held a valid Massachusetts motor vehicle operator's license. The Massachusetts Registry of Motor Vehicle records did not reveal any traffic violations or motor vehicle accidents involving the driver.

Metallurgical Analysis of Failure

Metallurgical examination of the failed equalizer beam end and attachment point assembly by the Safety Board indicated that the equalizer beam section failed through a section of cavities, in groovelike alignment, on the inside diameter surface of the equalizer beam end bushing housing. Metallographic examination disclosed that these cavities had been produced by heating the material to or above its melting point. Details of the metallurgical examination are contained in Appendix A.

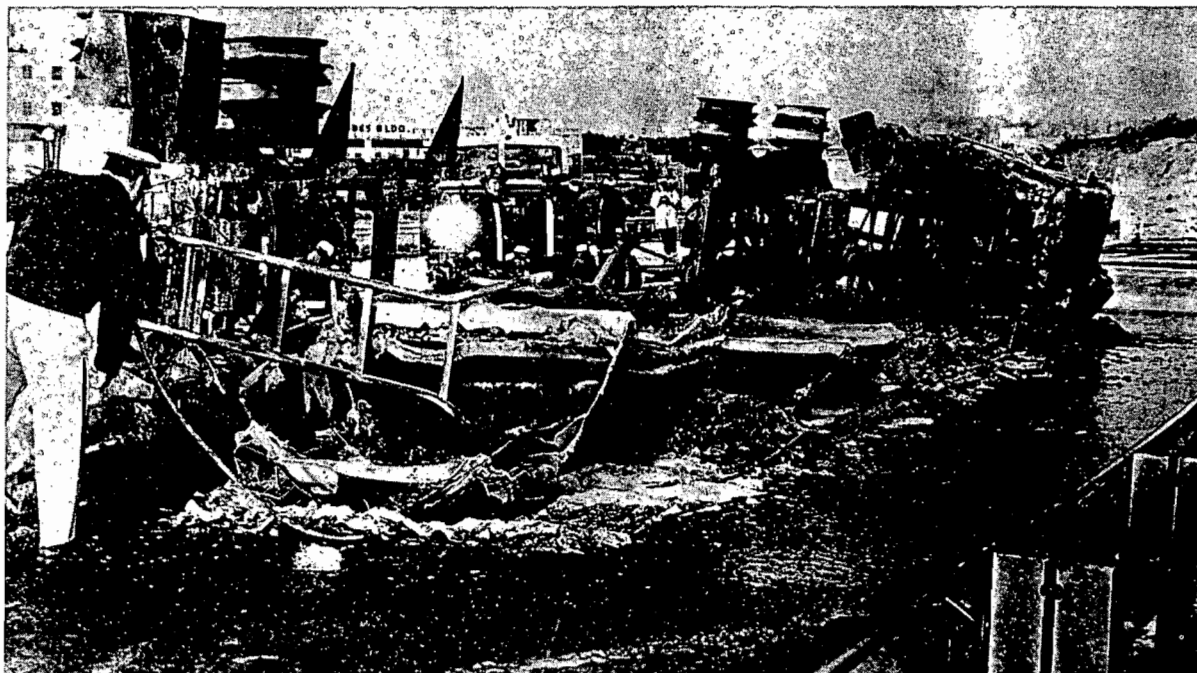

Figure 7. Final position of truck after redirection back into roadway and slide on right side along pavement, showing remaining portions of cargo tank shell material following fire.

Dunstable Accident

On January 2, 1974, the Safety Board was notified of another accident involving an equalizer beam failure which occurred on December 6, 1973, at Dunstable, Mass. Subsequent metallurgical examination of the failed equalizer beam center hole revealed a series of cavities, oriented in a groovelike alignment, similar to those found in the Braintree accident. The failure occurred through this series of cavities. The examination disclosed that the other two bushing holes in the failed beam and all three bushing holes in the right side equalizer beam also contained cavities. A summary of the Dunstable accident is contained in Appendix B.

Applicable Regulations and Manuals

Federal regulations pertinent to the accident include 49 CFR 178.340, which concerns general design and construction requirements applicable to cargo tanks; 49 CFR 391.51(b)(1), which requires a certificate of medical qualification of drivers; and sections of the Manual on Traffic Control Devices published by the Federal Highway Administration (FHWA) pertaining to the posting of traffic controls for highway construction and maintenance.

ANALYSIS

Vehicle Kinematics

When the rear end of the left equalizer beam failed as the truck bounced across the depression in the road, the left end of the rear tractor tandem axle was released from its engagement with the equalizer beam. (See Figure 8.) The left end of the axle pivoted rearward until it was restrained by the center mounted tandem assembly torque rod and the right equalizer beam-to-axle attachment. The misaligned rear axle tires caused the truck to veer across the road into the right-side guardrail. The driver was not able to overcome the rear axle steering with the tractor's conventional steering system.

The tire marks at the accident scene support this sequence of events. The rubber transfers and scuff marks which coincided with the width between the tires of the tandem wheels of the tractor indicated a side slippage to the left as the tires on the misaligned tandem axle steered the tractor to the right. This action exerted considerable cornering action between the rear dual tires and the surface of the road, which left the crosswise striation markings.

The four parallel tire marks probably resulted from braking of the trailer tandem wheels. The trailer wheels, 35 feet behind the tractor tandem wheels, off-tracked to the right of the tractor tire paths.

When the rear end of the left equalizer beam failed, it dropped 12 inches to the pavement. The rear end was being pushed downward with a calculated force of 9,000 pounds. The drop allowed the left rear side of the tractor frame to drop approximately 6 inches, which caused the front end of the trailer to lean toward the left approximately 11 degrees. While the truck was being steered to the right, a centrifugal force acted to the left. When the truck struck and was redirected along the guardrail, the centrifugal force changed from a leftward force to a rightward force. The rightward force at the truck's 71.8-inch-high center of gravity and the resisting force of the 2.5-foot-high guardrail against the right-side truck tires set up a loading couple on the truck. Because they were on a dirt surface which offered little traction, the right-side tires slipped to the left, out from under the overturning truck, as the truck slid along the guardrail.

There are thousands of tractor-semitrailers (tank) with the same dimensional configuration as the truck involved in this accident. The 71.8-inch center of gravity height is representative of this type of truck when loaded. The 2.5-foot guardrail height is also representative of typical guardrail installations. In this accident, the guardrail redirected the truck and kept it on the road, because of the low angle of impact and the relatively low tire-to-dirt coefficient of friction. The loading couple set up by the force, acting at the center

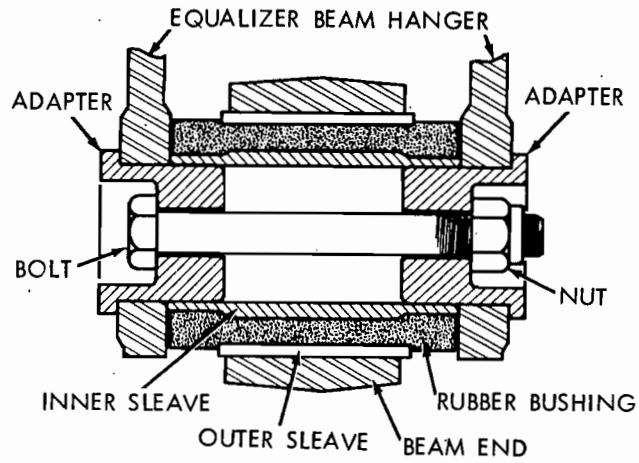

a. SECTIONAL VIEW OF BOLT TYPE EQUALIZER BEAM END MOUNTING.

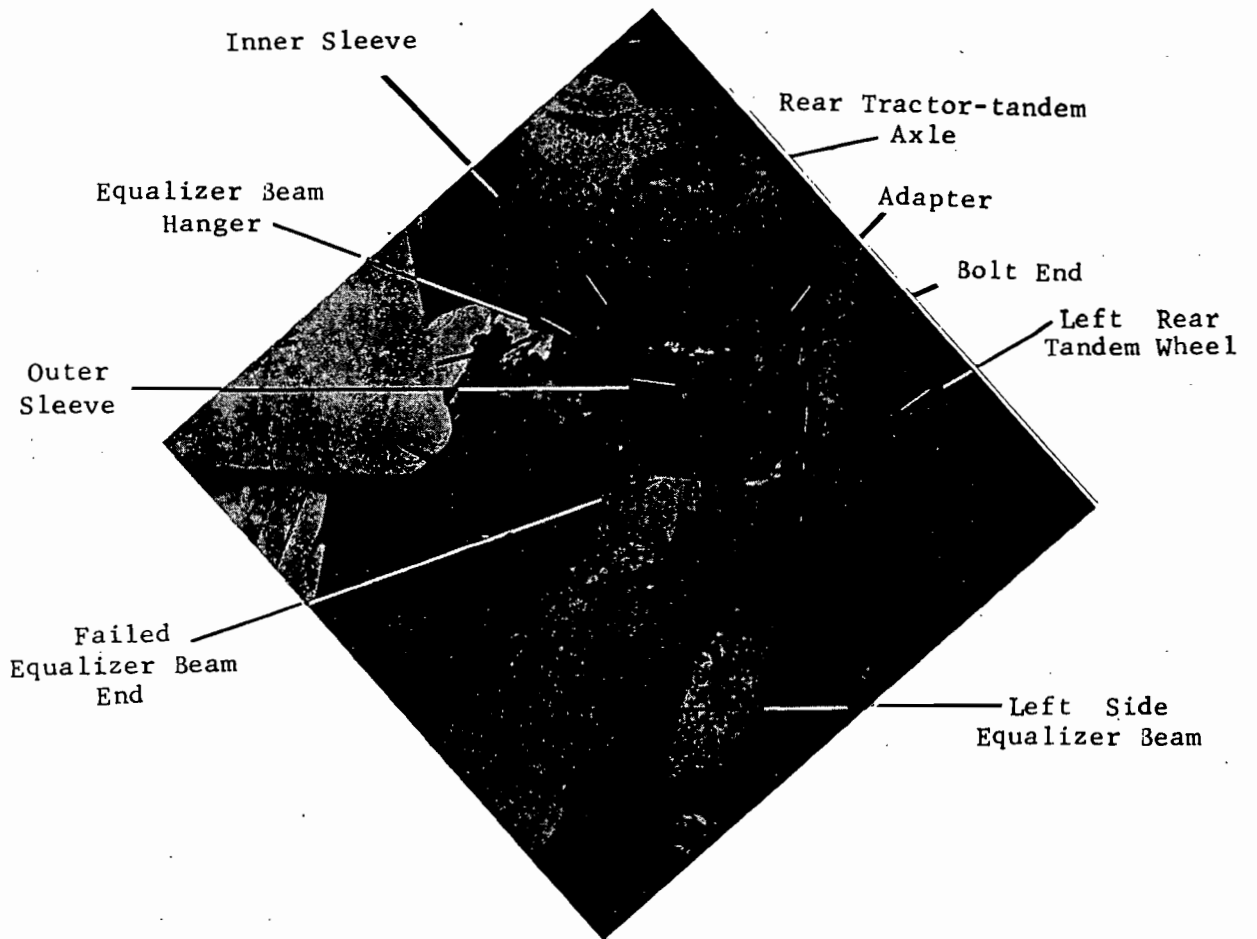

b. Failed equalizer beam end, and beam hanger.

Figure 8. Equalizer beam end assembly components.

of gravity height and the resisting guardrail were sufficient to overturn the truck. If the angle of impact had been greater or the guardrail weaker, the truck would probably have gone through the guardrail in an upright attitude. If the coefficient of friction between the highway shoulder and the truck tires had been greater, it is likely that the truck would have turned completely over the guardrail. Thus, the incompatibility between the truck's high center of gravity and the guardrail is a significant factor in this accident.

Equalizer Beam Failure

Dynamic loads were imposed on all four tractor tandem suspension equalizer beam ends as the truck bounced across the minor depression in the road surface at 55 mph. The load imposed on the upper quadrant of the rear end of the left equalizer beam exceeded the strength of the weakened beam end.

Metallurgical examination of the failed beam end disclosed that the cavities on the inside-diameter surface of the equalizer beam end had been produced by heat--probably from the flame of a cutting torch. Hoppy's Oil Service bought the truck new in 1970. The maintenance records did not reveal any maintenance or repair work performed on the equalizer beams before or after March 21, 1973, when the worn bushings and sleeves were removed and replaced. The damage must have occurred during that operation. Supplement 588 to the International Harvester's Motor Truck Service Manual states that the proper method for removing worn equalizer beam bushings and sleeves and for installing new ones is by means of a press. (See Appendix C.) The use of a cutting torch or of other heat methods is not mentioned in the manual. Similarly, Hendrickson Manufacturing Company Service Bulletin AA-17730-70, which pertains to the RT-RTE series of Hendrickson tandem axle units, illustrates the proper method for removing worn equalizer beam bushings and sleeves and for installing new ones by means of a press. (See Appendix D.) The use of a cutting torch or other heat methods is not mentioned in the bulletin in connection with removing bushings and sleeves from equalizer beams or removing the bolt-type beam end mounting used on the suspension assembly involved in this accident. However, the bulletin does suggest as an alternate method, removing tube-type beam and mountings from the beam end hanger by cutting through the tube with a cutting torch. Caution in using a cutting torch is advised, because some beams are forged aluminum or nodular iron which can be damaged by heat.

Although the equalizer beam end bushing involved in this accident did not have tube-type mounting, the Safety Board is concerned with the reference in the Hendrickson service bulletin to the use of a cutting torch. Maintenance personnel could construe the alternative use of a cutting torch approved for one type of mounting to be proper for other types of mountings and mounting components.

The joined cavities in the failed area were in a groove-like alignment roughly parallel to the axis of the bushing hole. The alignment was consistent with the configuration which would result from use of a cutting torch to remove the worn equalizer beam bushing from the bushing hole. The fact that all other bushing holes had similar alignment of cavities in the bushing holes substantiates the conclusion that a cutting torch had been used for bushing removal. The alignment of cavities created a discontinuity on the inside-diameter surface of the equalizer beam end and caused a stress concentration of sufficient magnitude to initiate failure of the beam end when it was exposed to additional dynamic loadings imposed by the road surface depression.

The precise stress concentration is difficult to determine, because not only the cross-sectional shape and depth of the discontinuity but also the metallurgical properties of the basic material must be considered. For example, the relatively low-strength, coarse-grained, nodular iron in the equalizer beam was more susceptible to heat than steel would have been. The material hardness increased by the heat from 245 to 550 Brinell in the bottom of the heat-induced cavities. This change in microstructure reduced material ductility and made the material conducive to brittle fracture. The maximum stress at the surface discontinuity when the beam was loaded was at least two times what it would have been if the discontinuity had not been present. Thus, the effect of the cutting torch on the beam end combined with the load imposed when the truck hit the depression to produce a sudden unexpected failure.

Crashworthiness of Truck

As the trailer was overturning, its right-side shell was punctured and ripped by the top surface of the guardrail posts.

The other two openings in the tank shell were in the area of the abrasion marks which resulted from the tank's sliding on the road. These openings were located at points where the interior baffles contacted the tank shell. The edges of the baffles produced pressure points, which pressed the aluminum shell against the road surface. Some type of abrasion protection, such as rub rails, would prevent such failures.

The Safety Board knows of no tests of the ability of cargo tanks to withstand overturn onto guardrails or sliding on pavement after overturn. Viewed as a crashworthiness test, this accident demonstrates the inadequacy of this type of cargo tank to resist failure.

CONCLUSIONS

1. At the time of the accident, the truck was traveling at 55 mph; the driver had not reduced speed to the posted advisory maximum safe speed of 50 mph.

2. Once the equalizer beam failed, there was nothing the driver could have done to prevent the accident.
3. Vehicle maintenance and repair procedures which involved the use of a cutting torch to remove worn equalizer beam bushings and sleeves produced cavities in the equalizer beam parent material, and created stress raisers which reduced the strength of the material.
4. The Board could not determine who removed the bushings from the equalizer beam.
5. The sudden dynamic loads imposed on the weakened equalizer beam as the truck bounced across the depression in the road surface were the immediate cause of the equalizer beam failure.
6. The vehicle cargo overweight of 4,535 pounds contributed adversely to the dynamic loads on the tractor tandem suspension.
7. The guardrail design and installation initially performed as desired by redirecting the truck along the guardrail.
8. The loading couple resulting from the rightward centrifugal force on the vehicle's high center of gravity and the relatively low guardrail produced a tripping action which overturned the truck.
9. The aluminum alloy cargo-tank shell was punctured when the truck overturned onto the guardrail and the steel posts punctured the tank material.
10. The aluminum alloy cargo-tank shell failed to resist abrasion as the truck slid along the pavement.
11. Fire initiated in the area of the trailer as the truck came to rest. The ignition source was probably ferrous metal-to-metal or ferrous metal-to-pavement sparking during the truck's slide along the guardrail and the pavement.

PROBABLE CAUSE

The National Transportation Safety Board determines that the cause of loss of control and subsequent overturn of the truck was the failure of the rear end of the left equalizer beam of the tractor tandem suspension. The failure was precipitated by the increased dynamic loading imposed on the equalizer beam as the truck traversed a depression in the road. Contributing to the failure of the equalizer beam were: (1) Inappropriate maintenance and repair procedures used to remove worn

bushings and sleeves from the beam, (2) the overweight cargo, and (3) the presence of the minor depression in the road.

RECOMMENDATIONS

On March 15, 1974, as a result of the Board's investigation of this accident, the National Transportation Safety Board issued three recommendations to the Federal Highway Administration. (See Appendix E.) By letter of August 23, 1974, the FHWA advised that these recommendations were under study by the BMCS/FHWA.

The Safety Board further recommends that:

1. The American Trucking Association, Inc., and the Motor Vehicle Manufacturers Association publicize the significance of proper vehicle maintenance and repair procedures with particular emphasis on the importance of not using heat of any kind in those areas where heat may adversely alter the strength characteristics of structural components. (Recommendation H-74-31)
2. The Commonwealth of Massachusetts increase their enforcement of the motor vehicle gross weight regulations presently on its statutes. (Recommendation H-74-32)
3. The Office of Hazardous Materials (Office of the Secretary, Department of Transportation) and the Bureau of Motor Carrier Safety (Federal Highway Administration) review 49 CFR 178.340 to determine if the regulation as presently written is intended to provide protection against puncture or abrasion of cargo tank walls during predictable accident environments. If this is not the case, consider the necessity of rewriting the regulation to provide this protection. (Recommendation H-74-33)
4. That Hendrickson Manufacturing Company and International Harvester Company revise their respective maintenance and repair manuals and service bulletins to delete any reference to the use of heat-producing (ovens, burning, or cutting torch) methods in the performance of maintenance or repair operations that could in any way effect the strength characteristics of any vehicle component and further, to insure that the manuals and service bulletins carry conspicuous warnings against the use of such heat-producing methods. (Recommendation H-74-34)

BY THE NATIONAL TRANSPORTATION SAFETY BOARD

/s/ FRANCIS H. McADAMS
Member

/s/ LOUIS M. THAYER
Member

/s/ ISABEL A. BURGESS
Member

/s/ WILLIAM R. HALEY
Member

John H. Reed, Chairman, did not participate in the adoption of this report.

October 2, 1974

APPENDIX A

NATIONAL TRANSPORTATION SAFETY BOARD
Bureau of Aviation Safety
Washington, D.C.

December 3, 1973

METALLURGICAL LABORATORY REPORT NO. 74-21

A. ACCIDENT

Place : Massachusetts State Route 128, Braintree, Massachusetts
Date : October 18, 1973
Vehicle: Hoppy's Oil Company Truck

B. COMPONENTS EXAMINED

Attachment Point Assembly

1. Section of cast steel equalizer beam
2. Steel bushing

C. SUBMITTED BY

Mr. Hanes G. Gibson
Bureau of Surface Transportation Safety
National Transportation Safety Board
Washington, D. C. 20591

D. SUMMARY

Metallurgical examination of the attachment point assembly indicated that the equalizer beam section failed by overload through a cavity on the inside diameter surface. Metallographic examination of the cavity disclosed that it was produced by heating the material to a temperature to or above its melting point, probably with a cutting torch. Examination of the steel bushing showed several shallow grooves which appeared to have been produced by abrasion. These grooves did not appear to be related to the damage on the inside diameter surface of the equalizer beam.

E. DETAILS OF THE EXAMINATION

An overall view of the components examined is shown in Figure 1. The bushing at the attachment point (indicated by the letter "A" in Figure 1) was examined microscopically and found to be free of cracks.

The equalizer beam (indicated by the letter "B" in Figure 1) fractured in two places, as shown by arrows "c" and "d" in Figure 1. Examination of the fracture surfaces, with the aid of a binocular microscope, showed no evidence of fatigue or corrosion. Both fractures appeared to be typical of an overload failure.

A closeup view of fracture surface "d" is shown in Figure 2. As indicated by the bracket in Figure 2, the fracture initiated along a cavity 1 3/4 inches in length on the inside diameter surface. The cavity was heavily oxidized and appeared typical of that produced by a cutting torch. The maximum depth of the cavity was approximately 3/16 inch in the area indicated by the line E-E in Figure 2. The original section thickness in this area was 3/4 inch. Thus, approximately 25 percent of the section thickness in this area was removed prior to the fracture initiation. Another cavity similar in appearance to that at the fracture was observed in a location of 1 1/2 inches from the fracture. The location of this cavity is denoted by bracket "g" in Figure 3.

A transverse metallographic microsection through the fracture plane at the location indicated by the line E-E in Figure 2 is shown in Figure 4. The original inside diameter surface relative to the cavity is indicated by a dashed line in Figure 4. Figure 5 is a higher magnification photomicrograph of the section through the cavity surface. Two distinct zones are outlined by the brackets "j" and "k" in Figure 5. The original base metal structure, as outlined by bracket "j", is essentially composed of a pearlite matrix with a dispersion of graphite nodules which complies with the manufacturer's specifications. Bracket "k" outlines a zone having a microstructure distinctly different from that of the base metal. This layer approximately 0.009 inch thick indicates a high temperature transformation of the original microstructure. The microstructural transformations in this zone are typical of what would be expected if the material was heated to or above its melting point and cooled rapidly.

Hardness measurements were made on the undamaged surface of the broken equalizer beam section. The reading averaged Rockwell "C" 60. Using the Wilson conversion chart No. 60, this converts to approximately a Brinell hardness value of 245. This hardness is within International Harvester's material specification E-10 requirements of Brinell for 1H grade 100-65-03 nodular iron casting. Microscopic inspection of the outside diameter surface of the steel bushing indicated by the letter "A" in Figure 1, revealed several shallow longitudinal grooves which appeared to have been produced by abrasion. The orientation of these grooves relative to the bushing surface is indicated by the white in Figure 1. These grooves did not appear to be related to the cavity locations on the mating inside diameter surface of the equalizer beam.

F. DISCUSSION

The metallurgical examination disclosed that the overload failure of the equalizer beam precipitated from deep cavities on the inside diameter surface. The factors which likely contributed to the failure are: (1) loss of section thickness which could have significantly reduced the load carrying capacity of the equalizer beam, (2) reduced ductility by the formation of a brittle zone at the cavity surface, and (3) alteration of the local stress distribution by the creation of stress raisers in the cavity region. Steel castings are characteristically notch sensitive, thus it is probable that the latter factor was the primary cause of the overload failure.

Metallographic examination of the fracture surface indicated that the cavity was produced by heating the material to its melting point. The orientation and shape of the cavities suggests they were produced with a cutting torch.

/s/ Jerry A. Houck

Jerry A. Houck
Metallurgist

Attachments

NATIONAL TRANSPORTATION SAFETY BOARD
Bureau of Aviation Safety
Washington, D.C.

January 30, 1974

ADDENDUM A TO METALLURGICAL LABORATORY REPORT NO. 74-21

A. ACCIDENT

Place : Massachusetts State Route 128, Braintree, Mass.
Date : October 18, 1973
Vehicle: Hoppy's Oil Company Truck

Add the following to the end of the information headed (F. DISCUSSION):

Figure 5 shows the microstructure of a section adjacent to the cavity surface in the fractured equalizer beam. Two distinct zones are outlined by brackets in this figure. The zone denoted by bracket "J" is the original microstructure of the nodular iron casting material and is essentially composed of a pearlite matrix with a dispersion of graphite spheroids. The hardness of this zone was approximately equivalent to Brinell 245.

A transformed zone at the cavity surface is outlined by the bracket "K". The microstructure in this zone is a structure composed essentially of white martensite and fine pearlite, typical of what might be expected if the beam was heated to a high temperature and subsequently rapidly cooled. Tukon microhardness measurements made in this transformed zone gave results averaging Knoop 643 which converts to approximately Brinell 550, as shown on Wilson Mechanical Instrument Chart No. 60.

Typically, the microstructure observed in the transformed zone indicates poor impact properties and low ductility. Material having this microstructure would be expected to fracture in a brittle manner.

/s/ Jerry A. Houck

Jerry A. Houck
Metallurgist

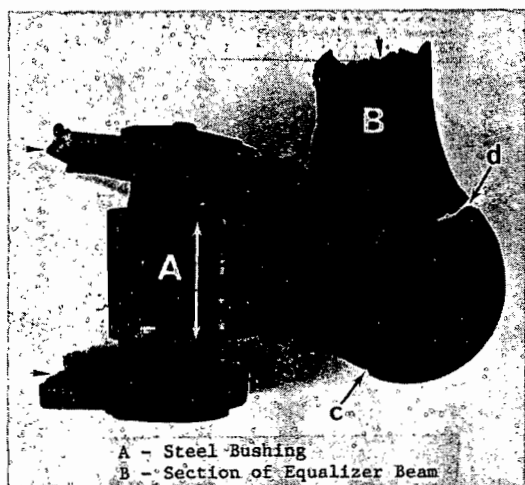

Figure A-1. Photograph of assembly point casting and section of equalizer beam. Arrows "c" and "d" indicate the fracture locations. The arrowheads indicate surfaces which were cut in the field to facilitate examination of the parts. The white arrow denotes the orientation of shallow grooves found on the outside diameter surface of the bushing.

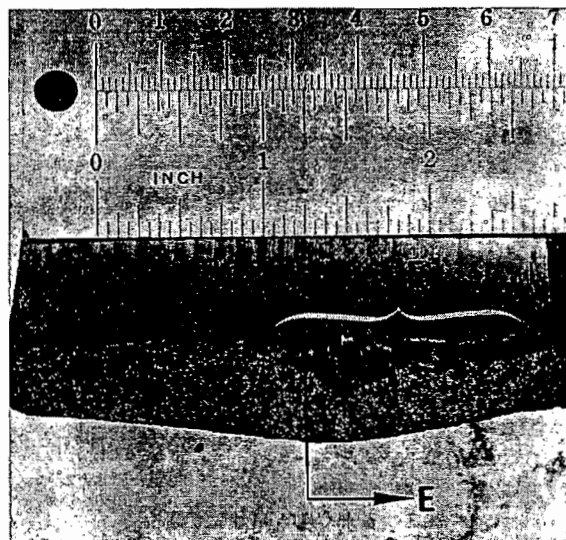

Figure A-2. Surface of fracture indicated by arrow "d" in Figure A-1. Bracket denotes location of cavities. Arrowheads indicate extent of cavities from the inside diameter surface. Line E-E indicates location of metallographic microsection shown in Figure A-4.

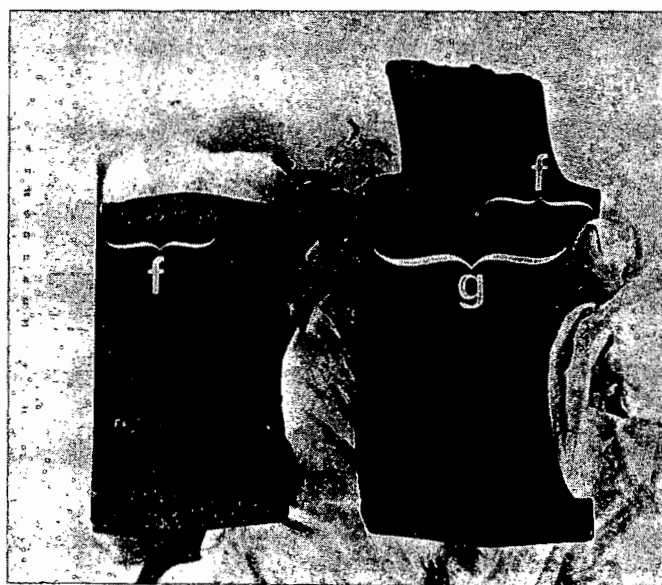

Figure A-3. Broken section of equalizer beam showing fracture surfaces and locations of cavities on the inside diameter surface. Brackets "f" and "g" denote areas of cavities.

Metallurgical Report No. 74-21
APPENDIX A

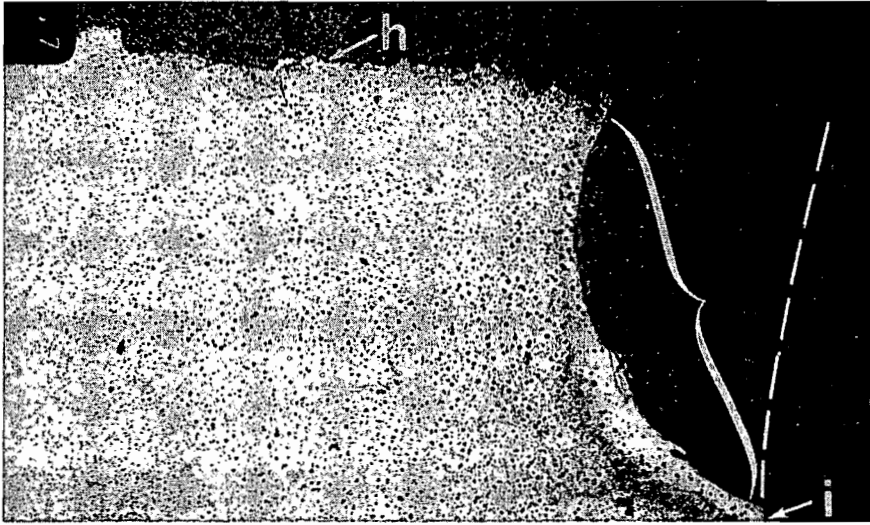

Figure A-4. Metallographic microsection through the origin area of fracture "d" along section E-E in Figure A-2. The dashed line outlines the approximate location of the original inside diameter surface. The fracture plane is marked by arrow "h". A small section of the undamaged inside diameter surface is denoted by arrow "i". The bracket outlines the cavity surface. X6

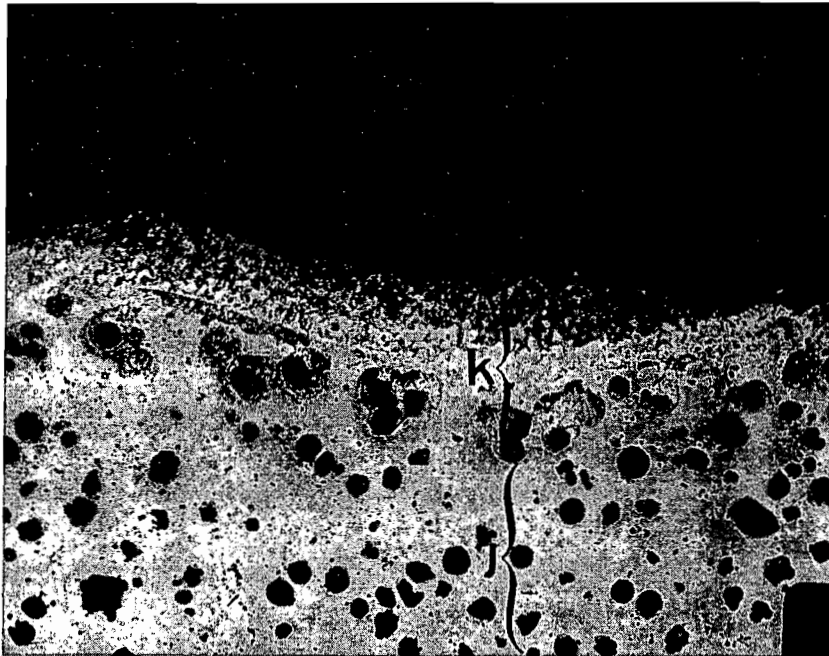

Figure A-5. Higher magnification photomicrograph of Figure A-4 at the cavity surface showing alteration of the original microstructure. Bracket "j" denotes original microstructure and bracket "k" denotes zone containing transformed microstructure. X50

APPENDIX B

SUMMARY OF ACCIDENT IN DUNSTABLE, MASS.

At 3:24 p.m. on December 6, 1973, a tractor semitrailer (dump), carrying 35.5 cubic yards of gravel (calculated to have weighed 86,265 pounds (dry) to 120,771 pounds (wet) ^{5/}, was traveling east on Massachusetts State Route 113 through the town of Dunstable, Massachusetts, at a speed of approximately 35 mph. The gross weight of the vehicle and load was calculated to have been from 115,980 to 149,980 pounds (depending if the gravel was dry or wet) or 42,980 to 76,980 pounds over the gross weight of 73,000 pounds permitted by Massachusetts statutes. Route 113 is an asphalt concrete paved road, one lane in each direction, and was in a rough "wash-board" condition in the area of the accident. As the truck was traversing the "wash-board" section of road, the left-side equalizer beam of the tractor tandem suspension failed at the equalizer beam center bushing hole. (See Figure B-1.) The failure of the left-side equalizer beam center hole permitted the left end of the tractor-tandem axle to pivot rearward, causing a steering action to the right, and loss of driver control. The truck veered to the right, off the road and struck a tree head-on, causing the trailer to jackknife and the truck to overturn.

Examination of the failed equalizer beam revealed that the equalizer beam section failed through a series of cavities, oriented in a groove-like alignment, on the inside diameter surface of the equalizer beam center hole. (See Figures B-1(a), (b), and (c).) Laboratory examination of the cavities disclosed that they had been produced by heating the parent material to a temperature to or above its melting point, probably with a cutting torch. The other two bushing holes in the failed equalizer beam, and the three bushing holes in the right side equalizer beam, also bore cavities similar in appearance to those found in the failed center bushing hole.

The tractor was a 1970 Brockway, Model N361TL, serial number 74200, New Hampshire registration 2604, and was registered for a gross weight of 73,000 pounds. The tractor was equipped with a Hendrickson RTE 380 tandem rear suspension, and 11:00/22 tires. The empty weight of the tractor was approximately 15,000 pounds. No overweight permits had been issued by the State of New Hampshire or the Commonwealth of Massachusetts for this vehicle.

The semitrailer was a 1971 Fruehauf, 35.5 cubic yard dump body trailer, serial number 888702, equipped with a tandem axle suspension

^{5/} Marks Standard Handbook for Mechanical Engineers, Seventh Edition, p. 6-8.

and 11:00/22 tires. The empty weight of the semitrailer was approximately 14,980 pounds.

Tacey Transportation Corporation maintenance records for the vehicle revealed that the tractor tandem suspension equalizer beams had been rebushed by Northeast Equipment Sales, Inc., Londonderry, New Hampshire, on or about November 16, 1973, 20 days before the accident.

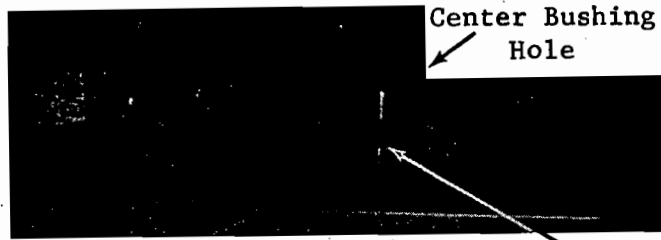

a. Left-side equalizer beam showing failure area.

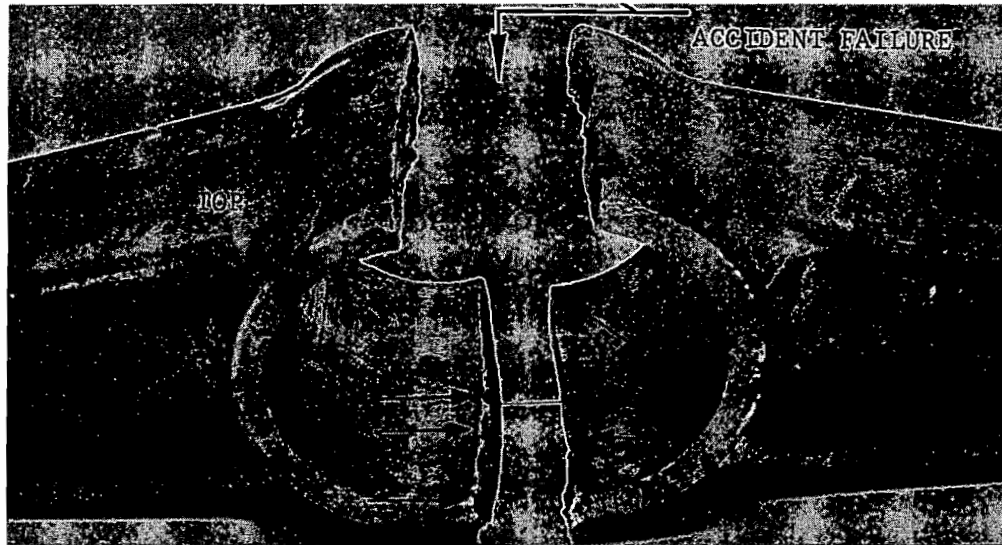

b. Failed center attachment point, arrows indicate cutting torch induced cavities.

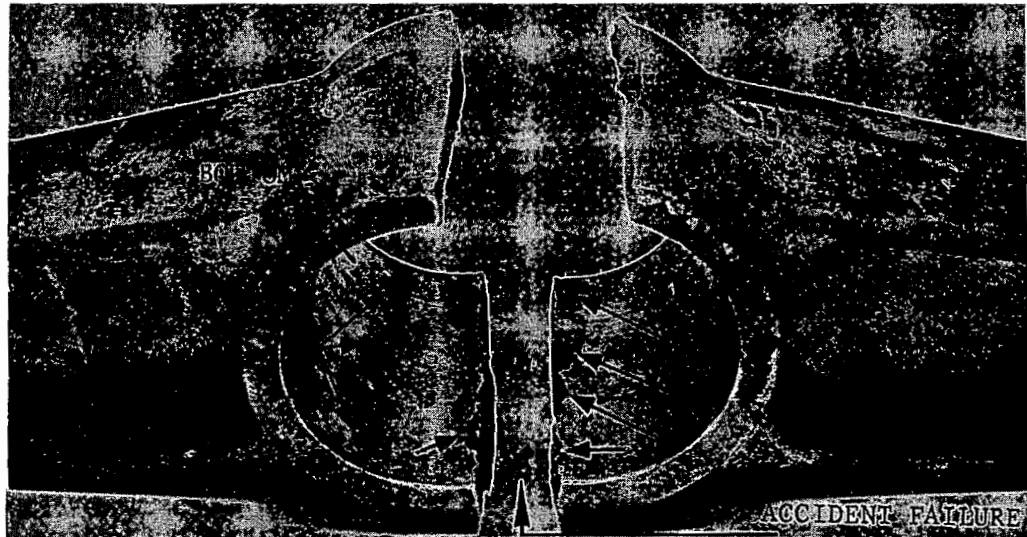

c. Failed center attachment point, arrows indicate cutting torch induced cavities.

Figure B-1. Failed equalizer beam, Dunstable, Massachusetts, accident.



Excerpts from the Motor Truck Service Manual.

SUPPLEMENT NO. 588

Replace old section with
this Revised section in
your CTS-2001 Manual.

SPRINGS

EQUALIZING BEAM SUSPENSION

RUBBER BUSHED TYPE

(HENDRICKSON)

INDEX

<u>Subject</u>	<u>Page</u>
TORQUE SPECIFICATIONS	2
DESCRIPTION	3
LUBRICATION	4
DISASSEMBLY	4
CLEANING AND INSPECTION	5
REPAIRS	5
REPLACING EQUALIZER BEAM BUSHINGS	
With Equalizer Beam Removed	5
With Equalizer Beam In Position	10
REPLACING TORQUE ROD BUSHINGS	7
ASSEMBLY	
Leaf Spring Type	7
Rubber Cushion Type	10
ADAPTER CHART	10



DISASSEMBLY

Except for different suspension (leaf springs or rubber cushions) and slight variations in size, all equalizing beam suspension systems are disassembled in the same manner. There are several approaches to servicing the suspension system, but when a major overhaul is required, the complete tandem unit can be removed from the truck chassis. Torque arms, equalizer beams, springs, and other parts, however, may be removed separately as required. When complete removal is performed, be careful when disconnecting torque rods, springs, or rubber cushions from the frame since axle assemblies are free to roll or pivot at the equalizer beam ends. Use jacks and other equipment and block vehicle securely to prevent harm to personnel and to avoid damage to the unit.

Suggested disassembly procedure is as follows:

1. Disconnect propeller shafts, inter-axle lock control linkage (or piping), and brake lines from axles.
2. Place both rear axles on floor stands and remove wheels and tires.
3. Using overhead crane, raise truck frame sufficiently to relieve weight from suspension system. Block frame securely.
4. Disconnect torque rods from axle housing by loosening locknuts and driving the shaft from the bushing and the axle housing bracket.
5. Disconnect equalizer beams from axle housings:

(Bolt Type Beam End Mounting, Fig. 5

- a. Remove equalizer beam end bolt.
- b. Drive bushing adapters out of bushing and axle housing brackets.

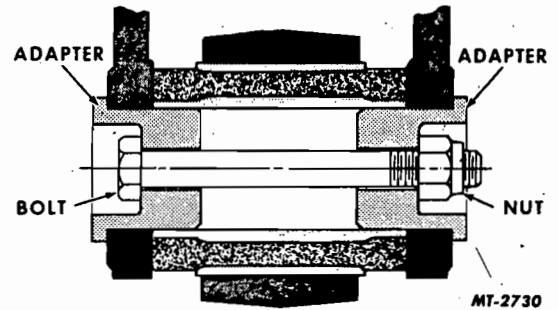

Fig. 5 Sectional View of Bolt Type Equalizer Beam End Mounting.

REPAIRS

Most repairs to the suspension system consist of replacing worn or damaged parts. Rebuilding and rebushing of leaf type springs are standard procedures as covered in "Springs," General Section, CTS-2119. The major item which will concern the serviceman is removal and replacement of the rubber bushings.

While the bushings have long life and replacement will be limited, they can be replaced if damaged or deteriorated. Special service tools for performing this task are available and though recommended are not absolutely necessary. If press equipment is available, standard steel tubing having diameters to match the bushing sleeves (metal bands surrounding rubber bushings) can be used as adapters for removing and installing the bushings (see Adapter Chart). Press pressures required to remove the bushing and sleeve assemblies will generally be between 35 and 50 tons.

Suggested procedures for replacing the various bushings are outlined below:

REPLACING EQUALIZER BEAM BUSHINGS
(Equalizer Beam Removed)



Removing Equalizer Beam End Bushing

1. Cut off rubber bushing flush with equalizer beam, as shown in Fig. 7. Rubber must be removed to permit adapter to contact bushing sleeve squarely.



Fig. 7 Preparing For Removal of Beam End Bushing.

2. Remove bushing set screw (Fig. 7).
3. Support beam in press. Using a piece of standard tubing (which will contact the bushing sleeve) as an adapter, press the bushing from the beam. See Fig. 8.

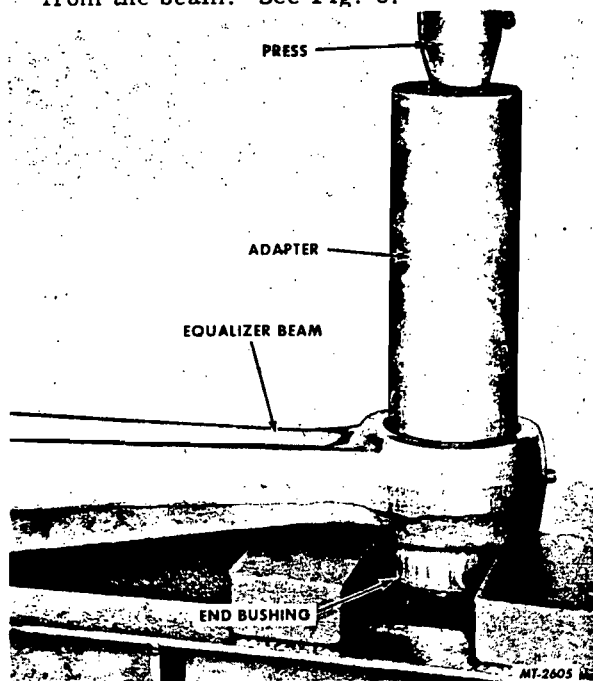

Fig. 8 Removing Equalizer Beam End Bushing.

Installing Equalizer Beam End Bushing

1. Apply a thin coat of white lead to outer diameter of bushing sleeve.
2. Install sheave puller over bushing and compress rubber until puller jaws will seat on the end of the bushing sleeve. Refer to Fig. 12.

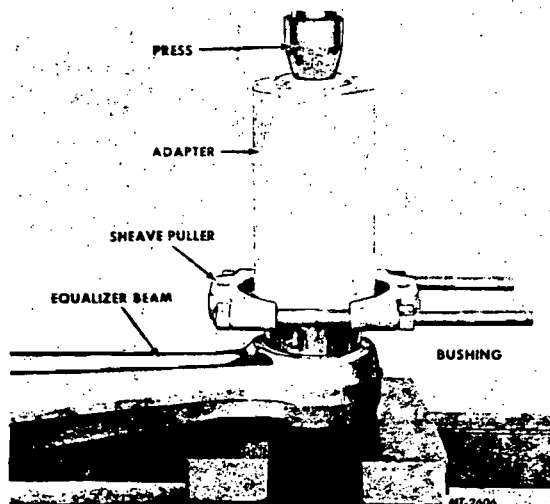

Fig. 9 Installing Equalizer Beam End Bushing.

4. Continue pressing until bushing is centered in beam.
5. Install bushing set screw and tighten to specified torque. (See Torque Chart).

Service Bulletin

AA-17730-70

APPENDIX D

HENDRICKSON TANDEM AXLE UNITS

RT-RTE SERIES

Excerpts from the Hendrickson Mfg. Co. Service Bulletin.

SERVICE
INSTRUCTIONS

<u>Subject:</u>	<u>Page</u>
1. DESCRIPTION	1
2. ALIGNMENT	1A
3. LUBRICATION	1A
4. TORQUE SPECIFICATIONS	2
5. DISASSEMBLY	3
6. CLEANING AND INSPECTION	6
7. REPAIRS	6
8. TOOLS	10
9. ASSEMBLY	12
10. WELDING PROCEDURE	14



HENDRICKSON MFG. CO. • 8001 WEST 47TH STREET
 LYONS (CHICAGO SUBURB), ILLINOIS
 REVISED: May 31, 1968



- H. Disconnect equalizer beams from axles. There are two types of beam end mountings. One is a 2½" diameter tube with a thin self-locking nut at each end. This tube can sometimes be removed by removing the nuts and using a spacer bushing between one nut and beam hanger, tightening the nut to pull the tube loose. If this method does not loosen the tube and a portable hack saw is available, the tube can be sawed through along the inside surface of the beam hanger. Another method would be to cut away the rubber extruding from each side of the beam and use a cutting torch to burn through the tube. If torch is used, caution must be used as some beams are forged aluminum or nodular iron which could be damaged by heat. (See Service Bulletin AA-17730-58 - For Pulling Adapter No. Y-859)

The other mounting is an adapter in each side of beam hanger with a draw bolt and lock nut. (See Drawing No. BA-11210-8)

To facilitate the removal of the adapters, a relief is provided on each side of the adapters to allow a chisel to be driven between the flange of adapter and beam hanger.

To remove the adapters, remove draw bolt and drive chisel first on one side, then on the other side of adapter. This action will wedge out the adapter. (Fig. 5)



Fig. 5 - Removing Beam End Adapter

After removing this first adapter, the opposite adapter can be driven out with impact hammer or heavy bar and hammer. (See Service Bulletin No. AA-17730-58 for end bushing adapter puller Y-865) The 2½" beam end tube and the adapter installation are interchangeable.



B. Replacing Equalizer Beam Bushings (With special tools - Owatonna Tool Company)

On beam end bushings, cut off rubber bushing flush with equalizer beam as shown in Fig. 6. Rubber must be removed to permit pulling adapter No. Y-855 to contact bushing outer sleeve squarely. A vertical horizontal press or Portopower and frame stand can be used for removal and installation. Support beam in press and press the bushing from the beam. Apply a thin coat of white lead to diameter of new bushing sleeve and using Tools Y-856, installing adapter clamp and Y-857 clamp plate, press new bushing into beam.

Important: In the event of spring pin breakage, a new pin and spring eye bushing must be installed. Bell mouthed condition of old bushing will cause early failure to pin.

The beam center sleeve is removed and installed in the same manner using Tool Y-852 for R-265, R-320 and R-340, and Tool Y-861 pulling adapter for R-365 and R-380. For installing, use Tool Y-853 installing adapter for R-265, R-320 and R-340 and Y-862 for R-365.



Fig. 6 - Cutting Off Rubber Bushing

C. Replacing Equalizer Beam Bushings (With shop made adapters - See Adapter Chart).



Cut rubber off on one side of end bushing (Fig. 6) flush with equalizer beam to permit shop made Adapter No. 1 to contact outside sleeve of bushing squarely. On new bushing to be installed, apply a thin coat of white lead to outer diameter sleeve. To install new end bushing, use a sheave puller to compress the extruded rubber of the new bushing, until puller jaws seat against the outside sleeve. Use No. 2 shop made adapter to fit over rubber and press against jaws of sheaves to install bushing into beam end. (See Fig. 7)



Fig. 7 - Pressing in End Bushing

D. Replacement of equalizing beam center bushing only.

This bushing can be removed and new bushings installed without removing the beam from the axles. This, of course, requires special tools such as the tools developed and sold by Owatonna Tool Co., Owatonna, Minnesota. (See Service Bulletin AA-17730-58) Preparation for use of the above mentioned or similar tools is as follows:

Remove the four caps below the underside of the center of the beams. With hoist or jacks, lift the rear of frame until all weight is removed from beams. With 2" hole saw for the 320 and 340 units and 2½" saw for 365 and 380 units, remove the center plug of the outside center tube from one bushing. This center plug can also be burned out or chipped out to remove. You can now remove the center cross tube by sliding out through opening.

Note: Caution must be used if any burning is done during this operation as some of these beams are aluminum and some are nodular iron, and these metals can easily become brittle with heat at quite low temperatures. Our forged steel beam is not as sensitive.

You can now pull out the center bushing of both beams and pull in the new bushings. Note that the length of the outer sleeve of bushing is longer than the length of the beam center hole. This difference in length should be visibly equally divided on each side of the beam. Install cross tube in both center bushings, then weld retaining caps in outer sleeve of center bushings.

NATIONAL TRANSPORTATION SAFETY BOARD
WASHINGTON, D.C.

APPENDIX E

ISSUED: March 15, 1974

Forwarded to:

Honorable Norbert T. Tiemann
Administrator
Federal Highway Administration
400 Seventh Street, S. W.
Washington, D. C. 20590

} SAFETY RECOMMENDATION(S)

H-74-1 through 3

During the investigation of two recent tractor-semitrailer accidents, the National Transportation Safety Board has discovered a serious safety problem in the maintenance operation for the replacement of tractor-tandem equalizer beam bushings. We believe that this problem should be brought to the attention of all commercial motor vehicle owners and maintenance personnel.

Both accidents were the direct result of the failure of the tractor-tandem suspension equalizer beam. In each accident, failure occurred after maintenance personnel used a cutting torch to cut the worn bushings from the equalizer beams while they were preparing to install new bushings. The cutting torch produced cavities in the parent material of the equalizer beam, which created stress raisers through which failure occurred.

The first accident involved a fully loaded gasoline tanker. As a result of the accident, the vehicle was destroyed by fire and the driver was burned to death. The second accident involved a loaded dump truck (tractor-semitrailer) which struck a tree, jackknifed, and overturned. The driver survived. In both accidents the tractor-semitrailer suddenly, and without warning, went out of control and overturned.

In both accidents, loss of control resulted from the failure of the left-side tandem suspension equalizer beam. Both failures occurred through one of the three bushing holes. The alignment of the tractor-tandem drive axles depends upon the structural integrity of the equalizer beams. (See Photograph 1.) In each accident, when the beam failed, the rear axle rotated rearward on the left side, which caused the tractor to steer uncontrollably toward the right.

Inspection of the equalizer beams from both of the tractors revealed cavities in the surface of the equalizer beam bushing holes. These cavities were oriented in a groove-like alignment, roughly parallel to the axis of

Honorable Norbert T. Tiemann

-2-

the holes. (See Photographs 2 and 3.) Metallurgical examination of the failed bushing holes confirmed that the cavities in the surface of the parent material resulted from use of a cutting torch. Since the other bushing holes had similar cavities, it is concluded that a cutting torch had been used to remove the old bushings. The cavities in the parent material created stress raisers which initiated the failure of the equalizer beam. After this inappropriate maintenance, the tractors were returned to use. At the time of each accident, cold weather and impact loadings, caused by minor road surface depressions, contributed to the failure of the equalizer beams.

According to the suspension manufacturer, about 500,000 vehicles are equipped with similar suspensions. Vehicle and suspension manufacturers publish maintenance manuals and issue bulletins which describe the proper procedure for removing and installing equalizer beam bushings. The manuals and bulletins specify the use of suitable presses and do not suggest the use of flame-type cutting torches.

It is important to emphasize that the circumstances associated with these two accidents must be considered only as examples of what can happen as a result of unorthodox maintenance and repair practices. The important lesson to be learned by these accidents is that the improper use of cutting torches created stress raisers which adversely affected the strength characteristics of the equalizer beam. Furthermore, it should also be noted that the indiscriminate application of heat to any heat-treated vehicle component, whether by cutting torch, by welding, or by heating in an oven, can reduce strength characteristics or can cause the component to fail, even without the occurrence of cavities.

The Safety Board has no reason to believe that the suspensions involved in the two accidents were inadequate components, until they were exposed to damage by cutting torches. However, because of the large number of these suspensions in use, and because of the strong probability that other vehicle maintenance personnel are cutting the old bushings out of the equalizer beams with cutting torches, the National Transportation Safety Board recommends that the Federal Highway Administration disseminate throughout the motor carrier industry the following recommendations:

1. All commercial-motor-vehicle maintenance and repair personnel:
 - (a) Not use cutting torches to remove equalizer beam bushings. (Recommendation H-74-1)
 - (b) Follow the instructions in the maintenance manuals and bulletins provided by the equipment manufacturers and use appropriate mechanical devices (presses, pullers, etc.) when removing and installing all bushings and bearings. (Recommendation H-74-2)

Honorable Norbert T. Tiemann

-3-

2. All commercial-motor-vehicle operators review their past maintenance records to determine if there has been any bushing or bearing removal and replacement, and thoroughly examine those components to ascertain if they have been heated, if cavities have been produced, or otherwise damaged by a cutting torch, and if so, replace any components which have been subjected to a cutting torch.
(Recommendation H-74-3)

REED, Chairman, McADAMS, THAYER, BURGESS, and HALEY, Members, concurred in the above recommendations.

By John H. Reed
Chairman

Enclosure:

cc: Secretary DOT
American Trucking Association
International Harvester Company
Hendrickson Manufacturing Company

CATASTROPHIC FAILURES DUE TO USE OF CUTTING TORCH
TO REMOVE BUSHINGS FROM EQUALIZER BEAMS

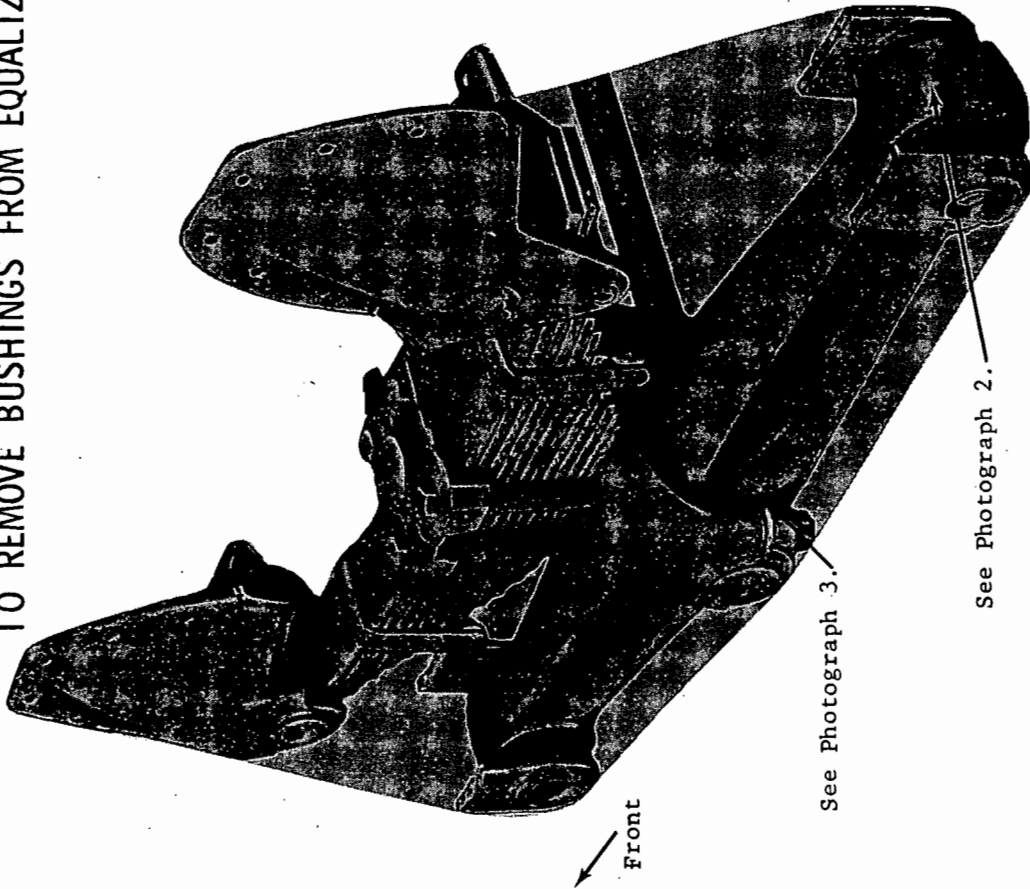

Photograph 1. Typical equalizer beam installation.

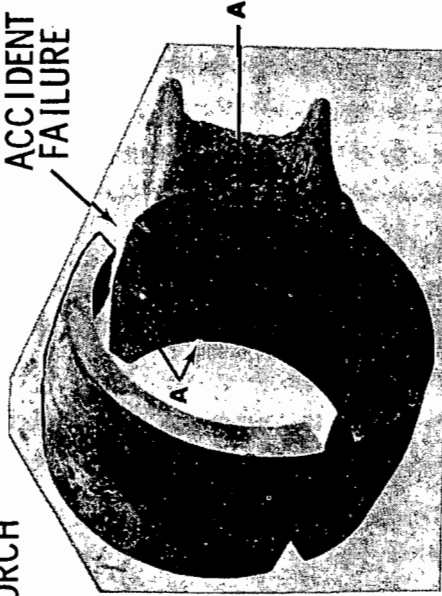

Photograph 2. Equalizer beam rear attachment point - (Braitree accident).

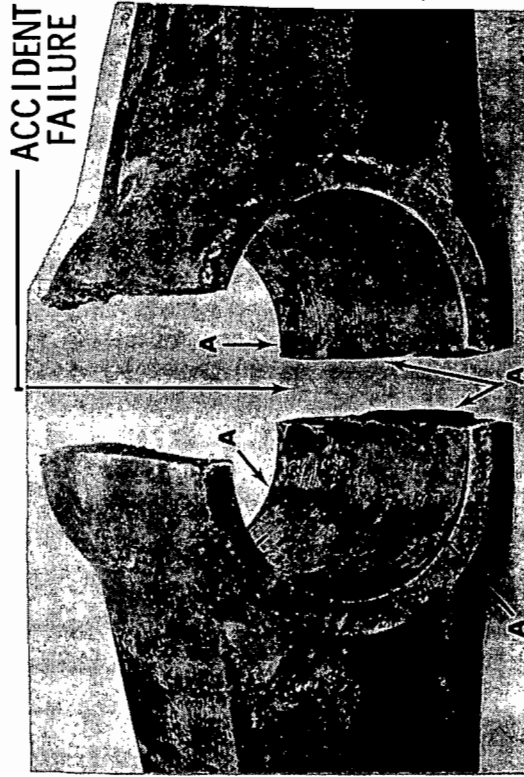

Photograph 3. Equalizer beam center attachment point - (Dunstable accident).

NOTE: Arrows on Photographs 2 and 3 indicate location of cutting torch induced cavities.