

FILE



U.S. CONSUMER PRODUCT SAFETY COMMISSION
WASHINGTON, D. C. 20207

#301

28 JUN 1982

OFFICE OF THE
GENERAL COUNSEL

Mr. M. Carl Johnson, Jr.
President
The Sensation Corporation
3601 North 16th Street
Omaha, Nebraska 68110

Dear Mr. Johnson:

This letter responds to your letter of May 12, 1982, in which you request a determination of whether Sensation models 14W5-3, 24S5-9, 24S5-11, 11L5-6, 11L5-8, and 14L2-2 3.0 HP Cemetery Model are consumer products and thus subject to the Safety Standard for Walk-Behind Power Lawn Mowers, 16 C.F.R. Part 1205. You later requested that model 11L2 also be included in our determination; The data-you have submitted indicate that these mowers are not consumer products, because consumers do not appear to "customarily" use them.

The term "consumer product" is defined in 15 U.S.C. § 2052(a)(1), and the term does not include "any article which is not customarily produced or distributed for sale to, or use or consumption by, or enjoyment of, a consumer." The legislative history of this section indicates that products that are not used more than occasionally by consumers are not consumer products. H.R. Rep. No. 92-1153, 92d. Cong., 2d. Sess. 27 (1972).

In general, we have established no specific criteria to determine whether consumers use a product more than occasionally. Instead, we review all available information relevant to a particular determination.

In the case of these mowers, you have submitted the following data which indicate that the current use and distribution patterns of those mowers are such that these mowers do not fall within the definition of the term "consumer product":

ADVISORY OPINION /

1. The combination of the price, weight, horsepower, and (especially in the case of the cemetery model) purpose of these models support the likelihood of a low level of consumer usage.

2. All of your advertising is carried out in trade publications.

3. Your distribution system relies entirely on **independent** distributors who sell the mowers directly to large-scale commercial buyers or to commercial dealers. None of these models are marketed through mass merchandisers or discount stores.

4. The survey of all your distributors showed that not more than five percent of these mowers are sold to consumers.

5. These models are relatively low production items.

Our technical **staff** has reviewed the information which you submitted, and no information that would contradict any of the factors mentioned above has been brought to our attention. Therefore, based on all of these factors, we reached our conclusion that, at the present **time**, the use and distribution patterns of these mowers are such that they are not consumer products.

We wish to stress, however, that this determination is based primarily on the information supplied by you, and, if data showing different use or distribution patterns become available, our determination could change. For example, if consumer use patterns were to change in the future so that these mowers would be used more than occasionally by consumers, they could then be considered subject to the standard.

Sincerely,



Martin Howard Katz
General Counsel

FILE - Power lawn Mowers

UNITED STATES GOVERNMENT

U.S. CONSUMER PRODUCT
SAFETY COMMISSION

Memorandum

TO : Carl Blechschmidt, OPM
 Through: Harry Cohen, OPM
 Martin Howard Katz, General Counsel
 Stephen Lemberg, Acting Deputy General Counsel

DATE: 21 May 1962

FROM : Harleigh Ewell, CGC HE

SUBJECT: Request for Jurisdictional Determination Over Certain Power Lawn
 Mowers Manufactured by the Sensation Corporatim

Attached is a copy of a request from the Sensation Corporation for a determination of whether certain of their mowers are consumer products and thus subject to the Safety Standard for Walk-Behind Power Lawn Mowers. Please give us any comments the staff may have that would bear on the extent to which consumers may buy or use these mowers.



THE **SENSATION** CORP.

3601 NORTH 16TH STREET

OMAHA, NEBRASKA 66110

TELEPHONE (402) US-3664

May 12, 1982

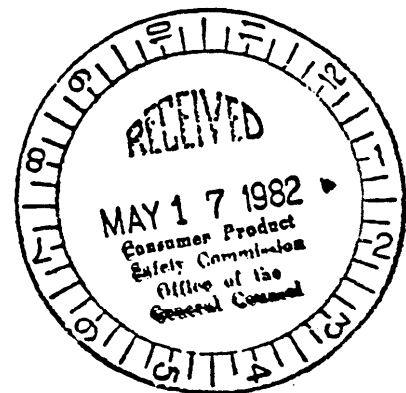

Mr. Martin Katz, Esq.
General Counsel
Office of the Secretary
Consumer Product Safety Commission
Washington, DC 20007

RE: REQUEST FOR A DETERMINATION THAT SENSATION 5.0 HP HEAVY-DUTY COMMERCIAL MOWER MODELS 14W5-3, 24S5-9, 24S5-11, 11L5-6 AND 11L5-8 AND SENSATION MODEL 14L2-2 3.0 HP CEMETERY MODEL ARE NOT CONSUMER PRODUCTS AND THUS NOT SUBJECT TO THE SAFETY STANDARDS FOR WALK BEHXND MOWERS.

Dear Mr. Katz:

The Sensation Corporation is a 4¹/₂ year old manufacturer of heavy-duty **commercial** mowers. Some of our mowers may be used by a few consumers, but the majdrity of our mowers are used primarily (or virtually 100%) by the **commercial** or professional user.

Perhaps 10% - 30% of our 19" and 21" 3.5 HP and 4.0 HP mowers may end up being used by consumers. Therefore, we will not request that these units be exempted from the safety standards.

As a result, w~~e~~ are only requesting that our 5.0 HP walk behind mowers, i.e. the 24" and 21" units and our 3.0 HP 14" model be declared exempt. We know that the Commission has granted an exemption to Toro and Snapper for their 5.0 HP units and since our comparable models are considered to be even more "Mack Truck" oriented, we hope that the Commission will make a favorable ruling on our above request as soon as possible.

We, of course, as listed below, can support the fact that these mowers are used primarily by **commercial** and professional users.

The following information is enclosed in order to support our request:

1. Five copies of a specification sheet for each of the above referenced models.

MANUFACTURERS OF QUALITY OUTDOOR EQUIPMENT

4

Page two
TO: Martin Katz, Esq.
May 12, 1982

2. We conducted research with all of our customers to determine what percentage of the users of these mowers were consumer and what percentage were used by commercial or professional users. All of our returned questionnaires are on file in our office. The results are as follows:

<u>Model</u>	<u>Description</u>	<u>% Consumer</u>	<u>% Commercial</u>
14W5-3	24" 5.0 HP Push, Hi Wheeler Weed Cutter	5	45
24S5-9	24" 5.0 HP Self-Propelled Hi Wheeler Weed Cutter	4	96
24S5-11	24" 5.0 HP Self-Propelled Hi Wheeler Weed Cutter	0	100
11L5-6	21" 5.0 HP Push Mower	3	97
11L5-8	21" 5.0 HP Push Mower	2	98
14L2-2	14" 3.0 HP Cemetery Trimmer Mower	1	99

As you can see, commercial users account for a minimum of 95% of the users of these mowers, i.e. only 5% or less of the users are consumers.

3. Five sets of our suggested factory list prices are enclosed and we have underlined in red ink the prices of the above models that we are requesting be exempted from the safety standards due to their being used as commercial mowers.

We hope that after you examine the above data that the Commission will grant us the same exemption already given to our much larger competitors, Toro and Snapper . . . particularly since we are essentially a producer of only heavy-duty mowers for the commercial user.

Respectfully,

THE SENSATION CORPORATION

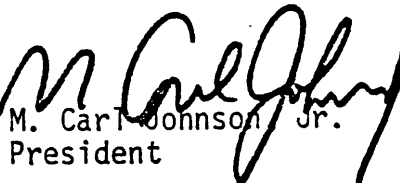
M. Carl Johnson, Jr.
President

Enclosures

MCJ: pf

SENSATION

PRICES EFFECTIVE November 6, 1981

F.O.B. OMAHA, NE.

MODEL	DESCRIPTION	SUGGESTED LIST	W/HDL.
<u>HEAVY DUTY WALK-BEHIND (PUSH) MOWERS - CHUTE DEFLECTOR INCLUDED</u>			
11L2-0	21" 4.3 HP Kawasaki 2-cycle	\$534.95	96
11L3-2	21" 3.5 HP B&S Engine w/valve rotator	369.95	84
11L4-3	21" 4.0 HP B&S Engine w/valve rotator	379.95	85
11L5-6	21" 5.0 HP B&S Engine	424.95	95
11L5-8	21" 5.0 HP B&S I/C Engine 2/cast iron cylinder sleeve	469.95	95
14L2-1	14" 3.0 HP B&S Engine - Cemetery Model	259.95	47
19L4-1	19' 4.0 B&S Engine w/valve rotator	364.95	81
<u>STANDARD WALK-BEHIND (PUSH) MOWERS - CHUTE DEFLECTOR INCLUDED</u>			
11G3-4	21" 3.5 HP B&S Engine w/valve rotator	369.95	81
11G4-4	21" 4.0 HP B&S Engine w/valve rotator	379.95	82
11G5-8	21" 5.0 HP B&S Engine	424.95	91
19C3-3	19" 3.5 HP B&S Engine w/valve rotator	334.95	76
11J3-3	21" 3.5 HP B&S Engine w/valve rotator	349.95	77
<u>ACCESSORIES FOR SENSATION PUSH MOWERS</u>			
90A9-4	Grass Catcher. Fits all G, 19L and 11L series mowers. Poly, front door opening.	42.95	12
90A9-6 OPEI	Grass Catcher. Fits all G, 19L and 11L series mowers. Front door opening, poly.	49.95	12
90B9-6 OPEI	Grass Catcher. Fits all G and 19L series mowers. Side positioning. Rear door, screen.	54.65	12
90J9-4 OPEI	Grass Catcher w/poly reinforced side panel. Rear positioning. Fits all 11L series.	54.95	12
<u>THIRTY (30) DAYS LEAD TIME IS REQUIRED ON EACH ITEM</u>			
11G5-10	21' 5.0 HP B&S L/C Engine w/cast iron cylinder sleeve	474.95	93
63P5-0	Leaf Blower. 5.0 HP B&S 10 x 3.50/4.00 pneumatic	449.95	100
73P5-0	Vacuum. 5.0 HP B&S 10 x 3.50/4.00 pneumatic, 13" impeller	854.95	165

ALL PRICES SUBJECT TO CHANGE WITHOUT NOTIFICATION

THE SENSATION CORPORATION
 3601 No. 16th St., Omaha, Nebraska 68110 U.S.A. (402) 345-3884

4



PRICES EFFECTIVE November 6, 1981

F.O.B. OMAHA, NE.

MODEL	DESCRIPTION	SUGGESTED LIST	W/HDL
<u>ACCESSORIES FOR SENSATION PUSH MOWERS</u>			
3XAC-2	Air Cleaner Kit w/snorkel tube. Fits all' mowers w/B&S Engine.	\$ 37.95	2
3XCD	Chute Deflector Kits. (Specify 14", 19", or 21")	9 . 7 5	2-1/3
3XGT-2	Auxiliary 5 Qt. Gas Tank Kit. Fits 19" and 21" push mowers.	39.95	2
3XHA- 3	Height Adjuster Kit. Fits most Sensation 19" and 21" mowers.	35.95	2
3xsc	Slip Clutch Kit. Fits 19" and 21" mowers. (Specify model to be used on.)	8.95	1
3XWP-0	Wear Plate Kit. Fits 19" and 21" mowers.	5.85	1
<u>HEAVY DUTY SELF-PROPELLED MOWER AND ACCESSORIES</u>			
21S4-1	21" 4.0 HP B&S Engine w/valve rotator, height adjuster, safety rear door, adjustable ground speed, w/ht. adj.	524.95	99
90S9-1	OPEI Grass Catcher w/poly mesh side and top panel. Rear positioning. Fits Model 21S4.	59.95	12
3XGT-5	Auxiliary 5 Qt. Gas Tank Kit. Fits Model 21S4..	39.95	2
<u>COMMERCIAL DECAL:</u> If you require the "Commercial" label not to be affixed to models in your 1982 order, you must request the removal of the label when you place your order.			
<u>HEAVY DUTY HI WHEEL WEED & GRASS MOWERS AND ACCESSORIES</u>			
<u>24S5-9</u>	<u>24" 5.0 HP B&S Engine!, self-propelled, 3-speed forward 6 reverse transmission - differential. Spoke wheels & pneumatic tires.</u>	899.95	193
<u>24S5-11</u>	<u>24" 5.0 HP B&S I/C Engine w/cast iron cylinder sleeve. Self-propelled, 3-speed forward and reverse transmission - differential. Dual controls. Spoke wheels & pneumatic tires.</u>	949.95	195
<u>14W5-3</u>	<u>24" 5.0 HP B&S Engine, push mower.</u>	589.95	155
3XGT-4	Auxiliary 5 Qt. Gas Tank Kit. Fits push and self-propelled hi wheel weed mowers.	39.95	3
<u>POWER RAKE AND AERATOR/SLICER AND ACCESSORIES</u>			
10R5-0	5.0 HP Power Rake	529.95	138
10A5-0	5.0 HP Power Aerator/Slicer	534.95	142
3XRS-0	Power Rake Assembly	104.95	23
3XSA-0	Power Slicer/Aerator Assembly	119.95	27

ALL PRICES SUBJECT TO CHANGE WITHOUT NOTIFICATION

THE SENSATION CORPORATION
3601 No. 16th St. Omaha, Nebraska 68110 U.S.A. (402) 345-3884

Sensation

Made in U.S.A.

24" COMMERCIAL HI WHEELER WEED & GRASS MOWER

24S5-9

STD. SELF PROPELLED



THE SENSATION CORPORATION

3601 North 16th Street, Omaha, Nebraska 68110 U.S.A. (402) 345-3884

24S5-9 Hi Wheeler — 4 Cycle

SPECIFICATIONS

Engine Specifications

Type	Briggs & Stratton 5 H.P. 4 cycle
Bore	2.56 in.
Stroke	2.43 in.
Displacement	12.57 cu. in. (206 cc)
Type of Governor	Mechanical
Type of Main Bearings	(2) Aluminum alloy
Type of Con. Rod Bearing	Aluminum alloy
Crankshaft	Case hardened steel
Starter	Recoil starter
Fuel Tank Capacity	2 quarts
Cylinder	Aluminum alloy
Valve Rotator	None
Warranty	1 year

Mower Specifications

Discharge	Rear — Semi mulcher
Blade	Formed Airlift
Blade Material	Hardened mag-carbon steel
Blade Belt Material	Specially formulated raw edge fiberglass cords
Blade Clutch	Tight/Slack V-Belt operated by lever on handle
Blade Stoppage	Brake band on blade spindle
Blade Attachment	Steel saddle on spindle
Safety Interlock	Blade disengaged switch
Width of Cut	24" Nominal
Height of Cut	1½" to 3" — 4 position adjustment
Handle	¾ OD steel tubing x 16 ga. one piece with 16 ga. brace to frame
Throttle Control	Remote control on handle
Cutting Deck	13 ga. steel with protective shield between rear wheels
Engine Base	11 ga. steel
Frame	14 ga. square steel tubing
Wheel Construction	Front — 20 ga. steel discs Rear — 18 ga. steel rim with (16) ¼" spokes
Front Wheel Bearings	Greaseable shielded ball bearings, replaceable (2 each wheel)
Tires	Front — 6 x 1.50 semi pneumatic Rear — 20 x 2.125 heavy duty pneumatic tire and tube with rim liner
Tire Load Rating	Front — 50 lbs, Rear — 175 lbs @ 30 psi
Crankshaft Protection	Belt drive
Weight	165 lbs.
Certification	Complies with ANSI B71.1-1980 and C.P.S.C.
Warranty	1 year Homeowner 1 year Commercial effective 2-1 -81

Drive Train Specifications

Type of Drive	Rear wheel
Ground Speed	1.3, 2.0 and 2.9 MPH forward 1.5 MPH reverse
Ground Speed Adjustment	3 speeds forward, 1 reverse
Live Axle	¾" solid steel w/differential
Rear Wheel Bearings	Self aligning ball bearings
Differential	Full differential
Clutch Control	Tight/Slack V-Belt operated by "Dead-Man" lever on handle
Drive Train Components	Belt from engine to transmission, chain from transmission to differential
Traction Ratio	9.6:1 to 22.4:1
Belt & Chain Guards	Heavy duty plastic
Safety Interlock	Transmission neutral switch

Accessories Available

5 Qt. Gas Tank	Model 3XGT
Riding Sulky	Model 3XSU
Remote Air Cleaner	Model 3XAC

The Sensation Corporation reserves the right to incorporate changes in design without notice or obligation to make changes on units previously sold. Continual progress is a tradition with Sensation.

Sensation[®]

**21" COMMERCIAL
HEAVY DUTY
WALK BEHIND
MOWER**

1115-6

SHP REAR HANDLE

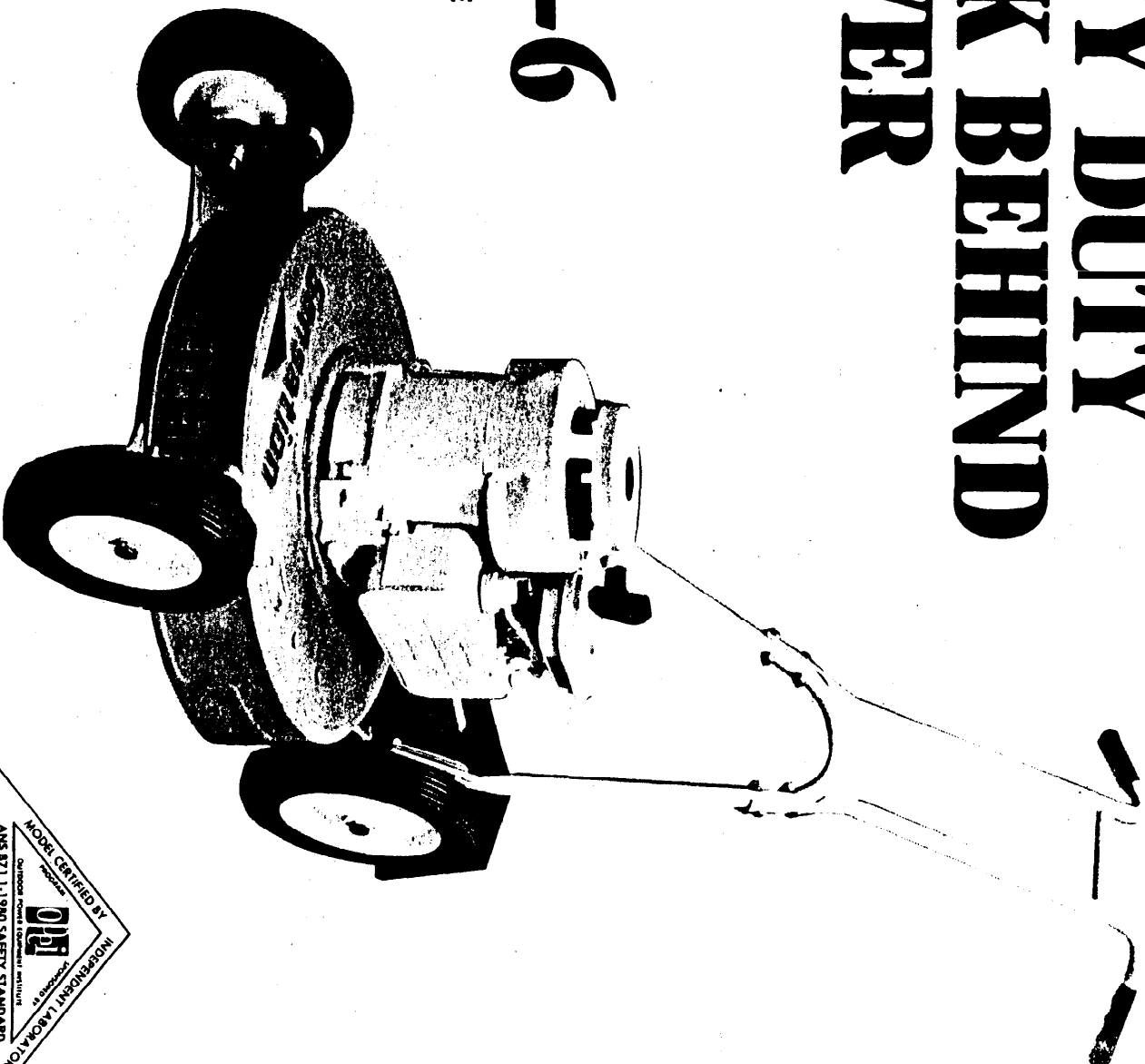

THE SENSATION CORPORATION
3601 North 16th Street, Omaha, Nebraska 68110 U.S.A. (402) 345-3884

Engine Specifications

Type	* *	Briggs & Stratton 5.0 HP 4 cycle
Bore	* *	2.56 in.
Stroke		2.43 in.
Displacement		12.57 cu. in. (206 cc)
Type of Governor		Mechanical
Type of Main Bearings		(2) Aluminum alloy
Type of Con. Rod Bearing		Aluminum alloy
Crankshaft		Case hardened steel
Starter		Recoil starter
Fuel Tank Capacity		2 quarts
Cylinder		Aluminum alloy
Valve Rotator		None
Warranty		1 year

Mower Specifications

Blade	*	Welded tip — Non clog suction lift with balanced flywheel
Blade Material		Hardened mag-carbon steel with one. fastener to engine crankshaft
Blade Attachment		Zinc blade adaptor with safety shear pins
Width of cut		21" Nominal
Height of Cut1" to 3" (bolt on wheel) in ¼" increments, 9 position adjustment
Handle		¾" O.D. steel tubing X 16 ga. upper, 14 ga. lower & separate halves with two position handle height adjustment, rigid mount
Throttle Control		Manual on engine
Cutting Deck		High-strength rust proof mag-aluminum alloy casting, protective shield between rear wheels, steel chute deflector
Wheel Disc Construction18 ga. steel with grease zirk fitting
Wheel Bearings		Greaseable heavy duty extended inner race shielded ball bearings, replaceable (2 ea. wheel)
Tire Size		Front — 8 X 1.75 W semi pneumatic Rear — 10 X 1.75 W semi pneumatic Load rating — 150 lbs. Replaceable tires
Crankshaft Support		Die cast aluminum anti-bend crankshaft protector
Weight		80 lbs.
Certification		Complies with ANSI B71.1-1980 and CPSC
Warranty5 year Homeowner 90 day Commercial

Accessories Available

Grass Catcher	Model 90J9
Height Adjusters	"Quick Adjust" Model 3XHA
-Deck Side Wear Plate	Model 3XWP
Blade Slip Clutch	Model 3XSC
5 qt Gas Tank	Model 3XGT
Remote Air Cleaner	Model 3XAC
Gyro Safety Blade	Model 3XGB
Formed Air Lift Blade	P/N 123-106
Grease Gun	Model 3XG G

Sensation

Made in U.S.A.*

14" COMMERCIAL HEAVY DUTY WALK BEHIND MOWER

14L2-2

3HP TRIMMER

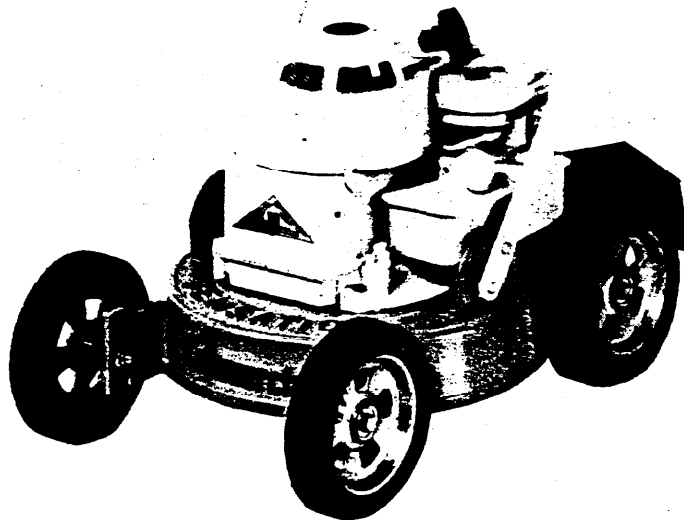

12

THE SENSATION CORPORATION
3601 North 16th Street, Omaha, Nebraska 68110 U.S.A. (402) 345-3884

14L2-2 Trimmer 14" — 4-cycle

SPECIFICATIONS

Engine Specifications

Type	• rigs & Stratton 3.0 HP 4 cycle
Bore	2.56 in.
Stroke	1.75 in.
Displacement	9.02 cu. in. (148cc)
Type of Governor	Pneumatic
Type of Main Bearings	(2) Aluminum alloy
Type of Con. Rod Bearing	Aluminum alloy
Crankshaft	Case hardened steel
Starter	Recoil starter
Fuel Tank Capacity	1 quart
Cylinder	Aluminum alloy
Valve Rotator	None
Warranty	1 year

Mower Specifications

Blade	Formed Airlift
Blade Material	Hardened mag-carbon steel with one fastener to engine crankshaft
Blade Attachment	Zinc blade adaptor with safety shear pins
Width of cut	14" Nominal
Height of Cut	1-1/4" to 3-1/4" (bolt on wheel) in 1/2" increments, 4 position adjustment
Handle	7/8" 0.0. steel tubing X 16 ga. upper, 14 ga. lower, in separate halves, rigid mount
Throttle Control	Dial-trol on engine
Cutting Deck	High-strength rust proof mag-aluminum alloy casting, protective shield between rear wheels, steel chute deflector
Wheel Construction	Aluminum alloy-mag style
Wheel Bearings	Greaseable bearings, replaceable (2 ea. wheel)
Tire Size	7 X 1.50 semi pneumatic
Weight	43 lbs.
Certification	Complies with ANSI B71.1-1980 and CPSC
Warranty	5 year Homeowner 1 year Commercial effective 2-1-81

Accessories Available

Remote Air Cleaner	Model 3XAC
--------------------	------------

Sensation

Made in U.S.A.

21" COMMERCIAL HEAVY DUTY WALK-BEHIND MOWER

11L5-8

5HP I/C ENGINE

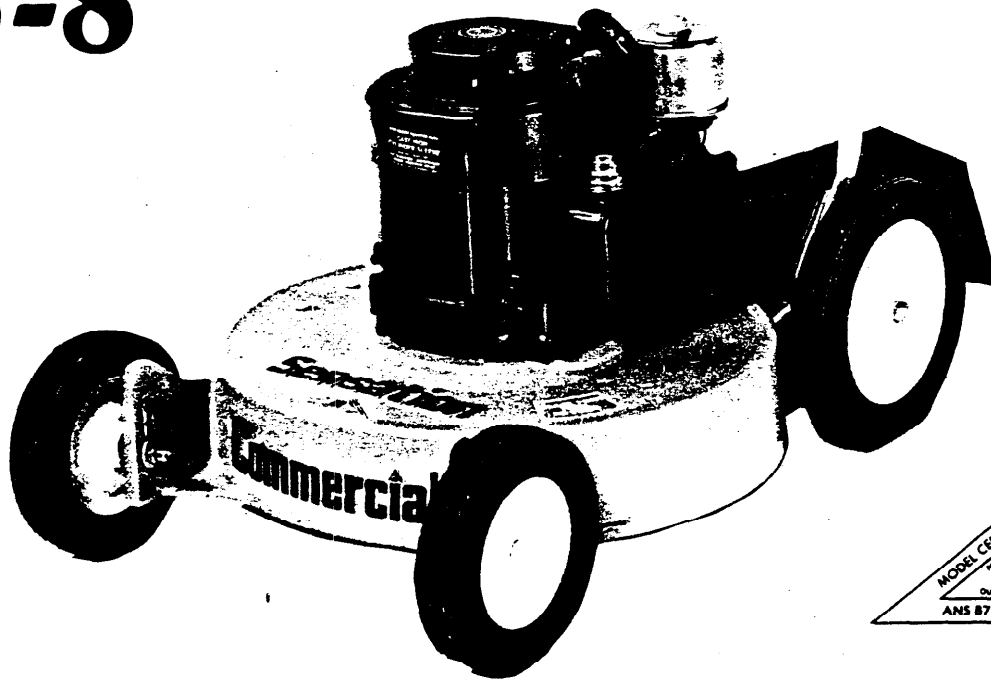

14

THE SENSATION CORPORATION
3601 North 16th Street, Omaha, Nebraska 68110 U.S.A. (402) 345-3884

11L5-8 Commercial 21" — 4-cycle I/C

SPECIFICATIONS

Engine Specifications

Type	Briggs & Stratton 5.0 HP I/C 4 cycle
Bore	2.56 in.
Stroke	2.43 in.
Displacement	12.57 cu. in. (206 cc)
Type of Governor	Mechanical
Type of Main Bearings	(1) Aluminum alloy (1) Ball bearing
Type of Con. Rod Bearing	Aluminum alloy
Crankshaft	Case hardened steel
Starter	Recoil starter
Fuel Tank Capacity	2 quarts
Cylinder Liner	Cast iron sleeve
Air Cleaner	Dual element
Valves & Valve Seats	Stellite
Valve Rotator	Exhaust Valve
Warranty	1 year

Mower Specifications

Blade	Welded tip — Non clog suction lift with balanced flywheel
Blade Material	Hardened mag-carbon steel with one fastener to engine crankshaft
Blade Attachment	Zinc blade adaptor with safety shear pins
Width of Cut	21" Nominal
Height of Cut	1" to 3" (bolt on wheel) in 1/4" increments, 9 position adjustment
Handle	7/8" 0.0. steel tubing X 16 ga. upper, 14 ga. lower, in separate halves with two-position handle height adjustment, rigid mount
Throttle Control	Manual on engine
Cutting Deck	High-strength rust proof mag-aluminum alloy casting, protective shield between rear wheels, steel chute deflector
Wheet Disc Construction	18 g a. steel with grease zirk fitting
Wheel Bearings	Greaseable heavy duty extended inner race shielded ball bearings, replaceable (2 ea. wheel)
Tire Size	Front — 8 X 1.75 W semi pneumatic Rear — 10 X 1.75 W semi pneumatic Load rating — 150 lbs. Replaceable tires
Crankshaft Support	Die cast aluminum anti-bend crankshaft protector
Weight	80 lbs.
Certification	Complies with ANSI B71.1-1980 and CPSC
Warranty	5 year Homeowner 1 year Commercial effective 2-1-81

Accessories

Available

Grass Catcher	Model 90J9
Height Adjusters	"Quick Adjust" Model 3XHA
Deck Side Wear Plate	Model 3XWP
Blade Slip Clutch	Model 3XSC
5 qt Gas Tank	Model 3XGT
Remote Air Cleaner	Model 3XAC
Formed Air Lift Blade	P/N 123-106

15

Sensation

24" COMMERCIAL HI WHEELER 'WEED & GRASS MOWER

14W5-3

PUSH MODEL

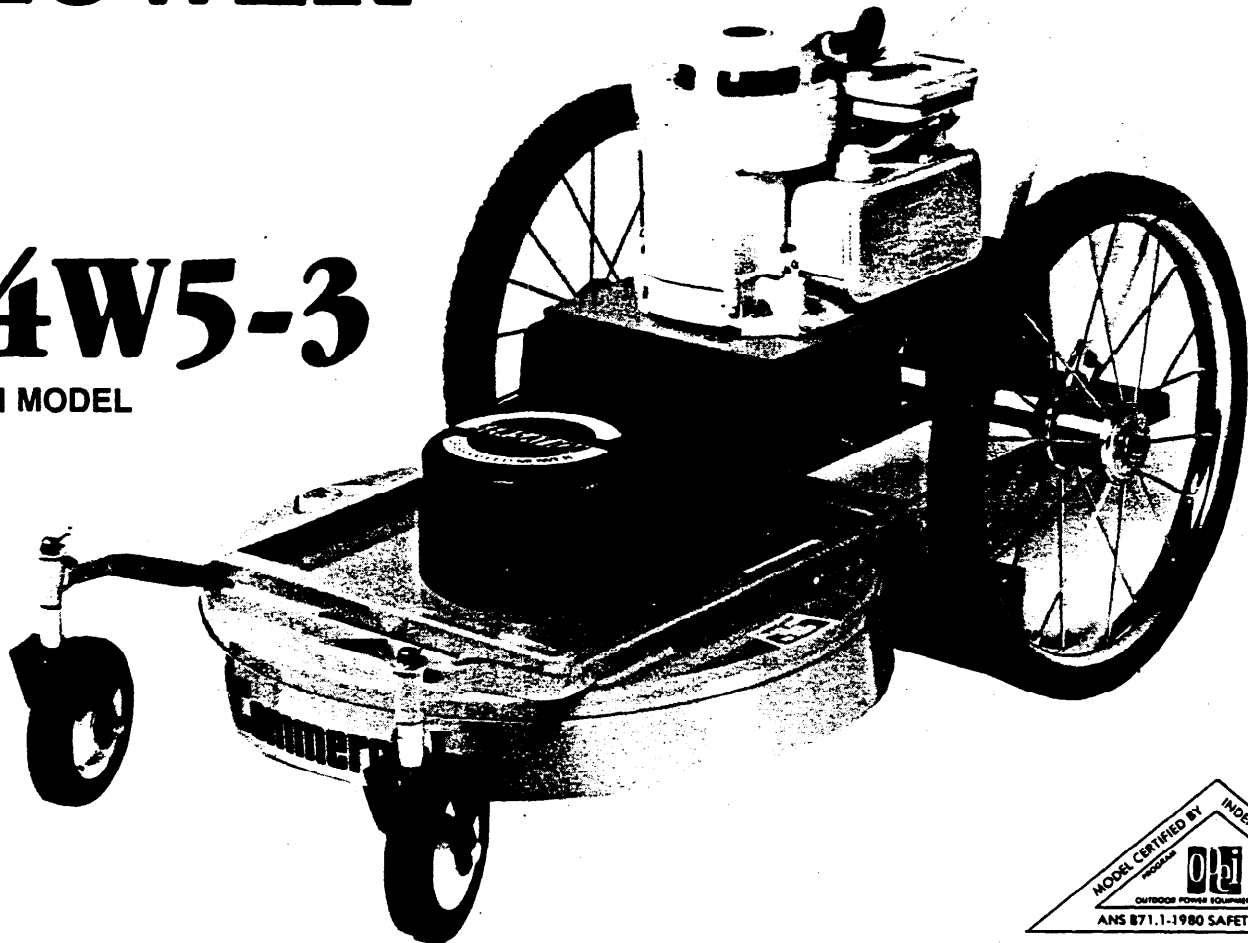

16

THE SENSATION CORPORATION
3601 North 16th Street, Omaha, Nebraska 68110 U.S.A. (402) 345-3884

14W5-3 Hi Wheeler — 4 Cycle

SPECIFICATIONS

Engine Specifications

Type	Briggs & Stratton 5 H.P. 4 cycle
Bore	2.56 in.
Stroke	2.43 in.
Displacement	12.57 cu. in. (206 cc)
Type of Governor	Mechanical
Type of Main Bearings	(2) Aluminum alloy
Type of Con. Rod Bearing	Aluminum alloy
Crankshaft	Case hardened steel
Starter	Recoil starter
Fuel Tank Capacity	2 quarts
Cylinder	Aluminum alloy
Valve Rotator	None
Warranty	1 year

Mower Specifications

Discharge	Rear — Semi mulcher
Blade	Formed Airlift
Blade Material	Hardened mag-carbon steel
Blade Belt Material	Specially formulated raw edge fiberglass cords
Blade Clutch	Centrifugal clutch on engine crankshaft for easy starting
Blade Attachment	Steel saddle on spindle
Width of Cut	24" Nominal
Height of Cut	1½" to 3" — 4 position adjustment
Handle	¾ OD steel tubing x 16 ga. one piece with 16 ga. brace to frame
Throttle Control	Manual on engine
Cutting Deck	13 ga. steel with protective shield between rear wheels
Engine Base	11 ga. steel
Frame	14 ga. square steel tubing
Wheel Construction	Front — 20 ga. steel disc Rear — 18 ga. steel rim with (20) 3/16" spokes
Front Wheel Bearings	Greaseable shielded ball bearings, replaceable (2 each wheel)
Tires	Front — 6 x 1.50 semi pneumatic Rear — 20 x 1.75 semi pneumatic
Tire Load Rating	Front — 50 lbs, Rear — 115lbs
Crankshaft Protection	Belt drive
Weight	131 lbs.
Certification	Complies with ANSI 871.1-I 980 and C.P.S.C.
Warranty	1 year Homeowner 90 day Commercial

Accessories Available

5 Qt. Gas Tank	Model 3XGT
Remote Air Cleaner	Model 3XAC
Grease Gun	Model 3XGG

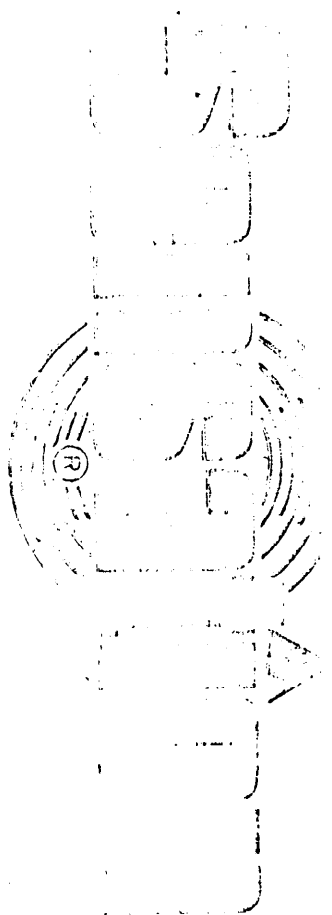

ALL COMMERCIAL
MILL WHEELS
AND GRASS
MOWERS

Engine Specifications

Type	Briggs & Stratton 5 H P 4 Cycle 1/C
Bore	2.56 III
Stroke	2.43 in
Displacement	1% 57 cuin (206 cc.)
Type of Governor	Mechanical
Type of Main Bearings	(1) Ball bearing (1) Aluminum alloy
Type of Con. Rod Bearing	Aluminum alloy
Crankshaft	Case hardened steel
Starter	Recoil starter
Fuel Tank Capacity	2 quarts
Cylinder	Aluminum alloy
Valve Rotator	Exhaust valve
Warranty	1 year

Mower Specifications

Discharge	Rear — Semi-mulcher
Blade	Formed Airlift
Blade Material	Hardened mng-carbon steel
Blade Belt Material	Specially formulated raw edge fiberglass cords
Blade Clutch	Tight Slack V-Belt operated by lever on handle
Blade Stoppage	Brake band on blade spindle
Blade Attachment	Steel saddle on spindle
Safety Interlock	Blade disengaged switch
Width of Cut	24" Nominal
Height of Cut	1 1/2" to 3" — 4 position adjustment
Handle	7/8" OD steel tubing x 16 ga. one piece with 16 ga. brace to frame
Throttle Control	Remote control on handle
Cutting Deck	13 ga steel with protective shield between rear wheels
Engine Base	11 ga steel
Frame	14 ga square steel tubing
Wheel Construction	Front -- 20 ga. steel discs Rear — 18 ga. steel rim with (16) 1.4" spokes
Front Wheel Bearings	Greaseable shielded ball bearings, replaceable (2 each wheel)
Tires	Front — 6 x 1.50 semi pneumatic Rear - 20 x 2.125 heavy duty pneumatic tire and tube with rim liner
Tire Load Rating	Front — 50 lbs, Rear — 175 lbs @ 30 psi
Crankshaft Protection	Belt drive
Weight	165 lbs.
Certification	Complies with ANSI B7111980 and C PS C
Warranty	1 year Homeowner 90 day commercial

Drive Train Specifications

Type of Drive	Rear wheel
Ground Speed	13, 20 and 29 MPH forward 1.5 MPH reverse
Ground Speed Adjustment	3 speeds forward, 1 reverse
Live Axle	1 1/4" solid steel w differential
Rear Wheel Bearings	Self aligning ball bearings
Differential	Full differential
Clutch Control	Tight Slack V Belt operated by dual "Dead Man" levers on handle
Drive Train Components	Belt from engine to transmission, chain from transmission to differential
Reduction Ratio	9.6:1 to 22.4:1
Belt & Chain Guards	Heavy duty plastic
Safety Interlock	Transmission neutral switch

Accessories Available

5 Qt. Gas Tank	Model 2XGT
Blade Saver	Model 2XGU
Remote Air Cleaner	Model 2XAC
Reverse Fan	Model 2XGF

The Sensation Corporation reserves the right to incorporate changes in design without notice or obligation to make changes in the price of the product. Continual progress is a tradition with Sensation.