USING THE NEW AMERICAN FACTFINDER

Finding Economic Data
on AFF

Version 2

Last Updated: 9/20/12



TABLE OF CONTENTS

TABLE OF CONTENTS	2
WHAT IS AMERICAN FACTFINDER?	3
WHERE DO I BEGIN?	4
WORKING WITH SEARCH RESULTS.....	5
OPENING TABLES FROM THE SEARCH RESULTS.....	18
LET’S REVIEW.....	20
TABLE VIEW	21
USING TABLE TOOLS	22
SAVING TABLES	26
CREATING MAPS.....	31
DEFINITIONS AND RELATED TEXT	34
FEEDBACK.....	36
FURTHER HELP.....	37
APPENDIX.....	38

WHAT IS AMERICAN FACTFINDER?

American FactFinder (AFF) is the Census Bureau's primary dissemination tool for many Census Bureau Programs, including:

- Decennial Census
- American Community Survey
- Population Estimates
- Economic Census of the United States
- Economic Census of the Island Areas
- Survey of Business Owners
- Commodity Flow Survey
- County & ZIP Code Business Patterns
- Nonemployer Statistics
- Annual Survey of Manufacturers

These programs listed above account for more than 60 datasets and publish data for over 12 million different geographies.

To accommodate this large amount of data, AFF follows a **topic based approach**. You build a search by selecting keywords and filters from different search menus. As you add additional keywords and filters, the search results become limited to only the tables that meet the criteria. Once you have refined the search results to a suitable level, you can either download or view one or more tables. The table(s) will display the data selected.

WHERE DO I BEGIN?

To begin, go to the AFF main page (<http://factfinder2.census.gov/>). On the main page, there are several different ways for you to start your search. Regardless of which search path you choose, you will be taken to the search results page.

The screenshot shows the American FactFinder homepage with the following elements and callouts:

- 1**: Quick Start search box with a "GO" button.
- 2**: Search menus on the left side, including Topics, Geographies, Race and Ethnic Groups, Industry Codes, and EEO Occupation Codes.
- 3**: Address Search box with a "GO" button.
- 4**: Direct Link to the FTP Site under the "View the American FactFinder Data Release Schedule" section.
- 5**: Reference Maps section with a "GO" button.
- 6**: Load Query button under the "Load Query" section.

- | | |
|----------------------------|--------------------------------------|
| 1 Quick Start | 4 Direct Link to the FTP Site |
| 2 Search Menus | 5 Reference Maps |
| 3 Search by Address | 6 Load Query |

WORKING WITH SEARCH RESULTS

Once you start a search from the main page, you are taken to the Search Results Page. Here you can choose to continue searching, view a table, or download a table using any of the options below.

The screenshot shows the U.S. Census Bureau FactFinder interface. At the top, there are navigation tabs: MAIN, SEARCH, WHAT WE PROVIDE, and USING FACTFINDER. The search results page displays a table of results for the query 'Your Selections'. The table has columns for ID, Table, File or Document Title, Dataset, and About. The results are filtered by 'Program: Survey of Business Owners', 'Economic Place: Bend city, Oregon', and 'NAICS/NAICS Based Industry: 212221: Gold ore mining'. The search results table is highlighted with a red circle labeled '2'. The search filters on the left are highlighted with red circles labeled '1', '4', '5', and '6'. The search input field is highlighted with a red circle labeled '3'.

- 1 - Your Selections Box
- 2 - Search Results
- 3 - Keyword Search
- 4 - Topics Menu
- 5 - Geographies Menu
- 6 - Industry Codes Menu

YOUR SELECTIONS BOX

Each time you add a keyword or filter to your search, it moves to Your Selections. Each time you add or remove an item in Your Selections, the search menus and search results update to reflect the items in Your Selections.

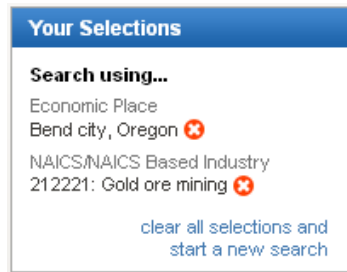

To remove a particular item, click the  icon.

To start a new search, click [clear all selections and start a new search](#).

KEYWORD SEARCH

Quick Start

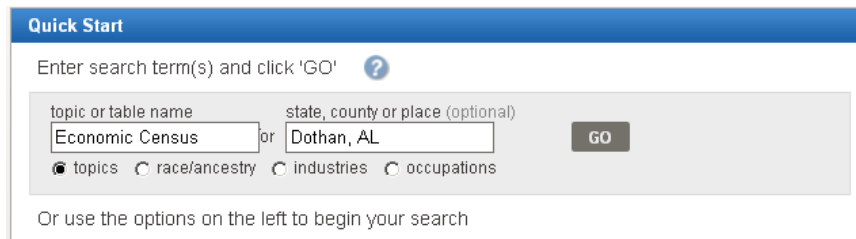

Quick Start is located on the main page. It's split into two separate boxes, which allow you to search for both a keyword and geography. Valid keyword searches are:

- Dataset (e.g. Economic Census)
- ID (e.g., EC0700A1, see the [Appendix](#) for more information on table IDs)
- Table Title (e.g., EC0700A1: All sectors: Geographic Area Series: Economy-Wide Key Statistics: 2007)
- Predefined keywords that correspond to specific tables (e.g., "ASM" brings back Annual Survey of Manufactures tables)
- Single geographies (Geographies that define a part of a larger geography are invalid, e.g., Part of Dothan, AL in Henry County)

Helpful Hint

Quick Start & the "Narrow your search" box are recommend for users who know specifically what table or series of tables they are interested in.

If you are looking for specific **Geographies** and **Industry Codes** use the Geography & Industry Codes Search Menus discussed in this guide.

Narrow your search

The **Narrow your search** box allows you to use keywords to refine a list of search results. The Narrow your search box follows the same rules as Quick Start with the following exceptions:

- It will only search within the available search results.
- It will not search for Geographies or Industry Codes.

To search these items:

1. Type a keyword or ID number into the “Narrow your search” box and click “Go”.

Narrow your search:

2. Your keyword is added to the Your Selections box. The Search Results will narrow down to tables related to your keyword.

The screenshot shows the search interface. On the left, the 'Your Selections' box contains 'Retail' circled in red. On the right, the 'Recommendations (1)' box shows a blue banner with 'Search Results: 1 of 1 tables and other products match 'Your Selections'' circled in red. Below this, there is a table with one row:

ID	Table, File or Document Title	Dataset	About
<input type="checkbox"/> EC0244A1	Retail Trade: Geographic Area Series: Summary Statistics: 2002	2002 Economic Census	

TOPICS MENU

By using the Topics menu, you can narrow your Search Results by **year, business and industry characteristics, program or survey**, and other topics of interest. We recommended that you start here.

For this example, let's say you are interested in finding Economic Census data. Here are the steps you would take:

1. Select the Topics box to open the Topics menu.

The screenshot shows the 'Topics' button on the left and the 'Select Topics' dialog box on the right. The dialog box has a title bar 'Select Topics' and a 'CLOSE X' button. The main content area is titled 'Select Topics to add to 'Your Selections'' and contains a list of topics with expand/collapse icons:

- + People
- + Housing
- + Business and Industry
- + Year
- + Product Type
- + Program
- + Dataset

At the bottom of the dialog box, there is a checkbox labeled 'Include archived products in your search' with a question mark icon.

2. Select "Program", then "Economic Census"

To close the "Select Topics" overlay, click the **CLOSE X** button on the top right of the menu.

3. "Economic Census" moves to the Your Selections box. The Search Results will narrow down to tables in the Economic Census program.

Select Topics To search for tables and o

Select Topics to add to 'Your Selections'

- + People
- + Housing
- + Business and Industry
- + Year
- + Product Type
- Program
 - American Community Survey (32,004)
 - Annual Survey of Manufactures (92)
 - Business Expenses Survey (8)
 - Business Patterns (68)
 - Commodity Flow Survey (214)
 - Decennial Census (7,840)
 - Economic Census (2,017)**
 - Nonemployer Statistics (26)
 - Population Estimates (141)
 - Survey of Business Owners (394)
- + Dataset

Your Selections

Search using

Program:
Economic Census **X**

clear all selections and start a new search

Search Results: 1-25 of 2,017 tables and other products match 'Your Selections'

Selected: View | Download | Compare | Clear All ?

Narrow your search: **GO**

ID	Table, File or Document Title
----	-------------------------------

Helpful Hint

There are some helpful tools in the Topics menu for experienced users of our economic data.

You can find data by **program/survey**... ...and also by **economic series**.

Program

- American Community Survey (32,004)
- Annual Survey of Manufactures (92)
- Business Expenses Survey (8)
- Business Patterns (68)
- Commodity Flow Survey (214)
- Decennial Census (7,840)
- Economic Census (2,017)
- Nonemployer Statistics (26)
- Population Estimates (141)
- Survey of Business Owners (394)

Business and Industry

- + Assets & Capital Expenditures
- + Business Characteristic
- + Business Owner
- Economic Series
 - Advance Report (6)
 - Company Statistics (197)
 - Core Statistics (12)
 - Enterprise Statistics (208)
 - Establishment/Firm Size (196)

GEOGRAPHIES MENU

The Census Bureau recognizes **over 12 million different geographies** in the United States. Because of the complexities of finding 12 million different geographies, AFF has split the geographies into three separate indices and developed four different methods to find your geography. They are as follows:

1. Most Requested Index (Default) – This is the default index. All possible geographies for which Economic Programs publish data are available here.
2. Show all summary levels – This has all possible geographies except individual blocks.
3. Individual Blocks – Only has individual blocks. The Decennial Census is the only dataset that uses this index.

The four different submenus are **List, Filter, Address, and Map**.

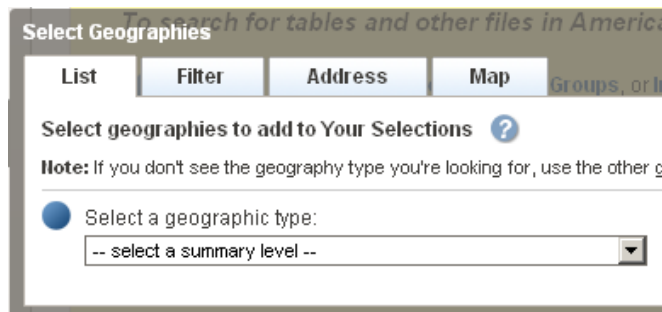

Choosing Geographies via the “List Tab”

The “List Tab” creates a list of relevant geographies based off how you may answer several guiding questions. Currently, choosing geographies via the List tab covers a small subset of census geographies. Over the next year, it will continue to be updated eventually include all geographies. If you do not see a geography you are interested in, please use the Filter tab.

So, let us use the List tab to find data for All States in the United States. We will assume that you have already selected the Program, Economic Census, from the Topics menu.

1. Select the Geographies box to open the Geographies Menu.
2. The menu will open in a window above the Search Results. It will ask you to select a geographic type. Using the drop down, select “State”.

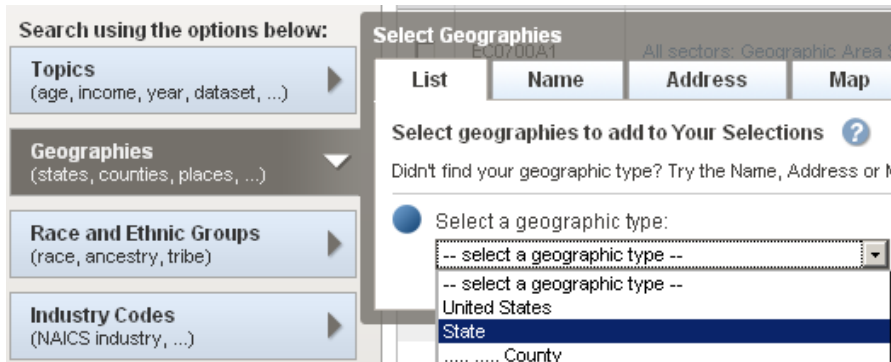

Helpful Hint

A Geographic Type will be grayed-out if it is not relevant to the items in Your Selections. If you select a grayed-out geographic type, you will receive an error.

- Once you have selected “State”, a list of possible geographies will appear below. You can either select each state individually or select a group of States by choosing “All States within the United States”. Once you have made your choices, click the Add to Your Selections button.

The screenshot displays the search results page for the Census Bureau. On the left, the 'Your Selections' panel shows the search criteria: Program: Economic Census, State, and All States within United States. The 'Search using the options below' section includes filters for Topics, Geographies, Race and Ethnic Groups, Industry Codes, and EEO Occupation Codes. The main search results area shows 'Search Results: 1-25 of 333 tables and other products'. Below this, there is a 'Narrow your search' field and a 'GO' button. The 'Select Geographies' section is active, showing a list of geographic areas. The 'Geographic type' is set to 'State', and the list includes 'All States within United States', Alabama, Alaska, Arizona, Arkansas, California, Colorado, Connecticut, Delaware, and District of Columbia. The 'ADD TO YOUR SELECTIONS' button is highlighted at the bottom.

- To add other geographies, simply change the geographic type and answer the questions relevant to that Geographic Type.

Choosing a Geography via the “Filter Tab”

The “Filter Tab” allows users to search for geographies by using filters to find their results. When using the “Filter Tab”, there are 4 main areas that users will utilize: ① Geography Text Box ② Your Geography Filters ③ Geography Filter Options ④ Geography Results

The screenshot shows the 'Select Geographies' interface with the 'Filter' tab selected. The search box (1) contains '(Alabama, Marengo County, ...)'. The 'Your Geography Filters' section (2) is empty. The 'Geography Filter Options' section (3) shows 'Geographic Type' expanded with 'City or Town (6)' selected. The 'Geography Results' section (4) shows a table with columns 'Geography Name', 'Geography Type', and 'About'. The table lists various states and their types.

Geography Name	Geography Type	About
<input type="checkbox"/> United States	Nation	?
<input type="checkbox"/> All States within United States	State	?
<input type="checkbox"/> Alabama	State	?
<input type="checkbox"/> Alaska	State	?
<input type="checkbox"/> Arizona	State	?
<input type="checkbox"/> Arkansas	State	?
<input type="checkbox"/> California	State	?
<input type="checkbox"/> Colorado	State	?

For this example, let's say you are interested in data for the Consolidated City of Louisville, KY. Here are the steps you would take (Let's assume the selections made in the Topics Menu & List tabs are still in Your Selections):

1. Select the Filter tab on the top of the Geography Menu to activate the Filter search.
2. You can find Louisville, KY using one of four different ways:
 - a. Type in “Louisville metro government, KY” into the search box and click “GO”, “Louisville metro government, KY” is added to Your Geography Filters and the Geography Results are limited to geographies with “Louisville metro government, KY” in the name. The Consolidated City of Louisville/ Jefferson county Metro Government, KY will be the second result in the Geography Results.
 - b. Drilling down using the “Geography Filter Options”,
 - i. Select City or Town from the already expanded Geographic Type option. City or Town is added to Your Geography Filters and the Geography Results are limited to only the geographies tagged with City or Town.
 - ii. Staying in the Geography Filter Options, expand Within State and select Kentucky. Kentucky is added to Your Geography Filters and the results are limited to City or Towns within the state of Kentucky. The Consolidated City of Louisville/Jefferson County Metro Government, KY will be the remaining result.

- Once you have found your geography, place a check next to the Consolidated City of Louisville/Jefferson County Metro Government and click the Add button located at the top of the search to add the Consolidated City of Louisville/Jefferson County Metro Government to Your Selections.

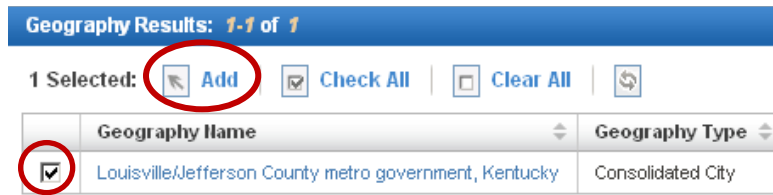

- To close the "Select Geographies" overlay, click the **CLOSE X** button on the top-right corner of the overlay.

See the [Appendix](#) for help finding **specific geography types**, like offshore areas, metropolitan areas, and ZIP codes.

Helpful Hint

Be careful when looking for **cities and towns**. For economic data, these are called "Economic Places" and are classified separately from other types of places.

Look for "**Economic Place**" as the Geography Type when looking for city or town data.

	Geography Name	Geography Type	About
<input type="checkbox"/>	Baltimore city, Maryland	Economic Place	

Choosing All Geographies within a Geographic Area

For some geographic levels, AFF has certain group geographies (e.g., All States within the United States) available for selection. This allows you to add multiple geographies at one time.

Helpful Hint

Groups of geographies, like “All Counties in Alabama”, use an “**OR**” statement.

For example, selecting “All Counties in Alabama” tells AFF “I want tables with data for Autauga County **OR** Baldwin County **OR** Barbour County **OR** ...”

If a table contains at least one of these geographies, the table will appear in the Search Results.

Keep this in mind when adding groups of geographies to Your Selections.

Searching for a Geography using the Address Tab

You can access the Address tab by either clicking the link on the main page or by selecting the tab in the Geography menu. The address tab allows you to find Geographies attached to a specific address for a given year.

Input an address + ZIP code, address + city + state, or address + city + state + ZIP code in the relevant text boxes and click go.

For this example let’s use “4600 Silver Hill Rd, Suitland, MD 20746”.

Select Geographies 2008 County Business Patterns: Geography Area Series: County Business Patterns 2008 B...

List Filter Address Map Compare Clear All ?

Enter a street address, city and state, or a street address and ZIP code. Click 'Go'. ?

Note: address search will use the latest available address data beginning with 2008 and working backward

street address city state zip

4600 Silver Hill Rd Suitland Maryland 20746 GO

Geographies containing 4600 SILVER HILL RD, SUITLAND, MD, 20746:
Select geographies to add to Your Selections

After clicking go you will get a list of geographies that the address is included in. On the left will be geography names and on the right will be the geographic type. Simply click on a geography’s name in the left hand column to add them to Your Selections. To add multiple geographies, click on each geography you wish to add.

Geography Results:	
Geography Name	Geography Type
Maryland	State
Prince George's County, Maryland	County
District 6, Spauldings; Prince George's County, Maryland	County Subdivision
Census Tract 8024.05, Prince George's County, Maryland	Census Tract
Block Group 1, Census Tract 8024.05, Prince George's County, Maryland	Block Group
Suitland-Silver Hill CDP, Maryland	Place
Washington-Arlington-Alexandria, DC-VA-MD-WV Metro Area	Metropolitan Statistical Area/Micropolitan Statistical Area
Washington-Arlington-Alexandria, DC-VA-MD-WV Metro Division; Washington-Arlington-Alexandria, DC-VA-MD-WV Metro Area	Metropolitan Division

While this is a quick way to add specific geographies, you should take into account that this function allows you to select geographies from multiple programs at the same time. There is a chance you can select a geography that is invalid for the Economic Programs. To mitigate some of these issues, you should select either a Year or Dataset from the Topics menu before adding geographies to Your Selections.

Selecting Geographies using the Map Tab

The map tab allows you to create reference maps and select geographies. You can get to the map tab by either selecting a state from the Reference Map drop down located on the main page or by clicking the map tab in the geography menu.

To select geographies from the map:

- Select a starting geographic area from the geography pull down menu followed by a selection tool in the Select Geographies box.

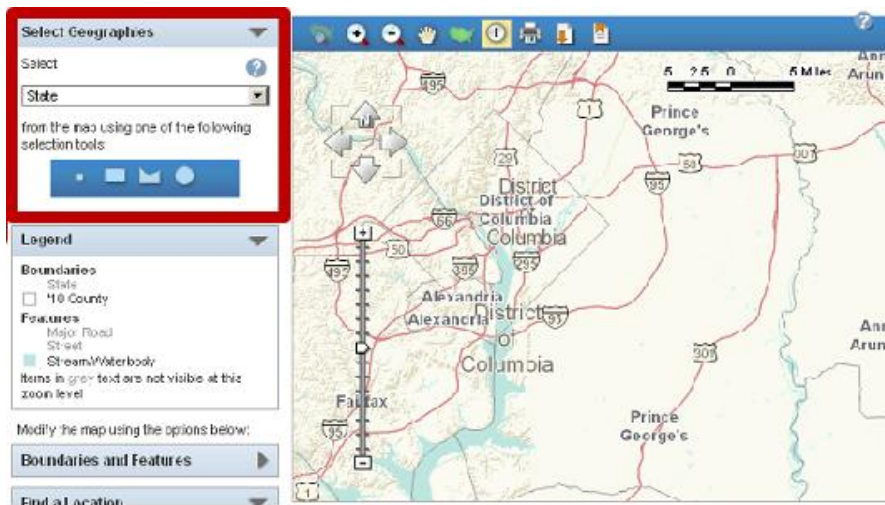



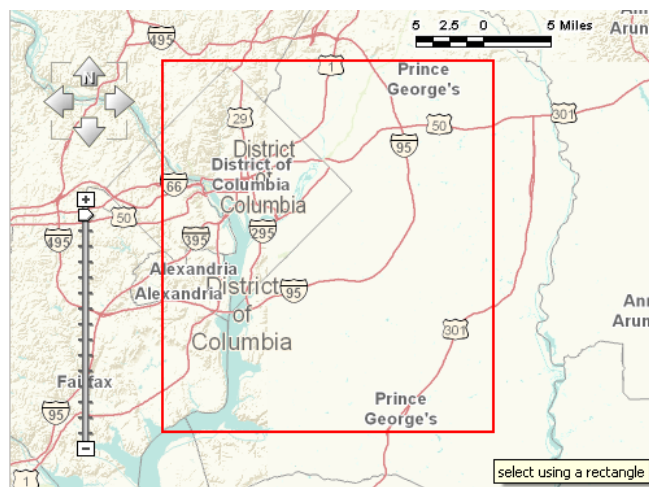



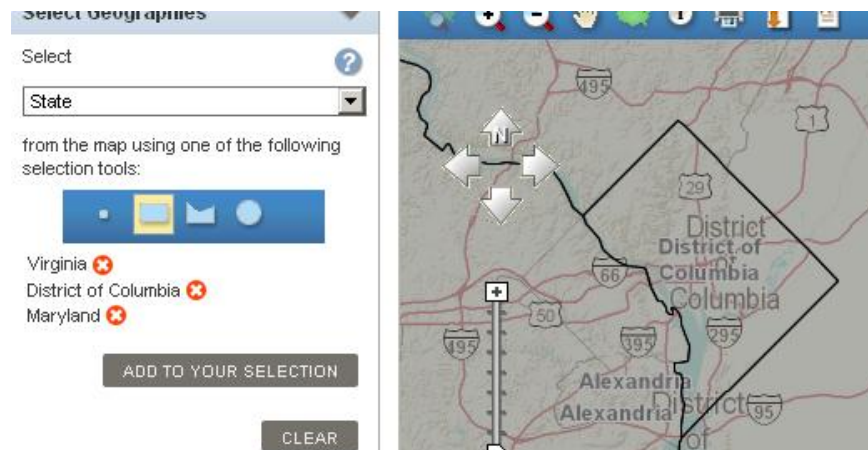

- Click and drag your selection tool on the map, click again to close the rectangle (in this example, the rectangle tool was used).



- All geographies that are touched by the rectangle will become highlighted and an option to add the selected geographies will appear in the Select Geography box.



- From the map toolbar you can :
 - Zoom to a state (Only active at the national zoom level) 
 - Zoom in & Zoom out  (Active at all zoom levels except the national level. At that level simply click on an area to zoom or use Zoom to a state)
 - Pan 
 - Go to US extent 
 - Info (Get a list of geos that intersect at that point) 
 - Print 
 - Download 
 - Bookmark/Save Query 
- Manipulate the Boundaries & Features of the map. (For more information please see the Create a map section)
- Create a reference map.
 - In addition to selecting geographies, users can create a reference map based off of the geographies they have in Your Selections

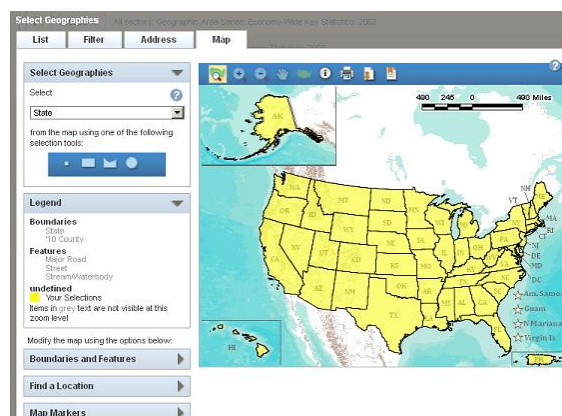

INDUSTRY CODES (INCLUDING PRODUCTS AND SERVICES) MENU

The Census Bureau uses thousands of individual codes to classify **industries, products, services, materials, fuels, and commodities**. Like geographies, AFF also has a separate menu with similar functions for choosing these codes. The four main parts of the Industry Codes menu are Industry Codes text box, Your Industry Code Filters, Industry Code Filters, and the Industry Code Results.

To search for tables and other files in American FactFinder:

Select Industry Codes

Enter an industry, product, or commodity name or code, or use the Industry Code Filter Options below

Enter an industry, product, or commodity name or code

Your Industry Code Filters

'Your Industry Codes Filters' is empty

Industry Code Filter Options

Code Type

- Commodity (Commodity Flow Survey Only) (671)
- Material/Fuel (2,005)
- NAICS/NAICS Based Industry (8,123)
- Product and Service (31,054)

Include in results:

- All codes
- Individual codes
- Groups of codes

Select industry codes to add to Your Selections

Industry Code Results: 1-25 of 41,853

Selected: Check All

	Code	Description
<input type="checkbox"/>	ALL	All available codes
<input type="checkbox"/>	ALL-L2	All available Sector codes
<input type="checkbox"/>	ALL-L3	All available Subsector codes
<input type="checkbox"/>	ALL-L4	All available Industry Group codes

Helpful Hint

Industries are classified by the North American Industry Classification System (**NAICS**).

Industry search works better when you enter the specific NAICS code for your industry of interest.

Find NAICS codes easily at www.census.gov/naics.

Searching for a code

For this example, let us say you are interested in data for dog and cat food manufacturing. Assume that the selections made in the other sections are still in Your Selections. Because there are already selections in Your Selections, you will only see codes that are available in the Economic Census and publish data for states & the consolidated city of Louisville/Jefferson County Metro Government, KY. Here are the steps you would take:

1. Select the Industry Codes box to open the "Industry Codes" menu.
2. You can find dog and cat food manufacturing using one of two different ways:
 - a. Typing in "dog and cat food manufacturing" into the search box
 - i. "dog and cat food manufacturing" is added to Your Industry Code Filters and the Industry Code Results update to only include codes that have "dog and cat food manufacturing" in their name.
 - ii. Dog and Cat Food Manufacturing, Code 311111 will be the top result.

- b. Drilling down using the “Industry Code Filter Options”.
 - i. Expand Code Type and select NAICS Based Industry. NAICS Based Industry is added to Your Industry Code Filters, and the Industry Code Results are limited to only NAICS Based Codes.
 - ii. Staying in the Industry Code Filter Options, expand Industry Sector and select 31-33 Manufacturing. Sector 31-33 is added to Your Industry Code Filter Selections. Dog and Cat Food Manufacturing, Code 311111 is the seventh result.

Note: Depending on where a particular code falls in the NAICS hierarchy, it may be necessary to continue using the Industry Code Filter options.

- 3. Once you have found your industry, place a check next to Code 311111, Dog and Cat Food Manufacturing and click the Add button located at the top of the search to add the code.

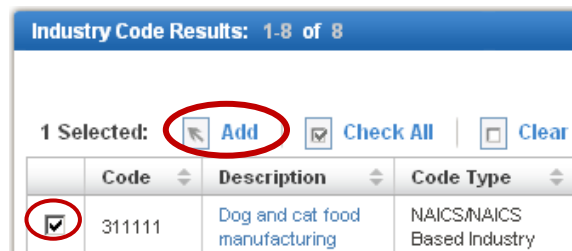

Choosing All Codes within a Code Level

For some geographic levels, AFF has certain group codes (e.g., All Available Sector Codes, All L-2) available for selection. This allows you to add multiple codes at one time.

Helpful Hint

Groups of codes, like “All available Sector codes”, use an **“OR” statement**.

For example, selecting “All available Sector codes” tells AFF “I want tables with data for Mining **OR** Utilities **OR** Construction **OR** Manufacturing **OR**...”

If a table contains one or more of more of these individual codes, the table will appear in the Search Results.

Keep this in mind when adding groups of codes to Your Selections.

OPENING TABLES FROM THE SEARCH RESULTS

After using the search menus, you have two possible search results. They represent the only tables that are from an Economic Census, have State & Consolidated City as relevant geographies, and publish data for NAICS Code 311111, “Dog and Cat Food Manufacturing”.

OPENING A SINGLE TABLE

To open a single table, click on the hyperlinked table title.

Search Results: 1-2 of 2 tables and other products match 'Your Selections' pe

Selected: View | Download | Compare | Clear All ?

Search for: **GO**

	ID	Table, File or Document Title	Dataset
<input type="checkbox"/>	EC0700A1	All sectors: Geographic Area Series: Economy-Wide Key Statistics: 2007	2007 Economic Census
<input type="checkbox"/>	EC0731A1	Manufacturing: Geographic Area Series: Industry Statistics for the States, Metropolitan and Micropolitan Statistical Areas, Counties, and Places: 2007	2007 Economic Census

Selected: View | Download | Compare | Clear All ?

OPENING MULTIPLE TABLES

To open multiple tables:

1. Check off the check boxes of the tables you are interested in, and click “View”.

Search Results: 1-2 of 2 tables and other products match 'Your Selections'

2 Selected: View | Download | Compare | Clear All ?

Search for: **GO**

	ID	Table, File or Document Title	Dataset
<input checked="" type="checkbox"/>	EC0700A1	All sectors: Geographic Area Series: Economy-Wide Key Statistics: 2007	2007 Economic Census
<input checked="" type="checkbox"/>	EC0731A1	Manufacturing: Geographic Area Series: Industry Statistics for the States, Metropolitan and Micropolitan Statistical Areas, Counties, and Places: 2007	2007 Economic Census

2 Selected: View | Download | Compare | Clear All ?

2. The first table displays. To view the next table, click the right-arrow button near the top right of the window.



Helpful Hint

You can **download tables** directly from the Search Results. These downloads only contain data specified by Your Selections and may not be the full tables. You can download up to 10 tables with 50,000 geographies and 500,000 rows of data in each table

Simply check off the tables you want, and click "Download". These downloads are in .ZIP format.

Search Results: 1-25 of 466 tables and other products match 'Your Selections'

2 Selected: View **Download** Compare | Clear All ?

Search for:

	ID	Table, File or Document Title
<input checked="" type="checkbox"/>	EC0200A1	All sectors: Geographic Area Series: Economy-Wide Key Statistics: 2002
<input checked="" type="checkbox"/>	EC0200CA2	All sectors: Core Business Statistics Series: Advance Comparative Statistics for the United States (1997 NAICS Basis): 2002 and 1997

LET'S REVIEW

Let's review what we've gone over so far. Using the Topics, Geography, and Industry Code Menus, we built a search that would allow you to find the number of establishments that manufacture dog & cat food in all 50 states and Louisville, KY, according to the 2007 Economic Census.

Using this knowledge, let's find how many Hispanic Owned Restaurants are in each state?

Step	Action	Result
1	Start at http://factfinder2.census.gov . Click Topics on the Main page.	Topics expand, and you are taken to the Search Page.
2	Expand the People topic, followed by the Race & Ethnicity subtopic. Select the Hispanic or Latino subtopic.	Hispanic or Latino" is added to "Your Selections". The Topics, Geographies, Industry Codes, and Search Results update to reflect the items in Your Selections.
3	Staying in Topics, expand the Business & Industry topic and then the Business Owner subtopic. Select Owner's Race and Ethnicity .	"Owner's Race and Ethnicity" is added to "Your Selections". The Topics, Geographies, Industry Codes, and Search Results update to reflect the items in "Your Selections"
4	Click on the Geographies located on the left hand side of the page to open the Select Geographies menu.	The Select Geographies menu opens in an overlay on top of the search results page.
5	Using the List tab, select State as the geographic type, then select All States within the United States from the results list. Click Add to Your Selections, to add All States within the United States to Your Selections.	"All States within the United States" is added to "Your Selections". The Topics, Geographies, Industry Codes, and Search Results update to reflect the items in "Your Selections".
6	Click on the Industry Codes button located on the left hand side, below the Geographies button.	The Select Industry Codes menu opens in an overlay on top of the Search results page.
7	Using the search box, type in "restaurant" and click Go. In the Industry Code Results, check off the box next to NAICS code 7221 Full Service Restaurants and then click add. 7221 Full Service Restaurants is now added to Your Selections. You can now close the Select Industry Codes menu.	"7221 Full Service Restaurants" is now added to Your Selections. The Topics, Geographies, Industry Codes, and Search Results update to reflect the items in "Your Selections".
8	There will be 1 table in your search results. Check off the box next to SB0700CSA03 , and either click View or Download .	The table either appears or downloads.

TABLE VIEW

MAIN SEARCH WHAT WE PROVIDE USING FACTFINDER [Feedback](#) [FAQs](#) [Glossary](#) [Help](#)

Results - Click [Back to Search](#) to select other tables or geographies

[BACK TO SEARCH](#) Result 1 of 1 [VIEW ALL AS PDF](#)

EC0700A1 All sectors: Geographic Area Series: Economy-Wide Key Statistics: 2007
2007 Economic Census

Table View

Actions: [Table Tools](#) [Bookmark](#) [Print](#) [Download](#) [Create Map](#)

Table Tools: [Reset Table](#) [Show Hidden Rows/Columns](#) [Transpose Rows/Columns](#)

Legend: show/hide rows and columns collapse/expand data categories rearrange columns rearrange rows sort ascending/descending filter rows

[View Geography Notes](#) [View Table Notes](#)

This table is displayed with default geographies and industry codes. Not all rows may be displayed below. Click [Back to Search](#) to select other geographies or industry codes using the search options on the left.

The table contains a total of 3,342,969 data rows.

The data in this file come from separate 2007 Economic Census Industry Series, Geographic Area Series, and Summary Series data files, as well as data files from the 2007 Economic Census of Island Areas and the 2007 Nonemployer Statistics. These files are released on a flow basis from March 2009 through mid-2011. The national data are subject to change; they will be replaced when updated data are added from the Geographic Area Series and Summary Series in 2010 and 2011. The first 4 data fields are for establishments of firms with payroll (employers), and the last 2 data fields are for establishments of firms with no paid employees (nonemployers). For information on confidentiality protection, sampling error, nonsampling error, and definitions, see [Survey Methodology](#) [pdf].

Geographic area name	2007 North American Industry Classification System (NAICS)	Meaning of 2007 North American Industry Classification System (NAICS)	Meaning of Type of operation or tax status code	Year	Number of employer establishments	Employer value of sales, shipments, receipts, revenue, or business done (\$1,000)	Annual payroll (\$1,000)	Number of paid employees for pay period including March 12	Number of nonemployer establishments	Nonemployer value of sales, shipments, receipts, revenue, or business done (\$1,000)
United States	21	Mining, quarrying, and oil and gas extraction	Total	2007	22,667	413,524,731	40,687,472	730,433	101,607	9,012,220
United States	22	Utilities	Total	2007	16,578	584,192,658	51,653,618	637,247	17,573	727,843
United States		Construction	Total	2007	729,345	1,731,841,830	331,002,718	7,316,240	2,657,360	159,041,760
United States	31-33	Manufacturing	Total	2007	332,536	5,319,456,312	613,768,568	13,395,670	328,060	16,332,595

- Feedback
- Print
- Show Hidden Columns
- Rearrange Columns
- Program/Survey Information
- Download
- Transpose Rows/Columns
- Filter Rows
- Table Tools
- Creating Maps
- Table Notes
- Sort Rows
- Bookmark
- Reset Table
- Definitions
- Hide Columns

USING TABLE TOOLS

Once you have opened a table, there are many things you can do with the rows and columns.

First, you need to **activate the Table Tools** by clicking the “Modify Table” button.



To change geography and industry selections, click the “Back to Search” button to return to the search menu.







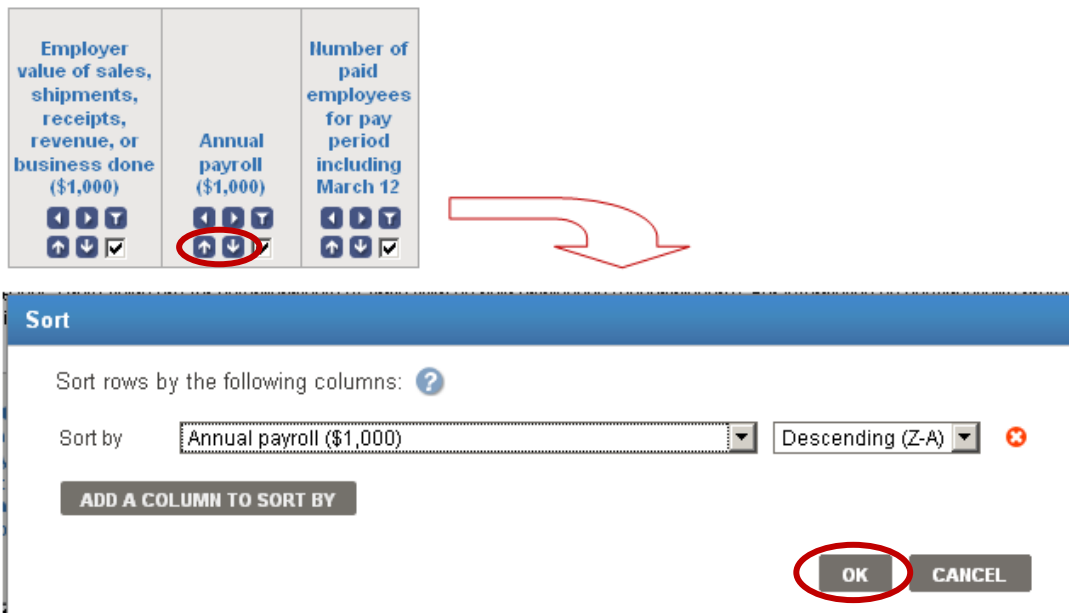











ROW ACTIONS

Sort Rows

You can sort the rows of a table in **ascending and descending** order using the sort buttons ( ) inside the column header.



You have the option to sort up to three columns. Click “OK” to view the sorted table.

Geographic area name   	2007 North American Industry Classification System (NAICS) code   	Meaning of 2007 North American Industry Classification System (NAICS) code   	Meaning of Type of operation or tax status code   	Year code  	Number of employer establishments  	Annual payroll (\$1,000)   
United States	62	Health care and social assistance	All establishments	2007	784,626	662,719,938
United States	31-33	Manufacturing	Total	2007	332,536	613,768,568
United States	52	Finance and insurance	Total	2007	501,713 ⁽¹⁾	502,416,670 ⁽¹⁾
United States	54	Professional, scientific, and technical services	All establishments	2007	847,492	502,074,331

Filter Rows

You can reduce the amount of rows in the table by **filtering** on a dimension or data item by using the filter rows button ().

For this example, let's say you are only interested in rows of data for establishments exempt from federal income tax.

Here are the steps you would take:

1. Click the "filter rows" button beneath the "Meaning of Type of operation or tax status code".

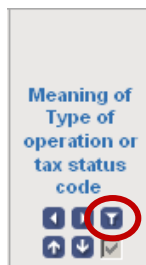

- The “Filter Dimension” overlay displays. Check off “Establishments exempt from federal income tax”, and click “OK”.

- The table returns with rows for only establishments exempt from federal income tax.

Geographic area name	2007 North American Industry Classification System (NAICS) code	Meaning of 2007 North American Industry Classification System (NAICS) code	Meaning of Type of operation or tax status code	Year code	Number of employer establishments
United States	54	Professional, scientific, and technical services	Establishments exempt from federal income tax	2007	4,885
United States	61	Educational services	Establishments exempt from federal income tax	2007	11,595

Helpful Hint

You can filter rows using the values of a data item, or **numeric variable**, such as annual payroll.

The filter uses Boolean operators (less than, greater than, etc.) to compare data against a number you specify.

COLUMN ACTIONS

Show Hidden Columns

Not all columns in a table are displayed. These hidden columns can include geography codes, noise infusion ranges, and/or relative standard errors. Casual data users usually do not care about these.

To **show hidden columns**, click the “Show Hidden Rows/Columns” button.

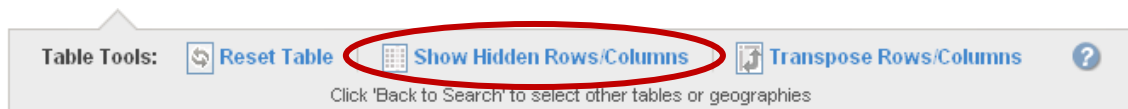

Hide Columns

To **hide columns** you are not interested in, uncheck the checkbox () inside the column header.

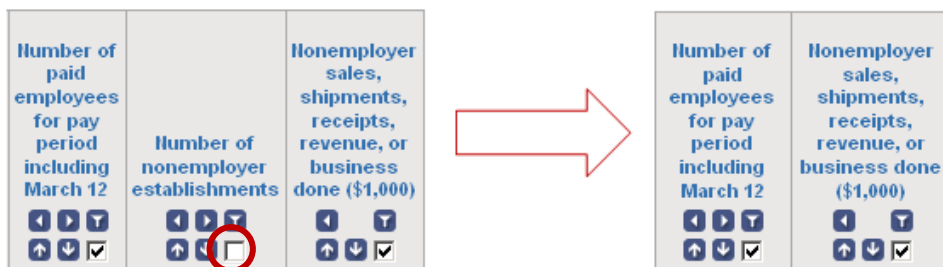

Rearrange Columns

To **rearrange the order of columns**, use the left/right arrow buttons () inside the column header.



TRANSPOSE ROWS/COLUMNS

To transpose, or **switch the position of**, rows and columns, click the “Transpose Rows/Columns” button.

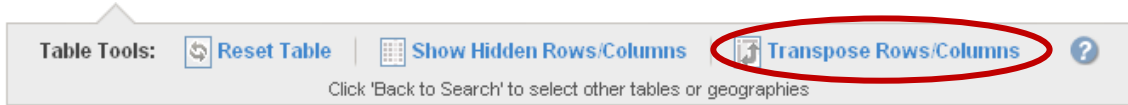

RESET TABLE

To restore a modified table to its **default view**, click the “Reset Table” button.

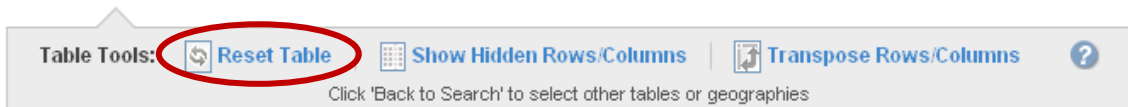

SAVING TABLES

You can save your work after modifying a table by **bookmarking**, **printing**, or **downloading** it.

BOOKMARKING

To **bookmark a table** with Your Selections, click the “Bookmark” button.



If the table is in its original format and contains a limited number of geographies and/or industries, you can create a bookmark by saving it into your browser’s bookmarks or favorites. You also have the option to copy and paste the bookmark into another browser or email.

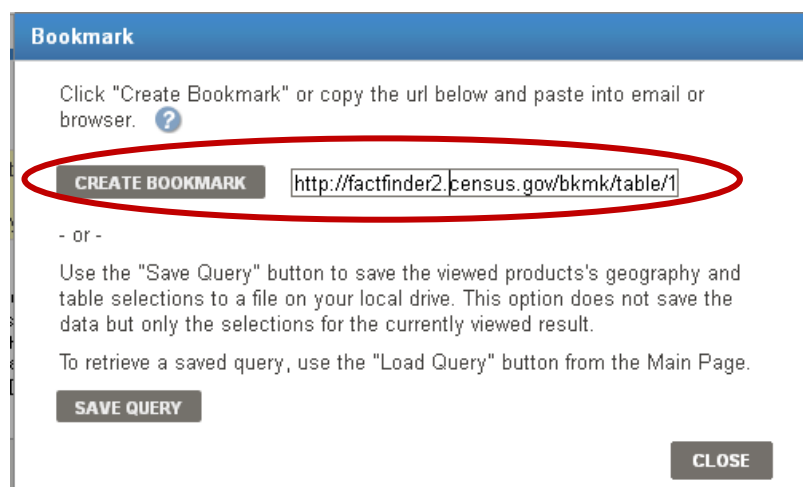

If the table was modified or contains too many geographies and/or industries, you may need to save a **query file** onto your computer.

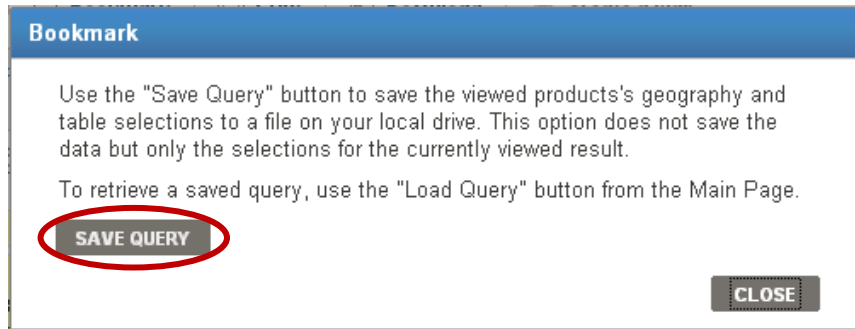

The query file maintains all your selections and modifications for the table. To retrieve the table, you can upload the query file by clicking the "Load Query" button on the left-hand side of AFF's Main page, factfinder2.census.gov.

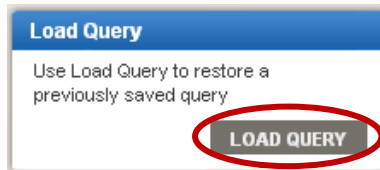

Helpful Hint

Saved query files can be **e-mailed**, **transferred** or **copied** like any other computer file.

PRINTING

To **print a table** with Your Selections:

1. Select the "Print" button.

Actions:  [Modify Table](#) |  [Bookmark](#) |  [Print](#) |  [Download](#)

2. Use the radio buttons to choose the orientation and paper size and click "OK".

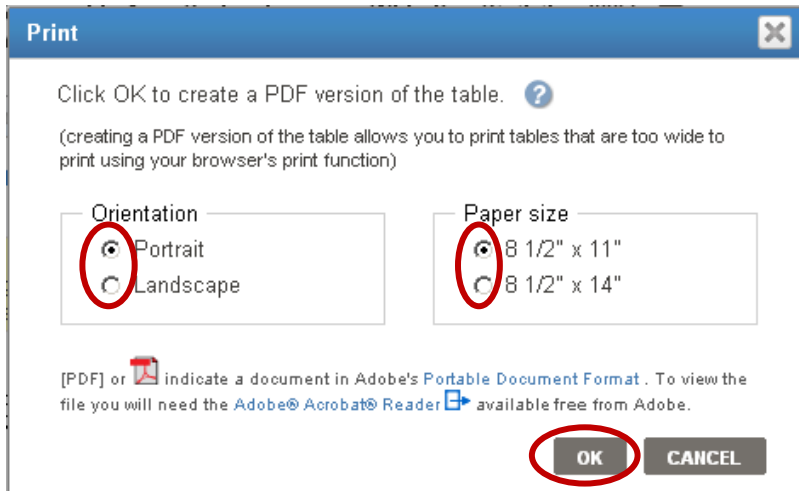

3. AFF will build a PDF that is print friendly. Click "OPEN" to open the PDF.

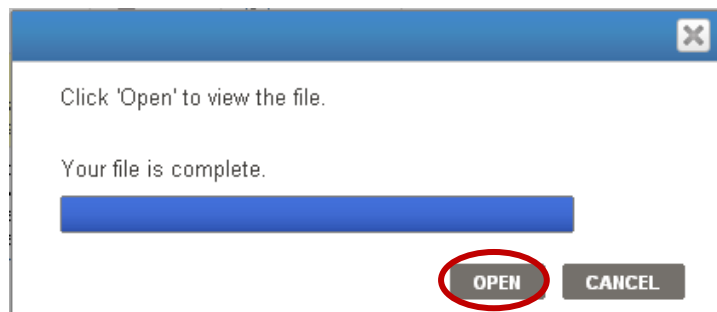

4. Print the PDF using your browser's print function. **Note:** The PDF file contains **all rows** in Your Selections (not just the rows displayed on a given page).

DOWNLOADING

When downloading a table you have several options. To **download a table as displayed** with Your Selections:

1. Select the "Download" button.



2. Use the radio buttons to choose a download format (.csv, PDF, .xls, or .rtf) and click "OK".

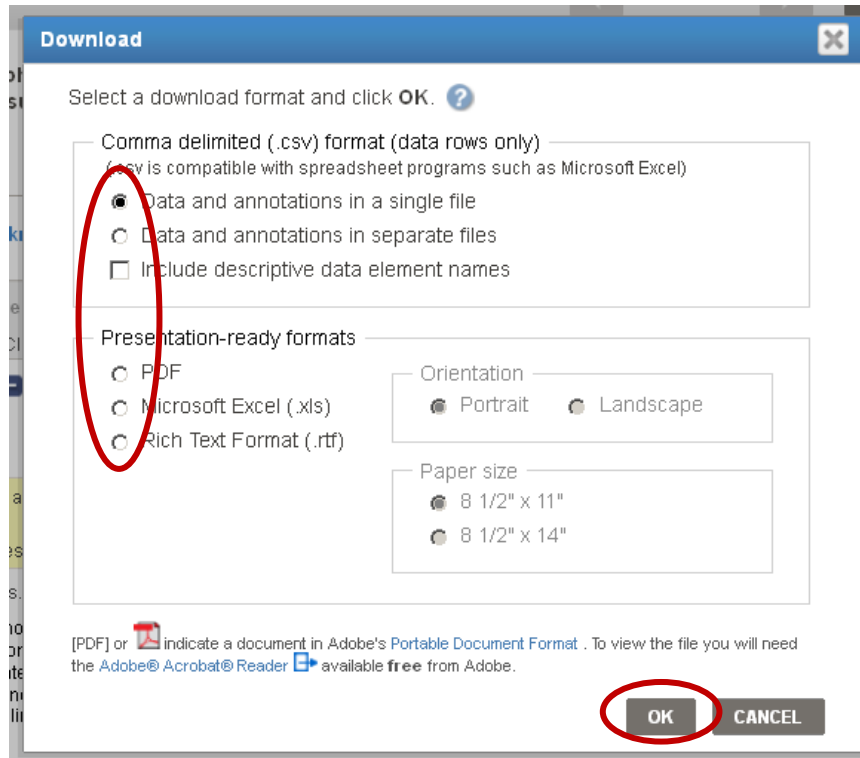

3. AFF will build your file. Click "Download" to save the file to your computer.

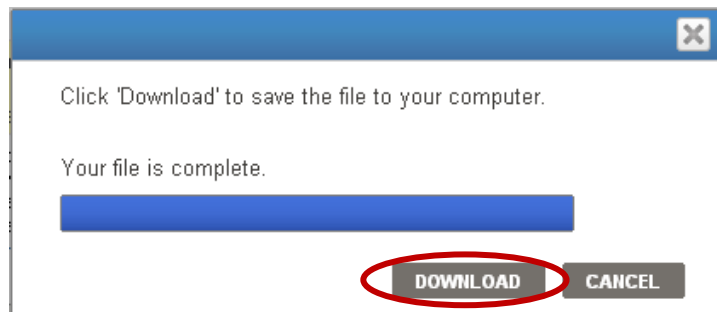

Download Formats

Comma Delimited Format (.csv)

The .csv format is ideal for users who wish to manipulate a table. Tables in a .csv format can have any table annotations attached to the table or in a separate file. AFF allows users to download a table with up to 50,000 geographies and 500,000 rows of data. AFF will save any table modifications made before downloading in the downloaded .csv file.

Tables with less than 5,000 rows – use PDF, .xls, or .rtf

If your table has less than 5,000 rows, and you do not want to manipulate data, you can download the table in the following formats:

- Portable Document Format (.pdf)
- Microsoft Excel (.xls)
- Rich Text Format (.rtf)

For pdf & .rtf downloads have a limit of 5,000 columns and 5,000 data rows. The xls download has a limit of 230 columns and 5,000 data rows.

Helpful Hints

Use the CSV format for importing tables into **databases** and **data manipulation software**.

For users who want to download an entire dataset use the **FTP** link located on the main page.

CREATING MAPS

In addition to the default Table View, you can also view selected data from a table in a color-coded map.

First, you need to **activate the Map View** by clicking the “Create a Map” button.



SELECTING THE DATA TO MAP

Next, you select the data column in the table that you’d like to map by clicking on a data value in the table.

For this example, let’s map the **sales of automobile dealers for the counties in Maryland**.

Click on any data value in the “Sales (\$1,000)” column.

Geographic area name	2007 North American Industry Classification System (NAICS) code	Meaning of 2007 North American Industry Classification System (NAICS) code	Year code	Number of establishments	Sales (\$1,000)	Annual payroll (\$1,000)	First-quarter payroll (\$1,000)	Number of paid employees for pay period including March 12	Sales, receipts, or revenue from administrative records (%)	Sales, receipts, or revenue estimated (%)
Allegany County, Maryland	4411	Automobile dealers	2007	15	D	D	D	e	D	D
Anne Arundel County, Maryland	4411	Automobile dealers	2007	74	4,713,523	126,518	31,870	3,193	19.2	0.9
Baltimore County, Maryland	4411	Automobile dealers	2007	104	2,822,775	261,334	61,105	5,649	2.1	3.5
Caroline County, Maryland	4411	Automobile dealers	2007	6	119,119	7,912	1,968	197	80.8	8.3
Carroll County, Maryland	4411	Automobile dealers	2007	36	D	D	D	f	D	D

Helpful Hints

For tables from the Economic Census and related programs, a map can only be created from a table that contains data for **more than one of the same geographic type and has available shapefiles. In other words, part level geographies can not be mapped.**

The exception to this rule are Quick Tables from the demographic programs. In these tables you can map a single geography provided

To confirm that the data selected was correct, click the Show Map button.

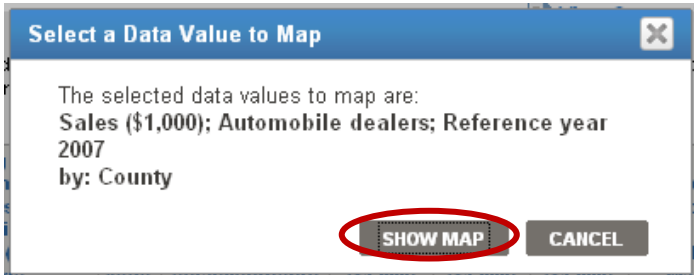

A color-coded map representing the sales of automobile dealer establishments for counties in Maryland displays.

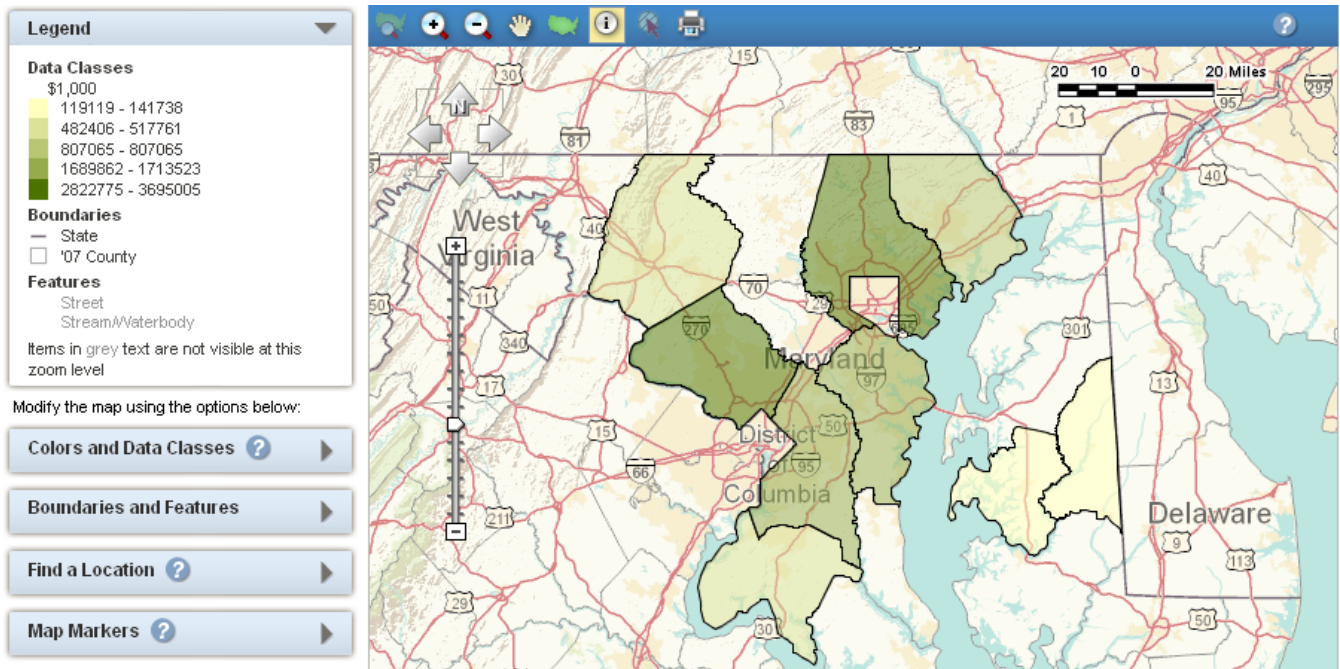

Helpful Hint

When the data for a geography are **withheld to avoid disclosing data for individual companies** (shown with a "D" in the table) **or were not published**, the geography is not shaded in the map.

MANIPULATING THE MAP

You can modify the map (including changing the colors and data classes used in the map and changing the boundaries and features displayed in the map) by using the map options.

Modify the map using the options below:

- [Colors and Data Classes ?](#) ▶
- [Boundaries and Features](#) ▶
- [Find a Location ?](#) ▶
- [Map Markers ?](#) ▶

Using the tools at the top of the map, you can pan and zoom on the map.



DOWNLOADING A MAP

In addition to the formats discussed in the [Downloading](#), section of this document, maps are downloadable in the following formats:

- JPEG
- Shapefiles
 - They will include all map layers that are available on the screen. The shapefiles can be loaded into most GIS applications.
- CSV downloads only contain the associated values on the map

DEFINITIONS AND RELATED TEXT

DEFINITIONS

Definitions are available for all items that are hyperlinked within the table. Definitions are provided for:

- most column names,
- flags (symbols),
- NAICS codes and descriptions, and
- other dimension descriptions.

To access the definition of an item, click the hyperlinked text. For the full definition, click “more »”.

Geographic area name	2007 North American Industry Classification System (NAICS)	Meaning of 2007 North American Industry Classification System	Meaning of Type of operation or tax status	Year	Number of employer	Employer value of sales, shipments, receipts, revenue, or business done (\$1,000)
United States	21	Wholesale trade The Wholesale Trade sector comprises establishments engaged in wholesaling merchandise, generally without transformation, and rendering services incidental to the sale of merchandise. The merchandise described in this sector includes the outputs of agriculture, mining, manufacturing, and certain ...				413,524,731
United States	22					584,192,658
United States	23	more »				731,841,830
United States	31-33	Manufacturing	Total	2007	332,536	5,319,456,312
United States	42	Wholesale trade	Wholesale Trade	2007	434,983	6,515,708,554

TABLE NOTES

Each table has descriptive text associated with it that includes geographic coverage, industry detail, data limitations, and other table-specific information.

To access table notes, click the “View Table Notes” button on the top-right of the table.



PROGRAM/SURVEY INFORMATION

Information is provided for each economic data program or survey. This information includes:

- overview, purposes, uses, and historical information for the program,
- methodology for collecting and processing the data, and
- details on industry/geography coverage and data products.

To access information on the table's program, click the  button next to the table title and select the "Program", "Survey", and "Data Set" links at the beginning of the pop-up window.

EC0700A1

Economy-Wide Key Statistics: 2007
2007 Economic Census



FACTFINDER HELP

ABOUT THE DATA

Program

Economic Census

Survey

Economic Census United States

Data Set

2007 Economic Census

Table

EC0700A1 - All sectors: Geographic Area
Series: Economy-Wide Key Statistics: 2007

FEEDBACK

We would like to hear your feedback on the new American FactFinder.

To submit feedback and suggestions, use the "Feedback" link on the top-right of the page.

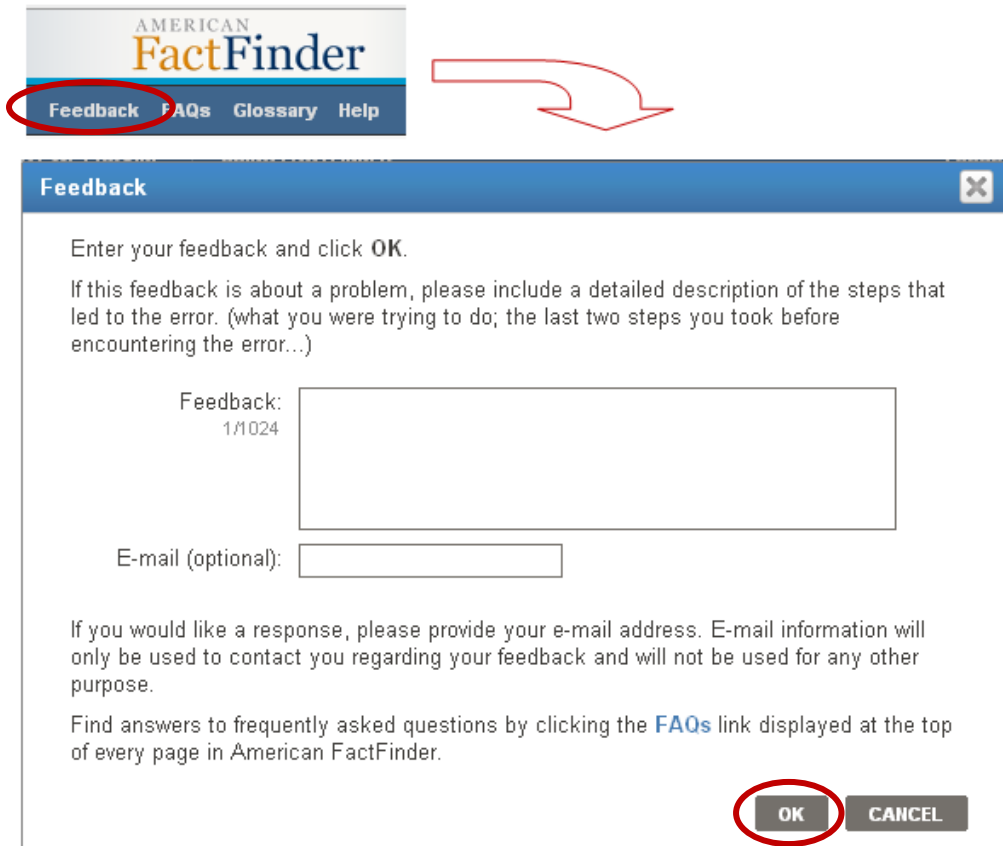

FURTHER HELP

RELATED WEBSITES

- Annual Survey of Manufactures – www.census.gov/manufacturing/asm
- Census Bureau Economic Statistics – www.census.gov/econ
- Commodity Flow Survey – www.census.gov/econ/cfs
- County Business Patterns – www.census.gov/econ/cbp
- Economic Census of the Island Areas – www.census.gov/econ/islandareas
- Economic Census of the United States
 - 2012 – www.census.gov/econ/census
 - 2007 – www.census.gov/econ/census07
 - 2002 – www.census.gov/econ/census02
 - 1997 – www.census.gov/epcd/www/econ97.html
 - 1992 – www.census.gov/epcd/www/92result.html
- Help Section on AFF – http://factfinder2.census.gov/help/en/american_factfinder_help.htm
- Nonemployer Statistics – www.census.gov/econ/nonemployer
- North American Industry Classification System (NAICS) – www.census.gov/eos/www/naics
- Survey of Business Owners – www.census.gov/econ/sbo

CONTACT US

- Using the Data
 - Telephone – (301)763-2547, Toll-free – (877)790-1876
 - E-mail – econ@census.gov
- NAICS
 - Telephone – (301)763-2790
 - E-mail – naics@census.gov
- Help with American FactFinder
 - Telephone – (301)763-5185
 - E-mail – epcd.dissemination@census.gov
- Contacts by Industry – www.census.gov/econ/census07/www/contact_info/contacts_by_industry.html
- Contacts by Program or Survey – www.census.gov/econ/census07/www/contact_info/contacts_by_census_or_survey.html

APPENDIX

TABLE IDS

Tables IDs for economic data tables are constructed as follows:

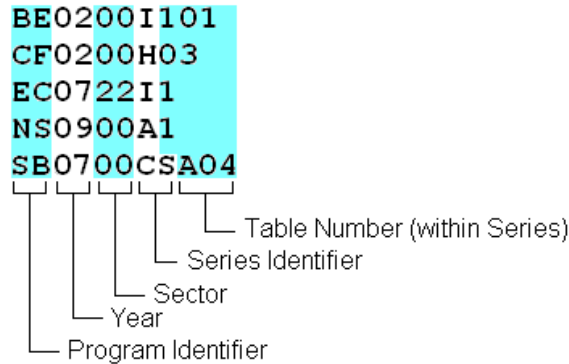

Program Identifier	Program Name
AM	Annual Survey of Manufactures
BE	Business Expenses Survey
CF	Commodity Flow Survey
CB	County Business Patterns
EC	Economic Census of the United States
IA	Economic Census of Island Areas
NS	Nonemployer Statistics
SB	Survey of Business Owners

Helpful Hint

In the Keyword Search box, you can use an **asterisk (*)** to search for groups of table using part of their Table IDs.

For example, "EC07*" brings back all 2007 Economic Census tables. "EC*42*" brings back all Economic Census Wholesale Trade tables for all years of available data.

Sector Number	Sector Name	Sector Number	Sector Name
00	Multi-sector	53	Real Estate and Rental and Leasing
11	Agriculture, Forestry, Fishing and Hunting	54	Professional, Scientific, and Technical Services
21	Mining, Quarrying, and Oil and Gas Extraction	55	Management of Companies and Enterprises
22	Utilities	56	Administrative and Support and Waste Management and Remediation Services
23	Construction	61	Educational Services
31	Manufacturing (NAICS 31-33)	62	Health Care and Social Assistance
42	Wholesale Trade	71	Arts, Entertainment, and Recreation
44	Retail Trade (NAICS 44-45)	72	Accommodation and Food Services
48	Transportation and Warehousing (NAICS 48-49)	81	Other Services (except Public Administration)
51	Information	92	Public Administration
52	Finance and Insurance		

Series Identifier	Series Name
A	Geographic Area Series
C	Core Business Statistics Series
CS	Company Statistics Series
CZ	ZIP Code Business Statistics
E	Exports Series
GS	General Statistics
H	Hazardous Materials Series
I	Industry Series
P	Commodity Flow Survey Advance Report
S	Subject Series
SA	Subject Series: Location of Manufacturing/Mining Plants
SG	Summary Series: General Summary
SL	Subject Series: Product Lines
SM	Summary Series: Materials & Fuels Consumed
SP	Summary Series: Products & Services Summary
SR	Subject Series: Concentration Ratios
SS	Subject Series: Establishment & Firm Size
SX	Subject Series: Miscellaneous Subjects
VS	Value of Product Shipments
Z	ZIP Code Statistics

GEOGRAPHY SELECTION

This section demonstrates the steps to get to a single geographic area or an entire group of geographic areas using the **Select Geographies** overlay.

These steps illustrate a single way to select area(s) in AFF. In many cases, there is more than one way to add these areas to Your Selections.

Helpful Hint

To see all the types of geographies available, select the “all summary levels” radio button above the Geography Results.

all summary levels

Geographic Area Type	Steps to Retrieve Data for a Single Area	Steps to Retrieve Data for all Geographic Areas within a Type
United States	(ex: U.S.) <ul style="list-style-type: none"> Select United States from the Geography Results list 	N/A
States and equivalents ¹	(ex: New York) <ul style="list-style-type: none"> Select New York from the Geography Results list 	(ex: All States in the U.S.) <ul style="list-style-type: none"> Select All States within United States from the Geography Results list
Counties and equivalents ²	(ex: Westchester County, NY) <ul style="list-style-type: none"> Select County from the Geographic Type list in the Geography Filter Options menu Expand the Within State list in the Geography Filter Options menu and select New York Select Westchester County, New York from the Geography Results list 	(ex: All Counties in New York) <ul style="list-style-type: none"> Select County from the Geographic Type list in the Geography Filter Options menu Select All Counties within New York from the Geography Results list
Consolidated Cities	(ex: Milford city, CT) <ul style="list-style-type: none"> Expand the Summary Level list in the Geography Filter Options menu and select 170 – Consolidated City Select Milford city, Connecticut from the Geography Results list 	(ex: All Consolidated Cities in the U.S.) <ul style="list-style-type: none"> Expand the Summary Level list in the Geography Filter Options menu and select 170 – Consolidated City Select all of the consolidated cities presented in the Geography Results list
Economic Places ³	(ex: White Plains city, NY) [The Enter a geography name search system is the easiest way to access data for this type of geography.] <ul style="list-style-type: none"> Type in White Plains in the Enter a geography name search box, select White Plains city, New York, and click Go Select the Economic Place White Plains city, New York from the Geography Results list 	(ex: All Economic Places in Westchester County, NY) <ul style="list-style-type: none"> Select City or town from the Geographic Type list in the Geography Filter Options menu Expand the Summary Level list in the Geography Filter Options menu and select E60 – Economic Place Expand the Within State list in the Geography Filter Options menu and select New York Select All Economic Places fully-or-partially within Westchester County, New York from the Geography Results list

¹ Includes the 50 U.S. states, the District of Columbia, and Puerto Rico and the Island Areas (American Samoa, Guam, Commonwealth of the Northern Mariana Islands, and the US Virgin Islands).

² Includes parishes in Louisiana, boroughs and census areas in Alaska, Districts in American Samoa and Guam, municipalities in the Commonwealth of the Northern Mariana Islands, and *municipios* in Puerto Rico.

³ Economic Places include incorporated cities and unincorporated areas (also known as Census Designated Places) with 5,000 or more population or jobs. For the 12 “strong minor civil division states” (X), this also includes county subdivisions. This area also includes a “balance of county” record for all counties in the U.S. except counties completely comprised of economic places (no remainder) and counties with no recognized economic places. For American Samoa, “counties” are treated as place equivalents.

Geographic Area Type	Steps to Retrieve Data for a Single Area	Steps to Retrieve Data for all Geographic Areas within a Type
County Parts of Economic Places that Cross County Boundaries	<p>(ex: New York city, NY (New York County part))</p> <ul style="list-style-type: none"> Expand the Summary Level list in the Geography Filter Options menu and select E65 – County (or part) Expand the Within State list in the Geography Filter Options menu and select New York Select New York County, New York city, New York from the Geography Results list 	<p>(ex: New York city, NY (Bronx, Kings, New York, Queens, and Richmond County parts))</p> <ul style="list-style-type: none"> Expand the Summary Level list in the Geography Filter Options menu and select E65 – County (or part) Expand the Within State list in the Geography Filter Options menu and select New York Select all 5 parts of the New York city, NY Economic Place presented in the Geography Results list
Combined Statistical Areas (CSA)	<p>(ex: New York-Newark-Bridgeport, NY-NJ-CT-PA CSA)</p> <ul style="list-style-type: none"> Expand the Summary Level list in the Geography Filter Options menu and select 330 – Combined Statistical Area Select New York-Newark-Bridgeport, NY-NJ-CT-PA CSA from the Geography Results list 	<p>(ex: All CSAs in the U.S.)</p> <ul style="list-style-type: none"> Expand the Summary Level list in the Geography Filter Options menu and select 330 – Combined Statistical Area Select All Combined Statistical Areas within United States from the Geography Results list
Metropolitan and Micropolitan Statistical Areas	<p>(ex: New York-Northern New Jersey-Long Island, NY-NJ-PA Metro Area)</p> <ul style="list-style-type: none"> Select Metro/Micro Area from the Geographic Type list in the Geography Filter Options menu Expand the Within State list in the Geography Filter Options menu and select New York Select New York-Northern New Jersey-Long Island, NY-NJ-PA Metro Area from the Geography Results list 	<p>(ex: All Metro & Micro Areas in New York state)</p> <ul style="list-style-type: none"> Select Metro/Micro Area from the Geographic Type list in the Geography Filter Options menu Expand the Within State list in the Geography Filter Options menu and select New York Select All Metropolitan and Micropolitan Statistical Areas (or parts) within New York from the Geography Results list
Metropolitan Divisions	<p>(ex: New York-White Plains-Wayne, NY-NJ Metro Division)</p> <ul style="list-style-type: none"> Select Other from the Geographic Type list in the Geography Filter Options menu Expand the Within Metropolitan Statistical Area/Micropolitan Statistical Area list in the Geography Filter Options menu and select New York-Northern New Jersey-Long Island, NY-NJ-PA Select New York-White Plains-Wayne, NY-NJ-PA Metro Area from the Geography Results list 	<p>(ex: All Metro Divisions in the New York-Northern New Jersey-Long Island, NY-NJ-PA Metro Area)</p> <ul style="list-style-type: none"> Select Other from the Geographic Type list in the Geography Filter Options menu Expand the Within Metropolitan Statistical Area/Micropolitan Statistical Area list in the Geography Filter Options menu and select New York-Northern New Jersey-Long Island, NY-NJ-PA Select all of the metro divisions presented in the Geography Results list
Census Regions (Construction sector and Commodity Flow Survey only)	<p>(ex: Northeast Region)</p> <ul style="list-style-type: none"> Select Other from the Geographic Type list in the Geography Filter Options menu Select Northeast Region from the Geography Results list 	<p>(ex: All Regions in the U.S.)</p> <ul style="list-style-type: none"> Select Other from the Geographic Type list in the Geography Filter Options menu Select all of the regions presented in the Geography Results list

Geographic Area Type	Steps to Retrieve Data for a Single Area	Steps to Retrieve Data for all Geographic Areas within a Type
Census Divisions (Commodity Flow Survey only)	(ex: Middle Atlantic Division) <ul style="list-style-type: none"> Select Other from the Geographic Type list in the Geography Filter Options menu Select Middle Atlantic Division from the Geography Results list 	(ex: All Divisions in the U.S.) <ul style="list-style-type: none"> Select Other from the Geographic Type list in the Geography Filter Options menu Select all of the divisions presented in the Geography Results list
Commercial Regions (Puerto Rico only)	(ex: San Juan PR Commercial Region) <ul style="list-style-type: none"> Expand the Summary Level list in the Geography Filter Options menu and select E20 – Commercial Region Select San Juan Commercial Region from the Geography Results list 	(ex: All Commercial Regions in PR) <ul style="list-style-type: none"> Expand the Summary Level list in the Geography Filter Options menu and select E20 – Commercial Region Select all of the commercial regions presented in the Geography Results list
ZIP Codes	(ex: 10601: White Plains, New York) [The Enter a geography name search system is the easiest way to access data for this type of geography.] <ul style="list-style-type: none"> Type in 10601 in the Enter a geography name search box and click Go Select ZIP 10601 (White Plains, NY) from the Geography Results list 	(ex: All ZIP Codes in White Plains, NY) <ul style="list-style-type: none"> Select ZIP Code/ZCTA from the Geographic Type list in the Geography Filter Options menu Expand the Within State list in the Geography Filter Options menu and select New York Expand the Within Place list in the Geography Filter Options menu and select White Plains Select All 5-Digit ZIP Codes fully-or-partially within White Plains city, New York from the Geography Results list
Offshore Areas (Mining Only)	(ex: Mining Offshore Areas) <ul style="list-style-type: none"> Select Offshore areas not associated with a state from the Geography Results list 	N/A
Non-Metro Areas ⁴	(ex: Area Outside New York Metropolitan Areas) <ul style="list-style-type: none"> Expand the Summary Level list in the Geography Filter Options menu and select E32 – Not in Metropolitan / Micropolitan Statistical Area Select Not in metropolitan or micropolitan area, New York (part); New York from the Geography Results list 	(ex: All Areas Outside State Metropolitan Areas in the U.S.) <ul style="list-style-type: none"> Expand the Summary Level list in the Geography Filter Options menu and select E32 – Not in Metropolitan / Micropolitan Statistical Area Select all of the non-metro areas presented in the Geography Results list
“Statewide” Counties (County Business Patterns Only)	(ex: Statewide New York) <ul style="list-style-type: none"> Select County from the Geographic Type list in the Geography Filter Options menu Expand the Within State list in the Geography Filter Options menu and select New York Select Statewide, New York; New York from the Geography Results list 	(ex: All Statewide Areas in the U.S.) <ul style="list-style-type: none"> To select these geographies, follow the same steps to select for a single state but repeat for each state

⁴ Non-metro data are only available for 46 of the 50 states. Non-metro data are not available for Connecticut, Delaware, New Jersey, and Rhode Island since all of the counties in these states are in a metro area.

NAICS STRUCTURE

The North American Industry Classification System (NAICS) uses a hierarchical structure. A "hierarchy" is the relationship of one item to a particular category.

The organization of NAICS is as follows:

- **Sector:** 2-digit code
 - **Subsector:** 3-digit code
 - **Industry Group:** 4-digit code
 - **NAICS Industry:** 5-digit code
 - **National Industry:** 6-digit code

Note: Three sectors are represented by a range of 2-digit codes. These include Manufacturing (31-33), Retail Trade (44-45) and Transportation and Warehousing (48-49).

Example:

Sector	44-45	Retail Trade
Subsector	441	Motor Vehicle and Parts Dealers
Industry Group	4412	Other Motor Vehicle Dealers
NAICS Industry	44122	Motorcycle, Boat, and Other Motor Vehicle Dealers
National Industry	441221	Motorcycle, ATV, and Personal Watercraft Dealers

Note: Some data sets also display data at the 7- and 8-digit levels. Although these codes are NAICS-based codes, they are not included in the official classification system.

More information on NAICS can be found at www.census.gov/naics.