

Figure 307.2
of Protruding Objects



Guidance on the 2010 ADA Standards for Accessible Design

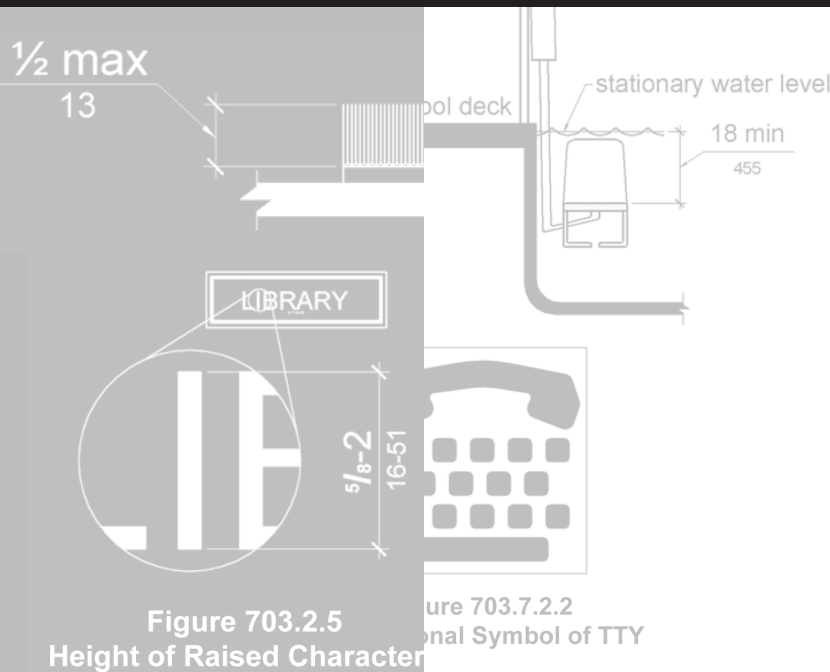
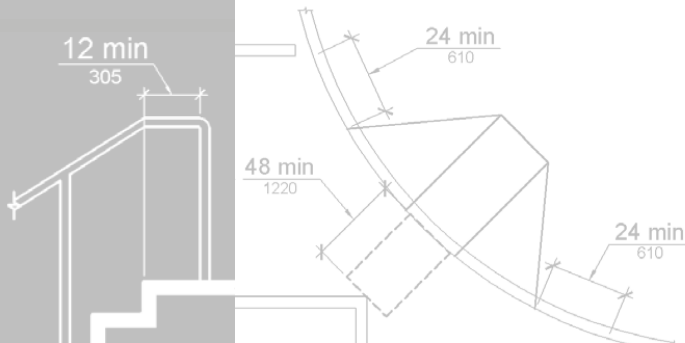

Figure 703.2.5
Height of Raised Character

Figure 703.7.2.2
International Symbol of TTY



Department of Justice
September 15, 2010

Reproduction of this document is encouraged.

This publication may be viewed or downloaded
from the ADA website (www.ADA.gov).
Additional copies may be obtained
by calling the ADA Information Line:

800-514-0301 (voice)
800-514-0383 (TTY)

September 15, 2010

Contents

1	Introduction.....	1
2	State and Local Government Facilities: Guidance on the Revisions to 28 CFR 35.151....	3
3	Public Accommodations and Commercial Facilities: Guidance on the Revisions to 28 CFR part 36, subpart D.....	39
4	Appendix B to part 36: Analysis and Commentary on the 2010 ADA Standards for Accessible Design.....	69

1 Introduction

The Department of Justice published its revised regulations for Titles II and III of the Americans with Disabilities Act of 1990 “ADA” in the *Federal Register* on September 15, 2010, which include the 2010 Standards for Accessible Design “2010 Standards” or “Standards”. In the revised regulations, the Department included detailed guidance with a section-by-section analysis of the revisions.

The following includes guidance from the revised regulations related to 28 CFR 35.151; 28 CFR part 36, subpart D; and the 2004 ADAAG. It addresses changes to the Standards, the reasoning behind those changes, and responses to public comments received on these topics

For More Information

For information about the ADA, including the revised 2010 ADA regulations, please visit the Department’s website www.ADA.gov; or, for answers to specific questions, call the toll-free ADA Information Line at 800-514-0301 (voice) or 800-514-0383 (TTY).

2 State and Local Government Facilities

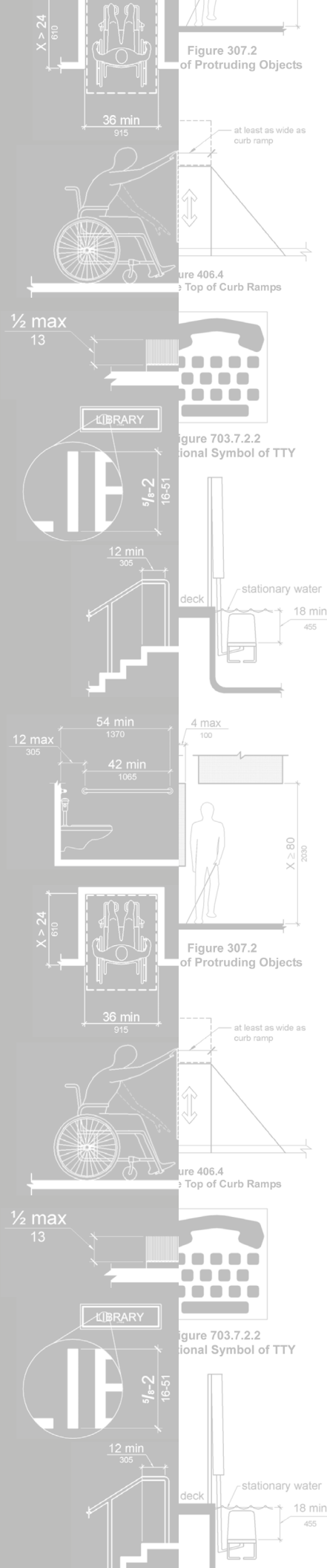

State and Local Government Facilities: Guidance on the Revisions to 28 CFR Section 35.151

Section 35.151(a), which provided that those facilities that are constructed or altered by, on behalf of, or for the use of a public entity shall be designed, constructed, or altered to be readily accessible to and usable by individuals with disabilities, is unchanged in the final rule, but has been redesignated as Sec. 35.151(a)(1). The Department has added a new section, designated as Sec. 35.151(a)(2), to provide that full compliance with the requirements of this section is not required where an entity can demonstrate that it is structurally impracticable to meet the requirements. Full compliance will be considered structurally impracticable only in those rare circumstances when the unique characteristics of terrain prevent the incorporation of accessibility features. This exception was contained in the title III regulation and in the 1991 Standards (applicable to both public accommodations and facilities used by public entities), so it has applied to any covered facility that was constructed under the 1991 Standards since the effective date of the ADA. The Department added it to the text of Sec. 35.151 to maintain consistency between the design requirements that apply under title II and those that apply under title III. The Department received no significant comments about this section.

Section 35.151(b) Alterations

The 1991 title II regulation does not contain any specific regulatory language comparable to the 1991 title III regulation relating to alterations and path of travel for covered entities, although the 1991 Standards describe standards for path of travel during alterations to a primary function. See 28 CFR part 36, app A., section 4.1.6(a) (2009).

The path of travel requirements contained in the title III regulation are based on section 303(a)(2) of the ADA, 42 U.S.C. 12183(a)(2), which provides that when an entity undertakes an alteration to a place of public accommodation or commercial facility that affects or could affect the usability of or access to an area that contains a primary function, the entity shall ensure that, to the maximum extent feasible, the path of travel to the altered area--and the restrooms, telephones, and drinking fountains serving it--is readily accessible to and usable by individuals with disabilities, including individuals who use wheelchairs.

The NPRM proposed amending Sec. 35.151 to add both the path of travel requirements and the exemption relating to barrier removal (as modified to apply to the program accessibility standard in title II) that are contained in the title III regulation to the title II regulation. Proposed Sec. 35.151(b)(4) contained the requirements for path of travel. Proposed

Section 35.151 -- Title II Regulation

Sec. 35.151(b)(2) stated that the path of travel requirements of Sec. 35.151(b)(4) shall not apply to measures taken solely to comply with program accessibility requirements.

Where the specific requirements for path of travel apply under title III, they are limited to the extent that the cost and scope of alterations to the path of travel are disproportionate to the cost of the overall alteration, as determined under criteria established by the Attorney General.

The Access Board included the path of travel requirement for alterations to facilities covered by the standards (other than those subject to the residential facilities standards) in section 202.4 of 2004 ADAAG. Section 35.151(b)(4)(iii) of the final rule establishes the criteria for determining when the cost of alterations to the path of travel is “disproportionate” to the cost of the overall alteration.

The NPRM also provided that areas such as supply storage rooms, employee lounges and locker rooms, janitorial closets, entrances, and corridors are not areas containing a primary function. Nor are restroom areas considered to contain a primary function unless the provision of restrooms is a primary purpose of the facility, such as at a highway rest stop. In that situation, a restroom would be considered to be an “area containing a primary function” of the facility.

The Department is not changing the requirements for program accessibility. As provided in Sec. 35.151(b)(2) of the regulation, the path of travel requirements of Sec. 35.151(b)(4) only apply to alterations undertaken solely for purposes other than to meet the program accessibility requirements. The exemption for the specific path of travel requirement was included in the regulation to ensure that the specific requirements and disproportionality exceptions for path of travel are not applied when areas are being altered to meet the title II program accessibility requirements in Sec. 35.150. In contrast, when areas are being altered to meet program accessibility requirements, they must comply with all of the applicable requirements referenced in section 202 of the 2010 Standards. A covered title II entity must provide accessibility to meet the requirements of Sec. 35.150 unless doing so is an undue financial and administrative burden in accordance with Sec. 35.150(a)(3). A covered title II entity may not use the disproportionality exception contained in the path of travel provisions as a defense to providing an accessible route as part of its obligation to provide program accessibility. The undue financial and administrative burden standard does not contain any bright line financial tests.

The Department’s proposed Sec. 35.151(b)(4) adopted the language now contained in Sec. 36.403 of the title III regulation, including the disproportionality limitation (i.e., alterations made to

provide an accessible path of travel to the altered area would be deemed disproportionate to the overall alteration when the cost exceeds 20 percent of the cost of the alteration to the primary function area). Proposed Sec. 35.151(b)(2) provided that the path of travel requirements do not apply to alterations undertaken solely to comply with program accessibility requirements.

The Department received a substantial number of comments objecting to the Department's adoption of the exemption for the path of travel requirements when alterations are undertaken solely to meet program accessibility requirements. These commenters argued that the Department had no statutory basis for providing this exemption nor does it serve any purpose. In addition, these commenters argued that the path of travel exemption has the effect of placing new limitations on the obligations to provide program access. A number of commenters argued that doing away with the path of travel requirement would render meaningless the concept of program access. They argued that just as the requirement to provide an accessible path of travel to an altered area (regardless of the reason for the alteration), including making the restrooms, telephones, and drinking fountains that serve the altered area accessible, is a necessary requirement in other alterations, it is equally necessary for alterations made to provide program access. Several commenters expressed concern that a readily accessible path of travel be available to

ensure that persons with disabilities can get to the physical location in which programs are held. Otherwise, they will not be able to access the public entity's service, program, or activity. Such access is a cornerstone of the protections provided by the ADA. Another commenter argued that it would be a waste of money to create an accessible facility without having a way to get to the primary area. This commenter also stated that the International Building Code (IBC) requires the path of travel to a primary function area, up to 20 percent of the cost of the project. Another commenter opposed the exemption, stating that the trigger of an alteration is frequently the only time that a facility must update its facilities to comply with evolving accessibility standards.

In the Department's view, the commenters objecting to the path of travel exemption contained in Sec. 35.151(b)(2) did not understand the intention behind the exemption. The exemption was not intended to eliminate any existing requirements related to accessibility for alterations undertaken in order to meet program access obligations under Sec. 35.149 and Sec. 35.150. Rather, it was intended to ensure that covered entities did not apply the path of travel requirements in lieu of the overarching requirements in this Subpart that apply when making a facility accessible in order to comply with program accessibility. The exemption was also intended to make it clear that the disproportionality test contained in the path of travel standards is not applicable in determining whether

Section 35.151 -- Title II Regulation

providing program access results in an undue financial and administration burden within the meaning of Sec. 35.150(a)(3). The exemption was also provided to maintain consistency with the title III path of travel exemption for barrier removal, see Sec. 36.304(d), in keeping with the Department's regulatory authority under title II of the ADA. See 42 U.S.C. 12134(b); see also H. R Rep. No. 101B485, pt. 2, at 84 (1990) ("The committee intends, however, that the forms of discrimination prohibited by section 202 be identical to those set out in the applicable provisions of titles I and III of this legislation.").

For title II entities, the path of travel requirements are of significance in those cases where an alteration is being made solely for reasons other than program accessibility. For example, a public entity might have six courtrooms in two existing buildings and might determine that only three of those courtrooms and the public use and common use areas serving those courtrooms in one building are needed to be made accessible in order to satisfy its program access obligations. When the public entity makes those courtrooms and the public use and common use areas serving them accessible in order to meet its program access obligations, it will have to comply with the 2010 Standards unless the public entity can demonstrate that full compliance would result in undue financial and administrative burdens as described in Sec. 35.150(a)(3). If such action would result in an undue financial or administrative

burden, the public entity would nevertheless be required to take some other action that would not result in such an alteration or such burdens but would ensure that the benefits and services provided by the public entity are readily accessible to persons with disabilities. When the public entity is making modifications to meet its program access obligation, it may not rely on the path of travel exception under Sec. 35.151(b)(4), which limits the requirement to those alterations where the cost and scope of the alterations are not disproportionate to the cost and scope of the overall alterations. If the public entity later decides to alter courtrooms in the other building, for purposes of updating the facility (and, as previously stated, has met its program access obligations) then in that case, the public entity would have to comply with the path of travel requirements in the 2010 Standards subject to the disproportionality exception set forth in Sec. 35.151(b)(4).

The Department has slightly revised proposed Sec. 35.151(b)(2) to make it clearer that the path of travel requirements only apply when alterations are undertaken solely for purposes other than program accessibility.

Section 35.151(b)(4)(ii)(C) Path of travel--safe harbor

In Sec. 35.151(b)(4)(ii)(C) of the NPRM, the Department included a provision that stated that public entities that have brought required elements of path of travel into compliance

with the 1991 Standards are not required to retrofit those elements in order to reflect incremental changes in the 2010 Standards solely because of an alteration to a primary function area that is served by that path of travel. In these circumstances, the public entity is entitled to a safe harbor and is only required to modify elements to comply with the 2010 Standards if the public entity is planning an alteration to the element.

A substantial number of commenters objected to the Department's imposition of a safe harbor for alterations to facilities of public entities that comply with the 1991 Standards. These commenters argued that if a public entity is already in the process of altering its facility, there should be a legal requirement that individuals with disabilities be entitled to increased accessibility by using the 2010 Standards for path of travel work. They also stated that they did not believe there was a statutory basis for "grandfathering" facilities that comply with the 1991 Standards.

The ADA is silent on the issue of "grandfathering" or establishing a safe harbor for measuring compliance in situations where the covered entity is not undertaking a planned alteration to specific building elements. The ADA delegates to the Attorney General the responsibility for issuing regulations that define the parameters of covered entities' obligations when the statute does not directly address an issue. This regulation

implements that delegation of authority.

One commenter proposed that a previous record of barrier removal be one of the factors in determining, prospectively, what renders a facility, when viewed in its entirety, usable and accessible to persons with disabilities. Another commenter asked the Department to clarify, at a minimum, that to the extent compliance with the 1991 Standards does not provide program access, particularly with regard to areas not specifically addressed in the 1991 Standards, the safe harbor will not operate to relieve an entity of its obligations to provide program access.

One commenter supported the proposal to add a safe harbor for path of travel.

The final rule retains the safe harbor for required elements of a path of travel to altered primary function areas for public entities that have already complied with the 1991 Standards with respect to those required elements. The Department believes that this safe harbor strikes an appropriate balance between ensuring that individuals with disabilities are provided access to buildings and facilities and potential financial burdens on existing public entities that are undertaking alterations subject to the 2010 Standards. This safe harbor is not a blanket exemption for facilities. If a public entity undertakes an alteration to a primary function area, only the required elements of a path of travel to that area that already comply with the 1991

Section 35.151 -- Title II Regulation

Standards are subject to the safe harbor. If a public entity undertakes an alteration to a primary function area and the required elements of a path of travel to the altered area do not comply with the 1991 Standards, then the public entity must bring those elements into compliance with the 2010 Standards.

Section 35.151(b)(3) Alterations to historic facilities

The final rule renumbers the requirements for alterations to historic facilities enumerated in current Sec. 35.151(d)(1) and (2) as Sec. 35.151(b)(3)(i) and (ii). Currently, the regulation provides that alterations to historic facilities shall comply to the maximum extent feasible with section 4.1.7 of UFAS or section 4.1.7 of the 1991 Standards. See 28 CFR 35.151(d)(1). Section 35.151(b)(3)(i) of the final rule eliminates the option of using UFAS for alterations that commence on or after March 15, 2012. The substantive requirement in current Sec. 35.151(d)(2)--that alternative methods of access shall be provided pursuant to the requirements of Sec. 35.150 if it is not feasible to provide physical access to an historic property in a manner that will not threaten or destroy the historic significance of the building or facility--is contained in Sec. 35.151(b)(3)(ii).

Section 35.151(c) Accessibility standards for new construction and alterations

Section 35.151(c) of the NPRM proposed to adopt ADA Chapter 1, ADA Chapter 2, and Chapters 3 through 10 of the Americans with Disabilities Act and Architectural Barriers Act Guidelines (2004 ADAAG) into the ADA Standards for Accessible Design (2010 Standards). As the Department has noted, the development of these standards represents the culmination of a lengthy effort by the Access Board to update its guidelines, to make the Federal guidelines consistent to the extent permitted by law, and to harmonize the Federal requirements with the private sector model codes that form the basis of many State and local building code requirements. The full text of the 2010 Standards is available for public review on the ADA Home Page (<http://www.ada.gov>) and on the Access Board's Web site (<http://www.access-board.gov/gs.htm>) (last visited June 24, 2010). The Access Board site also includes an extensive discussion of the development of the 2004 ADA/ABA Guidelines, and a detailed comparison of the 1991 Standards, the 2004 ADA/ABA Guidelines, and the 2003 International Building Code.

Section 204 of the ADA, 42 U.S.C. 12134, directs the Attorney General to issue regulations to implement title II that are consistent with the minimum guidelines published by

the Access Board. The Attorney General (or his designee) is a statutory member of the Access Board (see 29 U.S.C. 792(a)(1)(B)(vii)) and was involved in the development of the 2004 ADAAG. Nevertheless, during the process of drafting the NPRM, the Department reviewed the 2004 ADAAG to determine if additional regulatory provisions were necessary. As a result of this review, the Department decided to propose new sections, which were contained in Sec. 35.151(e)(h) of the NPRM, to clarify how the Department will apply the proposed standards to social service center establishments, housing at places of education, assembly areas, and medical care facilities. Each of these provisions is discussed below.

Congress anticipated that there would be a need for close coordination of the ADA building requirements with State and local building code requirements. Therefore, the ADA authorized the Attorney General to establish an ADA code certification process under title III of the ADA. That process is addressed in 28 CFR part 36, subpart F. Revisions to that process are addressed in the regulation amending the title III regulation published elsewhere in the Federal Register today. In addition, the Department operates an extensive technical assistance program. The Department anticipates that once this rule is final, revised technical assistance material will be issued to provide guidance about its implementation.

Section 35.151(c) of the 1991 title II regulation establishes two standards for accessible new construction and alteration. Under paragraph (c), design, construction, or alteration of facilities in conformance with UFAS or with the 1991 Standards (which, at the time of the publication of the rule were also referred to as the Americans with Disabilities Act Accessibility Guidelines for Buildings and Facilities (1991 ADAAG)) is deemed to comply with the requirements of this section with respect to those facilities (except that if the 1991 Standards are chosen, the elevator exemption does not apply). The 1991 Standards were based on the 1991 ADAAG, which was initially developed by the Access Board as guidelines for the accessibility of buildings and facilities that are subject to title III. The Department adopted the 1991 ADAAG as the standards for places of public accommodation and commercial facilities under title III of the ADA and it was published as Appendix A to the Department's regulation implementing title III, 56 FR 35592 (July 26, 1991) as amended, 58 FR 17522 (April 5, 1993), and as further amended, 59 FR 2675 (Jan. 18, 1994), codified at 28 CFR part 36 (2009).

Section 35.151(c) of the final rule adopts the 2010 Standards and establishes the compliance date and triggering events for the application of those standards to both new construction and alterations. Appendix B of the final title III rule (Analysis and

Section 35.151 -- Title II Regulation

Commentary on the 2010 ADA Standards for Accessible Design) (which will be published today elsewhere in this volume and codified as Appendix B to 28 CFR part 36) provides a description of the major changes in the 2010 Standards (as compared to the 1991 ADAAG) and a discussion of the public comments that the Department received on specific sections of the 2004 ADAAG. A number of commenters asked the Department to revise certain provisions in the 2004 ADAAG in a manner that would reduce either the required scoping or specific technical accessibility requirements. As previously stated, although the ADA requires the enforceable standards issued by the Department under title II and title III to be consistent with the minimum guidelines published by the Access Board, it is the sole responsibility of the Attorney General to promulgate standards and to interpret and enforce those standards. The guidelines adopted by the Access Board are “minimum guidelines.” 42 U.S.C. 12186(c).

Compliance date. When the ADA was enacted, the effective dates for various provisions were delayed in order to provide time for covered entities to become familiar with their new obligations. Titles II and III of the ADA generally became effective on January 26, 1992, six months after the regulations were published. See 42 U.S.C. 12131 note; 42 U.S.C. 12181 note. New construction under title II and alterations under either title II or title III had to comply with the design standards on that date. See

42 U.S.C. 12183(a)(1). For new construction under title III, the requirements applied to facilities designed and constructed for first occupancy after January 26, 1993--18 months after the 1991 Standards were published by the Department. In the NPRM, the Department proposed to amend Sec. 35.151(c)(1) by revising the current language to limit the application of the 1991 standards to facilities on which construction commences within six months of the final rule adopting revised standards. The NPRM also proposed adding paragraph (c)(2) to Sec. 35.151, which states that facilities on which construction commences on or after the date six months following the effective date of the final rule shall comply with the proposed standards adopted by that rule.

As a result, under the NPRM, for the first six months after the effective date, public entities would have the option to use either UFAS or the 1991 Standards and be in compliance with title II. Six months after the effective date of the rule, the new standards would take effect. At that time, construction in accordance with UFAS would no longer satisfy ADA requirements. The Department stated that in order to avoid placing the burden of complying with both standards on public entities, the Department would coordinate a government-wide effort to revise Federal agencies' section 504 regulations to adopt the 2004 ADAAG as the standard for new construction and alterations.

The purpose of the proposed six-month delay in requiring compliance with the 2010 Standards was to allow covered entities a reasonable grace period to transition between the existing and the proposed standards. For that reason, if a title II entity preferred to use the 2010 Standards as the standard for new construction or alterations commenced within the six-month period after the effective date of the final rule, such entity would be considered in compliance with title II of the ADA.

The Department received a number of comments about the proposed six-month effective date for the title II regulation that were similar in content to those received on this issue for the proposed title III regulation. Several commenters supported the six-month effective date. One commenter stated that any revisions to its State building code becomes effective six months after adoption and that this has worked well. In addition, this commenter stated that since 2004 ADAAG is similar to IBC 2006 and ICC/ANSI A117.1-2003, the transition should be easy. By contrast, another commenter advocated for a minimum 12-month effective date, arguing that a shorter effective date could cause substantial economic hardships to many cities and towns because of the lengthy lead time necessary for construction projects. This commenter was concerned that a six-month effective date could lead to projects having to be completely redrawn, rebid, and rescheduled to ensure compliance with the new standards. Other commenters advocated

that the effective date be extended to at least 18 months after the publication of the rule. One of these commenters expressed concern that the kinds of bureaucratic organizations subject to the title II regulations lack the internal resources to quickly evaluate the regulatory changes, determine whether they are currently compliant with the 1991 standards, and determine what they have to do to comply with the new standards. The other commenter argued that 18 months is the minimum amount of time necessary to ensure that projects that have already been designed and approved do not have to undergo costly design revisions at taxpayer expense.

The Department is persuaded by the concerns raised by commenters for both the title II and III regulations that the six-month compliance date proposed in the NPRM for application of the 2010 Standards may be too short for certain projects that are already in the midst of the design and permitting process. The Department has determined that for new construction and alterations, compliance with the 2010 Standards will not be required until 18 months from the date the final rule is published. Until the time compliance with the 2010 Standards is required, public entities will have the option of complying with the 2010 Standards, the UFAS, or the 1991 Standards. However, public entities that choose to comply with the 2010 Standards in lieu of the 1991 Standards or UFAS prior to the compliance date described in this rule must choose

Section 35.151 -- Title II Regulation

one of the three standards, and may not rely on some of the requirements contained in one standard and some of the requirements contained in the other standards.

Triggering event. In Sec. 35.151(c)(2) of the NPRM, the Department proposed that the commencement of construction serve as the triggering event for applying the proposed standards to new construction and alterations under title II. This language is consistent with the triggering event set forth in Sec. 35.151(a) of the 1991 title II regulation. The Department received only four comments on this section of the title II rule. Three commenters supported the use of “start of construction” as the triggering event. One commenter argued that the Department should use the “last building permit or start of physical construction, whichever comes first,” stating that “altering a design after a building permit has been issued can be an undue burden.”

After considering these comments, the Department has decided to continue to use the commencement of physical construction as the triggering event for application of the 2010 Standards for entities covered by title II. The Department has also added clarifying language at Sec. 35.151(c)(4) to the regulation to make it clear that the date of ceremonial groundbreaking or the date a structure is razed to make it possible for construction of a facility to take place does not qualify as the commencement of physical construction.

Section 234 of the 2010 Standards provides accessibility guidelines for newly designed and constructed amusement rides. The amusement ride provisions do not provide a “triggering event” for new construction or alteration of an amusement ride. An industry commenter requested that the triggering event of “first use,” as noted in the Advisory note to section 234.1 of the 2004 ADAAG, be included in the final rule. The Advisory note provides that “[a] custom designed and constructed ride is new upon its first use, which is the first time amusement park patrons take the ride.” The Department declines to treat amusement rides differently than other types of new construction and alterations. Under the final rule, they are subject to Sec. 35.151(c). Thus, newly constructed and altered amusement rides shall comply with the 2010 Standards if the start of physical construction or the alteration is on or after 18 months from the publication date of this rule. The Department also notes that section 234.4.2 of the 2010 Standards only applies where the structural or operational characteristics of an amusement ride are altered. It does not apply in cases where the only change to a ride is the theme.

Noncomplying new construction and alterations. The element-by-element safe harbor referenced in Sec. 35.150(b)(2) has no effect on new or altered elements in existing facilities that were subject to the 1991 Standards or UFAS on the date that they were constructed or altered,

but do not comply with the technical and scoping specifications for those elements in the 1991 Standards or UFAS. Section 35.151(c)(5) of the final rule sets forth the rules for noncompliant new construction or alterations in facilities that were subject to the requirements of this part. Under those provisions, noncomplying new construction and alterations constructed or altered after the effective date of the applicable ADA requirements and before March 15, 2012 shall, before March 15, 2012, be made accessible in accordance with either the 1991 Standards, UFAS, or the 2010 Standards. Noncomplying new construction and alterations constructed or altered after the effective date of the applicable ADA requirements and before March 15, 2012, shall, on or after March 15, 2012 be made accessible in accordance with the 2010 Standards.

Section 35.151(d) Scope of coverage

In the NPRM, the Department proposed a new provision, Sec. 35.151(d), to clarify that the requirements established by Sec. 35.151, including those contained in the 2004 ADAAG, prescribe what is necessary to ensure that buildings and facilities, including fixed or built-in elements in new or altered facilities, are accessible to individuals with disabilities. Once the construction or alteration of a facility has been completed, all other aspects of programs, services, and activities conducted in that facility are subject

to the operational requirements established in this final rule. Although the Department may use the requirements of the 2010 Standards as a guide to determining when and how to make equipment and furnishings accessible, those determinations fall within the discretionary authority of the Department.

The Department also wishes to clarify that the advisory notes, appendix notes, and figures that accompany the 1991 and 2010 Standards do not establish separately enforceable requirements unless specifically stated otherwise in the text of the standards. This clarification has been made to address concerns expressed by ANPRM commenters who mistakenly believed that the advisory notes in the 2004 ADAAG established requirements beyond those established in the text of the guidelines (e.g., Advisory 504.4 suggests, but does not require, that covered entities provide visual contrast on stair tread nosing to make them more visible to individuals with low vision). The Department received no significant comments on this section and it is unchanged in the final rule.

Definitions of residential facilities and transient lodging. The 2010 Standards add a definition of “residential dwelling unit” and modify the current definition of “transient lodging.” Under section 106.5 of the 2010 Standards, “residential dwelling unit” is defined as “[a] unit intended to be used as a residence, that is primarily long-term in nature” and does not include transient

Section 35.151 -- Title II Regulation

lodging, inpatient medical care, licensed long-term care, and detention or correctional facilities. Additionally, section 106.5 of the 2010 Standards changes the definition of “transient lodging” to a building or facility “containing one or more guest room(s) for sleeping that provides accommodations that are primarily short-term in nature.” “Transient lodging” does not include residential dwelling units intended to be used as a residence. The references to “dwelling units” and “dormitories” that are in the definition of the 1991 Standards are omitted from the 2010 Standards.

The comments about the application of transient lodging or residential standards to social service center establishments, and housing at a place of education are addressed separately below. The Department received one additional comment on this issue from an organization representing emergency response personnel seeking an exemption from the transient lodging accessibility requirements for crew quarters and common use areas serving those crew quarters (e.g., locker rooms, exercise rooms, day room) that are used exclusively by on-duty emergency response personnel and that are not used for any public purpose. The commenter argued that since emergency response personnel must meet certain physical qualifications that have the effect of exempting persons with mobility disabilities, there is no need to build crew quarters and common use areas

serving those crew quarters to meet the 2004 ADAAG. In addition, the commenter argued that applying the transient lodging standards would impose significant costs and create living space that is less usable for most emergency response personnel.

The ADA does not exempt spaces because of a belief or policy that excludes persons with disabilities from certain work. However, the Department believes that crew quarters that are used exclusively as a residence by emergency response personnel and the kitchens and bathrooms exclusively serving those quarters are more like residential dwelling units and are therefore covered by the residential dwelling standards in the 2010 Standards, not the transient lodging standards. The residential dwelling standards address most of the concerns of the commenter. For example, the commenter was concerned that sinks in kitchens and lavatories in bathrooms that are accessible under the transient lodging standards would be too low to be comfortably used by emergency response personnel. The residential dwelling standards allow such features to be adaptable so that they would not have to be lowered until accessibility was needed. Similarly, grab bars and shower seats would not have to be installed at the time of construction provided that reinforcement has been installed in walls and located so as to permit their installation at a later date.

Section 35.151(e)
Social service center establishments

In the NPRM, the Department proposed a new Sec. 35.151(e) requiring group homes, halfway houses, shelters, or similar social service center establishments that provide temporary sleeping accommodations or residential dwelling units to comply with the provisions of the 2004 ADAAG that apply to residential facilities, including, but not limited to, the provisions in sections 233 and 809.

The NPRM explained that this proposal was based on two important changes in the 2004 ADAAG. First, for the first time, residential dwelling units are explicitly covered in the 2004 ADAAG in section 233. Second, the 2004 ADAAG eliminates the language contained in the 1991 Standards addressing scoping and technical requirements for homeless shelters, group homes, and similar social service center establishments. Currently, such establishments are covered in section 9.5 of the transient lodging section of the 1991 Standards. The deletion of section 9.5 creates an ambiguity of coverage that must be addressed.

The NPRM explained the Department's belief that transferring coverage of social service center establishments from the transient lodging standards to the residential facilities standards would alleviate conflicting requirements for social service center providers. The Department believes that a

substantial percentage of social service center establishments are recipients of Federal financial assistance from the Department of Housing and Urban Development (HUD). The Department of Health and Human Services (HHS) also provides financial assistance for the operation of shelters through the Administration for Children and Families programs. As such, these establishments are covered both by the ADA and section 504 of the Rehabilitation Act. UFAS is currently the design standard for new construction and alterations for entities subject to section 504. The two design standards for accessibility--the 1991 Standards and UFAS--have confronted many social service providers with separate, and sometimes conflicting, requirements for design and construction of facilities. To resolve these conflicts, the residential facilities standards in the 2004 ADAAG have been coordinated with the section 504 requirements. The transient lodging standards, however, are not similarly coordinated. The deletion of section 9.5 of the 1991 Standards from the 2004 ADAAG presented two options: (1) Require coverage under the transient lodging standards, and subject such facilities to separate, conflicting requirements for design and construction; or (2) require coverage under the residential facilities standards, which would harmonize the regulatory requirements under the ADA and section 504. The Department chose the option that harmonizes the regulatory requirements: coverage under the residential facilities standards.

Section 35.151 -- Title II Regulation

In the NPRM, the Department expressed concern that the residential facilities standards do not include a requirement for clear floor space next to beds similar to the requirement in the transient lodging standards and as a result, the Department proposed adding a provision that would require certain social service center establishments that provide sleeping rooms with more than 25 beds to ensure that a minimum of 5 percent of the beds have clear floor space in accordance with section 806.2.3 or 2004 ADAAG.

In the NPRM, the Department requested information from providers who operate homeless shelters, transient group homes, halfway houses, and other social service center establishments, and from the clients of these facilities who would be affected by this proposed change, asking, “[t]o what extent have conflicts between the ADA and section 504 affected these facilities? What would be the effect of applying the residential dwelling unit requirements to these facilities, rather than the requirements for transient lodging guest rooms?” 73 FR 34466, 34491 (June 17, 2008).

Many of the commenters supported applying the residential facilities requirements to social service center establishments, stating that even though the residential facilities requirements are less demanding in some instances, the existence of one clear standard will result in an overall increased level of accessibility by eliminating the

confusion and inaction that are sometimes caused by the current existence of multiple requirements. One commenter also stated that “it makes sense to treat social service center establishments like residential facilities because this is how these establishments function in practice.”

Two commenters agreed with applying the residential facilities requirements to social service center establishments but recommended adding a requirement for various bathing options, such as a roll-in shower (which is not required under the residential standards).

One commenter objected to the change and asked the Department to require that social service center establishments continue to comply with the transient lodging standards. One commenter stated that it did not agree that the standards for residential coverage would serve persons with disabilities as well as the 1991 transient lodging standards. This commenter expressed concern that the Department had eliminated guidance for social service agencies and that the rule should be put on hold until those safeguards are restored. Another commenter argued that the rule that would provide the greatest access for persons with disabilities should prevail.

Several commenters argued for the application of the transient lodging standards to all social service center establishments except

those that were “intended as a person’s place of abode,” referencing the Department’s question related to the definition of “place of lodging” in the title III NPRM. One commenter stated that the International Building Code requires accessible units in all transient facilities. The commenter expressed concern that group homes should be built to be accessible, rather than adaptable.

The Department continues to be concerned about alleviating the challenges for social service providers that are also subject to section 504 and would likely be subject to conflicting requirements if the transient lodging standards were applied. Thus, the Department has retained the requirement that social service center establishments comply with the residential dwelling standards. The Department believes, however, that social service center establishments that provide emergency shelter to large transient populations should be able to provide bathing facilities that are accessible to persons with mobility disabilities who need roll-in showers. Because of the transient nature of the population of these large shelters, it will not be feasible to modify bathing facilities in a timely manner when faced with a need to provide a roll-in shower with a seat when requested by an overnight visitor. As a result, the Department has added a requirement that social service center establishments with sleeping accommodations for more than 50 individuals must provide at least one roll-in shower with a seat that complies with the

relevant provisions of section 608 of the 2010 Standards. Transfer-type showers are not permitted in lieu of a roll-in shower with a seat and the exceptions in sections 608.3 and 608.4 for residential dwelling units are not permitted. When separate shower facilities are provided for men and for women, at least one roll-in shower shall be provided for each group. This supplemental requirement to the residential facilities standards is in addition to the supplemental requirement that was proposed in the NPRM for clear floor space in sleeping rooms with more than 25 beds.

The Department also notes that while dwelling units at some social service center establishments are also subject to the Fair Housing Act (FHAct) design and construction requirements that require certain features of adaptable and accessible design, FHAct units do not provide the same level of accessibility that is required for residential facilities under the 2010 Standards. The FHAct requirements, where also applicable, should not be considered a substitute for the 2010 Standards. Rather, the 2010 Standards must be followed in addition to the FHAct requirements.

The Department also notes that whereas the NPRM used the term “social service establishment,” the final rule uses the term “social service center establishment.” The Department has made this editorial change so that the final rule is consistent with the terminology used in the ADA. See 42 U.S.C. 12181(7)(k).

**Section 35.151(f)
Housing at a place of education**

The Department of Justice and the Department of Education share responsibility for regulation and enforcement of the ADA in postsecondary educational settings, including its requirements for architectural features. In addition, the Department of Housing and Urban Development (HUD) has enforcement responsibility for housing subject to title II of the ADA. Housing facilities in educational settings range from traditional residence halls and dormitories to apartment or townhouse-style residences. In addition to title II of the ADA, public universities and schools that receive Federal financial assistance are also subject to section 504, which contains its own accessibility requirements through the application of UFAS. Residential housing in an educational setting is also covered by the FHAct, which requires newly constructed multifamily housing to include certain features of accessible and adaptable design. Covered entities subject to the ADA must always be aware of, and comply with, any other Federal statutes or regulations that govern the operation of residential properties.

Although the 1991 Standards mention dormitories as a form of transient lodging, they do not specifically address how the ADA applies to dormitories or other types of residential housing provided in an educational setting. The 1991 Standards also do not contain any specific provisions for residential

facilities, allowing covered entities to elect to follow the residential standards contained in UFAS. Although the 2004 ADAAG contains provisions for both residential facilities and transient lodging, the guidelines do not indicate which requirements apply to housing provided in an educational setting, leaving it to the adopting agencies to make that choice. After evaluating both sets of standards, the Department concluded that the benefits of applying the transient lodging standards outweighed the benefits of applying the residential facilities standards. Consequently, in the NPRM, the Department proposed a new Sec. 35.151(f) that provided that residence halls or dormitories operated by or on behalf of places of education shall comply with the provisions of the proposed standards for transient lodging, including, but not limited to, the provisions in sections 224 and 806 of the 2004 ADAAG.

Both public and private school housing facilities have varied characteristics. College and university housing facilities typically provide housing for up to one academic year, but may be closed during school vacation periods. In the summer, they are often used for short-term stays of one to three days, a week, or several months. Graduate and faculty housing is often provided year-round in the form of apartments, which may serve individuals or families with children. These housing facilities are diverse in their layout. Some are double-occupancy rooms with a shared toilet and bathing room, which may be

inside or outside the unit. Others may contain cluster, suite, or group arrangements where several rooms are located inside a defined unit with bathing, kitchen, and similar common facilities. In some cases, these suites are indistinguishable in features from traditional apartments. Universities may build their own housing facilities or enter into agreements with private developers to build, own, or lease housing to the educational institution or to its students. Academic housing may be located on the campus of the university or may be located in nearby neighborhoods.

Throughout the school year and the summer, academic housing can become program areas in which small groups meet, receptions and educational sessions are held, and social activities occur. The ability to move between rooms--both accessible rooms and standard rooms--in order to socialize, to study, and to use all public use and common use areas is an essential part of having access to these educational programs and activities. Academic housing is also used for short-term transient educational programs during the time students are not in regular residence and may be rented out to transient visitors in a manner similar to a hotel for special university functions.

The Department was concerned that applying the new construction requirements for residential facilities to educational housing facilities could hinder access to educational programs for students with disabilities.

Elevators are not generally required under the 2004 ADAAG residential facilities standards unless they are needed to provide an accessible route from accessible units to public use and common use areas, while under the 2004 ADAAG as it applies to other types of facilities, multistory public facilities must have elevators unless they meet very specific exceptions. In addition, the residential facilities standards do not require accessible roll-in showers in bathrooms, while the transient lodging requirements require some of the accessible units to be served by bathrooms with roll-in showers. The transient lodging standards also require that a greater number of units have accessible features for persons with communication disabilities. The transient lodging standards provide for installation of the required accessible features so that they are available immediately, but the residential facilities standards allow for certain features of the unit to be adaptable. For example, only reinforcements for grab bars need to be provided in residential dwellings, but the actual grab bars must be installed under the transient lodging standards. By contrast, the residential facilities standards do require certain features that provide greater accessibility within units, such as more usable kitchens, and an accessible route throughout the dwelling. The residential facilities standards also require 5 percent of the units to be accessible to persons with mobility disabilities, which is a continuation of the same scoping that is currently required under UFAS, and is therefore applicable to

Section 35.151 -- Title II Regulation

any educational institution that is covered by section 504. The transient lodging standards require a lower percentage of accessible sleeping rooms for facilities with large numbers of rooms than is required by UFAS. For example, if a dormitory had 150 rooms, the transient lodging standards would require seven accessible rooms while the residential standards would require eight. In a large dormitory with 500 rooms, the transient lodging standards would require 13 accessible rooms and the residential facilities standards would require 25. There are other differences between the two sets of standards as well with respect to requirements for accessible windows, alterations, kitchens, accessible route throughout a unit, and clear floor space in bathrooms allowing for a side transfer.

In the NPRM, the Department requested public comment on how to scope educational housing facilities, asking, “[w]ould the residential facility requirements or the transient lodging requirements in the 2004 ADAAG be more appropriate for housing at places of education? How would the different requirements affect the cost when building new dormitories and other student housing?” 73 FR 34466, 34492 (June 17, 2008).

The vast majority of the comments received by the Department advocated using the residential facilities standards for housing at a place of education instead of the transient lodging standards, arguing that housing at places of public education are in

fact homes for the students who live in them. These commenters argued, however, that the Department should impose a requirement for a variety of options for accessible bathing and should ensure that all floors of dormitories be accessible so that students with disabilities have the same opportunities to participate in the life of the dormitory community that are provided to students without disabilities. Commenters representing persons with disabilities and several individuals argued that, although the transient lodging standards may provide a few more accessible features (such as roll-in showers), the residential facilities standards would ensure that students with disabilities have access to all rooms in their assigned unit, not just to the sleeping room, kitchenette, and wet bar. One commenter stated that, in its view, the residential facilities standards were congruent with overlapping requirements from HUD, and that access provided by the residential facilities requirements within alterations would ensure dispersion of accessible features more effectively. This commenter also argued that while the increased number of required accessible units for residential facilities as compared to transient lodging may increase the cost of construction or alteration, this cost would be offset by a reduced need to adapt rooms later if the demand for accessible rooms exceeds the supply. The commenter also encouraged the Department to impose a visitability (accessible doorways and necessary clear floor space for turning radius) requirement for both the residential facilities

and transient lodging requirements to allow students with mobility impairments to interact and socialize in a fully integrated fashion.

Two commenters supported the Department's proposed approach. One commenter argued that the transient lodging requirements in the 2004 ADAAG would provide greater accessibility and increase the opportunity of students with disabilities to participate fully in campus life. A second commenter generally supported the provision of accessible dwelling units at places of education, and pointed out that the relevant scoping in the International Building Code requires accessible units "consistent with hotel accommodations."

The Department has considered the comments recommending the use of the residential facilities standards and acknowledges that they require certain features that are not included in the transient lodging standards and that should be required for housing provided at a place of education. In addition, the Department notes that since educational institutions often use their academic housing facilities as short-term transient lodging in the summers, it is important that accessible features be installed at the outset. It is not realistic to expect that the educational institution will be able to adapt a unit in a timely manner in order to provide accessible accommodations to someone attending a one-week program during the summer.

The Department has determined that the best approach to this type of housing is to continue to require the application of transient lodging standards, but at the same time to add several requirements drawn from the residential facilities standards related to accessible turning spaces and work surfaces in kitchens, and the accessible route throughout the unit. This will ensure the maintenance of the transient lodging standard requirements related to access to all floors of the facility, roll-in showers in facilities with more than 50 sleeping rooms, and other important accessibility features not found in the residential facilities standards, but will also ensure usable kitchens and access to all the rooms in a suite or apartment.

The Department has added a new definition to Sec. 35.104, "Housing at a Place of Education," and has revised Sec. 35.151(f) to reflect the accessible features that now will be required in addition to the requirements set forth under the transient lodging standards. The Department also recognizes that some educational institutions provide some residential housing on a year-round basis to graduate students and staff which is comparable to private rental housing, and which contains no facilities for educational programming. Section 35.151(f)(3) exempts from the transient lodging standards apartments or townhouse facilities provided by or on behalf of a place of education that are leased on a year-round basis exclusively to graduate students or faculty, and do not

Section 35.151 -- Title II Regulation

contain any public use or common use areas available for educational programming; instead, such housing shall comply with the requirements for residential facilities in sections 233 and 809 of the 2010 Standards.

Section 35.151(f) uses the term “sleeping room” in lieu of the term “guest room,” which is the term used in the transient lodging standards. The Department is using this term because it believes that, for the most part, it provides a better description of the sleeping facilities used in a place of education than “guest room.” The final rule states that the Department intends the terms to be used interchangeably in the application of the transient lodging standards to housing at a place of education.

Section 35.151(g) Assembly areas

In the NPRM, the Department proposed Sec. 35.151(g) to supplement the assembly area requirements of the 2004 ADAAG, which the Department is adopting as part of the 2010 Standards. The NPRM proposed at Sec. 35.151(g)(1) to require wheelchair spaces and companion seating locations to be dispersed to all levels of the facility and are served by an accessible route. The Department received no significant comments on this paragraph and has decided to adopt the proposed language with minor modifications. The Department has retained the substance of

this section in the final rule but has clarified that the requirement applies to stadiums, arenas, and grandstands. In addition, the Department has revised the phrase “wheelchair and companion seating locations” to “wheelchair spaces and companion seats.”

Section 35.151(g)(1) ensures that there is greater dispersion of wheelchair spaces and companion seats throughout stadiums, arenas, and grandstands than would otherwise be required by sections 221 and 802 of the 2004 ADAAG. In some cases, the accessible route may not be the same route that other individuals use to reach their seats. For example, if other patrons reach their seats on the field by an inaccessible route (e.g., by stairs), but there is an accessible route that complies with section 206.3 of the 2010 Standards that could be connected to seats on the field, wheelchair spaces and companion seats must be placed on the field even if that route is not generally available to the public.

Regulatory language that was included in the 2004 ADAAG advisory, but that did not appear in the NPRM, has been added by the Department in Sec. 35.151(g)(2). Section 35.151(g)(2) now requires an assembly area that has seating encircling, in whole or in part, a field of play or performance area such as an arena or stadium, to place wheelchair spaces and companion seats around the entire facility. This rule, which is designed to prevent a public entity from

placing wheelchair spaces and companion seats on one side of the facility only, is consistent with the Department's enforcement practices and reflects its interpretation of section 4.33.3 of the 1991 Standards.

In the NPRM, the Department proposed Sec. 35.151(g)(2) which prohibits wheelchair spaces and companion seating locations from being "located on, (or obstructed by) temporary platforms or other moveable structures." Through its enforcement actions, the Department discovered that some venues place wheelchair spaces and companion seats on temporary platforms that, when removed, reveal conventional seating underneath, or cover the wheelchair spaces and companion seats with temporary platforms on top of which they place risers of conventional seating. These platforms cover groups of conventional seats and are used to provide groups of wheelchair seats and companion seats.

Several commenters requested an exception to the prohibition of the use of temporary platforms for public entities that sell most of their tickets on a season-ticket or other multi-event basis. Such commenters argued that they should be able to use temporary platforms because they know, in advance, that the patrons sitting in certain areas for the whole season do not need wheelchair spaces and companion seats. The Department declines to adopt such an exception. As it explained in detail in the NPRM, the

Department believes that permitting the use of movable platforms that seat four or more wheelchair users and their companions have the potential to reduce the number of available wheelchair seating spaces below the level required, thus reducing the opportunities for persons who need accessible seating to have the same choice of ticket prices and amenities that are available to other patrons in the facility. In addition, use of removable platforms may result in instances where last minute requests for wheelchair and companion seating cannot be met because entire sections of accessible seating will be lost when a platform is removed. See 73 FR 34466, 34493 (June 17, 2008). Further, use of temporary platforms allows facilities to limit persons who need accessible seating to certain seating areas, and to relegate accessible seating to less desirable locations. The use of temporary platforms has the effect of neutralizing dispersion and other seating requirements (e.g., line of sight) for wheelchair spaces and companion seats. Cf. *Independent Living Resources v. Oregon Arena Corp.*, 1 F. Supp. 2d 1159, 1171 (D. Or. 1998) (holding that while a public accommodation may "infill" wheelchair spaces with removable seats when the wheelchair spaces are not needed to accommodate individuals with disabilities, under certain circumstances "[s]uch a practice might well violate the rule that wheelchair spaces must be dispersed throughout the arena in a manner that is roughly proportionate to the overall distribution of seating"). In addition, using temporary

Section 35.151 -- Title II Regulation

platforms to convert unsold wheelchair spaces to conventional seating undermines the flexibility facilities need to accommodate secondary ticket markets exchanges as required by Sec. 35.138(g) of the final rule.

As the Department explained in the NPRM, however, this provision was not designed to prohibit temporary seating that increases seating for events (e.g., placing temporary seating on the floor of a basketball court for a concert). Consequently, the final rule, at Sec. 35.151(g)(3), has been amended to clarify that if an entire seating section is on a temporary platform for a particular event, then wheelchair spaces and companion seats may be in that seating section. However, adding a temporary platform to create wheelchair spaces and companion seats that are otherwise dissimilar from nearby fixed seating and then simply adding a small number of additional seats to the platform would not qualify as an “entire seating section” on the platform. In addition, Sec. 35.151(g)(3) clarifies that facilities may fill in wheelchair spaces with removable seats when the wheelchair spaces are not needed by persons who use wheelchairs.

The Department has been responsive to assembly areas’ concerns about reduced revenues due to unused accessible seating. Accordingly, the Department has reduced scoping requirements significantly--by almost half in large assembly areas--and determined that allowing assembly areas to infill unsold wheelchair spaces with readily

removable temporary individual seats appropriately balances their economic concerns with the rights of individuals with disabilities. See section 221.2 of the 2010 Standards.

For stadium-style movie theaters, in Sec. 35.151(g)(4) of the NPRM the Department proposed requiring placement of wheelchair seating spaces and companion seats on a riser or cross-aisle in the stadium section of the theater and placement of such seating so that it satisfies at least one of the following criteria: (1) It is located within the rear 60 percent of the seats provided in the auditorium; or (2) it is located within the area of the auditorium where the vertical viewing angles are between the 40th to 100th percentile of vertical viewing angles for all seats in that theater as ranked from the first row (1st percentile) to the back row (100th percentile). The vertical viewing angle is the angle between a horizontal line perpendicular to the seated viewer’s eye to the screen and a line from the seated viewer’s eye to the top of the screen.

The Department proposed this bright-line rule for two reasons: (1) The movie theater industry petitioned for such a rule; and (2) the Department has acquired expertise on the design of stadium style theaters from litigation against several major movie theater chains. See *U.S. v. AMC Entertainment*, 232 F. Supp. 2d 1092 (C.D. Ca. 2002), rev’d in part, 549 F. 3d 760 (9th Cir. 2008); *U.S. v. Cinemark USA, Inc.*, 348 F. 3d 569 (6th Cir. 2003), cert. denied, 542 U.S. 937 (2004).

Two industry commenters--at least one of whom otherwise supported this rule--requested that the Department explicitly state that this rule does not apply retroactively to existing theaters. Although this rule on its face applies to new construction and alterations, these commenters were concerned that the rule could be interpreted to apply retroactively because of the Department's statement in the ANPRM that this bright-line rule, although newly-articulated, does not represent a "substantive change from the existing line-of-sight requirements" of section 4.33.3 of the 1991 Standards. See 69 FR 58768, 58776 (Sept. 30, 2004).

Although the Department intends for Sec. 35.151(g)(4) of this rule to apply prospectively to new construction and alterations, this rule is not a departure from, and is consistent with, the line-of-sight requirements in the 1991 Standards. The Department has always interpreted the line-of-sight requirements in the 1991 Standards to require viewing angles provided to patrons who use wheelchairs to be comparable to those afforded to other spectators. Section 35.151(g)(4) merely represents the application of these requirements to stadium-style movie theaters.

One commenter from a trade association sought clarification whether Sec. 35.151(g)(4) applies to stadium-style theaters with more than 300 seats, and argued that it should not since dispersion requirements apply in those theaters. The Department declines to limit this rule to stadium-style theaters with 300 or

fewer seats; stadium-style theaters of all sizes must comply with this rule. So, for example, stadium-style theaters that must vertically disperse wheelchair and companion seats must do so within the parameters of this rule.

The NPRM included a provision that required assembly areas with more than 5,000 seats to provide at least five wheelchair spaces with at least three companion seats for each of those five wheelchair spaces. The Department agrees with commenters who asserted that group seating is better addressed through ticketing policies rather than design and has deleted that provision from this section of the final rule.

Section 35.151(h) Medical care facilities

In the 1991 title II regulation, there was no provision addressing the dispersion of accessible sleeping rooms in medical care facilities. The Department is aware, however, of problems that individuals with disabilities face in receiving full and equal medical care when accessible sleeping rooms are not adequately dispersed. When accessible rooms are not fully dispersed, a person with a disability is often placed in an accessible room in an area that is not medically appropriate for his or her condition, and is thus denied quick access to staff with expertise in that medical specialty and specialized equipment. While the Access Board did not establish specific design requirements for dispersion

Section 35.151 -- Title II Regulation

in the 2004 ADAAG, in response to extensive comments in support of dispersion it added an advisory note, Advisory 223.1 General, encouraging dispersion of accessible rooms within the facility so that accessible rooms are more likely to be proximate to appropriate qualified staff and resources.

In the NPRM, the Department sought additional comment on the issue, asking whether it should require medical care facilities, such as hospitals, to disperse their accessible sleeping rooms, and if so, by what method (by specialty area, floor, or other criteria). All of the comments the Department received on this issue supported dispersing accessible sleeping rooms proportionally by specialty area. These comments, from individuals, organizations, and a building code association, argued that it would not be difficult for hospitals to disperse rooms by specialty area, given the high level of regulation to which hospitals are subject and the planning that hospitals do based on utilization trends. Further, commenters suggested that without a requirement, it is unlikely that hospitals would disperse the rooms. In addition, concentrating accessible rooms in one area perpetuates segregation of individuals with disabilities, which is counter to the purpose of the ADA.

The Department has decided to require medical care facilities to disperse their accessible sleeping rooms in a manner that is proportionate by type of medical specialty.

This does not require exact mathematical proportionality, which at times would be impossible. However, it does require that medical care facilities disperse their accessible rooms by medical specialty so that persons with disabilities can, to the extent practical, stay in an accessible room within the wing or ward that is appropriate for their medical needs. The language used in this rule (“in a manner that is proportionate by type of medical specialty”) is more specific than that used in the NPRM (“in a manner that enables patients with disabilities to have access to appropriate specialty services”) and adopts the concept of proportionality proposed by the commenters. Accessible rooms should be dispersed throughout all medical specialties, such as obstetrics, orthopedics, pediatrics, and cardiac care.

Section 35.151(i) Curb ramps

Section 35.151(e) on curb ramps in the 1991 rule has been redesignated as Sec. 35.151(i). In the NPRM, the Department proposed making a minor editorial change to this section, deleting the phrase “other sloped areas” from the two places in which it appears in the 1991 title II regulation. In the NPRM, the Department stated that the phrase “other sloped areas” lacks technical precision. The Department received no significant public comments on this proposal. Upon further consideration, however, the Department has concluded that the regulation should acknowledge that there are times

when there are transitions from sidewalk to road surface that do not technically qualify as “curb ramps” (sloped surfaces that have a running slope that exceed 5 percent). Therefore, the Department has decided not to delete the phrase “other sloped areas.”

Section 35.151(j)
Residential housing for sale to individual owners

Although public entities that operate residential housing programs are subject to title II of the ADA, and therefore must provide accessible residential housing, the 1991 Standards did not contain scoping or technical standards that specifically applied to residential housing units. As a result, under the Department’s title II regulation, these agencies had the choice of complying with UFAS, which contains specific scoping and technical standards for residential housing units, or applying the ADAAG transient lodging standards to their housing. Neither UFAS nor the 1991 Standards distinguish between residential housing provided for rent and those provided for sale to individual owners. Thus, under the 1991 title II regulation, public entities that construct residential housing units to be sold to individual owners must ensure that some of those units are accessible. This requirement is in addition to any accessibility requirements imposed on housing programs operated by public entities that receive Federal financial assistance from Federal agencies such as HUD.

The 2010 Standards contain scoping and technical standards for residential dwelling units. However, section 233.3.2 of the 2010 Standards specifically defers to the Department and to HUD, the standard-setting agency under the ABA, to decide the appropriate scoping for those residential dwelling units built by or on behalf of public entities with the intent that the finished units will be sold to individual owners. These programs include, for example, HUD’s public housing and HOME programs as well as State-funded programs to construct units for sale to individuals. In the NPRM, the Department did not make a specific proposal for this scoping. Instead, the Department stated that after consultation and coordination with HUD, the Department would make a determination in the final rule. The Department also sought public comment on this issue stating that “[t]he Department would welcome recommendations from individuals with disabilities, public housing authorities, and other interested parties that have experience with these programs. Please comment on the appropriate scoping for residential dwelling units built by or on behalf of public entities with the intent that the finished units will be sold to individual owners.” 73 FR 34466, 34492 (June 17, 2008).

All of the public comments received by the Department in response to this question were supportive of the Department’s ensuring that the residential standards apply to housing built on behalf of public entities with the

Section 35.151 -- Title II Regulation

intent that the finished units would be sold to individual owners. The vast majority of commenters recommended that the Department require that projects consisting of five or more units, whether or not the units are located on one or multiple locations, comply with the 2004 ADAAG requirements for scoping of residential units, which require that 5 percent, and no fewer than one, of the dwelling units provide mobility features, and that 2 percent, and no fewer than one, of the dwelling units provide communication features. See 2004 ADAAG Section 233.3. These commenters argued that the Department should not defer to HUD because HUD has not yet adopted the 2004 ADAAG and there is ambiguity on the scope of coverage of pre-built for sale units under HUD's current section 504 regulations. In addition, these commenters expressed concern that HUD's current regulation, 24 CFR 8.29, presumes that a prospective buyer is identified before design and construction begins so that disability features can be incorporated prior to construction. These commenters stated that State and Federally funded homeownership programs typically do not identify prospective buyers before construction has commenced. One commenter stated that, in its experience, when public entities build accessible for-sale units, they often sell these units through a lottery system that does not make any effort to match persons who need the accessible features with the units that have those features. Thus, accessible units are often sold to persons without

disabilities. This commenter encouraged the Department to make sure that accessible for-sale units built or funded by public entities are placed in a separate lottery restricted to income-eligible persons with disabilities.

Two commenters recommended that the Department develop rules for four types of for-sale projects: single family pre-built (where buyer selects the unit after construction), single family post-built (where the buyer chooses the model prior to its construction), multi-family pre-built, and multi-family post-built. These commenters recommended that the Department require pre-built units to comply with the 2004 ADAAG 233.1 scoping requirements. For post-built units, the commenters recommended that the Department require all models to have an alternate design with mobility features and an alternate design with communications features in compliance with 2004 ADAAG. Accessible models should be available at no extra cost to the buyer. One commenter recommended that, in addition to required fully accessible units, all ground floor units should be readily convertible for accessibility or for sensory impairments technology enhancements.

The Department believes that consistent with existing requirements under title II, housing programs operated by public entities that design and construct or alter residential units for sale to individual owners should comply with the 2010 Standards, including the requirements for residential facilities in

sections 233 and 809. These requirements will ensure that a minimum of 5 percent of the units, but no fewer than one unit, of the total number of residential dwelling units will be designed and constructed to be accessible for persons with mobility disabilities. At least 2 percent, but no fewer than one unit, of the total number of residential dwelling units shall provide communication features.

The Department recognizes that there are some programs (such as the one identified by the commenter), in which units are not designed and constructed until an individual buyer is identified. In such cases, the public entity is still obligated to comply with the 2010 Standards. In addition, the public entity must ensure that pre-identified buyers with mobility disabilities and visual and hearing disabilities are afforded the opportunity to buy the accessible units. Once the program has identified buyers who need the number of accessible units mandated by the 2010 Standards, it may have to make reasonable modifications to its policies, practices, and procedures in order to provide accessible units to other buyers with disabilities who request such units.

The Department notes that the residential facilities standards allow for construction of units with certain features of adaptability. Public entities that are concerned that fully accessible units are less marketable may choose to build these units to include the allowable adaptable features, and then

adapt them at their own expense for buyers with mobility disabilities who need accessible units. For example, features such as grab bars are not required but may be added by the public entity if needed by the buyer at the time of purchase and cabinets under sinks may be designed to be removable to allow access to the required knee space for a forward approach.

The Department agrees with the commenters that covered entities may have to make reasonable modifications to their policies, practices, and procedures in order to ensure that when they offer pre-built accessible residential units for sale, the units are offered in a manner that gives access to those units to persons with disabilities who need the features of the units and who are otherwise eligible for the housing program. This may be accomplished, for example, by adopting preferences for accessible units for persons who need the features of the units, holding separate lotteries for accessible units, or other suitable methods that result in the sale of accessible units to persons who need the features of such units. In addition, the Department believes that units designed and constructed or altered that comply with the requirements for residential facilities and are offered for sale to individuals must be provided at the same price as units without such features.

Section 35.151(k)
Detention and correctional facilities

The 1991 Standards did not contain specific accessibility standards applicable to cells in correctional facilities. However, correctional and detention facilities operated by or on behalf of public entities have always been subject to the nondiscrimination and program accessibility requirements of title II of the ADA. The 2004 ADAAG established specific requirements for the design and construction and alterations of cells in correctional facilities for the first time.

Based on complaints received by the Department, investigations, and compliance reviews of jails, prisons, and other detention and correctional facilities, the Department has determined that many detention and correctional facilities do not have enough accessible cells, toilets, and shower facilities to meet the needs of their inmates with mobility disabilities and some do not have any at all. Inmates are sometimes housed in medical units or infirmaries separate from the general population simply because there are no accessible cells. In addition, some inmates have alleged that they are housed at a more restrictive classification level simply because no accessible housing exists at the appropriate classification level. The Department's compliance reviews and investigations have substantiated certain of these allegations.

The Department believes that the insufficient number of accessible cells is, in part, due to the fact that most jails and prisons were built long before the ADA became law and, since then, have undergone few alterations that would trigger the obligation to provide accessible features in accordance with UFAS or the 1991 Standards. In addition, the Department has found that even some new correctional facilities lack accessible features. The Department believes that the unmet demand for accessible cells is also due to the changing demographics of the inmate population. With thousands of prisoners serving life sentences without eligibility for parole, prisoners are aging, and the prison population of individuals with disabilities and elderly individuals is growing. A Bureau of Justice Statistics study of State and Federal sentenced inmates (those sentenced to more than one year) shows the total estimated count of State and Federal prisoners aged 55 and older grew by 36,000 inmates from 2000 (44,200) to 2006 (80,200). William J. Sabol et al., *Prisoners in 2006*, Bureau of Justice Statistics Bulletin, Dec. 2007, at 23 (app. table 7), available at <http://bjs.ojp.usdoj.gov/index.cfm?ty=pbdetail&iid=908> (last visited July 16, 2008); Allen J. Beck et al., *Prisoners in 2000*, Bureau of Justice Statistics Bulletin, Aug. 2001, at 10 (Aug. 2001) (Table 14), available at bjs.ojp.usdoj.gov/index.cfm?ty=pbdetail&iid=927 (last visited July 16, 2008). This jump constitutes an increase of 81 percent in prisoners aged 55 and older during this period.

In the NPRM, the Department proposed a new section, Sec. 35.152, which combined a range of provisions relating to both program accessibility and application of the proposed standards to detention and correctional facilities. In the final rule, the Department is placing those provisions that refer to design, construction, and alteration of detention and correction facilities in a new paragraph (k) of Sec. 35.151, the section of the rule that addresses new construction and alterations for covered entities. Those portions of the final rule that address other issues, such as placement policies and program accessibility, are placed in the new Sec. 35.152.

In the NPRM, the Department also sought input on how best to meet the needs of inmates with mobility disabilities in the design, construction, and alteration of detention and correctional facilities. The Department received a number of comments in response to this question.

New Construction. The NPRM did not expressly propose that new construction of correctional and detention facilities shall comply with the proposed standards because the Department assumed it would be clear that the requirements of Sec. 35.151 would apply to new construction of correctional and detention facilities in the same manner that they apply to other facilities constructed by covered entities. The Department has decided to create a new section, Sec. 35.151(k)(1), which clarifies

that new construction of jails, prisons, and other detention facilities shall comply with the requirements of 2010 Standards. Section 35.151(k)(1) also increases the scoping for accessible cells from the 2 percent specified in the 2004 ADAAG to 3 percent.

Alterations. Although the 2010 Standards contain specifications for alterations in existing detention and correctional facilities, section 232.2 defers to the Attorney General the decision as to the extent these requirements will apply to alterations of cells. The NPRM proposed at Sec. 35.152(c) that “[a]lterations to jails, prisons, and other detention and correctional facilities will comply with the requirements of Sec. 35.151(b).” 73 FR 34466, 34507 (June 17, 2008). The final rule retains that requirement at Sec. 35.151(k)(2), but increases the scoping for accessible cells from the 2 percent specified in the 2004 ADAAG to 3 percent.

Substitute cells. In the ANPRM, the Department sought public comment about the most effective means to ensure that existing correctional facilities are made accessible to prisoners with disabilities and presented three options: (1) Require all altered elements to be accessible, which would maintain the current policy that applies to other ADA alteration requirements; (2) permit substitute cells to be made accessible within the same facility, which would permit correctional authorities to meet their obligation by providing the

Section 35.151 -- Title II Regulation

required accessible features in cells within the same facility, other than those specific cells in which alterations are planned; or (3) permit substitute cells to be made accessible within a prison system, which would focus on ensuring that prisoners with disabilities are housed in facilities that best meet their needs, as alterations within a prison environment often result in piecemeal accessibility.

In Sec. 35.152(c) of the NPRM, the Department proposed language based on Option 2, providing that when cells are altered, a covered entity may satisfy its obligation to provide the required number of cells with mobility features by providing the required mobility features in substitute cells (i.e., cells other than those where alterations are originally planned), provided that each substitute cell is located within the same facility, is integrated with other cells to the maximum extent feasible, and has, at a minimum, physical access equal to that of the original cells to areas used by inmates or detainees for visitation, dining, recreation, educational programs, medical services, work programs, religious services, and participation in other programs that the facility offers to inmates or detainees.

The Department received few comments on this proposal. The majority who chose to comment supported an approach that allowed substitute cells to be made accessible within the same facility. In their view, such an approach balanced administrators'

needs, cost considerations, and the needs of inmates with disabilities. One commenter noted, however, that with older facilities, required modifications may be inordinately costly and technically infeasible. A large county jail system supported the proposed approach as the most viable option allowing modification or alteration of existing cells based on need and providing a flexible approach to provide program and mobility accessibility. It noted, as an alternative, that permitting substitute cells to be made accessible within a prison system would also be a viable option since such an approach could create a centralized location for accessibility needs and, because that jail system's facilities were in close proximity, it would have little impact on families for visitation or on accessible programming.

A large State department of corrections objected to the Department's proposal. The commenter stated that some very old prison buildings have thick walls of concrete and reinforced steel that are difficult, if not impossible to retrofit, and to do so would be very expensive. This State system approaches accessibility by looking at its system as a whole and providing access to programs for inmates with disabilities at selected prisons. This commenter explained that not all of its facilities offer the same programs or the same levels of medical or mental health services. An inmate, for example, who needs education, substance abuse treatment, and sex offender counseling may be transferred between facilities in order to meet his needs.

The inmate population is always in flux and there are not always beds or program availability for every inmate at his security level. This commenter stated that the Department's proposed language would put the State in the position of choosing between adding accessible cells and modifying paths of travel to programs and services at great expense or not altering old facilities, causing them to become in states of disrepair and obsolescent, which would be fiscally irresponsible.

The Department is persuaded by these comments and has modified the alterations requirement in Sec. 35.151(k)(2)(iv) in the final rule to allow that if it is technically infeasible to provide substitute cells in the same facility, cells can be provided elsewhere within the corrections system.

Number of accessible cells. Section 232.2.1 of the 2004 ADAAG requires at least 2 percent, but no fewer than one, of the cells in newly constructed detention and correctional facilities to have accessibility features for individuals with mobility disabilities. Section 232.3 provides that, where special holding cells or special housing cells are provided, at least one cell serving each purpose shall have mobility features. The Department sought input on whether these 2004 ADAAG requirements are sufficient to meet the needs of inmates with mobility disabilities. A major association representing county jails throughout the country stated that the 2004 ADAAG 2 percent requirement for

accessible cells is sufficient to meet the needs of county jails. Similarly, a large county sheriff's department advised that the 2 percent requirement far exceeds the need at its detention facility, where the average age of the population is 32. This commenter stressed that the regulations need to address the differences between a local detention facility with low average lengths of stay as opposed to a State prison housing inmates for lengthy periods. This commenter asserted that more stringent requirements will raise construction costs by requiring modifications that are not needed. If more stringent requirements are adopted, the commenter suggested that they apply only to State and Federal prisons that house prisoners sentenced to long terms. The Department notes that a prisoner with a mobility disability needs a cell with mobility features regardless of the length of incarceration. However, the length of incarceration is most relevant in addressing the needs of an aging population.

The overwhelming majority of commenters responded that the 2 percent ADAAG requirement is inadequate to meet the needs of the incarcerated. Many commenters suggested that the requirement be expanded to apply to each area, type, use, and class of cells in a facility. They asserted that if a facility has separate areas for specific programs, such as a dog training program or a substance abuse unit, each of these areas should also have 2 percent accessible cells but not less than one. These same commenters

Section 35.151 -- Title II Regulation

suggested that 5-7 percent of cells should be accessible to meet the needs of both an aging population and the larger number of inmates with mobility disabilities. One organization recommended that the requirement be increased to 5 percent overall, and that at least 2 percent of each type and use of cell be accessible. Another commenter recommended that 10 percent of cells be accessible. An organization with extensive corrections experience noted that the integration mandate requires a sufficient number and distribution of accessible cells so as to provide distribution of locations relevant to programs to ensure that persons with disabilities have access to the programs.

Through its investigations and compliance reviews, the Department has found that in most detention and correctional facilities, a 2 percent accessible cell requirement is inadequate to meet the needs of the inmate population with disabilities. That finding is supported by the majority of the commenters that recommended a 5-7 percent requirement. Indeed, the Department itself requires more than 2 percent of the cells to be accessible at its own corrections facilities. The Federal Bureau of Prisons is subject to the requirements of the 2004 ADAAG through the General Services Administration's adoption of the 2004 ADAAG as the enforceable accessibility standard for Federal facilities under the Architectural Barriers Act of 1968. 70 FR 67786, 67846-47 (Nov. 8, 2005). However, in order to meet

the needs of inmates with mobility disabilities, the Bureau of Prisons has elected to increase that percentage and require that 3 percent of inmate housing at its facilities be accessible. Bureau of Prisons, Design Construction Branch, Design Guidelines, Attachment A: Accessibility Guidelines for Design, Construction, and Alteration of Federal Bureau of Prisons (Oct. 31, 2006).

The Department believes that a 3 percent accessible requirement is reasonable. Moreover, it does not believe it should impose a higher percentage on detention and corrections facilities than it utilizes for its own facilities. Thus, the Department has adopted a 3 percent requirement in Sec. 35.151(k) for both new construction and alterations. The Department notes that the 3 percent requirement is a minimum. As corrections systems plan for new facilities or alterations, the Department urges planners to include numbers of inmates with disabilities in their population projections in order to take the necessary steps to provide a sufficient number of accessible cells to meet inmate needs.

Dispersion of Cells. The NPRM did not contain express language addressing dispersion of cells in a facility. However, Advisory 232.2 of the 2004 ADAAG recommends that “[a]ccessible cells or rooms should be dispersed among different levels of security, housing categories, and holding classifications (e.g., male/female and adult/juvenile) to facilitate access.” In explaining the basis for recommending,

but not requiring, this type of dispersal, the Access Board stated that “[m]any detention and correctional facilities are designed so that certain areas (e.g., ‘shift’ areas) can be adapted to serve as different types of housing according to need” and that “[p]lacement of accessible cells or rooms in shift areas may allow additional flexibility in meeting requirements for dispersion of accessible cells or rooms.”

The Department notes that inmates are typically housed in separate areas of detention and correctional facilities based on a number of factors, including their classification level. In many instances, detention and correctional facilities have housed inmates in inaccessible cells, even though accessible cells were available elsewhere in the facility, because there were no cells in the areas where they needed to be housed, such as in administrative or disciplinary segregation, the women’s section of the facility, or in a particular security classification area.

The Department received a number of comments stating that dispersal of accessible cells together with an adequate number of accessible cells is necessary to prevent inmates with disabilities from placement in improper security classification and to ensure integration. Commenters recommended modification of the scoping requirements to require a percentage of accessible cells in each program, classification, use or service area. The Department is persuaded by these comments. Accordingly, Sec. 35.151(k)

(1) and (k)(2) of the final rule require accessible cells in each classification area.

Medical facilities. The NPRM also did not propose language addressing the application of the 2004 ADAAG to medical and long-term care facilities in correctional and detention facilities. The provisions of the 2004 ADAAG contain requirements for licensed medical and long-term care facilities, but not those that are unlicensed. A disability advocacy group and a number of other commenters recommended that the Department expand the application of section 232.4 to apply to all such facilities in detention and correctional facilities, regardless of licensure. They recommended that whenever a correctional facility has a program that is addressed specifically in the 2004 ADAAG, such as a long-term care facility, the 2004 ADAAG scoping and design features should apply for those elements. Similarly, a building code organization noted that its percentage requirements for accessible units is based on what occurs in the space, not on the building type.

The Department is persuaded by these comments and has added Sec. 35.151(k)(3), which states that “[w]ith respect to medical and long-term care facilities in jails, prisons, and other detention and correctional facilities, public entities shall apply the 2010 Standards technical and scoping requirements for those facilities irrespective of whether those facilities are licensed.”

3 Public Accommodations and Commercial Facilities

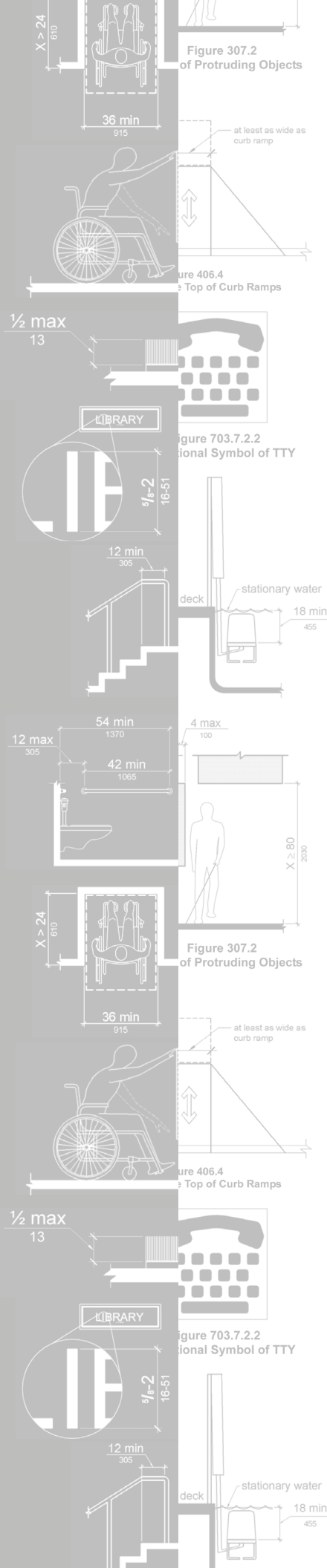

Public Accommodations and Commerical Facilities: Guidance on the Revisions to 28 CFR part 36, Subpart D

Subpart D establishes the title III requirements applicable to new construction and alterations. The Department has amended this subpart to adopt the 2004 ADAAG, set forth the effective dates for implementation of the 2010 Standards, and make related revisions as described below.

Section 36.403 Alterations: Path of Travel

In the NPRM, the Department proposed one change to Sec. 36.403 on alterations and path of travel by adding a path of travel safe harbor. Proposed Sec. 36.403(a) (1) stated that if a private entity has constructed or altered required elements of a path of travel in accordance with the 1991 Standards, the private entity is not required to retrofit such elements to reflect incremental changes in the 2010 Standards solely because of an alteration to a primary function area served by that path of travel.

A substantial number of commenters objected to the Department’s creation of a safe harbor for alterations to required elements of a path of travel that comply with the current 1991 Standards. These commenters argued that if a public accommodation already is in the process of

altering its facility, there should be a legal requirement that individuals with disabilities are entitled to increased accessibility provided by the 2004 ADAAG for path of travel work. These commenters also stated that they did not believe there was a statutory basis for “grandfathering” facilities that comply with the 1991 Standards. Another commenter argued that the updates incorporated into the 2004 ADAAG provide very substantial improvements for access, and that since there already is a 20 percent cost limit on the amount that can be expended on path of travel alterations, there is no need for a further limitation.

Some commenters supported the safe harbor as lessening the economic costs of implementing the 2004 ADAAG for existing facilities. One commenter also stated that without the safe harbor, entities that already have complied with the 1991 Standards will have to make and pay for compliance twice, as compared to those entities that made no effort to comply in the first place. Another commenter asked that the safe harbor be revised to include pre-ADA facilities that have been made compliant with the 1991 Standards to the extent “readily achievable” or, in the case of alterations, “to the maximum extent feasible,” but that are not in full compliance with the 1991 Standards.

The final rule retains the safe harbor for required elements of a path of travel to altered primary function areas for private entities that already have complied with

Subpart D – Title III Regulation

the 1991 Standards with respect to those required elements. As discussed with respect to Sec. 36.304, the Department believes that this safe harbor strikes an appropriate balance between ensuring that individuals with disabilities are provided access to buildings and facilities and mitigating potential financial burdens on existing places of public accommodation that are undertaking alterations subject to the 2010 Standards. This safe harbor is not a blanket exemption for facilities. If a private entity undertakes an alteration to a primary function area, only the required elements of a path of travel to that area that already comply with the 1991 Standards are subject to the safe harbor. If a private entity undertakes an alteration to a primary function area and the required elements of a path of travel to the altered area do not comply with the 1991 Standards, then the private entity must bring those elements into compliance with the 2010 Standards.

Section 36.405 Alterations: Historic Preservation

In the 1991 rule, the Department provided guidance on making alterations to buildings or facilities that are eligible for listing in the National Register of Historic Places under the National Historic Preservation Act or that are designated as historic under State or local law. That provision referenced the 1991 Standards. Because those cross-references to the 1991 Standards are no longer

applicable, it is necessary in this final rule to provide new regulatory text. No substantive change in the Department's approach in this area is intended by this revision.

Section 36.406 Standards for New Construction and Alterations

Applicable standards. Section 306 of the ADA, 42 U.S.C. 12186, directs the Attorney General to issue regulations to implement title III that are consistent with the guidelines published by the Access Board. As described in greater detail elsewhere in this Appendix, the Department is a statutory member of the Access Board and was involved significantly in the development of the 2004 ADAAG. Nonetheless, the Department has reviewed the standards and has determined that additional regulatory provisions are necessary to clarify how the Department will apply the 2010 Standards to places of lodging, social service center establishments, housing at a place of education, assembly areas, and medical care facilities. Those provisions are contained in Sec. 36.406(c)-(g). Each of these provisions is discussed below.

Section 36.406(a) adopts the 2004 ADAAG as part of the 2010 Standards and establishes the compliance date and triggering events for the application of those standards to both new construction and alterations. Appendix B of this final rule (Analysis and Commentary on the 2010

ADA Standards for Accessible Design) provides a description of the major changes in the 2010 Standards (as compared to the 1991 ADAAG) and a discussion of the public comments that the Department received on specific sections of the 2004 ADAAG. A number of commenters asked the Department to revise certain provisions in the 2004 ADAAG in a manner that would reduce either the required scoping or specific technical accessibility requirements. As previously stated, the ADA requires the Department to adopt standards consistent with the guidelines adopted by the Access Board. The Department will not adopt any standards that provide less accessibility than is provided under the guidelines contained in the 2004 ADAAG because the guidelines adopted by the Access Board are “minimum guidelines.” 42 U.S.C. 12186(c).

In the NPRM, the Department specifically proposed amending Sec. 36.406(a) by dividing it into two sections. Proposed Sec. 36.406(a)(1) specified that new construction and alterations subject to this part shall comply with the 1991 Standards if physical construction of the property commences less than six months after the effective date of the rule. Proposed Sec. 36.406(a)(2) specified that new construction and alterations subject to this part shall comply with the proposed standards if physical construction of the property commences six months or more after the effective date of the rule. The Department also proposed

deleting the advisory information now published in a table at Sec. 36.406(b). *Compliance date.* When the ADA was enacted, the compliance dates for various provisions were delayed in order to provide time for covered entities to become familiar with their new obligations. Titles II and III of the ADA generally became effective on January 26, 1992, six months after the regulations were published. See 42 U.S.C. 12131 note; 42 U.S.C. 12181 note. New construction under title II and alterations under either title II or title III had to comply with the design standards on that date. See 42 U.S.C. 12131 note; 42 U.S.C. 12183(a)(2). For new construction under title III, the requirements applied to facilities designed and constructed for first occupancy after January 26, 1993--18 months after the 1991 Standards were published by the Department. See 42 U.S.C. 12183(a)(1).

The Department received numerous comments on the issue of effective date, many of them similar to those received in response to the ANPRM. A substantial number of commenters advocated a minimum of 18 months from publication of the final rule to the effective date for application of the standards to new construction, consistent with the time period used for implementation of the 1991 Standards. Many of these commenters argued that the 18-month period was necessary to minimize the likelihood of having to redesign projects already in the design and permitting stages

Subpart D – Title III Regulation

at the time that the final rule is published. According to these commenters, large projects take several years from design to occupancy, and can be subject to delays from obtaining zoning, site approval, third-party design approval (i.e., architectural review), and governmental permits. To the extent the new standards necessitate changes in any previous submissions or permits already issued, businesses might have to expend significant funds and incur delays due to redesign and resubmission.

Some commenters also expressed concern that a six-month period would be hard to implement given that many renovations are planned around retail selling periods, holidays, and other seasonal concerns. For example, hotels plan renovations during their slow periods, retail establishments avoid renovations during the major holiday selling periods, and businesses in certain parts of the country cannot do any major construction during parts of the winter.

Some commenters argued that chain establishments need additional time to redesign their “master facility” designs for replication at multiple locations, taking into account both the new standards and applicable State and local accessibility requirements.

Other commenters argued for extending the effective date from six months to a minimum of 12 months for many of

the same reasons, and one commenter argued that there should be a tolling of the effective date for those businesses that are in the midst of the permitting process if the necessary permits are delayed due to legal challenges or other circumstances outside the business’s control.

Several commenters took issue with the Department’s characterization of the 2004 ADAAG and the 1991 Standards as two similar rules. These commenters argued that many provisions in the 2004 ADAAG represent a “substantial and significant” departure from the 1991 Standards and that it will take a great deal of time and money to identify all the changes and implement them. In particular, they were concerned that small businesses lacked the internal resources to respond quickly to the new changes and that they would have to hire outside experts to assist them. One commenter expressed concern that regardless of familiarity with the 2004 ADAAG, since the 2004 ADAAG standards are organized in an entirely different manner from the 1991 Standards, and contain, in the commenter’s view, extensive changes, it will make the shift from the old to the new standards quite complicated.

Several commenters also took issue with the Department’s proffered rationale that by adopting a six-month effective date, the Department was following the precedent of other Federal agencies that have adopted the 2004 ADAAG for facilities whose

accessibility they regulate. These commenters argued that the Department's title III regulation applies to a much broader range and number of facilities and programs than the other Federal agencies (i.e., Department of Transportation and the General Services Administration) and that those agencies regulate accessibility primarily in either governmental facilities or facilities operated by quasi-governmental authorities.

Several commenters representing the travel, vacation, and golf industries argued that the Department should adopt a two-year effective date for new construction. In addition to many of the arguments made by commenters in support of an 18-month effective date, these commenters also argued that a two-year time frame would allow States with DOJ-certified building codes to have the time to amend their codes to meet the 2004 ADAAG so that design professionals can work from compatible codes and standards.

Several commenters recommended treating alterations differently than new construction, arguing for a one-year effective date for alterations. Another commenter representing building officials argued that a minimum of a six-month phase-in for alterations was sufficient, since a very large percentage of alteration projects "are of a scale that they should be able to accommodate the phase-in."

In contrast, many commenters argued that the proposed six-month effective date should be retained in the final rule.

The Department has been persuaded by concerns raised by some of the commenters that the six month compliance date proposed in the NPRM for application of the 2010 Standards may be too short for certain projects that are already in the midst of the design and permitting process. The Department has determined that for new construction and alterations, compliance with the 2010 Standards will not be required until 18 months from the date the final rule is published. This is consistent with the amount of time given when the 1991 regulation was published. Since many State and local building codes contain provisions that are consistent with 2004 ADAAG, the Department has decided that public accommodations that choose to comply with the 2010 Standards as defined in Sec. 36.104 before the compliance date will still be considered in compliance with the ADA. However, public accommodations that choose to comply with the 2010 Standards in lieu of the 1991 Standards prior to the compliance date described in this rule must choose one or the other standard, and may not rely on some of the requirements contained in one standard and some of the requirements contained in the other standard.

Subpart D – Title III Regulation

Triggering event. In the NPRM, the Department proposed using the start of physical construction as the triggering event for applying the proposed standards to new construction under title III. This triggering event parallels that for the alterations provisions (i.e., the date on which construction begins), and would apply clearly across all types of covered public accommodations. The Department also proposed that for prefabricated elements, such as modular buildings and amusement park rides and attractions, or installed equipment, such as ATMs, the start of construction means the date on which the site preparation begins. Site preparation includes providing an accessible route to the element.

The Department’s NPRM sought public comment on how to define the start of construction and the practicality of applying commencement of construction as a triggering event. The Department also requested input on whether the proposed definition of the start of construction was sufficiently clear and inclusive of different types of facilities. The Department also sought input about facilities subject to title III for which commencement of construction would be ambiguous or problematic.

The Department received numerous comments recommending that the Department adopt a two-pronged approach to defining the triggering event. In those

cases where permits are required, the Department should use “date of permit application” as the effective date triggering event, and if no permit is required, the Department should use “start of construction.” A number of these commenters argued that the date of permit application is appropriate because the applicant would have to consider the applicable State and Federal accessibility standards in order to submit the designs usually required with the application. Moreover, the date of permit application is a typical triggering event in other code contexts, such as when jurisdictions introduce an updated building code. Some commenters expressed concern that using the date of “start of construction” was problematic because the date can be affected by factors that are outside the control of the owner. For example, an owner can plan construction to start before the new standards take effect and therefore use the 1991 Standards in the design. If permits are not issued in a timely manner, then the construction could be delayed until after the effective date, and then the project would have to be redesigned. This problem would be avoided if the permit application date was the triggering event. Two commenters expressed concern that the term “start of construction” is ambiguous, because it is unclear whether start of construction means the razing of structures on the site to make way for a new facility or means site preparation, such as regrading or laying the foundation.

One commenter recommended using the “signing date of a construction contract,” and an additional commenter recommended that the new standards apply only to “buildings permitted after the effective date of the regulations.”

One commenter stated that for facilities that fall outside the building permit requirements (ATMs, prefabricated saunas, small sheds), the triggering event should be the date of installation, rather than the date the space for the facility is constructed.

The Department is persuaded by the comments to adopt a two-pronged approach to defining the triggering event for new construction and alterations. The final rule states that in those cases where permits are required, the triggering event shall be the date when the last application for a building permit application or permit extension is certified to be complete by a State, county, or local government, or in those jurisdictions where the government does not certify completion of applications, the date when the last application for a building permit or permit extension is received by the State, county, or local government. If no permits are required, then the triggering event shall be the “start of physical construction or alterations.” The Department has also added clarifying language related to the term “start of physical construction or alterations” to make it clear that “start of physical construction or

alterations” is not intended to mean the date of ceremonial groundbreaking or the date a structure is razed to make it possible for construction of a facility to take place.

Amusement rides. Section 234 of the 2010 Standards provides accessibility guidelines for newly designed and constructed amusement rides. The amusement ride provisions do not provide a “triggering event” for new construction or alteration of an amusement ride. An industry commenter requested that the triggering event of “first use” as noted in the Advisory note to section 234.1 of the 2004 ADAAG be included in the final rule. The Advisory note provides that “[a] custom designed and constructed ride is new upon its first use, which is the first time amusement park patrons take the ride.” The Department declines to treat amusement rides differently than other types of new construction and alterations and under the final rule, they are subject to Sec. 36.406(a)(3). Thus, newly constructed and altered amusement rides shall comply with the 2010 Standards if the start of physical construction or the alteration is on or after 18 months from the publication date of this rule. The Department also notes that section 234.4.2 of the 2010 Standards only applies where the structural or operational characteristics of an amusement ride are altered. It does not apply in cases where the only change to a ride is the theme.

Noncomplying new construction and alterations. The element-by-element safe harbor referenced in Sec. 36.304(d)(2) has no effect on new or altered elements in existing facilities that were subject to the 1991 Standards on the date that they were constructed or altered, but do not comply with the technical and scoping specifications for those elements in the 1991 Standards. Section 36.406(a)(5) of the final rule sets forth the rules for noncompliant new construction or alterations in facilities that were subject to the requirements of this part. Under those provisions, noncomplying new construction and alterations constructed or altered after the effective date of the applicable ADA requirements and before March 15, 2012 shall, before March 15, 2012, be made accessible in accordance with either the 1991 Standards or the 2010 Standards. Noncomplying new construction and alterations constructed or altered after the effective date of the applicable ADA requirements and before March 15, 2012, shall, on or after March 15, 2012, be made accessible in accordance with the 2010 Standards.

Section 36.406(b) Application of Standards to Fixed Elements

The final rule contains a new Sec. 36.406(b) that clarifies that the requirements established by this section, including those contained in the 2004 ADAAG, prescribe the requirements necessary to ensure that fixed or built-in elements in new

or altered facilities are accessible to individuals with disabilities. Once the construction or alteration of a facility has been completed, all other aspects of programs, services, and activities conducted in that facility are subject to the operational requirements established elsewhere in this final rule. Although the Department has often chosen to use the requirements of the 1991 Standards as a guide to determining when and how to make equipment and furnishings accessible, those coverage determinations fall within the discretionary authority of the Department.

The Department is also clarifying that the advisory notes, appendix notes, and figures that accompany the 1991 and 2010 Standards do not establish separately enforceable requirements unless otherwise specified in the text of the standards. This clarification has been made to address concerns expressed by ANPRM commenters who mistakenly believed that the advisory notes in the 2004 ADAAG established requirements beyond those established in the text of the guidelines (e.g., Advisory 504.4 suggests, but does not require, that covered entities provide visual contrast on stair tread nosings to make them more visible to individuals with low vision). The Department received no comments on this provision in the NPRM.

Section 36.406(c) Places of Lodging

In the NPRM, the Department proposed a new definition for public accommodations that are “places of lodging” and a new Sec. 36.406(c) to clarify the scope of coverage for places of public accommodation that meet this definition. For many years the Department has received inquiries from members of the public seeking clarification of ADA coverage of rental accommodations in timeshares, condominium hotels, and mixed-use and corporate hotel facilities that operate as places of public accommodation (as that term is now defined in Sec. 36.104). These facilities, which have attributes of both residential dwellings and transient lodging facilities, have become increasingly popular since the ADA’s enactment in 1990 and make up the majority of new hotel construction in some vacation destinations. The hybrid residential and lodging characteristics of these new types of facilities, as well as their ownership characteristics, complicate determinations of ADA coverage, prompting questions from both industry and individuals with disabilities. While the Department has interpreted the ADA to encompass these hotel-like facilities when they are used to provide transient lodging, the regulation previously has specifically not addressed them. In the NPRM, the Department proposed a new Sec. 36.406(c), entitled “Places of Lodging,” which was intended to clarify that places of lodging, including certain timeshares,

condominium hotels, and mixed-use and corporate hotel facilities, shall comply with the provisions of the proposed standards, including, but not limited to, the requirements for transient lodging in sections 224 and 806 of the 2004 ADAAG.

The Department’s NPRM sought public input on this proposal. The Department received a substantial number of comments on these issues from industry representatives, advocates for persons with disabilities, and individuals. A significant focus of these comments was on how the Department should define and regulate vacation rental units in timeshares, vacation communities, and condo-hotels where the units are owned and controlled by individual owners and rented out some portion of time to the public, as compared to traditional hotels and motels that are owned, controlled, and rented to the public by one entity.

Scoping and technical requirements applicable to “places of lodging.” In the NPRM, the Department asked for public comment on its proposal in Sec. 36.406(c) to apply to places of lodging the scoping and technical requirements for transient lodging, rather than the scoping and technical requirements for residential dwelling units.

Commenters generally agreed that the transient lodging requirements should apply to places of lodging. Several commenters

Subpart D – Title III Regulation

stated that the determination as to which requirements apply should be made based on the intention for use at the time of design and construction. According to these commenters, if units are intended for transient rentals, then the transient lodging standards should apply, and if they are intended to be used for residential purposes, the residential standards should apply. Some commenters agreed with the application of transient lodging standards to places of lodging in general, but disagreed about the characterization of certain types of facilities as covered places of lodging.

The Department agrees that the scoping and technical standards applicable to transient lodging should apply to facilities that contain units that meet the definition of “places of lodging.”

Scoping for timeshare or condominium hotels. In the NPRM, the Department sought comment on the appropriate basis for determining scoping for a timeshare or condominium-hotel. A number of commenters indicated that scoping should be based on the usage of the facility. Only those units used for short-term stays should be counted for application of the transient lodging standards, while units sold as residential properties should be treated as residential units not subject to the ADA. One commenter stated that scoping should be based on the maximum number of sleeping units available for public

rental. Another commenter pointed out that unlike traditional hotels and motels, the number of units available for rental in a facility or development containing individually owned units is not fixed over time. Owners have the right to participate in a public rental program some, all, or none of the time, and individual owner participation changes from year to year.

The Department believes that the determination for scoping should be based on the number of units in the project that are designed and constructed with the intention that their owners may participate in a transient lodging rental program. The Department cautions that it is not the number of owners that actually exercise their right to participate in the program that determines the scoping. Rather it is the units that could be placed into an on-site or off-site transient lodging rental program. In the final rule, the Department has added a provision to Sec. 36.406(c) (3), which states that units intended to be used exclusively for residential purposes that are contained in facilities that also meet the definition of place of lodging are not covered by the transient lodging standards. Title III of the ADA does not apply to units designed and constructed with the intention that they be rented or sold as exclusively residential units. Such units are covered by the Fair Housing Act (FHAct), which contains requirements for certain features of accessible and adaptable design both

for units and for public and common use areas. All units designed and constructed with the intention that they may be used for both residential and transient lodging purposes are covered by the ADA and must be counted for determining the required number of units that must meet the transient lodging standards in the 2010 Standards. Public use and common use areas in facilities containing units subject to the ADA also must meet the 2010 Standards. In some developments, units that may serve as residential units some of the time and rental units some of the time will have to meet both the FHAct and the ADA requirements. For example, all of the units in a vacation condominium facility whose owners choose to rent to the public when they are not using the units themselves would be counted for the purposes of determining the appropriate number of units that must comply with the 2010 Standards. In a newly constructed condominium that has three floors with units dedicated to be sold solely as residential housing and three floors with units that may be used as residences or hotel units, only the units on the three latter floors would be counted for applying the 2010 Standards. In a newly constructed timeshare development containing 100 units, all of which may be made available to the public through an exchange or rental program, all 100 units would be counted for purposes of applying the 2010 Standards.

One commenter also asked the Department for clarification of how to count individually owned “lock-off units.” Lock-off units are units that are multi-bedroom but can be “locked off” into two separate units, each having individual external access. This commenter requested that the Department state in the final rule that individually owned lock-off units do not constitute multiple guest rooms for purposes of calculating compliance with the scoping requirements for accessible units, since for the most part the lock-off units are used as part of a larger accessible unit, and portions of a unit not locked off would constitute both an accessible one-bedroom unit or an accessible two-bedroom unit with the lock-off unit.

It is the Department’s view that lock-off units that are individually owned that can be temporarily converted into two units do not constitute two separate guest rooms for purposes of calculating compliance with the scoping requirements.

One commenter asked the Department how developers should scope units where buildings are constructed in phases over a span of years, recommending that the scoping be based on the total number of units expected to be constructed at the project and not on a building-by-building basis or on a phase-by-phase basis. The Department does not think scoping should be based on planned number of units, which may or may not be actually constructed over a period

Subpart D – Title III Regulation

of years. However, the Department recognizes that resort developments may contain buildings and facilities that are of all sizes from single-unit cottages to facilities with hundreds of units. The Department believes it would be appropriate to allow designers, builders, and developers to aggregate the units in facilities with 50 or fewer units that are subject to a single permit application and that are on a common site or that are constructed at the same time for the purposes of applying the scoping requirements in table 224.2. Facilities with more than 50 units should be scoped individually in accordance with the table. The regulation has been revised to reflect this application of the scoping requirements.

One commenter also asked the Department to use the title III regulation to declare that timeshares subject to the transient lodging standards are exempt from the design and construction requirements of the FHAct. The coverage of the FHAct is set by Congress and interpreted by regulations issued by the Department of Housing and Urban Development. The Department has no authority to exempt anyone from coverage of the FHAct.

Application of ADA to places of lodging that contain individually owned units. The Department believes that regardless of ownership structure for individual units, rental programs (whether they are on- or off-site) that make transient lodging guest

rooms available to the public must comply with the general nondiscrimination requirements of the ADA. In addition, as provided in Sec. 36.406(c), newly constructed facilities that contain accommodations intended to be used for transient lodging purposes must comply with the 2010 Standards.

In the NPRM, the Department asked for public comment on several issues related to ensuring the availability of accessible units in a rental program operated by a place of lodging. The Department sought input on how it could address a situation in which a new or converted facility constructs the required number of accessible units, but the owners of those units choose not to participate in the rental program; whether the facility has an obligation to encourage or require owners of accessible units to participate in the rental program; and whether the facility developer, the condominium association, or the hotel operator has an obligation to retain ownership or control over a certain number of accessible units to avoid this problem.

In the NPRM, the Department sought public input on how to regulate scoping for a timeshare or condominium-rental facility that decides, after the sale of units to individual owners, to begin a rental program that qualifies the facility as a place of lodging, and how the condominium association, operator, or developer should determine which units to make accessible.

A number of commenters expressed concerns about the ability of the Department to require owners of accessible units to participate in the rental program, to require developers, condo associations, or homeowners associations to retain ownership of accessible units, and to impose accessibility requirements on individual owners who choose to place inaccessible units into a rental program after purchase. These commenters stated that individuals who purchase accessible vacation units in condominiums, individual vacation homes, and timeshares have ownership rights in their units and may choose lawfully to make their units available to the public some, all, or none of the time. Commenters advised the Department that the Securities and Exchange Commission takes the position that if condominium units are offered in connection with participation in a required rental program for any part of the year, require the use of an exclusive rental agent, or impose conditions otherwise restricting the occupancy or rental of the unit, then that offering will be viewed as an offering of securities in the form of an investment (rather than a real estate offering). SEC Release No. 33-5347, Guidelines as to the Applicability of the Federal Securities Laws to Offers and Sales of Condominiums or Units in a Real Estate Development (Jan. 4, 1973). Consequently, most condominium developers do not impose such restrictions at the time of sale. Moreover, owners who choose to rent their units as a short-

term vacation rental can select any rental or management company to lease and manage their unit, or they may rent them out on their own. They also may choose never to lease those units. Thus, there are no guarantees that at any particular time, accessible units will be available for rental by the public. According to this commenter, providing incentives for owners of accessible units to place their units in the rental program will not work, because it does not guarantee the availability of the requisite number of rooms dispersed across the development, and there is not any reasonable, identifiable source of funds to cover the costs of such incentives.

A number of commenters also indicated that it potentially is discriminatory as well as economically infeasible to require that a developer hold back the accessible units so that the units can be maintained in the rental program year-round. One commenter pointed out that if a developer did not sell the accessible condominiums or timeshares in the building inventory, the developer would be subject to a potential ADA or FHAct complaint because persons with disabilities who wanted to buy accessible units rather than rent them each year would not have the option to purchase them. In addition, if a developer held back accessible units, the cost of those units would have to be spread across all the buyers of the inaccessible units, and in many cases would make the project

Subpart D – Title III Regulation

financially infeasible. This would be especially true for smaller projects. Finally, this commenter argued that requiring units to be part of the common elements that are owned by all of the individual unit owners is infeasible because the common ownership would result in pooled rental income, which would transform the owners into participants in a rental pool, and thus turn the sale of the condominiums into the sale of securities under SEC Release 33-5347.

Several commenters noted that requiring the operator of the rental program to own the accessible units is not feasible either because the operator of the rental program would have to have the funds to invest in the purchase of all of the accessible units, and it would not have a means of recouping its investment. One commenter stated that in Texas, it is illegal for on-site rental programs to own condominium units. Another commenter noted that such a requirement might lead to the loss of on-site rental programs, leaving owners to use individual third-party brokers, or rent the units privately. One commenter acknowledged that individual owners cannot be required to place their units in a rental pool simply to offer an accessible unit to the public, since the owners may be purchasing units for their own use. However, this commenter recommended that owners who choose to place their units in a rental pool be required to contribute to a fund that would be used to renovate units that are placed in the rental

pool to increase the availability of accessible units. One commenter argued that the legal entity running the place of lodging has an obligation to retain control over the required number of accessible units to ensure that they are available in accordance with title III.

A number of commenters also argued that the Department has no legal authority to require individual owners to engage in barrier removal where an existing development adds a rental program. One commenter stated that Texas law prohibits the operator of on-site rental program from demanding that alterations be made to a particular unit. In addition, under Texas law, condominium declarations may not require some units and not others to make changes, because that would lead to unequal treatment of units and owners, which is not permissible.

One commenter stated that since it was not possible for operators of rental programs offering privately owned condominiums to comply with accessible scoping, the Department should create exemptions from the accessible scoping, especially for existing facilities. In addition, this commenter stated that if an operator of an on-site rental program were to require renovations as a condition of participation in the rental program, unit owners might just rent their units through a different broker or on their own, in which case such requirements would not apply.

A number of commenters argued that if a development decides to create a rental program, it must provide accessible units. Otherwise the development would have to ensure that units are retrofitted. A commenter argued that if an existing building is being converted, the Department should require that if alterations of the units are performed by an owner or developer prior to sale of the units, then the alterations requirements should apply, in order to ensure that there are some accessible units in the rental pool. This commenter stated that because of the proliferation of these type of developments in Hawaii, mandatory alteration is the only way to guarantee the availability of accessible units in the long run. In this commenter's view, since conversions almost always require makeover of existing buildings, this will not lead to a significant expense.

The Department agrees with the commenters that it would not be feasible to require developers to hold back or purchase accessible units for the purposes of making them available to the public in a transient lodging rental program, nor would it be feasible to require individual owners of accessible units to participate in transient lodging rental programs.

The Department recognizes that places of lodging are developed and financed under myriad ownership and management structures and agrees that there will be

circumstances where there are legal barriers to requiring compliance with either the alterations requirements or the requirements related to barrier removal. The Department has added an exception to Sec. 36.406(c), providing that in existing facilities that meet the definition of places of lodging, where the guest rooms are not owned or substantially controlled by the entity that owns, leases, or operates the overall facility and the physical features of the guest room interiors are controlled by their individual owners, the units are not subject to the alterations requirement, even where the owner rents the unit out to the public through a transient lodging rental program. In addition, the Department has added an exception to the barrier removal requirements at Sec. 36.304(g) providing that in existing facilities that meet the definition of places of lodging, where the guest rooms are not owned or substantially controlled by the entity that owns, leases, or operates the overall facility and the physical features of the guest room interiors are controlled by their individual owners, the units are not subject to the barrier removal requirement. The Department notes, however, that there are legal relationships for some timeshares and cooperatives where the ownership interests do not convey control over the physical features of units. In those cases, it may be the case that the facility has an obligation to meet the alterations or barrier removal requirements or to maintain accessible features.

Section 36.406(d) Social Service Center Establishments

In the NPRM, the Department proposed a new Sec. 36.406(d) requiring group homes, halfway houses, shelters, or similar social service center establishments that provide temporary sleeping accommodations or residential dwelling units to comply with the provisions of the 2004 ADAAG that apply to residential facilities, including, but not limited to, the provisions in sections 233 and 809.

The NPRM explained that this proposal was based on two important changes in the 2004 ADAAG. First, for the first time, residential dwelling units are explicitly covered in the 2004 ADAAG in section 233. Second, the 2004 ADAAG eliminates the language contained in the 1991 Standards addressing scoping and technical requirements for homeless shelters, group homes, and similar social service center establishments. Currently, such establishments are covered in section 9.5 of the transient lodging section of the 1991 Standards. The deletion of section 9.5 creates an ambiguity of coverage that must be addressed.

The NPRM explained the Department's belief that transferring coverage of social service center establishments from the transient lodging standards to the residential facilities standards would alleviate conflicting requirements for social service providers.

The Department believes that a substantial percentage of social service providers are recipients of Federal financial assistance from the Department of Housing and Urban Development (HUD). The Department of Health and Human Services (HHS) also provides financial assistance for the operation of shelters through the Administration for Children and Families programs. As such, they are covered both by the ADA and section 504. UFAS is currently the design standard for new construction and alterations for entities subject to section 504. The two design standards for accessibility--the 1991 Standards and UFAS--have confronted many social service providers with separate, and sometimes conflicting, requirements for design and construction of facilities. To resolve these conflicts, the residential facilities standards in the 2004 ADAAG have been coordinated with the section 504 requirements. The transient lodging standards, however, are not similarly coordinated. The deletion of section 9.5 of the 1991 Standards from the 2004 ADAAG presented two options: (1) Require coverage under the transient lodging standards, and subject such facilities to separate, conflicting requirements for design and construction; or (2) require coverage under the residential facilities standards, which would harmonizes the regulatory requirements under the ADA and section 504. The Department chose the option that harmonizes the regulatory requirements: coverage under the residential facilities standards.

In the NPRM, the Department expressed concern that the residential facilities standards do not include a requirement for clear floor space next to beds similar to the requirement in the transient lodging standards; as a result, the Department proposed adding a provision that would require certain social service center establishments that provide sleeping rooms with more than 25 beds to ensure that a minimum of 5 percent of the beds have clear floor space in accordance with section 806.2.3 of the 2004 ADAAG.

The Department requested information from providers who operate homeless shelters, transient group homes, halfway houses, and other social service center establishments, and from the clients of these facilities who would be affected by this proposed change. In the NPRM, the Department asked to what extent conflicts between the ADA and section 504 have affected these facilities and what the effect would be of applying the residential dwelling unit requirements to these facilities, rather than the requirements for transient lodging guest rooms.

Many of the commenters supported applying the residential facilities requirements to social service center establishments stating that even though the residential facilities requirements are less demanding, in some instances, the existence of one clear standard will result in an overall

increased level of accessibility by eliminating the confusion and inaction that are sometimes caused by the current existence of multiple requirements. One commenter stated that the residential facilities guidelines were more appropriate because individuals housed in social service center establishments typically stay for a prolonged period of time, and guests of a transient lodging facility typically are not housed to participate in a program or receive services.

One commenter opposed to the proposed section argued for the application of the transient lodging standards to all social service center establishments except those that were “intended as a person’s place of abode,” referencing the Department’s question related to the definition of place of lodging in the title III NPRM. A second commenter stated that the use of transient lodging guidelines would lead to greater accessibility.

The Department continues to be concerned about alleviating the challenges for social service providers that are also subject to section 504 and that would likely be subject to conflicting requirements if the transient lodging standard were applied. Thus, the Department has retained the requirement that social service center establishments comply with the residential dwelling standards. The Department did not receive comments regarding adding a requirement for bathing options, such as

Subpart D – Title III Regulation

a roll-in shower, in social service center establishments operated by public accommodations. The Department did, however, receive comments in support of adding such a requirement regarding public entities under title II. The Department believes that social service center establishments that provide emergency shelter to large transient populations should be able to provide bathing facilities that are accessible to persons with mobility disabilities who need roll-in showers. Because of the transient nature of the population of these large shelters, it will not be feasible to modify bathing facilities in a timely manner when faced with a need to provide a roll-in shower with a seat when requested by an overnight visitor. As a result, the Department has added a requirement that social service center establishments with sleeping accommodations for more than 50 individuals must provide at least one roll-in shower with a seat that complies with the relevant provisions of section 608 of the 2010 Standards. Transfer-type showers are not permitted in lieu of a roll-in shower with a seat, and the exceptions in sections 608.3 and 608.4 for residential dwelling units are not permitted. When separate shower facilities are provided for men and for women, at least one roll-in shower must be provided for each group. This supplemental requirement to the residential facilities standards is in addition to the supplemental requirement that was proposed in the NPRM for clear floor space in sleeping rooms with more than 25 beds.

The Department also notes that while dwelling units at some social service center establishments are also subject to FHAct design and construction requirements that require certain features of adaptable and accessible design, FHAct units do not provide the same level of accessibility that is required for residential facilities under the 2010 Standards. The FHAct requirements, where also applicable, should not be considered a substitute for the 2010 Standards. Rather, the 2010 Standards must be followed in addition to the FHAct requirements.

The Department also notes that while in the NPRM the Department used the term “social service establishment,” the final rule uses the term “social service center establishment.” The Department has made this editorial change so that the final rule is consistent with the terminology used in the ADA. See 42 U.S.C. 12181(7)(K).

Section 36.406(e) Housing at a Place of Education

The Department of Justice and the Department of Education share responsibility for regulation and enforcement of the ADA in postsecondary educational settings, including architectural features. Housing types in educational settings range from traditional residence halls and dormitories to apartment or townhouse-style residences. In addition to title III of the ADA,

universities and schools that are recipients of Federal financial assistance also are subject to section 504, which contains its own accessibility requirements currently through the application of UFAS. Residential housing, including housing in an educational setting, is also covered by the FHAct, which requires newly constructed multifamily housing to include certain features of accessible and adaptable design. Covered entities subject to the ADA must always be aware of, and comply with, any other Federal statutes or regulations that govern the operation of residential properties.

Although the 1991 Standards mention dormitories as a form of transient lodging, they do not specifically address how the ADA applies to dormitories and other types of residential housing provided in an educational setting. The 1991 Standards also do not contain any specific provisions for residential facilities, allowing covered entities to elect to follow the residential standards contained in UFAS. Although the 2004 ADAAG contains provisions for both residential facilities and transient lodging, the guidelines do not indicate which requirements apply to housing provided in an educational setting, leaving it to the adopting agencies to make that choice. After evaluating both sets of standards, the Department concluded that the benefits of applying the transient lodging standards outweighed the benefits of applying the residential facilities standards. Consequently,

in the NPRM, the Department proposed a new Sec. 36.406(e) that provided that residence halls or dormitories operated by or on behalf of places of education shall comply with the provisions of the proposed standards for transient lodging, including, but not limited to, the provisions in sections 224 and 806 of the 2004 ADAAG.

Private universities and schools covered by title III as public accommodations are required to make their programs and activities accessible to persons with disabilities. The housing facilities that they provide have varied characteristics. College and university housing facilities typically provide housing for up to one academic year, but may be closed during school vacation periods. In the summer, they often are used for short-term stays of one to three days, a week, or several months. Graduate and faculty housing often is provided year-round in the form of apartments, which may serve individuals or families with children. These housing facilities are diverse in their layout. Some are double-occupancy rooms with a shared toilet and bathing room, which may be inside or outside the unit. Others may contain cluster, suite, or group arrangements where several rooms are located inside a defined unit with bathing, kitchen, and similar common facilities. In some cases, these suites are indistinguishable in features from traditional apartments. Universities may build their own housing facilities or enter into agreements with

Subpart D – Title III Regulation

private developers to build, own, or lease housing to the educational institution or to its students. Academic housing may be located on the campus of the university or may be located in nearby neighborhoods.

Throughout the school year and the summer, academic housing can become program areas in which small groups meet, receptions and educational sessions are held, and social activities occur. The ability to move between rooms--both accessible rooms and standard rooms--in order to socialize, to study, and to use all public use and common use areas is an essential part of having access to these educational programs and activities. Academic housing also is used for short-term transient educational programs during the time students are not in regular residence and may be rented out to transient visitors in a manner similar to a hotel for special university functions.

The Department was concerned that applying the new construction requirements for residential facilities to educational housing facilities could hinder access to educational programs for students with disabilities. Elevators generally are not required under the 2004 ADAAG residential facilities standards unless they are needed to provide an accessible route from accessible units to public use and common use areas, while under the 2004 ADAAG as it applies to other types of facilities, multistory private facilities must have elevators unless they meet very

specific exceptions. In addition, the residential facilities standards do not require accessible roll-in showers in bathrooms, while the transient lodging requirements require some of the accessible units to be served by bathrooms with roll-in showers. The transient lodging standards also require that a greater number of units have accessible features for persons with communication disabilities. The transient lodging standards provide for installation of the required accessible features so that they are available immediately, but the residential facilities standards allow for certain features of the unit to be adaptable. For example, only reinforcements for grab bars need to be provided in residential dwellings, but the actual grab bars must be installed under the transient lodging standards. By contrast, the residential facilities standards do require certain features that provide greater accessibility within units, such as usable kitchens and an accessible route throughout the dwelling. The residential facilities standards also require 5 percent of the units to be accessible to persons with mobility disabilities, which is a continuation of the same scoping that is currently required under UFAS and is therefore applicable to any educational institution that is covered by section 504. The transient lodging standards require a lower percentage of accessible sleeping rooms for facilities with large numbers of rooms than is required by UFAS. For example, if a dormitory has 150 rooms, the transient lodging standards would require 7

accessible rooms, while the residential standards would require 8. In a large dormitory with 500 rooms, the transient lodging standards would require 13 accessible rooms, and the residential facilities standards would require 25. There are other differences between the two sets of standards, including requirements for accessible windows, alterations, kitchens, an accessible route throughout a unit, and clear floor space in bathrooms allowing for a side transfer.

In the NPRM, the Department requested public comment on how to scope educational housing facilities, and it asked whether the residential facilities requirements or the transient lodging requirements in the 2004 ADAAG would be more appropriate for housing at places of education and asked how the different requirements would affect the cost of building new dormitories and other student housing. See 73 FR 34508, 34545 (June 17, 2008).

The Department received several comments on this issue under title III. One commenter stated that the Department should adopt the residential facilities standards for housing at a place of education. In the commenter's view, the residential facilities standards are congruent with overlapping requirements imposed by HUD, and the residential facilities requirements would ensure dispersion of accessible features more effectively. This commenter also argued that while the increased number

of required accessible units for residential facilities as compared to transient lodging may increase the cost of construction or alteration, this cost would be offset by a reduced need later to adapt rooms if the demand for accessible rooms exceeds the supply. The commenter also encouraged the Department to impose a visitability (accessible doorways and necessary clear floor space for turning radius) requirement for both the residential facilities and transient lodging requirements to allow students with mobility impairments to interact and socialize in a fully integrated fashion. Another commenter stated that while dormitories should be treated like residences as opposed to transient lodging, the Department should ensure that "all floors are accessible," thus ensuring community integration and visitability. Another commenter argued that housing at a place of education is comparable to residential housing, and that most of the housing types used by schools do not have the same amenities and services or function like transient lodging and should not be treated as such.

Several commenters focused on the length of stay at this type of housing and suggested that if the facilities are subject to occupancy for greater than 30 days, the residential standards should apply. Another commenter supported the Department's adoption of the transient lodging standards, arguing this will provide greater accessibility and therefore increase opportunities

Subpart D – Title III Regulation

for students with disabilities to participate. One commenter, while supporting the use of transient lodging standards in this area, argued that the Department also should develop regulations relating to the usability of equipment in housing facilities by persons who are blind or visually impaired. Another commenter argued that the Department should not impose the transient lodging requirements on K-12 schools because the cost of adding elevators can be prohibitive, and because there are safety concerns related to evacuating students in wheelchairs living on floors above the ground floor in emergencies causing elevator failures.

The Department has considered the comments recommending the use of the residential facilities standards and acknowledges that they require certain features that are not included in the transient lodging standards and that should be required for housing provided at a place of education. In addition, the Department notes that since educational institutions often use their academic housing facilities as short-term transient lodging in the summers, it is important that accessible features be installed at the outset. It is not realistic to expect that the educational institution will be able to adapt a unit in a timely manner in order to provide accessible accommodations to someone attending a one-week program during the summer.

The Department has determined that the best approach to this type of housing is to continue to require the application of transient lodging standards but, at the same time, to add several requirements drawn from the residential facilities standards related to accessible turning spaces and work surfaces in kitchens, and the accessible route throughout the unit. This will ensure the maintenance of the transient lodging standard requirements related to access to all floors of the facility, roll-in showers in facilities with more than 50 sleeping rooms, and other important accessibility features not found in the residential facilities standards, but also will ensure usable kitchens and access to all the rooms in a suite or apartment.

The Department has added a new definition to Sec. 36.104, “Housing at a Place of Education,” and has revised Sec. 36.406(e) to reflect the accessible features that now will be required in addition to the requirements set forth under the transient lodging standards. The Department also recognizes that some educational institutions provide some residential housing on a year-round basis to graduate students and staff that is comparable to private rental housing but contains no facilities for educational programming. Section 36.406(e)(3) exempts from the transient lodging standards apartments or townhouse facilities that are provided with a lease on a year-round

basis exclusively to graduate students or faculty and that do not contain any public use or common use areas available for educational programming; instead, such housing must comply with the requirements for residential facilities in sections 233 and 809 of the 2010 Standards.

The regulatory text uses the term “sleeping room” in lieu of the term “guest room,” which is the term used in the transient lodging standards. The Department is using this term because it believes that for the most part, it provides a better description of the sleeping facilities used in a place of education than “guest room.” The final rule states in Sec. 36.406(e) that the Department intends the terms to be used interchangeably in the application of the transient lodging standards to housing at a place of education.

Section 36.406(f) Assembly Areas

In the NPRM, the Department proposed Sec. 36.406(f) to supplement the assembly area requirements of the 2004 ADAAG, which the Department is adopting as part of the 2010 Standards. The NPRM proposed at Sec. 36.406(f)(1) to require wheelchair spaces and companion seating locations to be dispersed to all levels of the facility that are served by an accessible route. The Department received no significant comments on this paragraph and has decided to adopt the proposed language with minor modifications.

Section 36.406(f)(1) ensures that there is greater dispersion of wheelchair spaces and companion seats throughout stadiums, arenas, and grandstands than would otherwise be required by sections 221 and 802 of the 2004 ADAAG. In some cases, the accessible route may not be the same route that other individuals use to reach their seats. For example, if other patrons reach their seats on the field by an inaccessible route (e.g., by stairs), but there is an accessible route that complies with section 206.3 of the 2004 ADAAG that could be connected to seats on the field, wheelchair spaces and companion seats must be placed on the field even if that route is not generally available to the public.

Regulatory language that was included in the 2004 ADAAG advisory, but that did not appear in the NPRM, has been added by the Department in Sec. 36.406(f)(2). Section 36.406(f)(2) now requires an assembly area that has seating encircling, in whole or in part, a field of play or performance area, such as an arena or stadium, to place wheelchair spaces and companion seats around the entire facility. This rule, which is designed to prevent a public accommodation from placing wheelchair spaces and companion seats on one side of the facility only, is consistent with the Department’s enforcement practices and reflects its interpretation of section 4.33.3 of the 1991 Standards.

Subpart D – Title III Regulation

In the NPRM, the Department proposed Sec. 36.406(f)(2), which prohibits wheelchair spaces and companion seating locations from being “located on (or obstructed by) temporary platforms * * *.” 73 FR 34508, 34557 (June 17, 2008). Through its enforcement actions, the Department discovered that some venues place wheelchair spaces and companion seats on temporary platforms that, when removed, reveal conventional seating underneath, or cover the wheelchair spaces and companion seats with temporary platforms on top of which they place risers of conventional seating. These platforms cover groups of conventional seats and are used to provide groups of wheelchair seats and companion seats.

Several commenters requested an exception to the prohibition of the use of temporary platforms for public accommodations that sell most of their tickets on a season-ticket or other multi-event basis. Such commenters argued that they should be able to use temporary platforms because they know, in advance, that the patrons sitting in certain areas for the whole season do not need wheelchair spaces and companion seats. The Department declines to adopt such an exception. As it explained in detail in the NPRM, the Department believes that permitting the use of movable platforms that seat four or more wheelchair users and their companions have the potential to reduce the number of available wheelchair seating spaces below the level

required, thus reducing the opportunities for persons who need accessible seating to have the same choice of ticket prices and amenities that are available to other patrons in the facility. In addition, use of removable platforms may result in instances where last minute requests for wheelchair and companion seating cannot be met because entire sections of accessible seating will be lost when a platform is removed. See 73 FR 34508, 34546 (June 17, 2008). Further, use of temporary platforms allows facilities to limit persons who need accessible seating to certain seating areas, and to relegate accessible seating to less desirable locations. The use of temporary platforms has the effect of neutralizing dispersion and other seating requirements (e.g., line of sight) for wheelchair spaces and companion seats. Cf. *Independent Living Resources v. Oregon Arena Corp.*, 1 F. Supp. 2d 1159, 1171 (D. Or. 1998) (holding that while a public accommodation may “infill” wheelchair spaces with removable seats when the wheelchair spaces are not needed to accommodate individuals with disabilities, under certain circumstances “[s]uch a practice might well violate the rule that wheelchair spaces must be dispersed throughout the arena in a manner that is roughly proportionate to the overall distribution of seating”). In addition, using temporary platforms to convert unsold wheelchair spaces to conventional seating undermines the flexibility facilities need to accommodate secondary ticket market exchanges as required by Sec. 36.302(f)(7) of the final rule.

As the Department explained in the NPRM, however, this provision was not designed to prohibit temporary seating that increases seating for events (e.g., placing temporary seating on the floor of a basketball court for a concert). Consequently, the final rule, at Sec. 36.406(f)(3), has been amended to clarify that if an entire seating section is on a temporary platform for a particular event, then wheelchair spaces and companion seats may also be in that seating section. However, adding a temporary platform to create wheelchair spaces and companion seats that are otherwise dissimilar from nearby fixed seating and then simply adding a small number of additional seats to the platform would not qualify as an “entire seating section” on the platform. In addition, Sec. 36.406(f)(3) clarifies that facilities may fill in wheelchair spaces with removable seats when the wheelchair spaces are not needed by persons who use wheelchairs.

The Department has been responsive to assembly areas’ concerns about reduced revenues due to unused accessible seating. Accordingly, the Department has reduced scoping requirements significantly--by almost half in large assembly areas--and determined that allowing assembly areas to in-fill unsold wheelchair spaces with readily removable temporary individual seats appropriately balances their economic concerns with the rights of individuals with disabilities. See section 221.1 of the 2010 Standards.

For stadium-style movie theaters, in Sec. 36.406(f)(4) of the NPRM the Department proposed requiring placement of wheelchair seating spaces and companion seats on a riser or cross-aisle in the stadium section of the theater that satisfies at least one of the following criteria: (1) It is located within the rear 60 percent of the seats provided in the auditorium; or (2) It is located within the area of the auditorium where the vertical viewing angles are between the 40th and 100th percentile of vertical viewing angles for all seats in that theater as ranked from the first row (1st percentile) to the back row (100th percentile). The vertical viewing angle is the angle between a horizontal line perpendicular to the seated viewer’s eye to the screen and a line from the seated viewer’s eye to the top of the screen.

The Department proposed this bright-line rule for two reasons: (1) the movie theater industry petitioned for such a rule; and (2) the Department has acquired expertise in the design of stadium-style theaters during its litigation with several major movie theater chains. See *United States v. AMC Entertainment, Inc.*, 232 F. Supp.2d 1092 (C.D. Cal. 2002), rev’d in part, 549 F.3d 760 (9th Cir. 2008); *United States v. Cinemark USA, Inc.*, 348 F.3d 569 (6th Cir. 2003). Two industry commenters--at least one of whom otherwise supported this rule--requested that the Department explicitly state that this rule does not apply retroactively to existing theaters. Although this provision on its face

Subpart D – Title III Regulation

applies to new construction and alterations, these commenters were concerned that the rule could be interpreted to apply retroactively because of the Department’s statements in the NPRM and ANPRM that this bright line rule, although newly articulated, is not a new standard but “merely codifi[es] longstanding Department requirement[s],” 73 FR 34508, 34534 (June 17, 2008), and does not represent a “substantive change from the existing line-of-sight requirements” of section 4.33.3 of the 1991 Standards, 69 FR 58768, 58776 (Sept. 30, 2004).

Although the Department intends for Sec. 36.406(f)(4) of this rule to apply prospectively to new construction and alterations, this rule is not a departure from, and is consistent with, the line-of-sight requirements in the 1991 Standards. The Department has always interpreted the line-of-sight requirements in the 1991 Standards to require viewing angles provided to patrons who use wheelchairs to be comparable to those afforded to other spectators. Section 36.406(f)(4) merely represents the application of these requirements to stadium-style movie theaters.

One commenter from a trade association sought clarification whether Sec. 36.406(f)(4) applies to stadium-style theaters with more than 300 seats, and argued that it should not since dispersion requirements apply in those theaters. The Department declines to limit this rule to stadium-style

theaters with 300 or fewer seats; stadium-style theaters of all sizes must comply with this rule. So, for example, stadium-style theaters that must vertically disperse wheelchair spaces and companion seats must do so within the parameters of this rule.

The NPRM included a provision that required assembly areas with more than 5,000 seats to provide at least five wheelchair spaces with at least three companion seats for each of those five wheelchair spaces. The Department agrees with commenters who asserted that group seating is better addressed through ticketing policies rather than design and has deleted that provision from this section of the final rule.

Section 36.406(g) Medical Care Facilities

In the 1991 title III regulation, there was no provision addressing the dispersion of accessible sleeping rooms in medical care facilities. The Department is aware, however, of problems that individuals with disabilities face in receiving full and equal medical care when accessible sleeping rooms are not adequately dispersed. When accessible rooms are not fully dispersed, a person with a disability is often placed in an accessible room in an area that is not medically appropriate for his or her condition, and is thus denied quick access to staff with expertise in that medical specialty

and specialized equipment. While the Access Board did not establish specific design requirements for dispersion in the 2004 ADAAG, in response to extensive comments in support of dispersion it added an advisory note, Advisory 223.1 General, encouraging dispersion of accessible rooms within the facility so that accessible rooms are more likely to be proximate to appropriate qualified staff and resources.

In the NPRM, the Department sought additional comment on the issue, asking whether it should require medical care facilities, such as hospitals, to disperse their accessible sleeping rooms, and if so, by what method (by specialty area, floor, or other criteria). All of the comments the Department received on this issue supported dispersing accessible sleeping rooms proportionally by specialty area. These comments from individuals, organizations, and a building code association, argued that it would not be difficult for hospitals to disperse rooms by specialty area, given the high level of regulation to which hospitals are subject and the planning that hospitals do based on utilization trends. Further, comments suggest that without a requirement, it is unlikely that hospitals would disperse the rooms. In addition, concentrating accessible rooms in one area perpetuates segregation of individuals with disabilities, which is counter to the purpose of the ADA.

The Department has decided to require medical care facilities to disperse their accessible sleeping rooms in a manner that is proportionate by type of medical specialty. This does not require exact mathematical proportionality, which at times would be impossible. However, it does require that medical care facilities disperse their accessible rooms by medical specialty so that persons with disabilities can, to the extent practical, stay in an accessible room within the wing or ward that is appropriate for their medical needs. The language used in this rule (“in a manner that is proportionate by type of medical specialty”) is more specific than that used in the NPRM (“in a manner that enables patients with disabilities to have access to appropriate specialty services”) and adopts the concept of proportionality proposed by the commenters. Accessible rooms should be dispersed throughout all medical specialties, such as obstetrics, orthopedics, pediatrics, and cardiac care.

4

Analysis and Commentary on the 2010 Standards for Accessible Design

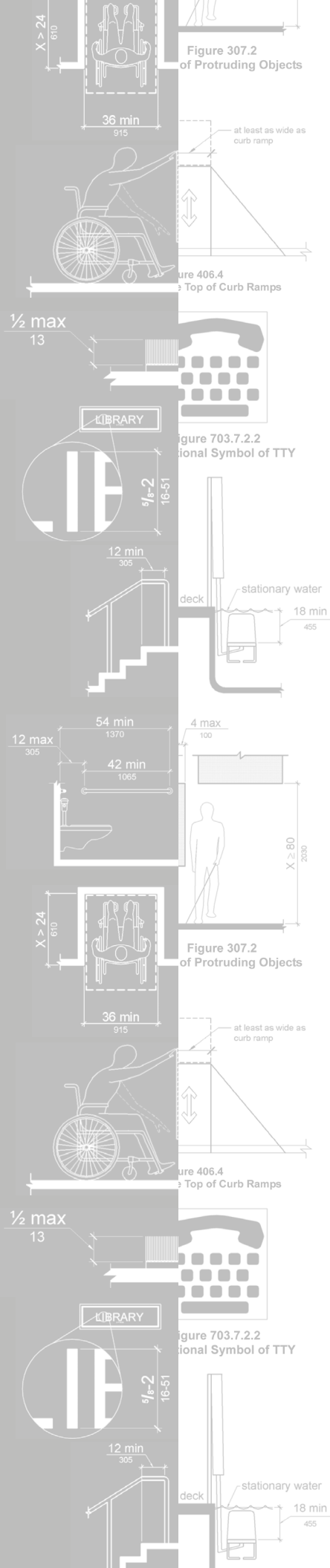

Appendix B to part 36: Analysis and Commentary on the 2010 ADA Standards for Accessible Design

The following is a discussion of substantive changes in the scoping and technical requirements for new construction and alterations resulting from the adoption of new ADA Standards for Accessible Design (2010 Standards) in the final rules for title II (28 CFR part 35) and title III (28 CFR part 36) of the Americans with Disabilities Act (ADA). The full text of the 2010 Standards is available for review at www.ada.gov.

In the Department's revised ADA title II regulation, 28 CFR 35.104 Definitions, the Department defines the term "2010 Standards" to mean the 2010 ADA Standards for Accessible Design. The 2010 Standards consist of the 2004 ADA Accessibility Guidelines (ADAAG) and the requirements contained in 28 CFR 35.151.

In the Department's revised ADA title III regulation, 28 CFR 36.104 Definitions, the Department defines the term "2010 Standards" to mean the 2010 ADA Standards for Accessible Design. The 2010 Standards consist of the 2004 ADA Accessibility Guidelines (ADAAG) and the requirements contained in 28 CFR part 36 subpart D.

This summary addresses selected substantive changes between the 1991 ADA Standards for Accessible Design (1991 Standards) codified at 28 CFR part 36, app. A (2009) and the 2010 Standards.

Editorial changes are not discussed. Scoping and technical requirements are discussed together, where appropriate, for ease of understanding the requirements. In addition, this document addresses selected public comments received by the Department in response to its September 2004 Advance Notice of Proposed Rulemaking (ANPRM) and its June 2008 Notice of Proposed Rulemaking (NPRM).

The ANPRM and NPRM issued by the Department concerning the proposed 2010 Standards stated that comments received by the Access Board in response to its development of the ADAAG upon which the 2010 Standards are based would be considered in the development of the final Standards. Therefore, the Department will not restate here all of the comments and responses to them issued by the Access Board. The Department is supplementing the Access Board's comments and responses with substantive comments and responses here. Comments and responses addressed by the Access Board that also were separately submitted to the Department will not be restated in their entirety here.

Section-by-Section Analysis with Public Comments

Application and Administration

102 Dimensions for Adults and Children

Section 2.1 of the 1991 Standards stated that the specifications were based upon adult dimensions and anthropometrics.

The 1991 Standards did not provide specific requirements for children's elements or facilities.

Section 102 of the 2010 Standards states that the technical requirements are based on adult dimensions and anthropometrics. In addition, technical requirements are also provided based on children's dimensions and anthropometrics for drinking fountains, water closets and other elements located in toilet compartments, lavatories and sinks, dining surfaces, and work surfaces.

103 Equivalent Facilitation

This section acknowledges that nothing in these requirements prevents the use of designs, products, or technologies as alternatives to those prescribed, provided that the alternatives result in substantially equivalent or greater accessibility and usability.

A commenter encouraged the Department to include a procedure for determining equivalent facilitation. The Department believes that the responsibility for determining and demonstrating equivalent facilitation

properly rests with the covered entity. The purpose of allowing for equivalent facilitation is to encourage flexibility and innovation while still ensuring access. The Department believes that establishing potentially cumbersome bureaucratic provisions for reviewing requests for equivalent facilitation is inappropriate.

104 Conventions

Dimensions. Section 104.1 of the 2010 Standards notes that dimensions not stated as a "maximum" or "minimum" are absolute. Section 104.1.1 of the 2010 Standards provides that all dimensions are subject to conventional industry tolerances except where the requirement is stated as a range with specific minimum and maximum end points. A commenter stated that the 2010 Standards restrict the application of construction tolerances only to those few requirements that are expressed as an absolute dimension.

This is an incorrect interpretation of sections 104.1 and 104.1.1 of the 2010 Standards. Construction and manufacturing tolerances apply to absolute dimensions as well as to dimensions expressed as a maximum or minimum. When the requirement states a specified range, such as in section 609.4 where grab bars must be installed between 33 inches and 36 inches above the finished floor, that range provides an adequate

tolerance. Advisory 104.1.1 gives further guidance about tolerances.

Section 104.2 of the 2010 Standards provides that where the required number of elements or facilities to be provided is determined by calculations of ratios or percentages and remainders or fractions result, the next greater whole number of such elements or facilities shall be provided. Where the determination of the required size or dimension of an element or facility involves ratios or percentages, rounding down for values less than one-half is permissible.

A commenter stated that it is customary in the building code industry to round up rather than down for values less than one-half. As noted here, where the 2010 Standards provide for scoping, any resulting fractional calculations will be rounded to the next whole number. The Department is retaining the portion of section 104.2 that permits rounding down for values less than one-half where the determination of the required size or dimension of an element or facility involves ratios or percentages. Such practice is standard with the industry, and is in keeping with model building codes.

105 Referenced Standards

Section 105 lists the industry requirements that are referenced in the 2010 Standards. This section also clarifies that where there is a difference between a provision of the 2010 Standards and the referenced requirements, the provision of the 2010 Standards applies.

106 Definitions

Various definitions have been added to the 2010 Standards and some definitions have been deleted.

One commenter asked that the term public right-of-way be defined; others asked that various terms and words defined by the 1991 Standards, but which were eliminated from the 2010 Standards, plus other words and terms used in the 2010 Standards, be defined.

The Department believes that it is not necessary to add definitions to this text because section 106.3 of the 2010 Standards provides that the meanings of terms not specifically defined in the 2010 Standards, in the Department's ADA regulations, or in referenced standards are to be defined by collegiate dictionaries in the sense that the context implies. The Department believes that this provision adequately addresses these commenters' concerns.

Scoping and Technical Requirements

202 Existing Buildings and Facilities

Alterations. Under section 4.1.6(1)(c) of the 1991 Standards if alterations to single elements, when considered together, amount to an alteration of a room or space in a building or facility, the entire room or space would have to be made accessible. This requirement was interpreted to mean that

if a covered entity chose to alter several elements in a room there would come a point when so much work had been done that it would be considered that the entire room or space would have to be made accessible. Under section 202.3 of the 2010 Standards entities can alter as many elements within a room or space as they like without triggering a requirement to make the entire room or space accessible based on the alteration of individual elements. This does not, however, change the requirement that if the intent was to alter the entire room or space, the entire room or space must be made accessible and comply with the applicable requirements of Chapter 2 of the 2010 Standards.

Alterations to Primary Function Areas.

Section 202.4 restates a current requirement under title III, and therefore represents no change for title III facilities or for those title II facilities that have elected to comply with the 1991 Standards. However, under the revised title II regulation, state and local government facilities that have previously elected to comply with the Uniform Federal Accessibility Standards (UFAS) instead of the 1991 Standards will no longer have that option, and thus will now be subject to the path of travel requirement. The path of travel requirement provides that when a primary function area of an existing facility is altered, the path of travel to that area (including restrooms, telephones, and drinking fountains serving the area) must also be made accessible, but only to the extent that the cost of doing so does not exceed twenty percent (20%) of the cost of the alterations to the primary

function area. The UFAS requirements for a substantial alteration, though different, may have covered some of the items that will now be covered by the path of travel requirement.

Visible Alarms in Alterations to Existing Facilities. The 1991 Standards, at sections 4.1.3(14) and 4.1.6(1)(b), and sections 202.3 and 215.1 of the 2010 Standards require that when existing elements and spaces of a facility are altered, the alterations must comply with new construction requirements. Section 215.1 of the 2010 Standards adds a new exception to the scoping requirement for visible alarms in existing facilities so that visible alarms must be installed only when an existing fire alarm system is upgraded or replaced, or a new fire alarm system is installed.

Some commenters urged the Department not to include the exception and to make visible alarms a mandatory requirement for all spaces, both existing and new. Other commenters said that the exception will make the safety of individuals with disabilities dependent upon the varying age of existing fire alarm systems. Other commenters suggested that including this requirement, even with the exception, will result in significant cost to building owners and operators.

The Department believes that the language of the exception to section 215.1 of the 2010 Standards strikes a reasonable balance between the interests of individuals with disabilities and those of the business

community. If undertaken at the time a system is installed, whether in a new facility or in a planned system upgrade, the cost of adding visible alarms is reasonable. Over time, existing facilities will become fully accessible to individuals who are deaf or hard of hearing, and will add minimal costs to owners and operators.

203 General Exceptions

Limited Access Spaces and Machinery Spaces. The 1991 Standards, at section 4.1.1, contain an exception that exempts “non-occupiable” spaces that have limited means of access, such as ladders or very narrow passageways, and that are visited only by service personnel for maintenance, repair, or occasional monitoring of equipment, from all accessibility requirements. Sections 203.4 and 203.5 of the 2010 Standards expand this exception by removing the condition that the exempt spaces be “non-occupiable,” and by separating the other conditions into two independent exceptions: one for spaces with limited means of access, and the other for machinery spaces. More spaces are exempted by the exception in the 2010 Standards.

203, 206 and 215 Employee Work Areas

Common Use Circulation Paths in Employee Work Areas. The 1991 Standards at section 4.1.1(3), and the 2010 Standards at section 203.9, require employee work areas in new construction and alterations *only* to be designed

and constructed so that individuals with disabilities can approach, enter, and exit the areas. Section 206.2.8 of the 2010 Standards requires accessible common use circulation paths within employee work areas unless they are subject to exceptions in sections 206.2.8, 403.5, 405.5, and 405.8. The ADA, 42 U.S.C. 12112 (b)(5)(A) and (B), requires employers to make reasonable accommodations in the workplace for individuals with disabilities, which may include modifications to work areas when needed. Providing increased access in the facility at the time of construction or alteration will simplify the process of providing reasonable accommodations when they are needed.

The requirement for accessible common use circulation paths will not apply to existing facilities pursuant to the readily achievable barrier removal requirement. The Department has consistently taken the position that barrier removal requirements do not apply to areas used exclusively by employees because the purpose of title III is to ensure that access is provided to clients and customers. See Appendix B to the 1991 regulation implementing title III, 28 CFR part 36.

Several exceptions to section 206.2.8 of the 2010 Standards exempt common use circulation paths in employee work areas from the requirements of section 402 where it may be difficult to comply with the technical requirements for accessible routes due to the size or function of the area:

- Employee work areas, or portions of employee work areas, that are less than 300 square feet and are elevated 7 inches or more above the ground or finish floor, where elevation is essential to the function of the space, are exempt.
- Common use circulation paths within employee work areas that are less than 1,000 square feet and are defined by permanently installed partitions, counters, casework, or furnishings are exempt. Kitchens in quick service restaurants, cocktail bars, and the employee side of service counters are frequently covered by this exception.
- Common use circulation paths within employee work areas that are an integral component of equipment are exempt. Common use circulation paths within large pieces of equipment in factories, electric power plants, and amusement rides are covered by this exception.
- Common use circulation paths within exterior employee work areas that are fully exposed to the weather are exempt. Farms, ranches, and outdoor maintenance facilities are covered by this exception.
- Machinery and equipment are permitted to reduce the clear width of common use circulation paths where the reduction is essential to the function of the work performed. Machinery and equipment that must be placed a certain way to work properly, or for ergonomics or to prevent workplace injuries are covered by this exception.
- Handrails are not required on ramps, provided that they can be added in the future.

The 2010 Standards in sections 403.5 and 405.8 also contain exceptions to the technical requirements for accessible routes for circulation paths in employee work areas:

Commenters stated that the requirements set out in the 2010 Standards for accessible common use circulation paths in employee work areas are inappropriate, particularly in commercial kitchens, storerooms, and behind cocktail bars where wheelchairs would not be easily accommodated. These commenters further urged the Department not to adopt a requirement that circulation paths in employee work areas be at least 36 inches wide, including those at emergency exits.

These commenters misunderstand the scope of the provision. Nothing in the 2010 Standards requires all circulation paths in non-exempt areas to be accessible. The Department recognizes that building codes and fire and life safety codes, which are adopted by all of the states, require *primary* circulation paths in facilities, including employee work areas, to be at least 36 inches wide for purposes of emergency egress. Accessible routes also are at least 36 inches wide. Therefore, the Department anticipates that covered entities will be

able to satisfy the requirement to provide accessible circulation paths by ensuring that their required *primary* circulation paths are accessible.

Individual employee work stations, such as a grocery checkout counter or an automobile service bay designed for use by one person, do not contain common use circulation paths and are not required to comply. Other work areas, such as stockrooms that typically have narrow pathways between shelves, would be required to design only one accessible circulation path into the stockroom. It would not be necessary to make each circulation path in the room accessible. In alterations it may be technically infeasible to provide accessible common use circulation paths in some employee work areas. For example, in a stock room of a department store significant existing physical constraints, such as having to move walls to avoid the loss of space to store inventory, may mean that it is technically infeasible (see section 106.5 “Defined Terms” of the 2010 Standards) to make even the primary common use circulation path in that stock room wide enough to be accessible. In addition, the 2010 Standards include exceptions for common use circulation paths in employee work areas where it may be difficult to comply with the technical requirements for accessible routes due to the size or function of the areas. The Department believes that these exceptions will provide the flexibility necessary to ensure that this requirement does not interfere with legitimate business operations.

Visible Alarms. Section 215.3 of the 2010 Standards provides that where employee work areas in newly constructed facilities have audible alarm coverage they are required to have wiring systems that are capable of supporting visible alarms that comply with section 702 of the 2010 Standards. The 1991 Standards, at section 4.1.1(3), require visible alarms to be provided where audible fire alarm systems are provided, but do not require areas used only by employees as work areas to be equipped with accessibility features. As applied to office buildings, the 1991 Standards require visible alarms to be provided in public and common use areas such as hallways, conference rooms, break rooms, and restrooms, where audible fire alarm systems are provided.

Commenters asserted that the requirements of section 215.3 of the 2010 Standards would be burdensome to meet. These commenters also raised concerns that all employee work areas within existing buildings and facilities must be equipped with accessibility features.

The commenters’ concerns about section 215.3 of the 2010 Standards represent a misunderstanding of the requirements applicable to employee work areas. Newly constructed buildings and facilities merely are required to provide wiring so that visible alarm systems can be added as needed to accommodate employees who are deaf or hard of hearing. This is a minimal requirement without significant impact.

The other issue in the comments represents a misunderstanding of the Department's existing regulatory requirements. Employee common use areas in covered facilities (e.g., locker rooms, break rooms, cafeterias, toilet rooms, corridors to exits, and other common use spaces) were required to be accessible under the 1991 Standards; areas in which employees actually perform their jobs are required to enable a person using a wheelchair or mobility device to approach, enter, and exit the area. The 2010 Standards require increased access through the accessible *common use* circulation path requirement, but neither the 1991 Standards nor the 2010 Standards require employee work stations to be accessible. Access to specific employee *work stations* is governed by title I of the ADA.

205 and 309 Operable Parts

Section 4.1.3, and more specifically sections 4.1.3(13), 4.27.3, and 4.27.4 of the 1991 Standards, require operable parts on accessible elements, along accessible routes, and in accessible rooms and spaces to comply with the technical requirements for operable parts, including height and operation. The 1991 Standards, at section 4.27.3, contain an exception, “ * * * where the use of special equipment dictates otherwise or where electrical and communications systems receptacles are not normally intended for use by building occupants,” from the technical requirement for the height of operable parts. Section 205.1 of the 2010 Standards divides this exception into three

exceptions covering operable parts intended only for use by service or maintenance personnel, electrical or communication receptacles serving a dedicated use, and floor electrical receptacles. Operable parts covered by these new exceptions are exempt from all of the technical requirements for operable parts in section 309. The 2010 Standards also add exceptions that exempt certain outlets at kitchen counters; heating, ventilating and air conditioning diffusers; redundant controls provided for a single element, other than light switches; and exercise machines and equipment from all of the technical requirements for operable parts. Exception 7, in section 205.1 of the 2010 Standards, exempts cleats and other boat securement devices from the accessible height requirement. Similarly, section 309.4 of the 2010 Standards exempts gas pump nozzles, but only from the technical requirement for activating force.

Reach Ranges. The 1991 Standards set the maximum height for side reach at 54 inches above the floor. The 2010 Standards, at section 308.3, lower that maximum height to 48 inches above the finish floor or ground. The 2010 Standards also add exceptions, as discussed above, to the scoping requirement for operable parts for certain elements that, among other things, will exempt them from the reach range requirements in section 308.

The 1991 Standards, at sections 4.1.3, 4.27.3, and 4.2.6, and the 2010 Standards, at sections 205.1, 228.1, 228.2, 308.3, and 309.3, require operable parts of accessible

elements, along accessible routes, and in accessible rooms and spaces to be placed within the forward or side-reach ranges specified in section 308. The 2010 Standards also require at least five percent (5%) of mailboxes provided in an interior location and at least one of each type of depository, vending machine, change machine, and gas pump to meet the technical requirements for a forward or a side reach.

Section 4.2.6 of the 1991 Standards specifies a maximum 54-inch high side reach and a minimum 9-inch low side reach for an unobstructed reach depth of 10 inches maximum. Section 308.3.1 of the 2010 Standards specifies a maximum 48-inch high side reach and a minimum 15-inch low side reach where the element being reached for is unobstructed. Section 308.3.1, Exception 1, permits an obstruction that is no deeper than 10 inches between the edge of the clear floor or ground space and the element that the individual with a disability is trying to reach. Changes in the side-reach range for new construction and alterations in the 2010 Standards will affect a variety of building elements such as light switches, electrical outlets, thermostats, fire alarm pull stations, card readers, and keypads.

Commenters were divided in their views about the changes to the unobstructed side-reach range. Disability advocacy groups and others, including individuals of short stature, supported the modifications to the proposed reach range requirements. Other commenters stated that the new reach range requirements

will be burdensome for small businesses to comply with. These comments argued that the new reach range requirements restrict design options, especially in residential housing.

The Department continues to believe that data submitted by advocacy groups and others provides compelling evidence that lowered reach range requirements will better serve significantly greater numbers of individuals with disabilities, including individuals of short stature, persons with limited upper body strength, and others with limited use of their arms and fingers. The change to the side-reach range was developed by the Access Board over a prolonged period in which there was extensive public participation. This process did not produce any significant data to indicate that applying the new unobstructed side-reach range requirement in new construction or during alterations would impose a significant burden.

206 and Chapter 4 Accessible Routes

Slope. The 2010 Standards provide, at section 403.3, that the cross slope of walking surfaces not be steeper than 1:48. The 1991 Standards' cross slope requirement was that it not exceed 1:50. A commenter recommended increasing the cross slope requirement to allow a maximum of ½ inch per foot (1:24) to prevent imperfections in concrete surfaces from ponding water. The Department continues to believe that the requirement that a cross slope not be steeper

than 1:48 adequately provides for water drainage in most situations. The suggested changes would double the allowable cross slope and create a significant impediment for many wheelchair users and others with a mobility disability.

Accessible Routes from Site Arrival Points and Within Sites. The 1991 Standards, at sections 4.1.2(1) and (2), and the 2010 Standards, at sections 206.2.1 and 206.2.2, require that at least one accessible route be provided within the site from site arrival points to an accessible building entrance and that at least one accessible route connect accessible facilities on the same site. The 2010 Standards also add two exceptions that exempt site arrival points and accessible facilities within a site from the accessible route requirements where the only means of access between them is a vehicular way that does not provide pedestrian access.

Commenters urged the Department to eliminate the exception that exempts site arrival points and accessible facilities from the accessible route requirements where the only means of access between them is a vehicular way not providing pedestrian access. The Department declines to accept this recommendation because the Department believes that its use will be limited. If it can be reasonably anticipated that the route between the site arrival point and the accessible facilities will be used by pedestrians, regardless of whether a pedestrian route is provided, then this

exception will not apply. It will apply only in the relatively rare situations where the route between the site arrival point and the accessible facility dictates vehicular access – for example, an office complex on an isolated site that has a private access road, or a self-service storage facility where all users are expected to drive to their storage units.

Another commenter suggested that the language of section 406.1 of the 2010 Standards is confusing because it states that curb ramps on accessible routes shall comply with 406, 405.2 through 405.5, and 405.10. The 1991 Standards require that curb ramps be provided wherever an accessible route crosses a curb.

The Department declines to change this language because the change is purely editorial, resulting from the overall changes in the format of the 2010 Standards. It does not change the substantive requirement. In the 2010 Standards all elements on a required accessible route must be accessible; therefore, if the accessible route crosses a curb, a curb ramp must be provided.

Areas of Sport Activity. Section 206.2.2 of the 2010 Standards requires at least one accessible route to connect accessible buildings, facilities, elements, and spaces on the same site. Advisory section 206.2.2 adds the explanation that an accessible route must connect the boundary of each area of sport activity (e.g., courts and playing fields, whether indoor or outdoor). Section 206.2.12 of the 2010 Standards further requires that

in court sports the accessible route must directly connect both sides of the court.

Limited-Use/Limited-Application Elevators, Destination-Oriented Elevators and Private Residence Elevators.

The 1991 Standards, at section 4.1.3(5), and the 2010 Standards, at sections 206.2 and 206.6, include exceptions to the scoping requirement for accessible routes that exempt certain facilities from connecting each story with an elevator. If a facility is exempt from the scoping requirement, but nonetheless installs an elevator, the 1991 Standards require the elevator to comply with the technical requirements for elevators. The 2010 Standards add a new exception that allows a facility that is exempt from the scoping requirement to install a limited-use/limited-application (LULA) elevator. LULA elevators are also permitted in the 1991 Standards and the 2010 Standards as an alternative to platform lifts. The 2010 Standards also add a new exception that permits private residence elevators in multi-story dwelling and transient lodging units. The 2010 Standards contain technical requirements for LULA elevators at section 408 and private residence elevators at section 409.

Section 407.2.1.4 of the 2010 Standards includes an exception to the technical requirements for locating elevator call buttons for destination-oriented elevators. The advisory at section 407.2.1.4 describes lobby controls for destination-oriented elevator systems. Many elevator manufacturers have

recently developed these new “buttonless” elevator control systems. These new, more efficient elevators are usually found in high-rise buildings that have several elevators. They require passengers to enter their destination floor on an entry device, usually a keypad, in the elevator lobby. The system then sends the most efficient car available to take all of the passengers going to the sixth floor, for example, only to the sixth floor, without making stops at the third, fourth, and fifth floors on the way to the sixth floor. The challenge for individuals who are blind or have low vision is how to know which elevator car to enter, after they have entered their destination floor into the keypad.

Commenters requested that the Department impose a moratorium on the installation of destination-oriented elevators arguing that this new technology presents wayfinding challenges for persons who are blind or have low vision.

Section 407.2.1.5 of the 2010 Standards allows destination-oriented elevators to not provide call buttons with visible signals to indicate when each call is registered and when each call is answered *provided* that visible and audible signals, compliant with 407.2.2 of the 2010 Standards, indicating which elevator car to enter, are provided. This will require the responding elevator car to automatically provide audible and visible communication so that the system will always verbally and visually indicate which elevator car to enter.

As with any new technology, all users must have time to become acquainted with how to use destination-oriented elevators. The Department will monitor the use of this new technology and work with the Access Board so that there is not a decrease in accessibility as a result of permitting this new technology to be installed.

Accessible Routes to Tiered Dining Areas in Sports Facilities. The 1991 Standards, at sections 4.1.3(1) and 5.4, and section 206.2.5 of the 2010 Standards require an accessible route to be provided to all dining areas in new construction, including raised or sunken dining areas. The 2010 Standards add a new exception for tiered dining areas in sports facilities. Dining areas in sports facilities are typically integrated into the seating bowl and are tiered to provide adequate lines of sight for individuals with disabilities. The new exception requires accessible routes to be provided to at least 25 percent (25%) of the tiered dining areas in sports facilities. Each tier must have the same services and the accessible routes must serve the accessible seating.

Accessible Routes to Press Boxes. The 1991 Standards, at sections 4.1.1(1) and 4.1.3(1), cover all areas of newly constructed facilities required to be accessible, and require an accessible route to connect accessible entrances with all accessible spaces and elements within the facility. Section 201.1 of the 2010 Standards requires that all areas of newly designed

and constructed buildings and facilities and altered portions of existing buildings and facilities be accessible. Sections 206.2.7(1) and (2) of the 2010 Standards add two exceptions that exempt small press boxes that are located in bleachers with entrances on only one level, and small press boxes that are free-standing structures elevated 12 feet or more above grade, from the accessible route requirement when the aggregate area of all press boxes in a sports facility does not exceed 500 square feet. The Department anticipates that this change will significantly reduce the economic impact on smaller sports facilities, such as those associated with high schools or community colleges.

Public Entrances. The 1991 Standards, at sections 4.1.3(8) and 4.1.6(1)(h), require at least fifty percent (50%) of public entrances to be accessible. Additionally, the 1991 Standards require the number of accessible public entrances to be equivalent to the number of exits required by applicable building and fire codes. With very few exceptions, building and fire codes require at least two exits to be provided from spaces within a building and from the building itself. Therefore, under the 1991 Standards where two public entrances are planned in a newly constructed facility, both entrances are required to be accessible.

Instead of requiring accessible entrances based on the number of public entrances provided or the number of exits required (whichever is greater), section 206.4.1

of the 2010 Standards requires at least sixty percent (60%) of public entrances to be accessible. The revision is intended to achieve the same result as the 1991 Standards. Thus, under the 2010 Standards where two public entrances are planned in a newly constructed facility, both entrances must be accessible.

Where multiple public entrances are planned to serve different site arrival points, the 1991 Standards, at section 4.1.2(1), and section 206.2.1 of the 2010 Standards require at least one accessible route to be provided from each type of site arrival point provided, including accessible parking spaces, accessible passenger loading zones, public streets and sidewalks, and public transportation stops, to an accessible public entrance that serves the site arrival point.

Commenters representing small businesses recommended retaining the 1991 requirement for fifty percent (50%) of public entrances of covered entities to be accessible. These commenters also raised concerns about the impact upon existing facilities of the new sixty percent (60%) requirement.

The Department believes that these commenters misunderstand the 1991 Standards. As explained above, the requirements of the 1991 Standards generally require more than fifty percent (50%) of entrances in small facilities to be accessible. Model codes require that most buildings have more than one means of egress. Most buildings have more than

one entrance, and the requirements of the 1991 Standards typically resulted in these buildings having more than one accessible entrance. Requiring at least sixty percent (60%) of public entrances to be accessible is not expected to result in a substantial increase in the number of accessible entrances compared to the requirements of the 1991 Standards. In some very large facilities this change may result in fewer accessible entrances being required by the 2010 Standards. However, the Department believes that the realities of good commercial design will result in more accessible entrances being provided for the convenience of all users.

The 1991 Standards and the 2010 Standards also contain exceptions that limit the number of accessible entrances required in alterations to existing facilities. When entrances to an existing facility are altered and the facility has an accessible entrance, the entrance being altered is not required to be accessible, unless a primary function area also is altered and then an accessible path of travel must be provided to the primary function area to the extent that the cost to do so is not disproportionate to the overall cost of the alteration.

Alterations to Existing Elevators. When a single space or element is altered, the 1991 Standards, at sections 4.1.6(1)(a) and (b), require the space or element to be made accessible. When an element in one elevator is altered, the 2010 Standards, at section 206.6.1, require the same element to be

altered in all elevators that are programmed to respond to the same call button as the altered elevator.

The 2010 Standards, at sections 407.2.1 - 407.4.7.1.2, also contain exceptions to the technical requirements for elevators when existing elevators are altered that minimize the impact of this change.

Commenters expressed concerns about the requirement that when an element in one elevator is altered, the 2010 Standards, at section 206.6.1, will require the same element to be altered in all elevators that are programmed to respond to the same call button as the altered elevator. Commenters noted that such a requirement is burdensome and will result in costly efforts without significant benefit to individuals with disabilities.

The Department believes that this requirement is necessary to ensure that when an individual with a disability presses a call button, an accessible elevator will arrive. Without this requirement, individuals with disabilities would have to wait unnecessarily for an accessible elevator to make its way to them arbitrarily. The Department also believes that the effort required to meet this provision is minimal in the majority of situations because it is typical to upgrade all of the elevators in a bank at the same time.

Accessible Routes in Dwelling Units with Mobility Features. Sections 4.34.1 and 4.34.2 of the UFAS require the living area,

kitchen and dining area, bedroom, bathroom, and laundry area, where provided, in covered dwelling units with mobility features to be on an accessible route. Where covered dwelling units have two or more bedrooms, at least two bedrooms are required to be on an accessible route.

The 2010 Standards at sections 233.3.1.1, 809.1, 809.2, 809.2.1, and 809.4 will require all spaces and elements within dwelling units with mobility features to be on an accessible route. These changes exempt unfinished attics and unfinished basements from the accessible route requirement. Section 233.3.5 of the 2010 Standards also includes an exception to the dispersion requirement that permits accessible single-story dwelling units to be constructed, where multi-story dwelling units are one of the types of units provided.

Location of Accessible Routes. Section 4.3.2(1) of the 1991 Standards requires accessible routes connecting site arrival points and accessible building entrances to coincide with general circulation paths, to the maximum extent feasible. The 2010 Standards require all accessible routes to coincide with or be located in the same general area as general circulation paths. Additionally, a new provision specifies that where a circulation path is interior, the required accessible route must also be located in the interior of the facility. The change affects a limited number of buildings. Section 206.3 of the 2010 Standards requires all accessible routes to coincide with or

be located in the same general area as general circulation paths. Designing newly constructed interior accessible routes to coincide with or to be located in the same area as general circulation paths will not typically present a difficult design challenge and is expected to impose limited design constraints. The change will have no impact on exterior accessible routes. The 1991 Standards and the 2010 Standards also require accessible routes to be located in the interior of the facility where general circulation paths are located in the interior of the facility. The revision affects a limited number of buildings.

Location of Accessible Routes to Stages.

The 1991 Standards at section 4.33.5 require an accessible route to connect the accessible seating and the performing area. Section 206.2.6 of the 2010 Standards requires the accessible route to directly connect the seating area and the accessible seating, stage, and all areas of the stage, where a circulation path directly connects the seating area and the stage. Both the 1991 Standards and the 2010 Standards also require an accessible route to connect the stage and ancillary areas, such as dressing rooms, used by performers. The 2010 Standards do not require an additional accessible route to be provided to the stage. Rather, the changes specify where the accessible route to the stage, which is required by the 1991 Standards, must be located.

207 Accessible Means of Egress

General. The 1991 Standards at sections 4.1.3(9); 4.1.6(1)(g); and 4.3.10 establish scoping and technical requirements for accessible means of egress. Section 207.1 of the 2010 Standards reference the International Building Code (IBC) for scoping and technical requirements for accessible means of egress.

The 1991 Standards require the same number of accessible means of egress to be provided as the number of exits required by applicable building and fire codes. The IBC requires at least one accessible means of egress and at least two accessible means of egress where more than one means of egress is required by other sections of the building code. The changes in the 2010 Standards are expected to have minimal impact since the model fire and life safety codes, which are adopted by all of the states, contain equivalent requirements with respect to the number of accessible means of egress.

The 1991 Standards require areas of rescue assistance or horizontal exits in facilities with levels above or below the level of exit discharge. Areas of rescue assistance are spaces that have direct access to an exit, stair, or enclosure where individuals who are unable to use stairs can go to call for assistance and wait for evacuation. The 2010 Standards incorporate the requirements established by the IBC. The IBC requires an evacuation elevator designed with standby power and other safety features that can

be used for emergency evacuation of individuals with disabilities in facilities with four or more stories above or below the exit discharge level, and allows exit stairways and evacuation elevators to be used as an accessible means of egress in conjunction with areas of refuge or horizontal exits. The change is expected to have minimal impact since the model fire and life safety codes, adopted by most states, already contain parallel requirements with respect to evacuation elevators.

The 1991 Standards exempt facilities equipped with a supervised automatic sprinkler system from providing areas of rescue assistance, and also exempt alterations to existing facilities from providing an accessible means of egress. The IBC exempts buildings equipped with a supervised automatic sprinkler system from certain technical requirements for areas of refuge, and also exempts alterations to existing facilities from providing an accessible means of egress.

The 1991 and 2010 Standards require signs that provide direction to or information about functional spaces to meet certain technical requirements. The 2010 Standards, at section 216.4, address exit signs. This section is consistent with the requirements of the IBC. Signs used for means of egress are covered by this scoping requirement. The requirements in the 2010 Standards require tactile signs complying with sections 703.1, 703.2 and 703.5 at doors at exit passageways, exit discharge, and at exit

stairways. Directional exit signs and signs at areas of refuge required by section 216.4.3 must have visual characters and features complying with section 703.5.

Standby Power for Platform Lifts. The 2010 Standards at section 207.2 require standby power to be provided for platform lifts that are permitted to serve as part of an accessible means of egress by the IBC. The IBC permits platform lifts to serve as part of an accessible means of egress in a limited number of places where platform lifts are allowed in new construction. The 1991 Standards, at 4.1.3 (5) Exception 4 (a) through (d), and the 2010 Standards, at sections 206.7.1 through 206.7.10, similarly limit the places where platform lifts are allowed in new construction.

Commenters urged the Department to reconsider provisions that would require standby power to be provided for platform lifts. Concerns were raised that ensuring standby power would be too burdensome. The Department views this issue as a fundamental life safety issue. Lift users face the prospect of being trapped on the lift in the event of a power failure if standby power is not provided. The lack of standby power could be life-threatening in situations where the power failure is associated with a fire or other emergency. The use of a platform lift is generally only one of the options available to covered entities. Covered entities that are concerned about the costs associated with maintaining standby power for a lift may

wish to explore design options that would incorporate the use of a ramp.

208 and 502 Parking Spaces

General. Where parking spaces are provided, the 1991 Standards, at sections 4.1.2 (5)(a) and (7) and 7(a), and the 2010 Standards, at section 208.1, require a specified number of the parking spaces to be accessible. The 2010 Standards, at section 208, include an exception that exempts parking spaces used exclusively for buses, trucks, delivery vehicles, law enforcement vehicles, or for purposes of vehicular impound, from the scoping requirement for parking spaces, provided that when these lots are accessed by the public the lot has an accessible passenger loading zone.

The 2010 Standards require accessible parking spaces to be identified by signs that display the International Symbol of Accessibility. Section 216.5, Exceptions 1 and 2, of the 2010 Standards exempt certain accessible parking spaces from this signage requirement. The first exception exempts sites that have four or fewer parking spaces from the signage requirement. Residential facilities where parking spaces are assigned to specific dwelling units are also exempted from the signage requirement.

Commenters stated that the first exception, by allowing a small parking lot with four or fewer spaces not to post a sign at its one accessible space, is problematic because it could allow all drivers to park in accessible

parking spaces. The Department believes that this exception provides necessary relief for small business entities that may otherwise face the prospect of having between twenty-five percent (25%) and one hundred percent (100%) of their limited parking area unavailable to their customers because they are reserved for the exclusive use of persons whose vehicles display accessible tags or parking placards. The 2010 Standards still require these businesses to ensure that at least one of their available parking spaces is designed to be accessible.

A commenter stated that accessible parking spaces must be clearly marked. The Department notes that section 502.6 of the 2010 Standards provides that accessible parking spaces must be identified by signs that include the International Symbol of Accessibility. Also, section 502.3.3 of the 2010 Standards requires that access aisles be marked so as to discourage parking in them.

Access Aisle. Section 502.3 of the 2010 Standards requires that an accessible route adjoin each access aisle serving accessible parking spaces. The accessible route connects each access aisle to accessible entrances.

Commenters questioned why the 2010 Standards would permit an accessible route used by individuals with disabilities to coincide with the path of moving vehicles. The Department believes that the 2010 Standards appropriately recognize that not all

parking facilities provide separate pedestrian routes. Section 502.3 of the 2010 Standards provides the flexibility necessary to permit designers and others to determine the most appropriate location of the accessible route to the accessible entrances. If all pedestrians using the parking facility are expected to share the vehicular lanes, then the ADA permits covered entities to use the vehicular lanes as part of the accessible route. The advisory note in section 502.3 of the 2010 Standards, however, calls attention to the fact that this practice, while permitted, is not ideal. Accessible parking spaces must be located on the shortest accessible route of travel to an accessible entrance. Accessible parking spaces and the required accessible route should be located where individuals with disabilities do not have to cross vehicular lanes or pass behind parked vehicles to have access to an accessible entrance. If it is necessary to cross a vehicular lane because, for example, local fire engine access requirements prohibit parking immediately adjacent to a building, then a marked crossing running perpendicular to the vehicular route should be included as part of the accessible route to an accessible entrance.

Van Accessible Parking Spaces. The 1991 Standards, at sections 4.1.2 (5) (b), 4.6.3, 4.6.4, and 4.6.5, require one in every eight accessible parking spaces to be van accessible. Section 208.2.4 of the 2010 Standards requires one in every six accessible parking spaces to be van accessible.

A commenter asked whether automobiles other than vans may park in van accessible parking spaces. The 2010 Standards do not prohibit automobiles other than vans from using van accessible parking spaces. The Department does not distinguish between vehicles that are actual “vans” versus other vehicles such as trucks, station wagons, sport utility vehicles, etc. since many vehicles other than vans may be used by individuals with disabilities to transport mobility devices.

Commenters’ opinions were divided on this point. Facility operators and others asked for a reduction in the number of required accessible parking spaces, especially the number of van accessible parking spaces, because they claimed these spaces often are not used. Individuals with disabilities, however, requested an increase in the scoping requirements for these parking spaces.

The Department is aware that a strong difference of opinion exists between those who use such spaces and those who must provide or maintain them. Therefore, the Department did not increase the total number of accessible spaces required. The only change was to increase the proportion of spaces that must be accessible to vans and other vehicles equipped to transport mobility devices.

Direct Access Entrances from Parking Structures. Where levels in a parking garage have direct connections for pedestrians to another facility, the 1991

Standards, at section 4.1.3(8)(b)(i), require at least one of the direct connections to be accessible. The 2010 Standards, at section 206.4.2, require all of these direct connections to be accessible.

209 and 503 Passenger Loading Zones and Bus Stops

Passenger Loading Zones at Medical Care and Long-Term Care Facilities. Sections 6.1 and 6.2 of the 1991 Standards and section 209.3 of the 2010 Standards require medical care and long-term care facilities, where the period of stay exceeds 24 hours, to provide at least one accessible passenger loading zone at an accessible entrance. The 1991 Standards also require a canopy or roof overhang at this passenger loading zone. The 2010 Standards do not require a canopy or roof overhang.

Commenters urged the Department to reinstate the requirement for a canopy or roof overhang at accessible passenger loading zones at medical care and long-term care facilities. While the Department recognizes that a canopy or roof overhang may afford useful protection from inclement weather conditions to everyone using a facility, it is not clear that the absence of such protection would impede access by individuals with disabilities. Therefore, the Department declined to reinstate that requirement.

Passenger Loading Zones. Where passenger loading zones are provided, the 1991 Standards, at sections 4.1.2(5) and

4.6.6, require at least one passenger loading zone to be accessible. Sections 209.2.1 and 503 of the 2010 Standards, require facilities such as airport passenger terminals that have long, continuous passenger loading zones to provide one accessible passenger loading zone in every continuous 100 linear feet of loading zone space. The 1991 Standards and the 2010 Standards both include technical requirements for the vehicle pull-up space (96 inches wide minimum and 20 feet long minimum). Accessible passenger loading zones must have an access aisle that is 60 inches wide minimum and extends the full length of the vehicle pull-up space. The 1991 Standards permit the access aisle to be on the same level as the vehicle pull-up space, or on the sidewalk. The 2010 Standards require the access aisle to be on the same level as the vehicle pull-up space and to be marked so as to discourage parking in the access aisle.

Commenters expressed concern that certain covered entities, particularly airports, cannot accommodate the requirements of the 2010 Standards to provide passenger loading zones, and urged a revision that would require one accessible passenger loading zone located in reasonable proximity to each building entrance served by the curb.

Commenters raised a variety of issues about the requirements at section 503 of the 2010 Standards stating that the requirements for an access aisle, width, length, and marking of passenger loading zones are not clear, do not fully meet the needs of individuals

with disabilities, may run afoul of state or local requirements, or may not be needed because many passenger loading zones are typically staffed by doormen or valet parkers. The wide range of opinions expressed in these comments indicates that this provision is controversial. However, none of these comments provided sufficient data to enable the Department to determine that the requirement is not appropriate.

Valet Parking and Mechanical Access Parking Garages. The 1991 Standards, at sections 4.1.2(5)(a) and (e), and sections 208.2, 209.4, and 209.5 of the 2010 Standards require parking facilities that provide valet parking services to have an accessible passenger loading zone. The 2010 Standards extend this requirement to mechanical access parking garages. The 1991 Standards contained an exception that exempted valet parking facilities from providing accessible parking spaces. The 2010 Standards eliminate this exception. The reason for not retaining the provision is that valet parking is a service, not a facility type.

Commenters questioned why the exception for valet parking facilities from providing accessible parking spaces was eliminated. The provision was eliminated because valet parkers may not have the skills necessary to drive a vehicle that is equipped to be accessible, including use of hand controls, or when a seat is not present to accommodate a driver using a wheelchair. In that case, permitting the individual with a disability

to self-park may be a required reasonable modification of policy by a covered entity.

210 and 504 Stairways

The 1991 Standards require stairs to be accessible only when they provide access to floor levels not otherwise connected by an accessible route (e.g., where the accessible route is provided by an elevator, lift, or ramp). The 2010 Standards, at sections 210.1 and 504, require all *newly constructed stairs* that are part of a *means of egress* to comply with the requirements for accessible stairs, which include requirements for accessible treads, risers, and handrails. In existing facilities, where floor levels are connected by an accessible route, only the handrail requirement will apply when the stairs are altered. Exception 2 to section 210.1 of the 2010 Standards permits altered stairs to not comply with the requirements for accessible treads and risers where there is an accessible route between floors served by the stairs.

Most commenters were in favor of this requirement for handrails in alterations and stated that adding handrails to stairs during alterations would be feasible and not costly while providing important safety benefits. The Department believes that it strikes an appropriate balance by focusing the expanded requirements on new construction. The 2010 Standards apply to stairs which are part of a required means of egress. Few stairways are not part of a means of egress. The 2010 Standards are consistent with

most building codes which do not exempt stairways when the route is also served by a ramp or elevator.

211 and 602 Drinking Fountains

Sections 4.1.3(10) and 4.15 of the 1991 Standards and sections 211 and 602 of the 2010 Standards require drinking fountains to be provided for persons who use wheelchairs and for others who stand. The 1991 Standards require wall and post-mounted cantilevered drinking fountains mounted at a height for wheelchair users to provide clear floor space for a forward approach with knee and toe clearance and free standing or built-in drinking fountains to provide clear floor space for a parallel approach. The 2010 Standards require drinking fountains mounted at a height for wheelchair users to provide clear floor space for a forward approach with knee and toe clearance, and include an exception for a parallel approach for drinking fountains installed at a height to accommodate very small children. The 2010 Standards also include a technical requirement for drinking fountains for standing persons.

212 and 606 Kitchens, Kitchenettes, Lavatories, and Sinks

The 1991 Standards, at sections 4.24, and 9.2.2(7), contain technical requirements for sinks and only have specific scoping requirements for sinks in transient lodging. Section 212.3 of the 2010 Standards

requires at least five percent (5%) of sinks in each accessible space to comply with the technical requirements for sinks. The technical requirements address clear floor space, height, faucets, and exposed pipes and surfaces. The 1991 Standards, at section 4.24, and the 2010 Standards, at section 606, both require the clear floor space at sinks to be positioned for a forward approach and knee and toe clearance to be provided under the sink. The 1991 Standards, at section 9.2.2(7), allow the clear floor space at kitchen sinks and wet bars in transient lodging guest rooms with mobility features to be positioned for either a forward approach with knee and toe clearance or for a parallel approach. The 2010 Standards include an exception that permits the clear floor space to be positioned for a parallel approach at kitchen sinks in any space where a cook top or conventional range is not provided, and at a wet bar.

A commenter stated that it is unclear what the difference is between a sink and a lavatory, and that this is complicated by requirements that apply to sinks (five percent (5%) accessible) and lavatories (at least one accessible). The term “lavatory” generally refers to the specific type of plumbing fixture required for hand washing in toilet and bathing facilities. The more generic term “sink” applies to all other types of sinks located in covered facilities.

A commenter recommended that the mounting height of sinks and lavatories

should take into consideration the increased use of three-wheeled scooters and some larger wheelchairs. The Department is aware that the use of three-wheeled scooters and larger wheelchairs may be increasing and that some of these devices may require changes in space requirements in the future. The Access Board is funding research to obtain data that may be used to develop design guidelines that provide access to individuals using these mobility devices.

213, 603, 604, and 608 Toilet and Bathing Facilities, Rooms, and Compartments

General. Where toilet facilities and bathing facilities are provided, they must comply with section 213 of the 2010 Standards.

A commenter recommended that all accessible toilet facilities, toilet rooms, and compartments should be required to have signage indicating that such spaces are restricted solely for the use of individuals with disabilities. The Department believes that it is neither necessary nor appropriate to restrict the use of accessible toilet facilities. Like many other facilities designed to be accessible, accessible toilet facilities can and do serve a wide range of individuals with and without disabilities.

A commenter recommended that more than one wheelchair accessible compartment be provided in toilet rooms serving airports and train stations because these compartments are likely to be occupied by individuals with luggage and persons with disabilities often take longer to use them. The Access Board

is examining airport terminal accessibility as part of an ongoing effort to facilitate accessibility and promote effective design. As part of these efforts, the Access Board will examine requirements for accessible toilet compartments in larger airport restrooms. The Department declines to change the scoping for accessible toilet compartments at this time.

Ambulatory Accessible Toilet

Compartments. Section 213.3.1 of the 2010 Standards requires multi-user men's toilet rooms, where the total of toilet compartments and urinals is six or more, to contain at least one ambulatory accessible compartment. The 1991 Standards count only toilet stalls (compartments) for this purpose. The 2010 Standards establish parity between multi-user women's toilet rooms and multi-user men's toilet rooms with respect to ambulatory accessible toilet compartments.

Urinals. Men's toilet rooms with only one urinal will no longer be required to provide an accessible urinal under the 2010 Standards. Such toilet rooms will still be required to provide an accessible toilet compartment. Commenters urged that the exception be eliminated. The Department believes that this change will provide flexibility to many small businesses and it does not alter the requirement that all common use restrooms must be accessible.

Multiple Single-User Toilet Rooms. Where multiple single-user toilet rooms are clustered in a single location, fifty percent (50%),

rather than the one hundred percent (100%) required by the 1991 Standards, are required to be accessible by section 213.2, Exception 4 of the 2010 Standards. Section 216.8 of the 2010 Standards requires that accessible single-user toilet rooms must be identified by the International Symbol of Accessibility where all single-user toilet rooms are not accessible.

Hospital Patient Toilet Rooms. An exception was added in section 223.1 of the 2010 Standards to allow toilet rooms that are part of critical or intensive care patient sleeping rooms to no longer be required to provide mobility features.

Water Closet Location and Rear Grab Bar. Section 604.2 of the 2010 Standards allows greater flexibility for the placement of the centerline of wheelchair accessible and ambulatory accessible water closets. Section 604.5.2, Exception 1 permits a shorter grab bar on the rear wall where there is not enough wall space due to special circumstances (e.g., when a lavatory or other recessed fixture is located next to the water closet and the wall behind the lavatory is recessed so that the lavatory does not overlap the required clear floor space at the water closet). The 1991 Standards contain no exception for grab bar length, and require the water closet centerline to be exactly 18 inches from the side wall, while the 2010 Standards requirement allows the centerline to be between 16 and 18 inches from the side wall in wheelchair accessible

toilet compartments and 17 to 19 inches in ambulatory accessible toilet compartments.

Water Closet Clearance. Section 604.3 of the 2010 Standards represents a change in the accessibility requirements where a lavatory is installed adjacent to the water closet. The 1991 Standards allow the nearest side of a lavatory to be placed 18 inches minimum from the water closet centerline and 36 inches minimum from the side wall adjacent to the water closet. However, locating the lavatory so close to the water closet prohibits many individuals with disabilities from using a side transfer. To allow greater transfer options, including side transfers, the 2010 Standards prohibit lavatories from overlapping the clear floor space at water closets, except in covered residential dwelling units.

A majority of commenters, including persons who use wheelchairs, strongly agreed with the requirement to provide enough space for a side transfer. These commenters believed that the requirement will increase the usability of accessible single-user toilet rooms by making side transfers possible for many individuals who use wheelchairs and would have been unable to transfer to a water closet using a side transfer even if the water closet complied with the 1991 Standards. In addition, many commenters noted that the additional clear floor space at the side of the water closet is also critical for those providing assistance with transfers and personal care for persons with disabilities. Numerous comments noted that this requirement is

already included in other model accessibility standards and many state and local building codes and its adoption in the 2010 Standards is an important part of harmonization efforts. The Department agrees that the provision of enough clear floor space to permit side transfers at water closets is an important feature that must be provided to ensure access for persons with disabilities in toilet and bathing facilities. Furthermore, the adoption of this requirement closely harmonizes with the model codes and many state and local building codes.

Other commenters urged the Department not to adopt section 604.3 of the 2010 Standards claiming that it will require single-user toilet rooms to be two feet wider than the 1991 Standards require, and this additional requirement will be difficult to meet. Multiple commentators also expressed concern that the size of single-user toilet rooms would be increased but they did not specify how much larger such toilet rooms would have to be in their estimation. In response to these concerns, the Department developed a series of single-user toilet room floor plans demonstrating that the total square footage between representative layouts complying with the 1991 Standards and the 2010 Standards are comparable. The Department believes the floor plan comparisons clearly show that size differences between the two Standards are not substantial and several of the 2010 Standards-compliant plans do not require additional square footage compared to the 1991 Standards plans. These single-user toilet room floor plans are shown below.

Several commenters concluded that alterations of single-user toilet rooms should be exempt from the requirements of section 604.3 of the 2010 Standards because of the significant reconfiguration and reconstruction that would be required, such as moving plumbing fixtures, walls, and/or doors at significant additional expense. The Department disagrees with this conclusion since it fails to take into account several key points. The 2010 Standards contain provisions for in-swinging doors, 603.2.3, Exception 2, and recessed fixtures adjacent to water closets, 604.5.2, Exception 1. These provisions give flexibility to create more compact room designs and maintain required clearances around fixtures. As with the 1991 Standards, any alterations must comply to the extent that it is technically feasible to do so.

The requirements at section 604.3.2 of the 2010 Standards specify how required clearance around the water closet can overlap with specific elements and spaces. An exception that applies only to covered residential dwelling units permits a lavatory to be located no closer than 18 inches from the centerline of the water closet. The requirements at section 604.3.2 of the 2010 Standards increase accessibility for individuals with disabilities. One commenter expressed concern about other items that might overlap the clear floor space, such as dispensers, shelves, and coat hooks on the side of the water closet where a wheelchair would be positioned for a transfer. Section 604.3.2 of the 2010 Standards allows items

such as associated grab bars, dispensers, sanitary napkin disposal units, coat hooks, and shelves to overlap the clear floor space. These are items that typically do not affect the usability of the clear floor space.

Toilet Room Doors. Sections 4.22.2 and 4.22.3 of the 1991 Standards and Section 603.2.3 of the 2010 Standards permit the doors of all toilet or bathing rooms with in-swinging doors to swing into the required turning space, but not into the clear floor space required at any fixture. In single-user toilet rooms or bathing rooms, Section 603.2.3 Exception 2 of the 2010 Standards permits the door to swing into the clear floor space of an accessible fixture if a clear floor space that measures at least 30 inches by 48 inches is provided outside of the door swing.

Several commenters expressed reservations about Exception 2 of Section 603.2.3. Concerns were raised that permitting doors of single-user toilet or bathing rooms with in-swinging doors to swing into the clearance around any fixture will result in inaccessibility to individuals using larger wheelchairs and scooters. Additionally, a commenter stated that the exception would require an unacceptable amount of precision maneuvering by individuals who use standard size wheelchairs. The Department believes that this provision achieves necessary flexibility while providing a minimum standard for maneuvering space. The standard does permit additional maneuvering space to be provided, if needed.

In the NPRM, the Department provided a series of plan drawings illustrating comparisons of the minimum size single-user toilet rooms. These floor plans showed typical examples that met the minimum requirements of the proposed ADA Standards. A commenter was of the opinion that the single-user toilet plans shown in the NPRM demonstrated that the new requirements will not result in a substantial increase in room size. Several other commenters representing industry offered criticisms of the single-user toilet floor plans to support their assertion that a 2010 Standards-compliant single-user toilet room will never be smaller and will likely be larger than such a toilet room required under the 1991 Standards. Commenters also asserted that the floor plans prepared by the Department were of a very basic design which could be accommodated in a minimal sized space whereas the types of facilities their customers demand would require additional space to be added to the rooms shown in the floor plans. The Department recognizes that there are many design choices that can affect the size of a room or space. Choices to install additional features may result in more space being needed to provide sufficient clear floor space for that additional feature to comply. However, many facilities that have these extra features also tend to have ample space to meet accessibility requirements. Other commenters asserted that public single-user toilet rooms always include a closer and a latch on the entry door, requiring a larger clear floor space than shown on the

push side of the door shown in Plan 1B. The Department acknowledges that in instances where a latch is provided and a closer is required by other regulations or codes, the minimum size of a room with an out-swinging door may be slightly larger than as shown in Plan 1C.

Additional floor plans of single-user toilet rooms are now included in further response to the commentary received.

Comparison of Single-User Toilet Room Layouts

1991 Standards

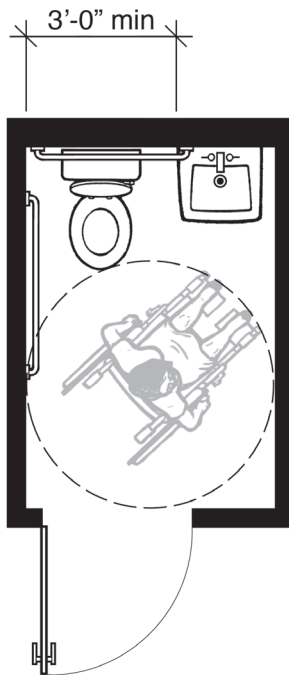

Plan-1A: 1991 Standards Minimum with Out-Swinging Door

5'-0" x 7'-3" • 36.25 Square Feet

This plan shows a typical example of a single-user toilet room that meets the minimum requirements of the 1991 Standards. The size of this space is determined by the minimum width required for the water closet and lavatory between the side walls, the minimum wheelchair turning space, and the space required for the out-swinging door. A lavatory with knee space can overlap the clear floor space required for the water closet provided that at least 36 inches of clearance is maintained between the side wall next to the water closet and the lavatory (see section 4.16.2 and Fig. 28 of the 1991 Standards). A wheelchair turning space meeting section 4.2.3 of the 1991 Standards must be provided. The size of this room requires that the entry door swing out. The room would be larger if the door were in-swinging.

2010 Standards

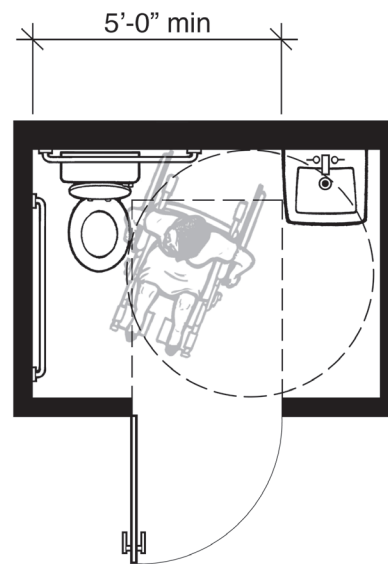

Plan-1B: 2010 Standards Minimum with Out-Swinging Door

7'-0" x 5'-0" • 35.00 Square Feet

This plan shows a typical example of a single-user toilet room that meets the minimum requirements of the 2010 Standards. Features include: five-foot minimum width between the side wall of the water closet and the lavatory; 60-inch minimum circular wheelchair turning space; and 36-inch by 48-inch clear maneuvering space for the out-swinging entry door. Section 604.3.1 of the 2010 Standards requires a floor clearance at a water closet that is a minimum of 60 inches wide by 56 inches deep regardless of approach. Section 604.3.2 prohibits any other plumbing fixtures from being located in this clear space, except in residential dwelling units. The 2010 Standards, at section 304.3, allows the turning space to extend into toe and knee space provided beneath fixtures and other elements. Required maneuvering space for the entry door (inside the room) must be clear of all fixtures. If the door had both a closer and latch, section 404.2.4.1 and Figure 404.2.4.1(c) require additional space on the latch side.

This layout is three point five percent (3.5%) smaller than the accompanying Plan-1A: 1991 Standards Minimum with Out-Swinging Door example.

Comparison of Single-User Toilet Room Layouts

2010 Standards

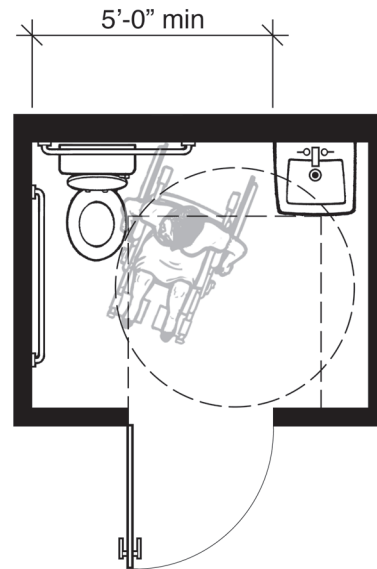

Plan-1C: 2010 Standards Minimum with Out-Swinging Door

(entry door has both closer and latch)

7'-0" x 5'-6" • 38.50 Square Feet

This plan shows the same typical features of a single-user toilet room that meets the minimum requirements of the 2010 Standards as Plan-1B does except the entry door has both a closer and latch. Because the door has both a closer and latch, a minimum additional foot of maneuvering space is required on the latch side (see section 404.2.4.1 and Figure 404.2.4.1(c) of the 2010 Standards).

This layout is six point two percent (6.2%) larger than the accompanying Plan-1A: 1991 Standards Minimum with Out-Swinging Door example.

Comparison of Single-User Toilet Room Layouts

1991 Standards

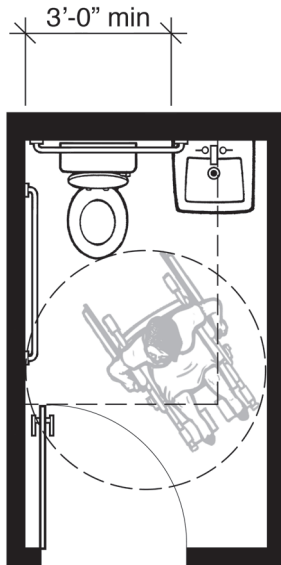

Plan-2A: 1991 Standards Minimum with In-Swinging Door

5'-0" x 8'-6" • 42.50 Square Feet

This plan shows a typical example of a single-user toilet room that meets the minimum requirements of the 1991 Standards. Depending on the width of the hallway and other circulation issues, it can be preferable to swing the entry door into the toilet room. Businesses and public entities typically prefer to have an in-swinging door. The in-swinging door increases overall room size because it cannot swing over the required clear floor space at any accessible fixture, (see section 4.22.2 of the 1991 Standards). This increases the room depth from Plan-1A. The door is permitted to swing over the required turning space shown as a 60-inch circle.

2010 Standards

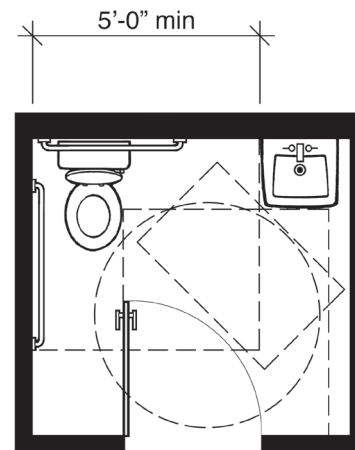

Plan-2B: 2010 Standards Minimum with In-Swinging Door

7'-0" x 6'-6" • 45.50 Square Feet

This plan shows a typical example of a single-user toilet room that meets the minimum requirements of the 2010 Standards when the entry door swings into the room. In the 2010 Standards an exception allows the entry door to swing over the clear floor spaces and clearances required at the fixtures if a clear floor space complying with section 305.3 (minimum 30 inches by 48 inches) is provided outside the arc of the door swing, section 603.3.3 exception 2. The required maneuvering space for the door, section 404.2.4.1 and Figure 404.2.4.1(a), also is a factor in room size. This clear space cannot be obstructed by the plumbing fixtures. Note that this layout provides more space for turning when the door is closed than Plan-1B.

This layout is seven percent (7%) larger than the accompanying Plan-2A: 1991 Standards Minimum with In-Swinging Door example.

Comparison of Single-User Toilet Room Layouts

2010 Standards

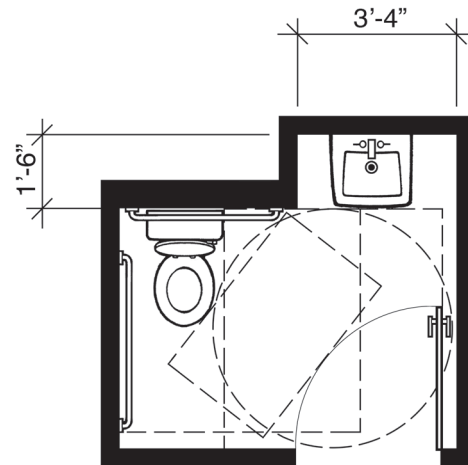

Plan-2C: 2010 Standards Minimum with In-Swinging Door

7'-0" x 6'-6" • 40.00 Square Feet
(plumbing chase not included)

This plan shows the same typical features of a single-user toilet room that meets the minimum requirements of the 2010 Standards as Plan-2B when the entry door swings into the room. Note that this layout also provides more space for turning when the door is closed than Plan-1B.

This layout is six point two five percent (6.25%) smaller than the accompanying Plan-2A: 1991 Standards Minimum with In-Swinging Door example.

Comparison of Single-User Toilet Room Layouts

1991 Standards and 2010 Standards

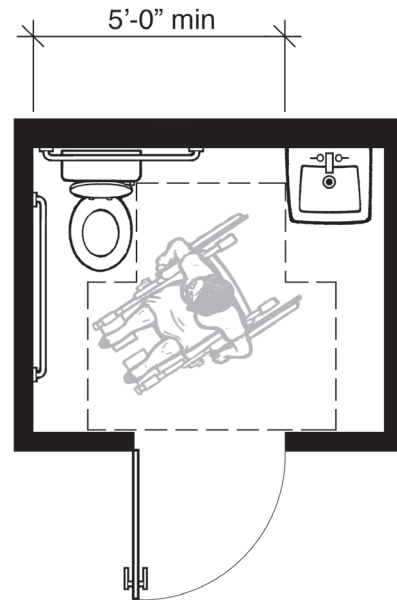

Plan-3: Meets Both 1991 Standards and 2010 Standards

7'-0" x 5'-9" • 40.25 Square Feet

This plan shows an example of a single-user toilet room that meets the minimum requirements of both the 1991 Standards and 2010 Standards. A T-shaped turning space has been used (see Fig. 3(a) of the 1991 Standards and Figure 304.3.2 of the 2010 Standards) to maintain a compact room size. An out-swinging door also minimizes the overall layout depth and cannot swing over the required clear floor space or clearance at any accessible plumbing fixture.

This layout is eleven percent (11%) larger than the Plan-1A: 1991 Standards Minimum with Out-Swinging Door example shown at the beginning of these plan comparisons.

Comparison of Single-User Toilet Room “Pairs” With Fixtures Side-by-Side

1991 Standards

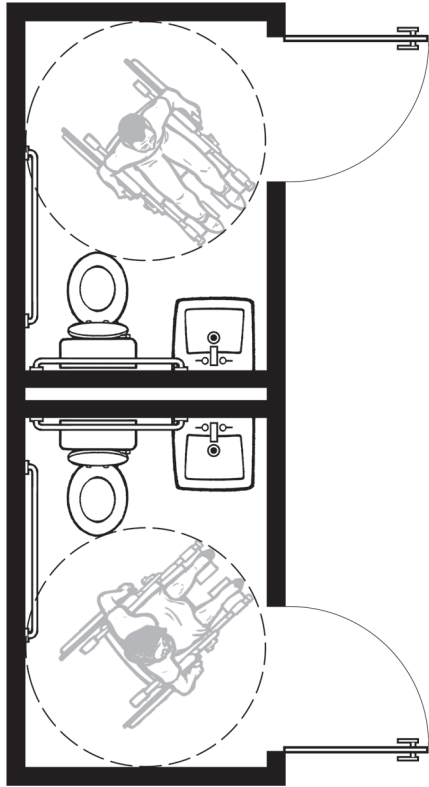

Plan-1A Pair: 1991 Standards with Out-Swinging Doors

**Two 5'-0" x 7'-3" Rooms –
72.50 Square Feet Total**

2010 Standards

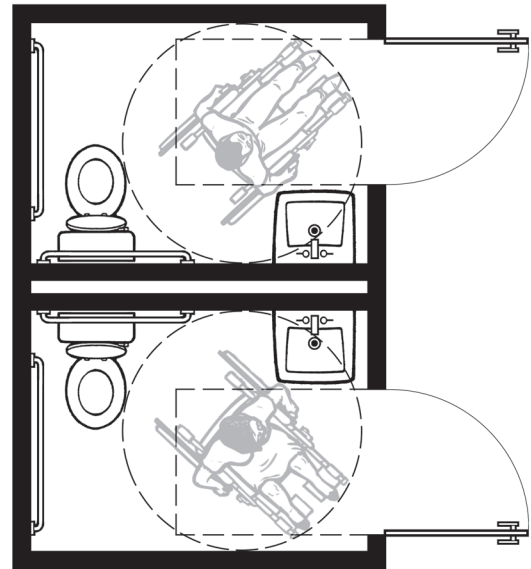

Plan-1B Pair: 2010 Standards with Out-Swinging Doors

**Two 7'-0" x 5'-0" Rooms –
70.00 Square Feet Total**

These plans show men's/women's room configurations using Plans 1A and 1B.

Comparison of Single-User Toilet Room “Pairs” With Fixtures Side-by-Side

2010 Standards

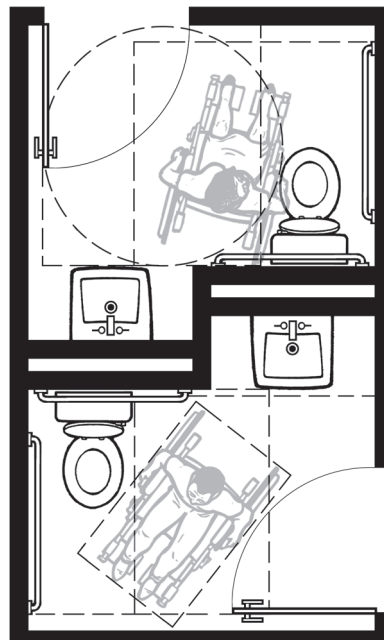

Plan-2C Pair: 2010 Standards with In-Swinging Doors

**Two 7'-2" x 6'-6" Rooms -
82.00 Square Feet Total**

This plan shows a men's/women's room
configuration using Plan 2C.

Toilet Paper Dispensers. The provisions for toilet paper dispensers at section 604.7 of the 2010 Standards require the dispenser to be located seven inches minimum and nine inches maximum in front of the water closet measured to the centerline of the dispenser. The paper outlet of the dispenser must be located 15 inches minimum and 48 inches maximum above the finish floor. In the 1991 Standards the location of the toilet paper dispenser is determined by the centerline and forward edge of the dispenser. In the 2010 Standards the mounting location of the toilet paper dispenser is determined by the centerline of the dispenser and the location of the outlet for the toilet paper.

One commenter discussed the difficulty of using large roll toilet paper dispensers and dispensers with two standard size rolls stacked on top of each other. The size of the large dispensers can block access to the grab bar and the outlet for the toilet paper can be too low or too high to be usable. Some dispensers also control the delivery of the toilet paper which can make it impossible to get the toilet paper. Toilet paper dispensers that control delivery or do not allow continuous paper flow are not permitted by the 1991 Standards or the 2010 Standards. Also, many of the large roll toilet paper dispensers do not comply with the 2010 Standards since their large size does not allow them to be mounted 12 inches above or 1 ½ inches below the side grab bar as required by section 609.3.

Shower Spray Controls. In accessible bathtubs and shower compartments, sections 607.6 and 608.6 of the 2010 Standards require shower spray controls to have an on/off control and to deliver water that is 120°F (49°C) maximum. Neither feature was required by the 1991 Standards, but may be required by plumbing codes. Delivering water that is no hotter than 120°F (49°C) will require controlling the maximum temperature at each accessible shower spray unit.

Shower Compartments. The 1991 Standards at sections 4.21 and 9.1.2 and the 2010 Standards at section 608 contain technical requirements for transfer-type and roll-in shower compartments. The 2010 Standards provide more flexibility than the 1991 Standards as follows:

- Transfer-type showers are exactly 36 inches wide by 36 inches long.
- The 1991 Standards and the 2010 Standards permit a ½-inch maximum curb in transfer-type showers. The 2010 Standards add a new exception that permits a 2-inch maximum curb in transfer-type showers in alterations to existing facilities, where recessing the compartment to achieve a ½-inch curb will disturb the structural reinforcement of the floor slab.
- Roll-in showers are 30 inches wide minimum by 60 inches long minimum. Alternate roll-in showers are 36 inches wide by 60 inches long minimum, and have a 36-inch minimum wide opening on the

long side of the compartment. The 1991 Standards require alternate roll-in showers in a portion of accessible transient lodging guest rooms, but provision of this shower type in other facilities is generally permitted as an equivalent facilitation. The 1991 Standards require a seat to be provided adjacent to the opening; and require the controls to be located on the side adjacent to the seat. The 2010 Standards permit alternate roll-in showers to be used in any facility, only require a seat in transient lodging guest rooms, and allow location of controls on the back wall opposite the seat as an alternative.

Commenters raised concerns that adding a new exception that permits a 2-inch maximum curb in transfer-type showers in alterations to existing facilities, where recessing the compartment to achieve a ½-inch curb will disturb the structural reinforcement of the floor slab, will impair the ability of individuals with disabilities to use transfer-type showers.

The exception in section 608.7 of the 2010 Standards permitting a 2-inch maximum curb in transfer-type showers is allowed only in existing facilities where provision of a ½-inch high threshold would disturb the structural reinforcement of the floor slab. Whenever this exception is used the least high threshold that can be used should be provided, up to a maximum height of 2 inches. This exception is intended to provide some flexibility where the existing structure precludes full compliance.

Toilet and Bathing Rooms. Section 213 of the 2010 Standards sets out the scoping requirements for toilet and bathing rooms.

Commenters recommended that section 213, Toilet Facilities and Bathing Facilities, of the 2010 Standards include requirements that unisex toilet and bathing rooms be provided in certain facilities. These commenters suggested that unisex toilet and bathing rooms are most useful as companion care facilities.

Model plumbing and building codes require single-user (unisex or family) toilet facilities in certain occupancies, primarily assembly facilities, covered malls, and transportation facilities. These types of toilet rooms provide flexibility for persons needing privacy so that they can obtain assistance from family members or persons of the opposite sex. When these facilities are provided, both the 1991 Standards and 2010 Standards require that they be accessible. The 2010 Standards do not scope unisex toilet facilities because plumbing codes generally determine the number and type of plumbing fixtures to be provided in a particular occupancy and often determine whether an occupancy must provide separate sex facilities in addition to single-user facilities. However, the scoping at section 213.2.1 of the 2010 Standards coordinates with model plumbing and building code requirements which will permit a small toilet room with two water closets or one water closet and one urinal to be considered a single-user toilet room provided that the room has a privacy latch. In this way, a

person needing assistance from a person of the opposite sex can lock the door to use the facility while temporarily inconveniencing only one other potential user. These provisions strike a reasonable balance and impose less impact on covered entities.

A commenter recommended that in shower compartments rectangular seats as provided in section 610.3.1 of the 2010 Standards should not be permitted as a substitute for L-shaped seats as provided in 610.3.2.

The 2010 Standards do not indicate a preference for either rectangular or L-shaped seats in shower compartments. L-shaped seats in transfer and certain roll-in showers have been used for many years to provide users with poor balance additional support because they can position themselves in the corner while showering.

214 and 611 Washing Machines and Clothes Dryers

Sections 214.2 (washing machines) and 214.3 (clothes dryers) of the 2010 Standards specify the number of each type of these machines required to be accessible (one to two depending upon the total number of machines provided) and section 611 specifies the technical requirements. An exception will permit the maximum height for the tops of these machines to be 2 inches higher than the general requirement for maximum high reach over an obstruction.

A commenter objected to the scoping provision for accessible washing machines and clothes dryers stating that the probability is low that more than one accessible machine would be needed at the same time in the laundry facility of a place of transient lodging.

The scoping in this provision is based on the relative size of the facility. The Department assumes that the size of the facility (and, therefore, the number of accessible machines provided) will be determined by the covered entity's assessment of the demand for laundry facilities. The Department declines to assume that persons with disabilities will have less use for accessible facilities in transient lodging than in other public accommodations.

216 and 703 Signs

The following types of signs, though they are not specifically subject to the 1991 Standards requirement for signs, will now be explicitly exempted by sections 216 and 703 of the 2010 Standards. These types of signs include: seat and row designations in assembly areas; occupant names, building addresses; company names and logos; signs in parking facilities (except those identifying accessible parking spaces and means of egress); and exterior signs identifying permanent rooms and spaces that are not located at the door to the space they serve. This requirement also clarifies that the exception for temporary signs applies to signs used for seven days or less.

The 2010 Standards retain the option to provide one sign where both visual and tactile characters are provided or two signs, one with visual, and one with tactile characters.

217 and 704 Telephones

Drive-up Public Telephones. Where public telephones are provided, the 1991 Standards, at section 4.1.3(17)(a), and section 217.2 of the 2010 Standards, require a certain number of telephones to be wheelchair accessible. The 2010 Standards add a new exception that exempts drive-up public telephones.

Text Telephones (TTY). Section 4.1.3(17) of the 1991 Standards requires a public TTY to be provided if there are four or more public pay telephones at a site and at least one is in an interior location. Section 217.4.2 of the 2010 Standards requires that a building or facility provide a public TTY on each floor that has four or more public telephones, and in each telephone bank that has four or more telephones. Additionally, section 217.4.4 of the 2010 Standards requires that at least one public TTY be installed where four or more public pay telephones are provided on an exterior site. Section 217.4.5 of the 2010 Standards also requires that a public TTY be provided where at least one public pay telephone is provided at a public rest stop, emergency roadside stop, or service plaza. Section 217.4.6 of the 2010 Standards also requires that a public TTY be provided at each location where at least one public pay telephone is provided serving a hospital

emergency room, a hospital recovery room, or a hospital waiting room. Section 217.4.7 of the 2010 Standards also requires that, in addition to the requirements for a public TTY to be provided at each location where at least four or more public pay telephones are provided at a bank of pay telephones and where at least one public pay telephone is provided on a floor or in a public building, where at least one public pay telephone serves a particular entrance to a bus or rail facility at least one public TTY must serve that entrance. In airports, in addition to the requirements for the provision of a public TTY at phone banks, on floors, and in public buildings with pay phones, where four or more public pay phones are located in a terminal outside the security areas, in a concourse within the security areas, or a baggage claim area in a terminal at least one public TTY must be provided. Section 217.4.8 of the 2010 Standards also requires that a TTY be provided in at least one secured area where at least one pay telephone is provided in a secured area used only by detainees or inmates and security personnel in detention and correctional facilities.

Wheelchair Accessible Telephones

Section 217.2 of the 2010 Standards requires that where public telephones are provided wheelchair accessible telephones complying with section 704.2 must be provided in accordance with Table 217.2.

A commenter stated that requiring installation of telephones within the proposed reach range requirements would adversely impact public and telephone owners and operators. According to the commenter, individuals without disabilities will not use telephones that are installed within the reach range requirements because they may be inconvenienced by having to stoop to operate these telephones, and, therefore, owners and operators will lose revenue due to less use of public telephones.

This comment misunderstands the scoping requirements for wheelchair accessible telephones. Section 217.2 of the 2010 Standards provides that where one or more single units are provided, only one unit per floor, level, or exterior site is required to be wheelchair accessible. However, where banks of telephones are provided, only one telephone in each bank is required to be wheelchair accessible. The Department believes these scoping requirements for wheelchair accessible telephones are reasonable and will not result in burdensome obligations or lost revenue for owners and operators.

218 and 810 Transportation Facilities

Detectable Warnings. Detectable warnings provide a distinctively textured surface of truncated domes. The 1991 Standards at sections 4.1.3(15), 4.7.7, 4.29.2, 4.29.5, 4.29.6, and 10.3.1(8) require detectable warnings at curb ramps, hazardous vehicular

areas, reflecting pools, and transit platform edges. The 2010 Standards at sections 218, 810.5, 705.1, and 705.2 only require detectable warnings at transit platform edges. The technical specifications for the diameter and spacing of the truncated domes have also been changed. The 2010 Standards also delete the requirement for the material used to contrast in resiliency or sound-on-cane contact from adjoining walking surfaces at interior locations.

The 2010 Standards apply to detectable warnings on developed sites. They do not apply to the public right-of-way. Scoping for detectable warnings at all locations other than transit platform edges has been eliminated from the 2010 Standards. However, because detectable warnings have been shown to significantly benefit individuals with disabilities at transit platform edges, the 2010 Standards provide scoping and technical requirements for detectable warnings at transit platform edges.

219 and 706 Assistive Listening Systems

Signs. Section 216.10 of the 2010 Standards requires each covered assembly area to provide signs at each auditorium to inform patrons that assistive listening systems are available. However, an exception to this requirement permits assembly areas that have ticket offices or ticket windows to display the required signs at the ticket window.

A commenter recommended eliminating the exception at 216.10 because, for example, people who buy tickets through the mail, by subscription, or on-line may not need to stop at a ticket office or window upon arrival at the assembly area. The Department believes that an individual's decision to purchase tickets before arriving at a performance does not limit the discretion of the assembly operator to use the ticket window to provide other services to its patrons. The Department retained the exception at 216.10 to permit the venue operator some flexibility in determining how to meet the needs of its patrons.

Audible Communication. The 1991 Standards, at section 4.1.3(19)(b), require assembly areas, where audible communication is integral to the use of the space, to provide an assistive listening system if they have an audio amplification system or an occupant load of 50 or more people and have fixed seating. The 2010 Standards at section 219 require assistive listening systems in spaces where communication is integral to the space and audio amplification is provided and in courtrooms.

The 1991 Standards require receivers to be provided for at least four percent (4%) of the total number of fixed seats. The 2010 Standards, at section 219.3, revise the percentage of receivers required according to a table that correlates the required number of receivers to the seating capacity of the facility. Small facilities will continue to provide receivers for four percent (4%) of the seats.

The required percentage declines as the size of the facility increases. The changes also require at least twenty-five percent (25%), but no fewer than two, of the receivers to be hearing-aid compatible. Assembly areas served by an induction loop assistive listening system will not have to provide hearing-aid compatible receivers.

Commenters were divided in their opinion of this change. The Department believes that the reduction in the required number of assistive listening systems for larger assembly areas will meet the needs of individuals with disabilities. The new requirement to provide hearing-aid compatible receivers should make assistive listening systems more usable for people who have been underserved until now.

Concerns were raised that the requirement to provide assistive listening systems may have an adverse impact on restaurants. This comment misunderstands the scope of coverage. The 2010 Standards define the term "assembly area" to include facilities used for entertainment, educational, or civic gatherings. A restaurant would fall within this category only if it is presenting programs to educate or entertain diners, and it provides an audio amplification system.

Same Management or Building. The 2010 Standards add a new exception that allows multiple assembly areas that are in the same building and under the same management, such as theaters in a multiplex cinema and lecture halls in a college building, to

calculate the number of receivers required based on the total number of seats in all the assembly areas, instead of each assembly area separately, where the receivers are compatible with the assistive listening systems used in each of the assembly areas.

Mono Jacks, Sound Pressure, Etc.

Section 4.33.7 of the 1991 Standards does not contain specific technical requirements for assistive listening systems. The 2010 Standards at section 706 require assistive listening systems to have standard mono jacks and will require hearing-aid compatible receivers to have neck loops to interface with telecoils in hearing aids. The 2010 Standards also specify sound pressure level, signal-to-noise ratio, and peak clipping level. Currently available assistive listening systems typically meet these technical requirements.

220 and 707 Automatic Teller Machines and Fare Machines

Section 707 of the 2010 Standards adds specific technical requirements for speech output, privacy, tactilely-discernible input controls, display screens, and Braille instructions to the general accessibility requirements set out in the 1991 Standards. Machines shall be speech enabled and exceptions are provided that cover when audible tones are permitted, when advertisements or similar information are provided, and where speech synthesis cannot be supported. The 1991 Standards require these machines to be accessible to

and independently usable by persons with visual impairments, but do not contain any technical specifications.

221 Assembly Areas

Wheelchair Spaces/Companion Seats.

Owners of large assembly areas have historically complained to the Department that the requirement for one percent (1%) of seating to be wheelchair seating is excessive and that wheelchair seats are not being sold. At the same time, advocates have traditionally argued that persons who use wheelchairs will increasingly participate in activities at assembly areas once they become accessible and that at least one percent (1%) of seats should be accessible.

The 1991 Standards, at sections 4.1.3(19)(a) and 4.33.3, require assembly areas to provide wheelchair and companion seats. In assembly areas with a capacity of more than five hundred seats, accessible seating at a ratio of one percent (1%) (plus one seat) of the number of traditional fixed seats must be provided. The 2010 Standards, at section 221.2, require assembly areas with 501 to 5000 seats to provide at least six wheelchair spaces and companion seats plus one additional wheelchair space for each additional 150 seats (or fraction thereof) between 501 through 5000. In assembly areas with more than 5000 seats at least 36 wheelchair spaces and companion seats plus one additional wheelchair space for each

200 seats (or fraction thereof) more than 5000 are required. See sections 221.1 and 221.2 of the 2010 Standards.

Commenters questioned why scoping requirements for large assembly areas are being reduced. During the development of the 2004 ADAAG, industry providers, particularly those representing larger stadium-style assembly areas, supplied data to the Access Board demonstrating the current scoping requirements for large assembly areas often exceed the demand. Based on the data provided to the Access Board, the Department believes the reduced scoping requirements will adequately meet the needs of individuals with disabilities, while balancing concerns of the industry.

Commenters representing assembly areas supported the reduced scoping. One commenter asked that scoping requirements for larger assembly areas be reduced even further. Although the commenter referenced data demonstrating that wheelchair spaces in larger facilities with seating capacities of 70,000 or more may not be used by individuals with disabilities, the data was not based on actual results, but was calculated at least in part based on probability assumptions. The Department is not convinced that further reductions should be made based upon those projections and that further reductions would not substantially limit accessibility at assembly areas for persons who use wheelchairs.

Section 221.2.1.3 of the 2010 Standards clarifies that the scoping requirements for wheelchair spaces and companion seats are to be applied separately to general seating areas and to each luxury box, club box, and suite in arenas, stadiums, and grandstands. In assembly areas other than arenas, stadiums, and grandstands, the scoping requirements will not be applied separately. Thus, in performing arts facilities with tiered boxes designed for spatial and acoustical purposes, the scoping requirement is to be applied to the seats in the tiered boxes. The requisite number of wheelchair spaces and companion seats required in the tiered boxes are to be dispersed among at least twenty percent (20%) of the tiered boxes. For example, if a performing arts facility has 20 tiered boxes with 10 fixed seats in each box, for a total of 200 seats, at least five wheelchair spaces and companion seats must be provided in the boxes, and they must be dispersed among at least four of the 20 boxes.

Commenters raised concerns that the 2010 Standards should clarify requirements for scoping of seating areas and that requiring accessible seating in each luxury box, club box, and suite in arenas, stadiums and grandstands could result in no wheelchair and companion spaces available for individuals with disabilities in the general seating area(s). These comments appear to misunderstand the requirements. The 2010 Standards require each luxury box, club box, and suite in an arena, stadium or grandstand to be accessible and to contain wheelchair

spaces and companion seats as required by sections 221.2.1.1, 221.2.1.2 and 221.3. In addition, the remaining seating areas not located in boxes must also contain the number of wheelchair and companion seating locations specified in the 2010 Standards based on the total number of seats in the entire facility excluding luxury boxes, club boxes and suites.

Wheelchair Space Overlap in Assembly Areas. Section 4.33.3 of the 1991 Standards and the 2010 Standards, at sections 402, 403.5.1, 802.1.4, and 802.1.5, require walkways that are part of an accessible route to have a 36-inch minimum clear width. Section 802.1.5 of the 2010 Standards specifically prohibits accessible routes from overlapping wheelchair spaces. This change is consistent with the technical requirements for accessible routes, since the clear width of accessible routes cannot be obstructed by any object. The 2010 Standards also specifically prohibit wheelchair spaces from overlapping circulation paths. An advisory note clarifies that this prohibition applies only to the circulation path width required by applicable building codes and fire and life safety codes since the codes prohibit obstructions in the required width of assembly aisles.

Section 802.1.5 of the 2010 Standards provides that where a main circulation path is located in front of a row of seats that contains a wheelchair space and the circulation path is wider than required by applicable building codes and fire and life safety codes,

the wheelchair space may overlap the “extra” circulation path width. Where a main circulation path is located behind a row of seats that contains a wheelchair space and the wheelchair space is entered from the rear, the aisle in front of the row may need to be wider in order not to block the required circulation path to the other seats in the row, or a mid-row opening may need to be provided to access the required circulation path to the other seats.

Line of Sight and Dispersion of Wheelchair Spaces in Assembly Areas.

Section 4.33.3 of the 1991 Standards requires wheelchair spaces and companion seats to be an integral part of any fixed seating plan in assembly areas and to provide individuals with disabilities a choice of admission prices and lines of sight comparable to those available to other spectators. Section 4.33.3 also requires wheelchair spaces and companion seats to be dispersed in assembly areas with more than 300 seats. Under the 1991 Standards, sports facilities typically located some wheelchair spaces and companion seats on each accessible level of the facility. In 1994, the Department issued official guidance interpreting the requirement for comparable lines of sight in the 1991 Standards to mean wheelchair spaces and companion seats in sports stadia and arenas must provide patrons with disabilities and their companions with lines of sight over standing spectators to the playing field or performance area, where spectators were expected to stand during events. See “Accessible Stadiums,”

www.ada.gov/stadium.pdf. The Department also interpreted the section 4.33.3 comparable lines of sight requirement to mean that wheelchair spaces and companion seats in stadium-style movie theaters must provide patrons with disabilities and their companions with viewing angles comparable to those provided to other spectators.

Sections 221.2.3 and 802.2 of the 2010 Standards add specific technical requirements for providing lines of sight over seated and standing spectators and also require wheelchair spaces and companion seats (per section 221.3) to provide individuals with disabilities choices of seating locations and viewing angles that are substantially equivalent to, or better than, the choices of seating locations and viewing angles available to other spectators. This applies to all types of assembly areas, including stadium-style movie theaters, sports arenas, and concert halls. These rules are expected to have minimal impact since they are consistent with the Department's longstanding interpretation of the 1991 Standards and technical assistance.

Commenters stated that the qualitative viewing angle language contained in section 221.2.3 is not appropriate for an enforceable regulatory standard unless the terms of such language are defined. Other commenters requested definitions for viewing angles, an explanation for precisely how viewing angles are measured, and an explanation for precisely how to evaluate whether one viewing angle is better than another viewing

angle. The Department is convinced that the regulatory language in the 2010 Standards is sufficient to provide a performance-based standard for designers, architects, and other professionals to design facilities that provide comparable lines of sight for wheelchair seating in assembly areas, including viewing angles. The Department believes that as a general rule, the vast variety of sizes and configurations in assembly areas requires it to establish a performance standard for designers to adapt to the specific circumstances of the venue that is being designed. The Department has implemented more explicit requirements for stadium-style movie theaters in 28 CFR 36.406(f) and 35.151(g) of the final regulations based on experience and expertise gained after several major enforcement actions.

Another commenter inquired as to what determines whether a choice of seating locations or viewing angles is better than that available to all other spectators. The answer to this question varies according to each assembly area that is being designed, but designers and venue operators understand which seats are better and that understanding routinely drives design choices made to maximize profit and successful operation of the facility, among other things. For example, an "equivalent or better" line of sight in a major league football stadium would be different than for a 350-seat lecture hall. This performance standard is based upon the underlying principle of equal opportunity for a good viewing experience for everyone, including persons with disabilities. The

Department believes that for each specific facility that is designed, the owner, operator, and design professionals will be able to distinguish easily between seating locations and the quality of the associated lines of sight from those seating locations in order to decide which ones are better than others. The wheelchair locations do not have to be exclusively among the seats with the very best lines of sight nor may they be exclusively among the seats with the worst lines of sight. Rather, wheelchair seating locations should offer a choice of viewing experiences and be located among the seats where most of the audience chooses to sit.

Section 4.33.3 of the 1991 Standards requires wheelchair spaces and companion seating to be offered at a choice of admission prices, but section 221.2.3.2 of the 2010 Standards no longer requires wheelchair spaces and companion seats to be dispersed based on admission prices. Venue owners and operators commented during the 2004 ADAAG rulemaking process that pricing is not always established at the design phase and may vary from event to event within the same facility, making it difficult to determine where to place wheelchair seats during the design and construction phase. Their concern was that a failure by the venue owner or operator to provide a choice of ticket prices for wheelchair seating as required by the 1991 Standards governing new construction could somehow unfairly subject parties involved in the design and construction to liability unknowingly.

Sections 221.2.3.2 and 221.3 of the 2010 Standards require wheelchair spaces and companion seats to be vertically dispersed at varying distances from the screen, performance area, or playing field. The 2010 Standards, at section 221.2.3.2, also require wheelchair spaces and companion seats to be located in each balcony or mezzanine served by an accessible route. The final regulations at 28 CFR 35.151(g)(1) and 36.406(f)(1) also require assembly areas to locate wheelchair spaces and companion seats at all levels of the facility that include seating and that are served by an accessible route. The Department interprets that requirement to mean that wheelchair and companion seating must be provided in a particular area even if the accessible route may not be the same route that other individuals use to reach their seats. For example, if other patrons reach their seats on the field by an inaccessible route (e.g., by stairs), but there is an accessible route that complies with section 206.3 that could be connected to seats on the field, accessible seats must be placed on the field even if that route is not generally available to the public. The 2010 Standards, at section 221.2.3.2, provide an exception for vertical dispersion in assembly areas with 300 or fewer seats if the wheelchair spaces and companion seats provide viewing angles that are equivalent to, or better than, the average viewing angle provided in the facility.

Section 221.3 of the 2010 Standards requires wheelchair spaces and companion seats to be dispersed horizontally. In addition, 28 CFR 35.151(g)(2) and 36.406(f)(2) require assembly areas that have seating around the field of play or performance area to place wheelchair spaces and companion seating all around that field of play or performance area.

Stadium-Style Movie Theaters

Pursuant to 28 CFR 35.151(g) and 36.406(f), in addition to other obligations, stadium-style movie theaters must meet horizontal and vertical dispersion requirements set forth in sections 221.2.3.1 and 221.2.3.2 of the 2010 Standards; placement of wheelchair and companion seating must be on a riser or cross-aisle in the stadium section of the theater; and placement of such seating must satisfy at least one of the following criteria: (i) it is located within the rear sixty percent (60%) of the seats provided in the auditorium; or (ii) it is located within the area of the auditorium where the vertical viewing angles are between the 40th and 100th percentile of vertical viewing angles for all seats in that theater as ranked from the first row (1st percentile) to the back row (100th percentile). The line-of-sight requirements recognize the importance to the movie-going experience of viewing angles, and the final regulations ensure that movie patrons with disabilities are provided views of the movie screen comparable to other theater patrons. Some commenters supported regulatory language that would require stadium-style theaters to meet standards of accessibility

equal to those of non-stadium-style theaters, with larger theaters being required to provide accessible seating locations and viewing angles equal to those offered to individuals without disabilities.

One commenter noted that stadium-style movie theaters, sports arenas, music venues, theaters, and concert halls each pose unique conditions that require separate and specific standards to accommodate patrons with disabilities, and recommended that the Department provide more specific requirements for sports arenas, music venues, theaters, and concert halls. The Department has concluded that the 2010 Standards will provide sufficient flexibility to adapt to the wide variety of assembly venues covered.

Companion Seats. Section 4.33.3 of the 1991 Standards required at least one fixed companion seat to be provided next to each wheelchair space. The 2010 Standards at sections 221.3 and 802.3 permit companion seats to be movable. Several commenters urged the Department to ensure that companion seats are positioned in a manner that places the user at the same shoulder height as their companions using mobility devices. The Department recognizes that some facilities have created problems by locating the wheelchair space and companion seat on different floor elevations (often a difference of one riser height). Section 802.3.1 of the 2010 Standards addresses this problem by requiring the wheelchair space and the companion seat to be on the same

floor elevation. This solution should prevent any vertical discrepancies that are not the direct result of differences in the sizes and configurations of wheelchairs.

Designated Aisle Seats. Section 4.1.3(19) (a) of the 1991 Standards requires one percent (1%) of fixed seats in assembly areas to be designated aisle seats with either no armrests or folding or retractable armrests on the aisle side of the seat. The 2010 Standards, at sections 221.4 and 802.4, base the number of required designated aisle seats on the total number of aisle seats, instead of on all of the seats in an assembly area as the 1991 Standards require. At least five percent (5%) of the aisle seats are required to be designated aisle seats and to be located closest to accessible routes. This option will almost always result in fewer aisle seats being designated aisle seats compared to the 1991 Standards. The Department is aware that sports facilities typically locate designated aisle seats on, or as near to, accessible routes as permitted by the configuration of the facility.

One commenter recommended that section 221.4, Designated Aisle Seats, be changed to require that aisle seats be on an accessible route, and be integrated and dispersed throughout an assembly area. Aisle seats, by their nature, typically are located within the general seating area, and integration occurs almost automatically. The issue of dispersing aisle seats or locating them on accessible routes is much more challenging.

During the separate rulemaking on the 2004 ADAAG the Access Board specifically requested public comment on the question of whether aisle seats should be required to be located on accessible routes. After reviewing the comments submitted during the 2004 Access Board rulemaking, the Access Board concluded that this could not be done without making significant and costly changes in the design of most assembly areas. However, section 221.4 of the 2004 ADAAG required that designated aisle seats be the aisle seats closest to accessible routes. The Department proposed the same provision and concurs in the Access Board's conclusion and declines to implement further changes.

Team or Player Seating Areas. Section 221.2.1.4 of the 2010 Standards requires that at least one wheelchair space compliant with section 802.1 be provided in each team or player seating area serving areas of sport activity. For bowling lanes, the requirement for a wheelchair space in player seating areas is limited to lanes required to be accessible.

Lawn Seating. The 1991 Standards, at section 4.1.1(1), require all areas of newly constructed facilities to be accessible, but do not contain a specific scoping requirement for lawn seating in assembly areas. The 2010 Standards, at section 221.5, specifically require lawn seating areas and exterior overflow seating areas without fixed seats to connect to an accessible route.

Aisle Stairs and Ramps in Assembly Areas. Sections 4.1.3 and 4.1.3(4) of the 1991 Standards require that interior and exterior stairs connecting levels that are not connected by an elevator, ramp, or other accessible means of vertical access must comply with the technical requirements for stairs set out in section 4.9 of the 1991 Standards. Section 210.1 of the 2010 Standards requires that stairs that are part of a means of egress shall comply with section 504's technical requirements for stairs. The 1991 Standards do not contain any exceptions for aisle stairs in assembly areas. Section 210.1, Exception 3 of the 2010 Standards adds a new exception that exempts aisle stairs in assembly areas from section 504's technical requirements for stairs, including section 505's technical requirements for handrails.

Section 4.8.5 of the 1991 Standards exempts aisle ramps that are part of an accessible route from providing handrails on the side adjacent to seating. The 2010 Standards, at section 405.1, exempt aisle ramps adjacent to seating in assembly areas and not serving elements required to be on an accessible route, from complying with all of section 405's technical requirements for ramps. Where aisle ramps in assembly areas serve elements required to be on an accessible route, the 2010 Standards require that the aisle ramps comply with section 405's technical requirements for ramps. Sections 505.2 and 505.3 of the 2010 Standards provide exceptions for aisle ramp handrails. Section 505.2 states that in assembly areas,

a handrail may be provided at either side or within the aisle width when handrails are not provided on both sides of aisle ramps. Section 505.3 states that, in assembly areas, handrails need not be continuous in aisles serving seating.

222 and 803 Dressing, Fitting, and Locker Rooms

Dressing rooms, fitting rooms, and locker rooms are required to comply with the accessibility requirements of sections 222 and 803 of the 2010 Standards. Where these types of rooms are provided in clusters, five percent (5%) but at least one room in each cluster must comply. Some commenters stated that clothing and retail stores would have to expand and reconfigure accessible dressing, fitting and locker rooms to meet the changed provision for clear floor space alongside the end of the bench. Commenters explained that meeting the new requirement would result in a loss of sales and inventory space. Other commenters also expressed opposition to the changed requirement in locker rooms for similar reasons.

The Department reminds the commenters that the requirements in the 2010 Standards for the clear floor space to be beside the short axis of the bench in an accessible dressing, fitting, or locker room apply only to new construction and alterations. The requirements for alterations in the 2010 Standards at section 202.3 do not include the requirement from the 1991 Standards at section 4.1.6(1)(c) that if alterations to

single elements, when considered together, amount to an alteration of a room or space in a building or facility, the entire space shall be made accessible. Therefore, under the 2010 Standards, the alteration requirements only apply to specific elements or spaces that are being altered. So providing the clear floor space at the end of the bench as required by the 2010 Standards instead of in front of the bench as is allowed by the 1991 Standards would only be required when the bench in the accessible dressing room is altered or when the entire dressing room area is altered.

224 and 806 Transient Lodging Guest Rooms

Scoping. The minimum number of guest rooms required to be accessible in transient lodging facilities is covered by section 224 of the 2010 Standards. Scoping requirements for guest rooms with mobility features and guest rooms with communication features are addressed at section 224.2 and section 224.4, respectively. Under the 1991 Standards all newly constructed guest rooms with mobility features must provide communication features. Under the 2010 Standards, in section 224.5, at least one guest room with mobility features must also provide communication features. Additionally, not more than ten percent (10%) of the guest rooms required to provide mobility features and also equipped with communication features can be used to satisfy the minimum number of guest rooms required to provide communication features.

Some commenters opposed requirements for guest rooms accessible to individuals with mobility disabilities stating that statistics provided by the industry demonstrate that all types of accessible guest rooms are unused. They further claimed that the requirements of the 2010 Standards are too burdensome to meet in new construction, and that the requirements will result in a loss of living space in places of transient lodging. Other commenters urged the Department to increase the number of guest rooms required to be accessible. The number of guest rooms accessible to individuals with mobility disabilities and the number accessible to persons who are deaf or who are hard of hearing in the 2010 Standards are consistent with the 1991 Standards and with the IBC. The Department continues to receive complaints about the lack of accessible guest rooms throughout the country. Accessible guest rooms are used not only by individuals using mobility devices such as wheelchairs and scooters, but also by individuals with other mobility disabilities including persons who use walkers, crutches, or canes.

Data provided by the Disability Statistics Center at the University of California, San Francisco demonstrated that the number of adults who use wheelchairs has been increasing at the rate of six percent (6%) per year from 1969 to 1999; and by 2010, it was projected that two percent (2%) of the adult population would use wheelchairs. In addition to persons who use wheelchairs, three percent (3%) of adults used crutches, canes, walkers, and other mobility devices in 1999;

and the number was projected to increase to four percent (4%) by 2010. Thus, in 2010, up to six percent (6%) of the population may need accessible guest rooms.

Dispersion. The 2010 Standards, in section 224.5, set scoping requirements for dispersion in facilities covered by the transient lodging provisions. This section covers guest rooms with mobility features and guest rooms with communication features and applies in new construction and alterations. The primary requirement is to provide choices of types of guest rooms, number of beds, and other amenities comparable to the choices provided to other guests. An advisory in section 224.5 provides guidance that “factors to be considered in providing an equivalent range of options may include, but are not limited to, room size, bed size, cost, view, bathroom fixtures such as hot tubs and spas, smoking and nonsmoking, and the number of rooms provided.”

Commenters asked the Department to clarify what is meant by various terms used in section 224.5 such as “classes,” “types,” “options,” and “amenities.” Other commenters asked the Department to clarify and simplify the dispersion requirements set forth in section 224.5 of the 2010 Standards, in particular the scope of the term “amenities.” One commenter expressed concern that views, if considered an amenity, would further complicate room categories and force owners and operators to make an educated guess.

Other commenters stated that views should only be a dispersion criteria if view is a factor for pricing room rates.

These terms are not to be considered terms of art, but should be used as in their normal course. For example, “class” is defined by Webster’s Dictionary as “a division by quality.” “Type” is defined as “a group of * * * things that share common traits or characteristics distinguishing them as an identifiable group or class.” Accordingly, these terms are not intended to convey different concepts, but are used as synonyms. In the 2010 Standards, section 224.5 and its advisory require dispersion in such a varied range of hotels and lodging facilities that the Department believes that the chosen terms are appropriate to convey what is intended. Dispersion required by this section is not “one size fits all” and it is imperative that each covered entity consider its individual circumstance as it applies this requirement. For example, a facility would consider view as an amenity if some rooms faced mountains, a beach, a lake, or other scenery that was considered to be a premium. A facility where view was not marketed or requested by guests would not factor the view as an amenity for purposes of meeting the dispersion requirement.

Section 224.5 of the 2010 Standards requires that guest rooms with mobility features and guest rooms with communication features “shall be dispersed among the various classes of guest rooms, and shall provide choices of types of guest rooms, number of

beds, and other amenities comparable to the choices provided to other guests. When the minimum number of guest rooms required is not sufficient to allow for complete dispersion, guest rooms shall be dispersed in the following priority: guest room type, number of beds and amenities.”

This general dispersion requirement is intended to effectuate Congress’ directive that a percentage of each class of hotel rooms is to be fully accessible to persons with disabilities. See H.R. Rep. No. 101-485 (II) at 391. Accordingly, the promise of the ADA in this instance is that persons with disabilities will have an equal opportunity to benefit from the various options available to hotel guests without disabilities, from single occupancy guest rooms with limited features (and accompanying limited price tags) to luxury suites with lavish features and choices. The inclusion of section 224.5 of the 2010 Standards is not new. Substantially similar language is contained in section 9.1.4 of the 1991 Standards.

Commenters raised concerns that the factors included in the advisory to section 224.5 of the 2010 Standards have been expanded. The advisory provides: “[f]actors to be considered in providing an equivalent range of options may include, but are not limited to, room size, bed size, cost, view, bathroom fixtures such as hot tubs and spas, smoking and nonsmoking, and the number of rooms provided.”

As previously discussed, the advisory materials provided in the 2010 Standards are meant to be illustrative and do not set out specific requirements. In this particular instance, the advisory materials for section 224.5 set out some of the common types of amenities found at transient lodging facilities, and include common sense concepts such as view, bathroom fixtures, and smoking status. The intention of these factors is to indicate to the hospitality industry the sorts of considerations that the Department, in its enforcement efforts since the enactment of the ADA, has considered as amenities that should be made available to persons with disabilities, just as they are made available to guests without disabilities.

Commenters offered several suggestions for addressing dispersion. One option included the flexibility to use an equivalent facilitation option similar to that provided in section 9.1.4(2) of the 1991 Standards.

The 2010 Standards eliminated all specific references to equivalent facilitation. Since Congress made it clear that each class of hotel room is to be available to individuals with disabilities, the Department declines to adopt such a specific limitation in favor of the specific requirement for new construction and alterations found in section 224.5 of the 2010 Standards.

In considering the comments of the hospitality industry from the ANPRM and the Department’s enforcement efforts in this area, the Department sought

comment in the NPRM on whether the dispersion requirements should be applied proportionally, or whether the requirements of section 224.5 of the 2010 Standards would be complied with if access to at least one guest room of each type were to be provided.

One commenter expressed concern about requiring different guest room types to be proportionally represented in the accessible guest room pool as opposed to just having each type represented. Some commenters also expressed concern about accessible guest rooms created in pre-1993 facilities and they requested that such accessible guest rooms be safe harbored just as they are safe harbored under the 1991 Standards. In addition, one commenter requested that the proposed dispersion requirements in section 224.5 of the 2010 Standards not be applied to pre-1993 facilities even when they are altered. Some commenters also offered a suggestion for limitations to the dispersion requirements as an alternative to safe harboring pre-1993 facilities. The suggestion included: (1) Guest rooms' interior or exterior footprints may remain unchanged in order to meet the dispersion requirements; (2) Dispersion should only be required among the types of rooms affected by an alteration; and (3) Subject to (1) and (2) above and technical feasibility, a facility would need to provide only one guest room in each guest room type such as single, double and suites. One commenter requested an exception to the dispersion criteria that applies to both existing and new multi-story timeshare facilities. This requested exception waives

dispersion based on views to the extent that up to eight units may be vertically stacked in a single location.

Section 224.1.1 of the 2010 Standards sets scoping requirements for alterations to transient lodging guest rooms. The advisory to section 224.1.1 further explains that compliance with 224.5 is more likely to be achieved if all of the accessible guest rooms are not provided in the same area of the facility, when accessible guest rooms are added as a result of subsequent alterations.

Some commenters requested a specific exemption for small hotels of 300 or fewer guest rooms from dispersion regarding smoking rooms. The ADA requires that individuals with disabilities be provided with the same range of options as persons without disabilities, and, therefore, the Department declines to add such an exemption. It is noted, however, that the existence of this language in the advisory does not require a place of transient lodging that does not offer smoking guest rooms at its facility to do so only for individuals with disabilities.

Guest Rooms with Mobility Features.

Scoping provisions for guest rooms with mobility features are provided in section 224.2 of the 2010 Standards. Scoping requirements for alterations are included in 224.1.1. These scoping requirements in the 2010 Standards are consistent with the 1991 Standards.

One commenter expressed opposition to the new scoping provisions for altered guest rooms, which, according to the commenter, require greater numbers of accessible guest rooms with mobility features.

Section 224.1.1 of the 2010 Standards provides scoping requirements for alterations to guest rooms in existing facilities. Section 224.1.1 modifies the scoping requirements for new construction in section 224 by limiting the application of section 224 requirements only to those guest rooms being altered or added until the number of such accessible guest rooms complies with the minimum number required for new construction in section 224.2 of the 2010 Standards. The minimum required number of accessible guest rooms is based on the total number of guest rooms altered or added instead of the total number of guest rooms provided. These requirements are consistent with the requirements in the 1991 Standards. Language in the 2010 Standards clarifies the provision of section 104.2 of the 2010 Standards which requires rounding up values to the next whole number for calculations of percentages in scoping.

Guest Rooms with Communication

Features. The revisions at section 224.4 of the 2010 Standards effect no substantive change from the 1991 Standards with respect to the number of guest rooms required to provide communication features. The scoping requirement is consolidated into a single table, instead of appearing in three

sections as in the 1991 Standards. The revised provisions also limit the overlap between guest rooms required to provide mobility features and guest rooms required to provide communication features. Section 224.5 of the 2010 Standards requires that at least one guest room providing mobility features must also provide communications features. At least one, but not more than ten percent (10%), of the guest rooms required to provide mobility features can also satisfy the minimum number of guest rooms required to provide communication features.

Commenters suggested that the requirements for scoping and dispersion of guest rooms for persons with mobility impairments and guest rooms with communication features are too complex for the industry to effectively implement.

The Department believes the requirements for guest rooms with communications features in the 2010 Standards clarify the requirements necessary to provide equal opportunity for travelers with disabilities. Additional technical assistance will be made available to address questions before the rule goes into effect.

Visible Alarms in Guest Rooms with Communication Features.

The 1991 Standards at sections 9.3.1 and 4.28.4 require transient lodging guest rooms with communication features to provide either permanently installed visible alarms that are connected to the building fire alarm system or portable visible alarms that are connected

to a standard 110-volt electrical outlet and are both activated by the building fire alarm system and provide a visible alarm when the single station smoke detector is activated. Section 215.4 of the 2010 Standards no longer includes the portable visible alarm option and instead requires that transient lodging guest rooms with communication features be equipped with a fire alarm system which includes permanently installed audible and visible alarms in accordance with NFPA 72 National Fire Alarm Code (1999 or 2002 edition). Such guest rooms with communication features are also required by section 806.3.2 of the 2010 Standards to be equipped with visible notification devices that alert room occupants of incoming telephone calls and a door knock or bell.

The 2010 Standards add a new exception for alterations to existing facilities that exempts existing fire alarm systems from providing visible alarms, unless the fire alarm system itself is upgraded or replaced, or a new fire alarm system is installed. Transient lodging facilities that alter guest rooms are not required to provide permanently installed visible alarms complying with the NFPA 72 if the existing fire alarm system has not been upgraded or replaced, or a new fire alarm system has not been installed.

Commenters representing small providers of transient lodging raised concerns about the proposed changes to prohibit the use

of portable visible alarms used in transient lodging guest rooms. These commenters recommended retaining requirements that allow the use of portable visible alarms.

Persons who are deaf or hard of hearing have reported that portable visible alarms used in transient lodging guest rooms are deficient because the alarms are not activated by the building fire alarm system, and the alarms do not work when the building power source goes out in emergencies. The 2010 Standards are consistent with the model building, fire, and life safety codes as applied to newly constructed transient lodging facilities. One commenter sought confirmation of its understanding of visible alarm requirements from the Department. This commenter interpreted the exception to section 215.1 of the 2010 Standards and the Department's commentary to the NPRM to mean that if a transient lodging facility does not have permanently installed visible alarms in its communication accessible guest rooms, it will not be required to provide such alarms until such time that its fire alarm system is upgraded or replaced, or a new fire alarm system is installed. In addition, this commenter also understood that, if a hotel already has permanently installed visible alarms in all of its mobility accessible guest rooms, it would not have to relocate such visible alarms and other communication features in those rooms to other guest rooms to comply with the ten percent (10%) overlap requirement until the alarm system is upgraded or replaced.

This commenter's interpretation and understanding are consistent with the Department's position in this matter. Section 215.4 of the 2010 Standards requires that guest rooms required to have communication features be equipped with a fire alarm system complying with section 702. Communication accessible guest rooms are required to have all of the communication features described in section 806.3 of the 2010 Standards including a fire alarm system which provides both audible and visible alarms. The exception to section 215.1 of the 2010 Standards, which applies only to fire alarm requirements for guest rooms with communication features in existing facilities, exempts the visible alarm requirement until such time as the existing fire alarm system is upgraded or replaced, or a new fire alarm system is installed. If guest rooms in existing facilities are altered and they are required by section 224 of the 2010 Standards to have communication features, such guest rooms are required by section 806.3 to have all other communication features including notification devices.

Vanity Counter Space. Section 806.2.4.1 of the 2010 Standards requires that if vanity countertop space is provided in inaccessible transient lodging guest bathrooms, comparable vanity space must be provided in accessible transient lodging guest bathrooms.

A commenter questioned whether in existing facilities vanity countertop space may be provided through the addition of a shelf. Another commenter found the term

"comparable" vague and expressed concern about confusion the new requirement would cause. This commenter suggested that the phrase "equal area in square inches" be used instead of comparable vanity space.

In some circumstances, the addition of a shelf in an existing facility may be a reasonable way to provide a space for travelers with disabilities to use their toiletries and other personal items. However, this is a determination that must be made on a case-by-case basis. Comparable vanity countertop space need not be one continuous surface and need not be exactly the same size as the countertops in comparable guest bathrooms. For example, accessible shelving within reach of the lavatory could be stacked to provide usable surfaces for toiletries and other personal items.

Shower and Sauna Doors in Transient Lodging Facilities. Section 9.4 of the 1991 Standards and section 206.5.3 of the 2010 Standards both require passage doors in transient lodging guest rooms that do not provide mobility features to provide at least 32 inches of clear width. Congress directed this requirement to be included so that individuals with disabilities could visit guests in other rooms. See H. Rept. 101-485, pt. 2, at 118 (1990); S. Rept. 101-116, at 70 (1989). Section 224.1.2 of the 2010 Standards adds a new exception to clarify that shower and sauna doors in such inaccessible guest rooms are exempt from the requirement for passage doors to provide at least 32 inches of clear width. Two commenters requested

that saunas and steam rooms in existing facilities be exempt from the section 224.1.2 requirement and that the requirement be made applicable to new construction only.

The exemption to the section 224.1.2 requirement for a 32-inch wide clearance at doors to shower and saunas applies only to those showers and saunas in guest rooms which are not required to have mobility features. Showers and saunas in other locations, including those in common use areas and guest rooms with mobility features, are required to comply with the 32-inch clear width standard as well as other applicable accessibility standards. Saunas come in a variety of types: portable, pre-built, pre-cut, and custom-made. All saunas except for custom-made saunas are made to manufacturers' standard dimensions. The Department is aware that creating the required 32-inch clearance at existing narrower doorways may not always be technically feasible. However, the Department believes that owners and operators will have an opportunity to provide the required doorway clearance, unless doing so is technically infeasible, when an alteration to an existing sauna is undertaken. Therefore, the Department has retained these requirements.

Platform Lifts in Transient Lodging Guest Rooms and Dwelling Units. The 1991 Standards, at section 4.1.3(5), exception 4, and the 2010 Standards, at sections 206.7 and 206.7.6, both limit the locations where platform lifts are permitted to be used as part

of an accessible route. The 2010 Standards add a new scoping requirement that permits platform lifts to be used to connect levels within transient lodging guest rooms and dwelling units with mobility features.

806 Transient Lodging Guest Rooms

In the NPRM, the Department included floor plans showing examples of accessible guest rooms and bathrooms designs with mobility features to illustrate how compliance with the 2010 Standards could be accomplished with little or no additional space compared to designs that comply with the 1991 Standards.

Commenters noted that the Department's plans showing accessible transient lodging guest rooms compliant with the 2010 Standards were not common in the transient lodging industry and also noted that the plans omitted doors at sleeping room closets.

The Department agrees that the configuration of the accessible bathrooms is somewhat different from past designs used by the industry, but this was done to meet the requirements of the 2010 Standards. The plans were provided to show that, with some redesign, the 2010 Standards do not normally increase the square footage of an accessible sleeping room or bathroom with mobility features in new construction. The Department has also modified several accessible guest room plans to show that doors can be installed on closets and comply with the 2010 Standards.

A commenter stated that the Department's drawings suggest that the fan coil units for heat and air conditioning are overhead, while the typical sleeping room usually has a vertical unit, or a packaged terminal air conditioning unit within the room. The Department's drawings are sample plans, showing the layout of the space, relationship of elements to each other, and required clear floor and turning spaces. It was not the intent of the Department to provide precise locations for all elements, including heating and air conditioning units.

Commenters noted that in guest rooms with two beds, each bed was positioned close to a wall, reducing access on one side. Another commenter stated that additional housekeeping time is needed to clean the room when beds are placed closer to walls. The 2010 Standards require that, when two beds are provided, there must be at least 36 inches of clear space between the beds. The plans provided in the NPRM showed two bed arrangements with adequate clear width complying with the 1991 Standards and the 2010 Standards. Additional space can be provided on the other side of the beds to facilitate housekeeping as long as the clear floor space between beds is at least 36 inches wide.

Commenters stated that chases in sleeping room bathrooms that route plumbing and other utilities can present challenges when modifying existing facilities. In multi-story facilities, relocating or re-routing these elements may not be possible, limiting

options for providing access. The Department recognizes that relocating mechanical chases in multi-story facilities may be difficult or impossible to accomplish. While these issues do not exist in new facilities, altered existing facilities must comply with the 2010 Standards to the extent that it is technically feasible to do so. When an alteration cannot fully comply because it is technically infeasible to do so, the alteration must still be designed to comply to the greatest extent feasible.

Commenters noted that on some of the Department's plans where a vanity is located adjacent to a bathtub, the vanity may require more maintenance due to exposure to water. The Department agrees that it would be advisable that items placed next to a bathtub or shower be made of materials that are not susceptible to water damage.

Transient Lodging Guest Room Floor Plans and Related Text

The Department has included the following floor plans showing application of the requirements of the 2010 Standards without significant loss of guest room living space in transient lodging compared to the 1991 Standards.

Plan 1A: 13-Foot Wide Accessible Guest Room

This drawing shows an accessible 13-foot wide guest room with features that comply with the 2010 Standards. Features include a standard bathtub with a seat, comparable vanity, clothes closet with swinging doors, and door connecting to adjacent guest room. Furnishings include a king bed and additional seating.

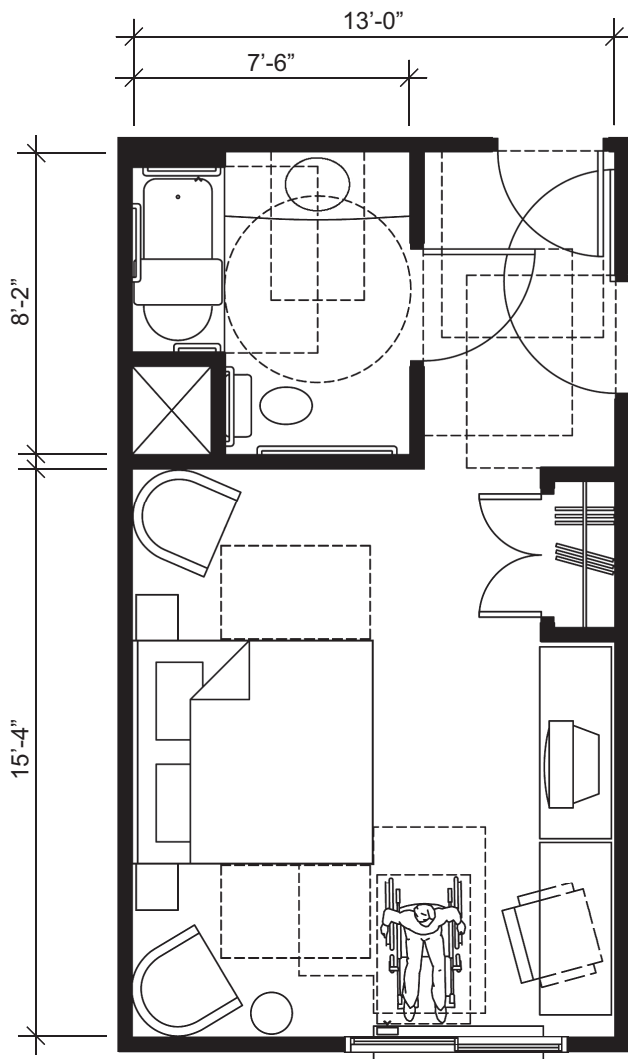

The following accessible features are provided in the bathroom:

- Comparable vanity counter top space (section 806);
- Bathtub with a lavatory at the control end (section 607.2);
- Removable bathtub seat (section 607.3);
- Clearance in front of the bathtub extends its full length and is 30 inches wide min. (section 607.2);
- Recessed bathtub location permits shorter rear grab bar at water closet (section 604.5.2);
- Circular turning space in room (section 603.2.1);
- Required clear floor spaces at fixtures and turning space overlap (section 603.2.2);
- Turning space includes knee and toe clearance at lavatory (section 304.3);
- Water closet clearance is 60 inches at back wall and 56 inches deep (section 604.3);
- Centerline of the water closet at 16-18 inches from side wall (section 604.2); and
- No other fixtures or obstructions located within required water closet clearance (section 604.3).

The following accessible features are provided in the living area:

- T-shaped turning space (section 304.3.2);
- Accessible route (section 402);
- Clear floor space on both sides of the bed (section 806.2.3);
- Maneuvering clearances at all doors (section 404.2);
- Accessible operable window (section 309); and
- Accessible controls for the heat and air conditioning (section 309).

Plan 1B: 13-Foot Wide Accessible Guest Room

This drawing shows an accessible 13-foot wide guest room with features that comply with the 2010 Standards. Features include a standard bathtub with a seat, comparable vanity, clothes closet with swinging doors, and door connecting to adjacent guest room. Furnishings include two beds.

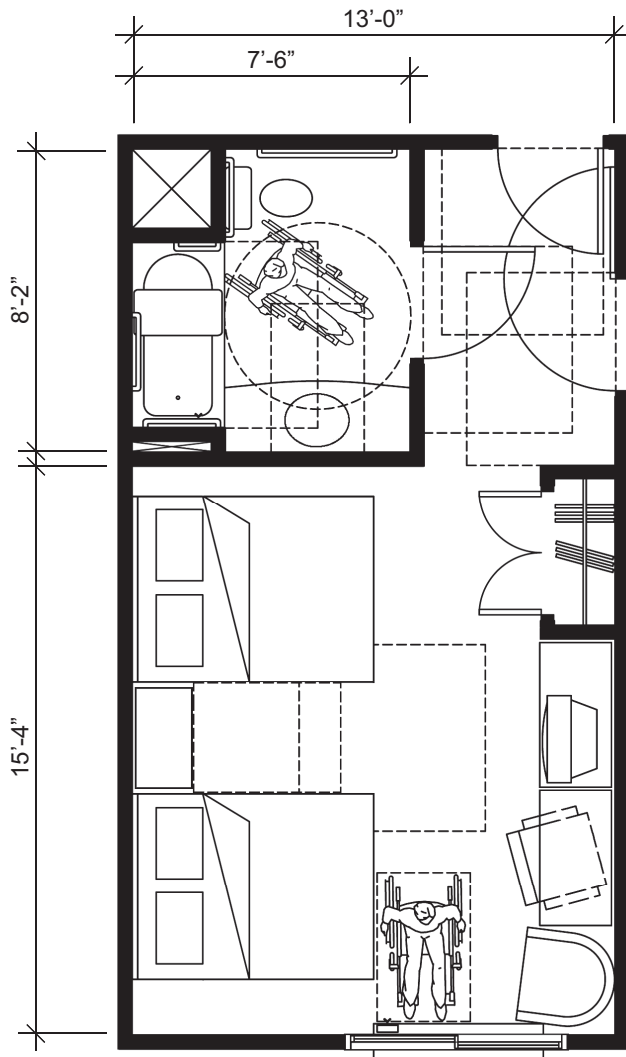

The following accessible features are provided in the bathroom:

- Comparable vanity counter top space (section 806);
- Bathtub with a lavatory at the control end (section 607.2);
- Removable bathtub seat (section 607.3);
- Clearance in front of the bathtub extends its full length and is 30 inches wide min. (section 607.2);
- Recessed bathtub location permits shorter rear grab bar at water closet (section 604.5.2);
- Circular turning space in room (section 603.2.1);
- Required clear floor spaces at fixtures and turning space overlap (section 603.2.2);
- Turning space includes knee and toe clearance at lavatory (section 304.3);
- Water closet clearance is 60 inches at back wall and 56 inches deep (section 604.3);
- Centerline of the water closet at 16-18 inches from side wall (section 604.2); and
- No other fixtures or obstructions located within required water closet clearance (section 604.3);

The following accessible features are provided in the living area:

- T-shaped turning space (section 304.3.2);
- Accessible route (section 402);
- Clear floor space between beds (section 806.2.3);
- Maneuvering clearances at all doors (section 404.2);
- Accessible operable window (section 309); and
- Accessible controls for the heat and air conditioning (section 309).

Plan 2A: 13-Foot Wide Accessible Guest Room

This drawing shows an accessible 13-foot wide guest room with features that comply with the 2010 Standards. Features include a standard roll-in shower with a seat, comparable vanity, wardrobe, and door connecting to adjacent guest room. Furnishings include a king bed and additional seating.

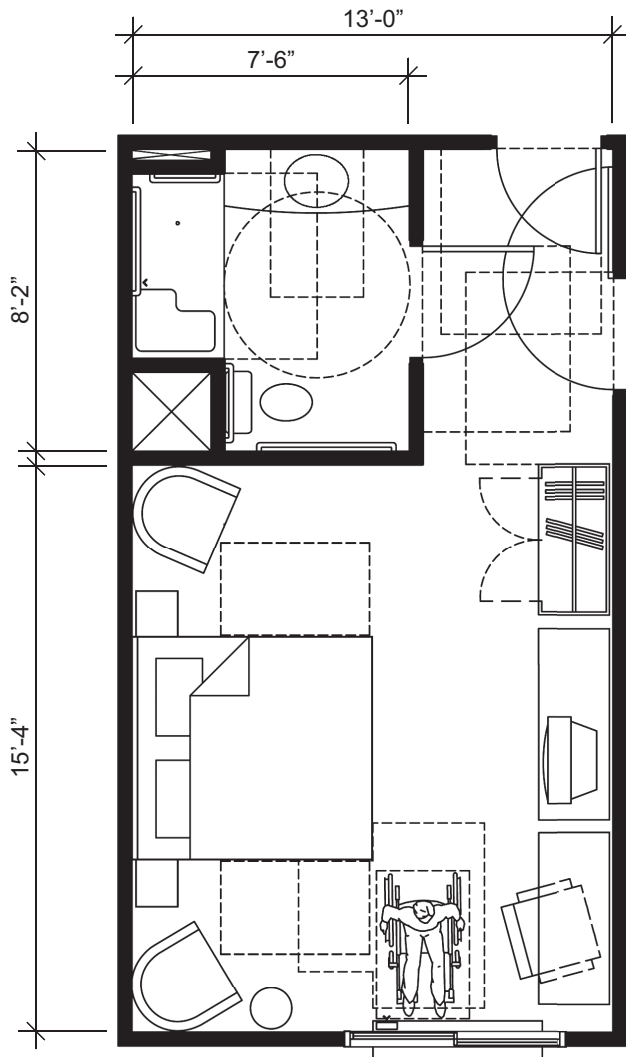

The following accessible features are provided in the bathroom:

- Comparable vanity counter top space (section 806);
- Standard roll-in type shower with folding seat (section 608.2.2);
- Recessed roll-in shower location permits shorter rear grab bar at water closet (section 604.5.2);
- Clear floor space adjacent to shower min. 30 inches wide by 60 inches long (section 608.2.2);
- Circular turning space in room (section 603.2.1);
- Required clear floor spaces at fixtures and turning space overlap (section 603.2.2);
- Turning space includes knee and toe clearance at lavatory (section 304.3);
- Water closet clearance is 60 inches at back wall and 56 inches deep (section 604.3);
- Centerline of the water closet at 16-18 inches from side wall (section 604.2); and
- No other fixtures or obstructions located within required water closet clearance (section 604.3).

The following accessible features are provided in the living area:

- T-shaped turning space (section 304.3.2);
- Accessible route (section 402);
- Clear floor space on both sides of the bed (section 806.2.3);
- Maneuvering clearances at all doors (section 404.2);
- Accessible operable window (section 309); and
- Accessible controls for the heat and air conditioning (section 309).

Plan 2B: 13-Foot Wide Accessible Guest Room

This drawing shows an accessible 13-foot wide guest room with features that comply with the 2010 Standards. Features include an alternate roll-in shower with a seat, comparable vanity, wardrobe, and door connecting to adjacent guest room. Furnishings include two beds.

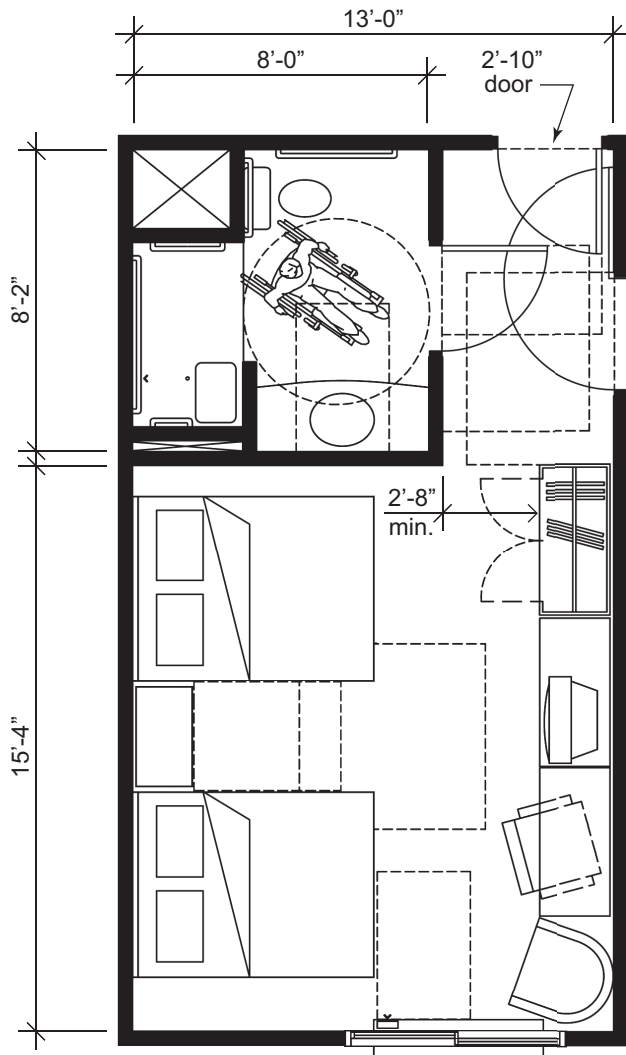

The following accessible features are provided in the bathroom:

- Comparable vanity counter top space (section 806);
- Alternate roll-in type shower with folding seat is 36 inches deep and 60 inches wide (section 608.2.3);
- Alternate roll-in shower has a 36-inch wide entry at one end of the long side of the compartment (section 608.2.3);
- Recessed alternate roll-in shower location permits shorter rear grab bar at water closet (section 604.5.2);
- Circular turning space in room (section 603.2.1);
- Required clear floor spaces at fixtures and turning space overlap (section 603.2.2);
- Turning space includes knee and toe clearance at lavatory (section 304.3);
- Water closet clearance is 60 inches at back wall and 56 inches deep (section 604.3);
- Centerline of the water closet at 16-18 inches from side wall (section 604.2); and
- No other fixtures or obstructions located within required water closet clearance (section 604.3).

The following accessible features are provided in the living area:

- T-shaped turning space (section 304.3.2);
- Accessible route (section 402);
- Clear floor space between beds (section 806.2.3);
- Maneuvering clearances at all doors (section 404.2);
- Accessible operable window (section 309); and
- Accessible controls for the heat and air conditioning (section 309).

Plan 3A: 12-Foot Wide Accessible Guest Room

This drawing shows an accessible 12-foot wide guest room with features that comply with the 2010 Standards. Features include a bathtub with a seat, comparable vanity, open clothes closet, and door connecting to adjacent guest room. Furnishings include a king bed and additional seating.

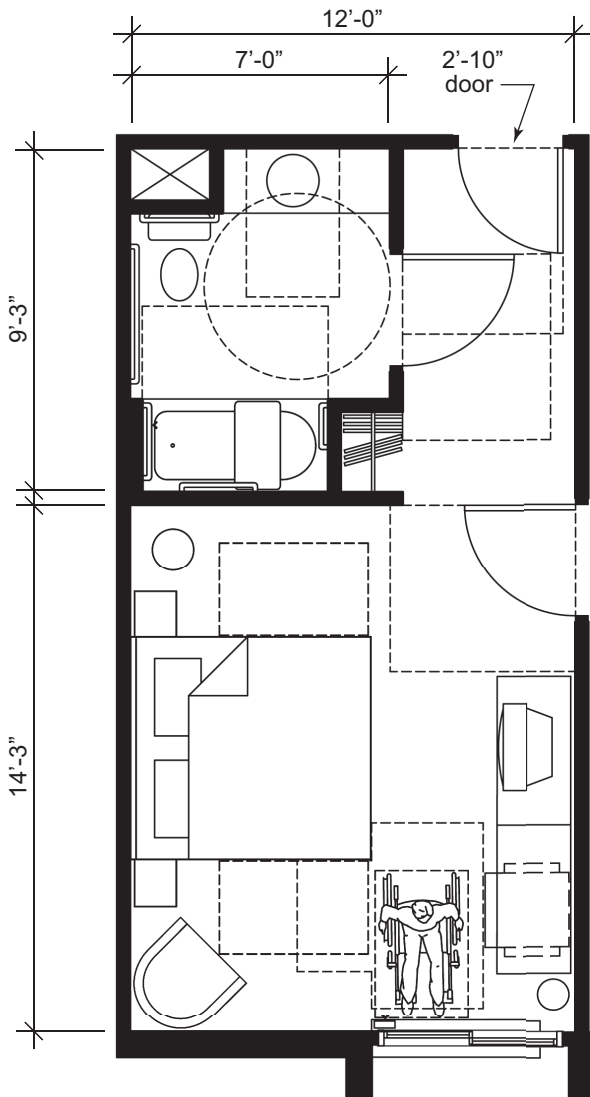

The following accessible features are provided in the bathroom:

- Comparable vanity counter top space (section 806);
- Bathtub (section 607.2);
- Removable bathtub seat (section 607.3);
- Clearance in front of the bathtub extends its full length and is 30 inches wide min. (section 607.2);
- Recessed lavatory with vanity countertop permits shorter rear grab bar at water closet (section 604.5.2);
- Circular turning space in room (section 603.2.1);
- Required clear floor spaces at fixtures and turning space overlap (section 603.2.2);
- Turning space includes knee and toe clearance at lavatory (section 304.3);
- Water closet clearance is 60 inches at back wall and 56 inches deep (section 604.3);
- Centerline of the water closet at 16-18 inches from side wall (section 604.2); and
- No other fixtures or obstructions located within required water closet clearance (section 604.3).

The following accessible features are provided in the living area:

- T-shaped turning space (section 304.3.2);
- Accessible route (section 402);
- Clear floor space on both sides of the bed (section 806.2.3);
- Maneuvering clearances at all doors (section 404.2);
- Accessible operable window (section 309); and
- Accessible controls for the heat and air conditioning (section 309).

Plan 3B: 12-Foot Wide Accessible Guest Room

This drawing shows an accessible 12-foot wide guest room with features that comply with the 2010 Standards. Features include a standard roll-in shower with a seat, comparable vanity, wardrobe, and door connecting to adjacent guest room. Furnishings include two beds.

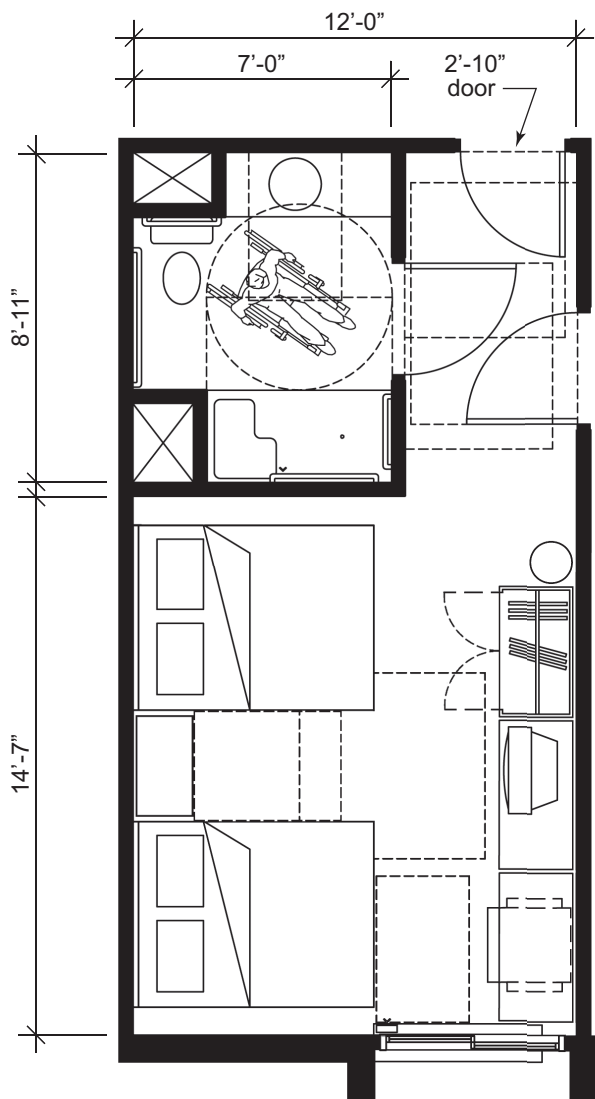

The following accessible features are provided in the bathroom:

- Comparable vanity counter top space (section 806);
- Standard roll-in type shower with folding seat (section 608.2.2);
- Recessed lavatory with vanity counter top permits shorter rear grab bar at water closet (section 604.5.2);
- Clear floor space adjacent to shower min. 30 inches wide by 60 inches long (section 608.2.2);
- Circular turning space in room (section 603.2.1);
- Required clear floor spaces at fixtures and turning space overlap (section 603.2.2);
- Turning space includes knee and toe clearance at lavatory (section 304.3);
- Water closet clearance is 60 inches at back wall and 56 inches deep (section 604.3);
- Centerline of the water closet at 16-18 inches from side wall (section 604.2); and
- No other fixtures or obstructions located within required water closet clearance (section 604.3).

The following accessible features are provided in the living area:

- T-shaped turning space (section 304.3.2);
- Accessible route (section 402);
- Clear floor space between beds (section 806.2.3);
- Maneuvering clearances at all doors (section 404.2);
- Accessible operable window (section 309); and
- Accessible controls for the heat and air conditioning (section 309).

Plan 4A: 13-Foot Wide Accessible Guest Room

This drawing shows an accessible 13-foot wide guest room with features that comply with the 2010 Standards. Features include a standard roll-in shower with a seat, comparable vanity, clothes closet with swinging doors, and door connecting to adjacent guest room. Furnishings include a king bed and additional seating.

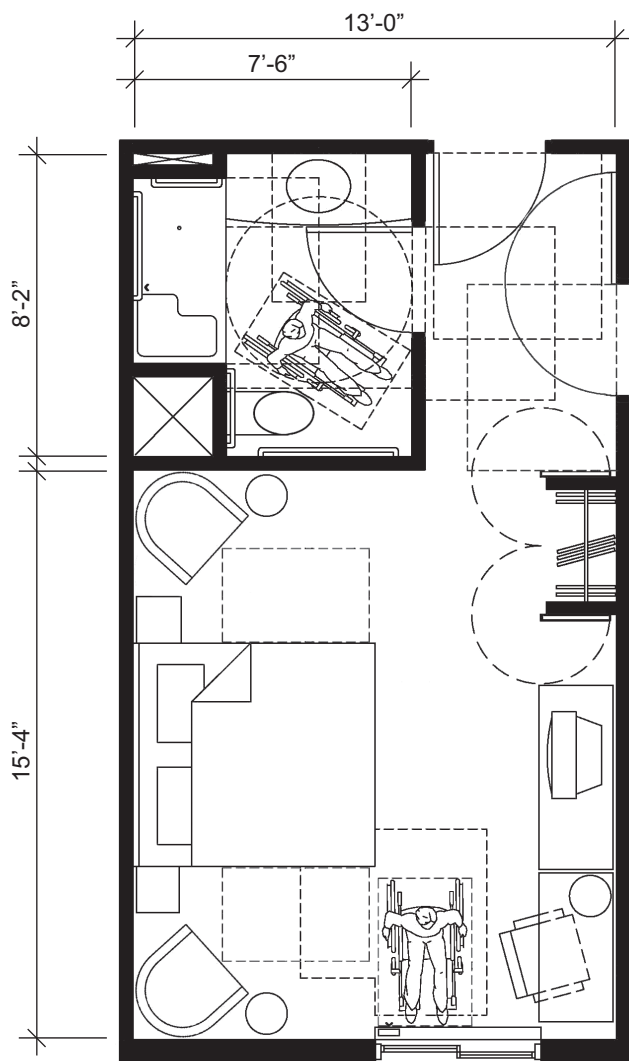

The following accessible features are provided in the bathroom:

- Comparable vanity counter top space (section 806);
- Standard roll-in type shower with folding seat (section 608.2.2);
- Clear floor space adjacent to shower min. 30 inches wide by 60 inches long (section 608.2.2);
- Recessed roll-in shower location permits shorter rear grab bar at water closet (section 604.5.2);
- Circular turning space in room (section 603.2.1);
- Required clear floor spaces at fixtures and turning space overlap (section 603.2.2);
- Turning space includes knee and toe clearance at lavatory (section 304.3);
- Water closet clearance is 60 inches at back wall and 56 inches deep (section 604.3);
- Centerline of the water closet at 16-18 inches from side wall (section 604.2); and
- No other fixtures or obstructions located within required water closet clearance (section 604.3).
- 30-inch wide by 48-inch long minimum clear floor space provided beyond the arc of the swing of the entry door (section 603.2.3 exception 2).

The following accessible features are provided in the living area:

- T-shaped turning space (section 304.3.2);
- Accessible route (section 402);
- Clear floor space on both sides of the bed (section 806.2.3);
- Maneuvering clearances at all doors (section 404.2);
- Accessible operable window (section 309); and
- Accessible controls for the heat and air conditioning (section 309).

Plan 4B: 13-Foot Wide Accessible Guest Room

This drawing shows an accessible 13-foot wide guest room with features that comply with the 2010 Standards. Features include an alternate roll-in shower with a seat, comparable vanity, wardrobe, and door connecting to adjacent guest room. Furnishings include two beds.

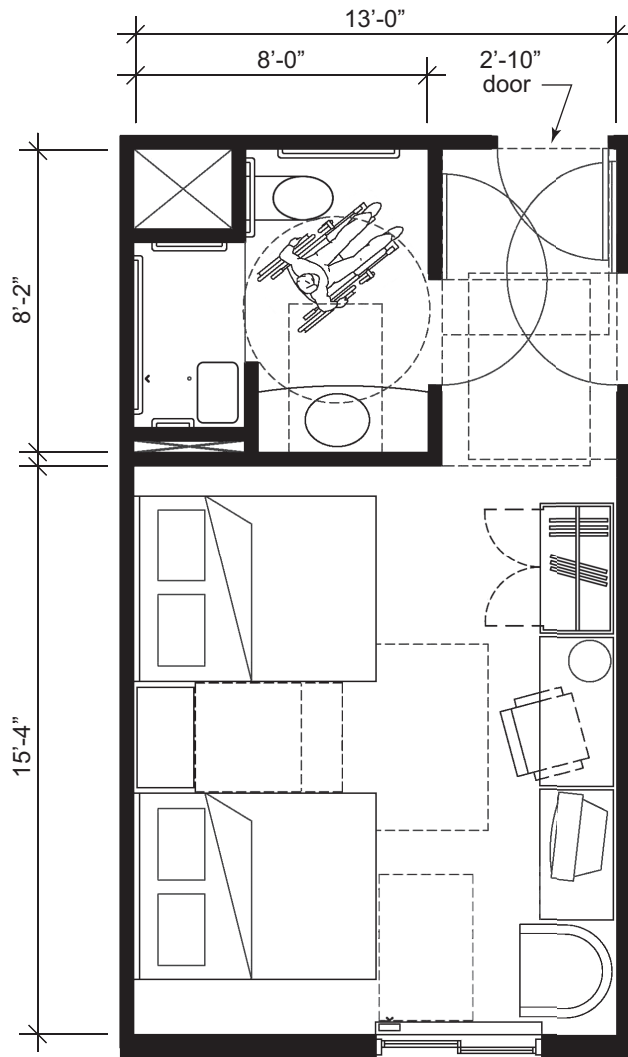

The following accessible features are provided in the bathroom:

- Comparable vanity counter top space (section 806);
- Alternate roll-in type shower with folding seat is 36 inches deep and 60 inches wide (section 608.2.3);
- Alternate roll-in shower has a 36-inch wide entry at one end of the long end of the compartment (section 608.2.3);
- Recessed alternate roll-in shower location permits shorter rear grab bar at water closet (section 604.5.2);
- Circular turning space in room (section 603.2.1);
- Required clear floor spaces at fixtures and turning space overlap (section 603.2.2);
- Turning space includes knee and toe clearance at lavatory (section 304.3);
- Water closet clearance is 60 inches at back wall and 56 inches deep (section 604.3);
- Centerline of the water closet at 16-18 inches from side wall (section 604.2); and
- No other fixtures or obstructions located within required water closet clearance (section 604.3).

The following accessible features are provided in the living area:

- T-shaped turning space (section 304.3.2);
- Accessible route (section 402);
- Clear floor space between beds (section 806.2.3);
- Maneuvering clearances at all doors (section 404.2);
- Accessible operable window (section 309); and
- Accessible controls for the heat and air conditioning (section 309).

Plan 5A: 13-Foot Wide Accessible Guest Room

This drawing shows an accessible 13-foot wide guest room with features that comply with the 2010 Standards. Features include a transfer shower, comparable vanity, clothes closet with swinging door, and door connecting to adjacent guest room. Furnishings include a king bed and additional seating.

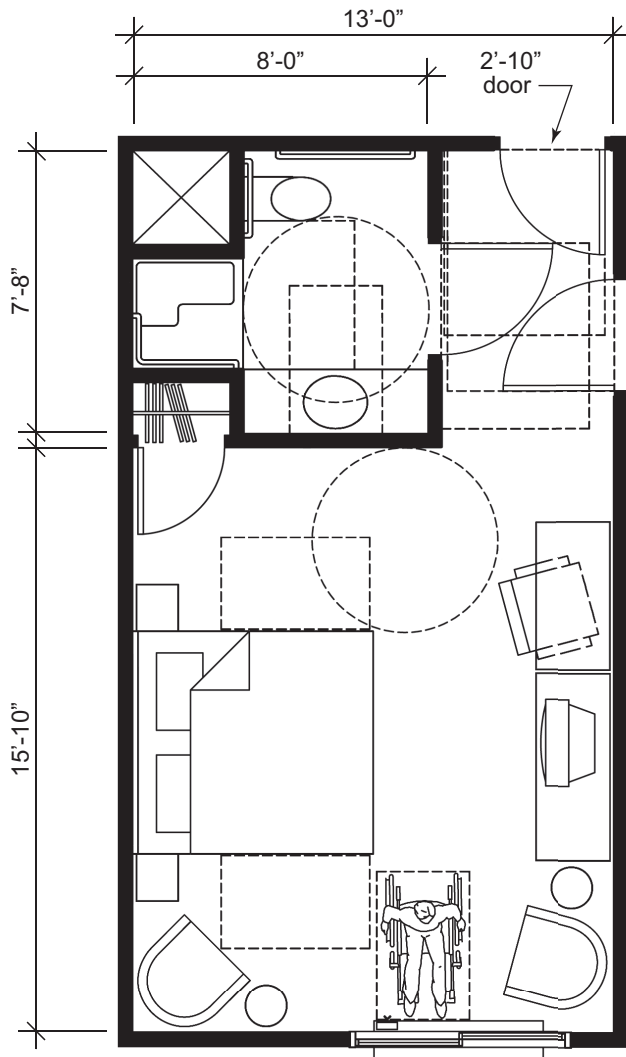

The following accessible features are provided in the bathroom:

- Comparable vanity counter top space (section 806);
- Transfer shower (section 603.2);
- Shower seat (section 610.3);
- Clearance in front of the shower extends beyond the seat and is 36 inches wide min. (section 607.2);
- Recessed transfer shower location permits shorter rear grab bar at water closet (section 604.5.2);
- Circular turning space in room (section 603.2.1);
- Required clear floor spaces at fixtures and turning space overlap (section 603.2.2);
- Water closet clearance is 60 inches at back wall and 56 inches deep (section 604.3);
- Centerline of the water closet at 16 inches from side wall (section 604.2); and
- No other fixtures or obstructions located within required water closet clearance (section 604.3).

The following accessible features are provided in the living area:

- Circular turning space (section 304.3.2);
- Accessible route (section 402);
- Clear floor space on both sides of the bed (section 806.2.3);
- Maneuvering clearances at all doors (section 404.2);
- Accessible operable window (section 229); and
- Accessible controls for the heat and air conditioning (section 309).

Plan 5B: 13-Foot Wide Accessible Guest Room

This drawing shows an accessible 13-foot wide guest room with features that comply with the 2010 Standards. Features include a transfer shower, comparable vanity, open clothes closet, and door connecting to adjacent guest room. Furnishings include two beds.

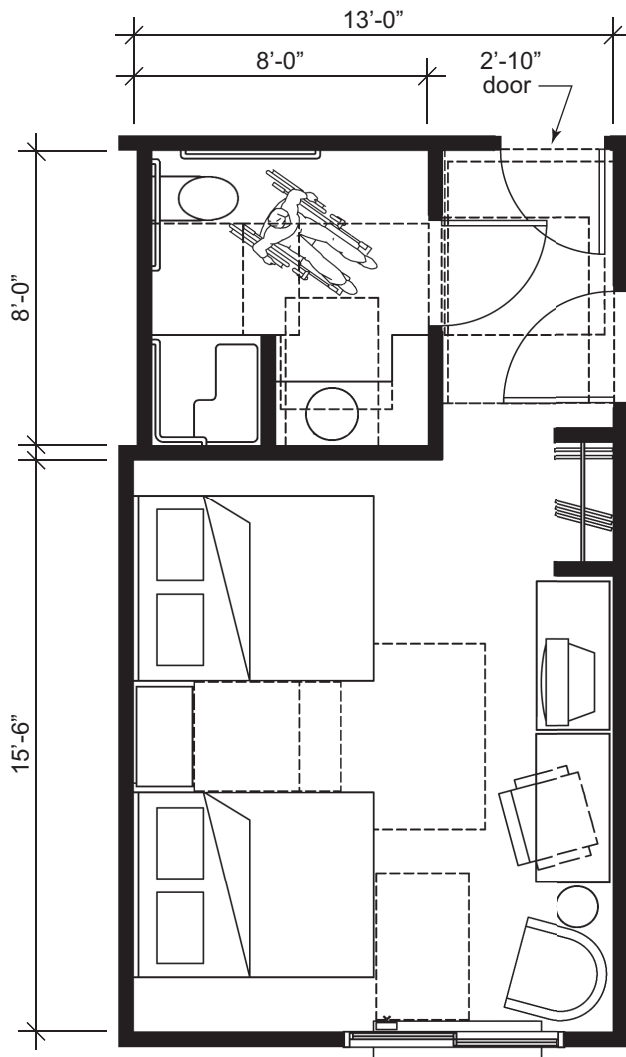

The following accessible features are provided in the bathroom:

- Comparable vanity counter top space (section 806);
- Transfer shower (section 603.2);
- Shower seat (section 610.3);
- Clearance in front of the shower extends beyond the seat and is 36 inches wide min. (section 607.2);
- Lavatory with vanity counter top recessed to permit shorter rear grab bar at water closet (section 604.5.2);
- T-shaped turning space in room (section 603.2.1);
- Required clear floor spaces at fixtures and turning space overlap (section 603.2.2);
- Water closet clearance is 60 inches at back wall and 56 inches deep (section 604.3);
- Centerline of the water closet at 16-18 inches from side wall (section 604.2); and
- No other fixtures or obstructions located within required water closet clearance (section 604.3).

The following accessible features are provided in the living area:

- T-shaped turning space (section 304.3.2);
- Accessible route (section 402);
- Clear floor space between beds (section 806.2.3);
- Maneuvering clearances at all doors (section 404.2);
- Accessible operable window (section 229); and
- Accessible controls for the heat and air conditioning (section 309).

Plan 6A: 12-Foot Wide Accessible Guest Room

This drawing shows an accessible 12-foot wide guest room with features that comply with the 2010 Standards. Features include a transfer shower, water closet length (rim to rear wall) 24 inches maximum, comparable vanity, clothes closet with swinging door, and door connecting to adjacent guest room. Furnishings include a king bed and additional seating.

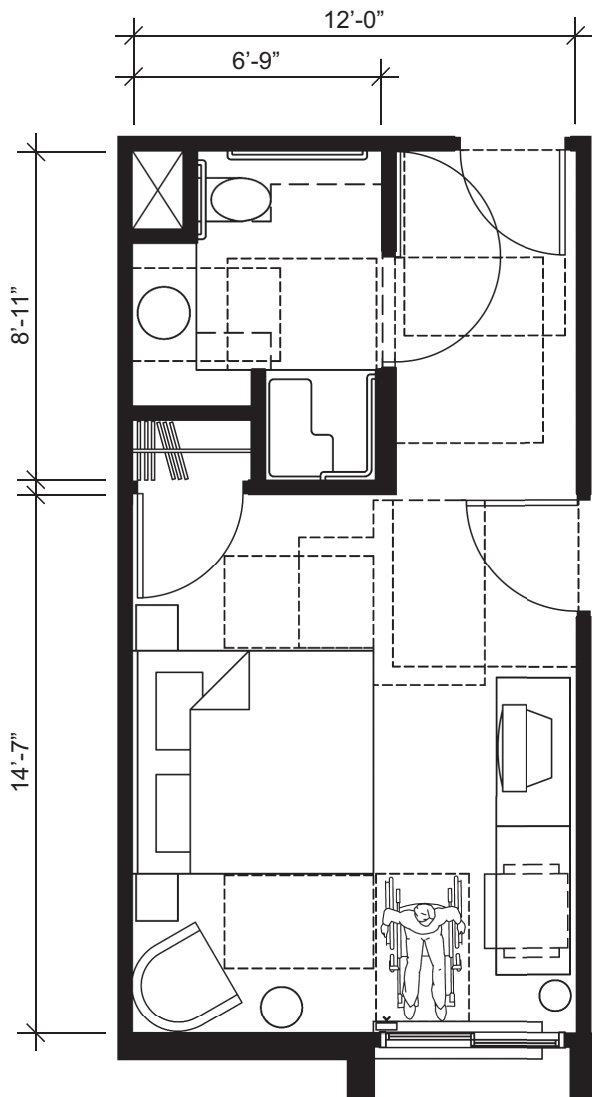

The following accessible features are provided in the bathroom:

- Comparable vanity counter top space (section 806);
- Transfer shower (section 603.2);
- Shower seat (section 610.3);
- Clearance in front of the shower extends beyond the seat and is 36 inches wide min. (section 607.2);
- Recessed lavatory with vanity counter top permits shorter rear grab bar at water closet (section 604.5.2);
- T-shaped turning space in room (section 603.2.1);
- Required clear floor spaces at fixtures and turning space overlap (section 603.2.2);
- Water closet clearance is 60 inches at back wall and 56 inches deep (section 604.3);
- Centerline of the water closet at 16 inches from side wall (section 604.2); and
- No other fixtures or obstructions located within required water closet clearance (section 604.3).

The following accessible features are provided in the living area:

- T-shaped turning space (section 304.3.2);
- Accessible route (section 402);
- Clear floor space on both sides of the bed (section 806.2.3);
- Maneuvering clearances at all doors (section 404.2);
- Accessible operable window (section 229); and
- Accessible controls for the heat and air conditioning (section 309).

Plan 6B: 12-Foot Wide Accessible Guest Room

This drawing shows an accessible 12-foot wide guest room with features that comply with the 2010 Standards. Features include a transfer shower, water closet length (rim to rear wall) 24 inches maximum, comparable vanity, wardrobe, and door connecting to adjacent guest room. Furnishings include two beds.

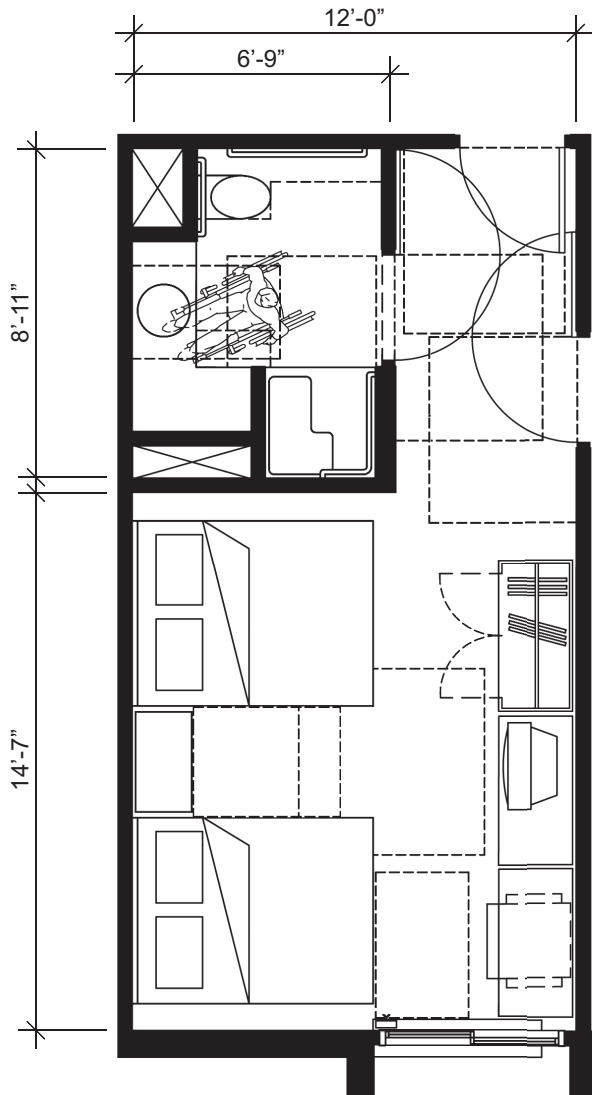

The following accessible features are provided in the bathroom:

- Comparable vanity counter top space (section 806);
- Transfer shower (section 603.2);
- Shower seat (section 610.3);
- Clearance in front of the shower extends beyond the seat and is 36 inches wide min. (section 607.2);
- Recessed lavatory with vanity counter top permits shorter rear grab bar at water closet (section 604.5.2);
- Circular turning space in room (section 603.2.1);
- Required clear floor spaces at fixtures and turning space overlap (section 603.2.2);
- Water closet clearance is 60 inches at back wall and 56 inches deep (section 604.3);
- Centerline of the water closet at 16 inches from side wall (section 604.2); and
- No other fixtures or obstructions located within required water closet clearance (section 604.3).

The following accessible features are provided in the living area:

- Circular turning space (section 304.3.2);
- Accessible route (section 402);
- Clear floor space between beds (section 806.2.3);
- Maneuvering clearances at all doors (section 404.2);
- Accessible operable window (section 229); and
- Accessible controls for the heat and air conditioning (section 309).

225 and 811 Storage

Section 225 of the 2010 Standards provides that where storage is provided in accessible spaces, at least one of each type shall comply with the 2010 Standards. Self-service shelving is required to be on an accessible route, but is not required to comply with the reach range requirements. These requirements are consistent with the 1991 Standards.

Section 225.3 adds a new scoping requirement for self-storage facilities. Facilities with 200 or fewer storage spaces will be required to make at least five percent (5%) of the storage spaces accessible. Facilities with more than 200 storage spaces will be required to provide ten accessible storage spaces, plus two percent (2%) of the total storage spaces over 200.

Sections 225.2.1 and 811 of the 2010 Standards require lockers to meet accessibility requirements. Where lockers are provided in clusters, five percent (5%) but at least one locker in each cluster will have to comply. Under the 1991 Standards, only one locker of each type provided must be accessible.

Commenters recommended that the Department adopt language requiring public accommodations to provide access to all self-service shelves and display areas available to customers. Other commenters opposed

this requirement as too burdensome to retail and other entities and claimed that significant revenue would be lost if this requirement were to be implemented.

Other commenters raised concerns that section 225.2.2 of the 2010 Standards scopes only self-service shelving whereas section 4.1.3(12)(b) of the 1991 Standards applies to both “shelves or display units.”

Although “display units” were not included in the 2010 Standards under the belief that displays are not to be touched and therefore by definition cannot be “self-service,” both the 2010 Standards and the 1991 Standards should be read broadly to apply to all types of shelves, racks, hooks, and similar self-service merchandising fittings, including self-service display units. Such fixtures are permitted to be installed above or below the reach ranges possible for many persons with disabilities so that space available for merchandising is used as efficiently as possible.

226 and 902 Dining Surfaces and Work Surfaces

Section 226.1 of the 2010 Standards require that where dining surfaces are provided for the consumption of food or drink, at least five percent (5%) of the seating spaces and standing spaces at the dining surfaces comply with section 902. Section 902.2 requires the provision of accessible knee and toe clearance.

Commenters stated that basing accessible seating on seating spaces and standing spaces potentially represents a significant increase in scoping, particularly given the ambiguity in what represents a “standing space” and urged a return to the 1991 Standard of requiring accessible seating based on fixed dining tables. The scoping change merely takes into account that tables may vary in size so that basing the calculation on the number of tables rather than on the number of individuals that may be accommodated by the tables could unnecessarily restrict opportunities for persons with disabilities. The revised scoping permits greater flexibility by allowing designers to disperse accessible seating and standing spaces throughout the dining area. Human factors data, which is readily available to designers, provides information about the amount of space required for both eating and drinking while seated or standing.

227 and 904 Sales and Service

Check-Out Aisles and Sales and Service Counters. The 1991 Standards, at section 7.2, and the 2010 Standards, at section 904.4, contain technical requirements for sales and service counters. The 1991 Standards generally require sales and service counters to provide an accessible portion at least 36 inches long and no higher than 36 inches above the finish floor. The nondiscrimination requirements of the ADA regulations require the level of service provided at the accessible portion

of any sales and service counter to be the same as the level of service provided at the inaccessible portions of the counter.

The 2010 Standards specify different lengths for the accessible portion of sales and service counters based on the type of approach provided. Where a forward approach is provided, the accessible portion of the counter must be at least 30 inches long and no higher than 36 inches, and knee and toe space must be provided under the counter. The requirement that knee and toe space be provided where only clear floor space for a forward approach to a sales and service counter is provided is not a new requirement. It is a clarification of the ongoing requirement that part of the sales and service counter be accessible. This requirement applies to the entire accessible part of sales and service counters and requires that the accessible clear floor or ground space adjacent to those counters be kept clear of merchandise, equipment, and other items so that the accessible part of the counter is readily accessible to and usable by individuals with disabilities. The accessible part of the counter must also be staffed and provide an equivalent level of service as that provided to all customers.

Where clear floor space for a parallel approach is provided, the accessible portion of the counter must be at least 36 inches long and no higher than 36 inches above the finish floor. A clear floor or ground space that is at least 48 inches long x 30 inches wide

must be provided positioned for a parallel approach adjacent to the 36-inch minimum length of counter.

Section 904.4 of the 2010 Standards includes an exception for alterations to sales and service counters in existing facilities. It permits the accessible portion of the counter to be at least 24 inches long, where providing a longer accessible counter will result in a reduction in the number of existing counters at work stations or existing mailboxes, provided that the required clear floor or ground space is centered on the accessible length of the counter.

Section 904.4 of the 2010 Standards also clarifies that the accessible portion of the counter must extend the same depth as the sales or service counter top. Where the counter is a single-height counter, this requirement applies across the entire depth of the counter top. Where the counter is a split-height counter, this requirement applies only to the customer side of the counter top. The employee-side of the counter top may be higher or lower than the customer-side of the counter top.

Commenters recommended that the Department consider a regulatory alternative exempting small retailers from the new knee and toe clearance requirement and retaining existing wheelchair accessibility standards for sales and service counters. These commenters believed that the knee

and toe clearance requirements will cause a reduction in the sales and inventory space at check-out aisles and other sales and service counters.

Both the 1991 and the 2010 Standards permit covered entities to determine whether they will provide a forward or a parallel approach to sales and service counters. So any facility that does not wish to provide the knee or toe clearance required for a front approach to such a counter may avoid that option. However, the Department believes that permitting a forward approach without requiring knee and toe clearance is not adequate to provide accessibility because the person using a wheelchair will be prevented from coming close enough to the counter to see the merchandise or to transact business with a degree of convenience that is comparable to that provided to other customers.

A parallel approach to sales and service counters also can provide the accessibility required by the 2010 Standards. Individuals using wheelchairs can approach sales and service counters from the side, and, assuming the necessary elements, features, or merchandise necessary to complete a business transaction are within the reach range requirements for a side approach, the needs of individuals with disabilities can be met effectively.

Section 227 of the 2010 Standards clarifies the requirements for food service lines. Queues and waiting lines serving counters

or check-out aisles, including those for food service, must be accessible to individuals with disabilities.

229 Windows

A new requirement at section 229.1 of the 2010 Standards provides that if operable windows are provided for building users, then at least one window in an accessible space must be equipped with controls that comply with section 309.

Commenters generally supported this provision but some commenters asked whether the maximum five-pounds (5 lbs.) of force requirement of section 309 applies to the window latch itself or only to the force required to open the window. Section 309 applies to all controls and operating mechanisms, so the latch must comply with the requirement to operate with no more than five pounds of force (5 lbf).

230 and 708 Two-Way Communication Systems

New provisions of the 2010 Standards at sections 230.1 and 708 require two-way communications systems to be equipped with visible as well as audible signals.

231 and 808 Judicial Facilities and Courtrooms

Section 231 of the 2010 Standards adds requirements for accessible courtrooms, holding cells, and visiting areas.

Accessible Courtroom Stations. Sections 231.2, 808, 304, 305, and 902 of the 2010 Standards provide increased accessibility at courtroom stations. Clear floor space for a forward approach is required for all courtroom stations (judges' benches, clerks' stations, bailiffs' stations, deputy clerks' stations, court reporters' stations, and litigants' and counsel stations). Other applicable specifications include accessible work surface heights and toe and knee clearance.

Accessible Jury Boxes, Attorney Areas, and Witness Stands. Section 206.2.4 of the 2010 Standards requires, in new construction and alterations, at least one accessible route to connect accessible building or facility entrances with all accessible spaces and elements within the building or facility that are connected by a circulation path unless they are exempted by Exceptions 1 - 7 of section 206.2.3. Advisory 206.2.4 Spaces and Elements Exception 1 explains that the exception allowing raised courtroom stations to be used by court employees, such as judge's benches, to be adaptable does not apply to areas of the courtroom likely to be used by members of the public such as jury areas, attorney areas, or witness stands. These areas must be on an accessible route at the time of initial construction or alteration.

Raised Courtroom Stations Not for Members of the Public. Section 206.2.4, Exception 1 of the 2010 Standards provides that raised courtroom stations that are used by judges, clerks, bailiffs, and court reporters will not have to provide full vertical access

when first constructed or altered if they are constructed to be easily adaptable to provide vertical accessibility.

One commenter suggested that a sufficient number of accessible benches for judges with disabilities, in addition to requiring accessible witness stands and attorney areas, be required. The Department believes that the requirements regarding raised benches for judges are easily adaptable to provide vertical access in the event a judge requires an accessible bench. Section 206.2.4 of the 2010 Standards provides that raised courtroom stations used by judges and other judicial staff do not have to provide full vertical access when first constructed or altered as long as the required clear floor space, maneuvering space, and electrical service, where appropriate, is provided at the time of new construction or can be achieved without substantial reconstruction during alterations.

A commenter asserted that there is nothing inherent in clerks' stations, jury boxes, and witness stands that require them to be raised. While it would, of course, be easiest to provide access by eliminating height differences among courtroom elements, the Department recognizes that accessibility is only one factor that must be considered in the design process of a functioning courtroom. The need to ensure the ability of the judge to maintain order, the need to ensure sight lines among the judge, the witness, the jury, and other participants, and the need to maintain the security of the participants all affect

the design of the space. The Department believes that the 2010 Standards have been drafted in a way that will achieve accessibility without unduly constraining the ability of a designer to address the other considerations that are unique to courtrooms.

Commenters argued that permitting courtroom stations to be adaptable rather than fully accessible at the time of new construction likely will lead to discrimination in hiring of clerks, court reporters, and other court staff. The Department believes that the provisions will facilitate, not hinder, the hiring of court personnel who have disabilities. All courtroom work stations will be on accessible routes and will be required to have all fixed elements designed in compliance with the 2010 Standards. Elevated work stations for court employees may be designed to add vertical access as needed. Since the original design must provide the proper space and electrical wiring to install vertical access, the change should be easily accomplished.

232 Detention Facilities and Correctional Facilities

Section 232 of the 2010 Standards establishes requirements for the design and construction of cells, medical care facilities, and visiting areas in detention facilities and in correctional facilities. Section 35.151(k) of the Department's title II rule provides scoping for newly constructed general holding cells and general housing cells requiring mobility features compliant with section 807.2 of the 2010 Standards in a minimum of three

percent (3%) of cells, but no fewer than one cell. Section 232.2 of the 2010 Standards provides scoping for newly constructed cells with communications features requiring a minimum of two percent (2%) of cells, but at least one cell, to have communication features.

The Department's title II rule at § 35.151(k) also specifies scoping for alterations to detention and correctional facilities. Generally a minimum of three percent (3%), but no fewer than one, of the total number of altered cells must comply with section 807.2 of the 2010 Standards and be provided within each facility. Altered cells with mobility features must be provided in each classification level, including administrative and disciplinary segregation, each use and service area, and special program. The Department notes that the three percent (3%), but no fewer than one, requirement is a minimum. As corrections systems plan for new facilities or alterations, the Department urges planners to include in their population estimates a projection of the numbers of inmates with disabilities so as to have sufficient numbers of accessible cells to meet inmate needs.

233 Residential Facilities

Homeless Shelters, Group Homes, and Similar Social Service Establishments.

Section 233 of the 2010 Standards includes specific scoping and technical provisions that apply to new construction and alteration of residential facilities. In the 1991 Standards

scoping and technical requirements for homeless shelters, group homes, and similar social service establishments were included in section 9 Transient Lodging. These types of facilities will be covered by section 233 of the 2010 Standards and by 28 CFR 35.151(e) and 36.406(d) and will be subject to requirements for residential facilities rather than the requirements for transient lodging. This approach will harmonize federal accessibility obligations under both the ADA and section 504 of the Rehabilitation Act of 1973, as amended. In sleeping rooms with more than 25 beds that are covered by § 36.406(d) a minimum of five percent (5%) of the beds must have clear floor space compliant with section 806.2.3 of the 2010 Standards. In large facilities with more than 50 beds, at least one roll-in shower compliant with section 608.2.2 or section 608.2.3 of the 2010 Standards must be provided. Where separate shower facilities are provided for men and for women, at least one roll-in shower must be provided for each gender.

Housing Operated By or On Behalf of Places of Education. Housing at a place of education includes: residence halls, dormitories, suites, apartments, or other places of residence operated by or on behalf of places of education. Residence halls or dormitories operated by or on behalf of places of education are covered by the provisions in sections 224 and 806 of the 2010 Standards. The Department has included in the title III rule at § 36.406(e) requirements that apply to housing at places of education that clarify requirements for

residence halls and dormitories and other types of student housing. Requirements for housing at a place of education covered by the title II rule are included at § 35.151(f).

Kitchens and Kitchenettes. Section 4.34.2 of the UFAS requires a clear turning space at least 60 inches in diameter or an equivalent T-shaped turning space in kitchens. Section 4.34.6 requires a clearance between opposing base cabinets, counters, appliances, or walls of at least 40 inches except in a U-shaped kitchen where the minimum clearance is 60 inches.

Section 804 of the 2010 Standards provides technical requirements for kitchens and kitchenettes. Section 804.2.1 requires that pass through kitchens, which have two entries and counters, appliances, or cabinets on two opposite sides or opposite a parallel wall, provide at least 40 inches minimum clearance. Section 804.2.2 requires that U-shaped kitchens, which are enclosed on three continuous sides, provide at least 60 inches minimum clearance between all opposing base cabinets, countertops, appliances, or walls within kitchen work areas. Kitchens that do not have a cooktop or conventional range are exempt from the clearance requirements but still must provide an accessible route.

If a kitchen does not have two entries, the 2010 Standards require the kitchen to have 60 inches minimum clearance between the opposing base cabinets, counters, appliances, or walls.

One commenter supported the provisions of section 804 of the 2010 Standards but sought clarification whether this section applies to residential units only, or to lodging and office buildings as well. Section 212 makes section 804 applicable to all kitchens and kitchenettes in covered buildings.

Residential Facilities. Section 4.1.4(11) of the UFAS contains scoping requirements for the new construction of housing. Under the 1991 title II regulation, state and local governments had the option of complying with the UFAS or the 1991 Standards. After the compliance date for the 2010 Standards, state and local governments will no longer have the option of complying with the UFAS, but will have to use the 2010 Standards for new construction and alterations.

Sections 233.1, 233.2, 233.3, 233.3.1, and 233.3.2 of the 2010 Standards differentiate between entities subject to the United States Department of Housing and Urban Development (HUD) regulations implementing section 504 of the Rehabilitation Act of 1973 and entities not subject to the HUD regulations. The HUD regulations apply to recipients of federal financial assistance through HUD, and require at least five percent (5%) of dwelling units in multi-family projects of five or more dwelling units to provide mobility features and at least two percent (2%) of the dwelling units to provide communication features. The HUD regulations define a project unique to its programs as “one or more residential structures which are covered by a single

contract for federal financial assistance or application for assistance, or are treated as a whole for processing purposes, whether or not located on a common site.” To avoid any potential conflicts with the HUD regulations, the 2010 Standards require residential dwelling units subject to the HUD regulations to comply with the scoping requirements in the HUD regulations, instead of the scoping requirements in the 2010 Standards.

For entities not subject to the HUD regulations, the 2010 Standards require at least five percent (5%) of the dwelling units in residential facilities to provide mobility features, and at least two percent (2%) of the dwelling units to provide communication features. The 2010 Standards define facilities in terms of buildings located on a site. The 2010 Standards permit facilities that contain 15 or fewer dwelling units to apply the scoping requirements to all the dwelling units that are constructed under a single contract, or are developed as whole, whether or not located on a common site.

Alterations to Residential Facilities.

Section 4.1.6 of the UFAS requires federal, state, and local government housing to comply with the general requirements for alterations to facilities. Applying the general requirements for alterations to housing can result in partially accessible dwelling units where single elements or spaces in dwelling units are altered.

The 2010 Standards, at sections 202.3 Exception 3, 202.4, and 233.3, contain

specific scoping requirements for alterations to dwelling units. Dwelling units that are not required to be accessible are exempt from the general requirements for alterations to elements and spaces and for alterations to primary function areas.

The scoping requirements for alterations to dwelling units generally are based on the requirements in the UFAS:

- Where a building is vacated for purposes of alterations and has more than 15 dwelling units, at least five percent (5%) of the altered dwelling units are required to provide mobility features and at least two percent (2%) of the dwelling units are required to provide communication features.
- Where a bathroom or a kitchen is substantially altered in an individual dwelling unit and at least one other room is also altered, the dwelling unit is required to comply with the scoping requirements for new construction until the total number of dwelling units in the facility required to provide mobility features and communication features is met.

As with new construction, the 2010 Standards permit facilities that contain 15 or fewer dwelling units to apply the scoping requirements to all the dwelling units that are altered under a single contract, or are developed as a whole, whether or not located on a common site. The 2010 Standards also permit a comparable dwelling unit to provide

mobility features where it is not technically feasible for the altered dwelling unit to comply with the technical requirements.

234 and 1002 Amusement Rides

New and Altered Permanently Installed Amusement Rides. Section 234 of the 2010 Standards sets out scoping requirements and section 1002 sets out the technical requirements for the accessibility of permanently installed amusement rides. These requirements apply to newly designed and constructed amusement rides and used rides when certain alterations are made.

A commenter raised concerns that smaller amusement parks tend to purchase used rides more frequently than new rides, and that the conversion of a used ride to provide the required accessibility may be difficult to ensure because of the possible complications in modifying equipment to provide accessibility.

The Department agrees with this commenter. The Department notes, however, that the 2010 Standards will require modifications to existing amusement rides when a ride's structural and operational characteristics are altered to the extent that the ride's performance differs from that specified by the manufacturer or the original design. Such an extensive alteration to an amusement ride may well require that new load and unload areas be designed and constructed. When load and unload areas serving existing amusement rides are newly designed and

constructed they must be level, provide wheelchair turning space, and be on an accessible route compliant with Chapter 4 of the 2010 Standards except as modified by section 1002.2 of the 2010 Standards.

Mobile or Portable Amusement Rides. The exception in section 234.1 of the 2010 Standards exempts mobile or portable amusement rides, such as those set up for short periods of time at carnivals, fairs or festivals, from having to comply with the 2010 Standards. However, even though the mobile/portable ride itself is not subject to the Standards, these facilities are still subject to the ADA's general requirement to ensure that individuals with disabilities have an equal opportunity to enjoy the services and amenities of these facilities.

Subject to these general requirements, mobile or portable amusement rides should be located on an accessible route and the load and unload areas serving a ride should provide a level wheelchair turning space to provide equal opportunity for individuals with disabilities to be able to participate on the amusement ride to the extent feasible.

One commenter noted that the exception in Section 234.1 of the 2010 Standards for mobile or portable amusement rides limits the opportunities of persons with disabilities to participate on amusement rides because traveling or temporary amusement rides by their nature come to their customers' town or a nearby town rather than the customer having to go to them and so are

less expensive than permanent amusement parks. While the Department understands the commenter's concerns, the Department notes that most amusement rides are too complex to be reasonably modified or re-engineered to accommodate the majority of individuals with disabilities and that additional complexities and safety concerns are added when the rides are mobile or portable.

A commenter asked that section 234 of the 2010 Standards make clear that the requirements for accessible routes include the routes leading up to and including the loading and unloading areas of amusement rides. Sections 206.2.9 and 1002.2 of the 2010 Standards clarify that the requirements for accessible routes include the routes leading up to and including the loading and unloading areas of amusement rides.

A commenter requested that the final rule specifically allow for wheelchair access through the exit or other routes, or alternate means of wheelchair access routes to amusement rides. The commenter stated that the concept of wheelchair access through the exit or alternate routes was a base assumption for the 2010 Standards. The commenter noted that the concept is apparent in the signage and load/unload area provisions in Section 216.12 (" * * * where accessible unload areas also serve as accessible load areas, signs indicating the location of the accessible load and unload areas shall be provided at entries to queues and waiting lines"). The Department agrees

with the commenter that accessible load and unload areas may be the same where signs that comply with section 216.12 are provided.

Wheelchair Space or Transfer Seat or Transfer Device. Sections 234.3 and 1002.4 - 1002.6 of the 2010 Standards provide that each new and altered amusement ride, except for mobile/portable rides and a few additional excepted rides, will be required to provide at least one type of access by means of one wheelchair space or one transfer seat or one transfer device (the design of the transfer device is not specified).

Commenters urged the Department to revise the requirements for wheelchair spaces and transfer seats and devices because most amusement rides are too complex to be reasonably modified or re-engineered to accommodate the majority of individuals with disabilities. They argued that the experience of amusement rides will be significantly reduced if the proposed requirements are implemented.

The 2004 ADAAG, which the Department adopted as part of the 2010 Standards, was developed with the assistance of an advisory committee that included representation from the design staffs of major amusement venues and from persons with disabilities. The Department believes that the resulting 2004 ADAAG reflected sensitivity to the complex problems posed in adapting existing rides by focusing on new rides that can be designed from the outset to be accessible.

To permit maximum design flexibility, the 2010 Standards permit designers to determine whether it is more appropriate to permit individuals who use wheelchairs to remain in their chairs on the ride, or to provide for transfer access.

Maneuvering Space in Load and Unload Areas. Sections 234.2 and 1002.3 of the 2010 Standards require that a level wheelchair turning space be provided at the load and unload areas of each amusement ride. The turning space must comply with sections 304.2 and 304.3.

Signs Required at Waiting Lines to Amusement Rides. Section 216.12 of the 2010 Standards requires signs at entries to queues and waiting lines identifying type and location of access for the amusement ride.

235 and 1003 Recreational Boating Facilities

These sections require that accessible boat slips and boarding piers be provided. Most commenters approved of the requirements for recreational boating facility accessibility and urged the Department to keep regulatory language consistent with those provisions. They commented that the requirements appropriately reflect industry conditions. Individual commenters and disability organizations agreed that the 2010 Standards achieve acceptable goals for recreational boating facility access.

Accessible Route. Sections 206.2.10 and 1003.2 of the 2010 Standards require an accessible route to all accessible boating facilities, including boat slips and boarding piers at boat launch ramps. Section 1003.2.1 provides a list of exceptions applicable to structures such as gangways, transition plates, floating piers, and structures containing combinations of these elements that are affected by water level changes. The list of exceptions specifies alternate design requirements applicable to these structures which, because of water level variables, cannot comply with the slope, cross slope, and handrail requirements for fixed ramps contained in sections 403.3, 405.2, 405.3, 405.6, and 405.7 of the 2010 Standards. Exceptions 3 and 4 in Section 1003.2.1, which permit a slope greater than that specified in Section 405.2, are available for structures that meet specified length requirements. Section 206.7.10 permits the use of platform lifts as an alternative to gangways that are part of accessible routes.

Commenters raised concerns that because of water level fluctuations it may be difficult to provide accessible routes to all accessible boating facilities, including boat slips and boarding piers at boat launch ramps. One of the specific concerns expressed by several commenters relates to the limits for running slope permitted on gangways that are part of an accessible route as gangways may periodically have a steeper slope than is permitted for a fixed ramp. The exceptions contained in section 1003.2 of the 2010 Standards modify the requirements of

Chapter 4. For example, where the total length of a gangway or series of gangways serving as an accessible route is 80 feet or more an exception permits the slope on gangways to exceed the maximum slope in section 405.2.

Some commenters suggested that permissible slope variations could be reduced further by introducing a formula that ties required gangway length to anticipated water level fluctuations. Such a formula would incorporate predictions of tidal level changes such as those issued by the National Oceanographic and Atmospheric Administration (NOAA) and the United States Geologic Survey (USGS). This suggested approach would be an alternative to the gangway length exceptions and limits in section 1003.2.1 of the 2010 Standards. These commenters noted that contemporary building materials and techniques make gangways of longer length and alternative configurations achievable. These commenters provided at least one example of a regional regulatory authority using this type of formula. While this approach may be successfully implemented and consistent with the goals of the ADA, the example provided was applied in a highly developed area containing larger facilities. The Department has considered that many facilities do not have sufficient resources available to take advantage of the latest construction materials and design innovations. Other commenters supported compliance exceptions for facilities that are subject to extreme tidal conditions. One commenter noted that if a facility is

located in an area with limited space and extreme tidal variations, a disproportionately long gangway might intrude into water travel routes. The Department has considered a wide range of boating facility characteristics including size, water surface areas, tidal fluctuations, water conditions, variable resources, whether the facility is in a highly developed or remote location, and other factors. The Department has determined that the 2010 Standards provide sufficient flexibility for such broad application. Additionally, the length requirement for accessible routes in section 1003.2.1 provides an easily determinable compliance standard.

Accessible Boarding Piers. Where boarding piers are provided at boat launch ramps, sections 235.3 and 1003.3.2 of the 2010 Standards require that at least five percent (5%) of boarding piers, but at least one, must be accessible.

Accessible Boat Slips. Sections 235.2 and 1003.3.1 of the 2010 Standards require that a specified number of boat slips in each recreational boating facility meet specified accessibility standards. The number of accessible boat slips required by the 2010 Standards is set out in a chart in section 235.2. One accessible boat slip is required for facilities containing 25 or fewer total slips. The number of required accessible boat slips increases with the total number of slips at the facility. Facilities containing more than one thousand (1000) boat slips are required to provide twelve (12) accessible boat slips plus

one for each additional one hundred slips at the facility.

One commenter asserted the need for specificity in the requirement for dispersion of accessible slips. Section 235.2.1 of the 2010 Standards addresses dispersion and requires that boat slips “shall be dispersed throughout the various types of boat slips provided.” The commenter was concerned that if a marina could not put accessible slips all on one pier, it would have to reconstruct the entire facility to accommodate accessible piers, gangways, docks and walkways. The provision permits required accessible boat slips to be grouped together. The Department recognizes that economical and structural feasibility may produce this result. The 2010 Standards do not require the dispersion of the physical location of accessible boat slips. Rather, the dispersion must be among the various types of boat slips offered by the facility. Section 235.2.1 of the 2010 Standards specifies that if the required number has been met, no further dispersion is required. For example, if a facility offers five different ‘types’ of boat slips but is only required to provide three according to the table in Section 235.2, that facility is not required to provide more than three accessible boat slips, but the three must be varied among the five ‘types’ of boat slips available at the facility.

236 and 1004 Exercise Machines and Equipment

Accessible Route to Exercise Machines and Equipment. Section 206.2.13 of the 2010 Standards requires an accessible route to serve accessible exercise machines and equipment.

Commenters raised concerns that the requirement to provide accessible routes to serve accessible exercise machines and equipment will be difficult for some facilities to provide, especially some transient lodging facilities that typically locate exercise machines and equipment in a single room. The Department believes that this requirement is a reasonable one in new construction and alterations because accessible exercise machines and equipment can be located so that an accessible route can serve more than one piece of equipment.

Exercise Machines and Equipment.

Section 236 of the 2010 Standards requires at least one of each type of exercise machine to meet clear floor space requirements of section 1004.1. Types of machines are generally defined according to the muscular groups exercised or the kind of cardiovascular exercise provided.

Several commenters were concerned that existing facilities would have to reduce the number of available exercise equipment and machines in order to comply with the 2010 Standards. One commenter submitted prototype drawings showing equipment and

machine layouts with and without the required clearance specified in the 2010 Standards. The accessible alternatives all resulted in a loss of equipment and machines. However, because these prototype layouts included certain possibly erroneous assumptions about the 2010 Standards, the Department wishes to clarify the requirements.

Section 1004.1 of the 2010 Standards requires a clear floor space “positioned for transfer or for use by an individual seated in a wheelchair” to serve at least one of each type of exercise machine and equipment. This requirement provides the designer greater flexibility regarding the location of the clear floor space than was employed by the commenter who submitted prototype layouts. The 2010 Standards do not require changes to exercise machines or equipment in order to make them more accessible to persons with disabilities. Even where machines or equipment do not have seats and typically are used by individuals in a standing position, at least one of each type of machine or equipment must have a clear floor space. Therefore, it is reasonable to assume that persons with disabilities wishing to use this type of machine or equipment can stand or walk, even if they use wheelchairs much of the time. As indicated in Advisory 1004.1, “the position of the clear floor space may vary greatly depending on the use of the equipment or machine.” Where exercise equipment or machines require users to stand on them, the clear floor space need not be located parallel to the length of the machine or equipment in order to provide

a lateral seat-to-platform transfer. It is permissible to locate the clear floor space for such machines or equipment in the aisle behind the device and to overlap the clear floor space and the accessible route.

Commenters were divided in response to the requirement for accessible exercise machines and equipment. Some supported requirements for accessible machines and equipment; others urged the Department not to require accessible machines and equipment because of the costs involved. The Department believes that the requirement strikes an appropriate balance in ensuring that persons with disabilities, particularly those who use wheelchairs, will have the opportunity to use the exercise equipment. Providing access to exercise machines and equipment recognizes the need and desires of individuals with disabilities to have the same opportunity as other patrons to enjoy the advantages of exercise and maintaining health.

237 and 1005 Fishing Piers and Platforms

Accessible Route. Sections 206.2.14 and 1005.1 of the 2010 Standards require an accessible route to each accessible fishing pier and platform. The exceptions described under Recreational Boating above also apply to gangways and floating piers. All commenters supported the requirements for accessible routes to fishing piers and platforms.

Accessible Fishing Piers and Platforms.

Sections 237 and 1005 of the 2010 Standards require at least twenty-five percent (25%) of railings, guards, or handrails (if provided) to be at a 34-inch maximum height (so that a person seated in a wheelchair can cast a fishing line over the railing) and to be located in a variety of locations on the fishing pier or platform to give people a variety of locations to fish. An exception allows a guard required to comply with the IBC to have a height greater than 34 inches. If railings, guards, or handrails are provided, accessible edge protection and clear floor or ground space at accessible railings are required. Additionally, at least one turning space complying with section 304.3 of the 2010 Standards is required to be provided on fishing piers and platforms.

Commenters expressed concerns about the provision for fishing piers and platforms at the exception in section 1005.2.1 of the 2010 Standards that allows a maximum height of 42 inches for a guard when the pier or platform is covered by the IBC. Two commenters stated that allowing a 42-inch guard or railing height for facilities covered by another building code would be difficult to enforce. They also thought that this would hinder access for persons with disabilities because the railing height would be too high for a person seated in a wheelchair to reach over with their fishing pole in order to fish. The Department understands these concerns but believes that the railing height exception is necessary in order to avoid confusion

resulting from conflicting accessibility requirements, and therefore has retained this exception.

238 and 1006 Golf Facilities

Accessible Route. Sections 206.2.15, 1006.2, and 1006.3 of the 2010 Standards require an accessible route to connect all accessible elements within the boundary of the golf course and, in addition, to connect golf car rental areas, bag drop areas, teeing grounds, putting greens, and weather shelters. An accessible route also is required to connect any practice putting greens, practice teeing grounds, and teeing stations at driving ranges that are required to be accessible. An exception permits the accessible route requirements to be met, within the boundaries of the golf course, by providing a “golf car passage” (the path typically used by golf cars) if specifications for width and curb cuts are met.

Most commenters expressed the general viewpoint that nearly all golf courses provide golf cars and have either well-defined paths or permit the cars to drive on the course where paths are not present, and thus meet the accessible route requirement.

The Department received many comments requesting clarification of the term “golf car passage.” Some commenters recommended additional regulatory language specifying that an exception from a pedestrian route requirement should be allowed only when a golf car passage provides unobstructed

access onto the teeing ground, putting green, or other accessible element of the course so that an accessible golf car can have full access to those elements. These commenters cautioned that full and equal access would not be provided if a golfer were required to navigate a steep slope up or down a hill or a flight of stairs in order to get to the teeing ground, putting green, or other accessible element of the course.

Conversely, another commenter requesting clarification of the term “golf car passage” argued that golf courses typically do not provide golf car paths or pedestrian paths up to actual tee grounds or greens, many of which are higher or lower than the car path. This commenter argued that if golf car passages were required to extend onto teeing grounds and greens in order to qualify for an exception, then some golf courses would have to substantially regrade teeing grounds and greens at a high cost.

Some commenters argued that older golf courses, small nine-hole courses, and executive courses that do not have golf car paths would be unable to comply with the accessible route requirements because of the excessive cost involved. A commenter noted that, for those older courses that have not yet created an accessible pedestrian route or golf car passage, the costs and impacts to do so should be considered.

A commenter argued that an accessible route should not be required where natural terrain makes it infeasible to create an accessible

route. Some commenters cautioned that the 2010 Standards would jeopardize the integrity of golf course designs that utilize natural terrain elements and elevation changes to set up shots and create challenging golf holes.

The Department has given careful consideration to the comments and has decided to adopt the 2010 Standards requiring that at least one accessible route connect accessible elements and spaces within the boundary of the golf course including teeing grounds, putting greens, and weather shelters, with an exception provided that golf car passages shall be permitted to be used for all or part of required accessible routes. In response to requests for clarification of the term “golf car passage,” the Department points out that golf car passage is merely a pathway on which a motorized golf car can operate and includes identified or paved paths, teeing grounds, fairways, putting greens, and other areas of the course. Golf cars cannot traverse steps and exceedingly steep slopes. A nine-hole golf course or an executive golf course that lacks an identified golf car path but provides golf car passage to teeing grounds, putting greens, and other elements throughout the course may utilize the exception for all or part of the accessible pedestrian route. The exception in section 206.2.15 of the 2010 Standards does not exempt golf courses from their obligation to provide access to necessary elements of the golf course; rather, the exception allows a golf course to use a golf car passage for part or all of the accessible pedestrian route to ensure that

persons with mobility disabilities can fully and equally participate in the recreational activity of playing golf.

Accessible Teeing Grounds, Putting Greens, and Weather Shelters. Sections 238.2 and 1006.4 of the 2010 Standards require that golf cars be able to enter and exit each putting green and weather shelter. Where two teeing grounds are provided, the forward teeing ground is required to be accessible (golf car can enter and exit). Where three or more teeing grounds are provided, at least two, including the forward teeing ground, must be accessible.

A commenter supported requirements for teeing grounds, particularly requirements for accessible teeing grounds, noting that accessible teeing grounds are essential to the full and equal enjoyment of the golfing experience.

A commenter recommended that existing golf courses be required to provide access to only one teeing ground per hole. The majority of commenters reported that most public and private golf courses already provide golf car passage to teeing grounds and greens. The Department has decided that it is reasonable to maintain the requirement. The 2010 Standards provide an exception for existing golf courses with three or more teeing grounds not to provide golf car passage to the forward teeing ground where terrain makes such passage infeasible.

Section 1006.3.2 of the 2010 Standards requires that where curbs or other constructed barriers prevent golf cars from entering a fairway, openings 60 inches wide minimum shall be provided at intervals not to exceed 75 yards.

A commenter disagreed with the requirement that openings 60 inches wide minimum be installed at least every 75 yards, arguing that a maximum spacing of 75 yards may not allow enough flexibility for terrain and hazard placements. To resolve this problem, the commenter recommended that the standards be modified to require that each golf car passage include one 60-inch wide opening for an accessible golf car to reach the tee, and that one opening be provided where necessary for an accessible golf car to reach a green. The requirement for openings where curbs or other constructed barriers may otherwise prevent golf cars from entering a fairway allows the distance between openings to be less than every 75 yards. Therefore, the Department believes that the language in section 1006.3.2 of the 2010 Standards allows appropriate flexibility. Where a paved path with curbs or other constructed barrier exists, the Department believes that it is essential that openings be provided to enable golf car passages to access teeing grounds, fairways and putting greens, and other required elements. Golf car passage is not restricted to a paved path with curbs. Golf car passage also includes fairways, teeing grounds, putting greens, and other areas on which golf cars operate.

Accessible Practice Putting Greens, Practice Teeing Grounds, and Teeing Stations at Driving Ranges. Section 238.3 of the 2010 Standards requires that five percent (5%) but at least one of each of practice putting greens, practice teeing grounds, and teeing stations at driving ranges must permit golf cars to enter and exit.

239 and 1007 Miniature Golf Facilities

Accessible Route to Miniature Golf Course Holes. Sections 206.2.16, 239.3, and 1007.2 of the 2010 Standards require an accessible route to connect accessible miniature golf course holes and the last accessible hole on the course directly to the course entrance or exit. Accessible holes are required to be consecutive with an exception permitting one break in the sequence of consecutive holes provided that the last hole on the miniature golf course is the last hole in the sequence.

Many commenters supported expanding the exception from one to multiple breaks in the sequence of accessible holes. One commenter noted that permitting accessible holes with breaks in sequence would enable customers with disabilities to enjoy the landscaping, water and theme elements of the miniature golf course. Another commenter wrote in favor of allowing multiple breaks in accessible holes with a connecting accessible route.

Other commenters objected to allowing multiple breaks in the sequence of miniature

golf holes. Commenters opposed to this change argued that allowing any breaks in the sequence of accessible holes at a miniature golf course would disrupt the flow of play for persons with disabilities and create a less socially integrated experience. A commenter noted that multiple breaks in sequence would not necessarily guarantee the provision of access to holes that are most representative of those with landscaping, water elements, or a fantasy-like experience.

The Department has decided to retain the exception without change. Comments did not provide a sufficient basis on which to conclude that allowing multiple breaks in the sequence of accessible holes would necessarily increase integration of accessible holes with unique features of miniature golf courses. Some designs of accessible holes with multiple breaks in the sequence might provide equivalent facilitation where persons with disabilities gain access to landscaping, water or theme elements not otherwise represented in a consecutive configuration of accessible holes. A factor that might contribute to equivalent facilitation would be an accessible route designed to bring persons with disabilities to a unique feature, such as a waterfall, that would otherwise not be served by an accessible route connecting consecutive accessible holes.

Specified exceptions are permitted for accessible route requirements when located on the playing surfaces near holes.

Accessible Miniature Golf Course Holes.

Sections 239.2 and 1007.3 of the 2010 Standards require at least fifty percent (50%) of golf holes on miniature golf courses to be accessible, including providing a clear floor or ground space that is 48 inches minimum by 60 inches minimum with slopes not steeper than 1:48 at the start of play.

240 and 1008 Play Areas

Section 240 of the 2010 Standards provides scoping for play areas and section 1008 provides technical requirements for play areas. Section 240.1 of the 2010 Standards sets requirements for play areas for children ages 2 and over and covers separate play areas within a site for specific age groups. Section 240.1 also provides four exceptions to the requirements that apply to family child care facilities, relocation of existing play components in existing play areas, amusement attractions, and alterations to play components where the ground surface is not altered.

Ground Surfaces. Section 1008.2.6 of the 2010 Standards provides technical requirements for accessible ground surfaces for play areas on accessible routes, clear floor or ground spaces, and turning spaces. These ground surfaces must follow special rules, incorporated by reference from nationally recognized standards for accessibility and safety in play areas, including those issued by the American Society for Testing and Materials (ASTM).

A commenter recommended that the Department closely examine the requirements for ground surfaces at play areas. The Department is aware that there is an ongoing controversy about play area ground surfaces arising from a concern that some surfaces that meet the ASTM requirements at the time of installation will become inaccessible if they do not receive constant maintenance. The Access Board is also aware of this issue and is working to develop a portable field test that will provide more relevant information on installed play surfaces. The Department would caution covered entities selecting among the ground surfacing materials that comply with the ASTM requirements that they must anticipate the maintenance costs that will be associated with some of the products. Permitting a surface to deteriorate so that it does not meet the 2010 Standards would be an independent violation of the Department's ADA regulations.

Accessible Route to Play Components.

Section 206.2.17 of the 2010 Standards provides scoping requirements for accessible routes to ground level and elevated play components and to soft contained play structures. Sections 240.2 and 1008 of the 2010 Standards require that accessible routes be provided for play components. The accessible route must connect to at least one ground level play component of each different type provided (e.g., for different experiences such as rocking, swinging, climbing, spinning, and sliding). Table 240.2.1.2 sets

requirements for the number and types of ground level play components required to be on accessible routes. When elevated play components are provided, an accessible route must connect at least fifty percent (50%) of the elevated play components. Section 240.2.1.2, provides an exception to the requirements for ground level play components if at least fifty percent (50%) of the elevated play components are connected by a ramp and at least three of the elevated play components connected by the ramp are different types of play components.

The technical requirements at section 1008 include provisions where if three or fewer entry points are provided to a soft contained play structure, then at least one entry point must be on an accessible route. In addition, where four or more entry points are provided to a soft contained play structure, then at least two entry points must be served by an accessible route.

If elevated play components are provided, fifty percent (50%) of the elevated components are required to be accessible. Where 20 or more elevated play components are provided, at least twenty five percent (25%) will have to be connected by a ramp. The remaining play components are permitted to be connected by a transfer system. Where less than 20 elevated play components are provided, a transfer system is permitted in lieu of a ramp.

A commenter noted that the 2010 Standards allow for the provision of transfer steps to

elevated play structures based on the number of elevated play activities, but asserted that transfer steps have not been documented as an effective means of access.

The 2010 Standards recognize that play structures are designed to provide unique experiences and opportunities for children. The 2010 Standards provide for play components that are accessible to children who cannot transfer from their wheelchair, but they also provide opportunities for children who are able to transfer. Children often interact with their environment in ways that would be considered inappropriate for adults. Crawling and climbing, for example, are integral parts of the play experience for young children. Permitting the use of transfer platforms in play structures provides some flexibility for creative playground design.

Accessible Play Components. Accessible play components are required to be on accessible routes, including elevated play components that are required to be connected by ramps. These play components must also comply with other accessibility requirements, including specifications for clear floor space and seat heights (where provided).

A commenter expressed concerns that the general requirements of section 240.2.1 of the 2010 Standards and the advisory accompanying section 240.2.1 conflict. The comment asserts that section 240.2.1 of the 2010 Standards provides that the only requirement for integration of equipment is

where there are two or more required ground level play components, while the advisory appears to suggest that all accessible components must be integrated.

The commenter misinterprets the requirement. The ADA mandates that persons with disabilities be able to participate in programs or activities in the most integrated setting appropriate to their needs. Therefore, all accessible play components must be integrated into the general playground setting. Section 240.2.1 of the 2010 Standards specifies that where there is more than one accessible ground level play component, the components must be both dispersed and integrated.

241 and 612 Saunas and Steam Rooms

Section 241 of the 2010 Standards sets scoping for saunas and steam rooms and section 612 sets technical requirements including providing accessible turning space and an accessible bench. Doors are not permitted to swing into the clear floor or ground space for the accessible bench. The exception in section 612.2 of the 2010 Standards permits a readily removable bench to obstruct the required wheelchair turning space and the required clear floor or ground space. Where they are provided in clusters, five percent (5%) but at least one sauna or steam room in each cluster must be accessible.

Commenters raised concerns that the safety of individuals with disabilities outweighs the

usefulness in providing accessible saunas and steam rooms. The Department believes that there is an element of risk in many activities available to the general public. One of the major tenets of the ADA is that individuals with disabilities should have the same opportunities as other persons to decide what risks to take. It is not appropriate for covered entities to prejudge the abilities of persons with disabilities.

242 and 1009 Swimming Pools, Wading Pools, and Spas

Accessible Means of Entry to Pools.

Section 242 of the 2010 Standards requires at least two accessible means of entry for larger pools (300 or more linear feet) and at least one accessible entry for smaller pools. This section requires that at least one entry will have to be a sloped entry or a pool lift; the other could be a sloped entry, pool lift, a transfer wall, or a transfer system (technical specifications for each entry type are included at section 1009).

Many commenters supported the scoping and technical requirements for swimming pools. Other commenters stated that the cost of requiring facilities to immediately purchase a pool lift for each indoor and outdoor swimming pool would be very significant especially considering the large number of swimming pools at lodging facilities. One commenter requested that the Department clarify what would be an “alteration” to a swimming pool that would trigger the

obligation to comply with the accessible means of entry in the 2010 Standards.

Alterations are covered by section 202.3 of the 2010 Standards and the definition of “alteration” is provided at section 106.5. A physical change to a swimming pool which affects or could affect the usability of the pool is considered to be an alteration. Changes to the mechanical and electrical systems, such as filtration and chlorination systems, are not alterations. Exception 2 to section 202.3 permits an altered swimming pool to comply with applicable requirements to the maximum extent feasible if full compliance is technically infeasible. “Technically infeasible” is also defined in section 106.5 of the 2010 Standards.

The Department also received comments suggesting that it is not appropriate to require two accessible means of entry to wave pools, lazy rivers, sand bottom pools, and other water amusements where there is only one point of entry. Exception 2 of Section 242.2 of the 2010 Standards exempts pools of this type from having to provide more than one accessible means of entry provided that the one accessible means of entry is a swimming pool lift compliant with section 1009.2, a sloped entry compliant with section 1009.3, or a transfer system compliant with section 1009.5 of the 2010 Standards.

Accessible Means of Entry to Wading Pools. Sections 242.3 and 1009.3 of the 2010 Standards require that at least one

sloped means of entry is required into the deepest part of each wading pool.

Accessible Means of Entry to Spas.

Sections 242.4 and 1009.2, 1009.4, and 1009.5 of the 2010 Standards require spas to meet accessibility requirements, including an accessible means of entry. Where spas are provided in clusters, five percent (5%) but at least one spa in each cluster must be accessible. A pool lift, a transfer wall, or a transfer system will be permitted to provide the required accessible means of entry.

243 Shooting Facilities with Firing Positions

Sections 243 and 1010 of the 2010 Standards require an accessible turning space for each different type of firing position at a shooting facility if designed and constructed on a site. Where firing positions are provided in clusters, five percent (5%), but at least one position of each type in each cluster must be accessible.

Additional Technical Requirements

302.1 Floor or Ground Surfaces

Both section 4.5.1 of the 1991 Standards and section 302.2 of the 2010 Standards require that floor or ground surfaces along accessible routes and in accessible rooms and spaces be stable, firm, slip-resistant, and comply with either section 4.5 in the case of the 1991 Standards or section 302 in the case of the 2010 Standards.

Commenters recommended that the Department apply an ASTM Standard (with modifications) to assess whether a floor surface is “slip resistant” as required by section 302.1 of the 2010 Standards. The Department declines to accept this recommendation since, currently, there is no generally accepted test method for the slip-resistance of all walking surfaces under all conditions.

304 Turning Space

Section 4.2.3 of the 1991 Standards and Section 304.3 of the 2010 Standards allow turning space to be either a circular space or a T-shaped space. Section 304.3 permits turning space to include knee and toe clearance complying with section 306. Section 4.2.3 of the 1991 Standards did not specifically permit turning space to include knee and toe clearance. Commenters urged the Department to retain the turning space requirement, but exclude knee and toe clearance from being permitted as part of this space. They argued that wheelchairs and other mobility devices are becoming larger and that more individuals with disabilities are using electric three and four-wheeled scooters which cannot utilize knee clearance.

The Department recognizes that the technical specifications for T-shaped and circular turning spaces in the 1991 and 2010 Standards, which are based on manual wheelchair dimensions, may not adequately meet the needs of individuals using larger electric scooters. However, there is no

consensus about the appropriate dimension on which to base revised requirements. The Access Board is conducting research to study this issue in order to determine if new requirements are warranted. For more information, see the Access Board’s website at <http://www.access-board.gov/research/current-projects.htm#suny>. The Department plans to wait for the results of this study and action by the Access Board before considering any changes to the Department’s rules. Covered entities may wish to consider providing more than the minimum amount of turning space in confined spaces where a turn will be required. Appendix section A4.2.3 and Fig. A2 of the 1991 Standards provide guidance on additional space for making a smooth turn without bumping into surrounding objects.

404 Doors, Doorways, and Gates

Automatic Door Break Out Openings. The 1991 Standards do not contain any technical requirement for automatic door break out openings. The 2010 Standards at sections 404.1, 404.3, 404.3.1, and 404.3.6 require automatic doors that are part of a means of egress and that do not have standby power to have a 32-inch minimum clear break out opening when operated in emergency mode. The minimum clear opening width for automatic doors is measured with all leaves in the open position. Automatic bi-parting doors or pairs of swinging doors that provide a 32-inch minimum clear break out opening in emergency mode when both leaves are opened manually meet the

technical requirement. Section 404.3.6 of the 2010 Standards includes an exception that exempts automatic doors from the technical requirement for break out openings when accessible manual swinging doors serve the same means of egress.

Maneuvering Clearance or Standby Power for Automatic Doors. Section 4.13.6 of the 1991 Standards does not require maneuvering clearance at automatic doors. Section 404.3.2 of the 2010 Standards requires automatic doors that serve as an accessible means of egress to either provide maneuvering clearance or to have standby power to operate the door in emergencies. This provision has limited application and will affect, among others, in-swinging automatic doors that serve small spaces.

Commenters urged the Department to reconsider provisions that would require maneuvering clearance or standby power for automatic doors. They assert that these requirements would impose unreasonable financial and administrative burdens on all covered entities, particularly smaller entities. The Department declines to change these provisions because they are fundamental life-safety issues. The requirement applies only to doors that are part of a means of egress that must be accessible in an emergency. If an emergency-related power failure prevents the operation of the automatic door, a person with a disability could be trapped unless there is either adequate maneuvering room to open the door manually or a back-up power source.

Thresholds at Doorways. The 1991 Standards, at section 4.13.8, require the height of thresholds at doorways not to exceed ½ inch and thresholds at exterior sliding doors not to exceed ¾ inch. Sections 404.1 and 404.2.5 of the 2010 Standards require the height of thresholds at all doorways that are part of an accessible route not to exceed ½ inch. The 1991 Standards and the 2010 Standards require raised thresholds that exceed ¼ inch in height to be beveled on each side with a slope not steeper than 1:2. The 2010 Standards include an exception that exempts existing and altered thresholds that do not exceed ¾ inch in height and are beveled on each side from the requirement.

505 Handrails

The 2010 Standards add a new technical requirement at section 406.3 for handrails along walking surfaces.

The 1991 Standards, at sections 4.8.5, 4.9.4, and 4.26, and the 2010 Standards, at section 505, contain technical requirements for handrails. The 2010 Standards provide more flexibility than the 1991 Standards as follows:

- Section 4.26.4 of the 1991 Standards requires handrail gripping surfaces to have edges with a minimum radius of 1/8 inch. Section 505.8 of the 2010 Standards requires handrail gripping surfaces to have rounded edges.

- Section 4.26.2 of the 1991 Standards requires handrail gripping surfaces to have a diameter of 1 ¼ inches to 1 ½ inches, or to provide an equivalent gripping surface. Section 505.7 of the 2010 Standards requires handrail gripping surfaces with a circular cross section to have an outside diameter of 1 ¼ inches to 2 inches. Handrail gripping surfaces with a non-circular cross section must have a perimeter dimension of 4 inches to 6 ¼ inches, and a cross section dimension of 2 ¼ inches maximum.
 - Sections 4.8.5 and 4.9.4 of the 1991 Standards require handrail gripping surfaces to be continuous, and to be uninterrupted by newel posts, other construction elements, or obstructions. Section 505.3 of the 2010 Standards sets technical requirements for continuity of gripping surfaces. Section 505.6 requires handrail gripping surfaces to be continuous along their length and not to be obstructed along their tops or sides. The bottoms of handrail gripping surfaces must not be obstructed for more than twenty percent (20%) of their length. Where provided, horizontal projections must occur at least 1 ½ inches below the bottom of the handrail gripping surface. An exception permits the distance between the horizontal projections and the bottom of the gripping surface to be reduced by 1/8 inch for each ½ inch of additional handrail perimeter dimension that exceeds 4 inches.
 - Section 4.9.4 of the 1991 Standards requires handrails at the bottom of stairs to continue to slope for a distance of the width of one tread beyond the bottom riser nosing and to further extend horizontally at least 12 inches. Section 505.10 of the 2010 Standards requires handrails at the bottom of stairs to extend at the slope of the stair flight for a horizontal distance at least equal to one tread depth beyond the last riser nosing. Section 4.1.6(3) of the 1991 Standards has a special technical provision for alterations to existing facilities that exempts handrails at the top and bottom of ramps and stairs from providing full extensions where it will be hazardous due to plan configuration. Section 505.10 of the 2010 Standards has a similar exception that applies in alterations.
- A commenter noted that handrail extensions are currently required at the top and bottom of stairs, but the proposed regulations do not include this requirement, and urged the Department to retain the current requirement. Other commenters questioned the need for the extension at the bottom of stairs.
- Sections 505.10.2 and 505.10.3 of the 2010 Standards require handrail extensions at both the top and bottom of a flight of stairs. The requirement in the 1991 Standards that handrails extend horizontally at least 12 inches beyond the width of one tread at the bottom of a stair was changed in the 2004 ADAAG by the Access Board in response to public comments. Existing horizontal handrail

extensions that comply with 4.9.4(2) of the 1991 Standards should meet or exceed the requirements of the 2010 Standards.

Commenters noted that the 2010 Standards will require handrail gripping surfaces with a circular cross section to have an outside diameter of 2 inches, and that this requirement would impose a physical barrier to individuals with disabilities who need the handrail for stability and support while accessing stairs.

The requirement permits an outside diameter of 1 ¼ inches to 2 inches. This range allows flexibility in meeting the needs of individuals with disabilities and designers and architects. The Department is not aware of any data indicating that an outside diameter of 2 inches would pose any adverse impairment to use by individuals with disabilities.

Handrails Along Walkways. The 1991 Standards do not contain any technical requirement for handrails provided along walkways that are not ramps. Section 403.6 of the 2010 Standards specifies that where handrails are provided along walkways that are not ramps, they shall comply with certain technical requirements. The change is expected to have minimal impact.

