

AIP
AERONAUTICAL INFORMATION PUBLICATION
UNITED STATES OF AMERICA

TWENTY-FIRST EDITION

10 MARCH 2011

CONSULT NOTAM FOR LATEST INFORMATION

DEPARTMENT OF TRANSPORTATION
FEDERAL AVIATION ADMINISTRATION

AIP
AERONAUTICAL INFORMATION PUBLICATION
UNITED STATES OF AMERICA

PART 1
GENERAL (GEN)

PART 1 – GENERAL (GEN)

GEN 0.

GEN 0.1 Preface

1. Name of the Publishing Authority

1.1 The United States of America Aeronautical Information Publication (AIP) is published by the authority of the Federal Aviation Administration.

2. Applicable ICAO Documents

2.1 The AIP is prepared in accordance with the Standards and Recommended Practices (SARP) of Annex 15 to the Convention on International Civil Aviation and the Aeronautical Information Services Manual (ICAO Doc 8126). Charts contained in the AIP are produced in accordance with Annex 4 to the Convention on International Civil Aviation and the Aeronautical Chart Manual (ICAO Doc 8697). Differences from ICAO Standards, Recommended Practices and Procedures are given in subsection GEN 1.7.

3. The AIP Structure and Established Regular Amendment Interval

3.1 The AIP Structure

The AIP is made up of three Parts; General (GEN), En Route (ENR), and Aerodromes (AD); each divided into sections and subsections as applicable, containing various types of information subjects.

3.1.1 PART 1 – General (GEN)

PART 1 consists of five sections containing information as briefly described hereafter:

3.1.1.1 GEN 0. – Preface; Record of AIP Amendments; Checklist of AIP Pages; and Table of Contents to PART 1.

3.1.1.2 GEN 1. National Regulations and Requirements – Designated Authorities; Entry, Transit, and Departure of Aircraft; Entry, Transit, and Departure of Passengers and Crew; Entry, Transit, and Departure of Cargo; Aircraft Instruments, Equip-

ment, and Flight Documents; Summary of National Regulations and International Agreements/Conventions; and Differences from ICAO Standards, Recommended Practices, and Procedures.

3.1.1.3 GEN 2. Tables and Codes – Measuring System, Time System, and Aircraft Markings; Abbreviations Used in AIS Publications; Chart Symbols; Location Indicators; List of Radio Navigation Aids; Conversion Tables; and Sunrise/Sunset Tables.

3.1.1.4 GEN 3. Services – Aeronautical Information Services; Aeronautical Charts; Air Traffic Services; Communication Service; Meteorological Services; Search and Rescue; and Aircraft Rescue and Fire Fighting Communications.

3.1.1.5 GEN 4. Charges for Aerodromes/Heliports and Air Navigation Services – Fees and Charges; and Air Navigation Facility Charges.

3.1.2 PART 2 – En Route (ENR)

PART 2 consists of seven sections containing information as briefly described hereafter:

3.1.2.1 ENR 0. – Checklist of AIP Pages; and the Table of Contents to PART 2.

3.1.2.2 ENR 1. General Rules and Procedures – General Rules; Visual Flight Rules; Instrument Flight Rules; ATS Airspace Classification; Holding, Approach, and Departure Procedures; Altimeter Setting Procedures; Flight Planning; Interception of Civil Aircraft, National Security and Interception Procedures; Medical Facts for Pilots; Safety, Hazard, and Accident Reports; North Atlantic (NAT) Timekeeping Procedures; and Area Navigation (RNAV) and Required Navigation Performance (RNP).

3.1.2.3 ENR 2. Air Traffic Services Airspace.

3.1.2.4 ENR 3. ATS routes – Area Navigation Routes; and Other Routes.

3.1.2.5 ENR 4. Navigation Aids/Systems – Navigation Aids – En Route; and Special Navigation Systems.

3.1.2.6 ENR 5. Navigation Warnings – Prohibited, Restricted, and Other Areas; Military Exercise and Training Areas; Bird Migration and Areas with Sensitive Fauna; and Potential Flight Hazards.

3.1.2.7 ENR 6. Helicopter Operations – Helicopter IFR Operations; and Special Operations.

3.1.3 PART 3 – Aerodromes (AD)

PART 3 consists of three sections containing information as briefly described hereafter:

3.1.3.1 AD 0. – Checklist of AIP Pages; and Table of Contents to PART 3.

3.1.3.2 AD 1. Aerodromes – Introduction – Aerodrome Availability.

3.1.3.3 AD 2. Aerodromes – Listing of Aerodromes.

3.2 Regular Amendment Interval

Regular amendments to the AIP will be issued every 6 months on Aeronautical Information Regulation and Control (AIRAC) effective dates listed in TBL GEN 0.1-1. A list of all AIRAC effective dates are contained in TBL GEN 0.1-2.

TBL GEN 0.1-1
Publication Schedule

New Edition or Amendment	Cutoff Date for Submission	Effective Date of Publication
Twenty-First Edition	8/26/10	3/10/11
Amendment 1	3/10/11	8/25/11
Amendment 2	8/25/11	2/9/12
Amendment 3	2/9/12	7/26/12

TBL GEN 0.1-2
AIRAC System Effective Dates

2011	2012	2013	2014	2015
13 JAN	12 JAN	10 JAN	9 JAN	8 JAN
10 FEB	9 FEB	7 FEB	6 FEB	5 FEB
10 MAR	8 MAR	7 MAR	6 MAR	5 MAR
7 APR	5 APR	4 APR	3 APR	2 APR
5 MAY	3 MAY	2 MAY	1 MAY	30 APR
2 JUN	31 MAY	30 MAY	29 MAY	28 MAY
30 JUN	28 JUN	27 JUN	26 JUN	25 JUN
28 JUL	26 JUL	25 JUL	24 JUL	23 JUL
25 AUG	23 AUG	22 AUG	21 AUG	20 AUG
22 SEP	20 SEP	19 SEP	18 SEP	17 SEP
20 OCT	18 OCT	17 OCT	16 OCT	15 OCT
17 NOV	15 NOV	14 NOV	13 NOV	12 NOV
15 DEC	13 DEC	12 DEC	11 DEC	10 DEC

4. Service to Contact in Case of Detected AIP Errors or Omissions

4.1 In the compilation of the AIP, care has been taken to ensure that the information contained therein is accurate and complete. Any errors and omissions which may be detected, as well as any correspondence concerning the Aeronautical Information Publication, should be referred to:

Federal Aviation Administration
System Operations Services
System Operations Airspace and AIM Office
Publications
800 Independence Avenue, S.W.
Washington DC 20591
USA

5. Subscription Information

5.1 The AIP is offered for sale on a subscription basis from:

Superintendent of Documents
U.S. Government Printing Office
P.O. Box 979050
St. Louis, MO 63197-9000

Telephone (202) 512-1800

The AIP may be ordered via the internet at:

<http://bookstore.gpo.gov>.

GEN 0.2 Record of AIP Amendments

AIP Amendments			
Amendment Number	Effective Date	Date Inserted	Inserted By

GEN 0.3 Record of AIP Supplements – Not applicable

GEN 0.4 Checklist of Pages

PAGE	DATE
PART 1 – GENERAL (GEN)	
GEN 0	
0.1-1	10 MAR 11
0.1-2	10 MAR 11
0.1-3	10 MAR 11
0.2-1	10 MAR 11
0.4-1	10 MAR 11
0.4-2	10 MAR 11
0.4-3	10 MAR 11
0.6-1	10 MAR 11
GEN 1	
1.1-1	10 MAR 11
1.1-2	10 MAR 11
1.1-3	10 MAR 11
1.1-4	10 MAR 11
1.2-1	10 MAR 11
1.2-2	10 MAR 11
1.2-3	10 MAR 11
1.2-4	10 MAR 11
1.2-5	10 MAR 11
1.2-6	10 MAR 11
1.2-7	10 MAR 11
1.2-8	10 MAR 11
1.2-9	10 MAR 11
1.3-1	10 MAR 11
1.3-2	10 MAR 11
1.3-3	10 MAR 11
1.4-1	10 MAR 11
1.4-2	10 MAR 11
1.4-3	10 MAR 11
1.4-4	10 MAR 11
1.5-1	10 MAR 11
1.6-1	10 MAR 11
1.6-2	10 MAR 11
1.7-1	10 MAR 11
1.7-2	10 MAR 11
1.7-3	10 MAR 11
1.7-4	10 MAR 11
1.7-5	10 MAR 11
1.7-6	10 MAR 11
1.7-7	10 MAR 11
1.7-8	10 MAR 11
1.7-9	10 MAR 11
1.7-10	10 MAR 11
1.7-11	10 MAR 11
1.7-12	10 MAR 11
1.7-13	10 MAR 11

PAGE	DATE
1.7-14	10 MAR 11
1.7-15	10 MAR 11
1.7-16	10 MAR 11
1.7-17	10 MAR 11
1.7-18	10 MAR 11
1.7-19	10 MAR 11
1.7-20	10 MAR 11
1.7-21	10 MAR 11
1.7-22	10 MAR 11
1.7-23	10 MAR 11
1.7-24	10 MAR 11
1.7-25	10 MAR 11
1.7-26	10 MAR 11
1.7-27	10 MAR 11
1.7-28	10 MAR 11
1.7-29	10 MAR 11
1.7-30	10 MAR 11
1.7-31	10 MAR 11
1.7-32	10 MAR 11
1.7-33	10 MAR 11
1.7-34	10 MAR 11
1.7-35	10 MAR 11
1.7-36	10 MAR 11
1.7-37	10 MAR 11
1.7-38	10 MAR 11
1.7-39	10 MAR 11
1.7-40	10 MAR 11
1.7-41	10 MAR 11
1.7-42	10 MAR 11
1.7-43	10 MAR 11
1.7-44	10 MAR 11
1.7-45	10 MAR 11
1.7-46	10 MAR 11
1.7-47	10 MAR 11
1.7-48	10 MAR 11
1.7-49	10 MAR 11
1.7-50	10 MAR 11
1.7-51	10 MAR 11
1.7-52	10 MAR 11
1.7-53	10 MAR 11
1.7-54	10 MAR 11
1.7-55	10 MAR 11
1.7-56	10 MAR 11
1.7-57	10 MAR 11
1.7-58	10 MAR 11
1.7-59	10 MAR 11
1.7-60	10 MAR 11

PAGE	DATE
1.7-61	10 MAR 11
1.7-62	10 MAR 11
1.7-63	10 MAR 11
1.7-64	10 MAR 11
1.7-65	10 MAR 11
1.7-66	10 MAR 11
1.7-67	10 MAR 11
1.7-68	10 MAR 11
1.7-69	10 MAR 11
1.7-70	10 MAR 11
1.7-71	10 MAR 11
1.7-72	10 MAR 11
1.7-73	10 MAR 11
1.7-74	10 MAR 11
1.7-75	10 MAR 11
1.7-76	10 MAR 11
1.7-77	10 MAR 11
1.7-78	10 MAR 11
1.7-79	10 MAR 11
1.7-80	10 MAR 11
1.7-81	10 MAR 11
1.7-82	10 MAR 11
1.7-83	10 MAR 11
1.7-84	10 MAR 11
1.7-85	10 MAR 11
1.7-86	10 MAR 11
1.7-87	10 MAR 11
1.7-88	10 MAR 11
1.7-89	10 MAR 11
1.7-90	10 MAR 11
1.7-91	10 MAR 11
1.7-92	10 MAR 11
1.7-93	10 MAR 11
1.7-94	10 MAR 11
1.7-95	10 MAR 11
1.7-96	10 MAR 11
1.7-97	10 MAR 11
1.7-98	10 MAR 11
1.7-99	10 MAR 11
1.7-100	10 MAR 11
1.7-101	10 MAR 11
1.7-102	10 MAR 11
1.7-103	10 MAR 11
GEN 2	
2.1-1	10 MAR 11
2.1-2	10 MAR 11

PAGE	DATE
2.2-1	10 MAR 11
2.2-2	10 MAR 11
2.2-3	10 MAR 11
2.2-4	10 MAR 11
2.2-5	10 MAR 11
2.3-1	10 MAR 11
2.4-1	10 MAR 11
2.5-1	10 MAR 11
2.6-1	10 MAR 11
2.6-2	10 MAR 11
2.6-3	10 MAR 11
2.6-4	10 MAR 11
2.6-5	10 MAR 11
2.6-6	10 MAR 11
2.6-7	10 MAR 11
2.7-1	10 MAR 11
GEN 3	
3.1-1	10 MAR 11
3.1-2	10 MAR 11
3.1-3	10 MAR 11
3.1-4	10 MAR 11
3.1-5	10 MAR 11
3.2-1	10 MAR 11
3.2-2	10 MAR 11
3.2-3	10 MAR 11
3.2-4	10 MAR 11
3.2-5	10 MAR 11
3.2-6	10 MAR 11
3.2-7	10 MAR 11
3.2-8	10 MAR 11
3.2-9	10 MAR 11
3.2-10	10 MAR 11
3.2-11	10 MAR 11
3.2-12	10 MAR 11
3.2-13	10 MAR 11
3.3-1	10 MAR 11
3.3-2	10 MAR 11
3.3-3	10 MAR 11
3.3-4	10 MAR 11
3.3-5	10 MAR 11
3.3-6	10 MAR 11
3.3-7	10 MAR 11
3.3-8	10 MAR 11
3.3-9	10 MAR 11
3.3-10	10 MAR 11
3.3-11	10 MAR 11
3.3-12	10 MAR 11
3.3-13	10 MAR 11
3.3-14	10 MAR 11
3.3-15	10 MAR 11

PAGE	DATE
3.3-16	10 MAR 11
3.3-17	10 MAR 11
3.4-1	10 MAR 11
3.4-2	10 MAR 11
3.4-3	10 MAR 11
3.4-4	10 MAR 11
3.4-5	10 MAR 11
3.4-6	10 MAR 11
3.4-7	10 MAR 11
3.4-8	10 MAR 11
3.4-9	10 MAR 11
3.4-10	10 MAR 11
3.4-11	10 MAR 11
3.4-12	10 MAR 11
3.4-13	10 MAR 11
3.4-14	10 MAR 11
3.4-15	10 MAR 11
3.4-16	10 MAR 11
3.4-17	10 MAR 11
3.4-18	10 MAR 11
3.4-19	10 MAR 11
3.4-20	10 MAR 11
3.4-21	10 MAR 11
3.4-22	10 MAR 11
3.4-23	10 MAR 11
3.4-24	10 MAR 11
3.5-1	10 MAR 11
3.5-2	10 MAR 11
3.5-3	10 MAR 11
3.5-4	10 MAR 11
3.5-5	10 MAR 11
3.5-6	10 MAR 11
3.5-7	10 MAR 11
3.5-8	10 MAR 11
3.5-9	10 MAR 11
3.5-10	10 MAR 11
3.5-11	10 MAR 11
3.5-12	10 MAR 11
3.5-13	10 MAR 11
3.5-14	10 MAR 11
3.5-15	10 MAR 11
3.5-16	10 MAR 11
3.5-17	10 MAR 11
3.5-18	10 MAR 11
3.5-19	10 MAR 11
3.5-20	10 MAR 11
3.5-21	10 MAR 11
3.5-22	10 MAR 11
3.5-23	10 MAR 11
3.5-24	10 MAR 11

PAGE	DATE
3.5-25	10 MAR 11
3.5-26	10 MAR 11
3.5-27	10 MAR 11
3.5-28	10 MAR 11
3.5-29	10 MAR 11
3.5-30	10 MAR 11
3.5-31	10 MAR 11
3.5-32	10 MAR 11
3.5-33	10 MAR 11
3.5-34	10 MAR 11
3.5-35	10 MAR 11
3.5-36	10 MAR 11
3.5-37	10 MAR 11
3.5-38	10 MAR 11
3.5-39	10 MAR 11
3.5-40	10 MAR 11
3.5-41	10 MAR 11
3.5-42	10 MAR 11
3.5-43	10 MAR 11
3.5-44	10 MAR 11
3.5-45	10 MAR 11
3.5-46	10 MAR 11
3.5-47	10 MAR 11
3.5-48	10 MAR 11
3.5-49	10 MAR 11
3.5-50	10 MAR 11
3.5-51	10 MAR 11
3.5-52	10 MAR 11
3.5-53	10 MAR 11
3.5-54	10 MAR 11
3.5-55	10 MAR 11
3.5-56	10 MAR 11
3.5-57	10 MAR 11
3.5-58	10 MAR 11
3.5-59	10 MAR 11
3.5-60	10 MAR 11
3.5-61	10 MAR 11
3.5-62	10 MAR 11
3.5-63	10 MAR 11
3.5-64	10 MAR 11
3.5-65	10 MAR 11
3.5-66	10 MAR 11
3.5-67	10 MAR 11
3.5-68	10 MAR 11
3.5-69	10 MAR 11
3.5-70	10 MAR 11
3.5-71	10 MAR 11
3.5-72	10 MAR 11
3.5-73	10 MAR 11
3.5-74	10 MAR 11

PAGE	DATE
3.5-75	10 MAR 11
3.5-76	10 MAR 11
3.5-77	10 MAR 11
3.5-78	10 MAR 11
3.5-79	10 MAR 11
3.5-80	10 MAR 11
3.5-81	10 MAR 11
3.5-82	10 MAR 11
3.5-83	10 MAR 11
3.5-84	10 MAR 11
3.5-85	10 MAR 11
3.6-1	10 MAR 11
3.6-2	10 MAR 11
3.6-3	10 MAR 11

PAGE	DATE
3.6-4	10 MAR 11
3.6-5	10 MAR 11
3.6-6	10 MAR 11
3.6-7	10 MAR 11
3.6-8	10 MAR 11
3.6-9	10 MAR 11
3.6-10	10 MAR 11
3.6-11	10 MAR 11
3.6-12	10 MAR 11
3.6-13	10 MAR 11
3.6-14	10 MAR 11
3.6-15	10 MAR 11
3.6-16	10 MAR 11
3.6-17	10 MAR 11

PAGE	DATE
3.6-18	10 MAR 11
3.6-19	10 MAR 11
3.6-20	10 MAR 11
3.7-1	10 MAR 11
3.7-2	10 MAR 11
GEN 4	
4.1-1	10 MAR 11
4.2-1	10 MAR 11

GEN 0.5 List of Hand Amendments to the AIP – Not applicable

GEN 0.6 Table of Contents to Part 1

	<i>Page</i>
GEN 1. National Regulations and Requirements	
GEN 1.1 Designated Authorities	GEN 1.1-1
GEN 1.2 Entry, Transit, and Departure of Aircraft	GEN 1.2-1
GEN 1.3 Entry, Transit, and Departure of Passengers and Crew	GEN 1.3-1
GEN 1.4 Entry, Transit, and Departure of Cargo	GEN 1.4-1
GEN 1.5 Aircraft Instruments, Equipment, and Flight Documents	GEN 1.5-1
GEN 1.6 Summary of National Regulations and International Agreements/Conventions ...	GEN 1.6-1
GEN 1.7 Differences From ICAO Standards, Recommended Practices and Procedures	GEN 1.7-1
GEN 2. Tables and Codes	
GEN 2.1 Measuring System, Time System, and Aircraft Markings	GEN 2.1-1
GEN 2.2 Abbreviations Used in AIS Publications	GEN 2.2-1
GEN 2.3 Chart Symbols	GEN 2.3-1
GEN 2.4 Location Indicators	GEN 2.4-1
GEN 2.5 List of Radio Navigation Aids	GEN 2.5-1
GEN 2.6 Conversion Tables	GEN 2.6-1
GEN 2.7 Sunrise/Sunset Tables	GEN 2.7-1
GEN 3. Services	
GEN 3.1 Aeronautical Information Services	GEN 3.1-1
GEN 3.2 Aeronautical Charts	GEN 3.2-1
GEN 3.3 Air Traffic Services	GEN 3.3-1
GEN 3.4 Communication Service	GEN 3.4-1
GEN 3.5 Meteorological Services	GEN 3.5-1
GEN 3.6 Search and Rescue	GEN 3.6-1
GEN 3.7 Aircraft Rescue and Fire Fighting Communications	GEN 3.7-1
GEN 4. Charges for Aerodromes/Heliports and Air Navigation Services	
GEN 4.1 Fees and Charges	GEN 4.1-1
GEN 4.2 Air Navigation Facility Charges	GEN 4.2-1

GEN 1. NATIONAL REGULATIONS AND REQUIREMENTS

GEN 1.1 Designated Authorities

1. Introduction

1.1 The requirements for entry and departure of aircraft engaged in international flights and the standard procedure for clearance of these aircraft at all international airports are given for the information and guidance of operators conducting international flights. The information contained in this section does not replace, amend or change in any manner, the current regulations of the designated authorities, listed below, which are of concern to international air travel.

2. Designated Authorities

2.1 The postal, telex and telegraphic addresses of the designated authorities concerned with the entry, transit, and departures of international air travel are as follows:

Customs
<i>Postal Address:</i> Department of the Treasury U.S. Customs Service 1300 Pennsylvania Ave., NW Washington, DC 20229
<i>Telephone:</i> 202-927-6724
<i>Commercial Telegraphic Address:</i> None

Immigrations
<i>Postal Address:</i> Department of Justice Immigration and Naturalization Service 425 I Street, NW Washington, D.C. 20001
<i>Telephone:</i> 202-514-2000
<i>Telex:</i> None
<i>Commercial Telegraphic Address:</i> None

Health
<i>Postal Address:</i> Center for Disease Control Quarantine Division Atlanta, Georgia 30333
<i>Telephone:</i> 404-639-3311
<i>Fax:</i> 404-639-2599
<i>Commercial Telegraphic Address:</i> None

Agriculture Quarantine
<i>Postal Address:</i> Department of Agriculture Animal and Plant Health Inspection Service 4700 River Road, Unit 38 Riverdale, MD 20737
<i>Telephone:</i> 301-734-7799
<i>Fax:</i> 301-734-3222
<i>Commercial Telegraphic Address:</i> None

Regulations Governing Air Carriers
<i>Postal Address:</i> Department of Transportation Office of The Secretary Office of International Aviation 400 7th St. SW Washington, D.C. 20590
<i>Telephone:</i> 202-366-2423
<i>Fax:</i> 202-366-3694
<i>Commercial Telegraphic Address:</i> (MARAD WASH) Attention Office of International Aviation X-40

Regulations Governing Export of Aircraft and Commodities
<i>Postal Address:</i> Department of Commerce Bureau of Export Administration 14th and Constitution Ave., NW Washington, D.C. 20230
<i>Telephone:</i> 202-482-3881
<i>Fax:</i> 202-482-3322
<i>Commercial Telegraphic Address:</i> None

Regulations Governing Firearms (Import)
<i>Postal Address:</i> Department of the Treasury Internal Revenue Service Director of Alcohol, Tobacco and Firearms Division 650 Massachusetts Avenue, NW Washington, D.C. 20226
<i>Telephone:</i> 202-927-7777
<i>Fax:</i> 202-927-7862
<i>Commercial Telegraphic Address:</i> None

Regulations Governing Military Type Hardware (Export)
<i>Postal Address:</i> Department of State Defense Trade Center 1701 North Fort Myers Drive Rosslyn, Virginia 2209
<i>Telephone:</i> 703-875-6650
<i>Fax:</i> 703-875-5663
<i>Commercial Telegraphic Address:</i> None

3. Applicable ICAO Documents

3.1 National regulations and practices concerning facilitation of international air transport are being carried out at all international airports as far as possible in accordance with the provisions set forth in the Standards and Recommended Practices of Annex 9 to the Convention on International Civil Aviation. Differences from certain Annex 9 provisions exist only in those cases where it has not yet been possible to amend national legislation accordingly. Continuous efforts are being made to eliminate these differences.

4. Customs Offices Service/Area Port Directors

4.1 Address all correspondence to the Service/Area Port Director of Customs at the following locations:

Location	Address
Anchorage	605 W Fourth Avenue Anchorage, AK 99501
Atlanta	700 Doug Davis Drive Atlanta, GA 30354
Baltimore	40 S Gay Street Baltimore, MD 21202
Baton Rouge	5353 Essen Lane Baton Rouge, LA 70809
Blaine	9901 Pacific Highway Blaine, WA 98230
Boston	10 Causeway Street, Suite 603 Boston, MA 22220
Buffalo	111 W Huron Street Buffalo, NY 14202
Calais	1 Main Street Calais, ME 46190
Calexico	P.O. Box 632 Calexico, CA 92231
Champlain	198 W Service Road Champlain, NY 12919

Location	Address
Charleston	200 E Bay Street Charleston, SC 29401
Charlotte	1901 Cross Beam Drive Charlotte, NC 28217
Charlotte/ Amalie	Main Post Office Sugar Estate St. Thomas, USVI 00801
Chicago	610 S Canal Street Chicago, IL 60607
Christiansted	1B La Grande Princess, P.O. Box 249 Christiansted, St. Croix USVI 00820
Cleveland	6747 Engle Road Middleburg Heights, OH 44130
Dallas/Ft. Worth	P.O. Box 619050 DFW Airport, TX 75261
Denver	4735 Oakland Street Denver, CO 80239
Derby Line	Interstate 91 Derby Line, VT 58300
Detroit	477 Michigan Avenue, Suite 200 Detroit, MI 48226
Douglas	First Street & Pan American Avenue Douglas, AZ 85607
Duluth	515 W First Street Duluth, MN 55801
El Paso	797 S Saragosa Road El Paso, TX 79907
Grand Rapids	Kent County Airport Grand Rapids, MI 49512
Great Falls	300 Second Avenue South Great Falls, MT 59405
Greenville/ Spartanburg	150-A W Phillips Road Greer, SC 29650
Harrisburg	Harrisburg International Airport Building 135 Middletown, PA 17057
Hartford	135 High Street Hartford, CT 61030
Highgate Springs	RR 2 Box 170 Swanton, VT 54880
Honolulu	335 Merchant Street Honolulu, HI 96813
Houlton	RR 3 Box 5300 Houlton, ME 47300
Houston/ Galveston	2350 N Sam Houston Parkway East, Suite 1000 Houston, TX 77032

Location	Address
Jacksonville	2831 Talleyrand Avenue Jacksonville, FL 32206
Kansas City	2701 Rockcreek Parkway, Suite 202 N Kansas City, MO 64116
Laredo/ Colombia	P.O. Box 3130 Laredo, TX 78044
Los Angeles/ Airport Area	11099 S La Cienega Boulevard Los Angeles, CA 90045
Los Angeles/ Long Beach Seaport Area	300 S. Ferry Street Terminal Island, CA 90731
Louisville	601 W Broadway Louisville, KY 40202
Miami Airport	6601 W 25th Street Miami, FL 33102
Miami Seaport	1500 Port Boulevard Miami, FL 33132
Milwaukee	6269 Ace Industries Drive Cudahy, WI 53110
Minneapolis	330 Second Avenue South, Suite 560 Minneapolis, MN 55401
Mobile	150 N Royal Street, Room 3004 Mobile, AL 36602
Nashville	P.O. Box 270008 Nashville, TN 37227
New Orleans	423 Canal Street New Orleans, LA 70130
New York	6 World Trade Center New York, NY 10048
New York/JFK Area	Building 77 Jamaica, NY 11430
New York/ Newark Area	1210 Corbin Street Elizabeth, NJ 07201
Nogales	9 N Grand Avenue Nogales, AZ 85621
Norfolk	200 Granby Street, Suite 839 Norfolk, VA 23510
Ogdensburg	127 N Water Street Ogdensburg, NY 13669
Orlando	5390 Bear Road Orlando, FL 32827
Oroville	Rt 1 Box 130 Oroville, WA 98844
Otay Mesa	9777 Via De La Amistad San Diego, CA 92173
Pembina	122 W Stutsman Pembina, ND 58271

Location	Address
Philadelphia	Second and Chestnut Streets Philadelphia, PA 19106
Phoenix	1315 S 27th Street Phoenix, AZ 85034
Port Huron	526 Water Street Port Huron, MI 48060
Portland, ME	312 Fore Street Portland, ME 04101
Portland, OR	P.O. Box 55580 Portland, OR 97238-5580
Providence	49 Pavilion Avenue Providence, RI 02905
Raleigh/Durham	120 Southcenter Court, Suite 500 Morrisville, NC 27560
Richmond	4501 Williamsburg Road, Suite G Richmond, VA 23231
San Antonio	9800 Airport Boulevard, Suite 1103 San Antonio, TX 78216
San Francisco	555 Battery Street San Francisco, CA 94126
San Juan	#1 La Puntilla San Juan, PR 00901
San Luis	P.O. Box H San Luis, AZ 85349
San Ysidro	720 E San Ysidro Boulevard San Ysidro, CA 92173
Sault Ste Marie	International Bridge Plaza Sault Ste Marie, MI 49783
Savannah	One East Bay Street Savannah, GA 31401
Seattle	1000 Second Avenue, Suite 2100 Seattle, WA 98104
St. Albans	P.O. Box 1490 St. Albans, VT 05478
St. Louis	4477 Woodson Road St. Louis, MO 63134
Syracuse	4034 S Service Road N Syracuse, NY 13212
Tacoma	2202 Port of Tacoma Road Tacoma, WA 98421
Tampa	1624 E 7th Avenue, Suite 101 Tampa, FL 33605
Tucson	7150 S Tucson Boulevard Tucson, AZ 85706
Washington, DC	P.O. Box 17423 Washington, DC 20041
Wilmington, NC	One Virginia Avenue Wilmington, NC 28401

5. Customs Management Centers

5.1 Address all correspondence to the Customs Management Centers' Directors at the following locations:

Arizona	4740 North Oracle Road Suite 310 Tucson, AZ 85705
Caribbean Area	#1 La Puntilla Street Room 203 San Juan, PR 00901
East Great Lakes	4455 Genesee Street Buffalo, NY 14225
East Texas	2323 S Shepard Street Suite 1200 Houston, TX 77019
Gulf	423 Canal Street, Room 337 New Orleans, LA 70130
Mid America	610 S Canal Street, Suite 900 Chicago, IL 60607
Mid Atlantic	103 S Gay Street, Suite 208 Baltimore, MD 21202
Mid Pacific	33 New Montgomery Street Suite 1601 San Francisco, CA 94105
New York	6 World Trade Center Room 716 New York, NY 10048
North Atlantic	10 Causeway Street, Room 801 Boston, MA 02222
North Florida	1624 E Seventh Avenue Suite 301 Tampa, FL 33605

North Pacific	8337 NE Alderwood Road Room 200 Mailing Address: P.O. Box 55700 Portland, OR 97238-5700
Northwest Great Plains	1000 Second Avenue, Suite 2200 Seattle, WA 98104
South Atlantic	1691 Phoenix Boulevard Suite 270 College Park, GA 30349
South Florida	909 SE First Avenue, Suite 980 Miami, FL 33131
South Pacific	One World Trade Center P.O. Box 32639 Long Beach, CA 90815
South Texas	P.O. Box 3130, Building #2 Lincoln-Juarez Bridge Laredo, TX 78044
Southern California	610 W Ash Street, Suite 1200 San Diego, CA 92101
West Great Lakes	613 Abbott Street, 3rd Floor Detroit, MI 48226
West Texas/New Mexico	9400 Viscount Boulevard Suite 104 El Paso, TX 79925

6. Customs Headquarters

6.1 Address all correspondence to:

Commissioner of Customs
1300 Pennsylvania Avenue, N.W.
Washington, D.C. 20229.

GEN 1.2 Entry, Transit, and Departure of Aircraft

1. General

1.1 All flights into or over the territories of the U.S. and landing in such territories shall be carried out in accordance with the regulations of the U.S. regarding civil aviation.

1.2 Aircraft landing in or departing from the territories of the U.S. must first land at, or finally depart from, an international airport (see AD 2) except as may be otherwise noted in this section.

1.3 All aircraft entering the U.S. must land at a designated international airport of entry unless prior approval to land at a landing rights or other airport has been obtained from U.S. Customs. The terms “international airport of entry” refers to any airport designated by the Secretary of the Treasury or the Commissioner of Customs as a port of entry for civil aircraft arriving in the U.S. from any place outside thereof and for cargo carried on such aircraft. (Note: Frequently the word “international” is included in the name of an airport for other than Customs purposes, in which case it has no special Customs meaning.) The term “landing rights airport” refers to an airport of entry at which permission to land must be granted by the appropriate Customs officer with acknowledgement of the Immigration and Naturalization Service, the Public Health Service, and the Animal and Plant Health Inspection Service of the Department of Agriculture. Such landing rights are required before an aircraft may land at an airport which has not been designated for Customs purposes as an international airport of entry. In the case of scheduled aircraft, such permission shall be obtained from the Service/Area Director of Customs of the Port (see GEN 1.1, paragraph 4.) where the first landing will occur. In all other cases, including private aircraft, landing permission may be obtained from the Port Director of Customs (see GEN 1.1, paragraph 4.) or the Customs officer in charge of the port of entry or Customs station nearest the intended place of landing. All persons entering the U.S. must be inspected for U.S. Customs, Immigration, and Public Health purposes.

1.4 Subject to the observance of the applicable rules, conditions, and limitations of the Federal Aviation Regulations and the Department of Transportation

(DOT)/Office of the Secretary of Transportation (OST), Office of International Aviation, as described below, foreign civil aircraft registered and manufactured in any foreign country which is a member of the International Civil Aviation Organization (ICAO) may be navigated in the U.S. Foreign civil aircraft manufactured in a country which at the time of manufacture was not a member of ICAO may be navigated in the U.S. if the country has notified ICAO that the aircraft meets the standards described in the Chicago Convention or if a notice has been filed with the DOT/OST, Office of International Aviation, through diplomatic channels, that the aircraft meets the standards described in the Chicago Convention.

1.5 Aircraft registered under the laws of foreign countries, not members of the ICAO, may be navigated in U.S. territory only when authorized by the DOT/OST, Office of International Aviation.

1.6 All foreign civil aircraft operated to, from, or within the U.S. must carry on board effective certificates of registration and air worthiness issued by the country of registry. Also, each member of the flight crew must carry a valid airman certificate or license authorizing that member to perform their assigned functions in the aircraft.

1.7 Transportation of firearms by aircraft passengers. Regulations of the Alcohol, Tobacco and Firearms Division of the Internal Revenue Service make it unlawful for any person knowingly to deliver or cause to be delivered to any common or contract carrier for transportation or shipment in interstate or foreign commerce, to persons other than licensed importers, licensed manufacturers, licensed dealers, or licensed collectors, any package or other container in which there is any firearm or ammunition without written notice to the carrier that such firearm or ammunition is being transported or shipped; except that any passenger who owns or legally possesses a firearm or ammunition being transported aboard any common or contract carrier for movement with the passenger in interstate or foreign commerce may deliver said firearm or ammunition into the custody of the pilot, captain, conductor or operator of such common or contract carrier for the duration of the trip.

1.8 Miscellaneous Information

1.8.1 Commercial air transport operators in the U.S. must adhere to Annex 6 – Operation of Aircraft with the proviso that aircraft which have no operators' local representative available to them will be required to carry a fixed fuel reserve of not less than 45 minutes at the approved fuel consumption rate plus a variable reserve equivalent to 15% of the fuel required from departure to destination and to an alternate if an alternate is required; or where the reserve calculated in accordance with the above exceeds two hours at the approved fuel consumption rate – two hours reserve fuel.

2. Scheduled Common Carriage Flights

2.1 General

2.1.1 Generally, when an operator of an aircraft advertises its transportation services to the general public or particular classes or segments of the public for compensation or hire, it is a common carrier. In turn, the transportation service the operator performs is considered to be in common carriage. The scheduled flights into, from and landing in the territory of the U.S. for purposes of loading or unloading passengers, cargo and mail (revenue flights), must first obtain from the U.S. DOT/OST, Office of International Aviation (X-40), a foreign air carrier permit. Applications for common carrier authority must be filed with X-40. If X-40, with the President's approval, determines that the carrier is fit, willing, and able to perform the service it proposes and that the service is in the public interest, X-40 shall issue the carrier a foreign air carrier permit, subject to the disapproval of the President of the U.S.

2.1.2 The scheduled flights in transit across the territory of the U.S. or landing for reasons other than for the purpose of loading and unloading of passengers, cargo or mail (nonrevenue flights), which are registered in a State which is a party to the International Air Services Transit Agreement, shall submit a notice of transit to X-40. The notice of transit must be submitted at least 15 days prior to the flight and must include:

2.1.2.1 Name, country of organization and nationality (including the nationality of all ownership interests) of the operator;

2.1.2.2 Name of the country in which the aircraft to be used in the service is registered;

2.1.2.3 A full description of the proposed operations including the type of operations (passenger, property, mail, or combination), date of commencement, duration and frequency of flights, and routing (including each terminal and intermediate point that will be served);

2.1.2.4 Copies of advertising of the flights, if advertised in the U.S.

2.1.3 If the notice is timely filed, the flights may be operated in the absence of a contrary notification from X-40.

2.1.4 Scheduled flights in transit across the territory of the U.S. or landing for reasons other than for the purpose of loading and unloading of passengers, cargo or mail (nonrevenue flights), which are registered in a State which is not a party to the International Air Services Transit Agreement, must obtain prior permission from X-40 at least 15 days prior to the flight. All permission requests must include the same information as requested in paragraph 2.1.2 (See also paragraph 1.5). The carrier may not transit U.S. territory unless and until it receives a foreign aircraft permit to do so from X-40.

2.1.5 The permission to transit U.S. territory as described above also includes the right to make stops in the U.S. for technical purposes (for example, refueling and servicing of the aircraft) as long as the stopover does not exceed 24 hours. Stopovers which do exceed 24 hours are permitted only in those cases where a transfer of passengers, property or mail to another aircraft is necessary for the safety of the aircraft, passengers, property, or crew. Stopovers for the pleasure or convenience of passengers are not included in the transit authority.

2.2 Documentary Requirements for Clearance of Aircraft

2.2.1 The undermentioned documents must be submitted to U.S. authorities for clearance on entry and departure of aircraft. All documents listed below must follow the ICAO standard format as set forth in the relevant appendixes to Annex 9, and are acceptable only when furnished in English.

2.2.2 Aircraft Documents Required (Arrival and Departure)

TBL GEN 1.2-1

Required by	General Declaration	*Passenger Manifest	Cargo Manifest
Customs Agriculture	1	0	1
Plant and Quarantine	1	0	1
Immigrations	1	0	1
Public Health	1	0	0
Total	4	0	3
*See paragraph 2.4 in GEN 1.3			

2.3 Public Health Measures Applied to Aircraft

2.3.1 At airports without Public Health Service Quarantine staff, the Customs, Immigration, or Agriculture Officer present will represent the Public Health Service.

2.3.2 No public health measures are required to be carried out with respect to aircraft entering U.S. territory except that disinfection of an aircraft may be required if it has left a foreign area that is infected with insect-borne communicable disease and the aircraft is suspected of harboring insects of public health importance. Disinfection is defined as: “The operation in which measures are taken to kill the insect vectors of human disease present in carriers and containers.”

2.3.3 Disinfection shall be the responsibility of the air carrier and shall be subject to monitoring by the Director of the Public Health Service.

2.3.4 Disinfection of the aircraft shall be accomplished immediately after landing and blocking. The cargo compartment shall be disinfected before the mail, baggage, and other cargo are discharged and the rest of the aircraft shall be disinfected after passengers and crew deplane.

2.3.5 Disinfection shall be performed with an approved insecticide in accordance with the manufacturer’s instructions. The current list of approved insecticides and sources may be obtained from the Division of Quarantine, Center for Prevention Services, Centers for Disease Control, Atlanta, GA 30333.

2.3.6 All food and potable water taken on board an aircraft at any airport and intended for human consumption thereon shall be obtained from sources

approved in accordance with Title 21, Code of Federal Regulations, Parts 1240 and 1250.

2.3.7 Aircraft inbound or outbound on an international flight shall not discharge over the U.S. any excrement or waste water or other polluting materials. Arriving aircraft shall discharge such matter only at servicing areas approved under regulations cited in paragraph 2.3.6 above.

2.3.8 Aircraft on an international voyage, which are in traffic between U.S. airports, shall be subject to inspection when there occurs on board, among passengers or crew, any death, or any ill person, or when illness is suspected to be caused by insanitary conditions.

3. Nonscheduled, Noncommon Carriage Flights

3.1 General

3.1.1 Nonscheduled, noncommon carriage flights are transportation services for remuneration or hire that are not offered to the general public.

3.1.2 Nonscheduled flights in transit across the territory of the U.S. or landing for reasons other than the purposes of loading and unloading passengers, cargo or mail (nonrevenue flights) which are registered in a State which is a member of the International Civil Aviation Organization (ICAO) may do so without the necessity of obtaining prior permission, provided passengers are not permitted to leave the airport during stopover or provided that each stopover does not exceed 24 hours. Stopovers which do exceed 24 hours are permitted only in those cases where a transfer of passengers, property or mail to another aircraft is necessary for the safety of the aircraft, passengers, property, or crew. Stopovers for the pleasure or convenience of passengers are not included in the transit authority.

3.1.3 Nonscheduled flights landing in the territory of the U.S. for reasons of loading or unloading passengers, cargo or mail (revenue flights), must obtain prior permission from the DOT/OST, Office of International Aviation (X-40), at least 15 days prior to the flight. All permission requests must include:

3.1.3.1 Name and address of applicant.

3.1.3.2 Aircraft make, model, and registration or identification marks.

3.1.3.3 Country in which the aircraft is registered.

3.1.3.4 Name and address of registered owner of aircraft.

3.1.3.5 Type of flight(s) (passenger, cargo, or agricultural or industrial operation).

3.1.3.6 Purpose of flight(s).

3.1.3.7 Date of the flight(s).

3.1.3.8 Routing of the flight(s).

3.1.3.9 Number of flights.

3.1.3.10 Name of charterer.

3.1.3.11 Charter price.

3.1.4 Applications should be made on DOT/OST, Office of International Aviation Form 4509; however, if time does not permit, applications by telegram will be accepted as long as they include the information described above. Telegraphic applications must include a prepaid voucher sufficient to allow a sixty word reply. The permit must be carried aboard the aircraft during flight over U.S. territory.

3.2 The following commercial air operations require preflight authorization from X-40:

3.2.1 Agricultural and industrial operations which include, but are not limited to, such services as crop dusting, pest control, pipeline patrols, mapping, surveying, banner towing, or skywriting.

3.2.2 Occasional and infrequent planeload charter flights carrying persons or property to and/or from the U.S. The number of these flights that may be performed is limited to six in any calendar year. Foreign civil aircraft are not permitted to transport persons or property or mail for compensation or hire between points wholly within the U.S.

3.2.3 Continuing cargo operations for one or more contractors. Applicants may be authorized to serve up to 10 different contractors in a 12-month period; however, authorization may be granted only if it is clear that the service is not in common carriage and the carrier and contractor enter into a contract which provides for (a) continuing cargo operations for a period of at least 6 months; (b) an absolute or minimum number of flights or volume of cargo to be transported; and (c) a guarantee by the contractor to the carrier to pay for the minimum number of flights to be performed or volume of cargo to be transported whether or not he/she uses the capacity. Continuing

cargo operations wholly within the U.S. cannot be authorized.

3.2.4 Persons wishing to operate foreign civil aircraft from, to, or within the U.S. other than as described in this Section may request permission to perform those services by filing an application with X-40. The application should include the information described above in this section. Permission to perform these services may be granted if X-40 finds that the service is consistent with applicable law and is in the interest of the public of the U.S.

3.2.5 Nonscheduled flights in transit across the territory of the U.S. or landing with or without purposes of loading and unloading passengers, cargo or mail (revenue or nonrevenue flights) which are registered in a State which is not a member of the International Civil Aviation Organization (ICAO) must obtain prior permission from X-40 at least 15 days prior to the flight. All permission requests must include the same information as requested in paragraph 3.1.3. (See also paragraph 1.5).

3.3 Documentary Requirements for Clearance of Aircraft

3.3.1 Same requirements as for scheduled flights; in addition, Customs Form 178 must be filled out for all private aircraft arrivals.

4. Private Flights

4.1 Procedures

4.1.1 Private aircraft that operate to, from, within, or transit territorial airspace of the United States must meet special security requirements in effect through Special Notices pursuant to 14 CFR Section 99.7, Special Security Instructions.

REFERENCE-

FAA Notices to Airmen (NOTAMS), Special Notices, at (http://www.faa.gov/pilots/flt_plan/notams/).
International Flight Information Manual for U.S. Prohibitions, Restrictions, and Notices, at (http://www.faa.gov/airports_airtraffic/air_traffic/publications/ifim/).

4.1.2 If an operator intends to carry out a private flight in transit across the territory of the U.S. with intermediate landing, the operator must provide advance notice of arrival to U.S. Customs officials at or nearest the first intended landing. Custom officials, upon notification, will notify the necessary Immigration, Public Health, and Agriculture officials. Advance notice must be received in sufficient time to enable the officials designated to inspect the aircraft

to reach the place of landing before the arrival of the aircraft. At least one hour advance notice is required for this purpose during regular business hours. More advance notice may be required during other times (see Aerodrome Section).

4.1.3 Notification of arrival must include:

4.1.3.1 Type of aircraft and registration number.

4.1.3.2 Name of aircraft commander.

4.1.3.3 Number of alien passengers.

4.1.3.4 Number of U.S. citizen passengers.

4.1.3.5 Place of last foreign departure.

4.1.3.6 Estimated time and location of crossing U.S. border/coastline.

4.1.3.7 Name of intended U.S. airport of first landing (designated airport).

4.1.3.8 Estimated time of arrival.

4.1.4 Private aircraft arriving from Canada or Mexico may request that advance notice of arrival to Customs officers be included in the flight plan to be transmitted to a Federal Aviation Administration (FAA) facility which is filed in those countries if destined to an airport in the U.S. where flight notification advise Customs (ADCUS) Service is available. An ADCUS message in the remarks section of the plan consists of the word ADCUS followed by the pilots name and the number of persons on board (POB) with a notation of the number of non-U.S. citizens (i.e.; ADCUS John Doe 5 POB 2 NON). This notification may be provided through FAA; however, this entails the relaying of information and is not as timely or reliable as direct communication. It is recommended that if possible, pilots attempt to communicate directly with Customs by telephone or other means to insure that an officer will be available at the time requested. It is the ultimate responsibility of the pilot to insure Customs is properly notified, and the failure to do so may subject the pilot to penalty action. At those airports where ADCUS service is available, the FAA will forward the ADCUS information to the Customs official on duty. At a landing rights airport such notices will then be treated as an application for permission to land. A flight plan notice must be filed sufficiently before the estimated time of arrival of the flight to permit Customs to make a determination as to whether or not to grant the requested landing rights.

4.1.5 Aircraft may use the following method of notifying Customs when departing from a country or remote area where a pre-departure flight plan cannot be filed or an advise Customs (ADCUS) message cannot be included in a pre-departure flight plan: Call the nearest en route domestic or international FAA flight service station as soon as it is estimated that radio communications can be established and file a VFR or DVFR flight plan and include as the last item the ADCUS information. The station with which such a flight plan is filed will forward it to the appropriate FAA station who will notify the Customs office responsible for the destination airport.

4.1.6 If the pilot fails to include “advise Customs” in the radioed flight plan, it will be assumed that the pilot has made other arrangements, and FAA will not advise Customs.

4.1.7 FAA assumes no responsibility for any delays in advising Customs if the flight plan is given to FAA too late for delivery to Customs before arrival of the aircraft. *It is still the pilot's responsibility to give timely notice even though a flight plan is given to FAA.* FAA cannot relay an “advise Customs” flight plan if the pilot indicates a destination airport where flight service notice to Customs is NOT available. When dependable facilities for giving timely notice of arrival are not available, a landing shall be made at a place where the necessary facilities do exist before coming into any area from any place outside the U.S.

4.1.8 All private aircraft arriving in the U.S. via (a) the U.S./Mexican border or the Pacific Coast from a foreign place in the Western Hemisphere south of 33 degrees north latitude or (b) the Gulf of Mexico and Atlantic Coasts from a foreign place in the Western Hemisphere south of 30 degrees north latitude, from any place in Mexico, or from the U.S. Virgin Islands, shall furnish a notice of intended arrival to the Customs service at the *nearest* designated airport, listed in paragraph 6., to the point of first border or coastline crossing. They must land at this airport for inspection, unless they have an overflight exemption, see paragraph 4.5. Landing rights must be obtained from Customs to land at designated airports that are *not* also approved as international airports. The requirement to furnish an advance notice of intended arrival shall not apply to private aircraft departing from Puerto Rico and conducting their flights under instrument flight rules (IFR) until crossing the U.S. coastline or proceeding north of 30 degrees north latitude prior to crossing the

coastline. The notice must be furnished at least one hour before crossing the U.S. coastline or border. The notice may be furnished directly to Customs by telephone, radio, or other means, or may be furnished by means of an ADCUS message in the flight plan through the FAA to Customs. The FAA will accept these notices up to 23 hours in advance.

4.1.9 A one-hour advance notice of coastline or border penetration (but not landing) is required of private aircraft arriving in the continental U.S. from Puerto Rico that are *not* conducting their flight on an IFR flight plan and those private aircraft that have flown beyond the inner boundary of the Air Defense Identification Zone (ADIZ) south of 30 degrees north latitude on the Atlantic Coast, beyond the inner boundary of the Gulf Coast ADIZ, south of the U.S./Mexican border, or beyond the inner boundary of the Pacific Coast ADIZ south of 33 degrees north latitude *which have not landed in a foreign place*. This notice requirement may be satisfied by either filing a flight plan with the FAA and placing ADCUS in the remarks section of the flight plan or by contacting Customs directly at least one hour prior to the inbound crossing of the U.S. border or coastline.

4.2 Notice to Customs

4.2.1 The notice to Customs required by paragraph 4.1.9 of this section shall include the following:

4.2.1.1 Aircraft registration number.

4.2.1.2 Name of aircraft commander.

4.2.1.3 Number of U.S. citizen passengers.

4.2.1.4 Number of alien passengers.

4.2.1.5 Place of last departure.

4.2.1.6 Estimated time and location of crossing U.S. border/coastline.

4.2.1.7 Name of U.S. airport of first landing (one of the designated airports listed in paragraph 6 of this section, unless an exemption has been granted in accordance with paragraph 4.5 of this section).

4.2.1.8 Estimated time of arrival.

4.3 Landing Requirement

4.3.1 Private aircraft that are coming from a foreign place are required to furnish a notice of intended arrival in compliance with paragraphs 4.1.9 and 4.2 of this section and must land for Customs processing

at the nearest designated airport to the border or coastline crossing point as listed in paragraph 6 of this section, unless exempted from this requirement in accordance with paragraph 4.5 of this section. In addition to the requirements of this paragraph, private aircraft commanders must comply with all other landing and notice of arrival requirements. This landing requirement shall not apply to private aircraft that have not landed in a foreign place or are arriving directly from Puerto Rico.

4.4 Private Aircraft Defined

4.4.1 For the purpose of this section, “private aircraft” means any civil aircraft not being used to transport persons or property for compensation or hire. The term “person transported for compensation or hire” means a person who would not be transported unless there was some payment or other consideration, including monetary or services rendered, by or for the person and who is not connected with the operation of the aircraft or its navigation, ownership, or business. An aircraft will be presumed to not be carrying persons or merchandise for hire, and thus will be a private aircraft for Customs purposes, when the aircraft is transporting only the aircraft owner’s employees, invited guests, or the aircraft owner’s own property. This presumption may be overcome by evidence that the employees, “guests,” or property are being transported for compensation or other consideration. If an aircraft is used by a group of individuals, one of whom is the pilot making the flight for his/her own convenience, and all persons aboard the aircraft including the pilot contribute equally toward payment of the expense of operating the aircraft owned or rented by them, the aircraft would be considered private.

4.5 Exemption from the Landing Requirement

4.5.1 The owner or aircraft commander of a private aircraft required to furnish a notice of intended arrival in compliance with paragraph 4.1.9 of this section may request an exemption from the landing requirement specified in paragraph 4.3 of this section. If approved, the applicant is bound to comply with all other requirements, including operating at or above 12,500 feet mean sea level, providing advance notice of penetration to U.S. Customs at least one hour in advance of crossing the border or coastline, furnishing advance notice of arrival at the first intended airport of landing, etc. The request should be addressed to the Port Director of U.S. Customs having jurisdiction over the airport to be utilized most

frequently when arriving from points south of the U.S. Requests for exemptions can be for either a single specific flight or term (one year) approval. Applications for a single overflight exemption must be received at least 15 days in advance of the intended date of arrival; for term exemption, at least 30 days in advance.

4.5.2 Air charters or taxi service cannot be granted an unqualified term exemption since they cannot reasonably comply with the requirements of a term application, namely, comprehensive details of the passengers they will transport in the course of one year. By submitting all other details, air charters/taxis will accrue the benefit of “conditional” approval. This approval is called conditional because the operator must receive the concurrence of the Port Director prior to each trip. Concurrence will be based upon factors such as the foreign point of departure to the U.S. and the passengers being transported. The benefit realized by the charter/taxi operator is that the time constraints listed above for timely submission of single overflight exemptions can be drastically reduced. Local Customs Ports will establish minimum time frames in accordance with their own requirements.

4.5.3 Required elements of any overflight exemption include the following:

4.5.3.1 Aircraft registration number and serial number.

4.5.3.2 Identification information for the aircraft (make, model, color scheme, and type, such as turboprop, etc.).

4.5.3.3 A statement that the aircraft is equipped with a functioning mode C (altitude reporting) transponder which will be in use during the overflight.

4.5.3.4 A statement that the aircraft is capable of flying above 12,500 feet and that it will be operated at such an altitude when utilizing the overflight exemption unless ordered to fly at a lower altitude by FAA air traffic controllers.

4.5.3.5 Names, home addresses, social security numbers (optional), and dates of birth of owners of the aircraft. (If the aircraft is being operated under a lease, the name and address of the lessee, in addition to that of the owner.)

4.5.3.6 Names, home addresses, social security numbers (optional), dates of birth, and any FAA

certificate numbers of all crew members that the applicant wishes to have approved. Individual applications from each crew member must also be attached and should take the form of a signed letter from the crew member in question. The applicant must verify the accuracy of the information provided by the crew member to the best of the applicants ability. The application must contain a statement to this effect.

4.5.3.7 Names, home addresses, social security numbers (optional), and dates of birth of usual and potential passengers to the greatest extent possible. An approved passenger must be on board to utilize the overflight exemption.

4.5.3.8 Description of usual or anticipated cargo or baggage.

4.5.3.9 Description of the company’s usual business activity, if the aircraft is company owned.

4.5.3.10 Name of intended airport(s) of first landing in the U.S. (The overflight exemption will only be valid to fly to airports preapproved by Customs).

4.5.3.11 Foreign place(s) from which the flight(s) will originate.

4.5.3.12 Reason for the request of overflight exemption.

4.5.4 Information should be as complete and accurate as possible and should be specific rather than general. The following points will assist in preparing an acceptable application:

4.5.4.1 Include all potential crew members who might be present on the aircraft during the term of the desired exemption. In order for overflight exemptions to remain valid, all crew members on a flight must have been listed on your application.

4.5.4.2 Provide as many identifiers as possible for all crew and passengers. Social security numbers, passport numbers, aircraft pilot license numbers, etc., will contribute greatly to expediting background investigations.

4.5.4.3 Describe the type of business the corporation is engaged in. If the corporation that owns the aircraft is merely an air transportation service for the benefit of an affiliated company, please provide details.

4.5.4.4 List the foreign cities and countries the aircraft will visit. It is to your advantage to describe the nature of your business in each location, or to

indicate that certain destinations are vacation/entertainment locations.

4.5.4.5 The reason for overflight exemption requests should be as tangible and concretely stated as possible. Estimate the costs incurred by making an extra landing at a “designated airport” (fuel, wear on aircraft components, landing fees, additional time/distance).

4.5.4.6 Provide an estimate of the number of nautical flying miles which will be saved on an annual basis if the exemption is granted.

4.5.4.7 Companies involved in air ambulance-type operations may be granted a single overflight exemption when emergency situations arise, as well as in the case of nonemergency transport for individuals seeking medical treatment. Both U.S. and foreign registered aircraft will be eligible for the special exemption. The applicant must provide all the necessary information normally required for an overflight exemption. Customs should be notified at least 24 hours prior to departure. If this cannot be accomplished, Customs will allow receipt of the overflight exemption application up to departure time, as well as in flight through a flight service station.

4.5.5 Applicants should be aware that the processing of term applications requires time for all background reports to be prepared for the deciding official. Incomplete applications will not be processed, and the applicant will be notified of the specific additional information that must be supplied. Should an application for overflight be denied at the district level, an appeal process is available. Letters of denial will include the name and address of the Service/Area Director of Customs responsible for the district office that denied your application. You may petition the Service/Area Director for reconsideration of your request.

5. Public Health Measures Applied to Aircraft

5.1 Same requirements as for scheduled flights.

6. Airports Designated as Entry Points

6.1 Airports Designated as Entry Points for Aircraft Arriving from Mexico and Other Foreign Countries

in the Western Hemisphere South of 30 Degrees North Latitude.

TBL GEN 1.2-2

Location	Airport Name
ARIZONA	
Douglas	Bisbee-Douglas International
Douglas	Douglas Municipal
Nogales	Nogales International
Tucson	Tucson International
Yuma	Yuma International
CALIFORNIA	
Calexico	Calexico International
San Diego	Brown Field
FLORIDA	
Fort Lauderdale	Fort Lauderdale Executive
Fort Lauderdale	Fort Lauderdale-Hollywood International
Key West	Key West International
Miami	Miami International
Miami	Opa-Locka
Miami	Tamiami
West Palm Beach	Palm Beach International
Fort Pierce	St. Lucie County
Tampa	Tampa International
LOUISIANA	
New Orleans	New Orleans Lakefront
New Orleans	New Orleans International (Moisant Field)
NEW MEXICO	
Santa Teresa	Santa Teresa
NORTH CAROLINA	
Wilmington	New Hanover County
TEXAS	
Beaumont	Jefferson County
Brownsville	Brownsville International
Corpus Christi	Corpus Christi International
Del Rio	Del Rio International
Eagle Pass	Eagle Pass Municipal
El Paso	El Paso International
Houston	William P. Hobby
Laredo	Laredo International
McAllen	Miller International
Presidio	Presidio-Lely International

7. Entry and Clearance – Cuba

7.1 Aircraft arriving from or departing for Cuba must land at or depart from Miami International Airport. Upon arrival, the pilot will present a manifest of all passengers on board to an officer of the U.S. Immigration and Naturalization Service or to a Customs officer acting as an Immigration officer. No passenger arriving from Cuba by aircraft will be released by Customs, nor will the aircraft be cleared or permitted to depart before the passenger is released

by an Immigration officer or a Customs officer acting on behalf of that agency.

7.2 Aircraft proceeding to Cuba are required to have a validated license issued by the Department of Commerce or a license issued by the Department of State.

7.3 These special requirements do not apply to aircraft arriving from or departing to the U.S. Naval Base at Guantanamo Bay. Aircraft from this base must meet the same requirements as aircraft arriving from other Caribbean nations.

GEN 1.3 Entry, Transit, and Departure of Passengers and Crew

1. Customs Requirements

1.1 Incoming passengers are required to complete a customs declaration. All baggage or articles belonging to the disembarking passengers are subject to customs inspection. Permission of the Customs officer is required prior to discharging any merchandise or baggage not previously cleared by Customs or prior to permitting passengers or persons employed on the aircraft not cleared by Customs to depart unless such removal or departure is necessary for the purpose of safety or the preservation of life or property. In case of an emergency or forced landing, Customs, Immigration, Public Health, and Agriculture officials must be notified immediately.

1.2 No departure formalities are required upon departure for embarking passengers.

1.3 Any aircraft departing from the U.S. on a business or pleasure flight to unauthorized destinations (see GEN 1.4, paragraphs 3.3 and 3.4) or aircraft carrying passengers or merchandise for hire, or which will take on board or discharge passengers anywhere outside the U.S., is required to obtain clearance at the customs port of entry at or nearest the last place of take-off from the U.S.

1.4 A private aircraft departing from the U.S. on a business or pleasure flight to an authorized destination, is not required to present a departure manifest or have a U.S. Customs clearance of any type, although modified, military-type, privately owned aircraft are subject to certain restrictions (see GEN 1.4, paragraph 5.8) under the regulations of the Office of Munitions Control of the Department of State.

2. Immigration Requirements

2.1 Aircraft operators are required to present all persons for U.S. immigration inspection. Aliens must comply with all provisions of current immigration laws and regulations. Aliens who are lawfully domiciled residents of the U.S., must, with certain exceptions not generally applicable here, present their valid alien registration cards (Form I-151) issued by the Immigration Office. U.S. citizens must be able to satisfy inspectors of their citizenship and

should, therefore, carry with them sufficient identification.

2.2 Valid passports and visas are required for all alien passengers arriving and departing on the same or through flights or transferring to another flight at the same or a nearby airport. The visa requirement may be exempted for passengers in direct transit with a layover period of up to eight hours who are passengers on scheduled air carriers which are signatory to a previously approved transit agreement with the Immigration and Naturalization Service.

2.3 An alien passenger entering the U.S. for the purpose of immigration must hold a valid passport and an immigration visa, the latter being issued at U.S. Consulates abroad. Temporary visitors must be in possession of a valid passport and visa.

2.4 Flight crew members must be in possession of a valid passport and visa regardless of length of stay unless the crew members are exempted through previous agreement. (See paragraph 2.2.)

2.5 Arrival and Departure Manifests

2.5.1 Neither arrival nor departure manifests containing information on all passengers are required in the U.S. However, the U.S. Immigration and Naturalization Service does require the completion and submission to immigration officials, of an arrival/departure card for each nonresident alien entering the U.S., regardless of length of stay.

2.6 Arriving Flights

2.6.1 The captain or agent of every aircraft (other than private) arriving in the U.S. from a foreign place or from an outlying possession of the U.S. is responsible for and must ensure that an arrival/departure card (Form I-94) is prepared by each nonresident alien passenger and is presented to the immigration officer at the port of arrival. The I-94 card, however, is not required for the citizens of Canada and the French islands of St. Pierre and Miquelon, near Newfoundland. In addition, an arrival/departure card is not required for an arriving, direct transit passenger at a U.S. port from which the passenger will depart directly to a foreign place or an outlying possession of the U.S. on the same flight, provided that a listing which includes the number of such direct transit

passengers is provided or that the number of such passengers are noted on the U.S. Customs Service Form 7507 or on the International Civil Aviation Organization's General Declaration and such passengers remain, during ground time, in a separate area under the direction and control of the Customs Service.

2.6.2 Captains of private aircraft not engaged in the carriage of persons or cargo for hire (nonrevenue flights) are not required to present arrival-departure cards (Form I-94). This, however, does not relieve a nonresident alien passenger from the responsibility of completing and submitting a Form I-94 to immigration officials when required. Most alien passengers must execute and present Form I-94 (revised March 1, 1986). Prior editions may not be used. Form I-94 must be completed by all persons except U.S. citizens, returning resident aliens, aliens with immigrant visas, and Canadians visiting or in transit. Mexican nationals in possession of Immigration Form I-86 or Form I-586 are exempt from Form I-94 reporting requirements when their itinerary is limited to California, Arizona, New Mexico, or Texas and will not exceed 72 hours in duration. This exemption does not apply when travel will exceed 25 miles from the international border between Mexico and the U.S. Travel to Nevada by Mexican nationals is exempted for periods of less than 30 days. Mexican nationals proceeding to destinations more than 25 miles from the border in these states will have to obtain a visitor's permit I-444 when arriving in the U.S. Mexican nationals presenting official or diplomatic passports and destined to the U.S. for purposes other than permanent assignment are exempted from Form I-94 reporting requirements.

2.6.3 Completion of the arrival-departure cards (Form I-94) must be as follows:

2.6.3.1 Alien passengers on temporary visit in the U.S. must complete all items of Form I-94 in duplicate, one copy of which is attached to the passport for surrender to immigration officials upon departure.

2.6.3.2 Alien passengers in direct transit, when required to complete Form I-94, are to insert the symbol TRWOV on the line headed "Passenger Boarded At" and need not complete items 3, 8, and 9. Form I-94 is to be completed in single copy only.

2.6.3.3 When the Form I-94 is required by individuals entering the U.S. by private aircraft it should indicate PRIVATE in block #7-Airline and Flight Number. They do not need to complete block #9-City Where You Boarded. All other items on the form are self-explanatory and should be completed prior to actual arrival in the U.S.

2.6.4 When inspection of an arriving passenger is deferred at the request of the air carrier to another port of debarkation, the required forms relating to any such passenger shall be returned, together with a Form I-92, when the Form I-94 procedure is used, for presentation by the captain, master, or agent at the port where inspection is to be conducted.

2.7 Departing Flights

2.7.1 The captain or agent of every aircraft (other than private) departing from the U.S. for a foreign place or an outlying possession of the U.S. is responsible for and must ensure that all alien passengers on board (except for citizens of Canada and the French islands of St. Pierre and Miqueion, near Newfoundland), surrender to the immigration officer at the port of departure, prior to departure, the passport copy of the arrival/departure card (Form I-94) which was completed upon arrival in the U.S. Aircraft departing on regularly scheduled flights from the U.S., however, may collect the cards and defer their presentation, along with either the Bureau of Customs Form 7507 or the ICAO General Declaration, containing the listing of alien direct transit passengers for whom the arrival/departure card was not prepared upon arrival.

2.7.2 Private aircraft owners are responsible for the proper completion and submission of Form I-94 for all crew and passengers affected by the reporting requirement. Departure documents should be annotated on the reverse of the document to indicate Port of Departure and Date of Departure. Following Carrier, print the word PRIVATE. In the space provided for Flight Number/Ship Name, print the aircraft's tail number. Departure documents should be submitted to a U.S. Immigration or U.S. Customs inspector at the time of departure from the U.S. or mailed to the Appalachian Computer Service address in London, KY. Aircraft owners are responsible for the submission of all I-94 Departure Records upon departure to a foreign destination.

2.7.3 Resident aliens of the U.S. who will be traveling abroad under a foreign passport must ensure that their Alien Registration Card, Form 151, is available for presentation to gain re-entry into the U.S. upon completion of trip.

2.8 Currency Reporting Requirements

2.8.1 There is no limitation in terms of the total amount of monetary instruments which may be brought into or taken out of the U.S., nor is it illegal to do so. However, if you transport or cause to be transported (including by mail or other means), more than \$10,000 in monetary instruments on any occasion into or out of the U.S., or if you receive more than that amount, you must file a report (Customs Form 4790) with U.S. Customs (Currency and Foreign Transactions Reporting Act, 31 U.S.C. 1101, et seq.). Monetary instruments include U.S. or foreign coin in current circulation, currency, traveler's checks, money orders, and negotiable instruments or investment securities in bearer form. Failure to comply can result in civil and criminal penalties.

3. Public Health Requirements

3.1 Disembarking passengers are not required to present a vaccination certificate except when coming

directly from an area infected with cholera, yellow fever, or smallpox. Smallpox vaccination is necessary only if, within the 14 days before arrival, the traveler has been in a country reporting smallpox.

3.2 The pilot in command of an aircraft destined for a U.S. airport must report immediately to the Quarantine Station at or nearest the airport at which the aircraft will arrive, the occurrence, on board, of any death or any ill person among passengers or crew. Ill person is defined as:

3.2.1 Temperature of 100 degrees Fahrenheit (38 degrees Celsius) or greater accompanied by rash, glandular swelling, or jaundice, or which has persisted for more than 48 hours; or

3.2.2 Diarrhea, defined as the occurrence in a 24-hour period of three or more loose stools or of a greater than normal (for the person) amount of loose stools.

3.3 The pilot in command is responsible for detaining the aircraft and persons and things arriving thereon and keeping them free from unauthorized contact pending release when required by Sections 71.31, 71.46, 71.62, 71.63, and 71.102 of the Foreign Quarantine Regulations of the Public Health Service (Part 71, Title 42, Code of Federal Regulations).

GEN 1.4 Entry, Transit, and Departure of Cargo

1. Requirements Concerning Cargo and Other Articles

1.1 Customs entry and clearance of cargo and unaccompanied baggage destined for points within U.S. territory must be completed at the first international airport of entry.

1.2 Transshipment of cargo and other articles must be dealt with at the first international airport of entry according to related regulations. All aircraft entering the U.S. or arriving any place in the U.S. from any other place in the U.S. carrying residue foreign cargo shall not depart from the place of landing without receiving permission from the Customs officer.

2. Agricultural Quarantine Requirements

2.1 The U.S. Department of Agriculture, Plant Protection and Quarantine Division (PPQ), has strict requirements regarding the entry, handling and disposition of garbage and galley refuse on all flights arriving from any foreign country, except Canada (7 CFR Parts 94 and 330). A list of sanitary international airports approved by PPQ can be secured from any PPQ office at major airports (see Aerodrome Section).

2.2 Meat, meat products, milk, live birds, poultry, or other domestic farm animals can only enter the U.S. under certain conditions from certain countries under the regulations of the PPQ.

2.3 No insects or other plant pests shall knowingly be transported into the U.S. If the pilot of any aircraft has reason to believe any flying or crawling insects are aboard his/her aircraft, such information should be relayed to the nearest PPQ office or inspector when landing.

2.4 Permits are required to bring most fruits, vegetables, plants, seeds, etc., into the U.S. from foreign countries. A guide to restricted or prohibited products can be secured from any PPQ office.

2.5 Dogs, cats, monkeys, psittacine birds (parrot family), turtles, shipments of disease organisms and vectors, and dead bodies are subject to entry

restrictions prescribed in the Foreign Quarantine Regulations of the Public Health Service (42 CFR Part 71, Subject J).

3. Exportation of Aircraft, Cargo, and Other Articles

3.1 All U.S. and foreign registered aircraft departing the U.S. for a foreign destination on a temporary sojourn must have export authorization. The two types of export authorization are a license exception (AVS) and a license. Detailed information on both the license exception and the license can be obtained from:

The U. S. Department of Commerce
Bureau of Export Administration
Exporter Counseling Division
Washington, DC 20230
Telephone: (202) 482-4811
Facsimile: (202) 482-3617

3.2 A license exception (AVS) is an authorization to export the aircraft if certain criteria are satisfied. This exception does not require an application nor will there be an issuance of a license document prior to the flight.

REFERENCE-
15 CFR Section 740.15

3.3 License exception AVS authorizes an operating civil aircraft of foreign registry that has been in the U.S. on a temporary sojourn to depart from the U.S. under its own power for any destination, provided that:

3.3.1 No sale or transfer of operational control of the aircraft to nationals of Cuba, Iran, Iraq, Libya, North Korea, Sudan, or Syria has occurred while in the U.S.

3.3.2 The aircraft is not departing for the purpose of sale or transfer of operational control to nationals of Cuba, Iran, Iraq, Libya, North Korea, Sudan, or Syria; and

3.3.3 It does not carry from the U.S. any item for which an export license is required and has not been granted by the U.S. Government.

3.4 License exception AVS authorizes a civil aircraft of U.S. registry operating under an Air Carrier Operating Certificate, Commercial Operating Certificate, or Air Taxi Operating Certificate issued by the Federal Aviation Administration or conducting flights under operating specifications approved by the Federal Aviation Administration pursuant to 14 CFR Part 129 of the regulations of the Federal Aviation Administration, may depart from the U.S. under its own power for any destination provided that:

3.4.1 The aircraft does not depart for the purpose of sale, lease or other disposition of operational control of the aircraft or its equipment, parts, accessories, or components to a foreign country or any national thereof.

3.4.2 The aircraft's U.S. registration will not be changed while abroad.

3.4.3 The aircraft is not to be used in any foreign military activity while abroad; and

3.4.4 The aircraft does not carry from the U.S. any item for which a license is required and has not been granted by the U.S. Government.

3.5 License exception AVS authorizes any other operating civil aircraft of U.S. registry to depart from the U.S. under its own power for any destination, except to Cuba, Iran, Iraq, Sudan, Syria, Libya, and North Korea (flights to these destinations require a license), provided that:

3.5.1 The aircraft does not depart for the purpose of sale, lease or other disposition of operational control of the aircraft, or its equipment, parts, accessories, or components to a foreign country or national thereof.

3.5.2 The aircraft's U.S. registration will not be changed while abroad.

3.5.3 The aircraft is not to be used in any foreign military activity while abroad.

3.5.4 The aircraft does not carry from the U.S. any item for which an export license is required and has not been granted by the U.S. Government; and

3.5.5 The aircraft will be operated while abroad by a U.S. licensed pilot, except that during domestic flights within a foreign country, the aircraft may be operated by a pilot currently licensed by that foreign country.

3.6 A license authorizes the departure of the aircraft within the special limitations set forth in the license document. It is issued only on the basis of a formal application requesting the issuance of a license prior to the flight.

3.7 Once it has been determined that an export license is required, an application for the license should be submitted to the Bureau of Export Administration, U.S. Department of Commerce. An application consists of Form BXA-748P (multipurpose application). This form and information on the application process can be obtained free of charge from either the U.S. Department of Commerce in Washington or any of its District Offices. (See paragraph 4.)

3.8 Applications for validated licenses by non-U.S. citizens require that the applicant appoint an agent subject to U.S. jurisdiction to act in his/her behalf. If an emergency situation necessitates the expedition of the application process, contact the Counseling Division Staff of the Bureau of Export Administration (telephone 202-482-4811) or any Department of Commerce District Office for assistance.

4. Department of Commerce District Office Locations

TBL GEN 1.4-1

State	City
Alabama	Birmingham
Alaska	Anchorage
Arizona	Phoenix
California	Los Angeles
California	San Francisco
Colorado	Denver
Connecticut	Hartford
Florida	Miami
Georgia	Atlanta
Georgia	Savannah
Hawaii	Honolulu
Illinois	Chicago
Indiana	Indianapolis
Iowa	Des Moines
Louisiana	New Orleans
Maryland	Baltimore
Massachusetts	Boston
Michigan	Detroit
Minnesota	Minneapolis
Missouri	St. Louis
Nebraska	Omaha
Nevada	Reno
New Jersey	Newark
New Mexico	Albuquerque
New York	Buffalo
New York	New York
North Carolina	Greensboro
Ohio	Cincinnati
Ohio	Cleveland
Oregon	Portland
Pennsylvania	Philadelphia
Pennsylvania	Pittsburgh
Puerto Rico	San Juan
South Carolina	Columbia
Tennessee	Memphis
Texas	Dallas
Texas	Houston
Utah	Salt Lake City
Washington	Seattle

West Virginia	Charleston
Wisconsin	Milwaukee
Wyoming	Cheyenne

5. Regulations Concerning Civil Movement of Arms, Ammunition, and Military Type Aircraft

5.1 Importation of military type aircraft and the carriage or importation of firearms or ammunition are regulated by the U.S. Department of the Treasury, Division of Alcohol, Tobacco and Firearms.

5.2 A permit must be obtained from the Alcohol, Tobacco and Firearms Division for the importation of certain military type aircraft regardless of demilitarization. Aircraft that are exempt from permits are specifically listed in the regulations on Importation of Arms, Ammunition and Implements of War (26 CFR Part 180).

5.3 A permit must be obtained from the Alcohol, Tobacco and Firearms Division for the importation of firearms and ammunition for commercial transactions.

5.4 Transportation or shipment of firearms or ammunition in interstate or foreign commerce to persons other than licensed importers, licensed manufacturers, licensed dealers or licensed collectors, without written notice to the carrier that such firearms or ammunition is being transported or shipped is unlawful.

5.5 Any passenger who owns or legally possesses a firearm or ammunition being transported aboard any common or contract carrier for movement with the passenger must deliver said firearm or ammunition into the custody of the pilot, captain, conductor, or operator of such common or contract carrier for the duration of the trip.

5.6 Applications for permits should be made on Form 6 (Firearms), preferably 30 days in advance of importation. Form IRS-4522, International Import Certificate, may also be required by the exporting country and should accompany applications on Form 6 (Firearms) when necessary.

5.7 Exportation of military type aircraft are regulated by the U.S. Department of State, Office of Munitions Control.

5.8 A license must be obtained from the Office of Munitions Control, Department of State, for the exportation from the U. S. of certain military type aircraft regardless of demilitarization. Aircraft that are exempt from licenses are specifically listed in the regulations on International Traffic in Arms (22 CFR Part 121). Applications for licenses are made as follows:

5.8.1 For permanent export, on Form DSP-5. Apply at least 30, preferable 60, days in advance. A Form DSP-63a may also be required from the importing country.

5.8.2 For temporary export, on Form DSP-73. Apply at least 10 days in advance.

GEN 1.5 Aircraft Instruments, Equipment, and Flight Documents

1. General

1.1 Commercial air transport aircraft operating in the U.S. airspace must adhere to the provisions of

Annex 6, Operation of Aircraft, Part One, Chapter Six (Airplane Instruments, Equipment and Flight Documents) and Chapter Seven (Airplane Communications and Navigation Equipment).

GEN 1.6 Summary of National Regulations and International Agreements/Conventions

1. Summary of National Regulations

1.1 Air regulations for the U.S. and areas under its jurisdiction are published in Title 14 of the U.S. Code of Federal Regulations (CFR) Parts 1-199, entitled the Federal Aviation Administration, Department of Transportation. It is essential that persons engaged in air operations in the U.S. airspace be acquainted with the relevant regulations. Copies of the 14 CFR parts may be purchased from the:

Superintendent of Documents
Attn: New Orders
P.O. Box 371954
Pittsburgh, PA 15250-7954
Telephone: 202-512-1800

The Code of Federal Regulations is available electronically at:

<http://www.gpoaccess.gov/nara/index.html>

1.2 The following is a partial list of Federal Aviation Regulations and their respective subject matter:

TBL GEN 1.6-1

14 CFR Part No.	Title
1	Definitions and abbreviations
11	General rulemaking procedures
13	Investigative and enforcement procedures
21	Certification procedures for products and parts
23	Airworthiness standards: normal, utility, acrobatic, and commuter category airplanes
25	Airworthiness standards: transport category airplanes
27	Airworthiness standards: normal category rotorcraft
29	Airworthiness Standards: transport category rotorcraft
31	Airworthiness standards: manned free balloons
33	Airworthiness standards: aircraft engines

14 CFR Part No.	Title
35	Airworthiness standards: propellers
36	Noise standards: aircraft type and airworthiness certification
39	Airworthiness directives
43	Maintenance, preventive maintenance, rebuilding, and alteration
45	Identification and registration marking
47	Aircraft registration
49	Recording of aircraft titles and security documents
61	Certification: Pilots, flight instructors, and ground instructors
63	Certification: Flight crewmembers other than pilots
65	Certification: Airmen other than flight crewmembers
67	Medical standards and certification
71	Designation of Class A, B, C, D, and E airspace areas; airways; routes; and reporting points
73	Special use airspace
77	Objects affecting navigable airspace
91	General operating and flight rules
93	Special air traffic rules and airport traffic patterns
95	IFR altitudes
97	Standard instrument approach procedures
99	Security control of air traffic
101	Moored balloons, kites, unmanned rockets, and unmanned free balloons
103	Ultralight vehicles
105	Parachute jumping
107	Airport security
108	Airplane operator security
109	Indirect air carrier security
119	Certification: Air carriers and commercial operators
121	Operating requirements: Domestic, flag, and supplemental operations

14 CFR Part No.	Title
125	Certification and operations: Airplanes having a seating capacity of 20 or more passengers or a maximum payload capacity of 6,000 pounds or more
129	Operations: Foreign air carriers and foreign operations of U.S. registered aircraft engaged in common carriage
133	Rotorcraft external load operations
135	Operating requirements: Commuter and on-demand operations
137	Agricultural aircraft operations
139	Certification and operations: Land airports serving certain air carriers
141	Pilot schools
142	Training centers
145	Repair stations
147	Aviation maintenance technician schools
150	Airport noise compatibility planning
151	Federal aid to airports
152	Airport aid program
155	Release of airport property from surplus property disposal restrictions

14 CFR Part No.	Title
156	State block grant pilot program
157	Notice of construction, alteration, activation, and deactivation of airports
158	Passenger facility charges (PFCs)
161	Notice and approval of airport noise and access restrictions
169	Expenditure of Federal funds for nonmilitary airports or air navigation facilities thereon
170	Establishment and discontinuance criteria for air traffic control services and navigational facilities
171	Non-Federal navigation facilities
183	Representatives of the Administrator
185	Testimony by employees and production of records in legal proceedings, and service of legal process and pleadings
187	Fees
189	Use of Federal Aviation Administration communications system
191	Protection of sensitive security information
198	Aviation insurance

GEN 1.7 Differences From ICAO Standards, Recommended Practices and Procedures

NOTE-

See GEN 1.6 for the availability of Title 14 of the U.S. Code of Federal Regulations Parts 1-199.

ANNEX 1 - PERSONNEL LICENSING	
Chapter 1	Definitions and General Rules Concerning Licences
1.1 Chapter 1 Std.	The U.S. does not require the training organizations to have a quality assurance system as outlined in ICAO Annex 1, Appendix 2, Item 3.
1.1 Chapter 1 Std.	The U.S. issues a certificate and ATC ratings, not a license
1.2.5.2 Chapter 1 Std.	The maximum validity allowed for non-FAA air traffic controllers (required to hold an FAA Second-Class airman medical certificate) is 12 months. The maximum validity allowed for FAA air traffic controllers is 24 months for those under age 40 who work at FAA terminals or centers. Free balloon and glider pilots are not required to hold medical certificates but are prohibited from operating during periods of medical deficiency.
1.2.5.2.2 Chapter 1 Std.	U.S. commercial pilots engaged in single-crew, commercial air transport operations carrying passengers have a 12-month validity on their medical assessments regardless of age.
1.2.5.2.4 Chapter 1 Rec.	Free balloon and glider pilots are not required to hold a medical certificate but are prohibited from operating during periods of medical deficiency. Private pilots over age 50 have a 24-month validity on their medical assessments.
1.2.5.2.5 Chapter 1 Std.	The U.S. does not defer medical examinations.
1.2.9.1 Chapter 1 Std.	The United States has no "retesting" requirement, as applicants must be able to read, speak, write and understand the English language at license issue.
1.2.9.2 Chapter 1 Std.	The U.S. does not require Air traffic controllers or aeronautical station operators to demonstrate the ability to speak and understand the language.
Chapter 2	Licences and Ratings for Pilots
2.1.9.3 Chapter 2 Std.	The United States permits some SIC time to meet the total flight time requirements but not all SIC time is creditable.
2.2.3 Chapter 2 Std.	Student pilots must meet the requirements of an FAA Third-Class medical certificate which, though not identical, meet the intent of ICAO Class 2.
2.3.1.6 Chapter 2 Std.	Private pilots must meet the requirements of an FAA Third-Class Medical Certificate which, though not identical, meet the intent of ICAO Class 2.
2.4.1.6 Chapter 2 Std.	Commercial pilots must meet the requirements of an FAA Second-Class Medical Certificate which, though not identical, meet the intent of ICAO Class 1.
2.5.1.1 Chapter 2 Std.	Minimum age is 23 years.
2.5.1.6 Chapter 2 Std.	Airline transport pilots must meet the requirements of an FAA First-Class Medical Certificate which, though not identical, meet the intent of ICAO Class 1.

2.6.1.5.1 Chapter 2 Std.	Private pilots who hold an airplane instrument rating are not required to comply with ICAO Class 1 hearing standards. U.S. hearing requirements are identical for FAA First- and Third-Class medical certificates and, though not identical to ICAO, meet the intent of ICAO Class 1 hearing standards.
2.6.1.5.2 Chapter 2 Rec.	Private pilots are not required to comply with ICAO Class 1 physical, mental, and visual requirements to hold an airplane instrument rating.
2.7.1.6 Chapter 2 Std.	Private pilots must meet the requirements of an FAA Third-Class Medical Certificate which, though not identical, meet the intent of ICAO Class 2.
2.8.1.6 Chapter 2 Std.	Commercial pilots must meet the requirements of an FAA Second-Class Medical Certificate which, though not identical, meet the intent of ICAO Class 1.
2.9.1.6 Chapter 2 Std.	Airline transport pilots must meet the requirements of an FAA First-Class Medical Certificate which, though not identical, meet the intent of ICAO Class 1.
2.10.1.5.1 Chapter 2 Std.	Private pilots who hold a helicopter instrument rating are not required to comply with ICAO Class 1 hearing standards. U.S. hearing requirements are identical for FAA First- and Third-Class medical certificates and, though not identical to ICAO, meet the intent of ICAO Class 1 hearing standards.
2.10.1.5.2 Chapter 2 Rec.	Private pilots are not required to comply with ICAO Class 1 physical, mental, and visual requirements to hold a helicopter instrument rating.
2.12.1.5 Chapter 2 Std.	Glider pilots are not required to hold a medical certificate but are prohibited from operating during periods of medical deficiency.
2.13.1.5	Free balloon pilots are not required to hold a medical certificate but are prohibited from operating during periods of medical deficiency.
Chapter 3	Licences for Flight Crew Members Other Than Licences for Pilots
3.2.1.5 Chapter 3 Std.	Flight navigators must meet the requirements of an FAA Second-Class medical certificate which, though not identical, meet the intent of ICAO Class 1.
3.3.1.5 Chapter 3 Std.	Flight engineers must meet the requirements of an FAA Second-Class medical certificate which, though not identical, meet the intent of ICAO Class 1.
Chapter 4	Licences and Ratings for Personnel Other Than Flight Crew Members
4.2.2.3.1 Chapter 4 Rec.	The United States endorses the certification privileges on the licence.
4.2.2.4 Chapter 4 Std.	The United States does not allow an approved maintenance organization to appoint non-licensed personnel to exercise the privileges of 4.2.2 within the U.S.
4.3.1.3 Chapter 4 Std.	a) No experience is required for applicants who have satisfactorily completed an approved training course. b) 18 months' experience is required.
4.3.1.4 Chapter 4 Std.	Non-FAA air traffic controllers must meet the requirements of an FAA Second-Class medical certificate which, though not identical, meet the intent of ICAO Class 3.
4.4.2.2.1 Chapter 4 Std.	There is no minimum experience requirement for ratings other than control tower.
4.5.1.1 Chapter 4 Std.	The United States requires the applicant shall not be less than 23 years of age.
4.5.1.3.2 Chapter 4 Std.	The United States permits the applicant to have two years of experience in the last three years.
Chapter 5	Specifications for Personnel Licences
5.1.3.1 Chapter 5 Std.	The United States is transitioning to a plastic multi color certificate.

5.1.3.2 Chapter 5 Std.	The FAA is transitioning to a plastic multi color certificate.
Chapter 6	Medical Provisions for Licencing
6.3.1.2 Chapter 6 Std.	An FAA First-Class medical certificate is required when exercising the privileges of an airline transport pilot and an FAA Second-Class medical certificate is required when exercising the privileges of a commercial pilot, a flight engineer, or a flight navigator.
6.3.2.6 Chapter 6 Std.	Electrocardiography is required for airline transport pilots but not for commercial pilots.
6.3.2.6.1 Chapter 6 Std.	Electrocardiography is required in re-examination of airline transport pilot applicants over the age of 40 every 12 months. Electrocardiography is not specifically required for commercial pilots unless clinically indicated.
6.3.2.6.2 Chapter 6 Rec.	Electrocardiography is required in re-examination of airline transport pilot applicants over the age of 40 every 12 months. Electrocardiography is not specifically required for commercial pilots unless clinically indicated.
6.3.2.9.1 Chapter 6 Rec.	Chest radiography is not specifically required unless clinically indicated.
6.3.3.4 Chapter 6 Std.	The demonstration of compliance with the visual requirements to be made with only one pair of correcting lenses is not specifically required.
6.3.3.4.1 Chapter 6 Std.	A requirement that a spare set of corrective lenses be readily available when exercising privileges is not established.
6.3.4.1.1 Chapter 6 Std.	Applicants are not required to demonstrate normal hearing against a background noise that reproduces or simulates the masking properties of flight deck noise upon speech and beacon signals.
6.3.4.1.2 Chapter 6 Std.	Applicants are not required to take a practical hearing test.
6.4.1.1 Chapter 6 Std.	Free balloon and glider pilots are not required to hold a medical certificate but are prohibited from operating during periods of medical deficiency.
6.4.1.2 Chapter 6 Std.	Free balloon and glider pilots are not required to hold a medical certificate but are prohibited from operating during periods of medical deficiency.
6.4.2.6 Chapter 6 Std.	Electrocardiography for applicants for third-class airman (private pilot) medical certification is not required at first issue unless clinically indicated.
6.4.2.6.1 Chapter 6 Std.	Routine electrocardiography for applicants for FAA third-class airman (private pilot) medical certification is not required unless clinically indicated.
6.4.2.6.2 Chapter 6 Rec.	Electrocardiography for applicants for FAA third-class airman (private pilot) medical certification is not required at first issue unless clinically indicated.
6.4.2.9.1 Chapter 6 Rec.	Radiography for private pilots is not specifically required unless clinically indicated.
6.4.3.4 Chapter 6 Std.	The demonstration of compliance with the visual requirements to be made with only one pair of corrective lenses is not specifically required.
6.4.3.4.1 Chapter 6 Std.	The requirement that a spare set of corrective lenses be readily available when exercising the privileges of the license is not established
6.5.2.6 Chapter 6 Std.	Electrocardiography is required for FAA air traffic controllers at first issue but not for non-FAA ATCs unless clinically indicated.
6.5.2.6.1 Chapter 6 Std.	Electrocardiography is required for FAA ATCs but not for non-FAA ATCs unless clinically indicated.

6.5.3.4 Chapter 6 Std.	The demonstration of compliance with the visual requirements to be made with only one pair of corrective lenses is not specifically required.
6.5.3.4.1 Chapter 6 Std.	A requirement that a spare set of corrective lenses be readily available when exercising the privileges of the licence is not established
6.5.4.1.1 Chapter 6 Std.	Applicants are not required to demonstrate normal hearing against a background noise that reproduces or simulates an air traffic control working environment.
6.5.4.1.2 Chapter 6 Std.	Applicants are not required to take a practical hearing test.

ANNEX 2 – RULES OF THE AIR	
Chapter 1	Definitions
Advisory Airspace	Advisory service available in terminal areas and Class C outer area
Aerodrome control tower	In the U.S., an “aerodrome control facility” is referred to as a “tower” or “airport traffic control tower”; “aerodrome control” is referred to as “airport traffic control service.”
Aerodrome Traffic Zone	There are no more Control Zones (Airport Traffic Zones) or Airport Traffic Areas (ATA). In the 7110.65, PCG, Controlled Airspace covers the defined dimensions of airspace. Class D was formerly the ATA (normally a 5NM radius around the airport). The old Control Zones were extensions of the ATA to encompass (ILS) Approach Paths.
Airborne collision avoidance	The U.S. uses “traffic alert collision avoidance system (TCAS).” TCAS is an airborne collision avoidance system based on radar beacon signals and operates independent of ground-based equipment. TCAS-I generates traffic advisories only. TCAS-II generates traffic advisories and resolution (collision avoidance) advisories in the vertical plane.
Airborne Collision Avoidance System (ACAS)	The U.S. uses “traffic alert collision avoidance system (TCAS).” TCAS is an airborne collision avoidance system based on radar beacon signals and operates independent of ground-based equipment. TCAS – I generates traffic advisories only. TCAS – II generates traffic advisories and resolution (collision avoidance) advisories in the vertical plane.
Air-ground Control Radio Station	FAA Pilot Controller Glossary, as amended by GENOT 5/55 (10/4/05) defines (in part) Flight Service Station (FSS) as “air traffic facilities which provide pilot briefing, en route communications and VFR search and rescue services, assist lost aircraft and aircraft in emergency situations, relay ATC clearances, originate Notices to Airmen, broadcast aviation weather and NAS information and receive and process IFR flight plans,...provide enroute flight advisory service (Flight Watch), (and) issue airport advisories.” In the FAA, Flight Service Stations perform most air traffic air-to-ground radio functions other than the separation of aircraft.
Air-taxiing	The U.S. uses “hover taxi” for this maneuver above 100 feet above ground level (AGL) and “air taxi” below 100 feet AGL.
Area control service	The U.S. does not use the term “area control service” to indicate controlled flight in controlled areas.
Area control centre	The U.S. equivalent facility for an Area Control Centre (ACC) is an Air Route Traffic Control Center (ARTCC).
ATS route	In U.S. domestic airspace, the term “ATS route” is not used. Routes in the U.S. include VOR airways, jet routes, substitute routes, and off-airway routes. The U.S. also uses instrument departure procedures (DPs) and standard terminal arrivals (STARs).
Controlled airspace	The U.S. terms for controlled airspace have different parameters than for ICAO.
Current Flight Plan	FAA Pilot Controller Glossary (PCG) defines flight plan as “specified information relating to the intended flight of an aircraft that is filed orally or in writing with an FSS or an ATC facility.” The Pilot Controller Glossary makes a specific distinction between current flight plan and filed flight plans, defining filed flight plans as “filed...without any subsequent changes or clearances.” Therefore, the PCG definition of flight plan includes changes brought about by clearances or amendments
Danger area	The term “danger area” is not used within the U.S. or any of its possessions or territories.
Estimated off-block time	The U.S. uses the term “estimated departure time” for domestic operations.
Flight information centre	The U.S. does not operate flight information centers (FICs). In the U.S., the services provided by FICs are performed by air traffic control (ATC) facilities, automated flight service stations (AFSSs), and rescue coordination centers (RCCs).
Ground Visibility	The U.S. defines Ground Visibility as: Prevailing horizontal visibility near the earth’s surface as reported by the United States National Weather Service or an accredited observer.

Instrument meteorological conditions	The U.S. air traffic service units use the phrase “IFR conditions.”
Level	The U.S. uses “altitude” or “flight level” rather than “level” and “cruising altitude” rather than “cruising level.” The term “level” is not used to mean “height,” “altitude,” or “flight level.” The U.S. only uses flight level at FL 180 and above
Movement area	In the U.S., the term “movement area” means “the runways, taxiways, and other areas of an airport/heliport which are utilized for taxiing, hover taxiing, air-taxiing, take-off and landing of aircraft, exclusive of loading ramps and parking areas. At those airport/heliports with a tower, specific approval for entry onto the movement area must be obtained from ATC.” The U.S. does not use an all-inclusive term to denote the movement area plus loading ramps and parking areas of an airport, nor does the U.S. use the term “maneuvering area” in any related context.
Repetitive flight plan (RPL)	The U.S. uses the term “stored flight plan” for domestic operations.
Terminal control area	In the U.S., “terminal control area” has been replaced by “Class B airspace/area.” Standard IFR services are provided to IFR aircraft operating in Class B airspace. Class B airspace CFR 14 part 71.41, exceeds TCA with more restrictive airman’s qualifications and aircraft certifications.
Total estimated elapsed time	The U.S. uses “estimated time en route” for domestic operations.
Traffic Avoidance Advice	The U.S. uses the term Traffic Advisory
Transition altitude	In U.S. domestic airspace, “transition altitude,” “layer” and “level” are not used; however, in the U.S., flight levels begin at FL 180 where the reference datum of 29.92 inches of mercury is used as the constant atmospheric pressure. Below FL 180, altitudes are based on barometric pressure readings. QNH and QFE altimeter settings are not provided in domestic U.S. airspace.
Visibility	The U.S. defines Visibility as: The ability, as determined by atmospheric conditions and expressed in units of distance, to see and identify prominent unlighted objects by day and prominent lighted objects by night. Visibility is reported as statute miles, hundreds of feet, or meters. The U.S. identifies the following classes of visibility: Flight Visibility, Ground Visibility, Prevailing Visibility, Runway Visibility Value, and Runway Visual Range.
Visual meteorological conditions	The U.S. air traffic service units use the phrase “VFR conditions.”
Chapter 2	Applicability of the Rules of the Air
2.2	See difference under “Movement area.”
2.5	Except in an emergency, no pilot of a civil aircraft may allow a person who appears to be intoxicated or who demonstrates by manner or physical indications that the individual is under the influence of drugs (except a medical patient under proper care) to be carried in that aircraft.
Chapter 3	General Rules
3.1.8	In addition, aircraft shall not be flown in formation flight when passengers are carried for hire.
3.2 Note	See difference under “Movement area.”
3.2.2.6.1	See difference under “Movement area.”
3.2.3.2 d)	The U.S. national regulations do not require aircraft on the movement area of an airport, whose engines are running, to display lights which indicate that fact from sunset to sunrise.

3.2.5	<p>Unless otherwise authorized or required by ATC, no person may operate an aircraft within a Class B, C, or D surface area except for the purpose of landing at, or taking off from, an airport within that area.</p> <p>In addition, in the case of a helicopter approaching to land, avoid the flow of fixed-wing aircraft.</p> <p>In addition, no person may, within a Class B, C, or D surface area operate an aircraft to, from, or on an airport having a control tower operated by the U.S. unless two-way radio communications are maintained between that aircraft and the control tower.</p>
3.3.1.2	<p>In the U.S., ATC flight plans are not required for VFR flight in Class C, D, or E airspace.</p>
3.3.1.2.1 d)	<p>Requirements pertaining to filing flight plans for flights operating across U.S. borders and for identification purposes are described in 14 CFR Part 91 (Section 91.84) and Part 99.</p>
3.3.1.2.2	<p>The U.S. requires that domestic flight plans be submitted at least 30 minutes before departure. For international flights, the U.S. recommends that they be transmitted so that they are received by ATC authorities in each Flight Information Region (FIR) to be entered, at least 2 hours prior to entry, unless otherwise provided in that State's requirements.</p>
3.6.1	<p>Air traffic control clearances are not needed for VFR flight in U.S. Class C, D, or E airspace.</p>
3.6.2.4	<p>When meteorological conditions fall below the minimum specified for en route VFR flights, the pilot of the aircraft shall not continue his/her flight in such conditions, except in emergency, beyond the extent necessary to return to his/her departure point or to the nearest suitable landing point.</p>

3.6.5.2 (Communicati on Failure)	<p>Two-way Radio Communications Failure</p> <p>a. It is virtually impossible to provide regulations and procedures applicable to all possible situations associated with two-way radio communications failure. During two-way radio communications failure, when confronted by a situation not covered in the regulation, pilots are expected to exercise good judgment in whatever action they elect to take. Should the situation so dictate they should not be reluctant to use the emergency action contained in 14 CFR Section 91.3(b)</p> <p>b. Whether two-way communications failure constitutes an emergency depends on the circumstances, and in any event, it is a determination made by the pilot. 14 CFR Section 91.3(b) authorizes a pilot to deviate from any rule in Subparts A and B to the extent required to meet an emergency.</p> <p>c. In the event of two-way radio communications failure, ATC service will be provided on the basis that the pilot is operating in accordance with 14 CFR Section 91.185. A pilot experiencing two-way communications failure should (unless emergency authority is exercised) comply with 14 CFR Section 91.185 quoted below</p> <p>1. General. Unless otherwise authorized by ATC, each pilot who has two-way radio communications failure when operating under IFR shall comply with the rules of this section.</p>
3.6.5.2.2	<p>In the event of two-way communications failure in the U.S., ATC service is predicated on pilot compliance with the provisions of 14 CFR Part 91 (Section 91.185). If the failure occurs in IMC, or if VFR cannot be complied with, each pilot is to continue the flight according to the following:</p> <p><u>Route</u></p> <ul style="list-style-type: none">a) By the route assigned in the last ATC clearance received;b) If being radar vectored, by the direct route from the point of failure to the fix, route, or airway specified in the vector clearance;c) In the absence of an assigned route, by the route that ATC has advised may be expected in a further clearance; ord) In the absence of an assigned route or a route that ATC has advised may be expected in a further clearance, by the route filed in the flight plan. <p><u>Altitude</u> – At the HIGHEST of the following altitudes or flight levels FOR THE ROUTE SEGMENT BEING FLOWN:</p> <ul style="list-style-type: none">a) The altitude or flight level assigned in the last ATC clearance received;b) The minimum altitude/flight level as prescribed for IFR operations; orc) The altitude or flight level ATC has advised may be expected in a further clearance. <p><u>IFR conditions</u> – If the failure occurs in IFR conditions, or if subparagraph 2 above cannot be complied with, each pilot shall continue the flight according to the following:</p> <ul style="list-style-type: none">(a) Route.<ul style="list-style-type: none">(1) By the route assigned in the last ATC clearance received;(2) If being radar vectored, by the direct route from the point of radio failure to the fix, route, or airway specified in the vector clearance;(3) In the absence of an assigned route, by the route that ATC has advised may be expected in a further clearance; or(4) In the absence of an assigned route of a route that ATC has advised may be expected in a further clearance by the route filed in the flight plan.(b) Altitude. At the HIGHEST of the following altitudes or flight levels FOR THE ROUTE SEGMENT BEING FLOWN:<ul style="list-style-type: none">(1) The altitude or flight level assigned in the last ATC clearance received;(2) The minimum altitude (converted, if appropriate) to minimum flight level as prescribed in 14 CFR Section 91.121(c) for IFR operations; or(3) The altitude or flight level ATC has advised may be expected in a further clearance.

Basic VFR Weather Minimums

Airspace	Flight Visibility	Distance from Clouds
Class A	Not Applicable	Not Applicable
Class B	3 statute miles	Clear of Clouds
Class C	3 statute miles	500 feet below 1,000 feet above 2,000 feet horizontal
Class D	3 statute miles	500 feet below 1,000 feet above 2,000 feet horizontal
Class E Less than 10,000 feet MSL	3 statute miles	500 feet below 1,000 feet above 2,000 feet horizontal
At or above 10,000 feet MSL	5 statute miles	1,000 feet below 1,000 feet above 1 statute mile horizontal
Class G 1,200 feet or less above the surface (regardless of MSL altitude).		
Day, except as provided in Section 91.155(b)	1 statute mile	Clear of clouds
Night, except as provided in Section 91.155(b)	3 statute miles	500 feet below 1,000 feet above 2,000 feet horizontal
More than 1,200 feet above the surface but less than 10,000 feet MSL.		
Day	1 statute mile	500 feet below 1,000 feet above 2,000 feet horizontal
Night	3 statute miles	500 feet below 1,000 feet above 2,000 feet horizontal
More than 1,200 feet above the surface and at or above 10,000 feet MSL.	5 statute miles	1,000 feet below 1,000 feet above 1 statute mile horizontal

Chapter 4	Visual Flight Rules
4.1 and Table 4-1	There is no Class F airspace in the U.S. Basic VFR weather minimums are listed in the table above.
4.1 a)	Except as otherwise authorized by the appropriate air traffic control unit for special VFR flights within Class B, C, D, or E surface areas, no person may operate an aircraft under VFR when the flight visibility is less, or at a distance from clouds that is less than that prescribed for the corresponding altitude and class of airspace in the table above.
4.1 b)	Class G Airspace: Notwithstanding the provisions of paragraph a) of this section, the following operations may be conducted in Class G airspace below 1,200 feet above the surface: 1) Helicopter. A helicopter may be operated clear of clouds if operated at a speed that allows the pilot adequate opportunity to see any air traffic or obstruction in time to avoid collision. 2) Airplane. When the visibility is less than 3 statute miles but not less than 1 statute mile during night hours, an airplane may be operated clear of clouds if operated in an airport traffic pattern within one-half mile of the runway.

4.1 c)	Except as provided in 4.2, no person may operate an aircraft under VFR within the lateral boundaries of the surface areas of Class B, Class C, Class D, or Class E airspace designated for an airport when the ceiling is less than 1,000 feet.
4.1 d)	Except as provided in 4.2, no person may take-off or land an aircraft, or enter the traffic pattern area of an airport under VFR, within the lateral boundaries of the surface area of Class B, Class C, Class D, or Class E airspace designed for an airport: <ol style="list-style-type: none"> 1) unless ground visibility at that airport is at least 3 statute miles; or 2) if ground visibility is not reported at that airport, unless flight visibility during landing or takeoff, or while operating in the traffic pattern is at least 3 statute miles.
4.2	In the U.S., no person may operate an aircraft beneath the ceiling under VFR within the lateral boundaries of controlled airspace designated to the surface for an airport when the ceiling is less than 1,000 feet. No person may take-off or land an aircraft (other than a helicopter) under special VFR (SVFR) unless ground visibility is at least 1 statute mile or if ground visibility is not reported, unless flight visibility is at least 1 statute mile. The U.S. restricts the ceiling to 1,000 ft. and ground visibility of 3 miles and greater.
4.2 a)	When an appropriate ATC clearance has been received, the special weather minimums in this section apply to the operation of an aircraft in a Class B, C, D, or E surface area under VFR. <ol style="list-style-type: none"> 1) No person may operate an aircraft in a Class B, C, D, or E surface area under VFR except clear of clouds; 2) No person may operate an aircraft (other than a helicopter) in a Class B, C, D or E surface area under VFR unless flight visibility is at least 1 statute mile; 3) No person may take-off or land an aircraft (other than a helicopter) at any airport in a Class B, C, D or E surface area under VFR: <ol style="list-style-type: none"> a) unless ground visibility at that airport is at least 1 statute mile; or b) if ground visibility is not reported at that airport, unless flight visibility during landing or take-off is at least 1 statute mile.
4.3	The U.S. does not prohibit VFR flight between sunset and sunrise.
4.4	In the U.S., VFR flight is not permitted within Class A airspace designated in 14 CFR Part 71 unless otherwise authorized by ATC. In the U.S., an ATC clearance is needed for VFR flight only in Class B airspace area. The U.S. limits VFR flights up to FL 180.
4.5	The U.S. limits VFR flights up to FL 180.
4.6	In addition, anywhere, an altitude allowing, if a power unit fails, an emergency landing without due hazard to persons or property on the surface.
4.7	In addition, grid tracks are not used to determine cruising altitudes in polar areas. True tracks are used to determine cruising levels above FL 230 in the area north of Alaska bounded by the true North Pole to 72°00'00 N, 141°00'00 W; to 72°00'00 N, 158°00'00 W; to 68°00'00 N, 168°58'23 W; to point of beginning. The U.S. has named this area the Anchorage Arctic CTA/FIR for national reference purposes.
4.8	In U.S. Class C and D airspace/areas, an ATC clearance is not required for VFR flights.
Chapter 5	Instrument Flight Rules
5.1.2	In the U.S., minimum altitudes for IFR flights are 2,000 feet above the highest obstacle within a horizontal distance of 4 nautical miles from the course to be flown in mountainous terrain and 1,000 feet above the highest obstacle within a horizontal distance of 4 nautical miles from the course to be flown in non-mountainous terrain.
5.2.2	See difference under paragraph 4.7.
5.3.1	See difference under paragraph 4.7.

Further differences which exist by virtue of the fact that the Annex contains no comparable standards for the U.S. national regulations.	<p>1) The regulations covering the selection and use of alternate airports in respect to ceiling and visibility minima, require that:</p> <p>Unless otherwise authorized by the FAA Administrator, no person may include an alternate airport in an IFR flight plan unless current weather forecasts indicate that, at the estimated time of arrival at the alternate airport, the ceiling and visibility at that airport will be at or above the alternate airport weather minima.</p>
	<p>2) Operation under IFR in Class A, B, C, D, or E airspace malfunction reports:</p> <p>a) The pilot-in-command of each aircraft operated in Class A, B, C, D or E airspace under IFR shall report as soon as practical to ATC any malfunctions of navigational, approach, or communication equipment occurring in flight.</p> <p>b) In each report the pilot-in-command shall include:</p> <ol style="list-style-type: none">1) aircraft identification.2) equipment affected.3) degree to which the capability of the pilot to operate under IFR in the ATC system is impaired; and4) nature and extent of assistance desired from ATC.
	<p>3) When an aircraft has been cleared to maintain “VFR conditions on top,” the pilot is responsible to fly at an appropriate VFR altitude, comply with VFR visibility and distance from cloud criteria, and to be vigilant so as to see and avoid other aircraft.</p>
	<p>4) Aircraft speed:</p> <p>a) Unless otherwise authorized by the FAA Administrator, no person may operate an aircraft below 10,000 feet MSL at an indicated airspeed of more than 250 kt (288 m.p.h.).</p> <p>b) Unless otherwise authorized or required by ATC, no person may operate an aircraft within Class B, C, or D surface area at an indicated airspeed of more than 200 kt (230 m.p.h.). This paragraph 4b) does not apply to operations within Class B airspace. Such operations shall comply with paragraph 4a) of this section.</p> <p>c) No person may operate an aircraft in the airspace underlying Class B airspace, or in a VFR corridor designated through Class B airspace, at an indicated airspeed of more than 200 kt (230 m.p.h.).</p> <p>d) If the minimum safe airspeed for any operation is greater than the maximum speed prescribed in this section, the aircraft may be operated at that minimum speed.</p>

<p>5) Operating rules and pilot and equipment requirements for flight in Class B airspace.</p> <p>a) Operating rules. No person may operate an aircraft within Class B airspace except in compliance with the following rules:</p> <p>1) No person may operate an aircraft within Class B airspace unless that person has received an appropriate authorization from ATC prior to operation of that aircraft in that area.</p> <p>2) Unless otherwise authorized by ATC, each person operating a large turbine engine-powered airplane to or from a primary airport shall operate at or above the designated floors while within the lateral limits of the Class B airspace.</p> <p>3) Any person conducting pilot training operations at an airport within Class B airspace shall comply with any procedures established by ATC for such operations in Class B airspace.</p> <p>b) Pilot requirements. No person may take off or land a civil aircraft at an airport within Class B airspace or operate a civil aircraft within Class B airspace unless:</p> <p>1) The pilot-in-command holds at least a private pilot certificate; or</p> <p>2) The aircraft is operated by a student pilot who has met the requirements (14 CFR Part 61 (Section 61.95)).</p> <p>c) Communications and navigation requirements. Unless otherwise authorized by ATC, no person may operate an aircraft within Class B airspace unless that aircraft is equipped with:</p> <p>1) For IFR operations, an operable VOR or TACAN receiver, and</p> <p>2) For all operations, an operable two-way radio capable of communications with ATC on appropriate frequencies for that Class B airspace.</p> <p>d) Transponder requirements. No person may operate an aircraft in Class B airspace unless the aircraft is equipped with the applicable operating transponder and automatic altitude reporting equipment.</p>
<p>6) Operating rules and pilot and equipment requirements for operating in Class C airspace.</p> <p>a) General. For the purpose of this section, the primary airport is the airport designated in 14 CFR Part 71, for which the Class C airspace is designated. A satellite airport is any other airport within the Class C airspace.</p> <p>b) Deviations. An operator may deviate from any provisions of this section under the provisions of an ATC authorization issued by the ATC facility giving jurisdiction of the Class C airspace. ATC may authorize a deviation on a continuing basis or for an individual flight, as appropriate.</p> <p>c) Arrivals and overflights. No person may operate an aircraft in Class C airspace unless two-way radio communication is established with the ATC facility having jurisdiction over the Class C airspace prior to entering that area and is thereafter maintained with the ATC facility having jurisdiction over the Class C airspace while within that area.</p> <p>d) Departures. No person may operate an aircraft within Class C airspace except as follows:</p> <p>1) From the primary airport or satellite airport with an operating control tower, unless two-way radio communication is established and maintained with the control tower, and thereafter as instructed by ATC while operating in the Class C airspace.</p> <p>2) From a satellite airport without an operating control tower, unless two-way radio communication is established as soon as practical after departing and thereafter maintained with the ATC facility having jurisdiction over the Class C airspace.</p> <p>e) Traffic patterns. No person may take off or land an aircraft at a satellite airport within Class C airspace except in compliance with FAA arrival and departure traffic patterns.</p> <p>f) Equipment requirements. Unless otherwise authorized by the ATC facility having jurisdiction over the Class C airspace, no person may operate an aircraft within Class C airspace unless that aircraft is equipped with the applicable equipment specified in 14 CFR Part 91 (Section 91.215).</p>

	<p>7) Except for persons operating gliders below the floor of Class A airspace, no person may operate an aircraft in Class B, C, D, or E airspace of the 48 contiguous States and the District of Columbia above 10,000 feet MSL, excluding that airspace at and below 2,500 feet AGL, unless that aircraft is equipped with an operable radar beacon transponder having at least a Mode 3/A 4096-code capability, replying to Mode 3/A interrogation with the code specified by ATC, and automatic altitude reporting equipment having a Mode C capability that automatically replies to Mode C interrogations by transmitting pressure altitude information in 100-foot increments.</p> <p>8) Compliance with ATC clearances and instructions:</p> <ul style="list-style-type: none">a) When an ATC clearance has been obtained, no pilot-in-command may deviate from that clearance, except in an emergency, unless an amended clearance is obtained. A pilot-in-command may cancel an IFR flight plan if that pilot is operating in VFR weather conditions outside of Class A airspace. If a pilot is uncertain of the meaning of an ATC clearance, the pilot shall immediately request clarification from ATC.b) Except in an emergency, no person may operate an aircraft contrary to an ATC instruction in an area in which ATC is exercised.c) Each pilot-in-command who, in an emergency, deviates from an ATC clearance or instruction shall notify ATC of that deviation as soon as possible.d) Each pilot-in-command who is given priority by ATC in an emergency shall submit a detailed report of that emergency within 48 hours to the manager of that ATC facility, if requested by ATC.e) Unless otherwise authorized by ATC, no person operating an aircraft may operate that aircraft according to any clearance or instruction that has been issued to the pilot of another aircraft for radar ATC purposes.
Appendix 1	Signals
4.1.1	<p>The flashing white signal to aircraft in flight, meaning “land at this aerodrome and proceed to apron” is not used in the United States.</p> <p>In addition, the alternating red and green signal to aircraft on the ground or in flight means exercise extreme caution.</p>

PANS – RAC – DOC 4444	
There are several substantive differences between the U.S. procedures and those of ICAO, in addition to some minor variations in detail which are not considered significant. These differences are the result of initiatives and/or refinements which the U.S. has effected in the interest of improving the safety and efficiency of air traffic services.	
Part I	Definitions
Airborne collision avoidance system	The U.S. uses traffic alert and collision avoidance system (TCAS).
AIRMET information	In the U.S., AIRMET stands for Airman’s Meteorological Information which is in-flight weather advisories issued only to amend the area forecast concerning weather phenomena which are of operational interest to all aircraft and potentially hazardous to aircraft having limited capability because of lack of equipment, instrumentation, or pilot qualifications. AIRMETs concern weather of less severity than that covered by SIGMETs or convective SIGMETs. AIRMETs cover moderate icing, moderate turbulence, sustained winds of 30 kt or more at the surface, widespread areas of ceilings less than 1,000 feet and/or visibility less than 3 miles, and extensive mountain obscurement.
Air-report	The U.S. does not normally use the term “air-report.” Pilot weather reports (PIREPs), position, and operational reports are used. PIREPs include reports of strong frontal activity, squall lines, thunderstorms, light to severe icing, wind shear and turbulence (including clear air turbulence) of moderate or greater intensity, volcanic eruptions and volcanic ash clouds, and other conditions pertinent to flight safety. They may include information on ceilings, visibility, thunderstorms, icing of light degree or greater, wind shear and its effect on airspeed, or volcanic ash clouds, but do not usually include air temperature.
Air-taxiing	In the U.S., the term “hover taxi” is sometimes used to indicate the ICAO term “air-taxiing.” Additionally, in the U.S., air taxi is used to indicate certain commercial aircraft operations. For those operations, usually a special call sign is used, or the prefix “Tango” is added to the aircraft call sign.
ALERFA	The U.S. does not use the code words ALERFA, DETRESFA, and INCERFA to designate an alert phase, a distress phase, or an uncertainty phase in domestic airspace. The U.S. uses information request (INREQ) and alert notice (ALNOT) in domestic airspace.
Area control service	The U.S. does not use the term “area control service” to indicate controlled flight in controlled areas.
ATS route	In U.S. domestic airspace, the term “ATS route” is not used. Routes in the U.S. include VOR airways, jet routes, substitute routes, off-airway routes, RNAV routes and colored airways. The U.S. also uses instrument departure procedures (DPs), and standard terminal arrivals (STARs).
Automatic dependent surveillance (ADS)	The U.S. has not yet published ATS procedures for the use of Automatic Dependent Surveillance (ADS).
Control zone	The U.S. uses “surface area” in place of the ICAO term “control zone.” Surface area is defined as the airspace contained by the lateral boundary of the Class B, C, D or E airspace designated for an airport that begins at the surface and extends upward.
Controlled airspace	The U.S. uses the following definition of controlled airspace found in 14 CFR Section 1.1: “Controlled airspace means an airspace of defined dimensions within which air traffic control service is provided to IFR flights and to VFR flights in accordance with the airspace classification.”
Cruising level	The U.S. uses the term “cruising altitude.”
Decision altitude	Approach with vertical guidance (VNAV).
DETRESFA	See ALERFA.
Flight information centre	In the U.S., the services provided by flight information centers (FICs) are conducted by air traffic control (ATC) facilities, automated flight service stations (AFSSs), and rescue coordination centers (RCCs).

Glide path	The U.S. uses “glideslope” rather than “glide path” although the terms are sometimes interchangeable. For the U.S., a glideslope provides vertical guidance for aircraft during approach and landing.
Holding point	The U.S. uses “holding fix” rather than “holding point.”
Holding procedure	In the U.S., a hold procedure is also used during ground operations to keep aircraft within a specified area or at a specified point while awaiting further clearance from air traffic control.
INCERFA	See ALERFA.
Level	The U.S. uses “altitude” or “flight level” rather than “level.”
Movement area	In the U.S., the “movement area” is equivalent to the ICAO “maneuvering area” which does not include parking areas.
Pilot-in-Command	Designated by operator, or in the case of general aviation, the owner, as being in command and charged with the safe conduct of a flight.
Slush	In the U.S., “slush” is not used as a weather phenomena.
Standard instrument arrival (STAR)	The U.S. uses the acronym STAR to define a standard terminal arrival.
Standard instrument departure (SID)	The U.S. uses the term departure procedure (DP) in lieu of SID.
Stopway	The U.S. does not define a stopway as a rectangular area.
Taxi-holding position	In the U.S., “line up and wait” means taxi onto the departure runway in take-off position and hold while the ICAO “taxi-holding position” or “taxi-holding point” is a designated position that provides adequate clearance from a runway.
Terminal control area	In the U.S., the term “terminal control area” has been replaced by “Class B airspace.” Standard IFR services should be provided to IFR aircraft operating in Class B airspace.
Track	The U.S. uses the term “course” instead of “track.”
Transition altitude, transition layer, and transition level	In U.S. domestic airspace, transition altitude, layer, and level are not used. U.S. flight levels begin at FL 180 where a barometric altimeter setting of 29.92 inches of mercury is used as the constant atmospheric pressure. Below FL 180, altitudes are based on barometric pressure readings.
Visibility	Definitions are different.
Visual approach	In the U.S., aircrews may execute visual approaches when the pilot has either the airport or the preceding aircraft in sight and is instructed to follow it.
Part IV	General Provisions
3.2.1.1	Transfer of control points vary depending on numerous factors.
3.2.1.3	Transfer of control varies.
3.3.1a	The U.S. does not “release” aircraft. Handoff is used.
4.1	In the U.S., flight information and alerting services are provided by ATC facilities, AFSSs, and RCCs.
5.7.5.1	The flight crew shall read back to the air traffic controller safety-related parts of ATC clearances.
6.1.5	Mach speeds at or above 7,600 Meters (FL 250).
6.3.6	Only minor speed reductions of 20 knots should be used on intermediate or final approach.
6.3.7	Speed control after 7KM (4NM) should not be applied.
8, 8.4	The U.S. uses a flight plan format different from the ICAO model discussed in Appendix 2. The U.S. ATS facilities will transmit ICAO repetitive flight plans (RPLs) even though a different format is used for stored flight plans.

9.3	ATS units are not required to advise a pilot who has canceled an IFR flight plan that IMC conditions are likely to be encountered along the route of flight; however, if a pilot informs a controller of a desire to change from IFR to VFR, the controller will request that the pilot contact the appropriate AFSS.
10.2.2	Standard IFR services should be provided to IFR aircraft operating in Class B airspace. U.S. Class B airspace includes a speed restriction of 250 kt indicated airspeed or less.
10.2.3	U.S. ATS controllers do not normally include clearance for transonic acceleration in their ATC clearances.
12.1.1, 12.1.1.1, 12.2	In U.S. domestic airspace, transition altitude, layer, and level are not used. U.S. flight levels begin at FL 180 where a barometric altimeter setting of 29.92 inches of mercury is used as the constant atmospheric pressure. Below FL 180, altitudes are based on barometric pressure readings. QNH and QFE altimeter settings are not provided in domestic U.S. airspace.
13.1	In the U.S., the word “heavy” is used in all communications with or about heavy jet aircraft in the terminal environment. In the en route environment, “heavy” is used in all communications with or about heavy jet aircraft with a terminal facility, when the en route center is providing approach control service, when the separation from a following aircraft may become less than five miles by approved procedure, and when issuing traffic advisories.
13.4.1	Flight Progress Strips shall be retained for at least 30 days.
14.3, 14.4	The U.S. has not yet published ATS procedures for the use of Automatic Dependent Surveillance (ADS).
15.1, 15.2, 15.3, 15.4, 15.5, 15.6, 16	The U.S. does not normally use the term “air-report.” Pilot weather reports (PIREPs), position, and operational reports are used. PIREPs include reports of strong frontal activity, squall lines, thunderstorms, light to severe icing, wind shear and turbulence (including clear air turbulence) of moderate or greater intensity, volcanic eruptions and volcanic ash clouds, and other conditions pertinent to flight safety. They may include information on ceilings, visibility, thunderstorms, icing of light degree or greater, wind shear and its effect on airspeed, or volcanic ash clouds, but do not usually include air temperature.
18	The U.S. has procedures for a duplicate aircraft identification watch and notification to airline operators but does not publish national procedures for on-the-spot temporary changes to aircraft call signs in accordance with ICAO guidelines.
19	The U.S. uses traffic alert and collision avoidance system (TCAS). U.S. controllers are not to issue control instructions that are contrary to the TCAS resolution advisory (RA) procedure that a crew member advises is being executed.
Part V	Separation Methods and Minima
	Remark: The U.S. does not use the term “area control service” to indicate controlled flight in controlled areas.
1.1	In U.S. airspace, only conflict resolution (not separation) is provided between IFR and VFR operations. Separation is provided between IFR and Special VFR (SVFR) aircraft only within the lateral boundaries of Class B, C, D, or E control zones (the U.S. term is surface areas) below 10,000 feet MSL.
3.4.1	U.S. rules allow assignment of altitude to second aircraft after first aircraft has been issued climb/descent and is observed or reports leaving that altitude.
5.2	Whenever the other aircraft concerned are within 5 minutes flying time of the holding area.
8	The U.S. uses the term “course” instead of “track.” “Reciprocal” courses are sometimes referred to as “opposite” courses. The wording of the definitions for U.S. <i>same</i> , <i>crossing</i> , or <i>opposite/reciprocal</i> courses differs from the ICAO worded definitions, but the intent appears to be the same.
8.2.1.1, 8.3.1.1.1	The U.S. uses 22 kt instead of 20 kt and 44 kt instead of 40 kt.
8.4.1	The U.S. does not conduct direct pilot-controller high frequency (HF) communications. The U.S. is establishing direct pilot-controller data link communications where HF is currently being used.

14.1	In U.S. Class A and B airspace, separation is provided for all aircraft. In U.S. Class C airspace, separation is provided between IFR and SVFR aircraft; conflict resolution is provided between IFR and VFR operations.
17.3	In the U.S., if the communications failure occurs in IFR conditions, or if VFR cannot be complied with, each pilot shall continue the flight according to the following requirements: <u>Route</u> <ul style="list-style-type: none"> a) By the route assigned in the last ATC clearance received; b) If being radar vectored, by the direct route from the point of failure to the fix, route, or airway specified in the vector clearance; c) In the absence of an assigned route, by the route that ATC has advised may be expected in a further clearance; or d) In the absence of an assigned route or a route that ATC has advised may be expected in a further clearance, by the route filed in the flight plan. <u>Altitude</u> – At the highest of the following altitudes or flight levels for the route segment being flown: <ul style="list-style-type: none"> a) The altitude or flight level assigned in the last ATC clearance received; b) The minimum altitude as prescribed in 14 CFR Part 91 (Section 91.121(c)) for IFR operations; or c) The altitude or flight level ATC has advised may be expected in a further clearance.
Part VI	Separation in the Vicinity of Aerodromes
5.7.1	Arriving aircraft – delay of 10 minutes or more.
5.8.1	Onward clearance time.
7.3.1.2	Parallel approaches, separate radar controllers
7.3.2.9	PAOAS Criteria.
7.3.2.9	45 degree track.
7.3.2.10	Both controllers are advised when visual separation is applied.
7.3.5.3	SRA
9	In the U.S., aircrews may execute visual approaches when the pilot has either the airport or the preceding aircraft in sight and is instructed to follow it. A contact approach is one wherein an aircraft on an IFR flight plan, having an air traffic control authorization, operating clear of clouds with at least 1 mile flight visibility and a reasonable expectation of continuing to the destination airport by visual reference in those conditions, may deviate from the instrument approach procedure and proceed to the destination airport by visual reference to the surface. This approach will only be authorized when requested by the pilot and the reported ground visibility at the destination airport is at least 1 statute mile.
15	Except where a “runway use” program is in effect, in the U.S. the runway used will be the one most nearly aligned with the wind when 5 kt or more, or the “calm wind” runway when less than 5 kt unless use of another runway will be operationally advantageous or is requested by a pilot.
Part VII	Aerodrome Control Service
2.2	When neither communications nor radar contact can be established for 30 minutes (or prior, if appropriate), U.S. controllers will consider an aircraft overdue and will initiate overdue aircraft procedures including reporting to the ARTCC or AFSS.
5.3.1.1.2	Taxi clearance.
6.1.2	In the U.S., airport lighting is not used for en route navigation.
8.4.3	Takeoff clearance shall include the designator of the runway.
9.3.1	Landing clearance shall include the designator of the runway.
10.3	In the U.S., “line up and wait” means taxi onto the departure runway in takeoff position and hold while the ICAO “taxi-holding position” or “taxi-holding point” is a designated position that provides adequate clearance from a runway.

10.5, 10.5.1	In the U.S., the term “hover taxi” is sometimes used to indicate the ICAO term “air-taxiing.” In the U.S., air-taxiing is the preferred method for helicopter movements on airports provided ground operations/conditions permit.
11.2.1	In the U.S., for movements of other than aircraft traffic (i.e., vehicles, equipment, and personnel), steady green means cleared to cross, proceed, go; flashing green is not applicable; flashing white means return to starting point on airport; and alternating red and green means a general warning signal to exercise extreme caution.
11.2.2	U.S. controllers do not normally flash runway or taxiway lights.
15.1, 15.2	In the U.S., landing clearance to a succeeding aircraft in a landing sequence need not be withheld if the controller observes the positions of the aircraft and determines that prescribed runway separation will exist when the aircraft crosses the landing threshold. Controllers issue traffic information to the succeeding aircraft if it has not previously been reported.
16	ICAO aircraft wake turbulence categories (heavy, medium, light) and FAA weight classes (heavy, large, small) differ. Also, for landing aircraft, wake turbulence separation is defined differently. The U.S. makes special provisions for any aircraft landing behind a B-757 (4 miles for a large aircraft behind or 5 miles for a small aircraft behind).
17	<p>Special VFR operations may be conducted in the U.S. under the following weather minimums and requirements below 10,000 feet MSL within the airspace contained by the upward extension of the lateral boundaries of the controlled airspace designated to the surface for an airport. These minimums and requirements are found in 14 CFR Section 91.157.</p> <p>Special VFR operations may only be conducted:</p> <ol style="list-style-type: none"> (1) With an ATC clearance; (2) Clear of clouds; (3) Except for helicopters, when flight visibility is at least 1 statute mile; and (4) Except for helicopters, between sunrise and sunset (or in Alaska, when the sun is 6 degrees or more below the horizon) unless: <ol style="list-style-type: none"> (i) The person being granted the ATC clearance meets the applicable requirements for instrument flight; and (ii) The aircraft is equipped as required in 14 CFR Sec. 91.205(d). <p>No person may take off or land an aircraft (other than a helicopter) under special VFR:</p> <ol style="list-style-type: none"> (1) Unless ground visibility is at least 1 statute mile; or (2) If ground visibility is not reported, unless flight visibility is at least 1 statute mile.
Part VIII	Radar Services
6.5.2	The U.S. has not implemented cold temperature corrections to the radar minimum vectoring altitude chart.
7.4.4.1	See Part VII, Aerodrome Control Service, 16.
7.6	U.S. ATS units do not accept aircraft speeds in metric terms nor do they use the term “minimum clean speed.” The U.S. does use phrases such as “maintain maximum forward speed” or “maintain slowest practical speed.”
9.3.5, 9.3.6	The U.S. normally uses “glideslope” rather than “glide path” although they are sometimes interchangeable. For the U.S., a glideslope provides vertical guidance for aircraft during approach and landing.
Part IX	Flight Information and Alerting Service
1.3.2	See Part IV, General Provision, 15.1.
1.3.7	The U.S. does not have special procedures for the transmission of information to supersonic aircraft.
1.4.1, 1.4.2, 1.4.3	Class F airspace is not used in the U.S. Traffic advisories are provided in Class C airspace and, workload permitting, in Class D, Class E, and Class G airspace.
2.1.2, 2.1.3, 2.2.1	The U.S. does not use “operations normal” or “QRU” messages. U.S. controllers are not normally familiar with the term “uncertainty phase.”

Part X	Co-ordination
3.2.10	See Part IV, General Provision, 14.3.
3.3.1.1, 3.3.2.1	Except for a VFR aircraft practicing an instrument approach, an IFR approach clearance in the U.S. automatically authorizes the aircraft to execute the missed approach procedure depicted for the instrument approach being flown. No additional coordination is normally needed between the approach and en route controllers. Once an aircraft commences a missed approach, it may be radar vectored.
Part XI	Air Traffic Services Messages
1.3	The existing U.S. ATS automation system does not process logical acknowledgment messages (LAMs).
4.2.2.2.1	See Part IV, General Provision, 8.
4.2.3.1, 4.2.3.6, 4.2.4, 4.2.5.1, 4.2.5.4	See 1.3, above.
4.2.5.5	See Part IV, General Provision, 15.1.
4.3.1.2.1	In the U.S., traffic information messages include the position of the traffic (aircraft concerned).
4.3.2.2.1, 4.3.2.3.5	U.S. controllers do not use the term “CAVOK.” However, the ceiling/sky condition, visibility, and obstructions to vision may be omitted if the ceiling is above 5,000 feet and the visibility is more than 5 miles.
4.3.2.2.1, 4.3.2.3.2, 4.3.2.3.3	U.S. controllers do not give wind speed, visibility, or RVR/RVV values in metric terms. RVR values are given in 100– or 200–foot increments while RVV values are given in 1/4–mile increments.
4.3.2.3.1	In the U.S., the criteria for a variable wind is wind speed greater than 6 kt and direction varies by 60 degrees or more. If the wind is 1 kt but 6 kt, the wind direction may be replaced by “VRB” followed by the speed or reported as observed. “VRB” would be spoken as “wind variable at <speed>.”
4.3.2.3.3.1	RVR values between 400m and 800m in increments of 50m.
4.3.2.3.4.1	For weather phenomena, the U.S. uses “ice crystals” instead of “diamond dust” and does not use the term “dust devils.”
4.3.2.3.4.2	Additionally, the U.S. uses “supercooled” (or freezing) and “partial” as descriptors for weather phenomena.
4.3.2.3.5	In the U.S., CLR is used at automated stations for SKC when no clouds below 12,000 feet are reported. SCT indicates cloud coverage between 3–4 oktas; FEW indicates cloud coverage >0 but 2 oktas.
4.3.2.3.5.1	Abbreviation NSC.
4.3.2.3.6	In the U.S., since the Celsius scale is not as finely graduated as the Fahrenheit scale, the hourly temperature and dew point to the nearest tenth of a degree will be encoded in the additive data section of METAR remarks.
4.3.2.3.7	In the U.S., an “A” precedes the altimeter which is given in inches of mercury.
Part XII	Phraseologies
2.3	In the U.S., “proceed” or “hold” may be used for aircraft or equipment/vehicle/personnel operations, while “taxi” and “cleared” should only be used as appropriate for aircraft instructions.
2.4 2.7	In the U.S., conditional clearances are not usually issued. However, traffic that may affect the clearance is usually issued to the aircraft with the clearance. Restricted clearances may also be issued.
2.5, 2.6, 2.7, 2.8	In the U.S., pilots may acknowledge some clearances, instructions, or other information by using “wilco,” “roger,” “affirmative,” or other words or remarks. If the pilot reads back information, the controller should ensure the readback is correct or make corrections as appropriate.
2.8, 3.1.1 3.1.2	The U.S. uses “altitude” or “flight level” rather than “level”; and “cruising altitude” rather than “cruising level.” The term “level” is not used to mean “height,” “altitude,” or “flight level” in the U.S. The U.S. sometimes uses “altitude” to mean “altitude” or “flight level.”

3.1.1, 3.1.2	U.S. ATIS units do not normally accept aircraft speeds or altitudes in metric terms nor do they use the term “minimum clean speed.” The U.S. does not use the term “level” in lieu of “flight level” or “altitude.” The U.S. also uses the phrases “maintain the highest/lowest practical speed” and “increase or reduce to a specified speed or by a specified number of knots.”
3.1.2	See Part IX, Flight Information and Alerting Service, 1.3.7. Also, the term “step climb” is not used in the U.S. The word “immediately” is used only when expeditious compliance is required to avoid an imminent situation. Instead of “maintain own separation and VMC ‘from,’ ‘above,’ or ‘below’ . . .,” U.S. controllers say “maintain visual separation ‘from’ that traffic.” For TCAS resolution advisories in the U.S., pilots would advise “clear of conflict, returning to . . .”
3.1.2a,ii	To and maintain block (level) to (level).
3.1.4	See Part IV, General Provision, 18.
3.1.6	See Part XI, ATIS Messages, 4.3.2.2.1.
3.1.6	See Part IV, General Provision, 12.1.
3.1.6 Note 2	“Midpoint” and “rollout” may be omitted.
3.1.9i	Temperature issued with Braking Action.
3.2.1	The U.S. uses the phraseology “rest of route remains unchanged.”
3.3.1	Instead of “track,” U.S. controllers would advise pilots to “fly a (degree) bearing/azimuth from/to (fix) until (time)” or “until reaching (fix or altitude),” and if required, “before proceeding on course.”
3.4.7	See Part IV, General Provision, 12.1.
3.4.8	See Part VII, Aerodrome Control Service, 10.3. Also, U.S. controllers do not use the term “backtrack.”
3.4.11	U.S. controllers do not say “line up” or “wait.” Clearance to enter runway and await take-off clearance is stated “taxi into position and hold.”
3.4.11	The U.S. does not have additional phraseology to stop a take-off after an aircraft has commenced take-off roll.
3.4.13	See 3.3.1, above.
3.4.14	See Part IV, General Provision, 12.1.
3.4.16	The U.S. does not use the term “low pass” for a clearance.
4.1.1	U.S. controllers do not use the phrases “identified” or “not identified [position]” to replace “radar contact [position].”
4.1.3	U.S. controllers do not say “closing [slowly (or quickly)] [from the left (or from the right)]” nor “heading is good” nor “rate of descent is good” nor do they give “(number) meters left (or right) of course or too high or too low.” In case of elevation failure, U.S. controllers advise “no glidepath information available . . .” instead of “elevation element unserviceable . . .”
4.1.5	The U.S. does not use the phraseology “Start and stop all turns on the command ‘now’.”
4.1.5c	Start and stop all turns on the command “NOW.”
4.1.6	See 3.1.1, above.
4.1.10	U.S. controllers say “radar service terminated” not “radar control terminated.” U.S. controllers do not say “will shortly lose identification” or “identification lost.”
4.1.11	The U.S. does not use the same phraseology for secondary radar failures. The U.S. does use (name of facility) beacon interrogator inoperative/malfunctioning. Primary radar failure is covered where secondary radar service is still available with the note that traffic advisories available on radar transponder aircraft only.
4.2.1	U.S. controllers would use “airport” rather than “field.”
4.2.2	In the U.S., pilots are not told “you will intercept (radio aid or track) (distance) from (significant point or touchdown).” Neither are pilots informed “closing from left (or right) [report established]” nor “this turn will take you through (aid) [reason]” nor “taking you through (aid) [reason].” Also, see 3.1.1, above.

4.2.3	U.S. ATIS units use “course” rather than “track.”
4.2.3	The U.S. uses the phraseology for a traffic alert in lieu of the phrase “to avoid traffic”; however, the sense of urgency is the same as the word “immediately” is used by both PANS ATM and FAA.
4.2.4.1	U.S. controllers say “this will be a P–A–R/surveillance approach to runway (number) or airport/runway (number) or airport/heliport.” U.S. controllers do not say “approach completed . . .” U.S. controllers say “your missed approach procedure is (missed approach procedure)” and, if needed, “execute missed approach.”
4.2.4.2	For PAR approaches, U.S. controllers say “begin descent” and for surveillance approaches, U.S. controllers say “descend to your minimum descent altitude.”
4.2.4.4	The wheels down check is only done by U.S. military ATIS units; the phraseology is “check wheels down” for military tower controllers and “wheels should be down” for military ATIS radar units.
4.2.4.5	Although U.S. controllers say “go around,” they do not say “continue visually or go around.” In that case, they would say “if runway, approach/runway lights, not in sight, execute missed approach” or “if not visual, (advise you) execute missed approach.” Also, see 4.2.4.1, above.
4.2.5.1	See 4.2.4.1, above.
4.2.5.3	See Part VIII, Radar Services, 9.3.5 and 4.1.3, above.
4.2.5.4	See 4.1.3 and 4.2.4.2, above.
4.2.5.7	See 4.2.4.1, above.
4.2.5.8	See 4.2.4.5, above.
4.3.3	When a transponder appears inoperative or malfunctioning, U.S. controllers would instruct “. . . reset transponder, squawk” or “. . . your transponder appears inoperative/malfunctioning, reset, squawk . . .”
4.3.6, 4.3.8	U.S. controllers do not say “squawk Charlie.” U.S. controllers may ask a pilot to “ident” or “squawk standby” or “squawk low/normal” or “squawk MAYDAY on 7700” or “squawk altitude.”
4.3.9	For aircraft above FL 180, U.S. controllers would say, “confirm using two niner niner two as your altimeter setting, verify altitude” or “stop altitude squawk” “stop altitude squawk; altitude differs by (number) feet.” U.S. controllers would not say “stop squawk Charlie.”
4.3.10	See 4.3.6, above.
4.3.11, 4.3.12	See 4.3.9, above.
4.3.13	U.S. controllers would say “verify at (altitude)” and/or “verify assigned altitude.”
6.1.1	U.S. controllers would issue MEA/MVA/MOCA/MIA instead of QNH.
Part XIV	Procedures Related to Emergencies, Communication Failure and Contingencies
3	The U.S. has organized this material from the perspective of the controller. ICAO has outlined information the pilot can expect to provide.
4.3	The U.S. uses 2,000 feet above the highest obstacle and for separation from other aircraft, 1,000 feet above or 2,000 feet below and 5 miles. This includes VFR aircraft.
6.1	The U.S. does not have a section pertaining to emergency separation.
6.3	As previously covered in past differences, the U.S. uses TCAS. U.S. orders speak to controller actions when advised of an aircraft responding to a resolution alert (RA).
Appendix 1	Instructions for Air-reporting by Voice Communications
AIREP Form of Air-report	See Part IV, General Provision, 15.1.

Appendix 2	Flight Plan
	See Part IV, General Provision, 8.
2.2 (Item 15)	U.S. ATS units do not accept cruising speeds nor filed altitudes/flight levels in metric terms. The U.S. accepts filed Mach Number expressed as M followed by 3 figures.
2.2 (Item 18)	The U.S. requires filed FIR boundary designators and accumulated estimated elapsed times to such points or FIR boundaries in the sequence and form as prescribed in 2.2, Item 18 of Doc 4444, Appendix 2.
Appendix 3	ATS Messages
1.1.1	See Part XI, ATS Messages, 1.3.
1.6.2	See Part XII, Phraseologies, 2.8.
1.8.1 (Field Type 3), (Field Type 15), and (Field Type 18).	See Part XI, ATS Messages. 1.3. See Appendix 2, Flight Plan, 2.2 (Item 15) and 2.2 (Item 18).
2.1, 2.4.5, 2.5	See Part XI, ATS Messages 1.3.
Attachment B	This section now appears in the Air Traffic Services Planning Manual (Doc 9426).
3.2 (Item 15)	See Appendix 2, Flight Plan, 2.2 (Item 15).
3.2 (Item 18)	See Appendix 2, Flight Plan, 2.2 (Item 18).

ANNEX 3 – METEOROLOGICAL SERVICE FOR INTERNATIONAL AIR NAVIGATION	
PART I (Core SARPs)	
Chapter 2	General Provisions
2.1.5	The United States has its own standards on the qualifications and training of meteorological personnel providing service for international air navigation.
2.2	The United States has not instituted an ISO 9000 series of quality assurance standards for meteorological services. This difference is applicable to other subsequent paragraphs in 2.2.
2.3.3	There are no provisions to notify the meteorological office of flight schedules, delays, or cancellation of flights.
Chapter 3	World Area Forecast System and Meteorological Offices
3.4.2 g)	United States MWO's do not supply information received concerning the accidental release of radioactive material into the atmosphere to associated ACC/FIC.
Chapter 4	Meteorological Observations and Reports
4.3.2 a)	The United States does not issue local routine reports or local special reports. This difference is applicable to subsequent paragraphs that relate to the provision of local routine and special reports in Annex 3.
4.5.1 d)	This field is also used to denote a correction to the METAR/SPECI by "COR". This difference is also applicable to Table A3–2, METAR and SPECI.
4.6.2.1	The United States reports visibility in statute miles. This is also applicable to Table A3–5, Ranges and resolution for numerical elements included in METAR and SPECI. This difference is also applicable to Table A3–2, METAR and SPECI.
4.6.3.3	RVR values in the METAR/SPECI code forms are reported in feet (FT). This is also applicable to Table A3–5, Ranges and resolution for numerical elements included in METAR and SPECI. This difference is also applicable to Table A3–2, METAR and SPECI.
4.6.3.4	U.S. practice is to report only the touchdown zone in the METAR. This difference is also applicable to Table A3–2, METAR and SPECI.
4.6.7	The United States provides atmospheric pressure in inches of mercury. This is also applicable to Table A3–5, Ranges and resolution for numerical elements included in METAR and SPECI.
Chapter 5	Aircraft observations and reports
5.5	Urgent Pilot Reports (UUA) are used in lieu of Special Aircraft observations, to include Hail (GR, GS), Low Level Wind Shear (within 2000ft of surface), severe icing, severe extreme turbulence, tornado, funnel cloud or water spout (FC), and volcanic eruption and/or volcanic ash. In addition, Route Pilot Reports and UAA identify the location of the weather phenomenon by NAVAIDS.
Chapter 6	Forecasts
6.3	Landing forecasts are provided by the TAF.
6.3.3	The United States does not provide trend forecasts as part of the METAR or SPECI. This difference is also applicable to Table A3–2, METAR and SPECI. This difference is also applicable to App 4 Sec 2 that defines 'Criteria Related to Trend Forecasts'.
6.4	Takeoff forecasts are provided by the TAF. This difference is also applicable to App 4 Sec 3, 'Criteria Related to Forecasts for Take-Off'.

6.5	<p>The United States provides an Area Forecast (FA) in place of a GAMET. AIRMETs are issued every 6 hours on a scheduled basis. The FA and AIRMET are valid from the surface to FL450. The FA and AIRMET formats differ from Table A5–4 and Table 6–1. Specifically, the FA are issued three times a day in the United States, with the exception of Alaska and Hawaii where they are issued four times a day. They are valid for a 12–hour period beginning 1 hour after issuance and have an 18–hour outlook.</p> <p>This is also applicable to Part 1: 7.2, Part II, Appendix 5: 4, Part II, Appendix 6:2.1, and Part II, Appendix 8: 4.1.2 (use of templates.)</p>
Chapter 7	SIGMET and AIRMET Information, Aerodrome Warnings and Wind Shear Warnings
7.2.3	United States practice is to issue an AIRMET every six hours on a scheduled basis. The United States is developing capabilities to issue an AIRMET on a scheduled basis every 3 hours, which would exceed the SARP standard that an AIRMET is not to be issued more than every 4 hours.
7.4.1	<p>The United States does not provide wind shear warnings. The United States believes wind shear alerts are timelier to flight crews in landing and takeoff than wind shear warnings and thus provide a greater level of safety. In addition, the information is duplicative in nature in that wind shear warnings could be delayed while wind shear alerts are provided via automated systems that allow for immediate data link to flight crews through ATS systems.</p> <p>This difference is also applicable to App 6: 6.2.</p>
Chapter 9	Service for operators and flight crew members
9.2.3 & 9.2.4	United States meteorological offices have no means to communicate directly to flight crews if there is a divergence in the forecast from what is provided in the flight document folder.
9.3.3	United States meteorological offices have no means to provide updates to flight document folders or to contact the operator.
PART II	APPENDICES and ATTACHMENTS
APPENDIX 3	Technical specifications related to meteorological observations and reports
2.2	The United States does not use the term CAVOK in meteorological reports. This difference is also applicable to Table A3–2, METAR and SPECI.
2.3.1 c)	The U.S. does not prepare SPECI for changes in air temperature.
2.3.2 a)	U.S. practices require SPECI for wind shift when wind direction changes by 45 degrees or more in less than 15 minutes and the wind speed is 10 knots or more throughout the wind shift.
2.3.2 b)	U.S. practices do not require SPECI for increases of mean surface wind speed.
2.3.2 c)	U.S. practices require SPECI for squall, where squall is defined as a strong wind characterized by a sudden onset in which the wind speed increases at least 16 knots and is sustained at least 22 knots or more for at least one minute.
2.3.2d)	U.S. practices do not require SPECI for wind direction changes based on local criteria.
2.3.2f)	SPECI are not prepared for the equivalents in feet of 150, 350, or 600 meters. United States military stations may not report a SPECI based on RVR.
2.3.2 g/h)	<p>Practices do not require SPECI for the onset, cessation, or change in intensity of:</p> <ul style="list-style-type: none"> – freezing fog. – moderate or heavy precipitation (including showers thereof). – low drifting dust, sand or snow. – blowing dust, sand or snow (including snowstorm). – duststorm. – sandstorm.

2.3.2 i) and j)	The United States provides a SPECI when a layer of clouds or obscurations aloft is present below 1000 ft and no layer aloft was reported below 1000 ft in the preceding report. A SPECI is also reported when the ceiling decreases or increases at these markers: 3000, 1500, 1000, 500ft or lowest published instrument approach procedures. SPECI is made when the ceiling (rounded off to reportable values) forms or dissipates below, decreases to less than, or if below, increases to equal or exceed: 3,000 feet, 1,500 feet, 1,000 feet, 500 feet or lowest standard instrument approach procedure minimum published in the National Ocean Survey (NOS) <i>U.S. Terminal Procedures</i> . If none published, then 200 feet.
4.1.1.2	The United States does not provide wind representatives for specific runways but does provide a wind representative for the airport.
4.1.3.1 b)	The United States provides a 2–minute average wind observation for the METAR/SPECI.
4.1.5.2b)	The wind direction may be considered variable if, during the 2–min evaluation period, the wind speed is 6 KT or less. Also, the wind direction shall be considered variable if, during the 2–min evaluation period, it varies by 60 deg or more when the wind speed is greater than 6 KT.
4.1.5.2c)	United States practices define wind gust as rapid fluctuations in wind speed with a variation of 10 knots or more between peaks and lulls. Wind speed data for the most recent 10 minutes is examined and a gust, the maximum instantaneous wind speed during that 10–minute period, is reported if the definition above is met during that period.
4.2.4.4	The United States does not report the lowest visibility in lieu of prevailing visibility. The United States always reports prevailing visibility and does not report lowest visibility if the lowest visibility is different from prevailing visibility
4.2.4.5	The United States does not use “NDV”, no direction variations can be given for visibility. This difference is also applicable to Table A3–2, METAR and SPECI
4.3.6.1	The United States reports RVR in increments of 100 feet up to 1,000 feet, increments of 200 feet from 1,000 feet to 3,000 feet, and increments of 500 feet above 3,000 feet to 6,000 feet.
4.3.6.5b), 4.3.6.6	The United States reports RVR for a single designated runway in the METAR/SPECI. RVR tendency is not reported. This difference is also applicable to Table A3–2, METAR and SPECI.
4.4	The following weather elements are augmented manually at designated automated stations observation sites: FC, TS, GR, GS, and VA. At selected airports, additional present weather elements may be provided. With the exception of volcanic ash, present weather is reported when prevailing visibility is less than 7 statute miles or considered operationally significant. Volcanic ash is always reported when observed.
4.4.2.6	The practice with respect to the proximity indicator VC is between 5 to 10 statute miles from the point of observation with the exception of precipitation for which the VC indicates > 0 to 10 statute miles from the point of observation.
4.5.4	<p>The United States reports only up to 3 layers at automated sites and up to 6 layers at manual sites. Cloud layer amounts are a summation of layers at or below a given level, utilizing cumulative cloud amount. In addition, at automated sites, which are unstaffed, cloud layers above 12,000 ft are not reported. At staffed automated sites, clouds above 12,000 ft may be augmented. CAVOK and NSC are not used.</p> <p>In addition, the United States does not use “//” when cloud type can not be observed; “NCD” when no clouds are detected; or “/////” for CB or TCU when not detected by automated observing systems.</p> <p>In the United States the symbol “//”, when used in the cloud section of the METAR, refers to a mountain station where the layer is below the station level. This difference is also applicable to Table A3–2, METAR and SPECI.</p>
4.8	<p>The United States has a Remarks Section that provides similar information.</p> <p>This difference is also applicable to Table A3–2, METAR and SPECI.</p>

4.8.1.4	Wind shear is not included in the METAR/SPECI code form in the U.S remarks. This difference is also applicable to Table A3–2, METAR and SPECI.
4.8.1.5	Sea–surface temperature, the state of the sea and state of the runway are not provided in the METAR/SPECI code form in the U.S. remarks. This difference is also applicable to Table A3–2, METAR and SPECI.
APPENDIX 4	Technical specifications related to aircraft observations and reports
3.1.4	The United States MWOs do not issue special air reports.
APPENDIX 5	Technical specifications related to forecasts
1.2.2	Forecast visibility increments used consist of 1/4 mile from 0 (zero) to 1 mile, 1/2 mile from 1 to 2 miles, and 1 mile above 2 miles. Note: miles are statute miles.
1.2.3	Practices require forecast of non–convective low–level wind shear within 2,000 feet of the ground in the Optional Group. The forecast consists of WS (wind shear); heights of the wind shear in hundreds of feet; and wind speed and direction above the wind shear height, using METAR and TAF coding regulations.
1.2.4	The United States does not use CAVOK and NSC in the TAF. This difference is also applicable to Table A5–1, Template for TAF. The non–application of the use of NSC also applies to App 5. 1.3.1 i)
1.3.1 e)	Change groups and amendment criteria below 1/2 statute mile (800 meters) are not used. This difference is also applicable to Table A5–1, Template for TAF.
1.3.1 j)	The 100–foot (30 meter) change group and amendment criterion is not used. This difference is also applicable to Table A5–1, Template for TAF.
1.3.2	The United States does not use the change indicator “BECMG”. This difference is also applicable to Table A5–1, Template for TAF and to other subsequent sections including 1.3.3 and 1.3.4 where BECMG is referenced.
1.4	The United States does not use “PROB 40” in the TAF. “PROB 30” will not be used in the first nine (9) hours of every TAF’s valid period, including amendments. This difference is also applicable to Table A5–1, Template for TAF. Note also that Military TAFs do not use the “PROB” groups.
4.1 i)	Practice is not to include thunderstorms information in Area Forecasts. See difference filed for Part I 6.6 that the United States does not provide the GAMET but does provide an Area Forecast.
4.3	U.S. practices do require reporting of ISOL, OCNL or FREQ in accordance with the guidance on the use of the terms given in App 6. The United States reports “isolated” (ISOL) when the phenomena affect an area less than approximately 3,000 square miles or are widely separated in time, and widespread (WDSPR) to mean more than 50 percent of the area.
APPENDIX 6	Technical specifications related to SIGMET and AIRMET information, aerodrome warnings and wind shear warnings and alerts
1.1.3	SIGMET messages in the CONUS use VORs in place of lat/long and do not reference FIRs. SIGMETs are issued by alphanumeric series, e.g., Kilo 1, 2, 3 etc. In the conterminous U.S., convective SIGMETs are issued in lieu of SIGMETs for convection. They are issued as hourly bulletins for the East, Central, and Western United States and thus they do not indicate the FIR. Connective SIGMETs have an outlook section. This difference is also applicable to Table A6–1, Template for SIGMET and AIRMET messages.
1.1.4	Convective SIGMETs for the conterminous U.S. are issued with the non–standard WMO Header designator “WST” and use a lower criteria. Practices are to issue a SIGMET for mountain wave only when accompanied by severe turbulence. In addition, the U.S. does not issue a SIGMET for radioactive clouds. This difference is also applicable to Table A6–1, Template for SIGMET and AIRMET messages.

2.1.2, 2.1.3	AIRMETs in the conterminous U.S. are issued as bulletins for the East, West, and Central U.S. in conjunction with area forecast turbulence, icing, and ceiling and visibility, and thus do not comply with template for FIR or series numbering format. This difference is also applicable to Table A6-1, Template for SIGMET and AIRMET messages.
2.1.4	AIRMET in the conterminous U.S. on a routine schedule for icing, turbulence, sustained surface winds, ceiling/visibility and convection. Practices do not include use of ISOL, OCNL or FRQ. This difference is also applicable to Table A6-1, Template for SIGMET and AIRMET messages. The U.S. does not include cloud amount or type in AIRMET.
4.2.1	U.S. practices do require reporting of ISOL, OCNL or FREQ in accordance with the guidance on the use of the terms given in App 6. The United States reports “isolated” (ISOL) when the phenomena affect an area less than approximately 3,000 square miles or are widely separated in time, and widespread (WDSPR) to mean more than 50 percent of the area.
5.1, 5.1.3	The United States does provide for tsunamis in the aerodrome warning. The U.S. issues airport warning messages similar to the ICAO format (Table A6-2, Template for aerodrome warnings) only at selected airports based on a bilateral agreement between the airport authority and the NWS Forecast Office.

ANNEX 4 – AERONAUTICAL CHARTS	
Chapter 1	Definitions
Air taxiway	The U.S. does not depict defined surfaces for air-taxiing of helicopters.
Danger area	The term “danger area” will not be used in reference to areas within the U.S. or in any of its possessions or territories.
Final approach and take-off area (FATO)	The U.S. does not depict final approach and take-off areas (FATOs).
Helicopter stand	The U.S. does not use this term.
Prohibited area Restricted area	<p>The U.S. will employ the terms “prohibited area” and “restricted area” substantially in accordance with the definitions established and, additionally, will use the following terms: “Alert area.”</p> <p>Airspace which may contain a high volume of pilot training activities or an unusual type of aerial activity, neither of which is hazardous to aircraft.</p> <p>“Controlled firing area.” Airspace wherein activities are conducted under conditions so controlled as to eliminate the hazards to nonparticipating aircraft and to ensure the safety of persons and property on the ground.</p> <p>“Warning area.” Airspace which may contain hazards to nonparticipating aircraft in international airspace.</p> <p>“Maneuvering area.” This term is not used by the U.S.</p> <p>“Military operations area (MOA).” An MOA is an airspace assignment of defined vertical and lateral dimensions established outside Class A airspace to separate/segregate certain military activities from IFR traffic and to identify for VFR traffic where these activities are conducted.</p> <p>“Movement area.” Movement area is defined by the U.S. as the runways, taxiways, and other areas of an airport which are utilized for taxiing, take-off, and landing of aircraft, exclusive of loading ramp and parking areas.</p>
Touchdown and lift-off area (TLOF)	The U.S. does not use this term.
Chapter 1.1	Definitions
Aerodrome reference point	Airport Reference Point is the approximate geometric center of all usable runway surfaces.
Airway	Airways are Class E airspace.
Area Minimum Altitude	Off Route Obstruction Clearance Altitude (OROCA) used.
Arrival Routes	Arrival routes are also identified on Standard Terminal Arrival (STAR).
Clearway	Obstacle and terrain may not extend above specified limits in a Clearway.
Displaced Threshold	Displaced threshold is located at other than the designated beginning of the runway.
Final Approach	Final approach begins at the final approach fix or point and extends to the airport or the point where a circle-to-land maneuver or a missed approach is executed.
Flight Level	Flight level is related to a reference datum of 29.92 inches of mercury.
Glide Path	Glideslope is used instead of glide path.
Helicopter Stand	Helipad is used vice helicopter stand.
Instrument Approach Procedure	Instrument approach procedure begins at the initial approach point vice defined arrival route.

Intermediate Approach Segment	Intermediate approach segment is that segment between the intermediate fix or point and the final approach fix.
Minimum obstacle clearance altitude (MOCA)	MOCA also assures acceptable navigational signal coverage within 22 NM of a VOR.
Minimum sector altitude	Minimum Sector Altitude is centered on the navigation facility upon which the procedure is predicated.
Missed approach point	Missed approach point based on acquiring the required visual reference.
Missed approach procedure	Missed approach procedure is conducted when the approach cannot be completed to a landing.
Movement Area	Movement area also includes areas used by helicopters in taxiing. It does not include loading ramps or parking areas.
Obstacle	Obstacles may include terrain and objects of natural growth.
Obstacle clearance altitude (OCA) or Obstacle clearance height (OCH)	Decision Altitude and Decision Height used vice Obstacle Clearance Altitude and Obstacle Clearance Height.
Obstacle free zone	Obstacle Free Zone also includes airspace above runway surface.
Precision approach procedure	MLS also included as a Precision approach procedure.
Procedure turn	Procedure turn is used only on intermediate approach segment or final approach course.
Prohibited area	Permission of the using agency is required before using Prohibited airspace.
Terminal arrival altitude (TAA)	Terminal Arrival Areas defined by the extension of the IAF legs and the intermediate segment course.
Touchdown zone	Touchdown zone is the first 3000 feet of the runway beginning at the threshold.
Track	Track is the actual flight path of the aircraft over the surface of the earth.
Vectoring	Vectoring based on use of radar.
Visual approach procedure	Visual approach procedure is conducted on an IFR flight plan which authorizes the pilot to proceed visually and clear of clouds to the airport.
Chapter 1.2	Applicability
1.2.2	Charts vary in their conformance to ICAO Standards.
1.2.2.1	Charts vary in their conformance to ICAO Recommended Practices.
Chapter 2	General Specifications
2.1	The titles of charts produced by the U.S. are not those provided for in Annex 4.
2.1.7	Charts are True North oriented except as indicated.
2.1.8	Sheet size of charts varies dependent on chart type.

2.2.1	The marginal note layouts, in some cases, differ from those set forth in Appendices 1, 5, and 6.
2.3.1	Marginal note layouts vary by chart type
2.4	Symbols do not universally conform to Appendix 2.
2.4.1	Visibility distances are expressed in statute miles and fractions thereof.
2.4.4	Conversion scale (meters/feet) is not shown on Radio Navigation Charts.
2.5.4	Linear dimensions are expressed in feet.
2.5.7	Conversion scales are not universally used.
2.6.2	Some charts have no linear scale.
2.9.2	Abbreviations used are from FAA Order 7340.1, not ICAO Doc 8400.
2.11	Color schemes differ by chart series.
2.12.2	Hypsometric tints differ by chart series.
2.12.3.1	Unreliable spot elevations are shown with an “x” preceding the value.
2.14.1	Vertical limits of airspace are not shown.
2.18.3.1	Julian Calendar is also used.
Chapter 3	Aerodrome Obstacle Chart – ICAO Type A (Operating Limitations)
3.1	The U.S. produces an Airport Obstruction Chart which covers the basic requirements called for by Aerodrome Obstruction Chart – ICAO Type A.
3.2.1	Availability of chart is not dependent on provision of other charts.
3.2.2	Notification is not made when chart is not required.
3.3.2	Linear dimensions are expressed in feet.
3.6	Country name is not used.
3.8.1.3	Obstacles shown only in relation to FAR 77
3.8.3.1	Only total pavement distance is shown
Chapter 4	Aerodrome Obstacle Chart – ICAO Type B
4.1	The U.S. produces an Airport Obstruction Chart which covers the basic requirements called for by Aerodrome Obstruction Chart – ICAO Type B.
4.2.1	Availability of chart is not dependent on provision of other charts
4.3.2	Linear dimensions are shown in feet.
4.6	Country name is not used
Chapter 5	Aerodrome Obstacle Chart – ICAO Type C
5.8.1	The navigation grid on U.S. Aircraft Position Chart 3097 comprises lines parallel to 54° West Meridian and the navigation grid on U.S. Aircraft Position Chart 3096 comprises lines parallel to 92° West Meridian. These changes to the ICAO Standard were made to provide navigation grid lines vertical to a great circle projection base.
Chapter 6	Precision Approach Terrain Chart – ICAO
6.9.1.1	Only outbound magnetic bearings from VOR facilities and inbound magnetic bearings to low/medium frequency radio navigation facilities are shown.

Chapter 7	En Route Chart – ICAO
7.1	Simplified versions are not included in the AIP.
7.6.2	Off Route Obstruction Clearance Altitude (OROCA) is shown.
7.9.3.1.1	Coordinates are shown in degrees, minutes and hundredths of minutes. DME antenna elevation is not shown. Vertical limits of airspace are shown in tabulated data form. RNP type designation is not shown. Coordinates of significant points are not shown. Bearings are shown to the nearest degree and distances to the nearest mile. Logon address is not shown.
7.9.3.1.1 1) and 5)	The U.S. depicts geographic positions in degrees and minutes to the hundredth of a degree.
Chapter 8	Area Chart – ICAO
8.1	Area charts produced only where the amount of detail required results in congestion of information on an IFR Enroute Low Altitude chart.
8.3.1	Departure and Arrival routes are not shown.
8.9.1	Only airports shown are those with hard surface runways of 3000 feet or longer and/or with an Instrument Approach Procedure.
8.9.3	Off Route Obstruction Clearance Altitude (OROCA) is shown.
8.9.3.1.1 1) and 6)	The U.S. depicts geographic positions in degrees and minutes to the hundredth of a degree.
8.9.4.1.1	Coordinates are shown in degrees, minutes and hundredths of minutes. DME antenna elevation is not shown. Vertical limits of airspace are shown in tabulated data form. Terminal routings are not shown. Coordinates of significant points are not shown. Bearings are shown to the nearest degree and distances to the nearest mile. Minimum vectoring altitudes are not shown. Logon address is not shown.
Chapter 9	Standard Departure Chart – Instrument (SID) – ICAO
9.2	Charts are provided only when a procedure has been established.
9.3.1	Charts covering continental U.S. between latitudes 24° and 52° North are based on standard parallels at 33° and 45° and between latitudes 52° and 72° North on standard parallels at 55° and 65°.
9.3.2	Charts are not generally drawn to scale.
9.3.3	Scale bar is not shown.
9.4.1	The U.S. uses a sheet numbering system which differs from the index in Appendix 7.
9.4.2	Parallels and meridians are not shown.
9.4.3	Graduation marks are not shown.
9.5	Procedure route is identified in accordance with FAA Order 8260.46
9.6.1	Culture and topography are not shown.
9.6.2	Relief is not shown.
9.8.3.2*	The elevation of the highest point on any sheet is not always cleared of hypsometric tinting.
9.9.1.2	Secondary airports are shown only when designated.
9.9.2	Danger areas are not shown. Vertical limits are not shown.
9.9.3.1	Minimum Sector Altitude is not shown.
9.9.3.1.1 2d) and 3)	The U.S. depicts geographic positions in degrees and minutes to the hundredth of a degree.
9.9.3.2	Area minimum altitudes are not shown.

9.9.4.1.1	Coordinates for NAVAIDs and Significant Points are shown in degrees, minutes and hundredths of minutes. Bearings are shown to the nearest degree and distances to the nearest mile. DME antenna elevation is not shown. Obstacles are depicted textually with position and height, and without regard for penetration of OIS. Minimum vectoring altitudes are not shown.
9.10.1	Heliports are not shown.
Chapter 10	Standard Arrival Chart – Instrument (STAR) – ICAO
10.2	Charts are provided only when a procedure has been established.
10.3.2	Charts are not generally drawn to scale.
10.3.3	Scale bar is not shown.
10.4.2	Parallels and meridians are not shown.
10.4.3	Graduation marks are not shown.
10.5	Procedure route is identified in accordance with FAA Order 7100.9
10.6.1	Culture and topography are not shown.
10.6.2	Relief is not shown.
10.8.3.2*	The elevation of the highest point on any sheet is not always cleared of hypsometric tinting.
10.9.1.1	Airports are shown by symbol vice pattern.
10.9.1.2	Secondary airports are shown only when designated.
10.9.2	Danger areas are not shown. Vertical limits are not shown.
10.9.3.1	Minimum Sector Altitude is not shown.
10.9.3.1.1 2d) and 3)	The U.S. depicts geographic positions in degrees and minutes to the hundredth of a degree.
10.9.3.2	Area minimum altitudes are not shown.
10.9.4.1.1	Bearings are shown to the nearest degree and distances to the nearest mile. Coordinates for NAVAIDs and Significant Points are shown in degrees, minutes and hundredths of minutes. DME antenna elevation is not shown. Minimum vectoring altitudes are not shown.
Chapter 11	Instrument Approach Chart – ICAO
11.3.3	Scale is not shown.
11.3.3.1	Distance circle is centered on NAVAID used for final approach segment, except when location of the airport, radio aid to navigation and/or procedure pattern necessitates that the ring be centered on other facilities or geographical points for better portrayal of the instrument approach procedure.
11.3.3.2	Distance between components and between last component and runway shown.
11.4	Sheet size is 8.25 inches by 5.375 inches
11.5.2	Graduation marks are not shown.
11.7.1	Culture information is not shown. Topographic information is not named. Hydrographic features are shaded.
11.7.2	Terrain charting criteria does not include approach gradient steeper than optimal due to terrain.
11.7.3	Terrain is not charted if Std 11.7.2 is not met.
11.8.1	Magnetic variation is shown only in areas of compass instability and on charts North of 67 degrees of latitude.
11.9.3	Grid meridian is not shown.
11.10.1.1	Abandoned airports are not shown
11.10.2.2	Obstacles that are the determining factor for an OCA/OCH are not necessarily shown.
11.10.2.7	Obstacle free zones are not shown.
11.10.3	Vertical limits are not shown.

11.10.4.3	The U.S. does not depict geographic position of the final approach fix. Geographic coordinates are not shown.
11.10.5	Terminal arrival areas are shown vice terminal arrival altitude.
11.10.6.1	Arrowed, dashed line is shown vice arrowed, dotted line. Times required for the procedure are not shown. Magnetic bearings to the airport from the final approach NAVAID are not shown. Circling prohibitions are indicated by textual note vice graphic boundaries.
11.10.6.2	Distance to airport from final approach NAVAID is not shown.
11.10.6.3	Arrows are not shown on procedure track line except to indicate heading changes. Missed approach segment is shown by arrowed, dashed line. Arrowed, dashed line is used for other segments vice arrowed, dotted line. Times required for the procedure are not shown. Intermediate approach fix/point is not shown where no course reversal is authorized. Distance between components is shown vice a distance scale.
11.10.6.4	Parentheses are not shown.
11.10.6.5	Ground profile and shaded altitude blocks are not shown.
11.10.7.1	Procedure landing minima are shown vice aerodrome operating minima.
11.10.7.2	Decision Altitude/Height (DA/H) shown vice OCA/H.
11.10.8.2	Altitude/height table is not shown.
11.10.8.3	Altitude/height table is not shown.
11.10.8.4	Rate of descent table is not shown.
11.10.8.5	Descent gradient is not shown. Parentheses are not shown
11.10.8.6	Reference datum height is not shown. Descent angle shown to the nearest hundredth of a degree.
11.10.8.8	Cautionary note is dependent on multiple criteria.
11.10.9	Geographical coordinates are not shown. Fix formation bearings shown to the nearest degree. Mileages are shown to the nearest mile. Descent angles are not shown.
Chapter 12	Visual Approach Chart – ICAO
12.1	Charts provide visual arrival routes and altitudes.
12.2	Chart provided only when visual approach procedure has been established.
12.2.1	Stopways are not indicated.
12.3.3	Charts are shown at scale of 1:250,000
12.4	Sheet size is 8.25 inches by 5.375 inches.
12.5.2	Graduation marks are not shown
12.5.5.2.1	The datum (MSL) is stated in the Instrument Approach Chart legend, not on the chart.
12.6.2	Runway threshold elevations are not shown.
12.7.1.1	Place names are not shown.
12.8	Magnetic variation is shown only in areas of compass instability and on charts North of 67 degrees of latitude.
12.9.3	Grid meridian is not shown.
12.10.1.1	Abandoned airports are not shown
12.10.1.2	Airport elevation is not shown
12.10.2.3	Height of obstacle above Mean Sea Level is shown.
12.10.2.3.1	Parentheses are not shown.
12.10.3	Danger areas are not shown. Vertical limits are not shown.
12.10.4	Control zones and Traffic zones are not shown. Vertical limits are not shown.

12.10.5.3	VASI, MEHT, and angle of displacement are not shown.
Chapter 13	Aerodrome/Heliport Chart – ICAO
13.1	Airport Diagrams are developed for complex runway and taxiway layouts and to provide information for updating computer based navigation systems. Helicopter movement is supported only with the location of helipads.
13.3.1	Scale varies to allow depiction of one whole degree of latitude and longitude.
13.3.2	Latitude and longitude graticules are shown vice linear scale.
13.6.1	Latitude and longitude graticules are shown vice geographical coordinates. Elevations for runway ends, parking areas, and the airport are shown. Clearways are not shown. Parking areas and ramps are shown with their designations and without details. Taxiways and identification only are shown. Standard taxi routes are not shown. Boundaries of air traffic service are not shown. RNR observation sites are not shown. Approach and runway lighting are not shown. VASI systems are not shown. VOR checkpoint and frequency are not shown. Logon address is not shown.
13.6.1.d Surface type for heliports.	The U.S. does not show “type of surface for heliports.”
13.6.2 Elevated helidecks, etc.	The U.S. does not show “surface level, elevated, or helidecks.” Helicopter pads only are shown. Touchdown and liftoff areas are not shown. Final approach and takeoff areas are not shown. Safety areas are not shown. Clearways are not shown. Visual aids are not shown. Declared distances are not shown.
Chapter 14	Aerodrome Ground Movement Chart – ICAO
14.6.1 c)	The U.S. does not depict geographic positions of aircraft stands.
14.6.1 f)	The U.S. does not depict taxiway centerline points.
Chapter 16	World Aeronautical Chart – ICAO 1:1 000 000
16.3.1	Linear scales are shown in the following order: nautical miles, statute miles, kilometers.
16.4.3	Charts are folded in eleven vertical panels and one horizontal fold.
16.4.4	Sheet lines are shown on Title Panel chart index.
16.4.5	ICAO has not been notified of chart sheet lines.
16.5.1	Standard parallels are for each 8 degrees and are shown 1 degree and 20 minutes in from the Northern and Southern edges of the chart. Charts are not produced above 80 degrees latitude.
16.5.2	Distance between parallels is 1 degree. Above 56 degrees North, latitude graduation marks are shown only on every even degree of longitude. Distance between longitude meridians is 1 degree. Above 64 degrees North, meridian graduation marks are shown every 5 minutes.
16.5.3.1	Lengths of interval marks are as follow: 1 minute – .045 inches; 5 minutes – .065 inches; 10 minutes – .10 inches on both sides.
16.6	Chart numbering is indicated on Title Panel chart index.
16.7.2.1	Railroads are not shown within outlined populated areas.
16.7.2.2	Tunnels, if possible, are shown wherever they exist.
16.7.3.1	Roads are shown for radar and visual value and for distinct configurations that provide visual checkpoint value.
16.7.3.2	Roads are not shown within outlined populated areas.
16.7.9.2	Coordinates shown to the nearest minute.
16.7.9.3	Halo effect only shown for elevation value.
16.7.10.1	Notes will read ‘Relief data incomplete’ or ‘Limits of reliable relief information.’
16.7.10.2	Unreliable spot elevations are shown with an ‘x’ preceding the value.
16.7.12.1	Wooded areas are not shown.

16.7.13	Date of topographic information is not shown.
16.8.2	Date of isogonic information is shown in the chart legend.
16.9.2.1	Only airports published in the National Flight Data Digest are charted. They may be omitted if in congested areas or if airports with better facilities are nearby.
16.9.2.2	Other than hard surface runways are shown by symbol.
16.9.3.1	Obstacles greater than 200 feet are shown. Obstacles 200 feet or less may be shown.
16.9.4	Alert Areas, Military Operating Areas and Warning Areas are also shown.
16.9.5.1	Class D airspace and Class E (surface) airspace are not shown.
16.9.6	NAVAIDs without voice capability are shown with their frequency underlined.
16.9.7.1	Only aeronautical ground lights that operate continuously are shown.
16.9.9.2	Only marine lights that operate year round, with a range of at least 10 NM, and are omnidirectional are shown.
Chapter 17	Aeronautical Chart – ICAO 1:500 000
17.3.1	Linear scales are shown in the following order: nautical miles, statute miles, kilometers.
17.4.3	Charts are folded in eleven vertical panels and one horizontal fold.
17.4.4	Relationship of chart to WAC series is not shown.
17.5.4.1	The 10 minute interval mark is .10 inches on both sides of the graticule line.
17.6.1.1	Relationship of chart to WAC series is not shown.
17.7.2.2	Tunnels, if possible, are shown wherever they exist. Prominent tunnels are shown pictorially.
17.7.3.1	Roads are shown for radar and visual value and for distinct configurations that provide visual checkpoint value.
17.7.3.2	Roads are not shown within outlined populated areas. Dual lane highways are shown within large scale insets.
17.7.9.2	Coordinates are shown to the nearest minute.
17.7.9.3	Halo effect is only shown for elevation value.
17.7.10.1	Notes will read ‘Relief data incomplete’ or ‘Limits of reliable relief information.’
17.7.10.2	Unreliable spot elevations are shown with an ‘x’ preceding the value.
17.7.12.1	Wooded areas are not shown.
17.7.13	Date of topographic information is not shown.
17.8.2	Date of isogonic information is shown in the chart legend.
17.9.2.1	Only airports published in the National Flight Data Digest are charted. They may be omitted if in congested areas or if airports with better facilities are nearby.
17.9.2.2	Other than hard surface runways are shown by symbol.
17.9.2.3	Only abandoned airports with at least a 3000 feet hard surface runway and with landmark value are shown.
17.9.3.1	Obstacles greater than 200 feet are shown. Obstacles 200 feet or less may be shown.
17.9.4	Alert Areas, Military Operations Areas, and Warning Areas are also shown.
17.9.6	NAVAIDs without voice capability are shown with their frequency underlined.
17.9.7.1	Only aeronautical ground lights that operate continuously are shown.
17.9.7.2	Only marine lights that operate year round, with a range of at least 10 NM, and are omnidirectional are shown.

Appendix 2	ICAO Chart Symbols
No. 21	Tidal flats are shown in brown stipple over the blue open water tint.
No. 45	Rocks awash are shown by a six–armed symbol as adopted by the International Hydrographic Bureau.
No. 54, 61	Spaces between sides of bridge and road or railroad symbols are filled solid.
No. 70	Oil or gas fields are shown with an oil well derrick symbol.
No. 77	Ruins are shown by a solid square, properly annotated.
No. 94	<p>The runway surface indicator (letter H) and the lighting indicator (letter L) are not normally used on high altitude Radio Navigation Charts. Only those airports with a minimum of 5,000 feet hard–surfaced runways are shown.</p> <p>The letter H is not used on low altitude Radio Navigation Charts. All airports depicted have hard–surfaced runways, excepting that where the letter “S” follows the runway length, the runway surface is soft.</p> <p>On Visual Navigation Charts of the 1:500 000 scale, a miniature runway layout depiction indicates airports with hard–surfaced runways at least 1,500 feet long.</p>
No. 110	Aerodrome traffic zones are termed “SURFACE AREAS” in U.S. usage. These are all of standard dimensions. Limits are not shown, but airports at which SURFACE AREAS have been established are indicated by a color–coded airport symbol.
No. 113	Limits of advisory areas are shown on Radio Navigation Charts with a crenellated line. This depiction is indicated in the legend as the border of an Air Route Traffic Control Center (ARTCC).
No. 116	The nomenclature “non–compulsory” is used instead of “on request” for appropriate position reporting points.
No. 127	Isogonic lines are shown on Radio Navigation Charts only as short sections of continuous lines extending inward from the neat lines.
*Indicates ICAO Recommended Practice.	

ANNEX 5 – UNITS OF MEASUREMENT TO BE USED IN AIR-GROUND COMMUNICATIONS
<i>General Statement:</i> Most of the individual SI quantities and measurement units listed in the Annex are not commonly used in routine international air operations. Although most U.S. national standards and practices do not specifically utilize the SI units, the SI units of measurement are acceptable and not prohibited from use by U.S. regulations. Under the present operational practices, these differences are not significant and are identified in U.S. Aeronautical Information and Technical Publications. In accordance with Article 38 of the Convention, the U.S. wishes to file the enclosed Notice of Differences to Annex 5, Fourth Edition, as amended by Amendment 13. Only those differences recognized as necessary for the safety or regularity of international air navigation and required for day-to-day operations in U.S. airspace are listed separately in this notification. In addition, we do not support the establishment of dates for planning purpose for termination of the use of bar, knot, nautical mile, and foot. (Chapter 4, Table 4-1) Until sufficient operational analysis identifies and resolves the safety issues, the establishment of termination dates for use of the bar, knot, nautical mile, and foot is unacceptable.
Reference: Table 3-4, Chapter 3, Annex 5, Fourth Edition, as Amended by Amendment 13.

Chapter 3	Standard application of units of measurement		
3.2.2 Table 3-3 Table 3-4	Table 3-4 Ref 1.12, runway length and Ref 1.13 runway visual range, unit of measure is in feet. Table 3-4 Ref 1.16, visibility unit of measure is statute miles (SM). Table 3-4 Ref 3.2, altimeter setting, unit of measure is reported as inches of mercury. Table 3-4, Ref 3.3, atmospheric pressure, unit of measure is in inches of mercury.		
Chapter 3.3 (Table 3-4)			
Ref. No.	Quantity	Unit (SI)	Differences as of 5 January 1988
1.4	distance (short)	meter	foot
1.12	runway length	meter	foot
1.13	runway visual range	meter	foot
1.15	time	hour and minute, the day of 24 hours beginning at midnight UTC	Time may be given in local time
1.16	visibility	kilometer	statute mile and fraction
2.12	mass (weight)	kilogram	pound (lb)
3.2	altimeter setting	hectopascal	inches of mercury
6.7	temperature	°C	C° except Fahrenheit used for surface air and dew point temperature
10.1	absorbed dose	Gy	rd
10.2	absorbed dose rate	Gy/s	rd/s
10.4	dose equivalent	Sv	rem
10.5	radiation exposure	C/kg	R
10.6	exposure rate	C/kg·s	R/s
All non-SI alternative units listed in this table will continue to be utilized where permitted. (1.1, 1.3, 1.5, 1.7, 4.1, 4.7, 4.15, 4.16)			
Attachment B	Guidance on the application of System of Units (SI)		
5.4.2	Specifications differ from Attachment B, Style and usage, Para 5.4 Numbers. Comma is not acceptable as a decimal marker. Comma is used to separate digits in groups of three.		

ANNEX 6 – OPERATION OF AIRCRAFT	
PART I	
Chapter 1	Definitions
Aerodrome operating minima	This term is not used in the U.S.
Category I (Cat I) operation	For a Category I operation, the U.S. requires a decision height (DH) of not less than 200 feet and either visibility of not less than 1/2 mile or a runway visual range of 2,400 feet (RVR 1,800 feet with operative touchdown zone and runway centerline lights).
Category II (Cat II) operation	The U.S. requires that Category II provide approaches to minima of less than 200 feet decision height/2,400 runway visual range to as low as 100 feet decision height/1,200 feet runway visual range.
Category IIIA (Cat IIIA) operation	U.S. criteria are the same as those adopted in Part 1 of Annex 6. However, the runway visual range is expressed as not less than 700 feet (200 meters).
Category IIIB (Cat IIIB) operation	U.S. criteria are the same as those adopted in Part 1 of Annex 6. However, the runway visual range is expressed as less than 700 feet (200 meters) but not less than 150 feet (50 meters).
Cruising level	The term “cruising altitude” is used in lieu of “cruising level” in U.S. ATC phraseology.
Decision height	Although not identical, the U.S. definition of decision height is not substantially different.
General aviation operation	<p>General aviation is defined as all civil aviation operations other than scheduled air transportation and nonscheduled air transport operations for remuneration or hire. The classification of general aviation flying by powered aircraft is, as follows:</p> <p>Instructional flying. Use of an aircraft for purposes of flight instruction with an instructor. The flights may be performed by aero-clubs, flying schools, fixed-base operators, or commercial operators.</p> <p>Business flying. Use of an aircraft to carry personnel and/or property to meet the transport needs of officials of a business, firm, company, or corporation. These flights may be performed by a commercial pilot or by a private pilot.</p> <p>Pleasure flying. Use of an aircraft for personal or recreational purpose not associated with a business or profession.</p> <p>Aerial work. Use of an aircraft for activities such as: (1) crop dusting, chemical or fertilizer spraying, seed dissemination, prevention of frost formation, insect fighting, animal herding, or (2) aerial photography, patrol and surveillance, prospecting, construction, advertising, medical relief, and rescue work.</p> <p>Other flying. All flights by pilots for maintaining their flight proficiency should also be included under this heading as well as all general aviation flights that cannot be included in the above four categories.</p>

Instrument meteorological conditions (IMC)	The U.S. difference, as stated in the Supplement to Annex 2, 5th Edition, dated February 1967 as amended by Amendment 1 is as follows: It will be impracticable to implement the terms “instrument meteorological conditions” and “visual meteorological conditions,” abbreviated as “IMC” and “VMC” as they appear in Chapter 1, Definitions, and within the other paragraphs of the Annex where they appear.
Visual meteorological conditions (VMC)	Use of the terms “IFR conditions” and “VFR conditions” rather than “instrument meteorological conditions” and “visual meteorological conditions” will have no effect with respect to the safety of air navigation. The terms “IFR conditions” and “VFR conditions” have been in effect in the U.S. for many years and are well known to all pilots and providers of the various aeronautical services. Therefore, a change from the present phraseology to the new phraseology would, in so far as the U.S. is concerned, impose a change which is not justified from the standpoint of improvement of the overall aviation procedures and practices. U.S. Federal Aviation Regulations specify the use of the phrases “IFR conditions” and “VFR conditions.”
Maximum mass	The U.S. Federal Aviation Regulations state “weight” rather than “mass.”
Obstacle clearance limit (OCL)	This term is not used in the U.S. Federal Aviation Regulations.
Pressure altitude	Although not identical, the U.S. definition of pressure altitude is not substantially different.
Synthetic flight trainer: flight simulator, flight procedures trainer, basic instrument flight trainer	The U.S. does not have a regulatory definition of these terms; however, the terms are in common usage in the U.S. and have a meaning that is similar to the ICAO definition.
Chapter 4	Flight Operations
4.3.1 d)	The U.S. Federal Aviation Regulations state “weight” rather than “mass.”
4.3.7.2	When refueling with passengers embarking, on board, or disembarking an airplane, two-way communication is not required between the ground crew supervising the refueling and the qualified personnel on board the airplane. The U.S. refueling safety procedures which meet the intent of this Standard are contained in each operator’s approved operating manual.
4.3.8.2	U.S. regulations require descent within 4 minutes to 14,000 feet rather than 13,000 feet (620 hPa).
4.4.4.4	U.S. regulations require all occupants of seats equipped with combined safety belts and shoulder harnesses to be properly secured during take-offs and landings and still be able to properly perform their assigned duties.
4.4.9.2	The U.S. Federal Aviation Administration (FAA) develops standard flight operational noise abatement procedures for each airplane type. Alternative flight operational noise procedures are also developed by the FAA for certain airports that have unique noise situations.
Chapter 5	Aeroplane Performance Operating Limitations
5.2.6, 5.2.7 a), b), c), d)	The U.S. Federal Aviation Regulations state “weight” rather than “mass.”
5.2.8.1	U.S. regulations do not require that account be taken of the loss, if any, of runway length due to alignment of the airplane prior to take-off in determining the length of the runway available.
Chapter 6	Aeroplane Instruments, Equipment and Flight Documents
6.2.4.2	The U.S. Federal Aviation Regulations express lengths in feet and inches.

6.3	<p>a) Large airplanes that have a U.S. original type certificate issued on or before 30 September 1969, which are certificated for operations above 25,000 feet altitude or are turbine-engine powered must have one or more flight data recorders that record data from which time, altitude, airspeed, vertical acceleration, heading and the time of each radio transmission either to or from air traffic control (ATC) can be determined.</p> <p>b) Large airplanes that have a U.S. original type certificate issued after 30 September 1969, which are certificated for operations above 25,000 feet altitude or are turbine-engined powered must have one or more flight data recorders that record data from which the following information may be determined: time, altitude, airspeed, vertical acceleration, heading, time of each radio transmission either to or from ATC, pitch attitude, roll attitude, sideslip angle or lateral acceleration, pitch trim position, control column or pitch control surface position, control wheel or lateral control surface position, rudder pedal or yaw control surface position, thrust of each engine, position of each thrust reverser, trailing edge flap or cockpit flap control position, and leading edge flap or cockpit flap control position.</p>
6.3.1.1	Pursuant with above paragraph a), recorders do not record engine power, configuration, or operation. Pursuant with paragraph b), recorders do not record operation.
6.3.1.2	Pursuant with above paragraph a), recorders do not record engine power or configuration of lift and drag devices.
6.3.5.1	The U.S. does not require such equipage for all aircraft which meet this weight criterion. U.S. regulations (14 CFR 135.152) only require that multi-engine, turbine-powered airplanes or rotorcraft with 10-19 seats that are brought onto the U.S. register after 11 October 1991, be equipped with the flight data recorder specified in this standard.
6.4	Although the U.S. does provide air traffic control services to aircraft operating under VFR, it does not specifically provide for en route “controlled VFR flights” in the ICAO context. The U.S. does not, therefore, have specific requirements or regulations regarding airman certification or aircraft minimum equipment for “controlled VFR flights.”
6.5.1 a), c)	<p>The U.S. Federal Aviation Regulations do not require all seaplanes for all flights to be equipped with:</p> <p>a) equipment for making the sound signals prescribed in the International Regulations for Preventing Collisions at Sea; or</p> <p>b) one sea anchor (drogue).</p>
6.5.3.1	The U.S. defines extended over water operations for aircraft other than helicopters as an operation over water at a horizontal distance of more than 50 nautical miles from the nearest shoreline.
6.7.5	U.S. regulations require that oxygen dispensing units capable of being automatically presented to the passengers and cabin attendants (before the cabin pressure altitude exceeds 15,000 feet) be installed, in all transport category aircraft approved to operate <u>above 30,000 feet</u> , type certificated on or after 1 September 1977.
6.9.2	The U.S. Federal Aviation Regulations state “weight” and express weight in pounds.
6.12	The U.S. Federal Aviation Regulations do not require airplanes operated above 15,000 meters (49,000 feet) to carry equipment to measure and indicate continuously the dose rate of total cosmic radiation being received and the cumulative dose on each flight.
6.15.1, 6.15.2	The U.S. Federal Aviation Regulations state “weight” and express weight in pounds.
6.17.1	The U.S. only requires one automatic-type, emergency locator transmitter in operable condition that meets the requirement of TSO-C91. However, installations of emergency locator transmitters which occur after 21 June 1995 must meet the requirements of TSO-C91A.
6.17.2	Emergency locator transmitters are not required for: turbojet-powered aircraft, aircraft while engaged in scheduled flights by scheduled air carriers, or aircraft while used to show compliance with regulators or crew training.
6.18.1	U.S. regulations do not require such airplanes to be equipped with an airborne collision avoidance system (ACAS II). U.S. regulations only require equipage with TCAS II which is not equivalent to ACAS II.
6.18.2	U.S. regulations do not require such airplanes to be equipped with an airborne collision avoidance system (ACAS II). U.S. regulations only require equipage with TCAS I.

6.19	U.S. regulations do not require that all airplanes be equipped with pressure–altitude reporting transponders. The U.S. requirement for pressure altitude reporting transponders depends on the specific airspace in which airplanes fly.
Chapter 8	Aeroplane Maintenance
8.1.3	U.S. regulations do not require persons who sign maintenance releases to be licensed strictly in accordance with the provisions of Annex 1. U.S. requirements do not include knowledge of human performance/limitations or entries on the license such as specific aircraft model and avionics systems or components (or under broad categories).
8.7.5.4	There is no comparable requirement in U.S. regulations for training in knowledge and skills related to human performance.
8.7.6.2	U.S. regulations require that records of work shall be retained until the work is repeated, superseded by other work or for one year after the work is performed.
8.8.2	The U.S. does not require records to be maintained after the end of the operating life of the unit.
Chapter 9	Aeroplane Flight Crew
9.5	The U.S. Federal Aviation Regulations do not require a flight crew member to have a spare set of suitable lenses readily available when exercising the privileges of a license for which he/she was assessed as fit subject to suitable correcting lenses being worn. However, the U.S. practice is to require extra correcting lenses when a flight crew member’s defective visual acuity necessitates a limitation; i.e., worse than 20/100 uncorrected distance visual acuity.
Chapter 11	Manuals, Logs and Records
11.1.11	a) Operators may conduct operations without an approved minimum equipment (MEL) list provided all instruments and equipment are fully operable. b) The U.S. prohibits operations to be conducted solely under the provisions of a master minimum equipment list (MMEL). Each operator must develop its own MEL, based on the MMEL, which includes operational procedures. When approved, the MEL may be used only by the individual operator.
PART II	
General	The U.S. does not accept any provision of Annexes 2, 6, 10, or 11 or any other Annex as a Standard or Recommended Practice as applicable to State aircraft. In accordance with Article 3(a) of the Convention of International Civil Aviation, the Convention and its Annexes are not applicable to State aircraft. In so far as any provisions of Annexes 2, 6, 10 or 11 address the operation or control of State aircraft, the U.S. considers such provisions to be in the nature of a special recommendation of the Council, advisory only, and not requiring the filing of differences under Article 38 of the Convention.
Chapter 1	Definitions
Category I (Cat I) operation	For a Category I operation, the U.S. requires a decision height (DH) of not less than 200 feet and either visibility of not less than 1/2 mile or a runway visual range of 2,400 feet (RVR 1,800 feet with operative touchdown zone and runway centerline lights).
Category II (Cat II) operation	The U.S. requires that Category II provide approaches to minima of less than 200 feet DH/2,400 runway visual range to as low as 100 feet DH/1,200 runway visual range.
Category IIIA (Cat IIIA) operation	U.S. criteria are the same as those adopted in Part 1 of Annex 6. However, the runway visual range is expressed as not less than 700 feet (200 meters).
Category IIIB (Cat IIIB) operation	U.S. criteria are the same as those adopted in Part 1 of Annex 6. However, the runway visual range is expressed as less than 700 feet (200 meters), but not less than 150 feet (50 meters).

Minimum descent altitude (MDA) or minimum descent height (MDH)	The U.S. does not use MDH (or height above airport) as an altitude or height in a nonprecision approach or circling approach below which descent must not be made without the required visual reference.
Chapter 3	General
3.5	The pilot-in-command is not required to have available on board the airplane essential information concerning search and rescue services.
Chapter 4	Flight Preparation and In-Flight Procedures
4.3	Except as provided for in 14 CFR 91.519 for large and turbine-powered, multi-engine airplanes, the pilot-in-command is not required to ensure that crew members and passengers are familiar with the location and use of emergency exits, life jackets, oxygen dispensing equipment, or other emergency equipment provided for individual use.
4.6.2.1	A destination alternate airport is not required when the weather at the airport of intended landing is forecast to have a ceiling of at least 2,000 feet and a visibility of at least 3 miles. In addition, standard alternate airport minima are prescribed as follows: 600-foot ceiling and 2 miles visibility are prescribed for precision approaches, and 800-foot ceiling and 2 miles visibility for nonprecision approaches.
4.6.2.2 b)	The forecast period for the destination alternate airport is from 1 hour before to 1 hour after the estimated time of arrival. In addition, the minima for ceiling/visibility at the airport of intended landings are 2,000 feet and 3 miles; that is, when at least such minima exist, no alternate airport is required.
4.6.3	A flight is permitted to continue towards the airport of intended landing when the latest available meteorological information indicates that conditions at that airport will, at the expected time of arrival, be at or below the specified airport meteorological minima.
4.9	The pilot-in-command is not required to ensure that all persons on board the aircraft during an emergency are instructed in emergency procedures.
4.14 b)	The pilot-in-command is not required to discontinue a flight at the nearest suitable airport when flight crew members' capacity to perform functions is significantly reduced by impairment of faculties from causes such as fatigue, sickness or lack of oxygen.
4.18.1, 4.18.2	The recommendation concerning aircraft refueling with passengers on board is not addressed in U.S. regulations. U.S. experience has not demonstrated a need for such regulation.
Chapter 6	Aeroplane Instruments and Equipment
6.1.3.1.1	All airplanes on all flights are not required to be equipped with an accessible first aid kit, portable fire extinguishers, seat or berth for each person, current and suitable air navigation charts, or spare electrical fuses. However, spare fuses are required on all airplanes operated at night or under instrument flight rules. In addition, general aviation aircraft presently are not required to carry on board either procedures, as prescribed in Annex 2, for pilots-in-command of intercepted aircraft or visual signals for use by intercepting and intercepted aircraft. (See ENR 1.12, Interception of Civil Aircraft National Security and Interception Procedures.)
6.1.3.1.2	All airplanes on all flights are not required to be equipped with ground/air signal codes for search and rescue purposes.
6.2.1 b), c)	An accurate time piece and a sensitive pressure altimeter are not required for VFR flight.
6.3.1 a), b), c), and d)	The U.S. does not require all seaplanes on all flights to be equipped with the items listed in subparagraphs a), b), c), and d).
6.3.2	Single-engine airplanes flying over water are not required to be equipped with life jackets or equivalent individual flotation devices when the airplane is operated more than 50 nautical miles from land suitable for an emergency landing.

6.3.3 a)	Only large and turbine-powered, multi-engine airplanes are required to carry life preservers or an approved flotation means for each occupant of an airplane on a flight over water more than 50 nautical miles from the nearest shore.
6.3.3 b)	Only large and turbine-powered, multi-engine airplanes on flights over water for more than 30 minutes flying time or 100 nautical miles from the nearest shore are required to have life rafts and pyrotechnic signaling devices.
6.4	Not all airplanes on flights over land areas designated as areas in which search and rescue would be especially difficult are specifically required to be equipped with signaling devices or life-saving equipment.
6.5	All airplanes on high altitude flights, both pressurized and unpressurized, are required to carry oxygen for the crew and passengers.
6.6 f), h), and i)	All airplanes when operated in accordance with the instrument flight rules or when the airplane cannot be maintained in a desired altitude without reference to one or more flight instruments are not required to be equipped with: -- an outside air temperature indicator. -- an airspeed indicating system with a means of preventing malfunctioning due to condensation or icing; or -- a rate of climb and descent indicator.
6.7 a), c), d), e) and f)	All airplanes operated at night are not required to be equipped with: -- A turn and bank indicator. -- An attitude indicator (artificial horizon). -- A heading indicator (directional gyroscope). -- A means of indicating whether the supply of power to the gyroscope instruments is adequate. -- A sensitive pressure altimeter. -- A means of indicating the outside air temperature. -- A timepiece with a sweep second hand. -- An airspeed indicating system with a means of preventing malfunctioning due to either condensation or icing. -- A rate-of-climb and descent indicator. -- A landing light. -- Illumination for flight instruments and equipment. -- Lights in passenger compartments; or -- An electric torch for each crewmember station.
6.9	The U.S. does not require general aviation aircraft to be equipped with ground proximity warning systems.
6.10.3.1 and Recommendation 6.10.3.2	The requirement for U.S. general aviation airplanes to be equipped with flight data recorders (FDRs) is based on passenger and engine configurations. Specifically, FDRs are required for U.S. civil registered multiengine, turbine-powered airplanes having a passenger seating configuration of 10 passengers or more, excluding any pilot seats.
6.10.4.1 and Recommendation 6.10.4.2	The requirement for U.S. general aviation airplanes to be equipped with cockpit voice recorders (CVRs) is based on passenger, crew, and engine configurations. Specifically, CVRs are required for U.S. civil registered multiengine, turbine-powered airplanes having a passenger seating configuration of six passengers or more, and for which two pilots are required by type certification.
6.10.7.2	U.S. regulations do not require that flight recorders be deactivated upon completion of flight time following an accident or incident, or prohibit their reactivation before their disposition is determined. U.S. regulations require that such recorders be operated continuously from the use of checklist before the flight to completion of the final checklist at the end of the flight (14 CFR Section 91.609(d) and (g)).
6.12.1	Emergency locator transmitters are not required for: turbojet-powered aircraft while operated in scheduled flights by scheduled air carriers; training operations within a 50-nautical mile radius of the airport from which the flight began; flight operations incident to design and testing; flight operations of new aircraft incident to manufacture, preparation, and delivery; agricultural aircraft operations; aircraft certificated for research and development purposes; operations showing compliance with regulations, crew training, exhibition, air racing, or market surveys; or aircraft equipped to carry not more than one person.

Recommendation 6.14	U.S. regulations do not require that flight crew members communicate through boom or throat microphones below the transition level/altitude.
Chapter 7	Aeroplane Communication and Navigation Equipment
7.1.1	All airplanes operated at night are not required to have radio communications equipment capable of conducting two-way communications with aeronautical stations.
7.1.2	When more than one radio communications equipment unit is required, it is not required that each unit be independent of the other or others.
7.1.4	Except when operating under instrument flight rules, airplanes operated on extended flights over water or on flights over underdeveloped land are not required to have radio communications equipment capable of conducting two-way communications at any time during flight with aeronautical stations.
7.1.5	The U.S. does not base its requirement for radio communications equipment in general aviation aircraft on the criteria included in ICAO Annex 6, Part II (Chapters 6 and 7); for example, all night operations, operations over land areas in which search and rescue would be especially difficult, etc. Instead, U.S. requirements for such equipment is based upon the type of airspace with which the aircraft is to be involved; that is, use of controlled airspace such as terminal control areas (Class B Airspace), airport radar service areas, and positive control areas (Class A Airspace). Thus, U.S. requirements do not depend on such ICAO factors as time of day of the operation or the nature of the land over which the operation is to be conducted. Where such equipment is required by U.S. regulations, the aeronautical emergency frequency of 121.5 MHz is automatically available to all such radio-equipped aircraft since the VHF communications frequency range encompasses the emergency frequency of 121.5 MHz.
7.2.4	An airplane is not required to be provided with navigation equipment to ensure that, in the event of the failure of one item of equipment at any stage of the flight, the remaining equipment will enable the airplane to proceed in accordance with 7.2.1.
Chapter 8	Aeroplane Maintenance
8.3.2	The U.S. does not require records to be maintained after the end of the operating life of the unit.
PART III	
SECTION I	
General	The U.S. does not accept any provision of Annexes 2, 6, 10, or 11 or any other Annex as a Standard or Recommended Practice as applicable to State aircraft. In accordance with Article 3(a) of the Convention of International Civil Aviation, the Convention and its Annexes are not applicable to State aircraft. In so far as any provisions of Annexes 2, 6, 10, or 11 address the operation or control of State aircraft, the U.S. considers such provisions to be in the nature of a special recommendation of the Council, advisory only, and not requiring the filing of differences under Article 38 of the Convention.
Chapter 1	Definitions
Minimum descent altitude (MDA) or minimum descent height (MDH)	The U.S. does not use MDH (or height above airport) as an altitude or height in a non-precision approach or circling approach below which descent must not be made without the required visual reference.
Performance Class 1 helicopter	The U.S. does not have performance class designations for helicopters.
Performance Class 2 helicopter	The U.S. does not have performance class designations for helicopters.
Performance Class 3 helicopter	The U.S. does not have performance class designations for helicopters.

SECTION II – International Commercial Air Transport	
2.2.11	The U.S. regulations require that helicopters flown over water in passenger-carrying operations must simply be equipped with flotation devices.
2.3.4.1 b)	The U.S. has no requirement that a point of no return (PNR) be determined.
2.3.4.3	The U.S. has no related requirement for the use of on-shore versus off-shore alternate heliports.
2.3.6.2 b)	The requirement for fuel reserves for VFR operations is 20 minutes at normal cruise speed.
2.3.6.3.1	There is no U.S. requirement for maintenance of a specific altitude above a destination. In addition, the U.S. requirement is based on normal cruise speed, not holding speed, and provides for a single, 30-minute reserve.
2.3.6.3.2	There is no requirement for maintenance of a specific altitude above an alternate. In addition, the requirement is based on normal cruise speed, no holding speed, and provides for a single, 30-minute reserve.
2.3.6.3.3	The U.S. has no related requirement. If the destination weather so requires, an alternate must be specified and a 30-minute fuel reserve carried.
Chapter 3	Helicopter Performance Operating Limitations
3.1.1	The U.S. has no related performance class requirements.
Chapter 4	Helicopter Instruments, Equipment and Flight Documents
4.3.3.1 and Recommendation 4.3.3.2	The U.S. requires that multi-engine, turbine-powered rotorcraft having a passenger seating configuration of 20 or more seats be equipped with one or more flight recorders. In addition, multi-engine, turbine-powered rotorcraft, brought onto the U.S. register after 1 October 1991 having a passenger seating configuration of 10 to 19 seats must have one or more flight recorders.
4.3.5	The U.S. requires cockpit voice recorders in all multi-engine, turbine-powered rotorcraft having a passenger seating configuration of 20 or more seats and in all multi-engine, turbine-powered rotorcraft having a passenger seating configuration of six or more and for which two pilots are required by certification or operating rules.
4.5.1	U.S. regulations require that helicopters flown over water in passenger-carrying operations must simply be equipped with flotation devices.
4.5.2.1	Life rafts and pyrotechnic signaling devices are only required for extended over-water operations; that is, with respect to helicopters, an operation over water at a horizontal distance of more than 50 nautical miles from the nearest shoreline and more than 50 nautical miles from an off-shore heliport structure.
4.7 (all)	The U.S. does not require rotorcraft to carry emergency locator transmitters.
4.11.1 c)	The U.S. requires only one landing light for operations conducted at night for hire.
4.15	U.S. regulations do not require that all helicopters be equipped with pressure-altitude reporting transponders. The U.S. requirement for pressure-altitude reporting transponders depends on the specific airspace in which helicopters fly.
Chapter 6	Helicopter Maintenance
6.3	There is no comparable requirement in U.S. regulations for training in knowledge and skills related to human performance.
Chapter 7	Helicopter Flight Crew
7.4.1	Recency of experience need not be in the same type of helicopter.
7.4.2	Recency of experience need not be in the same type of helicopter.
7.4.3.3	There is no U.S. equivalent for nonscheduled, commercial helicopter operations.
7.5	The U.S. has no related requirement.
Chapter 11	Security
11.1	The U.S. has no related requirement.

SECTION III – International General Aviation	
Chapter 2	Flight Operations
2.3.1 b), c), d), and e	The U.S. has no related requirement.
2.3.2	The U.S. has no related requirement.
2.6.2.1	A destination alternate heliport is not required when the weather at the heliport of intended landing is forecast to have a ceiling of at least 2,000 feet and a visibility of at least 3 miles. In addition, standard alternate heliport minima are prescribed as follows: 600-foot ceiling and 2 miles visibility are prescribed for precision approaches, and 800-foot ceiling and 2 miles visibility for non-precision approaches.
2.6.2.2	The forecast period for the destination heliport is from 1 hour before to 1 hour after the estimated time of arrival. In addition, the minima for ceiling/visibility at the heliport of intended landing are 2,000 feet and 3 miles; that is, when at least such minima exist, no alternate heliport is required.
2.7.1 b)	The U.S. has no related requirement.
2.7.2	The U.S. has no requirement for one engine inoperative performance capability.
2.8.2b)	The U.S. requirement for fuel reserves for VFR operations is 20 minutes at normal cruise speed.
2.8.3.1	There is no U.S. requirement for maintenance of a specific altitude above the destination. In addition, the requirement is based on normal cruise speed, not holding speed, and provides for a single 30-minute reserve.
2.8.3.2	There is no U.S. requirement for maintenance of a specific altitude above the alternate. In addition, the requirement is based on normal cruise speed, not holding speed, and provides for a single 30-minute reserve.
2.8.3.3	The U.S. has no related requirement. If the destination weather so requires, an alternate must be specified and a 30-minute fuel reserve carried.
2.8.4 d)	The U.S. has no related requirement.
2.9.1	The U.S. oxygen supply requirement applies to crew members at altitudes between 12,500 and 14,000 feet. For passengers, the requirement applies above 15,000 feet.
2.10	The U.S. requirement for flight crew members applies at altitudes above 14,000 feet.
2.11	The pilot-in-command is not required to ensure that all persons on board the aircraft during an emergency are instructed in emergency procedures.
2.14 b)	The U.S. has no related requirement.
2.17	The U.S. has no related requirement.
2.18	The recommendations concerning aircraft refueling with passengers on board are not addressed in U.S. regulations. U.S. experience has not demonstrated a need for such regulation.
2.19	The U.S. has no related requirement.
Chapter 3	Helicopter Performance Operating Limitations
3.3	The U.S. does not have performance class designations for helicopters.
3.4	The U.S. does not have performance class designations for helicopters.
Chapter 4	Helicopter Instruments, Equipment and Flight Documents
4.1.3.1	The U.S. does not require general aviation helicopters to be equipped with a first aid kit or portable fire extinguishers, or to have procedures for pilots-in-command of intercepted aircraft or a list of visual signals for use by intercepting and intercepted aircraft. Spare fuses are not required for day VFR operations.
4.1.3.2	The U.S. has no related requirement.
4.1.3.3	The U.S. requires rotorcraft manufactured after 16 September 1992 to be equipped with a safety belt and shoulder harness for each occupant's seat.
4.1.4.1	The U.S. has no related requirement.
4.1.4.2	The U.S. has no related requirement.

4.2.1	An accurate time piece is not required for VFR flight. In addition, a non-sensitive pressure altimeter is required.
4.3.1	The U.S. has no related requirement.
4.3.2.1	Approved flotation gear and at least one pyrotechnic signaling device are required for aircraft operating for hire over water and beyond a power-off gliding distance from shore.
4.3.2.3	The U.S. has no related requirement.
4.3.2.6	The U.S. has no related requirement.
4.4	The U.S. has no related requirement.
4.6 f)	Only one attitude indicator (artificial horizon) is required.
4.7.1	Landing lights and electric torches are not required for all night operations.
4.9.3.1 and Recommendation 4.9.3.2	The requirement for U.S. general aviation helicopters to be equipped with flight data recorders (FDRs) is based on passenger and engine configurations. Specifically, FDRs are required for U.S. civil registered multiengine, turbine-powered rotorcraft having a passenger seating configuration of 10 passengers or more, excluding any pilot seats.
4.9.4.1 and Recommendation 4.9.4.2	The requirement for U.S. general aviation helicopters to be equipped with cockpit voice recorders (CVRs) is based on passenger, crew, and engine configurations. Specifically, CVRs are required for U.S. civil registered multiengine, turbine-powered rotorcraft having a passenger seating configuration of six passengers or more, and for which two pilots are required by type certification.
4.9.7.2	U.S. regulations do not require that flight recorders be deactivated upon completion of flight time following an accident or incident, or prohibit their reactivation before their disposition is determined. U.S. regulations require that such recorders be operated continuously from the use of checklist before the flight to completion of the final checklist at the end of the flight (14 CFR 91.609 (d) and (g)).
4.10	Emergency locator transmitters are not required for rotorcraft.
4.12	U.S. regulations do not require that flight crew members communicate through boom or throat microphones below the transition level/altitude.
Chapter 5	Helicopter Communication and Navigation Equipment
5.2.2	The U.S. has no minimum navigation equipment requirement for VFR flights.

ANNEX 7 – AIRCRAFT NATIONALITY AND REGISTRATION MARKS	
3.3.1 and 4.2.1	The marks on wing surfaces are not required.
3.2.5 and Section 8	Identification plates are not required on unmanned, free balloons.
4.2.2	The minimum height of marks on small (12,500 lb or less), fixed-wing aircraft is 3 inches when none of the following exceeds 180 knots true airspeed: (1) design cruising speed; (2) maximum operating limit speed; (3) maximum structural cruising speed; and (4) if none of the foregoing speeds have been determined for the aircraft, the speed shown to be the maximum cruising speed of the aircraft.
Section 6	A centralized registry of unmanned free balloons is not maintained. Operators are required to furnish the nearest ATC facility with a prelaunch notice containing information on the date, time, and location of release, and the type of balloon. This information is not maintained for any specified period of time.

ANNEX 8 – AIRWORTHINESS OF AIRCRAFT	
PART II Procedures for Certification and Continued Airworthiness	
Chapter 4	Continued Airworthiness of Aircraft
4.2.3 (d)	This provision requires the State of Registry to address mandatory continuing airworthiness information from the State of Design. The U.S. does not generally issue Airworthiness Directives for non-type certificated aircraft. This includes foreign aircraft that are U.S.-registered, but operate under experimental rather than standard airworthiness certificates.
PART III Aeroplanes	
Part IIIA	
Chapter 4	Design and Construction
4.1.6 (b), 4.1.6 (g), 4.1.6 (h), 4.1.6 (i)	The United States does not have similar requirements. The FAA has begun work in an effort to amend the U.S. regulations with the purpose of eventually meeting the intent of these provisions.
Chapter 8	Instruments and Equipment
8.4.1	ICAO requires that airplanes operating on the movement area of an airport shall have airplane lights of such intensity, color, fields of coverage and other characteristics to furnish personnel on the ground with as much time as possible for interpretation and for subsequent maneuver necessary to avoid a collision. The FAA has no such requirement.
8.4.2 (b)	This provision addresses the lights’ affect on outside observers in reference to “harmful dazzle.” The U.S. regulations do not address the affect of aircraft lights on outside observers. However, visibility to other pilots and the lights’ affect on the flight crew is addressed.
Chapter 9	Operating Limitations and Information
9.3.5	The United States does not have similar requirements. The FAA has begun work in an effort to amend the U.S. regulations with the purpose of eventually meeting the intent of these provisions.
Chapter 11	Security
11.2, 11.3, 11.4	With the exception of the door required by 11.3, the United States does not have similar requirements. The FAA has begun work in an effort to amend the U.S. regulations with the purpose of eventually meeting the intent of these provisions.
Part IIIB	
Large Aeroplane Certification	
D.2 (b)	The United States does not have a specific requirement for physical separation of systems. However, physical separation is considered in the means of compliance to various regulations such as 25.1309, 25.901(c) and 25.903(d). The FAA has begun to work in an effort to amend U.S. regulations with the purpose of eventually meeting the intent of these provisions.
D.2 (f)	The provision requires lavatory fire protection systems (detection and suppression) for all airplanes covered by Part IIIB. U.S. regulations only require lavatory fire protection systems for airplanes with 20 or more passengers.
D.2 (g)	Paragraph D.2.g.1 of the ICAO standard requires a fire suppression system for each cargo compartment accessible to a crewmember in a passenger-carrying airplane. U.S. requirements permit manual fire fighting in an accessible cargo compartment by a crewmember or members for an all-passenger-carrying airplane or a passenger-cargo combination carrying airplane. Additionally, the FAA does not have specific requirements to consider the effects of explosions or incendiary devices.
D.2 (h)	The United States does have provisions to protect against possible instances of cabin depressurization. However, the FAA does not have specific requirements to consider the effects of explosions or incendiary devices.

D.2 (i)	The United States does not have similar requirements and has begun work in an effort to amend the U.S. regulations to explicitly address the effects of explosions or incendiary devices.
D.5.	While there are no specific electrical bonding requirements in the FARs, U.S. regulations address lightning and system requirements. The FARs do not address the protection of those persons coming into contact with an airplane on the ground or in the water.
F.4.1	ICAO requires that airplanes operating on the movement area of an airport shall have airplane lights of such intensity, color, fields of coverage and other characteristics to furnish personnel on the ground with as much time as possible for interpretation and for subsequent maneuver necessary to avoid a collision. The U.S. has no such requirement.
F.4.2 (b)	This provision addresses the lights' affect on outside observers in reference to "harmful dazzle." The U.S. regulations do not address the affect of aircraft lights on outside observers. However, visibility to other pilots and the lights' affect on the flight crew is addressed.
F.5.	U.S. regulations do not address electromagnetic interference from external sources. High Intensity Radiated Fields (HIRF) are addressed by Special Conditions but only for flight critical systems, not flight essential systems.
G.3.5.	The United States does not have similar requirements. The FAA has begun work in an effort to amend the U.S. regulations with the purpose of eventually meeting the intent of these provisions.
K.2, K.3.1, K.3.2, K.4	With respect to K.1 and K.3, the United States does not have any specific requirements. With respect to K.2 the FAA has no current requirements with respect to the flight crew compartment bulkhead. The FAA has begun work in an effort to amend the U.S. regulations with the purpose of eventually meeting the intent of these provisions.
PART IV Helicopters	
Part IVA	
Chapter 2	Flight
2.2.3.1, 2.2.3.1.1 – 2.2.3.1.4	These provisions address take-off performance data for all classes of helicopters and require that this performance data include the take-off distance required. However, the United States has adopted the requirements only for Category A helicopters.
Chapter 6	Rotor and Power Transmissions Systems and Powerplant Installation
6.7	This provision requires that there be a means for restarting a helicopter's engine at altitudes up to a declared maximum altitude. In some cases the FAA does not require demonstration of engine restart capability. Since there is a different level of certitude for transport and normal category helicopters in the United States, the engine restart capability is only required for Category A and B helicopters (14 CFR Part 29) and Category A normal helicopters (14 CFR Part 27).
Chapter 7	Instruments and Equipment
7.4.2	This provision addresses the need to switch off or reduce the intensity of the flashing lights. The United States has minimum acceptable intensities that are prescribed for navigation lights and anti-collision lights. No reduction below these levels is possible.
7.4.2 (b)	This provision addresses the lights' affect on outside observers in reference to "harmful dazzle." The U.S. regulations do not address the affect of aircraft lights on outside observers. However, visibility to other pilots and the lights' affect on the flight crew is addressed.
PART V Lighting and Marking	
I.5 (e)	The United States does not have a requirement similar to I.5(e). 14 CFR part 23 does not address the impact of fuel spillage on emergency lighting systems.
PART VII Propellers	
Sub-Part B	Design and Construction
B.2	U.S. Regulations do not require a failure analysis.
Sub-Part C	Test and Inspections
C.2 (c)	U.S. Regulations do not contain bird impact or lightning strike requirements.

ANNEX 9 – FACILITATION	
*The list of differences include Guam, Puerto Rico, and the U.S. Virgin Islands. The status of implementation of Annex 9 in Guam with respect to public health quarantine is not covered in the list of differences.	
Chapter 2	Entry and Departure of Aircraft
2.3	Written crew baggage declaration is required in certain circumstances, and a special Embarkation/Disembarkation Card is required for most alien crew members.
2.4	A General Declaration for all inbound and for outbound flights with commercial cargo are required. However, the General Declaration outbound flights with commercial cargo shall not be required if the declaratory statement is made on the air cargo manifest. No declaration is required for outbound flights without commercial cargo if Customs clearance is obtained by telephone.
Remarks	19 CFR 122
2.4.1	Each crew member must be listed showing surname, given name, and middle initial.
2.4.4	The signing or stamping of the General Declaration protects the carrier by serving as proof of clearance.
2.5	The crew list is required by statute.
2.7	There is a statutory requirement for the Cargo Manifest.
2.8	In order to combat illicit drug smuggling, the U.S. requires the additional following information: the shipper's and the consignee's name and address, the type of air waybills, weight, and number of house air waybills. The manifest submitted in electronic form may become legally acceptable in the future. However, until the compliance rate for the automated manifest is acceptable, the U.S. must be able to require the written form of the manifest.
Remarks	19 CFR 122.48
2.9	Nature of goods information is required.
2.10	Stores list required in all cases but may be recorded on General Declaration in lieu of a separate list.
2.17	A cargo manifest is required except for merchandise, baggage and stores arriving from and departing for a foreign country on the same through flight. "All articles on board which must be licensed by the Secretary of State shall be listed on the cargo manifest." "Company mail shall be listed on the cargo manifest."
2.18	Traveling general declaration and manifest, crew purchases and stores list as well as a permit to proceed are required under various conditions when aircraft arrive in the U.S. from a foreign area with cargo shown on the manifest to be traveling to other airports in the U.S. or to foreign areas.
2.21	There is a statutory requirement that such changes can only be made prior to or at the time of formal entry of the aircraft.
2.25	The U.S. does not support the use of insecticides in aircraft with passengers present. Pesticides registered for such use should not be inhaled. In effect, the passenger safety issue has precluded the use of such insecticides in the presence of passengers since 1979.
2.35	Advance notice is required of the number of citizens and aliens on board (non-scheduled flights only).
2.40	A copy of the contract for remuneration or hire is required to be a part of the application in the case of non-common carrier operations.
2.41	Single inspection is accorded certain aircraft not by size of aircraft but rather by type of operation. Loads (cargo) of an agricultural nature require inspection by a plant or animal quarantine inspector.
2.41c	Fees are charged for services provided in connection with the arrival of private aircraft (nonscheduled aircraft).
Chapter 3	Entry and Departure of Persons and Their Baggage
3.3	Medical reports are required in some cases.
Remarks	8 CFR 212.7 and INA 234
3.4	Documents such as visas with certain security devices serve as identity documents.

3.4.1	The U.S. has not standardized the personal identification data included in all national passports to conform with the recommendation in Doc 9303.
3.5.6	U.S. passport fees exceed the cost of the operation.
3.5.7	U.S. allows separate passports for minor dependents under the age of 16 entering the U.S. with a parent or legal guardian.
3.7	The U.S. has a pilot program that allows nationals of certain countries which meet certain criteria to seek admission to the U.S. without a visa for up to 90 days as a visitor for pleasure or business.
Remarks	22 CFR 41.112(d) INA 212(d)(4), INA 238, 8 CFR 214.2(c) INA 217
	The law permits visa waivers for aliens from contiguous countries and adjacent islands or in emergency cases. Visas are also waived for admissible aliens arriving on a carrier which is signatory to an agreement assuring immediate transit of its passengers provided they have a travel document or documents establishing identity, nationality, and ability to enter some country other than the U.S.
3.8	The U.S. charges a fee for visas.
3.8.3	Duration of stay is determined at port of entry.
Remarks	INA 217
3.8.4	A visitor to the U.S. cannot enter without documentation.
Remarks	INA 212(a) (26)
3.8.5	Under U.S. law, the duration of stay is determined by the Immigration Authorities at the port of entry and thus cannot be shown on the visa at the time of issuance.
3.10	Embarkation/Disembarkation Card does not conform to Appendix 4 in some particulars.
3.10.1	The operator is responsible for passengers' presentation of completed embarkation/disembarkation cards.
Remarks	8 CFR 299.3
3.10.2	Embarkation/Disembarkation cards may be purchased from the U.S. Government, Superintendent of Documents.
Remarks	8 CFR 299.3
3.14.2	The U.S. fully supports the electronic Advance Passenger Information (API) systems. However, the WCO/IATA Guideline is too restrictive and does not conform to the advancements in the PAXLIST EDIFACT international standard.
3.15	U.S. Federal Inspection Services' officials see individuals more than once.
3.16	Written baggage declarations by crew members are required in some instances.
3.17.1	The U.S. uses a multiple channel system rather than the dual channel clearance system.
3.23, 3.23.1	Statute requires a valid visa and passport of all foreign crew members.
3.24, 3.24.1, 3.25, 3.25.1, 3.25.2, 3.25.3	Crew members, except those eligible under Visa Waiver Pilot Program guidelines, are required to have valid passports and valid visas to enter the U.S.
Remarks	INA 212(a) (26), INA 252 and 253, 8 CFR 214.1(a), 8 CFR 252.1(c)
3.26, 3.27, 3.28, 3.29	Passports and visas are required for crew and non-U.S. nationals to enter the U.S.
3.33	Does not apply to landing card.
3.35	Law requires that the alien shall be returned to the place whence he/she came. Interpretation of this provision requires that he/she be returned to the place where he/she began his/her journey and not only to the point where he/she boarded the last-used carrier.
3.35.1	Law requires that certain aliens be deported from the U.S. at the expense of the transportation line which brought them to the U.S.
3.36	Statute provides for a fine if a passenger is not in possession of proper documents.
3.39.3	NOTE: The U.S. considers security for individuals in airline custody to be the carrier's responsibility.

3.40.2	Annex 9 recommends that fines and penalties be mitigated if an alien with a document deficiency is eventually admitted to the country of destination.
3.43	Operator can be held responsible for some detention costs.
Chapter 4	Entry and Departure of Cargo and Other Articles
4.20	The Goods Declaration as defined by the Kyoto Convention serves as the fundamental Customs document rather than the commercial invoice.
4.40	Aircraft equipment and parts, certified for use in civil aircraft, may be entered duty-free by any nation entitled to most-favored nation tariff treatment. Security equipment and parts, unless certified for use in the aircraft, are not included.
4.41	Customs currently penalizes the exporting carrier for late filing of Shipper's Export Declarations (SEDs) and inaccuracies on bills of lading with respect to the SEDs.
4.42	Regulations require entry of such items, most of which are dutiable by law.
4.44	Certain items in this category are dutiable by law.
4.48	Carriers are required to submit new documentation to explain the circumstances under which cargo manifest is not unladen. No penalty is imposed if the carrier properly reports this condition.
4.50	The procedures for adding, deleting, or correcting manifest items require filing a separate document.
4.55	The U.S. requires a transportation in-bond entry or a special manifest bonded movement for this type of movement.
Chapter 5	Traffic Passing Through the Territory of a Contracting State
5.1	Such traffic must be inspected at airports where passengers are required to disembark from the aircraft and no suitable sterile area is available.
5.2	Passports and visas are waived for admissible aliens arriving on a carrier which is signatory to an agreement assuring immediate transit of its passengers provided they have a travel document or documents establishing identity, nationality, and ability to enter some country other than the U.S.
5.3	Such traffic must be inspected at airports where no suitable sterile area is available.
5.4	Passports and visas are waived for admissible aliens arriving on a carrier which is signatory to an agreement assuring immediate transit of its passengers provided they have a travel document or documents establishing identity, nationality, and ability to enter some country other than the U.S.
5.4.1	Passengers will not be required to obtain and present visas if they will be departing from the U.S. within 8 hours of arrival or on the first flight thereafter departing for their destination.
5.8	Examination of transit traffic is required by law. Transit passengers without visas are allowed one stopover between the port of arrival and their foreign destination.
5.9	Passports and visas are required generally for transit passengers who are remaining in the U.S. beyond 8 hours or beyond the first available flight to their foreign destinations.
Chapter 6	International Airports – Facilities and Services for Traffic
6.3.1	Procedures involving scheduling committees raise a number of anti-trust problems under U.S. law.
6.33	Sterile physical facilities shall be provided, and in-transit passengers within those areas shall be subject to immigration inspection at any time.
Remarks	OI 214.2(c)
6.34	The U.S. inspects crew and passengers in transit.
6.36	The U.S. inspects crew and passengers in transit.
6.56	Operators of aircraft are statutorily required to pay overtime charges for federal inspections conducted outside normal scheduled hours of operation. This requirement places aircraft operators in a less favorable position than operators of highway vehicles and ferries who are statutorily exempt from such charges.

Chapter 8	Other Facilitation Provisions
8.1	Separate bonds are required.
8.3.2	Visas are issued by the Department of State and are not issued at ports of entry.

ANNEX 10 – AERONAUTICAL TELECOMMUNICATIONS	
ANNEX 10 – VOLUME 1 – RADIO NAVIGATION AIDS	
PART I	
Chapter 3	Specifications for Radio Navigation Aids
3.1.2.1.1	Remote control and monitoring is implemented at all ILS installations for CAT II and III. Most, but not all, CAT I installations are monitored. A–CAT II and III; C– CAT I
3.1.4.1, 3.1.4.2, 3.1.4.3	The U.S. does not require such equipage for aircraft. The United States does not require such equipage for aircraft. Interference from FM broadcast signals will not adversely affect aircraft navigation and communications systems in the United States airspace
3.1.7.3.1 c)	When necessary to achieve coverage to the edges of the localizer course, the U.S. authorizes coverage over a greater distance than that specified in 3.1.7.3.1 c); i.e., up to 1,200 meters (4,000 feet) along the localizer course centerline.
3.3.8.1, 3.3.8.2, 3.3.8.3	The U.S. does not require such equipage for aircraft. The United States does not require such equipage for aircraft. Interference from FM broadcast signals will not adversely affect aircraft navigation and communications systems in the United States airspace.
3.5.5.4.1.	DME interrogator accuracy specified in this paragraph is not included in FAA avionics requirements.
3.7.3.4.4.3	Current satellite contract calls for –150dBW under the conditions specified in 3.7.3.4.4.3. Difference is greater signal power than called for in Annex 10.
PART II	
Chapter 4	
4.1.5.2	In the U.S., the shortage of communications channels, compared with the total operational requirement, has resulted in the geographical separation between facilities working on the same frequency being considerably less (up to 50 percent reduction) than the Standard defined for such separation.
ANNEX 10 – VOLUME II – COMMUNICATION PROCEDURES INCLUDING THOSE WITH PANS STATUS	
Chapter 3	General Procedures for the International Aeronautical Telecommunication Service
3.2.2, 3.2.3	US regulations do not have any specific procedures for closing down international aeronautical stations. All international aeronautical stations in the U.S. operate continuously (24 hours a day and seven days a week)
3.3.2	Class B traffic, including reservation messages pertaining to flights scheduled to depart within 72 hours, shall not be acceptable for transmission over U.S. Government operated AFTN circuits, except in those cases where it has been determined by the U.S. that adequate non–government facilities are not available.
Chapter 4	
4.4.2	In the Caribbean Region, U.S. industry–operated AFTN terminals will continue to accept messages in both ICAO and non–ICAO formats. The U.S. now accepts only messages in ICAO format from other states, including the Caribbean Region.
Chapter 5	Aeronautical Mobile Service – Voice Communications
5.1.5	US regulations do not require pilots to wait 10 seconds before making a second call. US regulations only require "a few seconds" instead of "10 seconds".
5.2.1.3.1.1	The U.S. will use the term "hundred" in stating altitude numbers by radiotelephone. Whole hundreds will be spoken as follows: 400 – "Four hundred" 4,500 – "Four thousand five hundred"

5.2.1.3.1.2	The U.S. will use the term “point” in lieu of “decimal” in stating frequencies: 126.55 MHz – “One two six point five five” 8,828.5 MHz – “Eight eight two eight point five”
5.2.1.6.1	Air route traffic control centers will use “center” rather than “control” in their radiotelephone identification. Example: “Washington Center.” Approach control service units will use “approach control” or “departure control” rather than “approach” in their radiotelephone identification. Example: “Washington Approach Control” or “Washington Departure Control.” Aerodrome control towers will use “ground control” or “clearance delivery” rather than “tower” in their radiotelephone identification, where appropriate, to identify ground control services. Example: “Washington Ground Control” or “Washington Clearance Delivery.”
5.2.1.6 5.2.1.6.2.1.1 5.2.1.6.2.2.1	U.S. procedures allow abbreviation of only Type a) call signs and limit abbreviation to not less than three characters following the first character of the registration marking or the manufacturer of the aircraft. Also, the U.S. does not use call signs comprised of aircraft operating agency telephony designators in combination with aircraft registration markings (Type b).
Remarks	To facilitate understanding, examples (5.2.1.6) should follow rather than precede corresponding provisions which govern them (5.2.1.6.2.1.1 and 5.2.1.6.2.2.1).
5.2.2.1.1.1 5.2.2.1.1.2	The U.S. Federal Aviation Regulations do not require that a continuous airborne guard on VHF121.5 MHz be maintained.
5.2.2.7.1.2	US regulations do not specifically require pilots to send a message twice preceded with the phrase “TRANSMITTING BLIND”. US regulations provides general procedures which allow pilots to make blind transmissions in case of emergency.
5.2.2.7.1.3.2	US regulations do not specifically require pilots to make a blind transmission preceded by “TRANSMITTING BLIND DUE TO RECEIVER FAILURE” with respect to the continuation of the flight of the aircraft. US regulations provide general procedures which allow pilots to make appropriate blind transmissions.
5.2.2.7.2.1, 5.2.2.7.2.2	US regulations do not specifically require aeronautical stations to get assistance from other aircraft in case of communications failure. US regulations require aeronautical stations to use “all appropriate means” available to re-establish communications with aircraft.
5.2.2.7.2.3	US regulations do not specifically require aeronautical stations to send blind transmissions. US regulations require aeronautical stations to use “all appropriate means” available to re-establish communications with aircraft.
5.2.2.7.2.4	US regulations do not provide this specific standard. US regulations require aeronautical stations to use “all appropriate means” available to re-establish communications with aircraft.
5.2.2.7.3.1	US regulations do not specifically require pilots to make a blind transmission preceded by “TRANSMITTING BLIND DUE TO RECEIVER FAILURE”. US regulations provide general procedures which allow pilots to make appropriate blind transmissions.
ANNEX 10 – VOLUME III – COMMUNICATION SYSTEMS	
PART I – DIGITAL DATA COMMUNICATION SYSTEMS	
Chapter 1	Definitions
ATN Directory Services	The FAA has not implemented the DIR as part of the AMHS Extended Service. The Basic Service AMHS has been implemented.
ATN Security Services	The ATN Security Service can be implemented as part of the AMHS Extended Service.

Authentication	This is a part of ATN Security Services of the ATN DIR/AMHS Extended Service that has not been implemented.
Security Management	This is a part of ATN Security Services capability of the ATN DIR/AMHS Extended Service that has not been implemented.
Chapter 3	Aeronautical Telecommunication Network
3.2.1	The Ground-to-Ground ATN service based on OSI has been implemented (AMHS) but not Air-to-Ground.
3.2.2	ATN Ground-to-Ground service does not support sections a) 4) APC, c), e), f) and g)
3.2.3	FAA ATN currently does not support these services.
3.3.1	FAA ATN service does not support a) ATS to aircraft and c) AOC.
3.4.1.4, 3.4.16, 3.4.19, 3.4.32	The FAA ATN only supports AMHS (ground service).
Chapter 4	
4.2.1.2 4.2.1.3	In the U.S., AMSS terminals <u>shall have</u> the capability of operating in the frequency bands 1544-1559 MHz and 1645.5-1660.5 MHz bands. (NOTE: Use of the band 1544-1545/1645.5-1646.5 MHz by the mobile satellite service is limited to distress and safety.)
PART II	
2.3.3.1 2.3.3.2 2.3.3.3	The U.S. does not require such equipage for aircraft.
ANNEX 10 – VOLUME IV – SURVEILLANCE AND COLLISION AVOIDANCE SYSTEMS	
Chapter 3	Surveillance Systems
3.1.1.7.13	SPI required to be transmitted for 18 +/- 1 second. US regulations are more stringent than ICAO.
3.1.2.6.5.2	In the request to downlink, Annex 10 assigns bits 0 to 7, many of them are reserved. The FAA Order 6365.1A implements this requirement assigning bits 0 and 1 and the bits 2 through 15 are not assigned.
3.1.2.10.4.3.3	Annex 10 requires "If antenna selection is based on signal level, it shall be carried out at all signal levels between MTL and -21 dBm." The RTCA MOPS for Mode S transponders, DO-181c, does not specify the range of signal levels over which the antenna selection must correctly be accomplished. FAA Order 6365.1A paragraph 5.5.1 addresses the issue of antenna selection. However, the TSO standard conferred upon manufacturers does not require implementation.
3.1.2.11.3	The US National Standard for the Mode S Beacon System, FAA Order 6365.1A, paragraph 6.3 requires – When the interrogator transmitter is not transmitting an interrogation, its output does not exceed -5 dBm effective radiated power at any frequency. This requirement exceeds the ICAO SARPs frequency of interest 960 to 1215 MHz.
Chapter 4	Airborne Collision Avoidance System
4.1	US documentation contains the following definition for TA: Information given to the pilot pertaining to the position of another aircraft in the immediate vicinity. The information contains no suggested maneuver. The ICAO SARPs considers this a potential threat. The TAs are issued to show all nearby traffic. TCAS does not determine by a test or analysis that some of these aircraft may be a potential threat. Information given to the pilot pertaining to the position of another aircraft in the immediate vicinity. The information contains no suggested maneuver.
4.2.3.3	The TSO-C118 (RTCA DO-197) implements this requirement. However, requirement of limiting Mode S power to the level of Mode A/C (paragraph 4.2.3.4) is not implemented.
4.3.1.1.1	Specifies a nominal cycle of 1 second
4.3.2.1.2	The US specifies a false track probability of less than 1.2% for Mode A/C and less than 0.1% for Mode S.

4.3.2.2.2 4.3.2.2.2.2 4.3.2.2.2.2.2 4.3.2.2.2.2.3	TCAS II Version 6.04A Enhanced Interference Limiting Algorithms won't comply with these sections of the standards and recommended practices (SARPs). See remark below.
4.3.5.1	TCAS II Version 6.04A Enhanced won't comply because it has a 3-second coordination delay. See remark below.
4.3.5.3	TCAS II Version 6.04A Enhanced does not comply since the section implies a requirement for reversals in some instances in encounters between two TCAS II-equipped aircraft. See remark below.
4.3.5.4	TCAS II Version 6.04A Enhanced does not comply since the section explicitly requires reversal of coordinated resolution advisories (RAs) under some circumstances. See remark below.
4.3.5.5	TCAS II Version 6.04A Enhanced does not comply since it contains a dormancy requirement, does not have 5-second targets, and only has surveillance of $\pm 3,000$ feet in altitude. See remark below.
4.3.8.4.2.2.1 4.3.8.4.2.2.1.1	TCAS II Version 6.04A Enhanced has different RA Report formats in DF = 20, 21 replies. See remark below.
4.3.8.4.2.2.1.3	TCAS II Version 6.04A Enhanced has different RA Report formats in DF = 20, 21 replies. See remark below. US documentation contains an additional requirement After an RA has been terminated: by TCAS, it is still required to be reported by the Mode S transponder for 18±1 seconds.
4.3.8.4.2.2.1.4 4.3.8.4.2.2.1.5 4.3.8.4.2.2.1.6 4.3.8.4.2.2.1.6.1 4.3.8.4.2.2.1.6.2 4.3.8.4.2.2.1.6.3	TCAS II Version 6.04A Enhanced has different RA Report formats in DF = 20, 21 replies. See remark below.
4.3.8.4.2.2.2 4.3.8.4.2.2.3	TCAS Version 6.04 Enhanced has different Data Link Capability format in DF = 20, 21 replies. See remark below.
4.3.8.4.2.3.2.3	TCAS Version 6.04 Enhanced has different Data Link Capability format in DF = 20, 21 replies. See remark below. The US uses "don't descend" vs. "do not pass below" and "Don't climb" vs. "do not pass above"
4.3.8.4.2.3.2.5	Limited to TCAS with horizontal on-board resolution equipment
4.3.8.4.2.3.2.7	Limited to TCAS with horizontal on-board resolution equipment
4.3.8.4.2.3.4 4.3.8.4.2.3.4.1 4.3.8.4.2.3.4.2 4.3.8.4.2.3.4.3 4.3.8.4.2.3.4.4	TCAS II Version 6.04A Enhanced RA does not meet the Broadcast format specified in these sections. See remark below.
4.3.8.4.2.3.4.5	TCAS II Version 6.04A Enhanced RA does not meet the Broadcast format specified in these sections. See remark below. The US specifies a different bit coding scheme. The US has implemented the AID code. The bit pattern documented in the RTCA document is in the bit order as received from the control head. The Annex 10 SARPs show the bit order of the RF transmission.
4.3.8.4.2.3.4.6	TCAS II Version 6.04A Enhanced RA does not meet the Broadcast format specified in these sections. See remark below.
4.3.8.4.2.4.2.1 4.3.8.4.2.4.2.3 4.3.8.4.2.4.2.4	TCAS II Version 6.04A Enhanced has a different Coordination Reply format in DF = 16 replies. See remark below.

Remark	The U.S. does not require TCAS II Version 7 (ACAS II) equipage in its National Airspace System.
4.3.9.3.1	The US specifies 10 ft or less.
ACAS	The US uses the term Traffic Alert and Collision Avoidance System (TCAS). The difference of terminology does not impact interoperability of the systems.
ANNEX 10 – VOLUME V – AERONAUTICAL RADIO FREQUENCY SPECTRUM UTILIZATION	
Chapter 2	Distress frequencies
2.1.2	Emergency locator transmitters (ELT) installed on or after 1 January 2002 do not have to operate on both 406 MHz and 121.5 MHz in the US.
2.1.3	Effective date of 1 January 2005 for emergency locator transmitters to operate on both 406 MHz and 121.5 MHz was not met in the US.
Chapter 4	Utilization of frequencies above 30 MHz
4.1.1.1	The 121.5 MHz aeronautical emergency channel guard-band is reduced to 25 kHz. In the U.S. this 121.5 MHz channel is protected on either side by a single 25 kHz channel centered on frequencies 121.475 MHz and 121.525 MHz. The other four (4) guard band channels, centered on frequencies 121.425 MHz, 121.450MHz, 121.550MHz, and 121.575MHz are utilized to transmit weather information on simplex operations (ground-to-air only) using 25kHz channels. The maximum transmit power of the ground-based equipment is limited to 2.5 W. The ground-based equipment must also meet specific output spectral masks (defined as ± 25 kHz -33 dBm $- 33$ dBm; ± 50 kHz -45 dBm $- 45$ dBm; ± 75 kHz -47 dBm)
4.1.2.1	The minimum frequency separation of 8.33 KHz has not been adopted in the US.
4.1.2.2.1	Mandatory carriage of 8.33 KHz equipment has not been established in the US.
4.1.2.2.2	8.33 KHz radios are not safeguarded with respect to its suitability for AM(R)S in the US
4.1.2.2.3	FAA has not issued a mandatory carriage of VDL Mode 3 and VDL Mode 4.
4.1.2.2.3.1	FAA has not issued a mandatory carriage of VDL Mode 3.
4.1.2.2.4	No provision to safeguard VDL Mode 3 and Mode 4 with respect to its suitability for AM(R)S currently exists in the US.
4.1.3.1.6	The US does not require aircraft flying within the US airspace to meet one of the characteristics dealing with the FM interference immunity performance.
4.1.3.2.1	The frequency 123.45 MHz is not designated for air-to-air communications in the US airspace.
4.1.3.2.2	The frequency 123.45 MHz is not designated for air-to-air communications in remote and oceanic areas within the US airspace.
4.1.4.2	The US does not require aircraft flying within the US airspace to meet one of the characteristics dealing with the FM interference immunity performance.
4.2.3	The US does not follow the VOR assignment priority as defined in Section 4.2.3.

ANNEX 11 – AIR TRAFFIC SERVICES	
Chapter 1	Definitions
Accepting Unit	The term "receiving facility" is used.
Advisory Airspace	Advisory service is provided in terminal radar service areas and the outer area associated with class C airspace areas as well as Class E airspace.
Advisory Route	Advisory service is provided in terminal radar service areas and the outer area associated with class C airspace areas as well as Class E airspace.
ACAS	Traffic Alert and Collision Avoidance System (TCAS) – An airborne collision avoidance system based on radar beacon signals which operates independent of ground-based equipment. 14 CFR 1.1 further defines and breaks down TCAS into TCAS 1 – provides traffic advisories 2 – provides traffic advisories and resolution advisories in the vertical plane and 3 – provides traffic advisories and resolution advisories in the vertical and horizontal planes.
AIRMET	FAA Pilot Controller Glossary defines (in part) AIRMET as "In-flight weather advisories issued only to amend the area forecast concerning weather phenomena which are of operational interest to all aircraft and potentially hazardous to aircraft having limited capability because of lack of equipment instrumentation or pilot qualifications...." The ICAO definition of AIRMET narrows the purpose of the advisory to "low-level aircraft operations", where the FAA has a more broad definition to encompass "all aircraft and ... aircraft having limited capability..." Also, ICAO uses the term "forecast ... for the flight information region" where the FAA uses "area forecast". Difference in character (terminology) for area forecast. FAA uses AIRMETs for broader purpose.
Air traffic control unit	The U.S. uses the term "air traffic control facility". (i.e. En Route, Terminal, or Flight Service)
Air traffic services reporting office	FAA Pilot Control Glossary defines (in part) Flight Service Stations (FSS) as "air traffic facilities which provide pilot briefing, en route communications and VFR search and rescue services, assist lost aircraft in emergency situations, relay ATC clearances, originate notices to airmen, broadcast aviation weather and NAS information, receive and process IFR flight plans...." FSS's are available to receive any reports concerning air traffic services as well as accept and file flight plans.
Air traffic services unit	The U.S. uses "Air Route Traffic Control Center".
Air-taxiing	U.S. uses "hover taxi" for this maneuver above 100 feet above ground level (AGL) and "air taxi" below 100 feet AGL.
Airborne collision avoidance	The U.S. uses "traffic alert collision avoidance system (TCAS)." TCAS is an airborne collision avoidance system based on radar beacon signals and operates independent of ground-based equipment. TCAS-1 generates traffic advisories only. TCAS-II generates traffic advisories and resolution (collision avoidance) advisories in the vertical plane.
Airway	A Class E airspace area established in the form of a corridor, the centerline of which is defined by radio navigational aids.
Alert Phase	Alert – a notification to a position that there is an aircraft-to-aircraft or aircraft-to-airspace conflict as detected by automated problem detection.
Altitude	Height above ground level (AGL), mean sea level (MSL) or indicate altitude.
Apron Management Service	Ground control or ramp control provide the same service. There is no formal definition in the Pilot Controller Glossary.

Area Control Centre	The U.S. uses the terms “Traffic Control Center”, “Radar Approach Control Facility”, and “Tower” to define a facility that provides air traffic control service to aircraft operating on IFR flight plans within controlled airspace and principally during the en route phase of flight. When equipment capabilities and controller workload permit, certain advisory/assistance services may be provided to VFR aircraft.
Area Control Service	Air Traffic Control – A service operated by appropriate authority to promote the safe, orderly and expeditious flow of air traffic.
Controlled flight	The US uses the term “IFR Clearance”.
Control Zone	The US uses the term “Surface Area”. Surface area is airspace contained by the lateral boundary of the Class B, C, D, or E airspace designated for an airport that begins at the surface and extends upward.
Cruising Level	Cruising Altitude – an altitude or flight level maintained during en route level flight. This is a constant altitude and should not be confused with a cruise clearance.
Downstream Clearance	Same as air traffic control clearance. Authorization for an aircraft to proceed under conditions specified by an air traffic control unit.
Flight Information Centre	In the US, flight information service and alerting service are often provided by flight service stations.
Level	The term “altitude” is used.
Manoeuvring Area	Any locality either on land, water, or structures, including airports/heliports and intermediate landing fields, which is used, or intended to be used, for the landing and takeoff of aircraft whether or not facilities are provided for the shelter, servicing, or for receiving or discharging passengers or cargo.
Meteorological office	No PCG definition. However FSSs perform this duty.
Movement Area	The runways, taxiways, and other areas of an airport/heliport which are utilized for taxiing/hover taxiing, air taxiing, takeoff, and landing of aircraft, exclusive of loading ramps and parking areas. At those airports/heliports with a tower, specific approval for entry onto the movement area must be obtained from ATC.
Pilot-in-command	The person who has final authority for the operation and safety of the flight has been designated as pilot in command before or during the flight and hold the appropriate category, class and type rating for the flight.
Traffic avoidance advice	US uses the term “Safety Alert”
Traffic information	US uses the term “Traffic Advisory”
Waypoint	A predetermined geographical position used for route/instrument approach definition, progress reports, published VFR routes, visual reporting points or points for transitioning and/or circumnavigating controlled and/or special use airspace, that is defined relative to a VORTAC station or in terms of latitude/longitude coordinates.
Chapter 2	General

2.3.2	Annex 11, paragraph 2.3.2 directs the flight information service to accomplish objective d) of para 2.2, “to provide advice and information for the safe and efficient conduct of flight.” Details on procedures to accomplish this objective are contained in FAA Order 7210.3, Part 4, Flight Service Stations. Specific procedures for accomplishing this objective are contained in FAA Order 7110.10, Flight Services. Also, the FAA Pilot Controller Glossary defines Flight Service Stations as “air traffic facilities which provide pilot briefing, en route communications and VFR search and rescue services, assist lost aircraft and aircraft in emergency situations, relay ATC clearances, originate Notices to Airmen, broadcast aviation weather and NAS information, receive and process IFR flight plans, and monitor NAVAIDs. In addition, at selected locations, FSSs provide En Route Flight Advisory Service (Flight Watch), take weather observations, issue airport advisories, and advise Customs and Immigration of transborder flights.
2.5.2.2.1	FAA uses the generic term “controlled airspace” and “surface areas”
2.5.2.2.1.1	FAA also provides this service in Class E.
2.5.2.2.2	Annex 11, paragraph 2.3.2 directs the flight information service to accomplish objective d) of para 2.2, ”to provide advice and information for the safe and efficient conduct of flight.” Details on procedures to accomplish this objective are contained in FAA Order 7210.3, Part 4, Flight Service Stations. Specific procedures for accomplishing this objective are contained in FAA Order 7110.10, Flight Services. Also, the FAA Pilot Controller Glossary defines Flight Service Stations as ”air traffic facilities which provide pilot briefing, en route communications and VFR search and rescue services, assist lost aircraft and aircraft in emergency situations, relay ATC clearances, originate Notices to Airmen, broadcast aviation weather and NAS information, receive and process IFR flight plans, and monitor NAVAIDs. In addition, at selected locations, FSSs provide En Route Flight Advisory Service (Flight Watch), take weather observations, issue airport advisories, and advise Customs and Immigration of transborder flights.
2.6	The Class F airspace is not used in the designation of U.S. airspace.
2.6.1	The U.S. has chosen not to use Class F airspace.
2.9	Converting the present U.S. system for identifying ATS routes and significant points to conform to the provisions of amended paragraphs 2.9 – 2.9.2, 2.11 – 2.11.3, Appendix 1 and Appendix 2 is an effort of considerable magnitude and complexity. The U.S. has an ongoing program to accomplish the conversion, but it is estimated that a period of 2 to 5 years will be required for full compliance.
2.10.3.2.2	Class E–5 700/1200–foot airspace areas are used for transitioning aircraft to/from the terminal or en route environment.
2.10.3.3	En Route Domestic Airspace Areas consist of Class E airspace that extends upward from a specified altitude to provide controlled airspace in those areas where there is a requirement to provide IFR en route ATC services but the Federal airway structure is inadequate. En Route Domestic Airspace Areas may be designated to serve en route operations when there is a requirement to provide ATC service but the desired routing does not qualify for airway designation. Offshore/ Control Airspace Areas are locations designated in international airspace (between the U.S. 12–mile territorial limit and the CTA/FIR boundary, and within areas of domestic radio navigational signal or ATC radar coverage) wherein domestic ATC procedures may be used for separation purposes.
2.10.5.1	A Class D airspace area shall be of sufficient size to: 1. Allow for safe and efficient handling of operations. 2. Contain IFR arrival operations while between the surface and 1,000 feet above the surface, and IFR departure operations while between the surface and 1,000 feet above the surface, and IFR departure operations while between the surface and the base of adjacent controlled airspace.

2.10.5.2	A Class D airspace area shall be of sufficient size to: 1. Allow for safe and efficient handling of operations. 2. Contain IFR arrival operations while between the surface and 1,000 feet above the surface, and IFR departure operations while between the surface and the base of adjacent controlled airspace. Size and shape may vary to provide for 1 and 2. The emphasis is that a Class D area shall be sized to contain the intended operations.
2.10.5.3	Refer to Surface Areas
2.11	Converting the present U.S. system for identifying ATS routes and significant points to conform to the provisions of amended paragraphs 2.9 – 2.9.2, 2.11 – 2.11.3, Appendix 1 and Appendix 2 is an effort of considerable magnitude and complexity. The U.S. has an ongoing program to accomplish the conversion, but it is estimated that a period of 2 to 5 years will be required for full compliance.
2.25.5	No time is issued prior to taxi for take-off. Time checks are given to the nearest quarter minute.
2.27.5	Process is described in the FAA Safety Management System Manual and the FAA Order 1100.161.
Appendix 1 Appendix 2	Converting the present U.S. system for identifying ATS routes and significant points to conform to the provisions of amended paragraphs 2.9 – 2.9.2, 2.11 – 2.11.3, Appendix 1 and Appendix 2 is an effort of considerable magnitude and complexity. The U.S. has an ongoing program to accomplish the conversion, but it is estimated that a period of 2 to 5 years will be required for full compliance.
Chapter 3	Air Traffic Control Service
3.2	Air Route Traffic Control Facilities (ARTCC) are used instead of Area Control Service, and Terminal Control Facilities instead of Approach Control Service.
3.3.3 Exception Clause	Clearances may be issued to conduct flight in VFR conditions without a pilot request if the clearance would result in noise abatement benefits or when a pilot conducts a practice instrument approach.
3.6.2.4	The U.S does not specify notification of 2-way communication. The accepting unit shall not alter the clearance of an aircraft that has not yet reached the transfer of control point without the prior approval of the transferring unit.
3.7.3.1	Air crews are not required to read back clearances, only to acknowledge receipt of clearances.
3.7.3.1.1	Air crews are not required to read back clearances, only to acknowledge receipt of clearances.
3.7.4.3	4–3–8. COORDINATION WITH RECEIVING FACILITY Coordinate with the receiving facility before the departure of an aircraft if the departure point is less than 15 minutes flying time from the transferring facility’s boundary unless an automatic transfer of of data between automated systems will occur, in which case the flying time requirement may be reduced to 5 minutes or replaced with a mileage from the boundary parameter when mutually agreeable to both facilities.
3.7.4.4	4–4–5. CLASS G AIRSPACE Include routes through Class G airspace only when requested by the pilot. NOTE–1. Flight plans filed for random RNAV routes through Class G airspace are considered a request by the pilot. 2. Flight plans containing MTR segments in/through Class G airspace are considered a request by the pilot. Air Traffic Control Clearance means an authorization by air traffic control within controlled airspace.
Chapter 4	Flight Information Service
4.2.2	No Class F airspace. Collision Hazard information is provided between known traffic to aircraft in Class G airspace.
4.2.2 b)	No provision is made for the issuance of collision hazard information to flights operating in Class G airspace.
4.3.4.4 h) 4.3.4.8	The U.S. requires that the current altimeter setting be included in the ATIS broadcast. Information contained in a current ATIS broadcast, the receipt of which has been acknowledged by an aircraft, is not included in a directed transmission to the aircraft unless requested by the pilot.
4.3.5 4.3.6 4.3.7	The order in which information is listed in ATIS broadcast messages is not mandated and certain elements are regarded as optional.
Chapter 6	Air Traffic Services Requirements for Communications

6.1.1.4 6.2.2.3.8	The US uses a 45 day retention period.
6.2.3.6	The US has a 45 day or longer retention period, with some exceptions. US en route facilities using system analysis recording tapes as their radar retention media shall retain radar data for 15 days. Facilities using a teletype emulator or console printout must be retained for 30 days unless they are related to an accident or incident. A facility using a console typewriter printout take-up device may retain the printout on the spool for 15 days after the last date on the spool. If a request is received to retain data information following an accident or incident, the printout of the relative data will suffice and the tape/disc may then be returned to service through the normal established rotational program.
6.3.1.3	The US has a 45 day or longer retention period except that those facilities utilizing an analog voice recorder system shall retain voice recordings for 15 days.
6.4.1.2	The US retains surveillance data recordings for 45 days or longer when they are pertinent to an accident or incident investigation, except that en route facilities using system analysis recording tapes as their radar retention media (regardless of the type of voice recorder system being used) shall retain voice recordings for 15 days and those facilities using an analog voice recorder system shall retain voice recordings for 15 days. FAA's Air Traffic Control System Command Center shall retain voice recordings for 15 days.
Chapter 7	Air Traffic Services Requirements for Information
7.1.5	The term "communication station" is not used but the flight information is passed.
7.6	Temporary Flight Restrictions (TFRs) are the mechanism that would be implemented in such cases.
Appendix 1	Principles Governing the Identification of RNP Types and the Identification of ATS Routes Other Than Standard Departure and Arrival Routes
	See 2.9, above.
2.2.1	Routes designated to serve aircraft operating from 18,000 MSL up to and including FL 450 are referred to as "jet routes" and are designated with the letter "J" followed by a number of up to three digits.
Appendix 2	Principles Governing the Establishment and Identification of Significant Points
	See 2.9, above.
2.1	The U.S. will not comply with this guidance in naming the Missed Approach Point (MAP) located at the landing threshold.
Appendix 4	ATS Airspace Classifications
	It should be noted that the term "Class B airspace" as used in the U.S. is more restrictive than that specified by ICAO. Flights within Class B Airspace in the U.S. must be operated in accord with the provisions of 14 CFR Part 91 (Section 91.90).
	Speed restrictions do not necessarily apply to aircraft operating beyond 12 NM from the coast line within the U.S. Flight Information Region, in offshore Class E airspace below 10,000 feet MSL. However, in airspace underlying a Class B airspace area designated for an airport, or in a VFR corridor designated through such a Class B airspace area, pilots are expected to comply with the 200 knot speed limit specified in 14 CFR Part 91 (Sections 91.117(c) and 91.703). This difference will allow airspeed adjustments exceeding 250 knots, thereby improving air traffic services, enhancing safety and expediting air traffic movement.

ANNEX 12 – SEARCH AND RESCUE

There are no reportable differences between U.S. regulations and the Standards and Recommended Practices contained in this Annex.

ANNEX 13 – AIRCRAFT ACCIDENT INVESTIGATION	
Chapter 5	Investigation
5.12	<p>The full exchange of information is vital to effective accident investigation and prevention. The U.S. supports, in principle, measures that are intended to facilitate the development and sharing of information. The laws of the U.S. require the determination and public reporting of the facts, circumstances, and probable cause of every civil aviation accident. This requirement does not confine the public disclosure of such information to an accident investigation. However, the laws of the U.S. do provide some protection against public dissemination of certain information of a medical or private nature.</p> <p>Also, U.S. law prohibits the disclosure of cockpit voice recordings to the public and limits the disclosure of cockpit voice recording transcript to that specific information which is deemed pertinent and relevant by the investigative authority. However, U.S. Courts can order the disclosure of the foregoing information for other than accident investigation purposes. The standard for determining access to this information does not consider the adverse domestic or international effects on investigations that might result from such access.</p>
5.25 h)	<p>Investigative procedures observed by the U.S. allow full participation in all progress and investigation planning meetings; however, deliberations related to analysis, findings, probable causes, and safety recommendations are restricted to the investigative authority and its staff. However, participation in these areas is extended through timely written submissions, as specified in paragraph 5.25 i).</p>
5.26 b)	<p>The U.S. supports, in principle, the privacy of the State conducting the investigation regarding the progress and the findings of that investigation. However, the laws of the U.S. facilitate the public disclosure of information held by U.S. government agencies and U.S. commercial business. The standard for determining public access to information requested from a U.S. government agency or a commercial business does not consider or require the expressed consent of the State conducting the investigation.</p>
Chapter 6	Reporting
6.13	<p>The U.S. supports the principle of not circulating, publishing, or providing access to a draft report or any part thereof unless such a report or document has already been published or released by the State which conducted the investigation. However, the laws of the U.S. facilitate the public disclosure of information held by government agencies and commercial business. The U.S. government may not be able to restrict public access to a draft report or any part thereof on behalf of the State conducting the investigation. The standard for determining public access to information requested from a U.S. government agency or a commercial business does not consider or require the expressed consent of the State conducting an investigation.</p>

ANNEX 14 – AERODROMES	
VOLUME 1 – AERODROME DESIGN AND OPERATIONS	
Chapter 1	General
1.2.1	<p>Airports in the U.S. are for the most part owned and operated by local governments and quasi-government organizations formed to operate transportation facilities. The Federal Government provides air traffic control, operates and maintains NAVAIDs, provides financial assistance for airport development, certifies major airports, and issues standards and guidance for airport planning, design, and operational safety.</p> <p>There is general conformance with the Standards and Recommended Practices of Annex 14, Volume I. At airports with scheduled passenger service using aircraft having more than nine seats, compliance with standards is enforced through regulation and certification. At other airports, compliance is achieved through the agreements with individual airports under which Federal development funds were granted; or, through voluntary actions.</p>
1.3.1 1.3.2 1.3.3 1.3.4	<p>In the U.S., the Airport Reference Code is a two-component indicator relating the standards used in the airport’s design to a combination of dimensional and operating characteristics of the largest aircraft expected to use the airport. The first element, Aircraft Approach Category, corresponds to the ICAO PANS-OPS approach speed groupings. The second, Airplane Design Group, corresponds to the wingspan groupings of code element 2 of the Annex 14, Aerodrome Reference Code. See below:</p>

TBL GEN 1.7-1
Airport Reference Code (ARC)

Aircraft Approach Category	Approximate Annex 14 Code Number
A	1
B	2
C	3
D	4
E	-
Airplane Design Group	Corresponding Annex 14 Code Letter
I	A
II	B
III	C
IV	D
V	E
VI	F (proposed)

EXAMPLE: AIRPORT DESIGNED FOR B747-400 ARC D-V.

Chapter 2	Aerodrome Data
2.2.1	The airport reference point is recomputed when the ultimate planned development of the airport is changed.
2.9.6 2.9.7	Minimum friction values have not been established to indicate that runways are “slippery when wet.” However, U.S. guidance recommends that pavements be maintained to the same levels indicated in the ICAO Airport Services Manual.
2.11.3	If inoperative fire fighting apparatus cannot be replaced immediately, a NOTAM must be issued. If the apparatus is not restored to service within 48 hours, operations shall be limited to those compatible with the lower index corresponding to operative apparatus.
2.12 e)	Where the original VASI is still installed, the threshold crossing height is reported as the center of the on-course signal, not the top of the red signal from the downwind bar.

Chapter 3	Physical Characteristics
3.1.2*	The crosswind component is based on the ARC: 10.5 kt for AI and BI; 13 kt for AII and BII; 16 kt for AIII, BIII and CI through DIII; 20 kts for AIV through DVI.
3.1.9*	Runway widths (in meters) used in design are shown in the table below:

Width of Runway in Meters

Aircraft Approach Category	Airplane Design Group					
	I	II	III	IV	V	VI
A	18 ¹	23 ¹	---	---	45	60
B	18 ¹	23 ¹	---	---	45	60
C	30	30	30 ²	45	45	60
D	30	30	30 ²	45	45	60

¹The width of a precision (lower than 3/4 statute mile approach visibility minimums) runway is 23 meters for a runway which is to accommodate only small (less than 5,700 kg) airplanes and 30 meters for runways accommodating larger airplanes.

²For airplanes with a maximum certificated take-off mass greater than 68,000 kg, the standard runway width is 45 meters.

3.1.12*	Longitudinal runway slopes of up to 1.5 percent are permitted for aircraft approach categories C and D except for the first and last quarter of the runway where the maximum slope is 0.8 percent.
3.1.18*	Minimum and maximum transverse runway slopes are based on aircraft approach categories as follows: For categories A and B: 1.0 – 2.0 percent C and D: 1.0 – 1.5 percent
3.2.2	The U.S. does not require that the minimum combined runway and shoulder widths equal 60 meters. The widths of shoulders are determined independently.
3.2.3*	The transverse slope on the innermost portion of the shoulder can be as high as 5 percent.
3.3.3 3.3.4* 3.3.5*	A strip width of 120 meters is used for code 3 and 4 runways for precision, nonprecision, and non-instrumented operations. For code 1 and 2 precision runways, the width is 120 meters. For non-precision/visual runways, widths vary from 37.5 meters up to 120 meters.
3.3.9*	Airports used exclusively by small aircraft (U.S. Airplane Design Group I) may be graded to distances as little as 18 meters from the runway centerline.
3.3.14*	The maximum transverse slope of the graded portion of the strip can be 3 percent for aircraft approach categories C and D and 5 percent for aircraft approach categories A and B.
3.3.15*	The U.S. does not have standards for the maximum transverse grade on portions of the runway strip falling beyond the area that is normally graded.
3.3.17*	Runways designed for use by smaller aircraft under non-instrument conditions may be graded to distances as little as 18 meters from the runway centerline (U.S. Airplane Design Groups I and II).
3.4.2*	For certain code 1 runways, the runway end safety areas may be only 72 meters.
3.7.1* 3.7.2*	The U.S. does not provide Standards or Recommended Practices for radio altimeter operating areas.
3.8.3*	The U.S. specifies a 6 meter clearance for Design Group VI airplanes.
3.8.4*	The taxiway width for Design Group VI airplanes is 30 meters.
3.8.5*	The U.S. also permits designing taxiway turns and intersections using the judgmental oversteering method.

3.8.7*	Minimum separations between runway and taxiway centerlines, and minimum separations between taxiways and taxilanes and between taxiway/taxilanes and fixed/moveable objects are shown in the tables that follow. Generally, U.S. separations are larger for non-instrumented runways, and smaller for instrumented runways, than the Annex. Values are also provided for aircraft with wingspans up to 80 meters.
--------	---

Minimum Separations Between Runway Centerline and Parallel Taxiway/Taxilane Centerline

Operation	Aircraft Approach Category	Airplane Design Group						
		I ¹	I	II	III	IV	V	VI
Visual runways and runways with not lower than 3/4-statute mile (1,200 meters) approach visibility minimums	A and B	150 feet 45 meters	225 feet 67.5 meters	240 feet 72 meters	300 feet 90 meters	400 feet 120 meters	--	--
Runways with lower than 3/4-statute mile (1,200 meters) approach visibility minimums	A and B	200 feet 60 meters	250 feet 75 meters	300 feet 90 meters	350 feet 105 meters	400 feet 120 meters	--	--
Visual runways and runways with not lower than 3/4-statute mile (1,200 meters) approach visibility minimums	C and D	--	300 feet 90 meters	300 feet 90 meters	400 feet 120 meters	400 feet 120 meters	400 ² feet 120 ² meters	600 feet 180 meters
Runways with lower than 3/4-statute mile (1,200 meters) approach visibility minimums	C and D	--	400 feet 120 meters	400 feet 120 meters	400 feet 120 meters	400 feet 120 meters	400 ² feet 120 ² meters	600 feet 180 meters

¹These dimensional standards pertain to facilities for small airplanes exclusively.

²Corrections are made for altitude: 120 meters separation for airports at or below 410 meters; 135 meters for altitudes between 410 meters and 2,000 meters; and, 150 meters for altitudes above 2,000 meters.

Minimum Taxiway and Taxilane Separations:

	Airplane Design Group					
	I	II	III	IV	V	VI
Taxiway centerline to parallel taxiway/taxilane centerline	69 feet 21 meters	105 feet 32 meters	152 feet 46.5 meters	215 feet 65.5 meters	267 feet 81 meters	324 feet 99 meters
Fixed or movable object	44.5 feet 13.5 meters	65.5 feet 20 meters	93 feet 28.5 meters	129.5 feet 39.5 meters	160 feet 48 meters	193 feet 59 meters
Taxilane centerline to parallel taxilane centerline	64 feet 19.5 meters	97 feet 29.5 meters	140 feet 42.5 meters	198 feet 60 meters	245 feet 74.5 meters	298 feet 91 meters
Fixed or movable object	39.5 feet 12 meters	57.5 feet 17.5 meters	81 feet 24.5 meters	112.5 feet 34 meters	138 feet 42 meters	167 feet 51 meters

3.8.10*	Line-of-sight standards for taxiways are not provided in U.S. practice, but there is a requirement that the sight distance along a runway from an intersecting taxiway must be sufficient to allow a taxiing aircraft to safely enter or cross the runway.
3.8.11*	Transverse slopes of taxiways are based on aircraft approach categories. For categories C and D, slopes are 1.0–1.5 percent; for A and B, 1.0–2.0 percent.
3.11.5	The runway centerline to taxi-holding position separation for code 1 is 38 meters for non-precision operations and 53 meters for precision. Code 3 and 4 precision operations require a separation of 75 meters, except for “wide bodies,” which require 85 meters.

Dimensions and Slopes for Protective Areas and Surfaces

	Precision Approach	Non-precision Instrument Approach			Visual Runway	
	All runways	All runways ^a	Runways other than utility ^b	Utility runways ^d	Runways other than utility	Utility runways
Width of inner edge	305 meters	305 meters	152 meters	152 meters	152 meters	76 meters ^c
Divergency (each side)	15 percent	15 percent	15 percent	15 percent	10 percent	10 percent
Final width	4,877 meters	1,219 meters	1,067 meters ^c	610 meters	475 meters ^c	381 meters ^c
Length	15,240 meters	3,048 meters ^c	3,048 meters ^c	1,524 meters ^c	1,524 meters ^c	1,524 meters ^c
Slope: inner 3,049 meters	2 percent	2.94 percent ^c	2.94 percent ^c	5 percent ^c	5 percent ^c	5 percent ^c
Slope: beyond 3,048 meters	2.5 percent ^c					

^aWith visibility minimum as low as 1.2 km; ^bwith visibility minimum greater than 1.2 km; ^ccriteria less demanding than Annex 14 Table 4–1 dimensions and slopes. ^dUtility runways are intended to serve propeller-driven aircraft having a maximum take-off mass of 5,570 kg.

Chapter 4	Obstacle Restriction and Removal
4.1	Obstacle limitation surfaces similar to those described in 4.1–4.20 are found in 14 CFR Part 77.
4.1.21	A balked landing surface is not used.
4.1.25	The U.S. does not establish take-off climb obstacle limitation areas and surface, <i>per se</i> , but does specify protective surfaces for each end of the runway based on the type of approach procedures available or planned. The dimensions and slopes for these surfaces and areas are listed in the table above.
4.2	The dimensions and slopes of U.S. approach areas and surfaces are set forth in the above table. Aviation regulations do not prohibit construction of fixed objects above the surfaces described in these sections.
4.2.1	Primary surface is also used as a civil airport imaginary surface. Primary surface is a surface longitudinally centered on a runway. U.S. uses the width of the primary surface of a runway as prescribed in 14 CFR Part 77.25 for the most precise approach existing or planned for either end of that runway.
4.2.8	The slope and dimensions of the approach surface applied to each end of a runway are determined by the most precise approach existing or planned for that runway end.
4.2.9	Approach surfaces are applied to each end of each runway based upon the type of approach available or planned for that runway end.
4.2.10, 4.2.11	Any proposed construction of or alteration to an existing structure is normally considered to be physically shielded by one or more existing permanent structure(s), natural terrain, or topographic feature(s) of equal or greater height if the structure under consideration is located within the lateral dimensions of any runway approach surface but would not exceed an overall height above the established airport elevation greater than that of the outer extremity of the approach surface, and located within, but would not penetrate, the shadow plane(s) of the shielding structure(s).
4.2.12	The basic principle in applying shielding guidelines is whether the location and height of the structures are such that aircraft, when operating with due regard for the shielding structure, would not collide with that structure.
4.2.16	The size of each imaginary surface is based on the category of each runway according to the type of approach available or planned for that runway. The slope and dimensions of the approach surface applied to each end of a runway are determined by the most precise approach existing or planned for that runway end.
4.2.17	Approach surfaces are applied to each end of each runway based upon the type of approach available or planned for that runway end.
Chapter 5	Visual Aids for Navigation

5.2.1.7*	The U.S. does not require unpaved taxiways to be marked.
5.2.2.2*	The U.S. does not require a runway designator marking for unpaved runways.
5.2.2.4	Zeros are not used to precede single-digit runway markings. An optional configuration of the numeral 1 is available to designate a runway 1 and to prevent confusion with the runway centerline.
5.2.4.2* 5.2.4.3*	Threshold markings are not required, but sometimes provided, for non-instrument runways that do not serve international operations.
5.2.4.5	The current U.S. standard for threshold designation is eight stripes, except that more than eight stripes may be used on runways wider than 45 meters. After 1 January 2008, the U.S. standard will comply with Annex 14.
5.2.4.6	The width and spacing of threshold stripes will comply with Annex 14 after 1 January 2008.
5.2.4.10	When a threshold is temporarily displaced, there is no requirement that runway or taxiway edge markings, prior to the displaced threshold, be obscured. These markings are removed only if the area is unsuitable for the movement of aircraft.
5.2.5.2 5.2.5.3*	Aiming point markings are required on precision instrument runways and code 3 and 4 runways used by jet aircraft.
5.2.5.4	The aiming point marking commences 306 meters from the threshold at all runways.
5.2.6.3	The U.S. pattern for touchdown zone markings, when installed on both runway ends, is only applicable to runways longer than 4,990 feet. On shorter runways, the three pair of markings closest to the runway midpoint are eliminated.
5.2.6.4	The U.S. standard places the aiming point marking 306 meters from the threshold where it replaces one of the pair of three stripe threshold markings. The 306 meters location is used regardless of runway length.
5.2.6.5*	Touchdown zone markings are not required at a non-precision approach runway, though they may be provided.
5.2.7.4*	Runway side stripe markings on a non-instrument runway may have an over-all width of 0.3 meter.
5.2.8.3	Taxiway centerline markings are never installed longitudinally on a runway even if the runway is part of a standard taxi route.
5.2.9.5*	The term "ILS" is used instead of CAT I, CAT II, CAT III.
5.2.11.4 5.2.11.5* 5.2.11.6*	Check-point markings are provided, but the circle is 3 meters in diameter, and the directional line may be of varying width and length. The color is the yellow used for taxiway markings.
5.2.12	Standards for aircraft stand markings are not provided.
5.2.13.1*	Apron safety lines are not required although many airports have installed them.
5.2.14.1	The U.S. does not have standards for holding position markings on roadways that cross runways. Local traffic control practices are used.
5.3.1.1 5.3.1.2*	The U.S. does not have regulations to prevent the establishment of non-aviation ground lights that might interfere with airport operations.
5.3.1.3 5.3.1.4	New approach lighting installations will meet the frangibility requirements. Some existing non-frangible systems may not be replaced before 1 January 2005.
5.3.2.1* 5.3.2.2* 5.3.2.3*	There is no requirement for an airport to have emergency runway lighting available if it does not have a secondary power source. Some airports do have these systems, and there is an FAA specification for these lights.
5.3.3.1 5.3.3.3	Only airports served by aircraft having more than 30 seats are required to have a beacon, though they are available at many others.
5.3.3.6	Although the present U.S. standard for beacons calls for 24-30 flashes per minute, some older beacons may have flash rates as low as 12 flashes per minute.
5.3.3.8	Coded identification beacons are not required and are not commonly installed. Typically, airport beacons conforming to 5.3.3.6 are installed at locations served by aircraft having more than 30 seats.

5.3.4.1	While the U.S. has installed an approach light system conforming to the specifications in 5.3.4.10 through 5.3.4.19, it also provides for a lower cost system consisting of medium intensity approach lighting and sequenced flashing lights (MALSF) at some locations.
5.3.4.2	In addition to the system described in 5.3.4.1, a system consisting of omnidirectional strobe lights (ODALS) located at 90 meters intervals extending out to 450 meters from the runway threshold is used at some locations.
5.3.4.10 through 5.3.4.19	The U.S. standard for a precision approach category I lighting system is a medium intensity approach lighting system with runway alignment indicator lights (MALSR). This system consists of 3 meters barrettes at 60 meters intervals out to 420 meters from the threshold and sequenced flashing lights at 60 meters intervals from 480 meters to 900 meters. A crossbar 20 meters in length is provided 300 meters from the threshold. The total length of this system is dependent upon the ILS glide path angle. For angles 2.75° and higher, the length is 720 meters.
5.3.4.16 5.3.4.31	The capacitor discharge lights can be switched on or off when the steady-burning lights of the approach lighting system are operating. However, they cannot be operated when the other lights are not in operation.
5.3.4.20	The U.S. standard for a precision approach category II and III lighting system has a total length dependent upon the ILS glide path angle. For angles 2.75° and higher, the length is 720 meters.
5.3.5.1 5.3.5.3 5.3.5.4	Visual approach slope indicator systems are not required for all runways used by turbojets except runways involved with land and hold short operations that do not have an electronic glideslope system.
5.3.5.2	In addition to PAPI and APAPI systems, VASI and AVASI type systems remain in service at U.S. airports with commercial service. Smaller general aviation airports may have various other approach slope indicators including tri-color and pulsating visual approach slope indicators.
5.3.5.27	The U.S. standard for PAPI allows for the distance between the edge of the runway and the first light unit to be reduced to 9 meters for code 1 runways used by nonjet aircraft.
5.3.5.42	The PAPI obstacle protection surface used is as follows: The surface begins 90 meters in front of the PAPI system (toward the threshold) and proceeds outward into the approach zone at an angle 1 degree less than the aiming angle of the third light unit from the runway. The surface flares 10 degrees on either side of the extended runway centerline and extends 4 statute miles from its point of origin.
5.3.8.4	The U.S. permits the use of omnidirectional runway threshold identification lights.
5.3.13.2	The U.S. does not require the lateral spacing of touchdown zone lights to be equal to that of touchdown zone marking when runways are less than 45 meters wide. The lateral distance between the markings is 22 meters when installed on runways with a width of 45 meters or greater. The distance is proportionately smaller for narrower runways. The lateral distance between touchdown zone lights is nominally 22 meters but may be reduced to 20 meters to avoid construction problems.
5.3.14	The U.S. has no provision for stopway lights.
5.3.15.1 5.3.15.2*	Taxiway centerline lights are required only below 183 meters RVR on designated taxi routes. However, they are generally recommended whenever a taxiing problem exists.
5.3.15.3 8.2.3	Taxiway centerline lights are not provided on runways forming part of a standard taxi route even for low visibility operations. Under these conditions, the taxi path is coincident with the runway centerline, and the runway lights are illuminated.
5.3.15.5	Taxiway centerline lights on exit taxiways presently are green. However, the new U.S. standard which is scheduled to be published by 1 January 98 will comply with the alternating green/yellow standard of Annex 14.
5.3.15.7*	The U.S. permits an offset of up to 60 cm.
5.3.16.2 8.2.3	Taxiway edge lights are not provided on runways forming part of a standard taxi route.

5.3.17.1 5.3.17.2* 5.3.17.3 5.3.17.4* 5.3.17.5*	Stop bars are required only for runway visual range conditions less than a value of 183 meters at taxiway/runway intersections where the taxiway is lighted during low visibility operations. Once installed, controlled stop bars are operated at RVR conditions less than a value of 350 meters.														
5.3.17.6	Elevated stop bar lights are normally installed longitudinally in line with taxiway edge lights. Where edge lights are not installed, the stop bar lights are installed not more than 3 meters from the taxiway edge.														
5.3.17.9	The beamspread of elevated stop bar lights differs from the in-pavement lights. The inner isocandela curve for the elevated lights is ± 7 horizontal and ± 4 vertical.														
5.3.17.12	The U.S. standard for stop bars, which are switchable in groups, does not require the taxiway centerline lights beyond the stop bars to be extinguished when the stop bars are illuminated. The taxiway centerline lights which extend beyond selectively switchable stop bars are grouped into two segments of approximately 45 meters each. A sensor at the end of the first segment re-illuminates the stop bar and extinguishes the first segment of centerline lights. A sensor at the end of the second segment extinguishes that segment of centerline lights.														
5.3.18.1*	Taxiway intersection lights are also used at other hold locations on taxiways such as low visibility holding points.														
5.3.18.2	Taxiway intersection lights are collocated with the taxiway intersection marking. The marking is located at the following distances from the centerline of the intersecting taxiway: <table border="0" style="margin-left: 40px;"> <thead> <tr> <th style="text-align: left;">Airplane Design Group</th> <th style="text-align: left;">Distance</th> </tr> </thead> <tbody> <tr> <td>I</td> <td>13.5 meters</td> </tr> <tr> <td>II</td> <td>20 meters</td> </tr> <tr> <td>III</td> <td>28.5 meters</td> </tr> <tr> <td>IV</td> <td>39 meters</td> </tr> <tr> <td>V</td> <td>48.5 meters</td> </tr> <tr> <td>VI</td> <td>59 meters</td> </tr> </tbody> </table>	Airplane Design Group	Distance	I	13.5 meters	II	20 meters	III	28.5 meters	IV	39 meters	V	48.5 meters	VI	59 meters
Airplane Design Group	Distance														
I	13.5 meters														
II	20 meters														
III	28.5 meters														
IV	39 meters														
V	48.5 meters														
VI	59 meters														
5.3.19.1 5.3.19.2*	Runway guard lights are required only for runway visual range conditions less than a value of 350 meters.														
5.3.19.4 5.3.19.5	Runway guard lights are placed at the same distance from the runway centerline as the aircraft holding distance, or within a few feet of this location.														
5.3.19.12	The new U.S. standard for in-pavement runway guard lights complies with Annex 14. However, there may be some existing systems that do not flash alternately.														
5.3.20.4*	The U.S. does not set aviation standards for flood lighting aprons.														
5.3.21	The U.S. does not provide standards for visual docking guidance systems. U.S. manufacturers of these devices generally adhere to ICAO SARPS.														
5.3.23.1	The U.S. does not have a requirement for providing roadholding position lights during RVR conditions less than a value of 350 meters.														
5.4.1.2	Signs are often installed a few centimeters taller than specified in Annex 14, Volume 1, Table 5-4.														
5.4.1.5	Sign inscriptions are slightly larger, and margins around the sign slightly smaller, than indicated in Annex 14, Volume 1, Appendix 4.														
5.4.1.6	The sign luminance requirements are not as high as specified in Appendix 4. The U.S. does not specify a nighttime color requirement in terms of chromaticity.														
5.4.2.2 5.4.2.4 5.4.2.9 5.4.2.14 5.4.2.16	All signs used to denote precision approach holding positions have the legend "ILS."														
5.4.2.6	U.S. practice uses the NO ENTRY sign to prohibit entry by aircraft only.														
5.4.2.8 5.4.2.10	The second mandatory instruction sign is usually not installed unless added guidance is necessary.														

5.4.2.15	Signs for holding aircraft and vehicles from entering areas where they would infringe on obstacle limitation surfaces or interfere with NAVAIDs are inscribed with the <i>designator of the approach</i> , followed by the letters “APCH”; <i>for example</i> , “15–APCH.”
5.4.3.13 5.4.3.15	U.S. practice is to install signs about 3 to 5 meters closer to the taxiway/runway (See Annex 14, Table 5–4).
5.4.3.16	The U.S. does not have standards for the location of runway exit signs.
5.4.3.24	A yellow border is used on all location signs, regardless of whether they are stand-alone or collocated with other signs.
5.4.3.26	U.S. practice is to use Pattern A on runway vacated signs, except that Pattern B is used to indicate that an ILS critical area has been cleared.
5.4.3.30*	The U.S. does not have standards for signs used to indicate a series of taxi-holding positions on the same taxiway.
5.4.4.4*	The inscription, “VOR Check Course,” is placed on the sign in addition to the VOR and DME data.
5.4.5.1*	The U.S. does not have requirements for airport identification signs, though they are usually installed.
5.4.6.1*	Standards are not provided for signs used to identify aircraft stands.
5.4.7.2	The distance from the edge of road to the road-holding position sign conforms to local highway practice.
5.5.2.2* 5.5.7.1*	Boundary markers may be used to denote the edges of an unpaved runway.
5.5.3	There is no provision for stopway edge markers.
Chapter 6	Visual Aids for Denoting Obstacles
6.1	Recommended practices for marking and lighting obstacles are found in FAA Advisory Circular 70/7460–1J, Obstruction Marking and Lighting.
6.1.3	Any temporary or permanent structure, including all appurtenances, that exceeds an overall height of 200 feet (61m) above ground level or exceeds any obstruction standard contained in 14 CFR Part 77, should normally be marked and/or lighted.
6.2.1	This chapter provides recommended guidelines to make certain structures conspicuous to pilots during daylight hours. One way of achieving this conspicuity is by painting and/or marking these structures. Recommendations on marking structures can vary depending on terrain features, weather patterns, geographic location, and in the case of wind turbines, number of structures and overall layout of design.
6.2.3*	The maximum dimension of the rectangles in a checkered pattern is 6 meters on a side.
6.2.7	Markers should be displayed in conspicuous positions on or adjacent to the structure so as to retain the general definition of the structure. They should be recognizable in clear air from a distance of at least 4,000 feet (1219m) and in all directions from which aircraft are likely to approach. Markers should be distinctively shaped, i.e., spherical or cylindrical, so they are not mistaken for items that are used to convey other information. They should be replaced when faded or otherwise deteriorated.
6.2.11	Flag markers should be displayed around, on top, or along the highest edge of the obstruction. When flags are used to mark extensive or closely grouped obstructions, they should be displayed approximately 50 feet (15m) apart. The flag stakes should be of such strength and height that they will support the flags above all surrounding ground, structures, and/or objects of natural growth.
6.2.12	Each side of the flag marker should be at least 2 feet (0.6m) in length. Standard does not specifically address mobile objects.
6.2.14	Color patterns. Flags should be colored as follows: solid, orange and white, and checkerboard. Standard does not specifically address mobile objects.

6.3.1	Obstruction lighting may be displayed on structures as follows: aviation red obstruction lights; medium intensity flashing white obstruction lights, high intensity flashing white obstruction lights, dual lighting, obstruction lights during construction, obstruction lights in urban areas, and temporary construction equipment lighting.
6.3.11	The height of the structure AGL determines the number of light levels. Recommendations on marking structures can vary depending on terrain features, weather patterns, geographic location, and in the case of wind turbines, number of structures and overall layout of design.
6.3.13	When a structure lighted by a high intensity flashing light system is topped with an antenna or similar appurtenance exceeding 40 feet (12m) in height, a medium intensity flashing white light (L-865) should be placed within 40 feet (12m) from the tip of the appurtenance. This light should operate 24 hours a day and flash simultaneously with the rest of the lighting system.
6.3.14	The number of light units recommended depends on the diameter of the structure at the top.
6.3.16	Lights should be installed on the highest point at each end. At intermediate levels, lights should be displayed for each 150 feet (46m) or fraction thereof. The vertical position of these lights should be equidistant between the top lights and the ground level as the shape and type of obstruction will permit. One such light should be displayed at each outside corner on each level with the remaining lights evenly spaced between the corner lights.
6.3.17	Lights should be installed on the highest point at each end. At intermediate levels, lights should be displayed for each 150 feet (46m) or fraction thereof. The vertical position of these lights should be equidistant between the top lights and the ground level as the shape and type of obstruction will permit. One such light should be displayed at each outside corner on each level with the remaining lights evenly spaced between the corner lights.
6.3.18	Lights should be installed on the highest point at each end. At intermediate levels, lights should be displayed for each 150 feet (46m) or fraction thereof. The vertical position of these lights should be equidistant between the top lights and the ground level as the shape and type of obstruction will permit. One such light should be displayed at each outside corner on each level with the remaining lights evenly spaced between the corner lights.
6.3.19, 6.3.20	One or more light units is needed to obtain the desired horizontal coverage. The number of light units recommended per level (except for the supporting structures of catenary wires and buildings) depends upon the average outside diameter of the specific structure, and the horizontal beam width of the light fixture. The light units should be installed in a manner to ensure an unobstructed view of the system by a pilot approaching from any direction. The number of lights recommended is the minimum. The U.S. does not utilize Type A or Type B obstacle lights. Recommendations on marking structures can vary depending on terrain features, weather patterns, geographic location, and in the case of wind turbines, number of structures and overall layout of design.
6.3.21* 6.3.22*	The effective intensity, for daylight-luminance background, of Type A high-intensity obstacle lights is 270,000 cd ± 25 percent. The effective intensity, for daylight-luminance background, of Type B high-intensity obstacle lights is 140,000 cd ± 25 percent.
6.3.22	The height of the structure AGL determines the number of light levels. The light levels may be adjusted slightly, but not to exceed 10 feet (3m) when necessary to accommodate guy wires and personnel who replace or repair light fixtures. If an adjacent object shields any light, horizontal placement of the lights should be adjusted or additional lights should be mounted on that object to retain or contribute to the definition of the obstruction. Recommendations on marking structures can vary depending on terrain features, weather patterns, geographic location, and in the case of wind turbines, number of structures and overall layout of design.

<p>6.3.23, 6.3.24, 6.3.27, 6.3.29</p>	<p>Red obstruction lights are used to increase conspicuity during nighttime. The red obstruction lighting system is composed of flashing omni directional beacons (L–864) and/or steady burning (L–810) lights. When one or more levels is comprised of flashing beacon lighting, the lights should flash simultaneously.</p> <p>The U.S. does not utilize Type A, B, C, or D obstacle lights. Recommendations on marking structures can vary depending on terrain features, weather patterns, geographic location, and in</p>
<p>6.3.28</p>	<p>When objects within a group of obstructions are approximately the same overall height above the surface and are located a maximum of 150 feet (46m) apart, the group of obstructions may be considered an extensive obstruction. Install light units on the same horizontal plane at the highest portion or edge of prominent obstructions. Light units should be placed to ensure that the light is visible to a pilot approaching from any direction.</p>
<p>6.3.30, 6.3.31, 6.3.32</p>	<p>The medium intensity flashing white light system is normally composed of flashing omni directional lights. Medium intensity flashing white obstruction lights may be used during daytime and twilight with automatically selected reduced intensity for nighttime operation.</p> <p>The U.S. does not utilize Type A, B, or C obstacle lights. Medium intensity flashing white (L–865) obstruction lights may provide conspicuity both day and night. Recommendations on marking structures can vary depending on terrain features, weather patterns, geographic location, and in the case of structures and overall layout of design.</p>
<p>6.3.35</p>	<p>Use high intensity flashing white obstruction lights during daytime with automatically selected reduced intensities for twilight and nighttime operations. When high intensity white lights are operated 24 hours a day, other methods of marking and lighting may be omitted.</p> <p>The U.S. does not utilize Type A obstacle lights. Lighting with high intensity (L–856) flashing white obstruction lights provides the highest degree of conspicuity both day and night. Recommendations on marking structures can vary depending on terrain features, weather patterns, geographic location, and in the case of wind turbines, number of structures and overall layout of design.</p>
<p>Chapter 7</p>	<p>Visual Aids for Denoting Restricted Use Areas</p>
<p>7.1.2*</p>	<p>A “closed” marking is not used with partially closed runways. See 5.2.4.10, above.</p>
<p>7.1.4</p>	<p>Crosses with shapes similar to figure 7.1, illustration b) are used to indicate closed runways and taxiways. The cross for denoting a closed runway is yellow.</p>
<p>7.1.5</p>	<p>In the U.S. when a runway is permanently closed, only the threshold marking, runway designation marking, and touchdown zone marking need be obliterated. Permanently closed taxiways need not have the markings obliterated.</p>
<p>7.1.7</p>	<p>The U.S. does not require unserviceability lights across the entrance to a closed runway or taxiway when it is intersected by a night–use runway or taxiway.</p>
<p>7.4.4</p>	<p>Flashing yellow lights are used as unserviceability lights. The intensity is such as to be adequate to delineate a hazardous area.</p>
<p>Chapter 8</p>	<p>Equipment and Installations</p>
<p>8.1.5* 8.1.6* 8.1.7 8.1.8</p>	<p>A secondary power supply for non–precision instrument and non–instrument approach runways is not required, nor is it required for all precision approach runways.</p> <p>The U.S. does not provide secondary power specifically for take–off operations below 550 meters RVR.</p>
<p>8.2.1</p>	<p>There is no requirement in the U.S. to interleave lights as described in the Aerodrome Design Manual, Part 5.</p>
<p>8.2.3</p>	<p>See 5.3.15.3 and 5.3.16.2</p>
<p>8.7.2* 8.7.3 8.7.4*</p>	<p>Glide slope facilities and certain other installations located within the runway strip, or which penetrate obstacle limitation surfaces, may not be frangibly mounted.</p>

8.9.7*	A surface movement surveillance system is recommended for operations from 350 meters RVR down to 183 meters. Below 183 meters RVR, a surface movement radar or alternative technology is generally required.
Chapter 9	Emergency and Other Services
9.1.1	Emergency plans such as those specified in this section are required only at airports serving scheduled air carriers using aircraft having more than 30 seats. These airports are certificated under 14 CFR Part 139. In practice, other airports also prepare emergency plans.
9.1.12	Full-scale airport emergency exercises are conducted at intervals, not to exceed three years, at airports with scheduled passenger service using aircraft with more than 30 seats.
9.2.1	Rescue and fire fighting equipment and services such as those specified in this section are required only at airports serving scheduled air carriers in aircraft having more than 30 seats. Such airports generally equate to ICAO categories 4 through 9. Other airports have varying degrees of services and equipment.
9.2.3*	There is no plan to eliminate, after 1 January 2005, the current practice of permitting a reduction of one category in the index when the largest aircraft has fewer than an average of five scheduled departures a day.
9.2.4 9.2.5	The level of protection at U.S. airports is derived from the length of the largest aircraft serving the airport similar to the Annex's procedure, except that maximum fuselage width is not used. U.S. indices A-E are close equivalents of the Annex's categories 5-9. The U.S. does not have an equivalent to category 10.

Fire Extinguishing Agents and Equipment

Index	Aircraft length		Total minimum quantities of extinguishing agents		Minimum trucks	Discharge rate ¹
	More than	Not more than	Dry chemical	Water for protein foam		
A		27 meters	225 kg	0	1	See below
B	27 meters	38 meters	225 kg	5,700 L	1	See below
C	38 meters	48 meters	225 kg	5,700 L	2	See below
D	48 meters	60 meters	225 kg	5,700 L	3	See below
E	60 meters		225 kg	11,400 L	3	See below

¹Truck size
1,900 L but less than 7,600
7,600 L or greater

Discharge rate
at least 1,900 L per minute but not more than 3,800 L per minute
at least 2,280 L per minute but not more than 4,560 L per minute

9.2.10	The required firefighting equipment and agents by index are shown in the table above. The substitution equivalencies between complementary agents and foam meeting performance level A are also used for protein and fluoroprotein foam. Equivalencies for foam meeting performance level B are used only for aqueous film forming foams.
9.2.18*	There is no specific requirement to provide rescue equipment as distinguished from firefighting equipment.
9.2.19*	At least one apparatus must arrive and apply foam within 3 minutes with all other required vehicles arriving within 4 minutes. Response time is measured from the alarm at the equipment's customary assigned post to the commencement of the application of foam at the mid-point of the farthest runway.
9.2.29*	For ICAO category 6 (U.S. index B), the U.S. allows one vehicle.
9.4.4	At the present time, there is no requirement to perform tests using a continuous friction measuring device with self-wetting features. Some U.S. airports own these devices, while others use less formal methods to monitor build-up of rubber deposits and the deterioration of friction characteristics.
9.4.15	The standard grade for temporary ramps is 15 feet longitudinal per 1 inch of height (0.56 percent slope) maximum, regardless of overlay depth.
9.4.19	There is no U.S. standard for declaring a light unserviceable if it is out of alignment or if its intensity is less than 50 percent of its specified value.

*Indicates ICAO Recommended Practice

ANNEX 14 – AERODROMES	
VOLUME II – HELIPORTS	
Chapter 1	Definitions
Declared distances	The U.S. does not use declared distances (take-off distance available, rejected take-off distance available, or landing distance available) in designing heliports.
Final approach and take-off area (FATO)	The U.S. “take-off and landing area” is comparable to the ICAO FATO, and the U.S. “FATO” is more comparable to the ICAO TLOF. The U.S. definition for the FATO stops with “the take-off manoeuvre is commenced.” This difference in definition reflects a variation in concept. The rejected take-off distance is an operational computation and is not required as part of the design.
Helicopter stand	The U.S. does not use the term “helicopter stand.” Instead, the U.S. considers paved or unpaved aprons, helipads, and helidecks, all as helicopter parking areas; i.e., helicopter stands.
Safety area	The U.S. considers the safety area to be part of the take-off and landing area which surrounds the FATO and does not call for or define a separate safety area.
Touchdown and lift-off area (TLOF)	The U.S. differs in the definition by considering helipads and helidecks to be FATO. The U.S. does not define the load bearing area on which the helicopter may touch down or lift-off as a TLOF.
Chapter 2	Heliport Data
2.1 d)	The U.S. does not measure or report a safety area as a separate feature of a heliport.
2.2	The U.S. does not “declare” distances for heliports.
Chapter 3	Physical Characteristics
3.1.2	The U.S. does not distinguish between single-engine and multi-engine helicopters for the purposes of heliport design standards. Neither does the U.S. design or classify heliports on the basis of helicopter performance. The U.S. FATO dimensions are at least equal to the rotor diameter of the design single rotor helicopter and the area must be capable of providing ground effect. The U.S. does not have alternative design standards for water FATOs, elevated heliports, or helidecks.
3.1.3	The U.S. has a single gradient standard; i.e., 5 percent, except in fueling areas where the limit is 2 percent, which is applicable for all portions of heliports.
3.1.6 3.1.7* 3.1.8*	The U.S. does not require or provide criteria for clearways in its design standards. It does encourage ownership and clearing of the land underlying the innermost portion of the approach out to where the approach surface is 10.5 meters above the level of the take-off surface.
3.1.14 to 3.1.21	Safety areas are considered part of the take-off and landing area (or primary surface) in U.S. heliport design. The take-off and landing area of the U.S. design criteria, based on 2 rotor diameters, provides for the ICAO safety area; however, the surface does not have to be continuous with the FATO or be load bearing.
3.1.22	Taxiway widths are twice the undercarriage width of the design helicopter.
3.1.23	The U.S. requires 1.25 rotor diameters plus 2 meters of separation between helicopter ground taxiways.
3.1.24	The U.S. gradient standard for taxiways is a maximum of 5 percent.
3.1.32*	The U.S. sets no gradient standards for air taxiways.
3.1.33	The U.S. requires 1.5 rotor diameters of separation between hover or air taxiways.
3.1.34	The U.S. standards for air taxiways and air transit routes are combined as the standards for hover taxiways noted in paragraphs 3.1.23, 3.1.24 and 3.1.33.
3.1.35	The U.S. sets no maximum turning angle or minimum radius of turn on hover taxiways.
3.1.36	The U.S. gradient standard for aprons is a maximum of 5 percent except in fueling areas where it is 2 percent.
3.1.37	The U.S. criterion for object clearances is 1/3 rotor diameter or 3 meters, whichever is greater.
3.1.38	The U.S. standard for helipads (comparable to helicopter stands) is 1.5 times the undercarriage length or width, whichever is greater.

3.1.39	The U.S. standard for separation between FATO center and the centerline of the runway is 120 meters.
3.2.2	The U.S. does not apply either a performance related or an alternative design standard for elevated heliport facilities.
3.2.5 to 3.2.10	The U.S. does not use safety areas in its heliport design.
3.3 3.4	In the U.S., shipboard and relocatable off–shore helicopter “helideck” facilities are under the purview of the U.S. Coast Guard and utilize the International Maritime Organization (IMO) code. Fixed off–shore helideck facilities are under the purview of the Department of Interior based on their document 351DM2. Coastal water helideck facilities are under the purview of the individual affected States.
Chapter 4	Obstacle Restriction and Removal
4.1.1	The U.S. approach surface starts at the edge of the take–off and landing area.
4.1.2 a)	The U.S. approach surface width adjacent to the heliport take–off and landing area is a minimum of 2 rotor diameters.
4.1.2 b) 2)	The U.S. precision instrument approach surface flares from a width of 2 rotor diameters to a width of 1,800 meters at the 7,500 meters outer end. The U.S. does not use a note similar to the one that follows 4.1.4, as it does not differentiate between helicopter requirements on the basis of operational performance.
4.1.5	The outer limit of the U.S. transitional surfaces adjacent to the take–off and landing area is 76 meters from the centerline of the VFR approach/departure surfaces. The transitional surface width decreases to zero at a point 1,220 meters from the take–off and landing area. It does not terminate at an inner horizontal surface or at a predetermined height.
4.1.6	The U.S. transitional surfaces have a fixed width, 76 meters less the width of the take–off and landing area, from the approach centerline for visual operations and an outwardly flaring width to 450 meters for precision instrument operations. The U.S. does not use an inner horizontal surface nor terminate the transitional surfaces at a fixed/predetermined height.
4.1.7 b)	Since the U.S. includes the safety area in the take–off and landing area, the comparable elevation is at the elevation of the FATO.
4.1.9 through 4.1.20	The U.S. does not use the inner horizontal surface, the conical surface, or take–off climb surface described in these paragraphs or the note following paragraph 4.1.20 for heliport design.
4.1.21 through 4.1.25	The U.S. does not have alternative criteria for floating or fixed–in–place helidecks.
4.2	The U.S. has no requirement for a note similar to the one following the heading “Obstacle limitation requirements.”
4.2.1	The U.S. criteria does not require a take–off climb surface or a conical obstacle limitation surface to establish a precision instrument approach procedure.
4.2.2	The U.S. criteria does not require a take–off climb surface or a conical obstacle limitation surface to establish a non–precision instrument approach procedure.
4.2.3	The U.S. criteria does not require a take–off climb obstacle limitation surface to establish a non–instrument approach procedure.
4.2.4*	The U.S. has no requirement for protective surfaces such as an inner horizontal surface or a conical surface.
4.2.5	The U.S. does not have tables for heliport design comparable to the ICAO Tables 4–1 to 4–4.
4.2.6	The U.S. subscribes to the intent of this paragraph to limit object heights in the heliport protective surfaces but uses fewer surfaces with different dimensions for those surfaces.
4.2.7*	The U.S. subscribes to the intent of this paragraph but uses different dimensional surfaces.
4.2.8	The U.S. criterion requires that a heliport have at least one approach and departure route and encourages multiple approaches separated by arcs of 90 to 180 degrees.
4.2.9*	The U.S. has no requirement that a heliport’s approach surfaces provide 95 percent usability.

4.2.10	Since the U.S. does not differentiate between surface level and elevated heliports, the comments to paragraphs 4.2.1 through 4.2.5 above apply.
4.2.11	The U.S. has no requirement for a take-off climb surface. It does require at least one approach/departure surface and encourages that there be as many approaches as is practical separated by arcs of 90 to 180 degrees.
4.2.12 through 4.2.22	Since the U.S. does not have alternative design criteria for helidecks or shipboard heliports, there are no comparable U.S. protective surface requirements.
Tables 4-1, 4-2, 4-3, 4-4	The U.S. does not have tables comparable to the ICAO Tables 4-1 to 4-4.
Chapter 5	Visual Aids
5.2.1	The U.S. does not have criteria for markings to be used in defining winching areas.
5.2.3.3	The U.S. maximum mass markings are specified in 1,000 pound units rather than tonnes or kilograms.
5.2.4.3	The U.S. criterion requires FATO markers but is not specific on the number or spacing between markers.
5.2.4.4	The U.S. criteria for FATO markers is not dimensionally specific.
5.2.6	The U.S. does not require, or have criteria for, marking an aiming point.
5.2.7.1	The U.S. does not require specific criteria for marking floating or off-shore fixed-in-place helicopter or helideck facilities.
5.2.8	The U.S. does not require marking the touchdown area.
5.2.9	The U.S. does not have criteria for heliport name markings.
5.2.10	The U.S. does not have a requirement to mark helideck obstacle-free sectors.
5.2.12.2	The U.S. criterion places the air taxiway markers along the edges of the routes rather than on the centerline.
5.2.12.3	The U.S. criterion for air taxiway markers does not specify the viewing area or height to width ratio.
5.3.2.3	The U.S. heliport beacon flashes white-green-yellow colors rather than a series of timed flashes.
5.3.2.5*	The U.S. criteria is not specific on the light intensity of the flash.
5.3.3.3	The U.S. criterion specifies a 300 meters approach light system configuration. The light bars are spaced at 30 meters intervals. The first two bars of the configuration are single lights, the next two bars are two lights, then two bars with three lights, then two bars with four lights, and finally two bars with five lights.
5.3.3.4	The U.S. approach light system uses aimed PAR-56 lights.
5.3.3.6	The U.S. heliport approach light system does not contain flashing lights.
5.3.5.2 a)	The U.S. requires an odd number of lights, but not less than three lights per side.
5.3.5.2 b)	The U.S. requires a minimum of eight lights for a circular FATO and does not specify the distance between lights.
5.3.5.4*	The U.S. criteria does not specify light distribution.
5.3.6	The U.S. does not have specific criteria for aiming point lights.
5.3.8	The U.S. does not have standards for winching area lighting.
Chapter 6	Heliport Services
6.1*	The U.S. requirements for rescue and fire fighting services at certificated heliports are found in 14 CFR Part 139. Criteria for other heliports are established by the National Fire Protection Association (NFPA) pamphlets 403 or 418, or in regulations of local fire departments.

*Indicates ICAO Recommended Practice

ANNEX 15 – AERONAUTICAL INFORMATION SERVICES	
Chapter 2	Definitions
ASHTAM	The U.S. doesn't have a series of NOTAM called ASHTAM, although notification procedures are written on handling of Volcanic Ash activity.
Danger area	"Danger area" is not used in reference to areas within the U.S. or in any of its possessions or territories.
Integrated Aeronautical Information Package	The U.S. does not produce the entire information package. The U.S. does not use the term Integrated Aeronautical Information Package. The U.S. provides the elements contained in the ICAO Integrated Aeronautical Information Package individually from several different sources and not from a single source.
Maneuvering area	This term is not used by the U.S.
Movement area	The runways, taxiways, and other areas of an airport/heliport which are utilized for taxiing/hover-taxiing, air-taxiing, takeoff, and landing of aircraft, exclusive of loading ramps and parking areas. At those airports/heliports with a tower, specific approval for entry onto the movement area must be obtained from ATC.
Pre-flight Information Bulletin (PIB)	The US does not use the term PIB. However, current NOTAM information is gathered and available through different sources.
Prohibited area Restricted area	The terms "prohibited area" and "restricted area" will be employed substantially in accordance with the definitions established. Additionally, the following terms will be used: Alert area. Airspace which may contain a high volume of pilot training activities or an unusual type of aerial activity, neither of which is hazardous to aircraft. Alert areas are depicted on aeronautical charts for the information of nonparticipating pilots. All activities within an alert area are conducted in accordance with Federal Aviation Regulations, and pilots of participating aircraft as well as pilots transiting the area are equally responsible for collision avoidance. Controlled firing area. Airspace wherein activities are conducted under conditions so controlled as to eliminate hazards to nonparticipating aircraft and to ensure the safety of persons and property on the ground. Warning area. Airspace which may contain hazards to nonparticipating aircraft in international airspace. Military operations area (MOA). An airspace assignment of defined vertical and lateral dimensions established outside Class A airspace to separate/segregate certain military activities from IFR traffic and to identify for VFR traffic where these activities are conducted.
SNOWTAM	The US presents the information in a different manner via a NOTAM.
Chapter 3	General
3.1.7	Data is available, but not as an Integrated Aeronautical Information Package.
3.2.12	The US does not present the information in an integrated package. NFDC is responsible for the validation / verification procedures that ensure that quality requirements and traceability of aeronautical data are met.
3.3.1	The U.S. does not provide an Integrated Aeronautical Information Package. There is no single office for this function. This data can be obtained from different offices (NOTAM, Publications & NFDC)
3.3.5	The U.S. does not provide an Integrated Aeronautical Information Package. The U.S. does provide all of this information, but not from a single source. Information may be obtained from various offices, but not a single office.
3.3.6	The U.S. does not provide an Integrated Aeronautical Information Package. The U.S. provides the elements contained in the ICAO Integrated Aeronautical Information Package individually from several different sources and not from a single source.

3.6.1	The U.S. does not produce an Integrated Aeronautical Information Package. The individual elements of the ICAO Integrated Aeronautical Information are available in plain text.
3.6.6.3	The US does not use a nationality letter in the identification of Special Use Airspace (SUA). The US does not use the letter D for danger area.
3.7.2.2	The US utilizes Geoid–03 which is a component of the North American Vertical Datum of 1988 (NAVD 88).
Chapter 4	Aeronautical Information Publications (AIP)
4.1.3	The US does not produce an Aircraft Parking / Docking Chart.
4.2.8 4.3.4	The U.S. does not publish an aeronautical information regulation and control (AIRAC).
4.4 4.5	The U.S. does not issue AIP supplements. Corrections or changes from the latest amendments to the AIP are carried as NOTAMs.
Chapter 5	NOTAM
5.1.1.2	The U.S. does not routinely issue “trigger NOTAMs” referencing published material when an AIP amendment is issued.
5.1.1.4	FAA Order states at least 3 days (versus 7 days) notice required
5.2.1	The current U.S. system numbers international NOTAMs consecutively by the location in the A field. The U.S. routinely issues over 70,000 outgoing international NOTAMs each year. Only series A is used for international distribution. This precludes numbering the NOTAMs by the originator. The US does not utilize the ICAO format as noted in Appendix 6.
5.2.3	The U.S. periodically issues multipart NOTAMs which are transmitted as multiple telecommunication messages. The nature of the NOTAM material is such that it will not always fit in one message. The U.S. does not use the term SNOWTAM. Procedures for reporting snow, slush, ice and water are outlined in FAA Order 7930.2K.
5.2.4	The U.S. doesn’t have a series of NOTAM called ASHTAM, although notification procedures are written on handling of Volcanic Ash activity.
5.2.8.1	The monthly checklist of NOTAMs does not specifically reference printed publications, such as AIP amendments.
5.2.8.3	A monthly printed plain language summary of NOTAMs in force is not issued. The International NOTAM publication, issued biweekly, is not inclusive of all U.S. international NOTAMs.
5.3.2	The U.S. does not use the System NOTAM format at this time. The format used is based on the previous ICAO Class I format. See notes on Appendix 6 for details.
Chapter 6	Aeronautical Information Regulation and Control (AIRAC)
	See 4.2.8.

Chapter 8	Pre–Flight and Post–Flight Information
8.1.2.1 f)	NOTAMs relating to bird hazards are relayed as local NOTAM information and are not disseminated internationally. The information is available from the local flight service station during preflight briefing.
8.1.3	The FAA does not use PIBs, but does provide pertinent NOTAM information in plain language form every 28 days in a document called the Notices to Airmen Publication (NTAP).
8.2.2	The FAA provides all of this information, but not from a single source.
Appendix 1	Contents of Aeronautical Information Publication (AIP)
	The U.S. does not publish sunrise/sunset tables in the AIP.
GEN 3.1.3 4)	The U.S. does not publish pre–flight information bulletins (PIBs).
Appendix 2	SNOWTAM Format
	The U.S. does not use the SNOWTAM for issuance of winter weather information. Snow conditions are reported using our current international NOTAM format (Class I).
Appendix 3	ASHTAM Format
1.3	ASHTAM information will continue to be distributed as an International NOTAM.
2.1	The heading will not be entered as stated.
3	ASHTAM information will be distributed in U.S. International NOTAM format.
Appendix 6	NOTAM Format
	The U.S. is not prepared to transition to the System NOTAM format. NOTAMs are processed in the previous ICAO Class I format.
1.2 General	Multiple conditions, for a single location, may be reported in a NOTAM.
2 NOTAM numbering	The U.S. numbers NOTAMs consecutively by location, not by country of origin. Due to the volume of international NOTAMs generated by the U.S., the current U.S. numbering scheme is expected to continue.
3 Qualifiers	The current software will not accept the Item Q) qualifiers line.
5 Item B)	Item B) is currently issued as an eight digit date–time group. The U.S. also uses the initials “WIE” (with immediate effect) for NOTAMs that take effect immediately upon issuance. The U.S. does not include an Item B) in NOTAMCs. The assumption is that all cancellations take effect immediately when issued. While this date–time group could be added to NOTAMCs, the U.S. position is that it is unnecessary.
6 Item C)	Item C), like item B), is currently issued as an eight digit date–time group. The U.S. also uses the initials “UFN” (until further notice) for NOTAMs that have an uncertain duration.
8 Item E)	U.S. NOTAMs do not contain Item E) information for NOTAMCs. Remark: Item E) contains the NOTAM Code (Q–code) in addition to plain language and ICAO abbreviations.

ANNEX 16 – ENVIRONMENTAL PROTECTION	
VOLUME I – AIRCRAFT NOISE	
Reference: Part 36 of Title 14 of the United States Code of Federal Regulations	
Chapter 1	
1.7	Each person who applies for a type certificate for an airplane covered by 14 CFR Part 36, irrespective of the date of application for the type certificate, must show compliance with Part 36.
Chapter 2	
2.1.1	For type design change applications made after 14 August 1989, if an airplane is a Stage 3 airplane prior to a change in type design, it must remain a Stage 3 airplane after the change in type design regardless of whether Stage 3 compliance was required before the change in type design.
2.3.1 a)	Sideline noise is measured along a line 450 meters from and parallel to the extended runway centerline for two- and three-engine aircraft; for four-engine aircraft, the sideline distance is 0.35 NM.
2.4.2	Noise level limits for Stage 2 derivative aircraft depend upon whether the engine by-pass ratio is less than two. If it is, the Stage 2 limits apply. Otherwise, the limits are the Stage 3 limits plus 3 dB or the Stage 2 value, whichever is lower.
2.4.2.2 b)	Take-off noise limits for three-engine, Stage 2 derivative airplanes with a by-pass ratio equal to or greater than 2 are 107 EPNdB for maximum weights of 385,000 kg (850,000 lb) or more, reduced by 4 dB per halving of the weight down to 92 EPNdB for maximum weights of 28,700 kg (63,177 lb) or less. Aircraft with a by-pass ratio less than 2 only need meet the Stage 2 limits.
2.5.1	Trade-off sum of excesses not greater than 3 EPNdB and no excess greater than 2 EPNdB.
2.6.1.1	For airplanes that do not have turbo-jet engines with a by-pass ratio of 2 or more, the following apply: <ul style="list-style-type: none"> a) four-engine airplanes – 214 meters (700 feet); b) all other airplanes – 305 meters (1,000 feet). For all airplanes that have turbo-jet engines with a by-pass ratio of 2 or more, the following apply: <ul style="list-style-type: none"> a) four-engine airplanes – 210 meters (689 feet); b) three-engine airplanes – 260 meters (853 feet); c) airplanes with fewer than three engines – 305 meters (1,000 feet). The power may not be reduced below that which will provide level flight for an engine inoperative or that will maintain a climb gradient of at least 4 percent, whichever is greater.
Chapter 3	
3.1.1	For type design change applications made after 14 August 1989, if an airplane is a Stage 3 airplane prior to a change in type design, it must remain a Stage 3 airplane after the change in type design regardless of whether Stage 3 compliance was required before the change in type design.
3.3.1 a) 2)	The U.S. has no equivalent provision in 14 CFR Part 36.
3.3.2.2	A minimum of two microphones symmetrically positioned about the test flight track must be used to define the maximum sideline noise. This maximum noise may be assumed to occur where the aircraft reaches 305 meters (1,000 feet). 14 CFR Part 36 does not require symmetrical measurements to be made at each and every point for propeller-driven airplane sideline noise determination.
3.6.2.1 c)	Under 14 CFR Part 36, during each test take-off, simultaneous measurements should be made at the sideline noise measuring stations on each side of the runway and also at the take-off noise measuring station. If test site conditions make it impractical to simultaneously measure take-off and sideline noise, and if each of the other sideline measurement requirements is met, independent measurements may be made of the sideline noise under simulated flight path techniques. If the reference flight path includes a power cutback before the maximum possible sideline noise level is developed, the reduced sideline noise level, which is the maximum value developed by the simulated flight path technique, must be the certificated sideline noise value.

3.6.2.1 d)	14 CFR Part 36 specifies the day speeds and the acoustic reference speed to be the minimum approved value of $V_2 + 10$ kt, or the all-engines operating speed at 35 feet (for turbine-engine powered airplanes) or 50 feet (for reciprocating-engine powered airplanes), whichever speed is greater as determined under the regulations constituting the type certification basis of the airplane. The test must be conducted at the test day speeds ± 3 kt.
3.7.4	If a take-off test series is conducted at weights other than the maximum take-off weight for which noise certification is requested: a) at least one take-off test must be at or above that maximum weight; b) each take-off test weight must be within +5 or -10 percent of the maximum weight. If an approach test series is conducted at weights other than the maximum landing weight for which certification is requested: a) at least one approach test must be conducted at or above that maximum weight; b) each test weight must exceed 90 percent of the maximum landing weight. Total EPNL adjustment for variations in approach flight path from the reference flight path and for any difference between test engine thrust or power and reference engine thrust or power must not exceed 2 EPNdB.
Chapter 5	
5.1.1	Applies to all large transport category aircraft (as they do to all subsonic turbo-jet aircraft regardless of category). Commuter category aircraft, propeller-driven airplanes below 8,640 kg (19,000 lb) are subject to 14 CFR Part 36, Appendix F or to Appendix G, depending upon the date of completion of the noise certification tests.
Chapter 6	
6.1.1	Applies to new, all propeller-driven airplane types below 19,000 lb (8,640 kg.) in the normal, commuter, utility, acrobatic, transport, or restricted categories for which the noise certification tests are completed before 22 December 1988.
Chapter 8	
General	14 CFR Part 36 (Section 36.1 (h)) defines Stage 1 and Stage 2 noise levels and Stage 1 and Stage 2 helicopters. These definitions parallel those used in 14 CFR Part 36 for turbo-jets and are used primarily to simplify the acoustical change provisions in Section 36.11. 14 CFR Part 36 (Section 36.805(c)) provides for certain derived versions of helicopters for which there are no civil prototypes to be certificated above the noise level limits.
8.1.1 a)	Applicable to new helicopter types for which application for an original type certificate was made on or after 6 March 1988.
8.1.1 b)	Applicable only to “acoustical changes” for which application for an amended or supplemental type certificate was made on or after 6 March 1988.
8.4	14 CFR Part 36 Appendix H specifies a slightly different rate of allowable maximum noise levels as a function of helicopter mass. The difference can lead to a difference in the calculated maximum noise limits of 0.1 EPNdB under certain roundoff condition.
8.6.3.1 b)	Does not include the V_{NE} speeds.
8.7	14 CFR Part 36 Appendix H does not permit certain negative corrections. Annex 16 has no equivalent provision.
8.7.4	EPNL correction must be less than 2.0 EPNdB for any combination of lateral deviation, height, approach angle and, in the case of flyover, thrust or power. Corrections to the measured data are required if the tests were conducted below the reference weight. Corrections to the measured data are required if the tests were conducted at other than reference engine power.
8.7.5	The rotor speed must be maintained within one percent of the normal operating RPM during the take-off procedure.
8.7.8	The helicopter shall fly within $\pm 10^\circ$ from the zenith for approach and take-off, but within $\pm 5^\circ$ from the zenith for horizontal flyover.

Chapter 10	
General	Exception from acoustical change rule given for aircraft with flight time prior to 1 January 1955 and land configured aircraft reconfigured with floats or skis.
10.1.1	Applies to new, amended, or supplemental type certificates for propeller-driven airplanes not exceeding 8,640 kg (19,000 lb) for which noise certification tests have not been completed before 22 December 1988.
10.4	The maximum noise level is a constant 73 dBA up to 600 kg (1,320 lb). Above that weight, the limit increases at the rate of 1 dBA/75kg (1 dBA/165 lb) up to 85 dBA at 1,500 kg (3,300 lb) after which it is constant up to and including 8,640 kg (19,000 lb).
10.5.2, second phase, d)	For variable-pitch propellers, the definition of engine power is different in the second segment of the reference path. Maximum continuous installed power instead of maximum power is used.
Chapter 11	
11.1	14 CFR Part 36 Appendix J was effective 11 September 1992 and applies to those helicopters for which application for a type certificate was made on or after 6 March 1986.
11.4	14 CFR Part 36 Appendix J specifies a slightly different rate of allowable maximum noise levels as a function of helicopter mass. The difference can lead to a difference in the calculated maximum noise limits of 0.1 EPNdB under certain roundoff condition.
11.6	14 CFR Part 36 Appendix J prescribes a ±15 meter limitation on the allowed vertical deviation about the reference flight path. Annex 16 has no equivalent provision.
PART V	
General	No comparable provision exists in U.S. Federal Regulations. Any local airport proprietor may propose noise abatement operating procedures to the FAA which reviews them for safety and appropriateness.
Appendix 1	
General	Sections 3, 8, and 9 of Appendix 1 which contain the technical specifications for equipment, measurement and analysis and data correction for Chapter 2 aircraft and their derivatives differ in many important aspects from the corresponding requirements in Appendix 2 which has been updated several times. 14 CFR Part 36 updates have generally paralleled those of Appendix 2 of Annex 16. These updated requirements are applicable in the U.S. to both Stage 2 and Stage 3 aircraft and their derivatives.
2.2.1	A minimum of two microphones symmetrically positioned about the test flight track must be used to define the maximum sideline noise. This maximum noise may be assumed to occur where the aircraft reaches 305 meters (1,000 feet), except for four-engine, Stage 2 aircraft for which 439 meters (1,440 feet) may be used.
2.2.2	No obstructions in the cone defined by the axis normal to the ground and the half-angle 80° from the axis.
2.2.3 c)	Relative humidity and ambient temperature over the sound path between the aircraft and 10 meters above the ground at the noise measuring site is such that the sound attenuation in the 8 kHz one-third octave band is not greater than 12 dB/100 meters and the relative humidity is between 20 and 95 percent. However, if the dew point and dry bulb temperature used for obtaining relative humidity are measured with a device which is accurate to within one-half a degree Celsius, the sound attenuation rate shall not exceed 14 dB/100 meters in the 8 kHz one-third octave band.
2.2.3 d)	Test site average wind not above 12 kt and average cross-wind component not above 7 kt.
2.3.4	The aircraft position along the flight path is related to the recorded noise 10 dB downpoints.
2.3.5	At least one take-off test must be a maximum take-off weight and the test weight must be within +5 or -10 percent of maximum certificated take-off weight.
Appendix 2	
2.2.1	A minimum of two symmetrically placed microphones must be used to define the maximum sideline noise at the point where the aircraft reaches 305 meters.

2.2.2	When a multiple layering calculation is required, the atmosphere between the airplane and the ground shall be divided into layers. These layers are not required to be of equal depth, and the maximum layer depth must be 100 meters.
2.2.2 b)	14 CFR Part 36 specifies that the lower limit of the temperature test window is 36 degrees Fahrenheit (2.2 degrees Celsius). Annex 16 provides 10 degrees Celsius as the lower limit for the temperature test window. 14 CFR Part 36 does not specify that the airport facility used to obtain meteorological condition measurements be within 2,000 meters of the measurement site.
2.2.2 c)	14 CFR Part 36 imposes a limit of 14 dB/100 meters in the 8 kHz one-third octave band when the temperature and dew point are measured with a device which is accurate to within one-half a degree Celsius.
2.2.3	14 CFR Part 36 requires that the limitations on the temperature and relative humidity test window must apply over the whole noise propagation path between a point 10 meters above the ground and the helicopter. Annex 16 specifies that the limitations on the temperature and relative humidity test window apply only at a point 10 meters above the ground. 14 CFR Part 36 requires that corrections for sound attenuation must be based on the average of temperature and relative humidity readings at 10 meters and the helicopter. Annex 16 implies that the corrections for sound absorption are based on the temperature and relative humidity measured at 10 meters only.
3.2.6	No equivalent requirement.
3.4.5	For each detector/integrator the response to a sudden onset or interruption of a constant sinusoidal signal at the respective one-third octave band center frequency must be measured at sampling times 0.5, 1.0, 1.5, and 2.0 seconds after the onset or interruption. The rising responses must be the following amounts before the steady-state level: 0.5 seconds: 4.0 ± 1.0 dB 1.0 seconds: 1.75 ± 0.75 dB 1.5 seconds: 1.0 ± 0.5 dB 2.0 seconds: 0.6 ± 0.5 dB
3.4.5 (Note 1)	No equivalent provision in 14 CFR Part 36.
3.5.2	No equivalent requirement.
5.4	14 CFR Part 36 requires that the difference between airspeed and groundspeed shall not exceed 10 kt between the 10 dB down time period.
8.4.2	14 CFR Part 36 specifies a value of -10 in the adjustment for duration correction. Annex 16 specifies a value of -7.5.
9.1.2, 9.1.3	14 CFR Part 36 always requires use of the integrated procedure if the corrected take-off or approach noise level is within 1.0 dB of the applicable noise limit.
Appendix 6	
4.4.1	The microphone performance, not its dimensions, is specified. The microphone must be mounted 1.2 meters (4 feet) above ground level. A windscreen must be employed when the wind speed is in excess of 9 km/h (5 kt).
5.2.2 a)	Reference conditions are different. Noise data outside the applicable range must be corrected to 77 degrees F and 70 percent humidity.
5.2.2 c)	There is no equivalent provision in 14 CFR Part 36. Fixed-pitch propeller-driven airplanes have a special provision. If the propeller is fixed-pitch and the test power is not within 5 percent of reference power, a helical tip Mach number correction is required.

ANNEX 16 – ENVIRONMENTAL PROTECTION	
VOLUME II – AIRCRAFT ENGINE EMISSIONS	
Chapter 1	
	The U.S. currently has regulations prohibiting intentional fuel venting from turbojet, turbofan and turboprop aircraft, but we do not now have a regulation preventing the intentional fuel venting from helicopter engines.

ANNEX 17 – SECURITY – SAFEGUARDING INTERNATIONAL CIVIL AVIATION AGAINST ACTS OF UNLAWFUL INTERFERENCE

There are no reportable differences between U.S. regulations and the Standards and Recommended Practices contained in this Annex.

ANNEX 18 – THE SAFE TRANSPORT OF DANGEROUS GOODS BY AIR
Adopted by the ICAO Council 6/26/81
Effective Date: 1/1/83
Applicability Date: 1/1/84
(Note: Differences are to be filed with ICAO by 6/1/83).

PANS ATM Doc 4444	
There are several substantive differences between the U.S. procedures and those of ICAO, in addition to some minor variations in detail which are not considered significant. These differences are the result of initiatives and/or refinements which the U.S. has effected in the interest of improving the safety and efficiency of air traffic.	
PAN ATM Doc 4444 15th Edition	7110.65 S
CHAPTER 1	Definitions
Definitions	U.S. uses Word Meanings, Definitions (PG Glossary) and Abbreviations
Affirm	U.S. has no phraseology using “AFFIRM”. U.S. uses “ AFFIRMATIVE ” – “ Yes ”. ; or “ ACKNOWLEDGE ; or Roger, Wilco ”
Airborne Collision Avoidance System	The U.S. uses traffic alert and collision avoidance system (TCAS).
Aircraft	U.S. uses “ Aircraft ” to mean the airframe, crew members, or both.
AIRMET	In the U.S., AIRMET stands for Airman’s Meteorological Information which is in-flight weather advisories issued only to amend the area forecast concerning weather phenomena which are of operational interest to all aircraft and potentially hazardous to aircraft having limited capability because of lack of equipment, instrumentation, or pilot qualifications. AIRMETs concern weather of less severity than that covered by SIGMETs or convective SIGMETs. AIRMETs cover moderate icing, moderate turbulence, sustained winds of 30 kt or more at the surface, widespread areas of ceilings less than 1,000 feet and/or visibility less than 3 miles, and extensive mountain obscurement.
Air-report	The U.S. does not normally use the term “air-report.” Pilot weather reports (PIREPs), position, and operational reports are used. PIREPs include reports of strong frontal activity, squall lines, thunderstorms, light to severe icing, wind shear and turbulence (including clear air turbulence) of moderate or greater intensity, volcanic eruptions and volcanic ash clouds, and other conditions pertinent to flight safety. They may include information on ceilings, visibility, thunderstorms, icing of light degree or greater, wind shear and its effect on airspeed, or volcanic ash clouds, but do not usually include air temperature.
Air-taxiing	In the U.S., the term “hover taxi” is sometimes used to indicate the ICAO term “air-taxiing.” In the U.S., air-taxiing is the preferred method for helicopter movements on airports provided ground operations/conditions permit. Additionally, in the U.S., air taxi is used to indicate certain commercial aircraft operations. For those operations, usually a special call sign is used, or the prefix “Tango” is added to the aircraft call sign.
ALERFA	The U.S. does not use the code words ALERFA, DETRESFA, and INCERFA to designate an alert.
Altitude	U.S. uses “ Altitude ” to mean indicated altitude mean sea level (MSL), flight level (FL), or both.
Approval Request	U. S. uses “ APREQ ”
Approved separation	U.S. uses “ Approved separation ” to mean separation in accordance with the applicable minima in this manual.
Area control service	The U.S. does not use the term “area control service” to indicate controlled flight in controlled areas.
ATS route	In U.S. domestic airspace, the term “ATS route” is not used. Routes in the U.S. include VOR airways, jet routes, substitute routes, off-airway routes, RNAV routes and colored airways. The U.S. also uses instrument departure procedures (DPs), and standard terminal arrivals (STARs).
Automatic Dependent Surveillance (ADS)	The U.S. has not yet published ATS procedures for the use of Automatic Dependent Surveillance (ADS).

Control zone	The U.S. uses “surface area” in place of the ICAO term “control zone.” Surface area is defined as the airspace contained by the lateral boundary of the Class B, C, D or E airspace designated for an airport that begins at the surface and extends upward.
Controlled airspace	The U.S. uses the following definition of controlled airspace found in 14 CFR Section 1.1: “Controlled airspace means an airspace of defined dimensions within which air traffic control service is provided to IFR flights and to VFR flights in accordance with the airspace classification.”
Course, bearing, azimuth, heading, and wind direction	U.S. uses “ Course, bearing, azimuth, heading, and wind direction ” information and it shall always be magnetic unless specifically stated otherwise.
Cruising level	The U.S. uses the term “cruising altitude.”
Decision altitude	Approach with vertical guidance (VNAV).
DETRESFA	See ALERFA.
Expedite	U.S. uses “ EXPEDITE ” by ATC when prompt compliance is required to avoid the development of an imminent situation. Expedite climb/descent normally indicates to a pilot that the approximate best rate of climb/descent should be used without requiring an exceptional change in aircraft handling characteristics.
Flight information centre	In the U.S., the services provided by flight information centers (FICs) are conducted by air traffic control (ATC) facilities, automated flight service stations (AFSSs), and rescue coordination centers (RCCs).
Glide path	The U.S. uses “glideslope” rather than “glide path” although the terms are sometimes interchangeable. For the U.S., a glideslope provides vertical guidance for aircraft during approach and landing.
Holding procedure	In the U.S., a hold procedure is also used during ground operations to keep aircraft within a specified area or at a specified point while awaiting further clearance from air traffic control.
Holding point	The U.S. uses “holding fix” rather than “holding point.”
INCERFA	See ALERFA.
Kilometres	U.S. ATIS units do not accept aircraft speeds in metric terms nor do they use the term “minimum clean speed.” The U.S. does use phrases such as “maintain maximum forward speed” or “maintain slowest practical speed.”
Level	The U.S. uses “altitude” or “flight level” rather than “level.”
May or need not	U.S. uses “ May ” or “ need not ” means a procedure is optional .
Miles	U.S. uses “ Miles ” to mean nautical miles unless otherwise specified, and means statute miles in conjunction with visibility .
Minute	U.S. uses “ minute plus 30 seconds ”, except when time checks are given to the nearest quarter minute.
Movement area	In the U.S., the “movement area” is equivalent to the ICAO “maneuvering area” which does not include parking areas.
Pilot-in-Command	Designated by operator, or in the case of general aviation, the owner, as being in command and charged with the safe conduct of a flight.
Plural	U.S. uses “ Plural words to include the singular ”.
Runway	U.S. uses “ Runway ”, which means the runway used by aircraft , and in discussions of separation standards is applicable to helipads with accompanying takeoff/ landing courses.
Shall	U.S. uses “ Shall ” or an action verb in the imperative sense, to mean a procedure is mandatory .
Should	U.S. uses “ Should ” to mean a procedure is recommended .
Singular	U.S. uses “ Singular words to include the plural ”.
Slush	In the U.S., “slush” is not used as a weather phenomenon.
Standard instrument arrival (STAR)	The U.S. uses the acronym STAR to define a standard terminal arrival.
Standard instrument departure (SID)	The U.S. uses the term departure procedure (DP) in lieu of SID.
Stand-by	U. S. uses “ STAND BY ” to mean the controller or pilot must pause for a few seconds, usually to attend to other duties of a higher priority. Also means to wait as in “stand by for clearance.” The caller should reestablish contact if a delay is lengthy. “Stand by” is not an approval or denial.
Stopway	The U.S. does not define a “stopway” as a rectangular area.

Taxi-holding position	In the U.S., “taxi into position and hold” means taxi onto the departure runway in take-off position and hold while the ICAO “taxi-holding position” or “taxi-holding point” is a designated position that provides adequate clearance from a runway.
Terminal control area	In the U.S., the term “terminal control area” has been replaced by “Class B airspace.” Standard IFR services should be provided to IFR aircraft operating in Class B airspace.
Time	U.S. when uses “ Time ” for ATC operational activities, is the hour and the minute in Coordinated Universal Time (UTC). Change to the next minute is made at the minute plus 30 seconds, except time checks are given to the nearest quarter minute
Track	The U.S. uses the term “course” instead of “track.”
Transition altitude, transition layer, and transition level	In U.S. domestic airspace, transition altitude, layer, and level are not used. U.S. flight levels begin at FL 180 where a barometric altimeter setting of 29.92 inches of mercury is used as the constant atmospheric pressure. Below FL 180, altitudes are based on barometric pressure readings.
Visibility	Definitions are different.
Visual Approach	In the U.S., aircrews may execute visual approaches when the pilot has either the airport or the preceding aircraft in sight and is instructed to follow it.
Will	U.S. uses “ Will ” means futurity, not a requirement for the application of a procedure.
CHAPTER 4	GENERAL PROVISIONS FOR AIR TRAFFIC SERVICES
4.13.4	Flight Progress Strips shall be retained for at least 15 days. (7110.3 3-4-4b)
4.3.2.1	Transfer of control points vary depending on numerous factors.
4.3.3.1	Transfer of control varies.
4.3.3.1a/ b	The U.S. does not “release” aircraft. Handoff is used.
4.4	In the U.S., flight information and alerting services are provided by ATC facilities, AFSSs, and RCCs.
4.5.6.2	U.S. ATS controllers do not normally include clearance for transonic acceleration in their ATC clearances.
4.5.7.3 LEVELS Except as provided for in Chapter 6, 6.3.2 and 6.5.1.5, use of standard departure and arrival clearances, instructions included in clearances relating to levels shall consist of the items specified in Chapter 11, 11.4.2.6.2.2. 4.10.4 Provision of altimeter setting information	In U.S. domestic airspace, transition altitude, layer, and level are not used. U.S. flight levels begin at FL180 where a barometric altimeter setting of 29.92 inches of mercury is used as the constant atmospheric pressure. Below FL 180, altitudes are based on barometric pressure readings. QNH and QFE altimeter settings are not provided in domestic U.S. airspace.
4.5.7.5	The flight crew shall read back to the air traffic controller safety-related parts of ATC clearances.
4.6.3.6	Only minor speed reductions of 20 knots should be used on intermediate or final approach.
4.6.3.7	Speed control after 7KM (4NM) should not be applied.
4.8.3	ATS units are not required to advise a pilot who has canceled an IFR flight plan that IMC conditions are likely to be encountered along the route of flight; however, if a pilot informs a controller of a desire to change from IFR to VFR, the controller will request that the pilot contact the appropriate AFSS.
4.9.2	In the U.S., the word “heavy” is used in all communications with or about heavy jet aircraft in the terminal environment. In the en route environment, “heavy” is used in all communications with or about heavy jet aircraft with a terminal facility, when the en route center is providing approach control service, when the separation from a following aircraft may become less than five miles by approved procedure, and when issuing traffic advisories.
4.11 POSITION REPORTING	The U.S. has different criteria to make position reports. 5 -1-12. POSITION REPORTING

4.11.4 Transmission of ADS-C reports	The U.S. has not yet published ATS procedures for the use of Automatic Dependent Surveillance- Contract (ADS-C).
4.12.2 Contents of routine air-reports 4.12.3 Contents of special air-reports	The U.S. does not normally use the term “air-report.” Pilot weather reports (PIREPs), position, and operational reports are used. PIREPs include reports of strong frontal activity, squall lines, thunderstorms, light to severe icing, wind shear and turbulence (including clear air turbulence) of moderate or greater intensity, volcanic eruptions and volcanic ash clouds, and other conditions pertinent to flight safety. They may include information on ceilings, visibility, thunderstorms, icing of light degree or greater, wind shear and its effect on airspeed, or volcanic ash clouds, but do not usually include air temperature.
4.13.4	Flight Progress Strips shall be retained for at least 15 days. (7110.3 3-4-4b)
4.15 DATA LINK COMMUNICATIONS INITIATION PROCEDURES	The U.S. has not yet published ATS procedures for the use of Datalink
CHAPTER 5	SEPARATION METHODS AND MINIMA
5.2.1 General	In U.S. airspace, only conflict resolution (not separation) is provided between IFR and VFR operations. Separation is provided between IFR and Special VFR (SVFR) aircraft only within the lateral boundaries of Class B, C, D, or E control zones (the U.S. term is surface areas) below 10,000 feet MSL.
5.2.1 General	In U.S. Class A and B airspace, separation is provided for all aircraft. In U.S. Class C airspace, separation is provided between IFR and SVFR aircraft; conflict resolution is provided between IFR and VFR operations.
5.3.1 Vertical separation application 5.3.4 Vertical separation during climb or descent	U.S. rules allow assignment of altitude to second aircraft after first aircraft has been issued climb/descent and is observed or reports leaving that altitude. 7110.65 6-6-1. APPLICATION 6-6-2. EXCEPTIONS
5.4.2.2.1c/ d	The U.S. uses 22 kt instead of 20 kt and 44 kt instead of 40 kt.
5.4.2.1.5	The U.S. uses the term “course” instead of “track.” “Reciprocal” courses are sometimes referred to as “opposite” courses. The wording of the definitions for U.S. <i>same</i> , <i>crossing</i> , or <i>opposite/reciprocal</i> courses differs from the ICAO worded definitions, but the intent appears to be the same.
5.4.2.6.4.3.3 Conflict is resolved within a further 7 1/2 minutes.	U. S. 3. When an ADS-C periodic or waypoint change event report is overdue by <i>3 minutes</i> , the controller shall take action to obtain an ADS-C report. 4. If no report is received within <i>6 minutes</i> of the time the original report was due, the controller shall take action to apply another form of separation. 7110.65 8-9-3. LONGITUDINAL SEPARATION
CHAPTER 6	SEPARATION IN THE VICINITY OF AERODROMES
6.3.2.5 COMMUNICATION FAILURE 8.8.3.2 COMPLETE AIRCRAFT COMMUNICATION FAILURE 15.3 AIR-GROUND COMMUNICATIONS FAILURE	In the U.S., if the communications failure occurs in IFR conditions, or if VFR cannot be complied with, each pilot shall continue the flight according to the following requirements: Route a) By the route assigned in the last ATC clearance received; b) If being radar vectored, by the direct route from the point of failure to the fix, route, or airway specified in the vector clearance; c) In the absence of an assigned route, by the route that ATC has advised may be expected in a further clearance; or d) In the absence of an assigned route or a route that ATC has advised may be expected in a further clearance, by the route filed in the flight plan. Altitude - At the highest of the following altitudes or flight levels for the route segment being flown: a) The altitude or flight level assigned in the last ATC clearance received; b) The minimum altitude as prescribed in 14 CFR Part 91 (Section 91.121(c)) for IFR operations; or c) The altitude or flight level ATC has advised may be expected in a further clearance.
6.3.3.3	Arriving aircraft - delay of 10 minutes or more. 7110.65 4-7-11 d 5
6.5.5.2	Onward clearance time. 7110.65 PG EXPECT FURTHER CLEARANCE (TIME)- The time a pilot can expect to receive clearance beyond a clearance limit

6.7.3.1.2 Whenever parallel approaches are carried out, separate controllers should be responsible for the sequencing and spacing of arriving aircraft to each runway	U.S. has no criteria for separate radar controllers in conducting Parallel approaches.
6.7.3.2.9	U.S. has no parallel approach obstacle assessment surfaces (PAOAS) Criteria.
6.7.3.2.9	U.S. has no criteria for a “45 degree track”.
6.7.3.2.10 a)	U.S. has no criteria for both controllers to be advised when visual separation is applied.
6.7.3.5.3 b)	U.S. has no surveillance radar approach (SRA)
6.7.3.5.3 c)	In the U.S., aircrews may execute visual approaches when the pilot has either the airport or the preceding aircraft in sight and is instructed to follow it. A contact approach is one wherein an aircraft on an IFR flight plan, having an air traffic control authorization, operating clear of clouds with at least 1 mile flight visibility and a reasonable expectation of continuing to the destination airport by visual reference in those conditions, may deviate from the instrument approach procedure and proceed to the destination airport by visual reference to the surface. This approach will only be authorized when requested by the pilot and the reported ground visibility at the destination airport is at least 1 statute mile.
CHAPTER 7	PROCEDURES FOR AERODROME CONTROL SERVICE
7.2 SELECTION OF RUNWAY-IN-USE	Except where a “runway use” program is in effect, in the U.S. the runway used will be the one most nearly aligned with the wind when 5 kt or more, or the “calm wind” runway when less than 5 kt unless use of another runway will be operationally advantageous or is requested by a pilot.
7.4.1.1 START-UP TIME PROCEDURES	U.S. has no start up procedures, taxi clearance.
7.6.3.2.3.2 <i>Light signal from aerodrome control</i>	In the U.S., for movements of other than aircraft traffic (i.e., vehicles, equipment, and personnel), steady green means cleared to cross, proceed, go; flashing green is not applicable; flashing white means return to starting point on airport; and alternating red and green means a general warning signal to exercise extreme caution.
7.6.3.2.3.3 Flashing runway or taxiway lights	U.S. controllers do not flash runway or taxiway lights to instruct aircraft to “vacate the runway and observe the tower for light signal.”
7.10.2 Clearance to land	In the U.S., landing clearance to a succeeding aircraft in a landing sequence need not be withheld if the controller observes the positions of the aircraft and determines that prescribed runway separation will exist when the aircraft crosses the landing threshold. Controllers issue traffic information to the succeeding aircraft if it has not previously been reported.
7.11.4 For the purpose of reduced runway separation, aircraft shall be classified as follows: <i>Also Chapter 4, Section 4.9 and Chapter 5, Section 5.8, respectively.</i>	ICAO aircraft wake turbulence categories (heavy, medium, light) and FAA weight classes (heavy, large, small) differ. Also, for landing aircraft, wake turbulence separation is defined differently. The U.S. makes special provisions for any aircraft landing behind a B-757 (4 miles for a large aircraft behind or 5 miles for a small aircraft behind).

<p>7.14 AUTHORIZATION OF SPECIAL VFR FLIGHTS</p>	<p>Special VFR operations may be conducted in the U.S. under the following weather minimums and requirements below 10,000 feet MSL within the airspace contained by the upward extension of the lateral boundaries of the controlled airspace designated to the surface for an airport. These minimums and requirements are found in 14 CFR Section 91.157.</p> <p>Special VFR operations may only be conducted:</p> <p>(1) With an ATC clearance;</p> <p>(2) Clear of clouds;</p> <p>(3) Except for helicopters, when flight visibility is at least 1 statute mile; and</p> <p>(4) Except for helicopters, between sunrise and sunset (or in Alaska, when the sun is 6 degrees or more below the horizon) unless:</p> <p>(i) The person being granted the ATC clearance meets the applicable requirements for instrument flight; and</p> <p>(ii) The aircraft is equipped as required in 14 CFR Sec. 91.205(d).</p> <p>No person may take off or land an aircraft (other than a helicopter) under special VFR:</p> <p>(1) Unless ground visibility is at least 1 statute mile; or</p> <p>(2) If ground visibility is not reported, unless flight visibility is at least 1 statute mile.</p>
<p>CHAPTER 8</p>	<p>ATS SURVEILLANCE SERVICES</p>
<p>8.6.5.2</p>	<p>The U.S. has not implemented cold temperature corrections to the radar minimum vectoring altitude</p>
<p>CHAPTER 9</p>	<p>FLIGHT INFORMATION SERVICE AND ALERTING SERVICE</p>
<p>9.1.3.7 TRANSMISSION OF INFORMATION TO SUPERSONIC AIRCRAFT</p>	<p>The U.S. does not have special procedures for the transmission of information to supersonic aircraft.</p>
<p>9.1.4.1.1</p>	<p>Class F airspace is not used in the U.S. Traffic advisories are provided in Class C airspace and, workload permitting, in Class D, Class E, and Class G airspace.</p>
<p>9.2.1.2</p>	<p>The U.S. does not use “operations normal” or “QRU” messages. U.S. controllers are not normally familiar with the term “uncertainty phase.”</p>
<p>CHAPTER 10</p>	<p>COORDINATION</p>
<p>10.1.3.1 DIVISION OF CONTROL</p>	<p>Except for a VFR aircraft practicing an instrument approach, an IFR approach clearance in the U.S. automatically authorizes the aircraft to execute the missed approach procedure depicted for the instrument approach being flown. No additional coordination is normally needed between the approach and en route controllers. Once an aircraft commences a missed approach, it may be radar vectored.</p>
<p>CHAPTER 11</p>	<p>AIR TRAFFIC SERVICES MESSAGES</p>
<p>11.1.2 Emergency messages</p>	<p>U.S. uses different emergency messages. 7110.10 T Chapter 8. Search and Rescue (SAR) Procedures for VFR Aircraft</p>
<p>11.4.2.3.6 LOGICAL ACKNOWLEDGEMENT MESSAGES (LAM)</p>	<p>The existing U.S. ATS automation system does not process logical acknowledgment messages (LAMs).</p>
<p>CHAPTER 12</p>	<p>PHRASEOLOGIES</p>
<p>12.3.1 General to require action when convenient m) WHEN READY (instruction);</p>	<p>U.S. does not use this phraseology. 7110.65 4-5-7. ALTITUDE INFORMATION PHRASEOLOGY CLIMB/ DESCEND AT PILOT’S DISCRETION 1. The pilot is expected to commence descent upon receipt of the clearance and to descend at the suggested rates specified in the AIM, 4-4-9, Adherence to Clearance, until reaching FL 280. At that point, the pilot is authorized to continue descent to FL 240 within the context of the term “at pilot’s discretion” as described in the AIM. f. When the “pilot’s discretion” portion of a climb/descent clearance is being canceled by assigning a new altitude, inform the pilot that the new altitude is an “amended altitude.” EXAMPLE- “American Eighty Three, amend altitude, descend and maintain Flight Level two six zero.”</p>
<p>12.3.1.2 2) TO AND MAINTAIN BLOCK (level) TO (level);</p>	<p>U.S. uses “maintain block (altitude) through (altitude). 7110.65 4-5-7. g. ALTITUDE INFORMATION</p>

<p>12.3.1.2 n) MAINTAIN OWN SEPARATION AND VMC [FROM (level)] [TO (level)]; o) MAINTAIN OWN SEPARATION AND VMC ABOVE (or BELOW, or TO) (level);</p>	<p>U.S. does not use “maintain own separation and VMC ‘from,’ ‘above,’ or ‘below’ . . . ,” U.S. controllers say “maintain visual separation ‘from’ that traffic.”</p>
<p>12.3.1.2 *t) CLEAR OF CONFLICT, RETURNING TO (assigned clearance);</p>	<p>TCAS resolution advisories in the U.S., pilots would advise “clear of conflict, returning to ...”</p>
<p>12.3.1.5 CHANGE OF CALL SIGN</p>	<p>U.S. has no phraseology or approved procedure to advise aircraft to change call signs. The U.S. has procedures for a duplicate aircraft identification watch and notification to airline operators but does not publish national procedures for on-the-spot temporary changes to aircraft call signs in accordance with ICAO guidelines.</p>
<p>12.3.1.6 TRAFFIC INFORMATION</p>	<p>In the U.S., traffic information messages include the position of the traffic (aircraft concerned).</p>
<p>12.3.1.7 a) METEOROLOGICAL CONDITIONS</p>	<p>In the U.S., the criterion for a variable wind is: wind speed greater than 6 kt and direction varies by 60 degrees or more. If the wind is >1 kt but <6 kt, the wind direction may be replaced by “VRB” followed by the speed or reported as observed. “VRB” would be spoken as “wind variable at <speed>.”</p>
<p>12.3.1.7 d)e)f) METEOROLOGICAL CONDITIONS</p>	<p>U.S. controllers do not give wind speed, visibility, or RVR/RVV values in metric terms. RVR values are given in 100- or 200-foot increments while RW values are given in Venule increments. 2-8-2. ARRIVAL/DEPARTURE RUNWAY VISIBILITY</p>
<p>12.3.1.7 j) METEOROLOGICAL CONDITIONS</p>	<p>U.S. controllers do not use the term “CAVOK.” However, the ceiling/sky condition, visibility, and obstructions to vision may be omitted if the ceiling is above 5,000 feet and the visibility is more than 5 miles.</p>
<p>12.3.1.10 g) AERODROME INFORMATION BRAKING ACTION REPORTED BY (aircraft type) AT (time) GOOD (or MEDIUM, or POOR)</p>	<p>U.S. use BRAKING ACTION terms “good,” “fair,” “poor,” “nil,” or combination of these terms. “Braking action fair to poor, reported by a heavy D-C Ten.”. 7110.65 3-3-4.</p>
<p>12.3.1.10 i) BRAKING ACTION [(location)] (measuring equipment used), RUNWAY (number), TEMPERATURE [MINUS] (number), WAS (reading) AT (time);</p>	<p>U.S. does not issue Temperature with Braking Action. 7110.65 3-3-4.</p>

12.3.2.2 INDICATION OF ROUTE AND CLEARANCE LIMIT	U.S. will issue a clearance “direct” to a point on the previously issued route. PHRASEOLOGY CLEARED DIRECT (fix). NOTE Clearances authorizing “direct” to a point on a previously issued route do not require the phrase “rest of route unchanged.” However, it must be understood where the previously cleared route is resumed. When necessary, “ rest of route unchanged ” may be used to clarify routing. 7110.65 4-4-1. ROUTE USE & 4-2-5. ROUTE OR ALTITUDE AMENDMENTS 3.
12.3.2.5 Emergency Descent	U.S. has no phraseology or instruction for emergency descent:
12.3.2.8 b) ADVISE IF ABLE TO CROSS (significant point) AT (time or level)	U.S. has no phraseology for “ADVISE IF ABLE”. U.S. does have phraseology “Advise if unable...”
12.3.4.7 n),o),p) BACKTRACT APPROVED	U.S. has no phraseology using ”BACKTRACT”. U.S. does use BACK-TAXI (7110.65) – A term used by air traffic controllers to taxi an aircraft on the runway opposite to the traffic flow. The aircraft may be instructed to back-taxi to the beginning of the runway or at some point before reaching the runway end for the purpose of departure or to exit the runway.
12.3.4.11 a), b) TAKE-OFF CLEARANCE 12.3.4.16 LANDING CLEARANCE	In U.S. runway number is specified after take off or landing clearance. Issue a take-off clearance in the following form: Phraseology: LEFT/RIGHT TURN OUT, CLEARED FOR TAKEOFF RUNWAY (number). Phraseology: CLEARED TO LAND RUNWAY (number).
12.3.4.11 TAKE-OFF CLEARANCE when take-off clearance has not been complied with c) Vacate 12.3.4.20 RUNWAY VACATING AND COMMUNICATIONS AFTER LANDING b	U.S. uses CLEAR OF THE RUNWAY a. Taxiing aircraft, which is approaching a runway, is clear of the runway when all parts of the U.S. uses aircraft are held short of the applicable runway holding position marking. b. A pilot or controller may consider an aircraft, which is exiting or crossing a runway, to be clear of the runway when all parts of the aircraft are beyond the runway edge and there are no restrictions to its continued movement beyond the applicable runway holding position marking. c. Pilots and controllers shall exercise good judgment to ensure that adequate separation exists between all aircraft on runways and taxiways at airports with inadequate runway edge lines or holding position markings.
12.3.4.11 TAKE-OFF CLEARANCE ... to cancel a take-off clearance e) HOLD POSITION, CANCEL TAKE-OFF I SAY AGAIN CANCEL TAKE-OFF (reasons); ... to stop a take-off after an aircraft has	U.S. uses different phraseology to cancel a take off. 3-9-10. CANCELLATION OF TAKEOFF CLEARANCE PHRASEOLOGY CANCEL TAKEOFF CLEARANCE (reason). If circumstances require, cancel a previously issued take-off clearance and, when appropriate, inform the aircraft of the reason. Phraseology If a clearance to take off is cancelled: A. before the aircraft has started to roll — TAKE-OFF CLEARANCE CANCELLED; B. after the aircraft has started to roll — ABORT TAKEOFF.

12.3.4.13 b) JOIN (position in circuit) (direction of circuit) (runway number) [SURFACE] WIND (direction and speed) (units) TEMPERATURE [MINUS] (number) QNH (or QFE) (number) [(units)] [TRAFFIC (detail)]	U.S. uses PHRASEOLOGY: ENTER LEFT/RIGHT BASE. STRAIGHT-IN. MAKE STRAIGHT-IN. STRAIGHT-IN APPROVED. RIGHT TRAFFIC. MAKE RIGHT TRAFFIC. RIGHT TRAFFIC APPROVED. CONTINUE. b. Runway in use. c. Surface wind. d. Altimeter setting. REFERENCE FAAO 7110.65, Current Settings, Para 2-7-1. e. Any supplementary information. f. Clearance to land. g. Requests for additional position reports. Use prominent geographical fixes which can be easily recognized from the air, preferably those depicted on sectional charts. This does not preclude the use of the legs of the traffic pattern as reporting points.
12.3.5.6 HANDOVER	U.S. does not use radar handover. 7110.65 5-4-3. METHODS PHRASEOLOGY HANDOFF/ POINT OUT/TRAFFIC (aircraft position) (aircraft ID),or (discrete beacon code point out only) (altitude, restrictions, and other appropriate information, if applicable). c. When receiving a handoff, point out, or traffic restrictions, respond to the transferring controller as follows: PHRASEOLOGY- (Aircraft ID) (restrictions, if applicable) RADAR CONTACT, or (aircraft ID or discrete beacon code) (restrictions, if applicable) POINT OUT APPROVED, or TRAFFIC OBSERVED,
12.3.5.7 Expedite Clearance	U.S. has no phraseology to expedite clearance.
12.4.1.1 IDENTIFICATION OF AIRCRAFT f) NOT IDENTIFIED [reason], [RESUME (or CONTINUE) OWN NAVIGATION]	U.S. controllers do not say “will shortly lose identification” or “identification lost.” 7110.65 5-6-2 PHRASEOLOGY RADAR CONTACT LOST (alternative instructions when required). PHRASEOLOGY-(Position with respect to course/fix along route).
12.4.2.1 VECTORIZING FOR APPROACH VECTORIZING FOR VISUAL APPROACH RUNWAY (number) REPORT FIELD (or RUNWAY) IN SIGHT	U.S. would use “airport or runway” rather than “field.” 7-4-2. VECTORS FOR VISUAL APPROACH PHRASEOLOGY- (ACID) FLY HEADING OR TURN RIGHT/LEFT HEADING (degrees) VECTOR FOR VISUAL APPROACH TO (airport name). PHRASEOLOGY 5-11-2. VISUAL REFERENCE REPORT “REPORT (runway, approach/runway lights or airport) IN SIGHT. REPORT WHEN ABLE TO PROCEED VISUALLY TO AIRPORT/HELIPORT.”
12.4.2.4.4 CHECKS CHECK GEAR DOWN [AND LOCKED]	U.S. uses “CHECK WHEELS DOWN”. 7110.65 2-1-24. WHEELS DOWN CHECK PHRASEOLOGY
12.4.2.5 PAR APPROACH	U.S. controllers say “this will be a P-A-R/surveillance approach to runway (number) or airport/runway (number) or airport/heliport.” U.S. controllers do not say “approach completed”. U.S. controllers say “your missed approach procedure is (missed approach procedure)” and, if needed, “execute missed approach.” For PAR approaches, U.S. controllers say “begin descent” and for surveillance approaches, U.S. controllers say “descend to your minimum descent altitude.” 7110.65 5-12-8. APPROACH GUIDANCE TERMINATION lights in sight and requested to or advised that he/she will proceed visually, and has been instructed to proceed visually, all PAR approach procedures shall be discontinued. d. Continue to monitor final approach and frequency. Pilots shall remain on final controller’s frequency until touchdown or otherwise instructed. 5-12-9. COMMUNICATION TRANSFER PHRASEOLOGY CONTACT (terminal control function) (frequency, if required) AFTER LANDING

<p>12.4.3.12 TO REQUEST PRESSURE SETTING CHECK AND CONFIRMATION OF LEVEL 12.4.3.13 To REQUEST TERMINATION OF PRESSURE-ALTITUDE TRANSMISSION BECAUSE OF FAULTY OPERATION</p>	<p>U.S., for aircraft above FL 180, U.S. controllers would say, “confirm using two niner niner two as your altimeter setting, verify altitude” or “stop altitude squawk” “stop altitude squawk; altitude differs by (number) feet.” U.S. controllers would not say “stop squawk Charlie”. 7110.65 5-2-22. BEACON TERMINATION Inform an aircraft when you want it to turn off its transponder.</p>
<p>12.4.3.14 TO REQUEST LEVEL CONFIRM (level)</p>	<p>U.S. controllers would say “verify at (altitude)” and/or “verify assigned altitude.” 7110.65 5-2-17. 1. Issue the correct altimeter setting and confirm the pilot has accurately reported the altitude. PHRASEOLOGY- (Location) ALTIMETER (appropriate altimeter), VERIFY ALTITUDE.</p>
<p>12.6.1 Alerting phraseologies</p>	<p>U.S. controllers would issue MEA/MVA/MOCA/MIA instead of QNH. 7110.65</p>
<p>CHAPTER 15</p>	<p>PROCEDURES RELATED TO EMERGENICES, COMMUNICATION FAILURE AND CONTINGENCIES</p>
<p>15.1 Emergency procedures</p>	<p>When neither communications nor radar contact can be established for 30 minutes (or prior, if appropriate), U.S. controllers will consider an aircraft overdue and will initiate overdue aircraft procedures including reporting to the ARTCC or AFSS.</p>
<p>15.1.3 Unlawful interference and aircraft bomb threat</p>	<p>U.S. has difference updated. 5-2-13, Code Monitor Note 1. & 2. “10-2-6 HIJACKED AIRCRAFT 10-2-6. HIJACKED AIRCRAFT Hijack attempts or actual events are a matter of national security and require special handling. Policy and procedures for hijack situations are detailed in FAAO JO 7610.4, Special Operations. FAAO JO 7610.4 describes reporting requirements, air crew procedures, air traffic procedures and escort or interceptor procedures for hijack situations. REFERENCE FAAO JO 7610.4, Hijacked/Suspicious Aircraft Reporting and Procedures, Chapter 7. FAAO 7110.65, Code Monitor, Para 5-2-13.</p>
<p>15.4.1 Strayed VFR flights and VFR flights encountering adverse meteorological conditions</p>	<p>U.S. does not use the terms “strayed” or “unidentified” aircraft. 7110.65 10-3-1. OVERDUE AIRCRAFT</p>
<p>15.7.3 Procedures in regard to aircraft equipped with airborne collision avoidance systems (ACAS)</p>	<p>The U.S. uses traffic alert and collision avoidance system (TCAS). U.S. controllers are not to issue control instructions that are contrary to the TCAS resolution advisory (RA) procedure that a crew member advises is being executed. U.S. orders speak to controller actions when advised of an aircraft responding to a resolution alert (RA).</p>
<p>APPENDIX 1</p>	<p>INSTRUCTIONS FOR AIR-REPORTING BY VOICE COMMUNICATIONS</p>
<p>AIREP Form of Air-report</p>	<p>U.S. uses Pilot Reports (UAs), or Urgent Pilot Reports (UUAs).</p>
<p>APPENDIX 2</p>	<p>FLIGHT PLAN</p>
<p></p>	<p>Remark: The U.S. uses a flight plan format different from the ICAO model discussed in Appendix 2. The U.S. ATS facilities will transmit ICAO repetitive flight plans (RPLs) even though a different format is used for stored flight plans</p>
<p>A2-5 Wake</p>	<p>ICAO aircraft wake turbulence categories (heavy, medium, light) and FAA weight classes (heavy, large, small) differ. Also, for landing aircraft, wake turbulence separation is defined differently. The U.S. makes special provisions for any aircraft landing behind a B-757 (4 miles for a large aircraft behind or 5 miles for a small aircraft behind).</p>

A2-7 (Item 15)	U.S. ATIS units do not accept cruising speeds nor filed altitudes/flight levels in metric terms. The U.S. accepts filed Mach Number expressed as M followed by 3 figures.
A2-7 (Item 15)	The U.S. requires filed FIR boundary designators and accumulated estimated elapsed times to such points or FIR boundaries in the sequence and form as prescribed in 2.2, Item 18 of Doc 4444, Appendix 2
APPENDIX 3	AIR TRAFFIC SERVICES MESSAGES
APPENDIX 4	AIR TRAFFIC INCIDENT REPORT
Appendix 4	U.S. has their accident/incident report in FAA Notice 8020.134
APPENDIX 5	CONTROLLER-PILOT DATA LINK COMMUNICATIONS (CPDLC) MESSAGE SET
Appendix 5	U.S. has no CPDLC message set

PANS - OPS - 8168/611	
VOLUME 1	
PART III	
Table III-1-1 and Table III-1-2	The “Max speeds for visual maneuvering (Circling)” must not be applied to circling procedures in the U.S. Comply with the airspeeds and circling restrictions in ENR 1.5, paragraphs 11.1 and 11.6, in order to remain within obstacle protection areas. The table listed below shows aircraft categories with an associated maximum airspeed and distance to remain within from the end of runway.

Aircraft Category	Speeds for Circling (Kts)	Circling Area Maximum Radii from Runway Threshold (NM)
A	Speed less than 91 Knots	1.3
B	Speed 91 Knots or more but less than 121 Knots	1.5
C	Speed 121 Knots or more but less than 141 Knots	1.7
D	Speed 141 Knots or more but less than 166 Knots	2.3
E	Speed 166 Knots or more	4.5

PART IV	
1.2.1	The airspeeds contained in ENR 1.5 shall be used in U.S. CONTROLLED AIRSPACE.

PAN – ABC – DOC 8400

Differences between abbreviations used in U.S. AIP, International NOTAMs Class I and Class II, and Notices to Airmen Publication and ICAO PANS – ABC are listed in GEN 2.2. For other U.S. listings of abbreviations (contractions) for general use, air traffic control, and National Weather Service (NWS), which differ in some respects, see U.S. publication Contractions Handbook (DOT/FAA Order 7340.1). In addition, various U.S. publications contain abbreviations of terms used therein, particularly those unique to that publication.

GEN 2. TABLES AND CODES

GEN 2.1 Measuring System, Time System, and Aircraft Markings

1. Units of Measurement

1.1 The following table identifies the units of measurement that have been selected for use in messages transmitted by all U.S. aeronautical stations, in the U.S. AIP, NOTAM dissemination, and other publications.

2. Time System

2.1 Coordinated Universal Time (UTC) is used in the Air Traffic and Communication services provided and in most documents published by the Aeronautical Information Services.

2.2 When local mean time is used, it will be so indicated as local standard time (LST). See

FIG GEN 2.1-1 for a depiction of the standard time zones within the continental U.S.

3. Geodetic Reference Datum

3.1 All published geographic coordinates indicating latitude and longitude are expressed in terms of the World Geodetic System – 1984 (WGS-84) geodetic reference datum.

4. Nationality and Registration Marks

4.1 The nationality mark for the aircraft registered in the U.S. is the letter N, followed by a series of numbers or a series of numbers and letters.

TBL GEN 2.1-1

For Measurements of:	Units used:
Distance used in navigation, position reporting, etc. – generally in excess of 2 to 3 nautical miles	Nautical miles and tenths
Relatively short distances such as those relating to aerodrome (e.g., runway lengths)	Feet
Altitudes, elevations and heights	Feet
Horizontal speed, including wind speed	Knots
Vertical speed	Feet per minute
Wind direction for landing and taking off	Degrees magnetic
Wind direction except for landing and taking off	Degrees true
Visibility, including runway visual	Statute miles or feet
Altimeter Setting	Inches of mercury
Temperature	Degrees Fahrenheit
Weight	Pounds
Time	Hours and minutes, the day of 24 hours beginning at midnight Coordinated Universal Time

FIG GEN 2.1-1

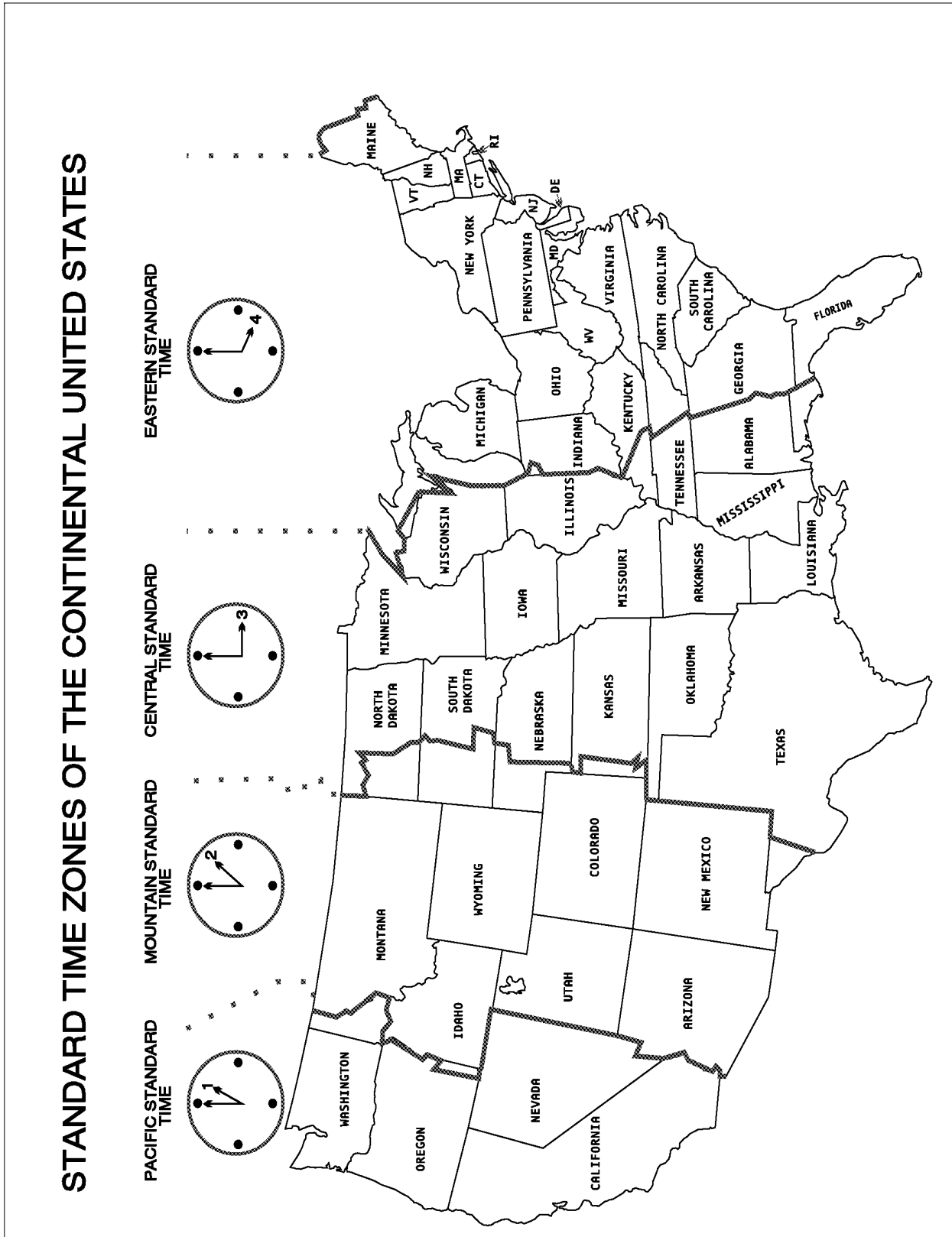

GEN 2.2 Abbreviations Used in AIS Publications

NOTE-

An “s” may be added for plural. ICAO indicates ICAO usage.

A	
/	and
AAS	airport advisory service
A/C	approach control
ICAO:	AAP – approach control; AC – altocumulus
ACFT	aircraft
ACR	air carrier
ADF	automatic direction finder
AER	approach end runway
AFIS	Automatic Flight Information Service
AFT	after
AGL	above ground level
AHRS	Attitude Heading Reference System
AIM	Aeronautical Information Manual
ALS	approach light system
ALSF-1	standard 2400’ high-intensity approach lighting system with sequenced flashers (Category I configuration)
ALSF-2	standard 2400’ high-intensity approach lighting system with sequenced flashers (Category II configuration)
ALSTG	altimeter setting
ALT	altitude
ALTM	altimeter
ALTN	alternate
AMDT	amendment
ICAO:	AMD – amendment
APCH	approach
APCHG	approaching
APRX	approximate
APV	approve or approved or approval
ARPT	airport
ICAO:	AD – aerodrome
ARR	arrive or arrival
ARSR	air route surveillance radar
ARTCC	air route traffic control center
ASDE	airport surface detection equipment
ASPH	asphalt

ATCT	air traffic control tower
ATD	along-track distance
ASR	airport surveillance radar
ATIS	automatic terminal information service
AVBL	available
AWY	airway
B	
BC	back course
BCN	beacon
BCST	broadcast
BLDG	building
BRG	bearing
BTN	between
BYD	beyond
C	
CAT	category
ICAO:	CAT – clear air turbulence
CFR	Code of Federal Regulations
CFR	crash fire rescue
CLNC	clearance
ICAO:	CLR – clear/cleared to/clearance
CLSD	close or closed or closing
CMSND	commissioned
CNTR	center
CNTRLN	centerline
ICAO:	CL – centerline
COMLO	compass locator
CONST	construction
CPTY	capacity
CRS	course
CTC	contact
ICAO:	CTR – control zone
D	
ICAO:	D – danger area
ICAO:	D – downward (tendency in RVR during previous 10 minutes)
DALGT	daylight
DCMSND	decommissioned

DDT	runway weight bearing capacity for aircraft with double dual-tandem type landing gear
DEGS	degrees
ICAO:	C – degrees Celsius (Centigrade) F – degrees Fahrenheit
DEP	depart; departure
ICAO:	DEP – depart/departure/departure message
DF	direction finder
ICAO:	DF – I am connecting you to the station you request
DH	decision height
DME	UHF standard (TACAN compatible distance measuring equipment)
ICAO:	DME – distance measuring equipment
DSPLCD	displaced
DSTC	distance
ICAO:	DIST – distance
DT	runway weight bearing capacity for aircraft with dual-tandem type landing gear
DURG	during
ICAO:	DRG – during
DVFR	defense visual flight rule
DW	runway weight bearing capacity for aircraft with dual-wheel type landing gear
E	
E	east
ICAO:	E – east/east longitude
EFAS	en route flight advisory service
EQUIP	equipment
ICAO:	EQPT – equipment
ETA	estimated time of arrival
ETE	estimated time en route
EXCP	except
ICAO:	EXC–except
EXTD	extend or extended
F	
FAF	final approach fix
FAR	Federal Aviation Regulation
FDC	flight data center
FI/P	flight information (permanent)

FI/T	flight information (temporary)
FL	flight level
FM	fan marker
FM	from
ICAO:	FM – from; FM – from (followed by time weather change is forecast to begin)
FREQ	frequency
FRQ	frequent
FSS	Flight Service Station
FT	feet
G	
GOVT	government
GP	glide path
ICAO:	GP – glide path
GS	glide slope
ICAO:	GS – ground speed; GS – small hail and/or snow pellets
GWT	gross weight
H	
HAA	height above airport
HAT	height above touchdown
ICAO:	HGT – height/height above
HIRL	High intensity runway lights
HOL	holiday
HWY	highway
I	
IAF	initial approach fix
IAP	instrument approach procedure
ICAO:	INA – initial approach
IDENT	identification
ICAO:	ID – identifier/identification/identify
IF	intermediate fix
ICAO:	IF – intermediate approach fix
IFR	instrument flight rules
IFSS	international flight service station
ILS	instrument landing system
INFO	information
INOP	inoperative
INS	Inertial Navigation System
INT	intersection
INTL	international

INTST	intensity
IRU	Inertial Reference Unit
ISMLS	interim standard microwave landing system
J	
J-bar	jet runway barrier
K	
KHZ	kilohertz
L	
L	left (used only to designate rwys; e.g., rwy 12L)
ICAO:	L – left/runway identification/locator
LAT	latitude
LB	pounds (weight)
LCTD	located
LDA	localizer type directional aid
ICAO:	LDA – landing distance available LLZ – localizer
LDIN	lead-in lighting system
LGTD	lighted
LMM	compass locator at ILS middle marker
LNDG	landing
ICAO:	LDG – landing
LOC	localizer
ICAO:	LOC–localizer or locally or location or located
LOM	compass locator at ILS outer marker
LONG	longitude
LRCO	limited remote communications outlet
M	
MAA	maximum authorized altitude
MAG	magnetic
MAINT	maintain, maintenance
ICAO:	MNTN – maintain; MAINT – maintenance
MALS	medium intensity approach light system
MALSR	medium intensity approach light system with runway alignment indicator lights
MAP	missed approach point
ICAO:	MAP – aeronautical maps and charts
MAX	maximum
MCA	minimum crossing altitude
MDA	minimum descent altitude
MEA	minimum en route IFR altitude
MHZ	megahertz
MIN	minimum or minute

MIRL	medium intensity runway edge lights
MLS	microwave landing system
MM	middle marker ILS
MOCA	minimum obstruction clearance altitude
MRA	minimum reception altitude
MSA	minimum safe altitude
MSL	mean sea level
MUNI	municipal
N	
N	north
NA	not authorized
NATL	national
NAVAID	navigational aid
NDB	nondirectional radio beacon
NM	nautical mile(s)
NOPT	no procedure turn required
NR	number
O	
OBSTN	obstruction
ODALS	omnidirectional approach lighting system
OM	outer marker ILS
OPER	operate
OPN	operation
ICAO:	OPR – operator/operate/operative/operating/operational
ORIG	original
OTS	out of service
OVRN	overrun
P	
PAR	precision approach radar
PAT	pattern
PCN	pavement classification number
PERMLY	permanently
POB	persons on board
PPR	prior permission required
PROC	procedure
Q	
QUAD	quadrant
R	
R	right (used only to designate rwys; e.g., rwy 19R)

ICAO:	R – received (acknowledgement of receipt)/red/restricted area (followed by identification)/right (runway identification)
RADAR	radio detection and ranging
RAPCON	radar approach control (USAF)
RCAG	remote communications air/ground
RCLS	runway centerline lights system
ICAO:	RCL – runway centerline
RCO	remote communications outlet
RCV	receive
RCVG	receiving
REIL	runway end identifier lights
REQ	request
RNAV	area navigation
RRP	runway reference point
REL	runway entrance lights
RSTRD	restricted
RTS	returned to service
RVR	runway visual range
RVRM	runway visual range midpoint
RVRR	runway visual range rollout
RVRT	runway visual range touchdown
RVV	runway visibility values
RWSL	runway status light
RWY	runway
ICAO:	RWY–runway
S	
S	runway weight bearing capacity for aircraft with single–wheel type landing gear
S	south
ICAO:	S – south/south latitude
SDF	simplified directional facility
SEC	second
SFC	surface
SFL	sequenced flashing lights
SI	straight–in approach
ICAO:	STA – straight–in approach
SM	statute mile(s)
SR	sunrise
SS	sunset
ICAO:	SS – sandstorm
SSALF	simplified short approach lighting system with sequenced flashers

SSALR	simplified short approach lighting system with runway alignment indicator lights
SSALS	simplified short approach lighting system
STOL	short take–off and landing runway
ICAO:	STOL – short takeoff and landing
SVC	service
ICAO:	SVC – service message
T	
T	true (after a bearing)
ICAO:	T – temperature
TAC	terminal area chart
TACAN	UHF navigational facility – omnidirectional course and distance information
ICAO:	TACAN – VHF tactical navigational aid
TAS	true air speed
ICAO:	TMA – TERMINAL CONTROL AREA
TCH	threshold crossing height
TFC	traffic
THL	takeoff hold lights
THR	threshold
THRU	through
ICAO:	THRU – through/I am connecting you to another switchboard
TKOF	take–off
TEMPRLY	temporarily
TMPRY	temporary/temporarily
ICAO:	TEMPO – Temporary/temporarily
TPA	traffic pattern altitude
TRACON	terminal radar approach control
TRML	terminal
TRSA	terminal radar service area
TSNT	transient
TWEB	transcribed weather broadcast
TWR	tower
TWY	taxiway
U	
UAS	Unmanned Aircraft System
UAVBL	unavailable
UHF	ultra high frequency
UNLGTD	unlighted

UNMON	unmonitored
UNSKED	unscheduled
UNUSBL	unusable
ICAO:	U/S – unserviceable
V	
VASI	visual approach slope indicator
VCNTY	vicinity
VDP	visual descent point
VFR	visual flight rules
VHF	very high frequency
VOR	VHF omni-directional radio range
VORTAC	Combined VOR and TACAN system (collocated)
VOT	a VOR Receiver testing facility

VSBY	visibility
ICAO:	VIS – visibility
W	
W	west
WEA	weather
ICAO:	WX – weather
WKDAY	weekday
WKEND	weekend
WPT	waypoint
WS	Weather Service
WT	weight
Z	
Z	Coordinated Universal Time
ICAO:	UTC – Coordinated Universal Time

GEN 2.3 Chart Symbols

Aeronautical chart symbols are published in the Chart Users Guide published by the National Aeronautical Charting Office (NACO).

Copies are available at the following address:

NACO Distribution Division
Federal Aviation Administration
Riverdale, MD 20737-1199.

GEN 2.4 Location Indicators

Location identifiers authorized by the Federal Aviation Administration, Department of the Navy, and Transport Canada and U.S. airspace fixes and procedure codes are published in FAA Order 7350.7,

Location Identifiers. This publication may be purchased as a subscription from the U.S. Government Printing Office.

GEN 2.5 List of Radio Navigation Aids

A listing of navigation aids is not available. See individual aeronautical charts for specific information.

GEN 2.6 Conversion Tables

TBL GEN 2.6-1

ft/M										
ft	0	1	2	3	4	5	6	7	8	9
0	0	0.30	0.61	0.91	1.22	1.52	1.83	2.13	2.44	2.74
10	3.05	3.35	3.66	3.96	4.27	4.57	4.88	5.18	5.49	5.79
20	6.10	6.40	6.71	7.01	7.32	7.62	7.92	8.23	8.53	8.84
30	9.14	9.45	9.75	10.06	10.36	10.67	10.97	11.28	11.58	11.89
40	12.19	12.50	12.80	13.11	13.41	13.72	14.02	14.33	14.73	14.94
50	15.24	15.54	15.85	16.15	16.46	16.76	17.07	17.37	17.68	17.98
60	18.29	18.59	18.90	19.20	19.51	19.81	20.12	20.42	20.73	21.03
70	21.34	21.64	21.95	22.25	22.56	22.86	23.16	23.47	23.77	24.08
80	24.38	24.69	24.99	25.30	25.60	25.91	26.21	26.52	26.82	27.13
90	27.43	27.74	28.04	28.35	28.65	28.96	29.26	29.57	29.87	30.18
	0	10	20	30	40	50	60	70	80	90
100	30.48	33.53	36.58	39.62	42.67	45.72	48.77	51.82	54.86	57.91
200	60.96	64.01	67.06	70.10	73.15	76.20	79.25	82.30	85.34	88.39
300	91.44	94.49	97.54	100.53	103.63	106.68	109.73	112.78	115.82	118.87
400	121.92	124.97	128.02	131.06	134.11	137.16	140.21	143.26	146.30	149.35
500	152.40	155.45	158.50	161.54	164.59	167.64	170.69	173.74	176.78	179.83
600	182.88	185.93	188.98	192.02	195.07	198.12	201.17	204.22	207.26	210.31
700	213.36	216.41	219.46	222.50	225.55	228.60	231.65	234.70	237.74	240.79
800	243.84	246.89	249.94	252.98	256.03	259.09	262.13	265.18	268.22	271.27
900	274.32	277.37	280.42	283.42	286.51	289.56	292.61	295.66	298.70	301.75
	0	100	200	300	400	500	600	700	800	900
1000	304.80	335.28	365.76	396.24	426.72	457.20	487.68	518.16	548.64	579.12
2000	609.60	640.08	670.56	701.04	731.52	762.00	792.48	822.96	853.44	883.92
3000	914.40	944.88	975.36	1005.8	1036.3	1066.8	1097.3	1127.8	1158.2	1188.7
4000	1219.2	1249.7	1280.2	1310.6	1341.6	1371.6	1402.1	1432.6	1463.0	1493.5
5000	1524.0	1554.5	1585.0	1615.4	1645.9	1676.4	1706.9	1737.4	1767.8	1798.3
6000	1828.8	1859.3	1889.8	1920.2	1950.7	1981.2	2011.7	2042.2	2072.6	2103.1
7000	2133.6	2164.1	2194.6	2225.0	2255.5	2286.0	2316.5	2347.0	2377.4	2407.9
8000	2438.4	2468.9	2499.4	2529.8	2560.3	2590.8	2621.3	2651.8	2682.2	2712.7
9000	2743.2	2773.7	2804.2	2834.6	2865.1	2895.6	2926.1	2956.6	2987.0	3017.5
	0	1000	2000	3000	4000	5000	6000	7000	8000	9000
10000	3048.0	3352.8	3657.6	3962.4	4267.2	4572.0	4876.8	5181.6	5486.4	5791.2
20000	6096.0	6400.8	6705.6	7010.4	7315.2	7620.0	7924.8	8229.6	8534.4	8839.2
30000	9144.0	9448.8	9753.6	10058	10363	10668	10937	11278	11582	11887
40000	12192	12497	12802	13106	13411	13716	14021	14326	14630	14935
50000	15240	15545	15850	16154	16459	16764	17069	17374	17678	17983

TBL GEN 2.6-2

M/ft										
M	0	1	2	3	4	5	6	7	8	9
0	0	3.28	6.56	9.84	13.12	16.40	19.68	22.97	26.25	29.53
10	32.81	36.09	39.37	42.65	45.93	49.21	52.49	55.77	59.05	62.34
20	65.62	68.90	72.18	75.46	78.74	82.02	85.30	88.58	91.86	95.14
30	98.42	101.70	104.99	108.27	111.55	114.83	118.11	121.39	124.67	127.95
40	131.23	134.51	137.79	141.07	144.36	147.64	150.92	154.20	157.48	160.76
50	164.04	167.32	170.60	173.88	177.16	180.44	183.72	187.01	190.29	193.57
60	196.85	200.13	203.41	206.69	209.97	213.25	216.53	219.81	223.09	226.38
70	229.66	232.94	236.22	239.50	242.78	246.06	249.34	252.62	255.90	259.18
80	262.46	265.74	269.03	272.31	275.59	278.87	282.15	285.43	288.71	291.99
90	295.27	298.55	301.83	305.11	308.40	311.68	314.96	318.24	321.52	324.80
	0	10	20	30	40	50	60	70	80	90
100	328.08	360.89	393.70	426.50	459.31	492.12	524.93	557.74	590.54	623.35
200	656.16	688.97	721.78	754.58	787.39	820.20	853.01	885.82	918.62	951.43
300	984.24	1017.0	1049.9	1082.7	1115.5	1148.3	1181.1	1213.9	1246.7	1279.5
400	1312.3	1345.1	1377.9	1410.7	1443.6	1476.4	1509.2	1542.0	1574.8	1607.6
500	1640.4	1673.2	1706.0	1738.8	1771.6	1804.4	1837.2	1870.1	1902.9	1935.7
600	1968.5	2001.3	2034.1	2066.9	2099.7	2132.5	2165.3	2198.1	2230.9	2263.8
700	2296.6	2329.4	2362.2	2395.0	2427.8	2460.6	2493.4	2526.2	2559.0	2591.8
800	2624.6	2657.4	2690.3	2723.1	2755.9	2788.7	2821.5	2854.3	2887.1	2919.9
900	2952.7	2985.5	3018.3	3051.1	3084.0	3116.8	3149.6	3182.4	3215.2	3248.0
	0	100	200	300	400	500	600	700	800	900
1000	3280.8	3608.0	3937.0	4265.0	4593.1	4921.2	5249.3	5577.4	5905.4	6233.5
2000	6561.6	6889.7	7217.8	7545.8	7873.9	8202.0	8530.1	8858.2	9186.2	9514.3
3000	9842.4	10170	10499	10827	11155	11483	11811	12139	12467	12795
4000	13123	13451	13779	14107	14436	14764	15092	15420	15748	16076
5000	16404	16732	17060	17388	17716	18044	18372	18701	19029	19357
6000	19685	20013	20341	20669	20997	21325	21653	21981	22309	22638
7000	22966	23294	23622	23950	24278	24606	24934	25262	25590	25918
8000	26246	26574	26903	27231	27559	27887	28215	28543	28871	29199
9000	29527	29855	30183	30511	30840	31168	31496	31824	32152	32480

TBL GEN 2.6-3

INTERNATIONAL NAUTICAL MILES TO STATUTE MILES										
1 nautical mile = 6,076.10 feet or 1,852 meters 1 statute mile = 5,280 feet or 1,609.35 meters										
NM	0	1	2	3	4	5	6	7	8	9
0	0.000	1.151	2.302	3.452	4.603	5.754	6.905	8.055	9.206	10.357
10	11.508	12.659	13.809	14.960	16.111	17.262	18.412	19.563	20.714	21.865
20	23.016	24.166	25.317	26.468	27.619	28.769	29.920	31.071	32.222	33.373
30	34.523	35.674	36.825	37.976	39.126	40.277	41.428	42.579	43.730	44.880
40	46.031	47.182	48.333	49.483	50.634	51.785	52.936	54.087	55.237	56.388
50	57.539	58.690	59.840	60.991	62.142	63.293	64.444	65.594	66.745	67.896
60	69.047	70.197	71.348	72.499	73.650	74.801	75.951	77.102	78.253	79.404
70	80.554	81.705	82.856	84.007	85.158	86.308	87.459	88.610	89.761	90.911
80	92.062	93.213	94.364	95.515	96.665	97.816	98.967	100.118	101.268	102.419
90	103.570	104.721	105.871	107.022	108.173	109.324	110.475	111.625	112.776	113.927

TBL GEN 2.6-4

STATUTE MILES TO INTERNATIONAL NAUTICAL MILES										
SM	0	1	2	3	4	5	6	7	8	9
0	0.000	0.869	1.738	2.607	3.476	4.345	5.214	6.083	6.952	7.821
10	8.690	9.559	10.428	11.297	12.166	13.035	13.904	14.773	15.642	16.511
20	17.380	18.249	19.118	19.986	20.855	21.724	22.593	23.462	24.331	25.200
30	26.069	26.938	27.807	28.676	29.545	30.414	31.283	32.152	33.021	33.890
40	34.759	35.628	36.497	37.366	38.235	39.104	39.973	40.842	41.711	42.580
50	43.449	44.318	45.187	46.056	46.925	47.794	48.663	49.532	50.401	51.270
60	52.139	53.008	53.877	54.746	55.615	56.484	57.353	58.222	59.091	59.959
70	60.828	61.697	62.566	63.435	64.304	65.173	66.042	66.911	67.780	68.649
80	69.518	70.387	71.256	72.125	72.994	73.863	74.732	75.601	76.470	77.339
90	78.208	79.077	79.946	80.815	81.684	82.553	83.422	84.291	85.160	86.029

TBL GEN 2.6-5

CONVERSION TABLE - NM/ft										
NM	0	1	2	3	4	5	6	7	8	9
0	0	607	1215	1822	2430	3037	3645	4252	4860	5467
1	6075	6682	7289	7897	8504	9112	9719	10327	10934	11542
2	12149	12757	13364	13971	14579	15186	15794	16401	17009	17616
3	18224	18831	19439	20046	20653	21261	21868	22476	23083	23691
4	24298	24906	25513	26121	26728	27335	27943	28550	29158	29765
5	30373	30980	31588	32195	32803	33410	34017	34625	35232	35840
6	36447	37055	37662	38270	38877	39485	40092	40700	41307	41914
7	42522	43129	43737	44344	44952	45559	46167	46774	47382	47989
8	48596	49204	49811	50419	51026	51634	52241	52849	53456	54064
9	54671	55278	55886	56493	57101	57708	58316	58923	59531	60138

TBL GEN 2.6-6

CONVERSION TABLE - ft/NM										
ft	0	1	2	3	4	5	6	7	8	9
0	0	0.016	0.033	0.049	0.066	0.082	0.099	0.115	0.132	0.148
1000	0.165	0.181	0.197	0.214	0.230	0.247	0.263	0.280	0.296	0.313
2000	0.329	0.346	0.362	0.379	0.395	0.411	0.428	0.444	0.461	0.477
3000	0.494	0.510	0.527	0.543	0.560	0.576	0.593	0.609	0.625	0.642
4000	0.658	0.675	0.691	0.708	0.724	0.741	0.757	0.774	0.790	0.806
5000	0.823	0.839	0.856	0.872	0.889	0.905	0.922	0.938	0.955	0.971
6000	0.988	1.004	1.020	1.037	1.053	1.070	1.086	1.103	1.119	1.136
7000	1.152	1.169	1.185	1.202	1.218	1.234	1.251	1.267	1.284	1.300
8000	1.317	1.333	1.350	1.366	1.383	1.399	1.416	1.432	1.448	1.465
9000	1.481	1.498	1.514	1.531	1.547	1.564	1.580	1.597	1.613	1.629
	0	1000	2000	3000	4000	5000	6000	7000	8000	9000
10000	1.646	1.811	1.975	2.140	2.304	2.469	2.634	2.798	2.963	3.127
20000	3.292	3.457	3.621	3.786	3.950	4.115	4.280	4.444	4.609	4.773
30000	4.938	5.103	5.267	5.432	5.596	5.761	5.926	6.090	6.255	6.419
40000	6.584	6.749	6.913	7.078	7.242	7.407	7.572	7.736	7.901	8.065
50000	8.230	8.395	8.559	8.724	8.888	9.053	9.218	9.382	9.547	9.711

TBL GEN 2.6-7

MB/INS						°C/°F					
MB	INS	MB	INS	MB	INS	°C	°F	°C	°F	°C	°F
948	27.99	982	29.00	1016	30.00	-60	-76.0	-15	15	30	86.0
949	28.02	983	29.03	1017	30.03	-59	-74.2	-14	6.8	31	87.8
950	28.05	984	29.06	1018	30.06	-58	-72.4	-13	8.6	32	89.6
951	28.08	985	29.09	1019	30.09	-57	-70.6	-12	10.4	33	91.4
952	28.11	986	29.12	1020	30.12	-56	-68.8	-11	12.2	34	93.2
953	28.14	987	29.15	1021	30.15	-55	-67.0	-10	14.0	35	95.0
954	28.17	988	29.18	1022	30.18	-54	-65.2	-9	15.8	36	96.8
955	28.20	989	29.21	1023	30.21	-53	-63.4	-8	17.6	37	98.6
956	28.23	990	29.23	1024	30.24	-52	-61.6	-7	19.4	38	100.4
957	28.26	991	29.26	1025	30.27	-51	-59.8	-6	21.2	39	102.2
958	28.29	992	29.29	1026	30.30	-50	-58.0	-5	23.0	40	104.0
959	28.32	993	29.32	1027	30.33	-49	-56.2	-4	24.8	42	105.8
960	28.35	994	29.35	1028	30.36	-48	-54.4	-3	26.6	42	107.6
961	28.38	995	29.38	1029	30.39	-47	-52.6	-2	28.4	43	109.4
962	28.41	996	29.41	1030	30.42	-46	-50.8	-1	30.2	44	111.2
963	28.44	997	29.44	1031	30.45	-45	-49.0	0	32.0	45	113.0
964	28.47	998	29.47	1032	30.47	-44	-47.2	1	33.8	46	114.8
965	28.50	999	29.50	1033	30.50	-43	-45.4	2	35.6	47	116.6
966	28.53	1000	29.53	1034	30.53	-42	-43.6	3	37.4	48	118.4
967	28.56	1001	29.56	1035	30.56	-41	-41.8	4	39.2	49	120.2
968	28.59	1002	29.59	1036	30.59	-40	-40.0	5	41.0	50	122.0
969	28.61	1003	29.62	1037	30.62	-39	-38.2	6	42.8	51	123.8
970	28.64	1004	29.65	1038	30.65	-38	-36.4	7	44.6	52	125.6
971	28.67	1005	29.68	1039	30.68	-37	-34.6	8	46.4	53	127.4
972	28.70	1006	29.71	1040	30.71	-36	-32.8	9	48.2	54	129.2
973	28.73	1007	29.74	1041	30.74	-35	-31.0	10	50.0	55	131.0
974	28.76	1008	29.77	1042	30.77	-34	-29.2	11	51.8	56	132.8
975	28.79	1009	29.80	1043	30.80	-33	-27.4	12	53.6	57	134.6
976	28.82	1010	29.83	1044	30.83	-32	-25.6	13	55.4	58	136.4
977	28.85	1011	29.86	1045	30.86	-31	-23.8	14	57.2	59	138.2
978	28.88	1012	29.88	1046	30.89	-30	-22.0	15	59.0	60	140.0
979	28.91	1013	29.91	1047	30.92	-29	-20.2	16	60.8	61	141.8
980	28.94	1014	29.94	1048	30.95	-28	-18.4	17	62.6	62	143.6
981	28.97	1015	29.97	1049	30.98	-27	-16.6	18	64.4	63	145.4
				1050	31.01	-26	-14.8	19	66.2	64	147.2
						-24	-11.2	21	69.8	66	150.8
						-23	-9.4	22	71.6	67	152.6
						-22	-7.6	23	73.4	68	154.4
						-21	-5.8	24	75.2	69	156.2
						-20	-4.0	25	77.0	70	158.0
						-19	-2.2	26	78.7		
						-18	-0.4	27	80.6		
						-17	1.4	28	82.4		
						-16	3.2	29	84.2		

TBL GEN 2.6-8

litres/imperial gallons						litres/U.S. gallons					
L	IMP	L	IMP	L	IMP	L	U.S.	L	U.S.	L	U.S.
1	.22	41	9.02	81	17.82	1	.26	41	10.83	81	21.40
3	.66	43	9.46	83	18.26	3	.79	43	11.36	83	21.93
4	.88	44	9.68	84	18.48	4	1.06	44	11.63	84	22.19
5	1.10	45	9.90	85	18.70	5	1.32	45	11.89	85	22.46
6	1.32	46	10.12	86	18.92	6	1.59	46	12.15	86	22.72
7	1.54	47	10.34	87	19.14	7	1.85	47	12.42	87	22.99
8	1.76	48	10.56	88	19.36	8	2.11	48	12.68	88	22.35
9	1.98	49	10.78	89	19.58	9	2.38	49	12.95	89	23.51
10	2.20	50	11.00	90	19.80	10	2.64	50	13.21	90	23.78
11	2.42	51	11.22	91	20.02	11	2.91	51	13.47	91	24.04
12	2.64	52	11.44	92	20.24	12	3.17	52	13.74	92	24.31
13	2.86	53	11.66	93	20.46	13	3.44	53	14.00	93	24.57
14	3.08	54	11.88	94	20.68	14	3.70	54	14.27	94	24.84
15	3.30	55	12.10	95	20.90	15	3.96	55	14.53	95	25.10
16	3.52	56	12.32	96	21.12	16	4.23	56	14.80	96	25.36
17	3.74	57	12.54	97	21.34	17	4.49	57	15.06	97	25.63
18	3.86	58	12.76	98	21.56	18	4.76	58	15.32	98	25.89
19	4.18	59	12.98	99	21.78	19	5.02	59	15.59	99	26.16
20	4.40	60	13.20	100	22.00	20	5.28	60	15.85	100	26.42
21	4.62	61	13.42	200	44.00	21	5.55	61	16.12	200	52.84
22	4.84	62	13.64	300	66.00	22	5.81	62	16.38	300	79.26
23	5.06	63	13.86	400	88.00	23	6.08	63	16.65	400	105.68
24	5.28	64	14.08	500	110.00	24	6.34	64	16.91	500	132.10
25	5.50	65	14.30	600	132.00	25	6.61	65	17.17	600	158.52
26	5.72	66	14.52	700	154.00	26	6.87	66	17.44	700	184.94
27	5.94	67	14.74	800	176.00	27	7.13	67	17.70	800	211.36
28	6.16	68	14.96	900	198.00	28	7.40	68	17.97	900	237.78
29	6.38	69	15.18	1000	220.00	29	7.66	69	18.23	1000	264.2
30	6.60	70	15.40	2000	440.00	30	7.93	70	18.49	2000	528.4
31	6.82	71	15.62	3000	660.00	31	8.19	71	18.76	3000	792.6
32	7.04	72	15.84	4000	880.00	32	8.45	72	19.02	4000	1056.8
33	7.26	73	16.06	5000	1100.00	33	8.72	73	19.29	5000	1321.0
34	7.48	74	16.28	6000	1320.00	34	8.98	74	19.55	6000	1585.2
35	7.70	75	16.50	7000	1540.00	35	9.25	75	19.82	7000	1849.4
36	7.92	76	16.72	8000	1760.00	36	9.51	76	20.08	8000	2113.6
37	8.14	77	16.94	9000	1980.00	37	9.78	77	20.34	9000	2377.8
38	8.36	78	17.16	10000	2200.00	38	10.04	78	20.61	10000	2642.0
39	8.58	79	17.38			39	10.30	79	20.87		
40	8.80	80	17.60			40	10.57	80	21.14		

TBL GEN 2.6-9

Kg/lb											
kg	lb	kg	lb	kg	lb	kg	lb	kg	lb	kg	lb
1	2.20	28	61.73	52	114.64	76	167.55	100	220.5	16000	35273.6
2	4.41	29	63.93	53	116.84	77	169.75	200	440.9	17000	37478.2
3	6.61	30	6.14	54	119.05	78	171.96	300	661.4	18000	39682.2
4	8.82	31	68.34	55	121.25	79	174.16	400	881.8	19000	41887.4
5	11.02	32	70.55	56	123.46	80	176.37	500	1102.3	20000	44092.0
6	13.23	33	72.75	57	125.66	81	178.57	600	1322.8	21000	46296.6
7	15.43	34	74.96	58	127.87	82	180.78	700	1543.2	22000	48501.2
8	17.64	35	77.16	59	130.07	83	182.98	800	1763.7	23000	50705.8
9	19.84	36	79.37	60	132.28	84	185.19	900	1984.1	24000	52910.4
10	22.05	37	81.57	61	134.48	85	187.39	1000	2204.6	25000	55115.0
11	24.25	38	83.78	62	136.69	86	189.60	2000	4409.2	26000	57319.6
12	26.46	39	85.98	63	138.98	87	191.80	3000	6613.8	27000	59524.2
13	28.66	40	88.18	64	141.09	88	194.01	4000	8818.4	28000	61728.8
14	30.86	41	90.39	65	143.30	89	196.21	5000	11023.0	29000	63933.5
15	33.07	42	92.59	66	145.50	90	198.41	6000	13227.6	30000	66138.0
16	35.27	43	94.80	67	147.71	91	200.62	7000	15432.2	35000	77161.0
17	37.48	44	97.00	68	149.91	92	202.82	8000	17636.8	40000	88184.0
18	39.68	45	99.21	69	152.12	93	205.03	9000	19841.4	45000	99207.0
19	41.89	46	101.41	70	154.32	94	207.23	10000	22046.0	50000	110230.0
20	44.09	47	103.62	71	156.53	95	209.44	11000	24250.6	60000	132276.0
21	46.30	48	105.82	72	158.73	96	211.64	12000	26455.2	70000	154322.0
22	48.50	49	108.03	73	160.94	97	213.85	13000	28659.8	80000	176368.0
23	50.71	50	110.23	74	163.14	98	216.05	14000	30864.4	90000	198414.0
24	52.91	51	112.44	75	165.35	99	218.26	15000	33069.0	100000	220460.0
25	55.12										
26	57.32										
27	59.52										

GEN 2.7 Sunrise/Sunset Tables

The U.S. does not publish sunrise/sunset tables.

GEN 3. SERVICES

GEN 3.1 Aeronautical Information Services

1. Aeronautical Information Service

1.1 The U.S. Aeronautical Information Service is the National Flight Data Center, which forms a part of the Air Traffic Airspace Management of the Federal Aviation Administration.

Postal Address:
Federal Aviation Administration
National Flight Data Center
800 Independence Avenue, SW.
Washington, D.C. 20591
Telephone: 202-267-9311
Telex: 892-562
Commercial Telegraphic Address: FAA WASH
AFTN Address: KRWAYAYX

1.2 The U.S. NOTAM office is located at the following address:

Postal Address:
Federal Aviation Administration
U.S. NOTAM Office
Air Traffic Control System Command Center
13600 EDS Drive
Herndon, VA 20171-3225
Telephone: 703-904-4557
Toll Free: 1-888-876-6826
Facsimile: 703-904-4437
Telex: 892-562
AFTN Address (Administrative):
KDCAYNXX
AFTN (NOTAM): KDZZNAXX

2. Area of Responsibility of AIS

2.1 The National Flight Data Center is responsible for the collection, validation, and dissemination of aeronautical information for the U.S. and areas under its jurisdiction for air traffic control purposes.

3. Aeronautical Publications

3.1 United States AIP

3.1.1 The AIP, issued in one volume, is the basic aeronautical information document published for

international use. It contains information of a lasting character, with interim updates published in various other publications. The AIP is available in English only and is maintained on a current basis by a 6-month amendment service.

3.2 NOTAM Publication

3.2.1 NOTAM information is published in booklet form every 28 days, entitled Notices to Airmen. This booklet disseminates aeronautical information of operational significance concerning airspace, procedures, and information concerning the status of both international and domestic airports and navigational aids.

3.3 Aeronautical Information Circulars

3.3.1 These circulars, called Advisory Circulars, contain information of general or technical interest relating to administrative or aviation matters which are inappropriate to either the AIP or the NOTAM. Advisory Circulars are available in English only. A checklist of outstanding circulars is issued annually.

3.4 En route Aeronautical Charts, En Route Supplements, Approach Procedure Charts, Regional Airport/Facility Directories

3.4.1 These publications, available in English only, contain specific information on airspace, airports, navigational aids, and flight procedures applicable to the regional areas of the U.S. and the territories and airspace under its jurisdiction. These publications are available by subscription only.

4. Distribution of Publications

4.1 The AIP subscriptions, including amendments, are made available to foreign aeronautical authorities on a reciprocal basis through the Federal Aviation Administration, AAT-30, 800 Independence Avenue, SW., Washington, D.C. 20591 upon request. Address corrections and changes in distribution to foreign aeronautical authorities are also accomplished through this office. See information in paragraph 1.2 for published NOTAMs.

4.2 Private paying subscriptions must be obtained for each separate AIP document from the:

Superintendent of Documents
U.S. Government Printing Office
P. O. Box 371954
Pittsburgh, PA 15250-7954
Telephone: 202-512-1800
Internet: <http://www.gpoaccess.gov>

4.3 Advisory Circulars are available, upon request, from the:

U.S. Department of Transportation
Subsequent Distribution Office
Ardmore East Business Center
3341 Q 75th Avenue
Landover, MD 20785

4.4 All domestic chart and chart products as well as National Imagery and Mapping Agency (NIMA) world-wide products are available upon subscription from the:

NACO Distribution Division
Federal Aviation Administration
Riverdale, Maryland 20737-1199
Telephone: 800-638-8972

5. NOTAM Service

5.1 NOTAM Publication (Postal Distribution)

5.1.1 NOTAM publication distribution, by means of the Notices to Airmen publication, is in booklet form which contains a recapitulation of pertinent or permanent information of concern to airspace, facilities, services, and procedures which are of interest to both international and domestic civil aviation users. The information contained will eventually be published in either the U.S. AIP or in other publications for domestic use, as applicable. The Notices to Airmen publication will also contain information regarding temporary changes or unscheduled interruptions to flight procedures and navigational aids or airport services, the duration of which is expected to last seven or more days. Distribution of the Notices to Airmen publication parallels NOTAM Class I and AIP distribution.

5.2 NOTAM Class I (Telecommunication Distribution)

5.2.1 NOTAM Class I distribution is used mainly for the notification of temporary information of timely

significance such as unforeseen changes in services, facilities, airspace utilization, or any other emergency. Distribution is via telecommunications through the International NOTAM Office of the National Flight Data Center, in accordance with the following classifications:

5.2.1.1 International NOTAM. NOTAM containing full information on all airports, facilities and flight procedures available for use by international civil aviation. NOTAMs are given selected distribution to adjacent or appropriate International NOTAM Offices which require their exchange.

5.2.1.2 International Airspace NOTAM. NOTAM containing short term information pertaining to potentially hazardous international and domestic airspace utilization which is of concern to international flights. NOTAMs are given selected distribution to adjacent or appropriate International NOTAM Offices which require their exchange.

5.2.1.3 International Airspace NOTAM. NOTAM containing permanent changes—en route airway structure/aeronautical service and information of a general nature. NOTAMs are given selected distribution to adjacent or appropriate International NOTAM Offices which require their exchange.

5.2.1.4 International OMEGA and LORAN Facilities status of the OMEGA or LORAN Navigational Aid Facilities. NOTAMs are given selected distribution to adjacent or appropriate International NOTAM Offices which require their exchange.

5.2.1.5 Domestic NOTAM. NOTAM containing information of concern to aircraft other than those engaged in international civil aviation. Distribution is to local or national users only. (See ENR 1.10.)

5.2.2 Each NOTAM is assigned a four digit serial number which is followed by the location indicator for which the series is applicable. The serial numbers start with number 0001 at 0000 UTC on 1 July of each year. Each serial number is preceded by a letter:

5.2.2.1 “A” for NOTAM classification “1.”

NOTE—

NOTAM number one for the year 1984 for the New York, John F. Kennedy International Airport would read A0001/84 KJFK. All NOTAMs issued will be preceded by an “A.”

5.2.2.2 “B” for NOTAM classification “2.” (Air-space): the identifier of the affected air traffic control center/FIR will be used.

NOTE-

NOTAM number one for the year 1984 for the Oakland ARTCC/FIR (Pacific Ocean Area) would read A0001/84 KZOA.

5.2.2.3 “C” for NOTAM classification “3” (Permanent Airspace): The KFDC identifier will be used for data of permanent airway/aeronautical services and of a general nature that are transmitted as NOTAMs and are given selected distribution to adjacent or appropriate International NOTAM Offices which require their exchange.

NOTE-

NOTAM number one for the year 1984 for KFDC is A0001/84 KFDC.

5.2.2.4 “D” for NOTAM classification “4” (OMEGA/LORAN facilities): The KNMH will be used for OMEGA/LORAN information that is transmitted to all NOTAM Offices that exchange information with the U.S. International NOTAM Office.

NOTE-

NOTAM number one for the year 1984 concerning the status of OMEGA Station Norway would read A0001/84 KNMH.

5.2.2.5 “E” for NOTAM classification “5” (domestic): No application (see ENR 1.10.)

5.3 Each NOTAM is provided with an identification letter adjoining the end of the word NOTAM meaning:

5.3.1 NOTAMN: NOTAM containing new information.

5.3.2 NOTAMC: NOTAM cancelling a previous NOTAM indicated.

5.3.3 NOTAMR: NOTAM replacing a previous NOTAM indicated.

5.4 A checklist of NOTAMs currently in force for each international NOTAM classification is issued each month over the Aeronautical Fixed Telecommunications Network (AFTN) to each International NOTAM office which exchanges International NOTAMs with the U.S. International NOTAM Office.

5.5 NOTAM Class I information is exchanged between the U.S. International NOTAM Office and the following International NOTAM Offices.

TBL GEN 3.1-1

COUNTRY	CITY
AFGHANISTAN	KABUL
ALBANIA	ROME
ALGERIA	ALGIERS
ANGOLA	LUANDA
ARGENTINA	BUENOS AIRES
AUSTRALIA	SIDNEY
AUSTRIA	VIENNA
AZORES	SANTO MARIA
BAHAMAS	NASSAU
BAHRAIN	BAHRAIN
BANGLADESH	DHAKA (DACCA)
BELGIUM	BRUSSELS
BERMUDA	BERMUDA
BOLIVIA	LA PAZ
BOSNIA	ZAGREB
BRAZIL	RIO DE JANEIRO
BULGARIA	SOFIA
CAMBODIA	PHNOM-PEHN
CANADA	OTTAWA
CAPE VERDE ISLANDS	AMILCAR CABRAL
CHILE	SANTIAGO
CHINA	BEIJING
CHINA (FORMOSA)	TAIPEI
COLOMBIA	BOGOTA
CONGO	BRAZZAVILLE
CROATIA	ZAGREB
CUBA	HAVANA
CYPRUS	NICOSIA
CZECH REPUBLIC	PRAGUE
DENMARK	COPENHAGEN
DOMINICAN REPUBLIC	SANTO DOMINGO
ECUADOR	GUAYAQUIL
ENGLAND	LONDON
ESTONIA	TALLINN
ETHIOPIA	ADDIS ABABA
EYGPT	CAIRO
FIJI	NANDI
FINLAND	HELSINKI
FRANCE	PARIS

COUNTRY	CITY
FRENCH GUIANA	MARTINIQUE
FRENCH POLYNESIA	TAHITI
GERMANY (WEST)	FRANKFURT
GHANA	ACCRA
GREECE	ATHENS
GREENLAND	SONDRE STROMFJORD
GUYANA	GEORGETOWN
HAITI	PORT-AU-PRINCE
HONDURAS	TEQUICIGALPA
HONG KONG	HONG KONG
HUNGARY	BUDAPEST
ICELAND	REYKJAVIK
INDIA	BOMBAY
INDIA	CALCUTTA
INDIA	DELHI
INDIA	MADRAS
INDONESIA	JAKARTA
IRAN	TEHRAN (NOT AVBL)
IRELAND	SHANNON
ISRAEL	TEL AVIV
ITALY	ROME
JAMAICA	KINGSTON
JAPAN	TOKYO
JORDAN	AMMAN
KENYA	NAIROBI
KOREA (SOUTH)	SEOUL
KUWAIT	KUWAIT
LATVIA	MOSCOW
LEBANON	BEIRUT
LIBERIA	ROBERTS
LIBYA	TRIPOLI
MALAYSIA	KUALA LUMPUR
MALTA	LUQA
MAURITIUS	PLAISANCE
MAYNMAR	RANGOON
MEXICO	MEXICO CITY
MOROCCO	CASABLANCA
MOZAMBIQUE	MAPUTO
NAMIBIA	JOHANNESBURG
NAURU ISLAND	NAURU
NETHERLANDS	AMSTERDAM
NETHERLANDS ANTILLES	CURACAO

COUNTRY	CITY
NEW GUINEA	PORT MOSEBY
NEW ZEALAND	AUCKLAND
NIGERIA	LAGOS
NORWAY	OSLO
OMAN	MUSCAT
PAKISTAN	KARACHI
PANAMA	TOCUMEN
PARAGUAY	ASUNCION
PERU	LIMA
PHILLIPINES	MANILLA
POLAND	WARSAW
PORTUGAL	LISBON
ROMANIA	BUCHAREST
RUSSIA	MOSCOW
SAMOA	FALEOLA
SAUDI ARABIA	JEDDAH
SENEGAL	DAKAR
SEYCHELLES	MAHE
SINGAPORE	SINGAPORE
SLOVAKIA	BRATISLAVA
SOLOMON ISLANDS	HONIARA
SOUTH AFRICA	JOHANNESBURG
SPAIN	MADRID
SRI LANKA	COLOMBO
SUDAN	KHARTOUM
SURINAME	PARAMARIBO
SWEDEN	STOCKHOLM
SWITZERLAND	ZURICH
SYRIA	DAMASCUS
TANZANIA	DAR-ES-SALAAM
THAILAND	BANKOK
TRINIDAD	PORT OF SPAIN
TUNISIA	TUNIS
TURKEY	ANKARA
URUGUAY	MONTEVIDEO
VIET NAM	HO CHI MINH CITY
VENEZUELA	CARACAS
YEMEN	ADEN
YUGOSLAVIA	BELGRADE
ZAIRE	KINSHASA
ZAMBIA	LUSAKA
ZIMBABWE	HARARE

6. Pre-Flight Information Service at Aerodromes Available to International Flights

6.1 Pre-Flight Information Units in the U.S. are Flight Service Stations (FSS) operated by either FAA (in Alaska) or by federal contract facilities (elsewhere in the U.S.).

6.2 Flight Service Stations (FSSs) are air traffic facilities which provide pilot briefings, flight plan processing, en route radio communications, search and rescue services, and assistance to lost aircraft and aircraft in emergency situations. FSSs also relay ATC clearances, process Notices to Airmen, broadcast aviation weather and aeronautical information, and notify Customs and Border

Protection of transborder flights. In addition, at selected locations FSSs provide En Route Flight Advisory Service (Flight Watch) and Airport Advisory Service (AAS). In Alaska, designated FSSs also provide TWEB recordings and take weather observations.

6.3 FSS locations, services and telephone information are available in the U.S. Airport/Facility Directory, Supplement Alaska, and Pacific Chart Supplement.

6.4 Flight Service Stations have telecommunications access to all of the weather and NOTAM information available for preflight briefing to international locations with which the U.S. International NOTAM office exchanges information.

GEN 3.2 Aeronautical Charts

1. General

1.1 Civil aeronautical charts for the U.S. and its territories, and possessions are produced by the National Aeronautical Charting Office (NACO), <http://www.naco.faa.gov>, which is part of FAA's office of Technical Operations Aviation Systems Standards.

2. Obtaining Aeronautical Charts

2.1 Most charts and publications described in this chapter can be obtained by subscription or one-time sales from:

NACO Distribution Division
Federal Aviation Administration
6303 Ivy Lane, Suite 400
Greenbelt, MD 20770
Telephone: 1-800-638-8972
(Toll free within U.S.)
301-436-8301/6990
301-436-6829 (FAX)

e-mail: 9-AMC-Chartsales@faa.gov

2.2 Public sales of charts and publications are also available through a network of FAA chart agents primarily located at or near major civil airports. A listing of products and agents is printed in the free FAA catalog, *Aeronautical Charts and Related Products*. (FAA Stock No. ACATSET). A free quarterly bulletin, *Dates of Latest Editions*, (FAA Stock No. 5318), is also available from NACO.

3. Selected Charts and Products Available

VFR Navigation Charts
IFR Navigation Charts
Planning Charts
Supplementary Charts and Publications
Digital Products

4. General Description of Each Chart Series

4.1 VFR Navigation Charts

4.1.1 Sectional Aeronautical Charts. Sectional Charts are designed for visual navigation of slow to medium speed aircraft. The topographic information consists of contour lines, shaded relief, drainage

patterns, and an extensive selection of visual checkpoints and landmarks used for flight under VFR. Cultural features include cities and towns, roads, railroads, and other distinct landmarks. The aeronautical information includes visual and radio aids to navigation, airports, controlled airspace, special-use airspace, obstructions, and related data. Scale 1 inch = 6.86nm/1:500,000. 60 x 20 inches folded to 5 x 10 inches. Revised semiannually, except most Alaskan charts are revised annually. (See FIG GEN 3.2-1 and FIG GEN 3.2-11.)

4.1.2 VFR Terminal Area Charts (TAC). TACs depict the airspace designated as Class B airspace. While similar to sectional charts, TACs have more detail because the scale is larger. The TAC should be used by pilots intending to operate to or from airfields within or near Class B or Class C airspace. Areas with TAC coverage are indicated by a • on the Sectional Chart indexes. Scale 1 inch = 3.43nm/1:250,000. Charts are revised semiannually, except Puerto Rico-Virgin Islands which is revised annually. (See FIG GEN 3.2-1 and FIG GEN 3.2-11.)

4.1.3 World Aeronautical Charts (WAC). WACs cover land areas for navigation by moderate speed aircraft operating at high altitudes. Included are city tints, principal roads, railroads, distinctive landmarks, drainage patterns, and relief. Aeronautical information includes visual and radio aids to navigation, airports, airways, special-use airspace, and obstructions. Because of a smaller scale, WACs do not show as much detail as sectional or TACs, and therefore are not recommended for exclusive use by pilots of low speed, low altitude aircraft. Scale 1 inch = 13.7nm/ 1:1,000,000. 60 x 20 inches folded to 5 x 10 inches. WACs are revised annually, except for a few in Alaska and the Caribbean, which are revised biennially. (See FIG GEN 3.2-12 and FIG GEN 3.2-13.)

4.1.4 U.S. Gulf Coast VFR Aeronautical Chart. The Gulf Coast Chart is designed primarily for helicopter operation in the Gulf of Mexico area. Information depicted includes offshore mineral leasing areas and blocks, oil drilling platforms, and high density helicopter activity areas. Scale 1 inch = 13.7nm/1:1,000,000. 55 x 27 inches folded to 5 x 10 inches. Revised annually.

FIG GEN 3.2-1
Sectional and VFR Terminal Area Charts for the Conterminous U.S.,
Hawaii, Puerto Rico, and Virgin Islands

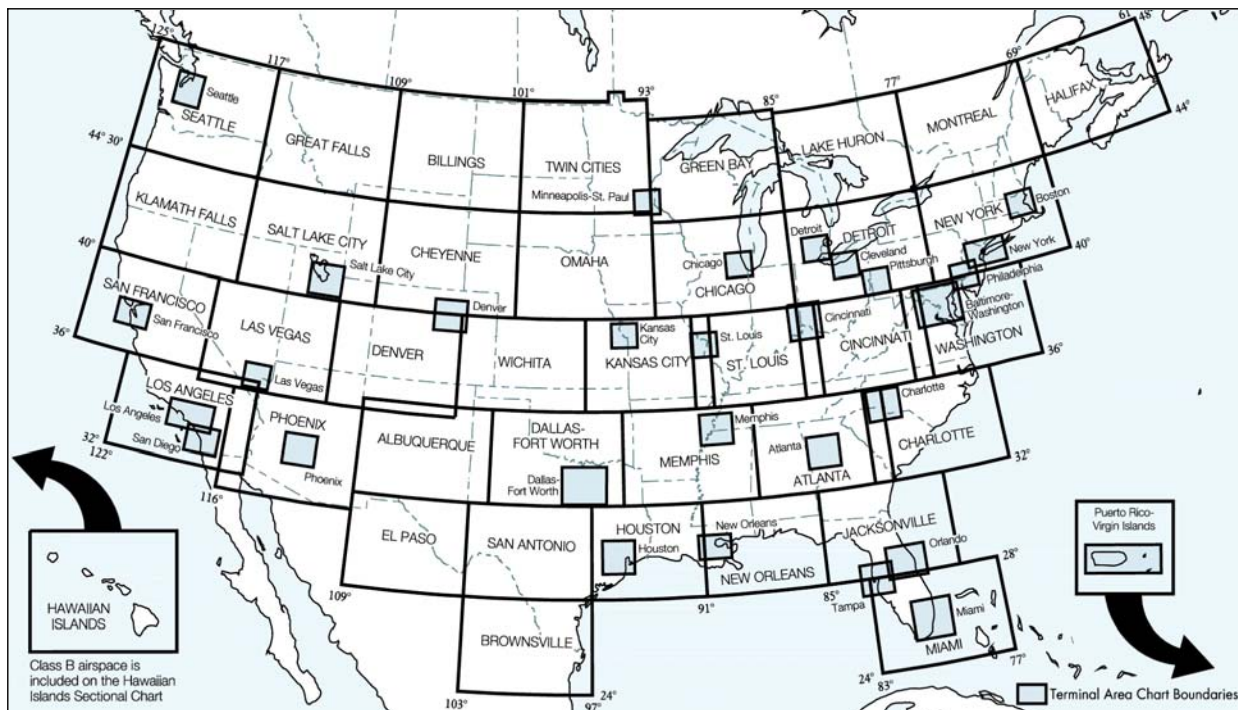

4.1.5 Grand Canyon VFR Aeronautical Chart.

Covers the Grand Canyon National Park area and is designed to promote aviation safety, flight free zones, and facilitate VFR navigation in this popular area. The chart contains aeronautical information for general aviation VFR pilots on one side and commercial VFR air tour operators on the other side.

4.1.6 Helicopter Route Charts. A three-color chart series which shows current aeronautical information useful to helicopter pilots navigating in areas with high concentrations of helicopter activity. Information depicted includes helicopter routes, four classes of heliports with associated frequency and lighting capabilities, NAVAIDs, and obstructions. In addition, pictorial symbols, roads, and easily identified geographical features are portrayed. Helicopter charts have a longer life span than other chart products and may be current for several years. All new editions of these charts are printed on a durable plastic material. Helicopter Route Charts are updated as requested by the FAA. Scale 1 inch = 1.71nm/1:125,000. 34 x 30 inches folded to 5 x 10 inches.

4.2 IFR Navigation Charts

4.2.1 IFR Enroute Low Altitude Charts (Conterminous U.S. and Alaska). Enroute low altitude charts provide aeronautical information for navigation under IFR conditions below 18,000 feet MSL. This four-color chart series includes airways; limits of controlled airspace; VHF NAVAIDs with frequency, identification, channel, geographic coordinates; airports with terminal air/ground communications; minimum enroute and obstruction clearance altitudes; airway distances; reporting points; special use airspace; and military training routes. Scales vary from 1 inch = 5nm to 1 inch = 20nm. 50 x 20 inches folded to 5 x 10 inches. Charts revised every 56 days. *Area charts* show congested terminal areas at a large scale. They are included with subscriptions to any conterminous U.S. Set Low (Full set, East or West sets). (See FIG GEN 3.2-2 and FIG GEN 3.2-4.)

FIG GEN 3.2-2
Enroute Low Altitude Instrument Charts for the Conterminous U.S. (Includes Area Charts)

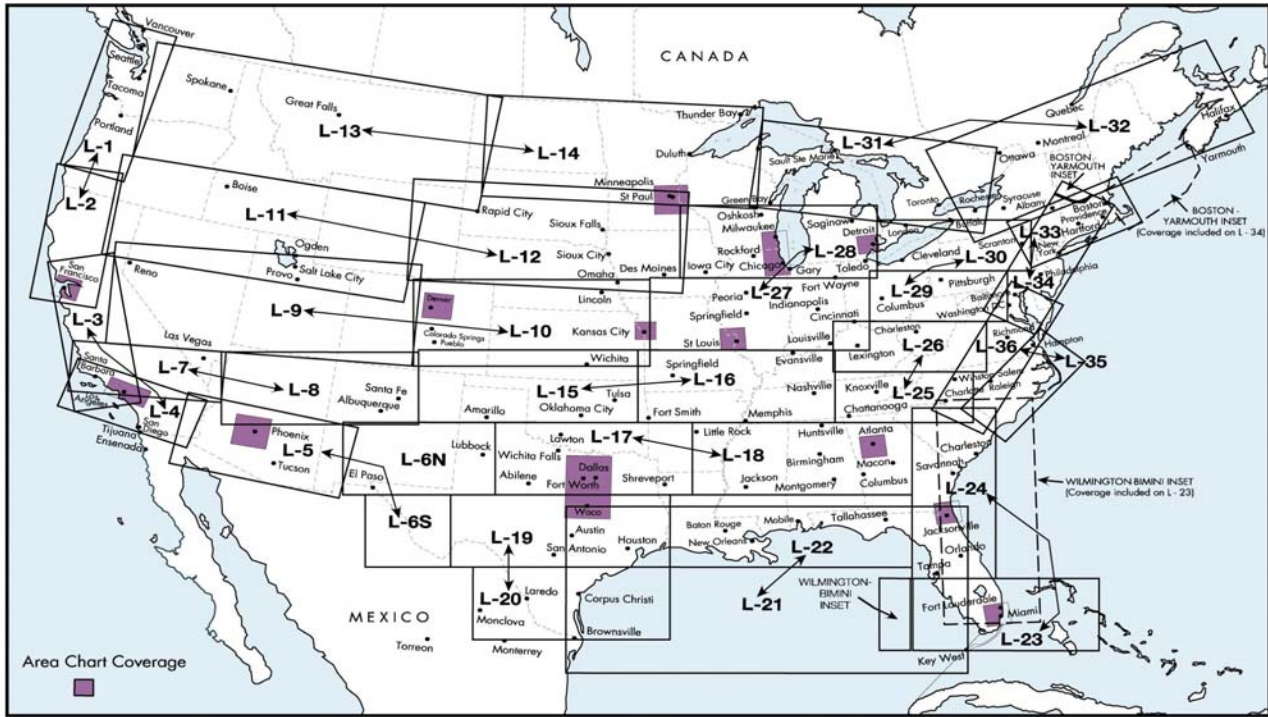
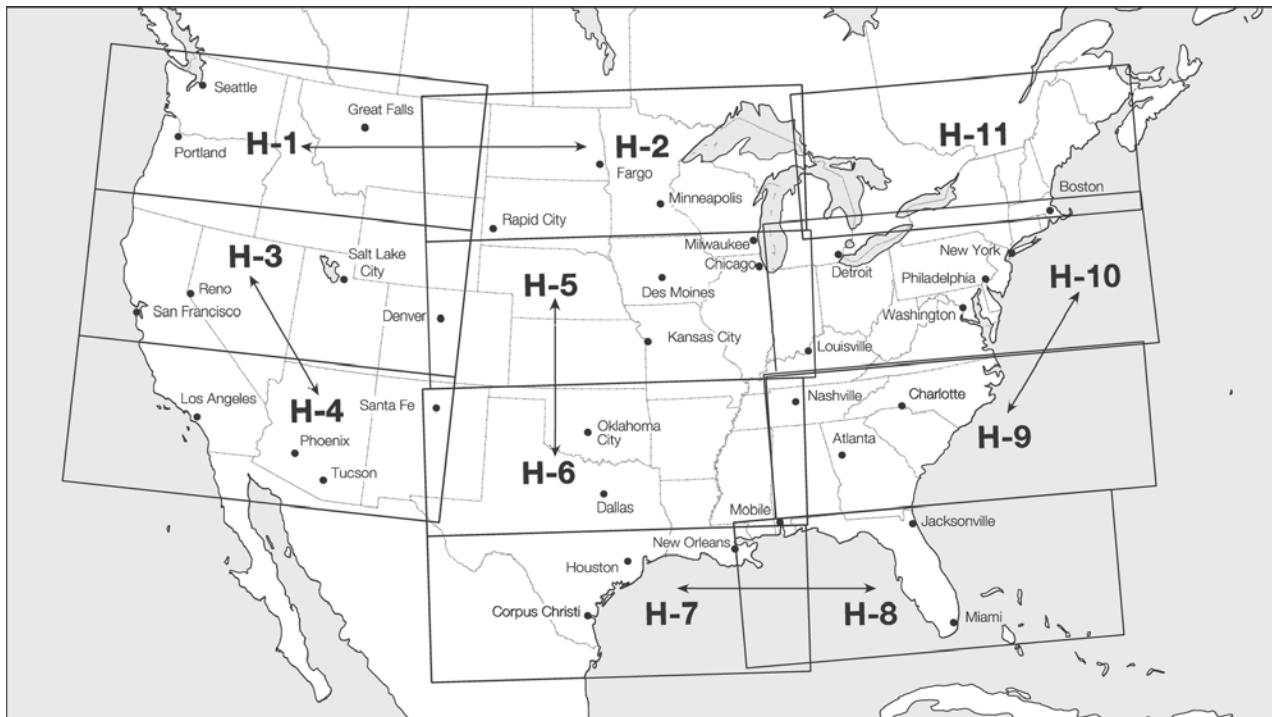

FIG GEN 3.2-3
Enroute High Altitude Charts for the Conterminous U.S.



4.2.2 IFR Enroute High Altitude Charts (Conterminous U.S. and Alaska). Enroute high altitude charts are designed for navigation at or above 18,000 feet MSL. This four-color chart series includes the jet route structure; VHF NAVAIDs with frequency,

identification, channel, geographic coordinates; selected airports; reporting points. Scales vary from 1 inch = 45nm to 1 inch = 18nm. 55 x 20 inches folded to 5 x 10 inches. Revised every 56 days. (See FIG GEN 3.2-3 and FIG GEN 3.2-5.)

**FIG GEN 3.2-4
Alaska Enroute Low Altitude Chart**

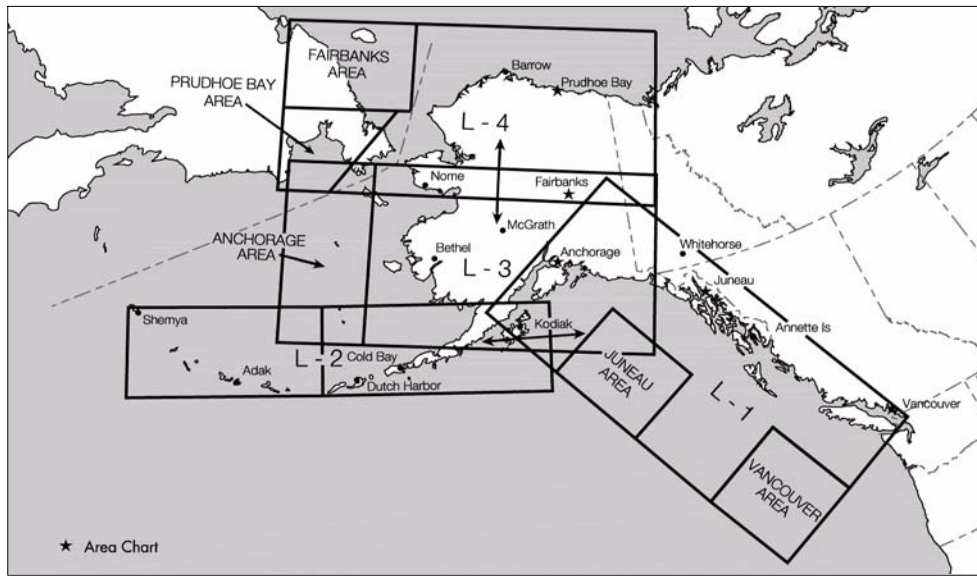

**FIG GEN 3.2-5
Alaskan Enroute High Altitude Chart**

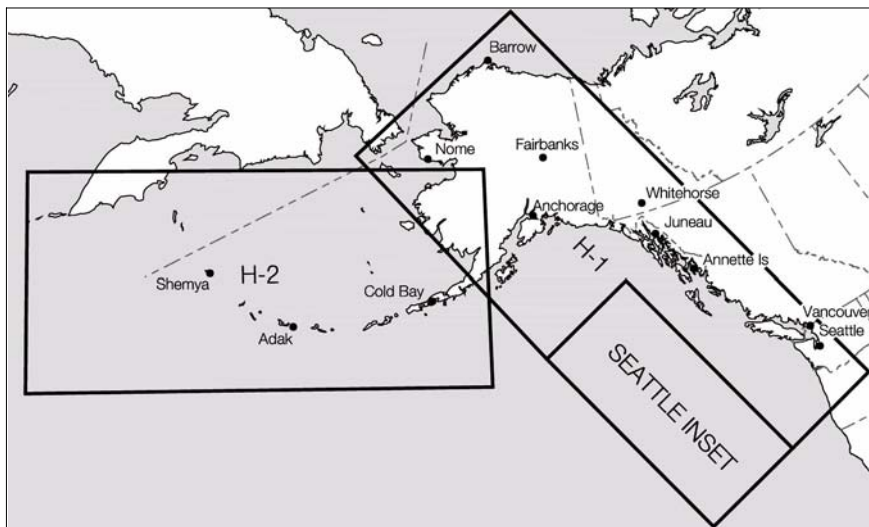

4.2.3 U.S. Terminal Procedures Publication (TPP). TPPs are published in 24 loose-leaf or perfect bound volumes covering the conterminous U.S., Puerto Rico, and the Virgin Islands. A Change Notice is published at the midpoint between revisions in bound volume format and is available on the internet for free download at the NACO web site. (See FIG GEN 3.2-10.) The TPPs include:

4.2.3.1 Instrument Approach Procedure (IAP) Charts. IAP charts portray the aeronautical data that is required to execute instrument approaches to airports. Each chart depicts the IAP, all related navigation data, communications information, and an airport sketch. Each procedure is designated for use with a specific electronic navigational aid, such as ILS, VOR, NDB, RNAV, etc.

4.2.3.2 Instrument Departure Procedure (DP) Charts. DP charts are designed to expedite clearance delivery and to facilitate transition between takeoff and en route operations. They furnish pilots' departure routing clearance information in graphic and textual form.

4.2.3.3 Standard Terminal Arrival (STAR) Charts. STAR charts are designed to expedite ATC arrival procedures and to facilitate transition between en route and instrument approach operations. They depict preplanned IFR ATC arrival procedures in graphic and textual form. Each STAR procedure is presented as a separate chart and may serve either a single airport or more than one airport in a given geographic area.

4.2.3.4 Airport Diagrams. Full page airport diagrams are designed to assist in the movement of ground traffic at locations with complex runway/taxiway configurations and provide information for updating geodetic position navigational systems aboard aircraft. Airport diagrams are available for free download at the NACO website.

4.2.4 Alaska Terminal Procedures Publication. This publication contains all terminal flight procedures for civil and military aviation in Alaska. Included are IAP charts, DP charts, STAR charts, airport diagrams, radar minimums, and supplementary support data such as IFR alternate minimums, take-off minimums, rate of descent tables, rate of

climb tables and inoperative components tables. Volume is 5-3/8 x 8-1/4 inch top bound. Publication revised every 56 days with provisions for a Terminal Change Notice, as required.

4.3 Planning Charts

4.3.1 U.S. IFR/VFR Low Altitude Planning Chart. This chart is designed for preflight and en route flight planning for IFR/VFR flights. Depiction includes low altitude airways and mileage, NAVAIDs, airports, special use airspace, cities, times zones, major drainage, a directory of airports with their airspace classification, and a mileage table showing great circle distances between major airports. Scale 1 inch = 47nm/ 1:3,400,000. Chart revised annually, and is available either folded or unfolded for wall mounting. (See FIG GEN 3.2-6.)

FIG GEN 3.2-6
Planning Charts

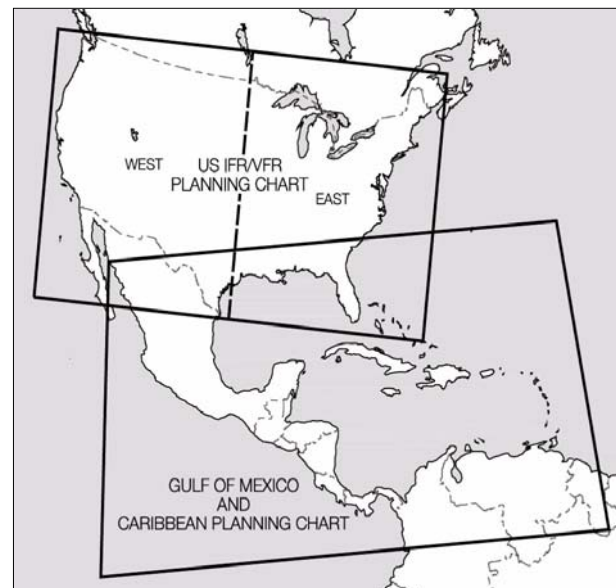

4.3.2 Gulf of Mexico and Caribbean Planning Chart. This is a VFR planning chart on the reverse side of the *Puerto Rico – Virgin Islands VFR Terminal Area Chart*. Information shown includes mileage between airports of entry, a selection of special use airspace and a directory of airports with their available services. Scale 1 inch = 85nm/1:6,192,178. 60 x 20 inches folded to 5 x 10 inches. The chart is revised annually. (See FIG GEN 3.2-6.)

FIG GEN 3.2-7
Airport/Facility Directory Geographic Areas

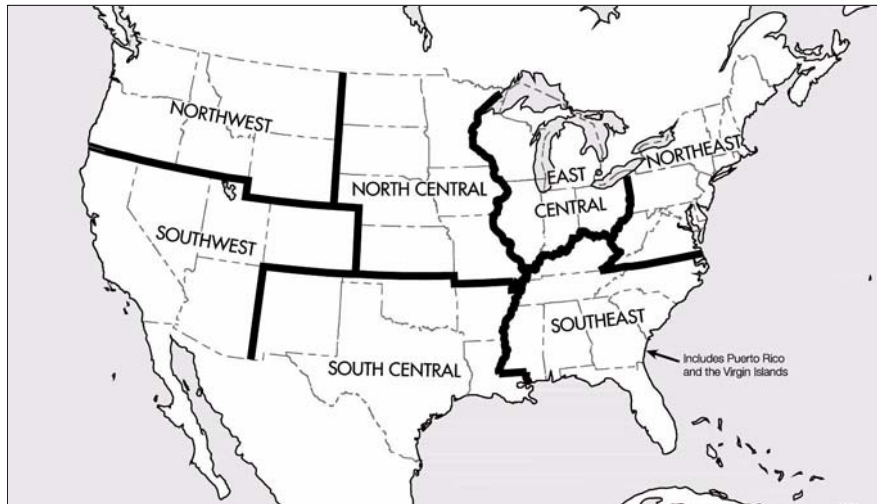

4.3.3 Charted VFR Flyway Planning Charts.

This chart is printed on the reverse side of selected TAC charts. The coverage is the same as the associated TAC. Flyway planning charts depict flight paths and altitudes recommended for use to bypass high traffic areas. Ground references are provided as a guide for visual orientation. Flyway planning charts are designed for use in conjunction with TACs and sectional charts and are not to be used for navigation. Chart scale 1 inch = 3.43nm/1:250,000.

4.4 Supplementary Charts and Publications

4.4.1 Airport/Facility Directory (A/FD). This 7-volume booklet series contains data on airports, seaplane bases, heliports, NAVAIDs, communications data, weather data sources, airspace, special notices, and operational procedures. Coverage includes the conterminous U.S., Puerto Rico, and the Virgin Islands. The A/FD shows data that cannot be readily depicted in graphic form; e.g. airport hours of operations, types of fuel available, runway widths, lighting codes, etc. The chart bulletin section of the A/FD also provides a means for pilots to update visual charts between edition dates. (A/FD is published every 56 days while sectional and Terminal Area Charts are generally revised every six months). The

VFR Chart Update Bulletins are available for free download from the NACO web site. Volumes are side-bound 5-3/8 x 8-1/4 inches. (See FIG GEN 3.2-7.)

4.4.2 Supplement Alaska. This is a civil/military flight information publication issued by FAA every 56 days. It is a single volume booklet designed for use with appropriate IFR or VFR charts. The Supplement Alaska contains an airport/facility directory, airport sketches, communications data, weather data sources, airspace, listing of navigational facilities, and special notices and procedures. Volume is side-bound 5-3/8 x 8-1/4 inches.

4.4.3 Chart Supplement Pacific. This supplement is designed for use with appropriate VFR or IFR enroute charts. Included in this one-volume booklet are the airport/facility directory, communications data, weather data sources, airspace, navigational facilities, special notices, and Pacific area procedures. IAP charts, DP charts, STAR charts, airport diagrams, radar minimums, and supporting data for the Hawaiian and Pacific Islands are included. The manual is published every 56 days. Volume is side-bound 5-3/8 x 8-1/4 inches.

4.4.4 North Pacific Route Charts. These charts are designed for FAA controllers to monitor transoceanic flights. They show established intercontinental air routes, including reporting points with geographic positions. Composite Chart: scale 1 inch = 164NM/1:12,000,000. 48 x 41-1/2 inches. Area Charts: scale 1 inch = 95.9nm/1:7,000,000. 52 x 40-1/2 inches. All charts are shipped unfolded. Charts are revised every 56 days. (See FIG GEN 3.2-8.)

4.4.5 North Atlantic Route Chart. Designed for FAA controllers to monitor transatlantic flights, this 5-color chart shows oceanic control areas, coastal navigation aids, oceanic reporting points, and NAVAID geographic coordinates. Full Size Chart: scale 1 inch = 113.1nm/1:8,250,000. Chart is shipped flat only. Half Size Chart: scale 1 inch = 150.8nm/1:11,000,000. Chart is 29-3/4 x 20-1/2 inches, shipped folded to 5 x 10 inches only. Chart are revised every 56 days. (See FIG GEN 3.2-9.)

FIG GEN 3.2-8
North Pacific Oceanic Route Charts

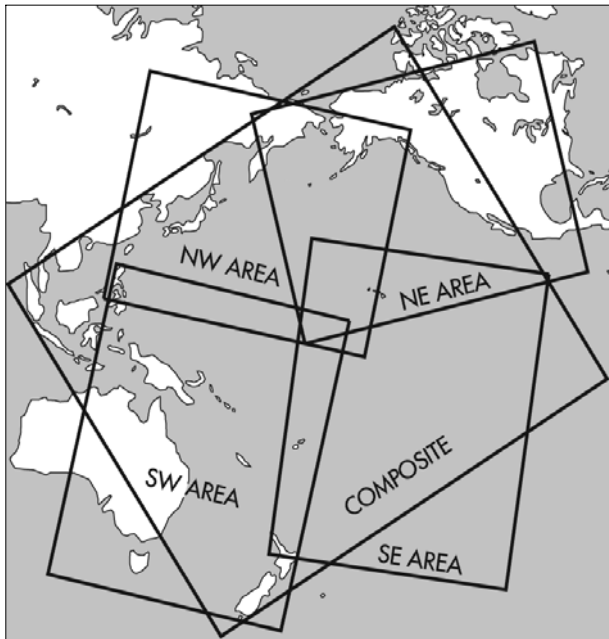
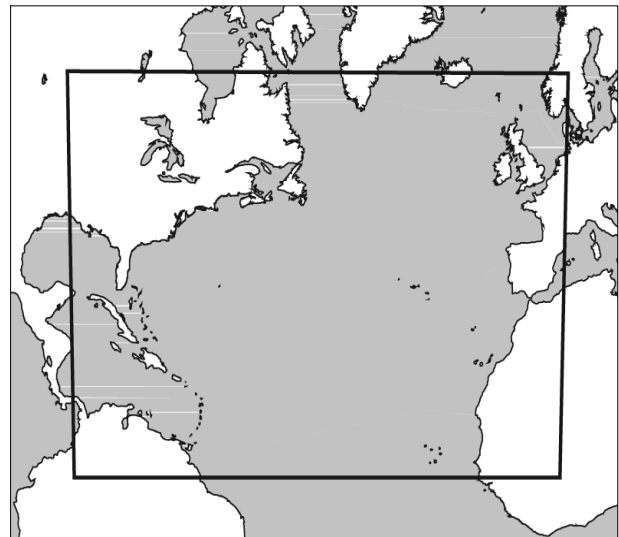

FIG GEN 3.2-9
North Atlantic Route Chart



4.4.6 Airport Obstruction Charts (OC). The OC is a 1:12,000 scale graphic depicting 14 CFR Part 77, *Objects Affecting Navigable Airspace* surfaces, a representation of objects that penetrate these surfaces, aircraft movement and apron areas, navigational aids, prominent airport buildings, and a selection of roads and other planimetric detail in the airport vicinity. Also included are tabulations of runway and other operational data.

4.4.7 FAA Aeronautical Chart User’s Guide. A booklet designed to be used as a teaching aid and reference document. It describes the substantial amount of information provided on FAA’s aeronautical charts and publications. It includes explanations and illustrations of chart terms and symbols organized by chart type. The users guide is available for free download at the NACO web site.

4.5 Digital Products

4.5.1 The Digital Aeronautical Information CD (DAICD). The DAICD is a combination of the NAVAID Digital Data File, the Digital Chart Supplement, and the Digital Obstacle File on one Compact Disk. These three digital products are no longer sold separately. The files are updated every 56 days and are available by subscription only.

4.5.1.1 The NAVAID Digital Data File. This file contains a current listing of NAVAIDs that are compatible with the National Airspace System. This file contains all NAVAIDs including ILS and its components, in the U.S., Puerto Rico, and the Virgin Islands plus bordering facilities in Canada, Mexico, and the Atlantic and Pacific areas.

4.5.1.2 The Digital Obstacle File. This file describes all obstacles of interest to aviation users in the U.S., with limited coverage of the Pacific, Caribbean, Canada, and Mexico. The obstacles are assigned unique numerical identifiers, accuracy codes, and listed in order of ascending latitude within each state or area.

4.5.1.3 The Digital Aeronautical Chart Supplement (DACS). The DACS is specifically designed to provide digital airspace data not otherwise readily available. The supplement includes a *Change Notice* for IAPFIX.dat at the mid–point between revisions. The *Change Notice* is available only by free download from the NACO website.

The DACS individual data files are:

ENHIGH.DAT: High altitude airways (conterminous U.S.)

ENLOW.DAT: Low altitude airways (conterminous U.S.)

IAPFIX.DAT: Selected instrument approach procedure NAVAID and fix data.

MTRFIX.DAT: Military training routes data.

ALHIGH.DAT: Alaska high altitude airways data.

ALLOW.DAT: Alaska low altitude airways data.

PR.DAT: Puerto Rico airways data.

HAWAII.DAT: Hawaii airways data.

BAHAMA.DAT: Bahamas routes data.

OCEANIC.DAT: Oceanic routes data.

STARS.DAT: Standard terminal arrivals data.

DP.DAT: Instrument departure procedures data.

LOPREF.DAT: Preferred low altitude IFR routes data.

HIPREF.DAT: Preferred high altitude IFR routes data.

ARF.DAT: Air route radar facilities data.

ASR.DAT: Airport surveillance radar facilities data.

4.5.2 The National Flight Database (NFD) (ARINC 424 [Ver 13 & 15]). The NFD is a basic digital dataset, modeled to an international standard, which can be used as a basis to support GPS navigation. Initial data elements included are: Airport and Helicopter Records, VHF and NDB Navigation aids, en route waypoints and airways. Additional data elements will be added in subsequent releases to include: departure procedures, standard terminal arrivals, and GPS/RNAV instrument approach procedures. The database is updated every 28 days. The data is available by subscription only and is distributed on CD–ROM or by ftp download.

4.5.3 Sectional Raster Aeronautical Charts (SRAC). These digital VFR charts are geo–referenced scanned images of FAA sectional charts. Additional digital data may easily be overlaid on the raster image using commonly available Geographic Information System software. Data such as weather, temporary flight restrictions, obstacles, or other geospatial data can be combined with SRAC data to support a variety of needs. Most SRACs are provided in two halves, a north side and a south side. The file resolution is 200 dots per inch and the data is 8–bit color. The data is provided as a GeoTIFF and distributed on DVD–R media. The root mean square error of the transformation will not exceed two pixels. SRACs DVDs are updated every 28 days and are available by subscription only.

FIG GEN 3.2-10
U.S. Terminal Publication Volumes

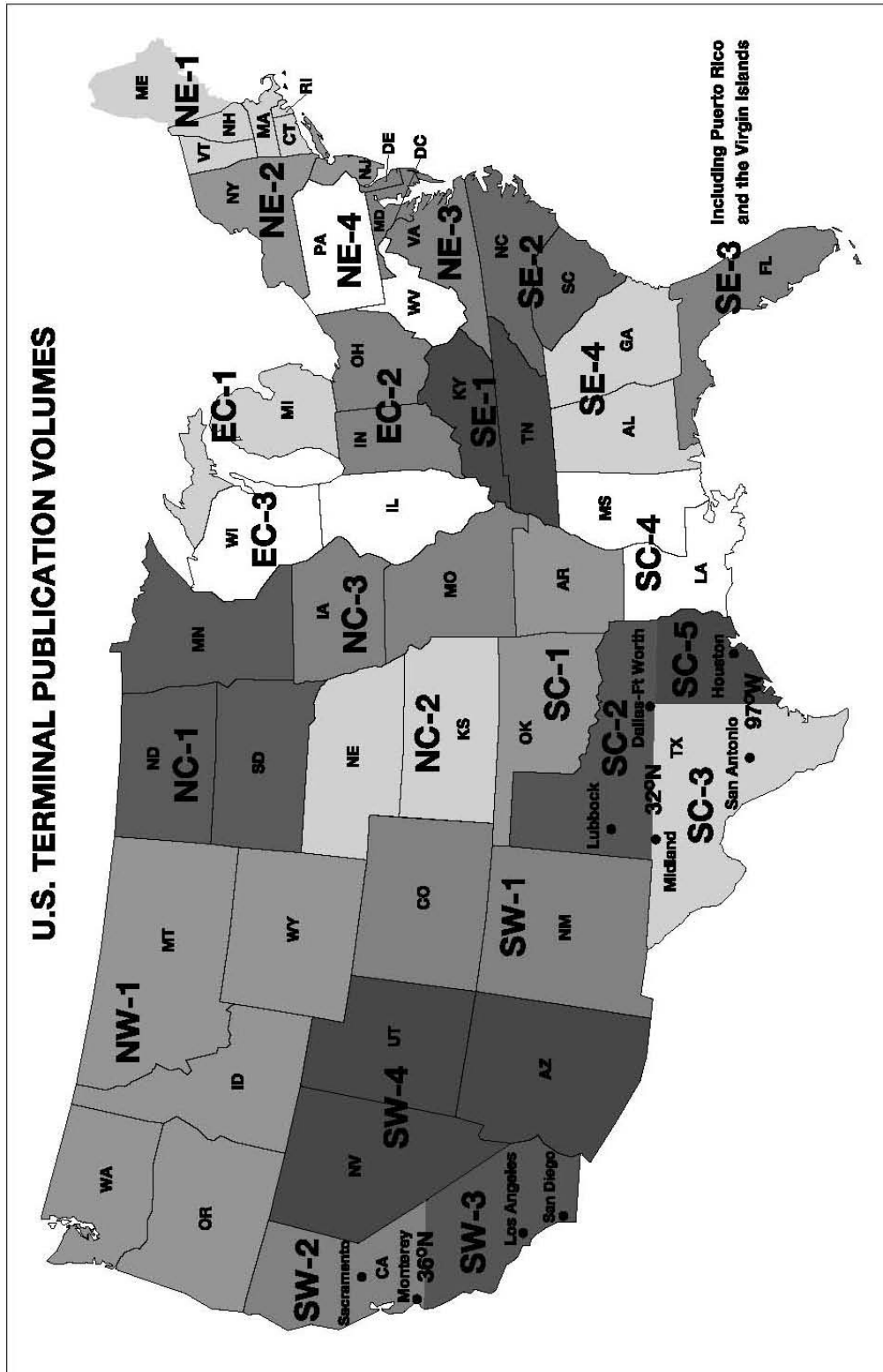

FIG GEN 3.2-II
Sectional and VFR Terminal Area Charts for Alaska

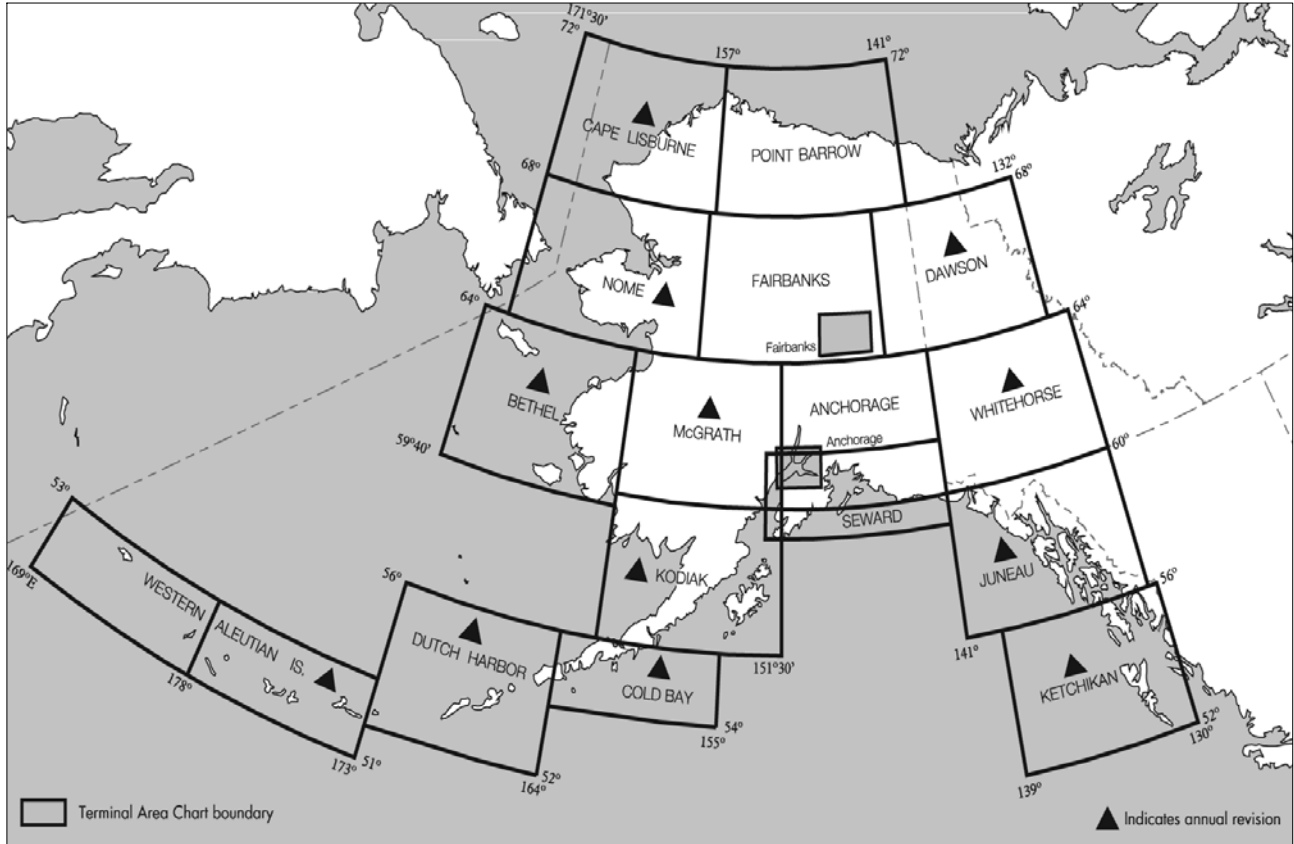

FIG GEN 3.2-12
World Aeronautical Charts for Alaska

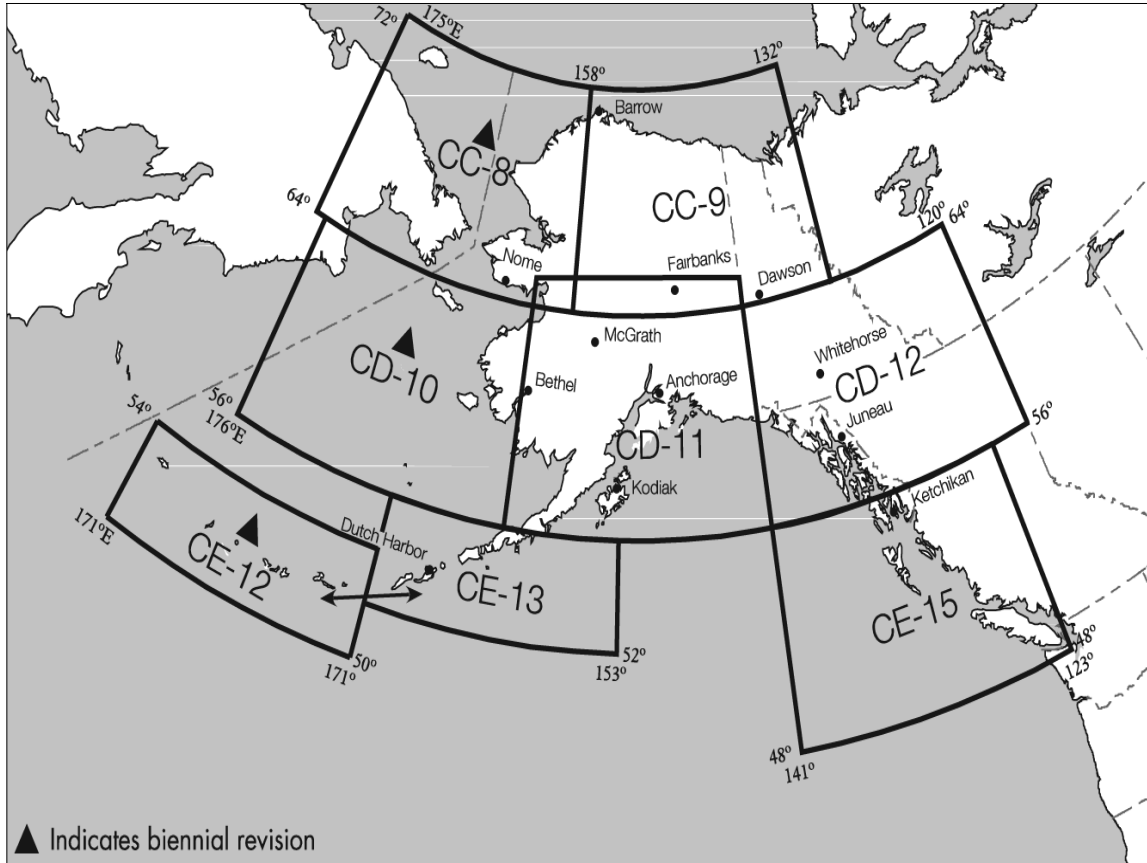

FIG GEN 3.2-13
World Aeronautical Charts for the Conterminous U.S.,
Mexico, and the Caribbean Areas



5. National Imagery and Mapping Agency (NIMA) Products

5.1 How to Order NIMA Products. FAA catalog of *NIMA Public Sale Aeronautical Charts and Publications* (FAA Stock No. DMAACATSET), is available from the FAA NACO Distribution Division. The catalog describes available charts and publications primarily covering areas outside the U.S. A free quarterly bulletin, *Dates of Latest Editions – NIMA Aeronautical Charts and Publications* (FAA Stock No. DADOLE), is also available from FAA.

5.1.1 Flight Information Publication (FLIP) Planning Documents

General Planning (GP)
Area Planning
Area Planning – Special Use Airspace –
Planning Charts

5.1.2 FLIP Enroute Charts and Chart Supplements

Pacific, Australasia, and Antarctica
United States – IFR and VFR Supplements
Flight Information Handbook
Caribbean and South America – Low Altitude
Caribbean and South America – High Altitude
Europe, North Africa, and Middle East –
Low Altitude
Europe, North Africa, and Middle East –
High Altitude
Africa
Eastern Europe and Asia
Area Arrival Charts

5.1.3 FLIP Instrument Approach Procedures (IAPs)

Africa
Canada and North Atlantic
Caribbean and South America
Eastern Europe and Asia
Europe, North Africa, and Middle East
Pacific, Australasia, and Antarctica
VFR Arrival/Departure Routes – Europe and Korea
United States

5.1.4 Miscellaneous DOD Charts and Products

Aeronautical Chart Updating Manual (CHUM)
DOD Weather Plotting Charts (WPC)
Tactical Pilotage Charts (TPC)
Operational Navigation Charts (ONC)
Global Navigation and Planning Charts (GNC)
Global LORAN-C Navigation Charts (GLCC)
LORAN-C Coastal Navigation Charts (LCNC)
Jet Navigation Charts (JNC) and Universal Jet
Navigation Charts (JNU)
Jet Navigation Charts (JNCA)
Aerospace Planning Charts (ASC)
Oceanic Planning Charts (OPC)
Joint Operations Graphics – Air (JOG-A)
Standard Index Charts (SIC)
Universal Plotting Sheet (VP-OS)
Sight Reduction Tables for Air Navigation (PUB249)
Plotting Sheets (VP-30)
Dial-Up Electronic CHUM

GEN 3.3 Air Traffic Services

1. Responsible Authority

1.1 The authority responsible for the overall administration of air traffic services provided for civil aviation in the U.S. and its territories, possessions and international airspace under its jurisdiction is the Associate Administrator for Air Traffic Services, acting under the authority of the Federal Aviation Administration (FAA).

Postal Address:

Director
Air Traffic Operations Program (ATP-1)
Federal Aviation Administration
800 Independence Ave., SW
Washington, D.C. 20591
U.S.A.
Telephone: 202-267-9155
Telex: 892-562
Commercial Telegraphic Address: FAA WSH
AFTN Address: KDCAYAYX

2. Area of Responsibility

2.1 Air traffic services as indicated in the following paragraphs are provided for the entire territory of the conterminous U.S., Alaska, Hawaii, Puerto Rico and the U.S. Virgin Islands, as well as the international airspace in oceanic areas under the jurisdiction of the U.S. which lies within the ICAO Caribbean (CAR), North Atlantic (NAT), North American (NAM) and Pacific (PAC) regions.

3. Air Traffic Services

3.1 With the exception of terminal control services at certain civil aerodromes and military aerodromes, air traffic service in the U.S. is provided by the Air Traffic Operations Program, FAA, Department of Transportation (DOT), U.S. Government.

3.2 Air Traffic control is exercised within the area of responsibility of the U.S.:

3.2.1 On all airways.

3.2.2 In Class B, C, D, and E Airspace; and

3.2.3 Within the Class A airspace whose vertical extent is from 18,000 feet to and including FL 600 throughout most of the conterminous U.S. and, in Alaska, from 18,000 feet to and including FL 600 but

not including the airspace less than 1,500 feet above the surface of the earth and the Alaskan Peninsula west of longitude 160° 00 West. (A complete description of Class A airspace is contained in the Code of Federal Regulations (CFR), Title 14, Part 71.)

3.3 Air traffic control and alerting services are provided by various air traffic control (ATC) units and are described in ENR 1.1.

3.4 Radar service is an integral part of the air traffic system. A description of radar services and procedures is provided in ENR 1.1.

3.5 The description of airspace designated for air traffic services is found in ENR 1.4.

3.6 Procedural data and descriptions are found in ENR 1.5.

3.7 Numerous restricted and prohibited areas are established within U.S. territory. These areas, none of which interfere with normal air traffic, are explained in ENR 1.5. Activation of areas subject to intermittent activity is notified in advance by a Notice to Airmen (NOTAM), giving reference to the area by its identification.

3.8 In general, the air traffic rules and procedures in force and the organization of the air traffic services are in conformity with ICAO Standards, Recommended Practices and Procedures. Differences between the national and international rules and procedures are given in GEN 1.7. The regional supplementary procedures and altimeter setting procedures are reproduced in full with an indication wherein there is a difference.

3.9 Coordination between the operator and air traffic services is effected in accordance with 2.11 of Annex II, and 2.1.1.4 and 2.1.2.5 of Part VIII of the PANS-RAC (DOC 4444-RAC/501).

3.10 Minimum flight altitudes on the ATS routes as listed in ENR 1.4 have been determined so as to ensure at least 1,000 feet vertical clearance above the highest obstacle within 4 nautical miles (NM) on each side of the centerline of the route. However, where the regular divergence (4.5 degrees) of the navigational aid signal in combination with the distance between the navigational aids could result in the aircraft being more than 4 NM on either side of the centerline, the

4 NM protection limit is increased by the extent to which the divergence is more than 4 NM from the centerline.

3.11 Pilot Visits to Air Traffic Facilities. Pilots are encouraged to visit air traffic facilities (Airport Traffic Control Towers (ATCTs), Air Route Traffic Control Centers (ARTCCs), and Flight Service Stations (FSSs)) and familiarize themselves with the ATC system. On rare occasions, facilities may not be able to approve a visit because of workload or other reasons. Pilots should contact the facility prior to the visit and advise of the number of persons in the group, the time and date of the proposed visit, and the primary interest of the group. With this information available, the facility can prepare an itinerary and have someone available to guide the group through the facility.

3.12 Operation Take-off and Operation Raincheck. Operation Take-off is a program that educates pilots in how best to utilize the FSS modernization efforts and services available in Automated Flight Service Stations (AFSS), as stated in FAA Order 7230.17, Pilot Education Program – Operation Takeoff. Operation Raincheck is a program designed to familiarize pilots with the ATC system, its functions, responsibilities, and benefits.

4. En Route Procedures

4.1 Air Route Traffic Control Center (ARTCC)

An ARTCC is a facility established to provide air traffic control service to aircraft operating on instrument flight rule (IFR) flight plans within CONTROLLED AIRSPACE and principally during the en route phase of flight. When equipment capabilities and controller workload permit, certain advisory/assistance services may be provided to visual flight rule (VFR) aircraft.

4.2 ARTCC Communications

4.2.1 Direct Communications, Controllers and Pilots

4.2.1.1 ARTCCs are capable of direct communications with IFR air traffic on certain frequencies. Maximum communications coverage is possible through the use of Remote Center Air/Ground (RCAG) sites comprised of very high frequency (VHF) and ultra high frequency (UHF) transmitters

and receivers. These sites are located throughout the U.S. Although they may be several hundred miles away from the ARTCC, they are remoted to the various centers by land lines or microwave links. As IFR operations are expedited through the use of direct communications, pilots are requested to use these frequencies strictly for communications pertinent to the control of IFR aircraft. Flight plan filing, en route weather, weather forecasts, and similar data should be requested through Flight Service Stations, company radio, or appropriate military facilities capable of performing these services.

4.2.1.2 An ARTCC is divided into sectors. Each sector is handled by one or a team of controllers and has its own sector discrete frequency. As a flight progresses from one sector to another, the pilot is requested to change to the appropriate sector discrete frequency.

4.2.1.3 Controller Pilot Data Link Communications (CPDLC) is a system that supplements air/ground voice communications. As a result, it expands two-way air traffic control air/ground communications capabilities. Consequently, the air traffic system's operational capacity is increased and any associated air traffic delays become minimized. A related safety benefit is that pilot/controller read-back and hear-back errors will be significantly reduced. The CPDLC's principal operating criteria are:

a) Voice remains the primary and controlling air/ground communications means.

b) Participating aircraft will need to have the appropriate CPDLC avionics equipment in order to receive uplink or transmit downlink messages.

c) CPDLC Build 1 offers four ATC data link services. These are altimeter setting (AS), transfer of communications (TC), initial contact (IC), and menu text messages (MT).

1) Altimeter settings are usually transmitted automatically when a CPDLC session and eligibility has been established with an aircraft. A controller may also manually send an altimeter setting message.

NOTE-

When conducting instrument approach procedures, pilots are responsible to obtain and use the appropriate altimeter setting in accordance with 14 CFR Section 97.20. CPDLC issued altimeter settings are excluded for this purpose.

2) Initial contact is a safety validation transaction that compares a pilot's initiated altitude downlink message with an aircraft's ATC host computer stored altitude. If an altitude mismatch is detected, the controller will verbally provide corrective action.

3) Transfer of communications automatically establishes data link contact with a succeeding sector.

4) Menu text transmissions are scripted nontrajectory altering uplink messages.

NOTE-

Initial use of CPDLC will be at the Miami Air Route Traffic Control Center (ARTCC). Air carriers will be the first users. Subsequently, CPDLC will be made available to all NAS users. Later versions will include trajectory altering services and expanded clearance and advisory message capabilities.

4.2.2 ATC Frequency Change Procedures

4.2.2.1 The following phraseology will be used by controllers to effect a frequency change:

EXAMPLE-

(Aircraft identification) CONTACT (facility name or location name and terminal function) (frequency) AT (time, fix, or altitude).

NOTE-

Pilots are expected to maintain a listening watch on the transferring controller's frequency until the time, fix, or altitude specified. ATC will omit frequency change restrictions whenever pilot compliance is expected upon receipt.

4.2.2.2 The following phraseology should be utilized by pilots for establishing contact with the designated facility:

a) When operating in a radar environment:

1) On initial contact, the pilot should inform the controller of the aircraft's assigned altitude preceded by the words "level," or "climbing to," or "descending to," as appropriate; and the aircraft's present vacating altitude, if applicable.

EXAMPLE-

1. *(Name) CENTER, (aircraft identification), LEVEL (altitude or flight level).*

2. *(Name) CENTER, (aircraft identification), LEAVING (exact altitude or flight level), CLIMBING TO OR DESCENDING TO (altitude or flight level).*

NOTE-

Exact altitude or flight level means to the nearest 100 foot increment. exact altitude or flight level reports on initial contact provide ATC with information required prior to using Mode C altitude information for separation purposes.

b) When operating in a nonradar environment:

1) On initial contact, the pilot should inform the controller of the aircraft's present position, altitude and time estimate for the next reporting point.

EXAMPLE-

(Name) CENTER, (aircraft identification), (POSITION), (altitude), ESTIMATING (reporting point) at (time).

2) After initial contact, when a position report will be made, the pilot should give the controller a complete position report.

EXAMPLE-

(Name) CENTER, (aircraft identification), (position), (time), (altitude), (type of flight plan), (ETA and name of next reporting point), (the name of the next succeeding reporting point), AND (remarks).

REFERENCE-

AIP, Position Reporting, Paragraph 6.

4.2.2.3 At times controllers will ask pilots to verify the fact that they are at a particular altitude. The phraseology used will be: "VERIFY AT (altitude)." In climbing/descending situations, controllers may ask pilots to "VERIFY ASSIGNED ALTITUDE AS (altitude)." Pilots should confirm that they are at the altitude stated by the controller or that the assigned altitude is correct as stated. If this is not the case, they should inform the controller of the actual altitude being maintained or the different assigned altitude.

CAUTION-

Pilots should not take action to change their actual altitude or different assigned altitude to that stated in the controller's verification request unless the controller specifically authorizes a change.

4.2.3 ARTCC Radio Frequency Outage.

ARTCC's normally have at least one back-up radio receiver and transmitter system for each frequency which can usually be pressed into service quickly with little or no disruption of ATC service. Occasionally, technical problems may cause a delay but switchover seldom takes more than 60 seconds. When it appears that the outage will not be quickly remedied, the ARTCC will usually request a nearby aircraft, if there is one, to switch to the affected frequency to broadcast communications instructions. It is important, therefore, that the pilot wait at least

one minute before deciding that the ARTCC has actually experienced a radio frequency failure. When such an outage does occur, the pilot should, if workload and equipment capability permit, maintain a listening watch on the affected frequency while attempting to comply with the recommended communications procedures which follow.

4.2.3.1 If two-way communications cannot be established with the ARTCC after changing frequencies, a pilot should attempt to recontact the transferring controller for the assignment of an alternative frequency or other instructions.

4.2.3.2 When an ARTCC radio frequency failure occurs after two-way communications have been established, the pilot should attempt to reestablish contact with the center on any other known ARTCC frequency, preferably that of the next responsible sector when practicable, and ask for instructions. However, when the next normal frequency change along the route is known to involve another ATC facility, the pilot should contact that facility, if feasible, for instructions. If communications cannot be reestablished by either method, the pilot is expected to request communications instructions from the FSS appropriate to the route of flight.

NOTE–

The exchange of information between an aircraft and an ARTCC through an FSS is quicker than relay via company radio because the FSS has direct interphone lines to the responsible ARTCC sector. Accordingly, when circumstances dictate a choice between the two, during an ARTCC frequency outage, relay via FSS radio is recommended.

5. Radio Communications Failure

5.1 Pilots of IFR flights experiencing two-way radio failure are expected to adhere to the procedures prescribed in GEN 3.4, paragraph 12.

REFERENCE–

14 CFR Section 91.185

6. Position Reporting

6.1 The safety and effectiveness of traffic control depends to a large extent on accurate position reporting. In order to provide the proper separation and expedite aircraft movements, ATC must be able to make accurate estimates of the progress of every aircraft operating on an IFR flight plan.

6.2 Position Identification

6.2.1 When a position report is to be made passing a VOR radio facility, the time reported should be the time at which the first complete reversal of the “to/from” indicator is accomplished.



6.2.2 When a position report is made passing a facility by means of an airborne automatic direction finder (ADF), the time reported should be the time at which the indicator makes a complete reversal.

6.2.3 When an aural or light-panel indication is used to determine the time passing a reporting point, such as a fan marker, Z marker, cone of silence or intersection of range courses, the time should be noted when the signal is first received and again when it ceases. The mean of these two times should then be taken as the actual time over the fix.

6.2.4 If a position is given with respect to distance and direction from a reporting point, the distance and direction should be computed as accurately as possible.

6.2.5 Except for terminal transition purposes, position reports or navigation with reference to aids not established for use in the structure in which flight is being conducted will not normally be required by ATC.

6.3 Position Reporting Points

6.3.1 Federal Aviation Regulations require pilots to maintain a listening watch on the appropriate frequency and, unless operating under the provisions of subparagraph 6.4, to furnish position reports passing certain reporting points. Reporting points are indicated by symbols on en route charts. The designated compulsory reporting point symbol is the solid triangle ; the “on request” reporting point symbol is the open triangle . Reports passing an “on request” reporting point are only necessary when requested by ATC.

6.4 Position Reporting Requirements

6.4.1 Flights Along Airways or Routes. A position report is required by all flights regardless of altitude, including those operating in accordance with an ATC clearance specifying “VFR-on-top,” over each designated compulsory reporting point along the route being flown.

6.4.2 Flight Along a Direct Route. Regardless of the altitude or flight level being flown, including flights operating in accordance with an ATC clearance specifying “VFR-on-top,” pilots shall report over each reporting point used in the flight plan to define the route of flight.

6.4.3 Flights in a Radar Environment. When informed by ATC that their aircraft are in “RADAR CONTACT,” PILOTS SHOULD DISCONTINUE POSITION REPORTS OVER DESIGNATED REPORTING POINTS. They should resume normal position reporting when ATC advises “RADAR CONTACT LOST” or “RADAR SERVICE TERMINATED.”

NOTE-

ATC will inform pilots that they are in “radar contact” (a) When their aircraft is initially identified in the ATC system; and (b) When radar identification is reestablished after radar service has been terminated or radar contact has been lost. Subsequent to being advised that the controller has established radar contact, this fact will not be repeated to the pilot when handed off to another controller. At times, the aircraft identity will be confirmed by the receiving controller; however, this should not be construed to mean that radar contact has been lost. The identity of transponder-equipped aircraft will be confirmed by asking the pilot to “ident, squawk standby,” or to change codes. Aircraft without transponders will be advised of their position to confirm identity. In this case, the pilot is expected to advise the controller if in disagreement with the position given. If the pilot cannot confirm the accuracy of the position given because of not being tuned to the NAVAID referenced by the controller, the pilot should ask for another radar position relative to the tuned in NAVAID.

6.5 Position Report Items

6.5.1 Position reports should include the following items:

6.5.1.1 Identification.

6.5.1.2 Position.

6.5.1.3 Time.

6.5.1.4 Altitude or flight level (Include actual altitude or flight level when operating on a clearance specifying “VFR-on-top.”).

6.5.1.5 Type of flight plan (not required in IFR position reports made directly to ARTCCs or approach control).

6.5.1.6 ETA and name of next reporting point.

6.5.1.7 The name only of the next succeeding reporting point along the route of flight.

6.5.1.8 Pertinent remarks.

7. Additional Reports

7.1 The following reports should be made to ATC or FSS facilities without a specific request:

7.1.1 At all times, report:

7.1.1.1 When vacating any previously assigned altitude/flight level for a newly assigned altitude/flight level.

7.1.1.2 When an altitude change will be made if operating on a clearance specifying “VFR-on-top.”

7.1.1.3 When unable to climb/descend at a rate of at least 500 feet per minute.

7.1.1.4 When approach has been missed. (Request clearance for specific action; i.e., to alternative airport, another approach, etc.).

7.1.1.5 Change in the average true airspeed (at cruising altitude) when it varies by 5 percent or 10 knots (whichever is greater) from that filed in the flight plan.

7.1.1.6 The time and altitude/flight level reaching a holding fix or point to which cleared.

7.1.1.7 When leaving any assigned holding fix or point.

NOTE-

The reports in subparagraphs 7.1.1.6 and 7.1.1.7 may be omitted by pilots of aircraft involved in instrument training at military area facilities when radar service is being provided.

7.1.1.8 Any loss, in controlled airspace, of VOR, TACAN, ADF, low frequency navigation receiver capability, GPS anomalies while using installed IFR-certified GPS/GNSS receivers, complete or partial loss of ILS receiver capability or impairment of air/ground communications capability. Reports should include aircraft identification, equipment affected, degree to which the capability to operate under IFR in the ATC system is impaired, and the nature and extent of assistance desired from ATC.

NOTE-

When reporting GPS anomalies, include the location and altitude of the anomaly. Be specific when describing the location and include duration of the anomaly if necessary.

7.1.1.9 Any information relating to the safety of flight.

NOTE–

Other equipment installed in an aircraft may effectively impair safety and/or the ability to operate under IFR. If such equipment; e.g., airborne weather radar, malfunctions and in the pilot's judgment either safety or IFR capabilities are affected, reports should be made as above.

7.2 When not in radar contact, report:

7.2.1 When leaving the final approach fix inbound on final approach (nonprecision approach) or when leaving the outer marker or fix used in lieu of the outer marker inbound on final approach (precision approach); or

7.2.2 A corrected estimate at any time it becomes apparent that an estimate as previously submitted is in error in excess of 3 minutes. For flights in the North Atlantic (NAT), a revised estimate is required if the error is 3 minutes or more.

7.3 Pilots encountering weather conditions which have not been forecast, or hazardous conditions which have been forecast, are expected to forward a report of such weather to ATC.

8. Quota Flow Control

8.1 Quota Flow Control is designed to balance the ATC system demand with system capacity.

8.2 ARTCCs will hold the optimum number of aircraft that their primary and secondary holding fixes will safely accommodate without imposing undue limitations on the control of other traffic operating within the ARTCC's airspace. This is based on the user's requirement to continue operating to a terminal regardless of the acceptance rate at that terminal. When staffing, equipment, or severe weather will inhibit the number of aircraft the arrival ARTCC may safely hold, a reduction may be necessary.

8.3 When an ARTCC is holding the optimum number of aircraft, the adjacent ARTCCs will be issued quotas concerning aircraft which can be cleared into the impacted ARTCC's airspace. When the adjacent center's demand exceeds the quota, aircraft will be held in the adjacent ARTCC's airspace until they can be permitted to proceed.

8.4 The size of the hourly quota will be based initially on the projected acceptance rate and thereafter on the actual landing and diversion totals. Once quotas have been imposed, departures in the arrival and adjacent ARTCC's area to the affected airport may be assigned ground delay, if necessary, to limit airborne holding to ATC capacity. However, when a forecast of improved acceptance rate appears reliable, in the opinion of the arrival ARTCC, additional above-quota flights may be approved based on the expectation that by the time these additional above-quota flights become an operational factor in the affected area, the system will be able to absorb them without undue difficulty.

8.5 Long distance flights, which originate beyond the adjacent ARTCC area, will normally be permitted to proceed to a point just short of the arrival ARTCC boundary where a delay, at least equal to the delays (ground/airborne) being encountered, will be assigned.

8.6 ARTCCs imposing ground delays make efforts to advise the users when lengthy delays are a prospect to preclude unnecessary boarding and subsequent unloading prior to actual takeoff due to lengthy unanticipated ground delays. Users should advise the ARTCC through FSS or operation offices when there is any significant change in the proposed departure time so as to permit more efficient flow control planning. Airborne aircraft holding in the adjacent ARTCC airspace generally receive more benefit than ground delayed aircraft when increases unexpectedly develop in the quota number because the reaction time is less. For this reason, whenever operationally feasible, adjacent ARTCCs may offer airborne delay within their areas instead of ground delay.

8.7 Flights originating beyond the adjacent ARTCC areas may not have sufficient fuel to absorb the total anticipated delay while airborne. Accordingly, the concerned adjacent ARTCC may permit these flights to land in its area while retaining previously accumulated delay for the purpose of quota priority. When the amount of air traffic backlogging in an adjacent ARTCC area is approaching the saturation point, additional en route traffic will be subject to prior approval.

8.8 Generally, movement of arrival aircraft into the impacted airport terminal area will be made on the basis that those flights with the most accumulated delay, either ground, airborne, or a combination of

both, normally receive priority over other traffic. This applies only to delays encountered because of the situation at the airport of intended landing.

8.9 Pilots/operators are advised to check for flow control advisories which are transmitted to FSSs, to selected airline dispatch offices, and to ARTCCs.

9. Advisory and Air Traffic Information Services

9.1 Approach Control Service for VFR Arriving Aircraft

9.1.1 Numerous approach control facilities have established programs for arriving VFR aircraft to contact approach control for landing information. This information includes: wind, runway, and altimeter setting at the airport of intended landing. This information may be omitted if contained in the ATIS broadcast and the pilot states the appropriate ATIS code.

NOTE-

Pilot use of "have numbers" does not indicate receipt of the ATIS broadcast. In addition, the controller will provide traffic advisories on a workload permitting basis.

9.1.2 Such information will be furnished upon initial contact with the concerned approach control facility. The pilot will be requested to change to the tower frequency at a predetermined time or point, to receive further landing information.

9.1.3 Where available, use of this procedure will not hinder the operation of VFR flights by requiring excessive spacing between aircraft or devious routing. Radio contact points will be based on time or distance rather than on landmarks.

9.1.4 Compliance with this procedure is not mandatory, but pilot participation is encouraged. (See ENR 1.1, paragraph 39, Terminal Radar Services for VFR Aircraft.)

NOTE-

Approach control services for VFR aircraft are normally dependent on air traffic control radar. These services are not available during periods of a radar outage. Approach control services for VFR aircraft are limited when Center Radar ARTS Presentation/ Processing (CENRAP) is in use.

9.2 Traffic Advisory Practices at Airports Without Operating Control Towers

9.2.1 Airport Operations Without an Operating Control Tower

9.2.1.1 There is no substitute for alertness while in the vicinity of an airport. It is essential that pilots be alert and look for other traffic and exchange traffic information when approaching or departing an airport without an operating control tower. This is of particular importance since other aircraft may not have communication capability or, in some cases, pilots may not communicate their presence or intentions when operating into or out of such airports. To achieve the greatest degree of safety, it is essential that all radio-equipped aircraft transmit/receive on a common frequency identified for the purpose of airport advisories.

9.2.1.2 An airport may have a full or part-time tower or FSS located on the airport, a full or part-time UNICOM station or no aeronautical station at all. There are three ways for pilots to communicate their intention and obtain airport/traffic information when operating at an airport that does not have an operating tower: by communicating with an FSS, a UNICOM operator, or by making a self-announce broadcast.

9.2.1.3 Many airports are now providing completely automated weather, radio check capability and airport advisory information on an automated UNICOM system. These systems offer a variety of features, typically selectable by microphone clicks, on the UNICOM frequency. Availability of the automated UNICOM will be published in the Airport/Facility Directory and approach charts.

9.2.2 Communicating on a Common Frequency

9.2.2.1 The key to communicating at an airport without an operating control tower is selection of the correct common frequency. The acronym, CTAF, which stands for common traffic advisory frequency, is synonymous with this program. A CTAF is a frequency designated for the purpose of carrying out airport advisory practices while operating to or from an airport without an operating control tower. The CTAF may be a UNICOM, MULTICOM, FSS, or tower frequency and is identified in appropriate aeronautical publications.

9.2.2.2 The CTAF frequency for a particular airport is contained in the Airport/Facility Directory (A/FD), Alaska Supplement, Alaska Terminal Publication, Instrument Approach Procedure Charts, and Instrument Departure Procedure (DP) charts. Also, the CTAF frequency can be obtained by contacting any

FSS. Use of the appropriate CTAF, combined with a visual alertness and application of the following recommended good operating practices, will enhance safety of flight into and out of all uncontrolled airports.

9.2.3 Recommended Traffic Advisory Practices

9.2.3.1 Pilots of inbound aircraft should monitor and communicate on the designated CTAF from 10 miles to landing. Pilots of departing aircraft should monitor/communicate on the appropriate frequency from start-up, during taxi, and until 10 miles from the airport unless the Code of Federal Regulations (CFR) or local procedures require otherwise.

9.2.3.2 Pilots of aircraft conducting other than arriving or departing operations at altitudes normally used by arriving and departing aircraft should monitor/communicate on the appropriate frequency while within 10 miles of the airport unless required to do otherwise by the CFR or local procedures. Such operations include parachute jumping/dropping (see ENR 5.1, paragraph 2.3, Parachute Jump Aircraft Operations), en route, practicing maneuvers, etc.

9.2.4 Airport Advisory/Information Services Provided by a FSS

9.2.4.1 There are three advisory type services provided at selected airports.

a) Local Airport Advisory (LAA) is provided at airports that have a FSS physically located on the airport, which does not have a control tower or where the tower is operated on a part-time basis. The CTAF for LAA airports is disseminated in the appropriate aeronautical publications.

b) Remote Airport Advisory (RAA) is provided at selected very busy GA airports, which do not have an operating control tower. The CTAF for RAA airports is disseminated in the appropriate aeronautical publications. Hours of operation may be changed by NOTAM D.

c) Remote Airport Information Service (RAIS) is provided in support of special events at nontowered airports by request from the airport authority and shall be published as a NOTAM D.

9.2.4.2 In communicating with a CTAF FSS, check the airport's automated weather and establish two-way communications before transmitting outbound/inbound intentions or information. An inbound aircraft should initiate contact approximately

10 miles from the airport, reporting aircraft identification and type, altitude, location relative to the airport, intentions (landing or over flight), possession of the automated weather, and request airport advisory or airport information service. A departing aircraft should initiate contact before taxiing, reporting aircraft identification and type, VFR or IFR, location on the airport, intentions, direction of take-off, possession of the automated weather, and request airport advisory or information service, as applicable. Also, report intentions before taxiing onto the active runway for departure. If you must change frequencies for other service after initial report to FSS, return to FSS frequency for traffic update.

a) Inbound

EXAMPLE–

Vero Beach radio, Centurion Six Niner Delta Delta is ten miles south, two thousand, landing Vero Beach. I have the automated weather, request airport advisory.

b) Outbound

EXAMPLE–

Vero Beach radio, Centurion Six Niner Delta Delta, ready to taxi to runway 22, VFR, departing to the southwest. I have the automated weather, request airport advisory.

9.2.4.3 Airport advisory service includes wind direction and velocity, favored or designated runway, altimeter setting, known airborne and ground traffic, NOTAMs, airport taxi routes, airport traffic pattern information, and instrument approach procedures. These elements are varied so as to best serve the current traffic situation. Some airport managers have specified that under certain wind or other conditions designated runways be used. Pilots should advise the FSS of the runway they intend to use.

9.2.4.4 Automatic Flight Information Service (AFIS) – Alaska FSSs Only

a) Alaska FSSs AFIS is the continuous broadcast of recorded noncontrol information at airports in Alaska where a Flight Service Station (FSS) provides local airport advisory service. Its purpose is to improve FSS Specialist efficiency by reducing frequency congestion on the local airport advisory frequency. The AFIS broadcast will automate the repetitive transmission of essential but routine information (weather, favored runway, breaking action, airport NOTAMs, other applicable information). The information is continuously broadcast over a discrete VHF radio frequency (usually the ASOS

frequency). Use of AFIS is not mandatory, but pilots who choose to utilize two-way radio communications with the FSS are urged to listen to AFIS, as it relieves frequency congestion on the local airport advisory frequency. AFIS broadcasts are updated upon the receipt of any official hourly and special weather, worsening braking action reports, and changes in other pertinent data. When a pilot acknowledges receipt of the AFIS broadcast, FSS Specialists may omit those items contained in the broadcast if they are current. When rapidly changing conditions exist, the latest ceiling, visibility, altimeter, wind or other conditions may be omitted from the AFIS and will be issued by the Flight Service Specialist on the appropriate radio frequency.

EXAMPLE-

“Kotzebue information ALPHA. One six five five zulu. Wind, two one zero at five; visibility two, fog; ceiling one hundred overcast; temperature minus one two, dew point minus one four; altimeter three one zero five. Altimeter in excess of three one zero zero, high pressure altimeter setting procedures are in effect. Favored runway two six. Weather in Kotzebue surface area is below V-F-R minima – an ATC clearance is required. Contact Kotzebue Radio on 123.6 for traffic advisories and advise intentions. Notice to Airmen, Hotham NDB out of service. Transcribed Weather Broadcast out of service. Advise on initial contact you have ALPHA.”

NOTE-

The absence of a sky condition or ceiling and/or visibility on Alaska FSS AFIS indicates a sky condition or ceiling of 5,000 feet or above and visibility of 5 miles or more. A remark may be made on the broadcast, “the weather is better than 5000 and 5.”

b) Pilots should listen to Alaska FSSs AFIS broadcasts whenever Alaska FSSs AFIS is in operation.

NOTE-

Some Alaska FSSs are open part time and/or seasonally.

c) Pilots should notify controllers on initial contact that they have received the Alaska FSSs AFIS broadcast by repeating the phonetic alphabetic letter appended to the broadcast.

EXAMPLE-

“Information Alpha received.”

d) While it is a good operating practice for pilots to make use of the Alaska FSS AFIS broadcast where it is available, some pilots use the phrase “have numbers” in communications with the FSS. Use of

this phrase means that the pilot has received wind, runway, and altimeter information ONLY and the Alaska FSS does not have to repeat this information. It does not indicate receipt of the AFIS broadcast and should never be used for this purpose.

CAUTION-

All aircraft in the vicinity of an airport may not be in communication with the FSS.

9.2.5 Information Provided by Aeronautical Advisory Stations (UNICOM)

9.2.5.1 UNICOM is a nongovernment air/ground radio communication station which may provide airport information at public use airports where there is no tower or FSS.

9.2.5.2 On pilot request, UNICOM stations may provide pilots with weather information, wind direction, the recommended runway, or other necessary information. If the UNICOM frequency is designated as the CTAF, it will be identified in appropriate aeronautical publications.

9.2.5.3 Unavailability of Information from FSS or UNICOM. Should LAA by an FSS or Aeronautical Advisory Station UNICOM be unavailable, wind and weather information may be obtainable from nearby controlled airports via Automatic Terminal Information Service (ATIS) or Automated Weather Observing System (AWOS) frequency.

9.2.6 Self-Announce Position and/or Intentions

9.2.6.1 General. Self-announce is a procedure whereby pilots broadcast their position or intended flight activity or ground operation on the designated CTAF. This procedure is used primarily at airports which do not have an FSS on the airport. The self-announce procedure should also be used if a pilot is unable to communicate with the FSS on the designated CTAF. Pilots stating, “Traffic in the area, please advise” is not a recognized Self-Announce Position and/or Intention phrase and should not be used under any condition.

9.2.6.2 If an airport has a tower which is temporarily closed or operated on a part-time basis, and there is no FSS on the airport or the FSS is closed, use the CTAF to self-announce your position or intentions.

9.2.6.3 Where there is no tower, FSS, or UNICOM station on the airport, use MULTICOM frequency 122.9 for self-announce procedures. Such airports

will be identified in appropriate aeronautical information publications.

9.2.6.4 Practice Approaches. Pilots conducting practice instrument approaches should be particularly alert for other aircraft that may be departing in the opposite direction. When conducting any practice approach, regardless of its direction relative to other airport operations, pilots should make announcements on the CTAF as follows:

a) Departing the final approach fix, inbound (nonprecision approach) or departing the outer marker or fix used in lieu of the outer marker, inbound (precision approach).

b) Established on the final approach segment or immediately upon being released by ATC.

c) Upon completion or termination of the approach; and

d) Upon executing the missed approach procedure.

9.2.6.5 Departing aircraft should always be alert for arrival aircraft coming from the opposite direction.

9.2.6.6 Recommended Self-Announce Phraseologies. It should be noted that aircraft operating to or from another nearby airport may be making self-announce broadcasts on the same UNICOM or MULTICOM frequency. To help identify one airport from another, the airport name should be spoken at the beginning and end of each self-announce transmission.

a) Inbound

EXAMPLE–

Strawn traffic, Apache Two Two Five Zulu, (position), (altitude), (descending) or entering downwind/base/final (as appropriate) runway one seven full stop/touch-and-go, Strawn.

Strawn traffic Apache Two Two Five Zulu clear of runway one seven Strawn.

b) Outbound

EXAMPLE–

Strawn traffic, Queen Air Seven One Five Five Bravo (location on airport) taxiing to runway two six Strawn.

Strawn traffic, Queen Air Seven One Five Five Bravo

departing runway two six. “Departing the pattern to the (direction), climbing to (altitude) Strawn.”

c) Practice Instrument Approach

EXAMPLE–

Strawn traffic, Cessna Two One Four Three Quebec (position from airport) inbound descending through (altitude) practice (name of approach) approach runway three five Strawn.

Strawn traffic, Cessna Two One Four Three Quebec practice (type) approach completed or terminated runway three five Strawn.

9.2.7 UNICOM Communication Procedures

9.2.7.1 In communicating with a UNICOM station, the following practices will help reduce frequency congestion, facilitate a better understanding of pilot intentions, help identify the location of aircraft in the traffic pattern, and enhance safety of flight:

a) Select the correct UNICOM frequency.

b) State the identification of the UNICOM station you are calling in each transmission.

c) Speak slowly and distinctly.

d) Report approximately 10 miles from the airport, reporting altitude, and state your aircraft type, aircraft identification, location relative to the airport, state whether landing or overflight, and request wind information and runway in use.

e) Report on downwind, base and final approach.

f) Report leaving the runway.

9.2.7.2 Recommended UNICOM Phraseologies:

a) Inbound.

PHRASEOLOGY–

FREDERICK UNICOM CESSNA EIGHT ZERO ONE TANGO FOXTROT 10 MILES SOUTHEAST DESCENDING THROUGH (altitude) LANDING FREDERICK, REQUEST WIND AND RUNWAY INFORMATION FREDERICK.

FREDERICK TRAFFIC CESSNA EIGHT ZERO ONE TANGO FOXTROT ENTERING DOWNWIND/BASE/FINAL (as appropriate) FOR RUNWAY ONE NINER FULL STOP/TOUCH-AND-GO FREDERICK.

FREDERICK TRAFFIC CESSNA EIGHT ZERO ONE TANGO FOXTROT CLEAR OF RUNWAY ONE NINER FREDERICK.

b) Outbound

PHRASEOLOGY-

FREDERICK UNICOM CESSNA EIGHT ZERO ONE TANGO FOXTROT (location on airport) TAXIING TO RUNWAY ONE NINE, REQUEST WIND AND TRAFFIC INFORMATION FREDERICK.

FREDERICK TRAFFIC CESSNA EIGHT ZERO ONE TANGO FOXTROT DEPARTING RUNWAY ONE NINE. "REMAINING IN THE PATTERN" OR "DEPARTING THE PATTERN TO THE (direction) (as appropriate)" FREDERICK.

9.3 IFR Approaches/Ground Vehicle Operations

9.3.1 IFR Approaches. When operating in accordance with an IFR clearance and ATC approves a change to the advisory frequency, make an expeditious change to the CTAF and employ the recommended traffic advisory procedures.

9.3.2 Ground Vehicle Operation. Airport ground vehicles equipped with radios should monitor the CTAF frequency when operating on the airport movement area and remain clear of runways/taxiways being used by aircraft. Radio transmissions from ground vehicles should be confined to safety-related matters.

9.3.3 Radio Control of Airport Lighting Systems.

Whenever possible, the CTAF will be used to control airport lighting systems at airports without operating control towers. This eliminates the need for pilots to change frequencies to turn the lights on and allows a continuous listening watch on a single frequency. The CTAF is published on the instrument approach chart and in other appropriate aeronautical information publications. For further details concerning radio controlled lights, see Advisory Circular 150/5340.27.

TBL GEN 3.3-1
Summary of Recommended Communication Procedures

			COMMUNICATION/BROADCAST PROCEDURES		
	Facility at Airport	Frequency Use	Outbound	Inbound	Practice Instrument Approach
1.	UNICOM (No Tower or FSS)	Communicate with UNICOM station on published CTAF frequency (122.7; 122.8; 122.725; 122.975; or 123.0). If unable to contact UNICOM station, use self-announce procedures on CTAF.	Before taxiing and before taxiing onto the runway for departure.	10 miles out; entering downwind, base, and final; leaving the runway.	
2.	No Tower, FSS, or UNICOM	Self-announce on MULTICOM frequency 122.9.	Before taxiing and before taxiing onto the runway for departure.	10 miles out; entering downwind, base, and final; leaving the runway.	Departing final approach fix (name) or on final approach segment inbound.
3.	No Tower in operation, FSS open	Communicate with FSS on CTAF frequency.	Before taxiing and before taxiing onto the runway for departure.	10 miles out; entering downwind, base, and final; leaving the runway.	Approach completed/terminated.
4.	FSS closed (No Tower)	Self-announce on CTAF.	Before taxiing and before taxiing onto the runway for departure.	10 miles out; entering downwind, base, and final; leaving the runway.	
5.	Tower or FSS not in operation	Self-announce on CTAF.	Before taxiing and before taxiing onto the runway for departure.	10 miles out; entering downwind, base, and final; leaving the runway.	

9.4 Designated UNICOM/MULTICOM Frequencies

9.4.1 Frequency Use

9.4.1.1 TBL GEN 3.3-2 depicts UNICOM and MULTICOM frequency uses as designated by the Federal Communications Commission (FCC).

NOTE-

1. In some areas of the country, frequency interference may be encountered from nearby airports using the same UNICOM frequency. Where there is a problem, UNICOM operators are encouraged to develop a “least interference” frequency assignment plan for airports concerned using the frequencies designated for airports without operating control towers. UNICOM licensees are encouraged to apply for UNICOM 25 KHz spaced channel frequencies. Due to the extremely limited number of frequencies with 50 KHz channel spacing, 25 KHz channel spacing should be implemented. UNICOM licensees may then request FCC to assign frequencies in accordance with the plan, which FCC will review and consider for approval.

2. Wind direction and runway information may not be available on UNICOM frequency 122.950.

9.4.1.2 TBL GEN 3.3-3 depicts other frequency uses as designated by the FCC.

9.5 Use of UNICOM for ATC purposes

9.5.1 UNICOM service may be used for air traffic control purposes, only under the following circumstances:

9.5.1.1 Revision to proposed departure time.

9.5.1.2 Takeoff, arrival, or flight plan cancellation time.

9.5.1.3 ATC clearance, provided arrangements are made between the ATC facility and the UNICOM licensee to handle such messages.

**TBL GEN 3.3-2
UNICOM/MULTICOM Frequency Usage**

Use	Frequency
Airports without an operating control tower.	122.700 122.725 122.800 122.975 123.000 123.050 123.075
(MULTICOM FREQUENCY) Activities of a temporary, seasonal, emergency nature or search and rescue, as well as, airports with no tower, FSS, or UNICOM.	122.900
(MULTICOM FREQUENCY) Forestry management and fire suppression, fish and game management and protection, and environmental monitoring and protection.	122.925
Airports with a control tower or FSS on airport.	122.950

**TBL GEN 3.3-3
Other Frequency Usage Designated by FCC**

Use	Frequency
Air-to-air communication (private fixed wing aircraft).	122.750
Air-to-air communications (general aviation helicopters).	123.025
Aviation instruction, Glider, Hot Air Balloon (not to be used for advisory service).	123.300 123.500

9.6 Automatic Terminal Information Service (ATIS)

9.6.1 ATIS is the continuous broadcast of recorded noncontrol information in selected high activity terminal areas. Its purpose is to improve controller effectiveness and to relieve frequency congestion by automating the repetitive transmission of essential but routine information. The information is continuously broadcast over a discrete VHF radio frequency or the voice portion of a local NAVAID. ATIS transmissions on a discrete VHF radio frequency are engineered to be receivable to a maximum of 60 NM from the ATIS site and a maximum altitude of 25,000 feet AGL. At most locations, ATIS signals may be received on the surface of the airport, but local conditions may limit the maximum ATIS reception distance and/or altitude. Pilots are urged to cooperate in the ATIS program as it relieves frequency congestion on approach control, ground control, and local control frequencies. The Airport/Facility Directory indicates airports for which ATIS is provided.

9.6.2 ATIS information includes the time of the latest weather sequence, ceiling, visibility, obstructions to visibility, temperature, dew point (if available), wind direction (magnetic), and velocity, altimeter, other pertinent remarks, instrument approach, and runway in use. The ceiling/sky condition, visibility, and obstructions to vision may be omitted from the ATIS broadcast if the ceiling is above 5,000 feet and the visibility is more than 5 miles. The departure runway will only be given if different from the landing runway except at locations having a separate ATIS for departure. The broadcast may include the appropriate frequency and instructions for VFR arrivals to make initial contact with approach control. Pilots of aircraft arriving or departing the terminal area can receive the continuous ATIS broadcast at times when cockpit duties are least pressing and listen to as many repeats as desired. ATIS broadcast shall be updated upon the receipt of any official hourly and special weather. A new recording will also be made when there is a change in other pertinent data such as runway change, instrument approach in use, etc.

SAMPLE BROADCAST–

DULLES INTERNATIONAL INFORMATION SIERRA. 1300ZULU WEATHER. MEASURED CEILING THREE THOUSAND OVERCAST. VISIBILITY THREE, SMOKE. TEMPERATURE SIX EIGHT. WIND THREE FIVE ZERO

AT EIGHT. ALTIMETER TWO NINER NINER TWO. ILS RUNWAY ONE RIGHT APPROACH IN USE. LANDING RUNWAY ONE RIGHT AND LEFT. DEPARTURE RUNWAY THREE ZERO. ARMEL VORTAC OUT OF SERVICE. ADVISE YOU HAVE SIERRA.

9.6.3 Pilots should listen to ATIS broadcasts whenever ATIS is in operation.

9.6.4 Pilots should notify controllers on initial contact that they have received the ATIS broadcast by repeating the alphabetical code word appended to the broadcast.

EXAMPLE–

“Information Sierra received.”

9.6.5 When the pilot acknowledges receipt of the ATIS broadcast, controllers may omit those items contained on the broadcast if they are current. Rapidly changing conditions will be issued by ATC and the ATIS will contain words as follows:

EXAMPLE–

“Latest ceiling/visibility/altimeter/wind/(other conditions) will be issued by approach control/tower.”

NOTE–

The absence of a sky condition/ceiling and/or visibility on ATIS indicates a sky condition/ceiling of 5,000 feet or above and visibility of 5 miles or more. A remark may be made on the broadcast, “the weather is better than 5,000 and 5,” or the existing weather may be broadcast.

9.6.6 Controllers will issue pertinent information to pilots who do not acknowledge receipt of a broadcast or who acknowledge receipt of a broadcast which is not current.

9.6.7 To serve frequency–limited aircraft, FSSs are equipped to transmit on the omnirange frequency at most en route VORs used as ATIS voice outlets. Such communication interrupts the ATIS broadcast. Pilots of aircraft equipped to receive on other FSS frequencies are encouraged to do so in order that these override transmissions may be kept to an absolute minimum.

9.6.8 While it is a good operating practice for pilots to make use of the ATIS broadcast where it is available, some pilots use the phrase “Have Numbers” in communications with the control tower. Use of this phrase means that the pilot has received wind, runway and altimeter information ONLY and the tower does not have to repeat this information. It does not indicate receipt of the ATIS broadcast and should never be used for this purpose.

9.7 Airport Reservation Operations and Special Traffic Management Programs

9.7.1 This section describes procedures for obtaining required airport reservations at airports designated by the FAA and for airports operating under Special Traffic Management Programs.

9.7.2 Slot Controlled Airports.

9.7.2.1 The FAA may adopt rules to require advance operations for unscheduled operations at certain airports. In addition to the information in the rules adopted by the FAA, a listing of the airports and relevant information will be maintained on the FAA Web site listed below.

9.7.2.2 The FAA has established an Airport Reservation Office (ARO) to receive and process reservations for unscheduled flights at the slot controlled airports. The ARO uses the Enhanced Computer Voice Reservation System (e-CVRS) to allocate reservations. Reservations will be available beginning 72 hours in advance of the operation at the slot controlled airport. Refer to the Web site or touch-tone phone interface for the current listing of slot controlled airports, limitations, and reservation procedures.

NOTE-

The web interface/telephone numbers to obtain a reservation for unscheduled operations at a slot controlled airport are:

1. *<http://www.fly.faa.gov/ecvrs>.*
2. *Touch-tone: 1-800-875-9694 or 703-707-0568. (e-CVRS interface).*
3. *Trouble number: 703-904-4452.*

9.7.2.3 For more detailed information on operations and reservation procedures at a slot controlled airport, please see Advisory Circular 93-1A, Reservations for Unscheduled Operations at Slot

Controlled Airports. A copy of the Advisory Circular may be obtained via the Internet at: <http://www.faa.gov>.

9.7.3 Special Traffic Management Programs (STMP)

9.7.3.1 Special procedures may be established when a location requires special traffic handling to accommodate above normal traffic demand (e.g., the Indianapolis 500, Super Bowl) or reduced airport capacity (e.g., airport runway/taxiway closures for airport construction). The special procedures may remain in effect until the problem has been resolved or until local traffic management procedures can handle the situation and a need for special handling no longer exists.

9.7.3.2 There will be two methods available for obtaining slot reservations through the ATCSCC: the web interface and the touch-tone interface. If these methods are used, a NOTAM will be issued relaying the web site address and toll free telephone number. Be sure to check current NOTAMs to determine: what airports are included in the STMP; the dates and times reservations are required; the time limits for reservation requests; the point of contact for reservations; and any other instructions.

9.7.4 Users may contact the ARO at 703-904-4452 if they have a problem making a reservation or have a question concerning the slot controlled airport/STMP regulations or procedures.

9.7.5 Making Reservations

9.7.5.1 Internet Users. Detailed information and User Instruction Guides for using the Web interface to the reservation systems are available on the websites for the slot controlled airports (e-CVRS), <http://www.fly.faa.gov/ecvrs>; and STMPs (e-STMP), <http://www.fly.faa.gov/estmp>.

9.7.5.2 Telephone users. When using the telephone to make a reservation, you are prompted for input of information about what you wish to do. All input is accomplished using the keypad on the telephone. The only problem with a telephone is that most keys have a letter and number associated with them. When the system asks for a date or time, it is expecting an input of numbers. A problem arises when entering an aircraft call sign or tail number. The system does not detect if you are entering a letter (alpha character) or a number. Therefore, when entering an aircraft call sign or tail number two keys are used to represent each letter or number. When entering a number, precede the number you wish by the number 0 (zero) i.e., 01, 02, 03, 04, . . . If you wish to enter a letter, first press the key on which the letter appears and then press 1, 2, or 3, depending upon whether the letter you desire is the first, second, or third letter on that key. For example to enter the letter “N” first press the “6” key because “N” is on that key, then press the “2” key because the letter “N” is the second letter on the “6” key. Since there are no keys for the letters “Q” and

“Z” e-CVRS pretends they are on the number “1” key. Therefore, to enter the letter “Q”, press 11, and to enter the letter “Z” press 12.

NOTE-
Users are reminded to enter the “N” character with their tail numbers. (See TBL GEN 3.3-4 and TBL GEN 3.3-5 Helpful Key Entries).

TBL GEN 3.3-4

Codes for Call Sign/Tail Number Input Only			
A-21	J-51	S-73	1-01
B-22	K-52	T-81	2-02
C-23	L-53	U-82	3-03
D-31	M-61	V-83	4-04
E-32	N-62	W-91	5-05
F-33	O-63	X-92	6-06
G-11	P-71	Y-93	7-07
H-42	Q-11	Z-12	8-08
I-43	R-72	0-00	9-09

TBL GEN 3.3-5
Helpful Key Entries

#	After entering a call sign/tail number, depressing the “pound key” (#) twice will indicate the end of the entry.
*2	Will take the user back to the start of the process.
*3	Will repeat the call sign/tail number used in a previous reservation.
*5	Will repeat the previous question.
*8	Tutorial Mode: In the tutorial mode each prompt for input includes a more detailed description of what is expected as input. *8 is a toggle on/off switch. If you are in tutorial mode and enter *8, you will return to the normal mode.
*0	Expert Mode: In the expert mode, each prompt for input is brief with little or no explanation. Expert mode is also on/off toggle.

9.8 Operations at Uncontrolled Airports with Automated Surface Observing System (ASOS)/Automated Weather Sensor System (AWSS)/Automated Weather Observation System (AWOS)

9.8.1 Many airports throughout the National Airspace System are equipped with either ASOS, AWSS, or AWOS. At most airports with an operating control tower or human observer, the weather will be available to you in a METAR hourly or special observation format on the Automatic Terminal Information Service (ATIS) or directly transmitted from the controller/observer.

9.8.2 At uncontrolled airports that are equipped with ASOS/AWSS/AWOS with ground-to-air broadcast capability, the one-minute updated airport weather should be available to you within approximately 25 NM of the airport below 10,000 feet. The frequency for the weather broadcast will be published on sectional charts and in the Airport/Facility Directory. Some part-time towered airports may also broadcast the automated weather on their ATIS frequency during the hours that the tower is closed.

9.8.3 Controllers issue SVFR or IFR clearances based on pilot request, known traffic and reported weather; i.e., METAR/SPECI observations, when they are available. Pilots have access to more current weather at uncontrolled ASOS/AWSS/AWOS airports than do the controllers who may be located several miles away. Controllers will rely on the pilot to determine the current airport weather from the ASOS/AWSS/AWOS. All aircraft arriving or departing an ASOS/AWSS/AWOS equipped uncontrolled airport should monitor the airport weather frequency to ascertain the status of the airspace. Pilots in Class E airspace must be alert for changing weather conditions which may effect the status of the airspace from IFR/VFR. If ATC service is required for IFR/SVFR approach/departure or requested for VFR service, the pilot should advise the controller that he/she has received the one-minute weather and state his/her intentions.

EXAMPLE-

“I have the (airport) one-minute weather, request an ILS runway 14 approach.”

REFERENCE-

Section GEN 3.5, Paragraph 7, Weather Observing Programs.

GEN 3.4 Communication Service

1. Responsible Authority

1.1 The authority responsible for the administration of communications services in the U.S. is the Federal Aviation Administration, Communication, Navigation, Surveillance, and Infrastructure.

Postal Address:

Federal Aviation Administration
Communications, Navigation, Surveillance, and
Infrastructure (ARN-1)
400 7th Street, SW
Washington, D.C. 20590

AFTN Address: KDCAYAYX

Commercial Telegraphic Address:

ACIVAIR Washington DC
Telex: 892-562

2. Area of Responsibility

2.1 Communications services are available on a continuous basis without charge to the user. The Air Traffic Services Division is responsible for the establishment of the operational requirements of the U.S. communications system. Responsibility for the day to day operation of these services resides with the local air traffic facility. Enquiries or complaints regarding any communications services or facilities should be referred to the relevant air traffic facility or to the Federal Aviation Administration, Air Traffic Operations Services, as appropriate.

3. Types of Services

3.1 Radio Navigation Service

3.1.1 Various types of air navigation aids are in use today, each serving a special purpose. These aids have varied owners and operators, namely: the Federal Aviation Administration, the military services, private organizations; and individual states and foreign governments. The Federal Aviation Administration has the statutory authority to establish, operate, and maintain air navigation facilities and to prescribe standards for the operation of any of these aids which are used by both civil and military aircraft for instrument flight in federally controlled airspace.

These aids are tabulated in the Airport/Facility Directory by State.

3.1.2 Pilots should be aware of the possibility of momentary erroneous indications on cockpit displays when the primary signal generator for a ground-based navigational transmitter (for example, a glideslope, VOR, or nondirectional beacon) is inoperative. Pilots should disregard any navigation indication, regardless of its apparent validity, if the particular transmitter was identified by NOTAM or otherwise as unusable or inoperative.

3.1.3 The following types of radio navigation aids are provided in the U.S.:

3.1.3.1 VHF Direction-Finding (VHF-DF).

3.1.3.2 LF Non-Directional Beacon (NDB).

3.1.3.3 VHF Omni-Directional Radio Range (VOR).

3.1.3.4 Distance Measuring Equipment (DME).

3.1.3.5 Tactical Air Navigation (TACAN).

3.1.3.6 Instrument Landing System (ILS).

3.1.3.7 Final Approach Simplified Directional Facility (SDF).

3.1.3.8 Precision Approach Radar (PAR) at certain military aerodromes.

3.1.3.9 LORAN.

3.1.3.10 Global Positioning System (GPS).

3.1.4 NAVAID Service Volumes

3.1.4.1 Most air navigation radio aids which provide positive course guidance have a designated standard service volume (SSV). The SSV defines the reception limits of unrestricted NAVAIDs which are usable for random/unpublished route navigation.

3.1.4.2 A NAVAID will be classified as restricted if it does not conform to flight inspection signal strength and course quality standards throughout the published SSV. However, the NAVAID should not be considered usable at altitudes below that which could be flown while operating under random route IFR conditions; even though these altitudes may lie within the designated SSV.

NOTE-

Refer to Federal Aviation Regulations (14 CFR Section 91.177) for minimum altitudes for IFR operations. Service volume restrictions are first published in the Notices to Airman (NOTAMs) and then with the alphabetical listing of the NAVAIDs in the Airport/Facility Directory.

3.1.4.3 Standard service volume limitations do not apply to published IFR routes or procedures.

3.1.4.4 VOR/DME/TACAN Standard Service Volumes (SSV):

a) SSVs are graphically shown in FIG GEN 3.4-1, FIG GEN 3.4-2, FIG GEN 3.4-3, FIG GEN 3.4-4, and FIG GEN 3.4-5. The SSV of a station is indicated by using the class designator as a prefix to the station type designation.

EXAMPLE-

TVOR, LDME, and HVORTAC.

b) Within 25 NM, the bottom of the T service volume is defined by the curve in FIG GEN 3.4-4. Within 40 NM, the bottoms of the L and H service volumes are defined by the curve in FIG GEN 3.4-5.

FIG GEN 3.4-1

Standard High Altitude Service Volume
(See FIG GEN 3.4-5 for altitudes below 1,000 feet.)

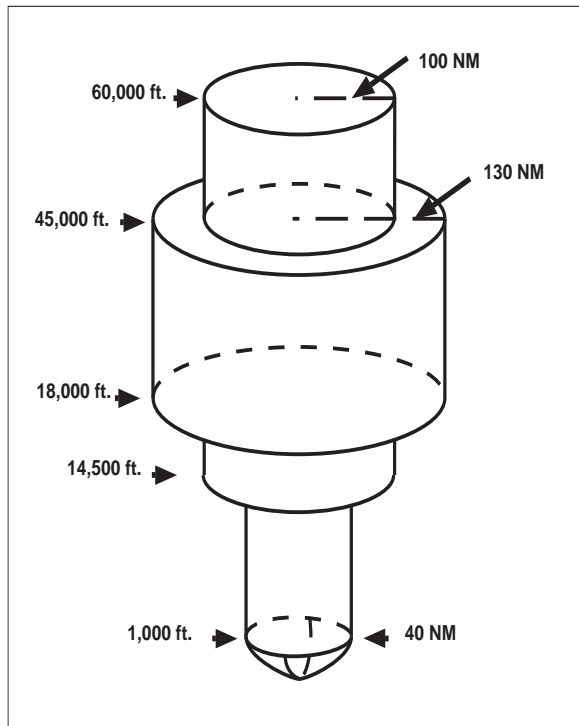

FIG GEN 3.4-2

Standard Low Altitude Service Volume
(See FIG GEN 3.4-5 for altitudes below 1,000 feet.)

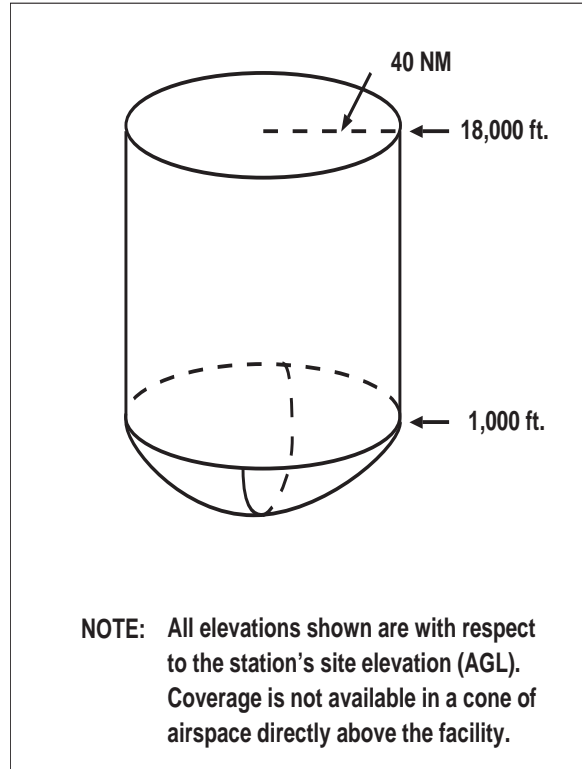
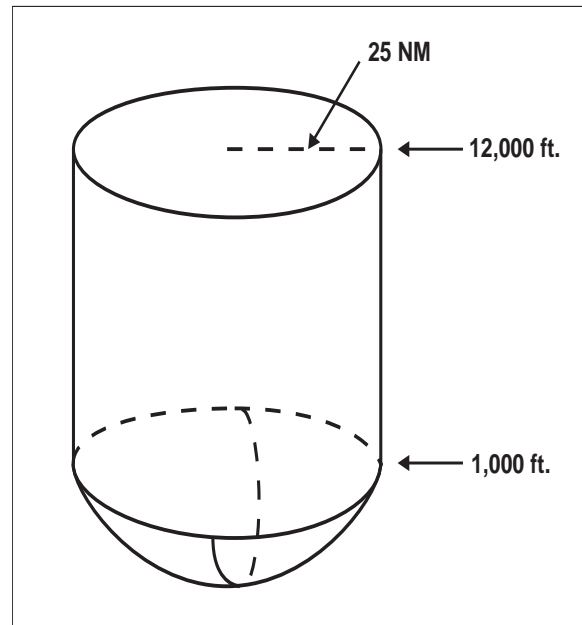

FIG GEN 3.4-3

Standard Terminal Service Volume
(See FIG GEN 3.4-4 for altitudes below 1,000 feet.)



3.1.4.5 Nondirectional Radio Beacon (NDB)

a) NDBs are classified according to their intended use.

b) The ranges of NDB service volumes are shown in TBL GEN 3.4-2. The distances (radius) are the same at all altitudes.

TBL GEN 3.4-1
VOR/DME/TACAN Standard Service Volumes

SSV Class Designator	Altitude and Range Boundaries
T (Terminal)	From 1,000 feet above ground level (AGL) up to and including 12,000 feet AGL at radial distances out to 25 NM.
L (Low Altitude)	From 1,000 feet AGL up to and including 18,000 feet AGL at radial distances out to 40 NM.
H (High Altitude)	From 1,000 feet AGL up to and including 14,500 feet AGL at radial distances out to 40 NM. From 14,500 feet AGL up to and including 60,000 feet at radial distances out to 100 NM. From 18,000 feet AGL up to and including 45,000 feet AGL at radial distances out to 130 NM.

TBL GEN 3.4-2
NDB Service Volumes

Class	Distance (Radius)
Compass Locator	15 NM
MH	25 NM
H	50 NM*
HH	75 NM

* Service ranges of individual facilities may be less than 50 nautical miles (NM). Restrictions to service volumes are first published as a Notice to Airmen and then with the alphabetical listing of the NAVAID in the A/FD.

FIG GEN 3.4-4
Service Volume Lower Edge Terminal

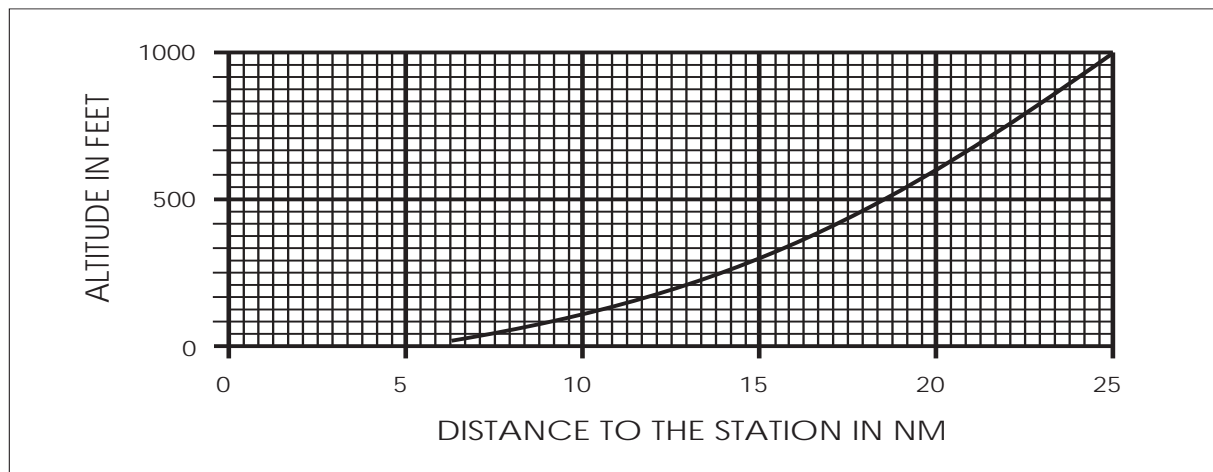
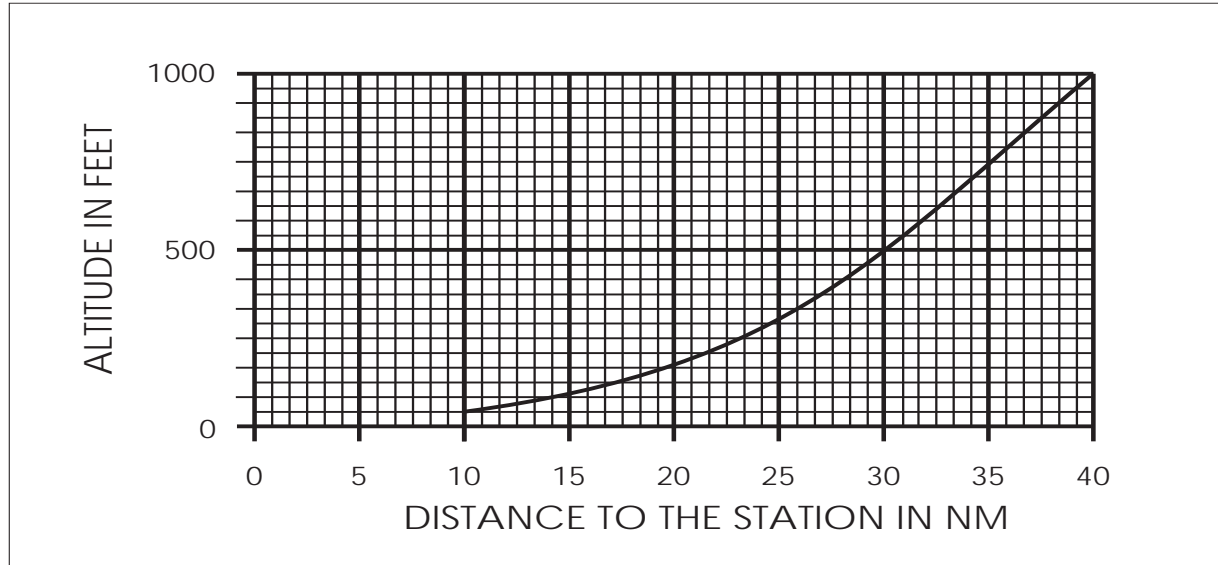

FIG GEN 3.4-5
Service Volume Lower Edge
Standard High and Low



3.1.5 NAVAIDs with Voice

3.1.5.1 Voice equipped en route radio navigational aids are under the operational control of either an FAA Automated Flight Service Station (AFSS) or an approach control facility. The voice communication is available on some facilities. Hazardous Inflight Weather Advisory Service (HIWAS) broadcast capability is available on selected VOR sites throughout the conterminous U.S. and does not provide two-way voice communication. The availability of two-way voice communication and HIWAS is indicated in the A/FD and aeronautical charts.

3.1.5.2 Unless otherwise noted on the chart, all radio navigation aids operate continuously except during shutdowns for maintenance. Hours of operation of facilities not operating continuously are annotated on charts and in the Airport/Facility Directory.

3.2 Mobile Service

3.2.1 The aeronautical stations (Airport Traffic Control Towers, Air Route Traffic Control Centers, and Flight Service Stations) maintain a continuous watch on their assigned frequencies during the published hours of service unless otherwise notified. An aircraft should normally communicate with the

air-ground control radio station which exercises control in the area in which it is flying. Aircraft should maintain continuous watch on the appropriate frequency of the control station and should not abandon watch, except in an emergency, without informing the control radio station.

3.2.2 Flight Service Stations (FSSs) are allocated frequencies for different functions. For Airport Advisory Service, the pilot should contact the FSS on 123.6 MHz. Individually assigned FSS frequencies are listed in Airport/Facility Directory under the FSS entry. If you are in doubt as to what frequency to use to contact an FSS, transmit on 122.1 MHz and advise the FSS of the frequency on which you are receiving.

3.3 Fixed Service

3.3.1 Messages to be transmitted over the Aeronautical Fixed Service are accepted only if they satisfy the requirements of:

3.3.1.1 ICAO Annex 10, Vol. II, Chapter 3, paragraph 3.3.

3.3.1.2 Are prepared in the form specified in Annex 10.

3.3.1.3 The text of an individual message does not exceed 200 groups.

3.3.2 General aircraft operating messages, Class B traffic, including reservation messages pertaining to flights scheduled to depart within 72 hours, shall not be acceptable for transmission over U.S. government operated telecommunications circuits except in those cases where it has been determined by the U.S. that adequate non-government facilities are not available.

3.4 Broadcast Service

3.4.1 The following meteorological broadcasts are available for the use of aircraft in flight:

3.4.1.1 LF Transcribed Weather Broadcast (TWEB).

3.4.1.2 Sub-Area Meteorological Broadcast (Volmet).

3.4.1.3 VHF RTF Meteorological Broadcasts.

3.4.2 Full details of broadcast service are given in GEN 3.5, Meteorological Services.

3.4.3 All broadcast services to aircraft are provided in the English language only.

4. Aeronautical Fixed Services

4.1 General

4.1.1 All U.S. ATC facilities have the ability to communicate with all other ATS facilities via either telephone or other domestic telecommunications systems. Circuit diagrams depicting these connections are not available for this publication due to the number of ATS facilities available in the U.S.

4.2 The Domestic Telecommunications Network

4.2.1 The U.S. Domestic telecommunications network is an automated system operating through the National Airspace Data Interchange Network (NADIN) in Atlanta, GA, and Salt Lake City, NV. All Flight Service Stations (FSS) and Air Route Traffic Control Centers (ARTCC) connect through the NATCOM. All FSS and ARTCC facilities have both transmit and receive capabilities.

4.2.2 Airport Air Traffic Control Towers (ATCT) and Approach Control (A/C) Facilities do not connect with this system. Messages originating from or destined to these facilities are relayed through the associated FSS. Associated FSSs for these facilities are listed in the Airport/Facility Directory.

4.2.3 Airport administrative offices, airport managers or airport administrative officials do not normally connect with the domestic telecommunications network. Urgent messages destined to these facilities must be forwarded to the associated FSS for relay or the message must be sent through commercial telegraphic systems.

4.3 The International Message Network (Aeronautical Fixed Telecommunications Network–AFTN)

4.3.1 AFTN messages originating from outside the U.S. domestic telecommunications system must be prepared in accordance with ICAO procedures. All incoming messages are received by NADIN and relayed to the addressed facility through automated procedures. The automated system will interpret the international address group and automatically forward the message via the domestic system to the addressee. For example, a message addressed KIKKYFYX will be accepted by AFTN and relayed to IKK (Kankakee FSS). The Kankakee FSS will manually relay this message to the intended recipient when necessary. Intended recipients are to be addressed in the first line of the message text.

4.3.2 All international flight plans entering the U.S. system must adhere to ICAO format. These flight plans are to be forwarded, via AFTN, to each affected, U.S. controlled, Flight Information Region (FIR) or Air Route Traffic Control Center (ARTCC) outside the continental U.S. (e.g., Miami FIR, San Juan, P.R. ARTCC) or the first FIR/ARTCC for flights entering the continental U.S. (e.g., New York FIR/ARTCC). If the flight plan content is acceptable, it is entered into the ARTCC system and is forwarded, automatically, via ARTCC computer, to all subsequently affected domestic ARTCCs. Flight plans which cannot be processed are rejected at the point of entry into the U.S. system and the originator is queried. Format adherence, once the flight plan is in the ARTCC system, is assured since each of the ARTCCs are automated facilities. Each subsequent ARTCC computer, however, will process incoming flight plans according to the requested routing. Flight plans can be rejected by any ARTCC due to errors in routing. Rejected flight plans, regardless of reason or point of rejection, are held in suspense until the needed clarification is received by the ARTCC facility.

4.4 Radio Communications Phraseology and Techniques

4.4.1 General

4.4.1.1 Radio communications are a critical link in the ATC system. The link can be a strong bond between pilot and controller – or it can be broken with surprising speed and disastrous results. Discussion herein provides basic procedures for new pilots and also highlights safe operating concepts for all pilots.

4.4.1.2 The single, most important thought in pilot–controller communications is understanding. It is essential, therefore, that pilots acknowledge each radio communication with ATC by using the appropriate aircraft call sign. Brevity is important, and contacts should be kept as brief as possible, but the controller must know what you want to do before he/she can properly carry out his/her control duties. And you, the pilot, must know exactly what he/she wants you to do. Since concise phraseology may not always be adequate, use whatever words are necessary to get your message across. Pilots are to maintain vigilance in monitoring air traffic control radio communications frequencies for potential traffic conflicts with their aircraft especially when operating on an active runway and/or when conducting a final approach to landing.

4.4.1.3 All pilots will find the Pilot/Controller Glossary very helpful in learning what certain words or phrases mean. Good phraseology enhances safety and is the mark of a professional pilot. Jargon, chatter and “CB” slang have no place in ATC communications. The Pilot/Controller Glossary is the same glossary used in the ATC controller’s handbook. We recommend that it be studied and reviewed from time to time to sharpen your communication skills.

4.4.2 Radio Technique

4.4.2.1 Listen before you transmit. Many times you can get the information you want through ATIS or by monitoring the frequency. Except for a few situations where some frequency overlap occurs, if you hear someone else talking, the keying of your transmitter will be futile and you will probably jam their receivers causing them to repeat their call. If you have just changed frequency, pause for your receiver to tune, listen, and make sure the frequency is clear.

4.4.2.2 Think before keying your transmitter. Know what you want to say and if it is lengthy; e.g., a flight plan or IFR position report, jot it down. (But do not lock your head in the cockpit.)

4.4.2.3 The microphone should be very close to your lips and after pressing the mike button, a slight pause may be necessary to be sure the first word is transmitted. Speak in a normal conversational tone.

4.4.2.4 When you release the button, wait a few seconds before calling again. The controller or FSS specialist may be jotting down your number, looking for your flight plan, transmitting on a different frequency, or selecting his/her transmitter to your frequency.

4.4.2.5 Be alert to the sounds or lack of sounds in your receiver. Check your volume, recheck your frequency, and make sure that your microphone is not stuck in the transmit position. Frequency blockage can, and has, occurred for extended periods of time due to unintentional transmitter operation. This type of interference is commonly referred to as a “stuck mike,” and controllers may refer to it in this manner when attempting to assign an alternate frequency. If the assigned frequency is completely blocked by this type of interference, use the procedures described in paragraph 12., Two-Way Radio Communications Failure.

4.4.2.6 Be sure that you are within the performance range of your radio equipment and the ground station equipment. Remote radio sites do not always transmit and receive on all of a facilities’ available frequencies, particularly with regard to VOR sites where you can hear but not reach a ground station’s receiver. Remember that higher altitude increases the range of VHF “line of sight” communications.

4.4.3 Aircraft Call Signs

4.4.3.1 Improper use of call signs can result in pilots executing a clearance intended for another aircraft. Call signs should never be abbreviated on an initial contact or at any time when other aircraft call signs have similar numbers/sounds or identical letters/numbers, (e.g., Cessna 6132F, Cessna 1622F, Baron 123F, Cherokee 7732F, etc.).

EXAMPLE–

As an example, assume that a controller issues an approach clearance to an aircraft at the bottom of a holding stack and an aircraft with a similar call sign (at the top of the stack) acknowledges the clearance with the last two or three numbers of his/her call sign. If the aircraft at the bottom of

the stack did not hear the clearance and intervene, flight safety would be affected, and there would be no reason for either the controller or pilot to suspect that anything is wrong. This kind of “human factors” error can strike swiftly and is extremely difficult to rectify.

4.4.3.2 Pilots, therefore, must be certain that aircraft identification is complete and clearly identified before taking action on an ATC clearance. ATC specialists will not abbreviate call signs of air carrier or other civil aircraft having authorized call signs. ATC specialists may initiate abbreviated call signs of other aircraft by using the prefix and the last three digits/letters of the aircraft identification after communications are established. The pilot may use the abbreviated call sign in subsequent contacts with the ATC specialist. When aware of similar/identical call signs, ATC specialists will take action to minimize errors by emphasizing certain numbers/letters, by repeating the entire call sign, repeating the prefix, or by asking pilots to use a different call sign temporarily. Pilots should use the phrase “Verify clearance for (your complete call sign)” if doubt exists concerning proper identity.

4.4.3.3 Civil aircraft pilots should state the aircraft type, model or manufacturer’s name followed by the digits/letters of the registration number. When the aircraft manufacturer’s name or model is stated, the prefix “N” is dropped.

EXAMPLE-
“Bonanza Six Five Five Golf,” “Douglas One One Zero,” “Breezy Six One Three Romeo Experimental” (Omit “Experimental” after initial contact).

4.4.3.4 Air taxi or other commercial operators not having FAA authorized call signs should prefix their normal identification with the phonetic word “Tango.”

EXAMPLE-
“Tango Aztec Two Four Six Four Alpha.”

4.4.3.5 Air carriers and commuter air carriers having FAA authorized call signs should identify themselves by stating the complete call sign, using group form for the numbers.

EXAMPLE-
“United Twenty-five, Midwest Commuter Seven Eleven.”

4.4.3.6 Military aircraft use a variety of systems including serial numbers, word call signs and combinations of letters/numbers.

EXAMPLE-
“Army Copter 48931” “Air Force 61782” “REACH 31792” “Pat 157” “AirEvac 17652” “Navy Golf Alpha Kilo 21” “Marine 4 Charlie 36”

4.4.3.7 Air Ambulance Flights. Because of the priority afforded air ambulance flights in the ATC system, extreme discretion is necessary when using the term “LIFEGUARD.” It is only intended for those missions of an urgent medical nature and to be utilized only for that portion of the flight requiring expeditious handling. When requested by the pilot, necessary notification to expedite ground handling of patients, etc., is provided by ATC; however, when possible, this information should be passed in advance through non-ATC communications systems.

a) Civilian air ambulance flights responding to medical emergencies (first call to an accident scene, carrying patients, organ donors, organs, or other urgently needed lifesaving medical material) will be expedited by ATC when necessary. When expeditious handling is necessary, add the word “LIFEGUARD” in the remarks section of the flight plan. In radio communications, use the call sign “LIFEGUARD” followed by the aircraft registration letters/numbers.

b) Similar provisions have been made for the use of “Air-Evac” and “Med-Evac” by military air ambulance flights, except that these military flights will receive priority only when specifically requested.

EXAMPLE-
“Lifeguard Two Six Four Six.”

c) Air carrier and air taxi flights responding to medical emergencies will also be expedited by ATC when necessary. The nature of these medical emergency flights usually concerns the transportation of urgently needed lifesaving medical materials or vital organs. IT IS IMPERATIVE THAT THE COMPANY/PILOT DETERMINE, BY THE NATURE/URGENCY OF THE SPECIFIC MEDICAL CARGO, IF PRIORITY ATC ASSISTANCE IS REQUIRED. Pilots shall ensure that the word “LIFEGUARD” is included in the remarks section of the flight plan and use the call sign “LIFEGUARD” followed by the company name and flight number, for

all transmissions when expeditious handling is required. It is important for ATC to be aware of “LIFEGUARD” status, and it is the pilot’s responsibility to ensure that this information is provided to ATC.

EXAMPLE–
“Lifeguard Delta Thirty–seven.”

4.4.3.8 Student Pilots Radio Identification. The FAA desires to help the student pilot in acquiring sufficient practical experience in the environment in which he/she will be required to operate. To receive additional assistance while operating in areas of concentrated air traffic, a student pilot need only identify himself/herself as a student pilot during his/her initial call to an FAA radio facility. For instance, “Dayton Tower, Fleetwing One Two Three Four, Student Pilot.” This special identification will alert FAA air traffic control personnel and enable them to provide the student pilot with such extra assistance and consideration as he/she may need. It is recommended that student pilots identify themselves as such, on initial contact with each clearance delivery prior to taxiing, ground control, tower, approach and departure control frequency, or FSS contact.

4.4.4 Description of Interchange or Leased Aircraft

4.4.4.1 Controllers issue traffic information based on familiarity with airline equipment and color/markings. When an air carrier dispatches a flight using another company’s equipment and the pilot does not advise the terminal ATC facility, the possible confusion in aircraft identification can compromise safety.

4.4.4.2 Pilots flying an “interchange” or “leased” aircraft not bearing the colors/markings of the company operating the aircraft should inform the terminal ATC facility on first contact the name of the operating company and trip number, followed by the company name as displayed on the aircraft, and aircraft type.

EXAMPLE–
AIR CAL 311, United (Interchange/Lease), Boeing 727.

4.4.5 Ground Station Call Signs

4.4.5.1 Pilots, when calling a ground station, should begin with the name of the facility being called followed by the type of the facility being called, as indicated in the following examples.

TBL GEN 3.4–3
Calling a Ground Station

Facility	Call Sign
Airport UNICOM	“Shannon UNICOM”
FAA Flight Service Station	“Chicago Radio”
FAA Flight Service Station (En Route Flight Advisory Service (Weather))	“Seattle Flight Watch”
Airport Traffic Control Tower	“Augusta Tower”
Clearance Delivery Position (IFR)	“Dallas Clearance Delivery”
Ground Control Position in Tower	“Miami Ground”
Radar or Nonradar Approach Control Position	“Oklahoma City Approach”
Radar Departure Control Position	“St. Louis Departure”
FAA Air Route Traffic Control Center	“Washington Center”

4.5 Radio Communications Phraseology

4.5.1 Phonetic Alphabet

4.5.1.1 The International Civil Aviation Organization (ICAO) phonetic alphabet is used by FAA personnel when communications conditions are such that the information cannot be readily received without their use. Air traffic control facilities may also request pilots to use phonetic letter equivalents when aircraft with similar sounding identifications are receiving communications on the same frequency. Pilots should use the phonetic alphabet when identifying their aircraft during initial contact with air traffic control facilities. Additionally, use the phonetic equivalents for single letters and to spell out groups of letters or difficult words during adverse communications conditions.

TBL GEN 3.4-4

Character	Morse Code	Telephony	Phonic (Pronunciation)
A		Alfa	(AL-FAH)
B		Bravo	(BRAH-VOH)
C		Charlie	(CHAR-LEE) or (SHAR-LEE)
D		Delta	(DELL-TAH)
E		Echo	(ECK-OH)
F		Foxtrot	(FOKS-TROT)
G		Golf	(GOLF)
H		Hotel	(HOH-TEL)
I		India	(IN-DEE-AH)
J		Juliatt	(JEW-LEE-ETT)
K		Kilo	(KEY-LOH)
L		Lima	(LEE-MAH)
M		Mike	(MIKE)
N		November	(NO-VEM-BER)
O		Oscar	(OSS-CAH)
P		Papa	(PAH-PAH)
Q		Quebec	(KEH-BECK)
R		Romeo	(ROW-ME-OH)
S		Sierra	(SEE-AIR-RAH)
T		Tango	(TANG-GO)
U		Uniform	(YOU-NEE-FORM) or (OO-NEE-FORM)
V		Victor	(VIK-TAH)
W		Whiskey	(WISS-KEY)
X		Xray	(ECKS-RAY)
Y		Yankee	(YANG-KEY)
Z		Zulu	(ZOO-LOO)
1		One	(WUN)
2		Two	(TOO)
3		Three	(TREE)
4		Four	(FOW-ER)
5		Five	(FIFE)
6		Six	(SIX)
7		Seven	(SEV-EN)
8		Eight	(AIT)
9		Nine	(NIN-ER)
0		Zero	(ZEE-RO)

4.5.2 Figures

4.5.2.1 Figures indicating hundreds and thousands in round numbers, as for ceiling heights, and upper wind levels up to 9,900, shall be spoken in accordance with the following:

EXAMPLE-

1. 500 five hundred
2. 4,500 four thousand five hundred

4.5.2.2 Numbers above 9,900 shall be spoken by separating the digits preceding the word “thousand.”

EXAMPLE-

1. 10,000 one zero thousand
2. 13,500 one three thousand five hundred

4.5.2.3 Transmit airway or jet route numbers as follows:

EXAMPLE-

1. V12 Victor Twelve
2. J533 J Five Thirty- Three

4.5.2.4 All other numbers shall be transmitted by pronouncing each digit.

EXAMPLE-

10 one zero

4.5.2.5 When a radio frequency contains a decimal point, the decimal point is spoken as “Point.”

EXAMPLE-

122.1 one two two point one

NOTE-

ICAO procedures require the decimal point be spoken as “decimal.” The FAA will honor such usage by military aircraft and all other aircraft required to use ICAO procedures.

4.5.3 Altitudes and Flight Levels

4.5.3.1 Up to but not including 18,000 feet MSL, by stating the separate digits of the thousands, plus the hundreds.

EXAMPLE-

1. 12,000 one two thousand
2. 12,500 one two thousand five hundred

4.5.3.2 At and above 18,000’ MSL (FL 180) by stating the words “flight level” followed by the separated digits of the flight level.

EXAMPLE-

1. 190 Flight Level One Niner Zero
2. 275 Flight Level Two Seven Five

4.5.4 Directions

4.5.4.1 The three digits of a magnetic course, bearing, heading or wind direction, should always be magnetic. The word “true” must be added when it applies.

EXAMPLE–

1. (Magnetic course) 005 zero zero five
2. (True course) 050 zero five zero true
3. (Magnetic bearing) 360 three six zero
4. (Magnetic heading) 100 heading one zero zero
5. (Wind direction) 220 wind two two zero

4.5.5 Speeds

4.5.5.1 The separate digits of the speed are to be followed by the word “KNOTS” except that controllers may omit the word “KNOTS” when using speed adjustment procedures (e.g., “REDUCE/INCREASE SPEED TO TWO FIVE ZERO”).

EXAMPLE–

1. (Speed) 250 two five zero knots
2. (Speed) 190 one niner zero knots

4.5.5.2 The separate digits of the Mach number are to be preceded by the word “Mach.”

EXAMPLE–

1. (Mach number) 1.5 Mach one point five
2. (Mach number) 0.64 Mach point six four
3. (Mach number) 0.7 Mach point seven

4.5.6 Time

4.5.6.1 FAA uses Coordinated Universal Time (UTC) for all operations. The word “local” or the time zone equivalent shall be used to denote local when local time is given during radio and telephone communications. The term “ZULU” may be used to denote UTC.

EXAMPLE–

0920 UTC zero niner two zero,
zero one two zero pacific or local,
or one twenty AM

4.5.6.2 To convert from Standard Time to UTC:

TBL GEN 3.4–5

Standard Time to Coordinated Universal Time

Eastern Standard Time Central Standard Time	Add 5 hours
Mountain Standard Time	Add 6 hours
Pacific Standard Time Alaska Standard Time	Add 7 hours
Hawaii Standard Time	Add 8 hours
	Add 9 hours
	Add 10 hours

NOTE–

For daylight time, subtract 1 hour.

4.5.6.3 A reference may be made to local daylight or standard time utilizing the 24–hour clock system. The hour is indicated by the first two figures and the minutes by the last two figures.

EXAMPLE–

1. 0000 zero zero zero zero
2. 0920 zero niner two zero

4.5.6.4 Time may be stated in minutes only (two figures) in radio telephone communications when no misunderstanding is likely to occur.

4.5.6.5 Current time in use at a station is stated in the nearest quarter minute in order that pilots may use this information for time checks. Fractions of a quarter minute or more, but less than eight seconds more, are stated as the preceding quarter minute; fractions of a quarter minute of eight seconds or more are stated as the succeeding quarter minute.

EXAMPLE–

1. 0929:05 time, zero niner two niner
2. 0929:10 time, zero niner two niner and one–quarter

4.5.7 Communications with Tower when Aircraft Transmitter/Receiver or Both are Inoperative

4.5.7.1 Arriving Aircraft

a) Receiver Inoperative. If you have reason to believe your receiver is inoperative, remain outside or above Class D airspace until the direction and flow of traffic has been determined; then, advise the tower of your type aircraft, position, altitude, intention to land, and request that you be controlled with light signals. When you are approximately 3 to 5 miles from the airport, advise the tower of your position and join the airport traffic pattern. From this point on, watch the tower for light signals. Thereafter, if a complete pattern is made, transmit your position when downwind and/or turning base leg.

b) Transmitter Inoperative. Remain outside or above Class D airspace until the direction and flow of traffic has been determined, then join the airport traffic pattern. Monitor the primary local control frequency as depicted on sectional charts for landing or traffic information, and look for a light signal which may be addressed to your aircraft. During hours of daylight, acknowledge tower transmissions or light signals by rocking your wings. At night, acknowledge by blinking the landing or navigational lights.

NOTE–

To acknowledge tower transmissions during daylight hours, hovering helicopters will turn in the direction of the controlling facility and flash the landing light. While in flight, helicopters should show their acknowledgment of receiving a transmission by making shallow banks in opposite directions. At night, helicopters will acknowledge receipt of transmissions by flashing either the landing or the search light.

c) Transmitter and Receiver Inoperative. Remain outside or above Class D airspace until the direction and flow of traffic has been determined, then join the airport traffic pattern and maintain visual contact with tower to receive light signals.

4.5.7.2 Departing Aircraft. If you experience radio failure prior to leaving the parking area, make every effort to have the equipment repaired. If you are unable to have the malfunction repaired, call the tower by telephone and request authorization to depart without two-way radio communications. If tower authorization is granted, you will be given departure information and requested to monitor the tower frequency or watch for light signals, as appropriate. During daylight hours, acknowledge tower transmissions or light signals by moving the ailerons or rudder. At night, acknowledge by blinking the landing or navigation lights. If radio malfunction occurs after departing the parking area, watch the tower for light signals or monitor tower frequency.

4.5.8 Contact Procedures

4.5.8.1 Initial Contact

a) The terms “initial contact” or “initial call up” mean the first radio call you make to a given facility,

or the first call to a different controller/FSS specialist within a facility. Use the following format:

- 1) Name of facility being called.
- 2) Your full aircraft identification as filed in the flight plan or as discussed under aircraft call signs.
- 3) When operating on an airport surface, state your position.
- 4) The type of message to follow or your request if it is short; and
- 5) The word “Over,” if required.

EXAMPLE–

1. “New York Radio, Mooney Three One One Echo.”
2. “Columbia Ground, Cessna Three One Six Zero Foxtrot, south ramp, I–F–R Memphis.”
3. “Miami Center, Baron Five Six Three Hotel, request VFR traffic advisories.”

b) Many FSSs are equipped with remote communications outlets and can transmit on the same frequency at more than one location. The frequencies available at specific locations are indicated on charts above FSS communications boxes. To enable the specialist to utilize the correct transmitter, advise the location and frequency on which you expect a reply.

EXAMPLE–

St. Louis FSS can transmit on frequency 122.3 at either Farmington, MO, or Decatur, IL. If you are in the vicinity of Decatur, your callup should be “Saint Louis radio, Piper Six Niner Six Yankee, receiving Decatur One Two Two Point Three.”

c) If radio reception is reasonably assured, inclusion of your request, your position or altitude, the phrase “Have numbers” or “Information Charlie received” (for ATIS) in the initial contact helps decrease radio frequency congestion. Use discretion and do not overload the controller with information he/she does not need. When you do not get a response from the ground station, recheck your radios or use another transmitter and keep the next contact short.

EXAMPLE–

“Atlanta Center, Duke Four One Romeo, request VFR traffic advisories, Twenty Northwest Rome, Seven Thousand Five Hundred, over.”

4.5.9 Initial Contact when your Transmitting and Receiving Frequencies are Different

4.5.9.1 If you are attempting to establish contact with a ground station and you are receiving on a different frequency than that transmitted, indicate the VOR name or the frequency on which you expect a reply. Most FSSs and control facilities can transmit on several VOR stations in the area. Use the appropriate FSS call sign as indicated on charts.

EXAMPLE–

New York FSS transmits on the Kennedy, Deer Park and Calverton VORTACs. If you are in the Calverton area, your callup should be “New York Radio, Cessna Three One Six Zero Foxtrot, receiving Riverhead VOR, over.”

4.5.9.2 If the chart indicates FSS frequencies above the VORTAC or in FSS communications boxes, transmit or receive on those frequencies nearest your location.

4.5.9.3 When unable to establish contact and you wish to call any ground station, use the phrase “any radio (tower) (station), give Cessna Three One Six Zero Foxtrot a call on (frequency) or (VOR).” If an emergency exists or you need assistance, so state.

4.5.10 Subsequent Contacts and Responses to Call Up from a Ground Facility. Use the same format as used for initial contact except you should state your message or request with the call up in one transmission. The ground station name and the word “Over” may be omitted if the message requires an obvious reply and there is no possibility for misunderstandings. You should acknowledge all callups or clearances unless the controller of FSS specialist advises otherwise. There are some occasions when the controller must issue time-critical instructions to other aircraft and he/she may be in a position to observe your response, either visually or on radar. If the situation demands your response, take appropriate action or immediately advise the facility of any problem. Acknowledge with your aircraft identification, either at the beginning or at the end of your transmission, and one of the words “Wilco, Roger, Affirmative, Negative” or other appropriate remarks; e.g., “Piper Two One Four Lima, Roger.” If you have been receiving services such as VFR traffic advisories and you are leaving the area or changing frequencies, advise the ATC facility and terminate contact.

4.6 Acknowledgement of Frequency Changes

4.6.1 When advised by ATC to change frequencies, acknowledge the instruction. If you select the new frequency without an acknowledgement, the controller’s workload is increased because he/she has no way of knowing whether you received the instruction or have had radio communications failure.

4.6.2 At times, a controller/specialist may be working a sector with multiple frequency assignments. In order to eliminate unnecessary verbiage and to free the controller/specialist for higher priority transmissions, the controller/specialist may request the pilot “(Identification), change to my frequency 123.4.” This phrase should alert the pilot that he/she is only changing frequencies, not controller/specialist, and that initial call-up phraseology may be abbreviated.

EXAMPLE–

“United Two Twenty-two on One Two Three Point Four” or “One Two Three Point Four, United Two Twenty-two.”

4.6.3 Compliance with Frequency Changes.

When instructed by ATC to change frequencies, select the new frequency as soon as possible unless instructed to make the change at a specific time, fix, or altitude. A delay in making the change could result in an untimely receipt of important information. If you are instructed to make the frequency change at a specific time, fix, or altitude, monitor the frequency you are on until reaching the specified time, fix, or altitudes unless instructed otherwise by ATC.

5. Communications for VFR Flights

5.1 FSSs and Supplemental Weather Service Locations (SWSLs) are allocated frequencies for different functions; for example, 122.0 MHz is assigned as the En Route Flight Advisory Service frequency at selected FSSs. In addition, certain FSSs provide Local Airport Advisory on 123.6 MHz or other frequencies which can be found in the A/FD. If you are in doubt as to what frequency to use, 122.2 MHz is assigned to the majority of FSSs as a common en route simplex frequency.

NOTE–

In order to expedite communications, state the frequency being used and the aircraft location during initial call-up.

EXAMPLE–

Dayton radio, November One Two Three Four Five on one two two point two, over Springfield V–O–R, over.

5.1.1 Certain VOR voice channels are being utilized for recorded broadcasts; i.e., ATIS, HIWAS, etc. These services and appropriate frequencies are listed in the Airport/Facility Directory. On VFR flights, pilots are urged to monitor these frequencies. When in contact with a control facility, notify the controller if you plan to leave the frequency to monitor these broadcasts.

5.2 Hazardous Area Reporting Service

5.2.1 Selected FSSs provide flight monitoring where regularly traveled VFR routes cross large bodies of water, swamps, and mountains, for the purpose of expeditiously alerting Search and Rescue facilities when required.

5.2.1.1 When requesting the service either in person, by telephone or by radio, pilots should be prepared to give the following information: type of aircraft, altitude, indicated airspeed, present position, route of flight, heading.

5.2.1.2 Radio contacts are desired at least every 10 minutes. If contact is lost for more than 15 minutes, Search and Rescue will be alerted. Pilots are responsible for cancelling their request for service when they are outside the service area boundary. Pilots experiencing two-way radio failure are expected to land as soon as practicable and cancel their request for the service. FIG GEN 3.4-6, Hazardous Area Reporting Service, includes the areas and the FSS facilities involved in this program.

5.2.2 Long Island Sound Reporting Service (LIRS)

5.2.2.1 The New York and Bridgeport FSS Radio Sectors provide Long Island Sound Reporting service on request for aircraft traversing Long Island Sound.

5.2.2.2 When requesting the service, pilots should ask for SOUND REPORTING SERVICE and should be prepared to provide the following appropriate information:

- a) Type and color of aircraft.
- b) The specific route and altitude across the sound including the shore crossing point.
- c) The overwater crossing time.
- d) Number of persons on board.
- e) True air speed.

5.2.2.3 Radio contacts are desired at least every 10 minutes; however, for flights of shorter duration, a midsound report is requested. If contact is lost for more than 15 minutes, Search and Rescue will be alerted. Pilots are responsible for cancelling their request for the Long Island Sound Reporting Service when outside the service area boundary. Aircraft experiencing radio failure will be expected to land as soon as practicable and cancel their request for the service.

5.2.2.4 Communications. Primary communications – pilot transmits 122.1 MHz and listens on the VOR frequency.

TBL GEN 3.4-6

New York FSS Radio Sector Controls		
	Transmits	Receives
Hampton RCO	122.6 MHz	122.6 MHz
Calverton VOR	117.2 MHz	Standard FSS frequencies
Kennedy VORTAC	115.9 MHz	122.1 MHz
Bridgeport FSS Radio Sector Controls		
	Transmits	Receives
Madison VORTAC	110.4 MHz	122.1 MHz
Groton VOR	110.85 MHz	122.1 MHz
Bridgeport VOR	108.8 MHz	122.1 MHz

FIG GEN 3.4-6
Hazardous Area Reporting Service

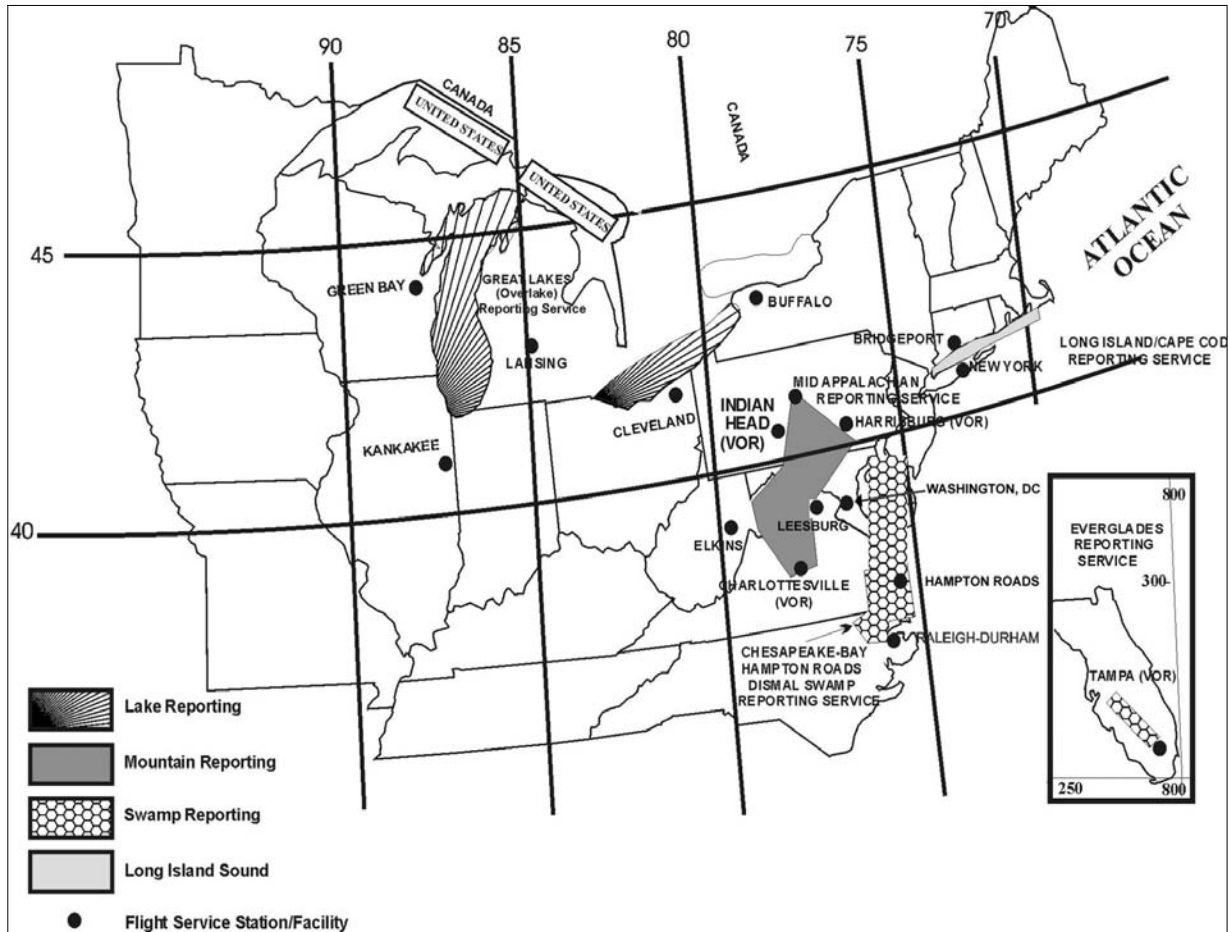

5.2.3 Block Island Reporting Service (BIRS)

5.2.3.1 Within the Long Island Reporting Service, the New York FSS Radio Sector also provides an additional service for aircraft operating between Montauk Point and Block Island. When requesting this service, pilots should ask for **BLOCK ISLAND REPORTING SERVICE** and should be prepared to provide the same flight information as that required for the Long Island Sound Reporting Service.

5.2.3.2 A minimum of three position reports are mandatory for this service. These are:

- a) Report leaving Montauk Point or Block Island.

- b) Midway report.

c) Report when over Montauk Point or Block Island at which time the pilot cancels the overwater service.

5.2.3.3 Communications. Pilots are to transmit and receive on 122.6 MHz.

5.2.3.4 Pilots are advised that 122.6 MHz is a remote receiver located at the Hampton VORTAC site and designed to provide radio coverage between Hampton and Block Island. Flights proceeding beyond Block Island may contact the Bridgeport FSS Radio Sector by transmitting on 122.1 MHz and listening on Groton VOR frequency 110.85 MHz.

5.2.4 Cape Cod and Islands Radar Overwater Flight Following

5.2.4.1 In addition to normal VFR radar advisory service, traffic permitting, Otis Approach Control provides a radar overwater flight following service for aircraft traversing the Cape Code and adjacent island area. Pilots desiring this service may contact Cape RAPCON on 118.2 MHz.

5.2.4.2 Pilots requesting this service should be prepared to give the following information:

- a) Type and color of aircraft.
- b) Altitude.
- c) Position and heading.
- d) Route of flight.
- e) True airspeed.

5.2.4.3 For best radar coverage, pilots are encouraged to fly at 1,500 feet MSL or above.

5.2.4.4 Pilots are responsible for cancelling their request for overwater flight following when they are over the mainland and/or outside the service area boundary.

5.2.5 Lake Reporting Service

5.2.5.1 Cleveland and Lansing FSS Radio Sectors provide Lake Reporting Service on request for aircraft traversing the western half of Lake Erie. Green Bay, Kankakee, Lansing, and Terre Haute FSS Radio Sectors provide Lake Reporting Service on request for aircraft traversing Lake Michigan.

a) When requesting the service, pilots should ask for LAKE REPORTING SERVICE.

b) Pilots not on a VFR flight plan should be prepared to provide all information that is normally provided for a complete VFR flight plan.

c) Pilots already on a VFR flight plan should be prepared to provide the following information:

- 1) Aircraft or flight identification.
- 2) Type of aircraft.
- 3) Near–shore crossing point or last fix before crossing.
- 4) Proposed time over near–shore crossing point or last fix before crossing.
- 5) Proposed altitude.

- 6) Proposed route of flight.
- 7) Estimated time over water.
- 8) Next landing point.
- 9) AFSS/FSS having complete VFR flight plan information.

d) Radio contacts must not exceed 10 minutes when pilots fly at an altitude that affords continuous communications. If radio contact is lost for more than 15 minutes (5 minutes after a scheduled reporting time), Search and Rescue (SAR) will be alerted.

5.2.5.2 The estimated time for crossing the far shore will be the scheduled reporting time for aircraft that fly at an altitude that does not afford continuous communication coverage while crossing the lake. If radio contact is not established within 5 minutes of that time, SAR will be alerted.

5.2.5.3 Pilots are responsible for canceling their request for Lake Reporting Service when outside the service area boundary. Aircraft experiencing radio failure will be expected to land as soon as practicable and cancel their Lake Reporting Service flight plan.

5.2.5.4 Communications. Primary communications – Pilots should communicate with the following facilities on the indicated frequencies:

a) Cleveland FSS Radio Sector Controls:

- 1) Cleveland RCO (FSS transmits and receives on 122.35 or 122.55 MHz).
- 2) Sandusky VOR (FSS transmits on 109.2 and receives on 122.1 MHz).

b) Green Bay FSS Radio Sector Controls:

- 1) Escanaba VORTAC (FSS transmits on 110.8 and receives on 122.1 MHz).
- 2) Green Bay RCO (FSS transmits and receives on 122.55 MHz).
- 3) Manistique RCO (FSS transmits and receives on 122.25 MHz).
- 4) Manitowoc VOR (FSS transmits on 111.0 and receives on 122.1 MHz).
- 5) Menominee VOR (FSS transmits on 109.6 and receives on 122.1 MHz).
- 6) Milwaukee RCO (FSS transmits and receives on 122.65 MHz).
- 7) Falls VOR (FSS transmits on 110.0 and receives on 122.1 MHz).

c) Kankakee FSS Radio Sector Controls:

1) Chicago Heights VORTAC (FSS transmits on 114.2 and receives on 122.1 MHz).

2) Meigs RCO (FSS transmits and receives on 122.15 MHz).

3) Waukegan RCO (FSS transmits and receives on 122.55 MHz).

d) Lansing FSS Radio Sector Controls:

1) **Lake Erie.** Detroit City RCO (FSS transmits and receives on 122.55 MHz).

2) Lake Michigan:

(a) Keeler VORTAC (FSS transmits on 116.6 and receives on 122.1 MHz).

(b) Ludington RCO (FSS transmits and receives on 122.45 MHz).

(c) Manistee VORTAC (FSS transmits on 111.4 and receives on 122.1 MHz).

(d) Muskegon RCO (FSS transmits and receives on 122.5 MHz).

(e) Pellston RCO (FSS transmits and receives on 122.3 MHz).

(f) Pullman VORTAC (FSS transmits on 112.1 and receives on 122.1 MHz).

(g) Traverse City RCO (FSS transmits and receives on 122.65 MHz).

e) Terre Haute FSS Radio Sector Controls. South Bend RCO (FSS transmits and receives on 122.6 MHz).

5.2.5.5 Florida Everglades Reporting Service. This service is offered by Miami Automated International Flight Service Station (MIA AIFSS), in extreme southern Florida. The service is provided to aircraft crossing the Florida Everglades, between Lee County (Ft. Myers, FL) VORTAC (RSW) on the northwest side, and Dolphin (Miami, FL) VOR (DHP) on the southeast side.

a) The pilot must request the service from Miami AIFSS.

b) MIA AIFSS frequency information, 122.2, 122.3, and 122.65.

c) The pilot must file a VFR flight plan with the remark: ERS.

d) The pilot must maintain 2000 feet of altitude.

e) The pilot must make position reports every ten (10) minutes. SAR begins fifteen (15) minutes after position report is not made on time.

f) The pilot is expected to land as soon as is practical, in the event of two-way radio failure, and advise MIA AIFSS that the service is terminated.

g) The pilot must notify Miami AIFSS when the flight plan is cancelled or the service is suspended.

6. Over-water Flights Radio Procedure

6.1 Pilots should remember that there is a need to continuously guard the VHF emergency frequency 121.5 MHz when on long over-water flights, except when communications on other VHF channels, equipment limitations, or cockpit duties prevent simultaneous guarding of two channels. Guarding of 121.5 MHz is particularly critical when operating in proximity to flight information region (FIR) boundaries; for example, operations on Route R220 between Anchorage and Tokyo, since it serves to facilitate communications with regard to aircraft which may experience in-flight emergencies, communications, or navigational difficulties. (Reference ICAO Annex 10, Vol II Paras. 5.2.2.1.1.1 and 5.2.2.1.1.2.)

7. Radio Communications and Navigation Facilities

7.1 A complete listing of air traffic radio communications facilities and frequencies and radio navigation facilities and frequencies is contained in the Airport/Facility Directory. Similar information for the Pacific and Alaskan areas is contained in the Pacific and Alaskan Supplements (See GEN 3.2, Aeronautical Charts).

8. U.S. Aeronautical Telecommunications Services

8.1 The following services are available for aircraft engaged in international or overseas flight.

8.2 The aeronautical voice communication stations listed are available to and utilized by the U.S. Federal Aviation Administration Air Traffic Control Centers for air traffic control purposes.

8.3 The frequencies in use will depend upon the time of day or night and conditions which affect radio wave propagation. Voice communications handled on a single channel simplex basis (i.e., with the aircraft and the ground station using the same frequency for transmission and reception) unless otherwise noted in remarks.

8.4 The stations will remain on continuous watch for aircraft within their communications areas and, when practicable, will transfer this watch to another station when the aircraft reaches the limit of the communications area.

8.5 Stations listed below which are designated "FAA" are operated by the U.S. Federal Aviation Administration. Stations designated "ARINC" are operated by Aeronautical Radio, Incorporated, 2551 Riva Road, Annapolis, MD 21401. Contact the Aviation Voice Services Support Section at 410-266-4430, E:Mail AGOPS@arinc.com or cable HDQXGXA. (See TBL GEN 3.4-7.)

8.6 All users of the North Atlantic HF MWARA services should consult International NOTAMS and ICAO Regional Supplementary Procedures, Docu-

ment 7030, for current procedures concerning the operational use of the North Atlantic HF families. At present, procedures for the distribution of HF communications traffic in the North Atlantic are:

8.6.1 All aircraft registered in the hemisphere west of 30W should use family alpha on the southern routes and family bravo on the central and northern routes. (Southern routes are those which enter the New York, San Juan and Santa Maria FIRs. The central and northern routes comprise all others).

8.6.2 All aircraft registered in the hemisphere east of 30W should use family alpha on the southern routes and family charlie on the central and northern routes.

8.6.3 All aircraft should use family alpha on the southern route and family delta on the central and northern routes while outside the organized track system (OTS).

8.6.4 Aircraft registered in Australia will use families designated to aircraft registered east of 30W.

8.7 Aircraft operating in the Anchorage Arctic CTA/FIR beyond line of sight range of remote control VHF air/ground facilities operated from the Anchorage ACC, shall maintain communications with Cambridge Bay radio and a listening or SELCAL watch on HF frequencies of the North Atlantic D (NAT D) network (2971 kHz, 4675 kHz, 8891 kHz and 11279 kHz). Additionally, and in view of reported marginal reception of the Honolulu Pacific Volmet broadcasts in that and adjacent Canadian airspace, Cambridge Bay radio can provide Anchorage and Fairbanks surface observations and terminal forecasts to flight crews on request.

TBL GEN 3.4-7

Station and Operating Agency	Radio Call	Transmitting Frequencies	Remarks
HONOLULU (FAA)	Honolulu Radio	122.6 122.2 #121.5 MHz	#Emergency. Frequency 122.1 also available for receiving only.
	Volmet	2863 6679 8828 13282 kHz	Broadcasts at H+00-05 and H+30-35; Aerodrome Forecasts, Honolulu, Hilo, Agana, Honolulu. SIGMET. Hourly Report, Honolulu, Hilo, Kahului, Agana, Honolulu.
			Broadcasts at H+05-10 and H+35-40; Hourly Reports, San Francisco, Los Angeles, Seattle, Portland, Sacramento, Ontario, Las Vegas. SIGMET. Aerodrome Forecasts, San Francisco, Seattle, Los Angeles.
			Broadcasts at H+25-30 and H+55-60; Hourly Reports, Anchorage, Elmendorf, Fairbanks, Cold Bay, King Salmon, Vancouver. SIGMET. Aerodrome Forecasts, Anchorage, Fairbanks, Cold Bay, Vancouver.
MIAMI (FAA)	Miami Radio	126.7 118.4 126.9 122.2 122.4 122.75 123.65 127.9 MHz	Local and Short Range.
		#121.5 MHz	#Emergency.
NEW YORK (FAA)	New York Radio (Volmet)	3485* 6604 10051 13270* kHz	*3485 Volmet broadcasts from 1 hour after sunset to 1 hour before sunrise.
			*13270 Volmet broadcasts from 1 hour before sunrise to 1 hour after sunset.
			Broadcasts at H+00-05; Aerodrome Forecasts, Detroit, Chicago, Cleveland. Hourly Reports, Detroit, Chicago, Cleveland, Niagara Falls, Milwaukee, Indianapolis.
			Broadcasts at H+05-10; SIGMET (Oceanic-New York). Aerodrome Forecasts, Bangor, Pittsburgh, Charlotte. Hourly Reports, Bangor, Pittsburgh, Windsor Locks, St. Louis, Charlotte, Minneapolis.
			Broadcasts at H+10-15; Aerodrome Forecasts, New York, Newark, Boston. Hourly reports, New York, Newark, Boston, Baltimore, Philadelphia, Washington.
			Broadcasts at H+15-20; SIGMET (Oceanic-Miami/San Juan). Aerodrome Forecasts, Bermuda, Miami, Atlanta. Hourly Reports, Bermuda, Miami, Nassau, Freeport, Tampa, West Palm Beach, Atlanta.
			Broadcasts at H+30-35; Aerodrome Forecasts, Niagara Falls, Milwaukee, Indianapolis. Hourly Reports Detroit, Chicago, Cleveland, Niagara Falls, Milwaukee, Indianapolis.
			Broadcasts at H+35-40; SIGMET (Oceanic-New York). Aerodrome Forecasts, Windsor Locks, St. Louis. Hourly Reports, Bangor, Pittsburgh, Windsor Locks, St. Louis, Charlotte, Minneapolis.
			Broadcasts at H+40-45; Aerodrome Forecasts, Baltimore, Philadelphia, Washington. Hourly Reports, New York, Newark, Boston, Baltimore, Philadelphia, Washington.
			Broadcasts at H+45-50; SIGMET (Oceanic-Miami/San Juan). Aerodrome Forecasts, Nassau, Freeport. Hourly Reports, Bermuda, Miami, Nassau, Freeport, Tampa, West Palm Beach, Atlanta.

Station and Operating Agency	Radio Call	Transmitting Frequencies	Remarks
NEW YORK (ARINC)	New York	3016 5598 8906 13306 17946 21964 kHz	North Atlantic Family A Network.
		2962 6628 8825 11309 13354 17952 kHz	North Atlantic Family E Network.
		2887 3455 5550 6577 8846 11396 kHz	Caribbean Family A Network.
		5520 6586 8918 11330 13297 17907 kHz	Caribbean Family B Network.
		3494 6640 8933 11342 13330 17925 kHz	Long Distance Operations Control (LDOC) Service (phone-patch). Communications are limited to operational control matters only. Public correspondence (personal messages) to/from crew or passengers cannot be accepted. Note: New York ARINC can also provide HF communications over South America on these LDOC frequencies through their remote site located in Santa Cruz, Boliva.
		129.90 MHz	Extended range VHF. Coverage area includes Canadian Maritime Provinces, and oceanic routes to Bermuda and the Caribbean, from Boston, New York and Washington areas to approximately 250 nautical miles from the east coast.
		130.7 MHz	Extended range VHF. Full period service is provided within most of the Gulf of Mexico. Also on routes between Miami and San Juan to a distance of approximately 250 nautical miles from the Florida coast and within approximately 250 nautical miles of San Juan. Note: New York ARINC also provides VHF communications over the Northern two-thirds of Mexico on 130.7 MHz for 14 CFR Section 121.99 compliance.
			Note: Due to the distances involved, signal levels received by aircraft communicating with New York ARINC in the Gulf of Mexico on frequency 130.700 MHz will be weaker than normally encountered in VHF communications. Most aircraft usually have the squelch setup to communicate where signal levels are much higher and to totally eliminate background noise for the flight crew. In order to increase the range and maximize the coverage area, aircraft are asked to utilize the following squelch settings on their VHF radios while monitoring or communicating with New York ARINC. On aircraft with an OPEN/CLOSE squelch switch, the squelch should be set to the OPEN position while communicating or after being SELCAL'ed. Aircraft with an adjustable system should first set their squelch to fully open position and then adjust to where the noise is reduced or just closed. This will allow the weakest signals to be heard. Utilizing this procedure will increase the background noise heard by the flight crew but will allow communications at a much greater range.

Station and Operating Agency	Radio Call	Transmitting Frequencies	Remarks
		436623* 631–244–2492	Aircraft operating within the New York Oceanic FIR.
			*Note: This satellite Voice Air/Ground calling number is available to call ARINC and will be recognized and converted by all Ground Earth Station (GES) service providers to the appropriate Public Service Telephone Network (PTSN) or direct dial number for this communications center.
SAN FRANCISCO (ARINC)	San Francisco	3413 3452 5574 6673 8843 10057 13354 kHz	Central East Pacific One Network.
		2869 5547 11282 13288 21964 kHz	Central East Pacific Two Network.
		2998 4666 6532 8903 11384 13300 17904 21985 kHz	Central West Pacific Network.
		3467 5643 8867 13261 17904 kHz	South Pacific Network.
		2932 5628 5667 6655 8915 8951 10048 11330 13273 13339 17946 21925 kHz	North Pacific Network
		3494 6640 11342 13348 17925 21964 kHz	Long Distance Operations Control (LDOC) Service (phone–patch). Communications are limited to operational control matters only. Public correspondence (personal messages) to/from crew or passengers cannot be accepted. Note: San Francisco ARINC can also provide HF communications along the polar routes on these LDOC frequencies through their remote site located at Barrow, Alaska.
		131.95 MHz	Extended range VHF. Coverage area includes area surrounding the Hawaiian Islands and along the tracks from HNL to the mainland. Coverage extends out approximately 250 NM from Hawaii and from the West coast.
		129.40 MHz	For en route communications for aircraft operating on Seattle/Anchorage/Routes.
		436625* 925–371–3920	Aircraft operating within the Oakland and Anchorage Oceanic FIRs.
			*Note: This satellite Voice Air/Ground calling number is available to call ARINC and will be recognized and converted by all Ground Earth Station (GES) service providers to the appropriate Public Service Telephone Network (PTSN) or direct dial number for this communications center.
OAKLAND (FAA)	Oakland Radio	122.5 122.2 #121.5 MHz	#Emergency.
SAN JUAN P.R. (FAA)	San Juan Radio	#121.5 122.2 126.7 123.65 #243.0 255.4 114.0 113.5 108.2 108.6 109.0 110.6 MHz	Unscheduled broadcasts H+00, H+15, H+30 and H+45 as appropriate, for Weather and Military Activity Advisories, on 110.6, 109.0, 108.6, 108.2, 113.5, and 114.0 MHz. #Emergency. For frequencies 114.0, 113.5, 108.2 and 109.0 MHz use 122.1 MHz for transmissions to San Juan Radio. For frequency 108.6 use 123.6 MHz.

9. Selective Calling System (SELCAL) Facilities Available

9.1 The SELCAL is a communication system which permits the selective calling of individual aircraft over radio-telephone channels from the ground station to properly equipped aircraft, so as to eliminate the need for the flight crew to constantly monitor the frequency in use.

TBL GEN 3.4-8

Location	Operator	HF	VHF
New York	ARINC	X	X
San Francisco	ARINC	X	X

10. Special North Atlantic, Caribbean, and Pacific Area Communications

10.1 VHF air-to-air frequencies enable aircraft engaged on flights over remote and oceanic areas out of range of VHF ground stations to exchange necessary operational information and to facilitate the resolution of operational problems.

10.2 Frequencies have been designated as follows:

TBL GEN 3.4-9

Area	Frequency
North Atlantic	123.45 MHz
Caribbean	123.45 MHz
Pacific	123.45 MHz

11. Distress and Urgency Communications

11.1 A pilot who encounters a distress or urgency condition can obtain assistance simply by contacting the air traffic facility or other agency in whose area of responsibility the aircraft is operating, stating the nature of the difficulty, pilot's intentions, and assistance desired. Distress and urgency communications procedures are prescribed by the International Civil Aviation Organization (ICAO), however, and have decided advantages over the informal procedure described above.

11.2 Distress and urgency communications procedures discussed in the following paragraphs relate to the use of air ground voice communications.

11.3 The initial communication, and if considered necessary, any subsequent transmissions by an aircraft in distress should begin with the signal MAYDAY, preferably repeated three times. The signal PAN-PAN should be used in the same manner for an urgency condition.

11.4 Distress communications have absolute priority over all other communications, and the word MAYDAY commands radio silence on the frequency in use. Urgency communications have priority over all other communications except distress, and the word PAN-PAN warns other stations not to interfere with urgency transmissions.

11.5 Normally, the station addressed will be the air traffic facility or other agency providing air traffic services, on the frequency in use at the time. If the pilot is not communicating and receiving services, the station to be called will normally be the air traffic facility or other agency in whose area of responsibility the aircraft is operating, on the appropriate assigned frequency. If the station addressed does not respond, or if time or the situation dictates, the distress or urgency message may be broadcast, or a collect call may be used, addressing "Any Station (Tower) (Radio) (Radar)."

11.6 The station addressed should immediately acknowledge a distress or urgency message, provide assistance, coordinate and direct the activities of assisting facilities, and alert the appropriate Search and Rescue coordinator if warranted. Responsibility will be transferred to another station only if better handling will result.

11.7 All other stations, aircraft and ground, will continue to listen until it is evident that assistance is being provided. If any station becomes aware that the station being called either has not received a distress or urgency message, or cannot communicate with the aircraft in difficulty, it will attempt to contact the aircraft and provide assistance.

11.8 Although the frequency in use or other frequencies assigned by ATC are preferable, the following emergency frequencies can be used for distress or urgency communications, if necessary or desirable:

11.8.1 121.5 MHz and 243.0 MHz. Both have a range generally limited to line of sight. 121.5 MHz is guarded by direction finding stations and some military and civil aircraft. 243.0 MHz is guarded by military aircraft. Both 121.5 MHz and 243.0 MHz are

guarded by military towers, most civil towers, flight service stations, and radar facilities. Normally ARTCC emergency frequency capability does not extend to radar coverage limits. If an ARTCC does not respond when called on 121.5 MHz or 243.0 MHz, call the nearest tower or flight service station.

11.8.2 2182 kHz. The range is generally less than 300 miles for the average aircraft installation. It can be used to request assistance from stations in the maritime service. 2182 kHz is guarded by major radio stations serving Coast Guard Rescue Coordination Centers and Coast Guard units along the sea coasts of the U.S. and shores of the Great Lakes. The call “Coast Guard” will alert all Coast Guard Radio Stations within range. 2182 kHz is also guarded by most commercial coast stations and some ships and boats.

12. Two-Way Radio Communications Failure

12.1 It is virtually impossible to provide regulations and procedures applicable to all possible situations associated with two-way radio communications failure. During two-way radio communications failure when confronted by a situation not covered in the regulation, pilots are expected to exercise good judgment in whatever action they elect to take. Should the situation so dictate, they should not be reluctant to use the emergency action contained in 14 CFR Section 91.3(b).

12.2 Whether two-way communications failure constitutes an emergency depends on the circumstances, and in any event is a determination made by the pilot. 14 CFR Section 91.3 authorizes a pilot to deviate from any rule to the extent required to meet an emergency.

12.3 In the event of two-way radio communications failure, ATC service will be provided on the basis that the pilot is operating in accordance with 14 CFR Section 91.185. A pilot experiencing two-way communications failure should (unless emergency authority is exercised) comply with 14 CFR Section 91.185 as indicated below.

12.4 Unless otherwise authorized by ATC, each pilot who has two-way radio communications failure when operating under IFR shall comply with the following conditions:

12.4.1 If the failure occurs in VFR conditions, or if VFR conditions are encountered after the failure, each pilot shall continue the flight under VFR and land as soon as practicable.

NOTE–

This procedure also applies when two-way radio failure occurs while operating in Class A airspace. The primary objective of this provision in 14 CFR Section 91.185 is to preclude extended IFR operation by these aircraft within the ATC system. Pilots should recognize that operation under these conditions may unnecessarily as well as adversely affect other users of the airspace, since ATC may be required to reroute or delay other users in order to protect the failure aircraft. However, it is not intended that the requirement to “land as soon as practicable” be construed to mean “as soon as possible.” Pilots retain the prerogative of exercising their best judgment and are not required to land at an unauthorized airport, at an airport unsuitable for the type of aircraft flown, or to land only minutes short of their intended destination.

12.4.2 If the failure occurs in IFR conditions, or if VFR conditions cannot be complied with, each pilot shall continue the flight according to the following requirements.

12.5 Route requirements:

12.5.1 By the route assigned in the last ATC clearance received.

12.5.2 If being radar vectored, by the direct route from the point of radio failure to the fix, route, or airway specified in the vector clearance.

12.5.3 In the absence of an assigned route, by the route that ATC has advised may be expected in a further clearance.

12.5.4 In the absence of an assigned route or a route that ATC has advised may be expected in a further clearance, by the route filed in the flight plan.

12.6 Altitude requirements. At the HIGHEST of the following altitudes or flight levels FOR THE ROUTE SEGMENT BEING FLOWN:

12.6.1 The altitude or flight level assigned in the last ATC clearance received.

12.6.2 The minimum altitude (converted, if appropriate, to minimum flight level as prescribed in 14 CFR Section 91.121(c)) for IFR operations.

12.6.3 The altitude or flight level ATC has advised may be expected in a further clearance.

NOTE–

The intent of the rule is that a pilot who has experienced two-way radio failure should select the appropriate altitude for the particular route segment being flown and make the necessary altitude adjustments for subsequent route segments. If the pilot received an “expect further clearance” containing a higher altitude to expect at a specified time or fix, he/she should maintain the highest of the following altitudes until that time/fix: (1) his/her last assigned altitude, or (2) the minimum altitude/flight level for IFR operations.

Upon reaching the time/fix specified, the pilot should commence his/her climb to the altitude he/she was advised to expect. If the radio failure occurs after the time/fix specified, the altitude to be expected is not applicable and the pilot should maintain an altitude consistent with 1 or 2 above.

If the pilot receives an “expect further clearance” containing a lower altitude, the pilot should maintain the highest of 1 or 2 above until that time/fix specified in paragraph 12.7, Leave Clearance Limit.

EXAMPLE–

1. *A pilot experiencing two-way radio failure at an assigned altitude of 7,000 feet is cleared along a direct route which will require a climb to a minimum IFR altitude of 9,000 feet, should climb to reach 9,000 feet at the time or place where it becomes necessary (see 14 CFR Section 91.177(b)). Later while proceeding along an airway with an MEA of 5,000 feet, the pilot would descend to 7,000 feet (the last assigned altitude), because that altitude is higher than the MEA.*

2. *A pilot experiencing two-way radio failure while being progressively descended to lower altitudes to begin an approach is assigned 2,700 feet until crossing the VOR and then cleared for the approach. The MOCA along the airway is 2,700 feet and MEA is 4,000 feet. The aircraft is within 22 NM of the VOR. The pilot should remain at 2,700 feet until crossing the VOR because that altitude is the minimum IFR altitude for the route segment being flown.*

3. *The MEA between a and b – 5,000 feet. The MEA between b and c – 5,000 feet. The MEA between c and d – 11,000 feet. The MEA between d and e – 7,000 feet. A pilot had been cleared via a, b, c, d, to e. While flying between a and b the assigned altitude was 6,000 feet and the pilot was told to expect a clearance to 8,000 feet at b. Prior to receiving the higher altitude assignment, the pilot experienced two-way failure. The pilot would maintain 6,000 to b, then climb to 8,000 feet (the altitude the pilot was advised to expect.) The pilot would maintain 8,000 feet, then climb to 11,000 at c, or prior to c if necessary to comply with an MCA at c. (14 CFR Section 91.177(b).) Upon reaching d, the pilot would descend to 8,000 feet (even though the MEA was 7,000 feet), as 8,000 was the highest of the altitude situations stated in the rule 14 CFR Section 91.185.*

12.7 Leave Clearance Limit

12.7.1 When the clearance limit is a fix from which an approach begins, commence descent or descent and approach as close as possible to the expect further clearance time if one has been received, or if one has not been received, as close as possible to the estimated time of arrival as calculated from the filed or amended (with ATC) estimated time en route.

12.7.2 If the clearance limit is not a fix from which an approach begins, leave the clearance limit at the expect further clearance time if one has been received, or if none has been received, upon arrival over the clearance limit, and proceed to a fix from which an approach begins and commence descent or descent and approach as close as possible to the estimated time of arrival as calculated from the filed or amended (with ATC) estimated time en route.

13. Transponder Operation During Two-Way Communications Failure

13.1 If an aircraft with a coded radar beacon transponder experiences a loss of two-way radio capability, the pilot should adjust the transponder to reply on Mode 3/A, Code 7600.

13.2 The pilot should understand that the aircraft may not be in an area of radar coverage.

14. Reestablishing Radio Contact

14.1 In addition to monitoring the NAVAID voice feature, the pilot should attempt to reestablish communications by attempting contact:

14.1.1 On the previously assigned frequency.

14.1.2 With an FSS or ARINC.

14.2 If communications are established with an FSS or ARINC, the pilot should advise the aircraft's position, altitude, and last assigned frequency; then

request further clearance from the controlling facility. The preceding does not preclude the use of 121.5 MHz. There is no priority on which action should be attempted first. If the capability exists, do all at the same time.

NOTE-

Aeronautical Radio Incorporated (ARINC) is a commercial communications corporation which designs, constructs, operates, leases or otherwise engages in radio activities serving the aviation community. ARINC has the capability of relaying information to/from ATC facilities throughout the country.

GEN 3.5 Meteorological Services

1. Meteorological Authority

1.1 The meteorological services for civil aviation are prepared by the National Oceanic and Atmospheric Administration (NOAA) of the U.S. Department of Commerce.

Postal Address:

National Weather Service
National Oceanic and Atmospheric Administration
Department of Commerce
1325 East West Highway
Silver Spring, Maryland 20910

Telephone: 301-713-1726

Telex: None

Commercial Telegraphic Address:

METEO WASHINGTON DC

1.2 Meteorological Offices

1.2.1 FAA Flight Service Stations

1.2.1.1 A complete listing of FAA Flight Service Stations and their telephone numbers is contained in the Airport/Facility Directory. Additionally, communications data and en route services provided by FAA Flight Service Stations are contained in the same publication. Similar information for the Pacific and Alaskan areas is contained in the Pacific and Alaskan Supplements. (See GEN 3.2, Aeronautical Charts.)

1.3 Climatological Summaries

1.3.1 Requests for copies of climatological summaries are made available through the:

National Climatic Data Center
Department of Commerce
National Oceanic and Atmospheric Administration
Environmental Data Services Branch
Federal Building
Asheville, North Carolina 28801

2. Area of Responsibility

2.1 The National Weather Service (NWS) is responsible for providing meteorological services for the 50 states of the U.S., its external territories, and possessions.

2.2 International Flight Documentation Sites.

Airports listed below are designated as international flight documentation sites.

TBL GEN 3.5-1

Location	Airport Name	Indicator
Anchorage, AK	Anchorage International	PANC
Atlanta, GA	William B. Hartsfield International	KATL
Baltimore, MD	Baltimore-Washington International	KBWI
Boston, MA	General Edward Lawrence Logan International	KBOS
Charlotte, NC	Charlotte/Douglas International	KCLT
Chicago, IL	O'Hare International	KORD
Cincinnati, OH	Cincinnati/Northern Kentucky International	KCVG
Dallas-Ft. Worth, TX	Dallas-Ft. Worth International	KDFW
Detroit, MI	Detroit Metropolitan Wayne County	KDTW
Fairbanks, AK	Fairbanks International	PAFA
Guam	Guam/Agana Naval Air Station	NOCD AGANA
Hartford, CT	Bradley International	KBDL
Houston, TX	George Bush Intercontinental/Houston	KIAH
Kahului, HI	Kahului	PHOG
Las Vegas, NV	McCarran International	KLAS
Los Angeles, CA	Los Angeles International	KLAX
Miami, FL	Miami International	KMIA
Minneapolis, MN	Minneapolis-St. Paul International (Wold-Chamberlain)	KMSP
New Orleans, LA	New Orleans International (Moisant Field)	KMSY
New York, NY	John F. Kennedy International	KJFK
Newark, NJ	Newark International	KEWR
Orlando, FL	Orlando International	KMCO
Pago Pago, American Samoa	Pago Pago International	NSTU
Philadelphia, PA	Philadelphia International	KPHL
Pittsburgh, PA	Pittsburgh International	KPIT
Portland, OR	Portland International	KPDX
Raleigh-Durham, NC	Raleigh-Durham International	KRDU
San Francisco, CA	San Francisco International	KSFO
San Juan, PR	Luis Munoz Marin International	TJSJ
Seattle, WA	Seattle-Tacoma International	KSEA
Tampa, FL	Tampa International	KTPA
Washington, DC	Washington Dulles International	KIAD

2.2.1 Climatological information, basically in the form of climatological summaries, is available at all designated international airports in the U.S.

2.2.2 Flight documentation is provided in the form of copies of facsimile charts, copies of teletype-writer forecasts, and airport forecast decode sheets. Flight documentation materials are available at all destination regular airport meteorological stations. English is the language used for all U.S. flight documentation. Briefings can be provided either in person or received by telephone at all airport meteorological offices.

2.2.3 All airport forecasts (TAF) prepared for U.S. international airports cover the following validity periods: 00-24 UTC, 06-06 UTC, 12-12 UTC, and 18-18 UTC. At the present time, specific landing forecasts are not made for any U.S. airport. The portion of the airport's TAF valid closest to the time of landing is used in lieu of a landing forecast.

2.2.4 Supplementary information available at U.S. meteorological airport offices includes extended weather and severe weather outlooks, pilot reports, runway braking action reports (during the winter), relative humidity, times of sunrise and sunset, surface and upper air analyses, radar echo charts, and forecasts of maximum and minimum surface temperatures.

2.2.5 All meteorological offices shown as taking routine aviation observations also take unscheduled special aviation observations when meteorological conditions warrant.

3. Types of Service Provided

3.1 Area Forecast Charts (Facsimile Form)

3.1.1 The U.S. has one Area Forecast Center, the National Center for Environmental Predictions (NCEP), located in Suitland, Maryland. The NCEP prepares current weather, significant weather, forecast weather, constant pressure, and tropopause-vertical wind shear charts for the U.S., the Caribbean and Northern South America, the North Atlantic, and the North Pacific areas. The NCEP also prepares a constant pressure and tropopause-vertical wind shear chart for Canada.

3.2 Local and Regional Aviation Forecasts (Printed Form)

3.2.1 Numerous forecasts and weather advisories are prepared which serve local and regional areas of the U.S. These forecasts are generally prepared by the NWS on a scheduled basis or, as in the case of severe weather advisories, as needed. These forecasts are Area Forecast (FA), Airport Forecast (TAF), Severe Weather Forecast (WW), Hurricane Advisories (WT), Winds and Temperature Aloft Forecast (FD), Simplified Surface Analyses (AS), 12- and 24-Hour Prognoses (FS), and flight advisory notices, such as SIGMETs (WS), AIRMETs (text bulletins-[WA] and graphics [G-AIRMET]), Center Weather Advisories (CWA), and Radar Weather Reports (SD).

3.3 Preflight Briefing Services

3.3.1 Preflight briefing services and flight documentation are provided through the FAA's Automated Flight Service Stations (AFSS).

3.4 National Weather Service Aviation Products

3.4.1 Weather service to aviation is a joint effort of the NWS, the FAA, the military weather services, and other aviation oriented groups and individuals. The NWS maintains an extensive surface, upper air, and radar weather observing program and a nationwide aviation weather forecasting service. Pilot weather briefings are provided by personnel at Flight Service Stations operated by FAA (in Alaska) or by federal contract facilities (elsewhere in the U.S.). Surface weather observations are taken by the NWS and NWS-certified FAA, contract, and supplemental observers and by automated observing systems. (See paragraph 7., Weather Observing Programs.)

3.4.2 Weather element values may be expressed by using different measurement systems depending on several factors including the user of the weather products; i.e., the general public, aviation interests, international services, or a combination of these users. FIG GEN 3.5-1, Weather Elements Conversion Tables, provides conversion tables for the weather elements that will be most often encountered by pilots.

FIG GEN 3.5-1
Weather Elements Conversion Tables

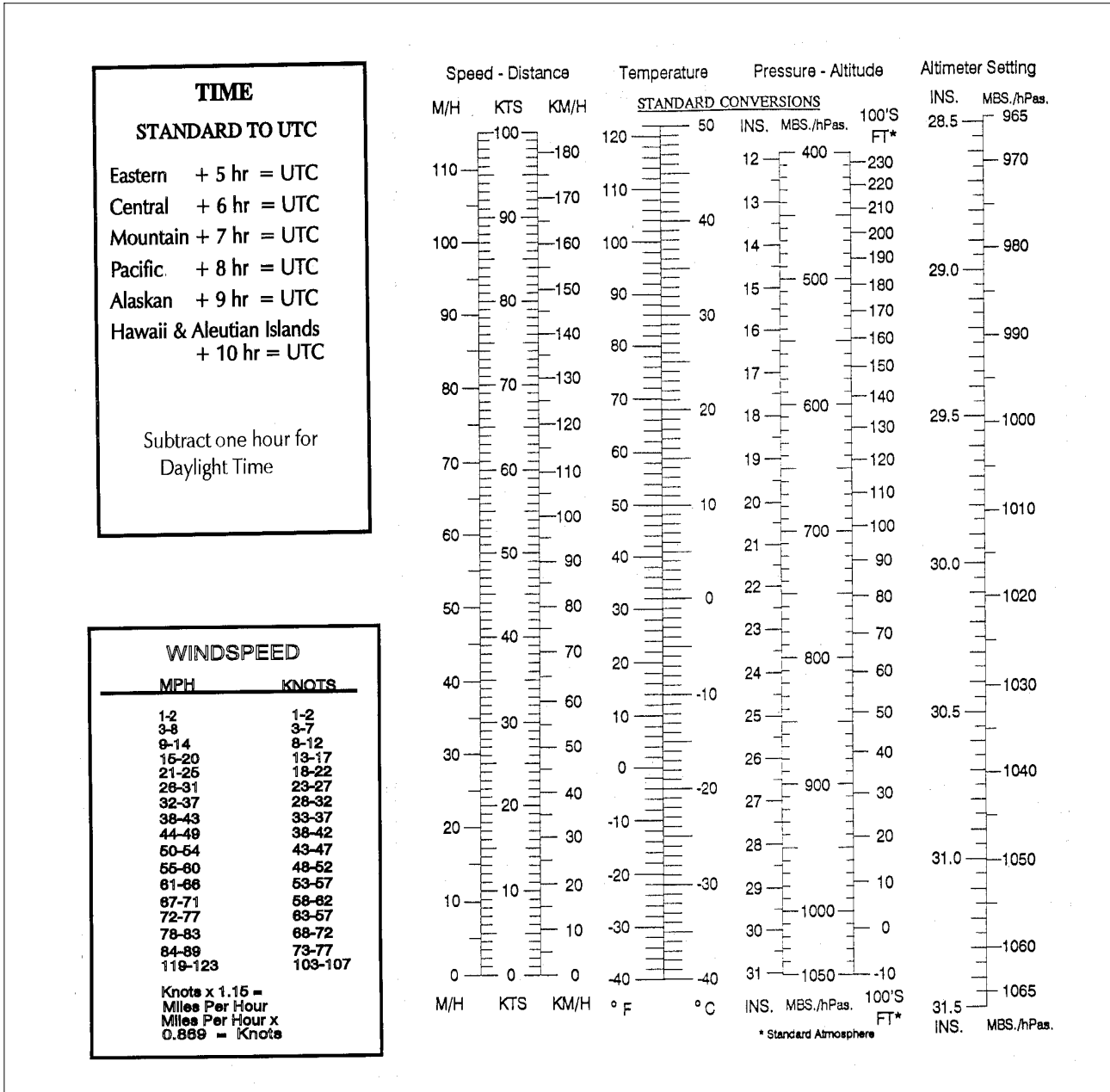

3.5 FAA Weather Services

3.5.1 The FAA maintains a nationwide network of AFSSs/FSSs to serve the weather needs of pilots. In addition, NWS meteorologists are assigned to all Air Route Traffic Control Centers (ARTCCs) as part the Center Weather Service Unit (CWSU). They provide advisory service and short-term forecasts (nowcasts) to support the needs of the FAA and other users of the national airspace system.

3.5.2 The primary source of preflight weather briefings is an individual briefing obtained from a briefer at the AFSS/FSS. These briefings, which are tailored to your specific flight, are available 24 hours a day through the use of toll free number 1-800-WX-BRIEF Numbers for these services can be found in the Airport/Facility Directory under the "FAA and NWS Telephone Numbers" section. They may also be listed in the U.S. Government section of

your local telephone directory under Department of Transportation, Federal Aviation Administration.

3.5.3 Other Sources of Weather Information

3.5.3.1 Telephone Information Briefing Service (TIBS) (AFSS); and in Alaska, Transcribed Weather Broadcast (TWEB) locations, and telephone access to the TWEB (TEL-TWEB) provide continuously updated recorded weather information for short or local flights. Separate paragraphs in this section give additional information regarding these services.

3.5.3.2 Weather and aeronautical information is also available from numerous private industry sources on an individual or contract pay basis. Information on how to obtain this service should be available from local pilot organizations.

3.5.3.3 The Direct User Access System (DUATS) can be accessed by U.S. certified pilots with a current medical certificate toll-free via personal computer. Pilots can receive alpha-numeric preflight weather data and file domestic VFR and IFR flight plans. The following are the contract DUATS vendors:

Computer Sciences Corporation (CSC)
15000 Conference Center Drive
Chantilly, VA 22021-3808
Internet Access: <http://www.duats.com>
Telnet Access (modem terminal-style):
(800) 767-9989 or
<telnet://direct.duats.com>
For customer service: (800) 345-3828

Data Transformation Corporation (DTC)
108-D Greentree Road
Turnersville, NJ 08012
Internet Access: <http://www.duat.com>
For customer service: (800)243-3828

3.5.4 Inflight weather information is available from any AFSS/FSS within radio range. The common frequency for all AFSSs is 122.2. Discrete frequencies for individual stations are listed in the Airport/Facility Directory. See paragraph 6 for information on broadcasts. En Route Flight Advisory Service (EFAS) is provided to serve the non-routine weather needs of pilots in flight. See paragraph 3.8, En Route Flight Advisory Service (EFAS), for details on this service.

3.6 Use of Aviation Weather Products

3.6.1 Air carriers and operators certificated under the provisions of 14 CFR Part 119 are required to use the aeronautical weather information systems defined in the Operations Specifications issued to that certificate holder by the FAA. These systems may utilize basic FAA/National Weather Service (NWS) weather services, contractor- or operator-proprietary weather services and/or Enhanced Weather Information System (EWINS) when approved in the Operations Specifications. As an integral part of this system approval, the procedures for collecting, producing and disseminating aeronautical weather information, as well as the crew member and dispatcher training to support the use of system weather products, must be accepted or approved.

3.6.2 Operators not certificated under the provisions of 14 CFR Part 119 are encouraged to use FAA/NWS products through Flight Service Stations, Direct User Access Terminal System (DUATS), and/or Flight Information Services Data Link (FISDL).

3.6.3 The suite of available aviation weather product types is expanding, with the development of new sensor systems, algorithms and forecast models. The FAA and NWS, supported by the National Center for Atmospheric Research and the Forecast Systems Laboratory, develop and implement new aviation weather product types through a comprehensive process known as the Aviation Weather Technology Transfer process. This process ensures that user needs and technical readiness requirements are met before experimental products mature to operational application.

3.6.4 The FAA, in conjunction with the NWS, established the Aviation Weather Technology Transfer (AWTT) Board so that newly developed aviation weather products meet regulatory requirements and enhance safety. The AWTT is charged with managing and accelerating the transfer of these products into operational use. Members of the AWTT Board include mid-level managers from the FAA and NWS who are responsible for various aspects of the development and use of aviation weather products (e.g., aviation weather R & D, transition of weather products from R & D to operational use, etc.).

3.6.5 The AWTT is a management-review and decision-making process that applies criteria to weather products at various development stages

(decision stages, i.e., “D–stages”). The D–stages are composed of the following:

3.6.5.1 (D1) Sponsorship of user needs.

3.6.5.2 (D2) R & D and controlled testing.

3.6.5.3 (D3) Experimental application.

3.6.5.4 (D4) Operational application.

3.6.6 Weather products maturing into the D3 experimental stage of the AWTT process are often made available to the public on the Aviation Weather Center’s Experimental Aviation Digital Data Service (ADDSD) website at: <http://weather.aero/>. The intent is to allow public access to this information in order to obtain feedback for product development and improvement. However, it is important to note that weather products displayed on this site are experimental, and although they may appear to be fully operational products, they are subject to change without notification and may *not* be used for any flight related decisions. At the D4 stage, the FAA approves a weather product for operational use by end users (with restrictions, if necessary), and the product is made available to the public via long–line circuit, satellite, and/or other means of communication.

3.6.7 Pilots and operators should be aware that weather services provided by entities other than FAA, NWS or their contractors (such as the DUATS and FISDL providers) may not meet FAA/NWS quality control standards. Hence, operators and pilots contemplating using such services should request and/or review an appropriate description of services and provider disclosure. This should include, but is not limited to, the type of weather product (e.g., current weather or forecast weather), the currency of the product (i.e., product issue and valid times), and the relevance of the product. Pilots and operators should be cautious when using unfamiliar products, or products not supported by FAA/NWS technical specifications.

NOTE–

When in doubt, consult with a FAA Flight Service Station Specialist.

3.6.8 In addition, pilots and operators should be aware there are weather services and products available from government organizations beyond the scope of the AWTT process mentioned earlier in this section. For example, governmental agencies such as the NWS, the Aviation Weather Center (AWC), and the National Center for Atmospheric Research (NCAR) display weather “model data” and “experimental” products which require training and/or expertise to properly interpret and use. These products are developmental prototypes that are subject to ongoing research and can change without notice. Therefore, some data on display by government organizations, or government data on display by independent organizations may be unsuitable for flight planning purposes. Operators and pilots contemplating using such services should request and/or review an appropriate description of services and provider disclosure. This should include, but is not limited to, the type of weather product (e.g., current weather or forecast weather), the currency of the product (i.e., product issue and valid times), and the relevance of the product. Pilots and operators should be cautious when using unfamiliar weather products.

NOTE–

When in doubt, consult with a FAA Flight Service Station Specialist.

3.6.9 The development of new weather products coupled with increased access to these products via the public Internet, created confusion within the aviation community regarding the relationship between regulatory requirements and new weather products. Consequently, FAA differentiates between those weather products that may be utilized to comply with regulatory requirements and those that may only be used to improve situational awareness. To clarify the proper use of aviation weather products to meet the requirements of 14 CFR, FAA defines weather products as follows:

3.6.9.1 Primary Weather Product. An aviation weather product that meets all the regulatory requirements and safety needs for use in making flight related, aviation weather decisions.

3.6.9.2 Supplementary Weather Product. An aviation weather product that may be used for enhanced situational awareness. If utilized, a supplementary weather product must only be used in conjunction with one or more primary weather product. In addition, the FAA may further restrict the use of supplementary aviation weather products through limitations described in the product label.

NOTE–

An aviation weather product produced by the Federal Government and managed by the AWTT is classified a primary weather product unless designated a supplementary weather product by the FAA.

3.6.10 In developing the definitions of primary and supplementary weather products, it is not the intent of FAA to change or increase the regulatory burden on the user. Rather, the definitions are meant to eliminate confusion by differentiating between weather products that may be utilized to meet regulatory requirements and other weather products that may only be used to improve situational awareness.

3.6.11 All flight–related, aviation weather decisions must be based on primary weather products. Supplementary weather products augment the primary products by providing additional weather information but may not be used as stand–alone weather products to meet aviation weather regulatory requirements or without the relevant primary products. When discrepancies exist between primary and supplementary weather products describing the same weather phenomena, users must base flight–related decisions on the primary weather product. Furthermore, multiple primary products may be necessary to meet all aviation weather regulatory requirements.

3.6.12 The development of enhanced communications capabilities, most notably the Internet, has allowed pilots access to an ever–increasing range of weather service providers and proprietary products. The FAA has identified three distinct types of weather information available to pilots and operators.

3.6.12.1 Observations. Raw weather data collected by some type of sensor suite including surface and airborne observations, radar, lightning, satellite imagery, and profilers.

3.6.12.2 Analysis. Enhanced depiction and/or interpretation of observed weather data.

3.6.12.3 Forecasts. Predictions of the development and/or movement of weather phenomena based on meteorological observations and various mathematical models.

3.6.13 Not all sources of aviation weather information are able to provide all three types of weather information. The FAA has determined that operators and pilots may utilize the following approved sources of aviation weather information:

3.6.13.1 Federal Government. The FAA and NWS collect raw weather data, analyze the observations, and produce forecasts. The FAA and NWS disseminate meteorological observations, analyses, and forecasts through a variety of systems. In addition, the Federal Government is the only approval authority for sources of weather observations; for example, contract towers and airport operators may be approved by the Federal Government to provide weather observations.

3.6.13.2 Enhanced Weather Information System (EWINS). An EWINS is an FAA approved, proprietary system for tracking, evaluating, reporting, and forecasting the presence or lack of adverse weather phenomena. An EWINS is authorized to produce flight movement forecasts, adverse weather phenomena forecasts, and other meteorological advisories. For more detailed information regarding EWINS, see the Aviation Weather Services Advisory Circular 00–45 and the Air Transportation Operations Inspector’s Handbook 8400.10.

3.6.13.3 Commercial Weather Information Providers. In general, commercial providers produce proprietary weather products based on NWS/FAA products with formatting and layout modifications but no material changes to the weather information itself. This is also referred to as “repackaging.” In addition, commercial providers may produce analyses, forecasts, and other proprietary weather products that substantially alter the information contained in government–produced products. However, those proprietary weather products that substantially alter government–produced weather products or information, may only be approved for use by 14 CFR Part 121 and Part 135 certificate holders if the commercial provider is EWINS qualified.

NOTE-

Commercial weather information providers contracted by FAA to provide weather observations, analyses, and forecasts (e.g., contract towers) are included in the Federal Government category of approved sources by virtue of maintaining required technical and quality assurance standards under Federal Government oversight.

3.6.14 As a point of clarification, Advisory Circular 00-62, Internet Communications of Aviation Weather and NOTAMS, describes the process for a weather information provider to become a Qualified Internet Communications Provider (QICP) and only applies to 14 CFR Part 121 and Part 135 certificate holders. Therefore, pilots conducting operations under 14 CFR Part 91 may access weather products via the public Internet.

3.7 Preflight Briefing

3.7.1 Flight Service Stations are the primary source of obtaining preflight briefings and inflight weather information. Flight Service Specialists are qualified and certificated by the NWS as Pilot Weather Briefers. They are not authorized to make original forecasts, but are authorized to translate and interpret available forecasts (TAF) and reports (METAR/SPECI) directly into terms describing the weather conditions which you can expect along your flight route and at your destination. Available aviation weather reports and forecasts are displayed at each AFSS/FSS. Some of the larger AFSSs/FSSs provide a separate display for pilot use. Pilots should feel free to use these self-briefing displays where available, or to ask for a briefing or for assistance from the specialist on duty. Three basic types of preflight briefings are available: Standard Briefing, Abbreviated Briefing, and Outlook Briefing. You should specify to the briefer the type of briefing you want, along with appropriate background information. This will enable the briefer to tailor the information to your intended flight. The following paragraphs describe the types of briefings available and the information provided in each.

3.7.2 Standard Briefing. You should request a Standard Briefing any time you are planning a flight and you have not received a previous briefing or have not received preliminary information through mass dissemination media; e.g., TIBS, TWEB (Alaska only), etc. International data may be inaccurate or incomplete. If you are planning a flight outside of U.S. controlled airspace, the briefer will advise you

to check data as soon as practical after entering foreign airspace, unless you advise that you have the international cautionary advisory. The briefer will automatically provide the following information in the sequence listed, except as noted, when it is applicable to your proposed flight.

3.7.2.1 Adverse Conditions. Significant meteorological and/or aeronautical information that might influence the pilot to alter or cancel the proposed flight; for example, hazardous weather conditions, airport closures, air traffic delays, etc. Pilots should be especially alert for current or forecast weather that could reduce flight minimums below VFR or IFR conditions. Pilots should also be alert for any reported or forecast icing if the aircraft is not certified for operating in icing conditions. Flying into areas of icing or weather below minimums could have disastrous results.

3.7.2.2 VFR Flight Not Recommended. When VFR flight is proposed and sky conditions or visibilities are present or forecast, surface or aloft, that, in the briefer's judgment, would make flight under VFR doubtful, the briefer will describe the conditions, describe the affected locations, and use the phrase "*VFR flight not recommended.*" This recommendation is advisory in nature. The final decision as to whether the flight can be conducted safely rests solely with the pilot. Upon receiving a "*VFR flight not recommended*" statement, the non-IFR rated pilot will need to make a "go or no go" decision. This decision should be based on weighing the current and forecast weather conditions against the pilot's experience and ratings. The aircraft's equipment, capabilities and limitations should also be considered.

NOTE-

Pilots flying into areas of minimal VFR weather could encounter unforecasted lowering conditions that place the aircraft outside the pilot's ratings and experience level. This could result in spatial disorientation and/or loss of control of the aircraft.

3.7.2.3 Synopsis. A brief statement describing the type, location, and movement of weather systems and/or air masses which might affect the proposed flight.

NOTE-

The first 3 elements of a standard briefing may be combined in any order when the briefer believes it will help to describe conditions more clearly.

3.7.2.4 Current Conditions. Reported weather conditions applicable to the flight will be summarized from all available sources; e.g., METARs, PIREPs, RAREPs. This element may be omitted if the proposed time of departure is beyond two hours, unless the information is specifically requested by the pilot.

3.7.2.5 En Route Forecast. En route conditions forecast for the proposed route are summarized in logical order; i.e., departure–climbout, en route, and descent.

3.7.2.6 Destination Forecast. The destination forecast (TAF) for the planned estimated time of arrival (ETA). Any significant changes within 1 hour before and after the planned arrival are included.

3.7.2.7 Winds Aloft. Forecast winds aloft for the proposed route will be provided using degrees of the compass. The briefer will interpolate wind directions and speeds between levels and stations as necessary to provide expected conditions at planned altitudes.

3.7.2.8 Notices to Airmen (NOTAMs)

a) Available NOTAM (D) information pertinent to the proposed flight, including special use airspace (SUA) NOTAMs for restricted areas, aerial refueling, and night vision goggles (NVG).

NOTE–

Other SUA NOTAMs (D), such as military operations area (MOA), military training route (MTR), and warning area NOTAMs, are considered “upon request” briefing items as indicated in paragraph 3.7.2.10.

b) Prohibited Areas P–40, P–49, P–56, and the special flight rules area (SFRA) for Washington, DC.

c) FSS briefers do not provide FDC NOTAM information for special instrument approach procedures unless specifically asked. Pilots authorized by the FAA to use special instrument approach procedures must specifically request FDC NOTAM information for these procedures.

NOTE–

NOTAM information may be combined with current conditions when the briefer believes it is logical to do so.

NOTE–

NOTAM (D) information and Flight Data Center NOTAMs which have been published in the Notices to Airmen Publication are not included in pilot briefings unless a review of this publication is specifically requested by the pilot. For complete flight information you are urged to review both the Notices to Airmen Publication and the

Airport/Facility Directory in addition to obtaining a briefing.

3.7.2.9 Air Traffic Control (ATC) Delays. Any known ATC delays and flow control advisories which might affect the proposed flight.

3.7.2.10 Pilots may obtain the following from flight service station briefers upon request:

a) Information on Special Use Airspace (SUA) and SUA related airspace, except those listed in paragraph 3.7.2.8.

NOTE–

1. *For the purpose of this paragraph, SUA and related airspace includes the following types of airspace: alert area, military operations area (MOA), warning area, and air traffic control assigned airspace (ATCAA). MTR data includes the following types of airspace: IFR training routes (IR), VFR training routes (VR), and slow training routes (SR).*

2. *Pilots are encouraged to request updated information from ATC facilities while in flight.*

b) A review of the Notices to Airmen publication for pertinent NOTAMs and Special Notices.

c) Approximate density altitude data.

d) Information regarding such items as air traffic services and rules, customs/immigration procedures, ADIZ rules, and search and rescue.

e) LORAN–C NOTAMs, available military NOTAMs, runway friction measurement value NOTAMs.

f) GPS RAIM availability for 1 hour before to 1 hour after ETA, or a time specified by the pilot.

g) Other assistance as required.

3.7.3 Abbreviated Briefing. Request an Abbreviated Briefing when you need information to supplement mass disseminated data, to update a previous briefing, or when you need only one or two specific items. Provide the briefer with appropriate background information, the time you received the previous information, and/or the specific items needed. You should indicate the source of the information already received so that the briefer can limit the briefing to the information that you have not received, and/or appreciable changes in meteorological/aeronautical conditions since your previous briefing. To the extent possible, the briefer will provide the information in the sequence shown for a Standard Briefing. If you request only one or two

specific items, the briefer will advise you if adverse conditions are present or forecast. Adverse conditions contain both meteorological and aeronautical information. Details on these conditions will be provided at your request.

3.7.4 Outlook Briefing. You should request an Outlook Briefing whenever your proposed time of departure is 6 or more hours from the time of the briefing. The briefer will provide available forecast data applicable to the proposed flight. This type of briefing is provided for planning purposes only. You should obtain a Standard or Abbreviated Briefing prior to departure in order to obtain such items as adverse conditions, current conditions, updated forecasts, winds aloft, and NOTAMs.

3.7.5 Inflight Briefing. You are encouraged to obtain your preflight briefing by telephone or in person before departure. In those cases where you need to obtain a preflight briefing or an update to a previous briefing by radio, you should contact the nearest AFSS/FSS to obtain this information. After communications have been established, advise the specialist of the type briefing you require and provide appropriate background information. You will be provided information as specified in the above paragraphs, depending on the type of briefing requested. In addition, the specialist will recommend shifting to the Flight Watch frequency when conditions along the intended route indicate that it would be advantageous to do so. Remember that weather conditions can change rapidly and that a “go or no go” decision, as mentioned in paragraph 3.7.2.2, should be assessed at all phases of flight.

3.7.6 Following any briefing, feel free to ask for any information that you or the briefer may have missed. It helps to save your questions until the briefing has been completed. This way the briefer is able to present the information in a logical sequence and lessens the chance of important items being overlooked.

3.8 En Route Flight Advisory Service (EFAS)

3.8.1 EFAS (radio call “Flight Watch”) is a service specifically designed to provide en route aircraft with timely and meaningful weather advisories pertinent to the type of flight intended, route of flight, and altitude. In conjunction with this service, EFAS is also a central collection and distribution point for

pilot-reported weather information. EFAS is provided by specially trained FSS specialists controlling multiple remote communications outlets covering a large geographical area and is normally available throughout the conterminous U.S. and Puerto Rico from 6 a.m. to 10 p.m. EFAS provides communications capabilities for aircraft flying at 5,000 feet AGL to 17,500 feet MSL on a common frequency of 122.0 MHz. Discrete EFAS frequencies have been established to ensure communications coverage from 18,000 through 45,000 MSL serving in each specific ARTCC area. These discrete frequencies may be used below 18,000 feet when coverage permits reliable communication.

NOTE–

When an EFAS outlet is located in a time zone different from the zone in which the flight watch control station is located, the availability of service may be plus or minus 1 hour from the normal operating hours.

3.8.2 In some regions of the contiguous U.S., especially those that are mountainous, it is necessary to be above 5000 feet AGL in order to be at an altitude where the EFAS frequency, 122.0 MHz, is available. Pilots should take this into account when flight planning. Other AFSS communication frequencies may be available at lower altitudes. See FIG GEN 3.5–2.

3.8.3 Contact flight watch by using the name of the ARTCC facility serving the area of your location, followed by your aircraft identification and the name of the nearest VOR to your position. The specialist needs to know this approximate location to select the most appropriate outlet for communications coverage.

EXAMPLE–

Cleveland flight watch, Cessna One Three Four Two Kilo, Mansfield V–O–R, over.

3.8.4 Charts depicting the location of the flight watch control stations (parent facility) and the outlets they use are contained in the Airport/Facility Directory. If you do not know in which flight watch area you are flying, initiate contact by using the words “FLIGHT WATCH,” your aircraft identification, and the name of the nearest VOR. The facility will respond using the name of the flight watch facility.

EXAMPLE–

Flight watch, Cessna One Two Three Four Kilo, Mansfield V–O–R, over.

3.8.5 Radio outlets that provide En Route Flight Advisory Service are listed in the Airport/Facility Directory.

3.8.6 EFAS is not intended to be used for filing or closing flight plans, position reporting, getting complete preflight briefings, or obtaining random weather reports and forecasts. En route flight advisories are tailored to the phase of flight that begins after climb-out and ends with descent to land. Immediate destination weather and terminal airport forecasts will be provided on request. Pilots requesting information not within the scope of flight watch will be advised of the appropriate AFSS/FSS frequency to contact to obtain the information. Pilot participation is essential to the success of EFAS by providing a continuous exchange of information on weather, winds, turbulence, flight visibility, icing or other hazardous conditions between pilots and flight watch specialists. Pilots are encouraged to report good weather as well as bad, and to confirm both expected conditions and unexpected conditions to EFAS facilities.

3.9 Inflight Aviation Weather Advisories

3.9.1 Background

3.9.1.1 Inflight Aviation Weather Advisories are forecasts to advise en route aircraft of development of potentially hazardous weather. All inflight aviation weather advisories in the conterminous U.S. are issued by the Aviation Weather Center (AWC) in Kansas City, Missouri. The Weather Forecast Office (WFO) in Honolulu issues advisories for the Hawaiian Islands. In Alaska, the Alaska Aviation Weather Unit (AAWU) issues inflight aviation weather advisories. All heights are referenced MSL, except in the case of ceilings (CIG) which indicate AGL.

3.9.1.2 There are three types of inflight aviation weather advisories: the Significant Meteorological Information (SIGMET), the Convective SIGMET and the Airmen’s Meteorological Information (AIRMET—text or graphical product). All of these advisories, with the exception of G–AIRMET, use the same location identifiers (either VORs, airports, or well-known geographic areas) (G–AIRMET uses Lat./Long.) to describe the hazardous weather areas. See FIG GEN 3.5–3 and FIG GEN 3.5–4. Graphics with improved clarity can be found in the latest version of Advisory Circular AC 00–45, Aviation Weather Services, which is available on the following Web site: <http://www.faa.gov>.

3.9.1.3 Two other weather products supplement these Inflight Aviation Weather Advisories:

- a) The Severe Weather Watch Bulletins (WWs), (with associated Alert Messages) (AWW), and
- b) The Center Weather Advisories (CWAs).

3.9.2 SIGMET (WS)/AIRMET (text [WA] or graphical [G–AIRMET])

SIGMETs/AIRMETs (text or graphical [CONUS-only] products) are issued corresponding to the Area Forecast (FA) areas described in FIG GEN 3.5–5, FIG GEN 3.5–6 and FIG GEN 3.5–7. The maximum forecast period is 4 hours for SIGMETs and 6 hours for AIRMETs. The G–AIRMET is issued over the CONUS every 6 hours, valid at 3-hour increments through 12 hours, with optional forecasts possible during the first 6 hours. The first 6 hours of the G–AIRMET correspond to the 6-hour period of the AIRMET. SIGMETs and AIRMETs are considered “widespread” because they must be either affecting or be forecasted to affect an area of at least 3,000 square miles at any one time. However, if the total area to be affected during the forecast period is very large, it could be that in actuality only a small portion of this total area would be affected at any one time.

FIG GEN 3.5-2
EFAS Radio Coverage Areas

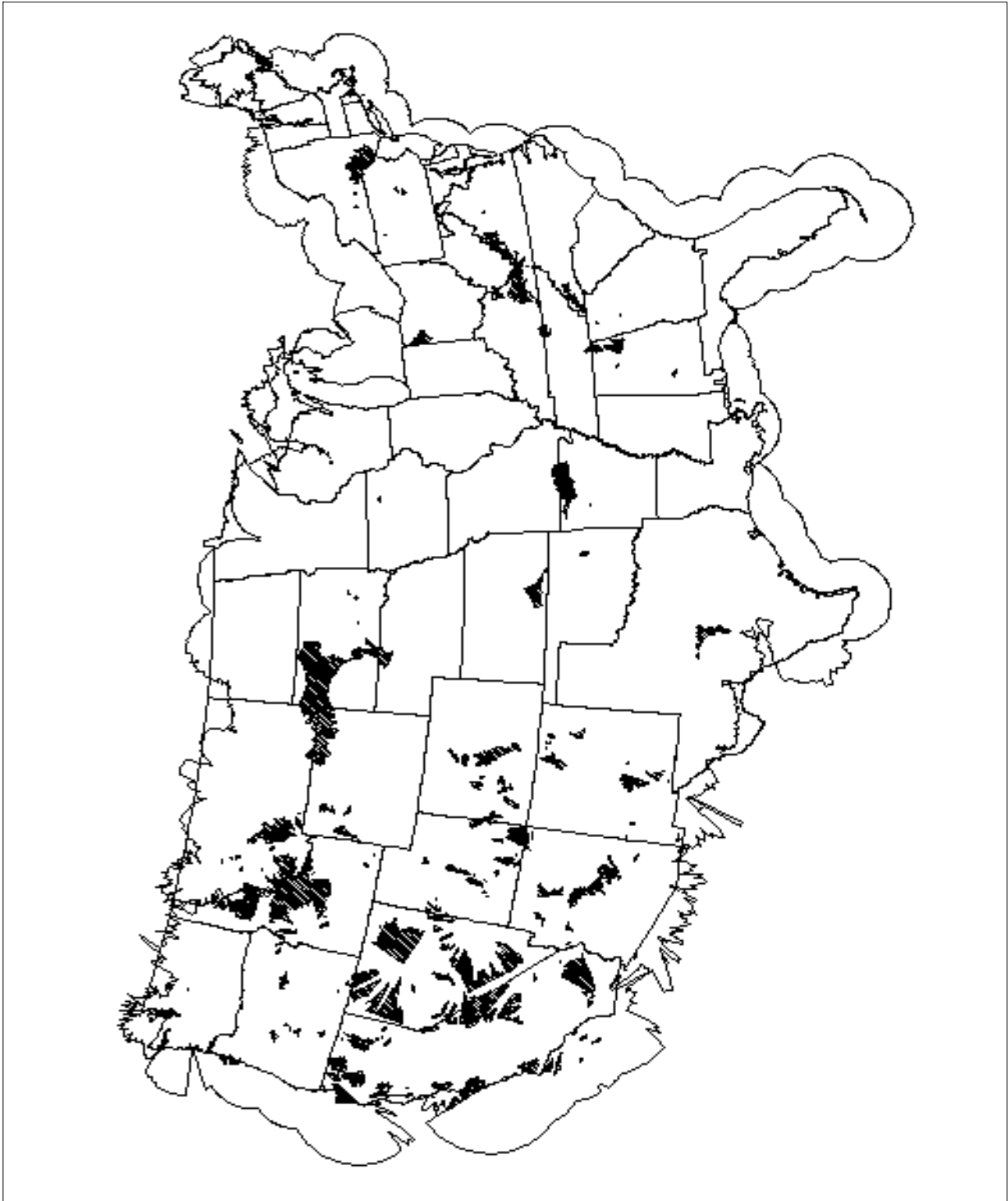

NOTE-
EFAS radio coverage at 5000 feet AGL. The shaded areas depict limited coverage areas in which altitudes above 5000 feet AGL would be required to contact EFAS.

FIG GEN 3.5-3
Inflight Advisory Plotting Chart

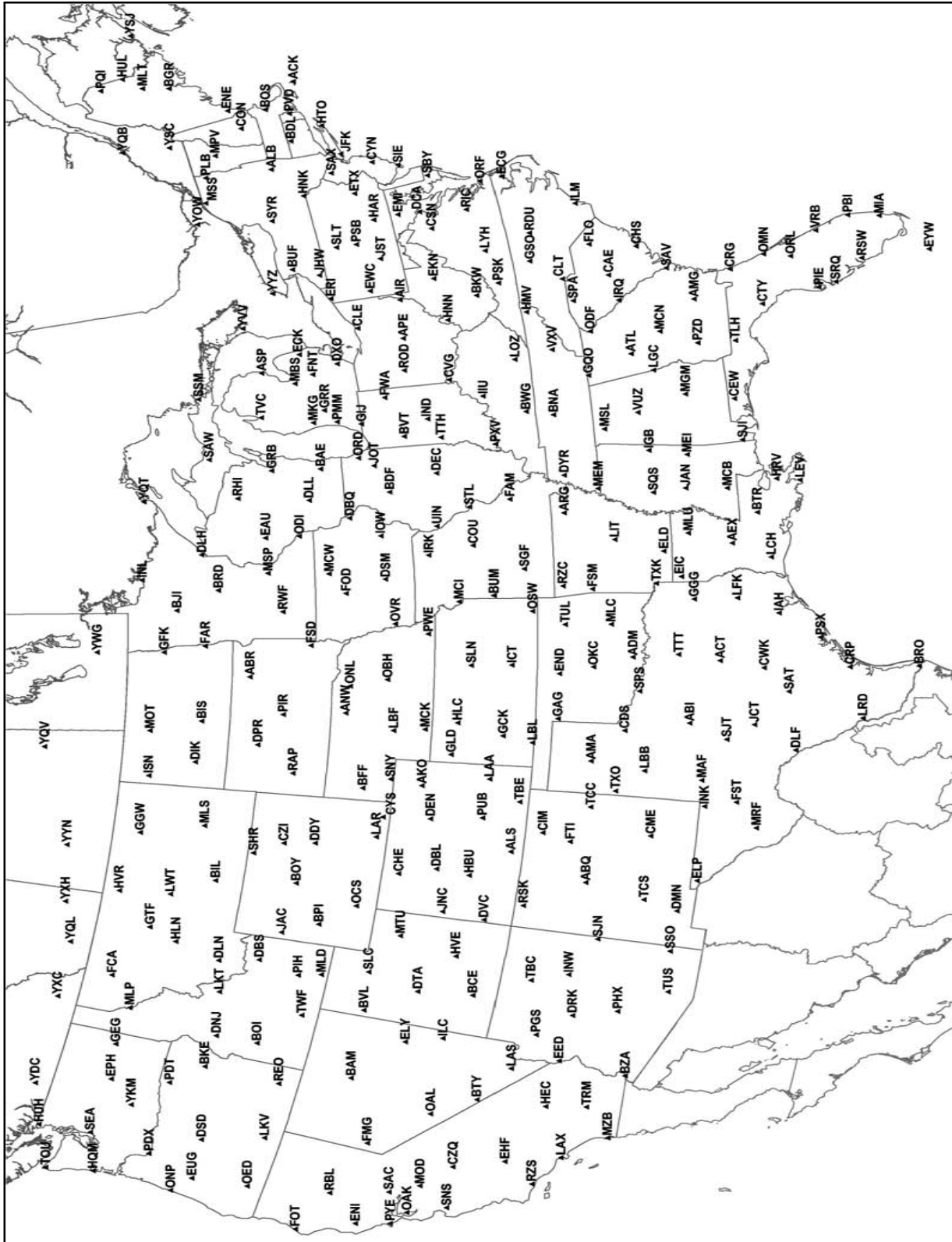

FIG GEN 3.5-4
Geographical Areas and Terrain Features

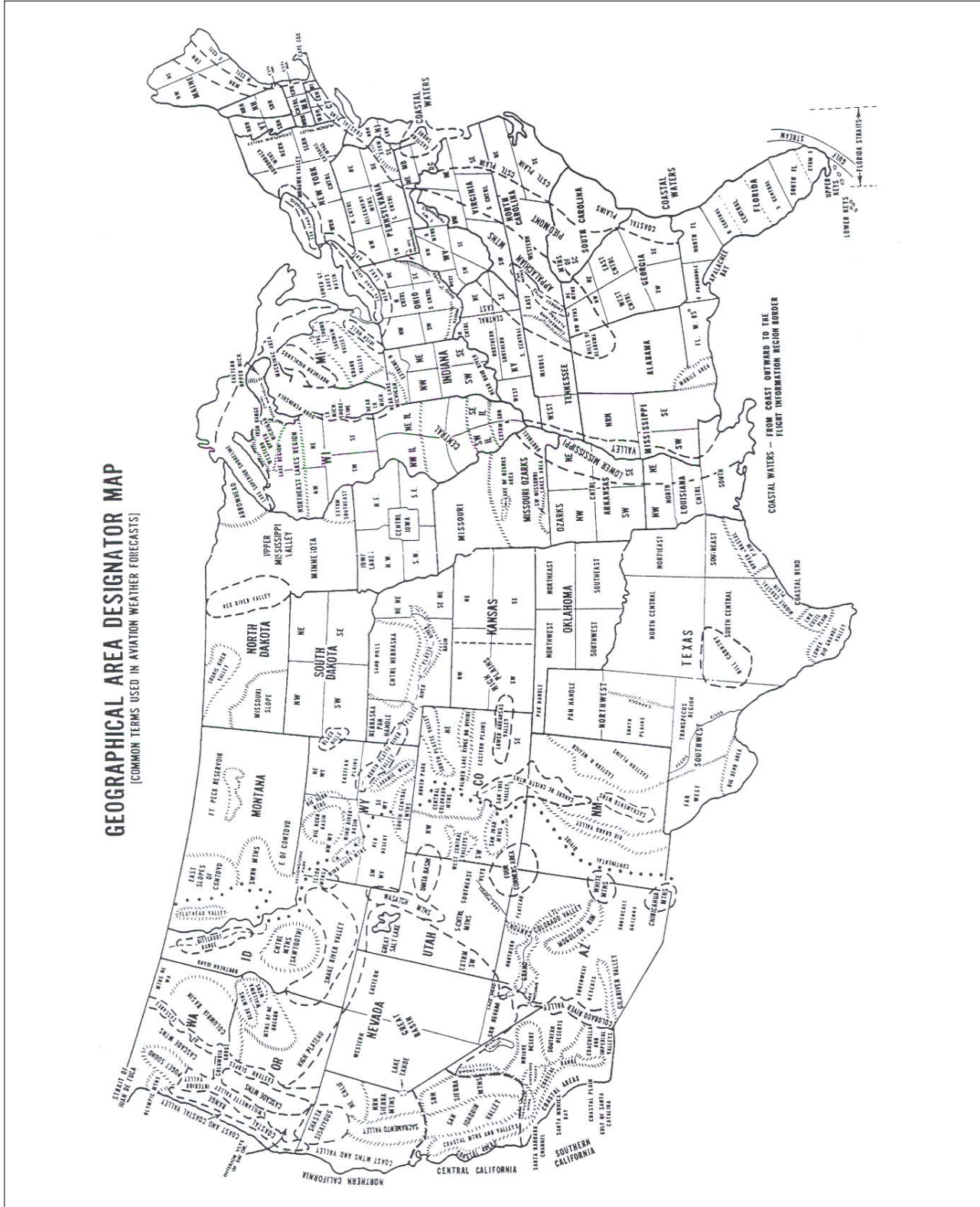

FIG GEN 3.5-5
Aviation Area Forecasts
FA Locations - Contiguous United States

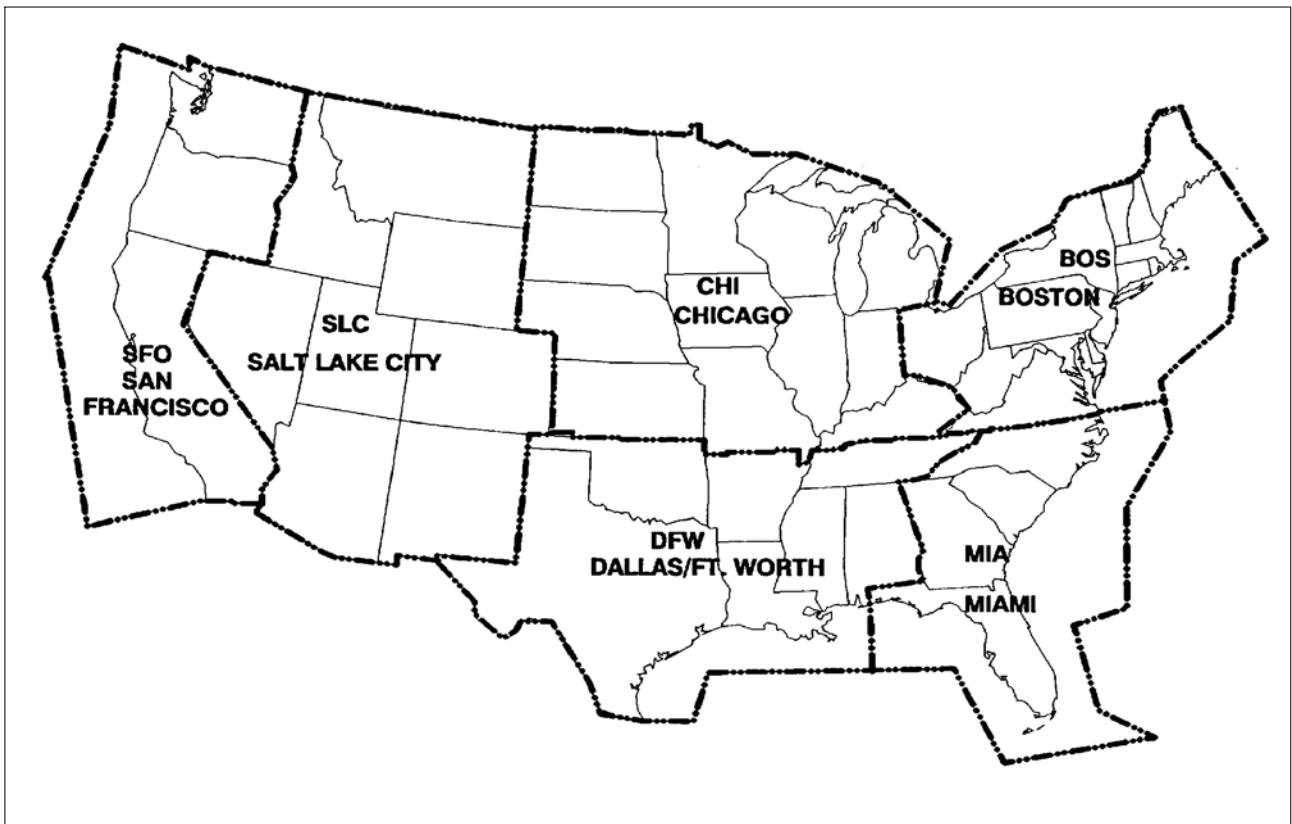

FIG GEN 3.5-6
Alaska Area Forecast Sectors

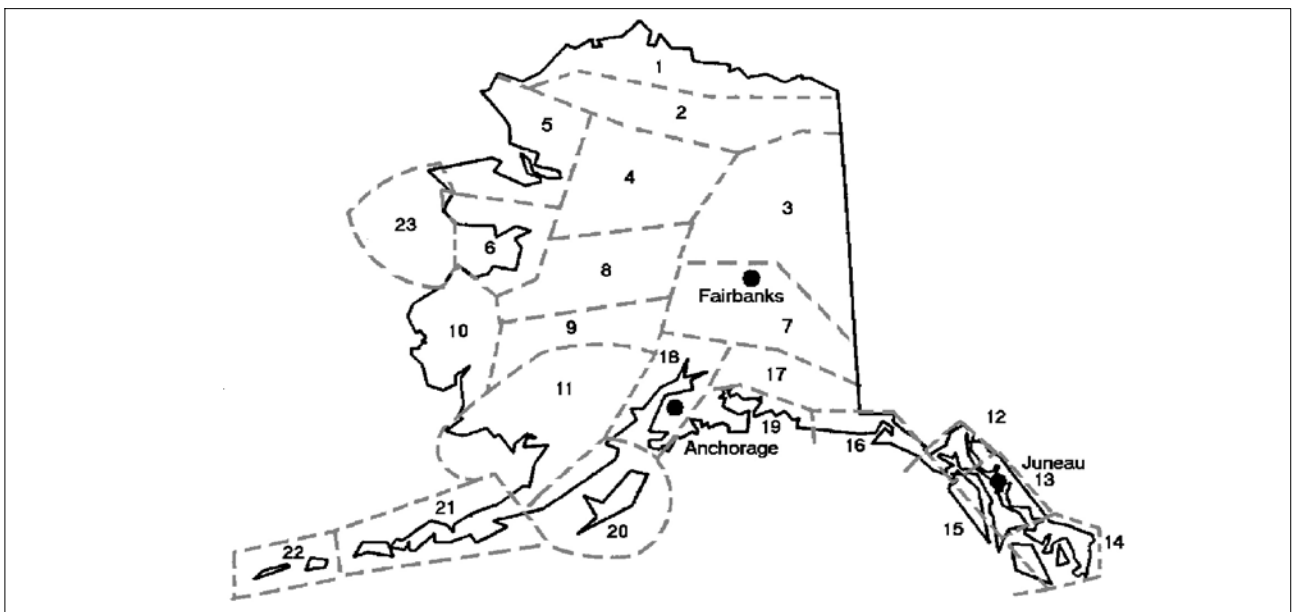
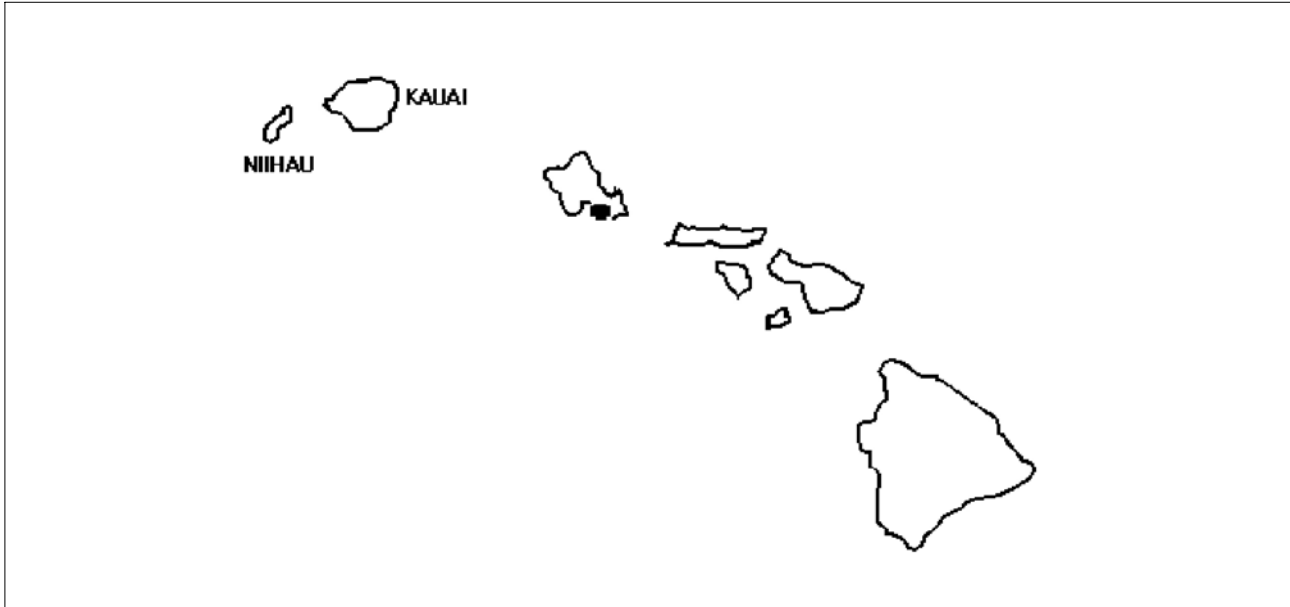

FIG GEN 3.5-7
Hawaii Area Forecast Locations



3.9.3 SIGMET (WS)

3.9.3.1 A SIGMET advises of nonconvective weather that is potentially hazardous to all aircraft. SIGMETs are unscheduled products that are valid for 4 hours. However, conditions that are associated with hurricanes are valid for 6 hours. Unscheduled updates and corrections are issued as necessary. In the conterminous U.S., SIGMETs are issued when the following phenomena occur or are expected to occur:

- a) Severe icing not associated with thunderstorms.
- b) Severe or extreme turbulence or clear air turbulence (CAT) not associated with thunderstorms.
- c) Dust storms or sandstorms lowering surface or inflight visibilities to below 3 miles.
- d) Volcanic ash.

3.9.3.2 In Alaska and Hawaii, SIGMETs are also issued for:

- a) Tornadoes.
- b) Lines of thunderstorms.
- c) Embedded thunderstorms.
- d) Hail greater than or equal to $\frac{3}{4}$ inch in diameter.

3.9.3.3 SIGMETs are identified by an alphabetic designator from November through Yankee excluding Sierra and Tango. (Sierra, Tango, and Zulu are reserved for AIRMET text [WA] products;

G-AIRMETS do not use the Sierra, Tango, or Zulu designators.) The first issuance of a SIGMET will be labeled as UWS (Urgent Weather SIGMET). Subsequent issuances are at the forecasters discretion. Issuance for the same phenomenon will be sequentially numbered, using the original designator until the phenomenon ends. For example, the first issuance in the Chicago (CHI) FA area for phenomenon moving from the Salt Lake City (SLC) FA area will be SIGMET Papa 3, if the previous two issuances, Papa 1 and Papa 2, had been in the SLC FA area. Note that no two different phenomena across the country can have the same alphabetic designator at the same time.

EXAMPLE-

Example of a SIGMET:

```
BOSR WS 050600  
SIGMET ROMEO 2 VALID UNTIL 051000  
ME NH VT  
FROM CAR TO YSJ TO CON TO MPV TO CAR  
MOD TO OCNL SEV TURB BLW 080 EXP DUE TO STG  
NWLY FLOW. CONDS CONTG BYD  
1000Z.
```

3.9.3.4 Convective SIGMET (WST)

a) Convective SIGMETs are issued in the conterminous U.S. for any of the following:

- 1) Severe thunderstorm due to:

- a) Surface winds greater than or equal to 50 knots.

(b) Hail at the surface greater than or equal to $\frac{3}{4}$ inches in diameter.

(c) Tornadoes.

2) Embedded thunderstorms.

3) A line of thunderstorms.

4) Thunderstorms producing precipitation greater than or equal to heavy precipitation affecting 40 percent or more of an area at least 3,000 square miles.

b) Any convective SIGMET implies severe or greater turbulence, severe icing, and low-level wind shear. A convective SIGMET may be issued for any convective situation that the forecaster feels is hazardous to all categories of aircraft.

c) Convective SIGMET bulletins are issued for the western (W), central (C), and eastern (E) United States. (Convective SIGMETs are not issued for Alaska or Hawaii.) The areas are separated at 87 and 107 degrees west longitude with sufficient overlap to cover most cases when the phenomenon crosses the boundaries. Bulletins are issued hourly at H+55. Special bulletins are issued at any time as required and updated at H+55. If no criteria meeting convective SIGMET requirements are observed or forecasted, the message “CONVECTIVE SIGMET... NONE” will be issued for each area at H+55. Individual convective SIGMETs for each area (W, C, E) are numbered sequentially from number one each day, beginning at 00Z. A convective SIGMET for a continuing phenomenon will be reissued every hour at H+55 with a new number. The text of the bulletin consists of either an observation and a forecast or just a forecast. The forecast is valid for up to 2 hours.

EXAMPLE–

Example of a Convective SIGMET:

MKCC WST 251655

CONVECTIVE SIGMET 54C

VALID UNTIL 1855Z

WI IL

FROM 30E MSN–40ESE DBQ

DMSHG LINE TS 15 NM WIDE MOV FROM 30025KT.
TOPS TO FL450. WIND GUSTS TO 50 KT POSS.

CONVECTIVE SIGMET 55C

VALID UNTIL 1855Z

WI IA

FROM 30NNW MSN–30SSE MCW

DVLPG LINE TS 10 NM WIDE MOV FROM 30015KT.
TOPS TO FL300.

CONVECTIVE SIGMET 56C

VALID UNTIL 1855Z

MT ND SD MN IA MI

LINE TS 15 NM WIDE MOV FROM 27020KT. TOPS TO
FL380.

OUTLOOK VALID 151855–252255

FROM 60NW ISN–INL–TVC–SBN–BRL–FSD–
BIL–60NW ISN

IR STLT IMGRY SHOWS CNVTV CLD TOP TEMPS
OVER SRN WI HAVE BEEN WARMING STEADILY
INDCG A WKNG TREND. THIS ALSO REFLECTED BY
LTST RADAR AND LTNG DATA. WKNG TREND OF
PRESENT LN MAY CONT...HWVR NEW DVLPMT IS
PSBL ALG OUTFLOW BDRY AND/OR OVR NE IA/SW
WI BHD CURRENT ACT.

A SCND TS IS CONTG TO MOV EWD THRU ERN MT
WITH NEW DVLPMT OCRG OVR CNTRL ND. MT ACT
IS MOVG TWD MORE FVRBL AMS OVR THE WRN
DAKS WHERE DWPTS ARE IN THE UPR 60S WITH
LIFTED INDEX VALUES TO MS 6. TS EXPD TO INCR IN
COVERAGE AND INTSTY DURG AFTN HRS.

WST ISSUANCES EXPD TO BE RQRD THRUT AFTN
HRS WITH INCRG PTNTL FOR STGR CELLS TO
CONTAIN LRG HAIL AND PSBLY DMGG SFC WINDS.

3.9.3.5 International SIGMET

a) Some NWS offices have been designated by the ICAO as Meteorological Watch Offices (MWOs). These offices are responsible for issuing International SIGMETs for designated areas that include Alaska, Hawaii, portions of the Atlantic and Pacific Oceans, and the Gulf of Mexico.

b) The offices which issue International SIGMETs are:

1) The AWC in Kansas City, Missouri.

2) The AAWU in Anchorage, Alaska.

3) The WFO in Honolulu, Hawaii.

4) The WFO on Guam Island in the Pacific Ocean.

c) These SIGMETs are considered “widespread” because they must be either affecting or be forecasted to affect an area of at least 3,000 square miles at any one time. The International SIGMET is issued for 6 hours for volcanic ash events, 6 hours for hurricanes and tropical storms, and 4 hours for all other events. Like the domestic SIGMETs, International SIGMETs are also identified by an alphabetic designator from Alpha through Mike and are numbered sequentially until that weather phenomenon ends. The criteria for an International SIGMET are:

- 1) Thunderstorms occurring in lines, embedded in clouds, or in large areas producing tornadoes or large hail.
- 2) Tropical cyclones.
- 3) Severe icing.
- 4) Severe or extreme turbulence.
- 5) Dust storms and sandstorms lowering visibilities to less than 3 miles.
- 6) Volcanic ash.

EXAMPLE-

Example of an International SIGMET:

WSNT06 KKCI 022014
SIGA0F
KZMA KZNY TJZS SIGMET FOXTROT 3 VALID
022015/030015 KKCI- MIAMI OCEANIC FIR NEW
YORK OCEANIC FIR SAN JUAN FIR FRQ TS WI AREA
BOUNDED BY 2711N6807W 2156N6654W 2220N7040W
2602N7208W 2711N6807W. TOPS TO FL470. MOV NE
15KT. WKN. BASED ON SAT AND LTG OBS.
MOSHER

3.9.3.6 AIRMET (WA)

a) AIRMETs (WAs) are advisories of significant weather phenomena but describe conditions at intensities lower than those which require the issuance of SIGMETs. AIRMETs are intended for dissemination to all pilots in the preflight and en route phase of flight to enhance safety. AIRMET information is available in two formats: text bulletins (WA) and graphics (G-AIRMET). Both formats meet the criteria of paragraph 3.6.9.1 and are issued on a scheduled basis every 6 hours beginning at 0145 UTC during Central Daylight Time and at 0245 UTC during Central Standard Time. Unscheduled updates and corrections are issued as necessary. Each AIRMET Bulletin contains any current AIRMETs in effect and an outlook for conditions expected after the

AIRMET valid period. AIRMETs contain details about IFR, extensive mountain obscuration, turbulence, strong surface winds, icing, and freezing levels.

b) There are three AIRMETs: Sierra, Tango, and Zulu. After the first issuance each day, scheduled or unscheduled bulletins are numbered sequentially for easier identification.

1) AIRMET Sierra describes IFR conditions and/or extensive mountain obscurations.

2) AIRMET Tango describes moderate turbulence, sustained surface winds of 30 knots or greater, and/or nonconvective low-level wind shear.

3) AIRMET Zulu describes moderate icing and provides freezing level heights.

EXAMPLE-

Example of AIRMET Sierra issued for the Chicago FA area:

CHIS WA 131445
AIRMET SIERRA UPDT 2 FOR IFR AND MTN OBSCN
VALID UNTIL 132100.
AIRMET IFR...KY
FROM 20SSW HNN TO HMV TO 50ENE DYR TO20SSW
HNN
CIG BLW 010/VIS BLW 3SM PCPN/BR/FG. CONDS
ENDG BY 18Z.

AIRMET IFR...MN LS
FROM INL TO 70W YQT TO 40ENE DLH TO
30WNW DLH TO 50SE GFK TO 20 ENE GFK TO
INL
CIG BLW 010/VIS BLW 3SM BR. CONDS ENDG 15-
18Z.

AIRMET IFR...KS
FROM 30N SLN TO 60E ICT TO 40S ICT TO 50W
LBL TO 30SSW GLD TO 30N SLN
CIG BLW 010/VIS BLW 3SM PCPN/BR/FG. CONDS
ENDG 15-18Z.

AIRMET MTN OBSCN...KY TN
FROM HNN TO HMV TO GQO TO LOZ TO HNN
MTN OBSC BY CLDS/PCPN/BR. CONDS CONTG
BYD 21Z THRU 03Z.

EXAMPLE-

Example of AIRMET Tango issued for the Salt Lake City FA area:

SLCT WA 131445
AIRMET TANGO UPDT 2 FOR TURB VALID UNTIL
131200.
AIRMET TURB...MT

FROM 40NW HVR TO 50SE BIL TO 60E DLN TO
60SW YQL TO 40NW HVR
MOD TURB BLW 150. CONDS DVLPG 18–21Z.
CONDS CONTG BYD 21Z THRU 03Z.

AIRMET TURB....ID MT WY NV UT CO
FROM 100SE MLS TO 50SSW BFF TO 20SW BTY
TO 40SW BAM TO 100SE MLS
MOD TURB BTN FL310 AND FL410. CONDS
CONTG BYD 21Z ENDG 21–00Z.

AIRMET TURB...NV AZ NM CA AND CSTL WTRS
FROM 100WSW ENI TO 40W BTY TO 40S LAS TO
30ESE TBE TO INK TO ELP TO 50S TUS TO BZA
TO 20S MZB TO 150SW PYE TO 100WSW ENI
MOD TURB BTWN FL210 AND FL380. CONDS
CONTG BYD 21Z THRU 03Z.

....

EXAMPLE–

**Example of AIRMET Zulu issued for the San Francisco
FA area:**

SFOZ WA 131445
AIRMET ZULU UPDT 2 FOR ICE AND FRZLVL VALID
UNTIL 132100.
NO SGFNT ICE EXP OUTSIDE OF CNVTV ACT.

FRZLVL....RANGING FROM SFC–105 ACRS AREA
MULT FRZLVL BLW 080 BOUNDED BY 40SE
YDC–60NNW GEG–60SW MLP–30WSW BKE–
20SW BAM–70W BAM–40SW YKM–40E HUH–
40SE YDC
SFC ALG 20NNW HUH–30SSE HUH–60S SEA
50NW LKV–60WNWOAL–30SW OAL
040 ALG 40W HUH–30W HUH–30NNW SEA–40N
PDX–20NNW DSD
080 ALG 160NW FOT–80SW ONP–50SSW EUG
40SSE OED–50SSE CZQ–60E EHF–40WSW LAS

....

3.9.3.7 Graphical AIRMETs (G–AIRMETs)

a) G–AIRMETs found on the Aviation Weather Center webpage at <http://aviationweather.gov>, are graphical forecasts of en–route weather hazards valid at discrete times no more than 3 hours apart for a period of up to 12 hours into the future (for example, 00, 03, 06, 09, and 12 hours). Additional forecasts may be inserted during the first 6 hours (for example, 01, 02, 04, and 05). 00 hour represents the initial conditions, and the subsequent graphics depict the area affected by the particular hazard at that valid time. Forecasts valid at 00 through 06 hours correspond to the text AIRMET bulletin. Forecasts valid at 06 through 12 hours correspond to the text

bulletin outlook. G–AIRMET depicts the following en route aviation weather hazards:

- 1) Instrument flight rule conditions (ceiling < 1000' and/or surface visibility <3 miles)
- 2) Mountain obscuration
- 3) Icing
- 4) Freezing level
- 5) Turbulence
- 6) Low level wind shear (LLWS)
- 7) Strong surface winds

b) G–AIRMETs are snap shots at discrete time intervals as defined above. The text AIRMET is the result of the production of the G–AIRMET but provided in a time smear for a 6hr valid period. G–AIRMETs provide a higher forecast resolution than text AIRMET products. Since G–AIRMETs and text AIRMETs are created from the same forecast “production” process, there exists perfect consistency between the two. Using the two together will provide clarity of the area impacted by the weather hazard and improve situational awareness and decision making.

Interpolation of time periods between G–AIRMET valid times: Users must keep in mind when using the G–AIRMET that if a 00 hour forecast shows no significant weather and a 03 hour forecast shows hazardous weather, they must assume a change is occurring during the period between the two forecasts. It should be taken into consideration that the hazardous weather starts immediately after the 00 hour forecast unless there is a defined initiation or ending time for the hazardous weather. The same would apply after the 03 hour forecast. The user should assume the hazardous weather condition is occurring between the snap shots unless informed otherwise. For example, if a 00 hour forecast shows no hazard, a 03 hour forecast shows the presence of hazardous weather, and a 06 hour forecast shows no hazard, the user should assume the hazard exists from the 0001 hour to the 0559 hour time period.

EXAMPLE–

See FIG GEN 3.5–8 for an example of the G–AIRMET graphical product.

3.9.3.8 Severe Weather Watch Bulletins (WWs) and Alert Messages (AWWs)

a) WWs define areas of possible severe thunderstorms or tornado activity. The bulletins are issued by

the Storm Prediction Center (SPC) in Norman, OK. WWs are unscheduled and are issued as required.

b) A severe thunderstorm watch describes areas of expected severe thunderstorms. (Severe thunderstorm criteria are $\frac{3}{4}$ -inch hail or larger and/or wind gusts of 50 knots [58 mph] or greater.)

c) A tornado watch describes areas where the threat of tornadoes exists.

d) In order to alert the WFOs, CWSUs, FSSs, and other users, a preliminary notification of a watch called the Alert Severe Weather Watch bulletin (AWW) is sent before the WW. (WFOs know this product as a SAW).

EXAMPLE-

Example of an AWW:

MKC AWW 011734

WW 75 TORNADO TX OK AR 011800Z-020000Z

AXIS..80 STATUTE MILES EAST AND WEST OF A LINE..60ESE DAL/DALLAS TX/ - 30 NW ARG/WALNUT RIDGE AR/

..AVIATION COORDS.. 70NM E/W /58W GGG - 25NW ARG/

HAIL SURFACE AND ALOFT..1 $\frac{3}{4}$ INCHES. WIND GUSTS..70 KNOTS. MAX TOPS TO 450. MEAN WIND VECTOR 24045.

e) Soon after the AWW goes out, the actual watch bulletin itself is issued. A WW is in the following format:

1) Type of severe weather watch, watch area, valid time period, type of severe weather possible, watch axis, meaning of a watch, and a statement that persons should be on the lookout for severe weather.

2) Other watch information; i.e., references to previous watches.

3) Phenomena, intensities, hail size, wind speed (knots), maximum cumulonimbus (CB) tops, and estimated cell movement (mean wind vector).

4) Cause of severe weather.

5) Information on updating Convective Outlook (AC) products.

EXAMPLE-

Example of a WW:

BULLETIN - IMMEDIATE BROADCAST REQUESTED
TORNADO WATCH NUMBER 381

STORM PREDICTION CENTER NORMAN OK

556 PM CDT MON JUN 2 1997

THE STORM PREDICTON CENTER HAS ISSUED A
TORNADO WATCH FOR PORTIONS OF NORTHEAST

NEW MEXICO TEXAS PANHANDLE

EFFECTIVE THIS MONDAY NIGHT AND TUESDAY MORNING FROM 630 PM UNTIL MIDNIGHT CDT.

TORNADOES...HAIL TO 2 $\frac{3}{4}$ INCHES IN DIAMETER...THUNDERSTORM WIND GUSTS TO 80 MPH...AND DANGEROUS LIGHTNING ARE POSSIBLE IN THESE AREAS.

THE TORNADO WATCH AREA IS ALONG AND 60 STATUTE MILES NORTH AND SOUTH OF A LINE FROM 50 MILES SOUTHWEST OF RATON NEW MEXICO TO 50 MILES EAST OF AMARILLO TEXAS.

REMEMBER...A TORNADO WATCH MEANS CONDITIONS ARE FAVORABLE FOR TORNADOES AND SEVERE THUNDERSTORMS IN AND CLOSE TO THE WATCH AREA. PERSONS IN THESE AREAS SHOULD BE ON THE LOOKOUT FOR THREATENING WEATHER CONDITIONS AND LISTEN FOR LATER STATEMENTS AND POSSIBLE WARNINGS.

OTHER WATCH INFORMATION...CONTINUE... WW 378...WW 379...WW 380

DISCUSSION...THUNDERSTORMS ARE INCREASING OVER NE NM IN MOIST SOUTHEASTERLY UPSLOPE FLOW. OUTFLOW BOUNDARY EXTENDS EASTWARD INTO THE TEXAS PANHANDLE AND EXPECT STORMS TO MOVE ESE ALONG AND NORTH OF THE BOUNDARY ON THE N EDGE OF THE CAP. VEERING WINDS WITH HEIGHT ALONG WITH INCREASING MID LVL FLOW INDICATE A THREAT FOR SUPERCELLS.

AVIATION...TORNADOES AND A FEW SEVERE THUNDERSTORMS WITH HAIL SURFACE AND ALOFT TO 2 $\frac{3}{4}$ INCHES. EXTREME TURBULENCE AND SURFACE WIND GUSTS TO 70 KNOTS. A FEW CUMULONIMBI WITH MAXIMUM TOPS TO 550. MEAN STORM MOTION VECTOR 28025.

f) Status reports are issued as needed to show progress of storms and to delineate areas no longer under the threat of severe storm activity. Cancellation bulletins are issued when it becomes evident that no severe weather will develop or that storms have subsided and are no longer severe.

g) When tornadoes or severe thunderstorms have developed, the local WFO office will issue the warnings covering those areas.

3.9.3.9 Center Weather Advisories (CWAs)

a) CWAs are unscheduled inflight, flow control, air traffic, and air crew advisory. By nature of its short lead time, the CWA is not a flight planning product. It is generally a nowcast for conditions beginning within the next two hours. CWAs will be issued:

1) As a supplement to an existing SIGMET, Convective SIGMET or AIRMET.

2) When an Inflight Advisory has not been issued but observed or expected weather conditions meet SIGMET/AIRMET criteria based on current pilot reports and reinforced by other sources of information about existing meteorological conditions.

3) When observed or developing weather conditions do not meet SIGMET, Convective SIGMET, or AIRMET criteria; e.g., in terms of intensity or area coverage, but current pilot reports or other weather information sources indicate that existing or anticipated meteorological phenomena will adversely affect the safe flow of air traffic within the ARTCC area of responsibility.

b) The following example is a CWA issued from the Kansas City, Missouri, ARTCC. The “3” after ZKC in the first line denotes this CWA has been issued for the third weather phenomena to occur for the day. The “301” in the second line denotes the phenomena number again (3) and the issuance number (01) for this phenomena. The CWA was issued at 2140Z and is valid until 2340Z.

EXAMPLE–
ZKC3 CWA 032140
ZKC CWA 301 VALID UNTIL 032340
ISOLD SVR TSTM over KCOU MOVG SWWD 10
KTS ETC.

4. Categorical Outlooks

4.1 Categorical outlook terms describing general ceiling and visibility conditions for advance planning purposes are used only in area forecasts. They are defined as follows:

4.1.1 LIFR (Low IFR) – Ceiling less than 500 feet and/or visibility less than 1 mile.

4.1.2 IFR – Ceiling 500 to less than 1,000 feet and/or visibility 1 to less than 3 miles.

4.1.3 MVFR (Marginal VFR) – Ceiling 1,000 or 3,000 feet and/or visibility 3 to 5 miles inclusive.

4.1.4 VFR – Ceiling greater than 3,000 feet and visibility greater than 5 miles; includes sky clear.

4.2 The cause of LIFR, IFR, or MVFR is indicated by either ceiling or visibility restrictions or both. The contraction “CIG” and/or weather and obstruction to vision symbols are used. If winds or gusts of 25 knots or greater are forecast for the outlook period, the word “WIND” is also included for all categories, including VFR.

EXAMPLE–
LIFR CIG–low IFR due to low ceiling.

IFR FG–IFR due to visibility restricted by fog.

MVFR CIG HZ FU–marginal VFR due both to ceiling and to visibility restricted by haze and smoke.

IFR CIG RA WIND–IFR due both to low ceiling and to visibility restricted by rain; wind expected to be 25 knots or greater.

FIG GEN 3.5-8
G-AIRMET Graphical Product

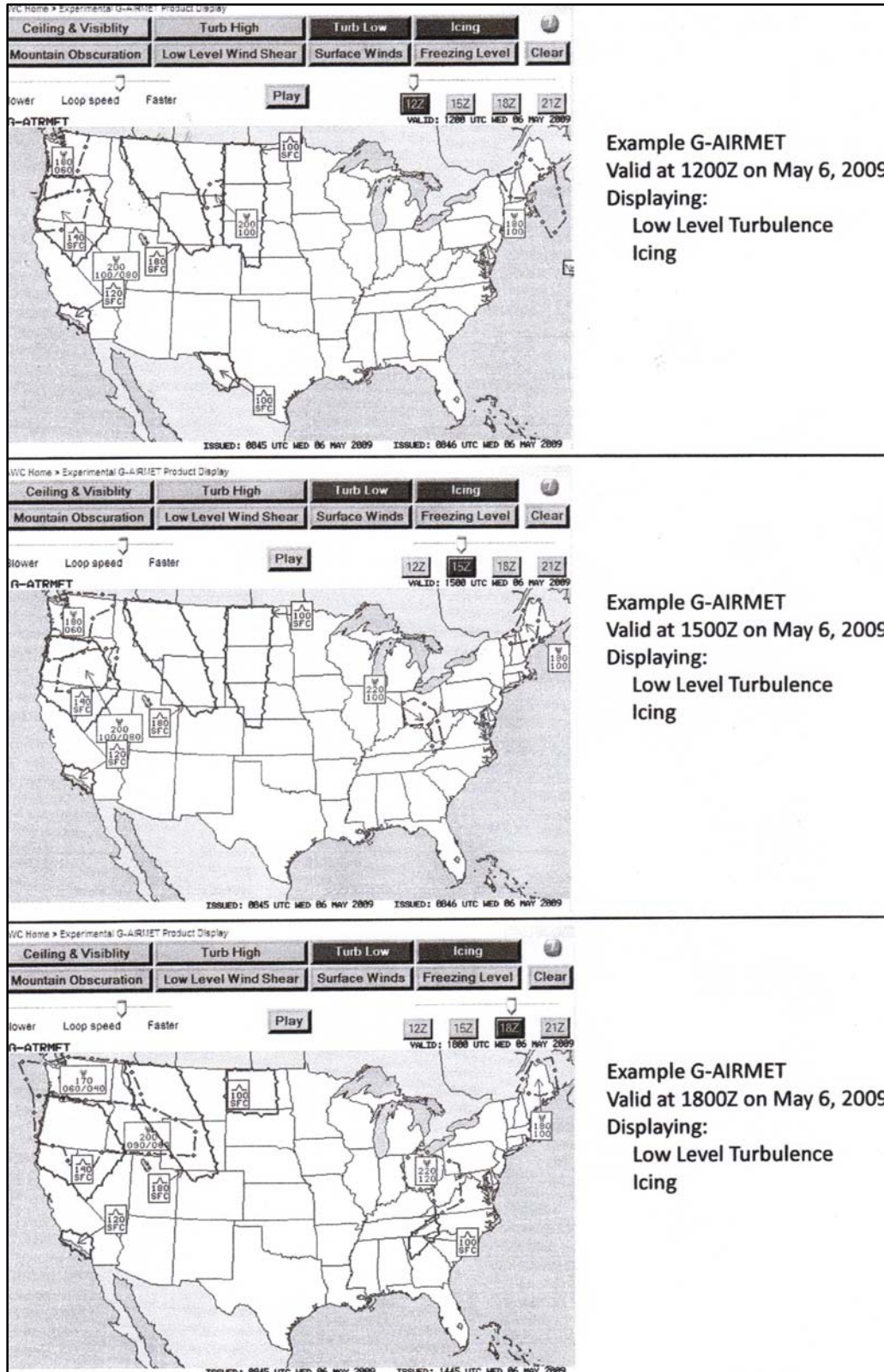

5. Telephone Information Briefing Service (TIBS)

5.1 TIBS, provided by automated flight service stations (AFSSs), is a continuous recording of meteorological and aeronautical information, available by telephone. Each AFSS provides at least four route and/or area briefings. In addition, airspace procedures and special announcements (if applicable) concerning aviation interests are also available. Depending upon user demand, other items may be provided; i.e., METAR observations, terminal airport forecasts, winds aloft, and temperatures aloft forecasts.

6. Inflight Weather Broadcasts

6.1 Weather Advisory Broadcasts. ARTCCs' broadcast a Severe Weather Forecast Alert (AWW), Convective SIGMET, or CWA alert once on all frequencies, except emergency, when any part of the area described is within 150 miles of the airspace under their jurisdiction. These broadcasts contain SIGMET or CWA identification and a brief description of the weather activity and general area affected.

EXAMPLE–

Attention all aircraft, SIGMET Delta Three, from Myton to Tuba City to Milford, severe turbulence and severe clear icing below one zero thousand feet. Expected to continue beyond zero three zero zero zulu.

EXAMPLE–

Attention all aircraft, Convective SIGMET Two Seven Eastern. From the vicinity of Elmira to Phillipsburg. Scattered embedded thunderstorms moving east at one zero knots. A few intense level five cells, maximum tops four five zero.

EXAMPLE–

Attention all aircraft, Kansas City Center weather advisory one zero three. Numerous reports of moderate to severe icing from eight to niner thousand feet in a three zero mile radius of St. Louis. Light or negative icing reported from four thousand to one two thousand feet remainder of Kansas City Center area.

NOTE–

Terminal control facilities have the option to limit the AWW, Convective SIGMET, SIGMET, or CWA broadcast as follows: local control and approach control positions may opt to broadcast SIGMET or CWA alerts only when any part of the area described is within 50 miles of the airspace under their jurisdiction.

6.2 Hazardous Inflight Weather Advisory Service (HIWAS). This is a continuous broadcast of inflight weather advisories including summarized AWWs, SIGMETs, Convective SIGMETs, CWAs, AIRMETs (text [WA] or graphical [G–AIRMET] product), and urgent PIREPs. HIWAS has been adopted as a national program and will be implemented throughout the conterminous U.S. as resources permit. In those areas where HIWAS is commissioned, ARTCC, Terminal ATC, and AFSS/FSS facilities have discontinued the broadcast of inflight advisories. HIWAS is an additional source of hazardous weather information which makes these data available on a continuous basis. It is not, however, a replacement for preflight or inflight briefings or real-time weather updates from Flight Watch (EFAS). As HIWAS is implemented in individual center areas, the commissioning will be advertised in the Notices to Airmen publication.

6.2.1 Where HIWAS has been implemented, a HIWAS alert will be broadcast on all except emergency frequencies once upon receipt by ARTCC and terminal facilities which will include an alert announcement, frequency instruction, number, and type of advisory updated; for example, AWW, SIGMET, Convective SIGMET, or CWA.

EXAMPLE–

Attention all aircraft. Hazardous weather information (SIGMET, Convective SIGMET, AIRMET (text [WA] or graphical [G–AIRMET] product), urgent pilot weather report [UUA], or Center Weather Advisory [CWA]), (number or numbers) for (geographical area) available on HIWAS, flight watch, or flight service frequencies.

6.2.2 In HIWAS ARTCC areas, AFSSs/FSSs will broadcast a HIWAS update announcement once on all except emergency frequencies upon completion of recording an update to the HIWAS broadcast. Included in the broadcast will be the type of advisory update; for example, AWW, SIGMET, Convective SIGMET, or CWA.

EXAMPLE–

Attention all aircraft. Hazardous weather information for (geographical area) available from flight watch or flight service.

6.2.3 HIWAS availability is shown on IFR En Route Low Altitude Charts and VFR Sectional Charts. The symbol depiction is identified in the chart legend.

7. Flight Information Services (FIS)

7.1 FIS. Aviation weather and other operational information may be displayed in the cockpit through the use of FIS. FIS systems are of two basic types: Broadcast only systems (called FIS–B) and two–way request/reply systems. Broadcast system components include a ground– or space–based transmitter, an aircraft receiver, and a portable or installed cockpit display device. Two–way systems utilize transmitter/receivers at both the ground– or space–based site and the aircraft.

7.1.1 Broadcast FIS (i.e., FIS–B) allows the pilot to passively collect weather and other operational data and to display that data at the appropriate time. In addition to textual weather products such as Aviation Routine Weather Reports (METARs)/Aviation Selected Special Weather Reports (SPECIs) and Terminal Area Forecasts (TAFs), graphical weather products such as radar composite/mosaic images, temporary flight restricted airspace and other NOTAMs may be provided to the cockpit. Two–way FIS services permit the pilot to make specific weather and other operational information requests for cockpit display. A FIS service provider will then prepare a reply in response to that specific request and transmit the product to that specific aircraft.

7.1.2 FIS services are available from four types of service providers:

7.1.2.1 A private sector FIS provider operating under service agreement with the FAA using broadcast data link over VHF aeronautical spectrum and whose products have been reviewed and accepted by the FAA prior to transmission. (Products and services are defined under subparagraph 7.3.)

7.1.2.2 Through an FAA operated service using a broadcast data link on the ADS–B UAT network. (Products and services are defined under subparagraph 7.4.)

7.1.2.3 Private sector FIS providers operating under customer contracts using aeronautical spectrum.

7.1.2.4 Private sector FIS providers operating under customer contract using methods other than aeronautical spectrum, including Internet data–to–the–cockpit service providers.

7.1.3 FIS is a method of receiving aviation weather and other operational data in the cockpit that augments traditional pilot voice communication with

FAA’s Flight Service Stations (FSSs), ATC facilities, or Airline Operations Control Centers (AOCCs). FIS is not intended to replace traditional pilot and controller/flight service specialist/aircraft dispatcher pre–flight briefings or inflight voice communications. FIS; however, can provide textual and graphical background information that can help abbreviate and improve the usefulness of such communications. FIS enhances pilot situational awareness and improves safety.

7.1.4 To ensure airman compliance with Federal Aviation Regulations, manufacturer’s operating manuals should remind airmen to contact ATC controllers, FSS specialists, operator dispatchers, or airline operations control centers for general and mission critical aviation weather information and/or NAS status conditions (such as NOTAMs, Special Use Airspace status, and other government flight information). If FIS products are systemically modified (for example, are displayed as abbreviated plain text and/or graphical depictions), the modification process and limitations of the resultant product should be clearly described in the vendor’s user guidance.

7.2 Operational Use of FIS. Regardless of the type of FIS system being used, several factors must be considered when using FIS:

7.2.1 Before using FIS for inflight operations, pilots and other flight crewmembers should become familiar with the operation of the FIS system to be used, the airborne equipment to be used, including its system architecture, airborne system components, coverage service volume and other limitations of the particular system, modes of operation and indications of various system failures. Users should also be familiar with the specific content and format of the services available from the FIS provider(s). Sources of information that may provide this specific guidance include manufacturer’s manuals, training programs and reference guides.

7.2.2 FIS should not serve as the sole source of aviation weather and other operational information. ATC, AFSSs and, if applicable, AOCC VHF/HF voice remain as a redundant method of communicating aviation weather, NOTAMs, and other operational information to aircraft in flight. FIS augments these traditional ATC/FSS/AOCC services and, for some products, offers the advantage of being displayed as graphical information. By using FIS for orientation, the usefulness of information received from

conventional means may be enhanced. For example, FIS may alert the pilot to specific areas of concern that will more accurately focus requests made to FSS or AOCC for inflight updates or similar queries made to ATC.

7.2.3 The airspace and aeronautical environment is constantly changing. These changes occur quickly and without warning. Critical operational decisions should be based on use of the most current and appropriate data available. When differences exist between FIS and information obtained by voice communication with ATC, FSS, and/or AOCC (if applicable), pilots are cautioned to use the most recent data from the most authoritative source.

7.2.4 FIS aviation weather products (e.g., graphical ground-based radar precipitation depictions) are not appropriate for tactical avoidance of severe weather such as negotiating a path through a weather hazard area. FIS supports strategic weather decision making such as route selection to avoid a weather hazard area in its entirety. The misuse of information beyond its applicability may place the pilot and aircraft in jeopardy. In addition, FIS should never be used in lieu of an individual pre-flight weather and flight planning briefing.

7.2.5 FIS NOTAM products, including Temporary Flight Restriction (TFR) information, are advisory-use information and are intended for situational awareness purposes only. Cockpit displays of this information are not appropriate for tactical navigation – pilots should stay clear of any geographic area displayed as a TFR NOTAM. Pilots should contact FSSs and/or ATC while en route to obtain updated information and to verify the cockpit display of NOTAM information.

7.2.6 FIS supports better pilot decision making by increasing situational awareness. Better decision-making is based on using information from a variety of sources. In addition to FIS, pilots should take advantage of other weather/NAS status sources, including, briefings from Flight Service Stations, FAA’s en route “Flight Watch” service, data from other air traffic control facilities, airline operation control centers, pilot reports, as well as their own observations.

7.3 FAA FISDL (VHF) Service. The FAA’s FISDL (VHF datalink) system is a VHF Data Link

(VDL) Mode 2 implementation that provides pilots and flight crews of properly equipped aircraft with a cockpit display of certain aviation weather and flight operational information. This information may be displayed in both textual and graphical formats. The system is operated under a service agreement with the FAA, using broadcast data link on VHF aeronautical spectrum on two 25 KHz spaced frequencies (136.450 and 136.475 MHz). The FAA FISDL (VHF) service is designed to provide coverage throughout the continental U.S. from 5,000 feet AGL to 17,500 feet MSL, except in areas where this is not feasible due to mountainous terrain. Aircraft operating near transmitter sites may receive useable FISDL signals at altitudes lower than 5,000 feet AGL, including on the surface in some locations, depending on transmitter/aircraft line of sight geometry. Aircraft operating above 17,500 feet MSL may also receive useable FISDL signals under certain circumstances.

7.3.1 FAA FISDL (VHF) service provides, free of charge, the following basic text products:

7.3.1.1 Aviation Routine Weather Reports (METARs).

7.3.1.2 Aviation Selected Special Weather Reports (SPECIs).

7.3.1.3 Terminal Area Forecasts (TAFs), and their amendments.

7.3.1.4 Significant Meteorological Information (SIGMETs).

7.3.1.5 Convective SIGMETs.

7.3.1.6 AIRMET text bulletins (WA).

7.3.1.7 Pilot Reports (both urgent and routine) (PIREPs); and,

7.3.1.8 Severe Weather Forecast Alerts and Warnings (AWWs/WW) issued by the NOAA Storm Prediction Center (SPC).

7.3.2 The format and coding of these text products are described in Advisory Circular AC-00-45, Aviation Weather Services, and FIG GEN 3.5-24 and FIG GEN 3.5-25, Key to Aerodrome Forecast (TAF) and Aviation Routine Weather Report (METAR).

7.3.3 Additional products, called “Value-Added Products,” are also available from the vendor on a paid subscription basis. Details concerning the

content, format, symbology and cost of these products may be obtained from the vendor.

7.4 FAA’s Flight Information Service–Broadcast (FIS–B) Service. FIS–B is a ground–based broadcast service provided through the FAA’s Automatic Dependent Surveillance – Broadcast Services (ADS–B) Universal Access Transceiver (UAT) network. The service provides users with a 978 MHz data link capability when operating within range and line–of–sight of a transmitting ground station. FIS–B enables users of properly equipped aircraft to receive and display a suite of broadcast weather and aeronautical information products. Services are currently available in specific geographic regions of the U.S. with NAS–wide service availability planned for 2013.

7.4.1 The following list represents the initial suite of text and graphical products available through FIS–B and provided free–of–charge. Detailed information concerning FIS–B meteorological products can be found in Advisory Circular 00–45, Aviation Weather Services. Information on Special Use Airspace (SUA), Temporary Flight Restriction (TFR) and Notice to Airmen (NOTAM) products can be found in Chapters ENR 1 and ENR 5 of this manual.

7.4.1.1 Text: Aviation Routine Weather Report (METAR) and Special Aviation Report (SPECI);

7.4.1.2 Text: Pilot Weather Report (PIREP);

7.4.1.3 Text: Winds and Temperatures Aloft;

7.4.1.4 Text: Terminal Area Forecast (TAF) and amendments;

7.4.1.5 Text: Notice to Airmen (NOTAM) Distant and Flight Data Center;

7.4.1.6 Text/Graphic: Airmen’s Meteorological Conditions (AIRMET);

7.4.1.7 Text/Graphic: Significant Meteorological Conditions (SIGMET);

7.4.1.8 Text/Graphic: Convective SIGMET;

7.4.1.9 Text/Graphic: Special Use Airspace (SUA);

7.4.1.10 Text/Graphic: Temporary Flight Restriction (TFR) NOTAM; and

7.4.1.11 Graphic: NEXRAD Composite Reflectivity Products (Regional and National).

7.4.2 Users of FIS–B should familiarize themselves with the operational characteristics and limitations of

the system, including: system architecture; service environment; product lifecycles; modes of operation; and indications of system failure.

7.4.3 FIS–B products are updated and transmitted at specific intervals based primarily on product issuance criteria. Update intervals are defined as the rate at which the product data is available from the source for transmission. Transmission intervals are defined as the amount of time within which a new or updated product transmission must be completed and/or the rate or repetition interval at which the product is rebroadcast. Update and transmission intervals for each product are provided in NO TAG.

7.4.4 Where applicable, FIS–B products include a look–ahead range expressed in nautical miles (NM) for three service domains: Airport Surface; Terminal Airspace; and En–route/Gulf–of–Mexico (GOMEX). NO TAG provides service domain availability and look–ahead ranging for each FIS–B product.

7.4.5 Prior to using this capability, users should familiarize themselves with the operation of FIS–B avionics by referencing the applicable User’s Guides. Guidance concerning the interpretation of information displayed should be obtained from the appropriate avionics manufacturer.

7.4.6 FIS–B malfunctions not attributed to aircraft system failures or covered by active NOTAM should be reported by radio or telephone to the nearest FSS facility. Malfunctions may also be reported by submitting FAA Form 8740–5, Safety Improvement Report via mail, fax, or email to your local Flight District Standards Office, Safety Program Manager.

7.5 Non–FAA FISDL Systems. Several commercial vendors also provide customers with FIS data over both the aeronautical spectrum and on other frequencies using a variety of data link protocols. In some cases, the vendors provide only the communications system that carries customer messages, such as the Aircraft Communications Addressing and Reporting System (ACARS) used by many air carrier and other operators.

7.5.1 Operators using non–FAA FIS data for inflight weather and other operational information should ensure that the products used conform to FAA/NWS standards. Specifically, aviation weather and NAS status information should meet the following criteria:

TBL GEN 3.5–2

Product	Update Interval	Transmission Interval	Service Domain and Look-ahead Range (NM)
AIRMET	As Available	5 minutes	100 (Airport Surface), 500 (Terminal, Enroute/ GOMEX)
SIGMET & Convective SIGMET	As Available, then at 15 minute intervals for 1 hour	5 minutes	100 (Airport Surface), 500 (Terminal, Enroute/ GOMEX)
METAR/SPECI	1 minute (where available), As Available otherwise	5 minute	100 (Airport Surface), 500 (Terminal, Enroute/ GOMEX)
NEXRAD Composite Reflectivity (National)	~5 minutes precipitation mode 10 minutes for clear air mode	15 minutes	CONUS
NEXRAD Composite Reflectivity (Regional)	~5 minutes precipitation mode 10 minutes for clear air mode	2.5 minutes	250
NOTAM (D) / FDC (including TFR)	As Available	10 minutes	100
PIREP	As Available	10 minutes	N/A (Airport Surface), 500 (Terminal, Enroute/ GOMEX)
SUA	As Available	10 minutes	N/A (Airport Surface), 500 (Terminal, Enroute/ GOMEX)
TAF/AMEND	8 Hours	10 minutes	100 (Airport Surface), 500 (Terminal, Enroute/ GOMEX)
Winds & Temperatures Aloft	12 Hours	10 minutes	1,000

7.5.1.1 The products should be either FAA/NWS “accepted” aviation weather reports or products, or based on FAA/NWS accepted aviation weather reports or products. If products are used which do not meet this criteria, they should be so identified. The operator must determine the applicability of such products to their particular flight operations.

7.5.1.2 In the case of a weather product which is the result of the application of a process which alters the form, function or content of the base FAA/NWS accepted weather product(s), that process, and any limitations to the application of the resultant product, should be described in the vendor’s user guidance material.

7.5.2 An example would be a NEXRAD radar composite/mosaic map, which has been modified by changing the scaling resolution. The methodology of assigning reflectivity values to the resultant image components should be described in the vendor’s guidance material to ensure that the user can accurately interpret the displayed data.

8. Weather Observing Programs

8.1 Manual Observations. Aviation Routine Weather Reports (METAR) are taken at more than 600 locations in the U.S. With only a few exceptions, these stations are located at airport sites and most are staffed by FAA or NWS personnel who manually

observe, perform calculations, and enter the observation into the distribution system. The format and coding of these observations are contained in FIG GEN 3.5–24.

8.2 Automated Weather Observing System (AWOS)

8.2.1 Automated weather reporting systems are increasingly being installed at airports. These systems consist of various sensors, a processor, a computer-generated voice subsystem, and a transmitter to broadcast local, minute-by-minute weather data directly to the pilot.

NOTE–
When the barometric pressure exceeds 31.00 inches Hg., see Section ENR 1.7, Altimeter Setting Procedures.

8.2.2 The AWOS observations will include the prefix “AUTO” to indicate that the data are derived from an automated system. Some AWOS locations will be augmented by certified observers who will provide weather and obstruction to vision information in the remarks of the report when the reported visibility is less than 3 miles. These sites, along with the hours of augmentation, are published in the Airport/Facility Directory. Augmentation is identified in the observation as “OBSERVER WEATHER.” The AWOS wind speed, direction and gusts, temperature, dew point, and altimeter setting are exactly the same as for manual observations. The AWOS will also report density altitude when it exceeds the field elevation by more than 1,000 feet. The reported visibility is derived from a sensor near the touchdown of the primary instrument runway. The visibility sensor output is converted to a visibility value using a 10-minute harmonic average. The reported sky condition/ceiling is derived from the ceilometer located next to the visibility sensor. The AWOS algorithm integrates the last 30 minutes of ceilometer data to derive cloud layers and heights. This output may also differ from the observer sky condition in that the AWOS is totally dependent upon the cloud advection over the sensor site.

8.2.3 Referred to as AWOS, these real-time systems are operationally classified into nine basic levels:

8.2.3.1 AWOS–A only reports altimeter setting.

NOTE–
Any other information is advisory only.

8.2.3.2 AWOS–AV reports altimeter and visibility;

NOTE–
Any other information is advisory only.

8.2.3.3 AWOS–I usually reports altimeter setting, wind data, temperature, dew point, and density altitude.

8.2.3.4 AWOS–2 provides the information provided by AWOS–I, plus visibility.

8.2.3.5 AWOS–3 provides the information provided by AWOS–2, plus cloud/ceiling data.

8.2.3.6 AWOS–3P provides reports the same as the AWOS 3 system, plus a precipitation identification sensor.

8.2.3.7 AWOS–3PT reports the same as the AWOS 3P System, plus thunderstorm/lightning reporting capability.

8.2.3.8 AWOS–3T reports the same as AWOS 3 system and includes a thunderstorm/lightning reporting capability.

8.2.3.9 AWOS–4 reports the same as the AWOS 3 system, plus precipitation occurrence, type and accumulation, freezing rain, thunderstorm, and runway surface sensors.

8.2.4 The information is transmitted over a discrete VHF radio frequency or the voice portion of a local NAVAID. AWOS transmissions on a discrete VHF radio frequency are engineered to be receivable to a maximum of 25 NM from the AWOS site and a maximum altitude of 10,000 feet AGL. At many locations, AWOS signals may be received on the surface of the airport, but local conditions may limit the maximum AWOS reception distance and/or altitude. The system transmits a 20- to 30-second weather message updated each minute. Pilots should monitor the designated frequency for the automated weather broadcast. A description of the broadcast is contained in paragraph 8.3, Automated Weather Observing System (AWOS) Broadcasts. There is no two-way communication capability. Most AWOS sites also have a dial-up capability so that the minute-by-minute weather messages can be accessed via telephone.

8.2.5 AWOS information (system level, frequency, phone number) concerning specific locations is published, as the systems become operational, in the Airport/Facility Directory and, where applicable, on published Instrument Approach Procedure (IAP) charts. Selected individual systems may be incorpo-

rated into nationwide data collection and dissemination networks in the future.

8.3 Automated Weather Observing System (AWOS) Broadcasts. Computer-generated voice is used in AWOS to automate the broadcast of the minute-by-minute weather observations. In addition, some systems are configured to permit the addition of an operator-generated voice message; e.g., weather remarks, following the automated parameters. The phraseology used generally follows that used for other weather broadcasts. Following are explanations and examples of the exceptions.

8.3.1 Location and Time. The location/name and the phrase “AUTOMATED WEATHER OBSERVATION” followed by the time are announced.

8.3.1.1 If the airport’s specific location is included in the airport’s name, the airport’s name is announced.

EXAMPLE–

“Bremerton National Airport automated weather observation one four five six zulu.”

“Ravenswood Jackson County Airport automated weather observation one four five six zulu.”

8.3.1.2 If the airport’s specific location is not included in the airport’s name, the location is announced followed by the airport’s name.

EXAMPLE–

“Sault Ste. Marie, Chippewa County International Airport automated weather observation.”

“Sandusky, Cowley Field automated weather observation.”

8.3.1.3 The word “TEST” is added following “OBSERVATION” when the system is not in commissioned status.

EXAMPLE–

“Bremerton National Airport automated weather observation test one four five six zulu.”

8.3.1.4 The phrase “TEMPORARILY INOPERATIVE” is added when the system is inoperative.

EXAMPLE–

“Bremerton National Airport automated weather observing system temporarily inoperative.”

8.3.2 Ceiling and Sky Cover

8.3.2.1 Ceiling is announced as either “CEILING” or “INDEFINITE CEILING.” The phrases “MEASURED CEILING” and “ESTIMATED CEILING”

are not used. With the exception of indefinite ceilings, all automated ceiling heights are measured.

EXAMPLE–

“Bremerton National Airport automated weather observation one four five six zulu, ceiling two thousand overcast.”

“Bremerton National Airport automated weather observation one four five six zulu, indefinite ceiling two hundred.”

8.3.2.2 The word “CLEAR” is not used in AWOS due to limitations in the height ranges of the sensors. No clouds detected is announced as, “No clouds below XXX” or, in newer systems as, “Clear below XXX” (where XXX is the range limit of the sensor).

EXAMPLE–

“No clouds below one two thousand.”

“Clear below one two thousand.”

8.3.2.3 A sensor for determining ceiling and sky cover is not included in some AWOS. In these systems, ceiling and sky cover are not announced. “SKY CONDITION MISSING” is announced only if the system is configured with a ceilometer, and the ceiling and sky cover information is not available.

8.3.3 Visibility

8.3.3.1 The lowest reportable visibility value in AWOS is “less than $\frac{1}{4}$.” It is announced as “VISIBILITY LESS THAN ONE QUARTER.”

8.3.3.2 A sensor for determining visibility is not included in some AWOSs. In these systems, visibility is not announced. “VISIBILITY MISSING” is announced only if the system is configured with a visibility sensor and visibility information is not available.

8.3.4 Weather. In the future, some AWOSs are to be configured to determine the occurrence of precipitation. However, the type and intensity may not always be determined. In these systems, the word “PRECIPITATION” will be announced if precipitation is occurring, but the type and intensity are not determined.

8.3.5 Remarks. If remarks are included in the observation, the word “REMARKS” is announced following the altimeter setting. Remarks are announced in the following order of priority:

8.3.5.1 Automated “remarks.”

- a) Variable visibility.
- b) Density altitude.

8.3.5.2 Manual input remarks. Manual input remarks are prefaced with the phrase “OBSERVER WEATHER.” As a general rule the manual remarks are limited to:

- a) Type and intensity of precipitation.
- b) Thunderstorms, intensity (if applicable), and direction.
- c) Obstructions to vision when the visibility is less than 7 miles.

EXAMPLE–

“Remarks...density altitude, two thousand five hundred...visibility variable between one and two...wind direction variable between two four zero and three one zero...observed weather...thunderstorm moderate rain showers and mist...thunderstorm overhead.”

8.3.5.3 If an automated parameter is “missing” and no manual input for that parameter is available, the parameter is announced as “MISSING.” For example, a report with the dew point “missing,” and no manual input available, would be announced as follows:

EXAMPLE–

“Ceiling one thousand overcast, visibility three, precipitation, temperature three zero, dew point missing, wind calm, altimeter three zero zero one.”

8.3.5.4 “REMARKS” are announced in the following order of priority:

- a) Automated “REMARKS”:
 - 1) Variable visibility.
 - 2) Density altitude.

b) Manual Input “REMARKS.” As a general rule, the remarks are announced in the same order as the parameters appear in the basic text of the observation.

EXAMPLE–

“Remarks, density altitude, two thousand five hundred, visibility variable between one and two, wind direction variable between two four zero and three one zero, observer ceiling estimated two thousand broken, observer temperature two, dew point minus five.”

8.4 Automated Surface Observing System (ASOS)/Automated Weather Sensor System (AWSS)

8.4.1 The ASOS/AWSS is the primary surface weather observing system of the U.S. The program to install and operate these systems throughout the U.S. is a joint effort of the NWS, the FAA and the

Department of Defense. AWSS is a follow-on program that provides identical data as ASOS. ASOS/AWSS is designed to support aviation operations and weather forecast activities. The ASOS/AWSS will provide continuous minute-by-minute observations and perform the basic observing functions necessary to generate an aviation routine weather report (METAR) and other aviation weather information. The information may be transmitted over a discrete VHF radio frequency or the voice portion of a local NAVAID. ASOS/AWSS transmissions on a discrete VHF radio frequency are engineered to be receivable to a maximum of 25 NM from the ASOS/AWSS site and a maximum altitude of 10,000 feet AGL. At many locations, ASOS/AWSS signals may be received on the surface of the airport, but local conditions may limit the maximum reception distance and/or altitude. While the automated system and the human may differ in their methods of data collection and interpretation, both produce an observation quite similar in form and content. For the “objective” elements such as pressure, ambient temperature, dew point temperature, wind, and precipitation accumulation, both the automated system and the observer use a fixed location and time-averaging technique. The quantitative differences between the observer and the automated observation of these elements are negligible. For the “subjective” elements, however, observers use a fixed time, spatial averaging technique to describe the visual elements (sky condition, visibility and present weather), while the automated systems use a fixed location, time averaging technique. Although this is a fundamental change, the manual and automated techniques yield remarkably similar results within the limits of their respective capabilities. (See FIG GEN 3.5–26 and FIG GEN 3.5–27, Key to Decode an ASOS/AWSS (METAR) Observation.

8.4.2 System Description

8.4.2.1 The ASOS/AWSS at each airport location consists of four main components:

- a) Individual weather sensors.
- b) Data collection and processing units.
- c) Peripherals and displays.

8.4.2.2 The ASOS/AWSS sensors perform the basic function of data acquisition. They continuously sample and measure the ambient environment, derive

raw sensor data and make them available to the collection and processing units.

8.4.3 Every ASOS/AWSS will contain the following basic set of sensors.

8.4.3.1 Cloud height indicator (one or possibly three).

8.4.3.2 Visibility sensor (one or possibly three).

8.4.3.3 Precipitation identification sensor.

8.4.3.4 Freezing rain sensor.

8.4.3.5 Pressure sensors (two sensors at small airports; three sensors at large airports).

8.4.3.6 Ambient temperature/dew point temperature sensor.

8.4.3.7 Anemometer (wind direction and speed sensor).

8.4.3.8 Rainfall accumulation sensor.

8.4.4 The ASOS/AWSS data outlets include:

8.4.4.1 Those necessary for on-site airport users.

8.4.4.2 National communications networks.

8.4.4.3 Computer-generated voice (available through FAA radio broadcast to pilots and dial-in telephone line).

NOTE–

Wind direction broadcast over FAA radios is in reference to magnetic north.

8.5 A comparison of weather observing programs and the elements observed by each are in TBL GEN 3.5–3, Weather Observing Programs.

8.6 Service Standards. During 1995, a government/industry team worked to comprehensively reassess the requirements for surface observations at the nation's airports. That work resulted in agreement on a set of service standards and the FAA and NWS ASOS sites to which the standards would apply. The term "Service Standards" refers to the level of detail in the weather observation. The service standards consist of four different levels of service (A, B, C, and D) as described below. Specific observational elements included in each service level are listed in

TBL GEN 3.5–4, Weather Observation Service Standards.

8.6.1 Service Level D defines the minimum acceptable level of service. It is a completely automated service in which the ASOS/AWSS observation will constitute the entire observation; i.e., no additional weather information is added by a human observer. This service is referred to as a stand alone D site.

8.6.2 Service Level C is a service in which the human observer, usually an air traffic controller, augments or adds information to the automated observation. Service Level C also includes backup of ASOS/AWSS elements in the event of an ASOS/AWSS malfunction or an unrepresentative ASOS/AWSS report.

8.6.3 In backup, the human observer inserts the correct or missing value for the automated ASOS/AWSS elements. This service is provided by air traffic controllers under the Limited Aviation Weather Reporting Station (LAWRS) process, FSS and NWS observers, and, at selected sites, Non-Federal Observation Program observers.

Two categories of airports require detail beyond Service Level C in order to enhance air traffic control efficiency and increase system capacity. Services at these airports are typically provided by contract weather observers, NWS observers, and, at some locations, FSS observers.

8.6.4 Service Level B is a service in which weather observations consist of all elements provided under Service Level C, plus augmentation of additional data beyond the capability of the ASOS/AWSS. This category of airports includes smaller hubs or airports special in other ways that have worse than average bad weather operations for thunderstorms and/or freezing/frozen precipitation, and/or that are remote airports.

8.6.5 Service Level A, the highest and most demanding category, includes all the data reported in Service Standard B, plus additional requirements as specified. Service Level A covers major aviation hubs and/or high volume traffic airports with average or worse weather.

TBL GEN 3.5-3
Weather Observing Programs

Element Reported Type	Wind	Visibility	Temperature Dew Point	Altimeter	Density Altimeter	Cloud/Ceiling	Precipitation Identification	Thunderstorm/ Lightning	Precipitation Occurrence	Rainfall Accumulation	Runway Surface Condition	Freezing Rain Occurrence	Remarks
AWSS	X	X	X	X	X	X	X			X		X	X
ASOS	X	X	X	X	X	X	X			X		X	X
AWOS-A				X									
AWOS-A/V		X		X									
AWOS-1	X		X	X	X								
AWOS-2	X	X	X	X	X								
AWOS-3	X	X	X	X	X	X							
AWOS-3P	X	X	X	X	X	X	X						
AWOS-3T	X	X	X	X	X	X		X					
AWOS-3P/T	X	X	X	X	X	X	X	X					
AWOS-4	X	X	X	X	X	X	X	X	X	X	X	X	
Manual	X	X	X	X		X	X						X

REFERENCE— FAA Order 7900.5B, Surface Weather Observing, for element reporting.

TBL GEN 3.5–4
Weather Observation Service Standards

SERVICE LEVEL A	
Service Level A consists of all the elements of Service Levels B, C and D plus the elements listed to the right, if observed.	10 minute longline RVR at predated sites or additional visibility increments of 1/8, 1/16 and 0 Sector visibility Variable sky condition Cloud layers above 12,000 feet and cloud types Widespread dust, sand and other obscurations Volcanic eruptions
SERVICE LEVEL B	
Service Level B consists of all the elements of Service Levels C and D plus the elements listed to the right, if observed.	Longline RVR at predated sites (may be instantaneous readout) Freezing drizzle versus freezing rain Ice pellets Snow depth & snow increasing rapidly remarks Thunderstorm and lightning location remarks Observed significant weather not at the station remarks
SERVICE LEVEL C	
Service Level C consists of all the elements of Service Level D plus augmentation and backup by a human observer or an air traffic control specialist on location nearby. Backup consists of inserting the correct value if the system malfunctions or is unrepresentative. Augmentation consists of adding the elements listed to the right, if observed. During hours that the observing facility is closed, the site reverts to Service Level D.	Thunderstorms Tornadoes Hail Virga Volcanic ash Tower visibility Operationally significant remarks as deemed appropriate by the observer
SERVICE LEVEL D	
This level of service consists of an ASOS or AWSS continually measuring the atmosphere at a point near the runway. The ASOS or AWSS senses and measures the weather parameters listed to the right.	Wind Visibility Precipitation/Obstruction to vision Cloud height Sky cover Temperature Dew point Altimeter

9. Weather Radar Services

9.1 The National Weather Service operates a network of radar sites for detecting coverage, intensity, and movement of precipitation. The network is supplemented by FAA and DOD radar sites in the western sections of the country. Local warning radars augment the network by operating on an as needed basis to support warning and forecast programs.

9.2 Scheduled radar observations are taken hourly and transmitted in alpha-numeric format on weather telecommunications circuits for flight planning purposes. Under certain conditions special radar reports are issued in addition to the hourly transmittals. Data contained in the reports is also collected by the National Meteorological Center and used to prepare hourly national radar summary charts for dissemination on facsimile circuits.

9.3 All En route Flight Advisory Service facilities and many Automated Flight Service Stations have equipment to directly access the radar displays from the individual weather radar sites. Specialists at these locations are trained to interpret the display for pilot briefing and inflight advisory services. The Center Weather Service Units located in the ARTCCs also have access to weather radar displays and provide support to all air traffic facilities within their center's area.

9.4 A clear radar display (no echoes) does not mean that there is no significant weather within the coverage of the radar site. Clouds and fog are not detected by the radar. However, when echoes are present, turbulence can be implied by the intensity of the precipitation, and icing is implied by the presence of the precipitation at temperatures at or below zero degrees Celsius. Used in conjunction with other weather products, radar provides invaluable information for weather avoidance and flight planning.

9.5 Additional information on weather radar products and services can be found in FAA Advisory Circular 00-45, "Aviation Weather Services."

REFERENCE-

Pilot/Controller Glossary Term- Precipitation Radar Weather Descriptions.

AIP, Thunderstorms, GEN 3.5, Paragraph 27.

Airport/Facility Directory, Charts, NWS Upper Air Observing Stations and Weather Network for the location of specific radar sites.

10. ATC Inflight Weather Avoidance Assistance

10.1 ATC Radar Weather Display

10.1.1 ATC radars are able to display areas of precipitation by sending out a beam of radio energy that is reflected back to the radar antenna when it strikes an object or moisture which may be in the form of rain drops, hail, or snow. The larger the object is, or the more dense its reflective surface, the stronger the return will be presented. Radar weather processors indicate the intensity of reflective returns in terms of decibels (dBZ). ATC systems cannot detect the presence or absence of clouds. The ATC systems can often determine the intensity of a precipitation area, but the specific character of that area (snow, rain, hail, VIRGA, etc.) cannot be determined. For this reason, ATC refers to all weather areas displayed on ATC radar scopes as "precipitation."

10.1.2 All ATC facilities using radar weather processors with the ability to determine precipitation intensity, will describe the intensity to pilots as:

10.1.2.1 "LIGHT" (< 30 dBZ)

10.1.2.2 "MODERATE" (30 to 40 dBZ)

10.1.2.3 "HEAVY" (> 40 to 50 dBZ)

10.1.2.4 "EXTREME" (> 50 dBZ)

10.1.3 ATC facilities that, due to equipment limitations, cannot display the intensity levels of precipitation, will describe the location of the precipitation area by geographic position, or position relative to the aircraft. Since the intensity level is not available, the controller will state "INTENSITY UNKNOWN."

10.1.4 ARTCC facilities normally use a Weather and Radar Processor (WARP) to display a mosaic of data obtained from multiple NEXRAD sites. There is a time delay between actual conditions and those displayed to the controller. For example, the precipitation data on the ARTCC controller's display could be up to 6 minutes old. When the WARP is not available, a second system, the narrowband Air Route Surveillance Radar (ARSR) can display two distinct levels of precipitation intensity that will be described to pilots as "MODERATE" (30 to 40 dBZ) and "HEAVY TO EXTREME" (> 40 dBZ). The WARP processor is only used in ARTCC facilities.

10.1.5 ATC radar is not able to detect turbulence. Generally, turbulence can be expected to occur as the rate of rainfall or intensity of precipitation increases. Turbulence associated with greater rates of rainfall/precipitation will normally be more severe than any associated with lesser rates of rainfall/precipitation. Turbulence should be expected to occur near convective activity, even in clear air. Thunderstorms are a form of convective activity that imply severe or greater turbulence. Operation within 20 miles of thunderstorms should be approached with great caution, as the severity of turbulence can be markedly greater than the precipitation intensity might indicate.

10.2 Weather Avoidance Assistance

10.2.1 To the extent possible, controllers will issue pertinent information of weather or chaff areas and assist pilots in avoiding such areas if requested. Pilots should respond to a weather advisory by either acknowledging the advisory or by acknowledging the advisory and requesting an alternative course of action as follows:

10.2.1.1 Request to deviate off course by stating the number of miles and the direction of the requested deviation. In this case, when the requested deviation is approved the pilot is expected to provide his/her own navigation, to maintain the altitude assigned by ATC, and to remain within the specified mileage of his/her original course.

10.2.1.2 Request a new route to avoid the affected area.

10.2.1.3 Request a change of altitude.

10.2.1.4 Request radar vectors around the affected areas.

10.2.2 For obvious reasons of safety, an IFR pilot must not deviate from the course or altitude/flight level without a proper ATC clearance. When weather conditions encountered are so severe that an immediate deviation is determined to be necessary and time will not permit approval by ATC, the pilot's emergency authority may be exercised.

10.2.3 When the pilot requests clearance for a route deviation or for an ATC radar vector, the controller must evaluate the air traffic picture in the affected area and coordinate with other controllers (if ATC jurisdictional boundaries may be crossed) before replying to the request.

10.2.4 It should be remembered that the controller's primary function is to provide safe separation between aircraft. Any additional service, such as weather avoidance assistance, can only be provided to the extent that it does not derogate the primary function. It is also worth noting that the separation workload is generally greater than normal when weather disrupts the usual flow of traffic. ATC radar limitations and frequency congestion may also be factors in limiting the controller's capability to provide additional service.

10.2.5 It is very important that the request for deviation or radar vector be forwarded to ATC as far in advance as possible. Delay in submitting it may delay or even preclude ATC approval or require that additional restrictions be placed on the clearance. Insofar as possible, the following information should be furnished to ATC when requesting clearance to detour around weather activity:

10.2.5.1 Proposed point where detour will commence.

10.2.5.2 Proposed route and extent of detour (direction and distance).

10.2.5.3 Point where original route will be resumed.

10.2.5.4 Flight conditions (IFR or VFR).

10.2.5.5 Any further deviation that may become necessary as the flight progresses.

10.2.5.6 Advise if the aircraft is equipped with functioning airborne radar.

10.2.6 To a large degree, the assistance that might be rendered by ATC will depend upon the weather information available to controllers. Due to the extremely transitory nature of severe weather situations, the controller's weather information may be of only limited value if based on weather observed on radar only. Frequent updates by pilots giving specific information as to the area affected, altitudes, intensity, and nature of the severe weather can be of considerable value. Such reports are relayed by radio or phone to other pilots and controllers, and they also receive widespread teletypewriter dissemination.

10.2.7 Obtaining IFR clearance or an ATC radar vector to circumnavigate severe weather can often be accommodated more readily in the en route areas away from terminals because there is usually less congestion and, therefore, greater freedom of action. In terminal areas, the problem is more acute because

of traffic density, ATC coordination requirements, complex departure and arrival routes, and adjacent airports. As a consequence, controllers are less likely to be able to accommodate all requests for weather detours in a terminal area or be in a position to volunteer such routes to the pilot. Nevertheless, pilots should not hesitate to advise controllers of any observed severe weather and should specifically advise controllers if they desire circumnavigation of observed weather.

10.3 ATC Severe Weather Avoidance Plans

10.3.1 Air Route Traffic Control Centers and some Terminal Radar Control facilities utilize plans for severe weather avoidance within their control areas. Aviation-oriented meteorologists provide weather information. Preplanned alternate route packages developed by the facilities are used in conjunction with flow restrictions to ensure a more orderly flow of traffic during periods of severe or adverse weather conditions.

10.3.2 During these periods, pilots may expect to receive alternative route clearances. These routes are predicated upon the forecasts of the meteorologist and coordination between the Air Traffic Control System Command Center and the other centers. The routes are utilized as necessary in order to allow as many aircraft as possible to operate in any given area, and frequently they will deviate from the normal preferred routes. With user cooperation, this plan may significantly reduce delays.

10.4 Procedures for Weather Deviations and Other Contingencies in Oceanic Controlled Airspace

10.4.1 When the pilot initiates communications with ATC, rapid response may be obtained by stating “WEATHER DEVIATION REQUIRED” to indicate priority is desired on the frequency and for ATC response.

10.4.2 The pilot still retains the option of initiating the communications using the urgency call “PAN–PAN” three times to alert all listening parties of a special handling condition which will receive ATC priority for issuance of a clearance or assistance.

10.4.3 ATC will:

10.4.3.1 Approve the deviation, or

10.4.3.2 Provide vertical separation and then approve the deviation, or

10.4.3.3 If ATC is unable to establish vertical separation, ATC shall advise the pilot that standard separation cannot be applied; provide essential traffic information for all affected aircraft, to the extent practicable; and if possible, suggest a course of action. ATC may suggest that the pilot climb or descend to a contingency altitude (1,000 feet above or below that assigned if operating above FL 290; 500 feet above or below that assigned if operating at or below FL 290).

PHRASEOLOGY–
STANDARD SEPARATION NOT AVAILABLE; DEVIATE AT PILOT’S DISCRETION; SUGGEST CLIMB (or descent) TO (appropriate altitude); TRAFFIC (position and altitude); REPORT DEVIATION COMPLETE.

10.4.4 The pilot will follow the ATC advisory altitude when approximately 10 NM from track as well as execute the procedures detailed in paragraph 10.4.5.

10.4.5 If contact cannot be established or a revised ATC clearance or advisory is not available and deviation from track is required, the pilot shall take the following actions:

10.4.5.1 If possible, deviate away from an organized track or route system.

10.4.5.2 Broadcast aircraft position and intentions on the frequency in use, as well as on frequency 121.5 MHz at suitable intervals stating: flight identification (operator call sign), flight level, track code or ATS route designator, and extent of deviation expected.

10.4.5.3 Watch for conflicting traffic both visually and by reference to the Traffic Alert and Collision Avoidance System (TCAS), if equipped.

10.4.5.4 Turn on aircraft exterior lights.

10.4.5.5 Deviations of less than 10 NM or operations within COMPOSITE (NOPAC and CEPAC) Airspace, should REMAIN at ASSIGNED altitude. Otherwise, when the aircraft is approximately 10 NM from track, initiate an altitude change based upon the following criteria:

TBL GEN 3.5–5

Route Centerline/Track	Deviations >10 NM	Altitude Change
East 000 – 179°M	Left Right	Descend 300 Feet Climb 300 Feet
West 180–359°M	Left Right	Climb 300 Feet Descend 300 Feet
<i>Pilot Memory Slogan: “East right up, West right down.”</i>		

10.4.5.6 When returning to track, be at the assigned flight level when the aircraft is within approximately 10 NM of centerline.

10.4.5.7 If contact was not established prior to deviating, continue to attempt to contact ATC to obtain a clearance. If contact was established, continue to keep ATC advised of intentions and obtain essential traffic information.

11. Notifications Required From Operators

11.1 Preflight briefing and flight documentation services provided by AFSSs do not require prior notification.

11.2 Preflight briefing and flight documentation services provided by a National Weather Service Office (or contract office) are available upon request for long-range international flights for which meteorological data packages are prepared for the pilot-in-command. Briefing times should be coordinated between the local representative and the local meteorological office.

11.3 Flight Service Stations do not normally have the capability to prepare meteorological data packages for a preflight briefing.

12. Weather Observing Systems and Operating Procedures

For surface wind readings, most meteorological reporting stations have a direct reading, 3-cup anemometer wind system for which a 1-minute mean wind speed and direction (based on true north) is taken. Some stations also have a continuous wind speed recorder which is used in determining the gustiness of the wind.

13. Runway Visual Range (RVR)

There are currently two configurations of the RVR, commonly identified as Taskers and New Generation RVR. The Taskers use transmissometer technology. The New Generation RVRs use forward scatter technology and are currently being deployed to replace the existing Taskers.

13.1 RVR values are measured by transmissometers mounted on 14-foot towers along the runway. A full RVR system consists of:

13.1.1 A transmissometer projector and related items.

13.1.2 A transmissometer receiver (detector) and related items.

13.1.3 An analog recorder.

13.1.4 A signal data converter and related items.

13.1.5 A remote digital or remote display programmer.

13.2 The transmissometer projector and receiver are mounted on towers 250 feet apart. A known intensity of light is emitted from the projector and is measured by the receiver. Any obscuring matter, such as rain, snow, dust, fog, haze, or smoke, reduces the light intensity arriving at the receiver. The resultant intensity measurement is then converted to an RVR value by the signal data converter. These values are displayed by readout equipment in the associated air traffic facility and updated approximately once every minute for controller issuance to pilots.

13.3 The signal data converter receives information on the high-intensity runway edge light setting in use (step 3, 4, or 5), transmission values from the transmissometer, and the sensing of day or night conditions. From the three data sources, the system will compute appropriate RVR values.

13.4 An RVR transmissometer established on a 250-foot baseline provides digital readouts to a minimum of 600 feet, which are displayed in 200-foot increments to 3,000 feet, and in 500-foot increments from 3,000 feet to a maximum value of 6,000 feet.

13.5 RVR values for Category IIIa operations extend down to 700-foot RVR; however, only 600 and 800 feet are reportable RVR increments. The 800 RVR reportable value covers a range of 701 feet to 900 feet and is therefore a valid minimum indication of Category IIIa operations.

13.6 Approach categories with the corresponding minimum RVR values are listed in TBL GEN 3.5–6.

TBL GEN 3.5–6
Approach Category/Minimum RVR Table

Category	Visibility (RVR)
Nonprecision	2,400 feet
Category I	1,800 feet*
Category II	1,000 feet
Category IIIa	700 feet
Category IIIb	150 feet
Category IIIc	0 feet

* 1,400 feet with special equipment and authorization

13.7 Ten-minute maximum and minimum RVR values for the designated RVR runway are reported in the body of the aviation weather report when the prevailing visibility is less than 1 mile and/or the RVR is 6,000 feet or less. ATCTs report RVR when the prevailing visibility is 1 mile or less and/or the RVR is 6,000 feet or less.

13.8 Details on the requirements for the operational use of RVR are contained in FAA Advisory Circular 97–1, “Runway Visual Range (RVR).” Pilots are responsible for compliance with minimums prescribed for their class of operations in appropriate Federal Aviation Regulations and/or operations specifications.

13.8.1 RVR values are also measured by forward scatter meters mounted on 14-foot frangible fiberglass poles. A full RVR system consists of:

13.8.1.1 Forward scatter meter with a transmitter, receiver and associated items.

13.8.1.2 A runway light intensity monitor (RLIM).

13.8.1.3 An ambient light sensor (ALS).

13.8.1.4 A data processor unit (DPU).

13.8.1.5 A controller display (CD).

13.8.2 The forward scatter meter is mounted on a 14-foot frangible pole. Infrared light is emitted from the transmitter and received by the receiver. Any obscuring matter such as rain, snow, dust, fog, haze, or smoke increases the amount of scattered light reaching the receiver. The resulting measurement along with inputs from the runway light intensity

monitor and the ambient light sensor are forwarded to the DPU which calculates the proper RVR value. The RVR values are displayed locally and remotely on controller displays.

13.8.3 The runway light intensity monitors both the runway edge and centerline light step settings (steps 1 through 5). Centerline light step settings are used for CAT IIIb operations. Edge light step settings are used for CAT I, II, and IIIa operations.

13.8.4 New Generation RVRs can measure and display RVR values down to the lowest limits of Category IIIb operations (150 foot RVR). RVR values are displayed in 100-foot increments and are reported as follows:

13.8.4.1 100-foot increments for products below 800 feet.

13.8.4.2 200-foot increments for products between 800 feet and 3,000 feet.

13.8.4.3 500-foot increments for products between 3,000 feet and 6,500 feet.

13.8.4.4 25-meter increments for products below 150 meters.

13.8.4.5 50-meter increments for products between 150 meters and 800 meters.

13.8.4.6 100-meter increments for products between 800 meters and 1,200 meters.

13.8.4.7 200-meter increments for products between 1,200 meters and 2,000 meters.

14. Reporting of Cloud Heights

14.1 Ceiling, by definition in Federal Aviation Regulations, and as used in Aviation Weather Reports and Forecasts, is the height above ground (or water) level of the lowest layer of clouds or obscuring phenomenon that is reported as “broken,” “overcast,” or “the vertical visibility into an obscuration.” For example, an aerodrome forecast which reads “BKN030” refers to heights above ground level (AGL). An area forecast which reads “BKN030” states that the height is above mean sea level (MSL). See FIG GEN 3.5–24 for the Key to Routine Aviation Weather Reports and Forecasts for the definition of “broken,” “overcast,” and “obscuration.”

14.2 Information on cloud base height is obtained by use of ceilometers (rotating or fixed beam), ceiling lights, ceiling balloons, pilot reports, and observer estimations. The systems in use by most reporting stations are either the observer estimation or the rotating beam ceilometer.

14.3 Pilots usually report height values above mean sea level, since they determine heights by the altimeter. This is taken into account when disseminating and otherwise applying information received from pilots. (“Ceiling” heights are always above ground level.) In reports disseminated as pilot reports, height references are given the same as received from pilots; that is, above mean sea level.

14.4 In area forecasts or inflight Advisories, ceilings are denoted by the contraction “CIG” when used with sky cover symbols as in “LWRG TO CIG OVC005,” or the contraction “AGL” after the forecast cloud height value. When the cloud base is given in height above mean sea level, it is so indicated by the contraction “MSL” or “ASL” following the height value. The heights of cloud tops, freezing level, icing, and turbulence are always given in heights above mean sea level (ASL or MSL).

15. Reporting Prevailing Visibility

15.1 Surface (horizontal) visibility is reported in METAR reports in terms of statute miles and increments thereof; e.g., $\frac{1}{16}$, $\frac{1}{8}$, $\frac{3}{16}$, $\frac{1}{4}$, $\frac{5}{16}$, $\frac{3}{8}$, $\frac{1}{2}$, $\frac{5}{8}$, $\frac{3}{4}$, $\frac{7}{8}$, 1, $1\frac{1}{8}$, etc. (Visibility reported by an unaugmented automated site is reported differently than in a manual report; i.e., ASOS/AWSS: 0, $\frac{1}{16}$, $\frac{1}{8}$, $\frac{1}{4}$, $\frac{1}{2}$, $\frac{3}{4}$, 1, $1\frac{1}{4}$, $1\frac{1}{2}$, $1\frac{3}{4}$, 2, $2\frac{1}{2}$, 3, 4, 5, etc., AWOS: $M\frac{1}{4}$, $\frac{1}{4}$, $\frac{1}{2}$, $\frac{3}{4}$, 1, $1\frac{1}{4}$, $1\frac{1}{2}$, $1\frac{3}{4}$, 2, $2\frac{1}{2}$, 3, 4, 5, etc.) Visibility is determined through the ability to see and identify preselected and prominent objects at a known distance from the usual point of observation. Visibilities which are determined to be less than 7 miles, identify the obscuring atmospheric condition; e.g., fog, haze, smoke, etc., or combinations thereof.

15.2 Prevailing visibility is the greatest visibility equalled or exceeded throughout at least one-half the horizon circle, not necessarily contiguous. Segments of the horizon circle which may have a significantly different visibility may be reported in the remarks

section of the weather report; i.e., the southeastern quadrant of the horizon circle may be determined to be 2 miles in mist while the remaining quadrants are determined to be 3 miles in mist.

15.3 When the prevailing visibility at the usual point of observation, or at the tower level, is less than 4 miles, certificated tower personnel will take visibility observations in addition to those taken at the usual point of observation. The lower of these two values will be used as the prevailing visibility for aircraft operations.

16. Estimating Intensity of Rain and Ice Pellets

16.1 Rain

16.1.1 Light. From scattered drops that, regardless of duration, do not completely wet an exposed surface up to a condition where individual drops are easily seen.

16.1.2 Moderate. Individual drops are not clearly identifiable; spray is observable just above pavements and other hard surfaces.

16.1.3 Heavy. Rain seemingly falls in sheets; individual drops are not identifiable; heavy spray to a height of several inches is observed over hard surfaces.

16.2 Ice Pellets

16.2.1 Light. Scattered pellets that do not completely cover an exposed surface regardless of duration. Visibility is not affected.

16.2.2 Moderate. Slow accumulation on the ground. Visibility is reduced by ice pellets to less than 7 statute miles.

16.2.3 Heavy. Rapid accumulation on the ground. Visibility is reduced by ice pellets to less than 3 statute miles.

17. Estimating the Intensity of Snow or Drizzle (Based on Visibility)

17.1 Light. Visibility more than $\frac{1}{2}$ statute mile.

17.2 Moderate. Visibility from more than $\frac{1}{4}$ statute mile to $\frac{1}{2}$ statute mile.

17.3 Heavy. Visibility $\frac{1}{4}$ statute mile or less.

18. Pilot Weather Reports (PIREPs)

18.1 FAA air traffic facilities are required to solicit PIREPs when the following conditions are reported or forecast: ceilings at or below 5,000 feet, visibility at or below 5 miles (surface or aloft), thunderstorms and related phenomena, icing of a light degree or greater, turbulence of a moderate degree or greater, wind shear, and reported or forecast volcanic ash clouds.

18.2 Pilots are urged to cooperate and promptly volunteer reports of these conditions and other atmospheric data, such as cloud bases, tops and layers, flight visibility, precipitation, visibility restrictions (haze, smoke, and dust), wind at altitude, and temperature aloft.

18.3 PIREPs should be given to the ground facility with which communications are established; i.e., EFAS, AFSS/FSS, ARTCC, or terminal ATC. Radio call “FLIGHT WATCH,” which serves as a collection point for the exchange of PIREPs with en route aircraft, is one of the primary duties of EFAS facilities.

18.4 If pilots do not make PIREPs by radio, it is helpful if, upon landing, they report to the nearest AFSS/FSS or Weather Forecast Office the inflight conditions which they encountered. Some of the uses made of the reports are:

18.4.1 The ATCT uses the reports to expedite the flow of air traffic in the vicinity of the field and for hazardous weather avoidance procedures.

18.4.2 The AFSS/FSS uses the reports to brief other pilots, to provide inflight advisories and weather avoidance information to en route aircraft.

18.4.3 The ARTCC uses the reports to expedite the flow of en route traffic, to determine most favorable altitudes, and to issue hazardous weather information within the center’s area.

18.4.4 The NWS uses the reports to verify or amend conditions contained in aviation forecasts and advisories; (In some cases, pilot reports of hazardous conditions are the triggering mechanism for the issuance of advisories.)

18.4.5 The NWS, other government organizations, the military, and private industry groups use PIREPs for research activities in the study of meteorological phenomena.

18.4.6 All air traffic facilities and the NWS forward the reports received from pilots into the weather distribution system to assure the information is made available to all pilots and other interested parties.

18.5 The FAA, NWS, and other organizations that enter PIREPs into the weather reporting system use the format listed in TBL GEN 3.5–7, PIREP Element Code Chart. Items 1 through 6 are included in all transmitted PIREPs along with one or more of items 7 through 13. Although the PIREP should be as complete and concise as possible, pilots should not be overly concerned with strict format or phraseology. The important thing is that the information is relayed so other pilots may benefit from your observation. If a portion of the report needs clarification, the ground station will request the information.

18.6 Completed PIREPs will be transmitted to weather circuits as in the following examples:

EXAMPLE–

KCMH UA/OV APE 230010/TM 1516/FL085/TP BE20/SK BKN065/WX FV03SM HZ FU/TA 20/TB LGT.

Translation: one zero miles southwest of Appleton VOR; time 1516 UTC; altitude eight thousand five hundred; aircraft type BE20; base of the broken cloud layer is six thousand five hundred; flight visibility 3 miles with haze and smoke; air temperature 20 degrees Celsius; light turbulence.

EXAMPLE–

KCRW UA/OV KBKW 360015–KCRW/TM 1815/FL120/TP BE99/SK IMC/WX RA–/TA M08/WV 290030/TB LGT–MDT/IC LGT RIME/RM MDT MXD ICG DURC KROA NWBND FL080–100 1750Z.

Translation: from 15 miles north of Beckley VOR to Charleston VOR; time 1815 UTC; altitude 12,000 feet; type aircraft, BE–99; in clouds; rain; temperature minus 8 Celsius; wind 290 degrees magnetic at 30 knots; light to moderate turbulence; light rime icing during climb northwestbound from Roanoke, VA, between 8,000 and 10,000 feet at 1750 UTC.

TBL GEN 3.5-7
PIREP Element Code Chart

	PIREP ELEMENT	PIREP CODE	CONTENTS
1.	3-letter station identifier	XXX	Nearest weather reporting location to the reported phenomenon
2.	Report type	UA or UUA	Routine or urgent PIREP
3.	Location	/OV	In relation to a VOR
4.	Time	/TM	Coordinated Universal Time
5.	Altitude	/FL	Essential for turbulence and icing reports
6.	Type aircraft	/TP	Essential for turbulence and icing reports
7.	Sky cover	/SK	Cloud height and coverage (sky clear, few, scattered, broken, or overcast)
8.	Weather	/WX	Flight visibility, precipitation, restrictions to visibility, etc.
9.	Temperature	/TA	Degrees Celsius
10.	Wind	/WV	Direction in degrees magnetic north and speed in knots
11.	Turbulence	/TB	See paragraph 22.
12.	Icing	/IC	See paragraph 20.
13.	Remarks	/RM	For reporting elements not included or to clarify previously reported items

19. Mandatory MET Points

19.1 Within the ICAO CAR/SAM Regions and within the U.S. area of responsibility, several mandatory MET reporting points have been

established. These points are located within the Houston, Miami, and San Juan Flight Information Regions (FIR). These points have been established for flights between the South American and Caribbean Regions and Europe, Canada and the U.S.

19.2 Mandatory MET Reporting Points Within the Houston FIR

Point	For Flights Between
ABBOT	Acapulco and Montreal, New York, Toronto, Mexico City and New Orleans.
ALARD	New Orleans and Belize, Guatemala, San Pedro Sula, Mexico City and Miami, Tampa.
ARGUS	Toronto and Guadalajara, Mexico City, New Orleans and Mexico City.
SWORD	Dallas-Fort Worth, New Orleans, Chicago and Cancun, Cozumel, and Central America.

19.3 Mandatory MET Reporting Points Within the Miami FIR

Point	For Flights Between
Grand Turk	New York and Aruba, Curacao, Kingston, Miami and Belem, St. Thomas, Rio de Janeiro, San Paulo, St. Croix, Kingston and Bermuda.
GRATX	Madrid and Miami, Havana.
MAPYL	New York and Guayaquil, Montego Bay, Panama, Lima, Atlanta and San Juan.
RESIN	New Orleans and San Juan.
SLAPP	New York and Aruba, Curacao, Kingston, Port-au-Prince, Bermuda and Freeport, Nassau, New York and Barranquilla, Bogota, Santo Domingo, Washington and Santo Domingo, Atlanta and San Juan.

19.4 Mandatory MET Reporting Points Within the San Juan FIR

Point	For Flights Between
GRANN	Toronto and Barbados, New York and Fort de France. At intersection of routes A321, A523, G432.
KRAFT	San Juan and Buenos Aires, Caracas, St. Thomas, St. Croix, St. Maarten, San Juan, Kingston and Bermuda.
PISAX	New York and Barbados, Fort de France, Bermuda and Antigua, Barbados.

TBL GEN 3.5-8

Intensity	Ice Accumulation
Trace	Ice becomes perceptible. Rate of accumulation slightly greater than rate of sublimation. Deicing/anti-icing equipment is not utilized unless encountered for an extended period of time (over 1 hour).
Light	The rate of accumulation may create a problem if flight is prolonged in this environment (over 1 hour). Occasional use of deicing/anti-icing equipment removes/prevents accumulation. It does not present a problem if the deicing/anti-icing equipment is used.
Moderate	The rate of accumulation is such that even short encounters become potentially hazardous and use of deicing/anti-icing equipment or diversion is necessary.
Severe	The rate of accumulation is such that deicing/anti-icing equipment fails to reduce or control the hazard. Immediate diversion is necessary.
Pilot Report: Aircraft Identification, Location, Time (UTC), Intensity of Type ¹ , Altitude/FL, Aircraft Type, Indicated Air Speed (IAS), and Outside Air Temperature (OAT) ² .	
¹ Rime or Clear Ice: Rime ice is a rough, milky, opaque ice formed by the instantaneous freezing of small supercooled water droplets. Clear ice is a glossy, clear, or translucent ice formed by the relatively slow freezing of large supercooled water droplets.	
² The Outside Air Temperature (OAT) should be requested by the AFSS/FSS or ATC if not included in the PIREP.	

20. PIREPs Relating to Airframe Icing

20.1 The effects of ice accretion on aircraft are: cumulative-thrust is reduced, drag increases, lift lessens, weight increases. The results are an increase in stall speed and a deterioration of aircraft performance. In extreme cases, 2 to 3 inches of ice can form on the leading edge of the airfoil in less than 5 minutes. It takes but 1/2 inch of ice to reduce the lifting power of some aircraft by 50 percent and to increase the frictional drag by an equal percentage.

20.2 A pilot can expect icing when flying in visible precipitation, such as rain or cloud droplets, and the temperature is between +02 and -10 degrees Celsius.

When icing is detected, a pilot should do one of two things (particularly if the aircraft is not equipped with deicing equipment). The pilot should get out of the area of precipitation or go to an altitude where the temperature is above freezing. This “warmer” altitude may not always be a lower altitude. Proper preflight action includes obtaining information on the freezing level and the above-freezing levels in precipitation areas. Report the icing to an ATC or FSS facility, and if operating IFR, request new routing or altitude if icing will be a hazard. Be sure to give the type of aircraft to ATC when reporting icing. TBL GEN 3.5-8, describes how to report icing conditions.

21. Definitions of Inflight Icing Terms

See TBL GEN 3.5-9, Icing Types, and TBL GEN 3.5-10, Icing Conditions.

TBL GEN 3.5-9
Icing Types

Clear Ice	See Glaze Ice.
Glaze Ice	Ice, sometimes clear and smooth, but usually containing some air pockets, which results in a lumpy translucent appearance. Glaze ice results from supercooled drops/droplets striking a surface but not freezing rapidly on contact. Glaze ice is denser, harder, and sometimes more transparent than rime ice. Factors, which favor glaze formation, are those that favor slow dissipation of the heat of fusion (i.e., slight supercooling and rapid accretion). With larger accretions, the ice shape typically includes “horns” protruding from unprotected leading edge surfaces. It is the ice shape, rather than the clarity or color of the ice, which is most likely to be accurately assessed from the cockpit. The terms “clear” and “glaze” have been used for essentially the same type of ice accretion, although some reserve “clear” for thinner accretions which lack horns and conform to the airfoil.
Intercycle Ice	Ice which accumulates on a protected surface between actuation cycles of a deicing system.
Known or Observed or Detected Ice Accretion	Actual ice observed visually to be on the aircraft by the flight crew or identified by on-board sensors.
Mixed Ice	Simultaneous appearance or a combination of rime and glaze ice characteristics. Since the clarity, color, and shape of the ice will be a mixture of rime and glaze characteristics, accurate identification of mixed ice from the cockpit may be difficult.
Residual Ice	Ice which remains on a protected surface immediately after the actuation of a deicing system.
Rime Ice	A rough, milky, opaque ice formed by the rapid freezing of supercooled drops/droplets after they strike the aircraft. The rapid freezing results in air being trapped, giving the ice its opaque appearance and making it porous and brittle. Rime ice typically accretes along the stagnation line of an airfoil and is more regular in shape and conformal to the airfoil than glaze ice. It is the ice shape, rather than the clarity or color of the ice, which is most likely to be accurately assessed from the cockpit.
Runback Ice	Ice which forms from the freezing or refreezing of water leaving protected surfaces and running back to unprotected surfaces.

Note-

Ice types are difficult for the pilot to discern and have uncertain effects on an airplane in flight. Ice type definitions will be included in the AIP for use in the “Remarks” section of the PIREP and for use in forecasting.

TBL GEN 3.5-10
Icing Conditions

Appendix C Icing Conditions	Appendix C (14 CFR, Part 25 and 29) is the certification icing condition standard for approving ice protection provisions on aircraft. The conditions are specified in terms of altitude, temperature, liquid water content (LWC), representative droplet size (mean effective drop diameter [MED]), and cloud horizontal extent.
Forecast Icing Conditions	Environmental conditions expected by a National Weather Service or an FAA-approved weather provider to be conducive to the formation of inflight icing on aircraft.
Freezing Drizzle (FZDZ)	Drizzle is precipitation at ground level or aloft in the form of liquid water drops which have diameters less than 0.5 mm and greater than 0.05 mm. Freezing drizzle is drizzle that exists at air temperatures less than 0°C (supercooled), remains in liquid form, and freezes upon contact with objects on the surface or airborne.
Freezing Precipitation	Freezing precipitation is freezing rain or freezing drizzle falling through or outside of visible cloud.
Freezing Rain (FZRA)	Rain is precipitation at ground level or aloft in the form of liquid water drops which have diameters greater than 0.5 mm. Freezing rain is rain that exists at air temperatures less than 0°C (supercooled), remains in liquid form, and freezes upon contact with objects on the ground or in the air.
Icing in Cloud	Icing occurring within visible cloud. Cloud droplets (diameter < 0.05 mm) will be present; freezing drizzle and/or freezing rain may or may not be present.
Icing in Precipitation	Icing occurring from an encounter with freezing precipitation, that is, supercooled drops with diameters exceeding 0.05 mm, within or outside of visible cloud.
Known Icing Conditions	Atmospheric conditions in which the formation of ice is observed or detected in flight. <i>Note—</i> <i>Because of the variability in space and time of atmospheric conditions, the existence of a report of observed icing does not assure the presence or intensity of icing conditions at a later time, nor can a report of no icing assure the absence of icing conditions at a later time.</i>
Potential Icing Conditions	Atmospheric icing conditions that are typically defined by airframe manufacturers relative to temperature and visible moisture that may result in aircraft ice accretion on the ground or in flight. The potential icing conditions are typically defined in the Airplane Flight Manual or in the Airplane Operation Manual.
Supercooled Drizzle Drops (SCDD)	Synonymous with freezing drizzle aloft.
Supercooled Drops or /Droplets	Water drops/droplets which remain unfrozen at temperatures below 0°C. Supercooled drops are found in clouds, freezing drizzle, and freezing rain in the atmosphere. These drops may impinge and freeze after contact on aircraft surfaces.
Supercooled Large Drops (SLD)	Liquid droplets with diameters greater than 0.05 mm at temperatures less than 0°C, i.e., freezing rain or freezing drizzle.

22. PIREPs Relating to Turbulence

22.1 When encountering turbulence, pilots are urgently requested to report such conditions to ATC as soon as practicable. PIREPs relating to turbulence should state:

22.1.1 Aircraft location.

22.1.2 Time of occurrence in UTC.

22.1.3 Turbulence intensity.

22.1.4 Whether the turbulence occurred in or near clouds.

22.1.5 Aircraft altitude, or flight level.

22.1.6 Type of aircraft.

22.1.7 Duration of turbulence.

EXAMPLE-

1. Over Omaha, 1232Z, moderate turbulence in clouds at Flight Level three one zero, Boeing 707.

2. From five zero miles south of Albuquerque to three zero miles north of Phoenix, 1250Z, occasional moderate chop at Flight Level three three zero, DC8.

22.2 Duration and classification of intensity should be made using TBL GEN 3.5-11, Turbulence Reporting Criteria Table.

TBL GEN 3.5-11

Turbulence Reporting Criteria Table

Intensity	Aircraft Reaction	Reaction inside Aircraft	Reporting Term-Definition
Light	Turbulence that momentarily causes slight, erratic changes in altitude and/or attitude (pitch, roll, yaw). Report as Light Turbulence ; ¹ or Turbulence that causes slight, rapid and somewhat rhythmic bumpiness without appreciable changes in altitude or attitude. Report as Light Chop .	Occupants may feel a slight strain against seat belts or shoulder straps. Unsecured objects may be displaced slightly. Food service may be conducted, and little or no difficulty is encountered in walking.	Occasional-Less than 1/3 of the time. Intermittent-1/3 to 2/3. Continuous-More than 2/3.
Moderate	Turbulence that is similar to Light Turbulence but of greater intensity. Changes in altitude and/or attitude occur, but the aircraft remains in positive control at all times. It usually causes variations in indicated airspeed. Report as Moderate Turbulence ; ¹ or Turbulence that is similar to Light Chop but of greater intensity. It causes rapid bumps or jolts without appreciable changes in aircraft altitude or attitude. Report as Moderate Chop . ¹	Occupants feel definite strains against seat belts or shoulder straps. Unsecured objects are dislodged. Food service and walking are difficult.	NOTE 1. Pilots should report location(s), time (UTC), intensity, whether in or near clouds, altitude, type of aircraft and, when applicable, duration of turbulence. 2. Duration may be based on time between two locations or over a single location. All locations should be readily identifiable.
Severe	Turbulence that causes large, abrupt changes in altitude and/or attitude. It usually causes large variations in indicated airspeed. Aircraft may be momentarily out of control. Report as Severe Turbulence . ¹	Occupants are forced violently against seat belts or shoulder straps. Unsecured objects are tossed about. Food service and walking are impossible.	EXAMPLES: a. Over Omaha. 1232Z, Moderate Turbulence, in cloud, Flight Level 310, B707.
Extreme	Turbulence in which the aircraft is violently tossed about and is practically impossible to control. It may cause structural damage. Report as Extreme Turbulence . ¹		b. From 50 miles south of Albuquerque to 30 miles north of Phoenix, 1210Z to 1250Z, occasional Moderate Chop, Flight Level 330, DC8.
¹ High level turbulence (normally above 15,000 feet ASL) not associated with cumuliform cloudiness, including thunderstorms, should be reported as clear air turbulence (CAT) preceded by the appropriate intensity, or light or moderate chop.			

23. Wind Shear PIREPs

23.1 Because unexpected changes in wind speed and direction can be hazardous to aircraft operations at low altitudes on approach to and departing from airports, pilots are urged to promptly volunteer reports to controllers of wind shear conditions they encounter. An advance warning of this information will assist other pilots in avoiding or coping with a wind shear on approach or departure.

23.2 When describing conditions, the use of the terms “negative” or “positive” wind shear should be avoided. PIREPs of negative wind shear on final, intended to describe loss of airspeed and lift, have been interpreted to mean that no wind shear was encountered. The recommended method for wind shear reporting is to state the loss/gain of airspeed and the altitude(s) at which it was encountered.

EXAMPLE–

1. *Denver Tower, Cessna 1234 encountered wind shear, loss of 20 knots at 400.*

2. *Tulsa Tower, American 721 encountered wind shear on final, gained 25 knots between 600 and 400 feet followed by loss of 40 knots between 400 feet and surface.*

Pilots using Inertial Navigation Systems should report the wind and altitude both above and below the shear layer.

EXAMPLE–

Miami Tower, Gulfstream 403 Charlie encountered an abrupt wind shear at 800 feet on final, max thrust required.

Pilots who are not able to report wind shear in these specific terms are encouraged to make reports in terms of the effect upon their aircraft.

24. Clear Air Turbulence (CAT) PIREPs

24.1 Clear air turbulence (CAT) has become a very serious operational factor to flight operations at all levels and especially to jet traffic flying in excess of 15,000 feet. The best available information on this phenomenon must come from pilots via the PIREP procedures. All pilots encountering CAT conditions are urgently requested to report time, location, and intensity (light, moderate, severe, or extreme) of the element to the FAA facility with which they are maintaining radio contact. If time and conditions permit, elements should be reported according to the standards for other PIREPs and position reports. See TBL GEN 3.5–11, Turbulence Reporting Criteria Table.

25. Microbursts

25.1 Relatively recent meteorological studies have confirmed the existence of microburst phenomena. Microbursts are small-scale intense downdrafts which, on reaching the surface, spread outward in all directions from the downdraft center. This causes the presence of both vertical and horizontal wind shears that can be extremely hazardous to all types and categories of aircraft, especially at low altitudes. Due to their small size, short life-span, and the fact that they can occur over areas without surface precipitation, microbursts are not easily detectable using conventional weather radar or wind shear alert systems.

25.2 Parent clouds producing microburst activity can be any of the low or middle layer convective cloud types. Note however, that microbursts commonly occur within the heavy rain portion of thunderstorms, and in much weaker, benign-appearing convective cells that have little or no precipitation reaching the ground.

25.3 The life cycle of a microburst as it descends in a convective rain shaft is seen in FIG GEN 3.5–9, Evolution of a Microburst. An important consideration for pilots is the fact that the microburst intensifies for about 5 minutes after it strikes the ground.

25.4 Characteristics of microbursts include:

25.4.1 Size. The microburst downdraft is typically less than 1 mile in diameter as it descends from the cloud base to about 1,000–3,000 feet above the ground. In the transition zone near the ground, the downdraft changes to a horizontal outflow that can extend to approximately 2 1/2 miles in diameter.

25.4.2 Intensity. The downdrafts can be as strong as 6,000 feet per minute. Horizontal winds near the surface can be as strong as 45 knots resulting in a 90-knot shear (headwind to tailwind change for a traversing aircraft) across the microburst. These strong horizontal winds occur within a few hundred feet of the ground.

25.4.3 Visual Signs. Microbursts can be found almost anywhere that there is convective activity. They may be embedded in heavy rain associated with a thunderstorm or in light rain in benign-appearing virga. When there is little or no precipitation at the surface accompanying the microburst, a ring of blowing dust may be the only visual clue of its existence.

FIG GEN 3.5-9
Evolution of a Microburst

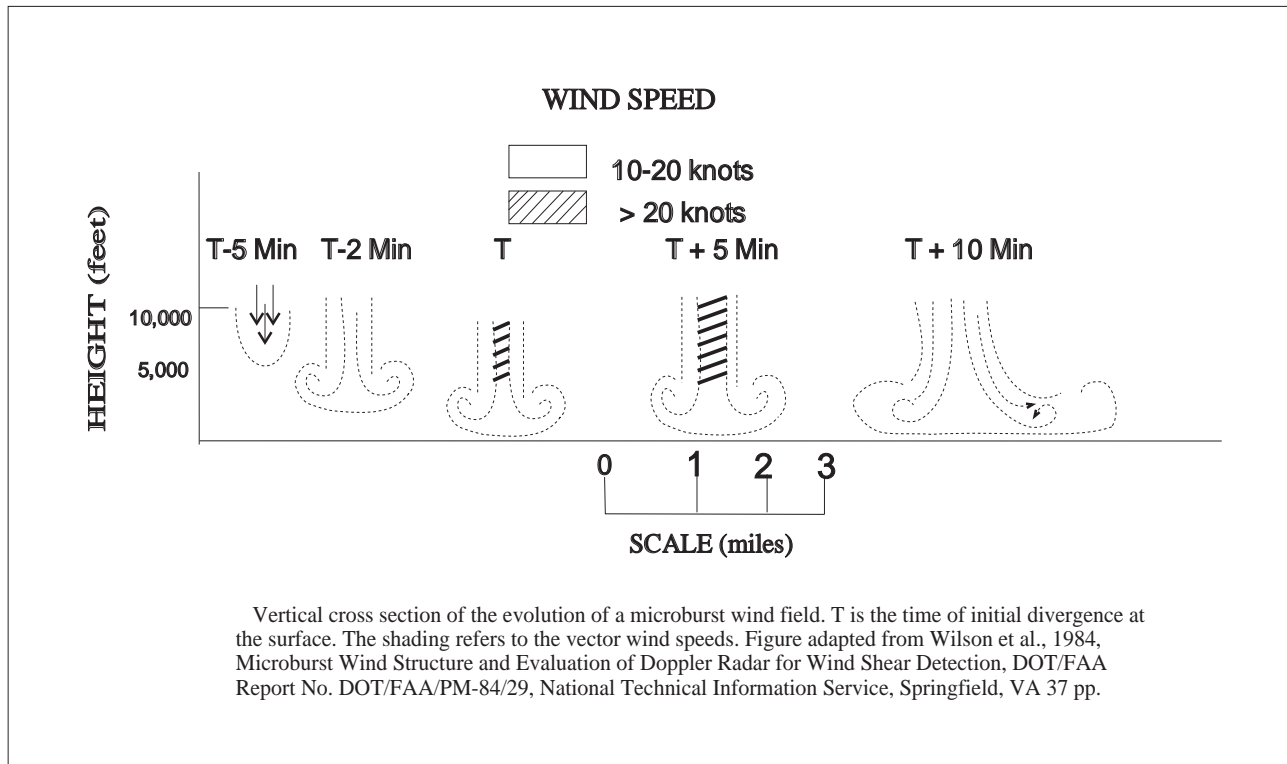

25.4.4 Duration. An individual microburst will seldom last longer than 15 minutes from the time it strikes the ground until dissipation. The horizontal winds continue to increase during the first 5 minutes with the maximum intensity winds lasting approximately 2-4 minutes. Sometimes microbursts are

concentrated into a line structure and, under these conditions, activity may continue for as long as 1 hour. Once microburst activity starts, multiple microbursts in the same general area are not uncommon and should be expected.

FIG GEN 3.5-10
Microburst Encounter During Takeoff

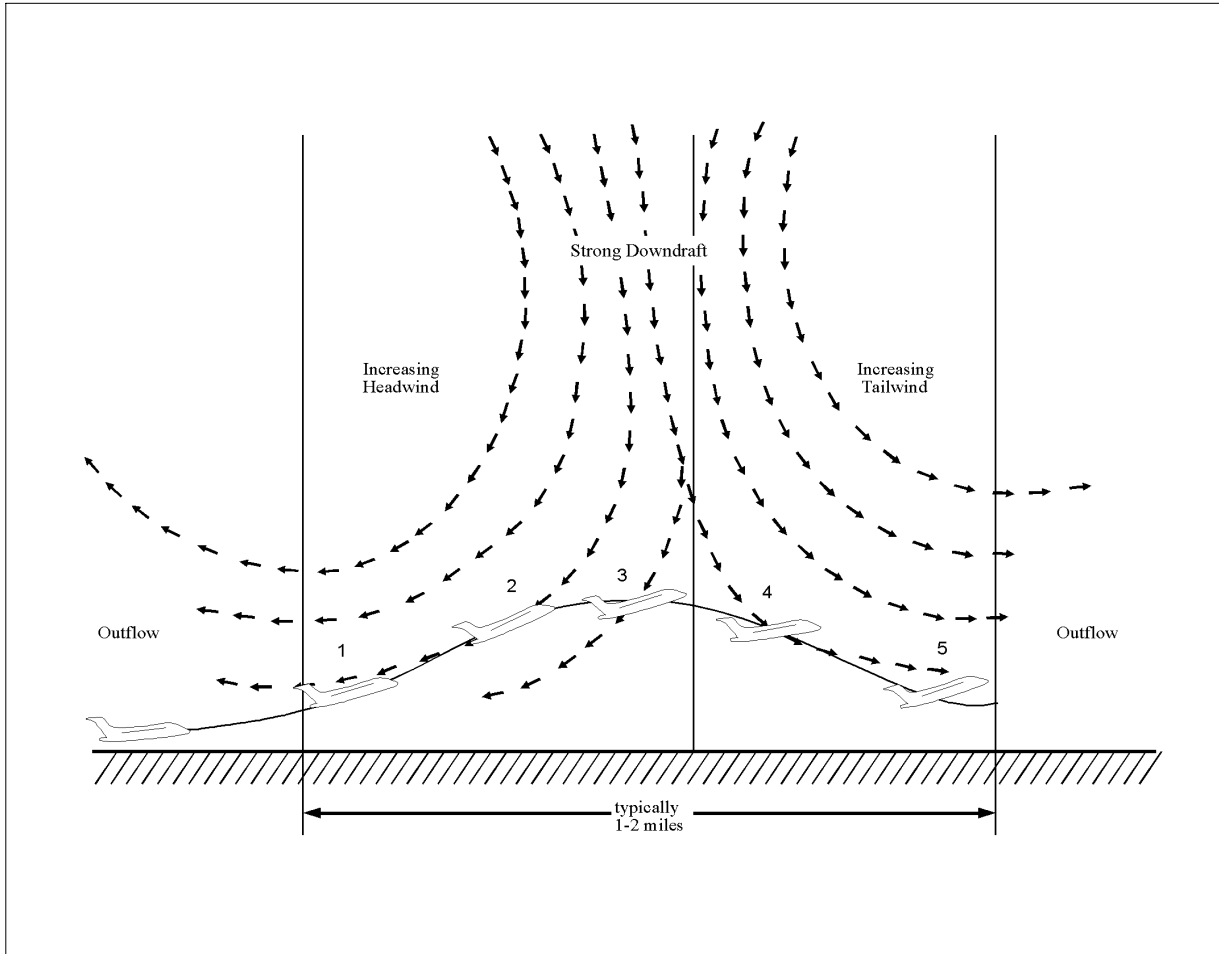

NOTE-

A microburst encounter during takeoff. The airplane first encounters a headwind and experiences increasing performance (1), this is followed in short succession by a decreasing headwind component (2), a downdraft (3), and finally a strong tailwind (4), where 2 through 5 all result in decreasing performance of the airplane. Position (5) represents an extreme situation just prior to impact. Figure courtesy of Walter Frost, FWG Associates, Inc., Tullahoma, Tennessee.

25.5 Microburst wind shear may create a severe hazard for aircraft within 1,000 feet of the ground, particularly during the approach to landing and landing and take-off phases. The impact of a microburst on aircraft which have the unfortunate

experience of penetrating one is characterized in FIG GEN 3.5-10. The aircraft may encounter a headwind (performance increasing), followed by a downdraft and a tailwind (both performance decreasing), possibly resulting in terrain impact.

FIG GEN 3.5-II

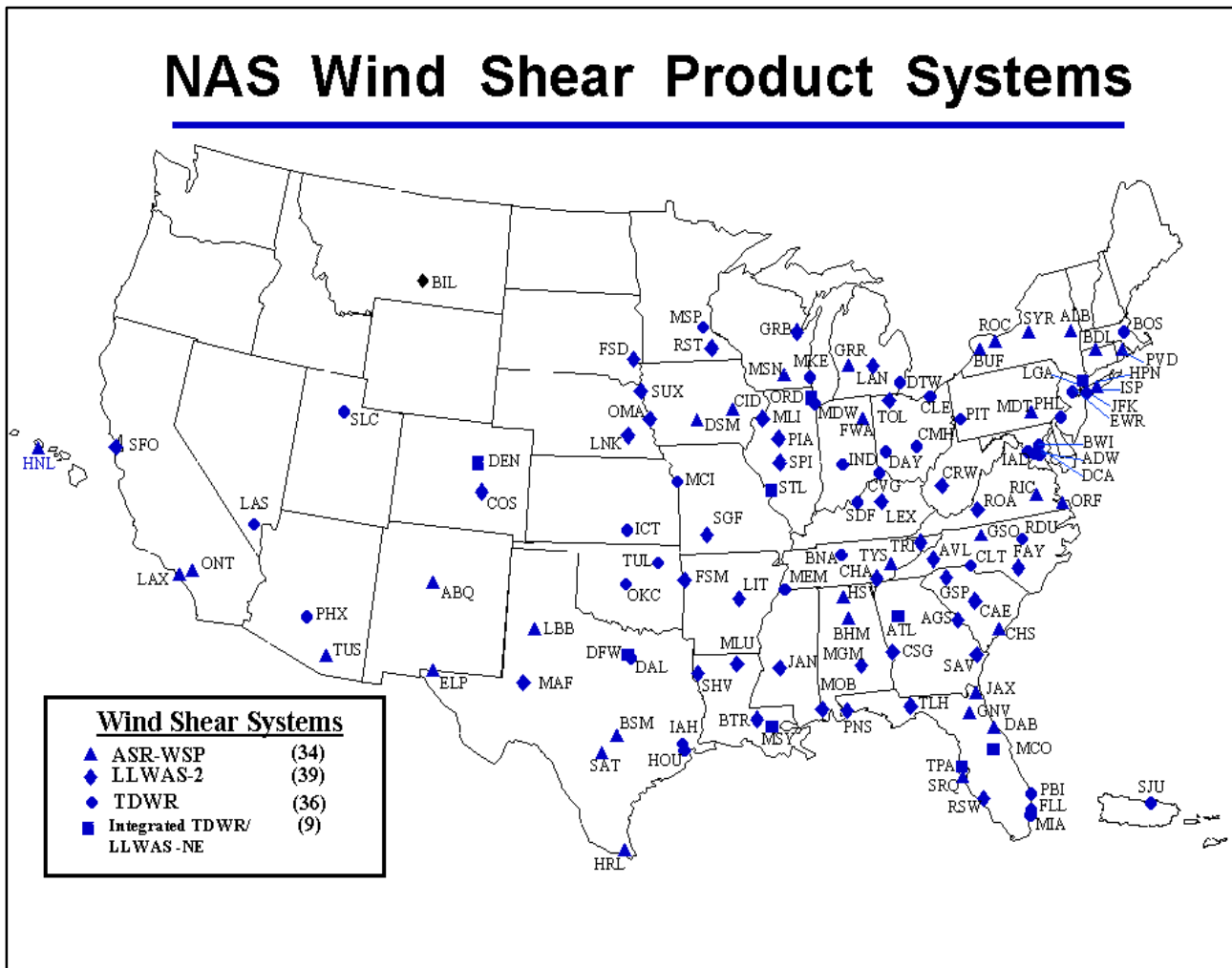

25.6 Detection of Microbursts, Wind Shear, and Gust Fronts

25.6.1 FAA’s Integrated Wind Shear Detection Plan

25.6.1.1 The FAA currently employs an integrated plan for wind shear detection that will significantly improve both the safety and capacity of the majority of the airports currently served by the air carriers. This plan integrates several programs, such as the Integrated Terminal Weather System (ITWS), Terminal Doppler Weather Radar (TDWR), Weather System Processor (WSP), and Low Level Wind Shear Alert Systems (LLWAS) into a single strategic

concept that significantly improves the aviation weather information in the terminal area. (See FIG GEN 3.5-11.)

25.6.1.2 The wind shear/microburst information and warnings are displayed on the ribbon display terminal (RBDT) located in the tower cabs. They are identical (and standardized) to those in the LLWAS, TDWR and WSP systems, and designed so that the controller does not need to interpret the data, but simply read the displayed information to the pilot. The RBDTs are constantly monitored by the controller to ensure the rapid and timely dissemination of any hazardous event(s) to the pilot.

FIG GEN 3.5–12

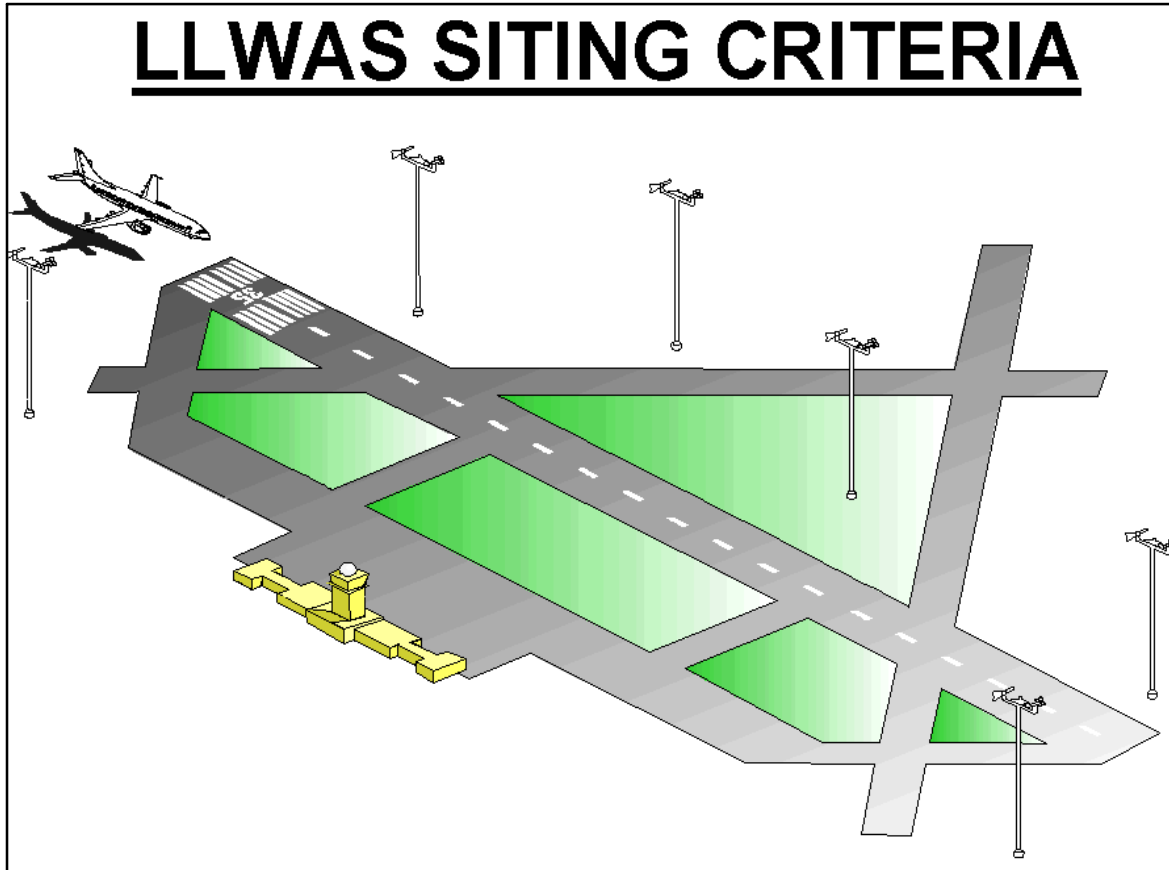

25.6.1.3 The early detection of a wind shear/microburst event, and the subsequent warning(s) issued to an aircraft on approach or departure, will alert the pilot/crew to the potential of, and to be prepared for, a situation that could become very dangerous! Without these warnings, the aircraft may NOT be able to climb out of or safely transition the event, resulting in a catastrophe. The air carriers, working with the FAA, have developed specialized training programs using their simulators to train and prepare their pilots on the demanding aircraft procedures required to escape these very dangerous wind shear and/or microburst encounters.

25.6.1.4 Low Level Wind Shear Alert System (LLWAS)

a) The LLWAS provides wind data and software processes to detect the presence of hazardous wind shear and microbursts in the vicinity of an airport. Wind sensors, mounted on poles sometimes as high as 150 feet, are (ideally) located 2,000 – 3,500 feet, but not more than 5,000 feet, from the centerline of

the runway. (See FIG GEN 3.5–12.)

b) The LLWAS was fielded in 1988 at 110 airports across the nation. Many of these systems have been replaced by new terminal doppler weather radar (TDWR) and weather systems processor (WSP) technology. Eventually all LLWAS systems will be phased out; however, 39 airports will be upgraded to the LLWAS–NE (Network Expansion) system, which employs the very latest software and sensor technology. The new LLWAS–NE systems will not only provide the controller with wind shear warnings and alerts, including wind shear/microburst detection at the airport wind sensor location, but will also provide the location of the hazards relative to the airport runway(s). It will also have the flexibility and capability to grow with the airport as new runways are built. As many as 32 sensors, strategically located around the airport and in relationship to its runway configuration, can be accommodated by the LLWAS–NE network.

FIG GEN 3.5-13

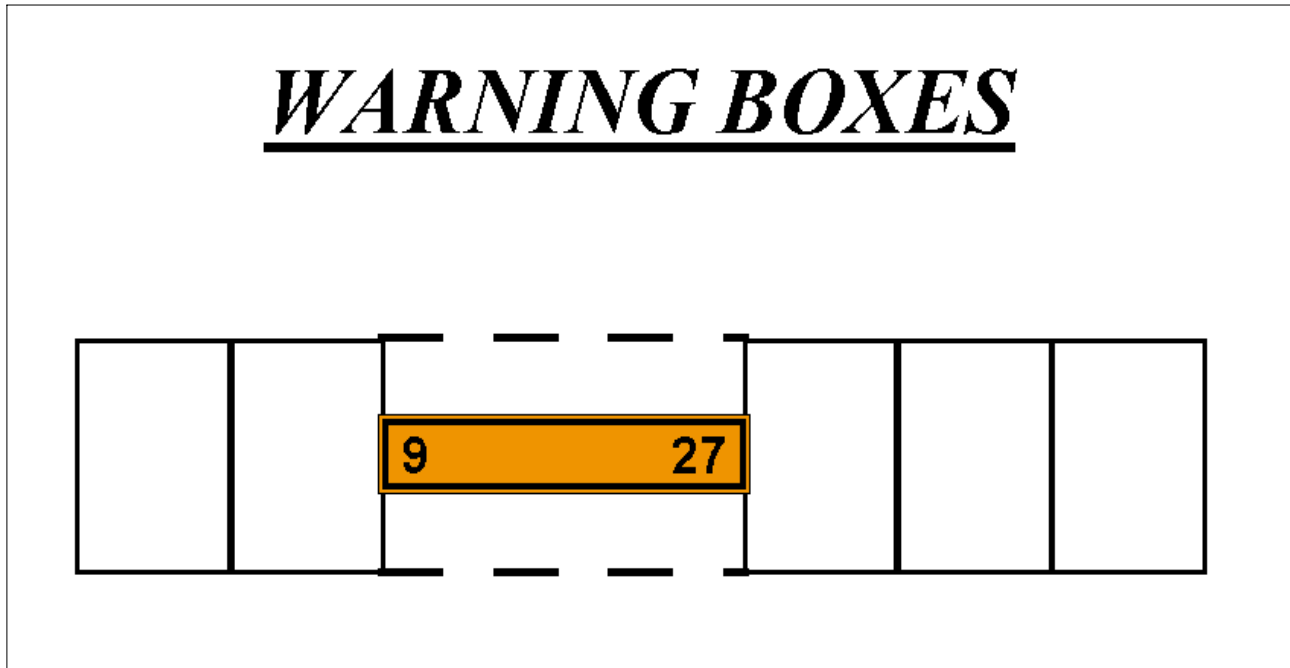

25.6.1.5 Terminal Doppler Weather Radar (TDWR)

a) TDWRs are being deployed at 45 locations across the U.S. Optimum locations for TDWRs are 8 to 12 miles from the airport proper, and designed to look at the airspace around and over the airport to detect microbursts, gust fronts, wind shifts, and precipitation intensities. TDWR products advise the controller of wind shear and microburst events impacting all runways and the areas $\frac{1}{2}$ mile on either side of the extended centerline of the runways and to a distance of 3 miles on final approach and 2 miles on departure. FIG GEN 3.5-13 is a theoretical view of the runway and the warning boxes that the software uses to determine the location(s) of wind shear or microbursts. These warnings are displayed (as depicted in the examples in subparagraph e) on the ribbon display terminal located in the tower cabs.

b) It is very important to understand what TDWR DOES NOT DO:

1) It **DOES NOT** warn of wind shear outside of the alert boxes (on the arrival and departure ends of the runways).

2) It **DOES NOT** detect wind shear that is NOT a microburst or a gust front.

3) It **DOES NOT** detect gusty or cross wind conditions.

4) It **DOES NOT** detect turbulence.

However, research and development is continuing on these systems. Future improvements may include such areas as storm motion (movement), improved gust front detection, storm growth and decay, microburst prediction, and turbulence detection.

c) TDWR also provides a geographical situation display (GSD) for supervisors and traffic management specialists for planning purposes. The GSD displays (in color) 6 levels of weather (precipitation), gust fronts and predicted storm movement(s). This data is used by the tower supervisor(s), traffic management specialists, and controllers to plan for runway changes and arrival/departure route changes in order to reduce aircraft delays and increase airport capacity.

25.6.1.6 Weather Systems Processor (WSP)

a) The WSP provides the controller, supervisor, traffic management specialist, and ultimately the pilot, with the same products as the terminal doppler weather radar at a fraction of the cost. This is accomplished by utilizing new technologies to access the weather channel capabilities of the existing ASR-9 radar located on or near the airport, thus

eliminating the requirements for a separate radar location, land acquisition, support facilities, and the associated communication landlines and expenses.

b) The WSP utilizes the same RBDT display as the TDWR and LLWAS, and, like the TDWR, has a GSD for planning purposes by supervisors, traffic management specialists, and controllers. The WSP GSD emulates the TDWR display; i.e., it also depicts 6 levels of precipitation, gust fronts and predicted storm movement, and like the TDWR, GSD is used to plan for runway changes and arrival/departure route changes in order to reduce aircraft delays and to increase airport capacity.

c) This system is currently under development and is operating in a developmental test status at the Albuquerque, New Mexico, airport. When fielded, the WSP is expected to be installed at 34 airports across the nation, substantially increasing the safety of flying.

25.6.1.7 Operational Aspects of LLWAS, TDWR, and WSP

To demonstrate how this data is used by both the controller and the pilot, 3 ribbon display examples and their explanations are presented:

a) MICROBURST ALERTS

EXAMPLE–

This is what the controller sees on his/her ribbon display in the tower cab.

27A MBA 35K– 2MF 250 20

NOTE–

(See FIG GEN 3.5–14 to see how the TDWR/WSP determines the microburst location).

This is what the controller will say when issuing the alert.

PHRASEOLOGY–

RUNWAY 27 ARRIVAL, MICROBURST ALERT, 35 KT LOSS 2 MILE FINAL, THRESHOLD WINDS 250 AT 20.

In plain language, the controller is telling the pilot that on approach to runway 27, there is a microburst alert on the approach lane to the runway, and to anticipate or expect a 35–knot loss of airspeed at approximately 2 miles out on final approach (where the aircraft will first encounter the phenomena). With that information, the aircrew is forewarned, and should be prepared to apply wind shear/microburst escape procedures should they decide to continue the approach. Additionally, the surface winds at the airport for landing runway 27 are reported as 250 degrees at 20 knots.

NOTE–

Threshold wind is at pilot’s request or as deemed appropriate by the controller.

b) WIND SHEAR ALERTS

EXAMPLE–

This is what the controller sees on his/her ribbon display in the tower cab.

27A WSA 20K– 3MF 200 15

NOTE–

(See FIG GEN 3.5–15 to see how the TDWR/WSP determines the wind shear location).

This is what the controller will say when issuing the alert.

PHRASEOLOGY–

RUNWAY 27 ARRIVAL, WIND SHEAR ALERT, 20 KT LOSS 3 MILE FINAL, THRESHOLD WINDS 200 AT 15.

In plain language, the controller is advising the aircraft arriving on runway 27 that at 3 miles out the pilot should expect to encounter a wind shear condition that will decrease airspeed by 20 knots and possibly the aircraft will encounter turbulence. Additionally, the airport surface winds for landing runway 27 are reported as 200 degrees at 15 knots.

NOTE–

Threshold wind is at pilot’s request or as deemed appropriate by the controller.

FIG GEN 3.5-14

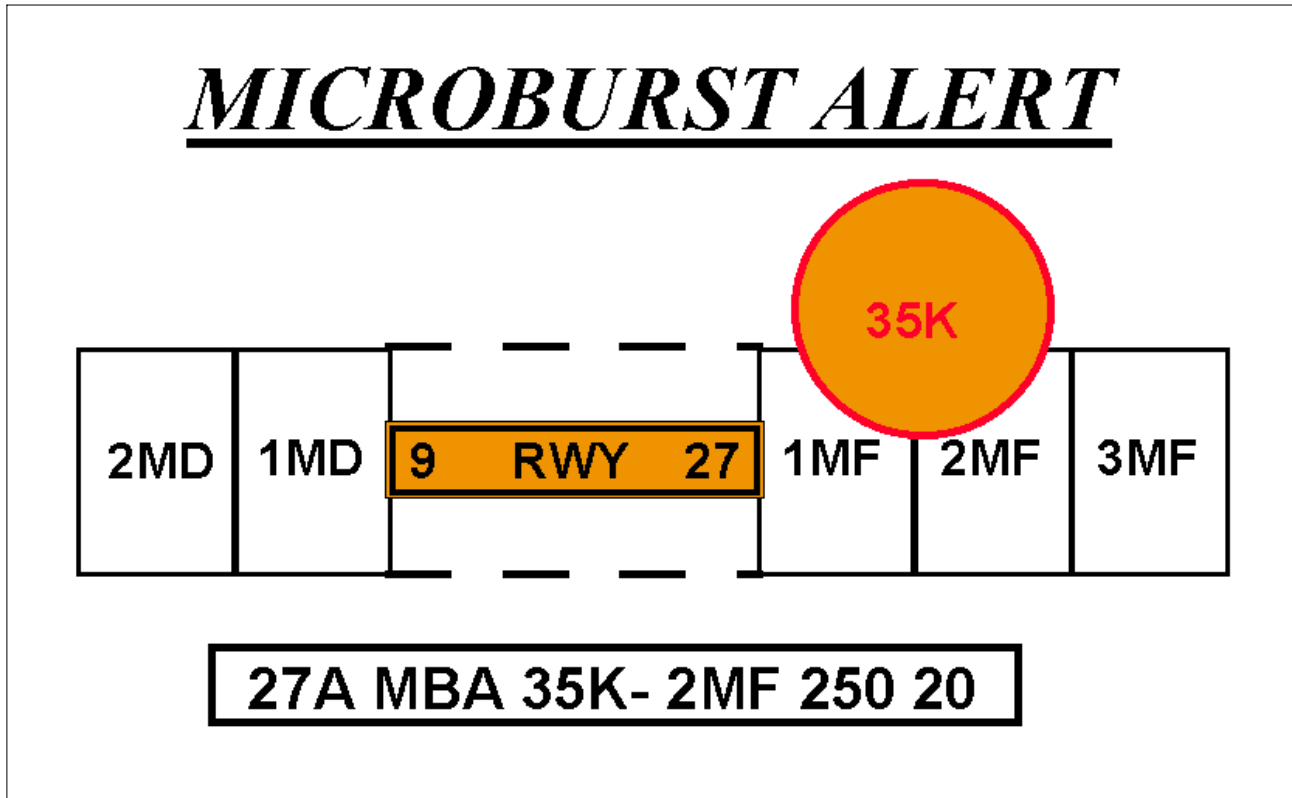

FIG GEN 3.5-15

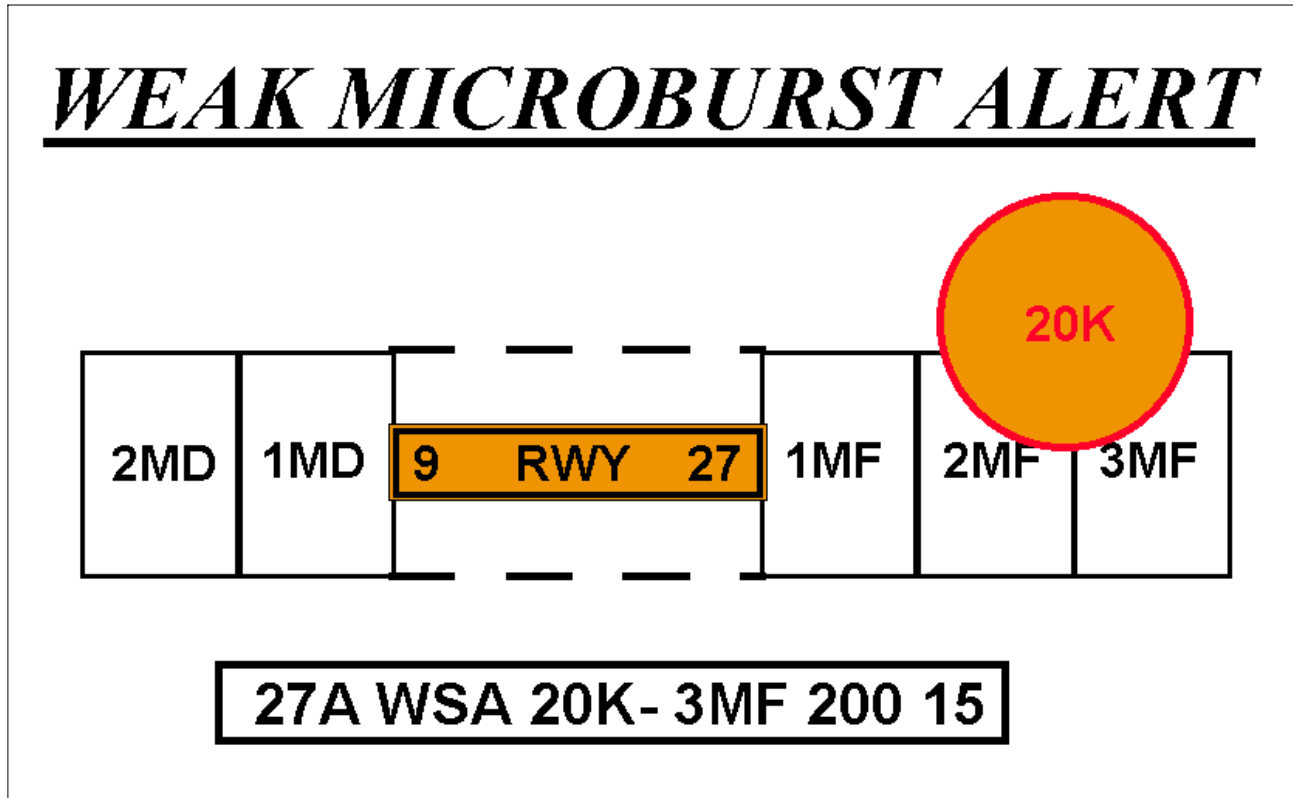
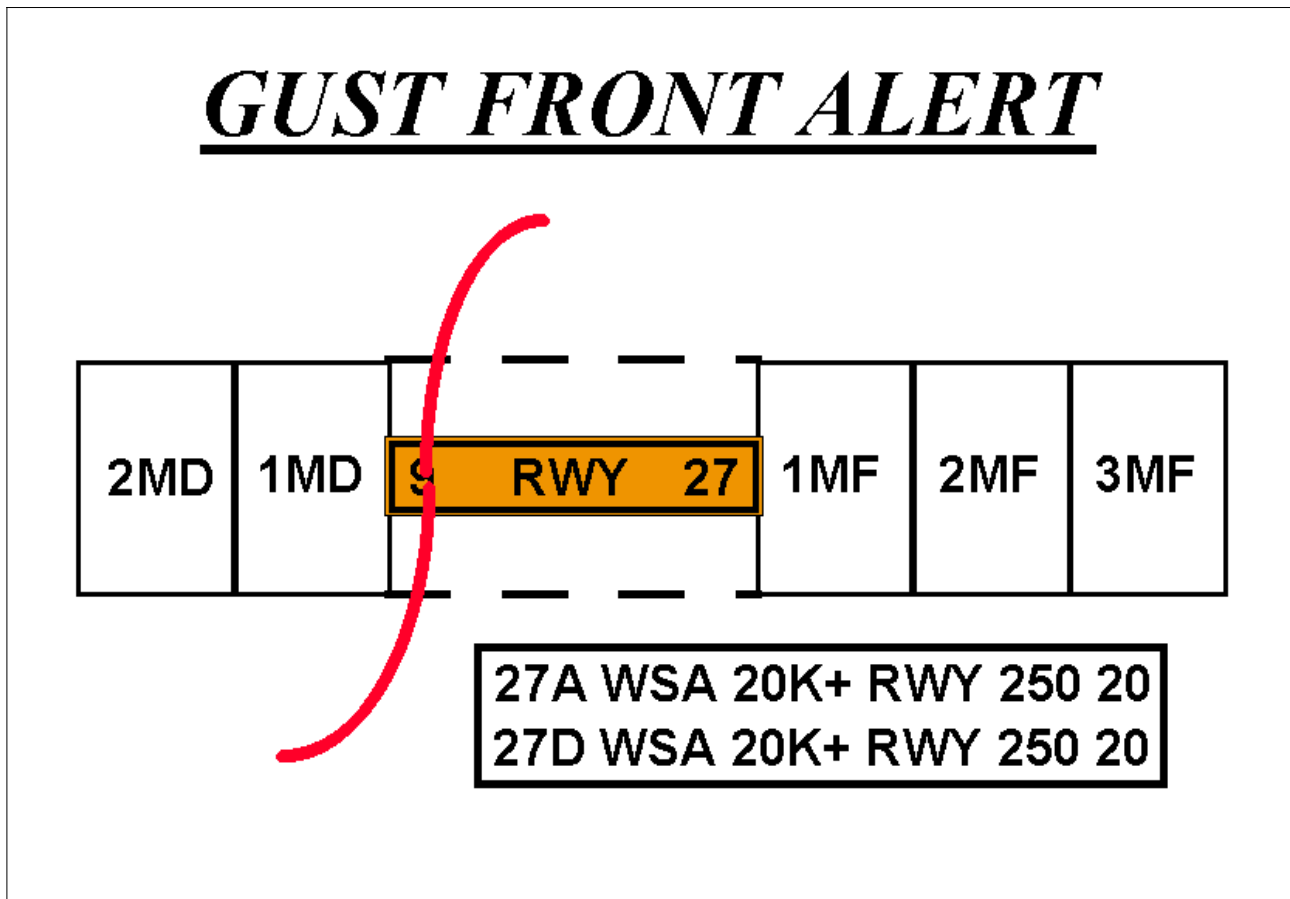

FIG GEN 3.5-16



c) MULTIPLE WIND SHEAR ALERTS

EXAMPLE-

This is what the controller sees on his/her ribbon display in the tower cab.

27A WSA 20K+ RWY 250 20
27D WSA 20K+ RWY 250 20

NOTE-

(See FIG GEN 3.5-16 to see how the TDWR/WSP determines the gust front/wind shear location).

This is what the controller will say when issuing the alert.

PHRASEOLOGY-

MULTIPLE WIND SHEAR ALERTS.

RUNWAY 27 ARRIVAL, WIND SHEAR ALERT, 20 KT GAIN ON RUNWAY;

RUNWAY 27 DEPARTURE, WIND SHEAR ALERT, 20 KT GAIN ON RUNWAY, WINDS 250 AT 20.

EXAMPLE-

In this example, the controller is advising arriving and departing aircraft that they could encounter a wind shear condition right on the runway due to a gust front (significant change of wind direction) with the possibility of a 20 knot gain in airspeed associated with the gust front. Additionally, the airport surface winds (for the runway in use) are reported as 250 degrees at 20 knots.

25.6.1.8 The Terminal Weather Information for Pilots System (TWIP)

a) With the increase in the quantity and quality of terminal weather information available through TDWR, the next step is to provide this information directly to pilots rather than relying on voice communications from ATC. The National Airspace System has long been in need of a means of delivering terminal weather information to the cockpit more efficiently in terms of both speed and accuracy to enhance pilot awareness of weather hazards and to reduce air traffic controller workload. With the TWIP

capability, terminal weather information, both alphanumerically and graphically, is now available directly to the cockpit on a test basis at 9 locations.

b) TWIP products are generated using weather data from the TDWR or the Integrated Terminal Weather System (ITWS) testbed. TWIP products are generated and stored in the form of text and character graphic messages. Software has been developed to allow TDWR or ITWS to format the data and send the TWIP products to a database resident at Aeronautical Radio, Inc. (ARINC). These products can then be accessed by pilots using the ARINC Aircraft Communications Addressing and Reporting System (ACARS) data link services. Airline dispatchers can also access this database and send messages to specific aircraft whenever wind shear activity begins or ends at an airport.

c) TWIP products include descriptions and character graphics of microburst alerts, wind shear alerts, significant precipitation, convective activity within 30 NM surrounding the terminal area, and expected weather that will impact airport operations. During inclement weather; i.e., whenever a predetermined level of precipitation or wind shear is detected within 15 miles of the terminal area, TWIP products are updated once each minute for text messages and once every 5 minutes for character graphic messages. During good weather (below the predetermined precipitation or wind shear parameters) each message is updated every 10 minutes. These products are intended to improve the situational awareness of the pilot/flight crew, and to aid in flight planning prior to arriving or departing the terminal area. It is important to understand that, in the context of TWIP, the predetermined levels for inclement versus good weather has nothing to do with the criteria for VFR/MVFR/IFR/LIFR; it only deals with precipitation, wind shears, and microbursts.

26. PIREPs Relating to Volcanic Ash Activity

26.1 Volcanic eruptions which send ash into the upper atmosphere occur somewhere around the world several times each year. Flying into a volcanic ash cloud can be exceedingly dangerous. At least two B747s have lost all power in all four engines after such an encounter. Regardless of the type aircraft, some damage is almost certain to ensue after an encounter with a volcanic ash cloud.

26.2 While some volcanoes in the U.S. are monitored, many in remote areas are not. These unmonitored volcanoes may erupt without prior warning to the aviation community. A pilot observing a volcanic eruption who has not had previous notification of it may be the only witness to the eruption. Pilots are strongly encouraged to transmit a PIREP regarding volcanic eruptions and any observed volcanic ash clouds.

26.3 Pilots should submit PIREPs regarding volcanic activity using the Volcanic Activity Reporting form (VAR) as illustrated in FIG GEN 3.5–31. (If a VAR form is not immediately available, relay enough information to identify the position and type of volcanic activity.)

26.4 Pilots should verbally transmit the data required in items 1 through 8 of the VAR as soon as possible. The data required in items 9 through 16 of the VAR should be relayed after landing, if possible.

27. Thunderstorms

27.1 Turbulence, hail, rain, snow, lightning, sustained updrafts and downdrafts, and icing conditions are all present in thunderstorms. While there is some evidence that maximum turbulence exists at the middle level of a thunderstorm, recent studies show little variation of turbulence intensity with altitude.

27.2 There is no useful correlation between the external visual appearance of thunderstorms and the severity or amount of turbulence or hail within them. Also, the visible thunderstorm cloud is only a portion of a turbulent system whose updrafts and downdrafts often extend far beyond the visible storm cloud. Severe turbulence can be expected up to 20 miles from severe thunderstorms. This distance decreases to about 10 miles in less severe storms. These turbulent areas may appear as a well-defined echo on weather radar.

27.3 Weather radar, airborne or ground-based, will normally reflect the areas of moderate to heavy precipitation. (Radar does not detect turbulence.) The frequency and severity of turbulence generally increases with the areas of highest liquid water content of the storm. NO FLIGHT PATH THROUGH AN AREA OF STRONG OR VERY STRONG RADAR ECHOES SEPARATED BY 20–30 MILES OR LESS MAY BE CONSIDERED FREE OF SEVERE TURBULENCE.

27.4 Turbulence beneath a thunderstorm should not be minimized. This is especially true when the relative humidity is low in any layer between the surface and 15,000 feet. Then the lower altitudes may be characterized by strong out-flowing winds and severe turbulence.

27.5 The probability of lightning strikes occurring to aircraft is greatest when operating at altitudes where temperatures are between -5 C and +5 C. Lightning can strike aircraft flying in the clear in the vicinity of a thunderstorm.

27.6 Current weather radar systems are able to objectively determine precipitation intensity. These precipitation intensity areas are described as “light,” “moderate,” “heavy,” and “extreme.”

REFERENCE-
Pilot/Controller Glossary Term- Precipitation Radar Weather Descriptions.

EXAMPLE-
Alert provided by an ATC facility to an aircraft: (aircraft identification) EXTREME precipitation between ten o'clock and two o'clock, one five miles. Precipitation area is two five miles in diameter.

EXAMPLE-
Alert provided by an AFSS/FSS: (aircraft identification) EXTREME precipitation two zero miles west of Atlanta V-O-R, two five miles wide, moving east at two zero knots, tops flight level three niner zero.

28. Thunderstorm Flying

28.1 Above all, remember this: never regard any thunderstorm lightly, even when radar observers report the echoes are of light intensity. Avoiding thunderstorms is the best policy. Following are some Do's and Don'ts of thunderstorm avoidance:

28.1.1 Don't land or takeoff in the face of an approaching thunderstorm. A sudden gust front of low-level turbulence could cause loss of control.

28.1.2 Don't attempt to fly under a thunderstorm even if you can see through to the other side. Turbulence and wind shear under the storm could be disastrous.

28.1.3 Don't fly without airborne radar into a cloud mass containing scattered embedded thunderstorms. Scattered thunderstorms not embedded usually can be visually circumnavigated.

28.1.4 Don't trust the visual appearance to be a reliable indicator of the turbulence inside a thunderstorm.

28.1.5 Do avoid by at least 20 miles any thunderstorm identified as severe or giving an intense radar echo. This is especially true under the anvil of a large cumulonimbus.

28.1.6 Do clear the top of a known or suspected severe thunderstorm by at least 1,000 feet altitude for each 10 knots of wind speed at the cloud top. However, the altitude capability of most aircraft make it unlikely that the aircraft will be able to clear the storm top.

28.1.7 Do circumnavigate the entire area if the area has 6/10 thunderstorm coverage.

28.1.8 Do remember that vivid and frequent lightning indicates the probability of a severe thunderstorm.

28.1.9 Do regard as extremely hazardous any thunderstorm that tops 35,000 feet or higher whether the top is visually sighted or determined by radar.

28.2 If you cannot avoid penetrating a thunderstorm, before entering the storm, you should do the following:

28.2.1 Tighten your safety belt, put on your shoulder harness if you have one, and secure all loose objects.

28.2.2 Plan and hold your course to take you through the storm in a minimum time.

28.2.3 To avoid the most critical icing, establish a penetration altitude below the freezing level or above the level of -15 C.

28.2.4 Verify that pitot heat is on and turn on carburetor heat or jet engine anti-ice. Icing can be rapid at any altitude and cause almost instantaneous power failure and/or loss of airspeed indication.

28.2.5 Establish power settings for turbulence penetration airspeed recommended in your aircraft manual.

28.2.6 Turn up cockpit lights to highest intensity to lessen danger of temporary blindness from lightning.

28.2.7 If using automatic pilot, disengage altitude hold mode and speed hold mode. The automatic altitude and speed controls will increase maneuvers of the aircraft thus increasing structural stresses.

28.2.8 If using airborne radar, tilt the antenna up and down occasionally. This will permit you to detect other thunderstorm activity at altitudes other than the one being flown.

28.3 Following are some Do's and Don'ts during the thunderstorm penetration:

28.3.1 Do keep your eyes on your instruments. Looking outside the cockpit can increase danger of temporary blindness from lightning.

28.3.2 Don't change power settings; maintain settings for the recommended turbulence penetration airspeed.

28.3.3 Don't attempt to maintain constant altitude; let the aircraft "ride the waves."

28.3.4 Don't turn back once you are in the thunderstorm. A straight course through the storm most likely will get you out of the hazards more quickly. In addition, turning maneuvers increase stress on the aircraft.

29. Wake Turbulence

29.1 General

29.1.1 Every aircraft generates a wake while in flight. Initially, when pilots encountered this wake in flight, the disturbance was attributed to "prop wash." It is known, however, that this disturbance is caused by a pair of counterrotating vortices trailing from the wing tips. The vortices from larger aircraft pose problems to encountering aircraft. For instance, the wake of these aircraft can impose rolling moments exceeding the roll control authority of the encountering aircraft. Further, turbulence generated within the vortices can damage aircraft components and equipment if encountered at close range. The pilot must learn to envision the location of the vortex wake generated by larger (transport category) aircraft and adjust the flight path accordingly.

29.1.2 During ground operations and during takeoff, jet engine blast (thrust stream turbulence) can cause damage and upsets if encountered at close range. Exhaust velocity versus distance studies at various thrust levels have shown a need for light aircraft to maintain an adequate separation behind large turbojet aircraft. Pilots of larger aircraft should be particularly careful to consider the effects of their "jet blast" on other aircraft, vehicles, and maintenance equipment during ground operations.

29.2 Vortex Generation

29.2.1 Lift is generated by the creation of a pressure differential over the wing surface. The lowest pressure occurs over the upper wing surface and the highest pressure under the wing. This pressure differential triggers the roll up of the airflow aft of the wing resulting in swirling air masses trailing downstream of the wing tips. After the roll up is completed, the wake consists of two counter rotating cylindrical vortices. Most of the energy is within a few feet of the center of each vortex, but pilots should avoid a region within about 100 feet of the vortex core. (See FIG GEN 3.5–17.)

29.3 Vortex Strength

29.3.1 The strength of the vortex is governed by the weight, speed, and shape of the wing of the generating aircraft. The vortex characteristics of any given aircraft can also be changed by extension of flaps or other wing configuring devices as well as by change in speed. However, as the basic factor is weight, the vortex strength increases proportionately. Peak vortex tangential speeds up to almost 300 feet per second have been recorded. The greatest vortex strength occurs when the generating aircraft is HEAVY, CLEAN, and SLOW.

29.3.2 Induced Roll

29.3.2.1 In rare instances, a wake encounter could cause inflight structural damage of catastrophic proportions. However, the usual hazard is associated with induced rolling moments which can exceed the roll control authority of the encountering aircraft. In flight experiments, aircraft have been intentionally flown directly up trailing vortex cores of larger aircraft. It was shown that the capability of an aircraft to counteract the roll imposed by the wake vortex primarily depends on the wing span and counter-control responsiveness of the encountering aircraft.

29.3.2.2 Counter-control is usually effective and induced roll minimal in cases where the wing span and ailerons of the encountering aircraft extend beyond the rotational flow field of the vortex. It is more difficult for aircraft with short wing span (relative to the generating aircraft) to counter the imposed roll induced by vortex flow. Pilots of short-span aircraft, even of the high-performance type, must be especially alert to vortex encounters. (See FIG GEN 3.5–18.)

29.3.2.3 The wake of larger aircraft requires the respect of all pilots.

29.4 Vortex Behavior

29.4.1 Trailing vortices have certain behavioral characteristics which can help a pilot visualize the wake location and thereby take avoidance precautions.

29.4.1.1 Vortices are generated from the moment aircraft leave the ground, since trailing vortices are a by-product of wing lift. Prior to takeoff or touchdown pilots should note the rotation or touchdown point of the preceding aircraft. (See FIG GEN 3.5-19.)

29.4.1.2 The vortex circulation is outward, upward and around the wing tips when viewed from either ahead or behind the aircraft. Tests with large aircraft have shown that the vortices remain spaced a bit less than a wing span apart, drifting with the wind, at altitudes greater than a wing span from the ground. In view of this, if persistent vortex turbulence is encountered, a slight change of altitude and lateral position (preferably upwind) will provide a flight path clear of the turbulence.

29.4.1.3 Flight tests have shown that the vortices from larger (transport category) aircraft sink at a rate of several hundred feet per minute, slowing their descent and diminishing in strength with time and distance behind the generating aircraft. Atmospheric turbulence hastens breakup. Pilots should fly at or above the preceding aircraft's flight path, altering course as necessary to avoid the area behind and below the generating aircraft. However, vertical separation of 1,000 feet may be considered safe. (See FIG GEN 3.5-20.)

FIG GEN 3.5-17
Wake Vortex Generation

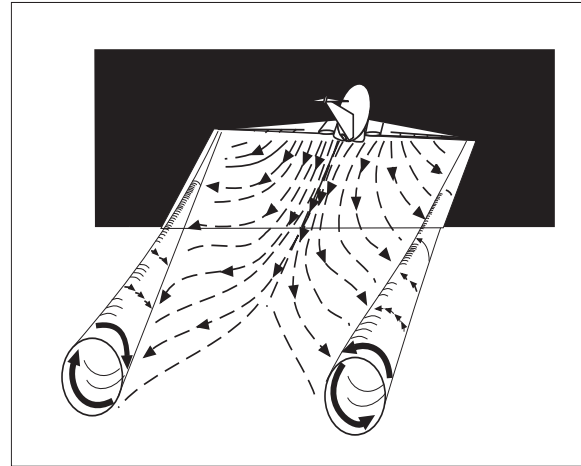

FIG GEN 3.5-18
Wake Encounter Counter Control

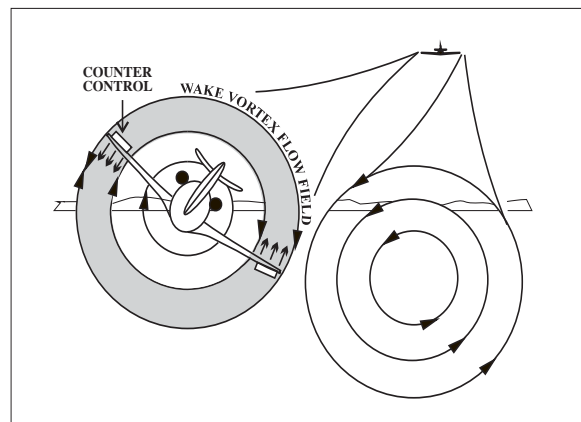

FIG GEN 3.5-19
Wake Ends/Wake Begins

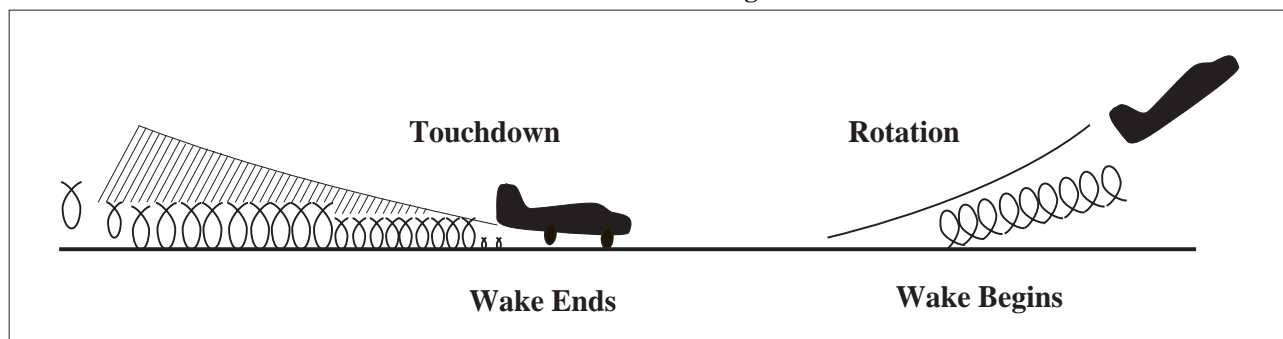

FIG GEN 3.5-20
Vortex Flow Field

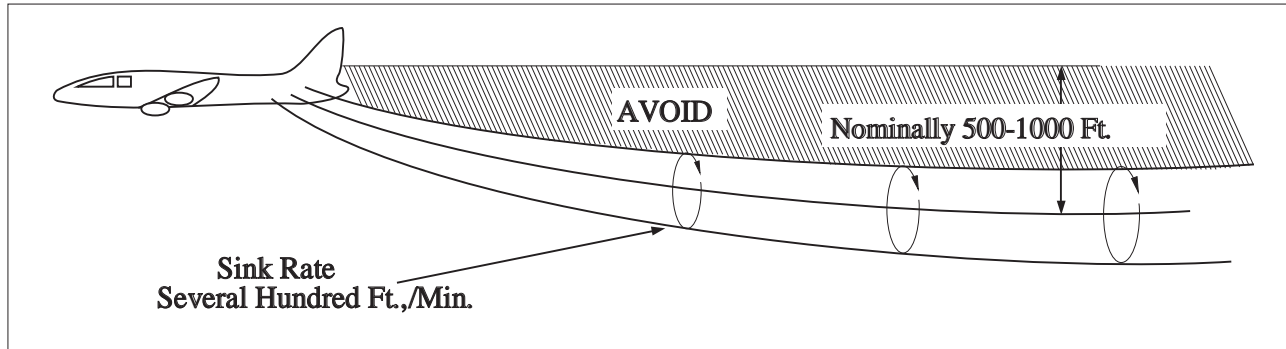
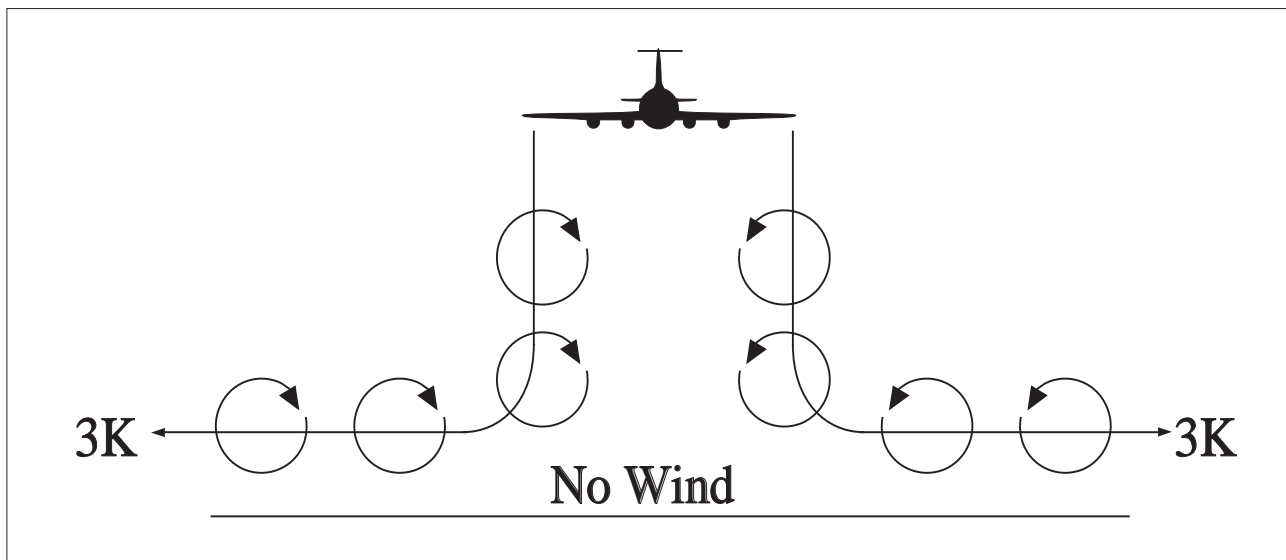

FIG GEN 3.5-21
Vortex Movement Near Ground - No Wind



29.4.1.4 When the vortices of larger aircraft sink close to the ground (within 100 to 200 feet), they tend to move laterally over the ground at a speed of 2 or 3 knots. (See FIG GEN 3.5-21.)

29.4.1.5 There is a small segment of the aviation community that have become convinced that wake vortices may “bounce” up to twice their nominal steady state height. With a 200-foot span aircraft, the “bounce” height could reach approximately 200 feet AGL. This conviction is based on a single unsubstantiated report of an apparent coherent vortical flow that was seen in the volume scan of a research sensor. No one can say what conditions cause vortex bouncing, how high they bounce, at what angle they bounce, or how many times a vortex

may bounce. On the other hand, no one can say for certain that vortices never “bounce.” Test data have shown that vortices can rise with the air mass in which they are embedded. Wind shear, particularly, can cause vortex flow field “tilting.” Also, ambient thermal lifting and orographic effects (rising terrain or tree lines) can cause a vortex flow field to rise. Notwithstanding the foregoing, pilots are reminded that they should be alert at all times for possible wake vortex encounters when conducting approach and landing operations. The pilot has the ultimate responsibility for ensuring appropriate separations and positioning of the aircraft in the terminal area to avoid the wake turbulence created by a preceding aircraft.

FIG GEN 3.5-22
Vortex Movement Near Ground – with Cross Winds

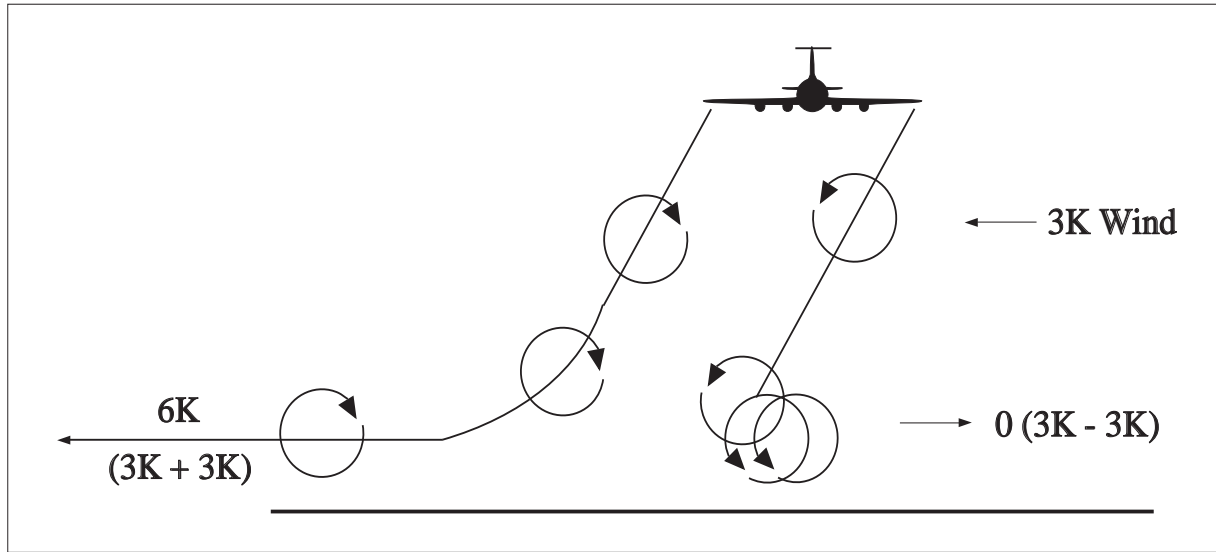
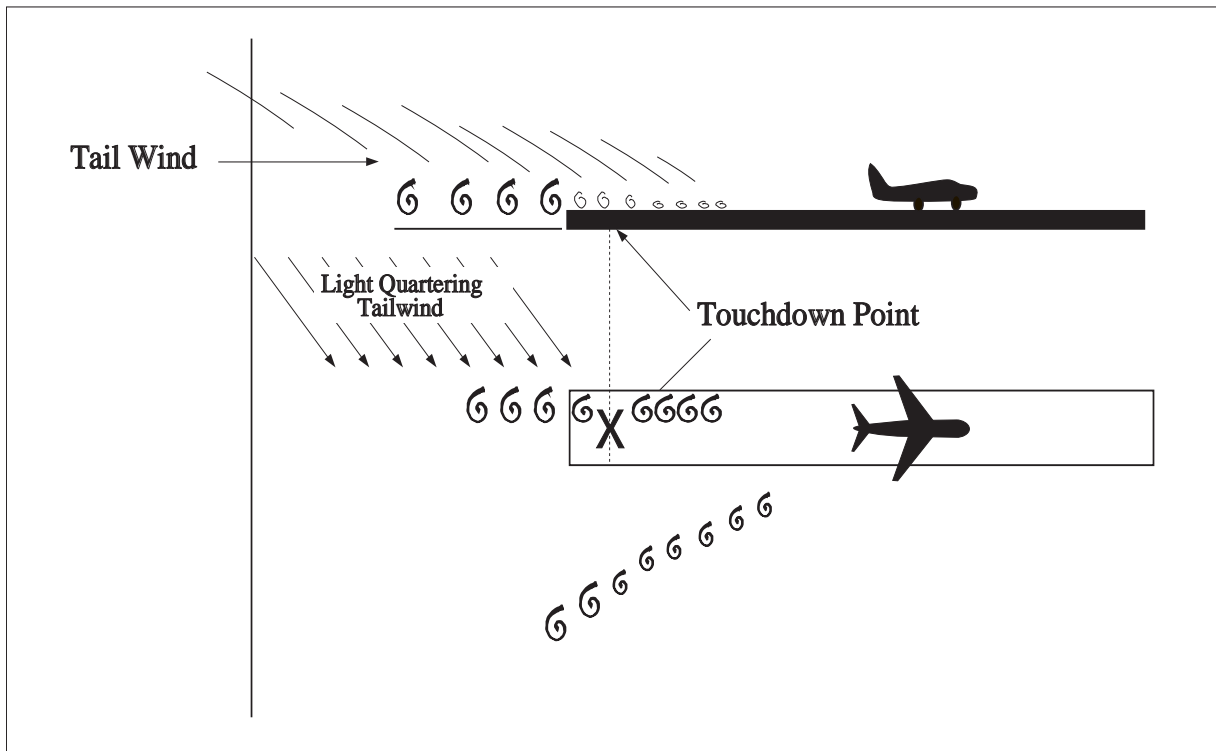

FIG GEN 3.5-23
Vortex Movement in Ground Effect – Tailwind



29.4.2 A crosswind will decrease the lateral movement of the upwind vortex and increase the movement of the downwind vortex. Thus a light wind with a cross-runway component of 1 to 5 knots could result in the upwind vortex remaining in the touchdown zone for a period of time and hasten the drift of the downwind vortex toward another runway.

(See FIG GEN 3.5-22.) Similarly, a tailwind condition can move the vortices of the preceding aircraft forward into the touchdown zone. **THE LIGHT QUARTERING TAILWIND REQUIRES MAXIMUM CAUTION.** Pilots should be alert to larger aircraft upwind from their approach and takeoff flight paths. (See FIG GEN 3.5-23.)

29.5 Operations Problem Areas

29.5.1 A wake encounter can be catastrophic. In 1972 at Fort Worth, Texas, a DC–9 got too close to a DC–10 (two miles back), rolled, caught a wingtip, and cartwheeled coming to rest in an inverted position on the runway. All aboard were killed. Serious and even fatal general aviation accidents induced by wake vortices are not uncommon. However, a wake encounter is not necessarily hazardous. It can be one or more jolts with varying severity depending upon the direction of the encounter, weight of the generating aircraft, size of the encountering aircraft, distance from the generating aircraft, and point of vortex encounter. The probability of induced roll increases when the encountering aircraft’s heading is generally aligned with the flight path of the generating aircraft.

29.5.2 AVOID THE AREA BELOW AND BEHIND THE GENERATING AIRCRAFT, ESPECIALLY AT LOW ALTITUDE WHERE EVEN A MOMENTARY WAKE ENCOUNTER COULD BE HAZARDOUS. This is not easy to do. Some accidents have occurred even though the pilot of the trailing aircraft had carefully noted that the aircraft in front was at a considerably lower altitude. Unfortunately, this does not ensure that the flight path of the lead aircraft will be below that of the trailing aircraft.

29.5.3 Pilots should be particularly alert in calm wind conditions and situations where the vortices could:

29.5.3.1 Remain in the touchdown area.

29.5.3.2 Drift from aircraft operating on a nearby runway.

29.5.3.3 Sink into the takeoff or landing path from a crossing runway.

29.5.3.4 Sink into the traffic pattern from other airport operations.

29.5.3.5 Sink into the flight path of VFR aircraft operating on the hemispheric altitude 500 feet below.

29.5.4 Pilots of all aircraft should visualize the location of the vortex trail behind larger aircraft and use proper vortex avoidance procedures to achieve safe operation. It is equally important that pilots of larger aircraft plan or adjust their flight paths to minimize vortex exposure to other aircraft.

29.6 Vortex Avoidance Procedures

29.6.1 Under certain conditions, airport traffic controllers apply procedures for separating IFR aircraft. If a pilot accepts a clearance to visually follow a preceding aircraft, the pilot accepts responsibility for separation and wake turbulence avoidance. The controllers will also provide to VFR aircraft, with whom they are in communication and which in the tower’s opinion may be adversely affected by wake turbulence from a larger aircraft, the position, altitude and direction of flight of larger aircraft followed by the phrase “CAUTION – WAKE TURBULENCE.” After issuing the caution for wake turbulence, the airport traffic controllers generally do not provide additional information to the following aircraft unless the airport traffic controllers know the following aircraft is overtaking the preceding aircraft. WHETHER OR NOT A WARNING OR INFORMATION HAS BEEN GIVEN, HOWEVER, THE PILOT IS EXPECTED TO ADJUST AIRCRAFT OPERATIONS AND FLIGHT PATH AS NECESSARY TO PRECLUDE SERIOUS WAKE ENCOUNTERS. When any doubt exists about maintaining safe separation distances between aircraft during approaches, pilots should ask the control tower for updates on separation distance and aircraft groundspeed.

29.6.2 The following vortex avoidance procedures are recommended for the various situations:

29.6.2.1 Landing Behind a Larger Aircraft – Same Runway. Stay at or above the larger aircraft’s final approach flight path – note its touchdown point – land beyond it.

29.6.2.2 Landing Behind a Larger Aircraft – When a Parallel Runway is Closer Than 2,500 Feet. Consider possible drift to your runway. Stay at or above the larger aircraft’s final approach flight path – note its touchdown point.

29.6.2.3 Landing Behind a Larger Aircraft – Crossing Runway. Cross above the larger aircraft’s flight path.

29.6.2.4 Landing Behind a Departing Larger Aircraft – Same Runway. Note the larger aircraft’s rotation point – land well prior to rotation point.

29.6.2.5 Landing Behind a Departing Larger Aircraft – Crossing Runway. Note the larger aircraft’s rotation point – if past the intersection – continue the approach – land prior to the

intersection. If larger aircraft rotates prior to the intersection, avoid flight below the larger aircraft's flight path. Abandon the approach unless a landing is ensured well before reaching the intersection.

29.6.2.6 Departing Behind a Larger Aircraft.

Note the larger aircraft's rotation point – rotate prior to larger aircraft's rotation point – continue climb above the larger aircraft's climb path until turning clear of the larger aircraft's wake. Avoid subsequent headings which will cross below and behind a larger aircraft. Be alert for any critical takeoff situation which could lead to a vortex encounter.

29.6.2.7 Intersection Takeoffs – Same Runway.

Be alert to adjacent larger aircraft operations, particularly upwind of your runway. If intersection takeoff clearance is received, avoid subsequent headings which will cross below a larger aircraft's path.

29.6.2.8 Departing or Landing After a Larger Aircraft Executing a Low Approach, Missed Approach, Or Touch-and-go Landing.

Because vortices settle and move laterally near the ground, the vortex hazard may exist along the runway and in your flight path after a larger aircraft has executed a low approach, missed approach, or a touch-and-go landing, particular in light quartering wind conditions. You should ensure that an interval of at least 2 minutes has elapsed before your takeoff or landing.

29.6.2.9 En Route VFR (Thousand-foot Altitude Plus 500 Feet). Avoid flight below and behind a large aircraft's path. If a larger aircraft is observed above on the same track (meeting or overtaking) adjust your position laterally, preferably upwind.

29.7 Helicopters

29.7.1 In a slow hover-taxi or stationary hover near the surface, helicopter main rotor(s) generate downwash producing high velocity outwash vortices to a distance approximately three times the diameter of the rotor. When rotor downwash hits the surface, the resulting outwash vortices have behavioral characteristics similar to wing tip vortices produced by fixed-wing aircraft. However, the vortex circulation is outward, upward, around, and away from the main rotor(s) in all directions. Pilots of small aircraft should avoid operating within three rotor diameters of any helicopter in a slow hover-taxi or stationary hover. In forward flight, departing or landing helicopters produce a pair of strong,

high-speed trailing vortices similar to wing tip vortices of larger fixed-wing aircraft. Pilots of small aircraft should use caution when operating behind or crossing behind landing and departing helicopters.

29.8 Pilot Responsibility

29.8.1 Government and industry groups are making concerted efforts to minimize or eliminate the hazards of trailing vortices. However, the flight disciplines necessary to ensure vortex avoidance during VFR operations must be exercised by the pilot. Vortex visualization and avoidance procedures should be exercised by the pilot using the same degree for concern as in collision avoidance.

29.8.2 Wake turbulence may be encountered by aircraft in flight as well as when operating on the airport movement area.

29.8.3 Pilots are reminded that in operations conducted behind all aircraft, acceptance of instructions from ATC in the following situations is an acknowledgment that the pilot will ensure safe takeoff and landing intervals and accepts the responsibility of providing his/her own wake turbulence separation:

29.8.3.1 Traffic information.

29.8.3.2 Instructions to follow an aircraft.

29.8.3.3 The acceptance of a visual approach clearance.

29.8.4 For operations conducted behind heavy aircraft, ATC will specify the word "heavy" when this information is known. Pilots of heavy aircraft should always use the word "heavy" in radio communications.

29.8.5 Heavy and large jet aircraft operators should use the following procedures during an approach to landing. These procedures establish a dependable baseline from which pilots of in-trail, lighter aircraft may reasonably expect to make effective flight path adjustments to avoid serious wake vortex turbulence.

29.8.5.1 Pilots of aircraft that produce strong wake vortices should make every attempt to fly on the established glidepath, not above it; or, if glidepath guidance is not available, to fly as closely as possible to a "3-1" glidepath, not above it.

EXAMPLE–

Fly 3,000 feet at 10 miles from touchdown, 1,500 feet at 5 miles, 1,200 feet at 4 miles, and so on to touchdown.

29.8.5.2 Pilots of aircraft that produce strong wake vortices should fly as closely as possible to the approach course centerline or to the extended centerline of the runway of intended landing as appropriate to conditions.

29.8.6 Pilots operating lighter aircraft on visual approaches in-trail to aircraft producing strong wake vortices should use the following procedures to assist in avoiding wake turbulence. These procedures apply only to those aircraft that are on visual approaches.

29.8.6.1 Pilots of lighter aircraft should fly on or above the glidepath. Glidepath reference may be furnished by an ILS, by a visual approach slope system, by other ground-based approach slope guidance systems, or by other means. In the absence of visible glidepath guidance, pilots may very nearly duplicate a 3-degree glideslope by adhering to the “3 to 1” glidepath principle.

EXAMPLE–

Fly 3,000 feet at 10 miles from touchdown, 1,500 feet at 5 miles, 1,200 feet at 4 miles, and so on to touchdown.

29.8.6.2 If the pilot of the lighter following aircraft has visual contact with the preceding heavier aircraft and also with the runway, the pilot may further adjust for possible wake vortex turbulence by the following practices:

- a) Pick a point of landing no less than 1,000 feet from the arrival end of the runway.
- b) Establish a line-of-sight to that landing point that is above and in front of the heavier preceding aircraft.
- c) When possible, note the point of landing of the heavier preceding aircraft and adjust point of intended landing as necessary.

EXAMPLE–

A puff of smoke may appear at the 1,000-foot markings of the runway, showing that touchdown was at that point; therefore, adjust point of intended landing to the 1,500-foot markings.

- d) Maintain the line-of-sight to the point of intended landing above and ahead of the heavier preceding aircraft; maintain it to touchdown.
- e) Land beyond the point of landing of the preceding heavier aircraft.

29.8.7 During visual approaches pilots may ask ATC for updates on separation and groundspeed with respect to heavier preceding aircraft, especially when there is any question of safe separation from wake turbulence.

29.9 Air Traffic Wake Turbulence Separations

29.9.1 Because of the possible effects of wake turbulence, controllers are required to apply no less than specified minimum separation for aircraft operating behind a heavy jet and, in certain instances, behind large nonheavy aircraft; i.e., B757 aircraft.

29.9.1.1 Separation is applied to aircraft operating directly behind a heavy and/or B757 jet at the same altitude or less than 1,000 feet below:

- a) Heavy jet behind heavy jet–4 miles.
- b) Large/heavy behind B757 – 4 miles.
- c) Small behind B757–5 miles.
- d) Small/large aircraft behind heavy jet – 5 miles.

29.9.1.2 Also, separation, measured at the time the preceding aircraft is over the landing threshold, is provided to small aircraft:

- a) Small aircraft landing behind heavy jet – 6 miles.
- b) Small aircraft landing behind B757 – 5 miles.
- c) Small aircraft landing behind large aircraft – 4 miles.

NOTE–

Aircraft classes are listed in the Pilot/Controller Glossary in the Aeronautical Information Manual.

29.9.1.3 Additionally, appropriate time or distance intervals are provided to departing aircraft. Two minutes or the appropriate 4 or 5 mile radar separation when takeoff behind a heavy/B757 jet will be:

- a) From the same threshold.
- b) On a crossing runway and projected flight paths will cross.
- c) From the threshold of a parallel runway when staggered ahead of that of the adjacent runway by less than 500 feet and when the runways are separated by less than 2,500 feet.

NOTE–

Controllers may not reduce or waive these intervals.

29.9.2 A 3-minute interval will be provided for a small aircraft taking off:

29.9.2.1 From an intersection on the same runway (same or opposite direction) behind a departing large aircraft.

29.9.2.2 In the opposite direction on the same runway behind a large aircraft takeoff or low/missed approach.

NOTE–

This 3-minute interval may be waived upon specific pilot request.

29.9.3 A 3-minute interval will be provided for all aircraft taking off when the operations are as described in paragraph 29.9.2 above, the preceding aircraft is a heavy and/or a B757 jet, and the operations are on either the same runway or parallel runways separated by less than 2,500 feet. Controllers may not reduce or waive this interval.

29.9.4 Pilots may request additional separation; i.e., 2 minutes instead of 4 or 5 miles for wake turbulence avoidance. This request should be made as soon as practical on ground control and at least before taxiing onto the runway.

NOTE–

Federal Aviation Administration Regulations state: “The pilot in command of an aircraft is directly responsible for and is the final authority as to the operation of that aircraft.”

29.9.5 Controllers may anticipate separation and need not withhold a takeoff clearance for an aircraft departing behind a large/heavy aircraft if there is reasonable assurance the required separation will exist when the departing aircraft starts takeoff roll.

30. International Civil Aviation Organization (ICAO) Weather Formats

30.1 The U.S. uses the ICAO world standard for aviation weather reporting and forecasting. The utilization of terminal forecasts affirms U.S. commitment to a single global format for aviation weather. The World Meteorological Organization’s (WMO) publication No. 782, “Aerodrome Reports and Forecasts,” contains the base METAR and TAF code as adopted by the WMO member countries.

30.2 Although the METAR code is adopted worldwide, each country is allowed to make

modifications or exceptions to the code for use in their particular country; e.g., the U.S. will continue to use statute miles for visibility, feet for RVR values, knots for wind speed, inches of mercury for altimetry, and will continue reporting prevailing visibility rather than lowest sector visibility. A METAR report contains the following sequence of elements in the following order:

30.2.1 Type of report.

30.2.2 ICAO station identifier.

30.2.3 Date and time of report.

30.2.4 Modifier (as required).

30.2.5 Wind.

30.2.6 Visibility.

30.2.7 Runway Visual Range (RVR).

30.2.8 Weather phenomena.

30.2.9 Sky conditions.

30.2.10 Temperature/Dew point group.

30.2.11 Altimeter.

30.2.12 Remarks (RMK).

30.3 The following paragraphs describe the elements in a METAR report.

30.3.1 Type of Report. There are two types of reports:

30.3.1.1 The METAR, an aviation routine weather report.

30.3.1.2 The SPECI, a nonroutine (special) aviation weather report.

The type of report (METAR or SPECI) will always appear as the lead element of the report.

30.3.2 ICAO Station Identifier. The METAR code uses ICAO 4-letter station identifiers. In the contiguous 48 states, the 3-letter domestic station identifier is prefixed with a “K”; i.e., the domestic identifier for Seattle is SEA while the ICAO identifier is KSEA. For Alaska, all station identifiers start with “PA”; for Hawaii, all station identifiers start with “PH.” The identifier for the eastern Caribbean is “T” followed by the individual country’s letter; i.e., Puerto Rico is “TJ.” For a complete worldwide listing see ICAO Document 7910, “Location Indicators.”

30.3.3 Date and Time of Report. The date and time the observation is taken are transmitted as a six-digit date/time group appended with Z to denote Coordinated Universal Time (UTC). The first two digits are the date followed with two digits for hour and two digits for minutes.

EXAMPLE–
172345Z (the 17th day of the month at 2345Z)

30.3.4 Modifier (As Required). “AUTO” identifies a METAR/SPECI report as an automated weather report with no human intervention. If “AUTO” is shown in the body of the report, the type of sensor equipment used at the station will be encoded in the remarks section of the report. The absence of “AUTO” indicates that a report was made manually by an observer or that an automated report had human augmentation/backup. The modifier “COR” indicates a corrected report that is sent out to replace an earlier report with an error.

NOTE–
There are two types of automated stations, AO1 for automated weather reporting stations without a precipitation discriminator, and AO2 for automated stations with a precipitation discriminator. (A precipitation discriminator can determine the difference between liquid and frozen/freezing precipitation). This information appears in the remarks section of an automated report.

30.3.5 Wind. The wind is reported as a five digit group (six digits if speed is over 99 knots). The first three digits are the direction from which the wind is blowing, in tens of degrees referenced to true north, or “VRB” if the direction is variable. The next two digits is the wind speed in knots, or if over 99 knots, the next three digits. If the wind is gusty, it is reported as a “G” after the speed followed by the highest gust reported. The abbreviation “KT” is appended to denote the use of knots for wind speed.

EXAMPLE–
13008KT – wind from 130 degrees at 8 knots

08032G45KT – wind from 080 degrees at 32 knots with gusts to 45 knots

VRB04KT – wind variable in direction at 4 knots

00000KT – wind calm

210103G130KT – wind from 210 degrees at 103 knots with gusts to 130 knots

If the wind direction is variable by 60 degrees or more and the speed is greater than 6 knots, a variable group consisting of the extremes of the wind direction separated by a “V” will follow the prevailing wind group.

32012G22KT 280V350

30.3.5.1 Peak Wind. Whenever the peak wind exceeds 25 knots, “PK WND” will be included in Remarks; e.g., PK WND 280045/1955 “Peak wind two eight zero at four five occurred at one nine five five.” If the hour can be inferred from the report time, only the minutes will be appended; e.g., PK WND 34050/38 “Peak wind three four zero at five zero occurred at three eight past the hour.”

30.3.5.2 Wind Shift. Whenever a wind shift occurs, “WSHFT” will be included in remarks followed by the time the wind shift began; e.g., WSHFT 30 FROPA “Wind shift at three zero due to frontal passage.”

30.3.6 Visibility. Prevailing visibility is reported in statute miles with “SM” appended to it.

EXAMPLE–
7SM seven statute miles
15SM fifteen statute miles
1/2SM one-half statute mile

30.3.6.1 Tower/Surface Visibility. If either tower or surface visibility is below 4 statute miles, the lesser of the 2 will be reported in the body of the report; the greater will be reported in remarks.

30.3.6.2 Automated Visibility. ASOS/AWSS visibility stations will show visibility 10 or greater than 10 miles as “10SM.” AWOS visibility stations will show visibility less than 1/4 statute mile as “M¹/₄SM” and visibility 10 or greater than 10 miles as “10SM.”

30.3.6.3 Variable Visibility. Variable visibility is shown in remarks when rapid increase or decrease by 1/2 statute mile or more and the average prevailing visibility is less than 3 statute miles; e.g., VIS 1V2 means “visibility variable between 1 and 2 statute miles.”

30.3.6.4 Sector Visibility. Sector visibility is shown in remarks when it differs from the prevailing visibility, and either the prevailing or sector visibility is less than 3 statute miles.

EXAMPLE–
VIS N2 visibility north two

30.3.7 Runway Visual Range (when reported). “R” identifies the group followed by the runway heading (and parallel runway designator, if needed) “/” and the visual range in feet (meters in other countries) followed with “FT.” (“Feet” is not spoken.)

30.3.7.1 Variability Values. When RVR varies by more than on reportable value, the lowest and highest values are shown with “V” between them.

30.3.7.2 Maximum/Minimum Range. “P” indicates an observed RVR is above the maximum value for this system (spoken as “more than”). “M” indicates an observed RVR is below the minimum value which can be determined by the system (spoken as “less than”).

EXAMPLE-
R32L/1200FT – Runway Three Two Left R-V-R one thousand two hundred

R27R/M1000V4000FT – Runway Two Seven Right R-V-R variable from less than one thousand to four thousand.

30.3.8 Weather Phenomena. In METAR, weather is reported in the format:

Intensity / Proximity / Descriptor /
Precipitation / Obstruction to Visibility /
Other

NOTE-
The “/” above and in the following descriptions (except as the separator between the temperature and dew point) are for separation purposes in this publication and do not appear in the actual METARs.

30.3.8.1 Intensity applies only to the first type of precipitation reported. A “-” denotes light, no symbol denotes moderate, and a “+” denotes heavy.

30.3.8.2 Proximity applies to and is reported only for weather occurring in the vicinity of the airport (between 5 and 10 miles of the point(s) of observation). It is denoted by the letters “VC.” (Intensity and “VC” will not appear together in the weather group.)

30.3.8.3 Descriptor. These eight descriptors apply to the precipitation or obstructions to visibility:

TS	thunderstorm
DR	low drifting
SH	showers
MI	shallow
FZ	freezing
BC	patches
BL	blowing
PR	partial

NOTE-
Although “TS” and “SH” are used with precipitation and may be preceded with an intensity symbol, the intensity still applies to the precipitation not the descriptor.

30.3.8.4 Precipitation. There are nine types of precipitation in the METAR code:

RA	rain
DZ	drizzle
SN	snow
GR	hail (¹ / ₄ or greater)
GS	small hail/snow pellets
PL	ice pellets
SG	snow grains
IC	ice crystals
UP	unknown precipitation (automated stations only)

EXAMPLE-

TSRA	thunderstorm with moderate rain
+SN	heavy snow
-RA FG	light rain and fog
BRHZ	mist and haze (visibility ⁵ / ₈ mile or greater)
FZDZ	freezing drizzle
VCSH	rain shower in the vicinity
+SHRASNPL	heavy rain showers, snow, ice pellets (Intensity indicator refers to the predominant rain.)

30.3.8.5 Obstructions to Visibility. Obscurations are any phenomena in the atmosphere, other than precipitation, that reduce horizontal visibility. There are eight types of obscuration phenomena in the METAR code:

FG	fog (visibility less than $\frac{5}{8}$ mile)
HZ	haze
FU	smoke
PY	spray
BR	mist (visibility $\frac{5}{8}$ –6 miles)
SA	sand
DU	dust
VA	volcanic ash

NOTE–
Fog (FG) is observed or forecast only when the visibility is less than $\frac{5}{8}$ mile. Otherwise, mist (BR) is observed or forecast.

30.3.8.6 Other. There are five categories of other weather phenomena which are reported when they occur:

SQ	squall
SS	sandstorm
DS	duststorm
PO	dust/sand whirls
FC	funnel cloud
+FC	tornado/waterspout

30.3.9 Sky Condition. In METAR, sky condition is reported in the format:

Amount / Height / (Type) or Indefinite Ceiling / Height

30.3.9.1 Amount. The amount of sky cover is reported in eighths of sky cover, using contractions:

SKC	clear (no clouds)
FEW	$>\frac{0}{8}$ to $\frac{2}{8}$ cloud cover
SCT	scattered ($\frac{3}{8}$ to $\frac{4}{8}$ cloud cover)
BKN	broken ($\frac{5}{8}$ to $\frac{7}{8}$ cloud cover)
OVC	overcast ($\frac{8}{8}$ cloud cover)
CB	cumulonimbus when present
TCU	towering cumulus when present

NOTE–

1. “SKC” will be reported at manual stations. “CLR” will be used at automated stations when no clouds below 12,000 feet are reported.

2. A ceiling layer is not designated in the METAR code. For aviation purposes, the ceiling is the lowest broken or overcast layer, or vertical visibility into obscuration. Also, there is no provision for reporting thin layers in the METAR code. When clouds are thin, that layer shall be reported as if it were opaque.

30.3.9.2 Height. Cloud bases are reported with three digits in hundreds of feet. (Clouds above 12,000 feet cannot be reported by an automated station.)

30.3.9.3 Type. If towering cumulus clouds (TCU) or cumulonimbus clouds (CB) are present, they are reported after the height which represents their base.

EXAMPLE–
SCT025TCU BKN080 BKN250 – “two thousand five hundred scattered towering cumulus, ceiling eight thousand broken, two five thousand broken.”

SCT008 OVC012CB – “eight hundred scattered ceiling one thousand two hundred overcast cumulonimbus clouds.”

30.3.9.4 Vertical Visibility (indefinite ceiling height). The height into an indefinite ceiling is preceded by “VV” and followed by three digits indicating the vertical visibility in hundreds of feet. This layer indicates total obscuration.

EXAMPLE–
 $\frac{1}{8}$ SM FG VV006 – visibility one eighth, fog, indefinite ceiling six hundred.

30.3.9.5 Obscurations are reported when the sky is partially obscured by a ground-based phenomena by indicating the amount of obscuration as FEW, SCT, BKN followed by three zeros (000). In remarks, the obscuring phenomenon precedes the amount of obscuration and three zeros.

EXAMPLE–
BKN000 (IN BODY) – “sky partially obscured.”

FU BKN000 (IN REMARKS) – “smoke obscuring five– to seven–eighths of the sky.”

30.3.9.6 When sky conditions include a layer aloft other than clouds, such as smoke or haze, the type of phenomena, sky cover, and height are shown in remarks.

EXAMPLE-

BKN020 (IN BODY) – “ceiling two thousand broken.”
RMK FU BKN020 – “broken layer of smoke aloft, based at two thousand.”

30.3.9.7 Variable Ceiling. When a ceiling is below three thousand and is variable, the remark “CIG” will be shown followed with the lowest and highest ceiling heights separated by a “V.”

EXAMPLE-

CIG 005V010 – “ceiling variable between five hundred and one thousand.”

30.3.9.8 Second Site Sensor. When an automated station uses meteorological discontinuity sensors, remarks will be shown to identify site specific sky conditions which differ and are lower than conditions reported in the body.

EXAMPLE-

CIG 020 RY11 – “ceiling two thousand at Runway One One.”

30.3.9.9 Variable Cloud Layer. When a layer is varying in sky cover, remarks will show the variability range. If there is more than one cloud layer, the variable layer will be identified by including the layer height.

EXAMPLE-

SCT V BKN – “scattered layer variable to broken.”

BKN025 V OVC – “broken layer at two thousand five hundred variable to overcast.”

30.3.9.10 Significant Clouds. When significant clouds are observed, they are shown in remarks, along with the specified information as shown below:

a) Cumulonimbus (CB), or Cumulonimbus Mammatus (CBMAM), distance (if known), direction from the station, and direction of movement, if known. If the clouds are beyond 10 miles from the airport, DSNT will indicate distance.

EXAMPLE-

CB W MOV E – “cumulonimbus west moving east.”

CBMAM DSNT S – “cumulonimbus mammatus distant south.”

b) Towering Cumulus (TCU), location, (if known), or direction from the station.

EXAMPLE-

TCU OHD – “towering cumulus overhead.”

TCU W – “towering cumulus west.”

c) Altocumulus Castellanus (ACC), Stratocumulus Standing Lenticular (SCSL), Altocumulus Standing Lenticular (ACSL), Cirrocumulus Standing Lenticular (CCSL) or rotor clouds, describing the clouds (if needed), and the direction from the station.

ACC W	“altocumulus castellanus west”
ACSL SW-S	“standing lenticular altocumulus southwest through south”
APRNT ROTOR CLD S	“apparent rotor cloud south”
CCSL OVR E	“standing lenticular cirrocumulus over the east”

30.3.10 Temperature/Dew Point. Temperature and dew point are reported in two, two-digit groups in degrees Celsius, separated by a solidus (/). Temperatures below zero are prefixed with an “M.” If the temperature is available but the dew point is missing, the temperature is shown followed by a solidus. If the temperature is missing, the group is omitted from the report.

EXAMPLE-

15/08 “temperature one five, dew point 8”
00/M02 “temperature zero, dew point minus 2”
M05/ “temperature minus five, dew point missing”

30.3.11 Altimeter. Altimeter settings are reported in a four-digit format in inches of mercury prefixed with an “A” to denote the units of pressure.

EXAMPLE-

A2995 “altimeter two niner niner five”

30.3.12 Remarks. Remarks will be included in all observations, when appropriate. The contraction “RMK” denotes the start of the remarks section of a METAR report.

Location of a phenomena within 5 statute miles of the point of observation will be reported as at the station. Phenomena between 5 and 10 statute miles will be reported in the vicinity, “VC.” Phenomena beyond 10 statute miles will be shown as distant, “DSNT.” Distances are in statute miles except for automated lightning remarks which are in nautical miles. Movement of clouds or weather will be indicated by the direction toward which the phenomena is moving.

There are two categories of remarks: Automated, Manual, and Plain Language; and Additive and Automated Maintenance Data.

30.3.12.1 Automated, Manual, and Plain Language Remarks. This group of remarks may be generated from either manual or automated weather reporting stations and generally elaborates on parameters reported in the body of the report. Plain language remarks are only provided by manual stations.

1) Volcanic Eruptions
2) Tornado, Funnel Cloud, Waterspout
3) Type of Automated Station (AO1 or AO2)
4) Peak Wind
5) Wind Shift
6) Tower or Surface Visibility
7) Variable Prevailing Visibility
8) Sector Visibility
9) Visibility at Second Location
10) Dispatch Visual Range
11) Lightning (freq) LTG (type) (loc)
12) Beginning/Ending Time of Precipitation
13) Beginning/Ending Time of Thunderstorms
14) Thunderstorm Location; Movement Direction
15) Hailstone Size
16) Virga
17) Variable Ceiling
18) Obscurations
19) Variable Sky Condition
20) Significant Cloud Types
21) Ceiling Height at Second Location
22) Pressure Rising or Falling Rapidly
23) Sea–Level Pressure
24) Aircraft Mishap (not transmitted)
25) No SPECI Reports Taken
26) Snow Increasing Rapidly
27) Other Significant Information

30.3.12.2 Additive and Automated Maintenance Data Remarks.

1) Hourly Precipitation
2) Precipitation Amount
3) 24–Hour Precipitation
4) Snow Depth on Ground
5) Water Equivalent of Snow on Ground
6) Cloud Types
7) Duration of Sunshine
8) Hourly Temperature and Dew Point (Tenths)
9) 6–Hour Maximum Temperature
10) 6–Hour Minimum Temperature
11) 24–Hour Maximum/Minimum Temperatures
12) Pressure Tendency
13) Sensor Status:
WINO
ZRANO
SNO
VRNO
PNO
VISNO

EXAMPLE–
METAR report and explanation:

METAR KSFO 041453Z AUTO VRB02KT 3SM BR CLR 15/12 A3012 RMK AO2

METAR	Type of report (aviation routine weather report)
KSFO	Station identifier (San Francisco, CA)
041453Z	Date/Time (4th day of month; time 1453 UTC)
AUTO	Fully automated; no human intervention
VRB02KT	Wind (wind variable at two)
3SM	Visibility (visibility three statute miles)
BR	Visibility obscured by mist
CLR	No clouds below one two thousand
15/12	Temperature one five; dew point one two
A3012	Altimeter three zero one two
RMK	Remarks
AO2	This automated station has a weather discriminator (for precipitation).

EXAMPLE-

METAR report and explanation:

METAR KBNA 281250Z 33018KT 290V360 1/2SM R31/2700FT SN BLSN FG VV008 00/M03 A2991 RMK RAE42SNB42

METAR	Aviation routine weather report
KBNA	Nashville, TN
281250Z	28th day of month; time 1250 UTC
(no modifier)	This is a manually generated report, due to the absence of "AUTO" and "AO1 or AO2" in remarks.
33018KT	Wind three three zero at one eight
290V360	Wind variable between two nine zero and three six zero
1/2SM	Visibility one half statute mile
R31/2700FT	Runway three one RVR two thousand seven hundred feet
SN	Moderate snow
BLSN FG	Visibility obscured by blowing snow and fog
VV008	Indefinite ceiling eight hundred
00/M03	Temperature zero; dew point minus three
A2991	Altimeter two niner niner one
RMK	Remarks
RAE36	Rain ended at three six
SNB42	Snow began at four two

EXAMPLE-

SPECI report and explanation:

SPECI KCVG 152224Z 28024G36KT 3/4SM +TSRA BKN008 OVC020CB 28/23 A3000 RMK TSRAB24 TS W MOV E.

SPECI	Nonroutine aviation special weather report
KCVG	Cincinnati, OH
152224Z	15th day of month; time 2224 UTC
(no modifier)	This is a manually generated report due to the absence of "AUTO" and "AO1 or AO2" in remarks.
28024G36KT	Wind two eight zero at two four gusts three six
3/4SM	Visibility three fourths statute mile
+TSRA	Thunderstorms, heavy rain
BKN008	Ceiling eight hundred broken
OVC020CB	Two thousand overcast cumulonimbus clouds
28/23	Temperature two eight; dew point two three
A3000	Altimeter three zero zero zero
RMK	Remarks
TSRAB24	Thunderstorm and rain began at two four
TS W MOV E	Thunderstorm west moving east

30.4 Aerodrome Forecast (TAF). A concise statement of the expected meteorological conditions at an airport during a specified period. At most locations, TAFs have a 24 hour forecast period. However, TAFs for some locations have a 30 hour forecast period. These forecast periods may be shorter in the case of an amended TAF. TAFs use the same codes as METAR weather reports. They are scheduled four times daily for 24-hour periods beginning at 0000Z, 0600Z, 1200Z, and 1800Z.

Forecast times in the TAF are depicted in two ways. The first is a 6-digit number to indicate a specific point in time, consisting of a two-digit date, two-digit hour, and two-digit minute (such as issuance time or FM). The second is a pair of four-digit numbers separated by a “/” to indicate a beginning and end for a period of time. In this case, each four-digit pair consists of a two-digit date and a two-digit hour.

TAFs are issued in the following format:

TYPE OF REPORT/ICAO STATION IDENTIFIER/DATE AND TIME OF ORIGIN/VALID PERIOD DATE AND TIME/FORECAST METEOROLOGICAL CONDITIONS

NOTE–

The “/” above and in the following descriptions are for separation purposes in this publication and do not appear in the actual TAFs.

TAF KORD 051130Z 0512/0618 14008KT 5SM BR BKN030
TEMPO 0513/0516 1 1/2SM BR
FM051600 16010KT P6SM SKC
FM052300 20013G20KT 4SM SHRA OVC020
PROB40 0600/0606 2SM TSRA OVC008CB
BECMG 0606/0608 21015KT P6SM NSW SCT040

TAF format observed in the above example:

TAF = type of report

KORD = ICAO station identifier

051130Z = date and time of origin (issuance time)

0512/0618 = valid period date and times

14008KT 5SM BR BKN030 = forecast meteorological conditions

30.4.1 Explanation of TAF elements

30.4.1.1 Type of Report. There are two types of TAF issuances, a routine forecast issuance (TAF) and an amended forecast (TAF AMD). An amended TAF is issued when the current TAF no longer adequately describes the on-going weather or the forecaster feels the TAF is not representative of the current or expected weather. Corrected (COR) or delayed (RTD) TAFs are identified only in the communications header which precedes the actual forecasts.

30.4.1.2 ICAO Station Identifier. The TAF code uses ICAO 4-letter location identifiers as described in the METAR section.

30.4.1.3 Date and Time of Origin. This element is the date and time the forecast is actually prepared. The format is a two-digit date and four-digit time followed, without a space, by the letter “Z.”

30.4.1.4 Valid Period Date and Time. The UTC valid period of the forecast consists of two four-digit sets, separated by a “/”. The first four-digit set is a two-digit date followed by the two-digit beginning hour, and the second four-digit set is a two-digit date followed by the two-digit ending hour. Although most airports have a 24-hour TAF, a select number of airports have a 30-hour TAF. In the case of an amended forecast, or a forecast which is corrected or delayed, the valid period may be for less than 24 hours. Where an airport or terminal operates on a part-time basis (less than 24 hours/day), the TAFs issued for those locations will have the abbreviated statement “NIL AMD SKED AFT (closing time) Z” added to the end of the forecasts. For the TAFs issued while these locations are closed, the word “NIL” will appear in place of the forecast text. A delayed (RTD) forecast will then be issued for these locations after two complete observations are received.

30.4.1.5 Forecast Meteorological Conditions. This is the body of the TAF. The basic format is:

Wind / Visibility / Weather / Sky Condition /
Optional Data (Wind Shear)

The wind, visibility, and sky condition elements are always included in the initial time group of the forecast. Weather is included only if significant to aviation. If a significant, lasting change in any of the elements is expected during the valid period, a new time period with the changes is included. It should be noted that with the exception of an “FM” group, the new time period will include only those elements

which are expected to change; i.e., if a lowering of the visibility is expected but the wind is expected to remain the same, the new time period reflecting the lower visibility would not include a forecast wind. The forecast wind would remain the same as in the previous time period.

Any temporary conditions expected during a specific time period are included with that time period. The following describes the elements in the above format.

a) Wind. This five (or six) digit group includes the expected wind direction (first 3 digits) and speed (last 2 digits or 3 digits if 100 knots or greater). The contraction “KT” follows to denote the units of wind speed. Wind gusts are noted by the letter “G” appended to the wind speed followed by the highest expected gust.

NOTE-

A variable wind direction is noted by “VRB” where the three digit direction usually appears. A calm wind (3 knots or less) is forecast as “0000KT.”

EXAMPLE-

18010KT – wind one eight zero at one zero (wind is blowing from 180 at 10 knots).

35012G20KT – wind three five zero at one two gust two zero

b) Visibility. The expected prevailing visibility up to and including 6 miles is forecast in statute miles, including fractions of miles, followed by “SM” to note the units of measure. Expected visibilities greater than 6 miles are forecast as P6SM (Plus six statute miles).

EXAMPLE-

*1/2SM visibility one-half
4SM visibility four
P6SM visibility more than six*

c) Weather. The expected weather phenomena is coded in TAF reports using the same format, qualifiers, and phenomena contractions as METAR reports (except UP).

Obscurations to vision will be forecast whenever the prevailing visibility is forecast to be 6 statute miles or less.

If no significant weather is expected to occur during a specific time period in the forecast, the weather group is omitted for that time period. If, after a time period in which significant weather has been forecast, a change to a forecast of no significant weather

occurs, the contraction NSW (no significant weather) will appear as the weather group in the new time period. (NSW is included only in becoming (BECMG) or temporary (TEMPO) groups.)

d) Sky Condition. TAF sky condition forecasts use the METAR format described in the METAR section. Cumulonimbus clouds (CB) are the only cloud type forecast in TAFs.

When clear skies are forecast, the contraction “SKC” will always be used. The contraction “CLR” is never used in the aerodrome forecast (TAF).

When the sky is obscured due to a surface-based phenomenon, vertical visibility (VV) into the obscuration is forecast. The format for vertical visibility is “VV” followed by a three-digit height in hundreds of feet.

NOTE-

As in METAR, ceiling layers are not designated in the TAF code. For aviation purposes, the ceiling is the lowest broken or overcast layer or vertical visibility into a complete obscuration.

SKC	“sky clear”
SCT005 BKN025CB	“five hundred scattered, ceiling two thousand five hundred broken cumulonimbus clouds”
VV008	“indefinite ceiling eight hundred”

e) Optional Data (Wind Shear). Wind Shear is the forecast of non-convective, low-level winds (up to 2,000 feet). The forecast includes the letters “WS” followed by the height of the wind shear, the wind direction and wind speed at the indicated height and the ending letters “KT” (knots). Height is given in hundreds of feet (AGL) up to and including 2,000 feet. Wind shear is encoded with the contraction “WS” followed by a three-digit height, slant character “/” and winds at the height indicated in the same format as surface winds. The wind shear element is omitted if not expected to occur.

WS010/18040KT	“low level wind shear at one thousand, wind one eight zero at four zero”
---------------	--

30.5 Probability Forecast. The probability or chance of thunderstorms or other precipitation events occurring, along with associated weather conditions (wind, visibility, and sky conditions). The PROB30 group is used when the occurrence of thunderstorms

or precipitation is 30–39% and the PROB40 group is used when the occurrence of thunderstorms or precipitation is 40–49%. This is followed by two four–digit groups separated by a “/”, giving the beginning date and hour, and the ending date and hour of the time period during which the thunderstorms or precipitation are expected.

NOTE–

Neither PROB30 nor PROB40 will be shown during the first six hours of a forecast.

EXAMPLE–

PROB40 2221/2302 1/2SM +TSRA “chance between 2100Z and 0200Z of visibility one–half statute mile in thunderstorms and heavy rain.”

PROB30 3010/3014 1SM RASN . “chance between 1000Z and 1400Z of visibility one statute mile in mixed rain and snow.”

30.6 Forecast Change Indicators. The following change indicators are used when either a rapid, gradual, or temporary change is expected in some or all of the forecast meteorological conditions. Each change indicator marks a time group within the TAF report.

30.6.1 From (FM) Group. The FM group is used when a rapid change, usually occurring in less than one hour, in prevailing conditions is expected. Typically, a rapid change of prevailing conditions to more or less a completely new set of prevailing conditions is associated with a synoptic feature passing through the terminal area (cold or warm frontal passage). Appended to the “FM” indicator is the six–digit date, hour, and minute the change is expected to begin and continues until the next change group or until the end of the current forecast. A “FM” group will mark the beginning of a new line in a TAF report (indented 5 spaces). Each “FM” group contains all the required elements–wind, visibility, weather, and sky condition. Weather will be omitted

in “FM” groups when it is not significant to aviation. FM groups will not include the contraction NSW.

EXAMPLE–

FM210100 14010KT P6SM SKC – “after 0100Z on the 21st, wind one four zero at one zero, visibility more than six, sky clear.”

30.6.2 Becoming (BECMG) Group. The BECMG group is used when a gradual change in conditions is expected over a longer time period, usually two hours. The time period when the change is expected is two four–digit groups separated by a “/”, with the beginning date and hour, and ending date and hour of the change period which follows the BECMG indicator. The gradual change will occur at an unspecified time within this time period. Only the changing forecast meteorological conditions are included in BECMG groups. The omitted conditions are carried over from the previous time group.

EXAMPLE–

OVC012 BECMG 0114/0116 BKN020 – “ceiling one thousand two hundred overcast. Then a gradual change to ceiling two thousand broken between 1400Z on the 1st and 1600Z on the 1st.”

30.6.3 Temporary (TEMPO) Group. The TEMPO group is used for any conditions in wind, visibility, weather, or sky condition which are expected to last for generally less than an hour at a time (occasional), and are expected to occur during less than half the time period. The TEMPO indicator is followed by two four–digit groups separated by a “/”. The first four digit group gives the beginning date and hour, and the second four digit group gives the ending date and hour of the time period during which the temporary conditions are expected. Only the changing forecast meteorological conditions are included in TEMPO groups. The omitted conditions are carried over from the previous time group.

EXAMPLE–

1. *SCT030 TEMPO 0519/0523 BKN030 – “three thousand scattered with occasional ceilings three thousand broken between 1900Z on the 5th and 2300Z on the 5th.”*

2. *4SM HZ TEMPO 1900/1906 2SM BR HZ – “visibility four in haze with occasional visibility two in mist and haze between 0000Z on the 19th and 0600Z on the 19th.”*

FIG GEN 3.5-24



Key to Aerodrome Forecast (TAF) and Aviation Routine Weather Report (METAR) (Front)



TAF	KPIT 091730Z 0918/1024 15005KT 5SM HZ FEW020 WS010/31022KT FM091930 30015G25KT 3SM SHRA OVC015 TEMPO 0920/0922 1/2SM +TSRA OVC008CB FM100100 27008KT 5SM SHRA BKN020 OVC040 PROB30 1004/1007 1SM -RA BR FM101015 18005KT 6SM -SHRA OVC020 BECMG 1013/1015 P6SM NSW SKC
NOTE: Users are cautioned to confirm DATE and TIME of the TAF. For example FM100000 is 0000Z on the 10th . Do not confuse with 1000Z!	
METAR	KPIT 091955Z COR 22015G25KT 3/4SM R28L/2600FT TSRA OVC010CB 18/16 A2992 RMK SLP045 T01820159

Forecast	Explanation	Report
TAF	Message type: <u>TAF</u> -routine or <u>TAF AMD</u> -amended forecast, <u>METAR</u> -hourly, <u>SPECI</u> -special or <u>TESTM</u> -non-commissioned ASOS report	METAR
KPIT	ICAO location indicator	KPIT
091730Z	Issuance time: ALL times in UTC " <u>Z</u> ", 2-digit date, 4-digit time	091955Z
0918/1024	Valid period, either 24 hours or 30 hours. The first two digits of EACH four digit number indicate the date of the valid period, the final two digits indicate the time (valid from 18Z on the 9 th to 24Z on the 10 th). In U.S. METAR: <u>COR</u> rected ob; or <u>AUTOM</u> ated ob for automated report with no human intervention; omitted when observer logs on.	COR
15005KT	Wind: 3 digit true-north direction, nearest 10 degrees (or <u>VaRiA</u> ble); next 2-3 digits for speed and unit, <u>KT</u> (KMH or MPS); as needed, <u>G</u> ust and maximum speed; 00000KT for calm; for METAR, if direction varies 60 degrees or more, <u>V</u> ariability appended, e.g., 180 <u>V</u> 260	22015G25KT
5SM	Prevailing visibility; in U.S., Statute <u>M</u> iles & fractions; above 6 miles in TAF Plus <u>6SM</u> . (Or, 4-digit minimum visibility in meters and as required, lowest value with direction)	3/4SM
	Runway Visual Range: <u>R</u> ; 2-digit runway designator <u>L</u> eft, <u>C</u> enter, or <u>R</u> ight as needed; " <u>L</u> ", Minus or Plus in U.S., 4-digit value, <u>F</u> ee <u>T</u> in U.S., (usually meters elsewhere); 4-digit value <u>V</u> ariability 4-digit value (and tendency <u>D</u> own, <u>U</u> p or <u>N</u> o change)	R28L/2600FT
HZ	Significant present, forecast and recent weather: see table (on back)	TSRA
FEW020	Cloud amount, height and type: <u>S</u> ky <u>C</u> lear 0/8, <u>F</u> EW >0/8-2/8, <u>S</u> ca <u>T</u> tered 3/8-4/8, <u>B</u> ro <u>K</u> e <u>N</u> 5/8-7/8, <u>O</u> ver <u>C</u> ast 8/8; 3-digit height in hundreds of ft; <u>T</u> owering <u>C</u> umulus or <u>C</u> umulonim <u>B</u> us in <u>M</u> ETAR; in <u>T</u> AF, only <u>C</u> B. <u>V</u> ertical <u>V</u> isibility for obscured sky and height "VV004". More than 1 layer may be reported or forecast. In automated <u>M</u> ETAR reports only, <u>C</u> lea <u>R</u> for "clear below 12,000 feet"	OVC 010CB
	Temperature: degrees Celsius; first 2 digits, temperature " <u>L</u> " last 2 digits, dew-point temperature; <u>M</u> inus for below zero, e.g., M06	18/16
	Altimeter setting: indicator and 4 digits; in U.S., <u>A</u> -inches and hundredths; (<u>Q</u> -hectoPascals, e.g., Q1013)	A2992
WS010/31022KT	In U.S. <u>T</u> AF, non-convective low-level (≤2,000 ft) <u>W</u> ind <u>S</u> hear; 3-digit height (hundreds of ft); " <u>L</u> "; 3-digit wind direction and 2-3 digit wind speed above the indicated height, and unit, <u>KT</u>	

FIG GEN 3.5-25



Key to Aerodrome Forecast (TAF) and Aviation Routine Weather Report (METAR) (Back)



	In METAR , ReMarK indicator & remarks. For example: Sea- Level Pressure in hectoPascals & tenths, as shown: 1004.5 hPa; Temp/ dew-point in tenths °C, as shown: temp. 18.2°C, dew-point 15.9°C	RMK SLP045 T01820159
FM091930	FroM : changes are expected at: 2-digit date, 2-digit hour, and 2-digit minute beginning time: indicates significant change. Each FM starts on a new line, indented 5 spaces	
TEMPO 0920/0922	TEMPO rary: changes expected for <1 hour and in total, < half of the period between the 2-digit date and 2-digit hour beginning, and 2-digit date and 2-digit hour ending time	
PROB30 1004/1007	PROB ability and 2-digit percent (30 or 40): probable condition in the period between the 2-digit date & 2-digit hour beginning time, and the 2-digit date and 2-digit hour ending time	
BECMG 1013/1015	BECO minG: change expected in the period between the 2-digit date and 2-digit hour beginning time, and the 2-digit date and 2-digit hour ending time	

Table of Significant Present, Forecast and Recent Weather - Grouped in categories and used in the order listed below; or as needed in TAF, No Significant Weather.			
Qualifiers			
Intensity or Proximity			
“.” = Light	No sign = Moderate	“+” = Heavy	
“VC” = Vicinity, but not at aerodrome. In the US METAR, 5 to 10 SM from the point of observation. In the US TAF, 5 to 10 SM from the center of the runway complex. Elsewhere, within 8000m.			
Descriptor			
BC – Patches	BL – Blowing	DR – Drifting	FZ – Freezing
MI – Shallow	PR – Partial	SH – Showers	TS – Thunderstorm
Weather Phenomena			
Precipitation			
DZ – Drizzle	GR – Hail	GS – Small Hail/Snow Pellets	
IC – Ice Crystals	PL – Ice Pellets	RA – Rain	SG – Snow Grains
SN – Snow	UP – Unknown Precipitation in automated observations		
Obscuration			
BR – Mist (≥5/8SM)	DU – Widespread Dust	FG – Fog (<5/8SM)	FU – Smoke
HZ – Haze	PY – Spray	SA – Sand	VA – Volcanic Ash
Other			
DS – Dust Storm	FC – Funnel Cloud	+FC – Tornado or Waterspout	
PO – Well developed dust or sand whirls		SQ – Squall	SS – Sandstorm
<ul style="list-style-type: none"> - Explanations in parentheses “()” indicate different worldwide practices. - Ceiling is not specified; defined as the lowest broken or overcast layer, or the vertical visibility. - NWS TAFs exclude BECMG groups and temperature forecasts, NWS TAFS do not use PROB in the first 9 hours of a TAF; NWS METARs exclude trend forecasts. US Military TAFs include Turbulence and Icing groups. 			

31. Meteorological Broadcasts (ATIS, VHF and LF)

31.1 Continuous Transcribed Weather Broadcasts (TWEB)

31.1.1 Weather broadcasts are made continuously over selected navigational aids. These broadcasts contain the general weather forecasts and winds up to 12,000 feet within a 250-mile radius of the radio. In some cases the forecasts are for route of flight rather than the general area. They also broadcast pilot reports, radar reports, and hourly weather reports of selected locations within a 400-mile radius of the broadcast station.

31.2 Automatic Terminal Information Service (ATIS) Broadcasts

31.2.1 These broadcasts are made continuously and include as weather information only the ceiling, visibility, wind, and altimeter setting of the aerodrome at which they are located.

31.3 Scheduled Weather Broadcasts (SWB)

31.3.1 Scheduled broadcasts are made only in Alaska at 15 minutes past the hour over en route navigational aids not used for TWEB or ATIS. These broadcasts contain hourly weather reports of selected locations within 150 miles of the station and weather

advisories, pilot weather reports, radar weather reports, and Notices to Airmen (NOTAMs).

31.4 Navigational Aids Providing Broadcast Services

31.4.1 A compilation of navigational aids over which weather broadcasts are transmitted is not available for this publication. Complete information concerning all navigational aids providing this service is contained in the Airport/Facility directory. Similar information for the Pacific and Alaskan areas is contained in the Pacific and Alaska Supplements.

31.5 Hazardous Inflight Weather Advisory Service (HIWAS)

31.5.1 A 24-hour continuous broadcast of hazardous inflight weather is available on selected navigational outlets. Broadcasts include: severe weather forecast alerts (AWW), airman's meteorological information (AIRMET—text [WA] or graphical [G-AIRMET] product), significant meteorological information (SIGMET), Convective SIGMET (WST), urgent pilot weather reports (UUA), hazardous portions of the domestic area forecasts (FA), and center weather advisories (CWA). HIWAS broadcast outlets are identified on en route/sectional charts and in airport facility directories. For further details, contact your nearest FSS.

TBL GEN 3.5-12

Meteorological Broadcasts (VOLMET)							
Name	Call Sign	Frequency	Broadcast	Form	Contents	Emission	Remarks
Honolulu	Honolulu Radio	2863, 6679, 8828, 13282 kHz	H00-05 and H30-35	Forecasts	PHNL Honolulu PHTO Hilo PGUM Guam	Voice	Plain language English
				SIGMET	Oakland FIR		
				Hourly Reports	PHNL Honolulu PHTO Hilo PHOG Kahului PGUM Guam		
			E05-10 and E35-40	Hourly Reports	KSFO San Francisco KSEA Seattle KLAX Los Angeles KPDX Portland KSMF Sacramento KONT Ontario KLAS Las Vegas		
				SIGMET	Oakland FIR		
				Aerodrome Forecasts	KSFO San Francisco KSEA Seattle KLAX Los Angeles		
			E25-30 and E55-00	Hourly Reports	PANC Anchorage PAED ElmendorfAFB PAFA Fairbanks PACD Cold Bay PAKN King Salmon CYVR Vancouver		
				SIGMET	Oakland FIR		
				Forecasts	PANC Anchorage PAFA Fairbanks PACD Cold Bay CYVR Vancouver		
New York	New York Radio	3485, 6604, 10051, 13270 kHz	H00-05	Aerodrome Forecasts	KDTW Detroit KCLE Cleveland KCVG Cincinnati	Voice	Plain language English
				Hourly Reports	KDTW Detroit KCLE Cleveland KCVG Cincinnati KIND Indianapolis KPIT Pittsburgh		
			H05-10	SIGMET	Oceanic - New York FIR		
				Aerodrome Forecasts	KBGR Bangor KBDL Windsor Locks KCLT Charlotte		
				Hourly Reports	KBGR Bangor KBDL Windsor Locks KORF Norfolk KCLT Charlotte		
			H10-15	Aerodrome Forecasts	KJFK New York KEWR Newark KBOS Boston		
				Hourly Reports	KJFK New York KEWR Newark KBOS Boston KBAL Baltimore KIAD Washington		

Meteorological Broadcasts (VOLMET) – continued							
Name	Call Sign	Frequency	Broadcast	Form	Contents	Emission	Remarks
			H15-20	SIGMET	Oceanic – Miami FIR/San Juan FIR		
				Aerodrome Forecasts	MXKF Bermuda KMIA Miami KATL Atlanta		
				Hourly Reports	MXKF Bermuda KMIA Miami MYNN Nassau KMCO Orlando KATL Atlanta		
			H30-35	Aerodrome Forecasts	KORD Chicago KMKE Milwaukee KMSP Minneapolis		
				Hourly Reports	KORD Chicago KMKE Milwaukee KMSP Minneapolis KDTW Detroit KBOS Boston		
			E35-40	SIGMET	Oceanic – New York FIR		
				Aerodrome Forecasts	KIND Indianapolis KSTL St. Louis KPIT Pittsburgh		
				Hourly Reports	KIND Indianapolis KSTL St. Louis KPIT Pittsburgh KACY Atlantic City		
			E40-45	Aerodrome Forecasts	KBAL Baltimore KPHL Philadelphia KIAD Washington		
				Hourly Reports	KBAL Baltimore KPHL Philadelphia KIAD Washington KJFK New York KEWR Newark		
			E45-50	SIGMET	Oceanic – Miami FIR/San Juan FIR		
				Aerodrome Forecasts	MYNN Nassau KMCO Orlando		
				Hourly Reports	MXKF Bermuda KMIA Miami MYNN Nassau KMCO Orlando KATL Atlanta KTPA Tampa KPBI West Palm Beach		
All stations operate on A3 emission H24.							
All broadcasts are made 24 hours daily, seven days a week.							

FIG GEN 3.5-26

Key to Decode an ASOS/AWSS (METAR) Observation (Front)

<p>METAR KABC 121755Z AUTO 21016G24KT 180V240 1SM R11/P6000FT -RA BR BKN015 OVC025 06/04 A2990 RMK A02 PK WND 20032/25 WSHFT 1715 VIS 3/4V1 1/2 VIS 3/4 RWY11 RAB07 CIG 013V017 CIG 017 RWY11 PRESFR SLP125 P0003 6009 T00640036 10066 21012 58033 TSNO \$</p>		METAR
TYPE OF REPORT	METAR: hourly (scheduled report); SPECI: special (unscheduled) report.	KABC
STATION IDENTIFIER	Four alphabetic characters; ICAO location identifiers.	121755Z
DATE/TIME	All dates and times in UTC using a 24-hour clock; two-digit date and four-digit time; always appended with <u>Z</u> to indicate UTC.	AUTO
REPORT MODIFIER	Fully automated report, no human intervention; removed when observer signed-on.	21016G24KT 108V240
WIND DIRECTION AND SPEED	Direction in tens of degrees from true north (first three digits); next two digits: speed in whole knots; as needed <u>G</u> usts (character) followed by maximum observed speed; always appended with <u>K</u> T to indicate knots; 00000KT for calm; if direction varies by 60° or more a <u>V</u> ariable wind direction group is reported.	ISM
VISIBILITY	Prevailing visibility in statute miles and fractions (space between whole miles and fractions); always appended with <u>M</u> to indicate statute miles.	R11/P6000FT
RUNWAY VISUAL RANGE	10-minute RVR value in hundreds of feet; reported if prevailing visibility is ≤ one mile or RVR ≤6000 feet; always appended with <u>FT</u> to indicate feet; value prefixed with <u>M</u> or <u>P</u> to indicate value is lower or higher than the reportable RVR value.	-RA BR
WEATHER PHENOMENA	RA: liquid precipitation that does not freeze; SN: frozen precipitation other than hail; UP: precipitation of unknown type; intensity prefixed to precipitation: light (-), moderate (no sign), heavy (+); FG: fog; FZFG: freezing fog (temperature below 0°C); BR: mist; HZ: haze; SQ: squall; maximum of three groups reported; augmented by observer: FC (funnel cloud/tornado/waterspout); TS(thunderstorm); GR (hail); GS (small hail; <1/4 inch); FZRA (intensity; freezing rain); VA (volcanic ash).	BKN015 OVC025
SKY CONDITION	Cloud amount and height: CLR (no clouds detected below 12000 feet); FEW (few); SCT (scattered); BKN (broken); OVC (overcast); followed by 3-digit height in hundreds of feet; or vertical visibility (<u>VV</u>) followed by height for indefinite ceiling.	06/04
TEMPERATURE/DEW POINT	Each is reported in whole degrees Celsius using two digits; values are separated by a solidus; sub-zero values are prefixed with an <u>M</u> (minus).	A2990
ALTIMETER	Altimeter always prefixed with an <u>A</u> indicating inches of mercury; reported using four digits: tens, units, tenths, and hundredths.	

FIG GEN 3.5-27

Key to Decode an ASOS/AWSS (METAR) Observation (Back)

REMARKS IDENTIFIER: RMK	RMK
TORNADIC ACTIVITY: Augmented; report should include TORNADO, FUNNEL CLOUD, or WATERSPOUT, time begin/end, location, movement; e.g., TORNADO B25 N MOV E.	
TYPE OF AUTOMATED STATION: AO2; automated station with precipitation discriminator.	AO2
PEAK WIND: PK WND dddd(f)/(hh)mm; direction in tens of degrees, speed in whole knots, and time.	PK WND 20032/25
WIND SHIFT: WSHIFT (hh)mm	WSHFT 1715
TOWER OR SURFACE VISIBILITY: TWR VIS vvvvv; visibility reported by tower personnel, e.g., TWR VIS 2; SFC VIS vvvvv; visibility reported by ASOS, e.g., SFC VIS 2.	
VARIABLE PREVAILING VISIBILITY: VIS v _n V _n V _n V _n V _n V _n V _n ; reported if prevailing visibility is <3 miles and variable.	VIS 3/4V1 1/2
VISIBILITY AT SECOND LOCATION: VIS vvvvv [LOC]; reported if different than the reported prevailing visibility in body of report.	VIS 3/4 RWY11
LIGHTNING: [FREQ] LTG [LOC]; when detected the frequency and location is reported, e.g., FRQ LTG NE.	
BEGINNING AND ENDING OF PRECIPITATION AND THUNDERSTORMS: w'w'B(hh)mmE(hh)mm	RAB07
VIRGA: Augmented; precipitation not reaching the ground, e.g., VIRGA.	
VARIABLE CEILING HEIGHT: CIG h _n h _n h _n Vh _n h _n h _n ; reported if ceiling in body of report is <3000 feet and variable.	CIG 013V017
CEILING HEIGHT AT SECOND LOCATION: CIG hhh [LOC]; Ceiling height reported if secondary ceilometer site is different than the ceiling height in the body of the report.	CIG 017 RWY11
PRESSURE RISING OR FALLING RAPIDLY: PRESRR or PRESFR; pressure rising or falling rapidly at time of observation.	PRESFR
SEA-LEVEL PRESSURE: SLPppp; tens, units, and tenths of SLP in hPa.	SLP125
HOURLY PRECIPITATION AMOUNT: Prrrr; in .01 inches since last METAR; a trace is P0000.	P0003
3- AND 6-HOUR PRECIPITATION AMOUNT: 6RRRR; precipitation amount in .01 inches for past 6 hours reported in 00, 06, 12, and 18 UTC observations and for past 3 hours in 03, 09, 15, and 21 UTC observations; a trace is 60000.	60009
24-HOUR PRECIPITATION AMOUNT: 7R ₂₄ R ₂₄ R ₂₄ ; precipitation amount in .01 inches for past 24 hours reported in 12 UTC observation, e.g., 70015.	
HOURLY TEMPERATURE AND DEW POINT: Ts _n T _a T _s T _a T _n T _a T _s T _a ; tenth of degree Celsius; s _n : 1 if temperature below 0° C and 0 if temperature 0° C or higher.	T00640036
6-HOUR MAXIMUM TEMPERATURE: 1s _n T _x T _x T _x ; tenth of degree Celsius; 00, 06, 12, 18 UTC; s _n : 1 if temperature below 0° C and 0 if temperature 0° C or higher.	10066
6-HOUR MINIMUM TEMPERATURE: 2s _n T _n T _n T _n ; tenth of degree Celsius; 00, 06, 12, 18 UTC; s _n : 1 if temperature below 0° C and 0 if temperature 0° C or higher.	21012
24-HOUR MAXIMUM AND MINIMUM TEMPERATURE: 4s _n T _x T _x T _x T _x T _n T _n T _n T _n ; tenth of degree Celsius; reported at midnight local standard time; 1 if temperature below 0° C and 0 if temperature 0° C or higher, e.g., 400461006.	
PRESSURE TENDENCY: 5app; the character (a) and change in pressure (ppp); tenths of hPa) the past 3 hours.	58033
SENSOR STATUS INDICATORS: RVRNO: RVR missing; PWNO: precipitation identifier information not available; PNO: precipitation amount not available; FZRANO: freezing rain information not available; TSNO: thunderstorm information not available; VISNO [LOC]: visibility at secondary location not available, e.g., VISNO RWY06; CHINO [LOC]: (cloud-height-indicator) sky condition at secondary location not available, e.g., CHINO RWY06.	TSNO
MAINTENANCE CHECK INDICATOR: Maintenance needed on the system.	\$

If an element or phenomena does not occur, is missing, or cannot be observed, the corresponding group and space are omitted (body and/or remarks) from that particular report, except for Sea-Level Pressure (SLPppp). SLPNO shall be reported in a METAR when the SLP is not available.
U.S. DEPARTMENT OF TRANSPORTATION • FEDERAL AVIATION ADMINISTRATION • Aviation Weather Directorate, 400 7th Street, SW, Rooms 8200-8326, Washington, D.C. 20591

FIG GEN 3.5-28
NEXRAD Coverage

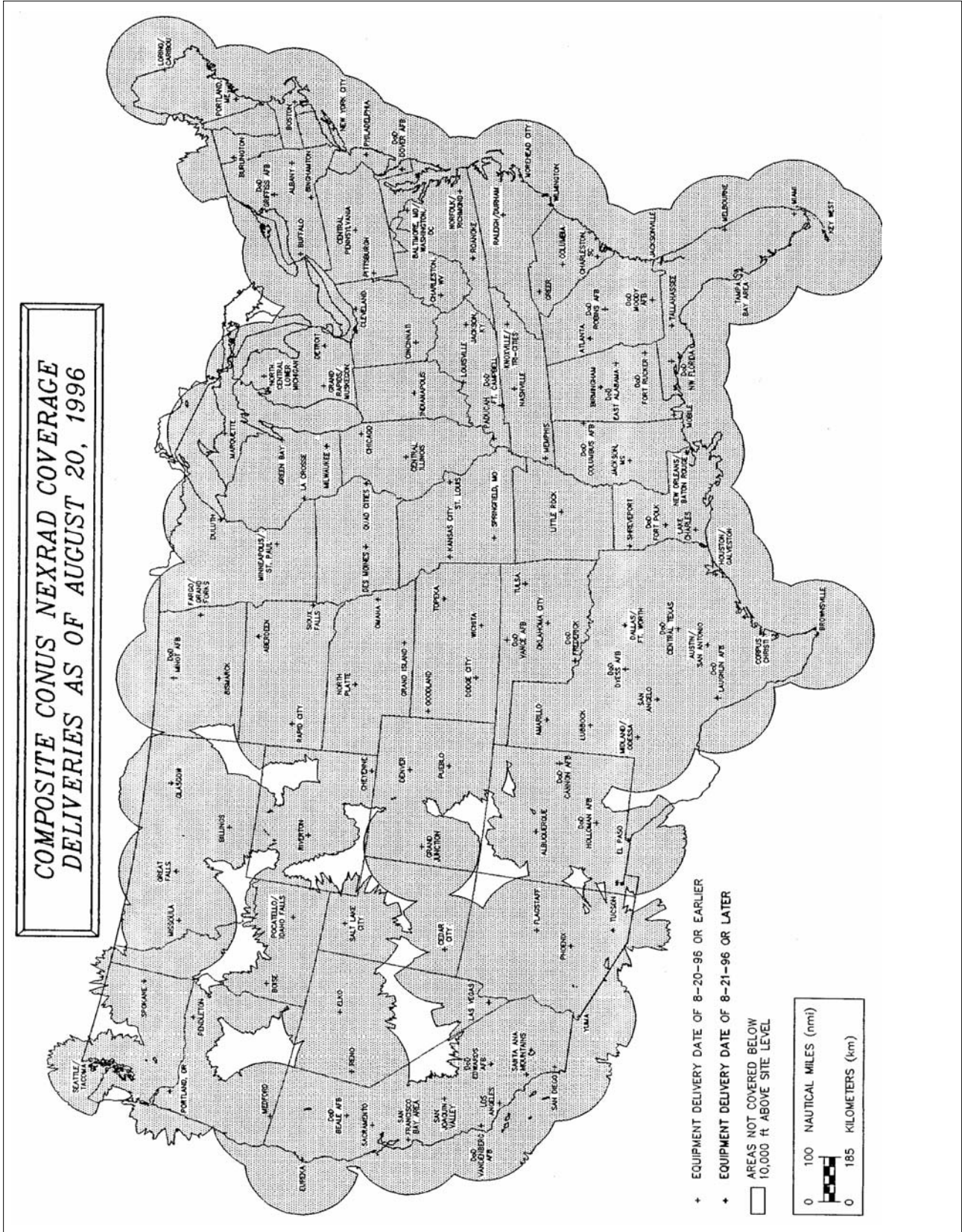

FIG GEN 3.5-29
NEXRAD Coverage

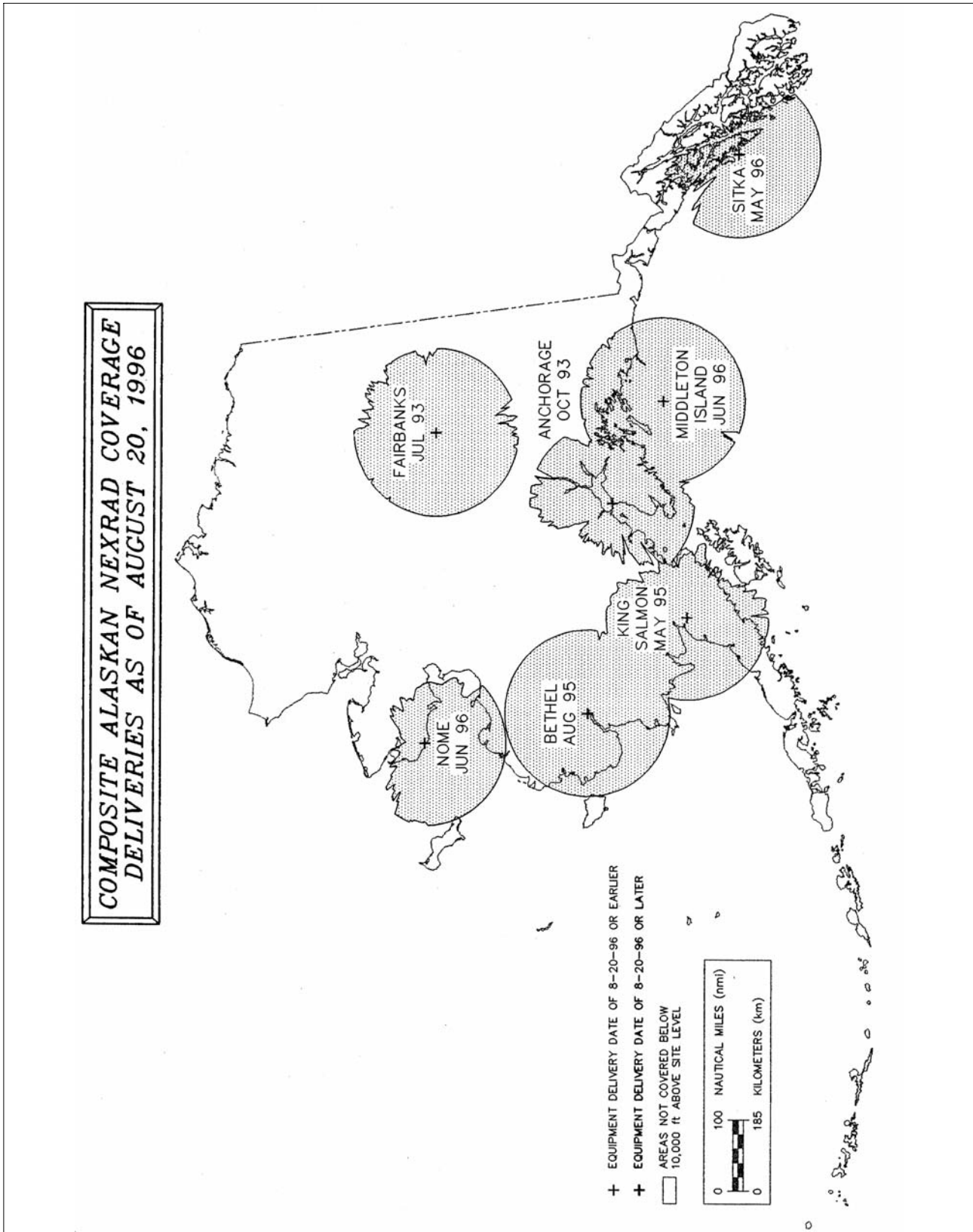

FIG GEN 3.5-30
NEXRAD Coverage

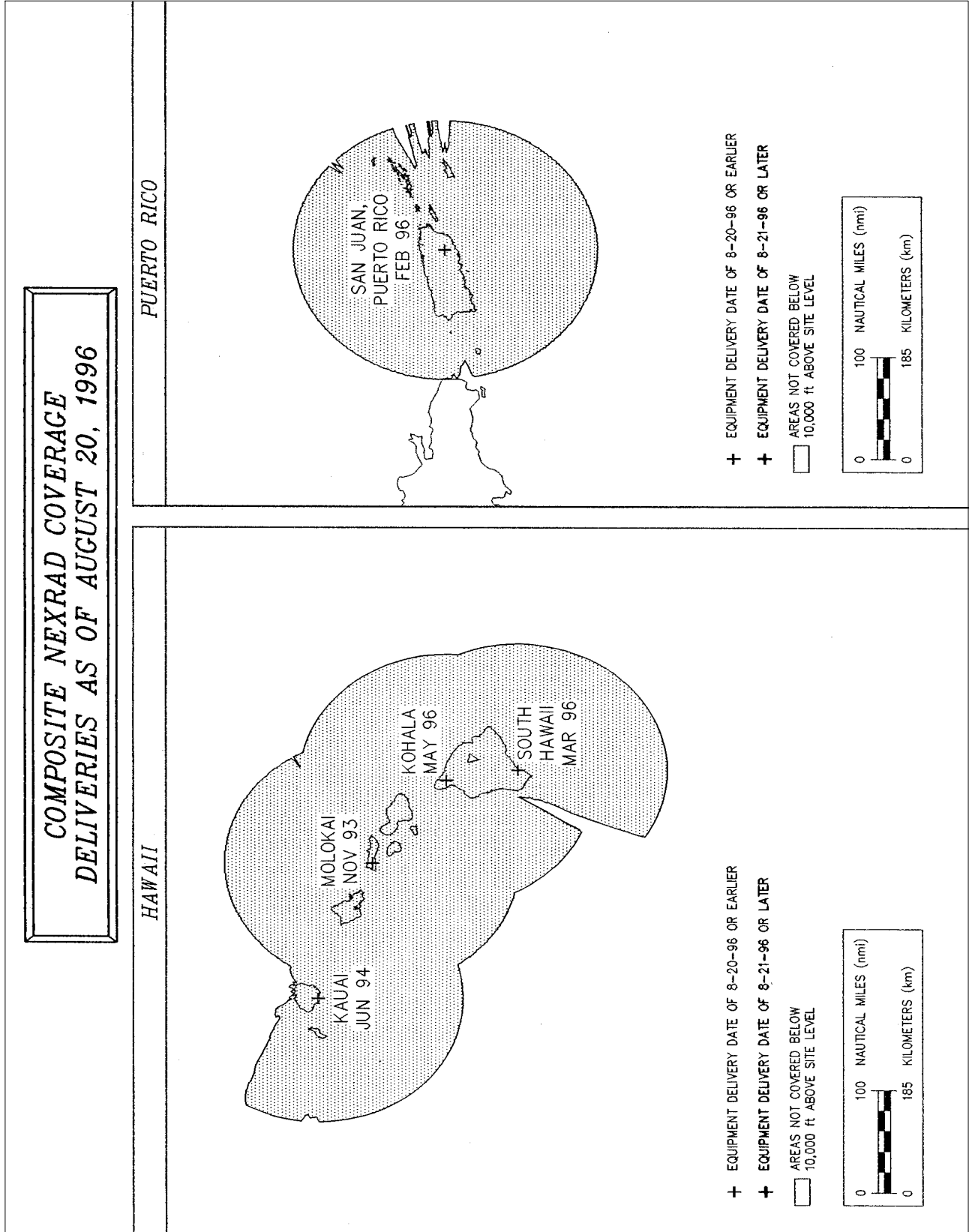

FIG GEN 3.5-31

Volcanic Activity Reporting Form (VAR)

Date _____

SECTION 1 - Transmit to ATC via radio	1. Aircraft Identification			
	2. Position			
	3. Time (UTC)			
	4. Flight level or altitude			
	5. Position/location of volcanic activity or ash cloud			
	6. Air temperature			
	7. Wind			
	8. Supplementary Information (Brief description of activity including vertical and lateral extent of the ash cloud, horizontal movement, rate of growth, etc., as available.)			
Mark the appropriate box(s)				
SECTION 2 - Complete and forward as directed	9. Density of ash cloud	<input type="checkbox"/> wispy	<input type="checkbox"/> moderately dense	<input type="checkbox"/> very dense
	10. Color of ash	<input type="checkbox"/> white <input type="checkbox"/> black	<input type="checkbox"/> light gray	<input type="checkbox"/> dark gray
	11. Eruption	<input type="checkbox"/> continuous	<input type="checkbox"/> intermittent	<input type="checkbox"/> not visible
	12. Position of activity	<input type="checkbox"/> summit <input type="checkbox"/> multiple	<input type="checkbox"/> side <input type="checkbox"/> not observed	<input type="checkbox"/> single
	13. Other observed features of eruption	<input type="checkbox"/> lightning <input type="checkbox"/> ash fallout	<input type="checkbox"/> glow <input type="checkbox"/> mushroom cloud	<input type="checkbox"/> large rocks <input type="checkbox"/> none
	14. Effect on aircraft	<input type="checkbox"/> communications <input type="checkbox"/> pitot static <input type="checkbox"/> none	<input type="checkbox"/> navigation system <input type="checkbox"/> windscreen	<input type="checkbox"/> engines <input type="checkbox"/> other windows
	15. Other effects	<input type="checkbox"/> turbulence <input type="checkbox"/> ash deposits	<input type="checkbox"/> St. Elmo's fire	<input type="checkbox"/> fumes
	16. Other information deemed useful			

Forward completed form via mail to:
Global Volcanism Program
NHB-119
Smithsonian Institution
Washington, DC 20560

Or Fax to:
Global Volcanism Program
(202) 357-2476

GEN 3.6 Search and Rescue

1. Responsible Authority

1.1 The Search and Rescue (SAR) service in the U.S. and its area of jurisdiction is organized in accordance with the Standards and Recommended Practices of ICAO Annex 12 by the Federal Aviation Administration with the collaboration of the U.S. Coast Guard and the U.S. Air Force. The Coast Guard and the Air Force are the responsible SAR authorities and have the responsibility for making the necessary facilities available. Postal and telegraphic addresses for the Federal Aviation Administration are given in . The appropriate addresses for Coast Guard and Air Force offices are:

Air Force

Postal Address:

Inland SAR Coordinator
Commander ARRS
USAF RCC
Tyndall AFB, FL

Telegraphic Address: None.

Telex: None.

Telephone: 1-800-851-3051,

Commercial: 850-283-5955, or

Defense Switching Network: 523-5955.

Coast Guard

Postal Address:

United States Coast Guard
Search and Rescue Division (GOSR/73)
400 7th Street, S.W.
Washington, D.C. 20590

Telegraphic Address: None.

Telex: 89 2427

2. Types of Service

2.1 Details of the Rescue Coordination Centers (RCCs) and related rescue units are given in this section. In addition, various elements of state and local police organizations are available for search and rescue missions when required. The aeronautical, maritime and public telecommunication services are available to the search and rescue organizations.

2.2 Aircraft, both land and amphibious based, are used, as well as land and seagoing vessels, when required, and carry survival equipment. Airborne

survival equipment, capable of being dropped, consists of inflatable rubber dinghies equipped with medical supplies, emergency rations and survival radio equipment. Aircraft and marine craft are equipped to communicate on 121.5, 123.1, 243.0, 500 kHz, 2182 kHz, and 8364 kHz. Ground rescue teams are equipped to communicate on 121.5 MHz, 500 kHz, and 8364 kHz. SAR aircraft and marine craft are equipped with direction finding equipment and radar.

3. SAR Agreements

3.1 Bilateral agreements exist between the U.S. and the following neighboring States of the NAM region: Canada and Mexico.

3.1.1 There are two agreements with Canada. One provides for public aircraft of either country which are engaged in air search and rescue operations to enter or leave either country without being subjected to immigration or customs formalities normally required. The other permits vessels and wrecking appliances of either country to render aid and assistance on specified border waters and on the shores and in the waters of the other country along the Atlantic and Pacific Coasts within a distance of 30 miles from the international boundary on those coasts. A post operations report is required.

3.1.2 The agreement with Mexico applies to territorial waters and shores of each country within 200 miles of the border on the Gulf Coast and within 270 miles of the border on the Pacific Coast. It permits the vessels and aircraft of either country to proceed to the assistance of a distressed vessel or aircraft of their own registry upon notification of entry and of departure of the applicable waters and shores.

3.2 In situations not falling under the above agreements, requests from States to participate in a SAR operation within the U.S. for aircraft of their own registry may be addressed to the nearest RCC. The RCC would reply, and issue appropriate instructions.

4. General Conditions of Availability

4.1 The SAR service and facilities in the U.S. are available to the neighboring States within the NAM, NAT, CAR, PAC Regions upon request to the appropriate RCC at all times when they are not engaged in search and rescue activity in their home territory. All facilities are specialized in SAR techniques and functions.

5. Applicable ICAO Documents

Annex 12	Search and Rescue
Annex 13	Aircraft Accident Inquiry
Doc 7030	Regional Supplementary Procedures for Alerting and Search and Rescue Services applicable to the NAM, NAT, CAR, PAC Regions.

6. Differences from ICAO Standards, Recommended Practices and Procedures

6.1 Differences from ICAO Standards, Recommended Practices and Procedures are listed in GEN 1.7.

7. Emergency Locator Transmitters

7.1 General

7.1.1 ELTs are required for most General Aviation airplanes.

*REFERENCE—
14 CFR SECTION 91.207.*

7.1.2 ELTs of various types were developed as a means of locating downed aircraft. These electronic, battery operated transmitters operate on one of three frequencies. These operating frequencies are 121.5 MHz, 243.0 MHz, and the newer 406 MHz. ELTs operating on 121.5 MHz and 243.0 MHz are analog devices. The newer 406 MHz ELT is a digital transmitter that can be encoded with the owner's contact information or aircraft data. The latest 406 MHz ELT models can also be encoded with the aircraft's position data which can help SAR forces locate the aircraft much more quickly after a crash. The 406 MHz ELTs also transmits a stronger signal when activated than the older 121.5 MHz ELTs.

7.1.2.1 The Federal Communications Commission (FCC) requires 406 MHz ELTs be registered with the

National Oceanic and Atmospheric Administration (NOAA) as outlined in the ELT's documentation. The FAA's 406 MHz ELT Technical Standard Order (TSO) TSO-C126 also requires that each 406 MHz ELT be registered with NOAA. The reason is NOAA maintains the owner registration database for U.S. registered 406 MHz alerting devices, which includes ELTs. NOAA also operates the United States' portion of the Cospas-Sarsat satellite distress alerting system designed to detect activated ELTs and other distress alerting devices.

7.1.2.2 In the event that a properly registered 406 MHz ELT activates, the Cospas-Sarsat satellite system can decode the owner's information and provide that data to the appropriate search and rescue (SAR) center. In the United States, NOAA provides the alert data to the appropriate U.S. Air Force Rescue Coordination Center (RCC) or U.S. Coast Guard Rescue Coordination Center. That RCC can then telephone or contact the owner to verify the status of the aircraft. If the aircraft is safely secured in a hangar, a costly ground or airborne search is avoided. In the case of an inadvertent 406 MHz ELT activation, the owner can deactivate the 406 MHz ELT. If the 406 MHz ELT equipped aircraft is being flown, the RCC can quickly activate a search. 406 MHz ELTs permit the Cospas-Sarsat satellite system to narrow the search area to a more confined area compared to that of a 121.5 MHz or 243.0 MHz ELT. 406 MHz ELTs also include a low-power 121.5 MHz homing transmitter to aid searchers in finding the aircraft in the terminal search phase.

7.1.2.3 Each analog ELT emits a distinctive downward swept audio tone on 121.5 MHz and 243.0 MHz.

7.1.2.4 If "armed" and when subject to crash-generated forces, ELTs are designed to automatically activate and continuously emit their respective signals, analog or digital. The transmitters will operate continuously for at least 48 hours over a wide temperature range. A properly installed, maintained, and functioning ELT can expedite search and rescue operations and save lives if it survives the crash and is activated.

7.1.2.5 Pilots and their passengers should know how to activate the aircraft's ELT if manual activation is required. They should also be able to verify the aircraft's ELT is functioning and transmitting an alert after a crash or manual activation.

7.1.2.6 Because of the large number of 121.5 MHz ELT false alerts and the lack of a quick means of verifying the actual status of an activated 121.5 MHz or 243.0 MHz analog ELT through an owner registration database, U.S. SAR forces do not respond as quickly to initial 121.5/243.0 MHz ELT alerts as the SAR forces do to 406 MHz ELT alerts. Compared to the almost instantaneous detection of a 406 MHz ELT, SAR forces' normal practice is to wait for either a confirmation of a 121.5/243.0 MHz alert by additional satellite passes or through confirmation of an overdue aircraft or similar notification. In some cases, this confirmation process can take hours. SAR forces can initiate a response to 406 MHz alerts in minutes compared to the potential delay of hours for a 121.5/243.0 MHz ELT.

7.1.3 The Cospas-Sarsat system has announced the termination of satellite monitoring and reception of the 121.5 MHz and 243.0 MHz frequencies in 2009. The Cospas-Sarsat system will continue to monitor the 406 MHz frequency. What this means for pilots is that after the termination date, those aircraft with only 121.5 MHz or 243.0 MHz ELTs onboard will have to depend upon either a nearby Air Traffic Control facility receiving the alert signal or an overflying aircraft monitoring 121.5 MHz or 243.0 MHz detecting the alert. To ensure adequate monitoring of these frequencies and timely alerts after 2009, all airborne pilots should periodically monitor these frequencies to try and detect an activated 121.5/243.0 MHz ELT.

7.2 ELT Testing

7.2.1 ELTs should be tested in accordance with the manufacturer's instructions, preferably in a shielded or screened room or specially designed test container to prevent the broadcast of signals which could trigger a false alert.

7.2.2 When this cannot be done, aircraft operational testing is authorized as follows:

7.2.2.1 Analog 121.5/243 MHz ELTs should only be tested during the first 5 minutes after any hour. If operational tests must be made outside of this period, they should be coordinated with the nearest FAA Control Tower or FSS. Tests should be no longer than three audible sweeps. If the antenna is removable, a dummy load should be substituted during test procedures.

7.2.2.2 Digital 406 MHz ELTs should only be tested in accordance with the unit's manufacturer's instructions.

7.2.2.3 Airborne tests are not authorized.

7.3 False Alarms

7.3.1 Caution should be exercised to prevent the inadvertent activation of ELTs in the air or while they are being handled on the ground. Accidental or unauthorized activation will generate an emergency signal that cannot be distinguished from the real thing, leading to expensive and frustrating searches. A false ELT signal could also interfere with genuine emergency transmissions and hinder or prevent the timely location of crash sites. Frequent false alarms could also result in complacency and decrease the vigorous reaction that must be attached to all ELT signals.

7.3.2 Numerous cases of inadvertent activation have occurred as a result of aerobatics, hard landings, movement by ground crews and aircraft maintenance. These false alarms can be minimized by monitoring 121.5 MHz and/or 243.0 MHz as follows:

7.3.2.1 In flight when a receiver is available.

7.3.2.2 Before engine shut down at the end of each flight.

7.3.2.3 When the ELT is handled during installation or maintenance.

7.3.2.4 When maintenance is being performed near the ELT.

7.3.2.5 When a ground crew moves the aircraft.

7.3.2.6 If an ELT signal is heard, turn off the aircraft's ELT to determine if it is transmitting. If it has been activated, maintenance might be required before the unit is returned to the "ARMED" position. You should contact the nearest Air Traffic facility and notify it of the inadvertent activation.

7.4 Inflight Monitoring and Reporting

7.4.1 Pilots are encouraged to monitor 121.5 MHz and/or 243.0 MHz while in flight to assist in identifying possible emergency ELT transmissions. On receiving a signal, report the following information to the nearest air traffic facility:

7.4.1.1 Your position at the time the signal was first heard.

7.4.1.2 Your position at the time the signal was last heard.

7.4.1.3 Your position at maximum signal strength.

7.4.1.4 Your flight altitudes and frequency on which the emergency signal was heard: 121.5 MHz or 243.0 MHz. If possible, positions should be given relative to a navigation aid. If the aircraft has homing equipment, provide the bearing to the emergency signal with each reported position.

8. National Search and Rescue Plan

8.1 By federal interagency agreement, the National Search and Rescue Plan provides for the effective use of all available facilities in all types of SAR missions. These facilities include aircraft, vessels, pararescue and ground rescue teams, and emergency radio fixing. Under the Plan, the U.S. Coast Guard is responsible for the coordination of SAR in the Maritime Region, and the U.S. Air Force is responsible in the Inland Region. To carry out these responsibilities, the Coast Guard and the Air Force have established RCCs to direct SAR activities within their regions. For aircraft emergencies, distress and urgency information normally will be passed to the appropriate RCC through an air route traffic control center (ARTCC) or flight service station (FSS).

8.2 Coast Guard Rescue Coordination Centers

TBL GEN 3.6-1

Coast Guard Rescue Coordination Centers	
Alameda, CA 510-437-3701	Miami, FL 305-415-6800
Boston, MA 617-223-8555	New Orleans, LA 504-589-6225
Cleveland, OH 216-902-6117	Portsmouth, VA 757-398-6390
Honolulu, HI 808-541-2500	Seattle, WA 206-220-7001
Juneau, AK 907-463-2000	San Juan, PR 787-289-2042

8.3 Coast Guard Rescue Coordination Centers are served by major radio stations which guard 2182 kHz (VOICE). In addition, Coast Guard units along the seacoasts of the U.S. and shores of the Great Lakes guard 2182 kHz. The call “COAST GUARD” will alert all Coast Guard Radio Stations within range. 2182 kHz is also guarded by most commercial coast stations and some ships and boats.

8.4 Air Force Rescue Coordination Centers

TBL GEN 3.6-2

Air Force Rescue Coordination Center	
Tyndall AFB, Florida	Phone
Commercial	850-283-5955
WATS	800-851-3051
DSN	523-5955

TBL GEN 3.6-3

**Air Command Rescue Coordination Center
Alaska**

Alaskan Air Command Rescue Coordination Center	
Elemendorf AFB, Alaska	Phone
Commercial	907-428-7230 or 800-420-7230 (outside Anchorage)
DSN	317-551-7230

8.5 Joint Rescue Coordination Center Hawaii

TBL GEN 3.6-4

Honolulu Joint Rescue Coordination Center	
HQ 14th CG District Honolulu	Phone
Commercial	808-541-2500
DSN	448-0301

9. Procedures and Signals for Aircraft in Emergency

9.1 Search and Rescue

9.1.1 Search and Rescue is a life-saving service provided through the combined efforts of the federal agencies signatory to the National SAR Plan, and the agencies responsible for SAR within each State. Operational resources are provided by the U.S. Coast Guard, Department of Defense components, the Civil Air Patrol, the Coast Guard Auxiliary, state, county and local law enforcement and other public safety agencies, and private volunteer organizations. Services include search for missing aircraft, survival aid, rescue, and emergency medical help for the occupants after an accident site is located.

9.2 Emergency and Overdue Aircraft

9.2.1 ARTCCs and FSSs will alert the SAR system when information is received from any source that an aircraft is in difficulty, overdue, or missing.

9.2.2 Radar facilities providing radar flight following or advisories consider the loss of radar and radios, without service termination notice, to be a possible emergency. Pilots receiving VFR services from radar facilities should be aware that SAR may be initiated under these circumstances.

9.2.3 A filed flight plan is the most timely and effective indicator that an aircraft is overdue. Flight plan information is invaluable to SAR forces for search planning and executing search efforts. Prior to departure on every flight, local or otherwise, someone at the departure point should be advised of your destination and the route of flight if other than direct. Search efforts are often wasted and rescue is often delayed because of pilots who thoughtlessly take off without telling anyone where they are going. File a flight plan for your safety.

9.2.4 According to the National Search and Rescue Plan, “The life expectancy of an injured survivor decreases as much as 80 percent during the first 24 hours, while the chances of survival of uninjured survivors rapidly diminishes after the first 3 days.”

9.2.5 An Air Force Review of 325 SAR missions conducted during a 23-month period revealed that “Time works against people who experience a distress but are not on a flight plan, since 36 hours

normally pass before family concern initiates an (alert).”

9.3 VFR Search and Rescue Protection

9.3.1 To receive this valuable protection, file a VFR or DVFR Flight Plan with an FAA FSS. For maximum protection, file only to the point of first intended landing, and refile for each leg to final destination. When a lengthy flight plan is filed, with several stops en route and an ETE to final destination, a mishap could occur on any leg, and unless other information is received, it is probable that no one would start looking for you until 30 minutes after your ETA at your final destination.

9.3.2 If you land at a location other than the intended destination, report the landing to the nearest FAA FSS and advise them of your original destination.

9.3.3 If you land en route and are delayed more than 30 minutes, report this information to the nearest FSS and give them your original destination.

9.3.4 If your ETE changes by 30 minutes or more, report a new ETA to the nearest FSS and give them your original destination. Remember that if you fail to respond within one-half hour after your ETA at final destination, a search will be started to locate you.

9.3.5 It is important that you CLOSE YOUR FLIGHT PLAN IMMEDIATELY AFTER ARRIVAL AT YOUR FINAL DESTINATION WITH THE FSS DESIGNATED WHEN YOUR FLIGHT PLAN WAS FILED. The pilot is responsible for closure of a VFR or DVFR flight plan; they are not closed automatically. This will prevent needless search efforts.

9.3.6 The rapidity of rescue on land or water will depend on how accurately your position may be determined. If a flight plan has been followed and your position is on course, rescue will be expedited.

9.4 Survival Equipment

9.4.1 For flight over uninhabited land areas, it is wise to take suitable survival equipment depending on type of climate and terrain.

9.4.2 If forced landing occurs at sea, chances for survival are governed by degree of crew proficiency in emergency procedures and by effectiveness of water survival equipment.

9.5 Body Signal Illustrations

9.5.1 If you are forced down and are able to attract the attention of the pilot of a rescue airplane, the body signals illustrated on the following pages can be used to transmit messages to the pilot circling over your location.

9.5.2 Stand in the open when you make the signals.

9.5.3 Be sure the background, as seen from the air, is not confusing.

9.5.4 Go through the motions slowly and repeat each signal until you are positive that the pilot understands you.

9.6 Observance of a Downed Aircraft

9.6.1 Determine if the crash is marked with yellow cross; if so, the crash has already been reported and identified.

9.6.2 Determine, if possible, the type and number of the aircraft and whether there is evidence of survivors.

9.6.3 Fix, as accurately as possible, the exact location of the crash.

9.6.4 If circumstances permit, orbit the scene to guide in other assisting units or until relieved by another aircraft.

9.6.5 Transmit information to the nearest FAA or other appropriate radio facility.

9.6.6 Immediately after landing, make a complete report to nearest FAA, Air Force, or Coast Guard installation. The report may be made by long distance collect telephone.

FIG GEN 3.6-1
Ground-Air Visual Code for Use by Survivors

NO.	MESSAGE	CODE SYMBOL
1	Require assistance	V
2	Require medical assistance	X
3	No or Negative	N
4	Yes or Affirmative	Y
5	Proceeding in this direction	↑

IF IN DOUBT, USE INTERNATIONAL SYMBOL S O S
INSTRUCTIONS

1. Lay out symbols by using strips of fabric or parachutes, pieces of wood, stones, or any available material.
2. Provide as much color contrast as possible between material used for symbols and background against which symbols are exposed.
3. Symbols should be at least 10 feet high or larger. Care should be taken to lay out symbols exactly as shown.
4. In addition to using symbols, every effort is to be made to attract attention by means of radio, flares, smoke, or other available means.
5. On snow covered ground, signals can be made by dragging, shoveling or tramping. Depressed areas forming symbols will appear black from the air.
6. Pilot should acknowledge message by rocking wings from side to side.

FIG GEN 3.6-2
Ground-Air Visual Code for use by Ground Search Parties

NO.	MESSAGE	CODE SYMBOL
1	Operation completed.	LLL
2	We have found all personnel.	LL
3	We have found only some personnel.	++
4	We are not able to continue. Returning to base.	XX
5	Have divided into two groups. Each proceeding in direction indicated.	↔
6	Information received that aircraft is in this direction.	→ →
7	Nothing found. Will continue search.	NN

Note: These visual signals have been accepted for international use and appear in Annex 12 to the Convention on International Civil Aviation.

FIG GEN 3.6-3
Urgent Medical Assistance

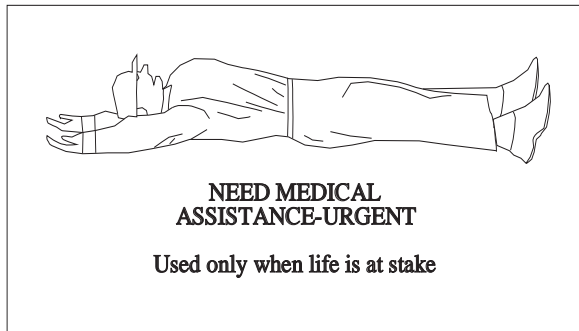

FIG GEN 3.6-5
Short Delay

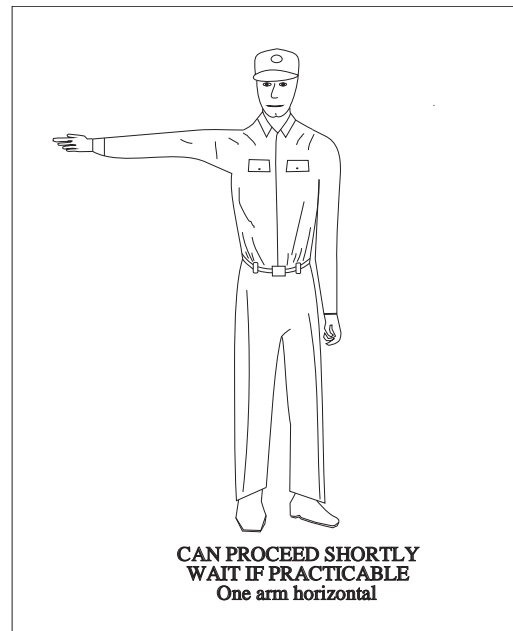

FIG GEN 3.6-4
All OK

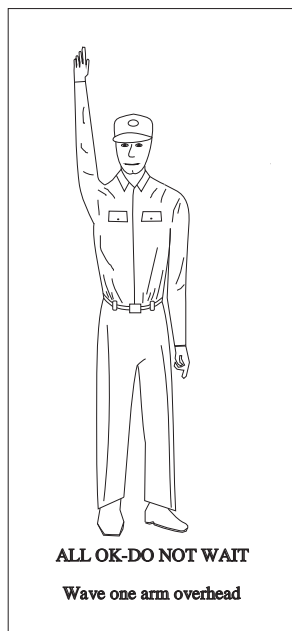

FIG GEN 3.6-6
Long Delay

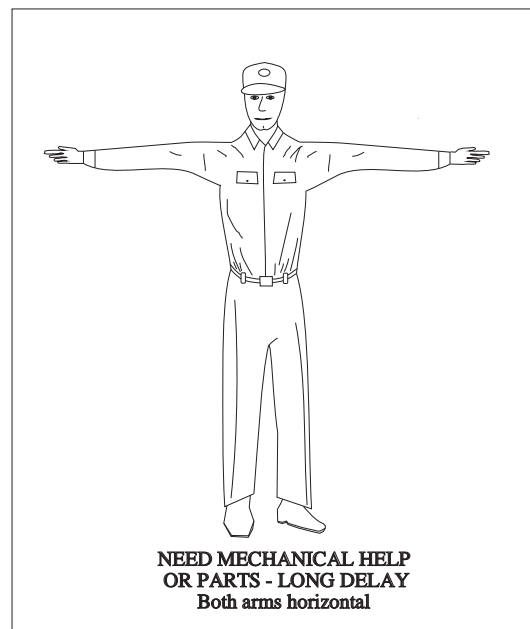

FIG GEN 3.6-7
Drop Message

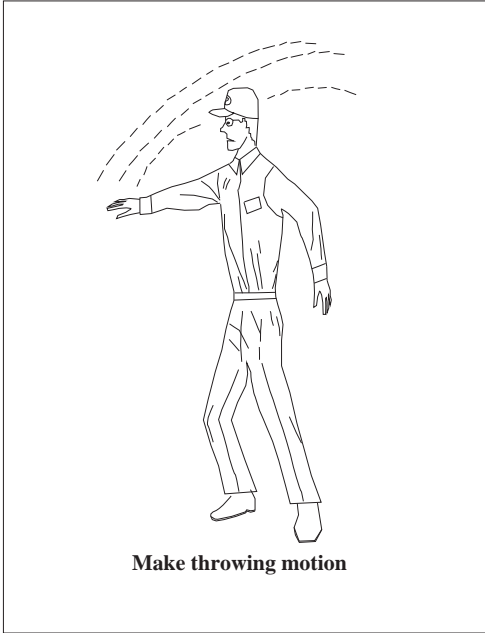

FIG GEN 3.6-9
Do Not Land Here

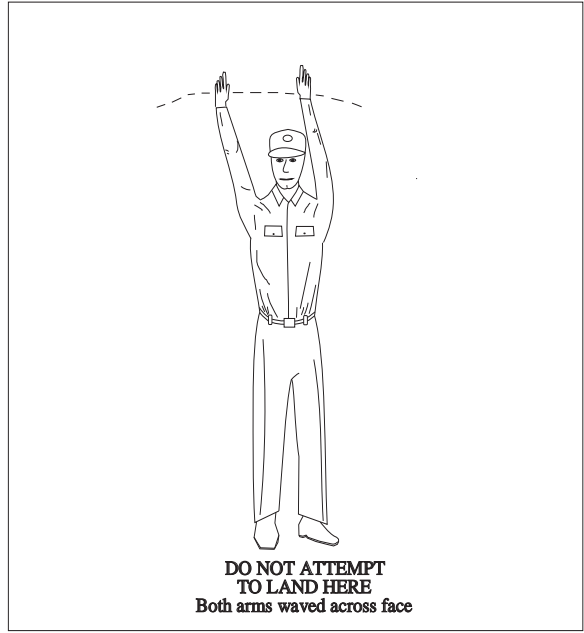

FIG GEN 3.6-8
Receiver Operates

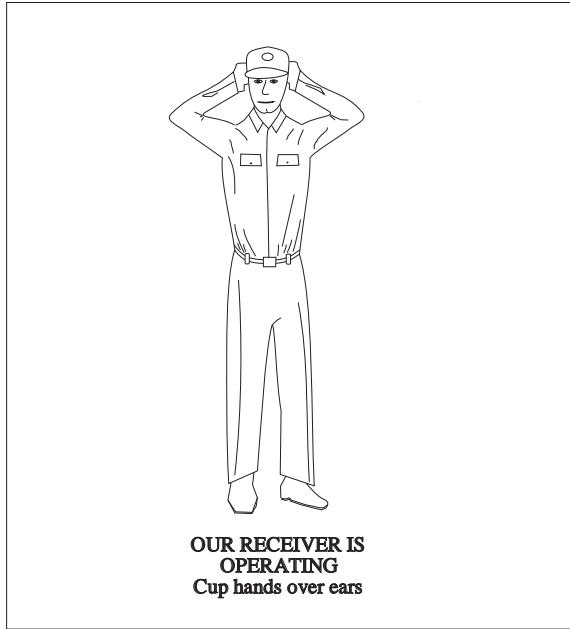

FIG GEN 3.6-10
Land Here

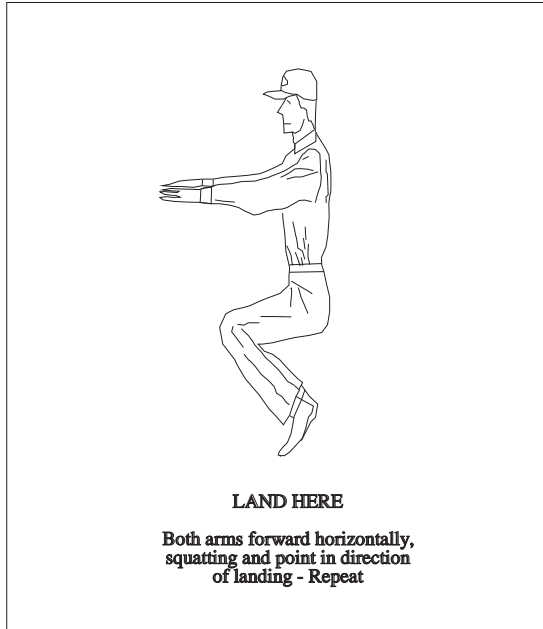

FIG GEN 3.6-11
Negative (Ground)

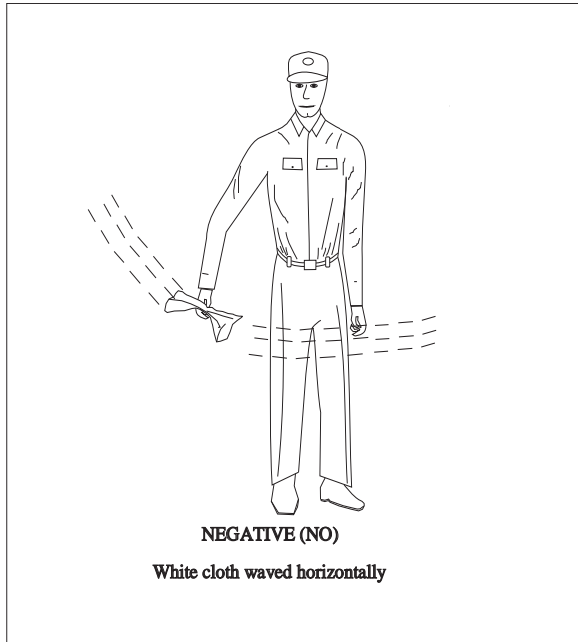

FIG GEN 3.6-13
Pick Us Up

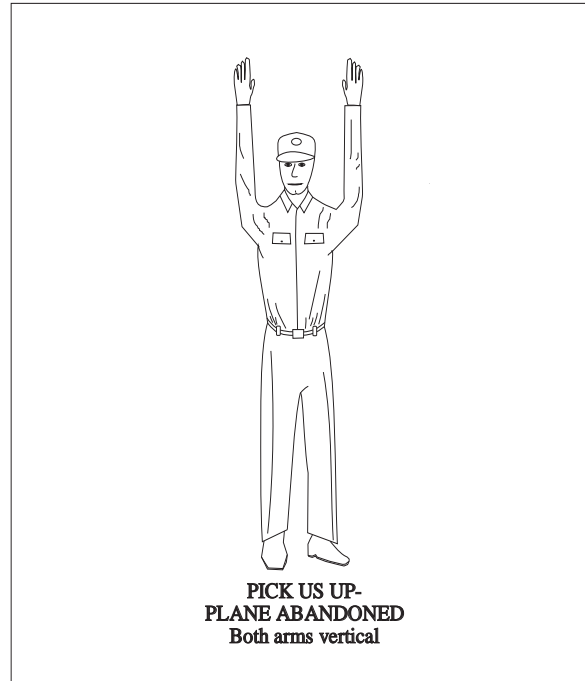

FIG GEN 3.6-12
Affirmative (Ground)

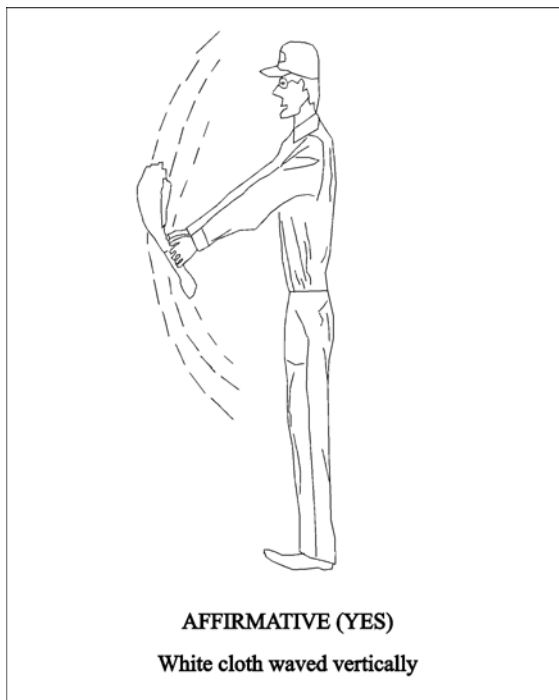

FIG GEN 3.6-14
Affirmative (Aircraft)

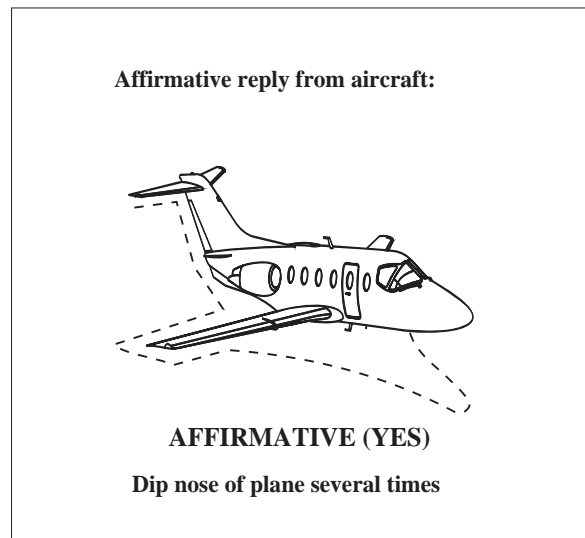

FIG GEN 3.6-15
Negative (Aircraft)

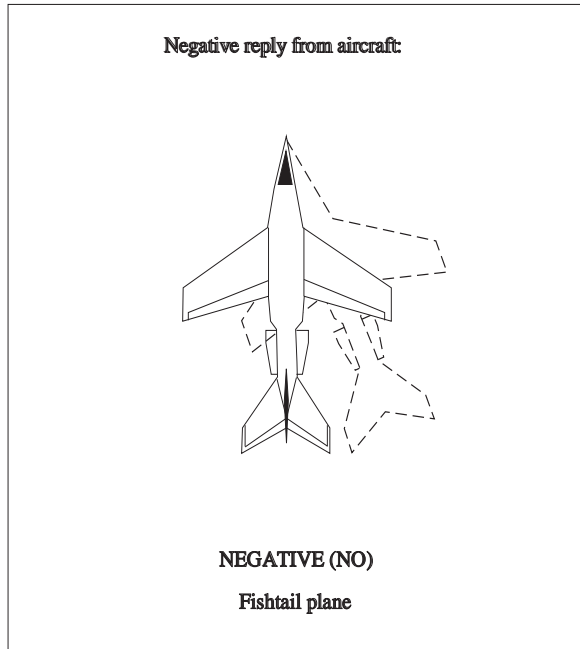

FIG GEN 3.6-16
Message received and understood (Aircraft)

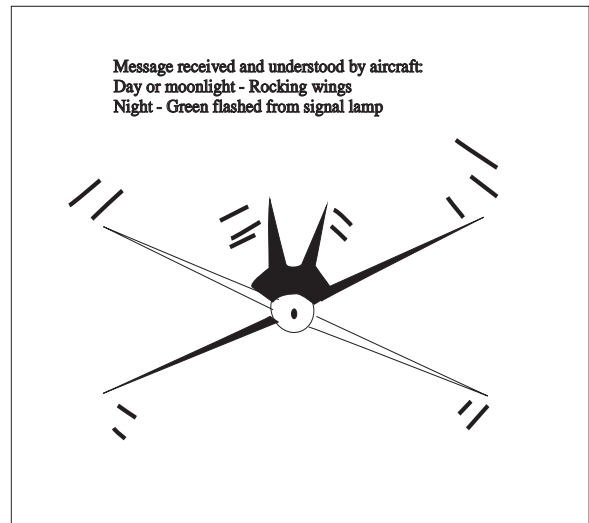
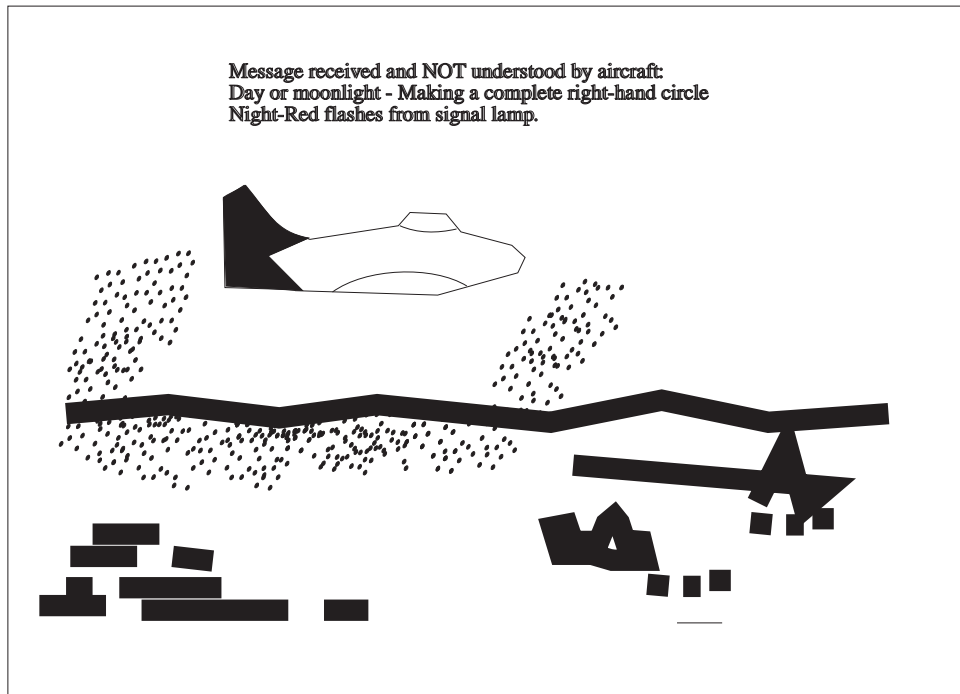

FIG GEN 3.6-17
Message received and NOT understood (Aircraft)



10. Pilot Responsibility and Authority

10.1 The pilot in command of an aircraft is directly responsible for, and is the final authority as to the operation of that aircraft. In an emergency requiring immediate action, the pilot in command may deviate from any rule in Title 14 of the Code of Federal Regulations (CFR), Part 91, Subpart A, General, and Subpart B, Flight Rules, to the extent required to meet that emergency (14 CFR Section 91.3(b)).

10.2 If the emergency authority of 14 CFR Section 91.3(b) is used to deviate from the provisions of an air traffic control clearance, the pilot in command must notify ATC as soon as possible and obtain an amended clearance (14 CFR Section 91.123(c)).

10.3 Unless deviation is necessary under the emergency authority of 14 CFR Section 91.3, pilots of IFR flights experiencing two-way radio communications failure are expected to adhere to the procedures prescribed under “IFR operations; two-way radio communications failure.” (14 CFR Section 91.185)

11. Distress and Urgency Communications

11.1 A pilot who encounters a distress or urgency condition can obtain assistance simply by contacting the air traffic facility or other agency in whose area of responsibility the aircraft is operating, stating the nature of the difficulty, pilot’s intentions, and assistance desired. Distress and urgency communications procedures prescribed by the International Civil Aviation Organization (ICAO), however, have decided advantages over the informal procedure described above.

11.2 Distress and urgency communications procedures discussed in the following paragraphs relate to the use of air-ground voice communications.

11.3 The initial communication, and if considered necessary, any subsequent transmissions by an aircraft in distress should begin with the signal MAYDAY, preferably repeated three times. The signal PAN-PAN should be used in the same manner for an urgency condition.

11.4 Distress communications have absolute priority over all other communications, and the word MAYDAY commands radio silence on the frequency

in use. Urgency communications have priority over all other communications except distress, and the word PAN-PAN warns other stations not to interfere with urgency transmissions.

11.5 Normally, the station addressed will be the air traffic facility or other agency providing air traffic services on the frequency in use at the time. If the pilot is not communicating and receiving services, the station to be called will normally be the air traffic facility or other agency in whose area of responsibility the aircraft is operating on the appropriate assigned frequency. If the station addressed does not respond, or if time or the situation dictates, the distress or urgency message may be broadcast, or a collect call may be used, addressing “Any Station (Tower) (Radio) (Radar).”

11.6 The station addressed should immediately acknowledge a distress or urgency message, provide assistance, coordinate and direct the activities of assisting facilities, and alert the appropriate search and rescue coordinator if warranted. Responsibility will be transferred to another station only if better handling will result.

11.7 All other stations, aircraft and ground, will continue to listen until it is evident that assistance is being provided. If any station becomes aware that the station being called either has not received a distress or urgency message, or cannot communicate with the aircraft in difficulty, it will attempt to contact the aircraft and provide assistance.

11.8 Although the frequency in use or other frequencies assigned by ATC are preferable, the following emergency frequencies can be used for distress or urgency communications, if necessary or desirable:

11.8.1 121.5 MHz and 243.0 MHz – Both have a range generally limited to line of sight. 121.5 MHz is guarded by direction finding stations and some military and civil aircraft. 243.0 MHz is guarded by military aircraft. Both 121.5 MHz and 243.0 MHz are guarded by military towers, most civil towers, flight service stations, and radar facilities. Normally ARTCC emergency frequency capability does not extend to radar coverage limits. If an ARTCC does not respond when called on 121.5 MHz or 243.0 MHz, call the nearest tower or flight service station.

11.8.2 2182 kHz – The range is generally less than 300 miles for the average aircraft installation. It can be used to request assistance from stations in the maritime service. 2182 kHz is guarded by major radio stations serving Coast Guard Rescue Coordination Centers, and Coast Guard units along the sea coasts of the U.S. and shores of the Great Lakes. The call “Coast Guard” will alert all Coast Guard Radio Stations within range. 2182 kHz is also guarded by most commercial coast stations and some ships and boats.

12. Emergency Condition – Request Assistance Immediately

12.1 Pilots do not hesitate to declare an emergency when they are faced with distress conditions such as fire, mechanical failure, or structural damage. However, some are reluctant to report an urgency condition when they encounter situations which may not be immediately perilous, but are potentially catastrophic. An aircraft is in at least an urgency condition the moment the pilot becomes doubtful about position, fuel endurance, weather, or any other condition that could adversely affect flight safety. This is the time to ask for help, not after the situation has developed into a distress condition.

12.2 Pilots who become apprehensive for their safety for any reason should request assistance immediately. Ready and willing help is available in the form of radio, radar, direction finding stations and other aircraft. Delay has caused accidents and cost lives. Safety is not a luxury. Take action.

13. Obtaining Emergency Assistance

13.1 A pilot in any distress or urgency condition should immediately take the following action, not necessarily in the order listed, to obtain assistance:

13.1.1 Climb, if possible, for improved communications and better radar and direction finding detection. However, it must be understood that unauthorized climb or descent under IFR conditions within CONTROLLED AIRSPACE is prohibited, except as permitted by 14 CFR Section 91.3(b).

13.1.2 If equipped with a radar beacon transponder (civil) or IFF/SIF (military):

13.1.2.1 Continue squawking assigned Mode A/3 discrete code/VFR code and Mode C altitude encoding when in radio contact with an air traffic facility or other agency providing air traffic services, unless instructed to do otherwise.

13.1.2.2 If unable to immediately establish communications with an air traffic facility/agency, squawk Mode A/3, Code 7700/Emergency and Mode C.

13.1.2.3 Transmit a distress or urgency message consisting of as many as necessary of the following elements, preferably in the order listed:

- a) If distress, MAYDAY, MAYDAY, MAYDAY; if urgency, PAN-PAN, PAN-PAN, PAN-PAN.
- b) Name of station addressed.
- c) Aircraft identification and type.
- d) Nature of distress or urgency.
- e) Weather.
- f) Pilots intentions and request.
- g) Present position, and heading; or if lost, last known position, time, and heading since that position.
- h) Altitude or flight level.
- i) Fuel remaining in minutes.
- j) Number of people on board.
- k) Any other useful information.

13.1.3 After establishing radio contact, comply with advice and instructions received. Cooperate. Do not hesitate to ask questions or clarify instructions when you do not understand or if you cannot comply with clearances. Assist the ground station to control communications on the frequency in use. Silence interfering radio stations. Do not change frequency or change to another ground station unless absolutely necessary. If you do, advise the ground station of the new frequency and station name prior to the change, transmitting in the blind if necessary. If two-way communications cannot be established on the frequency, return immediately to the frequency or station where two-way communications last existed.

13.1.4 When in a distress condition with bailout, crash landing, or ditching imminent, take the following additional actions to assist search and rescue units:

13.1.4.1 Time and circumstances permitting, transmit as many as necessary of the message elements in subparagraph 13.1.2.3 and any of the following you think might be helpful:

- a) ELT status.
- b) Visible landmarks.
- c) Aircraft color.
- d) Number of persons on board.
- e) Emergency equipment on board.

13.1.4.2 Actuate your ELT if the installation permits.

13.1.4.3 For bailout, and for crash landing or ditching if risk of fire is not a consideration, set your radio for continuous transmission.

13.1.4.4 If it becomes necessary to ditch, make every effort to ditch near a surface vessel. If time permits, an FAA facility should be able to get the position of the nearest commercial or Coast Guard vessel from a Coast Guard Rescue Coordination Center.

13.2 After a crash landing unless you have good reason to believe that you will not be located by search aircraft or ground teams, it is best to remain with your aircraft and prepare means for signalling search aircraft.

14. Radar Service for VFR Aircraft in Difficulty

14.1 Radar equipped air traffic control facilities can provide radar assistance and navigation service (vectors) to VFR aircraft in difficulty when the pilot can talk with the controller, and the aircraft is within radar coverage. Pilots should clearly understand that authorization to proceed in accordance with such radar navigational assistance does not constitute authorization for the pilot to violate Federal Aviation Regulations. In effect, assistance is provided on the basis that navigational guidance information is advisory in nature, and the responsibility for flying the aircraft safely remains with the pilot.

14.2 Experience has shown that many pilots who are not qualified for instrument flight cannot maintain control of their aircraft when they encounter clouds

or other reduced visibility conditions. In many cases, the controller will not know whether flight into instrument conditions will result from his/her instructions. To avoid possible hazards resulting from being vectored into IFR conditions, a pilot in difficulty should keep the controller advised of the weather conditions in which he/she is operating and the weather along the course ahead, and observe the following:

14.2.1 If a course of action is available which will permit flight and a safe landing in VFR weather conditions, noninstrument rated pilots should choose the VFR condition rather than requesting a vector or approach that will take them into IFR weather conditions; or

14.2.2 If continued flight in VFR conditions is not possible, the noninstrument rated pilot should so advise the controller and indicating the lack of an instrument rating, declare a distress condition.

14.2.3 If the pilot is instrument rated and current, and the aircraft is instrument equipped, the pilot should so indicate by requesting an IFR flight clearance. Assistance will then be provided on the basis that the aircraft can operate safely in IFR weather conditions.

15. Direction Finding Instrument Approach Procedure

15.1 Direction finding (DF) equipment has long been used to locate lost aircraft and to guide aircraft to areas of good weather or to airports; and now at most DF equipped airports, DF instrument approaches may be given to aircraft in emergency.

15.2 Experience has shown that a majority of actual emergencies requiring DF assistance involve pilots with a minimum of flight experience. With this in mind, DF approach procedures provide maximum flight stability in the approach by utilizing small turns, and descents in a wings level attitude. The DF specialist will give the pilot headings to fly and tell the pilot when to begin descent.

15.3 DF instrument approach procedures are for emergency use only and will not be given to IFR weather conditions unless the pilot has declared an emergency.

15.4 To become familiar with the procedures and other benefits of DF, pilots are urged to request practice guidance and approaches in VFR weather conditions. DF specialists welcome the practice and, workload permitting, will honor such requests.

16. Intercept and Escort

16.1 The concept of airborne intercept and escort is based on the SAR aircraft establishing visual and/or electronic contact with an aircraft in difficulty, providing inflight assistance, and escorting it to a safe landing. If bailout, crash landing or ditching becomes necessary, SAR operations can be conducted without delay. For most incidents, particularly those occurring at night and/or during instrument flight conditions, the availability of intercept and escort services will depend on the proximity of SAR units with suitable aircraft on alert for immediate dispatch. In limited circumstances, other aircraft flying in the vicinity of an aircraft in difficulty can provide these services.

16.2 If specifically requested by a pilot in difficulty or if a distress condition is declared, SAR coordinators will take steps to intercept and escort an aircraft. Steps may be initiated for intercept and escort if an urgency condition is declared and unusual circumstances make such action advisable.

16.3 It is the pilot's prerogative to refuse intercept and escort services. Escort services will normally be provided to the nearest adequate airport. Should the pilot receiving escort services continue on to another location after reaching a safe airport, or decide not to divert to the nearest safe airport, the escort aircraft is not obligated to continue and further escort is discretionary. The decision will depend on the circumstances of the individual incident.

17. Visual Emergency Signals

NOTE–

See FIG GEN 3.6–1 through FIG GEN 3.6–17.

18. Ditching Procedures

18.1 In order to select a proper ditching course for an aircraft, a basic knowledge of sea evaluation and other factors involved is required. Selection of the ditching heading may well determine the difference between survival and disaster.

(See FIG GEN 3.6–18, FIG GEN 3.6–19, FIG GEN 3.6–20, and FIG GEN 3.6–21).

18.2 Common Oceanographic Terminology:

18.2.1 Sea. The condition of the surface that is the result of both waves and swells.

18.2.2 Wave (or Chop). The condition of the surface caused by local winds.

18.2.3 Swell. The condition of the surface which has been caused by a distant disturbance.

18.2.4 Swell Face. The side of the swell toward the observer. The backside is the side away from the observer. These definitions apply regardless of the direction of swell movement.

18.2.5 Primary Swell. The swell system having the greatest height from trough to crest.

18.2.6 Secondary Swells. Those swell systems of less height than the primary swell.

18.2.7 Fetch. The distance the waves have been driven by a wind blowing in a constant direction, without obstruction.

18.2.8 Swell Period. The time interval between the passage of two successive crests at the same spot in the water, measured in seconds.

18.2.9 Swell Velocity. The velocity with which the swell advances with relation to a fixed reference point, measured in knots. There is little movement of water in the horizontal direction. Swells move primarily in a vertical motion, similar to the motion observed when shaking out a carpet.

18.2.10 Swell Direction. The direction from which a swell is moving. This direction is not necessarily the result of the wind present at the scene. The swell encountered may be moving into or across the local wind. Swells, once set in motion, tend to maintain their original direction for as long as they continue in deep water, regardless of changes in wind direction.

18.2.11 Swell Height. The height between crest and trough, measured in feet. The vast majority of ocean swells are lower than 12 to 15 feet, and swells over 25 feet are not common at any spot on the oceans. Successive swells may differ considerably in height.

18.3 Swells

18.3.1 It is extremely dangerous to land into the wind without regard to sea conditions. The swell system, or systems, must be taken into consideration.

FIG GEN 3.6-18
Single Swell (15 knot wind)

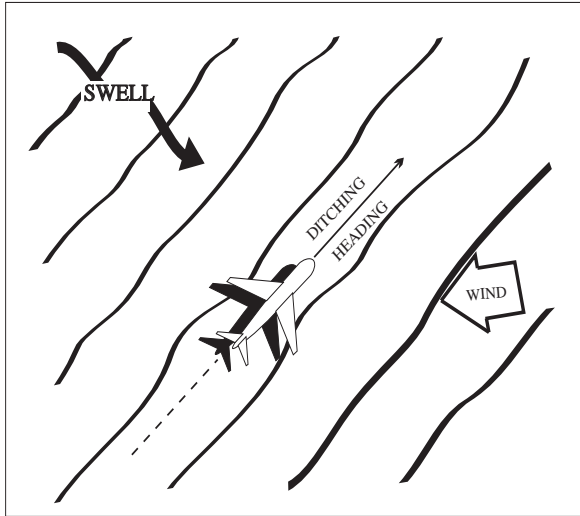

FIG GEN 3.6-20
Double Swell (30 knot wind)

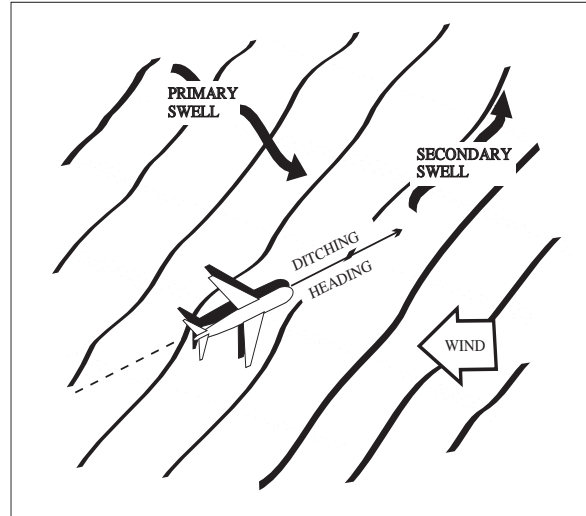

FIG GEN 3.6-19
Double Swell (15 knot wind)

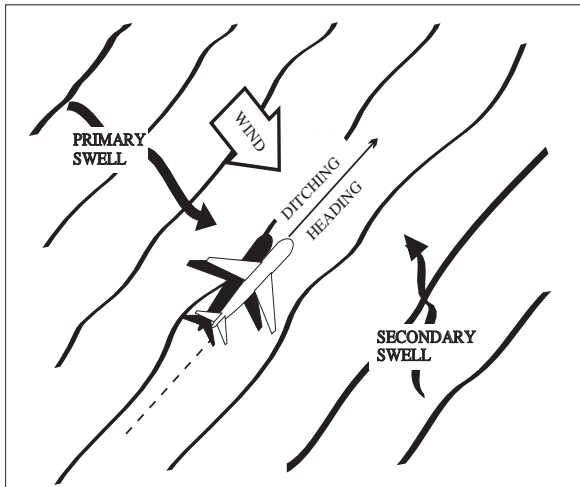

FIG GEN 3.6-21
(50 knot wind)

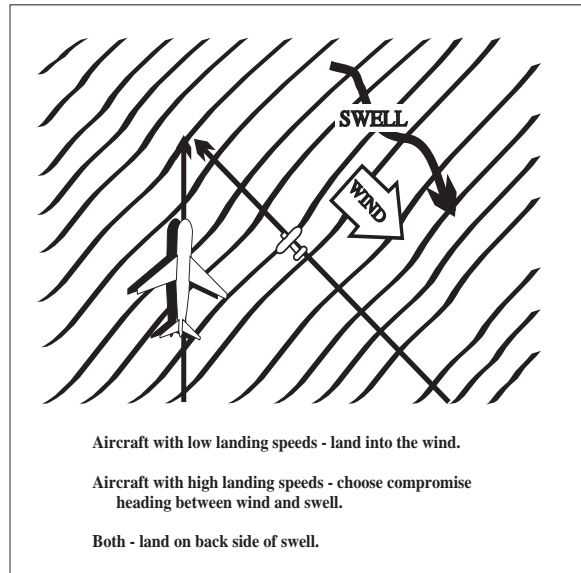
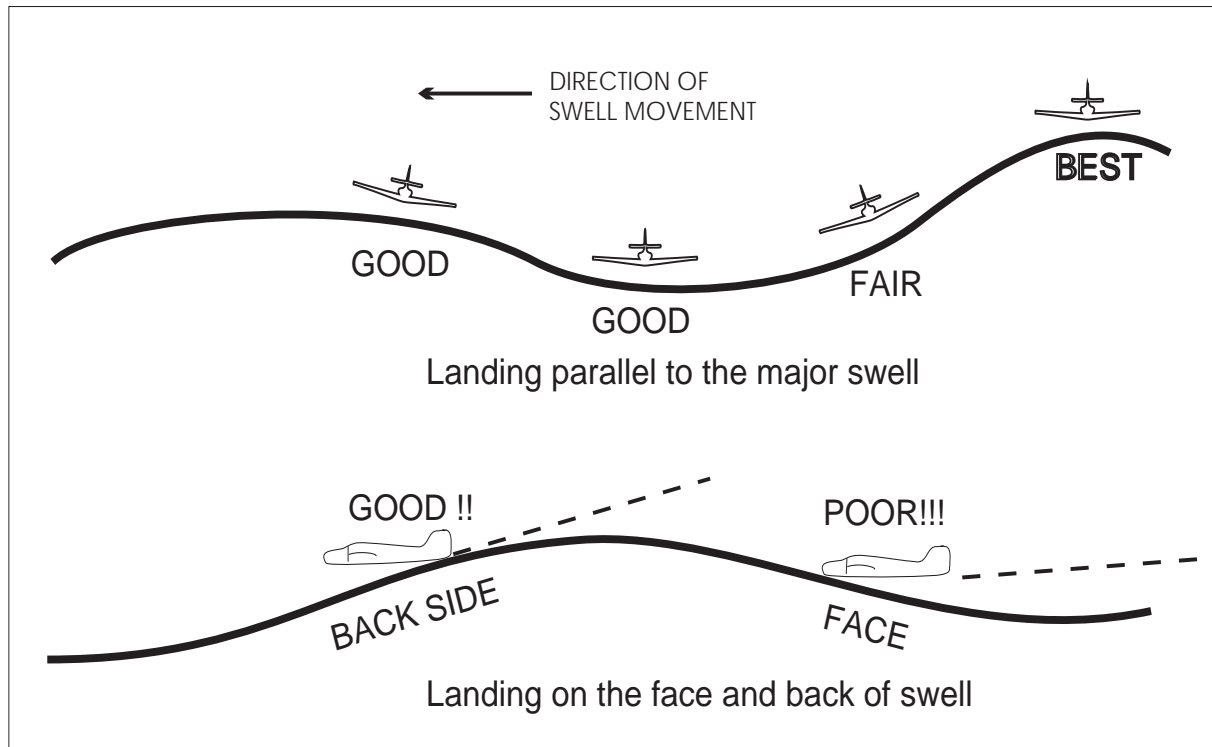

FIG GEN 3.6-22
Wind-Swell-Ditch Heading



18.3.2 In ditching parallel to the swell, it makes little difference whether touchdown is on top of the crest or in the trough. It is preferable, if possible, to land on the top or back side of the swell. After determining which heading (and its reciprocal) will parallel the swell, select the heading with the most into the wind component.

18.3.3 If only one swell system exists, the problem is relatively simple – even with a high, fast system. Unfortunately, most cases involve two or more systems running in different directions. With many systems present, the sea presents a confused appearance. One of the most difficult situations occurs when two swell systems are at right angles. For example, if one system is 8 feet high, and the other 3 feet, a landing parallel to the primary system, and down swell on the secondary system is indicated. If both systems are of equal height, a compromise may be advisable – selecting an intermediate heading at 45 degrees down swell to both systems. When landing down a secondary swell, attempt to touchdown on the back side, not on the face of the swell. Remember one axiom – **AVOID THE FACE OF A SWELL.**

18.3.4 If the swell system is formidable, it is considered advisable, in landplanes, to accept more crosswind in order to avoid landing directly into the swell.

18.3.5 The secondary swell system is often from the same direction as the wind. Here, the landing may be made parallel to the primary system, with the wind and secondary system at an angle. There is a choice of two headings paralleling the primary system. One heading is downwind and down the secondary swell; and the other is into the wind and into the secondary swell. The choice of heading will depend on the velocity of the wind versus the velocity and height of the secondary swell.

18.4 Wind

18.4.1 The simplest method of estimating the wind direction and velocity is to examine the wind streaks on the water. These appear as long streaks up and down wind. Some persons may have difficulty determining wind direction after seeing the streaks in the water. Whitecaps fall forward with the wind but are overrun by the waves thus producing the illusion that the foam is sliding backward. Knowing this, and by observing the direction of the streaks, the wind

direction is easily determined. Wind velocity can be accurately estimated by noting the appearance of the whitecaps, foam and wind streaks.

18.5 Preditching Preparation

18.5.1 A successful aircraft ditching is dependent on three primary factors. In order of importance they are:

18.5.1.1 Sea conditions and wind.

18.5.1.2 Type of aircraft.

18.5.1.3 Skill and technique of pilot.

18.5.2 The behavior of the aircraft on making contact with the water will vary within wide limits according to the state of the sea. If landed parallel to a single swell system, the behavior of the aircraft may approximate that to be expected on a smooth sea. If landed into a heavy swell or into a confused sea, the deceleration forces may be extremely great – resulting in breaking up of the aircraft. Within certain limits, the pilot is able to minimize these forces by proper sea evaluation and selection of ditching heading.

18.5.3 When on final approach the pilot should look ahead and observe the surface of the sea. There may be shadows and whitecaps – signs of large seas. Shadows and whitecaps close together indicate that the seas are short and rough. Touchdown in these areas is to be avoided. Select and touchdown in any area (only about 500 feet is needed) where the shadows and whitecaps are not so numerous.

18.5.4 Touchdown should be at the lowest speed and rate of descent which permit safe handling and optimum nose up attitude on impact. Once first impact has been made there is often little the pilot can do to control a landplane.

18.6 Ditching

18.6.1 Once preditching preparations are completed, the pilot should turn to the ditching heading and commence letdown. The aircraft should be flown low over the water, and slowed down until ten knots or so above stall. At this point, additional power should be used to overcome the increased drag caused by the noseup attitude. When a smooth stretch of water appears ahead, cut power, and touchdown at the best recommended speed as fully stalled as possible. By cutting power when approaching a relatively smooth area, the pilot will prevent over shooting and will touchdown with less chance of planing off into a

second uncontrolled landing. Most experienced seaplane pilots prefer to make contact with the water in a semi-stalled attitude, cutting power as the tail makes contact. This technique eliminates the chance of misjudging altitude with a resultant heavy drop in a fully stalled condition. Care must be taken not to drop in a fully stalled condition. Care must be taken not to drop the aircraft from too high altitude, or to balloon due to excessive speed. The altitude above water depends on the aircraft. Over glassy smooth water, or at night without sufficient light, it is very easy for even the most experienced pilots to misjudge altitude by 50 feet or more. Under such conditions, carry enough power to maintain 9° to 12° noseup attitude, and 10° to 20° over stalling speed until contact is made with the water. The proper use of power on the approach is of great importance. If power is available on one side only, a little power should be used to flatten the approach; however, the engine should not be used to such an extent that the aircraft cannot be turned against the good engines right down to the stall with a margin of rudder movement available. When near the stall, sudden application of excessive unbalanced power may result in loss of directional control. If power is available on one side only, a slightly higher than normal glide approach speed should be used. This will insure good control and some margin of speed after leveling off without excessive use of power. The use of power in ditching is so important that when it is certain that the coast cannot be reached, the pilot should, if possible, ditch before fuel is exhausted. The use of power in a night or instrument ditching is far more essential than under daylight contact conditions.

18.6.2 If no power is available, a greater than normal approach speed should be used down to the flare-out. This speed margin will allow the glide to be broken early and more gradually, thereby giving the pilot time and distance to feel for the surface – decreasing the possibility of stalling high or flying into the water. When landing parallel to a swell system, little difference is noted between landing on top of a crest or in the trough. If the wings of the aircraft are trimmed to the surface of the sea rather than the horizon, there is little need to worry about a wing hitting a swell crest. The actual slope of a swell is very gradual. If forced to land into a swell, touchdown should be made just after passage of the crest. If contact is made on the face of the swell, the aircraft

may be swamped or thrown violently into the air, dropping heavily into the next swell. If control surfaces remain intact, the pilot should attempt to maintain the proper nose attitude by rapid and positive use of the controls.

18.7 After Touchdown

18.7.1 In most cases drift caused by crosswind can be ignored; the forces acting on the aircraft after touchdown are of such magnitude that drift will be only a secondary consideration. If the aircraft is under good control, the “crab” may be kicked out with rudder just prior to touchdown. This is more important with high wing aircraft, for they are laterally unstable on the water in a crosswind, and may roll to the side in ditching.

NOTE-

This information has been extracted from the publication “Aircraft Emergency Procedures Over Water.”

19. Fuel Dumping

19.1 Should it become necessary to dump fuel, the pilot should immediately advise ATC. Upon receipt of advice that an aircraft will dump fuel, ATC will broadcast or cause to be broadcast immediately and every 3 minutes thereafter on appropriate ATC, FSS, and airline company radio frequencies the following:

EXAMPLE-

ATTENTION ALL AIRCRAFT-FUEL DUMPING IN PROGRESS-OVER (location) AT (altitude) BY (type aircraft) (flight direction).

19.2 Upon receipt of such a broadcast, pilots of aircraft affected, which are not on IFR flight plans or special VFR clearances, should clear the area specified in the advisory. Aircraft on IFR flight plans or special VFR clearances will be provided specific separation by ATC. At the termination of the fuel dumping operation, pilots should advise ATC. Upon receipt of such information, ATC will issue, on appropriate frequencies, the following:

EXAMPLE-

ATTENTION ALL AIRCRAFT-FUEL DUMPING BY-(type aircraft) TERMINATED.

20. Special Emergency (Air Piracy)

20.1 A special emergency is a condition of air piracy, or other hostile act by a person(s) aboard an aircraft, which threatens the safety of the aircraft or its passengers.

20.2 The pilot of an aircraft reporting a special emergency condition should:

20.2.1 If circumstances permit, apply distress or urgency radio – telephony procedures. Include the details of the special emergency.

20.2.2 If circumstances do not permit the use of prescribed distress or urgency procedures, transmit:

20.2.2.1 On the air-ground frequency in use at the time.

20.2.2.2 As many as possible of the following elements spoken distinctly and in the following order.

a) Name of the station addressed (time and circumstances permitting).

b) The identification of the aircraft and present position.

c) The nature of the special emergency condition and pilot intentions (circumstances permitting).

d) If unable to provide this information, use code words and/or transponder setting for indicated meanings as follows:

Spoken Words

TRANSPONDER SEVEN FIVE ZERO ZERO

Meaning

Am being hijacked/forced to a new destination

Transponder Setting

Mode 3/A, Code 7500

NOTE-

Code 7500 will never be assigned by ATC without prior notification from the pilot that the aircraft is being subjected to unlawful interference. The pilot should refuse the assignment of this code in any other situation and inform the controller accordingly. Code 7500 will trigger the special emergency indicator in all radar ATC facilities.

20.3 Air traffic controllers will acknowledge and confirm receipt of transponder Code 7500 by asking the pilot to verify it. If the aircraft is not being subjected to unlawful interference, the pilot should respond to the query by broadcasting in the clear that the aircraft is not being subjected to unlawful interference. Upon receipt of this information, the controller will request the pilot to verify the code selection depicted in the code selector windows in the transponder control panel and change the code to the appropriate setting. If the pilot replies in the affirmative or does not reply, the controller will not

ask further questions but will flight follow, respond to pilot requests, and notify appropriate authorities.

20.4 If it is possible to do so without jeopardizing the safety of the flight, the pilot of a hijacked U.S. passenger aircraft, after departing from the cleared routing over which the aircraft was operating, will attempt to do one or more of the following things insofar as circumstances may permit:

20.4.1 Maintain a true airspeed of no more than 400 knots and, preferably, an altitude of between 10,000 and 25,000 feet.

20.4.2 Fly a course toward the destination which the hijacker has announced.

20.5 If these procedures result in either radio contact or air intercept, the pilot will attempt to comply with any instructions received which may direct the aircraft to an appropriate landing field or alter the aircraft's flight path off its current course, away from protected airspace.

21. FAA K–9 Explosives Detection Team Program

21.1 The FAA's Office of Civil Aviation Security Operations manages the FAA K–9 Explosives Detection Team Program, which was established in 1972. Through a unique agreement with law enforcement agencies and airport authorities, the FAA has strategically placed FAA-certified K–9 teams (a team is one handler and one dog) at airports throughout the country. If a bomb threat is received while an aircraft is in flight, the aircraft can be directed to an airport with this capability.

21.2 The FAA provides initial and refresher training for all handlers, provides single purpose explosive detector dogs, and requires that each team is annually evaluated in five areas for FAA certification: aircraft (wide body and narrow body), vehicles, terminal, freight, (cargo), and luggage. If you desire this service, notify your company or an FAA air traffic control facility.

21.3 FAA Sponsored Explosives Detection Dog/Handler Team Locations

TBL GEN 3.6–5

Airport Symbol	Location
ATL	Atlanta, Georgia
BHM	Birmingham, Alabama
BOS	Boston, Massachusetts
BUF	Buffalo, New York
CLT	Charlotte, North Carolina
ORD	Chicago, Illinois
CVG	Cincinnati, Ohio
DFW	Dallas, Texas
DEN	Denver, Colorado
DTW	Detroit, Michigan
IAH	Houston, Texas
JAX	Jacksonville, Florida
MCI	Kansas City, Missouri
LAX	Los Angeles, California
MEM	Memphis, Tennessee
MIA	Miami, Florida
MKE	Milwaukee, Wisconsin
MSY	New Orleans, Louisiana
MCO	Orlando, Florida
PHX	Phoenix, Arizona
PIT	Pittsburgh, Pennsylvania
PDX	Portland, Oregon
SLC	Salt Lake City, Utah
SFO	San Francisco, California
SJU	San Juan, Puerto Rico
SEA	Seattle, Washington
STL	St. Louis, Missouri
TUS	Tucson, Arizona
TUL	Tulsa, Oklahoma

21.4 If due to weather or other considerations an aircraft with a suspected hidden explosive problem were to land or intended to land at an airport other than those listed above, it is recommended they call the FAA's Washington Operations Center (telephone 202–267–3333, if appropriate) or have an air traffic facility with which you can communicate contact the above center requesting assistance.

GEN 3.7 Aircraft Rescue and Fire Fighting Communications

1. Discrete Emergency Frequency

1.1 Direct contact between an emergency aircraft flight crew, Aircraft Rescue and Fire Fighting Incident Commander (ARFF IC), and the Airport Traffic Control Tower (ATCT) is possible on an aeronautical radio frequency (Discrete Emergency Frequency [DEF]) designated by Air Traffic Control (ATC) from the operational frequencies assigned to that facility.

1.2 Emergency aircraft at airports without an ATCT (or when the ATCT is closed) may contact the ARFF IC (if ARFF service is provided) on the Common Traffic Advisory Frequency (CTAF) published for the airport or the civil emergency frequency 121.5 MHz.

2. Radio Call Signs

Preferred radio call sign for the ARFF IC is “(location/facility) Command” when communicating with the flight crew and the FAA ATCT.

EXAMPLE-
LAX Command.
Washington Command.

3. ARFF Emergency Hand Signals

In the event that electronic communications cannot be maintained between the ARFF IC and the flight crew, standard emergency hand signals as depicted in FIG GEN 3.7-1 through FIG GEN 3.7-3 should be used. These hand signals should be known and understood by all cockpit and cabin aircrew, and all ARFF firefighters.

FIG GEN 3.7-1

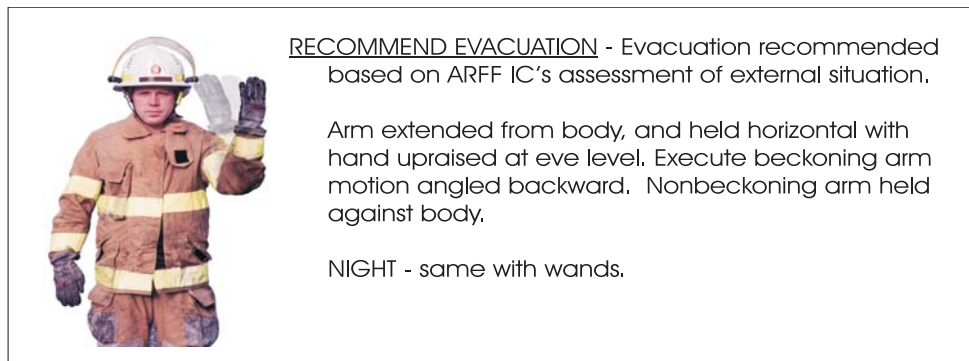

FIG GEN 3.7-2

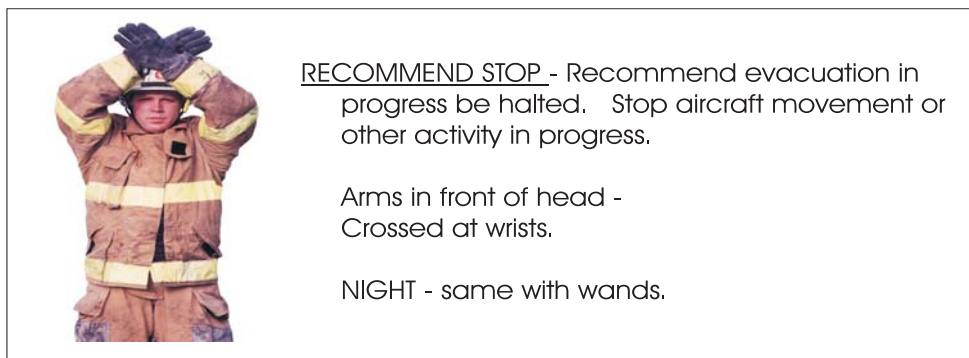
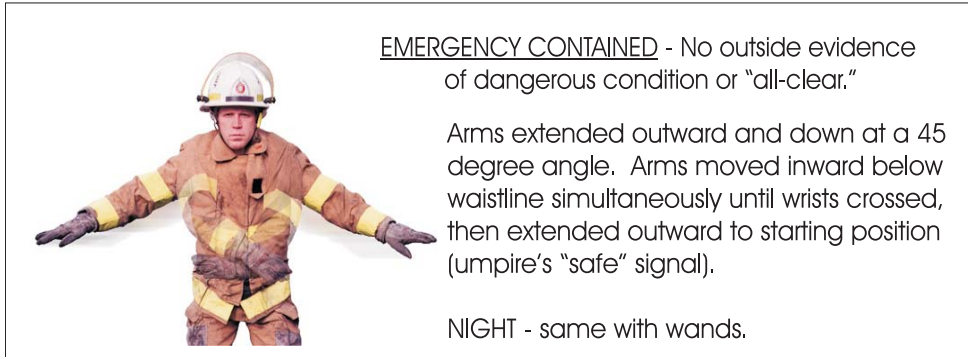

FIG GEN 3.7-3



GEN 4. CHARGES FOR AERODROMES/HELIPORTS AND AIR NAVIGATION SERVICES

GEN 4.1 Fees and Charges

1. General

1.1 Charges for services and facilities vary from aerodrome to aerodrome, and information concerning such charges may be obtained at the aerodromes. Unless alternative arrangements have been made, all charges for the use of the aerodrome, such as landing fees, passenger service charges, cargo charges, storage charges, and the like, are payable on demand or before the aircraft departs the aerodrome. All such charges are established by and payable to the various administrative authorities of the various aerodromes.

1.2 A private aircraft will be charged a processing fee of \$25 once every calendar year. This will be charged the first time the aircraft arrives from a foreign place in the calendar year or may be paid in advance. This fee is charged to the aircraft, not the pilot, and the receipt should be kept with the aircraft.

1.3 Commercial aircraft operators will be charged a processing fee of \$5 per paying passenger for each arrival from foreign to the U.S. This fee will not be charged for passengers arriving from Canada, Mexico, and certain nearby Caribbean countries.

2. Charges for Inspection Services

2.1 Generally speaking, free service is provided at airports during regular business hours (usually 8 a.m. to 5 p.m.), Monday through Saturday, and from 8 a.m. to 5 p.m. on Sundays and national holidays. However, tours of duty at airports are based on the need for services and are altered at some ports to coincide with schedule changes and peak workloads.

2.2 Overtime charges may be imposed, in certain cases, for Immigration and Naturalization Services and Public Health Service quarantine inspection of aircraft whose operations are not covered by published schedules. Information concerning such charges may be obtained from the Immigration and Naturalization Office and the Public Health Service Medical Officer in Charge at, or nearest, the intended place of landing.

3. Penalties for Violations

3.1 Since the law provides for substantial penalties for violations of the Customs regulations, aircraft operators and pilots should make every effort to comply with them.

3.2 A \$5,000 penalty will be assessed for common violations such as:

3.2.1 Failure to report arrival.

3.2.2 Failure to obtain landing rights.

3.2.3 Failure to provide advance notice of arrival.

3.2.4 Failure to provide penetration report on southern border.

3.2.5 Departing without permission or discharging passengers or cargo without permission.

REFERENCE-
19 CFR 122.161.

NOTE-

1. *Importation of contraband, including agricultural materials, or undeclared merchandise can result in penalty action and seizure of aircraft, which varies according to the nature of the violation and pertinent provision of law.*

2. *The above penalties are double to \$10,000 for a second offense. Seizure of aircraft may occur at any time depending upon the circumstances behind the violation.*

3. *If a penalty is incurred, application may be made to the customs officer in charge for a reduction in amount or cancellation, giving the grounds upon which relief is believed to be justified. If the operator or pilot desires to petition further for relief of the penalty, he/she may appeal to the appropriate district Director of Customs. If still further review of the penalty is desired, written appeal may be made to the proper regional Commissioner of Customs and, in some cases, to Customs Headquarters.*

3.3 Any person violating any provision of the Public Health Service regulations shall be subject to a fine of not more than \$1,000 or to imprisonment for not more than 1 year, or both, as provided in section 368 of the Public Health Service Act (42 U.S.C. 271).

GEN 4.2 Air Navigation Facility Charges

The Federal Aviation Administration does not charge for the use of Federal air navigation facilities or telecommunications services.

AIP
AERONAUTICAL INFORMATION PUBLICATION
UNITED STATES OF AMERICA

PART 2
EN ROUTE (ENR)

PART 2 – EN ROUTE (ENR)

ENR 0.

- ENR 0.1 Preface – Not applicable
- ENR 0.2 Record of AIP Amendments – See GEN 0.2-1
- ENR 0.3 Record of AIP Supplements – Not applicable

ENR 0.4 Checklist of Pages

PAGE	DATE
PART 2 – EN ROUTE (ENR)	
ENR 0	
0.4-1	10 MAR 11
0.4-2	10 MAR 11
0.4-3	10 MAR 11
0.6-1	10 MAR 11
ENR 1	
1.1-1	10 MAR 11
1.1-2	10 MAR 11
1.1-3	10 MAR 11
1.1-4	10 MAR 11
1.1-5	10 MAR 11
1.1-6	10 MAR 11
1.1-7	10 MAR 11
1.1-8	10 MAR 11
1.1-9	10 MAR 11
1.1-10	10 MAR 11
1.1-11	10 MAR 11
1.1-12	10 MAR 11
1.1-13	10 MAR 11
1.1-14	10 MAR 11
1.1-15	10 MAR 11
1.1-16	10 MAR 11
1.1-17	10 MAR 11
1.1-18	10 MAR 11
1.1-19	10 MAR 11
1.1-20	10 MAR 11
1.1-21	10 MAR 11
1.1-22	10 MAR 11
1.1-23	10 MAR 11
1.1-24	10 MAR 11
1.1-25	10 MAR 11
1.1-26	10 MAR 11
1.1-27	10 MAR 11
1.1-28	10 MAR 11
1.1-29	10 MAR 11
1.1-30	10 MAR 11
1.1-31	10 MAR 11
1.1-32	10 MAR 11

PAGE	DATE
1.1-33	10 MAR 11
1.1-34	10 MAR 11
1.1-35	10 MAR 11
1.1-36	10 MAR 11
1.1-37	10 MAR 11
1.1-38	10 MAR 11
1.1-39	10 MAR 11
1.1-40	10 MAR 11
1.1-41	10 MAR 11
1.1-42	10 MAR 11
1.1-43	10 MAR 11
1.1-44	10 MAR 11
1.1-45	10 MAR 11
1.1-46	10 MAR 11
1.1-47	10 MAR 11
1.1-48	10 MAR 11
1.1-49	10 MAR 11
1.1-50	10 MAR 11
1.1-51	10 MAR 11
1.1-52	10 MAR 11
1.1-53	10 MAR 11
1.1-54	10 MAR 11
1.1-55	10 MAR 11
1.1-56	10 MAR 11
1.1-57	10 MAR 11
1.1-58	10 MAR 11
1.1-59	10 MAR 11
1.1-60	10 MAR 11
1.1-61	10 MAR 11
1.1-62	10 MAR 11
1.1-63	10 MAR 11
1.1-64	10 MAR 11
1.1-65	10 MAR 11
1.1-66	10 MAR 11
1.1-67	10 MAR 11
1.1-68	10 MAR 11
1.1-69	10 MAR 11
1.1-70	10 MAR 11
1.1-71	10 MAR 11

PAGE	DATE
1.1-72	10 MAR 11
1.1-73	10 MAR 11
1.1-74	10 MAR 11
1.1-75	10 MAR 11
1.1-76	10 MAR 11
1.1-77	10 MAR 11
1.1-78	10 MAR 11
1.1-78	10 MAR 11
1.1-80	10 MAR 11
1.1-81	10 MAR 11
1.2-1	10 MAR 11
1.3-1	10 MAR 11
1.4-1	10 MAR 11
1.4-2	10 MAR 11
1.4-3	10 MAR 11
1.4-4	10 MAR 11
1.4-5	10 MAR 11
1.4-6	10 MAR 11
1.4-7	10 MAR 11
1.4-8	10 MAR 11
1.4-9	10 MAR 11
1.4-10	10 MAR 11
1.4-11	10 MAR 11
1.4-12	10 MAR 11
1.4-13	10 MAR 11
1.4-14	10 MAR 11
1.4-15	10 MAR 11
1.4-16	10 MAR 11
1.5-1	10 MAR 11
1.5-2	10 MAR 11
1.5-3	10 MAR 11
1.5-4	10 MAR 11
1.5-5	10 MAR 11
1.5-6	10 MAR 11
1.5-7	10 MAR 11
1.5-8	10 MAR 11
1.5-9	10 MAR 11
1.5-10	10 MAR 11
1.5-11	10 MAR 11
1.5-12	10 MAR 11

PAGE	DATE
1.5-13	10 MAR 11
1.5-14	10 MAR 11
1.5-15	10 MAR 11
1.5-16	10 MAR 11
1.5-17	10 MAR 11
1.5-18	10 MAR 11
1.5-19	10 MAR 11
1.5-20	10 MAR 11
1.5-21	10 MAR 11
1.5-22	10 MAR 11
1.5-23	10 MAR 11
1.5-24	10 MAR 11
1.5-25	10 MAR 11
1.5-26	10 MAR 11
1.5-27	10 MAR 11
1.5-28	10 MAR 11
1.5-29	10 MAR 11
1.5-30	10 MAR 11
1.5-31	10 MAR 11
1.5-32	10 MAR 11
1.5-33	10 MAR 11
1.5-34	10 MAR 11
1.5-35	10 MAR 11
1.5-36	10 MAR 11
1.5-37	10 MAR 11
1.5-38	10 MAR 11
1.5-39	10 MAR 11
1.5-40	10 MAR 11
1.5-41	10 MAR 11
1.5-42	10 MAR 11
1.5-43	10 MAR 11
1.5-44	10 MAR 11
1.5-45	10 MAR 11
1.5-46	10 MAR 11
1.5-47	10 MAR 11
1.5-48	10 MAR 11
1.5-49	10 MAR 11
1.5-50	10 MAR 11
1.5-51	10 MAR 11
1.5-52	10 MAR 11
1.5-53	10 MAR 11
1.5-54	10 MAR 11
1.5-55	10 MAR 11
1.5-56	10 MAR 11
1.5-57	10 MAR 11
1.5-58	10 MAR 11
1.5-59	10 MAR 11
1.5-60	10 MAR 11
1.5-61	10 MAR 11
1.5-62	10 MAR 11
1.5-63	10 MAR 11
1.5-64	10 MAR 11

PAGE	DATE
1.5-65	10 MAR 11
1.5-66	10 MAR 11
1.5-67	10 MAR 11
1.5-68	10 MAR 11
1.5-69	10 MAR 11
1.5-70	10 MAR 11
1.5-71	10 MAR 11
1.5-72	10 MAR 11
1.5-73	10 MAR 11
1.5-74	10 MAR 11
1.6-1	10 MAR 11
1.7-1	10 MAR 11
1.7-2	10 MAR 11
1.7-3	10 MAR 11
1.7-4	10 MAR 11
1.8-1	10 MAR 11
1.9-1	10 MAR 11
1.10-1	10 MAR 11
1.10-2	10 MAR 11
1.10-3	10 MAR 11
1.10-4	10 MAR 11
1.10-5	10 MAR 11
1.10-6	10 MAR 11
1.10-7	10 MAR 11
1.10-8	10 MAR 11
1.10-9	10 MAR 11
1.10-10	10 MAR 11
1.10-11	10 MAR 11
1.10-12	10 MAR 11
1.10-13	10 MAR 11
1.10-14	10 MAR 11
1.10-15	10 MAR 11
1.10-16	10 MAR 11
1.10-17	10 MAR 11
1.10-18	10 MAR 11
1.10-19	10 MAR 11
1.10-20	10 MAR 11
1.10-21	10 MAR 11
1.11-1	10 MAR 11
1.11-2	10 MAR 11
1.12-1	10 MAR 11
1.12-2	10 MAR 11
1.12-3	10 MAR 11
1.12-4	10 MAR 11
1.12-5	10 MAR 11
1.12-6	10 MAR 11
1.12-7	10 MAR 11
1.13-1	10 MAR 11
1.14-1	10 MAR 11
1.15-1	10 MAR 11
1.15-2	10 MAR 11

PAGE	DATE
1.15-3	10 MAR 11
1.15-4	10 MAR 11
1.15-5	10 MAR 11
1.15-6	10 MAR 11
1.15-7	10 MAR 11
1.15-8	10 MAR 11
1.16-1	10 MAR 11
1.16-2	10 MAR 11
1.16-3	10 MAR 11
1.17-1	10 MAR 11
1.18-1	10 MAR 11
1.19-1	10 MAR 11
1.19-2	10 MAR 11
1.19-3	10 MAR 11
1.19-4	10 MAR 11
1.19-5	10 MAR 11
1.19-6	10 MAR 11
1.19-7	10 MAR 11
1.19-8	10 MAR 11
ENR 2	
2-1	10 MAR 11
ENR 3	
3.1-1	10 MAR 11
3.2-1	10 MAR 11
3.3-1	10 MAR 11
3.4-1	10 MAR 11
3.5-1	10 MAR 11
3.5-2	10 MAR 11
3.5-3	10 MAR 11
ENR 4	
4.1-1	10 MAR 11
4.1-2	10 MAR 11
4.1-3	10 MAR 11
4.1-4	10 MAR 11
4.1-5	10 MAR 11
4.1-6	10 MAR 11
4.1-7	10 MAR 11
4.1-8	10 MAR 11
4.1-9	10 MAR 11
4.1-10	10 MAR 11
4.1-11	10 MAR 11
4.1-12	10 MAR 11
4.1-13	10 MAR 11
4.1-14	10 MAR 11
4.1-15	10 MAR 11
4.1-16	10 MAR 11
4.1-17	10 MAR 11
4.1-18	10 MAR 11
4.1-19	10 MAR 11
4.1-20	10 MAR 11

ENR 0.6 Table of Contents to Part 2

	<i>Page</i>
ENR 1. GENERAL RULES AND PROCEDURES	
ENR 1.1 General Rules	ENR 1.1-1
ENR 1.2 Visual Flight Rules	ENR 1.2-1
ENR 1.3 Instrument Flight Rules	ENR 1.3-1
ENR 1.4 ATS Airspace Classification	ENR 1.4-1
ENR 1.5 Holding, Approach, and Departure Procedures	ENR 1.5-1
ENR 1.6 [Reserved]	ENR 1.6-1
ENR 1.7 Altimeter Setting Procedures	ENR 1.7-1
ENR 1.8 [Reserved]	ENR 1.8-1
ENR 1.9 [Reserved]	ENR 1.9-1
ENR 1.10 Flight Planning (Restriction, Limitation or Advisory Information)	ENR 1.10-1
ENR 1.11 Addressing of Flight Plans for Domestic or International Flight Planning	ENR 1.11-1
ENR 1.12 Interception of Civil Aircraft, National Security, and Interception Procedures ...	ENR 1.12-1
ENR 1.13 [Reserved]	ENR 1.13-1
ENR 1.14 [Reserved]	ENR 1.14-1
ENR 1.15 Medical Facts for Pilots	ENR 1.15-1
ENR 1.16 Safety, Hazard, and Accident Reports	ENR 1.16-1
ENR 1.17 North Atlantic (NAT) Timekeeping Procedures	ENR 1.17-1
ENR 1.18 North Atlantic (NAT) Safety Information	ENR 1.18-1
ENR 1.19 Area Navigation (RNAV) and Required Navigation Performance (RNP)	ENR 1.19-1
ENR 2. AIR TRAFFIC SERVICES AIRSPACE	ENR 2-1
ENR 3. ATS ROUTES	
ENR 3.1 Lower ATS Routes	ENR 3.1-1
ENR 3.2 Upper ATS Routes	ENR 3.2-1
ENR 3.3 Area Navigation (RNAV) Routes	ENR 3.3-1
ENR 3.4 [Reserved]	ENR 3.4-1
ENR 3.5 Other Routes	ENR 3.5-1
ENR 4. NAVIGATION AIDS/SYSTEMS	
ENR 4.1 Navigation Aids – En Route	ENR 4.1-1
ENR 4.2 Special Navigation Systems	ENR 4.2-1
ENR 5. NAVIGATION WARNINGS	
ENR 5.1 Prohibited, Restricted, and Other Areas	ENR 5.1-1
ENR 5.2 Military Exercise and Training Areas	ENR 5.2-1
ENR 5.3 [Reserved]	ENR 5.3-1
ENR 5.4 [Reserved]	ENR 5.4-1
ENR 5.5 [Reserved]	ENR 5.5-1
ENR 5.6 Bird Migration and Areas with Sensitive Fauna	ENR 5.6-1
ENR 5.7 Potential Flight Hazards	ENR 5.7-1
ENR 6. HELICOPTER OPERATIONS	
ENR 6.1 Helicopter IFR Operations	ENR 6.1-1
ENR 6.2 Special Operations	ENR 6.2-1

ENR 1. GENERAL RULES AND PROCEDURES

ENR 1.1 General Rules

1. Differences between National and International Rules and Procedures

1.1 The air traffic rules and procedures applicable to air traffic in U.S. Class A, B, C, D and E airspace conform with Annexes 2 and 11 to the Convention on International Civil Aviation and to those portions applicable to aircraft in the Procedures for Air Navigation Services – Rules of the Air and Air Traffic Services (Doc 4444 – RAC/501/10) and to the Regional Supplementary Procedures (DOC 7030) applicable to the NAM, NAT, CAR and PAC Regions, except as noted in the cases below. All differences have been registered with the International Civil Aviation Organization.

1.1.1 Annex 2 – Rules of the Air

NOTE–
See GEN 1.7.

1.1.2 Annex 11 – Air Traffic Services

NOTE–
See GEN 1.7.

1.1.3 Procedures for Air Navigation Services – Rules of the Air (DOC 4444) and Air Traffic Services (RAC/501/10)

NOTE–
See GEN 1.7.

1.1.4 Regional Supplementary Procedures (Doc 7030)

NOTE–
See GEN 1.7.

2. Airport Operations

2.1 General

2.1.1 Increased traffic congestion, aircraft in climb and descent attitudes, and pilots preoccupation with cockpit duties are some factors that increase the hazardous accident potential near the airport. The situation is further compounded when the weather is marginal; that is, just meeting VFR requirements. Pilots must be particularly alert when operating in the vicinity of an airport. This section defines some rules,

practices, and procedures that pilots should be familiar with, and adhere to, for safe airport operations.

2.1.2 Each airport operator regularly serving scheduled air carriers has put into use security measures designed to prevent or deter unauthorized persons from having access to “Air Operations Area.” The “Air Operations Area” means any area of the airport used or intended to be used for landing, takeoff, or surface maneuvering of aircraft. Pilots are encouraged to obtain airport security instructions by posted signs or radio communication.

3. Airports With an Operating Control Tower

3.1 Towers have been established to provide for a safe, orderly, and expeditious flow of traffic on and in the vicinity of an airport. When the responsibility has been so delegated, towers also provide for the separation of IFR aircraft in the terminal areas (Approach Control).

3.2 When operating at an airport where traffic control is being exercised by a control tower, pilots are required to maintain two-way radio contact with the tower while operating within the Class B, Class C, and Class D surface area unless the tower authorizes otherwise. Initial callup should be made about 15 miles from the airport. Unless there is a good reason to leave the tower frequency before exiting the Class B, Class C, and Class D surface area, it is a good operating practice to remain on the tower frequency for the purpose of receiving traffic information. In the interest of reducing tower frequency congestion, pilots are reminded that it is not necessary to request permission to leave the tower frequency once outside of Class B, Class C, and Class D surface area. Not all airports with an operating control tower will have Class D airspace. These airports do not have weather reporting which is a requirement for surface-based controlled airspace, previously known as a control zone. The controlled airspace over these airports will normally begin at 700 feet or 1,200 feet above ground

level and can be determined from the visual aeronautical charts. Pilots are expected to use good operating practices and communicate with the control tower as described in this section.

3.3 When necessary, the tower controller will issue clearances or other information for aircraft to generally follow the desired flight path (traffic pattern) when flying in the Class D airspace, and the proper taxi routes when operating on the ground. If not otherwise authorized or directed by the tower, pilots approach to land in an airplane must circle the airport to the left, and pilots approaching to land in a helicopter must avoid the flow of fixed-wing traffic. However, an appropriate clearance must be received from the tower before landing.

3.4 The following terminology for the various components of a traffic pattern has been adopted as standard for use by control towers and pilots:

3.4.1 Upwind leg. A flight path parallel to the landing runway in the direction of landing.

3.4.2 Crosswind leg. A flight path at right angles to the landing runway off its takeoff end.

3.4.3 Downwind leg. A flight path parallel to the landing runway in the opposite direction of landing.

3.4.4 Base leg. A flight path at right angles to the landing runway off its approach end and extending from the downwind leg to the intersection of the extended runway centerline.

3.4.5 Final approach. A flight path in the direction of landing along the extended runway centerline from the base leg to the runway.

NOTE-

FIG ENR 1.1-1 is intended only to illustrate terminology used in identifying various components of a traffic pattern. It should not be used as a reference or guide on how to enter a traffic pattern.

3.5 Many towers are equipped with a tower radar display. The radar uses are intended to enhance the effectiveness and efficiency of the local control, or tower, position. They are not intended to provide radar services or benefits to pilots except as they may accrue through a more efficient tower operation. The four basic uses are:

3.5.1 To determine an aircraft's exact location. This is accomplished by radar identifying the VFR aircraft through any of the techniques available to a radar position; such as, having the aircraft ident. Once identified, the aircraft's position and spatial relationship to other aircraft can be quickly determined, and standard instructions regarding VFR operation in the aircraft traffic area will be issued. Once initial radar identification of a VFR aircraft has been established and the appropriate instructions have been issued, radar monitoring may be discontinued; the reason being that the local controller's primary means of surveillance in VFR conditions is usually scanning the airport and local area.

3.5.2 To provide radar traffic advisories. Radar traffic advisories may be provided to the extent that the local controller is able to monitor the radar display. Local control has primary control responsibilities to the aircraft operating on the runways which will normally supersede radar monitoring duties.

3.5.3 To provide a direction or suggested heading. The local controller may provide pilots flying VFR with generalized instructions which will facilitate operations; e.g., "PROCEED SOUTHWEST BOUND, ENTER A RIGHT DOWNWIND RUNWAY THREE ZERO;" or provide a suggested heading to establish radar identification or as an advisory aid to navigation; e.g., "SUGGESTED HEADING TWO TWO ZERO, FOR RADAR IDENTIFICATION." In both cases, the instructions are advisory aids to the pilot flying VFR and are not radar vectors. PILOTS HAVE COMPLETE DISCRETION REGARDING ACCEPTANCE OF THE SUGGESTED HEADING OR DIRECTION AND HAVE SOLE RESPONSIBILITY FOR SEEING AND AVOIDING OTHER AIRCRAFT.

FIG ENR 1.1-1
Components of a Traffic Pattern

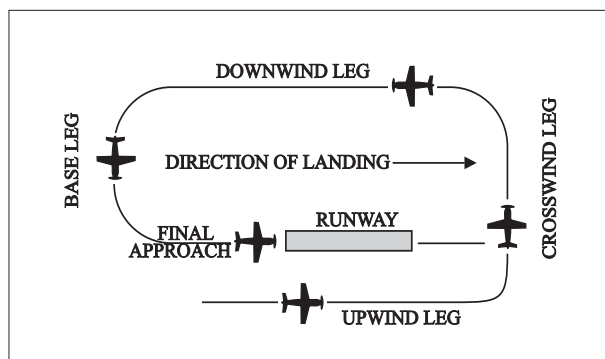

3.5.4 To provide information and instructions to aircraft operating within Class D airspace. In an example of this situation, the local controller would use the radar to advise a pilot on an extended downwind when to turn base leg.

NOTE-

The above tower radar applications are intended to augment the standard functions of the local control position. There is no controller requirement to maintain constant radar identification and, in fact, such a requirement could compromise the local controller's ability to visually scan the airport and local area to meet FAA responsibilities to the aircraft operating on the runways and within Class D airspace. Normally, pilots will not be advised of being in radar contact since that continued status cannot be guaranteed and since the purpose of the radar identification is not to establish a link for the provision of radar services.

3.6 A few of the radar-equipped towers are authorized to use the radar to ensure separation between aircraft in specific situations, while still others may function as limited radar approach controls. The various radar uses are strictly a function of FAA operational need. The facilities may be indistinguishable to pilots since they are all referred to as tower and no publication lists the degree of radar use. **THEREFORE, WHEN IN COMMUNICATION WITH A TOWER CONTROLLER WHO MAY HAVE RADAR AVAILABLE, DO NOT ASSUME THAT CONSTANT RADAR MONITORING AND COMPLETE ATC RADAR SERVICES ARE BEING PROVIDED.**

4. Traffic Patterns

4.1 At most airports and military air bases, traffic pattern altitudes for propeller driven aircraft generally extend from 600 feet to as high as 1,500 feet above the ground. Also, traffic pattern altitudes for military turbojet aircraft sometimes extend up to 2,500 feet above the ground. Therefore, pilots of en route aircraft should be constantly on the alert for other aircraft in traffic patterns and avoid these areas whenever possible. Traffic pattern altitudes should be maintained unless otherwise required by the applicable distance from cloud criteria (14 CFR Section 91.155.)

(See FIG ENR 1.1-2 and FIG ENR 1.1-3.)

4.2 Unexpected Maneuvers in the Airport Traffic Pattern

4.2.1 There have been several incidents in the vicinity of controlled airports that were caused primarily by aircraft executing unexpected maneuvers. ATC service is based upon observed or known traffic and airport conditions. Controllers establish the sequence of arriving and departing aircraft by requiring them to adjust flight as necessary to achieve proper spacing. These adjustments can only be based on observed traffic, accurate pilot reports, and anticipated aircraft maneuvers. Pilots are expected to cooperate so as to preclude disruption of traffic flow or creation of conflicting patterns. The pilot in command of an aircraft is directly responsible for and is the final authority as to the operation of that aircraft.

4.2.2 On occasion it may be necessary for pilots to maneuver their aircraft to maintain spacing with the traffic they have been sequenced to follow. The controller can anticipate minor maneuvering such as shallow "S" turns. The controller cannot, however, anticipate a major maneuver such as a 360-degree turn. If a pilot makes a 360-degree turn after obtaining a landing sequence, the result is usually a gap in the landing interval and more importantly it causes a chain reaction which may result in a conflict with following traffic and interruption of the sequence established by the tower or approach controller. Should a pilot decide to make maneuvering turns to maintain spacing behind a preceding aircraft, the pilot should always advise the controller if at all possible. Except when requested by the controller or in emergency situations, a 360-degree turn should never be executed in the traffic pattern or when receiving radar service without first advising the controller.

FIG ENR 1.1-2
Traffic Pattern Operations
Single Runway

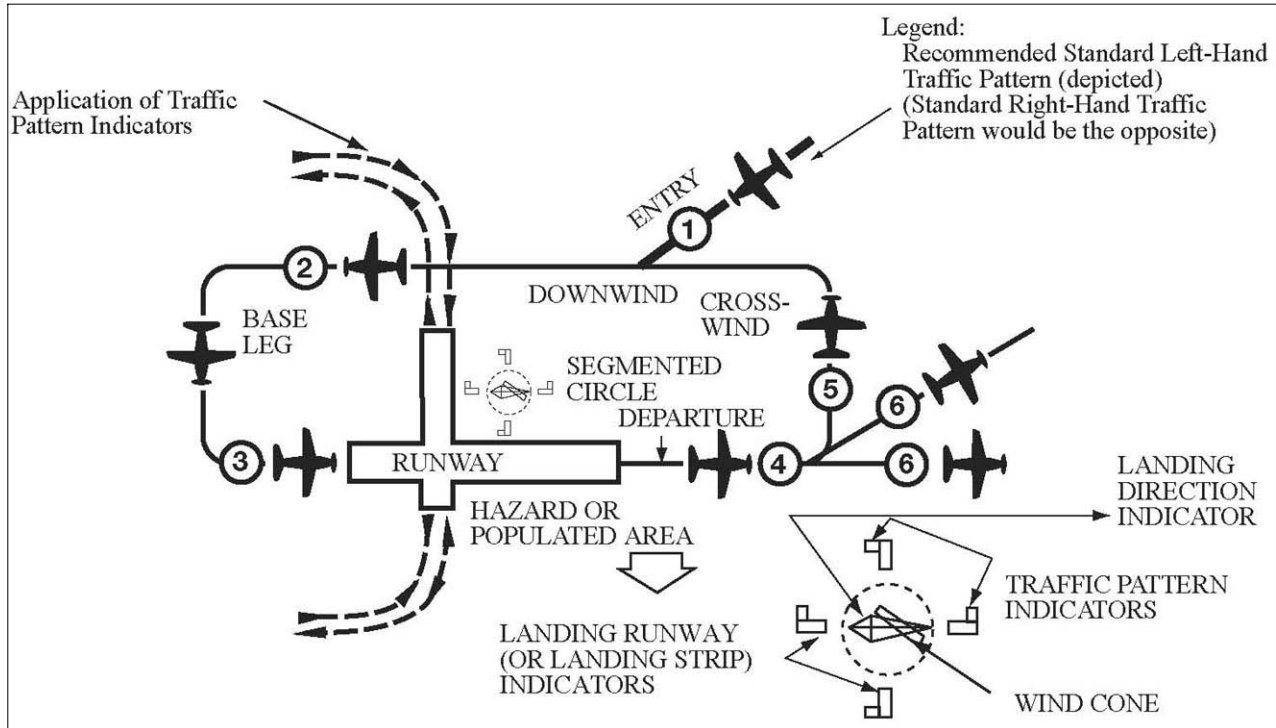

**EXAMPLE—
KEY TO TRAFFIC PATTERN OPERATIONS**

1. Enter pattern in level flight, abeam the midpoint of the runway, at pattern altitude. (1,000' AGL is recommended pattern altitude unless established otherwise.)
2. Maintain pattern altitude until abeam approach end of the landing runway on downwind leg.
3. Complete turn to final at least $1/4$ mile from the runway.

4. Continue straight ahead until beyond departure end of runway.
5. If remaining in the traffic pattern, commence turn to crosswind leg beyond the departure end of the runway within 300 feet of pattern altitude.
6. If departing the traffic pattern, continue straight out, or exit with a 45 degree turn (to the left when in a left-hand traffic pattern; to the right when in a right-hand traffic pattern) beyond the departure end of the runway, after reaching pattern altitude.

FIG ENR 1.1-3
Traffic Pattern Operations
Parallel Runways

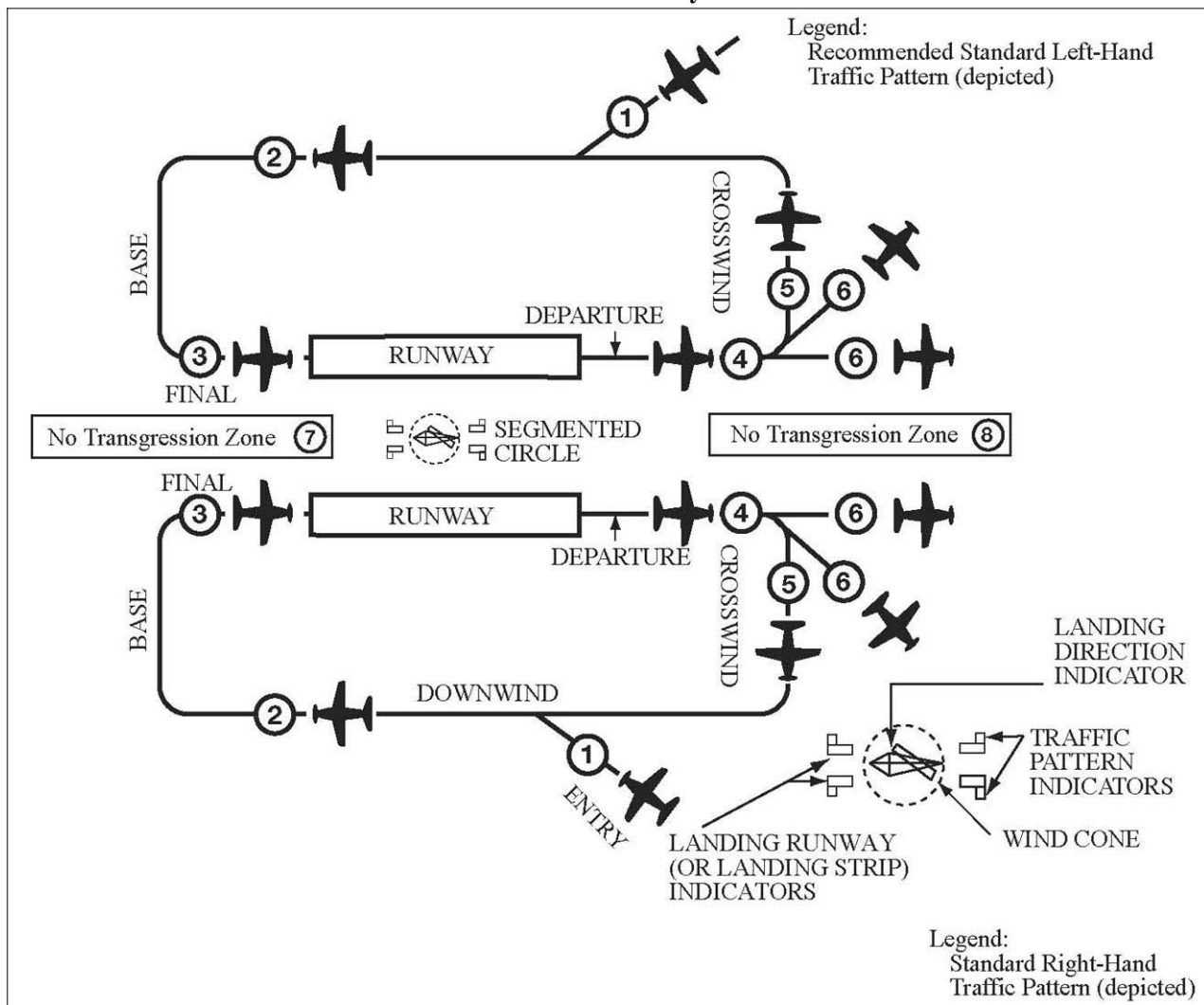

**EXAMPLE-
KEY TO TRAFFIC PATTERN OPERATIONS**

1. Enter pattern in level flight, abeam the midpoint of the runway, at pattern altitude. (1,000' AGL is recommended pattern altitude unless established otherwise.)
2. Maintain pattern altitude until abeam approach end of the landing runway on downwind leg.
3. Complete turn to final at least 1/4 mile from the runway.
4. Continue straight ahead until beyond departure end of runway.

5. If remaining in the traffic pattern, commence turn to crosswind leg beyond the departure end of the runway within 300 feet of pattern altitude.
6. If departing the traffic pattern, continue straight out, or exit with a 45 degree turn (to the left when in a left-hand traffic pattern; to the right when in a right-hand traffic pattern) beyond the departure end of the runway, after reaching pattern altitude.
7. Do not overshoot final or continue on a track which will penetrate the final approach of the parallel runway.
8. Do not continue on a track which will penetrate the departure path of the parallel runway.

5. Visual Indicators at Airports Without an Operating Control Tower

5.1 At those airports without an operating control tower, a segmented circle visual indicator system, if installed, is designed to provide traffic pattern information. The segmented circle system consists of the following components:

5.1.1 The Segmented Circle. Located in a position affording maximum visibility to pilots in the air and on the ground and providing a centralized location for other elements of the system.

5.1.2 The Wind Direction Indicator. A wind cone, wind sock, or wind tee installed near the operational runway to indicate wind direction. The large end of the wind cone/wind sock points into the wind as does the large end (cross bar) of the wind tee. In lieu of a tetrahedron and where a wind sock or wind cone is collocated with a wind tee, the wind tee may be manually aligned with the runway in use to indicate landing direction. These signaling devices may be located in the center of the segmented circle and may be lighted for night use. Pilots are cautioned against using a tetrahedron to indicate wind direction.

5.1.3 The Landing Direction Indicator. A tetrahedron is installed when conditions at the airport warrant its use. It may be used to indicate the direction of landings and takeoffs. A tetrahedron may be located at the center of a segmented circle and may be lighted for night operations. The small end of the tetrahedron points in the direction of landing. Pilots are cautioned against using a tetrahedron for any purpose other than as an indicator of landing direction. Further, pilots should use extreme caution when making runway selection by use of a tetrahedron in very light or calm wind conditions as the tetrahedron may not be aligned with the designated calm-wind runway. At airports with control towers, the tetrahedron should only be referenced when the control tower is not in operation. Tower instructions supersede tetrahedron indications.

5.1.4 Landing Strip Indicators. Installed in pairs as shown in the segmented circle diagram, and used to show the alignment of landing strips.

5.1.5 Traffic Pattern Indicators. Arranged in pairs in conjunction with landing strip indicators and used to indicate the direction of turns when there is a variation from the normal left traffic pattern. If there

is no segmented circle installed at the airport, traffic pattern indicators may be installed on or near the end of the runway.

5.2 Preparatory to landing at an airport without a control tower, or when the control tower is not in operation, the pilot should concern himself with the indicator for the approach end of the runway to be used. When approaching for landing, all turns must be made to the left unless a traffic pattern indicator indicates that turns should be made to the right. If the pilot will mentally enlarge the indicator for the runway to be used, the base and final approach legs of the traffic pattern to be flown immediately become apparent. Similar treatment of the indicator at the departure end of the runway will clearly indicate the direction of turn after takeoff.

5.3 When two or more aircraft are approaching an airport for the purpose of landing, the pilot of the aircraft at the lower altitude has the right-of-way over the pilot of the aircraft at the higher altitude. However, the pilot operating at the lower altitude should not take advantage of another aircraft, which is on final approach to land, by cutting in front of, or overtaking that aircraft.

6. Ground Control Frequencies

6.1 Pilots of departing aircraft should communicate with the control tower on the appropriate ground control/clearance delivery frequency prior to starting engines to receive engine start time, taxi and/or clearance information. Unless otherwise advised by the tower, remain on that frequency during taxiing and runup, then change to local control frequency when ready to request takeoff clearance.

NOTE—

Pilots are encouraged to monitor the local tower frequency as soon as practical consistent with other ATC requirements.

6.2 The tower controller will consider that pilots of turbine-powered aircraft are ready for takeoff when they reach the runway or warm-up block unless advised otherwise.

6.3 The majority of ground control frequencies are in the 121.6–121.9 MHz bandwidth. Ground control frequencies are provided to eliminate frequency congestion on the tower (local control) frequency and are limited to communications between the tower and aircraft on the ground and between the tower and utility vehicles on the airport, provide a clear VHF

channel for arriving and departing aircraft. They are used for issuance of taxi information, clearances, and other necessary contacts between the tower and aircraft or other vehicles operated on the airport. A pilot who has just landed should not change from the tower frequency to the ground control frequency until directed to do so by the controller. Normally, only one ground control frequency is assigned at an airport; however, at locations where the amount of traffic so warrants, a second ground control frequency and/or another frequency designated as a clearance delivery frequency, may be assigned.

6.4 A controller may omit the ground or local control frequency if the controller believes the pilot knows which frequency is in use. If the ground control frequency is in the 121 MHz bandwidth the controller may omit the numbers preceding the decimal point; e.g., 121.7, “CONTACT GROUND POINT SEVEN.” However, if any doubt exists as to what frequency is in use, the pilot should promptly request the controller to provide that information.

6.5 Controllers will normally avoid issuing a radio frequency change to helicopters, known to be single-piloted, which are hovering, air taxiing, or flying near the ground. At times, it may be necessary for pilots to alert ATC regarding single pilot operations to minimize delay of essential ATC communications. Whenever possible, ATC instructions will be relayed through the frequency being monitored until a frequency change can be accomplished. Pilots must promptly advise ATC if they are unable to comply with a frequency change. Also, pilots should advise ATC if they must land to accomplish the frequency change unless it is clear the

landing; e.g., on a taxiway or in a helicopter operating area, will have no impact on other air traffic.

7. Traffic Control Light Signals

7.1 The following procedures are used by airport traffic control towers in the control of aircraft, ground vehicles, equipment, and personnel not equipped with radio. These same procedures will be used to control aircraft, ground vehicles, equipment, and personnel equipped with radio if radio contact cannot be established. Airport traffic control personnel use a directive traffic control signal which emits an intense narrow beam of a selected color (either red, white, or green) when controlling traffic by light signals.

7.2 Although the traffic signal light offers the advantage that some control may be exercised over nonradio-equipped aircraft, pilots should be cognizant of the disadvantages which are:

7.2.1 The pilot may not be looking at the control tower at the time a signal is directed toward him/her; and

7.2.2 The directions transmitted by a light signal are very limited since only approval of a pilot’s anticipated actions may be transmitted. No supplement or explanatory information may be transmitted except by the use of the “General Warning Signal” which advises the pilot to be on the alert.

7.3 Between sunset and sunrise, a pilot wishing to attract the attention of the control tower should turn on a landing light and taxi the aircraft into a position, clear of the active runway, so that light is visible to the tower. The landing light should remain on until appropriate signals are received from the tower.

TBL ENR 1.1-1
Air Traffic Control Tower Light Gun Signals

Color and Type of Signal	Meaning		
	Movement of Vehicles, Equipment and Personnel	Aircraft on the Ground	Aircraft in Flight
Steady green	Cleared to cross, proceed or go	Cleared for takeoff	Cleared to land
Flashing green	Not applicable	Cleared for taxi	Return for landing (to be followed by steady green at the proper time)
Steady red	STOP	STOP	Give way to other aircraft and continue circling
Flashing red	Clear the taxiway/runway	Taxi clear of the runway in use	Airport unsafe, do not land
Flashing white	Return to starting point on airport	Return to starting point on airport	Not applicable
Alternating red and green	Exercise extreme caution	Exercise extreme caution	Exercise extreme caution

8. Use of Runways/Declared Distances

8.1 Runways are identified by numbers which indicate the nearest 10-degree increment of the azimuth of the runway centerline. For example, where the magnetic azimuth is 183 degrees, the runway designation would be 18; for a magnetic azimuth of 87 degrees, the runway designation would be 9. For a magnetic azimuth ending in the number 5, such as 185, the runway designation could be either 18 or 19. Wind direction issued by the tower is also magnetic, and wind velocity is in knots.

8.2 Airport proprietors are responsible for taking the lead in local aviation noise control. Accordingly, they may propose specific noise abatement plans to the FAA. If approved, these plans are applied in the form of Formal or Informal Runway Use Programs for noise abatement purposes.

8.3 At airports where no runway use program is established, ATC clearance may specify:

8.3.1 The runway most nearly aligned with the wind when it is five knots or more.

8.3.2 The “calm wind” runway when wind is less than five knots.

8.3.3 Another runway if operationally advantageous.

NOTE–

It is not necessary for a controller to specifically inquire if the pilot will use a specific runway or to offer the pilot a choice of runways. If a pilot prefers to use a different runway than that specified or the one most nearly aligned with the wind, the pilot is expected to inform ATC accordingly.

8.4 At airports where a runway use program is established, ATC will assign runways deemed to have the least noise impact. If in the interest of safety a runway different than that specified is preferred, the pilot is expected to advise ATC accordingly. ATC will honor such requests and advise pilots when the requested runway is noise sensitive. When use of a runway other than the one assigned is requested, pilot cooperation is encouraged to preclude disruption of traffic flows or creation of conflicting patterns.

8.5 Declared Distances.

8.5.1 Declared distances for a runway represent the maximum distances available and suitable for meeting takeoff and landing distance performance requirements. These distances are determined in

accordance with FAA runway design standards by adding to the physical length of paved runway any clearway or stopway and subtracting from that sum any lengths necessary to obtain the standard runway safety areas, runway object free areas, or runway protection zones. As a result of these additions and subtractions, the declared distances for a runway may be more or less than the physical length of the runway as depicted on aeronautical charts and related publications, or available in electronic navigation databases provided by either the U.S. Government or commercial companies.

8.5.2 All 14 CFR Part 139 airports report declared distances for each runway. Other airports may also report declared distances for a runway if necessary to meet runway design standards or to indicate the presence of a clearway or stopway. Where reported, declared distances for each runway end are published in the Airport/Facility Directory (A/FD). For runways without published declared distances, the declared distances may be assumed to be equal to the physical length of the runway unless there is a displaced landing threshold, in which case the Landing Distance Available (LDA) is shortened by the amount of the threshold displacement.

NOTE–

*A symbol **D** is shown on U.S. Government charts to indicate that runway declared distance information is available (See appropriate A/FD, Alaska, or Pacific Supplement).*

8.5.2.1 The FAA uses the following definitions for runway declared distances (See FIG ENR 1.1–4).

REFERENCE–

Pilot/Controller Glossary Terms: “Accelerate–Stop Distance Available,” “Landing Distance Available,” “Takeoff Distance Available,” “Takeoff Run Available,” “Stopway,” and “Clearway.”

a) Takeoff Run Available (TORA) – The runway length declared available and suitable for the ground run of an airplane taking off.

The TORA is typically the physical length of the runway, but it may be shorter than the runway length if necessary to satisfy runway design standards. For example, the TORA may be shorter than the runway length if a portion of the runway must be used to satisfy runway protection zone requirements.

b) Takeoff Distance Available (TODA) – The takeoff run available plus the length of any remaining runway or clearway beyond the far end of the takeoff run available.

The TODA is the distance declared available for satisfying takeoff distance requirements for airplanes where the certification and operating rules and available performance data allow for the consideration of a clearway in takeoff performance computations.

NOTE-

The length of any available clearway will be included in the TODA published in the A/FD's entry for that runway end.

c) Accelerate-Stop Distance Available (ASDA) – The runway plus stopway length declared available and suitable for the acceleration and deceleration of an airplane aborting a takeoff.

The ASDA may be longer than the physical length of the runway when a stopway has been designated available by the airport operator, or it may be shorter than the physical length of the runway if necessary to use a portion of the runway to satisfy runway design standards; for example, where the airport operator uses a portion of the runway to achieve the runway safety area requirement. ASDA is the distance used to satisfy the airplane accelerate-stop distance performance requirements where the certification and operating rules require accelerate-stop distance computations.

NOTE-

The length of any available stopway will be included in the ASDA published in the A/FD's entry for that runway end.

d) Landing Distance Available (LDA) – The runway length declared available and suitable for a landing airplane.

The LDA may be less than the physical length of the runway or the length of the runway remaining beyond a displaced threshold if necessary to satisfy runway design standards; for example, where the airport operator uses a portion of the runway to achieve the runway safety area requirement.

Although some runway elements (such as stopway length and clearway length) may be available information, pilots must use the declared distances determined by the airport operator and not attempt to independently calculate declared distances by adding those elements to the reported physical length of the runway.

8.5.2.2 The airplane operating rules and/or the airplane operating limitations establish minimum distance requirements for takeoff and landing and

are based on performance data supplied in the Airplane Flight Manual or Pilot's Operating Handbook. The minimum distances required for takeoff and landing obtained either in planning prior to takeoff or in performance assessments conducted at the time of landing must fall **within** the applicable declared distances before the pilot can accept that runway for takeoff or landing.

8.5.2.3 Runway design standards may impose restrictions on the amount of runway available for use in takeoff and landing that are not apparent from the reported physical length of the runway or from runway markings and lighting. The runway elements of Runway Safety Area (RSA), Runway Object Free Area (ROFA), and Runway Protection Zone (RPZ) may reduce a runway's declared distances to less than the physical length of the runway at geographically constrained airports (See FIG ENR 1.1-5). When considering the amount of runway available for use in takeoff or landing performance calculations, the declared distances published for a runway must always be used in lieu of the runway's physical length.

REFERENCE-

AC 150/5300-13, Airport Design.

8.5.2.4 While some runway elements associated with declared distances may be identifiable through runway markings or lighting (for example, a displaced threshold or a stopway), the individual declared distance limits are not marked or otherwise identified on the runway. An aircraft is **not prohibited** from operating beyond a declared distance limit during the takeoff, landing, or taxi operation provided the runway surface is appropriately marked as usable runway (See FIG ENR 1.1-5). The following examples clarify the intent of this paragraph.

REFERENCE-

*AIM, Runway Markings, Paragraph 2-3-3.
AC 150/5340-1, Standards for Airport Markings.*

EXAMPLE-

1. *The declared LDA for runway 9 must be used when showing compliance with the landing distance requirements of the applicable airplane operating rules and/or airplane operating limitations or when making a before landing performance assessment. The LDA is less than the physical runway length, not only because of the displaced threshold, but also because of the subtractions necessary to meet the RSA beyond the far end of the runway. However, during the actual landing operation, it is permissible for the airplane to roll beyond the unmarked end of the LDA.*

2. The declared ASDA for runway 9 must be used when showing compliance with the accelerate-stop distance requirements of the applicable airplane operating rules and/or airplane operating limitations. The ASDA is less than the physical length of the runway due to subtractions

necessary to achieve the full RSA requirement. However, in the event of an aborted takeoff, it is permissible for the airplane to roll beyond the unmarked end of the ASDA as it is brought to a full-stop on the remaining usable runway.

FIG ENR 1.1-4
Declared Distances with Full-Standard Runway Safety Areas, Runway Object Free Areas, and Runway Protection Zones

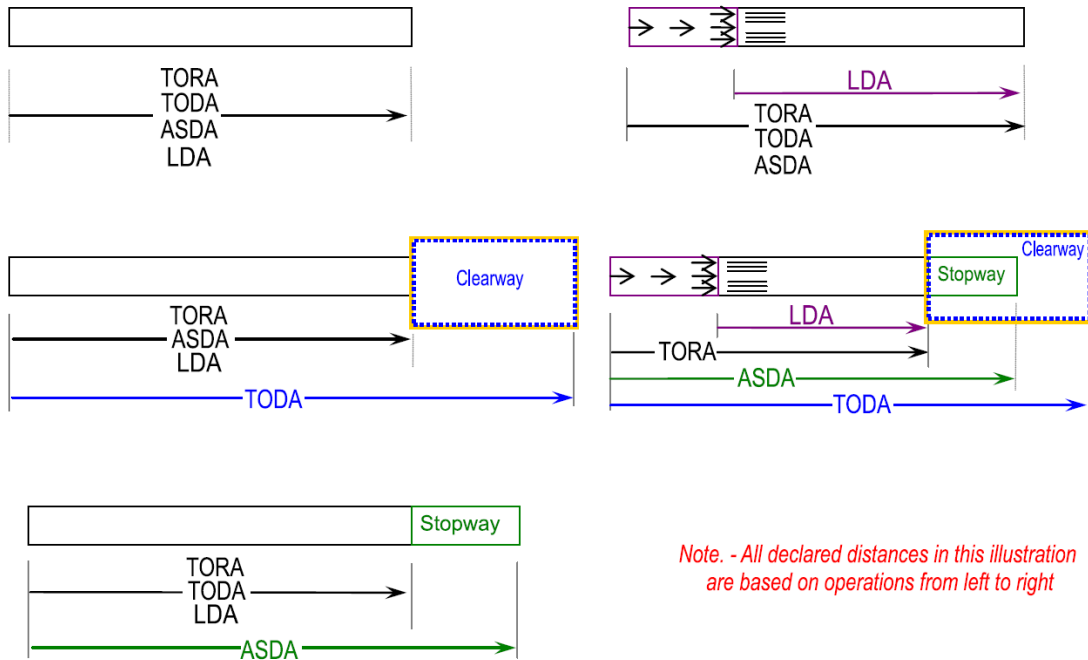

Note. - All declared distances in this illustration are based on operations from left to right

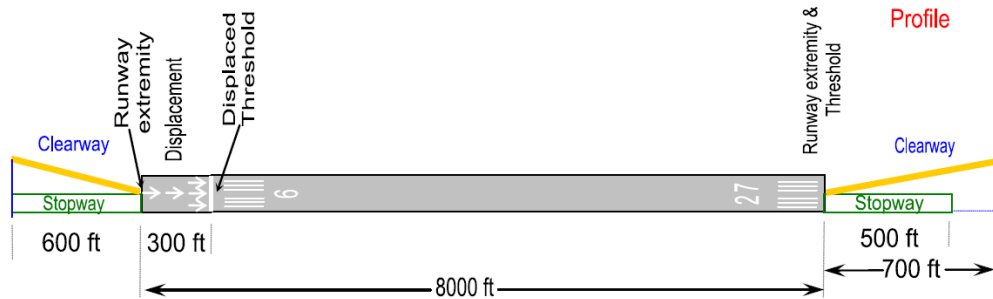

Runway	Length (feet)	TORA	ASDA	TODA	LDA
9	8000	8000	8500	8700	7700
27	8000	8000	8600	8600	8000

FIG ENR 1.1-5
Effects of a Geographical Constraint on a Runway's Declared Distances

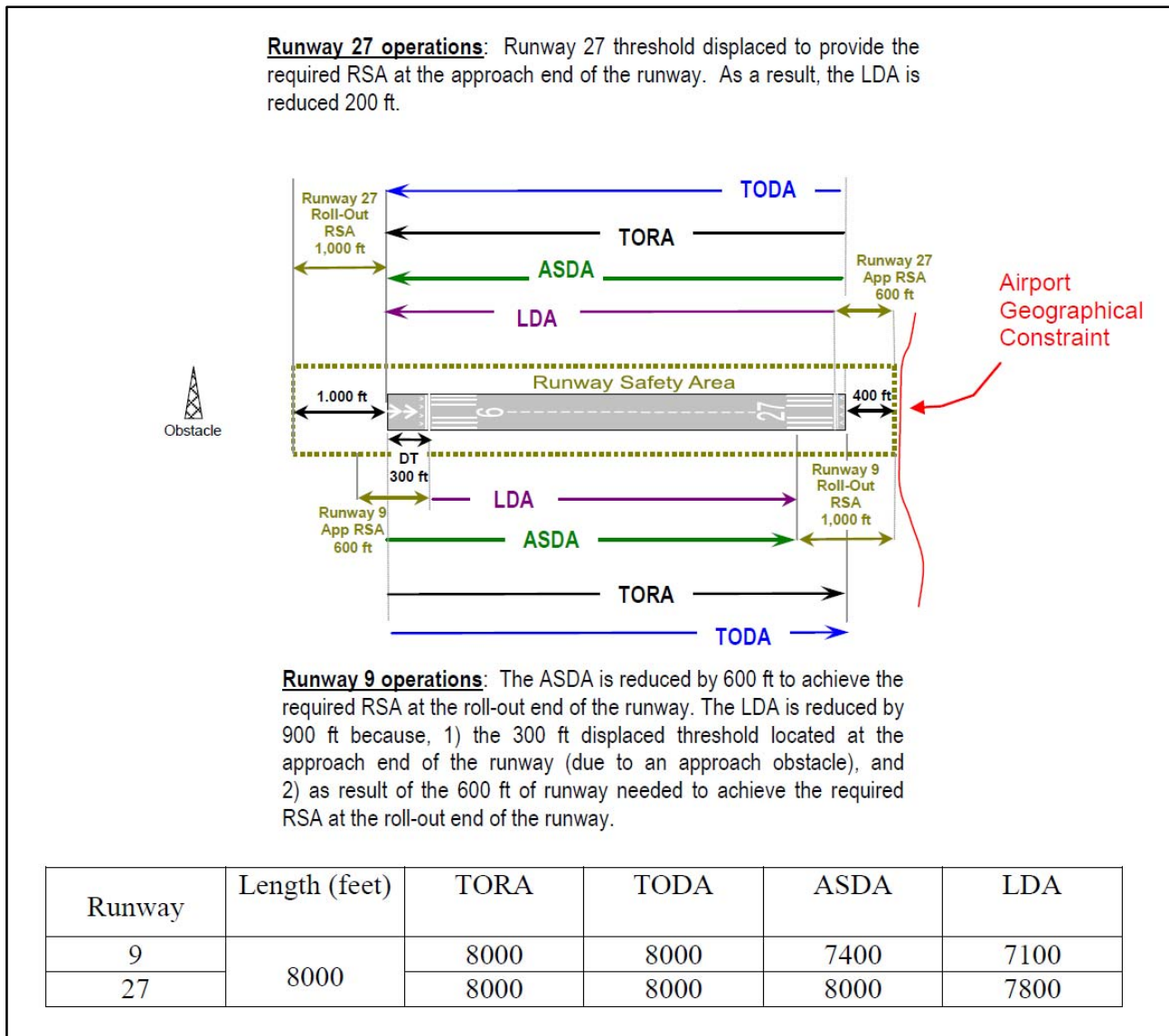

NOTE-

A runway's RSA begins a set distance prior to the threshold and will extend a set distance beyond the end of the runway depending on the runway's design criteria. If these required lengths cannot be achieved, the ASDA and/or LDA will be reduced as necessary to obtain the required lengths to the extent practicable.

9. Low Level Wind Shear/Microburst Detection Systems

9.1 Low Level Wind Shear Alert System (LLWAS), Terminal Doppler Weather Radar (TDWR), Weather System Processor (WSP), and Integrated Terminal Weather System (ITWS) display information on hazardous wind shear and microburst activity in the vicinity of an airport to air traffic controllers who relay this information to pilots.

9.1.1 LLWAS provides wind shear alert and gust front information but does not provide microburst alerts. The LLWAS is designed to detect low level wind shear conditions around the periphery of an airport. It does not detect wind shear beyond that limitation. Controllers will provide this information to pilots by giving the pilot the airport wind followed by the boundary wind.

EXAMPLE–

Wind shear alert, airport wind 230 at 8, south boundary wind 170 at 20.

9.1.2 LLWAS “network expansion,” (LLWAS NE) and LLWAS Relocation/Sustainment (LLWAS–RS) are systems integrated with TDWR. These systems provide the capability of detecting microburst alerts and wind shear alerts. Controllers will issue the appropriate wind shear alerts or microburst alerts. In some of these systems controllers also have the ability to issue wind information oriented to the threshold or departure end of the runway.

EXAMPLE–

Runway 17 arrival microburst alert, 40 knot loss 3 mile final.

NOTE–

Reference GEN 3.5, Paragraph 25, Microbursts.

9.1.3 More advanced systems are in the field or being developed such as ITWS. ITWS provides alerts for microbursts, wind shear, and significant thunderstorm activity. ITWS displays wind information oriented to the threshold or departure end of the runway.

9.1.4 The WSP provides weather processor enhancements to selected Airport Surveillance Radar (ASR)–9 facilities. The WSP provides Air Traffic with detection and alerting of hazardous weather such as wind shear, microbursts, and significant thunderstorm activity. The WSP displays terminal area 6 level weather, storm cell locations and movement, as well as the location and predicted future position

and intensity of wind shifts that may affect airport operations. Controllers will receive and issue alerts based on Areas Noted for Attention (ARENA). An ARENA extends on the runway center line from a 3 mile final to the runway to a 2 mile departure.

9.1.5 An airport equipped with the LLWAS, ITWS, or WSP is so indicated in the Airport/Facility Directory under Weather Data Sources for that particular airport.

10. Braking Action Reports and Advisories

10.1 When available, ATC furnishes pilots the quality of braking action received from pilots or airport management. The quality of braking action is described by the terms “good,” “fair,” “poor,” and “nil,” or a combination of these terms. When pilots report the quality of braking action by using the terms noted above, they should use descriptive terms that are easily understood, such as, “braking action poor the first/last half of the runway,” together with the particular type of aircraft.

10.2 For NOTAM purposes, braking action reports are classified according to the most critical term (“fair,” “poor,” or “nil”) used and issued as a NOTAM(D).

10.3 When tower controllers have received runway braking action reports which include the terms “poor” or “nil” or whenever weather conditions are conducive to deteriorating or rapidly changing runway braking conditions, the tower will include on the ATIS broadcast the statement, “BRAKING ACTION ADVISORIES ARE IN EFFECT.”

10.4 During the time that Braking Action Advisories are in effect, ATC will issue the latest braking action report for the runway in use to each arriving and departing aircraft. Pilots should be prepared for deteriorating braking conditions and should request current runway condition information if not volunteered by controllers. Pilots should also be prepared to provide a descriptive runway condition report to controllers after landing.

11. Runway Friction Reports and Advisories

11.1 Friction is defined as the ratio of the tangential force needed to maintain uniform relative motion between two contacting surfaces (aircraft tires to the pavement surface) to the perpendicular force holding

them in contact (distributed aircraft weight to the aircraft tire area). Simply stated, friction quantifies slipperiness of pavement surfaces.

11.2 The Greek letter MU (pronounced “myew”), is used to designate a friction value representing runway surface conditions.

11.3 MU (friction) values range from 0 to 100 where zero is the lowest friction value and 100 is the maximum friction value obtainable. For frozen contaminants on runway surfaces, a MU value of 40 or less is the level when the aircraft braking performance starts to deteriorate and directional control begins to be less responsive. The lower the MU value, the less effective braking performance becomes and the more difficult directional control becomes.

11.4 At airports with friction measuring devices, airport management should conduct friction measurements on runways covered with compacted snow and/or ice.

11.4.1 Numerical readings may be obtained by using any FAA approved friction measuring device. As these devices do not provide equal numerical readings on contaminated surfaces, it is necessary to designate the type of friction measuring device used.

11.4.2 When the MU value for any one-third zone of an active runway is 40 or less, a report should be given to ATC by airport management for dissemination to pilots. The report will identify the runway, the time of measurement, the type of friction measuring device used, MU values for each zone, and the contaminant conditions; e.g., wet snow, dry snow, slush, deicing chemicals, etc. Measurements for each one-third zone will be given in the direction of takeoff and landing on the runway. A report should also be given when MU values rise above 40 in all zones of a runway previously reporting a MU below 40.

11.4.3 Airport management should initiate a NO-TAM(D) when the friction measuring device is out of service.

11.4.4 When MU reports are provided by airport management, the ATC facility providing approach control or local airport advisory will provide the report to any pilot upon request.

11.4.5 Pilots should use MU information with other knowledge including aircraft performance characteristics, type, weight, previous experience, wind

conditions, and aircraft tire type (i.e., bias ply vs. radial constructed) to determine runway suitability.

11.4.6 No correlation has been established between MU values and the descriptive terms “good,” “fair,” “poor,” and “nil” used in braking action reports.

12. Communications Prior to Departure

12.1 Nontower Controlled Airports

12.1.1 At airports not served by a FSS located on the airport, the pilot in command should broadcast his/her intentions on the prescribed frequency prior to aircraft movement and departure.

12.1.2 At airports served by a FSS located on the airport, the pilot in command should obtain airport advisory service prior to aircraft movement and departure.

12.1.3 Aircraft departing on an IFR clearance must obtain the clearance prior to departure via telephone, the appropriate FSS, or via direct communications with the ATC facility issuing the clearance as appropriate. An IFR clearance does not relieve the pilot from the communication stated above prior to aircraft movement and departure.

12.2 Tower Controlled Airports

12.2.1 Pilots of departing aircraft should communicate with the control tower on the appropriate ground control/clearance delivery frequency prior to starting engines to receive engine start time, taxi, and/or clearance information. Unless otherwise advised by the tower, remain on the frequency during taxiing and run up, then change to local control frequency when ready to request takeoff clearance.

NOTE-

Refer to Automatic Terminal Information Service (ATIS) for continuous broadcast of terminal information.

13. Gate Holding Due to Departure Delays

13.1 Pilots should contact ground control/clearance delivery prior to starting engines as gate hold procedures will be in effect whenever departure delays exceed or are anticipated to exceed 15 minutes. The sequence for departure will be maintained in accordance with initial call up unless modified by flow control restrictions. Pilots should monitor the ground control/clearance delivery frequency for engine startup advisories or new proposed start time if the delay changes.

13.2 The tower controller will consider that pilots of turbine-powered aircraft are ready for takeoff when they reach the runway/warm-up block unless advised otherwise.

14. Taxiing

14.1 General. Approval must be obtained prior to moving an aircraft or vehicle onto the movement area during the hours an airport traffic control tower is in operation.

14.1.1 Always state your position on the airport when calling the tower for taxi instructions.

14.1.2 The movement area is normally described in local bulletins issued by the airport manager or control tower. These bulletins may be found in FSSs, fixed base operators offices, air carrier offices, and operations offices.

14.1.3 The control tower also issues bulletins describing areas where they cannot provide airport traffic control service due to nonvisibility or other reasons.

14.1.4 A clearance must be obtained prior to taxiing on a runway, taking off, or landing during the hours an airport traffic control tower is in operation.

14.1.5 A clearance must be obtained prior to crossing any runway. ATC will issue an explicit clearance for all runway crossings.

14.1.6 When assigned a takeoff runway, ATC will first specify the runway, issue taxi instructions, and state any hold short instructions or runway crossing clearances if the taxi route will cross a runway. This does not authorize the aircraft to “enter” or “cross” the assigned departure runway at any point. In order to preclude misunderstandings in radio communications, ATC will not use the word “cleared” in conjunction with authorization for aircraft to taxi. **AIR TRAFFIC CONTROLLERS ARE REQUIRED TO OBTAIN A READBACK FROM THE PILOT OF ALL RUNWAY HOLD SHORT INSTRUCTIONS.**

14.1.7 When issuing taxi instructions to any point other than an assigned takeoff runway, ATC will specify the point to taxi to, issue taxi instructions, and state any hold short instructions or runway crossing clearances if the taxi route will cross a runway.

14.1.8 If a pilot is expected to hold short of a runway approach (“APPCH”) area or ILS holding position (see FIG AD 1.1–24, Taxiways Located in Runway Approach Area, in Section AD 1.1, Aerodrome Availability), ATC will issue instructions.

14.1.9 When taxi instructions are received from the controller, pilots should always read back:

14.1.9.1 The runway assignment.

14.1.9.2 Any clearance to enter a specific runway.

14.1.9.3 Any instruction to hold short of a specific runway or line up and wait.

14.1.10 Controllers are required to request a readback of runway hold short assignment when it is not received from the pilot/vehicle.

14.2 ATC clearances or instructions pertaining to taxiing are predicated on known traffic and known physical airport conditions. Therefore, it is important that pilots clearly understand the clearance or instruction. Although an ATC clearance is issued for taxiing purposes, when operating in accordance with the Federal Regulations, it is the responsibility of the pilot to avoid collision with other aircraft. Since “the pilot in command of an aircraft is directly responsible for, and is the final authority as to, the operation of that aircraft” the pilot should obtain clarification of any clearance or instruction which is not understood.

14.2.1 Good operating practice dictates that pilots acknowledge all runway crossing, hold short, or takeoff clearances unless there is some misunderstanding, at which time the pilot should query the controller until the clearance is understood. **AIR TRAFFIC CONTROLLERS ARE REQUIRED TO OBTAIN FROM THE PILOT A READBACK OF ALL RUNWAY HOLD SHORT INSTRUCTIONS.** Pilots operating a single pilot aircraft should monitor only assigned ATC communications after being cleared onto the active runway for departure. Single pilot aircraft should not monitor other than ATC communications until flight from Class D airspace is completed. This same procedure should be practiced from after receipt of the clearance for landing until the landing and taxi activities are complete. Proper effective scanning for other aircraft, surface vehicles, or other objects should be continuously exercised in all cases.

14.2.2 If the pilot is unfamiliar with the airport or for any reason confusion exists as to the correct taxi routing, a request may be made for progressive taxi

instructions which include step-by-step routing directions. Progressive instructions may also be issued if the controller deems it necessary due to traffic or field conditions (for example, construction or closed taxiways).

14.3 At those airports where the United States Government operates the control tower and ATC has authorized noncompliance with the requirement for two-way radio communications while operating within Class D airspace, or at those airports where the United States Government does not operate the control tower and radio communications cannot be established, pilots shall obtain a clearance by visual light signal prior to taxiing on a runway and prior to takeoff and landing.

14.4 The following phraseologies and procedures are used in radio–telephone communications with aeronautical ground stations.

14.4.1 Request for taxi instructions prior to departure. State your aircraft identification, location, type of operation planned (VFR or IFR), and the point of first intended landing.

EXAMPLE–

Aircraft: “Washington ground, Beechcraft One Three One Five Niner at hangar eight, ready to taxi, I–F–R to Chicago.”

Tower: “Beechcraft One Three One Five Niner, Washington ground, runway two seven, taxi via taxiways Charlie and Delta, hold short of runway three three left.”

Aircraft: “Beechcraft One Three One Five Niner, hold short of runway three three left.”

14.4.2 Receipt of Air Traffic Control Clearance. Air route traffic control clearances are relayed to pilots by airport traffic controllers in the following manner:

EXAMPLE–

Tower: “Beechcraft One Three One Five Niner, cleared to the Chicago Midway Airport via Victor Eight, maintain eight thousand.”

Aircraft: “Beechcraft One Three One Five Niner, cleared to the Chicago Midway Airport via Victor Eight, maintain eight thousand.”

NOTE–

Normally, an ATC IFR clearance is relayed to a pilot by the ground controller. At busy locations, however, pilots may be instructed by the ground controller to “contact clearance delivery” on a frequency designated for this purpose. No surveillance or control over the movement of traffic is exercised by this position of operation. (See paragraph 27., ATC Clearances and Aircraft Separation.)

14.4.3 Request for Taxi Instructions After Landing. State your aircraft identification, location, and that you request taxi instructions.

EXAMPLE–

Aircraft: “Dulles ground, Beechcraft One Four Two Six One clearing runway one right on taxiway echo three, request clearance to Page.”

Tower: “Beechcraft One Four Two Six One, Dulles ground, taxi to Page via taxiways echo three, echo one, and echo niner.”

or

Aircraft: “Orlando ground, Beechcraft One Four Two Six One clearing runway one eight left at taxiway bravo three, request clearance to Page.”

Tower: “Beechcraft One Four Two Six One, Orlando ground, hold short of runway one eight right.”

Aircraft: “Beechcraft One Four Two Six One, hold short of runway one eight right.”

15. Taxi During Low Visibility

15.1 Pilots and aircraft operators should be constantly aware that during certain low visibility conditions the movement of aircraft and vehicles on airports may not be visible to the tower controller. This may prevent visual confirmation of an aircraft’s adherence to taxi instructions.

15.2 Of vital importance is the need for pilots to notify the controller when difficulties are encountered or at the first indication of becoming disoriented. Pilots should proceed with extreme caution when taxiing toward the sun. When vision difficulties are encountered, pilots should immediately inform the controller.

15.3 Advisory Circular 120–57, Surface Movement Guidance and Control System, commonly known as SMGCS (pronounced “SMIGS”) requires a low visibility taxi plan for any airport which has takeoff or landing operations in less than 1,200 feet runway visual range (RVR) visibility conditions. These plans,

which affect aircrew and vehicle operators, may incorporate additional lighting, markings, and procedures to control airport surface traffic. They will be addressed at two levels: operations less than 1,200 feet RVR to 600 feet RVR and operations less than 600 feet RVR.

NOTE–

Specific lighting systems and surface markings may be found in paragraph 14, Taxiway Lights, and paragraph 18, Taxiway Markings, in Section AD 1.1, Aerodrome Availability.

15.4 When low visibility conditions exist, pilots should focus their entire attention on the safe operation of the aircraft while it is moving. Checklists and nonessential communication should be withheld until the aircraft is stopped and the brakes set.

16. Intersection Takeoffs

16.1 In order to enhance airport capacities, reduce taxiing distances, minimize departure delays, and provide for more efficient movement of air traffic, controllers may initiate intersection takeoffs as well as approve them when the pilot requests. If for ANY reason a pilot prefers to use a different intersection or the full length of the runway or desires to obtain the distance between the intersection and the runway end, **THE PILOT IS EXPECTED TO INFORM ATC ACCORDINGLY.**

16.2 An aircraft is expected to taxi to (but not onto) the end of the assigned runway unless prior approval for an intersection departure is received from ground control.

16.3 Pilots should state their position on the airport when calling the tower for takeoff from a runway intersection.

EXAMPLE–

Cleveland Tower, Apache Three Seven Two Two Papa, at the intersection of taxiway oscar and runway two three right, ready for departure.

16.4 Controllers are required to separate small aircraft (12,500 pounds or less maximum certificated takeoff weight) departing (same or opposite direction) from an intersection behind a large nonheavy aircraft on the same runway by ensuring that at least a 3–minute interval exists between the time the preceding large aircraft has taken off and the succeeding small aircraft begins takeoff roll. To inform the pilot of the required 3–minute hold, the

controller will state, “Hold for wake turbulence.” If after considering wake turbulence hazards, the pilot feels that a lesser time interval is appropriate, the pilot may request a waiver to the 3–minute interval. Pilots must initiate such a request by stating, “Request waiver to 3–minute interval,” or by making a similar statement. Controllers may then issue a takeoff clearance if other traffic permits, since the pilot has accepted the responsibility for wake turbulence separation.

16.5 The 3–minute interval is not required when the intersection is 500 feet or less from the departure point of the preceding aircraft and both aircraft are taking off in the same direction. Controllers may permit the small aircraft to alter course after takeoff to avoid the flight path of the preceding departure.

16.6 The 3–minute interval is mandatory behind a heavy aircraft in all cases.

17. VFR Flights in Terminal Areas

17.1 Use reasonable restraint in exercising the prerogative of VFR flight, especially in terminal areas. The weather minimums and distances from clouds are minimums. Giving yourself a greater margin in specific instances is just good judgment.

17.1.1 Approach Area. Conducting a VFR operation in Class D and E Airspace when the official visibility is 3 or 4 miles is not prohibited, but good judgment would dictate that you keep out of the approach area.

17.1.2 Reduced Visibility. It has always been recognized that precipitation reduces forward visibility. Consequently, although again it may be perfectly legal to cancel your IFR flight plan at any time you can proceed VFR, it is good practice, when precipitation is occurring, to continue IFR operation into a terminal area until you are reasonably close to your destination.

17.1.3 Simulated Instrument Flights. In conducting simulated instrument flights, be sure that the weather is good enough to compensate for the restricted visibility of the safety pilot and your greater concentration on your flight instruments. Give yourself a greater margin when your flight plan lies in or near a busy airway or close to an airport.

18. Low Approach

18.1 A low approach (sometimes referred to as a low pass) is the go-around maneuver following approach.

Instead of landing or making a touch-and-go, a pilot may wish to go around (low approach) in order to expedite a particular operation—a series of practice instrument approaches is an example of such an operation. Unless otherwise authorized by ATC, the low approach should be made straight ahead with no turns or climb made until the pilot has made a thorough visual check for other aircraft in the area.

18.2 When operating within Class D airspace, a pilot intending to make a low approach should contact the tower for approval. This request should be made prior to starting the final approach.

18.3 When operating to an airport within Class E airspace, a pilot intending to make a low approach should, prior to leaving the final approach fix inbound (nonprecision approach) or the outer marker or fix used in lieu of the outer marker inbound (precision approach), so advise the FSS, UNICOM, or make a broadcast as appropriate.

19. Practice Instrument Approaches

19.1 Various air traffic incidents required adoption of measures to achieve more organized and controlled operations where practice instrument approaches are conducted. Practice instrument approaches are considered to be instrument approaches made by either a VFR aircraft not on an IFR flight plan or an aircraft on an IFR flight plan. To achieve this and thereby enhance air safety, it is Air Traffic Operations policy to provide for separation of such operations at locations where approach control facilities are located and, as resources permit, at certain other locations served by ARTCCs or approach control facilities. Pilot requests to practice instrument approaches may be approved by ATC subject to traffic and workload conditions. Pilots should anticipate that in some instances the controller may find it necessary to deny approval or withdraw previous approval when traffic conditions warrant. It must be clearly understood, however, that even though the controller may be providing separation, pilots on VFR flight plans are required to comply with basic visual flight rules (14 CFR Section 91.155). Application of ATC procedures or any action taken by the controller to avoid traffic conflicts does not relieve IFR and VFR pilots of their responsibility to see and avoid other traffic while operating in VFR conditions (14 CFR Section 91.113). In addition to the normal IFR separation minimums (which

includes visual separation) during VFR conditions, 500 feet vertical separation may be applied between VFR aircraft and between a VFR aircraft and an IFR aircraft. Pilots not on IFR flight plans desiring practice instrument approaches should always state “practice” when making requests to ATC. Controllers will instruct VFR aircraft requesting an instrument approach to maintain VFR. This is to preclude misunderstandings between the pilot and controller as to the status of the aircraft. If the pilot wishes to proceed in accordance with instrument flight rules, he/she must specifically request and obtain an IFR clearance.

19.2 Before practicing an instrument approach, pilots should inform the approach control facility or the tower of the type of practice approach they desire to make and how they intend to terminate it; i.e., full-stop landing, touch-and-go, or missed/low approach maneuver. This information may be furnished progressively when conducting a series of approaches. Pilots on an IFR flight plan, who have made a series of instrument approaches to full stop landings, should inform ATC when they make their final landing. The controller will control flights practicing instrument approaches so as to ensure that they do not disrupt the flow of arriving and departing itinerant IFR or VFR aircraft. The priority afforded itinerant aircraft over practice instrument approaches is not intended to be so rigidly applied that it causes a grossly inefficient application of services. A minimum delay to itinerant traffic may be appropriate to allow an aircraft practicing an approach to complete that approach.

NOTE—

A clearance to land means that appropriate separation on the landing runway will be ensured. A landing clearance does not relieve the pilot from compliance with any previously issued restriction.

19.3 At airports without a tower, pilots wishing to make practice instrument approaches should notify the facility having control jurisdiction of the desired approach as indicated on the approach chart. All approach control facilities and ARTCCs are required to publish a Letter to Airmen depicting those airports where they provide standard separation to both VFR and IFR aircraft conducting practice instrument approaches.

19.4 The controller will provide approved separation between both VFR and IFR aircraft when authorization is granted to make practice approaches

to airports where an approach control facility is located and to certain other airports served by approach control or an ARTCC. Controller responsibility for separation of VFR aircraft begins at the point where the approach clearance becomes effective or when the aircraft enters Class B or TRSA airspace whichever comes first.

19.5 VFR aircraft practicing instrument approaches are not automatically authorized to execute the missed approach procedure. This authorization must be specifically requested by the pilot and approved by the controller. Separation will not be provided unless the missed approach has been approved by ATC.

19.6 Except in an emergency, aircraft cleared to practice instrument approaches must not deviate from the approved procedure until cleared to do so by the controller.

19.7 At radar approach control locations when a full approach procedure (procedure turn, etc.) cannot be approved, pilots should expect to be vectored to a final approach course for a practice instrument approach which is compatible with the general direction of traffic at that airport.

19.8 When granting approval for a practice instrument approach, the controller will usually ask the pilot to report to the tower prior to or over the final approach fix inbound (nonprecision approaches) or over the outer marker or fix used in lieu of the outer marker inbound (precision approaches).

19.9 When authorization is granted to conduct practice instrument approaches to an airport with a tower but where approved standard separation is not provided to aircraft conducting practice instrument approaches, the tower will approve the practice approach, instruct the aircraft to maintain VFR, and issue traffic information, as required.

19.10 When a pilot notifies an FSS providing Airport Advisory Service of intent to conduct a practice instrument approach and if separation will be provided, he/she will be instructed to contact the appropriate facility on a specified frequency prior to initiating the approach. At airports where separation is not provided, the FSS will acknowledge the message and issue known traffic information but will neither approve or disapprove the approach.

19.11 Pilots conducting practice instrument approaches should be particularly alert for other aircraft

operating in the local traffic pattern or in proximity to the airport.

20. Option Approach

20.1 The “Cleared for the Option” procedure will permit an instructor pilot/flight examiner/pilot the option to make a touch-and-go, low approach, missed approach, stop-and-go, or full stop landing. This procedure can be very beneficial in a training situation in that neither the student pilot nor examinee would know what maneuver would be accomplished. The pilot should make a request for this procedure passing the final approach fix inbound on an instrument approach or entering downwind for a VFR traffic pattern. The advantages of this procedure as a training aid are that it enables an instructor/examiner to obtain the reaction of a trainee/examinee under changing conditions, the pilot would not have to discontinue an approach in the middle of the procedure due to student error or pilot proficiency requirements, and finally it allows more flexibility and economy in training programs. This procedure will only be used at those locations with an operational control tower and will be subject to ATC approval/disapproval.

21. Communications Release of IFR Aircraft Landing at an Airport Without an Operating Control Tower

21.1 Aircraft operating on an IFR flight plan, landing at an airport without an operating control tower will be advised to change to the airport advisory frequency when direct communication with ATC is no longer required.

22. Pilot Responsibilities When Conducting Land and Hold Short Operations (LAHSO)

22.1 LAHSO is an acronym for “Land And Hold Short Operations.” These operations include landing and holding short of an intersecting runway, an intersecting taxiway, or some other designated point on a runway other than an intersecting runway or taxiway. (See FIG ENR 1.1–6, FIG ENR 1.1–7, FIG ENR 1.1–8.)

22.2 Pilot Responsibilities and Basic Procedures

22.2.1 LAHSO is an air traffic control procedure that requires pilot participation to balance the needs for

increased airport capacity and system efficiency, consistent with safety. This procedure can be done safely **provided** pilots and controllers are knowledgeable and understand their responsibilities. The following paragraphs outline specific pilot/operator responsibilities when conducting LAHSO.

22.2.2 At controlled airports, air traffic may clear a pilot to land and hold short. Pilots may accept such a clearance provided that the pilot-in-command determines that the aircraft can safely land and stop within the Available Landing Distance (ALD). ALD data are published in the special notices section of the Airport/Facility Directory (A/FD) and in the U.S. Terminal Procedures Publications. Controllers will also provide ALD data upon request. Student pilots or pilots not familiar with LAHSO should not participate in the program.

FIG ENR 1.1-6

Land and Hold Short of an Intersecting Runway

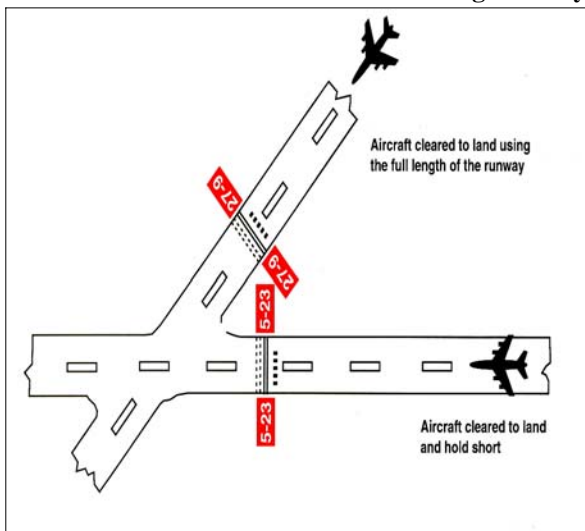
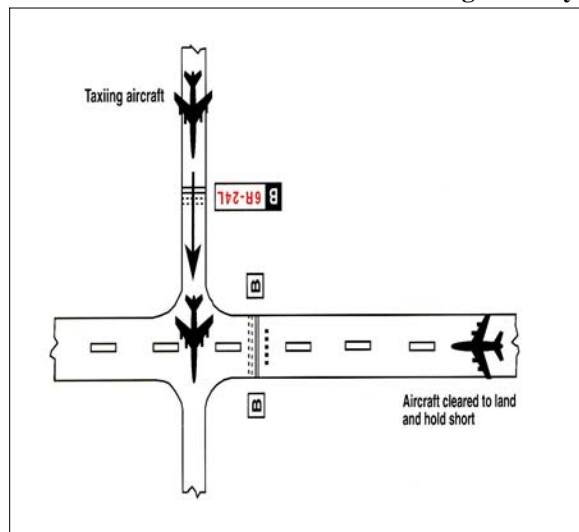

FIG ENR 1.1-7

Land and Hold Short of an Intersecting Taxiway



EXAMPLE-

FIG ENR 1.1-8 – Holding short at a designated point may be required to avoid conflicts with the runway safety area/flight path of a nearby runway.

NOTE-

Each figure shows the approximate location of LAHSO markings, signage, and in-pavement lighting when installed.

REFERENCE-

AIP, Part 3 – Aerodromes.

FIG ENR 1.1-8

Land and Hold Short of a Designated Point on a Runway Other Than an Intersecting Runway or Taxiway

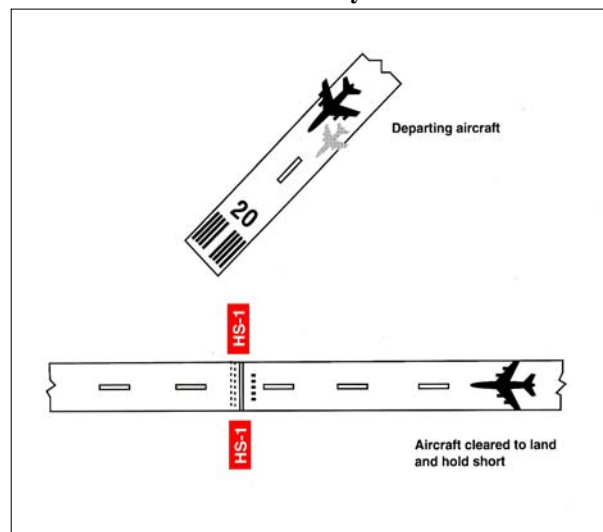

22.2.3 The pilot-in-command has the final authority to accept or decline any land and hold short clearance. The safety and operation of the aircraft remain the responsibility of the pilot. Pilots are expected to decline a LAHSO clearance if they determine it will compromise safety.

22.2.4 To conduct LAHSO, pilots should become familiar with all available information concerning LAHSO at their destination airport. Pilots should have, *readily available*, the **published ALD** and runway **slope information** for **all** LAHSO runway combinations at **each** airport of intended landing. Additionally, knowledge about landing performance data permits the pilot to *readily* determine that the ALD for the assigned runway is sufficient for safe LAHSO. As part of a pilot's preflight planning process, pilots should determine if their destination airport has LAHSO. If so, their preflight planning process should include an assessment of which LAHSO combinations would work for them given their aircraft's required landing distance. Good pilot decision-making is knowing in advance whether one can accept a LAHSO clearance if offered.

22.2.5 For those airplanes flown with two crewmembers, effective **intra-cockpit** communication between cockpit crewmembers is also critical. There have been several instances where the pilot working the radios accepted a LAHSO clearance but then simply forgot to tell the pilot flying the aircraft.

22.2.6 If, for any reason, such as difficulty in discerning the location of a LAHSO intersection, wind conditions, aircraft condition, etc., the pilot elects to request to land on the full length of the runway, to land on another runway, or to decline LAHSO, a pilot is expected to promptly inform ATC, ideally even before the clearance is issued. **A LAHSO clearance, once accepted, must be adhered to, just as any other ATC clearance, unless an amended clearance is obtained or an emergency occurs. A LAHSO clearance does not preclude a rejected landing.**

22.2.7 A pilot who accepts a LAHSO clearance should land and exit the runway at the first convenient taxiway (unless directed otherwise) before reaching the hold short point. Otherwise, the pilot must stop and hold at the hold short point. **If a rejected landing becomes necessary after accepting a LAHSO clearance, the pilot should maintain safe separa-**

tion from other aircraft or vehicles, and should promptly notify the controller.

22.2.8 Controllers need a full read back of all LAHSO clearances. Pilots should read back their LAHSO clearance and include the words, "HOLD SHORT OF (RUNWAY/TAXIWAY/OR POINT)" in their acknowledgment of all LAHSO clearances. In order to reduce frequency congestion, pilots are encouraged to read back the LAHSO clearance without prompting. Don't make the controller have to ask for a read back!

22.3 LAHSO Situational Awareness

22.3.1 Situational awareness is **vital** to the success of LAHSO. Situational awareness starts with having current airport information in the cockpit, readily accessible to the pilot. (An airport diagram assists pilots in identifying their location on the airport, thus reducing requests for "progressive taxi instructions" from controllers.)

22.3.2 Situational awareness includes effective pilot-controller radio communication. ATC expects pilots to specifically acknowledge and read back all LAHSO clearances as follows:

EXAMPLE–

ATC: "(Aircraft ID) cleared to land runway six right, hold short of taxiway bravo for crossing traffic (type aircraft)."

Aircraft: "(Aircraft ID), wilco, cleared to land runway six right to hold short of taxiway bravo."

ATC: "(Aircraft ID) cross runway six right at taxiway bravo, landing aircraft will hold short."

Aircraft: "(Aircraft ID), wilco, cross runway six right at bravo, landing traffic (type aircraft) to hold."

22.3.3 Situational awareness also includes a thorough understanding of the airport markings, signage, and lighting associated with LAHSO. These visual aids consist of a three-part system of **yellow hold-short markings, red and white signage** and, in certain cases, **in-pavement lighting**. Visual aids assist the pilot in determining where to hold short. FIG ENR 1.1–6, FIG ENR 1.1–7, FIG ENR 1.1–8 depict how these markings, signage, and lighting combinations will appear once installed. Pilots are cautioned that not all airports conducting LAHSO have installed any or all of the above markings, signage, or lighting.

22.3.4 Pilots should only receive a LAHSO clearance when there is a minimum ceiling of 1,000 feet and 3 statute miles visibility. The intent of having "basic" VFR weather conditions is to allow

pilots to maintain visual contact with other aircraft and ground vehicle operations. Pilots should consider the effects of prevailing inflight visibility (such as landing into the sun) and how it may affect overall situational awareness. Additionally, surface vehicles and aircraft being taxied by maintenance personnel may also be participating in LAHSO, especially in those operations that involve crossing an active runway.

23. Exiting the Runway after Landing

23.1 The following procedures must be followed after landing and reaching taxi speed.

23.1.1 Exit the runway without delay at the first available taxiway or on a taxiway as instructed by ATC. Pilots shall not exit the landing runway onto another runway unless authorized by ATC. At airports with an operating control tower, pilots should not stop or reverse course on the runway without first obtaining ATC approval.

23.1.2 Taxi clear of the runway unless otherwise directed by ATC. An aircraft is considered clear of the runway when all parts of the aircraft are past the runway edge and there are no restrictions to its continued movement beyond the runway holding position markings. In the absence of ATC instruc-

tions, the pilot is expected to taxi clear of the landing runway by taxiing beyond the runway holding position markings associated with the landing runway, even if that requires the aircraft to protrude into or cross another taxiway or ramp area. Once all parts of the aircraft have crossed the runway holding position markings, the pilot must hold unless further instructions have been issued by ATC.

NOTE-

1. The tower will issue the pilot instructions which will permit the aircraft to enter another taxiway, runway, or ramp area when required.

2. Guidance contained in subparagraphs 23.1.1 and 23.1.2 above is considered an integral part of the landing clearance and satisfies the requirement of 14 CFR Section 91.129.

23.1.3 Immediately change to ground control frequency when advised by the tower and obtain a taxi clearance.

NOTE-

1. The tower will issue instructions required to resolve any potential conflicts with other ground traffic prior to advising the pilot to contact ground control.

2. A clearance from ATC to taxi to the ramp authorizes the aircraft to cross all runways and taxiway intersections. pilots not familiar with the taxi route should request specific taxi instructions from ATC.

24. Hand Signals

FIG ENR 1.1-9
Signalman Directs Towing

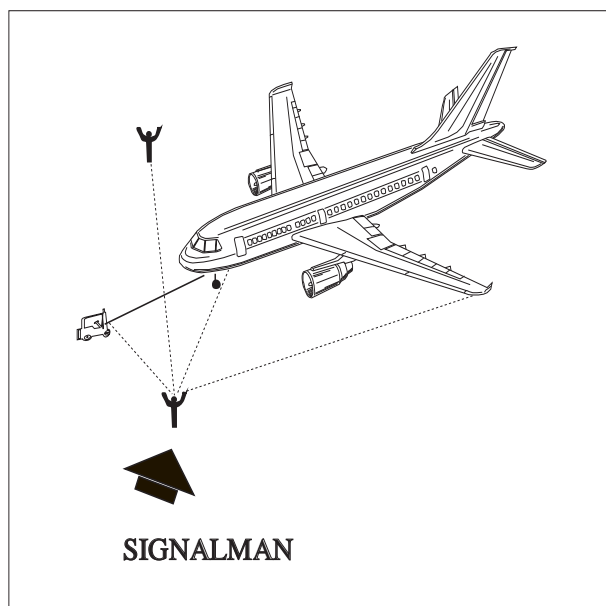

FIG ENR 1.1-10
Signalman's Position

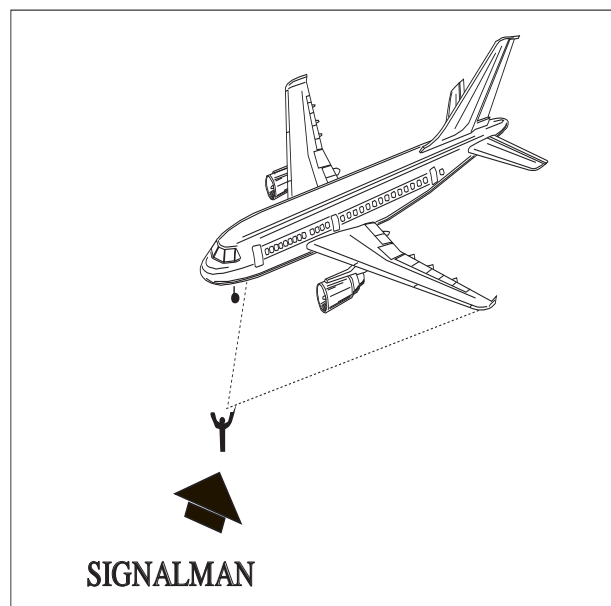

FIG ENR 1.1-11
All Clear
(O.K.)

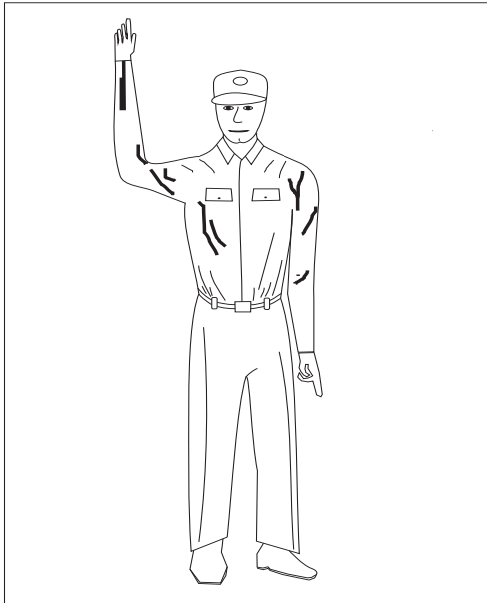

FIG ENR 1.1-13
Pull Chocks

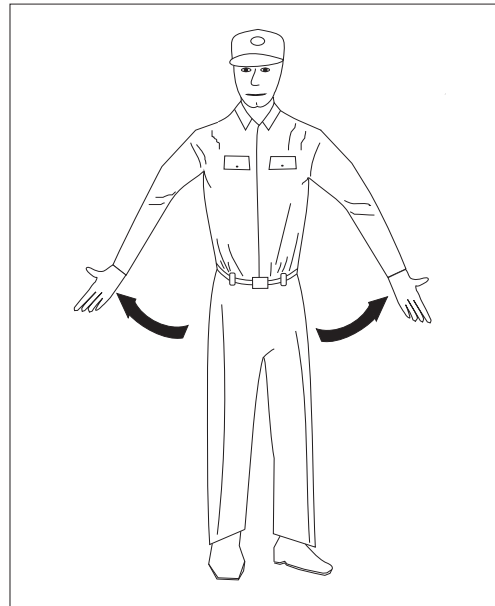

FIG ENR 1.1-12
Start Engine

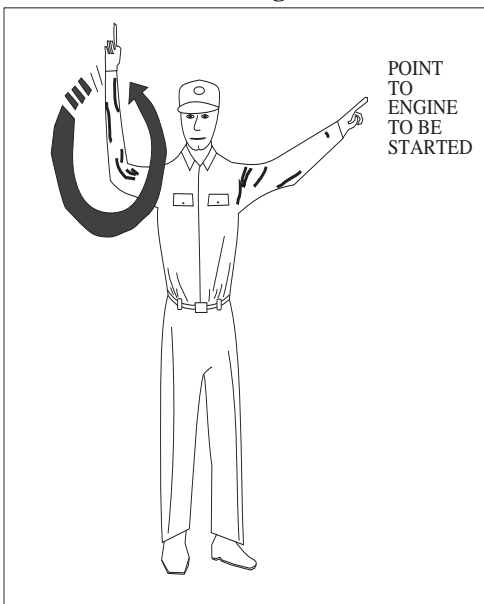

FIG ENR 1.1-14
Proceed Straight Ahead

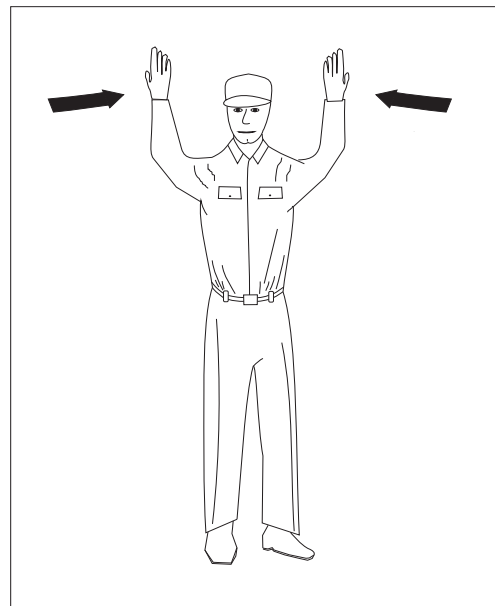

FIG ENR 1.1-15
Left Turn

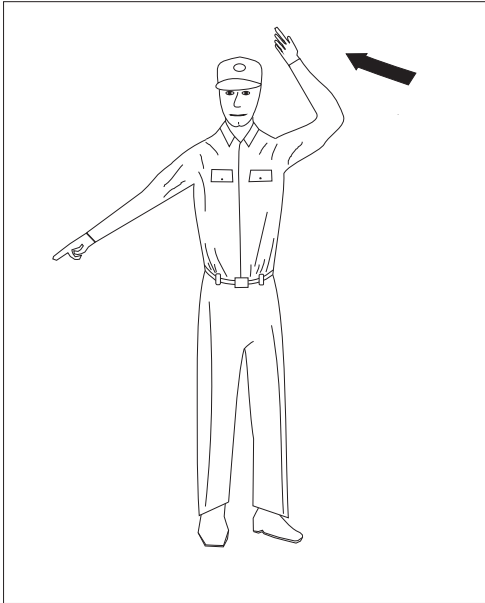

FIG ENR 1.1-17
Slow Down

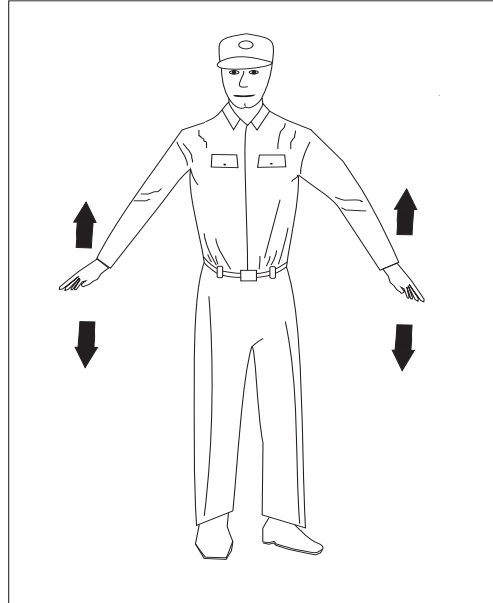

FIG ENR 1.1-16
Right Turn

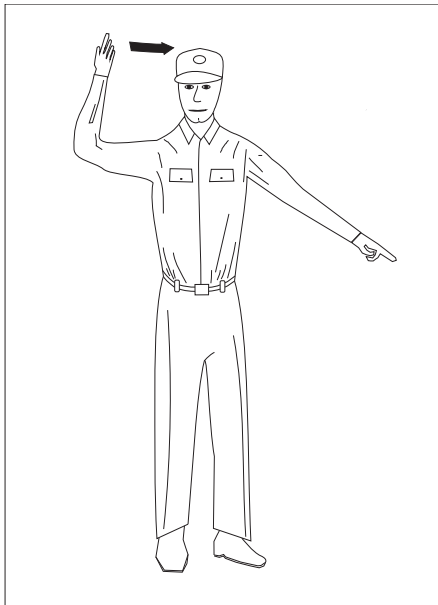

FIG ENR 1.1-18
Flagman Directs Pilot

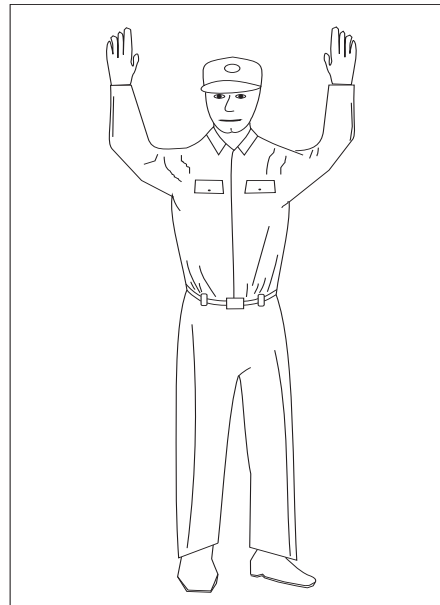

FIG ENR 1.1-19
Insert Chocks

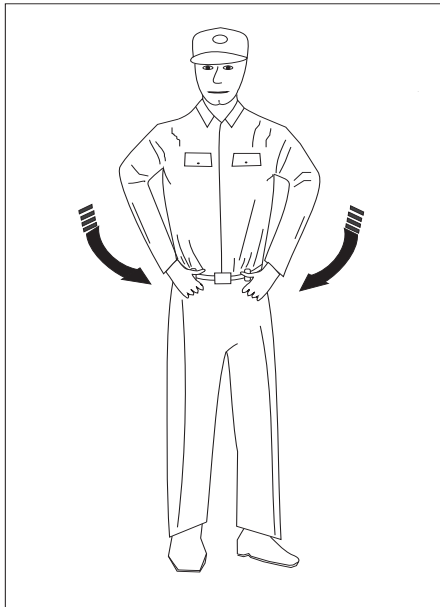

FIG ENR 1.1-21
Night Operation

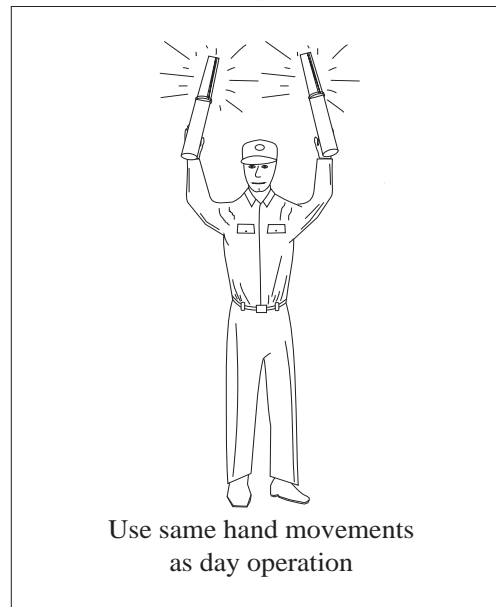

FIG ENR 1.1-20
Cut Engines

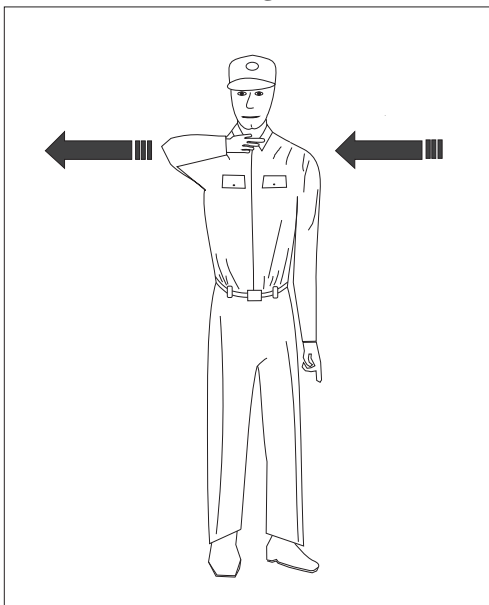
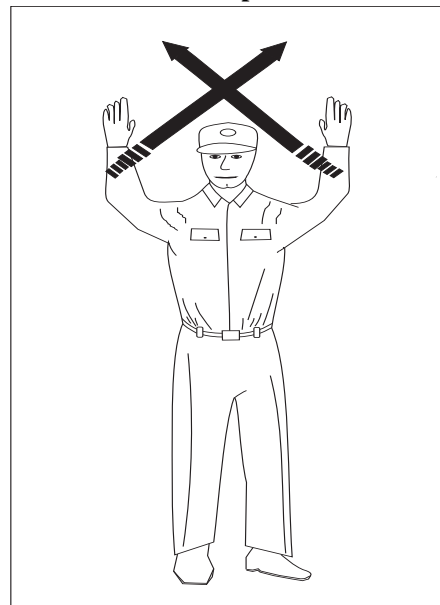

FIG ENR 1.1-22
Stop



25. Use of Aircraft Lights

25.1 Aircraft position lights are required to be lighted on aircraft operated on the surface and in flight from sunset to sunrise. In addition, aircraft equipped with an anti-collision light system are required to operate that light system during all types of operations (day and night). However, during any adverse meteorological conditions, the pilot-in-command may determine that the anti-collision lights should be turned off when their light output would constitute a hazard to safety (14 CFR Section 91.209). Supplementary strobe lights should be turned off on the ground when they adversely affect ground personnel or other pilots, and in flight when there are adverse reflection from clouds.

25.2 An aircraft anti-collision light system can use one or more rotating beacons and/or strobe lights, be colored either red or white, and have different (higher than minimum) intensities when compared to other aircraft. Many aircraft have both a rotating beacon and a strobe light system.

25.3 The FAA has a voluntary pilot safety program, *Operation Lights On*, to enhance the see-and-avoid concept. Pilots are encouraged to turn on their landing lights during takeoff; i.e., either after takeoff clearance has been received or when beginning takeoff roll. Pilots are further encouraged to turn on their landing lights when operating below 10,000 feet, day or night, especially when operating within 10 miles of any airport or in conditions of reduced visibility and in areas where flocks of birds may be expected; i.e., coastal areas, lake areas, around refuse dumps, etc. Although turning on aircraft lights does enhance the see-and-avoid concept, pilots should not become complacent about keeping a sharp lookout for other aircraft. Not all aircraft are equipped with lights, and some pilots may not have their lights turned on. Aircraft manufacturers' recommendations for operation of landing lights and electrical systems should be observed.

25.4 Prop and jet blast forces generated by large aircraft have overturned or damaged several smaller

aircraft taxiing behind them. To avoid similar results and in the interest of preventing upsets and injuries to ground personnel from such forces, the FAA recommends that air carriers and commercial operators turn on their rotating beacons anytime their aircraft engines are in operation. General aviation pilots using rotating beacon-equipped aircraft are also encouraged to participate in this program which is designed to alert others to the potential hazard. Since this is a voluntary program, exercise caution and do not rely solely on the rotating beacon as an indication that aircraft engines are in operation.

25.5 At the discretion of the pilot-in-command turn on all external illumination, including landing lights, when taxiing on, across, or holding in position on any runway. This increases the conspicuity of the aircraft to controllers and other pilots approaching to land, taxiing, or crossing the runway. Pilots should comply with any equipment operating limitations and consider the effects of landing and strobe lights on other aircraft in their vicinity. When cleared for takeoff pilots should turn on any remaining exterior lights.

26. Flight Inspection/"Flight Check" Aircraft in Terminal Areas

26.1 "Flight Check" is a call sign used to alert pilots and air traffic controllers when an FAA aircraft is engaged in flight inspection/certification of NAVAIDs and flight procedures. Flight check aircraft fly preplanned high/low altitude flight patterns such as grids, orbits, DME arcs, and tracks, including low passes along the full length of the runway to verify NAVAID performance.

26.2 Pilots should be especially watchful and avoid the flight paths of any aircraft using the call sign "Flight Check." These flights will normally receive special handling from ATC. Pilot patience and cooperation in allowing uninterrupted recordings can significantly help expedite flight inspections, minimize costly, repetitive runs, and reduce the burden on the U.S. taxpayer.

27. ATC Clearances and Aircraft Separation

27.1 Clearance

27.1.1 A clearance issued by ATC is predicated on known traffic and known physical airport conditions. An ATC clearance means an authorization by ATC, for the purpose of preventing collision between known aircraft, for an aircraft to proceed under specified conditions within Classes A, B, C, D, and E airspace. **IT IS NOT AUTHORIZATION FOR A PILOT TO DEVIATE FROM ANY RULE, REGULATION OR MINIMUM ALTITUDE NOR TO CONDUCT UNSAFE OPERATION OF THE AIRCRAFT.**

27.1.2 14 CFR Section 91.3(a) states: “The pilot in command of an aircraft is directly responsible for, and is the final authority as to, the operation of that aircraft.” If ATC issues a clearance that would cause a pilot to deviate from a rule or regulation, or in the pilot’s opinion, would place the aircraft in jeopardy, **IT IS THE PILOT’S RESPONSIBILITY TO REQUEST AN AMENDED CLEARANCE.** Similarly, if a pilot prefers to follow a different course of action, such as make a 360-degree turn for spacing to follow traffic when established in a landing or approach sequence, land on a different runway, takeoff from a different intersection, takeoff from the threshold instead of an intersection, or delay operation, **THE PILOT IS EXPECTED TO INFORM ATC ACCORDINGLY.** When the pilot requests a different course of action, however, the pilot is expected to cooperate so as to preclude the disruption of the traffic flow or the creation of conflicting patterns. The pilot is also expected to use the appropriate aircraft call sign to acknowledge all ATC clearances, frequency changes, or advisory information.

27.1.3 Each pilot who deviates from an ATC clearance in response to a traffic alert and collision avoidance system resolution advisory shall notify ATC of that deviation as soon as possible.

27.1.4 When weather conditions permit, during the time an IFR flight is operating, it is the direct responsibility of the pilot to avoid other aircraft since VFR flights may be operating in the same area without the knowledge of ATC, and traffic clearances provide standard separation only between IFR flights.

27.2 Clearance Prefix

A clearance, information, or request for information originated by an ATC facility and relayed to the pilot through an air/ground communication station will be prefixed by “ATC CLEARS,” “ATC ADVISES,” or “ATC REQUESTS.”

27.3 Clearance Items

27.3.1 An ATC clearance normally contains the following:

27.3.1.1 Clearance Limit. The traffic clearance issued prior to departure will normally authorize flight to the airport of intended landing. Under certain conditions at some locations, a short-range clearance procedure is utilized whereby a clearance is issued to a fix within or just outside the terminal area and pilots are advised of the frequency on which they will receive the long-range clearance direct from the center controller.

27.3.1.2 Departure Procedure. Headings to fly and altitude restrictions may be issued to separate a departure from other air traffic in the terminal area. Where the volume of traffic warrants, instrument departure procedures (DPs) have been developed. (See ENR 1.5.)

27.3.1.3 Route of Flight

a) Clearances are normally issued for the altitude/flight level and route filed by the pilot. However, due to traffic conditions, it is frequently necessary for ATC to specify an altitude/flight level or route different from that requested by the pilot. In addition, flow patterns have been established in certain congested areas, or between congested areas, whereby traffic capacity is increased by routing all traffic on preferred routes. Information on these flow patterns is available in offices where preflight briefing is furnished or where flight plans are accepted.

b) When required, air traffic clearances include data to assist pilots in identifying radio reporting points. It is the responsibility of a pilot to notify ATC immediately if the radio equipment cannot receive the type of signals the pilot must utilize to comply with the clearance.

27.3.1.4 Altitude Data

a) The altitude/flight level instructions in an ATC clearance normally require that a pilot “MAINTAIN” the altitude/flight level to which the flight will operate when in Classes A, B, C, D, and E airspace. Altitude/flight level changes while en route should be requested prior to the time the change is desired.

b) When possible, if the altitude assigned is different than that requested by the pilot, ATC will inform an aircraft when to expect climb or descent clearance or to request altitude change from another facility. If this has not been received prior to crossing the boundary of the ATC facility’s area and assignment at a different flight level is still desired, the pilot should reinitiate the request with the next facility.

c) The term “CRUISE” may be used instead of “MAINTAIN” to assign a block of airspace, to a pilot, from the minimum IFR altitude up to and including the altitude specified in the cruise clearance. The pilot may level off at any intermediate altitude within this block of airspace. Climb/descent within the block is to be made at the discretion of the pilot. However, once the pilot starts descent and verbally reports leaving an altitude in the block, the pilot may not return to that altitude without additional ATC clearance.

27.3.1.5 Holding Instructions

a) Whenever an aircraft is cleared to a fix other than the destination airport and delay is expected, it is the responsibility of the ATC controller to issue complete holding instructions (unless the pattern is charted), an EFC time, and a best estimate of any additional en route/terminal delay.

b) If the holding pattern is charted and the controller doesn’t issue complete holding instructions, the pilot is expected to hold as depicted on the appropriate chart. When the pattern is charted, the controller may omit all holding instructions except the charted holding direction and the statement “AS PUBLISHED;” e.g., “HOLD EAST AS PUBLISHED.” Controllers shall always issue complete holding instructions when pilots request them.

NOTE–

Only those holding patterns depicted on U.S. government or commercially produced charts which meet FAA requirements should be used.

c) If no holding pattern is charted and holding instructions have not been issued, the pilot should ask ATC for holding instructions prior to reaching the fix. This procedure will eliminate the possibility of an aircraft entering a holding pattern other than that desired by ATC. If unable to obtain holding instructions prior to reaching the fix (due to frequency congestion, stuck microphones, etc.), hold in a standard pattern on the course on which you approached the fix and request further clearance as soon as possible. In this event, the altitude/flight level of the aircraft at the clearance limit will be protected so that separation will be provided as required.

d) When an aircraft is 3 minutes or less from a clearance limit and a clearance beyond the fix has not been received, the pilot is expected to start a speed reduction so that the aircraft will cross the fix, initially, at or below the maximum holding airspeed.

e) When no delay is expected, the controller should issue a clearance beyond the fix as soon as possible and, whenever possible, at least 5 minutes before the aircraft reaches the clearance limit.

f) Pilots should report to ATC the time and altitude/flight level at which the aircraft reaches the clearance limit and report leaving the clearance limit.

NOTE–

In the event of two–way communications failure, pilots are required to comply with 14 CFR Section 91.185.

27.4 Amended Clearances

27.4.1 Amendments to the initial clearance will be issued at any time an air traffic controller deems such action necessary to avoid possible confliction between aircraft. Clearances will require that a flight “hold” or change altitude prior to reaching the point where standard separation from other IFR traffic would no longer exist.

NOTE–

Some pilots have questioned this action and requested “traffic information” and were at a loss when the reply indicated “no traffic reported.” In such cases the controller has taken action to prevent a traffic confliction which would have occurred at a distant point.

27.4.2 A pilot may wish an explanation of the handling of the flight at the time of occurrence; however, controllers are not able to take time from their immediate control duties, nor can they afford to overload the ATC communications channels to furnish explanations. Pilots may obtain an explanation by directing a letter or telephone call to the chief controller of the facility involved.

27.4.3 Pilots have the privilege of requesting a different clearance from that which has been issued by ATC if they feel that they have information which would make another course of action more practicable or if aircraft equipment limitations or company procedures forbid compliance with the clearance issued.

27.4.4 Pilots should pay particular attention to the clearance and not assume that the route and altitude/flight level are the same as requested in the flight plan. It is suggested that pilots make a written report of clearances at the time they are received, and verify, by a repeat back, any portions that are complex or about which a doubt exists. It will be the responsibility of each pilot to accept or refuse the clearance issued.

27.5 Special VFR Clearance

27.5.1 An ATC clearance must be obtained *prior* to operating within a Class B, Class C, Class D, and Class E surface area when the weather is less than that required for VFR flight. A VFR pilot may request and be given a clearance to enter, leave or operate within most Class D and Class E surface areas and some Class B and Class C surface areas in special VFR conditions, traffic permitting, and providing such flight will not delay IFR operations. All special VFR flights must remain clear of clouds. The visibility requirements for Special VFR aircraft (other than helicopters) are:

27.5.1.1 At least one statute mile flight visibility for operations within Classes B, C, D, and E surface areas.

27.5.1.2 At least one statute mile ground visibility if taking off or landing. If ground visibility is not reported at that airport, the flight visibility must be at least one statute mile.

27.5.1.3 The restrictions in subparagraphs 27.5.1.1 and 27.5.1.2 do not apply to helicopters. Helicopters must remain clear of clouds and may operate in Classes B, C, D, and E surface areas with less than one statute mile visibility.

27.5.2 When a control tower is located within a Class B, Class C, and Class D surface area, requests for clearances should be to the tower. If no tower is located within the surface area, a clearance may be obtained from the nearest tower, FSS or ARTCC.

27.5.3 It is not necessary to file a complete flight plan with the request for clearance, but pilots should state their intentions in sufficient detail to permit ATC to fit their flight into the traffic flow. The clearance will not contain a specific altitude as the pilot must remain clear of clouds. The controller may require the pilot to fly at or below a certain altitude due to other traffic, but the altitude specified will permit flight at or above the minimum safe altitude. In addition, at radar locations, flight may be vectored if necessary for control purposes or on pilot request.

NOTE–

The pilot is responsible for obstacle or terrain clearance (reference 14 CFR Section 91.119).

27.5.4 Special VFR clearances are effective within Classes B, C, D, and E surface areas only. ATC does not provide separation after an aircraft leaves Class D surface area on a special VFR clearance.

27.5.5 Special VFR operations by fixed-wing aircraft are prohibited in some Classes B and C surface areas due to the volume of IFR traffic. A list of these Classes B and C surface areas is contained in 14 CFR Part 91, Appendix D, Section 3 and also depicted on Sectional Aeronautical Charts.

27.5.6 ATC provides separation between special VFR flights and between them and other IFR flights.

27.5.7 Special VFR operations by fixed-wing aircraft are prohibited between sunset and sunrise unless the pilot is instrument rated and the aircraft is equipped for IFR flight.

27.5.8 Pilots arriving or departing an uncontrolled airport that has automated weather broadcast capability (ASOS/AWSS/AWOS) should monitor the broadcast frequency, advise the controller that they have the “one-minute weather,” and state intentions prior to operating within the Class B, Class C, Class D, or Class E surface areas.

NOTE–

One-minute weather is the most recent one minute updated weather broadcast received by a pilot from an uncontrolled airport ASOS/AWSS/AWOS.

28. Pilot Responsibilities Upon Clearance Issuance

28.1 Record ATC Clearance. When conducting an IFR operation, make a written record of your ATC clearance. The specified conditions which are a part of your air traffic clearance may be somewhat different from those included in your flight plan. Additionally, ATC may find it necessary to ADD conditions, such as a particular departure route. The very fact that ATC specifies different or additional conditions means that other aircraft are involved in the traffic situation.

28.2 ATC Clearance/Instruction Readback. Pilots of airborne aircraft should read back those parts of the ATC clearances/instructions containing altitude assignments or vectors, as a means of mutual verification. The readback of the “numbers” serves as a double check between pilots and controllers, and as such, it is an invaluable aid in reducing the kinds of communications errors that occur when a number is either “misheard” or is incorrect.

28.2.1 Include the aircraft identification in all readbacks and acknowledgments. This aids controllers in determining that the correct aircraft received the clearance or instruction. The requirement to include aircraft identification in all readbacks and acknowledgments becomes more important as frequency congestion increases and when aircraft with similar call signs are on the same frequency.

EXAMPLE–

“Climbing to Flight Level three three zero, United Twelve” or “November Five Charlie Tango, roger, cleared to land.”

28.2.2 Read back altitudes, altitude restrictions, and vectors in the same sequence as they are given in the clearance/instruction.

28.2.3 Altitudes contained in charted procedures such as DPs, instrument approaches, etc., should not be read back unless they are specifically stated by the controller.

28.3 It is the responsibility of the pilot to accept or refuse the clearance issued.

29. IFR Clearance VFR–On–Top

29.1 A pilot on an IFR flight plan operating in VFR weather conditions, may request VFR–on–top in lieu of an assigned altitude. This would permit pilots to select an altitude or flight level of their choice (subject to any ATC restrictions).

29.2 Pilots desiring to climb through a cloud, haze, smoke, or other meteorological formation and then either cancel their IFR flight plan or operate VFR–on–top may request a climb to VFR–on–top. The ATC authorization shall contain either a top report or a statement that no top report is available, and a request to report reaching VFR–on–top. Additionally, the ATC authorization may contain a clearance limit, routing and an alternative clearance if VFR–on–top is not reached by a specified altitude.

29.3 A pilot on an IFR flight plan operating in VFR conditions may request to climb/descend in VFR conditions.

29.4 ATC may not authorize VFR–on–top/VFR conditions operations unless the pilot requests the VFR operation or a clearance to operate in VFR conditions will result in noise abatement benefits where part of the IFR departure route does not conform to an FAA approved noise abatement route or altitude.

29.5 When operating in VFR conditions with an ATC authorization to “maintain VFR–on–top” or “maintain VFR conditions,” pilots on IFR flight plans must:

29.5.1 Fly at the appropriate VFR altitude as prescribed in 14 CFR Section 91.159.

29.5.2 Comply with the VFR visibility and distance from cloud criteria in 14 CFR Section 91.155 (Basic VFR Weather Minimums).

NOTE–

See AIP, GEN 1.7, Annex 2, Rules of the Air, for a table showing basic VFR weather minimums.

29.5.3 Comply with instrument flight rules that are applicable to this flight; i.e., minimum IFR altitude, position reporting, radio communications, course to be flown, adherence to ATC clearance, etc. Pilots should advise ATC prior to any altitude change to insure the exchange of accurate traffic information.

29.6 ATC authorization to “maintain VFR–on–top” is not intended to restrict pilots so that they must operate only above an obscuring meteorological formation (layer). Instead, it permits operation above, below, between layers or in areas where there is no meteorological obscuration. It is imperative that clearance to operate “VFR–on–top/VFR conditions” does not imply cancellation of the IFR flight plan.

29.7 Pilots operating VFR–on–top/VFR conditions may receive traffic information from ATC on other pertinent IFR or VFR aircraft. However, aircraft operating in Class B or Class C airspace and TRSAs shall be separated as required by FAA Order 7110.65, Air Traffic Control.

NOTE–

When operating in VFR weather conditions, it is the pilot’s responsibility to be vigilant so as to see and avoid other aircraft.

30. VFR/IFR Flights

30.1 A pilot departing VFR, either intending to or needing to obtain an IFR clearance en route, must be aware of the position of the aircraft and the relative terrain/obstructions. When accepting a clearance below the minimum en route altitude (MEA)/minimum IFR altitude (MIA)/minimum vector altitude (MVA)/off route obstruction clearance altitude (OROCA), pilots are responsible for their own terrain/obstruction clearance until reaching the MEA/MIA/MVA/OROCA. If the pilots are unable to maintain terrain/obstruction clearance, the controller should be advised and pilots should state their intentions.

NOTE–

OROCA is an off route altitude which provides obstruction clearance with a 1,000 foot buffer in nonmountainous terrain areas and a 2,000 foot buffer in designated mountainous areas within the U.S. This altitude may not provide signal coverage from ground based navigational aids, air traffic control radar, or communications coverage.

31. Adherence to Clearance

31.1 When air traffic clearance has been obtained under either the Visual or Instrument Flight Rules, the pilot in command of the aircraft shall not deviate from the provisions thereof unless an amended clearance is obtained. When ATC issues a clearance or instruction, pilots are expected to execute its provisions upon receipt. ATC, in certain situations, will include the word “IMMEDIATELY” in a clearance or instruction to impress urgency of an imminent situation, and expeditious compliance by the pilot is expected and necessary for safety. The addition of a VFR or other restriction; i.e., climb or descent point or time, crossing altitude, etc., does not authorize a pilot to deviate from the route of flight or any other provision of the ATC clearance.

31.2 When a heading is assigned or a turn is requested by ATC, pilots are expected to promptly initiate the turn, to complete the turn, and to maintain the new heading unless issued additional instructions.

31.3 The term “at pilot’s discretion” included in the altitude information of an ATC clearance means that ATC has offered the pilot the option to start climb or descent when the pilot wishes, is authorized to conduct the climb or descent at any rate, and to temporarily level off at any intermediate altitude as desired. However, once the aircraft has vacated an altitude, it may not return to that altitude.

31.4 When ATC has not used the term “AT PILOT’S DISCRETION” nor imposed any climb or descent restrictions, pilots should initiate climb or descent promptly on acknowledgement of the clearance. Descend or climb at an optimum rate consistent with the operating characteristics of the aircraft to 1,000 feet above or below the assigned altitude, and then attempt to descend or climb at a rate of between 500 and 1,500 fpm until the assigned altitude is reached. If at anytime the pilot is unable to climb or descend at a rate of at least 500 feet a minute, advise ATC. If it is necessary to level off at an intermediate altitude during climb or descent, advise ATC, except when leveling off at 10,000 feet MSL on descent, or 2,500 feet above airport elevation (prior to entering a Class C or Class D surface area), when required for speed reduction (14 CFR Section 91.117).

NOTE–

Leveling off at 10,000 feet MSL on descent or 2,500 feet above airport elevation (prior to entering a Class C or Class D surface area) to comply with 14 CFR Section 91.117 airspeed restrictions is commonplace. Controllers anticipate this action and plan accordingly. Leveling off at any other time on climb or descent may seriously affect air traffic handling by ATC. Consequently, it is imperative that pilots make every effort to fulfill the above expected actions to aid ATC in safely handling and expediting traffic.

31.5 If the altitude information of an ATC DESCENT clearance includes a provision to “CROSS (fix) AT” or “AT OR ABOVE/BELOW (altitude),” the manner in which the descent is executed to comply with the crossing altitude is at the pilot’s discretion. This authorization to descend at pilot’s discretion is only applicable to that portion of the flight to which the crossing altitude restriction applies, and the pilot is expected to comply with the crossing altitude as a provision of the clearance. Any other clearance in which pilot execution is optional will so state: “AT PILOT’S DISCRETION.”

EXAMPLE–

1. “United Four Seventeen, descend and maintain six thousand.”

NOTE–

1. The pilot is expected to commence descent upon receipt of the clearance and to descend at the suggested rates until reaching the assigned altitude of 6,000 feet.

EXAMPLE–

2. “United Four Seventeen, descend at pilot’s discretion, maintain six thousand.”

NOTE–

2. The pilot is authorized to conduct descent within the context of the term at pilot’s discretion as described above.

EXAMPLE–

3. “United Four Seventeen, cross Lakeview V–O–R at or above Flight Level two zero zero, descend and maintain six thousand.”

NOTE–

3. The pilot is authorized to conduct descent at pilot’s discretion until reaching Lakeview VOR and must comply with the clearance provision to cross the Lakeview VOR at or above FL 200. After passing Lakeview VOR, the pilot is expected to descend at the suggested rates until reaching the assigned altitude of 6,000 feet.

EXAMPLE–

4. “United Four Seventeen, cross Lakeview V–O–R at six thousand, maintain six thousand.”

NOTE–

4. The pilot is authorized to conduct descent at pilot’s discretion, however, must comply with the clearance provision to cross the Lakeview VOR at 6,000 feet.

EXAMPLE–

5. “United Four Seventeen, descend now to Flight Level two seven zero, cross Lakeview V–O–R at or below one zero thousand, descend and maintain six thousand.”

NOTE–

5. The pilot is expected to promptly execute and complete descent to FL 270 upon receipt of the clearance. After reaching FL 270 the pilot is authorized to descend “at pilot’s discretion” until reaching Lakeview VOR. The pilot must comply with the clearance provision to cross Lakeview VOR at or below 10,000 feet. After Lakeview VOR the pilot is expected to descend at the suggested rates until reaching 6,000 feet.

EXAMPLE–

6. “United Three Ten, descend now and maintain Flight Level two four zero, pilot’s discretion after reaching Flight Level two eight zero.”

NOTE–

6. The pilot is expected to commence descent upon receipt of the clearance and to descend at the suggested rates until reaching FL 280. At that point, the pilot is authorized to continue descent to FL 240 within the context of the term “at pilot’s discretion” as described above.

31.6 In case emergency authority is used to deviate from the provisions of an ATC clearance, the pilot in command shall notify ATC as soon as possible and obtain an amended clearance. In an emergency situation which results in no deviation from the rules prescribed in 14 CFR Part 91 but which requires ATC to give priority to an aircraft, the pilot of such aircraft shall, when requested by ATC, make a report within 48 hours of such emergency situation to the manager of that ATC facility.

31.7 The guiding principle is that the last ATC clearance has precedence over the previous ATC clearance. When the route or altitude in a previously issued clearance is amended, the controller will restate applicable altitude restrictions. If altitude to maintain is changed or restated, whether prior to departure or while airborne, and previously issued altitude restrictions are omitted, those altitude restrictions are canceled, including Departure Procedures and Standard Terminal Arrival Route (STAR) altitude restrictions.

EXAMPLE–

1. A departure flight receives a clearance to destination airport to maintain FL 290. The clearance incorporates a DP which has certain altitude crossing restrictions. Shortly after takeoff, the flight receives a new clearance changing the maintaining FL from 290 to 250. If the altitude restrictions are still applicable, the controller restates them.

2. A departing aircraft is cleared to cross Fluky Intersection at or above 3,000 feet, Gordonville VOR at or above 12,000 feet, maintain FL 200. Shortly after departure, the altitude to be maintained is changed to FL 240. If the altitude restrictions are still applicable, the controller issues an amended clearance as follows: “cross Fluky Intersection at or above three thousand, cross Gordonville V–O–R at or above one two thousand, maintain Flight Level two four zero.”

3. An arriving aircraft is cleared to the destination airport via V45 Delta VOR direct; the aircraft is cleared to cross Delta VOR at 10,000 feet, and then to maintain 6,000 feet. Prior to Delta VOR, the controller issues an amended clearance as follows: “turn right heading one eight zero for vector to runway three six I–L–S approach, maintain six thousand.”

NOTE–

Because the altitude restriction “cross Delta V–O–R at 10,000 feet” was omitted from the amended clearance, it is no longer in effect.

31.8 Pilots of turbojet aircraft equipped with afterburner engines should advise ATC prior to takeoff if they intend to use afterburning during their climb to the en route altitude. Often, the controller may be able to plan traffic to accommodate a high performance climb and allow the aircraft to climb to the planned altitude without restriction.

31.9 If an “expedite” climb or descent clearance is issued by ATC, and the altitude to maintain is subsequently changed or restated without an expedite instruction, the expedite instruction is canceled. Expedite climb/descent normally indicates to the pilot that the approximate best rate of climb/descent should be used without requiring an exceptional change in aircraft handling characteristics. Normally controllers will inform pilots of the reason for an instruction to expedite.

32. IFR Separation Standards

32.1 ATC effects separation of aircraft vertically by assigning different altitudes; longitudinally by providing an interval expressed in time or distance

between aircraft on the same, converging, or crossing courses; and laterally by assigning different flight paths.

32.2 Separation will be provided between all aircraft operating on IFR flight plans except during that part of the flight (outside Class B airspace or a TRSA) being conducted on a VFR–on–top/VFR conditions clearance. Under these conditions, ATC may issue traffic advisories, but it is the sole responsibility of the pilot to be vigilant so as to see and avoid other aircraft.

32.3 When radar is employed in the separation of aircraft at the same altitude, a minimum of 3 miles separation is provided between aircraft operating within 40 miles of the radar antenna site, and 5 miles between aircraft operating beyond 40 miles from the antenna site. These minimums may be increased or decreased in certain specific situations.

NOTE–

Certain separation standards are increased in the terminal environment when Center Radar Arts Presentation/Processing (CENRAP) is being utilized.

33. Speed Adjustments

33.1 ATC will issue speed adjustments to pilots of radar–controlled aircraft to achieve or to maintain required or desired spacing.

33.2 ATC will express all speed adjustments in terms of knots based on indicated airspeed (IAS) in 10–knot increments except that at or above FL 240 speeds may be expressed in terms of Mach numbers in .01 increments. The use of Mach numbers is restricted to turbojet aircraft with Mach meters.

33.3 Pilots of aircraft in U.S. domestic Class A, B, C, D, and E airspace complying with speed adjustments should maintain a speed within plus or minus 10 knots or 0.02 Mach number, whichever is less, of the assigned speed.

33.4 Pilots of aircraft in offshore controlled airspace or oceanic controlled airspace shall adhere to the ATC assigned airspeed and shall request ATC approval before making any change thereto. If it is essential to make an immediate temporary change in the Mach number (e.g., due to turbulence), ATC shall be notified as soon as possible. If it is not feasible to maintain the last assigned Mach number during an en route climb or descent due to aircraft performance, advise ATC at the time of the request.

33.5 When ATC assigns speed adjustments, it will be in accordance with the following recommended minimums:

33.5.1 To aircraft operating between FL 280 and 10,000 feet, a speed not less than 250 knots or the equivalent Mach number.

NOTE–

1. On a standard day the Mach numbers equivalent to 250 knots CAS (subject to minor variations) are:

FL 240–0.6

FL 250–0.61

FL 260–0.62

FL 270–0.64

FL 280–0.65

FL 290–0.66.

2. When an operational advantage will be realized, speeds lower than the recommended minima may be applied.

33.5.2 To arriving turbojet aircraft operating below 10,000 feet, a speed not less than 210 knots, except within 20 flying miles of the airport of intended landing, a speed not less than 170 knots.

33.5.3 To arriving reciprocating engine or turboprop aircraft within 20 flying miles of the runway threshold of the airport of intended landing, a speed not less than 150 knots.

33.5.4 Departures, for turbojet aircraft, a speed not less than 230 knots; for reciprocating engine aircraft, a speed not less than 150 knots.

33.6 When ATC combines a speed adjustment with a descent clearance, the sequence of delivery with the word “then” between, indicates the expected order of execution; i.e., “DESCEND AND MAINTAIN (altitude); THEN, REDUCE SPEED TO (speed),” or “REDUCE SPEED TO (speed); THEN, DESCEND AND MAINTAIN (altitude).”

NOTE–

The maximum speeds below 10,000 feet as established in 14 CFR Section 91.117 still apply. If there is any doubt concerning the manner in which such a clearance is to be executed, request clarification from ATC.

33.7 If ATC determines (before an approach clearance is issued) that it is no longer necessary to apply speed adjustment procedures, they will inform the pilot to resume normal speed. Approach clearances supersede any prior speed adjustment assignments, and pilots are expected to make their own speed adjustments, as necessary, to complete the approach. Under certain circumstances however, it

may be necessary for ATC to issue further speed adjustments after approach clearance is issued to maintain separation between successive arrivals. Under such circumstances, previously issued speed adjustments will be restated if that speed is to be maintained or additional speed adjustments are requested. ATC must obtain pilot concurrence for speed adjustments after approach clearances are issued. Speed adjustments should not be assigned inside the final approach fix on final or a point 5 miles from the runway, whichever is closer to the runway.

NOTE–

An instruction to “resume normal speed” does not delete speed restrictions that are contained in a published procedure, unless specifically stated by ATC, nor does it relieve the pilot of those speed restrictions which are applicable to 14 CFR Section 91.117.

33.8 The pilots retain the prerogative of rejecting the application of speed adjustment by ATC if the minimum safe airspeed for any particular operation is greater than the speed adjustment. IN SUCH CASES, PILOTS ARE EXPECTED TO ADVISE ATC OF THE SPEED THAT WILL BE USED.

33.9 Pilots are reminded that they are responsible for rejecting the application of speed adjustment by ATC if, in their opinion, it will cause them to exceed the maximum indicated airspeed prescribed by 14 CFR Section 91.117(a), (c) and (d). IN SUCH CASES, THE PILOT IS EXPECTED TO SO INFORM ATC. Pilots operating at or above 10,000 feet MSL who are issued speed adjustments which exceed 250 knots IAS and are subsequently cleared below 10,000 feet MSL are expected to comply with 14 CFR Section 91.117(a).

33.10 Speed restrictions of 250 knots do not apply to U.S. registered aircraft operating beyond 12 nautical miles from the coastline within the U.S. Flight Information Region, in Class E airspace below 10,000 feet MSL. However, in airspace underlying a Class B airspace area designated for an airport, or in a VFR corridor designated through such as a Class B airspace area, pilots are expected to comply with the 200 knot speed limit specified in 14 CFR Section 91.117(c).

33.11 For operations in a Class C and Class D surface area, ATC is authorized to request or approve a speed greater than the maximum indicated airspeeds prescribed for operation within that airspace (14 CFR Section 91.117(b)).

NOTE–

Pilots are expected to comply with the maximum speed of 200 knots when operating beneath Class B airspace or in a Class B VFR corridor (14 CFR Section 91.117(c) and (d)).

33.12 When in communication with the ARTCC or approach control facility, pilots should, as a good operating practice, state any ATC assigned speed restriction on initial radio contact associated with an ATC communications frequency change.

34. Runway Separation

34.1 Tower controllers establish the sequence of arriving and departing aircraft by requiring them to adjust flight or ground operation as necessary to achieve proper spacing. They may “HOLD” an aircraft short of the runway to achieve spacing between it and another arriving aircraft; the controller may instruct a pilot to “EXTEND DOWNWIND” in order to establish spacing from another arriving or departing aircraft. At times a clearance may include the word “IMMEDIATE.” For example: “CLEARED FOR IMMEDIATE TAKEOFF.” In such cases “IMMEDIATE” is used for purposes of air traffic separation. It is up to the pilot to refuse the clearance if, in the pilot’s opinion, compliance would adversely affect the operation.

35. Visual Separation

35.1 Visual separation is a means employed by ATC to separate aircraft in terminal areas and en route airspace. There are two methods employed to effect this separation:

35.1.1 The tower controller sees the aircraft involved and issues instructions, as necessary, to ensure that the aircraft avoid each other.

35.1.2 A pilot sees the other aircraft involved and upon instructions from the controller provides separation by maneuvering the aircraft to avoid it. When pilots accept responsibility to maintain visual separation, they must maintain constant visual surveillance and not pass the other aircraft until it is no longer a factor.

NOTE–

Traffic is no longer a factor when during approach phase the other aircraft is in the landing phase of flight or executes a missed approach; and during departure or en route, when the other aircraft turns away or is on a diverging course.

35.2 A pilot’s acceptance of instructions to follow another aircraft or provide visual separation from it is an acknowledgment that the pilot will maneuver the aircraft as necessary to avoid the other aircraft or to maintain in-trail separation. In operations conducted behind heavy jet aircraft, it is also an acknowledgment that the pilot accepts the responsibility for wake turbulence separation.

NOTE–

When a pilot has been told to follow another aircraft or to provide visual separation from it, the pilot should promptly notify the controller if visual contact with the other aircraft is lost or cannot be maintained or if the pilot cannot accept the responsibility for the separation for any reason.

35.3 Scanning the sky for other aircraft is a key factor in collision avoidance. Pilots and copilots (or the right seat passenger) should continuously scan to cover all areas of the sky visible from the cockpit. Pilots must develop an effective scanning technique which maximizes one’s visual capabilities. Spotting a potential collision threat increases directly as more time is spent looking outside the aircraft. One must use timesharing techniques to effectively scan the surrounding airspace while monitoring instruments as well.

35.4 Since the eye can focus only on a narrow viewing area, effective scanning is accomplished with a series of short, regularly spaced eye movements that bring successive areas of the sky into the central visual field. Each movement should not exceed ten degrees, and each area should be observed for at least one second to enable collision detection. Although many pilots seem to prefer the method of horizontal back-and-forth scanning every pilot should develop a scanning pattern that is not only comfortable but assures optimum effectiveness. Pilots should remember, however, that they have a regulatory responsibility (14 CFR Section 91.113) to see and avoid other aircraft when weather conditions permit.

36. Use of Visual Clearing Procedures

36.1 Before Takeoff. Prior to taxiing onto a runway or landing area in preparation for takeoff, pilots should scan the approach areas for possible landing traffic, executing appropriate clearing maneuvers to provide them a clear view of the approach areas.

36.2 Climbs and Descents. During climbs and descents in flight conditions which permit visual detection of other traffic, pilots should execute gentle banks, left and right at a frequency which permits continuous visual scanning of the airspace about them.

36.3 Straight and Level. Sustained periods of straight and level flight in conditions which permit visual detection of other traffic should be broken at intervals with appropriate clearing procedures to provide effective visual scanning.

36.4 Traffic Patterns. Entries into traffic patterns while descending create specific collision hazards and should be avoided.

36.5 Traffic at VOR Sites. All operators should emphasize the need for sustained vigilance in the vicinity of VORs and airway intersections due to the convergence of traffic.

36.6 Training Operations. Operators of pilot training programs are urged to adopt the following practices:

36.6.1 Pilots undergoing flight instruction at all levels should be requested to verbalize clearing procedures (call out, “Clear” left, right, above, or below) to instill and sustain the habit of vigilance during maneuvering.

36.6.2 High-wing Airplane. Momentarily raise the wing in the direction of the intended turn and look.

36.6.3 Low-wing Airplane. Momentarily lower the wing in the direction of the intended turn and look.

36.6.4 Appropriate clearing procedures should precede the execution of all turns including chandelles, lazy eights, stalls, slow flight, climbs, straight and level, spins, and other combination maneuvers.

37. Surveillance Systems

37.1 Radar

37.1.1 Capabilities

37.1.1.1 Radar is a method whereby radio waves are transmitted into the air and are then received when they have been reflected by an object in the path of the beam. Range is determined by measuring the time it takes (at the speed of light) for the radio wave to go out to the object and then return to the receiving antenna. The direction of a detected object from a radar site is determined by the position of the rotating antenna when the reflected portion of the radio wave is received.

37.1.1.2 More reliable maintenance and improved equipment have reduced radar system failures to a negligible factor. Most facilities actually have some components duplicated – one operating and another which immediately takes over when a malfunction occurs to the primary component.

37.1.2 Limitations

37.1.2.1 It is very important for the aviation community to recognize the fact that there are limitations to radar service and that ATC controllers may not always be able to issue traffic advisories concerning aircraft which are not under ATC control and cannot be seen on radar. (See FIG ENR 1.1–23).

FIG ENR 1.1–23
Limitations to Radar Service

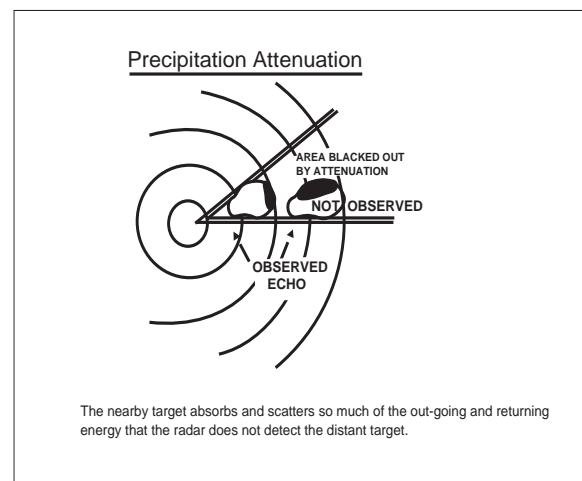

a) The characteristics of radio waves are such that they normally travel in a continuous straight line unless they are:

1) “Bent” by abnormal atmospheric phenomena such as temperature inversions.

2) Reflected or attenuated by dense objects such as heavy clouds, precipitation, ground obstacles, mountains, etc.

3) Screened by high terrain features.

b) The bending of radar pulses, often called anomalous propagation or ducting, may cause many extraneous blips to appear on the radar operator’s display if the beam has been bent toward the ground, or may decrease the detection range if the wave is bent upward. It is difficult to solve the effects of anomalous propagation, but using beacon radar and electronically eliminating stationary and slow moving targets by a method called moving target indicator (MTI) usually negate the problem.

c) Radar energy that strikes dense objects will be reflected and displayed on the operator’s scope, thereby blocking out aircraft at the same range and greatly weakening or completely eliminating the display of targets at a greater range. Again, radar beacon and MTI are effectively used to combat ground clutter and weather phenomena, and a method of circularly polarizing the radar beam will eliminate some weather returns. A negative characteristic of MTI is that an aircraft flying a speed that coincides with the canceling signal of the MTI (tangential or “blind” speed) may not be displayed to the radar controller.

d) Relatively low altitude aircraft will not be seen if they are screened by mountains or are below the radar beam due to earth curvature. The only solution to screening is the installation of strategically placed multiple radars, which has been done in some areas.

e) There are several other factors which affect radar control. The amount of reflective surface of an aircraft will determine the size of the radar return. Therefore, a small light airplane or a sleek jet fighter will be more difficult to see on radar than a large commercial jet or military bomber. Here again, the use of radar beacon is invaluable if the aircraft is equipped with an airborne transponder. All ARTCC radars in the conterminous U.S. and many airport surveillance radars have the capability to interrogate

Mode C and display altitude information to the controller from appropriately equipped aircraft. However, there are a number of airport surveillance radars that do not have Mode C display capability and, therefore, altitude information must be obtained from the pilot.

f) At some locations within the ATC en route environment, secondary–radar–only (no primary radar) gap filler systems are used to give lower altitude radar coverage between two larger radar systems, each of which provides both primary and secondary radar coverage. In those geographical areas served by secondary–radar–only, aircraft without transponders cannot be provided with radar service. Additionally, transponder equipped aircraft cannot be provided with radar advisories concerning primary targets and weather.

g) The controller’s ability to advise a pilot flying on instruments or in visual conditions of the aircraft’s proximity to another aircraft will be limited if the unknown aircraft is not observed on radar, if no flight plan information is available, or if the volume of traffic and workload prevent issuing traffic information. First priority is given to establishing vertical, lateral, or longitudinal separation between aircraft flying IFR under the control of ATC.

37.2 Air Traffic Control Radar Beacon System (ATCRBS)

37.2.1 The ATCRBS, sometimes referred to as a secondary surveillance radar, consists of three main components:

37.2.1.1 Interrogator. Primary radar relies on a signal being transmitted from the radar antenna site and for this signal to be reflected or “bounced back” from an object (such as an aircraft). This reflected signal is then displayed as a “target” on the controller’s radar scope. In the ATCRBS, the Interrogator, a ground–based radar beacon transmitter–receiver, scans in synchronism with the primary radar and transmits discrete radio signals which repetitiously requests all transponders, on the mode being used, to reply. The replies received are then mixed with the primary returns and both are displayed on the same radar scope.

37.2.1.2 Transponder. This airborne radar beacon transmitter–receiver automatically receives the signals from the interrogator and selectively replies with a specific pulse group (code) only to those interrogations being received on the mode to which

it is set. These replies are independent of, and much stronger than a primary radar return.

37.2.1.3 Radar scope. The radar scope used by the controller displays returns from both the primary radar system and the ATCRBS. These returns, called targets, are what the controller refers to in the control and separation of traffic.

37.2.2 The job of identifying and maintaining identification of primary radar targets is a long and tedious task for the controller. Some of the advantages of ATCRBS over primary radar are:

37.2.2.1 Reinforcement of radar targets.

37.2.2.2 Rapid target identification.

37.2.2.3 Unique display of selected codes.

37.2.3 A part of the ATCRBS ground equipment is the decoder. This equipment enables the controller to assign discrete transponder codes to each aircraft under his/her control. Normally only one code will be assigned for the entire flight. Assignments are made by the ARTCC computer on the basis of the National Beacon Code Allocation Plan. The equipment is also designed to receive Mode C altitude information from the aircraft. See FIG ENR 1.1–24 and FIG ENR 1.1–25 for an illustration of the target symbology depicted on radar scopes in the NAS Stage A (en route), the ARTS III (terminal) Systems, and other nonautomated (broadband) radar systems.

37.3 Surveillance Radar

37.3.1 Surveillance radars are divided into two general categories: Airport Surveillance Radar (ASR) and Air Route Surveillance Radar (ARSR).

37.3.1.1 ASR is designed to provide relatively short range coverage in the general vicinity of an airport and to serve as an expeditious means of handling terminal area traffic through observation of precise aircraft locations on a radar scope. The ASR can also be used as an instrument approach aid.

37.3.1.2 ARSR is a long-range radar system designed primarily to provide a display of aircraft locations over large areas.

37.3.1.3 Center Radar Automated Radar Terminal Systems (ARTS) Processing (CENRAP) was developed to provide an alternative to a nonradar environment at terminal facilities should an ASR fail or malfunction. CENRAP sends aircraft radar beacon target information to the ASR terminal facility equipped with ARTS. Procedures used for the separation of aircraft may increase under certain conditions when a facility is utilizing CENRAP, because radar target information updates at a slower rate than the normal ASR radar. Radar services for VFR aircraft are also limited during CENRAP operations because of the additional workload required to provide services to IFR aircraft.

37.3.2 Surveillance radars scan through 360 degrees of azimuth and present target information on a radar display located in a tower or center. This information is used independently or in conjunction with other navigational aids in the control of air traffic.

37.4 Precision Approach Radar (PAR)

37.4.1 PAR is designed for use as a landing aid rather than an aid for sequencing and spacing aircraft. PAR equipment may be used as a primary landing aid (See ENR 1.5 for additional information), or it may be used to monitor other types of approaches. It is designed to display range, azimuth, and elevation information.

37.4.2 Two antennas are used in the PAR array, one scanning a vertical plane, and the other scanning horizontally. Since the range is limited to 10 miles, azimuth to 20 degrees, and elevation to 7 degrees, only the final approach area is covered. Each scope is divided into two parts. The upper half presents altitude and distance information, and the lower half presents azimuth and distance.

FIG ENR 1.1-24
ARTS III Radar Scope With Alphanumeric Data

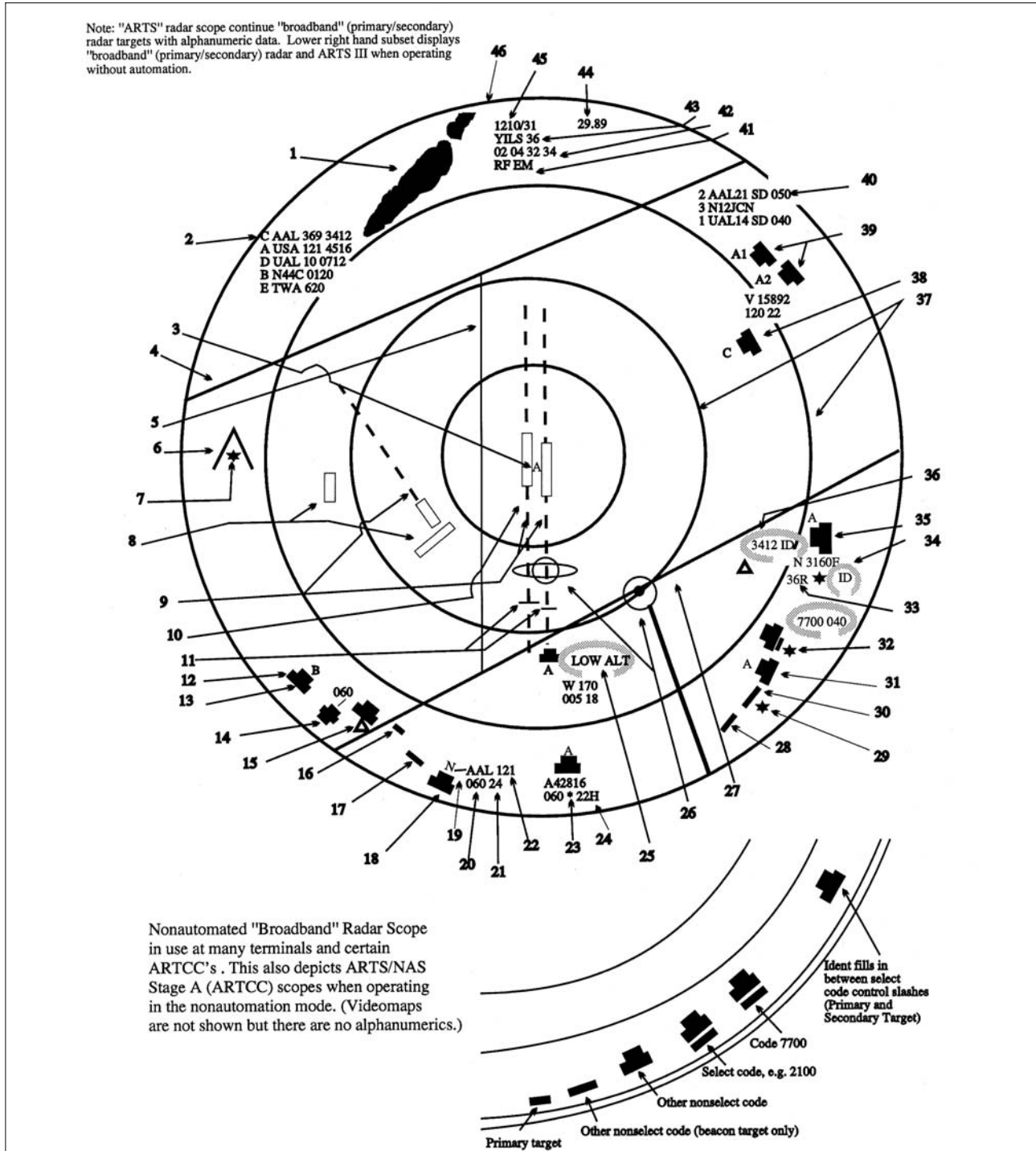

NOTE-

A number of radar terminals do not have ARTS equipment. Those facilities and certain ARTCCs outside the contiguous U.S. would have radar displays similar to the lower right hand subset. ARTS facilities and NAS Stage A ARTCCs, when operating in the nonautomation mode, would also have similar displays and certain services based on automation may not be available.

EXAMPLE–

1. Areas of precipitation (can be reduced by CP)
2. Arrival/departure tabular list
3. Trackball (control) position symbol (A)
4. Airway (lines are sometimes deleted in part)
5. Radar limit line for control
6. Obstruction (video map)
7. Primary radar returns of obstacles or terrain (can be removed by MTI)
8. Satellite airports
9. Runway centerlines (marks and spaces indicate miles)
10. Primary airport with parallel runways
11. Approach gates
12. Tracked target (primary and beacon target)
13. Control position symbol
14. Untracked target select code (monitored) with Mode C readout of 5,000'
15. Untracked target without Mode C
16. Primary target
17. Beacon target only (secondary radar) (transponder)
18. Primary and beacon target
19. Leader line
20. Altitude Mode C readout is 6,000'
(Note: readouts may not be displayed because of nonreceipt of beacon information, garbled beacon signals, and flight plan data which is displayed alternately with the altitude readout)
21. Ground speed readout is 240 knots
(Note: readouts may not be displayed because of a loss of beacon signal, a controller alert that a pilot was squawking emergency, radio failure, etc.)
22. Aircraft ID
23. Asterisk indicates a controller entry in Mode C block. In this case 5,000' is entered and "05" would alternate with Mode C readout.
24. Indicates heavy
25. "Low ALT" flashes to indicate when an aircraft's predicted descent places the aircraft in an unsafe proximity to terrain.
(Note: this feature does not function if the aircraft is not squawking Mode C. When a helicopter or aircraft is known to be operating below the lower safe limit, the "low ALT" can be changed to "inhibit" and flashing ceases.)
26. NAVAIDs
27. Airways
28. Primary target only
29. Nonmonitored. No Mode C (an asterisk would indicate nonmonitored with Mode C)
30. Beacon target only (secondary radar based on aircraft transponder)
31. Tracked target (primary and beacon target) control position A
32. Aircraft is squawking emergency code 7700 and is nonmonitored, untracked, Mode C
33. Controller assigned runway 36 right alternates with Mode C readout
(Note: a three letter identifier could also indicate the arrival is at specific airport)
34. Ident flashes
35. Identing target blossoms
36. Untracked target identing on a selected code
37. Range marks (10 and 15 miles) (can be changed/offset)
38. Aircraft controlled by center
39. Targets in suspend status
40. Coast/suspend list (aircraft holding, temporary loss of beacon/target, etc.)
41. Radio failure (emergency information)
42. Select beacon codes (being monitored)
43. General information (ATIS, runway, approach in use)
44. Altimeter setting
45. Time
46. System data area

EXAMPLE-

Target symbols:

1. Uncorrelated primary radar target [○] [+]
2. Correlated primary radar target []
*See note below.
3. Uncorrelated beacon target [/]
4. Correlated beacon target [\]
5. Identifying beacon target [≡]

*Note: in Number 2 correlated means the association of radar data with the computer projected track of an identified aircraft.

Position symbols:

6. Free track (no flight plan tracking) []
7. Flat track (flight plan tracking) [◇]
8. Coast (beacon target lost) [#]
9. Present position hold [□]

Data block information:

10. Aircraft ident
*See note below.
11. Assigned altitude FL 280, Mode C altitude same or within 200' of assigned altitude.
*See note below.
12. Computer ID #191, handoff is to sector 33
(0-33 would mean handoff accepted)
*See note below.
13. Assigned altitude 17,000', aircraft is climbing, Mode C readout was 14,300 when last beacon interrogation was received.
14. Leader line connecting target symbol and data block.
15. Track velocity and direction vector line (projected ahead of target)

16. Assigned altitude 7,000, aircraft is descending, last Mode C readout (or last reported altitude) was 100' above FL 230

17. Transponder code shows in full data block only when different than assigned code

18. Aircraft is 300' above assigned altitude

19. Reported altitude (no Mode C readout) same as assigned. (An "n" would indicate no reported altitude.)

20. Transponder set on emergency Code 7700. (EMRG flashes to attract attention.)

21. Transponder Code 1200 (VFR) with no Mode C

22. Code 1200 (VFR) with Mode C and last altitude readout

23. Transponder set on radio failure Code 7600 (RDOF flashes)

24. Computer ID #228, CST indicates target is in coast status

25. Assigned altitude FL 290, transponder code (these two items constitute a "limited data block")

*Note: numbers 10, 11, and 12 constitute a "full data block"

Other symbols:

26. Navigational aid
27. Airway or jet route
28. Outline of weather returns based on primary radar. "H" represents areas of high density precipitation which might be thunderstorms. Radial lines indicated lower density precipitation.
29. Obstruction
30. Airports
Major: □
Small: ▤

37.5 Airport Surface Detection Equipment – Model X (ASDE–X)

TBL ENR 1.1-2

37.5.1 The Airport Surface Detection Equipment – Model X (ASDE–X) is a multi–sensor surface surveillance system the FAA is acquiring for airports in the United States. This system will provide high resolution, short–range, clutter free surveillance information about aircraft and vehicles, both moving and fixed, located on or near the surface of the airport’s runways and taxiways under all weather and visibility conditions. The system consists of:

37.5.1.1 A Primary Radar System. ASDE–X system coverage includes the airport surface and the airspace up to 200 feet above the surface. Typically located on the control tower or other strategic location on the airport, the Primary Radar antenna is able to detect and display aircraft that are not equipped with or have malfunctioning transponders.

37.5.1.2 Interfaces. ASDE–X contains an automation interface for flight identification via all automation platforms and interfaces with the terminal radar for position information.

37.5.1.3 ASDE–X Automation. A Multi–sensor Data Processor (MSDP) combines all sensor reports into a single target which is displayed to the air traffic controller.

37.5.1.4 Air Traffic Control Tower Display. A high resolution, color monitor in the control tower cab provides controllers with a seamless picture of airport operations on the airport surface.

37.5.2 The combination of data collected from the multiple sensors ensures that the most accurate information about aircraft location is received in the tower, thereby increasing surface safety and efficiency.

37.5.3 The following facilities have been projected to receive ASDE–X:

STL	Lambert–St. Louis International
CLT	Charlotte Douglas International
SDF	Louisville International Standiford
DFW	Dallas/Ft. Worth International
ORD	Chicago O’Hare International
LAX	Los Angeles International
ATL	Hartsfield Atlanta International
IAD	Washington Dulles International
SEA	Seattle–Tacoma International
MKE	General Mitchell International
MCO	Orlando International
PVD	Theodore Francis Green State
PHX	Phoenix Sky Harbor International
MEM	Memphis International
RDU	Raleigh–Durham International
HOU	William P. Hobby (Houston, TX)
BDL	Bradley International
SJC	San Jose International
SAT	San Antonio International
SMF	Sacramento International
FLL	Ft. Lauderdale/Hollywood
HNL	Honolulu International – Hickam AFB
OAK	Metropolitan Oakland International
IND	Indianapolis International
TPA	Tampa International
BUR	Burbank–Glendale–Pasadena
CMH	Port Columbus International
MDW	Chicago Midway
COS	Colorado Springs Municipal
SNA	John Wayne – Orange County
ONT	Ontario International
AUS	Austin–Bergstrom International
RNO	Reno/Tahoe International
ABQ	Albuquerque International Sunport
SJU	San Juan International

37.6 Radar Availability

37.6.1 FAA radar units operate continuously at the locations shown in the Airport/Facility Directory, and their services are available to all pilots, both civil and military. Contact the associated FAA control tower or ARTCC on any frequency guarded for initial instructions, or in an emergency, any FAA facility for information on the nearest radar service.

37.7 Transponder Operation

37.7.1 General

37.7.1.1 Pilots should be aware that proper application of these procedures will provide both VFR and IFR aircraft with a high degree of safety in the environment where high-speed closure rates are possible. Transponders substantially increase the capability of radar to see an aircraft, and the Mode C feature enables the controller to quickly determine where potential traffic conflicts may exist. Even VFR pilots who are not in contact with ATC will be afforded greater protection from IFR aircraft and VFR aircraft which are receiving traffic advisories. Nevertheless, pilots should never relax their visual scanning vigilance for other aircraft.

37.7.1.2 ATCRBS is similar to and compatible with military coded radar beacon equipment. Civil Mode A is identical to military Mode 3.

37.7.1.3 Civil and military transponders should be adjusted to the “on” or normal operating position as late as practicable prior to takeoff and to “off” or “standby” as soon as practicable after completing landing roll, unless the change to “standby” has been accomplished previously at the request of ATC. IN ALL CASES, WHILE IN CLASS A, B, C, D, AND E AIRSPACE EACH PILOT OPERATING AN AIRCRAFT EQUIPPED WITH AN OPERABLE ATC TRANSPONDER MAINTAINED IN ACCORDANCE WITH 14 CFR SECTION 91.413 SHALL OPERATE THE TRANSPONDER, INCLUDING MODE C IF INSTALLED, ON THE APPROPRIATE CODE OR AS ASSIGNED BY ATC. IN CLASS G AIRSPACE, THE TRANSPONDER SHOULD BE OPERATING WHILE AIRBORNE UNLESS OTHERWISE REQUESTED BY ATC.

37.7.1.4 If a pilot on an IFR flight elects to cancel the IFR flight plan prior to reaching destination, the pilot should adjust the transponder according to VFR operations.

37.7.1.5 If entering U.S. domestic controlled airspace from outside the U.S., the pilot should advise on first radio contact with a U.S. radar ATC facility that such equipment is available by adding “transponder” to the aircraft identification.

37.7.1.6 It should be noted by all users of ATC transponders that the coverage they can expect is limited to “line of sight.” Low altitude or aircraft antenna shielding by the aircraft itself may result in reduced range. Range can be improved by climbing to a higher altitude. It may be possible to minimize antenna shielding by locating the antenna where dead spots are only noticed during abnormal flight attitudes.

37.7.1.7 If operating at an airport with Airport Surface Detection Equipment – Model X (ASDE-X), transponders should be transmitting (on position) continuously with altitude reporting while moving on the airport surface.

37.7.1.8 Aircraft equipped with ADS-B (1090 ES or UAT) must operate the equipment in the transmit mode (on position) at all times while on any airport surface.

NOTE-

For a complete description of operating limitations and procedures, pilots of aircraft equipped with ADS-B should refer to AIP, Automatic Dependant Surveillance – Broadcast Services, ENR 1.1 Paragraph 46.

37.7.2 Transponder Code Designation

37.7.2.1 For ATC to utilize one or a combination of the 4096 discrete codes, FOUR DIGIT CODE DESIGNATION will be used; e.g., code 2100 will be expressed as TWO ONE ZERO ZERO. Due to the operational characteristics of the rapidly expanding automated ATC system, THE LAST TWO DIGITS OF THE SELECTED TRANSPONDER CODE SHOULD ALWAYS READ ‘00’ UNLESS SPECIFICALLY REQUESTED BY ATC TO BE OTHERWISE.

37.7.3 Automatic Altitude Reporting (Mode C)

37.7.3.1 Some transponders are equipped with a Mode C automatic altitude reporting capability. This system converts aircraft altitude in 100 foot increments to coded digital information which is

transmitted together with Mode C framing pulses to the interrogating radar facility. The manner in which transponder panels are designed differs, therefore, a pilot should be thoroughly familiar with the operation of the transponder so that ATC may realize its full capabilities.

37.7.3.2 Adjust transponder to reply on the Mode A/3 code specified by ATC and, if equipped, to reply on Mode C with altitude reporting capability activated unless deactivation is directed by ATC or unless the installed aircraft equipment has not been tested and calibrated as required by 14 CFR Section 91.217. If deactivation is required by ATC, run off the altitude reporting feature of your transponder. An instruction by ATC to “STOP ALTITUDE SQUAWK, ALTITUDE DIFFERS (number of feet) FEET,” may be an indication that your transponder is transmitting incorrect altitude information or that you have an incorrect altimeter setting. While an incorrect altimeter setting has no effect on the Mode C altitude information transmitted by your transponder (transponders are preset at 29.92), it would cause you to fly at an actual altitude different from your assigned altitude. When a controller indicates that an altitude readout is invalid, the pilot should initiate a check to verify that the aircraft altimeter is set correctly.

37.7.3.3 Pilots of aircraft with operating Mode C altitude reporting transponders should exact altitude/flight level to the nearest hundred foot increment when establishing initial contact with an ATC. Exact altitude/flight level reports on initial contact provide ATC with information that is required prior to using Mode C altitude information for separation purposes. This will significantly reduce altitude verification requests.

37.7.4 Transponder IDENT Feature

37.7.4.1 The transponder shall be operated only as specified by ATC. Activate the “IDENT” feature only upon request of the ATC controller.

37.7.5 Code Changes

37.7.5.1 When making routine code changes, pilots should avoid inadvertent selection of Codes 7500, 7600, or 7700 thereby causing momentary false alarms at automated ground facilities. For example when switching from Code 2700 to Code 7200, switch first to 2200 then 7200, NOT to 7700 and then 7200. This procedure applies to nondiscrete

Code 7500 and all discrete codes in the 7600 and 7700 series (i.e., 7600–7677, 7700–7777) which will trigger special indicators in automated facilities. Only nondiscrete Code 7500 will be decoded as the hijack code.

37.7.5.2 Under no circumstances should a pilot of a civil aircraft operate the transponder on Code 7777. This code is reserved for military interceptor operations.

37.7.5.3 Military pilots operating VFR or IFR within restricted/warning areas should adjust their transponders to Code 4000, unless another code has been assigned by ATC.

37.7.6 Mode C Transponder Requirements

37.7.6.1 Specific details concerning requirements to carry and operate Mode C transponders, as well as exceptions and ATC authorized deviations from the requirements are found in 14 CFR Sections 91.215 and 99.12.

37.7.6.2 In general, the CFR requires aircraft to be equipped with Mode C transponders when operating:

a) At or above 10,000 feet MSL over the 48 contiguous states or the District of Columbia, excluding that airspace below 2,500 feet AGL.

b) Within 30 miles of a Class B airspace primary airport, below 10,000 feet MSL. Balloons, gliders, and aircraft not equipped with an engine driven electrical system are excepted from the above requirements when operating below the floor of Class A airspace and/or; outside of Class B airspace and below the ceiling of the Class B airspace (or 10,000 feet MSL, whichever is lower).

c) Within and above all Class C airspace up to 10,000 feet MSL.

d) Within 10 miles of certain designated airports from the surface to 10,000 feet MSL, excluding that airspace which is both outside Class D airspace and below 1,200 feet AGL. Balloons, gliders and aircraft not equipped with an engine driven electrical system are excepted from this requirement.

37.7.6.3 14 CFR Section 99.12 requires all aircraft flying into, within, or across the contiguous U.S. ADIZ be equipped with a Mode C or Mode S transponder. Balloons, gliders, and aircraft not equipped with an engine driven electrical system are excepted from this requirement.

37.7.6.4 Pilots shall ensure that their aircraft transponder is operating on an appropriate ATC assigned VFR/IFR code and Mode C when operating in such airspace. If in doubt about the operational status of either feature of your transponder while airborne, contact the nearest ATC facility or FSS and they will advise you what facility you should contact for determining the status of your equipment.

37.7.6.5 Inflight requests for “immediate” deviation from the transponder requirements may be approved by controllers only when the flight will continue IFR or when weather conditions prevent VFR descent and continued VFR flight in airspace not affected by the CFR. All other requests for deviation should be made by contacting the nearest FSS or air traffic facility in person or by telephone. The nearest ARTCC will normally be the controlling agency and is responsible for coordinating requests involving deviations in other ARTCC’s areas.

37.7.7 Transponder Operation Under Visual Flight Rules (VFR)

37.7.7.1 Unless otherwise instructed by an ATC Facility, adjust transponder to reply on Mode 3/A Code 1200 regardless of altitude.

37.7.7.2 Adjust transponder to reply on Mode C, with altitude reporting capability activated if the aircraft is so equipped, unless deactivation is directed by ATC or unless the installed equipment has not been tested and calibrated as required by 14 CFR Section 91.217. If deactivation is required and your transponder is so designed, turn off the altitude reporting switch and continue to transmit Mode C framing pulses. If this capability does not exist, turn off Mode C.

37.7.8 Radar Beacon Phraseology

37.7.8.1 Air traffic controllers, both civil and military, will use the following phraseology when referring to operation of the ATCRBS. Instructions by ATC refer only to Mode A/3 or Mode C operations and do not affect the operation of the transponder on other modes.

a) SQUAWK (number). Operate radar beacon transponder on designated code in Mode A/3.

b) IDENT. Engage the “IDENT” feature (military I/P) of the transponder.

c) SQUAWK (number) AND IDENT. Operate transponder on specified code in Mode A/3 and engage the “IDENT” (military I/P) feature.

d) SQUAWK STANDBY. Switch transponder to standby position.

e) SQUAWK LOW/NORMAL. Operate transponder on low or normal sensitivity as specified. Transponder is operated in “NORMAL” position unless ATC specified “LOW.” (“ON” is used instead of “NORMAL” as a master control label on some types of transponders.)

f) SQUAWK ALTITUDE. Activate Mode C with automatic altitude reporting.

g) STOP ALTITUDE SQUAWK. Turn off altitude reporting switch and continue transmitting Mode C framing pulses. If your equipment does not have this capability, turn off Mode C.

h) STOP SQUAWK (mode in use). Switch off specified mode. (Use for military aircraft when the controller is unaware if a military service requires the aircraft to continue operating on another mode.)

i) STOP SQUAWK. Switch off transponder.

j) SQUAWK MAYDAY. Operate transponder in the emergency position. (Mode A Code 7700 for civil transponder. Mode 3 Code 7700 and emergency feature for military transponder.)

k) SQUAWK VFR. Operate radar beacon transponder on code 1200 in the MODE A/3, or other appropriate VFR code.

37.8 Emergency Operation

37.8.1 When an emergency occurs, the pilot of an aircraft equipped with a coded radar beacon transponder who desires to alert a ground radar facility to an emergency condition and who cannot establish communications without delay with an ATC facility may adjust the transponder to reply on Mode A/3, Code 7700.

37.8.2 Pilots should understand that they may not be within a radar coverage area and that, even if they are, certain radar facilities are not yet equipped to automatically recognize Code 7700 as an emergency signal. Therefore, they should establish radio communications with an ATC facility as soon as possible.

37.9 Radio Failure Operation

37.9.1 Should the pilot of an aircraft equipped with a coded radar beacon transponder experience a loss of two-way radio capability the pilot should:

37.9.1.1 Adjust the transponder to reply on MODE A/3, Code 7600.

37.9.1.2 Understand that the aircraft may not be in an area of radar coverage.

37.9.2 Pilots should understand that they may not be in an area of radar coverage. Also, many radar facilities are not presently equipped to automatically display Code 7600 and will interrogate 7600 only when the aircraft is under direct radar control at the time of radio failure. However, replying on Code 7700 first, increases the probability of early detection of a radio failure condition.

37.10 Radar Services

37.10.1 Safety Alert

37.10.1.1 A safety alert will be issued to pilots of aircraft being controlled by ATC if the controller is aware the aircraft is at an altitude which, in the controller's judgment, places the aircraft in unsafe proximity to terrain, obstructions, or other aircraft. The provision of this service is contingent upon the capability of the controller to have an awareness of situations involving unsafe proximity to terrain, obstructions, and uncontrolled aircraft. The issuance of a safety alert cannot be mandated, but it can be expected on a reasonable, though intermittent, basis. Once the alert is issued, it is solely the pilot's prerogative to determine what course of action, if any, will be taken. This procedure is intended for use in time critical situations where aircraft safety is in question. Noncritical situations should be handled via the normal traffic alert procedures.

37.10.2 Terrain/Obstruction Alert

37.10.2.1 Controllers will immediately issue an alert to the pilots of aircraft under their control when they recognize that the aircraft is at an altitude which, in their judgment, may be in unsafe proximity to terrain/obstructions. The primary method of detecting unsafe proximity is through Mode C automatic altitude reports.

EXAMPLE–

Low altitude alert, check your altitude immediately. The, as appropriate, MEA/MVA/MOCA in your area is (altitude) or, if past the final approach fix (nonprecision approach) or the outer marker or fix used in lieu of the outer marker

(precision approach), the, as appropriate, MDA/DH (if known) is (altitude).

37.10.2.2 Terminal Automated Radar Terminal System (ARTS) IIIA, Common ARTS (to include ARTS IIIE and ARTS IIE) (CARTS), Micro En Route Automated Radar Tracking System (MEARTS), and Standard Terminal Automation Replacement System (STARS) facilities have an automated function which, if operating, alerts controllers when a tracked Mode C equipped aircraft under their control is below or is predicted to be below a predetermined minimum safe altitude. This function, called Minimum Safe Altitude Warning (MSAW), is designed solely as a controller aid in detecting potentially unsafe aircraft proximity to terrain/obstructions. The ARTS IIIA, CARTS, MEARTS, and STARS facility will, when MSAW is operating, provide MSAW monitoring for all aircraft with an operating Mode C altitude encoding transponder that are tracked by the system and are:

a) Operating on a IFR flight plan.

b) Operating VFR and have requested MSAW monitoring.

37.10.2.3 Terminal AN/TPX–42A (number beacon decoder system) facilities have an automated function called Low Altitude Alert System (LAAS). Although not as sophisticated as MSAW, LAAS alerts the controller when a Mode C transponder equipped aircraft operating on a IFR flight plan is below a predetermined minimum safe altitude.

NOTE–

Pilots operating VFR may request MSAW or LAAS monitoring if their aircraft are equipped with Mode C transponders.

EXAMPLE–

Apache Three Three Papa requests MSAW/LAAS.

37.10.3 Aircraft Conflict Alert

37.10.3.1 Controllers will immediately issue an alert to the pilots of aircraft under their control if they are aware of an aircraft that is not under their control at an altitude which, in the controller's judgment, places both aircraft in unsafe proximity to each other. With the alert, when feasible, the controller will offer the pilot the position of the traffic if time permits and an alternate course(s) of action. Any alternate course of action the controller may recommend to the pilot will be predicated only on other traffic in the controller's jurisdiction.

EXAMPLE–

American Three, traffic alert, (position of traffic, if time

permits), advise you turn right/left heading (degrees) and/or climb/descend to (altitude) immediately.

37.10.4 Radar Traffic Information Service (RTIS)

37.10.4.1 This is a service provided by radar ATC facilities. Pilots receiving this service are advised of any radar target observed on the radar display which may be in such proximity to the position of their aircraft or its intended route of flight that it warrants their attention. This service is not intended to relieve the pilot of the responsibility for continual vigilance to see and avoid other aircraft.

a) Purpose of this Service

1) The issuance of traffic information as observed on a radar display is based on the principle of assisting and advising a pilot that a particular radar target's position and track indicates it may intersect or pass in such proximity to the intended flight path that it warrants the pilot's attention. This is to alert the pilot to the traffic, to be on the lookout for it, and thereby be in a better position to take appropriate action should the need arise.

2) Pilots are reminded that the surveillance radar used by ATC does not provide altitude information unless the aircraft is equipped with Mode C and the radar facility is capable of displaying altitude information.

b) Provisions of the Service

1) Many factors, such as limitations of the radar, volume of traffic, controller workload, and communications frequency congestion could prevent the controller from providing this service. Controllers possess complete discretion for determining whether they are able to provide or continue to provide this service in a specific case. The controller's reason against providing or continuing to provide the service in a particular case is not subject to question nor need it be communicated to the pilot. In other words, the provision of this service is entirely dependent upon whether controllers believe they are in a position to provide it. Traffic information is routinely provided to all aircraft operating on IFR flight plans except when the pilot declines the service, or the pilot is operating within Class A airspace. Traffic information may be provided to flights not operating on IFR Flight Plans when requested by pilots of such flights.

NOTE-

Radar ATC facilities normally display and monitor both primary and secondary radar when it is available, except that secondary radar may be used as the sole display source in Class A airspace, and under some circumstances outside of Class A airspace (beyond primary coverage and in en route areas where only secondary is available). Secondary radar may also be used outside Class A airspace as the sole display source when the primary radar is temporarily unusable or out of service. Pilots in contact with the affected ATC facility are normally advised when a temporary outage occurs; i.e., "primary radar out of service; traffic advisories available on transponder aircraft only." This means simply that only the aircraft which have transponders installed and in use will be depicted on ATC radar indicators when the primary radar is temporarily out of service.

2) When receiving VFR radar advisory service, pilots should monitor the assigned frequency at all times. This is to preclude controllers' concern for radio failure of emergency assistance to aircraft under the controller's jurisdiction. VFR radar advisory service does not include vectors away from conflicting traffic unless requested by the pilot. When advisory service is no longer desired, advise the controller before changing frequencies, then change your transponder code to 1200 if applicable. THE, as appropriate, MEA/MVA/MOCA IN YOUR AREA IS (altitude) or if past the final approach fix, THE, as appropriate, MDA/DH (if known) is (altitude). Except in programs where radar service is automatically terminated, the controller will advise the aircraft when radar is terminated.

NOTE-

Participation by VFR pilots in formal programs implemented at certain terminal locations constitutes pilot request. This also applies to participating pilots at those locations where arriving VFR flights are encouraged to make their first contact with the tower on the approach control frequency.

c) Issuance of Traffic Information. Traffic information will include the following concerning a target which may constitute traffic for an aircraft that is:

1) Radar identified.

(a) Azimuth from the aircraft in terms of the twelve hour clock.

(b) When rapidly maneuvering civil test or military aircraft prevent accurate issuance of traffic as in a) above, specify the direction from an aircraft's position in terms of the eight cardinal compass points

(N, NE, E, SE, S, SW, W, NW). This method shall be terminated at the pilot's request.

- (c) Distance from the aircraft in nautical miles.
- (d) Direction in which the target is proceeding.
- (e) Type of aircraft and altitude if known.

EXAMPLE-

Traffic 10 o'clock, 3 miles, west-bound (type aircraft and altitude, if known, of the observed traffic). The altitude may be known, by means of Mode C, but not verified with the pilot for accuracy. (To be valid for separation purposes by ATC, the accuracy of Mode C readouts must be verified. This is usually accomplished upon initial entry into the radar system by a comparison of the readout to pilot stated altitude, or the field elevation in the case of continuous readout being received from an aircraft on the airport.) When necessary to issue traffic advisories containing unverified altitude information, the controller will issue the advisory in the same manner as if it were verified due to the accuracy of these readouts. The pilot may, upon receipt of traffic information, request a vector (heading) to avoid such traffic. The vector will be provided to the extent possible as determined by the controller provided the aircraft to be vectored is within the airspace under the jurisdiction of the controller.

2) Not radar identified

- (a) Distance and direction with respect to a fix.
- (b) Direction in which the target is proceeding.
- (c) Type of aircraft and altitude if known.

EXAMPLE-

Traffic 8 miles south of the airport northeastbound, (type aircraft and altitude if known).

(d) The examples depicted in FIG ENR 1.1-26 and FIG ENR 1.1-27 point out the possible error in the position of this traffic when it is necessary for a pilot to apply drift correction to maintain this track. This error could also occur in the event a change in course is made at the time radar traffic information is issued.

**FIG ENR 1.1-26
Induced Error in Position of Traffic**

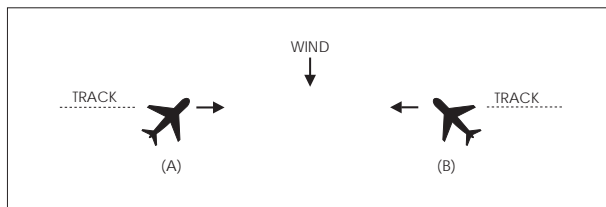

EXAMPLE-

In FIG ENR 1.1-26, traffic information would be issued to the pilot of aircraft "A" as 12 o'clock. The actual position of the traffic as seen by the pilot of aircraft "A" would be one o'clock. Traffic information issued to aircraft "B" would also be given as 12 o'clock, but in this case, the pilot of "B" would see the traffic at 11 o'clock.

**FIG ENR 1.1-27
Induced Error in Position of Traffic**

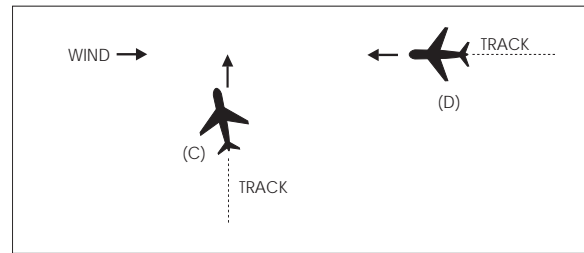

EXAMPLE-

In FIG ENR 1.1-27, traffic information would be issued to the pilot of aircraft "C" as two o'clock. The actual position of the traffic as seen by the pilot of aircraft "C" would be three o'clock. Traffic information issued to aircraft "D" would be at an 11 o'clock position. Since it is not necessary for the pilot of aircraft "D" to apply wind correction (CRAB) to remain on track, the actual position of the traffic issued would be correct. Since the radar controller can only observe aircraft track (course) on the radar display, traffic advisories are issued accordingly, and pilots should give due consideration to this fact when looking for reported traffic.

37.11 Radar Assistance to VFR Aircraft

37.11.1 Radar equipped FAA ATC facilities provide radar assistance and navigation service (vectors) to VFR aircraft provided the aircraft can communicate with the facility, are within radar coverage, and can be radar identified.

37.11.2 Pilots should clearly understand that authorization to proceed in accordance with such radar navigational assistance does not constitute authorization for the pilot to violate Federal Aviation Regulations. In effect, assistance provided is on the basis that navigational guidance information issued is advisory in nature and the job of flying the aircraft safely remains with the pilot.

37.11.3 In many cases, controllers will be unable to determine if flight into instrument conditions will result from their instructions. To avoid possible hazards resulting from being vectored into IFR conditions, pilots should keep controllers advised of the weather conditions in which they are operating and along the course ahead.

37.11.4 Radar navigation assistance (vectors) may be initiated by the controller when one of the following conditions exist:

37.11.4.1 The controller suggests the vector and the pilot concurs.

37.11.4.2 A special program has been established and vectoring service has been advertised.

37.11.4.3 In the controller’s judgment the vector is necessary for air safety.

37.11.5 Radar navigation assistance (vectors) and other radar derived information may be provided in response to pilot requests. Many factors, such as limitations of radar, volume of traffic, communications frequency, congestion, and controller workload could prevent the controller from providing it. Controllers have complete discretion for determining if they are able to provide the service in a particular case. Their decision not to provide the service in a particular case is not subject to question.

38. Operational Policy/Procedures for Reduced Vertical Separation Minimum (RVSM) in the Domestic U.S., Alaska, Offshore Airspace and the San Juan FIR

38.1 Applicability and RVSM Mandate (Date/Time and Area)

38.1.1 Applicability. The policies, guidance and direction in this section apply to RVSM operations in the airspace over the lower 48 states, Alaska, Atlantic and Gulf of Mexico High Offshore Airspace and airspace in the San Juan FIR where VHF or UHF voice direct controller–pilot communication (DCPC) is normally available. Policies, guidance and direction for RVSM operations in oceanic airspace where VHF or UHF voice DCPC is not available and the airspace of other countries are posted on the FAA “RVSM Documentation” Webpage described in paragraph 38.3, Aircraft and Operator Approval Policy/Procedures, RVSM Monitoring and Databases for Aircraft and Operator Approval.

38.1.2 Mandate. At 0901 UTC on January 20, 2005, the FAA implemented RVSM between flight level (FL) 290–410 (inclusive) in the following

airspace: the airspace of the lower 48 states of the United States, Alaska, Atlantic and Gulf of Mexico High Offshore Airspace and the San Juan FIR. (A chart showing the location of offshore airspace is posted on the Domestic U.S. RVSM (DRVSM) Webpage. See paragraph 38.3.) On the same time and date, RVSM was also introduced into the adjoining airspace of Canada and Mexico to provide a seamless environment for aircraft traversing those borders. In addition, RVSM was implemented on the same date in the Caribbean and South American regions.

38.1.3 RVSM Authorization. In accordance with 14 CFR Section 91.180, with only limited exceptions, prior to operating in RVSM airspace, operators and aircraft must have received RVSM authorization from the responsible civil aviation authority. (See paragraph 38.10, Procedures for Accommodation of Non–RVSM Aircraft.) If the operator or aircraft or both have not been authorized for RVSM operations, the aircraft will be referred to as a “non–RVSM” aircraft. Paragraph 38.10 discusses ATC policies for accommodation of non–RVSM aircraft flown by the Department of Defense, Air Ambulance (Lifeguard) operators, foreign State governments and aircraft flown for certification and development. Paragraph 38.11, Non–RVSM Aircraft Requesting Climb to and Descent from Flight Levels Above RVSM Airspace Without Intermediate Level Off, contains policies for non–RVSM aircraft climbing and descending through RVSM airspace to/from flight levels above RVSM airspace.

38.1.4 Benefits. RVSM enhances ATC flexibility, mitigates conflict points, enhances sector throughput, reduces controller workload and enables crossing traffic. Operators gain fuel savings and operating efficiency benefits by flying at more fuel efficient flight levels and on more user preferred routings.

38.2 Flight Level Orientation Scheme

Altitude assignments for direction of flight follow a scheme of odd altitude assignment for magnetic courses 000–179 degrees and even altitudes for magnetic courses 180–359 degrees for flights up to and including FL 410, as indicated in FIG ENR 1.1–28.

FIG ENR 1.1–28
Flight Level Orientation Scheme

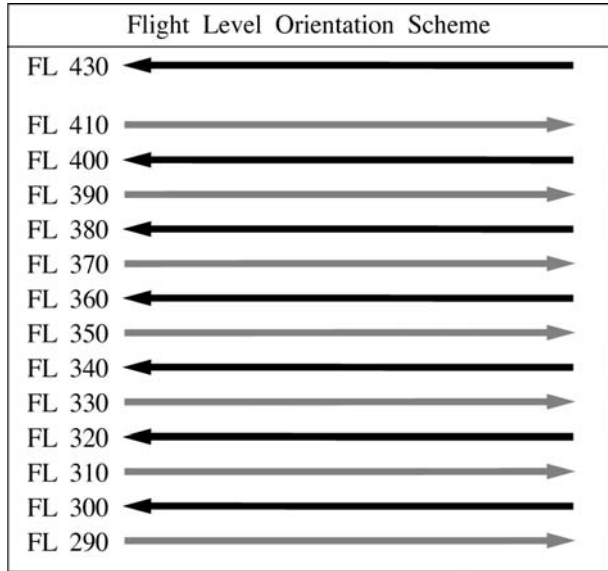

NOTE—
Odd Flight Levels: Magnetic Course 000–179 Degrees
Even Flight Levels: Magnetic Course 180–359 Degrees.

38.3 Aircraft and Operator Approval Policy/ Procedures, RVSM Monitoring and Databases for Aircraft and Operator Approval

38.3.1 RVSM Authority. 14 CFR Section 91.180 applies to RVSM operations within the U.S. 14 CFR Section 91.706 applies to RVSM operations outside the U.S. Both sections require that the operator obtain authorization prior to operating in RVSM airspace. 14 CFR Section 91.180 requires that, prior to conducting RVSM operations within the U.S., the operator obtain authorization from the FAA or from the responsible authority, as appropriate. In addition, it requires that the operator and the operator’s aircraft comply with the standards of 14 CFR Part 91 Appendix G (Operations in RVSM Airspace).

38.3.2 Sources of Information. The FAA RVSM Website Homepage can be accessed at: http://www.faa.gov/about/office_org/headquarters_offices/ato/service_units/enroute/rvsm/. The “RVSM Documentation” and “Domestic RVSM” webpages are linked to the RVSM Homepage. “RVSM Documentation” contains guidance and direction for an operator to obtain aircraft and operator approval to conduct RVSM operations. It provides information for DRVSM and oceanic and international RVSM airspace. It is recommended that operators planning to operate in Domestic U.S.

RVSM airspace first review the following documents to orient themselves to the approval process.

38.3.2.1 Under “Area of Operations Specific Information,” the document, “Basic Operator Information on DRVSM Programs,” provides an overview of the DRVSM program and the related aircraft and operator approval programs.

38.3.2.2 In the “Getting Started” section, review the “RVSM Approval Checklist – U.S. Operators” or “RVSM Approval Checklist – Non–U.S. Operators” (as applicable). These are job aids or checklists that show aircraft/operator approval process events with references to related RVSM documents published on the website.

38.3.2.3 Under “Documents Applicable to All RVSM Approvals,” review “RVSM Area New to the Operator.” This document provides a guide for operators that are conducting RVSM operations in one or more areas of operation, but are planning to conduct RVSM operations in an area where they have not previously conducted RVSM operations, such as the U.S.

38.3.3 TCAS Equipage. TCAS equipage requirements are contained in 14 CFR Sections 121.356, 125.224, 129.18 and 135.189. Part 91 Appendix G does not contain TCAS equipage requirements specific to RVSM, however, Appendix G does require that aircraft equipped with TCAS II and flown in RVSM airspace be modified to incorporate TCAS II Version 7.0 or a later version.

38.3.4 Aircraft Monitoring. Operators are required to participate in the RVSM aircraft monitoring program. The “Monitoring Requirements and Procedures” section of the RVSM Documentation Webpage contains policies and procedures for participation in the monitoring program. Ground-based and GPS-based monitoring systems are available for the Domestic RVSM program. Monitoring is a quality control program that enables the FAA and other civil aviation authorities to assess the in-service altitude-keeping performance of aircraft and operators.

38.3.5 Registration on RVSM Approvals Databases. The “Registration on RVSM Approvals Database” section of the RVSM Documentation Webpage provides policies/procedures for operator and aircraft registration on RVSM approvals databases.

38.3.5.1 Purpose of RVSM Approvals Databases.

ATC does not use RVSM approvals databases to determine whether or not a clearance can be issued into RVSM airspace. RVSM program managers do regularly review the operators and aircraft that operate in RVSM airspace to identify and investigate those aircraft and operators flying in RVSM airspace, but not listed on the RVSM approvals databases.

38.3.5.2 Registration of U.S. Operators. When U.S. operators and aircraft are granted RVSM authority, the FAA Flight Standards office makes an input to the FAA Program Tracking and Reporting Subsystem (PTRS). The Separation Standards Group at the FAA Technical Center obtains PTRS operator and aircraft information to update the FAA maintained U.S. Operator/Aircraft RVSM Approvals Database. Basic database operator and aircraft information can be viewed on the RVSM Documentation Webpage by clicking on the appropriate database icon.

38.3.5.3 Registration of Non-U.S. Operators.

Non-U.S. operators can find policy/procedures for registration on the North American Approvals Registry and Monitoring Organization (NAARMO) database in the “Registration on RVSM Approvals Database” section of RVSM Documentation.

38.4 Flight Planning into RVSM Airspace

38.4.1 Operators that do not file the correct aircraft equipment suffix on the FAA or ICAO Flight Plan may be denied clearance into RVSM airspace. Policies for the FAA Flight Plan are detailed in subparagraph 38.4.3 below. Policies for the ICAO Flight Plan are detailed in subparagraph 38.4.4.

38.4.2 The operator will annotate the equipment block of the FAA or ICAO Flight Plan with an aircraft equipment suffix indicating RVSM capability only after the responsible civil aviation authority has determined that both the operator and its aircraft are RVSM-compliant and has issued RVSM authorization to the operator.

38.4.3 General Policies for FAA Flight Plan Equipment Suffix. TBL ENR 1.10–2, Aircraft Suffixes, allows operators to indicate that the aircraft has both RVSM and Advanced Area Navigation (RNAV) capabilities or has only RVSM capability.

38.4.3.1 The operator will annotate the equipment block of the FAA Flight Plan with the appropriate aircraft equipment suffix from TBL ENR 1.10–2.

38.4.3.2 Operators can only file one equipment suffix in block 3 of the FAA Flight Plan. Only this equipment suffix is displayed directly to the controller.

38.4.3.3 Aircraft with RNAV Capability. For flight in RVSM airspace, aircraft with RNAV capability, but not Advanced RNAV capability, will file “/W”. Filing “/W” will not preclude such aircraft from filing and flying direct routes in en route airspace.

38.4.4 Policy for ICAO Flight Plan Equipment Suffixes.

38.4.4.1 Operators/aircraft that are RVSM-compliant and that file ICAO flight plans will file “/W” in block 10 (Equipment) to indicate RVSM authorization and will also file the appropriate ICAO Flight Plan suffixes to indicate navigation and communication capabilities. The equipment suffixes in TBL ENR 1.10–2 are for use only in an FAA Flight Plan (FAA Form 7233–1).

38.4.4.2 Operators/aircraft that file ICAO flight plans that include flight in Domestic U.S. RVSM airspace must file “/W” in block 10 to indicate RVSM authorization.

38.4.5 Importance of Flight Plan Equipment Suffixes. The operator must file the appropriate equipment suffix in the equipment block of the FAA Flight Plan (FAA Form 7233–1) or the ICAO Flight Plan. The equipment suffix informs ATC:

38.4.5.1 Whether or not the operator and aircraft are authorized to fly in RVSM airspace.

38.4.5.2 The navigation and/or transponder capability of the aircraft (e.g., advanced RNAV, Transponder with Mode C).

38.4.6 Significant ATC uses of the flight plan equipment suffix information are:

38.4.6.1 To issue or deny clearance into RVSM airspace.

38.4.6.2 To apply a 2,000 foot vertical separation minimum in RVSM airspace to aircraft that are not authorized for RVSM, but are in one of the limited categories that the FAA has agreed to accommodate. (See paragraphs 38.10, Procedures for Accommodation of Non-RVSM Aircraft, and 38.11, Non-RVSM

Aircraft Requesting Climb to and Descent from Flight Levels Above RVSM Airspace Without Intermediate Level Off, for policy on limited operation of unapproved aircraft in RVSM airspace).

38.4.6.3 To determine if the aircraft has “Advanced RNAV” capabilities and can be cleared to fly procedures for which that capability is required.

38.5 Pilot RVSM Operating Practices and Procedures

38.5.1 RVSM Mandate. If either the operator or the aircraft or both have not received RVSM authorization (non–RVSM aircraft), the pilot will neither request nor accept a clearance into RVSM airspace unless:

38.5.1.1 The flight is conducted by a non–RVSM DOD, Lifeguard, certification/development or foreign State (government) aircraft in accordance with paragraph 38.10, Procedures for Accommodation of Non–RVSM Aircraft.

38.5.1.2 The pilot intends to climb to or descend from FL 430 or above in accordance with paragraph 38.11, Non–RVSM Aircraft Requesting Climb to and Descent from Flight Levels Above RVSM Airspace Without Intermediate Level Off.

38.5.1.3 An emergency situation exists.

38.5.2 Basic RVSM Operating Practices and Procedures. Appendix 4 of Guidance 91–RVSM contains pilot practices and procedures for RVSM. Operators must incorporate Appendix 4 practices and procedures, as supplemented by the applicable paragraphs of this section, into operator training or pilot knowledge programs and operator documents containing RVSM operational policies. Guidance 91–RVSM is published on the RVSM Documentation Webpage under “Documents Applicable to All RVSM Approvals.”

38.5.3 Appendix 4 contains practices and procedures for flight planning, preflight procedures at the aircraft, procedures prior to RVSM airspace entry, inflight (en route) procedures, contingency procedures and post flight.

38.5.4 The following paragraphs either clarify or supplement Appendix 4 practices and procedures.

38.6 Guidance on Severe Turbulence and Mountain Wave Activity (MWA)

38.6.1 Introduction/Explanation

38.6.1.1 The information and practices in this paragraph are provided to emphasize to pilots and controllers the importance of taking appropriate action in RVSM airspace when aircraft experience severe turbulence and/or MWA that is of sufficient magnitude to significantly affect altitude–keeping.

38.6.1.2 Severe Turbulence. Severe turbulence causes large, abrupt changes in altitude and/or attitude usually accompanied by large variations in indicated airspeed. Aircraft may be momentarily out of control. Encounters with severe turbulence must be remedied immediately in any phase of flight. Severe turbulence may be associated with MWA.

38.6.1.3 Mountain Wave Activity (MWA)

a) Significant MWA occurs both below and above the floor of RVSM airspace, FL 290. MWA often occurs in western states in the vicinity of mountain ranges. It may occur when strong winds blow perpendicular to mountain ranges resulting in up and down or wave motions in the atmosphere. Wave action can produce altitude excursions and airspeed fluctuations accompanied by only light turbulence. With sufficient amplitude, however, wave action can induce altitude and airspeed fluctuations accompanied by severe turbulence. MWA is difficult to forecast and can be highly localized and short lived.

b) Wave activity is not necessarily limited to the vicinity of mountain ranges. Pilots experiencing wave activity anywhere that significantly affects altitude–keeping can follow the guidance provided below.

c) Inflight MWA Indicators (Including Turbulence). Indicators that the aircraft is being subjected to MWA are:

- 1) Altitude excursions and/or airspeed fluctuations with or without associated turbulence.
- 2) Pitch and trim changes required to maintain altitude with accompanying airspeed fluctuations.
- 3) Light to severe turbulence depending on the magnitude of the MWA.

38.6.1.4 Priority for Controller Application of Merging Target Procedures

a) Explanation of Merging Target Procedures. As described in subparagraph 38.6.3.3 below, ATC will use “merging target procedures” to mitigate the effects of both severe turbulence and MWA. The procedures in subparagraph 38.6.3.3 have been adapted from existing procedures published in FAA Order 7110.65, Air Traffic Control, paragraph 5–1–8, Merging Target Procedures. Paragraph 5–1–8 calls for en route controllers to advise pilots of potential traffic that they perceive may fly directly above or below his/her aircraft at minimum vertical separation. In response, pilots are given the option of requesting a radar vector to ensure their radar target will not merge or overlap with the traffic’s radar target.

b) The provision of “merging target procedures” to mitigate the effects of severe turbulence and/or MWA is not optional for the controller, but rather is a priority responsibility. Pilot requests for vectors for traffic avoidance when encountering MWA or pilot reports of “Unable RVSM due turbulence or MWA” are considered first priority aircraft separation and sequencing responsibilities. (FAA Order 7110.65, paragraph 2–1–2, Duty Priority, states that the controller’s first priority is to separate aircraft and issue safety alerts).

c) Explanation of the term “traffic permitting.” The contingency actions for MWA and severe turbulence detailed in paragraph 38.9, Contingency Actions: Weather Encounters and Aircraft System Failures, state that the controller will “vector aircraft to avoid merging targets with traffic at adjacent flight levels, traffic permitting.” The term “traffic permitting” is not intended to imply that merging target procedures are not a priority duty. The term is intended to recognize that, as stated in FAA Order 7110.65, paragraph 2–1–2, Duty Priority, there are circumstances when the controller is required to perform more than one action and must “exercise their best judgment based on the facts and circumstances known to them” to prioritize their actions. Further direction given is: “That action which is most critical from a safety standpoint is performed first.”

38.6.1.5 TCAS Sensitivity. For both MWA and severe turbulence encounters in RVSM airspace, an additional concern is the sensitivity of collision avoidance systems when one or both aircraft operating in close proximity receive TCAS advisories in response to disruptions in altitude hold capability.

38.6.2 Pre-flight tools. Sources of observed and forecast information that can help the pilot ascertain the possibility of MWA or severe turbulence are: Forecast Winds and Temperatures Aloft (FD), Area Forecast (FA), SIGMETs and PIREPs.

38.6.3 Pilot Actions When Encountering Weather (e.g., Severe Turbulence or MWA)

38.6.3.1 Weather Encounters Inducing Altitude Deviations of Approximately 200 feet. When the pilot experiences weather induced altitude deviations of approximately 200 feet, the pilot will contact ATC and state “Unable RVSM Due (state reason)” (e.g., turbulence, mountain wave). See contingency actions in paragraph 38.9.

38.6.3.2 Severe Turbulence (including that associated with MWA). When pilots encounter severe turbulence, they should contact ATC and report the situation. Until the pilot reports clear of severe turbulence, the controller will apply merging target vectors to one or both passing aircraft to prevent their targets from merging:

EXAMPLE–

“Yankee 123, FL 310, unable RVSM due severe turbulence.”

“Yankee 123, fly heading 290; traffic twelve o’clock, 10 miles, opposite direction; eastbound MD–80 at FL 320” (or the controller may issue a vector to the MD–80 traffic to avoid Yankee 123).

38.6.3.3 MWA. When pilots encounter MWA, they should contact ATC and report the magnitude and location of the wave activity. When a controller makes a merging targets traffic call, the pilot may request a vector to avoid flying directly over or under the traffic. In situations where the pilot is experiencing altitude deviations of 200 feet or greater, the pilot will request a vector to avoid traffic. Until the pilot reports clear of MWA, the controller will apply merging target vectors to one or both passing aircraft to prevent their targets from merging:

EXAMPLE–

“Yankee 123, FL 310, unable RVSM due mountain wave.”

“Yankee 123, fly heading 290; traffic twelve o’clock, 10 miles, opposite direction; eastbound MD–80 at FL 320” (or the controller may issue a vector to the MD–80 traffic to avoid Yankee 123).

38.6.3.4 FL Change or Re-route. To leave airspace where MWA or severe turbulence is being encountered, the pilot may request a FL change and/or re-route, if necessary.

38.7 Guidance on Wake Turbulence

38.7.1 Pilots should be aware of the potential for wake turbulence encounters in RVSM airspace. Experience gained since 1997 has shown that such encounters in RVSM airspace are generally moderate or less in magnitude.

38.7.2 Prior to DRVSM implementation, the FAA established provisions for pilots to report wake turbulence events in RVSM airspace using the NASA Aviation Safety Reporting System (ASRS). A “Safety Reporting” section established on the FAA RVSM Documentation webpage provides contacts, forms, and reporting procedures.

38.7.3 To date, wake turbulence has not been reported as a significant factor in DRVSM operations. European authorities also found that reports of wake turbulence encounters did not increase significantly after RVSM implementation (eight versus seven reports in a ten-month period). In addition, they found that reported wake turbulence was generally similar to moderate clear air turbulence.

38.7.4 Pilot Action to Mitigate Wake Turbulence Encounters

38.7.4.1 Pilots should be alert for wake turbulence when operating:

- a) In the vicinity of aircraft climbing or descending through their altitude.
- b) Approximately 10–30 miles after passing 1,000 feet below opposite-direction traffic.
- c) Approximately 10–30 miles behind and 1,000 feet below same-direction traffic.

38.7.4.2 Pilots encountering or anticipating wake turbulence in DRVSM airspace have the option of requesting a vector, FL change, or if capable, a lateral offset.

NOTE–

1. *Offsets of approximately a wing span upwind generally can move the aircraft out of the immediate vicinity of another aircraft’s wake vortex.*

2. *In domestic U.S. airspace, pilots must request clearance to fly a lateral offset. Strategic lateral offsets flown in oceanic airspace do not apply.*

38.7.5 The FAA will track wake turbulence events as an element of its post implementation program. The FAA will advertise wake turbulence reporting procedures to the operator community and publish reporting procedures on the RVSM Documentation Webpage (See address in paragraph 38.3, Aircraft and Operator Approval Policy/Procedures, RVSM Monitoring and Databases for Aircraft and Operator Approval.

38.8 Pilot/Controller Phraseology

TBL ENR 1.1–3 shows standard phraseology that pilots and controllers will use to communicate in DRVSM operations.

TBL ENR 1.1–3
Pilot/Controller Phraseology

Message	Phraseology
For a controller to ascertain the RVSM approval status of an aircraft:	(call sign) confirm RVSM approved
Pilot indication that flight is RVSM approved	Affirm RVSM
Pilot report of lack of RVSM approval (non–RVSM status). Pilot will report non–RVSM status, as follows: <ul style="list-style-type: none"> a. On the initial call on any frequency in the RVSM airspace and . . . b. In all requests for flight level changes pertaining to flight levels within the RVSM airspace and . . . c. In all read backs to flight level clearances pertaining to flight levels within the RVSM airspace and . . . d. In read back of flight level clearances involving climb and descent through RVSM airspace (FL 290 – 410) 	Negative RVSM, (supplementary information, e.g., “Certification flight”).
Pilot report of one of the following after entry into RVSM airspace: all primary altimeters, automatic altitude control systems or altitude alerters have failed. (See paragraph 38.9, Contingency Actions: Weather Encounters and Aircraft System Failures). NOTE– <i>This phrase is to be used to convey both the initial indication of RVSM aircraft system failure and on initial contact on all frequencies in RVSM airspace until the problem ceases to exist or the aircraft has exited RVSM airspace.</i>	Unable RVSM Due Equipment
ATC denial of clearance into RVSM airspace	Unable issue clearance into RVSM airspace, maintain FL
*Pilot reporting inability to maintain cleared flight level due to weather encounter. (See paragraph 38.9, Contingency Actions: Weather Encounters and Aircraft System Failures).	*Unable RVSM due (state reason) (e.g., turbulence, mountain wave)
ATC requesting pilot to confirm that an aircraft has regained RVSM–approved status or a pilot is ready to resume RVSM	Confirm able to resume RVSM
Pilot ready to resume RVSM after aircraft system or weather contingency	Ready to resume RVSM

38.9 Contingency Actions: Weather Encounters and Aircraft System Failures

TBL ENR 1.1–4 provides pilot guidance on actions to take under certain conditions of aircraft system

failure and weather encounters. It also describes the expected ATC controller actions in these situations. It is recognized that the pilot and controller will use judgment to determine the action most appropriate to any given situation.

TBL ENR 1.1–4

Contingency Actions: Weather Encounters and Aircraft System Failures

Initial Pilot Actions in Contingency Situations	
<p>Initial pilot actions when unable to maintain flight level (FL) or unsure of aircraft altitude—keeping capability:</p> <ul style="list-style-type: none"> Notify ATC and request assistance as detailed below. Maintain cleared flight level, to the extent possible, while evaluating the situation. Watch for conflicting traffic both visually and by reference to TCAS, if equipped. Alert nearby aircraft by illuminating exterior lights (commensurate with aircraft limitations). 	
Severe Turbulence and/or Mountain Wave Activity (MWA) Induced Altitude Deviations of Approximately 200 feet	
<p>Pilot will:</p> <ul style="list-style-type: none"> When experiencing severe turbulence and/or MWA induced altitude deviations of approximately 200 feet or greater, pilot will contact ATC and state “Unable RVSM Due (state reason)” (e.g., turbulence, mountain wave) If not issued by the controller, request vector clear of traffic at adjacent FLs If desired, request FL change or re–route Report location and magnitude of turbulence or MWA to ATC <p>See paragraph 38.6, Guidance on Severe Turbulence and Mountain Wave Activity (MWA), for detailed guidance.</p>	<p>Controller will:</p> <ul style="list-style-type: none"> Vector aircraft to avoid merging target with traffic at adjacent flight levels, traffic permitting Advise pilot of conflicting traffic Issue FL change or re–route, traffic permitting Issue PIREP to other aircraft <p>Paragraph 38.6 explains “traffic permitting.”</p>

Mountain Wave Activity (MWA) Encounters – General	
<p>Pilot actions:</p> <p>Contact ATC and report experiencing MWA</p> <p>If so desired, pilot may request a FL change or re-route</p> <p>Report location and magnitude of MWA to ATC</p> <p>See paragraph 38.6 for guidance on MWA.</p>	<p>Controller actions:</p> <p>Advise pilot of conflicting traffic at adjacent FL</p> <p>If pilot requests, vector aircraft to avoid merging target with traffic at adjacent RVSM flight levels, traffic permitting</p> <p>Issue FL change or re-route, traffic permitting</p> <p>Issue PIREP to other aircraft</p> <p>Paragraph 38.6 explains “traffic permitting.”</p>
<p><i>NOTE–</i> MWA encounters do not necessarily result in altitude deviations on the order of 200 feet. The guidance below is intended to address less significant MWA encounters.</p>	
Wake Turbulence Encounters	
<p>Pilot should:</p> <p>Contact ATC and request vector, FL change or, if capable, a lateral offset</p> <p>See paragraph 38.7, Guidance on Wake Turbulence.</p>	<p>Controller should:</p> <p>Issue vector, FL change or lateral offset clearance, traffic permitting</p> <p>Paragraph 38.6 explains “traffic permitting.”</p>
“Unable RVSM Due Equipment” Failure of Automatic Altitude Control System, Altitude Alerter or All Primary Altimeters	
<p>Pilot will:</p> <p>Contact ATC and state “Unable RVSM Due Equipment”</p> <p>Request clearance out of RVSM airspace unless operational situation dictates otherwise</p>	<p>Controller will:</p> <p>Provide 2,000 feet vertical separation or appropriate horizontal separation</p> <p>Clear aircraft out of RVSM airspace unless operational situation dictates otherwise</p>
One Primary Altimeter Remains Operational	
<p>Pilot will:</p> <p>Cross check stand-by altimeter</p> <p>Notify ATC of operation with single primary altimeter</p> <p>If unable to confirm primary altimeter accuracy, follow actions for failure of all primary altimeters</p>	<p>Controller will:</p> <p>Acknowledge operation with single primary altimeter</p>

Transponder Failure	
Pilot will: Contact ATC and request authority to continue to operate at cleared flight level Comply with revised ATC clearance, if issued	Controller will: Consider request to continue to operate at cleared flight level Issue revised clearance, if necessary
NOTE– <i>14 CFR Section 91.215 (ATC transponder and altitude reporting equipment and use) regulates operation with the transponder inoperative.</i>	

38.10 Procedures for Accommodation of Non-RVSM Aircraft

38.10.1 General Policies for Accommodation of Non-RVSM Aircraft

38.10.1.1 The RVSM mandate calls for only RVSM authorized aircraft/operators to fly in designated RVSM airspace with limited exceptions. The policies detailed below are intended exclusively for use by aircraft that the FAA has agreed to accommodate. They are not intended to provide other operators a means to circumvent the normal RVSM approval process.

38.10.1.2 If either the operator or aircraft or both have not been authorized to conduct RVSM operations, the aircraft will be referred to as a “non-RVSM” aircraft. 14 CFR Section 91.180 and Part 91 Appendix G enable the FAA to authorize a deviation to operate a non-RVSM aircraft in RVSM airspace.

38.10.1.3 Non-RVSM aircraft flights will be handled on a workload permitting basis. The vertical separation standard applied between aircraft not approved for RVSM and all other aircraft shall be 2,000 feet.

38.10.1.4 Required Pilot Calls. The pilot of non-RVSM aircraft will inform the controller of the lack of RVSM approval in accordance with the direction provided in paragraph 38.8, Pilot/Controller Phraseology.

38.10.2 Categories of Non-RVSM Aircraft that may be Accommodated

Subject to FAA approval and clearance, the following categories of non-RVSM aircraft may operate in domestic U.S. RVSM airspace provided they have an operational transponder.

38.10.2.1 Department of Defense (DOD) aircraft.

38.10.2.2 Flights conducted for aircraft certification and development purposes.

38.10.2.3 Active air ambulance flights utilizing a “Lifeguard” call sign.

38.10.2.4 Aircraft climbing/descending through RVSM flight levels (without intermediate level off) to/from FLs above RVSM airspace (Policies for these flights are detailed in paragraph 38.11, Non-RVSM Aircraft Requesting Climb to and Descent from Flight Levels Above RVSM Airspace Without Intermediate Level Off.

38.10.2.5 Foreign State (government) aircraft.

38.10.3 Methods for operators of non-RVSM aircraft to request access to RVSM Airspace. Operators may:

38.10.3.1 LOA/MOU. Enter into a Letter of Agreement (LOA)/Memorandum of Understanding (MOU) with the RVSM facility (the Air Traffic facility that provides air traffic services in RVSM airspace). Operators must comply with LOA/MOU.

38.10.3.2 File-and-Fly. File a flight plan to notify the FAA of their intention to request access to RVSM airspace.

NOTE–

Priority for access to RVSM airspace will be afforded to RVSM compliant aircraft, then File-and-Fly flights.

38.10.4 Center Phone Numbers. Center phone numbers are posted on the RVSM Documentation Webpage, North American RVSM, Domestic U.S. RVSM section. This address provides direct access to the phone number listing:

http://www.faa.gov/ats/ato/150_docs/Center_Phone_No._Non-RVSM_Acft.doc

38.11 Non-RVSM Aircraft Requesting Climb to and Descent from Flight Levels Above RVSM Airspace Without Intermediate Level Off

38.11.1 File-and-Fly. Operators of Non-RVSM aircraft climbing to and descending from RVSM flight levels should just file a flight plan.

38.11.2 Non-RVSM aircraft climbing to and descending from flight levels above RVSM airspace will be handled on a workload permitting basis. The vertical separation standard applied in RVSM airspace between non-RVSM aircraft and all other aircraft shall be 2,000 feet.

38.11.3 Non-RVSM aircraft climbing to/descending from RVSM airspace can only be considered for accommodation provided:

38.11.3.1 Aircraft is capable of a continuous climb/descent and does not need to level off at an intermediate altitude for any operational considerations and

38.11.3.2 Aircraft is capable of climb/descent at the normal rate for the aircraft.

38.11.4 Required Pilot Calls. The pilot of non-RVSM aircraft will inform the controller of the lack of RVSM approval in accordance with the direction provided in paragraph 38.8, Pilot/Controller Phraseology.

39. Terminal Radar Services for VFR Aircraft

39.1 Basic Radar Service

39.1.1 In addition to the use of radar for the control of IFR aircraft, all commissioned radar facilities provide the following basic radar services for VFR aircraft:

39.1.1.1 Safety alerts.

39.1.1.2 Traffic advisories.

39.1.1.3 Limited radar vectoring (on a workload permitting basis).

39.1.1.4 Sequencing at locations where procedures have been established for this purpose and/or when covered by a letter of agreement.

NOTE–

When the stage services were developed, two basic radar services (traffic advisories and limited vectoring) were identified as “Stage I.” This definition became unnecessary and the term “Stage I” was eliminated from use. The term “Stage II” has been eliminated in conjunction with the airspace reclassification, and sequencing services to locations with local procedures and/or letters of agreement to provide this service have been included in basic services to VFR aircraft. These basic services will still be provided by all terminal radar facilities whether they include Class B, C, D, or E airspace. “Stage III” services have been replaced with “Class B” and “Terminal Radar Service Area” service where applicable.

39.1.2 Vectoring service may be provided when requested by the pilot or with pilot concurrence when suggested by ATC.

39.1.3 Pilots of arriving aircraft should contact approach control on the publicized frequency and give their position, altitude, aircraft call sign, type aircraft, radar beacon code (if transponder equipped), destination, and should request traffic information.

39.1.4 Approach control will issue wind and runway, except when the pilot states “have numbers” or this information is contained in the ATIS broadcast and the pilot states that the current ATIS information has been received. Traffic information is provided on a workload permitting basis. Approach control will specify the time or place at which the pilot is to contact the tower on local control frequency for further landing information. Radar service is automatically terminated and the aircraft need not be advised of termination when an arriving VFR aircraft receiving radar services to a tower-controlled airport

where basic radar service is provided has landed, or to all other airports, is instructed to change to tower or advisory frequency.

39.1.5 Sequencing for VFR aircraft is available at certain terminal locations (see locations listed in the Airport/Facility Directory). The purpose of the service is to adjust the flow of arriving VFR and IFR aircraft into the traffic pattern in a safe and orderly manner and to provide radar traffic information to departing VFR aircraft. Pilot participation is urged but is not mandatory. Traffic information is provided on a workload permitting basis. Standard radar separation between VFR or between VFR and IFR aircraft is not provided.

39.1.5.1 Pilots of arriving VFR aircraft should initiate radio contact on the publicized frequency with approach control when approximately 25 miles from the airport at which sequencing services are being provided. On initial contact by VFR aircraft, approach control will assume that sequencing service is requested. After radar contact is established, the pilot may use pilot navigation to enter the traffic pattern or, depending on traffic conditions, approach control may provide the pilot with routings or vectors necessary for proper sequencing with other participating VFR and IFR traffic en route to the airport. When a flight is positioned behind a preceding aircraft and the pilot reports having that aircraft in sight, the pilot will be instructed to follow the preceding aircraft. **THE ATC INSTRUCTION TO FOLLOW THE PRECEDING AIRCRAFT DOES NOT AUTHORIZE THE PILOT TO COMPLY WITH ANY ATC CLEARANCE OR INSTRUCTION ISSUED TO THE PRECEDING AIRCRAFT.** If other “nonparticipating” or “local” aircraft are in the traffic pattern, the tower will issue a landing sequence. If an arriving aircraft does not want radar service, the pilot should state “NEGATIVE RADAR SERVICE” or make a similar comment, on initial contact with approach control.

39.1.5.2 Pilots of departing VFR aircraft are encouraged to request radar traffic information by notifying ground control on initial contact with their request and proposed direction of flight.

EXAMPLE-

Xray ground control, November One Eight Six, Cessna One Seventy Two, ready to taxi, VFR southbound at 2,500, have information bravo and request radar traffic information.

NOTE-

Following takeoff, the tower will advise when to contact departure control.

39.1.5.3 Pilots of aircraft transiting the area and in radar contact/communication with approach control will receive traffic information on a controller workload permitting basis. Pilots of such aircraft should give their position, altitude, aircraft call sign, aircraft type, radar beacon code (if transponder equipped), destination, and/or route of flight.

39.2 Terminal Radar Service Area (TRSA) Service (Radar Sequencing and Separation Service for VFR Aircraft in a TRSA).

39.2.1 This service has been implemented at certain terminal locations. The service is advertised in the Airport/Facility Directory. The purpose of this service is to provide separation between all participating VFR aircraft and all IFR aircraft operating within the airspace defined as the TRSA. Pilot participation is urged but is not mandatory.

39.2.2 If any aircraft does not want the service, the pilot should state “NEGATIVE TRSA SERVICE” or make a similar comment, on initial contact with approach control or ground control, as appropriate.

39.2.3 TRSAs are depicted on sectional aeronautical charts and listed in the Airport/Facility Directory.

39.2.4 While operating within a TRSA, pilots are provided TRSA service and separation as prescribed in this paragraph. In the event of a radar outage, separation and sequencing of VFR aircraft will be suspended as this service is dependent on radar. The pilot will be advised that the service is not available and will be issued wind, runway information, and the time or place to contact the tower. Traffic information will be provided on a workload permitting basis.

39.2.5 Visual separation is used when prevailing conditions permit and it will be applied as follows:

39.2.5.1 When a VFR flight is positioned behind a preceding aircraft and the pilot reports having that aircraft in sight, the pilot will be instructed by ATC to follow the preceding aircraft. **THE ATC INSTRUCTION TO FOLLOW THE PRECEDING AIRCRAFT DOES NOT AUTHORIZE THE PILOT TO COMPLY WITH ANY ATC CLEARANCE OR INSTRUCTION ISSUED TO THE PRECEDING AIRCRAFT.** Radar service will be continued to the runway.

39.2.5.2 If other “nonparticipating” or “local” aircraft are in the traffic pattern, the tower will issue a landing sequence.

39.2.5.3 Departing VFR aircraft may be asked if they can visually follow a preceding departure out of the TRSA. The pilot will be instructed to follow the other aircraft provided that the pilot can maintain visual contact with that aircraft.

39.2.6 VFR aircraft will be separated from VFR/IFR aircraft by one of the following:

39.2.6.1 500 feet vertical separation.

39.2.6.2 Visual separation.

39.2.6.3 Target resolution (a process to ensure that correlated radar targets do not touch).

39.2.7 Participating pilots operating VFR in a TRSA:

39.2.7.1 Must maintain an altitude when assigned by ATC unless the altitude assignment is to maintain at or below a specified altitude. ATC may assign altitudes for separation that do not conform to 14 CFR Section 91.159. When the altitude assignment is no longer needed for separation or when leaving the TRSA, the instruction will be broadcast, “RESUME APPROPRIATE VFR ALTITUDES.” Pilots must then return to an altitude that conforms to 14 CFR Section 91.159 as soon as practicable.

39.2.7.2 When not assigned an altitude, the pilot should coordinate with ATC prior to any altitude change.

39.2.8 Within the TRSA, traffic information on observed but unidentified targets will, to the extent possible, be provided to all IFR and participating VFR aircraft. The pilot will be vectored upon request to avoid the observed traffic, provided the aircraft to be vectored is within the airspace under the jurisdiction of the controller.

39.2.9 Departing aircraft should inform ATC of their intended destination and/or route of flight and proposed cruising altitude.

39.2.10 ATC will normally advise participating VFR aircraft when leaving the geographical limits of the TRSA. Radar service is not automatically terminated with this advisory unless specifically stated by the controller.

39.3 Class C Service. This service provides, in addition to basic radar service, approved separation between IFR and VFR aircraft, and sequencing of VFR arrivals to the primary airport.

39.4 Class B Service. This service provides, in addition to basic radar service, approved separation of aircraft based on IFR, VFR, and/or weight, and sequencing of VFR arrivals to the primary airport(s).

39.5 PILOT RESPONSIBILITY. THESE SERVICES ARE NOT TO BE INTERPRETED AS RELIEVING PILOTS OF THEIR RESPONSIBILITIES TO SEE AND AVOID OTHER TRAFFIC OPERATING IN BASIC VFR WEATHER CONDITIONS, TO ADJUST THEIR OPERATIONS AND FLIGHT PATH AS NECESSARY TO PRECLUDE SERIOUS WAKE ENCOUNTERS, TO MAINTAIN APPROPRIATE TERRAIN AND OBSTRUCTION CLEARANCE, OR TO REMAIN IN WEATHER CONDITIONS EQUAL TO OR BETTER THAN THE MINIMUMS REQUIRED BY 14 CFR SECTION 91.155. WHENEVER COMPLIANCE WITH AN ASSIGNED ROUTE, HEADING AND/OR ALTITUDE IS LIKELY TO COMPROMISE PILOT RESPONSIBILITY RESPECTING TERRAIN AND OBSTRUCTION CLEARANCE, VORTEX EXPOSURE, AND WEATHER MINIMUMS, APPROACH CONTROL SHOULD BE SO ADVISED AND A REVISED CLEARANCE OR INSTRUCTION OBTAINED.

39.6 ATC services for VFR aircraft participating in terminal radar services are dependent on ATC radar. Services for VFR aircraft are not available during periods of radar outage and are limited during CENRAP operations. The pilot will be advised when VFR services are limited or not available.

NOTE-

Class B and Class C airspace are areas of regulated airspace. The absence of ATC radar does not negate the requirement of an ATC clearance to enter Class B airspace or two-way radio contact with ATC to enter Class C airspace.

40. Tower En Route Control (TEC)

40.1 TEC is an ATC program to provide a service to aircraft proceeding to and from metropolitan areas. It links designated approach control areas by a network of identified routes made up of the existing airway structure of the National Airspace System. The FAA has initiated an expanded TEC program to include as many facilities as possible. The program’s intent is to

provide an overflow resource in the low altitude system which would enhance ATC services. A few facilities have historically allowed turbojets to proceed between certain city pairs, such as Milwaukee and Chicago, via tower en route and these locations may continue this service. However, the expanded TEC program will be applied, generally, for nonturbojet aircraft operating at and below 10,000 feet. The program is entirely within the approach control airspace of multiple terminal facilities. Essentially, it is for relatively short flights. Participating pilots are encouraged to use TEC for flights of 2 hours duration or less. If longer flights are planned, extensive coordination may be required with the multiple complex which could result in unanticipated delays.

40.2 There are no unique requirements upon pilots to use the TEC program. Normal flight plan filing procedures will ensure proper flight plan processing. Pilots should include the acronym “TEC” in the remarks section of the flight plan when requesting tower en route.

40.3 All approach controls in the system may not operate up to the maximum TEC altitude of 10,000 feet. IFR flight may be planned to any satellite airport in proximity to the major primary airport via the same routing.

41. Services in Offshore Controlled Airspace

41.1 Pilots requesting TEC are subject to the same delay factor at the destination airport as other aircraft in the ATC system. In addition, departure and en route delays may occur depending upon individual facility workload. When a major metropolitan airport is incurring significant delays, pilots in the TEC program may want to consider an alternative airport experiencing no delay.

41.2 Flights which operate between the U.S. 3-mile territorial limit and the adjoining oceanic controlled airspace/flight information region (CTA/FIR) boundaries generally operate in airspace designated by federal regulation as “controlled airspace,” or “offshore controlled airspace.”

41.3 Within the designated areas ATC radar surveillance, ground based navigational signal

coverage, and air/ground communications are capable of supporting air traffic services comparable to those provided over U.S. domestic controlled airspace.

41.4 Pilots should be aware that domestic procedures will be applied in offshore controlled airspace to both VFR and IFR aircraft using ATC services.

42. Pilot/Controller Roles/Responsibilities

42.1 General

42.1.1 The roles and responsibilities of the pilot and controller for effective participation in the ATC system are contained in several documents. Pilot responsibilities are in the Federal Aviation Regulations (Title 14 of the U.S. Code of Federal Regulations) and the air traffic controller’s are in FAA Order 7110.65, Air Traffic Control, and supplemental FAA directives. Additional and supplemental information for pilots can be found in the current Aeronautical Information Manual, Notices to Airmen, advisory circulars, and aeronautical charts. Since there are many other excellent publications produced by nongovernment organizations as well as other Government organizations with various updating cycles, questions concerning the latest or most current material can be resolved by cross-checking with the above mentioned documents.

42.1.2 The pilot in command of an aircraft is directly responsible for and is the final authority as to the safe operation of that aircraft. In an emergency requiring immediate action, the pilot in command may deviate from any rule in the General, Subpart A, and Flight Rules, Subpart B, in accordance with 14 CFR Section 91.3.

42.1.3 The air traffic controller is responsible to give first priority to the separation of aircraft and to the issuance of radar safety alerts; second priority to other services that are required, but do not involve separation of aircraft; and third priority to additional services to the extent possible.

42.1.4 In order to maintain a safe and efficient air traffic system, it is necessary that every party fulfill their responsibilities to the fullest.

42.1.5 The responsibilities of the pilot and the controller intentionally overlap in many areas providing a degree of redundancy. Should one or the other fail in any manner, this overlapping responsibility is expected to compensate, in many cases, for failures that may affect safety.

42.1.6 The following, while not intended to be all inclusive, is a brief listing of pilot and controller responsibilities for some commonly used procedures or phases of flight. More detailed explanations are contained in the appropriate Federal Aviation Regulations, Advisory Circulars, and similar publications. The information provided here is an overview of the principles involved and is not meant as an interpretation of the rules nor is it intended to extend or diminish responsibilities.

42.2 Air Traffic Clearance

42.2.1 Pilot

42.2.1.1 Acknowledges receipt and understanding of an ATC clearance.

42.2.1.2 Reads back any hold short of runway instructions issued by ATC.

42.2.1.3 Requests clarification or amendment, as appropriate, any time a clearance is not fully understood, or considered unacceptable from a safety standpoint.

42.2.1.4 Promptly complies with an air traffic clearance upon receipt, except as necessary to cope with an emergency. Advises ATC as soon as possible and obtains an amended clearance if deviation is necessary.

NOTE–

A clearance to land means that appropriate separation on the landing runway will be ensured. A landing clearance does not relieve the pilot from compliance with any previously issued altitude crossing restriction.

42.2.2 Controller

42.2.2.1 Issues appropriate clearances for the operation being, or to be, conducted in accordance with established criteria.

42.2.2.2 Assigns altitudes in IFR clearances that are at or above the minimum IFR altitudes in Classes A, B, C, D, and E airspace.

42.2.2.3 Ensures acknowledgements by the pilot for issued information, clearance, or instructions.

42.2.2.4 Ensures that readbacks by the pilot of altitude, heading, or other items are correct. If incorrect, distorted, or incomplete, makes corrections as appropriate.

42.3 Contact Approach

42.3.1 Pilot

42.3.1.1 This approach must be requested by the pilot and is made in lieu of a standard or special instrument approach.

42.3.1.2 By requesting the contact approach, the pilot indicates that the flight is operating clear of clouds, has at least 1 mile flight visibility, and can reasonably expect to continue to the destination airport in those conditions.

42.3.1.3 Be aware that while conducting a contact approach, the pilot assumes responsibility for obstruction clearance.

42.3.1.4 Advises ATC immediately if you are unable to continue the contact approach or if you encounter less than 1 mile flight visibility.

42.3.1.5 Be aware that, if radar service is being received, it may automatically terminate when the pilot is told to contact the tower. “Radar service terminated” is used by ATC to inform a pilot that he/she will no longer be provided any of the services that could be received while in radar contact.

REFERENCE–

The Pilot/Controller Glossary is published in the Aeronautical Information Manual (AIM) and FAA Orders 7110.10, Flight Services, and 7110.65, Air Traffic Control.

42.3.2 Controller

42.3.2.1 Issues clearance for contact approach only when requested by the pilot. Does not solicit the use of this procedure.

42.3.2.2 Before issuing clearance, ascertains that reported ground visibility at destination airport is at least 1 mile.

42.3.2.3 Provides approved separation between aircraft cleared for contact approach and other IFR or special VFR aircraft. When using vertical separation, does not assign a fixed altitude but clears the aircraft at or below an altitude which is at least 1,000 feet below any IFR traffic but not below minimum safe altitudes prescribed in 14 CFR Section 91.119.

42.3.2.4 Issues alternative instructions if, in the controller's judgment, weather conditions may make completion of the approach impractical.

42.4 Instrument Approach

42.4.1 Pilot

42.4.1.1 Be aware that the controller issues clearance for approach based only on known traffic.

42.4.1.2 Follows the procedures as shown on the instrument approach chart including all restrictive notations, such as:

- a) Procedure not authorized at night.
- b) Approach not authorized when local area altimeter not available.
- c) Procedure not authorized when control tower not in operation.
- d) Procedure not authorized when glide slope not used.
- e) Straight-in minimums not authorized at night.
- f) Radar required.
- g) The circling minimums published on the instrument approach chart provide adequate obstruction clearance. The pilot should not descend below the circling altitude until the aircraft is in a position to make final descent for landing. Sound judgment and knowledge of the pilot's and the aircraft's capabilities are the criteria for a pilot to determine the exact maneuver in each instance since airport design and the aircraft position, altitude, and airspeed must all be considered. (See ENR 1.5, paragraph 11.6, Circling Minimums.)

42.4.1.3 Upon receipt of an approach clearance while on an unpublished route or being radar vectored:

- a) Complies with the minimum altitude for IFR.
- b) Maintains last assigned altitude until established on a segment of a published route or Instrument Approach Procedure (IAP), at which time published altitudes apply.

42.4.2 Controller

42.4.2.1 Issues an approach clearance based on known traffic.

42.4.2.2 Issues an IFR approach clearance only after aircraft is established on a segment of published route or IAP; or assigns an appropriate altitude for the aircraft to maintain until so established.

42.5 Missed Approach

42.5.1 Pilot

42.5.1.1 Executes a missed approach when one of the following conditions exist:

a) Arrival at the missed approach point (MAP) or the decision height (DH) and visual reference to the runway environment is insufficient to complete the landing.

b) Determines that a safe approach or landing is not possible (see ENR 1.5 paragraph 27.8).

c) Instructed to do so by ATC.

42.5.1.2 Advises ATC that a missed approach will be made. Include the reason for the missed approach unless initiated by ATC.

42.5.1.3 Complies with the missed approach instructions for the IAP being executed from the MAP, unless other missed approach instructions are specified by ATC.

42.5.1.4 If executing a missed approach prior to reaching the MAP, fly the lateral navigation path of the instrument procedure to the MAP. Climb to the altitude specified in the missed approach procedure, except when a maximum altitude is specified between the final approach fix (FAF) and the MAP. In that case, comply with the maximum altitude restriction. Note, this may require a continued descent on the final approach.

42.5.1.5 Following a missed approach, requests clearance for specific action; i.e., another approach, hold for improved conditions, proceed to an alternate airport, etc.

42.5.2 Controller

42.5.2.1 Issues an approved alternate missed approach procedure if it is desired that the pilot execute a procedure other than as depicted on the instrument approach chart.

42.5.2.2 May vector a radar identified aircraft executing a missed approach when operationally advantageous to the pilot or the controller.

42.5.2.3 In response to the pilot's stated intentions, issues a clearance to an alternate airport, to a holding fix, or for reentry into the approach sequence, as traffic conditions permit.

42.6 Radar Vectors

42.6.1 Pilot

42.6.1.1 Promptly complies with headings and altitudes assigned to you by the controller.

42.6.1.2 Questions any assigned heading or altitude believed to be incorrect.

42.6.1.3 If operating VFR and compliance with any radar vector or altitude would cause a violation of any Federal Aviation Regulation, advises ATC and obtain a revised clearance or instruction.

42.6.2 Controller

42.6.2.1 Vectors aircraft in Class A, B, C, D, and E airspace:

- a) For separation.
- b) For noise abatement.
- c) To obtain an operational advantage for the pilot or the controller.

42.6.2.2 Vectors aircraft in Class A, B, C, D, E, and G airspace when requested by the pilot.

42.6.2.3 Vectors IFR aircraft at or above minimum vectoring altitudes.

42.6.2.4 May vector VFR aircraft, not at an ATC assigned altitude, at any altitude. In these cases, terrain separation is the pilot's responsibility.

42.7 Speed Adjustments

42.7.1 Pilot (In U.S. Domestic Class A, B, C, D, and E airspace)

42.7.2 Except as stated in paragraphs 42.7.5 and 42.7.6, advises ATC anytime the true airspeed at cruising level varies or is expected to vary by plus or minus 10 knots or 0.02 Mach number, whichever is less, of the filed true airspeed.

42.7.3 Complies with speed adjustments from ATC unless:

42.7.3.1 Except as stated in paragraphs 42.7.5 and 42.7.6, advises ATC anytime the true airspeed at cruising level varies or is expected to vary by plus or minus 10 knots or 0.02 Mach number, whichever is less, of the filed true airspeed.

42.7.3.2 Complies with speed adjustments from ATC unless:

a) The minimum or maximum safe airspeed for any particular operation is greater or less than the requested airspeed. In such cases, advises ATC.

b) Operating at or above 10,000 feet MSL on an ATC assigned SPEED ADJUSTMENT of more than 250 knots IAS and subsequent clearance is received for descent below 10,000 feet MSL. In such cases, pilots are expected to comply with 14 CFR Section 97.117(a).

42.7.4 Controller (In U.S. Domestic Class A, B, C, D, and E Airspaces)

42.7.4.1 Assigns aircraft to speed adjustments when necessary, but not as a substitute for good vectoring technique.

42.7.4.2 Adheres to the restrictions of FAA Order 7110.65, Air Traffic Control, as to when speed adjustment procedures may be applied.

42.7.4.3 Avoids speed adjustments requiring alternate decreases and increases.

42.7.4.4 Assigns speed adjustments to a specified IAS knots/Mach number or to increase or decrease speed utilizing increments of 10 knots or multiples thereof.

42.7.4.5 Advises pilots to resume normal speed when speed adjustments are no longer required.

42.7.4.6 Gives due consideration to aircraft capabilities to reduce speed while descending.

42.7.5 Pilot (In Oceanic Class A and E Airspace)

42.7.5.1 If ATC has not assigned an airspeed, advises ATC anytime the true airspeed at cruising level varies or is expected to vary by ± 10 knots or 0.02 Mach number, whichever is less, of the filed true airspeed.

42.7.5.2 If ATC has assigned an airspeed, aircraft shall adhere to the ATC assigned airspeed and shall request ATC approval before making any change thereto. If it is essential to make an immediate temporary change in the Mach number (e.g., due to turbulence), ATC shall be notified as soon as possible. If it is not feasible, due to aircraft performance, to maintain the last assigned Mach number during an en route climb or descent, advises ATC at the time of the request.

42.7.6 Controller (In Oceanic Class A and E Airspace)

42.7.6.1 Assigns airspeed when necessary for separation of aircraft to comply with 14 CFR, ICAO regulations and procedures, or letters of agreement.

42.8 Traffic Advisories (Traffic Information)

42.8.1 Pilot

42.8.1.1 Acknowledges receipt of traffic advisories.

42.8.1.2 Informs controller if traffic is in sight.

42.8.1.3 Advises ATC if a vector to avoid traffic is desired.

42.8.1.4 Does not expect to receive radar traffic advisories on all traffic. Some aircraft may not appear on the radar display. Be aware that the controller may be occupied with high priority duties and unable to issue traffic information for a variety of reasons.

42.8.1.5 Advises controller if service is not desired.

42.8.2 Controller

42.8.2.1 Issues radar traffic to the maximum extent consistent with higher priority duties except in Class A airspace.

42.8.2.2 Provides vectors to assist aircraft to avoid observed traffic when requested by the pilot.

42.8.2.3 Issues traffic information to aircraft in Class D airspace for sequencing purposes.

42.8.2.4 Controllers are required to issue to each aircraft operating on intersecting or nonintersecting converging runways where projected flight paths will cross.

42.9 Safety Alert

42.9.1 Pilot

42.9.1.1 Initiates appropriate action if a safety alert is received from ATC.

42.9.1.2 Be aware that this service is not always available and that many factors affect the ability of the controller to be aware of a situation in which unsafe proximity to terrain, obstructions, or another aircraft may be developing.

42.9.2 Controller

42.9.2.1 Issues a safety alert if aware an aircraft under their control is at an altitude which, in the controller's judgment, places the aircraft in unsafe proximity to terrain, obstructions, or another aircraft. Types of safety alerts are:

a) **Terrain/Obstruction Alerts.** Immediately issued to an aircraft under their control if aware the aircraft is at an altitude believed to place the aircraft in unsafe proximity to terrain/obstruction.

b) **Aircraft Conflict Alerts.** Immediately issued to an aircraft under their control if aware of an aircraft not under their control at an altitude believed to place the aircraft in unsafe proximity to each other. With the alert, they offer the pilot an alternative if feasible.

42.9.2.2 Discontinues further alerts if informed by the pilot action is being taken to correct the situation or that the other aircraft is in sight.

42.10 See and Avoid

42.10.1 Pilot

42.10.1.1 When meteorological conditions permit, regardless of type of flight plan or whether or not under control of a radar facility, the pilot is responsible to see and avoid other traffic, terrain, or obstacles.

42.10.2 Controller

42.10.2.1 Provides radar traffic information to radar identified aircraft operating outside positive control airspace on a workload permitting basis.

42.10.2.2 Issues a safety advisory to an aircraft under their control if aware the aircraft is at an altitude believed to place the aircraft in unsafe proximity to terrain, obstructions or other aircraft.

42.11 Visual Approach

42.11.1 Pilot

42.11.1.1 If a visual approach is not desired, advises ATC.

42.11.1.2 Complies with controller's instructions for vectors toward the airport of intended landing or to a visual position behind a preceding aircraft.

42.11.1.3 The pilot must, at all times, have either the airport or the preceding aircraft in sight. After being cleared for a visual approach, proceed to the airport in a normal manner or follow the preceding aircraft. Remain clear of clouds while conducting a visual approach.

42.11.1.4 If the pilot accepts a visual approach clearance to visually follow a preceding aircraft, you are required to establish a safe landing interval behind the aircraft you were instructed to follow. You are responsible for wake turbulence separation.

42.11.1.5 Advise ATC immediately if the pilot is unable to continue following the preceding aircraft, cannot remain clear of clouds, needs to climb, or loses sight of the airport.

42.11.1.6 Be aware that radar service is automatically terminated, without being advised by ATC, when the pilot is instructed to change to advisory frequency.

42.11.1.7 Be aware that there may be other traffic in the traffic pattern and the landing sequence may differ from the traffic sequence assigned by the approach control or ARTCC.

42.11.2 Controller

42.11.2.1 Does not clear an aircraft for a visual approach unless reported weather at the airport is ceiling at or above 1,000 feet and visibility is 3 miles or greater. When weather is not available for the destination airport, informs the pilot and does not initiate a visual approach to that airport unless there is reasonable assurance that descent and flight to the airport can be made visually.

42.11.2.2 Issues visual approach clearance when the pilot reports sighting either the airport or a preceding aircraft which is to be followed.

42.11.2.3 Provides separation except when visual separation is being applied by the pilot.

42.11.2.4 Continues flight following and traffic information until the aircraft has landed or has been instructed to change to advisory frequency.

42.11.2.5 Informs the pilot when the preceding aircraft is a heavy.

42.11.2.6 When weather is available for the destination airport, does not initiate a vector for a visual approach unless the reported ceiling at the airport is 500 feet or more above the MVA and visibility is 3 miles or more. If vectoring weather minima are not available but weather at the airport is ceiling at or above 1,000 feet and visibility of 3 miles or greater, visual approaches may still be conducted.

42.11.2.7 Informs the pilot conducting the visual approach of the aircraft class when pertinent traffic is known to be a heavy aircraft.

42.12 Visual Separation

42.12.1 Pilot

42.12.1.1 Acceptance of instructions to follow another aircraft or to provide visual separation from it is an acknowledgment that the pilot will maneuver the aircraft as necessary to avoid the other aircraft or to maintain in-trail separation. Pilots are responsible to maintain visual separation until flight paths (altitudes and/or courses) diverge.

42.12.1.2 If instructed by ATC to follow another aircraft or to provide visual separation from it, promptly notify the controller if you lose sight of that aircraft, are unable to maintain continued visual contact with it, or cannot accept the responsibility for your own separation for any reason.

42.12.1.3 The pilot also accepts responsibility for wake turbulence separation under these conditions.

42.12.2 Controller Applies Visual Separation Only:

42.12.2.1 Within the terminal area when a controller has both aircraft in sight or by instructing a pilot who sees the other aircraft to maintain visual separation from it.

42.12.2.2 Pilots are responsible to maintain visual separation until flight paths (altitudes and/or courses) diverge.

42.12.2.3 Within en route airspace when aircraft are on opposite courses and one pilot reports having seen the other aircraft and that the aircraft have passed each other.

42.13 VFR-on-top

42.13.1 Pilot

42.13.1.1 This clearance must be requested by the pilot on an IFR flight plan, and if approved, allows the pilot the choice to select (subject to any ATC restrictions) an altitude or flight level in lieu of an assigned altitude.

NOTE-

1. *VFR-on-top is not permitted in certain airspace areas, such as Class A airspace, certain restricted areas, etc. Consequently, IFR flights operating VFR-on-top will avoid such airspace.*

2. *See paragraph 32. of this section, IFR Separation Standards; GEN 3.3 paragraph 6, Position Reporting; and GEN 3.3 paragraph 7, Additional Reports.*

42.13.1.2 By requesting a VFR-on-top clearance, the pilot assumes the sole responsibility to be vigilant so as to see and avoid other aircraft and to:

a) Fly at the appropriate VFR altitude as prescribed in 14 CFR Section 91.159.

b) Comply with the VFR visibility and distance from clouds criteria in 14 CFR Section 91.155 (Basic VFR Weather Minimums).

c) Comply with instrument flight rules that are applicable to this flight; i.e., minimum IFR altitudes, position reporting, radio communications, course to be flown, adherence to ATC clearance, etc.

d) Advise ATC prior to any altitude change to ensure the exchange of accurate traffic information.

42.13.2 Controller

42.13.2.1 May clear an aircraft to maintain VFR-on-top if the pilot of an aircraft on an IFR flight plan requests the clearance.

42.13.2.2 Informs the pilot of an aircraft cleared to climb to VFR-on-top the reported height of the tops or that no top report is available; issues an alternate clearance if necessary; and once the aircraft reports reaching VFR-on-top, reclears the aircraft to maintain VFR-on-top.

42.13.2.3 Before issuing clearance, ascertains that the aircraft is not in or will not enter Class A airspace.

42.14 Instrument Departures

42.14.1 Pilot

42.14.1.1 Prior to departure, considers the type of terrain and other obstructions on or in the vicinity of the departure airport.

42.14.1.2 Determines if obstruction avoidance can be maintained visually or that the departure procedure should be followed.

42.14.1.3 Determines whether a departure procedure and/or instrument departure procedure (DP) is available for obstruction avoidance.

42.14.1.4 At airports where instrument approach procedures have not been published, hence no published departure procedure, determines what action will be necessary and takes such action that will assure a safe departure.

42.14.2 Controller

42.14.2.1 At locations with airport traffic control service, when necessary, specifies direction of takeoff/turn or initial heading to be flown after takeoff.

42.14.2.2 At locations without airport traffic control service but within Class E surface area, when necessary to specify direction of takeoff/turn or initial heading to be flown, obtains pilot's concurrence that the procedure will allow him/her to comply with local traffic patterns, terrain, and obstruction avoidance.

42.14.2.3 Includes established departure procedures as part of the air traffic control clearance when pilot compliance is necessary to ensure separation.

42.15 Minimum Fuel Advisory

42.15.1 Pilot

42.15.1.1 Advises ATC of your "minimum fuel" status when your fuel supply has reached a state where, upon reaching destination, you cannot accept any undue delay.

42.15.1.2 Be aware that this is not an emergency situation but merely an advisory that indicates an emergency situation is possible should any undue delay occur.

42.15.1.3 On initial contact the term “minimum fuel” should be used after stating call sign.

EXAMPLE–

Salt Lake Approach, United 621, “minimum fuel.”

42.15.1.4 Be aware a minimum fuel advisory does not imply a need for traffic priority.

42.15.1.5 If the remaining usable fuel supply suggests the need for traffic priority to ensure a safe landing, you should declare an emergency due to low fuel, and report the fuel remaining in minutes.

42.15.2 Controller

42.15.2.1 When an aircraft declares a state of “minimum fuel,” relay this information to the facility to whom control jurisdiction is transferred.

42.15.2.2 Be alert for any occurrence which might delay the aircraft.

43. Traffic Alert and Collision Avoidance System (TCAS I & II)

43.1 TCAS I provides proximity warning only, to assist the pilot in the visual acquisition of intruder aircraft. No recommended avoidance maneuvers are provided nor authorized as a direct result of a TCAS I warning. It is intended for use by smaller commuter aircraft holding 10 to 30 passenger seats, and general aviation aircraft.

43.2 TCAS II provides traffic advisories (TAs) and resolution advisories (RAs). RAs provide recommended maneuvers in a vertical direction (climb or descend only) to avoid conflicting traffic. Airline aircraft, and larger commuter and business aircraft holding 31 passenger seats or more, use TCAS II equipment.

43.3 Each pilot who deviates from an ATC clearance in response to a TCAS II RA shall notify ATC of that deviation as soon as practicable and expeditiously return to the current ATC clearance when the traffic conflict is resolved.

43.4 Deviations from rules, policies, or clearances should be kept to the minimum necessary to satisfy a TCAS II RA.

43.5 The serving IFR air traffic facility is not responsible for providing approved standard IFR separation to an aircraft after a TCAS II RA maneuver until one of the following conditions exists:

43.5.1 The aircraft has returned to its assigned altitude and course.

43.5.2 Alternate ATC instructions have been issued.

43.6 TCAS does not alter or diminish the pilot’s basic authority and responsibility to ensure safe flight. Since TCAS does not respond to aircraft which are not transponder equipped or aircraft with a transponder failure, TCAS alone does not ensure safe separation in every case.

43.7 At this time, no air traffic service nor handling is predicated on the availability of TCAS equipment in the aircraft.

44. Strategic Lateral Offset Procedure (SLOP) While within Oceanic Airspace

44.1 These procedures have been developed in accordance with the ICAO PANS–ATM, 15.2.4.

44.2 It has been determined that allowing aircraft conducting oceanic flight to fly lateral offsets, not to exceed 2 NM right of center line, will provide an additional safety margin and mitigate the risk of conflict when non–normal events, such as aircraft navigation errors, altitude deviation errors and turbulence–induced altitude–keeping errors, occur.

44.3 These procedures are authorized in US–controlled Oceanic Airspace and also the airspace surrounding the island of Bermuda, the airspace controlled by Honolulu Control Facility (CF) and the airspace controlled by Guam Combined Center Radar Approach Control (CERAP).

44.4 These procedures provide for offsets within the following guidelines: Along a route or track there will be three positions that an aircraft may fly; center line or one or two miles right of center line. Offsets will not exceed 2 NM right of center line. The intent of this procedure is to reduce risk (add safety margin) by distributing aircraft laterally across the three available positions.

44.4.1 Aircraft without automatic offset programming capability must fly the center line.

44.4.2 An aircraft overtaking another aircraft should offset within the confines of this procedure, if capable, so as to create the least amount of wake turbulence for the aircraft being overtaken.

44.4.3 Pilots should also fly one of the three positions shown above to avoid wake turbulence.

44.4.4 Pilots should use whatever means available to determine the best flight path to fly.

44.4.5 Aircraft should not offset to the left of center line nor offset more than 2 NM right of center line. Pilots may contact other aircraft on VHF frequency 123.45, as necessary, to coordinate the best wake turbulence offset option.

NOTE–

It is recognized that pilots will use their judgment to determine the action most appropriate to any given situation and have the final authority and responsibility for the safe operations of the aircraft.

44.4.6 Pilots may apply an offset outbound after the oceanic entry point. Aircraft transiting Bermuda airspace, Honolulu CF airspace or Guam CERAP airspace may remain on their established offset.

44.4.7 There is no ATC clearance required for this procedure and it is not necessary that ATC be advised.

45. Traffic Information Service (TIS)

45.1 Introduction

The Traffic Information Service (TIS) provides information to the cockpit via data link, that is similar to VFR radar traffic advisories normally received over voice radio. Among the first FAA–provided data services, TIS is intended to improve the safety and efficiency of “see and avoid” flight through an automatic display that informs the pilot of nearby traffic and potential conflict situations. This traffic

display is intended to assist the pilot in visual acquisition of these aircraft. TIS employs an enhanced capability of the terminal Mode S radar system, which contains the surveillance data, as well as the data link required to “uplink” this information to suitably–equipped aircraft (known as a TIS “client”). TIS provides estimated position, altitude, altitude trend, and ground track information for up to 8 intruder aircraft within 7 NM horizontally, +3,500 and –3,000 feet vertically of the client aircraft (see FIG ENR 1.1–29, TIS Proximity Coverage Volume). The range of a target reported at a distance greater than 7 NM only indicates that this target will be a threat within 34 seconds and does not display a precise distance. TIS will alert the pilot to aircraft (under surveillance of the Mode S radar) that are estimated to be within 34 seconds of potential collision, regardless of distance or altitude. TIS surveillance data is derived from the same radar used by ATC; this data is uplinked to the client aircraft on each radar scan (nominally every 5 seconds).

45.2 Requirements

45.2.1 In order to use TIS, the client and any intruder aircraft must be equipped with the appropriate cockpit equipment and fly within the radar coverage of a Mode S radar capable of providing TIS. Typically, this will be within 55 NM of the sites depicted in FIG ENR 1.1–30, Terminal Mode S Radar Sites. ATC communication is not a requirement to receive TIS, although it may be required by the particular airspace or flight operations in which TIS is being used.

FIG ENR 1.1-29
TIS Proximity Coverage Volume

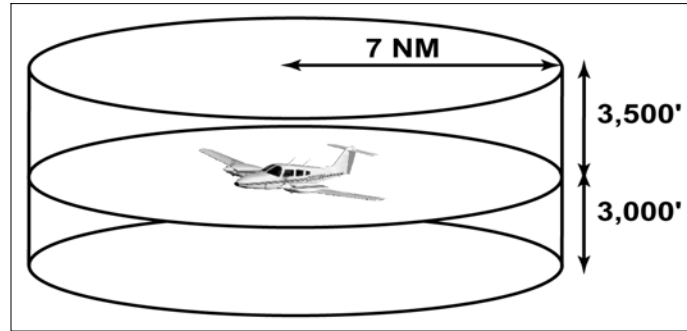

FIG ENR 1.1-30
Terminal Mode S Radar Sites

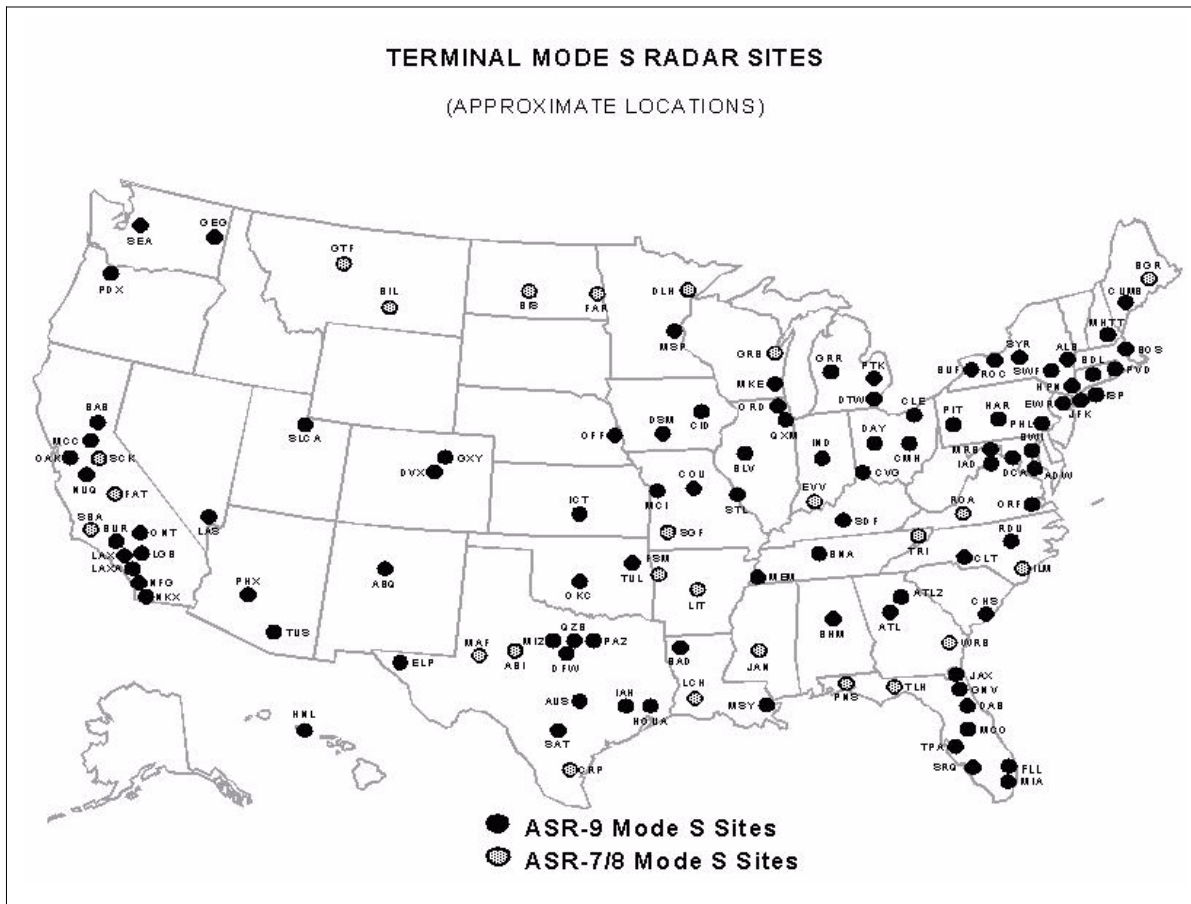
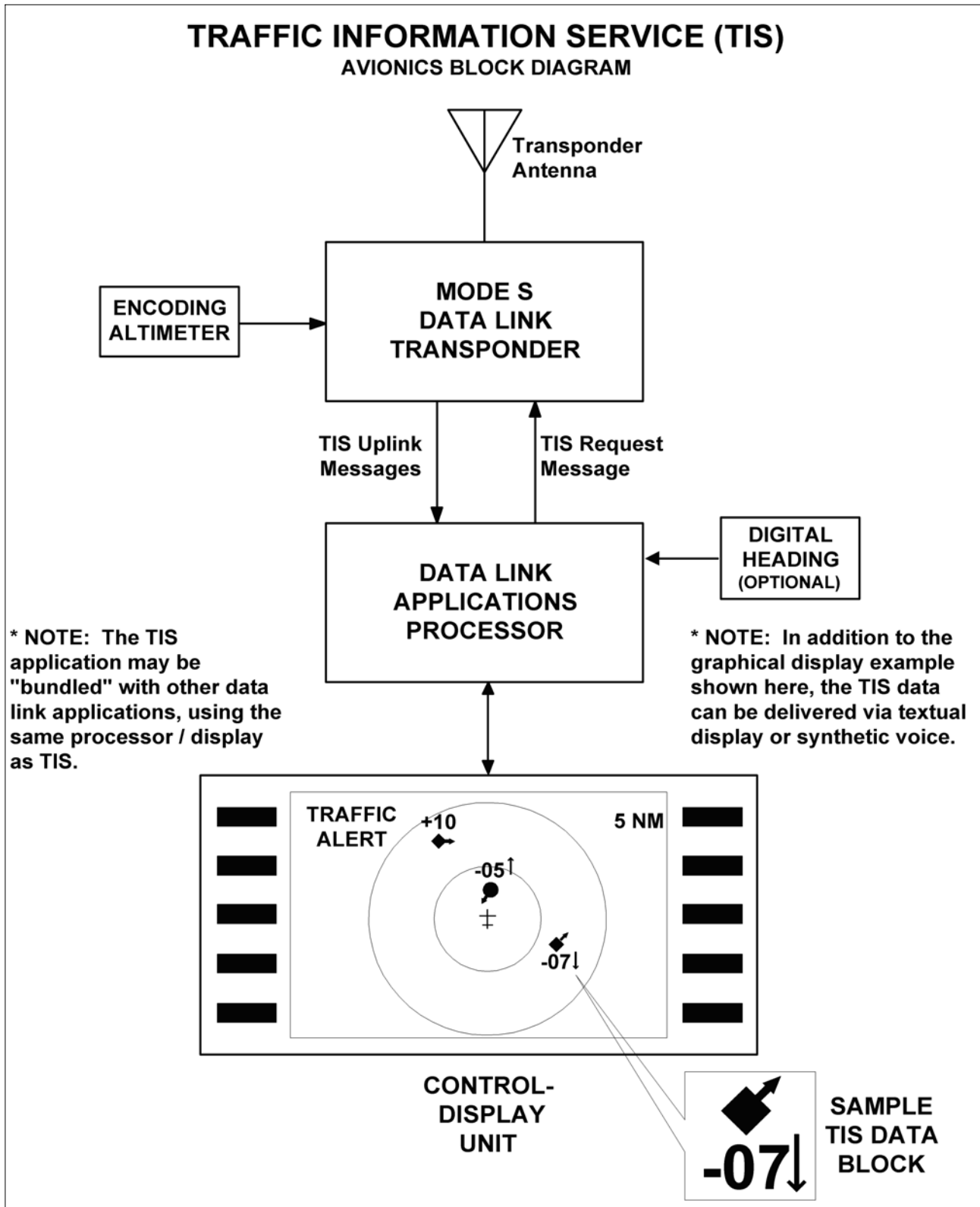

FIG ENR 1.1-31
Traffic Information Service (TIS)
Avionics Block Diagram



45.2.2 The cockpit equipment functionality required by a TIS client aircraft to receive the service consists of the following (refer to FIG ENR 1.1–31):

45.2.2.1 Mode S data link transponder with altitude encoder.

45.2.2.2 Data link applications processor with TIS software installed.

45.2.2.3 Control–display unit.

45.2.2.4 Optional equipment includes a digital heading source to correct display errors caused by “crab angle” and turning maneuvers.

NOTE–

Some of the above functions will likely be combined into single pieces of avionics, such as subparagraphs 45.2.2.1 and 45.2.2.2.

45.2.3 To be visible to the TIS client, the intruder aircraft must, at a minimum, have an operating transponder (Mode A, C or S). All altitude information provided by TIS from intruder aircraft is derived from Mode C reports, if appropriately equipped.

45.2.4 TIS will initially be provided by the terminal Mode S systems that are paired with ASR–9 digital primary radars. These systems are in locations with the greatest traffic densities, thus will provide the greatest initial benefit. The remaining terminal Mode S sensors, which are paired with ASR–7 or ASR–8 analog primary radars, will provide TIS pending modification or relocation of these sites. See FIG ENR 1.1–30, Terminal Mode S Radar Sites, for site locations. There is no mechanism in place, such as NOTAMs, to provide status update on individual radar sites since TIS is a nonessential, supplemental information service.

The FAA also operates en route Mode S radars (not illustrated) that rotate once every 12 seconds. These sites will require additional development of TIS before any possible implementation. There are no plans to implement TIS in the en route Mode S radars at the present time.

45.3 Capabilities

45.3.1 TIS provides ground–based surveillance information over the Mode S data link to properly equipped client aircraft to aid in visual acquisition of proximate air traffic. The actual avionics capability of each installation will vary and the supplemental handbook material must be consulted prior to using TIS. A maximum of eight (8) intruder aircraft may be displayed; if more than eight aircraft match intruder parameters, the eight “most significant” intruders are uplinked. These “most significant” intruders are usually the ones in closest proximity and/or the greatest threat to the TIS client.

45.3.2 TIS, through the Mode S ground sensor, provides the following data on each intruder aircraft:

45.3.2.1 Relative bearing information in 6–degree increments.

45.3.2.2 Relative range information in 1/8 NM to 1 NM increments (depending on range).

45.3.2.3 Relative altitude in 100–foot increments (within 1,000 feet) or 500–foot increments (from 1,000–3,500 feet) if the intruder aircraft has operating altitude reporting capability.

45.3.2.4 Estimated intruder ground track in 45–degree increments.

45.3.2.5 Altitude trend data (level within 500 fpm or climbing/descending >500 fpm) if the intruder aircraft has operating altitude reporting capability.

45.3.2.6 Intruder priority as either a “traffic advisory” or “proximate” intruder.

45.3.3 When flying from surveillance coverage of one Mode S sensor to another, the transfer of TIS is an automatic function of the avionics system and requires no action from the pilot.

45.3.4 There are a variety of status messages that are provided by either the airborne system or ground equipment to alert the pilot of high priority intruders and data link system status. These messages include the following:

45.3.4.1 Alert. Identifies a potential collision hazard within 34 seconds. This alert may be visual and/or audible, such as a flashing display symbol or a headset tone. A target is a threat if the time to the closest approach in vertical and horizontal coordinates is less than 30 seconds and the closest approach is expected to be within 500 feet vertically and 0.5 nautical miles laterally.

45.3.4.2 TIS Traffic. TIS traffic data is displayed.

45.3.4.3 Coasting. The TIS display is more than 6 seconds old. This indicates a missing uplink from the ground system. When the TIS display information is more than 12 seconds old, the “No Traffic” status will be indicated.

45.3.4.4 No Traffic. No intruders meet proximate or alert criteria. This condition may exist when the TIS system is fully functional or may indicate “coasting” between 12 and 59 seconds old (see paragraph 45.3.4.3 above).

45.3.4.5 TIS Unavailable. The pilot has requested TIS, but no ground system is available. This condition will also be displayed when TIS uplinks are missing for 60 seconds or more.

45.3.4.6 TIS Disabled. The pilot has not requested TIS or has disconnected from TIS.

45.3.4.7 Good-bye. The client aircraft has flown outside of TIS coverage.

NOTE–

Depending on the avionics manufacturer implementation, it is possible that some of these messages will not be directly available to the pilot.

45.3.5 Depending on avionics system design, TIS may be presented to the pilot in a variety of different displays, including text and/or graphics. Voice annunciation may also be used, either alone or in combination with a visual display. FIG ENR 1.1–31, Traffic Information Service (TIS), Avionics Block Diagram, shows an example of a TIS display using symbology similar to the Traffic Alert and Collision Avoidance System (TCAS) installed on most passenger air carrier/commuter aircraft in the U.S. The small symbol in the center represents the client aircraft and the display is oriented “track up,” with the 12 o’clock position at the top. The range rings indicate 2 and 5 NM. Each intruder is depicted by a symbol positioned at the approximate relative bearing and range from the client aircraft. The circular symbol near the center indicates an “alert” intruder and the diamond symbols indicate “proximate” intruders.

45.3.6 The inset in the lower right corner of FIG ENR 1.1–31, Traffic Information Service (TIS), Avionics Block Diagram, shows a possible TIS data

block display. The following information is contained in this data block:

45.3.6.1 The intruder, located approximately four o’clock, three miles, is a “proximate” aircraft and currently not a collision threat to the client aircraft. This is indicated by the diamond symbol used in this example.

45.3.6.2 The intruder ground track diverges to the right of the client aircraft, indicated by the small arrow.

45.3.6.3 The intruder altitude is 700 feet less than or below the client aircraft, indicated by the “–07” located under the symbol.

45.3.6.4 The intruder is descending >500 fpm, indicated by the downward arrow next to the “–07” relative altitude information. The absence of this arrow when an altitude tag is present indicates level flight or a climb/descent rate less than 500 fpm.

NOTE–

If the intruder did not have an operating altitude encoder (Mode C), the altitude and altitude trend “tags” would have been omitted.

45.4 Limitations

45.4.1 TIS is **NOT** intended to be used as a collision avoidance system and does not relieve the pilot responsibility to “see and avoid” other aircraft (see paragraph 42.10, See and Avoid). TIS shall not be for avoidance maneuvers during IMC or other times when there is no visual contact with the intruder aircraft. TIS provides proximity warning only, to assist the pilot in the visual acquisition of intruder aircraft. It is intended for use by aircraft in which TCAS is not required. **No recommended avoidance maneuvers are provided for, nor authorized, as a direct result of a TIS intruder display or TIS alert.**

45.4.2 TIS does not alter or diminish the pilot’s basic authority and responsibility to ensure safe flight. Since TIS does not respond to aircraft which are not transponder equipped, aircraft with a transponder failure, or aircraft out of radar coverage, TIS alone does not ensure safe separation in every case.

45.4.3 At this time, no air traffic service nor handling is predicated on the availability of TIS equipment in the aircraft.

45.4.4 While TIS is a useful aid to visual traffic avoidance, it has some system limitations that must be fully understood to ensure proper use. Many of these limitations are inherent in secondary radar surveillance. In other words, the information provided by TIS will be no better than that provided to ATC. Other limitations and anomalies are associated with the TIS predictive algorithm.

45.4.4.1 Intruder Display Limitations. TIS will only display aircraft with operating transponders installed. TIS relies on surveillance of the Mode S radar, which is a “secondary surveillance” radar similar to the ATCRBS described in paragraph 37.2, Air Traffic Control Radar Beacon System (ATCRBS).

45.4.4.2 TIS Client Altitude Reporting Requirement. Altitude reporting is required by the TIS client aircraft in order to receive TIS. If the altitude encoder is inoperative or disabled, TIS will be unavailable, as TIS requests will not be honored by the ground system. As such, TIS requires altitude reporting to determine the Proximity Coverage Volume as indicated in FIG ENR 1.1–29. TIS users must be alert to altitude encoder malfunctions, as TIS has no mechanism to determine if client altitude reporting is correct. A failure of this nature will cause erroneous and possibly unpredictable TIS operation. If this malfunction is suspected, confirmation of altitude reporting with ATC is suggested.

45.4.4.3 Intruder Altitude Reporting. Intruders without altitude reporting capability will be displayed without the accompanying altitude tag. Additionally, nonaltitude reporting intruders are assumed to be at the same altitude as the TIS client for alert computations. This helps to ensure that the pilot will be alerted to all traffic under radar coverage, but the actual altitude difference may be substantial. Therefore, visual acquisition may be difficult in this instance.

45.4.4.4 Coverage Limitations. Since TIS is provided by ground-based, secondary surveillance radar, it is subject to all limitations of that radar. If an aircraft is not detected by the radar, it cannot be displayed on TIS. Examples of these limitations are as follows:

a) TIS will typically be provided within 55 NM of the radars depicted in FIG ENR 1.1–30, Terminal Mode S Radar Sites. This maximum range can vary by radar site and is always subject to “line of sight” limitations; the radar and data link signals will be blocked by obstructions, terrain, and curvature of the earth.

b) TIS will be unavailable at low altitudes in many areas of the country, particularly in mountainous regions. Also, when flying near the “floor” of radar coverage in a particular area, intruders below the client aircraft may not be detected by TIS.

c) TIS will be temporarily disrupted when flying directly over the radar site providing coverage if no adjacent site assumes the service. A ground-based radar, like a VOR or NDB, has a zenith cone, sometimes referred to as the cone of confusion or cone of silence. This is the area of ambiguity directly above the station where bearing information is unreliable. The zenith cone setting for TIS is 34 degrees: any aircraft above that angle with respect to the radar horizon will lose TIS coverage from that radar until it is below this 34 degree angle. The aircraft may not actually lose service in areas of multiple radar coverage since an adjacent radar will provide TIS. If no other TIS-capable radar is available, the “Good-bye” message will be received and TIS terminated until coverage is resumed.

45.4.4.5 Intermittent Operations. TIS operation may be intermittent during turns or other maneuvering, particularly if the transponder system does not include antenna diversity (antenna mounted on the top and bottom of the aircraft). As in subparagraph 45.4.4.4 above, TIS is dependent on two-way, “line of sight” communications between the aircraft and the Mode S radar. Whenever the structure of the client aircraft comes between the transponder antenna (usually located on the underside of the aircraft) and the ground-based radar antenna, the signal may be temporarily interrupted.

45.4.4.6 TIS Predictive Algorithm. TIS information is collected one radar scan prior to the scan during which the uplink occurs. Therefore, the surveillance information is approximately 5 seconds old. In order to present the intruders in a “real time” position, TIS uses a “predictive algorithm” in its tracking software. This algorithm uses track history data to extrapolate intruders to their expected positions consistent with the time of display in the

cockpit. Occasionally, aircraft maneuvering will cause this algorithm to induce errors in the TIS display. These errors primarily affect relative bearing information; intruder distance and altitude will remain relatively accurate and may be used to assist in “see and avoid.” Some of the more common examples of these errors are as follows:

a) When client or intruder aircraft maneuver excessively or abruptly, the tracking algorithm will report incorrect horizontal position until the maneuvering aircraft stabilizes.

b) When a rapidly closing intruder is on a course that crosses the client at a shallow angle (either overtaking or head on) and either aircraft abruptly changes course within $\frac{1}{4}$ NM, TIS will display the intruder on the opposite side of the client than it actually is.

These are relatively rare occurrences and will be corrected in a few radar scans once the course has stabilized.

45.4.4.7 Heading/Course Reference. Not all TIS aircraft installations will have onboard heading reference information. In these installations, aircraft course reference to the TIS display is provided by the Mode S radar. The radar only determines ground track information and has no indication of the client aircraft heading. In these installations, all intruder bearing information is referenced to ground track and does not account for wind correction. Additionally, since ground-based radar will require several scans to determine aircraft course following a course change, a lag in TIS display orientation (intruder aircraft bearing) will occur. As in subparagraph 45.4.4.6 above, intruder distance and altitude are still usable.

45.4.4.8 Closely-Spaced Intruder Errors. When operating more than 30 NM from the Mode S sensor, TIS forces any intruder within $\frac{3}{8}$ NM of the TIS client to appear at the same horizontal position as the client aircraft. Without this feature, TIS could display intruders in a manner confusing to the pilot in critical

situations (e.g., a closely-spaced intruder that is actually to the right of the client may appear on the TIS display to the left). At longer distances from the radar, TIS cannot accurately determine relative bearing/distance information on intruder aircraft that are in close proximity to the client.

Because TIS uses a ground-based, rotating radar for surveillance information, the accuracy of TIS data is dependent on the distance from the sensor (radar) providing the service. This is much the same phenomenon as experienced with ground-based navigational aids, such as VOR or NDB. As distance from the radar increases, the accuracy of surveillance decreases. Since TIS does not inform the pilot of distance from the Mode S radar, the pilot must assume that any intruder appearing at the same position as the client aircraft may actually be up to $\frac{3}{8}$ NM away in any direction. Consistent with the operation of TIS, an alert on the display (regardless of distance from the radar) should stimulate an outside visual scan, intruder acquisition, and traffic avoidance based on outside reference.

45.5 Reports of TIS Malfunctions

45.5.1 Users of TIS can render valuable assistance in the early correction of malfunctions by reporting their observations of undesirable performance. Reporters should identify the time of observation, location, type and identity of aircraft, and describe the condition observed; the type of transponder processor, and software in use can also be useful information. Since TIS performance is monitored by maintenance personnel rather than ATC, it is suggested that malfunctions be reported in the following ways:

45.5.1.1 By radio or telephone to the nearest Flight Service Station (FSS) facility.

45.5.1.2 By FAA Form 8740–5, Safety Improvement Report, a postage-paid card designed for this purpose. These cards may be obtained at FAA FSSs, General Aviation District Offices, Flight Standards District Offices, and General Aviation Fixed Based Operations.

46. Automatic Dependent Surveillance–Broadcast (ADS–B) Services

46.1 Introduction

46.1.1 Automatic Dependent Surveillance–Broadcast (ADS–B) is a surveillance technology being deployed throughout the NAS (see FIG ENR 1.1–32). The ADS–B system is composed of aircraft avionics and a ground infrastructure. Onboard avionics determine the position of the aircraft by using the GNSS and transmit its position along with additional information about the aircraft to ground stations for use by ATC and other ADS–B services. This information is transmitted at a rate of approximately once per second.

46.1.2 In the United States, ADS–B equipped aircraft exchange information is on one of two frequencies: 978 or 1090 MHz. The 1090 MHz frequency is associated with Mode A, C, and S transponder operations. 1090 MHz transponders with integrated ADS–B functionality extend the transponder message sets with additional ADS–B

information. This additional information is known as an “extended squitter” message and referred to as 1090ES. ADS–B equipment operating on 978 MHz is known as the Universal Access Transceiver (UAT).

46.1.3 ADS B avionics can have the ability to both transmit and receive information. The transmission of ADS–B information from an aircraft is known as ADS–B Out. The receipt of ADS–B information by an aircraft is known as ADS–B In. On January 1, 2020, all aircraft operating within the airspace defined in 14 CFR part 91, § 91.225 will be required to transmit the information defined in § 91.227 using ADS–B Out avionics.

46.1.4 In general, operators flying at 18,000 feet and above will require equipment which uses 1090 ES. Those that do not fly above 18,000 may use either UAT or 1090ES equipment. (Refer to 14 CFR 91.225 and 91.227.) While the regulation will not require it, operators equipped with ADS–B In will realize additional benefits from ADS–B broadcast services: Traffic Information Service – Broadcast (TIS–B) and Flight Information Service – Broadcast (FIS–B).

FIG ENR 1.1–32
ADS–B, TIS–B, and FIS–B:
Broadcast Services Architecture

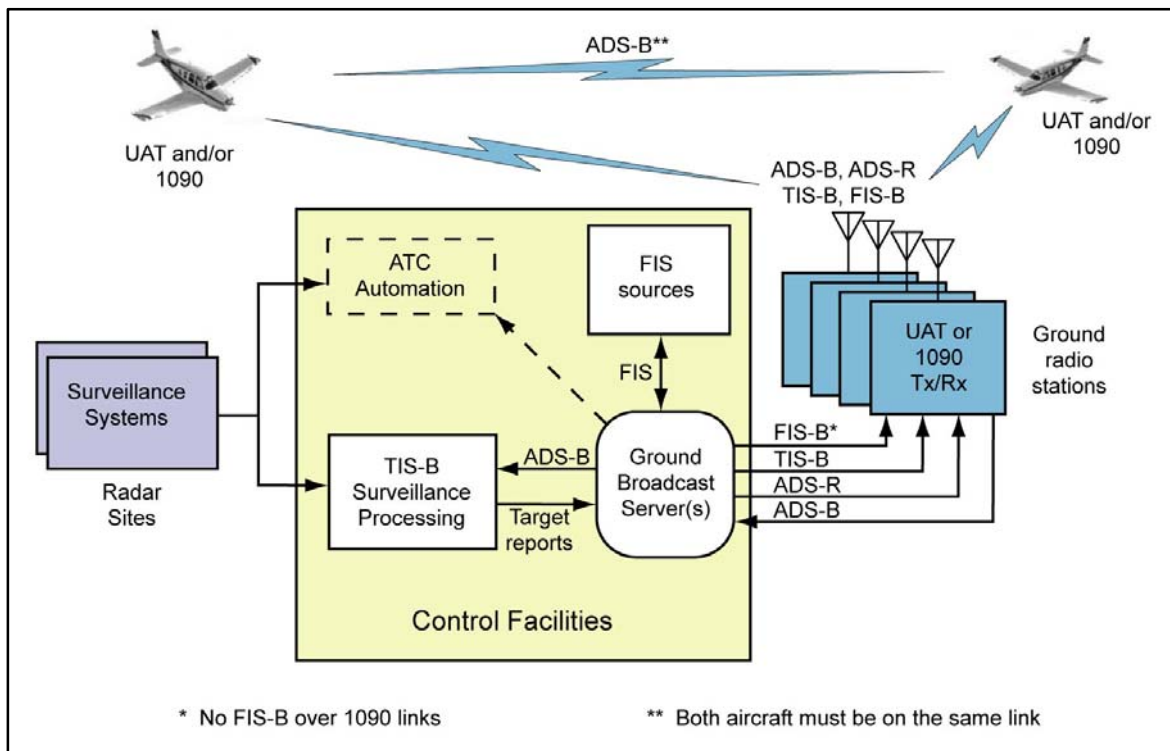

46.2 ADS-B Certification and Performance Requirements

ADS-B equipment may be certified as a surveillance source for air traffic separation services using ADS-B Out. ADS-B equipment may also be certified for use with ADS-B In advisory services that enable appropriately equipped aircraft to display traffic and flight information. Refer to the aircraft's flight manual supplement or Pilot Operating Handbook for the capabilities of a specific aircraft installation.

46.3 ADS-B Capabilities

46.3.1 ADS-B enables improved surveillance services, both air-to-air and air-to-ground, especially in areas where radar is ineffective due to terrain or where it is impractical or cost prohibitive. Initial NAS applications of air-to-air ADS-B are for "advisory" use only, enhancing a pilot's visual acquisition of other nearby equipped aircraft either when airborne or on the airport surface. Additionally, ADS-B will enable ATC and fleet operators to monitor aircraft throughout the available ground station coverage area.

46.3.2 ADS-B avionics typically allow pilots to enter the aircraft's call sign and Air Traffic Control (ATC)-assigned transponder code, which will be transmitted to other aircraft and ground receivers. Pilots are cautioned to use care when selecting and entering the aircraft's identification and transponder codes. Some installations may require separate entries of this information into both the ADS-B system and the transponder. Therefore, it is **extremely important to ensure that the transponder and ADS-B codes being transmitted are identical to avoid false conflict alerts within the ATC system.**

46.3.3 ADS B systems integrated with the transponder will automatically set the applicable emergency status when 7500, 7600, or 7700 are entered into the transponder. ADS B systems not integrated with the transponder, or systems with optional emergency codes, will require that the appropriate emergency code is entered through a pilot interface. **ADS-B is intended for in-flight and airport surface use. ADS-B systems should be turned "on" -- and remain "on" -- whenever operating in the air and moving on the airport surface. Civil and military**

Mode A/C transponders and ADS-B systems should be adjusted to the "on" or normal operating position as soon as practical, unless the change to "standby" has been accomplished previously at the request of ATC. Mode S transponders should be left on whenever power is applied to the aircraft.

46.4 ATC Surveillance Services using ADS-B – Procedures and Recommended Phraseology – For Use In Alaska Only

Radar procedures, with the exceptions found in this paragraph, are identical to those procedures prescribed for radar in the AIP.

46.4.1 Preflight:

If a request for ATC services is predicated on ADS-B and such services are anticipated when either a VFR or IFR flight plan is filed, the aircraft's "N" number or call-sign as filed in "Block 2" of the Flight Plan shall be entered in the ADS-B avionics as the aircraft's flight ID.

46.4.2 Inflight:

When requesting ADS-B services while airborne, pilots should ensure that their ADS-B equipment is transmitting their aircraft's "N" number or call sign prior to contacting ATC. To accomplish this, the pilot must select the ADS-B "broadcast flight ID" function.

NOTE-

The broadcast "VFR" or "Standby" mode built into some ADS-B systems will not provide ATC with the appropriate aircraft identification information. This function should first be disabled before contacting ATC.

46.4.3 Aircraft with an Inoperative/Malfunctioning ADS-B Transmitter or in the Event of an Inoperative Ground Broadcast Transceiver (GBT).

46.4.3.1 ATC will inform the flight crew when the aircraft's ADS-B transmitter appears to be inoperative or malfunctioning:

PHRASEOLOGY-

YOUR ADS-B TRANSMITTER APPEARS TO BE INOPERATIVE/MALFUNCTIONING. STOP ADS-B TRANSMISSIONS.

46.4.3.2 ATC will inform the flight crew when the GBT transceiver becomes inoperative or malfunctioning, as follows:

PHRASEOLOGY—

(Name of facility) *GROUND BASED TRANSCEIVER INOPERATIVE/MALFUNCTIONING.*

(And if appropriate) *RADAR CONTACT LOST.*

NOTE—

An inoperative or malfunctioning GBT may also cause a loss of ATC surveillance services.

46.4.3.3 ATC will inform the flight crew if it becomes necessary to turn off the aircraft's ADS-B transmitter.

PHRASEOLOGY—

STOP ADS-B TRANSMISSIONS.

46.4.3.4 Other malfunctions and considerations: Loss of automatic altitude reporting capabilities (encoder failure) will result in loss of ATC altitude advisory services.

46.5 ADS-B Limitations

46.5.1 The ADS-B cockpit display of traffic is NOT intended to be used as a collision avoidance system and does not relieve the pilot's responsibility to "see and avoid" other aircraft. (See paragraph 42.10, See and Avoid). ADS-B provides proximity warning only to assist the pilot in the visual acquisition of other aircraft. ADS-B shall not be used for avoidance maneuvers during IMC or other times when there is no visual contact with the intruder aircraft. ADS-B is intended only to assist in visual acquisition of other aircraft. No avoidance maneuvers are provided nor authorized, as a direct result of an ADS-B display or an ADS-B alert.

46.5.2 ADS-B does not alter or diminish the pilot's basic authority and responsibility to ensure safe flight. ADS-B only displays aircraft that are ADS-B equipped; therefore, aircraft that are not ADS-B equipped or aircraft that are experiencing an ADS-B failure will not be displayed. ADS-B alone does not ensure safe separation.

46.5.3 Presently, no air traffic services or handling is predicated on the availability of an ADS-B cockpit display. A "traffic-in-sight" reply to ATC must be based on seeing an aircraft out-the-window, NOT on the cockpit display.

46.5.4 Use of ADS-B radar services is limited to the service volume of the GBT.

NOTE—

The coverage volume of GBTs are limited to line-of-sight.

46.6 Reports of ADS-B Malfunctions

Users of ADS-B can provide valuable assistance in the correction of malfunctions by reporting instances of undesirable system performance. Reports should identify the time of observation, location, type and identity of aircraft, and describe the condition observed; the type of avionics system and its software version in use should also be included. Since ADS-B performance is monitored by maintenance personnel rather than ATC, it is suggested that malfunctions be reported in any one of the following ways:

46.6.1 By radio or telephone to the nearest Flight Service Station (FSS) facility.

46.6.2 By FAA Form 8740-5, Safety Improvement Report, a postage-paid card is designed for this purpose. These cards may be obtained from FAA FSSs, Flight Standards District Offices, and general aviation fixed-based operators.

46.6.3 By reporting the failure directly to the FAA Safe Flight 21 program at 1-877-FLYADSB or <http://www.adsb.gov>.

47. Traffic Information Service-Broadcast (TIS-B)

47.1 Introduction

TIS-B is the broadcast of ATC derived traffic information to ADS-B equipped (1090ES or UAT) aircraft from ground radio stations. The source of this traffic information is derived from ground-based air traffic surveillance radar sensors. TIS-B service will be available throughout the NAS where there are both adequate surveillance coverage (radar) from ground sensors and adequate broadcast coverage from ADS-B ground radio stations. The quality level of traffic information provided by TIS-B is dependent upon the number and type of ground sensors available as TIS-B sources and the timeliness of the reported data.

47.2 TIS-B Requirements

In order to receive TIS-B service, the following conditions must exist:

47.2.1 Aircraft must be equipped with an ADS-B transmitter/receiver or transceiver, and a cockpit display of traffic information (CDTI).

47.2.2 Aircraft must fly within the coverage volume of a compatible ground radio station that is configured for TIS-B uplinks. (Not all ground radio

stations provide TIS–B due to a lack of radar coverage or because a radar feed is not available).

47.2.3 Aircraft must be within the coverage of and detected by at least one ATC radar serving the ground radio station in use.

47.3 TIS–B Capabilities

47.3.1 TIS–B is intended to provide ADS–B equipped aircraft with a more complete traffic picture in situations where not all nearby aircraft are equipped with ADS–B Out. This advisory–only application is intended to enhance a pilot’s visual acquisition of other traffic.

47.3.2 Only transponder–equipped targets (i.e., Mode A/C or Mode S transponders) are transmitted through the ATC ground system architecture. Current radar siting may result in limited radar surveillance coverage at lower altitudes near some airports, with subsequently limited TIS–B service volume coverage. If there is no radar coverage in a given area, then there will be no TIS–B coverage in that area.

47.4 TIS–B Limitations

47.4.1 TIS–B is NOT intended to be used as a collision avoidance system and does not relieve the pilot’s responsibility to “see and avoid” other aircraft, in accordance with 14CFR §91.113b. TIS–B must not be used for avoidance maneuvers during times when there is no visual contact with the intruder aircraft. TIS–B is intended only to assist in the visual acquisition of other aircraft.

NOTE–

No aircraft avoidance maneuvers are authorized as a direct result of a TIS–B target being displayed in the cockpit.

47.4.2 While TIS–B is a useful aid to visual traffic avoidance, its inherent system limitations must be understood to ensure proper use.

47.4.2.1 A pilot may receive an intermittent TIS–B target of themselves, typically when maneuvering (e.g., climbing turns) due to the radar not tracking the aircraft as quickly as ADS–B.

47.4.2.2 The ADS–B–to–radar association process within the ground system may at times have difficulty correlating an ADS–B report with corresponding radar returns from the same aircraft. When this happens the pilot may see duplicate traffic symbols (i.e., “TIS–B shadows”) on the cockpit display.

47.4.2.3 Updates of TIS–B traffic reports will occur less often than ADS–B traffic updates. TIS–B position updates will occur approximately once every 3–13 seconds depending on the type of radar system in use within the coverage area. In comparison, the update rate for ADS–B is nominally once per second.

47.4.2.4 The TIS–B system only uplinks data pertaining to transponder–equipped aircraft. Aircraft without a transponder will not be displayed as TIS–B traffic.

47.4.2.5 There is no indication provided when any aircraft is operating inside or outside the TIS–B service volume, therefore it is difficult to know if one is receiving uplinked TIS–B traffic information.

47.4.3 Pilots and operators are reminded that the airborne equipment that displays TIS–B targets is for pilot situational awareness only and is not approved as a collision avoidance tool. Unless there is an imminent emergency requiring immediate action, any deviation from an air traffic control clearance in response to perceived converging traffic appearing on a TIS–B display must be approved by the controlling ATC facility before commencing the maneuver, except as permitted under certain conditions in 14CFR §91.123. Uncoordinated deviations may place an aircraft in close proximity to other aircraft under ATC control not seen on the airborne equipment and may result in a pilot deviation or other incident.

47.5 Reports of TIS–B Malfunctions

Users of TIS–B can provide valuable assistance in the correction of malfunctions by reporting instances of undesirable system performance. Reporters should identify the time of observation, location, type and identity of the aircraft, and describe the condition observed; the type of avionics system and its software version used. Since TIS–B performance is monitored by maintenance personnel rather than ATC, it is suggested that malfunctions be reported in any one of the following ways:

47.5.1 By radio or telephone to the nearest Flight Service Station (FSS) facility.

47.5.2 By FAA Form 8740–5, Safety Improvement Report, a postage–paid card is designed for this purpose. These cards may be obtained from FAA FSSs, Flight Standards District Offices, and general aviation fixed–based operators.

47.5.3 By reporting the failure directly to the FAA Surveillance and Broadcast Services Program Office at 1-877-FLYADSB or <http://www.adsb.gov>.

48. Heavy Traffic Around Military Fields

48.1 Pilots are advised to exercise vigilance when in close proximity to most military airports. These

airports may have jet aircraft traffic patterns extending up to 2,500 feet above the surface. In addition, they may have an unusually heavy concentration of jet aircraft operating within a 25-nautical mile radius and from the surface to all altitudes. The precautionary note also applies to the larger civil airports.

ENR 1.2 Visual Flight Rules

See ENR 1.1, ENR 1.4, and ENR 1.10.

ENR 1.3 Instrument Flight Rules

See ENR 1.1, ENR 1.4, and ENR 1.10.

ENR 1.4 ATS Airspace Classification

1. General

1.1 There are two categories of airspace or airspace areas:

1.1.1 Regulatory (Class A, B, C, D, and E airspace areas, restricted and prohibited areas).

1.1.2 Nonregulatory (military operations areas (MOAs), warning areas, alert areas, and controlled firing areas).

NOTE-

Additional information on special use airspace (prohibited areas, restricted areas, warning areas, MOAs, alert areas, and controlled firing areas) may be found in Section ENR 5.1, Prohibited, Restricted and Other Areas, paragraph 1 and Section ENR 5.2, Military Exercise and Training Areas, paragraphs 1. through 3.

1.2 Within these two categories, there are four types:

1.2.1 Controlled.

1.2.2 Uncontrolled.

1.2.3 Special use.

1.2.4 Other airspace.

1.3 The categories and types of airspace are dictated by:

1.3.1 The complexity or density of aircraft movements.

1.3.2 The nature of the operations conducted within the airspace.

1.3.3 The level of safety required.

1.3.4 The national and public interest.

1.4 It is important that pilots be familiar with the operational requirements for each of the various types or classes of airspace. Subsequent sections will cover each class in sufficient detail to facilitate understanding.

1.5 General Dimensions of Airspace Segments

1.5.1 Refer to Title 14 of the U.S. Code of Federal Regulations (14 CFR) for specific dimensions, exceptions, geographical areas covered, exclusions,

specific transponder or equipment requirements, and flight operations.

REFERENCE-

See GEN 1.7, Annex 2, for U.S. Differences From ICAO Standards, Recommended Practices and Procedures.

1.6 Hierarchy of Overlapping Airspace Designations

1.6.1 When overlapping airspace designations apply to the same airspace, the operating rules associated with the more restrictive airspace designation apply.

1.6.2 For the purpose of clarification:

1.6.2.1 Class A airspace is more restrictive than Class B, Class C, Class D, Class E, or Class G airspace.

1.6.2.2 Class B airspace is more restrictive than Class C, Class D, Class E, or Class G airspace.

1.6.2.3 Class C airspace is more restrictive than Class D, Class E, or Class G airspace.

1.6.2.4 Class D airspace is more restrictive than Class E or Class G airspace.

1.6.2.5 Class E is more restrictive than Class G airspace.

1.7 Basic VFR Weather Minimums

1.7.1 No person may operate an aircraft under basic VFR when the flight visibility is less, or at a distance from clouds that is less, than that prescribed for the corresponding altitude and class of airspace. (See TBL ENR 1.4-1.)

NOTE-

Student pilots must comply with 14 CFR Section 61.89(A) (6) and (7).

1.7.2 Except as provided in 14 CFR Section 91.157, Special VFR Minimums, no person may operate an aircraft beneath the ceiling under VFR within the lateral boundaries of controlled airspace designated to the surface for an airport when the ceiling is less than 1,000 feet. (See 14 CFR Section 91.155(c).)

1.8 VFR Cruising Altitudes and Flight Levels

(See TBL ENR 1.4-2.)

TBL ENR 1.4-1
Basic VFR Weather Minimums

Airspace	Flight Visibility	Distance from Clouds
Class A	Not Applicable	Not Applicable
Class B	3 statute miles	Clear of Clouds
Class C	3 statute miles	500 feet below 1,000 feet above 2,000 feet horizontal
Class D	3 statute miles	500 feet below 1,000 feet above 2,000 feet horizontal
Class E Less than 10,000 feet MSL	3 statute miles	500 feet below 1,000 feet above 2,000 feet horizontal
At or above 10,000 feet MSL	5 statute miles	1,000 feet below 1,000 feet above 1 statute mile horizontal
Class G 1,200 feet or less above the surface (regardless of MSL altitude). Day, except as provided in 14 CFR Section 91.155(b)	1 statute mile	Clear of clouds
Night, except as provided in 14 CFR Section 91.155(b)	3 statute miles	500 feet below 1,000 feet above 2,000 feet horizontal
More than 1,200 feet above the surface but less than 10,000 feet MSL. Day	1 statute mile	500 feet below 1,000 feet above 2,000 feet horizontal
Night	3 statute miles	500 feet below 1,000 feet above 2,000 feet horizontal
More than 1,200 feet above the surface and at or above 10,000 feet MSL.	5 statute miles	1,000 feet below 1,000 feet above 1 statute mile horizontal

TBL ENR 1.4-2
VFR Cruising Altitudes and Flight Levels

If your magnetic course (ground track) is:	And you are more than 3,000 feet above the surface but below 18,000 feet MSL, fly:	And you are above 18,000 feet MSL to FL 290, fly:
0 to 179	Odd thousands MSL, plus 500 feet (3,500; 5,500; 7,500, etc.)	Odd Flight Levels plus 500 feet (FL 195; FL 215; FL 235, etc.)
180 to 359	Even thousands MSL, plus 500 feet (4,500; 6,500; 8,500, etc.)	Even Flight Levels plus 500 feet (FL 185; FL 205; FL 225, etc.)

2. Controlled Airspace

2.1 General

2.1.1 Controlled Airspace. A generic term that covers the different classification of airspace (Class A, Class B, Class C, Class D, and Class E airspace) and defined dimensions within which air traffic control service is provided to IFR flights and to VFR flights in accordance with the airspace classification. (See TBL ENR 1.4-3 for Airspace Classes). Airspace classes are pronounced in the ICAO phonetics for clarification. The term “class” may be dropped when referring to airspace in pilot/controller communications.

2.1.2 IFR Requirements. IFR operations in any class of controlled airspace requires that a pilot must file an IFR flight plan and receive an appropriate ATC clearance.

2.1.3 IFR Separation. Standard IFR separation is provided to all aircraft operating under IFR in controlled airspace.

2.1.4 VFR Requirements. It is the responsibility of the pilot to insure that ATC clearance or radio communication requirements are met prior to entry into Class B, Class C, or Class D airspace. The pilot retains this responsibility when receiving ATC radar advisories. (See 14 CFR Part 91.)

REFERENCE-
14 CFR Part 91.

2.1.5 Traffic Advisories. Traffic advisories will be provided to all aircraft as the controller’s work situation permits.

2.1.6 Safety Alerts. Safety Alerts are mandatory services and are provided to ALL aircraft. There are two types of Safety Alerts, Terrain/Obstruction Alert and Aircraft Conflict/Mode Intruder Alert.

2.1.6.1 Terrain/Obstruction Alert. A Terrain/Obstruction Alert is issued when, in the controller’s judgment, an aircraft’s altitude places it in unsafe proximity to terrain and/or obstructions.

TBL ENR 1.4-3
Airspace Classes

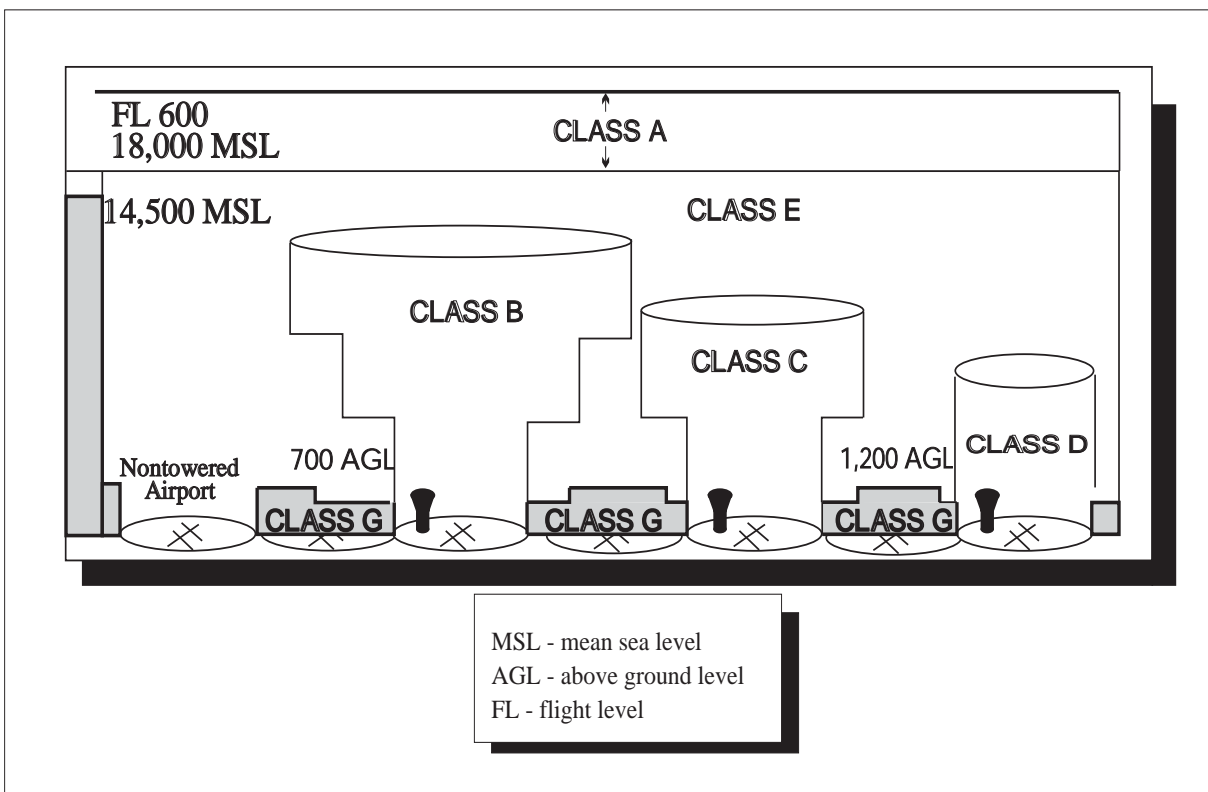

2.1.6.2 Aircraft Conflict/Mode C Intruder Alert.

An Aircraft Conflict/Mode C Intruder Alert is issued if the controller observes another aircraft which places it in an unsafe proximity. When feasible, the controller will offer the pilot an alternative course of action.

2.1.7 Ultralight Vehicles. No person may operate an ultralight vehicle within Class A, Class B, Class C, or Class D airspace or within the lateral boundaries of the surface area of Class E airspace designated for an airport unless that person has prior authorization from the ATC facility having jurisdiction over that airspace. (See 14 CFR Part 103.)

2.1.8 Unmanned Free Balloons. Unless otherwise authorized by ATC, no person may operate an unmanned free balloon below 2,000 feet above the surface within the lateral boundaries of Class B, Class C, Class D, or Class E airspace designated for an airport. (See 14 CFR Part 101.)

2.1.9 Parachute Jumps. No person may make a parachute jump, and no pilot in command may allow a parachute jump to be made from that aircraft, in or into Class A, Class B, Class C, or Class D airspace without, or in violation of, the terms of an ATC authorization issued by the ATC facility having jurisdiction over the airspace. (See 14 CFR Part 105.)

2.2 Class A Airspace

2.2.1 Definition. Generally, that airspace from 18,000 feet MSL up to and including FL 600, including the airspace overlying the waters within 12 nautical miles of the coast of the 48 contiguous States and Alaska; and designated international airspace beyond 12 nautical miles of the coast of the 48 contiguous States and Alaska within areas of domestic radio navigational signal or ATC radar coverage, and within which domestic procedures are applied.

2.2.2 Operating Rules and Pilot/Equipment Requirements. Unless otherwise authorized, all persons must operate their aircraft under IFR.

REFERENCE—
14 CFR Section 71.33 and Sections 91.167 through 91.193.

2.2.3 Charts. Class A airspace is not specifically charted.

2.3 Class B Airspace

2.3.1 Definition. Generally, that airspace from the surface to 10,000 feet MSL surrounding the nation's busiest airports in terms of IFR operations or passenger enplanements. The configuration of each Class B airspace area is individually tailored and consists of a surface area and two or more layers (some Class B airspace areas resemble upside-down wedding cakes), and is designed to contain all published instrument procedures once an aircraft enters the airspace. An ATC clearance is required for all aircraft to operate in the area, and all aircraft that are so cleared receive separation services within the airspace. The cloud clearance requirement for VFR operations is "clear of clouds."

2.3.2 Operating Rules and Pilot/Equipment Requirements for VFR Operations. Regardless of weather conditions, an ATC clearance is required prior to operating within Class B airspace. Pilots should not request a clearance to operate within Class B airspace unless the requirements of 14 CFR Section 91.215 and Section 91.131 are met. Included among these requirements are:

2.3.2.1 Unless otherwise authorized by ATC, aircraft must be equipped with an operable two-way radio capable of communicating with ATC on appropriate frequencies for that Class B airspace.

2.3.2.2 No person may take off or land a civil aircraft at the following primary airports within Class B airspace unless the pilot in command holds at least a private pilot certificate:

- a) Andrews Air Force Base, MD.
- b) Atlanta Hartsfield Airport, GA.
- c) Boston Logan Airport, MA.
- d) Chicago O'Hare Intl. Airport, IL.
- e) Dallas/Fort Worth Intl. Airport, TX.
- f) Los Angeles Intl. Airport, CA.
- g) Miami Intl. Airport, FL.
- h) Newark Intl. Airport, NJ.
- i) New York Kennedy Airport, NY.
- j) New York La Guardia Airport, NY.
- k) Ronald Reagan Washington National Airport, DC.

D) San Francisco Intl. Airport, CA.

2.3.2.3 No person may take off or land a civil aircraft at an airport within Class B airspace or operate a civil aircraft within Class B airspace unless:

- a) The pilot in command holds at least a private pilot certificate; or,
- b) The aircraft is operated by a student pilot or recreational pilot who seeks private pilot certification and has met the requirements of 14 CFR Section 61.95.

2.3.2.4 Unless otherwise authorized by ATC, each person operating a large turbine engine-powered airplane to or from a primary airport shall operate at or above the designated floors while within the lateral limits of Class B airspace.

2.3.2.5 Unless otherwise authorized by ATC, each aircraft must be equipped as follows:

- a) For IFR operations, an operable VOR or TACAN receiver.
- b) For all operations, a two-way radio capable of communications with ATC on appropriate frequencies for that area.
- c) Unless otherwise authorized by ATC, an operable radar beacon transponder with automatic altitude reporting equipment.

NOTE-
ATC may, upon notification, immediately authorize deviations from the altitude reporting equipment requirement; however, a request for deviation from the 4096 transponder equipment requirement must be submitted to the controlling ATC facility at least one hour before the proposed operation. (See ENR 1.1, paragraph 37.7, Transponder Operation).

2.3.2.6 Mode C Veil

a) The airspace within 30 nautical miles of an airport listed in Appendix D, Section 1 of 14 CFR Part 91 (generally primary airports within Class B airspace areas), from the surface upward to 10,000 feet mean sea level (MSL). Unless otherwise authorized by air traffic control, aircraft operating within this airspace must be equipped with automatic pressure altitude reporting equipment having Mode C capability.

b) However, aircraft that was not originally certificated with an engine-driven electrical system

or which has not subsequently been certified with a system installed, may conduct operations within a Mode C veil provided the aircraft remains outside Class A, B, or C airspace; and below the altitude of the ceiling of a Class B or Class C airspace area designated for an airport or 10,000 feet MSL, whichever is lower.

2.3.3 Charts. Class B airspace is charted on Sectional Charts, IFR En Route Low Altitude Charts, and Terminal Area Charts.

2.3.4 Flight Procedures

2.3.4.1 Flights. Aircraft within Class B airspace are required to operate in accordance with current IFR procedures. A clearance for a visual approach to a primary airport is not authorization for turbine powered airplanes to operate below the designated floors of the Class B airspace.

2.3.4.2 VFR Flights

a) Arriving aircraft must obtain an ATC clearance prior to entering Class B airspace and must contact ATC on the appropriate frequency, and in relation to geographical fixes shown on local charts. Although a pilot may be operating beneath the floor of the Class B airspace on initial contact, communications with ATC should be established in relation to the points indicated for spacing and sequencing purposes.

b) Departing aircraft require a clearance to depart Class B airspace and should advise the clearance delivery position of their intended altitude and route of flight. ATC will normally advise VFR aircraft when leaving the geographical limits of the Class B airspace. Radar service is not automatically terminated with this advisory unless specifically stated by the controller.

c) Aircraft not landing or departing the primary airport may obtain an ATC clearance to transit the Class B airspace when traffic conditions permit and provided the requirements of 14 CFR Section 91.131 are met. Such VFR aircraft are encouraged, to the extent possible, to operate at altitudes above or below the Class B airspace or transit through established VFR corridors. Pilots operating in VFR corridors are urged to use frequency 122.750 MHz for the exchange of aircraft position information.

2.3.5 ATC Clearances and Separation. An ATC clearance is required to enter and operate within Class B airspace. VFR pilots are provided sequencing and separation from other aircraft while operating within Class B airspace. (See ENR 1.1, paragraph 39., Terminal Radar Service for VFR Aircraft.)

NOTE–

1. *Separation and sequencing of VFR will be suspended in the event of a power outage as this service is dependent on radar. The pilot will be advised that the service is not available and issued wind, runway information, and the time or place to contact the tower.*

2. *Separation of VFR aircraft will be suspended during Center Radar Presentation (CENRAP) Operations. Traffic advisories and sequencing to the primary airport will be provided on a workload permitting basis. The pilot will be advised when CENRAP is in use.*

2.3.5.1 VFR aircraft are separated from all VFR/IFR aircraft which weigh 19,000 pounds or less by a minimum of:

- a) Target resolution; or
- b) 500 feet vertical separation; or
- c) Visual separation.

2.3.5.2 VFR aircraft are separated from all VFR/IFR aircraft which weigh more than 19,000 and turbojets by no less than:

- a) 1 1/2 miles lateral separation; or
- b) 500 feet vertical separation; or
- c) Visual separation.

2.3.5.3 This program is not to be interpreted as relieving pilots of their responsibilities to see and avoid other traffic operating in basic VFR weather conditions, to adjust their operations and flight path as necessary to preclude serious wake encounters, to maintain appropriate terrain and obstruction clearance, or to remain in weather conditions equal to or better than the minimums required by 14 CFR Section 91.155. Approach control should be advised and a revised clearance or instruction obtained when compliance with an assigned route, heading, and/or altitude is likely to compromise pilot responsibility with respect to terrain and obstruction clearance, vortex exposure, and weather minimums.

2.3.5.4 ATC may assign altitudes to VFR aircraft that do not conform to 14 CFR Section 91.159. “RESUME APPROPRIATE VFR ALTITUDES” will be broadcast when the altitude assignment is no longer needed for separation or when leaving Class B airspace. Pilots must return to an altitude that conforms to 14 CFR Section 91.159.

2.3.5.5 Proximity Operations. VFR aircraft operating in proximity to Class B airspace are cautioned against operating too closely to the boundaries, especially where the floor of the Class B airspace is 3,000 feet or less above the surface or where VFR cruise altitudes are at or near the floor of higher levels. Observance of this precaution will reduce the potential for encountering an aircraft operating at the altitudes of Class B floors. Additionally, VFR aircraft are encouraged to utilize the VFR Planning Chart as a tool for planning flight in proximity to Class B airspace. Charted VFR Flyway Planning charts are published on the back of the existing VFR Terminal Area Charts.

2.4 Class C Airspace

2.4.1 Definition. Generally, that airspace from the surface to 4,000 feet above the airport elevation (charted in MSL) surrounding those airports that have an operational control tower, are serviced by a radar approach control, and that have a certain number of IFR operations or passenger enplanements. Although the configuration of each Class C airspace area is individually tailored, the airspace usually consists of a surface area with a 5 NM radius, and an outer area with a 10 NM radius that extends no lower than 1,200 feet up to 4,000 feet above the airport elevation.

2.4.2 Outer Area. Class C airspace areas have a procedural (nonregulatory) Outer Area. Normally this area is 20 NM from the primary Class C airspace airport. Its vertical limit extends from the lower limits of radio/radar coverage up to the ceiling of the approach control’s delegated airspace, excluding the Class C airspace itself, and other airspace as appropriate. (This outer area is not charted.)

2.4.3 Charts. Class C airspace is charted on Sectional Charts, IFR En Route Low Altitude, and Terminal Area Charts where appropriate.

2.4.4 Operating Rules and Pilot Equipment Requirements

2.4.4.1 Pilot Certification. No specific certification required.

2.4.4.2 Equipment

a) Two-way radio.

b) Unless otherwise authorized by ATC, an operable radar beacon transponder with automatic altitude reporting equipment.

NOTE-

See Section ENR 1.1, paragraph 37.7, Transponder Operation, subparagraph 37.7.6 for Mode C Transponder Requirements for operating above Class C airspace.

c) Arrival or Through Flight Entry Requirements. Two-way radio communication must be established with the ATC facility providing ATC services prior to entry and thereafter maintain those communications while in Class C airspace. Pilots of arriving aircraft should contact the Class C airspace ATC facility on the publicized frequency and give their position, altitude, radar beacon code, destination, and request Class C service. Radio contact should be initiated far enough from the Class C airspace boundary to preclude entering Class C airspace before two-way radio communications are established.

NOTE-

1. *If the controller responds to a radio call with, “(aircraft callsign) standby,” radio communications have been established and the pilot can enter the Class C airspace.*

2. *If workload or traffic conditions prevent immediate provision of Class C services, the controller will inform the pilot to remain outside the Class C airspace until conditions permit the services to be provided.*

3. *It is important to understand that if the controller responds to the initial radio call without using the aircraft identification, radio communications have not been established and the pilot may not enter the Class C airspace.*

EXAMPLE-

1. *[Aircraft callsign] “remain outside the Class Charlie airspace and standby.”*

2. *“Aircraft calling Dulles approach control, standby.”*

d) Departures from:

1) A primary or satellite airport with an operating control tower. Two-way radio communications must be established and maintained with the control tower, and thereafter as instructed by ATC while operating in Class C airspace.

2) A satellite airport without an operating control tower. Two-way radio communications must be established as soon as practicable after departing with the ATC facility having jurisdiction over the Class C airspace.

e) Aircraft Speed. Unless otherwise authorized or required by ATC, no person may operate an aircraft at or below 2,500 feet above the surface within 4 nautical miles of the primary airport of a Class C airspace area at an indicated airspeed of more than 200 knots (230 mph).

2.4.5 Air Traffic Services. When two-way radio communications and radar contact are established, all participating VFR aircraft are:

2.4.5.1 Sequenced to the primary airport.

2.4.5.2 Provided Class C services within the Class C airspace and the Outer Area.

2.4.5.3 Provided basic radar services beyond the outer area on a workload permitting basis. This can be terminated by the controller if workload dictates.

2.4.6 Aircraft Separation. Separation is provided within the Class C airspace and the Outer Area after two-way radio communications and radar contact are established. VFR aircraft are separated from IFR aircraft within the Class C airspace by any of the following:

2.4.6.1 Visual separation.

2.4.6.2 500 feet vertical; except when operating beneath a heavy jet.

2.4.6.3 Target resolution.

NOTE-

1. *Separation and sequencing of VFR aircraft will be suspended in the event of a radar outage as this service is dependent on radar. The pilot will be advised that the service is not available and issued wind, runway information, and the time or place to contact the tower.*

2. *Separation of VFR aircraft will be suspended during CENRAP operations. Traffic advisories and sequencing to the primary airport will be provided on workload permitting basis. The pilot will be advised when CENRAP is in use.*

3. Pilot participation is voluntary within the outer area and can be discontinued within the outer area at the pilots request. Class C services will be provided in the outer area unless the pilot requests termination of the service.

4. Some facilities provide Class C services only during published hours. At other times, terminal IFR radar service will be provided. It is important to note that the communications requirements for entry into the airspace and transponder Mode C requirements are in effect at all times.

2.4.7 Secondary Airports

2.4.7.1 In some locations, Class C airspace may overlie the Class D surface area of a secondary airport. In order to allow that control tower to provide service to aircraft, portions of the overlapping Class C airspace may be procedurally excluded when the secondary airport tower is in operation. Aircraft operating in these procedurally excluded areas will only be provided airport traffic control services when in communication with the secondary airport tower.

2.4.7.2 Aircraft proceeding inbound to a satellite airport will be terminated at a sufficient distance to allow time to change to the appropriate tower or advisory frequency. Class C services to these aircraft will be discontinued when the aircraft is instructed to contact the tower or change to advisory frequency.

2.4.7.3 Aircraft departing secondary controlled airports will not receive Class C services until they have been radar identified and two-way communications have been established with the Class C airspace facility.

2.4.7.4 This program is not to be interpreted as relieving pilots of their responsibilities to see and avoid other traffic operating in basic VFR weather conditions, to adjust their operations and flight path as necessary to preclude serious wake encounters, to maintain appropriate terrain and obstruction clearance, or to remain in weather conditions equal to or better than the minimums required by 14 CFR Section 91.155. Approach control should be advised and a revised clearance or instruction obtained when compliance with an assigned route, heading, and/or altitude is likely to compromise pilot responsibility with respect to terrain and obstruction clearance, vortex exposure, and weather minimums.

2.4.8 Class C Airspace Areas By State

These states currently have designated Class C airspace areas that are depicted on sectional charts. Pilots should consult current sectional charts and NOTAMs for the latest information on services available. Pilots should be aware that some Class C airspace underlies or is adjacent to Class B airspace. (See TBL ENR 1.4–4.)

TBL ENR 1.4-4
Class C Airspace Areas by State

State/City	Airport
ALABAMA	
Birmingham	Birmingham–Shuttlesworth International
Huntsville	International–Carl T Jones Fld
Mobile	Regional
ALASKA	
Anchorage	Ted Stevens International
ARIZONA	
Davis–Monthan	AFB
Tucson	International
ARKANSAS	
Fayetteville (Springdale)	Northwest Arkansas Regional
Little Rock	Adams Field
CALIFORNIA	
Beale	AFB
Burbank	Bob Hope
Fresno	Yosemite International
Monterey	Peninsula
Oakland	Metropolitan Oakland International
Ontario	International
Riverside	March AFB
Sacramento	International
San Jose	Norman Y. Mineta International
Santa Ana	John Wayne/Orange County
Santa Barbara	Municipal
COLORADO	
Colorado Springs	Municipal
CONNECTICUT	
Windsor Locks	Bradley International
FLORIDA	
Daytona Beach	International
Fort Lauderdale	Hollywood International
Fort Myers	SW Florida Regional
Jacksonville	International
Orlando	Sanford International
Palm Beach	International
Pensacola	NAS
Pensacola	Regional
Sarasota	Bradenton International
Tallahassee	Regional
Whiting	NAS
GEORGIA	
Columbus	Metropolitan
Savannah	Hilton Head International
HAWAII	
Kahului	Kahului

IDAHO	
Boise	Air Terminal
ILLINOIS	
Champaign	Urbana U of Illinois–Willard
Chicago	Midway International
Moline	Quad City International
State/City	Airport
Peoria	Greater Peoria Regional
Springfield	Abraham Lincoln Capital
INDIANA	
Evansville	Regional
Fort Wayne	International
Indianapolis	International
South Bend	Regional
IOWA	
Cedar Rapids	The Eastern Iowa
Des Moines	International
KANSAS	
Wichita	Mid–Continent
KENTUCKY	
Lexington	Blue Grass
Louisville	International–Standiford Field
LOUISIANA	
Baton Rouge	Metropolitan, Ryan Field
Lafayette	Regional
Shreveport	Barksdale AFB
Shreveport	Regional
MAINE	
Bangor	International
Portland	International Jetport
MICHIGAN	
Flint	Bishop International
Grand Rapids	Gerald R. Ford International
Lansing	Capital City
MISSISSIPPI	
Columbus	AFB
Jackson	Jackson–Evers International
MISSOURI	
Springfield	Springfield–Branson National
MONTANA	
Billings	Logan International
NEBRASKA	
Lincoln	Lincoln
Omaha	Eppley Airfield
Offutt	AFB
NEVADA	
Reno	Reno/Tahoe International

State/City	Airport
NEW HAMPSHIRE	
Manchester	Manchester
NEW JERSEY	
Atlantic City	International
NEW MEXICO	
Albuquerque	International Sunport
NEW YORK	
Albany	International
Buffalo	Niagara International
Islip	Long Island MacArthur
Rochester	Greater Rochester International
Syracuse	Hancock International
NORTH CAROLINA	
Asheville	Regional
Fayetteville	Regional/Grannis Field
Greensboro	Piedmont Triad International
Pope	AFB
Raleigh	Raleigh–Durham International
OHIO	
Akron	Akron–Canton Regional
Columbus	Port Columbus International
Dayton	James M. Cox International
Toledo	Express
OKLAHOMA	
Oklahoma City	Will Rogers World
Tinker	AFB
Tulsa	International
OREGON	
Portland	International
PENNSYLVANIA	
Allentown	Lehigh Valley International
PUERTO RICO	
San Juan	Luis Munoz Marin International
RHODE ISLAND	
Providence	Theodore Francis Green State
SOUTH CAROLINA	
Charleston	AFB/International
Columbia	Metropolitan
Greer	Greenville–Spartanburg International

State/City	Airport
Myrtle Beach	Myrtle Beach International
Shaw	AFB
TENNESSEE	
Chattanooga	Lovell Field
Knoxville	McGhee Tyson
Nashville	International
TEXAS	
Abilene	Regional
Amarillo	Rick Husband International
Austin	Austin–Bergstrom International
Corpus Christi	International
Dyess	AFB
El Paso	International
Harlingen	Valley International
Laughlin	AFB
Lubbock	Preston Smith International
Midland	International
San Antonio	International
VERMONT	
Burlington	International
VIRGIN ISLANDS	
St. Thomas	Charlotte Amalie Cyril E. King
VIRGINIA	
Richmond	International
Norfolk	International
Roanoke	Regional/Woodrum Field
WASHINGTON	
Point Roberts	Vancouver International
Spokane	Fairchild AFB
Spokane	International
Whidbey Island	NAS, Ault Field
WEST VIRGINIA	
Charleston	Yeager
WISCONSIN	
Green Bay	Austin Straubel International
Madison	Dane County Regional–Traux Field
Milwaukee	General Mitchell International

2.5 Class D Airspace

2.5.1 Definition. Generally, that airspace from the surface to 2,500 feet above the airport elevation (charted in MSL) surrounding those airports that have an operational control tower. The configuration of each Class D airspace area is individually tailored and when instrument procedures are published, the airspace will normally be designed to contain the procedures.

2.5.2 Operating Rules and Pilot Equipment Requirements

2.5.2.1 Pilot Certification. No specific certification required.

2.5.2.2 Equipment. Unless otherwise authorized by ATC, an operable two-way radio is required.

2.5.2.3 Arrival or Through Flight Entry Requirements. Two-way radio communication must be established with the ATC facility providing ATC services prior to entry and thereafter maintain those communications while in the Class D airspace. Pilots of arriving aircraft should contact the control tower on the publicized frequency and give their position, altitude, destination, and any request(s). Radio contact should be initiated far enough from the Class D airspace boundary to preclude entering the Class D airspace before two-way radio communications are established.

NOTE–

1. *If the controller responds to a radio call with, “(aircraft callsign) standby,” radio communications have been established, and the pilot can enter the Class D airspace.*

2. *If workload or traffic conditions prevent immediate entry into Class D airspace, the controller will inform the pilot to remain outside the Class D airspace until conditions permit entry.*

EXAMPLE–

1. *“[Aircraft callsign] remain outside the Class Delta airspace and standby.”*

It is important to understand that if the controller responds to the initial radio call without using the aircraft callsign, radio communications have not been established, and the pilot may not enter the Class D airspace.

2. *“Aircraft calling Manassas tower standby.”*

At those airports where the control tower does not operate 24 hours a day, the operating hours of the tower will be listed on the appropriate charts and in the A/FD. During

the hours the tower is not in operation, the Class E surface area rules or a combination of Class E rules to 700 feet above ground level and Class G rules to the surface will become applicable. Check the A/FD for specifics.

2.5.2.4 Departures From:

a) A primary or satellite airport with an operating control tower. Two-way radio communications must be established and maintained with the control tower, and thereafter as instructed by ATC while operating in the Class D airspace.

b) A satellite airport without an operating control tower. Two-way radio communications must be established with the ATC facility having jurisdiction over the Class D airspace as soon as practicable after departing.

2.5.2.5 Aircraft Speed. Unless otherwise authorized or required by ATC, no person may operate an aircraft at or below 2,500 feet above the surface within 4 nautical miles of the primary airport of a Class D airspace area at an indicated airspeed of more than 200 knots (230 mph).

2.5.3 Class D airspace areas are depicted on Sectional and Terminal charts with blue segmented lines, and on IFR En Route Low Altitude charts with a boxed [D].

2.5.4 Arrival extensions for instrument approach procedures may be Class D or Class E airspace. As a general rule, if all extensions are 2 miles or less, they remain part of the Class D surface area. However, if any one extension is greater than 2 miles, then all extensions become Class E.

2.5.5 Separation for VFR Aircraft. No separation services are provided to VFR aircraft.

2.6 Class E Airspace

2.6.1 Definition. Generally, if the airspace is not Class A, Class B, Class C, or Class D, and it is controlled airspace, it is Class E airspace.

2.6.2 Operating Rules and Pilot/Equipment Requirements.

2.6.2.1 Pilot Certification. No specific certification required.

2.6.2.2 Equipment. No specific equipment required by the airspace.

2.6.2.3 Arrival or Through Flight Entry Requirements. No specific requirements.

2.6.3 Charts. Class E airspace below 14,500 feet MSL is charted on Sectional, Terminal, and IFR Enroute Low Altitude charts.

2.6.4 Vertical limits. Except for 18,000 feet MSL, Class E airspace has no defined vertical limit but rather it extends upward from either the surface or a designated altitude to the overlying or adjacent controlled airspace.

2.6.5 Types of Class E Airspace

2.6.5.1 Surface Area Designated for an Airport. When designated as a surface area for an airport, the airspace will be configured to contain all instrument procedures.

2.6.5.2 Extension to a Surface Area. There are Class E airspace areas that serve as extensions to Class B, Class C, and Class D surface areas designated for an airport. Such airspace provides controlled airspace to contain standard instrument approach procedures without imposing a communications requirement on pilots operating under VFR.

2.6.5.3 Airspace Used For Transition. There are Class E airspace areas beginning at either 700 or 1,200 feet AGL used to transition to/from the terminal or en route environment.

2.6.5.4 En Route Domestic Areas. There are Class E airspace areas that extend upward from a specified altitude and are en route domestic airspace areas that provide controlled airspace in those areas where there is a requirement to provide IFR en route ATC services, but the Federal airway system is inadequate.

2.6.5.5 Federal Airways. The Federal airways are Class E airspace areas and, unless otherwise specified, extend upward from 1,200 feet to, but not including, 18,000 feet MSL. The colored airways are Green, Red, Amber, and Blue. The VOR airways are classified as Domestic, Alaskan, and Hawaiian.

2.6.5.6 Offshore Airspace Areas. There are Class E airspace areas that extend upward from a specified altitude to, but not including, 18,000 feet MSL and are designated as offshore airspace areas. These areas provide controlled airspace beyond 12 nautical miles from the coast of the U.S. in those areas where there is a requirement to provide IFR en route ATC services and within which the U.S. is applying domestic procedures.

2.6.5.7 Unless designated at a lower altitude, Class E airspace begins at 14,500 feet MSL to, but not including 18,000 feet MSL overlying the 48 contiguous States including the waters within 12 nautical miles of the coast of the 48 contiguous States, the District of Columbia, Alaska, including waters within 12 nautical miles of the coast of Alaska, and that airspace above FL 600; excluding the Alaska peninsula west of longitude 160°00'00"W; and the airspace less than 1,500 feet above the surface of the earth unless specifically so designated.

2.6.6 Separation for VFR Aircraft. No separation services are provided to VFR aircraft.

3. Class G Airspace

3.1 General

Class G airspace (uncontrolled) is that portion of airspace that has not been designated as Class A, Class B, Class C, Class D, or Class E airspace.

3.2 VFR Requirements

Rules governing VFR flight have been adopted to assist the pilot in meeting his/her responsibility to see and avoid other aircraft. Minimum flight visibility and distance from clouds required for VFR flight are contained in 14 CFR Section 91.155. (See TBL ENR 1.4–1 for a tabular presentation of these rules).

3.3 IFR Requirements

3.3.1 Title 14 CFR specifies the pilot and aircraft equipment requirements for IFR flight. Pilots are reminded that in addition to altitude or flight level requirements, 14 CFR Section 91.177 includes a requirement to remain at least 1,000 feet (2,000 feet in designated mountainous terrain) above the highest obstacle within a horizontal distance of 4 nautical miles from the course to be flown.

3.3.2 IFR Altitudes. (See TBL ENR 1.4–5.)

4. Other Airspace Areas

4.1 Airport Advisory/Information Services

4.1.1 There are three advisory type services available at selected airports. Airports offering these services are listed in the A/FD and the published service hours may be changed by NOTAM D.

4.1.1.1 Local Airport Advisory (LAA) service is operated within 10 statute miles of an airport where a control tower is not operating but where a FSS is located on the airport. At such locations, the FSS provides a complete local airport advisory service to arriving and departing aircraft. During periods of fast changing weather the FSS will automatically provide Final Guard as part of the service from the time the aircraft reports “on-final” or “taking-the-active-runway” until the aircraft reports “on-the-ground” or “airborne.”

NOTE–

Current FAA policy, when requesting remote ATC services, requires that a pilot monitor the automated weather

broadcast at the landing airport prior to requesting ATC services. The FSS automatically provides Final Guard, when appropriate, during LAA/Remote Airport Advisory (RAA) operations. Final Guard is a value added wind/altimeter monitoring service, which provides an automatic wind and altimeter check during active weather situations when the pilot reports on-final or taking the active runway. During the landing or take-off operation when the winds or altimeter are actively changing the FSS will broadcast significant changes when the specialist believes the change might affect the operation. Pilots should acknowledge the first wind/altimeter check but due to cockpit activity no acknowledgement is expected for the blind broadcasts. It is prudent for a pilot to report on-the-ground or airborne to end the service.

**TBL ENR 1.4–5
IFR Altitudes
Class G Airspace**

If your magnetic course (ground track) is:	And you are below 18,000 feet MSL, fly:
0° to 179°	Odd thousands MSL, (3,000; 5,000; 7,000, etc.)
180° to 359°	Even thousands MSL, (2,000; 4,000; 6,000, etc.)

4.1.1.2 RAA service is operated within 10 statute miles of specified high activity GA airports where a control tower is not operating. Final Guard is automatically provided with RAA.

4.1.1.3 Remote Airport Information Service (RAIS) is provided in support of short term special events like small to medium fly-ins. The service is advertised by NOTAM D only. The FSS will not have access to a continuous readout of the current winds and altimeter; therefore, RAIS does not include weather and/or Final Guard service. However, known traffic, special event instructions, and all other services are provided.

NOTE–

The airport authority and/or manager should request RAIS support on official letterhead directly with the manager of the FSS that will provide the service at least 60 days in advance. Approval authority rests with the FSS manager and is based on workload and resource availability.

REFERENCE–

See GEN 3.3, Air Traffic Services, paragraph 9.2, Traffic Advisory Practices at Airports Without Operating Control Towers.

4.1.1.4 It is not mandatory that pilots participate in the Airport Advisory programs. Participation enhances safety for everyone operating around busy GA

airports; therefore, everyone is encouraged to participate and provide feedback that will help improve the program.

4.2 Published VFR Routes. Published VFR routes for transitioning around, under, and through complex airspace such as Class B airspace were developed through a number of FAA and industry initiatives. All of the following terms; i.e., “VFR Flyway,” “VFR Corridor,” “Class B Airspace VFR Transition Route,” and “Terminal Area VFR Route” have been used when referring to the same or different types of routes or airspace. The following paragraphs identify and clarify the functionality of each type of route, and specify where and when an ATC clearance is required.

4.2.1 VFR Flyways

4.2.1.1 VFR Flyways and their associated Flyway Planning charts were developed from the recommendations of a National Airspace Review Task Group. A VFR Flyway is defined as a general flight path not defined as a specific course, for use by pilots in planning flights into, out of, through, or near complex terminal airspace to avoid Class B airspace. An ATC clearance is NOT required to fly these routes.

4.2.1.2 VFR Flyways are depicted on the reverse side of some of the VFR Terminal Area Charts (TACs), commonly referred to as Class B airspace charts. Eventually all TACs will include a VFR Flyway Planning Chart. These charts identify VFR flyways designed to help VFR pilots avoid major controlled traffic flows. They may further depict multiple VFR routings throughout the area which may be used as an alternative to flight within Class B airspace. The ground references provide a guide for improved visual navigation. These routes are not intended to discourage requests for VFR operations within Class B airspace but are designed solely to assist pilots in planning for flights under and around busy Class B airspace without actually entering Class B airspace.

4.2.1.3 It is very important to remember that these suggested routes are not sterile of other traffic. The entire Class B airspace, and the airspace underneath it, may be heavily congested with many different types of aircraft. Pilot adherence to VFR rules must be exercised at all times. Further, when operating beneath Class B airspace, communications must be established and maintained between your aircraft and any control tower while transiting the Class B, Class C, and Class D surface areas of those airports under Class B Airspace.

4.2.2 VFR Corridors

4.2.2.1 The design of a few of the first Class B airspace areas provided a corridor for the passage of uncontrolled traffic. A VFR corridor is defined as airspace through Class B airspace, with defined vertical and lateral boundaries, in which aircraft may operate without an ATC clearance or communication with air traffic control.

4.2.2.2 These corridors are, in effect, a “hole” through Class B airspace. (See FIG ENR 1.4-1.) A classic example would be the corridor through the Los Angeles Class B airspace, which has been subsequently changed to Special Flight Rules airspace (SFR). A corridor is surrounded on all sides by Class B airspace and does not extend down to the surface like a VFR Flyway. Because of their finite lateral and vertical limits, and the volume of VFR traffic using a corridor, extreme caution and vigilance must be exercised.

**FIG ENR 1.4-1
Class B Airspace**

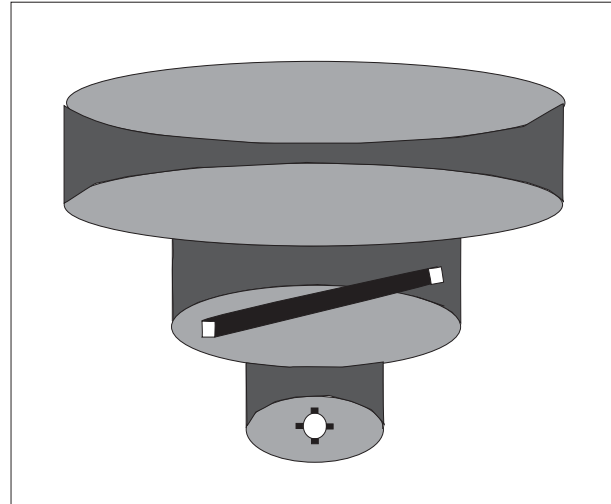

4.2.2.3 Because of the heavy traffic volume and the procedures necessary to efficiently manage the flow of traffic, it has not been possible to incorporate VFR corridors in the development or modifications of Class B airspace in recent years.

4.2.3 Class B Airspace VFR Transition Routes

4.2.3.1 To accommodate VFR traffic through certain Class B airspace, such as Seattle, Phoenix, and Los Angeles, Class B Airspace VFR Transition Routes were developed. A Class B Airspace VFR Transition Route is defined as a specific flight course depicted on a Terminal Area Chart (TAC) for transiting a specific Class B airspace. These routes include specific ATC assigned altitudes, and pilots must obtain an ATC clearance prior to entering Class B airspace on the route.

4.2.3.2 These routes, as depicted in FIG ENR 1.4-2, are designed to show the pilot where to position his/her aircraft outside of, or clear of, the Class B airspace where an ATC clearance can normally be expected with minimal or no delay. Until ATC authorization is received, pilots must remain clear of Class B airspace. On initial contact, pilots should advise ATC of their position, altitude, route name desired, and direction of flight. After a clearance is received, the pilot must fly the route as depicted and, most importantly, adhere to ATC instructions.

4.3 Terminal Radar Service Area (TRSA)

4.3.1 Background. The terminal radar service areas (TRSAs) were originally established as part of the Terminal Radar Program at selected airports. TRSAs were never controlled airspace from a regulatory standpoint because the establishment of TRSAs were never subject to the rulemaking process; consequently, TRSAs are not contained in 14 CFR Part 71 nor are there any TRSA operating rules in Part 91. Part of the Airport Radar Service Area (ARSA) program was to eventually replace all TRSAs. However, the ARSA requirements became relatively stringent, and it was subsequently decided that TRSAs would have to meet ARSA criteria before they would be converted. TRSAs do not fit into any of the U.S. Airspace Classes; therefore, they will continue to be non-Part 71 airspace areas where participating pilots can receive additional radar

services which have been redefined as TRSA Service.

4.3.2 TRSA Areas. The primary airport(s) within the TRSA become(s) Class D airspace. The remaining portion of the TRSA overlies other controlled airspace which is normally Class E airspace beginning at 700 or 1,200 feet and established to transition to/from the en route/terminal environment.

4.3.3 Participation. Pilots operating under VFR are encouraged to contact the radar approach control and avail themselves of the TRSA Services. However, participation is voluntary on the part of the pilot. See ENR 1.1, paragraph 39.2, for details and procedures.

4.3.4 Charts. TRSAs are depicted on VFR sectional and terminal area charts with a solid black line and altitudes for each segment. The Class D portion is charted with a blue segmented line.

FIG ENR 1.4-2
VFR Transition Route

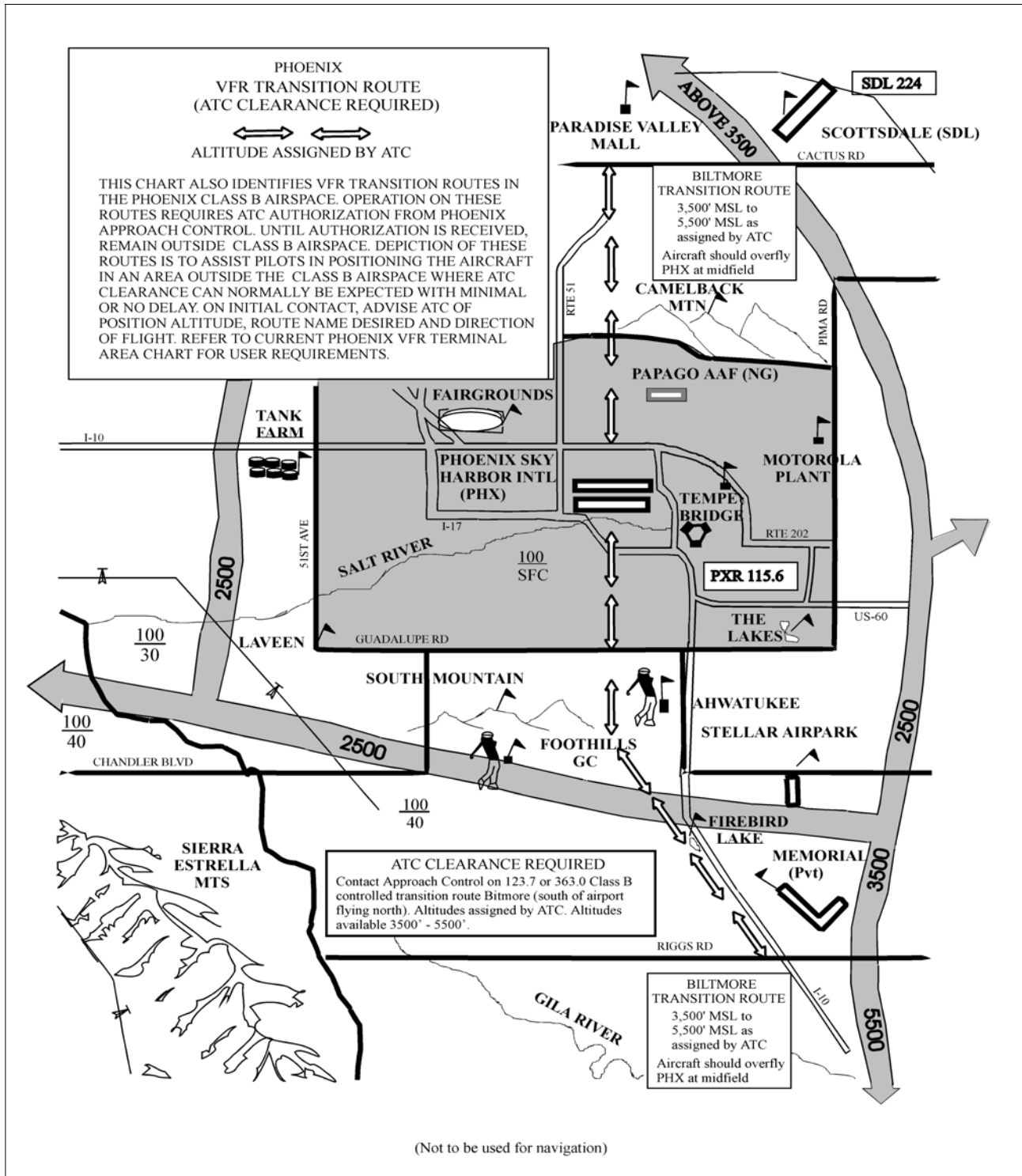

ENR 1.5 Holding, Approach, and Departure Procedures

1. Holding Procedures

1.1 Patterns at the most generally used holding fixes are depicted (charted) on U.S. Government or commercially produced (meeting FAA requirements) Low or High Altitude En route, Area, and STAR charts. Pilots are expected to hold in the pattern depicted unless specifically advised otherwise by ATC. (See ENR 1.1, paragraph 27., ATC Clearances and Aircraft Separations.)

NOTE-

Holding patterns that protect for a maximum holding airspeed other than the standard may be depicted by an icon, unless otherwise depicted. The icon is a standard holding pattern symbol (racetrack) with the airspeed restriction shown in the center. In other cases, the airspeed restriction will be depicted next to the standard holding pattern symbol.

1.2 An ATC clearance requiring an aircraft to hold at a fix where the pattern is not charted will include the following information:

1.2.1 Direction of holding from the fix in terms of the eight cardinal compass points; i.e., N, NE, E, SE, etc.

1.2.2 Holding fix. (The fix may be omitted if it is included at the beginning of the transmission as the clearance limit.)

1.2.3 Radial, course, bearing, airway, or route on which the aircraft is to hold.

1.2.4 Leg length in miles if DME or RNAV is to be used. (Leg length will be specified in minutes on pilot request or if the controller considers it necessary.)

1.2.5 Direction of turn if left turns are to be made, the pilot requests, or the controller considers it necessary.

1.2.6 Time to expect further clearance, and any pertinent additional delay information.

1.3 Typical Holding Pattern Example

1.3.1 When holding at a VOR station, pilots should begin the turn to the outbound leg at the time of the first complete reversal of the “to-from” indicator. See

GEN 3.4, paragraph 12, Two-Way Radio Communications Failure, for holding at the approach fix when radio failure occurs.

1.3.2 Holding Pattern Airspace Protection

Holding pattern airspace protection is based on the following procedures.

NOTE-

Holding pattern airspace protection design criteria is contained in FAA Handbook 7130.3, Holding Pattern Criteria.

1.3.2.1 Airspeeds

a) All aircraft may hold at the following altitudes and maximum holding airspeeds:

TBL ENR 1.5-1

Altitude (MSL)	Airspeed (KIAS)
MHA – 6,000'	200
6,001' – 14,000'	230
14,001' and above	265

b) The following are exceptions to the maximum holding airspeeds:

1) Holding patterns from 6,001' to 14,000' may be restricted to a maximum airspeed of 210 KIAS. This nonstandard pattern will be depicted by an icon.

2) Holding patterns may be restricted to a maximum speed. The speed restriction is depicted in parenthesis inside the holding pattern on the chart: e.g., (175). The aircraft should be at or below the maximum speed prior to initially crossing the holding fix to avoid exiting the protected airspace. Pilots unable to comply with the maximum airspeed restriction should notify ATC.

3) Holding patterns at USAF airfields only – 310 KIAS maximum, unless otherwise depicted.

4) Holding patterns at Navy fields only – 230 KIAS maximum, unless otherwise depicted.

FIG ENR 1.5-1
Holding Patterns

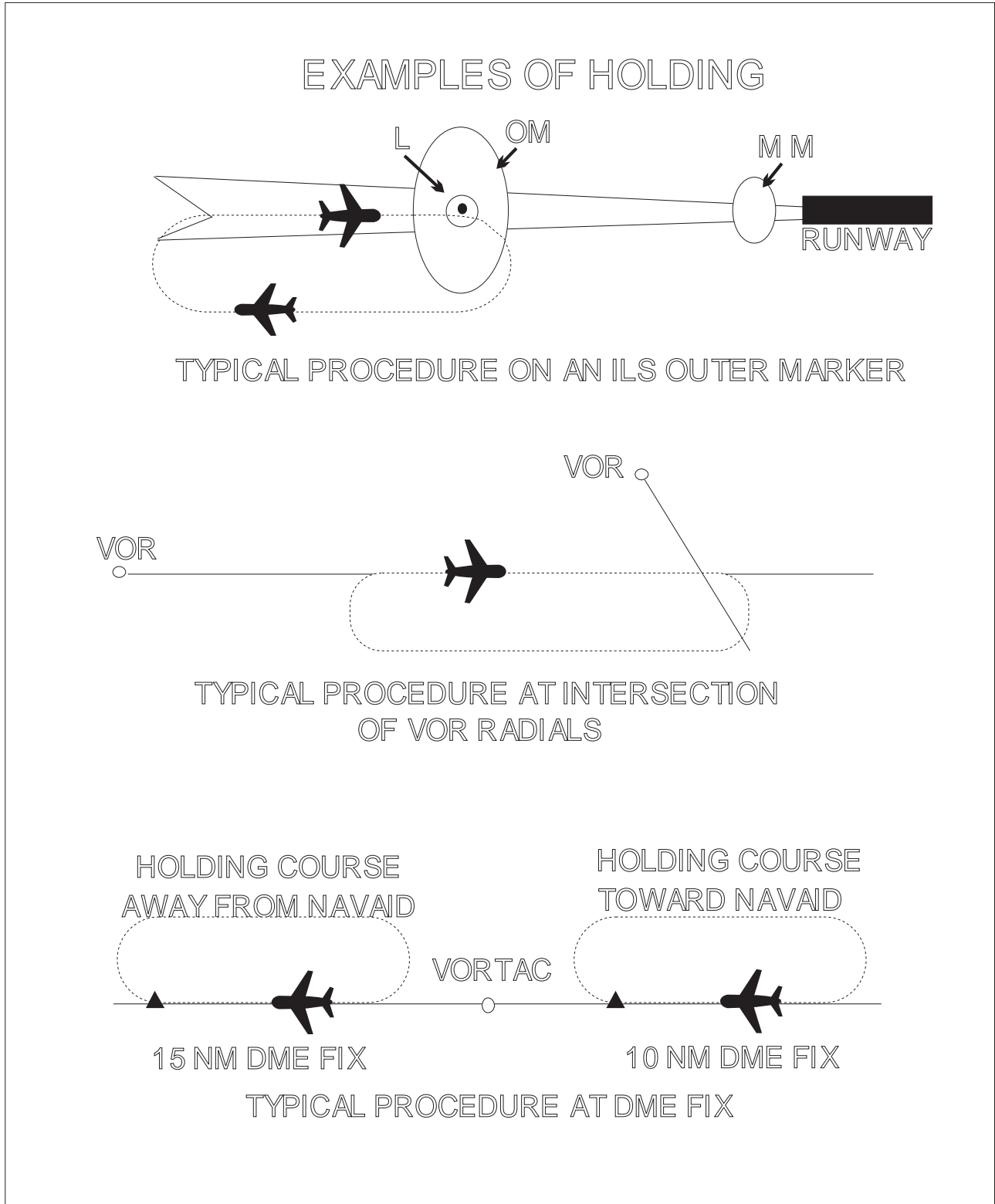

FIG ENR 1.5-2
Holding Pattern Descriptive Terms

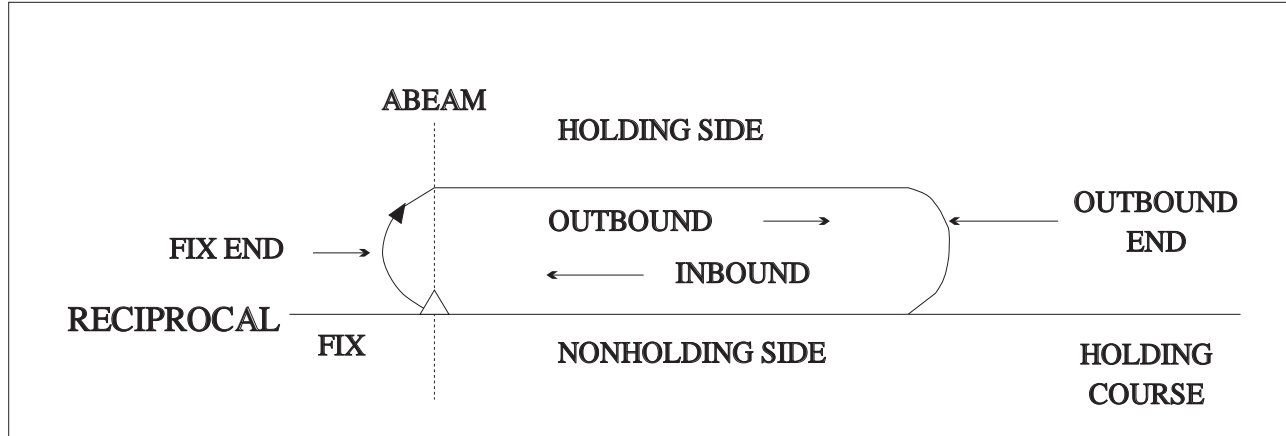
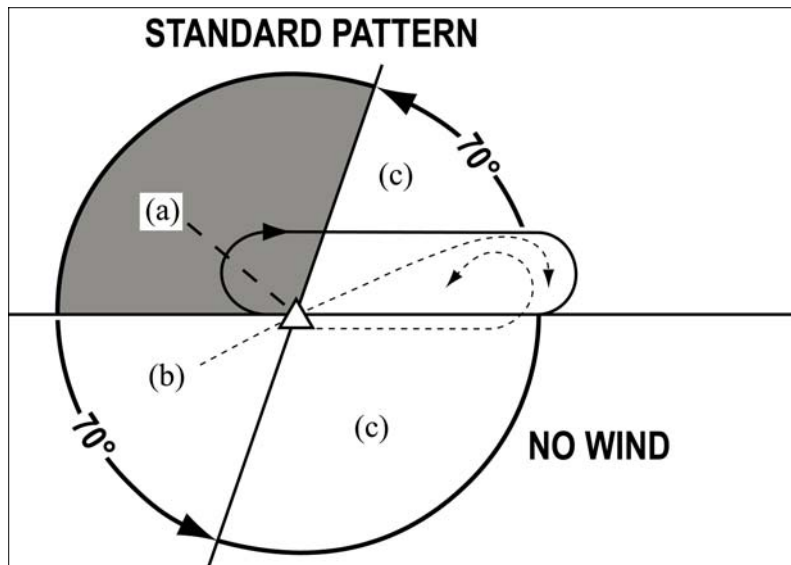

FIG ENR 1.5-3
Holding Pattern Entry Procedures



5) When a climb-in hold is specified by a **published procedure** (e.g., “Climb-in holding pattern to depart XYZ VORTAC at or above 10,000.” or “All aircraft climb-in TRUCK holding pattern to cross TRUCK Int at or above 11,500 before proceeding on course.”), additional obstacle protection area has been provided to allow for greater airspeeds in the climb for those aircraft requiring them. The holding pattern template for a maximum airspeed of 310 KIAS has been used for the holding pattern if there are no airspeed restrictions on the holding pattern as specified in subparagraph

b) 2) of this paragraph. Where the holding pattern is restricted to a maximum airspeed of 175 KIAS, the 200 KIAS holding pattern template has been applied for published climb-in hold procedures for altitudes 6,000 feet and below and the 230 KIAS holding pattern template has been applied for altitudes above 6,000 feet. The airspeed limitations in 14 CFR Section 91.117, Aircraft Speed, still apply.

c) The following phraseology may be used by an ATC specialist to advise a pilot of the maximum holding airspeed for a holding pattern airspace area.

PHRASEOLOGY-

(AIRCRAFT IDENTIFICATION) (holding instructions, when needed) **MAXIMUM HOLDING AIRSPEED IS** (speed in knots).

1.3.2.2 Entry Procedures (See FIG ENR 1.5-3.)

a) Parallel Procedure. When approaching the holding fix from anywhere in sector (a), the parallel entry procedure would be to turn to a heading to parallel the holding course outbound on the nonholding side for one minute, turn in the direction of the holding pattern through more than 180 degrees, and return to the holding fix or intercept the holding course inbound.

b) Teardrop Procedure. When approaching the holding fix from anywhere in sector (b), the teardrop entry procedure would be to fly to the fix, turn outbound to a heading for a 30 degree teardrop entry within the pattern (on the holding side) for a period of one minute, then turn in the direction of the holding pattern to intercept the inbound holding course.

c) Direct Entry Procedure. When approaching the holding fix from anywhere in sector (c), the direct entry procedure would be to fly directly to the fix and turn to follow the holding pattern.

d) While other entry procedures may enable the aircraft to enter the holding pattern and remain within protected airspace, the parallel, teardrop, and direct entries are the procedures for entry and holding recommended by the FAA.

1.3.2.3 Timing

a) Inbound Leg

1) At or below 14,000 feet MSL: 1 minute.

2) Above 14,000 feet MSL: 1¹/₂ minutes.

NOTE-

The initial outbound leg should be flown for 1 minute or 1¹/₂ minutes (appropriate to altitude). Timing for subsequent outbound legs should be adjusted, as necessary, to achieve proper inbound leg time. Pilots may use any navigational means available; i.e. DME, RNAV, etc., to insure the appropriate inbound leg times.

b) Outbound Leg timing begins *over/abeam* the fix, whichever occurs later. If the abeam position cannot be determined, start timing when turn to outbound is completed.

1.3.2.4 Distance Measuring Equipment (DME)/GPS Along-Track Distance (ATD).

DME/GPS holding is subject to the same entry and holding procedures except that distances (nautical miles) are used in lieu of time values. The outbound course of the DME/GPS holding pattern is called the outbound leg of the pattern. The controller or the instrument approach procedure chart will specify the length of the outbound leg. The end of the outbound leg is determined by the DME or ATD readout. The holding fix on conventional procedures, or controller defined holding based on a conventional navigation aid with DME, is a specified course or radial and distances are from the DME station for both the inbound and outbound ends of the holding pattern. When flying published GPS overlay or stand alone procedures with distance specified, the holding fix will be a waypoint in the database and the end of the outbound leg will be determined by the ATD. Some GPS overlay and early stand alone procedures may have timing specified. (See FIG ENR 1.5-4, FIG ENR 1.5-5 and FIG ENR 1.5-6.) See , paragraph 18., Global Positioning System (GPS), for requirements and restriction on using GPS for IFR operations.

1.3.2.5 Pilot Action

a) Start speed reduction when 3 minutes or less from the holding fix. Cross the holding fix, initially, at or below the maximum holding airspeed.

b) Make all turns during entry and while holding at:

- 1) 3 degrees per second.
- 2) 30 degree bank angle.
- 3) 25 degree bank angle provided a flight director system is used.

NOTE-
Use whichever requires the least bank angle.

**FIG ENR 1.5-4
Inbound Toward NAVAID**

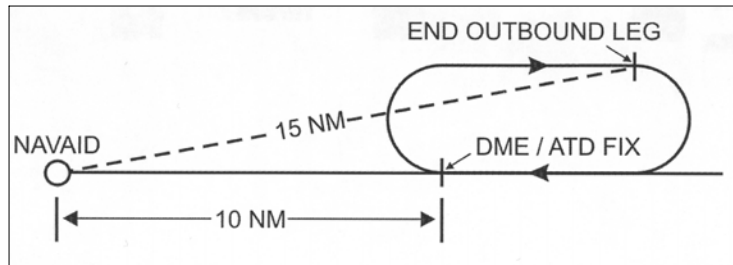

NOTE-
When the inbound course is toward the NAVAID, the fix distance is 10 NM, and the leg length is 5 NM, then the end of the outbound leg will be reached when the DME/ATD reads 15 NM.

**FIG ENR 1.5-5
Inbound Leg Away from NAVAID**

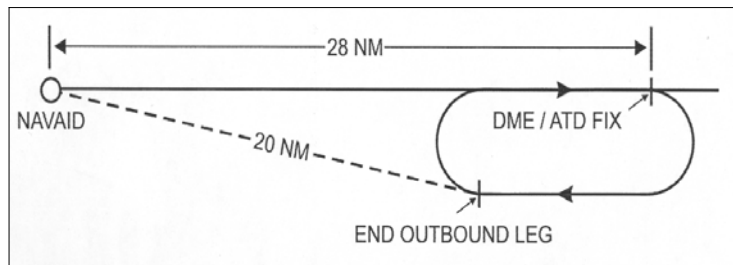

NOTE-
When the inbound course is away from the NAVAID and the fix distance is 28 NM, and the leg length is 8 NM, then the end of the outbound leg will be reached when the DME/ATD reads 20 NM.

**FIG ENR 1.5-6
GPS/RNAV Holding**

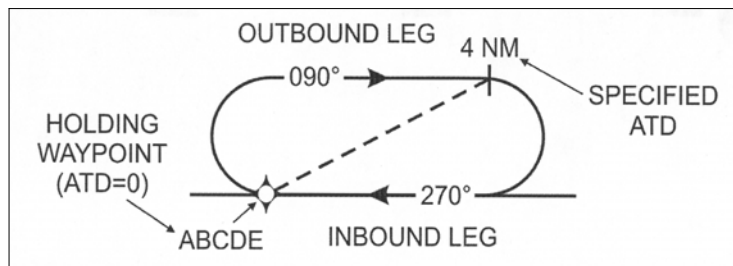

NOTE-
The inbound course is always toward the waypoint and the ATD is zero at the waypoint. The end of the outbound leg of the holding pattern is reached when the ATD reads the specified distance.

c) Compensate for wind effect primarily by drift correction on the inbound and outbound legs. When outbound, triple the inbound drift correction to avoid major turning adjustments; e.g., if correcting left by 8 degrees when inbound, correct right by 24 degrees when outbound.

d) Determine entry turn from aircraft heading upon arrival at the holding fix. Plus or minus 5° in heading is considered to be within allowable good operating limits for determining entry.

e) Advise ATC immediately what increased airspeed is necessary, if any, due to turbulence, icing, etc., or if unable to accomplish any part of the holding procedures. After such higher speeds are no longer necessary, operate according to the appropriate published holding speed and notify ATC.

NOTE-

Airspace protection for holding in turbulent air is based on a maximum of 280 KIAS or Mach 0.8, whichever is lower. Considerable impact on traffic flow will result when turbulent air holding patterns are used; thus, pilot discretion will ensure their use is limited to bona fide conditions/requirements.

1.3.2.6 Nonstandard Holding Pattern

a) Fix end and outbound end turns are made to the left. Entry procedures to a nonstandard pattern are oriented in relation to the 70 degree line on the holding side just as in the standard pattern.

b) When holding at a fix and instructions are received specifying the time of departure from the fix, the pilot should adjust the aircraft's flight path within the limits of the established holding pattern in order to leave the fix at the exact time specified. After departing the holding fix, normal speed is to be resumed with respect to other governing speed requirements such as terminal area speed limits, specific ATC requests, etc. Where the fix is associated with an instrument approach, and timed approaches are in effect, a procedure turn shall not be executed unless the pilot advises ATC, since aircraft holding are expected to proceed inbound on final approach directly from the holding pattern when approach clearance is received.

c) If an aircraft is established in a published holding pattern at an assigned altitude above the published minimum holding altitude and subsequently cleared for the approach, the pilot may descend to

the published minimum holding altitude. The holding pattern would only be a segment of the instrument approach procedure if it is published on the instrument procedure chart and is used in lieu of a procedure turn.

d) For those holding patterns where there are no published minimum holding altitudes, the pilot, upon receiving an approach clearance, must maintain the last assigned altitude until leaving the holding pattern and established on the inbound course. Thereafter, the published minimum altitude of the route segment being flown will apply. It is expected that the pilot will be assigned a holding altitude that will permit a normal descent on the inbound course.

1.4 Radar Surveillance of Outer-Fix Holding Pattern Airspace Areas

1.4.1 Whenever aircraft are holding at an outer fix, ATC will usually provide radar surveillance of the outer fix holding pattern airspace area, or any portion of it, if it is shown on the controller's radar scope.

1.4.2 The controller will attempt to detect any holding aircraft that stray outside the holding pattern airspace area and will assist any detected aircraft to return to the assigned airspace area.

1.4.3 Many factors could prevent ATC from providing this additional service, such as workload, number of targets, precipitation, ground clutter, and radar system capability. These circumstances may make it unfeasible to maintain radar identification of aircraft or to detect aircraft straying from the holding pattern. The provision of this service depends entirely upon whether the controller is in a position to provide it and does not relieve a pilot of the responsibility to adhere to an accepted ATC clearance.

2. Approach Procedures

2.1 Approach Control

2.1.1 Approach control is responsible for controlling all instrument flight operating within its area of responsibility. Approach control may serve one or more airfields, and control is exercised primarily by direct pilot/controller communications. Prior to arriving at the destination radio facility, instructions will be received from ARTCC to contact approach control on a specified frequency.

2.2 Radar Approach Control

2.2.1 Where radar is approved for approach control service, it is used not only for radar approaches (Airport Surveillance Radar (ASR) and Precision Approach Radar (PAR)) but is also used to provide vectors in conjunction with published nonradar approaches based on radio NAVAIDs (ILS, MLS, VOR, NDB, TACAN). Radar vectors can provide course guidance and expedite traffic to the final approach course of any established instrument approach procedure or to the traffic pattern for a visual approach. Approach control facilities that provide this radar service will operate in the following manner:

2.2.1.1 Arriving aircraft are either cleared to an outer fix most appropriate to the route being flown with vertical separation and, if required, given holding information or, when radar handoffs are effected between the ARTCC and approach control, or between two approach control facilities, aircraft are cleared to the airport or to a fix so located that the handoff will be completed prior to the time the aircraft reaches the fix. When radar handoffs are utilized, successive arriving flights may be handed off to approach control with radar separation in lieu of vertical separation.

2.2.1.2 After release to approach control, aircraft are vectored to the appropriate final approach course (ILS, MLS, VOR, ADF, etc.). Radar vectors and altitude or flight levels will be issued as required for spacing and separating aircraft. *Therefore, pilots must not deviate from the headings issued by approach control.* Aircraft will normally be informed when it is necessary to vector across the final approach course for spacing or other reasons. If approach course crossing is imminent and the pilot has not been informed that the aircraft will be vectored across the final approach course, the pilot should query the controller.

2.2.1.3 The pilot is not expected to turn inbound on the final approach course unless an approach clearance has been issued. This clearance will normally be issued with the final vector for interception of the final approach course, and the vector will be such as to enable the pilot to establish the aircraft on the final approach course prior to reaching the final approach fix.

2.2.1.4 In the case of aircraft already inbound on the final approach course, approach clearance will be issued prior to the aircraft reaching the final approach fix. When established inbound on the final approach course, radar separation will be maintained, and the pilot will be expected to complete the approach utilizing the approach aid designated in the clearance (ILS, MLS, VOR, radio beacons, etc.) as the primary means of navigation. Therefore, once established on the final approach course, pilots must not deviate from it unless a clearance to do so is received from ATC.

2.2.1.5 After passing the final approach fix on final approach, aircraft are expected to continue inbound on the final approach course and complete the approach or effect the missed approach procedure published for that airport.

2.2.2 ARTCCs are approved for and may provide approach control services to specific airports. The radar systems used by these centers do not provide the same precision as an ASR/PAR used by approach control facilities and towers, and the update rate is not as fast. Therefore, pilots may be requested to report established on the final approach course.

2.2.3 Whether aircraft are vectored to the appropriate final approach course or provide their own navigation on published routes to it, radar service is automatically terminated when the landing is completed or when instructed to change to advisory frequency at uncontrolled airports, whichever occurs first.

3. Standard Terminal Arrival (STAR), Area Navigation (RNAV) STAR, and Flight Management System Procedures (FMSP) for Arrivals

3.1 A STAR is an ATC coded IFR arrival route established for application to arriving IFR aircraft destined for certain airports. RNAV STAR/FMSP procedures for arrivals serve the same purpose but are only used by aircraft equipped with FMS or GPS. The purpose of both is to simplify clearance delivery procedures and facilitate transition between en route and instrument approach procedures.

3.1.1 STAR/RNAV STAR/FMSP procedures may have mandatory speeds and/or crossing altitudes published. Other STARs may have planning information depicted to inform pilots what clearances or restrictions to “**expect.**” “**Expect**” altitudes/speeds

are not considered STAR/RNAV STAR/FMSP procedures crossing restrictions unless verbally issued by ATC.

NOTE–

The “**expect**” altitudes/speeds are published so that pilots may have the information for planning purposes. These altitudes/speeds shall not be used in the event of lost communications unless ATC has specifically advised the pilot to expect these altitudes/speeds as part of a further clearance.

REFERENCE–

14 CFR Section 91.185c(2)(iii).

3.1.2 Pilots navigating on STAR/RNAV STAR/FMSP procedures shall maintain last assigned altitude until receiving authorization to descend so as to comply with all published/issued restrictions. This authorization will contain the phraseology “DESCEND VIA.”

3.1.2.1 Clearance to “descend via” authorizes pilots to:

a) Vertically and laterally navigate on a STAR/RNAV STAR/FMSP.

b) When cleared to a waypoint depicted on a STAR/RNAV STAR/FMSP, to descend from a previously assigned altitude at pilot’s discretion to the altitude depicted for that waypoint, and once established on the depicted arrival, to navigate laterally and vertically to meet all published restrictions.

NOTE–

1. Air traffic is responsible for obstacle clearance when issuing a “descend via” instruction to the pilot. The descend via is used in conjunction with STARs/RNAV STARs/FMSPs to reduce phraseology by not requiring the controller to restate the altitude at the next waypoint/fix to which the pilot has been cleared.

2. Air traffic will assign an altitude to cross the waypoint/fix, if no altitude is depicted at the waypoint/fix, for aircraft on a direct routing to a STAR/RNAV STAR/FMSP.

3. Minimum en route altitudes (MEA) are not considered restrictions; however, pilots are expected to remain above MEAs.

EXAMPLE–

1. **Lateral/routing clearance only.**

“Cleared Hadly One arrival.”

2. **Routing with assigned altitude:**

“Cleared Hadly One arrival, descend and maintain Flight Level two four zero.”

“Cleared Hadly One arrival, descend at pilot’s discretion, maintain Flight Level two four zero.”

3. Lateral/routing and vertical navigation clearance.

“Descend via the Civit One arrival.”

“Descend via the Civit One arrival, except, cross Arnes at or above one one thousand.”

4. Lateral/routing and vertical navigation clearance when assigning altitude not published on procedure.

“Descend via the Haris One arrival, except after Bruno, maintain one zero thousand.”

“Descend via the Haris One arrival, except cross Bruno at one three thousand then maintain one zero thousand.”

5. Direct routing to intercept a STAR/RNAV STAR/FMSP and vertical navigation clearance.

“Proceed direct Mahem, descend via Mahem One arrival.”

“Proceed direct Luxor, cross Luxor at or above flight level two zero zero, then descend via the Ksino One Arrival.”

NOTE–

1. In Example 2, pilots are expected to descend to FL 240 as directed, and maintain FL 240 until cleared for further vertical navigation with a newly assigned altitude or a “descend via” clearance.

2. In Example 4, the aircraft should track laterally and vertically on the Haris One arrival and should descend so as to comply with all speed and altitude restrictions until reaching Bruno and then maintain 10,000. Upon reaching 10,000, aircraft should maintain 10,000 until cleared by ATC to continue to descend.

3.1.2.2 Pilots cleared for vertical navigation using the phraseology “DESCEND VIA” shall inform ATC upon initial contact with a new frequency.

EXAMPLE–

“Delta One Twenty One leaving FL 240, descending via the Civit One arrival.”

3.1.2.3 Pilots of IFR aircraft destined to locations for which STARs have been published may be issued a clearance containing a STAR whenever ATC deems it appropriate.

3.2 Use of STARs requires pilot possession of at least the approved chart. RNAV STARs must be retrievable by the procedure name from the aircraft database and conform to charted procedure. As with any ATC clearance or portion thereof, it is the responsibility of each pilot to accept or refuse an issued STAR. Pilots should notify ATC if they do not wish to use a STAR by placing “NO STAR” in the remarks section of the flight plan or by the less desirable method of verbally stating the same to ATC.

3.3 STAR charts are published in the Terminal Procedures Publication (TPP) and are available on subscription from the National Aeronautical Charting Office.

3.4 RNAV STAR.

3.4.1 All public RNAV STARs are RNAV1. These procedures require system performance currently met by GPS or DME/DME/IRU RNAV systems that satisfy the criteria discussed in AC 90-100A, U.S. Terminal and En Route Area Navigation (RNAV) Operations. RNAV1 procedures require the aircraft's total system error remain bounded by ± 1 NM for 95% of the total flight time.

3.4.2 For procedures requiring GPS, if the navigation system does not automatically alert the flight crew of a loss of GPS, the operator must develop procedures to verify correct GPS operation.

4. Local Flow Traffic Management Program

4.1 This program is a continuing effort by the FAA to enhance safety, minimize the impact of aircraft noise, and conserve aviation fuel. The enhancement of safety and reduction of noise are achieved in this program by minimizing low altitude maneuvering of arriving turbojet and turboprop aircraft weighing more than 12,500 pounds and, by permitting departure aircraft to climb to high altitudes sooner, as arrivals are operating at higher altitudes at the points where their flight paths cross. The application of these procedures also reduces exposure time between controlled aircraft and uncontrolled aircraft at the lower altitudes in and around the terminal environment. Fuel conservation is accomplished by absorbing any necessary arrival delays for aircraft included in this program operating at the higher and more fuel efficient altitudes.

4.2 A fuel efficient descent is basically an uninterrupted descent (except where level flight is required for speed adjustment) from cruising altitude to the point when level flight is necessary for the pilot to stabilize the aircraft on final approach. The procedure for a fuel efficient descent is based on an altitude loss which is most efficient for the majority of aircraft being served. This will generally result in a descent gradient window of 250-350 feet per nautical mile.

4.3 When crossing altitudes and speed restrictions are issued verbally or are depicted on a chart, ATC

will expect the pilot to descend first to the crossing altitude and then reduce speed. Verbal clearances for descent will normally permit an uninterrupted descent in accordance with the procedure as described in paragraph 4.2 above. Acceptance of a charted fuel efficient descent (Runway Profile Descent) clearance requires the pilot to adhere to the altitudes, speeds, and headings depicted on the charts unless otherwise instructed by ATC. **PILOTS RECEIVING A CLEARANCE FOR A FUEL EFFICIENT DESCENT ARE EXPECTED TO ADVISE ATC IF THEY DO NOT HAVE RUNWAY PROFILE DESCENT CHARTS PUBLISHED FOR THAT AIRPORT OR ARE UNABLE TO COMPLY WITH THE CLEARANCE.**

5. Advance Information on Instrument Approaches

5.1 When landing at airports with approach control services and where two or more instrument approach procedures are published, pilots will be provided in advance of their arrival with the type of approach to expect or that they may be vectored for a visual approach. This information will be broadcast either by a controller or on ATIS. It will not be furnished when the visibility is three miles or better and the ceiling is at or above the highest initial approach altitude established for any low altitude instrument approach procedure for the airport.

5.2 The purpose of this information is to aid the pilot in planning arrival actions; however, it is not an ATC clearance or commitment and is subject to change. Pilots should bear in mind that fluctuating weather, shifting winds, blocked runway, etc., are conditions which may result in changes to approach information previously received. It is important that pilots advise ATC immediately if they are unable to execute the approach ATC advised will be used, or if they prefer another type of approach.

5.3 Aircraft destined to uncontrolled airports which have automated weather data with broadcast capability should monitor the ASOS/AWSS/AWOS frequency to ascertain the current weather for the airport. The pilot must advise ATC when he/she has received the broadcast weather and state his/her intentions.

NOTE-

1. ASOS/AWSS/AWOS should be set to provide one-minute broadcast weather updates at uncon-

trolled airports that are without weather broadcast capability by a human observer.

2. Controllers will consider the long line disseminated weather from an automated weather system at an uncontrolled airport as trend and planning information only and will rely on the pilot for current weather information for the airport. If the pilot is unable to receive the current broadcast weather, the last long–line disseminated weather will be issued to the pilot. When receiving IFR services, the pilot/aircraft operator is responsible for determining if weather/visibility is adequate for approach/landing.

5.4 When making an IFR approach to an airport not served by a tower or FSS, after the ATC controller advises “CHANGE TO ADVISORY FREQUENCY APPROVED,” you should broadcast your intentions, including the type of approach being executed, your position, and when over the final approach fix inbound (nonprecision approach) or when over the outer marker or the fix used in lieu of the outer marker inbound (precision approach). Continue to monitor the appropriate frequency (UNICOM, etc.) for reports from other pilots.

6. Approach Clearance

6.1 An aircraft which has been cleared to a holding fix and subsequently “cleared . . . approach” has not received new routing. Even though clearance for the approach may have been issued prior to the aircraft reaching the holding fix, ATC would expect the pilot to proceed via the holding fix (the last assigned route), and the feeder route associated with that fix (if a feeder route is published on the approach chart) to the initial approach fix (IAF) to commence the approach. **WHEN CLEARED FOR THE APPROACH, THE PUBLISHED OFF AIRWAY (FEEDER) ROUTES THAT LEAD FROM THE EN ROUTE STRUCTURE TO THE IAF ARE PART OF THE APPROACH CLEARANCE.**

6.2 If a feeder route to an IAF begins at a fix located along the route of flight prior to reaching the holding fix, and clearance for an approach is issued, a pilot should commence the approach via the published feeder route; i.e., the aircraft would not be expected to overfly the feeder route and return to it. The pilot is expected to commence the approach in a similar manner at the IAF, if the IAF for the procedure is located along the route of flight to the holding fix.

6.3 If a route of flight directly to the initial approach fix is desired, it should be so stated by the controller with phraseology to include the words “direct . . .,” “proceed direct” or a similar phrase which the pilot can interpret without question. If a pilot is uncertain of the clearance, immediately query ATC as to what route of flight is desired.

7. Landing Priority

7.1 A clearance for a specific type of approach (ILS, MLS, ADF, VOR, or straight–in approach) to an aircraft operating on an IFR flight plan does not mean that landing priority will be given over other traffic. Traffic control towers handle all aircraft, regardless of the type of flight plan, on a “first–come, first–served” basis. Therefore, because of local traffic or runway in use, it may be necessary for the controller, in the interest of safety, to provide a different landing sequence. In any case, a landing sequence will be issued to each aircraft as soon as possible to enable the pilot to properly adjust the aircraft’s flight path.

8. Procedure Turn and Hold–in–lieu of Procedure Turn

8.1 A procedure turn is the maneuver prescribed when it is necessary to reverse direction to establish the aircraft inbound on an intermediate or final approach course. The procedure turn or hold–in–lieu–of–PT is a required maneuver when it is depicted on the approach chart, unless cleared by ATC for a straight–in approach. Additionally, the procedure turn or hold–in–lieu–of–PT is not permitted when the symbol “No PT” is depicted on the initial segment being used, when a RADAR VECTOR to the final approach course is provided, or when conducting a timed approach from a holding fix. The altitude prescribed for the procedure turn is a minimum altitude until the aircraft is established on the inbound course. The maneuver must be completed within the distance specified in the profile view. For a hold–in–lieu–of–PT the holding pattern should be flown as depicted and the specified leg length/timing must not be exceeded.

NOTE–

The pilot may elect to use the procedure turn or hold–in–lieu–of–PT when it is not required by the procedure, but must first receive an amended clearance from ATC. If the pilot is uncertain whether the ATC clearance intends for a procedure turn to be conducted or

to allow for a straight-in approach, the pilot must immediately request clarification from ATC (14 CFR Section 91.123).

8.1.1 On U.S. Government charts, a barbed arrow indicates the maneuvering side of the outbound course on which the procedure turn is made. Headings are provided for course reversal using the 45 degree type procedure turn. However, the point at which the turn may be commenced and the type and rate of turn is left to the discretion of the pilot (limited by the charted remain within xx NM distance). Some of the options are the 45 degree procedure turn, the racetrack pattern, the teardrop procedure turn, or the 80 degree 260 degree course reversal. Racetrack entries should be conducted on the maneuvering side where the majority of protected airspace resides. If an entry places the pilot on the non-maneuvering side of the PT, correction to intercept the outbound course ensures remaining within protected airspace. Some procedure turns are specified by procedural track. These turns must be flown exactly as depicted.

8.1.2 Descent to the procedure turn (PT) completion altitude from the PT fix altitude (when one has been published or assigned by ATC) must not begin until crossing over the PT fix or abeam and proceeding outbound. Some procedures contain a note in the chart profile view that says “Maintain (altitude) or above until established outbound for procedure turn” (See FIG ENR 1.5-7). Newer procedures will simply depict an “at or above” altitude at the PT fix without a chart note (See FIG ENR 1.5-8). Both are there to ensure required obstacle clearance is provided in the procedure turn entry zone (See FIG ENR 1.5-9). Absence of a chart note or specified minimum altitude adjacent to the PT fix is an indication that

descent to the procedure turn altitude can commence immediately upon crossing over the PT fix, regardless of the direction of flight. This is because the minimum altitudes in the PT entry zone and the PT maneuvering zone are the same.

8.1.3 When the approach procedure involves a procedure turn, a maximum speed of not greater than 200 knots (IAS) should be observed from first overheading the course reversal IAF through the procedure turn maneuver to ensure containment within the obstruction clearance area. Pilots should begin the outbound turn immediately after passing the procedure turn fix. The procedure turn maneuver must be executed within the distance specified in the profile view. The normal procedure turn distance is 10 miles. This may be reduced to a minimum of 5 miles where only Category A or helicopter aircraft are to be operated or increased to as much as 15 miles to accommodate high performance aircraft.

8.1.4 A teardrop procedure or penetration turn may be specified in some procedures for a required course reversal. The teardrop procedure consists of departure from an initial approach fix on an outbound course followed by a turn toward and intercepting the inbound course at or prior to the intermediate fix or point. Its purpose is to permit an aircraft to reverse direction and lose considerable altitude within reasonably limited airspace. Where no fix is available to mark the beginning of the intermediate segment, it shall be assumed to commence at a point 10 miles prior to the final approach fix. When the facility is located on the airport, an aircraft is considered to be on final approach upon completion of the penetration turn. However, the final approach segment begins on the final approach course 10 miles from the facility.

FIG ENR 1.5-7

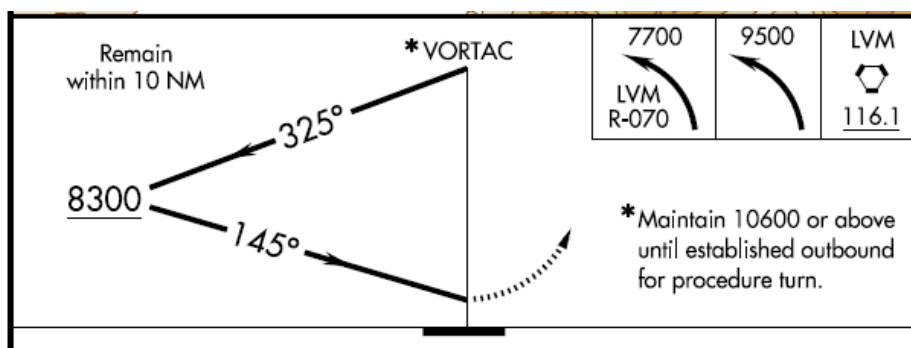
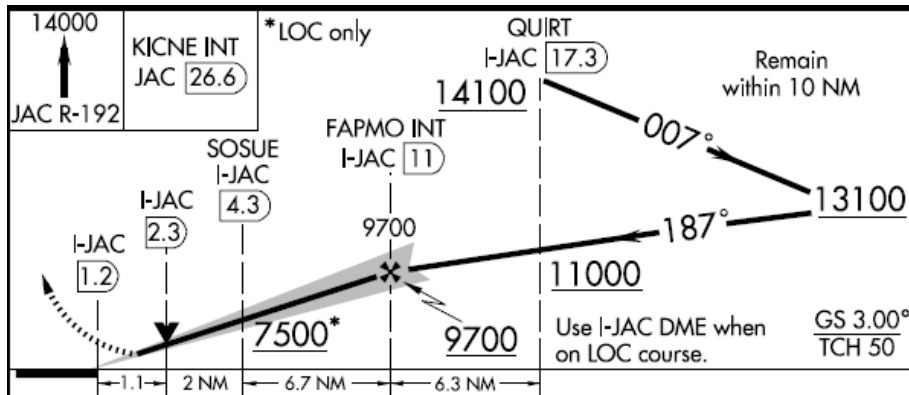

FIG ENR 1.5-8



8.1.5 A holding pattern in lieu of procedure turn may be specified for course reversal in some procedures. In such cases, the holding pattern is established over an intermediate fix or a final approach fix. The holding pattern distance or time specified in the profile view must be observed. For a hold-in-lieu-of-PT, the holding pattern direction must be flown as depicted and the specified leg length/timing must not be exceeded. Maximum holding airspeed limitations as set forth for all holding patterns apply. The holding pattern maneuver is completed when the aircraft is established on the inbound course after executing the appropriate entry. If cleared for the approach prior to returning to the holding fix, and the aircraft is at the prescribed altitude, additional circuits of the holding pattern are not necessary nor expected by ATC. If pilots elect to make additional circuits to lose excessive altitude or to become better established on course, it is their responsibility to so advise ATC upon receipt of their approach clearance.

NOTE-

Some approach charts have an arrival holding pattern depicted at the IAF using a “thin line” holding symbol. It is charted where holding is frequently required prior to starting the approach procedure so that detailed holding instructions are not required. The arrival holding pattern is not authorized unless assigned by Air Traffic Control. Holding at the same fix may also be depicted on the enroute chart. A hold-in-lieu of procedure turn is depicted by a “thick line” symbol, and is part of the instrument approach procedure as described in paragraph 8. (See U. S. Terminal Procedures booklets page G1 for both examples.)

8.1.6 A procedure turn is not required when an approach can be made directly from a specified intermediate fix to the final approach fix. In such cases, the term “NoPT” is used with the appropriate course and altitude to denote that the procedure turn is not required. If a procedure turn is desired, and when cleared to do so by ATC, descent below the procedure turn altitude should not be made until the aircraft is established on the inbound course, since some NoPT altitudes may be lower than the procedure turn altitudes.

FIG ENR 1.5-9

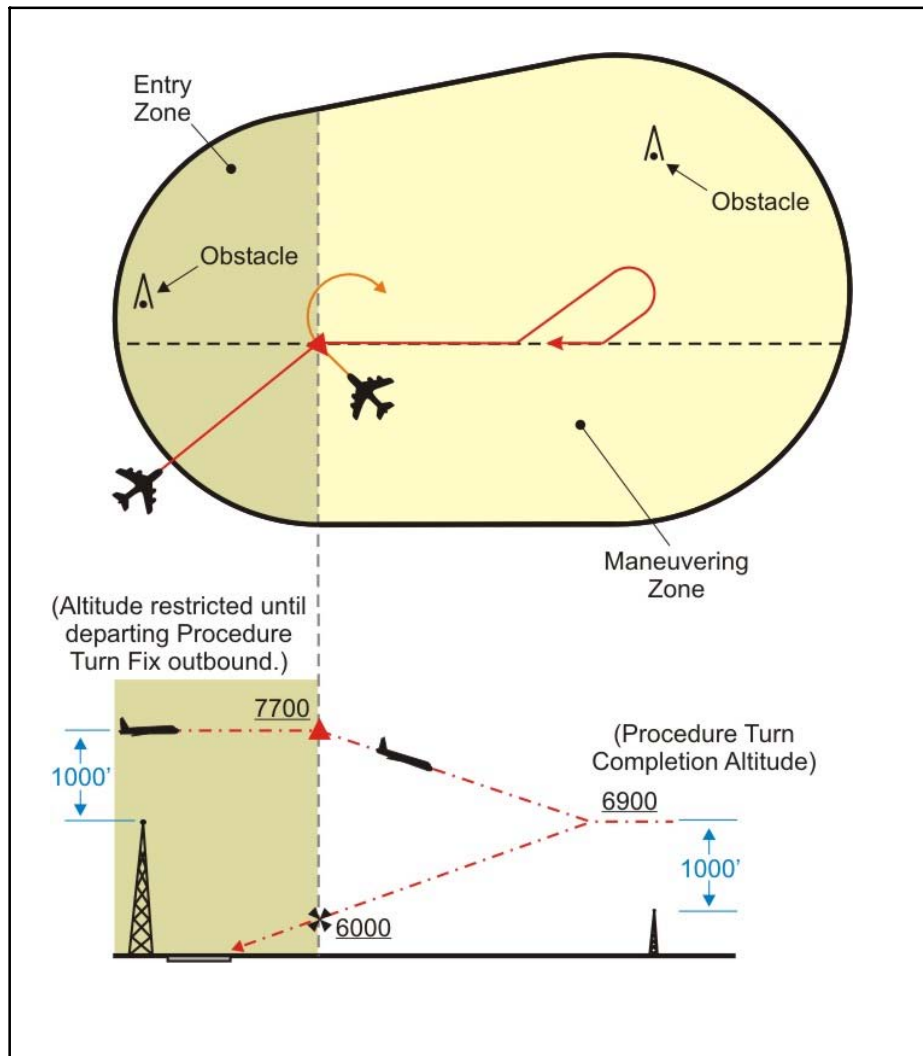

8.2 Limitations on Procedure Turns

8.2.1 In the case of a radar initial approach to a final approach fix or position, or a timed approach from a holding fix, or where the procedure specifies NoPT, no pilot may make a procedure turn unless, when final approach clearance is received, the pilot so advises ATC and a clearance is received to execute a procedure turn.

8.2.2 When a teardrop procedure turn is depicted and a course reversal is required, this type turn must be executed.

8.2.3 When a holding pattern replaces a procedure turn, the holding pattern must be followed, except when RADAR VECTORED is provided or when

NoPT is shown on the approach course. The recommended entry procedures will ensure the aircraft remains within the holding pattern's protected airspace. As in the procedure turn, the descent from the minimum holding pattern altitude to the final approach fix altitude (when lower) may not commence until the aircraft is established on the inbound course. Where a holding pattern is established in-lieu-of a procedure turn, the maximum holding pattern airspeeds apply.

NOTE-
See paragraph 1.3.2.1, Airspeeds.

8.2.4 The absence of the procedure turn barb in the plan view indicates that a procedure turn is not authorized for that procedure.

9. RNP SAAAR Instrument Approach Procedures

These procedures require authorization analogous to the special authorization required for Category II or III ILS procedures. Special aircraft and aircrew authorization required (SAAAR) procedures are to be conducted by aircrews meeting special training requirements in aircraft that meet the specified performance and functional requirements.

9.1 Unique characteristics of RNP SAAAR Approaches

9.1.1 RNP value. Each published line of minima has an associated RNP value. The indicated value defines the lateral and vertical performance requirements. A minimum RNP type is documented as part of the RNP SAAAR authorization for each operator and may vary depending on aircraft configuration or operational procedures (e.g., GPS inoperative, use of flight director vice autopilot).

9.1.2 Curved path procedures. Some RNP approaches have a curved path, also called a radius-to-a-fix (RF) leg. Since not all aircraft have the capability to fly these arcs, pilots are responsible for knowing if they can conduct an RNP approach with an arc or not. Aircraft speeds, winds and bank angles have been taken into consideration in the development of the procedures.

9.1.3 RNP required for extraction or not. Where required, the missed approach procedure may use RNP values less than RNP-1. The reliability of the navigation system has to be very high in order to conduct these approaches. Operation on these procedures generally requires redundant equipment, as no single point of failure can cause loss of both approach and missed approach navigation.

9.1.4 Non-standard speeds or climb gradients. RNP SAAAR approaches are developed based on standard approach speeds and a 200 ft/NM climb gradient in the missed approach. Any exceptions to

these standards will be indicated on the approach procedure, and the operator should ensure they can comply with any published restrictions before conducting the operation.

9.1.5 Temperature Limits. For aircraft using barometric vertical navigation (without temperature compensation) to conduct the approach, low and high-temperature limits are identified on the procedure. Cold temperatures reduce the glidepath angle while high temperatures increase the glidepath angle. Aircraft using baro VNAV with temperature compensation or aircraft using an alternate means for vertical guidance (e.g., SBAS) may disregard the temperature restrictions. The charted temperature limits are evaluated for the final approach segment only. Regardless of charted temperature limits or temperature compensation by the FMS, the pilot may need to manually compensate for cold temperature on minimum altitudes and the decision altitude.

9.1.6 Aircraft size. The achieved minimums may be dependent on aircraft size. Large aircraft may require higher minimums due to gear height and/or wingspan. Approach procedure charts will be annotated with applicable aircraft size restrictions.

9.2 Types of RNP SAAAR Approach Operations

9.2.1 RNP Stand-alone Approach Operations. RNP SAAAR procedures can provide access to runways regardless of the ground-based NAVAID infrastructure, and can be designed to avoid obstacles, terrain, airspace, or resolve environmental constraints.

9.2.2 RNP Parallel Approach (RPA) Operations. RNP SAAAR procedures can be used for parallel approaches where the runway separation is adequate (See FIG ENR 1.5–10). Parallel approach procedures can be used either simultaneously or as stand-alone operations. They may be part of either independent or dependent operations depending on the ATC ability to provide radar monitoring.

FIG ENR 1.5-10

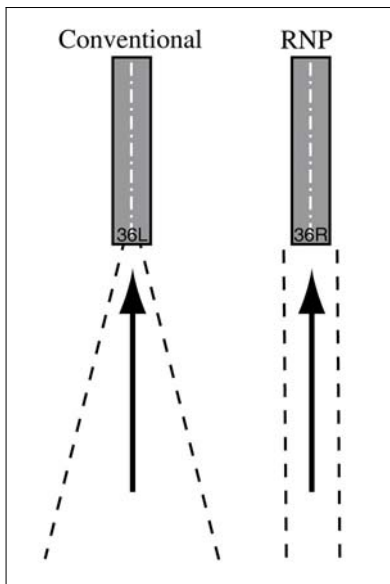

9.2.3 RNP Parallel Approach Runway Transitions (RPAT) Operations. RPAT approaches begin as a parallel IFR approach operation using simultaneous independent or dependent procedures. (See FIG ENR 1.5-11). Visual separation standards are used in the final segment of the approach after the final approach fix, to permit the RPAT aircraft to transition in visual conditions along a predefined lateral and vertical path to align with the runway centerline.

FIG ENR 1.5-11

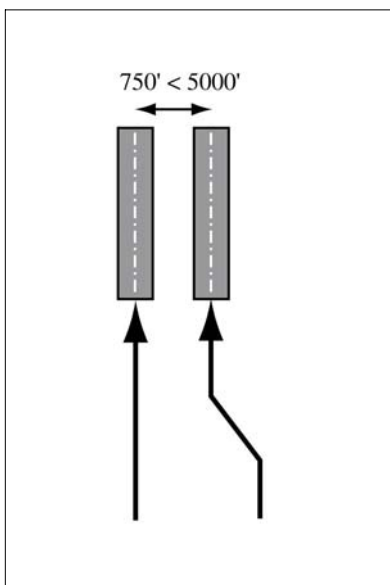

9.2.4 RNP Converging Runway Operations. At airports where runways converge, but may or may not intersect, an RNP SAAAR approach can provide a precise curved missed approach path that conforms to aircraft separation minimums for simultaneous operations (See FIG ENR 1.5-12). By flying this curved missed approach path with high accuracy and containment provided by RNP, dual runway operations may continue to be used to lower ceiling and visibility values than currently available. This type of operation allows greater capacity at airports where it can be applied.

FIG ENR 1.5-12

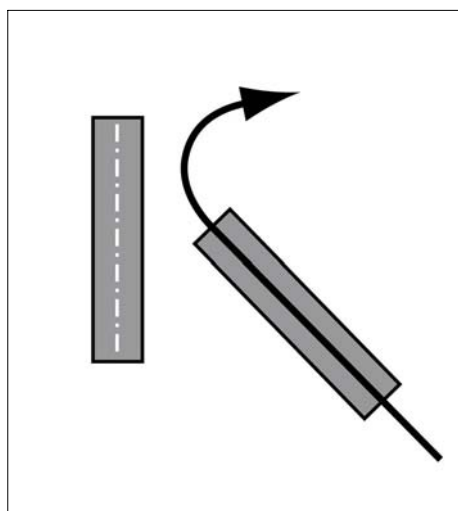

10. Side-step Maneuver

10.1 ATC may authorize a standard instrument approach procedure which serves either one of parallel runways that are separated by 1,200 feet or less followed by a straight-in landing on the adjacent runway.

10.2 Aircraft that will execute a side-step maneuver will be cleared for a specified approach procedure and landing on the adjacent parallel runway. Example, "cleared ILS runway 7 left approach, side-step to runway 7 right." Pilots are expected to commence the side-step maneuver as soon as possible after the runway or runway environment is in sight. Compliance with minimum altitudes associated with stepdown fixes is expected even after the side-step maneuver is initiated.

NOTE-
Side-step minima are flown to a Minimum Descent Altitude (MDA) regardless of the approach authorized.

10.3 Landing minimums to the adjacent runway will be based on nonprecision criteria and therefore higher than the precision minimums to the primary runway, but will normally be lower than the published circling minimums.

11. Approach and Landing Minimums

11.1 Landing Minimums. The rules applicable to landing minimums are contained in 14 CFR Section 91.175. TBL ENR 1.5–2 may be used to convert RVR to ground or flight visibility. For converting RVR values that fall between listed values, use the next higher RVR value; do not interpolate. For example, when converting 1800 RVR, use 2400 RVR with the resultant visibility of 1/2 mile.

TBL ENR 1.5–2
RVR Value Conversions

RVR	Visibility (statute miles)
1600	1/4
2400	1/2
3200	5/8
4000	3/4
4500	7/8
5000	1
6000	1 1/4

11.1.1 Aircraft approach category means a grouping of aircraft based on a speed of V_{REF} , if specified, or if V_{REF} is not specified, $1.3 V_{SO}$ at the maximum certified landing weight. V_{REF} , V_{SO} , and the maximum certified landing weight are those values as established for the aircraft by the certification authority of the country of registry. A pilot must use the minima corresponding to the category determined during certification or higher. Helicopters may use Category A minima. If it is necessary to operate at a speed in excess of the upper limit of the speed range for an aircraft’s category, the minimums for the higher category must be used. For example, an

airplane which fits into Category B, but is circling to land at a speed of 145 knots, must use the approach Category D minimums. As an additional example, a Category A airplane (or helicopter) which is operating at 130 knots on a straight-in approach must use the approach Category C minimums. See the following category limits:

- 11.1.1.1** Category A: Speed less than 91 knots.
- 11.1.1.2** Category B: Speed 91 knots or more but less than 121 knots.
- 11.1.1.3** Category C: Speed 121 knots or more but less than 141 knots.
- 11.1.1.4** Category D: Speed 141 knots or more but less than 166 knots.
- 11.1.1.5** Category E: Speed 166 knots or more.

NOTE–

V_{REF} in the above definition refers to the speed used in establishing the approved landing distance under the airworthiness regulations constituting the type certification basis of the airplane, regardless of whether that speed for a particular airplane is $1.3 V_{SO}$, $1.23 V_{SR}$, or some higher speed required for airplane controllability. This speed, at the maximum certificated landing weight, determines the lowest applicable approach category for all approaches regardless of actual landing weight.

11.2 Published Approach Minimums. Approach minimums are published for different aircraft categories and consist of a minimum altitude (DA, DH, MDA) and required visibility. These minimums are determined by applying the appropriate TERPS criteria. When a fix is incorporated in a nonprecision final segment, two sets of minimums may be published; one for the pilot that is able to identify the fix, and a second for the pilot that cannot. Two sets of minimums may also be published when a second altimeter source is used in the procedure. When a nonprecision procedure incorporates both a step-down fix in the final segment and a second altimeter source, two sets of minimums are published to account for the stepdown fix and a note addresses minimums for the second altimeter source.

FIG ENR 1.5-13
Final Approach Obstacle Clearance

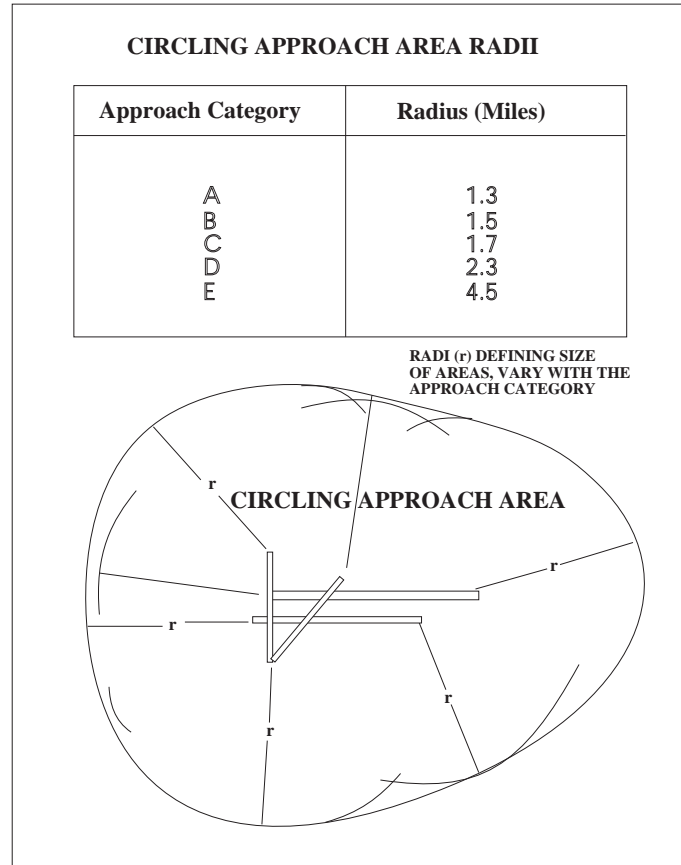

11.3 Obstacle Clearance. Final approach obstacle clearance is provided from the start of the final segment to the runway or missed approach point, whichever occurs last. Side-step obstacle protection is provided by increasing the width of the final approach obstacle clearance area.

11.3.1 Circling approach protected areas are defined by the tangential connection of arcs drawn from each runway end. The arc radii distance differs by aircraft approach category (see FIG ENR 1.5-13). Because of obstacles near the airport, a portion of the circling area may be restricted by a procedural note: e.g., “Circling NA E of RWY 17-35.” Obstacle clearance

is provided at the published minimums (MDA) for the pilot who makes a straight-in approach, side-steps, or circles. Once below the MDA the pilot must see and avoid obstacles. Executing the missed approach after starting to maneuver usually places the aircraft beyond the MAP. The aircraft is clear of obstacles when at or above the MDA while inside the circling area, but simply joining the missed approach ground track from the circling maneuver may not provide vertical obstacle clearance once the aircraft exits the circling area. Additional climb inside the circling area may be required before joining the missed approach track. See paragraph 27., Missed Approach, for additional considerations when starting a missed approach at other than the MAP.

FIG ENR 1.5-14
Precision Obstacle Free Zone (POFZ)

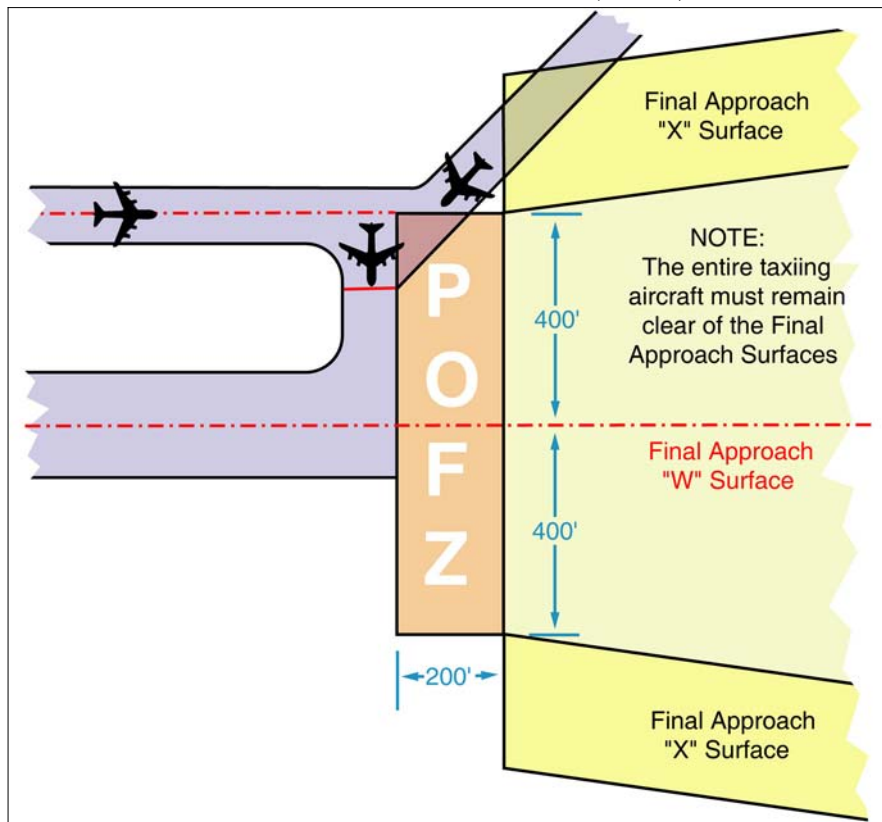

11.3.2 Precision Obstacle Free Zone (POFZ). A volume of airspace above an area beginning at the runway threshold, at the threshold elevation, and centered on the extended runway centerline. The POFZ is 200 feet (60m) long and 800 feet (240m) wide. The POFZ must be clear when an aircraft on a vertically guided final approach is within 2 nautical miles of the runway threshold and the reported ceiling is below 250 feet or visibility less than $\frac{3}{4}$ statute mile (SM) (or runway visual range below 4,000 feet). If the POFZ is not clear, the MINIMUM authorized height above touchdown (HAT) and visibility is 250 feet and $\frac{3}{4}$ SM. The POFZ is considered clear even if the wing of the aircraft holding on a taxiway waiting for runway clearance penetrates the POFZ; however, neither the fuselage nor the tail may infringe on the POFZ. The POFZ is applicable at all runway ends including displaced thresholds. (See FIG ENR 1.5-14.)

11.4 Straight-In Minimums are shown on the IAP when the final approach course is within 30 degrees of the runway alignment (15 degrees for GPS IAPs)

and a normal descent can be made from the IFR altitude shown on the IAP to the runway surface. When either the normal rate of descent or the runway alignment factor of 30 degrees (15 degrees for GPS IAPs) is exceeded, a straight-in minimum is not published and a circling minimum applies. The fact that a straight-in minimum is not published does not preclude pilots from landing straight-in if they have the active runway in sight and have sufficient time to make a normal approach for landing. Under such conditions and when ATC has cleared them for landing on that runway, pilots are not expected to circle even though only circling minimums are published. If they desire to circle, they should advise ATC.

11.5 Side-Step Maneuver Minimums. Landing minimums for a side-step maneuver to the adjacent runway will normally be higher than the minimums to the primary runway.

11.6 Circling Minimums. In some busy terminal areas, ATC may not allow circling and circling minimums will not be published. Published circling

minimums provide obstacle clearance when pilots remain within the appropriate area of protection. Pilots should remain at or above the circling altitude until the aircraft is continuously in a position from which a descent to a landing on the intended runway can be made at a normal rate of descent using normal maneuvers. Circling may require maneuvers at low altitude, at low airspeed, and in marginal weather conditions. Pilots must use sound judgment, have an in-depth knowledge of their capabilities, and fully understand the aircraft performance to determine the exact circling maneuver since weather, unique airport design, and the aircraft position, altitude, and airspeed must all be considered. The following basic rules apply:

11.6.1 Maneuver the shortest path to the base or downwind leg, as appropriate, considering existing weather conditions. There is no restriction from passing over the airport or other runways.

11.6.2 It should be recognized that circling maneuvers may be made while VFR or other flying is in progress at the airport. Standard left turns or specific instruction from the controller for maneuvering must be considered when circling to land.

11.6.3 At airports without a control tower, it may be desirable to fly over the airport to observe wind and turn indicators and other traffic which may be on the runway or flying in the vicinity of the airport.

REFERENCE—

AC 90–66A, Recommended Standards Traffic patterns for Aeronautical Operations at Airports without Operating Control Towers.

11.6.4 The missed approach point (MAP) varies depending upon the approach flown. For vertically guided approaches, the MAP is at the decision altitude/decision height. Non-vertically guided and circling procedures share the same MAP and the pilot determines this MAP by timing from the final approach fix, by a fix, a NAVAID, or a waypoint. Circling from a GLS, an ILS without a localizer line of minima or an RNAV (GPS) approach without an LNAV line of minima is prohibited.

11.7 Instrument Approaches at a Military Field. When instrument approaches are conducted by civil aircraft at military airports, they shall be conducted in accordance with the procedures and minimums approved by the military agency having jurisdiction over the airport.

12. Instrument Approach Procedure Charts

12.1 14 CFR Section 91.175(a), Instrument approaches to civil airports, requires the use of SIAP's prescribed for the airport in 14 CFR Part 97 unless otherwise authorized by the Administrator (including ATC). If there are military procedures published at a civil airport, aircraft operating under 14 CFR Part 91 must use the civil procedure(s). Civil procedures are defined with "FAA" in parenthesis; e.g., (FAA), at the top, center of the procedure chart. DOD procedures are defined using the abbreviation of the applicable military service in parenthesis; e.g., (USAF), (USN), (USA). 14 CFR Section 91.175(g), Military airports, requires civil pilots flying into or out of military airports to comply with the IAP's and takeoff and landing minimums prescribed by the authority having jurisdiction at those airports. Unless an emergency exists, civil aircraft operating at military airports normally require advance authorization, commonly referred to as "Prior Permission Required" or "PPR." Information on obtaining a PPR for a particular military airport can be found in the Airport/Facility Directory.

NOTE—

Civil aircraft may conduct practice VFR approaches using DOD instrument approach procedures when approved by the air traffic controller.

12.1.1 IAPs (standard and special, civil and military) are based on joint civil and military criteria contained in the U.S. Standard for TERPS. The design of IAPs based on criteria contained in TERPS, takes into account the interrelationship between airports, facilities, and the surrounding environment, terrain, obstacles, noise sensitivity, etc. Appropriate altitudes, courses, headings, distances, and other limitations are specified and, once approved, the procedures are published and distributed by government and commercial cartographers as instrument approach charts.

12.1.2 Not all IAPs are published in chart form. Radar IAPs are established where requirements and facilities exist but they are printed in tabular form in appropriate U.S. Government Flight Information Publications.

12.1.3 The navigation equipment required to join and fly an instrument approach procedure is indicated by the title of the procedure and notes on the chart.

12.1.3.1 Straight-in IAPs are identified by the navigational system providing the final approach

guidance and the runway to which the approach is aligned (e.g., VOR RWY 13). Circling only approaches are identified by the navigational system providing final approach guidance and a letter (e.g., VOR A). More than one navigational system separated by a slash indicates that more than one type of equipment must be used to execute the **final approach** (e.g., VOR/DME RWY 31). More than one navigational system separated by the word “or” indicates either type of equipment may be used to execute the **final approach** (e.g., VOR or GPS RWY 15).

12.1.3.2 In some cases, other types of navigation systems including radar may be required to execute other portions of the approach or to navigate to the IAF (e.g., an NDB procedure turn to an ILS, an NDB in the missed approach, or radar required to join the procedure or identify a fix). When radar or other equipment is required for procedure entry from the en route environment, a note will be charted in the **planview** of the approach procedure chart (e.g., RADAR REQUIRED or ADF REQUIRED). When radar or other equipment is required on portions of the procedure outside the final approach segment, including the missed approach, a note will be charted in the **notes box** of the pilot briefing portion of the approach chart (e.g., RADAR REQUIRED or DME REQUIRED). Notes are not charted when VOR is required outside the final approach segment. Pilots should ensure that the aircraft is equipped with the required NAVAID(s) in order to execute the approach, including the missed approach.

NOTE–

Some military (i.e., U.S. Air Force and U.S. Navy) IAPs have these “additional equipment required” notes charted only in the planview of the approach procedure and do not conform to the same application standards used by the FAA.

12.1.3.3 The FAA has initiated a program to provide a new notation for LOC approaches when charted on an ILS approach requiring other navigational aids to fly the final approach course. The LOC minimums will be annotated with the NAVAID required (e.g., “DME Required” or “RADAR Required”). During the transition period, ILS approaches will still exist without the annotation.

12.1.3.4 Many ILS approaches having minima based on RVR are eligible for a landing minimum of RVR 1800. Some of these approaches are to runways

that have touchdown zone and centerline lights. For many runways that do not have touchdown and centerline lights, it is still possible to allow a landing minimum of RVR 1800. For these runways, the normal ILS minimum of RVR 2400 can be annotated with a single or double asterisk or the dagger symbol “†”; for example “** 696/24 200 (200/1/2).” A note is included on the chart stating “**RVR 1800 authorized with use of FD or AP or HUD to DA.” The pilot must use the flight director, or autopilot with an approved approach coupler, or head up display to decision altitude or to the initiation of a missed approach. In the interest of safety, single pilot operators should not fly approaches to 1800 RVR minimums on runways without touchdown and centerline lights using only a flight director, unless accompanied by the use of an autopilot with an approach coupler.

12.1.3.5 The naming of multiple approaches of the same type to the same runway is also changing. Multiple approaches with the same guidance will be annotated with an alphabetical suffix beginning at the end of the alphabet and working backwards for subsequent procedures (e.g., ILS Z RWY 28, ILS Y RWY 28, etc.). The existing annotations such as ILS 2 RWY 28 or Silver ILS RWY 28 will be phased out and replaced with the new designation. The Cat II and Cat III designations are used to differentiate between multiple ILSs to the same runway unless there are multiples of the same type.

12.1.3.6 RNAV (GPS) approaches to LNAV, LP, LNAV/VNAV and LPV lines of minima using WAAS and RNAV (GPS) approaches to LNAV and LNAV/VNAV lines of minima using GPS are charted as RNAV (GPS) RWY (Number) (e.g., RNAV (GPS) RWY 21). VOR/DME RNAV approaches will continue to be identified as VOR/DME RNAV RWY (Number) (e.g., VOR/DME RNAV RWY 21). VOR/DME RNAV procedures which can be flown by GPS will be annotated with “or GPS” (e.g., VOR/DME RNAV or GPS RWY 31).

12.1.4 Approach minimums are based on the local altimeter setting for that airport, unless annotated otherwise; e.g., Oklahoma City/Will Rogers World approaches are based on having a Will Rogers World altimeter setting. When a different altimeter source is required, or more than one source is authorized, it will be annotated on the approach chart; e.g., use Sidney altimeter setting, if not received, use Scottsbluff altimeter setting. Approach minimums may be raised

when a nonlocal altimeter source is authorized. When more than one altimeter source is authorized, and the minima are different, they will be shown by separate lines in the approach minima box or a note; e.g., use Manhattan altimeter setting; when not available use Salina altimeter setting and increase all MDAs 40 feet. When the altimeter must be obtained from a source other than air traffic a note will indicate the source; e.g., Obtain local altimeter setting on CTAF. When the altimeter setting(s) on which the approach is based is not available, the approach is not authorized. Baro–VNAV must be flown using the local altimeter setting only. Where no local altimeter is available, the LNAV/VNAV line will still be published for use by WAAS receivers with a note that Baro–VNAV is not authorized. When a local and at least one other altimeter setting source is authorized and the local altimeter is not available Baro–VNAV is not authorized; however, the LNAV/VNAV minima can still be used by WAAS receivers using the alternate altimeter setting source.

NOTE–

Barometric Vertical Navigation (baro–VNAV). An RNAV system function which uses barometric altitude information from the aircraft’s altimeter to compute and present a vertical guidance path to the pilot. The specified vertical path is computed as a geometric path, typically computed between two waypoints or an angle based computation from a single waypoint. Further guidance may be found in Advisory Circular 90–105.

12.1.5 A pilot adhering to the altitudes, flight paths, and weather minimums depicted on the IAP chart or vectors and altitudes issued by the radar controller, is assured of terrain and obstruction clearance and runway or airport alignment during approach for landing.

12.1.6 IAPs are designed to provide an IFR descent from the en route environment to a point where a safe landing can be made. They are prescribed and approved by appropriate civil or military authority to ensure a safe descent during instrument flight conditions at a specific airport. It is important that pilots understand these procedures and their use prior to attempting to fly instrument approaches.

12.1.7 TERPS criteria are provided for the following types of instrument approach procedures:

12.1.7.1 Precision Approach (PA). An instrument approach based on a navigation system that provides course and glidepath deviation information meeting

the precision standards of ICAO Annex 10. For example, PAR, ILS, and GLS are precision approaches.

12.1.7.2 Approach with Vertical Guidance (APV). An instrument approach based on a navigation system that is not required to meet the precision approach standards of ICAO Annex 10 but provides course and glidepath deviation information. For example, Baro–VNAV, LDA with glidepath, LNAV/VNAV and LPV are APV approaches.

12.1.7.3 Nonprecision Approach (NPA). An instrument approach based on a navigation system which provides course deviation information, but no glidepath deviation information. For example, VOR, NDB and LNAV. As noted in subparagraph 12.8, Vertical Descent Angle (VDA) on Nonprecision Approaches, some approach procedures may provide a Vertical Descent Angle as an aid in flying a stabilized approach, without requiring its use in order to fly the procedure. This does not make the approach an APV procedure, since it must still be flown to an MDA and has not been evaluated with a glidepath.

12.2 The method used to depict prescribed altitudes on instrument approach charts differs according to techniques employed by different chart publishers. Prescribed altitudes may be depicted in four different configurations: minimum, maximum, mandatory, and recommended. The U.S. Government distributes charts produced by National Geospatial–Intelligence Agency (NGA) and FAA. Altitudes are depicted on these charts in the profile view with underscore, overscore, both or none to identify them as minimum, maximum, mandatory or recommended.

12.2.1 Minimum altitude will be depicted with the altitude value underscored. Aircraft are required to maintain altitude at or above the depicted value, e.g., 3000.

12.2.2 Maximum altitude will be depicted with the altitude value overscored. Aircraft are required to maintain altitude at or below the depicted value, e.g., 4000.

12.2.3 Mandatory altitude will be depicted with the altitude value both underscored and overscored. Aircraft are required to maintain altitude at the depicted value, e.g., 5000.

12.2.4 Recommended altitude will be depicted with no overscore or underscore. These altitudes are depicted for descent planning, e.g., 6000.

NOTE–

1. Pilots are cautioned to adhere to altitudes as prescribed because, in certain instances, they may be used as the basis for vertical separation of aircraft by ATC. When a depicted altitude is specified in the ATC clearance, that altitude becomes mandatory as defined above.

2. The ILS glide slope is intended to be intercepted at the published glide slope intercept altitude. This point marks the PFAF and is depicted by the "lightning bolt" symbol on U.S. Government charts. Intercepting the glide slope at this altitude marks the beginning of the final approach segment and ensures required obstacle clearance during descent from the glide slope intercept altitude to the lowest published decision altitude for the approach. Interception and tracking of the glide slope prior to the published glide slope interception altitude does not necessarily ensure that minimum, maximum, and/or mandatory altitudes published for any preceding fixes will be complied with during the descent. If the pilot chooses to track the glide slope prior to the glide slope interception altitude, they remain responsible for complying with published altitudes for any preceding stepdown fixes encountered during the subsequent descent.

12.3 Minimum Safe/Sector Altitudes (MSA) are published for emergency use on IAP charts. For conventional navigation systems, the MSA is normally based on the primary omnidirectional facility on which the IAP is predicated. The MSA depiction on the approach chart contains the facility identifier of the NAVAID used to determine the MSA altitudes. For RNAV approaches, the MSA is based on the runway waypoint (RWY WP) for straight-in approaches, or the airport waypoint (APT WP) for circling approaches. For GPS approaches, the MSA center will be the missed approach waypoint (MAWP). MSAs are expressed in feet above mean sea level and normally have a 25 NM radius; however, this radius may be expanded to 30 NM if necessary to encompass the airport landing surfaces. Ideally, a single sector altitude is established and depicted on the plan view of approach charts; however, when necessary to obtain relief from obstructions, the area may be further sectorized and as many as four MSAs established. When established, sectors may be no less than 90° in spread. MSAs provide 1,000 feet clearance over all obstructions but do not necessarily assure acceptable navigation signal coverage.

12.4 Terminal Arrival Area (TAA)

12.4.1 The objective of the TAA is to provide a seamless transition from the en route structure to the

terminal environment for arriving aircraft equipped with Flight Management System (FMS) and/or Global Positioning System (GPS) navigational equipment. The underlying instrument approach procedure is an area navigation (RNAV) procedure described in this section. The TAA provides the pilot and air traffic controller with a very efficient method for routing traffic into the terminal environment with little required air traffic control interface, and with minimum altitudes depicted that provide standard obstacle clearance compatible with the instrument procedure associated with it. The TAA will not be found on all RNAV procedures, particularly in areas of heavy concentration of air traffic. When the TAA is published, it replaces the MSA for that approach procedure. See FIG ENR 1.5–23 for a depiction of a RNAV approach chart with a TAA.

12.4.2 The RNAV procedure underlying the TAA will be the "T" design (also called the "Basic T"), or a modification of the "T." The "T" design incorporates from one to three IAFs; an intermediate fix (IF) that serves as a dual purpose IF (IAF); a final approach fix (FAF), and a missed approach point (MAP) usually located at the runway threshold. The three IAFs are normally aligned in a straight line perpendicular to the intermediate course, which is an extension of the final course leading to the runway, forming a "T." The initial segment is normally from 3–6 NM in length; the intermediate 5–7 NM, and the final segment 5 NM. Specific segment length may be varied to accommodate specific aircraft categories for which the procedure is designed. However, the published segment lengths will reflect the highest category of aircraft normally expected to use the procedure.

12.4.2.1 A standard racetrack holding pattern may be provided at the center IAF, and if present may be necessary for course reversal and for altitude adjustment for entry into the procedure. In the latter case, the pattern provides an extended distance for the descent required by the procedure. Depiction of this pattern in U.S. Government publications will utilize the "hold-in-lieu-of-PT" holding pattern symbol.

12.4.2.2 The published procedure will be annotated to indicate when the course reversal is not necessary when flying within a particular TAA area; e.g., "NoPT." Otherwise, the pilot is expected to execute the course reversal under the provisions of 14 CFR Section 91.175. The pilot may elect to use the course reversal pattern when it is not required by the

procedure, but must inform air traffic control and receive clearance to do so. (See FIG ENR 1.5-15, FIG ENR 1.5-16, FIG ENR 1.5-23, and para-

graph 8., Procedure Turn and Hold-in-lieu of Procedure Turn.)

FIG ENR 1.5-15
Basic "T" Design

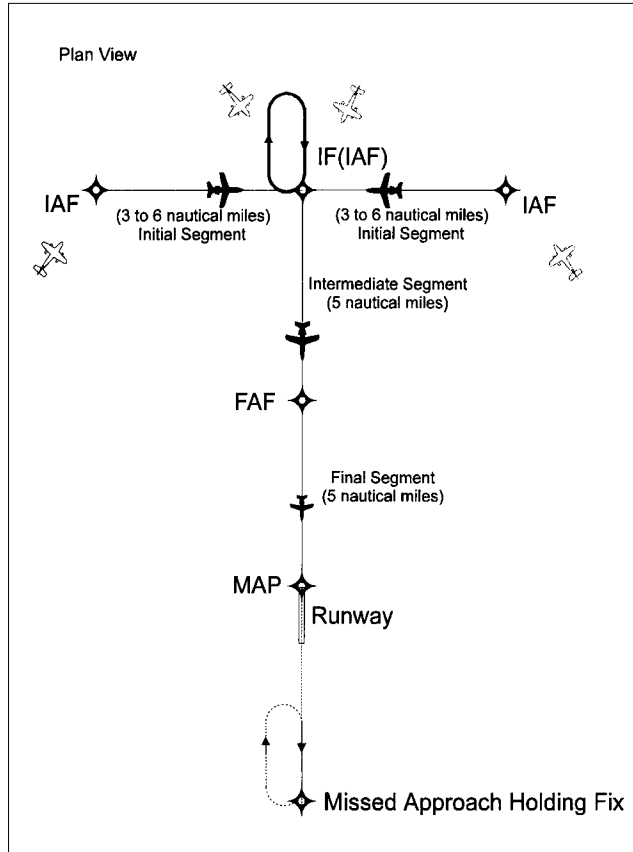

FIG ENR 1.5-16
Basic "T" Design

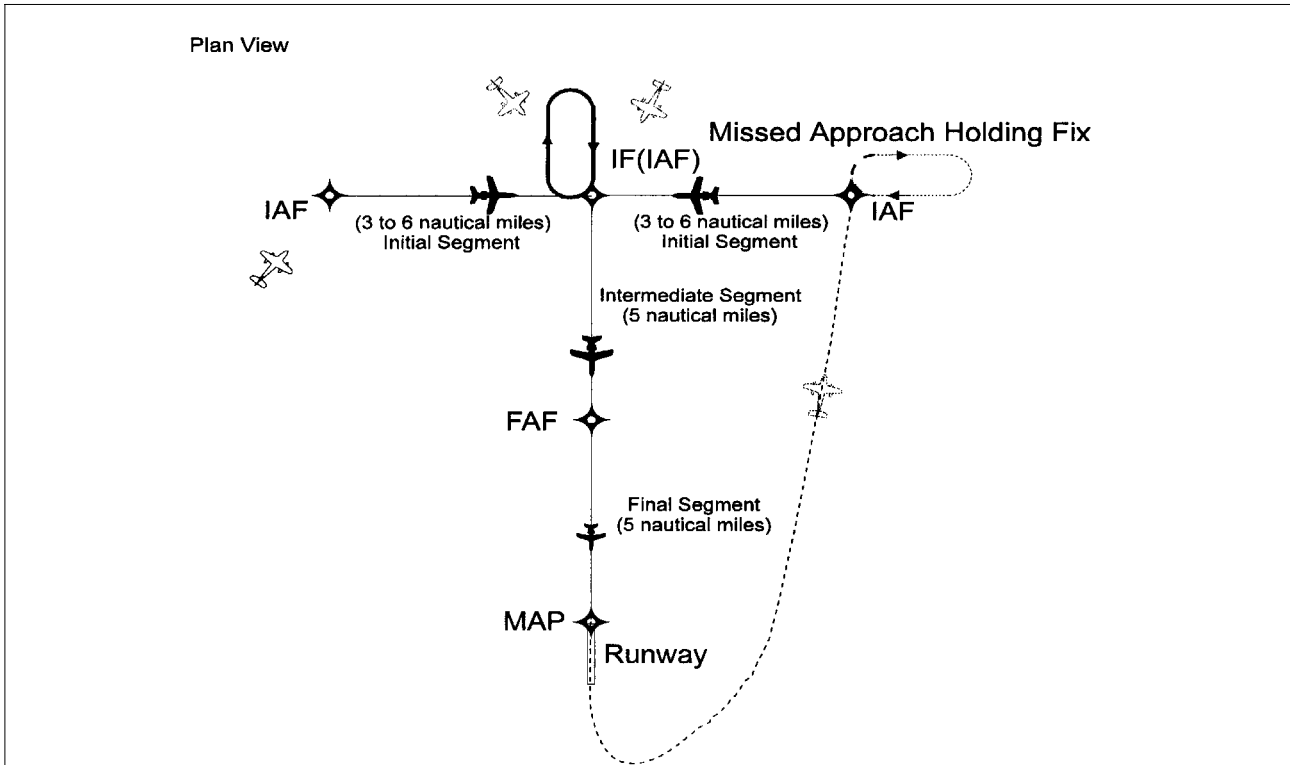
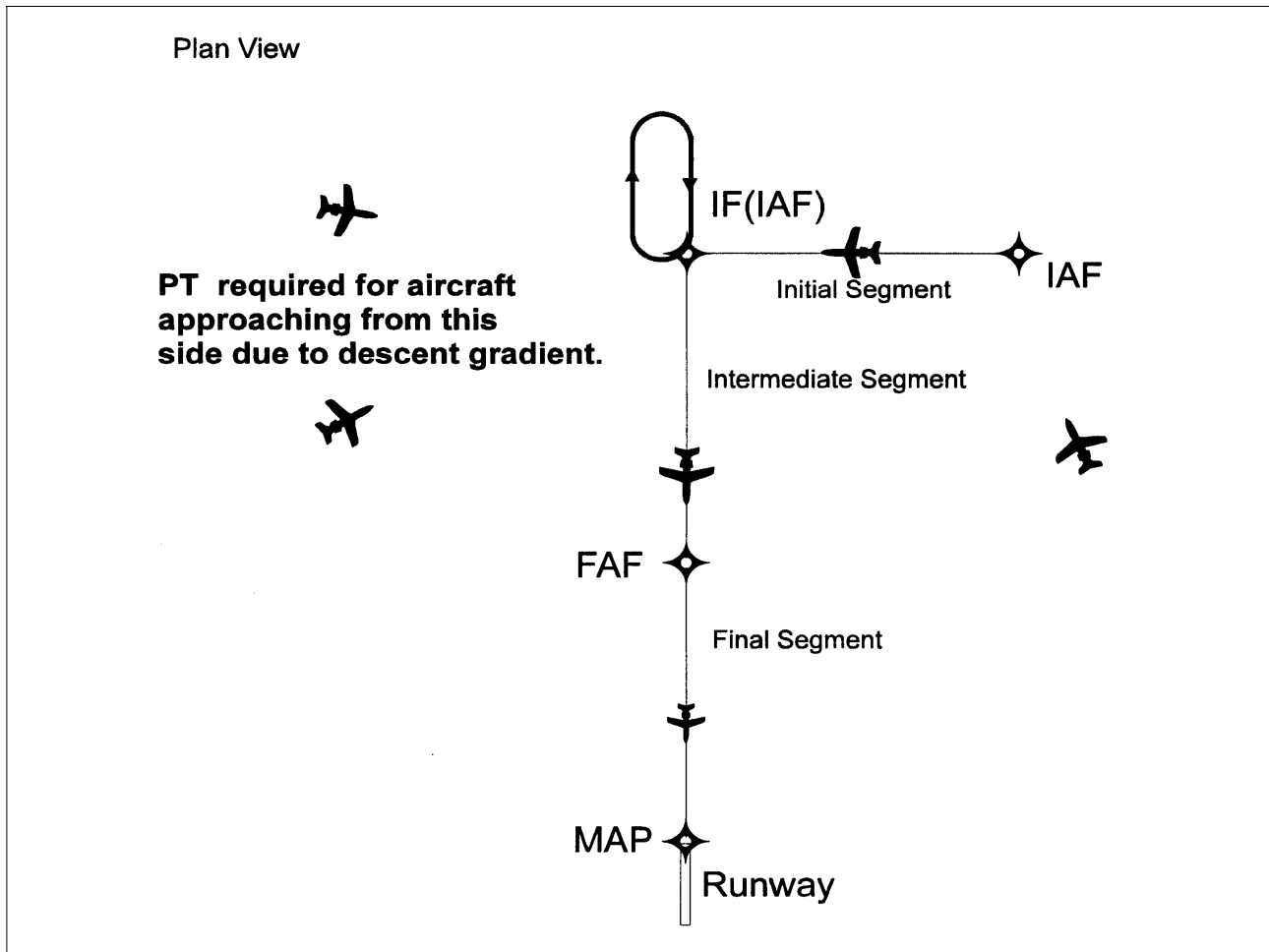

FIG ENR 1.5-17
Modified Basic "T"



12.4.3 The "T" design may be modified by the procedure designers where required by terrain or air traffic control considerations. For instance, the "T" design may appear more like a regularly or irregularly shaped "Y", or may even have one or both outboard

IAFs eliminated resulting in an upside down "L" or an "I" configuration. (See FIG ENR 1.5-17 and FIG ENR 1.5-24). Further, the leg lengths associated with the outboard IAFs may differ. (See FIG ENR 1.5-19 and FIG ENR 1.5-20.)

FIG ENR 1.5-18
Modified "T" Approach to Parallel Runways

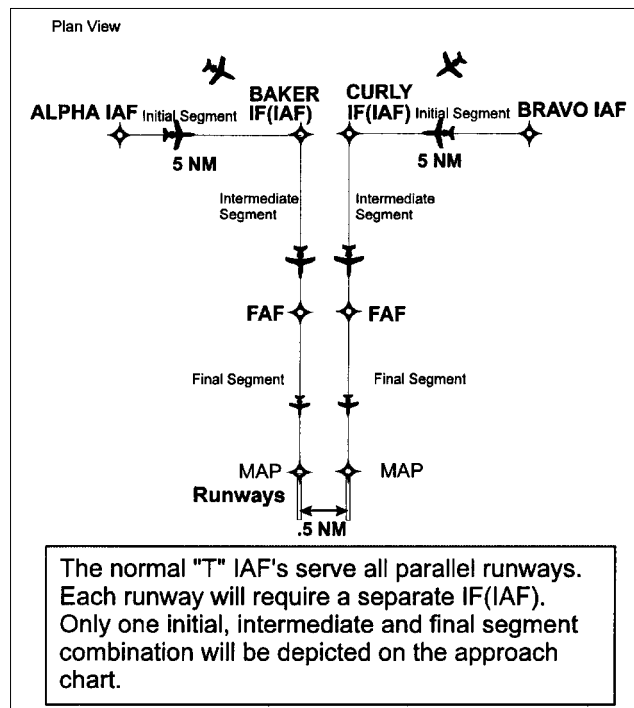

12.4.4 Another modification of the "T" design may be found at airports with parallel runway configurations. Each parallel runway may be served by its own "T" IAF, IF (IAF), and FAF combination, resulting in parallel final approach courses. (See FIG ENR 1.5-18). Common IAFs may serve both

runways; however, only the intermediate and final approach segments for the landing runway will be shown on the approach chart. (See FIG ENR 1.5-19 and FIG ENR 1.5-20.)

FIG ENR 1.5-19
“T” Approach with Common IAFs to Parallel Runways

FIG ENR 1.5-20
“T” Approach with Common IAFs to Parallel Runways

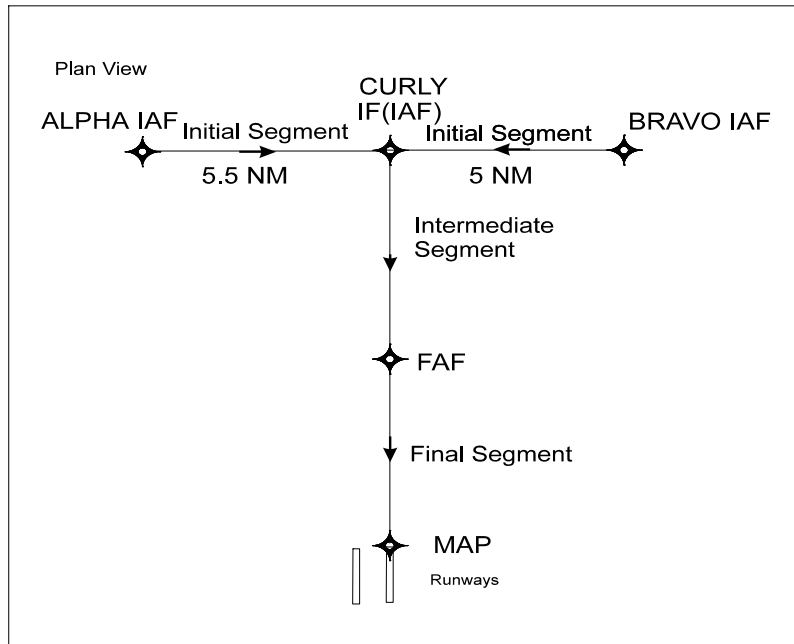
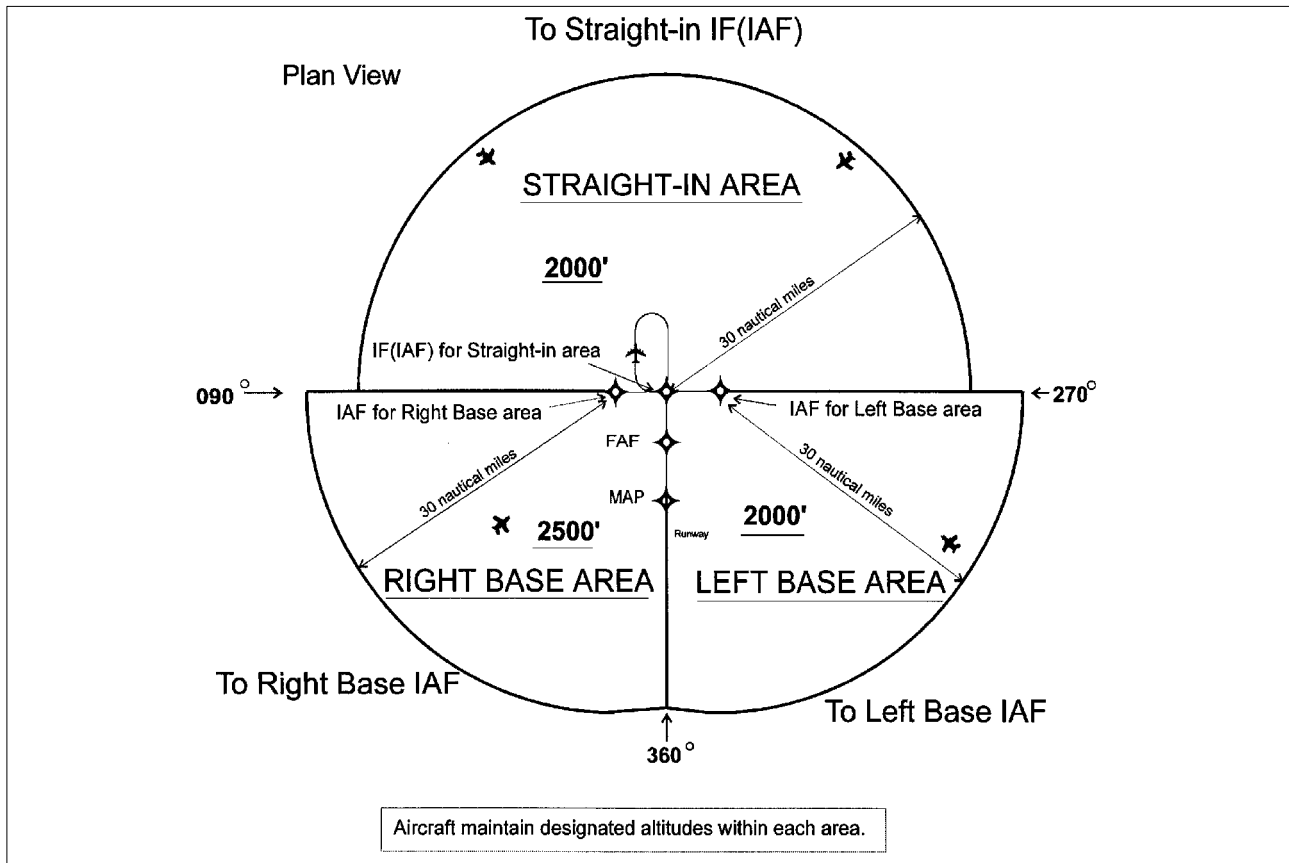

FIG ENR 1.5-21
TAA Area



12.4.5 The standard TAA consists of three areas defined by the extension of the IAF legs and the intermediate segment course. These areas are called the straight-in, left-base, and right-base areas. (See FIG ENR 1.5-21). TAA area lateral boundaries are identified by magnetic courses TO the IF (IAF). The straight-in area can be further divided into pie-shaped sectors with the boundaries identified by magnetic courses TO the IF (IAF), and may contain stepdown sections defined by arcs based on RNAV distances (DME or ATD) from the IF (IAF). The right/left-base areas can only be subdivided using arcs based on RNAV distances from the IAFs for those areas. Minimum MSL altitudes are charted within each of these defined areas/subdivisions that provide at least 1,000 feet of obstacle clearance, or more as necessary in mountainous areas.

12.4.5.1 Prior to arriving at the TAA boundary, the pilot can determine which area of the TAA the aircraft will enter by selecting the IF (IAF) to determine the magnetic bearing TO the center IF (IAF). That bearing should then be compared with the published bearings that define the lateral boundaries of the TAA

areas. Using the end IAFs may give a false indication of which area the aircraft will enter. This is critical when approaching the TAA near the extended boundary between the left and right-base areas, especially where these areas contain different minimum altitude requirements.

12.4.5.2 Pilots entering the TAA and cleared by air traffic control, are expected to proceed directly to the IAF associated with that area of the TAA at the altitude depicted, unless otherwise cleared by air traffic control. Cleared direct to an Initial Approach Fix (IAF) without a clearance for the procedure does not authorize a pilot to descend to a lower TAA altitude. If a pilot desires a lower altitude without an approach clearance, request the lower TAA altitude. If a pilot is not sure of what they are authorized or expected to do by air traffic, they should ask air traffic or request a specific clearance. Pilots entering the TAA with two-way radio communications failure (14 CFR Section 91.185, IFR Operations: Two-way Radio Communications Failure), must maintain the highest altitude prescribed by Section 91.185(c)(2) until arriving at the appropriate IAF.

FIG ENR 1.5-22
Sectored TAA Areas

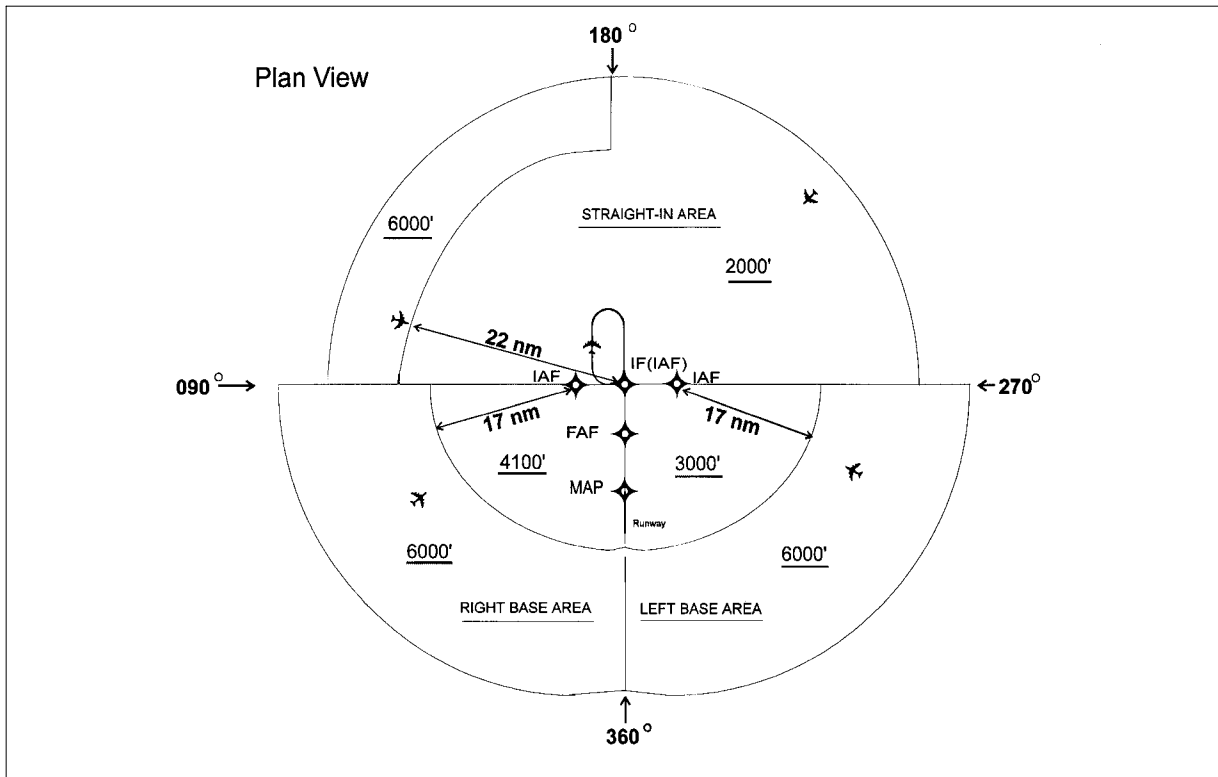

12.4.5.3 Depiction of the TAA on U.S. Government charts will be through the use of icons located in the plan view outside the depiction of the actual approach procedure. (See FIG ENR 1.5-23). Use of icons is necessary to avoid obscuring any portion of the “T” procedure (altitudes, courses, minimum altitudes, etc.). The icon for each TAA area will be located and oriented on the plan view with respect to the direction of arrival to the approach procedure, and will show all TAA minimum altitudes and sector/radius subdivisions for that area. The IAF for each area of the TAA is included on the icon where it appears on the approach, to help the pilot orient the icon to the approach procedure. The IAF name and the distance of the TAA area boundary from the IAF are included on the outside arc of the TAA area icon. Examples here are shown with the TAA around the approach to aid pilots in visualizing how the TAA corresponds to the approach and should not be confused with the actual approach chart depiction.

12.4.5.4 Each waypoint on the “T”, except the missed approach waypoint, is assigned a pronounceable 5-character name used in air traffic control communications, and which is found in the RNAV databases for the procedure. The missed approach waypoint is assigned a pronounceable name when it is not located at the runway threshold.

12.4.6 Once cleared to fly the TAA, pilots are expected to obey minimum altitudes depicted within the TAA icons, unless instructed otherwise by air traffic control. In FIG ENR 1.5-22, pilots within the left or right-base areas are expected to maintain a minimum altitude of 6,000 feet until within 17 NM of the associated IAF. After crossing the 17 NM arc, descent is authorized to the lower charted altitudes. Pilots approaching from the northwest are expected to maintain a minimum altitude of 6,000 feet, and when within 22 NM of the IF (IAF), descend to a minimum altitude of 2,000 feet MSL until reaching the IF (IAF).

FIG ENR 1.5-23
RNAV (GPS) Approach Chart

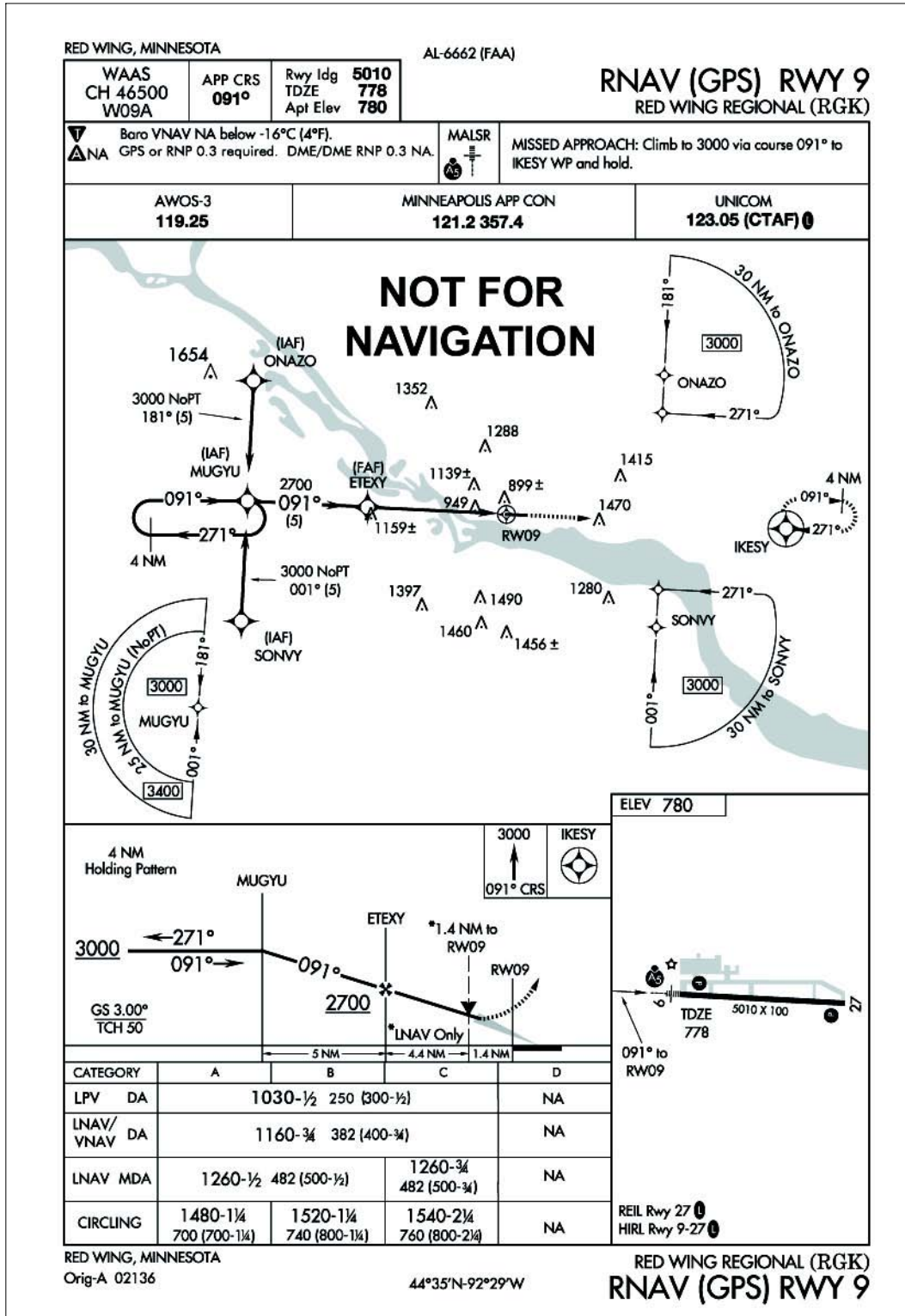

NOTE-
This chart has been modified to depict new concepts and may not reflect actual approach minima.

FIG ENR 1.5-24
**TAA with Left and Right
Base Areas Eliminated**

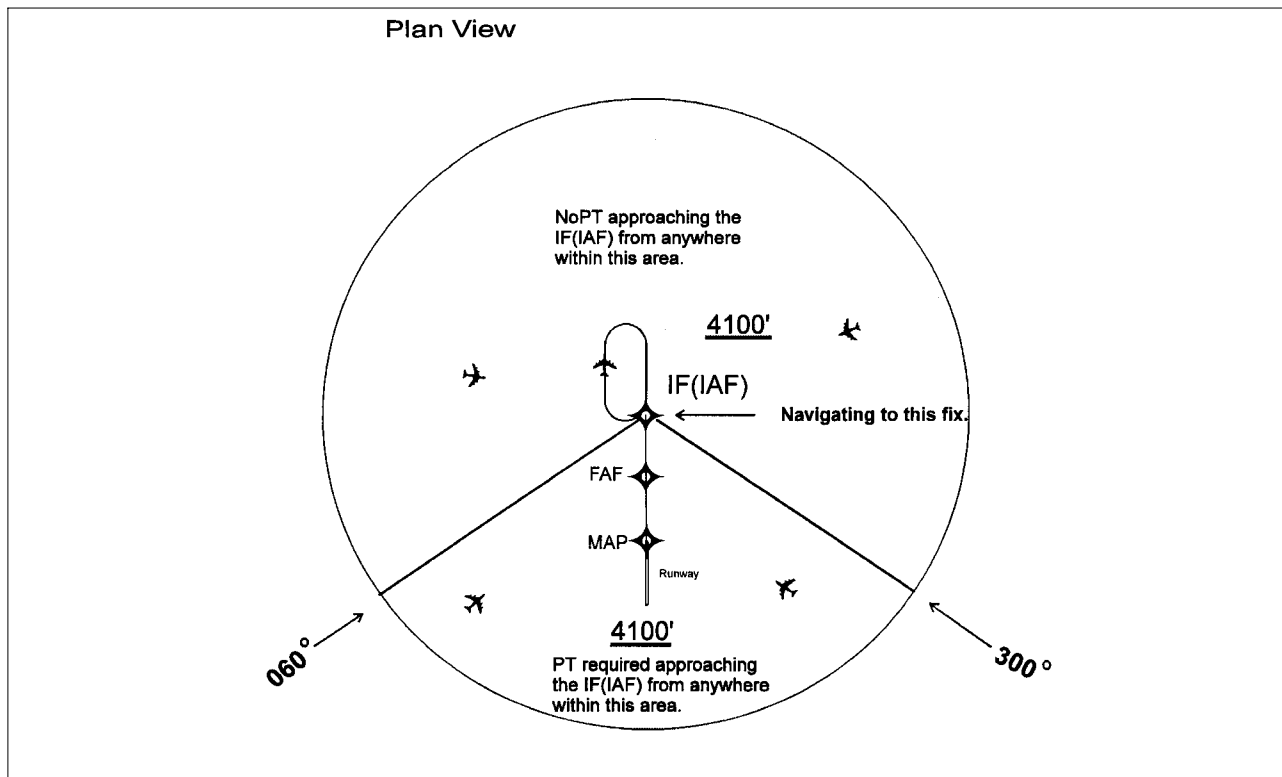

12.4.7 Just as the underlying “T” approach procedure may be modified in shape, the TAA may contain modifications to the defined area shapes and sizes. Some areas may even be eliminated, with other areas expanded as needed. FIG ENR 1.5-24 is an example of a design limitation where a course reversal is necessary when approaching the IF (IAF) from certain directions due to the amount of turn required at the IF (IAF). Design criteria require a course

reversal whenever this turn exceeds 120 degrees. In this generalized example, pilots approaching on a bearing TO the IF (IAF) from 300° clockwise through 060° are expected to execute a course reversal. The term “NoPT” will be annotated on the boundary of the TAA icon for the other portion of the TAA.

FIG ENR 1.5-25
TAA with Right Base Eliminated

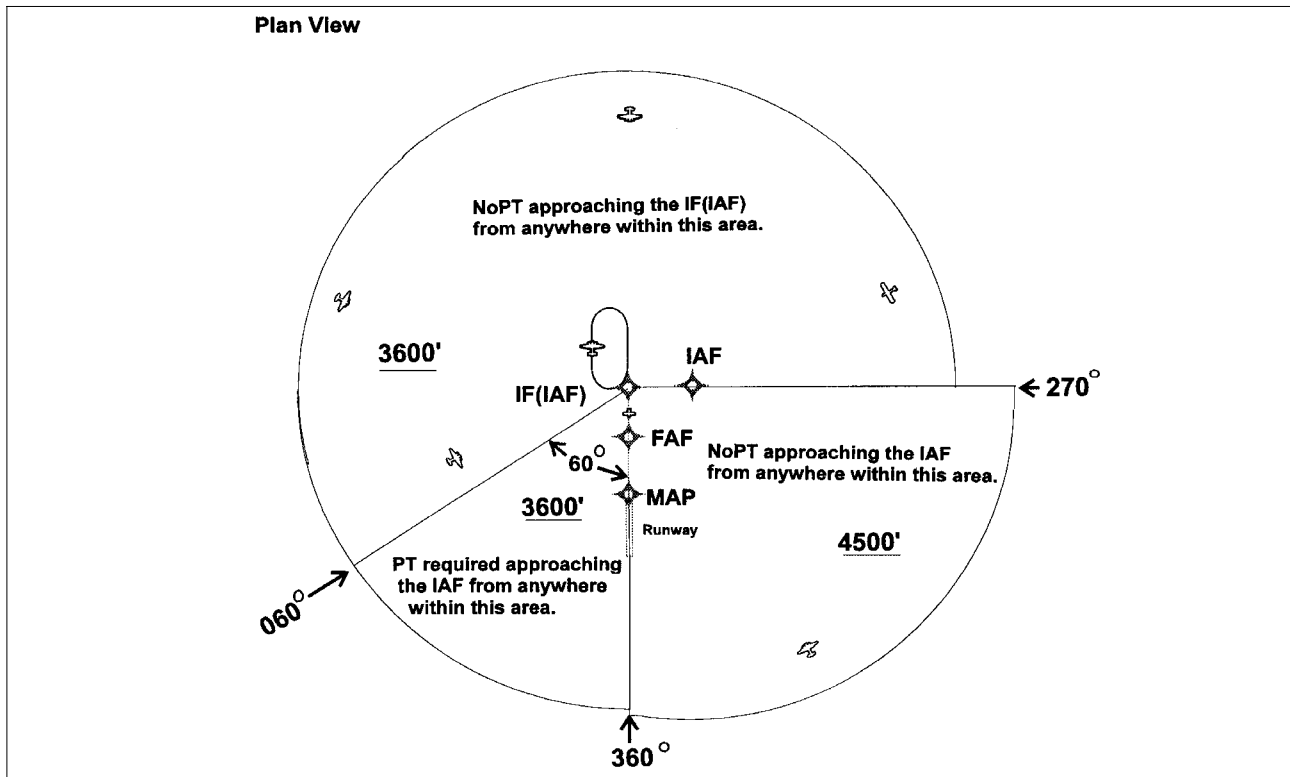

12.4.8 FIG ENR 1.5-25 depicts another TAA modification that pilots may encounter. In this generalized example, the right-base area has been eliminated. Pilots operating within the TAA between 360° clockwise to 060° bearing TO the IF (IAF) are expected to execute the course reversal in order to properly align the aircraft for entry onto the

intermediate segment. Aircraft operating in all other areas from 060° clockwise to 360° bearing TO the IF (IAF) need not perform the course reversal, and the term “NoPT” will be annotated on the TAA boundary of the icon in these areas. TAAs are no longer being produced with sections removed; however, some may still exist on previously published procedures.

FIG ENR 1.5-26
Examples of a TAA with Feeders from an Airway

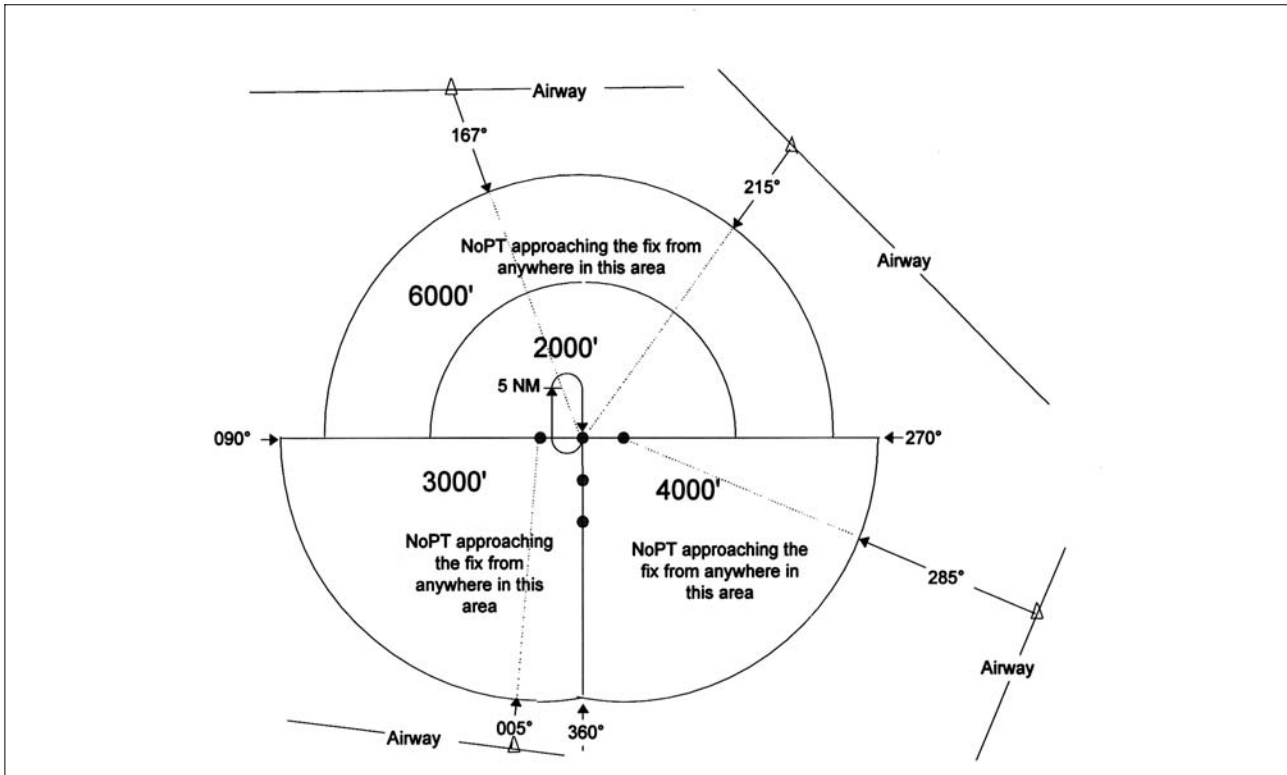

12.4.9 When an airway does not cross the lateral TAA boundaries, a feeder route will be established to provide a transition from the en route structure to the appropriate IAF. Each feeder route will terminate at the TAA boundary, and will be aligned along a path

pointing to the associated IAF. Pilots should descend to the TAA altitude after crossing the TAA boundary and cleared by air traffic control. (See FIG ENR 1.5-26.)

FIG ENR 1.5-27
Minimum Vectoring Altitude Charts

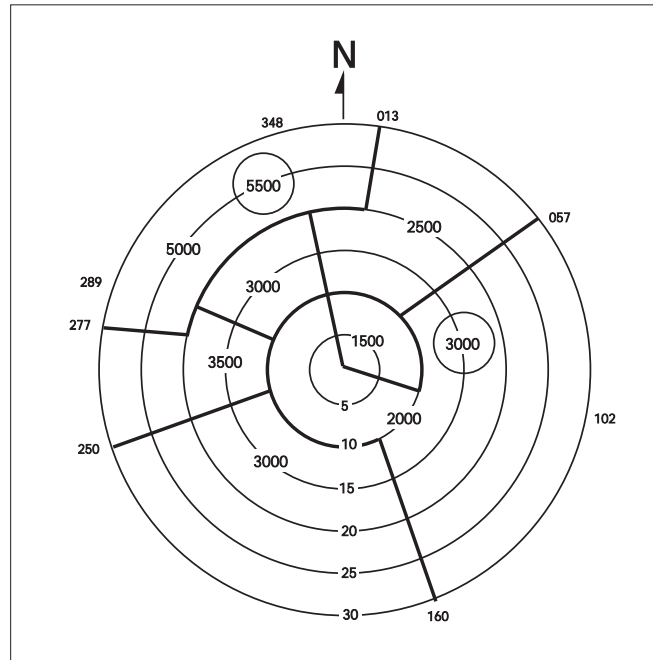

12.5 Minimum Vectoring Altitudes (MVAs) are established for use by ATC when radar ATC is exercised. MVA charts are prepared by air traffic facilities at locations where there are numerous different minimum IFR altitudes. Each MVA chart has sectors large enough to accommodate vectoring of aircraft within the sector at the MVA. Each sector boundary is at least 3 miles from the obstruction determining the MVA. To avoid a large sector with an excessively high MVA due to an isolated prominent obstruction, the obstruction may be enclosed in a buffer area whose boundaries are at least 3 miles from the obstruction. This is done to facilitate vectoring around the obstruction. (See FIG ENR 1.5-27.)

12.5.1 The minimum vectoring altitude in each sector provides 1,000 feet above the highest obstacle in nonmountainous areas and 2,000 feet above the highest obstacle in designated mountainous areas. Where lower MVAs are required in designated mountainous areas to achieve compatibility with terminal routes or to permit vectoring to an IAP, 1,000 feet of obstacle clearance may be authorized with the use of Airport Surveillance Radar (ASR). The minimum vectoring altitude will provide at least 300 feet above the floor of controlled airspace.

NOTE-
OROCA is an off-route altitude which provides obstruction clearance with a 1,000 foot buffer in nonmountainous terrain areas and a 2,000 foot buffer in designated mountainous areas within the U.S. This altitude may not provide signal coverage from ground-based navigational aids, air traffic control radar, or communications coverage.

12.5.2 Because of differences in the areas considered for MVA, and those applied to other minimum altitudes, and the ability to isolate specific obstacles, some MVAs may be lower than the nonradar Minimum En Route Altitudes (MEAs), Minimum Obstruction Clearance Altitudes (MOCAs) or other minimum altitudes depicted on charts for a given location. While being radar vectored, IFR altitude assignments by ATC will be at or above MVA.

12.6 Visual Descent Points (VDPs) are being incorporated in nonprecision approach procedures. The VDP is a defined point on the final approach course of a nonprecision straight-in approach procedure from which normal descent from the MDA to the runway touchdown point may be commenced, provided visual reference required by 14 CFR Section 91.175(c)(3) is established. The VDP will normally be identified by DME on VOR and LOC

procedures and by along track distance to the next waypoint for RNAV procedures. The VDP is identified on the profile view of the approach chart by the symbol: **V**.

12.6.1 VDPs are intended to provide additional guidance where they are implemented. No special technique is required to fly a procedure with a VDP. The pilot should not descend below the MDA prior to reaching the VDP and acquiring the necessary visual reference.

12.6.2 Pilots not equipped to receive the VDP should fly the approach procedure as though no VDP had been provided.

12.7 Visual Segment of a Published Instrument Approach Procedure. Instrument procedure designers perform a visual area obstruction evaluation off the approach end of each runway authorized for instrument landing, straight-in, or circling. Restrictions to instrument operations are imposed if penetrations of the obstruction clearance surfaces exist. These restrictions vary based on the severity of the penetrations, and may include increasing required visibility, denying VDPs, prohibiting night instrument operations to the runway, and/or provide a “Fly Visual” option to the landing surface.

12.7.1 In isolated cases, due to procedure design peculiarities, an IAP may contain a published visual flight path. These procedures are annotated “Fly Visual to Airport” or “Fly Visual.” A dashed arrow indicating the visual flight path will be included in the profile and plan views with an approximate heading and distance to the end of the runway. The depicted ground track associated with the visual segment should be flown as a “DR” course. When executing the visual segment, the flight visibility must not be less than that prescribed in the IAP, the pilot must remain clear of clouds and proceed to the airport maintaining visual contact with the ground. Altitude on the visual flight path is at the discretion of the pilot.

12.7.2 Since missed approach obstacle clearance is assured only if the missed approach is commenced at the published MAP or above the DA/MDA, the pilot should have preplanned climb out options based on aircraft performance and terrain features. Obstacle clearance is the sole responsibility of the pilot when the approach is continued beyond the MAP.

NOTE–

The FAA Administrator retains the authority to approve instrument approach procedures where the pilot may not necessarily have one of the visual references specified in CFR 14, part 91.175 and related rules. It is not a function of procedure design to ensure compliance with part 91.175. The annotation “Fly Visual to Airport” provides relief from part 91.175 requirements that the pilot have distinctly visible and identifiable visual references prior to descent below MDA/DA.

12.8 Charting of Close in Obstacles on Instrument Procedure Charts. Obstacles that are close to the airport may be depicted in either the planview of the instrument approach chart or the airport sketch. Obstacles are charted in only one of the areas, based on space available and distance from the runway. These obstacles could be in the visual segment of the instrument approach procedure. On nonprecision approaches, these obstacles should be considered when determining where to begin descent from the MDA (see “Pilot Operational Considerations When Flying Nonprecision Approaches” in this paragraph).

12.9 Vertical Descent Angle (VDA) on Nonprecision Approaches. FAA policy is to publish VDAs on all nonprecision approaches. Published along with VDA is the threshold crossing height (TCH) that was used to compute the angle. The descent angle may be computed from either the final approach fix (FAF), or a stepdown fix, to the runway threshold at the published TCH. A stepdown fix is only used as the start point when an angle computed from the FAF would place the aircraft below the stepdown fix altitude. The descent angle and TCH information are charted on the profile view of the instrument approach chart following the fix the angle was based on. The optimum descent angle is 3.00 degrees; and whenever possible the approach will be designed using this angle.

12.9.1 The VDA provides the pilot with information not previously available on nonprecision approaches. It provides a means for the pilot to establish a stabilized descent from the FAF or stepdown fix to the MDA. Stabilized descent is a key factor in the reduction of controlled flight into terrain (CFIT) incidents. However, pilots should be aware that **the published angle is for information only** – it is strictly advisory in nature. There is no implicit additional obstacle protection below the MDA. Pilots must still respect the published minimum descent altitude (MDA) unless the visual cues stated 14 CFR Section 91.175 are present and they can visually

acquire and avoid obstacles once below the MDA. The presence of a VDA does not guarantee obstacle protection in the visual segment and does not change any of the requirements for flying a nonprecision approach.

12.9.2 Additional protection for the visual segment below the MDA is provided if a VDP is published and descent below the MDA is started at or after the VDP. Protection is also provided, if a Visual Glide Slope Indicator (VGSI); e.g., VASI or PAPI, is installed and the aircraft remains on the VGSI glide path angle from the MDA. In either case, a chart note will indicate if the VDP or VGSI are not coincident with the VDA. On RNAV approach charts, a small shaded arrowhead shaped symbol (see the legend of the U.S. Terminal Procedures books, page H1) from the end of the VDA to the runway indicates that the 34:1 visual surface is clear.

12.9.3 Pilots may use the published angle and estimated/actual groundspeed to find a target rate of descent from the rate of descent table published in the back of the U.S. Terminal Procedures Publication. This rate of descent can be flown with the Vertical Velocity Indicator (VVI) in order to use the VDA as an aid to flying a stabilized descent. No special equipment is required.

12.9.4 Since one of the reasons for publishing a circling only instrument landing procedures is that the descent rate required exceeds the maximum allowed for a straight in approach, circling only procedures may have VDAs which are considerably steeper than the standard 3 degree angle on final. In this case, the VDA provides the crew with information about the descent rate required to land straight in from the FAF or step down fix to the threshold. This is not intended to imply that landing straight ahead is recommended, or even possible, since the descent rate may exceed the capabilities of many aircraft. The pilot must determine how to best maneuver the aircraft within the circling obstacle clearance area in order to land.

12.9.5 In rare cases the LNAV minima may have a lower HAT than minima with a glide path due to the location of the obstacles. This should be a clear indication to the pilot that obstacles exist below the MDA which the pilot must see in order to ensure adequate clearance. In those cases, the glide path may be treated as a VDA and used to descend to the LNAV MDA as long as all the rules for a nonprecision

approach are applied at the MDA. However, the pilot must keep in mind the information in this paragraph and in paragraph 12.10.

12.10 Pilot Operational Considerations When Flying Nonprecision Approaches. The missed approach point (MAP) on a nonprecision approach is not designed with any consideration to where the aircraft must begin descent to execute a safe landing. It is developed based on terrain, obstructions, NAVAID location and possibly air traffic considerations. Because the MAP may be located anywhere from well prior to the runway threshold to past the opposite end of the runway, the descent from the Minimum Descent Altitude (MDA) to the runway threshold cannot be determined based on the MAP location. Descent from MDA at the MAP when the MAP is located close to the threshold would require an excessively steep descent gradient to land in the normal touchdown zone. Any turn from the final approach course to the runway heading may also be a factor in when to begin the descent.

12.10.1 Pilots are cautioned that descent to a straight-in landing from the MDA at the MAP may be inadvisable or impossible, on a nonprecision approach, even if current weather conditions meet the published ceiling and visibility. Aircraft speed, height above the runway, descent rate, amount of turn and runway length are some of the factors which must be considered by the pilot to determine if a landing can be accomplished.

12.10.2 Visual descent points (VDPs) provide pilots with a reference for the optimal location to begin descent from the MDA, based on the designed vertical descent angle (VDA) for the approach procedure, assuming required visual references are available. Approaches without VDPs have not been assessed for terrain clearance below the MDA, and may not provide a clear vertical path to the runway at the normally expected descent angle. Therefore, pilots must be especially vigilant when descending below the MDA at locations without VDPs. This does not necessarily prevent flying the normal angle; it only means that obstacle clearance in the visual segment could be less and greater care should be exercised in looking for obstacles in the visual segment. Use of visual glide slope indicator (VGSI) systems can aid the pilot in determining if the aircraft is in a position to make the descent from the MDA. However, when the visibility is close to minimums, the VGSI may not be visible at the start descent point

for a “normal” glidepath, due to its location down the runway.

12.10.3 Accordingly, pilots are advised to carefully review approach procedures, prior to initiating the approach, to identify the optimum position(s), and any unacceptable positions, from which a descent to landing can be initiated (in accordance with 14 CFR Section 91.175(c)).

12.11 Area Navigation (RNAV) Instrument Approach Charts. Reliance on RNAV systems for instrument operations is becoming more commonplace as new systems such as GPS and augmented GPS such as the Wide Area Augmentation System (WAAS) are developed and deployed. In order to support full integration of RNAV procedures into the National Airspace System (NAS), the FAA developed a new charting format for IAPs (See FIG ENR 1.5–23). This format avoids unnecessary duplication and proliferation of instrument approach charts. The original stand alone GPS charts, titled simply “GPS,” are being converted to the newer format as the procedures are revised. One reason for the revision is the addition of WAAS based minima to the approach chart. The reformatted approach chart is titled “RNAV (GPS) RWY XX.” Up to four lines of minima are included on these charts. GLS (Ground Based Augmentation System (GBAS) Landing System) was a placeholder for future WAAS and LAAS minima, and the minima was always listed as N/A. The GLS minima line has now been replaced by the WAAS LPV (Localizer Performance with Vertical Guidance) minima on most RNAV (GPS) charts. LNAV/VNAV (lateral navigation/vertical navigation) was added to support both WAAS electronic vertical guidance and Barometric VNAV. LPV and LNAV/VNAV are both APV procedures as described in paragraph 12.1.7. The original GPS minima, titled “S–XX,” for straight in runway XX, is retitled LNAV (lateral navigation). Circling minima may also be published. A new type of nonprecision WAAS minima will also be published on this chart and titled LP (localizer performance). LP will be published in locations where vertically guided minima cannot be provided due to terrain and obstacles and therefore, no LPV or LNAV/VNAV minima will be published. Current plans call for LAAS based procedures to be published on a separate chart and for the GLS minima line to be used only for LAAS. ATC clearance for the RNAV procedure authorizes a properly certified pilot to utilize any

minimums for which the aircraft is certified: e.g. a WAAS equipped aircraft utilize the LPV or LP minima but a GPS only aircraft may not. The RNAV chart includes information formatted for quick reference by the pilot or flight crew at the top of the chart. This portion of the chart, developed based on a study by the Department of Transportation, Volpe National Transportation System Center, is commonly referred to as the pilot briefing.

12.11.1 The minima lines are:

12.11.1.1 GLS. “GLS” is the acronym for Ground Based Augmentation System (GBAS) Landing System. GBAS is the ICAO term for Local Area Augmentation System (LAAS). This line was originally published as a placeholder for both WAAS and LAAS minima and marked as N/A since no minima was published. As the concepts for LAAS and WAAS procedure publication have evolved, GLS will now be used only for LAAS minima, which will be on a separate approach chart. Most RNAV(GPS) approach charts have had the GLS minima line replaced by a WAAS LPV line of minima.

12.11.1.2 LPV. “LPV” is the acronym for localizer performance with vertical guidance. RNAV (GPS) approaches to LPV lines of minima take advantage of the improved accuracy of WAAS lateral and vertical guidance to provide an approach that is very similar to a Category I Instrument Landing System (ILS). The approach to LPV line of minima is designed for angular guidance with increasing sensitivity as the aircraft gets closer to the runway. The sensitivities are nearly identical to those of the ILS at similar distances. This was done intentionally to allow the skills required to proficiently fly an ILS to readily transfer to flying RNAV (GPS) approaches to the LPV line of minima. Just as with an ILS, the LPV has vertical guidance and is flown to a DA. Aircraft can fly this minima line with a statement in the Aircraft Flight Manual that the installed equipment supports LPV approaches. This includes Class 3 and 4 TSO–C146 WAAS equipment.

12.11.1.3 LNAV/VNAV. LNAV/VNAV identifies APV minimums developed to accommodate an RNAV IAP with vertical guidance, usually provided by approach certified Baro–VNAV, but with lateral and vertical integrity limits larger than a precision approach or LPV. LNAV stands for Lateral Navigation; VNAV stands for Vertical Navigation. This minima line can be flown by aircraft with a statement in the Aircraft Flight Manual that the

installed equipment supports GPS approaches and has an approach–approved barometric VNAV, or if the aircraft has been demonstrated to support LNAV/VNAV approaches. This includes Class 2, 3 and 4 TSO–C146 WAAS equipment. Aircraft using LNAV/VNAV minimums will descend to landing via an internally generated descent path based on satellite or other approach approved VNAV systems. Since electronic vertical guidance is provided, the minima will be published as a DA. Other navigation systems may be specifically authorized to use this line of minima, see Section A, Terms/Landing Minima Data, of the U.S. Terminal Procedures books.

12.11.1.4 LP. “LP” is the acronym for localizer performance. Approaches to LP lines of minima take advantage of the improved accuracy of WAAS to provide approaches, with lateral guidance and angular guidance. Angular guidance does not refer to a glideslope angle but rather to the increased lateral sensitivity as the aircraft gets closer to the runway, similar to localizer approaches. However, the LP line of minima is a Minimum Descent Altitude (MDA) rather than a DA (H). Procedures with LP lines of minima will not be published with another approach that contains approved vertical guidance (LNAV/VNAV or LPV). It is possible to have LP and LNAV published on the same approach chart but LP will only be published if it provides lower minima than an LNAV line of minima. LP is not a fail–down mode for LPV. LP will only be published if terrain, obstructions, or some other reason prevent publishing a vertically guided procedure. WAAS avionics may provide GNSS–based advisory vertical guidance during an approach to an LP line of minima (reference section 9.b for further information on advisory vertical guidance). Barometric altimeter information remains the primary altitude reference for complying with any altitude restrictions. WAAS equipment may not support LP, even if it supports LPV, if it was approved before TSO C–145B and TSO C–146B. Receivers approved under previous TSOs may require an upgrade by the manufacturer in order to be used to fly to LP minima. Receivers approved for LP must have a statement in the approved Flight Manual or Supplemental Flight Manual including LP as one of the approved approach types.

12.11.1.5 LNAV. This minima is for lateral navigation only, and the approach minimum altitude will be published as a minimum descent altitude (MDA). LNAV provides the same level of service as the

present GPS stand alone approaches. LNAV minimums support the following navigation systems: WAAS, when the navigation solution will not support vertical navigation; and, GPS navigation systems which are presently authorized to conduct GPS approaches. Existing GPS approaches continue to be converted to the RNAV (GPS) format as they are revised or reviewed.

NOTE–

GPS receivers approved for approach operations in accordance with: AC 20–138, Airworthiness Approval of Global Positioning System (GPS) Navigation Equipment for Use as a VFR and IFR Supplemental Navigation System, for stand–alone Technical Standard Order (TSO) TSO–C129 Class A(1) systems; or AC 20–130A, Airworthiness Approval of Navigation or Flight Management Systems Integrating Multiple Navigation Sensors, for GPS as part of a multi–sensor system, qualify for this minima. WAAS navigation equipment must be approved in accordance with the requirements specified in TSO–C145 or TSO–C146 and installed in accordance with Advisory Circular AC 20–138A, Airworthiness Approval of Global Navigation Satellite System (GNSS) Equipment.

12.11.2 Other systems may be authorized to utilize these approaches. See the description in Section A of the U.S. Terminal Procedures books for details. Operational approval must also be obtained for Baro–VNAV systems to operate to the LNAV/VNAV minimums. Baro–VNAV may not be authorized on some approaches due to other factors, such as no local altimeter source being available. Baro–VNAV is not authorized on LPV procedures. Pilots are directed to their local Flight Standards District Office (FSDO) for additional information.

NOTE–

RNAV and Baro–VNAV systems must have a manufacturer supplied electronic database which shall include the waypoints, altitudes, and vertical data for the procedure to be flown. The system must be able to retrieve the procedure by name from the aircraft navigation database, not just as a manually entered series of waypoints.

12.11.3 ILS or RNAV (GPS) charts.

12.11.3.1 Some RNAV (GPS) charts will also contain an ILS line of minima to make use of the ILS precision final in conjunction with the RNAV GPS capabilities for the portions of the procedure prior to the final approach segment and for the missed approach. Obstacle clearance for the portions of the procedure other than the final approach segment is still based on GPS criteria.

NOTE–

Some GPS receiver installations inhibit GPS navigation whenever ANY ILS frequency is tuned. Pilots flying aircraft with receivers installed in this manner must wait until they are on the intermediate segment of the procedure prior to the PFAF (PFAF is the active waypoint) to tune the ILS frequency and must tune the ILS back to a VOR frequency in order to fly the GPS based missed approach.

12.11.3.2 Charting. There are charting differences between ILS, RNAV (GPS), and GLS approaches.

- a) The LAAS procedure is titled “GLS RWY XX” on the approach chart.
- b) The VDB provides information to the airborne receiver where the guidance is synthesized.
- c) The LAAS procedure is identified by a four alpha–numeric character field referred to as the RPI or approach ID and is similar to the IDENT feature of the ILS.
- d) The RPI is charted.
- e) Most RNAV(GPS) approach charts have had the GLS (NA) minima line replaced by an LPV line of minima.
- f) Since the concepts for LAAS and WAAS procedure publication have evolved, GLS will now be used only for LAAS minima, which will be on a separate approach chart.

12.11.4 Required Navigation Performance (RNP)

12.11.4.1 Pilots are advised to refer to the “TERMS/LANDING MINIMUMS DATA” (Section A) of the U.S. Government Terminal Procedures books for aircraft approach eligibility requirements by specific RNP level requirements.

12.11.4.2 Some aircraft have RNP approval in their AFM without a GPS sensor. The lowest level of sensors that the FAA will support for RNP service is DME/DME. However, necessary DME signal may not be available at the airport of intended operations. For those locations having an RNAV chart published with LNAV/VNAV minimums, a procedure note may be provided such as “DME/DME RNP–0.3 NA.” This means that RNP aircraft dependent on DME/DME to achieve RNP–0.3 are not authorized to conduct this approach. Where DME facility availability is a factor, the note may read “DME/DME RNP–0.3 Authorized; ABC and XYZ Required.” This means that ABC and XYZ facilities have been determined by flight inspection to be required in the

navigation solution to assure RNP–0.3. VOR/DME updating must not be used for approach procedures.

12.11.5 CHART TERMINOLOGY

12.11.5.1 Decision Altitude (DA) replaces the familiar term Decision Height (DH). DA conforms to the international convention where altitudes relate to MSL and heights relate to AGL. DA will eventually be published for other types of instrument approach procedures with vertical guidance, as well. DA indicates to the pilot that the published descent profile is flown to the DA (MSL), where a missed approach will be initiated if visual references for landing are not established. Obstacle clearance is provided to allow a momentary descent below DA while transitioning from the final approach to the missed approach. The aircraft is expected to follow the missed instructions while continuing along the published final approach course to at least the published runway threshold waypoint or MAP (if not at the threshold) before executing any turns.

12.11.5.2 Minimum Descent Altitude (MDA) has been in use for many years, and will continue to be used for the LNAV only and circling procedures.

12.11.5.3 Threshold Crossing Height (TCH) has been traditionally used in “precision” approaches as the height of the glide slope above threshold. With publication of LNAV/VNAV minimums and RNAV descent angles, including graphically depicted descent profiles, TCH also applies to the height of the “descent angle,” or glidepath, at the threshold. Unless otherwise required for larger type aircraft which may be using the IAP, the typical TCH is 30 to 50 feet.

12.11.6 The MINIMA FORMAT will also change slightly.

12.11.6.1 Each line of minima on the RNAV IAP is titled to reflect the level of service available; e.g., GLS, LPV, LNAV/VNAV, LP, and LNAV. CIRCLING minima will also be provided.

12.11.6.2 The minima title box indicates the nature of the minimum altitude for the IAP. For example:

- a) DA will be published next to the minima line title for minimums supporting vertical guidance such as for GLS, LPV or LNAV/VNAV.
- b) MDA will be published where the minima line was designed to support aircraft with only lateral guidance available, such as LNAV or LP. Descent below the MDA, including during the missed

approach, is not authorized unless the visual conditions stated in 14 CFR Section 91.175 exist.

c) Where two or more systems, such as LPV and LNAV/VNAV, share the same minima, each line of minima will be displayed separately.

12.11.7 Chart Symbology changed slightly to include:

12.11.7.1 Descent Profile. The published descent profile and a graphical depiction of the vertical path to the runway will be shown. Graphical depiction of the RNAV vertical guidance will differ from the traditional depiction of an ILS glide slope (feather) through the use of a shorter vertical track beginning at the decision altitude.

a) It is FAA policy to design IAPs with minimum altitudes established at fixes/waypoints to achieve optimum stabilized (constant rate) descents within each procedure segment. This design can enhance the safety of the operations and contribute toward reduction in the occurrence of controlled flight into terrain (CFIT) accidents. Additionally, the National Transportation Safety Board (NTSB) recently emphasized that pilots could benefit from publication of the appropriate IAP descent angle for a stabilized descent on final approach. The RNAV IAP format includes the descent angle to the hundredth of a degree; e.g., **3.00 degrees**. The angle will be provided in the graphically depicted descent profile.

b) The stabilized approach may be performed by reference to vertical navigation information provided by WAAS or LNAV/VNAV systems; or for LNAV-only systems, by the pilot determining the appropriate aircraft attitude/groundspeed combination to attain a constant rate descent which best emulates the published angle. To aid the pilot, U.S. Government Terminal Procedures Publication charts publish an expanded Rate of Descent Table on the inside of the back hard cover for use in planning and executing precision descents under known or approximate groundspeed conditions.

12.11.7.2 Visual Descent Point (VDP). A VDP will be published on most RNAV IAPs. VDPs apply only to aircraft utilizing LP or LNAV minima, not LPV or LNAV/VNAV minimums.

12.11.7.3 Missed Approach Symbology. In order to make missed approach guidance more readily understood, a method has been developed to display

missed approach guidance in the profile view through the use of quick reference icons. Due to limited space in the profile area, only four or fewer icons can be shown. However, the icons may not provide representation of the entire missed approach procedure. The entire set of textual missed approach instructions are provided at the top of the approach chart in the pilot briefing. (See FIG ENR 1.5–23.)

12.11.7.4 Waypoints. All RNAV or GPS stand-alone IAPs are flown using data pertaining to the particular IAP obtained from an onboard database, including the sequence of all WPs used for the approach and missed approach, except that step down waypoints may not be included in some TSO-C-129 receiver databases. Included in the database, in most receivers, is coding that informs the navigation system of which WPs are fly-over (FO) or fly-by (FB). The navigation system may provide guidance appropriately – including leading the turn prior to a fly-by WP; or causing overflight of a fly-over WP. Where the navigation system does not provide such guidance, the pilot must accomplish the turn lead or waypoint overflight manually. Chart symbology for the FB WP provides pilot awareness of expected actions. Refer to the legend of the U.S. Terminal Procedures books.

12.11.7.5 TAAAs are described in subparagraph 12.4, Terminal Arrival Area (TAA). When published, the RNAV chart depicts the TAA areas through the use of “icons” representing each TAA area associated with the RNAV procedure (See FIG ENR 1.5–23). These icons are depicted in the plan view of the approach chart, generally arranged on the chart in accordance with their position relative to the aircrafts arrival from the en route structure. The WP, to which navigation is appropriate and expected within each specific TAA area, will be named and depicted on the associated TAA icon. Each depicted named WP is the IAF for arrivals from within that area. TAAAs may not be used on all RNAV procedures because of airspace congestion or other reasons.

12.11.7.6 Hot and Cold Temperature Limitations. A minimum and maximum temperature limitation is published on procedures which authorize Baro-VNAV operation. These temperatures represent the airport temperature above or below which Baro-VNAV is not authorized to LNAV/VNAV minimums. As an example, the limitation will read: “Uncompensated Baro-VNAV NA below -8°C (-18°F) or above 47°C (117°F).” This information will be found

in the upper left hand box of the pilot briefing. When the temperature is above the high temperature or below the low temperature limit, Baro–VNAV may be used to provide a stabilized descent to the LNAV MDA; however, extra caution should be used in the visual segment to ensure a vertical correction is not required. If the VGSI is aligned with the published glidepath, and the aircraft instruments indicate on glidepath, an above or below glidepath indication on the VGSI may indicate that temperature error is causing deviations to the glidepath. These deviations should be considered if the approach is continued below the MDA.

NOTE–

Many systems which apply Baro–VNAV temperature compensation only correct for cold temperature. In this case, the high temperature limitation still applies. Also, temperature compensation may require activation by maintenance personnel during installation in order to be functional, even though the system has the feature. Some systems may have a temperature correction capability, but correct the Baro–altimeter all the time, rather than just on the final, which would create conflicts with other aircraft if the feature were activated. Pilots should be aware of compensation capabilities of the system prior to disregarding the temperature limitations.

NOTE–

Temperature limitations do not apply to flying the LNAV/VNAV line of minima using approach certified WAAS receivers when LPV or LNAV/VNAV are annunciated to be available.

12.11.7.7 WAAS Channel Number/Approach ID.

The WAAS Channel Number is an optional equipment capability that allows the use of a 5–digit number to select a specific final approach segment without using the menu method. The Approach ID is an airport unique 4–character combination for verifying the selection and extraction of the correct final approach segment information from the aircraft database. It is similar to the ILS ident, but displayed visually rather than aurally. The Approach ID consists of the letter W for WAAS, the runway number, and a letter other than L, C or R, which could be confused with Left, Center and Right, e.g., W35A. Approach IDs are assigned in the order that WAAS approaches are built to that runway number at that airport. The WAAS Channel Number and Approach ID are displayed in the upper left corner of the approach procedure pilot briefing.

12.11.7.8 At locations where outages of WAAS vertical guidance may occur daily due to initial

system limitations, a negative W symbol (**W**) will be placed on RNAV (GPS) approach charts. Many of these outages will be very short in duration, but may result in the disruption of the vertical portion of the approach. The **W** symbol indicates that NOTAMs or Air Traffic advisories are not provided for outages which occur in the WAAS LNAV/VNAV or LPV vertical service. Use LNAV minima for flight planning at these locations, whether as a destination or alternate. For flight operations at these locations, when the WAAS avionics indicate that LNAV/VNAV or LPV service is available, then vertical guidance may be used to complete the approach using the displayed level of service. Should an outage occur during the procedure, reversion to LNAV minima may be required. As the WAAS coverage is expanded, the **W** will be removed.

13. Special Instrument Approach Procedures

13.1 Instrument Approach Procedure (IAP) charts reflect the criteria associated with the U.S. Standard for Terminal Instrument [Approach] Procedures (TERPs), which prescribes standardized methods for use in developing IAPs. Standard IAPs are published in the Federal Register (FR) in accordance with Title 14 of the Code of Federal Regulations, Part 97, and are available for use by appropriately qualified pilots operating properly equipped and airworthy aircraft in accordance with operating rules and procedures acceptable to the FAA. Special IAPs are also developed using TERPS but are not given public notice in the FR. The FAA authorizes only certain individual pilots and/or pilots in individual organizations to use special IAPs, and may require additional crew training and/or aircraft equipment or performance, and may also require the use of landing aids, communications, or weather services not available for public use. Additionally, IAPs that service private use airports or heliports are generally special IAPs.

14. Radar Approaches

14.1 The only airborne radio equipment required for radar approaches is a functioning radio transmitter and receiver. The radar controller vectors the aircraft to align it with the runway centerline. The controller continues the vectors to keep the aircraft on course until the pilot can complete the approach and landing by visual reference to the surface. There are two types

of radar approaches, “Precision” (PAR) and “Surveillance” (ASR).

14.2 A radar approach may be given to any aircraft upon request and may be offered to pilots of aircraft in distress or to expedite traffic; however, a surveillance approach might not be approved unless there is an ATC operational requirement, or in an unusual or emergency situation. Acceptance of a precision or surveillance approach by a pilot does not waive the prescribed weather minimums for the airport or for the particular aircraft operator concerned. The decision to make a radar approach when the reported weather is below the established minimums rests with the pilot.

14.3 Precision and surveillance approach minimums are published on separate pages in the Federal Aviation Administration Instrument Approach Procedure charts.

14.3.1 A Precision Approach (PAR) is one in which a controller provides highly accurate navigational guidance in azimuth and elevation to a pilot. Pilots are given headings to fly to direct them to and keep their aircraft aligned with the extended centerline of the landing runway. They are told to anticipate glidepath interception approximately 10 to 30 seconds before it occurs and when to start descent. The published decision height will be given only if the pilot requests it. If the aircraft is observed to deviate above or below the glidepath, the pilot is given the relative amount of deviation by use of terms “slightly” or “well” and is expected to adjust the aircrafts rate of descent to return to the glidepath. Trend information is also issued with respect to the elevation of the aircraft and may be modified by the terms “rapidly” and “slowly”; e.g., “well above glidepath, coming down rapidly.” Range from touchdown is given at least once each mile. If an aircraft is observed by the controller to proceed outside of specified safety zone limits in azimuth and/or elevation and continues to operate outside these prescribed limits, the pilot will be directed to execute a missed approach or to fly a specified course unless the pilot has the runway environment (runway, approach lights, etc.) in sight. Navigational guidance in azimuth and elevation is provided the pilot until the aircraft reaches the published decision height (DH). Advisory course and glidepath information is furnished by the controller until the aircraft passes over the landing threshold, at which point the pilot is

advised of any deviation from the runway centerline. Radar service is automatically terminated upon completion of the approach.

14.3.2 A Surveillance Approach (ASR) is one in which a controller provides navigational guidance in azimuth only. The pilot is furnished headings to fly to align the aircraft with the extended centerline of the landing runway. Since the radar information used for a surveillance approach is considerably less precise than that used for a precision approach, the accuracy of the approach will not be as great, and higher minimums will apply. Guidance in elevation is not possible but the pilot will be advised when to commence descent to the minimum descent altitude (MDA) or, if appropriate, to an intermediate “step down fix” minimum crossing altitude and subsequently to the prescribed MDA. In addition, the pilot will be advised of the location of the missed approach point (MAP) prescribed for the procedure and the aircrafts position each mile on final from the runway, airport/heliport, or MAP, as appropriate. If requested by the pilot, recommended altitudes will be issued at each mile, based on the descent gradient established for the procedure, down to the last mile that is at or above the MDA. Normally, navigational guidance will be provided until the aircraft reaches the MAP. Controllers will terminate guidance and instruct the pilot to execute a missed approach unless at the MAP the pilot has the runway, airport/heliport in sight or, for a helicopter point-in-space approach, the prescribed visual reference with the surface is established. Also, if at any time during the approach the controller considers that safe guidance for the remainder of the approach cannot be provided, the controller will terminate guidance and instruct the pilot to execute a missed approach. Similarly, guidance termination and missed approach will be effected upon pilot request, and for civil aircraft only, controllers may terminate guidance when the pilot reports the runway, airport/heliport, or visual surface route (point-in-space approach) in sight or otherwise indicates that continued guidance is not required. Radar service is automatically terminated at the completion of a radar approach.

NOTE-

1. *The published MDA for straight-in approaches will be issued to the pilot before beginning descent. When a surveillance approach will terminate in a circle-to-land maneuver, the pilot must furnish the aircraft approach category to the controller. The controller will then provide the pilot with the appropriate MDA.*

2. ASR approaches are not available when an ATC facility is using center radar arts presentation/ processing (CENRAP).

14.3.3 A No-Gyro Approach is available to a pilot under radar control who experiences circumstances wherein the directional gyro or other stabilized compass is inoperative or inaccurate. When this occurs, the pilot should so advise ATC and request a No-Gyro vector or approach. Pilots of aircraft not equipped with a directional gyro or other stabilized compass who desire radar handling may also request a No-Gyro vector or approach. The pilot should make all turns at standard rate and should execute the turn immediately upon receipt of instructions. For example, “TURN RIGHT,” “STOP TURN.” When a surveillance or precision approach is made, the pilot will be advised after the aircraft has been turned onto final approach to make turns at half standard rate.

15. Radar Monitoring of Instrument Approaches

15.1 PAR facilities operated by the FAA and the military services at some joint-use (civil/military) and military installations monitor aircraft on instrument approaches and issue radar advisories to the pilot when weather is below VFR minimum (1,000 and 3), at night, or when requested by a pilot. This service is provided only when the PAR final approach course coincides with the final approach of the navigational aid and only during the operational hours of the PAR. The radar advisories serve only as a secondary aid since the pilot has selected the navigational aid as the primary aid for the approach.

15.2 Prior to starting final approach, the pilot will be advised of the frequency on which the advisories will be transmitted. If, for any reason, radar advisories cannot be furnished, the pilot will be so advised.

15.3 Advisory information, derived from radar observations, includes information on:

15.3.1 Passing the final approach fix inbound (nonprecision approach) or passing the outer marker or the fix used in lieu of the outer marker inbound (precision approach).

15.3.2 Trend advisories with respect to elevation and/or azimuth radar position and movement will be provided.

NOTE–

At this point, the pilot may be requested to report sighting the approach lights or the runway.

NOTE–

Whenever the aircraft nears the PAR safety limit, the pilot will be advised that he/she is well above or below the glidepath or well left or right of course. Glidepath information is given only to those aircraft executing a precision approach, such as ILS or MLS. Altitude information is not transmitted to aircraft executing other than precision approaches because the descent portions of these approaches generally do not coincide with the depicted PAR glidepath. At locations where the MLS glidepath and PAR glidepath are not coincidental, only azimuth monitoring will be provided.

15.3.3 If, after repeated advisories, the aircraft proceeds outside the PAR safety limit or if a radical deviation is observed, the pilot will be advised to execute a missed approach if not visual.

15.4 Radar service is automatically terminated upon completion of the approach.

16. ILS Approach

16.1 Communications should be established with the appropriate FAA control tower or with the FAA FSS where there is no control tower, prior to starting an ILS approach. This is in order to receive advisory information as to the operation of the facility. It is also recommended that the aural signal of the ILS be monitored during an approach as to assure continued reception and receipt of advisory information, when available.

17. ILS/MLS Approaches to Parallel Runways

17.1 ATC procedures permit ILS instrument approach operations to dual or triple parallel runway configurations. ILS/MLS approaches to parallel runways are grouped into three classes: Parallel (dependent) ILS/MLS Approaches; Simultaneous Parallel (independent) ILS/MLS Approaches; and Simultaneous Close Parallel (independent) ILS Precision Runway Monitor (PRM) Approaches. (See FIG ENR 1.5–28.) The classification of a parallel runway approach procedure is dependent on adjacent parallel runway centerline separation, ATC procedures, and airport ATC radar monitoring and communications capabilities. At some airports one or more parallel localizer courses may be offset up to

3 degrees. Offset localizer configurations result in loss of Category II capabilities and an increase in decision height (50 feet).

17.2 Parallel approach operations demand heightened pilot situational awareness. A thorough Approach Procedure Chart review should be conducted with, as a minimum, emphasis on the following approach chart information: name and number of the approach, localizer frequency, inbound localizer/azimuth course, glide slope intercept altitude, decision height, missed approach instructions, special notes/procedures, and the assigned runway location/proximity to adjacent runways. Pilots will be advised that simultaneous ILS/MLS or simultaneous close parallel ILS PRM approaches are in use. This information may be provided through the ATIS.

17.3 The close proximity of adjacent aircraft conducting simultaneous parallel ILS/MLS and simultaneous close parallel ILS PRM approaches mandates strict pilot compliance with all ATC clearances. ATC assigned airspeeds, altitudes, and headings must be complied with in a timely manner. Autopilot coupled ILS/MLS approaches require pilot knowledge of procedures necessary to comply with ATC instructions. Simultaneous parallel ILS/MLS and simultaneous close parallel ILS PRM approaches necessitate precise localizer tracking to minimize final monitor controller intervention, and unwanted No Transgression Zone (NTZ) penetration. In the unlikely event of a breakout, a vector off the approach

course prior to the decision altitude (DA), ATC will not assign altitudes lower than the minimum vectoring altitude. Pilots should notify ATC immediately if there is a degradation of aircraft or navigation systems.

17.4 Strict radio discipline is mandatory during parallel ILS/MLS approach operations. This includes an alert listening watch and the avoidance of lengthy, unnecessary radio transmissions. Attention must be given to proper call sign usage to prevent the inadvertent execution of clearances intended for another aircraft. Use of abbreviated call signs must be avoided to preclude confusion of aircraft with similar sounding call signs. Pilots must be alert to unusually long periods of silence or any unusual background sounds in their radio receiver. A stuck microphone may block the issuance of ATC instructions by the final monitor controller during simultaneous parallel ILS/MLS and simultaneous close parallel ILS PRM approaches. For additional communications information, pilots should refer to GEN 3.4, paragraph 4.4, Radio Communications Phraseology and Techniques.

17.5 Use of Traffic Collision Avoidance Systems (TCAS) provides an additional element of safety to parallel approach operations. Pilots should follow recommended TCAS operating procedures presented in approved flight manuals, original equipment manufacturer recommendations, professional newsletters, and FAA publications.

FIG ENR 1.5-28
Parallel ILS Approaches

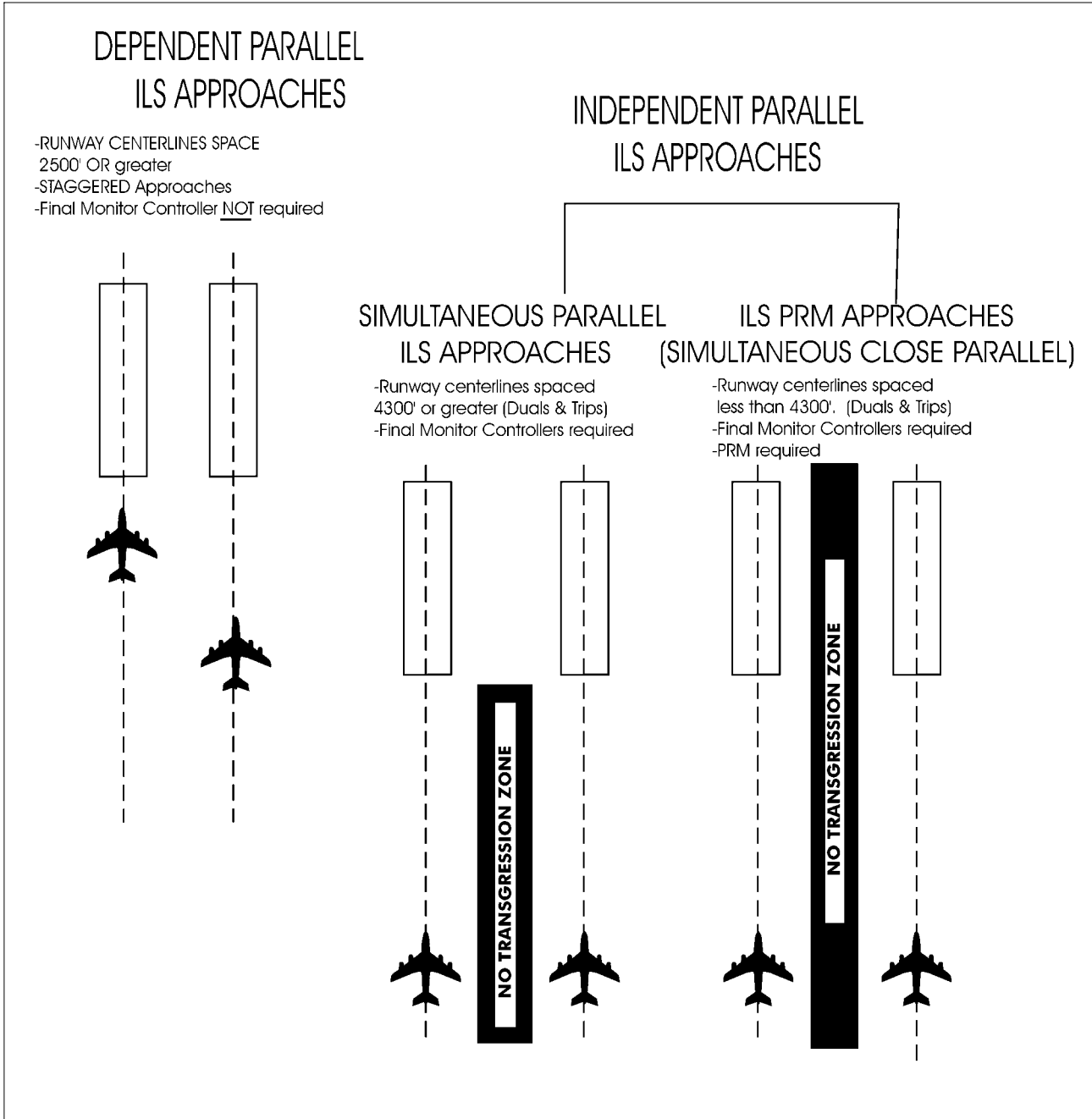
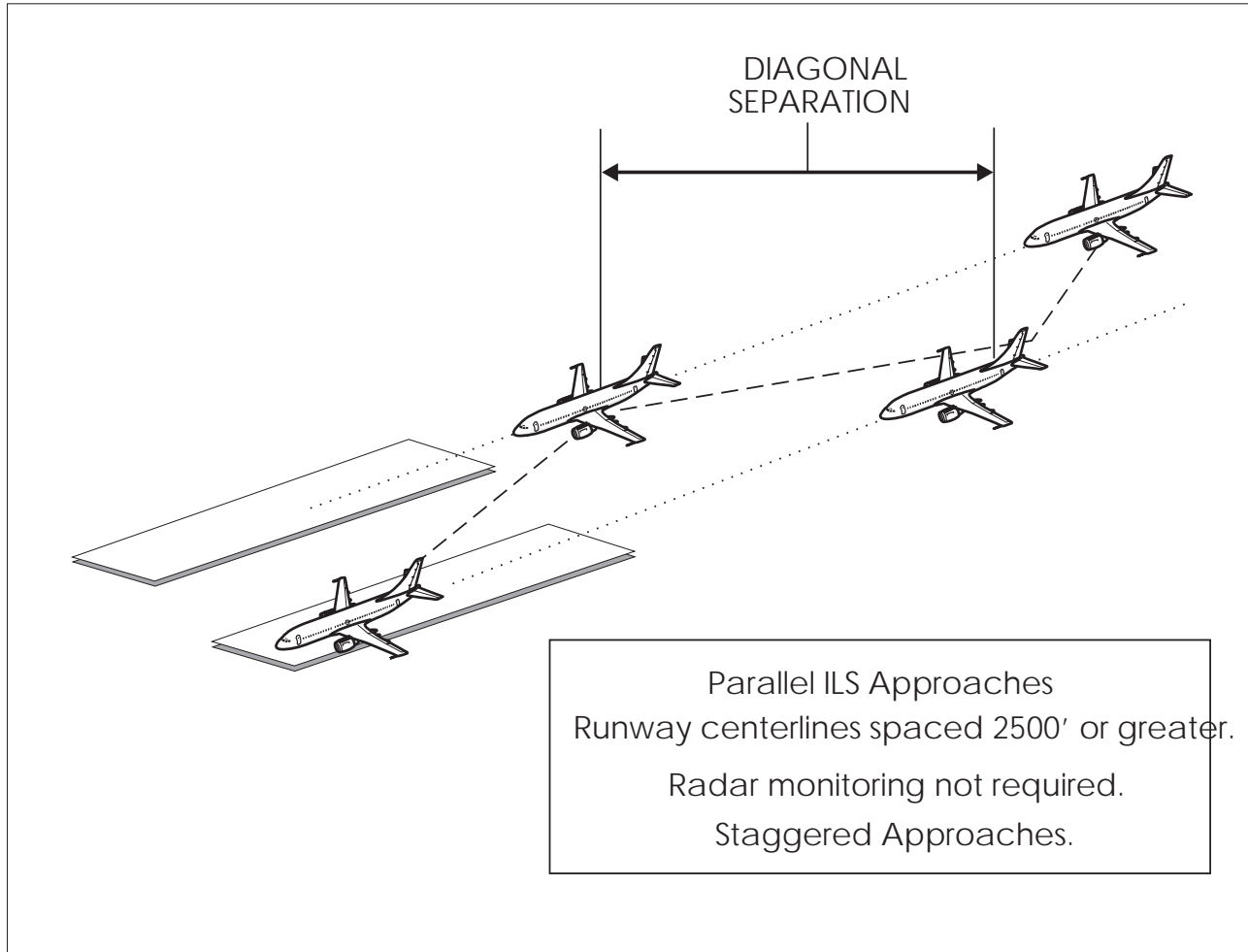

FIG ENR 1.5-29
Staggered ILS Approaches



18. Parallel ILS/MLS Approaches (Dependent) (See FIG ENR 1.5-29)

18.1 Parallel approaches are an ATC procedure permitting parallel ILS/MLS approaches to airports having parallel runways separated by at least 2,500 feet between centerlines. Integral parts of a total system are ILS/MLS, radar, communications, ATC procedures, and required airborne equipment.

18.2 A parallel (dependent) approach differs from a simultaneous (independent) approach in that, the minimum distance between parallel runway centerlines is reduced; there is no requirement for radar monitoring or advisories; and a staggered separation of aircraft on the adjacent localizer/azimuth course is required.

18.3 Aircraft are afforded a minimum of 1.5 miles radar separation diagonally between successive aircraft on the adjacent localizer/azimuth course when runway centerlines are at least 2,500 feet but no more than 4,300 feet apart. When runway centerlines are more than 4,300 feet but no more than 9,000 feet apart, a minimum of 2 miles diagonal radar separation is provided. Aircraft on the same localizer/azimuth course within 10 miles of the runway end are provided a minimum of 2.5 miles radar separation. In addition, a minimum of 1,000 feet vertical or a minimum of three miles radar separation is provided between aircraft during turn on to the parallel final approach course.

FIG ENR 1.5-30
Simultaneous Parallel ILS Approaches

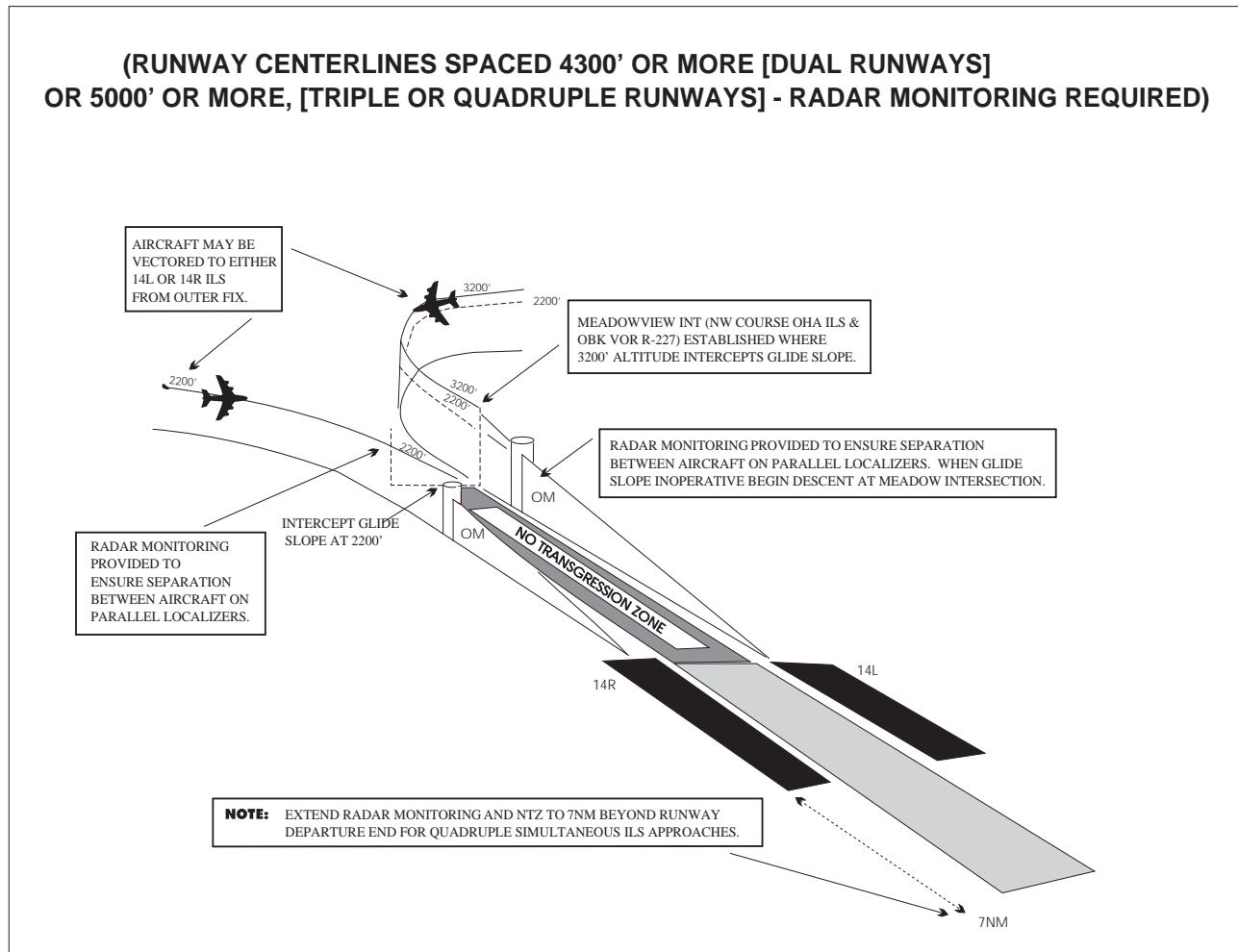

18.4 Whenever parallel ILS/MLS approaches are in progress, pilots are informed that approaches to both runways are in use. In addition, the radar controller will have the interphone capability of communicating with the tower controller where separation responsibility has not been delegated to the tower.

19. Simultaneous Parallel ILS/MLS Approaches (Independent) (See FIG ENR 1.5-30)

19.1 System. This approach system permits simultaneous ILS/MLS approaches to parallel runways with centerlines separated by 4,300 to 9,000 feet, and equipped with final monitor controllers. Simultaneous parallel ILS/MLS approaches require radar monitoring to ensure separation between aircraft on

the adjacent parallel approach course. Aircraft position is tracked by final monitor controllers who will issue instructions to aircraft observed deviating from the assigned localizer course. Staggered radar separation procedures are not utilized. Integral parts of a total system are ILS/MLS, radar, communications, ATC procedures, and required airborne equipment. The Approach Procedure Chart permitting simultaneous parallel ILS/MLS approaches will contain the note “simultaneous approaches authorized RWYS 14L and 14R,” identifying the appropriate runways as the case may be. When advised that simultaneous parallel ILS/MLS approaches are in progress, pilots shall advise approach control immediately of malfunctioning or inoperative receivers, or if a simultaneous parallel ILS/MLS approach is not desired.

19.2 Radar Monitoring. This service is provided for each simultaneous parallel ILS/MLS approach to ensure aircraft do not deviate from the final approach course. Radar monitoring includes instructions if an aircraft nears or penetrates the prescribed NTZ (an area 2,000 feet wide located equidistant between parallel final approach courses). This service will be provided as follows:

19.2.1 During turn on to parallel final approach, aircraft will be provided 3 miles radar separation or a minimum of 1,000 feet vertical separation. The assigned altitude must be maintained until intercepting the glide path, unless cleared otherwise by ATC. Aircraft will not be vectored to intercept the final approach course at an angle greater than thirty degrees.

19.2.2 The final monitor controller will have the capability of overriding the tower controller on the tower frequency.

19.2.3 Pilots will be instructed to monitor the tower frequency to receive advisories and instructions.

19.2.4 Aircraft observed to overshoot the turn-on or to continue on a track which will penetrate the NTZ will be instructed to return to the correct final approach course immediately. The final monitor

controller may also issue missed approach or breakout instructions to the deviating aircraft.

PHRASEOLOGY-

“(Aircraft call sign) YOU HAVE CROSSED THE FINAL APPROACH COURSE. TURN (left/right) IMMEDIATELY AND RETURN TO THE LOCALIZER/AZIMUTH COURSE.”

or

“(Aircraft call sign) TURN (left/right) AND RETURN TO THE LOCALIZER/AZIMUTH COURSE.”

19.2.5 If a deviating aircraft fails to respond to such instructions or is observed penetrating the NTZ, the aircraft on the adjacent final approach course may be instructed to alter course.

PHRASEOLOGY-

“TRAFFIC ALERT (aircraft call sign) TURN (left/right) IMMEDIATELY HEADING (degrees), (climb/descend) AND MAINTAIN (altitude).”

19.2.6 Radar monitoring will automatically be terminated when visual separation is applied, the aircraft reports the approach lights or runway in sight, or the aircraft is 1 mile or less from the runway threshold (for runway centerlines spaced 4,300 feet or greater). Final monitor controllers will not advise pilots when radar monitoring is terminated.

FIG ENR 1.5-31
ILS PRM Approaches
(Simultaneous Close Parallel)

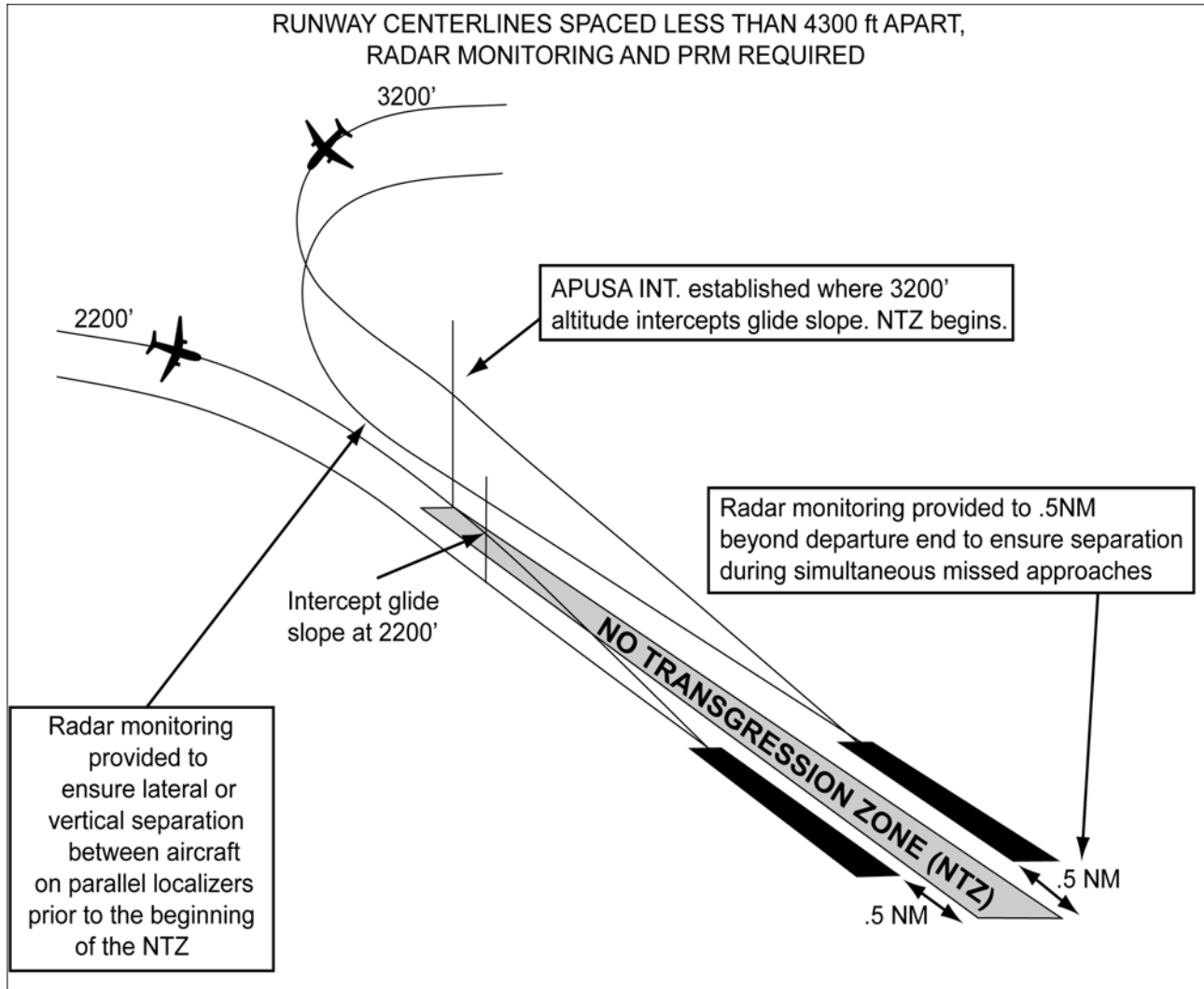

20. Simultaneous Close Parallel ILS PRM Approaches (Independent) and Simultaneous Offset Instrument Approaches (SOIA) (See FIG ENR 1.5-31)

20.1 System

20.1.1 ILS/PRM is an acronym for Instrument Landing System/Precision Runway Monitor.

20.1.1.1 An approach system that permits simultaneous ILS/PRM approaches to dual runways with centerlines separated by less than 4,300 feet but at least 3,400 feet for parallel approach courses, and at least 3,000 feet if one ILS is offset by 2.5 to 3.0 degrees. The airspace between the final approach courses contains a No Transgression Zone (NTZ)

with surveillance provided by two PRM monitor controllers, one for each approach course. To qualify for reduced lateral runway separation, monitor controllers must be equipped with high update radar and high resolution ATC radar displays, collectively called a PRM system. The PRM system displays almost instantaneous radar information. Automated tracking software provides PRM monitor controllers with aircraft identification, position, speed and a ten-second projected position, as well as visual and aural controller alerts. The PRM system is a supplemental requirement for simultaneous close parallel approaches in addition to the system requirements for simultaneous parallel ILS/MLS approaches described in paragraph 19., Simultaneous Parallel ILS/MLS Approaches (Independent).

20.1.1.2 Simultaneous close parallel ILS/PRM approaches are depicted on a separate Approach Procedure Chart titled ILS/PRM Rwy XXX (Simultaneous Close Parallel).

20.1.2 SOIA is an acronym for Simultaneous Offset Instrument Approach, a procedure used to conduct simultaneous approaches to runways spaced less than 3,000 feet, but at least 750 feet apart. The SOIA procedure utilizes an ILS/PRM approach to one runway and an offset Localizer Type Directional Aid (LDA)/PRM approach with glide slope to the adjacent runway.

20.1.2.1 The ILS/PRM approach plates used in SOIA operations are identical to other ILS/PRM approach plates, with an additional note, which provides the separation between the two runways used for simultaneous approaches. The LDA/PRM approach plate displays the required notations for closely spaced approaches as well as depicting the visual segment of the approach, and a note that provides the separation between the two runways used for simultaneous operations.

20.1.2.2 Controllers monitor the SOIA ILS/PRM and LDA/PRM approaches with a PRM system using high update radar and high-resolution ATC radar displays in exactly the same manner as is done for ILS/PRM approaches. The procedures and system requirements for SOIA ILS/PRM and LDA/PRM approaches are identical with those used for simultaneous close parallel ILS/PRM approaches until near the LDA/PRM approach missed approach point (MAP)---where visual acquisition of the ILS aircraft by the LDA aircraft must be accomplished. Since the ILS/PRM and LDA/PRM approaches are identical except for the visual segment in the SOIA concept, an understanding of the procedures for conducting ILS/PRM approaches is essential before conducting a SOIA ILS/PRM or LDA/PRM operation.

20.1.2.3 In SOIA, the approach course separation (instead of the runway separation) meets established close parallel approach criteria. Refer to FIG ENR 1.5–31 for the generic SOIA approach geometry. A visual segment of the LDA/PRM approach is established between the LDA MAP and the runway threshold. Aircraft transition in visual conditions from the LDA course, beginning at the LDA MAP, to align with the runway and can be stabilized by 500 feet above ground level (AGL) on

the extended runway centerline. Aircraft will be “paired” in SOIA operations, with the ILS aircraft ahead of the LDA aircraft prior to the LDA aircraft reaching the LDA MAP. A cloud ceiling for the approach is established so that the LDA aircraft has nominally 30 seconds to acquire the leading ILS aircraft prior to the LDA aircraft reaching the LDA MAP. If visual acquisition is not accomplished, a missed approach must be executed.

20.2 Requirements.

20.2.1 Besides system requirements as identified in subparagraph 20.1 above all pilots must have completed special training before accepting a clearance to conduct ILS/PRM or LDA/PRM Simultaneous Close Parallel Approaches.

20.2.1.1 Pilot Training Requirement. Pilots must complete special pilot training, as outlined below, before accepting a clearance for a simultaneous close parallel ILS/PRM or LDA/PRM approach.

a) For operations under 14 CFR Parts 121, 129, and 135 pilots must comply with FAA approved company training as identified in their Operations Specifications. Training, at a minimum, must require pilots to view the FAA video “ILS PRM AND SOIA APPROACHES: INFORMATION FOR AIR CARRIER PILOTS.” Refer to <http://www.faa.gov> for additional information and to view or download the video.

b) For operations under Part 91:

1) Pilots operating transport category aircraft must be familiar with PRM operations as contained in this section of the Aeronautical Information Publication (AIP). In addition, pilots operating transport category aircraft must view the FAA video “ILS PRM AND SOIA APPROACHES: INFORMATION FOR AIR CARRIER PILOTS.” Refer to <http://www.faa.gov> for additional information and to view or download the video.

2) Pilots *not* operating transport category aircraft must be familiar with PRM and SOIA operations as contained in this section of the AIP. The FAA strongly recommends that pilots *not* involved in transport category aircraft operations view the FAA video, “ILS PRM AND SOIA APPROACHES: INFORMATION FOR GENERAL AVIATION PILOTS.” Refer to <http://www.faa.gov> for additional information and to view or download the video.

FIG ENR 1.5-32
SOIA Approach Geometry

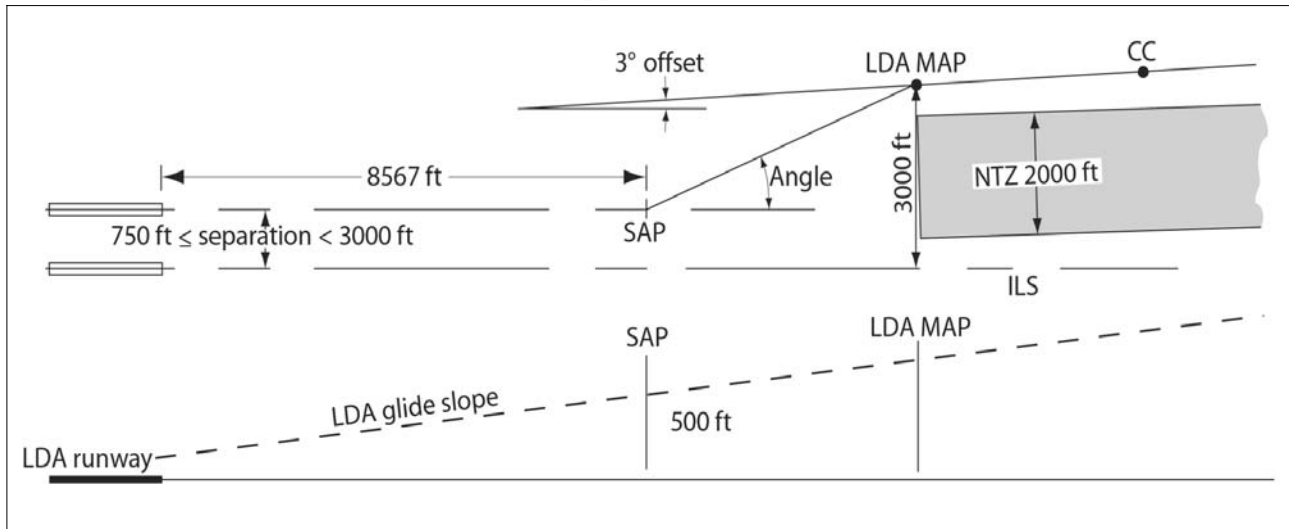

NOTE-

- SAP** The SAP is a design point along the extended centerline of the intended landing runway on the glide slope at 500 feet above the landing threshold. It is used to verify a sufficient distance is provided for the visual maneuver after the missed approach point (MAP) to permit the pilots to conform to approved, stabilized approach criteria.
- MAP** The point along the LDA where the course separation with the adjacent ILS reaches 3,000 feet. The altitude of the glide slope at that point determines the approach minimum descent altitude and is where the NTZ terminates. Maneuvering inside the MAP is done in visual conditions.
- Angle** Angle formed at the intersection of the extended LDA runway centerline and a line drawn between the LDA MAP and the SAP. The size of the angle is determined by the FAA SOIA computer design program, and is dependent on whether Heavy aircraft use the LDA and the spacing between the runways.
- Visibility** Distance from MAP to runway threshold in statute miles (light credit applies).
- Procedure** LDA aircraft must see the runway landing environment and, if less than standard radar separation exists between the aircraft on the adjacent ILS course, the LDA aircraft must visually acquire the ILS aircraft and report it in sight to ATC prior to the LDA MAP.
- CC** Clear Clouds.

20.2.1.2 ATC Directed Breakout. An ATC directed “breakout” is defined as a vector off the ILS or LDA approach course in response to another aircraft penetrating the NTZ, the 2,000 foot wide area located equidistance between the two approach courses that is monitored by the PRM monitor controllers.

20.2.1.3 Dual Communications. The aircraft flying the ILS/PRM or LDA/PRM approach must have the capability of enabling the pilot/s to listen to two communications frequencies simultaneously.

20.3 Radar Monitoring. Simultaneous close parallel ILS/PRM and LDA/PRM approaches require that final monitor controllers utilize the PRM system to ensure prescribed separation standards are met. Procedures and communications phraseology are also described in paragraph 19., Simultaneous Parallel ILS/MLS Approaches (Independent). A minimum of 3 miles radar separation or 1,000 feet vertical separation will be provided during the turn-on to close parallel final approach courses. To ensure separation is maintained, and in order to avoid an imminent situation during simultaneous close parallel ILS/PRM or SOIA ILS/PRM and LDA/PRM approaches, pilots must immediately comply with PRM monitor controller instructions. In the event of a missed approach, radar monitoring is provided to one-half mile beyond the most distant of the two runway departure ends for ILS/RPM approaches. In SOIA, PRM radar monitoring terminates at the LDA MAP. Final monitor controllers will not notify pilots when radar monitoring is terminated.

20.4 Attention All Users Page (AAUP). ILS/PRM and LDA/PRM approach charts have an AAUP associated with them that must be referred to in preparation for conducting the approach. This page contains the following instructions that must be followed if the pilot is unable to accept an ILS/PRM or LDA/PRM approach.

20.4.1 At airports that conduct PRM operations, (ILS/PRM or, in the case of airports where SOIAs are conducted, ILS/PRM and LDA/PRM approaches) pilots not qualified to except PRM approaches must contact the FAA Command Center prior to departure (1–800–333–4286) to obtain an arrival reservation (see FAA Advisory Circular 90–98, Simultaneous Closely Spaced Parallel Operations at Airports Using Precision Runway Monitor (PRM) Systems). Arriving flights that are unable to participate in ILS/PRM or LDA/PRM approaches and have not received an

arrival reservation are subject to diversion to another airport or delays. Pilots en route to a PRM airport designated as an alternate, unable to reach their filed destination, and who are not qualified to participate in ILS/PRM or LDA/PRM approaches must advise ATC as soon as practical that they are unable to participate. Pilots who are qualified to participate but experience an en route equipment failure that would preclude participation in PRM approaches should notify ATC as soon as practical.

20.4.2 The AAUP covers the following operational topics:

20.4.2.1 ATIS. When the ATIS broadcast advises ILS/PRM approaches are in progress (or ILS PRM and LDA PRM approaches in the case of SOIA), pilots should brief to fly the ILS/PRM or LDA/PRM approach. If later advised to expect the ILS or LDA approach (should one be published), the ILS/PRM or LDA/PRM chart may be used after completing the following briefing items:

- a) Minimums and missed approach procedures are unchanged.
- b) PRM Monitor frequency no longer required.
- c) ATC may assign a lower altitude for glide slope intercept.

NOTE–

In the case of the LDA/PRM approach, this briefing procedure only applies if an LDA approach is also published.

In the case of the SOIA ILS/PRM and LDA/PRM procedure, the AAUP describes the weather conditions in which simultaneous approaches are authorized:

Simultaneous approach weather minimums are X,XXX feet (ceiling), x miles (visibility).

20.4.2.2 Dual VHF Communications Required. To avoid blocked transmissions, each runway will have two frequencies, a primary and a monitor frequency. The tower controller will transmit on both frequencies. The monitor controller’s transmissions, if needed, will override both frequencies. Pilots will ONLY transmit on the tower controller’s frequency, but will listen to both frequencies. Begin to monitor the PRM monitor controller when instructed by ATC to contact the tower. The volume levels should be set about the same on both radios so that the pilots will be able to hear transmissions on at least one frequency if the other is blocked. Site specific procedures take

precedence over the general information presented in this paragraph. Refer to the AAUP for applicable procedures at specific airports.

20.4.2.3 Breakouts. Breakouts differ from other types of abandoned approaches in that they can happen anywhere and unexpectedly. Pilots directed by ATC to break off an approach must assume that an aircraft is blundering toward them and a breakout must be initiated **immediately**.

a) Hand-fly breakouts. All breakouts are to be hand-flown to ensure the maneuver is accomplished in the shortest amount of time.

b) ATC Directed “Breakouts.” ATC directed breakouts will consist of a turn and a climb or descent. Pilots must always initiate the breakout in response to an air traffic controller’s instruction. Controllers will give a descending breakout only when there are no other reasonable options available, but in no case will the descent be below the minimum vectoring altitude (MVA) which provides at least 1,000 feet required obstruction clearance. The AAUP provides the MVA in the final approach segment as X,XXX feet at (Name) Airport.

NOTE–
“TRAFFIC ALERT.” *If an aircraft enters the “NO TRANSGRESSION ZONE” (NTZ), the controller will breakout the threatened aircraft on the adjacent approach. The phraseology for the breakout will be:*

PHRASEOLOGY–
TRAFFIC ALERT, (aircraft call sign) TURN (left/right) IMMEDIATELY, HEADING (degrees), CLIMB/DESCEND AND MAINTAIN (altitude).

20.4.2.4 ILS/PRM Navigation. The pilot may find crossing altitudes along the final approach course. The pilot is advised that descending on the ILS glideslope ensures complying with any charted crossing restrictions.

20.4.2.5 SOIA AAUP differences from ILS PRM AAUP

a) ILS/PRM LDA Traffic (only published on ILS/PRM AAUP when the ILS PRM approach is used in conjunctions with an LDA/PRM approach to the adjacent runway). To provide better situational awareness, and because traffic on the LDA may be visible on the ILS aircraft’s TCAS, pilots are reminded of the fact that aircraft will be maneuvering behind them to align with the adjacent runway. While conducting the ILS/PRM approach to Runway XXX,

other aircraft may be conducting the offset LDA/PRM approach to Runway XXX. These aircraft will approach from the (left/right)–rear and will realign with runway XXX after making visual contact with the ILS traffic. Under normal circumstances these aircraft will not pass the ILS traffic.

b) SOIA LDA/PRM AAUP Items. The AAUP for the SOIA LDA/PRM approach contains most information found on ILS/PRM AAUPs. It replaces certain information as seen below and provides pilots with the procedures to be used in the visual segment of the LDA/PRM approach, from the time the ILS aircraft is visually acquired until landing.

c) SOIA LDA/PRM Navigation (replaces ILS/PRM 20.4.2.4 and 20.4.2.5 a) above). The pilot may find crossing altitudes along the final approach course. The pilot is advised that descending on the LDA glideslope ensures complying with any charted crossing restrictions. Remain on the LDA course until passing XXXXX (LDA MAP name) intersection prior to maneuvering to align with the centerline of runway XXX.

d) SOIA (Name) Airport Visual Segment (replaces ILS/PRM 20.4.2.5 a) above). Pilot procedures for navigating beyond the LDA MAP are spelled out. If ATC advises that there is traffic on the adjacent ILS, pilots are authorized to continue past the LDA MAP to align with runway centerline when:

- 1) the ILS traffic is in sight and is expected to remain in sight,
- 2) ATC has been advised that “traffic is in sight.”
- 3) the runway environment is in sight.

Otherwise, a missed approach must be executed. Between the LDA MAP and the runway threshold, pilots of the LDA aircraft are responsible for separating themselves visually from traffic on the ILS approach, which means maneuvering the aircraft as necessary to avoid the ILS traffic until landing, and providing wake turbulence avoidance, if applicable. Pilots should advise ATC, as soon as practical, if visual contact with the ILS traffic is lost and execute a missed approach unless otherwise instructed by ATC.

20.5 SOIA LDA Approach Wake Turbulence. Pilots are responsible for wake turbulence avoidance when maneuvering between the LDA missed approach point and the runway threshold.

20.6 Differences between ILS and ILS/PRM approaches of importance to the pilot.

20.6.1 Runway Spacing. Prior to ILS/PRM and LDA/PRM approaches, most ATC directed breakouts were the result of two aircraft in-trail on the same final approach course getting too close together. Two aircraft going in the same direction did not mandate quick reaction times. With PRM approaches, two aircraft could be along side each other, navigating on courses that are separated by less than 4,300 feet. In the unlikely event that an aircraft “blunders” off its course and makes a worst case turn of 30 degrees toward the adjacent final approach course, closing speeds of 135 feet per second could occur that constitute the need for quick reaction. A blunder has to be recognized by the monitor controller, and breakout instructions issued to the endangered aircraft. The pilot will not have any warning that a breakout is eminent because the blundering aircraft will be on another frequency. It is important that, when a pilot receives breakout instructions, he/she assumes that a blundering aircraft is about to or has penetrated the NTZ and is heading toward his/her approach course. The pilot must initiate a breakout as soon as safety allows. While conducting PRM approaches, pilots must maintain an increased sense of awareness in order to immediately react to an ATC instruction (**breakout**) and maneuver as instructed by ATC, away from a blundering aircraft.

20.6.2 Communications. To help in avoiding communication problems caused by stuck microphones and two parties talking at the same time, two frequencies for each runway will be in use during ILS/PRM and LDA/PRM approach operations, the primary tower frequency and the PRM monitor frequency. The tower controller transmits and receives in a normal fashion on the primary frequency and also transmits on the PRM monitor frequency. The monitor controller’s transmissions override on both frequencies. The pilots flying the approach will listen to both frequencies but only transmit on the primary tower frequency. If the PRM monitor controller initiates a breakout and the primary frequency is blocked by another transmission, the breakout instruction will still be heard on the PRM monitor frequency.

20.6.3 Hand-flown Breakouts. The use of the autopilot is encouraged while flying an ILS/PRM or LDA/PRM approach, but the autopilot must be disengaged in the rare event that a breakout is issued. Simulation studies of breakouts have shown that a hand-flown breakout can be initiated consistently faster than a breakout performed using the autopilot.

20.6.4 TCAS. The ATC breakout instruction is the primary means of conflict resolution. TCAS, if installed, provides another form of conflict resolution in the unlikely event other separation standards would fail. TCAS is not required to conduct a closely spaced approach.

The TCAS provides only vertical resolution of aircraft conflicts, while the ATC breakout instruction provides both vertical and horizontal guidance for conflict resolutions. Pilots should always immediately follow the TCAS Resolution Advisory (RA), whenever it is received. Should a TCAS RA be received before, during, or after an ATC breakout instruction is issued, the pilot should follow the RA, even if it conflicts with the climb/descent portion of the breakout maneuver. If following an RA requires deviating from an ATC clearance, the pilot shall advise ATC as soon as practical. While following an RA, it is extremely important that the pilot also comply with the turn portion of the ATC breakout instruction unless the pilot determines safety to be a factor. Adhering to these procedures assures the pilot that acceptable “breakout” separation margins will always be provided, even in the face of a normal procedural or system failure.

20.6.5 Breakouts. The probability is extremely low that an aircraft will “blunder” from its assigned approach course and enter the NTZ, causing ATC to “breakout” the aircraft approaching on the adjacent ILS course. However, because of the close proximity of the final approach courses, it is essential that pilots follow the ATC breakout instructions precisely and expeditiously. The controller’s “breakout” instructions provide conflict resolution for the threatened aircraft, with the turn portion of the “breakout” being the single most important element in achieving maximum protection. A descending breakout will only be issued when it is the only controller option. In no case will the controller descend an aircraft below the MVA, which will provide at least 1,000 feet clearance above obstacles. The pilot is not expected

to exceed 1,000 feet per minute rate of descent in the event a descending breakout is issued.

21. Simultaneous Converging Instrument Approaches

21.1 ATC may conduct instrument approaches simultaneously to converging runways; i.e., runways having an included angle from 15 to 100 degrees, at airports where a program has been specifically approved to do so.

21.2 The basic concept requires that dedicated, separate standard instrument approach procedures be developed for each converging runway included. Missed approach points must be at least 3 miles apart and missed approach procedures ensure that missed approach protected airspace does not overlap.

21.3 Other requirements are: radar availability, nonintersecting final approach courses, precision (ILS/MLS) approach systems on each runway, and if runways intersect, controllers must be able to apply visual separation as well as intersecting runway separation criteria. Intersecting runways also require minimums of at least 700-foot ceilings and 2 miles visibility. Straight-in approaches and landings must be made.

21.4 Whenever simultaneous converging approaches are in progress, aircraft will be informed by the controller as soon as feasible after initial contact or via ATIS. Additionally, the radar controller will have direct communications capability with the tower controller where separation responsibility has not been delegated to the tower.

22. Timed Approaches From a Holding Fix

22.1 Timed approaches may be conducted when the following conditions are met:

22.1.1 A control tower is in operation at the airport where the approaches are conducted.

22.1.2 Direct communications are maintained between the pilot and the center/approach controller until the pilot is instructed to contact the tower.

22.1.3 If more than one missed approach procedure is available, none requires a course reversal.

22.1.4 If only one missed approach procedure is available, the following conditions are met.

22.1.4.1 Course reversal is not required.

22.1.4.2 Reported ceiling and visibility are equal to or greater than the highest prescribed circling minimums for the instrument approach procedure.

22.1.5 When cleared for the approach, pilots shall not execute a procedure turn. (See 14 CFR Section 91.175j.)

22.2 Although the controller will not specifically state that “timed approaches are in progress,” the assigning a time to depart the final approach fix inbound (nonprecision approach) or the outer marker or the fix used in lieu of the outer marker inbound (precision approach) is indicative that timed approach procedures are being utilized, or in lieu of holding, the controller may use radar vectors to the final approach course to establish a mileage interval between aircraft that will insure the appropriate time sequence between the final approach fix/outer marker or the fix used in lieu of the outer marker and the airport.

22.3 Each pilot in an approach sequence will be given advance notice as to the time he/she should leave the holding point on approach to the airport. When a time to leave the holding point has been received, the pilot should adjust his/her flight path to leave the fix as closely as possible to the designated time. (See FIG ENR 1.5–33.)

FIG ENR 1.5-33
Timed Approaches from a Holding Fix

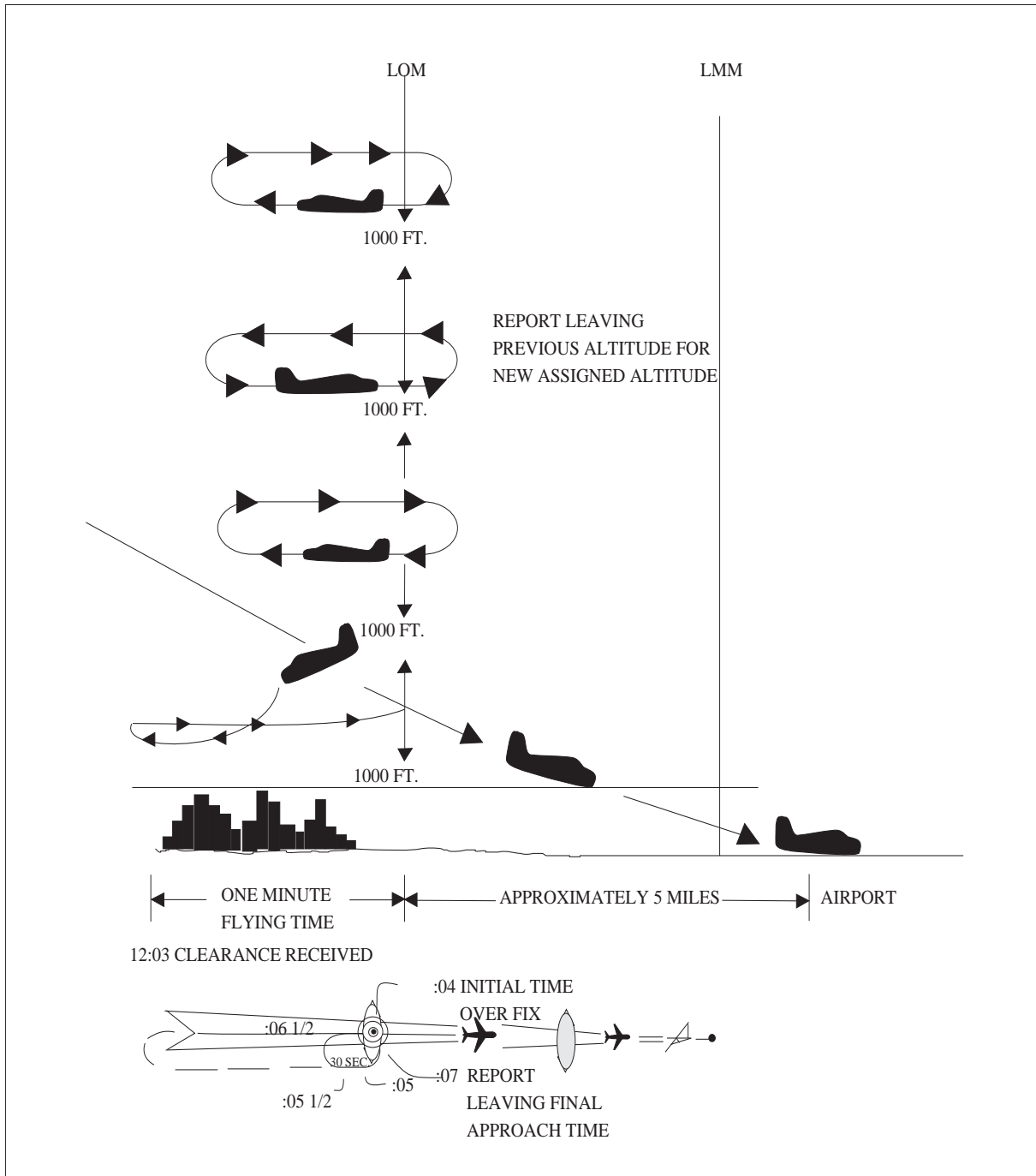

EXAMPLE-

At 12:03 local time, in the example shown, a pilot holding, receives instructions to leave the fix inbound at 12:07. These instructions are received just as the pilot has completed turn at the outbound end of the holding pattern and is proceeding inbound toward the fix. Arriving back over the fix, the pilot notes that the time is 12:04 and that there are 3 minutes to lose in order to leave the fix at the assigned time. Since the time remaining is more than two minutes, the pilot plans to fly a race track pattern rather than a 360 degree turn, which would use up 2 minutes. The turns at the ends of the race track pattern will consume approximately 2 minutes. Three minutes to go, minus 2 minutes required for the turns, leaves 1 minute for level flight. Since two portions of level flight will be required to get back to the fix inbound, the pilot halves the 1 minute remaining

and plans to fly level for 30 seconds outbound before starting the turn back to the fix on final approach. If the winds were negligible at flight altitude, this procedure would bring the pilot inbound across the fix precisely at the specified time of 12:07. However, if expecting headwind on final approach, the pilot should shorten the 30 second outbound course somewhat, knowing that the wind will carry the aircraft away from the fix faster while outbound and decrease the ground speed while returning to the fix. On the other hand, compensating for a tailwind on final approach, the pilot should lengthen the calculated 30 second outbound heading somewhat, knowing that the wind would tend to hold the aircraft closer to the fix while outbound and increase the ground speed while returning to the fix.

23. Contact Approach

23.1 Pilots operating in accordance with an IFR flight plan, provided they are clear of clouds and have at least 1 mile flight visibility and can reasonably expect to continue to the destination airport in those conditions, may request ATC authorization for a “contact approach.”

23.2 Controllers may authorize a “contact approach” provided:

23.2.1 The contact approach is specifically requested by the pilot. ATC cannot initiate this approach.

EXAMPLE–
Request contact approach.

23.2.2 The reported ground visibility at the destination airport is at least 1 statute mile.

23.2.3 The contact approach will be made to an airport having a standard or special instrument approach procedure.

23.2.4 Approved separation is applied between aircraft so cleared and between these aircraft and other IFR or special VFR aircraft.

EXAMPLE–
Cleared contact approach (and if required) at or below (altitude) (routing) if not possible (alternative procedures) and advise.

23.3 A contact approach is an approach procedure that may be used by a pilot (with prior authorization from ATC) in lieu of conducting a standard or special instrument approach procedure (IAP) to an airport. It is not intended for use by a pilot on an IFR flight clearance to operate to an airport not having a published and functioning IAP. Nor is it intended for an aircraft to conduct an instrument approach to one airport and then, when “in the clear,” discontinue that approach and proceed to another airport. In the execution of a contact approach, the pilot assumes the responsibility for obstruction clearance. If radar service is being received, it will automatically

terminate when the pilot is instructed to change to advisory frequency.

24. Use of Enhanced Flight Vision Systems (EFVS) on Instrument Approaches

24.1 An EFVS is an installed airborne system which uses an electronic means to provide a display of the forward external scene topography (the applicable natural or manmade features of a place or region especially in a way to show their relative positions and elevation) through the use of imaging sensors, such as forward looking infrared, millimeter wave radiometry, millimeter wave radar, and/or low light level image intensifying. The EFVS imagery is displayed along with the additional flight information and aircraft flight symbology required by 14 CFR 91.175 (m) on a head-up display (HUD), or an equivalent display, in the same scale and alignment as the external view and includes the display element, sensors, computers and power supplies, indications, and controls. The display is typically presented to the pilot by means of an approved HUD.

24.2 Basic Strategy Using EFVS. When flying an instrument approach procedure (IAP), if the runway environment cannot be visually acquired at decision altitude (DA) or minimum descent altitude (MDA) using natural vision, then a pilot may use an EFVS to continue descending down to 100 feet above the Touchdown Zone Elevation (TDZE), provided all of the visibility requirements of 14 CFR part 91.175 (l) are met. The primary reference for maneuvering the aircraft is based on what the pilot sees through the EFVS. At 100 feet above the TDZE, a pilot can continue to descend only when the visual reference requirements for descent below 100 feet can be seen using natural vision (without the aid of the EFVS). In other words, a pilot may not continue to rely on the EFVS sensor image to identify the required visual references below 100 feet above the TDZE. Supporting information is provided by the flight path vector (FPV), flight path angle (FPA) reference cue, onboard navigation system, and other imagery and

flight symbology displayed on the EFVS. The FPV and FPA reference cue, along with the EFVS imagery of the Touchdown Zone (TDZ), provide the primary vertical path reference for the pilot when vertical guidance from a precision approach or approach with vertical guidance is not available.

24.2.1 Straight-In Instrument Approach Procedures. An EFVS may be used to descend below DA or MDA from any straight-in IAP, other than Category II or Category III approaches, provided all of the requirements of 14 CFR part 91.175 (l) are met. This includes straight-in precision approaches, approaches with vertical guidance (for example, LPV or LNAV/VNAV), and non-precision approaches (for example, VOR, NDB, LOC, RNAV, GPS, LDA, SDF, etc.).

24.2.2 Circling Approach Procedure. An IAP with a circle-to-land maneuver or circle-to-land minimums does not meet criteria for straight-in landing minimums. While the regulations do not prohibit EFVS from being used during any phase of flight, they do prohibit it from being used for operational credit on anything but a straight-in IAP with straight-in landing minima. EFVS shall only be used during a circle-to-land maneuver provided the visual references required throughout the circling maneuver are distinctly visible using natural vision. An EFVS cannot be used to satisfy the requirement that an identifiable part of the airport be distinctly visible to the pilot during a circling maneuver at or above MDA or while descending below MDA from a circling maneuver.

24.2.3 Enhanced Flight Visibility. Flight visibility is determined by using natural vision, and enhanced flight visibility (EFV) is determined by using an EFVS. 14 CFR part 91.175 (l) requires that the EFV observed by using an EFVS cannot be less than the visibility prescribed in the IAP to be used in order to continue to descend below the DA or MDA.

24.3 EFVS Operations At or Below DA or MDA Down to 100 Feet Above the TDZE. The visual segment of an IAP begins at DA or MDA and continues to the runway. There are two means of operating in the visual segment—one is by using natural vision and the other is by using an EFVS. If the pilot determines that the EFV observed by using the EFVS is not less than the minimum visibility prescribed in the IAP being flown, and the pilot acquires the required visual references prescribed in

14 CFR part 91.175 (l)(3) using the EFVS, then the pilot can continue the approach to 100 feet above the TDZE. To continue the approach, the pilot uses the EFVS image to visually acquire the runway environment (the approach light system (ALS), if installed, or both the runway threshold and the TDZ), confirm lateral alignment, maneuver to the extended runway centerline earlier than would otherwise be possible, and continue a normal descent from the DA or MDA to 100 feet above the TDZE.

24.3.1 Required Visual References. In order to descend below DA or MDA, the following visual references (specified in 14 CFR part 91.175 (l)(3)) for the runway of intended landing must be distinctly visible and identifiable to the pilot using the EFVS:

24.3.1.1 The ALS (if installed), or

24.3.1.2 The following visual references in both (b)(1) and (b)(2) below:

a) The runway threshold, identified by at least one of the following: the beginning of the runway landing surface, the threshold lights, or the runway end identifier lights (REIL).

b) The TDZ, identified by at least one of the following: the runway TDZ landing surface, the TDZ lights, the TDZ markings, or the runway lights.

24.3.2 Comparison of Visual Reference Requirements for EFVS and Natural Vision. The EFVS visual reference requirements of 14 CFR part 91.175 (l)(3) comprise a more stringent standard than the visual reference requirements prescribed under 14 CFR part 91.175 (c)(3) when using natural vision. The more stringent standard is needed because an EFVS might not display the color of the lights used to identify specific portions of the runway or might not be able to consistently display the runway markings. The main differences for EFVS operations are that the visual glide slope indicator (VGSI) lights cannot be used as a visual reference, and specific visual references from both the threshold and TDZ must be distinctly visible and identifiable. However, when using natural vision, only one of the specified visual references must be visible and identifiable.

24.3.3 Visual References and Offset Approaches. Pilots must be especially knowledgeable of the approach conditions and approach course alignment when considering whether to rely on EFVS during a non-precision approach with an offset final approach course. Depending upon the combination of

crosswind correction and the lateral field of view provided by a particular EFVS, the required visual references may or may not be within the pilot's view looking through the EFVS display. Pilots conducting any non-precision approach must verify lateral alignment with the runway centerline when determining when to descend from MDA.

24.3.4 When to Go Around. Any pilot operating an aircraft with an EFVS installed should be aware that the requirements of 14 CFR part 91.175 (c) for using natural vision and the requirements of 14 CFR part 91.175 (l) for using an EFVS are different. A pilot would, therefore, first have to determine whether an approach will be commenced using natural vision or using an EFVS. While these two sets of requirements provide a parallel decisionmaking process, the requirements for when a missed approach must be executed differ. Using EFVS, a missed approach must be initiated at or below DA or MDA down to 100 feet above TDZE whenever the pilot determines that:

24.3.4.1 The EFV is less than the visibility minima prescribed for the IAP being used;

24.3.4.2 The required visual references for the runway of intended landing are no longer distinctly visible and identifiable to the pilot using the EFVS imagery;

24.3.4.3 The aircraft is not continuously in a position from which a descent to a landing can be made on the intended runway, at a normal rate of descent, using normal maneuvers; or

24.3.4.4 For operations under 14 CFR parts 121 and 135, the descent rate of the aircraft would not allow touchdown to occur within the TDZ of the runway of intended landing.

24.3.5 Missed Approach Considerations. It should be noted that a missed approach after passing the DA, or beyond the missed approach point (MAP), involves additional risk until established on the published missed approach segment. Initiating a go-around after passing the published MAP may result in loss of obstacle clearance. As with any approach, pilot planning should include contingencies between the published MAP and touchdown with reference to obstacle clearance, aircraft performance, and alternate escape plans.

24.4 EFVS Operations At and Below 100 Feet Above the TDZE. At and below 100 feet above the TDZE, the regulations do not require the EFVS to be turned off or the display to be stowed in order to continue to a landing. A pilot may continue the approach below this altitude using an EFVS as long as the required visual references can be seen through the display using natural vision. An operator may not continue to descend beyond this point by relying solely on the sensor image displayed on the EFVS.

24.4.1 Required Visual References. In order to descend below 100 feet above the TDZE, the flight visibility—assessed using natural vision—must be sufficient for the following visual references to be distinctly visible and identifiable to the pilot without reliance on the EFVS to continue to a landing:

24.4.1.1 The lights or markings of the threshold, or

24.4.1.2 The lights or markings of the TDZ.

It is important to note that from 100 feet above the TDZE and below, the flight visibility does not have to be equal to or greater than the visibility prescribed for the IAP in order to continue descending. It only has to be sufficient for the visual references required by 14 CFR part 91.175 (l)(4) to be distinctly visible and identifiable to the pilot without reliance on the EFVS.

24.4.2 Comparison of Visual Reference Requirements for EFVS and Natural Vision. Again, the visual reference requirements for EFVS in 14 CFR part 91.175 (l)(4) are more stringent than those required for natural vision in 14 CFR part 91.175 (c)(3). The main differences for EFVS operations are that the ALS and red terminating bars or red side row bars, the REIL, and the VASI cannot be used as visual references. Only very specific visual references from the threshold or the TDZ can be used (that is, the lights or markings of the threshold or the lights or markings of the TDZ).

24.4.3 When to Go Around. A missed approach must be initiated when the pilot determines that:

24.4.3.1 The flight visibility is no longer sufficient to distinctly see and identify the required visual references listed in 14 CFR part 91.175 (l)(4) using natural vision;

24.4.3.2 The aircraft is not continuously in a position from which a descent to a landing can be made on the intended runway, at a normal rate of descent, using normal maneuvers; or

24.4.3.3 For operations under 14 CFR parts 121 and 135, the descent rate of the aircraft would not allow touchdown to occur within the TDZ of the runway of intended landing.

24.4.4 While touchdown within the TDZ is not specifically addressed in the regulations for operators other than 14 CFR parts 121 and 135 operators, continued operations below DA or MDA where touchdown in the TDZ is not assured, where a high sink rate occurs, or where the decision to conduct a missed approach procedure is not executed in a timely manner, all create a significant risk to the operation.

24.4.5 Missed Approach Considerations. As noted earlier, a missed approach initiated after the DA or MAP involves additional risk. At 100 feet or less above the runway, it is likely that an aircraft is significantly below the TERPS missed approach obstacle clearance surface. Prior planning is recommended and should include contingencies between the published MAP and touchdown with reference to obstacle clearance, aircraft performance, and alternate escape plans.

24.4.6 Light Emitting Diode (LED) Airport Lighting Impact on EFVS Operations. The FAA has recently begun to replace incandescent lamps with LEDs at some airports in threshold lights, taxiway edge lights, taxiway centerline lights, low intensity runway edge lights, windcone lights, beacons, and some obstruction lighting. Pilots should be aware that LED lights cannot be sensed by current EFVS systems.

25. Visual Approach

25.1 A visual approach is conducted on an IFR flight plan and authorizes a pilot to proceed visually and clear of clouds to the airport. The pilot must have either the airport or the preceding identified aircraft in sight. This approach must be authorized and controlled by the appropriate air traffic control facility. Reported weather at the airport must have a ceiling at or above 1,000 feet and visibility 3 miles or greater. ATC may authorize this type approach when it will be operationally beneficial. Visual approaches are an IFR procedure conducted under Instrument Flight Rules in visual meteorological conditions. Cloud clearance requirements of 14 CFR Sec-

tion 91.155 are not applicable, unless required by operation specifications.

25.2 Operating to an Airport Without Weather Reporting Service. ATC will advise the pilot when weather is not available at the destination airport. ATC may initiate a visual approach provided there is a reasonable assurance that weather at the airport is a ceiling at or above 1,000 feet and visibility 3 miles or greater (e.g., area weather reports, PIREPs, etc.).

25.3 Operating to an Airport with an Operating Control Tower. Aircraft may be authorized to conduct a visual approach to one runway while other aircraft are conducting IFR or VFR approaches to another parallel, intersecting, or converging runway. When operating to airports with parallel runways separated by less than 2,500 feet, the succeeding aircraft must report sighting the preceding aircraft unless standard separation is being provided by ATC. When operating to parallel runways separated by at least 2,500 feet but less than 4,300 feet, controllers will clear/vector aircraft to the final at an angle not greater than 30 degrees unless radar, vertical, or visual separation is provided during the turn-on. The purpose of the 30 degree intercept angle is to reduce the potential for overshoots of the final and to preclude side-by-side operations with one or both aircraft in a belly-up configuration during the turn-on. Once the aircraft are established within 30 degrees of final, or on the final, these operations may be conducted simultaneously. When the parallel runways are separated by 4,300 feet or more, or intersecting/converging runways are in use, ATC may authorize a visual approach after advising all aircraft involved that other aircraft are conducting operations to the other runway. This may be accomplished through use of the ATIS.

25.4 Separation Responsibilities. If the pilot has the airport in sight but cannot see the preceding aircraft, ATC may clear the aircraft for a visual approach; however, ATC retains both separation and wake vortex separation responsibility. When visually following a preceding aircraft, acceptance of the visual approach clearance constitutes acceptance of pilot responsibility for maintaining a safe approach interval and adequate wake turbulence separation.

25.5 A visual approach is not an IAP and therefore has no missed approach segment. If a go around is necessary for any reason, aircraft operating at controlled airports will be issued an appropriate advisory/clearance/instruction by the tower. At

uncontrolled airports, aircraft are expected to remain clear of clouds and complete a landing as soon as possible. If a landing cannot be accomplished, the aircraft is expected to remain clear of clouds and contact ATC as soon as possible for further clearance. Separation from other IFR aircraft will be maintained under these circumstances.

25.6 Visual approaches reduce pilot/controller workload and expedite traffic by shortening flight paths to the airport. It is the pilot's responsibility to advise ATC as soon as possible if a visual approach is not desired.

25.7 Authorization to conduct a visual approach is an IFR authorization and does not alter IFR flight plan cancellation responsibility. See ENR 1.10, paragraph 11.2, Canceling IFR Flight Plan.

25.8 Radar service is automatically terminated, without advising the pilot, when the aircraft is instructed to change to advisory frequency.

26. Charted Visual Flight Procedures (CVFPs)

26.1 CVFPs are charted visual approaches established for environmental/noise considerations, and/or when necessary for the safety and efficiency of air traffic operations. The approach charts depict prominent landmarks, courses, and recommended altitudes to specific runways. CVFPs are designed to be used primarily for turbojet aircraft.

26.2 These procedures will be used only at airports with an operating control tower.

26.3 Most approach charts will depict some NAVAID information which is for supplemental navigational guidance only.

26.4 Unless indicating a Class B airspace floor, all depicted altitudes are for noise abatement purposes and are recommended only. Pilots are not prohibited from flying other than recommended altitudes if operational requirements dictate.

26.5 When landmarks used for navigation are not visible at night, the approach will be annotated "PROCEDURE NOT AUTHORIZED AT NIGHT."

26.6 CVFPs usually begin within 20 flying miles from the airport.

26.7 Published weather minimums for CVFPs are based on minimum vectoring altitudes rather than the recommended altitudes depicted on charts.

26.8 CVFPs are not instrument approaches and do not have missed approach segments.

26.9 ATC will not issue clearances for CVFPs when the weather is less than the published minimum.

26.10 ATC will clear aircraft for a CVFP after the pilot reports sighting a charted landmark or a preceding aircraft. If instructed to follow a preceding aircraft, pilots are responsible for maintaining a safe approach interval and wake turbulence separation.

26.11 Pilots should advise ATC if at any point they are unable to continue an approach or lose sight of a preceding aircraft. Missed approaches will be handled as a go-around.

27. Missed Approach

27.1 When a landing cannot be accomplished, advise ATC and, upon reaching the missed approach point defined on the approach procedure chart, the pilot must comply with the missed approach instructions for the procedure being used or with an alternate missed approach procedure specified by ATC.

27.2 Obstacle protection for missed approach is predicated on the missed approach being initiated at the decision altitude/height (DA/H) or at the missed approach point and not lower than minimum descent altitude (MDA). A climb gradient of at least 200 feet per nautical mile is required, (except for Copter approaches, where a climb of at least 400 feet per nautical mile is required), unless a higher climb gradient is published in the notes section of the approach procedure chart. When higher than standard climb gradients are specified, the end point of the non-standard climb will be specified at either an altitude or a fix. Pilots must preplan to ensure that the aircraft can meet the climb gradient (expressed in feet per nautical mile) required by the procedure in the event of a missed approach, and be aware that flying at a higher than anticipated ground speed increases the climb rate requirement (feet per minute). Tables for the conversion of climb gradients (feet per nautical mile) to climb rate (feet per minute), based on ground speed, are included on page D1 of the U.S. Terminal Procedures booklets. Reasonable buffers are provided for normal maneuvers. However, no consideration is given to an abnormally early turn.

Therefore, when an early missed approach is executed, pilots should, unless otherwise cleared by ATC, fly the IAP as specified on the approach plate to the missed approach point at or above the MDA or DH before executing a turning maneuver.

27.3 If visual reference is lost while circling to land from an instrument approach, the missed approach specified for that particular procedure must be followed (unless an alternate missed approach procedure is specified by ATC). To become established on the prescribed missed approach course, the pilot should make an initial climbing turn

toward the landing runway and continue the turn until established on the missed approach course. Inasmuch as the circling maneuver may be accomplished in more than one direction, different patterns will be required to become established on the prescribed missed approach course depending on the aircraft position at the time visual reference is lost. Adherence to the procedure will help assure that an aircraft will remain laterally within the circling and missed approach obstruction clearance areas. Refer to paragraph 27.8 concerning vertical obstruction clearance when starting a missed approach at other than the MAP. (See FIG ENR 1.5-34.)

FIG ENR 1.5-34
Circling and Missed Approach Obstruction Clearance Areas

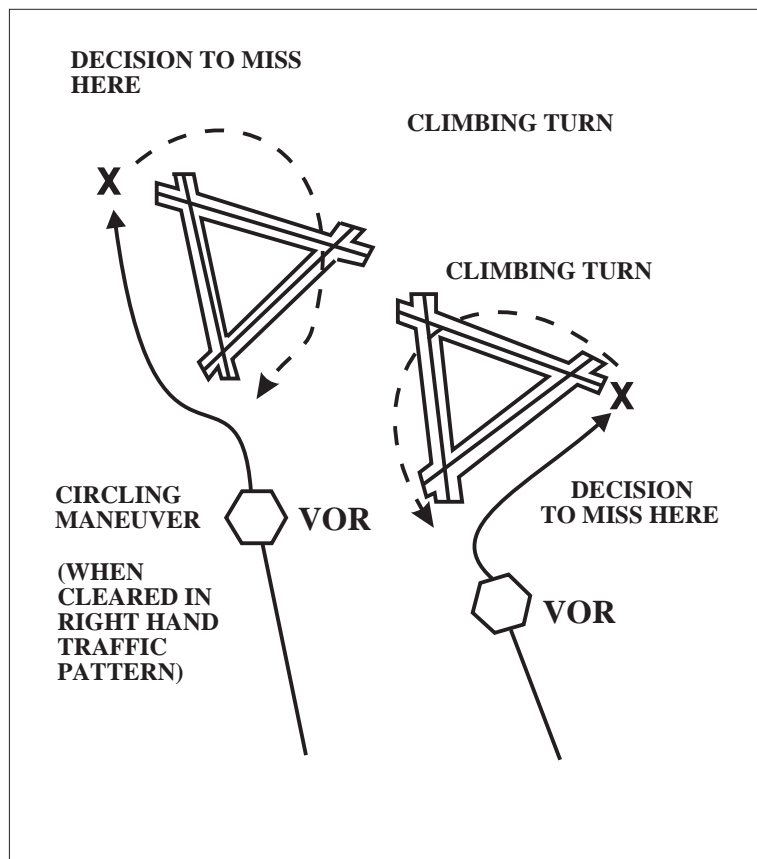

FIG ENR 1.5-35
Missed Approach

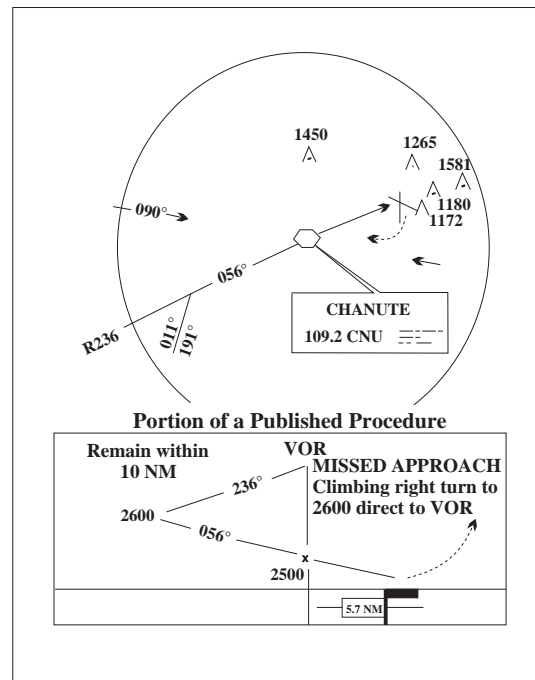
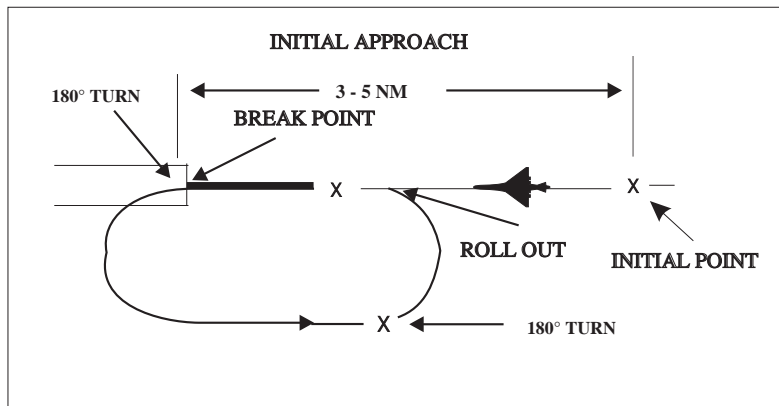

FIG ENR 1.5-36
Overhead Maneuver



27.4 At locations where ATC radar service is provided, the pilot should conform to radar vectors when provided by ATC in lieu of the published missed approach procedure.

27.5 Some locations may have a preplanned alternate missed approach procedure for use in the event the primary NAVAID used for the missed approach procedure is unavailable. To avoid confusion, the alternate missed approach instructions are not published on the chart. However, the alternate missed approach holding pattern will be depicted on the instrument approach chart for pilot situational awareness and to assist ATC by not having to issue detailed holding instructions. The alternate missed approach may be based on NAVAIDs not used in the approach procedure or the primary missed approach. When the alternate missed approach procedure is implemented by NOTAM, it becomes a mandatory part of the procedure. The NOTAM will specify both the textual instructions and any additional equipment requirements necessary to complete the procedure. Air traffic may also issue instructions for the alternate missed approach when necessary, such as when the primary missed approach NAVAID fails during the approach. Pilots may reject an ATC clearance for an alternate missed approach that requires equipment not necessary for the published approach procedure when the alternate missed approach is issued after beginning the approach. However, when the alternate missed approach is issued prior to beginning the approach the pilot must either accept the entire procedure (including the alternate missed approach), request a different approach procedure, or coordinate with ATC for alternative action to be taken, i.e., proceed to an alternate airport, etc.

27.6 When the approach has been missed, request a clearance for specific action; i.e., to alternative airport, another approach, etc.

27.7 Pilots must ensure that they have climbed to a safe altitude prior to proceeding off the published missed approach, especially in nonradar environments. Abandoning the missed approach prior to reaching the published altitude may not provide adequate terrain clearance. Additional climb may be required after reaching the holding pattern before proceeding back to the IAF or to an alternate.

27.8 A clearance for an instrument approach procedure includes a clearance to fly the published missed approach procedure, unless otherwise instruc-

ted by ATC. The published missed approach procedure provides obstacle clearance only when the missed approach is conducted on the missed approach segment from or above the missed approach point, and assumes a climb rate of 200 feet/NM or higher, as published. If the aircraft initiates a missed approach at a point other than the missed approach point (see paragraph 12.2), from below MDA or DA (H), or on a circling approach, obstacle clearance is not necessarily provided by following the published missed approach procedure, nor is separation assured from other air traffic in the vicinity.

In the event a balked (rejected) landing occurs at a position other than the published missed approach point, the pilot should contact ATC as soon as possible to obtain an amended clearance. If unable to contact ATC for any reason, the pilot should attempt to re-intercept a published segment of the missed approach and comply with route and altitude instructions. If unable to contact ATC, and in the pilot's judgment it is no longer appropriate to fly the published missed approach procedure, then consider either maintaining visual conditions if practicable and reattempt a landing, or a circle-climb over the airport. Should a missed approach become necessary when operating to an airport that is not served by an operating control tower, continuous contact with an air traffic facility may not be possible. In this case, the pilot should execute the appropriate go-around/missed approach procedure without delay and contact ATC when able to do so.

Prior to initiating an instrument approach procedure, the pilot should assess the actions to be taken in the event of a balked (rejected) landing beyond the missed approach point or below the MDA or DA (H) considering the anticipated weather conditions and available aircraft performance. 14 CFR 91.175(e) authorizes the pilot to fly an appropriate missed approach procedure that ensures obstruction clearance, but it does not necessarily consider separation from other air traffic. The pilot must consider other factors such as the aircraft's geographical location with respect to the prescribed missed approach point, direction of flight, and/or minimum turning altitudes in the prescribed missed approach procedure. The pilot must also consider aircraft performance, visual climb restrictions, charted obstacles, published obstacle departure procedure, takeoff visual climb requirements as expressed by nonstandard takeoff minima, other traffic expected to be in the vicinity, or

other factors not specifically expressed by the approach procedures.

28. Overhead Approach Maneuver

28.1 Pilots operating in accordance with an IFR flight plan in Visual Meteorological Conditions (VMC) may request ATC authorization for an overhead maneuver. An overhead maneuver is not an instrument approach procedure. Overhead maneuver patterns are developed at airports where aircraft have an operational need to conduct the maneuver. An aircraft conducting an overhead maneuver is considered to be VFR and the IFR flight plan is cancelled when the aircraft reaches the initial point on the initial approach portion of the maneuver. (See FIG ENR 1.5–36.) The existence of a standard overhead maneuver pattern does not eliminate the possible requirement for an aircraft to conform to conventional rectangular patterns if an overhead maneuver cannot be approved. Aircraft operating to an airport without a functioning control tower must initiate cancellation of an IFR flight plan prior to executing the overhead maneuver. Cancellation of the IFR flight plan must be accomplished after crossing the landing threshold on the initial portion of the maneuver or after landing. Controllers may authorize an overhead maneuver and issue the following to arriving aircraft:

28.1.1 Pattern altitude and direction of traffic. This information may be omitted if either is standard.

PHRASEOLOGY–
PATTERN ALTITUDE (altitude). RIGHT TURNS.

28.1.2 Request for a report on initial approach.

PHRASEOLOGY–
REPORT INITIAL.

28.1.3 “Break” information and a request for the pilot to report. The “Break Point” will be specified if nonstandard. Pilots may be requested to report “break” if required for traffic or other reasons.

PHRASEOLOGY–
*BREAK AT (specified point).
REPORT BREAK.*

29. Departure Procedures

29.1 Pre–Taxi Clearance Procedures

29.1.1 Locations where these procedures are in effect are indicated in the Airport/Facility Directory.

29.1.2 Certain airports have established programs whereby pilots of departing IFR aircraft may elect to receive their IFR clearances before they start taxiing for takeoff. The following provisions are included in such procedures:

29.1.2.1 Pilot participation is not mandatory.

29.1.2.2 Participating pilots call clearance delivery/ground control not more than 10 minutes before proposed taxi time.

29.1.2.3 IFR clearance (or delay information, if clearance cannot be obtained) is issued at the time of this initial call–up.

29.1.2.4 When the IFR clearance is received on clearance delivery frequency, pilots call ground control when ready to taxi.

29.1.2.5 Normally, pilots need not inform ground control that they have received IFR clearance on clearance delivery frequency. Certain locations may, however, require that the pilot inform ground control of a portion of the routing or that the IFR clearance has been received.

29.1.2.6 If a pilot cannot establish contact on clearance delivery frequency or has not received an IFR clearance before ready to taxi, the pilot should contact ground control and inform the controller accordingly.

30. Pre–departure Clearance Procedures

30.1 Many airports in the National Airspace System are equipped with the Tower Data Link System (TDLS) that includes the Pre–departure Clearance (PDC) function. The PDC function automates the Clearance Delivery operations in the ATCT for participating users. The PDC function displays IFR clearances from the ARTCC to the ATCT. The Clearance Delivery controller in the ATCT can append local departure information and transmit the clearance via data link to participating airline/service provider computers. The airline/service provider will then deliver the clearance via the Aircraft Communications Addressing and Reporting System (ACARS) or a similar data link system or, for nondata link equipped aircraft, via a printer located at the departure gate. PDC reduces frequency congestion, controller workload and is intended to mitigate

delivery/readback errors. Also, information from participating users indicates a reduction in pilot workload.

30.2 PDC is available only to participating aircraft that have subscribed to the service through an approved service provider.

30.3 Due to technical reasons, the following limitations currently exist in the PDC program:

30.3.1 Aircraft filing multiple flight plans are limited to one PDC clearance per departure airport within a 24-hour period. Additional clearances will be delivered verbally.

30.3.2 If the clearance is revised or modified prior to delivery, it will be rejected from PDC and the clearance will need to be delivered verbally.

30.4 No acknowledgment of receipt or readback is required for a PDC.

30.5 In all situations, the pilot is encouraged to contact clearance delivery if a question or concern exists regarding an automated clearance.

31. Taxi Clearance

31.1 Pilots on IFR flight plans should communicate with the control tower on the appropriate ground control/clearance delivery frequency prior to starting engines to receive engine start time, taxi, and/or clearance information.

32. Line Up and Wait (LUAW)

32.1 Line up and wait is an air traffic control (ATC) procedure designed to position an aircraft onto the runway for an imminent departure. The ATC instruction "LINE UP AND WAIT" is used to instruct a pilot to taxi onto the departure runway and line up and wait.

EXAMPLE-

Tower: "N234AR Runway 24L, line up and wait."

32.2 This ATC instruction is not an authorization to takeoff. In instances where the pilot has been instructed to "line up and wait" and has been advised of a reason/condition (wake turbulence, traffic on an intersecting runway, etc.) or the reason/condition is clearly visible (another aircraft that has landed on or is taking off on the same runway), and the reason/condition is satisfied, the pilot should expect

an imminent takeoff clearance, unless advised of a delay. If you are uncertain about any ATC instruction or clearance, contact ATC immediately.

32.3 If a takeoff clearance is not received within a reasonable amount of time after clearance to line up and wait, ATC should be contacted.

EXAMPLE-

Aircraft: Cessna 234AR holding in position Runway 24L.

Aircraft: Cessna 234AR holding in position Runway 24L at Bravo.

NOTE-

FAA analysis of accidents and incidents involving aircraft holding in position indicate that two minutes or more elapsed between the time the instruction was issued to "line up and wait" and the resulting event (for example, landover or go-around). Pilots should consider the length of time that they have been holding in position whenever they HAVE NOT been advised of any expected delay to determine when it is appropriate to query the controller.

REFERENCE-

Advisory Circulars 91-73A, Part 91 and Part 135 Single-Pilot Procedures during Taxi Operations, and 120-74A, Parts 91, 121, 125, and 135 Flightcrew Procedures during Taxi Operations.

32.4 Situational awareness during line up and wait operations is enhanced by monitoring ATC instructions/clearances issued to other aircraft. Pilots should listen carefully if another aircraft is on frequency that has a similar call sign and pay close attention to communications between ATC and other aircraft. If you are uncertain of an ATC instruction or clearance, query ATC immediately. Care should be taken to not inadvertently execute a clearance/instruction for another aircraft.

32.5 Pilots should be especially vigilant when conducting "line up and wait" operations at night or during reduced visibility conditions. They should scan the full length of the runway and look for aircraft on final approach or landing roll out when taxiing onto a runway. ATC should be contacted anytime there is a concern about a potential conflict.

32.6 When two or more runways are active, aircraft may be instructed to "LINE UP AND WAIT" on two or more runways. When multiple runway operations are being conducted, it is important to listen closely for your call sign and runway. Be alert for similar sounding call signs and acknowledge all instructions with your call sign. When you are holding in position and are not sure if the takeoff clearance was for you, ask ATC before you begin takeoff roll. ATC prefers

that you confirm a takeoff clearance rather than mistake another aircraft's clearance for your own.

32.7 When ATC issues intersection “line up and wait” and takeoff clearances, the intersection designator will be used. If ATC omits the intersection designator, call ATC for clarification.

EXAMPLE–

Aircraft: “Cherokee 234AR, Runway 24L at November 4, line up and wait.”

32.8 If landing traffic is a factor during line up and wait operations operations, ATC will inform the aircraft in position of the closest traffic that has requested a full-stop, touch-and-go, stop-and-go, or an unrestricted low approach to the same runway. Pilots should take care to note the position of landing traffic. ATC will also advise the landing traffic when an aircraft is authorized to “line up and wait” on the same runway.

EXAMPLE–

Tower: “Cessna 234AR, Runway 24L, line up and wait. Traffic a Boeing 737, six mile final.”

Tower: “Delta 1011, continue, traffic a Cessna 210 holding in position Runway 24L.”

NOTE–

ATC will normally withhold landing clearance to arrival aircraft when another aircraft is in position and holding on the runway.

32.9 Never land on a runway that is occupied by another aircraft, even if a landing clearance was issued. Do not hesitate to ask the controller about the traffic on the runway and be prepared to execute a go-around.

NOTE–

Always clarify any misunderstanding or confusion concerning ATC instructions or clearances. ATC should be advised immediately if there is any uncertainty about the ability to comply with any of their instructions.

33. Departure Restrictions, Clearance Void Times, Hold for Release, and Release Times

33.1 ATC may assign departure restrictions, clearance void times, hold for release, and release times, when necessary, to separate departures from other traffic or to restrict or regulate the departure flow.

33.1.1 Clearance Void Times. A pilot may receive a clearance, when operating from an airport without

a control tower, which contains a provision for the clearance to be void if not airborne by a specific time. A pilot who does not depart prior to the clearance void time must advise ATC as soon as possible of his or her intentions. ATC will normally advise the pilot of the time allotted to notify ATC that the aircraft did not depart prior to the clearance void time. This time cannot exceed 30 minutes. Failure of an aircraft to contact ATC within 30 minutes after the clearance void time will result in the aircraft being considered overdue and search and rescue procedures initiated.

NOTE–

1. *Other IFR traffic for the airport where the clearance is issued is suspended until the aircraft has contacted ATC or until 30 minutes after the clearance void time or 30 minutes after the clearance release time if no clearance void time is issued.*

2. *Pilots who depart at or after their clearance void time are not afforded IFR separation and may be in violation of 14 CFR Section 91.173 which requires that pilots receive an appropriate ATC clearance before operating IFR in Class A, B, C, D, and E airspace.*

EXAMPLE–

Clearance void if not off by (clearance void time) and, if required, if not off by (clearance void time) advise (facility) not later than (time) of intentions.

33.1.2 Hold for Release. ATC may issue “hold for release” instructions in a clearance to delay an aircrafts departure for traffic management reasons (i.e., weather, traffic volume, etc.). When ATC states in the clearance, “hold for release,” the pilot may not depart utilizing that IFR clearance until a release time or additional instructions are issued by ATC. This does not preclude the pilot from cancelling the IFR clearance with ATC and departing under VFR; but an IFR clearance may not be available after departure. In addition, ATC will include departure delay information in conjunction with “hold for release” instructions.

EXAMPLE–

(Aircraft identification) cleared to (destination) airport as filed, maintain (altitude), and, if required (additional instructions or information), hold for release, expect (time in hours and/or minutes) departure delay.

33.1.3 Release Times. A “release time” is a departure restriction issued to a pilot by ATC, specifying the earliest time an aircraft may depart. ATC will use “release times” in conjunction with traffic management procedures and/or to separate a departing aircraft from other traffic.

EXAMPLE–

(Aircraft identification) released for departure at (time in hours and/or minutes).

33.1.4 Expect Departure Clearance Time (EDCT). The EDCT is the runway release time assigned to an aircraft included in traffic management programs. Aircraft are expected to depart no earlier than 5 minutes before, and no later than 5 minutes after the EDCT.

33.2 If practical, pilots departing uncontrolled airports should obtain IFR clearances prior to becoming airborne when two-way communication with the controlling ATC facility is available.

34. Departure Control

34.1 Departure Control is an approach control function responsible for ensuring separation between departures. So as to expedite the handling of departures, Departure Control may suggest a takeoff direction other than that which may normally have been used under VFR handling. Many times it is preferred to offer the pilot a runway that will require the fewest turns after takeoff to place the pilot on course or selected departure route as quickly as possible. At many locations particular attention is paid to the use of preferential runways for local noise abatement programs, and route departures away from congested areas.

34.2 Departure Control utilizing radar will normally clear aircraft out of the terminal area using instrument departure procedures (DPs) via radio navigation aids. When a departure is to be vectored immediately following takeoff, the pilot will be advised prior to takeoff of the initial heading to be flown but may not be advised of the purpose of the heading. Pilots operating in a radar environment are expected to associate departure headings with vectors to their planned route of flight. When given a vector taking the aircraft off a previously assigned nonradar route, the pilot will be advised briefly what the vector is to achieve. Thereafter, radar service will be provided until the aircraft has been reestablished “on-course” using an appropriate navigation aid and the pilot has been advised of the aircraft’s position; or, a handoff is made to another radar controller with further surveillance capabilities.

34.3 Controllers will inform pilots of the departure control frequencies and, if appropriate, the trans-

ponder code before takeoff. Pilots should not operate their transponder until ready to start the takeoff roll, except at ASDE–X facilities where transponders should be transmitting “on” with altitude reporting continuously while operating on the airport surface if so equipped. Pilots should not change to the departure control frequency until requested. Controllers may omit the departure control frequency if a DP has or will be assigned and the departure control frequency is published on the DP.

35. Abbreviated IFR Departure Clearance (Cleared . . . as Filed) Procedures

35.1 ATC facilities will issue an abbreviated IFR departure clearance based on the ROUTE of flight filed in the IFR flight plan, provided the filed route can be approved with little or no revision. These abbreviated clearance procedures are based on the following conditions:

35.1.1 The aircraft is on the ground or it has departed VFR and the pilot is requesting IFR clearance while airborne.

35.1.2 That a pilot will not accept an abbreviated clearance if the route or destination of a flight plan filed with ATC has been changed by him/her or the company or the operations officer before departure.

35.1.3 That it is the responsibility of the company or operations office to inform the pilot when they make a change to the filed flight plan.

35.1.4 That it is the responsibility of the pilot to inform ATC in the initial call-up (for clearance) when the filed flight plan has been either:

35.1.4.1 Amended.

35.1.4.2 Canceled and replaced with a new filed flight plan.

NOTE–

The facility issuing a clearance may not have received the revised route or the revised flight plan by the time a pilot requests clearance.

35.2 Controllers will issue a detailed clearance when they know that the original filed flight plan has been changed or when the pilot requests a full route clearance.

35.3 The clearance as issued will include the destination airport filed in the flight plan.

35.4 ATC procedures now require the controller to state the DP name, the current number and the DP

Transition name after the phrase “Cleared to (destination) airport,” and prior to the phrase, “then as filed,” for ALL departure clearances when the DP or DP Transition is to be flown. The procedure applies whether or not the DP is filed in the flight plan.

35.5 Standard Terminal Arrivals (STARs), when filed in a flight plan, are considered a part of the filed route of flight and will not normally be stated in an initial departure clearance. If the ARTCC’s jurisdictional airspace includes both the departure airport and the fix where a STAR or STAR Transition begins, the STAR name, the current number, and the STAR Transition name MAY be stated in the initial clearance.

35.6 “Cleared to (destination) airport as filed” does NOT include the en route altitude filed in a flight plan. An en route altitude will be stated in the clearance or the pilot will be advised to expect an assigned/filed altitude within a given time frame or at a certain point after departure. This may be done verbally in the departure instructions or stated in the DP.

35.7 In a radar and a nonradar environment, the controller will state “Cleared to (destination) airport as filed” or:

35.7.1 If a DP or DP Transition is to be flown, specify the DP name, the current DP number, the DP Transition name, the assigned altitude/flight level, and any additional instructions (departure control frequency, beacon code assignment, etc.) necessary to clear a departing aircraft via the DP/DP Transition and the route filed.

EXAMPLE–
National Seven Twenty cleared to Miami Airport Intercontinental one departure, Lake Charles transition then as filed, maintain Flight Level two seven zero.

35.7.2 When there is no DP or when the pilot cannot accept a DP, specify the assigned altitude/flight level, and any additional instructions necessary to clear a departing aircraft via an appropriate departure routing and the route filed.

NOTE–
A detailed departure route description or a radar vector may be used to achieve the desired departure routing.

35.7.3 If necessary to make a minor revision to the filed route, specify the assigned DP/DP Transition (or departure routing), the revision to the filed route, the

assigned altitude/flight level, and any additional instructions necessary to clear a departing aircraft.

EXAMPLE–
Jet Star One Four Two Four cleared to Atlanta Airport, South Boston two departure then as filed except change route to read South Boston Victor 20 Greensboro, maintain one seven thousand.

35.7.4 Additionally, in a nonradar environment, specify one or more fixes as necessary to identify the initial route of flight.

EXAMPLE–
Cessna Three One Six Zero Foxtrot cleared to Charlotte Airport as filed via Brooke, maintain seven thousand.

35.8 To ensure success of the program, pilots should:

35.8.1 Avoid making changes to a filed flight plan just prior to departure.

35.8.2 State the following information in the initial call–up to the facility when no change has been made to the filed flight plan: Aircraft call sign, location, type operation (IFR), and the name of the airport (or fix) to which you expect clearance.

EXAMPLE–
“Washington clearance delivery (or ground control if appropriate) American Seventy Six at gate one, IFR Los Angeles.”

35.8.3 If the flight plan has been changed, state the change and request a full route clearance.

EXAMPLE–
“Washington clearance delivery, American Seventy Six at gate one. IFR San Francisco. My flight plan route has been amended (or destination changed). Request full route clearance.”

35.8.4 Request verification or clarification from ATC if ANY portion of the clearance is not clearly understood.

35.8.5 When requesting clearance for the IFR portion of a VFR–IFR flight, request such clearance prior to the fix where IFR operation is proposed to commence in sufficient time to avoid delay. Use the following phraseology:

EXAMPLE–
“Los Angeles center, Apache Six One Papa, VFR estimating Paso Robles VOR at three two, one thousand five hundred, request IFR to Bakersfield.”

36. Instrument Departure Procedures (DP) – Obstacle Departure Procedures (ODP) and Standard Instrument Departures (SID)

36.1 Instrument departure procedures are pre-planned instrument flight rule (IFR) procedures which provide obstruction clearance from the terminal area to the appropriate en route structure. There are two types of DPs, Obstacle Departure Procedures (ODPs), printed either textually or graphically, and Standard Instrument Departures (SIDs), always printed graphically. All DPs, either textual or graphic may be designed using either conventional or RNAV criteria. RNAV procedures will have RNAV printed in the title, e.g., SHEAD TWO DEPARTURE (RNAV). ODPs provide obstruction clearance via the least onerous route from the terminal area to the appropriate en route structure. ODPs are recommended for obstruction clearance and may be flown without ATC clearance unless an alternate departure procedure (SID or radar vector) has been specifically assigned by ATC. Graphic ODPs will have (OBSTACLE) printed in the procedure title, e.g., GEYSR THREE DEPARTURE (OBSTACLE), or, CROWN ONE DEPARTURE (RNAV)(OBSTACLE). Standard Instrument Departures are air traffic control (ATC) procedures printed for pilot/controller use in graphic form to provide obstruction clearance and a transition from the terminal area to the appropriate en route structure. SIDs are primarily designed for system enhancement and to reduce pilot/controller workload. ATC clearance must be received prior to flying a SID. All DPs provide the pilot with a way to depart the airport and transition to the en route structure safely. Pilots operating under 14 CFR Part 91 are strongly encouraged to file and fly a DP at night, during marginal Visual Meteorological Conditions (VMC) and Instrument Meteorological Conditions (IMC), when one is available. The following paragraphs will provide an overview of the DP program, why DPs are developed, what criteria are used, where to find them, how they are to be flown, and finally pilot and ATC responsibilities.

36.2 Why are DPs necessary? The primary reason is to provide obstacle clearance protection information to pilots. A secondary reason, at busier airports, is to increase efficiency and reduce communications and departure delays through the use of SIDs. When an instrument approach is initially developed for an airport, the need for DPs is assessed. The procedure

designer conducts an obstacle analysis to support departure operations. If an aircraft may turn in any direction from a runway within the limits of the assessment area (see paragraph 36.3.3) and remain clear of obstacles, that runway passes what is called a diverse departure assessment and no ODP will be published. A SID may be published if needed for air traffic control purposes. However, if an obstacle penetrates what is called the 40:1 obstacle identification surface, then the procedure designer chooses whether to:

36.2.1 Establish a steeper than normal climb gradient; or

36.2.2 Establish a steeper than normal climb gradient with an alternative that increases takeoff minima to allow the pilot to visually remain clear of the obstacle(s); or

36.2.3 Design and publish a specific departure route; or

36.2.4 A combination or all of the above.

36.3 What criteria is used to provide obstruction clearance during departure?

36.3.1 Unless specified otherwise, required obstacle clearance for all departures, including diverse, is based on the pilot crossing the departure end of the runway at least 35 feet above the departure end of runway elevation, climbing to 400 feet above the departure end of runway elevation before making the initial turn, and maintaining a minimum climb gradient of 200 feet per nautical mile (FPNM), unless required to level off by a crossing restriction, until the minimum IFR altitude. A greater climb gradient may be specified in the DP to clear obstacles or to achieve an ATC crossing restriction. If an initial turn higher than 400 feet above the departure end of runway elevation is specified in the DP, the turn should be commenced at the higher altitude. If a turn is specified at a fix, the turn must be made at that fix. Fixes may have minimum and/or maximum crossing altitudes that must be adhered to prior to passing the fix. In rare instances, obstacles that exist on the extended runway centerline may make an “early turn” more desirable than proceeding straight ahead. In these cases, the published departure instructions will include the language “turn left(right) as soon as practicable.” These departures will also include a ceiling and visibility minimum of at least 300 and 1. Pilots encountering one of these DPs should preplan the climb out to gain altitude and begin the turn as

quickly as possible within the bounds of safe operating practices and operating limitations. This type of departure procedure is being phased out.

NOTE-
“Practical” or “feasible” may exist in some existing departure text instead of “practicable.”

36.3.2 ODPs and SIDs assume normal aircraft performance, and that all engines are operating. Development of contingency procedures, required to cover the case of an engine failure or other emergency in flight that may occur after liftoff, is the responsibility of the operator. (More detailed information on this subject is available in Advisory Circular AC 120-91, Airport Obstacle Analysis, and in the “Departure Procedures” section of chapter 2 in the Instrument Procedures Handbook, FAA-H-8261-1.)

36.3.3 The 40:1 obstacle identification surface (OIS) begins at the departure end of runway (DER) and slopes upward at 152 FPNM until reaching the minimum IFR altitude or entering the en route structure. This assessment area is limited to 25 NM from the airport in nonmountainous areas and 46 NM in designated mountainous areas. Beyond this distance, the pilot is responsible for obstacle clearance if not operating on a published route, if below (having not reached) the MEA or MOCA of a published route, or an ATC assigned altitude. See FIG ENR 1.5-37. (Ref 14 CFR 91.177 for further information on en route altitudes.)

NOTE-
ODPs are normally designed to terminate within these distance limitations, however, some ODPs will contain routes that may exceed 25/46 NM; these routes will insure obstacle protection until reaching the end of the ODP.

36.3.4 Obstacles that are located within 1 NM of the DER and penetrate the 40:1 OCS are referred to as “low, close-in obstacles.” The standard required obstacle clearance (ROC) of 48 feet per NM to clear these obstacles would require a climb gradient greater than 200 feet per NM for a very short distance, only until the aircraft was 200 feet above the DER. To eliminate publishing an excessive climb gradient, the obstacle AGL/MSL height and location relative to the DER is noted in the “Take-off Minimums and (OBSTACLE) Departure Procedures” section of a given Terminal Procedures Publication (TPP) booklet. The purpose of this note is to identify the obstacle(s) and alert the pilot to the height and location of the obstacle(s) so they can be avoided. This can be accomplished in a variety of ways, e.g., the pilot may be able to see the obstruction and maneuver around the obstacle(s) if necessary; early liftoff/climb performance may allow the aircraft to cross well above the obstacle(s); or if the obstacle(s) cannot be visually acquired during departure, preflight planning should take into account what turns or other maneuver may be necessary immediately after takeoff to avoid the obstruction(s).

FIG ENR 1.5-37
Diverse Departure Obstacle Assessment to 25/46 NM

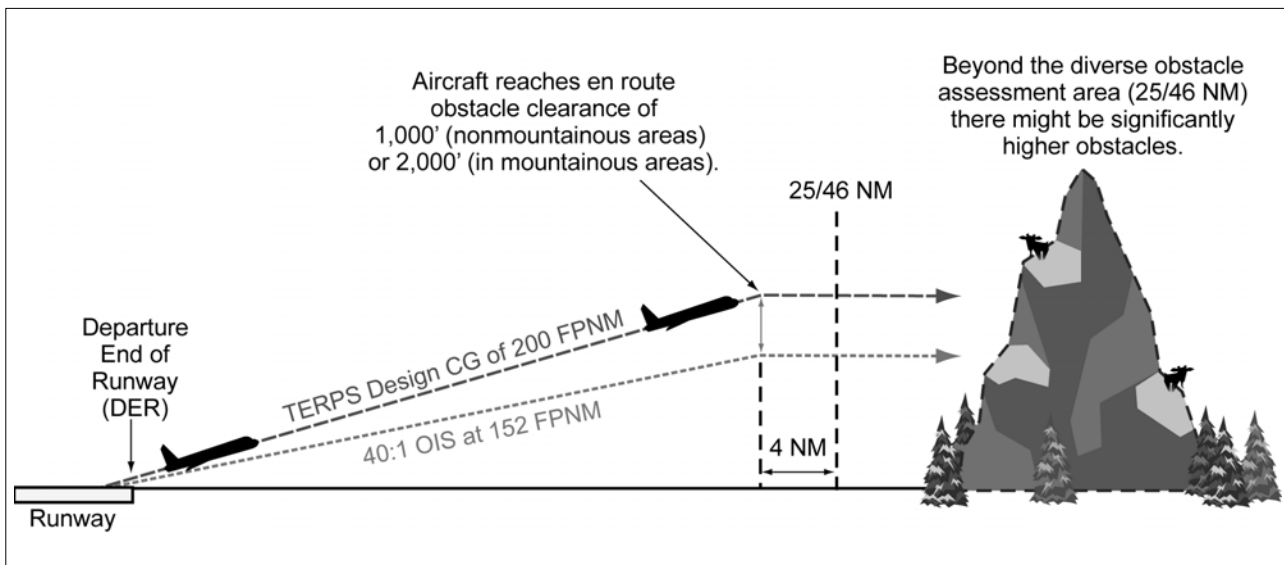

36.3.5 Climb gradients greater than 200 FPNM are specified when required to support procedure design constraints, obstacle clearance, and/or airspace restrictions. Compliance with a climb gradient for these purposes is mandatory when the procedure is part of the ATC clearance, unless increased takeoff minimums are provided and weather conditions allow compliance with these minimums. Additionally, ATC required crossing restrictions may also require climb gradients greater than 200 FPNM. These climb gradients may be amended or canceled at ATC's discretion. Multiple ATC climb gradients are permitted. An ATC climb gradient will not be used on an ODP.

EXAMPLE–

“Cross ALPHA intersection at or below 4000; maintain 6000.” The pilot climbs at least 200 FPNM to 6000. If 4000 is reached before ALPHA, the pilot levels off at 4000 until passing ALPHA; then immediately resumes at least 200 FPNM climb.

EXAMPLE–

“TAKEOFF MINIMUMS: RWY 27, Standard with a minimum climb of 280' per NM to 2500, ATC climb of 310' per NM to 4000 ft.” A climb of at least 280 FPNM is required to 2500 and is mandatory when the departure procedure is included in the ATC clearance. ATC requires a climb gradient of 310 FPNM to 4000, however, this ATC climb gradient may be amended or canceled.

36.3.6 Climb gradients may be specified only to an altitude/fix, above which the normal gradient applies.

EXAMPLE–

“Minimum climb 340 FPNM to ALPHA.” The pilot climbs at least 340 FPNM to ALPHA, then at least 200 FPNM to MIA.

36.3.7 Some DPs established solely for obstacle avoidance require a climb in visual conditions to cross the airport or an on-airport NAVAID in a specified direction, at or above a specified altitude. These procedures are called Visual Climb Over the Airport (VCOA).

EXAMPLE–

“Climb in visual conditions so as to cross the McElory Airport southbound, at or above 6000, then climb via Keemling radial zero three three to Keemling VORTAC.”

36.4 Who is responsible for obstacle clearance? DPs are designed so that adherence to the procedure

by the pilot will ensure obstacle protection. Additionally:

36.4.1 Obstacle clearance responsibility also rests with the pilot when he/she chooses to climb in visual conditions in lieu of flying a DP and/or depart under increased takeoff minima rather than fly the climb gradient. Standard takeoff minima are one statute mile for aircraft having two engines or less and one-half statute mile for aircraft having more than two engines. Specified ceiling and visibility minima (VCOA or increased takeoff minima) will allow visual avoidance of obstacles until the pilot enters the standard obstacle protection area. Obstacle avoidance is not guaranteed if the pilot maneuvers farther from the airport than the specified visibility minimum prior to reaching the specified altitude. DPs may also contain what are called Low Close in Obstacles. These obstacles are less than 200 feet above the departure end of runway elevation and within one NM of the runway end, and do not require increased takeoff minimums. These obstacles are identified on the SID chart or in the Take-off Minimums and (Obstacle) Departure Procedures section of the U. S. Terminal Procedure booklet. These obstacles are especially critical to aircraft that do not lift off until close to the departure end of the runway or which climb at the minimum rate. Pilots should also consider drift following lift-off to ensure sufficient clearance from these obstacles. That segment of the procedure that requires the pilot to see and avoid obstacles ends when the aircraft crosses the specified point at the required altitude. In all cases continued obstacle clearance is based on having climbed a minimum of 200 feet per nautical mile to the specified point and then continuing to climb at least 200 foot per nautical mile during the departure until reaching the minimum enroute altitude, unless specified otherwise.

36.4.2 ATC may assume responsibility for obstacle clearance by vectoring the aircraft prior to reaching the minimum vectoring altitude by using a Diverse Vector Area (DVA). The DVA has been assessed for departures which do not follow a specific ground track. ATC may also vector an aircraft off a previously assigned DP. In all cases, the 200 FPNM climb gradient is assumed and obstacle clearance is not provided by ATC until the controller begins to provide navigational guidance in the form of radar vectors.

NOTE–

When used by the controller during departure, the term “radar contact” should not be interpreted as relieving pilots of their responsibility to maintain appropriate terrain and obstruction clearance which may include flying the obstacle DP.

36.4.3 Pilots must preplan to determine if the aircraft can meet the climb gradient (expressed in feet per nautical mile) required by the departure procedure, and be aware that flying at a higher than anticipated ground speed increases the climb rate requirement in feet per minute. Higher than standard climb gradients are specified by a note on the departure procedure chart for graphic DPs, or in the Take-Off Minimums and (Obstacle) Departure Procedures section of the U.S. Terminal Procedures booklet for textual ODPs. The required climb gradient, or higher, must be maintained to the specified altitude or fix, then the standard climb gradient of 200 ft/NM can be resumed. A table for the conversion of climb gradient (feet per nautical mile) to climb rate (feet per minute), at a given ground speed, is included on page D1 of the U.S. Terminal Procedures booklets.

36.5 Where are DPs located? DPs will be listed by airport in the IFR Takeoff Minimums and (Obstacle) Departure Procedures Section, Section C, of the Terminal Procedures Publications (TPPs). If the DP is textual, it will be described in TPP Section C. SIDs and complex ODPs will be published graphically and named. The name will be listed by airport name and runway in Section C. Graphic ODPs will also have the term “(OBSTACLE)” printed in the charted procedure title, differentiating them from SIDs.

36.5.1 An ODP that has been developed solely for obstacle avoidance will be indicated with the symbol “T” on appropriate Instrument Approach Procedure (IAP) charts and DP charts for that airport. The “T” symbol will continue to refer users to TPP Section C. In the case of a graphic ODP, the TPP Section C will only contain the name of the ODP. Since there may be both a textual and a graphic DP, Section C should still be checked for additional information. The nonstandard minimums and minimum climb gradients found in TPP Section C also apply to charted DPs and radar vector departures unless different minimums are specified on the charted DP. Takeoff minimums and departure procedures apply to all runways unless otherwise specified. New graphic DPs will have all the information printed on the graphic depiction. As a general rule, ATC will only assign an ODP from a

nontowered airport when compliance with the ODP is necessary for aircraft to aircraft separation. Pilots may use the ODP to help ensure separation from terrain and obstacles.

36.6 Responsibilities

36.6.1 Each pilot, prior to departing an airport on an IFR flight should:

36.6.1.1 Consider the type of terrain and other obstacles on or in the vicinity of the departure airport;

36.6.1.2 Determine whether an ODP is available;

36.6.1.3 Determine if obstacle avoidance can be maintained visually or if the ODP should be flown; and

36.6.1.4 Consider the effect of degraded climb performance and the actions to take in the event of an engine loss during the departure. Pilots should notify ATC as soon as possible of reduced climb capability in that circumstance.

NOTE–

Guidance concerning contingency procedures that address an engine failure on takeoff after V_1 speed on a large or turbine-powered transport category airplane may be found in AC 120–91, Airport Obstacle Analysis.

36.6.2 After an aircraft is established on an SID and subsequently vectored or cleared off of the SID or SID transition, pilots must consider the SID canceled, unless the controller adds “expect to resume SID.” Aircraft may not be vectored off of an ODP until at or above the MVA/MIA, at which time the ODP is canceled.

36.6.3 Aircraft instructed to resume a SID that contains ATC altitude restrictions, shall be issued/reissued all applicable restrictions or shall be advised to comply with those restrictions.

36.6.4 If prior to or after takeoff an altitude restriction is issued by ATC, all previously issued “ATC” altitude restrictions are cancelled including those published on a SID.

36.6.5 ATC crossing altitude restrictions published on SIDs are identified on the chart with “(ATC)” following the altitude restriction. This will indicate to the pilot and the controller that this restriction is for ATC purposes and may be deleted by ATC. When an ATC crossing altitude has been established prior to the beginning of a transition route, a minimum altitude for obstruction clearance or other design constraints will also be published at the same fix

adjacent/below the “(ATC)” altitude. The absence of “(ATC)” at a “minimum altitude” indicates the restriction is there to support obstacle clearance, airspace restrictions, Navaid reception, and/or other reason(s) that mandate compliance. These altitudes CANNOT be lowered or cancelled by ATC. A standalone “(ATC)” altitude restriction may also be located on a transition route; however, it must never be lower than the published Minimum Enroute Altitude (MEA).

36.6.6 Altitude restrictions published on an ODP are necessary for obstacle clearance and/or design constraints. Compliance with these restrictions is mandatory and CANNOT be lowered or cancelled by

ATC.

36.7 RNAV Departure Procedures

36.7.1 All public RNAV SIDs and graphic ODPs are RNAV 1. These procedures generally start with an initial RNAV or heading leg near the departure runway end. In addition, these procedures require system performance currently met by GPS or DME/DME/IRU RNAV systems that satisfy the criteria discussed in AC 90-100A, U.S. Terminal and En Route Area Navigation (RNAV) Operations. RNAV 1 procedures require the aircraft’s total system error remain bounded by 1 NM for 95% of the total flight time.

ENR 1.6 [RESERVED]

ENR 1.7 Altimeter Setting Procedures

1. General

1.1 The accuracy of aircraft altimeters is subject to the following factors:

1.1.1 Nonstandard temperature of the atmosphere.

1.1.2 Nonstandard atmospheric pressure.

1.1.3 Aircraft static pressure systems (position error).

1.1.4 Instrument error.

1.2 EXTREME CAUTION SHOULD BE EXERCISED WHEN FLYING IN PROXIMITY TO OBSTRUCTIONS OR TERRAIN IN LOW TEMPERATURES AND PRESSURES. This is especially true in extremely cold temperatures that cause a large differential between the Standard Day temperature and actual temperature. This circumstance can cause serious errors that result in the aircraft being significantly lower than the indicated altitude.

NOTE-

Standard temperature at sea level is 15 degrees Celsius (59 degrees Fahrenheit). The temperature gradient from sea level is minus 2 degrees Celsius (3.6 degrees Fahrenheit) per 1,000 feet. Pilots should apply corrections for static pressure systems and/or instruments, if appreciable errors exist.

1.3 The adoption of a standard altimeter setting at the higher altitudes eliminates station barometer errors, some altimeter instrument errors, and errors caused by altimeter settings derived from different geographical sources.

2. Procedures

2.1 The cruising altitude or flight level of aircraft shall be maintained by reference to an altimeter which shall be set, when operating:

2.1.1 Below 18,000 feet MSL.

2.1.1.1 When the barometric pressure is 31.00 inches Hg. or less: to the current reported altimeter setting of a station along the route and within 100 NM of the aircraft, or if there is no station within this area, the current reported altimeter setting of an appropriate available station. When an aircraft is en route on an instrument flight plan, air traffic controllers will furnish this information to the pilot at

least once while the aircraft is in the controller's area of jurisdiction. In the case of an aircraft not equipped with a radio, set to the elevation of the departure airport or use an appropriate altimeter setting available prior to departure.

2.1.1.2 When the barometric pressure exceeds 31.00 inches Hg.: the following procedures will be placed in effect by NOTAM defining the geographic area affected:

a) For all aircraft. Set 31.00 inches for en route operations below 18,000 feet MSL. Maintain this setting until beyond the affected area or until reaching final approach segment. At the beginning of the final approach segment, the current altimeter setting will be set, if possible. If not possible, 31.00 inches will remain set throughout the approach. Aircraft on departure or missed approach will set 31.00 inches prior to reaching any mandatory/crossing altitude or 1,500 feet AGL, whichever is lower. (Air traffic control will issue actual altimeter settings and advise pilots to set 31.00 inches in their altimeters for en route operations below 18,000 feet MSL in affected areas.)

b) During preflight, barometric altimeters shall be checked for normal operation to the extent possible.

c) For aircraft with the capability of setting the current altimeter setting and operating into airports with the capability of measuring the current altimeter setting, no additional restrictions apply.

d) For aircraft operating VFR, there are no additional restrictions; however, extra diligence in flight planning and in operating in these conditions is essential.

e) Airports unable to accurately measure barometric pressures above 31.00 inches of Hg. will report the barometric pressure as "missing" or "in excess of 31.00 inches of Hg." Flight operations to and from those airports are restricted to VFR weather conditions.

f) For aircraft operating IFR and unable to set the current altimeter setting, the following restrictions apply:

1) To determine the suitability of departure alternate airports, destination airports, and destination alternate airports, increase ceiling requirements

by 100 feet and visibility requirements by $\frac{1}{4}$ statute mile for each $\frac{1}{10}$ of an inch of Hg., or any portion thereof, over 31.00 inches. These adjusted values are then applied in accordance with the requirements of the applicable operating regulations and operations specifications.

EXAMPLE-

Destination altimeter is 31.28 inches, ILS DH 250 feet (200- $\frac{1}{2}$). When flight planning, add 300- $\frac{3}{4}$ to the weather requirements which would become 500-1 $\frac{1}{4}$.

2) On approach, 31.00 inches will remain set. Decision height or minimum descent altitude shall be deemed to have been reached when the published altitude is displayed on the altimeter.

NOTE-

Although visibility is normally the limiting factor on an approach, pilots should be aware that when reaching DH the aircraft will be higher than indicated. Using the example above the aircraft would be approximately 300 feet higher.

3) These restrictions do not apply to authorized Category II and III ILS operations nor do they apply to certificate holders using approved QFE altimetry systems.

2.1.1.3 The FAA Regional Flight Standards Division Manager of the affected area is authorized to approve temporary waivers to permit emergency resupply or emergency medical service operation.

2.1.2 At or above 18,000 feet MSL: to 29.92 Hg (standard setting). The lowest usable flight level is determined by the atmospheric pressure in the area of operation, as shown in TBL ENR 1.7-1.

**TBL ENR 1.7-1
Lowest Usable Flight Level**

Altimeter Setting (Current Reported)	Lowest Usable Flight Level
29.92 or higher	180
29.91 to 29.42	185
29.41 to 28.92	190
28.91 to 28.42	195
28.41 to 27.92	200

2.1.3 Where the minimum altitude, as prescribed in 14 CFR Sections 91.159 and 91.119, is above 18,000 feet MSL the lowest usable flight level shall be the flight level equivalent of the minimum altitude plus the number of feet specified in TBL ENR 1.7-2.

**TBL ENR 1.7-2
Lowest Flight Level Correction Factor**

Altimeter Setting	Correction Factor
29.92 or higher	none
29.91 to 29.42	500 feet
29.41 to 28.92	1000 feet
28.91 to 28.42	1500 feet
28.41 to 27.92	2000 feet
27.91 to 27.42	2500 feet

EXAMPLE-

The minimum safe altitude of a route is 19,000 feet MSL and the altimeter setting is reported between 29.92 and 29.42 inches of mercury. The lowest usable flight level will be 195, which is the flight level equivalent of 19,500 feet MSL (minimum altitude plus 500 feet).

2.1.4 Aircraft operating in an offshore CONTROL AREA should use altimeter setting procedures as described above, unless directed otherwise by ATC.

NOTE-

Aircraft exiting the oceanic CTA/FIR destined for the U.S. or transitioning through U.S. offshore control areas should use the current reported altimeter of a station nearest to the route being flown. When entering an oceanic CTA/FIR from U.S. offshore control areas, pilots should change to the standard altimeter setting 29.92.

3. Altimeter Errors

3.1 Most pressure altimeters are subject to mechanical, elastic, temperature, and installation errors. (Detailed information regarding the use of pressure altimeters is found in the Instrument Flying Handbook, Chapter IV.) Although manufacturing and installation specification, as well as the periodic test and inspections required by regulations (14 CFR Part 43, Appendix E), act to reduce these errors--any scale error may be observed in the following manner:

3.1.1 Set the current reported altimeter setting on the altimeter setting scale.

3.1.2 Altimeter should now read field elevation if you are located on the same reference level used to establish the altimeter setting.

3.1.3 Note the variation between the known field elevation and the altimeter indication. If this variation is in the order of plus or minus 75 feet, the accuracy of the altimeter is questionable and the problem should be referred to an appropriately rated repair station for evaluation and possible correction.

3.2 Once in flight, it is very important to obtain frequently current altimeter settings en route. If you do not reset your altimeter when flying from an area of high pressure into an area of low pressure, your aircraft will be closer to the surface than your altimeter indicates. An inch error in the altimeter setting equals 1,000 feet of altitude. To quote an old saying: “GOING FROM A HIGH TO A LOW, LOOK OUT BELOW.”

3.3 Temperature also has an effect on the accuracy of altimeters and your altitude. The crucial values to consider are standard temperature versus the ambient (at altitude) temperature. It is this “difference” that causes the error in indicated altitude. When the air is warmer than standard, you are higher than your altimeter indicates. Subsequently, when the air is colder than standard you are lower than indicated. It is the magnitude of this “difference” that determines the magnitude of the error. When flying into a cooler air mass while maintaining a constant indicated altitude, you are losing true altitude. However, flying into a cooler air mass does not necessarily mean you will be lower than indicated if the *difference* is still on the plus side. For example, while flying at 10,000 feet (where **STANDARD** temperature is -5 degrees

Celsius (C)), the outside air temperature cools from +5 degrees C to 0 degrees C, the temperature error will nevertheless cause the aircraft to be **HIGHER** than indicated. It is the extreme “cold” difference that normally would be of concern to the pilot. Also, when flying in cold conditions over mountainous country, the pilot should exercise caution in flight planning both in regard to route and altitude to ensure adequate en route and terminal area terrain clearance.

3.4 TBL ENR 1.7-3, derived from ICAO formulas, indicates how much error can exist when the temperature is extremely cold. To use the table, find the reported temperature in the left column, then read across the top row to locate the height above the airport/reporting station (i.e., subtract the airport/reporting elevation from the intended flight altitude). The intersection of the column and row is how much *lower* the aircraft may actually be as a result of the possible cold temperature induced error.

3.5 The possible result of the above example should be obvious, particularly if operating at the minimum altitude or when conducting an instrument approach. When operating in extreme cold temperatures, pilots may wish to compensate for the reduction in terrain clearance by adding a cold temperature correction.

TBL ENR 1.7-3
ICAO COLD TEMPERATURE ERROR TABLE
Height Above Airport in Feet

	200	300	400	500	600	700	800	900	1000	1500	2000	3000	4000	5000
+10	10	10	10	10	20	20	20	20	20	30	40	60	80	90
0	20	20	30	30	40	40	50	50	60	90	120	170	230	280
-10	20	30	40	50	60	70	80	90	100	150	200	290	390	490
-20	30	50	60	70	90	100	120	130	140	210	280	420	570	710
-30	40	60	80	100	120	140	150	170	190	280	380	570	760	950
-40	50	80	100	120	150	170	190	220	240	360	480	720	970	1210
-50	60	90	120	150	180	210	240	270	300	450	590	890	1190	1500

EXAMPLE-
Temperature -10 degrees Celsius, and the aircraft altitude is 1,000 feet above the airport elevation. The chart shows that the reported current altimeter setting may place the aircraft as much as 100 feet below the altitude indicated by the altimeter.

4. High Barometric Pressure

4.1 Cold, dry air masses may produce barometric pressures in excess of 31.00 inches of Mercury, and many altimeters do not have an accurate means of being adjusted for settings of these levels. As noted in paragraph 3.2, when the altimeter cannot be set to the higher pressure setting, the aircraft actual altitude will be higher than the altimeter indicates.

4.2 When the barometric pressure exceeds 31.00 inches, air traffic controllers will issue the actual altimeter setting, and:

4.2.1 En Route/Arrivals. Advise pilots to remain set on 31.00 inches until reaching the final approach segment.

4.2.2 Departures. Advise pilots to set 31.00 inches prior to reaching any mandatory/crossing altitude or 1,500 feet, whichever is lower.

4.3 The altimeter error caused by the high pressure will be in the opposite direction to the error caused by the cold temperature.

5. Low Barometric Pressure

5.1 When abnormally low barometric pressure conditions occur (below 28.00), flight operations by aircraft unable to set the actual altimeter setting are not recommended.

NOTE-

The true altitude of the aircraft is lower than the indicated altitude if the pilot is unable to set the actual altimeter setting.

ENR 1.8 [RESERVED]

ENR 1.9 [RESERVED]

ENR 1.10 Flight Planning (Restriction, Limitation or Advisory Information)

1. Preflight Preparation

1.1 Every pilot is urged to receive a preflight briefing and to file a flight plan. This briefing should consist of the latest or most current weather, airport, and en route NAVAID information. Briefing service may be obtained from a flight service station (FSS) either by telephone or interphone, by radio when airborne, or by a personal visit to the station. In the 48 contiguous States, pilots with a current FAA medical certificate may access toll-free the Direct User Access Terminal System (DUATS) through a personal computer. DUATS will provide alpha-numeric preflight weather data and allow pilots to file domestic VFR and IFR flight plans.

REFERENCE-
GEN 3.5, paragraph 3.5.3.3 lists DUATS vendors.

NOTE-
Pilots filing flight plans via “fast file” who desire to have their briefing recorded, should include a statement at the end of the recording as to the source of their weather briefing.

1.2 The information required by the FAA to process flight plans is contained on FAA Form 7233-1, Flight Plan. The forms are available at all flight service stations.

REFERENCE-
AIP, ENR 1.10, paragraph 4., Flight Plan Requirements.

1.3 Consult an FSS or Weather Service Office (WSO) for a preflight weather briefing. Supplemental Weather Service Locations (SWSLs) do not provide weather briefings.

1.4 FSSs are required to advise of pertinent NOTAMs if a standard briefing is requested, but if they are overlooked, don't hesitate to remind the specialist that you have not received NOTAM information. Additionally, NOTAMs which are known in sufficient time for publication and are of 7 days duration or longer are normally incorporated into the Notices to Airmen publication and carried there until cancellation time. FDC NOTAMs, which apply to instrument flight procedures, are also included in Notices to Airmen publication up to and including the number indicated in the FDC NOTAM legend. These NOTAMs are not provided during a briefing unless specifically requested by the pilot

since the FSS specialist has no way of knowing whether the pilot has already checked Notices to Airmen publication prior to calling. Remember to ask for NOTAMs contained in the Notices to Airmen publication as they are not normally furnished during your briefing.

1.5 Pilots are urged to use only the latest issue of aeronautical charts in planning and conducting flight operations. Aeronautical charts are revised and reissued on a periodic basis to ensure that depicted data are current and reliable. In the conterminous U.S., sectional charts are updated each 6 months, IFR en route charts each 56 days, and amendments to civil IFR approach charts are accomplished on a 56-day cycle with a change notice volume issued on the 28-day mid-cycle. Charts that have been superseded by those of a more recent date may contain obsolete or incomplete flight information.

REFERENCE-
AIP, GEN 3.2, contains a description of aeronautical charts.

1.6 When requesting a preflight briefing, identify yourself as a pilot and provide the following:

1.6.1 Type of flight planned; e.g., VFR or IFR.

1.6.2 Aircraft number or pilot's name.

1.6.3 Aircraft type.

1.6.4 Departure airport.

1.6.5 Route of flight.

1.6.6 Destination.

1.6.7 Flight altitude(s).

1.6.8 ETD and ETE.

1.7 Prior to conducting a briefing, briefers are required to have the background information listed above so that they may tailor the briefing to the needs of the proposed flight. The objective is to communicate a “picture” of meteorological and aeronautical information necessary for the conduct of a safe and efficient flight. Briefers use all available weather and aeronautical information to summarize data applicable to the proposed flight. They do not read weather reports and forecasts verbatim unless specifically requested by the pilot. FSS briefers do not provide FDC NOTAM information for special

instrument approach procedures unless specifically asked. Pilots authorized by the FAA to use special instrument approach procedures must specifically request FDC NOTAM information for these procedures. Pilots who receive the information electronically will receive NOTAMs for special IAPs automatically.

REFERENCE–

See AIP, GEN 3.5 for meteorological services.

1.8 The Federal Aviation Administration has designated High Density Traffic Airports (HDTA) and has prescribed air traffic rules and requirements for operating aircraft (excluding helicopter operations) to and from these airports.

REFERENCE–

AIP, GEN 3.3, paragraph 9.7, Airport Reservations Operations and Procedures.

1.9 In addition to the filing of a flight plan, if the flight will traverse or land in one or more foreign countries, it is particularly important that pilots leave a complete itinerary with someone directly concerned and keep that person advised of the flight's progress. If serious doubt arises as to the safety of the flight, that person should first contact the FSS.

1.10 Pilots operating aircraft under the provisions of 14 CFR Part 135 and not having an FAA assigned 3-letter designator, are urged to prefix the normal aircraft registration (N) number with the letter "T" on flight plan filing.

EXAMPLE–

TN 1234B.

2. Follow IFR Procedures Even When Operating VFR

2.1 To maintain IFR proficiency, pilots are urged to practice IFR procedures whenever possible, even when operating VFR. Some suggested practices include:

2.1.1 Obtain a complete preflight and weather briefing. Check the NOTAMs.

2.1.2 File a flight plan. This is an excellent low-cost insurance policy. The cost is the time it takes to fill it out. The insurance includes the knowledge that someone will be looking for you if you become overdue at your destination.

2.1.3 Use current charts.

2.1.4 Use the navigation aids. Practice maintaining a good course by keeping the needle centered.

2.1.5 Maintain a constant altitude appropriate for direction of flight.

2.1.6 Estimate en route position times.

2.1.7 Make accurate and frequent position reports to the FSSs along your route of flight.

2.2 Simulated IFR flight is recommended (under the hood); however, pilots are cautioned to review and adhere to the requirements specified in 14 CFR Section 91.109 before and during such flight.

2.3 When flying VFR at night, in addition to the altitude appropriate for the direction of flight, pilots should maintain an altitude which is at or above the minimum en route altitude as shown on charts. This is especially true in mountainous terrain, where there is usually very little ground reference. Do not depend on your eyes alone to avoid rising unlighted terrain, or even lighted obstructions such as TV towers.

3. Domestic Notice to Airmen (NOTAM) System

3.1 Time-critical aeronautical information which is of either a temporary nature or is not sufficiently known in advance to permit publication on aeronautical charts or in other operational publications, receives immediate dissemination via the U.S. Notice to Airmen (NOTAM) System.

NOTE–

1. NOTAM information is that aeronautical information that could affect a pilot's decision to make a flight. It includes such information as airport or aerodrome primary runway closures, taxiways, ramps, obstructions, communications, airspace, changes in the status of navigational aids, ILSs, radar service availability, and other information essential to planned en route, terminal, or landing operations.

2. NOTAM information is transmitted using standard contractions to reduce transmission time. See TBL ENR 1.10–1 for a listing of the most commonly used contractions. For a complete listing of contractions, see FAA Order JO 7340.2, Contractions.

3.2 NOTAM information is classified into four categories. These are NOTAM (D) or distant, Flight Data Center (FDC) NOTAMs, Pointer NOTAMs, and Military NOTAMs.

TBL ENR 1.10-1
NOTAM CONTRACTIONS

A	
AADC	Approach and Departure Control
ABV	Above
A/C	Approach Control
ACCUM	Accumulate
ACFT	Aircraft
ACR	Air Carrier
ACTV/ACTVT	Active/Activate
ADF	Automatic Direction Finder
ADJ	Adjacent
ADZ/ADZD	Advise/Advised
AFD	Airport/Facility Directory
AFSS	Automated Flight Service Station
ALS	Approach Light System
ALTM	Altimeter
ALTN/ALTNLY	Alternate/Alternately
ALSTG	Altimeter Setting
AMDT	Amendment
APCH	Approach
APL	Airport Lights
ARFF	Aircraft Rescue & Fire Fighting
ARPT	Airport
ARSR	Air Route Surveillance Radar
ASDE	Airport Surface Detection Equipment
ASOS	Automated Surface Observing System
ASPH	Asphalt
ASR	Airport Surveillance Radar
ATC	Air Traffic Control
ATCT	Airport Traffic Control Tower
ATIS	Automated Terminal Information Service
AVBL	Available
AWOS	Automatic Weather Observing System
AWSS	Automatic Weather Sensor System
AZM	Azimuth
B	
BC	Back Course
BCN	Beacon
BERM	Snowbank/s Containing Earth/Gravel
BLO	Below
BND	Bound
BRAF	Braking Action Fair
BRAG	Braking Action Good
BRAN	Braking Action Nil
BRAP	Braking Action Poor
BYD	Beyond
C	
CAAS	Class A Airspace
CAT	Category
CBAS	Class B Airspace
CBSA	Class B Surface Area
CCAS	Class C Airspace
CCLKWS	Counterclockwise
CCSA	Class C Surface Area
CD	Clearance Delivery

CDAS	Class D Airspace
CDSA	Class D Surface Area
CEAS	Class E Airspace
CESA	Class E Surface Area
CFA	Controlled Firing Area
CGAS	Class G Airspace
CHG	Change
CLKWS	Clockwise
CLNC	Clearance
CLSD	Closed
CMSN/CMSND	Commission/Commissioned
CNCL/CNCLD/ CNL	Cancel/Canceled/Cancel
CNTRLN	Centerline
CONC	Concrete
CONT	Continue/Continuously
CRS	Course
CTAF	Common Traffic Advisory Frequency
CTLZ	Control Zone
D	
DALGT	Daylight
DCMS/DCMSND	Decommission/Decommissioned
DCT	Direct
DEP	Depart/Departure
DEPT	Department
DH	Decision Height
DISABLD	Disabled
DLA/DLAD	Delay/Delayed
DLT/DLTD	Delete/Deleted
DLY	Daily
DME	Distance Measuring Equipment
DMSTN	Demonstration
DP	Instrument Departure Procedure
DPCR	Departure Procedure
DRCT	Direct
DRFT/DRFTD	Drift/Drifted Snowbank/s Caused By Wind Action
DSPLCD	Displaced
DSTC	Distance
DWPNT	Dew Point
E	
E	East
EBND	Eastbound
EFAS	En Route Flight Advisory Service
EFF	Effective
ELEV	Elevate/Elevation
ENG	Engine
ENTR	Entire
EXCP	Except
F	
FA	Final Approach
FAC	Facility
FAF	Final Approach Fix
FDC	Flight Data Center

FM	Fan Marker
FREQ	Frequency
FRH	Fly Runway Heading
FRZN	Frozen
FRNZ SLR	Frozen Slush on Runway/s
FSS	Flight Service Station
G	
GC	Ground Control
GCA	Ground Controlled Approach
GOVT	Government
GP	Glide Path
GPS	Global Positioning System
GRVL	Gravel
GS	Glide Slope
H	
HAA	Height Above Airport
HAT	Height Above Touchdown
HAZ	Hazard
HEL	Helicopter
HELI	Heliport
HF	High Frequency
HIRL	High Intensity Runway Lights
HIWAS	Hazardous Inflight Weather Advisory Service
HOL	Holiday
HP	Holding Pattern
I	
IAP	Instrument Approach Procedure
IBND	Inbound
ID	Identification
IDENT	Identify/Identifier/Identification
IFR	Instrument Flight Rules
ILS	Instrument Landing System
IM	Inner Marker
IN	Inch/Inches
INDEFINELY	Indefinitely
INOP	Inoperative
INST	Instrument
INT	Intersection
INTST	Intensity
IR	Ice On Runway/s
L	
L	Left
LAA	Local Airport Advisory
LAT	Latitude
LAWRS	Limited Aviation Weather Reporting Station
LB	Pound/Pounds
LC	Local Control
LCL	Local
LCTD	Located
LDA	Localizer Type Directional Aid
LDIN	Lead In Lighting System
LGT/LGTD/LGTS	Light/Lighted/Lights
LIRL	Low Intensity Runway Edge Lights
LLWAS	Low Level Wind Shear Alert System

LMM	Compass Locator at ILS Middle Marker
LNDG	Landing
LOC	Localizer
LOM	Compass Locator at ILS Outer Marker
LONG	Longitude
LRN	LORAN
LSR	Loose Snow on Runway/s
LT	Left Turn After Take-off
M	
MALS	Medium Intensity Approach Lighting System
MALSF	Medium Intensity Approach Lighting System with Sequenced Flashers
MALSR	Medium Intensity Approach Lighting System with Runway Alignment Indicator Lights
MAP	Missed Approach Point
MCA	Minimum Crossing Altitude
MDA	Minimum Descent Altitude
MEA	Minimum En Route Altitude
MED	Medium
MIN	Minute
MIRL	Medium Intensity Runway Edge Lights
MLS	Microwave Landing System
MM	Middle Marker
MNM	Minimum
MOCA	Minimum Obstruction Clearance Altitude
MONTR	Monitor
MSA	Minimum Safe Altitude/Minimum Sector Altitude
MSAW	Minimum Safe Altitude Warning
MSL	Mean Sea Level
MU	Designate a Friction Value Representing Runway Surface Conditions
MUD	Mud
MUNI	Municipal
N	
N	North
NA	Not Authorized
NBND	Northbound
NDB	Nondirectional Radio Beacon
NE	Northeast
NGT	Night
NM	Nautical Mile/s
NMR	Nautical Mile Radius
NOPT	No Procedure Turn Required
NTAP	Notice To Airmen Publication
NW	Northwest
O	
OBSC	Obscured
OBSTN	Obstruction
OM	Outer Marker
OPER	Operate
OPN	Operation
ORIG	Original
OTS	Out of Service
OVR	Over

P	
PAEW	Personnel and Equipment Working
PAJA	Parachute Jumping Activities
PAPI	Precision Approach Path Indicator
PAR	Precision Approach Radar
PARL	Parallel
PAT	Pattern
PCL	Pilot Controlled Lighting
PERM/PERMLY	Permanent/Permanently
PLA	Practice Low Approach
PLW	Plow/Plowed
PN	Prior Notice Required
PPR	Prior Permission Required
PREV	Previous
PRIRA	Primary Radar
PROC	Procedure
PROP	Propeller
PSGR	Passenger/s
PSR	Packed Snow on Runway/s
PT/PTN	Procedure Turn
PVT	Private
R	
RAIL	Runway Alignment Indicator Lights
RCAG	Remote Communication Air/Ground Facility
RCL	Runway Centerline
RCLS	Runway Centerline Light System
RCO	Remote Communication Outlet
RCV/RCVR	Receive/Receiver
REF	Reference
REIL	Runway End Identifier Lights
RELCTD	Relocated
RMDR	Remainder
RNAV	Area Navigation
RPRT	Report
RQRD	Required
RRL	Runway Remaining Lights
RSVN	Reservation
RT	Right Turn after Take-off
RTE	Route
RTR	Remote Transmitter/Receiver
RTS	Return to Service
RUF	Rough
RVR	Runway Visual Range
RVRM	RVR Midpoint
RVRR	RVR Rollout
RVRT	RVR Touchdown
RVV	Runway Visibility Value
RY/RWY	Runway
S	
S	South
SAA	Special Activity Airspace
SBND	Southbound
SDF	Simplified Directional Facility
SE	Southeast
SECRA	Secondary Radar
SFL	Sequenced Flashing Lights

SI	Straight-In Approach
SIR	Packed or Compacted Snow and Ice on Runway/s
SKED	Scheduled
SLR	Slush on Runway/s
SNBNK	Snowbank/s Caused by Plowing
SND	Sand/Sanded
SNGL	Single
SNW	Snow
SPD	Speed
SR	Sunrise
SS	Sunset
SSALF	Simplified Short Approach Lighting System with Sequenced Flashers
SSALR	Simplified Short Approach Lighting System with Runway Alignment Indicator Lights
SSALS	Simplified Short Approach Lighting System
STAR	Standard Terminal Arrival
SUA	Special Use Airspace
SVC	Service
SW	Southwest
SWEPT	Swept or Broom/Broomed
T	
TACAN	Tactical Air Navigational Aid
TDZ/TDZL	Touchdown Zone/Touchdown Zone Lights
TFC	Traffic
TFR	Temporary Flight Restriction
TGL	Touch and Go Landings
THN	Thin
THR	Threshold
THRU	Through
TIL	Until
TKOF	Takeoff
TMPRY	Temporary
TRML	Terminal
TRNG	Training
TRSA	Terminal Radar Service Area
TRSN	Transition
TSNT	Transient
TWEB	Transcribed Weather Broadcast
TWR	Tower
TWY	Taxiway
U	
UNAVBL	Unavailable
UNLGTD	Unlighted
UNMKD	Unmarked
UNMON	Unmonitored
UNRELBL	Unreliable
UNUSBL	Unusable
V	
VASI	Visual Approach Slope Indicator
VDP	Visual Descent Point
VFR	Visual Flight Rules
VIA	By Way Of

VICE	Instead/Versus
VIS/VSBY	Visibility
VMC	Visual Meteorological Conditions
VOL	Volume
VOLMET	Meteorological Information for Aircraft in Flight
VOR	VHF Omni-Directional Radio Range
VORTAC	VOR and TACAN (collocated)
VOT	VOR Test Signal
W	
W	West
WBND	Westbound
WEA/WX	Weather
WI	Within
WKDAYS	Monday through Friday
WKEND	Saturday and Sunday
WND	Wind
WP	Waypoint
WSR	Wet Snow on Runway/s
WTR	Water on Runway/s
WX	Weather
/	And
+	In Addition/Also

Keyword	Definition
OBST	Obstruction
<i>Example</i>	ABC XX/XXX ABC <u>OBST</u> TOWER 283 (246 AGL) 2.2 S LGTS OTS (ASR 1065881) TIL 1003282300
Keyword	Definition
NAV	Navigation
<i>Example</i>	ABC XX/XXX ABC <u>NAV</u> VOR OTS
COM	Communications
<i>Example</i>	ABC XX/XXX ABC <u>COM</u> ATIS OTS
SVC	Services
<i>Example</i>	XX/XXX ABC <u>SVC</u> JET FUEL UNAVBL TIL 1003291600
AIRSPACE ..	Airspace
<i>Example</i>	ABC XX/XXX ABC <u>AIRSPACE</u> AIRSHOW ACFT 5000/BLW 5 NMR AIRPORT AVOIDANCE ADZD TIL 1003152200
U	Unverified Aeronautical Information (for use only where authorized by Letter of Agreement)*
O	Other Aeronautical Information**

3.2.1 NOTAM (D)

3.2.1.1 NOTAM (D) information is disseminated for all navigational facilities that are part of the National Airspace System (NAS), all public use airports, seaplane bases, and heliports listed in the Airport/Facility Directory (A/FD). This category of information is distributed automatically via Service A telecommunications systems. These NOTAMs remain available via Service A for the duration of their validity or until published.

All NOTAM Ds must have one of the following keywords as the first part of the text after the location identifier:

Keyword	Definition
RWY	Runway
<i>Example</i>	ABC XX/XXX ABC <u>RWY</u> 3/21 CLSD
TWY	Taxiway
<i>Example</i>	ABC XX/XXX ABC <u>TWY</u> F LGTS OTS
RAMP	Ramp
<i>Example</i>	ABC XX/XXX ABC <u>RAMP</u> TERMINAL EAST SIDE CONSTRUCTION
APRON	Apron
<i>Example</i>	ABC XX/XXX ABC <u>APRON</u> SW TWY C NEAR HANGARS CLSD
AD	Aerodrome
<i>Example</i>	ABC XX/XXX ABC <u>AD</u> ABN OTS

* **Unverified Aeronautical Information** can be movement area or other information received that meets NOTAM criteria and has not been confirmed by the Airport Manager (AMGR) or their designee. If Flight Service is unable to contact airport management, Flight Service shall forward (U) NOTAM information to the United States NOTAM System (USNS). Subsequent to USNS distribution of a (U) NOTAM, Flight Service will inform airport management of the action taken as soon as practical. Any such NOTAM will be prefaced with “(U)” as the keyword and followed by the appropriate keyword contraction, following the location identifier.

** **Other Aeronautical Information** is that which is received from any authorized source that may be beneficial to aircraft operations and does not meet defined NOTAM criteria. Any such NOTAM will be prefaced with “(O)” as the keyword following the location identifier.

3.2.1.2 NOTAM Ds that crossover into International NOTAMs

These NOTAMs contain the same data as NOTAM Ds, only they are referenced differently. They are categorized, stored, and issued with a series letter preceding them and are distributed via Service A to countries requesting NOTAMs for that airport. The FAA currently uses the Series A (and may use Series K) for this type of NOTAM.

3.2.2 FDC NOTAMs

3.2.2.1 On those occasions when it becomes necessary to disseminate information which is regulatory in nature, the National Flight Data Center (NFDC) in Washington, D.C., will issue an FDC NOTAM. FDC NOTAMs contain such things as amendments to published instrument approach procedures (IAPs) and other current aeronautical charts. They are also used to advertise temporary flight restrictions caused by such things as natural disasters or large scale public events that may generate a congestion of air traffic over a site.

3.2.2.2 FDC NOTAMs are transmitted via Service A only once and are kept on file at the FSS until published or canceled. FSSs are responsible for maintaining a file of current, unpublished FDC NOTAMs concerning conditions within 400 miles of their facilities. FDC information concerning conditions that are more than 400 miles from the FSS, or that is already published, is given only on request.

NOTE-

1. *DUATS vendors will provide FDC NOTAMs only upon site-specific requests using a location identifier.*

2. *NOTAM data may not always be current due to the changeable nature of the national airspace system components, delays inherent in processing the information, and occasional temporary outages of the United States NOTAM System. While en route, pilots should contact FSSs and obtain updated information for their route of flight and destination.*

3.2.3 Pointer NOTAMs. NOTAMs issued by a flight service station to highlight or point out another NOTAM, such as an FDC or NOTAM (D) NOTAM. This type of NOTAM will assist users in cross-referencing important information that may not be found under an airport or NAVAID identifier. Keywords in pointer NOTAMs must match the keywords in the NOTAM that is being pointed out. The keyword in pointer NOTAMs related to Temporary Flight Restrictions (TFR) must be AIRSPACE.

3.2.4 Special Use Airspace (SUA) NOTAMs. SUA NOTAMs are issued when Special Use Airspace will be active outside the published schedule times and when required by the published schedule. Pilots and other users are still responsible to check published schedule times for Special Use Airspace as well as any NOTAMs for that airspace.

3.2.5 Military NOTAMs. NOTAMs pertaining to U.S. Air Force, Army, Marine, and Navy navigational aids/airports that are part of the NAS.

3.3 An integral part of the NOTAM System is the Notice to Airmen publication, published every 28 days. Data is included in this publication to reduce congestion on the telecommunications circuits and, therefore, is not available via Service A. Once published, this information is not provided during pilot weather briefings unless specifically requested by the pilot. The Notice to Airmen publication contains four parts:

3.3.1 Part 1 contains three sections.

3.3.1.1 Notices which meet the criteria for NOTAM (D) which are expected to remain in effect for an extended period and FDC NOTAMs current at the time of publication. Occasionally, unique information is included in this section when it will contribute to flight safety.

3.3.1.2 Airports, Facilities, and Procedural NOTAMs.

3.3.1.3 General FDC NOTAMs.

3.3.2 Part 2 contains Revisions to Minimum En Route IFR Altitudes and Changeover Points Amendments.

3.3.3 Part 3 contains International Notices to Airmen.

3.3.4 Part 4 contains Graphic Notices. It includes special notices and notices containing graphics pertaining to almost every aspect of aviation; such as, military training areas, large scale sporting events that may attract media attention or draw large crowds of aircraft, chart corrections and additions, and air show information.

3.3.5 The number of the last FDC NOTAM included in the Notices to Airmen publication is noted on the first page to aid the user in updating the listing with any FDC NOTAMs which may have been issued between the cut-off date and the date the publication is received. All information contained will be carried until the information expires, is canceled, or in the case of permanent conditions, is published in other publications, such as the Airport/Facility Directory.

3.3.6 All new notices entered, excluding FDC NOTAMs, will be published only if the information is expected to remain in effect for at least 30 days after the effective date of the publication.

4. Flight Plan Requirements

4.1 The types of flight plans in U.S. airspace are:

4.1.1 Visual Flight Rules (VFR).

4.1.2 Defense Visual Flight Rules (DVFR).

4.1.3 Instrument Flight Rules (IFR).

4.1.4 Composite Flight Plan Visual–Instrument Flight Rules (VFR–IFR).

4.1.5 IFR flight plans requesting VFR operations.

NOTE–

ICAO flight plans are required whenever the flight intends to cross an international boundary or an oceanic CTA/FIR boundary. For flights departing U.S. airports and operating over U.S. domestic airspace and/or offshore control areas, but do not penetrate the oceanic CTA/FIR boundary or borders, a U.S. domestic flight plan is preferred.

4.2 Flight Plan–VFR Flights

4.2.1 Except for operations in or penetrating a Coastal or Domestic ADIZ or DEWIZ (see ENR 1.12, paragraph 1.2), a flight plan is not required for VFR flight; however, it is strongly recommended that one be filed.

4.2.2 To obtain maximum benefits of the flight plan program, flight plans should be filed directly with the nearest flight service station. For your convenience, FSSs provide aeronautical and meteorological briefings while accepting flight plans. Radio may be used to file if no other means are available. Also, some States operate aeronautical communications facilities which will accept and forward flight plans to the FSS for further handling.

4.2.3 When a “stopover” flight is anticipated to cover an extended period of time, it is recommended that a separate flight plan be filed for each “leg” when the stop is expected to be more than 1–hour duration.

4.2.4 Pilots are encouraged to give their departure times directly to the FSS serving the departure airport or as otherwise indicated by the FSS when the flight plan is filed. This will ensure more efficient flight plan service and permit the FSS to advise you of significant changes in aeronautical facilities or meteorological conditions. When a VFR flight plan is filed, it will be held by the FSS until 1 hour after the proposed departure time and then canceled unless:

4.2.4.1 The actual departure time is received.

4.2.4.2 A revised proposed departure time is received.

4.2.4.3 At a time of filing, the FSS is informed that the proposed departure time will be met, but actual time cannot be given because of inadequate communications (assumed departures).

4.2.5 On pilot’s request, at a location having an active tower, the aircraft identification will be forwarded by the tower to the FSS for reporting the actual departure time. This procedure should be avoided at busy airports.

4.2.6 Although position reports are not required for VFR flight plans, periodic reports to FAA flight service stations along the route are good practice. Such contacts permit significant information to be passed to the transiting aircraft and also serve to check the progress of the flight should it be necessary for any reason to locate the aircraft.

EXAMPLE–

1. *Bonanza 314K, over Kingfisher at (time), VFR flight plan, Tulsa to Amarillo.*

2. *Cherokee 5133J, over Oklahoma City at (time), Shreveport to Denver, no flight plan.*

4.2.7 Pilots not operating on an IFR flight plan, and when in level cruising flight, are cautioned to conform with VFR cruising altitudes appropriate to direction of flight.

4.2.8 When filing VFR flight plans, indicate aircraft equipment capabilities by appending the appropriate suffix to aircraft type in the same manner as that prescribed for IFR flight. Under some circumstances, ATC computer tapes can be useful in constructing the radar history of a downed or crashed aircraft. In each case, knowledge of the aircraft’s transponder equipment is necessary in determining whether or not such computer tapes might prove effective.

REFERENCE–

AIP, ENR 1.10, paragraph 5.1 and TBL ENR 1.10–2, Aircraft Equipment Suffixes.

4.2.9 Explanation of VFR Flight Plan Items.

4.2.9.1 **Block 1.** Check the type flight plan. Check both the VFR and IFR blocks if composite VFR/IFR.

4.2.9.2 **Block 2.** Enter your complete aircraft identification including the prefix “N” if applicable.

4.2.9.3 **Block 3.** Enter the designator for the aircraft, or if unknown, consult an FSS briefer.

4.2.9.4 **Block 4.** Enter your true airspeed (TAS).

4.2.9.5 Block 5. Enter the departure airport identifier code (or the airport name, city and state, if the identifier is unknown).

4.2.9.6 Block 6. Enter the proposed departure time in Coordinated Universal Time (UTC). If airborne, specify the actual or proposed departure time, as appropriate.

4.2.9.7 Block 7. Enter the appropriate VFR altitude (to assist the briefer in providing weather and wind information).

4.2.9.8 Block 8. Define the route of flight by using NAVAID identifier codes and airways.

4.2.9.9 Block 9. Enter the destination airport identifier code, or if unknown, the airport name.

NOTE-

Include the city name (or even the state name) if needed for clarity.

4.2.9.10 Block 10. Enter your estimated time en route, in hours and minutes.

4.2.9.11 Block 11. Enter only those remarks pertinent to ATC or to the clarification of other flight plan information such as the appropriate radiotelephony (call sign) associated with the designator filed in Block 2. Items of a personal nature are not accepted.

4.2.9.12 Specify the fuel on board, in hours and minutes.

4.2.9.13 Specify an alternate airport if desired.

4.2.9.14 Enter your complete name, address, and telephone number. Enter sufficient information to identify home base, airport, or operator.

NOTE-

This information is essential in the event of search and rescue operations.

4.2.9.15 Block 15. Enter total number of persons on board including crew (POB).

4.2.9.16 Block 16. Enter the predominant colors.

4.2.9.17 Block 17. (Optional) Record a destination telephone number to assist Search and Rescue should you fail to report or cancel your flight plan within 1/2 hour after your estimated time of arrival (ETA).

CAUTION-

A control tower at destination point does not automatically close VFR flight plans; it remains the responsibility of a pilot to close his/her own flight plan.

4.2.9.18 Record the FSS name for closing the flight plan. If the flight plan is closed with a different FSS or facility, state the recorded FSS name that would normally have closed your flight plan.

NOTE-

The information transmitted to the destination FSS will consist only of flight plans blocks 2, 3, 9, and 10. Estimated time en route (ETE) will be converted to the correct estimated time of arrival (ETA).

FIG ENR 1.10-1
FAA Flight Plan
Form 7233-1 (8-82)

U.S. DEPARTMENT OF TRANSPORTATION FEDERAL AVIATION ADMINISTRATION		(FAA USE ONLY) <input type="checkbox"/> PILOT BRIEFING <input type="checkbox"/> VNR <input type="checkbox"/> STOPOVER			TIME STARTED	SPECIALIST INITIALS	
FLIGHT PLAN							
1. TYPE	2. AIRCRAFT IDENTIFICATION	3. AIRCRAFT TYPE/ SPECIAL EQUIPMENT	4. TRUE AIRSPEED KTS	5. DEPARTURE POINT	6. DEPARTURE TIME		7. CRUISING ALTITUDE
	VFR				PROPOSED (Z)	ACTUAL (Z)	
	IFR						
DVFR							
8. ROUTE OF FLIGHT							
9. DESTINATION (Name of airport and city)		10. EST. TIME ENROUTE		11. REMARKS			
		HOURS	MINUTES				
12. FUEL ON BOARD		13. ALTERNATE AIRPORT(S)	14. PILOT'S NAME, ADDRESS & TELEPHONE NUMBER & AIRCRAFT HOME BASE			15. NUMBER ABOARD	
HOURS	MINUTES						
16. COLOR OF AIRCRAFT		17. DESTINATION CONTACT/TELEPHONE (OPTIONAL)					
		CIVIL AIRCRAFT PILOTS, FAR 91 requires you file an IFR flight plan to operate under instrument flight rules in controlled airspace. Failure to file could result in a civil penalty not to exceed \$1,000 for each violation (Section 901 of the Federal Aviation Act of 1958, as amended). Filing of a VFR flight plan is recommended as a good operating practice. See also Part 99 for requirements concerning DVFR flight plans.					
FAA Form 7233-1 (8-82)		CLOSE VFR FLIGHT PLAN WITH _____ FSS ON ARRIVAL					

**TBL ENR 1.10-2
Aircraft Suffixes**

Suffix	Equipment Capability
	NO DME
/X	No transponder
/T	Transponder with no Mode C
/U	Transponder with Mode C
	DME
/D	No transponder
/B	Transponder with no Mode C
/A	Transponder with Mode C
	TACAN ONLY
/M	No transponder
/N	Transponder with no Mode C
/P	Transponder with Mode C
	AREA NAVIGATION (RNAV)
/Y	LORAN, VOR/DME, or INS with no transponder
/C	LORAN, VOR/DME, or INS, transponder with no Mode C
/I	LORAN, VOR/DME, or INS, transponder with Mode C
	ADVANCED RNAV WITH TRANSPONDER AND MODE C (If an aircraft is unable to operate with a transponder and/or Mode C, it will revert to the appropriate code listed above under Area Navigation.)
/E	Flight Management System (FMS) with DME/DME and IRU position updating
/F	FMS with DME/DME position updating
/G	Global Navigation Satellite System (GNSS), including GPS or Wide Area Augmentation System (WAAS), with en route and terminal capability.
/R	Required Navigational Performance (RNP). The aircraft meets the RNP type prescribed for the route segment(s), route(s) and/or area concerned.
	Reduced Vertical Separation Minimum (RVSM). Prior to conducting RVSM operations within the U.S., the operator must obtain authorization from the FAA or from the responsible authority, as appropriate.
/J	/E with RVSM
/K	/F with RVSM
/L	/G with RVSM
/Q	/R with RVSM
/W	RVSM

4.3 Operational Information System (OIS)

4.3.1 The FAA’s Air Traffic Control System Command Center (ATCSCC) maintains a web site with near real–time National Airspace System (NAS) status information. NAS operators are encouraged to access the web site at www.fly.faa.gov prior to filing their flight plan.

4.3.2 The web site consolidates information from advisories. An advisory is a message that is disseminated electronically by the ATCSCC that contains information pertinent to the NAS.

4.3.2.1 Advisories are normally issued for the following items:

- a) Ground Stops.
- b) Ground Delay Programs.
- c) Route Information.
- d) Plan of Operations.
- e) Facility Outages and Scheduled Facility Outages.
- f) Volcanic Ash Activity Bulletins.
- g) Special Traffic Management Programs.

4.3.2.2 This list is not all–inclusive. Any time there is information that may be beneficial to a large number of people, an advisory may be sent. Additionally, there may be times when an advisory is not sent due to workload or the short length of time of the activity.

4.3.2.3 Route information is available on the web site and in specific advisories. Some route information, subject to the 56–day publishing cycle, is located on the “OIS” under “Products,” Route Management Tool (RMT), and “What’s New” Playbook. The RMT and Playbook contain routings for use by Air Traffic and NAS operators when they are coordinated “real–time” and are then published in an ATCSCC advisory.

4.3.2.4 Route advisories are identified by the word “Route” in the header; the associated action is required (RQD), recommended (RMD), planned (PLN), or for your information (FYI). Operators are expected to file flight plans consistent with the Route RQD advisories.

4.3.2.5 Electronic System Impact Reports are on the intranet at <http://www.atcsc.faa.gov/ois/> under

“System Impact Reports.” This page lists scheduled outages/events/projects that significantly impact the NAS; for example, runway closures, air shows, and construction projects. Information includes anticipated delays and traffic management initiatives (TMI) that may be implemented.

4.4 Flight Plan–Defense VFR (DVFR) Flights

4.4.1 VFR flights into a Coastal or Domestic ADIZ/DEWIZ are required to file DVFR flight plans for security purposes. Detailed ADIZ procedures are found in , paragraph 1., ENR 1.12.

*REFERENCE–
14 CFR Part 99.*

5. Flight Plan–IFR Flights

5.1 General

5.1.1 Prior to departure from within, or prior to entering Class A, B, C, D, and E airspace, a pilot must submit a complete flight plan and receive an air traffic clearance if weather conditions are below VFR minimums. Instrument flight plans may be submitted to the nearest flight service station or the airport traffic control tower either in person or by telephone (or by radio if no other means are available). Pilots should file IFR flight plans at least 30 minutes prior to estimated time of departure to preclude possible delay in receiving a departure clearance from ATC. To minimize your delay in entering a Class B, C, D, or E surface area at destination when IFR weather conditions exist or are forecast at the airport, an IFR flight plan should be filed before departure. Otherwise, a 30–minute delay is not unusual in receiving an ATC clearance because of time spent in processing flight plan data. Traffic saturation frequently prevents control personnel from accepting flight plans by radio. In such cases the pilot is advised to contact the nearest flight service station for the purpose of filing the flight plan.

NOTE–

1. *There are several methods of obtaining IFR clearance at nontower, non–Flight Service Stations and outlying airports. The procedure may vary due to geographical features, weather conditions, and the complexity of the ATC system. To determine the most effective means of receiving an IFR clearance, pilots should ask the nearest Flight Service Station for the most appropriate means of obtaining the IFR clearance.*

2. *When requesting an IFR clearance, it is highly recommended that the departure airport be identified by stating the city name and state and/or the airport location*

identifier in order to clarify to ATC the exact location of the intended airport of departure.

5.1.2 When filing an IFR flight plan, include as a prefix to the aircraft type, the number of aircraft when more than one and/or heavy aircraft indicator “H/” if appropriate.

EXAMPLE–
H/DC10/A
2/F15/A

5.1.3 When filing an IFR flight plan, identify the equipment capability by adding a suffix, preceded by a slant, to the AIRCRAFT TYPE, as shown in TBL ENR 1.10–2, Aircraft Suffixes.

NOTE–

1. ATC issues clearances based on filed suffixes. Pilots should determine the appropriate suffix based upon desired services and/or routing. For example, if a desired route/procedure requires GPS, a pilot should file /G even if the aircraft also qualifies for other suffixes.

2. For procedures requiring GPS, if the navigation system does not automatically alert the flight crew of a loss of GPS, the operator must develop procedures to verify correct GPS operation.

3. The suffix is not to be added to the aircraft identification or be transmitted by radio as part of the aircraft identification.

5.1.4 It is recommended that pilots file the maximum transponder or navigation capability of their aircraft in the equipment suffix. This will provide ATC with the necessary information to utilize all facets of navigational equipment and transponder capabilities available.

5.1.5 When filing an IFR flight plan via telephone or radio, it is highly recommended that the departure airport be clearly identified by stating the city name and state and/or airport location identifier. With cell phone use and flight service specialists covering larger areas of the country, clearly identifying the departure airport can prevent confusing your airport of departure with those of identical or similar names in other states.

5.2 Airways/Jet Routes Depiction on Flight Plan

5.2.1 It is vitally important that the route of flight be accurately and completely described in the flight plan. To simplify definition of the proposed route, and to facilitate air traffic control, pilots are requested to file via airways or jet routes established for use at the altitude or flight level planned.

5.2.2 If flight is to be conducted via designated airways or jet routes, describe the route by indicating the type and number designators of the airway(s) or jet route(s) requested. If more than one airway or jet route is to be used, clearly indicate points of transition. If the transition is made at an unnamed intersection, show the next succeeding NAVAID or named intersection on the intended route and the complete route from that point. Reporting points should be identified by using authorized name/code as depicted on appropriate aeronautical charts. The following two examples illustrate the need to specify the transition point when two routes share more than one transition fix.

EXAMPLE–

1. ALB J37 BUMPY J14 BHM

Spelled out: from Albany, New York, via Jet Route 37 transitioning to Jet Route 14 at BUMPY intersection, thence via Jet Route 14 to Birmingham, Alabama.

2. ALB J37 ENO J14 BHM

Spelled out: from Albany, New York, via Jet Route 37 transitioning to Jet Route 14 at Smyrna VORTAC (ENO) thence via Jet Route 14 to Birmingham, Alabama.

5.2.3 The route of flight may also be described by naming the reporting points or NAVAIDs over which the flight will pass, provided the points named are established for use at the altitude or flight level planned.

EXAMPLE–

BWI V44 SWANN V433 DQO

Spelled out: from Baltimore-Washington International, via Victor 44 to Swann intersection, transitioning to Victor 433 at Swann, thence via Victor 433 to Dupont.

5.2.4 When the route of flight is defined by named reporting points, whether alone or in combination with airways or jet routes, and the navigational aids (VOR, VORTAC, TACAN, LF, RBN) to be used for the flight are a combination of different types of aids, enough information should be included to clearly indicate the route requested.

EXAMPLE–

LAX J5 LKV J3 GEG YXC FL 330 J500 VLR J515 YWG
Spelled out: from Los Angeles International via Jet Route 5 Lakeview, Jet Route 3 Spokane, direct Cranbrook, British Columbia VOR/DME, Flight Level 330 Jet Route 500 to Langruth, Manitoba VORTAC, Jet Route 515 to Winnipeg, Manitoba.

5.2.5 When filing IFR, it is to the pilot’s advantage to file a “preferred route.”

NOTE–

Preferred IFR routes are described and tabulated in the Airport/Facility Directory.

5.2.6 ATC may issue a SID or a STAR as appropriate (See ENR 1.5, paragraph 3.).

NOTE–

Pilots not desiring a SID or STAR should so indicate in the remarks section of the flight plan as “no SID” or “no STAR.”

5.3 Direct Flights

5.3.1 All or any portions of the route which will not be flown on the radials or courses of established airways or routes, such as direct route flights, must be defined by indicating the radio fixes over which the flight will pass. Fixes selected to define the route shall be those over which the position of the aircraft can be accurately determined. Such fixes automatically become compulsory reporting points for the flight, unless advised otherwise by ATC. Only those navigational aids established for use in a particular structure; i.e., in the low or high structures, may be used to define the en route phase of a direct flight within that structure.

5.3.2 The azimuth feature of VOR aids and the azimuth and distance (DME) features of VORTAC and TACAN aids are assigned certain frequency protected areas of airspace which are intended for application to established airway and route use, and to provide guidance for planning flights outside of established airways or routes. These areas of airspace are expressed in terms of cylindrical service volumes of specified dimensions called “class limits” or “categories.”

5.3.3 An operational service volume has been established for each class in which adequate signal coverage and frequency protection can be assured. To facilitate use of VOR, VORTAC, or TACAN aids, consistent with their operational service volume limits, pilot use of such aids for defining a direct route of flight in Class A, B, C, D, and E airspace should not exceed the following:

5.3.3.1 Operations above Flight Level 450. Use aids not more than 200 nautical miles apart. These aids are depicted on En Route High Altitude Charts.

5.3.3.2 Operation off established routes from 18,000 feet MSL to Flight Level 450. Use aids not more than 260 nautical miles apart. These aids are depicted on En Route High Altitude Charts.

5.3.3.3 Operation off established airways below 18,000 feet MSL. Use aids not more than 80 nautical miles apart. These aids are depicted on En Route Low Altitude Charts.

5.3.3.4 Operation off established airways between 14,500 feet MSL and 17,999 feet MSL in the conterminous United States. (H) facilities not more than 200 NM apart may be used.

5.3.4 Increasing use of self-contained airborne navigational systems which do not rely on the VOR/VORTAC/TACAN system has resulted in pilot requests for direct routes which exceed NAVAID service volume limits. These direct route requests will be approved only in a radar environment, with approval based on pilot responsibility for navigation on the authorized direct route. “Radar flight following” will be provided by ATC for air traffic control purposes.

5.3.5 At times, ATC will initiate a direct route in a radar environment which exceeds NAVAID service volume limits. In such cases ATC will provide radar monitoring and navigational assistance as necessary.

5.3.6 Airway or jet route numbers, appropriate to the stratum in which operation will be conducted, may also be included to describe portions of the route to be flown.

EXAMPLE–

*MDW V262 BDF V10 BRL STJ SLN GCK
Spelled out: from Chicago Midway Airport via Victor 262 to Bradford, Victor 10 to Burlington, Iowa, direct St. Joseph, Missouri, direct Salina, Kansas, direct Garden City, Kansas.*

NOTE–

When route of flight is described by radio fixes, the pilot will be expected to fly a direct course between the points named.

5.3.7 Pilots are reminded that they are responsible for adhering to obstruction clearance requirements on those segments of direct routes that are outside of Class A, B, C, D, and E airspace. The MEAs and other altitudes shown on Low Altitude IFR En Route Charts pertain to those route segments within Class A, B, C, D, and E airspace, and those altitudes may not meet obstruction clearance criteria when operating off those routes.

5.4 Area Navigation (RNAV)

5.4.1 Random RNAV routes can only be approved in a radar environment. Factors that will be considered by ATC in approving random RNAV routes include

the capability to provide radar monitoring and compatibility with traffic volume and flow. ATC will radar monitor each flight; however, navigation on the random RNAV route is the responsibility of the pilot.

5.4.2 Pilots of aircraft equipped with approved area navigation equipment may file for RNAV routes throughout the National Airspace System and may be filed for in accordance with the following procedures.

5.4.2.1 File airport to airport flight plans.

5.4.2.2 File the appropriate RNAV capability certification suffix in the flight plan.

5.4.2.3 Plan the random route portion of the flight plan to begin and end over appropriate arrival and departure transition fixes or appropriate navigation aids for the altitude stratum within which the flight will be conducted. The use of normal preferred departure and arrival routes (DP/STAR), where established, is recommended.

5.4.2.4 File route structure transitions to and from the random route portion of the flight.

5.4.2.5 Define random routes by waypoints. File route description waypoints by using degree–distance fixes based on navigational aids which are appropriate for the altitude stratum.

5.4.2.6 File a minimum of one route description waypoint for each ARTCC through whose area the random route will be flown. These waypoints must be located within 200 NM of the preceding center’s boundary.

5.4.2.7 File an additional route description waypoint for each turnpoint in the route.

5.4.2.8 Plan additional route description waypoints as required to ensure accurate navigation via the filed route of flight. Navigation is the pilot’s responsibility unless ATC assistance is requested.

5.4.2.9 Plan the route of flight so as to avoid Prohibited and Restricted Airspace by 3 NM unless permission has been obtained to operate in that airspace and the appropriate ATC facilities are advised.

NOTE–

To be approved for use in the National Airspace System, RNAV equipment must meet the appropriate system availability, accuracy, and airworthiness standards. For additional guidance on equipment requirements see AC 20–130, Airworthiness Approval of Vertical Navigation (VNAV) Systems for use in the U.S. NAS and Alaska, or AC 20–138, Airworthiness Approval of Global Positioning System (GPS) Navigation Equipment for Use as a VFR and IFR Supplemental Navigation System. For airborne navigation database, see AC 90–94, Guidelines for Using GPS Equipment for IFR En Route and Terminal Operations and for Nonprecision Instrument Approaches in the U.S. National Airspace System, Section 2.

5.4.3 Pilots of aircraft equipped with latitude/longitude coordinate navigation capability independent of VOR/TACAN references may file for random RNAV routes at and above FL 390 within the conterminous U.S. using the following procedures:

5.4.3.1 File airport–to–airport flight plans prior to departure.

5.4.3.2 File the appropriate RNAV capability certification suffix in the flight plan.

5.4.3.3 Plan the random route portion of the flight to begin and end over published departure/arrival transition fixes or appropriate navigation aids for airports without published transition procedures. The use of preferred departure and arrival routes, such as DP and STAR where established, is recommended.

5.4.3.4 Plan the route of flight so as to avoid prohibited and restricted airspace by 3 NM unless permission has been obtained to operate in that airspace and the appropriate ATC facility is advised.

5.4.3.5 Define the route of flight after the departure fix, including each intermediate fix (turnpoint) and the arrival fix for the destination airport in terms of latitude/longitude coordinates plotted to the nearest minute or in terms of Navigation Reference System (NRS) waypoints. For latitude/longitude filing the arrival fix must be identified by both the latitude/longitude coordinates and a fix identifier.

EXAMPLE–

MIA¹ SRQ² 3407/10615³ 3407/11546 TNP⁴ LAX⁵

¹ *Departure Airport*

² *Departure Fix*

³ *Intermediate Fix (Turning Point)*

⁴ *Arrival Fix*

⁵ *Destination Airport*

or

ORD¹ IOW² KP49G³ KD34U⁴ KL16O⁵ OAL⁶ MOD2⁷
SFO⁸

¹ Departure airport.

² Transition fix (pitch point).

³ Minneapolis ARTCC waypoint.

⁴ Denver ARTCC Waypoint.

⁵ Los Angeles ARTCC waypoint (catch point).

⁶ Transition fix.

⁷ Arrival.

⁸ Destination airport.

5.4.3.6 Record latitude/longitude coordinates by four figures describing latitude in degrees and minutes followed by a solidus and five figures describing longitude in degrees and minutes.

5.4.3.7 File at FL 390 or above for the random RNAV portion of the flight.

5.4.3.8 Fly all routes/route segments on Great Circle tracks.

5.4.3.9 Make any in-flight requests for random RNAV clearances or route amendments to an en route ATC facility.

5.5 Flight Plan Form (See FIG ENR 1.10–1.)

5.5.1 Explanation of IFR Flight Plan Items.

5.5.1.1 Block 1. Check the type flight plan. Check both the VFR and IFR blocks if composite VFR/IFR.

5.5.1.2 Block 2. Enter your complete aircraft identification including the prefix “N” if applicable.

5.5.1.3 Block 3. Enter the designator for the aircraft, followed by a slant (/) and the transponder or DME equipment code letter; e.g., C-182/U. Heavy aircraft, add prefix “H” to aircraft type; example, H/DC10/R. Consult an FSS briefer for any unknown elements.

5.5.1.4 Block 4. Enter your computed true airspeed (TAS).

NOTE–

If the average TAS changes plus or minus 5 percent or 10 knots, whichever is greater, advise ATC.

5.5.1.5 Block 5. Enter the departure airport identifier code (or the airport name, city and state, if the identifier is unknown).

NOTE–

Use of identifier codes will expedite the processing of your flight plan.

5.5.1.6 Block 6. Enter the proposed departure time in Coordinated Universal Time (UTC) (Z). If airborne, specify the actual or proposed departure time as appropriate.

5.5.1.7 Block 7. Enter the requested en route altitude or flight level.

NOTE–

Enter only the initial requested altitude in this block. When more than one IFR altitude or flight level is desired along the route of flight, it is best to make a subsequent request direct to the controller.

5.5.1.8 Block 8. Define the route of flight by using NAVAID identifier codes (or names if the code is unknown), airways, jet routes, and waypoints (for RNAV).

NOTE–

Use NAVAIDs or waypoints to define direct routes and radials/bearing to define other unpublished routes.

5.5.1.9 Block 9. Enter the destination airport identifier code (or name if identifier is unknown).

5.5.1.10 Block 10. Enter your estimated time en route based on latest forecast winds.

5.5.1.11 Block 11. Enter only those remarks pertinent to ATC or to the clarification of other flight plan information such as the appropriate radiotelephony (call sign) associated with the designator filed in Block 2. Items of a personal nature are not accepted. Do not assume that remarks will be automatically transmitted to every controller. Specific ATC or en route requests should be made directly to the appropriate controller.

NOTE–

“DVRSN” should be placed in Block 11 only if the pilot/company is requesting priority handling to their original destination from ATC as a result of a diversion as defined in the Pilot/Controller Glossary.

5.5.1.12 Block 12. Specify the fuel on board, computed from the departure point.

5.5.1.13 Block 13. Specify an alternate airport if desired or required, but do not include routing to the alternate airport.

5.5.1.14 Block 14. Enter the complete name, address, and telephone number of pilot-in-command or, in the case of a formation flight, the formation commander. Enter sufficient information to identify home base, airport, or operator.

NOTE-

This information would be essential in the event of a search and rescue operation.

5.5.1.15 Block 15. Enter the total number of persons on board including crew.

5.5.1.16 Block 16. Enter the predominant colors.

NOTE-

Close IFR flight plans with tower, approach control, ARTCCs, or if unable, with FSS. When landing at an airport with a functioning control tower, IFR flight plans are automatically canceled.

5.5.2 The information transmitted to the ARTCC for IFR Flight Plans will consist of only flight plan blocks 2, 3, 4, 5, 6, 7, 8, 9, 10, and 11.

5.5.3 A description of the International Flight Plan Form is contained in the International Flight Information Manual (IFIM).

6. IFR Operations to High Altitude Destinations

6.1 Pilots planning IFR flights to airports located in mountainous terrain are cautioned to consider the necessity for an alternate airport even when the forecast weather conditions would technically relieve them from the requirement to file one.

6.2 The FAA has identified three possible situations where the failure to plan for an alternate airport when flying IFR to such destination airport could result in a critical situation if the weather is less than forecast and sufficient fuel is not available to proceed to a suitable airport.

6.2.1 An IFR flight to an airport where the Minimum Descent Altitudes (MDAs) or landing visibility minimums for *all instrument approaches* are higher than the forecast weather minimums specified in 14 CFR Section 91.167(b). For example, there are 3 high altitude airports in the U.S. with approved instrument approach procedures where all of the MDAs are greater than 2,000 feet and/or the landing visibility minimums are greater than 3 miles (Bishop, California; South Lake Tahoe, California; and Aspen-Pitkin Co/Sardy Field, Colorado). In the case

of these airports, it is possible for a pilot to elect, on the basis of forecasts, not to carry sufficient fuel to get to an alternate when the ceiling and/or visibility is actually lower than that necessary to complete the approach.

6.2.2 A small number of other airports in mountainous terrain have MDAs which are slightly (100 to 300 feet) below 2,000 feet AGL. In situations where there is an option as to whether to plan for an alternate, pilots should bear in mind that just a slight worsening of the weather conditions from those forecast could place the airport below the published IFR landing minimums.

6.2.3 An IFR flight to an airport which requires special equipment; i.e., DME, glide slope, etc., in order to make the available approaches to the lowest minimums. Pilots should be aware that all other minimums on the approach charts may require weather conditions better than those specified in 14 CFR Section 91.167(b). An inflight equipment malfunction could result in the inability to comply with the published approach procedures or, again, in the position of having the airport below the published IFR landing minimums for all remaining instrument approach alternatives.

7. Composite Flight Plan (VFR/IFR Flights)

7.1 Flight plans which specify VFR operation for one portion of a flight, and IFR for another portion, will be accepted by the FSS at the point of departure. If VFR flight is conducted for the first portion of the flight, the pilot should report his/her departure time to the FSS with which he/she filed his/her VFR/IFR flight plan; and, subsequently, close the VFR portion and request ATC clearance from the FSS nearest the point at which change from VFR to IFR is proposed. Regardless of the type facility you are communicating with (FSS, center, or tower), it is the pilot's responsibility to request that facility to "CLOSE VFR FLIGHT PLAN." The pilot must remain in VFR weather conditions until operating in accordance with the IFR clearance.

7.2 When a flight plan indicates IFR for the first portion of flight and VFR for the latter portion, the pilot will normally be cleared to the point at which the change is proposed. Once the pilot has reported over the clearance limit and does not desire further IFR clearance, he/she should advise air traffic control to cancel the IFR portion of his/her flight plan. Then,

he/she should contact the nearest FSS to activate the VFR portion of his/her flight plan. If the pilot desires to continue his/her IFR flight plan beyond the clearance limit, he/she should contact air traffic control at least five minutes prior to the clearance limit and request further IFR clearance. If the requested clearance is not received prior to reaching the clearance limit fix, the pilot will be expected to establish himself/herself in a standard holding pattern on the radial/course to the fix unless a holding pattern for the clearance limit fix is depicted on a U.S. Government or commercially produced (meeting FAA requirements) Low/High Altitude En Route, Area, or STAR chart. In this case the pilot will hold according to the depicted pattern.

8. Initiating a Change to Flight Plans on File

8.1 Changes to proposed flight plans should be initiated through the FSS with which the flight plan was originally filed. If this is not possible, initiate changes through the nearest FSS or ATC facility. All changes should be initiated at least 30 minutes prior to departure to insure that the change can be effected prior to the ATC clearance delivery.

9. Change in Proposed Departure Time

9.1 To prevent computer saturation in the en route environment, parameters have been established to delete proposed departure flight plans which have not been activated. Most centers have this parameter set so as to delete these flight plans a minimum of 1 hour after the proposed departure time. To ensure that a flight plan remains active, pilots whose actual departure time will be delayed 1 hour or more beyond their filed departure time, are requested to notify ATC of their departure time.

9.2 Due to traffic saturation, control personnel frequently will be unable to accept these revisions via radio. It is recommended that you forward these revisions to the nearest FSS.

10. Other Changes

10.1 In addition to altitude/flight level, destination, and/or route changes, increasing or decreasing the speed of an aircraft constitutes a change in a flight plan. Therefore, at any time the average true airspeed at cruising altitude between reporting points varies or

is expected to vary from that given in the flight plan by plus or minus 5 percent, or 10 knots, whichever is greater, air traffic control should be advised.

11. Canceling Flight Plans

11.1 Closing VFR and DVFR Flight Plans

11.1.1 A pilot is responsible for ensuring that his/her VFR or DVFR flight plan is canceled. You should close your flight plan with the nearest FSS, or if one is not available, you may request any ATC facility to relay your cancellation to the FSS. Control towers do not automatically close VFR or DVFR flight plans as they may not be aware that a particular VFR aircraft is on a flight plan. If you fail to report or cancel your flight plan within $\frac{1}{2}$ hour after your ETA, search and rescue procedures are started.

11.2 Canceling IFR Flight Plan

11.2.1 14 CFR Section 91.153 includes the statement “When a flight plan has been activated, the pilot in command, upon canceling or completing the flight under the flight plan, shall notify an FAA Flight Service Station or ATC facility.”

11.2.2 An IFR flight plan may be canceled at any time the flight is operating in VFR conditions outside Class A airspace by the pilot stating “CANCEL MY IFR FLIGHT PLAN” to the controller or air/ground station with which he/she is communicating. Immediately after canceling an IFR flight plan, a pilot should take necessary action to change to the appropriate air/ground frequency, VFR radar beacon code, and VFR altitude or flight level.

11.2.3 ATC separation and information services will be discontinued, including radar services (where applicable). Consequently, if the canceling flight desires VFR radar advisory service, the pilot must specifically request it.

NOTE—

Pilots must be aware that other procedures may be applicable to a flight that cancels an IFR flight plan within an area where a special program, such as a designated terminal radar service area, Class C airspace or Class B airspace, has been established.

11.2.4 If a DVFR flight plan requirement exists, the pilot is responsible for filing this flight plan to replace the canceled IFR flight plan. If a subsequent IFR operation becomes necessary, a new IFR flight plan must be filed and an ATC clearance obtained before operating in IFR conditions.

11.2.5 If operating on an IFR flight plan to an airport with a functioning control tower, the flight plan is automatically closed upon landing.

11.2.6 If operating on an IFR flight plan to an airport where there is no functioning control tower, the pilot must initiate cancellation of the IFR flight plan. This can be done after landing if there is a functioning FSS or other means of direct communications with ATC. In the event there is no FSS and air/ground communications with ATC is not possible below a certain altitude, the pilot would, weather conditions permitting, cancel his/her IFR flight plan while still airborne and able to communicate with ATC by radio. This will not only save the time and expense of canceling the flight plan by telephone but will quickly release the airspace for use by other aircraft.

11.3 RNAV and RNP Operations

11.3.1 During the pre-flight planning phase the availability of the navigation infrastructure required for the intended operation, including any non-RNAV contingencies, must be confirmed for the period of intended operation. Availability of the onboard navigation equipment necessary for the route to be flown must be confirmed.

11.3.2 If a pilot determines a specified RNP level cannot be achieved, revise the route or delay the operation until appropriate RNP level can be ensured.

11.3.3 The onboard navigation database must be current and appropriate for the region of intended operation and must include the navigation aids, waypoints, and coded terminal airspace procedures for the departure, arrival and alternate airfields.

11.3.4 During system initialization, pilots of aircraft equipped with a Flight Management System or other RNAV-certified system, must confirm that the navigation database is current, and verify that the aircraft position has been entered correctly. Flight crews should crosscheck the cleared flight plan against charts or other applicable resources, as well as the navigation system textual display and the aircraft map display. This process includes confirmation of the waypoints sequence, reasonableness of track angles and distances, any altitude or speed constraints, and identification of fly-by or fly-over

waypoints. A procedure shall not be used if validity of the navigation database is in doubt.

11.3.5 Prior to commencing takeoff, the flight crew must verify that the RNAV system is operating correctly and the correct airport and runway data have been loaded.

11.3.6 During the pre-flight planning phase RAIM prediction must be performed if TSO-C129() equipment is used to solely satisfy the RNAV and RNP requirement. GPS RAIM availability must be confirmed for the intended route of flight (route and time) using current GPS satellite information. In the event of a predicted, continuous loss of RAIM of more than five (5) minutes for any part of the intended flight, the flight should be delayed, canceled, or re-routed where RAIM requirements can be met. Operators may satisfy the predictive RAIM requirement through any one of the following methods:

11.3.6.1 Operators may monitor the status of each satellite in its plane/slot position, by accounting for the latest GPS constellation status (e.g., NOTAMs or NANUs), and compute RAIM availability using model-specific RAIM prediction software;

11.3.6.2 Operators may use the FAA en route and terminal RAIM prediction website: www.raimprediction.net;

11.3.6.3 Operators may contact a Flight Service Station (not DUATS) to obtain non-precision approach RAIM;

11.3.6.4 Operators may use a third party interface, incorporating FAA/VOLPE RAIM prediction data without altering performance values, to predict RAIM outages for the aircraft's predicted flight path and times;

11.3.6.5 Operators may use the receiver's installed RAIM prediction capability (for TSO-C129a/Class A1/B1/C1 equipment) to provide non-precision approach RAIM, accounting for the latest GPS constellation status (e.g., NOTAMs or NANUs). Receiver non-precision approach RAIM should be checked at airports spaced at intervals not to exceed 60 NM along the RNAV 1 procedure's flight track. "Terminal" or "Approach" RAIM must be available at the ETA over each airport checked; or,

11.3.6.6 Operators not using model-specific software or FAA/VOLPE RAIM data will need FAA operational approval.

NOTE–

If TSO–C145/C146 equipment is used to satisfy the RNAV and RNP requirement, the pilot/operator need not perform the prediction if WAAS coverage is confirmed to be available along the entire route of flight. Outside the U.S. or in areas where WAAS coverage is not available, operators using TSO–C145/C146 receivers are required to check GPS RAIM availability.

12. International Flight Plan (FAA Form 7233–4) – IFR Flights (For Domestic or International Flights)

12.1 FAA Form 7233–4, also known as the International Civil Aviation Organization (ICAO) FPL (Filed Flight Plan), is recommended for domestic IFR flights, and is mandatory for all IFR flights that will depart U.S. domestic airspace.

12.2 ICAO flight plans are to be filed according to ICAO Doc 4444, Procedures for Air Navigation Services — Air Traffic Management (PANS–ATM).

12.3 ICAO flight plans are required whenever the flight intends to cross an international boundary or an oceanic CTA/FIR boundary. For flights departing U.S. airports and operating over U.S. domestic airspace and/or offshore control areas, but do not penetrate the oceanic CTA/FIR boundary or borders, a U.S. domestic flight plan can be filed, but an **ICAO is always preferred.**

12.4 If the pilot intends to fly an RNAV arrival and/or departure, then an ICAO FPL must be filed using the qualifier “Z” in addition to the RNAV capabilities in Item 18. Operators should file their maximum capabilities in order to qualify for the most advanced procedures.

12.5 The pilot must file in accordance with (IAW) FAA Form 7233–4 for automatic assignment of RNAV Standard Instrument Departures (SIDs), Standard Terminal Arrival Routes (STARs), and/or Point to Point (PTP) in U.S. domestic airspace and include additional information per the below guidance:

12.5.1 If you are RNAV 1 and/or RNAV 2 capable:

12.5.1.1 Item 10, Equipment

In addition to identifying all available and

serviceable communication, navigation, approach aid, and surveillance equipment carried on your aircraft, **insert the character “Z”.**

12.5.1.2 Item 18, Other Information

Insert “NAV/RNV” followed by the appropriate RNAV accuracy value(s) per the following: To be assigned an RNAV 1 SID, **insert the characters “D1”.** To be assigned an RNAV 1 STAR, **insert the characters “A1”.** To be assigned en route extensions and/or RNAV PTP, **insert the characters “E2”.** To prevent assignment of an RNAV route or procedure, insert a numeric value of “0” for the segment of the flight. Alternatively, you may simply remove the segment of the flight indicator and numeric value from the character string.

EXAMPLE–

1. NAV/RNVD1 or NAV/RNVD1E0A0 (Same meaning)
2. NAV/RNVA1 or NAV/RNVD0E0A1 (Same meaning)
3. NAV/RNVE2 or NAV/RNVD0E2A0 (Same meaning)
4. NAV/RNVD1A1 or NAV/RNVD1E0A1 (Same meaning),
5. NAV/RNVD1E2A1.

12.5.2 If you are RNAV PTP capable, but not RNAV 1 and/or RNAV 2 capable:

12.5.2.1 Item 10, Equipment

In addition to identifying all available and serviceable communication, navigation, approach aid, and surveillance equipment carried on your aircraft, **insert the character “Z”.**

12.5.2.2 Item 18, Other Information

Insert “RMK/PTP” and “NAV/RNVE99”.

EXAMPLE–

RMK/PTP NAV/RNVE99

12.5.2.3 The following variations will be accepted in ERAS for automatic assignment of RNAV routes: One or more spaces may follow “NAV/.”

EXAMPLE–

NAV/ RNVD1A1. The “D”, “E”, and “A” characters may appear in any order following “NAV/RNV”.

EXAMPLE–

NAV/RNVD1A1E2 NAV/RNVA1D1E2.

Additional items required by other automation systems may be filed after “NAV/” in any order.

EXAMPLE–

NAV/RNP10 RNVD1E2A1, NAV/RNVD1E2A1 RNP4 NAV/RNAV1 RNAV5 RNVD1E2A1.

12.5.2.4 If the Item 18 entries following “NAV/” do not follow the above instructions, the flight plan will be accepted by ERAS, but **you will not be automatically assigned RNAV**. Common errors include: Putting spaces between RNV, D1, A1, and/or E2 – no spaces are allowed between the segments. Filing “RNAV” instead of “RNV” – RNAV is not acceptable in the U.S. domestic string after “NAV/”.

12.6 If the pilot intends to operate in RVSM airspace, he/she should file the qualifier “W” in order to be cleared into RVSM airspace.

12.7 For a copy of FAA Form 7233-4, and for information on how to complete the form, please go to: www.faa.gov/ato?k=fpl.

12.8 Planned Changes to Filed Flight Plans in 2012.

On November 15, 2012, the ICAO FPL will undergo significant changes regarding item and field contents for FPLs and related messages. For additional information go to: www.faa.gov/go/fpl2012.

ENR 1.11 Addressing of Flight Plans for Domestic or International Flight Planning

1. General Information

1.1 In order to safely and efficiently exercise their responsibilities, controllers must receive the most current and accurate flight plan information available. For departing aircraft, this information is normally received in the form of an ICAO Filed Flight Plan (FPL). For aircraft inbound from an adjacent facility, flight plan information may also be received in the form of an FPL, however, if available, the most current information is received via inter-facility automated interface in the form of a Current Flight Plan (CPL). Although the FPL and CPL are similar, they differ in that the FPL contains the requested route/altitude, while the CPL contains the route/altitude actually assigned to the aircraft.

1.2 Within domestic U.S. (contiguous 48 states) airspace, only the first en route facility needs to receive flight plan data, whether from the filer or an adjacent facility. This is due to the fact that U.S. en route computer systems automatically forward current flight plan data and revisions from facility to facility. The inappropriate addressing of an FPL by the filer may create processing and/or controller workload issues, resulting in delays.

1.3 Please refer to guidance in the scenarios below to ensure that FPLs are addressed correctly.

2. Addressing Guidance

NOTE-

In this section, U.S. Domestic Airspace includes the 48 contiguous states and Puerto Rico.

Please use the following criteria when selecting addresses for transmission of the ICAO FPL to U.S. Air Traffic Control (ATC):

2.1 Address the FPL to the departure ARTCC only. Do not address subsequent U.S. domestic facilities.

NOTE-

If a flight leaves U.S. domestic airspace and later re-enters U.S. domestic airspace, the return portion of the flight should be addressed per guidance in Scenarios 2.3 or 2.4 below, as applicable.

2.2 U.S. Domestic to International Destinations

Address the FPL to the departure ARTCC.

Do not address subsequent U.S. domestic facilities.

Address the FPL to New York, Oakland, and/or Anchorage Oceanic, as appropriate.

Address any non-U.S. FIRs in accordance with ICAO Doc 4444, Procedures for Air Navigation Services — Air Traffic Management, and other published procedures.

2.3 From Canada to or through U.S. Domestic Airspace

Address non-U.S. FIRs in accordance with ICAO Doc 4444 and other published procedures.

Do not address the FPL to any U.S. domestic ARTCC.

Address the FPL to New York, Oakland and/or Anchorage Oceanic, as appropriate.

Address any non-U.S. FIRs in accordance with ICAO Doc 4444 and other published procedures.

2.4 International (non-Canada) to or through U.S. Domestic Airspace

Address FPLs to non-U.S. FIRs in accordance with ICAO Doc 4444 and other published procedures.

Address the FPL to the first domestic U.S. ARTCC.

Do not address subsequent U.S. domestic facilities.

Address the FPL to New York, Oakland and/or Anchorage Oceanic, as appropriate

Address any non-U.S. FIRs in accordance with ICAO Doc 4444 and other published procedures.

3. Addresses to the Air Route Traffic Control Centers and to Flight Data

NOTE-

Messages addressed using an ARTCC flight data address (i.e., ZRZX) are not processed by the computer. Response and/or interpretation of these messages are dependent on flight data personnel action. Note: ZTZX (ATC Tower) is not used in the United States.

3.1 ARTCC NADIN/AFTN Addresses

The addressing convention used for U.S. domestic FIR/ARTCCs is as follows:

3.1.1 KZxxZRZX addresses the message only to the facility Flight Data Unit via Aeronautical Information System Replacement (AISR).

EXAMPLE-
KZLCZRZX

3.1.2 KZxxZQZX addresses the message to both Flight Data and the En Route Computer.

EXAMPLE-
KZLCZQZX

NOTE-
The New York Center (KZNY) requires additional addresses for flights entering the KZNY Oceanic FIR: KZWYZOZX, KZNYZRZC, and KZNYZRZD. Please review KZNY FIR NOTAMS for more information

NOTE-
The Oakland Center requires additional addresses when entering the KZOA Oceanic FIR: KZAKZQZX and KZCEZQZX.

ENR 1.12 Interception of Civil Aircraft, National Security, and Interception Procedures

1. National Security

1.1 National security in the control of air traffic is governed by 14 CFR Part 99.

1.2 All aircraft entering domestic U.S. airspace from points outside, must provide for identification prior to entry. To facilitate early aircraft identification of all aircraft in the vicinity of U.S. and international airspace boundaries, Air Defense Identification Zones (ADIZ) have been established. (See FIG ENR 1.12-1).

1.3 Operational requirements for aircraft operations associated with an ADIZ are as follows:

1.3.1 Flight Plan. Except as specified in subparagraphs 1.5 and 1.6 below, an IFR or DVFR flight plan must be filed with an appropriate aeronautical facility as follows:

1.3.1.1 Generally, for all operations that enter an ADIZ.

1.3.1.2 For operations that will enter or exit the U.S. and which will operate into, within or across the contiguous U.S. ADIZ regardless of true airspeed.

1.3.1.3 The flight plan must be filed before departure except for operations associated with the Alaskan ADIZ when the airport of departure has no facility for filing a flight plan, in which case the flight plan may be filed immediately after takeoff or when within range of the aeronautical facility.

1.3.2 Two-way Radio. For the majority of operations associated with an ADIZ, an operating two-way radio is required. See 14 CFR Section 99.1 for exceptions.

1.3.3 Transponder Requirements. Unless otherwise authorized by ATC, each aircraft conducting operations into, within, or across the contiguous U.S. ADIZ must be equipped with an operable radar beacon transponder having altitude reporting capability (Mode C), and that transponder must be turned on and set to reply on the appropriate code or as assigned by ATC.

1.3.4 Position Reporting

1.3.4.1 For IFR flight. Normal IFR position reporting.

1.3.4.2 For DVFR flights. The estimated time of ADIZ penetration must be filed with the aeronautical facility at least 15 minutes prior to penetration except for flight in the Alaskan ADIZ, in which case report prior to penetration.

1.3.4.3 For inbound aircraft of foreign registry. The pilot must report to the aeronautical facility at least 1 hour prior to ADIZ penetration.

1.3.5 Aircraft Position Tolerances

1.3.5.1 Over land, the tolerance is within plus or minus 5 minutes from the estimated time over a reporting point or point of penetration and within 10 NM from the centerline of an intended track over an estimated reporting point or penetration point.

1.3.5.2 Over water, the tolerance is plus or minus 5 minutes from the estimated time over a reporting point or point of penetration and within 20 NM from the centerline of the intended track over an estimated reporting point or point of penetration (to include the Aleutian Islands).

1.3.6 Land-Based ADIZ. Land-Based ADIZ are activated and deactivated over U.S. metropolitan areas as needed, with dimensions, activation dates and other relevant information disseminated via NOTAM.

1.3.6.1 In addition to requirements outlined in subparagraphs 1.3.1 through 1.3.3, pilots operating within a Land-Based ADIZ must report landing or leaving the Land-Based ADIZ if flying too low for radar coverage.

1.3.6.2 Pilots unable to comply with all requirements shall remain clear of Land-Based ADIZ. Pilots entering a Land-Based ADIZ without authorization or who fail to follow all requirements risk interception by military fighter aircraft.

FIG ENR 1.12-1
Air Defense Identification Zone Boundaries
Designated Mountainous Areas

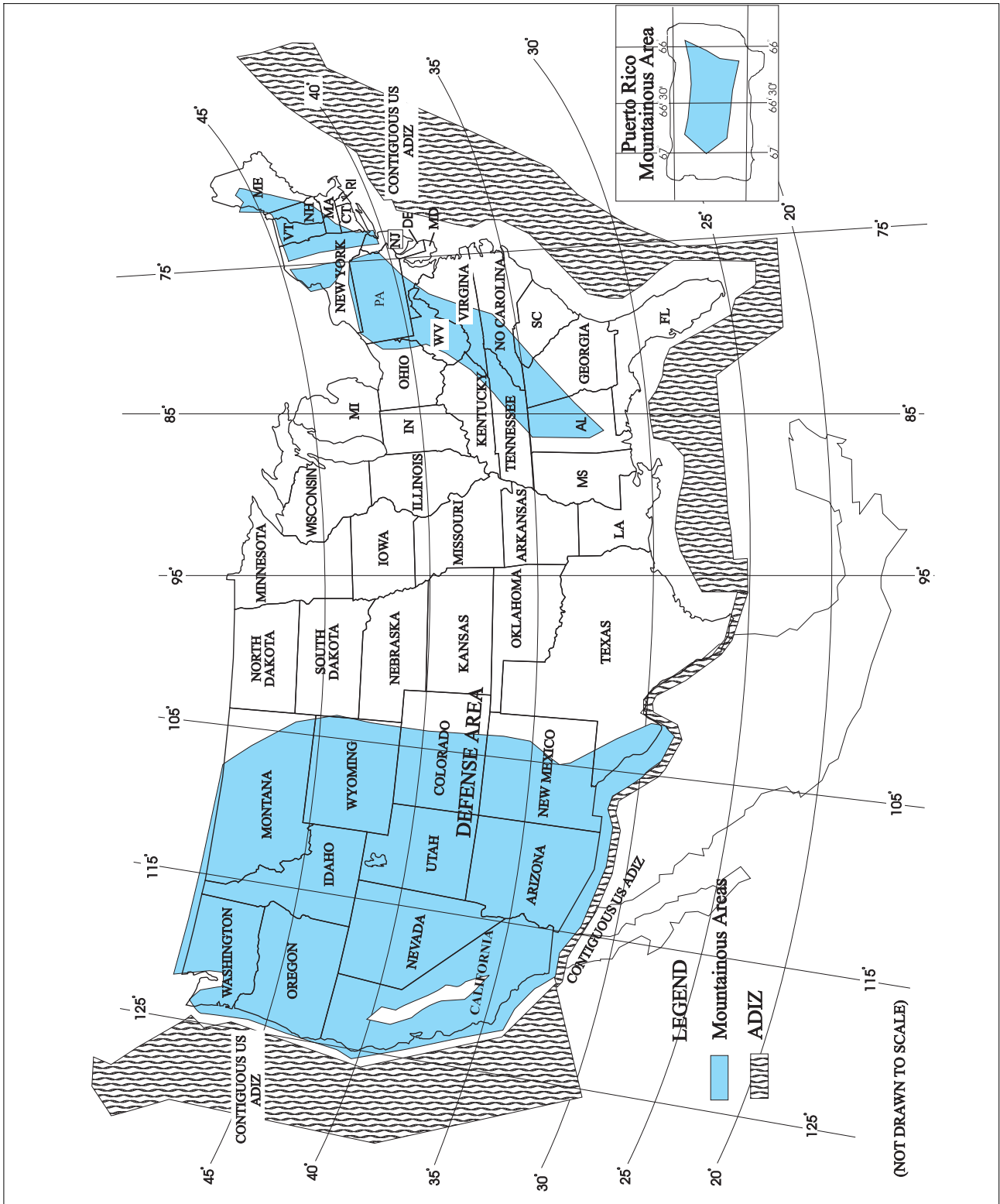

1.4 Except when applicable under 14 CFR Sections 99.7 and 99.12, Part 99 does not apply to aircraft operations:

1.4.1 Within the 48 contiguous states and the District of Columbia, or within the State of Alaska, and remains within 10 miles of the point of departure.

1.4.2 Over any island, or within 3 nautical miles of the coastline of any island, in the Hawaii ADIZ.

1.4.3 Associated with any ADIZ other than the contiguous U.S. ADIZ, when the aircraft true airspeed is less than 180 knots.

1.5 Authorizations to deviate from the requirements of Part 99 may also be granted by the ARTCC, on a local basis, for some operations associated with an ADIZ.

1.6 An air-filed VFR Flight Plan makes an aircraft subject to interception for positive identification when entering an ADIZ. Pilots are therefore urged to file the required DVFR flight plan either in person or by telephone prior to departure.

1.7 Special Security Instructions

1.7.1 During defense emergency or air defense emergency conditions, additional special security instructions may be issued in accordance with the Emergency Security Control of Air Traffic (ESCAT) Plan.

1.7.2 Under the provisions of the ESCAT Plan, the military will direct the action to be taken in regard to landing, grounding, diversion, or dispersal of aircraft and the control of air navigation aids in the defense of the U.S. during emergency conditions.

1.7.3 At the time a portion or all of ESCAT is implemented, ATC facilities will broadcast appropriate instructions received from the Air Traffic Control System Command Center (ATCSCC) over available ATC frequencies. Depending on instructions received from the ATCSCC, VFR flights may be directed to land at the nearest available airport, and IFR flights will be expected to proceed as directed by ATC.

1.7.4 Pilots on the ground may be required to file a flight plan and obtain an approval (through FAA) prior to conducting flight operation.

1.7.5 In view of the above, all pilots should guard an ATC or FSS frequency at all times while conducting flight operations.

2. Interception Procedures

2.1 General

2.1.1 Identification intercepts during peacetime operations are vastly different than those conducted under increased states of readiness. Unless otherwise directed by the control agency, intercepted aircraft will be identified by type only. When specific information is required (i.e., markings, serial numbers, etc.), the interceptor aircrew will respond only if the request can be conducted in a safe manner. During hours of darkness or instrument meteorological conditions (IMC), identification of unknown aircraft will be by type only. The interception pattern described below is the typical peacetime method used by air interceptor aircrews. In all situations, the interceptor aircrew will use caution to avoid startling the intercepted aircrew and/or passengers.

2.1.2 All aircraft operating in the U.S. national airspace, if capable, will maintain a listening watch on VHF guard 121.5 or UHF 243.0. It is incumbent on all aviators to know and understand their responsibilities if intercepted. Additionally, if the U.S. military intercepts an aircraft and flares are dispensed in the area of that aircraft, aviators will pay strict attention, contact air traffic control immediately on the local frequency or on VHF guard 121.5 or UHF 243.0 and follow the intercept's visual ICAO signals. Be advised that noncompliance may result in the use of force.

2.2 Intercept Phases (See FIG ENR 1.12-2)

2.2.1 Phase One – Approach Phase

2.2.1.1 During peacetime, intercepted aircraft will be approached from the stern. Generally two interceptor aircraft will be employed to accomplish the identification. The flight leader and wingman will coordinate their individual positions in conjunction with the ground controlling agency. Their relationship will resemble a line abreast formation. At night or in IMC, a comfortable radar trail tactic will be used. Safe vertical separation between interceptor aircraft and unknown aircraft will be maintained at all times.

FIG ENR 1.12-2
Interception Procedures

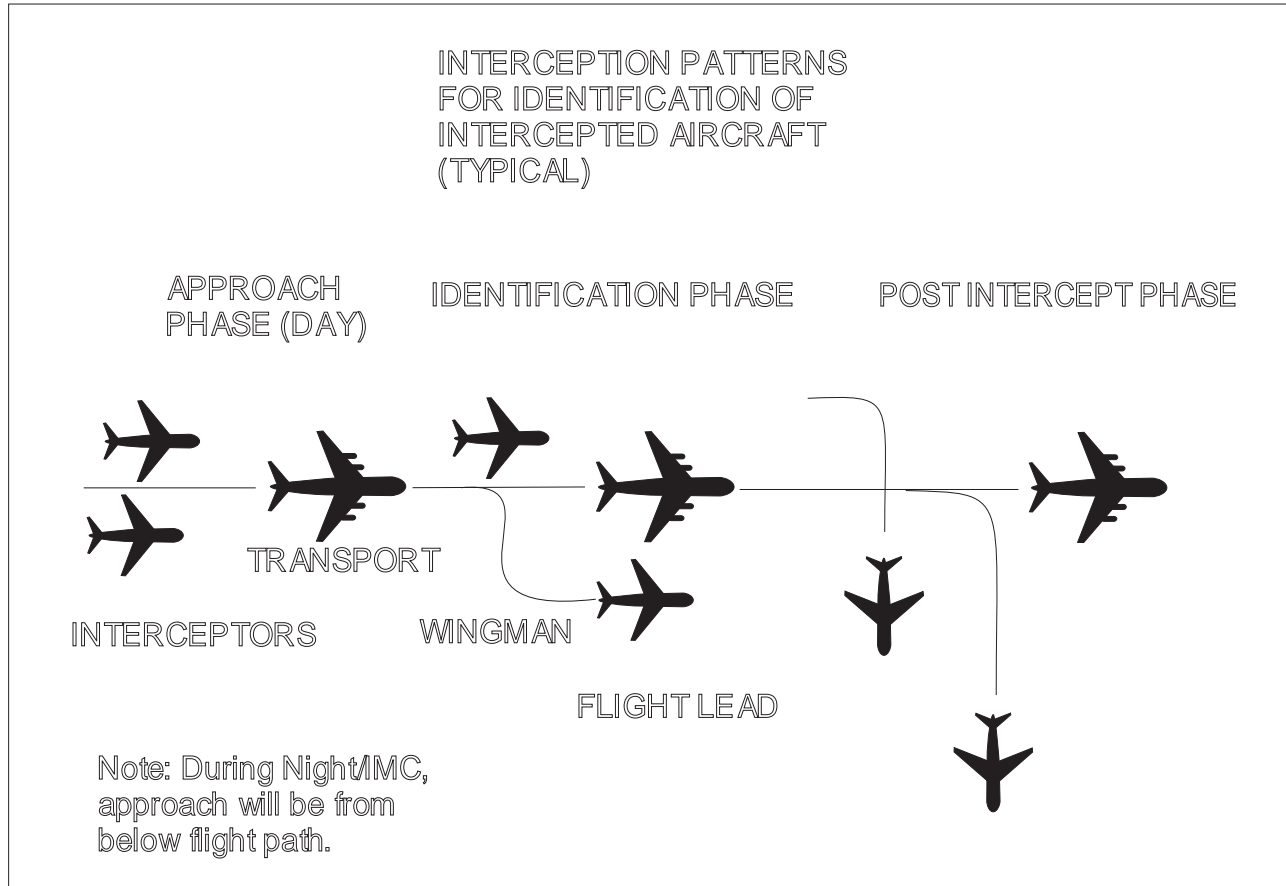

2.2.2 Phase Two – Identification Phase

2.2.2.1 The intercepted aircraft should expect to visually acquire the lead interceptor and possibly the wingman during this phase in visual meteorological conditions (VMC). The wingman will assume a surveillance position while the flight leader approaches the unknown aircraft. Intercepted aircraft personnel may observe the use of different drag devices to allow for speed and position stabilization during this phase. The flight leader will then initiate a gentle closure toward the intercepted aircraft, stopping at a distance no closer than absolutely

necessary to obtain the information needed. The interceptor aircraft will use every possible precaution to avoid startling intercepted aircrew or passengers. Additionally, the interceptor aircrews will constantly keep in mind that maneuvers considered normal to a fighter aircraft may be considered hazardous to passengers and crews of nonfighter aircraft. When interceptor aircrews know or believe that an unsafe condition exists, the identification phase will be terminated. As previously stated, during darkness or IMC, identification of unknown aircraft will be type only. Positive vertical separation will be maintained by interceptor aircraft throughout this phase.

2.2.3 Phase Three – Post Intercept Phase

2.2.3.1 Upon identification phase completion, the flight leader will turn away from the intercepted aircraft. The wingman will remain well clear and accomplish a rejoin with his/her leader.

2.3 Communication interface between interceptor aircrews and the ground controlling agency is essential to ensure successful intercepted completion. Flight safety is paramount. An aircraft which is intercepted by another aircraft shall immediately:

2.3.1 Follow the instructions given by the intercepting aircraft, interpreting and responding to the visual signals.

2.3.2 Notify, if possible, the appropriate air traffic services unit.

2.3.3 Attempt to establish radio communication with the intercepting aircraft or with the appropriate intercept control unit, by making a general call on the emergency frequency 243.0 MHz and repeating this call on the emergency frequency 121.5 MHz, if practicable, giving the identity and position of the aircraft and the nature of the flight.

2.3.4 If equipped with SSR transponder, select Mode 3/A Code 7700, unless otherwise instructed by the appropriate air traffic services unit. If any instructions received by radio from any sources conflict with those given by the intercepting aircraft

by visual or radio signal, the intercepted aircraft shall request immediate clarification while continuing to comply with the instructions given by the intercepting aircraft.

2.4 Interception Signals (See TBL ENR 1.12-1 and TBL ENR 1.12-2)

3. Law Enforcement Operations by Civil and Military Organizations

3.1 Special law enforcement operations

3.1.1 Special law enforcement operations include in-flight identification, surveillance, interdiction, and pursuit activities performed in accordance with official civil and/or military mission responsibilities.

3.1.2 To facilitate accomplishment of these special missions, exemptions from specified sections of the Federal Aviation Regulations have been granted to designated departments and agencies. However, it is each organization's responsibility to apprise air traffic control (ATC) of their intent to operate under an authorized exemption before initiating actual operations.

3.1.3 Additionally, some departments and agencies that perform special missions have been assigned coded identifiers to permit them to apprise ATC of ongoing mission activities and solicit special air traffic assistance.

**TBL ENR 1.12-1
Intercepting Signals**

INTERCEPTING SIGNALS				
Signals initiated by intercepting aircraft and responses by intercepted aircraft (as set forth in ICAO Annex 2-Appendix 1, 2.1)				
Series	INTERCEPTING Aircraft Signals	Meaning	INTERCEPTED Aircraft Responds	Meaning
1	<p>DAY-Rocking wings from a position slightly above and ahead of, and normally to the left of, the intercepted aircraft and, after acknowledgement, a slow level turn, normally to the left, on to the desired heading.</p> <p>NIGHT-Same and, in addition, flashing navigational lights at irregular intervals.</p> <p><i>NOTE 1-Meteorological conditions or terrain may require the intercepting aircraft to take up a position slightly above and ahead of, and to the right of, the intercepted aircraft and to make the subsequent turn to the right.</i></p> <p><i>NOTE 2-If the intercepted aircraft is not able to keep pace with the intercepting aircraft, the latter is expected to fly a series of race-track patterns and to rock its wings each time it passes the intercepted aircraft.</i></p>	<p>You have been intercepted. Follow me.</p>	<p>AEROPLANES: DAY-Rocking wings and following.</p> <p>NIGHT-Same and, in addition, flashing navigational lights at irregular intervals.</p> <p>HELICOPTERS: DAY or NIGHT-Rocking aircraft, flashing navigational lights at irregular intervals and following.</p>	<p>Understood, will comply.</p>
2	<p>DAY or NIGHT-An abrupt break-away maneuver from the intercepted aircraft consisting of a climbing turn of 90 degrees or more without crossing the line of flight of the intercepted aircraft.</p>	<p>You may proceed.</p>	<p>AEROPLANES: DAY or NIGHT-Rocking wings.</p> <p>HELICOPTERS: DAY or NIGHT-Rocking aircraft.</p>	<p>Understood, will comply.</p>
3	<p>DAY-Circling aerodrome, lowering landing gear and overflying runway in direction of landing or, if the intercepted aircraft is a helicopter, overflying the helicopter landing area.</p> <p>NIGHT-Same and, in addition, showing steady landing lights.</p>	<p>Land at this aerodrome.</p>	<p>AEROPLANES: DAY-Lowering landing gear, following the intercepting aircraft and, if after overflying the runway landing is considered safe, proceeding to land.</p> <p>NIGHT-Same and, in addition, showing steady landing lights (if carried).</p> <p>HELICOPTERS: DAY or NIGHT-Following the intercepting aircraft and proceeding to land, showing a steady landing light (if carried).</p>	<p>Understood, will comply.</p>

TBL ENR 1.12-2
Intercepting Signals

INTERCEPTING SIGNALS				
Signals and Responses During Aircraft Intercept				
Signals initiated by intercepted aircraft and responses by intercepting aircraft				
(as set forth in ICAO Annex 2-Appendix 1, 2.2)				
Series	INTERCEPTED Aircraft Signals	Meaning	INTERCEPTING Aircraft Responds	Meaning
4	<p>AEROPLANES: DAY-Raising landing gear while passing over landing runway at a height exceeding 300m (1,000 ft) but not exceeding 600m (2,000 ft) above the aerodrome level, and continuing to circle the aerodrome.</p> <p>NIGHT-Flashing landing lights while passing over landing runway at a height exceeding 300m (1,000 ft) but not exceeding 600m (2,000 ft) above the aerodrome level, and continuing to circle the aerodrome. If unable to flash landing lights, flash any other lights available.</p>	Aerodrome you have designated is inadequate.	<p>DAY or NIGHT-If it is desired that the intercepted aircraft follow the intercepting aircraft to an alternate aerodrome, the intercepting aircraft raises its landing gear and uses the Series 1 signals prescribed for intercepting aircraft.</p> <p>If it is decided to release the intercepted aircraft, the intercepting aircraft uses the Series 2 signals prescribed for intercepting aircraft.</p>	<p>Understood, follow me.</p> <p>Understood, you may proceed.</p>
5	<p>AEROPLANES: DAY or NIGHT-Regular switching on and off of all available lights but in such a manner as to be distinct from flashing lights.</p>	Cannot comply.	DAY or NIGHT-Use Series 2 signals prescribed for intercepting aircraft.	Understood.
6	<p>AEROPLANES: DAY or NIGHT-Irregular flashing of all available lights.</p> <p>HELICOPTERS: DAY or NIGHT-Irregular flashing of all available lights.</p>	In distress.	DAY or NIGHT-Use Series 2 signals prescribed for intercepting aircraft.	Understood.

ENR 1.13 [RESERVED]

ENR 1.14 [RESERVED]

ENR 1.15 Medical Facts for Pilots

1. Fitness for Flight

1.1 Medical Certification

1.1.1 All pilots except those flying gliders and free air balloons must possess valid medical certificates in order to exercise the privileges of their airman certificates. The periodic medical examinations required for medical certification are conducted by designated Aviation Medical Examiners, who are physicians with a special interest in aviation safety and training in aviation medicine.

1.1.2 The standards for medical certification are contained in the Federal Aviation Regulations (14 CFR Part 67). Pilots who have a history of certain medical conditions described in these standards are mandatorily disqualified from flying. These medical conditions include a personality disorder manifested by overt acts, a psychosis, alcoholism, drug dependence, epilepsy, an unexplained disturbance of consciousness, myocardial infarction, angina pectoris, and diabetes requiring medication for its control. Other medical conditions may be temporarily disqualifying, such as acute infections, anemia, and peptic ulcer. Pilots who do not meet medical standards may still be qualified under special issuance provisions or the exemption process. This may require that either additional medical information be provided or practical flight tests be conducted.

1.1.3 Student pilots should visit an aviation medical examiner as soon as possible in their flight training in order to avoid unnecessary training expenses should they not meet the medical standards. For the same reason, the student pilot who plans to enter commercial aviation should apply for the highest class of medical certificate that might be necessary in the pilot's career.

CAUTION—

The Federal Aviation Regulations prohibit a pilot who possesses a current medical certificate from performing crewmember duties while the pilot has a known medical condition or increase of a known medical condition that would make the pilot unable to meet the standards for the medical certificate.

1.2 Illness

1.2.1 Even a minor illness suffered in day-to-day living can seriously degrade performance of many piloting tasks vital to safe flight. Illness can produce fever and distracting symptoms that can impair judgment, memory, alertness, and the ability to make calculations. Although symptoms from an illness may be under adequate control with a medication, the medication itself may decrease pilot performance.

1.2.2 The safest rule is not to fly while suffering from any illness. If this rule is considered too stringent for a particular illness, the pilot should contact an aviation medical examiner for advice.

1.3 Medication

1.3.1 Pilot performance can be seriously degraded by both prescribed and over-the-counter medications, as well as by the medical conditions for which they are taken. Many medications, such as tranquilizers, sedatives, strong pain relievers, and cough-suppressant preparations, have primary effects that may impair judgment, memory, alertness, coordination, vision, and the ability to make calculations. Others, such as antihistamines, blood pressure drugs, muscle relaxants, and agents to control diarrhea and motion sickness, have side effects that may impair the same critical functions. Any medication that depresses the nervous system, such as a sedative, tranquilizer, or antihistamine, can make a pilot much susceptible to hypoxia (see below).

1.3.2 The Federal Aviation Regulations prohibit pilots from performing crewmember duties while using any medication that affects the faculties in any way contrary to safety. The safest rule is not to fly as a crewmember while taking any medication, unless approved to do so by the FAA.

1.4 Alcohol

1.4.1 Extensive research has provided a number of facts about the hazards of alcohol consumption and flying. As little as one ounce of liquor, one bottle of beer, or four ounces of wine can impair flying skills, with the alcohol consumed in these drinks being detectable in the breath and blood at least three hours. Even after the body completely destroys a moderate amount of alcohol, a pilot can still be severely

impaired for many hours by hangover. There is simply no way of increasing the destruction of alcohol or alleviating a hangover. Alcohol also renders a pilot much more susceptible to disorientation and hypoxia (see below).

1.4.2 A consistently high alcohol-related, fatal aircraft accident rate serves to emphasize that alcohol and flying are a potentially lethal combination. The Federal Aviation Regulations prohibit pilots from performing crewmember duties within eight hours after drinking any alcoholic beverage or while under the influence of alcohol. However, due to the slow destruction of alcohol, a pilot may still be under the influence eight hours after drinking a moderate amount of alcohol. Therefore, an excellent rule is to allow at least 12 to 24 hours between “bottle and throttle” depending on the amount of alcoholic beverage consumed.

1.5 Fatigue

1.5.1 Fatigue continues to be one of the most treacherous hazards to flight safety, as it may not be apparent to a pilot until serious errors are made. Fatigue is best described as either acute (short-term) or chronic (long-term).

1.5.2 A normal occurrence of everyday living, acute fatigue is the tiredness felt after long periods of physical and mental strain, including strenuous muscular effort, immobility, heavy mental workload, strong emotional pressure, monotony, and lack of sleep. Consequently, coordination and alertness, so vital to safe pilot performance, can be reduced. Acute fatigue is prevented by adequate rest and sleep, as well as regular exercise and proper nutrition.

1.5.3 Chronic fatigue occurs when there is not enough time for full recovery between episodes of acute fatigue. Performance continues to fall off, and judgment becomes impaired so that unwarranted risks may be taken. Recovery from chronic fatigue requires a prolonged period of rest.

1.6 Stress

1.6.1 Stress from the pressures of everyday living can impair pilot performance, often in very subtle ways. Difficulties, particularly at work, can occupy thought processes enough to markedly decrease alertness. Distraction can so interfere with judgment

that unwarranted risks are taken, such as flying into deteriorating weather conditions to keep on schedule. Stress and fatigue (see above) can be an extremely hazardous combination.

1.6.2 Most pilots do leave stress “on the ground.” Therefore when more than usual difficulties are being experienced, a pilot should consider delaying flight until these difficulties are satisfactorily resolved.

1.7 Emotion

1.7.1 Certain emotionally upsetting events, including a serious argument, death of a family member, separation or divorce, loss of job, and financial catastrophe, can render a pilot unable to fly an aircraft safely. The emotions of anger, depression, and anxiety from such events not only decrease alertness but also may lead to taking risks that border on self-destruction. Any pilot who experiences an emotionally upsetting event should not fly until satisfactorily recovered from it.

1.8 Personal Checklist

1.8.1 Aircraft accident statistics show that pilots should be conducting preflight checklists on themselves as well as their aircraft, for pilot impairment contributes to many more accidents than failure of aircraft systems. A personal checklist that can be easily committed to memory, which includes all of the categories of pilot impairment discussed in this section, is distributed by the FAA in form of a wallet-sized card.

1.9 PERSONAL CHECKLIST. *I’m physically and mentally safe to fly; not being impaired by:*

Illness

Medication

Stress

Alcohol

Fatigue

Emotion

2. Effects of Altitude

2.1 Hypoxia

2.1.1 Hypoxia is a state of oxygen deficiency in the body sufficient to impair functions of the brain and other organs. Hypoxia from exposure to altitude is due only to the reduced barometric pressures encountered at altitude, for the concentration of oxygen in the atmosphere remains about 21 percent from the ground out to space.

2.1.2 Although a deterioration in night vision occurs at a cabin pressure altitude as low as 5,000 feet, other significant effects of altitude hypoxia usually do not occur in the normal healthy pilot below 12,000 feet. From 12,000 to 15,000 feet of altitude, judgment, memory, alertness, coordination and ability to make calculations are impaired. Headache, drowsiness, dizziness and either a sense of well-being (euphoria) or belligerence occur. The effects appear following increasingly shorter periods of exposure to increasing altitude. In fact, pilot performance can seriously deteriorate within 15 minutes at 15,000 feet.

2.1.3 At cabin pressure altitudes above 15,000 feet, the periphery of the visual field grays out to a point where only central vision remains (tunnel vision). A blue coloration (cyanosis) of the fingernails and lips develops. The ability to take corrective and protective action is lost in 20 to 30 minutes at 18,000 feet and 5 to 12 minutes at 20,000 feet, followed soon thereafter by unconsciousness.

2.1.4 The altitude at which significant effects of hypoxia occur can be lowered by a number of factors. Carbon monoxide inhaled in smoking or from exhaust fumes (see below), lowered hemoglobin (anemia), and certain medications can reduce the oxygen-carrying capacity of the blood to the degree that the amount of oxygen provided to body tissues will already be equivalent to the oxygen provided to the tissues when exposed to cabin pressure altitude of several thousand feet. Small amounts of alcohol and low doses of certain drugs, such as antihistamines, tranquilizers, sedatives, and analgesics can, through their depressant actions, render the brain much more

susceptible to hypoxia. Extreme heat and cold, fever, and anxiety increase the body's demand for oxygen, and hence its susceptibility to hypoxia.

2.1.5 The effects of hypoxia are usually quite difficult to recognize, especially when they occur gradually. Since symptoms of hypoxia do not vary in an individual, the ability to recognize hypoxia can be greatly improved by experiencing and witnessing the effects of hypoxia during an altitude chamber "flight." The FAA provides this opportunity through aviation physiology training, which is conducted at the FAA Civil Aeromedical Institute and at many military facilities across the U.S. To attend the Physiological Training Program at the Civil Aeromedical Institute, Mike Monroney Aeronautical Center, Oklahoma City, OK, contact by telephone (405) 954-6212, or by writing Aerospace Medical Education Division, AAM-400, CAMI, Mike Monroney Aeronautical Center, P.O. Box 25082, Oklahoma City, OK 73125.

NOTE-

To attend the physiological training program at one of the military installations having the training capability, an application form and a fee must be submitted. Full particulars about location, fees, scheduling procedures, course content, individual requirements, etc., are contained in the physiological training application, Form Number AC-3150-7, which is obtained by contacting the Accident Prevention Specialist or the Office Forms Manager in the nearest FAA office.

2.1.6 Hypoxia is prevented by heeding factors that reduce tolerance to altitude, by enriching the inspired air with oxygen from an appropriate oxygen system and by maintaining a comfortable, safe cabin pressure altitude. For optimum protection, pilots are encouraged to use supplemental oxygen above 10,000 feet during the day, and above 5,000 feet at night. The Federal Aviation Regulations require that the minimum flight crew be provided with and use supplemental oxygen after 30 minutes of exposure to cabin pressure altitudes between 12,500 and 14,000 feet, and immediately on exposure to cabin pressure altitudes above 14,000. Every occupant of the aircraft must be provided with supplemental oxygen at cabin pressure altitudes above 15,000 feet.

2.2 Ear Block

2.2.1 As the aircraft cabin pressure decreases during ascent, the expanding air in the middle ear pushes the eustachian tube open and, by escaping down it to the nasal passages, equalizes in pressure with the cabin pressure. But during descent, the pilot must periodically open the eustachian tube to equalize pressure. This can be accomplished by swallowing, yawning, tensing muscles in the throat or, if these do not work, by the combination of closing the mouth, pinching the nose closed and attempting to blow through the nostrils (Valsalva maneuver).

2.2.2 Either an upper respiratory infection, such as a cold or sore throat, or a nasal allergic condition can produce enough congestion around the eustachian tube to make equalization difficult. Consequently, the difference in pressure between the middle ear and aircraft cabin can build up to a level that will hold the eustachian tube closed, making equalization difficult if not impossible. This problem is commonly referred to as an “ear block.”

2.2.3 An ear block produces severe ear pain and loss of hearing that can last from several hours to several days. Rupture of the ear drum can occur in flight or after landing. Fluid can accumulate in the middle ear and become infected.

2.2.4 An ear block is prevented by not flying with an upper respiratory infection or nasal allergic condition. Adequate protection is usually not provided by decongestant sprays or drops to reduce congestion around the eustachian tubes. Oral decongestants have side effects that can significantly impair pilot performance.

2.2.5 If an ear block does not clear shortly after landing, a physician should be consulted.

2.3 Sinus Block

2.3.1 During ascent and descent, air pressure in the sinuses equalizes with the aircraft cabin pressure through small openings that connect the sinuses to the nasal passages. Either an upper respiratory infection, such as a cold or sinusitis, or a nasal allergic condition can produce enough congestion around an opening to slow equalization and, as the difference in pressure between the sinus and cabin mounts, eventually plug the opening. This “sinus block” occurs most frequently during descent.

2.3.2 A sinus block can occur in the frontal sinuses, located above each eyebrow, or in the maxillary sinuses, located in each upper cheek. It will usually produce excruciating pain over the sinus area. A maxillary sinus block can also make the upper teeth ache. Bloody mucus may discharge from the nasal passages.

2.3.3 A sinus block is prevented by not flying with an upper respiratory infection or nasal allergic condition. Adequate protection is usually not provided by decongestant sprays or drops to reduce congestion around the sinus openings. Oral decongestants have side effects that can impair pilot performance.

2.3.4 If a sinus block does not clear shortly after landing, a physician should be consulted.

2.4 Decompression Sickness After Scuba Diving

2.4.1 A pilot or passenger who intends to fly after SCUBA diving should allow the body sufficient time to rid itself of excess nitrogen absorbed during diving. If not, decompression sickness due to evolved gas can occur during exposure to low altitude and create a serious inflight emergency.

2.4.2 The recommended waiting time before going to flight altitudes of up to 8,000 feet is at least 12 hours after diving which has not required controlled ascent (nondecompression stop diving), and at least 24 hours after diving which has required controlled ascent (decompression stop diving). The waiting time before going to flight altitudes above 8,000 feet should be at least 24 hours after any SCUBA dive. These recommended altitudes are actual flight altitudes above mean sea level (AMSL) and not pressurized cabin altitudes. This takes into consideration the risk of decompression of the aircraft during flight.

3. Hyperventilation in Flight

3.1 Hyperventilation, or an abnormal increase in the volume of air breathed in and out of the lungs, can occur subconsciously when a stressed situation is encountered in flight. As hyperventilation “blows off” excessive carbon dioxide from the body, a pilot can experience symptoms of lightheadedness, suffocation, drowsiness, tingling in the extremities, and coolness – and react to them with even greater hyperventilation. Incapacitation can eventually result from incoordination, disorientation, and painful muscle spasms. Finally, unconsciousness can occur.

3.2 The symptoms of hyperventilation subside within a few minutes after the rate and depth of breathing are consciously brought back under control. The buildup of carbon dioxide in the body can be hastened by controlled breathing in and out of a paper bag held over the nose and mouth.

3.3 Early symptoms of hyperventilation and hypoxia are similar. Moreover, hyperventilation and hypoxia can occur at the same time. Therefore, if a pilot is using an oxygen system when symptoms are experienced, the oxygen regulator should immediately be set to deliver 100 percent oxygen, and then the system checked to assure that it has been functioning effectively before giving attention to rate and depth of breathing.

4. Carbon Monoxide Poisoning in Flight

4.1 Carbon monoxide is a colorless, odorless, and tasteless gas contained in exhaust fumes. When breathed even in minute quantities over a period of time, it can significantly reduce the ability of the blood to carry oxygen. Consequently, effects of hypoxia occur (see subparagraph 2.1).

4.2 Most heaters in light aircraft work by air flowing over the manifold. Use of these heaters while exhaust fumes are escaping through manifold cracks and seals is responsible every year for several nonfatal and fatal aircraft accidents from carbon monoxide poisoning.

4.3 A pilot who detects the odor of exhaust or experiences symptoms of headache, drowsiness, or dizziness while using the heater should suspect carbon monoxide poisoning, and immediately shut off the heater and open air vents. If symptoms are severe, or continue after landing, medical treatment should be sought.

5. Illusions in Flight

5.1 Introduction. Many different illusions can be experienced in flight. Some can lead to spatial disorientation. Others can lead to landing errors. Illusions rank among the most common factors cited as contributing to fatal aircraft accidents.

5.2 Illusions Leading to Spatial Disorientation

5.2.1 Various complex motions and forces and certain visual scenes encountered in flight can create illusions of motion and position. Spatial disorientation from these illusions can be prevented only by visual reference to reliable, fixed points on the ground or to flight instruments.

5.2.2 The Leans. An abrupt correction of a banked attitude, which has been entered too slowly to stimulate the motion sensing system in the inner ear, can create the illusion of banking in the opposite direction. The disoriented pilot will roll the aircraft back into its original dangerous attitude or, if level flight is maintained, will feel compelled to lean in the perceived vertical plane until this illusion subsides.

5.2.3 Coriolis Illusion. An abrupt head movement in a prolonged constant-rate turn that has ceased stimulating the motion sensing system can create the illusion of rotation or movement in an entirely different axis. The disoriented pilot will maneuver the aircraft into a dangerous attitude in an attempt to stop rotation. This most overwhelming of all illusions in flight may be prevented by not making sudden, extreme head movements, particularly while making prolonged constant-rate turns under IFR conditions.

5.2.4 Graveyard Spin. A proper recovery from a spin that has ceased stimulating the motion sensing system can create the illusion of spinning in the opposite direction. The disoriented pilot will return the aircraft to its original spin.

5.2.5 Graveyard Spiral. An observed loss of altitude during a coordinated constant-rate turn that has ceased stimulating the motion sensing system can create the illusion of being in a descent with the wings level. The disoriented pilot will pull back on the controls, tightening the spiral and increasing the loss of altitude.

5.2.6 Somatogravic Illusion. A rapid acceleration during takeoff can create the illusion of being in a nose-up attitude. The disoriented pilot will push the aircraft into a nose-low, or dive attitude. A rapid deceleration by a quick reduction of the throttles can have the opposite effect, with the disoriented pilot pulling the aircraft into a nose-up, or stall attitude.

5.2.7 Inversion Illusion. An abrupt change from climb to straight and level flight can create the illusion of tumbling backwards. The disoriented pilot will push the aircraft abruptly into a nose-low attitude, possibly intensifying this illusion.

5.2.8 Elevator Illusion. An abrupt upward vertical acceleration, usually by an updraft, can create the illusion of being in a climb. The disoriented pilot will push the aircraft into a nose-low attitude. An abrupt downward vertical acceleration, usually by a downdraft, has the opposite effect, with the disoriented pilot pulling the aircraft into a nose-up attitude.

5.2.9 False Horizon. Sloping cloud formations, an obscured horizon, a dark scene spread with ground lights and stars, and certain geometric patterns of ground lights can create illusions of not being aligned correctly with the actual horizon. The disoriented pilot will place the aircraft in a dangerous attitude.

5.2.10 Autokinesis. In the dark, a static light will appear to move about when stared at for many seconds. The disoriented pilot will lose control of the aircraft in attempting to align it with the light.

5.3 Illusions Leading to Landing Errors

5.3.1 Various surface features and atmospheric conditions encountered in landing can create illusions of incorrect height above and distance from the runway threshold. Landing errors from these illusions can be prevented by anticipating them during approaches, aerial visual inspection of unfamiliar airports before landing, using electronic glide slope or VASI systems when available, and maintaining optimum proficiency in landing procedures.

5.3.2 Runway Width Illusion. A narrower-than-usual runway can create the illusion that the aircraft is at a higher altitude than it actually is. The pilot who does not recognize this illusion will fly a lower approach, with the risk of striking objects along the approach path or landing short. A wider-than-usual runway can have the opposite effect, with the risk of leveling out high and landing hard or overshooting the runway.

5.3.3 Runway and Terrain Slopes Illusion. An upsloping runway, upsloping terrain, or both, can

create the illusion that the aircraft is at a higher altitude than it actually is. The pilot who does not recognize this illusion will fly a lower approach. A downsloping runway, downsloping approach terrain, or both, can have the opposite effect.

5.3.4 Featureless Terrain Illusion. An absence of ground features, as when landing over water, darkened areas, and terrain made featureless by snow, can create the illusion that the aircraft is at a higher altitude than it actually is. The pilot who does not recognize this illusion will fly a lower approach.

5.3.5 Atmospheric Illusions. Rain on the wind-screen can create the illusion of greater height, and atmospheric haze can create the illusion of being at greater distance from the runway. The pilot who does not recognize these illusions will fly a lower approach. Penetration of fog can create the illusion of pitching up. The pilot who does not recognize this illusion will steepen the approach, often quite abruptly.

5.3.6 Ground Lighting Illusions. Lights along a straight path, such as a road, and even lights on moving trains can be mistaken for runway and approach lights. Bright runway and approach lighting systems, especially where few lights illuminate the surrounding terrain, may create the illusion of less distance to the runway. The pilot who does not recognize this illusion will fly a higher approach. Conversely, the pilot overflying terrain which has few lights to provide height cues may make lower than normal approach.

6. Vision in Flight

6.1 Introduction. Of the body senses, vision is the most important for safe flight. Major factors that determine how effectively vision can be used are the level of illumination and the technique of scanning the sky for other aircraft.

6.2 Vision Under Dim and Bright Illumination

6.2.1 Under conditions of dim illumination, small print and colors on aeronautical charts and aircraft instruments become unreadable unless adequate cockpit lighting is available. Moreover, another aircraft must be much closer to be seen unless its navigation lights are on.

6.2.2 In darkness, vision becomes more sensitive to light, a process called dark adaptation. Although exposure to total darkness for at least 30 minutes is required for complete dark adaptation, the pilot can achieve a moderate degree of dark adaptation within 20 minutes under dim red cockpit lighting. Since red light severely distorts colors, especially on aeronautical charts, and can cause serious difficulty in focusing the eyes on objects inside the aircraft, its use is advisable only where optimum outside night vision capability is necessary. Even so, white cockpit lighting must be available when needed for map and instrument reading, especially under IFR conditions. Dark adaptation is impaired by exposure to cabin pressure altitude above 5,000 feet, carbon monoxide inhaled in smoking and from exhaust fumes, deficiency of Vitamin A in the diet, and by prolonged exposure to bright sunlight. Since any degree of dark adaptation is lost within a few seconds of viewing a bright light, the pilot should close one eye when using a light to preserve some degree of night vision.

6.2.3 Excessive illumination, especially from light reflected off the canopy, surfaces inside the aircraft, clouds, water, snow, and desert terrain, can produce glare, with uncomfortable squinting, watering of the eyes, and even temporary blindness. Sunglasses for protection from glare should absorb at least 85 percent of visible light (15 percent transmittance) and all colors equally (neutral transmittance), with negligible image distortion from refractive and prismatic errors.

6.3 Scanning for Other Aircraft

6.3.1 Scanning the sky for other aircraft is a key factor in collision avoidance. It should be used continuously by the pilot and copilot (or right seat passenger) to cover all areas of the sky visible from the cockpit. Although pilots must meet specific visual acuity requirements, the ability to read an eye chart does not ensure that one will be able to efficiently spot other aircraft. Pilots must develop an effective scanning technique which maximizes one's visual capabilities. The probability of spotting a potential collision threat obviously increases with the time spent looking outside the cockpit. Thus, one must use timesharing techniques to efficiently scan the surrounding airspace while monitoring instruments as well.

6.3.2 While the eyes can observe an approximate 200 degree arc of the horizon at one glance, only a

very small center area called the fovea, in the rear of the eye, has the ability to send clear, sharply focused messages to the brain. All other visual information that is not processed directly through the fovea will be of less detail. An aircraft at a distance of 7 miles which appears in sharp focus within the foveal center of vision would have to be as close as 7/10 of a mile in order to be recognized if it were outside of foveal vision. Because the eyes can focus only on this narrow viewing area, effective scanning is accomplished with a series of short, regularly spaced eye movements that bring successive areas of the sky into the central visual field. Each movement should not exceed 10 degrees, and each area should be observed for at least one second to enable detection. Although horizontal back-and-forth eye movements seem preferred by most pilots, each pilot should develop a scanning pattern that is most comfortable and then adhere to it to assure optimum scanning.

6.3.3 Studies show that the time a pilot spends on visual tasks inside the cabin should represent no more than $1/4$ to $1/3$ of the scan time outside, or no more than 4 to 5 seconds on the instrument panel for every 16 seconds outside. Since the brain is already trained to process sight information that is presented from left to right, one may find it easier to start scanning over the left shoulder and proceed across the windshield to the right.

6.3.4 Pilots should realize that their eyes may require several seconds to refocus when switching views between items in the cockpit and distant objects. The eyes will also tire more quickly when forced to adjust to distances immediately after close-up focus, as required for scanning the instrument panel. Eye fatigue can be reduced by looking from the instrument panel to the left wing past the wing tip to the center of the first scan quadrant when beginning the exterior scan. After having scanned from left to right, allow the eyes to return to the cabin along the right wing from its tip inward. Once back inside, one should automatically commence the panel scan.

6.3.5 Effective scanning also helps avoid "empty-field myopia." This condition usually occurs when flying above the clouds or in a haze layer that provides nothing specific to focus on outside the aircraft. This causes the eyes to relax and seek a comfortable focal distance which may range from 10 to 30 feet. For the pilot, this means looking without seeing, which is dangerous.

7. Judgment Aspects of Collision Avoidance

7.1 Introduction. The most important aspects of vision and the techniques to scan for other aircraft are described in paragraph 6. above. Pilots should also be familiar with the following information to reduce the possibility of mid-air collisions.

7.2 Determining Relative Altitude. Use the horizon as a reference point. If the other aircraft is above the horizon, it is probably on a higher flight path. If the aircraft appears to be below the horizon, it is probably flying at a lower altitude.

7.3 Taking Appropriate Action. Pilots should be familiar with right-of-way rules so immediate evasive action can be taken if an aircraft is on an obvious collision course. Preferably, such actions will be in compliance with applicable Federal Aviation Regulations.

7.4 Consider Multiple Threats. The decision to climb, descend, or turn is a matter of personal judgment, but one should anticipate that the other pilot may also be making a quick maneuver. Watch the other aircraft during the maneuver and immediately begin your scanning again since there may be other aircraft in the area.

7.5 Target Acquisition. Anticipate the target in the location and ranges you are searching. Locate a sizable, distant object (e.g., a cloud formation, mountain peak, prominent landmark, building or pier) that is within range of the anticipated target, and focus your eyes on it as you begin each scan pattern.

7.6 Collision Course Targets. Any aircraft that appears to have no relative motion and stays in one scan quadrant is likely to be on a collision course. Also, if a target shows no lateral or vertical motion, but increases in size, TAKE EVASIVE ACTION.

7.7 Recognize High Hazard Areas

7.7.1 Airways, and especially VORs, and Class B, C, D, and E surface areas are places where aircraft tend to cluster.

7.7.2 Remember, most collisions occur during days when the weather is good. Being in a “radar environment” still requires vigilance to avoid collisions.

7.8 Cockpit Management. Studying maps, checklists, and manuals before flight, with various other proper preflight planning (e.g., noting necessary radio frequencies), and organizing cockpit materials can reduce the amount of time required to look at these items during flight permitting more scan time.

7.9 Windshield Conditions. Dirty or bug-smearing windshields can greatly reduce the ability of pilots to see other aircraft. Keep a clean windshield.

7.10 Visibility Conditions. Smoke, haze, dust, rain, and flying towards the sun can also greatly reduce the ability to detect targets.

7.11 Visual Obstruction in the Cockpit

7.11.1 Pilots need to move their heads to see around blind spots caused by fixed aircraft structures, such as door posts, wings, etc. It will be necessary at times to maneuver the aircraft (e.g., lift a wing) to facilitate seeing around this structure.

7.11.2 Pilots must insure that curtains and other cockpit objects (e.g., maps on glare shield) are removed and stowed during flight.

7.12 Lights On

7.12.1 Day or night, use of exterior lights can greatly increase the conspicuity of any aircraft.

7.12.2 Keep interior lights low at night.

7.13 ATC Support. ATC facilities often provide radar traffic advisories on a workload-permitting basis. Flight through Class C Airspace requires communication with ATC. Use this support whenever possible or when required.

ENR 1.16 Safety, Hazard, and Accident Reports

1. Aviation Safety Reporting Program

1.1 The FAA has established a voluntary program designed to stimulate the free and unrestricted flow of information concerning deficiencies and discrepancies in the aviation system. This is a positive program intended to ensure the safest possible system by identifying and correcting unsafe conditions before they lead to accidents. The primary objective of the program is to obtain information to evaluate and enhance the safety and efficiency of the present system.

1.2 This cooperative safety reporting program invites pilots, controllers, flight attendants, maintenance personnel and other users of the airspace system, or any other person, to file written reports of actual or potential discrepancies and deficiencies involving the safety of aviation operations. The operations covered by the program include departure, en route, approach, and landing operations and procedures, air traffic control procedures and equipment, crew and air traffic control communications, aircraft cabin operations, aircraft movement on the airport, near midair collisions, aircraft maintenance and record keeping, and airport conditions or services.

1.3 The report should give the date, time, location, persons and aircraft involved (if applicable), nature of the event, and all pertinent details.

1.4 To ensure receipt of this information, the program provides for the waiver of certain disciplinary actions against persons, including pilots and air traffic controllers, who file timely written reports concerning potentially unsafe incidents. To be considered timely, reports must be delivered or postmarked within 10 days of the incident unless that period is extended for good cause. Reports should be submitted on National Aeronautics and Space Administration (NASA) ARC Forms 277, which are available free of charge, postage prepaid, at FAA Flight Standards District Offices and Flight Service Stations, and from NASA, ASRS, P.O. Box 189, Moffet Field, CA 94035.

1.5 The FAA utilizes NASA to act as an independent third party to receive and analyze reports submitted

under the program. This program is described in Advisory Circular 00-46.

2. Aircraft Accident and Incident Reporting

2.1 Occurrences Requiring Notification

2.1.1 The operator of an aircraft shall immediately, and by the most expeditious means available, notify the nearest National Transportation Safety Board (NTSB) Field Office when:

2.1.1.1 An aircraft accident or any of the following listed incidents occur:

a) Flight control system malfunction or failure.

b) Inability of any required flight crewmember to perform normal flight duties as a result of injury or illness.

c) Failure of structural components of a turbine engine excluding compressor and turbine blades and vanes.

d) Inflight fire.

e) Aircraft collide in flight.

f) Damage to property, other than the aircraft, estimated to exceed \$25,000 for repair (including materials and labor) or fair market value in the event of total loss, whichever is less.

g) For large multi-engine aircraft (more than 12,500 pounds maximum certificated takeoff weight):

1) Inflight failure of electrical systems which requires the sustained use of an emergency bus powered by a back-up source such as a battery, auxiliary power unit, or air-driven generator to retain flight control or essential instruments.

2) Inflight failure of hydraulic systems that results in sustained reliance on the sole remaining hydraulic or mechanical system for movement of flight control surfaces.

3) Sustained loss of the power or thrust produced by two or more engines.

4) An evacuation of aircraft in which an emergency egress system is utilized.

2.1.1.2 An aircraft is overdue and is believed to have been involved in an accident.

2.2 Manner of Notification

2.2.1 The most expeditious method of notification to the NTSB by the operator will be determined by the circumstances existing at the time. The NTSB has advised that any of the following would be considered examples of the type of notification that would be acceptable:

2.2.1.1 Direct telephone notification.

2.2.1.2 Telegraphic notification.

2.2.1.3 Notification to the FAA who would in turn notify the NTSB by direct communication; i.e., dispatch or telephone.

2.3 Items to be Reported

2.3.1 The notification required above shall contain the following information, if available:

2.3.1.1 Type, nationality, and registration marks of the aircraft.

2.3.1.2 Name of owner and operator of the aircraft.

2.3.1.3 Name of the pilot-in-command.

2.3.1.4 Date and time of the accident.

2.3.1.5 Last point of departure and point of intended landing of the aircraft.

2.3.1.6 Position of the aircraft with reference to some easily defined geographical point.

2.3.1.7 Number of persons aboard, number killed, and number seriously injured.

2.3.1.8 Nature of the accident or incident, the weather, and the extent of damage to the aircraft, so far as is known.

2.3.1.9 A description of any explosives, radioactive materials, or other dangerous articles carried.

2.4 Follow-up Reports

2.4.1 The operator shall file a report on NTSB Form 6120.1 or 6120.2, available from the NTSB Field Offices, or the NTSB, Washington, D.C. 20594:

2.4.1.1 Within ten days after an accident.

2.4.1.2 When, after seven days, an overdue aircraft is still missing.

2.4.1.3 A report on an incident for which notification is required as described in paragraph 2.1 shall be filed only as requested by an authorized representative of the NTSB.

2.4.2 Each crewmember, if physically able at the time the report is submitted, shall attach a statement setting forth the facts, conditions and circumstances relating to the accident or occurrence as they appeared. If the crewmember is incapacitated, the statement shall be submitted as soon as physically possible.

2.5 Where to File the Reports

2.5.1 The operator of an aircraft shall file with the field office of the NTSB nearest the accident or incident any report required by this section.

2.5.2 The NTSB field offices are listed under U.S. Government in the telephone directories in the following cities: Anchorage, Alaska; Atlanta, Georgia; Chicago, Illinois; Denver, Colorado; Fort Worth, Texas; Los Angeles, California; Miami, Florida; Parsippany, New Jersey; and Seattle, Washington.

3. Near Midair Collision Reporting

3.1 Purpose and Data Uses. The primary purpose of the Near Midair Collision (NMAC) Reporting Program is to provide information for use in enhancing the safety and efficiency of the National Airspace System. Data obtained from NMAC reports are used by the FAA to improve the quality of FAA services to users and to develop programs, policies, and procedures aimed at the reduction of NMAC occurrences. All NMAC reports are thoroughly investigated by Flight Standards Facilities in coordination with Air Traffic Facilities. Data from these investigations are transmitted to FAA Headquarters in Washington, D.C., where they are compiled and analyzed, and where safety programs and recommendations are developed.

3.2 Definition. A near midair collision is defined as an incident associated with the operation of an aircraft in which a possibility of collision occurs as a result of proximity of less than 500 feet to another aircraft, or a report is received from a pilot or a flight crewmember stating that a collision hazard existed between two or more aircraft.

3.3 Reporting Responsibility. It is the responsibility of the pilot and/or flight crew to determine whether a near midair collision did actually occur and, if so, to initiate a NMAC report. Be specific, as ATC will not interpret a casual remark to mean that a NMAC is being reported. The pilot should state "I wish to report a near midair collision."

3.4 Where to File Reports. Pilots and/or flight crewmembers involved in NMAC occurrences are urged to report each incident immediately:

3.4.1 By radio or telephone to the nearest FAA ATC facility or FSS.

3.4.2 In writing, in lieu of the above, to the nearest Flight Standards District Office (FSDO).

3.5 Items to be Reported

3.5.1 Date and time (UTC) of incident.

3.5.2 Location of incident and altitude.

3.5.3 Identification and type of reporting aircraft, aircrew destination, name and home base of pilot.

3.5.4 Identification and type of other aircraft, aircrew destination, name and home base of pilot.

3.5.5 Type of flight plans; station altimeter setting used.

3.5.6 Detailed weather conditions at altitude or flight level.

3.5.7 Approximate courses of both aircraft: indicate if one or both aircraft were climbing or descending.

3.5.8 Reported separation in distance at first sighting, proximity at closest point horizontally and vertically, length of time in sight prior to evasive action.

3.5.9 Degree of evasive action taken, if any (from both aircraft, if possible).

3.5.10 Injuries, if any.

3.6 Investigation. The FSDO in whose area the incident occurred is responsible for the investigation and reporting of NMACs.

3.7 Existing radar, communication, and weather data will be examined in the conduct of the investigation. When possible, all cockpit crew members will be interviewed regarding factors involving the NMAC incident. Air traffic controllers will be interviewed in cases where one or more of the involved aircraft was provided ATC service. Both flight and ATC procedures will be evaluated. When the investigation reveals a violation of an FAA regulation, enforcement action will be pursued.

4. Unidentified Flying Object (UFO) Reports

4.1 Persons wanting to report UFO/unexplained phenomena activity should contact a UFO/unexplained phenomena reporting data collection center, such as Bigelow Aerospace Advanced Space Studies (BAASS) (voice: 1-877-979-7444 or e-mail: Reporting@baass.org), the National UFO Reporting Center, etc.

ENR 1.17 North Atlantic (NAT) Timekeeping Procedures

1. Prior to entry into NAT minimum navigation performance specifications (MNPS) airspace, the time reference system(s) to be used during the flight for calculation of waypoint estimated times of arrival (ETAs) and waypoint actual times of arrival (ATAs) shall be synchronized to universal coordinated time (UTC). All ETAs and ATAs passed to air traffic control shall be based on a time reference that has been synchronized to UTC or equivalent. Acceptable sources of UTC include:

1.1 WWV – National Institute of Standards and Technology (Fort Collins, Colorado). WWV operates 24 hours a day on 2500, 5000, 10000, 15000, 20000 kHz (AM/single sideband (SSB)) and provides UTC voice every minute.

1.2 GPS (corrected to UTC) – Available 24 hours a day to those pilots who can access the time signal over their shipboard GPS equipment.

1.3 CHU – National Research Council (NRC) – Available 24 hours a day on 3330, 7335, and 14670 kHz (SSB). In the final 10-second period of each minute, a bilingual station identification and time announcement is made. Since April 1990, the announced time is UTC.

1.4 BBC – British Broadcasting Corporation (United Kingdom). The BBC transmits on a number of domestic and world-wide frequencies and transmits the Greenwich time signal (referenced to UTC) once every hour on most frequencies, although there are some exceptions.

1.5 Any other source shown to the State of Registry or State of Operator (as appropriate) to be an equivalent source of UTC.

ENR 1.18 North Atlantic (NAT) Safety Information

1. Report Leaving, Report Reaching

1.1 The early discovery of altitude deviations is extremely important to the overall safety of NAT operations. Deferring the required reports of leaving and reaching flight levels until the next routine communication may lead to instances where aircraft fly at the incorrect flight level for long durations. This is not acceptable from a system safety standpoint. While the actual number of vertical errors in the NAT Region is relatively small, some of these errors continue undetected (and therefore uncorrected) for long durations.

1.2 In practical terms:

1.2.1 Report leaving a flight level as soon as the aircraft begins climb or descent;

1.2.2 Report reaching a flight level as soon as the aircraft is level; and

1.2.3 In RVSM airspace, provide the reports even if air traffic control has not specifically requested them.

2. Adherence to Oceanic Clearance

2.1 As a key part of ensuring the overall safety in the NAT Region, pilots are reminded of the importance of strict adherence to the oceanic clearance. The NAT oceanic clearance provides separation from all

known aircraft from the oceanic entry point to the oceanic exit point. This separation can only be assured if all aircraft enter oceanic airspace in accordance with their oceanic clearance.

2.2 Although it may be desirable to defer climb or descent to the cleared oceanic flight level, delaying the request to domestic air traffic control for a clearance may result in entering oceanic airspace at an incorrect flight level.

2.3 In practical terms:

2.3.1 Flights must enter oceanic airspace level at the cleared oceanic flight level;

2.3.2 Flights must enter oceanic airspace at the cleared oceanic entry point;

2.3.3 Flights must maintain the assigned true Mach number;

2.3.4 If a pilot cannot comply with any part of the oceanic clearance, air traffic control must be informed immediately;

2.3.5 Pilots must ensure that their aircraft performance enables them to maintain the cleared oceanic flight level for the entire oceanic crossing; and

2.3.6 If a pilot discovers that the aircraft is not able to reach or remain at a cleared flight level, air traffic control must be informed immediately.

ENR 1.19 Area Navigation (RNAV) and Required Navigation Performance (RNP)

1. Area Navigation (RNAV)

1.1 General. RNAV is a method of navigation that permits aircraft operation on any desired flight path within the coverage of ground or space based navigation aids or within the limits of the capability of self-contained aids, or a combination of these. In the future, there will be an increased dependence on the use of RNAV in lieu of routes defined by ground-based navigation aids.

1.2 RNAV routes and terminal procedures, including departure procedures (DPs) and standard terminal arrivals (STARs), are designed with RNAV systems in mind. There are several potential advantages of RNAV routes and procedures:

1.2.1 Time and fuel savings,

1.2.2 Reduced dependence on radar vectoring, altitude, and speed assignments allowing a reduction in required ATC radio transmissions, and

1.2.3 More efficient use of airspace.

1.3 In addition to information found in this manual, guidance for domestic RNAV DPs, STARs, and routes may also be found in Advisory Circular 90-100A, U.S. Terminal and En Route Area Navigation (RNAV) Operations.

1.4 RNAV Operations. RNAV procedures, such as DPs and STARs, demand strict pilot awareness and maintenance of the procedure centerline. Pilots should possess a working knowledge of their aircraft navigation system to ensure RNAV procedures are flown in an appropriate manner. In addition, pilots should have an understanding of the various waypoint and leg types used in RNAV procedures; these are discussed in more detail below.

1.4.1 Waypoints. A waypoint is a predetermined geographical position that is defined in terms of latitude/longitude coordinates. Waypoints may be a simple named point in space or associated with existing navaids, intersections, or fixes. A waypoint is most often used to indicate a change in direction, speed, or altitude along the desired path. RNAV procedures make use of both fly-over and fly-by waypoints.

1.4.1.1 Fly-by waypoints. Fly-by waypoints are used when an aircraft should begin a turn to the next course prior to reaching the waypoint separating the two route segments. This is known as turn anticipation.

1.4.1.2 Fly-over waypoints. Fly-over waypoints are used when the aircraft must fly over the point prior to starting a turn.

NOTE-

FIG ENR 1.19-1 illustrates several differences between a fly-by and a fly-over waypoint.

FIG ENR 1.19-1
Fly-by and Fly-over Waypoints

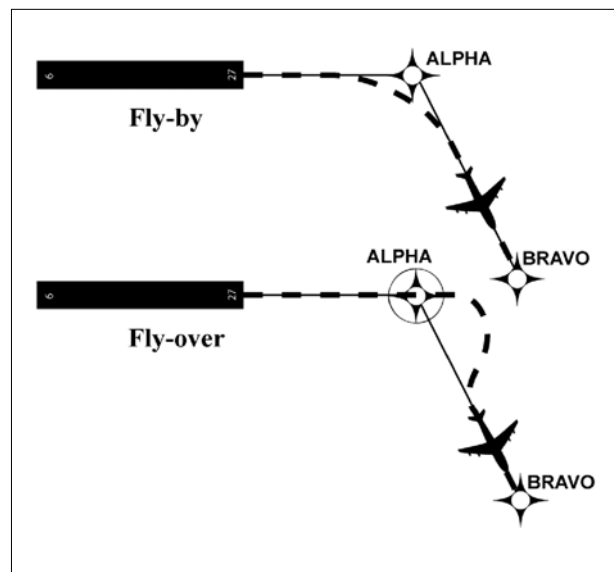

1.4.2 RNAV Leg Types. A leg type describes the desired path proceeding, following, or between waypoints on an RNAV procedure. Leg types are identified by a two-letter code that describes the path (e.g., heading, course, track, etc.) and the termination point (e.g., the path terminates at an altitude, distance, fix, etc.). Leg types used for procedure design are included in the aircraft navigation database, but not normally provided on the procedure chart. The narrative depiction of the RNAV chart describes how a procedure is flown. The “path and terminator concept” defines that every leg of a procedure has a termination point and some kind of path into that termination point. Some of the available leg types are described below.

1.4.2.1 Track to Fix. A Track to Fix (TF) leg is intercepted and acquired as the flight track to the following waypoint. Track to a Fix legs are sometimes called point-to-point legs for this reason. *Narrative: “on track 087 to CHEZZ WP.”* See FIG ENR 1.19-2.

1.4.2.2 Direct to Fix. A Direct to Fix (DF) leg is a path described by an aircraft’s track from an initial area direct to the next waypoint. *Narrative: “left turn direct BARGN WP.”* See FIG ENR 1.19-3.

NOTE-
FIG ENR 1.19-2, FIG ENR 1.19-3 and FIG ENR 1.19-4 illustrate TF, DF, CF and RF leg types.

FIG ENR 1.19-2
Track to Fix Leg Type

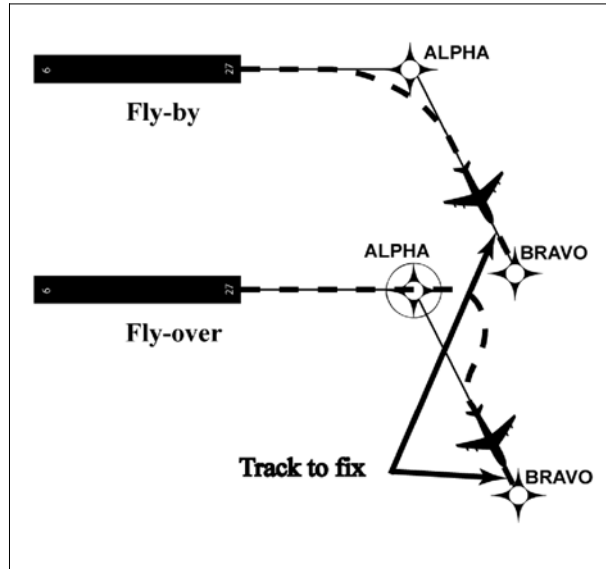
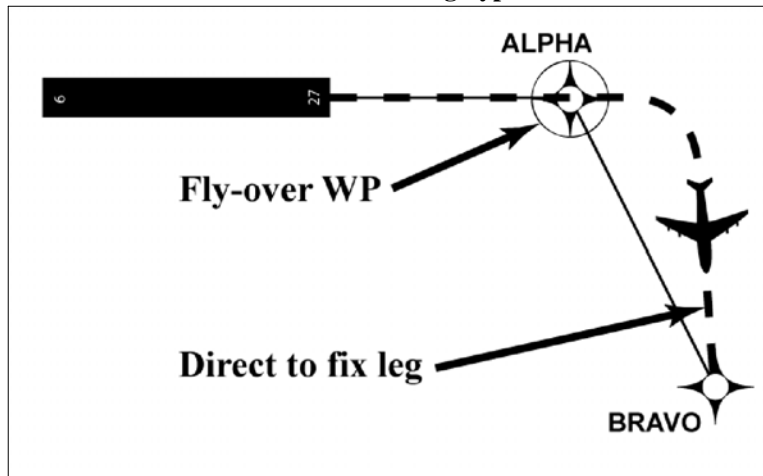
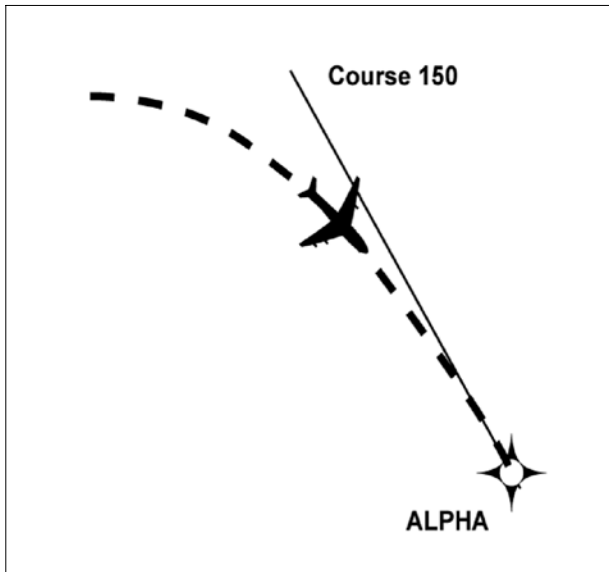

FIG ENR 1.19-3
Direct to Fix Leg Type



1.4.2.3 Course to Fix. A Course to Fix (CF) leg is a path that terminates at a fix with a specified course at that fix. *Narrative:* “on course 078 to PRIMY WP.” See FIG ENR 1.19-4.

FIG ENR 1.19-4
Course to Fix Leg Type



1.4.2.4 Radius to Fix. A Radius to Fix (RF) leg is defined as a constant radius circular path around a defined turn center that terminates at a fix. See FIG ENR 1.19-5.

FIG ENR 1.19-5
Radius to Fix Leg Type

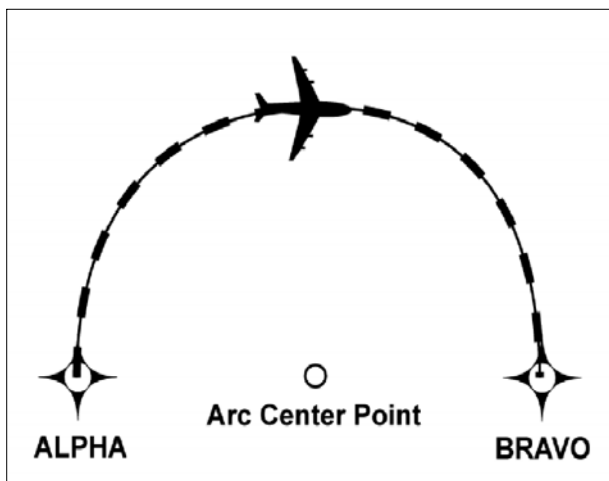

1.4.2.5 Heading. A Heading leg may be defined as, but not limited to, a Heading to Altitude (VA), Heading to DME range (VD), and Heading to Manual Termination, i.e., Vector (VM). *Narrative:* “climb heading 350 to 1500”, “heading 265, at 9 DME west of PXR VORTAC, right turn heading 360”, “fly heading 090, expect radar vectors to DRYHT INT.”

1.4.3 Navigation Issues. Pilots should be aware of their navigation system inputs, alerts, and annunciations in order to make better-informed decisions. In addition, the availability and suitability of particular sensors/systems should be considered.

1.4.3.1 GPS. Operators using TSO-C129 systems should ensure departure and arrival airports are entered to ensure proper RAIM availability and CDI sensitivity.

1.4.3.2 DME/DME. Operators should be aware that DME/DME position updating is dependent on FMS logic and DME facility proximity, availability, geometry, and signal masking.

1.4.3.3 VOR/DME. Unique VOR characteristics may result in less accurate values from VOR/DME position updating than from GPS or DME/DME position updating.

1.4.3.4 Inertial Navigation. Inertial reference units and inertial navigation systems are often coupled with other types of navigation inputs, e.g., DME/DME or GPS, to improve overall navigation system performance.

NOTE-
Specific inertial position updating requirements may apply.

1.4.4 Flight Management System (FMS). An FMS is an integrated suite of sensors, receivers, and computers, coupled with a navigation database. These systems generally provide performance and RNAV guidance to displays and automatic flight control systems.

1.4.4.1 Inputs can be accepted from multiple sources such as GPS, DME, VOR, LOC and IRU. These inputs may be applied to a navigation solution one at a time or in combination. Some FMSs provide for the detection and isolation of faulty navigation information.

1.4.4.2 When appropriate navigation signals are available, FMSs will normally rely on GPS and/or DME/DME (that is, the use of distance information from two or more DME stations) for position updates. Other inputs may also be incorporated based on FMS system architecture and navigation source geometry.

NOTE-

DME/DME inputs coupled with one or more IRU(s) are often abbreviated as DME/DME/IRU or D/D/I.

2. Required Navigation Performance (RNP)

2.1 General. RNP is RNAV with on-board navigation monitoring and alerting, RNP is also a statement of navigation performance necessary for operation within a defined airspace. A critical component of RNP is the *ability of the aircraft navigation system to monitor its achieved navigation performance, and to identify for the pilot whether the operational requirement is, or is not being met during an operation.* This on-board performance monitoring and alerting capability therefore allows a lessened reliance on air traffic control intervention (via radar monitoring, automatic dependent surveillance (ADS), multilateration, communications), and/or route separation to achieve the overall safety of the operation. RNP capability of the aircraft is a major component in determining the separation criteria to ensure that the overall containment of the operation is met.

The RNP capability of an aircraft will vary depending upon the aircraft equipment and the navigation

infrastructure. For example, an aircraft may be equipped and certified for RNP 1.0, but may not be capable of RNP 1.0 operations due to limited navaid coverage.

2.2 RNP Operations

2.2.1 RNP Levels. An RNP “level” or “type” is applicable to a selected airspace, route, or procedure. As defined in the Pilot/Controller Glossary, the RNP Level or Type is a value typically expressed as a distance in nautical miles from the intended centerline of a procedure, route, or path. RNP applications also account for potential errors at some multiple of RNP level (e.g., twice the RNP level).

2.2.1.1 Standard RNP Levels. U.S. standard values supporting typical RNP airspace are as specified in TBL ENR 1.19-1 below. Other RNP levels as identified by ICAO, other states and the FAA may also be used.

2.2.1.2 Application of Standard RNP Levels. U.S. standard levels of RNP typically used for various routes and procedures supporting RNAV operations may be based on use of a specific navigational system or sensor such as GPS, or on multi-sensor RNAV systems having suitable performance.

2.2.1.3 Depiction of Standard RNP Levels. The applicable RNP level will be depicted on affected charts and procedures.

TBL ENR 1.19-1
U.S. Standard RNP Levels

RNP Level	Typical Application	Primary Route Width (NM) – Centerline to Boundary
0.1 to 1.0	RNP SAAAR Approach Segments	0.1 to 1.0
0.3 to 1.0	RNP Approach Segments	0.3 to 1.0
1	Terminal and En Route	1.0
2	En Route	2.0

NOTE-

- The “performance” of navigation in RNP refers not only to the level of accuracy of a particular sensor or aircraft navigation system, but also to the degree of precision with which the aircraft will be flown.*
- Specific required flight procedures may vary for different RNP levels.*

TBL ENR 1.19-2
RNP Levels Supported for International Operations

RNP Level	Typical Application
4	Projected for oceanic/remote areas where 30 NM horizontal separation is applied
10	Oceanic/remote areas where 50 NM lateral separation is applied

2.3 Other RNP Applications Outside the U.S. The FAA and ICAO member states have led initiatives in implementing the RNP concept to oceanic operations. For example, RNP-10 routes have been established in the northern Pacific (NOPAC) which has increased capacity and efficiency by reducing the distance between tracks to 50 NM. (See TBL ENR 1.19-2.)

2.4 Aircraft and Airborne Equipment Eligibility for RNP Operations. Aircraft meeting RNP criteria will have an appropriate entry including special conditions and limitations in its Aircraft Flight Manual (AFM), or supplement. Operators of aircraft not having specific AFM-RNP certification may be issued operational approval including special conditions and limitations for specific RNP levels.

NOTE-
Some airborne systems use Estimated Position Uncertainty (EPU) as a measure of the current estimated navigational performance. EPU may also be referred to as Actual Navigation Performance (ANP) or Estimated Position Error (EPE).

3. Use of Suitable Area Navigation (RNAV) Systems on Conventional Procedures and Routes

3.1 Discussion. This paragraph sets forth policy, while providing operational and airworthiness guidance regarding the suitability and use of RNAV systems when operating on, or transitioning to, conventional, non-RNAV routes and procedures within the U.S. National Airspace System (NAS):

3.1.1 Use of a suitable RNAV system as a Substitute Means of Navigation when a Very-High Frequency (VHF) Omni-directional Range (VOR), Distance Measuring Equipment (DME), Tactical Air Navigation (TACAN), VOR/TACAN (VORTAC), VOR/DME, Non-directional Beacon (NDB), or compass locator facility including locator outer marker and locator middle marker is out-of-service (that is, the navigation aid (NAVAID) information is not

available); an aircraft is not equipped with an Automatic Direction Finder (ADF) or DME; or the installed ADF or DME on an aircraft is not operational. For example, if equipped with a suitable RNAV system, a pilot may hold over an out-of-service NDB.

3.1.2 Use of a suitable RNAV system as an Alternate Means of Navigation when a VOR, DME, VORTAC, VOR/DME, TACAN, NDB, or compass locator facility including locator outer marker and locator middle marker is operational and the respective aircraft is equipped with operational navigation equipment that is compatible with conventional nav aids. For example, if equipped with a suitable RNAV system, a pilot may fly a procedure or route based on operational VOR using that RNAV system without monitoring the VOR.

- NOTE-**
1. Additional information and associated requirements are available via a 90-series Advisory Circular titled "Use of Suitable RNAV Systems on Conventional Routes and Procedures."
 2. Good planning and knowledge of your RNAV system are critical for safe and successful operations.
 3. Pilots planning to use their RNAV system as a substitute means of navigation guidance in lieu of an out-of-service NAVAID may need to advise ATC of this intent and capability.
 4. The navigation database should be current for the duration of the flight. If the AIRAC cycle will change during flight, operators and pilots should establish procedures to ensure the accuracy of navigation data, including suitability of navigation facilities used to define the routes and procedures for flight. To facilitate validating database currency, the FAA has developed procedures for publishing the amendment date that instrument approach procedures were last revised. The amendment date follows the amendment number; for example, Amdt 4 14Jan10. Currency of graphic departure procedures and STARs may be ascertained by the numerical designation in the procedure title. If an amended chart is published for the procedure, or the procedure amendment date shown on the chart is on or after the expiration date of the database, the

operator must not use the database to conduct the operation.

3.2 Types of RNAV Systems that Qualify as a Suitable RNAV System. When installed in accordance with appropriate airworthiness installation requirements and operated in accordance with applicable operational guidance (e.g., aircraft flight manual and Advisory Circular material), the following systems qualify as a suitable RNAV system:

3.2.1 An RNAV system with TSO–C129/–C145/–C146 equipment, installed in accordance with AC 20–138, Airworthiness Approval of Global Positioning System (GPS) Navigation Equipment for Use as a VFR and IFR Supplemental Navigation System, or AC 20–130A, Airworthiness Approval of Navigation or Flight Management Systems Integrating Multiple Navigation Sensors, and authorized for instrument flight rules (IFR) en route and terminal operations (including those systems previously qualified for “GPS in lieu of ADF or DME” operations), or

3.2.2 An RNAV system with DME/DME/IRU inputs that is compliant with the equipment provisions of AC 90–100A, U.S. Terminal and En Route Area Navigation (RNAV) Operations, for RNAV routes. A table of compliant equipment is available at the following website:

http://www.faa.gov/about/office_org/headquarters_offices/avs/offices/afs/afs400/afs470/policy_guidance/

NOTE–

Approved RNAV systems using DME/DME/IRU, without GPS/WAAS position input, may only be used as a substitute means of navigation when specifically authorized by a Notice to Airmen (NOTAM) or other FAA guidance for a specific procedure. The NOTAM or other FAA guidance authorizing the use of DME/DME/IRU systems will also identify any required DME facilities based on an FAA assessment of the DME navigation infrastructure.

3.3 Uses of Suitable RNAV Systems. Subject to the operating requirements, operators may use a suitable RNAV system in the following ways.

3.3.1 Determine aircraft position relative to, or distance from a VOR (see NOTE 5 below), TACAN, NDB, compass locator, DME fix; or a named fix defined by a VOR radial, TACAN course, NDB bearing, or compass locator bearing intersecting a VOR or localizer course.

3.3.2 Navigate to or from a VOR, TACAN, NDB, or compass locator.

3.3.3 Hold over a VOR, TACAN, NDB, compass locator, or DME fix.

3.3.4 Fly an arc based upon DME.

NOTE–

1. The allowances described in this section apply even when a facility is identified as required on a procedure (for example, “Note ADF required”).

2. These operations do not include lateral navigation on localizer–based courses (including localizer back–course guidance) without reference to raw localizer data.

3. Unless otherwise specified, a suitable RNAV system cannot be used for navigation on procedures that are identified as not authorized (“NA”) without exception by a NOTAM. For example, an operator may not use a RNAV system to navigate on a procedure affected by an expired or unsatisfactory flight inspection, or a procedure that is based upon a recently decommissioned NAVAID.

4. Pilots may not substitute for the NAVAID (for example, a VOR or NDB) providing lateral guidance for the final approach segment. This restriction does not refer to instrument approach procedures with “or GPS” in the title when using GPS or WAAS. These allowances do not apply to procedures that are identified as not authorized (NA) without exception by a NOTAM, as other conditions may still exist and result in a procedure not being available. For example, these allowances do not apply to a procedure associated with an expired or unsatisfactory flight inspection, or is based upon a recently decommissioned NAVAID.

5. For the purpose of paragraph NO TAG, “VOR” includes VOR, VOR/DME, and VORTAC facilities and “compass locator” includes locator outer marker and locator middle marker.

3.4 Alternate Airport Considerations. For the purposes of flight planning, any required alternate airport must have an available instrument approach procedure that does not require the use of GPS. This restriction includes conducting a conventional approach at the alternate airport using a substitute means of navigation that is based upon the use of GPS. For example, these restrictions would apply when planning to use GPS equipment as a substitute means of navigation for an out–of–service VOR that supports an ILS missed approach procedure at an alternate airport. In this case, some other approach not reliant upon the use of GPS must be available. This restriction does not apply to RNAV systems using TSO–C145/–C146 WAAS equipment. For further WAAS guidance see ENR 4.1 paragraph 19.

3.5 General Operational Requirements

3.5.1 Pilots must comply with the guidelines contained in their AFM, AFM supplement, operating manual, or pilot's guide when operating their aircraft navigation system.

3.5.2 Pilots may not use their RNAV system as a substitute or alternate means of navigation guidance if their aircraft has an AFM or AFM supplement with a limitation to monitor the underlying navigation aids for the associated operation.

3.5.3 Pilots of aircraft with an AFM limitation that requires the aircraft to have other equipment appropriate to the route to be flown may only use their RNAV equipment as a substitute means of navigation in the contiguous U.S. In addition, pilots of these aircraft may not use their RNAV equipment as a substitute for inoperable or not-installed equipment.

3.5.4 Pilots must ensure their onboard navigation data is current, appropriate for the region of intended operation, and includes the navigation aids, waypoints, and relevant coded terminal airspace procedures for the departure, arrival, and alternate airfields.

NOTE-

The navigation database should be current for the duration of the flight. If the AIRAC cycle will change during flight, operators and pilots should establish procedures to ensure the accuracy of navigation data, including suitability of navigation facilities used to define the routes and procedures for flight. To facilitate validating database currency, the FAA has developed procedures for publishing the amendment date that instrument approach procedures were last revised. The amendment date follows the amendment number; for example, Amdt 4 14Jan10. Currency of graphic departure procedures and STARs may be ascertained by the numerical designation in the procedure title. If an amended chart is published for the procedure, or the procedure amendment date shown on the chart is on or after the expiration date of the database, the operator must not use the database to conduct the operation.

3.5.5 Pilots must extract procedures, waypoints, navaids, or fixes by name from the onboard navigation database and comply with the charted procedure or route.

3.5.6 For the purposes described in this paragraph, pilots may not manually enter published procedure or route waypoints via latitude/longitude, place/bearing, or place/bearing/distance into the aircraft system.

3.6 Operational Requirements for Departure and Arrival Procedures

3.6.1 Pilots of aircraft with standalone GPS receivers must ensure that CDI scaling (full-scale deflection) is either 1.0 NM or 0.3 NM.

3.6.2 In order to use a substitute means of navigation guidance on departure procedures, pilots of aircraft with RNAV systems using DME/DME/IRU, without GPS input, must ensure their aircraft navigation system position is confirmed, within 1,000 feet, at the start point of take-off roll. The use of an automatic or manual runway update is an acceptable means of compliance with this requirement. A navigation map may also be used to confirm aircraft position, if pilot procedures and display resolution allow for compliance with the 1,000-foot tolerance requirement.

3.7 Operational Requirements for Instrument Approach Procedures

3.7.1 When the use of RNAV equipment using GPS input is planned as a substitute means of navigation guidance for part of an instrument approach procedure at a destination airport, any required alternate airport must have an available instrument approach procedure that does not require the use of GPS. This restriction includes conducting a conventional approach at the alternate airport using a substitute means of navigation guidance based upon the use of GPS. This restriction does not apply to RNAV systems using WAAS as an input.

3.7.2 Pilots of aircraft with standalone GPS receivers must ensure that CDI sensitivity is 1 NM.

NOTE-

If using GPS distance as an alternate or substitute means of navigation guidance for DME distance on an instrument approach procedure, pilots must select a named waypoint from the onboard navigation database that is associated with the subject DME facility. Pilots should not rely on information from an RNAV instrument approach procedure, as distances on RNAV approaches may not match the distance to the facility.

3.8 Operational Requirements for Specific Inputs to RNAV Systems:

3.8.1 GPS

3.8.1.1 RNAV systems using GPS input may be used as an alternate means of navigation guidance without restriction if appropriate RAIM is available.

3.8.1.2 Operators of aircraft with RNAV systems that use GPS input but do not automatically alert the pilot of a loss of GPS, must develop procedures to verify correct GPS operation.

3.8.1.3 RNAV systems using GPS input may be used as a substitute means of navigation guidance provided RAIM availability for the operation is confirmed. During flight planning, the operator should confirm the availability of RAIM with the latest GPS NOTAMs. If no GPS satellites are scheduled to be out-of-service, then the aircraft can depart without further action. However, if any GPS satellites are scheduled to be out-of-service, then the operator must confirm the availability of GPS integrity (RAIM) for the intended operation. In the event of a predicted, continuous loss of RAIM of more than five (5) minutes for any part of the route or procedure, the operator should delay, cancel, or re-route the flight as appropriate. Use of GPS as a

substitute is not authorized when the RAIM capability of the GPS equipment is lost.

NOTE–

The FAA is developing a RAIM prediction service for general use. Until this capability is operational, a RAIM prediction does not need to be done for a departure or arrival procedure with an associated “RADAR REQUIRED” note charted or for routes where the operator expects to be in radar coverage. Operators may check RAIM availability for departure or arrival procedures at any given airport by checking approach RAIM for that location. This information is available upon request from a U.S. Flight Service Station, but is no longer available through DUATS.

3.8.2 WAAS

3.8.2.1 RNAV systems using WAAS input may be used as an alternate means of navigation guidance without restriction.

3.8.2.2 RNAV systems using WAAS input may be used as a substitute means of navigation guidance provided WAAS availability for the operation is confirmed. Operators must check WAAS NOTAMs.

3.8.3 DME/DME/IRU

3.8.3.1 RNAV systems using DME/DME/IRU, without GPS input, may be used as an alternate means of navigation guidance whenever valid DME/DME position updating is available.

ENR 2. Air Traffic Services Airspace

See GEN 3.3 and ENR 1.4.

ENR 3. ATS ROUTES

ENR 3.1 Lower ATS Routes

See also ENR 1.10, ENR 1.19, ENR 3.3, ENR 3.5, and Appendix 1.

1. Low Altitude ATS Route Structure

1.1 The U.S. does not use the term “Lower ATS Routes.” The published low altitude route structure in the U.S. consists of VOR Federal airways, L/MF Federal airways and low altitude RNAV routes (T-routes). The low altitude route structure is for use from 1,200 feet above the surface (or in some instances higher) up to but not including 18,000 feet MSL.

1.1.1 Route designators and significant points defining the routes are listed in FAA Order 7400.9, Airspace Designations and Reporting Points.

1.1.2 Applicable route tracks, radials, distances between points, changeover points, cruising altitudes for direction of flight, upper and lower limits, minimum flight altitudes and ARTCC boundaries are published on the IFR Enroute Low Altitude – U.S. chart series.

1.1.3 The low altitude routes are designated as Class E airspace.

ENR 3.2 Upper ATS Routes

See also ENR 1.10, ENR 1.19, ENR 3.3, ENR 3.5, and Appendix 1.

1. High Altitude ATS Route Structure

1.1 The U.S. does not use the term “Upper ATS Routes.” The published high altitude route structure in the U.S. consists of jet routes and high altitude RNAV routes (Q-routes). The high altitude route structure is for use at and above 18,000 feet MSL.

1.1.1 Jet route and Q-route designators and significant points defining the routes are listed in

FAA Order 7400.9, Airspace Designations and Reporting Points.

1.1.2 Applicable route tracks, radials, distances between points, changeover points, cruising altitudes for direction of flight, upper and lower limits, minimum flight altitudes and ARTCC boundaries are published on the IFR Enroute High Altitude – U.S. chart series.

1.1.3 The high altitude route structure is contained within Class A airspace.

ENR 3.3 Area Navigation (RNAV) Routes

1. RNAV Routes

1.1 Published RNAV routes, including Q-Routes and T-Routes, can be flight planned for use by aircraft with RNAV capability, subject to any limitations or requirements noted on en route charts, in applicable Advisory Circulars, or by NOTAM. RNAV routes are depicted in blue on aeronautical charts and are identified by the letter “Q” or “T” followed by the airway number (e.g., Q-13, T-205). Published RNAV routes are RNAV-2 except when specifically charted as RNAV-1. These routes require system performance currently met by GPS or DME/DME/IRU RNAV systems that satisfy the criteria discussed in AC 90-100A, U.S. Terminal and En Route Area Navigation (RNAV) Operations.

NOTE-
AC 90-100A does not apply to over water RNAV routes (reference 14 CFR Section 91.511, including the Q-routes in the Gulf of Mexico and the Atlantic routes) or Alaska

VOR/DME RNAV routes (“JxxxR”). The AC does not apply to off-route RNAV operations, Alaska GPS routes or Caribbean routes.

1.1.1 Q-routes are available for use by RNAV equipped aircraft between 18,000 feet MSL and FL 450 inclusive. Q-routes are depicted on Enroute High Altitude Charts.

1.1.2 T-routes are available for use by RNAV equipped aircraft from 1,200 feet above the surface (or in some instances higher) up to but not including 18,000 feet MSL. T-routes are depicted on Enroute Low Altitude Charts.

1.2 Unpublished RNAV routes are direct routes, based on area navigation capability, between waypoints defined in terms of latitude/longitude coordinates, degree-distance fixes, or offsets from established routes/airways at a specified distance and direction. Radar monitoring by ATC is required on all unpublished RNAV routes.

ENR 3.4 [RESERVED]

ENR 3.5 Other Routes

1. Airways and Route Systems

1.1 Three fixed route systems are established for air navigation purposes. They are the Federal airway system (consisting of VOR and L/MF routes), the jet route system, and the RNAV route system. To the extent possible, these route systems are aligned in an overlying manner to facilitate transition between each.

2. VOR and L/MF System

2.1 The VOR and L/MF (nondirectional radio beacons) Airway System consists of airways designated from 1,200 feet above the surface (or in some instances higher) up to but not including 18,000 feet MSL. These airways are depicted on IFR Enroute Low Altitude Charts.

NOTE-

The altitude limits of a victor airway should not be exceeded except to effect transition within or between route structures.

2.2 Except in Alaska, the VOR airways are: predicated solely on VOR or VORTAC navigation aids; depicted in black on aeronautical charts; and identified by a “V” (Victor) followed by the airway number (for example, V12).

NOTE-

Segments of VOR airways in Alaska are based on L/MF navigation aids and charted in brown instead of black on en route charts.

2.3 A segment of an airway which is common to two or more routes carries the numbers of all the airways which coincide for that segment. When such is the case, pilots filing a flight plan need to indicate only that airway number for the route filed.

NOTE-

A pilot who intends to make an airway flight, using VOR facilities, will simply specify the appropriate “victor” airway(s) in the flight plan. For example, if a flight is to be made from Chicago to New Orleans at 8,000 feet, using omniranges only, the route may be indicated as “departing from Chicago–Midway, cruising 8,000 feet via Victor 9 to Moisant International.” If flight is to be conducted in part by means of L/MF navigation aids and in part on omniranges, specifications of the appropriate airways in the flight plan will indicate which types of facilities will be used along the described routes, and, for IFR flight, permit

ATC to issue a traffic clearance accordingly. A route may also be described by specifying the station over which the flight will pass but in this case since many VORs and L/MF aids have the same name, the pilot must be careful to indicate which aid will be used at a particular location. This will be indicated in the route of flight portion of the flight plan by specifying the type of facility to be used after the location name in the following manner: Newark L/MF, Allentown VOR.

2.4 With respect to position reporting, reporting points are designed for VOR Airway Systems. Flights using Victor airways will report over these points unless advised otherwise by ATC.

2.5 The L/MF airways (colored airways) are predicated solely on L/MF navigation aids and are depicted in brown on aeronautical charts and are identified by color name and number; e.g., Amber One. Green and Red airways are plotted east and west. Amber and Blue airways are plotted north and south.

NOTE-

Except for G13 in North Carolina, the colored airway system exists only in the state of Alaska. All other such airways formerly so designated in the conterminous U.S. have been rescinded.

CAUTION-

Use of adjacently located LF/VHF airways and routes – many locations just outside the contiguous 48 states have two separate airway structures. One structure is made up from VORs and the other from L/MF NAVAIDs (nondirectional radio beacons). In some instances, the different routes appear to overlie each other. The NAVAIDs are sometimes depicted so close to each other that they will have the appearance of being collocated, or nearly so. Substituting a VOR radial for a nondirectional radio beacon bearing could, in many circumstances, cause an excessive “off course” navigational error. Strict adherence to the color coding of the route structure and NAVAID in use should be maintained. Chart procedures provide an excellent means of route differentiation through the use of color which is defined and explained in the legend.

2.6 The use of TSO-C145a or TSO-C146a GPS/WAAS navigation systems is allowed in Alaska as the only means of navigation on published air traffic routes including those Victor and colored airway segments designated with a second minimum en route altitude (MEA) depicted in blue and followed by the letter G at those lower altitudes. The

altitudes so depicted are below the minimum reception altitude (MRA) of the land-based navigation facility defining the route segment, and guarantee standard en route obstacle clearance and two-way communications. Air carrier operators requiring operations specifications are authorized to conduct operations on those routes in accordance with FAA operations specifications.

3. Jet Route System

3.1 The jet route system consists of jet routes established from 18,000 feet MSL to FL 450 inclusive.

3.2 These routes are depicted on En Route High Altitude Charts. Jet routes are depicted in black on aeronautical charts and are identified by a “J” (Jet) followed by the airway number; e.g., J12. Jet routes, as VOR airways, are predicated solely on VOR or VORTAC navigation facilities (except in Alaska).

NOTE-

Segments of jet routes in Alaska are based on L/MF navigation aids and are charted in brown color instead of black on en route charts.

3.3 With respect to position reporting, reporting points are designated for Jet Route Systems. Flights using jet routes will report over these points unless otherwise advised by ATC.

4. Radar Vectors

4.1 Controllers may vector aircraft within CONTROLLED AIRSPACE for separation purposes, noise abatement considerations, when an operational advantage will be realized by the pilot or the controller, or when requested by the pilot. Vectors outside of CONTROLLED AIRSPACE will be provided only on pilot request. Pilots will be advised as to what the vector is to achieve when the vector is controller initiated and will take the aircraft off a previously assigned nonradar route. To the extent possible, aircraft operating on RNAV routes will be allowed to remain on their own navigation.

5. Changeover Points (COPs)

5.1 COPs are prescribed for Federal airways, jet routes, area navigation routes, or other direct routes

for which an minimum en route altitude (MEA) is designated under 14 CFR Part 95. The COP is a point along the route or airway segment between two adjacent navigation facilities or waypoints where changeover navigation guidance should occur. At this point, the pilot should change navigation receiver frequency from the station behind the aircraft to the station ahead.

5.2 The COP is normally located midway between the navigation facilities for straight route segments, or at the intersection of radials or courses forming a dogleg in the case of dogleg route segments. When the COP is NOT located at the midway point, aeronautical charts will depict the COP location and give the mileage to the radio aids.

5.3 COPs are established for the purpose of preventing loss of navigation guidance, to prevent frequency interference from other facilities, and to prevent use of different facilities by different aircraft in the same airspace. Pilots are urged to observe COPs to the fullest extent.

6. Airway or Route Course Changes

6.1 Pilots of aircraft are required to adhere to airways/routes being flown. Special attention must be given to this requirement during course changes. Each course change consists of variables that make the technique applicable in each case a matter only the pilot can resolve. Some variables which must be considered are turn radius, wind effect, airspeed, degree of turn, and cockpit instrumentation. An early turn, as illustrated in FIG ENR 3.5-1, is one method of adhering to airways/routes. The use of any available cockpit instrumentation, such as distance measuring equipment, may be used by the pilot to lead the turn when making course changes. This is consistent with the intent of 14 CFR Section 91.181 which requires pilots to operate along the centerline of an airway and along the direct course between navigational aids or fixes.

6.2 Turns which begin at or after fix passage may exceed airway/route boundaries. FIG ENR 3.5-1 contains an example flight track depicting this, together with an example of an early turn.

FIG ENR 3.5-1
Adhering to Airways or Routes

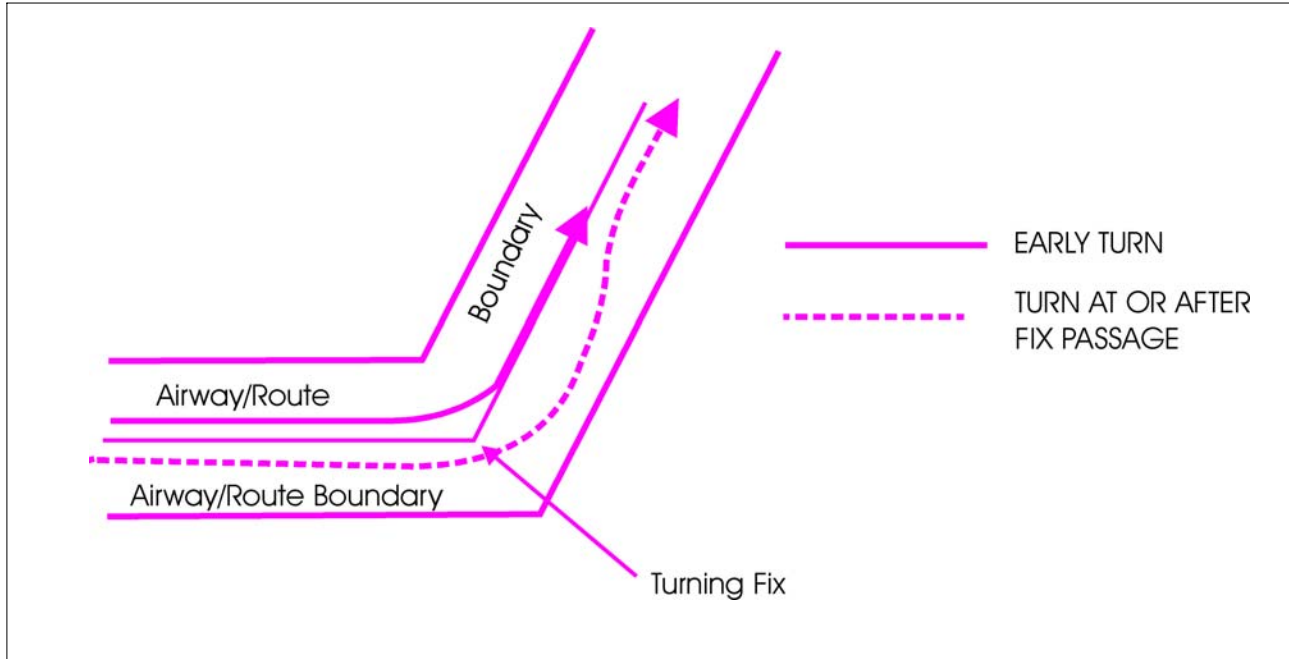

6.3 Without such actions, as leading a turn, aircraft operating in excess of 290 knots true airspeed (TAS) can exceed the normal airway/route boundaries depending on the amount of course change required, wind direction and velocity, the character of the turn fix, (DME, overhead navigation aid, or intersection), and the pilot's technique in making a course change. For example, a flight operating at 17,000 feet MSL with a TAS of 400 knots, a 25 degree bank, and a course change of more than 40 degrees would exceed the width of the airway/route; i.e., 4 nautical miles each side of centerline. However, in the airspace

below 18,000 feet MSL, operations in excess of 290 knots TAS are not prevalent and the provision of additional IFR separation in all course change situations for the occasional aircraft making a turn in excess of 290 knots TAS creates an unacceptable waste of airspace and imposes a penalty upon the preponderance of traffic which operates at low speeds. Consequently, the FAA expects pilots to lead turns and take other actions they consider necessary during the course changes to adhere as closely as possible to the airways or route being flown.

ENR 4. NAVIGATION AIDS/SYSTEMS

ENR 4.1 Navigation Aids – En Route

1. VHF Direction Finder

1.1 The VHF Direction Finder (VHF/DF) is one of the common systems that helps pilots without their being aware of its operation. It is a ground-based radio receiver used by the operator of the ground station. FAA facilities that provide VHF/DF service are identified in the Airport/Facility Directory (A/FD).

1.2 The equipment consists of a directional antenna system and a VHF radio receiver.

1.3 The VHF/DF receiver display indicates the magnetic direction of the aircraft from the ground station each time the aircraft transmits.

1.4 DF equipment is of particular value in locating lost aircraft and in helping to identify aircraft on radar.

2. Nondirectional Radio Beacon (NDB)

2.1 A low or medium frequency radio beacon transmits nondirectional signals whereby the pilot of an aircraft properly equipped can determine bearings and “home” on the station. These facilities normally operate in a frequency band of 190 to 535 kilohertz (kHz), according to ICAO Annex 10 the frequency range for NDBs is between 190 and 1750 kHz, and transmit a continuous carrier with either 400 or 1020 hertz (Hz) modulation. All radio beacons except the compass locators transmit a continuous three-letter identification in code except during voice transmissions.

2.2 When a radio beacon is used in conjunction with the Instrument Landing System markers, it is called a Compass Locator.

2.3 Voice transmissions are made on radio beacons unless the letter “W” (without voice) is included in the class designator (HW).

2.4 Radio beacons are subject to disturbances that may result in erroneous bearing information. Such disturbances result from such factors as lightning, precipitation, static, etc. At night radio beacons are vulnerable to interference from distant stations.

Nearly all disturbances which affect the aircraft’s Automatic Direction Finder (ADF) bearing also affect the facility’s identification. Noisy identification usually occurs when the ADF needle is erratic; voice, music, or erroneous identification will usually be heard when a steady false bearing is being displayed. Since ADF receivers do not have a “FLAG” to warn the pilot when erroneous bearing information is being displayed, the pilot should continuously monitor the NDB’s identification.

3. VHF Omni-directional Range (VOR)

3.1 VORs operate within the 108.0 – 117.95 MHz frequency band and have a power output necessary to provide coverage within their assigned operational service volume. They are subject to line-of-sight restrictions, and range varies proportionally to the altitude of the receiving equipment.

NOTE–

Normal service ranges for the various classes of VORs are given in GEN 3.4, TBL GEN 3.4-1, VOR/DME/TACAN Standard Service Volumes.

3.2 Most VORs are equipped for voice transmission on the VOR frequency. VORs without voice capability are indicated by the letter “W” (without voice) included in the class designator (VORW).

3.3 The effectiveness of the VOR depends upon proper use and adjustment of both ground and airborne equipment.

3.3.1 Accuracy. The accuracy of course alignment of the VOR is excellent, being generally plus or minus 1 degree.

3.3.2 Roughness. On some VORs, minor course roughness may be observed, evidenced by course needle or brief flag alarm activity (some receivers are more subject to these irregularities than others). At a few stations, usually in mountainous terrain, the pilot may occasionally observe a brief course needle oscillation, similar to the indication of “approaching station.” Pilots flying over unfamiliar routes are cautioned to be on the alert of these vagaries, and, in particular, to use the “to-from” indicator to determine positive station passage.

3.3.2.1 Certain propeller RPM settings or helicopter rotor speeds can cause the VOR Course Deviation Indicator (CDI) to fluctuate as much as plus or minus six degrees. Slight changes to the RPM setting will normally smooth out this roughness. Pilots are urged to check for this modulation phenomenon prior to reporting a VOR station or aircraft equipment for unsatisfactory operation.

3.4 The only positive method of identifying a VOR is by its Morse Code identification or by the recorded automatic voice identification which is always indicated by use of the word “VOR” following the range’s name. Reliance on determining the identification of an omnirange should never be placed on listening to voice transmissions by the FSS (or approach control facility) involved. Many FSS remotely operate several omniranges which have different names from each other and, in some cases, none have the name of the “parent” FSS. (During periods of maintenance the facility may radiate a T-E-S-T code (- - - -) or the code may be removed.)

3.5 Voice identification has been added to numerous VORs. The transmission consists of a voice announcement; i.e., “AIRVILLE VOR,” alternating with the usual Morse Code identification.

4. VOR Receiver Check

4.1 Periodic VOR receiver calibration is most important. If a receiver’s Automatic Gain Control or modulation circuit deteriorates, it is possible for it to display acceptable accuracy and sensitivity close into the VOR or VOT and display out-of-tolerance readings when located at greater distances where weaker signal areas exist. The likelihood of this deterioration varies between receivers, and is generally considered a function of time. The best assurance of having an accurate receiver is periodic calibration. Yearly intervals are recommended at which time an authorized repair facility should recalibrate the receiver to the manufacturer’s specifications.

4.2 14 CFR Section 91.171 provides for certain VOR equipment accuracy checks prior to flight under IFR. To comply with this requirement and to ensure satisfactory operation of the airborne system, the FAA has provided pilots with the following means of checking VOR receiver accuracy:

4.2.1 FAA VOR test facility (VOT) or a radiated test signal from an appropriately rated radio repair station.

4.2.2 Certified airborne check points.

4.2.3 Certified check points on the airport surface.

4.3 The FAA VOT transmits a test signal which provides a convenient means to determine the operational status and accuracy of a VOR receiver while on the ground where a VOT is located. The airborne use of VOT is permitted; however, its use is strictly limited to those areas/altitudes specifically authorized in the Airport/Facility Directory or appropriate supplement. To use the VOT service, tune in the VOT frequency on your VOR receiver. With the CDI centered, the omni-bearing selector should read 0° with the to/from indicator showing “from,” or the omni-bearing selector should read 180° with the to/from indicator showing “to.” Should the VOR receiver operate a Radio Magnetic Indicator (RMI), it will indicate 180° on any OBS setting. Two means of identification are used. One is a series of dots, and the other is a continuous tone. Information concerning an individual test signal can be obtained from the local FSS.

4.4 A radiated VOR test signal from an appropriately rated radio repair station serves the same purpose as an FAA VOR signal and the check is made in much the same manner as a VOT with the following differences:

4.4.1 The frequency normally approved by the FCC is 108.0 MHz.

4.4.2 Repair stations are not permitted to radiate the VOR test signal continuously, consequently the owner/operator must make arrangements with the repair station to have the test signal transmitted. This service is not provided by all radio repair stations. The aircraft owner or operator must determine which repair station in the local area provides this service. A representative of the repair station must make an entry into the aircraft logbook or other permanent record certifying to the radial accuracy and the date of transmission. The owner/operator or representative of the repair station may accomplish the necessary checks in the aircraft and make a logbook entry stating the results. It is necessary to verify which test radial is being transmitted and whether you should get a “to” or “from” indication.

4.5 Airborne and ground check points consist of certified radials that should be received at specific points on the airport surface, or over specific landmarks while airborne in the immediate vicinity of the airport.

4.5.1 Should an error in excess of plus or minus 4 degrees be indicated through use of a ground check, or plus or minus 6 degrees using the airborne check, IFR flight shall not be attempted without first correcting the source of the error.

CAUTION-

No correction other than the "correction card" figures supplied by the manufacturer should be applied in making these VOR receiver checks.

4.5.2 Locations of airborne check points, ground check points and VOTs are published in the A/FD.

4.5.3 If a dual system VOR (units independent of each other except for the antenna) is installed in the aircraft, one system may be checked against the other. Turn both systems to the same VOR ground facility and note the indicated bearing to that station. The maximum permissible variations between the two indicated bearings is 4 degrees.

5. Distance Measuring Equipment (DME)

5.1 In the operation of DME, paired pulses at a specific spacing are sent out from the aircraft (this is the interrogation) and are received at the ground station. The ground station (transponder) then transmits paired pulses back to the aircraft at the same pulse spacing but on a different frequency. The time required for the round trip of this signal exchange is measured in the airborne DME unit and is translated into distance (nautical miles (NM)) from the aircraft to the ground station.

5.2 Operating on the line-of-sight principle, DME furnishes distance information with a very high degree of accuracy. Reliable signals may be received at distances up to 199 NM at line-of-sight altitude with an accuracy of better than $\frac{1}{2}$ mile or 3% of the distance, whichever is greater. Distance information received from DME equipment is SLANT RANGE distance and not actual horizontal distance.

5.3 Operating frequency range of a DME according to ICAO Annex 10 is from 960 MHz to 1215 MHz. Aircraft equipped with TACAN equipment will receive distance information from a VORTAC automatically, while aircraft equipped with VOR must have a separate DME airborne unit.

5.4 VOR/DME, VORTAC, ILS/DME, and LOC/DME navigation facilities established by the FAA provide course and distance information from collocated components under a frequency pairing plan. Aircraft receiving equipment which provides for automatic DME selection assures reception of azimuth and distance information from a common source whenever designated VOR/DME, VORTAC, ILS/DME, and LOC/DME are selected.

5.5 Due to the limited number of available frequencies, assignment of paired frequencies is required for certain military noncollocated VOR and TACAN facilities which serve the same area but which may be separated by distances up to a few miles.

5.6 VOR/DME, VORTAC, ILS/DME, and LOC/DME facilities are identified by synchronized identifications which are transmitted on a time share basis. The VOR or localizer portion of the facility is identified by a coded tone modulated at 1020 Hz or by a combination of code and voice. The TACAN or DME is identified by a coded tone modulated at 1350 Hz. The DME or TACAN coded identification is transmitted one time for each three or four times that the VOR or localizer coded identification is transmitted. When either the VOR or the DME is inoperative, it is important to recognize which identifier is retained for the operative facility. A signal coded identification with a repetition interval of approximately 30 seconds indicates that the DME is operative.

5.7 Aircraft equipment which provides for automatic DME selection assures reception of azimuth and distance information from a common source whenever designated VOR/DME, VORTAC, and ILS/DME navigation facilities are selected. Pilots are cautioned to disregard any distance displays from automatically selected DME equipment when VOR or ILS facilities, which do not have the DME feature installed, are being used for position determination.

6. Tactical Air Navigation (TACAN)

6.1 For reasons peculiar to military or naval operations (unusual siting conditions, the pitching and rolling of a naval vessel, etc.) the civil VOR/DME system of air navigation was considered unsuitable for military or naval use. A new navigational system, Tactical Air Navigation (TACAN), was therefore developed by the military and naval forces to more readily lend itself to military and naval requirements. As a result, the FAA has integrated TACAN facilities with the civil VOR/DME program. Although the theoretical, or technical principles of operation of TACAN equipment are quite different from those of VOR/DME facilities, the end result, as far as the navigating pilot is concerned, is the same. These integrated facilities are called VORTACs.

6.2 TACAN ground equipment consists of either a fixed or mobile transmitting unit. The airborne unit in conjunction with the ground unit reduces the transmitted signal to a visual presentation of both azimuth and distance information. TACAN is a pulse system and operates in the UHF band of frequencies. Its use requires TACAN airborne equipment and does not operate through conventional VOR equipment.

6.3 A VORTAC is a facility consisting of two components, VOR and TACAN, which provides three individual services: VOR azimuth, TACAN azimuth, and TACAN distance (DME) at one site. Although consisting of more than one component, incorporating more than one operating frequency, and using more than one antenna system, a VORTAC is considered to be a unified navigational aid. Both components of a VORTAC are envisioned as operating simultaneously and providing the three services at all times.

6.4 Transmitted signals of VOR and TACAN are each identified by three-letter code transmission and are interlocked so that pilots using VOR azimuth and TACAN distance can be assured that both signals being received are definitely from the same ground station. The frequency channels of the VOR and the TACAN at each VORTAC facility are “paired” in accordance with a national plan to simplify airborne operation.

7. Instrument Landing System (ILS)

7.1 General

7.1.1 The ILS is designed to provide an approach path for exact alignment and descent of an aircraft on final approach to a runway.

7.1.2 The ground equipment consists of two highly directional transmitting systems and, along the approach, three (or fewer) marker beacons. The directional transmitters are known as the localizer and glide slope transmitters.

7.1.3 The system may be divided functionally into three parts:

7.1.3.1 Guidance information: localizer, glide slope.

7.1.3.2 Range information: marker beacon, DME.

7.1.3.3 Visual information: approach lights, touchdown and centerline lights, runway lights.

7.1.4 Precision radar, or compass locators located at the Outer Marker (OM) or Middle Marker (MM), may be substituted for marker beacons. DME, when specified in the procedure, may be substituted for the OM.

7.1.5 Where a complete ILS system is installed on each end of a runway (i.e., the approach end of runway 4 and the approach end of runway 22), the ILS systems are not in service simultaneously.

7.2 Localizer

7.2.1 The localizer transmitter, operates on one of 40 ILS channels within the frequency range of 108.10 MHz to 111.95 MHz. Signals provide the pilot with course guidance to the runway centerline.

7.2.2 The approach course of the localizer is called the front course and is used with other functional parts; e.g., glide slope, marker beacons, etc. The localizer signal is transmitted at the far end of the runway. It is adjusted for a course width (full scale fly-left to a full scale fly-right) of 700 feet at the runway threshold.

7.2.3 The course line along the extended centerline of a runway, in the opposite direction to the front course, is called the back course.

CAUTION-

Unless your aircraft's ILS equipment includes reverse sensing capability, when flying inbound on the back course it is necessary to steer the aircraft in the direction

opposite of the needle deflection on the airborne equipment when making corrections from off-course to on-course. This “flying away from the needle” is also required when flying outbound on the front course of the localizer. Do not use back course signals for approach unless a back course approach procedure is published for that particular runway and the approach is authorized by ATC.

7.2.4 Identification is in Morse Code and consists of a three-letter identifier preceded by the letter I () transmitted on the localizer frequency.

EXAMPLE-
I-DIA

7.2.5 The localizer provides course guidance throughout the descent path to the runway threshold from a distance of 18 NM from the antenna between an altitude of 1,000 feet above the highest terrain along the course line and 4,500 feet above the elevation of the antenna site. Proper off-course indications are provided throughout the following angular areas of the operational service volume:

7.2.5.1 To 10° either side of the course along a radius of 18 NM from the antenna.

7.2.5.2 From 10° to 35° either side of the course along a radius of 10 NM. (See FIG ENR 4.1-1.)

7.2.6 Unreliable signals may be received outside these areas.

FIG ENR 4.1-1
Limits of Localizer Coverage

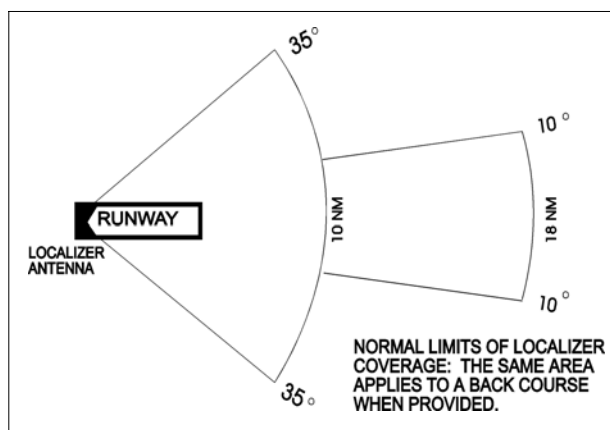

7.3 Localizer-Type Directional Aid

7.3.1 The localizer-type directional aid (LDA) is of comparable use and accuracy to a localizer but is not part of a complete ILS. The LDA course usually provides a more precise approach course than the similar Simplified Directional Facility (SDF) installation, which may have a course width of 6 degrees or 12 degrees.

7.3.2 The LDA is not aligned with the runway. Straight-in minimums may be published where alignment does not exceed 30 degrees between the course and runway. Circling minimums only are published where this alignment exceeds 30 degrees.

7.3.3 A very limited number of LDA approaches also incorporate a glideslope. These are annotated in the plan view of the instrument approach chart with a note, “LDA/Glideslope.” These procedures fall under a newly defined category of approaches called Approach with Vertical Guidance (APV) described in Section , paragraph 12., Instrument Approach Procedure Charts, subparagraph 12.1.7.2, Approach with Vertical Guidance (APV). LDA minima for with and without glideslope is provided and annotated on the minima lines of the approach chart as S-LDA/GS and S-LDA. Because the final approach course is not aligned with the runway centerline, additional maneuvering will be required compared to an ILS approach.

7.4 Glide Slope/Glide Path

7.4.1 The UHF glide slope transmitter, operating on one of the 40 ILS channels within the frequency range 329.15 MHz, to 335.00 MHz radiates its signals in the direction of the localizer front course.

CAUTION-

False glide slope signals may exist in the area of the localizer back course approach which can cause the glide slope flag alarm to disappear and present unreliable glide slope information. Disregard all glide slope signal indications when making a localizer back course approach unless a glide slope is specified on the approach and landing chart.

7.4.2 The glide slope transmitter is located between 750 and 1,250 feet from the approach end of the runway (down the runway) and offset 250–600 feet from the runway centerline. It transmits a glide path beam 1.4 degrees wide (vertically).

NOTE-

The term “glide path” means that portion of the glide slope that intersects the localizer.

7.4.3 The glide path projection angle is normally adjusted to 3 degrees above horizontal so that it intersects the middle marker at about 200 feet and the outer marker at about 1,400 feet above the runway elevation. The glide slope is normally usable to the distance of 10 NM. However, at some locations, the glide slope has been certified for an extended service volume which exceeds 10 NM.

7.4.4 Pilots must be alert when approaching glidepath interception. False courses and reverse sensing will occur at angles considerably greater than the published path.

7.4.5 Make every effort to remain on the indicated glide path. Exercise caution: avoid flying below the glide path to assure obstacle/terrain clearance is maintained.

REFERENCE–
14 CFR Section 91.129(e).

7.4.6 A glide slope facility provides descent information for navigation down to the lowest authorized decision height (DH) specified in the approved ILS approach procedure. The glidepath may not be suitable for navigation below the lowest authorized DH and any reference to glidepath indications below that height must be supplemented by visual reference to the runway environment. Glide slopes with no published DH are usable to runway threshold.

7.4.7 The published glide slope threshold crossing height (TCH) DOES NOT represent the height of the actual glide slope on course indication above the runway threshold. It is used as a reference for planning purposes which represents the height above the runway threshold that an aircraft's glide slope antenna should be, if that aircraft remains on a trajectory formed by the four-mile-to-middle marker glidepath segment.

7.4.8 Pilots must be aware of the vertical height between the aircraft's glide slope antenna and the main gear in the landing configuration and, at the DH, plan to adjust the descent angle accordingly if the published TCH indicates the wheel crossing height over the runway threshold may be satisfactory. Tests indicate a comfortable wheel crossing height is approximately 20 to 30 feet, depending on the type of aircraft.

NOTE–

The TCH for a runway is established based on several factors including the largest aircraft category that normally uses the runway, how airport layout effects the glide slope antenna placement, and terrain. A higher than optimum TCH, with the same glide path angle, may cause the aircraft to touch down further from the threshold if the trajectory of the approach is maintained until the flare. Pilots should consider the effect of a high TCH on the runway available for stopping the aircraft.

7.5 Distance Measuring Equipment (DME)

7.5.1 When installed with an ILS and specified in the approach procedure, DME may be used:

7.5.1.1 In lieu of the outer marker.

7.5.1.2 As a back course final approach fix.

7.5.1.3 To establish other fixes on the localizer course.

7.5.2 In some cases, DME from a separate facility may be used within Terminal Instrument Procedures (TERPS) limitations:

7.5.2.1 To provide ARC initial approach segments.

7.5.2.2 As a final approach fix for back course approaches.

7.5.2.3 As a substitute for the outer marker.

7.6 Marker Beacon

7.6.1 ILS marker beacons have a rated power output of 3 watts or less and an antenna array designed to produce an elliptical pattern with dimensions, at 1,000 feet above the antenna, of approximately 2,400 feet in width and 4,200 feet in length. Airborne marker beacon receivers with a selective sensitivity feature should always be operated in the "low" sensitivity position for proper reception of ILS marker beacons.

7.6.2 Ordinarily, there are two marker beacons associated with an ILS, the outer marker (OM) and the middle marker (MM). Locations with a Category II or III ILS also have an inner marker (IM). When an aircraft passes over a marker, the pilot will receive the following indications:

7.6.3 The OM normally indicates a position at which an aircraft at the appropriate altitude on the localizer course will intercept the ILS glide path.

7.6.4 The MM indicates a position approximately 3,500 feet from the landing threshold. This will also be the position where an aircraft on the glide path will be at an altitude of approximately 200 feet above the elevation of the touchdown zone.

7.6.5 The IM indicates a point at which an aircraft is at a designated decision height (DH) on the glide path between the middle marker and landing threshold.

7.6.6 A back course marker, normally indicates the ILS back course final approach fix where approach descent is commenced.

**TBL ENR 4.1-1
Marker Passage Indications**

Marker	Code	Light
OM	- - -	BLUE
MM	- -	AMBER
IM		WHITE
BC		WHITE

8. Compass Locator

8.1 Compass locator transmitters are often situated at the middle and outer marker sites. The transmitters have a power of less than 25 watts, a range of at least 15 miles, and operate between 190 and 535 kHz. At some locations, higher-powered radio beacons, up to 400 watts, are used as outer marker compass locators. These generally carry Transcribed Weather Broadcast (TWEB) information.

8.2 Compass locators transmit two-letter identification groups. The outer locator transmits the first two letters of the localizer identification group, and the middle locator transmits the last two letters of the localizer identification group.

9. ILS Frequency

9.1 The frequency pairs in TBL ENR 4.1-2 are allocated for ILS.

**TBL ENR 4.1-2
Frequency Pairs Allocated for ILS**

Localizer MHz	Glide Slope
108.10	334.70
108.15	334.55
108.3	334.10
108.35	333.95
108.5	329.90
108.55	329.75
108.7	330.50
108.75	330.35
108.9	329.30
108.95	329.15
109.1	331.40
109.15	331.25
109.3	332.00
109.35	331.85
109.50	332.60
109.55	332.45
109.70	333.20
109.75	333.05
109.90	333.80
109.95	333.65
110.1	334.40
110.15	334.25
110.3	335.00
110.35	334.85
110.5	329.60
110.55	329.45
110.70	330.20
110.75	330.05
110.90	330.80
110.95	330.65
111.10	331.70
111.15	331.55
111.30	332.30
111.35	332.15
111.50	332.9
111.55	332.75
111.70	333.5
111.75	333.35
111.90	331.1
111.95	330.95

10. ILS Minimums

10.1 The lowest authorized ILS minimums, with all required ground and airborne systems components operative, are:

10.1.1 Category I. Decision Height (DH) 200 feet and Runway Visual Range (RVR) 2,400 feet (with touchdown zone and centerline lighting, RVR 1,800 feet), or (with Autopilot or FD or HUD, RVR 1,800 feet);

10.1.2 Special Authorization Category I. DH 150 feet and Runway Visual Range (RVR) 1,400 feet, HUD to DH;

10.1.3 Category II. DH 100 feet and RVR 1,200 feet (with autoland or HUD to touchdown and noted on authorization, RVR 1,000 feet);

10.1.4 Special Authorization Category II with Reduced Lighting. DH 100 feet and RVR 1,200 feet with autoland or HUD to touchdown and noted on authorization, (touchdown zone, centerline lighting and ALSF-2 are not required);

10.1.5 Category IIIa. No DH or DH below 100 feet and RVR not less than 700 feet;

10.1.6 Category IIIb. No DH or DH below 50 feet and RVR less than 700 feet but not less than 150 feet; and

10.1.7 Category IIIc. No DH and no RVR limitation.

NOTE–

Special authorization and equipment are required for Category II and III.

11. Inoperative ILS Components

11.1 Inoperative Localizer. When the localizer fails, an ILS approach is not authorized.

11.2 Inoperative Glide Slope. When the glide slope fails, the ILS reverts to a nonprecision localizer approach.

REFERENCE–

See the Inoperative Component Table in the U.S. Government Terminal Procedures Publication (TPP) for adjustments to minimums due to inoperative airborne or ground system equipment.

12. ILS Course Distortion

12.1 All pilots should be aware that disturbance to ILS localizer/glide slope courses may occur when surface vehicles/aircraft are operated near the

localizer/glide slope antennas. Most ILS installations are subject to signal interference by either surface vehicles, aircraft, or both. ILS “CRITICAL AREAS” are established near each localizer and glide slope antenna.

12.2 Air traffic control issues control instructions to avoid interfering operations within ILS critical areas at controlled airports during the hours the airport traffic control tower is in operation as follows:

12.2.1 Weather Conditions. At or above 800 feet and/or visibility 2 miles.

12.2.1.1 No critical area protection action is provided.

12.2.1.2 If an aircraft advises the TOWER that an “AUTOLAND”/“COUPLED” approach will be conducted, an advisory will be promptly issued if a vehicle/aircraft will be in or over a critical area when the arriving aircraft is inside the ILS middle marker.

EXAMPLE–

Glide slope signal not protected.

12.2.2 Weather Conditions. Less than ceiling 800 feet and/or visibility 2 miles.

12.2.2.1 Glide Slope Critical Area. Vehicles/aircraft are not authorized in the area when an arriving aircraft is between the ILS final approach fix and the airport unless the aircraft has reported the airport in sight and is circling or side stepping to land on other than the ILS runway.

12.2.2.2 Localizer Critical Area. Except for aircraft that land, exit a runway, depart or miss approach, vehicles and aircraft are not authorized in or over the critical area when an arriving aircraft is between the ILS final approach fix and the airport. Additionally, when the ceiling is less than 200 feet and/or the visibility is RVR 2,000 or less, vehicle/aircraft operations in or over the area are not authorized when an arriving aircraft is inside the ILS middle marker.

12.3 Aircraft holding below 5000 feet between the outer marker and the airport may cause localizer signal variations for aircraft conducting the ILS approach. Accordingly, such holding is not authorized when weather or visibility conditions are less than ceiling 800 feet and/or visibility 2 miles.

12.4 Pilots are cautioned that vehicular traffic not subject to control by ATC may cause momentary deviation to ILS course/glide slope signals. Also, “critical areas” are not protected at uncontrolled

airports or at airports with an operating control tower when weather/visibility conditions are above those requiring protective measures. Aircraft conducting “coupled” or “autoland” operations should be especially alert in monitoring automatic flight control systems. (See FIG ENR 4.1-2.)

NOTE-
Unless otherwise coordinated through flight standards, ILS signals to Category 1 runways are not flight inspected below 100 feet AGL. Guidance signal anomalies may be encountered below this altitude.

FIG ENR 4.1-2
FAA Instrument Landing Systems

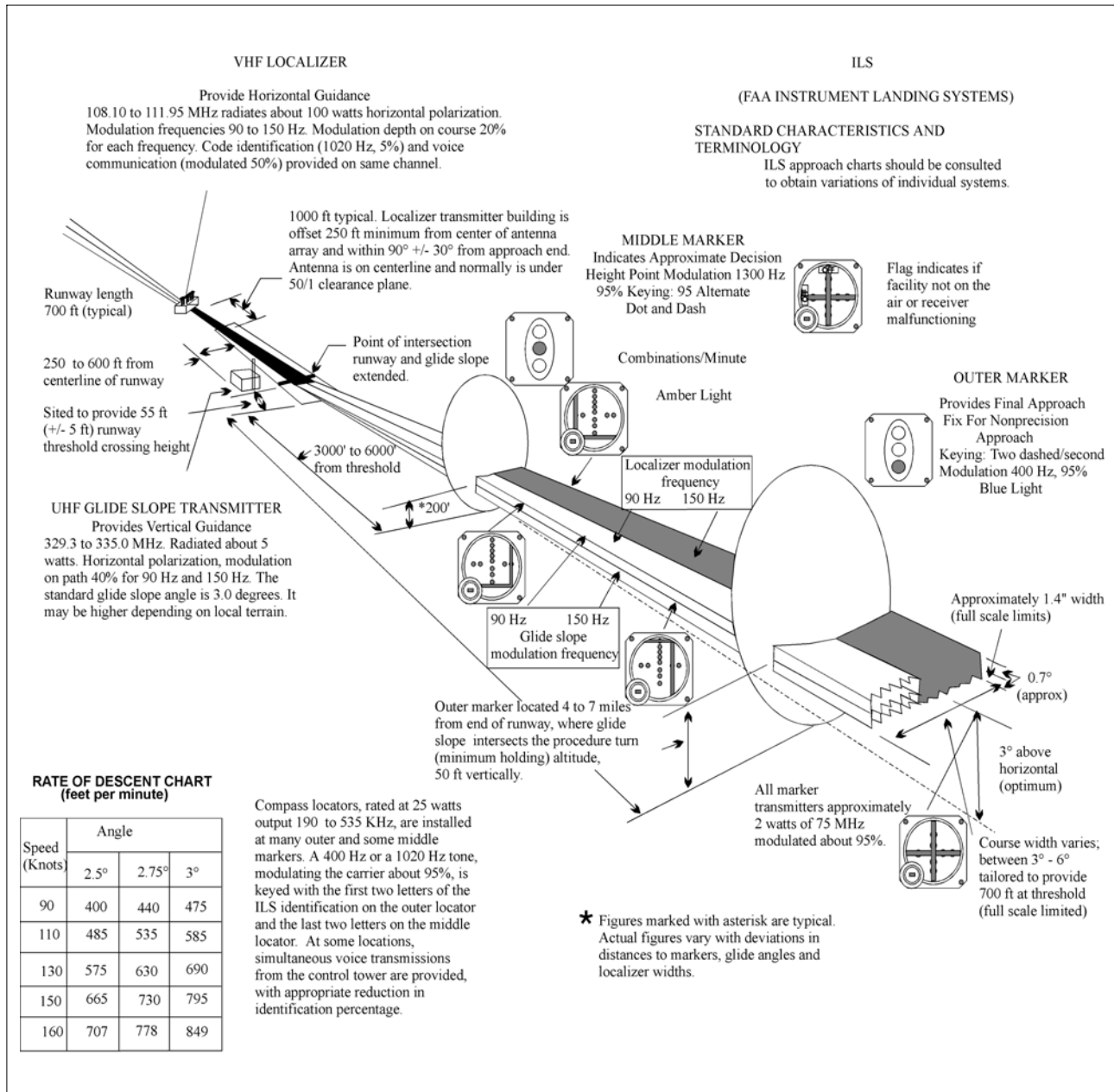

13. Continuous Power Facilities

13.1 In order to ensure that a basic ATC system remains in operation despite an area wide or catastrophic commercial power failure, key equipment and certain airports have been designated to provide a network of facilities whose operational capability can be utilized independent of any commercial power supply.

13.2 In addition to those facilities comprising the basic ATC system, the following approach and lighting aids have been included in this program for a selected runway:

13.2.1 ILS (Localizer, Glide Slope, Compass Locator, Inner, Middle and Outer Markers).

13.2.2 Wind Measuring Capability.

13.2.3 Approach Light System (ALS) or Short ALS (SALS).

13.2.4 Ceiling Measuring Capability.

13.2.5 Touchdown Zone Lighting (TDZL).

13.2.6 Centerline Lighting (CL).

13.2.7 Runway Visual Range (RVR).

13.2.8 High Intensity Runway Lighting (HIRL).

13.2.9 Taxiway Lighting.

13.2.10 Apron Light (Perimeter Only).

TBL ENR 4.1-3

Continuous Power Airports	
Airport/Ident	Runway No.
Albuquerque (ABQ)	08
Andrews AFB (ADW)	1L
Atlanta (ATL)	9R
Baltimore (BWI)	10
Bismarck (BIS)	31
Boise (BOI)	10R
Boston (BOS)	4R
Charlotte (CLT)	36L
Chicago (ORD)	14R
Cincinnati (CVG)	36
Cleveland (CLE)	5R
Dallas/Fort Worth (DFW)	17L
Denver (DEN)	35R
Des Moines (DSM)	30R

Continuous Power Airports	
Airport/Ident	Runway No.
Detroit (DTW)	3L
El Paso (ELP)	22
Great Falls (GTF)	03
Houston (IAH)	08
Indianapolis (IND)	4L
Jacksonville (JAX)	07
Kansas City (MCI)	19
Los Angeles (LAX)	24R
Memphis (MEM)	36L
Miami (MIA)	9L
Milwaukee (MKE)	01
Minneapolis (MSP)	29L
Nashville (BNA)	2L
Newark (EWR)	4R
New Orleans (MSY)	10
New York (JFK)	4R
New York (LGA)	22
Oklahoma City (OKC)	35R
Omaha (OMA)	14
Ontario, California (ONT)	26R
Philadelphia (PHL)	9R
Phoenix (PHX)	08R
Pittsburgh (PIT)	10L
Reno (RNO)	16
Salt Lake City (SLC)	34L
San Antonio (SAT)	12R
San Diego (SAN)	09
San Francisco (SFO)	28R
Seattle (SEA)	16R
St. Louis (STL)	24
Tampa (TPA)	36L
Tulsa (TUL)	35R
Washington (DCA)	36
Washington (IAD)	1R
Wichita (ICT)	01

13.3 The above have been designated “Continuous Power Airports,” and have independent back up capability for the equipment installed.

NOTE-

The existing CPA runway is listed. Pending and future changes at some locations will require a revised runway designation.

14. Simplified Directional Facility (SDF)

14.1 The SDF provides a final approach course similar to that of the ILS localizer. It does not provide glide slope information. A clear understanding of the ILS localizer and the additional factors listed below completely describe the operational characteristics and use of the SDF.

14.2 The SDF transmits signals within the range of 108.10 to 111.95 MHz.

14.3 The approach techniques and procedures used in an SDF instrument approach are essentially the same as those employed in executing a standard no-glide-slope localizer approach except the SDF course may not be aligned with the runway and the course may be wider, resulting in less precision.

14.4 Usable off-course indications are limited to 35 degrees either side of the course centerline. Instrument indications received beyond 35 degrees should be disregarded.

14.5 The SDF antenna may be offset from the runway centerline. Because of this, the angle of convergence between the final approach course and the runway bearing should be determined by reference to the instrument approach procedure chart. This angle is generally not more than 3 degrees. However, it should be noted that inasmuch as the approach course originates at the antenna site, an approach which is continued beyond the runway threshold will lead the aircraft to the SDF offset position rather than along the runway centerline.

14.6 The SDF signal is fixed at either 6 degrees or 12 degrees as necessary to provide maximum “fly ability” and optimum course quality.

14.7 Identification consists of a three-letter identifier transmitted in Morse Code on the SDF frequency. The appropriate instrument approach chart will indicate the identifier used at a particular airport.

15. Microwave Landing System (MLS)

15.1 General

15.1.1 The MLS provides precision navigation guidance for exact alignment and descent of aircraft on approach to a runway. It provides azimuth, elevation, and distance information. The elevation transmitter is located to the side of the runway near

the approach threshold. The precision DME, which provides range information, is normally collocated with the azimuth transmitter.

15.1.2 Both lateral and vertical guidance may be displayed on conventional course deviation indicators or incorporated into multipurpose cockpit displays. Range information can be displayed by conventional DME indicators and also incorporated into multipurpose displays.

15.1.3 The MLS supplements the ILS as the standard landing system in the U.S. for civil, military, and international civil aviation. At international airports, ILS service is protected to 2010.

15.1.4 The system may be divided into five functions:

15.1.4.1 Approach azimuth.

15.1.4.2 Back azimuth.

15.1.4.3 Approach elevation.

15.1.4.4 Range.

15.1.4.5 Data communications.

15.1.5 The standard configuration of MLS ground equipment includes:

15.1.5.1 An azimuth station to perform functions 15.1.4.1 and 15.1.4.5 above. In addition to providing azimuth navigation guidance, the azimuth station also transmits basic data which consists of information associated directly with the operation of the landing system, as well as advisory data on the performance of the ground equipment.

15.1.5.2 An elevation station to perform function 15.1.4.3.

15.1.5.3 Distance Measuring Equipment (DME) to perform function 15.1.4.4. The DME provides range guidance, both standard (DME/N) and precision DME (DME/P).

15.1.6 MLS Expansion Capabilities. The standard configuration can be expanded by adding one or more of the following functions or characteristics.

15.1.6.1 Back Azimuth. Provides lateral guidance for missed approach and departure navigation.

15.1.6.2 Auxiliary Data Transmissions. Provides additional data, including refined airborne positioning, meteorological information, runway status, and other supplementary information.

15.1.6.3 Expanded Service Volume (ESV). Provides proportional guidance to 60 degrees.

15.1.7 MLS identification is a four-letter designation starting with the letter M. It is transmitted in Morse Code at least six times per minute by the approach azimuth (and back azimuth) ground equipment.

15.2 Approach Azimuth Guidance

15.2.1 The azimuth station transmits MLS angle and data on one of the 200 channels within the frequency range of 5031 to 5091 MHz.

15.2.2 The equipment is normally located about 1,000 feet beyond the stop end of the runway, but there is considerable flexibility in selecting sites. For example, for heliport operations the azimuth transmitter can be collocated with the elevation transmitter.

15.2.3 The azimuth coverage extends: (See FIG ENR 4.1-3.)

FIG ENR 4.1-3
Coverage Volume
Azimuth

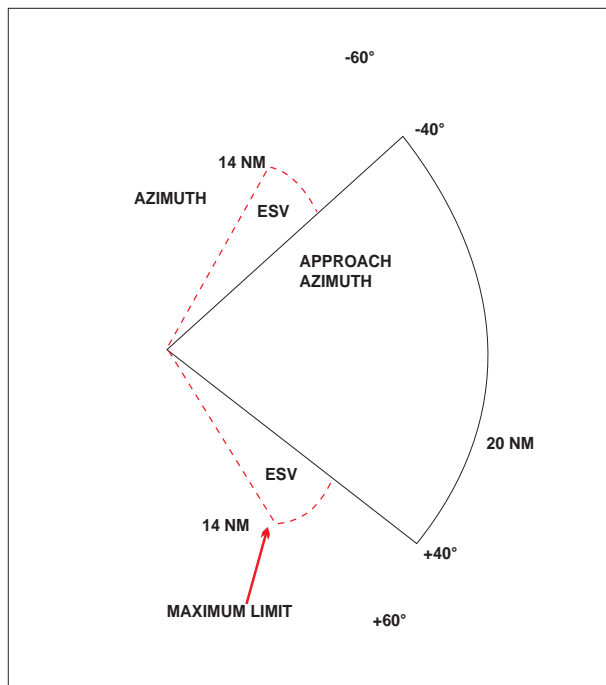

15.2.3.1 Laterally, at least 40 degrees on either side of the runway centerline in a standard configuration.

15.2.3.2 In elevation, up to an angle of 15 degrees – and to at least 20,000 feet.

15.2.3.3 In range, to at least 20 NM.

15.3 Elevation Guidance

15.3.1 The elevation station transmits signals on the same frequency as the azimuth station. A single frequency is time-shared between all angle and data functions.

15.3.2 The elevation transmitter is normally located about 400 feet from the side of the runway between runway threshold and the touchdown zone.

15.3.3 Elevation coverage is provided in the same airspace as the azimuth guidance signals:

15.3.3.1 In elevation, to at least +15 degrees.

15.3.3.2 Laterally, to fill the azimuth lateral coverage.

15.3.3.3 In range, to at least 20 NM. (See FIG ENR 4.1-4.)

FIG ENR 4.1-4
Coverage Volumes
Elevation

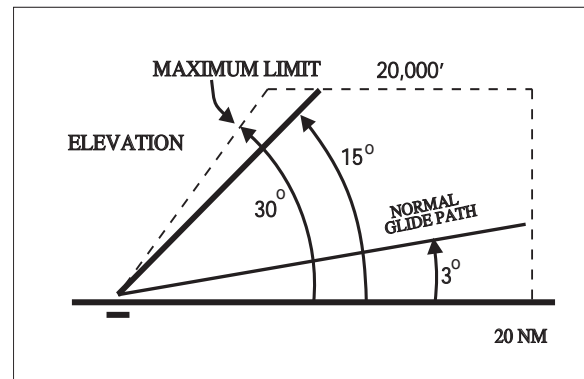

15.4 Range Guidance

15.4.1 The MLS Precision Distance Measuring Equipment (DME/P) functions the same as the navigation DME, but with some technical differences. The beacon transponder operates in the frequency band 962 to 1105 MHz and responds to an aircraft interrogator. The MLS DME/P accuracy is improved to be consistent with the accuracy provided by the MLS azimuth and elevation stations.

15.4.2 A DME/P channel is paired with the azimuth and elevation channel. A complete listing of the 200 paired channels of the DME/P with the angle functions is contained in FAA Standard 022 (MLS Interoperability and Performance Requirements).

15.4.3 The DME/N or DME/P is an integral part of the MLS and is installed at all MLS facilities unless a waiver is obtained. This occurs infrequently and only at outlying, low density airports where marker beacons or compass locators are already in place.

15.5 Data Communications

15.5.1 The data transmission can include both the basic and auxiliary data words. All MLS facilities transmit basic data. Where needed, auxiliary data can be transmitted.

15.5.2 Coverage Limits. MLS data are transmitted throughout the azimuth (and back azimuth when provided) coverage sectors.

15.5.3 Basic Data Content. Representative data include:

15.5.3.1 Station identification.

15.5.3.2 Exact locations of azimuth, elevation and DME/P stations (for MLS receiver processing functions).

15.5.3.3 Ground equipment performance level.

15.5.3.4 DME/P channel and status.

15.5.4 Auxiliary Data Content. Representative data include:

15.5.4.1 3-D locations of MLS equipment.

15.5.4.2 Waypoint coordinates.

15.5.4.3 Runway conditions.

15.5.4.4 Weather (e.g., RVR, ceiling, altimeter setting, wind, wake vortex, wind shear).

15.6 Operational Flexibility. The MLS has the capability to fulfill a variety of needs in the approach, landing, missed approach, and departure phases of flight. For example:

15.6.1 Curved and segmented approaches.

15.6.2 Selectable glide path angles.

15.6.3 Accurate 3-D positioning of the aircraft in space.

15.6.4 The establishment of boundaries to ensure clearance from obstructions in the terminal area.

15.7 While many of these capabilities are available to any MLS-equipped aircraft, the more sophisti-

cated capabilities (such as curved and segmented approaches) are dependent upon the particular capabilities of the airborne equipment.

15.8 Summary

15.8.1 Accuracy. The MLS provides precision, three-dimensional navigation guidance accurate enough for all approach and landing maneuvers.

15.8.2 Coverage. Accuracy is consistent throughout the coverage volumes shown in FIG ENR 4.1-5.

FIG ENR 4.1-5
Coverage Volumes
3-D Representation

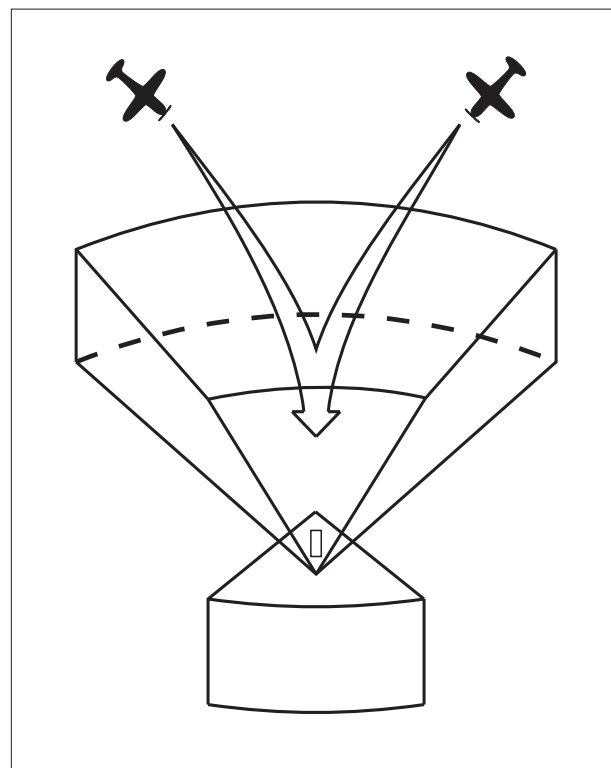

15.8.3 Environment. The system has low susceptibility to interference from weather conditions and airport ground traffic.

15.8.4 Channels. MLS has 200 channels – enough for any foreseeable need.

15.8.5 Data. The MLS transmits ground-air data messages associated with system operation.

15.8.6 Range Information. Continuous range information is provided with an accuracy of about 100 feet.

16. LORAN

16.1 Introduction

NOTE-

In accordance with the 2010 DHS Appropriations Act, the U.S. Coast Guard (USCG) terminated the transmission of all U.S. LORAN-C signals on 08 Feb 2010. The USCG also terminated the transmission of the Russian American signals on 01 Aug 2010, and the Canadian LORAN-C signals on 03 Aug 2010. For more information, visit <http://www.navcen.uscg.gov>. Operators should also note that TSO-C60b, AIRBORNE AREA NAVIGATION EQUIPMENT USING LORAN-C INPUTS, has been canceled by the FAA.

16.1.1 The LONg RANge Navigation-C (LORAN) system is a hyperbolic, terrestrial-based navigation system operating in the 90–110 kHz frequency band. LORAN, operated by the U.S. Coast Guard (USCG), has been in service for over 50 years and is used for navigation by the various transportation modes, as well as, for precise time and frequency applications. The system is configured to provide reliable, all weather navigation for marine users along the U.S. coasts and in the Great Lakes.

16.1.2 In the 1980's, responding to aviation user and industry requests, the USCG and FAA expanded LORAN coverage to include the entire continental U.S. This work was completed in late 1990, but the

LORAN system failed to gain significant user acceptance and primarily due to transmitter and user equipment performance limitations, attempts to obtain FAA certification of nonprecision approach capable receivers were unsuccessful. More recently, concern regarding the vulnerability of Global Positioning System (GPS) and the consequences of losing GPS on the critical U.S. infrastructure (e.g., NAS) has renewed and refocused attention on LORAN.

16.1.3 LORAN is also supported in the Canadian airspace system. Currently, LORAN receivers are only certified for en route navigation.

16.1.4 Additional information can be found in the "LORAN-C User Handbook," COMDT PUBP 16562.6, or the website:

<http://www.navcen.uscg.gov>.

16.2 LORAN Chain

16.2.1 The locations of the U.S. and Canadian LORAN transmitters and monitor sites are illustrated in FIG ENR 4.1-6. Station operations are organized into subgroups of four to six stations called "chains." One station in the chain is designated the "Master" and the others are "secondary" stations. The resulting chain based coverage is seen in FIG ENR 4.1-7.

FIG ENR 4.1-6
U.S. and Canadian LORAN System Architecture

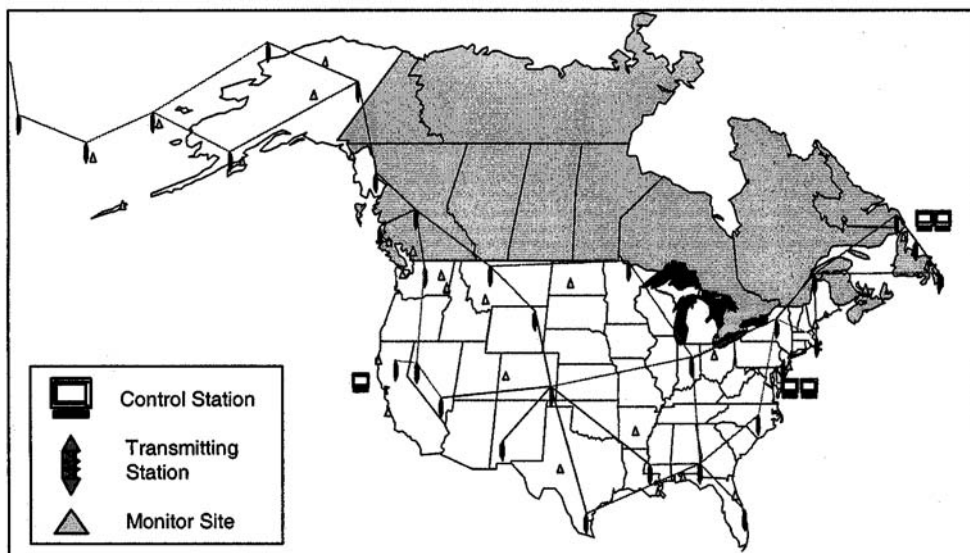
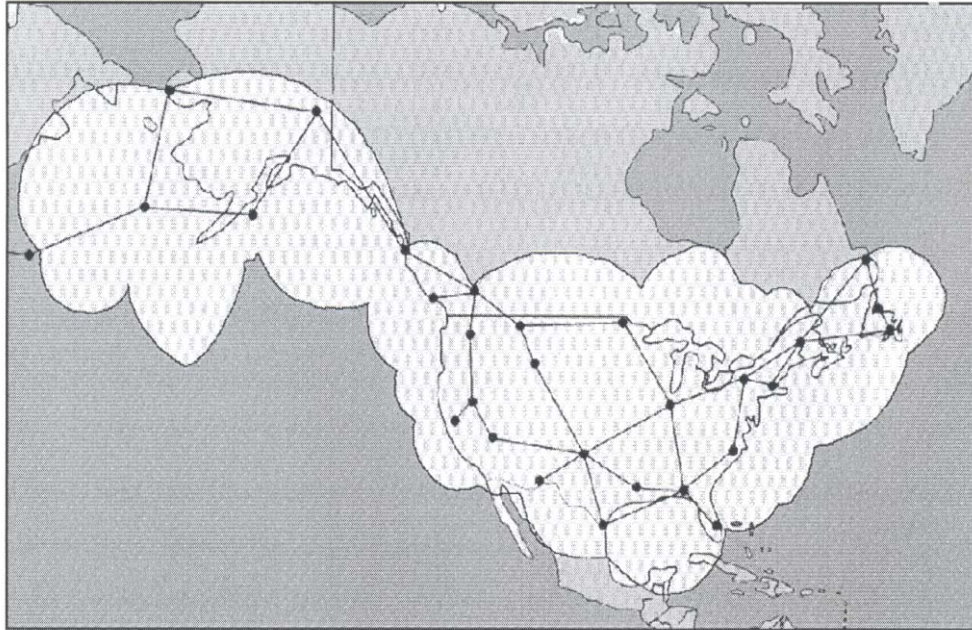

FIG ENR 4.1-7
LORAN Chain Based Coverage



16.2.2 The LORAN navigation signal is a carefully structured sequence of brief radio frequency pulses centered at 100 kHz. The sequence of signal transmissions consists of a pulse group from the Master (M) station followed at precise time intervals by groups from the secondary stations, which are designated by the U.S. Coast Guard with the letters V, W, X, Y and Z. All secondary stations radiate pulses in groups of eight, but for identification the Master signal has an additional ninth pulse. (See FIG ENR 4.1-8.) The timing of the LORAN system is tightly controlled and synchronized to Coordinated Universal Time (UTC). Like the GPS, this is a Stratum 1 timing standard.

16.2.3 The time interval between the reoccurrence of the Master pulse group is called the Group Repetition Interval (GRI). The GRI is the same for all stations in a chain and each LORAN chain has a unique GRI. Since all stations in a particular chain operate on the same radio frequency, the GRI is the key by which a LORAN receiver can identify and isolate signal groups from a specific chain.

EXAMPLE-

Transmitters in the Northeast U.S. chain (FIG ENR 4.1-9) operate with a GRI of 99,600 microseconds which is

shortened to 9960 for convenience. The master station (M) at Seneca, New York, controls secondary stations (W) at Caribou, Maine; (X) at Nantucket, Massachusetts; (Y) at Carolina Beach, North Carolina, and (Z) at Dana, Indiana. In order to keep chain operations precise, monitor receivers are located at Cape Elizabeth, ME; Sandy Hook, NJ; Dunbar Forest, MI, and Plumbrook, OH. Monitor receivers continuously measure various aspects of the quality (e.g., pulse shape) and accuracy (e.g., timing) of LORAN signals and report system status to a control station.

16.2.4 The line between the Master and each secondary station is the “baseline” for a pair of stations. Typical baselines are from 600 to 1000 nautical miles in length. The continuation of the baseline in either direction is a “baseline extension.”

16.2.5 At the LORAN transmitter stations there are cesium oscillators, transmitter time and control equipment, a transmitter, primary power (e.g., commercial or generator) and auxiliary power equipment (e.g., uninterruptible power supplies and generators), and a transmitting antenna (configurations may either have 1 or 4 towers) with the tower heights ranging from 700 to 1350 feet tall. Depending on the coverage area requirements a LORAN station transmits from 400 to 1,600 kilowatts of peak signal power.

16.2.6 The USCG operates the LORAN transmitter stations under a reduced staffing structure that is made possible by the remote control and monitoring of the critical station and signal parameters. The actual control of the transmitting station is accomplished remotely at Coast Guard Navigation Center (NAVCEN) located in Alexandria, Virginia. East Coast and Midwest stations are controlled by the NAVCEN. Stations on the West Coast and in Alaska are controlled by the NAVCEN Detachment (Det), located in Petaluma, California. In the event of a problem at one of these two 24 hour-a-day staffed sites, monitoring and control of the entire LORAN system can be done at either location. If both NACEN and NAVCEN Det are down or if there is an equipment problem at a specific station, local station personnel are available to operate and perform repairs at each LORAN station.

16.2.7 The transmitted signal is also monitored in the service areas (i.e., area of published LORAN coverage) and its status provided to NAVCEN and NAVCEN Det. The System Area Monitor (SAM) is a single site used to observe the transmitted signal

(signal strength, time difference, and pulse shape). If an out-of-tolerance situation that could affect navigation accuracy is detected, an alert signal called “Blink” is activated. Blink is a distinctive change in the group of eight pulses that can be recognized automatically by a receiver so the user is notified instantly that the LORAN system should not be used for navigation. Out-of-tolerance situations which only the local station can detect are also monitored. These situations when detected cause signal transmissions from a station to be halted.

16.2.8 Each individual LORAN chain provides navigation-quality signal coverage over an identified area as shown in FIG ENR 4.1–10 for the West Coast chain, GRI 9940. The chain Master station is at Fallon, Nevada, and secondary stations are at George, Washington; Middletown, California, and Searchlight, Nevada. In a signal coverage area the signal strength relative to the normal ambient radio noise must be adequate to assure successful reception. Similar coverage area charts are available for all chains.

FIG ENR 4.1-8
The LORAN Pulse and Pulse Group

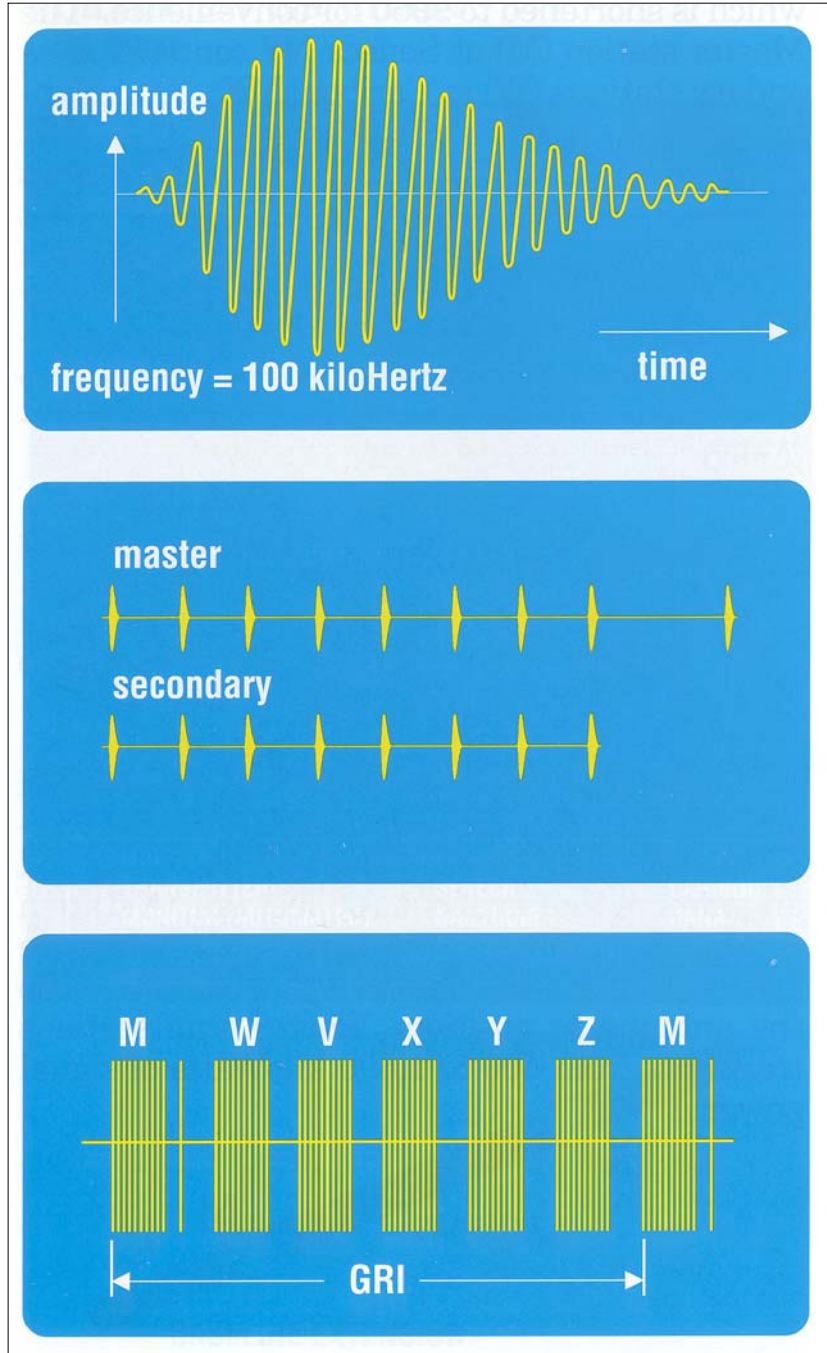

FIG ENR 4.1-9
Northeast U.S. LORAN Chain

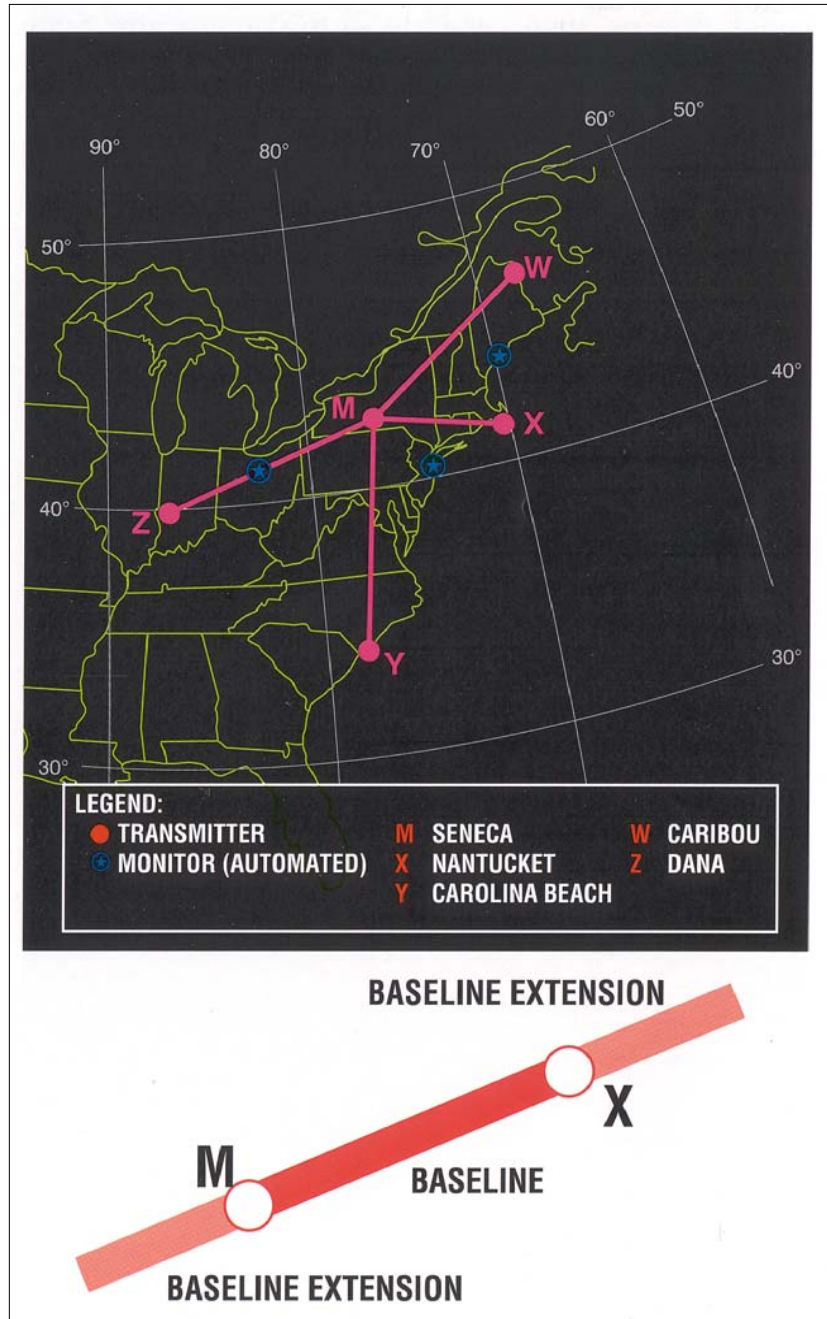
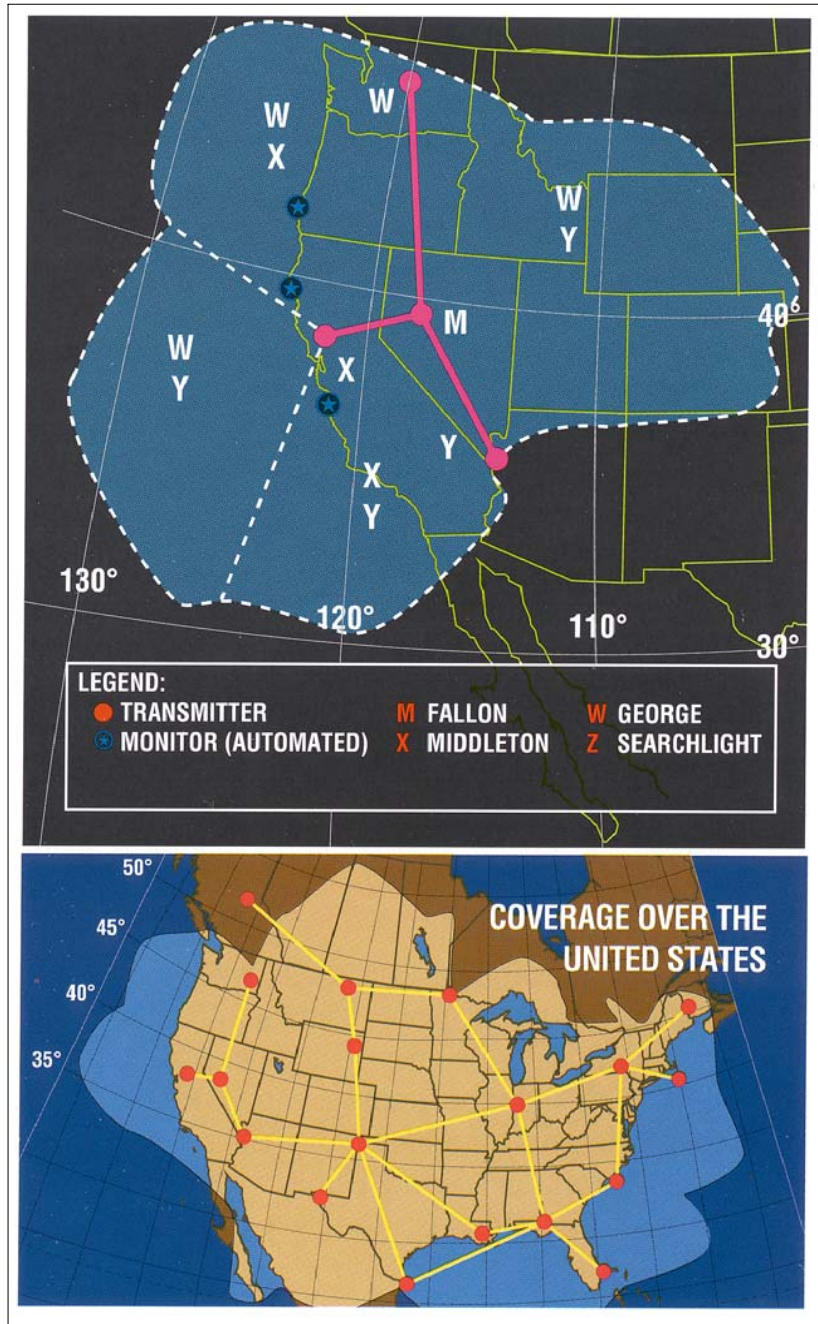

FIG ENR 4.1-10
West Coast U.S. LORAN Chain



16.3 The LORAN Receiver

16.3.1 For a currently certified LORAN aviation receiver to provide navigation information for a pilot, it must successfully receive, or “acquire,” signals from three or more stations in a chain. Acquisition involves the time synchronization of the receiver with the chain GRI, identification of the Master station signals from among those checked, identification of secondary station signals, and the proper selection of the tracking point on each signal at which measurements are made. However, a new generation of receivers has been developed that use pulses from all stations that can be received at the pilot’s location. Use of “all-in-view” stations by a receiver is made possible due to the synchronization of LORAN stations signals to UTC. This new generation of receivers, along with improvements at the transmitting stations and changes in system policy and operations doctrine may allow for LORAN’s use in nonprecision approaches. At this time these receivers are available for purchase, but none have been certified for aviation use.

16.3.2 The basic measurements made by certified LORAN receivers are the differences in time-of-arrival between the Master signal and the signals from each of the secondary stations of a chain. Each “time difference” (TD) value is measured to a precision of about 0.1 microseconds. As a rule of thumb, 0.1 microsecond is equal to about 100 feet.

16.3.3 An aircraft’s LORAN receiver must recognize three signal conditions:

16.3.3.1 Usable signals;

16.3.3.2 Absence of signals, and

16.3.3.3 Signal blink.

16.3.4 The most critical phase of flight is during the approach to landing at an airport. During the approach phase the receiver must detect a lost signal, or a signal Blink, within 10 seconds of the occurrence and warn the pilot of the event. At this time there are no receivers that are certified for nonprecision approaches.

16.3.5 Most certified receivers have various internal tests for estimating the probable accuracy of the current TD values and consequent navigation solutions. Tests may include verification of the timing alignment of the receiver clock with the LORAN pulse, or a continuous measurement of the signal-to-noise ratio (SNR). SNR is the relative strength of the LORAN signals compared to the local ambient noise level. If any of the tests fail, or if the quantities measured are out of the limits set for reliable navigation, then an alarm will be activated to alert the pilot.

16.3.6 LORAN signals operate in the low frequency band (90–110 kHz) that has been reserved for marine navigation signals. Adjacent to the band, however, are numerous low frequency communications transmitters. Nearby signals can distort the LORAN signals and must be eliminated by the receiver to assure proper operation. To eliminate interfering signals, LORAN receivers have selective internal filters. These filters, commonly known as “notch filters,” reduce the effect of interfering signals.

16.3.7 Careful installation of antennas, good metal-to-metal electrical bonding, and provisions for precipitation noise discharge on the aircraft are essential for the successful operation of LORAN receivers. A LORAN antenna should be installed on an aircraft in accordance with the manufacturer’s instructions. Corroded bonding straps should be replaced, and static discharge devices installed at points indicated by the aircraft manufacturer.

16.4 LORAN Navigation

16.4.1 An airborne LORAN receiver has four major parts:

16.4.1.1 Signal processor;

16.4.1.2 Navigation computer;

16.4.1.3 Control/display, and

16.4.1.4 Antenna.

16.4.2 The signal processor acquires LORAN signals and measures the difference between the time-of-arrival of each secondary station pulse group and the Master station pulse group. The measured TDs depend on the location of the receiver in relation to the three or more transmitters.

FIG ENR 4.1-11
First Line-of-Position

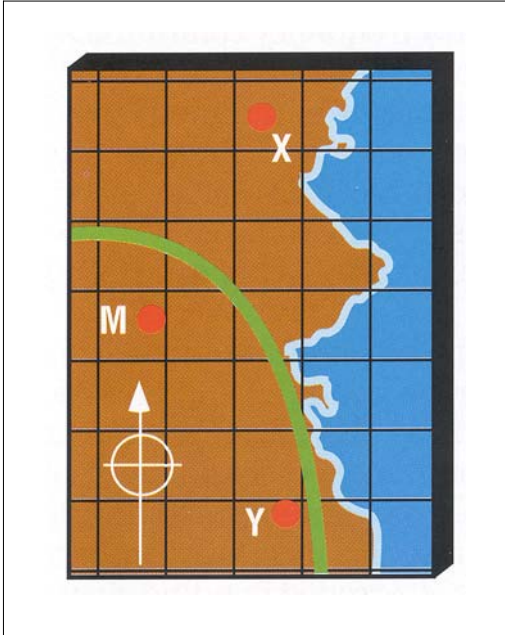

16.4.2.1 The first TD will locate an aircraft somewhere on a line-of-position (LOP) on which the receiver will measure the same TD value.

16.4.2.2 A second LOP is defined by a TD measurement between the Master station signal and the signal form another secondary station.

FIG ENR 4.1-12
Second Line-of-Position

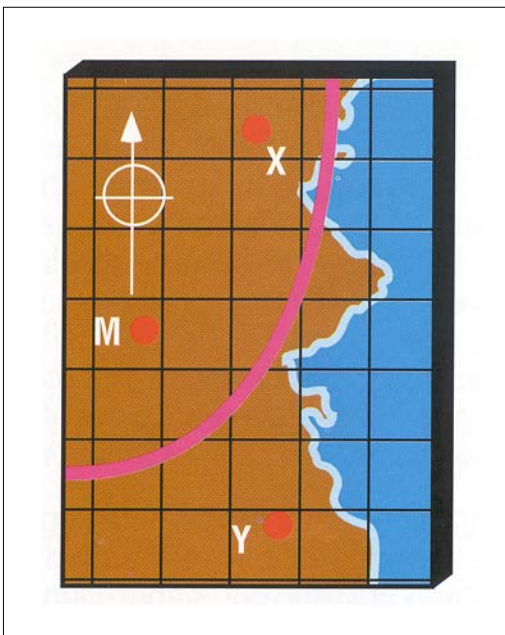

16.4.2.3 The intersection of the measured LOPs is the position of the aircraft.

FIG ENR 4.1-13
Intersection of Lines-of-Position

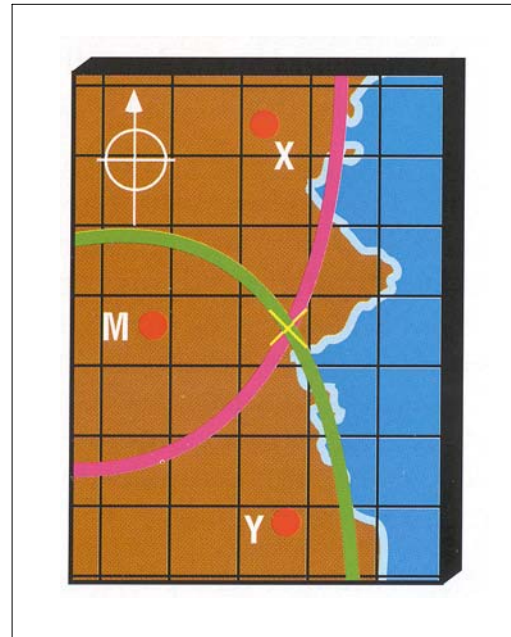

16.4.3 The navigation computer converts TD values to corresponding latitude and longitude. Once the time and position of the aircraft are established at two points, distance to destination, cross track error, ground speed, estimated time of arrival, etc., can be determined. Cross track error can be displayed as the vertical needle of a course deviation indicator, or digitally, as decimal parts of a mile left or right of course.

16.5 Notices to Airmen (NOTAMs) are issued for LORAN chain or station outages. Domestic NOTAM (D)s are issued under the identifier "LRN." International NOTAMs are issued under the KNMH series. Pilots may obtain these NOTAMs from FSS briefers upon request.

16.6 LORAN Status Information. To find out more information on the LORAN system and its operational status you can visit the website <http://www.navcen.uscg.gov/loran/default.htm> or contact NAVCEN's Navigation Information Service (NIS) watchstander, phone (703) 313-5900, fax (703) 313-5920.

NOTE-

In accordance with the 2010 DHS Appropriations Act, the U.S. Coast Guard (USCG) terminated the transmission of all U.S. LORAN-C signals on 08 Feb 2010. The USCG also

terminated the transmission of the Russian American signals on 01 Aug 2010, and the Canadian LORAN-C signals on 03 Aug 2010. For more information, visit <http://www.navcen.uscg.gov>. Operators should also note that TSO-C60b, AIRBORNE AREA NAVIGATION EQUIPMENT USING LORAN-C INPUTS, has been canceled by the FAA.

16.7 LORAN's future. The U.S. will continue to operate the LORAN system in the short term. During this time, the FAA LORAN evaluation program, being conducted with the support of a team comprising government, academia, and industry, will identify and assess LORAN's potential contributions to required navigation services for the National Airspace System (NAS), and support decisions regarding continued operation of the system. If the government concludes LORAN should not be kept as part of the mix of federally provided radio navigation systems, it will give the users of LORAN reasonable notice so that they will have the opportunity to transition to alternative navigation aids.

17. Inertial Reference Unit (IRU), Inertial Navigation System (INS), and Attitude Heading Reference System (AHRS)

17.1 IRUs are self-contained systems comprised of gyros and accelerometers that provide aircraft attitude (pitch, roll, and heading), position, and velocity information in response to signals resulting from inertial effects on system components. Once aligned with a known position, IRUs continuously calculate position and velocity. IRU position accuracy decays with time. This degradation is known as "drift."

17.2 INSs combine the components of an IRU with an internal navigation computer. By programming a series of waypoints, these systems will navigate along a predetermined track.

17.3 AHRSs are electronic devices that provide attitude information to aircraft systems such as weather radar and autopilot, but do not directly compute position information.

18. Global Positioning System (GPS)

18.1 System Overview

18.1.1 System Description. The Global Positioning System is a satellite-based radio navigation system, which broadcasts a signal that is used by receivers to

determine precise position anywhere in the world. The receiver tracks multiple satellites and determines a pseudorange measurement that is then used to determine the user location. A minimum of four satellites is necessary to establish an accurate three-dimensional position. The Department of Defense (DOD) is responsible for operating the GPS satellite constellation and monitors the GPS satellites to ensure proper operation. Every satellite's orbital parameters (ephemeris data) are sent to each satellite for broadcast as part of the data message embedded in the GPS signal. The GPS coordinate system is the Cartesian earth-centered earth-fixed coordinates as specified in the World Geodetic System 1984 (WGS-84).

18.1.2 System Availability and Reliability

18.1.2.1 The status of GPS satellites is broadcast as part of the data message transmitted by the GPS satellites. GPS status information is also available by means of the U.S. Coast Guard navigation information service: (703) 313-5907, Internet: <http://www.navcen.uscg.gov/>. Additionally, satellite status is available through the Notice to Airmen (NOTAM) system.

18.1.2.2 The operational status of GNSS operations depends upon the type of equipment being used. For GPS-only equipment TSO-C129a, the operational status of nonprecision approach capability for flight planning purposes is provided through a prediction program that is embedded in the receiver or provided separately.

18.1.3 Receiver Autonomous Integrity Monitoring (RAIM). When GNSS equipment is not using integrity information from WAAS or LAAS, the GPS navigation receiver using RAIM provides GPS signal integrity monitoring. RAIM is necessary since delays of up to two hours can occur before an erroneous satellite transmission can be detected and corrected by the satellite control segment. The RAIM function is also referred to as fault detection. Another capability, fault exclusion, refers to the ability of the receiver to exclude a failed satellite from the position solution and is provided by some GPS receivers and by WAAS receivers.

18.1.4 The GPS receiver verifies the integrity (usability) of the signals received from the GPS constellation through receiver autonomous integrity monitoring (RAIM) to determine if a satellite is providing corrupted information. At least 4 satellites

are required to obtain a navigation solution. At least 5 satellites (or 4 satellites and a barometric altimeter for baro-aiding) are required for RAIM. This is also known as fault detection (FD). An enhanced form of integrity, known as Fault Detection and Exclusion (FDE), uses a minimum of 6 satellites (or 5 satellites with baro-aiding) to not only detect a possible faulty satellite, but to exclude it from the navigation solution in order for the navigation function to continue without interruption.

NOTE–

Baro-aiding satisfies the RAIM requirement by substituting for one of the satellites. Baro-aiding is a method of augmenting the GPS integrity solution by using the barometric altimeter (a non-satellite input source).

NOTE–

The current altimeter setting must be entered into the receiver as described in the operating manual to ensure baro-aiding is available.

NOTE–

GPS derived altitude should not be relied upon to determine aircraft altitude since the vertical error can be quite large and no integrity is provided.

18.1.5 RAIM messages vary somewhat between receivers; however, generally there are two types. One type indicates that there are not enough satellites available to provide RAIM integrity monitoring and another type indicates that the RAIM integrity monitor has detected a potential error that exceeds the limit for the current phase of flight. Without RAIM capability, the pilot has no assurance of the accuracy of the GPS position.

18.1.6 Selective Availability. Selective Availability (SA) is a method by which the accuracy of GPS is intentionally degraded. This feature is designed to deny hostile use of precise GPS positioning data. SA was discontinued on May 1, 2000, but many GPS receivers are designed to assume that SA is still active. New receivers may take advantage of the discontinuance of SA based on the performance values in ICAO Annex 10, and do not need to be designed to operate outside of that performance.

18.1.7 The GPS constellation of 24 satellites is designed so that a minimum of five is always observable by a user anywhere on earth. The receiver uses data from a minimum of four satellites above the mask angle (the lowest angle above the horizon at which it can use a satellite).

18.1.8 The DOD declared initial operational capability (IOC) of the U.S. GPS on December 8, 1993. The FAA has granted approval for U.S. civil operators to use properly certified GPS equipment as a primary means of navigation in oceanic airspace and certain remote areas. Properly certified GPS equipment may be used as a supplemental means of IFR navigation for domestic en route, terminal operations, and certain instrument approach procedures (IAPs). This approval permits the use of GPS in a manner that is consistent with current navigation requirements as well as approved air carrier operations specifications.

18.2 VFR Use of GPS

18.2.1 GPS navigation has become a great asset to VFR pilots, providing increased navigation capability and enhanced situational awareness, while reducing operating costs due to greater ease in flying direct routes. While GPS has many benefits to the VFR pilot, care must be exercised to ensure that system capabilities are not exceeded.

18.2.2 Types of receivers used for GPS navigation under VFR are varied, from a full IFR installation being used to support a VFR flight, to a VFR only installation (in either a VFR or IFR capable aircraft) to a hand-held receiver. The limitations of each type of receiver installation or use must be understood by the pilot to avoid misusing navigation information. (See TBL ENR 4.1–5.) In all cases, VFR pilots should never rely solely on one system of navigation. GPS navigation must be integrated with other forms of electronic navigation (when possible), as well as pilotage and dead reckoning. Only through the integration of these techniques can the VFR pilot ensure accuracy in navigation.

18.2.3 Some critical concerns in VFR use of GPS include RAIM capability, database currency, and antenna location.

18.2.3.1 RAIM Capability. Many VFR GPS receivers and all hand-held units have no RAIM alerting capability. Loss of the required number of satellites in view, or the detection of a position error, cannot be displayed to the pilot by such receivers. In receivers with no RAIM capability, no alert would be provided to the pilot that the navigation solution had deteriorated, and an undetected navigation error could occur. A systematic cross-check with other navigation techniques would identify this failure, and

prevent a serious deviation. See subparagraphs 18.1.6 and 18.1.7 for more information on RAIM.

18.2.3.2 Database Currency

a) In many receivers, an updateable database is used for navigation fixes, airports, and instrument procedures. These databases must be maintained to the current update for IFR operation, but no such requirement exists for VFR use.

b) However, in many cases, the database drives a moving map display which indicates Special Use Airspace and the various classes of airspace, in addition to other operational information. Without a current database the moving map display may be outdated and offer erroneous information to VFR pilots wishing to fly around critical airspace areas, such as a Restricted Area or a Class B airspace segment. Numerous pilots have ventured into airspace they were trying to avoid by using an outdated database. If you don't have a current database in the receiver, disregard the moving map display for critical navigation decisions.

c) In addition, waypoints are added, removed, relocated, or renamed as required to meet operational needs. When using GPS to navigate relative to a named fix, a current database must be used to properly locate a named waypoint. Without the update, it is the pilot's responsibility to verify the waypoint location referencing to an official current source, such as the Airport/Facility Directory, Sectional Chart, or En Route Chart.

18.2.3.3 Antenna Location

a) In many VFR installations of GPS receivers, antenna location is more a matter of convenience than performance. In IFR installations, care is exercised to ensure that an adequate clear view is provided for the antenna to see satellites. If an alternate location is used, some portion of the aircraft may block the view of the antenna, causing a greater opportunity to lose navigation signal.

b) This is especially true in the case of hand-helds. The use of hand-held receivers for VFR operations is a growing trend, especially among rental pilots. Typically, suction cups are used to place the GPS antennas on the inside of cockpit windows. While this method has great utility, the antenna location is limited to the cockpit or cabin only and is rarely optimized to provide a clear view of available

satellites. Consequently, signal losses may occur in certain situations of aircraft–satellite geometry, causing a loss of navigation signal. These losses, coupled with a lack of RAIM capability, could present erroneous position and navigation information with no warning to the pilot.

c) While the use of a hand-held GPS for VFR operations is not limited by regulation, modification of the aircraft, such as installing a panel- or yoke-mounted holder, is governed by 14 CFR Part 43. Consult with your mechanic to ensure compliance with the regulation, and a safe installation.

18.2.4 As a result of these and other concerns, here are some tips for using GPS for VFR operations:

18.2.4.1 Always check to see if your unit has RAIM capability. If no RAIM capability exists, be suspicious of your GPS position when any disagreement exists with the position derived from other radio navigation systems, pilotage, or dead reckoning.

18.2.4.2 Check the currency of the database, if any. If expired, update the database using the current revision. If an update of an expired database is not possible, disregard any moving map display of airspace for critical navigation decisions. Be aware that named waypoints may no longer exist or may have been relocated since the database expired. At a minimum, the waypoints planned to be used should be checked against a current official source, such as the Airport/Facility Directory, or a Sectional Aeronautical Chart.

18.2.4.3 While hand-helds can provide excellent navigation capability to VFR pilots, be prepared for intermittent loss of navigation signal, possibly with no RAIM warning to the pilot. If mounting the receiver in the aircraft, be sure to comply with 14 CFR Part 43.

18.2.4.4 Plan flights carefully before taking off. If you wish to navigate to user-defined waypoints, enter them before flight, not on-the-fly. Verify your planned flight against a current source, such as a current sectional chart. There have been cases in which one pilot used waypoints created by another pilot that were not where the pilot flying was expecting. This generally resulted in a navigation error. Minimize head-down time in the aircraft and keep a sharp lookout for traffic, terrain, and obstacles.

Just a few minutes of preparation and planning on the ground will make a great difference in the air.

18.2.4.5 Another way to minimize head-down time is to become very familiar with your receiver's operation. Most receivers are not intuitive. The pilot must take the time to learn the various keystrokes, knob functions, and displays that are used in the operation of the receiver. Some manufacturers provide computer-based tutorials or simulations of their receivers. Take the time to learn about your particular unit before you try to use it in flight.

18.2.5 In summary, be careful not to rely on GPS to solve all your VFR navigational problems. Unless an IFR receiver is installed in accordance with IFR requirements, no standard of accuracy or integrity has been assured. While the practicality of GPS is compelling, the fact remains that only the pilot can navigate the aircraft, and GPS is just one of the pilot's tools to do the job.

18.3 VFR Waypoints

18.3.1 VFR waypoints provide VFR pilots with a supplementary tool to assist with position awareness while navigating visually in aircraft equipped with area navigation receivers. VFR waypoints should be used as a tool to supplement current navigation procedures. The uses of VFR waypoints include providing navigational aids for pilots unfamiliar with an area, waypoint definition of existing reporting points, enhanced navigation in and around Class B and Class C airspace, and enhanced navigation around Special Use Airspace. VFR pilots should rely on appropriate and current aeronautical charts published specifically for visual navigation. If operating in a terminal area, pilots should take advantage of the Terminal Area Chart available for that area, if published. The use of VFR waypoints does not relieve the pilot of any responsibility to comply with the operational requirements of 14 CFR Part 91.

18.3.2 VFR waypoint names (for computer-entry and flight plans) consist of five letters beginning with the letters "VP" and are retrievable from navigation databases. The VFR waypoint names are not intended to be pronounceable, and they are not for use in ATC communications. On VFR charts, stand-alone VFR waypoints will be portrayed using the same four-point star symbol used for IFR waypoints. VFR

waypoints collocated with visual check points on the chart will be identified by small magenta flag symbols. VFR waypoints collocated with visual check points will be pronounceable based on the name of the visual check point and may be used for ATC communications. Each VFR waypoint name will appear in parentheses adjacent to the geographic location on the chart. Latitude/longitude data for all established VFR waypoints may be found in the appropriate regional Airport/Facility Directory (A/FD).

18.3.3 VFR waypoints shall not be used to plan flights under IFR. VFR waypoints will not be recognized by the IFR system and will be rejected for IFR routing purposes.

18.3.4 When filing VFR flight plans, pilots may use the five letter identifier as a waypoint in the route of flight section if there is an intended course change at that point or if used to describe the planned route of flight. This VFR filing would be similar to how a VOR would be used in a route of flight. Pilots must use the VFR waypoints only when operating under VFR conditions.

18.3.5 Any VFR waypoints intended for use during a flight should be loaded into the receiver while on the ground and prior to departure. Once airborne, pilots should avoid programming routes or VFR waypoint chains into their receivers.

18.3.6 Pilots should be especially vigilant for other traffic while operating near VFR waypoints. The same effort to see and avoid other aircraft near VFR waypoints will be necessary, as was the case with VORs and NDBs in the past. In fact, the increased accuracy of navigation through the use of GPS will demand even greater vigilance, as off-course deviations among different pilots and receivers will be less. When operating near a VFR waypoint, use whatever ATC services are available, even if outside a class of airspace where communications are required. Regardless of the class of airspace, monitor the available ATC frequency closely for information on other aircraft operating in the vicinity. It is also a good idea to turn on your landing light(s) when operating near a VFR waypoint to make your aircraft more conspicuous to other pilots, especially when visibility is reduced. See paragraph 2., VFR in Congested Areas, in , for more information.

18.4 General Requirements

18.4.1 Authorization to conduct any GPS operation under IFR requires that:

18.4.1.1 GPS navigation equipment used must be approved in accordance with the requirements specified in TSO–C–129, or equivalent, and the installation must be done in accordance with Notice 8110.47 or 8110.48, or equivalent. Equipment approved in accordance with TSO–C–115a does not meet the requirements of TSO–C–129. VFR and hand-held GPS systems are not authorized for IFR navigation, instrument approaches, or as a principal instrument flight reference. During IFR operations they may be considered only an aid to situational awareness.

18.4.1.2 Aircraft using GPS navigation equipment under IFR must be equipped with an approved and operational alternate means of navigation appropriate to the flight. Active monitoring of alternative navigation equipment is not required if the GPS receiver uses RAIM for integrity monitoring. Active monitoring of an alternate means of navigation is required when the RAIM capability of the GPS equipment is lost.

18.4.1.3 Procedures must be established for use in the event that the loss of RAIM capability is predicted to occur. In situations where this is encountered, the flight must rely on other approved equipment, delay departure, or cancel the flight.

18.4.1.4 The GPS operation must be conducted in accordance with the FAA-approved aircraft flight manual (AFM) or flight manual supplement. Flight crew members must be thoroughly familiar with the particular GPS equipment installed in the aircraft, the receiver operation manual, and the AFM or flight manual supplement. Unlike ILS and VOR, the basic operation, receiver presentation to the pilot, and some capabilities of the equipment can vary greatly. Due to these differences, operation of different brands, or even models of the same brand, of GPS receiver under IFR should not be attempted without thorough study of the operation of that particular receiver and installation. Most receivers have a built-in simulator mode which will allow the pilot to become familiar with operation prior to attempting operation in the aircraft. Using the equipment in flight under VFR conditions prior to attempting IFR operation will allow further familiarization.

18.4.1.5 Aircraft navigating by IFR approved GPS are considered to be RNAV aircraft and have special equipment suffixes. File the appropriate equipment suffix in accordance with TBL ENR 4.1–4, on the ATC flight plan. If GPS avionics become inoperative, the pilot should advise ATC and amend the equipment suffix.

18.4.1.6 Prior to any GPS IFR operation, the pilot must review appropriate NOTAMs and aeronautical information. (See GPS NOTAMs/Aeronautical Information.)

18.4.1.7 Air carrier and commercial operators must meet the appropriate provisions of their approved operations specifications.

18.5 Use of GPS for IFR Oceanic, Domestic En Route, and Terminal Area Operations

18.5.1 GPS IFR operations in oceanic areas can be conducted as soon as the proper avionics systems are installed, provided all general requirements are met. A GPS installation with TSO–C–129 authorization in class A1, A2, B1, B2, C1, or C2 may be used to replace one of the other approved means of long-range navigation, such as dual INS. (See TBL ENR 4.1–4 and TBL ENR 4.1–5.) A single GPS installation with these classes of equipment which provide RAIM for integrity monitoring may also be used on short oceanic routes which have only required one means of long-range navigation.

18.5.2 GPS domestic en route and terminal IFR operations can be conducted as soon as proper avionics systems are installed, provided all general requirements are met. The avionics necessary to receive all of the ground-based facilities appropriate for the route to the destination airport and any required alternate airport must be installed and operational. Ground-based facilities necessary for these routes must also be operational.

18.5.2.1 GPS en route IFR RNAV operations may be conducted in Alaska outside the operational service volume of ground-based navigation aids when a TSO–C145a or TSO–C146a GPS/WAAS system is installed and operating. Ground-based navigation equipment is not required to be installed and operating for en route IFR RNAV operations when using GPS WAAS navigation systems. All operators should ensure that an alternate means of navigation is available in the unlikely event the GPS WAAS navigation system becomes inoperative.

**TBL ENR 4.1-4
GPS IFR Equipment Classes/Categories**

TSO-C129						
Equipment Class	RAIM	Int. Nav Sys. to Prov. RAIM Equiv.	Oceanic	En Route	Terminal	Nonprecision Approach Capable
Class A – GPS sensor and navigation capability.						
A1	yes		yes	yes	yes	yes
A2	yes		yes	yes	yes	no
Class B – GPS sensor data to an integrated navigation system (i.e. FMS, multi-sensor navigation system, etc.).						
B1	yes		yes	yes	yes	yes
B2	yes		yes	yes	yes	no
B3		yes	yes	yes	yes	yes
B4		yes	yes	yes	yes	no
Class C – GPS sensor data to an integrated navigation system (as in Class B) which provides enhanced guidance to an autopilot, or flight director, to reduce flight tech. errors. Limited to 14 CFR Part 121 or equivalent criteria.						
C1	yes		yes	yes	yes	yes
C2	yes		yes	yes	yes	no
C3		yes	yes	yes	yes	yes
C4		yes	yes	yes	yes	no

**TBL ENR 4.1-5
GPS Approval Required/Authorized Use**

Equipment Type ¹	Installation Approval Required	Operational Approval Required	IFR En Route ²	IFR Terminal ²	IFR Approach ³	Oceanic Remote	In Lieu of ADF and/or DME ³
Hand held ⁴	X ⁵						
VFR Panel Mount ⁴	X						
IFR En Route and Terminal	X	X	X	X			X
IFR Oceanic/Remote	X	X	X	X		X	X
IFR En Route, Terminal, and Approach	X	X	X	X	X		X

NOTE-

¹To determine equipment approvals and limitations, refer to the AFM, AFM supplements, or pilot guides.

²Requires verification of data for correctness if database is expired.

³Requires current database or verification that the procedure has not been amended since the expiration of the database.

⁴VFR and hand-held GPS systems are not authorized for IFR navigation, instrument approaches, or as a primary instrument flight reference. During IFR operations they may be considered only an aid to situational awareness.

⁵Hand-held receivers require no approval. However, any aircraft modification to support the hand-held receiver; i.e., installation of an external antenna or a permanent mounting bracket, does require approval.

18.5.3 The GPS Approach Overlay Program is an authorization for pilots to use GPS avionics under IFR for flying designated nonprecision instrument approach procedures, except LOC, LDA, and simplified directional facility (SDF) procedures. These procedures are now identified by the name of the procedure and “or GPS” (e.g., VOR/DME or GPS RWY 15). Other previous types of overlays have either been converted to this format or replaced with stand-alone procedures. Only approaches contained in the current onboard navigation database are authorized. The navigation database may contain information about nonoverlay approach procedures that is intended to be used to enhance position orientation, generally by providing a map, while flying these approaches using conventional NAV-AIDs. This approach information should not be confused with a GPS overlay approach (see the receiver operating manual, AFM, or AFM Supplement for details on how to identify these approaches in the navigation database).

NOTE–

Overlay approaches are predicated upon the design criteria of the ground-based NAVAID used as the basis of the approach. As such, they do not adhere to the design criteria described in Section ENR 1.5, paragraph 12.11, Area Navigation (RNAV) Instrument Approach Charts, for stand-alone GPS approaches.

18.5.4 GPS IFR approach operations can be conducted as soon as proper avionics systems are installed and the following requirements are met:

18.5.4.1 The authorization to use GPS to fly instrument approaches is limited to U.S. airspace.

18.5.4.2 The use of GPS in any other airspace must be expressly authorized by the FAA Administrator.

18.5.4.3 GPS instrument approach operations outside the U.S. must be authorized by the appropriate sovereign authority.

18.6 Equipment and Database Requirements

18.6.1 Authorization to fly approaches under IFR using GPS avionics systems requires that:

18.6.1.1 A pilot use GPS avionics with TSO–C–129, or equivalent, authorization in class A1, B1, B3, C1, or C3.

18.6.1.2 All approach procedures to be flown must be retrievable from the current airborne navigation database supplied by the TSO–C–129 equipment manufacturer or other FAA approved source. The system must be able to retrieve the procedure by name from the aircraft navigation database, not just as a manually entered series of waypoints.

18.6.1.3 Prior to using a procedure or waypoint retrieved from the airborne navigation database, the pilot should verify the validity of the database. This verification should include the following preflight and in-flight steps:

a) Preflight:

1) Determine the date of database issuance, and verify that the date/time of proposed use is before the expiration date/time.

2) Verify that the database provider has not published a notice limiting the use of the specific waypoint or procedure.

b) Inflight:

1) Determine that the waypoints and transition names coincide with names found on the procedure chart. Do not use waypoints, which do not exactly match the spelling shown on published procedure charts.

2) Determine that the waypoints are generally logical in location, in the correct order, and that their orientation to each other is as found on the procedure chart, both laterally and vertically.

NOTE–

There is no specific requirement to check each waypoint latitude and longitude, type of waypoint and/or altitude constraint, only the general relationship of waypoints in the procedure, or the logic of an individual waypoint's location.

3) If the cursory check of procedure logic or individual waypoint location, specified in 2) above, indicates a potential error, do not use the retrieved procedure or waypoint until a verification of latitude and longitude, waypoint type, and altitude constraints indicate full conformity with the published data.

18.7 GPS Approach Procedures

18.7.1 As the production of stand-alone GPS approaches has progressed, many of the original overlay approaches have been replaced with stand-alone procedures specifically designed for use by GPS systems. The title of the remaining GPS overlay procedures has been revised on the approach chart to “or GPS” (e.g., VOR or GPS RWY 24). Therefore, all the approaches that can be used by GPS now contain “GPS” in the title (e.g., “VOR or GPS RWY 24,” “GPS RWY 24,” or “RNAV (GPS) RWY 24”). During these GPS approaches, underlying ground-based NAVAIDs are not required to be operational and associated aircraft avionics need not be installed, operational, turned on or monitored (monitoring of the underlying approach is suggested when equipment is available and functional). Existing overlay approaches may be requested using the GPS title, such as “GPS RWY 24” for the VOR or GPS RWY 24.

NOTE–

Any required alternate airport must have an approved instrument approach procedure other than GPS that is anticipated to be operational and available at the estimated time of arrival, and which the aircraft is equipped to fly.

18.8 GPS NOTAMs/Aeronautical Information

18.8.1 GPS satellite outages are issued as GPS NOTAMs both domestically and internationally. However, the effect of an outage on the intended operation cannot be determined unless the pilot has a RAIM availability prediction program which allows excluding a satellite which is predicted to be out of service based on the NOTAM information.

18.8.2 The term UNRELIABLE is used in conjunction with GPS NOTAMs. The term UNRELIABLE is an advisory to pilots indicating the expected level of service may not be available. GPS operation may be NOTAMed UNRELIABLE due to testing or anomalies. Air Traffic Control will advise pilots requesting a GPS or RNAV (GPS) approach of GPS UNRELIABLE for:

18.8.2.1 NOTAMs not contained in the ATIS broadcast.

18.8.2.2 Pilot reports of GPS anomalies received within the preceding 15 minutes.

18.8.3 Civilian pilots may obtain GPS RAIM availability information for nonprecision approach procedures by specifically requesting GPS aeronautical information from an Automated Flight Service Station during preflight briefings. GPS RAIM aeronautical information can be obtained for a period of 3 hours (for example, if you are scheduled to arrive at 1215 hours, then the GPS RAIM information is available from 1100 to 1400 hours) or a 24 hour time frame at a particular airport. FAA briefers will provide RAIM information for a period of 1 hour before to 1 hour after the ETA hour, unless a specific time frame is requested by the pilot. If flying a published GPS departure, a RAIM prediction should also be requested for the departure airport.

18.8.4 The military provides airfield specific GPS RAIM NOTAMs for nonprecision approach procedures at military airfields. The RAIM outages are issued as M-series NOTAMs and may be obtained for up to 24 hours from the time of request.

18.8.5 Receiver manufacturers and/or database suppliers may supply “NOTAM” type information concerning database errors. Pilots should check these sources, when available, to ensure that they have the most current information concerning their electronic database.

18.9 Receiver Autonomous Integrity Monitoring (RAIM)

18.9.1 RAIM outages may occur due to an insufficient number of satellites or due to unsuitable satellite geometry which causes the error in the position solution to become too large. Loss of satellite reception and RAIM warnings may occur due to aircraft dynamics (changes in pitch or bank angle). Antenna location on the aircraft, satellite position relative to the horizon, and aircraft attitude may affect reception of one or more satellites. Since the relative positions of the satellites are constantly changing, prior experience with the airport does not guarantee reception at all times, and RAIM availability should always be checked.

18.9.2 If RAIM is not available, another type of navigation and approach system must be used, another destination selected, or the trip delayed until RAIM is predicted to be available on arrival. On longer flights, pilots should consider rechecking the RAIM prediction for the destination during the flight.

This may provide early indications that an unscheduled satellite outage has occurred since takeoff.

18.9.3 If a RAIM failure/status annunciation occurs prior to the final approach waypoint (FAWP), the approach should not be completed since GPS may no longer provide the required accuracy. The receiver performs a RAIM prediction by 2 NM prior to the FAWP to ensure that RAIM is available at the FAWP as a condition for entering the approach mode. **The pilot should ensure that the receiver has sequenced from “Armed” to “Approach” prior to the FAWP** (normally occurs 2 NM prior). Failure to sequence may be an indication of the detection of a satellite anomaly, failure to arm the receiver (if required), or other problems which preclude completing the approach.

18.9.4 If the receiver does not sequence into the approach mode or a RAIM failure/status annunciation occurs prior to the FAWP, the pilot should not descend to MDA, but should proceed to the missed approach waypoint (MAWP) via the FAWP, perform a missed approach, and contact ATC as soon as practical. Refer to the receiver operating manual for specific indications and instructions associated with loss of RAIM prior to the FAF.

18.9.5 If a RAIM failure occurs after the FAWP, the receiver is allowed to continue operating without an annunciation for up to 5 minutes to allow completion of the approach (see receiver operating manual). **If the RAIM flag/status annunciation appears after the FAWP, the missed approach should be executed immediately.**

18.10 Waypoints

18.10.1 GPS approaches make use of both fly-over and fly-by waypoints. Fly-by waypoints are used when an aircraft should begin a turn to the next course prior to reaching the waypoint separating the two route segments. This is known as turn anticipation and is compensated for in the airspace and terrain clearances. Approach waypoints, except for the MAWP and the missed approach holding waypoint (MAHWP), are normally fly-by waypoints. Fly-over waypoints are used when the aircraft must fly over the point prior to starting a turn. New approach charts depict fly-over waypoints as a circled waypoint symbol. Overlay approach charts

and some early stand alone GPS approach charts may not reflect this convention.

18.10.2 Since GPS receivers are basically “To-To” navigators, they must always be navigating to a defined point. On overlay approaches, if no pronounceable five-character name is published for an approach waypoint or fix, it was given a database identifier consisting of letters and numbers. These points will appear in the list of waypoints in the approach procedure database, but may not appear on the approach chart. A point used for the purpose of defining the navigation track for an airborne computer system (i.e., GPS or FMS) is called a Computer Navigation Fix (CNF). CNFs include unnamed DME fixes, beginning and ending points of DME arcs, and sensor final approach fixes (FAFs) on some GPS overlay approaches. To aid in the approach chart/database correlation process, the FAA has begun a program to assign five-letter names to CNFs and to chart CNFs on various FAA aeronautical products. These CNFs are not to be used for any air traffic control (ATC) application, such as holding for which the fix has not already been assessed. CNFs will be charted to distinguish them from conventional reporting points, fixes, intersections, and waypoints. The CNF name will be enclosed in parenthesis; e.g., (MABEE), and the name will be placed next to the CNF it defines. If the CNF is not at an existing point defined by means such as crossing radials or radial/DME, the point will be indicated by an “X.” The CNF name will not be used in filing a flight plan or in aircraft/ATC communications. Use current phraseology; e.g., facility name, radial, distance, to describe these fixes.

18.10.3 Unnamed waypoints in the database will be uniquely identified for each airport but may be repeated for another airport (e.g., RW36 will be used at each airport with a runway 36 but will be at the same location for all approaches at a given airport).

18.10.4 The runway threshold waypoint, which is normally the MAWP, may have a five letter identifier (e.g., SNEEZ) or be coded as RW## (e.g., RW36, RW36L). Those thresholds which are coded as five letter identifiers are being changed to the RW## designation. This may cause the approach chart and database to differ until all changes are complete. The runway threshold waypoint is also used as the center of the MSA on most GPS approaches. MAWPs not located at the threshold will have a five letter identifier.

18.11 Position Orientation

18.11.1 As with most RNAV systems, pilots should pay particular attention to position orientation while using GPS. Distance and track information are provided to the next active waypoint, not to a fixed navigation aid. Receivers may sequence when the pilot is not flying along an active route, such as when being vectored or deviating for weather, due to the proximity to another waypoint in the route. This can be prevented by placing the receiver in the nonsequencing mode. When the receiver is in the nonsequencing mode, bearing and distance are provided to the selected waypoint, and the receiver will not sequence to the next waypoint in the route until placed back in the auto sequence mode or the pilot selects a different waypoint. On overlay approaches, the pilot may have to compute the along track distance to stepdown fixes and other points due to the receiver showing along track distance to the next waypoint rather than DME to the VOR or ILS ground station.

18.12 Conventional Versus GPS Navigation Data

18.12.1 There may be slight differences between the course information portrayed on navigational charts and a GPS navigation display when flying authorized GPS instrument procedures or along an airway. All magnetic tracks defined by any conventional navigation aids are determined by the application of the station magnetic variation. In contrast, GPS RNAV systems may use an algorithm, which applies the local magnetic variation and may produce small differences in the displayed course. However, both methods of navigation should produce the same desired ground track when using approved, IFR navigation system. Should significant differences between the approach chart and the GPS avionics' application of the navigation database arise, the published approach chart, supplemented by NOTAMS, holds precedence.

18.12.2 Due to the GPS avionics' computation of great circle courses, and the variations in magnetic variation, the bearing to the next waypoint and the course from the last waypoint (if available) may not be exactly 180° apart when long distances are involved. Variations in distances will occur since GPS distance-to-waypoint values are along-track distances (ATD) computed to the next waypoint and the DME values published on underlying procedures are slant-range distances measured to the station.

This difference increases with aircraft altitude and proximity to the NAVAID

18.13 Departures and Instrument Departure Procedures (DPs)

18.13.1 The GPS receiver must be set to terminal (± 1 NM) course deviation indicator (CDI) sensitivity and the navigation routes contained in the database in order to fly published IFR charted departures and DPs. Terminal RAIM should be automatically provided by the receiver. (Terminal RAIM for departure may not be available unless the waypoints are part of the active flight plan rather than proceeding direct to the first destination.) Certain segments of a DP may require some manual intervention by the pilot, especially when radar vectored to a course or required to intercept a specific course to a waypoint. The database may not contain all of the transitions or departures from all runways and some GPS receivers do not contain DPs in the database. It is necessary that helicopter procedures be flown at 70 knots or less since helicopter departure procedures and missed approaches use a 20:1 obstacle clearance surface (OCS), which is double the fixed-wing OCS, and turning areas are based on this speed as well.

18.14 Flying GPS Approaches

18.14.1 Determining which area of the TAA the aircraft will enter when flying a "T" with a TAA must be accomplished using the bearing and distance to the IF(IAF). This is most critical when entering the TAA in the vicinity of the extended runway centerline and determining whether you will be entering the right or left base area. Once inside the TAA, all sectors and stepdowns are based on the bearing and distance to the IAF for that area, which the aircraft should be proceeding direct to at that time, unless on vectors. (See FIG ENR 1.5–17 and FIG ENR 1.5–18.)

18.14.2 Pilots should fly the full approach from an Initial Approach Waypoint (IAWP) or feeder fix unless specifically cleared otherwise. Randomly joining an approach at an intermediate fix does not assure terrain clearance.

18.14.3 When an approach has been loaded in the flight plan, GPS receivers will give an "arm" annunciation 30 NM straight line distance from the airport/heliport reference point. Pilots should arm the approach mode at this time, if it has not already been armed (some receivers arm automatically). Without arming, the receiver will not change from en route

CDI and RAIM sensitivity of ± 5 NM either side of centerline to ± 1 NM terminal sensitivity. Where the IAWP is inside this 30 mile point, a CDI sensitivity change will occur once the approach mode is armed and the aircraft is inside 30 NM. Where the IAWP is beyond 30 NM from the airport/heliport reference point, CDI sensitivity will not change until the aircraft is within 30 miles of the airport/heliport reference point even if the approach is armed earlier. Feeder route obstacle clearance is predicated on the receiver being in terminal (± 1 NM) CDI sensitivity and RAIM within 30 NM of the airport/heliport reference point, therefore, the receiver should always be armed (if required) not later than the 30 NM annunciation.

18.14.4 The pilot must be aware of what bank angle/turn rate the particular receiver uses to compute turn anticipation, and whether wind and airspeed are included in the receiver's calculations. This information should be in the receiver operating manual. Over or under banking the turn onto the final approach course may significantly delay getting on course and may result in high descent rates to achieve the next segment altitude.

18.14.5 When within 2 NM of the FAWP with the approach mode armed, the approach mode will switch to active, which results in RAIM changing to approach sensitivity and a change in CDI sensitivity. Beginning 2 NM prior to the FAWP, the full scale CDI sensitivity will smoothly change from ± 1 NM, to ± 0.3 NM at the FAWP. As sensitivity changes from ± 1 NM to ± 0.3 NM approaching the FAWP, with the CDI not centered, the corresponding increase in CDI displacement may give the impression that the aircraft is moving further away from the intended course even though it is on an acceptable intercept heading. Referencing the digital track displacement information (cross track error), if it is available in the approach mode, may help the pilot remain position oriented in this situation. Being established on the final approach course prior to the beginning of the sensitivity change at 2 NM will help prevent problems in interpreting the CDI display during ramp down. Therefore, requesting or accepting vectors which will cause the aircraft to intercept the final approach course within 2 NM of the FAWP is not recommended.

18.14.6 When receiving vectors to final, most receiver operating manuals suggest placing the receiver in the nonsequencing mode on the FAWP and manually setting the course. This provides an extended final approach course in cases where the aircraft is vectored onto the final approach course outside of any existing segment which is aligned with the runway. Assigned altitudes must be maintained until established on a published segment of the approach. Required altitudes at waypoints outside the FAWP or stepdown fixes must be considered. Calculating the distance to the FAWP may be required in order to descend at the proper location.

18.14.7 Overriding an automatically selected sensitivity during an approach will cancel the approach mode annunciation. If the approach mode is not armed by 2 NM prior to the FAWP, the approach mode will not become active at 2 NM prior to the FAWP, and the equipment will flag. In these conditions, the RAIM and CDI sensitivity will not ramp down, and the pilot should not descend to MDA, but fly to the MAWP and execute a missed approach. The approach active annunciator and/or the receiver should be checked to ensure the approach mode is active prior to the FAWP.

18.14.8 Do not attempt to fly an approach unless the procedure in the on-board database is current and identified as "GPS" on the approach chart. The navigation database may contain information about nonoverlay approach procedures that is intended to be used to enhance position orientation, generally by providing a map, while flying these approaches using conventional NAVAIDs. This approach information should not be confused with a GPS overlay approach (see the receiver operating manual, AFM, or AFM Supplement for details on how to identify these procedures in the navigation database). Flying point to point on the approach does not assure compliance with the published approach procedure. The proper RAIM sensitivity will not be available and the CDI sensitivity will not automatically change to ± 0.3 NM. Manually setting CDI sensitivity does not automatically change the RAIM sensitivity on some receivers. Some existing nonprecision approach procedures cannot be coded for use with GPS and will not be available as overlays.

18.14.9 Pilots should pay particular attention to the exact operation of their GPS receivers for performing holding patterns, and, in the case of overlay approaches, operations such as procedure turns. These procedures may require manual intervention by the pilot to stop the sequencing of waypoints by the receiver and to resume automatic GPS navigation sequencing once the maneuver is complete. The same waypoint may appear in the route of flight more than once consecutively (e.g., IAWP, FAWP, MAHWP on a procedure turn). Care must be exercised to ensure that the receiver is sequenced to the appropriate waypoint for the segment of the procedure being flown, especially if one or more fly–overs are skipped (e.g., FAWP rather than IAWP if the procedure turn is not flown). The pilot may have to sequence past one or more fly–overs of the same waypoint in order to start GPS automatic sequencing at the proper place in the sequence of waypoints.

18.14.10 Incorrect inputs into the GPS receiver are especially critical during approaches. In some cases, an incorrect entry can cause the receiver to leave the approach mode.

18.14.11 A fix on an overlay approach identified by a DME fix will not be in the waypoint sequence on the GPS receiver unless there is a published name assigned to it. When a name is assigned, the along track to the waypoint may be zero rather than the DME stated on the approach chart. The pilot should be alert for this on any overlay procedure where the original approach used DME.

18.14.12 If a visual descent point (VDP) is published, it will not be included in the sequence of waypoints. Pilots are expected to use normal piloting techniques for beginning the visual descent, such as ATD.

18.14.13 Unnamed stepdown fixes in the final approach segment will not be coded in the waypoint sequence of the aircraft’s navigation database and must be identified using ATD. Stepdown fixes in the final approach segment of RNAV (GPS) approaches are being named, in addition to being identified by ATD. However, since most GPS avionics do not accommodate waypoints between the FAF and MAP, even when the waypoint is named, the waypoints for these stepdown fixes may not appear in the sequence of waypoints in the navigation database. Pilots must continue to identify these stepdown fixes using ATD.

18.15 Missed Approach

18.15.1 A GPS missed approach requires pilot action to sequence the receiver past the MAWP to the missed approach portion of the procedure. The pilot must be thoroughly familiar with the activation procedure for the particular GPS receiver installed in the aircraft and must **initiate appropriate action after the MAWP**. Activating the missed approach prior to the MAWP will cause CDI sensitivity to immediately change to terminal (± 1 NM) sensitivity and the receiver will continue to navigate to the MAWP. The receiver will not sequence past the MAWP. Turns should not begin prior to the MAWP. If the missed approach is not activated, the GPS receiver will display an extension of the inbound final approach course and the ATD will increase from the MAWP until it is manually sequenced after crossing the MAWP.

18.15.2 Missed approach routings in which the first track is via a course rather than direct to the next waypoint **require additional action by the pilot** to set the course. Being familiar with all of the inputs required is especially critical during this phase of flight.

18.16 GPS Familiarization

18.16.1 Pilots should practice GPS approaches under visual meteorological conditions (VMC) until thoroughly proficient with all aspects of their equipment (receiver and installation) prior to attempting flight by IFR in instrument meteorological conditions (IMC). Some of the areas which the pilot should practice are:

18.16.1.1 Utilizing the receiver autonomous integrity monitoring (RAIM) prediction function.

18.16.1.2 Inserting a DP into the flight plan, including setting terminal CDI sensitivity, if required, and the conditions under which terminal RAIM is available for departure. (Some receivers are not DP or STAR capable.)

18.16.1.3 Programming the destination airport.

18.16.1.4 Programming and flying the overlay approaches (especially procedure turns and arcs).

18.16.1.5 Changing to another approach after selecting an approach.

18.16.1.6 Programming and flying “direct” missed approaches.

18.16.1.7 Programming and flying “routed” missed approaches.

18.16.1.8 Entering, flying, and exiting holding patterns, particularly on overlay approaches with a second waypoint in the holding pattern.

18.16.1.9 Programming and flying a “route” from a holding pattern.

18.16.1.10 Programming and flying an approach with radar vectors to the intermediate segment.

18.16.1.11 Indication of the actions required for RAIM failure both before and after the FAWP.

18.16.1.12 Programming a radial and distance from a VOR (often used in departure instructions).

19. Wide Area Augmentation System (WAAS)

19.1 General

19.1.1 The FAA developed the Wide Area Augmentation System (WAAS) to improve the accuracy, integrity and availability of GPS signals. WAAS will allow GPS to be used, as the aviation navigation system, from takeoff through Category I precision approach when it is complete. WAAS is a critical component of the FAA’s strategic objective for a seamless satellite navigation system for civil aviation, improving capacity and safety.

19.1.2 The International Civil Aviation Organization (ICAO) has defined Standards and Recommended Practices (SARPs) for satellite-based augmentation systems (SBAS) such as WAAS. Japan and Europe are building similar systems that are planned to be interoperable with WAAS: EGNOS, the European Geostationary Navigation Overlay System, and MSAS, the Japan Multifunctional Transport Satellite (MTSAT) Satellite-based Augmentation System. The merging of these systems will create a worldwide seamless navigation capability similar to GPS but with greater accuracy, availability and integrity.

19.1.3 Unlike traditional ground-based navigation aids, WAAS will cover a more extensive service area. Precisely surveyed wide-area ground reference stations (WRS) are linked to form the U.S. WAAS network. Signals from the GPS satellites are monitored by these WRSs to determine satellite clock and ephemeris corrections and to model the propagation effects of the ionosphere. Each station in the network relays the data to a wide-area master station (WMS) where the correction information is

computed. A correction message is prepared and uplinked to a geostationary satellite (GEO) via a ground uplink station (GUS). The message is then broadcast on the same frequency as GPS (L1, 1575.42 MHz) to WAAS receivers within the broadcast coverage area of the WAAS GEO.

19.1.4 In addition to providing the correction signal, the WAAS GEO provides an additional pseudorange measurement to the aircraft receiver, improving the availability of GPS by providing, in effect, an additional GPS satellite in view. The integrity of GPS is improved through real-time monitoring, and the accuracy is improved by providing differential corrections to reduce errors. The performance improvement is sufficient to enable approach procedures with GPS/WAAS glide paths (vertical guidance).

19.1.5 The FAA has completed installation of 25 WRSs, 2 WMSs, 4 GUSs, and the required terrestrial communications to support the WAAS network. Prior to the commissioning of the WAAS for public use, the FAA has been conducting a series of test and validation activities. Enhancements to the initial phase of WAAS will include additional master and reference stations, communication satellites, and transmission frequencies as needed.

19.1.6 GNSS navigation, including GPS and WAAS, is referenced to the WGS-84 coordinate system. It should only be used where the Aeronautical Information Publications (including electronic data and aeronautical charts) conform to WGS-84 or equivalent. Other countries civil aviation authorities may impose additional limitations on the use of their SBAS systems.

19.2 Instrument Approach Capabilities

19.2.1 A new class of approach procedures which provide vertical guidance, but which do not meet the ICAO Annex 10 requirements for precision approaches has been developed to support satellite navigation use for aviation applications worldwide. These new procedures called Approach with Vertical Guidance (APV), are defined in ICAO Annex 6, and include approaches such as the LNAV/VNAV procedures presently being flown with barometric vertical navigation (Baro-VNAV). These approaches provide vertical guidance, but do not meet the more stringent standards of a precision approach. Properly certified WAAS receivers will be able to fly these LNAV/VNAV procedures using a WAAS electronic

glide path, which eliminates the errors that can be introduced by using Barometric altimetry.

19.2.2 A new type of APV approach procedure, in addition to LNAV/VNAV, is being implemented to take advantage of the high accuracy guidance and increased integrity provided by WAAS. This WAAS generated angular guidance allows the use of the same TERPS approach criteria used for ILS approaches. The resulting approach procedure minima, titled LPV (localizer performance with vertical guidance), may have a decision altitude as low as 200 feet height above touchdown with visibility minimums as low as $\frac{1}{2}$ mile, when the terrain and airport infrastructure support the lowest minima. LPV minima is published on the RNAV (GPS) approach charts (see paragraph 12., Instrument Approach Procedure Charts).

19.2.3 A new nonprecision WAAS approach, called Localizer Performance (LP) is being added in locations where the terrain or obstructions do not allow publication of vertically guided LPV procedures. This new approach takes advantage of the angular lateral guidance and smaller position errors provided by WAAS to provide a lateral only procedure similar to an ILS Localizer. LP procedures may provide lower minima than a LNAV procedure due to the narrower obstacle clearance surface.

NOTE—

WAAS receivers certified prior to TSO C-145b and TSO C-146b, even if they have LPV capability, do not contain LP capability unless the receiver has been upgraded. Receivers capable of flying LP procedures must contain a statement in the Flight Manual Supplement or Approved Supplemental Flight Manual stating that the receiver has LP capability, as well as the capability for the other WAAS and GPS approach procedure types.

19.2.4 WAAS provides a level of service that supports all phases of flight, including RNAV (GPS) approaches to LNAV, LP, LNAV/VNAV and LPV lines of minima, within system coverage. Some locations close to the edge of the coverage may have a lower availability of vertical guidance.

19.3 General Requirements

19.3.1 WAAS avionics must be certified in accordance with Technical Standard Order (TSO) C-145A, Airborne Navigation Sensors Using the (GPS) Augmented by the Wide Area Augmentation System (WAAS); or TSO-146A, Stand-Alone Airborne Navigation Equipment Using the Global

Positioning System (GPS) Augmented by the Wide Area Augmentation System (WAAS), and installed in accordance with Advisory Circular (AC) 20-130A, Airworthiness Approval of Navigation or Flight Management Systems Integrating Multiple Navigation Sensors, or AC 20-138A, Airworthiness Approval of Global Positioning System (GPS) Navigation Equipment for Use as a VFR and IFR Navigation System.

19.3.2 GPS/WAAS operation must be conducted in accordance with the FAA-approved aircraft flight manual (AFM) and flight manual supplements. Flight manual supplements will state the level of approach procedure that the receiver supports. IFR approved WAAS receivers support all GPS only operations as long as lateral capability at the appropriate level is functional. WAAS monitors both GPS and WAAS satellites and provides integrity.

19.3.3 GPS/WAAS equipment is inherently capable of supporting oceanic and remote operations if the operator obtains a fault detection and exclusion (FDE) prediction program.

19.3.4 Air carrier and commercial operators must meet the appropriate provisions of their approved operations specifications.

19.3.5 Prior to GPS/WAAS IFR operation, the pilot must review appropriate Notices to Airmen (NOTAMs) and aeronautical information. This information is available on request from an Automated Flight Service Station. The FAA will provide NOTAMs to advise pilots of the status of the WAAS and level of service available.

19.3.5.1 The term UNRELIABLE is used in conjunction with GPS and WAAS NOTAMs. The term UNRELIABLE is an advisory to pilots indicating the expected level of WAAS service (LNAV/VNAV, LPV) may not be available; e.g., **!BOS BOS WAAS LPV AND LNAV/VNAV MNM UNREL WEF 0305231700 – 0305231815**. WAAS UNRELIABLE NOTAMs are predictive in nature and published for flight planning purposes. Upon commencing an approach at locations NOTAMed WAAS UNRELIABLE, if the WAAS avionics indicate LNAV/VNAV or LPV service is available, then vertical guidance may be used to complete the approach using the displayed level of service. Should an outage occur during the approach, reversion to LNAV minima may be required.

a) Area-wide WAAS UNAVAILABLE NOTAMs indicate loss or malfunction of the WAAS system. In flight, Air Traffic Control will advise pilots requesting a GPS or RNAV (GPS) approach of WAAS UNAVAILABLE NOTAMs if not contained in the ATIS broadcast.

b) Site-specific WAAS UNRELIABLE NOTAMs indicate an expected level of service, e.g., LNAV/VNAV or LPV may not be available. Pilots must request site-specific WAAS NOTAMs during flight planning. In flight, Air Traffic Control will not advise pilots of WAAS UNRELIABLE NOTAMs.

c) When the approach chart is annotated with the **W** symbol, site-specific WAAS UNRELIABLE NOTAMs or Air Traffic advisories are not provided for outages in WAAS LNAV/VNAV and LPV vertical service. Vertical outages may occur daily at these locations due to being close to the edge of WAAS system coverage. Use LNAV minima for flight planning at these locations, whether as a destination or alternate. For flight operations at these locations, when the WAAS avionics indicate that LNAV/VNAV or LPV service is available, then the vertical guidance may be used to complete the approach using the displayed level of service. Should an outage occur during the procedure, reversion to LNAV minima may be required.

NOTE—

*Area-wide WAAS UNAVAILABLE NOTAMs apply to all airports in the WAAS UNAVAILABLE area designated in the NOTAM, including approaches at airports where an approach chart is annotated with the **W** symbol.*

19.3.6 GPS/WAAS was developed to be used within SBAS GEO coverage (WAAS or other interoperable system) without the need for other radio navigation equipment appropriate to the route of flight to be flown. Outside the SBAS coverage or in the event of a WAAS failure, GPS/WAAS equipment reverts to GPS-only operation and satisfies the requirements for basic GPS equipment.

19.3.7 Unlike TSO-C129 avionics, which were certified as a supplement to other means of navigation, WAAS avionics are evaluated without reliance on other navigation systems. As such, installation of WAAS avionics does not require the aircraft to have other equipment appropriate to the route to be flown.

19.3.7.1 Pilots with WAAS receivers may flight plan to use any instrument approach procedure authorized for use with their WAAS avionics as the planned approach at a required alternate, with the following restrictions. When using WAAS at an alternate airport, flight planning must be based on flying the RNAV (GPS) LNAV minima line, or minima on a GPS approach procedure, or conventional approach procedure with “or GPS” in the title. Code of Federal Regulation (CFR) Part 91 nonprecision weather requirements must be used for planning. Upon arrival at an alternate, when the WAAS navigation system indicates that LNAV/VNAV or LPV service is available, then vertical guidance may be used to complete the approach using the displayed level of service. The FAA has begun removing the **▲ NA** (Alternate Minimums Not Authorized) symbol from select RNAV (GPS) and GPS approach procedures so they may be used by approach approved WAAS receivers at alternate airports. Some approach procedures will still require the **▲ NA** for other reasons, such as no weather reporting, so it cannot be removed from all procedures. Since every procedure must be individually evaluated, removal of the **▲ NA** from RNAV (GPS) and GPS procedures will take some time.

19.4 Flying procedures with WAAS

19.4.1 WAAS receivers support all basic GPS approach functions and provide additional capabilities. One of the major improvements is the ability to generate glide path guidance, independent of ground equipment or barometric aiding. This eliminates several problems such as hot and cold temperature effects, incorrect altimeter setting or lack of a local altimeter source. It also allows approach procedures to be built without the cost of installing ground stations at each airport or runway. Some approach certified receivers may only generate a glide path with performance similar to Baro-VNAV and are only approved to fly the LNAV/VNAV line of minima on the RNAV (GPS) approach charts. Receivers with additional capability (including faster update rates and smaller integrity limits) are approved to fly the LPV line of minima. The lateral integrity changes dramatically from the 0.3 NM (556 meter) limit for GPS, LNAV and LNAV/VNAV approach mode, to 40 meters for LPV. It also provides vertical integrity monitoring, which bounds the vertical error to 50 meters for LNAV/VNAV and LPVs with minima of

250' or above, and bounds the vertical error to 35 meters for LPVs with minima below 250'.

19.4.2 When an approach procedure is selected and active, the receiver will notify the pilot of the most accurate level of service supported by the combination of the WAAS signal, the receiver, and the selected approach, using the naming conventions on the minima lines of the selected approach procedure. For example, if an approach is published with LPV minima and the receiver is only certified for LNAV/VNAV, the equipment would indicate “LNAV/VNAV available,” even though the WAAS signal would support LPV. If flying an existing LNAV/VNAV procedure with no LPV minima, the receiver will notify the pilot “LNAV/VNAV available,” even if the receiver is certified for LPV and the signal supports LPV. If the signal does not support vertical guidance on procedures with LPV and/or LNAV/VNAV minima, the receiver annunciation will read “LNAV available.” On lateral only procedures with LP and LNAV minima the receiver will indicate “LP available” or “LNAV available” based on the level of lateral service available. Once the level of service notification has been given, the receiver will operate in this mode for the duration of the approach procedure, unless that level of service becomes unavailable. The receiver cannot change back to a more accurate level of service until the next time an approach is activated.

NOTE—

Receivers do not “fail down” to lower levels of service once the approach has been activated. If only the vertical off flag appears, the pilot may elect to use the LNAV minima if the rules under which the flight is operating allow changing the type of approach being flown after commencing the procedure. If the lateral integrity limit is exceeded on an LP approach, a missed approach will be necessary since there is no way to reset the lateral alarm limit while the approach is active.

19.4.3 Another additional feature of WAAS receivers is the ability to exclude a bad GPS signal and continue operating normally. This is normally accomplished by the WAAS correction information. Outside WAAS coverage or when WAAS is not available, it is accomplished through a receiver algorithm called FDE. In most cases this operation will be invisible to the pilot since the receiver will continue to operate with other available satellites after excluding the “bad” signal. This capability increases the reliability of navigation.

19.4.4 Both lateral and vertical scaling for the LNAV/VNAV and LPV approach procedures are different than the linear scaling of basic GPS. When the complete published procedure is flown, ± 1 NM linear scaling is provided until two (2) NM prior to the FAF, where the sensitivity increases to be similar to the angular scaling of an ILS. There are two differences in the WAAS scaling and ILS: 1) on long final approach segments, the initial scaling will be ± 0.3 NM to achieve equivalent performance to GPS (and better than ILS, which is less sensitive far from the runway); 2) close to the runway threshold, the scaling changes to linear instead of continuing to become more sensitive. The width of the final approach course is tailored so that the total width is usually 700 feet at the runway threshold. Since the origin point of the lateral splay for the angular portion of the final is not fixed due to antenna placement like localizer, the splay angle can remain fixed, making a consistent width of final for aircraft being vectored onto the final approach course on different length runways. When the complete published procedure is not flown, and instead the aircraft needs to capture the extended final approach course similar to ILS, the vector to final (VTF) mode is used. Under VTF the scaling is linear at ± 1 NM until the point where the ILS angular splay reaches a width of ± 1 NM regardless of the distance from the FAWP.

19.4.5 The WAAS scaling is also different than GPS TSO-C129 in the initial portion of the missed approach. Two differences occur here. First, the scaling abruptly changes from the approach scaling to the missed approach scaling, at approximately the departure end of the runway or when the pilot requests missed approach guidance rather than ramping as GPS does. Second, when the first leg of the missed approach is a Track to Fix (TF) leg aligned within 3 degrees of the inbound course, the receiver will change to 0.3 NM linear sensitivity until the turn initiation point for the first waypoint in the missed approach procedure, at which time it will abruptly change to terminal (± 1 NM) sensitivity. This allows the elimination of close in obstacles in the early part of the missed approach that may cause the DA to be raised.

19.4.6 A new method has been added for selecting the final approach segment of an instrument approach. Along with the current method used by most receivers using menus where the pilot selects the airport, the runway, the specific approach procedure

and finally the IAF, there is also a channel number selection method. The pilot enters a unique 5–digit number provided on the approach chart, and the receiver recalls the matching final approach segment from the aircraft database. A list of information including the available IAFs is displayed and the pilot selects the appropriate IAF. The pilot should confirm that the correct final approach segment was loaded by cross checking the Approach ID, which is also provided on the approach chart.

19.4.7 The Along–Track Distance (ATD) during the final approach segment of an LNAV procedure (with a minimum descent altitude) will be to the MAWP. On LNAV/VNAV and LPV approaches to a decision altitude, there is no missed approach waypoint so the along–track distance is displayed to a point normally located at the runway threshold. In most cases the MAWP for the LNAV approach is located on the runway threshold at the centerline, so these distances will be the same. This distance will always vary slightly from any ILS DME that may be present, since the ILS DME is located further down the runway. Initiation of the missed approach on the LNAV/VNAV and LPV approaches is still based on reaching the decision altitude without any of the items listed in 14 CFR Section 91.175 being visible, and must not be delayed until the ATD reaches zero. The WAAS receiver, unlike a GPS receiver, will automatically sequence past the MAWP if the missed approach procedure has been designed for RNAV. The pilot may also select missed approach prior to the MAWP, however, navigation will continue to the MAWP prior to waypoint sequencing taking place.

20. Ground Based Augmentation System (GBAS) Landing System (GLS)

20.1 General

20.1.1 The GLS provides precision navigation guidance for exact alignment and descent of aircraft on approach to a runway. It provides differential augmentation to the Global Navigation Satellite System (GNSS).

20.1.2 LAAS was developed as an “ILS look–alike” system from the pilot perspective. LAAS is based on GPS signals augmented by ground equipment and has been developed to provide GLS precision approaches similar to ILS at airfields.

20.1.3 GLS provides guidance similar to ILS approaches for the final approach segment; portions of the GLS approach prior to and after the final approach segment will be based on Area Navigation (RNAV) or Required Navigation Performance (RNP).

20.1.4 The equipment consists of a GBAS Ground Facility (GGF), four reference stations, a VHF Data Broadcast (VDB) uplink antenna, and an aircraft GBAS receiver.

20.2 Procedure

20.2.1 Pilots will select the five digit GBAS channel number of the associated approach within the Flight Management System (FMS) menu or manually select the five digits (system dependent). Selection of the GBAS channel number also tunes the VDB.

20.2.2 Following procedure selection, confirmation that the correct LAAS procedure is loaded can be accomplished by cross checking the charted Reference Path Indicator (RPI) or approach ID with the cockpit displayed RPI or audio identification of the RPI with Morse Code (for some systems).

20.2.3 The pilot will fly the GLS approach using the same techniques as an ILS, once selected and identified.

21. Precision Approach Systems Other Than ILS, GLS, and MLS

21.1 General

Approval and use of precision approach systems other than ILS, GLS, and MLS require the issuance of special instrument approach procedures.

21.2 Special Instrument Approach Procedure

21.2.1 Special instrument approach procedures must be issued to the aircraft operator if pilot training, aircraft equipment, and/or aircraft performance is different than published procedures. Special instrument approach procedures are not distributed for general public use. These procedures are issued to an aircraft operator when the conditions for operations approval are satisfied.

21.2.2 General aviation operators requesting approval for special procedures should contact the local Flight Standards District Office to obtain a letter of authorization. Air carrier operators requesting approval for use of special procedures should contact

their Certificate Holding District Office for authorization through their Operations Specification.

21.3 Transponder Landing System (TLS)

21.3.1 The TLS is designed to provide approach guidance utilizing existing airborne ILS localizer, glide slope, and transponder equipment.

21.3.2 Ground equipment consists of a transponder interrogator, sensor arrays to detect lateral and vertical position, and ILS frequency transmitters. The TLS detects the aircraft's position by interrogating its transponder. It then broadcasts ILS frequency signals to guide the aircraft along the desired approach path.

21.3.3 TLS instrument approach procedures are designated Special Instrument Approach Procedures. Special aircrew training is required. TLS ground equipment provides approach guidance for only one aircraft at a time. Even though the TLS signal is received using the ILS receiver, no fixed course or glidepath is generated. The concept of operation is very similar to an air traffic controller providing radar vectors, and just as with radar vectors, the guidance is valid only for the intended aircraft. The TLS ground equipment tracks one aircraft, based on its transponder code, and provides correction signals to course and glidepath based on the position of the tracked aircraft. Flying the TLS corrections computed for another aircraft will not provide guidance relative to the approach; therefore, aircrews must not use the TLS signal for navigation unless they have received approach clearance and completed the required coordination with the TLS ground equipment operator. Navigation fixes based on conventional NAVAIDs or GPS are provided in the special instrument approach procedure to allow aircrews to verify the TLS guidance.

21.4 Special Category I Differential GPS (SCAT-IDGPS)

21.4.1 The SCAT-I DGPS is designed to provide approach guidance by broadcasting differential correction to GPS.

21.4.2 SCAT-I DGPS procedures require aircraft equipment and pilot training.

21.4.3 Ground equipment consists of GPS receivers and a VHF digital radio transmitter. The SCAT-I DGPS detects the position of GPS satellites relative to GPS receiver equipment and broadcasts differential corrections over the VHF digital radio.

21.4.4 Category I Ground Based Augmentation System (GBAS) will displace SCAT-I DGPS as the public-use service.

22. Area Navigation

22.1 General

22.1.1 Area Navigation (RNAV) provides enhanced navigational capability to the pilot. RNAV equipment can compute the airplane position, actual track and ground speed and then provide meaningful information relative to a route of flight selected by the pilot. Typical equipment will provide the pilot with distance, time, bearing and crosstrack error relative to the selected "TO" or "active" waypoint and the selected route. Several navigational systems with different navigational performance characteristics are capable of providing area navigational functions. Present day RNAV includes INS, LORAN, VOR/DME, and GPS systems. Modern multi-sensor systems can integrate one or more of the above systems to provide a more accurate and reliable navigational system. Due to the different levels of performance, area navigational capabilities can satisfy different levels of required navigation performance (RNP).

22.2 RNAV Operations Incorporating RNP

22.2.1 During the past four decades, domestic and international air navigation have been conducted using a system of airways and instrument procedures based upon ground-based navigational systems such as NDB, VOR, and ILS. Reliance on ground-based navigational systems has served the aviation community well, but often results in less than optimal routes or instrument procedures and an inefficient use of airspace. With the widespread deployment of RNAV systems and the advent of GPS-based navigation, greater flexibility in defining routes, procedures, and airspace design is now possible with an associated increase in flight safety. To capitalize on the potential of RNAV systems, both the FAA and International Civil Aviation Organization (ICAO) are affecting a shift toward a new standard of navigation and airspace management called RNP.

22.2.2 Navigational systems are typically described as being sensor specific, such as a VOR or ILS system. By specifying airspace requirements as RNP, various navigation systems or combination of systems may be used as long as the aircraft can achieve the RNP. RNP is intended to provide a single

performance standard that can be used and applied by aircraft and aircraft equipment manufacturers, airspace planners, aircraft certification and operations, pilots and controllers, and international aviation authorities. RNP can be applied to obstacle clearance or aircraft separation requirements to ensure a consistent application level.

22.2.3 ICAO has defined RNP values for the four typical navigation phases of flight: oceanic, en route, terminal, and approach. The RNP applicable to a selected airspace, route, or procedure is designated by its RNP Level or Type. As defined in the Pilot/Controller Glossary, the RNP Level or Type is a value typically expressed as a distance, in nautical miles, from the procedure, route or path within which an aircraft would typically operate. RNP applications also provide performance to protect against larger errors at some multiple of RNP level (e.g., twice the RNP level).

22.3 Standard RNP Levels

22.3.1 U.S. standard values supporting typical RNP airspace are as specified in TBL ENR 4.1–6 below. Other RNP levels as identified by ICAO, other states and the FAA may also be used.

TBL ENR 4.1–6
U.S. Standard RNP Levels

RNP Level	Typical Application
.3	Approach
1	Departure, Terminal
2	En Route

22.3.1.1 Application of Standard RNP Levels. U.S. standard levels of RNP typically used for various routes and procedures supporting RNAV operations may be based on use of a specific navigational system or sensor such as GPS, or on multi-sensor RNAV systems having suitable performance. New RNAV routes and procedures will be FAA’s first public use procedures to include a specified RNP level. These procedures are being developed based on earth referenced navigation and do not rely on conventional ground-based navigational aids. Unless otherwise noted on affected charts or procedures, depiction of a specified RNP level will not preclude the use of other airborne RNAV navigational systems.

22.3.1.2 Depiction of Standard RNP Levels. The applicable RNP level will be depicted on affected

charts and procedures. For example, an RNAV departure procedure may contain a notation referring to eligible aircraft by equipment suffix and a phrase “or RNP–1.0.” A typical RNAV approach procedure may include a notation referring to eligible aircraft by specific navigation sensor(s), equipment suffix, and a phrase “or RNP–0.3.” Specific guidelines for the depiction of RNP levels will be provided through chart bulletins and accompany affected charting changes.

22.4 Aircraft and Airborne Equipment Eligibility for RNP Operations. Aircraft meeting RNP criteria will have an appropriate entry including special conditions and limitations, if any, in its Aircraft/Rotorcraft Flight Manual (AFM), or supplement. RNAV installations with AFM–RNP certification based on GPS or systems integrating GPS are considered to meet U.S. standard RNP levels for all phases of flight. Aircraft with AFM–RNP certification without GPS may be limited to certain RNP levels, or phases of flight. For example, RNP based on DME/DME without other augmentation may not be appropriate for phases of flight outside the certified DME service volume. Operators of aircraft not having specific AFM–RNP certification may be issued operational approval including special conditions and limitations, if any, for specific RNP levels. Aircraft navigation systems eligible for RNP airspace will be indicated on charts, or announced through other FAA media such as NOTAMs and chart bulletins.

22.5 Understanding RNP Operations. Pilots should have a clear understanding of the aircraft requirements for operation in a given RNP environment, and advise ATC if an equipment failure or other malfunction causes the aircraft to lose its ability to continue operating in the designated RNP airspace. When a pilot determines a specified RNP level cannot be achieved, he/she should be prepared to revise the route, or delay the operation until an appropriate RNP level can be ensured. Some airborne systems use terms other than RNP to indicate the current level of performance. Depending on the airborne system implementation, this may be displayed, and referred to, as actual navigation performance (ANP), estimate of position error (EPE), or other.

22.6 Other RNP Applications Outside the U.S. The FAA, in cooperation with ICAO member states has led initiatives in implementing the RNP

concept to oceanic operations. For example, RNP-10 routes have been established in the northern Pacific (NOPAC) which has increased capacity and efficiency by reducing the distance between tracks to 50 NM. Additionally, the FAA has assisted those U.S. air carriers operating in Europe where the routes have been designated as RNP-5. TBL ENR 4.1-7 below, shows examples of current and future RNP levels of airspace.

TBL ENR 4.1-7

RNP Levels Supported for International Operations

RNP Level	Typical Application
4	Projected for oceanic/remote areas where 30 NM horizontal separation is applied
5	European Basic RNAV (B-RNAV)
10	Oceanic/remote areas where 50 NM horizontal separation is applied

22.7 RNAV and RNP Operations

22.7.1 Pilot

22.7.1.1 If unable to comply with the requirements of an RNAV or RNP procedure, pilots must advise air traffic control as soon as possible. For example, “N1234, failure of GPS system, unable RNAV, request amended clearance.”

22.7.1.2 Pilots are not authorized to fly a published RNAV or RNP procedure (instrument approach, departure, or arrival procedure) unless it is retrievable by the procedure name from the current aircraft navigation database and conforms to the charted procedure. The system must be able to retrieve the procedure by name from the aircraft navigation database, not just as a manually entered series of waypoints.

22.7.1.3 Whenever possible, RNAV routes (Q- or T-route) should be extracted from the database in their entirety, rather than loading RNAV route waypoints from the database into the flight plan individually. However, selecting and inserting individual, named fixes from the database is permitted, provided all fixes along the published route to be flown are inserted.

22.7.1.4 Pilots must not change any database waypoint type from a fly-by to fly-over, or vice versa. No other modification of database waypoints or the creation of user-defined waypoints on

published RNAV or RNP procedures is permitted, except to:

a) Change altitude and/or airspeed waypoint constraints to comply with an ATC clearance/instruction.

b) Insert a waypoint along the published route to assist in complying with ATC instruction, example, “Descend via the WILMS arrival except cross 30 north of BRUCE at/or below FL 210.” This is limited only to systems that allow along-track waypoint construction.

22.7.1.5 Pilots of FMS-equipped aircraft, who are assigned an RNAV DP or STAR procedure and subsequently receive a change of runway, transition or procedure, shall verify that the appropriate changes are loaded and available for navigation.

22.7.1.6 For RNAV 1 DPs and STARs, pilots must use a CDI, flight director and/or autopilot, in lateral navigation mode. Other methods providing an equivalent level of performance may also be acceptable.

22.7.1.7 For RNAV 1 DPs and STARs, pilots of aircraft without GPS, using DME/DME/IRU, must ensure the aircraft navigation system position is confirmed, within 1,000 feet, at the start point of take-off roll. The use of an automatic or manual runway update is an acceptable means of compliance with this requirement. Other methods providing an equivalent level of performance may also be acceptable.

22.7.1.8 For procedures or routes requiring the use of GPS, if the navigation system does not automatically alert the flight crew of a loss of GPS, the operator must develop procedures to verify correct GPS operation.

22.7.1.9 RNAV terminal procedures (DP and STAR) may be amended by ATC issuing radar vectors and/or clearances direct to a waypoint. Pilots should avoid premature manual deletion of waypoints from their active “legs” page to allow for rejoining procedures.

22.7.1.10 RAIM Prediction: If TSO-C129 equipment is used to solely satisfy the RNAV and RNP requirement, GPS RAIM availability must be confirmed for the intended route of flight (route and time). If RAIM is not available, pilots need an approved alternate means of navigation.

REFERENCE-

AIP, RNAV and RNP Operations, ENR 1.10 para 11.3.

23. NAVAID Identifier Removal During Maintenance

23.1 During periods of routine or emergency maintenance, coded identification (or code and voice, where applicable) is removed from certain FAA NAVAIDs. Removal of the identification serves as warning to pilots that the facility is officially off the air for tune-up or repair and may be unreliable even though intermittent or constant signals are received.

NOTE-

During periods of maintenance, VHF ranges may radiate a T-E-S-T code (- ●●●-).

NOTE-

DO NOT attempt to fly a procedure that is NOTAMed out of service even if the identification is present. In certain cases, the identification may be transmitted for short periods as part of the testing.

24. User Reports on NAVAID Performance

24.1 Users of the National Airspace System can render valuable assistance in the early correction of NAVAID malfunctions by reporting their observation of undesirable performance. Although NAVAIDs are monitored by electronic detectors adverse effects of electronic interference, new obstructions or changes in terrain near the NAVAID can exist without detection by the ground monitors. Some of the characteristics of malfunction or deteriorating performance which should be reported are: erratic course or bearing indications; intermittent, or full, flag alarm; garbled, missing or obviously improper coded identification; poor quality communications reception; or, in the case of frequency interference, an audible hum or tone accompanying radio communications or navaid identification.

24.2 Reporters should identify the NAVAID, location of the aircraft, time of the observation, type of aircraft and describe the condition observed; the type of receivers in use will also be useful information. Reports can be made in any of the following ways:

24.2.1 Immediately, by radio communication to the controlling Air Route Traffic Control Center, Control Tower, or Flight Service Station. This provides the quickest result.

24.2.2 By telephone to the nearest FAA facility.

24.2.3 By FAA Form 8740-5, Safety Improvement Report, a postage-paid card designed for this purpose. These cards may be obtained at FAA Flight Service Stations, Flight Standards District Offices, and General Aviation Fixed Base Operations.

24.3 In aircraft that have more than one receiver, there are many combinations of possible interference between units. This can cause either erroneous navigation indications or, complete or partial blanking out of the communications. Pilots should be familiar enough with the radio installation of particular airplanes they fly to recognize this type of interference.

25. Radio Communications and Navigation Facilities

25.1 A complete listing of air traffic radio communications facilities and frequencies and radio navigation facilities and frequencies are contained in the Airport/Facility Directory. Similar information for the Pacific and Alaskan areas is contained in the Pacific and Alaskan Supplements.

ENR 4.2 Special Navigation Systems

1. Doppler Radar

1.1 Doppler Radar is a semiautomatic self-contained dead reckoning navigation system (radar sensor plus computer) which is not continuously dependent on information derived from ground based or external aids. The system employs radar signals to

detect and measure ground speed and drift angle, using the aircraft compass system as its directional reference. Doppler is less accurate than INS, however, and the use of an external reference is required for periodic updates if acceptable position accuracy is to be achieved on long range flights.

ENR 5. NAVIGATION WARNINGS

ENR 5.1 Prohibited, Restricted, and Other Areas

1. Special Use Airspace

1.1 General

1.1.1 Special use airspace consists of that airspace wherein activities must be confined because of their nature, or wherein limitations are imposed upon aircraft operations that are not a part of those activities, or both. Except for controlled firing areas, special use airspace areas are depicted on aeronautical charts.

1.1.2 Prohibited and restricted areas are regulatory special use airspace and are established in 14 CFR Part 73 through the rulemaking process.

1.1.3 Warning areas, military operations areas (MOAs), alert areas, and controlled firing areas (CFAs) are nonregulatory special use airspace. See Section for information on MOAs, alert areas, and CFAs.

1.1.4 Special use airspace descriptions (except CFAs) are contained in FAA Order 7400.8, Special Use Airspace.

1.1.5 Special use airspace (except CFAs) are charted on IFR and visual charts and include the hours of operation, altitudes, and the controlling agency.

1.2 Prohibited Areas

1.2.1 Prohibited areas contain airspace of defined dimensions identified by an area on the surface of the earth within which the flight of aircraft is prohibited. Such areas are established for security or other reasons associated with the national welfare. These areas are published in the Federal Register and are depicted on aeronautical charts.

1.3 Restricted Areas

1.3.1 Restricted areas contain airspace identified by an area on the surface of the earth within which the flight of aircraft, while not wholly prohibited, is subject to restrictions. Activities within these areas must be confined because of their nature or limitations imposed upon aircraft operations that are

not a part of those activities or both. Restricted areas denote the existence of unusual, often invisible, hazards to aircraft such as artillery firing, aerial gunnery, or guided missiles. Penetration of restricted areas without authorization from the using or controlling agency may be extremely hazardous to the aircraft and its occupants. Restricted areas are published in the Federal Register and constitute 14 CFR Part 73.

1.3.2 ATC facilities apply the following procedures when aircraft are operating on an IFR clearance (including those cleared by ATC to maintain VFR-on-top) via a route which lies within joint-use restricted airspace.

1.3.2.1 If the restricted area is not active and has been released to the controlling agency (FAA), the ATC facility will allow the aircraft to operate in the restricted airspace without issuing specific clearance for it to do so.

1.3.2.2 If the restricted area is active and has not been released to the controlling agency (FAA), the ATC facility will issue a clearance which will ensure the aircraft avoids the restricted airspace unless it is on an approved altitude reservation mission or has obtained its own permission to operate in the airspace and so informs the controlling facility.

NOTE-

The above apply only to joint-use restricted airspace and not to prohibited and nonjoint-use airspace. For the latter categories, the ATC facility will issue a clearance so the aircraft will avoid the restricted airspace unless it is on an approved altitude reservation mission or has obtained its own permission to operate in the airspace and so informs the controlling facility.

1.3.3 Restricted airspace is depicted on the en route chart appropriate for use at the altitude or flight level being flown. For joint-use restricted areas, the name of the controlling agency is shown on these charts. For all prohibited areas and nonjoint-use restricted areas, unless otherwise requested by the using agency, the phrase "NO A/G" is shown.

1.4 Warning Areas

1.4.1 A warning area is airspace of defined dimensions, extending from three nautical miles outward from the coast of the U.S., that contains activity that may be hazardous to nonparticipating aircraft. The purpose of such warning areas is to warn nonparticipating pilots of the potential danger. A warning area may be located over domestic or international waters or both.

2. Other Airspace Areas

2.1 National Security Area (NSA)

2.1.1 National Security Areas consist of airspace of defined vertical and lateral dimensions established at locations where there is a requirement for increased security and safety of ground facilities. Pilots are requested to voluntarily avoid flying through the depicted NSA. When it is necessary to provide a greater level of security and safety, flight in NSAs may be temporarily prohibited by regulation under the provisions of 14 CFR Section 99.7. Regulatory prohibitions will be issued by System Operations, System Operations Airspace and AIM Office, Airspace and Rules, and disseminated via NOTAM. Inquiries about NSAs should be directed to Airspace and Rules.

2.2 Temporary Flight Restrictions

2.2.1 General. This paragraph describes the types of conditions under which the FAA may impose temporary flight restrictions. It also explains which FAA elements have been delegated authority to issue a temporary flight restrictions NOTAM and lists the types of responsible agencies/offices from which the FAA will accept requests to establish temporary flight restrictions. The 14 CFR is explicit as to what operations are prohibited, restricted, or allowed in a temporary flight restrictions area. Pilots are responsible to comply with 14 CFR Sections 91.137, 91.138, 91.141, and 91.143 when conducting flight in an area where a temporary flight restrictions area is in effect, and should check appropriate NOTAMs during flight planning.

2.2.2 The purpose for establishing a temporary flight restrictions area is to:

2.2.2.1 Protect persons and property in the air or on the surface from an existing or imminent hazard associated with an incident on the surface when the

presence of low-flying aircraft would magnify, alter, spread, or compound that hazard (14 CFR Section 91.137(a)(1)).

2.2.2.2 Provide a safe environment for the operation of disaster relief aircraft (14 CFR Section 91.137(a)(2)).

2.2.2.3 Prevent an unsafe congestion of sightseeing aircraft above an incident or event which may generate a high degree of public interest (14 CFR Section 91.137(a)(3)).

2.2.2.4 Protect declared national disasters for humanitarian reasons in the State of Hawaii (14 CFR Section 91.138).

2.2.2.5 Protect the President, Vice President, or other public figures (14 CFR Section 91.141).

2.2.2.6 Provide a safe environment for space agency operations (14 CFR Section 91.143).

2.2.3 Except for hijacking situations, when the provisions of 14 CFR Section 91.137(a)(1) or (a)(2) are necessary, a temporary flight restrictions area will only be established by or through the area manager at the Air Route Traffic Control Center (ARTCC) having jurisdiction over the area concerned. A temporary flight restrictions NOTAM involving the conditions of 14 CFR Section 91.137(a)(3) will be issued at the direction of the service area office director having oversight of the airspace concerned. When hijacking situations are involved, a temporary flight restrictions area will be implemented through the TSA Aviation Command Center. The appropriate FAA air traffic element, upon receipt of such a request, will establish a temporary flight restrictions area under 14 CFR Section 91.137(a)(1).

2.2.4 The FAA accepts recommendations for the establishment of a temporary flight restrictions area under 14 CFR Section 91.137(a)(1) from military major command headquarters, regional directors of the Office of Emergency Planning, Civil Defense State Directors, State Governors, or other similar authority. For the situations involving 14 CFR Section 91.137(a)(2), the FAA accepts recommendations from military commanders serving as regional, subregional, or Search and Rescue (SAR) coordinators; by military commanders directing or coordinating air operations associated with disaster relief; or by civil authorities directing or coordinating organized relief air operations (includes representatives of the Office of Emergency Planning, U.S. Forest Service,

and State aeronautical agencies). Appropriate authorities for a temporary flight restrictions establishment under 14 CFR Section 91.137(a)(3) are any of those listed above or by State, county, or city government entities.

2.2.5 The type of restrictions issued will be kept to a minimum by the FAA consistent with achievement of the necessary objective. Situations which warrant the extreme restrictions of 14 CFR Section 91.137(a)(1) include, but are not limited to: toxic gas leaks or spills, flammable agents, or fumes which if fanned by rotor or propeller wash could endanger persons or property on the surface, or if entered by an aircraft could endanger persons or property in the air; imminent volcano eruptions which could endanger airborne aircraft and occupants; nuclear accident or incident; and hijackings. Situations which warrant the restrictions associated with 14 CFR Section 91.137(a)(2) include: forest fires which are being fought by releasing fire retardants from aircraft; and aircraft relief activities following a disaster (earthquake, tidal wave, flood, etc.). 14 CFR Section 91.137 (a)(3) restrictions are established for events and incidents that would attract an unsafe congestion of sightseeing aircraft.

2.2.6 The amount of airspace needed to protect persons and property or provide a safe environment for rescue/relief aircraft operations is normally limited to within 2,000 feet above the surface and within a 3-nautical-mile radius. Incidents occurring within Class B, Class C, or Class D airspace will normally be handled through existing procedures and should not require the issuance of a temporary flight restrictions NOTAM. Temporary flight restrictions affecting airspace outside of the U.S. and its territories and possessions are issued with verbiage excluding that airspace outside of the 12-mile coastal limits.

2.2.7 The FSS nearest the incident site is normally the “coordination facility.” When FAA communications assistance is required, the designated FSS will function as the primary communications facility for coordination between emergency control authorities and affected aircraft. The ARTCC may act as liaison for the emergency control authorities if adequate communications cannot be established between the designated FSS and the relief organization. For example, the coordination facility may relay authorizations from the on-scene emergency re-

sponse official in cases where news media aircraft operations are approved at the altitudes used by relief aircraft.

2.2.8 ATC may authorize operations in a temporary flight restrictions area under its own authority only when flight restrictions are established under 14 CFR Section 91.137(a)(2) and (a)(3). The appropriate ARTCC/airport traffic control tower manager will, however, ensure that such authorized flights do not hamper activities or interfere with the event for which restrictions were implemented. However, ATC will not authorize local IFR flights into the temporary flight restrictions area.

2.2.9 To preclude misunderstanding, the implementing NOTAM will contain specific and formatted information. The facility establishing a temporary flight restrictions area will format a NOTAM beginning with the phrase “FLIGHT RESTRICTIONS” followed by: the location of the temporary flight restrictions area; the effective period; the area defined in statute miles; the altitudes affected; the FAA coordination facility and commercial telephone number; the reason for the temporary flight restrictions; the agency directing any relief activities and its commercial telephone number; and other information considered appropriate by the issuing authority.

EXAMPLE-

1. 14 CFR Section 91.137(a)(1):

The following NOTAM prohibits all aircraft operations except those specified in the NOTAM.

FLIGHT RESTRICTIONS MATTHEWS, VIRGINIA, EFFECTIVE IMMEDIATELY UNTIL 9610211200. PURSUANT TO 14 CFR SECTION 91.137(A)(1) TEMPORARY FLIGHT RESTRICTIONS ARE IN EFFECT. RESCUE OPERATIONS IN PROGRESS. ONLY RELIEF AIRCRAFT OPERATIONS UNDER THE DIRECTION OF THE DEPARTMENT OF DEFENSE ARE AUTHORIZED IN THE AIRSPACE AT AND BELOW 5,000 FEET MSL WITHIN A 2-NAUTICAL-MILE RADIUS OF LASER AFB, MATTHEWS, VIRGINIA. COMMANDER, LASER AFB, IN CHARGE (897) 946-5543 (122.4). STEENSON FSS (792) 555-6141 (123.1) IS THE FAA COORDINATION FACILITY .

2. 14 CFR Section 91.137(a)(2):

The following NOTAM permits flight operations in accordance with 14 CFR Section 91.137(a)(2). The on-site emergency response official to authorize media aircraft operations below the altitudes used by the relief aircraft.

FLIGHT RESTRICTIONS 25 MILES EAST OF BRANSOME, IDAHO, EFFECTIVE IMMEDIATELY UNTIL 9601202359 UTC. PURSUANT TO 14 CFR SECTION 91.137(A)(2) TEMPORARY FLIGHT RESTRICTIONS ARE IN EFFECT WITHIN A 4-NAUTICAL-MILE RADIUS OF THE INTERSECTION OF COUNTY ROADS 564 AND 315 AT AND BELOW 3,500 FEET MSL TO PROVIDE A SAFE ENVIRONMENT FOR FIRE FIGHTING AIRCRAFT OPERATIONS. DAVIS COUNTY SHERIFF'S DEPARTMENT (792) 555-8122 (122.9) IS IN CHARGE OF ON-SCENE EMERGENCY RESPONSE ACTIVITIES. GLIVINGS FSS (792) 555-1618 (122.2) IS THE FAA COORDINATION FACILITY.

3. 14 CFR Section 91.137(a)(3):

The following NOTAM prohibits sightseeing aircraft operations.

FLIGHT RESTRICTIONS BROWN, TENNESSEE, DUE TO OLYMPIC ACTIVITY. EFFECTIVE 9606181100 UTC UNTIL 9607190200 UTC. PURSUANT TO 14 CFR SECTION 91.137(A)(3) TEMPORARY FLIGHT RESTRICTIONS ARE IN EFFECT WITHIN A 3-NAUTICAL-MILE RADIUS OF N355783/W835242 AND VOLUNTEER VORTAC 019 DEGREE RADIAL 3.7 DME FIX AT AND BELOW 2,500 FEET MSL. NORTON FSS (423) 555-6742 (126.6) IS THE FAA COORDINATION FACILITY.

4. 14 CFR Section 91.138:

The following NOTAM prohibits all aircraft except those operating under the authorization of the official in charge of associated emergency or disaster relief response activities, aircraft carrying law enforcement officials, aircraft carrying personnel involved in an emergency or legitimate scientific purposes, carrying properly accredited news media, and aircraft operating in accordance with an ATC clearance or instruction.

FLIGHT RESTRICTIONS KAPALUA, HAWAII, EFFECTIVE 9605101200 UTC UNTIL 9605151500 UTC. PURSUANT TO 14 CFR SECTION 91.138 TEMPORARY FLIGHT RESTRICTIONS ARE IN EFFECT WITHIN A 3-NAUTICAL-MILE RADIUS OF N205778/W1564038 AND MAUI /OGG/ VORTAC 275 DEGREE RADIAL AT 14.1 NAUTICAL MILES. JOHN DOE 808-757-4469 OR 122.4 IS IN CHARGE OF THE OPERATION. HONOLULU /HNL/ 808-757-4470 (123.6) AFSS IS THE FAA COORDINATION FACILITY.

5. 14 CFR Section 91.141:

The following NOTAM prohibits all aircraft.

FLIGHT RESTRICTIONS STILLWATER, OKLAHOMA, JUNE 21, 1996. PURSUANT TO 14 CFR SECTION 91.141 AIRCRAFT FLIGHT OPERATIONS ARE PROHIBITED WITHIN A 3-NAUTICAL-MILE RADIUS, BELOW 2000 FEET AGL OF N360962/ W970515 AND THE STILLWATER /SWO/ VOR/DME 176 DEGREE RADIAL 3.8-NAUTICAL-MILE FIX FROM 1400 LOCAL TIME TO 1700 LOCAL TIME JUNE 21, 1996 UNLESS OTHERWISE AUTHORIZED BY ATC.

6. 14 CFR Section 91.143:

The following NOTAM prohibits any aircraft of U.S. registry, or pilot of any aircraft under the authority of an airman certificate issued by the FAA.

KENNEDY SPACE CENTER SPACE OPERATIONS AREA EFFECTIVE IMMEDIATELY UNTIL 9610152100 UTC. PURSUANT TO SECTION 91.143, FLIGHT OPERATIONS CONDUCTED BY FAA CERTIFICATED PILOTS OR CONDUCTED IN AIRCRAFT OF U.S. REGISTRY ARE PROHIBITED AT ANY ALTITUDE FROM SURFACE TO UNLIMITED, WITHIN THE FOLLOWING AREA 30-NAUTICAL-MILE RADIUS OF THE MELBOURNE /MLB/ VORTAC 010 DEGREE RADIAL 21-NAUTICAL-MILE FIX. ST. PETERSBURG, FLORIDA, /PIE/ AFSS 813-545-1645 (122.2) IS THE FAA COORDINATION FACILITY AND SHOULD BE CONTACTED FOR THE CURRENT STATUS OF ANY AIRSPACE ASSOCIATED WITH THE SPACE SHUTTLE OPERATIONS. THIS AIRSPACE ENCOMPASSES R2933, R2932, R2931, R2934, R2935, W497A AND W158A. ADDITIONAL WARNING AND RESTRICTED AREAS WILL BE ACTIVE IN CONJUNCTION WITH THE OPERATIONS. PILOTS SHALL CONSULT ALL NOTAMS REGARDING THIS OPERATION.

2.3 Parachute Jump Aircraft Operations

2.3.1 Procedures relating to parachute jump areas are contained in 14 CFR Part 105. Tabulations of parachute jump areas in the U.S. are contained in the Airport/Facility Directory.

2.3.2 Pilots of aircraft engaged in parachute jump operations are reminded that all reported altitudes must be with reference to mean sea level, or flight level, as appropriate, to enable ATC to provide meaningful traffic information.

2.3.3 Parachute Operations in the Vicinity of an Airport Without an Operating Control Tower.

There is no substitute for alertness while in the vicinity of an airport. It is essential that pilots conducting parachute operations be alert, look for other traffic, and exchange traffic information as recommended in GEN 3.3, paragraph 9.2, Traffic Advisory Practices at Airports Without Operating

Control Towers. In addition, pilots should avoid releasing parachutes while in an airport traffic pattern when there are other aircraft in that pattern. Pilots should make appropriate broadcasts on the designated Common Traffic Advisory Frequency (CTAF), and monitor that CTAF until all parachute activity has terminated or the aircraft has left the area. Prior to commencing a jump operation, the pilot should broadcast the aircraft's altitude and position in relation to the airport, the approximate relative time when the jump will commence and terminate, and listen to the position reports of other aircraft in the area.

ENR 5.2 Military Exercise and Training Areas

1. Military Operations Area (MOA)

1.1 MOAs consist of airspace of defined vertical and lateral limits established for the purpose of separating certain military training activities from IFR traffic. Whenever a MOA is being used, nonparticipating IFR traffic may be cleared through a MOA if IFR separation can be provided by ATC. Otherwise, ATC will reroute or restrict nonparticipating IFR traffic.

1.2 Examples of activities conducted in MOAs include, but are not limited to: air combat tactics, air intercepts, aerobatics, formation training, and low-altitude tactics. Military pilots flying in an active MOA are exempted from the provisions of 14 CFR Section 91.303(c) and (d) which prohibits aerobatic flight within Class D and Class E surface areas, and within Federal airways. Additionally, the Department of Defense has been issued an authorization to operate aircraft at indicated airspeeds in excess of 250 knots below 10,000 feet MSL within active MOAs.

1.3 Pilots operating under VFR should exercise extreme caution while flying within a MOA when military activity is being conducted. The activity status (active/inactive) of MOAs may change frequently. Therefore, pilots should contact any FSS within 100 miles of the area to obtain accurate real-time information concerning the MOA hours of operation. Prior to entering an active MOA, pilots should contact the controlling agency for traffic advisories.

1.4 MOAs are depicted on Sectional, VFR Terminal Area, and En Route Low Altitude Charts.

2. Alert Areas

2.1 Alert Areas are depicted on aeronautical charts to inform nonparticipating pilots of areas that may contain a high volume of pilot training or an unusual type of aerial activity. Pilots should be particularly alert when flying in these areas. All activity within an Alert Area shall be conducted in accordance with FAA regulations, without waiver, and pilots of

participating aircraft as well as pilots transiting the area shall be equally responsible for collision avoidance.

3. Controlled Firing Area (CFA)

3.1 CFAs contain activities which, if not conducted in a controlled environment, could be hazardous to nonparticipating aircraft. The distinguishing feature of the CFA, as compared to other special use airspace, is that its activities are suspended immediately when spotter aircraft, radar, or ground lookout positions indicate an aircraft might be approaching the area. There is no need to chart CFAs since they do not cause a nonparticipating aircraft to change its flight path.

4. Military Training Route (MTR)

4.1 National security depends largely on the deterrent effect of our airborne military forces. To be proficient, the military services must train in a wide range of airborne tactics. One phase of this training involves “low level” combat tactics. The required maneuvers and high speeds are such that they may occasionally make the see-and-avoid aspect of VFR flight more difficult without increased vigilance in areas containing such operations. In an effort to ensure the greatest practical level of safety for all flight operations, the MTR program was conceived.

4.2 The MTR program is a joint venture by the FAA and the DOD. MTRs are mutually developed for use by the military for the purpose of conducting low-altitude, high-speed training. The routes above 1,500 feet above ground level (AGL) are developed to be flown, to the maximum extent possible, under IFR. The routes at 1,500 feet AGL and below are generally developed to be flown under VFR.

4.3 Generally, MTRs are established below 10,000 feet MSL for operations at speeds in excess of 250 knots. However, route segments may be defined at higher altitudes for purposes of route continuity. For example, route segments may be defined for descent, climbout, and mountainous terrain. There are IFR and VFR routes as follows:

4.3.1 IFR Military Training Routes–IR. Operations on these routes are conducted in accordance with IFR regardless of weather conditions.

4.3.2 VFR Military Training Routes–VR. Operations on these routes are conducted in accordance with VFR except flight visibility shall be 5 miles or more; and flights shall not be conducted below a ceiling of less than 3,000 feet AGL.

4.4 MTRs will be identified and charted as follows:

4.4.1 Route Identification

4.4.1.1 MTRs with no segment above 1,500 feet AGL shall be identified by four number characters; e.g., IR1206, VR1207.

4.4.1.2 MTRs that include one or more segments above 1,500 feet AGL shall be identified by three number characters; e.g., IR206, VR207.

4.4.1.3 Alternate IR/VR routes or route segments are identified by using the basic/principal route designation followed by a letter suffix, e.g., IR008A, VR1007B, etc.

4.4.2 Route Charting

4.4.2.1 IFR Low Altitude En Route Chart. This chart will depict all IR routes and all VR routes that accommodate operations above 1,500 feet AGL.

4.4.2.2 VFR Sectional Charts. These charts will depict military training activities such as IR, VR, MOA, restricted area, warning area, and alert area information.

4.4.2.3 Area Planning (AP/1B) Chart (DOD Flight Information Publication–FLIP). This chart is published by the DOD primarily for military users

and contains detailed information on both IR and VR routes.

4.5 The FLIP contains charts and narrative descriptions of these routes. This publication is available to the general public by single copy or annual subscription from:

National Aeronautical Charting Office (NACO)
Distribution Division
Federal Aviation Administration
6501 Lafayette Avenue
Riverdale, MD 20737-1199
Toll free phone: 1-800-638-8972
Commercial: 301-436-8301

4.5.1 This DOD FLIP is available for pilot briefings at FSSs and many airports.

4.6 Nonparticipating aircraft are not prohibited from flying within an MTR; however, extreme vigilance should be exercised when conducting flight through or near these routes. Pilots should contact FSSs within 100 NM of a particular MTR to obtain current information or route usage in their vicinity. Information available includes times of scheduled activity, altitudes in use on each route segment, and actual route width. Route width varies for each MTR and can extend several miles on either side of the charted MTR centerline. Route width information for IR and VR MTRs is also available in the FLIP AP/1B along with additional MTR (SR/AR) information. When requesting MTR information, pilots should give the FSS their position, route of flight, and destination in order to reduce frequency congestion and permit the FSS specialist to identify the MTR which could be a factor.

ENR 5.3 [RESERVED]

ENR 5.4 [RESERVED]

ENR 5.5 [RESERVED]

ENR 5.6 Bird Migration and Areas With Sensitive Fauna

1. Migratory Bird Activity

1.1 Bird strike risk increases because of bird migration during the months of March through April and August through November.

1.2 The altitudes of migrating birds vary with winds aloft, weather fronts, terrain elevations, cloud conditions, and other environmental variables. While over 90 percent of the reported bird strikes occur at or below 3,000 feet AGL, strikes at higher altitudes are common during migration. Ducks and geese are frequently observed up to 7,000 feet AGL and pilots are cautioned to minimize en route flying at lower altitudes during migration.

1.3 Considered the greatest potential hazard to aircraft because of their size, abundance, or habit of flying in dense flocks are gulls, waterfowl, vultures, hawks, owls, egrets, blackbirds, and starlings. Four major migratory flyways exist in the U.S. The Atlantic Flyway parallels the Atlantic coast, the Mississippi Flyway stretches from Canada through the Great Lakes and follows the Mississippi River. The Central Flyway represents a broad area east of the Rockies, stretching from Canada through Central America. The Pacific Flyway follows the west coast and overflies major parts of Washington, Oregon, and California. There are also numerous smaller flyways which cross these major north-south migratory routes.

2. Reducing Bird Strike Risks

2.1 The most serious strikes are those involving ingestion into an engine (turboprop and turbine jet engines) or windshield strikes. These strikes can result in emergency situations requiring prompt action by the pilot.

2.2 Engine ingestions may result in sudden loss of power or engine failure. Review engine out procedures, especially when operating from airports with known bird hazards or when operating near high bird concentrations.

2.3 Windshield strikes have resulted in pilots experiencing confusion, disorientation, loss of communications, and aircraft control problems. Pilots are encouraged to review their emergency procedures before flying in these areas.

2.4 When encountering birds en route, climb to avoid collision because birds in flocks generally distribute themselves downward, with lead birds being at the highest altitude.

2.5 Avoid overflight of known areas of bird concentration and flying low altitudes during bird migration. Charted wildlife refuges and other natural areas contain unusually high local concentration of birds which may create a hazard to aircraft.

3. Reporting Bird Strikes

3.1 Pilots are urged to report any bird or other wildlife strike using FAA Form 5200-7, Bird/Other Wildlife Strike Report (FIG ENR 5.6-1). Forms are available at any FSS or any FAA Regional Office. Wildlife strikes can also be reported electronically at: <http://wildlife-mitigation.tc.faa.gov>. The data derived from these reports are used to develop standards to cope with this potential hazard to aircraft and for documentation of necessary habitat control on airports.

4. Reporting Bird and Other Wildlife Activities

4.1 If you observe birds or other animals on or near the runway, request airport management to disperse the wildlife before taking off. Also contact the nearest FAA ARTCC, FSS, or tower (including non-Federal towers) regarding large flocks of birds and report the:

4.1.1 Geographic location.

4.1.2 Bird type (geese, ducks, gulls, etc.).

4.1.3 Approximate numbers.

4.1.4 Altitude.

4.1.5 Direction of bird flight path.

5. Pilot Advisories on Bird and Other Wildlife Hazards

5.1 Many airports advise pilots of other wildlife hazards caused by large animals on the runway through the Airport/Facility Directory and the NOTAM system. Collisions between landing and departing aircraft with animals on the runway are increasing and are not limited to rural airports. These accidents have also occurred at several major airports. Pilots should exercise extreme caution when warned of the presence of wildlife on and in the vicinity of airports. If in close proximity to movement areas you observe deer or other large animals, advise the FSS, tower, or airport management.

6. Flights Over Charted U.S. Wildlife Refuges, Parks, and Forest Service Areas

6.1 The landing of aircraft is prohibited on lands or waters administered by the National Park Service, U.S. Fish and Wildlife Service, or U.S. Forest Service without authorization from the respective agency. Exceptions include (1) when forced to land due to an emergency beyond the control of the operator, (2) at officially designated landing sites, or (3) an approved official business of the Federal Government.

6.2 All pilots are requested to maintain a minimum altitude of 2,000 feet above the terrain of the following: National Parks, Monuments, Seashores, Lakeshores, Recreation Areas and Scenic Riverways

administered by the National Park Service, National Wildlife Refuges, Big Game Refuges, Game Ranges, and Wildlife Ranges administered by the U.S. Fish and Wildlife Service, and Wilderness and Primitive Areas administered by the U.S. Forest Service.

NOTE-

FAA Advisory Circular 91-36, Visual Flight Rules (VFR) Flight Near Noise-sensitive Areas, defines the surface of a national park area (including parks, forests, primitive areas, wilderness areas, recreational areas, national seashores, national monuments, national lakeshores, and national wildlife refuge and range areas) as: "The highest terrain within 2,000 feet laterally of the route of flight, or the upper-most rim of a canyon or valley."

6.3 Federal statutes prohibit certain types of flight activity and/or provide altitude restrictions over designated U.S. Wildlife Refuges, Parks, and Forest Service Areas. These designated areas are charted on Sectional Charts, for example: Boundary Waters Canoe Wilderness Areas, Minnesota; Haleakala National Park, Hawaii; Yosemite National Park, California; and Grand Canyon National Park, Arizona,

6.4 Federal regulations also prohibit airdrops by parachute or other means of persons, cargo, or objects from aircraft on lands administered by the three agencies without authorization from the respective agency. Exceptions include: (1) emergencies involving the safety of human life or (2) threat of serious property loss.

FIG ENR 5.6-1
Bird/Other Wildlife Strike Report

Form Approved OMB NO. 2120-0018

 BIRD/OTHER WILDLIFE STRIKE REPORT U.S. Department of Transportation Federal Aviation Administration																																																	
1. Name of Operator	2. Aircraft Make/Model	3. Engine Make/Model																																															
4. Aircraft Registration	5. Date of Incident Month / Day / Year	6. Local Time of Incident <input type="checkbox"/> Dawn <input type="checkbox"/> Dusk — HR — MIN <input type="checkbox"/> Day <input type="checkbox"/> Night <input type="checkbox"/> AM <input type="checkbox"/> PM																																															
7. Airport Name	8. Runway Used	9. Location if En Route (Nearest Town/Reference & State)																																															
10. Height (AGL)	11. Speed (IAS)																																																
12. Phase of Flight <input type="checkbox"/> A. Parked <input type="checkbox"/> B. Taxi <input type="checkbox"/> C. Take-off Run <input type="checkbox"/> D. Climb <input type="checkbox"/> E. En Route <input type="checkbox"/> F. Descent <input type="checkbox"/> G. Approach <input type="checkbox"/> H. Landing Roll	13. Part(s) of Aircraft Struck or Damaged																																																
	<table border="1"> <thead> <tr> <th></th> <th>Struck</th> <th>Damaged</th> <th></th> <th>Struck</th> <th>Damaged</th> </tr> </thead> <tbody> <tr> <td>A. Radome</td> <td><input type="checkbox"/></td> <td><input type="checkbox"/></td> <td>H. Propeller</td> <td><input type="checkbox"/></td> <td><input type="checkbox"/></td> </tr> <tr> <td>B. Windshield</td> <td><input type="checkbox"/></td> <td><input type="checkbox"/></td> <td>I. Wing/Rotor</td> <td><input type="checkbox"/></td> <td><input type="checkbox"/></td> </tr> <tr> <td>C. Nose</td> <td><input type="checkbox"/></td> <td><input type="checkbox"/></td> <td>J. Fuselage</td> <td><input type="checkbox"/></td> <td><input type="checkbox"/></td> </tr> <tr> <td>D. Engine No. 1</td> <td><input type="checkbox"/></td> <td><input type="checkbox"/></td> <td>K. Landing Gear</td> <td><input type="checkbox"/></td> <td><input type="checkbox"/></td> </tr> <tr> <td>E. Engine No. 2</td> <td><input type="checkbox"/></td> <td><input type="checkbox"/></td> <td>L. Tail</td> <td><input type="checkbox"/></td> <td><input type="checkbox"/></td> </tr> <tr> <td>F. Engine No. 3</td> <td><input type="checkbox"/></td> <td><input type="checkbox"/></td> <td>M. Lights</td> <td><input type="checkbox"/></td> <td><input type="checkbox"/></td> </tr> <tr> <td>G. Engine No. 4</td> <td><input type="checkbox"/></td> <td><input type="checkbox"/></td> <td>N. Other:</td> <td><input type="checkbox"/></td> <td><input type="checkbox"/></td> </tr> </tbody> </table> <p>(Specify, if "N. Other" is checked)</p>			Struck	Damaged		Struck	Damaged	A. Radome	<input type="checkbox"/>	<input type="checkbox"/>	H. Propeller	<input type="checkbox"/>	<input type="checkbox"/>	B. Windshield	<input type="checkbox"/>	<input type="checkbox"/>	I. Wing/Rotor	<input type="checkbox"/>	<input type="checkbox"/>	C. Nose	<input type="checkbox"/>	<input type="checkbox"/>	J. Fuselage	<input type="checkbox"/>	<input type="checkbox"/>	D. Engine No. 1	<input type="checkbox"/>	<input type="checkbox"/>	K. Landing Gear	<input type="checkbox"/>	<input type="checkbox"/>	E. Engine No. 2	<input type="checkbox"/>	<input type="checkbox"/>	L. Tail	<input type="checkbox"/>	<input type="checkbox"/>	F. Engine No. 3	<input type="checkbox"/>	<input type="checkbox"/>	M. Lights	<input type="checkbox"/>	<input type="checkbox"/>	G. Engine No. 4	<input type="checkbox"/>	<input type="checkbox"/>	N. Other:	<input type="checkbox"/>
	Struck	Damaged		Struck	Damaged																																												
A. Radome	<input type="checkbox"/>	<input type="checkbox"/>	H. Propeller	<input type="checkbox"/>	<input type="checkbox"/>																																												
B. Windshield	<input type="checkbox"/>	<input type="checkbox"/>	I. Wing/Rotor	<input type="checkbox"/>	<input type="checkbox"/>																																												
C. Nose	<input type="checkbox"/>	<input type="checkbox"/>	J. Fuselage	<input type="checkbox"/>	<input type="checkbox"/>																																												
D. Engine No. 1	<input type="checkbox"/>	<input type="checkbox"/>	K. Landing Gear	<input type="checkbox"/>	<input type="checkbox"/>																																												
E. Engine No. 2	<input type="checkbox"/>	<input type="checkbox"/>	L. Tail	<input type="checkbox"/>	<input type="checkbox"/>																																												
F. Engine No. 3	<input type="checkbox"/>	<input type="checkbox"/>	M. Lights	<input type="checkbox"/>	<input type="checkbox"/>																																												
G. Engine No. 4	<input type="checkbox"/>	<input type="checkbox"/>	N. Other:	<input type="checkbox"/>	<input type="checkbox"/>																																												
14. Effect on Flight <input type="checkbox"/> None <input type="checkbox"/> Aborted Take-Off <input type="checkbox"/> Precautionary Landing <input type="checkbox"/> Engines Shut Down <input type="checkbox"/> Other: (Specify)	15. Sky Condition <input type="checkbox"/> No Cloud <input type="checkbox"/> Some Cloud <input type="checkbox"/> Overcast	16. Precipitation <input type="checkbox"/> Fog <input type="checkbox"/> Rain <input type="checkbox"/> Snow <input type="checkbox"/> None																																															
17. Bird/Other Wildlife Species	18. Number or birds seen and/or struck																																																
	<table border="1"> <thead> <tr> <th>Number of Birds</th> <th>Seen</th> <th>Struck</th> </tr> </thead> <tbody> <tr> <td>1</td> <td><input type="checkbox"/></td> <td><input type="checkbox"/></td> </tr> <tr> <td>2-10</td> <td><input type="checkbox"/></td> <td><input type="checkbox"/></td> </tr> <tr> <td>11-100</td> <td><input type="checkbox"/></td> <td><input type="checkbox"/></td> </tr> <tr> <td>more than 100</td> <td><input type="checkbox"/></td> <td><input type="checkbox"/></td> </tr> </tbody> </table>		Number of Birds	Seen	Struck	1	<input type="checkbox"/>	<input type="checkbox"/>	2-10	<input type="checkbox"/>	<input type="checkbox"/>	11-100	<input type="checkbox"/>	<input type="checkbox"/>	more than 100	<input type="checkbox"/>	<input type="checkbox"/>																																
Number of Birds	Seen	Struck																																															
1	<input type="checkbox"/>	<input type="checkbox"/>																																															
2-10	<input type="checkbox"/>	<input type="checkbox"/>																																															
11-100	<input type="checkbox"/>	<input type="checkbox"/>																																															
more than 100	<input type="checkbox"/>	<input type="checkbox"/>																																															
19. Size of Bird(s) <input type="checkbox"/> Small <input type="checkbox"/> Medium <input type="checkbox"/> Large																																																	
20. Pilot Warned of Birds <input type="checkbox"/> Yes <input type="checkbox"/> No																																																	
21. Remarks (Describe damage, injuries and other pertinent information)																																																	
DAMAGE / COST INFORMATION																																																	
22. Aircraft time out of service: _____ hours	23. Estimated cost of repairs or replacement (U.S. \$): \$ _____	24. Estimated other cost (U.S. \$) (e.g. loss of revenue, fuel, hotels): \$ _____																																															
Reported by (Optional)	Title	Date																																															
<p>Paperwork Reduction Act Statement: The information collected on this form is necessary to allow the Federal Aviation Administration to assess the magnitude and severity of the wildlife-aircraft strike problem in the U.S. The information is used in determining the best management practices for reducing the hazard to aviation safety caused by wildlife-aircraft strikes. We estimate that it will take approximately <u>5 minutes</u> to complete the form. If you wish to make any comments concerning the accuracy of this burden estimate and any suggestions for reducing this burden, send those comments to the Federal Aviation Administration, Management Staff, ARP-10, 800 Independence Avenue, SW, Washington, DC 20591. The information collected is voluntary. Please note that an agency may not conduct or sponsor, and a person is not required to respond to, a collection of information unless it displays a currently valid OMB control number. The OMB control number associated with this collection is 2120-0045.</p>																																																	

ENR 5.7 Potential Flight Hazards

1. Accident Causal Factors

1.1 The ten most frequent cause factors for General Aviation Accidents in 1992 that involve the pilot in command are:

1.1.1 Inadequate preflight preparation and/or planning.

1.1.2 Failure to obtain/maintain flying speed.

1.1.3 Failure to obtain/maintain flying speed.

1.1.4 Failure to maintain direction control.

1.1.5 Improper level off.

1.1.6 Failure to see and avoid objects or obstructions.

1.1.7 Mismanagement of fuel.

1.1.8 Improper in-flight decisions or planning.

1.1.9 Misjudgment of distance and speed.

1.1.10 Selection of unsuitable terrain.

1.1.11 Improper operation of flight controls.

1.2 The above factors have continued to plague General Aviation pilots over the years. This list remains relatively stable and points out the need for continued refresher training to establish a higher level of flight proficiency for all pilots. A part of the FAA's continuing effort to promote increased aviation safety is the Aviation Safety Program. For information on the FAA's Aviation Safety Program, readers can contact their nearest Flight Standards District Office's Safety Program Manager.

1.3 Be alert at all times, especially when the weather is good. Most pilots pay attention to business when they are operating in full IFR weather conditions, but strangely, air collisions almost invariably have occurred under ideal weather conditions. Unlimited visibility appears to encourage a sense of security which is not at all justified. Considerable information of value may be obtained by listening to advisories being issued in the terminal area, even though controller workload may prevent a pilot from obtaining individual service.

1.4 If you think another aircraft is too close to you, give way instead of waiting for the other pilot to respect the right-of-way to which you may be

entitled. It is a lot safer to pursue the right-of-way angle after you have completed your flight.

2. VFR In Congested Area

2.1 A high percentage of near midair collisions occur below 8,000 feet AGL and within 30 miles of an airport. When operating VFR in highly congested areas, whether you intend to land at an airport within the area or are just flying through, it is recommended that extra vigilance be maintained and that you monitor an appropriate control frequency. Normally the appropriate frequency is an approach control frequency. By such monitoring action you can "get the picture" of the traffic in your area. When the approach controller has radar, traffic advisories may be given to VFR pilots who request them, subject to the provisions included in ENR 1.1, paragraph 37.10.4, Radar Traffic Information Service (RTIS).

3. Obstructions to Flight

3.1 General

3.1.1 Many structures exist that could significantly affect the safety of your flight when operating below 500 feet above ground level (AGL), and particularly below 200 feet AGL. While 14 CFR Section 91.119 allows flight below 500 AGL when over sparsely populated areas or open water, such operations are very dangerous. At and below 200 feet AGL there are numerous power lines, antenna towers, etc., that are not marked and lighted as obstructions and therefore may not be seen in time to avoid a collision. Notices to Airmen (NOTAMs) are issued on those lighted structures experiencing temporary light outages. However, some time may pass before the FAA is notified of these outages, and the NOTAM issued, thus pilot vigilance is imperative.

3.2 Antenna Towers

3.2.1 Extreme caution should be exercised when flying less than 2,000 feet above ground level (AGL) because of numerous skeletal structures, such as radio and television antenna towers, that exceed 1,000 feet AGL with some extending higher than 2,000 feet AGL. Most skeletal structures are supported by guy wires which are very difficult to see in good weather and can be invisible at dusk or during

periods of reduced visibility. These wires can extend about 1,500 feet horizontally from a structure; therefore, all skeletal structures should be avoided horizontally by at least 2,000 feet. Additionally, new towers may not be on your current chart because the information was not received prior to the printing of the chart.

3.3 Overhead Wires

3.3.1 Overhead transmission and utility lines often span approaches to runways, natural flyways such as lakes, rivers, gorges, and canyons, and cross other landmarks pilots frequently follow such as highways, railroad tracks, etc. As with antenna towers, these high voltage/power lines or the supporting structures of these lines may not always be readily visible and the wires may be virtually impossible to see under certain conditions. In some locations, the supporting structures of overhead transmission lines are equipped with unique sequence flashing white strobe light systems to indicate that there are wires between the structures. However, many power lines do not require notice to the FAA and, therefore, are not marked and/or lighted. Many of those that do require notice do not exceed 200 feet AGL or meet the Obstruction Standard of 14 CFR Part 77 and, therefore, are not marked and/or lighted. All pilots are cautioned to remain extremely vigilant for these power lines or their supporting structures when following natural flyways or during the approach and landing phase. This is particularly important for seaplane and/or float equipped aircraft when landing on, or departing from, unfamiliar lakes or rivers.

3.4 Other Objects/Structures

3.4.1 There are other objects or structures that could adversely affect your flight such as construction cranes near an airport, newly constructed buildings, new towers, etc. Many of these structures do not meet charting requirements or may not yet be charted because of the charting cycle. Some structures do not require obstruction marking and/or lighting and some may not be marked and lighted even though the FAA recommended it.

4. Avoid Flight Beneath Unmanned Balloons

4.1 The majority of unmanned free balloons currently being operated have, extended below them, either a suspension device to which the payload or

instrument package is attached, or a trailing wire antenna, or both. In many instances these balloon subsystems may be invisible to the pilot until his/her aircraft is close to the balloon, thereby creating a potentially dangerous situation. Therefore, good judgment on the part of the pilot dictates that aircraft should remain well clear of all unmanned free balloons and flight below them should be avoided at all times.

4.2 Pilots are urged to report any unmanned free balloons sighted to the nearest FAA ground facility with which communication is established. Such information will assist FAA ATC facilities to identify and flight follow unmanned free balloons operating in the airspace.

5. Unmanned Aircraft

5.1 Unmanned Aircraft Systems (UAS), formerly referred to as “Unmanned Aerial Vehicles” (UAVs) or “drones,” are having an increasing operational presence in the NAS. Once the exclusive domain of the military, UAS are now being operated by various entities. Although these aircraft are “unmanned,” UAS are flown by a remotely located pilot and crew. Physical and performance characteristics of unmanned aircraft (UA) vary greatly and unlike model aircraft that typically operate lower than 400 feet AGL, UA may be found operating at virtually any altitude and any speed. Sizes of UA can be as small as several pounds to as large as a commercial transport aircraft. UAS come in various categories including airplane, rotorcraft, powered-lift (tilt-rotor), and lighter-than-air. Propulsion systems of UAS include a broad range of alternatives from piston powered and turbojet engines to battery and solar-powered electric motors.

5.2 To ensure segregation of UAS operations from other aircraft, the military typically conducts UAS operations within restricted or other special use airspace. However, UAS operations are now being approved in the NAS outside of special use airspace through the use of FAA-issued Certificates of Waiver or Authorization (COA) or through the issuance of a special airworthiness certificate. COA and special airworthiness approvals authorize UAS flight operations to be contained within specific geographic boundaries and altitudes, usually require coordination with an ATC facility, and typically require the issuance of a NOTAM describing the operation to be conducted. UAS approvals also require observers to

provide “see-and-avoid” capability to the UAS crew and to provide the necessary compliance with 14 CFR Section 91.113. For UAS operations approved at or above FL180, UAS operate under the same requirements as that of manned aircraft (i.e., flights are operated under instrument flight rules, are in communication with ATC, and are appropriately equipped).

5.3 UAS operations may be approved at either controlled or uncontrolled airports and are typically disseminated by NOTAM. In all cases, approved UAS operations shall comply with all applicable regulations and/or special provisions specified in the COA or in the operating limitations of the special airworthiness certificate. At uncontrolled airports, UAS operations are advised to operate well clear of all known manned aircraft operations. Pilots of manned aircraft are advised to follow normal operating procedures and are urged to monitor the CTAF for any potential UAS activity. At controlled airports, local ATC procedures may be in place to handle UAS operations and should not require any special procedures from manned aircraft entering or departing the traffic pattern or operating in the vicinity of the airport.

5.4 In addition to approved UAS operations described above, a recently approved agreement between the FAA and the Department of Defense authorizes small UAS operations wholly contained within Class G airspace, and in no instance, greater than 1200 feet AGL over military owned or leased property. These operations do not require any special authorization as long as the UA remains within the lateral boundaries of the military installation as well as other provisions including the issuance of a NOTAM. Unlike special use airspace, these areas may not be depicted on an aeronautical chart.

5.5 There are several factors a pilot should consider regarding UAS activity in an effort to reduce potential flight hazards. Pilots are urged to exercise increased vigilance when operating in the vicinity of restricted or other special use airspace, military operations areas, and any military installation. Areas with a preponderance of UAS activity are typically noted on sectional charts advising pilots of this activity. Since the size of a UA can be very small, they may be difficult to see and track. If a UA is encountered during flight, as with manned aircraft, never assume that the pilot or crew of the UAS can see

you, maintain increased vigilance with the UA and always be prepared for evasive action if necessary. Always check NOTAMs for potential UAS activity along the intended route of flight and exercise increased vigilance in areas specified in the NOTAM.

6. Mountain Flying

6.1 Your first experience of flying over mountainous terrain (particularly if most of your flight time has been over the flatlands of the midwest) could be a *never-to-be-forgotten nightmare* if proper planning is not done and if you are not aware of the potential hazards awaiting. Those familiar section lines are not present in the mountains; those flat, level fields for forced landings are practically nonexistent; abrupt changes in wind direction and velocity occur; severe updrafts and downdrafts are common, particularly near or above abrupt changes of terrain such as cliffs or rugged areas; even the clouds look different and can build up with startling rapidity. Mountain flying need not be hazardous if you follow the recommendations below:

6.1.1 File a Flight Plan. Plan your route to avoid topography which would prevent a safe forced landing. The route should be over populated areas and well known mountain passes. Sufficient altitude should be maintained to permit gliding to a safe landing in the event of engine failure.

6.1.2 Don't fly a light aircraft when the winds aloft, at your proposed altitude, exceed 35 miles per hour. Expect the winds to be of much greater velocity over mountain passes than reported a few miles from them. Approach mountain passes with as much altitude as possible. Downdrafts of from 1,500 to 2,000 feet per minute are not uncommon on the leeward side.

6.1.3 Don't fly near or above abrupt changes in terrain. Severe turbulence can be expected, especially in high wind conditions.

6.1.4 Understand Mountain Obscuration. The term Mountain Obscuration (MTOS) is used to describe a visibility condition that is distinguished from IFR because ceilings, by definition, are described as “above ground level” (AGL). In mountainous terrain clouds can form at altitudes significantly higher than the weather reporting station and at the same time nearby mountaintops may be obscured by low visibility. In these areas the ground level can also vary greatly over a small area.

Beware if operating VFR-on-top. You could be operating closer to the terrain than you think because the tops of mountains are hidden in a cloud deck below. MTOS areas are identified daily on The Aviation Weather Center located at:
<http://www.aviationweather.gov>.

6.2 Some canyons run into a dead end. Don't fly so far up a canyon that you get trapped. ALWAYS BE ABLE TO MAKE A 180 DEGREE TURN.

6.3 VFR flight operations may be conducted at night in mountainous terrain with the application of sound judgment and common sense. Proper pre-flight planning, giving ample consideration to winds and weather, knowledge of the terrain and pilot experience in mountain flying are prerequisites for safety of flight. Continuous visual contact with the surface and obstructions is a major concern and flight operations under an overcast or in the vicinity of clouds should be approached with extreme caution.

6.4 When landing at a high altitude field, the same indicated airspeed should be used as at low elevation fields. Remember: that due to the less dense air at altitude, this same indicated airspeed actually results in a higher true airspeed, a faster landing speed, and more important, a longer landing distance. During gusty wind conditions which often prevail at high altitude fields, a power approach and power landing is recommended. Additionally, due to the faster groundspeed, your takeoff distance will increase considerably over that required at low altitudes.

6.5 Effects of Density Altitude. Performance figures in the aircraft owner's handbook for length of takeoff run, horsepower, rate of climb, etc., are generally based on standard atmosphere conditions (59°F, pressure 29.92 inches of mercury) at sea level. However, inexperienced pilots as well as experienced pilots may run into trouble when they encounter an altogether different set of conditions. This is particularly true in hot weather and at higher elevations. Aircraft operations at altitudes above sea level and at higher than standard temperatures are commonplace in mountainous area. Such operations quite often result in a drastic reduction of aircraft performance capabilities because of the changing air density. Density altitude is a measure of air density. It is not to be confused with pressure altitude – true altitude or absolute altitude. It is not to be used as a height reference, but as a determining criteria in the performance capability of an aircraft. Air density

decreases with altitude. As air density decreases, density altitude increases. The further effects of high temperature and high humidity are cumulative, resulting in an increasing high density altitude condition. High density altitude reduces all aircraft performance parameters. To the pilot, this means that the normal horsepower output is reduced, propeller efficiency is reduced and a higher true airspeed is required to sustain the aircraft throughout its operating parameters. It means an increase in runway length requirements for takeoff and landings, and a decreased rate of climb. An average small airplane, for example, requiring 1,000 feet for takeoff at sea level under standard atmospheric conditions will require a takeoff run of approximately 2,000 at an operational altitude of 5,000 feet.

NOTE-

A turbo-charged aircraft engine provides some slight advantage in that it provides sea level horsepower up to a specified altitude above sea level.

6.6 Density Altitude Advisories. At airports with elevations of 2,000 feet and higher, control towers and FSSs will broadcast the advisory "Check Density Altitude" when the temperature reaches a predetermined level. These advisories will be broadcast on appropriate tower frequencies or, where available, ATIS. FSSs will broadcast these advisories as a part of Airport Advisory Service, and on TWEB.

6.6.1 These advisories are provided by air traffic facilities, as a reminder to pilots that high temperatures and high field elevations will cause significant changes in aircraft characteristics. The pilot retains the responsibility to compute density altitude, when appropriate, as a part of preflight duties.

NOTE-

All FSSs will compute the current density altitude upon request.

7. Use of Runway Half-way Signs at Unimproved Airports

7.1 When installed, runway half-way signs provide the pilot with a reference point to judge takeoff acceleration trends. Assuming that the runway length is appropriate for takeoff (considering runway condition and slope, elevation, aircraft weight, wind, and temperature), typical takeoff acceleration should allow the airplane to reach 70 percent of lift-off airspeed by the midpoint of the runway. The "rule of thumb" is that should airplane acceleration not allow

the airspeed to reach this value by the midpoint, the takeoff should be aborted, as it may not be possible to liftoff in the remaining runway.

7.2 Several points are important when considering using this “rule of thumb”:

7.2.1 Airspeed indicators in small airplanes are not required to be evaluated at speeds below stalling, and may not be usable at 70 percent of liftoff airspeed.

7.2.2 This “rule of thumb” is based on a uniform surface condition. Puddles, soft spots, areas of tall and/or wet grass, loose gravel, etc., may impede acceleration or even cause deceleration. Even if the airplane achieves 70 percent of liftoff airspeed by the midpoint, the condition of the remainder of the runway may not allow further acceleration. The entire length of the runway should be inspected prior to takeoff to ensure a usable surface.

7.2.3 This “rule of thumb” applies only to runway required for actual liftoff. In the event that obstacles affect the takeoff climb path, appropriate distance must be available after liftoff to accelerate to best angle of climb speed and to clear the obstacles. This will, in effect, require the airplane to accelerate to a higher speed by midpoint, particularly if the obstacles are close to the end of the runway. In addition, this technique does not take into account the effects of upslope or tailwinds on takeoff performance. These factors will also require greater acceleration than normal and, under some circumstances, prevent takeoff entirely.

7.2.4 Use of this “rule of thumb” does not alleviate the pilot’s responsibility to comply with applicable Federal Aviation Regulations, the limitations and performance data provided in the FAA approved Airplane Flight Manual (AFM), or, in the absence of an FAA approved AFM, other data provided by the aircraft manufacturer.

7.3 In addition to their use during takeoff, runway half-way signs offer the pilot increased awareness of his or her position along the runway during landing operations.

NOTE-

No FAA standard exists for the appearance of the runway half-way sign. FIG ENR 5.7-1 shows a graphical depiction of a typical runway half-way sign.

FIG ENR 5.7-1
Typical Runway Half-way Sign



8. Mountain Wave

8.1 Many pilots go all their lives without understanding what a mountain wave is. Quite a few have lost their lives because of this lack of understanding. One need not be a licensed meteorologist to understand the mountain wave phenomenon.

8.2 Mountain waves occur when air is being blown over a mountain range or even the ridge of a sharp bluff area. As the air hits the upwind side of the range, it starts to climb, thus creating what is generally a smooth updraft which turns into a turbulent downdraft as the air passes the crest of the ridge. From this point, for many miles downwind, there will be a series of downdrafts and updrafts. Satellite photos of the Rockies have shown mountain waves extending as far as 700 miles downwind of the range. Along the east coast area, such photos of the Appalachian chain have picked up the mountain wave phenomenon over a hundred miles eastward. All it takes to form a mountain wave is wind blowing across the range at 15 knots or better at an intersection angle of not less than 30 degrees.

8.3 Pilots from flatland areas should understand a few things about mountain waves in order to stay out of trouble. Approaching a mountain range from the upwind side (generally the west), there will usually be a smooth updraft; therefore, it is not quite as dangerous an area as the lee of the range. From the leeward side, it is always a good idea to add an extra thousand feet or so of altitude because downdrafts can exceed the climb capability of the aircraft. Never

expect an updraft when approaching a mountain chain from the leeward. Always be prepared to cope with a downdraft and turbulence.

8.4 When approaching a mountain ridge from the downwind side, it is recommended that the ridge be approached at approximately a 45° angle to the horizontal direction of the ridge. This permits a safer retreat from the ridge with less stress on the aircraft should severe turbulence and downdraft be experienced. If severe turbulence is encountered, simultaneously reduce power and adjust pitch until aircraft approaches maneuvering speed, then adjust power and trim to maintain maneuvering speed and fly away from the turbulent area.

9. Seaplane Safety

9.1 Acquiring a seaplane class rating affords access to many areas not available to landplane pilots. Adding a seaplane class rating to your pilot certificate can be relatively uncomplicated and inexpensive. However, more effort is required to become a safe, efficient, competent “bush” pilot. The natural hazards of the backwoods have given way to modern man-made hazards. Except for the far north, the available bodies of water are no longer the exclusive domain of the airman. Seaplane pilots must be vigilant for hazards such as electric power lines, power, sail and rowboats, rafts, mooring lines, water skiers, swimmers, etc.

9.2 Seaplane pilots must have a thorough understanding of the right-of-way rules as they apply to aircraft versus other vessels. Seaplane pilots are expected to know and adhere to both the United States Coast Guard’s (USCG) Navigation Rules, International-Inland, and Title 14 Code of Federal Regulations (CFR) Section 91.115, Right of Way Rules; Water Operations. The navigation rules of the road are a set of collision avoidance rules as they apply to aircraft on the water. A seaplane is considered a vessel when on the water for the

purposes of these collision avoidance rules. In general, a seaplane on the water shall keep well clear of all vessels and avoid impeding their navigation. The CFR requires, in part, that aircraft operating on the water “. . . shall, insofar as possible, keep clear of all vessels and avoid impeding their navigation and shall give way to any vessel or other aircraft that is given the right of way” This means that a seaplane should avoid boats and commercial shipping when on the water. If on a collision course, the seaplane should slow, stop, or maneuver to the right, away from the bow of the oncoming vessel. Also, while on the surface with an engine running, an aircraft must give way to all nonpowered vessels. Since a seaplane in the water may not be as maneuverable as one in the air, the aircraft on the water has right-of-way over one in the air, and one taking off has right-of-way over one landing. A seaplane is exempt from the USCG safety equipment requirements, including the requirements for Personal Floatation Devices (PFD). Requiring seaplanes on the water to comply with USCG equipment requirements in addition to the FAA equipment requirements would be an unnecessary burden on seaplane owners and operators.

9.3 Unless they are under Federal jurisdiction, navigable bodies of water are under the jurisdiction of the state, or in a few cases, privately owned. Unless they are specifically restricted, aircraft have as much right to operate on these bodies of water as other vessels. To avoid problems, check with Federal or local officials in advance of operating on unfamiliar waters. In addition to the agencies listed in TBL ENR 5.7-1, the nearest Flight Standards District Office can usually offer some practical suggestions as well as regulatory information. If you land on a restricted body of water because of an inflight emergency, or in ignorance of the restrictions you have violated, report as quickly as practical to the nearest local official having jurisdiction and explain your situation.

TBL ENR 5.7-1
**Jurisdictions Controlling Navigable
Bodies of Water**

AUTHORITY TO CONSULT FOR USE OF A BODY OF WATER		
Location	Authority	Contact
Wilderness Area	U.S. Department of Agriculture, Forest Service	Local forest ranger
National Forest	USDA Forest Service	Local forest ranger
National Park	U.S. Department of the Interior, National Park Service	Local park ranger
Indian Reservation	USDI, Bureau of Indian Affairs	Local Bureau office
State Park	State government or state forestry or park service	Local state aviation office for further information
Canadian National and Provincial Parks	Supervised and restricted on an individual basis from province to province and by different departments of the Canadian government; consult Canadian Flight Information Manual and/or Water Aerodrome Supplement	Park Superintendent in an emergency

9.4 When operating a seaplane over or into remote areas, appropriate attention should be given to survival gear. Minimum kits are recommended for summer and winter, and are required by law for flight into sparsely settled areas of Canada and Alaska. Alaska State Department of Transportation and Canadian Ministry of Transport officials can provide specific information on survival gear requirements. The kit should be assembled in one container and be easily reachable and preferably floatable.

9.5 The FAA recommends that each seaplane owner or operator provide flotation gear for occupants any time a seaplane operates on or near water. 14 CFR Section 91.205(b)(12) requires approved flotation gear for aircraft operated for hire over water and beyond power-off gliding distance from shore. FAA-approved gear differs from that required for

navigable waterways under USCG rules. FAA-approved life vests are inflatable designs as compared to the USCG's noninflatable PFDs that may consist of solid, bulky material. Such USCG PFDs are impractical for seaplanes and other aircraft because they may block passage through the relatively narrow exits available to pilots and passengers. Life vests approved under Technical Standard Order (TSO) C-13E contain fully inflatable compartments. The wearer inflates the compartments (AFTER exiting the aircraft) primarily by independent CO₂ cartridges, with an oral inflation tube as a backup. The flotation gear also contains a water-activated, self-illuminating signal light. The fact that pilots and passengers can easily don and wear inflatable life vests (when not inflated) provides maximum effectiveness and allows for unrestricted movement. It is imperative that passengers are briefed on the location and proper use of available PFDs prior to leaving the dock.

9.6 The FAA recommends that seaplane owners and operators obtain Advisory Circular (AC) 91-69, Seaplane Safety for 14 CFR Part 91 Operations, free from:

U.S. Department of Transportation
Subsequent Distribution Office, SVC-121.23
Ardmore East Business Center
3341 Q 75th Avenue
Landover, MD 20785
FAX: (301) 386-5394

The USCG Navigation Rules International-Inland (COMDTINST M16672.2B) is available for a fee from the Government Printing Office by facsimile request to (202) 512-2250. It can be ordered using Mastercard or Visa.

10. Flight Operations in Volcanic Ash

10.1 Severe volcanic eruptions which send ash into the upper atmosphere occur somewhere around the world several times each year. Flying into a volcanic ash cloud can be exceedingly dangerous. A B747-200 lost all four engines after such an encounter, and a B747-400 had the same nearly catastrophic experience. Piston-powered aircraft are less likely to lose power but severe damage is almost certain to ensue after an encounter with a volcanic ash cloud which is only a few hours old.

10.2 Most important is to avoid any encounter with volcanic ash. The ash plume may not be visible, especially in instrument conditions or at night; and even if visible, it is difficult to distinguish visually between an ash cloud and an ordinary weather cloud. Volcanic ash clouds are not displayed on airborne or ATC radar. The pilot must rely on reports from air traffic controllers and other pilots to determine the location of the ash cloud and use that information to remain well clear of the area. Every attempt should be made to remain on the upwind side of the volcano.

10.3 It is recommended that pilots encountering an ash cloud should immediately reduce thrust to idle (altitude permitting), and reverse course in order to escape from the cloud. Ash clouds may extend for hundreds of miles, and pilots should not attempt to fly through or climb out of the cloud. In addition, the following procedures are recommended:

10.3.1 Disengage the autothrottle if engaged. This will prevent the autothrottle from increasing engine thrust.

10.3.2 Turn on continuous ignition.

10.3.3 Turn on all accessory airbleeds including all air conditioning packs, nacelles, and wing anti-ice. This will provide an additional engine stall margin by reducing engine pressure.

10.4 The following has been reported by flight crews who have experienced encounters with volcanic dust clouds.

10.4.1 Smoke or dust appearing in the cockpit.

10.4.2 An acrid odor similar to electrical smoke.

10.4.3 Multiple engine malfunctions, such as compressor stalls, increasing EGT, torching from tailpipe, and flameouts.

10.4.4 At night, St. Elmo's fire or other static discharges accompanied by a bright orange glow in the engine inlets.

10.4.5 A fire warning in the forward cargo area.

10.5 It may become necessary to shut down and then restart engines to prevent exceeding EGT limits. Volcanic ash may block the pitot system and result in unreliable airspeed indications.

10.6 If you see a volcanic eruption and have not been previously notified of it, you may have been the first

person to observe it. In this case, immediately contact ATC and alert them to the existence of the eruption. If possible, use the Volcanic Activity Reporting Form (VAR) depicted at the end of GEN 3.5. Items 1 through 8 of the VAR should be transmitted immediately. The information requested in items 9 through 16 should be passed after landing. If a VAR form is not immediately available, relay enough information to identify the position and nature of the volcanic activity. Do not become unnecessarily alarmed if there is merely steam or very low-level eruptions of ash.

10.7 When landing at airports where volcanic ash has been deposited on the runway, be aware that even a thin layer of dry ash can be detrimental to braking action. Wet ash on the runway may also reduce effectiveness of braking. It is recommended that reverse thrust be limited to a minimum practical to reduce the possibility of reduced visibility and engine ingestion of airborne ash.

10.8 When departing from airports where volcanic ash has been deposited it is recommended that pilots avoid operating in visible airborne ash. Allow ash to settle before initiating takeoff roll. It is also recommended that flap extension be delayed until initiating the takeoff checklist and that a rolling takeoff be executed to avoid blowing ash back into the air.

11. Emergency Airborne Inspection of Other Aircraft

11.1 Providing airborne assistance to another aircraft may involve flying in very close proximity to that aircraft. Most pilots receive little, if any, formal training or instruction in this type of flying activity. Close proximity flying without sufficient time to plan (i.e., in an emergency situation), coupled with the stress involved in a perceived emergency can be hazardous.

11.2 The pilot in the best position to assess the situation should take the responsibility of coordinating the airborne intercept and inspection, taking into account the unique flight characteristics and differences of the category(s) of aircraft involved.

11.3 Some of the safety considerations are:

11.3.1 Area, direction, and speed of the intercept.

11.3.2 Aerodynamic effects (i.e., rotorcraft downwash) which may also affect.

11.3.3 Minimum safe separation distances.

11.3.4 Communications requirements, lost communications procedures, coordination with ATC.

11.3.5 Suitability of diverting the distressed aircraft to the nearest safe airport.

11.3.6 Emergency actions to terminate the intercept.

11.4 Close proximity, inflight inspection of another aircraft is uniquely hazardous. The pilot in command of the aircraft experiencing the problem/emergency must not relinquish his/her control of the situation and jeopardize the safety of his/her aircraft. The maneuver must be accomplished with minimum risk to both aircraft.

12. Precipitation Static

12.1 Precipitation static is caused by aircraft in flight coming in contact with uncharged particles. These particles can be rain, snow, fog, sleet, hail, volcanic ash, dust, any solid or liquid particles. When the aircraft strikes these neutral particles, the positive element of the particle is reflected away from the aircraft and the negative particle adheres to the skin of the aircraft. In a very short period of time a substantial negative charge will develop on the skin of the aircraft. If the aircraft is not equipped with static dischargers, or has an ineffective static discharger system, when a sufficient negative voltage level is reached, the aircraft may go into "CORONA." That is, it will discharge the static electricity from the extremities of the aircraft, such as the wing tips, horizontal stabilizer, vertical stabilizer, antenna, propeller tips, etc. This discharge of static electricity is what you will hear in your headphones and is what we call P-static.

12.2 A review of pilot reports often shows different symptoms with each problem that is encountered. The following list of problems is a summary of many pilot reports from many different aircraft. Each problem was caused by P-static:

12.2.1 Complete loss of VHF communications.

12.2.2 Erroneous magnetic compass readings (30% in error).

12.2.3 High pitched squeal on audio.

12.2.4 Motor boat sound on audio.

12.2.5 Loss of all avionics in clouds.

12.2.6 VLF navigation system inoperative most of the time.

12.2.7 Erratic instrument readouts.

12.2.8 Weak transmissions and poor receptivity of radios.

12.2.9 "St. Elmo's Fire" on windshield.

12.3 Each of these symptoms is caused by one general problem on the airframe. This problem is the inability of the accumulated charge to flow easily to the wing tips and tail of the airframe, and properly discharge to the airstream.

12.4 Static dischargers work on the principle of creating a relatively easy path for discharging negative charges that develop on the aircraft by using a discharger with fine metal points, carbon coated rods, or carbon wicks rather than wait until a large charge is developed and discharged off the trailing edges of the aircraft that will interfere with avionics equipment. This process offers approximately 50 decibels (dB) static noise reduction which is adequate in most cases to be below the threshold of noise that would cause interference in avionics equipment.

12.5 It is important to remember that precipitation static problems can only be corrected with the proper number of quality static dischargers, properly installed on a properly bonded aircraft. P-static is indeed a problem in the all weather operation of the aircraft, but there are effective ways to combat it. All possible methods of reducing the effects of P-static should be considered so as to provide the best possible performance in the flight environment.

12.6 A wide variety of discharger designs is available on the commercial market. The inclusion of well-designed dischargers may be expected to improve airframe noise in P-static conditions by as much as 50 dB. Essentially, the discharger provides a path by which accumulated charge may leave the airframe quietly. This is generally accomplished by providing a group of tiny corona points to permit onset of corona-current flow at a low aircraft potential. Additionally, aerodynamic design of dischargers to permit corona to occur at the lowest possible atmospheric pressure also lowers the corona threshold. In addition to permitting a low potential

discharge, the discharger will minimize the radiation of radio frequency (RF) energy which accompanies the corona discharge, in order to minimize effects of RF components at communications and navigation frequencies on avionics performance. These effects are reduced through resistive attachment of the corona point(s) to the airframe, preserving direct current connection but attenuating the higher frequency components of the discharge.

12.7 Each manufacturer of static dischargers offers information concerning appropriate discharger location on specific airframes. Such locations emphasize the trailing outboard surfaces of wings and horizontal tail surfaces, plus the tip of the vertical stabilizer, where charge tends to accumulate on the airframe. Sufficient dischargers must be provided to allow for current carrying capacity which will maintain airframe potential below the corona threshold of the trailing edges.

12.8 In order to achieve full performance of avionic equipment, the static discharge system will require periodic maintenance. A pilot's knowledge of P-static causes and effects is an important element in assuring optimum performance by early recognition of these types of problems.

13. Light Amplification by Stimulated Emission of Radiation (Laser) Operations and Reporting Illumination of Aircraft

13.1 Lasers have many applications. Of concern to users of the National Airspace System are those laser events that may affect pilots; e.g., outdoor laser light shows or demonstrations for entertainment and advertisement at special events and theme parks. Generally, the beams from these events appear as bright blue-green in color; however, they may be red, yellow, or white. Some laser systems produce light which is invisible to the human eye.

13.2 FAA regulations prohibit the disruption of aviation activity by any person on the ground or in the air. The FAA and the Food and Drug Administration (the Federal agency that has the responsibility to enforce compliance with Federal requirements for laser systems and laser light show products) are working together to ensure that operators of these devices do not pose a hazard to aircraft operators.

13.3 Pilots should be aware that illuminations from these laser operations is able to create temporary vision impairment miles from the actual location. In addition, these operations can produce permanent eye damage. Pilots should make themselves aware of where laser activities are being conducted and avoid the areas if possible.

13.4 Recent and increasing incidents of unauthorized illumination of aircraft by lasers, as well as the proliferation and increasing sophistication of laser devices available to the general public, dictates that the FAA, in coordination with other government agencies, take action to safeguard flights from these unauthorized illuminations.

13.5 Pilots should report laser illumination activity to the controlling Air Traffic Control facilities, Federal Contract Towers or Flight Service Stations as soon as possible after the event. The following information should be included:

13.5.1 UTC Date and Time of Event.

13.5.2 Call Sign or Aircraft Registration Number.

13.5.3 Type Aircraft.

13.5.4 Nearest Major City.

13.5.5 Altitude.

13.5.6 Location of Event (Latitude/Longitude and/or Fixed Radial Distance (FRD)).

13.5.7 Brief Description of the Event and any other Pertinent Information.

13.6 Pilots are also encouraged to complete the Laser Beam Exposure Questionnaire (See FIG ENR 5.7-2), and fax or email it, per the directions on the questionnaire, as soon as possible after landing.

13.7 When a laser event is reported to an air traffic facility, a general caution warning will be broadcasted on all appropriate frequencies every five minutes for 20 minutes and broadcasted on the ATIS for one hour following the report.

PHRASEOLOGY-

UNAUTHORIZED LASER ILLUMINATION EVENT, (UTC time), (location), (altitude), (color), (direction).

EXAMPLE-

"Unauthorized laser illumination event, at 0100z, 8 mile final runway 18R at 3,000 feet, green laser from the southwest."

FIG ENR 5.7-2
Laser Beam Exposure Questionnaire

LASER Beam Exposure Questionnaire

Fax to Washington Operations Control Center (W0CC) (202) 267-5289 ATTN: DEN

or

Email LaserReports@faa.gov

Pilot Name: _____ Phone Number: _____

Company: _____ Flight Number: _____

1. Date and time (UTC)? _____
2. Position of event (lat/long and/or FRD)? _____
3. Altitude? _____
4. What was the visibility? _____
5. What were the atmospheric conditions? (Circle those which apply) – Clear Overcast Rainy Foggy Hazy Sunny
6. What was the color(s) of the light? _____
7. Did the color(s) change during the exposure? _____
8. Did you attempt an evasive maneuver? _____
If yes, did the beam follow you as you tried to move away? _____
9. Can you estimate how far away the light source was from your location? _____
10. What was the position of the light relative to the aircraft? _____
11. Was the source moving? _____
12. Was the light coming directly from its source or did it appear to be reflected off other surfaces? _____
13. Were there multiple sources of light? _____
14. How long was the exposure? _____
15. Did the light seem to track your path or was there incidental contact? _____
16. What tasks were you performing when the exposure occurred? _____
17. Did the light prevent or hamper you from doing those tasks, or was the light more of an annoyance? _____
18. What were the visual effects you experienced (after-image, blind spot, flash-blindness, glare*)? _____
19. Did you report the incident by radio to ATC? _____

Any other pertinent information: _____

This questionnaire may be filled out by the competent authority during interviews with aircrews exposed to unauthorized laser illumination. This information will be used to aid in subsequent investigation by ATC, law enforcement and other governmental agencies to safeguard the safety and efficiency of civil aviation operation in the NAS.

**Examples of common visual effects:*

After image - An image that remains in the visual field after an exposure to a bright light

Blindspot - A temporary or permanent loss of vision of part of the visual field

Flash-blindness - The inability to see (either temporarily or permanently) caused by bright light entering the eye and persisting after the illumination has ceased

Glare - A temporary disruption in vision caused by the presence of a bright light (such as an oncoming car's headlights) within the individual's field of vision. Glare lasts only as long as the bright light is actually present within the individual's field of vision

Paperwork Reduction Act Statement: This form is being used to collect information regarding the unauthorized laser illumination of aircraft. We estimate that it will take 15 minutes to provide this information. The collection is voluntary. Note that an agency may not conduct a sponsor, and a person is not required to respond to, a collection of information unless it displays a currently valid OMB control number. The OMB control number associated with the collection is 2120-0698.

13.8 When laser activities become known to the FAA, Notices to Airmen (NOTAM) are issued to inform the aviation community of the events. Pilots should consult NOTAMs or the Special Notices Section of the Airport/Facility Directory for information regarding laser activities.

14. Flying in Flat Light and White Out Conditions

14.1 Flat Light. Flat light is an optical illusion, also known as “sector or partial white out.” It is not as severe as “white out” but the condition causes pilots to lose their depth-of-field and contrast in vision. Flat light conditions are usually accompanied by overcast skies inhibiting any visual clues. Such conditions can occur anywhere in the world, primarily in snow covered areas but can occur in dust, sand, mud flats, or on glassy water. Flat light can completely obscure features of the terrain, creating an inability to distinguish distances and closure rates. As a result of this reflected light, it can give pilots the illusion that they are ascending or descending when they may actually be flying level. However, with good judgment and proper training and planning, it is possible to safely operate an aircraft in flat light conditions.

14.2 White Out. As defined in meteorological terms, white out occurs when a person becomes engulfed in a uniformly white glow. The glow is a result of being surrounded by blowing snow, dust, sand, mud or water. There are no shadows, no horizon or clouds and all depth-of-field and orientation are lost. A white out situation is severe in that there are no visual references. Flying is not recommended in any white out situation. Flat light conditions can lead to a white out environment quite rapidly, and both atmospheric conditions are insidious; they sneak up on you as your visual references slowly begin to disappear. White out has been the cause of several aviation accidents.

14.3 Self Induced White Out. This effect typically occurs when a helicopter takes off or lands on a snow-covered area. The rotor down wash picks up particles and re-circulates them through the rotor down wash. The effect can vary in intensity depending upon the amount of light on the surface. This can happen on the sunniest, brightest day with good contrast everywhere. However, when it

happens, there can be a complete loss of visual clues. If the pilot has not prepared for this immediate loss of visibility, the results can be disastrous. Good planning does not prevent one from encountering flat light or white out conditions.

14.4 Never take off in a white out situation.

14.4.1 Realize that in flat light conditions it may be possible to depart but not to return to that site. During takeoff, make sure you have a reference point. Do not lose sight of it until you have a departure reference point in view. Be prepared to return to the takeoff reference if the departure reference does not come into view.

14.4.2 Flat light is common to snow skiers. One way to compensate for the lack of visual contrast and depth-of-field loss is by wearing amber tinted lenses (also known as blue blockers). Special note of caution: Eyewear is not ideal for every pilot. Take into consideration personal factors – age, light sensitivity, and ambient lighting conditions.

14.4.3 So what should a pilot do when all visual references are lost?

14.4.3.1 Trust the cockpit instruments.

14.4.3.2 Execute a 180 degree turnaround and start looking for outside references.

14.4.3.3 Above all – fly the aircraft.

14.4.4 Landing in Low Light Conditions. When landing in a low light condition – use extreme caution. Look for intermediate reference points, in addition to checkpoints along each leg of the route for course confirmation and timing. The lower the ambient light becomes, the more reference points a pilot should use.

14.4.5 Airport Landings.

14.4.5.1 Look for features around the airport or approach path that can be used in determining depth perception. Buildings, towers, vehicles or other aircraft serve well for this measurement. Use something that will provide you with a sense of height above the ground, in addition to orienting you to the runway.

14.4.5.2 Be cautious of snowdrifts and snow banks – anything that can distinguish the edge of the runway. Look for subtle changes in snow texture or shading to identify ridges or changes in snow depth.

14.4.6 Off-Airport Landings.

14.4.6.1 In the event of an off-airport landing, pilots have used a number of different visual cues to gain reference. Use whatever you must to create the contrast you need. Natural references seem to work best (trees, rocks, snow ribs, etc.)

- a) Over flight.
- b) Use of markers.
- c) Weighted flags.
- d) Smoke bombs.
- e) Any colored rags.
- f) Dye markers.
- g) Kool-aid.
- h) Trees or tree branches.

14.4.6.2 It is difficult to determine the depth of snow in areas that are level. Dropping items from the aircraft to use as reference points should be used as a visual aid only and not as a primary landing reference. Unless your marker is biodegradable, be sure to retrieve it after landing. Never put yourself in a position where no visual references exist.

14.4.6.3 Abort landing if blowing snow obscures your reference. Make your decisions early. Don't assume you can pick up a lost reference point when you get closer.

14.4.6.4 Exercise extreme caution when flying from sunlight into shade. Physical awareness may tell you that you are flying straight but you may actually be in a spiral dive with centrifugal force pressing against you. Having no visual references enhances this illusion. Just because you have a good visual reference does not mean that it's safe to continue. There may be snow-covered terrain not visible in the direction that you are traveling. Getting caught in a no visual reference situation can be fatal.

14.4.7 Flying Around a Lake.

14.4.7.1 When flying along lakeshores, use them as a reference point. Even if you can see the other side, realize that your depth perception may be poor. It is easy to fly into the surface. If you must cross the lake, check the altimeter frequently and maintain a safe altitude while you still have a good reference. Don't descend below that altitude.

14.4.7.2 The same rules apply to seemingly flat areas of snow. If you don't have good references, avoid going there.

14.4.8 Other Traffic. Be on the look out for other traffic in the area. Other aircraft may be using your same reference point. Chances are greater of colliding with someone traveling in the same direction as you, than someone flying in the opposite direction.

14.4.9 Ceilings. Low ceilings have caught many pilots off guard. Clouds do not always form parallel to the surface, or at the same altitude. Pilots may try to compensate for this by flying with a slight bank and thus creating a descending turn.

14.4.10 Glaciers. Be conscious of your altitude when flying over glaciers. The glaciers may be rising faster than you are climbing.

15. Operations in Ground Icing Conditions

15.1 The presence of aircraft airframe icing during takeoff, typically caused by improper or no deicing of the aircraft being accomplished prior to flight has contributed to many recent accidents in turbine aircraft. The General Aviation Joint Steering Committee (GAJSC) is the primary vehicle for government-industry cooperation, communication, and coordination on GA accident mitigation. The Turbine Aircraft Operations Subgroup (TAOS) works to mitigate accidents in turbine accident aviation. While there is sufficient information and guidance currently available regarding the effects of icing on aircraft and methods for deicing, the TAOS has developed a list of recommended actions to further assist pilots and operators in this area.

15.1.1 While the efforts of the TAOS specifically focus on turbine aircraft, it is recognized that their recommendations are applicable to and can be adapted for the pilot of a small, piston powered aircraft too.

15.2 The following recommendations are offered:

15.2.1 Ensure that your aircraft's lift-generating surfaces are COMPLETELY free of contamination before flight through a tactile (hands on) check of the critical surfaces when feasible. Even when otherwise permitted, operators should avoid smooth or polished frost on lift-generating surfaces as an acceptable preflight condition.

15.2.2 Review and refresh your cold weather standard operating procedures.

15.2.3 Review and be familiar with the Airplane Flight Manual (AFM) limitations and procedures necessary to deal with icing conditions prior to flight, as well as in flight.

15.2.4 Protect your aircraft while on the ground, if possible, from sleet and freezing rain by taking advantage of aircraft hangars.

15.2.5 Take full advantage of the opportunities available at airports for deicing. Do not refuse deicing services simply because of cost.

15.2.6 Always consider canceling or delaying a flight if weather conditions do not support a safe operation.

15.3 If you haven't already developed a set of Standard Operating Procedures for cold weather operations, they should include:

15.3.1 Procedures based on information that is applicable to the aircraft operated, such as AFM limitations and procedures;

15.3.2 Concise and easy to understand guidance that outlines best operational practices;

15.3.3 A systematic procedure for recognizing, evaluating and addressing the associated icing risk, and offer clear guidance to mitigate this risk;

15.3.4 An aid (such as a checklist or reference cards) that is readily available during normal day-to-day aircraft operations.

15.4 There are several sources for guidance relating to airframe icing, including:

<http://aircrafticing.grc.nasa.gov/index.html>

<http://www.ibac.org/is-bao/isbao.htm>

http://www.natasafety1st.org/bus_deice.htm

15.4.1 Advisory Circular (AC) 91-74, Pilot Guide, Flight in Icing Conditions.

15.4.2 AC 135-17, Pilot Guide Small Aircraft Ground Deicing.

15.4.3 AC 135-9, FAR Part 135 Icing Limitations.

15.4.4 AC 120-60, Ground Deicing and Anti-icing Program.

15.4.5 AC 135-16, Ground Deicing and Anti-icing Training and Checking.

15.5 The FAA Approved Deicing Program Updates is published annually as a Flight Standards Information Bulletin for Air Transportation and contains detailed information on deicing and anti-icing procedures and holdover times. It may be accessed at the following web site by selecting the current year's information bulletins:

http://www.faa.gov/library/manuals/examiners_inspectors/8400/fsat

16. Avoid Flight in the Vicinity of Thermal Plumes (Smoke Stacks and Cooling Towers)

16.1 Flight Hazards Exist Around Thermal Plumes. Thermal plumes are defined as visible or invisible emissions from power plants, industrial production facilities, or other industrial systems that release large amounts of vertically directed unstable gases. High temperature exhaust plumes may cause significant air disturbances such as turbulence and vertical shear. Other identified potential hazards include, but are not necessarily limited to, reduced visibility, oxygen depletion, engine particulate contamination, exposure to gaseous oxides, and/or icing. Results of encountering a plume may include airframe damage, aircraft upset, and/or engine damage/failure. These hazards are most critical during low altitude flight, especially during takeoff and landing.

16.2 When able, a pilot should fly upwind of possible thermal plumes. When a plume is visible via smoke or a condensation cloud, remain clear and realize a plume may have both visible and invisible characteristics. Exhaust stacks without visible plumes may still be in full operation, and airspace in the vicinity should be treated with caution. As with mountain wave turbulence or clear air turbulence, an invisible plume may be encountered unexpectedly. Cooling towers, power plant stacks, exhaust fans, and other similar structures are depicted in FIG ENR 5.7-3. Whether plumes are visible or invisible, the total extent of their unstable air is difficult to ascertain. FAA studies are underway to further characterize the effects of thermal plumes as exhaust effluents. Until the results of these studies are known and possible changes to rules and policy are identified and/or published, pilots are encouraged to

exercise caution when flying in the vicinity of thermal plumes. Pilots are encouraged to reference the Airport/Facility Directory where amplifying

notes may caution pilots and identify the location of structure(s) emitting thermal plumes.

FIG ENR 5.7-3
Plumes

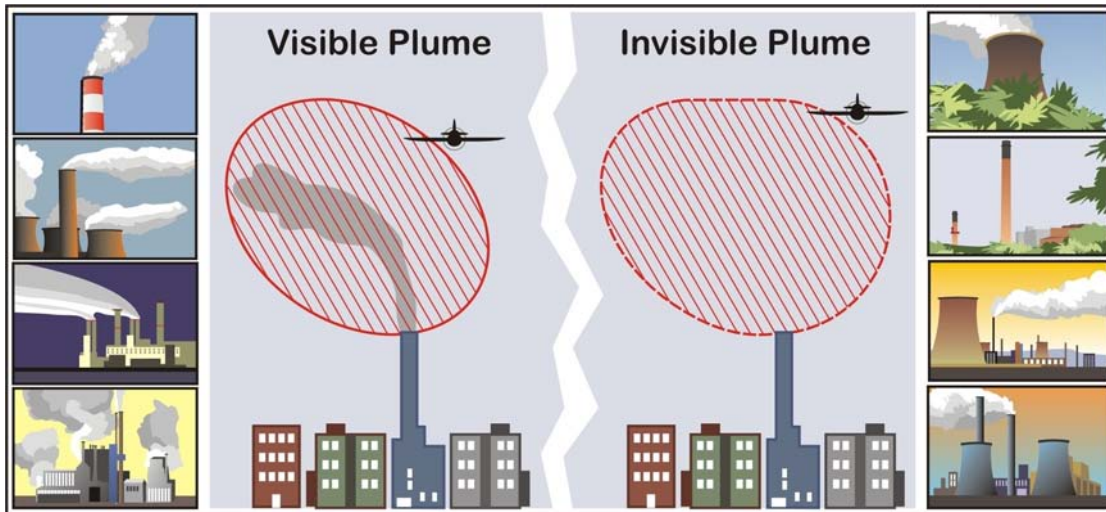

ENR 6. Helicopter Operations

ENR 6.1 Helicopter IFR Operations

1. Helicopter Flight Control Systems

1.1 The certification requirements for helicopters to operate under Instrument Flight Rules (IFR) are contained in 14 CFR Part 27, Airworthiness Standards: Normal Category Rotorcraft, and 14 CFR Part 29, Airworthiness Standards: Transport Category Rotorcraft. To meet these requirements, helicopter manufacturers usually utilize a set of stabilization and/or Automatic Flight Control Systems (AFCSs).

1.2 Typically, these systems fall into the following categories:

1.2.1 Aerodynamic surfaces, which impart some stability or control capability not found in the basic VFR configuration.

1.2.2 Trim systems, which provide a cyclic centering effect. These systems typically involve a magnetic brake/spring device, and may also be controlled by a four-way switch on the cyclic. This is a system that supports “hands on” flying of the helicopter by the pilot.

1.2.3 Stability Augmentation Systems (SASs), which provide short-term rate damping control inputs to increase helicopter stability. Like trim systems, SAS supports “hands on” flying.

1.2.4 Attitude Retention Systems (ATTs), which return the helicopter to a selected attitude after a disturbance. Changes in desired attitude can be accomplished usually through a four-way “beep” switch, or by actuating a “force trim” switch on the cyclic, setting the attitude manually, and releasing. Attitude retention may be a SAS function, or may be the basic “hands off” autopilot function.

1.2.5 Autopilot Systems (APs), which provide for “hands off” flight along specified lateral and vertical paths, including heading, altitude, vertical speed, navigation tracking, and approach. These systems typically have a control panel for mode selection, and system for indication of mode status. Autopilots may or may not be installed with an associated Flight Director System (FD). Autopilots typically control

the helicopter about the roll and pitch axes (cyclic control) but may also include yaw axis (pedal control) and collective control servos.

1.2.6 FDs, which provide visual guidance to the pilot to fly specific selected lateral and vertical modes of operation. The visual guidance is typically provided as either a “dual cue” (commonly known as a “cross-pointer”) or “single cue” (commonly known as a “vee-bar”) presentation superimposed over the attitude indicator. Some FDs also include a collective cue. The pilot manipulates the helicopter’s controls to satisfy these commands, yielding the desired flight path, or may couple the flight director to the autopilot to perform automatic flight along the desired flight path. Typically, flight director mode control and indication is shared with the autopilot.

1.3 In order to be certificated for IFR operation, a specific helicopter may require the use of one or more of these systems, in any combination.

1.4 In many cases, helicopters are certificated for IFR operations with either one or two pilots. Certain equipment is required to be installed and functional for two pilot operations, and typically, additional equipment is required for single pilot operation. These requirements are usually described in the limitations section of the Rotorcraft Flight Manual (RFM).

1.5 In addition, the RFM also typically defines systems and functions that are required to be in operation or engaged for IFR flight in either the single or two pilot configuration. Often, particularly in two pilot operation, this level of augmentation is less than the full capability of the installed systems. Likewise, single pilot operation may require a higher level of augmentation.

1.6 The RFM also identifies other specific limitations associated with IFR flight. Typically, these limitations include, but are not limited to:

1.6.1 Minimum equipment required for IFR flight (in some cases, for both single pilot and two pilot operations).

1.6.2 V_{MINI} (minimum speed – IFR).

NOTE–

V_{MINI} – Instrument flight minimum speed, utilized in complying with minimum limit speed requirements for instrument flight

NOTE–

The manufacturer may also recommend a minimum IFR airspeed during instrument approach.

1.6.3 V_{NEI} (never exceed speed – IFR).

NOTE–

V_{NEI} – Instrument flight never exceed speed, utilized instead of V_{NE} for compliance with maximum limit speed requirements for instrument flight

V_{NE} – Never exceed speed

1.6.4 Maximum approach angle.

1.6.5 Weight and center of gravity limits.

1.6.6 Aircraft configuration limitations (such as aircraft door positions and external loads).

1.6.7 Aircraft system limitations (generators, inverters, etc.).

1.6.8 System testing requirements (many avionics and AFCS/AP/FD systems incorporate a self-test feature).

1.6.9 Pilot action requirements (such as the pilot must have his/her hands and feet on the controls during certain operations, such as during instrument approach below certain altitudes).

1.7 It is very important that pilots be familiar with the IFR requirements for their particular helicopter. Within the same make, model and series of helicopter, variations in the installed avionics may change the required equipment or the level of augmentation for a particular operation.

1.8 During flight operations, pilots must be aware of the mode of operation of the augmentation systems, and the control logic and functions employed. For example, during an ILS approach using a particular system in the three-cue mode (lateral, vertical and collective cues), the flight director *collective cue* responds to glideslope deviation, while the horizontal bar of the “cross-pointer” responds to airspeed deviations. The same system, while flying an ILS in the two-cue mode, provides for the *horizontal bar* to respond to glideslope deviations. This concern is particularly significant when operating using two pilots. Pilots should have an established set of procedures and responsibilities for the control of flight director/autopilot modes for the various phases

of flight. Not only does a full understanding of the system modes provide for a higher degree of accuracy in control of the helicopter, it is the basis for crew identification of a faulty system.

1.9 Relief from the prohibition to takeoff with any inoperative instruments or equipment may be provided through a Minimum Equipment List (see 14 CFR Section 91.213 and 14 CFR Section 135.179, Inoperative Instruments and Equipment). In many cases, a helicopter configured for single pilot IFR may depart IFR with certain equipment inoperative, provided a crew of two pilots is used. Pilots are cautioned to ensure the pilot-in-command and second-in-command meet the requirements of 14 CFR Section 61.58, Pilot-in-Command Proficiency Check: Operation of Aircraft Requiring More Than One Pilot Flight Crewmember, and 14 CFR Section 61.55, Second-in-Command Qualifications, or 14 CFR Part 135, Operating Requirements: Commuter and On-Demand Operations, Subpart E, Flight Crewmember Requirements, and Subpart G, Crewmember Testing Requirements, as appropriate.

1.10 Experience has shown that modern AFCS/AP/FD equipment installed in IFR helicopters can, in some cases, be very complex. This complexity requires the pilot(s) to obtain and maintain a high level of knowledge of system operation, limitations, failure indications and reversionary modes. In some cases, this may only be reliably accomplished through formal training.

2. Helicopter Instrument Approaches

2.1 Helicopters are capable of flying any published 14 CFR Part 97, Standard Instrument Approach Procedures (SIAPs), for which they are properly equipped, subject to the following limitations and conditions:

2.1.1 Helicopters flying conventional (non-Copter) SIAPs may reduce the visibility minima to not less than one half the published Category A landing visibility minima, or $\frac{1}{4}$ statute mile visibility/1200 RVR, whichever is greater unless the procedure is annotated with “**Visibility Reduction by Helicopters NA.**” This annotation means that there are penetrations of the final approach obstacle identification surface (OIS) and that the 14 CFR Section 97.3 visibility reduction rule does not apply and you must take precaution to avoid any obstacles

in the visual segment. No reduction in MDA/DA is permitted. The helicopter may initiate the final approach segment at speeds up to the upper limit of the highest approach category authorized by the procedure, but must be slowed to no more than 90 KIAS at the missed approach point (MAP) in order to apply the visibility reduction. Pilots are cautioned that such a decelerating approach may make early identification of wind shear on the approach path difficult or impossible. If required, use the Inoperative Components and Visual Aids Table provided in the front cover of the U.S. Terminal Procedures Volume to derive the Category A minima before applying the 14 CFR Section 97.3(d-1) rule.

2.1.2 Helicopters flying Copter SIAPs may use the published minima, with no reductions allowed. The maximum airspeed is 90 KIAS on any segment of the approach or missed approach.

2.1.3 Helicopters flying GPS Copter SIAPs must limit airspeed to 90 KIAS or less when flying any segment of the procedure, except speeds must be limited to no more than 70 KIAS on the final and missed approach segments. Military GPS Copter SIAPs are limited to no more than 90 KIAS throughout the procedure. If annotated, holding may also be limited to no more than 70 KIAS. Use the published minima, no reductions allowed.

NOTE-

Obstruction clearance surfaces are based on the aircraft speed and have been designed on these approaches for 70 knots. If the helicopter is flown at higher speeds, it may fly outside of protected airspace. Some helicopters have a V_{MINI} greater than 70 knots; therefore, they can not meet the 70 knot limitation to conduct this type of procedure. Some helicopter autopilots, when used in the “go-around” mode, are programmed with a V_{YI} greater than 70 knots, therefore when using the autopilot “go-around” mode, they can not meet the 70 knot limitation to conduct this type of approach. It may be possible to use the autopilot for the missed approach in the other than the “go-around” mode and meet the 70 knot limitation to conduct this type of approach. When operating at speeds other than V_{YI} or V_Y , performance data may not be available in the RFM to predict compliance with climb gradient requirements. Pilots may use observed performance in similar weight/altitude/temperature/speed conditions to evaluate the suitability of performance. Pilots are cautioned to monitor climb performance to ensure compliance with procedure requirements.

NOTE-

*V_{MINI} – Instrument flight minimum speed, utilized in complying with minimum limit speed requirements for instrument flight
 V_{YI} – Instrument climb speed, utilized instead of V_Y for compliance with the climb requirements for instrument flight
 V_Y – Speed for best rate of climb*

2.1.4 TBL ENR 6.1-1 summarizes these requirements.

**TBL ENR 6.1-1
Helicopter Use of Standard Instrument Approach Procedures**

Procedure	Helicopter Visibility Minima	Helicopter MDA/DA	Maximum Speed Limitations
Conventional (non-Copter)	The greater of: one half the Category A visibility minima, 1/4 statute mile visibility, or 1200 RVR	As published for Category A	The helicopter may initiate the final approach segment at speeds up to the upper limit of the highest Approach Category authorized by the procedure, but must be slowed to no more than 90 KIAS at the MAP in order to apply the visibility reduction.
Copter Procedure	As published	As published	90 KIAS when on a published route/track.
GPS Copter Procedure	As published	As published	90 KIAS when on a published route or track, EXCEPT 70 KIAS when on the final approach or missed approach segment and, if annotated, in holding. Military procedures are limited to 90 KIAS for all segments.

NOTE-

Several factors effect the ability of the pilot to acquire and maintain the visual references specified in 14 CFR Section 91.175(c), even in cases where the flight visibility may be at the minimum derived by TBL ENR 6.1-1. These factors include, but are not limited to:

1. Cockpit cutoff angle (the angle at which the cockpit or other airframe structure limits downward visibility below the horizon).
2. Combinations of high MDA/DH and low visibility minimum, such as a conventional nonprecision approach with a reduced helicopter visibility minima (per 14 CFR Section 97.3).
3. Type, configuration, and intensity of approach and runway lighting systems.
4. Type of obscuring phenomenon and/or windshield contamination.

2.1.5 Even with weather conditions reported at or above landing minima, some combinations of reduced cockpit cutoff angle, minimal approach/runway lighting, and high MDA/DH coupled with a low visibility minima, the pilot may not be able to identify the required visual reference(s) during the approach, or those references may only be visible in a very small portion of the pilot's available field of view. Even if identified by the pilot, these visual references may not support normal maneuvering and normal rates of descent to landing. The effect of such a combination

may be exacerbated by other conditions such as rain on the windshield, or incomplete windshield defogging coverage.

2.1.6 Pilots are cautioned to be prepared to execute a missed approach even though weather conditions may be reported at or above landing minima.

NOTE-

See Section ENR 1.5, paragraph 27., Missed Approach, for additional information on missed approach procedures.

3. Helicopter Approach Procedures to VFR Heliports

3.1 Helicopter approaches may be developed for heliports that do not meet the design standards for an IFR heliport. The majority of IFR approaches to VFR heliports are developed in support of helicopter emergency medical services (HEMS) operators. These approaches can be developed from conventional NAVAIDs or a RNAV system (including GPS). They are developed either as a Special Approach (pilot training is required for special procedures due to their unique characteristics) or a public approach (no special training required). These instrument procedures are developed as either an approach designed to a specific landing site, or an approach designed to a point-in-space.

3.1.1 Approach to a specific landing site. The approach is aligned to a missed approach point from which a landing can be accomplished with a maximum course change of 30 degrees. The visual segment from the MAP to the landing site is evaluated for obstacle hazards. These procedures are annotated: “PROCEED VISUALLY FROM (NAMED MAP) OR CONDUCT THE SPECIFIED MISSED APPROACH.”

3.1.1.1 This phrase requires the pilot to either acquire and maintain visual contact with the landing site at or prior to the MAP, or execute a missed approach. The visibility minimum is based on the distance from the MAP to the landing site, among other factors.

3.1.1.2 The pilot is required to maintain the published minimum visibility throughout the visual segment.

3.1.1.3 Similar to an approach to a runway, the missed approach segment protection is not provided between the MAP and the landing site, and obstacle or terrain avoidance from the MAP to the landing site is the responsibility of the pilot.

3.1.1.4 Upon reaching the MAP defined on the approach procedure, or as soon as practicable after reaching the MAP, the pilot advises ATC whether proceeding visually and canceling IFR or complying with the missed approach instructions. See Section ENR 1.10, paragraph 11.2, Canceling IFR Flight Plan.

3.1.1.5 At least one of the following visual references must be visible or identifiable before the pilot may proceed visually:

- a) FATO or FATO lights.
- b) TLOF or TLOF lights.
- c) Heliport Instrument Lighting System (HILS).
- d) Heliport Approach Lighting System (HALS) or lead-in lights.
- e) Visual Glideslope Indicator (VGSI).
- f) Windsock or windsock light(s). See note below.
- g) Heliport beacon. See note below.

h) Other facilities or systems approved by the Flight Technologies and Procedures Division (AFS-400).

NOTE–

Windsock lights and heliport beacons should be located within 500 ft of the TLOF.

3.1.2 Approach to a Point-in-Space (PinS). At locations where the MAP is located more than 2 SM from the landing site, or the path from the MAP to the landing site is populated with obstructions which require avoidance actions or requires turns greater than 30 degrees, a PinS procedure may be developed. These approaches are annotated “PROCEED VFR FROM (NAMED MAP) OR CONDUCT THE SPECIFIED MISSED APPROACH.”

3.1.2.1 These procedures require the pilot, at or prior to the MAP, to determine if the published minimum visibility, or the weather minimums required by the operating rule, or operations specifications (whichever is higher) is available to safely transition from IFR to VFR flight. If not, the pilot must execute a missed approach. For Part 135 operations, pilots may not begin the instrument approach unless the latest weather report indicates that the weather conditions are at or above the authorized IFR minimums or the VFR weather minimums (as required by the class of airspace, operating rule and/or Operations Specifications) whichever is higher.

3.1.2.2 Visual contact with the landing site is not required; however, the pilot must maintain the appropriate VFR weather minimums throughout the visual segment. The visibility is limited to no lower than that published in the procedure, until canceling IFR.

3.1.2.3 IFR obstruction clearance areas are not applied to the VFR segment between the MAP and the landing site. Obstacle or terrain avoidance from the MAP to the landing site is the responsibility of the pilot.

3.1.2.4 Upon reaching the MAP defined on the approach procedure, or as soon as practicable after reaching the MAP, the pilot advises ATC whether proceeding VFR and canceling IFR, or complying with the missed approach instructions. See Section , paragraph 11.2, Canceling IFR Flight Plan.

3.1.2.5 If the visual segment penetrates Class B, C, or D airspace, pilots are responsible for obtaining a Special VFR clearance, when required.

4. The Gulf of Mexico Grid System

4.1 On October 8, 1998, the Southwest Regional Office of the FAA, with assistance from the Helicopter Safety Advisory Conference (HSAC), implemented the world’s first Instrument Flight Rules (IFR) Grid System in the Gulf of Mexico. This navigational route structure is completely independent of ground-based navigation aids (NAVAIDs) and was designed to facilitate helicopter IFR operations to offshore destinations. The Grid System is defined by over 300 offshore waypoints located 20 minutes apart (latitude and longitude). Flight plan routes are routinely defined by just 4 segments: departure point (lat/long), first en route grid waypoint, last en route grid waypoint prior to approach procedure, and destination point (lat/long). There are over 4,000 possible offshore landing sites. Upon reaching the waypoint prior to the destination, the pilot may execute an Offshore Standard Approach Procedure (OSAP), a Helicopter En Route Descent Areas (HEDA) approach, or an Airborne Radar Approach (ARA). For more information on these helicopter instrument procedures, refer to FAA AC 90–80B, Approval of Offshore Standard Approach Procedures, Airborne Radar Approaches, and Helicopter En Route Descent Areas, on the FAA web site <http://www.faa.gov> under Advisory Circulars. The return flight plan is just the reverse with the requested stand-alone GPS approach contained in the remarks section.

4.2 The large number (over 300) of waypoints in the grid system makes it difficult to assign phonetically pronounceable names to the waypoints that would be meaningful to pilots and controllers. A unique naming system was adopted that enables pilots and controllers to derive the fix position from the name. The five-letter names are derived as follows:

4.2.1 The waypoints are divided into sets of 3 columns each. A three-letter identifier, identifying a geographical area or a NAVAID to the north, represents each set.

4.2.2 Each column in a set is named after its position, i.e., left (L), center (C), and right (R).

4.2.3 The rows of the grid are named alphabetically from north to south, starting with A for the northern most row.

EXAMPLE–

LCHRC would be pronounced “Lake Charles Romeo Charlie.” The waypoint is in the right-hand column of the Lake Charles VOR set, in row C (third south from the northern most row).

4.3 In December 2009, significant improvements to the Gulf of Mexico grid system were realized with the introduction of ATC separation services using ADS–B. In cooperation with the oil and gas services industry, HSAC and Helicopter Association International (HAI), the FAA installed an infrastructure of ADS–B ground stations, weather stations (AWOS) and VHF remote communication outlets (RCO) throughout a large area of the Gulf of Mexico. This infrastructure allows the FAA’s Houston ARTCC to provide “domestic-like” air traffic control service in the offshore area beyond 12nm from the coastline to hundreds of miles offshore to aircraft equipped with ADS–B. Properly equipped aircraft can now be authorized to receive more direct routing, domestic en route separation minima and real time flight following. Operators who do not have authorization to receive ATC separation services using ADS–B, will continue to use the low altitude grid system and receive procedural separation from Houston ARTCC. Non-ADS–B equipped aircraft also benefit from improved VHF communication and expanded weather information coverage.

4.4 Three requirements must be met for operators to file IFR flight plans utilizing the grid:

4.4.1 The helicopter must be equipped for IFR operations and equipped with IFR approved GPS navigational units.

4.4.2 The operator must obtain prior written approval from the appropriate Flight Standards District Office through a Letter of Authorization or Operations Specification, as appropriate.

4.4.3 The operator must be a signatory to the Houston ARTCC Letter of Agreement.

4.5 Operators who wish to benefit from ADS–B based ATC separation services must meet the following additional requirements:

4.5.1 The Operator’s installed ADS–B Out equipment must meet the performance requirements of one of the following FAA Technical Standard Orders

(TSO), or later revisions: TSO-C154c, Universal Access Transceiver (UAT) Automatic Dependent Surveillance-Broadcast (ADS-B) Equipment, or TSO-C166b, Extended Squitter Automatic Dependent Surveillance-Broadcast (ADS-B) and Traffic Information.

4.5.2 Flight crews must comply with the procedures prescribed in the Houston ARTCC Letter of Agreement dated December 17, 2009, or later.

NOTE-

The unique ADS-B architecture in the Gulf of Mexico

depends upon reception of an aircraft's Mode C in addition to the other message elements described in 14 CFR 91.227. Flight crews must be made aware that loss of Mode C also means that ATC will not receive the aircraft's ADS-B signal.

4.6 FAA/NACO publishes the grid system waypoints on the IFR Gulf of Mexico Vertical Flight Reference Chart. A commercial equivalent is also available. The chart is updated annually and is available from a FAA chart agent or FAA directly, web site address: <http://www.naco.faa.gov>.

ENR 6.2 Special Operations

1. Offshore Helicopter Operations

1.1 Introduction

1.1.1 The offshore environment offers unique applications and challenges for helicopter pilots. The mission demands, the nature of oil and gas exploration and production facilities, and the flight environment (weather, terrain, obstacles, traffic), demand special practices, techniques and procedures not found in other flight operations. Several industry organizations have risen to the task of reducing risks in offshore operations, including the Helicopter Safety Advisory Conference (HSAC) (<http://www.hsac.org>), and the Offshore Committee of the Helicopter Association International (HAI) (<http://www.rotor.com>). The following recommended practices for offshore helicopter operations are based on guidance developed by HSAC for use in the Gulf of Mexico, and provided here with their permission. While not regulatory, these recommended practices provide aviation and oil and gas industry operators with useful information in developing procedures to avoid certain hazards of offshore helicopter operations.

NOTE-

Like all aviation practices, these recommended practices are under constant review. Any questions or feedback concerning these recommended procedures may be directed to the HSAC through the feedback feature of the HSAC web site (<http://www.hsac.org>).

1.2 Passenger Management on and about Heliport Facilities

1.2.1 Background. Several incidents involving offshore helicopter passengers have highlighted the potential for incidents and accidents on and about the heliport area. The following practices will minimize risks to passengers and others involved in heliport operations.

1.2.2 Recommended Practices

1.2.2.1 Heliport facilities should have a designated and posted passenger waiting area which is clear of the heliport, heliport access points, and stairways.

1.2.2.2 Arriving passengers and cargo should be unloaded and cleared from the heliport and access route prior to loading departing passengers and cargo.

1.2.2.3 Where a flight crew consists of more than one pilot, one crewmember should supervise the unloading/loading process from outside the aircraft.

1.2.2.4 Where practical, a designated facility employee should assist with loading/unloading, etc.

1.3 Crane-Helicopter Operational Procedures

1.3.1 Background. Historical experience has shown that catastrophic consequences can occur when industry safe practices for crane/helicopter operations are not observed. The following recommended practices are designed to minimize risks during crane and helicopter operations.

1.3.2 Recommended Practices

1.3.2.1 Personnel awareness

a) Crane operators and pilots should develop a mutual understanding and respect of the others' operational limitations and cooperate in the spirit of safety;

b) Pilots need to be aware that crane operators sometimes cannot release the load to cradle the crane boom, such as when attached to wire line lubricators or supporting diving bells; and

c) Crane operators need to be aware that helicopters require warm up before takeoff, a two-minute cool down before shutdown, and cannot circle for extended lengths of time because of fuel consumption.

1.3.2.2 It is recommended that when helicopters are approaching, maneuvering, taking off, or running on the heliport, cranes be shutdown and the operator leave the cab. Cranes not in use shall have their booms cradled, if feasible. If in use, the crane's boom(s) are to be pointed away from the heliport and the crane shutdown for helicopter operations.

1.3.2.3 Pilots will not approach, land on, takeoff, or have rotor blades turning on heliports of structures not complying with the above practice.

1.3.2.4 It is recommended that cranes on offshore platforms, rigs, vessels, or any other facility, which could interfere with helicopter operations (including approach/departure paths):

- a) Be equipped with a red rotating beacon or red high intensity strobe light connected to the system powering the crane, indicating the crane is under power;
- b) Be designed to allow the operator a maximum view of the helideck area and should be equipped with wide-angle mirrors to eliminate blind spots; and
- c) Have their boom tips, headache balls, and hooks painted with high visibility international orange.

1.4 Helicopter/Tanker Operations

1.4.1 Background. The interface of helicopters and tankers during shipboard helicopter operations is complex and may be hazardous unless appropriate procedures are coordinated among all parties. The following recommended practices are designed to minimize risks during helicopter/tanker operations.

1.4.2 Recommended Practices

1.4.2.1 Management, flight operations personnel, and pilots should be familiar with and apply the operating safety standards set forth in “Guide to Helicopter/Ship Operations”, International Chamber of Shipping, Third Edition, 5-89 (as amended), establishing operational guidelines/standards and safe practices sufficient to safeguard helicopter/tanker operations.

1.4.2.2 Appropriate plans, approvals, and communications must be accomplished prior to reaching the vessel, allowing tanker crews sufficient time to perform required safety preparations and position crew members to receive or dispatch a helicopter safely.

1.4.2.3 Appropriate approvals and direct communications with the bridge of the tanker must be maintained throughout all helicopter/tanker operations.

1.4.2.4 Helicopter/tanker operations, including landings/departures, shall not be conducted until the

helicopter pilot-in-command has received and acknowledged permission from the bridge of the tanker.

1.4.2.5 Helicopter/tanker operations shall not be conducted during product/cargo transfer.

1.4.2.6 Generally, permission will not be granted to land on tankers during mooring operations or while maneuvering alongside another tanker.

1.5 Helideck/Heliport Operational Hazard Warning(s) Procedures

1.5.1 Background

1.5.1.1 A number of operational hazards can develop on or near offshore helidecks or onshore heliports that can be minimized through procedures for proper notification or visual warning to pilots. Examples of hazards include but are not limited to:

a) Perforating operations: subparagraph 1.6.

b) H₂S gas presence: subparagraph 1.7.

c) Gas venting: subparagraph 1.8; or,

d) Closed helidecks or heliports: subparagraph 1.9 (unspecified cause).

1.5.1.2 These and other operational hazards are currently minimized through timely dissemination of a written Notice to Airmen (NOTAM) for pilots by helicopter companies and operators. A NOTAM provides a written description of the hazard, time and duration of occurrence, and other pertinent information. ANY POTENTIAL HAZARD should be communicated to helicopter operators or company aviation departments as early as possible to allow the NOTAM to be activated.

1.5.1.3 To supplement the existing NOTAM procedure and further assist in reducing these hazards, a standardized visual signal(s) on the helideck/heliport will provide a positive indication to an approaching helicopter of the status of the landing area. Recommended Practice(s) have been developed to reinforce the NOTAM procedures and standardize visual signals.

1.6 Drilling Rig Perforating Operations: Helideck/Heliport Operational Hazard Warning(s)/Procedure(s)

1.6.1 Background. A critical step in the oil well completion process is perforation, which involves the use of explosive charges in the drill pipe to open the pipe to oil or gas deposits. Explosive charges used in conjunction with perforation operations offshore can potentially be prematurely detonated by radio transmissions, including those from helicopters. The following practices are recommended.

1.6.2 Recommended Practices

1.6.2.1 Personnel Conducting Perforating Operations. Whenever perforating operations are scheduled and operators are concerned that radio transmissions from helicopters in the vicinity may jeopardize the operation, personnel conducting perforating operations should take the following precautionary measures:

a) Notify company aviation departments, helicopter operators or bases, and nearby manned platforms of the pending perforation operation so the Notice to Airmen (NOTAM) system can be activated for the perforation operation and the temporary helideck closure.

b) Close the deck and make the radio warning clearly visible to passing pilots, install a temporary

marking (described in subparagraph 1.9.1.2 with the words “NO RADIO” stenciled in red on the legs of the diagonals. The letters should be 24 inches high and 12 inches wide. (See FIG ENR 6.2-1.)

c) The marker should be installed during the time that charges may be affected by radio transmissions.

1.6.2.2 Pilots

a) Pilots when operating within 1,000 feet of a known perforation operation or observing the white X with red “NO RADIO” warning indicating perforation operations are underway will avoid radio transmissions from or near the helideck (within 1,000 feet) and will not land on the deck if the X is present. In addition to communications radios, radio transmissions are also emitted by aircraft radar, transponders, radar altimeters, and DME equipment, and ELTs.

b) Whenever possible, make radio calls to the platform being approached or to the Flight Following Communications Center at least one mile out on approach. Ensure all communications are complete outside the 1,000 foot hazard distance. If no response is received, or if the platform is not radio equipped, further radio transmissions should not be made until visual contact with the deck indicates it is open for operation (no white “X”).

FIG ENR 6.2-1
Closed Helideck Marking – No Radio

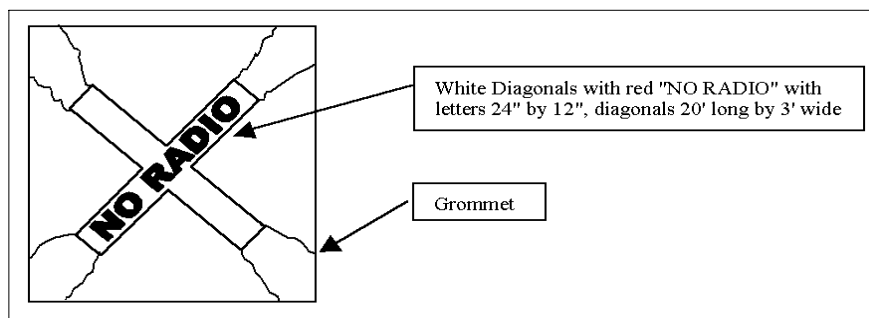

1.7 Hydrogen Sulfide Gas Helideck/Heliport Operational Hazard Warning(s)/Procedures

1.7.1 Background. Hydrogen sulfide (H₂S) gas: Hydrogen sulfide gas in higher concentrations (300–500 ppm) can cause loss of consciousness within a few seconds and presents a hazard to pilots on/near offshore helidecks. When operating in offshore areas that have been identified to have concentrations of hydrogen sulfide gas, the following practices are recommended.

1.7.2 Recommended Practices

1.7.2.1 Pilots

a) Ensure approved protective air packs are available for emergency use by the crew on the helicopter.

b) If shutdown on a helideck, request the supervisor in charge provide a briefing on location of protective equipment and safety procedures.

c) If while flying near a helideck and the visual red beacon alarm is observed or an unusually strong odor of “rotten eggs” is detected, immediately don the protective air pack, exit to an area upwind, and notify the suspected source field of the hazard.

1.7.2.2 Oil Field Supervisors

a) If presence of hydrogen sulfide is detected, a red rotating beacon or red high intensity strobe light adjacent to the primary helideck stairwell or wind indicator on the structure should be turned on to provide visual warning of hazard. If the beacon is to be located near the stairwell, the State of Louisiana “Offshore Heliport Design Guide” and FAA Advisory Circular AC 150/5390-2A, “Heliport Design Guide,” should be reviewed to ensure proper clearance on the helideck.

b) Notify nearby helicopter operators and bases of the hazard and advise when hazard is cleared.

c) Provide a safety briefing to include location of protective equipment to all arriving personnel.

d) Wind socks or indicator should be clearly visible to provide upwind indication for the pilot.

1.8 Gas Venting Helideck/Heliport Operational Hazard Warning(s)/Procedures – Operations Near Gas Vent Booms

1.8.1 Background. Ignited flare booms can release a large volume of natural gas and create a hot fire and intense heat with little time for the pilot to react. Likewise, unignited gas vents can release reasonably large volumes of methane gas under certain conditions. Thus, operations conducted very near unignited gas vents require precautions to prevent inadvertent ingestion of combustible gases by the helicopter engine(s). The following practices are recommended.

1.8.2 Pilots

1.8.2.1 Gas will drift upwards and downwind of the vent. Plan the approach and takeoff to observe and avoid the area downwind of the vent, remaining as far away as practicable from the open end of the vent boom.

1.8.2.2 Do not attempt to start or land on an offshore helideck when the deck is downwind of a gas vent unless properly trained personnel verify conditions are safe.

1.8.3 Oil Field Supervisors

1.8.3.1 During venting of large amounts of unignited raw gas, a red rotating beacon or red high intensity strobe light adjacent to the primary helideck stairwell or wind indicator should be turned on to provide visible warning of hazard. If the beacon is to be located near the stairwell, the State of Louisiana “Offshore Heliport Design Guide” and FAA Advisory Circular AC 150/ 5390-2A, Heliport Design Guide, should be reviewed to ensure proper clearance from the helideck.

1.8.3.2 Notify nearby helicopter operators and bases of the hazard for planned operations.

1.8.3.3 Wind socks or indicator should be clearly visible to provide upward indication for the pilot.

1.9 Helideck/Heliport Operational Warning(s)/Procedure(s) – Closed Helidecks or Heliports

1.9.1 Background. A white “X” marked diagonally from corner to corner across a helideck or heliport touchdown area is the universally accepted visual indicator that the landing area is closed for safety of other reasons and that helicopter operations are not permitted. The following practices are recommended.

1.9.1.1 Permanent Closing. If a helideck or heliport is to be permanently closed, X diagonals of the same size and location as indicated above should be used, but the markings should be painted on the landing area.

NOTE-

White Decks: If a helideck is painted white, then international orange or yellow markings can be used for the temporary or permanent diagonals.

1.9.1.2 Temporary Closing. A temporary marker can be used for hazards of an interim nature. This marker could be made from vinyl or other durable material in the shape of a diagonal “X.” The marker should be white with legs at least 20 feet long and 3 feet in width. This marker is designed to be quickly secured and removed from the deck using grommets and rope ties. The duration, time, location, and nature of these temporary closings should be provided to and coordinated with company aviation departments, nearby helicopter bases, and helicopter operators supporting the area. These markers **MUST** be removed when the hazard no longer exists. (See FIG ENR 6.2-2.)

1.10 Offshore (VFR) Operating Altitudes for Helicopters

1.10.1 Background. Mid-air collisions constitute a significant percentage of total fatal offshore helicopter accidents. A method of reducing this risk is the use of coordinated VFR cruising altitudes. To enhance safety through standardized vertical separation of helicopters when flying in the offshore environment, it is recommended that helicopter operators flying in a particular area establish a

cooperatively developed Standard Operating Procedure (SOP) for VFR operating altitudes. An example of such an SOP is contained in this example.

1.10.2 Recommended Practice Example

1.10.2.1 Field Operations. Without compromising minimum safe operating altitudes, helicopters working within an offshore field “constituting a cluster” should use altitudes not to exceed 500 feet.

1.10.2.2 En Route Operations

- a) Helicopters operating below 750’ AGL should avoid transitioning through offshore fields.
- b) Helicopters en route to and from offshore locations, below 3,000 feet, weather permitting, should use en route altitudes as outlined in TBL ENR 6.2-1.

TBL ENR 6.2-1

Magnetic Heading	Altitude
0° to 179°	750’
	1750’
	2750’
180° 359°	1250’
	2250’

- c) **Area Agreements.** See HSAC Area Agreement Maps for operating procedures for onshore high density traffic locations.

NOTE-

Pilots of helicopters operating VFR above 3,000 feet above the surface should refer to the current Federal Aviation Regulations (14 CFR Part 91), and Section ENR 1.4, Paragraph 1.7, Basic VFR Weather Minimums, of the AIP.

FIG ENR 6.2-2
Closed Helideck Marking

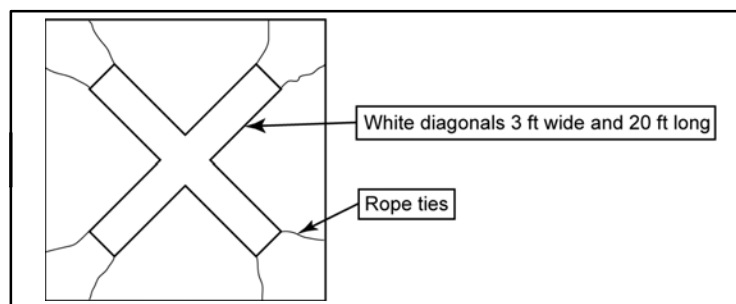

d) Landing Lights. Aircraft landing lights should be on to enhance aircraft identification:

- 1) During takeoff and landings;
- 2) In congested helicopter or fixed wing traffic areas;
- 3) During reduced visibility; or,
- 4) Anytime safety could be enhanced.

1.11 Offshore Helidecks/Landing Communications

1.11.1 Background. To enhance safety, and provide appropriate time to prepare for helicopter operations, the following is recommended when anticipating a landing on an offshore helideck.

1.11.2 Recommended Practices

1.11.2.1 Before landing on an offshore helideck, pilots are encouraged to establish communications with the company owning or operating the helideck if frequencies exist for that purpose.

1.11.2.2 When impracticable, or if frequencies do not exist, pilots or operations personnel should attempt to contact the company owning or operating the helideck by telephone. Contact should be made before the pilot departs home base/point of departure to advise of intentions and obtain landing permission if necessary.

NOTE-

It is recommended that communications be established a minimum of 10 minutes prior to planned arrival time. This practice may be a requirement of some offshore owner/operators.

NOTE-

1. See subparagraph 1.4 for Tanker Operations.
2. Private use Heliport. Offshore heliports are privately owned/operated facilities and their use is limited to persons having prior authorization to utilize the facility.

1.12 Two (2) Helicopter Operations on Offshore Helidecks

1.12.1 Background. Standardized procedures can enhance the safety of operating a second helicopter on an offshore helideck, enabling pilots to determine/maintain minimum operational parameters. Orientation of the parked helicopter on the helideck, wind and other factors may prohibit

multi-helicopter operations. More conservative Rotor Diameter (RD) clearances may be required under differing condition, i.e. temperature, wet deck, wind (velocity/direction/gusts), obstacles, approach/departure angles, etc. Operations are at the pilot's discretion.

1.12.2 Recommended Practice. Helideck size, structural weight capability, and type of main rotor on the parked and operating helicopter will aid in determining accessibility by a second helicopter. Pilots should determine that multi-helicopter deck operations are permitted by the helideck owner/operator.

1.12.3 Recommended Criteria

1.12.3.1 Minimum one-third rotor diameter clearance ($\frac{1}{3}$ RD). The landing helicopter maintains a minimum $\frac{1}{3}$ RD clearance between the tips of its turning rotor and the closest part of a parked and secured helicopter (rotors stopped and tied down).

1.12.3.2 Three foot parking distance from deck edge (3'). Helicopters operating on an offshore helideck land or park the helicopter with a skid/wheel assembly no closer than 3 feet from helideck edge.

1.12.3.3 Tiedowns. Main rotors on all helicopters that are shut down be properly secured (tied down) to prevent the rotor blades from turning.

1.12.3.4 Medium (transport) and larger helicopters should not land on any offshore helideck where a light helicopter is parked unless the light helicopter is properly secured to the helideck and has main rotor tied down.

1.12.3.5 Helideck owners/operators should ensure that the helideck has a serviceable anti-skid surface.

1.12.4 Weight and limitations markings on helideck. The helideck weight limitations should be displayed by markings visible to the pilot (see State of Louisiana "Offshore Heliport Design Guide" and FAA Advisory Circular AC 150/ 5390-2A, Heliport Design Guide).

NOTE-

Some offshore helideck owners/operators have restrictions on the number of helicopters allowed on a helideck. When helideck size permits, multiple (more than two) helicopter operations are permitted by some operators.

1.13 Helicopter Rapid Refueling Procedures (HRR)

1.13.1 Background. Helicopter Rapid Refueling (HRR), engine(s)/rotors operating, can be conducted safely when utilizing trained personnel and observing safe practices. This recommended practice provides minimum guidance for HRR as outlined in National Fire Protection Association (NFPA) and industry practices. For detailed guidance, please refer to National Fire Protection Association (NFPA) Document 407, “Standard for Aircraft Fuel Servicing,” 1990 edition, including 1993 HRR Amendment.

NOTE–

Certain operators prohibit HRR, or “hot refueling,” or may have specific procedures for certain aircraft or refueling locations. See the General Operations Manual and/or Operations Specifications to determine the applicable procedures or limitations.

1.13.2 Recommended Practices

1.13.2.1 Only turbine–engine helicopters fueled with JET A or JET A–1 with fueling ports located below any engine exhausts may be fueled while an onboard engine(s) is (are) operating.

1.13.2.2 Helicopter fueling while an onboard engine(s) is (are) operating should only be conducted under the following conditions:

a) A properly certificated and current pilot is at the controls and a trained refueler attending the fuel nozzle during the entire fuel servicing process. The pilot monitors the fuel quantity and signals the refueler when quantity is reached.

b) No electrical storms (thunderstorms) are present within 10 nautical miles. Lightning can travel great distances beyond the actual thunderstorm.

c) Passengers disembark the helicopter and move to a safe location prior to HRR operations. When the pilot–in–command deems it necessary for passenger safety that they remain onboard, passengers should be briefed on the evacuation route to follow to clear the area.

d) Passengers not board or disembark during HRR operations nor should cargo be loaded or unloaded.

e) Only designated personnel, trained in HRR operations should conduct HRR written authorization to include safe handling of the fuel and equipment. (See your Company Operations/Safety Manual for detailed instructions.)

f) All doors, windows, and access points allowing entry to the interior of the helicopter that are adjacent to or in the immediate vicinity of the fuel inlet ports kept closed during HRR operations.

g) Pilots insure that appropriate electrical/electronic equipment is placed in standby–off position, to preclude the possibility of electrical discharge or other fire hazard, such as [i.e., weather radar is on standby and no radio transmissions are made (keying of the microphone/transmitter)]. Remember, in addition to communications radios, radio transmissions are also emitted by aircraft radar, transponders, radar altimeters, DME equipment, and ELTs.

h) Smoking be prohibited in and around the helicopter during all HRR operations.

The HRR procedures are critical and present associated hazards requiring attention to detail regarding quality control, weather conditions, static electricity, bonding, and spill/fires potential.

Any activity associated with rotors turning (i.e.; refueling embarking/disembarking, loading/unloading baggage/freight; etc.) personnel should only approach the aircraft when authorized to do so. Approach should be made via safe approach path/walkway or “arc”– **remain clear of all rotors.**

NOTE–

1. *Marine vessels, barges etc.: Vessel motion presents additional potential hazards to helicopter operations (blade flex, aircraft movement).*

2. *See National Fire Protection Association (NFPA) Document 407, “Standard for Aircraft Fuel Servicing” for specifics regarding non–HRR (routine refueling operations).*

2. Helicopter Night VFR Operations

2.1 Effect of Lighting on Seeing Conditions in Night VFR Helicopter Operations

NOTE—

This guidance was developed to support safe night VFR helicopter emergency medical services (HEMS) operations. The principles of lighting and seeing conditions are useful in any night VFR operation.

While ceiling and visibility significantly affect safety in night VFR operations, lighting conditions also have a profound effect on safety. Even in conditions in which visibility and ceiling are determined to be visual meteorological conditions, the ability to discern unlighted or low contrast objects and terrain at night may be compromised. The ability to discern these objects and terrain is the seeing condition, and is related to the amount of natural and man made lighting available, and the contrast, reflectivity, and texture of surface terrain and obstruction features. In order to conduct operations safely, seeing conditions must be accounted for in the planning and execution of night VFR operations.

Night VFR seeing conditions can be described by identifying “high lighting conditions” and “low lighting conditions.”

2.1.1 High lighting conditions exist when one of two sets of conditions are present:

2.1.1.1 The sky cover is less than broken (less than 5/8 cloud cover), the time is between the local Moon rise and Moon set, and the lunar disk is at least 50% illuminated; or

2.1.1.2 The aircraft is operated over surface lighting which, at least, provides for the lighting of prominent obstacles, the identification of terrain features (shorelines, valleys, hills, mountains, slopes) and a horizontal reference by which the pilot may control the helicopter. For example, this surface lighting may be the result of:

a) Extensive cultural lighting (man-made, such as a built-up area of a city),

b) Significant reflected cultural lighting (such as the illumination caused by the reflection of a major metropolitan area’s lighting reflecting off a cloud ceiling), or

c) Limited cultural lighting combined with a high level of natural reflectivity of celestial illumination, such as that provided by a surface covered by snow or a desert surface.

2.1.2 Low lighting conditions are those that do not meet the high lighting conditions requirements.

2.1.3 Some areas may be considered a high lighting environment only in specific circumstances. For example, some surfaces, such as a forest with limited cultural lighting, normally have little reflectivity, requiring dependence on significant moonlight to achieve a high lighting condition. However, when that same forest is covered with snow, its reflectivity may support a high lighting condition based only on starlight. Similarly, a desolate area, with little cultural lighting, such as a desert, may have such inherent natural reflectivity that it may be considered a high lighting conditions area regardless of season, provided the cloud cover does not prevent starlight from being reflected from the surface. Other surfaces, such as areas of open water, may never have enough reflectivity or cultural lighting to ever be characterized as a high lighting area.

2.1.4 Through the accumulation of night flying experience in a particular area, the operator will develop the ability to determine, prior to departure, which areas can be considered supporting high or low lighting conditions. Without that operational experience, low lighting considerations should be applied by operators for both pre-flight planning and operations until high lighting conditions are observed or determined to be regularly available.

2.2 Astronomical Definitions and Background Information for Night Operations

2.2.1 Definitions

2.2.1.1 Horizon. Wherever one is located on or near the Earth’s surface, the Earth is perceived as essentially flat and, therefore, as a plane. If there are no visual obstructions, the apparent intersection of the sky with the Earth’s (plane) surface is the horizon, which appears as a circle centered at the observer. For rise/set computations, the observer’s eye is considered to be on the surface of the Earth, so that the horizon is geometrically exactly 90 degrees from the local vertical direction.

2.2.1.2 Rise, Set. During the course of a day the Earth rotates once on its axis causing the phenomena of rising and setting. All celestial bodies, the Sun, Moon, stars and planets, seem to appear in the sky at the horizon to the East of any particular place, then to cross the sky and again disappear at the horizon to the West. Because the Sun and Moon appear as circular disks and not as points of light, a definition of rise or set must be very specific, because not all of either body is seen to rise or set at once.

2.2.1.3 Sunrise and sunset refer to the times when the upper edge of the disk of the Sun is on the horizon, considered unobstructed relative to the location of interest. Atmospheric conditions are assumed to be average, and the location is in a level region on the Earth's surface.

2.2.1.4 Moonrise and moonset times are computed for exactly the same circumstances as for sunrise and sunset. However, moonrise and moonset may occur at any time during a 24 hour period and, consequently, it is often possible for the Moon to be seen during daylight, and to have moonless nights. It is also possible that a moonrise or moonset does not occur relative to a specific place on a given date.

2.2.1.5 Transit. The transit time of a celestial body refers to the instant that its center crosses an imaginary line in the sky – the observer's meridian – running from north to south.

2.2.1.6 Twilight. Before sunrise and again after sunset there are intervals of time, known as "twilight," during which there is natural light provided by the upper atmosphere, which does receive direct sunlight and reflects part of it toward the Earth's surface.

2.2.1.7 Civil twilight is defined to begin in the morning, and to end in the evening when the center of the Sun is geometrically 6 degrees below the horizon. This is the limit at which twilight illumination is sufficient, under good weather conditions, for terrestrial objects to be clearly distinguished.

2.2.2 Title 14 of the Code of Federal Regulations applies these concepts and definitions in addressing the definition of night (Section 1.1), the requirement for aircraft lighting (Section 91.209) and pilot recency of night experience (Section 61.67).

2.2.3 Information on Moon Phases and Changes in the Percentage of the Moon Illuminated

From any location on the Earth, the Moon appears to be a circular disk which, at any specific time, is illuminated to some degree by direct sunlight. During each lunar orbit (a lunar month), we see the Moon's appearance change from not visibly illuminated through partially illuminated to fully illuminated, then back through partially illuminated to not illuminated again. There are eight distinct, traditionally recognized stages, called phases. The phases designate both the degree to which the Moon is illuminated and the geometric appearance of the illuminated part. These phases of the Moon, in the sequence of their occurrence (starting from New Moon), are listed in FIG ENR 6.2-3.

2.2.3.1 The percent of the Moon's surface illuminated is a more refined, quantitative description of the Moon's appearance than is the phase. Considering the Moon as a circular disk, at New Moon the percent illuminated is 0; at First and Last Quarters it is 50%; and at Full Moon it is 100%. During the crescent phases the percent illuminated is between 0 and 50% and during gibbous phases it is between 50% and 100%.

2.2.3.2 For practical purposes, phases of the Moon and the percent of the Moon illuminated are independent of the location on the Earth from where the Moon is observed. That is, all the phases occur at the same time regardless of the observer's position.

2.2.3.3 For more detailed information, refer to the United States Naval Observatory site referenced below.

**FIG ENR 6.2-3
Phases of the Moon**

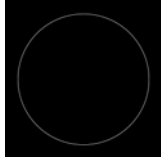

New Moon – The Moon’s unilluminated side is facing the Earth. The Moon is not visible (except during a solar eclipse).

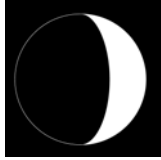

Waxing Crescent – The Moon appears to be partly but less than one-half illuminated by direct sunlight. The fraction of the Moon’s disk that is illuminated is increasing.

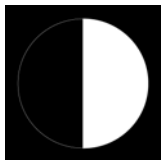

First Quarter – One-half of the Moon appears to be illuminated by direct sunlight. The fraction of the Moon’s disk that is illuminated is increasing.

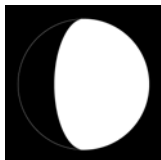

Waxing Gibbous – The Moon appears to be more than one-half but not fully illuminated by direct sunlight. The fraction of the Moon’s disk that is illuminated is increasing.

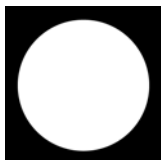

Full Moon – The Moon’s illuminated side is facing the Earth. The Moon appears to be completely illuminated by direct sunlight.

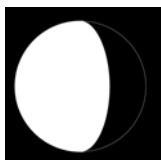

Waning Gibbous – The Moon appears to be more than one-half but not fully illuminated by direct sunlight. The fraction of the Moon’s disk that is illuminated is decreasing.

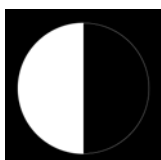

Last Quarter – One-half of the Moon appears to be illuminated by direct sunlight. The fraction of the Moon’s disk that is illuminated is decreasing.

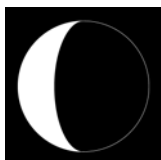

Waning Crescent – The Moon appears to be partly but less than one-half illuminated by direct sunlight. The fraction of the Moon’s disk that is illuminated is decreasing.

2.2.4 Access to Astronomical Data for Determination of Moon Rise, Moon Set, and Percentage of Lunar Disk Illuminated

2.2.4.1 Astronomical data for the determination of Moon rise and set and Moon phase may be obtained from the United States Naval Observatory using an interactive query available at: <http://aa.usno.navy.mil/>.

2.2.4.2 Click on “Data Services,” and then on “Complete Sun and Moon Data for One Day.”

2.2.4.3 You can obtain the times of sunrise, sunset, moonrise, moonset, transits of the Sun and Moon, and the beginning and end of civil twilight, along with information on the Moon’s phase by specifying the date and location in one of the two forms on this web page and clicking on the “Get data” button at the end of the form. Form “A” is used for cities or towns in the U.S. or its territories. Form “B” for all other locations. An example of the data available from this site is shown in TBL ENR 6.2-2.

2.2.4.4 Additionally, a yearly table may be constructed for a particular location by using the “Table of Sunrise/Sunset, Moonrise/Moonset, or Twilight Times for an Entire Year” selection.

3. Landing Zone Safety

3.1 This information is provided for use by helicopter emergency medical services (HEMS) pilots, program managers, medical personnel, law enforcement, fire, and rescue personnel to further their understanding of the safety issues concerning Landing Zones (LZs). It is recommended that HEMS operators establish working relationships with the ground responder organizations they may come in contact with in their flight operations and share this information in order to establish a common frame of reference for LZ selection, operations, and safety.

TBL ENR 6.2-2
Sample of Astronomical Data Available from the Naval Observatory

The following information is provided for New Orleans, Orleans Parish, Louisiana (longitude W90.1, latitude N30.0)	
Tuesday 29 May 2007	Central Daylight Time
SUN	
Begin civil twilight	5:34 a.m.
Sunrise	6:01 a.m.
Sun transit	12:58 p.m.
Sunset	7:55 p.m.
End civil twilight	8:22 p.m.
MOON	
Moonrise	5:10 p.m. on preceding day
Moonset	4:07 a.m.
Moonrise	6:06 p.m.
Moon transit	11:26 p.m.
Moonset	4:41 a.m. on following day
Phase of the Moon on 29 May: waxing gibbous with 95% of the Moon’s visible disk illuminated.	
Full Moon on 31 May 2007 at 8:04 p.m. Central Daylight Time.	

3.2 The information provided is largely based on the booklet, LZ – Preparing the Landing Zone, issued by National Emergency Medical Services Pilots Association (NEMSPA), and the guidance developed by the University of Tennessee Medical Center’s LIFE-STAR program, and is used with their permission. For additional information, go to: <http://www.nemspa.org/>.

3.3 Information concerning the estimation of wind velocity is based on the Beaufort Scale. See <http://www.spc.noaa.gov/faq/tornado/beaufort.html> for more information.

3.4 Selecting a Scene LZ

3.4.1 If the situation requires the use of a helicopter, first check to see if there is an area large enough to land a helicopter safely.

FIG ENR 6.2-4

Recommended Minimum Landing Zone Dimensions

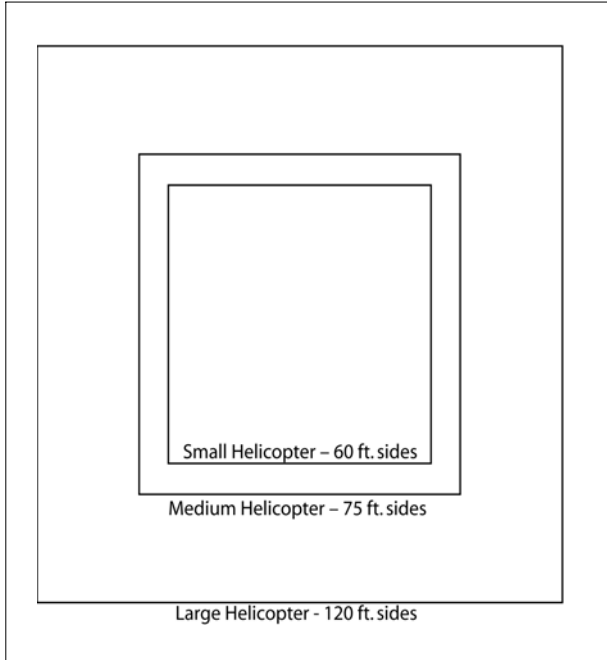

3.4.2 For the purposes of FIG ENR 6.2-4 the following are provided as examples of relative helicopter size:

3.4.2.1 Small Helicopter: Bell 206/407, Eurocopter AS-350/355, BO-105, BK-117.

3.4.2.2 Medium Helicopter: Bell UH-1 (Huey) and derivatives (Bell 212/412), Bell 222/230/430 Sikorsky S-76, Eurocopter SA-365.

3.4.2.3 Large Helicopter: Boeing Chinook, Eurocopter Puma, Sikorsky H-60 series (Blackhawk), SK-92.

3.4.3 The LZ should be level, firm and free of loose debris that could possibly blow up into the rotor system.

3.4.4 The LZ should be clear of people, vehicles and obstructions such as trees, poles and wires. Remember that wires are difficult to see from the air. The LZ must also be free of stumps, brush, post and large rocks. See FIG ENR 6.2-5.

FIG ENR 6.2-5

Landing Zone Hazards



3.4.5 Keep spectators back at least 200 feet. Keep emergency vehicles 100 feet away and have fire equipment (if available) standing by. Ground personnel should wear eye protection, if available, during landing and takeoff operations. To avoid loose objects being blown around in the LZ, hats should be removed; if helmets are worn, chin straps must be securely fastened.

3.4.6 Fire fighters (if available) should wet down the LZ if it is extremely dusty.

3.5 Helping the Flightcrew Locate the Scene

3.5.1 If the LZ coordinator has access to a GPS unit, the exact latitude and longitude of the LZ should be relayed to the HEMS pilot. If unable to contact the pilot directly, relay the information to the HEMS ground communications specialist for relaying to the pilot, so that they may locate your scene more efficiently. Recognize that the aircraft may approach from a direction different than the direct path from the takeoff point to the scene, as the pilot may have to detour around terrain, obstructions or weather en route.

3.5.2 Especially in daylight hours, mountainous and densely populated areas can make sighting a scene from the air difficult. Often, the LZ coordinator on the ground will be asked if she or he can see or hear the helicopter.

3.5.3 Flightcrews use a clock reference method for directing one another's attention to a certain direction from the aircraft. The nose of the aircraft is always 12 o'clock, the right side is 3 o'clock, etc. When the LZ coordinator sees the aircraft, he/she should use this method to assist the flightcrew by indicating the scene's clock reference position from the nose of the aircraft. For example, "Accident scene is located at your 2 o'clock position." See FIG ENR 6.2-6.

FIG ENR 6.2-6
"Clock" System for Identifying Positions Relative to the Nose of the Aircraft

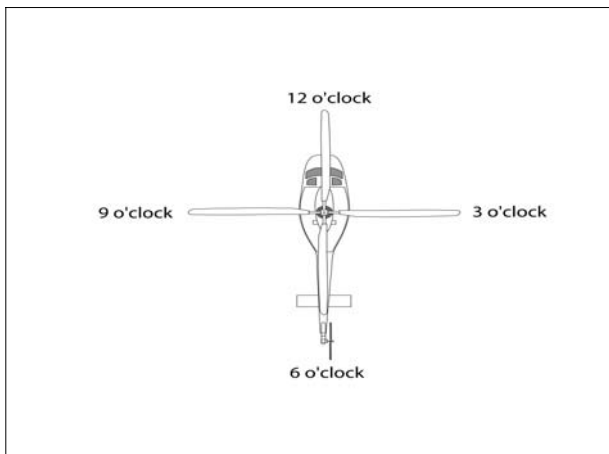

3.5.4 When the helicopter approaches the scene, it will normally orbit at least one time as the flight crew observes the wind direction and obstacles that could interfere with the landing. This is often referred to as the "high reconnaissance" maneuver.

3.6 Wind Direction and Touchdown Area

3.6.1 Determine from which direction the wind is blowing. Helicopters normally land and takeoff into the wind.

3.6.2 If contact can be established with the pilot, either directly or indirectly through the HEMS ground communications specialist, describe the wind in terms of the direction the wind is *from* and the speed.

3.6.3 Common natural sources of wind direction information are smoke, dust, vegetation movement, water streaks and waves. Flags, pennants, streamers can also be used. When describing the direction, use the compass direction from which the wind is blowing (example: from the North-West).

3.6.4 Wind speed can be measured by small hand-held measurement devices, or an observer's estimate can be used to provide velocity information. The wind value should be reported in knots (nautical miles per hour). If unable to numerically measure wind speed, use TBL ENR 6.2-3 to estimate velocity. Also, report if the wind conditions are gusty, or if the wind direction or velocity is variable or has changed recently.

3.6.5 If any obstacle(s) exist, insure their description, position and approximate height are communicated to the pilot on the initial radio call.

3.7 Night LZs

3.7.1 There are several ways to light a night LZ:

3.7.1.1 Mark the touchdown area with five lights or road flares, one in each corner and one indicating the direction of the wind. See FIG ENR 6.2-7.

FIG ENR 6.2-7
Recommended Lighting for Landing Zone Operations at Night

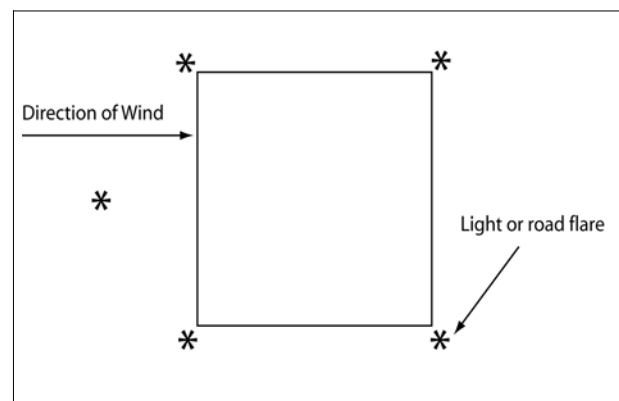

NOTE-
Road flares are an intense source of ignition and may be unsuitable or dangerous in certain conditions. In any case, they must be closely managed and firefighting equipment should be present when used. Other light sources are preferred, if available.

TBL ENR 6.2-3
Table of Common References for Estimating Wind Velocity

Wind (Knots)	Wind Classification	Appearance of Wind Effects	
		On the Water	On Land
Less than 1	Calm	Sea surface smooth and mirror-like	Calm, smoke rises vertically
1-3	Light Air	Scaly ripples, no foam crests	Smoke drift indicates wind direction, wind vanes are still
4-6	Light Breeze	Small wavelets, crests glassy, no breaking	Wind felt on face, leaves rustle, vanes begin to move
7-10	Gentle Breeze	Large wavelets, crests begin to break, scattered whitecaps	Leaves and small twigs constantly moving, light flags extended
11-16	Moderate Breeze	Small waves 1-4 ft. becoming longer, numerous whitecaps	Dust, leaves, and loose paper lifted, small tree branches move
17-21	Fresh Breeze	Moderate waves 4-8 ft taking longer form, many whitecaps, some spray	Small trees in leaf begin to sway
22-27	Strong Breeze	Larger waves 8-13 ft, whitecaps common, more spray	Larger tree branches moving, whistling in wires
28-33	Near Gale	Sea heaps up, waves 13-20 ft, white foam streaks off breakers	Whole trees moving, resistance felt walking against wind
34-40	Gale	Moderately high (13-20 ft) waves of greater length, edges of crests begin to break into spindrift, foam blown in streaks	Whole trees in motion, resistance felt walking against wind
41-47	Strong Gale	High waves (20 ft), sea begins to roll, dense streaks of foam, spray may reduce visibility	Slight structural damage occurs, slate blows off roofs
48-55	Storm	Very high waves (20-30 ft) with overhanging crests, sea white with densely blown foam, heavy rolling, lowered visibility	Seldom experienced on land, trees broken or uprooted, "considerable structural damage"
56-63	Violent Storm	Exceptionally high (30-45 ft) waves, foam patches cover sea, visibility more reduced	
64+	Hurricane	Air filled with foam, waves over 45 ft, sea completely white with driving spray, visibility greatly reduced	

EXAMPLE-

Wind from the South-East, estimated speed 15 knots. Wind shifted from North-East about fifteen minutes ago, and is gusty.

3.7.1.2 If chemical light sticks may be used, care should be taken to assure they are adequately secured against being dislodged by the helicopter’s rotor wash.

3.7.1.3 Another method of marking a LZ uses four emergency vehicles with their low beam headlights aimed toward the intended landing area.

3.7.1.4 A third method for marking a LZ uses two vehicles. Have the vehicles direct their headlight beams into the wind, crossing at the center of the LZ. (If fire/rescue personnel are available, the reflective stripes on their bunker gear will assist the pilot greatly.)

3.7.2 At night, spotlights, flood lights and hand lights used to define the LZ are not to be pointed at the helicopter. However, they are helpful when pointed toward utility poles, trees or other hazards to the landing aircraft. White lights such as spotlights, flashbulbs and hi-beam headlights ruin the pilot’s night vision and temporarily blind him. Red lights, however, are very helpful in finding accident locations and do not affect the pilot’s night vision as significantly.

3.7.3 As in Day LZ operations, ensure radio contact is accomplished between ground and air, if possible.

3.8 Ground Guide

3.8.1 When the helicopter is in sight, one person should assist the LZ Coordinator by guiding the helicopter into a safe landing area. In selecting an LZ Coordinator, recognize that medical personnel usually are very busy with the patient at this time. It is recommended that the LZ Coordinator be someone other than a medical responder, if possible. Eye protection should be worn. The ground guide should stand with his back to the wind and his arms raised over his head (flashlights in each hand for night operations.)

3.8.2 The pilot will confirm the LZ sighting by radio. If possible, once the pilot has identified the LZ, the ground guide should move out of the LZ.

3.8.3 As the helicopter turns into the wind and begins a descent, the LZ coordinator should provide assistance by means of radio contact, or utilize the “unsafe signal” to wave off the helicopter if the LZ is not safe (see FIG ENR 6.2–8). The LZ Coordinator

should be far enough from the touchdown area that he/she can still maintain visual contact with the pilot.

3.9 Assisting the Crew

3.9.1 After the helicopter has landed, do not approach the helicopter. The crew will approach you.

3.9.2 Be prepared to assist the crew by providing security for the helicopter. If asked to provide security, allow no one but the crew to approach the aircraft.

3.9.3 Once the patient is prepared and ready to load, allow the crew to open the doors to the helicopter and guide the loading of the patient.

3.9.4 When approaching or departing the helicopter, always be aware of the tail rotor and always follow the directions of the crew. Working around a running helicopter can be potentially dangerous. The environment is very noisy and, with exhaust gases and rotor wash, often windy. In scene operations, the surface may be uneven, soft, or slippery which can lead to tripping. Be very careful of your footing in this environment.

3.9.5 The tail rotor poses a special threat to working around a running helicopter. The tail rotor turns many times faster than the main rotor, and is often invisible even at idle engine power. Avoid walking towards the tail of a helicopter beyond the end of the cabin, unless specifically directed by the crew.

NOTE–

Helicopters typically have doors on the sides of the cabin, but many use aft mounted “clamshell” type doors for loading and unloading patients on litters or stretchers. When using these doors, it is important to avoid moving any further aft than necessary to operate the doors and load/unload the patient. Again, always comply with the crew’s instructions.

3.10 General Rules

3.10.1 When working around helicopters, always approach and depart from the front, never from the rear. Approaching from the rear can increase your risk of being struck by the tail rotor, which, when at operating engine speed, is nearly invisible.

3.10.2 To prevent injury or damage from the main rotor, never raise anything over your head.

3.10.3 If the helicopter landed on a slope, approach and depart from the down slope side only.

3.10.4 When the helicopter is loaded and ready for take off, keep the departure path free of vehicles and spectators. In an emergency, this area is needed to execute a landing.

3.11 Hazardous Chemicals and Gases

3.11.1 Responding to accidents involving hazardous materials requires special handling by fire/rescue units on the ground. Equally important are the preparations and considerations for helicopter operations in these areas.

3.11.2 Hazardous materials of concern are those which are toxic, poisonous, flammable, explosive, irritating, or radioactive in nature. Helicopter ambulance crews normally don't carry protective suits or breathing apparatuses to protect them from hazardous materials.

3.11.3 The helicopter ambulance crew must be told of hazardous materials on the scene in order to avoid the contamination of the crew. Patients/victims contaminated by hazardous materials may require special precautions in packaging before loading on the aircraft for the medical crew's protection, or may be transported by other means.

3.11.4 Hazardous chemicals and gases may be fatal to the unprotected person if inhaled or absorbed through the skin.

3.11.5 Upon initial radio contact, the helicopter crew must be made aware of any hazardous gases in the area. Never assume that the crew has already been informed. If the aircraft were to fly through the hazardous gases, the crew could be poisoned and/or the engines could develop mechanical problems.

3.11.6 Poisonous or irritating gases may cling to a victim's clothing and go unnoticed until the patient is loaded and the doors of the helicopter are closed. To avoid possible compromise of the crew, all of these patients must be decontaminated prior to loading.

3.12 Hand Signals

3.12.1 If unable to make radio contact with the HEMS pilot, use the signals in FIG ENR 6.2-8.

FIG ENR 6.2-8
Recommended Landing Zone Ground Signals

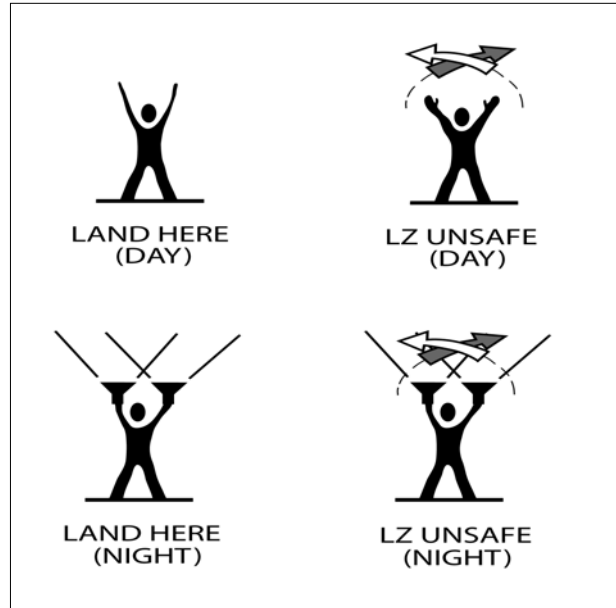

3.13 Emergency Situations

3.13.1 In the event of a helicopter accident in the vicinity of the LZ, consider the following:

3.13.1.1 Emergency Exits:

a) Doors and emergency exits are typically prominently marked. If possible, operators should familiarize ground responders with the door system on their helicopter in preparation for an emergency event.

b) In the event of an accident during the LZ operation, be cautious of hazards such as sharp and jagged metal, plastic windows, glass, any rotating components, such as the rotors, and fire sources, such as the fuel tank(s) and the engine.

3.13.1.2 Fire Suppression:

a) Helicopters used in HEMS operations are usually powered by turboshaft engines, which use jet fuel. Civil HEMS aircraft typically carry between 50 and 250 gallons of fuel, depending upon the size of the helicopter, and planned flight duration, and the fuel remaining after flying to the scene. Use water to control heat and use foam over fuel to keep vapors from ignition sources.

4. Emergency Medical Service (EMS) Multiple Helicopter Operations

4.1 Background. EMS helicopter operators often overlap other EMS operator areas. Standardized procedures can enhance the safety of operating multiple helicopters to landing zones (LZs) and to hospital heliports. Communication is the key to successful operations and in maintaining organization between helicopters, ground units and communication centers. EMS helicopter operators which operate in the same areas should establish joint operating procedures and provide them to related agencies.

4.2 Recommended Procedures.

4.2.1 Landing Zone Operations. The first helicopter to arrive on-scene should establish communications with the ground unit at least 10 NMs from the LZ to receive a LZ briefing and to provide ground control the number of helicopters that can be expected. An attempt should be made to contact other helicopters on 123.025 to pass on to them pertinent LZ information and the ground unit's frequency. Subsequent helicopters arriving on scene should establish communications on 123.025 at least 10 NMs from the LZ. After establishing contact on 123.025, they should contact the ground unit for additional information. All helicopters should monitor 123.025 at all times.

4.2.1.1 If the landing zone is not established by the ground unit when the first helicopter arrives, then the first helicopter should establish altitude and orbit location requirements for the other arriving helicopters. Recommended altitude separation between helicopters is 500 feet (weather and airspace

permitting). Helicopters can orbit on cardinal headings from the scene coordinates. (See FIG ENR 6.2–9)

4.2.1.2 Upon landing in the LZ, the first helicopter should update the other helicopters on the LZ conditions, i.e., space, hazards and terrain.

4.2.1.3 Before initiating any helicopter movement to leave the LZ, all operators should attempt to contact other helicopters on 123.025, and state their position and route of flight intentions for departing the LZ.

4.2.2 Hospital Operations. Because many hospitals require landing permission and have established procedures (frequencies to monitor, primary and secondary routes for approaches and departures, and orbiting areas if the heliport is occupied) pilots should always receive a briefing from the appropriate facility (communication center, flight following, etc.) before proceeding to the hospital.

4.2.2.1 In the event of multiple helicopters coming into the hospital heliport, the helicopter nearest to the heliport should contact other inbound helicopters on 123.025 and establish intentions. Follow the guidelines established in the LZ operations.

4.2.2.2 To facilitate approach times, the pilot-in-command of the helicopter occupying the hospital heliport should advise any other operators whether the patient will be off loaded with the rotor blades turning or stopped, and the approximate time to do so.

4.2.2.3 Before making any helicopter movement to leave the hospital heliport, all operators should attempt to contact other helicopters on 123.025 and state their position and route of flight intentions for departing the heliport.

FIG ENR 6.2-9
EMS Multiple Helicopter LZ/Heliport Operation

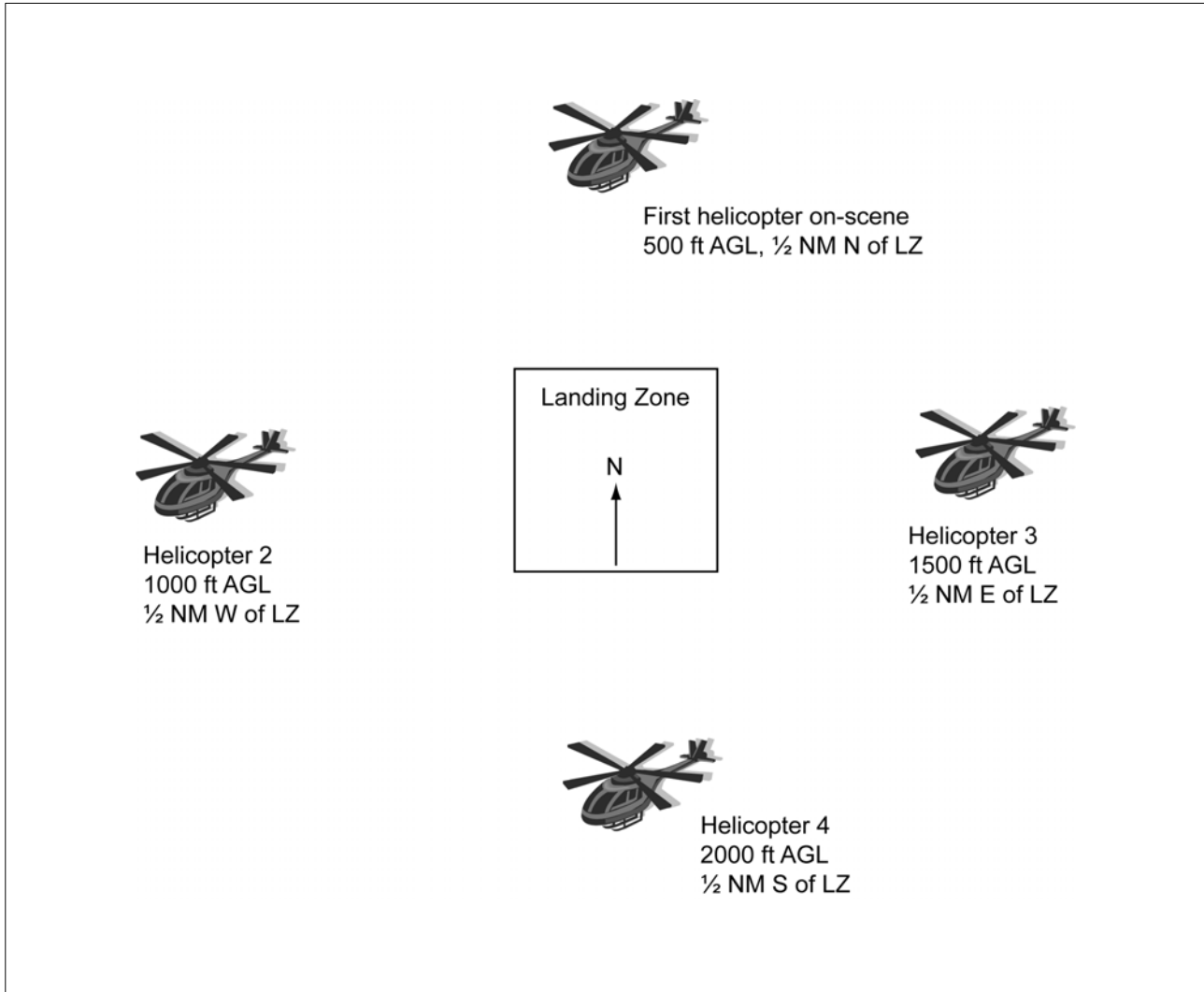

NOTE-

If the LZ/hospital heliport weather conditions or airspace altitude restrictions prohibit the recommended vertical separation, 1 NM separations should be kept between helicopter orbit areas.

AIP
AERONAUTICAL INFORMATION PUBLICATION
UNITED STATES OF AMERICA

PART 3
AERODROMES (AD)

PART 3 – AERODROMES (AD)

AD 0.

- AD 0.1 Preface – Not applicable
- AD 0.2 Record of AIP Amendments – See GEN 0.2-1
- AD 0.3 Record of AIP Supplements – Not applicable

AD 0.4 Checklist of Pages

PAGE	DATE	PAGE	DATE	PAGE	DATE
PART 3 – AERODROMES (AD)		1.1-31	10 MAR 11	2-21	10 MAR 11
AD 0		1.1-32	10 MAR 11	2-22	10 MAR 11
0.4-1	10 MAR 11	1.1-33	10 MAR 11	2-23	10 MAR 11
0.4-2	10 MAR 11	1.1-34	10 MAR 11	2-24	10 MAR 11
0.4-3	10 MAR 11	1.1-35	10 MAR 11	2-25	10 MAR 11
0.4-4	10 MAR 11	1.1-36	10 MAR 11	2-26	10 MAR 11
0.6-1	10 MAR 11	1.1-37	10 MAR 11	2-27	10 MAR 11
AD 1		1.1-38	10 MAR 11	2-28	10 MAR 11
1.1-1	10 MAR 11	1.1-39	10 MAR 11	2-29	10 MAR 11
1.1-2	10 MAR 11	1.1-40	10 MAR 11	2-30	10 MAR 11
1.1-3	10 MAR 11	1.1-41	10 MAR 11	2-31	10 MAR 11
1.1-4	10 MAR 11	1.1-42	10 MAR 11	2-32	10 MAR 11
1.1-5	10 MAR 11	1.1-43	10 MAR 11	2-33	10 MAR 11
1.1-6	10 MAR 11	1.1-44	10 MAR 11	2-34	10 MAR 11
1.1-7	10 MAR 11	1.1-45	10 MAR 11	2-35	10 MAR 11
1.1-8	10 MAR 11	1.1-46	10 MAR 11	2-36	10 MAR 11
1.1-9	10 MAR 11	1.1-47	10 MAR 11	2-37	10 MAR 11
1.1-10	10 MAR 11	1.1-48	10 MAR 11	2-38	10 MAR 11
1.1-11	10 MAR 11	1.1-49	10 MAR 11	2-39	10 MAR 11
1.1-12	10 MAR 11	AD 2		2-40	10 MAR 11
1.1-13	10 MAR 11	2-1	10 MAR 11	2-41	10 MAR 11
1.1-14	10 MAR 11	2-2	10 MAR 11	2-42	10 MAR 11
1.1-15	10 MAR 11	2-3	10 MAR 11	2-43	10 MAR 11
1.1-16	10 MAR 11	2-4	10 MAR 11	2-44	10 MAR 11
1.1-17	10 MAR 11	2-5	10 MAR 11	2-45	10 MAR 11
1.1-18	10 MAR 11	2-6	10 MAR 11	2-46	10 MAR 11
1.1-19	10 MAR 11	2-7	10 MAR 11	2-47	10 MAR 11
1.1-20	10 MAR 11	2-8	10 MAR 11	2-48	10 MAR 11
1.1-21	10 MAR 11	2-9	10 MAR 11	2-49	10 MAR 11
1.1-22	10 MAR 11	2-10	10 MAR 11	2-50	10 MAR 11
1.1-23	10 MAR 11	2-11	10 MAR 11	2-51	10 MAR 11
1.1-24	10 MAR 11	2-12	10 MAR 11	2-52	10 MAR 11
1.1-25	10 MAR 11	2-13	10 MAR 11	2-53	10 MAR 11
1.1-26	10 MAR 11	2-14	10 MAR 11	2-54	10 MAR 11
1.1-27	10 MAR 11	2-15	10 MAR 11	2-55	10 MAR 11
1.1-28	10 MAR 11	2-16	10 MAR 11	2-56	10 MAR 11
1.1-29	10 MAR 11	2-17	10 MAR 11	2-57	10 MAR 11
1.1-30	10 MAR 11	2-18	10 MAR 11	2-58	10 MAR 11
		2-19	10 MAR 11	2-59	10 MAR 11
		2-20	10 MAR 11	2-60	10 MAR 11

PAGE	DATE
2-61	10 MAR 11
2-62	10 MAR 11
2-63	10 MAR 11
2-64	10 MAR 11
2-65	10 MAR 11
2-66	10 MAR 11
2-67	10 MAR 11
2-68	10 MAR 11
2-69	10 MAR 11
2-70	10 MAR 11
2-71	10 MAR 11
2-72	10 MAR 11
2-73	10 MAR 11
2-74	10 MAR 11
2-75	10 MAR 11
2-76	10 MAR 11
2-77	10 MAR 11
2-78	10 MAR 11
2-79	10 MAR 11
2-80	10 MAR 11
2-81	10 MAR 11
2-82	10 MAR 11
2-83	10 MAR 11
2-84	10 MAR 11
2-85	10 MAR 11
2-86	10 MAR 11
2-87	10 MAR 11
2-88	10 MAR 11
2-89	10 MAR 11
2-90	10 MAR 11
2-91	10 MAR 11
2-92	10 MAR 11
2-93	10 MAR 11
2-94	10 MAR 11
2-95	10 MAR 11
2-96	10 MAR 11
2-97	10 MAR 11
2-98	10 MAR 11
2-99	10 MAR 11
2-100	10 MAR 11
2-101	10 MAR 11
2-102	10 MAR 11
2-103	10 MAR 11
2-104	10 MAR 11
2-105	10 MAR 11
2-106	10 MAR 11
2-107	10 MAR 11
2-108	10 MAR 11
2-109	10 MAR 11
2-110	10 MAR 11
2-111	10 MAR 11
2-112	10 MAR 11

PAGE	DATE
2-113	10 MAR 11
2-114	10 MAR 11
2-115	10 MAR 11
2-116	10 MAR 11
2-117	10 MAR 11
2-118	10 MAR 11
2-119	10 MAR 11
2-120	10 MAR 11
2-121	10 MAR 11
2-122	10 MAR 11
2-123	10 MAR 11
2-124	10 MAR 11
2-125	10 MAR 11
2-126	10 MAR 11
2-127	10 MAR 11
2-128	10 MAR 11
2-129	10 MAR 11
2-130	10 MAR 11
2-131	10 MAR 11
2-132	10 MAR 11
2-133	10 MAR 11
2-134	10 MAR 11
2-135	10 MAR 11
2-136	10 MAR 11
2-137	10 MAR 11
2-138	10 MAR 11
2-139	10 MAR 11
2-140	10 MAR 11
2-141	10 MAR 11
2-142	10 MAR 11
2-143	10 MAR 11
2-144	10 MAR 11
2-145	10 MAR 11
2-146	10 MAR 11
2-147	10 MAR 11
2-148	10 MAR 11
2-149	10 MAR 11
2-150	10 MAR 11
2-151	10 MAR 11
2-152	10 MAR 11
2-153	10 MAR 11
2-154	10 MAR 11
2-155	10 MAR 11
2-156	10 MAR 11
2-157	10 MAR 11
2-158	10 MAR 11
2-159	10 MAR 11
2-160	10 MAR 11
2-161	10 MAR 11
2-162	10 MAR 11
2-163	10 MAR 11
2-164	10 MAR 11

PAGE	DATE
2-165	10 MAR 11
2-166	10 MAR 11
2-167	10 MAR 11
2-168	10 MAR 11
2-169	10 MAR 11
2-170	10 MAR 11
2-171	10 MAR 11
2-172	10 MAR 11
2-173	10 MAR 11
2-174	10 MAR 11
2-175	10 MAR 11
2-176	10 MAR 11
2-177	10 MAR 11
2-178	10 MAR 11
2-179	10 MAR 11
2-180	10 MAR 11
2-181	10 MAR 11
2-182	10 MAR 11
2-183	10 MAR 11
2-184	10 MAR 11
2-185	10 MAR 11
2-186	10 MAR 11
2-187	10 MAR 11
2-188	10 MAR 11
2-189	10 MAR 11
2-190	10 MAR 11
2-191	10 MAR 11
2-192	10 MAR 11
2-193	10 MAR 11
2-194	10 MAR 11
2-195	10 MAR 11
2-196	10 MAR 11
2-197	10 MAR 11
2-198	10 MAR 11
2-199	10 MAR 11
2-200	10 MAR 11
2-201	10 MAR 11
2-202	10 MAR 11
2-203	10 MAR 11
2-204	10 MAR 11
2-205	10 MAR 11
2-206	10 MAR 11
2-207	10 MAR 11
2-208	10 MAR 11
2-209	10 MAR 11
2-210	10 MAR 11
2-211	10 MAR 11
2-212	10 MAR 11
2-213	10 MAR 11
2-214	10 MAR 11
2-215	10 MAR 11
2-216	10 MAR 11

PAGE	DATE
2-217	10 MAR 11
2-218	10 MAR 11
2-219	10 MAR 11
2-220	10 MAR 11
2-221	10 MAR 11
2-222	10 MAR 11
2-223	10 MAR 11
2-224	10 MAR 11
2-225	10 MAR 11
2-226	10 MAR 11
2-227	10 MAR 11
2-228	10 MAR 11
2-229	10 MAR 11
2-230	10 MAR 11
2-231	10 MAR 11
2-232	10 MAR 11
2-233	10 MAR 11
2-234	10 MAR 11
2-235	10 MAR 11
2-236	10 MAR 11
2-237	10 MAR 11
2-238	10 MAR 11
2-239	10 MAR 11
2-240	10 MAR 11
2-241	10 MAR 11
2-242	10 MAR 11
2-243	10 MAR 11
2-244	10 MAR 11
2-245	10 MAR 11
2-246	10 MAR 11
2-247	10 MAR 11
2-248	10 MAR 11
2-249	10 MAR 11
2-250	10 MAR 11
2-251	10 MAR 11
2-252	10 MAR 11
2-253	10 MAR 11
2-254	10 MAR 11
2-255	10 MAR 11
2-256	10 MAR 11
2-257	10 MAR 11
2-258	10 MAR 11
2-259	10 MAR 11
2-260	10 MAR 11
2-261	10 MAR 11
2-262	10 MAR 11
2-263	10 MAR 11
2-264	10 MAR 11
2-265	10 MAR 11
2-266	10 MAR 11
2-267	10 MAR 11
2-268	10 MAR 11

PAGE	DATE
2-269	10 MAR 11
2-270	10 MAR 11
2-271	10 MAR 11
2-272	10 MAR 11
2-273	10 MAR 11
2-274	10 MAR 11
2-275	10 MAR 11
2-276	10 MAR 11
2-277	10 MAR 11
2-278	10 MAR 11
2-279	10 MAR 11
2-280	10 MAR 11
2-281	10 MAR 11
2-282	10 MAR 11
2-283	10 MAR 11
2-284	10 MAR 11
2-285	10 MAR 11
2-286	10 MAR 11
2-287	10 MAR 11
2-288	10 MAR 11
2-289	10 MAR 11
2-290	10 MAR 11
2-291	10 MAR 11
2-292	10 MAR 11
2-293	10 MAR 11
2-294	10 MAR 11
2-295	10 MAR 11
2-296	10 MAR 11
2-297	10 MAR 11
2-298	10 MAR 11
2-299	10 MAR 11
2-300	10 MAR 11
2-301	10 MAR 11
2-302	10 MAR 11
2-303	10 MAR 11
2-304	10 MAR 11
2-305	10 MAR 11
2-306	10 MAR 11
2-307	10 MAR 11
2-308	10 MAR 11
2-309	10 MAR 11
2-310	10 MAR 11
2-311	10 MAR 11
2-312	10 MAR 11
2-313	10 MAR 11
2-314	10 MAR 11
2-315	10 MAR 11
2-316	10 MAR 11
2-317	10 MAR 11
2-318	10 MAR 11
2-319	10 MAR 11
2-320	10 MAR 11

PAGE	DATE
2-321	10 MAR 11
2-322	10 MAR 11
2-323	10 MAR 11
2-324	10 MAR 11
2-325	10 MAR 11
2-326	10 MAR 11
2-327	10 MAR 11
2-328	10 MAR 11
2-329	10 MAR 11
2-330	10 MAR 11
2-331	10 MAR 11
2-332	10 MAR 11
2-333	10 MAR 11
2-334	10 MAR 11
2-335	10 MAR 11
2-336	10 MAR 11
2-337	10 MAR 11
2-338	10 MAR 11
2-339	10 MAR 11
2-340	10 MAR 11
2-341	10 MAR 11
2-342	10 MAR 11
2-343	10 MAR 11
2-344	10 MAR 11
2-345	10 MAR 11
2-346	10 MAR 11
2-347	10 MAR 11
2-348	10 MAR 11
2-349	10 MAR 11
2-350	10 MAR 11
2-351	10 MAR 11
2-352	10 MAR 11
2-353	10 MAR 11
2-354	10 MAR 11
2-355	10 MAR 11
2-356	10 MAR 11
2-357	10 MAR 11
2-358	10 MAR 11
2-359	10 MAR 11
2-360	10 MAR 11
2-361	10 MAR 11
2-362	10 MAR 11
2-363	10 MAR 11
2-364	10 MAR 11
2-365	10 MAR 11
2-366	10 MAR 11
2-367	10 MAR 11
2-368	10 MAR 11
2-369	10 MAR 11
2-370	10 MAR 11
2-371	10 MAR 11
2-372	10 MAR 11

PAGE	DATE
2-373	10 MAR 11
2-374	10 MAR 11
2-375	10 MAR 11
2-376	10 MAR 11
2-377	10 MAR 11
2-378	10 MAR 11
2-379	10 MAR 11
2-380	10 MAR 11
2-381	10 MAR 11
2-382	10 MAR 11
2-383	10 MAR 11
2-384	10 MAR 11
2-385	10 MAR 11
2-386	10 MAR 11
2-387	10 MAR 11
2-388	10 MAR 11
2-389	10 MAR 11
2-390	10 MAR 11
2-391	10 MAR 11
2-392	10 MAR 11
2-393	10 MAR 11
2-394	10 MAR 11
2-395	10 MAR 11
2-396	10 MAR 11
2-397	10 MAR 11
2-398	10 MAR 11
2-399	10 MAR 11
2-400	10 MAR 11
2-401	10 MAR 11
2-402	10 MAR 11
2-403	10 MAR 11
2-404	10 MAR 11
2-405	10 MAR 11
2-406	10 MAR 11
2-407	10 MAR 11
2-408	10 MAR 11
2-409	10 MAR 11
2-410	10 MAR 11
2-411	10 MAR 11
2-412	10 MAR 11
2-413	10 MAR 11
2-414	10 MAR 11
2-415	10 MAR 11
2-416	10 MAR 11
2-417	10 MAR 11
2-418	10 MAR 11
2-419	10 MAR 11
2-420	10 MAR 11

PAGE	DATE
2-421	10 MAR 11
2-422	10 MAR 11
2-423	10 MAR 11
2-424	10 MAR 11
2-425	10 MAR 11
2-426	10 MAR 11
2-427	10 MAR 11
2-428	10 MAR 11
2-429	10 MAR 11
2-430	10 MAR 11
2-431	10 MAR 11
2-432	10 MAR 11
2-433	10 MAR 11
2-434	10 MAR 11
2-435	10 MAR 11
2-436	10 MAR 11
2-437	10 MAR 11
2-438	10 MAR 11
2-439	10 MAR 11
2-440	10 MAR 11
2-441	10 MAR 11
2-442	10 MAR 11
2-443	10 MAR 11
2-444	10 MAR 11
2-445	10 MAR 11
2-446	10 MAR 11
2-447	10 MAR 11
2-448	10 MAR 11
2-449	10 MAR 11
2-450	10 MAR 11
APPENDIX	
A-1	10 MAR 11
1 through 372	N/A

PAGE	DATE
INDEX	
I-1	10 MAR 11
I-2	10 MAR 11
I-3	10 MAR 11
I-4	10 MAR 11
I-5	10 MAR 11
I-6	10 MAR 11
I-7	10 MAR 11
I-8	10 MAR 11

AD 0.5 List of Hand Amendments to the AIP – Not applicable

AD 0.6 Table of Contents to Part 3

	<i>Page</i>
AD 1. AERODROMES – INTRODUCTION	
AD 1.1 Aerodrome Availability	AD 1.1-1
AD 2. AERODROMES	AD 2-1

AD 1. AERODROMES – INTRODUCTION

AD 1.1 Aerodrome Availability

1. General Regulations Concerning Airport Use

1.1 International arrivals with scheduled passenger service are not permitted to land at any aerodrome not listed in this AIP except in cases of real emergency or where special permission has been granted.

1.2 The conditions under which aircraft may land, be parked, housed or otherwise dealt with at U.S. aerodromes is under the control of the aerodrome owner/operator. Conditions and fees pertaining to landing, parking, or storing are variable from aerodrome to aerodrome and are not published in the U.S. AIP.

2. Landings Made Elsewhere Than at International Aerodromes

2.1 Permission to land at airports other than “international” and “landing rights” airports may be obtained in some limited cases; however, advance arrangements (preferably in writing) must be made with the U.S. Customs office nearest the airport of intended arrival (see GEN 1). Advance notice of arrival is required as usual. Pilots should be aware that mileage and per diem costs may be accrued in addition to any overtime charges if applicable.

2.2 If an emergency landing is made elsewhere than at an international aerodrome or a designated alternate aerodrome, the pilot in command shall report the landing as promptly as possible by telephone or the most convenient means to the nearest Customs office. He/she should keep all merchandise or baggage in a segregated place and should not permit any passenger or crewmember to depart the place of arrival or mingle with the public without official permission, unless it is necessary for preservation of life, health, or property.

3. Traffic of Persons and Vehicles on Aerodromes

3.1 The grounds of each aerodrome are divided into two zones:

3.1.1 A public zone comprising the part of the aerodrome open to the public; and

3.1.2 A restricted zone comprising the rest of the aerodrome.

3.2 Movement of Persons

3.2.1 Access to the restricted zone is authorized only under conditions prescribed by the rules governing the aerodrome as established by the officials responsible for aerodrome security.

3.2.2 The customs, security, immigration and health inspection offices and areas, and the premises assigned to transit traffic are normally accessible only to passengers, to staff members of the responsible authorities or airlines, and to authorized persons in pursuit of their duties.

3.2.3 The movement of persons having access to the restricted zone of the aerodrome is subject to the conditions prescribed by applicable air traffic and by the security regulations laid down by the person responsible for the management of the aerodrome.

3.3 Movement of Vehicles

3.3.1 The movement of vehicles in the restricted zone is strictly limited to vehicles driven or used by persons having official permission.

3.3.2 Drivers of vehicles, of whatever type, driving within the confines of the aerodrome, must respect the direction of traffic, the traffic signs, and the posted speed limits and generally comply with the provisions of the highway code and with instructions given by the competent authorities.

4. General Information and Aerodrome Lighting and Marking

4.1 Aerodrome lighting information is contained in paragraphs 12. through 16. Information on aerodrome marking aids and signs is contained in paragraph 17.

4.2 Designated international U.S. aerodromes with scheduled passenger service in large aircraft and certain airports designated as alternate service aerodromes are listed in , Aerodromes.

5. Aerodrome Administration

5.1 The administration of all airports is the responsibility of the aerodrome owner.

5.2 Ownership of aerodromes in the U.S. is vested in three different groups: the Federal Government, non-Federal governments, and private organizations or individuals. It is the policy of the U.S. Federal Government to have its aerodromes comply with ICAO Standards and Recommended Practices. Exceptions are noted as differences below and in GEN 1.7. Aerodromes owned by non-Federal governments and private organizations or individuals are encouraged to comply with International Standards and Recommended Practices in part through the regulation of aircraft operations into the aerodromes and in part through agreements under which Federal aid is made available for aerodrome development or improvement. Further compliance is by voluntary action on the part of the aerodrome owner.

6. Conditions of Availability

6.1 An aerodrome which is open for public use may be used by a particular aircraft upon consideration of the meteorological conditions existing at the time and provided that the aircraft's performance and load classification (runway weight-bearing classification) is consistent with the physical characteristics of the aerodrome.

6.2 Civil Use of Military Fields

6.2.1 Except at joint-use airfields, U.S. Army, Air Force, Navy, Marine Corps, and Coast Guard air-

fields are available for use by civil aircraft only with prior permission or in an emergency. An approved civil aircraft landing permit is required for use at all except Coast Guard airfields. With minor exceptions, authority to use military airfields is granted only to aircraft on official government business.

6.2.2 An application for a permit must be submitted to the appropriate military department a minimum of 30 days prior to the first intended landing. A permit application consists of Department of Defense Forms DD Form 2400, Civil Aircraft Certificate of Insurance; DD Form 2401, Civil Aircraft Landing Permit; and DD Form 2402, Hold Harmless Agreement.

6.2.3 Forms and instructions can be obtained from the following addresses.

Army: Director, USAASA
ATTN: MOAS-AS
Building 1466
9325 Gunston Road, Suite N319
Ft. Belvoir, VA 22060-5582
Telephone: (703) 806-4864

Air Force: HQ USAF/XOO-CA
1480 Air Force Pentagon,
Room 4D1010
Washington DC 20330-1480
Telephone: (703) 697-5967

Navy/
Marine Corps: Commander
Naval Facilities Engineering
Command, Code 141JB
200 Stovall Street, Room 10N45
Alexandria, VA 22332-2300
Telephone: (703) 325-0475

At Coast Guard airfields, prior permission must be requested from the commanding officer of the airfield to be used.

7. Applicable ICAO Documents

ICAO Standards and Recommended Practices contained in Annex 14 are applied with the exceptions noted in GEN 1.7, Differences from ICAO Standards, Recommended Practices and Procedures.

8. Maintenance of Aerodrome Movement Areas

8.1 It is the responsibility of the relevant aerodrome authority to maintain the aerodrome in a satisfactory condition.

8.2 Clearance of snow and measurement of snow, ice, standing water, braking action, etc., and the reporting of such pavement conditions is within the responsibility of the aerodrome authority.

9. Dissemination of Information on the Condition of Paved Surface

9.1 Information on surface condition of runways, taxiways and aprons will be published, when available and when necessary.

9.2 At aerodromes where an ATS unit is established, if a runway is affected by standing water, snow, slush or ice during the approach of an aircraft for landing, and such conditions are notified by the aerodrome management to the ATS unit, such conditions will be made available to the aircraft.

10. Rescue and Fire Fighting Facilities

10.1 Adequate rescue and fire-fighting vehicles, equipment and personnel are provided at aerodromes available for international commercial air transport.

10.2 Temporary interruptions to rescue and fire-fighting service, or non-availability of such services, are made known by NOTAM.

10.3 Certificated Aerodromes (14 CFR Part 139)

Aerodromes serving certain air carriers under 14 CFR Part 139 are indicated by a CFR Index which relates to the availability of crash, fire, and rescue equipment. (See TBL AD 1.1-1.)

11. Bird Concentrations in the Vicinity of Aerodromes

11.1 Animal and bird notices are not normally published in aerodrome remarks. Pilots should be aware that animals and birds are frequently found in the vicinity of aerodromes and should exercise due caution. However, selected bird notices may be published, but only after approval by the appropriate Regional Bird Hazard Group.

TBLAD 1.1-1

14 CFR PART 139 CERTIFICATED AIRPORTS

Indexes and Fire Fighting and Rescue Equipment Requirements

Airport Index	Required Number of Vehicles	Aircraft Length	Agent & Water for Foam
A	1	< 90'	500# DC or 450# DC + 100 gal H ₂ O
B	1 or 2	≥ 90' & < 126'	Index A + 1500 gal H ₂ O
C	2 or 3	≥ 126' & < 159'	Index A + 3000 gal H ₂ O
D	3	≥ 159' & < 200'	Index A + 4000 gal H ₂ O
E	3	≥ 200'	Index A + 6000 gal H ₂ O
> Greater Than; < Less Than; ≥ Equal To or Greater Than; H ₂ O Water; DC Dry Chemical			
NOTE-			
Vehicle and capacity requirements for airports holding limited operating certificates are determined on a case-by-case basis.			

12. Airport Lighting Aids

12.1 Approach Light Systems (ALS)

12.1.1 Approach light systems provide the basic means for transition from instrument flight to visual flight for landing. Operational requirements dictate the sophistication and configuration of the approach light system for a particular runway.

12.1.2 Approach light systems are a configuration of signal lights starting at the landing threshold and extending into the approach area a distance of 2400–3000 feet for precision instrument runways and 1400–1500 feet for nonprecision instrument runways. Some systems include sequenced flashing lights which appear to the pilot as a ball of light traveling towards the runway at high speed (twice each second).

12.2 Visual Glideslope Indicators

12.2.1 Visual Approach Slope Indicator (VASI)

12.2.1.1 The VASI is a system of lights so arranged to provide visual descent guidance information during the approach to a runway. These lights are visible from 3–5 miles during the day and up to 20 miles or more at night. The visual glide path of the VASI provides safe obstruction clearance within plus or minus 10 degrees of the extended runway centerline and to 4 NM from the runway threshold. Descent, using the VASI, should not be initiated until the aircraft is visually aligned with the runway. Lateral course guidance is provided by the runway or runway lights. In certain circumstances, the safe obstruction clearance area may be reduced due to local limitations, or the VASI may be offset from the extended runway centerline. This will be noted in the Airport/ Facility Directory.

12.2.1.2 VASI installations may consist of either 2, 4, 6, 12, or 16 light units arranged in bars referred to as near, middle, and far bars. Most VASI installations consist of 2 bars, near and far, and may consist of 2, 4, or 12 light units. Some airports have VASIs consisting of three bars, near, middle, and far, which provide an additional visual glide path to accommodate high cockpit aircraft. This installation may consist of either 6 or 16 light units. VASI installations consisting of 2, 4, or 6 lights units are located on one side of the runway, usually the left. Where the installation consists of 12 or 16 light units, the light units are located on both sides of the runway.

12.2.1.3 Two-bar VASI installations provide one visual glide path which is normally set at 3 degrees. Three-bar VASI installations provide two visual glide paths. The lower glide path is provided by the near and middle bars and is normally set at 3 degrees while the upper glide path, provided by the middle and far bars, is normally $1/4$ degree higher. This higher glide path is intended for use only by high cockpit aircraft to provide a sufficient threshold crossing height. Although normal glide path angles are three degrees, angles at some locations may be as high as 4.5 degrees to give proper obstacle clearance. Pilots of high performance aircraft are cautioned that use of VASI angles in excess of 3.5 degrees may cause an increase in runway length required for landing and rollout.

12.2.1.4 The basic principle of the VASI is that of color differentiation between red and white. Each light unit projects a beam of light having a white segment in the upper part of the beam and red segment in the lower part of the beam. The light units are arranged so that the pilot using the VASIs during an approach will see the combination of lights shown below.

12.2.1.5 For 2-BAR VASI (4 light units), see FIG AD 1.1-2.

12.2.1.6 For 3-BAR VASI (6 light units), see FIG AD 1.1-3.

12.2.1.7 For other VASI configurations, see FIG AD 1.1-4.

12.2.2 Precision Approach Path Indicator (PAPI). The precision approach path indicator (PAPI) uses light units similar to the VASI but are installed in a single row of either two or four light units. These lights are visible from about 5 miles during the day and up to 20 miles at night. The visual glide path of the PAPI typically provides safe obstruction clearance within plus or minus 10 degrees of the extended runway centerline and to 4 SM from the runway threshold. Descent, using the PAPI, should not be initiated until the aircraft is visually aligned with the runway. The row of light units is normally installed on the left side of the runway and the glide path indications are as depicted. Lateral course guidance is provided by the runway or runway lights. In certain circumstances, the safe obstruction clearance area may be reduced due to local limitations, or the PAPI may be offset from the

extended runway centerline. This will be noted in the Airport/ Facility Directory. (See FIG AD 1.1-5.)

12.2.3 Tri-color Systems. Tri-color visual approach slope indicators normally consist of a single light unit, projecting a three-color visual approach path into the final approach area of the runway upon which the indicator is installed. The below glide path indication is red, the above glide path indication is amber, and the on glide path indication is green. These types of indicators have a useful range of approximately $\frac{1}{2}$ to 1 mile during the day and up to 5 miles at night depending upon the visibility conditions. (See FIG AD 1.1-6.)

12.2.4 Pulsating Systems. Pulsating visual approach slope indicators normally consist of a single light unit projecting a two-color visual approach path into the final approach area of the runway upon which the indicator is installed. The on glide path indication is a steady white light. The slightly below glide path indication is a steady red light. If the aircraft descends further below the glide path, the red light starts to pulsate. The above glide path indication is a pulsating white light. The pulsating rate increases as the aircraft gets further above or below the desired glide slope. The useful range of the system is about four miles during the day and up to ten miles at night. (See FIG AD 1.1-7.)

12.2.5 Alignment of Elements Systems. Alignment of elements systems are installed on some small general aviation airports and are a low cost system consisting of painted plywood panels, normally black and white or fluorescent orange. Some of these systems are lighted for night use. The useful range of these systems is approximately $\frac{3}{4}$ mile. To use the system the pilot positions the aircraft so the elements are in alignment. The glide path indications are shown in FIG AD 1.1-8.

12.3 Runway End Identifier Lights (REIL)

12.3.1 REILs are installed at many airfields to provide rapid and positive identification of the approach end of a particular runway. The system consists of a pair of synchronized flashing lights, one of which is located laterally on each side of the runway threshold facing the approach area. They are effective for:

12.3.1.1 Identification of a runway surrounded by a preponderance of other lighting.

12.3.1.2 Identification of a runway which lacks contrast with surrounding terrain.

12.3.1.3 Identification of a runway during reduced visibility.

12.4 Runway Edge Light Systems

12.4.1 Runway edge lights are used to outline the edges of runways during periods of darkness or restricted visibility conditions. These light systems are classified according to the intensity or brightness they are capable of producing: they are the High Intensity Runway Lights (HIRL), Medium Intensity Runway Lights (MIRL), and the Low Intensity Runway Lights (LIRL). The HIRL and MIRL systems have variable intensity controls; whereas, the LIRLs normally have one intensity setting.

12.4.2 The runway edge lights are white; except on instrument runways, yellow replaces white on the last 2,000 feet or half the runway length, whichever is less, to form a caution zone for landings.

12.4.3 The lights marking the ends of the runway emit red light toward the runway to indicate the end of the runway to a departing aircraft and emit green outward from the runway end to indicate the threshold to landing aircraft.

12.5 In-Runway Lighting

12.5.1 Runway Centerline Lighting System (RCLS). Runway centerline lights are installed on some precision approach runways to facilitate landing under adverse visibility conditions. They are located along the runway centerline and are spaced at 50-foot intervals. When viewed from the landing threshold, the runway centerline lights are white until the last 3,000 feet of the runway. The white lights begin to alternate with red for the next 2,000 feet, and for the last 1,000 feet of the runway, all centerline lights are red.

12.5.2 Touchdown Zone Lights (TDZL). Touchdown zone lights are installed on some precision approach runways to indicate the touchdown zone when landing under adverse visibility conditions. They consist of two rows of transverse light bars disposed symmetrically about the runway centerline. The system consists of steady-burning white lights which start 100 feet beyond the landing threshold and extend to 3,000 feet beyond the landing threshold or to the midpoint of the runway, whichever is less.

FIG AD 1.1-1
Precision & Nonprecision Configurations

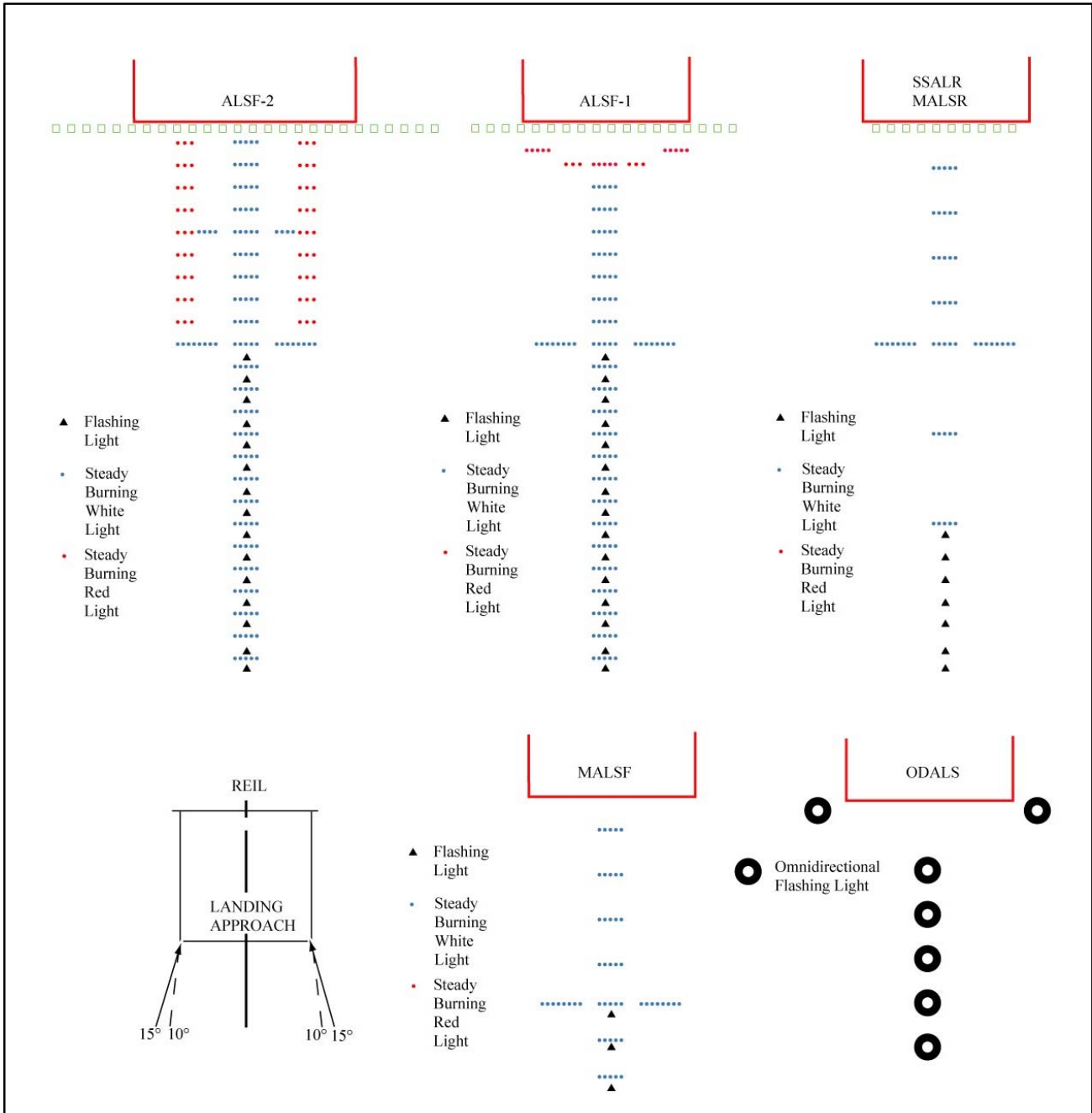

NOTE-
Civil ALSF-2 may be operated as SSALR during favorable weather conditions.

**FIG AD 1.1-2
2-Bar VASI**

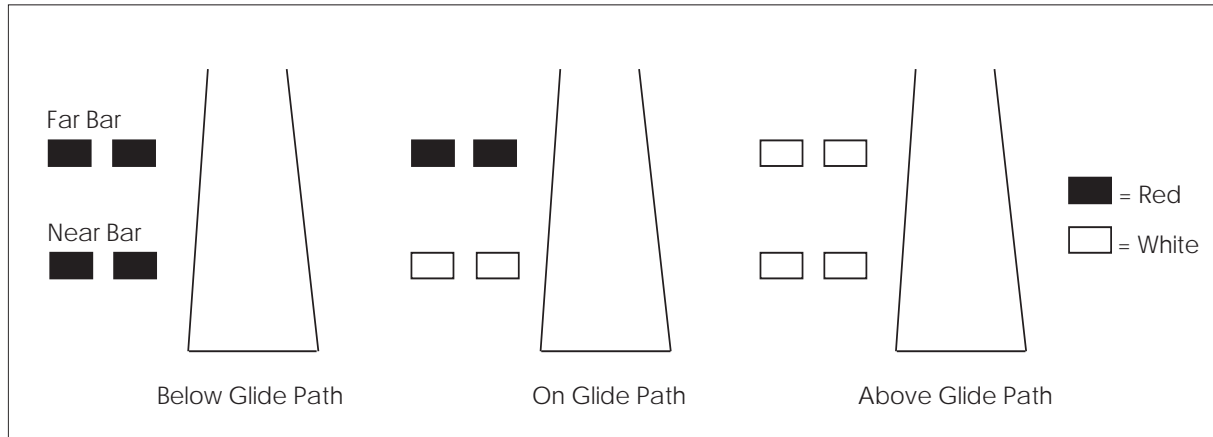

**FIG AD 1.1-3
3-Bar VASI**

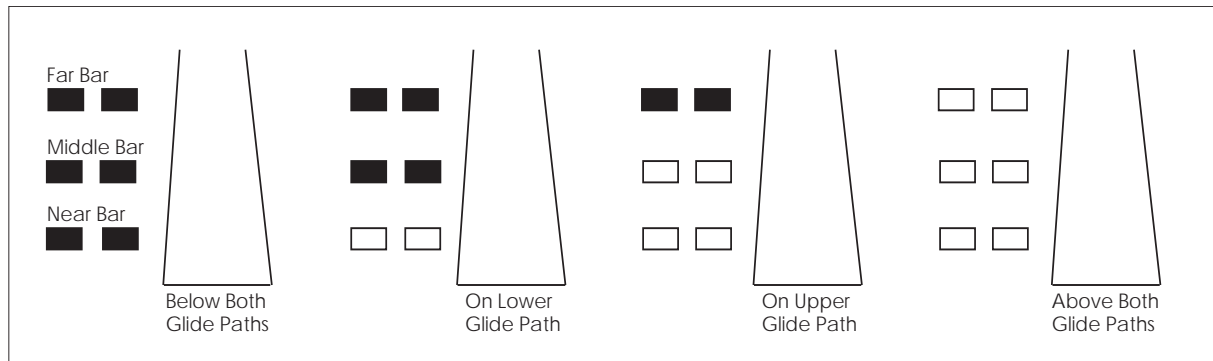

**FIG AD 1.1-4
VASI Variations**

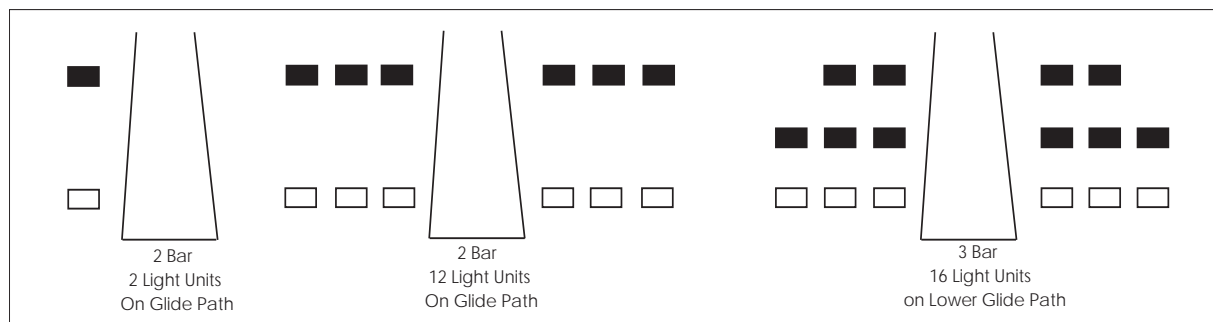

FIG AD 1.1-5
Precision Approach Path Indicator (PAPI)

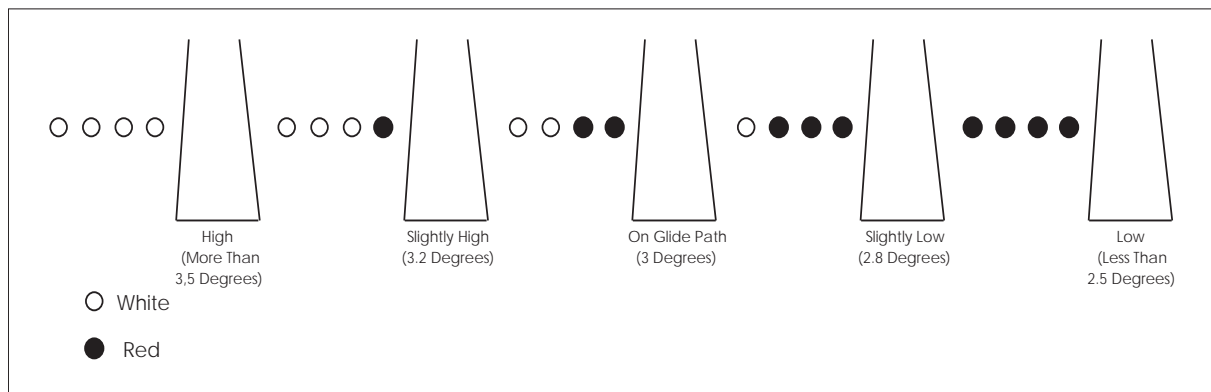
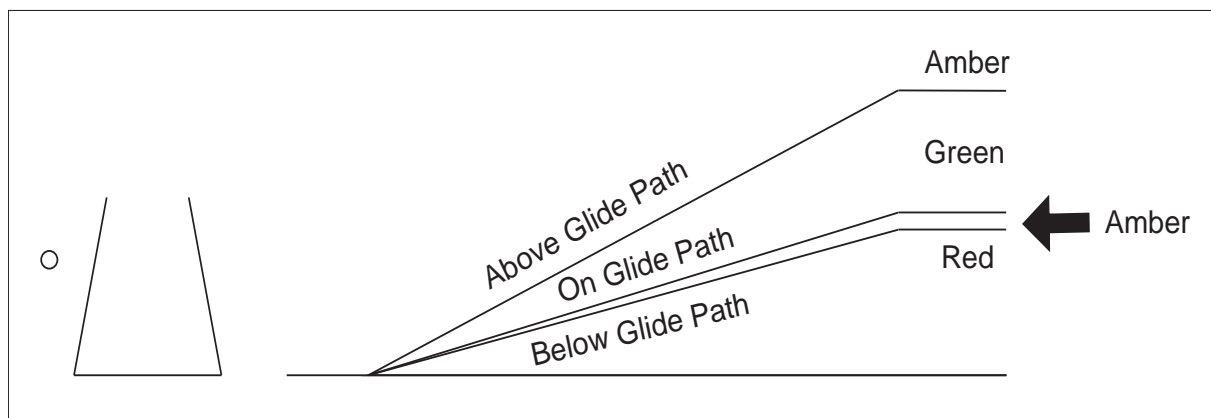

FIG AD 1.1-6
Tri-Color Visual Approach Slope Indicator



NOTE-

1. Since the tri-color VASI consists of a single light source which could possibly be confused with other light sources, pilots should exercise care to properly locate and identify the light signal.
2. When the aircraft descends from green to red, the pilot may see a dark amber color during the transition from green to red.

FIG AD 1.1-7
Pulsating Visual Approach Slope Indicator

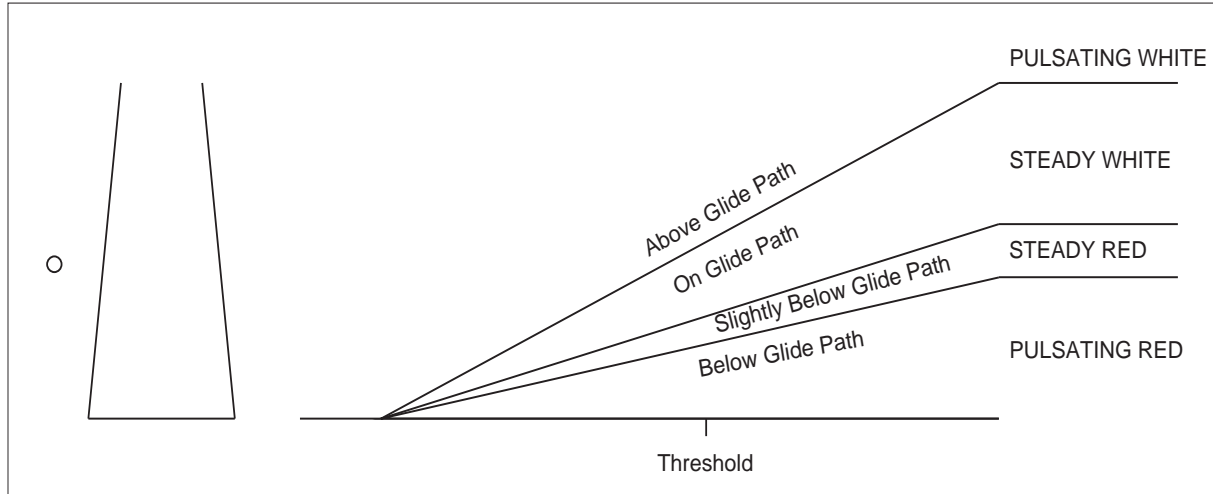

NOTE-
Since the PVASI consists of a single light source which could possibly be confused with other light sources, pilots should exercise care to properly locate and identify the light signal.

FIG AD 1.1-8
Alignment of Elements

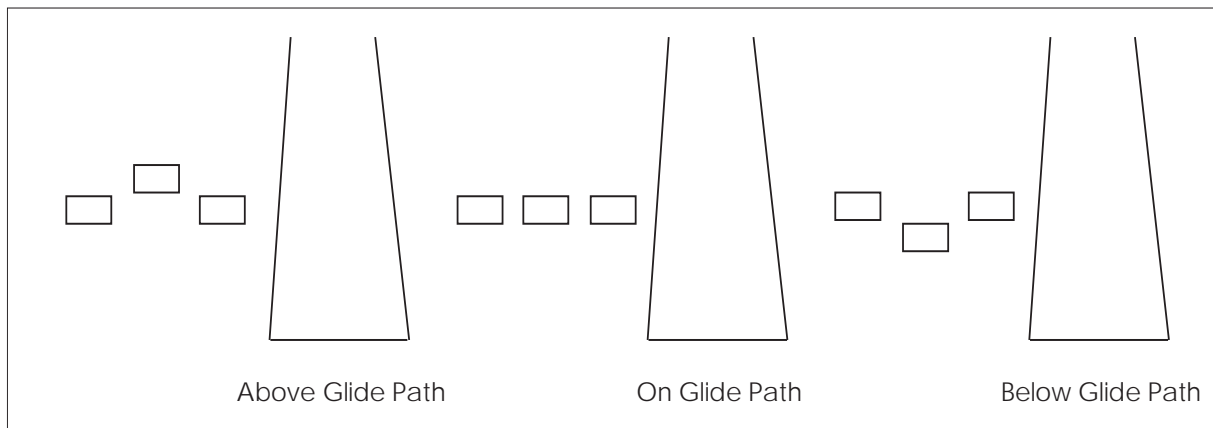

12.5.3 Taxiway Centerline Lead-Off Lights.

Taxiway centerline lead-off lights provide visual guidance to persons exiting the runway. They are color-coded to warn pilots and vehicle drivers that they are within the runway environment or instrument landing system/microwave landing system (ILS/MLS) critical area, whichever is more restrictive. Alternate green and yellow lights are installed, beginning with green, from the runway centerline to one centerline light position beyond the runway holding position or ILS/MLS critical area holding position.

12.5.4 Taxiway Centerline Lead-On Lights.

Taxiway centerline lead-on lights provide visual guidance to persons entering the runway. These “lead-on” lights are also color-coded with the same color pattern as lead-off lights to warn pilots and vehicle drivers that they are within the runway environment or instrument landing system/microwave landing system (ILS/MLS) critical area, whichever is more conservative. The fixtures used for lead-on lights are bidirectional, i.e., one side emits light for the lead-on function while the other side emits light for the lead-off function. Any fixture that emits yellow light for the lead-off function shall also emit yellow light for the lead-on function. (See FIG AD 1.1–12.)

12.5.5 Land and Hold Short Lights. Land and hold short lights are used to indicate the hold short point on certain runways which are approved for Land and Hold Short Operations (LAHSO). Land and hold short lights consist of a row of pulsing white lights installed across the runway at the hold short point. Where installed, the lights will be on anytime LAHSO is in effect. These lights will be off when LAHSO is not in effect.

*REFERENCE—
Section ENR 1.1, Paragraph 22, Pilot Responsibilities When Conducting Land and Hold Short Operations (LAHSO).*

12.6 Runway Status Light (RWSL) System

12.6.1 Introduction.

12.6.1.1 RWSL is a fully automated system that provides runway status information to pilots and surface vehicle operators to clearly indicate when it is unsafe to enter, cross, takeoff from, or land on a runway. The RWSL system processes information from surveillance systems and activates Runway Entrance Lights (REL), Takeoff Hold Lights (THL), Runway Intersection Lights (RIL), and Final

Approach Runway Occupancy Signal (FAROS) in accordance with the position and velocity of the detected traffic. REL, THL, and RIL are in-pavement light fixtures that are directly visible to pilots and surface vehicle operators. The FAROS annunciation is by means of flashing the Precision Approach Path Indicator (PAPI). RWSL is an independent safety enhancement that does not substitute for an ATC clearance. Clearance to enter, cross, takeoff from, land on, or operate on a runway must be issued by ATC. Although ATC has limited control over the system, personnel do not directly use, and may not be able to view, light fixture output in their operations.

12.6.2 Runway Entrance Lights (REL): The REL system is composed of flush mounted, in-pavement, unidirectional fixtures that are parallel to and focused along the taxiway centerline and directed toward the pilot at the hold line. An array of REL lights include the first light at the hold line followed by a series of evenly spaced lights to the runway edge; one additional light at the runway centerline is in line with the last two lights before the runway edge (see FIG AD 1.1–9 and FIG AD 1.1–10). When activated, the red lights indicate that there is high speed traffic on the runway or there is an aircraft on final approach within the activation area.

12.6.2.1 Operating Characteristics – Departing Aircraft:

When a departing aircraft reaches 30 knots, all taxiway intersections with REL arrays along the runway ahead of the aircraft will illuminate (see FIG AD 1.1–9). As the aircraft approaches an REL equipped taxiway intersection, the lights at that intersection extinguish approximately 3 to 4 seconds before the aircraft reaches it. This allows controllers to apply “anticipated separation” to permit ATC to move traffic more expeditiously without compromising safety. After the aircraft is declared “airborne” by the system, all REL lights associated with this runway will extinguish.

12.6.2.2 Operating Characteristics – Arriving Aircraft:

When an aircraft on final approach is approximately 1 mile from the runway threshold, all sets of REL light arrays along the runway illuminate. The distance is adjustable and can be configured for specific operations at particular airports. Lights extinguish at each equipped taxiway intersection approximately 3 to 4 seconds before the aircraft

reaches it to apply anticipated separation until the aircraft has slowed to approximately 80 knots (site adjustable parameter). Below 80 knots, all arrays that are not within 30 seconds of the aircraft's forward path are extinguished. Once the arriving aircraft slows to approximately 34 knots (site adjustable parameter), it is declared to be in a taxi state, and all lights extinguish.

12.6.2.3 What a pilot would observe: A pilot at or approaching the hold line to a runway will observe REL illumination and extinguishing in reaction to an aircraft or vehicle operating on the runway, or an arriving aircraft operating less than 1 mile from the runway threshold.

12.6.2.4 Whenever a pilot observes the red lights of the REL, that pilot will stop at the hold line or remain stopped. The pilot will then contact ATC for resolution if the clearance is in conflict with the lights. Should pilots note illuminated lights under circumstances when remaining clear of the runway is impractical for safety reasons (for example, aircraft is already on the runway), the crew should proceed according to their best judgment while understanding the illuminated lights indicate the runway is unsafe to enter or cross. Contact ATC at the earliest possible opportunity.

12.6.3 Takeoff Hold Lights (THL) : The THL system is composed of flush mounted, in-pavement, unidirectional fixtures in a double longitudinal row aligned either side of the runway centerline lighting. Fixtures are focused toward the arrival end of the runway at the "line up and wait" point, and they extend for 1,500 feet in front of the holding aircraft starting at a point 375 feet from the departure threshold (see FIG AD 1.1–11). Illuminated red lights provide a signal, to an aircraft in position for takeoff or rolling, that it is unsafe to takeoff because the runway is occupied or about to be occupied by another aircraft or ground vehicle. Two aircraft, or a surface vehicle and an aircraft, are required for the lights to illuminate. The departing aircraft must be in position for takeoff or beginning takeoff roll. Another aircraft or a surface vehicle must be on or about to cross the runway.

12.6.3.1 Operating Characteristics – Departing Aircraft:

THLs will illuminate for an aircraft in position for departure or departing when there is another aircraft

or vehicle on the runway or about to enter the runway (see FIG AD 1.1–9.) Once that aircraft or vehicle exits the runway, the THLs extinguish. A pilot may notice lights extinguish prior to the downfield aircraft or vehicle being completely clear of the runway but still moving. Like RELs, THLs have an "anticipated separation" feature.

NOTE–

When the THLs extinguish, this is not clearance to begin a takeoff roll. All takeoff clearances will be issued by ATC.

12.6.3.2 What a pilot would observe: A pilot in position to depart from a runway, or has begun takeoff roll, will observe THLs illuminate in reaction to an aircraft or vehicle on the runway or entering or crossing it. Lights will extinguish when the runway is clear. A pilot may observe several cycles of illumination and extinguishing depending on the amount of crossing traffic.

12.6.3.3 Whenever a pilot observes the red light of the THLs, the pilot will stop or remain stopped. The pilot will contact ATC for resolution if any clearance is in conflict with the lights. Should pilots note illuminated lights while in takeoff roll and under circumstances when stopping is impractical for safety reasons, the crew should proceed according to their best judgment while understanding the illuminated lights indicate that continuing the takeoff is unsafe. Contact ATC at the earliest possible opportunity.

12.6.4 Runway Intersection Lights (RIL): The RIL system is composed of flush mounted, in-pavement, unidirectional fixtures in a double longitudinal row aligned either side of the runway centerline lighting in the same manner as THLs. Their appearance to a pilot is similar to that of THLs. Fixtures are focused toward the arrival end of the runway, and they extend for 3,000 feet in front of an aircraft that is approaching an intersecting runway. They end at the Land and Hold Short Operation (LASHO) light bar or the hold short line for the intersecting runway.

12.6.4.1 Operating Characteristics – Departing Aircraft:

RILs will illuminate for an aircraft departing or in position to depart when there is high speed traffic operating on the intersecting runway (see FIG AD 1.1–9). Note that there must be an aircraft or vehicle in a position to observe the RILs for them to illuminate. Once that traffic passes through the intersection, the RILs extinguish.

FIG AD 1.1-9
Runway Status Light System

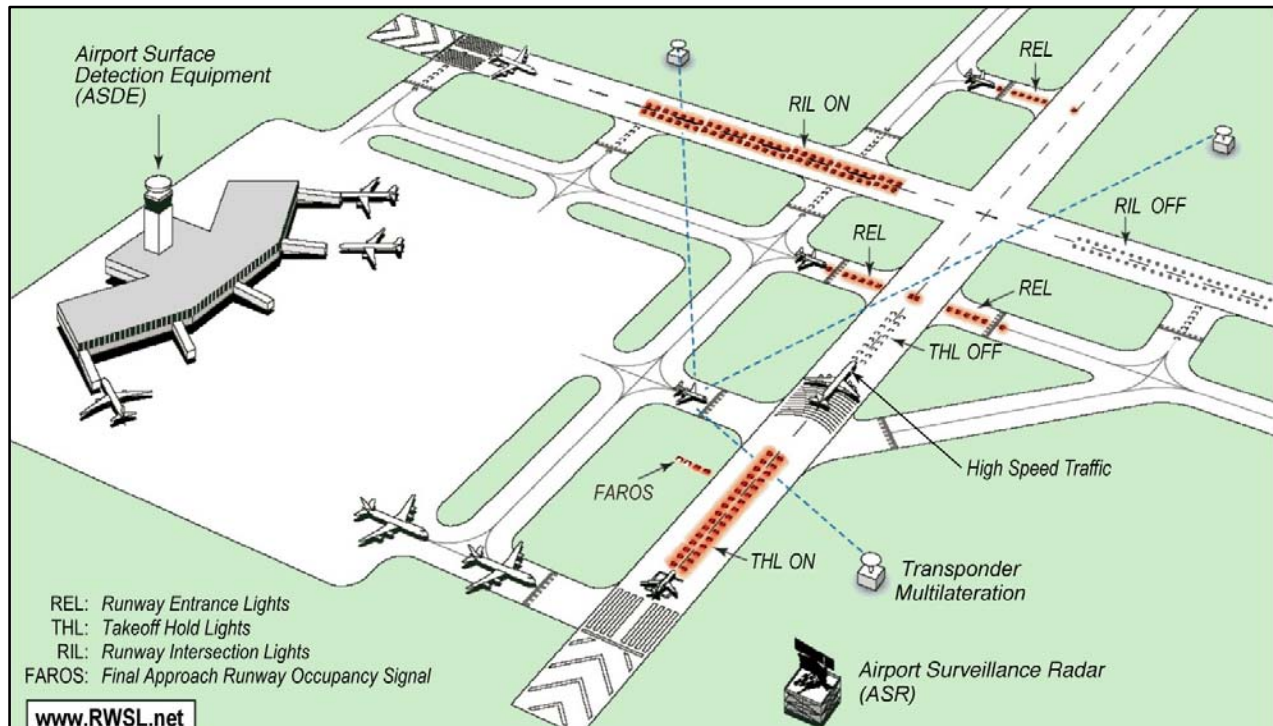

12.6.4.2 Operating Characteristics – Arriving Aircraft:

RILs will illuminate for an aircraft that has landed and is rolling out when there is high speed traffic on the intersecting runway that is ± 5 seconds of meeting at the intersection. Once that traffic passes through the intersection, the RILs extinguish.

12.6.4.3 What a pilot would observe: A pilot departing or arriving will observe RILs illuminate in reaction to the high speed traffic operation on the intersecting runway. The lights will extinguish when that traffic has passed through the runway intersection.

12.6.4.4 Whenever a pilot observes the red light of the RIL array, the pilot will stop before the LAHSO stop bar or the hold line for the intersecting runway. If a departing aircraft is already at high speed in the takeoff roll when the RILs illuminate, it may be impractical to stop for safety reasons. The crew should safely operate according to their best judgment while understanding the illuminated lights indicate that continuing the takeoff is unsafe. Contact ATC at the earliest possible opportunity.

12.6.4.5 The Final Approach Runway Occupancy Signal (FAROS) is activated by flashing of the Precision Approach Path Indicator (PAPI) (see FIG AD 1.1-9). When activated, the light fixtures of the PAPI flash or pulse to indicate to the pilot on an approach that the runway is occupied and that it may be unsafe to land.

a) Operating Characteristics:

If an aircraft or surface vehicle occupies a FAROS equipped runway, the PAPI(s) on that runway will flash or pulse. The glide path indication will not be affected, and the allotment of red and white PAPI lights observed by the pilot on approach will not change. Some FAROS systems will flash or pulse the PAPI when traffic enters the runway whether or not there is an aircraft on approach. Others will flash the PAPI only if there is an aircraft on approach and within 1.5 nautical miles of the landing threshold.

b) What a pilot would observe: A pilot on approach to the runway will observe the PAPI flash or pulse if there is traffic on the runway and will notice the PAPI ceases to flash or pulse when the traffic moves outside the hold short lines for the runway.

c) Whenever a pilot observes a flashing or pulsing PAPI, the pilot will verify the FAROS activation. At 500 feet above ground level (AGL), the contact height, the pilot must look for and acquire the traffic on the runway. At 300 feet AGL, the pilot must contact ATC for resolution if the clearance is in conflict with the FAROS indication. If the PAPI continues to flash or pulse, the pilot must execute an immediate “go around” and contact ATC at the earliest possible opportunity.

12.6.5 Pilot Actions

12.6.5.1 When operating at airports with RWSL, pilots will operate with the transponder “On” when departing the gate or parking area until it is shutdown upon arrival at the gate or parking area. This ensures interaction with the FAA surveillance systems which provide information to the RWSL system.

12.6.5.2 Pilots must always inform the ATCT when they have either stopped, are verifying a landing clearance, or are executing a missed approach due to RWSL or FAROS indication that are in conflict with ATC instructions. Pilots must request clarification of the taxi, takeoff, or landing clearance.

12.6.5.3 Never cross over illuminated red lights. Under normal circumstances, RWSL will confirm the pilot’s taxi or takeoff clearance. If RWSL indicates that it is unsafe to takeoff from, land on, cross, or enter a runway, immediately notify ATC of the conflict and confirm your clearance. Never land if PAPI continues to flash or pulse. Execute a go around and notify ATC.

12.6.5.4 Do not proceed when lights have extinguished without an ATC clearance. RWSL verifies an ATC clearance, it does not substitute for an ATC clearance.

12.6.6 ATC Control of RWSL System:

12.6.6.1 Controllers can set in-pavement lights to one of five (5) brightness levels to assure maximum conspicuity under all visibility and lighting conditions. REL, THL, and RIL subsystems may be independently set.

12.6.6.2 The system can be shutdown should RWSL operations impact the efficient movement of air traffic or contribute, in the opinion of the ATC Supervisor, to unsafe operations. REL, THL, RIL, and FAROS subsystems may be shutdown separately. Shutdown of the FAROS subsystem will not extinguish PAPI lights or impact its glide path

function. Whenever the system or a component is shutdown, a NOTAM must be issued, and the Automatic Terminal Information System (ATIS) must be updated.

12.7 Control of Lighting Systems

12.7.1 Operation of approach light systems and runway lighting is controlled by the control tower (ATCT). At some locations the FSS may control the lights where there is no control tower in operation.

12.7.2 Pilots may request that lights be turned on or off. Runway edge lights, in-pavement lights and approach lights also have intensity controls which may be varied to meet the pilot’s request. Sequenced flashing lights may be turned on and off. Some sequenced flashing system also have intensity control.

12.8 Pilot Control of Airport Lighting

12.8.1 Radio control of lighting is available at selected airports to provide airborne control of lights by keying the aircraft’s microphone. Control of lighting system is often available at locations without specified hours for lighting or where there is no control tower or FSS, or when the control tower or FSS is closed (locations with a part-time tower or FSS). All lighting systems which are radio controlled at an airport, whether on a single runway or multiple runways, operate on the same radio frequency. (See TBL AD 1.1–2 and TBL AD 1.1–3.)

12.8.2 With FAA approved systems, various combinations of medium intensity approach lights, runway lights, taxiways lights, VASI and/or REIL may be activated by radio control. On runways with both approach lighting and runway lighting (runway edge lights, taxiway lights, etc.) systems, the approach lighting system takes precedence for air-to-ground radio control over the runway lighting system which is set at a predetermined intensity step, based on expected visibility conditions. Runways without approach lighting may provide radio controlled intensity adjustments of runway edge lights. Other lighting systems, including VASI, REIL, and taxiway lights, may be either controlled with the runway edge lights or controlled independently of the runway edge lights.

12.8.3 The control system consists of a 3-step control responsive to 7, 5, and/or 3 microphone clicks. This 3-step control will turn on lighting facilities capable of either 3-step, 2-step or 1-step

operation. The 3-step and 2-step lighting facilities can be altered in intensity, while the 1-step cannot. All lighting is illuminated for a period of 15 minutes from the most recent time of activation and may not

be extinguished prior to end of the 15-minute period (except for 1-step and 2-step REILs which may be turned off when desired by keying the mike 5 or 3 times, respectively).

**FIGAD 1.1-10
Runway Entrance Lights**



**FIGAD 1.1-11
Takeoff Hold Lights**

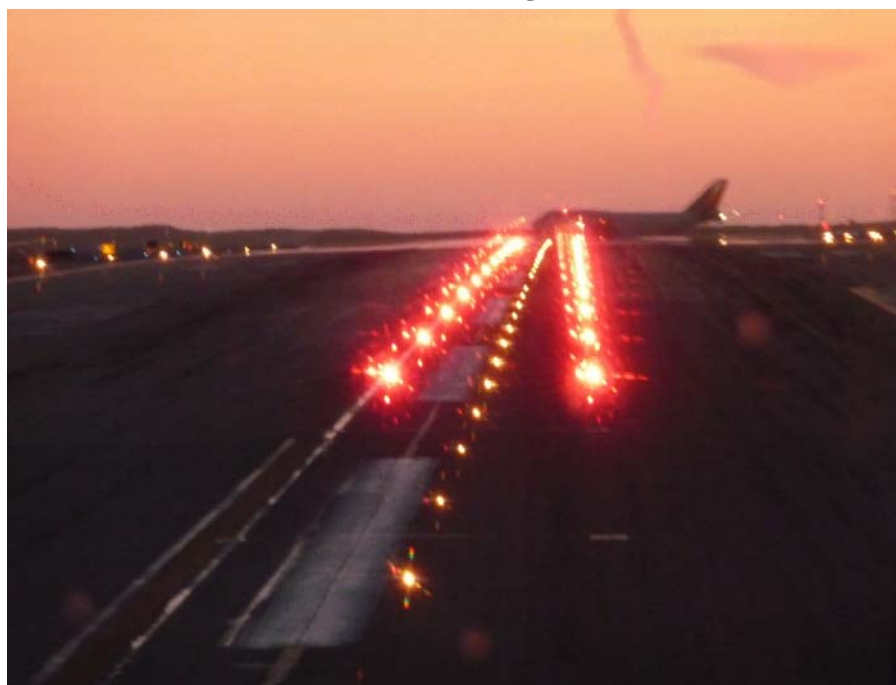

FIG AD 1.1-12
Taxiway Lead-On Light Configuration



TBLAD 1.1-2
Runways With Approach Lights

Lighting System	Number of Intensity Steps	Status During Nonuse Period	Intensity Step Selected Per Number of Mike Clicks		
			3 Clicks	5 Clicks	7 Clicks
Approach Lights (Med. Int.)	2	Off	Low	Low	High
Approach Lights (Med. Int.)	3	Off	Low	Med	High
MIRL	3	Off or Low	◆	◆	◆
HIRL	5	Off or Low	◆	◆	◆
VASI	2	Off	☆	☆	☆

NOTES: ◆Predetermined intensity step.
☆Low intensity for night use. High intensity for day use as determined by photocell control.

**TBLAD 1.1-3
Runways Without Approach Lights**

Lighting System	Number of Intensity Steps	Status During Nonuse Period	Intensity Step Selected Per Number of Mike Clicks		
			3 Clicks	5 Clicks	7 Clicks
MIRL	3	Off or Low	Low	Med.	High
HIRL	5	Off or Low	Step 1 or 2	Step 3	Step 5
LIRL	1	Off	On	On	On
VASI★	2	Off	◆	◆	◆
REIL★	1	Off	Off	On / Off	On
REIL★	3	Off	Low	Med.	High

NOTES: ◆Low intensity for night use. High intensity for day use as determined by photocell control.
★The control of VASI and/or REIL may be independent of other lighting systems.

12.8.4 Suggested use is to always initially key the mike 7 times; this assures that all controlled lights are turned on to the maximum available intensity. If desired, adjustment can then be made, where the capability is provided, to a lower intensity (or the REIL turned off) by keying 5 and/or 3 times. Due to the close proximity of airports using the same frequency, radio controlled lighting receivers may be set at a low sensitivity requiring the aircraft to be relatively close to activate the system. Consequently, even when lights are on, always key mike as directed when overflying an airport of intended landing or just prior to entering the final segment of an approach. This will assure the aircraft is close enough to activate the system and a full 15 minutes lighting duration is available. Approved lighting systems may be activated by keying the mike (within 5 seconds) as indicated in TBL AD 1.1-4.

**TBLAD 1.1-4
Radio Control System**

Key Mike	Function
7 times within 5 seconds	Highest intensity available
5 times within 5 seconds	Medium or lower intensity (Lower REIL or REIL-off)
3 times within 5 seconds	Lowest intensity available (Lower REIL or REIL-off)

12.8.5 The Airport/Facility Directory contains the types of lighting, runway, and the frequency that is used to activate the system for all public use airports

with FAA standard systems. Airports with instrument approach procedures include data on the approach chart identifying the light system(s), the runway on which they are installed, and the frequency that is used to activate the system(s).

NOTE-
Although the CTAF is used to activate the lights at many airports, other frequencies may also be used. The appropriate frequency for activating the lights on the airport is provided in the Airport/Facility Directory and the standard instrument approach procedures publications. It is not identified on the sectional charts.

12.8.6 Where the airport is not served by an instrument approach procedure, it may have either the standard FAA approach control system or an independent type system of different specification installed by the airport sponsor. The Airport/Facility Directory contains descriptions of pilot-controlled lighting systems for each airport having other than FAA approved systems, and explains the type lights, method of control, and operating frequency in clear text.

13. Airport/Heliport Beacons

13.1 Airport and heliport beacons have a vertical light distribution to make them most effective from one to ten degrees above the horizon; however, they can be seen well above and below this peak spread. The beacon may be an omnidirectional capacitor-discharge device, or it may rotate at a constant speed which produces the visual effect of flashes at regular

intervals. Flashes may be one or two colors alternately. The total number of flashes are:

13.1.1 24 to 30 per minute for beacons marking airports, landmarks, and points on Federal airways.

13.1.2 30 to 45 per minute for beacons marking heliports.

13.2 The colors and color combinations of beacons are:

13.2.1 White and Green—Lighted land airport.

13.2.2 *Green alone—Lighted land airport.

13.2.3 White and Yellow—Lighted water airport.

13.2.4 *Yellow alone—Lighted water airport.

13.2.5 Green, Yellow, and White—Lighted heliport.

NOTE—

**Green alone or yellow alone is used only in connection with a white-and-green or white-and-yellow beacon display, respectively.*

13.3 Military airport beacons flash alternately white and green, but are differentiated from civil beacons by dual-peaked (two quick) white flashes between the green flashes.

13.4 In Class B, C, D, and E surface areas, operation of the airport beacon during the hours of daylight indicates that the ground visibility is less than 3 miles and/or the ceiling is less than 1,000 feet. An ATC clearance in accordance with 14 CFR Part 91 is required for landing, takeoff and flight in the traffic pattern. Pilots should not rely solely on the operation of the airport beacon to indicate if weather conditions are IFR or VFR. At locations with control towers, when controls are in the tower, ATC personnel turn the beacon on. At many airports, the airport beacon is turned on by a photoelectric cell or time clocks and ATC personnel cannot control it. There is no regulatory requirement for daylight operation, and it is the pilot's responsibility to comply with proper pre-flight planning in accordance with 14 CFR Section 91.103.

14. Taxiway Lights

14.1 Taxiway Edge Lights. Taxiway edge lights are used to outline the edges of taxiways during periods of darkness or restricted visibility conditions. These fixtures emit blue light.

NOTE—

At most major airports these lights have variable intensity settings and may be adjusted at pilot request or when deemed necessary by the controller.

14.2 Taxiway Centerline Lights. Taxiway centerline lights are used to facilitate ground traffic under low visibility conditions. They are located along the taxiway centerline in a straight line on straight portions, on the centerline of curved portions, and along designated taxiing paths in portions of runways, ramps, and apron areas. Taxiway centerline lights are steady burning and emit green light.

14.3 Clearance Bar Lights. Clearance bar lights are installed at holding positions on taxiways in order to increase the conspicuity of the holding position in low visibility conditions. They may also be installed to indicate the location of an intersecting taxiway during periods of darkness. Clearance bars consist of three in-pavement, steady-burning yellow lights.

14.4 Runway Guard Lights. Runway guard lights are installed at taxiway/runway intersections. They are primarily used to enhance the conspicuity of taxiway/runway intersections during low visibility conditions, but may be used in all weather conditions. Runway guard lights consist of either a pair of elevated flashing yellow lights installed on either side of the taxiway, or a row of in-pavement yellow lights installed across the entire taxiway, at the runway holding position marking.

NOTE—

Some airports may have a row of three or five in-pavement yellow lights installed at taxiway/runway intersections. They should not be confused with clearance bar lights described in paragraph 14.3 above.

14.5 Stop Bar Lights. Stop bar lights, when installed, are used to confirm the ATC clearance to enter or cross the active runway in low visibility conditions (below 1,200 feet Runway Visual Range). A stop bar consists of a row of red, unidirectional, steady-burning in-pavement lights installed across the entire taxiway at the runway holding position, and elevated steady-burning red lights on each side. A controlled stop bar is operated in conjunction with the taxiway centerline lead-on lights which extend from the stop bar toward the runway. Following the ATC clearance to proceed, the stop bar is turned off and the lead-on lights are turned on. The stop bar and lead-on lights are automatically reset by a sensor or backup timer.

CAUTION-

Pilots should never cross a red illuminated stop bar, even if an ATC clearance has been given to proceed onto or across the runway.

NOTE-

If after crossing a stop bar, the taxiway centerline lead-on lights inadvertently extinguish, pilots should hold their position and contact ATC for further instructions.

15. Air Navigation and Obstruction Lighting

15.1 Aeronautical Light Beacons

15.1.1 An aeronautical light beacon is a visual NAVAID displaying flashes of white and/or colored light to indicate the location of an airport, a heliport, a landmark, a certain point of a Federal airway in mountainous terrain, or an obstruction. The light used may be a rotating beacon or one or more flashing lights. The flashing lights may be supplemented by steady burning lights of lesser intensity.

15.1.2 The color or color combination display by a particular beacon and/or its auxiliary lights tell whether the beacon is indicating a landing place, landmark, point of the Federal airways, or an obstruction. Coded flashes of the auxiliary lights, if employed, further identify the beacon site.

15.2 Code Beacons and Course Lights

15.2.1 Code Beacons. The code beacon, which can be seen from all directions, is used to identify airports and landmarks. The code beacon flashes the three- or four-character airport identifier in International Morse Code six to eight times per minute. Green flashes are displayed for land airports while yellow flashes indicate water airports.

15.2.2 Course Lights. The course light, which can be seen clearly from only one direction, is used only with rotating beacons of the Federal Airway System; two course lights, back to back, direct coded flashing beams of light in either direction along the course of airway.

NOTE-

Airway beacons are remnants of the "lighted" airways which antedated the present electronically equipped federal airways system. Only a few of those beacons exist today to mark airway segments in remote mountain areas. Flashes in Morse code identify the beacon site.

15.3 Obstruction Lights

15.3.1 Obstructions are marked/lighted to warn airmen of their presence during daytime and nighttime conditions. They may be marked/lighted in any of the following combinations:

15.3.1.1 Aviation Red Obstruction Lights. Flashing aviation red beacons (20 to 40 flashes per minute) and steady burning aviation red lights during nighttime operation. Aviation orange and white paint is used for daytime marking.

15.3.1.2 Medium Intensity Flashing White Obstruction Lights. Medium intensity flashing white obstruction lights may be used during daytime and twilight with automatically selected reduced intensity for nighttime operation. When this system is used on structures 500 feet (153 m) AGL or less in height, other methods of marking and lighting the structure may be omitted. Aviation orange and white paint is always required for daytime marking on structures exceeding 500 feet (153 m) AGL. This system is not normally installed on structures less than 200 feet (61 m) AGL.

15.3.1.3 High Intensity White Obstruction Lights. Flashing high intensity white lights during daytime with reduced intensity for twilight and nighttime operation. When this type system is used, the marking of structures with red obstruction lights and aviation orange and white paint may be omitted.

15.3.1.4 Dual Lighting. A combination of flashing aviation red beacons and steady burning aviation red lights for nighttime operation and flashing high intensity white lights for daytime operation. Aviation orange and white paint may be omitted.

15.3.1.5 Catenary Lighting. Lighted markers are available for increased night conspicuity of high-voltage (69KV or higher) transmission line catenary wires. Lighted markers provide conspicuity both day and night.

15.3.2 Medium intensity omnidirectional flashing white lighting system provides conspicuity both day and night on catenary support structures. The unique sequential/simultaneous flashing light system alerts pilots of the associated catenary wires.

15.3.3 High intensity flashing white lights are being used to identify some supporting structures of overhead transmission lines located across rivers, chasms, gorges, etc. These lights flash in a middle, top, lower light sequence at approximately 60 flashes

per minute. The top light is normally installed near the top of the supporting structure, while the lower light indicates the approximate lower portion of the wire span. The lights are beamed towards the companion structure and identify the area of the wire span.

15.3.4 High intensity flashing white lights are also employed to identify tall structures, such as chimneys and towers, and obstructions to air navigation. The lights provide a 360 degree coverage about the structure at 40 flashes per minute and consist of from one to seven levels of lights depending upon the height of the structure. Where more than one level is used, the vertical banks flash simultaneously.

16. Airport Lead-in Lighting System (LDIN)

16.1 The lead-in lighting system consists of a series of flashing lights installed at or near ground level to describe the desired course to a runway or final approach. Each group of lights is positioned and aimed so as to be conveniently sighted and followed from the approaching aircraft under conditions at or above approach minimums under consideration. The system may be curved, straight, or combination thereof, as required. The lead-in lighting system may be terminated at any approved approach lighting system, or it may be terminated at a distance from the landing threshold which is compatible with authorized visibility minimums permitting visual reference to the runway environment.

16.2 The outer portion uses groups of lights to mark segments of the approach path beginning at a point within easy visual range of a final approach fix. These groups are spaced close enough together (approximately one mile) to give continuous lead-in guidance. A group consists of at least three flashing lights in a linear or cluster configuration and may be augmented by steady burning lights where required. When practicable, groups flash in sequence toward runways. Each system is designed to suit local conditions and to provide the visual guidance intended. The design of all LDIN is compatible with the requirements of U.S. Standards for Terminal Instrument Procedures (TERPS) where such proce-

dures are applied for establishing instrument minimums.

17. Airport Marking Aids and Signs

17.1 General

17.1.1 Airport pavement markings and signs provide information that is useful to a pilot during takeoff, landing, and taxiing.

17.1.2 Uniformity in airport markings and signs from one airport to another enhances safety and improves efficiency. Pilots are encouraged to work with the operators of the airports they use to achieve the marking and sign standards described in this section.

17.1.3 Pilots who encounter ineffective, incorrect, or confusing markings or signs on an airport should make the operator of the airport aware of the problem. These situations may also be reported under the Aviation Safety Reporting Program as described in ENR 1.16. Pilots may also report these situations to the FAA Regional Airports Division.

17.1.4 The markings and signs described in this section reflect the current FAA recommended standards.

REFERENCE—

AC 150/5340–1, Standards for Airport Markings.
AC 150/5340–18, Standards for Airport Sign Systems.

17.2 Airport Pavement Markings

17.2.1 General. For the purpose of this presentation the Airport Pavement Markings have been grouped into the four areas:

17.2.1.1 Runway Markings.

17.2.1.2 Taxiway Markings.

17.2.1.3 Holding Position Markings.

17.2.1.4 Other Markings.

17.2.2 Marking Colors. Markings for runways are white. Markings defining the landing area on a heliport are also white except for hospital heliports which use a red “H” on a white cross. Markings for taxiways, areas not intended for use by aircraft (closed and hazardous areas), and holding positions (even if they are on a runway) are yellow.

17.3 Runway Markings

17.3.1 General. There are three types of markings for runways: visual, non precision instrument, and precision instrument. TBLAD 1.1-5 identifies the marking elements for each type of runway, and TBLAD 1.1-6 identifies runway threshold markings.

17.3.2 Runway Designators. Runway numbers and letters are determined from the approach direction. The runway number is the whole number nearest one-tenth the magnetic azimuth of the centerline of the runway, measured clockwise from the magnetic north. The letters differentiate between left (L), right (R), or center (C), parallel runways, as applicable:

17.3.2.1 For two parallel runways “L” “R.”

17.3.2.2 For three parallel runways “L” “C” “R.”

17.3.3 Runway Centerline Marking. The runway centerline identifies the center of the runway and provides alignment guidance during takeoff and

landing. The centerline consists of a line of uniformly spaced stripes and gaps.

17.3.4 Runway Aiming Point Marking. The aiming point marking serves as a visual aiming point for a landing aircraft. These two rectangular markings consist of a broad white stripe located on each side of the runway centerline and approximately 1,000 feet from the landing threshold. (See FIG AD 1.1-13.)

17.3.5 Runway Touchdown Zone Markers. The touchdown zone markings identify the touchdown zone for landing operations and are coded to provide distance information in 500 feet (150 m) increments. These markings consist of groups of one, two, and three rectangular bars symmetrically arranged in pairs about the runway centerline as shown in FIG AD 1.1-13, Precision Instrument Runway Markings. For runways having touchdown zone markings on both ends, those pairs of markings which extend to within 900 feet (270 m) of the midpoint between the thresholds are eliminated.

TBLAD 1.1-5
Runway Marking Elements

Marking Element	Visual Runway	Nonprecision Instrument Runway	Precision Instrument Runway
Designation	X	X	X
Centerline	X	X	X
Threshold	X ¹	X	X
Aiming Point	X ²	X	X
Touchdown Zone			X
Side Stripes			X

¹On runways used, or intended to be used, by international commercial transports.
²On runways 4,000 feet (1200 m) or longer used by jet aircraft.

TBLAD 1.1-6
Number of Runway Threshold Stripes

Runway Width	Number of Stripes
60 feet (18 m)	4
75 feet (23 m)	6
100 feet (30 m)	8
150 feet (45 m)	12
200 feet (60 m)	16

17.3.6 Runway Side Stripe Marking. Runway side stripes delineate the edges of the runway. They provide a visual contrast between the runway and the abutting terrain or shoulders. Side stripes consist of continuous white stripes located on each side of the runway. (See FIG AD 1.1–17.)

17.3.7 Runway Shoulder Markings. Runway shoulder stripes may be used to supplement runway side stripes to identify pavement areas contiguous to the runway sides that are not intended for use by aircraft. Runway shoulder stripes are yellow. (See FIG AD 1.1–15.)

17.3.8 Runway Threshold Markings. Runway threshold markings come in two configurations. They consist of either eight longitudinal stripes of uniform dimensions disposed symmetrically about the runway centerline, as shown in FIG AD 1.1–13, or the number of stripes is related to the runway width as indicated in TBL AD 1.1–6. A threshold marking helps identify the beginning of the runway that is available for landing. In some instances the landing threshold may be relocated or displaced.

17.3.8.1 Relocation of a Threshold. Sometimes construction, maintenance, or other activities require the threshold to be relocated towards the rollout end of the runway. (See FIG AD 1.1–16.) When a threshold is relocated, it closes not only a set portion of the approach end of a runway, but also shortens the length of the opposite direction runway. In these cases, a NOTAM should be issued by the airport operator identifying the portion of the runway that is closed; e.g., 10/28 W 900 CLSD. Because the duration of the relocation can vary from a few hours to several months, methods identifying the new threshold may vary. One common practice is to use a ten-foot wide white threshold bar across the width of the runway. Although the runway lights in the area between the old threshold and new threshold will not be illuminated, the runway markings in this area may or may not be obliterated, removed, or covered.

17.3.8.2 Displaced Threshold. A displaced threshold is a threshold located at a point on the runway other than the designated beginning of the runway. Displacement of a threshold reduces the length of runway available for landings. The portion of runway behind a displaced threshold is available for takeoffs in either direction and landings from the opposite direction. A ten-foot wide white threshold bar is

located across the width of the runway at the displaced threshold. White arrows are located along the centerline in the area between the beginning of the runway and displaced threshold. White arrowheads are located across the width of the runway just prior to the threshold bar, as shown in FIG AD 1.1–17.

NOTE–

Airport operator. When reporting the relocation or displacement of a threshold, the airport operator should avoid language which confuses the two.

17.3.9 Demarcation Bar. A demarcation bar delineates a runway with a displaced threshold from a blast pad, stopway, or taxiway that precedes the runway. A demarcation bar is 3 feet (1 m) wide and yellow, since it is not located on the runway. (See FIG AD 1.1–18.)

17.3.10 Chevrons. These markings are used to show pavement areas aligned with the runway that are unusable for landing, takeoff, and taxiing. Chevrons are yellow. (See FIG AD 1.1–19.)

17.3.11 Runway Threshold Bar. A threshold bar delineates the beginning of the runway that is available for landing when the threshold has been relocated or displaced. A threshold bar is 10 feet (3 m) in width and extends across the width of the runway, as shown in FIG AD 1.1–17.

18. Taxiway Markings

18.1 General. All taxiways should have centerline markings and runway holding position markings whenever they intersect a runway. Taxiway edge markings are present whenever there is a need to separate the taxiway from a pavement that is not intended for aircraft use or to delineate the edge of the taxiway. Taxiways may also have shoulder markings and holding position markings for Instrument Landing System/Microwave Landing System (ILS/MLS) critical areas, and taxiway/taxiway intersection markings.

18.2 Taxiway Centerline.

18.2.1 Normal Centerline. The taxiway centerline is a single continuous yellow line, 6 inches (15 cm) to 12 inches (30 cm) in width. This provides a visual cue to permit taxiing along a designated path. Ideally, the aircraft should be kept centered over this line during taxi. However, being centered on the taxiway centerline does not guarantee wingtip clearance with other aircraft or other objects.

18.2.2 Enhanced Centerline. At some airports, mostly the larger commercial service airports, an enhanced taxiway centerline will be used. The enhanced taxiway centerline marking consists of a parallel line of yellow dashes on either side of the normal taxiway centerline. The taxiway centerlines are enhanced for a maximum of 150 feet prior to a runway holding position marking. The purpose of this enhancement is to warn the pilot that he/she is approaching a runway holding position marking and should prepare to stop unless he/she has been cleared onto or across the runway by ATC. (See FIG AD 1.1–20.)

18.3 Taxiway Edge Markings. Taxiway edge markings are used to define the edge of the taxiway. They are primarily used when the taxiway edge does not correspond with the edge of the pavement. There are two types of markings depending upon whether the aircraft is suppose to cross the taxiway edge:

18.3.1 Continuous Markings. These consist of a continuous double yellow line, with each line being at least 6 inches (15 cm) in width spaced 6 inches (15 cm) apart. They are used to define the taxiway edge from the shoulder or some other abutting paved surface not intended for use by aircraft.

18.3.2 Dashed Markings. These markings are used when there is an operational need to define the edge of a taxiway or taxilane on a paved surface where the adjoining pavement to the taxiway edge is intended for use by aircraft; e.g., an apron. Dashed taxiway edge markings consist of a broken double yellow line, with each line being at least 6 inches (15 cm) in width, spaced 6 inches (15 cm) apart (edge to edge). These lines are 15 feet (4.5 m) in length with 25-foot (7.5 m) gaps. (See FIG AD 1.1–21.)

18.4 Taxi Shoulder Markings. Taxiways, holding bays, and aprons are sometimes provided with paved shoulders to prevent blast and water erosion. Although shoulders may have the appearance of full strength pavement, they are not intended for use by aircraft and may be unable to support an aircraft. Usually the taxiway edge marking will define this area. Where conditions exist such as islands or taxiway curves that may cause confusion as to which side of the edge stripe is for use by aircraft, taxiway shoulder markings may be used to indicate the pavement is unusable. Taxiway shoulder markings are yellow. (See FIG AD 1.1–22.)

18.5 Surface Painted Taxiway Direction Signs. Surface painted taxiway direction signs have a yellow background with a black inscription. These signs are provided when it is not possible to provide taxiway direction signs at intersections or when it is necessary to supplement such signs. These markings are located adjacent to the centerline with signs indicating turns to the left being on the left side of the taxiway centerline and signs indicating turns to the right being on the right side of the centerline. (See FIG AD 1.1–23.)

18.6 Surface Painted Location Signs. Surface painted location signs have a black background with a yellow inscription. When necessary, these markings are used to supplement location signs located along side the taxiway and assist the pilot in confirming the designation of the taxiway on which the aircraft is located. These markings are located on the right side of the centerline. (See FIG AD 1.1–23.)

18.7 Geographic Position Markings. These markings are located at points along low visibility taxi routes designated in the airport's Surface Movement Guidance Control System (SMGCS) plan. They are used to identify the location of taxiing aircraft during low visibility operations. Low visibility operations are those that occur when the runway visible range (RVR) is below 1,200 feet (360 m). They are positioned to the left of the taxiway centerline in the direction of taxiing. (See FIG AD 1.1–24.) The geographic position marking is a circle comprised of an outer black ring contiguous to a white ring with a pink circle in the middle. When installed on asphalt or other dark-colored pavements, the white ring and the black ring are reversed; i.e., the white ring becomes the outer ring and the black ring becomes the inner ring. It is designated with either a number or a number and letter. The number corresponds to the consecutive position of the marking on the route.

19. Holding Position Markings

19.1 Runway Holding Position Markings. For runways, these markings indicate where an aircraft is supposed to stop when approaching a runway. They consist of four yellow lines, two solid and two dashed, spaced six or twelve inches apart, and extending across the width of the taxiway or runway. The solid lines are always on the side where the aircraft is to hold. There are three locations where runway holding position markings are encountered.

19.1.1 Runway Holding Position Markings on Taxiways. These markings identify the locations on a taxiway where an aircraft is supposed to stop when it does not have clearance to proceed onto the runway. Generally, runway holding position markings also identify the boundary of the runway safety area for aircraft exiting the runway. The runway holding position markings are shown in FIG AD 1.1–25 and FIG AD 1.1–28. When instructed by ATC to, “Hold short of (runway “xx”),” the pilot must stop so that no part of the aircraft extends beyond the runway holding position marking. When approaching the runway, a pilot should not cross the runway holding position marking without ATC clearance at a controlled airport, or without making sure of adequate separation from other aircraft at uncontrolled airports. An aircraft exiting a runway is not clear of the runway until all parts of the aircraft have crossed the applicable holding position marking.

REFERENCE—
ENR 1.1, Exiting the Runway After Landing, paragraph 23.

19.1.2 Runway Holding Position Markings on Runways. These markings are installed on runways only if the runway is normally used by air traffic control for “land, hold short” operations or taxiing operations and have operational significance only for those two types of operations. A sign with a white inscription on a red background is installed adjacent to these holding position markings. (See FIG AD 1.1–26.) The holding position markings are placed on runways prior to the intersection with another runway, or some designated point. Pilots receiving instructions “cleared to land, runway “xx”” from air traffic control are authorized to use the entire landing length of the runway and should disregard any holding position markings located on the runway. Pilots receiving and accepting instructions “cleared to land runway “xx,” hold short of runway “yy”” from air traffic control must either exit runway “xx,” or stop at the holding position prior to runway “yy.”

19.1.3 Taxiways Located in Runway Approach Areas. These markings are used at some airports where it is necessary to hold an aircraft on a taxiway located in the approach or departure area of a runway so that the aircraft does not interfere with the operations on that runway. This marking is collocated with the runway approach area holding position sign. When specifically instructed by ATC “Hold short of (runway xx approach area)” the pilot should stop so no part of the aircraft extends beyond the holding

position marking. (See paragraph 21.2.2, Runway Approach Area Holding Position Sign, and FIG AD 1.1–27, Taxiways Located in Runway Approach Area.)

19.2 Holding Position Markings for Instrument Landing System (ILS). Holding position markings for ILS/MLS critical areas consist of two yellow solid lines spaced two feet apart connected by pairs of solid lines spaced ten feet apart extending across the width of the taxiway as shown in FIG AD 1.1–28. A sign with an inscription in white on a red background is installed adjacent to these hold position markings. When the ILS critical area is being protected, the pilot should stop so no part of his/her aircraft extends beyond the holding position marking. When approaching the holding position marking, a pilot should not cross the marking without ATC clearance. The ILS critical area is not clear until all parts of the aircraft have crossed the applicable holding position marking.

REFERENCE—
ENR 4.1, Instrument Landing System (ILS), paragraph 7.

19.3 Holding Position Markings for Taxiway/Taxiway Intersections. Holding position markings for taxiway/taxiway intersections consist of a single dashed line extending across the width of the taxiway as shown in FIG AD 1.1–29. They are installed on taxiways where air traffic control normally holds aircraft short of a taxiway intersection. When instructed by ATC “hold short of (taxiway)” the pilot should stop so no part of his/her aircraft extends beyond the holding position marking. When the marking is not present, the pilot should stop the aircraft at a point which provides adequate clearance from an aircraft on the intersecting taxiway.

19.4 Surface Painted Holding Position Signs. Surface painted holding position signs have a red background with a white inscription and supplement the signs located at the holding position. This type of marking is normally used where the width of the holding position on the taxiway is greater than 200 feet (60 m). It is located to the left side of the taxiway centerline on the holding side and prior to the holding position marking. (See FIG AD 1.1–23.)

20. Other Markings

20.1 Vehicle Roadway Markings. The vehicle roadway markings are used when necessary to define a pathway for vehicle operations on or crossing areas that are also intended for aircraft. These markings

consist of a white solid line to delineate each edge of the roadway and a dashed line to separate lanes within the edges of the roadway. In lieu of the solid lines, zipper markings may be used to delineate the edges of the vehicle roadway. (See FIG AD 1.1-30.) Details of the zipper markings are shown in FIG AD 1.1-31.

20.2 VOR Receiver Checkpoint Markings. The VOR receiver checkpoint marking allows the pilot to check aircraft instruments with navigational aid signals. It consists of a painted circle with an arrow in the middle; the arrow is aligned in the direction of the checkpoint azimuth. This marking, and an associated sign, is located on the airport apron or taxiway at a point selected for easy access by aircraft but where other airport traffic is not to be unduly obstructed. (See FIG AD 1.1-32.)

NOTE-

The associated sign contains the VOR station identification letter and course selected (published) for the check, the words "VOR check course," and DME data (when applicable). The color of the letters and numerals are black on a yellow background.

EXAMPLE-

VOR SIGN
DCA 176-356
VOR check course
DME XXX

20.3 Nonmovement Area Boundary Markings.

These markings delineate the movement area; i.e., area under air traffic control. These markings are yellow and located on the boundary between the movement and nonmovement area. The nonmovement area boundary markings consist of two yellow lines (one solid and one dashed) 6 inches (15cm) in width. The solid line is located on the nonmovement area side while the dashed yellow line is located on the movement area side. The nonmovement boundary marking area is shown in FIG AD 1.1-33.

20.4 Marking and Lighting of Permanently Closed Runways and Taxiways. For runways and taxiways which are permanently closed, the lighting circuits will be disconnected. The runway threshold, runway designation, and touchdown markings are obliterated and yellow crosses are placed at each end of the runway and at 1,000 foot intervals. (See FIG AD 1.1-34.)

20.5 Temporarily Closed Runways and Taxiways. To provide a visual indication to pilots that a runway

is temporarily closed, crosses are placed on the runway only at each end of the runway. The crosses are yellow in color. (See FIG AD 1.1-34.)

20.5.1 A raised lighted yellow cross may be placed on each runway end in lieu of the markings described in paragraph 20.4 to indicate the runway is closed.

20.5.2 A visual indication may not be present depending on the reason for the closure, duration of the closure, airfield configuration, and the existence and the hours of operation of an airport traffic control tower. Pilots should check NOTAMs and the Automated Terminal Information System (ATIS) for local runway and taxiway closure information.

20.5.3 Temporarily closed taxiways are usually treated as hazardous areas, in which no part of an aircraft may enter, and are blocked with barricades. However, as an alternative, a yellow cross may be installed at each entrance to the taxiway.

20.6 Helicopter Landing Areas. The markings illustrated in FIG AD 1.1-35 are used to identify the landing and takeoff area at a public use heliport and hospital heliport. The letter "H" in the markings is oriented to align with the intended direction of approach. FIG AD 1.1-35 also depicts the markings for a closed airport.

20.7 Airport Signs. There are six types of signs installed on airfields: mandatory instruction signs, location signs, direction signs, destination signs, information signs, and runway distance remaining signs. The characteristics and use of these signs are discussed below.

REFERENCE-

Advisory Circular-150/5340-18, Standards for Airport Sign Systems.

21. Mandatory Instruction Signs

21.1 These signs have a red background with a white inscription and are used to denote:

21.1.1 An entrance to a runway or critical area.

21.1.2 Land and Hold Short Operations (LAHSO) holding position signs on runways:

21.1.2.1 Hold short of Intersecting Runway.

21.1.2.2 Hold short of Intersecting Taxiway.

21.1.2.3 Hold short of a Point.

21.1.3 Areas where an aircraft is prohibited from entering.

21.2 Typical mandatory signs and applications are:

21.2.1 Runway Holding Position Sign. This sign is located at the holding position on taxiways that intersect a runway or on runways that intersect other runways. The inscription on the sign contains the designation of the intersecting runway as shown in FIG AD 1.1–36. The runway numbers on the sign are arranged to correspond to the respective runway threshold. For example, “15–33” indicates that the threshold for Runway 15 is to the left and the threshold for Runway 33 is to the right.

21.2.1.1 On taxiways that intersect the beginning of the takeoff runway, only the designation of the takeoff runway may appear on the sign as shown in FIG AD 1.1–37, while all other signs will have the designation of both runway directions.

21.2.1.2 If the sign is located on a taxiway that intersects the intersection of two runways, the designations for both runways will be shown on the sign along with arrows showing the approximate alignment of each runway as shown in FIG AD 1.1–38. In addition to showing the approximate runway alignment, the arrow indicates the direction to the threshold of the runway whose designation is immediately next to the arrow.

21.2.1.3 Land and Hold Short Operations (LAHSO) include landing and holding short of an intersecting runway, taxiway, or a designated point on the runway. LAHSO signs are mandatory signs when Air Traffic Control is operating under LAHSO. The holding position markings will be located on the runway pavement adjacent to the signs. Holding position markings are described in paragraph 19..

21.2.1.4 A runway holding position sign(s) will be installed on a runway that is normally used as a taxiway, adjacent to the holding position markings.

21.2.1.5 A runway holding position sign on a taxiway will be installed adjacent to holding position markings.

21.2.2 Runway Approach Area Holding Position Sign. At some airports, it is necessary to hold an aircraft on a taxiway located in the approach or departure area for a runway so that the aircraft does not interfere with operations on that runway. In these situations a sign with the designation of the approach end of the runway followed by a “dash” (–) and letters

“APCH” will be located at the holding position on the taxiway. Holding position markings in accordance with paragraph 20. will be located on the taxiway pavement. An example of this sign is shown in FIG AD 1.1–39. In this example, the sign may protect the approach to Runway 15 and/or the departure for Runway 33.

21.2.3 ILS Critical Area Holding Position Sign. At some airports, when the instrument landing system is being used, it is necessary to hold an aircraft on a taxiway at a location other than the holding position described in paragraph 19., Holding Position Markings. In these situations the holding position sign for these operations will have the inscription “ILS” and be located adjacent to the holding position marking on the taxiway described in paragraph 19.. An example of this sign is shown in FIG AD 1.1–40.

21.2.4 No Entry Sign. This sign, shown in FIG AD 1.1–41, prohibits an aircraft from entering an area. Typically, this sign would be located on a taxiway intended to be used in only one direction or at the intersection of vehicle roadways with runways, taxiways or aprons where the roadway may be mistaken as a taxiway or other aircraft movement surface.

NOTE–

The holding position sign provides the pilot with a visual cue as to the location of the holding position marking. The operational significance of holding position markings are described in paragraph 19..

22. Location Signs

Location signs are used to identify either a taxiway or runway on which the aircraft is located. Other location signs provide a visual cue to pilots to assist them in determining when they have exited an area. The various location signs are described below.

22.1 Taxiway Location Sign. This sign has a black background with a yellow inscription and yellow border as shown in FIG AD 1.1–42. The inscription is the designation of the taxiway on which the aircraft is located. These signs are installed along taxiways either by themselves or in conjunction with direction signs or runway holding position signs. (See FIG AD 1.1–43 and FIG AD 1.1–47.)

22.2 Runway Location Sign. This sign has a black background with a yellow inscription and yellow border as shown in FIG AD 1.1–44. The inscription is the designation of the runway on which the aircraft

is located. These signs are intended to complement the information available to pilots through their magnetic compass and typically are installed where the proximity of two or more runways to one another could cause pilots to be confused as to which runway they are on.

22.3 Runway Boundary Sign. This sign has a yellow background with a black inscription with a graphic depicting the pavement holding position marking as shown in FIG AD 1.1–45. This sign, which faces the runway and is visible to the pilot exiting the runway, is located adjacent to the holding position marking on the pavement. The sign is intended to provide pilots with another visual cue which they can use as a guide in deciding when they are “clear of the runway.”

22.4 ILS Critical Area Boundary Sign. This sign has a yellow background with a black inscription with a graphic depicting the ILS pavement holding position marking as shown in FIG AD 1.1–46. This sign is located adjacent to the ILS holding position marking on the pavement and can be seen by pilots leaving the critical area. The sign is intended to provide pilots with another visual cue which they can use as a guide in deciding when they are “clear of the ILS critical area.”

23. Direction Signs

23.1 Direction signs have a yellow background with a black inscription. The inscription identifies the designation(s) of the intersecting taxiway(s) leading out of intersection that a pilot would normally be expected to turn onto or hold short of. Each designation is accompanied by an arrow indicating the direction of the turn.

23.2 Except as noted in subparagraph 23.5, each taxiway designation shown on the sign is accompanied by only one arrow. When more than one taxiway designation is shown on the sign, each designation and its associated arrow is separated from the other taxiway designations by either a vertical message divider or a taxiway location sign as shown in FIG AD 1.1–47.

23.3 Direction signs are normally located on the left prior to the intersection. When used on a runway to indicate an exit, the sign is located on the same side of the runway as the exit. FIG AD 1.1–48 shows a direction sign used to indicate a runway exit.

23.4 The taxiway designations and their associated arrows on the sign are arranged clockwise starting from the first taxiway on the pilot’s left. (See FIG AD 1.1–47.)

23.5 If a location sign is located with the direction signs, it is placed so that the designations for all turns to the left will be to the left of the location sign; the designations for continuing straight ahead or for all turns to the right would be located to the right of the location sign. (See FIG AD 1.1–47.)

23.6 When the intersection is comprised of only one crossing taxiway, it is permissible to have two arrows associated with the crossing taxiway as shown in FIG AD 1.1–49. In this case, the location sign is located to the left of the direction sign.

24. Destination Signs

24.1 Destination signs also have a yellow background with a black inscription indicating a destination on the airport. These signs always have an arrow showing the direction of the taxiing route to that destination. FIG AD 1.1–50 is an example of a typical destination sign. When the arrow on the destination sign indicates a turn, the sign is located prior to the intersection.

24.2 Destinations commonly shown on these types of signs include runways, aprons, terminals, military areas, civil aviation areas, cargo areas, international areas, and fixed base operators. An abbreviation may be used as the inscription on the sign for some of these destinations.

24.3 When the inscription for two or more destinations having a common taxiing route are placed on a sign, the destinations are separated by a “dot” (●) and one arrow would be used as shown in FIG AD 1.1–51. When the inscription on a sign contains two or more destinations having different taxiing routes, each destination will be accompanied by an arrow and will be separated from the other destinations on the sign with a vertical black message divider as shown in FIG AD 1.1–52.

25. Information Signs

25.1 Information signs have a yellow background with a black inscription. They are used to provide the pilot with information on such things as areas that cannot be seen from the control tower, applicable radio frequencies, and noise abatement procedures.

The airport operator determines the need, size, and location for these signs.

26. Runway Distance Remaining Signs

26.1 Runway distance remaining signs have a black background with a white numeral inscription and may be installed along one or both side(s) of the runway. The number on the signs indicates the distance (in thousands of feet) of landing runway remaining. The last sign; i.e., the sign with the numeral “1,” will be located at least 950 feet from the runway end. FIG AD 1.1–53 shows an example of a runway distance remaining sign.

27. Aircraft Arresting Systems

27.1 Certain airports are equipped with a means of rapidly stopping military aircraft on a runway. This equipment, normally referred to as EMERGENCY ARRESTING GEAR, generally consists of pendant cables supported over the runway surface by rubber “donuts.” Although most devices are located in the overrun areas, a few of these arresting systems have cables stretched over the operational areas near the ends of a runway.

27.2 Arresting cables which cross over a runway require special markings on the runway to identify the cable location. These markings consist of 10 feet diameter solid circles painted “identification yellow,” 30 feet on center, perpendicular to the runway centerline across the entire runway width. Additional details are contained in AC 150/5220–9, Aircraft Arresting Systems for Joint Civil/Military Airports.

NOTE–

Aircraft operations on the runway are not restricted by the installation of aircraft arresting devices.

27.3 Engineered materials arresting systems (EMAS). EMAS, which are constructed of high energy-absorbing materials of selected strength, are located in the safety area beyond the end of the

runway. They are designed to crush under the weight of commercial aircraft and they exert deceleration forces on the landing gear. These systems do not affect the normal landing and takeoff of airplanes. More information concerning EMAS is in FAA Advisory Circular AC 150/5220–22, Engineered Materials Arresting Systems (EMAS) for Aircraft Overruns.

NOTE–

EMAS may be located as close as 35 feet beyond the end of the runway. Aircraft should never taxi or drive across the runway.

28. Security Identifications Display Area (Aerodrome Ramp Area)

28.1 Security Identification Display Areas (SIDA) are limited access areas that require a badge issued in accordance with procedures in CFR 49 Part 1542. Movement through or into these areas is prohibited without proper identification being displayed. If you are unsure of the location of a SIDA, contact the airport authority for additional information. Airports that have a SIDA must have the following information available:

28.1.1 A description and map detailing boundaries and pertinent features;

28.1.2 Measures used to perform the access control functions required under CFR 49 Part 1542.201(b)(1);

28.1.3 Procedures to control movement within the secured area, including identification media required under CFR 49 Part 1542.201(b)(3); and

28.1.4 A description of the notification signs required under CFR 49 Part 1542.201(b)(6).

28.2 Pilots or passengers without proper identification that are observed entering a SIDA (ramp area) may be reported to TSA or airport security. Pilots are advised to brief passengers accordingly.

FIG AD 1.1-13
Precision Instrument Runway Markings

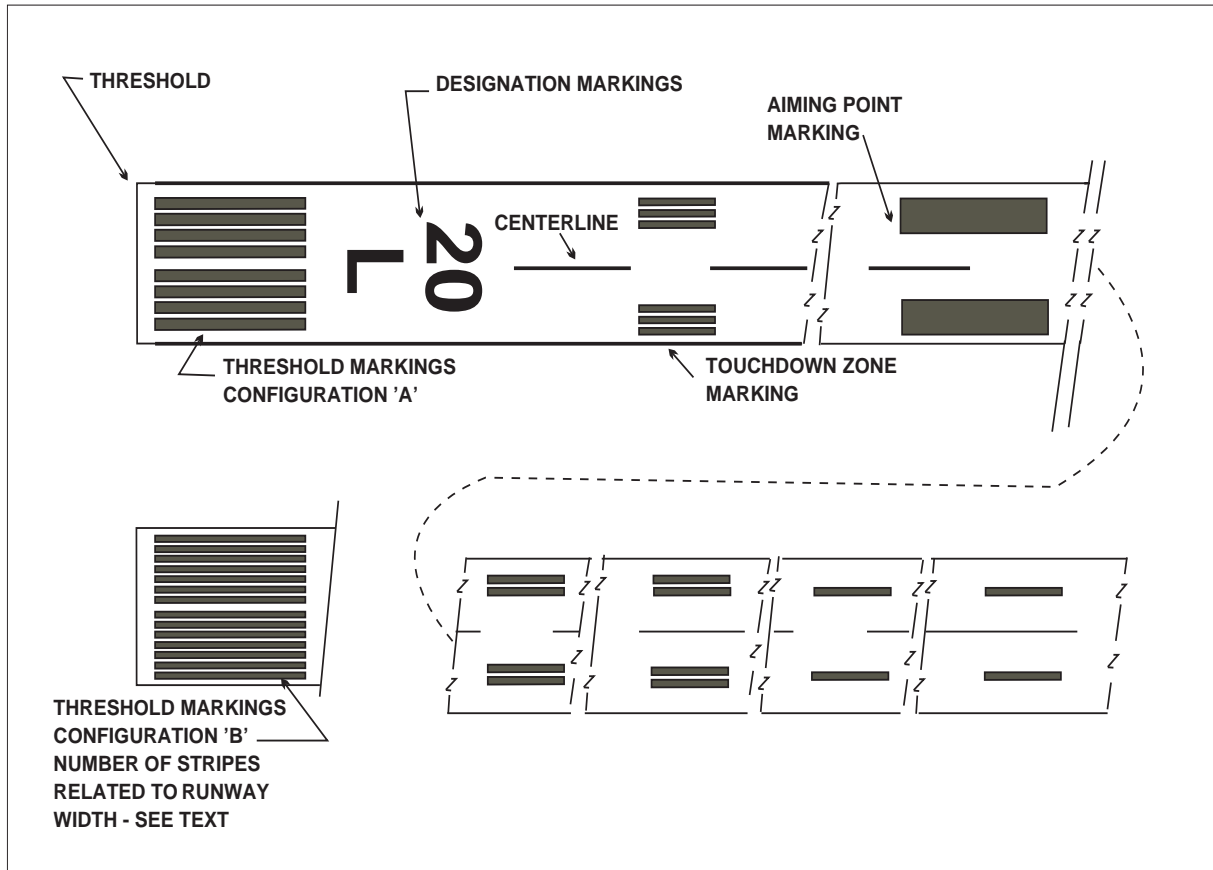

FIG AD 1.1-14
Nonprecision Instrument Runway and Visual Runway Markings

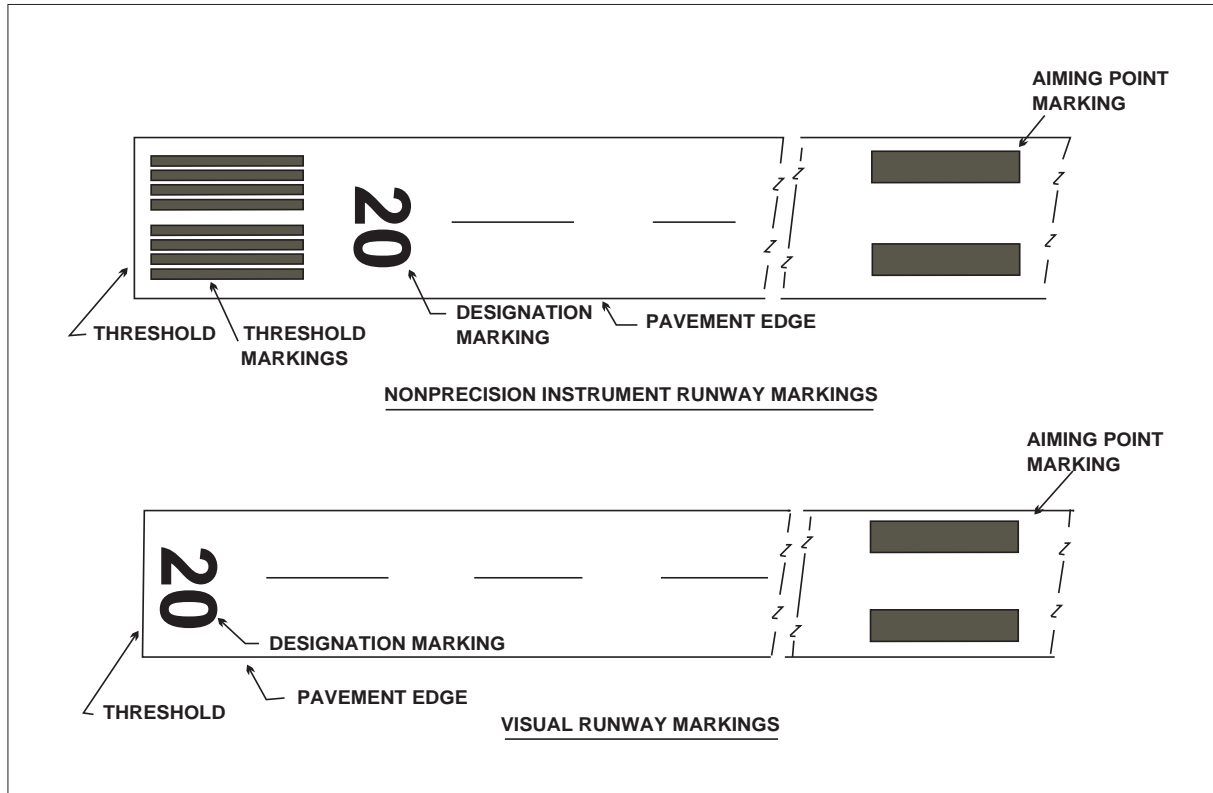

FIG AD 1.1-15
Runway Shoulder Markings

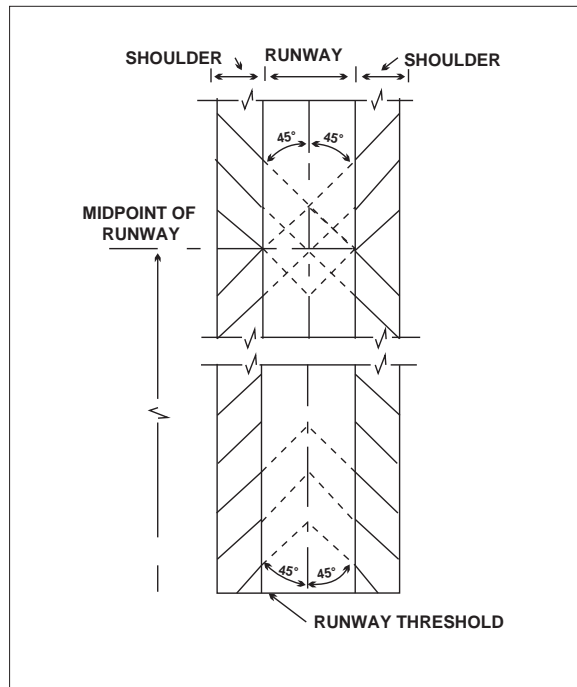

FIG AD 1.1-16
Relocation of a Threshold with Markings for Taxiway Aligned with Runway

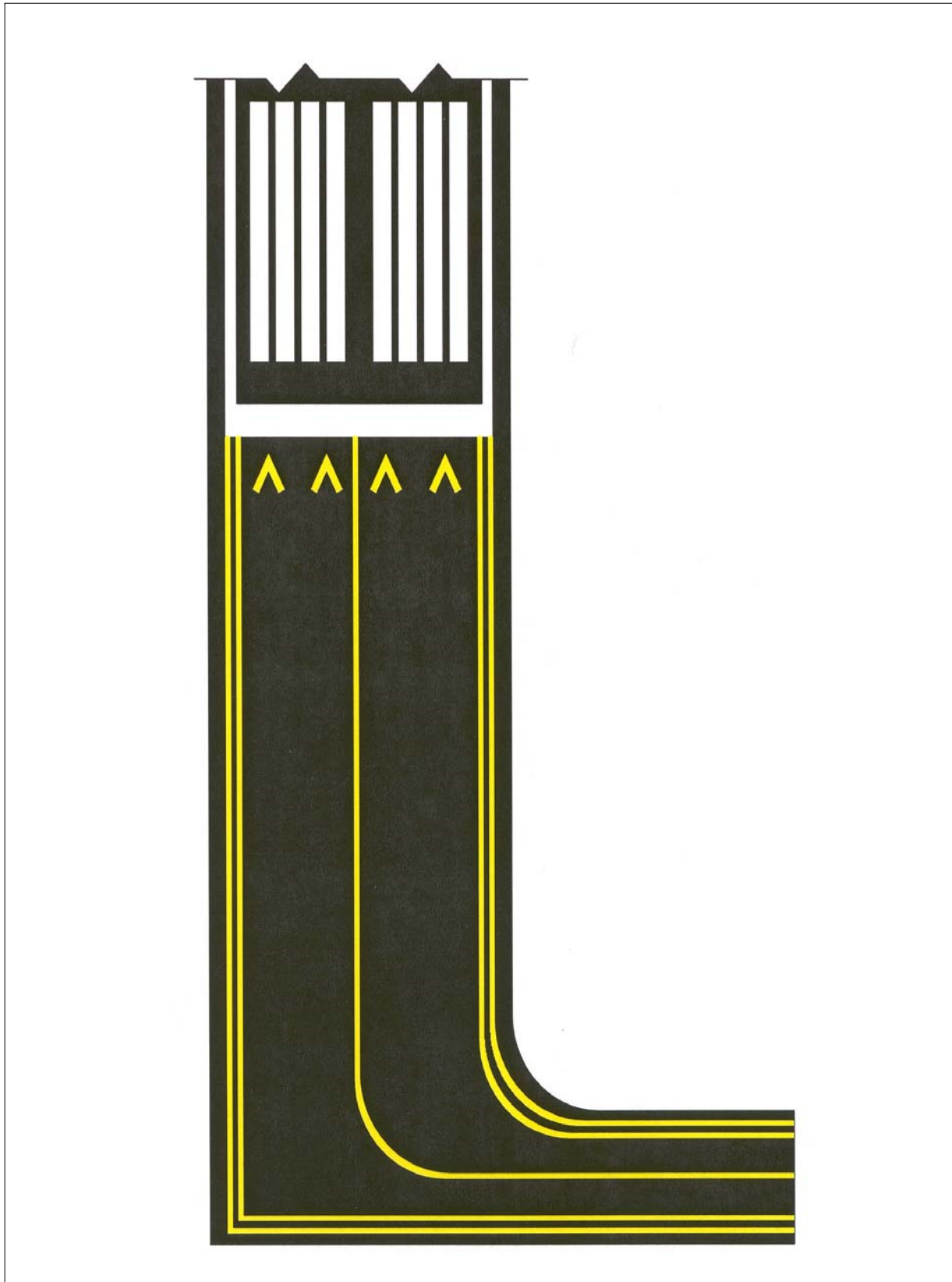

FIG AD 1.1-17
Displaced Threshold Markings

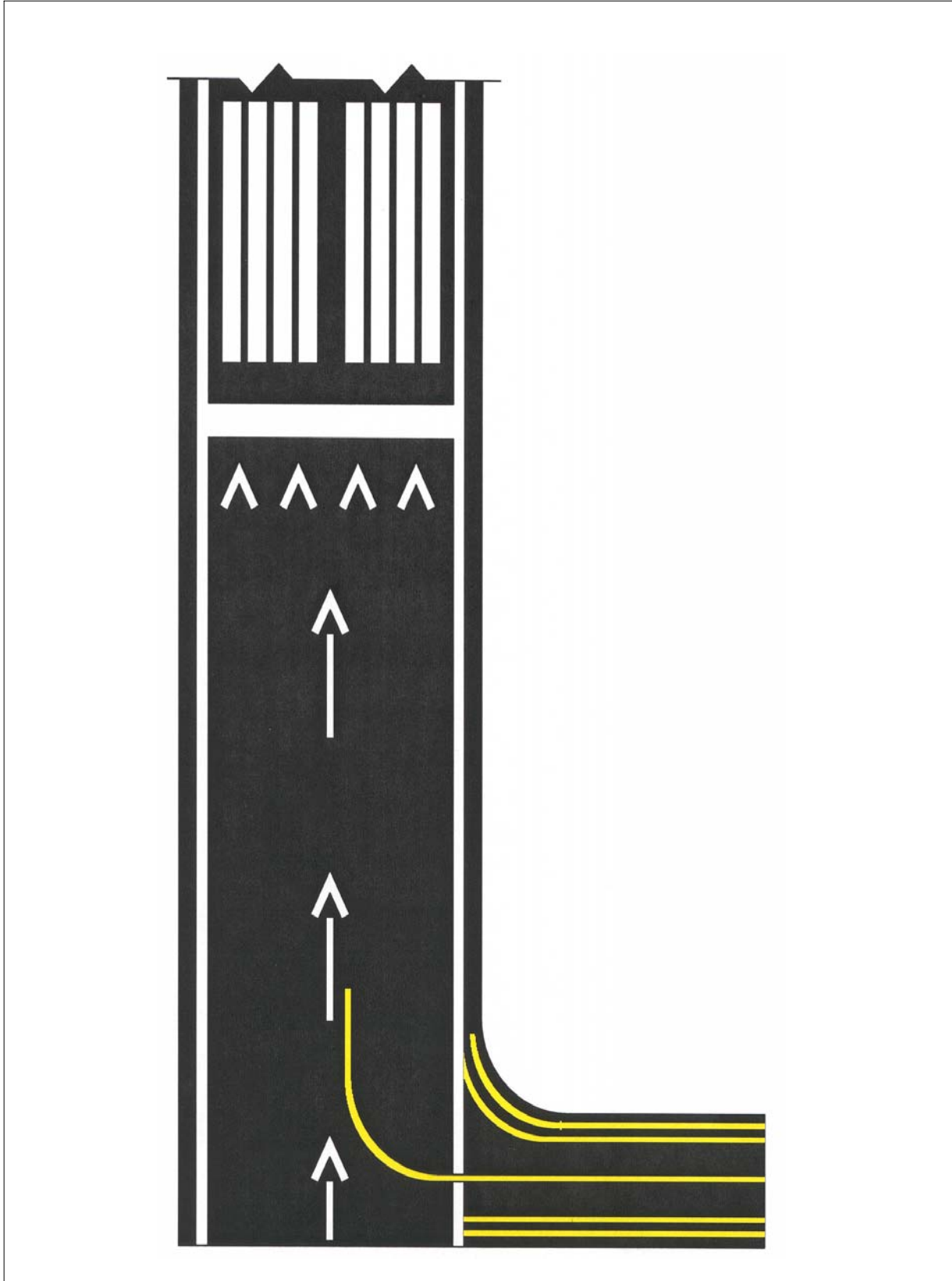

FIG AD 1.1-18
Markings for Blast Pad or Stopway or Taxiway Preceding a Displaced Threshold

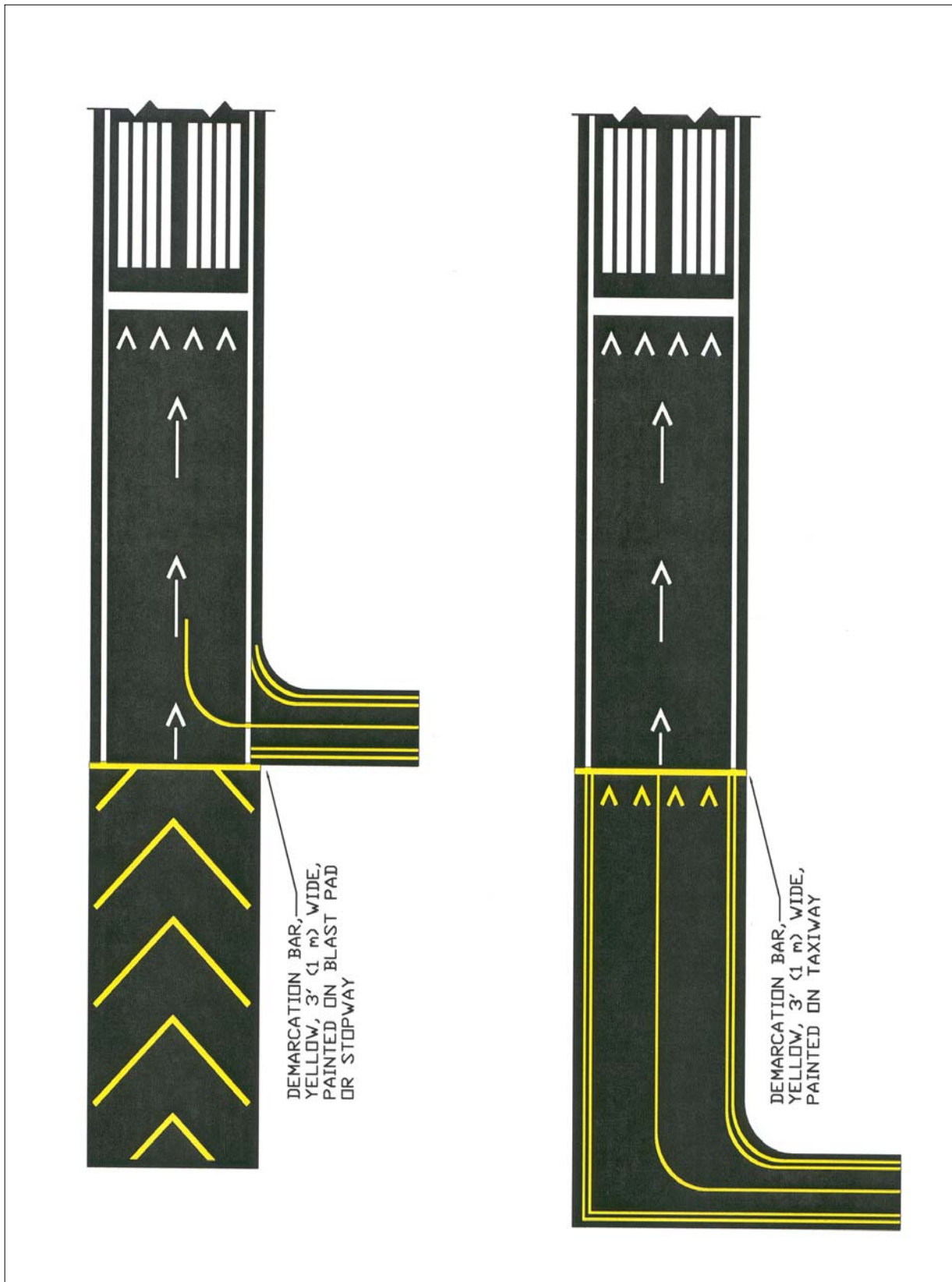

FIG AD 1.1-19
Markings for Blast Pads and Stopways

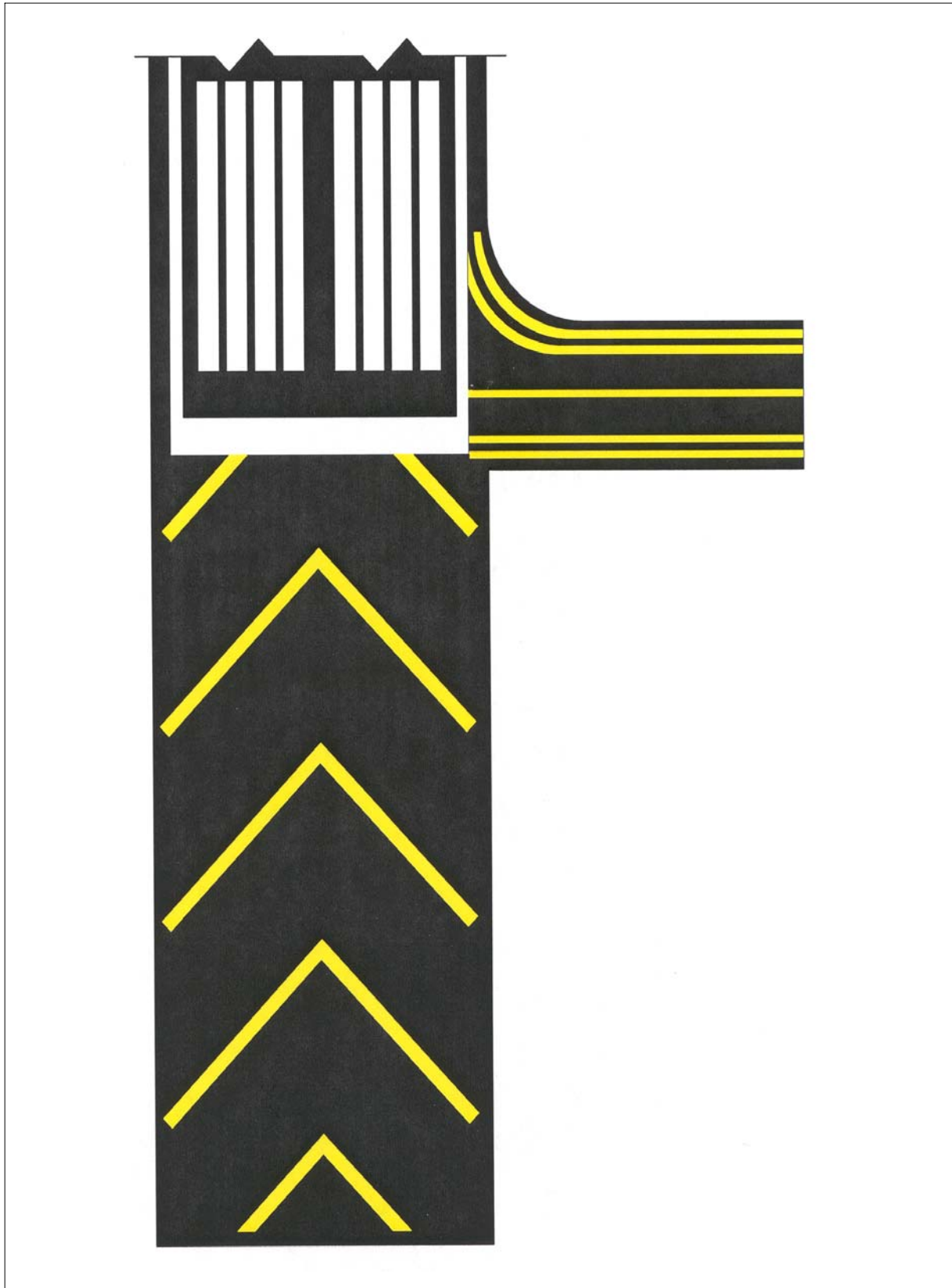

FIG AD 1.1-20
Enhanced Taxiway Centerline

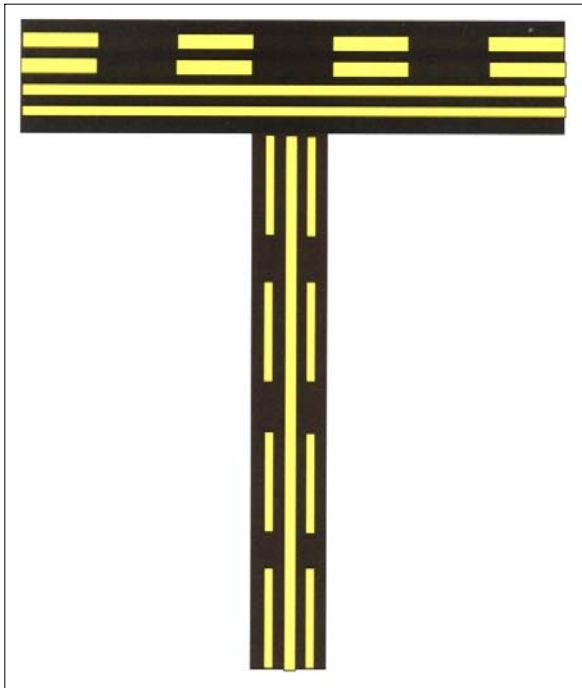

FIG AD 1.1-22
Taxi Shoulder Markings

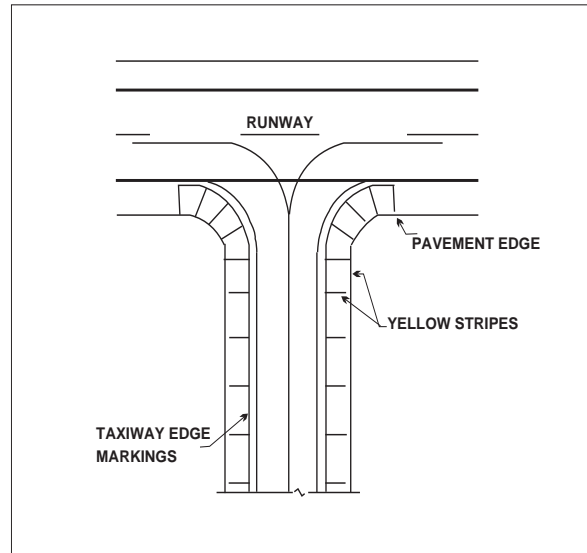

FIG AD 1.1-21
Dashed Markings

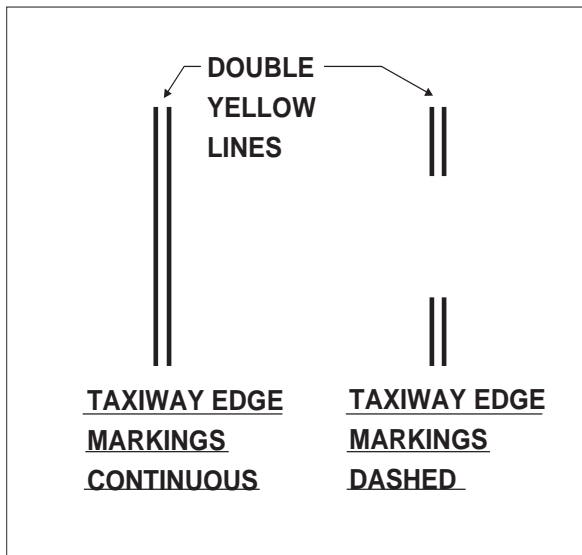

FIG AD 1.1-23
Surface Painted Signs

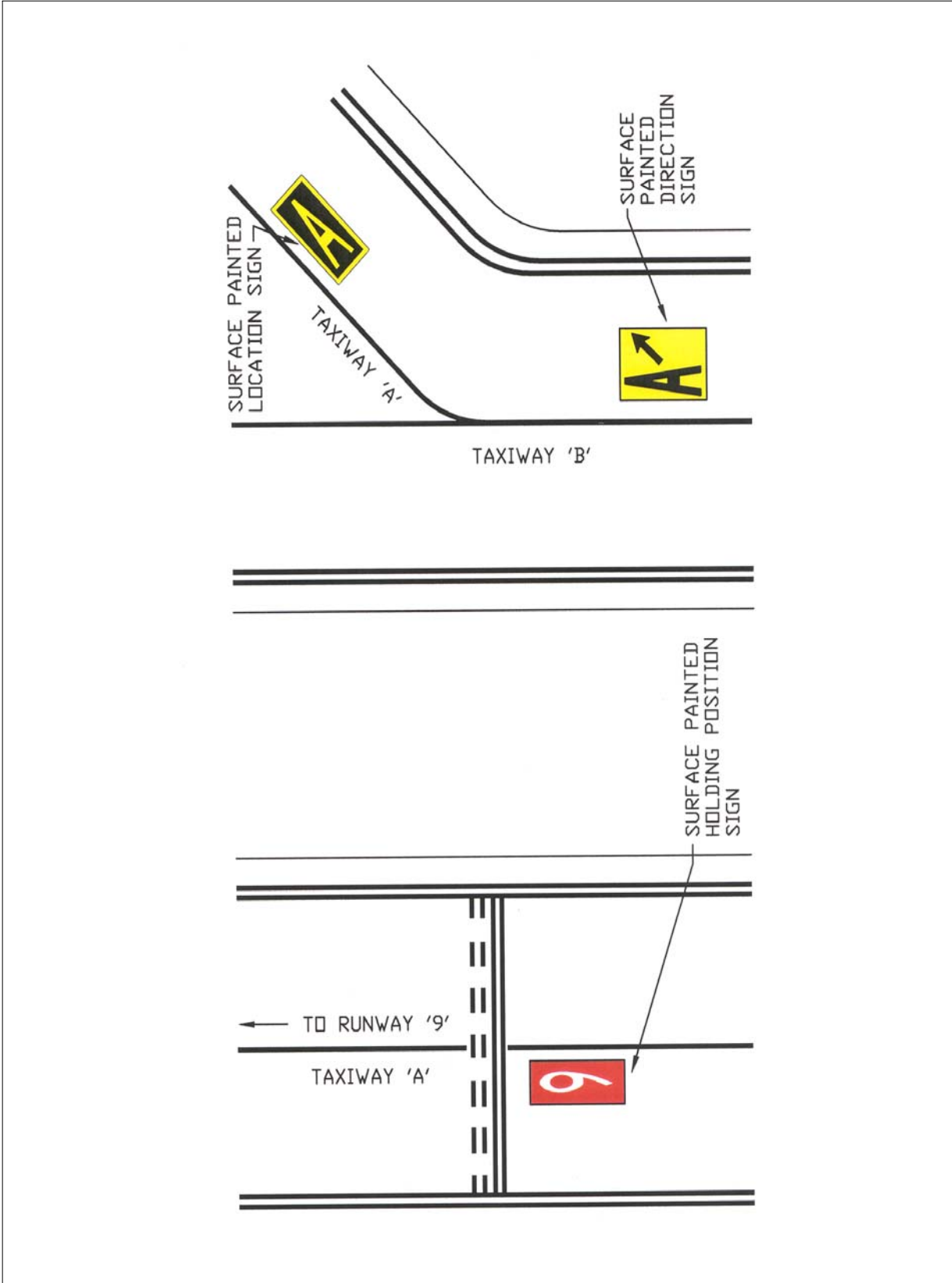

FIG AD 1.1-24
Geographic Position Markings

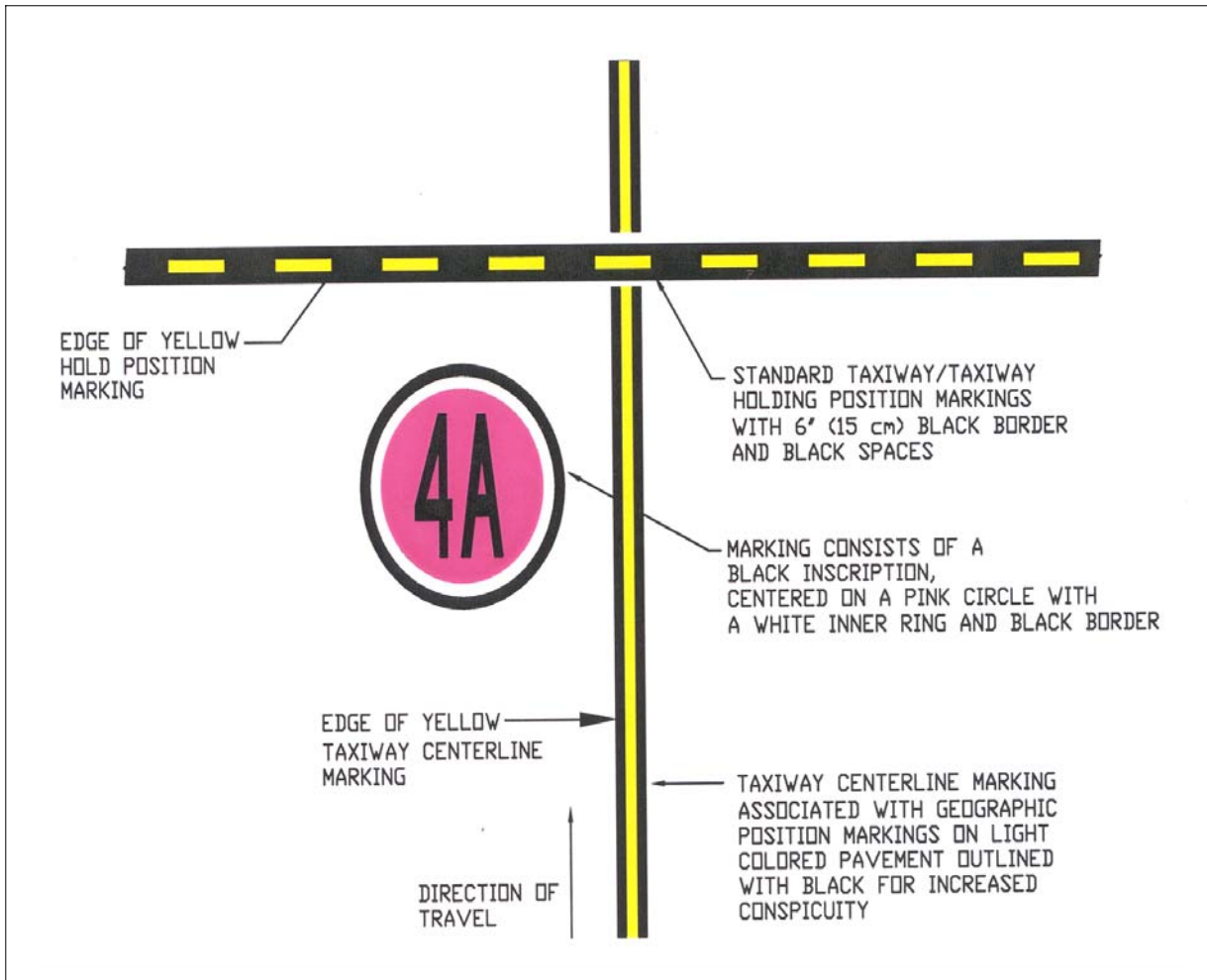

FIG AD 1.1-25
Runway Holding Position Markings on Taxiway

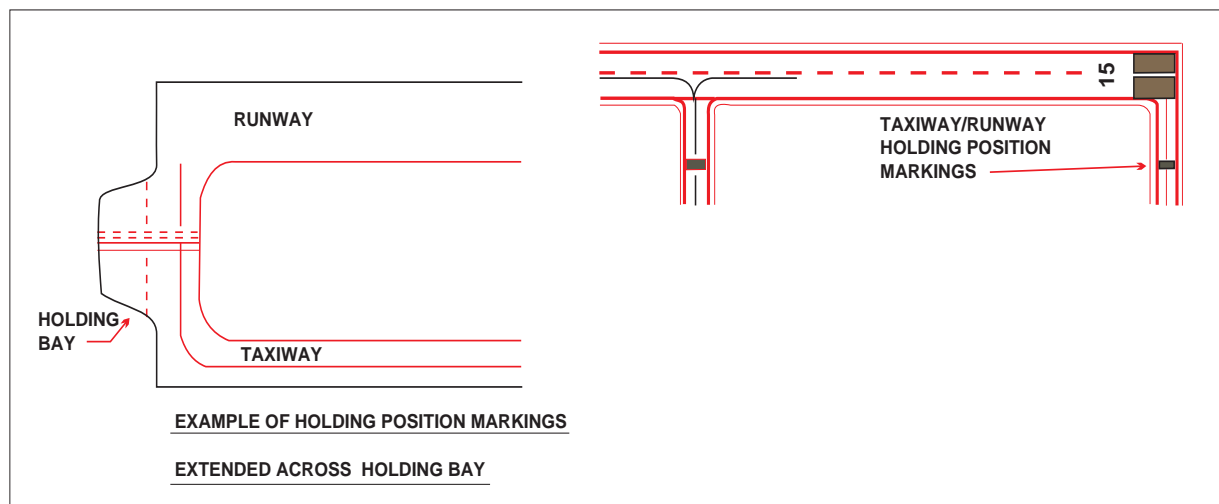

FIG AD 1.1-26
Runway Holding Position Markings on Runways

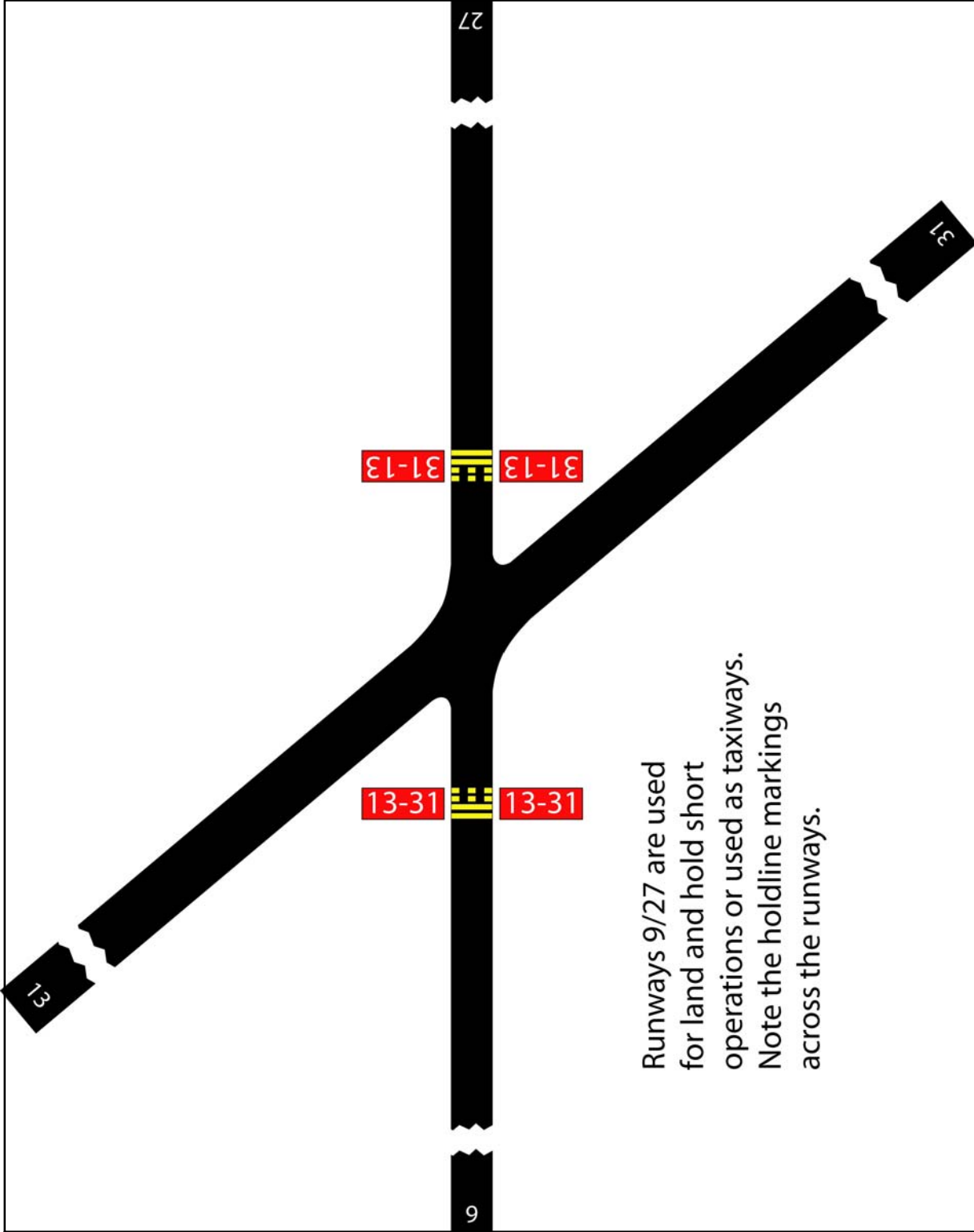

FIG AD 1.1-27
Taxiways Located in Runway Approach Area

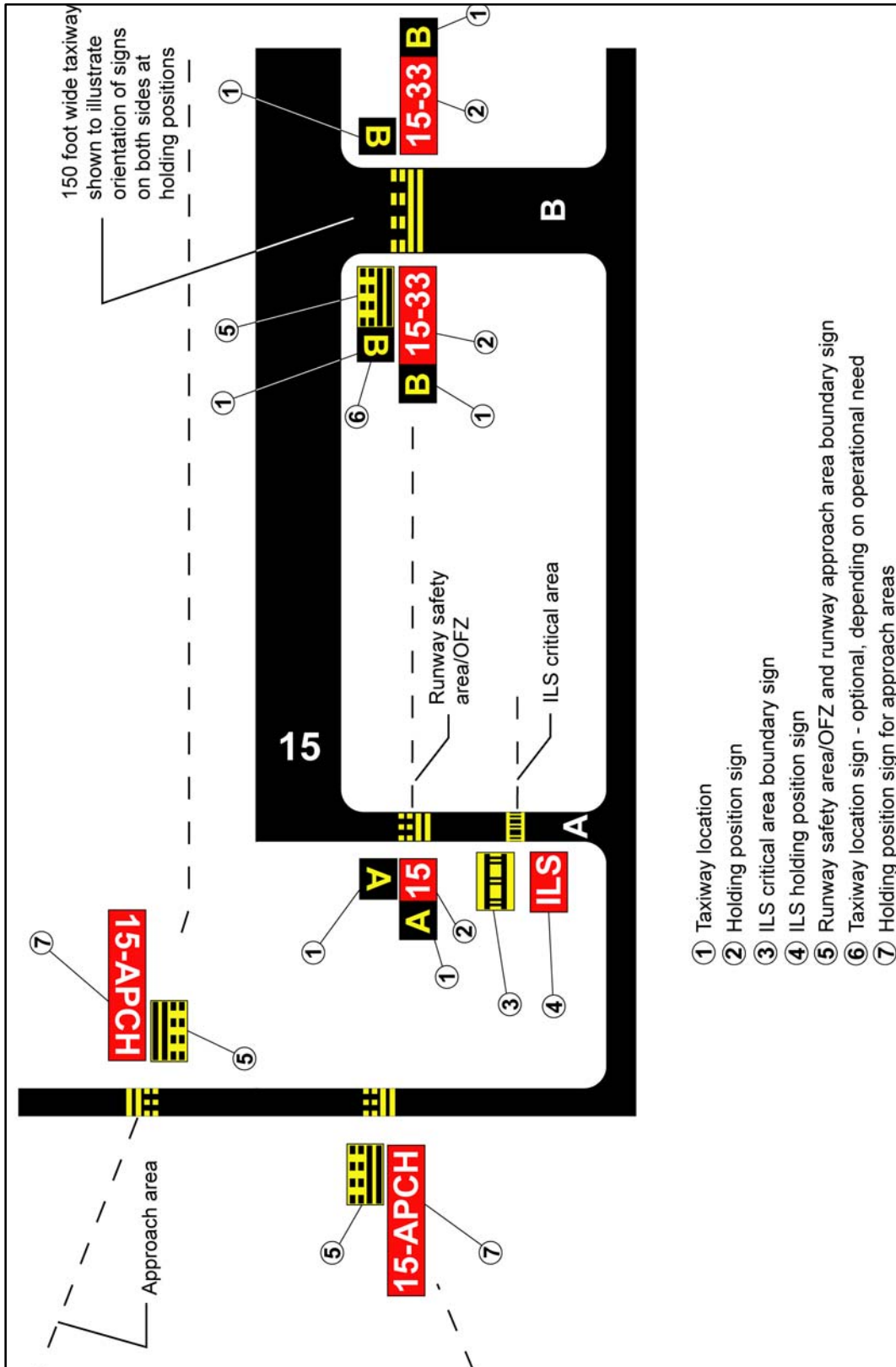

FIG AD 1.1-28
Holding Position Markings: ILS Critical Area

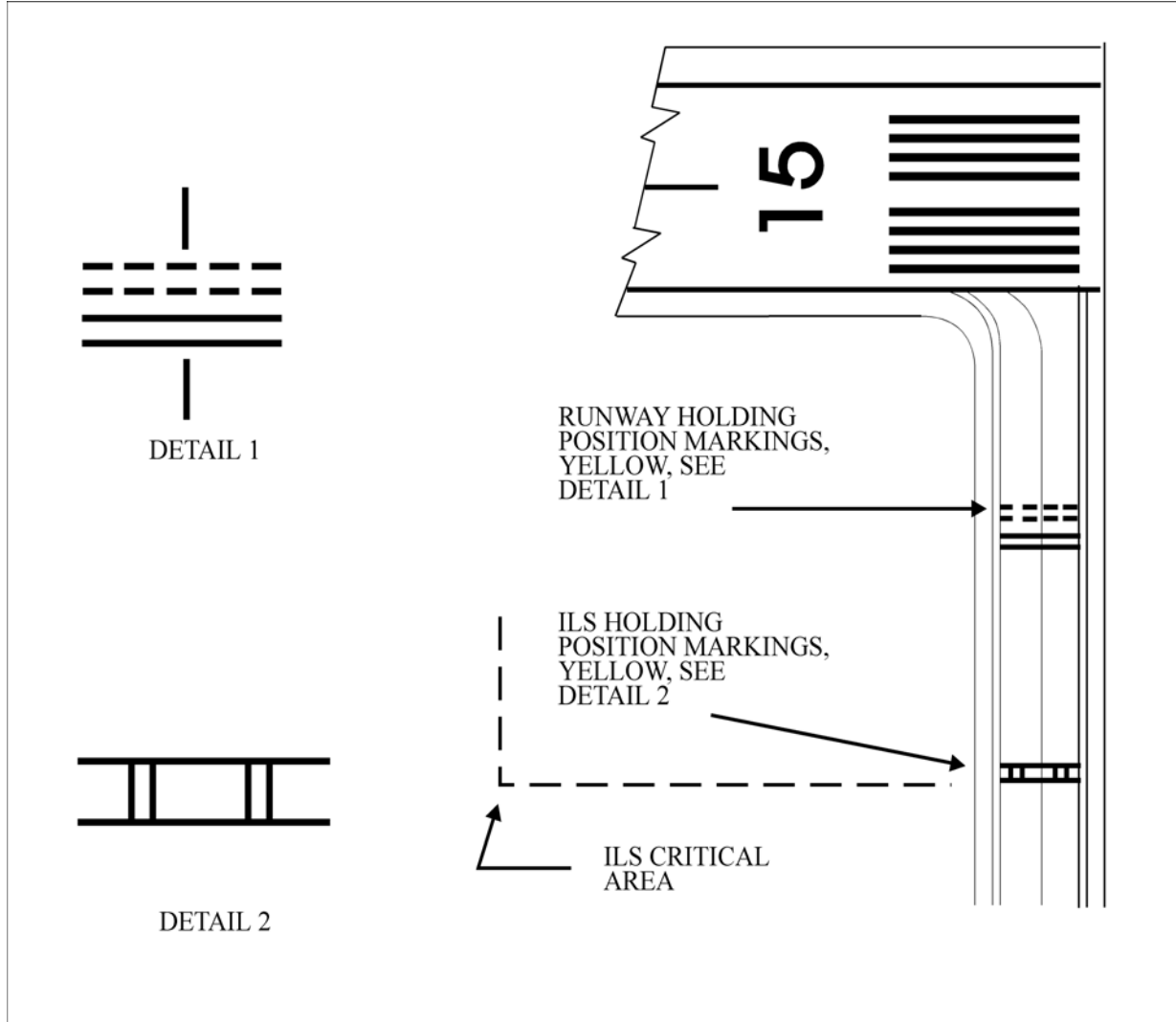

FIG AD 1.1-29
Holding Position Markings: Taxiway/Taxiway Intersections

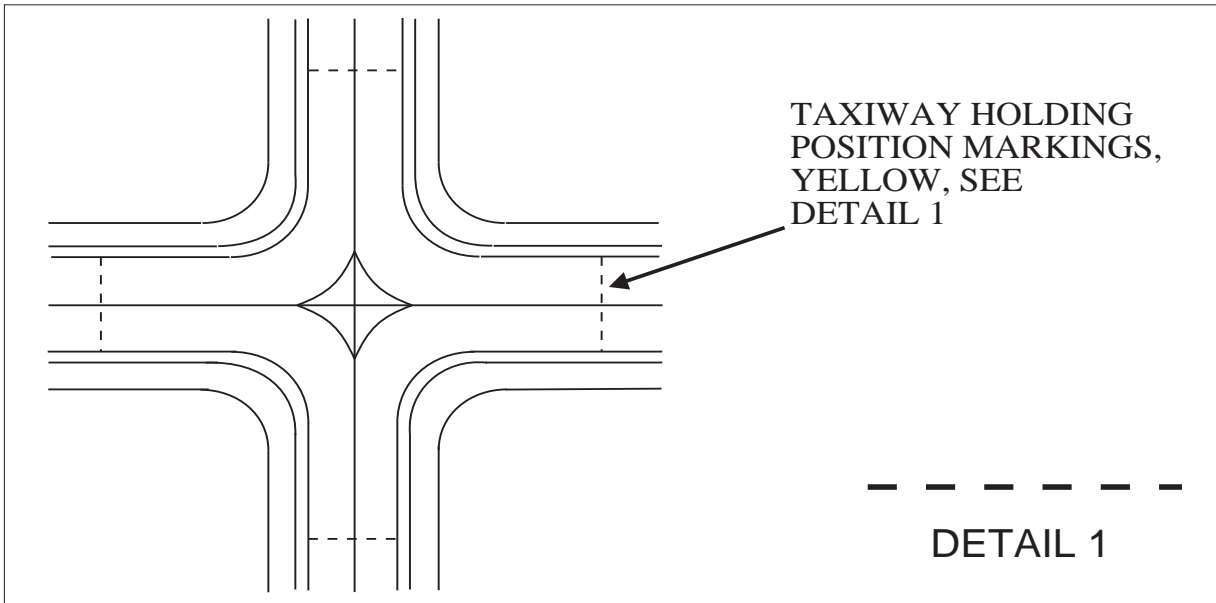

FIG AD 1.1-30
Vehicle Roadway Markings

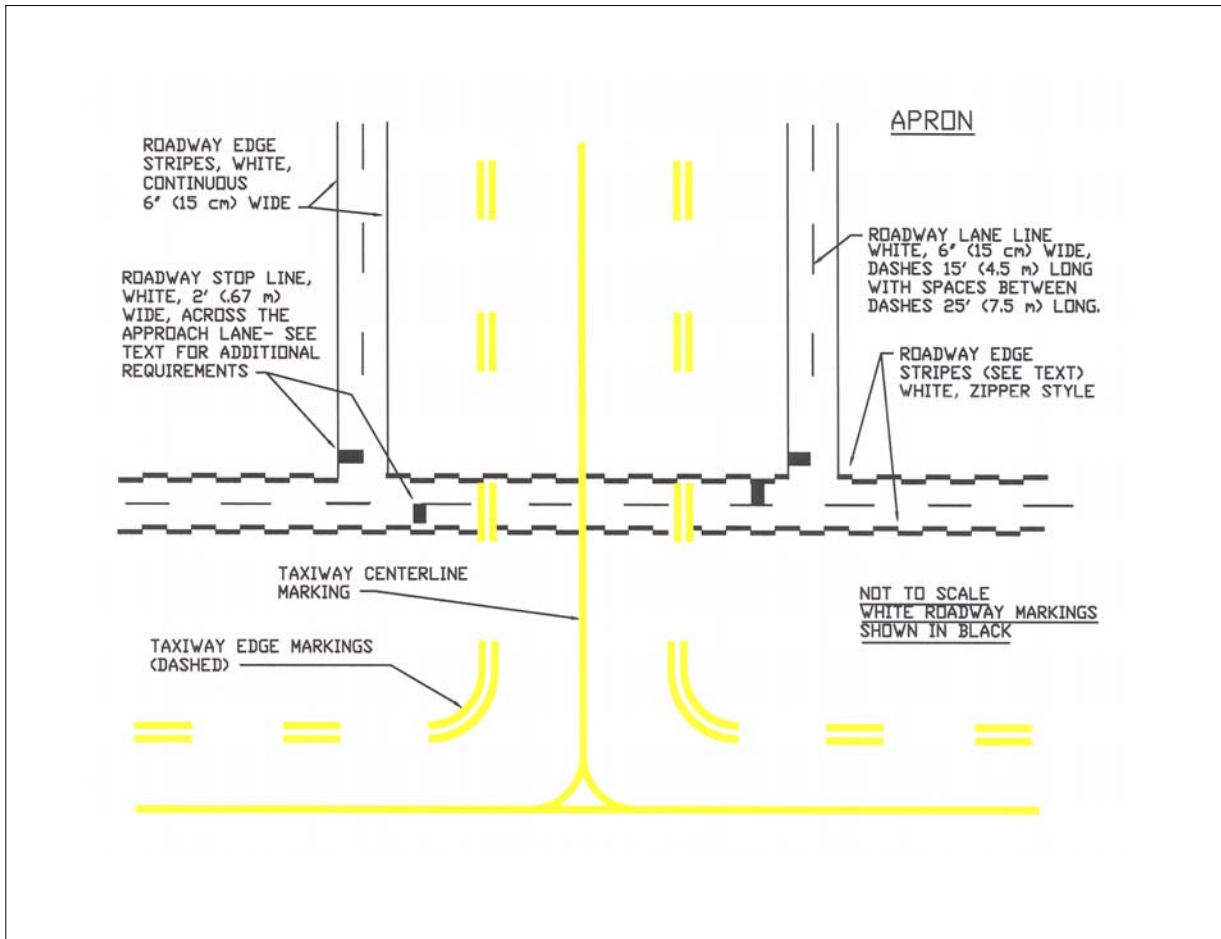

FIG AD 1.1-31
Roadway Edge Stripes, White, Zipper Style

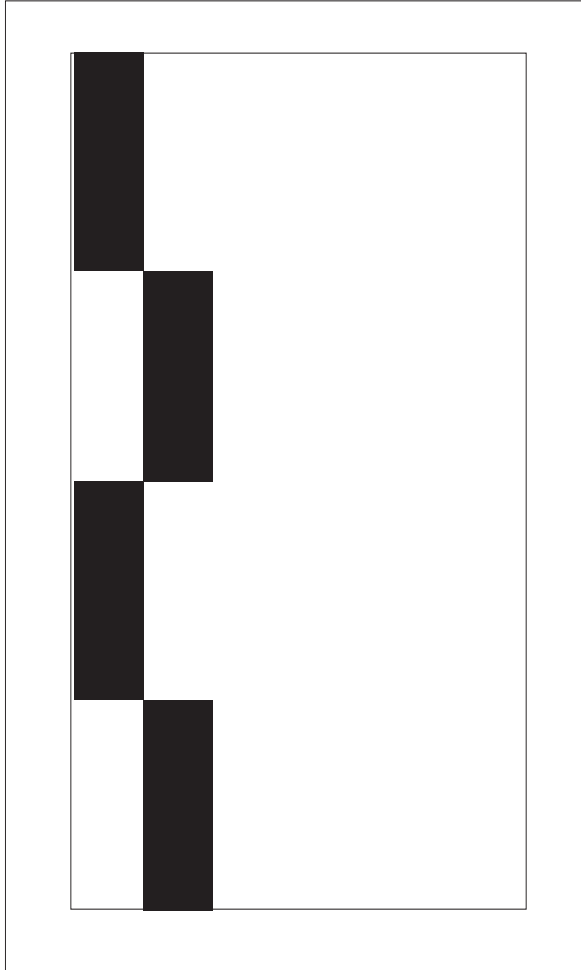

FIG AD 1.1-32
Ground Receiver Checkpoint Markings

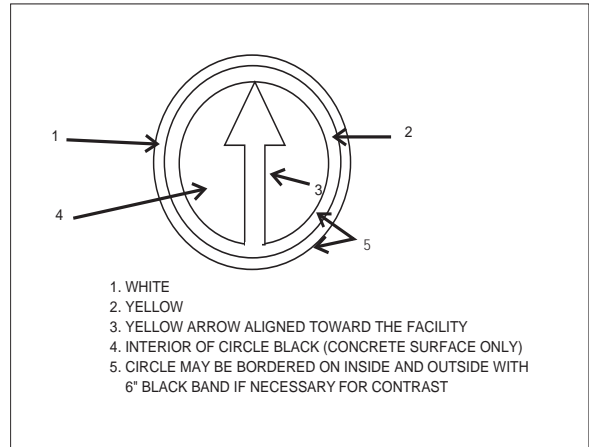

FIG AD 1.1-33
Nonmovement Area Boundary Markings

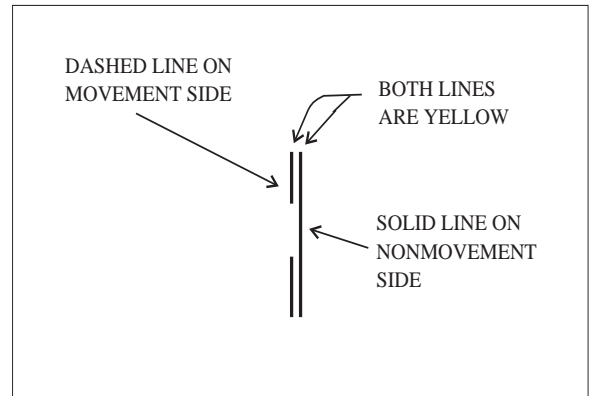

FIG AD 1.1-34
Closed or Temporarily Closed Runway and Taxiway Markings

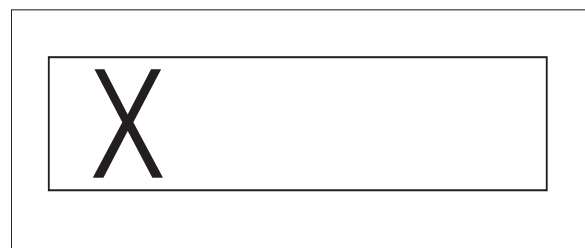

FIG AD 1.1-35
Helicopter Landing Areas

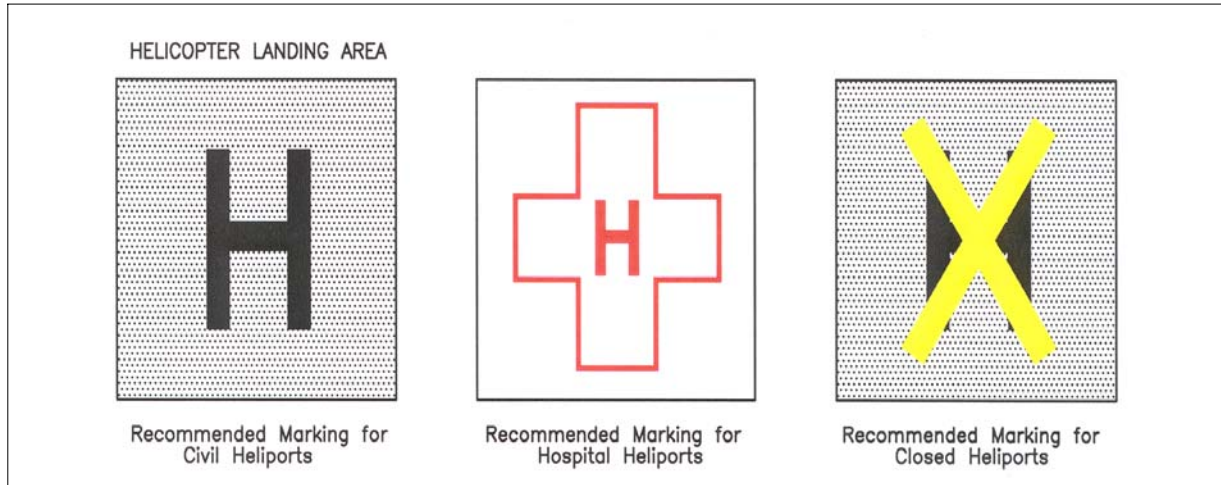

FIG AD 1.1-36
Runway Holding Position Sign



FIG AD 1.1-37
Holding Position Sign at Beginning of Takeoff Runway



FIG AD 1.1-38
Holding Position Sign for a Taxiway that Intersects the Intersection of Two Runways

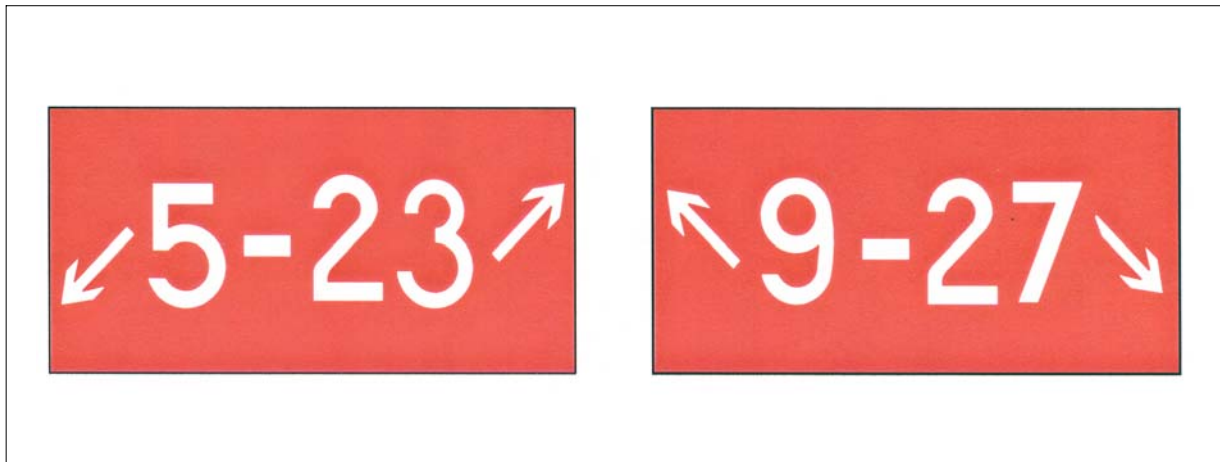

FIG AD 1.1-39
Holding Position Sign for a Runway Approach Area



FIG AD 1.1-40
Holding Position Sign for ILS Critical Area



FIG AD 1.1-41
Sign Prohibiting Aircraft Entry into an Area

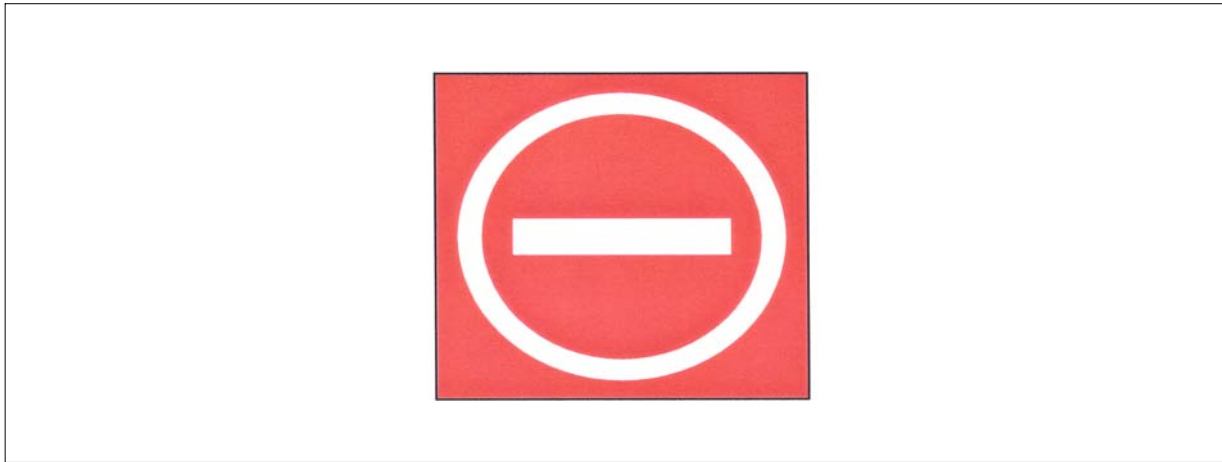

FIG AD 1.1-42
Taxiway Location Sign



FIG AD 1.1-43
Taxiway Location Sign Collocated with Runway Holding Position Sign

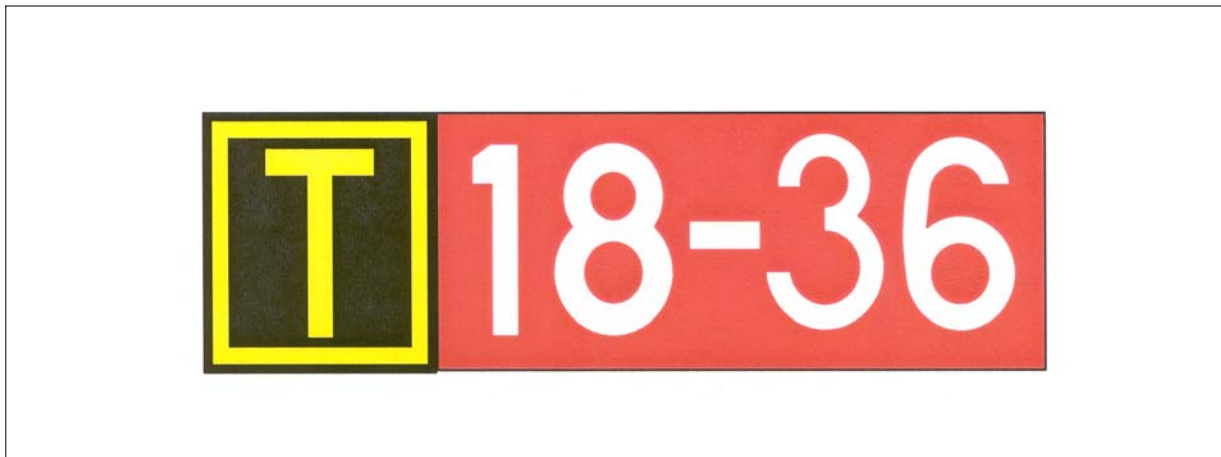

FIG AD 1.1-44
Runway Location Sign



FIG AD 1.1-45
Runway Boundary Sign



FIG AD 1.1-46
ILS Critical Area Boundary Sign

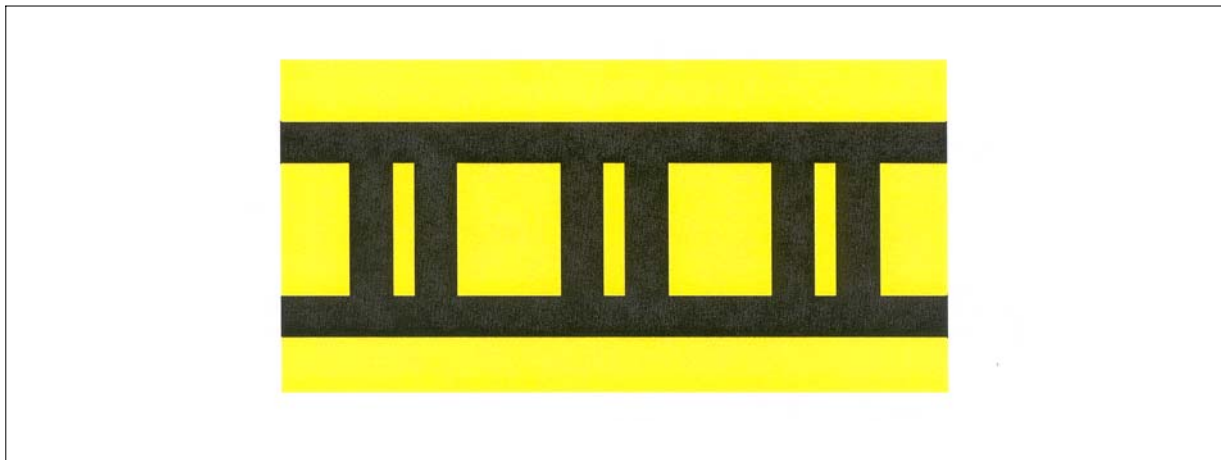

FIG AD 1.1-47
Direction Sign Array with Location Sign on Far Side of Intersection

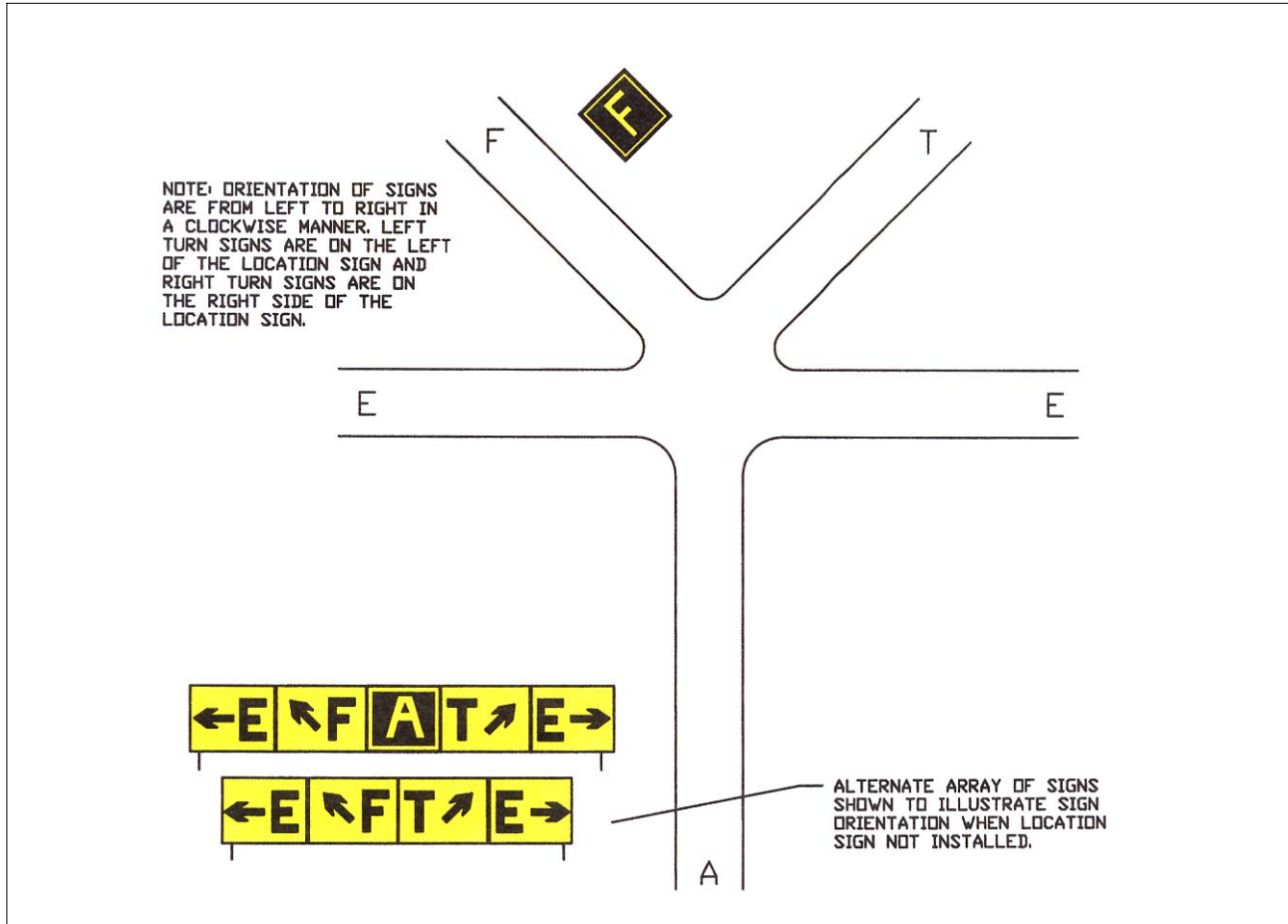

FIG AD 1.1-48
Direction Sign for Runway Exit



FIG AD 1.1-49
Direction Sign Array for Simple Intersection

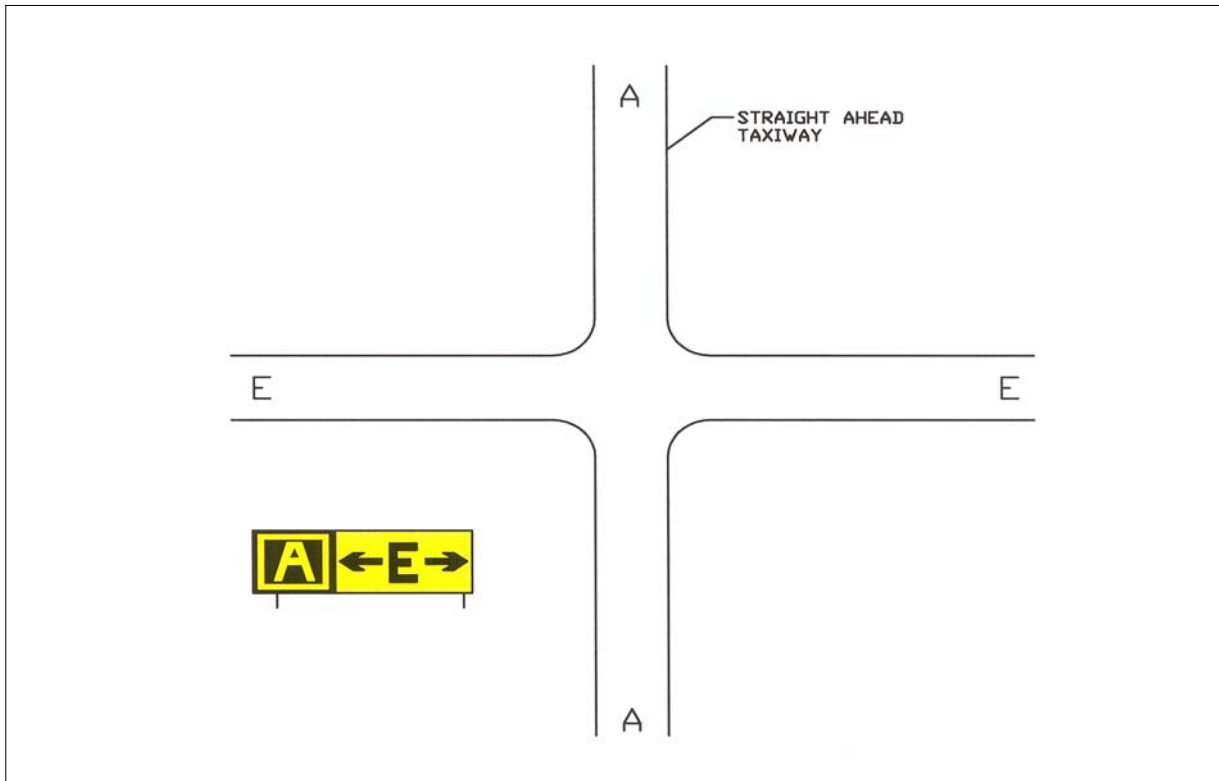

FIG AD 1.1-50
Destination Sign for Military Area



FIG AD 1.1-51
Destination Sign for Common Taxiing Route to Two Runways



FIG AD 1.1-52
Destination Sign for Different Taxiing Routes to Two Runways

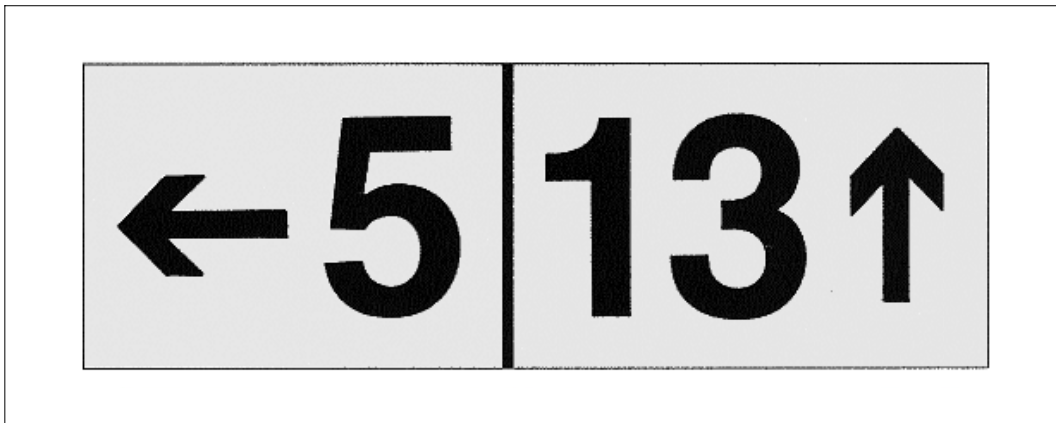

FIG AD 1.1-53
**Runway Distance Remaining Sign Indicating
3,000 feet of Runway Remaining**



FIG AD 1.1-54
Engineered Materials Arresting System (EMAS)



AD 2. AERODROMES

1. The following is a partial list of U.S. airports designated to serve international operations. This list contains U.S. airports with scheduled passenger service in large aircraft and certain airports designated as alternate service airports. Omitted from this list are designated general aviation airports, airports with scheduled cargo but no scheduled passenger service, and certain airports having international service in commuter-type aircraft.

ICAO ID	Location	Airport Name	Designation
Alaska			
PANC	Anchorage	Ted Stevens Anchorage International	Regular
PAED	Anchorage	Elmendorf AFB	Alternate
PACD	Cold Bay	Cold Bay	Alternate
PAEI	Fairbanks	Eielson AFB	Alternate
PAFA	Fairbanks	Fairbanks International	Regular
PAJN	Juneau	Juneau International	Regular
PAKN	King Salmon	King Salmon	Alternate
American Samoa			
NSTU	Pago Pago	Pago Pago International	Regular
Arizona			
KPHX	Phoenix	Phoenix Sky Harbor International	Regular
KTUS	Tucson	Tucson International	Regular
California			
KFAT	Fresno	Fresno Yosemite International	Alternate
KLAX	Los Angeles	Los Angeles International	Regular
KOAK	Oakland	Metropolitan Oakland International	Regular
KONT	Ontario	Ontario International	Alternate
KPMD	Palmdale	Palmdale Production Flight/Test Installation AF Plant #42	Alternate

ICAO ID	Location	Airport Name	Designation
KSMF	Sacramento	Sacramento International	Alternate
KSAN	San Diego	San Diego International	Regular
KSFO	San Francisco	San Francisco International	Regular
KSJC	San Jose	San Jose Norman Y. Mineta International	Regular
KSCK	Stockton	Stockton Metropolitan	Alternate
Colorado			
KDEN	Denver	Denver International	Regular
KPUB	Pueblo	Pueblo Memorial	Alternate
Connecticut			
KBDL	Windsor Locks	Bradley International	Regular
District of Columbia			
KIAD	Washington	Washington Dulles International	Regular
Florida			
KFLL	Fort Lauderdale	Fort Lauderdale/Hollywood International	Regular
KRSW	Fort Myers	Southwest Florida International	Regular
KMIA	Miami	Miami International	Regular
KMCO	Orlando	Orlando International	Regular
KTPA	Tampa	Tampa International	Regular
KPBI	West Palm Beach	Palm Beach International	Regular
Georgia			
KATL	Atlanta	Hartsfield – Jackson Atlanta International	Regular
Guam			
PGUM	Agana	Guam International	Regular
PGUA	Guam Island	Andersen AFB	Alternate
Hawaii			
PHTO	Hilo	Hilo International	Alternate
PHNL	Honolulu	Honolulu International	Regular
PHOG	Kahului	Kahului	Regular

ICAO ID	Location	Airport Name	Designation
Illinois			
KORD	Chicago	Chicago–O’Hare International	Regular
Indiana			
KIND	Indianapolis	Indianapolis International	Regular
Johnston Island			
PJON	Johnston Island	Johnston Atoll	Regular
Kansas			
KICT	Wichita	Wichita Mid–Continent	Alternate
Kentucky			
KCVG	Covington	Cincinnati/ Northern Kentucky International	Regular
Louisiana			
KMSY	New Orleans	Louis Armstrong New Orleans International	Regular
Maine			
KBGR	Bangor	Bangor International	Alternate
Maryland			
KBWI	Baltimore	Baltimore–Washington International Thurgood Marshall	Regular
Massachusetts			
KBOS	Boston	General Edward Lawrence Logan International	Regular
Michigan			
KDTW	Detroit	Detroit Metropolitan Wayne County	Regular
Minnesota			
KMSP	Minneapolis	Minneapolis–St. Paul International (Wold–Chamberlain)	Regular
Missouri			
KMCI	Kansas City	Kansas City International	Regular
KSTL	St. Louis	Lambert–St. Louis International	Regular

ICAO ID	Location	Airport Name	Designation
Nevada			
KLAS	Las Vegas	McCarran International	Regular
KRNO	Reno	Reno/Tahoe International	Regular
New Jersey			
KEWR	Newark	Newark Liberty International	Regular
New York			
KJFK	New York	John F. Kennedy International	Regular
KIAG	Niagara Falls	Niagara Falls International	Alternate
KSYR	Syracuse	Syracuse Hancock International	Regular
North Carolina			
KCLT	Charlotte	Charlotte/ Douglas International	Regular
KRDU	Raleigh–Durham	Raleigh–Durham International	Regular
Northern Mariana Islands			
PGSN	Saipan Island	Francisco C. Ada/Saipan International	Regular
Ohio			
KCLE	Cleveland	Cleveland–Hopkins International	Regular
KCMH	Columbus	Port Columbus International	Regular
Oregon			
KPDX	Portland	Portland International	Regular
Palau Island			
PTRO	Babelthuap Island	Babelthuap/ Koror	Regular
Pennsylvania			
KPHL	Philadelphia	Philadelphia International	Regular
KPIT	Pittsburgh	Pittsburgh International	Regular
Puerto Rico			
TJMZ	Mayaguez	Eugenio Maria De Hostos	Regular
TJSJ	San Juan	Luis Munoz Marin International	Regular

ICAO ID	Location	Airport Name	Designation
Tennessee			
KMEM	Memphis	Memphis International	Regular
KBNA	Nashville	Nashville International	Regular
Texas			
KDFW	Dallas	Dallas-Fort Worth International	Regular
KELP	El Paso	El Paso International	Regular
KIAH	Houston	George Bush Intercontinental/Houston	Regular
KLRD	Laredo	Laredo International	Regular
KSAT	San Antonio	San Antonio International	Regular
Utah			
KSLC	Salt Lake City	Salt Lake City International	Regular
Virgin Islands			
TIST	Charlotte Amalie St. Thomas	Cyril E. King	Regular
TISX	Christiansted St. Croix	Henry E Rohlsen	Regular

ICAO ID	Location	Airport Name	Designation
Washington			
KPAE	Everett	Snohomish County (Paine Field)	Alternate
KSEA	Seattle	Seattle-Tacoma International	Regular
KGEG	Spokane	Spokane International	Alternate
Wisconsin			
KMKE	Milwaukee	General Mitchell International	Regular

1.1 Diagrams of these airports, arranged alphabetically by state and in the order listed above, are on the pages following. The most up-to-date diagrams of these and other U.S. airports are in the Terminal Procedures Publication (TPP). For additional information on these airports, see the U.S. Airport/Facility Directory (A/FD).

1.2 Both the A/FD and TPP may be purchased from: National Aeronautical Charting Office (NACO) Distribution Division, Federal Aviation Administration 6303 Ivy Lane, Suite 400 Greenbelt, MD 20770 Telephone: 301-436-8301/6990 301-436-6829 (FAX) e-mail: 9-AMC-Chartsales@faa.gov

THIS PAGE IS INTENTIONALLY LEFT BLANK.

Anchorage, Alaska
Ted Stevens Anchorage International
ICAO Identifier PANC

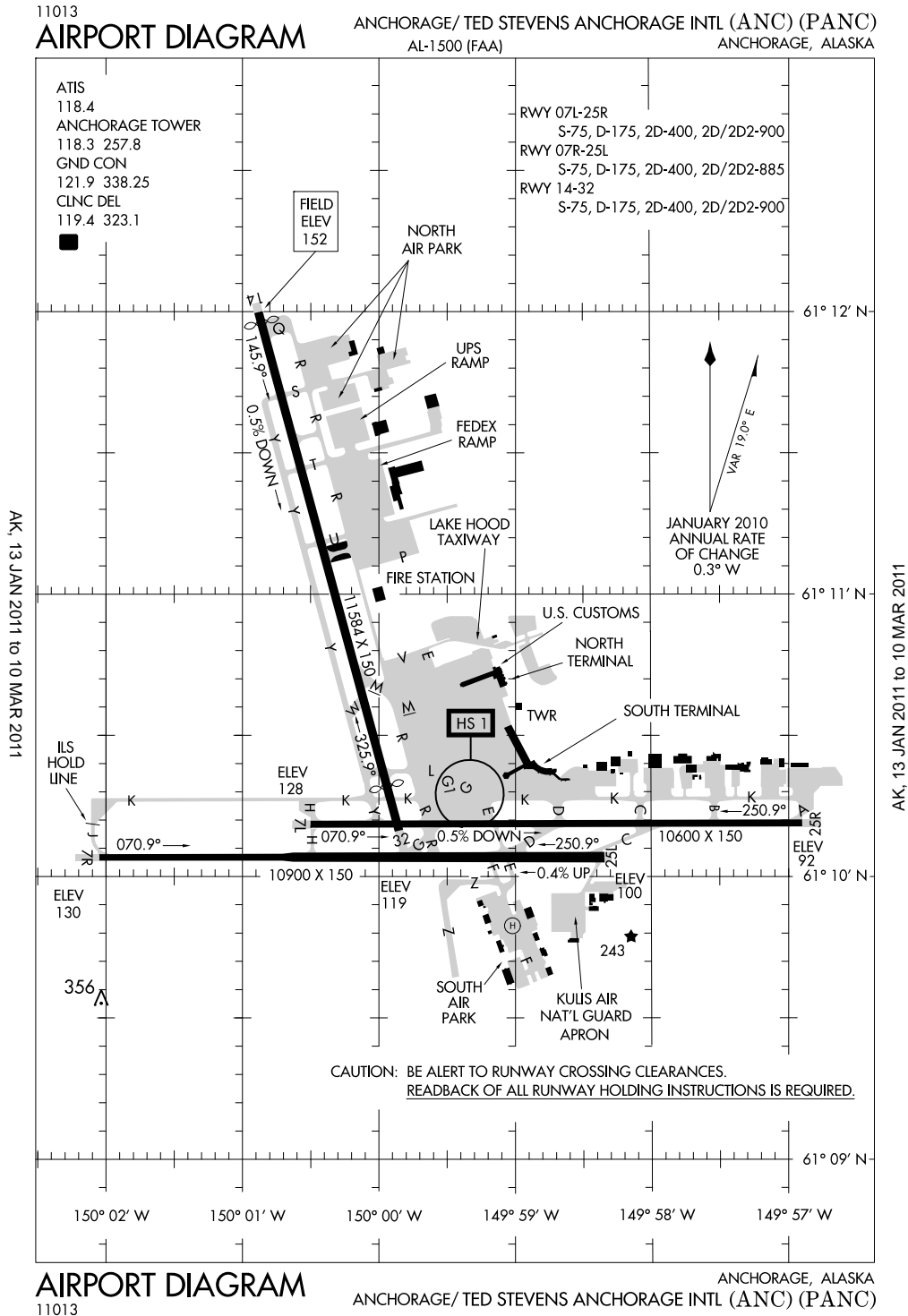

Anchorage, AK
Ted Stevens Anchorage Intl
ICAO Identifier PANC

AD 2.2 Aerodrome geographical and administrative data

- 2.2.1 Reference Point: 61-10-27.70N / 149-59-46.90W
- 2.2.2 From City: 4 Miles SW Of Anchorage, AK
- 2.2.3 Elevation: 152 ft
- 2.2.5 Magnetic variation: 21E (2005)
- 2.2.6 Airport Contact: John Parrott
BOX 196960
Anchorage, AK 99519
(907-266-2525)
- 2.2.7 Traffic: IFR/VFR

AD 2.3 Operational hours

- 2.3.1 - 2.3.11: ALL Months, ALL Days, ALL Hours

AD 2.4 Handling services and facilities

- 2.4.1 Cargo handling facilities: No
- 2.4.2 Fuel types: 100,100LL,A,A1
- 2.4.4 De-icing facilities: None
- 2.4.5 Hangar space: Yes
- 2.4.6 Repair facilities: Major

AD 2.6 Rescue and firefighting services

- 2.6.1 Aerodrome category for firefighting: ARFF Index I E certified on 4/1/2005

AD 2.12 Runway physical characteristics

- 2.12.1 Designation: 07L
- 2.12.2 True Bearing: 90
- 2.12.3 Dimensions: 10600 ft x 150 ft
- 2.12.5 Coordinates: 61-10-11.15N / 150-00-30.00W
- 2.12.6 Threshold elevation: 128 ft
- 2.12.6 Touchdown zone elevation: 128 ft
- 2.12.7 Slope: 0.5DOWN

- 2.12.1 Designation: 25R
- 2.12.2 True Bearing: 270
- 2.12.3 Dimensions: 10600 ft x 150 ft
- 2.12.5 Coordinates: 61-10-11.32N / 149-56-53.88W
- 2.12.6 Threshold elevation: 92 ft
- 2.12.6 Touchdown zone elevation: 92 ft

- 2.12.1 Designation: 07R

- 2.12.2 True Bearing: 90
- 2.12.3 Dimensions: 10900 ft x 150 ft
- 2.12.5 Coordinates: 61-10-00.00N / 150-02-00.00W
- 2.12.6 Threshold elevation: 130 ft
- 2.12.6 Touchdown zone elevation: 130 ft

- 2.12.1 Designation: 25L
- 2.12.2 True Bearing: 270
- 2.12.3 Dimensions: 10900 ft x 150 ft
- 2.12.5 Coordinates: 61-10-00.00N / 149-58-21.53W
- 2.12.6 Threshold elevation: 100 ft
- 2.12.6 Touchdown zone elevation: 115 ft
- 2.12.7 Slope: 0.4UP

- 2.12.1 Designation: 14
- 2.12.2 True Bearing: 165
- 2.12.3 Dimensions: 11584 ft x 150 ft
- 2.12.5 Coordinates: 61-11-59.97N / 150-00-52.84W
- 2.12.6 Threshold elevation: 152 ft
- 2.12.6 Touchdown zone elevation: 151 ft
- 2.12.7 Slope: 0.5DOWN

- 2.12.1 Designation: 32
- 2.12.2 True Bearing: 345
- 2.12.3 Dimensions: 11584 ft x 150 ft
- 2.12.5 Coordinates: 61-10-00.00N / 149-59-51.21W
- 2.12.6 Threshold elevation: 119 ft
- 2.12.6 Touchdown zone elevation: 121 ft

AD 2.13 Declared distances

- 2.13.1 Designation: 14
- 2.13.2 Takeoff run available: 10492
- 2.13.3 Takeoff distance available: 10492
- 2.13.4 Accelerate-stop distance available: 10492
- 2.13.5 Landing distance available: 10492

- 2.13.1 Designation: 32
- 2.13.2 Takeoff run available: 11584
- 2.13.3 Takeoff distance available: 12584
- 2.13.4 Accelerate-stop distance available: 11584
- 2.13.5 Landing distance available: 10692

AD 2.14 Approach and runway lighting

- 2.14.1 Designation: 07L
- 2.14.2 Approach lighting system: MALSR: 1400 feet medium intensity approach lighting system with runway alignment indicator lights

2.14.4 Visual approach slope indicator system:
4-light PAPI on right

2.14.1 Designation: 25R

2.14.4 Visual approach slope indicator system:
6-box VASI on left

2.14.10 Remarks: Upwind Threshold Crossing
Height 64.19' GA 3.25 Deg; Dwnwnd Threshold
Crossing Height 39.31' GA 3.00 Deg.

2.14.1 Designation: 07R

2.14.2 Approach lighting system: ALSF2: Standard
2400 feet high intensity approach lighting system
with sequenced flashers, category II or III
configuration

2.14.4 Visual approach slope indicator system:
4-light PAPI on left

2.14.1 Designation: 25L

2.14.4 Visual approach slope indicator system:
4-light PAPI on left

2.14.10 Remarks: PAPI, Runway 25L, Upwind
Threshold Crossing Height 101 Ft Glide Angle
3.25 Deg; Dwnwnd Threshold Crossing Height 75
Ft Glide Angle 3.00 Deg.

2.14.1 Designation: 14

2.14.2 Approach lighting system: Omnidirectional
approach lighting system

2.14.4 Visual approach slope indicator system:
4-light PAPI on left

2.14.1 Designation: 32

2.14.4 Visual approach slope indicator system:
4-light PAPI on left

**AD 2.18 Air traffic services communication
facilities**

2.18.1 Service designation: LCL/P

2.18.3 Service designation: 118.3 MHz

2.18.1 Service designation: D-ATIS

2.18.3 Service designation: 118.4 MHz

2.18.4 Hours of operation: 24

2.18.1 Service designation: APCH/P DEP/P
CLASS C

2.18.3 Service designation: 118.6 MHz

2.18.1 Service designation: APCH/P DEP/P
CLASS C IC

2.18.3 Service designation: 118.6 MHz

2.18.1 Service designation: APCH/P DEP/P
CLASS C

2.18.3 Service designation: 119.1 MHz

2.18.1 Service designation: APCH/P DEP/P
CLASS C

2.18.3 Service designation: 119.1 MHz

2.18.1 Service designation: CD/P

2.18.3 Service designation: 119.4 MHz

2.18.1 Service designation: EMERG

2.18.3 Service designation: 121.5 MHz

2.18.1 Service designation: GND/P

2.18.3 Service designation: 121.9 MHz

2.18.1 Service designation: APCH/P DEP/P
CLASS C

2.18.3 Service designation: 123.8 MHz

2.18.1 Service designation: APCH/P DEP/P
CLASS C

2.18.3 Service designation: 126.4 MHz

2.18.1 Service designation: CD/S

2.18.3 Service designation: 128.65 MHz

2.18.1 Service designation: APCH/S

2.18.3 Service designation: 134.1 MHz

2.18.1 Service designation: EMERG

2.18.3 Service designation: 243 MHz

2.18.1 Service designation: LCL/P

2.18.3 Service designation: 257.8 MHz

2.18.1 Service designation: APCH/P DEP/P
CLASS C

2.18.3 Service designation: 257.9 MHz

2.18.1 Service designation: APCH/P DEP/P
CLASS C

2.18.3 Service designation: 257.9 MHz

2.18.1 Service designation: RDR

2.18.3 Service designation: 259.1 MHz

2.18.1 Service designation: RDR

2.18.3 Service designation: 271.3 MHz

2.18.1 Service designation: APCH/P DEP/P
CLASS C IC

2.18.3 Service designation: 290.5 MHz

2.18.1 Service designation: APCH/P DEP/P
CLASS C

2.18.3 Service designation: 290.5 MHz

2.18.1 Service designation: RDR

2.18.3 Service designation: 320.1 MHz

2.18.1 Service designation: CD/P

2.18.3 Service designation: 323.1 MHz

2.18.1 Service designation: RDR

2.18.3 Service designation: 324.3 MHz

2.18.1 Service designation: RDR

2.18.3 Service designation: 327.1 MHz

2.18.1 Service designation: APCH/P DEP/P
CLASS C

2.18.3 Service designation: 363.2 MHz

2.18.1 Service designation: APCH/P DEP/P
CLASS C

2.18.3 Service designation: 363.2 MHz

2.18.1 Service designation: USB ANG OPS

2.18.3 Service designation: 4897.5 MHz

2.18.1 Service designation: ANG OPS

2.18.3 Service designation: 311 MHz

2.18.1 Service designation: GND/P

2.18.3 Service designation: 338.25 MHz

2.18.1 Service designation: ANG OPNS

2.18.3 Service designation: 140.15 MHz

AD 2.19 Radio navigation and landing aids

2.19.1 ILS type: Outer Marker for runway 07L.
Magnetic variation: 21E

2.19.2 ILS identification: TGN

2.19.5 Coordinates: 61-10-00.00N /
150-10-37.20W

2.19.6 Site elevation: 99999 ft

2.19.1 ILS type: Glide Slope for runway 07L.

Magnetic variation: 21E

2.19.2 ILS identification: TGN

2.19.5 Coordinates: 61-10-13.63N /
150-00-10.18W

2.19.6 Site elevation: 119 ft

2.19.1 ILS type: DME for runway 07L. Magnetic
variation: 21E

2.19.2 ILS identification: TGN

2.19.5 Coordinates: 61-10-14.27N /
149-56-32.40W

2.19.6 Site elevation: 99999 ft

2.19.1 ILS type: Localizer for runway 07L.
Magnetic variation: 21E

2.19.2 ILS identification: TGN

2.19.5 Coordinates: 61-10-11.33N /
149-56-32.63W

2.19.6 Site elevation: 78 ft

2.19.1 ILS type: Glide Slope for runway 07R.
Magnetic variation: 21E

2.19.2 ILS identification: ANC

2.19.5 Coordinates: 61-10-00.00N /
150-01-42.70W

2.19.6 Site elevation: 128 ft

2.19.1 ILS type: Inner Marker for runway 07R.
Magnetic variation: 21E

2.19.2 ILS identification: ANC

2.19.5 Coordinates: 61-10-00.00N /
150-02-23.05W

2.19.6 Site elevation: 99999 ft

2.19.1 ILS type: Outer Marker for runway 07R.
Magnetic variation: 21E

2.19.2 ILS identification: ANC

2.19.5 Coordinates: 61-10-00.00N /
150-10-37.20W

2.19.6 Site elevation: 99999 ft

2.19.1 ILS type: Middle Marker for runway 07R.
Magnetic variation: 21E

2.19.2 ILS identification: ANC

2.19.5 Coordinates: 61-10-00.00N /
150-02-56.82W

2.19.6 Site elevation: 99999 ft

2.19.1 ILS type: DME for runway 07R. Magnetic
variation: 21E

2.19.2 ILS identification: ANC

2.19.5 Coordinates: 61-10-00.00N /
149-57-58.68W

2.19.6 Site elevation: 99999 ft

2.19.1 ILS type: Localizer for runway 07R.
Magnetic variation: 21E

2.19.2 ILS identification: ANC

2.19.5 Coordinates: 61-10-00.00N /
149-57-55.49W

2.19.6 Site elevation: 98 ft

2.19.1 ILS type: Localizer for runway 14. Magnetic
variation: 21E

2.19.2 ILS identification: BSC

2.19.5 Coordinates: 61-09-59.91N /
149-59-45.63W

2.19.6 Site elevation: 122 ft

2.19.1 ILS type: DME for runway 14. Magnetic
variation: 21E

2.19.2 ILS identification: BSC

2.19.5 Coordinates: 61-10-00.00N /
149-59-40.34W

2.19.6 Site elevation: 135 ft

2.19.1 ILS type: Glide Slope for runway 14.
Magnetic variation: 21E

2.19.2 ILS identification: BSC

2.19.5 Coordinates: 61-11-45.22N /
150-00-52.60W

2.19.6 Site elevation: 142 ft

General Remarks:

MIGRATORY BIRDS IN THE VICINITY OF AIRPORT SPRING THROUGH FALL.

ONE HR PRIOR PERMISSION REQUIRED FOR NON-TRANSPONDER AIRCRAFT OPERATIONS.
PRIOR PERMISSION REQUIRED FOR NON-RADIO AIRCRAFT OPERATIONS. NO NIGHTTIME
NON-RADIO AIRCRAFT OPERATIONS PERMITTED. PILOTS MUST PROVIDE AN ESTIMATED
TIME OF ARRIVAL & REMAIN WITHIN PLUS OR MINUS 15 MINUTES OF ESTIMATED TIME OF
ARRIVAL.

FOR WEATHER SERVICE OFFICE PHONE 907-266-5105.

NOISE SENSITIVE AREA IN EFFECT; CONTACT AIRPORT MANAGER AT 907-266-2525 OR
AIRPORT OPERATIONS 907-266-2600 FOR FURTHER INFORMATION.

TO COORDINATE NON-TRANSPONDER OR NON-RADIO OPERATIONS CONTACT
AERONAUTICAL CHART ATCT AT 907-271-2700 DURING ADMIN HRS (0730-1600 WKDAYS).
DURING NON-ADMIN HRS & HOLIDAYS CONTACT FAA AT 907-271-5936.

KULIS ANG BASE PRIOR PERMISSION REQUIRED; CONTACT DSN (317) 626-1131 OR C (907)
249-1131. OPERATIONS MON-FRI 0730-1600. LIMITED AIRCRAFT PARKING; MARGINAL
WINGTIP CLEARANCE WHILE TAXIING ON PARKING RAMP. NO TRANSMIT ALERT. NO
SERVICE OR MAINT; EXCEPT C130H & HH60G; OR HANGAR SPACE.

COMMAND POST (CAMPER) MANNED 24 HRS; DSN (317) 626-1131 OR C (907) 249-1131.
CONTACT CAMPER 30 MIN OUT.

UNLIGHTED 489 FT TOWER 2 1/2 MILES NORTHEAST.

PORTIONS OF TAXIWAY K BETWEEN TAXIWAY H & TAXIWAY J NOT VISIBILITY FROM ATCT.

NO COMPASS CALIBRATION PAD.

RIGHT TURN OUT OF RAMP PARKING AREA R-2 THROUGH R-4 PROHIBITED.

USE FREQ 122.55 (RCO) FOR FILING, ACTIVATING & CANCELING FLIGHT PLANS IN THE ANCHORAGE BOWL AREA.

FAA RAMP PRIOR PERMISSION REQUIRED – CONTACT AERONAUTICAL CHART FLIGHT INSPECTION FIELD OFFICE FREQ 135.85, 907-271-2414 OR AVIATION 405-954-9780 MON-FRI 0600-1430L.

ANCHORAGE WX CAMERA AVAILABLE ON INTERNET AT
[HTTP://AKWEATHERCAMS.FAA.GOV](http://AKWEATHERCAMS.FAA.GOV)

ANCHORAGE AIRPORT TRAFFIC CONTROL TOWER HAS BEEN GRANTED A WAIVER TO THE GUIDELINES THAT PROHIBIT THE CONTROL TOWER FROM DIRECTING AN AIRCRAFT TO "LINEUP AND WAIT" AT AN INTERSECTION, BETWEEN SUNSET AND SUNRISE.

THIS WAIVER ALLOWS THE TOWER TO DIRECT THE AIRCRAFT TO "LINEUP AND WAIT" DURING PERIODS OF DARKNESS AT THE FOLLOWING INTERSECTION: RUNWAY 32 AT TAXIWAY KILO.

AIRCRAFT SHALL NOT "LINEUP AND WAIT" UNDER THE PROVISIONS OF THIS WAIVER WHEN THE SUBJECT INTERSECTION IS NOT VISIBLE FROM THE TOWER. WHEN THE PROVISIONS OF THIS WAIVER ARE BEING EXERCISED, THE AFFECTED RUNWAY SHALL BE USED FOR DEPARTURES ONLY.

INTERSECTION DEPARTURES WILL CONTINUE TO BE UTILIZED AT OTHER LOCATIONS BETWEEN SUNSET AND SUNRISE. HOWEVER, AIRCRAFT CANNOT BE DIRECTED TO "LINEUP AND WAIT" PRIOR TO TAKEOFF CLEARANCE.

MILITARY CONTRACT FUEL AVAILABLE, SIGNATURE FLIGHT SUPPORT, (907) 243-7627.

ANG – BASE OPS(KULIS OPS) DSN 626-1225,(907-249-1225) OPR 1630-0100Z++ MON – FRI, CLOSED WEEKEND AND HOLIDAY.

TAXIWAY V SECURITY GATE EAST OF TAXIWAY E; KEY 121.75 5 TIMES TO ACTIVATE.TWY V RESTRICTED TO AIRCRAFT WEIGHING 12500 LBS OR LESS. SUBJECT TO JET BLAST WEST OF TAXIWAY E.

Anchorage, Alaska Elmendorf AFB ICAO Identifier PAED

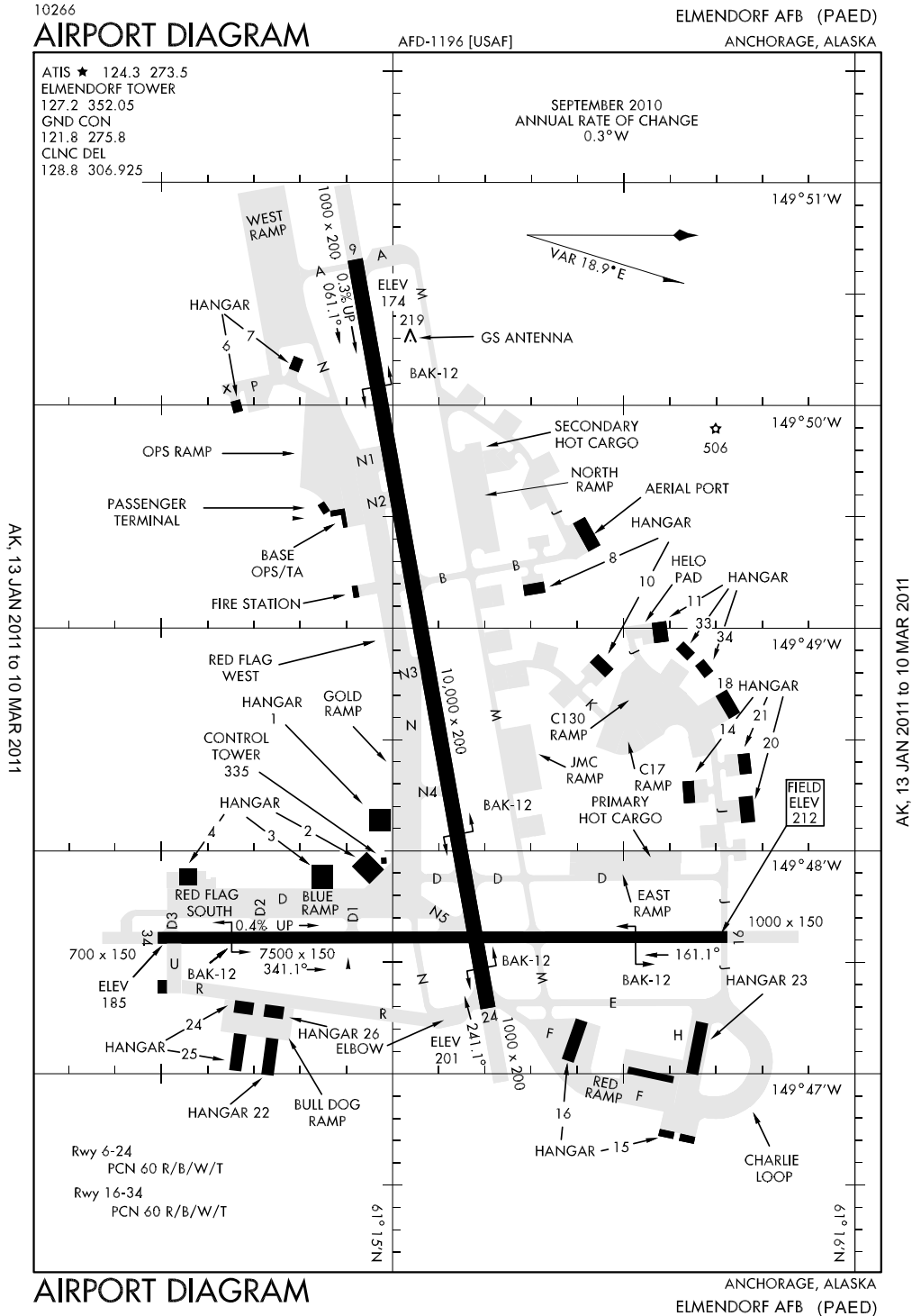

Anchorage, AK
Elmendorf AFB
ICAO Identifier PAED

AD 2.2 Aerodrome geographical and administrative data

- 2.2.1 Reference Point: 61-15-00.00N / 149-48-23.45W
- 2.2.2 From City: 3 Miles NE Of Anchorage, AK
- 2.2.3 Elevation: 212 ft
- 2.2.5 Magnetic variation: 21E (2005)
- 2.2.6 Airport Contact: Airfield Mgr
300SS/DOFJ
Elmendorf AFB, AK 99506
(907-552-2444)
- 2.2.7 Traffic: IFR/VFR

AD 2.3 Operational hours

- 2.3.1 - 2.3.11: ALL Months, ALL Days, ALL Hours

AD 2.4 Handling services and facilities

- 2.4.1 Cargo handling facilities: No
- 2.4.2 Fuel types: None
- 2.4.4 De-icing facilities: Fluid: Presair, De-Ice, Nitrogen-Lhnit.
- 2.4.5 Hangar space: No
- 2.4.6 Repair facilities: None

AD 2.6 Rescue and firefighting services

- 2.6.1 Aerodrome category for firefighting: None

AD 2.10 Aerodrome obstacles

- 2.10.1.a. Runway designation: 16
- 2.10.1.b Type of obstacle: Trees Hill. Not Lighted or Marked
- 2.10.1.a. Runway designation: 34
- 2.10.1.b Type of obstacle: Pline Tree. Not Lighted or Marked
- 2.10.1.a. Runway designation: 24
- 2.10.1.b Type of obstacle: Pline Pole. Not Lighted or Marked

AD 2.12 Runway physical characteristics

- 2.12.1 Designation: 16
- 2.12.2 True Bearing: 180
- 2.12.3 Dimensions: 7505 ft x 150 ft
- 2.12.4 PCN: 60 R/B/W/T
- 2.12.5 Coordinates: 61-15-43.45N /

- 149-47-36.51W
- 2.12.6 Threshold elevation: 212 ft

- 2.12.1 Designation: 34
- 2.12.2 True Bearing: 360
- 2.12.3 Dimensions: 7505 ft x 150 ft
- 2.12.4 PCN: 60 R/B/W/T
- 2.12.5 Coordinates: 61-14-29.54N / 149-47-36.55W
- 2.12.6 Threshold elevation: 185 ft

- 2.12.1 Designation: 06
- 2.12.2 True Bearing: 80
- 2.12.3 Dimensions: 10000 ft x 200 ft
- 2.12.4 PCN: 60 R/B/W/T
- 2.12.5 Coordinates: 61-14-55.08N / 149-50-39.33W
- 2.12.6 Threshold elevation: 175 ft

- 2.12.1 Designation: 24
- 2.12.2 True Bearing: 260
- 2.12.3 Dimensions: 10000 ft x 200 ft
- 2.12.4 PCN: 60 R/B/W/T
- 2.12.5 Coordinates: 61-15-12.17N / 149-47-18.01W
- 2.12.6 Threshold elevation: 201 ft

AD 2.14 Approach and runway lighting

- 2.14.1 Designation: 16
- 2.14.4 Visual approach slope indicator system: 4-light PAPI on left
- 2.14.10 Remarks: Non-Standard PAPI Glide Angle 4.2 Degs On Runway 16 Due To High Terrain.

- 2.14.1 Designation: 34
- 2.14.2 Approach lighting system: ALSAF: 3000 feet high intensity approach lighting system with centerline sequence flashers
- 2.14.4 Visual approach slope indicator system: 4-light PAPI on left

- 2.14.1 Designation: 06
- 2.14.2 Approach lighting system: ALSAF: 3000 feet high intensity approach lighting system with centerline sequence flashers
- 2.14.4 Visual approach slope indicator system: 4-light PAPI on left
- 2.14.10 Remarks: Approach Lights Extended 15'' Above Surface Up To 100' Prior To Threshold Runway 06 PAPI Unusable Beyond 8 Degs Either Side Of Course Path.

2.14.1 Designation: 24
2.14.4 Visual approach slope indicator system:
4-light PAPI on left
2.14.10 Remarks: PAPI Runway 24 Unusable
Beyond 7 Degrees Right Of Course.

AD 2.18 Air traffic services communication facilities

2.18.1 Service designation: 11AF RESCUE
COORD CNTR

2.18.3 Service designation: 123.1 MHz

2.18.1 Service designation: ATIS
2.18.3 Service designation: 124.3 MHz
2.18.4 Hours of operation: 0700-2300

2.18.1 Service designation: LCL/P
2.18.3 Service designation: 127.2 MHz

2.18.1 Service designation: PTD
2.18.3 Service designation: 134.8 MHz

2.18.1 Service designation: ATIS
2.18.3 Service designation: 273.5 MHz
2.18.4 Hours of operation: 0700-2300

2.18.1 Service designation: 11AF RESCUE
COORD CNTR
2.18.3 Service designation: 282.8 MHz

2.18.1 Service designation: PMSV
2.18.3 Service designation: 346.6 MHz

2.18.1 Service designation: AIR MOBILITY CTRL
CNTR (CALL "DENALI")
2.18.3 Service designation: 349.4 MHz

2.18.1 Service designation: PTD
2.18.3 Service designation: 372.2 MHz

2.18.1 Service designation: 11AF COMD CEN
2.18.3 Service designation: 381 MHz

2.18.1 Service designation: AIR MOBILITY CTRL
CNTR (CALL "DENALI")

General Remarks:

LANDING RUNWAY 16 NOT RECOMMENDED FOR JET AIRCRAFT EXCEPT DURING DAY VFR
DUE OBSTRUCTION 337' MSL LOCATED 1950' FROM THR & 574' W OF CENTERLINE.

HANGAR SPACE & WARM STORAGE EXTREMELY LIMITED OCT-MAY.

2.18.3 Service designation: 134.1 MHz
2.18.1 Service designation: LCL/P
2.18.3 Service designation: 352.05 MHz

2.18.1 Service designation: CD/P
2.18.3 Service designation: 128.8 MHz

2.18.1 Service designation: CD/P
2.18.3 Service designation: 306.925 MHz

2.18.1 Service designation: GND/P
2.18.3 Service designation: 121.8 MHz

2.18.1 Service designation: GND/P
2.18.3 Service designation: 275.8 MHz

AD 2.19 Radio navigation and landing aids

2.19.1 ILS type: Localizer for runway 06. Magnetic
variation: 25E

2.19.2 ILS identification: EDF

2.19.5 Coordinates: 61-15-14.02N /
149-46-47.94W

2.19.6 Site elevation: 99999 ft

2.19.1 ILS type: Glide Slope for runway 06.
Magnetic variation: 25E

2.19.2 ILS identification: EDF

2.19.5 Coordinates: 61-15-00.00N /
149-50-10.94W

2.19.6 Site elevation: 99999 ft

2.19.1 ILS type: Inner Marker for runway 06.
Magnetic variation: 25E

2.19.2 ILS identification: EDF

2.19.5 Coordinates: 61-14-52.87N /
149-51-00.00W

2.19.6 Site elevation: 192 ft

2.19.1 ILS type: Middle Marker for runway 06.
Magnetic variation: 25E

2.19.2 ILS identification: EDF

2.19.5 Coordinates: 61-14-49.02N /
149-51-49.94W

2.19.6 Site elevation: 99999 ft

PREVENTIVE MAINT: TACAN WED AND FRI 1600-1700Z; ILS TUE AND THR 1500-1700Z; PRECISION APPROACH RADAR SAT-SUN 1800-2000Z; AIRPORT SURVEILLANCE RADAR SAT-SUN 2000-2200.

QUIET HR 0630-1400Z WEEKDAYS; 0630-1600Z WEEKEND & HOLS, AIR MOBILITY COMMAND AIRCRAFT EXEMPT.

CAUTION: MOOSE ON & IN THE VICINITY OF RUNWAY.

DURING VISUAL METEOROLOGICAL CONDITIONS DEPS/MISSED APCHS/GO AROUNDS; AIRCRAFT SHALL MAINTAIN AT OR BELOW 1200' MSL UNTIL DEP END OF RUNWAY 05.

ALL FIGHTER AIRCRAFT ON ARR EXPECT REDUCED SEPARATION; SAME TYPE AIRCRAFT AND DAY 3000 FT; DISSIMILAR AIRCRAFT AND/OR NIGHT 6000 FT; AHEAD/BEHIND FORMATION LANDING-6000 FT.

NOTICE: A RIDGE EXTENDING FROM APPROXIMATELY 260 - 020 DEGREES ONE TO TWO MILES FROM THE TOWER PREVENTS OBSERVATION OF FOG OVER KNIK ARM. VISIBILITY MAY DROP RAPIDLY AS FOG POURS OVER RIDGE.

AIRCRAFT REQUIRING CUSTOMS CONTACT BASE OPERATIONS 90 MIN PRIOR TO ARRIVAL BY WAY OF GLOBAL RADIO.

ALL AIRCRAFT MAINTAIN IDLE POWER ON OUTBOARD ENGINE WHILE TAXIING.

NO SIGNS OR PAINTED HOLD SHORT LINES ON INTERSECTING RUNWAYS.

PRIOR PERMISSION REQUIRED REQUIRE FOR ALL AIRCRAFT EXCEPT NON-EXPLOSIVE LADEN AIR MOBILITY COMMAND CHANNEL MISSIONS, AND AIREVAC. PRIOR PERMISSION REQUIRED NUMBERS WILL BE PROVIDED BETWEEN 24 HRS & 5 DAYS PRIOR TO ARR, CONTACT BASE OPERATIONS DSN 317-552-2107/1202 OR C907-552-2107/1202. NON-AMC AIRCRAFT CONTACT BASE OPERATIONS PRIOR TO DEP FROM PREVIOUS STATION & 30 MIN PRIOR TO ARR FOR PARKING & SERVICING.

HEAVY MIGRATORY BIRD ACTIVATE DURING APR-MAY & AUG-OCT PERIODS WHICH MAY POSE A SIGNIFICANT HAZARD TO AIRCRAFT. REPORT ALL BIRD OR ANIMAL STRIKES ON OR IN THE VICINITY OF ELMENDORF TO PILOT TO DISPATCH OR WG/SE DSN 317-552-4128/3389.

(A70) EXTENSIVE SERVICE DELAY FOR FUEL.

ALL VIP AIRCRAFT CONTACT BASE OPERATIONS 30 MIN PRIOR TO ARR.

FLIGHTS ORIGINATING OUTSIDE THE STATE REFER TO THE USAF FOREIGN CLEARANCE GUIDE.

HEAVILY CONGESTED AIRSPACE SEE FAR PART 93 OR ALASKA SUPPLEMENT FOR ALL RESTRICTIONS ON FINAL APPROACH TO RUNWAY 05.

FREQUENT ACTIVITY IN R2203. WHEN UNABLE TO AVOID CONTACT ATCT.

ALL TRANSIENT AIRCREWS OPER OUT OF ELMENDORF INTENDING ON LOCAL MISSIONS

(COPE THUNDER, USARK, EXERCISES, GUARD AIRLIFT, OFF STATION TRAINING, ETC) MUST RECIEVE A LOCAL BRIEFING FROM 3 OG/CC AT 317-552-2262.

SPECIAL AIR TRAFFIC RULES FAR PART 93, SEE REGULATORY NOTICES IN THE SUPPLEMENT.

FIRST 1000 FT RUNWAY 05 & FIRST 1200 FT RUNWAY 23 ARE CONCRETE, MIDDLE 7800 FT IS ASPHALT.

LIMITED MAINTENANCE CAPABILITIES ON WEEKEND.

JOAP, JOINT OIL ANALYSIS PROGRAM AVAILABLE. L/H NIT, LOW & HIGH PRESSURE NITROGEN SERVICING AVAILABLE.

CHANGE JET AIRCRAFT STARTING UNITS (JASU) TO, (A/M32A-86), MC-1A), (MC-2A), (AM32A-60A). (AM32-95)150 +/-5 LBS/MIN (2055 +/-68CFM) AT 51 +/-02 PSIA. LASS 150 +/-5 LBS/MIN @ 49 +/-2 PSIA.

FUEL: J8

OIL: O-123, O-128, O-133, O-148, O-156, JOAP.

JOAP & LOW & HIGH PRESURE NITROGEN SERVICING FURNISHED DURING NORMAL DUTY HOURS, OTHER TIMES ON REQUEST.

FLUID: PRESAIR, DE-ICE, NITROGEN-L/H NIT.

ALL AIRCRAFT REQUIRE BARRIER REMOVAL MUST CONTACT AIRFIELD MANAGEMENT PRIOR TO DEPARTING PREVIOUS STATION.

PRIOR PERMISSION REQUIRED VALID 6 HRS PRIOR TO OR AFTER ESTIMATED TIME OF ARRIVAL. EARLY AND LATE ARRIVALS MUST BE RE-COORDINATED THROUGH AMOPS.

UNITS DEPLOYING MORE THAN TWO AIRCRAFT INTENDING TO FLY ANY SORTIES THAT ORIGINATE AND TERMINATE @ ELMENDORF MUST CONTACT 3 WG SCHEDULING DSN 317-552-2406 NOT LATER THAN 90 DAYS PRIOR TO ARRIVAL TO OBTAIN SPONSORING UNIT INFORMATION.

UNITS DEPLOYING WITH TWO OR LESS AIRCRAFT WILL CONTACT 3 WG SCHEDULING ASAP BUT NOT LATER THAN 30 DAYS PRIOR TO ARRIVAL.

RUNWAY 16/34 RUBBER ACCUMULATE NORTH & SOUTH 1000FT.

TAXIWAY D FROM TAXIWAY N TO TAXIWAY D3 LIMITED TO AIRCRAFT WITH WINGSPAN OF 138 FT OR LESS WHEN AIRCRAFT PARKED ON BLUE RAMP. AIRCRAFT WITH WINGSPAN OF OVER 138 FT CAN EXIT RUNWAY 34 AT TAXIWAY D2 TO TAXIWAY D3 FOR A RUNWAY 34 DEP.

TRANSIENT MAINTENANCE: AIRCRAFT SERVICES ARE LIMITED TO POL SERVICING, INTAKE/EXHAUST INSPECTIONS, F-16 CHIP DETECTOR INSPECTIONS AND END OF RUNWAY INSPECTIONS. TRANSIENT AIRCRAFT REQUIRING PRE/THRU/POST FLIGHT SUPPORT FOR LOCAL MISSIONS IS NOT AVAILABLE, AIRCREWS MUST DEPLOY WITH THEIR OWN MAINTENANCE SUPPORT.

INTERSECTION OF TAXIWAY J AND TAXIWAY B LIMITED TO AIRCRAFT WITH WINGSPAN 140FT OR LESS, VEHICLES AUTHORIZED. TAXIWAY N RESTRICTED TO AIRCRAFT W/LARGER THAN 94 FT WINGSPANS BETWEEN B TO N5, ALL OTHER AIRCRAFT WILL EXIT RUNWAY 06 AT TAXIWAY B TO ACCESS OPERATIONS RAMP.

FOR CURRENT RUNWAY CONDITION READING/RUNWAY SURFACE CONDITIONS ON RUNWAY 06/24 & RUNWAY 34/16 CONTACT TOWER.

IFF SERVICE AVAILABLE. AIRFIELD WX IS AUTOMATICALLY MONITOR BY AN/FQ-19 AUTOMATED WX OBSERVING SYSTEM AND BACKED-UP/ AUGMENTED BY HUMAN OBSERVER WHEN NECESSARY 24/7. DSN 317-552-4903/4397OR C907-552-4903/4397. FULL SERVICE WX BRIEFING 24HRS 17 OPERATIONAL WEATHER SQUADRON DSN 315-449-8333 OR C808-449-8333.

C17/C130 COVERT LANDING ZONE LIGHT AVAILABLE ON RY16/34. C17 COVERT LIGHTS AVAILABLE ON RUNWAY 16.

NIGHT VISION GOGGLE OPERATIONS ON RUNWAY 16/34 & RUNWAY 06/24 FROM 0400-1000Z++ MON-FRI.

DURING EVACUATION OF WX STATION, CONTACT 17 OPERATIONAL WX SQUADRON AT DSN 315-449-8333.

ALTERNATE WX LOCATION VISIBILITY OBSTRUCTED FROM SE-W DUE TO HANGARS. USE PHONE PATCH WHEN WX RELOCATES TO ALTERNATE LOCATION.PHONE PATCH CAPABILITY THROUGH 3 WG/CP AT 907-552-3000.

ATTENTION AIRCREWS: AIRFIELD MANAGEMENT NO LONGER RECEIVES OR ISSUES COMSEC MATERIAL. AIRFIELD MANAGEMENT HAS LIMITED STORAGE CAPABILITIES; ALL TRANSIENT AIRCREWS MUST SEAL COMSEC BAGS PRIOR TO STORAGE. ALL TOP SECRET STORAGE REQUEST WILL HAVE TO BE PRE-COORDINATED THROUGH THE 11AF SSO OFFICE AT DSN 317-552-2287 OR C907-552-2287.

CAUTION: TAXIWAY P AND TAXIWAY J BETWEEN TAXIWAY B AND TAXIWAY M DO NOT HAVE EDGE LIGHT, USE CAUTION DURING HR OF DARKNESS AND RESTRICTED VISIBILITY.

TAXIWAY J FROM TAXIWAY M TO TAXIWAY B LIMITED TO AIRCRAFT WITH WINGSPAN OF 158 FT OR LESS.

CAUTION: TWO C130'S OR TWO C17'S WILL BE OPERATING IFR BETWEEN 1500-2000 MSL FROM BGQ09310 INTO R2203 TO EDF32007 IN THE VICINITY OF BIG LAKE, PALMER, BIRCHWOOD, GOOSEBAY AND WASILLA, AK., WED 0300-0800Z++, THU 1700-0015Z++, FRI 0330-0630Z++.

TAXIWAY K RESTRICTED TO AIRCRAFT WITH WINGSPAN OF 185 FT OR LESS (C-17 OR SMALLER).

ASK AMOPS FOR PARKING LOCATION WHEN REQUESTING A PRIOR PERMISSION REQUIRED. CONTACT RAM SOUTH, 10 MINUTES PRIOR TO LANDING ON 124.65.

Cold Bay, Alaska
Cold Bay
ICAO Identifier PACD

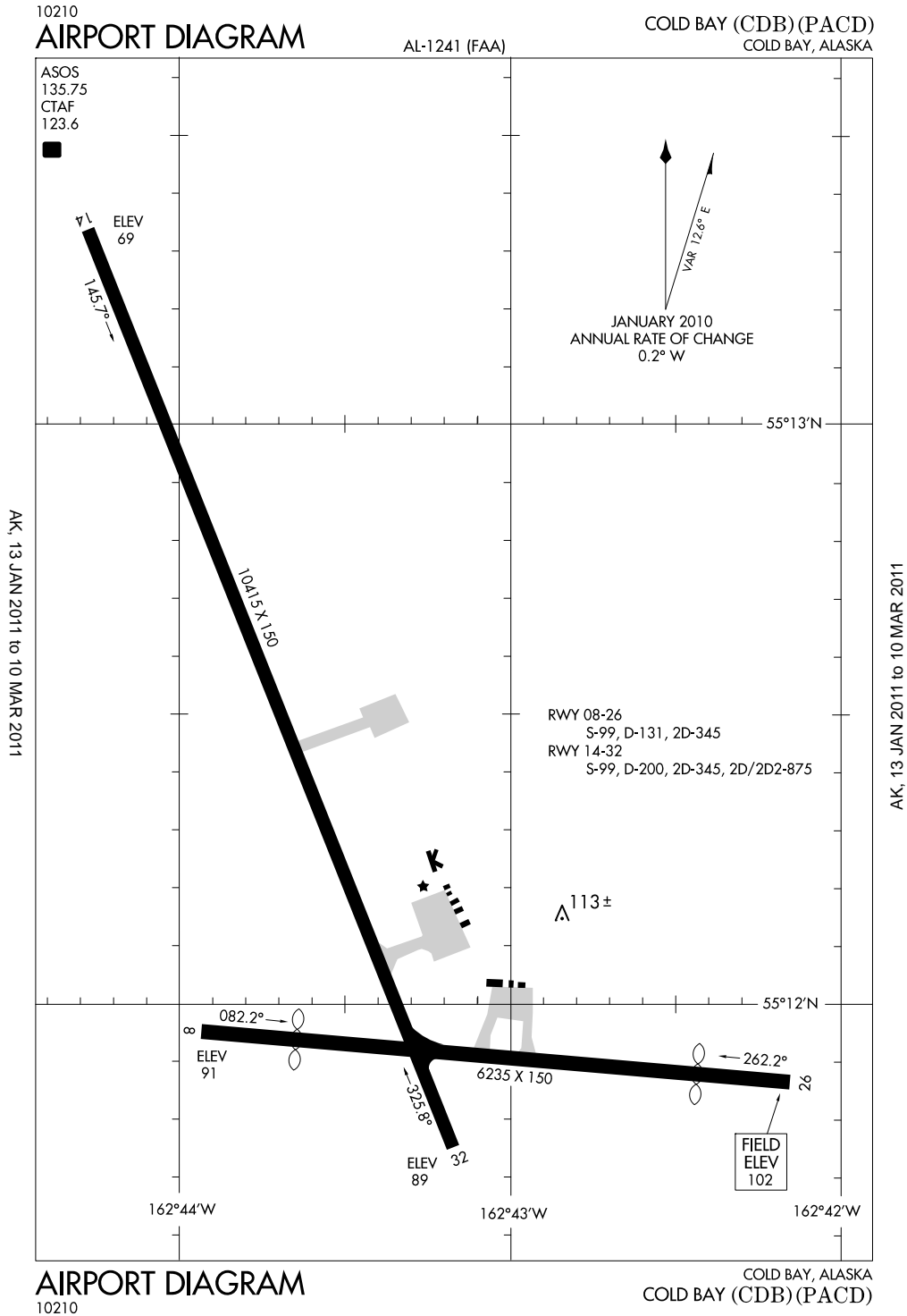

Cold Bay, AK
Cold Bay
ICAO Identifier PACD

AD 2.2 Aerodrome geographical and administrative data

- 2.2.1 Reference Point: 55-12-18.54N / 162-43-28.08W
- 2.2.2 From City: 0 Miles N Of Cold Bay, AK
- 2.2.3 Elevation: 102 ft
- 2.2.5 Magnetic variation: 14E (2005)
- 2.2.6 Airport Contact: Jeff Doerning
BOX 97
Cold Bay, AK 99571
(907-532-5000)
- 2.2.7 Traffic: IFR/VFR

AD 2.3 Operational hours

- 2.3.1 - 2.3.11: OCT-APR Months, ALL Days, 0630-1900 Hours

AD 2.4 Handling services and facilities

- 2.4.1 Cargo handling facilities: No
- 2.4.2 Fuel types: 100,A
- 2.4.4 De-icing facilities: None
- 2.4.5 Hangar space: Yes
- 2.4.6 Repair facilities: Minor
- 2.4.7 Remarks: Maint Duty Hrs: 0700 - 1800 Sun Thru Sat (1 May - 30 Sep); 0530 - 1800 (1 Oct - 30 Apr).

AD 2.6 Rescue and firefighting services

- 2.6.1 Aerodrome category for firefighting: ARFF Index I B certified on 5/1/1973
- 2.6.4 Remarks: Closed To Aircraft 0 Operations With More Than 30 Passenger Seats Except Prior Permission Required In Writing To Airport Manager Box 97 Cold Bay Ak 99571.

AD 2.12 Runway physical characteristics

- 2.12.1 Designation: 14
- 2.12.2 True Bearing: 158
- 2.12.3 Dimensions: 10415 ft x 150 ft
- 2.12.5 Coordinates: 55-13-20.62N / 162-44-16.51W
- 2.12.6 Threshold elevation: 69 ft
- 2.12.6 Touchdown zone elevation: 74 ft

- 2.12.1 Designation: 32
- 2.12.2 True Bearing: 338
- 2.12.3 Dimensions: 10415 ft x 150 ft

- 2.12.5 Coordinates: 55-11-45.16N / 162-43-10.26W
- 2.12.6 Threshold elevation: 89 ft
- 2.12.6 Touchdown zone elevation: 89 ft

- 2.12.1 Designation: 08
- 2.12.2 True Bearing: 95
- 2.12.3 Dimensions: 6235 ft x 150 ft
- 2.12.5 Coordinates: 55-11-57.13N / 162-43-56.05W
- 2.12.6 Threshold elevation: 91 ft
- 2.12.6 Touchdown zone elevation: 93 ft
- 2.12.7 Slope: 0.3UP

- 2.12.1 Designation: 26
- 2.12.2 True Bearing: 275
- 2.12.3 Dimensions: 6235 ft x 150 ft
- 2.12.5 Coordinates: 55-11-52.01N / 162-42-00.00W
- 2.12.6 Threshold elevation: 102 ft
- 2.12.6 Touchdown zone elevation: 96 ft

AD 2.13 Declared distances

- 2.13.1 Designation: 08
- 2.13.2 Takeoff run available: 6235
- 2.13.3 Takeoff distance available: 6235
- 2.13.4 Accelerate-stop distance available: 5235
- 2.13.5 Landing distance available: 4235

- 2.13.1 Designation: 26
- 2.13.2 Takeoff run available: 6235
- 2.13.3 Takeoff distance available: 6235
- 2.13.4 Accelerate-stop distance available: 5235
- 2.13.5 Landing distance available: 4235

AD 2.14 Approach and runway lighting

- 2.14.1 Designation: 14
- 2.14.2 Approach lighting system: MALSR: 1400 feet medium intensity approach lighting system with runway alignment indicator lights

- 2.14.1 Designation: 32
- 2.14.2 Approach lighting system: MALSR: 1400 feet medium intensity approach lighting system with runway alignment indicator lights
- 2.14.4 Visual approach slope indicator system: 4-box VASI on left

- 2.14.1 Designation: 08
- 2.14.4 Visual approach slope indicator system: 4-box VASI on left

2.14.10 Remarks: Line Of Sight For VASI Rwy 08
Offset 5 Degrees To The North.

162-44-00.00W
2.19.6 Site elevation: 68 ft

2.14.1 Designation: 26
2.14.4 Visual approach slope indicator system:
4-box VASI on left

2.19.1 ILS type: Outer Marker for runway 14.
Magnetic variation: 14E
2.19.2 ILS identification: CDB
2.19.5 Coordinates: 55-17-49.16N /

AD 2.19 Radio navigation and landing aids

2.19.1 ILS type: Localizer for runway 14. Magnetic
variation: 14E

162-47-24.07W
2.19.6 Site elevation: 36 ft

2.19.2 ILS identification: CDB
2.19.5 Coordinates: 55-11-41.02N /
162-43-00.00W
2.19.6 Site elevation: 89 ft

2.19.1 ILS type: Middle Marker for runway 14.
Magnetic variation: 14E
2.19.2 ILS identification: CDB
2.19.5 Coordinates: 55-13-53.76N /

2.19.1 ILS type: Glide Slope for runway 14.
Magnetic variation: 14E
2.19.2 ILS identification: CDB
2.19.5 Coordinates: 55-13-12.78N /

162-44-39.55W
2.19.6 Site elevation: 99999 ft

General Remarks:

SNOW & ICE REMOVAL AND AIRPORT HAZARD REPORTING ONLY PERFORMED DURING
DUTY HRS UNLESS BY PRIOR ARRANGEMENT IN WRITING WITH AIRPORT MANAGER.

LARGE BIRDS NEAR APPROACH ENDS OF ALL RUNWAYS.

BRAKELOCK TURNS NOT ALLOWED ON RUNWAYS.

CODE OF FEDERAL REGULATIONS INDEX B. INDEX MAY BE REDUCED FOR AIRCRAFT LESS
THAN 90'.

NO CUSTOMS AVAILABLE; WRITTEN PERMISSION REQUIRED FOR REFUELING STOPS 24-48
HRS IN ADVANCE IF ARRIVING FROM A FOREIGN COUNTY; FAX 907-271-2684 OR
907-271-2686.

TOWER 4.8 NAUTICAL MILE NW OF AIRPORT UNLIGHTED.

PERSONNEL AND EQUIPMENT MAY BE WORKING ON THE RUNWAY AT ANY TIME.

AIRPORT SAND LARGER GRADATION THAN FAA RECOMMENDED/SEE AC150/5200-30.

WX CAMERA AVAILABLE ON INTERNET AT [HTTP://AKWEATHERCAMS.FAA.GOV](http://AKWEATHERCAMS.FAA.GOV)

Fairbanks, Alaska
Eielson AFB
ICAO Identifier PAEI

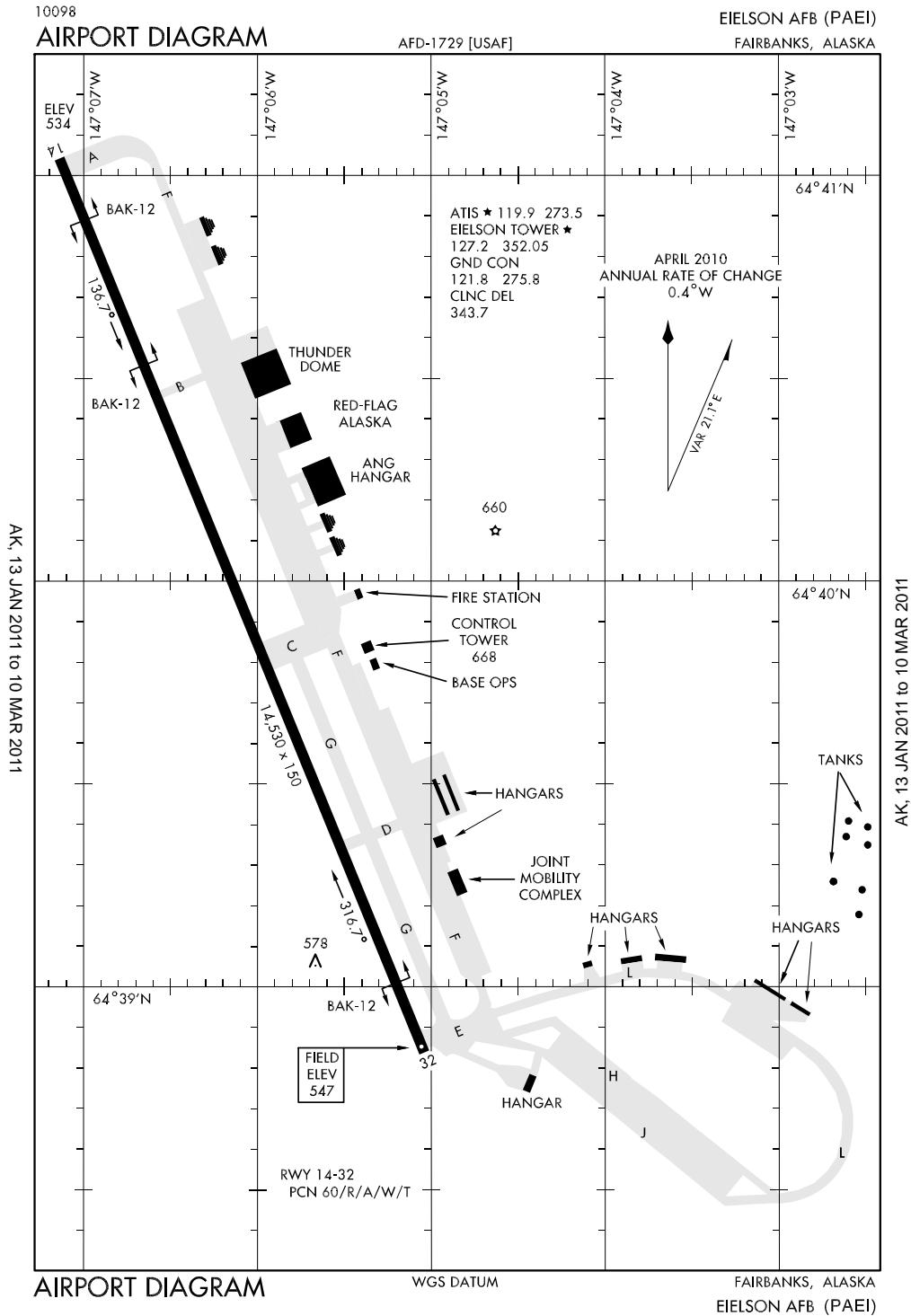

Fairbanks, AK
Eielson AFB
ICAO Identifier PAEI

147-05-00.00W
2.12.6 Threshold elevation: 547 ft
2.12.6 Touchdown zone elevation: 536 ft

AD 2.2 Aerodrome geographical and administrative data

2.2.1 Reference Point: 64-39-56.40N / 147-06-00.00W
2.2.2 From City: 17 Miles SE Of Fairbanks, AK
2.2.3 Elevation: 547 ft
2.2.5 Magnetic variation: 23E (2005)
2.2.6 Airport Contact: Chief Airfield Management
343 CSG/OTM
Eielson AFB, AK 99702
(907-377-3201)
2.2.7 Traffic: IFR/VFR

AD 2.3 Operational hours

2.3.1 - 2.3.11: ALL Months, ALL Days,
1600-0800Z++ Hours

AD 2.4 Handling services and facilities

2.4.1 Cargo handling facilities: No
2.4.2 Fuel types: None
2.4.4 De-icing facilities: None
2.4.5 Hangar space: Yes
2.4.6 Repair facilities: None

AD 2.6 Rescue and firefighting services

2.6.1 Aerodrome category for firefighting: None

AD 2.10 Aerodrome obstacles

2.10.1.a. Runway designation: 32
2.10.1.b Type of obstacle: Trees. Not Lighted or Marked

AD 2.12 Runway physical characteristics

2.12.1 Designation: 14
2.12.2 True Bearing: 159
2.12.3 Dimensions: 14530 ft x 150 ft
2.12.4 PCN: 60 R/A/W/T
2.12.5 Coordinates: 64-41-00.00N / 147-07-00.00W
2.12.6 Threshold elevation: 534 ft
2.12.6 Touchdown zone elevation: 547 ft

2.12.1 Designation: 32
2.12.2 True Bearing: 339
2.12.3 Dimensions: 14530 ft x 150 ft
2.12.4 PCN: 60 R/A/W/T
2.12.5 Coordinates: 64-38-49.49N /

AD 2.14 Approach and runway lighting

2.14.1 Designation: 14
2.14.4 Visual approach slope indicator system:
4-light PAPI on left
2.14.10 Remarks: Non Standard 2 Parallel Row
Approach Lights-Af Type E.

2.14.1 Designation: 32
2.14.2 Approach lighting system: ALSAF: 3000
feet high intensity approach lighting system with
centerline sequence flashers
2.14.4 Visual approach slope indicator system:
4-light PAPI on left

AD 2.18 Air traffic services communication facilities

2.18.1 Service designation: RDR SFA
2.18.3 Service designation: 118.6 MHz

2.18.1 Service designation: GND/P
2.18.3 Service designation: 121.8 MHz

2.18.1 Service designation: SUAIS RADIO
2.18.3 Service designation: 125.3 MHz

2.18.1 Service designation: LCL/P
2.18.3 Service designation: 127.2 MHz

2.18.1 Service designation: RDR SFA
2.18.3 Service designation: 259.1 MHz

2.18.1 Service designation: ATIS
2.18.3 Service designation: 273.5 MHz
2.18.4 Hours of operation: 1600-0800Z++

2.18.1 Service designation: GND/P
2.18.3 Service designation: 275.8 MHz

2.18.1 Service designation: RDR SFA
2.18.3 Service designation: 318.2 MHz

2.18.1 Service designation: RDR SFA
2.18.3 Service designation: 320.1 MHz

2.18.1 Service designation: RDR SFA
2.18.3 Service designation: 324.3 MHz

2.18.1 Service designation: CD
2.18.3 Service designation: 343.7 MHz

2.18.1 Service designation: PMSV
2.18.3 Service designation: 346.6 MHz

2.18.1 Service designation: PTD
2.18.3 Service designation: 372.2 MHz

2.18.1 Service designation: LCL/P
2.18.3 Service designation: 352.05 MHz

2.18.1 Service designation: PTD
2.18.3 Service designation: 139.3 MHz

2.18.1 Service designation: WING OPS
2.18.3 Service designation: 259.5 MHz

2.18.1 Service designation: SOURDOUGH
2.18.3 Service designation: 139.6 MHz

2.18.1 Service designation: CP (HAVE QUICK)
2.18.3 Service designation: 289.4 MHz

2.18.1 Service designation: 168 ANG OPS
2.18.3 Service designation: 238.3 MHz

2.18.1 Service designation: 168 ANG OPS
2.18.3 Service designation: 293.6 MHz

2.18.1 Service designation: ATIS
2.18.3 Service designation: 119.9 MHz
2.18.4 Hours of operation: 1600-0800Z++

2.18.1 Service designation: SOURDOUGH
2.18.3 Service designation: 359.15 MHz

AD 2.19 Radio navigation and landing aids

2.19.1 ILS type: Localizer for runway 32. Magnetic variation: 27E
2.19.2 ILS identification: EAF
2.19.5 Coordinates: 64-41-22.49N / 147-07-21.65W
2.19.6 Site elevation: 99999 ft

2.19.1 ILS type: Glide Slope for runway 32. Magnetic variation: 27E
2.19.2 ILS identification: EAF
2.19.5 Coordinates: 64-38-56.49N / 147-05-22.63W
2.19.6 Site elevation: 99999 ft

2.19.1 ILS type: Middle Marker for runway 32. Magnetic variation: 27E
2.19.2 ILS identification: EAF
2.19.5 Coordinates: 64-38-10.49N / 147-04-32.62W
2.19.6 Site elevation: 99999 ft

2.19.1 ILS type: Glide Slope for runway 14. Magnetic variation: 27E
2.19.2 ILS identification: EIL
2.19.5 Coordinates: 64-40-51.59N / 147-07-00.00W
2.19.6 Site elevation: 532 ft

2.19.1 ILS type: Localizer for runway 14. Magnetic variation: 27E
2.19.2 ILS identification: EIL
2.19.5 Coordinates: 64-38-33.05N / 147-04-51.27W
2.19.6 Site elevation: 548 ft

General Remarks:

TRANSMIT ALERT SERVICE AVAILABLE 0700-0000 MON-FRI EXCEPT HOLIDAY; OTHER TIMES PRIOR PERMISSION REQUIRED THROUGH BASE OPERATIONS OFFICE.

CRYPTO MATERIALS NOT AVAILABLE TRANSIENT CREW. ALL AIRCRAFT WITH VIP CONTACT BASE OPERATIONS 20-30 MINUTES PRIOR TO ESTIMATED TIME OF ARRIVAL WITH FIRM CHOCK TIME.

OVERHEAD TRAFFIC PATTERN ALTITUDE 2000 FT MSL; RECTANGULAR TRAFFIC PATTERN ALTITUDE 1500 FT MSL.

AVOID SMALL ARMS RANGE LOCATED 2.5 NAUTICAL MILE E OF APPROACH END RUNWAY 32. SMALL ARM RANGE ACTIVE WEEKEND 1700-0100Z++, SURFACE TO 3000 FT MSL.

CARGO & PASSENGER CARRYING AIRCRAFT CALL COMMAND POST 3 HRS PRIOR TO LANDING AND 30 MIN PRIOR TO LANDING AND STATE NUMBER OF PASSENGERS.

BASH PHASE II MONTHS ARE APR, MAY, AUG AND SEPT. DURING PERIODS OF STANDING WATER ON THE AIRFIELD, GULLS, DUCKS, GEESE AND OTHER BIRDS POSE A SIGNIFICANT HAZARD TO AIRCRAFT. REPORT ALL BIRD AND ANIMAL STRIKES ON & IN THE VICINITY OF EILSON TO AIRFIELD MANAGEMENT, DSN 317-377-1861, PILOT TO DISPATCH OR 354FE/SE DSN 317-377

BASE OPERATIONS DSN 317-377-1861/3201; TO AVOID DELAY FILE FLIGHT PLAN AT LEAST 2 HRS PRIOR TO ESTIMATED TIME OF DEPARTURE. ARRIVALS REQUIRING CUSTOMS MUST NOTIFY BASE OPERATIONS 1.5 HRS PRIOR TO LANDING; US IMMIGRATION SERVICE NOT AVAILABLE.

DEP AIRCRAFT REMAIN AT OR BELOW 1500 FT UNTIL DEP END OF RUNWAY.

ALL PACAF FIGHTER AIRCRAFT ON ARR EXPECT REDUCED RUNWAY SEPARATION; SIMILAR FIGHTER TYPE/DAY - 3000 FT; DISSIMILAR FIGHTER TYPE AND/OR NIGHT WET RUNWAY OR RUNWAY CONDITION READING REPORT LESS THAN 17 - 6000 FT; BEHIND FORMATION LANDING - 6000 FT; FIGHTER TYPE LANDING BEHIND NON-FTR TYPE - 9000 FT; RUNWAY CONDITION READING VALIDATED AS CONDITIONS WARRANT.

FLIGHTS ORIGINATING OUTSIDE OF THE STATE REFER TO ALASKA SECTION OF US AIR FORCE - FOREIGN CLEARANCE GUIDE.

LIMITED FLEET SERVICE AVAILABLE; NO POTABLE WATER. TRANSMIT BILLETING EXTREMELY LIMITED/EXTENSIVE FUEL DELAYS DURING RED FLAG ALASKA EXERCISE (APR-OCT).

ARCTIC GEAR IS STRONGLY ENCOURAGED DUE TO POSSIBLE EXTREME COLD TEMPERATURES 1 OCT - 31 AT SEA; LIMITED SUPPLIES ON HAND.

QUIET HRS 0800-1600Z++ EXCEPT REQUIRE OG/CC APPROVAL.

AIR TERMINAL AND GROUND HANDLING SERVICE OPRS 1630-0030Z++ WEEKDAYS. AIRCRAFT REQUIRING TERMINAL AND GROUND HANDLING SERVICE ARE REQUIRED TO PROVIDE ADVANCE NOTICE OR DELAYS IN SERVICE MAY BE EXPERIENCED. AIRCRAFT REQUIRING SERVICE SHOULD MAKE PRIOR COORDINATION WITH BASE OPERATIONS.

ALASKA ANG 168TH AREFS OPERATIONS DSN 317-377-8800.C 907-377-8800) ANG OPR 24 HRS.

FOR FLIGHT ADVISORIES OR STATUS OF RESTRICTED & MOAS CONTACT EIELSON RANGE CONTROL ON SAUIS RADIO 125.3 OR CALL 1-800-758-8723.

TAXIING PROHIBITED ON TAXIWAY 'F' FROM TAXIWAY 'C' TO TAXIWAY 'D' FOR AIRCRAFT WITH WINGSPAN GREATER THAN 133 FT WHEN ANY AIRCRAFT IS PARKED ON 'L' ROW.

RUNWAY 14 & 32 PAPI GS NOT COINCIDENTAL WITH ILS GS.

AIRPORT REMARKS: PRIOR PERMISSION REQUIRED NUMBER REQUIRED 24 HRS IN ADVANCE PRIOR TO FILING FLIGHT PLAN; CONTACT DSN 317-377-1861 C907-377-1861.

EXPECT ARRIVAL TIME RESTRICTION FOR ALL AIRCRAFT, EXCEPT AIREVAC & DV CODE 7 OR HIGHER

DURING BIRD WATCH CONDITION MODERATE LOCAL PATTERN WORK LIMITED TO MIN REQUIRE WITH/OG/CC APPROVAL, NO TOUCH AND GO LANDING, FORMATION TAKE-OFF, LANDING PROHIBITED AND LOW APPROACH LIMITED TO 300 FT AGL. DURING BIRD WATCH CONDITION SEVERE; TAKE-OFF, PATTERN, AND LANDING PROHIBITED WITHOUT OG/CC APPROVAL, EXCEPT FOR EMERGENCY.

MOOSE HAVE BEEN SPOTTED ON OR NEAR THE RUNWAY ENVIRONMENT ALL HRS OF THE DAY.

N & S BARRIER RUNOUT REDUCED TO 950 FT.

ALL TRANSIENT AIRCREWS MUST REGISTER WITH BASE OPERATIONS UPON ARRIVAL. SEE AP1 SUPPLEMENTARY AIRPORT REMARKS.

LIMITED SECRET AND COMSEC STORAGE AVAILABLE AT BASE OPERATIONS. BASE OPERATIONS DOES NOT HAVE COMSEC RESPONSIBILITIES. FOR TOP SECRET AND COMSEC ISSUE/STORAGE CONTACT COMMAND POST DSN 317-377-1500.

PORTIONS OF APRON 'O' ROW AND SOUTH RAMP NOT VISIBLE FROM TOWER.

ALL CONTINGENCY OPER CONTACT AIRPORT MANAGER FOR COORDINATION.

TRANSIENT ALERT: TRANSIENT MAINT LIMITED TO F16 SERVICING UPON AIRCREW REQ. THRU FLIGHT/BPO/PREFLIGHT INSPECTION OF F16 NOT AVAILABLE. PRE COORD WITH MAIN OPERATIONS CENTER DSN 317-377-1205.

AIRPORT OPR 1600-0800Z++. QUIET HRS 0700-1600Z++, EXCEPTIONS REQUIRE OPERATIONS GROUP COMMANDER APPROVAL.

RADIO/NAV/WEATHER REMARKS - (F) 1500-0700Z ++ DAILY.

ARTIC GEAR IS STRONGLY ENCOURAGED DUE TO EXTREME COLD TEMPARTURES OCT1-MAR31.

PERSONNEL AND EQUIPMENT WORKING ON RUNWAY 14-32 WHEN TOWER UNMANNED.

PRE-COORDINATE WITH MAINT OPERATIONS CENTER DSN 317-377-1205 NO LATER THAN 48 HRS FROM ESTIMATED TIME OF ARRIVAL.

AIRPORT REMARKS: PRIME KNIGHT NOT AVAILABLE.

AIRPORT REMARKS: RUNWAY 300 FT WIDE ENTIRE LENGTH, CENTER 150 FT USABLE.

FAIRBANKS FSS LOCAL CONTROL 474-0137. FOR FLIGHT ADVISORIES OR STATUS OF RESTRICTED AND MILITARY OPERATING AREAS, CONTACT EIELSON RANGE CONTROL ON SUAIS RADIO 125.3 OR TELEPHONE 1-800-758-8723. ASOS FREQ 119.275 IS ASSOCIATED WITH R-2205 YUKON TRAINING RANGE.

BASE OPERATIONS DOES NOT HAVE COMSEC RESPONSIBILITIES. BASE OPERATIONS WILL NOT ISSUE COMSEC.

ASOS FREQ 118.525 IS ASSOCIATED WITH R-2211 BLAIR LAKE TRAINING RANGE. PMSV: METRO BELOW 3000 FT RECEPTION FROM 300°-090° IS LIMITED BEYOND 15NM BY TERRAIN, BELOW 15000 FT LIMITED BEYOND 75NM, NO LIMITATIONS WITHIN 100NM AT 20000 FT.

AUGMENTATION CAPABLE DURING NORMAL OPR HR. DUR EVACUATION OF WX STATION CONTACT OP WX SQUADRON AT NUMBER ABOVE. ALTITUDE WX LOCATION VISIBILITY SEVERELY LIMITED DUE TO BUILDING AND PARK AIRCRAFT.

PHONE PATCH CAPABILITY THROUGH 354 FW/CP AT 907-377-1500. FMQ19 907-377-5846.

BRAKING ACTION ON RUNWAY SIGNIFICANTLY REDUCED DURING WET CONDITIONS. EXERCISE EXTREME CAUTION WHEN TRNS FR CONCRETE TO ASPHALT SURFACE.

AIRCRAFT USING TAXIWAY G RESTRICTED TO CENTER KEEL, E AND W TAXIWAY LINES CLOSED TO ALL AIRCRAFT MOVEMENT.

NONSTANDARD LIGHT, 2000 FT OF RUNWAY EDGE LIGHT BETWEEN DELTA-CHARLIE TAXIWAYS LOCATED 12 FT FR RUNWAY EDGE.

UNMONITORED WHEN PAEI TOWER CLOSED. FULL SERVICE AVAILABLE 1600-0800Z++, LIMITED SERVICE ON TIME. FULL SERVICE VARY WITH LOCAL FLYNG SCHEDULE. WX BRIEFING AVAILABLE DSN 317-377-3140/1160.

BRIEFING FOR TRANSMIT AIRCREWS BEYOND NORMAL OPR HRS BY WAY OF 17 OWS AT HICKAM AFB DSN 315-449-8333/7950 OR 315-448-3809; COM 808-449-8333/7950 OR 808-448-3809. AWOS IN USE.

Fairbanks, Alaska
Fairbanks International
ICAO Identifier PAFA

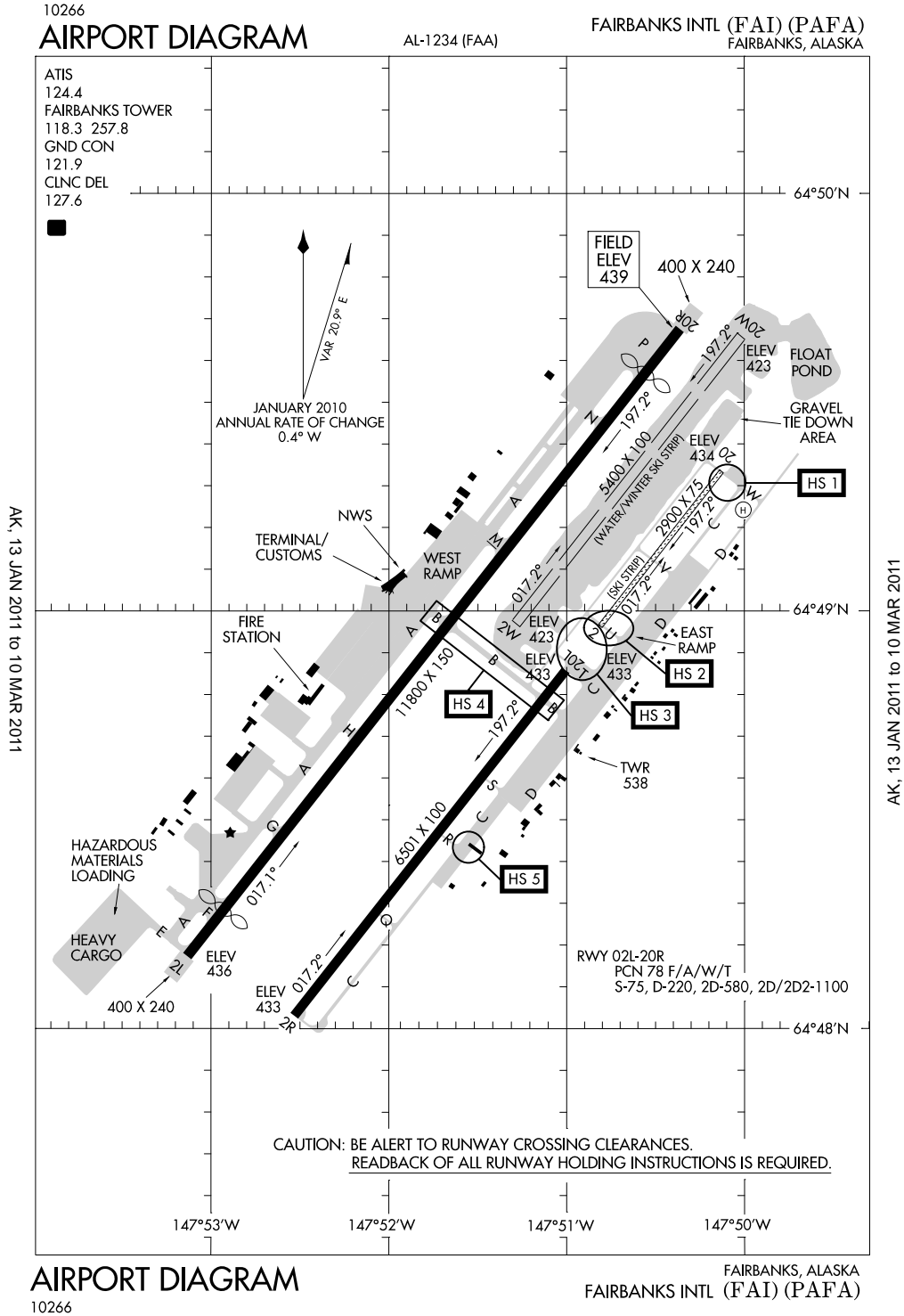

Fairbanks, AK
Fairbanks Intl
ICAO Identifier PAFA

AD 2.2 Aerodrome geographical and administrative data

- 2.2.1 Reference Point: 64-48-54.40N / 147-51-23.21W
- 2.2.2 From City: 3 Miles SW Of Fairbanks, AK
- 2.2.3 Elevation: 439 ft
- 2.2.5 Magnetic variation: 21E (2010)
- 2.2.6 Airport Contact: Jesse Vanderzanden
6450 AIRPORT WAY – SUITE 1
Fairbanks, AK 99709
(907-474-2500)
- 2.2.7 Traffic: IFR/VFR

AD 2.3 Operational hours

- 2.3.1 – 2.3.11: ALL Months, ALL Days, ALL Hours

AD 2.4 Handling services and facilities

- 2.4.1 Cargo handling facilities: No
- 2.4.2 Fuel types: 100LL,A1
- 2.4.4 De-icing facilities: None
- 2.4.5 Hangar space: Yes
- 2.4.6 Repair facilities: Major

AD 2.6 Rescue and firefighting services

- 2.6.1 Aerodrome category for firefighting: ARFF Index I C certified on 3/1/2005

AD 2.10 Aerodrome obstacles

- 2.10.1.a. Runway designation: 02L
- 2.10.1.b Type of obstacle: Tree (72 ft). Not Lighted or Marked
- 2.10.1.c Location of obstacle: 652 ft from Centerline

- 2.10.1.a. Runway designation: 20R
- 2.10.1.b Type of obstacle: Tree (86 ft). Not Lighted or Marked
- 2.10.1.c Location of obstacle: 430 ft from Centerline

- 2.10.1.a. Runway designation: 20W
- 2.10.1.b Type of obstacle: Fence (11 ft). Not Lighted or Marked
- 2.10.1.c Location of obstacle: 0 ft from Centerline

- 2.10.1.a. Runway designation: 02W

- 2.10.1.b Type of obstacle: Fence (14 ft). Not Lighted or Marked
- 2.10.1.c Location of obstacle: 170 ft from Centerline

- 2.10.1.a. Runway designation: 02R
- 2.10.1.b Type of obstacle: Trees (79 ft). Not Lighted or Marked
- 2.10.1.c Location of obstacle: 350 ft from Centerline

AD 2.12 Runway physical characteristics

- 2.12.1 Designation: 02L
- 2.12.2 True Bearing: 38
- 2.12.3 Dimensions: 11800 ft x 150 ft
- 2.12.4 PCN: 78 F/A/W/T
- 2.12.5 Coordinates: 64-48-00.00N / 147-53-00.00W
- 2.12.6 Threshold elevation: 436 ft
- 2.12.6 Touchdown zone elevation: 438 ft

- 2.12.1 Designation: 20R
- 2.12.2 True Bearing: 218
- 2.12.3 Dimensions: 11800 ft x 150 ft
- 2.12.4 PCN: 78 F/A/W/T
- 2.12.5 Coordinates: 64-49-40.91N / 147-50-21.13W
- 2.12.6 Threshold elevation: 439 ft
- 2.12.6 Touchdown zone elevation: 439 ft

- 2.12.1 Designation: 02W
- 2.12.2 True Bearing: 38
- 2.12.3 Dimensions: 5400 ft x 100 ft
- 2.12.5 Coordinates: 64-48-58.00N / 147-51-16.59W
- 2.12.6 Threshold elevation: 423 ft

- 2.12.1 Designation: 20W
- 2.12.2 True Bearing: 218
- 2.12.3 Dimensions: 5400 ft x 100 ft
- 2.12.5 Coordinates: 64-49-39.83N / 147-49-59.62W
- 2.12.6 Threshold elevation: 423 ft

- 2.12.1 Designation: 02R
- 2.12.2 True Bearing: 38
- 2.12.3 Dimensions: 6501 ft x 100 ft
- 2.12.5 Coordinates: 64-48-00.00N / 147-52-32.24W
- 2.12.6 Threshold elevation: 433 ft
- 2.12.6 Touchdown zone elevation: 433 ft

2.12.1 Designation: 20L
2.12.2 True Bearing: 218
2.12.3 Dimensions: 6501 ft x 100 ft
2.12.5 Coordinates: 64-48-51.24N /
147-50-59.67W
2.12.6 Threshold elevation: 433 ft
2.12.6 Touchdown zone elevation: 434 ft

2.12.1 Designation: 02
2.12.2 True Bearing: 38
2.12.3 Dimensions: 2900 ft x 75 ft
2.12.5 Coordinates: 64-48-57.80N /
147-50-47.60W
2.12.6 Threshold elevation: 433 ft

2.12.1 Designation: 20
2.12.2 True Bearing: 218
2.12.3 Dimensions: 2900 ft x 75 ft
2.12.5 Coordinates: 64-49-20.26N /
147-50-00.00W
2.12.6 Threshold elevation: 434 ft

AD 2.13 Declared distances

2.13.1 Designation: 02L
2.13.2 Takeoff run available: 11800
2.13.3 Takeoff distance available: 12800
2.13.4 Accelerate-stop distance available: 11800
2.13.5 Landing distance available: 11050

2.13.1 Designation: 20R
2.13.2 Takeoff run available: 11800
2.13.3 Takeoff distance available: 12800
2.13.4 Accelerate-stop distance available: 11800
2.13.5 Landing distance available: 11050

AD 2.14 Approach and runway lighting

2.14.1 Designation: 02L
2.14.2 Approach lighting system: ALSF2: Standard
2400 feet high intensity approach lighting system
with sequenced flashers, category II or III
configuration
2.14.4 Visual approach slope indicator system:
4-light PAPI on left

2.14.1 Designation: 20R
2.14.2 Approach lighting system: MALSR: 1400
feet medium intensity approach lighting system
with runway alignment indicator lights
2.14.4 Visual approach slope indicator system:
4-light PAPI on left

2.14.1 Designation: 02R
2.14.4 Visual approach slope indicator system:
4-light PAPI on left

2.14.1 Designation: 20L
2.14.4 Visual approach slope indicator system:
4-light PAPI on left

AD 2.18 Air traffic services communication facilities

2.18.1 Service designation: LCL/P
2.18.3 Service designation: 118.3 MHz

2.18.1 Service designation: APCH/S
2.18.3 Service designation: 118.6 MHz

2.18.1 Service designation: EMERG
2.18.3 Service designation: 121.5 MHz

2.18.1 Service designation: GND/P
2.18.3 Service designation: 121.9 MHz

2.18.1 Service designation: ATIS(907-456-1244)
2.18.3 Service designation: 124.4 MHz
2.18.4 Hours of operation: 24

2.18.1 Service designation: APCH/P DEP/P TRSA
IC
2.18.3 Service designation: 125.35 MHz

2.18.1 Service designation: APCH/P DEP/P TRSA
2.18.3 Service designation: 126.5 MHz

2.18.1 Service designation: CD/P
2.18.3 Service designation: 127.6 MHz

2.18.1 Service designation: EMERG
2.18.3 Service designation: 243 MHz

2.18.1 Service designation: LCL/P
2.18.3 Service designation: 257.8 MHz

2.18.1 Service designation: DEP/S
2.18.3 Service designation: 327.1 MHz

2.18.1 Service designation: APCH/P DEP/P TRSA
IC
2.18.3 Service designation: 363.2 MHz

2.18.1 Service designation: APCH/P DEP/P TRSA
2.18.3 Service designation: 381.4 MHz

AD 2.19 Radio navigation and landing aids

2.19.1 ILS type: Localizer for runway 02L.

Magnetic variation: 21E

2.19.2 ILS identification: CNA

2.19.5 Coordinates: 64-49-42.85N /
147-50-17.60W

2.19.6 Site elevation: 431 ft

2.19.1 ILS type: Inner Marker for runway 02L.

Magnetic variation: 21E

2.19.2 ILS identification: CNA

2.19.5 Coordinates: 64-48-00.00N /
147-53-12.50W

2.19.6 Site elevation: 531 ft

2.19.1 ILS type: Glide Slope for runway 02L.

Magnetic variation: 21E

2.19.2 ILS identification: CNA

2.19.5 Coordinates: 64-48-21.01N /
147-52-36.34W

2.19.6 Site elevation: 427 ft

2.19.1 ILS type: Middle Marker for runway 02L.

Magnetic variation: 21E

2.19.2 ILS identification: CNA

2.19.5 Coordinates: 64-47-53.40N /
147-53-39.80W

2.19.6 Site elevation: 99999 ft

2.19.1 ILS type: DME for runway 02L. Magnetic
variation: 21E

2.19.2 ILS identification: CNA

2.19.5 Coordinates: 64-48-21.34N /

147-52-35.90W

2.19.6 Site elevation: 449 ft

2.19.1 ILS type: Middle Marker for runway 20R.

Magnetic variation: 21E

2.19.2 ILS identification: FAI

2.19.5 Coordinates: 64-49-56.80N /
147-49-51.90W

2.19.6 Site elevation: 99999 ft

2.19.1 ILS type: Outer Marker for runway 20R.

Magnetic variation: 21E

2.19.2 ILS identification: FAI

2.19.5 Coordinates: 64-53-59.35N /
147-42-25.75W

2.19.6 Site elevation: 99999 ft

2.19.1 ILS type: Localizer for runway 20R.

Magnetic variation: 21E

2.19.2 ILS identification: FAI

2.19.5 Coordinates: 64-48-00.00N /
147-53-00.00W

2.19.6 Site elevation: 432 ft

2.19.1 ILS type: Glide Slope for runway 20R.

Magnetic variation: 21E

2.19.2 ILS identification: FAI

2.19.5 Coordinates: 64-49-24.41N /
147-50-39.79W

2.19.6 Site elevation: 430 ft

General Remarks:

MIGRATORY BIRDS IN THE VICINITY OF AIRPORT DURING SPRING THRU FALL.

ATCT LOCATED AT 64-48-39.438N 147-50-55.722W ELEVATION 538' MSL.

SEAPLANE BASE CONTROLLED BY FAIRBANKS INTL ATCT. CONTACT ATCT ON FREQ 118.3 AS SOON AS PRACTICAL AFTER START UP FOR TAXI ON THE POND. FLOAT POND TRAFFIC AS ASSIGNED BY FAIRBANKS ATCT. LIMITED TRANSIENT FLOAT PLANE PARKING AVAILABLE, CONTACT OPERATIONS 907-474-2530 FOR INFORMATION. SURFACE FROZEN IN WINTER, NOT MONT, AIR OPERATIONS NOT RECOMMENDED.

BE ALERT FOR SNOW REMOVAL EQUIPMENT OPERATIONS FROM 1 OCT TO 15 MAY.

MILITARY CONTRACT FUEL AVAILABLE.

BE ALERT: BLASTING AT 1500 MON-FRI 1 NAUTICAL MILE RADIUS OF 65 03N 147 37W OF TRUE NORTH MINE (2 NAUTICAL MILE NW OF PEDRO DOME) 1500 FT & BELOW.

FOR FLIGHTS IN MOA'S EAST OF FAIRBANKS RECOMMEND CONTACTING EIELSON RANGR CONTROL ON 125.3 OR CALL 1-800-758-8723 FOR INFORMATION ON MILITARY ACTIVITES.

NOISE ABATEMENT PROCEDURES IN EFECT FROM 2200-0800 ALL LARGE AIRCRAFT, TURBINE ENGINE, AND HEAVY AIRCRAFT UTILIZE RUNWAY 01L FOR ARRS AND 19R FOR DEPS WHEN WIND IS NOT AN OPERATIOINAL FACTOR.

RUNWAY 02R/20L CLOSED TO JET AIRCRAFT.

TRANSIENT PARKING EAST RAMP FOR NON JET AIRCRAFT WITH WINGSPAN LESS THAN 79 FT. NO TRANSIENT AIRCRAFT PARKING ON WEST RAMP, CONTACT APT OPERATIONS 907-474-2530 FOR INFORMATION & MEDIVAC PARKING. HELICOPTER ARRIVALS & DEPS FR NEW COMPASS ROSE OPER TO/FR EAST.

RUNWAYS 02W & 20W TOUCHDOWN REFERENCE MARKERS 500 FT FROM SHORELINE, MARKED WITH BUOYS DURING FLOAT SEASON.

TEMPORARY HELIPAD LOCATED ON EAST RAMP, SOUTH OF TAXIWAY W IN GRASSY AREA MARKED WITH ORANGE CONES. (MAY 1 THRU OCT 1)

FOR AVAILABILITY OF SUMMER GRAVEL STRIP RUNWAY 02/20 AND WINTER SKI STRIP RUNWAY 02/20 CONSULT LOCAL NOTAMS AND CONTACT TOWER PRIOR TO ARRIVAL /DEPARTURE.

N/S TAXIWAY (TWY A) IS WEST AND PARALLEL TO RUNWAY 02L/20R. BE ALERT TO AVOID LANDING ON TAXIWAY.

NO STEP TAXI EXCEPT IN CHANNEL.

NE COMPASS ROSE CLOSED TO HELICOPTERS OVER 12,500 LBS. FROST HEAVES SOUTH 2600 FT RUNWAY 02R/20L CONTACT AIRPORT OPERS 907-474-2530 WITH SAFETY CONCERNS. CONSULT NOTAMS FOR NW COMPASS ROSE AVAILABILITY. HELICOPTER ARRIVALS AND DEPARTURES FROM NW COMPASS ROSE OPR TO/FROM EAST.

RUNWAY 02/20 SKI STRIP HOLD LINES AND NE COMPASS ROSE MARKINGS OBSCURE FALL-SPRING.

Juneau, Alaska
Juneau International
ICAO Identifier PAJN

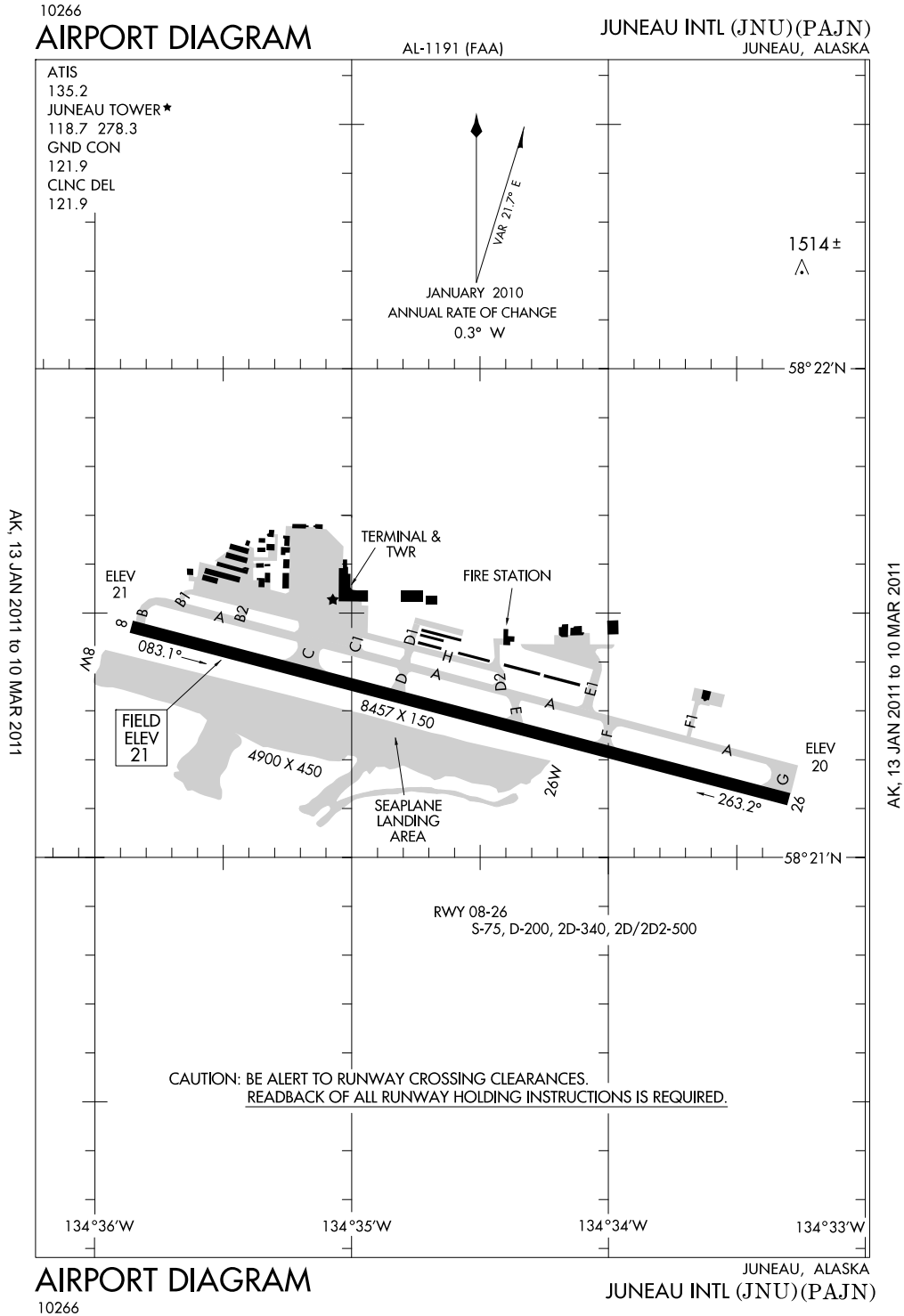

Juneau, AK
Juneau Intl
ICAO Identifier PAJN

AD 2.2 Aerodrome geographical and administrative data

- 2.2.1 Reference Point: 58-21-17.90N / 134-34-34.60W
- 2.2.2 From City: 7 Miles NW Of Juneau, AK
- 2.2.3 Elevation: 21 ft
- 2.2.5 Magnetic variation: 23E (2005)
- 2.2.6 Airport Contact: Jeannie Johnson
1873 SHELL SIMMONS DR, SUITE 201
Juneau, AK 99801 (907-789-7821)
- 2.2.7 Traffic: IFR/VFR

AD 2.3 Operational hours

- 2.3.1 - 2.3.11: ALL Months, ALL Days, ALL Hours

AD 2.4 Handling services and facilities

- 2.4.1 Cargo handling facilities: No
- 2.4.2 Fuel types: 100LL,80,A1+
- 2.4.4 De-icing facilities: None
- 2.4.5 Hangar space: Yes
- 2.4.6 Repair facilities: Major
- 2.4.7 Remarks: Airframe/Power Plant Service For Single/Twin Prop Eng Aircraft Turbin & Avionics.

AD 2.6 Rescue and firefighting services

- 2.6.1 Aerodrome category for firefighting: ARFF Index I B certified on 5/1/1973

AD 2.10 Aerodrome obstacles

- 2.10.1.a. Runway designation: 08
- 2.10.1.b Type of obstacle: Tower (573 ft). Marked and Lighted
- 2.10.1.c Location of obstacle: 900 ft from Centerline

AD 2.12 Runway physical characteristics

- 2.12.1 Designation: 08
- 2.12.2 True Bearing: 105
- 2.12.3 Dimensions: 8457 ft x 150 ft
- 2.12.5 Coordinates: 58-21-28.55N / 134-35-51.21W
- 2.12.6 Threshold elevation: 21 ft
- 2.12.6 Touchdown zone elevation: 21 ft

- 2.12.1 Designation: 26
- 2.12.2 True Bearing: 285

- 2.12.3 Dimensions: 8457 ft x 150 ft
- 2.12.5 Coordinates: 58-21-00.00N / 134-33-18.00W
- 2.12.6 Threshold elevation: 20 ft
- 2.12.6 Touchdown zone elevation: 20 ft

- 2.12.1 Designation: 08W
- 2.12.3 Dimensions: 4900 ft x 450 ft

- 2.12.1 Designation: 26W
- 2.12.3 Dimensions: 4900 ft x 450 ft

AD 2.14 Approach and runway lighting

- 2.14.1 Designation: 08
- 2.14.2 Approach lighting system: MALSR: 1400 feet medium intensity approach lighting system with runway alignment indicator lights
- 2.14.4 Visual approach slope indicator system: 4-box VASI on left
- 2.14.10 Remarks: VASI Aligned Aprxly 13 Degs Right Of Runway Centerline And Is Not Visible On Runway Cntrl. VASI Unusable Beyond 06 Degs Left Of Crs. Ldin Lights.

- 2.14.1 Designation: 26
- 2.14.4 Visual approach slope indicator system: 4-box VASI on right
- 2.14.10 Remarks: VASI Usable Only Within 2 Nm.

AD 2.18 Air traffic services communication facilities

- 2.18.1 Service designation: LCL/P
- 2.18.3 Service designation: 118.7 MHz

- 2.18.1 Service designation: CD
- 2.18.3 Service designation: 121.9 MHz

- 2.18.1 Service designation: GND/P
- 2.18.3 Service designation: 121.9 MHz

- 2.18.1 Service designation: NG OPS
- 2.18.3 Service designation: 124.65 MHz

- 2.18.1 Service designation: ATIS
- 2.18.3 Service designation: 135.2 MHz
- 2.18.4 Hours of operation: 24

- 2.18.1 Service designation: LCL/P
- 2.18.3 Service designation: 278.3 MHz

- 2.18.1 Service designation: NG OPS

2.18.3 Service designation: 64.7 MHz

134-38-10.36W

2.19.6 Site elevation: 161 ft

2.18.1 Service designation: SEASONAL USE ONLY.

2.19.1 ILS type: DME for runway 08. Magnetic variation: 23E

2.18.3 Service designation: 120.7 MHz

2.19.2 ILS identification: JDL

AD 2.19 Radio navigation and landing aids

2.19.5 Coordinates: 58-21-31.02N / 134-38-10.22W

2.19.1 ILS type: Localizer for runway 08. Magnetic variation: 23E

2.19.6 Site elevation: 175 ft

2.19.2 ILS identification: JDL

2.19.5 Coordinates: 58-21-32.04N /

General Remarks:

NATIONAL GUARD 24 HR PRIOR PERMISSION REQUIRED DUE TO LIMITED PARKING C907-789-3366. 0730-1600 WEEKDAYS CONTACT GUARD OPERATIONS 10 MIN PRIOR TO LANDING ON 124.65.

WILDLIFE & BIRDS ON & IN THE VICINITY OF AIRPORT.

BATTLESHIP ISLAND LDIN GROUPING; CENTER LIGHT 582132.88N 1344012.22W.
IJDL-LOCALIZER LDIN GROUPING; CENTER LIGHT 582132.02N 1343810.39W.

INCREASED HELICOPTER/LIGHT AIRCRAFT ACTIVITY APR 15-OCT 1 ENTIRE LENGTH ON GASTINEAU CHANNEL & WITHIN 5 MILES OF AIRPORT.

PARAGLIDING ACTIVITY 3 MILES N OF AIRPORT IN THE VICINITY OF THUNDER MOUNTAIN & OVER GASTINEAU CHANNEL NEARS DOWNTOWN APR 15-OCT 1 6000 FT & BELOW.

TRAFFIC PATTERN ALTITUDE 1500 AGL FOR LARGE TURBINE AIRCRAFT; 1000 FT AGL FOR FIXED WING AIRCRAFT; 500 FT AGL FOR HELICOPTERS.

FOR A LOCAL CALL TO JNU AUTOMATED FLIGHT SERVICE STATION CALL 907-789-7380.

TRANSIENT DOCK AVAILABLE FOR PUBLIC USE FOR UP TO SIX AIRCRAFT, SW CORNER.

SEE SPECIAL NOTICES AND GENERAL NOTICES FOR ADDITIONAL INFORMATION ON OPERATIONS IN JUNEAU AREA.

LENA POINT, PEDERSON HILL AND SISTERS ISLAND WX CAMERAS AVAILABLE ON INTERNET AT [HTTP://AKWEATHERCAMS.FAA.GOV](http://AKWEATHERCAMS.FAA.GOV)

COMPASS ROSE LOCATED ON TAXIWAY G AT EAST END OF TAXIWAY A NEAR APPROACH END RUNWAY 26.

RUNWAY 08/26 SAND USED TO ENHANCE RUNWAY FRICTION MAY NOT MEET FAA SPECS.

HEAVY EQUIPMENT BETWEEN TAXIWAY E1 & TAXIWAY F1 NORTH OF TAXIWAY A 0630-1730 MON-SAT.

RUNWAY 26 PERSONNEL AND EQUIPMENT WORKING APPROACH END RUNWAY 0700-1700 MON-SAT.

RUNWAY 08/26 PERSONNEL AND EQUIPMENT WORKING ADJACENT E 3000 FT SOUTH SIDE 0700-1700 MON-SAT.

King Salmon, Alaska
King Salmon
ICAO Identifier PAKN

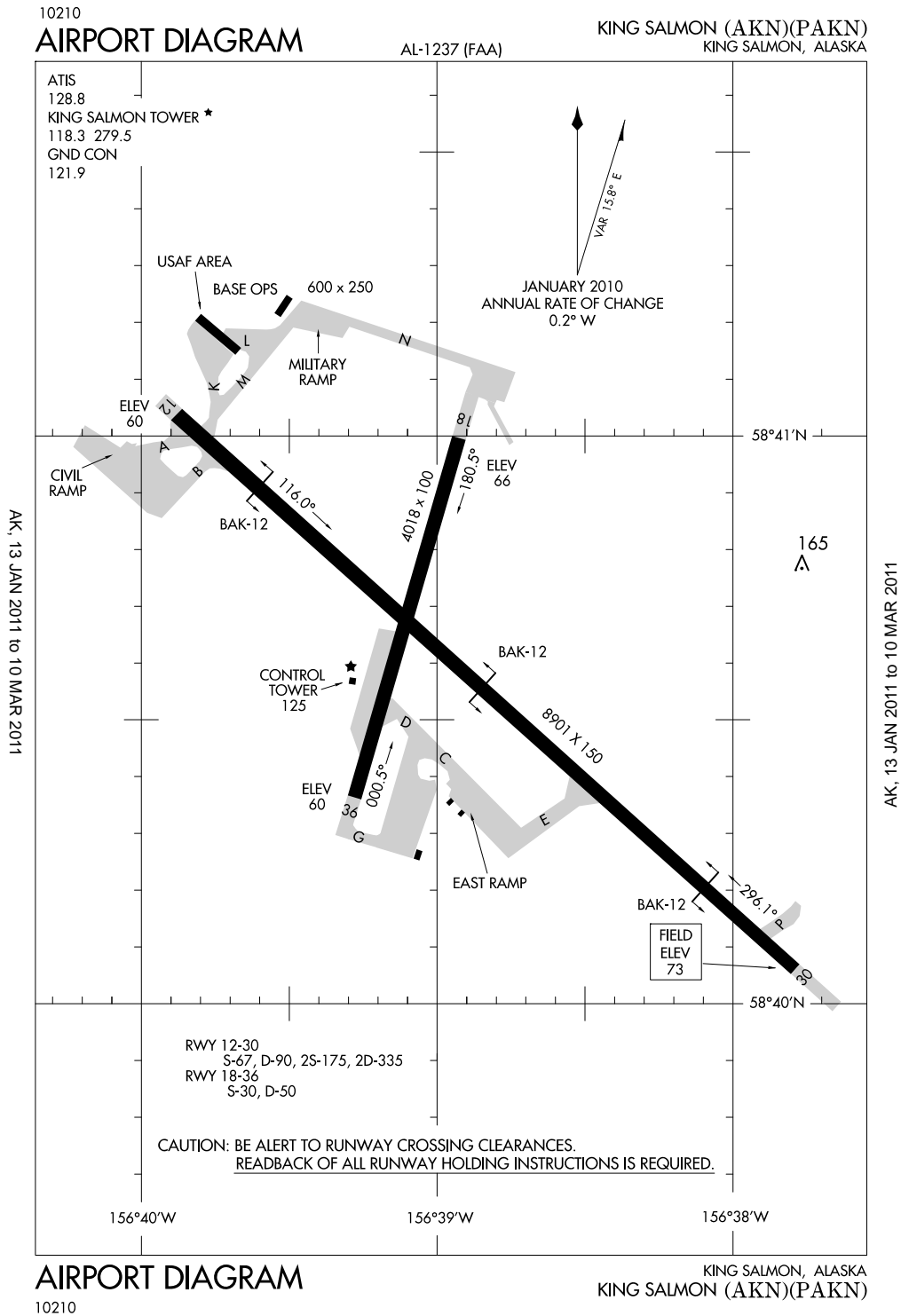

King Salmon, AK
King Salmon
ICAO Identifier PAKN

AD 2.2 Aerodrome geographical and administrative data

- 2.2.1 Reference Point: 58–40–35.38N / 156–38–55.29W
- 2.2.2 From City: 0 Miles SE Of King Salmon, AK
- 2.2.3 Elevation: 73 ft
- 2.2.5 Magnetic variation: 16E (2010)
- 2.2.6 Airport Contact: Jay Knight
PO BOX 65
King Salmon, AK 99613
(907–246–3325)
- 2.2.7 Traffic: IFR/VFR

AD 2.3 Operational hours

- 2.3.1 – 2.3.11: ALL Months, ALL Days, 0800–1600 Hours

AD 2.4 Handling services and facilities

- 2.4.1 Cargo handling facilities: No
- 2.4.2 Fuel types: 100LL,A,B
- 2.4.4 De-icing facilities: None
- 2.4.5 Hangar space: No
- 2.4.6 Repair facilities: Major
- 2.4.7 Remarks: Transient Parking Marked At North End Of General Aviation Ramp.

AD 2.6 Rescue and firefighting services

- 2.6.1 Aerodrome category for firefighting: ARFF Index I A certified on 3/21/2005
- 2.6.4 Remarks: Closed To Aircraft 0 Operations With More Than 30 Passenger Seats Except Prior Permission Required In Writing To Airport Manager PO Box 65 King Salmon Ak, 99613.

AD 2.10 Aerodrome obstacles

- 2.10.1.a. Runway designation: 18
- 2.10.1.b Type of obstacle: Trees (40 ft). Not Lighted or Marked
- 2.10.1.c Location of obstacle: 0 ft from Centerline

AD 2.12 Runway physical characteristics

- 2.12.1 Designation: 18
- 2.12.2 True Bearing: 196
- 2.12.3 Dimensions: 4018 ft x 100 ft
- 2.12.5 Coordinates: 58–40–59.78N / 156–38–55.61W
- 2.12.6 Threshold elevation: 66 ft

2.12.6 Touchdown zone elevation: 66 ft

- 2.12.1 Designation: 36
- 2.12.2 True Bearing: 16
- 2.12.3 Dimensions: 4018 ft x 100 ft
- 2.12.5 Coordinates: 58–40–21.80N / 156–39–16.96W
- 2.12.6 Threshold elevation: 60 ft
- 2.12.6 Touchdown zone elevation: 65 ft

- 2.12.1 Designation: NW
- 2.12.3 Dimensions: 4000 ft x 500 ft

- 2.12.1 Designation: SE
- 2.12.3 Dimensions: 4000 ft x 500 ft

- 2.12.1 Designation: 12
- 2.12.2 True Bearing: 132
- 2.12.3 Dimensions: 8901 ft x 150 ft
- 2.12.5 Coordinates: 58–41–00.00N / 156–39–53.02W
- 2.12.6 Threshold elevation: 60 ft
- 2.12.6 Touchdown zone elevation: 62 ft

- 2.12.1 Designation: 30
- 2.12.2 True Bearing: 312
- 2.12.3 Dimensions: 8901 ft x 150 ft
- 2.12.5 Coordinates: 58–40–00.00N / 156–37–47.63W
- 2.12.6 Threshold elevation: 73 ft
- 2.12.6 Touchdown zone elevation: 73 ft

AD 2.14 Approach and runway lighting

- 2.14.1 Designation: 12
- 2.14.2 Approach lighting system: ALSF2: Standard 2400 feet high intensity approach lighting system with sequenced flashers, category II or III configuration
- 2.14.4 Visual approach slope indicator system: 4–light PAPI on left
- 2.14.1 Designation: 30
- 2.14.4 Visual approach slope indicator system: 4–light PAPI on left

AD 2.18 Air traffic services communication facilities

- 2.18.1 Service designation: LCL/P
- 2.18.3 Service designation: 118.3 MHz
- 2.18.1 Service designation: GND/P

2.18.3 Service designation: 121.9 MHz

156-39-29.89W

2.19.6 Site elevation: 64 ft

2.18.1 Service designation: ATIS

2.18.3 Service designation: 128.8 MHz

2.18.4 Hours of operation: 24

2.19.1 ILS type: Middle Marker for runway 12.

Magnetic variation: 16E

2.19.2 ILS identification: AKN

2.18.1 Service designation: EMERG

2.19.5 Coordinates: 58-41-25.44N /

2.18.3 Service designation: 243 MHz

156-40-42.92W

2.19.6 Site elevation: 1 ft

2.18.1 Service designation: PTD

2.18.3 Service designation: 372.2 MHz

2.19.1 ILS type: Outer Marker for runway 12.

Magnetic variation: 16E

2.19.2 ILS identification: AKN

2.18.1 Service designation: LCL/P

2.18.3 Service designation: 279.5 MHz

2.19.5 Coordinates: 58-44-14.14N /

156-46-45.49W

2.19.6 Site elevation: 99999 ft

AD 2.19 Radio navigation and landing aids

2.19.1 ILS type: Localizer for runway 12. Magnetic variation: 16E

2.19.2 ILS identification: AKN

2.19.5 Coordinates: 58-39-56.55N /

156-37-32.37W

2.19.6 Site elevation: 78 ft

2.19.1 ILS type: DME for runway 12. Magnetic variation: 16E

2.19.2 ILS identification: AKN

2.19.5 Coordinates: 58-39-59.60N /

156-37-31.70W

2.19.6 Site elevation: 78 ft

2.19.1 ILS type: Glide Slope for runway 12.

Magnetic variation: 16E

2.19.2 ILS identification: AKN

2.19.5 Coordinates: 58-40-57.34N /

General Remarks:

LANDING AREA RUNWAY NW/SE ALSO USED BY BOATS.

FLOCKS OF LARGE MIGRATORY BIRDS IN VICINITY DURING SEASON.

OFF PAVEMENT OPERATIONS BY AIRCRAFT; INCLUDING HELICOPTERS; NOT AUTHORIZED AT THE AIR CARRIER APRON. NO LANDING; PARKING OR TAKE-OFFS PERMITTED FROM DIRT OR GRASS.

AIR DEFENSE ALERT FIGHTERS MAY SCRAMBLE AT ANY TIME.

ONE INCH DIP ON CENTERLINE 1850 FT FROM APPROACH END RUNWAY 36 EXTENDS TO THREE INCH DIP 25 FT WIDE ON WEST EDGE.

CIVILIAN TRANSIENT PARKING ON SE RAMP ONLY; OTHER PARKING LONGER THAN 48 HRS REQUIRES PERMIT.

ALL FIGHTER AIRCRAFT ON ARR EXPECT REDUCED SEPARATION; SIMILAR APPROACH CHARACTERISTICS AND DAY - 3000 FT; DISSIMILAR APPROACH CHARACTERISTICS AND/OR NIGHT - 6000 FT; AHEAD/BEHIND FORMATION LANDING - 6000 FT.

200 FT SAFETY AREA APPROACH END RUNWAY 12.

RUNWAY CONDITION READING UPDATED AS REQUIRED DURING 11TH AF FIGHTER FLYING WINDOW. AIRCREWS COORDINATE FOR RUNWAY CONDITION READING CHECKS WITH KING SALMON OPERATIONS AT OTHER TIMES. AIRCRAFT OPERATIONS RESTRICTED TO LOW APPROACH/FULL STOP LANDING ONLY.

FIGHTER AIRCRAFT COORDINATE DESIRED BARRIER CONFIGURATION OR ENGAGEMENT AS EARLY AS POSSIBLE. EXPECT AT LEAST 30 MIN DELAY FOR SHORT-NOTICE REQUIREMENT.

FLIGHTS ORIG OUTSIDE ALASKA REFER TO USAF FOREIGN CLEARANCE GUIDE. NO CUSTOMS AVAILABLE.

SNOW, ICE REMOVAL & AIRPORT HAZARD CONDITION PERFORMED & REPORTED DURING MAINT DUTY HRS.

USAF FACILITIES MINIMALLY OPR BY CIVIL CONTRACTORS WITH LIMITED SUPPORT CAPABILITY. TO CONFIRM OPR HRS NOT LATER THAN 24 HRS IN ADVANCE OF EXPECTED ARRIVAL.

MILITARY FIGHTERS/EMERGENCY DIVERTS CALL HARMONY BEFORE 100 NAUTICAL MILE INBOUND ON 391.2/140.1. NON-EMERG/NON-FTR AIRCRAFT CALL KING SALMON OPERATIONS; 24 HR POINT NORMALLY MONITORS COMMON TRAFFIC ADVISORY FREQUENCY DURING OPR HRS.

RUNWAY 18/36 NOT INSPECTED FOR MILITARY OPERATIONS.

AIRCRAFT RESCUE AND FIRE FIGHTING EQUIPMENT STAFFED DURING PERIODS OF AIR CARRIER ACTIVITY ONLY.

PRIVATE JETS MAY PARK ON THE SE SECTION OF E RAMP; CALL AIRPORT MANAGER AT 907-246-3325 FOR INFORMATION.

AIRPORT MAINT DUTY HRS 0800-1700.

AIRPORT SAND LARGER GRADATION THAN FAA RECOMMENDED/SEE AC150/5200-30.

EAST APRON: PAVEMENT CRUMBLING, POSSIBLE FOREIGN OBJECT DAMAGE HAZARD. JET AIRCRAFT BE ALERT DURING RUN-UP TO AVOID DAMAGE WITH JET WASH.

WX CAMERA AVAILABLE ON INTERNET AT [HTTP://AKWEATHERCAMS.FAA.GOV](http://AKWEATHERCAMS.FAA.GOV).

Pago Pago, American Samoa
Pago Pago/International
ICAO Identifier NSTU

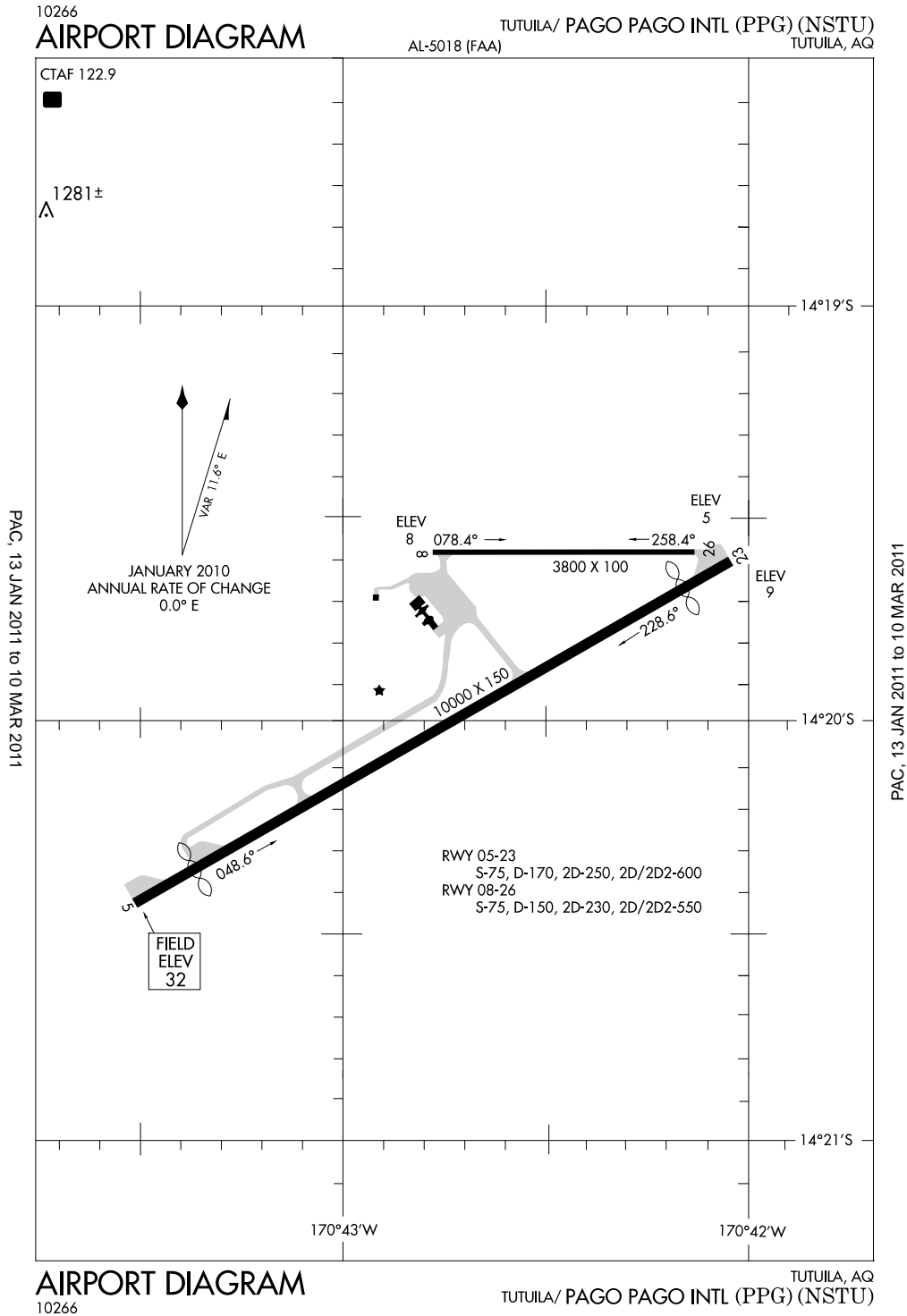

Pago Pago, AS
Pago Pago Intl
ICAO Identifier NSTU

AD 2.2 Aerodrome geographical and administrative data

- 2.2.1 Reference Point: 14-19-53.98S / 170-42-41.41W
- 2.2.2 From City: 3 Miles SW Of Pago Pago, AS
- 2.2.3 Elevation: 32 ft
- 2.2.5 Magnetic variation: 12E (1990)
- 2.2.6 Airport Contact: Tavita Fuimaono
DEPT OF PORT ADMIN, BOX 1539
Pago Pago, AS 96799 (684-733-4510)
- 2.2.7 Traffic: IFR/VFR

AD 2.3 Operational hours

- 2.3.1 - 2.3.11: ALL Months, ALL Days, ALL Hours

AD 2.4 Handling services and facilities

- 2.4.1 Cargo handling facilities: No
- 2.4.2 Fuel types: 100,A1+
- 2.4.4 De-icing facilities: None
- 2.4.5 Hangar space: No
- 2.4.6 Repair facilities: None

AD 2.6 Rescue and firefighting services

- 2.6.1 Aerodrome category for firefighting: ARFF Index I C certified on 5/1/1973

AD 2.10 Aerodrome obstacles

- 2.10.1.a. Runway designation: 05
- 2.10.1.b Type of obstacle: Hill (446 ft). Lighted
- 2.10.1.c Location of obstacle: 1000 ft from Centerline

- 2.10.1.a. Runway designation: 23
- 2.10.1.b Type of obstacle: Fence (8 ft). Lighted

AD 2.12 Runway physical characteristics

- 2.12.1 Designation: 08
- 2.12.2 True Bearing: 90
- 2.12.3 Dimensions: 3800 ft x 100 ft
- 2.12.5 Coordinates: 14-19-35.13S / 170-42-46.75W
- 2.12.6 Threshold elevation: 8 ft
- 2.12.6 Touchdown zone elevation: 6 ft

- 2.12.1 Designation: 26
- 2.12.2 True Bearing: 270

- 2.12.3 Dimensions: 3800 ft x 100 ft
- 2.12.5 Coordinates: 14-19-35.10S / 170-42-00.00W
- 2.12.6 Threshold elevation: 5 ft
- 2.12.6 Touchdown zone elevation: 6 ft

- 2.12.1 Designation: 05
- 2.12.2 True Bearing: 60
- 2.12.3 Dimensions: 10000 ft x 150 ft
- 2.12.5 Coordinates: 14-20-25.82S / 170-43-30.84W
- 2.12.6 Threshold elevation: 32 ft
- 2.12.6 Touchdown zone elevation: 30 ft

- 2.12.1 Designation: 23
- 2.12.2 True Bearing: 240
- 2.12.3 Dimensions: 10000 ft x 150 ft
- 2.12.5 Coordinates: 14-19-36.47S / 170-42-00.00W
- 2.12.6 Threshold elevation: 9 ft
- 2.12.6 Touchdown zone elevation: 9 ft

AD 2.13 Declared distances

- 2.13.1 Designation: 05
- 2.13.2 Takeoff run available: 9200
- 2.13.3 Takeoff distance available: 10200
- 2.13.4 Accelerate-stop distance available: 9200
- 2.13.5 Landing distance available: 8200

- 2.13.1 Designation: 23
- 2.13.2 Takeoff run available: 10000
- 2.13.3 Takeoff distance available: 10000
- 2.13.4 Accelerate-stop distance available: 10000
- 2.13.5 Landing distance available: 9200

AD 2.14 Approach and runway lighting

- 2.14.1 Designation: 05
- 2.14.2 Approach lighting system: MALSR: 1400 feet medium intensity approach lighting system with runway alignment indicator lights
- 2.14.4 Visual approach slope indicator system: 4-box VASI on left

- 2.14.1 Designation: 23
- 2.14.4 Visual approach slope indicator system: 4-light PAPI on left

AD 2.19 Radio navigation and landing aids

- 2.19.1 ILS type: Localizer for runway 05. Magnetic variation: 12E
- 2.19.2 ILS identification: TUT

2.19.5 Coordinates: 14-19-38.78S /
170-42-12.90W
2.19.6 Site elevation: 6 ft

2.19.1 ILS type: DME for runway 05. Magnetic
variation: 12E

2.19.2 ILS identification: TUT
2.19.5 Coordinates: 14-19-37.63S /
170-42-14.71W
2.19.6 Site elevation: 22 ft

2.19.1 ILS type: Glide Slope for runway 05.
Magnetic variation: 12E

2.19.2 ILS identification: TUT
2.19.5 Coordinates: 14-20-13.06S /
170-43-15.19W
2.19.6 Site elevation: 25 ft

2.19.1 ILS type: Middle Marker for runway 05.
Magnetic variation: 12E

2.19.2 ILS identification: TUT
2.19.5 Coordinates: 14-20-36.10S /
170-43-49.30W
2.19.6 Site elevation: 74 ft

General Remarks:

PERMANENT CABLE ACROSS MID PAGO PAGO HARBOR 4SM NNE AIRPORT, RISES ABRUPTLY TO 1609' MOUNTAIN ALAVA N SIDE OF HARBOR, EXTREMELY HAZARDOUS TO AIRCRAFT.

ALL FLIGHTS (EXCEPT SCHEDULED) PRIOR PERMISSION FROM AIRPORT MANAGER WITH 24 HRS PRIOR NOTICE.

SEA SPRAY FROM SURF & BLOW HOLES MAY DRIFT ACROSS RUNWAY 05/23 UNDER ROUGH SEA CONDITIONS.

ALL AIRCRAFT TRANSITING PAGO PAGO (EXCEPT COMMERCIAL CARRIERS) MUST MAKE FUEL ARRANGEMENTS WITH PPG AT 684-733-3158.

ALL AIRCRAFT EXCEEDING 100000 GROSS WEIGHT UPON TOUCHDOWN TAXI TO THR TURN-AROUND BEFORE TAXIING TO APRON. AIRCRAFT UNDER 100000 MAKE TURN-ARND WHERE FEASIBLE.

OLOTELE MOUNTAIN 1617 FT MSL 3.5 MILES WEST OF THRESHOLD RUNWAY 08.

PERMANENTLY LIGHTED & MARKED 226' TOWER ATOP MOUNTAIN ALAVA 4.3SM NNE AIRPORT.

PHONE NUMBER 685-42530 IS A DIRECT LINE THAT RINGS IN THE TOWER INSTEAD OF THE AIRPORT SWITCHBOARD.

PAGO PAGO IS OWNED BY THE AMERICAN SAMOA GOVERNMENT AND IS OPERATED BY THE PORT ADMINISTRATION, MATAGI R. M. MCMOORE, PORT DIRECTOR, PHONE 684-733-1119 AND PETER LEFITI, DEPUTY PORT ADMINISTRATOR, CELL PHONE 684-733-3051.

Phoenix, Arizona
Phoenix Sky Harbor International
ICAO Identifier KPHX

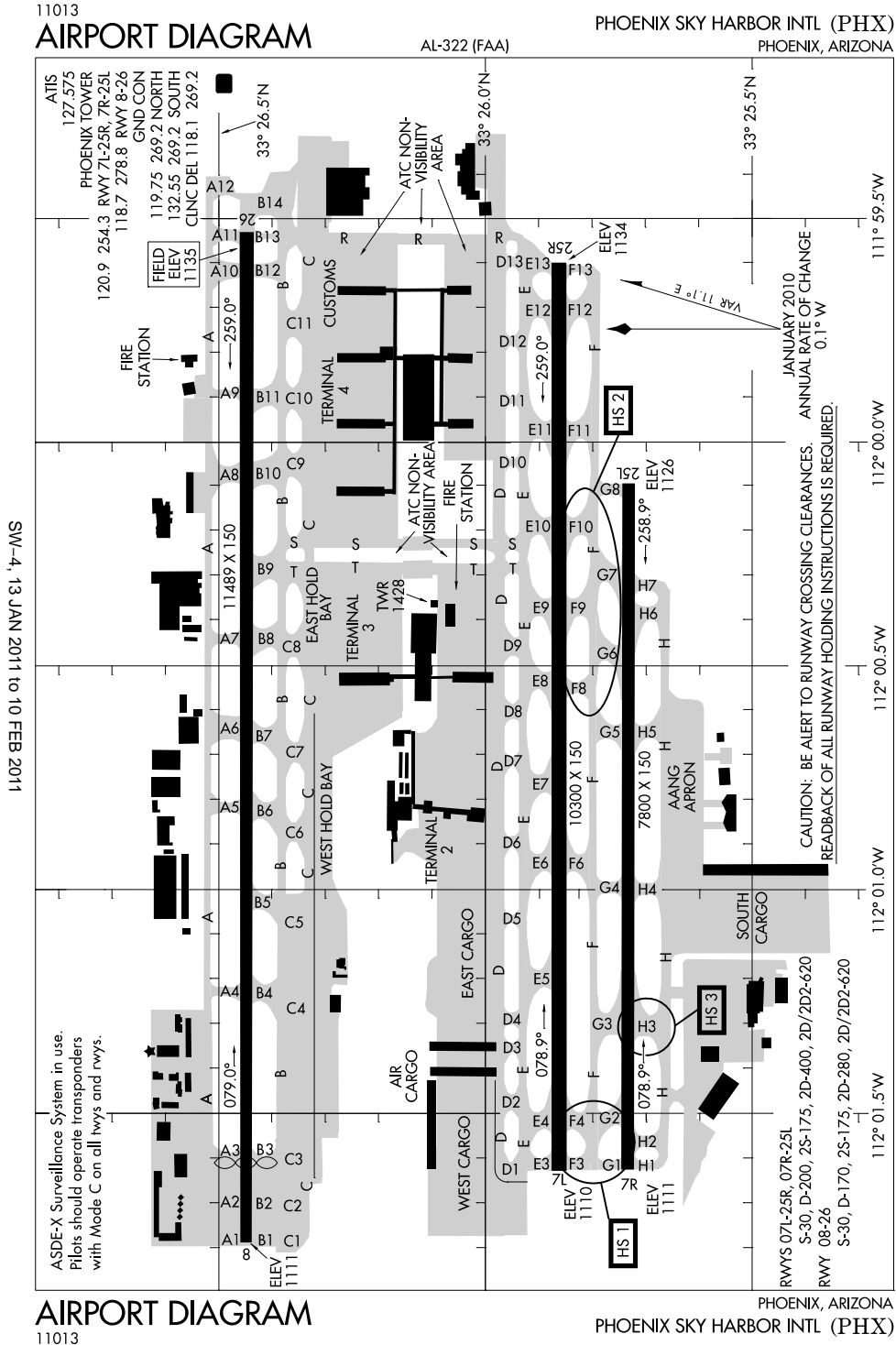

Phoenix, AZ
Phoenix Sky Harbor Intl
ICAO Identifier KPHX

AD 2.2 Aerodrome geographical and administrative data

- 2.2.1 Reference Point: 33-26-00.00N / 112-00-41.70W
- 2.2.2 From City: 3 Miles E Of Phoenix, AZ
- 2.2.3 Elevation: 1135 ft
- 2.2.5 Magnetic variation: 12E (2000)
- 2.2.6 Airport Contact: Danny Murphy
3400 SKY HARBOR BLVD, SUITE 3300
Phoenix, AZ 85034 (602-273-3300)
- 2.2.7 Traffic: IFR/VFR

AD 2.3 Operational hours

- 2.3.1 - 2.3.11: ALL Months, ALL Days, ALL Hours

AD 2.4 Handling services and facilities

- 2.4.1 Cargo handling facilities: No
- 2.4.2 Fuel types: 100LL,A
- 2.4.4 De-icing facilities: None
- 2.4.5 Hangar space: Yes
- 2.4.6 Repair facilities: Major

AD 2.6 Rescue and firefighting services

- 2.6.1 Aerodrome category for firefighting: ARFF Index I D certified on 5/1/1973

AD 2.10 Aerodrome obstacles

- 2.10.1.a. Runway designation: 08
- 2.10.1.b Type of obstacle: Bldg (66 ft). Not Lighted or Marked
- 2.10.1.c Location of obstacle: 503 ft from Centerline

- 2.10.1.a. Runway designation: 26
- 2.10.1.b Type of obstacle: Road (9 ft). Not Lighted or Marked
- 2.10.1.c Location of obstacle: 540 ft from Centerline

- 2.10.1.a. Runway designation: 07L
- 2.10.1.b Type of obstacle: Pole (62 ft). Not Lighted or Marked
- 2.10.1.c Location of obstacle: 750 ft from Centerline

- 2.10.1.a. Runway designation: 25R

- 2.10.1.b Type of obstacle: Ant (416 ft). Marked and Lighted
- 2.10.1.c Location of obstacle: 600 ft from Centerline

- 2.10.1.a. Runway designation: 07R
- 2.10.1.b Type of obstacle: Pole (33 ft). Lighted
- 2.10.1.c Location of obstacle: 640 ft from Centerline

- 2.10.1.a. Runway designation: 25L
- 2.10.1.b Type of obstacle: Ant (424 ft). Marked and Lighted
- 2.10.1.c Location of obstacle: 1193 ft from Centerline

AD 2.12 Runway physical characteristics

- 2.12.1 Designation: 08
- 2.12.2 True Bearing: 90
- 2.12.3 Dimensions: 11489 ft x 150 ft
- 2.12.5 Coordinates: 33-26-27.10N / 112-01-47.26W
- 2.12.6 Threshold elevation: 1111 ft
- 2.12.6 Touchdown zone elevation: 1118 ft

- 2.12.1 Designation: 26
- 2.12.2 True Bearing: 270
- 2.12.3 Dimensions: 11489 ft x 150 ft
- 2.12.5 Coordinates: 33-26-26.96N / 111-59-31.69W
- 2.12.6 Threshold elevation: 1135 ft
- 2.12.6 Touchdown zone elevation: 1135 ft

- 2.12.1 Designation: 07L
- 2.12.2 True Bearing: 90
- 2.12.3 Dimensions: 10300 ft x 150 ft
- 2.12.5 Coordinates: 33-25-51.81N / 112-01-37.56W
- 2.12.6 Threshold elevation: 1110 ft
- 2.12.6 Touchdown zone elevation: 1116 ft

- 2.12.1 Designation: 25R
- 2.12.2 True Bearing: 270
- 2.12.3 Dimensions: 10300 ft x 150 ft
- 2.12.5 Coordinates: 33-25-51.73N / 111-59-36.05W
- 2.12.6 Threshold elevation: 1134 ft
- 2.12.6 Touchdown zone elevation: 1134 ft

- 2.12.1 Designation: H1
- 2.12.3 Dimensions: 60 ft x 60 ft

2.12.1 Designation: 07R
2.12.2 True Bearing: 90
2.12.3 Dimensions: 7800 ft x 150 ft
2.12.5 Coordinates: 33-25-43.89N /
112-01-37.57W
2.12.6 Threshold elevation: 1111 ft
2.12.6 Touchdown zone elevation: 1116 ft

2.12.1 Designation: 25L
2.12.2 True Bearing: 270
2.12.3 Dimensions: 7800 ft x 150 ft
2.12.5 Coordinates: 33-25-43.84N /
112-00-00.00W
2.12.6 Threshold elevation: 1126 ft
2.12.6 Touchdown zone elevation: 1126 ft

AD 2.13 Declared distances

2.13.1 Designation: 08
2.13.2 Takeoff run available: 11489
2.13.3 Takeoff distance available: 11489
2.13.4 Accelerate-stop distance available: 11489
2.13.5 Landing distance available: 10591

2.13.1 Designation: 26
2.13.2 Takeoff run available: 11489
2.13.3 Takeoff distance available: 11489
2.13.4 Accelerate-stop distance available: 11489
2.13.5 Landing distance available: 11489

AD 2.14 Approach and runway lighting

2.14.1 Designation: 08
2.14.4 Visual approach slope indicator system:
4-light PAPI on left

2.14.1 Designation: 26
2.14.4 Visual approach slope indicator system:
4-light PAPI on left

2.14.1 Designation: 07L
2.14.2 Approach lighting system: MALSR: 1400
feet medium intensity approach lighting system
with runway alignment indicator lights
2.14.4 Visual approach slope indicator system:
4-light PAPI on left

2.14.1 Designation: 25R
2.14.4 Visual approach slope indicator system:
4-light PAPI on left

2.14.1 Designation: 07R
2.14.2 Approach lighting system: MALSR: 1400

feet medium intensity approach lighting system
with runway alignment indicator lights
2.14.4 Visual approach slope indicator system:
4-light PAPI on left

2.14.1 Designation: 25L
2.14.2 Approach lighting system: MALSR: 1400
feet medium intensity approach lighting system
with runway alignment indicator lights
2.14.4 Visual approach slope indicator system:
4-light PAPI on left

AD 2.18 Air traffic services communication facilities

2.18.1 Service designation: CD/P
2.18.3 Service designation: 118.1 MHz

2.18.1 Service designation: LCL/P
2.18.3 Service designation: 118.7 MHz

2.18.1 Service designation: APCH/P DEP/P
CLASS B
2.18.3 Service designation: 119.2 MHz

2.18.1 Service designation: GND/P (NORTH)
2.18.3 Service designation: 119.75 MHz

2.18.1 Service designation: APCH/P DEP/P
CLASS B
2.18.3 Service designation: 120.7 MHz

2.18.1 Service designation: LCL/P
2.18.3 Service designation: 120.9 MHz

2.18.1 Service designation: APCH/P DEP/P
CLASS B
2.18.3 Service designation: 123.7 MHz

2.18.1 Service designation: APCH/P DEP/P
CLASS B
2.18.3 Service designation: 123.7 MHz

2.18.1 Service designation: APCH/P DEP/P
CLASS B
2.18.3 Service designation: 124.1 MHz

2.18.1 Service designation: APCH/P DEP/P
CLASS B
2.18.3 Service designation: 124.1 MHz

2.18.1 Service designation: APCH/P DEP/P

CLASS B
2.18.3 Service designation: 126.8 MHz

2.18.1 Service designation: APCH/P DEP/P
CLASS B
2.18.3 Service designation: 126.8 MHz

2.18.1 Service designation: APCH/P DEP/P
CLASS B
2.18.3 Service designation: 126.8 MHz

2.18.1 Service designation: APCH/P DEP/P
CLASS B
2.18.3 Service designation: 126.8 MHz

2.18.1 Service designation: APCH/P DEP/P IC
2.18.3 Service designation: 128.65 MHz

2.18.1 Service designation: GND/P (SOUTH)
2.18.3 Service designation: 132.55 MHz

2.18.1 Service designation: APCH/P DEP/P
CLASS B
2.18.3 Service designation: 239 MHz

2.18.1 Service designation: EMERG
2.18.3 Service designation: 243 MHz

2.18.1 Service designation: LCL/P
2.18.3 Service designation: 254.3 MHz

2.18.1 Service designation: APCH/P DEP/P
CLASS B
2.18.3 Service designation: 256.9 MHz

2.18.1 Service designation: APCH/P DEP/P
CLASS B
2.18.3 Service designation: 256.9 MHz

2.18.1 Service designation: GND/P CD/P
2.18.3 Service designation: 269.2 MHz

2.18.1 Service designation: APCH/P DEP/P
CLASS B
2.18.3 Service designation: 269.6 MHz

2.18.1 Service designation: APCH/P DEP/P
CLASS B
2.18.3 Service designation: 269.6 MHz

2.18.1 Service designation: APCH/P DEP/P

CLASS B
2.18.3 Service designation: 269.6 MHz

2.18.1 Service designation: APCH/P DEP/P
CLASS B
2.18.3 Service designation: 269.6 MHz

2.18.1 Service designation: APCH/P DEP/P
CLASS B
2.18.3 Service designation: 363 MHz

2.18.1 Service designation: APCH/P DEP/P
CLASS B
2.18.3 Service designation: 363 MHz

2.18.1 Service designation: APCH/P DEP/P
CLASS B
2.18.3 Service designation: 124.9 MHz

2.18.1 Service designation: APCH/P DEP/P IC
2.18.3 Service designation: 353.8 MHz

2.18.1 Service designation: APCH/P DEP/P
CLASS B
2.18.3 Service designation: 353.8 MHz

2.18.1 Service designation: APCH/P DEP/P
CLASS B
2.18.3 Service designation: 281.45 MHz

2.18.1 Service designation: ATIS
2.18.3 Service designation: 127.575 MHz
2.18.4 Hours of operation: 24

2.18.1 Service designation: LCL/P
2.18.3 Service designation: 278.8 MHz

AD 2.19 Radio navigation and landing aids

2.19.1 ILS type: Localizer for runway 08. Magnetic variation: 12E
2.19.2 ILS identification: SYQ
2.19.5 Coordinates: 33-26-26.95N / 111-59-19.75W
2.19.6 Site elevation: 1145 ft

2.19.1 ILS type: DME for runway 08. Magnetic variation: 12E
2.19.2 ILS identification: SYQ
2.19.5 Coordinates: 33-26-24.32N / 111-59-19.70W
2.19.6 Site elevation: 1149 ft

2.19.1 ILS type: Glide Slope for runway 08.
Magnetic variation: 12E
2.19.2 ILS identification: SYQ
2.19.5 Coordinates: 33-26-29.65N /
112-01-24.63W
2.19.6 Site elevation: 1111 ft

2.19.1 ILS type: DME for runway 26. Magnetic
variation: 12E
2.19.2 ILS identification: CWJ
2.19.5 Coordinates: 33-26-24.18N /
112-01-59.25W
2.19.6 Site elevation: 1119 ft

2.19.1 ILS type: Glide Slope for runway 26.
Magnetic variation: 12E
2.19.2 ILS identification: CWJ
2.19.5 Coordinates: 33-26-29.60N /
111-59-44.43W
2.19.6 Site elevation: 1129 ft

2.19.1 ILS type: Localizer for runway 26. Magnetic
variation: 12E
2.19.2 ILS identification: CWJ
2.19.5 Coordinates: 33-26-27.11N /
112-01-59.23W
2.19.6 Site elevation: 1105 ft

2.19.1 ILS type: Localizer for runway 07L.
Magnetic variation: 12E
2.19.2 ILS identification: PHX
2.19.5 Coordinates: 33-25-51.72N /
111-59-20.41W
2.19.6 Site elevation: 1133 ft

2.19.1 ILS type: Middle Marker for runway 07L.
Magnetic variation: 12E
2.19.2 ILS identification: PHX
2.19.5 Coordinates: 33-25-51.76N /
112-02-00.00W
2.19.6 Site elevation: 1304 ft

2.19.1 ILS type: DME for runway 07L. Magnetic
variation: 12E
2.19.2 ILS identification: PHX
2.19.5 Coordinates: 33-25-54.14N /
111-59-19.06W
2.19.6 Site elevation: 1142 ft

2.19.1 ILS type: Outer Marker for runway 07L.
Magnetic variation: 12E

2.19.2 ILS identification: PHX
2.19.5 Coordinates: 33-25-53.81N /
112-06-23.58W
2.19.6 Site elevation: 1056 ft

2.19.1 ILS type: Glide Slope for runway 07L.
Magnetic variation: 12E
2.19.2 ILS identification: PHX
2.19.5 Coordinates: 33-25-49.05N /
112-01-25.22W
2.19.6 Site elevation: 1106 ft

2.19.1 ILS type: Glide Slope for runway 07R.
Magnetic variation: 12E
2.19.2 ILS identification: AHA
2.19.5 Coordinates: 33-25-41.10N /
112-01-25.10W
2.19.6 Site elevation: 1109 ft

2.19.1 ILS type: Localizer for runway 07R.
Magnetic variation: 12E
2.19.2 ILS identification: AHA
2.19.5 Coordinates: 33-25-43.83N /
111-59-57.89W
2.19.6 Site elevation: 1123 ft

2.19.1 ILS type: DME for runway 07R. Magnetic
variation: 12E
2.19.2 ILS identification: AHA
2.19.5 Coordinates: 33-25-46.37N /
111-59-57.82W
2.19.6 Site elevation: 1135 ft

2.19.1 ILS type: DME for runway 25L. Magnetic
variation: 12E
2.19.2 ILS identification: RJG
2.19.5 Coordinates: 33-25-46.37N /
111-59-57.82W
2.19.6 Site elevation: 1135 ft

2.19.1 ILS type: Glide Slope for runway 25L.
Magnetic variation: 12E
2.19.2 ILS identification: RJG
2.19.5 Coordinates: 33-25-41.06N /
112-00-16.87W
2.19.6 Site elevation: 1120 ft

2.19.1 ILS type: Localizer for runway 25L.
Magnetic variation: 12E
2.19.2 ILS identification: RJG
2.19.5 Coordinates: 33-25-43.90N /

112-01-48.76W
2.19.6 Site elevation: 1103 ft

General Remarks:

FEE FOR ALL CHARTERS; TRAVEL CLUBS AND CERTAIN REVENUE PRODUCING AIRCRAFT.

TRAINING BY CIVIL TURBOJET AIRCRAFT PROHIBITED EXCEPT PRIOR PERMISSION REQUIRED.

TAXIWAY A BETWEEN TAXIWAY A1 AND TAXIWAY A10 RESTRICTED TO AIRCRAFT WINGSPAN 125 FT OR LESS.

TAXIWAY D RESTRICTED TO AIRCRAFT WINGSPAN 171 FT OR LESS.

ILS (PHX) RUNWAY 07L ANTENNA LOCATED 525 FT WEST OF TAXIWAY G3, 117 FT NORTH TAXIWAY F CENTERLINE.

ILS (AHA) RUNWAY 07R ANTENNA LOCATED 525 FT. WEST OF TAXIWAY H3, 113 FT NORTH TAXIWAY H CENTERLINE.

AIRCRAFT ENGINE RUN-UP FOR MAINTENANCE PROHIBITED EXCEPT PRIOR PERMISSION REQUIRED. CONTACT DUTY SUPERVISORY (602) 273- 2008. NO ENGINE RUNS ON AIRPORT BETWEEN 2300 AND 0500.

ANG: PHASE II BASH (THE HIGH BIRD POTENTIAL HAZARD TIME PERIOD) IS IN EFFECTIVE AUG-OCT AND MAR-MAY.PHASE I BASH IS IN EFFECTIVE NOV-FEB AND JUN-JUL.

NOISE ABATEMENT PROCEDURES ARE IN AFFECT AT ALL TIMES. CONTACT 602-273-4300 FOR MORE INFORMATION.

NO EXPERIMENTAL FLIGHT OR GROUND DEMONSTRATION WITHOUT WRITTEN APPROVAL OF AVIATION DIRECTOR PHONE 602-273-2072.

PERSONNEL AND EQUIPMENT WORKING IN THE VICINITY OF TERMINALS 2,3 & 4.

BIRD ACTIVITY WITHIN 10 MILES OF AIRPORT UP TO 10,000 MSL.

TAXIWAY R AND PORTIONS OF TAXIWAYS S AND T DIRECTLY BELOW THE ATCT ARE NON VISIBLE AREAS FROM THE ATCT. PHOENIX ATCT UNABLE TO PROVIDE AIR TRAFFIC CONTROL SERVICES TO AIRCRAFT WHILE ON TAXIWAY R, AND PORTIONS OF TAXIWAYS S AND T.

ASDE-X SURVEILLANCE SYSTEM IN USE: PILOTS SHOULD OPERATE TRANSPONDERS WITH MODE C ON ALL TAXIWAYS AND RUNWAYS.

TAXIWAY D BETWEEN INTERSECTIONS TAXIWAYS D8 & D9 RESTRICTED TO AIRCRAFT WITH WINGSPAN 135 FT OR LESS.

**Tucson, Arizona
Tucson International
ICAO Identifier KTUS**

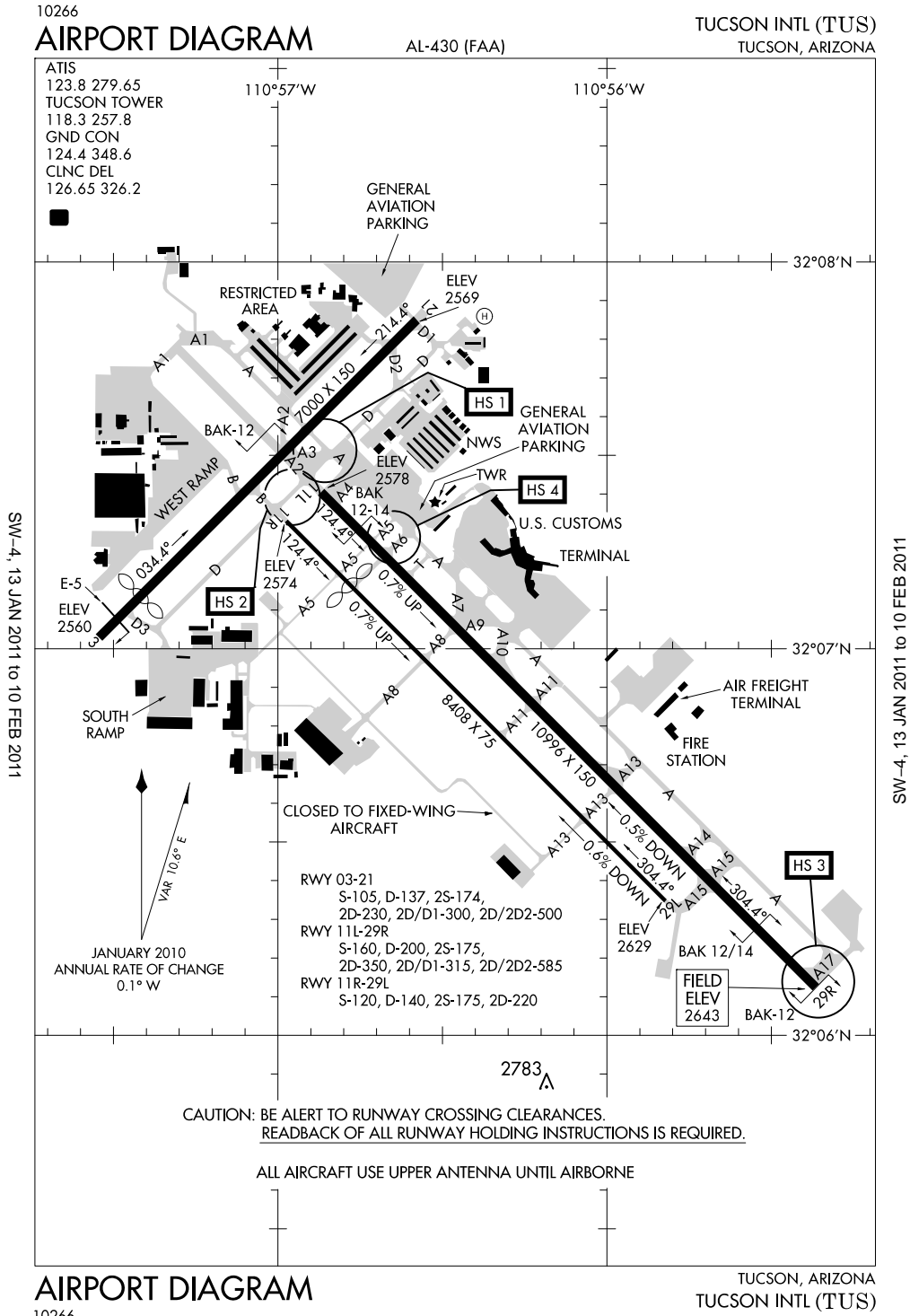

Tucson, AZ

Tucson Intl

ICAO Identifier KTUS

AD 2.2 Aerodrome geographical and administrative data

- 2.2.1 Reference Point: 32-06-57.90N / 110-56-27.70W
- 2.2.2 From City: 6 Miles S Of Tucson, AZ
- 2.2.3 Elevation: 2643 ft
- 2.2.5 Magnetic variation: 12E (1995)
- 2.2.6 Airport Contact: Bonnie Allin
TUCSON APT AUTH 7005 S PLUMER
Tucson, AZ 85706 (520-573-8100)
- 2.2.7 Traffic: IFR/VFR

AD 2.3 Operational hours

- 2.3.1 - 2.3.11: ALL Months, ALL Days, ALL Hours

AD 2.4 Handling services and facilities

- 2.4.1 Cargo handling facilities: No
- 2.4.2 Fuel types: 100LL,A
- 2.4.4 De-icing facilities: None
- 2.4.5 Hangar space: No
- 2.4.6 Repair facilities: Major

AD 2.6 Rescue and firefighting services

- 2.6.1 Aerodrome category for firefighting: ARFF Index I C certified on 5/1/1973

AD 2.10 Aerodrome obstacles

- 2.10.1.a. Runway designation: 29L
- 2.10.1.b Type of obstacle: Pole (37 ft). Lighted
- 2.10.1.c Location of obstacle: 350 ft from Centerline

- 2.10.1.a. Runway designation: 29R
- 2.10.1.b Type of obstacle: Gnd (8 ft). Not Lighted or Marked
- 2.10.1.c Location of obstacle: 500 ft from Centerline

- 2.10.1.a. Runway designation: 03
- 2.10.1.b Type of obstacle: Rr (21 ft). Not Lighted or Marked
- 2.10.1.c Location of obstacle: 250 ft from Centerline

AD 2.12 Runway physical characteristics

- 2.12.1 Designation: 11R

- 2.12.2 True Bearing: 135
- 2.12.3 Dimensions: 8408 ft x 75 ft
- 2.12.5 Coordinates: 32-07-19.57N / 110-56-58.75W
- 2.12.6 Threshold elevation: 2574 ft
- 2.12.6 Touchdown zone elevation: 2605 ft
- 2.12.7 Slope: 0.7UP

- 2.12.1 Designation: 29L
- 2.12.2 True Bearing: 315
- 2.12.3 Dimensions: 8408 ft x 75 ft
- 2.12.5 Coordinates: 32-06-20.72N / 110-55-49.66W
- 2.12.6 Threshold elevation: 2629 ft
- 2.12.6 Touchdown zone elevation: 2629 ft
- 2.12.7 Slope: 0.6DOWN

- 2.12.1 Designation: 11L
- 2.12.2 True Bearing: 135
- 2.12.3 Dimensions: 10996 ft x 150 ft
- 2.12.5 Coordinates: 32-07-24.13N / 110-56-52.48W
- 2.12.6 Threshold elevation: 2578 ft
- 2.12.6 Touchdown zone elevation: 2599 ft
- 2.12.7 Slope: 0.7UP

- 2.12.1 Designation: 29R
- 2.12.2 True Bearing: 315
- 2.12.3 Dimensions: 10996 ft x 150 ft
- 2.12.5 Coordinates: 32-06-00.00N / 110-55-22.15W
- 2.12.6 Threshold elevation: 2643 ft
- 2.12.6 Touchdown zone elevation: 2643 ft
- 2.12.7 Slope: 0.5DOWN

- 2.12.1 Designation: 03
- 2.12.2 True Bearing: 45
- 2.12.3 Dimensions: 7000 ft x 150 ft
- 2.12.5 Coordinates: 32-07-00.00N / 110-57-32.55W
- 2.12.6 Threshold elevation: 2560 ft
- 2.12.6 Touchdown zone elevation: 2572 ft

- 2.12.1 Designation: 21
- 2.12.2 True Bearing: 225
- 2.12.3 Dimensions: 7000 ft x 150 ft
- 2.12.5 Coordinates: 32-07-50.74N / 110-56-34.96W
- 2.12.6 Threshold elevation: 2569 ft
- 2.12.6 Touchdown zone elevation: 2573 ft

AD 2.13 Declared distances

- 2.13.1 Designation: 03
- 2.13.2 Takeoff run available: 7000
- 2.13.3 Takeoff distance available: 7000
- 2.13.4 Accelerate-stop distance available: 7000
- 2.13.5 Landing distance available: 6160

- 2.13.1 Designation: 21
- 2.13.2 Takeoff run available: 6000
- 2.13.3 Takeoff distance available: 7000
- 2.13.4 Accelerate-stop distance available: 6000
- 2.13.5 Landing distance available: 6000

AD 2.14 Approach and runway lighting

- 2.14.1 Designation: 11R
- 2.14.4 Visual approach slope indicator system:
4-light PAPI on left

- 2.14.1 Designation: 11L
- 2.14.2 Approach lighting system: MALSR: 1400 feet medium intensity approach lighting system with runway alignment indicator lights
- 2.14.4 Visual approach slope indicator system:
4-light PAPI on left

- 2.14.1 Designation: 29R
- 2.14.4 Visual approach slope indicator system:
4-light PAPI on left

- 2.14.1 Designation: 21
- 2.14.4 Visual approach slope indicator system:
4-light PAPI on left

AD 2.18 Air traffic services communication facilities

- 2.18.1 Service designation: LCL/P
- 2.18.3 Service designation: 118.3 MHz

- 2.18.1 Service designation: LCL/S
- 2.18.3 Service designation: 119 MHz

- 2.18.1 Service designation: EMERG
- 2.18.3 Service designation: 121.5 MHz

- 2.18.1 Service designation: ATIS (520)741-1177
- 2.18.3 Service designation: 123.8 MHz
- 2.18.4 Hours of operation: 24

- 2.18.1 Service designation: GND/P
- 2.18.3 Service designation: 124.4 MHz

- 2.18.1 Service designation: CD
- 2.18.3 Service designation: 126.65 MHz

- 2.18.1 Service designation: EMERG
- 2.18.3 Service designation: 243 MHz

- 2.18.1 Service designation: LCL/P
- 2.18.3 Service designation: 257.8 MHz

- 2.18.1 Service designation: CD
- 2.18.3 Service designation: 326.2 MHz

- 2.18.1 Service designation: GND/P
- 2.18.3 Service designation: 348.6 MHz

- 2.18.1 Service designation: ANG COMD POST
- 2.18.3 Service designation: 138.525 MHz

- 2.18.1 Service designation: ATIS
- 2.18.3 Service designation: 279.65 MHz
- 2.18.4 Hours of operation: 24

AD 2.19 Radio navigation and landing aids

- 2.19.1 ILS type: Localizer for runway 11L.
Magnetic variation: 12E
- 2.19.2 ILS identification: TUS
- 2.19.5 Coordinates: 32-05-53.51N /
110-55-00.00W
- 2.19.6 Site elevation: 2660 ft

- 2.19.1 ILS type: Glide Slope for runway 11L.
Magnetic variation: 12E
- 2.19.2 ILS identification: TUS
- 2.19.5 Coordinates: 32-07-14.77N /
110-56-48.06W
- 2.19.6 Site elevation: 2580 ft

- 2.19.1 ILS type: Middle Marker for runway 11L.
Magnetic variation: 12E
- 2.19.2 ILS identification: TUS
- 2.19.5 Coordinates: 32-07-51.90N /
110-57-22.60W
- 2.19.6 Site elevation: 2550 ft

- 2.19.1 ILS type: Outer Marker for runway 11L.
Magnetic variation: 12E
- 2.19.2 ILS identification: TUS
- 2.19.5 Coordinates: 32-10-54.55N /
111-00-57.52W
- 2.19.6 Site elevation: 2500 ft

2.19.1 ILS type: DME for runway 11L. Magnetic variation: 12E 110-55-00.00W
2.19.2 ILS identification: TUS 2.19.6 Site elevation: 2659 ft
2.19.5 Coordinates: 32-05-54.93N /

General Remarks:

AIRCRAFT DEPG RUNWAY 11R REQUIRED TO ATTAIN AT LEAST 400' AGL PRIOR TO STARTING TURN.

PORTIONS OF TAXIWAY D NOT VISIBLE FROM ATCT DUE TO HANGARS.

RUNWAY 11L/29R HAS DISTANCE REMAINING MARKINGS ON NE SIDE. RUNWAY 03/21 HAS DISTANCE REMAINING MARKERS ON SE SIDE.

NO B-747 TRAINING EXCEPT PRIOR PERMISSION REQUIRED; NO FLIGHT TRAINING 2200-0600 EXCEPT PRIOR PERMISSION REQUIRED; CALL FLIGHTLINE OFFICE 520-573-8128.

B747 AIRCRAFT TAXI WITH INBOARD ENGINES ONLY.

TAXIWAY T - GENERAL AVIATION TAXIWAY, 30,000 LBS OR LESS.

ANG: JUMP START AIRCRAFT CONTACT ANG CMD POST 520-295-6371 20 MIN PRIOR TO ARR.

ANG: PRIOR PERMISSION REQUIRED DSN 844-6371, C520-295-6371, FAX EXTENSION 6374.

ANG: BASE OPERATIONS OPR 1300-2400Z++MON-FRI EXCEPT HOLIDAY.

AIR CARRIERS USE RUNWAY 11L/29R.

RUNWAY 11R/29L RESTRICTED TO AIRCRAFT WITH WINGSPAN LESS THAN 73 FT & LANDING SPEED LESS THAN 120 KNOTS.

SERVICE-A-GEAR: BAK-12B IN RUNWAY 11L OVERRUN HAS 850' RUN OUT.

HELICOPTER OPERATIONS LOCATED SOUTH OF RUNWAY 11R/29L & WEST OF TAXIWAY A13.

Fresno, California
Fresno Yosemite International
ICAO Identifier KFAT

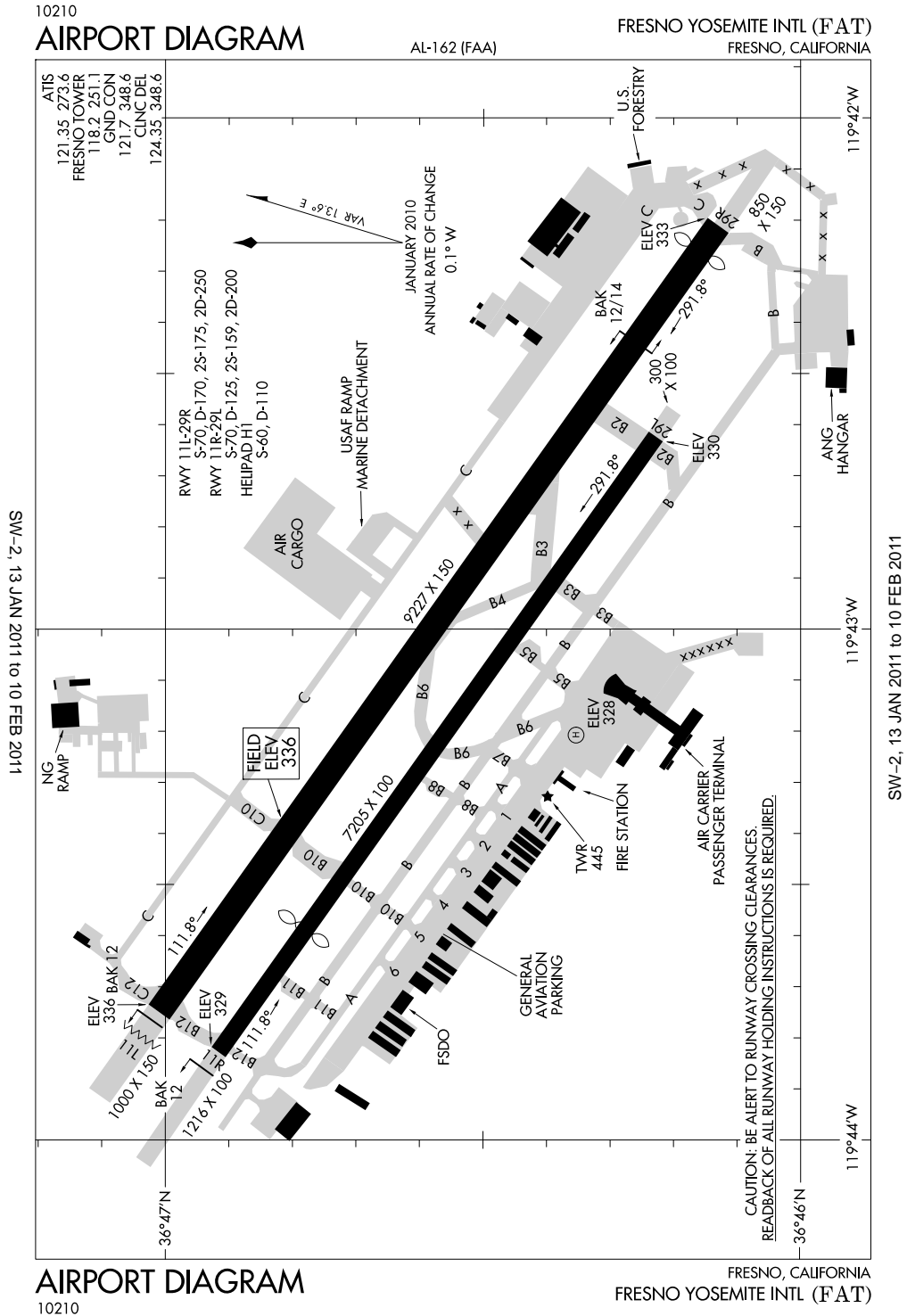

Fresno, CA
Fresno Yosemite Intl
ICAO Identifier KFAT

AD 2.2 Aerodrome geographical and administrative data

- 2.2.1 Reference Point: 36-46-34.30N / 119-43-00.00W
- 2.2.2 From City: 5 Miles NE Of Fresno, CA
- 2.2.3 Elevation: 336 ft
- 2.2.5 Magnetic variation: 14E (2005)
- 2.2.6 Airport Contact: Russell C. Widmar, A.A.E.
4995 E CLINTON WAY
Fresno, CA 93727
(559-621-4500)
- 2.2.7 Traffic: IFR/VFR

AD 2.3 Operational hours

- 2.3.1 - 2.3.11: ALL Months, ALL Days, ALL Hours

AD 2.4 Handling services and facilities

- 2.4.1 Cargo handling facilities: No
- 2.4.2 Fuel types: 100,A
- 2.4.4 De-icing facilities: None
- 2.4.5 Hangar space: Yes
- 2.4.6 Repair facilities: Major

AD 2.6 Rescue and firefighting services

- 2.6.1 Aerodrome category for firefighting: ARFF Index I B certified on 5/1/1973

AD 2.10 Aerodrome obstacles

- 2.10.1.a. Runway designation: 11L
- 2.10.1.b Type of obstacle: Pole (31 ft). Not Lighted or Marked
- 2.10.1.c Location of obstacle: 650 ft from Centerline
- 2.10.1.a. Runway designation: 29R
- 2.10.1.b Type of obstacle: Road (16 ft). Lighted
- 2.10.1.c Location of obstacle: 580 ft from Centerline

AD 2.12 Runway physical characteristics

- 2.12.1 Designation: H1
- 2.12.3 Dimensions: 70 ft x 70 ft
- 2.12.1 Designation: 11L
- 2.12.2 True Bearing: 125
- 2.12.3 Dimensions: 9227 ft x 150 ft

- 2.12.5 Coordinates: 36-47-00.00N / 119-43-45.17W
- 2.12.6 Threshold elevation: 336 ft
- 2.12.6 Touchdown zone elevation: 336 ft

- 2.12.1 Designation: 29R
- 2.12.2 True Bearing: 305
- 2.12.3 Dimensions: 9227 ft x 150 ft
- 2.12.5 Coordinates: 36-46-00.00N / 119-42-12.68W
- 2.12.6 Threshold elevation: 333 ft
- 2.12.6 Touchdown zone elevation: 333 ft

- 2.12.1 Designation: 11R
- 2.12.2 True Bearing: 125
- 2.12.3 Dimensions: 7205 ft x 100 ft
- 2.12.5 Coordinates: 36-46-55.01N / 119-43-49.70W
- 2.12.6 Threshold elevation: 329 ft
- 2.12.6 Touchdown zone elevation: 333 ft

- 2.12.1 Designation: 29L
- 2.12.2 True Bearing: 305
- 2.12.3 Dimensions: 7205 ft x 100 ft
- 2.12.5 Coordinates: 36-46-13.79N / 119-42-37.48W
- 2.12.6 Threshold elevation: 330 ft
- 2.12.6 Touchdown zone elevation: 330 ft

AD 2.14 Approach and runway lighting

- 2.14.1 Designation: 11L
- 2.14.4 Visual approach slope indicator system: 4-light PAPI on left
- 2.14.1 Designation: 29R
- 2.14.2 Approach lighting system: ALSF2: Standard 2400 feet high intensity approach lighting system with sequenced flashers, category II or III configuration
- 2.14.4 Visual approach slope indicator system: 4-light PAPI on left
- 2.14.1 Designation: 29L
- 2.14.4 Visual approach slope indicator system: 4-light PAPI on left

AD 2.18 Air traffic services communication facilities

- 2.18.1 Service designation: LCL/P
- 2.18.3 Service designation: 118.2 MHz

2.18.1 Service designation: APCH/S DEP/S
2.18.3 Service designation: 118.5 MHz

2.18.1 Service designation: APCH/P DEP/P
CLASS C IC
2.18.3 Service designation: 119.6 MHz

2.18.1 Service designation: ATIS
2.18.3 Service designation: 121.35 MHz
2.18.4 Hours of operation: 24

2.18.1 Service designation: EMERG
2.18.3 Service designation: 121.5 MHz

2.18.1 Service designation: GND/P
2.18.3 Service designation: 121.7 MHz

2.18.1 Service designation: CD/P
2.18.3 Service designation: 124.35 MHz

2.18.1 Service designation: NG OPS
2.18.3 Service designation: 132 MHz

2.18.1 Service designation: APCH/P DEP/P
CLASS C
2.18.3 Service designation: 132.35 MHz

2.18.1 Service designation: EMERG
2.18.3 Service designation: 243 MHz

2.18.1 Service designation: LCL/P
2.18.3 Service designation: 251.1 MHz

2.18.1 Service designation: NG OPNS
2.18.3 Service designation: 255.8 MHz

2.18.1 Service designation: ATIS
2.18.3 Service designation: 273.6 MHz
2.18.4 Hours of operation: 24

2.18.1 Service designation: ANG
2.18.3 Service designation: 298.3 MHz

2.18.1 Service designation: GND/P CD/P
2.18.3 Service designation: 348.6 MHz

2.18.1 Service designation: NG OPNS
2.18.3 Service designation: 40.95 MHz

2.18.1 Service designation: APCH/P DEP/P
CLASS C

2.18.3 Service designation: 323.25 MHz

2.18.1 Service designation: APCH/S DEP/S
2.18.3 Service designation: 268.7 MHz

2.18.1 Service designation: APCH/P DEP/P
CLASS C IC
2.18.3 Service designation: 351.95 MHz

AD 2.19 Radio navigation and landing aids

2.19.1 ILS type: Localizer for runway 11L.
Magnetic variation: 14E

2.19.2 ILS identification: RPW
2.19.5 Coordinates: 36-46-00.00N /
119-42-00.00W
2.19.6 Site elevation: 333 ft

2.19.1 ILS type: DME for runway 11L. Magnetic
variation: 14E

2.19.2 ILS identification: RPW
2.19.5 Coordinates: 36-47-10.83N /
119-43-56.63W
2.19.6 Site elevation: 330 ft

2.19.1 ILS type: Localizer for runway 29R.
Magnetic variation: 14E

2.19.2 ILS identification: FAT
2.19.5 Coordinates: 36-47-00.00N /
119-43-58.60W
2.19.6 Site elevation: 331 ft

2.19.1 ILS type: DME for runway 29R. Magnetic
variation: 14E

2.19.2 ILS identification: FAT
2.19.5 Coordinates: 36-47-10.83N /
119-43-56.63W
2.19.6 Site elevation: 347 ft

2.19.1 ILS type: Outer Marker for runway 29R.
Magnetic variation: 14E

2.19.2 ILS identification: FAT
2.19.5 Coordinates: 36-43-48.19N /
119-38-00.00W
2.19.6 Site elevation: 340 ft

2.19.1 ILS type: Middle Marker for runway 29R.
Magnetic variation: 14E

2.19.2 ILS identification: FAT
2.19.5 Coordinates: 36-45-47.67N /
119-41-37.41W
2.19.6 Site elevation: 330 ft

2.19.1 ILS type: Inner Marker for runway 29R.
Magnetic variation: 14E
2.19.2 ILS identification: FAT
2.19.5 Coordinates: 36-46-00.00N /
119-42-00.00W
2.19.6 Site elevation: 330 ft

2.19.1 ILS type: Glide Slope for runway 29R.
Magnetic variation: 14E
2.19.2 ILS identification: FAT
2.19.5 Coordinates: 36-46-18.84N /
119-42-23.48W
2.19.6 Site elevation: 331 ft

General Remarks:

FOR TAXIWAY A; 40 FT WIDE; PRIOR APPROVAL REQUIRED AIRCRAFT OVER 60000 LBS GROSS WEIGHT.

NO INTERSECTION DEPS TO THE NW EXCEPT THE INTERSECTION OF RUNWAY 29R AT TAXIWAY B2 OR DURING SINGLE RUNWAY OPERATIONS.

FRESNO YOSEMITE INTL IS NOISE SENSITIVE; NOISE ABATEMENT PROCEDURES IN EFFECT.

NO MULTIPLE APPROACHES AND LANDINGS 2200-0700 MONDAY THRU SATURDAY;
1800-1000 SUNDAY.

POSSIBLE WAKE TURBULENCE OR WIND SHEAR ARR TO RUNWAY 29L OR DEP FROM RUNWAY 11R. JET TESTING CONDUCTED AT AIR NATIONAL GUARD RAMP LOCATED AT SE CORNER OF AIRPORT.

(E93) HELIPORT LOCATED LATITUDE 36-46-20.82N LONG 119-43-11.51W.

NUMEROUS BIRDS IN THE VICINITY OF AIRPORT.

LIGHTED RUNWAY DISTANCE REMAINING MARKERS S SIDE OF RUNWAY 11R/29L; LIGHTED RUNWAY DISTANCE REMAINING MARKERS BOTH SIDES OF RUNWAY 11L/29R.

Los Angeles, California
Los Angeles International
ICAO Identifier KLAX

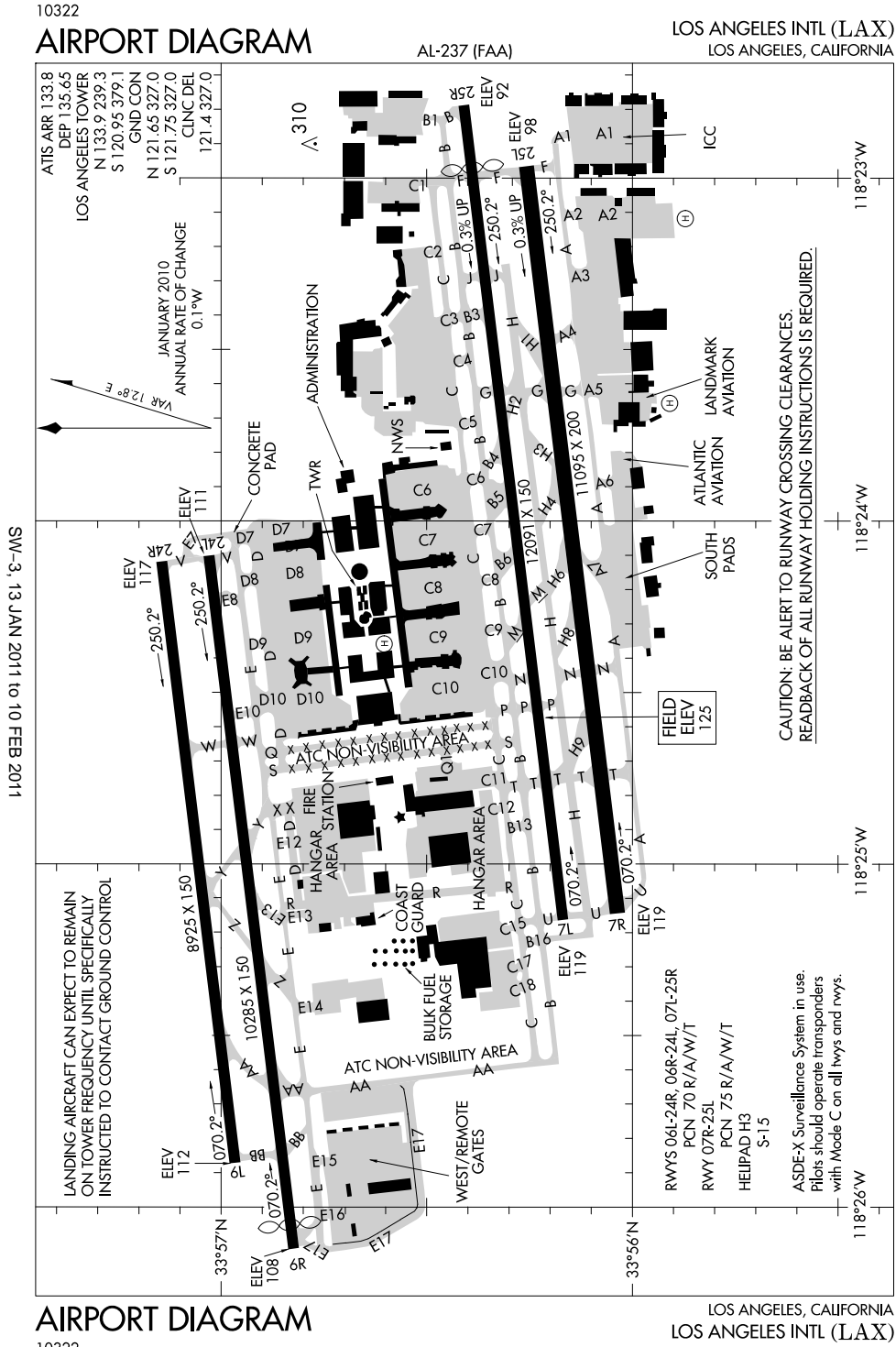

Los Angeles, CA
Los Angeles Intl
ICAO Identifier KLAX

AD 2.2 Aerodrome geographical and administrative data

- 2.2.1 Reference Point: 33-56-33.08N / 118-24-25.78W
- 2.2.2 From City: 9 Miles SW Of Los Angeles, CA
- 2.2.3 Elevation: 125 ft
- 2.2.5 Magnetic variation: 14E (1980)
- 2.2.6 Airport Contact: Jacqueline Yaft
ONE WORLD WAY
Los Angeles, CA 90009
(424-646-6450)
- 2.2.7 Traffic: IFR/VFR

AD 2.3 Operational hours

- 2.3.1 - 2.3.11: ALL Months, ALL Days, ALL Hours

AD 2.4 Handling services and facilities

- 2.4.1 Cargo handling facilities: No
- 2.4.2 Fuel types: A
- 2.4.4 De-icing facilities: None
- 2.4.5 Hangar space: No
- 2.4.6 Repair facilities: Major

AD 2.6 Rescue and firefighting services

- 2.6.1 Aerodrome category for firefighting: ARFF Index I E certified on 5/1/1973

AD 2.10 Aerodrome obstacles

- 2.10.1.a. Runway designation: 07R
- 2.10.1.b Type of obstacle: Pole (67 ft). Not Lighted or Marked
- 2.10.1.c Location of obstacle: 825 ft from Centerline

- 2.10.1.a. Runway designation: 25L
- 2.10.1.b Type of obstacle: Rr (21 ft). Not Lighted or Marked
- 2.10.1.c Location of obstacle: 600 ft from Centerline

- 2.10.1.a. Runway designation: 25R
- 2.10.1.b Type of obstacle: Rr (25 ft). Lighted
- 2.10.1.c Location of obstacle: 0 ft from Centerline

- 2.10.1.a. Runway designation: 06L
- 2.10.1.b Type of obstacle: Pole (61 ft). Not Lighted

- or Marked
- 2.10.1.c Location of obstacle: 300 ft from Centerline

- 2.10.1.a. Runway designation: 24R
- 2.10.1.b Type of obstacle: Sign (42 ft). Lighted
- 2.10.1.c Location of obstacle: 350 ft from Centerline

- 2.10.1.a. Runway designation: 06R
- 2.10.1.b Type of obstacle: Pole (9 ft). Not Lighted or Marked
- 2.10.1.c Location of obstacle: 375 ft from Centerline

AD 2.12 Runway physical characteristics

- 2.12.1 Designation: 07R
- 2.12.2 True Bearing: 83
- 2.12.3 Dimensions: 11095 ft x 200 ft
- 2.12.4 PCN: 75 R/A/W/T
- 2.12.5 Coordinates: 33-56-00.00N / 118-25-00.00W
- 2.12.6 Threshold elevation: 119 ft
- 2.12.6 Touchdown zone elevation: 125 ft

- 2.12.1 Designation: 25L
- 2.12.2 True Bearing: 263
- 2.12.3 Dimensions: 11095 ft x 200 ft
- 2.12.4 PCN: 75 R/A/W/T
- 2.12.5 Coordinates: 33-56-14.49N / 118-22-57.75W
- 2.12.6 Threshold elevation: 98 ft
- 2.12.6 Touchdown zone elevation: 104 ft

- 2.12.1 Designation: 07L
- 2.12.2 True Bearing: 83
- 2.12.3 Dimensions: 12091 ft x 150 ft
- 2.12.4 PCN: 70 R/A/W/T
- 2.12.5 Coordinates: 33-56-00.00N / 118-25-00.00W
- 2.12.6 Threshold elevation: 118 ft
- 2.12.6 Touchdown zone elevation: 126 ft

- 2.12.1 Designation: 25R
- 2.12.2 True Bearing: 263
- 2.12.3 Dimensions: 12091 ft x 150 ft
- 2.12.4 PCN: 70 R/A/W/T
- 2.12.5 Coordinates: 33-56-23.54N / 118-22-47.18W
- 2.12.6 Threshold elevation: 92 ft
- 2.12.6 Touchdown zone elevation: 102 ft

2.12.1 Designation: H1
2.12.3 Dimensions: 63 ft x 63 ft

2.12.1 Designation: 06L
2.12.2 True Bearing: 83
2.12.3 Dimensions: 8925 ft x 150 ft
2.12.4 PCN: 70 R/A/W/T
2.12.5 Coordinates: 33-56-56.79N /
118-25-52.16W
2.12.6 Threshold elevation: 112 ft
2.12.6 Touchdown zone elevation: 117 ft

2.12.1 Designation: 24R
2.12.2 True Bearing: 263
2.12.3 Dimensions: 8925 ft x 150 ft
2.12.4 PCN: 70 R/A/W/T
2.12.5 Coordinates: 33-57-00.00N /
118-24-00.00W
2.12.6 Threshold elevation: 117 ft
2.12.6 Touchdown zone elevation: 120 ft

2.12.1 Designation: 06R
2.12.2 True Bearing: 83
2.12.3 Dimensions: 10285 ft x 150 ft
2.12.4 PCN: 70 R/A/W/T
2.12.5 Coordinates: 33-56-48.27N /
118-26-00.00W
2.12.6 Threshold elevation: 108 ft
2.12.6 Touchdown zone elevation: 114 ft

2.12.1 Designation: 24L
2.12.2 True Bearing: 263
2.12.3 Dimensions: 10285 ft x 150 ft
2.12.4 PCN: 70 R/A/W/T
2.12.5 Coordinates: 33-57-00.00N /
118-24-00.00W
2.12.6 Threshold elevation: 111 ft
2.12.6 Touchdown zone elevation: 121 ft

AD 2.14 Approach and runway lighting

2.14.1 Designation: 07R
2.14.2 Approach lighting system: MALSR: 1400
feet medium intensity approach lighting system
with runway alignment indicator lights
2.14.4 Visual approach slope indicator system:
4-light PAPI on left

2.14.1 Designation: 25L
2.14.2 Approach lighting system: ALSF2: Standard
2400 feet high intensity approach lighting system
with sequenced flashers, category II or III

configuration
2.14.10 Remarks: Runway 25L ALSF2 Operates
As SSALR Till Weather Goes Below Vfr.

2.14.1 Designation: 07L
2.14.2 Approach lighting system: MALSR: 1400
feet medium intensity approach lighting system
with runway alignment indicator lights
2.14.4 Visual approach slope indicator system:
4-light PAPI on left

2.14.1 Designation: 25R
2.14.2 Approach lighting system: MALSR: 1400
feet medium intensity approach lighting system
with runway alignment indicator lights

2.14.1 Designation: 06L
2.14.2 Approach lighting system: MALSR: 1400
feet medium intensity approach lighting system
with runway alignment indicator lights
2.14.4 Visual approach slope indicator system:
4-light PAPI on left

2.14.1 Designation: 24R
2.14.2 Approach lighting system: ALSF2: Standard
2400 feet high intensity approach lighting system
with sequenced flashers, category II or III
configuration
2.14.4 Visual approach slope indicator system:
4-light PAPI on left

2.14.10 Remarks: Runway 24R ALSF2 Operates
As SSALR Till Weather Goes Below Vfr.

2.14.1 Designation: 06R
2.14.2 Approach lighting system: MALSR: 1400
feet medium intensity approach lighting system
with runway alignment indicator lights
2.14.4 Visual approach slope indicator system:
4-light PAPI on left

2.14.1 Designation: 24L
2.14.2 Approach lighting system: MALSR: 1400
feet medium intensity approach lighting system
with runway alignment indicator lights
2.14.4 Visual approach slope indicator system:
4-light PAPI on right

**AD 2.18 Air traffic services communication
facilities**

2.18.1 Service designation: LCL/P
2.18.3 Service designation: 119.8 MHz

2.18.1 Service designation: CD/S
2.18.3 Service designation: 120.35 MHz

2.18.1 Service designation: LCL/P IC
2.18.3 Service designation: 120.95 MHz

2.18.1 Service designation: CD/P
2.18.3 Service designation: 121.4 MHz

2.18.1 Service designation: EMERG
2.18.3 Service designation: 121.5 MHz

2.18.1 Service designation: GND/P
2.18.3 Service designation: 121.65 MHz

2.18.1 Service designation: GND/P
2.18.3 Service designation: 121.75 MHz

2.18.1 Service designation: SPECIAL FLIGHT
RULE AREA
2.18.3 Service designation: 128.55 MHz

2.18.1 Service designation: D-ATIS
2.18.3 Service designation: 133.8 MHz
2.18.4 Hours of operation: 24

2.18.1 Service designation: LCL/P IC
2.18.3 Service designation: 133.9 MHz

2.18.1 Service designation: D-ATIS
2.18.3 Service designation: 135.65 MHz
2.18.4 Hours of operation: 24

2.18.1 Service designation: LCL/P IC
2.18.3 Service designation: 239.3 MHz

2.18.1 Service designation: EMERG
2.18.3 Service designation: 243 MHz

2.18.1 Service designation: GND/P CD
2.18.3 Service designation: 327 MHz

2.18.1 Service designation: SAMSO FLT OPS
2.18.3 Service designation: 372.2 MHz

2.18.1 Service designation: LCL/P IC
2.18.3 Service designation: 379.1 MHz

AD 2.19 Radio navigation and landing aids

2.19.1 ILS type: Localizer for runway 07R.
Magnetic variation: 14E

2.19.2 ILS identification: MKZ
2.19.5 Coordinates: 33-56-15.76N /
118-22-45.34W
2.19.6 Site elevation: 92 ft

2.19.1 ILS type: DME for runway 07R. Magnetic
variation: 14E
2.19.2 ILS identification: MKZ
2.19.5 Coordinates: 33-56-13.25N /
118-22-45.55W
2.19.6 Site elevation: 92 ft

2.19.1 ILS type: Glide Slope for runway 07R.
Magnetic variation: 14E
2.19.2 ILS identification: MKZ
2.19.5 Coordinates: 33-56-00.00N /
118-24-55.54W
2.19.6 Site elevation: 119 ft

2.19.1 ILS type: Middle Marker for runway 07R.
Magnetic variation: 14E
2.19.2 ILS identification: MKZ
2.19.5 Coordinates: 33-55-58.50N /
118-25-41.70W
2.19.6 Site elevation: 104 ft

2.19.1 ILS type: Localizer for runway 25L.
Magnetic variation: 14E
2.19.2 ILS identification: LAX
2.19.5 Coordinates: 33-55-59.85N /
118-25-20.81W
2.19.6 Site elevation: 119 ft

2.19.1 ILS type: Inner Marker for runway 25L.
Magnetic variation: 14E
2.19.2 ILS identification: LAX
2.19.5 Coordinates: 33-56-16.30N /
118-22-46.10W
2.19.6 Site elevation: 91 ft

2.19.1 ILS type: Outer Marker for runway 25L.
Magnetic variation: 14E
2.19.2 ILS identification: LAX
2.19.5 Coordinates: 33-56-53.50N /
118-16-32.20W
2.19.6 Site elevation: 127 ft

2.19.1 ILS type: Middle Marker for runway 25L.
Magnetic variation: 14E
2.19.2 ILS identification: LAX
2.19.5 Coordinates: 33-56-18.50N /

118-22-23.90W

2.19.6 Site elevation: 84 ft

2.19.1 ILS type: Glide Slope for runway 25L.

Magnetic variation: 14E

2.19.2 ILS identification: LAX

2.19.5 Coordinates: 33-56-17.75N /

118-23-10.20W

2.19.6 Site elevation: 96 ft

2.19.1 ILS type: DME for runway 25L. Magnetic variation: 14E

2.19.2 ILS identification: LAX

2.19.5 Coordinates: 33-56-00.00N /

118-25-19.78W

2.19.6 Site elevation: 126 ft

2.19.1 ILS type: DME for runway 07L. Magnetic variation: 14E

2.19.2 ILS identification: IAS

2.19.5 Coordinates: 33-56-21.62N /

118-22-36.49W

2.19.6 Site elevation: 103 ft

2.19.1 ILS type: Localizer for runway 07L.

Magnetic variation: 14E

2.19.2 ILS identification: IAS

2.19.5 Coordinates: 33-56-24.72N /

118-22-35.64W

2.19.6 Site elevation: 88 ft

2.19.1 ILS type: Glide Slope for runway 07L.

Magnetic variation: 14E

2.19.2 ILS identification: IAS

2.19.5 Coordinates: 33-56-00.00N /

118-24-56.47W

2.19.6 Site elevation: 120 ft

2.19.1 ILS type: Middle Marker for runway 07L.

Magnetic variation: 14E

2.19.2 ILS identification: IAS

2.19.5 Coordinates: 33-56-00.00N /

118-25-46.90W

2.19.6 Site elevation: 99999 ft

2.19.1 ILS type: DME for runway 25R. Magnetic variation: 14E

2.19.2 ILS identification: CFN

2.19.5 Coordinates: 33-56-00.00N /

118-25-19.64W

2.19.6 Site elevation: 126 ft

2.19.1 ILS type: Outer Marker for runway 25R.

Magnetic variation: 14E

2.19.2 ILS identification: CFN

2.19.5 Coordinates: 33-56-53.50N /

118-16-32.20W

2.19.6 Site elevation: 99999 ft

2.19.1 ILS type: Localizer for runway 25R.

Magnetic variation: 14E

2.19.2 ILS identification: CFN

2.19.5 Coordinates: 33-56-00.00N /

118-25-17.98W

2.19.6 Site elevation: 119 ft

2.19.1 ILS type: Glide Slope for runway 25R.

Magnetic variation: 14E

2.19.2 ILS identification: CFN

2.19.5 Coordinates: 33-56-17.85N /

118-23-10.21W

2.19.6 Site elevation: 96 ft

2.19.1 ILS type: Middle Marker for runway 25R.

Magnetic variation: 14E

2.19.2 ILS identification: CFN

2.19.5 Coordinates: 33-56-25.90N /

118-22-24.40W

2.19.6 Site elevation: 87 ft

2.19.1 ILS type: Localizer for runway 06L.

Magnetic variation: 14E

2.19.2 ILS identification: UWU

2.19.5 Coordinates: 33-57-00.00N /

118-23-56.74W

2.19.6 Site elevation: 106 ft

2.19.1 ILS type: Glide Slope for runway 06L.

Magnetic variation: 14E

2.19.2 ILS identification: UWU

2.19.5 Coordinates: 33-56-54.57N /

118-25-39.81W

2.19.6 Site elevation: 109 ft

2.19.1 ILS type: DME for runway 06L. Magnetic variation: 14E

2.19.2 ILS identification: UWU

2.19.5 Coordinates: 33-57-00.00N /

118-23-56.09W

2.19.6 Site elevation: 120 ft

2.19.1 ILS type: Middle Marker for runway 06L.

Magnetic variation: 14E

2.19.2 ILS identification: UWU
2.19.5 Coordinates: 33-56-50.80N /
118-26-25.80W
2.19.6 Site elevation: 121 ft

2.19.1 ILS type: DME for runway 24R. Magnetic
variation: 14E
2.19.2 ILS identification: OSS
2.19.5 Coordinates: 33-56-51.00N /
118-26-27.00W
2.19.6 Site elevation: 133 ft

2.19.1 ILS type: Glide Slope for runway 24R.
Magnetic variation: 14E
2.19.2 ILS identification: OSS
2.19.5 Coordinates: 33-57-00.00N /
118-24-18.51W
2.19.6 Site elevation: 115 ft

2.19.1 ILS type: Inner Marker for runway 24R.
Magnetic variation: 14E
2.19.2 ILS identification: OSS
2.19.5 Coordinates: 33-57-00.00N /
118-23-56.00W
2.19.6 Site elevation: 105 ft

2.19.1 ILS type: Outer Marker for runway 24R.
Magnetic variation: 14E
2.19.2 ILS identification: OSS
2.19.5 Coordinates: 33-57-53.70N /
118-16-40.70W
2.19.6 Site elevation: 136 ft

2.19.1 ILS type: Localizer for runway 24R.
Magnetic variation: 14E
2.19.2 ILS identification: OSS
2.19.5 Coordinates: 33-56-53.17N /
118-26-27.50W
2.19.6 Site elevation: 123 ft

2.19.1 ILS type: Middle Marker for runway 24R.
Magnetic variation: 14E
2.19.2 ILS identification: OSS
2.19.5 Coordinates: 33-57-11.00N /
118-23-33.00W
2.19.6 Site elevation: 104 ft

2.19.1 ILS type: Localizer for runway 06R.
Magnetic variation: 14E
2.19.2 ILS identification: GPE
2.19.5 Coordinates: 33-57-00.00N /

118-23-55.57W
2.19.6 Site elevation: 106 ft

2.19.1 ILS type: Glide Slope for runway 06R.
Magnetic variation: 14E
2.19.2 ILS identification: GPE
2.19.5 Coordinates: 33-56-52.61N /
118-25-54.09W
2.19.6 Site elevation: 106 ft

2.19.1 ILS type: Middle Marker for runway 06R.
Magnetic variation: 14E
2.19.2 ILS identification: GPE
2.19.5 Coordinates: 33-56-45.50N /
118-26-33.30W
2.19.6 Site elevation: 65 ft

2.19.1 ILS type: DME for runway 06R. Magnetic
variation: 14E
2.19.2 ILS identification: GPE
2.19.5 Coordinates: 33-57-00.00N /
118-23-55.67W
2.19.6 Site elevation: 120 ft

2.19.1 ILS type: DME for runway 24L. Magnetic
variation: 14E
2.19.2 ILS identification: HQB
2.19.5 Coordinates: 33-56-49.97N /
118-26-22.78W
2.19.6 Site elevation: 133 ft

2.19.1 ILS type: Outer Marker for runway 24L.
Magnetic variation: 14E
2.19.2 ILS identification: HQB
2.19.5 Coordinates: 33-57-53.70N /
118-16-40.70W
2.19.6 Site elevation: 136 ft

2.19.1 ILS type: Localizer for runway 24L.
Magnetic variation: 14E
2.19.2 ILS identification: HQB
2.19.5 Coordinates: 33-56-46.73N /
118-26-22.18W
2.19.6 Site elevation: 122 ft

2.19.1 ILS type: Glide Slope for runway 24L.
Magnetic variation: 14E
2.19.2 ILS identification: HQB
2.19.5 Coordinates: 33-57-00.00N /
118-24-18.49W
2.19.6 Site elevation: 115 ft

2.19.1 ILS type: Middle Marker for runway 24L.
Magnetic variation: 14E
2.19.2 ILS identification: HQB

2.19.5 Coordinates: 33-57-00.00N /
118-23-31.30W
2.19.6 Site elevation: 103 ft

General Remarks:

NUMEROUS BIRDS ON AND IN VICINITY OF AIRPORT.

TURBULENCE MAY BE DEFLECTED UPWARD FROM THE BLAST FENCE 180' E OF RUNWAY 25R.

A 700 X 500' CLEARWAY HAS BEEN REESTABLISHED AT WEST END OF RUNWAY 24R.

NOISE SENSITIVE AIRPORT. ON WESTERLY TAKE-OFFS NO TURNS BEFORE CROSSING SHORELINE. OVER-OCEAN APPROACHES UTILIZED 2400-0630.

HELIPAD H1 CLOSED INDEFINITELY.

PRACTICE INSTRUMENT APPROACHES & TOUCH AND GO LANDINGS ARE PROHIBITED.

RUNWAY 25L PREFERRED EMERGENCY RUNWAY.

SIMULTANEOUS AIRCRAFT OPERATIONS PROHIBITED ON TAXIWAYS T AND H9 BETWEEN RUNWAY 07L/25R AND 07R/25L.

SIMULTANEOUS AIRCRAFT OPERATIONS PROHIBITED ON TAXIWAY H2 AND G BETWEEN RUNWAYS 07L/25R AND 07R/25L.

ASDE-X SURVEILLANCE SYSTEM IN USE: PILOTS SHOULD OPERATE TRANSPONDERS WITH MODE C ON ALL TAXIWAYS AND RUNWAYS.

MILITARY RESTRICTED: ALL MILITARY AIRCRAFT OFFICIAL BUSINESS ONLY, MIN 24 HR PRIOR PERMISSION REQUIRED, CONTACT 61 ABW/CP FLIGHT OPERATIONS DSN 633-3779/4014, C310-653-3779/4014.

MILITARY AF: ALL MILITARY AIRCREWS MUST CONTACT 61 ABW/CP FLIGHT OPERATIONS FOR PARK LOCATION/INSTR. NO GOVERNMENT TRANSPORTATION, QUARTERS OR SECURITY AVAILABLE. VIP NOTIFICATION PRO APPLY. USER FEES ASSESSED USING AVCARD CREDIT. CONTACT ATLANTIC AVIATION FBO 131.6 INBOUND. INBOUND RELAY ESTIMATED TIME OF ARRIVAL, VIP CODE, SERVICE REQUIRE 30 MIN PRIOR TO ARR.

WESTBOUND B747-400 AIRCRAFT ON TAXIWAY C PROHIBITED FROM SOUTHBOUND TURNS ONTO TAXIWAY P.

TAXIWAY C-7, C-8, C-9 NORTH OF TAXIWAY C) AND TAXIWAY D-7 SOUTH OF TAXIWAY E WILL NOT ACCOMMODATE B747 - 200 AND LARGER AIRCRAFT.

TAXIWAY D BETWEEN TAXIWAY D-7 AND D-8 (NORTH OF TERMINAL ONE) RESTRICTED TO B-767-300 AND SMALLER AIRCRAFT.

WEST REMOTE GATES: AIRCRAFT USE OF OPEN GATES AS TAXI PATH IS PROHIBITED (GATES 206, 207, 208, 209).

CONTACT LAX AIRFIELD OPERATIONS (310) 646-4265 FOR B-747-400/B-777-300 AND 300ER/A340-600 AIRCRAFT OPERATIONS RESTRICTIONS.

TOM BRADLEY INTERNATIONAL GATES: CHECK LAWA (LOS ANGELES WORLD AIRPORT) RULES AND REGULATIONS FOR LATEST OPERATING PROCEDURES.

TAXIWAY E-17: A340-600, B777-300/300ER AIRCRAFT NORTHBOUND TURN ONTO TAXIWAY E-17 FROM WESTBOUND TAXIWAY E PROHIBITED.

TAXIWAY E: A340-600, B777-300/300ER AIRCRAFT WESTBOUND TURN ONTO TAXIWAY E FROM SOUTHBOUND TAXIWAY BB PROHIBITED.

TAXIWAY C-8: A340-600, B777-300/300ER AIRCRAFT PROHIBITED ON TAXIWAY C-8 BETWEEN TAXIWAY B AND TAXIWAY C.

TAXIWAY C-9: A340-600, B777-300/300ER AIRCRAFT PROHIBITED ON TAXIWAY C-9 BETWEEN TAXIWAY B AND TAXIWAY C.

A-380 OPERATIONS CONTACT AIRFIELD OPERATIONS FOR TAXI INFORMATION.

Oakland, California Metropolitan Oakland International ICAO Identifier KOAK

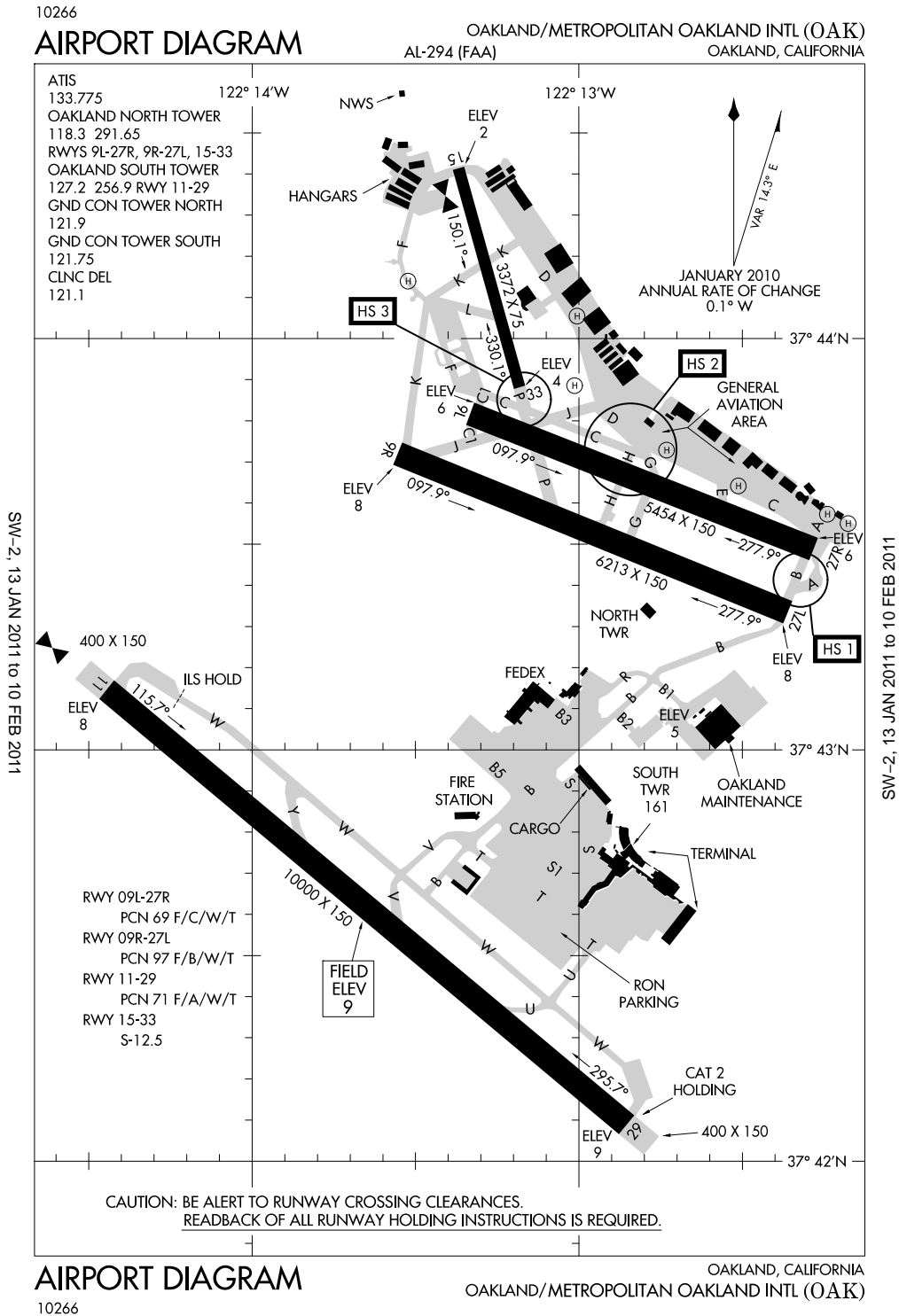

Oakland, CA
Metropolitan Oakland Intl
ICAO Identifier KOAK

AD 2.2 Aerodrome geographical and administrative data

- 2.2.1 Reference Point: 37-43-16.60N / 122-13-14.60W
- 2.2.2 From City: 4 Miles S Of Oakland, CA
- 2.2.3 Elevation: 9 ft
- 2.2.5 Magnetic variation: 16E (1995)
- 2.2.6 Airport Contact: Rob Forester
METROPOLITAN OAKLAND INTL ARPT
Oakland, CA 94621 (510-563-6436)
- 2.2.7 Traffic: IFR/VFR

AD 2.3 Operational hours

- 2.3.1 - 2.3.11: ALL Months, ALL Days, ALL Hours

AD 2.4 Handling services and facilities

- 2.4.1 Cargo handling facilities: No
- 2.4.2 Fuel types: 100LL,A
- 2.4.4 De-icing facilities: None
- 2.4.5 Hangar space: No
- 2.4.6 Repair facilities: Major

AD 2.6 Rescue and firefighting services

- 2.6.1 Aerodrome category for firefighting: ARFF Index I D certified on 5/1/1973

AD 2.10 Aerodrome obstacles

- 2.10.1.a Runway designation: 27R
- 2.10.1.b Type of obstacle: Bldg (11 ft). Lighted
- 2.10.1.c Location of obstacle: 480 ft from Centerline

AD 2.12 Runway physical characteristics

- 2.12.1 Designation: 09L
- 2.12.2 True Bearing: 112
- 2.12.3 Dimensions: 5454 ft x 150 ft
- 2.12.4 PCN: 69 F/C/W/T
- 2.12.5 Coordinates: 37-43-49.67N / 122-13-19.80W
- 2.12.6 Threshold elevation: 6 ft
- 2.12.6 Touchdown zone elevation: 6 ft

- 2.12.1 Designation: 27R
- 2.12.2 True Bearing: 292
- 2.12.3 Dimensions: 5454 ft x 150 ft
- 2.12.4 PCN: 69 F/C/W/T

- 2.12.5 Coordinates: 37-43-29.32N / 122-12-16.93W
- 2.12.6 Threshold elevation: 6 ft
- 2.12.6 Touchdown zone elevation: 7 ft

- 2.12.1 Designation: 09R
- 2.12.2 True Bearing: 112
- 2.12.3 Dimensions: 6213 ft x 150 ft
- 2.12.4 PCN: 97 F/B/W/T
- 2.12.5 Coordinates: 37-43-43.35N / 122-13-33.25W
- 2.12.6 Threshold elevation: 8 ft
- 2.12.6 Touchdown zone elevation: 9 ft

- 2.12.1 Designation: 27L
- 2.12.2 True Bearing: 292
- 2.12.3 Dimensions: 6213 ft x 150 ft
- 2.12.4 PCN: 97 F/B/W/T
- 2.12.5 Coordinates: 37-43-20.18N / 122-12-21.63W
- 2.12.6 Threshold elevation: 8 ft
- 2.12.6 Touchdown zone elevation: 9 ft

- 2.12.1 Designation: 11
- 2.12.2 True Bearing: 129
- 2.12.3 Dimensions: 10000 ft x 150 ft
- 2.12.4 PCN: 71 F/A/W/T
- 2.12.5 Coordinates: 37-43-00.00N / 122-14-26.65W
- 2.12.6 Threshold elevation: 8 ft
- 2.12.6 Touchdown zone elevation: 9 ft

- 2.12.1 Designation: 29
- 2.12.2 True Bearing: 310
- 2.12.3 Dimensions: 10000 ft x 150 ft
- 2.12.4 PCN: 71 F/A/W/T
- 2.12.5 Coordinates: 37-42-00.00N / 122-12-51.32W
- 2.12.6 Threshold elevation: 9 ft
- 2.12.6 Touchdown zone elevation: 9 ft

- 2.12.1 Designation: 15
- 2.12.2 True Bearing: 164
- 2.12.3 Dimensions: 3372 ft x 75 ft
- 2.12.5 Coordinates: 37-44-25.01N / 122-13-22.09W
- 2.12.6 Threshold elevation: 2 ft
- 2.12.6 Touchdown zone elevation: 5 ft

- 2.12.1 Designation: 33
- 2.12.2 True Bearing: 344

2.12.3 Dimensions: 3372 ft x 75 ft
2.12.5 Coordinates: 37-43-52.90N /
122-13-10.83W
2.12.6 Threshold elevation: 4 ft
2.12.6 Touchdown zone elevation: 5 ft

AD 2.14 Approach and runway lighting

2.14.1 Designation: 09L
2.14.4 Visual approach slope indicator system:
4-light PAPI on right

2.14.1 Designation: 27R
2.14.2 Approach lighting system: MALSR: 1400
feet medium intensity approach lighting system
with runway alignment indicator lights
2.14.4 Visual approach slope indicator system:
4-light PAPI on left

2.14.1 Designation: 09R
2.14.4 Visual approach slope indicator system:
4-light PAPI on right

2.14.1 Designation: 27L
2.14.4 Visual approach slope indicator system:
4-light PAPI on left

2.14.1 Designation: 11
2.14.2 Approach lighting system: MALSR: 1400
feet medium intensity approach lighting system
with runway alignment indicator lights
2.14.4 Visual approach slope indicator system:
4-light PAPI on left

2.14.1 Designation: 29
2.14.2 Approach lighting system: ALSF2: Standard
2400 feet high intensity approach lighting system
with sequenced flashers, category II or III
configuration
2.14.4 Visual approach slope indicator system:
4-light PAPI on left

AD 2.18 Air traffic services communication facilities

2.18.1 Service designation: LCL/P
2.18.3 Service designation: 118.3 MHz

2.18.1 Service designation: CD
2.18.3 Service designation: 121.1 MHz

2.18.1 Service designation: GND/P
2.18.3 Service designation: 121.75 MHz

2.18.1 Service designation: GND/P
2.18.3 Service designation: 121.9 MHz

2.18.1 Service designation: LCL/S
2.18.3 Service designation: 124.9 MHz

2.18.1 Service designation: LCL/P
2.18.3 Service designation: 127.2 MHz

2.18.1 Service designation: D-ATIS
2.18.3 Service designation: 133.775 MHz
2.18.4 Hours of operation: 24

2.18.1 Service designation: EMERG
2.18.3 Service designation: 243 MHz

2.18.1 Service designation: LCL/P
2.18.3 Service designation: 256.9 MHz

2.18.1 Service designation: LCL/P
2.18.3 Service designation: 291.65 MHz

AD 2.19 Radio navigation and landing aids

2.19.1 ILS type: Localizer for runway 27R.
Magnetic variation: 16E
2.19.2 ILS identification: OAK
2.19.5 Coordinates: 37-43-54.33N /
122-13-34.24W
2.19.6 Site elevation: 3 ft

2.19.1 ILS type: Middle Marker for runway 27R.
Magnetic variation: 16E
2.19.2 ILS identification: OAK
2.19.5 Coordinates: 37-43-16.88N /
122-11-38.86W
2.19.6 Site elevation: 10 ft

2.19.1 ILS type: Glide Slope for runway 27R.
Magnetic variation: 16E
2.19.2 ILS identification: OAK
2.19.5 Coordinates: 37-43-28.59N /
122-12-30.62W
2.19.6 Site elevation: 3 ft

2.19.1 ILS type: Outer Marker for runway 27R.
Magnetic variation: 16E
2.19.2 ILS identification: OAK
2.19.5 Coordinates: 37-41-54.13N /
122-07-25.03W
2.19.6 Site elevation: 30 ft

2.19.1 ILS type: Outer Marker for runway 11.
Magnetic variation: 16E
2.19.2 ILS identification: AAZ
2.19.5 Coordinates: 37-46-54.04N /
122-19-53.69W
2.19.6 Site elevation: 5 ft

2.19.1 ILS type: Middle Marker for runway 11.
Magnetic variation: 16E
2.19.2 ILS identification: AAZ
2.19.5 Coordinates: 37-43-31.45N /
122-15-00.00W
2.19.6 Site elevation: 5 ft

2.19.1 ILS type: Localizer for runway 11. Magnetic
variation: 16E
2.19.2 ILS identification: AAZ
2.19.5 Coordinates: 37-42-00.00N /
122-12-46.64W
2.19.6 Site elevation: 6 ft

2.19.1 ILS type: Glide Slope for runway 11.
Magnetic variation: 16E
2.19.2 ILS identification: AAZ
2.19.5 Coordinates: 37-43-00.00N /
122-14-13.82W
2.19.6 Site elevation: 4 ft

2.19.1 ILS type: Glide Slope for runway 29.
Magnetic variation: 16E
2.19.2 ILS identification: INB
2.19.5 Coordinates: 37-42-00.00N /
122-13-00.00W

2.19.6 Site elevation: 5 ft

2.19.1 ILS type: Outer Marker for runway 29.
Magnetic variation: 16E
2.19.2 ILS identification: INB
2.19.5 Coordinates: 37-39-00.00N /
122-08-25.68W
2.19.6 Site elevation: 5 ft

2.19.1 ILS type: Localizer for runway 29. Magnetic
variation: 16E
2.19.2 ILS identification: INB
2.19.5 Coordinates: 37-43-29.86N /
122-14-58.10W
2.19.6 Site elevation: 9 ft

2.19.1 ILS type: Middle Marker for runway 29.
Magnetic variation: 16E
2.19.2 ILS identification: INB
2.19.5 Coordinates: 37-41-44.61N /
122-12-20.00W
2.19.6 Site elevation: 10 ft

2.19.1 ILS type: Inner Marker for runway 29.
Magnetic variation: 16E
2.19.2 ILS identification: INB
2.19.5 Coordinates: 37-41-59.92N /
122-12-43.09W
2.19.6 Site elevation: 10 ft

General Remarks:

BIRDS ON & IN THE VICINITY OF AIRPORT.

400 FT BLAST PAD RUNWAY 29 & 500 FT BLAST PAD RUNWAY 11.

RUNWAYS 09L/27R & 09R/27L HAVE CENTERLINE REFLECTORS.

NOISE PROHIBITIONS NOT APPLICABLE IN EMERGENCY OR WHENEVER RUNWAY 11/29 IS
CLOSED DUE TO MAINT, SAFETY, WINDS OR WEATHER.

AIRCRAFT WITH EXPERIMENTAL OR LIMITED CERTIFICATION HAVING OVER 1000
HORSEPOWER OR 4000 LBS ARE RESTRICTED TO RUNWAY 11/29.

1000' CLEARWAYS RUNWAY 11 & 29.

100' LIGHTED MICROWAVE ANTENNA TOWER LOCATED 1320' WSW OF OAK VORTAC; S OF
UPWIND END OF RUNWAY 27L.

RUNWAYS 29, 27R AND RUNWAY 27L DISTANCE REMAINING SIGNS LEFT SIDE.

FOR NOISE ABATEMENT INFORMATION CONTACT NOISE ABATEMENT OFFICE AT (510) 563-6463.

RUNWAY 15/33 CLOSED TO AIR CARRIER AIRCRAFT.

PREFERENTIAL RUNWAY USE PROGRAM IN EFFECT 2200-0600. NORTH FIELD PREFERRED ARR RUNWAY 27L, NORTH FIELD PREFERRED DEP RUNWAYS 09R OR 27R. IF THESE RUNWAYS UNACCEPTABLE FOR SAFETY OR ATC INSTRUCTION THEN RUNWAY 11/29 MUST BE USED.

24 HR NOISE ABATEMENT PROCEDURE - TURBOJET AND TURBOFAN POWERED AIRCRAFT, TURBOROPS OVER 17, 000 LBS, FOUR-ENGINE RECIPROCATING POWERED AIRCRAFT, AND SURPLUS MILITARY AIRCRAFT OVER 12,500 POUNDS SHOULD NOT DEPART RUNWAYS 27R & 27R OR LAND ON RUNWAYS 09R & 09L.

INTERSECTION OF TAXIWAYS B, W AND V NOT VISIBLE FROM ATCT. TAXIWAY K BETWEEN RUNWAY 33 AND TAXIWAY D AND PORTIONS OF TAXIWAY D NOT VISIBLE FROM ATCT.

Ontario, California
Ontario International
ICAO Identifier KONT

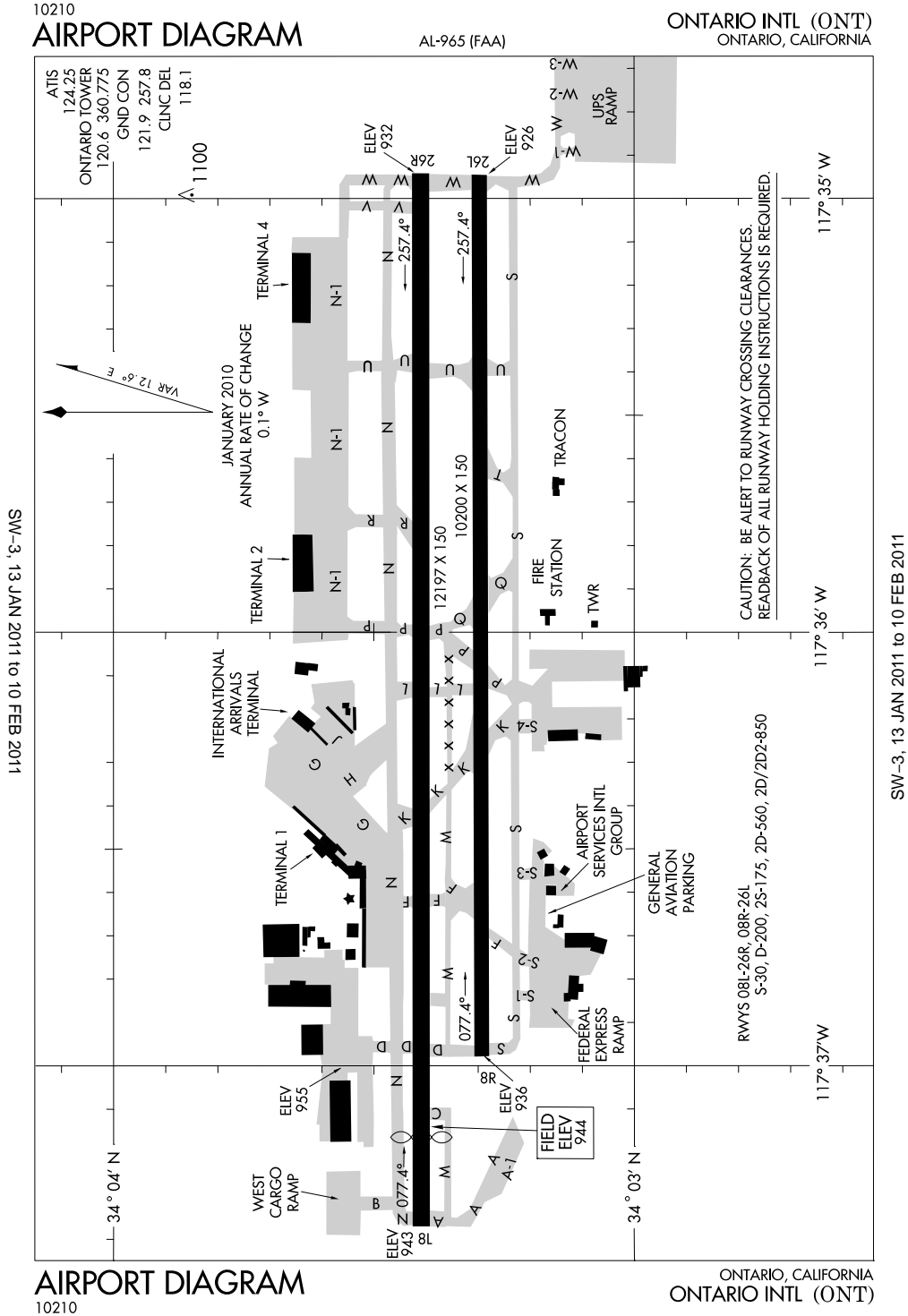

SW-3, 13 JAN 2011 to 10 FEB 2011

SW-3, 13 JAN 2011 to 10 FEB 2011

Ontario, CA
Ontario Intl
ICAO Identifier KONT

AD 2.2 Aerodrome geographical and administrative data

- 2.2.1 Reference Point: 34-03-21.60N / 117-36-00.00W
- 2.2.2 From City: 2 Miles E Of Ontario, CA
- 2.2.3 Elevation: 944 ft
- 2.2.5 Magnetic variation: 14E (1990)
- 2.2.6 Airport Contact: Jess Romo
ONTARIO INTERNATIONAL AIRPORT
Ontario, CA 91761 (909-975-5300)
- 2.2.7 Traffic: IFR/VFR

AD 2.3 Operational hours

- 2.3.1 - 2.3.11: ALL Months, ALL Days, ALL Hours

AD 2.4 Handling services and facilities

- 2.4.1 Cargo handling facilities: No
- 2.4.2 Fuel types: 100LL,A
- 2.4.4 De-icing facilities: None
- 2.4.5 Hangar space: No
- 2.4.6 Repair facilities: Major

AD 2.6 Rescue and firefighting services

- 2.6.1 Aerodrome category for firefighting: ARFF Index I D certified on 5/1/1973

AD 2.10 Aerodrome obstacles

- 2.10.1.a. Runway designation: 08L
- 2.10.1.b Type of obstacle: Rr (20 ft). Not Lighted or Marked
- 2.10.1.c Location of obstacle: 250 ft from Centerline

- 2.10.1.a. Runway designation: 26R
- 2.10.1.b Type of obstacle: Pole (40 ft). Not Lighted or Marked
- 2.10.1.c Location of obstacle: 400 ft from Centerline

- 2.10.1.a. Runway designation: 26L
- 2.10.1.b Type of obstacle: Pole (40 ft). Not Lighted or Marked
- 2.10.1.c Location of obstacle: 400 ft from Centerline

AD 2.12 Runway physical characteristics

- 2.12.1 Designation: 08L
- 2.12.2 True Bearing: 90
- 2.12.3 Dimensions: 12197 ft x 150 ft
- 2.12.5 Coordinates: 34-03-24.75N / 117-37-22.15W
- 2.12.6 Threshold elevation: 943 ft
- 2.12.6 Touchdown zone elevation: 944 ft

- 2.12.1 Designation: 26R
- 2.12.2 True Bearing: 270
- 2.12.3 Dimensions: 12197 ft x 150 ft
- 2.12.5 Coordinates: 34-03-24.82N / 117-34-57.19W
- 2.12.6 Threshold elevation: 932 ft
- 2.12.6 Touchdown zone elevation: 932 ft

- 2.12.1 Designation: 08R
- 2.12.2 True Bearing: 90
- 2.12.3 Dimensions: 10200 ft x 150 ft
- 2.12.5 Coordinates: 34-03-17.85N / 117-36-58.41W
- 2.12.6 Threshold elevation: 936 ft
- 2.12.6 Touchdown zone elevation: 936 ft

- 2.12.1 Designation: 26L
- 2.12.2 True Bearing: 270
- 2.12.3 Dimensions: 10200 ft x 150 ft
- 2.12.5 Coordinates: 34-03-17.89N / 117-34-57.19W
- 2.12.6 Threshold elevation: 926 ft
- 2.12.6 Touchdown zone elevation: 926 ft

AD 2.14 Approach and runway lighting

- 2.14.1 Designation: 08L
- 2.14.2 Approach lighting system: MALSR: 1400 feet medium intensity approach lighting system with runway alignment indicator lights
- 2.14.4 Visual approach slope indicator system: 4-light PAPI on left

- 2.14.1 Designation: 26R
- 2.14.2 Approach lighting system: MALSR: 1400 feet medium intensity approach lighting system with runway alignment indicator lights
- 2.14.4 Visual approach slope indicator system: 4-light PAPI on left

- 2.14.1 Designation: 08R
- 2.14.4 Visual approach slope indicator system: 4-light PAPI on left

- 2.14.1 Designation: 26L
- 2.14.2 Approach lighting system: ALSF2: Standard 2400 feet high intensity approach lighting system with sequenced flashers, category II or III configuration
- 2.14.4 Visual approach slope indicator system: 4-light PAPI on right

AD 2.18 Air traffic services communication facilities

- 2.18.1 Service designation: CD/P
- 2.18.3 Service designation: 118.1 MHz

- 2.18.1 Service designation: LCL/P
- 2.18.3 Service designation: 120.6 MHz

- 2.18.1 Service designation: EMERG
- 2.18.3 Service designation: 121.5 MHz

- 2.18.1 Service designation: GND/P
- 2.18.3 Service designation: 121.9 MHz

- 2.18.1 Service designation: D-ATIS)
- 2.18.3 Service designation: 124.25 MHz
- 2.18.4 Hours of operation: 24

- 2.18.1 Service designation: EMERG
- 2.18.3 Service designation: 243 MHz

- 2.18.1 Service designation: GND/P
- 2.18.3 Service designation: 257.8 MHz

- 2.18.1 Service designation: LCL/P
- 2.18.3 Service designation: 360.775 MHz

AD 2.19 Radio navigation and landing aids

- 2.19.1 ILS type: Glide Slope for runway 08L. Magnetic variation: 14E
- 2.19.2 ILS identification: AOD
- 2.19.5 Coordinates: 34-03-21.21N / 117-36-59.90W
- 2.19.6 Site elevation: 936 ft

- 2.19.1 ILS type: Middle Marker for runway 08L. Magnetic variation: 14E
- 2.19.2 ILS identification: AOD
- 2.19.5 Coordinates: 34-03-25.80N / 117-37-51.55W
- 2.19.6 Site elevation: 947 ft

- 2.19.1 ILS type: Localizer for runway 08L.

- Magnetic variation: 14E
- 2.19.2 ILS identification: AOD
- 2.19.5 Coordinates: 34-03-24.82N / 117-34-45.84W
- 2.19.6 Site elevation: 929 ft

- 2.19.1 ILS type: Glide Slope for runway 26R. Magnetic variation: 14E
- 2.19.2 ILS identification: ONT
- 2.19.5 Coordinates: 34-03-22.01N / 117-35-10.97W
- 2.19.6 Site elevation: 926 ft

- 2.19.1 ILS type: Outer Marker for runway 26R. Magnetic variation: 14E
- 2.19.2 ILS identification: ONT
- 2.19.5 Coordinates: 34-03-22.33N / 117-28-17.72W
- 2.19.6 Site elevation: 1010 ft

- 2.19.1 ILS type: Middle Marker for runway 26R. Magnetic variation: 14E
- 2.19.2 ILS identification: ONT
- 2.19.5 Coordinates: 34-03-24.79N / 117-34-24.33W
- 2.19.6 Site elevation: 940 ft

- 2.19.1 ILS type: DME for runway 26R. Magnetic variation: 14E
- 2.19.2 ILS identification: ONT
- 2.19.5 Coordinates: 34-03-22.15N / 117-37-26.54W
- 2.19.6 Site elevation: 958 ft

- 2.19.1 ILS type: Localizer for runway 26R. Magnetic variation: 14E
- 2.19.2 ILS identification: ONT
- 2.19.5 Coordinates: 34-03-24.76N / 117-37-26.68W
- 2.19.6 Site elevation: 945 ft

- 2.19.1 ILS type: DME for runway 26L. Magnetic variation: 14E
- 2.19.2 ILS identification: TWO
- 2.19.5 Coordinates: 34-03-20.47N / 117-37-00.00W
- 2.19.6 Site elevation: 948 ft

- 2.19.1 ILS type: Middle Marker for runway 26L. Magnetic variation: 14E
- 2.19.2 ILS identification: TWO

2.19.5 Coordinates: 34-03-17.88N /
117-34-24.41W
2.19.6 Site elevation: 924 ft

2.19.1 ILS type: Glide Slope for runway 26L.
Magnetic variation: 14E
2.19.2 ILS identification: TWO
2.19.5 Coordinates: 34-03-21.89N /
117-35-10.97W
2.19.6 Site elevation: 925 ft

2.19.1 ILS type: Inner Marker for runway 26L.
Magnetic variation: 14E
2.19.2 ILS identification: TWO
2.19.5 Coordinates: 34-03-17.89N /
117-34-47.85W
2.19.6 Site elevation: 921 ft

2.19.1 ILS type: Outer Marker for runway 26L.
Magnetic variation: 14E

2.19.2 ILS identification: TWO
2.19.5 Coordinates: 34-03-22.33N /
117-28-17.72W
2.19.6 Site elevation: 1010 ft

2.19.1 ILS type: Localizer for runway 26L.
Magnetic variation: 14E
2.19.2 ILS identification: TWO
2.19.5 Coordinates: 34-03-17.84N /
117-37-10.29W
2.19.6 Site elevation: 931 ft

General Remarks:

NO ACCESS TO RUNWAY 08R FROM TAXIWAY A.

FBO'S ON FREQ 130.75 AND 131.6.

TAXIWAY H RESTRICTED TO AIRCRAFT WITH WINGSPAN OF 124 FT OR SMALLER WHEN GATE 35A OCCUPIED BY B747 OR LARGER AIRCRAFT.

TAXIWAY J RESTRICTED TO AIRCRAFT WITH WINGSPAN OF 108 FT OR SMALLER.

WILDLIFE HAZARD MANAGEMENT PLAN IN EFFECT; POTENTIAL BIRD HAZARDS MAY EXIST ON AND IN THE VICINITY OF AIRPORT; BE ALERT TO LARGE NUMBERS OF STARLINGS AND CROWS POSSIBLE ON APPROACH TO RUNWAY 26L AND RUNWAY 26R, HAWKS, EAGLES, FALCONS AND OWLS SPOTTED ON OCCASION.

TAXIWAY M, TAXIWAY A, TAXIWAY S-3 AND TAXIWAY S-4 RESTRICTED TO AIRCRAFT WITH WINGSPAN 117 FT OR SMALLER.

PILOTS SHOULD USE JUDGEMENTAL OVERSTEER ON TAXIWAY A, TAXIWAY M, TAXIWAY H, TAXIWAY J, TAXIWAY S-3 AND TAXIWAY S-4.

NOISE ABATEMENT PROCEDURES IN EFFECT; FULL-LENGTH TURBOJET DEP ENCOURAGED, NIGHTLY PREFERENTIAL RUNWAY USAGE, 2100-0600.

EASTBOUND B747, B777, A330, A340 OR LARGER AIRCRAFT ON TAXIWAY S PROHIBITED FROM NORTHBOUND TURNS ONTO TAXIWAY K.

B747, B777, A330, A340 OR LARGER AIRCRAFT ON TAXIWAY S PROHIBITED FROM NORTHBOUND TURNS ONTO TAXIWAY P.

AIRCRAFT PARKING AND CONTRACT GROUND SERVICES ARE LIMITED FOR NON-SCHEDULED OPERATIONS. FOR SCHEDULING INFORMATION CALL AIRFIELD OPERATIONS (909)975-5344.

TAXIWAY W SOUTH OF TAXIWAY S IS A NON-MOVEMENT AREA; ALL AIRCRAFT CONTACT RAMP CONTROL 131.325 FOR ACCESS.

ALL MILITARY AND GENERAL AVIATION (FIXED OR ROTOR WING) AIRCRAFT OPERATIONS ARE RESTRICTED TO FBO FACILITIES WITH ADVANCE COORDINATION; OVERNIGHT TIEDOWN AND PARKING FEE.

TAXIWAY S SOUTH OF CENTERLINE BETWEEN TXLN S-2 AND S-3, AND THE SOUTHERN HALF OF TXLN S-2 AND S-3 ARE NOT VISIBLE FROM ATCT; PILOTS USE CAUTION ENTERING TXLN S-2 AND S-3.

Palmdale, California
Palmdale Production Flight/Test Installation
AF Plant #42
ICAO Identifier KPMD

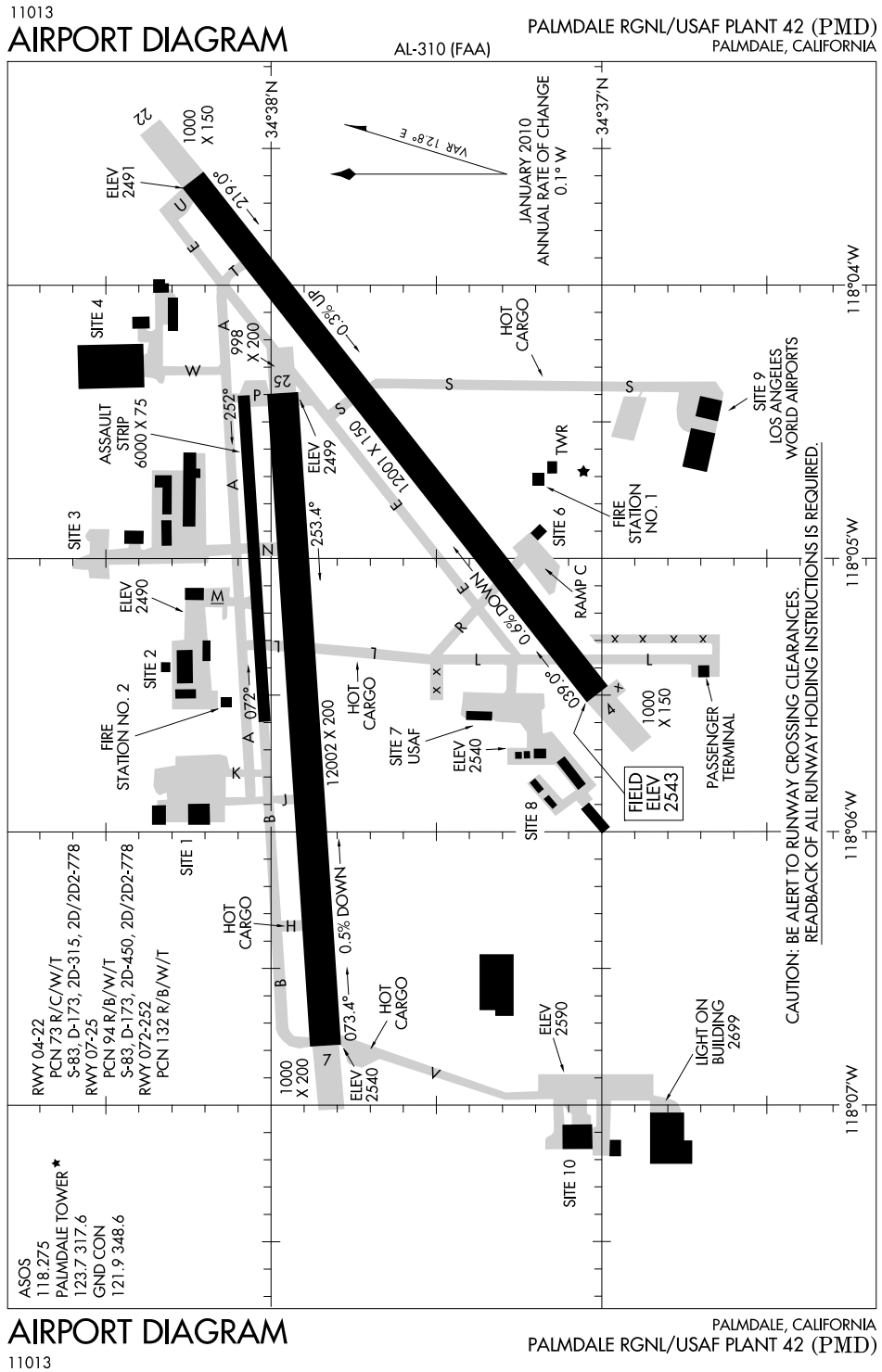

Palmdale, CA
Palmdale Rgnl/USAF Plant 42
ICAO Identifier KPMD

AD 2.2 Aerodrome geographical and administrative data

- 2.2.1 Reference Point: 34-37-45.80N / 118-05-00.00W
- 2.2.2 From City: 3 Miles NE Of Palmdale, CA
- 2.2.3 Elevation: 2543 ft
- 2.2.5 Magnetic variation: 15E (1985)
- 2.2.6 Airport Contact: Ken Neitzel (USAF)
2503 E AVE P
Palmdale, CA 93550
(661-272-6715)
- 2.2.7 Traffic: IFR/VFR

AD 2.3 Operational hours

- 2.3.1 - 2.3.11: ALL Months, ALL Days, 0430-2100 Hours

AD 2.4 Handling services and facilities

- 2.4.1 Cargo handling facilities: No
- 2.4.2 Fuel types: None
- 2.4.4 De-icing facilities: None
- 2.4.5 Hangar space: No
- 2.4.6 Repair facilities: None

AD 2.6 Rescue and firefighting services

- 2.6.1 Aerodrome category for firefighting: None

AD 2.10 Aerodrome obstacles

- 2.10.1.a. Runway designation: 04
- 2.10.1.b Type of obstacle: Hill. Not Lighted or Marked

AD 2.12 Runway physical characteristics

- 2.12.1 Designation: 07
- 2.12.2 True Bearing: 86
- 2.12.3 Dimensions: 12002 ft x 200 ft
- 2.12.4 PCN: 94 R/B/W/T
- 2.12.5 Coordinates: 34-37-50.11N / 118-06-47.03W
- 2.12.6 Threshold elevation: 2540 ft
- 2.12.6 Touchdown zone elevation: 2540 ft
- 2.12.7 Slope: 0.5DOWN

- 2.12.1 Designation: 25
- 2.12.2 True Bearing: 266
- 2.12.3 Dimensions: 12002 ft x 200 ft
- 2.12.4 PCN: 94 R/B/W/T

- 2.12.5 Coordinates: 34-37-57.99N / 118-04-23.74W
- 2.12.6 Threshold elevation: 2499 ft
- 2.12.6 Touchdown zone elevation: 2503 ft
- 2.12.7 Slope: 0.2UP

- 2.12.1 Designation: 04
- 2.12.2 True Bearing: 52
- 2.12.3 Dimensions: 12001 ft x 150 ft
- 2.12.4 PCN: 73 R/C/W/T
- 2.12.5 Coordinates: 34-37-00.00N / 118-05-29.80W
- 2.12.6 Threshold elevation: 2542 ft
- 2.12.6 Touchdown zone elevation: 2543 ft
- 2.12.7 Slope: 0.6DOWN

- 2.12.1 Designation: 22
- 2.12.2 True Bearing: 232
- 2.12.3 Dimensions: 12001 ft x 150 ft
- 2.12.4 PCN: 73 R/C/W/T
- 2.12.5 Coordinates: 34-38-14.24N / 118-03-36.97W
- 2.12.6 Threshold elevation: 2491 ft
- 2.12.6 Touchdown zone elevation: 2498 ft
- 2.12.7 Slope: 0.3UP

- 2.12.1 Designation: 072
- 2.12.3 Dimensions: 6000 ft x 75 ft
- 2.12.4 PCN: 132 R/B/W/T

- 2.12.1 Designation: 252
- 2.12.3 Dimensions: 6000 ft x 75 ft
- 2.12.4 PCN: 132 R/B/W/T

AD 2.14 Approach and runway lighting

- 2.14.1 Designation: 25
- 2.14.4 Visual approach slope indicator system: 4-light PAPI on left

- 2.14.1 Designation: 22
- 2.14.4 Visual approach slope indicator system: 4-light PAPI on left

AD 2.19 Radio navigation and landing aids

- 2.19.1 ILS type: Outer Marker for runway 25. Magnetic variation: 15E
- 2.19.2 ILS identification: PMD
- 2.19.5 Coordinates: 34-38-22.66N / 117-57-30.34W
- 2.19.6 Site elevation: 2550 ft

2.19.1 ILS type: Middle Marker for runway 25.

Magnetic variation: 15E

2.19.2 ILS identification: PMD

2.19.5 Coordinates: 34-38-00.00N /

118-03-46.16W

2.19.6 Site elevation: 2492 ft

2.19.1 ILS type: Localizer for runway 25. Magnetic
variation: 15E

2.19.2 ILS identification: PMD

2.19.5 Coordinates: 34-37-48.79N /

118-07-10.91W

2.19.6 Site elevation: 2552 ft

2.19.1 ILS type: Glide Slope for runway 25.

Magnetic variation: 15E

2.19.2 ILS identification: PMD

2.19.5 Coordinates: 34-38-00.00N /

118-04-40.08W

2.19.6 Site elevation: 2492 ft

General Remarks:

SERVICES NORMALLY ASSOCIATED WITH AN AFB, NOT AVAILABLE AT THIS INSTALLATION.

WHEN ATCT CLOSED AIRPORT CLOSED TO ALL TRAFFIC WITHOUT WRITTEN APPROVAL.

PARKING RAMP LOCATED S OF RUNWAY 22 & TAXIWAY V NOT VISIBLE FROM ATCT.

LIMITED FUELING AVAILABLE TO GOVERNMENT AIRCRAFT ONLY 0730-1730 WEEKDAY;
CALL PLANT OFFICE TO ARRANGE.

UNLIGHTED OBSTRUCTION SURROUND AIRFIELD.

DRAINAGE DITCHES PARALLEL ALL RUNWAYS.

BIRD HAZARD POTENTIAL EXISTS. MIGRATORY SEASON PHASE II 1 OCT - 31 AT SEA.
DURING BIRD WATCH CONDITION MODERATE, TAKE-OFF AND LANDING PERMITTED.
DURING BIRD WATCH CONDITION SEVERE, TAKE-OFF AND LANDING PROHIBITED.

MILITARY USE: ASSAULT LANDING ZONE LOCATED 1ST 6,000 EAST END OF TAXIWAY B,
ASSAULT LANDING ZONE 25 OPEN TO C-130 AIRCRAFT, PRIOR PERMISSION REQUIRED
ONLY; CALL 661-272-6715. ASSAULT LANDING ZONE ONE-WAY LANDING ASSAULT
LANDING ZONE 25 ONLY.

MISC: WINDS ARE ESTIMATE DUE TO FMQ-13 WIND SENSORS BEING ACCURATE TO WITHIN
ONLY +/- 2 KNOTS. ATC/WX WILL NOT INCLUDE/RELAY WIND CORRECTION INTO
FORECAST/PHRASEOLOGY. THEREFORE, AIRCREWS WILL INCORPORATE A +/- 2 KNOTS
ACCURACY INTO THEIR DECISION MAKING PROCESS FOR FLYING OPR.

OFFICIAL BUSINESS ONLY, MILITARY AIRPORT CIVIL USE REQUIRES USAF APPROVAL AND
DD FORM 2400/01/02.

CAUTION: RUNWAY EDGE LIGHT LOCATED 30' FR OUTSIDE SIDE STRIPE. 60' AGL STRING OF
UTILITY POLES VIOLATE RUNWAY 22 APPROACH CLEAR ZONE SURFACE N OF EXTENSION
CENTERLINE.

SERVICE-LGT: GATED THRESHOLD LIGHT RUNWAY 07-25 AND RUNWAY 04-22.

RESTRICTED: OFFICIAL BUSINESS ONLY, PRIOR PERMISSION REQUIRED FOR ALL FULL STOP
LANDING ONLY. CALL C661-272-6715 DURING DUTY HR, ON TIME C661-272-6600 AFTER
DUTY HR.

SERVICE-TRAN ALERT: NO FLEET SERVICE AVAILABLE.

MISC: COMSEC STORAGE UNAVAILABLE.

RESTRICTED: RUNWAY 252 MRK ONLY FOR C-130 ASSAULT OPR; ONE-WAY LANDING ONLY.
USE OF ASSAULT STRIP LANDING ZONE REQ PRIOR COORD WITH 146 OSF/OSK DSN 893-7590,
C805-986-7590.

**Sacramento, California
Sacramento International
ICAO Identifier KSMF**

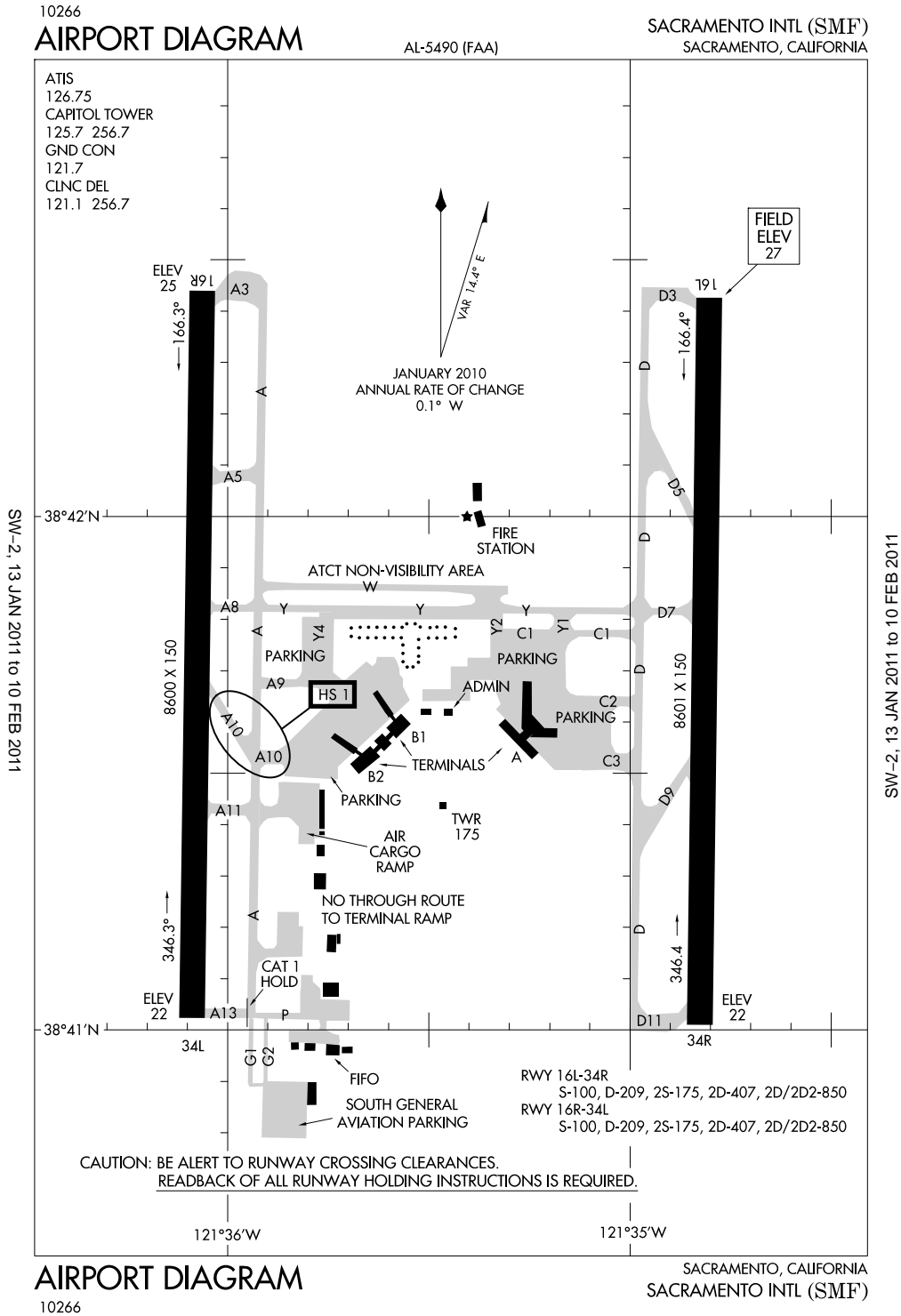

Sacramento, CA
Sacramento Intl
ICAO Identifier KSMF

AD 2.2 Aerodrome geographical and administrative data

- 2.2.1 Reference Point: 38-41-43.50N / 121-35-26.80W
- 2.2.2 From City: 10 Miles NW Of Sacramento, CA
- 2.2.3 Elevation: 27 ft
- 2.2.5 Magnetic variation: 17E (1980)
- 2.2.6 Airport Contact: Barry Rondinella
6900 AIRPORT BLVD
Sacramento, CA 95837
(916-874-0566)
- 2.2.7 Traffic: IFR/VFR

AD 2.3 Operational hours

- 2.3.1 - 2.3.11: ALL Months, ALL Days, ALL Hours

AD 2.4 Handling services and facilities

- 2.4.1 Cargo handling facilities: No
- 2.4.2 Fuel types: 100LL,A
- 2.4.4 De-icing facilities: None
- 2.4.5 Hangar space: No
- 2.4.6 Repair facilities: Minor

AD 2.6 Rescue and firefighting services

- 2.6.1 Aerodrome category for firefighting: ARFF Index I C certified on 5/1/1973

AD 2.12 Runway physical characteristics

- 2.12.1 Designation: 16L
- 2.12.2 True Bearing: 181
- 2.12.3 Dimensions: 8601 ft x 150 ft
- 2.12.5 Coordinates: 38-42-25.65N / 121-34-48.21W
- 2.12.6 Threshold elevation: 27 ft
- 2.12.6 Touchdown zone elevation: 27 ft

- 2.12.1 Designation: 34R
- 2.12.2 True Bearing: 1
- 2.12.3 Dimensions: 8601 ft x 150 ft
- 2.12.5 Coordinates: 38-41-00.00N / 121-34-49.64W
- 2.12.6 Threshold elevation: 22 ft
- 2.12.6 Touchdown zone elevation: 24 ft

- 2.12.1 Designation: 16R
- 2.12.2 True Bearing: 181

- 2.12.3 Dimensions: 8600 ft x 150 ft
- 2.12.5 Coordinates: 38-42-26.43N / 121-36-00.00W
- 2.12.6 Threshold elevation: 25 ft
- 2.12.6 Touchdown zone elevation: 25 ft

- 2.12.1 Designation: 34L
- 2.12.2 True Bearing: 1
- 2.12.3 Dimensions: 8600 ft x 150 ft
- 2.12.5 Coordinates: 38-41-00.00N / 121-36-00.00W
- 2.12.6 Threshold elevation: 22 ft
- 2.12.6 Touchdown zone elevation: 24 ft

AD 2.14 Approach and runway lighting

- 2.14.1 Designation: 16L
- 2.14.2 Approach lighting system: MALSR: 1400 feet medium intensity approach lighting system with runway alignment indicator lights
- 2.14.4 Visual approach slope indicator system: 4-light PAPI on left

- 2.14.1 Designation: 34R
- 2.14.4 Visual approach slope indicator system: 4-light PAPI on left

- 2.14.1 Designation: 16R
- 2.14.2 Approach lighting system: ALSF2: Standard 2400 feet high intensity approach lighting system with sequenced flashers, category II or III configuration
- 2.14.4 Visual approach slope indicator system: 4-light PAPI on right
- 2.14.10 Remarks: ALSF2 Unmonitored.

- 2.14.1 Designation: 34L
- 2.14.2 Approach lighting system: MALSR: 1400 feet medium intensity approach lighting system with runway alignment indicator lights
- 2.14.4 Visual approach slope indicator system: 4-box VASI on left

AD 2.18 Air traffic services communication facilities

- 2.18.1 Service designation: CD/P
- 2.18.3 Service designation: 121.1 MHz

- 2.18.1 Service designation: GND/P
- 2.18.3 Service designation: 121.7 MHz

- 2.18.1 Service designation: LCL/P

2.18.3 Service designation: 125.7 MHz

2.18.1 Service designation: D-ATIS

2.18.3 Service designation: 126.75 MHz

2.18.4 Hours of operation: 24

2.18.1 Service designation: CD/P GND/P LCL/P

2.18.3 Service designation: 256.7 MHz

AD 2.19 Radio navigation and landing aids

2.19.1 ILS type: Localizer for runway 16L.

Magnetic variation: 17E

2.19.2 ILS identification: MDK

2.19.5 Coordinates: 38-40-50.24N /

121-34-49.82W

2.19.6 Site elevation: 17 ft

2.19.1 ILS type: DME for runway 16L. Magnetic variation: 17E

2.19.2 ILS identification: MDK

2.19.5 Coordinates: 38-40-50.22N /

121-34-46.30W

2.19.6 Site elevation: 31 ft

2.19.1 ILS type: Glide Slope for runway 16L.

Magnetic variation: 17E

2.19.2 ILS identification: MDK

2.19.5 Coordinates: 38-42-15.23N /

121-34-44.35W

2.19.6 Site elevation: 22 ft

2.19.1 ILS type: Localizer for runway 16R.

Magnetic variation: 15E

2.19.2 ILS identification: SMF

2.19.5 Coordinates: 38-40-35.75N /

121-36-00.00W

2.19.6 Site elevation: 19 ft

2.19.1 ILS type: DME for runway 16R. Magnetic variation: 15E

2.19.2 ILS identification: SMF

2.19.5 Coordinates: 38-40-34.94N /

121-36-00.00W

2.19.6 Site elevation: 35 ft

2.19.1 ILS type: Inner Marker for runway 16R.

Magnetic variation: 15E

2.19.2 ILS identification: SMF

2.19.5 Coordinates: 38-42-34.10N /

121-36-00.00W

2.19.6 Site elevation: 21 ft

2.19.1 ILS type: Middle Marker for runway 16R.

Magnetic variation: 15E

2.19.2 ILS identification: SMF

2.19.5 Coordinates: 38-42-53.08N /

121-36-00.00W

2.19.6 Site elevation: 22 ft

2.19.1 ILS type: Glide Slope for runway 16R.

Magnetic variation: 15E

2.19.2 ILS identification: SMF

2.19.5 Coordinates: 38-42-15.86N /

121-36-00.00W

2.19.6 Site elevation: 23 ft

2.19.1 ILS type: Outer Marker for runway 16R.

Magnetic variation: 15E

2.19.2 ILS identification: SMF

2.19.5 Coordinates: 38-47-41.88N /

121-35-57.78W

2.19.6 Site elevation: 15 ft

2.19.1 ILS type: Localizer for runway 34L.

Magnetic variation: 17E

2.19.2 ILS identification: HUX

2.19.5 Coordinates: 38-42-35.72N /

121-36-00.00W

2.19.6 Site elevation: 23 ft

2.19.1 ILS type: Glide Slope for runway 34L.

Magnetic variation: 17E

2.19.2 ILS identification: HUX

2.19.5 Coordinates: 38-41-12.50N /

121-36-00.00W

2.19.6 Site elevation: 22 ft

2.19.1 ILS type: Outer Marker for runway 34L.

Magnetic variation: 17E

2.19.2 ILS identification: HUX

2.19.5 Coordinates: 38-37-00.00N /

121-36-11.87W

2.19.6 Site elevation: 15 ft

2.19.1 ILS type: Middle Marker for runway 34L.

Magnetic variation: 17E

2.19.2 ILS identification: HUX

2.19.5 Coordinates: 38-40-32.75N /

121-36-00.00W

2.19.6 Site elevation: 17 ft

2.19.1 ILS type: DME for runway 34L. Magnetic variation: 17E

2.19.2 ILS identification: HUX
2.19.5 Coordinates: 38-42-36.90N /
121-36-00.00W

2.19.6 Site elevation: 22 ft

General Remarks:

BIRDS ON AND IN VICINITY OF AIRPORT.

FAA GROSS WEIGHT STRENGTH EVALUATION DC-10-10 = 410000 LBS; DC-10-30 = 530000 LBS.

NOISE SENSITIVE AREAS W OF AIRPORT ON SAC RIVER. LOCAL TURN DISCOURAGED FOR JET AIRCRAFT. WHEN CONDUCTING IFR APPROACH IN VFR CONDITIONS EXECUTE MISSED APPROACH AT DEP END OF RUNWAYS. PLAN VFR PATTERNS TO E. USE MIN POWER SETTINGS.

ALL AIRCRAFT CONTACT ATC GROUND CONTROL PRIOR TO MOVEMENT ON RAMP.

CROP DUSTERS OPER IN THE VICINITY OF AIRPORT AT OR BELOW 200 FT AGL.

(A49A-16R) ALSF2 OPERS AS SSALR TILL WEATHER GOES BELOW VFR.

TAXIWAY REMARK #2: THE MAXIMUM ALLOWABLE GROSS AIRCRAFT LOAD FOR TAXIWAYS G1, G2, AND THE GENERAL AVIATION PARKING APRON IS: 70,000 LBS FOR SINGLE GEAR AIRCRAFT; 170,000 LBS FOR DUAL GEAR AIRCRAFT; AND 250,000 LBS FOR DUAL TANDEM GEAR AIRCRAFT.

TAXIWAY REMARK #2 CONT'D: AN AIRCRAFT CANNOT EXCEED THE AIRPLANE DESIGN GROUP III CRITERIA AND MUST HAVE A WHEEL BASE OF LESS THAN 60 FT.

MILITARY AIRCRAFT PARKING WILL BE LIMITED DUE TO CONSTRUCTION. CONTACT AIRPORT OPERATIONS IF PARKING IS REQUIRED (916) 806-5351.

TAXI LANE BETWEEN TAXIWAY A10 AND INTERSECTION OF TAXIWAY A9 & TAXIWAY Y4 CLOSED TO AIRCRAFT WITH WINGSPAN OVER 125 FT.

PORTION OF TAXIWAY W 500 FT EAST OF TAXIWAY A TO 2100 FT EAST OF TAXIWAY A IS NOT VISIBLE FROM ATCT.

TAXIWAY Y4 WILL BE OPEN AND RESTRICTED TO AIRCRAFT WITH A WINGSPAN OF LESS THAN 118 FT (GROUP III) AND WILL BE CLOSED NIGHTLY FOR REMAINING OVERNIGHT PARKING OR ANYTIME REMAINING OVERNIGHT PAD IS UTILIZED.

DUE TO CONSTRUCTION ACTIVITY, AIRCRAFT MAY ENCOUNTER DIFFICULTIES PERFORMING TRANSPONDER CHECKS IN AND AROUND GATES LOCATED AT TERMINAL B1 AND B2. PROBLEM MAY BE ALLEVIATED BY PERFORMING TRANSPONDER CHECKS WHILE TAXIING OUT TO TAXIWAY A.

NUMEROUS CONSTRUCTION CRANES AND EQUIPMENT WILL BE OPERATING SOUTH OF TAXIWAY W BETWEEN TAXIWAY Y2 AND THE REMAINING OVERNIGHT PAD. NO CRANE OR OTHER EQUIPMENT WILL BE MORE THAN 275 FT AGL. EQUIPMENT WILL BE FLAGGED AND LIGHTED OR LOWERED DURING THE HOURS OF LOW VISIBILITY OR DARKNESS.

COMMON USE JET BRIDGES B35 AND B37 ARE TO BE UTILIZED FOR AIRCRAFT TOW-IN AND TOW-OUT OPERATIONS ONLY. ALL OTHER AIRCRAFT, WITH THE EXCEPTION OF E120 OPERATIONS, MUST SHUT DOWN POWER PRIOR TO APPROACHING GATES AND SHALL BE TOWED INTO PLACE.

San Diego, California San Diego International ICAO Identifier KSAN

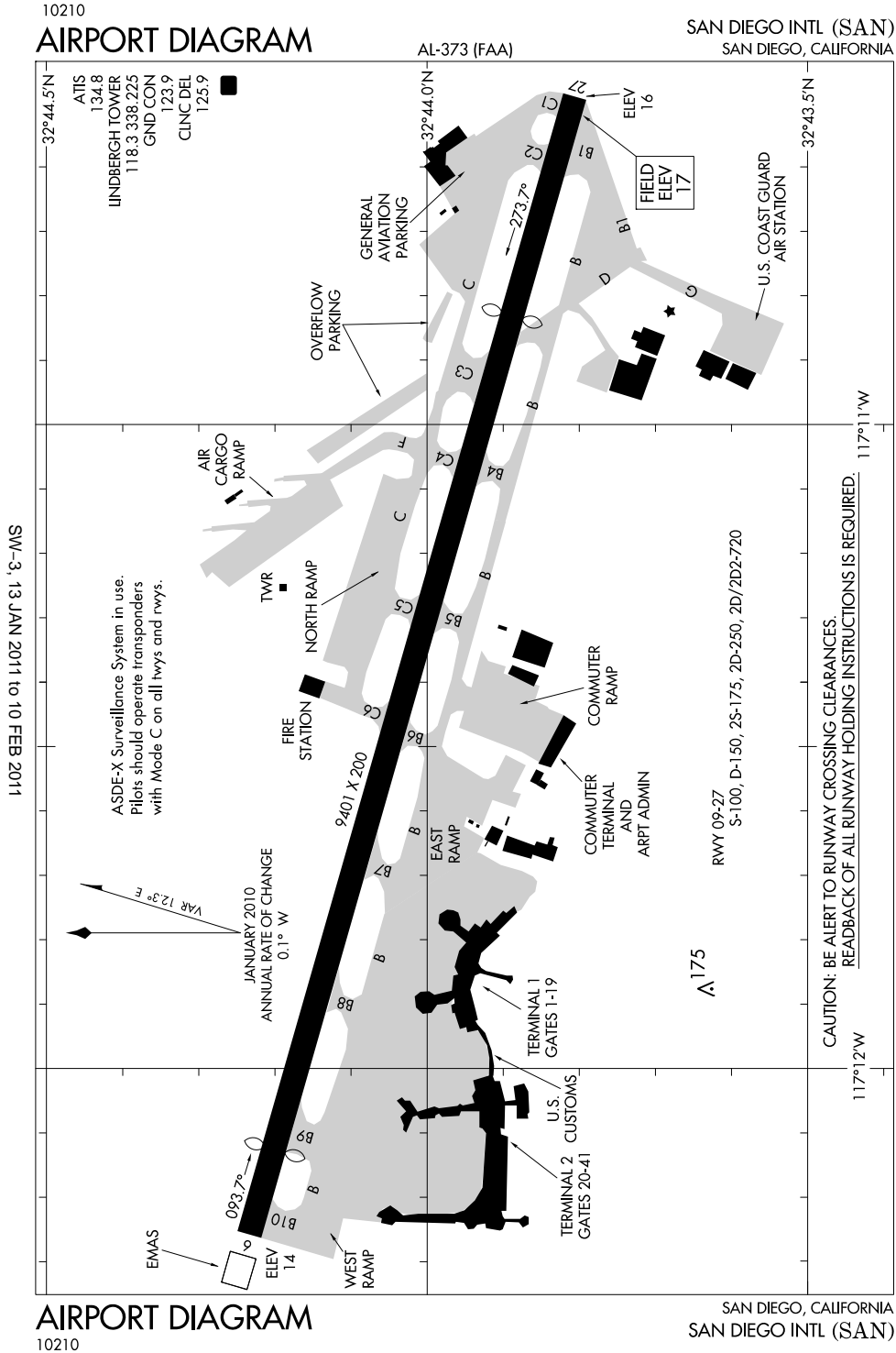

San Diego, CA
San Diego Intl
ICAO Identifier KSAN

AD 2.2 Aerodrome geographical and administrative data

- 2.2.1 Reference Point: 32-44-00.00N / 117-11-22.80W
- 2.2.2 From City: 2 Miles W Of San Diego, CA
- 2.2.3 Elevation: 17 ft
- 2.2.5 Magnetic variation: 14E (1980)
- 2.2.6 Airport Contact: Angela Shafer-Payne
3225 N HARBOR DRIVE
San Diego, CA 92101
(619) 400-2455
- 2.2.7 Traffic: IFR/VFR

AD 2.3 Operational hours

- 2.3.1 - 2.3.11: ALL Months, ALL Days, ALL Hours

AD 2.4 Handling services and facilities

- 2.4.1 Cargo handling facilities: No
- 2.4.2 Fuel types: 100LL,A
- 2.4.4 De-icing facilities: None
- 2.4.5 Hangar space: Yes
- 2.4.6 Repair facilities: Minor

AD 2.6 Rescue and firefighting services

- 2.6.1 Aerodrome category for firefighting: ARFF Index I D certified on 5/1/1973

AD 2.10 Aerodrome obstacles

- 2.10.1.a. Runway designation: 09
- 2.10.1.b Type of obstacle: Tree (31 ft). Not Lighted or Marked
- 2.10.1.c Location of obstacle: 385 ft from Centerline

- 2.10.1.a. Runway designation: 27
- 2.10.1.b Type of obstacle: Sign (61 ft). Not Lighted or Marked
- 2.10.1.c Location of obstacle: 500 ft from Centerline

AD 2.12 Runway physical characteristics

- 2.12.1 Designation: 09
- 2.12.2 True Bearing: 106
- 2.12.3 Dimensions: 9401 ft x 200 ft
- 2.12.5 Coordinates: 32-44-13.62N / 117-12-15.66W

- 2.12.6 Threshold elevation: 14 ft
- 2.12.6 Touchdown zone elevation: 17 ft

- 2.12.1 Designation: 27
- 2.12.2 True Bearing: 286
- 2.12.3 Dimensions: 9401 ft x 200 ft
- 2.12.5 Coordinates: 32-43-47.98N / 117-10-29.88W
- 2.12.6 Threshold elevation: 16 ft
- 2.12.6 Touchdown zone elevation: 17 ft

AD 2.13 Declared distances

- 2.13.1 Designation: 09
- 2.13.2 Takeoff run available: 9401
- 2.13.3 Takeoff distance available: 9401
- 2.13.4 Accelerate-stop distance available: 8280
- 2.13.5 Landing distance available: 7580

- 2.13.1 Designation: 27
- 2.13.2 Takeoff run available: 9401
- 2.13.3 Takeoff distance available: 9401
- 2.13.4 Accelerate-stop distance available: 9401
- 2.13.5 Landing distance available: 7591

AD 2.14 Approach and runway lighting

- 2.14.1 Designation: 09
- 2.14.2 Approach lighting system: MALSR: 1400 feet medium intensity approach lighting system with runway alignment indicator lights

- 2.14.1 Designation: 27
- 2.14.2 Approach lighting system: MALSR: 1400 feet medium intensity approach lighting system
- 2.14.4 Visual approach slope indicator system: 4-light PAPI on left
- 2.14.10 Remarks: PAPI 4-Box(L) 3.5 Degrees Angle; Threshold Crossing Height 66' From Displaced Thr; Baffled Horizontally 4.8 Degrees N Of Centerline And 10.0 Degrees S Of Centerline ; Lateral Coverage Has Been Narrowed To Avoid Obstacles; Close Alignment To Runway Centerline Is Necessary; Use Of Localizer Recommended. MALSR Rwy 27 Threshold To 1400'.

AD 2.18 Air traffic services communication facilities

- 2.18.1 Service designation: LCL/P
- 2.18.3 Service designation: 118.3 MHz

- 2.18.1 Service designation: GND/P
- 2.18.3 Service designation: 123.9 MHz

2.18.1 Service designation: CD
2.18.3 Service designation: 125.9 MHz

2.18.1 Service designation: D-ATIS
2.18.3 Service designation: 134.8 MHz
2.18.4 Hours of operation: 24

variation: 14E
2.19.2 ILS identification: SAN
2.19.5 Coordinates: 32-43-46.80N /
117-10-28.50W
2.19.6 Site elevation: 29 ft

2.18.1 Service designation: LCL/P
2.18.3 Service designation: 338.225 MHz

2.19.1 ILS type: Glide Slope for runway 09.
Magnetic variation: 14E
2.19.2 ILS identification: SAN
2.19.5 Coordinates: 32-44-10.40N /
117-11-49.98W
2.19.6 Site elevation: 13 ft

AD 2.19 Radio navigation and landing aids

2.19.1 ILS type: Localizer for runway 09. Magnetic
variation: 14E
2.19.2 ILS identification: SAN
2.19.5 Coordinates: 32-43-47.58N /
117-10-28.21W
2.19.6 Site elevation: 18 ft

2.19.1 ILS type: Localizer for runway 27. Magnetic
variation: 14E
2.19.2 ILS identification: UBR
2.19.5 Coordinates: 32-44-14.44N /
117-12-19.04W
2.19.6 Site elevation: 13 ft

2.19.1 ILS type: Middle Marker for runway 09.
Magnetic variation: 14E
2.19.2 ILS identification: SAN
2.19.5 Coordinates: 32-44-23.65N /
117-12-57.08W
2.19.6 Site elevation: 99999 ft

2.19.1 ILS type: DME for runway 27. Magnetic
variation: 14E
2.19.2 ILS identification: UBR
2.19.5 Coordinates: 32-44-11.40N /
117-12-19.91W
2.19.6 Site elevation: 26 ft

2.19.1 ILS type: DME for runway 09. Magnetic

General Remarks:

TERRAIN & BUILDINGS TO 500' MSL N & E WITHIN 1 1/2 MI.

PRACTICE APPROACHES AND TOUCH AND GO LANDING PROHIBITED.

POSSIBLE ERRONEOUS GROUND PROXIMITY WARNING SYSTEM ALERTS BETWEEN 1.6 & 1.3
DME WHILE ON PAPI APPROACH PATH FOR RUNWAY 27.

TO REDUCE JET BLAST IMPACT AT N END OF TAXIWAY F AIRCRAFT WILL NOT START
ENGINE UNTIL 800 FT FROM N END OF TAXIWAY F; ABEAM THE SECOND PARKING PAD.

ULTRALIGHT VEHICLES PROHIBITED ON AIRPORT.

747 AND LARGER AIRCRAFT ARE PROHIBITED FROM MAKING INTERSECTION TAKE-OFFS.

PRIOR PERMISSION REQUIRED FOR AIRCRAFT WITH WINGSPAN IN EXCESS OF 230 FT.

INTERMITTENT PRESENCE OF BIRDS ON AND IN THE VICINITY OF OF AIRPORT.

CROSS-BLEED ENGINE STARTS PERMITTED ONLY ON PARALLEL TAXIWAY WITH AIRCRAFT
ALIGNED ON TAXIWAY CENTERLINE.

OUTBOARD ENGINES OF FOUR-ENGINE AIRCRAFT ARE TO BE KEPT AT IDLE POWER FOR

ALL GROUND MANEUVERING.

TAXIING AIRCRAFT ARE PROHIBITED FROM PASSING TO THE SOUTH OF AIRCRAFT LOCATED ON TAXIWAY B INTO ALLEY LOCATED BETWEEN GATES 7 AND 14. TAXIING AIRCRAFT SHALL FOLLOW LEAD-IN LINES UNTIL THE NOSE WHEEL OF THE AIRCRAFT HAS ENTERED THE NON-MOVEMENT AREA OF THE ALLEY.

PILOTS REQUIRED TO CONTACT ATCT GROUND CONTROLLER PRIOR TO PUSHBACK, TOW OUT AND TAXI FOR TRAFFIC ADVISORIES.

MILITARY AIRCRAFT ON OFFICIAL BUSINESS ONLY CONTACT AIRPORT OPERATIONS AT 619-400-2710 FOR PRIOR PERMISSION REQUIRED.

ASDE-X SURVEILLANCE SYSTEM IN USE. PILOTS SHOULD OPERATE TRANSPONDERS WITH MODE C ON ALL TAXIWAYS AND RUNWAYS.

TAXIWAY C EDGE LIGHTS OUT OF SERVICE INDEFINITELY.

AIRCRAFT TAXIING ON TAXIWAY B EAST OF TAXIWAY B-6 RESTRICTED TO GROUP IV AIRCRAFT AND BELOW.

AIRCRAFT CROSSING RUNWAY 09/27 ON TAXIWAY C6, HOLD SHORT OF TAXIWAY C6 FACING WEST ON TAXIWAY C, PARALLEL TO RUNWAY.

DUE TO PERSONNEL AND EQUIPMENT WORKING ON RUNWAY 09/27, 30 MIN PRIOR PERMISSION REQUIRED 0830-1200 FOR ALL LANDINGS AND DEPARTURES CALL 619-400-2710.

San Francisco, California San Francisco International ICAO Identifier KSFO

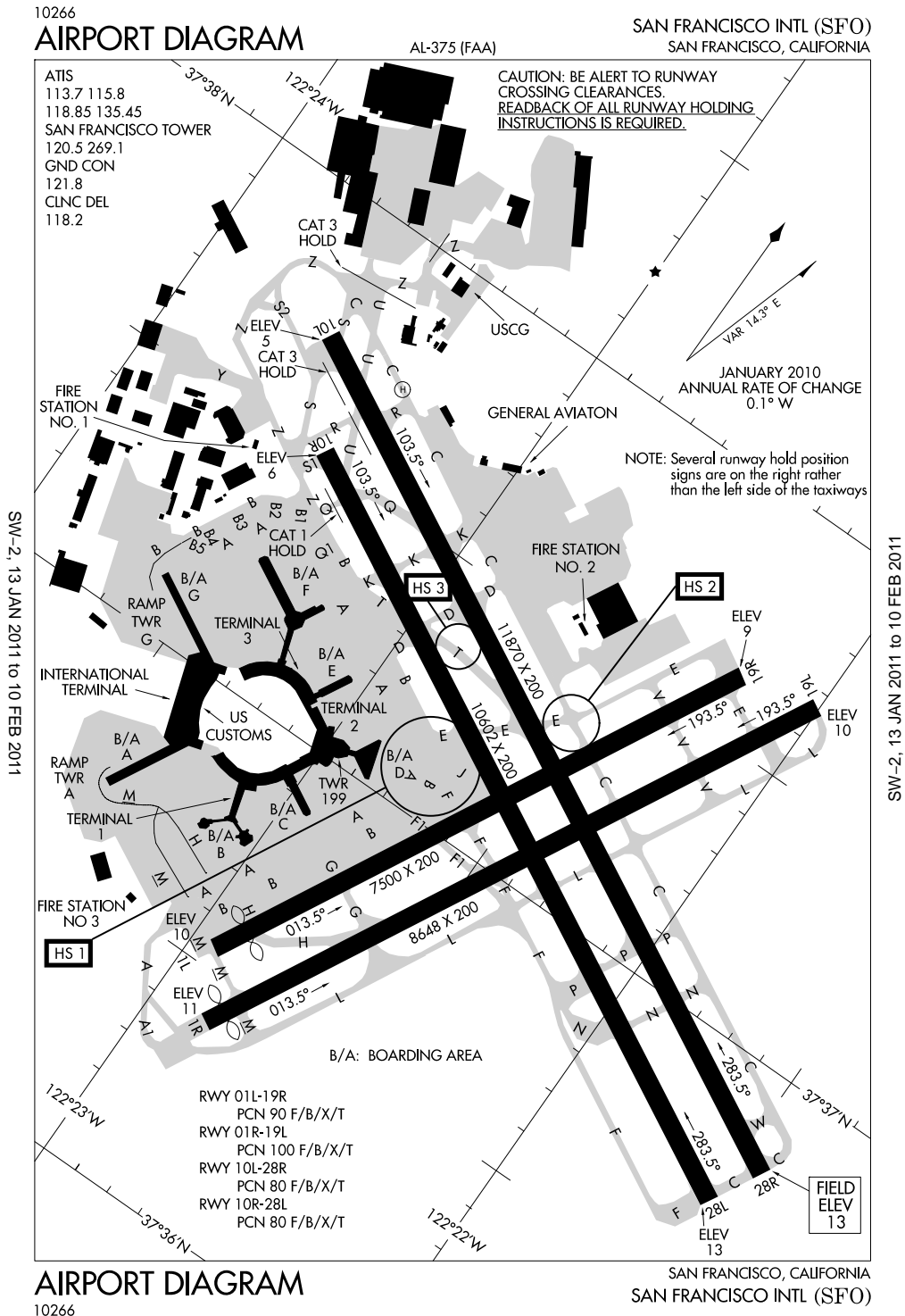

San Francisco, CA
San Francisco Intl
ICAO Identifier KSFO

AD 2.2 Aerodrome geographical and administrative data

- 2.2.1 Reference Point: 37-37-00.00N / 122-22-29.60W
- 2.2.2 From City: 8 Miles SE Of San Francisco, CA
- 2.2.3 Elevation: 13 ft
- 2.2.5 Magnetic variation: 17E (1975)
- 2.2.6 Airport Contact: John L. Martin
PO BOX 8097
San Francisco, CA 94128
(650-821-5000)
- 2.2.7 Traffic: IFR/VFR

AD 2.3 Operational hours

- 2.3.1 - 2.3.11: ALL Months, ALL Days, ALL Hours

AD 2.4 Handling services and facilities

- 2.4.1 Cargo handling facilities: No
- 2.4.2 Fuel types: 100,100LL,A
- 2.4.4 De-icing facilities: None
- 2.4.5 Hangar space: Yes
- 2.4.6 Repair facilities: Major

AD 2.6 Rescue and firefighting services

- 2.6.1 Aerodrome category for firefighting: ARFF Index I E certified on 5/1/1973

AD 2.10 Aerodrome obstacles

- 2.10.1.a. Runway designation: 01R
- 2.10.1.b Type of obstacle: Tree (177 ft). Not Lighted or Marked
- 2.10.1.c Location of obstacle: 200 ft from Centerline

- 2.10.1.a. Runway designation: 10L
- 2.10.1.b Type of obstacle: Tower (88 ft). Marked and Lighted
- 2.10.1.c Location of obstacle: 1300 ft from Centerline

- 2.10.1.a. Runway designation: 10R
- 2.10.1.b Type of obstacle: Tower (87 ft). Marked and Lighted
- 2.10.1.c Location of obstacle: 950 ft from Centerline

AD 2.12 Runway physical characteristics

- 2.12.1 Designation: 28X
- 2.12.3 Dimensions: 0 ft x 0 ft

- 2.12.1 Designation: 01L
- 2.12.2 True Bearing: 27
- 2.12.3 Dimensions: 7500 ft x 200 ft
- 2.12.4 PCN: 90 F/B/X/T
- 2.12.5 Coordinates: 37-36-32.35N / 122-22-55.92W
- 2.12.6 Threshold elevation: 10 ft
- 2.12.6 Touchdown zone elevation: 11 ft

- 2.12.1 Designation: 19R
- 2.12.2 True Bearing: 207
- 2.12.3 Dimensions: 7500 ft x 200 ft
- 2.12.4 PCN: 90 F/B/X/T
- 2.12.5 Coordinates: 37-37-37.94N / 122-22-12.44W
- 2.12.6 Threshold elevation: 9 ft
- 2.12.6 Touchdown zone elevation: 10 ft

- 2.12.1 Designation: 01R
- 2.12.2 True Bearing: 27
- 2.12.3 Dimensions: 8648 ft x 200 ft
- 2.12.4 PCN: 100 F/B/X/T
- 2.12.5 Coordinates: 37-36-24.54N / 122-22-50.57W
- 2.12.6 Threshold elevation: 11 ft
- 2.12.6 Touchdown zone elevation: 12 ft

- 2.12.1 Designation: 19L
- 2.12.2 True Bearing: 207
- 2.12.3 Dimensions: 8648 ft x 200 ft
- 2.12.4 PCN: 100 F/B/X/T
- 2.12.5 Coordinates: 37-37-40.17N / 122-22-00.00W
- 2.12.6 Threshold elevation: 10 ft
- 2.12.6 Touchdown zone elevation: 11 ft

- 2.12.1 Designation: 10L
- 2.12.2 True Bearing: 117
- 2.12.3 Dimensions: 11870 ft x 200 ft
- 2.12.4 PCN: 80 F/B/X/T
- 2.12.5 Coordinates: 37-37-43.45N / 122-23-36.20W
- 2.12.6 Threshold elevation: 5 ft
- 2.12.6 Touchdown zone elevation: 7 ft

- 2.12.1 Designation: 28R
- 2.12.2 True Bearing: 297

2.12.3 Dimensions: 11870 ft x 200 ft
2.12.4 PCN: 80 F/B/X/T
2.12.5 Coordinates: 37-36-48.71N /
122-21-25.70W
2.12.6 Threshold elevation: 13 ft
2.12.6 Touchdown zone elevation: 13 ft

2.12.1 Designation: 10R
2.12.2 True Bearing: 117
2.12.3 Dimensions: 10602 ft x 200 ft
2.12.4 PCN: 80 F/B/X/T
2.12.5 Coordinates: 37-37-31.04N /
122-23-26.58W
2.12.6 Threshold elevation: 6 ft
2.12.6 Touchdown zone elevation: 9 ft

2.12.1 Designation: 28L
2.12.2 True Bearing: 297
2.12.3 Dimensions: 10602 ft x 200 ft
2.12.4 PCN: 80 F/B/X/T
2.12.5 Coordinates: 37-36-42.15N /
122-21-30.03W
2.12.6 Threshold elevation: 13 ft
2.12.6 Touchdown zone elevation: 13 ft

AD 2.14 Approach and runway lighting

2.14.1 Designation: 19R
2.14.4 Visual approach slope indicator system:
4-light PAPI on left

2.14.1 Designation: 19L
2.14.4 Visual approach slope indicator system:
4-light PAPI on left
2.14.10 Remarks: Runway 19L MALSF Has A Non
Standard Length Of 1,115 Ft With 3 Sequenced
Flashers.

2.14.1 Designation: 10L
2.14.4 Visual approach slope indicator system:
4-light PAPI on left

2.14.1 Designation: 28R
2.14.2 Approach lighting system: ALSF2: Standard
2400 feet high intensity approach lighting system
with sequenced flashers, category II or III
configuration
2.14.4 Visual approach slope indicator system:
4-light PAPI on left

2.14.1 Designation: 10R
2.14.4 Visual approach slope indicator system:

4-light PAPI on left

2.14.1 Designation: 28L
2.14.2 Approach lighting system: SSALR:
Simplified short approach lighting system with
runway alignment indicator lights
2.14.4 Visual approach slope indicator system:
4-light PAPI on left

AD 2.18 Air traffic services communication facilities

2.18.1 Service designation: D-ATIS
2.18.3 Service designation: 113.7 MHz
2.18.4 Hours of operation: 24

2.18.1 Service designation: D-ATIS
2.18.3 Service designation: 115.8 MHz
2.18.4 Hours of operation: 24

2.18.1 Service designation: CD/P PTC
2.18.3 Service designation: 118.2 MHz

2.18.1 Service designation: D-ATIS
2.18.3 Service designation: 118.85 MHz
2.18.4 Hours of operation: 24

2.18.1 Service designation: LCL/P
2.18.3 Service designation: 120.5 MHz

2.18.1 Service designation: ILS PRM RY 28L IC
2.18.3 Service designation: 120.5 MHz

2.18.1 Service designation: LDA PRM RY 28R IC
2.18.3 Service designation: 120.5 MHz

2.18.1 Service designation: EMERG
2.18.3 Service designation: 121.5 MHz

2.18.1 Service designation: GND/P
2.18.3 Service designation: 121.8 MHz

2.18.1 Service designation: AS ASGND
2.18.3 Service designation: 128.65 MHz

2.18.1 Service designation: D-ATIS
2.18.3 Service designation: 135.45 MHz
2.18.4 Hours of operation: 24

2.18.1 Service designation: LCL/P
2.18.3 Service designation: 269.1 MHz

2.18.1 Service designation: IC
2.18.3 Service designation: 351.8 MHz

122-22-10.49W
2.19.6 Site elevation: 7 ft

2.18.1 Service designation: MONITOR ILS PRM
RY 28L
2.18.3 Service designation: 125.15 MHz

2.19.1 ILS type: Middle Marker for runway 19L.
Magnetic variation: 17E
2.19.2 ILS identification: SIA
2.19.5 Coordinates: 37-38-10.77N /
122-21-40.14W
2.19.6 Site elevation: 99999 ft

2.18.1 Service designation: MONITOR LDA PRM
RY 28R
2.18.3 Service designation: 127.675 MHz

2.19.1 ILS type: DME for runway 28R. Magnetic
variation: 15E
2.19.2 ILS identification: GWQ
2.19.5 Coordinates: 37-37-48.64N /
122-23-40.59W
2.19.6 Site elevation: 17 ft

AD 2.19 Radio navigation and landing aids

2.19.1 ILS type: Localizer for runway 28X.
Magnetic variation: 17E
2.19.2 ILS identification: FNP
2.19.5 Coordinates: 37-37-16.65N /
122-22-00.00W
2.19.6 Site elevation: 10 ft

2.19.1 ILS type: Middle Marker for runway 28R.
Magnetic variation: 15E
2.19.2 ILS identification: GWQ
2.19.5 Coordinates: 37-36-33.79N /
122-20-50.18W
2.19.6 Site elevation: 11 ft

2.19.1 ILS type: DME for runway 28X. Magnetic
variation: 17E
2.19.2 ILS identification: FNP
2.19.5 Coordinates: 37-37-14.97N /
122-22-00.00W
2.19.6 Site elevation: 10 ft

2.19.1 ILS type: Outer Marker for runway 28R.
Magnetic variation: 15E
2.19.2 ILS identification: GWQ
2.19.5 Coordinates: 37-34-19.93N /
122-15-35.65W
2.19.6 Site elevation: 11 ft

2.19.1 ILS type: Glide Slope for runway 28X.
Magnetic variation: 17E
2.19.2 ILS identification: FNP
2.19.5 Coordinates: 37-36-49.92N /
122-21-40.22W
2.19.6 Site elevation: 9 ft

2.19.1 ILS type: Inner Marker for runway 28R.
Magnetic variation: 15E
2.19.2 ILS identification: GWQ
2.19.5 Coordinates: 37-36-44.79N /
122-21-16.36W
2.19.6 Site elevation: 11 ft

2.19.1 ILS type: Localizer for runway 19L.
Magnetic variation: 17E
2.19.2 ILS identification: SIA
2.19.5 Coordinates: 37-36-16.27N /
122-22-56.05W
2.19.6 Site elevation: 10 ft

2.19.1 ILS type: Localizer for runway 28R.
Magnetic variation: 15E
2.19.2 ILS identification: GWQ
2.19.5 Coordinates: 37-37-46.34N /
122-23-43.12W
2.19.6 Site elevation: 5 ft

2.19.1 ILS type: DME for runway 19L. Magnetic
variation: 17E
2.19.2 ILS identification: SIA
2.19.5 Coordinates: 37-36-18.70N /
122-22-59.40W
2.19.6 Site elevation: 24 ft

2.19.1 ILS type: Glide Slope for runway 28R.
Magnetic variation: 15E
2.19.2 ILS identification: GWQ
2.19.5 Coordinates: 37-36-50.24N /
122-21-40.01W
2.19.6 Site elevation: 9 ft

2.19.1 ILS type: Glide Slope for runway 19L.
Magnetic variation: 17E
2.19.2 ILS identification: SIA
2.19.5 Coordinates: 37-37-31.57N /

2.19.1 ILS type: Glide Slope for runway 28L.
Magnetic variation: 17E
2.19.2 ILS identification: SFO
2.19.5 Coordinates: 37-36-50.12N /
122-21-40.09W
2.19.6 Site elevation: 9 ft

2.19.1 ILS type: Localizer for runway 28L.
Magnetic variation: 17E
2.19.2 ILS identification: SFO
2.19.5 Coordinates: 37-37-35.65N /
122-23-37.60W
2.19.6 Site elevation: 8 ft

2.19.1 ILS type: Outer Marker for runway 28L.
Magnetic variation: 17E
2.19.2 ILS identification: SFO
2.19.5 Coordinates: 37-34-19.93N /
122-15-35.65W
2.19.6 Site elevation: 99999 ft

2.19.1 ILS type: DME for runway 28L. Magnetic
variation: 17E
2.19.2 ILS identification: SFO
2.19.5 Coordinates: 37-37-33.93N /
122-23-39.54W
2.19.6 Site elevation: 22 ft

General Remarks:

FLOCKS OF BIRDS FEEDING ALONG SHORELINE ADJACENT TO AIRPORT; ON OCCASIONS FLY ACROSS VARIOUS PARTS OF THE AIRPORT.

HIGH SPEED TAXIWAY (T) GRAVELLED FULL WIDTH BETWEEN RUNWAY 28R AND 28L.

NOISE SENSITIVE AIRPORT; FOR NOISE ABATEMENT PROCEDURES CONTACT AIRPORT NOISE OFFICE MON-FRI 0800-1700 BY CALLING 650-821-5100.

747-400'S SHALL TAXI AT A SPEED OF LESS THAN 10 MPH ON ALL NON-RESTRICTED TAXIWAYS ON THE TERMINAL SIDE OF THE INTERSECTING RUNWAYS. MOVEMENT SPEED OF NOT MORE THAN 5 MPH IS REQUIRED WHEN TWO 747-400'S PASS OR OVERTAKE EACH OTHER ON PARALLEL TAXIWAYS A & B.

SEVERAL RUNWAY HOLD POSITION SIGNS ARE ON THE RIGHT RATHER THAN THE LEFT SIDE OF THE TAXIWAYS.

NO GROOVING EXISTS AT AIRPORT RUNWAY INTERSECTIONS.

RUNWAY 10 PREFERRED RUNWAY BETWEEN 0100-0600 WEATHER AND FLIGHT CONDITIONS PERMITTING.

AIRLINE PILOTS SHALL STRICTLY FOLLOW THE PAINTED NOSE GEAR LINES AND NO OVERSTEERING ADJUSTMENT IS PERMITTED.

PERSONNEL AND EQUIPMENT WORKING APPROACH END RUNWAYS 28L, 28R, 19L INDEFINITELY.

RUNWAYS 01L/19R, 01R/19L, 10R/28L, 10L/28R GROOVED FULL LENGTH EXCEPT AT RUNWAY INTERSECTIONS.

B747, B777, A330, A340 OR LARGER AIRCRAFT ARE RESTRICTED FROM USING TAXIWAY A1 WHEN B747-400, A340-600, OR LARGER AIRCRAFT ARE HOLDING SHORT OF RUNWAY 1R ON TAXIWAY A.

NON-STANDARD LATERAL SPACING OF HOLD BAR LIGHTS ON ALL RUNWAYS 10L/28R,

10R/28L, 01R/19L, AND 01L/19R.

TERMINAL 2 RAMP AREA CLOSED INDEFINITELY.

RAMP CLOSED TO AIRCRAFT WITH WINGSPANS OVER 117 FT AT TERMINAL 1, GATE C41 INDEFINITELY.

ALL OUTBOUND TAXIWAY YANKEE HEAVY AIRCRAFT WITH A WINGSPAN OF 171 FT. OR GREATER UNDER POWER PROHIBITED FROM ENTERING WESTBOUND TAXIWAY ZULU.

SIMULTANEOUS OPERATIONS IN EFFECT ALL RUNWAYS.

HELICOPTER LANDING AREA MARKED ON TAXIWAY (C) WEST OF TAXIWAY (R) OPERATIONS FOR CIVIL AND MILITARY USE.

San Jose, California Norman Y. Mineta San Jose International ICAO Identifier KSJC

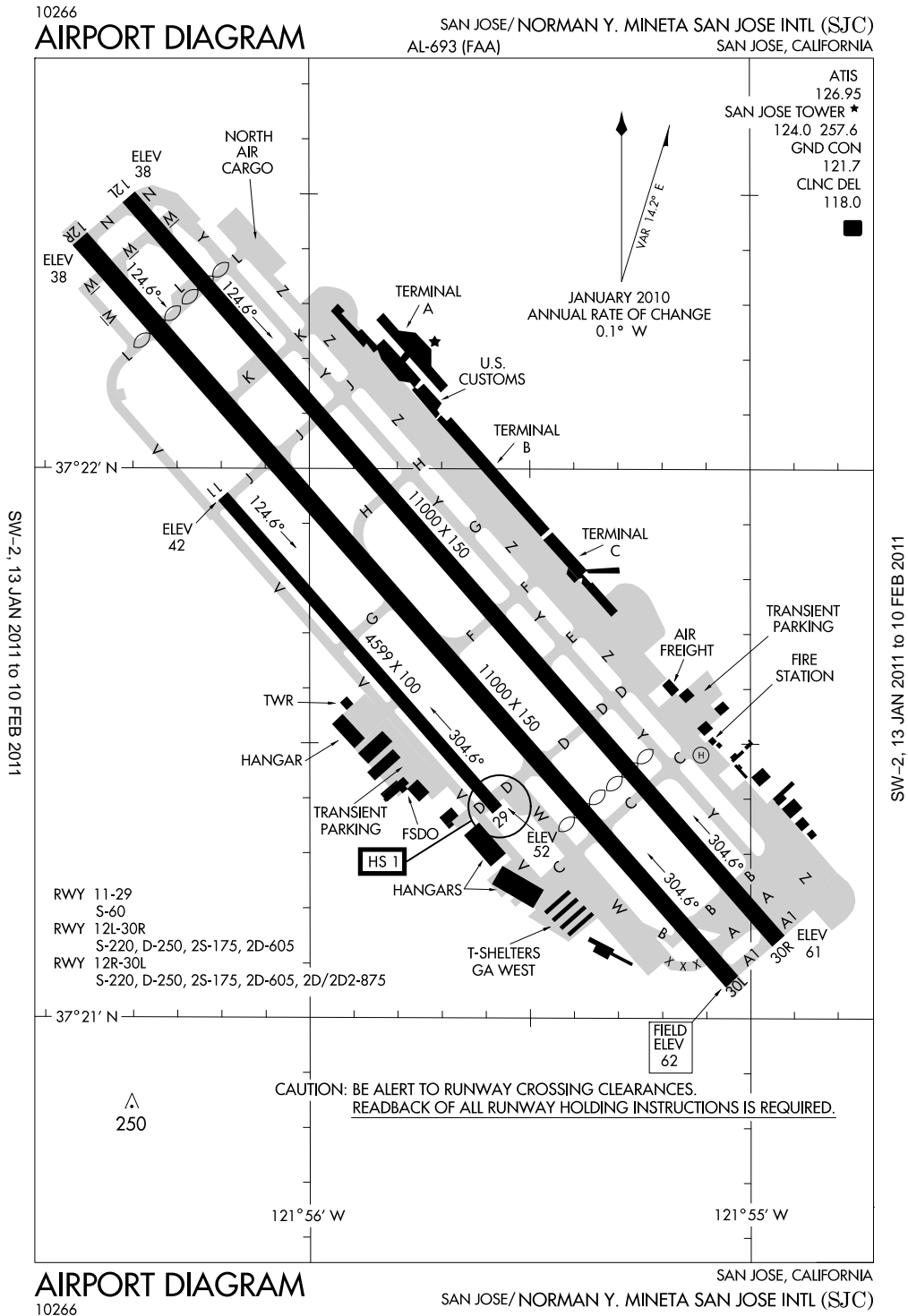

San Jose, CA
Norman Y. Mineta San Jose Intl
ICAO Identifier KSJC

AD 2.2 Aerodrome geographical and administrative data

- 2.2.1 Reference Point: 37-21-45.60N / 121-55-44.80W
2.2.2 From City: 2 Miles NW Of San Jose, CA
2.2.3 Elevation: 62 ft
2.2.5 Magnetic variation: 16E (1990)
2.2.6 Airport Contact: William Sherry, Aae
1732 N. FIRST ST SUITE 600
San Jose, CA 95112
(408-501-7600)
2.2.7 Traffic: IFR/VFR

AD 2.3 Operational hours

- 2.3.1 - 2.3.11: ALL Months, ALL Days, ALL Hours

AD 2.4 Handling services and facilities

- 2.4.1 Cargo handling facilities: No
2.4.2 Fuel types: 100LL,A
2.4.4 De-icing facilities: None
2.4.5 Hangar space: Yes
2.4.6 Repair facilities: Major

AD 2.6 Rescue and firefighting services

- 2.6.1 Aerodrome category for firefighting: ARFF Index I D certified on 5/1/1973
2.6.4 Remarks: Runway 12R/30L And Runway 12L/30R Far 139 Certified.

AD 2.10 Aerodrome obstacles

- 2.10.1.a. Runway designation: 29
2.10.1.b Type of obstacle: Tree (79 ft). Not Lighted or Marked
2.10.1.c Location of obstacle: 100 ft from Centerline
- 2.10.1.a. Runway designation: 12L
2.10.1.b Type of obstacle: Pole (32 ft). Not Lighted or Marked
2.10.1.c Location of obstacle: 580 ft from Centerline
- 2.10.1.a. Runway designation: 30R
2.10.1.b Type of obstacle: Tree (54 ft). Not Lighted or Marked
2.10.1.c Location of obstacle: 550 ft from

Centerline

- 2.10.1.a. Runway designation: 12R
2.10.1.b Type of obstacle: Pole (29 ft). Not Lighted or Marked
2.10.1.c Location of obstacle: 480 ft from Centerline
- 2.10.1.a. Runway designation: 30L
2.10.1.b Type of obstacle: Fence (14 ft). Not Lighted or Marked
2.10.1.c Location of obstacle: 170 ft from Centerline

AD 2.12 Runway physical characteristics

- 2.12.1 Designation: 11
2.12.2 True Bearing: 139
2.12.3 Dimensions: 4599 ft x 100 ft
2.12.5 Coordinates: 37-21-57.21N / 121-56-11.75W
2.12.6 Threshold elevation: 42 ft
2.12.6 Touchdown zone elevation: 49 ft

- 2.12.1 Designation: 29
2.12.2 True Bearing: 319
2.12.3 Dimensions: 4599 ft x 100 ft
2.12.5 Coordinates: 37-21-22.99N / 121-55-34.24W
2.12.6 Threshold elevation: 52 ft
2.12.6 Touchdown zone elevation: 52 ft

- 2.12.1 Designation: 12L
2.12.2 True Bearing: 139
2.12.3 Dimensions: 11000 ft x 150 ft
2.12.5 Coordinates: 37-22-29.97N / 121-56-24.63W
2.12.6 Threshold elevation: 38 ft
2.12.6 Touchdown zone elevation: 44 ft

- 2.12.1 Designation: 30R
2.12.2 True Bearing: 319
2.12.3 Dimensions: 11000 ft x 150 ft
2.12.5 Coordinates: 37-21-00.00N / 121-54-54.92W
2.12.6 Threshold elevation: 61 ft
2.12.6 Touchdown zone elevation: 55 ft

- 2.12.1 Designation: 12R
2.12.2 True Bearing: 139
2.12.3 Dimensions: 11000 ft x 150 ft
2.12.5 Coordinates: 37-22-25.42N /

121-56-31.15W
2.12.6 Threshold elevation: 38 ft
2.12.6 Touchdown zone elevation: 46 ft

2.12.1 Designation: 30L
2.12.2 True Bearing: 319
2.12.3 Dimensions: 11000 ft x 150 ft
2.12.5 Coordinates: 37-21-00.00N /
121-55-00.00W
2.12.6 Threshold elevation: 62 ft
2.12.6 Touchdown zone elevation: 57 ft

AD 2.13 Declared distances

2.13.1 Designation: 12L
2.13.2 Takeoff run available: 10125
2.13.3 Takeoff distance available: 11000
2.13.4 Accelerate-stop distance available: 10125
2.13.5 Landing distance available: 8810

2.13.1 Designation: 30R
2.13.2 Takeoff run available: 10020
2.13.3 Takeoff distance available: 11000
2.13.4 Accelerate-stop distance available: 10020
2.13.5 Landing distance available: 7479

2.13.1 Designation: 12R
2.13.2 Takeoff run available: 9883
2.13.3 Takeoff distance available: 11000
2.13.4 Accelerate-stop distance available: 9883
2.13.5 Landing distance available: 8584

2.13.1 Designation: 30L
2.13.2 Takeoff run available: 10142
2.13.3 Takeoff distance available: 11000
2.13.4 Accelerate-stop distance available: 10142
2.13.5 Landing distance available: 7605

AD 2.14 Approach and runway lighting

2.14.1 Designation: 11
2.14.4 Visual approach slope indicator system:
4-light PAPI on left

2.14.1 Designation: 29
2.14.4 Visual approach slope indicator system:
4-light PAPI on left

2.14.1 Designation: 12L
2.14.4 Visual approach slope indicator system:
4-light PAPI on right

2.14.1 Designation: 30R

2.14.4 Visual approach slope indicator system:
4-light PAPI on left

2.14.1 Designation: 12R
2.14.2 Approach lighting system: MALSR: 1400
feet medium intensity approach lighting system
with runway alignment indicator lights
2.14.4 Visual approach slope indicator system:
4-light PAPI on right

2.14.1 Designation: 30L
2.14.2 Approach lighting system: MALSR: 1400
feet medium intensity approach lighting system
with runway alignment indicator lights
2.14.4 Visual approach slope indicator system:
4-light PAPI on left

AD 2.18 Air traffic services communication facilities

2.18.1 Service designation: CD/P PTC
2.18.3 Service designation: 118 MHz

2.18.1 Service designation: GND/P
2.18.3 Service designation: 121.7 MHz

2.18.1 Service designation: LCL/P
2.18.3 Service designation: 124 MHz

2.18.1 Service designation: D-ATIS
2.18.3 Service designation: 126.95 MHz
2.18.4 Hours of operation: 24

2.18.1 Service designation: LCL/P IC
2.18.3 Service designation: 257.6 MHz

AD 2.19 Radio navigation and landing aids

2.19.1 ILS type: Localizer for runway 12R.
Magnetic variation: 16E
2.19.2 ILS identification: SLV
2.19.5 Coordinates: 37-21-00.00N /
121-55-00.00W
2.19.6 Site elevation: 75 ft

2.19.1 ILS type: DME for runway 12R. Magnetic
variation: 16E
2.19.2 ILS identification: SLV
2.19.5 Coordinates: 37-21-00.00N /
121-55-00.00W
2.19.6 Site elevation: 75 ft

2.19.1 ILS type: Glide Slope for runway 12R.

Magnetic variation: 16E
2.19.2 ILS identification: SLV
2.19.5 Coordinates: 37-22-00.00N /
121-56-14.57W
2.19.6 Site elevation: 36 ft

2.19.1 ILS type: Middle Marker for runway 12R.
Magnetic variation: 16E
2.19.2 ILS identification: SLV
2.19.5 Coordinates: 37-22-36.25N /
121-56-43.05W
2.19.6 Site elevation: 32 ft

2.19.1 ILS type: Outer Marker for runway 30L.
Magnetic variation: 16E
2.19.2 ILS identification: SJC
2.19.5 Coordinates: 37-17-30.79N /
121-51-11.03W
2.19.6 Site elevation: 99999 ft

2.19.1 ILS type: Middle Marker for runway 30L.
Magnetic variation: 16E
2.19.2 ILS identification: SJC
2.19.5 Coordinates: 37-20-56.13N /
121-54-53.62W

2.19.6 Site elevation: 99999 ft

2.19.1 ILS type: Glide Slope for runway 30L.
Magnetic variation: 16E
2.19.2 ILS identification: SJC
2.19.5 Coordinates: 37-21-33.00N /
121-55-27.86W
2.19.6 Site elevation: 48 ft

2.19.1 ILS type: DME for runway 30L. Magnetic
variation: 16E
2.19.2 ILS identification: SJC
2.19.5 Coordinates: 37-22-27.53N /
121-56-32.57W
2.19.6 Site elevation: 49 ft

2.19.1 ILS type: Localizer for runway 30L.
Magnetic variation: 16E
2.19.2 ILS identification: SJC
2.19.5 Coordinates: 37-22-27.15N /
121-56-33.06W
2.19.6 Site elevation: 49 ft

General Remarks:

BIRDS FREQUENTLY ON OR IN VICINITY OF AIRPORT.

TAXIWAY Y WILL BE PERIODICALLY RESTRICTED TO AIRCRAFT WITH A WINGSPAN OF LESS THAN 171 FT (MD-11 OR SMALLER) DURING B-777 OPERATIONS ON RUNWAY 12L/30R.

TAXIWAY Z WILL BE PERIODICALLY RESTRICTED TO AIRCRAFT WITH A WINGSPAN OF LESS THAN 118 FT (BBJ OR SMALLER) DURING B-777 OPERATIONS.

RUNWAY 11/29 LIMITED TO AIRCRAFT WITH WINGSPAN OF LESS THAN 79 FT AND APPROACH SPEED OF LESS THAN 121 KNOTS (GULFSTREAM I OR SMALLER).

TAXIWAY V LIMITED TO AIRCRAFT WITH WINGSPAN OF LESS THAN 118 FT (A321 OR SMALLER).

UNSCHEDULED OPERATIONS BY GROUP 5 AIRCRAFT (B747) AND LARGER NOT AUTH EXCEPT WITH PRIOR AIRPORT APPROVAL CONTACT AIRPORT MANAGER (408) 392-3501.

NOISE ABATEMENT PROCEDURE: RUNWAY 30L/12R IS PREFERRED ARRIVAL RUNWAY FOR JET AIRCRAFT AND RUNWAY 12L/30R IS THE PREFERRED DEP RUNWAY FOR JET AIRCRAFT. ALL JET AIRCRAFT TAKE-OFFS ARE TO BE INITIATED FROM END OF RUNWAY UNLESS DIRECTED OTHERWISE BY ATCT.

JET DEP ON RUNWAY 11/29 NOT AUTH EXCEPT FOR JETS UNDER 75,000 LBS MFG DESIGNED

CERT GROSS TAKE-OFF WGT AND ONLY DURING CLOSURES OF BOTH RUNWAY 12R/30L AND RUNWAY 12L/30R.

TAXIWAY W BETWEEN TAXIWAY B & TAXIWAY C RESTRICTED TO AIRCRAFT WITH A WINGSPAN OF 118 FT, (BBJ OR SMALLER). TAXIWAY G AND TAXIWAY J BETWEEN RUNWAY 12R/30L AND TAXIWAY V LIMITED TO 100,000 LBS GROSS TAKE-OFF WEIGHT.

CURFEW HRS 2300-0700 FAR 36 STAGE II, 2330-0630 FAR 36 STAGE III AIRCRAFT LISTED ON THE SCHEDULE OF AUTHORIZED AIRCRAFT ISSUED BY THE DIRECTOR OF AVIATION. DELAYED SCHEDULED FLIGHTS, AND ALTERNATE/EMERGENCY OPERATIONS MAY BE EXEMPT FROM CURFEW HOUR RESTRICTIONS.

PRIOR AIRPORT NOTIFICATION IS REQUIRED FOR ALL LATE/EARLY ARRIVALS. CONTACT MANAGER ON DUTY AT (408) 392-3501.

FIRST 400 FT RUNWAY 30R & RUNWAY 30L CLOSED FOR TAKE-OFF DC10, MD11, L1011.

ALL ENGINE RUN-UPS REQUIRE PRIOR AIRPORT APPROVAL, CONTACT MANAGER ON DUTY (408) 392-3501.

RUNWAY 11-29 RUN-UP AREA LIMITED TO AIRCRAFT 12,500 LBS OR LIGHTER.

TAXIWAY D BETWEEN TAXIWAY W AND TAXIWAY V LIMITED TO AIRCRAFT WITH A WINGSPAN OF LESS THAN 118 FT (A-321 OR SMALLER).

**Stockton, California
Stockton Metropolitan
ICAO Identifier KSKC**

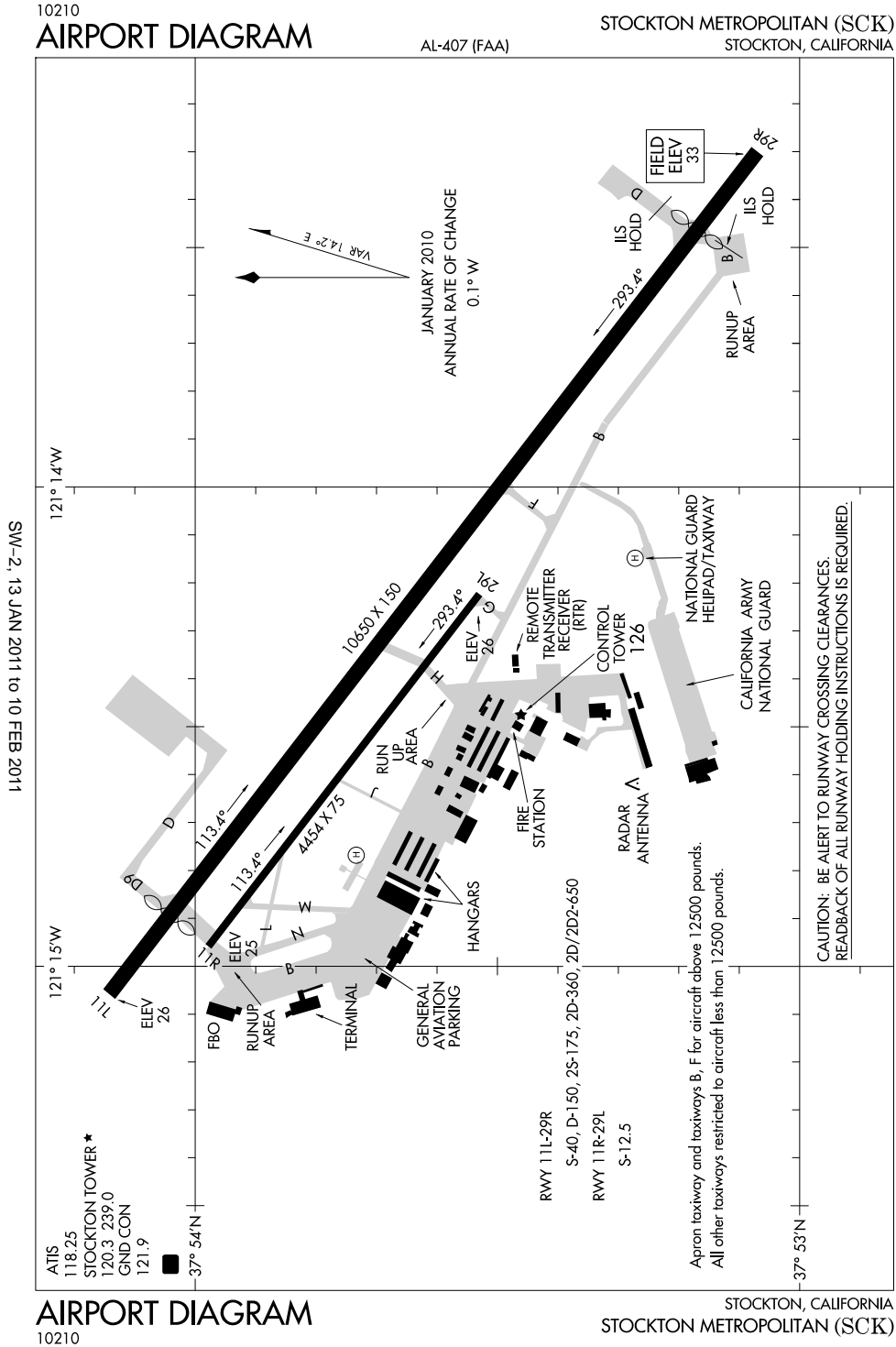

Stockton, CA
Stockton Metropolitan
ICAO Identifier KSKC

AD 2.2 Aerodrome geographical and administrative data

- 2.2.1 Reference Point: 37-53-39.00N / 121-14-17.90W
- 2.2.2 From City: 3 Miles SE Of Stockton, CA
- 2.2.3 Elevation: 33 ft
- 2.2.5 Magnetic variation: 14E (2010)
- 2.2.6 Airport Contact: Susan Palmeri
5000 S. AIRPORT WAY ROOM 202
Stockton, CA 95206 (209-468-4700)
- 2.2.7 Traffic: IFR/VFR

AD 2.3 Operational hours

- 2.3.1 - 2.3.11: ALL Months, ALL Days, ALL Hours

AD 2.4 Handling services and facilities

- 2.4.1 Cargo handling facilities: No
- 2.4.2 Fuel types: 100,100LL,A
- 2.4.4 De-icing facilities: None
- 2.4.5 Hangar space: Yes
- 2.4.6 Repair facilities: Major

AD 2.6 Rescue and firefighting services

- 2.6.1 Aerodrome category for firefighting: ARFF Index I B certified on 5/1/1973
- 2.6.4 Remarks: Closed To Unscheduled Air Carrier Operations With More Than 30 Passenger Seats Except One Hr Prior Permission Required Call Airport Manager (209) 468-4700 Or 4722; After Hrs Call (209) 468-4722.

AD 2.12 Runway physical characteristics

- 2.12.1 Designation: H1
- 2.12.3 Dimensions: 70 ft x 70 ft

- 2.12.1 Designation: 11L
- 2.12.2 True Bearing: 128
- 2.12.3 Dimensions: 10650 ft x 150 ft
- 2.12.5 Coordinates: 37-54-00.00N / 121-15-00.00W
- 2.12.6 Threshold elevation: 26 ft
- 2.12.6 Touchdown zone elevation: 29 ft

- 2.12.1 Designation: 29R
- 2.12.2 True Bearing: 308
- 2.12.3 Dimensions: 10650 ft x 150 ft

- 2.12.5 Coordinates: 37-53-00.00N / 121-13-17.91W
- 2.12.6 Threshold elevation: 33 ft
- 2.12.6 Touchdown zone elevation: 32 ft

- 2.12.1 Designation: 11R
- 2.12.2 True Bearing: 128
- 2.12.3 Dimensions: 4454 ft x 75 ft
- 2.12.5 Coordinates: 37-53-58.71N / 121-14-57.48W
- 2.12.6 Threshold elevation: 25 ft
- 2.12.6 Touchdown zone elevation: 26 ft

- 2.12.1 Designation: 29L
- 2.12.2 True Bearing: 308
- 2.12.3 Dimensions: 4454 ft x 75 ft
- 2.12.5 Coordinates: 37-53-31.86N / 121-14-13.44W
- 2.12.6 Threshold elevation: 26 ft
- 2.12.6 Touchdown zone elevation: 26 ft

AD 2.13 Declared distances

- 2.13.1 Designation: 11L
- 2.13.2 Takeoff run available: 9600
- 2.13.3 Takeoff distance available: 10600
- 2.13.4 Accelerate-stop distance available: 9690
- 2.13.5 Landing distance available: 8690

- 2.13.1 Designation: 29R
- 2.13.2 Takeoff run available: 10037
- 2.13.3 Takeoff distance available: 11037
- 2.13.4 Accelerate-stop distance available: 9701
- 2.13.5 Landing distance available: 8701

AD 2.14 Approach and runway lighting

- 2.14.1 Designation: 11L
- 2.14.4 Visual approach slope indicator system: 4-light PAPI on left

- 2.14.1 Designation: 29R
- 2.14.2 Approach lighting system: MALSR: 1400 feet medium intensity approach lighting system with runway alignment indicator lights
- 2.14.4 Visual approach slope indicator system: 4-light PAPI on left

AD 2.18 Air traffic services communication facilities

- 2.18.1 Service designation: ATIS(209-982-4667)
- 2.18.3 Service designation: 118.25 MHz
- 2.18.4 Hours of operation: 24

2.18.1 Service designation: LCL/P
2.18.3 Service designation: 120.3 MHz

2.18.1 Service designation: GND/P
2.18.3 Service designation: 121.9 MHz

2.18.1 Service designation: LCL/P
2.18.3 Service designation: 239 MHz

2.18.1 Service designation: ANG OPNS
2.18.3 Service designation: 49 MHz

2.18.1 Service designation: NG OPS
2.18.3 Service designation: 139.4 MHz

2.18.1 Service designation: NG OPS
2.18.3 Service designation: 356.9 MHz

AD 2.19 Radio navigation and landing aids

2.19.1 ILS type: Localizer for runway 29R.
Magnetic variation: 14E
2.19.2 ILS identification: SCK
2.19.5 Coordinates: 37-54-14.45N /
121-15-13.08W

2.19.6 Site elevation: 24 ft
2.19.1 ILS type: Glide Slope for runway 29R.
Magnetic variation: 14E

2.19.2 ILS identification: SCK
2.19.5 Coordinates: 37-53-20.80N /
121-13-36.95W

2.19.6 Site elevation: 29 ft

2.19.1 ILS type: Middle Marker for runway 29R.
Magnetic variation: 14E

2.19.2 ILS identification: SCK
2.19.5 Coordinates: 37-52-53.73N /
121-13-00.00W

2.19.6 Site elevation: 30 ft

2.19.1 ILS type: Outer Marker for runway 29R.
Magnetic variation: 14E

2.19.2 ILS identification: SCK
2.19.5 Coordinates: 37-49-54.28N /
121-08-00.00W

2.19.6 Site elevation: 52 ft

General Remarks:

SEAGULLS ON AND IN VICINITY OF AIRPORT MOSTLY DURING RAINY WEATHER.

AVOID OVERFLYING SAN JOAQUIN GENERAL HOSPITAL & THE CITY OF MANTECA.

AIRPORT CLOSED TO TOUCH AND GO LANDING & PLANNED LOW APPROACHES FOR TURBOJET AIRCRAFT 2200-0700 EXCEPT BY PRIOR PERMISSION REQUIRED FROM AIRPORT MANAGER PART 36 STAGE 3 AIRCRAFT.

PRACTICE CIRCLING APPROACHES TO RUNWAYS 11L/11R NOT AUTHORIZED FOR ANY TURBINE POWERED ACFT/PROP DRIVEN AIRCRAFT EXCEEDING 12500 LBS EXCEPT BY PRIOR PERMISSION REQUIRED FROM AIRPORT MANAGER.

MILITARY USE: ARRANGE OPR 1500-2330Z++ MON-FRI. DSN 466-5319, C209-983-5319, FAX 5391. PRIOR PERMISSION REQUIRED. LIMITED TRANSIENT SERVICE AND MAINT AVAILABLE FOR CH47.

THE FOLLOWING AREAS NOT VISIBLE FROM ATCT: TAXIWAY B FROM NORTH SIDE OF TERMINAL BUILDING TO 25 FT WEST OF TAXIWAY J. SOUTH HALF OF TAXIWAY B INTERMITTENTLY FROM TAXIWAY J TO 200 FT WEST OF TAXIWAY H. TRANSIENT PARKING AREA. ALL TERMINAL RAMPS. TAXIWAY B FROM APPROXIMATE 200 FT WEST AND EAST OF TAXIWAY J.

TRANSIENT PARKING AVAILABLE AT FBO.

BE ALERT TO ELEVATED MALSR APPROACH END RUNWAY 29R LOCATED AT DSPLCD THRESHOLD DEMARCATION BAR WHEN USING FULL LENGTH OF RUNWAY 29R.

Denver, Colorado
Denver International
ICAO Identifier KDEN

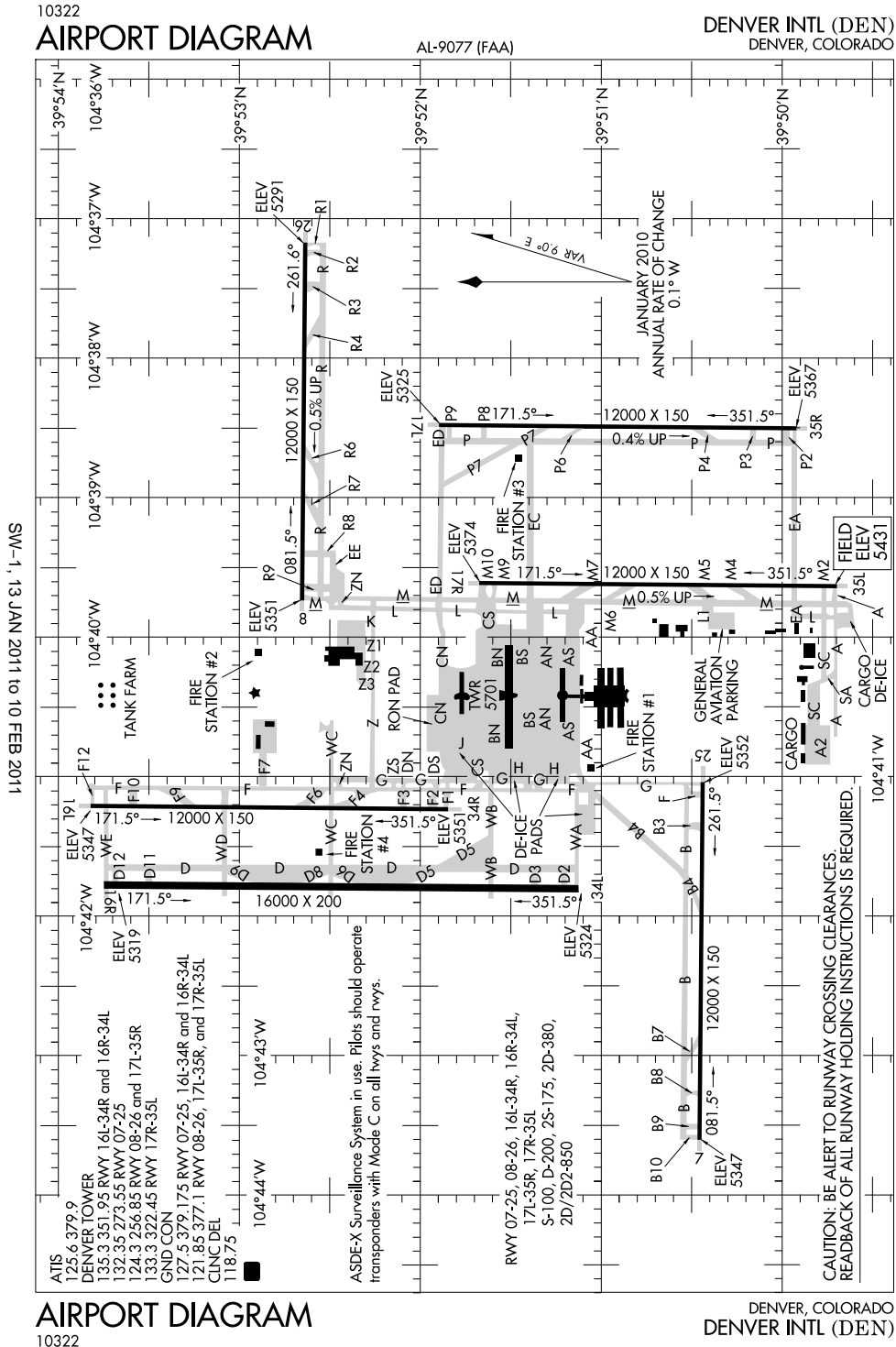

Denver, CO
Denver Intl
ICAO Identifier KDEN

AD 2.2 Aerodrome geographical and administrative data

- 2.2.1 Reference Point: 39-51-41.96N / 104-40-23.44W
- 2.2.2 From City: 16 Miles NE Of Denver, CO
- 2.2.3 Elevation: 5431 ft
- 2.2.5 Magnetic variation: 11E (1995)
- 2.2.6 Airport Contact: Kim Day
ADMIN BLDG, 8500 PENA BLVD
Denver, CO 80249 (303-342-2200)
- 2.2.7 Traffic: IFR/VFR

AD 2.3 Operational hours

- 2.3.1 - 2.3.11: ALL Months, ALL Days, ALL Hours

AD 2.4 Handling services and facilities

- 2.4.1 Cargo handling facilities: No
- 2.4.2 Fuel types: 100,100LL,A,MOGAS
- 2.4.4 De-icing facilities: None
- 2.4.5 Hangar space: Yes
- 2.4.6 Repair facilities: Major

AD 2.6 Rescue and firefighting services

- 2.6.1 Aerodrome category for firefighting: ARFF Index I E certified on 2/1/1995

AD 2.12 Runway physical characteristics

- 2.12.1 Designation: 07
- 2.12.2 True Bearing: 90
- 2.12.3 Dimensions: 12000 ft x 150 ft
- 2.12.5 Coordinates: 39-50-27.40N / 104-43-35.97W
- 2.12.6 Threshold elevation: 5347 ft
- 2.12.6 Touchdown zone elevation: 5348 ft

- 2.12.1 Designation: 25
- 2.12.2 True Bearing: 271
- 2.12.3 Dimensions: 12000 ft x 150 ft
- 2.12.5 Coordinates: 39-50-26.36N / 104-41-00.00W
- 2.12.6 Threshold elevation: 5352 ft
- 2.12.6 Touchdown zone elevation: 5352 ft

- 2.12.1 Designation: 16L
- 2.12.2 True Bearing: 181
- 2.12.3 Dimensions: 12000 ft x 150 ft

- 2.12.5 Coordinates: 39-53-49.33N / 104-41-12.50W
- 2.12.6 Threshold elevation: 5347 ft
- 2.12.6 Touchdown zone elevation: 5354 ft

- 2.12.1 Designation: 34R
- 2.12.2 True Bearing: 1
- 2.12.3 Dimensions: 12000 ft x 150 ft
- 2.12.5 Coordinates: 39-51-50.78N / 104-41-13.88W
- 2.12.6 Threshold elevation: 5351 ft
- 2.12.6 Touchdown zone elevation: 5351 ft

- 2.12.1 Designation: 08
- 2.12.2 True Bearing: 91
- 2.12.3 Dimensions: 12000 ft x 150 ft
- 2.12.5 Coordinates: 39-52-39.20N / 104-39-44.03W
- 2.12.6 Threshold elevation: 5351 ft
- 2.12.6 Touchdown zone elevation: 5351 ft

- 2.12.1 Designation: 26
- 2.12.2 True Bearing: 271
- 2.12.3 Dimensions: 12000 ft x 150 ft
- 2.12.5 Coordinates: 39-52-38.08N / 104-37-10.15W
- 2.12.6 Threshold elevation: 5291 ft
- 2.12.6 Touchdown zone elevation: 5306 ft

- 2.12.1 Designation: 17L
- 2.12.2 True Bearing: 181
- 2.12.3 Dimensions: 12000 ft x 150 ft
- 2.12.5 Coordinates: 39-51-53.83N / 104-38-28.70W
- 2.12.6 Threshold elevation: 5325 ft
- 2.12.6 Touchdown zone elevation: 5335 ft

- 2.12.1 Designation: 35R
- 2.12.2 True Bearing: 1
- 2.12.3 Dimensions: 12000 ft x 150 ft
- 2.12.5 Coordinates: 39-49-55.27N / 104-38-30.16W
- 2.12.6 Threshold elevation: 5367 ft
- 2.12.6 Touchdown zone elevation: 5367 ft

- 2.12.1 Designation: 17R
- 2.12.2 True Bearing: 181
- 2.12.3 Dimensions: 12000 ft x 150 ft
- 2.12.5 Coordinates: 39-51-40.48N / 104-39-36.56W
- 2.12.6 Threshold elevation: 5374 ft

2.12.6 Touchdown zone elevation: 5388 ft

2.12.1 Designation: 35L

2.12.2 True Bearing: 1

2.12.3 Dimensions: 12000 ft x 150 ft

2.12.5 Coordinates: 39-49-41.93N /
104-39-37.99W

2.12.6 Threshold elevation: 5430 ft

2.12.6 Touchdown zone elevation: 5431 ft

2.12.1 Designation: 16R

2.12.2 True Bearing: 180

2.12.3 Dimensions: 16000 ft x 200 ft

2.12.5 Coordinates: 39-53-44.87N /
104-41-45.90W

2.12.6 Threshold elevation: 5319 ft

2.12.6 Touchdown zone elevation: 5323 ft

2.12.1 Designation: 34L

2.12.2 True Bearing: 1

2.12.3 Dimensions: 16000 ft x 200 ft

2.12.5 Coordinates: 39-51-00.00N /
104-41-47.72W

2.12.6 Threshold elevation: 5324 ft

2.12.6 Touchdown zone elevation: 5324 ft

AD 2.13 Declared distances

2.13.1 Designation: 07

2.13.2 Takeoff run available: 12000

2.13.3 Takeoff distance available: 12000

2.13.4 Accelerate-stop distance available: 12000

2.13.5 Landing distance available: 12000

2.13.1 Designation: 25

2.13.2 Takeoff run available: 12000

2.13.3 Takeoff distance available: 13000

2.13.4 Accelerate-stop distance available: 12000

2.13.5 Landing distance available: 12000

2.13.1 Designation: 16L

2.13.2 Takeoff run available: 12000

2.13.3 Takeoff distance available: 12000

2.13.4 Accelerate-stop distance available: 12000

2.13.5 Landing distance available: 12000

2.13.1 Designation: 34R

2.13.2 Takeoff run available: 12000

2.13.3 Takeoff distance available: 13000

2.13.4 Accelerate-stop distance available: 12000

2.13.5 Landing distance available: 12000

2.13.1 Designation: 08

2.13.2 Takeoff run available: 12000

2.13.3 Takeoff distance available: 13000

2.13.4 Accelerate-stop distance available: 12000

2.13.5 Landing distance available: 12000

2.13.1 Designation: 26

2.13.2 Takeoff run available: 12000

2.13.3 Takeoff distance available: 12000

2.13.4 Accelerate-stop distance available: 12000

2.13.5 Landing distance available: 12000

2.13.1 Designation: 17L

2.13.2 Takeoff run available: 12000

2.13.3 Takeoff distance available: 12000

2.13.4 Accelerate-stop distance available: 12000

2.13.5 Landing distance available: 12000

2.13.1 Designation: 35R

2.13.2 Takeoff run available: 12000

2.13.3 Takeoff distance available: 12000

2.13.4 Accelerate-stop distance available: 12000

2.13.5 Landing distance available: 12000

2.13.1 Designation: 17R

2.13.2 Takeoff run available: 12000

2.13.3 Takeoff distance available: 12000

2.13.4 Accelerate-stop distance available: 12000

2.13.5 Landing distance available: 12000

2.13.1 Designation: 35L

2.13.2 Takeoff run available: 12000

2.13.3 Takeoff distance available: 12000

2.13.4 Accelerate-stop distance available: 12000

2.13.5 Landing distance available: 12000

2.13.1 Designation: 16R

2.13.2 Takeoff run available: 16000

2.13.3 Takeoff distance available: 16000

2.13.4 Accelerate-stop distance available: 16000

2.13.5 Landing distance available: 16000

2.13.1 Designation: 34L

2.13.2 Takeoff run available: 16000

2.13.3 Takeoff distance available: 16000

2.13.4 Accelerate-stop distance available: 16000

2.13.5 Landing distance available: 16000

AD 2.14 Approach and runway lighting

2.14.1 Designation: 07

2.14.2 Approach lighting system: MALSR: 1400

feet medium intensity approach lighting system with runway alignment indicator lights
2.14.4 Visual approach slope indicator system: 4-light PAPI on right

2.14.1 Designation: 25
2.14.2 Approach lighting system: MALSR: 1400 feet medium intensity approach lighting system with runway alignment indicator lights
2.14.4 Visual approach slope indicator system: 4-light PAPI on left

2.14.1 Designation: 16L
2.14.2 Approach lighting system: MALSR: 1400 feet medium intensity approach lighting system with runway alignment indicator lights
2.14.4 Visual approach slope indicator system: 4-light PAPI on left

2.14.1 Designation: 34R
2.14.2 Approach lighting system: ALSF2: Standard 2400 feet high intensity approach lighting system with sequenced flashers, category II or III configuration
2.14.4 Visual approach slope indicator system: 4-light PAPI on left

2.14.1 Designation: 08
2.14.2 Approach lighting system: MALSR: 1400 feet medium intensity approach lighting system with runway alignment indicator lights
2.14.4 Visual approach slope indicator system: 4-light PAPI on left

2.14.1 Designation: 26
2.14.2 Approach lighting system: MALSR: 1400 feet medium intensity approach lighting system with runway alignment indicator lights
2.14.4 Visual approach slope indicator system: 4-light PAPI on left

2.14.1 Designation: 17L
2.14.2 Approach lighting system: MALSR: 1400 feet medium intensity approach lighting system with runway alignment indicator lights
2.14.4 Visual approach slope indicator system: 4-light PAPI on left

2.14.1 Designation: 35R
2.14.2 Approach lighting system: ALSF2: Standard 2400 feet high intensity approach lighting system

with sequenced flashers, category II or III configuration
2.14.4 Visual approach slope indicator system: 4-light PAPI on right

2.14.1 Designation: 17R
2.14.2 Approach lighting system: MALSR: 1400 feet medium intensity approach lighting system with runway alignment indicator lights
2.14.4 Visual approach slope indicator system: 4-light PAPI on left

2.14.1 Designation: 35L
2.14.2 Approach lighting system: ALSF2: Standard 2400 feet high intensity approach lighting system with sequenced flashers, category II or III configuration
2.14.4 Visual approach slope indicator system: 4-light PAPI on right

2.14.1 Designation: 16R
2.14.2 Approach lighting system: MALSR: 1400 feet medium intensity approach lighting system with runway alignment indicator lights
2.14.4 Visual approach slope indicator system: 4-light PAPI on right

2.14.1 Designation: 34L
2.14.2 Approach lighting system: ALSF2: Standard 2400 feet high intensity approach lighting system with sequenced flashers, category II or III configuration
2.14.4 Visual approach slope indicator system: 4-light PAPI on left

AD 2.18 Air traffic services communication facilities

2.18.1 Service designation: CD/P
2.18.3 Service designation: 118.75 MHz

2.18.1 Service designation: APCH/P
2.18.3 Service designation: 120.35 MHz

2.18.1 Service designation: FINAL CTL
2.18.3 Service designation: 120.8 MHz

2.18.1 Service designation: GND/P
2.18.3 Service designation: 121.85 MHz

2.18.1 Service designation: LCL/P
2.18.3 Service designation: 124.3 MHz

2.18.1 Service designation: D-ATIS
2.18.3 Service designation: 125.6 MHz
2.18.4 Hours of operation: 24

2.18.1 Service designation: CLASS B DEP/P
2.18.3 Service designation: 126.1 MHz

2.18.1 Service designation: DEP/P
2.18.3 Service designation: 127.05 MHz

2.18.1 Service designation: CLASS B DEP/P
2.18.3 Service designation: 128.25 MHz

2.18.1 Service designation: CLASS B DEP/P
2.18.3 Service designation: 128.45 MHz

2.18.1 Service designation: LCL/P
2.18.3 Service designation: 133.3 MHz

2.18.1 Service designation: D-ATIS
2.18.3 Service designation: 134.025 MHz
2.18.4 Hours of operation: 24

2.18.1 Service designation: CLASS B
2.18.3 Service designation: 134.85 MHz

2.18.1 Service designation: LCL/P
2.18.3 Service designation: 322.45 MHz

2.18.1 Service designation: CLASS B DEP/P
2.18.3 Service designation: 360.75 MHz

2.18.1 Service designation: DEP/P
2.18.3 Service designation: 363.25 MHz

2.18.1 Service designation: CLASS B DEP/P
2.18.3 Service designation: 371.95 MHz

2.18.1 Service designation: GND/P
2.18.3 Service designation: 377.1 MHz

2.18.1 Service designation: CLASS B DEP/P
2.18.3 Service designation: 251.075 MHz

2.18.1 Service designation: CLASS B
2.18.3 Service designation: 251.125 MHz

2.18.1 Service designation: D-ATIS
2.18.3 Service designation: 379.9 MHz
2.18.4 Hours of operation: 24

2.18.1 Service designation: GND/P
2.18.3 Service designation: 127.5 MHz

2.18.1 Service designation: LCL/P
2.18.3 Service designation: 273.55 MHz

2.18.1 Service designation: LCL/P
2.18.3 Service designation: 132.35 MHz

2.18.1 Service designation: LCL/P
2.18.3 Service designation: 135.3 MHz

2.18.1 Service designation: LCL/P
2.18.3 Service designation: 256.85 MHz

2.18.1 Service designation: LCL/P
2.18.3 Service designation: 351.95 MHz

2.18.1 Service designation: GND/P
2.18.3 Service designation: 379.175 MHz

2.18.1 Service designation: APCH/P
2.18.3 Service designation: 379.3 MHz

2.18.1 Service designation: APCH/S
2.18.3 Service designation: 124.95 MHz

2.18.1 Service designation: APCH/S
2.18.3 Service designation: 346.4 MHz

2.18.1 Service designation: APCH/S
2.18.3 Service designation: 126.55 MHz

2.18.1 Service designation: APCH/S
2.18.3 Service designation: 269.525 MHz

2.18.1 Service designation: APCH/P
2.18.3 Service designation: 119.3 MHz

2.18.1 Service designation: APCH/P
2.18.3 Service designation: 307.3 MHz

AD 2.19 Radio navigation and landing aids

2.19.1 ILS type: Glide Slope for runway 07.
Magnetic variation: 11E
2.19.2 ILS identification: DZG
2.19.5 Coordinates: 39-50-23.26N /
104-43-22.65W
2.19.6 Site elevation: 5337 ft

2.19.1 ILS type: Outer Marker for runway 07.

Magnetic variation: 11E
2.19.2 ILS identification: DZG
2.19.5 Coordinates: 39-50-31.70N /
104-49-41.50W
2.19.6 Site elevation: 5215 ft

2.19.1 ILS type: Middle Marker for runway 07.
Magnetic variation: 11E
2.19.2 ILS identification: DZG
2.19.5 Coordinates: 39-50-27.60N /
104-44-11.80W
2.19.6 Site elevation: 5283 ft

2.19.1 ILS type: Localizer for runway 07. Magnetic
variation: 11E
2.19.2 ILS identification: DZG
2.19.5 Coordinates: 39-50-26.27N /
104-40-49.08W
2.19.6 Site elevation: 5352 ft

2.19.1 ILS type: DME for runway 07. Magnetic
variation: 11E
2.19.2 ILS identification: DZG
2.19.5 Coordinates: 39-50-23.66N /
104-40-48.62W
2.19.6 Site elevation: 5355 ft

2.19.1 ILS type: Localizer for runway 25. Magnetic
variation: 11E
2.19.2 ILS identification: ERP
2.19.5 Coordinates: 39-50-27.49N /
104-43-49.05W
2.19.6 Site elevation: 5345 ft

2.19.1 ILS type: DME for runway 25. Magnetic
variation: 11E
2.19.2 ILS identification: ERP
2.19.5 Coordinates: 39-50-23.66N /
104-40-48.38W
2.19.6 Site elevation: 5355 ft

2.19.1 ILS type: Glide Slope for runway 25.
Magnetic variation: 11E
2.19.2 ILS identification: ERP
2.19.5 Coordinates: 39-50-22.41N /
104-41-15.79W
2.19.6 Site elevation: 5341 ft

2.19.1 ILS type: Middle Marker for runway 25.
Magnetic variation: 11E
2.19.2 ILS identification: ERP

2.19.5 Coordinates: 39-50-26.10N /
104-40-25.50W
2.19.6 Site elevation: 5325 ft

2.19.1 ILS type: Outer Marker for runway 25.
Magnetic variation: 11E
2.19.2 ILS identification: ERP
2.19.5 Coordinates: 39-50-15.80N /
104-34-56.30W
2.19.6 Site elevation: 5319 ft

2.19.1 ILS type: Outer Marker for runway 16L.
Magnetic variation: 11E
2.19.2 ILS identification: LTT
2.19.5 Coordinates: 39-58-19.70N /
104-41-26.10W
2.19.6 Site elevation: 5161 ft

2.19.1 ILS type: Middle Marker for runway 16L.
Magnetic variation: 11E
2.19.2 ILS identification: LTT
2.19.5 Coordinates: 39-54-18.00N /
104-41-12.20W
2.19.6 Site elevation: 5347 ft

2.19.1 ILS type: Localizer for runway 16L.
Magnetic variation: 11E
2.19.2 ILS identification: LTT
2.19.5 Coordinates: 39-51-40.69N /
104-41-13.99W
2.19.6 Site elevation: 5340 ft

2.19.1 ILS type: DME for runway 16L. Magnetic
variation: 11E
2.19.2 ILS identification: LTT
2.19.5 Coordinates: 39-53-59.63N /
104-41-15.77W
2.19.6 Site elevation: 5354 ft

2.19.1 ILS type: Glide Slope for runway 16L.
Magnetic variation: 11E
2.19.2 ILS identification: LTT
2.19.5 Coordinates: 39-53-39.55N /
104-41-17.87W
2.19.6 Site elevation: 5343 ft

2.19.1 ILS type: Glide Slope for runway 34R.
Magnetic variation: 9E
2.19.2 ILS identification: OUF
2.19.5 Coordinates: 39-52-00.00N /
104-41-19.01W

2.19.6 Site elevation: 5343 ft

2.19.1 ILS type: Inner Marker for runway 34R.
Magnetic variation: 9E

2.19.2 ILS identification: OUF

2.19.5 Coordinates: 39-51-42.30N /
104-41-14.00W

2.19.6 Site elevation: 5342 ft

2.19.1 ILS type: Middle Marker for runway 34R.
Magnetic variation: 9E

2.19.2 ILS identification: OUF

2.19.5 Coordinates: 39-51-23.40N /
104-41-14.10W

2.19.6 Site elevation: 5298 ft

2.19.1 ILS type: DME for runway 34R. Magnetic
variation: 9E

2.19.2 ILS identification: OUF

2.19.5 Coordinates: 39-53-59.63N /
104-41-15.77W

2.19.6 Site elevation: 5354 ft

2.19.1 ILS type: Outer Marker for runway 34R.
Magnetic variation: 9E

2.19.2 ILS identification: OUF

2.19.5 Coordinates: 39-47-00.00N /
104-41-33.80W

2.19.6 Site elevation: 5561 ft

2.19.1 ILS type: Localizer for runway 34R.
Magnetic variation: 9E

2.19.2 ILS identification: OUF

2.19.5 Coordinates: 39-53-59.43N /
104-41-12.38W

2.19.6 Site elevation: 5346 ft

2.19.1 ILS type: DME for runway 08. Magnetic
variation: 11E

2.19.2 ILS identification: FUI

2.19.5 Coordinates: 39-52-41.90N /
104-39-57.58W

2.19.6 Site elevation: 5356 ft

2.19.1 ILS type: Glide Slope for runway 08.
Magnetic variation: 11E

2.19.2 ILS identification: FUI

2.19.5 Coordinates: 39-52-43.15N /
104-39-29.86W

2.19.6 Site elevation: 5339 ft

2.19.1 ILS type: Outer Marker for runway 08.
Magnetic variation: 11E

2.19.2 ILS identification: FUI

2.19.5 Coordinates: 39-52-40.50N /
104-46-20.00W

2.19.6 Site elevation: 5245 ft

2.19.1 ILS type: Localizer for runway 08. Magnetic
variation: 11E

2.19.2 ILS identification: FUI

2.19.5 Coordinates: 39-52-37.98N /
104-36-57.06W

2.19.6 Site elevation: 5280 ft

2.19.1 ILS type: Middle Marker for runway 08.
Magnetic variation: 11E

2.19.2 ILS identification: FUI

2.19.5 Coordinates: 39-52-39.40N /
104-40-19.50W

2.19.6 Site elevation: 5352 ft

2.19.1 ILS type: Localizer for runway 26. Magnetic
variation: 11E

2.19.2 ILS identification: JOY

2.19.5 Coordinates: 39-52-39.30N /
104-39-57.12W

2.19.6 Site elevation: 5345 ft

2.19.1 ILS type: Glide Slope for runway 26.
Magnetic variation: 11E

2.19.2 ILS identification: JOY

2.19.5 Coordinates: 39-52-42.22N /
104-37-22.38W

2.19.6 Site elevation: 5290 ft

2.19.1 ILS type: Outer Marker for runway 26.
Magnetic variation: 11E

2.19.2 ILS identification: JOY

2.19.5 Coordinates: 39-52-34.30N /
104-29-18.70W

2.19.6 Site elevation: 5111 ft

2.19.1 ILS type: Middle Marker for runway 26.
Magnetic variation: 11E

2.19.2 ILS identification: JOY

2.19.5 Coordinates: 39-52-37.80N /
104-36-31.00W

2.19.6 Site elevation: 5256 ft

2.19.1 ILS type: DME for runway 26. Magnetic
variation: 11E

2.19.2 ILS identification: JOY
2.19.5 Coordinates: 39-52-41.90N /
104-39-57.58W
2.19.6 Site elevation: 5356 ft

2.19.1 ILS type: Localizer for runway 17L.
Magnetic variation: 11E
2.19.2 ILS identification: BXP
2.19.5 Coordinates: 39-49-45.18N /
104-38-30.28W
2.19.6 Site elevation: 5360 ft

2.19.1 ILS type: Outer Marker for runway 17L.
Magnetic variation: 11E
2.19.2 ILS identification: BXP
2.19.5 Coordinates: 39-56-35.40N /
104-38-23.70W
2.19.6 Site elevation: 5161 ft

2.19.1 ILS type: Middle Marker for runway 17L.
Magnetic variation: 11E
2.19.2 ILS identification: BXP
2.19.5 Coordinates: 39-52-23.20N /
104-38-28.30W
2.19.6 Site elevation: 5323 ft

2.19.1 ILS type: Glide Slope for runway 17L.
Magnetic variation: 11E
2.19.2 ILS identification: BXP
2.19.5 Coordinates: 39-51-44.06N /
104-38-23.56W
2.19.6 Site elevation: 5323 ft

2.19.1 ILS type: DME for runway 17L. Magnetic
variation: 11E
2.19.2 ILS identification: BXP
2.19.5 Coordinates: 39-52-00.00N /
104-38-25.18W
2.19.6 Site elevation: 5342 ft

2.19.1 ILS type: DME for runway 35R. Magnetic
variation: 9E
2.19.2 ILS identification: DPP
2.19.5 Coordinates: 39-52-00.00N /
104-38-25.19W
2.19.6 Site elevation: 5342 ft

2.19.1 ILS type: Glide Slope for runway 35R.
Magnetic variation: 9E
2.19.2 ILS identification: DPP
2.19.5 Coordinates: 39-50-00.00N /

104-38-24.77W
2.19.6 Site elevation: 5356 ft

2.19.1 ILS type: Inner Marker for runway 35R.
Magnetic variation: 9E
2.19.2 ILS identification: DPP
2.19.5 Coordinates: 39-49-46.80N /
104-38-30.30W
2.19.6 Site elevation: 5361 ft

2.19.1 ILS type: Outer Marker for runway 35R.
Magnetic variation: 9E
2.19.2 ILS identification: DPP
2.19.5 Coordinates: 39-45-13.10N /
104-38-27.20W
2.19.6 Site elevation: 5504 ft

2.19.1 ILS type: Localizer for runway 35R.
Magnetic variation: 9E
2.19.2 ILS identification: DPP
2.19.5 Coordinates: 39-52-00.00N /
104-38-28.57W
2.19.6 Site elevation: 5332 ft

2.19.1 ILS type: Middle Marker for runway 35R.
Magnetic variation: 9E
2.19.2 ILS identification: DPP
2.19.5 Coordinates: 39-49-27.90N /
104-38-30.60W
2.19.6 Site elevation: 5356 ft

2.19.1 ILS type: Localizer for runway 17R.
Magnetic variation: 11E
2.19.2 ILS identification: ACX
2.19.5 Coordinates: 39-49-31.84N /
104-39-38.10W
2.19.6 Site elevation: 5424 ft

2.19.1 ILS type: DME for runway 17R. Magnetic
variation: 11E
2.19.2 ILS identification: ACX
2.19.5 Coordinates: 39-51-50.93N /
104-39-33.05W
2.19.6 Site elevation: 5385 ft

2.19.1 ILS type: Outer Marker for runway 17R.
Magnetic variation: 11E
2.19.2 ILS identification: ACX
2.19.5 Coordinates: 39-56-35.50N /
104-39-32.20W
2.19.6 Site elevation: 5286 ft

2.19.1 ILS type: Middle Marker for runway 17R.
Magnetic variation: 11E
2.19.2 ILS identification: ACX
2.19.5 Coordinates: 39-52-10.50N /
104-39-36.20W
2.19.6 Site elevation: 5365 ft

2.19.1 ILS type: Glide Slope for runway 17R.
Magnetic variation: 11E
2.19.2 ILS identification: ACX
2.19.5 Coordinates: 39-51-30.91N /
104-39-31.42W
2.19.6 Site elevation: 5374 ft

2.19.1 ILS type: Localizer for runway 35L.
Magnetic variation: 9E
2.19.2 ILS identification: AQD
2.19.5 Coordinates: 39-51-50.57N /
104-39-36.44W
2.19.6 Site elevation: 5374 ft

2.19.1 ILS type: DME for runway 35L. Magnetic
variation: 9E
2.19.2 ILS identification: AQD
2.19.5 Coordinates: 39-51-50.93N /
104-39-33.05W
2.19.6 Site elevation: 5384 ft

2.19.1 ILS type: Glide Slope for runway 35L.
Magnetic variation: 9E
2.19.2 ILS identification: AQD
2.19.5 Coordinates: 39-49-52.77N /
104-39-32.60W
2.19.6 Site elevation: 5419 ft

2.19.1 ILS type: Outer Marker for runway 35L.
Magnetic variation: 9E
2.19.2 ILS identification: AQD
2.19.5 Coordinates: 39-45-13.30N /
104-39-48.60W
2.19.6 Site elevation: 5606 ft

2.19.1 ILS type: Middle Marker for runway 35L.
Magnetic variation: 9E
2.19.2 ILS identification: AQD
2.19.5 Coordinates: 39-49-14.60N /
104-39-38.40W
2.19.6 Site elevation: 5411 ft

2.19.1 ILS type: Inner Marker for runway 35L.
Magnetic variation: 9E

2.19.2 ILS identification: AQD
2.19.5 Coordinates: 39-49-33.40N /
104-39-38.10W
2.19.6 Site elevation: 5426 ft

2.19.1 ILS type: Glide Slope for runway 16R.
Magnetic variation: 11E
2.19.2 ILS identification: DQQ
2.19.5 Coordinates: 39-53-34.83N /
104-41-51.28W
2.19.6 Site elevation: 5317 ft

2.19.1 ILS type: DME for runway 16R. Magnetic
variation: 11E
2.19.2 ILS identification: DQQ
2.19.5 Coordinates: 39-53-55.69N /
104-41-50.91W
2.19.6 Site elevation: 5311 ft

2.19.1 ILS type: Localizer for runway 16R.
Magnetic variation: 11E
2.19.2 ILS identification: DQQ
2.19.5 Coordinates: 39-50-56.79N /
104-41-47.83W
2.19.6 Site elevation: 5320 ft

2.19.1 ILS type: DME for runway 34L. Magnetic
variation: 9E
2.19.2 ILS identification: DXU
2.19.5 Coordinates: 39-53-55.64N /
104-41-50.91W
2.19.6 Site elevation: 5311 ft

2.19.1 ILS type: Localizer for runway 34L.
Magnetic variation: 9E
2.19.2 ILS identification: DXU
2.19.5 Coordinates: 39-53-54.87N /
104-41-45.79W
2.19.6 Site elevation: 5320 ft

2.19.1 ILS type: Glide Slope for runway 34L.
Magnetic variation: 9E
2.19.2 ILS identification: DXU
2.19.5 Coordinates: 39-51-17.60N /
104-41-52.85W
2.19.6 Site elevation: 5318 ft

2.19.1 ILS type: Inner Marker for runway 34L.
Magnetic variation: 9E
2.19.2 ILS identification: DXU
2.19.5 Coordinates: 39-50-58.29N /

104-41-47.82W
2.19.6 Site elevation: 5317 ft

General Remarks:

FIXED OR MOVABLE OBJECT LINE BETWEEN RAMP & SOUTH TAXIWAYS BN-BS REMOVED.

OVERHEAD PASSENGER BRIDGE ON SOUTH SIDE OF CONCOURSE 'A' PROVIDES 42 FT TAIL & 118 FT WINGSPAN CLEARANCE WHEN ON TAXIWAY CENTERLINE.

INSUFFICIENT TAXIWAY CORNER FILLET PAVEMENT IN THE SE CORNER OF THE TAXIWAY M/M2 INTERSECTION FOR AIRCRAFT WITH WINGSPANS OVER 107 FT.

FLIGHT NOTIFICATION SERVICE (ADCUS) AVAILABLE.

INFORMAL RUNWAY USE PROGRAM IS IN EFFECT 24 HRS A DAY. FOR ADDITIONAL NOISE ABATEMENT INFORMATION CONTACT AIRPORT MANAGEMENT AT 303-342-4200.

WATERFOWL AND MIGRATORY BIRD ACTIVITY IN THE VICINITY OF AIRPORT YEAR ROUND.

ASDE-X SURVEILLANCE SYSTEM IN USE: PILOTS SHOULD OPERATE TRANSPONDERS WITH MODE C ON ALL TAXIWAYS AND RUNWAYS.

Pueblo, Colorado Pueblo Memorial ICAO Identifier KPUB

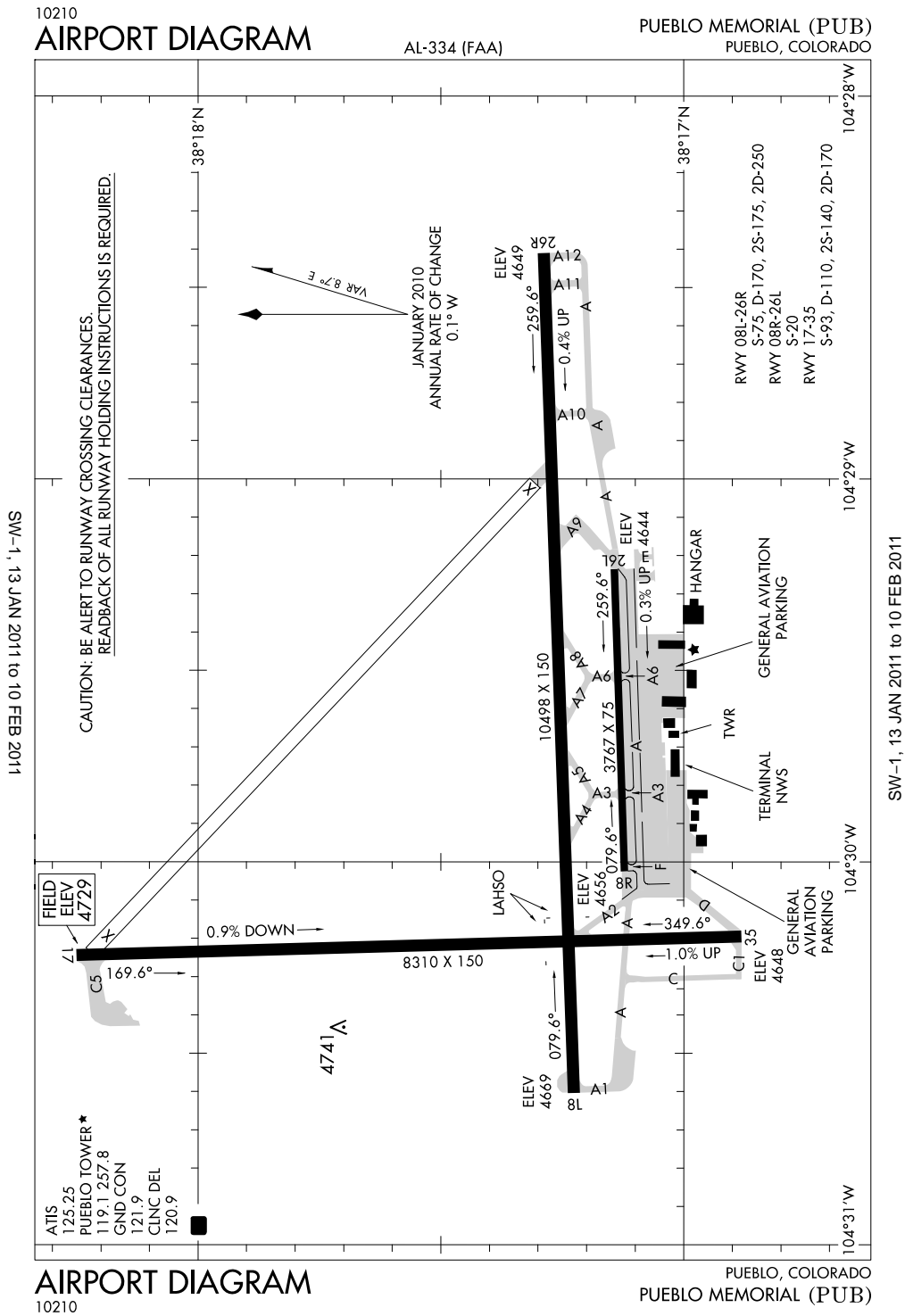

Pueblo, CO
Pueblo Memorial
ICAO Identifier KPUB

AD 2.2 Aerodrome geographical and administrative data

- 2.2.1 Reference Point: 38-17-20.90N / 104-29-47.40W
- 2.2.2 From City: 5 Miles E Of Pueblo, CO
- 2.2.3 Elevation: 4729 ft
- 2.2.5 Magnetic variation: 11E (1985)
- 2.2.6 Airport Contact: Mark Lovin
31201 BRYAN CIRCLE
Pueblo, CO 81001
(719-553-2760)
- 2.2.7 Traffic: IFR/VFR

AD 2.3 Operational hours

- 2.3.1 - 2.3.11: ALL Months, M-F Days, 0400-2300 Hours

AD 2.4 Handling services and facilities

- 2.4.1 Cargo handling facilities: No
- 2.4.2 Fuel types: 100LL,A
- 2.4.4 De-icing facilities: None
- 2.4.5 Hangar space: Yes
- 2.4.6 Repair facilities: Major

AD 2.6 Rescue and firefighting services

- 2.6.1 Aerodrome category for firefighting: ARFF Index Ii A certified on 5/1/1973

AD 2.10 Aerodrome obstacles

- 2.10.1.a. Runway designation: 26L
- 2.10.1.b Type of obstacle: Gnd (7 ft). Not Lighted or Marked
- 2.10.1.c Location of obstacle: 245 ft from Centerline
- 2.10.1.a. Runway designation: 08R
- 2.10.1.b Type of obstacle: Gnd (20 ft). Not Lighted or Marked
- 2.10.1.c Location of obstacle: 0 ft from Centerline

AD 2.12 Runway physical characteristics

- 2.12.1 Designation: 17
- 2.12.2 True Bearing: 178
- 2.12.3 Dimensions: 8310 ft x 150 ft
- 2.12.5 Coordinates: 38-18-15.06N / 104-30-14.69W
- 2.12.6 Threshold elevation: 4729 ft

- 2.12.6 Touchdown zone elevation: 4729 ft
- 2.12.7 Slope: 0.9DOWN

- 2.12.1 Designation: 35
- 2.12.2 True Bearing: 358
- 2.12.3 Dimensions: 8310 ft x 150 ft
- 2.12.5 Coordinates: 38-16-52.97N / 104-30-11.65W
- 2.12.6 Threshold elevation: 4648 ft
- 2.12.6 Touchdown zone elevation: 4677 ft
- 2.12.7 Slope: 1UP

- 2.12.1 Designation: 08L
- 2.12.2 True Bearing: 88
- 2.12.3 Dimensions: 10498 ft x 150 ft
- 2.12.5 Coordinates: 38-17-13.64N / 104-30-36.24W
- 2.12.6 Threshold elevation: 4669 ft
- 2.12.6 Touchdown zone elevation: 4671 ft
- 2.12.7 Slope: 0DOWN

- 2.12.1 Designation: 26R
- 2.12.2 True Bearing: 268
- 2.12.3 Dimensions: 10498 ft x 150 ft
- 2.12.5 Coordinates: 38-17-16.75N / 104-28-24.66W
- 2.12.6 Threshold elevation: 4649 ft
- 2.12.6 Touchdown zone elevation: 4659 ft

- 2.12.1 Designation: 08R
- 2.12.2 True Bearing: 88
- 2.12.3 Dimensions: 3767 ft x 75 ft
- 2.12.5 Coordinates: 38-17-00.00N / 104-30-00.00W
- 2.12.6 Threshold elevation: 4656 ft
- 2.12.6 Touchdown zone elevation: 4656 ft

- 2.12.1 Designation: 26L
- 2.12.2 True Bearing: 268
- 2.12.3 Dimensions: 3767 ft x 75 ft
- 2.12.5 Coordinates: 38-17-00.00N / 104-29-14.23W
- 2.12.6 Threshold elevation: 4644 ft
- 2.12.6 Touchdown zone elevation: 4655 ft
- 2.12.7 Slope: 0.3UP

AD 2.13 Declared distances

- 2.13.1 Designation: 17
- 2.13.2 Takeoff run available: 8308
- 2.13.3 Takeoff distance available: 8308
- 2.13.4 Accelerate-stop distance available: 8308

2.13.5 Landing distance available: 8308

2.13.1 Designation: 35

2.13.2 Takeoff run available: 8308

2.13.3 Takeoff distance available: 8308

2.13.4 Accelerate-stop distance available: 8308

2.13.5 Landing distance available: 8308

2.13.1 Designation: 08L

2.13.2 Takeoff run available: 10496

2.13.3 Takeoff distance available: 10496

2.13.4 Accelerate-stop distance available: 10496

2.13.5 Landing distance available: 10496

2.13.1 Designation: 26R

2.13.2 Takeoff run available: 10496

2.13.3 Takeoff distance available: 10496

2.13.4 Accelerate-stop distance available: 10496

2.13.5 Landing distance available: 10496

2.13.1 Designation: 08R

2.13.2 Takeoff run available: 3767

2.13.3 Takeoff distance available: 3767

2.13.4 Accelerate-stop distance available: 3767

2.13.5 Landing distance available: 3767

2.13.1 Designation: 26L

2.13.2 Takeoff run available: 3767

2.13.3 Takeoff distance available: 3767

2.13.4 Accelerate-stop distance available: 3767

2.13.5 Landing distance available: 3767

AD 2.14 Approach and runway lighting

2.14.1 Designation: 17

2.14.4 Visual approach slope indicator system:
4-light PAPI on left

2.14.1 Designation: 35

2.14.4 Visual approach slope indicator system:
4-light PAPI on left

2.14.1 Designation: 08L

2.14.2 Approach lighting system: MALSR: 1400
feet medium intensity approach lighting system
with runway alignment indicator lights

2.14.4 Visual approach slope indicator system:
4-light PAPI on left

2.14.1 Designation: 26R

2.14.4 Visual approach slope indicator system:
4-light PAPI on left

AD 2.18 Air traffic services communication facilities

2.18.1 Service designation: LCL/P

2.18.3 Service designation: 119.1 MHz

2.18.1 Service designation: EMERG

2.18.3 Service designation: 121.5 MHz

2.18.1 Service designation: GND/P

2.18.3 Service designation: 121.9 MHz

2.18.1 Service designation: ATIS

2.18.3 Service designation: 125.25 MHz

2.18.4 Hours of operation: 24

2.18.1 Service designation: EMERG

2.18.3 Service designation: 243 MHz

2.18.1 Service designation: LCL/P

2.18.3 Service designation: 257.8 MHz

2.18.1 Service designation: CLNC DEL

2.18.3 Service designation: 120.9 MHz

AD 2.19 Radio navigation and landing aids

2.19.1 ILS type: Localizer for runway 08L.

Magnetic variation: 11E

2.19.2 ILS identification: PUB

2.19.5 Coordinates: 38-17-17.20N /
104-28-00.00W

2.19.6 Site elevation: 4653 ft

2.19.1 ILS type: Glide Slope for runway 08L.

Magnetic variation: 11E

2.19.2 ILS identification: PUB

2.19.5 Coordinates: 38-17-18.93N /
104-30-21.58W

2.19.6 Site elevation: 4673 ft

2.19.1 ILS type: Outer Marker for runway 08L.

Magnetic variation: 11E

2.19.2 ILS identification: PUB

2.19.5 Coordinates: 38-17-00.00N /
104-38-49.50W

2.19.6 Site elevation: 4730 ft

2.19.1 ILS type: Middle Marker for runway 08L.

Magnetic variation: 11E

2.19.2 ILS identification: PUB

2.19.5 Coordinates: 38-17-12.61N /
104-31-20.10W

2.19.6 Site elevation: 99999 ft

2.19.1 ILS type: Glide Slope for runway 26R.
Magnetic variation: 11E

2.19.2 ILS identification: TFR

2.19.5 Coordinates: 38-17-21.37N /
104-28-39.20W

2.19.6 Site elevation: 4650 ft

2.19.1 ILS type: Localizer for runway 26R.
Magnetic variation: 11E

2.19.2 ILS identification: TFR

2.19.5 Coordinates: 38-17-13.25N /
104-30-52.56W

2.19.6 Site elevation: 4668 ft

2.19.1 ILS type: Outer Marker for runway 26R.
Magnetic variation: 11E

2.19.2 ILS identification: TFR

2.19.5 Coordinates: 38-17-26.64N /
104-21-17.89W

2.19.6 Site elevation: 4660 ft

2.19.1 ILS type: Middle Marker for runway 26R.
Magnetic variation: 11E

2.19.2 ILS identification: TFR

2.19.5 Coordinates: 38-17-17.69N /
104-27-45.32W

2.19.6 Site elevation: 4640 ft

General Remarks:

HIGH VOLUME TRAINING DA-20 AIRCRAFT SR-SS MON-FRI. OVERHEAD PATTERN DURING TRAINING. EXTENSIVE USE OF TRAINING AREA 12-28 DME N-SW OF AIRPORT 500 FT AGL-8500 FT MSL.

FREQUENT USAGE OF RUNWAYS 8R/26L AFTER SUNSET BY UNLIGHTED MILITARY TRANSIENT AIRCRAFT.

RUNWAY 8R/26L UNLIGHTED AND UNAVAILABLE AT NIGHT.

RUNWAY 8R/26L HAS BLUE TAXIWAY EDGE LIGHTS ON N EDGE.

BE ALERT; INTENSIVE USAF STUDENT TRAINING IN VICINITY OF COLORADO SPRINGS & PUEBLO COLORADO.

SEE FLIGHT INFORMATION PUBLICATION AP/1 SUPPLEMENTARY AIRPORT INFORMATION.

Windsor Locks, Connecticut Bradley International ICAO Identifier KBDL

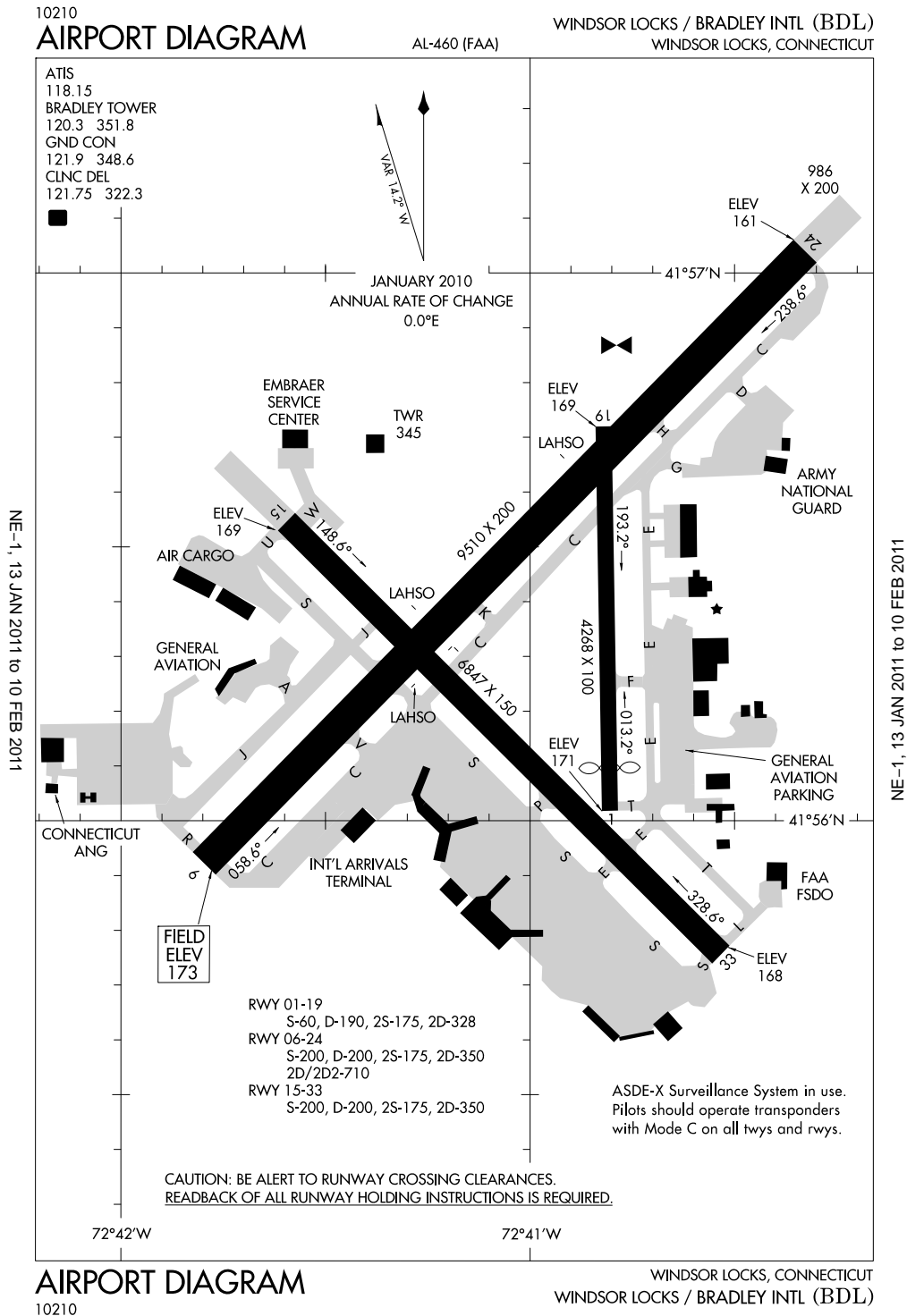

Windsor Locks, CT
Bradley Intl
ICAO Identifier KBDL

AD 2.2 Aerodrome geographical and administrative data

- 2.2.1 Reference Point: 41-56-20.00N / 72-40-59.60W
- 2.2.2 From City: 3 Miles W Of Windsor Locks, CT
- 2.2.3 Elevation: 173 ft
- 2.2.5 Magnetic variation: 14W (1980)
- 2.2.6 Airport Contact: Eric Waldron, A.A.E. Ace
BRADLEY INTL AIRPORT
Windsor Locks, CT 6096
(860-292-2001)
- 2.2.7 Traffic: IFR/VFR

AD 2.3 Operational hours

- 2.3.1 - 2.3.11: ALL Months, ALL Days, ALL Hours

AD 2.4 Handling services and facilities

- 2.4.1 Cargo handling facilities: No
- 2.4.2 Fuel types: 100LL,A
- 2.4.4 De-icing facilities: None
- 2.4.5 Hangar space: Yes
- 2.4.6 Repair facilities: Major

AD 2.6 Rescue and firefighting services

- 2.6.1 Aerodrome category for firefighting: ARFF Index I D certified on 5/1/1973

AD 2.10 Aerodrome obstacles

- 2.10.1.a. Runway designation: 15
- 2.10.1.b Type of obstacle: Trees (75 ft). Not Lighted or Marked
- 2.10.1.c Location of obstacle: 0 ft from Centerline

- 2.10.1.a. Runway designation: 33
- 2.10.1.b Type of obstacle: Trees (44 ft). Not Lighted or Marked
- 2.10.1.c Location of obstacle: 430 ft from Centerline

- 2.10.1.a. Runway designation: 19
- 2.10.1.b Type of obstacle: Trees (90 ft). Not Lighted or Marked
- 2.10.1.c Location of obstacle: 0 ft from Centerline

- 2.10.1.a. Runway designation: 01
- 2.10.1.b Type of obstacle: Acft (40 ft). Not Lighted

- or Marked
- 2.10.1.c Location of obstacle: 350 ft from Centerline

- 2.10.1.a. Runway designation: 06
- 2.10.1.b Type of obstacle: Trees (185 ft). Not Lighted or Marked
- 2.10.1.c Location of obstacle: 400 ft from Centerline

- 2.10.1.a. Runway designation: 24
- 2.10.1.b Type of obstacle: Trees (71 ft). Not Lighted or Marked
- 2.10.1.c Location of obstacle: 0 ft from Centerline

AD 2.12 Runway physical characteristics

- 2.12.1 Designation: 15
- 2.12.2 True Bearing: 134
- 2.12.3 Dimensions: 6847 ft x 150 ft
- 2.12.5 Coordinates: 41-56-32.63N / 72-41-35.71W
- 2.12.6 Threshold elevation: 169 ft
- 2.12.6 Touchdown zone elevation: 171 ft

- 2.12.1 Designation: 33
- 2.12.2 True Bearing: 314
- 2.12.3 Dimensions: 6847 ft x 150 ft
- 2.12.5 Coordinates: 41-55-45.32N / 72-40-30.96W
- 2.12.6 Threshold elevation: 168 ft
- 2.12.6 Touchdown zone elevation: 171 ft

- 2.12.1 Designation: 01
- 2.12.2 True Bearing: 359
- 2.12.3 Dimensions: 4268 ft x 100 ft
- 2.12.5 Coordinates: 41-56-00.00N / 72-40-48.30W
- 2.12.6 Threshold elevation: 171 ft
- 2.12.6 Touchdown zone elevation: 171 ft

- 2.12.1 Designation: 19
- 2.12.2 True Bearing: 179
- 2.12.3 Dimensions: 4268 ft x 100 ft
- 2.12.5 Coordinates: 41-56-43.21N / 72-40-49.25W
- 2.12.6 Threshold elevation: 169 ft
- 2.12.6 Touchdown zone elevation: 170 ft

- 2.12.1 Designation: 06
- 2.12.2 True Bearing: 44
- 2.12.3 Dimensions: 9510 ft x 200 ft

2.12.5 Coordinates: 41-55-55.25N /
72-41-47.69W
2.12.6 Threshold elevation: 173 ft
2.12.6 Touchdown zone elevation: 173 ft

2.12.1 Designation: 24
2.12.2 True Bearing: 224
2.12.3 Dimensions: 9510 ft x 200 ft
2.12.5 Coordinates: 41-57-00.00N /
72-40-19.68W
2.12.6 Threshold elevation: 161 ft
2.12.6 Touchdown zone elevation: 170 ft

AD 2.13 Declared distances

2.13.1 Designation: 15
2.13.2 Takeoff run available: 6847
2.13.3 Takeoff distance available: 6847
2.13.4 Accelerate-stop distance available: 6847
2.13.5 Landing distance available: 6847

2.13.1 Designation: 33
2.13.2 Takeoff run available: 6847
2.13.3 Takeoff distance available: 6847
2.13.4 Accelerate-stop distance available: 6847
2.13.5 Landing distance available: 6847

2.13.1 Designation: 01
2.13.2 Takeoff run available: 4268
2.13.3 Takeoff distance available: 4268
2.13.4 Accelerate-stop distance available: 4268

2.13.1 Designation: 19
2.13.5 Landing distance available: 4268

2.13.1 Designation: 06
2.13.2 Takeoff run available: 9509
2.13.3 Takeoff distance available: 9509
2.13.4 Accelerate-stop distance available: 9509
2.13.5 Landing distance available: 9509

2.13.1 Designation: 24
2.13.2 Takeoff run available: 9509
2.13.3 Takeoff distance available: 9509
2.13.4 Accelerate-stop distance available: 9509
2.13.5 Landing distance available: 9509

AD 2.14 Approach and runway lighting

2.14.1 Designation: 15
2.14.4 Visual approach slope indicator system:
4-light PAPI on left

2.14.1 Designation: 33
2.14.4 Visual approach slope indicator system:
4-light PAPI on right

2.14.1 Designation: 06
2.14.2 Approach lighting system: ALSF2: Standard
2400 feet high intensity approach lighting system
with sequenced flashers, category II or III
configuration
2.14.4 Visual approach slope indicator system:
4-light PAPI on left

2.14.1 Designation: 24
2.14.2 Approach lighting system: MALSR: 1400
feet medium intensity approach lighting system
with runway alignment indicator lights
2.14.4 Visual approach slope indicator system:
4-light PAPI on left

AD 2.18 Air traffic services communication facilities

2.18.1 Service designation: D-ATIS
2.18.3 Service designation: 118.15 MHz
2.18.4 Hours of operation: 24

2.18.1 Service designation: LCL/P
2.18.3 Service designation: 120.3 MHz

2.18.1 Service designation: EMERG
2.18.3 Service designation: 121.5 MHz

2.18.1 Service designation: CD/P
2.18.3 Service designation: 121.75 MHz

2.18.1 Service designation: GND/P
2.18.3 Service designation: 121.9 MHz

2.18.1 Service designation: NG OPS
2.18.3 Service designation: 123.45 MHz

2.18.1 Service designation: APCH/P DEP/P
CLASS C IC
2.18.3 Service designation: 123.95 MHz

2.18.1 Service designation: APCH/P DEP/P
CLASS C IC
2.18.3 Service designation: 125.35 MHz

2.18.1 Service designation: AS ASGND
2.18.3 Service designation: 125.65 MHz

2.18.1 Service designation: APCH/P CLASS C
2.18.3 Service designation: 127.225 MHz

2.18.1 Service designation: APCH/P DEP/P
CLASS IC
2.18.3 Service designation: 127.8 MHz

2.18.1 Service designation: EMERG
2.18.3 Service designation: 243 MHz

2.18.1 Service designation: NG OPS
2.18.3 Service designation: 243.9 MHz

2.18.1 Service designation: CD/P
2.18.3 Service designation: 322.3 MHz

2.18.1 Service designation: APCH/P CLASS C
2.18.3 Service designation: 323.2 MHz

2.18.1 Service designation: APCH/S DEP/S
CLASS C
2.18.3 Service designation: 327.1 MHz

2.18.1 Service designation: GND/P
2.18.3 Service designation: 348.6 MHz

2.18.1 Service designation: ANG-OPS
2.18.3 Service designation: 349.7 MHz

2.18.1 Service designation: LCL/P
2.18.3 Service designation: 351.8 MHz

2.18.1 Service designation: NG OPS
2.18.3 Service designation: 41.9 MHz

2.18.1 Service designation: ANG OPS
2.18.3 Service designation: 138.55 MHz

2.18.1 Service designation: APCH/P DEP/P
CLASS C IC
2.18.3 Service designation: 290.55 MHz

2.18.1 Service designation: APCH/P DEP/P
CLASS C IC
2.18.3 Service designation: 269.325 MHz

2.18.1 Service designation: APCH/P DEP/P
CLASS C IC
2.18.3 Service designation: 281.5 MHz

AD 2.19 Radio navigation and landing aids

2.19.1 ILS type: Glide Slope for runway 33.
Magnetic variation: 14W

2.19.2 ILS identification: IKX
2.19.5 Coordinates: 41-55-54.77N /
72-40-38.59W

2.19.6 Site elevation: 167 ft

2.19.1 ILS type: DME for runway 33. Magnetic
variation: 14W

2.19.2 ILS identification: IKX
2.19.5 Coordinates: 41-56-37.97N /
72-41-47.43W

2.19.6 Site elevation: 183 ft

2.19.1 ILS type: Outer Marker for runway 33.
Magnetic variation: 14W

2.19.2 ILS identification: IKX
2.19.5 Coordinates: 41-52-13.60N /
72-35-40.58W

2.19.6 Site elevation: 125 ft

2.19.1 ILS type: Localizer for runway 33. Magnetic
variation: 14W

2.19.2 ILS identification: IKX
2.19.5 Coordinates: 41-56-39.66N /
72-41-45.33W

2.19.6 Site elevation: 168 ft

2.19.1 ILS type: Localizer for runway 06. Magnetic
variation: 14W

2.19.2 ILS identification: BDL
2.19.5 Coordinates: 41-57-17.85N /
72-39-59.41W

2.19.6 Site elevation: 149 ft

2.19.1 ILS type: DME for runway 06. Magnetic
variation: 14W

2.19.2 ILS identification: BDL
2.19.5 Coordinates: 41-57-17.28N /
72-39-56.50W

2.19.6 Site elevation: 164 ft

2.19.1 ILS type: Glide Slope for runway 06.
Magnetic variation: 14W

2.19.2 ILS identification: BDL
2.19.5 Coordinates: 41-56-00.00N /
72-41-41.89W

2.19.6 Site elevation: 169 ft

2.19.1 ILS type: Inner Marker for runway 06.

Magnetic variation: 14W
2.19.2 ILS identification: BDL
2.19.5 Coordinates: 41-55-49.46N /
72-41-56.05W
2.19.6 Site elevation: 173 ft

2.19.1 ILS type: Outer Marker for runway 06.
Magnetic variation: 14W
2.19.2 ILS identification: BDL
2.19.5 Coordinates: 41-52-38.58N /
72-45-58.34W
2.19.6 Site elevation: 99999 ft

2.19.1 ILS type: Middle Marker for runway 06.
Magnetic variation: 14W
2.19.2 ILS identification: BDL
2.19.5 Coordinates: 41-55-35.77N /
72-42-13.17W
2.19.6 Site elevation: 166 ft

2.19.1 ILS type: Localizer for runway 24. Magnetic
variation: 14W
2.19.2 ILS identification: MYQ
2.19.5 Coordinates: 41-55-47.66N /
72-41-57.63W
2.19.6 Site elevation: 170 ft

2.19.1 ILS type: DME for runway 24. Magnetic
variation: 14W
2.19.2 ILS identification: MYQ
2.19.5 Coordinates: 41-57-17.35N /

72-39-56.33W
2.19.6 Site elevation: 99999 ft
2.19.1 ILS type: Outer Marker for runway 24.
Magnetic variation: 14W
2.19.2 ILS identification: MYQ
2.19.5 Coordinates: 42-01-16.18N /
72-34-53.96W
2.19.6 Site elevation: 114 ft

2.19.1 ILS type: Inner Marker for runway 24.
Magnetic variation: 14W
2.19.2 ILS identification: MYQ
2.19.5 Coordinates: 41-57-12.08N /
72-40-00.00W
2.19.6 Site elevation: 141 ft

2.19.1 ILS type: Glide Slope for runway 24.
Magnetic variation: 14W
2.19.2 ILS identification: MYQ
2.19.5 Coordinates: 41-56-53.58N /
72-40-25.96W
2.19.6 Site elevation: 157 ft

2.19.1 ILS type: Middle Marker for runway 24.
Magnetic variation: 14W
2.19.2 ILS identification: MYQ
2.19.5 Coordinates: 41-57-20.88N /
72-39-55.38W
2.19.6 Site elevation: 159 ft

General Remarks:

NUMEROUS BIRDS FREQUENTLY ON OR IN VICINITY OF AIRPORT.

OPERATIONS CONTACT AUTOVON 636-8385; COMMERCIAL 860-627-3001

ANG - OPR 0700-1530 TUES/FRI/SAT; 0700-2300 WED/THUR.

ANG - PRIOR PERMISSION REQUIRED V220-2356.

NO DE-ICING AVAILABLE AT ANG.

TAXIWAY J CLOSED BETWEEN S & R TO AIRCRAFT WITH WINGSPANS IN EXCESS OF 170 FT.

NO TRAINING FLIGHTS; NO PRACTICE APPROACHES; NO TOUCH AND GO LANDING
BETWEEN: 2300 - 0700 MON THRU SAT & 2300 - 1200 SUN.

(E117) CT ANG AND U.S. ARMY NATIONAL GUARD.

ASDE-X SURVEILLANCE SYSTEM IN USE. PILOTS SHOULD OPERATE TRANSPONDERS WITH MODE 'C' ON ALL TAXIWAYS & RUNWAYS.

RUNWAY 01/19 OPEN FOR AIRCRAFT WITH WINGSPAN LESS THAN 79 FT.

RUNWAY 01 IS CLOSED FOR ARRS TO ALL FIXED WING AIRCRAFT.

RUNWAY 19 CLOSED FOR DEPS TO ALL FIXED WING AIRCRAFT.

Washington, District of Columbia
Washington Dulles International
ICAO Identifier KIAD

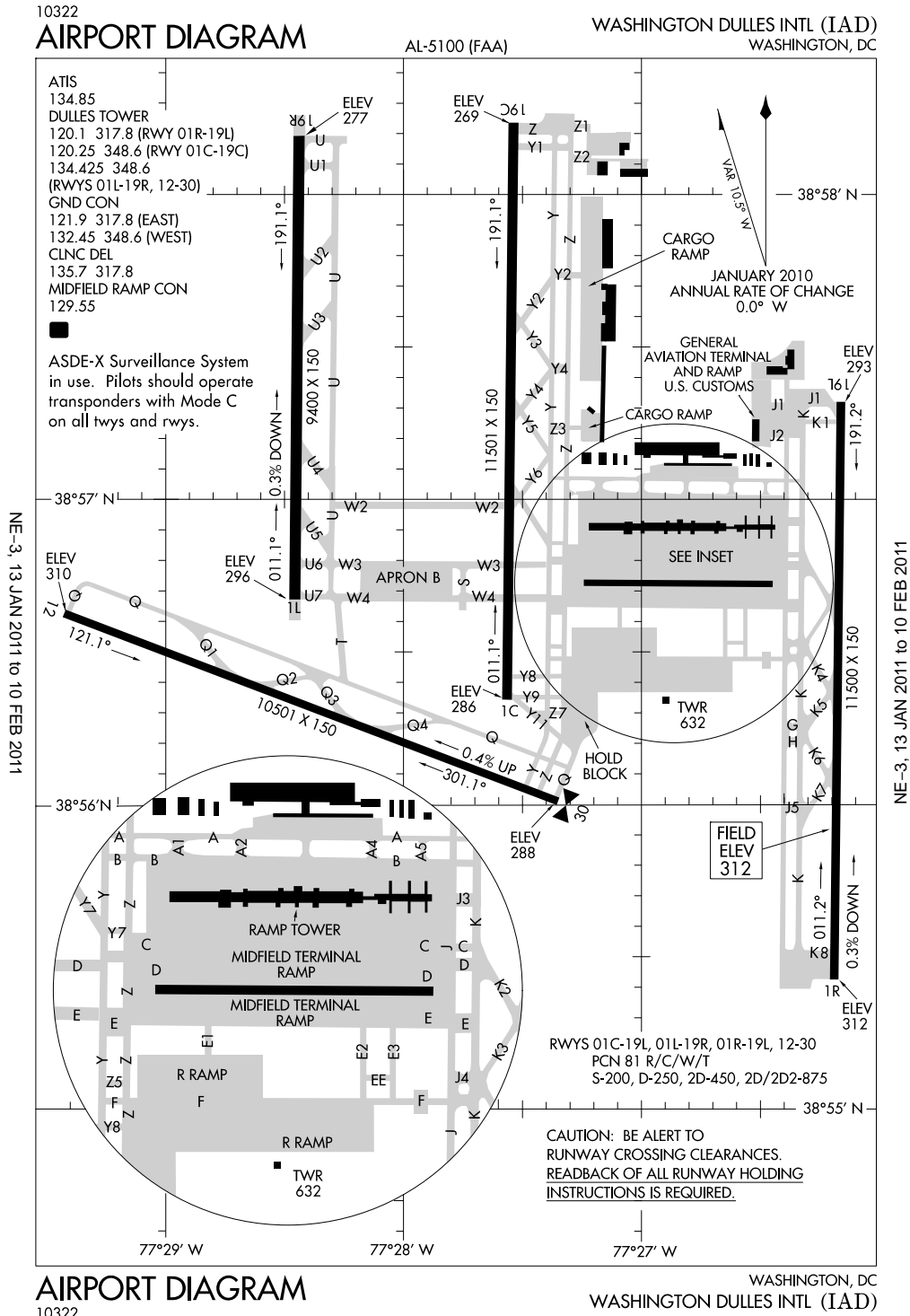

Washington, DC
Washington Dulles Intl
ICAO Identifier KIAD

AD 2.2 Aerodrome geographical and administrative data

2.2.1 Reference Point: 38-56-50.80N / 77-27-35.80W
2.2.2 From City: 20 Miles W Of Washington, VA
2.2.3 Elevation: 312 ft
2.2.5 Magnetic variation: 10W (2000)
2.2.6 Airport Contact: Christopher Browne
1 SAARINEN CIRCLE
Dulles, VA 20166
(703-572-2730)
2.2.7 Traffic: IFR/VFR
2.2.8 Remarks: Located In Both Fairfax County Va And Loudoun County Va.

AD 2.3 Operational hours

2.3.1 - 2.3.11: ALL Months, ALL Days, ALL Hours

AD 2.4 Handling services and facilities

2.4.1 Cargo handling facilities: No
2.4.2 Fuel types: 100LL,A
2.4.4 De-icing facilities: None
2.4.5 Hangar space: Yes
2.4.6 Repair facilities: Major

AD 2.6 Rescue and firefighting services

2.6.1 Aerodrome category for firefighting: ARFF Index I E certified on 5/1/1973

AD 2.10 Aerodrome obstacles

2.10.1.a. Runway designation: 01R
2.10.1.b Type of obstacle: Bldg (16 ft). Lighted
2.10.1.c Location of obstacle: 200 ft from Centerline
2.10.1.a. Runway designation: 19L
2.10.1.b Type of obstacle: Pole (38 ft). Not Lighted or Marked
2.10.1.c Location of obstacle: 720 ft from Centerline

AD 2.12 Runway physical characteristics

2.12.1 Designation: 12
2.12.2 True Bearing: 111
2.12.3 Dimensions: 10501 ft x 150 ft
2.12.4 PCN: 81 R/C/W/T

2.12.5 Coordinates: 38-56-37.58N / 77-29-25.60W
2.12.6 Threshold elevation: 310 ft
2.12.6 Touchdown zone elevation: 310 ft

2.12.1 Designation: 30
2.12.2 True Bearing: 291
2.12.3 Dimensions: 10501 ft x 150 ft
2.12.4 PCN: 81 R/C/W/T
2.12.5 Coordinates: 38-56-00.00N / 77-27-21.23W
2.12.6 Threshold elevation: 288 ft
2.12.6 Touchdown zone elevation: 288 ft
2.12.7 Slope: 0.4UP

2.12.1 Designation: 01L
2.12.2 True Bearing: 1
2.12.3 Dimensions: 9400 ft x 150 ft
2.12.4 PCN: 81 R/C/W/T
2.12.5 Coordinates: 38-56-41.88N / 77-28-29.32W
2.12.6 Threshold elevation: 296 ft
2.12.6 Touchdown zone elevation: 296 ft
2.12.7 Slope: 0.3DOWN

2.12.1 Designation: 19R
2.12.2 True Bearing: 181
2.12.3 Dimensions: 9400 ft x 150 ft
2.12.4 PCN: 81 R/C/W/T
2.12.5 Coordinates: 38-58-14.78N / 77-28-27.98W
2.12.6 Threshold elevation: 277 ft
2.12.6 Touchdown zone elevation: 278 ft

2.12.1 Designation: 01R
2.12.2 True Bearing: 1
2.12.3 Dimensions: 11500 ft x 150 ft
2.12.4 PCN: 81 R/C/W/T
2.12.5 Coordinates: 38-55-25.53N / 77-26-11.22W
2.12.6 Threshold elevation: 312 ft
2.12.6 Touchdown zone elevation: 312 ft
2.12.7 Slope: 0.3DOWN

2.12.1 Designation: 19L
2.12.2 True Bearing: 181
2.12.3 Dimensions: 11500 ft x 150 ft
2.12.4 PCN: 81 R/C/W/T
2.12.5 Coordinates: 38-57-19.19N / 77-26-00.00W
2.12.6 Threshold elevation: 293 ft

2.12.6 Touchdown zone elevation: 302 ft

2.12.1 Designation: 01C

2.12.2 True Bearing: 1

2.12.3 Dimensions: 11501 ft x 150 ft

2.12.4 PCN: 81 R/C/W/T

2.12.5 Coordinates: 38-56-20.64N /
77-27-35.21W

2.12.6 Threshold elevation: 286 ft

2.12.6 Touchdown zone elevation: 286 ft

2.12.1 Designation: 19C

2.12.2 True Bearing: 181

2.12.3 Dimensions: 11501 ft x 150 ft

2.12.4 PCN: 81 R/C/W/T

2.12.5 Coordinates: 38-58-14.30N /
77-27-33.57W

2.12.6 Threshold elevation: 269 ft

2.12.6 Touchdown zone elevation: 272 ft

AD 2.13 Declared distances

2.13.1 Designation: 12

2.13.2 Takeoff run available: 10501

2.13.3 Takeoff distance available: 10501

2.13.4 Accelerate-stop distance available: 10501

2.13.5 Landing distance available: 10501

2.13.1 Designation: 30

2.13.2 Takeoff run available: 10501

2.13.3 Takeoff distance available: 10501

2.13.4 Accelerate-stop distance available: 10501

2.13.5 Landing distance available: 10501

2.13.1 Designation: 01L

2.13.2 Takeoff run available: 9400

2.13.3 Takeoff distance available: 9400

2.13.4 Accelerate-stop distance available: 9400

2.13.5 Landing distance available: 9400

2.13.1 Designation: 19R

2.13.2 Takeoff run available: 9400

2.13.3 Takeoff distance available: 9400

2.13.4 Accelerate-stop distance available: 9400

2.13.5 Landing distance available: 9400

2.13.1 Designation: 01R

2.13.2 Takeoff run available: 11500

2.13.3 Takeoff distance available: 11500

2.13.4 Accelerate-stop distance available: 11500

2.13.5 Landing distance available: 11500

2.13.1 Designation: 19L

2.13.2 Takeoff run available: 11500

2.13.3 Takeoff distance available: 11500

2.13.4 Accelerate-stop distance available: 11500

2.13.5 Landing distance available: 11500

2.13.1 Designation: 01C

2.13.2 Takeoff run available: 11501

2.13.3 Takeoff distance available: 11501

2.13.4 Accelerate-stop distance available: 11501

2.13.5 Landing distance available: 11501

2.13.1 Designation: 19C

2.13.2 Takeoff run available: 11501

2.13.3 Takeoff distance available: 11501

2.13.4 Accelerate-stop distance available: 11501

2.13.5 Landing distance available: 11501

AD 2.14 Approach and runway lighting

2.14.1 Designation: 12

2.14.2 Approach lighting system: MALSR: 1400 feet medium intensity approach lighting system with runway alignment indicator lights

2.14.4 Visual approach slope indicator system: 4-light PAPI on right

2.14.1 Designation: 30

2.14.4 Visual approach slope indicator system: 4-light PAPI on left

2.14.1 Designation: 01L

2.14.2 Approach lighting system: ALSF2: Standard 2400 feet high intensity approach lighting system with sequenced flashers, category II or III configuration

2.14.4 Visual approach slope indicator system: 4-light PAPI on left

2.14.1 Designation: 19R

2.14.2 Approach lighting system: ALSF2: Standard 2400 feet high intensity approach lighting system with sequenced flashers, category II or III configuration

2.14.4 Visual approach slope indicator system: 4-light PAPI on left

2.14.1 Designation: 01R

2.14.2 Approach lighting system: ALSF2: Standard 2400 feet high intensity approach lighting system with sequenced flashers, category II or III configuration

2.14.4 Visual approach slope indicator system:
4-light PAPI on right

2.14.1 Designation: 19L

2.14.2 Approach lighting system: MALSR: 1400
feet medium intensity approach lighting system
with runway alignment indicator lights

2.14.4 Visual approach slope indicator system:
4-light PAPI on left

2.14.1 Designation: 01C

2.14.2 Approach lighting system: MALSR: 1400
feet medium intensity approach lighting system
with runway alignment indicator lights

2.14.4 Visual approach slope indicator system:
4-light PAPI on left

2.14.1 Designation: 19C

2.14.2 Approach lighting system: ALSF2: Standard
2400 feet high intensity approach lighting system
with sequenced flashers, category II or III
configuration

2.14.4 Visual approach slope indicator system:
4-light PAPI on right

AD 2.18 Air traffic services communication facilities

2.18.1 Service designation: LCL/P IC

2.18.3 Service designation: 120.1 MHz

2.18.1 Service designation: EMERG

2.18.3 Service designation: 121.5 MHz

2.18.1 Service designation: GND/P IC

2.18.3 Service designation: 121.9 MHz

2.18.1 Service designation: AS ASGND

2.18.3 Service designation: 125.8 MHz

2.18.1 Service designation: AS ASGND

2.18.3 Service designation: 128.42 MHz

2.18.1 Service designation: MIDFLD RAMP CTL

2.18.3 Service designation: 129.55 MHz

2.18.1 Service designation: GND/P IC

2.18.3 Service designation: 132.45 MHz

2.18.1 Service designation: AS ASGND

2.18.3 Service designation: 132.45 MHz

2.18.1 Service designation: D-ATIS

2.18.3 Service designation: 134.85 MHz

2.18.4 Hours of operation: 24

2.18.1 Service designation: CD/P

2.18.3 Service designation: 135.7 MHz

2.18.1 Service designation: EMERG

2.18.3 Service designation: 243 MHz

2.18.1 Service designation: LCL/P IC

2.18.3 Service designation: 348.6 MHz

2.18.1 Service designation: GND/P IC

2.18.3 Service designation: 348.6 MHz

2.18.1 Service designation: LCL/P IC

2.18.3 Service designation: 348.6 MHz

2.18.1 Service designation: GND/P IC

2.18.3 Service designation: 317.8 MHz

2.18.1 Service designation: LCL/P IC

2.18.3 Service designation: 317.8 MHz

2.18.1 Service designation: CD/P

2.18.3 Service designation: 317.8 MHz

2.18.1 Service designation: LCL/P IC

2.18.3 Service designation: 120.25 MHz

2.18.1 Service designation: LCL/P IC

2.18.3 Service designation: 134.425 MHz

AD 2.19 Radio navigation and landing aids

2.19.1 ILS type: Localizer for runway 12. Magnetic
variation: 10W

2.19.2 ILS identification: AJU

2.19.5 Coordinates: 38-55-57.51N /

77-27-00.00W

2.19.6 Site elevation: 281 ft

2.19.1 ILS type: Glide Slope for runway 12.

Magnetic variation: 10W

2.19.2 ILS identification: AJU

2.19.5 Coordinates: 38-56-30.40N /

77-29-15.54W

2.19.6 Site elevation: 304 ft

2.19.1 ILS type: Middle Marker for runway 12.

Magnetic variation: 10W

2.19.2 ILS identification: AJU
2.19.5 Coordinates: 38-56-47.20N /
77-29-58.37W
2.19.6 Site elevation: 319 ft

2.19.1 ILS type: Outer Marker for runway 12.
Magnetic variation: 10W
2.19.2 ILS identification: AJU
2.19.5 Coordinates: 38-58-35.61N /
77-36-00.00W
2.19.6 Site elevation: 382 ft

2.19.1 ILS type: Inner Marker for runway 01L.
Magnetic variation: 10W
2.19.2 ILS identification: OIU
2.19.5 Coordinates: 38-56-33.39N /
77-28-29.44W
2.19.6 Site elevation: 299 ft

2.19.1 ILS type: Localizer for runway 01L.
Magnetic variation: 10W
2.19.2 ILS identification: OIU
2.19.5 Coordinates: 38-58-24.77N /
77-28-27.84W
2.19.6 Site elevation: 278 ft

2.19.1 ILS type: Glide Slope for runway 01L.
Magnetic variation: 10W
2.19.2 ILS identification: OIU
2.19.5 Coordinates: 38-56-52.89N /
77-28-34.35W
2.19.6 Site elevation: 289 ft

2.19.1 ILS type: DME for runway 01L. Magnetic
variation: 10W
2.19.2 ILS identification: OIU
2.19.5 Coordinates: 38-58-25.07N /
77-28-31.14W
2.19.6 Site elevation: 275 ft

2.19.1 ILS type: Inner Marker for runway 19R.
Magnetic variation: 10W
2.19.2 ILS identification: ISU
2.19.5 Coordinates: 38-58-23.51N /
77-28-27.86W
2.19.6 Site elevation: 276 ft

2.19.1 ILS type: Localizer for runway 19R.
Magnetic variation: 10W
2.19.2 ILS identification: ISU
2.19.5 Coordinates: 38-56-31.90N /

77-28-29.46W
2.19.6 Site elevation: 299 ft

2.19.1 ILS type: Glide Slope for runway 19R.
Magnetic variation: 10W
2.19.2 ILS identification: ISU
2.19.5 Coordinates: 38-58-00.00N /
77-28-33.32W
2.19.6 Site elevation: 273 ft

2.19.1 ILS type: DME for runway 19R. Magnetic
variation: 10W
2.19.2 ILS identification: ISU
2.19.5 Coordinates: 38-58-25.08N /
77-28-31.16W
2.19.6 Site elevation: 275 ft

2.19.1 ILS type: Localizer for runway 01R.
Magnetic variation: 10W
2.19.2 ILS identification: IAD
2.19.5 Coordinates: 38-57-30.87N /
77-26-00.00W
2.19.6 Site elevation: 302 ft

2.19.1 ILS type: Inner Marker for runway 01R.
Magnetic variation: 10W
2.19.2 ILS identification: IAD
2.19.5 Coordinates: 38-55-17.13N /
77-26-11.35W
2.19.6 Site elevation: 319 ft

2.19.1 ILS type: Middle Marker for runway 01R.
Magnetic variation: 10W
2.19.2 ILS identification: IAD
2.19.5 Coordinates: 38-54-53.77N /
77-26-11.67W
2.19.6 Site elevation: 317 ft

2.19.1 ILS type: DME for runway 01R. Magnetic
variation: 10W
2.19.2 ILS identification: IAD
2.19.5 Coordinates: 38-55-11.08N /
77-26-00.00W
2.19.6 Site elevation: 314 ft

2.19.1 ILS type: Outer Marker for runway 01R.
Magnetic variation: 10W
2.19.2 ILS identification: IAD
2.19.5 Coordinates: 38-50-50.18N /
77-26-16.38W
2.19.6 Site elevation: 242 ft

2.19.1 ILS type: Glide Slope for runway 01R.
Magnetic variation: 10W
2.19.2 ILS identification: IAD
2.19.5 Coordinates: 38-55-35.85N /
77-26-00.00W
2.19.6 Site elevation: 307 ft

2.19.1 ILS type: Outer Marker for runway 19L.
Magnetic variation: 9W
2.19.2 ILS identification: SGC
2.19.5 Coordinates: 39-01-14.61N /
77-25-55.33W
2.19.6 Site elevation: 99999 ft

2.19.1 ILS type: Localizer for runway 19L.
Magnetic variation: 9W
2.19.2 ILS identification: SGC
2.19.5 Coordinates: 38-55-11.81N /
77-26-11.43W
2.19.6 Site elevation: 315 ft

2.19.1 ILS type: DME for runway 19L. Magnetic
variation: 9W
2.19.2 ILS identification: SGC
2.19.5 Coordinates: 38-55-11.08N /
77-26-00.00W
2.19.6 Site elevation: 314 ft

2.19.1 ILS type: Glide Slope for runway 19L.
Magnetic variation: 9W
2.19.2 ILS identification: SGC
2.19.5 Coordinates: 38-57-00.00N /
77-26-00.00W
2.19.6 Site elevation: 291 ft

2.19.1 ILS type: Middle Marker for runway 19L.
Magnetic variation: 9W
2.19.2 ILS identification: SGC
2.19.5 Coordinates: 38-57-43.15N /
77-26-00.00W
2.19.6 Site elevation: 99999 ft

2.19.1 ILS type: Localizer for runway 01C.
Magnetic variation: 10W
2.19.2 ILS identification: OSZ
2.19.5 Coordinates: 38-58-24.68N /
77-27-33.42W
2.19.6 Site elevation: 263 ft

2.19.1 ILS type: Glide Slope for runway 01C.
Magnetic variation: 10W

2.19.2 ILS identification: OSZ
2.19.5 Coordinates: 38-56-31.06N /
77-27-40.75W
2.19.6 Site elevation: 282 ft

2.19.1 ILS type: Outer Marker for runway 01C.
Magnetic variation: 10W
2.19.2 ILS identification: OSZ
2.19.5 Coordinates: 38-50-31.20N /
77-27-35.06W
2.19.6 Site elevation: 219 ft

2.19.1 ILS type: Middle Marker for runway 01C.
Magnetic variation: 10W
2.19.2 ILS identification: OSZ
2.19.5 Coordinates: 38-55-53.17N /
77-27-35.57W
2.19.6 Site elevation: 272 ft

2.19.1 ILS type: Glide Slope for runway 19C.
Magnetic variation: 10W
2.19.2 ILS identification: DLX
2.19.5 Coordinates: 38-58-00.00N /
77-27-38.79W
2.19.6 Site elevation: 265 ft

2.19.1 ILS type: Middle Marker for runway 19C.
Magnetic variation: 10W
2.19.2 ILS identification: DLX
2.19.5 Coordinates: 38-58-46.70N /
77-27-33.10W
2.19.6 Site elevation: 99999 ft

2.19.1 ILS type: Outer Marker for runway 19C.
Magnetic variation: 10W
2.19.2 ILS identification: DLX
2.19.5 Coordinates: 39-01-50.27N /
77-27-29.64W
2.19.6 Site elevation: 99999 ft

2.19.1 ILS type: Localizer for runway 19C.
Magnetic variation: 10W
2.19.2 ILS identification: DLX
2.19.5 Coordinates: 38-56-14.91N /
77-27-35.29W
2.19.6 Site elevation: 285 ft

2.19.1 ILS type: Inner Marker for runway 19C.
Magnetic variation: 10W
2.19.2 ILS identification: DLX
2.19.5 Coordinates: 38-58-23.00N /

77-27-33.44W
2.19.6 Site elevation: 264 ft

General Remarks:

ITINERANT AIRCRAFT CONTACT FBO ON 122.95 FOR SERVICES.

AIR CARRIER PUSH BACKS & POWER FROM ALL APRON POSITIONS REQUIRE CLEARANCE FROM MWAA RAMP TOWER.

DEER/LARGE FLOCKS OF BIRDS ON & IN THE VICINITY OF AIRPORT.

DURING PERIODS OF AIRCRAFT SATURATION LONG TERM PARKING MAY NOT BE AVAILABLE. SERVICES FOR FUEL AND GO ONLY WILL BE AVAILABLE.

FLIGHT TRAINING BETWEEN 2200-0700 IS PROHIBITED.

TAXILANE 'C' ACTIVE; PUSHBACK CLEARANCES ON NORTH SIDE OF MIDFIELD TERMINAL ARE ONTO TAXILANE 'D' ONLY UNLESS OTHERWISE AUTH.

PERSONNEL AND EQUIPMENT WORKING ADJACENT ALL RUNWAYS & TAXIWAYS INDEFINITELY.

ALL AIRCRAFT WITH WINGSPAN EXCEEDING 118 FT ARE RESTRICTED FROM USING TAXILANE A BETWEEN A1 & A5.

RUNUP BLOCKS FOR RUNWAY 30 DESIGNATED AS NON-MOVEMENT AREA. NUMEROUS FLAGGED & LIGHTED CRANES OPERATING IN MIDFIELD AREA.

ALL 180 DEGREE TURNS OUT OF APRON POSITIONS SHALL BE MADE USING MINIMUM POWER. DURING PERIODS OF AIRCRAFT SATURATION LONG TERM PARKING MAY NOT BE AVAILABLE.

LANDING FEE. FLIGHT NOTIFICATION SERVICE (ADCUS) AVAILABLE. NOTE: SEE SPECIAL NOTICES --CONTINUOUS POWER FACILITIES.

ASDE-X SURVEILLANCE SYSTEM IN USE: PILOTS SHOULD OPERATE ADDED TRANSPONDERS WITH MODE C ON ALL TAXIWAYS AND RUNWAYS.

TAXIWAY E1 RESTRICTED TO AIRCRAFT WITH A WINGSPAN LESS THAN 79 FT.

TAXIWAY J-3 CLOSED WEST OF TAXIWAY J.

Fort Lauderdale, Florida
Fort Lauderdale/Hollywood International
ICAO Identifier KFLI

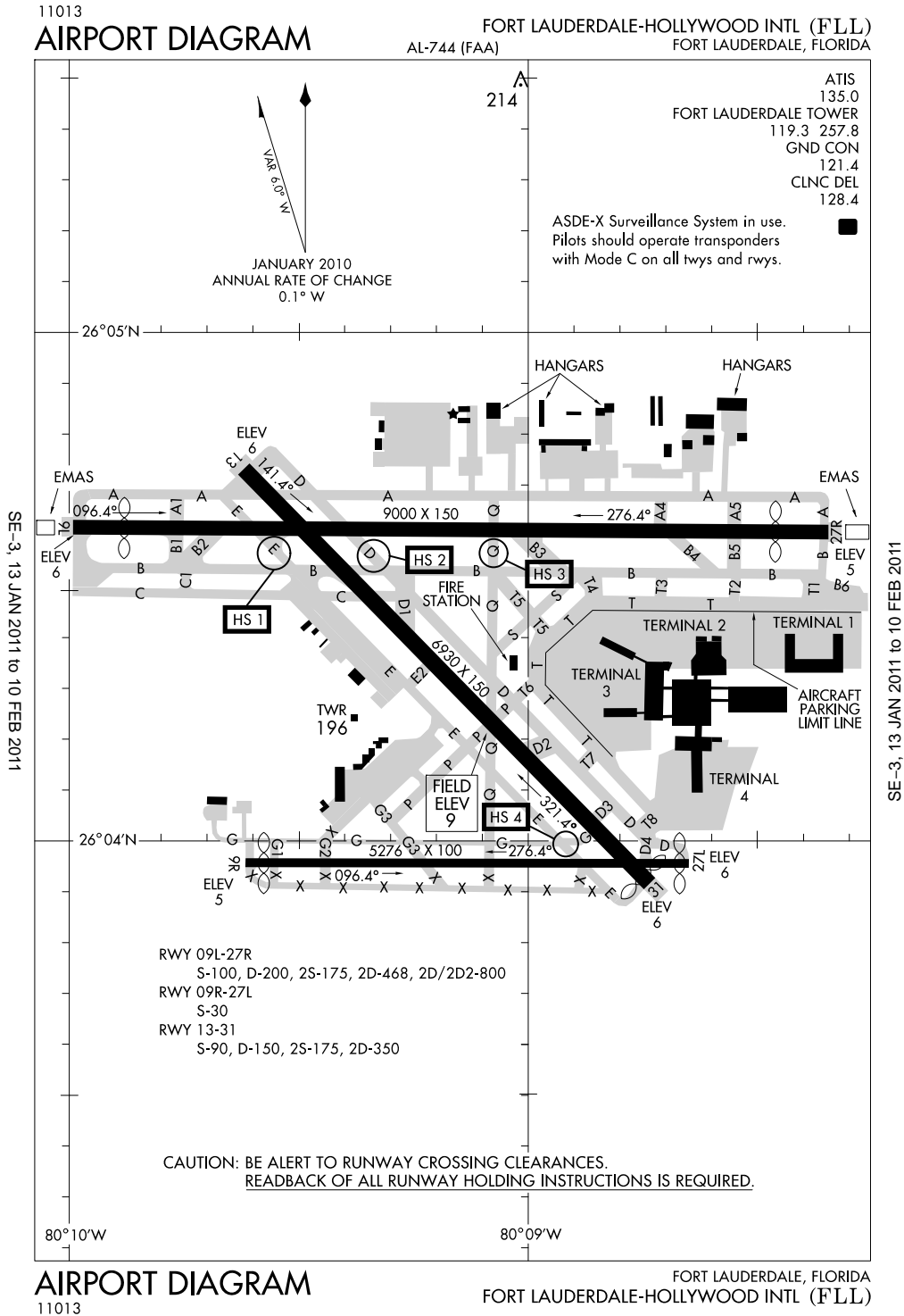

Fort Lauderdale, FL
Fort Lauderdale/Hollywood Intl
ICAO Identifier KFLI

AD 2.2 Aerodrome geographical and administrative data

- 2.2.1 Reference Point: 26-04-21.30N / 80-09-00.00W
- 2.2.2 From City: 3 Miles SW Of Fort Lauderdale, FL
- 2.2.3 Elevation: 9 ft
- 2.2.5 Magnetic variation: 3W (1985)
- 2.2.6 Airport Contact: Kent George
100 AVIATION BLVD
Ft Lauderdale, FL 33315
(954-359-6100)
- 2.2.7 Traffic: IFR/VFR

AD 2.3 Operational hours

- 2.3.1 - 2.3.11: ALL Months, ALL Days, ALL Hours

AD 2.4 Handling services and facilities

- 2.4.1 Cargo handling facilities: No
- 2.4.2 Fuel types: 100LL,A
- 2.4.4 De-icing facilities: None
- 2.4.5 Hangar space: Yes
- 2.4.6 Repair facilities: Major

AD 2.6 Rescue and firefighting services

- 2.6.1 Aerodrome category for firefighting: ARFF Index I E certified on 4/25/2005

AD 2.10 Aerodrome obstacles

- 2.10.1.a. Runway designation: 09L
- 2.10.1.b Type of obstacle: Road (14 ft). Not Lighted or Marked
- 2.10.1.c Location of obstacle: 0 ft from Centerline

- 2.10.1.a. Runway designation: 27R
- 2.10.1.b Type of obstacle: Rr (33 ft). Not Lighted or Marked
- 2.10.1.c Location of obstacle: 530 ft from Centerline

- 2.10.1.a. Runway designation: 09R
- 2.10.1.b Type of obstacle: Tree (35 ft). Not Lighted or Marked
- 2.10.1.c Location of obstacle: 50 ft from Centerline

- 2.10.1.a. Runway designation: 27L

- 2.10.1.b Type of obstacle: Pole (42 ft). Not Lighted or Marked
- 2.10.1.c Location of obstacle: 150 ft from Centerline

- 2.10.1.a. Runway designation: 31
- 2.10.1.b Type of obstacle: Rr (49 ft). Not Lighted or Marked
- 2.10.1.c Location of obstacle: 10 ft from Centerline

AD 2.12 Runway physical characteristics

- 2.12.1 Designation: 09L
- 2.12.2 True Bearing: 90
- 2.12.3 Dimensions: 9000 ft x 150 ft
- 2.12.5 Coordinates: 26-04-37.02N / 80-09-59.54W
- 2.12.6 Threshold elevation: 6 ft
- 2.12.6 Touchdown zone elevation: 7 ft

- 2.12.1 Designation: 27R
- 2.12.2 True Bearing: 270
- 2.12.3 Dimensions: 9000 ft x 150 ft
- 2.12.5 Coordinates: 26-04-36.45N / 80-08-20.84W
- 2.12.6 Threshold elevation: 5 ft
- 2.12.6 Touchdown zone elevation: 7 ft

- 2.12.1 Designation: 09R
- 2.12.2 True Bearing: 90
- 2.12.3 Dimensions: 5276 ft x 100 ft
- 2.12.5 Coordinates: 26-03-57.51N / 80-09-37.14W
- 2.12.6 Threshold elevation: 5 ft
- 2.12.6 Touchdown zone elevation: 6 ft

- 2.12.1 Designation: 27L
- 2.12.2 True Bearing: 270
- 2.12.3 Dimensions: 5276 ft x 100 ft
- 2.12.5 Coordinates: 26-03-57.16N / 80-08-39.29W
- 2.12.6 Threshold elevation: 6 ft
- 2.12.6 Touchdown zone elevation: 6 ft

- 2.12.1 Designation: 13
- 2.12.2 True Bearing: 135
- 2.12.3 Dimensions: 6930 ft x 150 ft
- 2.12.5 Coordinates: 26-04-44.05N / 80-09-37.40W
- 2.12.6 Threshold elevation: 6 ft
- 2.12.6 Touchdown zone elevation: 7 ft

- 2.12.1 Designation: 31
- 2.12.2 True Bearing: 315
- 2.12.3 Dimensions: 6930 ft x 150 ft
- 2.12.5 Coordinates: 26-03-55.21N / 80-08-44.00W
- 2.12.6 Threshold elevation: 6 ft
- 2.12.6 Touchdown zone elevation: 9 ft

AD 2.13 Declared distances

- 2.13.1 Designation: 09L
- 2.13.2 Takeoff run available: 9000
- 2.13.3 Takeoff distance available: 9000
- 2.13.4 Accelerate-stop distance available: 9000
- 2.13.5 Landing distance available: 8423

- 2.13.1 Designation: 27R
- 2.13.2 Takeoff run available: 9000
- 2.13.3 Takeoff distance available: 9000
- 2.13.4 Accelerate-stop distance available: 9000
- 2.13.5 Landing distance available: 8396

- 2.13.1 Designation: 09R
- 2.13.2 Takeoff run available: 5276
- 2.13.3 Takeoff distance available: 5276
- 2.13.4 Accelerate-stop distance available: 5276
- 2.13.5 Landing distance available: 4956

- 2.13.1 Designation: 27L
- 2.13.2 Takeoff run available: 5276
- 2.13.3 Takeoff distance available: 5276
- 2.13.4 Accelerate-stop distance available: 5276
- 2.13.5 Landing distance available: 5134

- 2.13.1 Designation: 13
- 2.13.2 Takeoff run available: 6930
- 2.13.3 Takeoff distance available: 6930
- 2.13.4 Accelerate-stop distance available: 6930
- 2.13.5 Landing distance available: 6930

- 2.13.1 Designation: 31
- 2.13.2 Takeoff run available: 6930
- 2.13.3 Takeoff distance available: 6930
- 2.13.4 Accelerate-stop distance available: 6930
- 2.13.5 Landing distance available: 6860

AD 2.14 Approach and runway lighting

- 2.14.1 Designation: 09L
- 2.14.2 Approach lighting system: MALSR: 1400 feet medium intensity approach lighting system with runway alignment indicator lights
- 2.14.4 Visual approach slope indicator system:

4-light PAPI on right

- 2.14.1 Designation: 27R
- 2.14.2 Approach lighting system: MALSR: 1400 feet medium intensity approach lighting system with runway alignment indicator lights
- 2.14.4 Visual approach slope indicator system: 4-light PAPI on left

- 2.14.1 Designation: 09R
- 2.14.4 Visual approach slope indicator system: 4-light PAPI on left

- 2.14.1 Designation: 27L
- 2.14.4 Visual approach slope indicator system: 4-light PAPI on left

- 2.14.1 Designation: 13
- 2.14.4 Visual approach slope indicator system: 4-light PAPI on left

- 2.14.1 Designation: 31
- 2.14.4 Visual approach slope indicator system: 4-light PAPI on left

AD 2.18 Air traffic services communication facilities

- 2.18.1 Service designation: LCL/P
- 2.18.3 Service designation: 119.3 MHz

- 2.18.1 Service designation: LCL/S
- 2.18.3 Service designation: 120.2 MHz

- 2.18.1 Service designation: GND/P
- 2.18.3 Service designation: 121.4 MHz

- 2.18.1 Service designation: GND/ALTERNATE
- 2.18.3 Service designation: 121.7 MHz

- 2.18.1 Service designation: CD/P PTC
- 2.18.3 Service designation: 128.4 MHz

- 2.18.1 Service designation: D-ATIS
- 2.18.3 Service designation: 135 MHz
- 2.18.4 Hours of operation: 24

- 2.18.1 Service designation: LCL/P
- 2.18.3 Service designation: 257.8 MHz

- 2.18.1 Service designation: RAMP CTL
- 2.18.3 Service designation: 118.175 MHz

AD 2.19 Radio navigation and landing aids

2.19.1 ILS type: Localizer for runway 09L.
Magnetic variation: 3W

2.19.2 ILS identification: LHI
2.19.5 Coordinates: 26-04-36.42N /
80-08-15.66W

2.19.6 Site elevation: 5 ft

2.19.1 ILS type: DME for runway 09L. Magnetic
variation: 3W

2.19.2 ILS identification: LHI
2.19.5 Coordinates: 26-04-40.17N /
80-08-15.66W

2.19.6 Site elevation: 11 ft

2.19.1 ILS type: Glide Slope for runway 09L.
Magnetic variation: 3W

2.19.2 ILS identification: LHI
2.19.5 Coordinates: 26-04-39.64N /
80-09-42.33W

2.19.6 Site elevation: 3 ft

2.19.1 ILS type: Middle Marker for runway 09L.
Magnetic variation: 3W

2.19.2 ILS identification: LHI
2.19.5 Coordinates: 26-04-37.62N /
80-10-35.57W

2.19.6 Site elevation: 99999 ft

2.19.1 ILS type: Localizer for runway 27R.
Magnetic variation: 3W

2.19.2 ILS identification: UDL
2.19.5 Coordinates: 26-04-37.04N /
80-10-00.00W

2.19.6 Site elevation: 5 ft

2.19.1 ILS type: DME for runway 27R. Magnetic
variation: 3W

2.19.2 ILS identification: UDL
2.19.5 Coordinates: 26-04-34.53N /

80-10-00.00W

2.19.6 Site elevation: 10 ft

2.19.1 ILS type: Middle Marker for runway 27R.
Magnetic variation: 3W

2.19.2 ILS identification: UDL
2.19.5 Coordinates: 26-04-36.29N /
80-07-54.09W

2.19.6 Site elevation: 10 ft

2.19.1 ILS type: Glide Slope for runway 27R.
Magnetic variation: 3W

2.19.2 ILS identification: UDL
2.19.5 Coordinates: 26-04-39.62N /
80-08-39.06W

2.19.6 Site elevation: 5 ft

2.19.1 ILS type: Localizer for runway 09R.
Magnetic variation: 3W

2.19.2 ILS identification: FLL
2.19.5 Coordinates: 26-03-57.14N /
80-08-36.11W

2.19.6 Site elevation: 5 ft

2.19.1 ILS type: Outer Marker for runway 09R.
Magnetic variation: 3W

2.19.2 ILS identification: FLL
2.19.5 Coordinates: 26-03-53.37N /
80-16-26.27W

2.19.6 Site elevation: 9 ft

2.19.1 ILS type: Localizer for runway 13. Magnetic
variation: 3W

2.19.2 ILS identification: LID
2.19.5 Coordinates: 26-03-50.87N /
80-08-39.26W

2.19.6 Site elevation: 5 ft

General Remarks:

CLOSED TO AIR CARRIER TRAINING. CLOSED TO LARGE AIRCRAFT TRAINING OVER 58000
LBS MAX CERTIFIED GROSS TAKE-OFF WEIGHT. CLOSED TO ALL TRAINING 2300-0700.

NOISE ABATEMENT IN EFFECT CONTACT AIRPORT NOISE ABATEMENT OFFICE-954-359-6181
FOR DETAILS.

JET RUNUPS PROHIBITED 2300-0700.

ALL RUNWAYS ARE NOISE SENSITIVE.

FLOCKS OF BIRDS ON AND IN THE VICINITY OF THE AIRPORT.

ALL WIDE BODY TYPE AIRCRAFT DEPARTING RUNWAY 9L SHOULD FOLLOW TAXIWAY CENTERLINE INTO POSITION ON RUNWAY.

TAXIWAYS SOUTH OF TAXIWAY C AND WEST OF RUNWAY 13/31 EXCEPT FOR TAXIWAYS P & E ARE 50 FT WIDE OR LESS; DESIGN CRITERIA FOR LARGE AIRCRAFT NOT MAINTAINED.

RUNWAY 09R/27L CLOSED TO AIRCRAFT IN EXCESS OF 58000 LBS MAX CERTIFICATED GROSS TAKE-OFF WEIGHT.

PRIOR PERMISSION REQUIRED FOR AIRCRAFT WITH EXPLOSIVES.

AIRCRAFT WITH WINGSPANS GREATER THAN 112 FT MAY UTILIZE TAXIWAY 'E' BETWEEN TAXIWAYS 'B'/'P' BY PRIOR PERMISSION REQUIRED ONLY.

ARR AIRCRAFT FROM THE NORTH MAINTAIN 6000 FT UNTIL ABEAM RUNWAY 09L ON DOWNWIND.

ARR AIRCRAFT FROM 'N' & 'W' MAINTAIN 6000 FT UNTIL ABEAM RUNWAY 27L, RUNWAY 27R ON DOWNWIND.

NO VFR APPROACHES OR BASE LEGS UNTIL OFFSHORE.

AIRCRAFT HOLDING SHORT FOR RUNWAY 27L AT D4 BE ALERT; RUNWAYS 31 AND 27L CAN BE CONFUSING.

BE ALERT: INTERSECTION OF TAXIWAY 'G' AND 'Q' NOT VISIBLE FROM TOWER.

TAXIWAY B6 CLOSED TO AIRCRAFT WITH WINGSPAN GREATER THAN 126 FT AND TAIL HEIGHT GREATER THAN 46 FT.

AIR CARRIER AIRCRAFT USE RAMP PUSH BACK PROCEDURES AS PRESCRIBED BY AIRPORT OPERATIONS.

STANDING WATER ON RUNWAY SAFETY AREA APPROACH END RUNWAY 27R.

EAST SIDE OF CONCOURSE B AVAILBLE ONLY TO AIRCRAFT WITH A WINGSPAN OF LESS THAN 124.9 FT.

AIRCRAFT OPERATING FROM TERMINAL 1, 2 AND GATES E1, E5, E7, E9, E10 AT TERMINAL 3 MUST CONTACT RAMP CONTROL. RAMP CONTROL EFFECTIVE 0600-2200.

ASDE-X SURVEILLANCE SYSTEM IN USE: PILOTS SHOULD OPERATE TRANSPONDERS WITH MODE 'C' ON ALL TAXIWAYS AND RUNWAYS.

CONCENTRATION OF BIRDS BELOW 500 FT, 2.0 NAUTICAL MILE WEST OF THE APPROACH ENDS OF RUNWAYS 9L & 9R.

CENTER 50 FT RUNWAY 09R/27L NOT GROOVED.

TURBULENCE BELOW 1000 FT OVER LANDFILL LOCATED 2NM W, AND OVER ELECTRIC POWER PLANT LOCATED 1 1/4 NAUTICAL MILE ENE.

Fort Myers, Florida Southwest Florida International ICAO Identifier KRSW

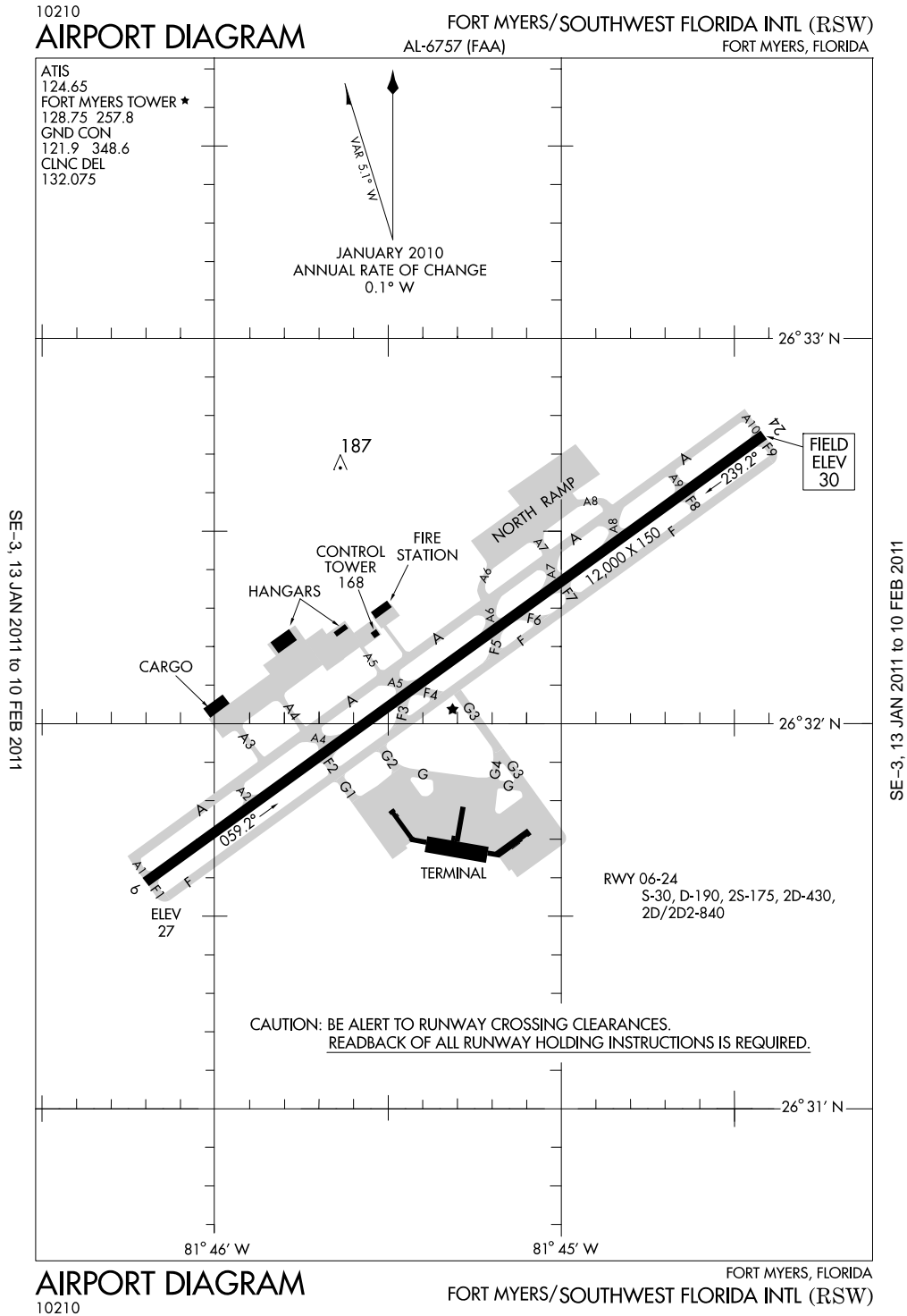

Fort Myers, FL
Southwest Florida Intl
ICAO Identifier KRSW

AD 2.2 Aerodrome geographical and administrative data

- 2.2.1 Reference Point: 26-32-10.20N / 81-45-18.60W
- 2.2.2 From City: 10 Miles SE Of Fort Myers, FL
- 2.2.3 Elevation: 30 ft
- 2.2.5 Magnetic variation: 4W (2000)
- 2.2.6 Airport Contact: Robert M. Ball
11000 TERMINAL ACCESS RD.
Fort Myers, FL 33913
(239--590-4800)
- 2.2.7 Traffic: IFR/VFR

AD 2.3 Operational hours

- 2.3.1 - 2.3.11: ALL Months, ALL Days, ALL Hours

AD 2.4 Handling services and facilities

- 2.4.1 Cargo handling facilities: No
- 2.4.2 Fuel types: 100LL,A
- 2.4.4 De-icing facilities: None
- 2.4.5 Hangar space: Yes
- 2.4.6 Repair facilities: Major

AD 2.6 Rescue and firefighting services

- 2.6.1 Aerodrome category for firefighting: ARFF Index I D certified on 5/1/1983
- 2.6.4 Remarks: Closed To Unscheduled Aircraft Operations With More Than 30 Passenger Seats Except Prior Permission Required Call Airport Manager (239) 590-4810.

AD 2.12 Runway physical characteristics

- 2.12.1 Designation: 06
 - 2.12.2 True Bearing: 54
 - 2.12.3 Dimensions: 12000 ft x 150 ft
 - 2.12.5 Coordinates: 26-31-35.35N / 81-46-12.07W
 - 2.12.6 Threshold elevation: 26 ft
 - 2.12.6 Touchdown zone elevation: 27 ft
-
- 2.12.1 Designation: 24
 - 2.12.2 True Bearing: 234
 - 2.12.3 Dimensions: 12000 ft x 150 ft
 - 2.12.5 Coordinates: 26-32-45.02N / 81-44-25.03W
 - 2.12.6 Threshold elevation: 30 ft

- 2.12.6 Touchdown zone elevation: 30 ft

AD 2.14 Approach and runway lighting

- 2.14.1 Designation: 06
- 2.14.2 Approach lighting system: MALSR: 1400 feet medium intensity approach lighting system with runway alignment indicator lights
- 2.14.4 Visual approach slope indicator system: 4-box VASI on left

- 2.14.1 Designation: 24
- 2.14.4 Visual approach slope indicator system: 4-light PAPI on left

AD 2.18 Air traffic services communication facilities

- 2.18.1 Service designation: APCH/P DEP/P CLASS C

- 2.18.3 Service designation: 119.75 MHz

- 2.18.1 Service designation: GND/P
- 2.18.3 Service designation: 121.9 MHz

- 2.18.1 Service designation: ATIS
- 2.18.3 Service designation: 124.65 MHz
- 2.18.4 Hours of operation: 24

- 2.18.1 Service designation: APCH/P DEP/P CLASS C

- 2.18.3 Service designation: 125.15 MHz

- 2.18.1 Service designation: APCH/P DEP/P CLASS C IC

- 2.18.3 Service designation: 126.8 MHz

- 2.18.1 Service designation: LCL/P
- 2.18.3 Service designation: 128.75 MHz

- 2.18.1 Service designation: CD/P
- 2.18.3 Service designation: 132.075 MHz

- 2.18.1 Service designation: LCL/P
- 2.18.3 Service designation: 257.8 MHz

- 2.18.1 Service designation: APCH/P DEP/P CLASS C

- 2.18.3 Service designation: 306.2 MHz

- 2.18.1 Service designation: APCH/P DEP/P CLASS C

- 2.18.3 Service designation: 327.8 MHz

2.18.1 Service designation: GND/P
2.18.3 Service designation: 348.6 MHz

2.18.1 Service designation: APCH/P DEP/P
CLASS C IC
2.18.3 Service designation: 385.45 MHz

AD 2.19 Radio navigation and landing aids

2.19.1 ILS type: Glide Slope for runway 06.
Magnetic variation: 4W
2.19.2 ILS identification: RSW
2.19.5 Coordinates: 26-31-38.24N /
81-46-00.00W
2.19.6 Site elevation: 26 ft

2.19.1 ILS type: Localizer for runway 06. Magnetic
variation: 4W
2.19.2 ILS identification: RSW
2.19.5 Coordinates: 26-32-51.12N /
81-44-15.66W
2.19.6 Site elevation: 28 ft

2.19.1 ILS type: Outer Marker for runway 06.
Magnetic variation: 4W
2.19.2 ILS identification: RSW
2.19.5 Coordinates: 26-29-00.00N /
81-50-00.00W
2.19.6 Site elevation: 10 ft

General Remarks:

PRIOR PERMISSION REQUIRED FOR TERMINAL RAMP CALL (239-590-4810)

AIR CARRIER PILOTS USE RAMP PROC AS PRESCRIBED BY AIRPORT OPERATIONS.

BIRDS & WILDLIFE ON AND IN THE VICINITY OF AIRPORT.

NO HELICOPTER OPERATIONS PERMITTED ON TERMINAL APRON.

LIGHTS ON PARALLEL ROAD & PARKING LOT NW OF RUNWAY 06/24 CAN BE MISTAKEN FOR
THE RUNWAY & APPROACH ENVIRONMENT.

ATCT CLEARANCE REQUIRED PRIOR TO ENTERING TAXIWAY 'F'.

AIRPORT HAS RUNWAY USE PROGRAM. USE DISTANT NOISE ABATEMENT DEP PROFILE.
VISUAL APPROACHES TO RUNWAY 06 W OF FORT MYERS BEACH ARE REQUESTED TO
MAINTAIN 3000 FT UNTIL CROSSING FORT MYERS BEACH SHORELINE 12 NAUTICAL MILE
SW OF AIRPORT. FOR NOISE ABATEMENT PROCEDURES CONTACT AIRPORT MANAGER
239-590-4810

CAUTION: OPEN BAGGAGE BAYS WITHIN TERMINAL AREA. AIRCREWS SHOULD USE
MINIMUM THRUST SETTINGS IN THESE AREAS, ESPECIALLY DURING SINGLE ENGINE TAXI.
CROSS-BLEED STARTS ONLY ALLOWED AFTER REACHING THE TUG RELEASE POINT.

Miami, Florida Miami International ICAO Identifier KMIA

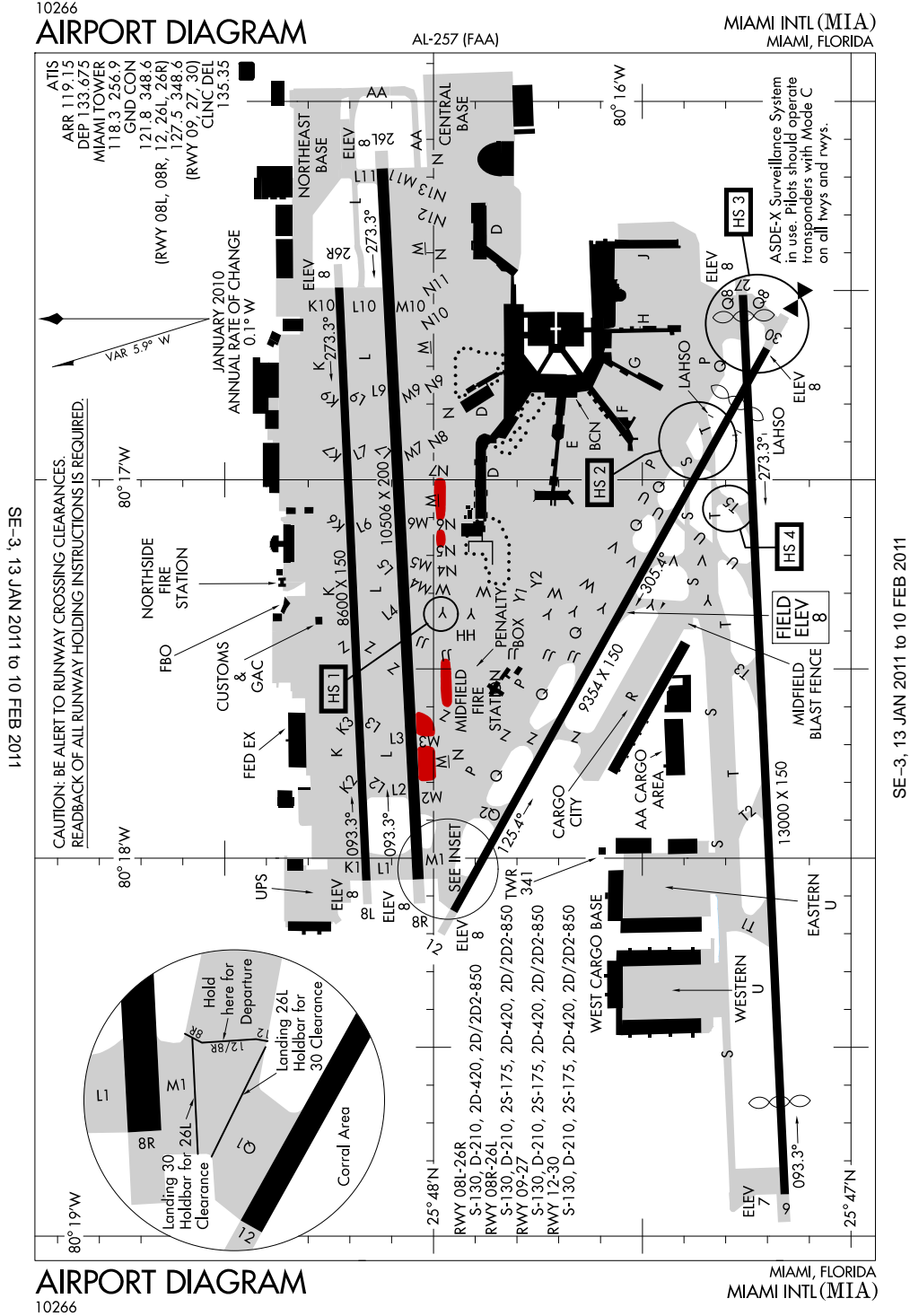

Miami, FL
Miami Intl
ICAO Identifier KMIA

AD 2.2 Aerodrome geographical and administrative data

- 2.2.1 Reference Point: 25-47-43.31N / 80-17-24.42W
- 2.2.2 From City: 8 Miles NW Of Miami, FL
- 2.2.3 Elevation: 8 ft
- 2.2.5 Magnetic variation: 5W (2000)
- 2.2.6 Airport Contact: Jose Abreu, P.E.
PO BOX 025504
Miami, FL 33102
(305-876-7077)
- 2.2.7 Traffic: IFR/VFR

AD 2.3 Operational hours

- 2.3.1 - 2.3.11: ALL Months, ALL Days, ALL Hours

AD 2.4 Handling services and facilities

- 2.4.1 Cargo handling facilities: No
- 2.4.2 Fuel types: 100,A
- 2.4.4 De-icing facilities: None
- 2.4.5 Hangar space: Yes
- 2.4.6 Repair facilities: Major

AD 2.6 Rescue and firefighting services

- 2.6.1 Aerodrome category for firefighting: ARFF Index I E certified on 5/1/1973

AD 2.10 Aerodrome obstacles

- 2.10.1.a. Runway designation: 30
- 2.10.1.b Type of obstacle: Tree (52 ft). Not Lighted or Marked
- 2.10.1.c Location of obstacle: 300 ft from Centerline

- 2.10.1.a. Runway designation: 12
- 2.10.1.b Type of obstacle: Tower (40 ft). Not Lighted or Marked
- 2.10.1.c Location of obstacle: 200 ft from Centerline

- 2.10.1.a. Runway designation: 09
- 2.10.1.b Type of obstacle: Rr (23 ft). Not Lighted or Marked
- 2.10.1.c Location of obstacle: 580 ft from Centerline

AD 2.12 Runway physical characteristics

- 2.12.1 Designation: 12
- 2.12.2 True Bearing: 119
- 2.12.3 Dimensions: 9354 ft x 150 ft
- 2.12.5 Coordinates: 25-47-57.43N / 80-18-00.00W
- 2.12.6 Threshold elevation: 8 ft
- 2.12.6 Touchdown zone elevation: 8 ft

- 2.12.1 Designation: 30
- 2.12.2 True Bearing: 299
- 2.12.3 Dimensions: 9354 ft x 150 ft
- 2.12.5 Coordinates: 25-47-11.85N / 80-16-39.14W
- 2.12.6 Threshold elevation: 8 ft
- 2.12.6 Touchdown zone elevation: 8 ft

- 2.12.1 Designation: 08R
- 2.12.2 True Bearing: 87
- 2.12.3 Dimensions: 10506 ft x 200 ft
- 2.12.5 Coordinates: 25-48-00.00N / 80-18-00.00W
- 2.12.6 Threshold elevation: 8 ft
- 2.12.6 Touchdown zone elevation: 8 ft

- 2.12.1 Designation: 26L
- 2.12.2 True Bearing: 267
- 2.12.3 Dimensions: 10506 ft x 200 ft
- 2.12.5 Coordinates: 25-48-00.00N / 80-16-10.33W
- 2.12.6 Threshold elevation: 8 ft
- 2.12.6 Touchdown zone elevation: 8 ft

- 2.12.1 Designation: 09
- 2.12.2 True Bearing: 87
- 2.12.3 Dimensions: 13000 ft x 150 ft
- 2.12.5 Coordinates: 25-47-00.00N / 80-18-53.34W
- 2.12.6 Threshold elevation: 7 ft
- 2.12.6 Touchdown zone elevation: 7 ft

- 2.12.1 Designation: 27
- 2.12.2 True Bearing: 267
- 2.12.3 Dimensions: 13000 ft x 150 ft
- 2.12.5 Coordinates: 25-47-15.83N / 80-16-31.26W
- 2.12.6 Threshold elevation: 8 ft
- 2.12.6 Touchdown zone elevation: 8 ft

- 2.12.1 Designation: 08L
- 2.12.2 True Bearing: 87

2.12.3 Dimensions: 8600 ft x 150 ft
2.12.5 Coordinates: 25-48-10.43N /
80-18-00.00W
2.12.6 Threshold elevation: 8 ft
2.12.6 Touchdown zone elevation: 8 ft

2.12.1 Designation: 26R
2.12.2 True Bearing: 267
2.12.3 Dimensions: 8600 ft x 150 ft
2.12.5 Coordinates: 25-48-14.33N /
80-16-31.55W
2.12.6 Threshold elevation: 8 ft
2.12.6 Touchdown zone elevation: 8 ft

AD 2.13 Declared distances

2.13.1 Designation: 12
2.13.2 Takeoff run available: 9354
2.13.3 Takeoff distance available: 9354
2.13.4 Accelerate-stop distance available: 8579
2.13.5 Landing distance available: 8579

2.13.1 Designation: 30
2.13.2 Takeoff run available: 9354
2.13.3 Takeoff distance available: 9354
2.13.4 Accelerate-stop distance available: 8852
2.13.5 Landing distance available: 7911

2.13.1 Designation: 09
2.13.2 Takeoff run available: 13000
2.13.3 Takeoff distance available: 13000
2.13.4 Accelerate-stop distance available: 12747
2.13.5 Landing distance available: 11397

2.13.1 Designation: 27
2.13.2 Takeoff run available: 13000
2.13.3 Takeoff distance available: 13000
2.13.4 Accelerate-stop distance available: 13000
2.13.5 Landing distance available: 12747

AD 2.14 Approach and runway lighting

2.14.1 Designation: 12
2.14.2 Approach lighting system: MALSR: 1400
feet medium intensity approach lighting system
with runway alignment indicator lights
2.14.4 Visual approach slope indicator system:
4-light PAPI on right

2.14.1 Designation: 30
2.14.2 Approach lighting system: MALSR: 1400 feet
medium intensity approach lighting system
2.14.4 Visual approach slope indicator system:

4-light PAPI on left

2.14.1 Designation: 08R
2.14.2 Approach lighting system: MALSR: 1400
feet medium intensity approach lighting system
with runway alignment indicator lights
2.14.4 Visual approach slope indicator system:
4-light PAPI on left

2.14.1 Designation: 26L
2.14.4 Visual approach slope indicator system:
4-light PAPI on left

2.14.1 Designation: 09
2.14.2 Approach lighting system: MALSR: 1400
feet medium intensity approach lighting system
with runway alignment indicator lights
2.14.4 Visual approach slope indicator system:
4-light PAPI on left

2.14.1 Designation: 27
2.14.2 Approach lighting system: MALSR: 1400
feet medium intensity approach lighting system
with runway alignment indicator lights
2.14.4 Visual approach slope indicator system:
4-light PAPI on left

2.14.1 Designation: 08L
2.14.4 Visual approach slope indicator system:
4-light PAPI on left

2.14.1 Designation: 26R
2.14.4 Visual approach slope indicator system:
4-light PAPI on left

AD 2.18 Air traffic services communication facilities

2.18.1 Service designation: LCL/P IC
2.18.3 Service designation: 118.3 MHz

2.18.1 Service designation: D-ATIS
2.18.3 Service designation: 119.15 MHz
2.18.4 Hours of operation: 24

2.18.1 Service designation: DEP/P
2.18.3 Service designation: 119.45 MHz

2.18.1 Service designation: APCH/P DEP/P
CLASS B
2.18.3 Service designation: 120.5 MHz

2.18.1 Service designation: EMERG
2.18.3 Service designation: 121.5 MHz

2.18.1 Service designation: GND/P IC
2.18.3 Service designation: 121.8 MHz

2.18.1 Service designation: LCL/P
2.18.3 Service designation: 123.9 MHz

2.18.1 Service designation: APCH/P DEP/P
CLASS B IC
2.18.3 Service designation: 124.85 MHz

2.18.1 Service designation: RTIS(120-300
WITHIN 25 NM)
2.18.3 Service designation: 125.25 MHz

2.18.1 Service designation: DEP/P
2.18.3 Service designation: 125.5 MHz

2.18.1 Service designation: APCH/S
2.18.3 Service designation: 125.75 MHz

2.18.1 Service designation: GND/P IC
2.18.3 Service designation: 127.5 MHz

2.18.1 Service designation: CD/P IC
2.18.3 Service designation: 135.35 MHz

2.18.1 Service designation: LCL/P IC
2.18.3 Service designation: 256.9 MHz

2.18.1 Service designation: DEP/P
2.18.3 Service designation: 290.325 MHz

2.18.1 Service designation: APCH/S
2.18.3 Service designation: 263.025 MHz

2.18.1 Service designation: APCH/P CLASS B IC
2.18.3 Service designation: 322.3 MHz

2.18.1 Service designation: GND/P IC
2.18.3 Service designation: 348.6 MHz

2.18.1 Service designation: DEP/P
2.18.3 Service designation: 354.1 MHz

2.18.1 Service designation: APCH/P DEP/P
CLASS B
2.18.3 Service designation: 379.9 MHz

2.18.1 Service designation: D-ATIS
2.18.3 Service designation: 133.675 MHz
2.18.4 Hours of operation: 24

2.18.1 Service designation: GATE HOLD
2.18.3 Service designation: 120.35 MHz

2.18.1 Service designation: LCL/P IC
2.18.3 Service designation: 118.3 MHz

2.18.1 Service designation: D-ATIS
2.18.3 Service designation: 119.15 MHz
2.18.4 Hours of operation: 24

2.18.1 Service designation: DEP/P
2.18.3 Service designation: 119.45 MHz

2.18.1 Service designation: APCH/P DEP/P
CLASS B
2.18.3 Service designation: 120.5 MHz

2.18.1 Service designation: EMERG
2.18.3 Service designation: 121.5 MHz

2.18.1 Service designation: GND/P IC
2.18.3 Service designation: 121.8 MHz

2.18.1 Service designation: LCL/P
2.18.3 Service designation: 123.9 MHz

2.18.1 Service designation: APCH/P DEP/P
CLASS B IC
2.18.3 Service designation: 124.85 MHz

2.18.1 Service designation: RTIS(120-300
WITHIN 25 NM)
2.18.3 Service designation: 125.25 MHz

2.18.1 Service designation: DEP/P
2.18.3 Service designation: 125.5 MHz

2.18.1 Service designation: APCH/S
2.18.3 Service designation: 125.75 MHz

2.18.1 Service designation: GND/P IC
2.18.3 Service designation: 127.5 MHz

2.18.1 Service designation: CD/P IC
2.18.3 Service designation: 135.35 MHz

2.18.1 Service designation: LCL/P IC
2.18.3 Service designation: 256.9 MHz

2.18.1 Service designation: DEP/P
2.18.3 Service designation: 290.325 MHz

2.18.1 Service designation: APCH/S
2.18.3 Service designation: 263.025 MHz

2.18.1 Service designation: APCH/P CLASS B IC
2.18.3 Service designation: 322.3 MHz

2.18.1 Service designation: GND/P IC
2.18.3 Service designation: 348.6 MHz

2.18.1 Service designation: DEP/P
2.18.3 Service designation: 354.1 MHz

2.18.1 Service designation: APCH/P DEP/P
CLASS B
2.18.3 Service designation: 379.9 MHz

2.18.1 Service designation: LCL/P IC

2.18.3 Service designation: 256.9 MHz

2.18.1 Service designation: DEP/P

2.18.3 Service designation: 290.325 MHz

2.18.1 Service designation: APCH/S

2.18.3 Service designation: 263.025 MHz

2.18.1 Service designation: APCH/P CLASS B IC

2.18.3 Service designation: 322.3 MHz

2.18.1 Service designation: GND/P IC

2.18.3 Service designation: 348.6 MHz

2.18.1 Service designation: DEP/P

2.18.3 Service designation: 354.1 MHz

2.18.1 Service designation: APCH/P DEP/P
CLASS B

2.18.3 Service designation: 379.9 MHz

2.18.1 Service designation: D-ATIS

2.18.3 Service designation: 133.675 MHz

2.18.4 Hours of operation: 24

2.18.1 Service designation: GATE HOLD

2.18.3 Service designation: 120.35 MHz

AD 2.19 Radio navigation and landing aids

2.19.1 ILS type: Localizer for runway 30. Magnetic
variation: 5W

2.19.2 ILS identification: DCX

2.19.5 Coordinates: 25-47-59.88N /
80-18-13.04W

2.19.6 Site elevation: 8 ft

2.19.1 ILS type: DME for runway 30. Magnetic
variation: 5W

2.19.2 ILS identification: DCX

2.19.5 Coordinates: 25-47-57.65N /
80-18-14.02W

2.19.6 Site elevation: 13 ft

2.19.1 ILS type: Glide Slope for runway 30.
Magnetic variation: 5W

2.19.2 ILS identification: DCX

2.19.5 Coordinates: 25-47-17.65N /
80-16-59.57W

2.19.6 Site elevation: 8 ft

2.19.1 ILS type: Glide Slope for runway 12.

Magnetic variation: 5W

2.19.2 ILS identification: GEM

2.19.5 Coordinates: 25-47-49.35N /
80-17-59.90W

2.19.6 Site elevation: 6 ft

2.19.1 ILS type: DME for runway 12. Magnetic
variation: 5W

2.19.2 ILS identification: GEM

2.19.5 Coordinates: 25-47-11.28N /
80-16-32.41W

2.19.6 Site elevation: 14 ft

2.19.1 ILS type: Localizer for runway 12. Magnetic
variation: 5W

2.19.2 ILS identification: GEM

2.19.5 Coordinates: 25-47-00.00N /
80-16-34.81W

2.19.6 Site elevation: 8 ft

2.19.1 ILS type: Localizer for runway 08R.
Magnetic variation: 5W

2.19.2 ILS identification: MFA

2.19.5 Coordinates: 25-48-00.00N /
80-16-00.00W

2.19.6 Site elevation: 6 ft

2.19.1 ILS type: Middle Marker for runway 08R.
Magnetic variation: 5W

2.19.2 ILS identification: MFA

2.19.5 Coordinates: 25-48-00.00N /
80-18-43.38W

2.19.6 Site elevation: 7 ft

2.19.1 ILS type: DME for runway 08R. Magnetic
variation: 5W

2.19.2 ILS identification: MFA

2.19.5 Coordinates: 25-48-00.00N /
80-16-00.00W

2.19.6 Site elevation: 8 ft

2.19.1 ILS type: Glide Slope for runway 08R.
Magnetic variation: 5W

2.19.2 ILS identification: MFA

2.19.5 Coordinates: 25-48-00.00N /
80-17-54.81W

2.19.6 Site elevation: 5 ft

2.19.1 ILS type: Glide Slope for runway 26L.
Magnetic variation: 5W

2.19.2 ILS identification: VIN

2.19.5 Coordinates: 25-48-00.00N /
80-16-22.51W
2.19.6 Site elevation: 5 ft

2.19.1 ILS type: Localizer for runway 26L.
Magnetic variation: 5W
2.19.2 ILS identification: VIN
2.19.5 Coordinates: 25-48-00.00N /
80-18-13.77W
2.19.6 Site elevation: 7 ft

2.19.1 ILS type: DME for runway 26L. Magnetic
variation: 5W
2.19.2 ILS identification: VIN
2.19.5 Coordinates: 25-48-00.00N /
80-18-13.80W
2.19.6 Site elevation: 12 ft

2.19.1 ILS type: Middle Marker for runway 26L.
Magnetic variation: 5W
2.19.2 ILS identification: VIN
2.19.5 Coordinates: 25-48-00.00N /
80-15-44.08W
2.19.6 Site elevation: 99999 ft

2.19.1 ILS type: Outer Marker for runway 26L.
Magnetic variation: 5W
2.19.2 ILS identification: VIN
2.19.5 Coordinates: 25-48-18.83N /
80-11-42.26W
2.19.6 Site elevation: 99999 ft

2.19.1 ILS type: Localizer for runway 09. Magnetic
variation: 5W
2.19.2 ILS identification: BUL
2.19.5 Coordinates: 25-47-16.18N /
80-16-23.08W
2.19.6 Site elevation: 8 ft

2.19.1 ILS type: Outer Marker for runway 09.
Magnetic variation: 5W
2.19.2 ILS identification: BUL
2.19.5 Coordinates: 25-46-59.33N /
80-23-00.00W
2.19.6 Site elevation: 5 ft

2.19.1 ILS type: Middle Marker for runway 09.
Magnetic variation: 5W
2.19.2 ILS identification: BUL
2.19.5 Coordinates: 25-47-00.00N /
80-19-00.00W

2.19.6 Site elevation: 5 ft

2.19.1 ILS type: Glide Slope for runway 09.
Magnetic variation: 5W
2.19.2 ILS identification: BUL
2.19.5 Coordinates: 25-47-00.00N /
80-18-26.71W
2.19.6 Site elevation: 54 ft

2.19.1 ILS type: Glide Slope for runway 27.
Magnetic variation: 5W
2.19.2 ILS identification: MIA
2.19.5 Coordinates: 25-47-11.56N /
80-16-56.66W
2.19.6 Site elevation: 7 ft

2.19.1 ILS type: Outer Marker for runway 27.
Magnetic variation: 5W
2.19.2 ILS identification: MIA
2.19.5 Coordinates: 25-47-26.47N /
80-11-39.14W
2.19.6 Site elevation: 99999 ft

2.19.1 ILS type: Localizer for runway 27. Magnetic
variation: 5W
2.19.2 ILS identification: MIA
2.19.5 Coordinates: 25-47-00.00N /
80-19-00.00W
2.19.6 Site elevation: 7 ft

2.19.1 ILS type: Middle Marker for runway 27.
Magnetic variation: 5W
2.19.2 ILS identification: MIA
2.19.5 Coordinates: 25-47-16.87N /
80-16-12.26W
2.19.6 Site elevation: 5 ft

2.19.1 ILS type: DME for runway 08L. Magnetic
variation: 5W
2.19.2 ILS identification: ROY
2.19.5 Coordinates: 25-48-17.24N /
80-16-20.64W
2.19.6 Site elevation: 8 ft

2.19.1 ILS type: Localizer for runway 08L.
Magnetic variation: 5W
2.19.2 ILS identification: ROY
2.19.5 Coordinates: 25-48-14.77N /
80-16-20.65W
2.19.6 Site elevation: 9 ft

2.19.1 ILS type: DME for runway 26R. Magnetic variation: 5W
2.19.2 ILS identification: CNV
2.19.5 Coordinates: 25-48-00.00N / 80-18-16.47W
2.19.6 Site elevation: 8 ft

2.19.1 ILS type: Localizer for runway 26R. Magnetic variation: 5W
2.19.2 ILS identification: CNV
2.19.5 Coordinates: 25-48-00.00N / 80-18-16.45W
2.19.6 Site elevation: 9 ft

General Remarks:

CLOSED NON ENGINE AIRCRAFT.

AIRCRAFT WITH A WINGSPAN GREATER THAN 170 FT ARE PROHIBITED FROM TAXIING ON TAXIWAY P EAST OF TAXIWAY U. AIRCRAFT WITH A WINGSPAN GREATER THAN 143 FT ARE PROHIBITED FROM USING TAXIWAY AA.

ALL TURBOJET AIRCRAFT USE DISTANT NOISE ABATEMENT DEP PROFILE FROM ALL RUNWAYS EXCEPT A320, B727, B737-800, B767-400, AND DC9 WHICH SHOULD USE CLOSE-IN NOISE ABATEMENT ABATEMENT PROFILE.

BIRDS ON & IN THE VICINITY OF AIRPORT.

RUNWAY 27 THRESHOLD LIGHTS OUT OF SERVICE INDEFINITELY.

PRIOR PERMISSION REQUIRED 3 HRS PRIOR TO ALL ARRIVALS ON THE GENERAL AVIATION CENTER (GAC) RAMP. CONTACT RAMP CONTROL AT 305-876-7550 AND UPON ARRIVAL ON FREQ 130.5. AIRCRAFT WITH WINGSPAN GREATER THAN 78 FT ARE PROHIBITED FROM ENTERING THE GENERAL AVIATION AIRCRAFT RAMP.

ALL MEDICAL EMERGENCIES ARRIVALS, WITH THE EXCEPTION OF AIR AMBULANCE FLIGHTS, MUST SECURE DOORS UNTIL AIRCRAFT RESCUE AND FIRE FIGHTING IS ON SCENE.

ASDE-X SURVEILLANCE SYSTEM IN USE: PILOTS SHOULD OPERATE TRANSPONDERS WITH MODE C ON ALL TAXIWAYS AND RUNWAYS.

INBOUND MILITARY FLIGHTS NOTIFY PRIOR NOTICE 100 NAUTICAL MILE RADIUS ON FREQ 130.5.

**Orlando, Florida
 Orlando International
 ICAO Identifier KMCO**

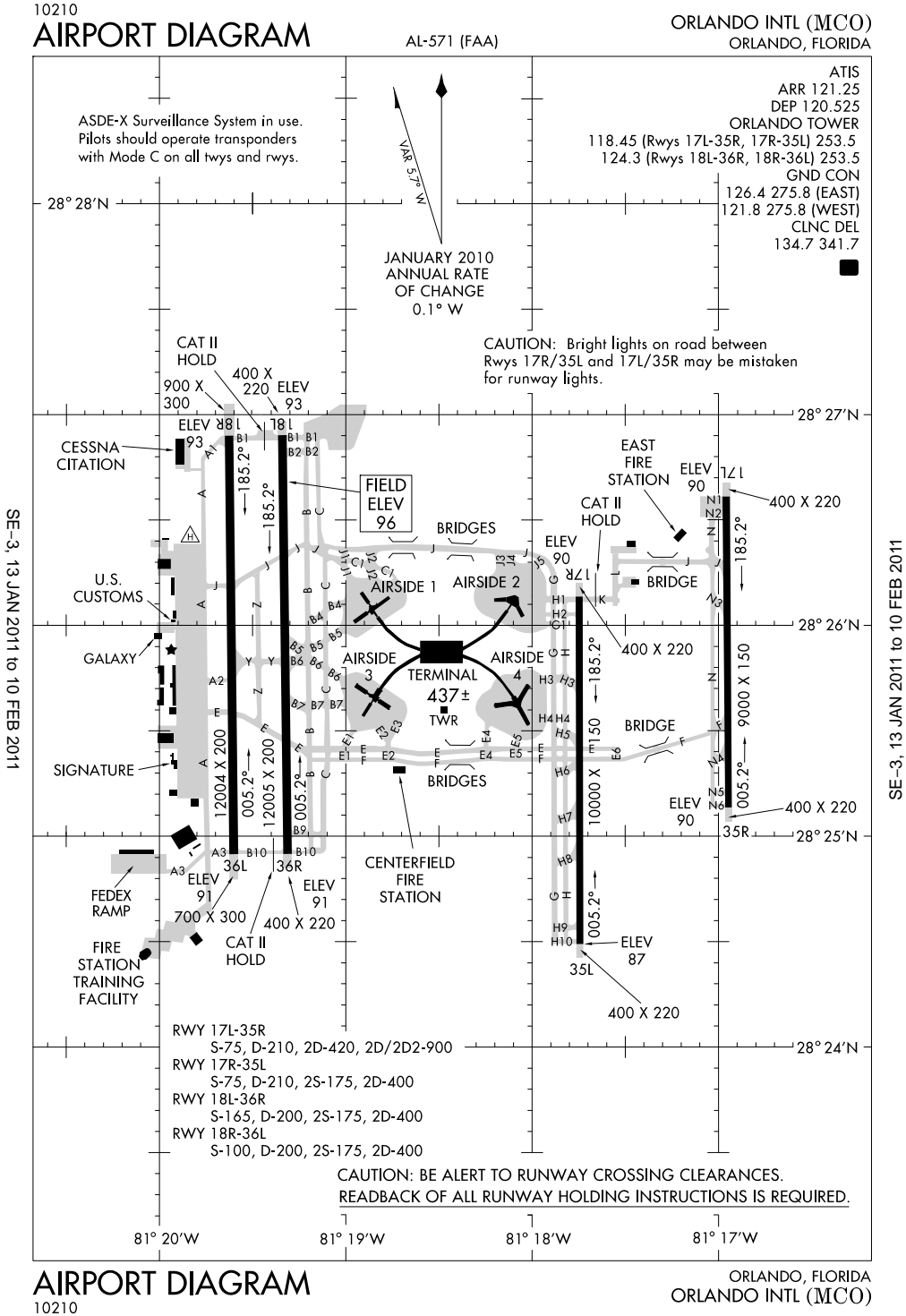

Orlando, FL
Orlando Intl
ICAO Identifier KMCO

AD 2.2 Aerodrome geographical and administrative data

- 2.2.1 Reference Point: 28-25-45.82N / 81-18-32.38W
- 2.2.2 From City: 6 Miles SE Of Orlando, FL
- 2.2.3 Elevation: 96 ft
- 2.2.5 Magnetic variation: 5W (2000)
- 2.2.6 Airport Contact: Steve Gardner
ONE AIRPORT BLVD
Orlando, FL 32827
(407-825-2001)
- 2.2.7 Traffic: IFR/VFR

AD 2.3 Operational hours

- 2.3.1 - 2.3.11: ALL Months, ALL Days, ALL Hours

AD 2.4 Handling services and facilities

- 2.4.1 Cargo handling facilities: No
- 2.4.2 Fuel types: 100LL,A
- 2.4.4 De-icing facilities: None
- 2.4.5 Hangar space: Yes
- 2.4.6 Repair facilities: Minor

AD 2.6 Rescue and firefighting services

- 2.6.1 Aerodrome category for firefighting: ARFF Index I E certified on 4/1/2005

AD 2.12 Runway physical characteristics

- 2.12.1 Designation: 17R
- 2.12.2 True Bearing: 179
- 2.12.3 Dimensions: 10000 ft x 150 ft
- 2.12.5 Coordinates: 28-26-00.00N / 81-17-45.17W
- 2.12.6 Threshold elevation: 90 ft
- 2.12.6 Touchdown zone elevation: 90 ft

- 2.12.1 Designation: 35L
- 2.12.2 True Bearing: 359
- 2.12.3 Dimensions: 10000 ft x 150 ft
- 2.12.5 Coordinates: 28-24-29.20N / 81-17-44.13W
- 2.12.6 Threshold elevation: 87 ft
- 2.12.6 Touchdown zone elevation: 88 ft

- 2.12.1 Designation: 18L
- 2.12.2 True Bearing: 179

- 2.12.3 Dimensions: 12005 ft x 200 ft
- 2.12.5 Coordinates: 28-26-54.00N / 81-19-20.30W
- 2.12.6 Threshold elevation: 92 ft
- 2.12.6 Touchdown zone elevation: 96 ft

- 2.12.1 Designation: 36R
- 2.12.2 True Bearing: 359
- 2.12.3 Dimensions: 12005 ft x 200 ft
- 2.12.5 Coordinates: 28-24-55.15N / 81-19-19.04W
- 2.12.6 Threshold elevation: 91 ft
- 2.12.6 Touchdown zone elevation: 92 ft

- 2.12.1 Designation: 18R
- 2.12.2 True Bearing: 179
- 2.12.3 Dimensions: 12004 ft x 200 ft
- 2.12.5 Coordinates: 28-26-53.86N / 81-19-37.11W
- 2.12.6 Threshold elevation: 92 ft
- 2.12.6 Touchdown zone elevation: 94 ft

- 2.12.1 Designation: 36L
- 2.12.2 True Bearing: 359
- 2.12.3 Dimensions: 12004 ft x 200 ft
- 2.12.5 Coordinates: 28-24-55.01N / 81-19-35.83W
- 2.12.6 Threshold elevation: 91 ft
- 2.12.6 Touchdown zone elevation: 93 ft

- 2.12.1 Designation: 17L
- 2.12.2 True Bearing: 179
- 2.12.3 Dimensions: 9000 ft x 150 ft
- 2.12.5 Coordinates: 28-26-37.31N / 81-16-57.29W
- 2.12.6 Threshold elevation: 90 ft
- 2.12.6 Touchdown zone elevation: 90 ft

- 2.12.1 Designation: 35R
- 2.12.2 True Bearing: 359
- 2.12.3 Dimensions: 9000 ft x 150 ft
- 2.12.5 Coordinates: 28-25-00.00N / 81-16-56.38W
- 2.12.6 Threshold elevation: 90 ft
- 2.12.6 Touchdown zone elevation: 90 ft

- 2.12.1 Designation: H1
- 2.12.3 Dimensions: 44 ft x 44 ft

AD 2.13 Declared distances

- 2.13.1 Designation: 18L

2.13.2 Takeoff run available: 12005
2.13.3 Takeoff distance available: 12005
2.13.4 Accelerate-stop distance available: 12005
2.13.5 Landing distance available: 12005

2.13.1 Designation: 36R
2.13.2 Takeoff run available: 12005
2.13.3 Takeoff distance available: 12005
2.13.4 Accelerate-stop distance available: 11601
2.13.5 Landing distance available: 11601

2.13.1 Designation: 18R
2.13.2 Takeoff run available: 12004
2.13.3 Takeoff distance available: 12004
2.13.4 Accelerate-stop distance available: 12004
2.13.5 Landing distance available: 12004

2.13.1 Designation: 36L
2.13.2 Takeoff run available: 12004
2.13.3 Takeoff distance available: 12004
2.13.4 Accelerate-stop distance available: 11621
2.13.5 Landing distance available: 11621

AD 2.14 Approach and runway lighting

2.14.1 Designation: 17R
2.14.2 Approach lighting system: ALSF2: Standard 2400 feet high intensity approach lighting system with sequenced flashers, category II or III configuration

2.14.1 Designation: 35L
2.14.2 Approach lighting system: ALSF2: Standard 2400 feet high intensity approach lighting system with sequenced flashers, category II or III configuration

2.14.1 Designation: 18L
2.14.4 Visual approach slope indicator system: 6-box VASI on left
2.14.10 Remarks: VASI Upwind Threshold Crossing Height 89.7' GA 3.25 Degs Downwind Threshold Crossing Height 52.4' GA 3.00 Degs.

2.14.1 Designation: 36R
2.14.2 Approach lighting system: ALSF2: Standard 2400 feet high intensity approach lighting system with sequenced flashers, category II or III configuration

2.14.1 Designation: 18R
2.14.2 Approach lighting system: MALSR: 1400

feet medium intensity approach lighting system with runway alignment indicator lights

2.14.1 Designation: 36L
2.14.4 Visual approach slope indicator system: 6-box VASI on left
2.14.10 Remarks: VASI Upwind Threshold Crossing Height 94' GA 3.25 Degs; Downwind Threshold Crossing Height 52' GA 3.00 Degs.

2.14.1 Designation: 17L
2.14.2 Approach lighting system: ALSF2: Standard 2400 feet high intensity approach lighting system with sequenced flashers, category II or III configuration
2.14.4 Visual approach slope indicator system: 4-light PAPI on left

2.14.1 Designation: 35R
2.14.2 Approach lighting system: ALSF2: Standard 2400 feet high intensity approach lighting system with sequenced flashers, category II or III configuration
2.14.4 Visual approach slope indicator system: 4-light PAPI on right

AD 2.18 Air traffic services communication facilities

2.18.1 Service designation: APCH/P DEP/P CLASS B

2.18.3 Service designation: 119.4 MHz

2.18.1 Service designation: APCH/P DEP/P CLASS B

2.18.3 Service designation: 120.15 MHz

2.18.1 Service designation: APCH/P DEP/P CLASS B

2.18.3 Service designation: 121.1 MHz

2.18.1 Service designation: D-ATIS ARR

2.18.3 Service designation: 121.25 MHz

2.18.4 Hours of operation: 24

2.18.1 Service designation: EMERG

2.18.3 Service designation: 121.5 MHz

2.18.1 Service designation: APCH/S

2.18.3 Service designation: 123.85 MHz

2.18.1 Service designation: LCL/P (RYS 18L/36R)

& 18R/36L)
2.18.3 Service designation: 124.3 MHz

2.18.1 Service designation: APCH/P DEP/P IC
CLASS B
2.18.3 Service designation: 124.8 MHz

2.18.1 Service designation: APCH/S
2.18.3 Service designation: 125.55 MHz

2.18.1 Service designation: APCH/S
2.18.3 Service designation: 134.05 MHz

2.18.1 Service designation: CD/P
2.18.3 Service designation: 134.7 MHz

2.18.1 Service designation: AR OPS
2.18.3 Service designation: 148.8 MHz

2.18.1 Service designation: EMERG
2.18.3 Service designation: 243 MHz

2.18.1 Service designation: APCH/P DEP/P
CLASS B
2.18.3 Service designation: 284.7 MHz

2.18.1 Service designation: APCH/P DEP/P IC
CLASS B
2.18.3 Service designation: 307 MHz

2.18.1 Service designation: APCH/S
2.18.3 Service designation: 339.8 MHz

2.18.1 Service designation: CD/P
2.18.3 Service designation: 341.7 MHz

2.18.1 Service designation: APCH/P DEP/P
CLASS B
2.18.3 Service designation: 351.9 MHz

2.18.1 Service designation: AR OPS
2.18.3 Service designation: 41.5 MHz

2.18.1 Service designation: D-ATIS
2.18.3 Service designation: 120.525 MHz
2.18.4 Hours of operation: 24

2.18.1 Service designation: LCL/P
2.18.3 Service designation: 253.5 MHz

2.18.1 Service designation: LCL/P (RYS 17L/35R

& 17R/35L)
2.18.3 Service designation: 118.45 MHz

2.18.1 Service designation: GND/P
2.18.3 Service designation: 121.8 MHz

2.18.1 Service designation: GND/P
2.18.3 Service designation: 275.8 MHz

2.18.1 Service designation: GND/P
2.18.3 Service designation: 126.4 MHz

2.18.1 Service designation: APCH/P DEP/P
CLASS B
2.18.3 Service designation: 119.475 MHz

AD 2.19 Radio navigation and landing aids

2.19.1 ILS type: Localizer for runway 17R.
Magnetic variation: 5W
2.19.2 ILS identification: DIZ
2.19.5 Coordinates: 28-24-18.77N /
81-17-44.02W
2.19.6 Site elevation: 82 ft

2.19.1 ILS type: DME for runway 17R. Magnetic
variation: 5W
2.19.2 ILS identification: DIZ
2.19.5 Coordinates: 28-24-18.95N /
81-17-47.07W
2.19.6 Site elevation: 86 ft

2.19.1 ILS type: Glide Slope for runway 17R.
Magnetic variation: 5W
2.19.2 ILS identification: DIZ
2.19.5 Coordinates: 28-25-57.84N /
81-17-40.58W
2.19.6 Site elevation: 87 ft

2.19.1 ILS type: Inner Marker for runway 17R.
Magnetic variation: 5W
2.19.2 ILS identification: DIZ
2.19.5 Coordinates: 28-26-16.70N /
81-17-45.26W
2.19.6 Site elevation: 86 ft

2.19.1 ILS type: Middle Marker for runway 17R.
Magnetic variation: 5W
2.19.2 ILS identification: DIZ
2.19.5 Coordinates: 28-26-34.25N /
81-17-45.43W
2.19.6 Site elevation: 82 ft

2.19.1 ILS type: DME for runway 35L. Magnetic variation: 5W
2.19.2 ILS identification: DDO
2.19.5 Coordinates: 28-26-18.45N / 81-17-48.12W
2.19.6 Site elevation: 100 ft

2.19.1 ILS type: Glide Slope for runway 35L. Magnetic variation: 5W
2.19.2 ILS identification: DDO
2.19.5 Coordinates: 28-24-39.53N / 81-17-39.76W
2.19.6 Site elevation: 84 ft

2.19.1 ILS type: Inner Marker for runway 35L. Magnetic variation: 5W
2.19.2 ILS identification: DDO
2.19.5 Coordinates: 28-24-20.54N / 81-17-44.05W
2.19.6 Site elevation: 87 ft

2.19.1 ILS type: Middle Marker for runway 35L. Magnetic variation: 5W
2.19.2 ILS identification: DDO
2.19.5 Coordinates: 28-24-00.00N / 81-17-43.84W
2.19.6 Site elevation: 83 ft

2.19.1 ILS type: Localizer for runway 35L. Magnetic variation: 5W
2.19.2 ILS identification: DDO
2.19.5 Coordinates: 28-26-18.60N / 81-17-45.27W
2.19.6 Site elevation: 87 ft

2.19.1 ILS type: Glide Slope for runway 36R. Magnetic variation: 5W
2.19.2 ILS identification: OJP
2.19.5 Coordinates: 28-25-00.00N / 81-19-23.63W
2.19.6 Site elevation: 88 ft

2.19.1 ILS type: Inner Marker for runway 36R. Magnetic variation: 5W
2.19.2 ILS identification: OJP
2.19.5 Coordinates: 28-24-46.65N / 81-19-18.94W
2.19.6 Site elevation: 87 ft

2.19.1 ILS type: Outer Marker for runway 36R. Magnetic variation: 5W

2.19.2 ILS identification: OJP
2.19.5 Coordinates: 28-20-38.35N / 81-19-18.23W
2.19.6 Site elevation: 68 ft

2.19.1 ILS type: Localizer for runway 36R. Magnetic variation: 5W
2.19.2 ILS identification: OJP
2.19.5 Coordinates: 28-27-00.00N / 81-19-20.38W
2.19.6 Site elevation: 91 ft

2.19.1 ILS type: Middle Marker for runway 36R. Magnetic variation: 5W
2.19.2 ILS identification: OJP
2.19.5 Coordinates: 28-24-31.89N / 81-19-18.77W
2.19.6 Site elevation: 85 ft

2.19.1 ILS type: DME for runway 36R. Magnetic variation: 5W
2.19.2 ILS identification: OJP
2.19.5 Coordinates: 28-27-00.00N / 81-19-18.03W
2.19.6 Site elevation: 91 ft

2.19.1 ILS type: Localizer for runway 18R. Magnetic variation: 5W
2.19.2 ILS identification: TFE
2.19.5 Coordinates: 28-24-42.58N / 81-19-35.70W
2.19.6 Site elevation: 87 ft

2.19.1 ILS type: Glide Slope for runway 18R. Magnetic variation: 5W
2.19.2 ILS identification: TFE
2.19.5 Coordinates: 28-26-43.50N / 81-19-32.52W
2.19.6 Site elevation: 89 ft

2.19.1 ILS type: Outer Marker for runway 18R. Magnetic variation: 5W
2.19.2 ILS identification: TFE
2.19.5 Coordinates: 28-33-00.00N / 81-19-38.75W
2.19.6 Site elevation: 103 ft

2.19.1 ILS type: Middle Marker for runway 18R. Magnetic variation: 5W
2.19.2 ILS identification: TFE
2.19.5 Coordinates: 28-27-20.04N /

81-19-37.39W
2.19.6 Site elevation: 90 ft

2.19.1 ILS type: DME for runway 18R. Magnetic variation: 5W

2.19.2 ILS identification: TFE

2.19.5 Coordinates: 28-24-42.05N /
81-19-38.48W

2.19.6 Site elevation: 86 ft

2.19.1 ILS type: DME for runway 17L. Magnetic variation: 5W

2.19.2 ILS identification: ARK

2.19.5 Coordinates: 28-24-58.00N /
81-16-51.68W

2.19.6 Site elevation: 86 ft

2.19.1 ILS type: Glide Slope for runway 17L. Magnetic variation: 5W

2.19.2 ILS identification: ARK

2.19.5 Coordinates: 28-26-26.95N /
81-16-52.59W

2.19.6 Site elevation: 90 ft

2.19.1 ILS type: Inner Marker for runway 17L. Magnetic variation: 5W

2.19.2 ILS identification: ARK

2.19.5 Coordinates: 28-26-45.82N /
81-16-57.38W

2.19.6 Site elevation: 90 ft

2.19.1 ILS type: Localizer for runway 17L. Magnetic variation: 5W

2.19.2 ILS identification: ARK

2.19.5 Coordinates: 28-24-57.81N /
81-16-56.27W

2.19.6 Site elevation: 94 ft

2.19.1 ILS type: Middle Marker for runway 17L. Magnetic variation: 5W

2.19.2 ILS identification: ARK

2.19.5 Coordinates: 28-26-59.83N /
81-16-57.52W

2.19.6 Site elevation: 90 ft

2.19.1 ILS type: Glide Slope for runway 35R. Magnetic variation: 5W

2.19.2 ILS identification: CER

2.19.5 Coordinates: 28-25-18.63N /
81-16-51.89W

2.19.6 Site elevation: 90 ft

2.19.1 ILS type: Inner Marker for runway 35R. Magnetic variation: 5W

2.19.2 ILS identification: CER

2.19.5 Coordinates: 28-24-59.68N /
81-16-56.29W

2.19.6 Site elevation: 90 ft

2.19.1 ILS type: DME for runway 35R. Magnetic variation: 5W

2.19.2 ILS identification: CER

2.19.5 Coordinates: 28-26-48.23N /
81-16-52.81W

2.19.6 Site elevation: 90 ft

2.19.1 ILS type: Localizer for runway 35R. Magnetic variation: 5W

2.19.2 ILS identification: CER

2.19.5 Coordinates: 28-26-47.70N /
81-16-57.40W

2.19.6 Site elevation: 90 ft

2.19.1 ILS type: Middle Marker for runway 35R. Magnetic variation: 5W

2.19.2 ILS identification: CER

2.19.5 Coordinates: 28-24-45.67N /
81-16-56.15W

2.19.6 Site elevation: 90 ft

General Remarks:

BIRDS & DEER ON & IN THE VICINITY OF AIRPORT.

24 HR PRIOR PERMISSION REQUIRED FOR HELIPAD LANDING CALL 407-825-2036.
COMMERCIAL OPERATIONS ONLY, NO PRIVATE OPERATIONS.

AVOID CONTACT WITH TAXIWAY EDGE LIGHTS; ALL AIRCRAFT DETERMINED TO BE FAA DESIGN GROUP IV AND ABOVE MUST PERFORM JUDGEMENTAL OVERSTEERING INSTEAD

OF COCKPIT CENTERLINE STEERING WHEN TAXIING.

WHEN OVERRUN LIGHTS ILS RUNWAY 7 AND MCO ILS RUNWAYS 17 & 18R SIMULTANEOUS OPERATIONS ARE CONDUCTED, ATC RADAR REQUIRED.

BRIGHT LIGHTS ON ROAD BETWEEN RUNWAY 17R/35L AND RUNWAY 17L/35R MAY BE MISTAKEN FOR RUNWAY LIGHTS.

ASDE-X SURVEILLANCE SYSTEM IN USE: PILOTS SHOULD OPERATE TRANSPONDERS WITH MODE 'C' ON ALL TAXIWAYS & RUNWAYS.

AIRCRAFT PARKED ON AIRSIDE 2 CENTERLINE WEST OF TAXIWAY G1 AND/OR SOUTH OF TAXIWAY J3 BETWEEN 2200 & 0700.

GROUND OPERATIONS OF AIRCRAFT WITH WINGSPAN GREATER THAN 213 FT MUST USE TAXIWAYS WEST OF RUNWAY 18L/36R EXCEPT NORTH OF TAXIWAY A WHICH IS RESTRICTED TO WINGSPAN LESS THAN 213 FT.

USE CAUTION IN VICINITY OF TAXIWAY "A" ALONG WEST RAMP.

UNLESS ADVISED BY AUTOMATIC TERMINAL INFORMATION SERVICE, DEPARTING FLIGHTS ON INITIAL CONTACT WITH GROUND CONTROL: AIRCRAFT ON WEST RAMP, AIRSIDE 1 & 3 (GATES 1-59) USE GROUND CONTROL 121.8. AIRCRAFT AT AIRSIDE 2 & 4 (GATES 60 AND HIGHER), USE GROUND CONTROL 126.4.

Tampa, Florida
Tampa International
ICAO Identifier KTPA

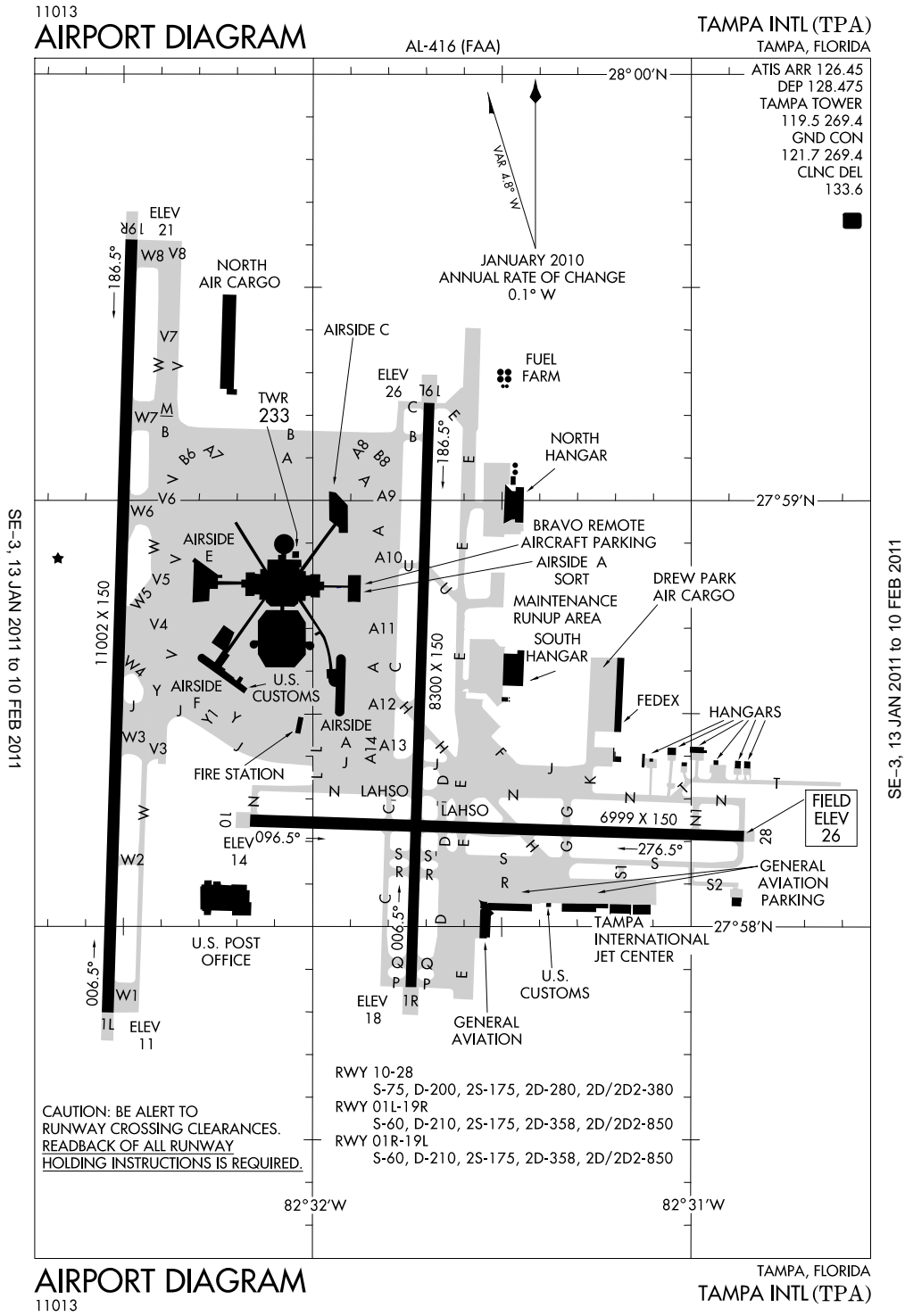

Tampa, FL
Tampa Intl
ICAO Identifier KTPA

AD 2.2 Aerodrome geographical and administrative data

- 2.2.1 Reference Point: 27-58-31.70N / 82-31-59.70W
- 2.2.2 From City: 6 Miles W Of Tampa, FL
- 2.2.3 Elevation: 26 ft
- 2.2.5 Magnetic variation: 5W (2010)
- 2.2.6 Airport Contact: Ed Cooley
PO BOX 22287
Tampa, FL 33622
(813-870-8700)
- 2.2.7 Traffic: IFR/VFR

AD 2.3 Operational hours

- 2.3.1 - 2.3.11: ALL Months, ALL Days, ALL Hours

AD 2.4 Handling services and facilities

- 2.4.1 Cargo handling facilities: No
- 2.4.2 Fuel types: 100LL,A
- 2.4.4 De-icing facilities: None
- 2.4.5 Hangar space: Yes
- 2.4.6 Repair facilities: Major

AD 2.6 Rescue and firefighting services

- 2.6.1 Aerodrome category for firefighting: ARFF Index I E certified on 5/1/1973

AD 2.10 Aerodrome obstacles

- 2.10.1.a. Runway designation: 10
- 2.10.1.b Type of obstacle: Trees (26 ft). Not Lighted or Marked
- 2.10.1.c Location of obstacle: 301 ft from Centerline

AD 2.12 Runway physical characteristics

- 2.12.1 Designation: 10
- 2.12.2 True Bearing: 92
- 2.12.3 Dimensions: 6999 ft x 150 ft
- 2.12.5 Coordinates: 27-58-14.99N / 82-32-00.00W
- 2.12.6 Threshold elevation: 14 ft
- 2.12.6 Touchdown zone elevation: 20 ft

- 2.12.1 Designation: 28
- 2.12.2 True Bearing: 272
- 2.12.3 Dimensions: 6999 ft x 150 ft

- 2.12.5 Coordinates: 27-58-12.89N / 82-30-51.89W
- 2.12.6 Threshold elevation: 26 ft
- 2.12.6 Touchdown zone elevation: 26 ft

- 2.12.1 Designation: 01R
- 2.12.2 True Bearing: 2
- 2.12.3 Dimensions: 8300 ft x 150 ft
- 2.12.5 Coordinates: 27-57-51.52N / 82-31-44.37W
- 2.12.6 Threshold elevation: 18 ft
- 2.12.6 Touchdown zone elevation: 18 ft

- 2.12.1 Designation: 19L
- 2.12.2 True Bearing: 182
- 2.12.3 Dimensions: 8300 ft x 150 ft
- 2.12.5 Coordinates: 27-59-13.66N / 82-31-41.57W
- 2.12.6 Threshold elevation: 26 ft
- 2.12.6 Touchdown zone elevation: 26 ft

- 2.12.1 Designation: 01L
- 2.12.2 True Bearing: 2
- 2.12.3 Dimensions: 11002 ft x 150 ft
- 2.12.5 Coordinates: 27-57-47.86N / 82-32-32.48W
- 2.12.6 Threshold elevation: 11 ft
- 2.12.6 Touchdown zone elevation: 11 ft

- 2.12.1 Designation: 19R
- 2.12.2 True Bearing: 182
- 2.12.3 Dimensions: 11002 ft x 150 ft
- 2.12.5 Coordinates: 27-59-36.74N / 82-32-28.78W
- 2.12.6 Threshold elevation: 21 ft
- 2.12.6 Touchdown zone elevation: 21 ft

AD 2.13 Declared distances

- 2.13.1 Designation: 10
- 2.13.2 Takeoff run available: 6999
- 2.13.3 Takeoff distance available: 6999
- 2.13.4 Accelerate-stop distance available: 6999
- 2.13.5 Landing distance available: 6999

- 2.13.1 Designation: 28
- 2.13.2 Takeoff run available: 6999
- 2.13.3 Takeoff distance available: 6999
- 2.13.4 Accelerate-stop distance available: 6500
- 2.13.5 Landing distance available: 6500

- 2.13.1 Designation: 01R

2.13.2 Takeoff run available: 8300
2.13.3 Takeoff distance available: 8300
2.13.4 Accelerate-stop distance available: 8300
2.13.5 Landing distance available: 8300

2.13.1 Designation: 19L
2.13.2 Takeoff run available: 8300
2.13.3 Takeoff distance available: 8300
2.13.4 Accelerate-stop distance available: 8300
2.13.5 Landing distance available: 8300

2.13.1 Designation: 01L
2.13.2 Takeoff run available: 11002
2.13.3 Takeoff distance available: 11002
2.13.4 Accelerate-stop distance available: 10800
2.13.5 Landing distance available: 10800

2.13.1 Designation: 19R
2.13.2 Takeoff run available: 11002
2.13.3 Takeoff distance available: 11002
2.13.4 Accelerate-stop distance available: 11002
2.13.5 Landing distance available: 11002

AD 2.14 Approach and runway lighting

2.14.1 Designation: 10
2.14.4 Visual approach slope indicator system:
4-light PAPI on left

2.14.1 Designation: 28
2.14.4 Visual approach slope indicator system:
4-light PAPI on left

2.14.1 Designation: 01R
2.14.4 Visual approach slope indicator system:
4-light PAPI on left

2.14.1 Designation: 19L
2.14.2 Approach lighting system: ALSF2: Standard
2400 feet high intensity approach lighting system
with sequenced flashers, category II or III
configuration
2.14.4 Visual approach slope indicator system:
4-light PAPI on left

2.14.1 Designation: 01L
2.14.2 Approach lighting system: ALSF2: Standard
2400 feet high intensity approach lighting system
with sequenced flashers, category II or III
configuration
2.14.4 Visual approach slope indicator system:
4-light PAPI on left

2.14.1 Designation: 19R
2.14.2 Approach lighting system: MALSR: 1400
feet medium intensity approach lighting system
with runway alignment indicator lights
2.14.4 Visual approach slope indicator system:
4-light PAPI on left

AD 2.18 Air traffic services communication facilities

2.18.1 Service designation: APCH/P DEP/P
2.18.3 Service designation: 118.15 MHz

2.18.1 Service designation: FINAL-CTL IC
2.18.3 Service designation: 118.5 MHz

2.18.1 Service designation: APCH/P DEP/P
2.18.3 Service designation: 118.8 MHz

2.18.1 Service designation: LCL/S
2.18.3 Service designation: 119.05 MHz

2.18.1 Service designation: LCL/P
2.18.3 Service designation: 119.5 MHz

2.18.1 Service designation: APCH/P DEP/P
CLASS B
2.18.3 Service designation: 119.65 MHz

2.18.1 Service designation: CLASS B
2.18.3 Service designation: 119.9 MHz

2.18.1 Service designation: GND/S
2.18.3 Service designation: 121.35 MHz

2.18.1 Service designation: EMERG
2.18.3 Service designation: 121.5 MHz

2.18.1 Service designation: GND/P
2.18.3 Service designation: 121.7 MHz

2.18.1 Service designation: CLASS B
2.18.3 Service designation: 125.3 MHz

2.18.1 Service designation: D-ATIS
2.18.3 Service designation: 126.45 MHz
2.18.4 Hours of operation: 24

2.18.1 Service designation: D-ATIS
2.18.3 Service designation: 128.475 MHz
2.18.4 Hours of operation: 24

2.18.1 Service designation: CD/P
2.18.3 Service designation: 133.6 MHz

2.18.1 Service designation: EMERG
2.18.3 Service designation: 243 MHz

2.18.1 Service designation: APCH/P DEP/P
2.18.3 Service designation: 269.1 MHz

2.18.1 Service designation: GND/P LCL/P
2.18.3 Service designation: 269.4 MHz

2.18.1 Service designation: CLASS B
2.18.3 Service designation: 290.3 MHz

2.18.1 Service designation: APCH/P DEP/P
2.18.3 Service designation: 285.625 MHz

2.18.1 Service designation: APCH/P DEP/P
CLASS B
2.18.3 Service designation: 353.575 MHz

2.18.1 Service designation: CLASS B
2.18.3 Service designation: 316.05 MHz

2.18.1 Service designation: APCH/S DEP/S
2.18.3 Service designation: 353.75 MHz

AD 2.19 Radio navigation and landing aids

2.19.1 ILS type: Glide Slope for runway 19L.
Magnetic variation: 5W
2.19.2 ILS identification: TPA
2.19.5 Coordinates: 27-59-00.00N /
82-31-37.46W
2.19.6 Site elevation: 24 ft

2.19.1 ILS type: Localizer for runway 19L.
Magnetic variation: 5W
2.19.2 ILS identification: TPA
2.19.5 Coordinates: 27-57-41.53N /
82-31-44.71W
2.19.6 Site elevation: 14 ft

2.19.1 ILS type: Middle Marker for runway 19L.
Magnetic variation: 5W
2.19.2 ILS identification: TPA
2.19.5 Coordinates: 27-59-43.35N /
82-31-40.56W
2.19.6 Site elevation: 99999 ft

2.19.1 ILS type: Inner Marker for runway 19L.

Magnetic variation: 5W
2.19.2 ILS identification: TPA
2.19.5 Coordinates: 27-59-23.06N /
82-31-41.25W
2.19.6 Site elevation: 99999 ft

2.19.1 ILS type: Outer Marker for runway 19L.
Magnetic variation: 5W
2.19.2 ILS identification: TPA
2.19.5 Coordinates: 28-05-00.00N /
82-31-30.91W
2.19.6 Site elevation: 99999 ft

2.19.1 ILS type: DME for runway 01R. Magnetic
variation: 5W
2.19.2 ILS identification: TWJ
2.19.5 Coordinates: 27-59-22.99N /
82-31-38.43W
2.19.6 Site elevation: 36 ft

2.19.1 ILS type: Localizer for runway 01R.
Magnetic variation: 5W
2.19.2 ILS identification: TWJ
2.19.5 Coordinates: 27-59-23.93N /
82-31-41.22W
2.19.6 Site elevation: 26 ft

2.19.1 ILS type: Localizer for runway 01L.
Magnetic variation: 5W
2.19.2 ILS identification: AMP
2.19.5 Coordinates: 27-59-44.78N /
82-32-28.51W
2.19.6 Site elevation: 21 ft

2.19.1 ILS type: Inner Marker for runway 01L.
Magnetic variation: 5W
2.19.2 ILS identification: AMP
2.19.5 Coordinates: 27-57-39.62N /
82-32-32.76W
2.19.6 Site elevation: 99999 ft

2.19.1 ILS type: Middle Marker for runway 01L.
Magnetic variation: 5W
2.19.2 ILS identification: AMP
2.19.5 Coordinates: 27-57-15.71N /
82-32-33.57W
2.19.6 Site elevation: 99999 ft

2.19.1 ILS type: Glide Slope for runway 01L.
Magnetic variation: 5W
2.19.2 ILS identification: AMP

2.19.5 Coordinates: 27-57-58.24N /
82-32-36.59W
2.19.6 Site elevation: 8 ft

2.19.5 Coordinates: 27-59-26.45N /
82-32-33.59W
2.19.6 Site elevation: 17 ft

2.19.1 ILS type: Outer Marker for runway 01L.
Magnetic variation: 5W
2.19.2 ILS identification: AMP
2.19.5 Coordinates: 27-51-40.23N /
82-32-44.85W
2.19.6 Site elevation: 99999 ft

2.19.1 ILS type: Middle Marker for runway 19R.
Magnetic variation: 5W
2.19.2 ILS identification: JRT
2.19.5 Coordinates: 28-00-00.00N /
82-32-27.94W
2.19.6 Site elevation: 21 ft

2.19.1 ILS type: Localizer for runway 19R.
Magnetic variation: 5W
2.19.2 ILS identification: JRT
2.19.5 Coordinates: 27-57-38.21N /
82-32-32.80W
2.19.6 Site elevation: 5 ft

2.19.1 ILS type: DME for runway 19R. Magnetic
variation: 5W
2.19.2 ILS identification: JRT
2.19.5 Coordinates: 27-57-38.34N /
82-32-30.27W
2.19.6 Site elevation: 12 ft

2.19.1 ILS type: Glide Slope for runway 19R.
Magnetic variation: 5W
2.19.2 ILS identification: JRT

General Remarks:

RUNWAY 19L IS NOISE SENSITIVE TO TURBOJET DEPARTURES. RUNWAY 01R IS NOISE SENSITIVE TO TURBOJET ARRIVALS. PUBLISHED NOISE ABATEMENT PROCEDURES IN EFFECT.

ONLY AIRCRAFT WITH PRIOR PERMISSION MAY USE TERMINAL APRON; ALL OTHERS USE GA APRON.

BIRD ACTIVITY ON AND IN VICINITY OF AIRPORT.

TAXIWAY RSTRS: AIRPLANE DESIGN GRP V OR LGR – TAXIWAY N WEST OF TAXIWAY L UNAVAILABLE. NORTH 1500 FT TAXIWAY E ALSO UNAVAILABLE FOR WINGSPAN GREATER THAN 171 FT UNLESS PRIOR PERMISSION REQUIRED FROM AIRPORT OPERATIONS.

TAXIWAY RSTRS: GRP IV AIRCRAFT WITH WINGSPAN GREATER THAN 117 FT -- TAXIWAY LANE E SOUTH OF TAXIWAY S, AND TAXIWAY R EAST OF TAXIWAY D ARE NON-MOVEMENT AREAS AND UNAVAILABLE WO PRIOR PERMISSION REQUIRED FROM AIRPORT OPERATIONS.

West Palm Beach, Florida Palm Beach International ICAO Identifier KPBI

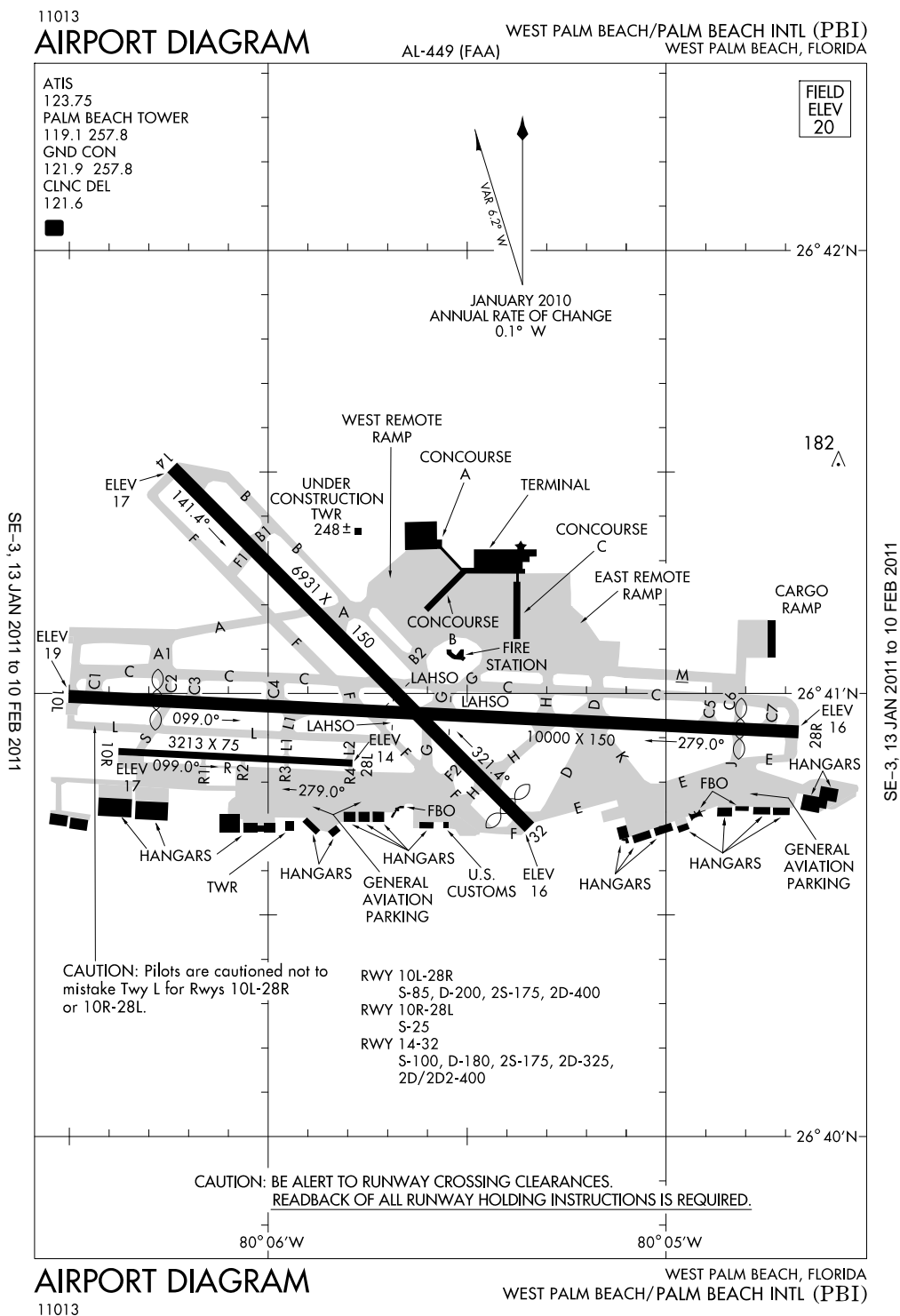

West Palm Beach, FL
Palm Beach Intl
ICAO Identifier KPBI

80-06-30.13W
2.12.6 Threshold elevation: 19 ft
2.12.6 Touchdown zone elevation: 19 ft

AD 2.2 Aerodrome geographical and administrative data

2.2.1 Reference Point: 26-40-59.40N / 80-05-44.10W
2.2.2 From City: 3 Miles W Of West Palm Beach, FL
2.2.3 Elevation: 20 ft
2.2.5 Magnetic variation: 6W (2010)
2.2.6 Airport Contact: Bruce V Pelly
BLDG 846-PALM BEACH INTL
West Palm Beach, FL 33406
(561-471-7412)
2.2.7 Traffic: IFR/VFR

2.12.1 Designation: 28R
2.12.2 True Bearing: 273
2.12.3 Dimensions: 10000 ft x 150 ft
2.12.5 Coordinates: 26-40-54.74N / 80-04-40.01W
2.12.6 Threshold elevation: 16 ft
2.12.6 Touchdown zone elevation: 18 ft

AD 2.3 Operational hours

2.3.1 - 2.3.11: ALL Months, ALL Days, ALL Hours

2.12.1 Designation: 10R
2.12.2 True Bearing: 93
2.12.3 Dimensions: 3213 ft x 75 ft
2.12.5 Coordinates: 26-40-52.28N / 80-06-22.64W
2.12.6 Threshold elevation: 17 ft
2.12.6 Touchdown zone elevation: 17 ft

AD 2.4 Handling services and facilities

2.4.1 Cargo handling facilities: No
2.4.2 Fuel types: 100LL,A
2.4.4 De-icing facilities: None
2.4.5 Hangar space: No
2.4.6 Repair facilities: Major

2.12.1 Designation: 28L
2.12.2 True Bearing: 273
2.12.3 Dimensions: 3213 ft x 75 ft
2.12.5 Coordinates: 26-40-50.74N / 80-05-47.26W
2.12.6 Threshold elevation: 14 ft
2.12.6 Touchdown zone elevation: 17 ft

AD 2.6 Rescue and firefighting services

2.6.1 Aerodrome category for firefighting: ARFF Index I D certified on 4/29/2005

2.12.1 Designation: 14
2.12.2 True Bearing: 135
2.12.3 Dimensions: 6931 ft x 150 ft
2.12.5 Coordinates: 26-41-30.60N / 80-06-14.48W
2.12.6 Threshold elevation: 17 ft
2.12.6 Touchdown zone elevation: 17 ft

AD 2.10 Aerodrome obstacles

2.10.1.a. Runway designation: 14
2.10.1.b Type of obstacle: Trees (84 ft). Not Lighted or Marked
2.10.1.c Location of obstacle: 150 ft from Centerline

2.12.1 Designation: 32
2.12.2 True Bearing: 315
2.12.3 Dimensions: 6931 ft x 150 ft
2.12.5 Coordinates: 26-40-41.91N / 80-05-20.62W
2.12.6 Threshold elevation: 16 ft
2.12.6 Touchdown zone elevation: 16 ft

2.10.1.a. Runway designation: 32
2.10.1.b Type of obstacle: Road (32 ft). Not Lighted or Marked
2.10.1.c Location of obstacle: 250 ft from Centerline

AD 2.12 Runway physical characteristics

2.12.1 Designation: 10L
2.12.2 True Bearing: 93
2.12.3 Dimensions: 10000 ft x 150 ft
2.12.5 Coordinates: 26-40-59.55N /

AD 2.13 Declared distances

2.13.1 Designation: 10L
2.13.2 Takeoff run available: 10000
2.13.3 Takeoff distance available: 10000
2.13.4 Accelerate-stop distance available: 10000
2.13.5 Landing distance available: 8800

2.13.1 Designation: 28R
2.13.2 Takeoff run available: 10000
2.13.3 Takeoff distance available: 10000
2.13.4 Accelerate-stop distance available: 10000
2.13.5 Landing distance available: 9189

2.13.1 Designation: 10R
2.13.2 Takeoff run available: 3213
2.13.3 Takeoff distance available: 3213
2.13.4 Accelerate-stop distance available: 3213
2.13.5 Landing distance available: 3213

2.13.1 Designation: 28L
2.13.2 Takeoff run available: 3213
2.13.3 Takeoff distance available: 3213
2.13.4 Accelerate-stop distance available: 3213
2.13.5 Landing distance available: 3213

2.13.1 Designation: 14
2.13.2 Takeoff run available: 6932
2.13.3 Takeoff distance available: 6932
2.13.4 Accelerate-stop distance available: 6000
2.13.5 Landing distance available: 6000

2.13.1 Designation: 32
2.13.2 Takeoff run available: 6932
2.13.3 Takeoff distance available: 6932
2.13.4 Accelerate-stop distance available: 6932
2.13.5 Landing distance available: 6514

AD 2.14 Approach and runway lighting

2.14.1 Designation: 10L
2.14.2 Approach lighting system: MALSR: 1400 feet medium intensity approach lighting system with runway alignment indicator lights
2.14.4 Visual approach slope indicator system: 4-light PAPI on right

2.14.1 Designation: 28R
2.14.4 Visual approach slope indicator system: 4-light PAPI on left

2.14.1 Designation: 10R
2.14.4 Visual approach slope indicator system: 4-light PAPI on left

2.14.1 Designation: 28L
2.14.4 Visual approach slope indicator system: 4-light PAPI on right

2.14.1 Designation: 14

2.14.4 Visual approach slope indicator system: 4-light PAPI on right

2.14.1 Designation: 32
2.14.4 Visual approach slope indicator system: 4-light PAPI on left

AD 2.18 Air traffic services communication facilities

2.18.1 Service designation: LCL/S
2.18.3 Service designation: 118.75 MHz

2.18.1 Service designation: LCL/P
2.18.3 Service designation: 119.1 MHz

2.18.1 Service designation: EMERG
2.18.3 Service designation: 121.5 MHz

2.18.1 Service designation: CD/P
2.18.3 Service designation: 121.6 MHz

2.18.1 Service designation: GND/P
2.18.3 Service designation: 121.9 MHz

2.18.1 Service designation: D-ATIS
2.18.3 Service designation: 123.75 MHz
2.18.4 Hours of operation: 24

2.18.1 Service designation: APCH/P CLASS C IC
2.18.3 Service designation: 124.6 MHz

2.18.1 Service designation: FINAL APCH
2.18.3 Service designation: 125 MHz

2.18.1 Service designation: DEP/P
2.18.3 Service designation: 125.2 MHz

2.18.1 Service designation: APCH/P CLASS C
2.18.3 Service designation: 125.2 MHz

2.18.1 Service designation: CLASS C /S
2.18.3 Service designation: 127.35 MHz

2.18.1 Service designation: DEP/P CLASS C
2.18.3 Service designation: 128.3 MHz

2.18.1 Service designation: EMERG
2.18.3 Service designation: 243 MHz

2.18.1 Service designation: GND/P LCL/P
2.18.3 Service designation: 257.8 MHz

2.18.1 Service designation: APCH/P CLASS C IC
2.18.3 Service designation: 317.4 MHz

2.18.1 Service designation: DEP/P CLASS C
2.18.3 Service designation: 343.6 MHz

2.18.1 Service designation: LCL/S
2.18.3 Service designation: 384.6 MHz

2.18.1 Service designation: DEP/P CLASS C
2.18.3 Service designation: 387.1 MHz

2.18.1 Service designation: APCH/P CLASS C
2.18.3 Service designation: 397.9 MHz

AD 2.19 Radio navigation and landing aids

2.19.1 ILS type: Outer Marker for runway 10L.
Magnetic variation: 6W
2.19.2 ILS identification: PBI
2.19.5 Coordinates: 26-41-15.72N /
80-12-36.74W
2.19.6 Site elevation: 17 ft

2.19.1 ILS type: Glide Slope for runway 10L.
Magnetic variation: 6W
2.19.2 ILS identification: PBI
2.19.5 Coordinates: 26-40-55.98N /
80-06-00.00W
2.19.6 Site elevation: 14 ft

General Remarks:

MIGRATORY BIRDS ON AND IN THE VICINITY OF AIRPORT.

NOISE ABATEMENT PROCEDURES IN EFFECT CALL (561) 471-7467.

ULTRALIGHT ACTIVITY IN THE VICINITY OF AIRPORT.

PORTIONS OF TAXIWAY 'F' S OF TAXIWAY 'G' TO APPROACH END RUNWAY 32 NOT VISIBLE FROM ATCT DUE TO BUILDINGS & PARKED AIRCRAFT.

BE ALERT; RUNWAYS 28L & 28R THRESHOLDS STAGGERED BY 5400 FT.

RUNWAY 10R/28L NON-AIR CARRIER AIRCRAFT ONLY.

BE ALERT: TAXIWAY L IS LOCATED BETWEEN RUNWAYS 10L/28R & 10R/28L. TAXIWAY L IS WIDER AND LONGER THAN RUNWAY 10R/28L - DO NOT CONFUSE TAXIWAY L FOR RUNWAY. TAXIWAY L LIMITED TO B-727-100 SERIES AND SMALLER AIRCRAFT.

2.19.1 ILS type: Localizer for runway 10L.
Magnetic variation: 6W
2.19.2 ILS identification: PBI
2.19.5 Coordinates: 26-40-54.27N /
80-04-28.92W
2.19.6 Site elevation: 13 ft

2.19.1 ILS type: Middle Marker for runway 10L.
Magnetic variation: 6W
2.19.2 ILS identification: PBI
2.19.5 Coordinates: 26-41-00.00N /
80-06-56.66W
2.19.6 Site elevation: 18 ft

2.19.1 ILS type: Localizer for runway 28R.
Magnetic variation: 6W
2.19.2 ILS identification: PWB
2.19.5 Coordinates: 26-40-59.91N /
80-06-38.53W
2.19.6 Site elevation: 18 ft

2.19.1 ILS type: Glide Slope for runway 28R.
Magnetic variation: 6W
2.19.2 ILS identification: PWB
2.19.5 Coordinates: 26-40-51.94N /
80-05-00.00W
2.19.6 Site elevation: 14 ft

Atlanta, Georgia Hartsfield-Jackson Atlanta International ICAO Identifier KATL

10322 **AIRPORT DIAGRAM** ATLANTA/ HARTSFIELD - JACKSON ATLANTA INTL (ATL)
AL-26 (FAA) ATLANTA, GEORGIA

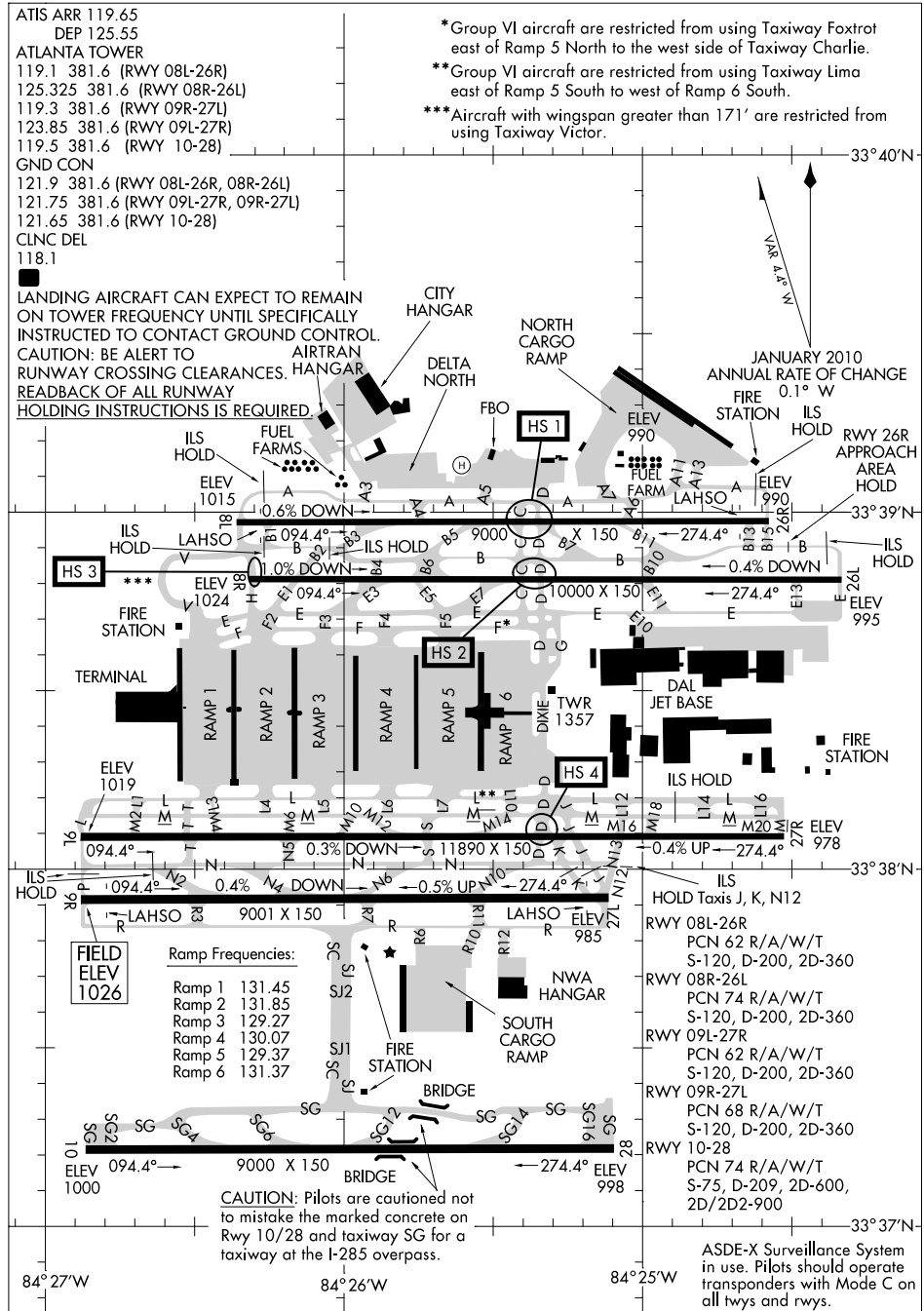

SE-4, 13 JAN 2011 to 10 FEB 2011

SE-4, 13 JAN 2011 to 10 FEB 2011

AIRPORT DIAGRAM ATLANTA, GEORGIA
10322 ATLANTA/ HARTSFIELD - JACKSON ATLANTA INTL (ATL)

Atlanta, GA
Hartsfield - Jackson Atlanta Intl
ICAO Identifier KATL

AD 2.2 Aerodrome geographical and administrative data

- 2.2.1 Reference Point: 33-38-12.19N / 84-25-41.04W
- 2.2.2 From City: 7 Miles S Of Atlanta, GA
- 2.2.3 Elevation: 1026 ft
- 2.2.5 Magnetic variation: 2W (1985)
- 2.2.6 Airport Contact: Benjamin Decosta
PO BOX 20509 AIRPORT OPNS
Atlanta, GA 30320
(404-530-6600)
- 2.2.7 Traffic: IFR/VFR

AD 2.3 Operational hours

- 2.3.1 - 2.3.11: ALL Months, ALL Days, ALL Hours

AD 2.4 Handling services and facilities

- 2.4.1 Cargo handling facilities: No
- 2.4.2 Fuel types: 100,100LL,A
- 2.4.4 De-icing facilities: None
- 2.4.5 Hangar space: Yes
- 2.4.6 Repair facilities: Major

AD 2.6 Rescue and firefighting services

- 2.6.1 Aerodrome category for firefighting: ARFF Index I E certified on 5/1/1973

AD 2.10 Aerodrome obstacles

- 2.10.1.a. Runway designation: 09L
- 2.10.1.b Type of obstacle: Other (108 ft). Not Lighted or Marked
- 2.10.1.c Location of obstacle: 200 ft from Centerline

- 2.10.1.a. Runway designation: 09R
- 2.10.1.b Type of obstacle: Tower (88 ft). Not Lighted or Marked
- 2.10.1.c Location of obstacle: 1000 ft from Centerline

- 2.10.1.a. Runway designation: 08L
- 2.10.1.b Type of obstacle: Sign (14 ft). Not Lighted or Marked
- 2.10.1.c Location of obstacle: 400 ft from Centerline

- 2.10.1.a. Runway designation: 26R
- 2.10.1.b Type of obstacle: Ant (53 ft). Not Lighted or Marked
- 2.10.1.c Location of obstacle: 800 ft from Centerline

- 2.10.1.a. Runway designation: 08R
- 2.10.1.b Type of obstacle: Rr (64 ft). Not Lighted or Marked
- 2.10.1.c Location of obstacle: 500 ft from Centerline

- 2.10.1.a. Runway designation: 26L
- 2.10.1.b Type of obstacle: Vent (13 ft). Not Lighted or Marked
- 2.10.1.c Location of obstacle: 560 ft from Centerline

- 2.10.1.a. Runway designation: 10
- 2.10.1.b Type of obstacle: Sign (51 ft). Not Lighted or Marked
- 2.10.1.c Location of obstacle: 770 ft from Centerline

- 2.10.1.a. Runway designation: 28
- 2.10.1.b Type of obstacle: Tower (136 ft). Lighted
- 2.10.1.c Location of obstacle: 410 ft from Centerline

AD 2.12 Runway physical characteristics

- 2.12.1 Designation: 09L
- 2.12.2 True Bearing: 90
- 2.12.3 Dimensions: 11890 ft x 150 ft
- 2.12.4 PCN: 62 R/A/W/T
- 2.12.5 Coordinates: 33-38-00.00N / 84-26-52.68W
- 2.12.6 Threshold elevation: 1019 ft
- 2.12.6 Touchdown zone elevation: 1019 ft
- 2.12.7 Slope: 0.3DOWN

- 2.12.1 Designation: 27R
- 2.12.2 True Bearing: 270
- 2.12.3 Dimensions: 11890 ft x 150 ft
- 2.12.4 PCN: 62 R/A/W/T
- 2.12.5 Coordinates: 33-38-00.00N / 84-24-32.07W
- 2.12.6 Threshold elevation: 978 ft
- 2.12.6 Touchdown zone elevation: 985 ft
- 2.12.7 Slope: 0.4UP

- 2.12.1 Designation: 09R

2.12.2 True Bearing: 90
2.12.3 Dimensions: 9001 ft x 150 ft
2.12.4 PCN: 68 R/A/W/T
2.12.5 Coordinates: 33-37-54.53N /
84-26-52.68W
2.12.6 Threshold elevation: 1026 ft
2.12.6 Touchdown zone elevation: 1026 ft
2.12.7 Slope: 0.4DOWN

2.12.1 Designation: 27L
2.12.2 True Bearing: 270
2.12.3 Dimensions: 9001 ft x 150 ft
2.12.4 PCN: 68 R/A/W/T
2.12.5 Coordinates: 33-37-54.56N /
84-25-00.00W
2.12.6 Threshold elevation: 985 ft
2.12.6 Touchdown zone elevation: 999 ft
2.12.7 Slope: 0.5UP

2.12.1 Designation: H1
2.12.3 Dimensions: 52 ft x 52 ft

2.12.1 Designation: 08L
2.12.2 True Bearing: 90
2.12.3 Dimensions: 9000 ft x 150 ft
2.12.4 PCN: 62 R/A/W/T
2.12.5 Coordinates: 33-38-58.32N /
84-26-20.49W
2.12.6 Threshold elevation: 1015 ft
2.12.6 Touchdown zone elevation: 1015 ft
2.12.7 Slope: 0.6DOWN

2.12.1 Designation: 26R
2.12.2 True Bearing: 270
2.12.3 Dimensions: 9000 ft x 150 ft
2.12.4 PCN: 62 R/A/W/T
2.12.5 Coordinates: 33-38-58.35N /
84-24-34.03W
2.12.6 Threshold elevation: 990 ft
2.12.6 Touchdown zone elevation: 990 ft

2.12.1 Designation: 08R
2.12.2 True Bearing: 90
2.12.3 Dimensions: 10000 ft x 150 ft
2.12.4 PCN: 74 R/A/W/T
2.12.5 Coordinates: 33-38-48.43N /
84-26-18.11W
2.12.6 Threshold elevation: 1024 ft
2.12.6 Touchdown zone elevation: 1024 ft
2.12.7 Slope: 1DOWN

2.12.1 Designation: 26L
2.12.2 True Bearing: 270
2.12.3 Dimensions: 10000 ft x 150 ft
2.12.4 PCN: 74 R/A/W/T
2.12.5 Coordinates: 33-38-48.46N /
84-24-19.83W
2.12.6 Threshold elevation: 995 ft
2.12.6 Touchdown zone elevation: 995 ft
2.12.7 Slope: 0.4DOWN

2.12.1 Designation: 10
2.12.2 True Bearing: 90
2.12.3 Dimensions: 9000 ft x 150 ft
2.12.4 PCN: 74 R/A/W/T
2.12.5 Coordinates: 33-37-12.98N /
84-26-52.36W
2.12.6 Threshold elevation: 1000 ft
2.12.6 Touchdown zone elevation: 1000 ft

2.12.1 Designation: 28
2.12.2 True Bearing: 270
2.12.3 Dimensions: 9000 ft x 150 ft
2.12.4 PCN: 74 R/A/W/T
2.12.5 Coordinates: 33-37-13.02N /
84-25-00.00W
2.12.6 Threshold elevation: 998 ft
2.12.6 Touchdown zone elevation: 998 ft

AD 2.13 Declared distances

2.13.1 Designation: 09L
2.13.2 Takeoff run available: 11890
2.13.3 Takeoff distance available: 11890
2.13.4 Accelerate-stop distance available: 11730
2.13.5 Landing distance available: 11730

2.13.1 Designation: 27R
2.13.2 Takeoff run available: 11890
2.13.3 Takeoff distance available: 11890
2.13.4 Accelerate-stop distance available: 11690
2.13.5 Landing distance available: 11690

2.13.1 Designation: 09R
2.13.2 Takeoff run available: 9000
2.13.3 Takeoff distance available: 9000
2.13.4 Accelerate-stop distance available: 9000
2.13.5 Landing distance available: 9000

2.13.1 Designation: 27L
2.13.2 Takeoff run available: 9000
2.13.3 Takeoff distance available: 9000
2.13.4 Accelerate-stop distance available: 8865

2.13.5 Landing distance available: 8865

2.13.1 Designation: 08L

2.13.2 Takeoff run available: 9000

2.13.3 Takeoff distance available: 9000

2.13.4 Accelerate-stop distance available: 8800

2.13.5 Landing distance available: 8800

2.13.1 Designation: 26R

2.13.2 Takeoff run available: 9000

2.13.3 Takeoff distance available: 9000

2.13.4 Accelerate-stop distance available: 8800

2.13.5 Landing distance available: 8800

AD 2.14 Approach and runway lighting

2.14.1 Designation: 09L

2.14.2 Approach lighting system: MALSR: 1400 feet medium intensity approach lighting system with runway alignment indicator lights

2.14.4 Visual approach slope indicator system: 4-light PAPI on right

2.14.1 Designation: 27R

2.14.2 Approach lighting system: MALS: 1400 feet medium intensity approach lighting system

2.14.4 Visual approach slope indicator system: 4-light PAPI on right

2.14.1 Designation: 09R

2.14.2 Approach lighting system: ALSF2: Standard 2400 feet high intensity approach lighting system with sequenced flashers, category II or III configuration

2.14.4 Visual approach slope indicator system: 4-light PAPI on left

2.14.1 Designation: 27L

2.14.2 Approach lighting system: MALSR: 1400 feet medium intensity approach lighting system with runway alignment indicator lights

2.14.4 Visual approach slope indicator system: 4-light PAPI on right

2.14.1 Designation: 08L

2.14.2 Approach lighting system: ALSF2: Standard 2400 feet high intensity approach lighting system with sequenced flashers, category II or III configuration

2.14.4 Visual approach slope indicator system: 4-light PAPI on left

2.14.1 Designation: 26R

2.14.2 Approach lighting system: MALSR: 1400 feet medium intensity approach lighting system with runway alignment indicator lights

2.14.4 Visual approach slope indicator system: 4-light PAPI on left

2.14.1 Designation: 08R

2.14.4 Visual approach slope indicator system: 4-light PAPI on left

2.14.1 Designation: 26L

2.14.2 Approach lighting system: MALSR: 1400 feet medium intensity approach lighting system with runway alignment indicator lights

2.14.4 Visual approach slope indicator system: 4-light PAPI on left

2.14.1 Designation: 10

2.14.2 Approach lighting system: ALSF2: Standard 2400 feet high intensity approach lighting system with sequenced flashers, category II or III configuration

2.14.1 Designation: 28

2.14.2 Approach lighting system: ALSF2: Standard 2400 feet high intensity approach lighting system with sequenced flashers, category II or III configuration

AD 2.18 Air traffic services communication facilities

2.18.1 Service designation: D-ATIS

2.18.3 Service designation: 119.65 MHz

2.18.4 Hours of operation: 24

2.18.1 Service designation: EMERG

2.18.3 Service designation: 121.5 MHz

2.18.1 Service designation: GND/P

2.18.3 Service designation: 121.75 MHz

2.18.1 Service designation: GND/P

2.18.3 Service designation: 121.9 MHz

2.18.1 Service designation: D-ATIS

2.18.3 Service designation: 125.55 MHz

2.18.4 Hours of operation: 24

2.18.1 Service designation: EMERG

2.18.3 Service designation: 243 MHz

- 2.18.1 Service designation: CD/P
- 2.18.3 Service designation: 118.1 MHz

- 2.18.1 Service designation: ILS PRM LCL/P
- 2.18.3 Service designation: 119.1 MHz

- 2.18.1 Service designation: ILS PRM LCL/P
- 2.18.3 Service designation: 125.325 MHz

- 2.18.1 Service designation: ILS PRM LCL/P
- 2.18.3 Service designation: 123.85 MHz

- 2.18.1 Service designation: ILS PRM LCL/P
- 2.18.3 Service designation: 119.3 MHz

- 2.18.1 Service designation: ILS PRM LCL/P
- 2.18.3 Service designation: 119.5 MHz

- 2.18.1 Service designation: GND/P
- 2.18.3 Service designation: 121.65 MHz

- 2.18.1 Service designation: LCL/P GND/P
- 2.18.3 Service designation: 381.6 MHz

- 2.18.1 Service designation: ILS PRM MONITOR/P
- 2.18.3 Service designation: 126.9 MHz

- 2.18.1 Service designation: ILS PRM MONITOR/P
- 2.18.3 Service designation: 132.55 MHz

- 2.18.1 Service designation: ILS PRM MONITOR/P
- 2.18.3 Service designation: 133.425 MHz

- 2.18.1 Service designation: DEP/P
- 2.18.3 Service designation: 135.375 MHz

AD 2.19 Radio navigation and landing aids

- 2.19.1 ILS type: Outer Marker for runway 09L.
Magnetic variation: 2W
- 2.19.2 ILS identification: HZK
- 2.19.5 Coordinates: 33-37-57.07N /
84-32-34.28W
- 2.19.6 Site elevation: 99999 ft

- 2.19.1 ILS type: Localizer for runway 09L.
Magnetic variation: 2W
- 2.19.2 ILS identification: HZK
- 2.19.5 Coordinates: 33-38-00.00N /
84-24-24.40W
- 2.19.6 Site elevation: 968 ft

- 2.19.1 ILS type: Glide Slope for runway 09L.
Magnetic variation: 2W
- 2.19.2 ILS identification: HZK
- 2.19.5 Coordinates: 33-38-00.00N /
84-26-39.67W
- 2.19.6 Site elevation: 1017 ft

- 2.19.1 ILS type: Middle Marker for runway 09L.
Magnetic variation: 2W
- 2.19.2 ILS identification: HZK
- 2.19.5 Coordinates: 33-38-00.00N /
84-27-20.50W
- 2.19.6 Site elevation: 987 ft

- 2.19.1 ILS type: DME for runway 09L. Magnetic
variation: 2W
- 2.19.2 ILS identification: HZK
- 2.19.5 Coordinates: 33-38-00.00N /
84-24-44.38W
- 2.19.6 Site elevation: 978 ft

- 2.19.1 ILS type: Middle Marker for runway 27R.
Magnetic variation: 2W
- 2.19.2 ILS identification: AFA
- 2.19.5 Coordinates: 33-38-00.00N /
84-23-54.35W
- 2.19.6 Site elevation: 954 ft

- 2.19.1 ILS type: Outer Marker for runway 27R.
Magnetic variation: 2W
- 2.19.2 ILS identification: AFA
- 2.19.5 Coordinates: 33-38-00.00N /
84-18-36.44W
- 2.19.6 Site elevation: 905 ft

- 2.19.1 ILS type: DME for runway 27R. Magnetic
variation: 2W
- 2.19.2 ILS identification: AFA
- 2.19.5 Coordinates: 33-38-00.00N /
84-24-44.38W
- 2.19.6 Site elevation: 978 ft

- 2.19.1 ILS type: Localizer for runway 27R.
Magnetic variation: 2W
- 2.19.2 ILS identification: AFA
- 2.19.5 Coordinates: 33-38-00.00N /
84-27-00.00W
- 2.19.6 Site elevation: 1020 ft

- 2.19.1 ILS type: Glide Slope for runway 27R.
Magnetic variation: 2W

2.19.2 ILS identification: AFA 84-27-00.00W
2.19.5 Coordinates: 33-38-00.00N / 2.19.6 Site elevation: 1022 ft
84-24-44.13W
2.19.6 Site elevation: 978 ft

2.19.1 ILS type: DME for runway 09R. Magnetic variation: 2W
2.19.2 ILS identification: FUN
2.19.5 Coordinates: 33-37-56.63N /
84-24-54.23W
2.19.6 Site elevation: 987 ft

2.19.1 ILS type: Outer Marker for runway 09R. Magnetic variation: 2W
2.19.2 ILS identification: FUN
2.19.5 Coordinates: 33-37-57.07N /
84-32-34.28W
2.19.6 Site elevation: 99999 ft

2.19.1 ILS type: Inner Marker for runway 09R. Magnetic variation: 2W
2.19.2 ILS identification: FUN
2.19.5 Coordinates: 33-37-54.52N /
84-27-00.00W
2.19.6 Site elevation: 99999 ft

2.19.1 ILS type: Localizer for runway 09R. Magnetic variation: 2W
2.19.2 ILS identification: FUN
2.19.5 Coordinates: 33-37-54.57N /
84-24-52.61W
2.19.6 Site elevation: 976 ft

2.19.1 ILS type: Glide Slope for runway 09R. Magnetic variation: 2W
2.19.2 ILS identification: FUN
2.19.5 Coordinates: 33-37-58.49N /
84-26-39.06W
2.19.6 Site elevation: 1017 ft

2.19.1 ILS type: Middle Marker for runway 09R. Magnetic variation: 2W
2.19.2 ILS identification: FUN
2.19.5 Coordinates: 33-37-55.50N /
84-27-19.55W
2.19.6 Site elevation: 99999 ft

2.19.1 ILS type: Localizer for runway 27L. Magnetic variation: 2W
2.19.2 ILS identification: FSQ
2.19.5 Coordinates: 33-37-54.53N /

2.19.1 ILS type: Glide Slope for runway 27L. Magnetic variation: 2W
2.19.2 ILS identification: FSQ
2.19.5 Coordinates: 33-37-58.52N /
84-25-16.60W
2.19.6 Site elevation: 986 ft

2.19.1 ILS type: Outer Marker for runway 27L. Magnetic variation: 2W
2.19.2 ILS identification: FSQ
2.19.5 Coordinates: 33-38-00.00N /
84-18-36.44W
2.19.6 Site elevation: 905 ft

2.19.1 ILS type: Middle Marker for runway 27L. Magnetic variation: 2W
2.19.2 ILS identification: FSQ
2.19.5 Coordinates: 33-37-53.22N /
84-24-32.44W
2.19.6 Site elevation: 940 ft

2.19.1 ILS type: Inner Marker for runway 27L. Magnetic variation: 2W
2.19.2 ILS identification: FSQ
2.19.5 Coordinates: 33-37-54.59N /
84-24-52.99W
2.19.6 Site elevation: 984 ft

2.19.1 ILS type: DME for runway 27L. Magnetic variation: 2W
2.19.2 ILS identification: FSQ
2.19.5 Coordinates: 33-37-52.64N /
84-27-00.00W
2.19.6 Site elevation: 1025 ft

2.19.1 ILS type: Localizer for runway 08L. Magnetic variation: 4W
2.19.2 ILS identification: HFW
2.19.5 Coordinates: 33-38-58.35N /
84-24-23.39W
2.19.6 Site elevation: 985 ft

2.19.1 ILS type: Outer Marker for runway 08L. Magnetic variation: 4W
2.19.2 ILS identification: HFW
2.19.5 Coordinates: 33-38-48.52N /
84-32-31.60W
2.19.6 Site elevation: 956 ft

2.19.1 ILS type: Inner Marker for runway 08L.
Magnetic variation: 4W
2.19.2 ILS identification: HFZ
2.19.5 Coordinates: 33-38-58.32N /
84-26-30.52W
2.19.6 Site elevation: 985 ft

2.19.1 ILS type: DME for runway 08L. Magnetic
variation: 4W
2.19.2 ILS identification: HFZ
2.19.5 Coordinates: 33-39-00.00N /
84-24-24.70W
2.19.6 Site elevation: 993 ft

2.19.1 ILS type: Glide Slope for runway 08L.
Magnetic variation: 4W
2.19.2 ILS identification: HFZ
2.19.5 Coordinates: 33-39-00.00N /
84-26-00.00W
2.19.6 Site elevation: 1002 ft

2.19.1 ILS type: Middle Marker for runway 08L.
Magnetic variation: 4W
2.19.2 ILS identification: HFZ
2.19.5 Coordinates: 33-38-58.31N /
84-26-47.75W
2.19.6 Site elevation: 1024 ft

2.19.1 ILS type: Glide Slope for runway 26R.
Magnetic variation: 4W
2.19.2 ILS identification: GXZ
2.19.5 Coordinates: 33-39-00.00N /
84-24-47.63W
2.19.6 Site elevation: 979 ft

2.19.1 ILS type: Outer Marker for runway 26R.
Magnetic variation: 4W
2.19.2 ILS identification: GXZ
2.19.5 Coordinates: 33-38-43.61N /
84-18-39.88W
2.19.6 Site elevation: 834 ft

2.19.1 ILS type: Inner Marker for runway 26R.
Magnetic variation: 4W
2.19.2 ILS identification: GXZ
2.19.5 Coordinates: 33-38-58.36N /
84-24-22.79W
2.19.6 Site elevation: 99999 ft

2.19.1 ILS type: DME for runway 26R. Magnetic
variation: 4W

2.19.2 ILS identification: GXZ
2.19.5 Coordinates: 33-39-00.00N /
84-26-27.65W
2.19.6 Site elevation: 1016 ft

2.19.1 ILS type: Middle Marker for runway 26R.
Magnetic variation: 4W
2.19.2 ILS identification: GXZ
2.19.5 Coordinates: 33-38-56.36N /
84-23-56.86W
2.19.6 Site elevation: 945 ft

2.19.1 ILS type: Localizer for runway 26R.
Magnetic variation: 4W
2.19.2 ILS identification: GXZ
2.19.5 Coordinates: 33-38-58.32N /
84-26-28.21W
2.19.6 Site elevation: 1012 ft

2.19.1 ILS type: Localizer for runway 08R.
Magnetic variation: 2W
2.19.2 ILS identification: ATL
2.19.5 Coordinates: 33-38-48.46N /
84-24-00.00W
2.19.6 Site elevation: 987 ft

2.19.1 ILS type: DME for runway 08R. Magnetic
variation: 2W
2.19.2 ILS identification: ATL
2.19.5 Coordinates: 33-38-46.18N /
84-24-00.00W
2.19.6 Site elevation: 993 ft

2.19.1 ILS type: Outer Marker for runway 08R.
Magnetic variation: 2W
2.19.2 ILS identification: ATL
2.19.5 Coordinates: 33-38-48.52N /
84-32-31.60W
2.19.6 Site elevation: 956 ft

2.19.1 ILS type: Middle Marker for runway 08R.
Magnetic variation: 2W
2.19.2 ILS identification: ATL
2.19.5 Coordinates: 33-38-49.70N /
84-26-48.56W
2.19.6 Site elevation: 1008 ft

2.19.1 ILS type: Inner Marker for runway 08R.
Magnetic variation: 2W
2.19.2 ILS identification: ATL
2.19.5 Coordinates: 33-38-48.43N /

84-26-28.57W

2.19.6 Site elevation: 1033 ft

2.19.1 ILS type: Glide Slope for runway 08R.
Magnetic variation: 2W

2.19.2 ILS identification: ATU

2.19.5 Coordinates: 33-38-52.40N /
84-26-00.00W

2.19.6 Site elevation: 1006 ft

2.19.1 ILS type: DME for runway 26L. Magnetic
variation: 2W

2.19.2 ILS identification: BRU

2.19.5 Coordinates: 33-38-50.57N /
84-26-28.39W

2.19.6 Site elevation: 1026 ft

2.19.1 ILS type: Outer Marker for runway 26L.
Magnetic variation: 2W

2.19.2 ILS identification: BRU

2.19.5 Coordinates: 33-38-43.61N /
84-18-39.88W

2.19.6 Site elevation: 99999 ft

2.19.1 ILS type: Glide Slope for runway 26L.
Magnetic variation: 2W

2.19.2 ILS identification: BRU

2.19.5 Coordinates: 33-38-52.41N /
84-24-32.84W

2.19.6 Site elevation: 988 ft

2.19.1 ILS type: Localizer for runway 26L.
Magnetic variation: 2W

2.19.2 ILS identification: BRU

2.19.5 Coordinates: 33-38-48.43N /
84-26-29.58W

2.19.6 Site elevation: 1032 ft

2.19.1 ILS type: Middle Marker for runway 26L.
Magnetic variation: 2W

2.19.2 ILS identification: BRU

2.19.5 Coordinates: 33-38-48.55N /
84-23-43.60W

2.19.6 Site elevation: 99999 ft

2.19.1 ILS type: Localizer for runway 10. Magnetic
variation: 2W

2.19.2 ILS identification: OMO

2.19.5 Coordinates: 33-37-13.02N /
84-24-53.99W

2.19.6 Site elevation: 970 ft

2.19.1 ILS type: DME for runway 10. Magnetic
variation: 2W

2.19.2 ILS identification: OMO

2.19.5 Coordinates: 33-37-12.45N /
84-24-53.96W

2.19.6 Site elevation: 970 ft

2.19.1 ILS type: Glide Slope for runway 10.
Magnetic variation: 2W

2.19.2 ILS identification: OMO

2.19.5 Coordinates: 33-37-00.00N /
84-26-38.76W

2.19.6 Site elevation: 985 ft

2.19.1 ILS type: Inner Marker for runway 10.
Magnetic variation: 2W

2.19.2 ILS identification: OMO

2.19.5 Coordinates: 33-37-12.98N /
84-27-00.00W

2.19.6 Site elevation: 993 ft

2.19.1 ILS type: DME for runway 28. Magnetic
variation: 2W

2.19.2 ILS identification: PKU

2.19.5 Coordinates: 33-37-12.41N /
84-27-00.00W

2.19.6 Site elevation: 970 ft

2.19.1 ILS type: Localizer for runway 28. Magnetic
variation: 2W

2.19.2 ILS identification: PKU

2.19.5 Coordinates: 33-37-12.97N /
84-27-00.00W

2.19.6 Site elevation: 970 ft

2.19.1 ILS type: Glide Slope for runway 28.
Magnetic variation: 2W

2.19.2 ILS identification: PKU

2.19.5 Coordinates: 33-37-17.07N /
84-25-19.84W

2.19.6 Site elevation: 990 ft

2.19.1 ILS type: Inner Marker for runway 28.
Magnetic variation: 2W

2.19.2 ILS identification: PKU

2.19.5 Coordinates: 33-37-13.02N /
84-24-55.77W

2.19.6 Site elevation: 974 ft

General Remarks:

BE ALERT TO RUNWAY CROSSING CLEARANCES. READBACK OF ALL RUNWAY HOLDING INSTRUCTIONS IS REQUIRED.

PREFERENTIAL RUNWAY USE IN EFFECT, EXPECT TO USE RUNWAYS 08R/26L, 09L/27R FOR DEPS; RUNWAYS 08L/26R, 09R/27L ARE USED PRIMARILY FOR ARRIVALS.

RUNUPS ARE PERMITTED AT VARIOUS SITES; COORDINATE USE OF CITY FACILITIES, MOVEMENT AREAS, ALLOWABLE NON-MOVEMENT AREAS WITH DEPT OF AVIATION OPERATIONS, 404-530-6620; AND COORDINATE THE USE OF THE AIRLINES' FACILITIES WITH THEM.

NOISE & OPERATIONS MONITORING SYSTEM (NOMS) PROGRAM IN EFFECT; CALL THE ATLANTA DEPT OF AVIATION 770-43-NOISE OR 770-436-6473 FOR MORE INFORMATION.

ALL RUNWAYS, TOUCH AND GO OPERATIONS, LOW APPROACHES, AND PRACTICE INSTRUMENT APPROACHES NOT PERMITTED.

GROUP VI AIRCRAFT(LOCKHEED GALAXY C-5; ANTONOV AN-124 & AN-125) WITH A WINGSPAN OF GREATER THAN 214 FT ARE RESTRICTED FROM USING TAXIWAY 'L' EAST OF RAMP 5 SOUTH TO THE WEST SIDE OF RAMP 6 SOUTH, AND TAXIWAY 'F' EAST OF RAMP 5 NORTH AND WEST OF TAXIWAY DIXIE.

ASDE-X SURVEILLANCE SYSTEM IN USE: PILOTS SHOULD OPERATE TRANSPONDERS WITH MODE C ON ALL TAXIWAYS AND RUNWAYS.

AIRCRAFT WITH WINGSPAN GREATER THAN 171 FT ARE RESTRICTED FROM USING TAXIWAY V.

RUNWAY 9L DEPARTURES CAN EXPECT INTERSECTION DEPARTURE FROM M2 WITH RUNWAY REMAINING 10,940 FT.

Agana, Guam
Guam International
ICAO Identifier PGUM

10210 AIRPORT DIAGRAM AL-2146 (FAA) GUAM INTL (GUM)(PGUM) GUAM, GQ

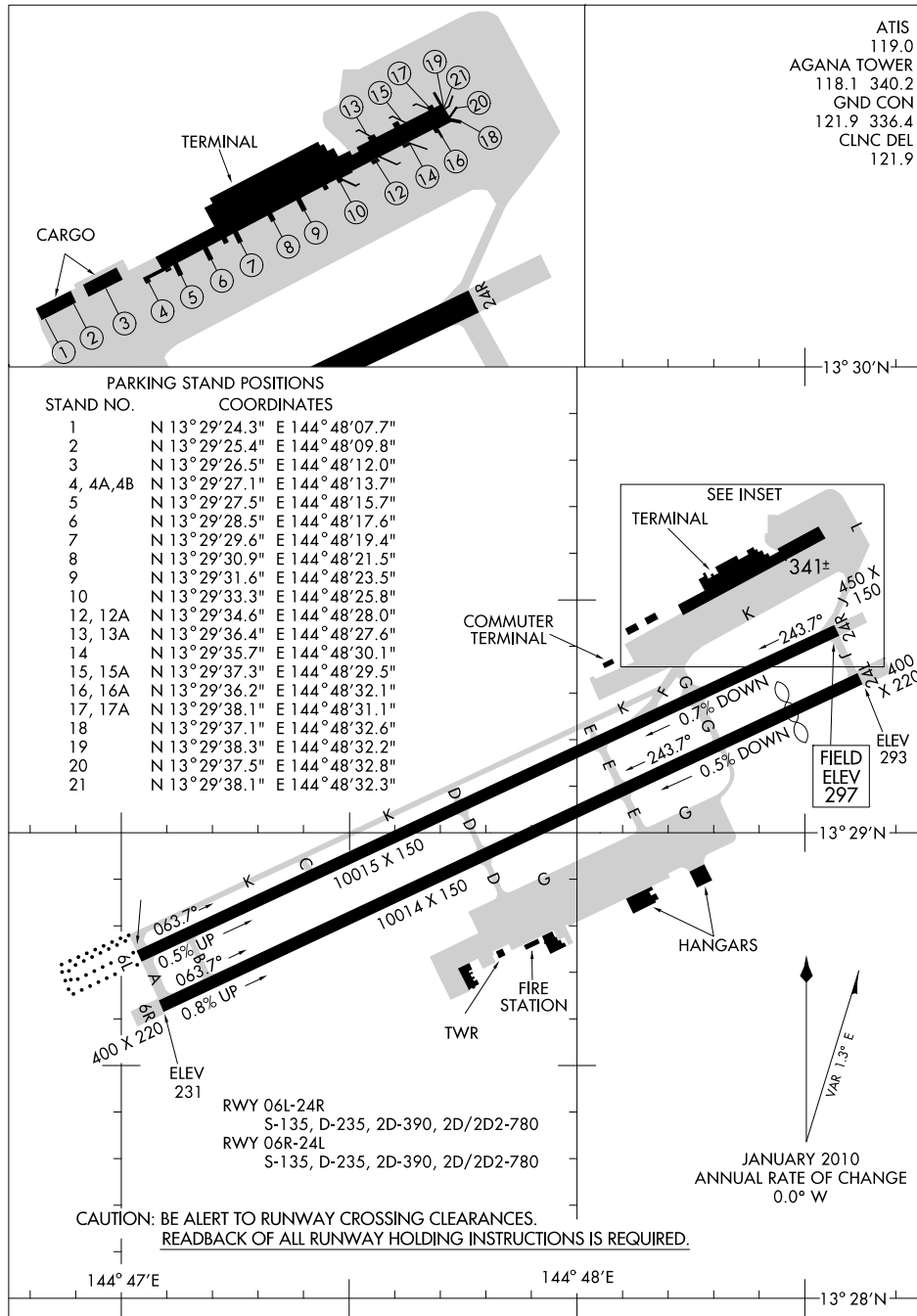

PAC, 13 JAN 2011 to 10 MAR 2011

PAC, 13 JAN 2011 to 10 MAR 2011

AIRPORT DIAGRAM GUAM, GQ
10210 GUAM INTL (GUM)(PGUM)

Agana, GU
Guam Intl
ICAO Identifier PGUM

AD 2.2 Aerodrome geographical and administrative data

- 2.2.1 Reference Point: 13-29-00.00N / 144-47-49.81E
- 2.2.2 From City: 3 Miles NE Of Agana, GU
- 2.2.3 Elevation: 297 ft
- 2.2.5 Magnetic variation: 2E (2000)
- 2.2.6 Airport Contact: Jess Q. Torres
P.O. BOX 8770
Tamuning, GU 96931
(671-646-0300)
- 2.2.7 Traffic: IFR/VFR

AD 2.3 Operational hours

- 2.3.1 - 2.3.11: ALL Months, ALL Days, ALL Hours

AD 2.4 Handling services and facilities

- 2.4.1 Cargo handling facilities: No
- 2.4.2 Fuel types: 100LL,A1
- 2.4.4 De-icing facilities: None
- 2.4.5 Hangar space: Yes
- 2.4.6 Repair facilities: Minor

AD 2.6 Rescue and firefighting services

- 2.6.1 Aerodrome category for firefighting: ARFF Index I E certified on 4/1/1995

AD 2.10 Aerodrome obstacles

- 2.10.1.a. Runway designation: 06L
- 2.10.1.b Type of obstacle: Tower (420 ft). Not Lighted or Marked
- 2.10.1.c Location of obstacle: 1500 ft from Centerline

- 2.10.1.a. Runway designation: 06R
- 2.10.1.b Type of obstacle: Tower (420 ft). Not Lighted or Marked
- 2.10.1.c Location of obstacle: 1500 ft from Centerline

- 2.10.1.a. Runway designation: 24L
- 2.10.1.b Type of obstacle: Hill (220 ft). Not Lighted or Marked
- 2.10.1.c Location of obstacle: 1200 ft from Centerline

AD 2.12 Runway physical characteristics

- 2.12.1 Designation: 06L
- 2.12.2 True Bearing: 65
- 2.12.3 Dimensions: 10015 ft x 150 ft
- 2.12.5 Coordinates: 13-28-44.07N / 144-47-00.00E
- 2.12.6 Threshold elevation: 239 ft
- 2.12.6 Touchdown zone elevation: 256 ft

- 2.12.1 Designation: 24R
- 2.12.2 True Bearing: 245
- 2.12.3 Dimensions: 10015 ft x 150 ft
- 2.12.5 Coordinates: 13-29-26.12N / 144-48-34.29E
- 2.12.6 Threshold elevation: 297 ft
- 2.12.6 Touchdown zone elevation: 297 ft

- 2.12.1 Designation: 06R
- 2.12.2 True Bearing: 65
- 2.12.3 Dimensions: 10014 ft x 150 ft
- 2.12.5 Coordinates: 13-28-37.78N / 144-47-00.00E
- 2.12.6 Threshold elevation: 231 ft
- 2.12.6 Touchdown zone elevation: 258 ft

- 2.12.1 Designation: 24L
- 2.12.2 True Bearing: 245
- 2.12.3 Dimensions: 10014 ft x 150 ft
- 2.12.5 Coordinates: 13-29-19.82N / 144-48-37.29E
- 2.12.6 Threshold elevation: 293 ft
- 2.12.6 Touchdown zone elevation: 289 ft

AD 2.14 Approach and runway lighting

- 2.14.1 Designation: 06L
- 2.14.2 Approach lighting system: MALSR: 1400 feet medium intensity approach lighting system with runway alignment indicator lights
- 2.14.4 Visual approach slope indicator system: 4-light PAPI on left

- 2.14.1 Designation: 24R
- 2.14.4 Visual approach slope indicator system: 4-light PAPI on left

- 2.14.1 Designation: 06R
- 2.14.2 Approach lighting system: MALSR: 1400 feet medium intensity approach lighting system with runway alignment indicator lights
- 2.14.4 Visual approach slope indicator system: 4-light PAPI on right

2.14.1 Designation: 24L
2.14.4 Visual approach slope indicator system:
PVASI on left

AD 2.19 Radio navigation and landing aids

2.19.1 ILS type: Localizer for runway 06L.

Magnetic variation: 2E

2.19.2 ILS identification: GUM

2.19.5 Coordinates: 13-29-30.59N /
144-48-44.07E

2.19.6 Site elevation: 308 ft

2.19.1 ILS type: Glide Slope for runway 06L.

Magnetic variation: 2E

2.19.2 ILS identification: GUM

2.19.5 Coordinates: 13-28-51.82N /
144-47-00.00E

2.19.6 Site elevation: 246 ft

2.19.1 ILS type: Outer Marker for runway 06L.

Magnetic variation: 2E

2.19.2 ILS identification: GUM

2.19.5 Coordinates: 13-26-41.70N /
144-42-29.30E

2.19.6 Site elevation: 99999 ft

2.19.1 ILS type: Middle Marker for runway 06L.

Magnetic variation: 2E

2.19.2 ILS identification: GUM

2.19.5 Coordinates: 13-28-33.30N /
144-46-31.80E

General Remarks:

1000' OVERRUN S END & 450' OVERRUN N END RUNWAY 6L-24R.

FOR PARKING INFORMATION ALL AIRCRAFT CONTACT RAMP CONTROL. ALL AIRCRAFT DEP
TERMINAL PARKING CONTACT RAMP CONTROL FOR ENGINE START AND PUSHBACK.

TRANSIENT AIRCRAFT PROVIDE 24 HRS ADVANCE INFORMATION TO EXECUTIVE MANAGER
GUAM INTL AIRPORT AUTHORITY; 1-671-646-0300/01/02 MON-FRI 0800-1700 OR FAX
1-671-646-8823.

EFFECTIVE RUNWAY GRADIENT RUNWAY 06L 0.46% UP NE; RUNWAY 24R 0.70% DOWN SW;
RUNWAY 06R 0.80 % UP NE; RUNWAY 24L 0.52% DOWN SW.

LIGHTED TOWER 780 FT 1.3 NAUTICAL MILE ENE OF RUNWAY 24L THRESHOLD.

RISING TERRAIN 75 FT FROM RUNWAY 24L THRESHOLD 140 FT EAST OF CENTERLINE
EXTENDED +8 FT.

DEP VFR AIRCRAFT MAINT RUNWAY HEADING UNTIL PAST DEP END OF RUNWAY AND
REACHING 1000 FT AGL; RIGHT PATTERN 24L/R DO NOT EXCEED 1500 FT AGL IN TRAFFIC
PATTERN.

2.19.6 Site elevation: 99999 ft

2.19.1 ILS type: DME for runway 06L. Magnetic
variation: 2E

2.19.2 ILS identification: GUM

2.19.5 Coordinates: 13-29-34.10N /
144-48-42.94E

2.19.6 Site elevation: 317 ft

2.19.1 ILS type: Glide Slope for runway 06R.

Magnetic variation: 2E

2.19.2 ILS identification: AWD

2.19.5 Coordinates: 13-28-38.00N /
144-47-15.40E

2.19.6 Site elevation: 237 ft

2.19.1 ILS type: Localizer for runway 06R.

Magnetic variation: 2E

2.19.2 ILS identification: AWD

2.19.5 Coordinates: 13-29-24.23N /
144-48-46.93E

2.19.6 Site elevation: 311 ft

2.19.1 ILS type: DME for runway 06R. Magnetic
variation: 2E

2.19.2 ILS identification: AWD

2.19.5 Coordinates: 13-29-21.74N /
144-48-48.12E

2.19.6 Site elevation: 316 ft

Guam Island, Guam Andersen Air Force Base ICAO Identifier PGUA

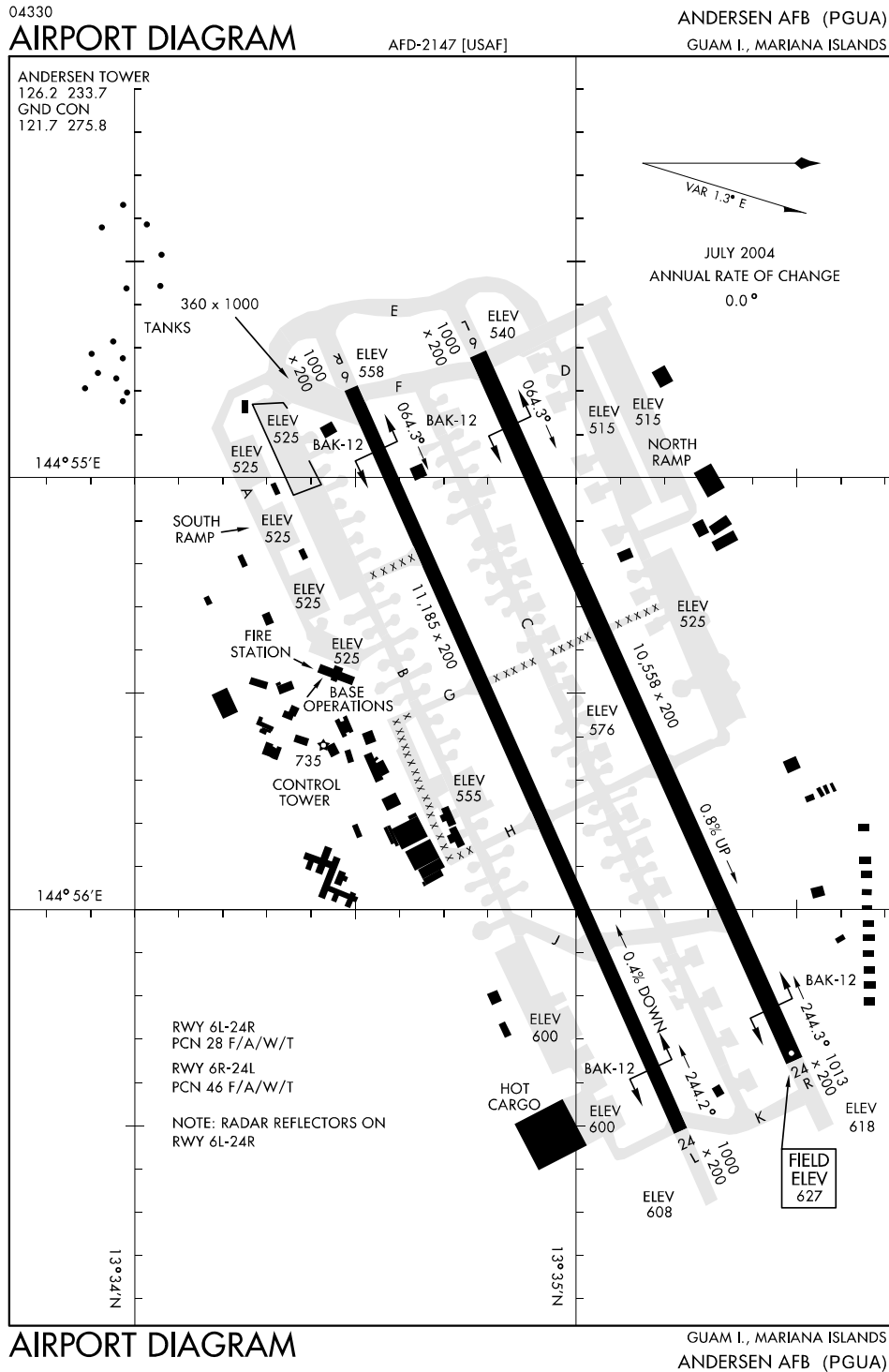

Andersen, Mariana Island, GU
Andersen AFB
ICAO Identifier PGUA

AD 2.2 Aerodrome geographical and administrative data

- 2.2.1 Reference Point: 13-35-00.00N / 144-55-48.24E
- 2.2.2 From City: 0 Miles N Of Andersen, Mariana Island, GU
- 2.2.3 Elevation: 612 ft
- 2.2.5 Magnetic variation: 2E (1980)
- 2.2.7 Traffic: IFR/VFR

AD 2.3 Operational hours

- 2.3.1 - 2.3.11: ALL Months, ALL Days, ALL Hours

AD 2.4 Handling services and facilities

- 2.4.1 Cargo handling facilities: No
- 2.4.2 Fuel types: None
- 2.4.4 De-icing facilities: None
- 2.4.5 Hangar space: Yes
- 2.4.6 Repair facilities: None

AD 2.6 Rescue and firefighting services

- 2.6.1 Aerodrome category for firefighting: None

AD 2.10 Aerodrome obstacles

- 2.10.1.a Runway designation: 06R
- 2.10.1.b Type of obstacle: Tower-L. Not Lighted or Marked

AD 2.12 Runway physical characteristics

- 2.12.1 Designation: 06L
- 2.12.3 Dimensions: 10549 ft x 200 ft
- 2.12.4 PCN: 88 R/B/W/T
- 2.12.5 Coordinates: 13-34-49.24N / 144-54-56.24E
- 2.12.6 Threshold elevation: 535 ft

- 2.12.1 Designation: 24R
- 2.12.3 Dimensions: 10549 ft x 200 ft
- 2.12.4 PCN: 88 R/B/W/T
- 2.12.5 Coordinates: 13-35-31.98N / 144-56-33.86E

- 2.12.6 Threshold elevation: 613 ft

- 2.12.1 Designation: 06R
- 2.12.3 Dimensions: 11204 ft x 200 ft
- 2.12.4 PCN: 45 R/B/W/T
- 2.12.5 Coordinates: 13-34-31.15N / 144-54-59.35E
- 2.12.6 Threshold elevation: 558 ft
- 2.12.6 Touchdown zone elevation: 558 ft

- 2.12.1 Designation: 24L
- 2.12.3 Dimensions: 11204 ft x 200 ft
- 2.12.4 PCN: 45 R/B/W/T
- 2.12.5 Coordinates: 13-35-16.58N / 144-56-43.01E
- 2.12.6 Threshold elevation: 608 ft
- 2.12.6 Touchdown zone elevation: 608 ft

AD 2.14 Approach and runway lighting

- 2.14.1 Designation: 06L
- 2.14.2 Approach lighting system: SALS: Short approach lighting system
- 2.14.4 Visual approach slope indicator system: 4-light PAPI on left

- 2.14.1 Designation: 24R
- 2.14.2 Approach lighting system: ALSF1: Standard 2400 feet high intensity approach lighting system with sequenced flashers, category 1 configuration
- 2.14.4 Visual approach slope indicator system: 4-light PAPI on left

- 2.14.1 Designation: 06R
- 2.14.2 Approach lighting system: ALSF1: Standard 2400 feet high intensity approach lighting system with sequenced flashers, category 1 configuration
- 2.14.4 Visual approach slope indicator system: 4-light PAPI on left

- 2.14.1 Designation: 24L
- 2.14.2 Approach lighting system: SALS: Short approach lighting system
- 2.14.4 Visual approach slope indicator system: 4-light PAPI on left
- 2.14.10 Remarks: Mod 1300' Length.

General Remarks:

FREQUENT RAIN SHOWERS OF SHORT DURATION, EXPECT WET RUNWAY BRAKING ACTION.

HAZARDOUS AIR TURBULENCE FINAL APPROACH RUNWAYS 24L/24R. NO VISIBILITY REFERENCE AVAILABLE ON NIGHT TAKE-OFF BEYOND END RUNWAY 6.

ARRESTING GEAR BAK-12 RUNWAYS 06L & 06R 30 MIN NOTICE REQUIRE.

AREA BETWEEN 1000' ROLL BAR AND THU LIGHT RUNWAY 06R AND 06L UNLIGHTED. LAST 642' PRIOR TO THU LIGHT 24R UNLIGHTED.

MAINT AVAILABLE 0100-0400 WEEKDAY ONLY; CLOSED WEEKEND & HOLIDAY.

BASE OPERATIONS V366-4188; FAX V366-6217.

TAXIWAY B AND C BETWEEN TAXIWAY J AND K CLOSED DUE TO CONSTRUCTION.

NO ARRESTING GEAR MARKERS LOCATED ON THE LEFT SIDE OF ALL APPROACH END BARRIERS.

RESTRICTED: BRAKING ACTION ON BOTH RUNWAYS MAY BE LESS THAN EXPECT DUE TO RUBBER BUILD-UP; PROBABILITY OF HYDROPLANING EXISTS.

RESTRICTED: PRIOR PERMISSION NOT REQUIRED FOR AIR MOBILITY COMMAND MSN. ALL AEROMEDICAL EVACUATION MISSIONS ARE REQUIRED TO CONTACT AMCC (DSN 366-2961, C671-366-2961) BY ANY MEANS AVAIL 3 HRS PRIOR TO ARR. ALL AIR MOBILITY COMMAND AIRCRAFT REQUIRE TO MAKE UHF CALL 30 MIN PRIOR ARR.

MISC: AIRFIELD MANAGEMENT HAS NO COMSEC STORAGE AVAILABLE FOR TRANSIENT AIRCREWS. TRANSMIT AIRCREWS CAN STORE COMSEC AT 36WG CIRCULAR POLARIZATION; AIR MOBILITY COMMAND AIRCREWS CAN STORE COMSEC AT AMCC.

MISC: ALL NON-AMC AIRCREWS INTENDING TO REMAINING OVERNIGHT MUST CHECK INTO AIRFIELD MANAGEMENT OPERATIONS AND PROVIDE POC INFORMATION UPON ARRIVAL.

MISC: BASE WX STATION PROVIDES CONTINUOUS 24-HOUR SERVICE OBSN, LIMITED WX BRIEF SUPPORT. WX OBSERVERS VIEW OBSTRUCTED BY BUILDINGS N-SSW. REMOTE WX BRIEF AVAILABLE CONTINUOUS 24-HOUR SERVICE FOR USAF/USA FOREIGN FR 17 OWS AT DSN 449-8333/7950, C808-448-3809.

RESTRICTED: ALL NON-AMC AIRCRAFT CONTACT 36 WG COMMAND POST 90 MIN OUT AND AT 30 MIN OUT PRIOR TO ARR.

MISC: AIRCRAFT EXCEEDING AIRFIELD WEIGHTS MUST REQUEST WEIGHT BEARING CAPACITY WAIVER WITH 24 HR NOTICE TO AIRFIELD OPERATIONS TO PROCESS ANY APPROVALS NEEDED. IF REQUESTS ARE NOT MADE WITHIN 24 HRS EXPECT DELAYS.

RESTRICTED #1 PART A: ALL AIRCRAFT DEP PGUA ARE REQUIRED TO HAVE A BROWN TREE SNAKE INSPECTION CONDUCTED BY USDA PRIOR TO ENGINE START.

RESTRICTED #1 PART B: OUTBND AIRCRAFT MUST CONTACT 36 WG COMMAND POST DSN 366-2981 3 HR PRIOR TO DEP AND/OR 3 HR PRIOR TO ESTIMATED TIME OF DEPARTURE CHANGE.

RESTRICTED #1 PART C: CONTACT 36 WG COMMAND POST AT DSN 366-2981 TO SCHEDULE BTS INSPECTIONS. FAILURE TO RECEIVE THIS INSPECTION WILL RESULT IN UNNECESSARY DELAYS AND PROBABLE DENIAL OF DEPARTURE CLEARANCE.

SERVICE-A-GEAR: CONTACT CONTROL TOWER 30 MIN PRIOR FOR DEPARTURE END BAK12 CABLE CONFIGURATION. 30 MIN PRIOR NOTICE REQ FOR CHANGE CONFIGURATION. BAK12 HOUSING LOCATED 317' FROM RUNWAY CENTERLINE, 217' FROM RUNWAY EDGE, MAX HEIGHT 8'. NO ARRESTING-GEAR MARKER LOCATED ON LEFT SIDE OF ALL APPROACH END BARRIERS.

RESTRICTED: PRIOR PERMISSION REQUIRED DSN 366-4188/2260.

MISC: ATTENTION: ALL DRY ICE REQ MUST BE MADE THRU 734TH MS/ATOC DSN 315-366-3125/3137/3162 OR C671-366-3125/3137/3162. REQ MUST BE MADE AT LEAST 24 HR IN ADVANCE FOR AIRCRAFT LANDING TUE-FRI AND 72 HR IN ADVANCE FOR AIRCRAFT LANDING SAT-MON. DUR HOLIDAY, ADD 2 HR TO COORD TIME.

RESTRICTED: RESTRICTIONS TO FLIGHT OPERATIONS DUR EA BIRD WATCH CONDITION. MODERATE: NO TOUCH AND GO LANDING. RESTRICTED LOW APPROACH NO LOWER THAN 200' OR AS DETERMINED BY SOF. SEVERE: RESTRICTED LOW APPROACH NO LOWER THAN 200' OR AS DETERMINED BY SOF. EMERGENCY LANDING AND 36 OG/CC APPROVE DEP ONLY. PHASE I: PHASE I:1 APR - 31 JUL. PHASE II: 1 AUG - 31 AT SEA.

RESTRICTED 1 OF 2: THERE WILL BE NO OVERFLIGHT OF MARIANA CROW TERRITORIES BELOW 1,000 FT AGL FROM SEP-MAY. OVERFLIGHT BELOW 1,000 FT AGL IS ALLOWED BETWEEN JUNE AND AUG, THE CROW NON-BREEDING SEASON.

RESTRICTED 2 OF 2: CROW NESTING TERRITORIES ARE IDENT BY DEPARTMENT OF AQUATIC AND WILDLIFE RESOURCES (DAWR) AND UPDATES WILL BE PROVIDED TO 36 CES/CEV AND 36TH OSS STAFFS.

MISC: RUNWAY 06L AND 06R UNDERRUNS 1000' AVAILABLE FOR TWY/TKOF. RUNWAY 24R UNDERRUN AVAILABLE 500' FOR TAXI/TKOF.

Hilo, Hawaii Hilo International ICAO Identifier PHTO

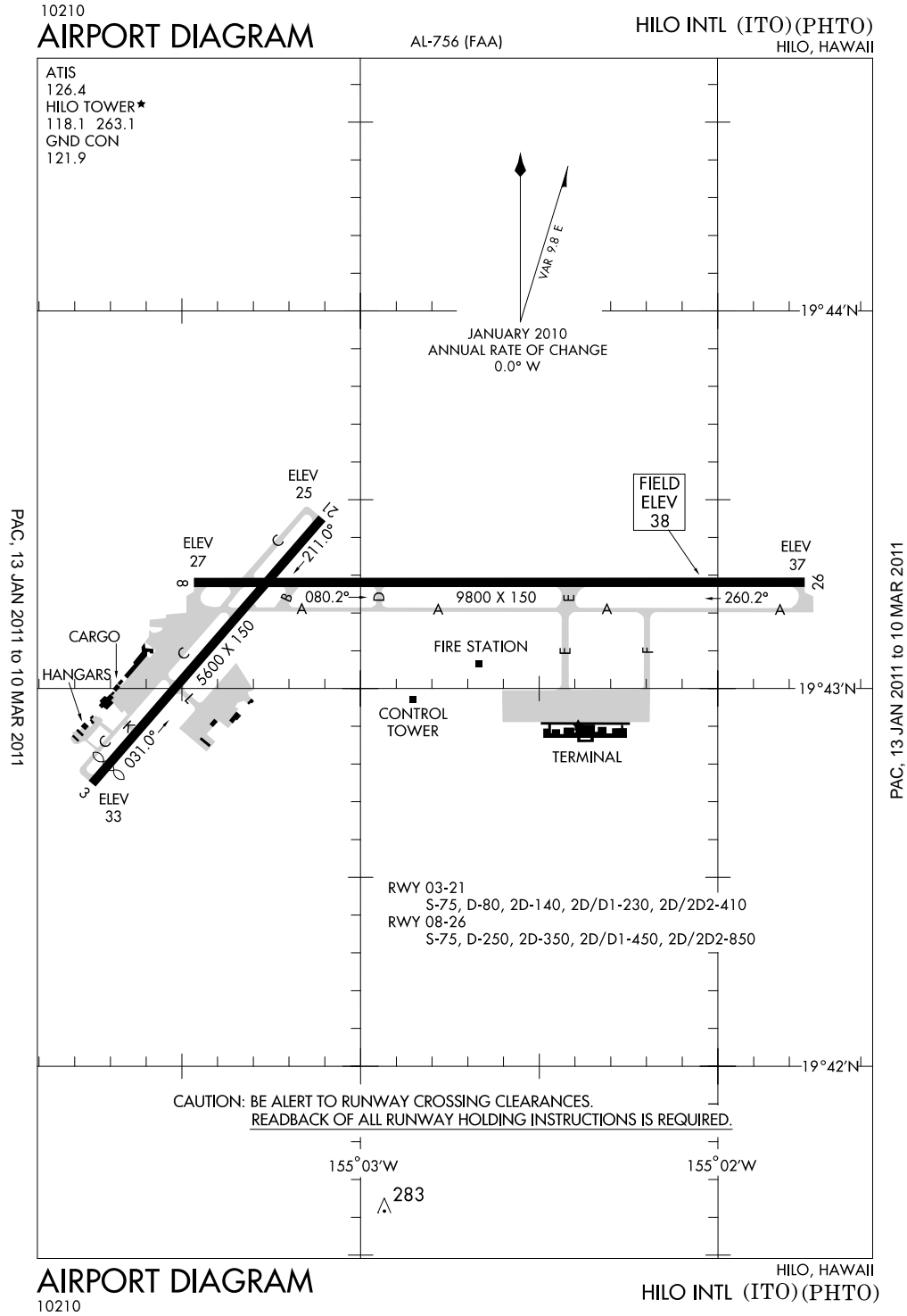

Hilo, HI
Hilo Intl
ICAO Identifier PHTO

AD 2.2 Aerodrome geographical and administrative data

- 2.2.1 Reference Point: 19-43-12.95N / 155-02-54.49W
- 2.2.2 From City: 2 Miles E Of Hilo, HI
- 2.2.3 Elevation: 38 ft
- 2.2.5 Magnetic variation: 11E (1985)
- 2.2.6 Airport Contact: Steven J. Santiago
ASSISTANT AIRPORT DISTRICT
MANAGER
Hilo, HI 96720 (808-961-9300)
- 2.2.7 Traffic: IFR/VFR

AD 2.3 Operational hours

- 2.3.1 - 2.3.11: ALL Months, ALL Days, 0700-2030 Hours

AD 2.4 Handling services and facilities

- 2.4.1 Cargo handling facilities: No
- 2.4.2 Fuel types: 100LL,A
- 2.4.4 De-icing facilities: None
- 2.4.5 Hangar space: No
- 2.4.6 Repair facilities: Minor

AD 2.6 Rescue and firefighting services

- 2.6.1 Aerodrome category for firefighting: ARFF Index I C certified on 5/1/1973

AD 2.10 Aerodrome obstacles

- 2.10.1.a. Runway designation: 08
- 2.10.1.b Type of obstacle: Tree (32 ft). Not Lighted or Marked
- 2.10.1.c Location of obstacle: 600 ft from Centerline

- 2.10.1.a. Runway designation: 26
- 2.10.1.b Type of obstacle: Tree (25 ft). Not Lighted or Marked
- 2.10.1.c Location of obstacle: 400 ft from Centerline

- 2.10.1.a. Runway designation: 03
- 2.10.1.b Type of obstacle: Fence (7 ft). Not Lighted or Marked
- 2.10.1.c Location of obstacle: 0 ft from Centerline

- 2.10.1.a. Runway designation: 21

- 2.10.1.b Type of obstacle: Pole (37 ft). Not Lighted or Marked
- 2.10.1.c Location of obstacle: 20 ft from Centerline

AD 2.12 Runway physical characteristics

- 2.12.1 Designation: 08
- 2.12.2 True Bearing: 90
- 2.12.3 Dimensions: 9800 ft x 150 ft
- 2.12.5 Coordinates: 19-43-16.93N / 155-03-27.99W
- 2.12.6 Threshold elevation: 27 ft
- 2.12.6 Touchdown zone elevation: 30 ft

- 2.12.1 Designation: 26
- 2.12.2 True Bearing: 270
- 2.12.3 Dimensions: 9800 ft x 150 ft
- 2.12.5 Coordinates: 19-43-16.92N / 155-01-45.41W
- 2.12.6 Threshold elevation: 37 ft
- 2.12.6 Touchdown zone elevation: 38 ft

- 2.12.1 Designation: 03
- 2.12.2 True Bearing: 41
- 2.12.3 Dimensions: 5600 ft x 150 ft
- 2.12.5 Coordinates: 19-42-44.96N / 155-03-44.78W
- 2.12.6 Threshold elevation: 33 ft
- 2.12.6 Touchdown zone elevation: 34 ft
- 2.12.7 Slope: 0.1DOWN

- 2.12.1 Designation: 21
- 2.12.2 True Bearing: 221
- 2.12.3 Dimensions: 5600 ft x 150 ft
- 2.12.5 Coordinates: 19-43-26.99N / 155-03-00.00W
- 2.12.6 Threshold elevation: 25 ft
- 2.12.6 Touchdown zone elevation: 31 ft
- 2.12.7 Slope: 0.1UP

AD 2.14 Approach and runway lighting

- 2.14.1 Designation: 08
- 2.14.2 Approach lighting system: Omnidirectional approach lighting system
- 2.14.4 Visual approach slope indicator system: 6-box VASI on left
- 2.14.10 Remarks: VASI Upwind Threshold Crossing Height 110.3' Glide Angle 3.25 Degs; Downwind Threshold Crossing Height 59.6' Glide Angle 3.00 Degs.

- 2.14.1 Designation: 26

2.14.2 Approach lighting system: MALSR: 1400 feet medium intensity approach lighting system with runway alignment indicator lights
2.14.4 Visual approach slope indicator system: 4-box VASI on left

2.14.1 Designation: 03
2.14.4 Visual approach slope indicator system: 4-box VASI on left
2.14.10 Remarks: VASI Usable Dist Limited To 4 Nm From Threshold Due Obstruction.

AD 2.18 Air traffic services communication facilities

2.18.1 Service designation: LCL/P
2.18.3 Service designation: 118.1 MHz

2.18.1 Service designation: APCH/P DEP/P
2.18.3 Service designation: 119.7 MHz

2.18.1 Service designation: EMERG
2.18.3 Service designation: 121.5 MHz

2.18.1 Service designation: GND/P
2.18.3 Service designation: 121.9 MHz

2.18.1 Service designation: ATIS
2.18.3 Service designation: 126.4 MHz
2.18.4 Hours of operation: 24

2.18.1 Service designation: EMERG
2.18.3 Service designation: 243 MHz

2.18.1 Service designation: LCL/P
2.18.3 Service designation: 263.1 MHz

2.18.1 Service designation: APCH/P DEP/P

General Remarks:

RUNWAY 08 PAVED 1325' MARKED BY CHEVRONS, UNUSABLE FOR LANDING/TAKEOFF/OVERUN/STY; CANNOT BE USED IN COMPUTING TAKE-OFF DATA.

ATCT CONTROLS ENTRY/EXIT TRAFFIC ON TAXIWAYS F&E TO EAST TERMINAL RAMP.

181' LIGHTED SMOKE STACK 1/2 STATUTE MILE SOUTH OF FIELD.

PRIOR PERMISSION REQUIRED FROM AIRPORT MANAGER FOR TRANSIENT PARKING.

BE ALERT OCCASIONAL BIRD FLOCKS ON AIRPORT AND IN FLIGHT ACROSS RUNWAY 08/26 AND 03/21.

2.18.3 Service designation: 269.2 MHz
2.18.1 Service designation: APCH/S DEP/S
2.18.3 Service designation: 323 MHz

2.18.1 Service designation: APCH/S DEP/S
2.18.3 Service designation: 120.25 MHz

AD 2.19 Radio navigation and landing aids

2.19.1 ILS type: DME for runway 26. Magnetic variation: 11E
2.19.2 ILS identification: ITO
2.19.5 Coordinates: 19-43-13.74N / 155-03-39.51W
2.19.6 Site elevation: 39 ft

2.19.1 ILS type: Glide Slope for runway 26. Magnetic variation: 11E
2.19.2 ILS identification: ITO
2.19.5 Coordinates: 19-43-20.89N / 155-01-58.10W
2.19.6 Site elevation: 33 ft

2.19.1 ILS type: Middle Marker for runway 26. Magnetic variation: 11E
2.19.2 ILS identification: ITO
2.19.5 Coordinates: 19-43-16.90N / 155-01-00.00W
2.19.6 Site elevation: 26 ft

2.19.1 ILS type: Localizer for runway 26. Magnetic variation: 11E
2.19.2 ILS identification: ITO
2.19.5 Coordinates: 19-43-16.93N / 155-03-38.78W
2.19.6 Site elevation: 26 ft

(A70A) JET FUEL AVAILABLE MON-SAT 0800-1700 CALL (808) 935-6881/6122 OR 961-6601.

(E93) NO MARKED PAD, HELICOPTER OPER FROM FBO HANGER AREA.

CLASS A AND B EXPLOSIVES PROHIBITED.

PRIOR PERMISSION REQUIRED FROM AIRPORT MANAGER FOR TRANSPORTATION OF CLASS C EXPLOSIVES AND HAZARDOUS MATERIAL IN OR OUT OF AIRPORT.

NOISE ABATEMENT: AVOID OVERFLIGHT OF NOISE SENSITIVE RESIDENTIAL AREAS N, W AND SW OF AIRPORT.

RUNWAY 3/21 CLOSED TO TURBINE AIRCRAFT 1800-0600.

RUNWAY 08/26 SINGLE-BELLY TWIN TANDEM (SBTT) GROSS WEIGHT 450,000 LBS.

RUNWAY 03/21 SINGLE-BELLY TWIN TANDEM (SBTT) GROSS WEIGHT 230,000 LBS.

STATIONARY CONSTRUCTION CRANE 180 MSL (155 AGL) LOCATED 1.5 MILES WEST-SOUTHWEST OF AIRPORT.

Honolulu, Hawaii Honolulu International ICAO Identifier PHNL

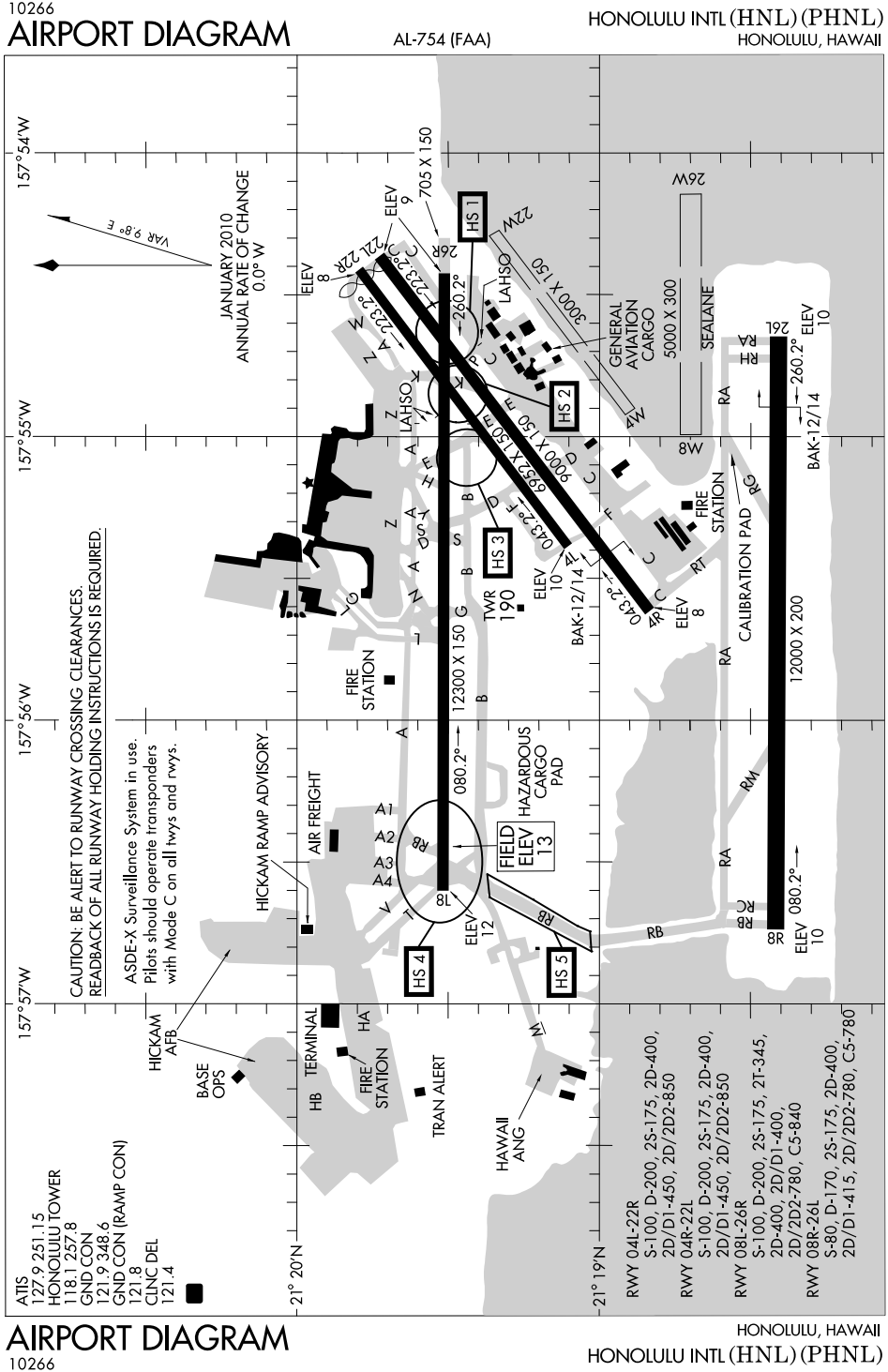

Honolulu, HI
Honolulu Intl
ICAO Identifier PHNL

AD 2.2 Aerodrome geographical and administrative data

- 2.2.1 Reference Point: 21-19-00.00N / 157-55-20.74W
- 2.2.2 From City: 3 Miles NW Of Honolulu, HI
- 2.2.3 Elevation: 13 ft
- 2.2.5 Magnetic variation: 11E (1990)
- 2.2.6 Airport Contact: Jim Pratt
300 RODGERS BLVD. #12
Honolulu, HI 96819
(808-836-6533)
- 2.2.7 Traffic: IFR/VFR

AD 2.3 Operational hours

- 2.3.1 - 2.3.11: ALL Months, ALL Days, ALL Hours

AD 2.4 Handling services and facilities

- 2.4.1 Cargo handling facilities: No
- 2.4.2 Fuel types: 100,80,A,A1+,B
- 2.4.4 De-icing facilities: None
- 2.4.5 Hangar space: No
- 2.4.6 Repair facilities: Major

AD 2.6 Rescue and firefighting services

- 2.6.1 Aerodrome category for firefighting: ARFF Index I E certified on 5/1/1973

AD 2.10 Aerodrome obstacles

- 2.10.1.a. Runway designation: 22L
- 2.10.1.b Type of obstacle: Stack (74 ft). Not Lighted or Marked
- 2.10.1.c Location of obstacle: 475 ft from Centerline

- 2.10.1.a. Runway designation: 04R
- 2.10.1.b Type of obstacle: Tree (20 ft). Not Lighted or Marked
- 2.10.1.c Location of obstacle: 200 ft from Centerline

- 2.10.1.a. Runway designation: 26R
- 2.10.1.b Type of obstacle: Road (15 ft). Not Lighted or Marked
- 2.10.1.c Location of obstacle: 500 ft from Centerline

- 2.10.1.a. Runway designation: 22R
- 2.10.1.b Type of obstacle: Ant (50 ft). Not Lighted or Marked
- 2.10.1.c Location of obstacle: 20 ft from Centerline

AD 2.12 Runway physical characteristics

- 2.12.1 Designation: 04R
- 2.12.2 True Bearing: 53
- 2.12.3 Dimensions: 9000 ft x 150 ft
- 2.12.5 Coordinates: 21-18-50.10N / 157-55-37.69W
- 2.12.6 Threshold elevation: 8 ft
- 2.12.6 Touchdown zone elevation: 9 ft

- 2.12.1 Designation: 22L
- 2.12.2 True Bearing: 233
- 2.12.3 Dimensions: 9000 ft x 150 ft
- 2.12.5 Coordinates: 21-19-43.76N / 157-54-21.65W
- 2.12.6 Threshold elevation: 9 ft
- 2.12.6 Touchdown zone elevation: 9 ft

- 2.12.1 Designation: 08L
- 2.12.2 True Bearing: 90
- 2.12.3 Dimensions: 12300 ft x 150 ft
- 2.12.5 Coordinates: 21-19-30.89N / 157-56-35.64W
- 2.12.6 Threshold elevation: 12 ft
- 2.12.6 Touchdown zone elevation: 13 ft

- 2.12.1 Designation: 26R
- 2.12.2 True Bearing: 270
- 2.12.3 Dimensions: 12300 ft x 150 ft
- 2.12.5 Coordinates: 21-19-30.88N / 157-54-25.54W
- 2.12.6 Threshold elevation: 9 ft
- 2.12.6 Touchdown zone elevation: 9 ft

- 2.12.1 Designation: 08R
- 2.12.2 True Bearing: 90
- 2.12.3 Dimensions: 12000 ft x 200 ft
- 2.12.5 Coordinates: 21-18-24.49N / 157-56-45.07W
- 2.12.6 Threshold elevation: 10 ft
- 2.12.6 Touchdown zone elevation: 10 ft

- 2.12.1 Designation: 26L
- 2.12.2 True Bearing: 270
- 2.12.3 Dimensions: 12000 ft x 200 ft
- 2.12.5 Coordinates: 21-18-24.48N / 157-54-38.15W

2.12.6 Threshold elevation: 10 ft
2.12.6 Touchdown zone elevation: 10 ft

2.12.1 Designation: 04L
2.12.2 True Bearing: 53
2.12.3 Dimensions: 6952 ft x 150 ft
2.12.5 Coordinates: 21-19-00.00N /
157-55-23.95W
2.12.6 Threshold elevation: 10 ft
2.12.6 Touchdown zone elevation: 10 ft

2.12.1 Designation: 22R
2.12.2 True Bearing: 233
2.12.3 Dimensions: 6952 ft x 150 ft
2.12.5 Coordinates: 21-19-47.45N /
157-54-25.22W
2.12.6 Threshold elevation: 8 ft
2.12.6 Touchdown zone elevation: 10 ft

2.12.1 Designation: 04W
2.12.2 True Bearing: 51
2.12.3 Dimensions: 3000 ft x 150 ft
2.12.5 Coordinates: 21-18-53.09N /
157-54-46.44W

2.12.1 Designation: 22W
2.12.2 True Bearing: 231
2.12.3 Dimensions: 3000 ft x 150 ft
2.12.5 Coordinates: 21-19-11.80N /
157-54-21.78W

2.12.1 Designation: 08W
2.12.2 True Bearing: 91
2.12.3 Dimensions: 5000 ft x 300 ft
2.12.5 Coordinates: 21-18-40.85N /
157-55-00.00W

2.12.1 Designation: 26W
2.12.2 True Bearing: 271
2.12.3 Dimensions: 5000 ft x 300 ft
2.12.5 Coordinates: 21-18-39.98N /
157-54-00.00W

AD 2.13 Declared distances

2.13.1 Designation: 04L
2.13.2 Takeoff run available: 6948
2.13.3 Takeoff distance available: 6948
2.13.4 Accelerate-stop distance available: 6398
2.13.5 Landing distance available: 6398

2.13.1 Designation: 22R

2.13.2 Takeoff run available: 6948
2.13.3 Takeoff distance available: 6948
2.13.4 Accelerate-stop distance available: 6948
2.13.5 Landing distance available: 6798

AD 2.14 Approach and runway lighting

2.14.1 Designation: 04R
2.14.2 Approach lighting system: MALSR: 1400
feet medium intensity approach lighting system
with runway alignment indicator lights
2.14.4 Visual approach slope indicator system:
4-light PAPI on left

2.14.1 Designation: 22L
2.14.4 Visual approach slope indicator system:
4-box VASI on left
2.14.10 Remarks: VASI Unusable Beyond 2 Nm
From Threshold
ry 22L VASI GA 3.0deg Threshold Crossing
Height 52 Ft.

2.14.1 Designation: 08L
2.14.2 Approach lighting system: MALSR: 1400
feet medium intensity approach lighting system
with runway alignment indicator lights
2.14.4 Visual approach slope indicator system:
4-light PAPI on left

2.14.1 Designation: 26R
2.14.4 Visual approach slope indicator system:
6-box VASI on left
2.14.10 Remarks: VASI Upper GA 3.25 Degrees
Threshold Crossing Height 96 Ft ; Lower GA 3.00
Degrees Threshold Crossing Height 52 Ft .

2.14.1 Designation: 08R
2.14.4 Visual approach slope indicator system:
6-box VASI on left
2.14.10 Remarks: VASI Runway 08R Upper GA
3.25 Degrees Threshold Crossing Height 96 Ft;
Lower GA 3.0 Degrees Threshold Crossing Height
52 Ft.

2.14.1 Designation: 26L
2.14.4 Visual approach slope indicator system:
4-light PAPI on left

2.14.1 Designation: 04L
2.14.4 Visual approach slope indicator system:
4-light PAPI on left

AD 2.18 Air traffic services communication facilities

2.18.1 Service designation: LCL/P

2.18.3 Service designation: 118.1 MHz

2.18.1 Service designation: DEP/P

2.18.3 Service designation: 118.3 MHz

2.18.1 Service designation: APCH/P

2.18.3 Service designation: 118.3 MHz

2.18.1 Service designation: CLASS B

2.18.3 Service designation: 119.1 MHz

2.18.1 Service designation: AS ASGND

2.18.3 Service designation: 120.9 MHz

2.18.1 Service designation: CD

2.18.3 Service designation: 121.4 MHz

2.18.1 Service designation: EMERG

2.18.3 Service designation: 121.5 MHz

2.18.1 Service designation: HONOLULU RAMP
ADVISORY

2.18.3 Service designation: 121.8 MHz

2.18.1 Service designation: GND/P

2.18.3 Service designation: 121.9 MHz

2.18.1 Service designation: LCL/S

2.18.3 Service designation: 123.9 MHz

2.18.1 Service designation: DEP/P CLASS B

2.18.3 Service designation: 124.8 MHz

2.18.1 Service designation: D-ATIS

2.18.3 Service designation: 127.9 MHz

2.18.4 Hours of operation: 24

2.18.1 Service designation: PTD

2.18.3 Service designation: 133.6 MHz

2.18.1 Service designation: HICKAM ADVSY
RAMP

2.18.3 Service designation: 133.6 MHz

2.18.1 Service designation: CP

2.18.3 Service designation: 141.8 MHz

2.18.1 Service designation: EMERG

2.18.3 Service designation: 243 MHz

2.18.1 Service designation: LCL/P

2.18.3 Service designation: 257.8 MHz

2.18.1 Service designation: DEP/P

2.18.3 Service designation: 269 MHz

2.18.1 Service designation: APCH/P

2.18.3 Service designation: 269 MHz

2.18.1 Service designation: CD

2.18.3 Service designation: 281.4 MHz

2.18.1 Service designation: AS ASGND

2.18.3 Service designation: 285.4 MHz

2.18.1 Service designation: ANG-OPNS

2.18.3 Service designation: 293.7 MHz

2.18.1 Service designation: SAC-OPNS

2.18.3 Service designation: 311 MHz

2.18.1 Service designation: DEP/P CLASS B

2.18.3 Service designation: 317.6 MHz

2.18.1 Service designation: APCH/P DEP/P

2.18.3 Service designation: 338.2 MHz

2.18.1 Service designation: GND/P

2.18.3 Service designation: 348.6 MHz

2.18.1 Service designation: PTD

2.18.3 Service designation: 372.2 MHz

2.18.1 Service designation: COMD POST

2.18.3 Service designation: 292.5 MHz

2.18.1 Service designation: SHAKA OPS

2.18.3 Service designation: 125.3 MHz

2.18.1 Service designation: SHAKA OPS

2.18.3 Service designation: 349.4 MHz

2.18.1 Service designation: HICKAM RAMP
ADVISORY

2.18.3 Service designation: 234.8 MHz

2.18.1 Service designation: D-ATIS

2.18.3 Service designation: 251.15 MHz

2.18.4 Hours of operation: 24

2.18.1 Service designation: CLASS B
2.18.3 Service designation: 239.05 MHz

157-54-16.41W
2.19.6 Site elevation: 6 ft

2.18.1 Service designation: LCL/S
2.18.3 Service designation: 273.575 MHz

2.19.1 ILS type: Middle Marker for runway 08L.
Magnetic variation: 11E

2.19.2 ILS identification: HNL

2.19.5 Coordinates: 21-19-31.00N /
157-57-10.30W

2.19.6 Site elevation: 99999 ft

AD 2.19 Radio navigation and landing aids

2.19.1 ILS type: Localizer for runway 04R.
Magnetic variation: 11E

2.19.2 ILS identification: IUM

2.19.5 Coordinates: 21-19-49.82N /
157-54-13.05W

2.19.6 Site elevation: 5 ft

2.19.1 ILS type: Glide Slope for runway 08L.

Magnetic variation: 11E

2.19.2 ILS identification: HNL

2.19.5 Coordinates: 21-19-26.68N /
157-56-22.59W

2.19.6 Site elevation: 7 ft

2.19.1 ILS type: DME for runway 04R. Magnetic
variation: 11E

2.19.2 ILS identification: IUM

2.19.5 Coordinates: 21-19-47.83N /
157-54-12.09W

2.19.6 Site elevation: 21 ft

2.19.1 ILS type: Outer Marker for runway 08L.

Magnetic variation: 11E

2.19.2 ILS identification: HNL

2.19.5 Coordinates: 21-19-29.70N /
158-02-55.90W

2.19.6 Site elevation: 99999 ft

2.19.1 ILS type: Glide Slope for runway 04R.
Magnetic variation: 11E

2.19.2 ILS identification: IUM

2.19.5 Coordinates: 21-18-53.99N /
157-55-26.90W

2.19.6 Site elevation: 6 ft

2.19.1 ILS type: Localizer for runway 26L.

Magnetic variation: 11E

2.19.2 ILS identification: EPC

2.19.5 Coordinates: 21-19-34.96N /
157-54-28.18W

2.19.6 Site elevation: 7 ft

2.19.1 ILS type: Middle Marker for runway 04R.
Magnetic variation: 11E

2.19.2 ILS identification: IUM

2.19.5 Coordinates: 21-18-33.00N /
157-55-59.70W

2.19.6 Site elevation: 4 ft

2.19.1 ILS type: DME for runway 26L. Magnetic

variation: 11E

2.19.2 ILS identification: EPC

2.19.5 Coordinates: 21-19-36.96N /
157-54-25.90W

2.19.6 Site elevation: 21 ft

2.19.1 ILS type: Localizer for runway 08L.
Magnetic variation: 11E

2.19.2 ILS identification: HNL

2.19.5 Coordinates: 21-19-30.88N /

General Remarks:

REMAIN AT LEAST 1 MILE OFF SHORE OF WAIKIKI DIAMOND HEAD KOKO HEAD & EWA BEACH. ARR RUNWAY 08L; FLY ILS APPROACH PROC OR A CLOSE-IN BASE LEG REMAINING OVER CENTER OF PEARL HARBOR CHANNEL. ARR 26L/R; RNM AT TRAFFIC PATTERN ALTITUDES AS LONG AS POSSIBLE BEFORE BEGINNING DESCENT FOR LANDING.

RUNWAY 04R/22L DC10 450000+; L-1011 450000+; RUNWAY 04L/22R DC10 450000; L-1011 450000+; RUNWAY 08L/26R DC10 400000; L-1011 410000; RUNWAY 08R/26L DC10 415000; L-1011 400000.

PRIOR PERMISSION REQUIRED FROM AIRPORT MANAGER FOR TRANSPORTATION OF CLASS A

OR B EXPLOSIVES IN AND/OR OUT OF HNL.

DUE TO NON-VISIBILITY TOWER UNABLE TO DETERMINE IF THE FOLLOWING AREAS ARE CLEAR OF OBSTRUCTIONS AND/OR TRAFFIC: PORTIONS OF TAXIWAY RB BETWEEN TAXIWAY B & RUNWAY 08R; PORTIONS OF INTER-ISLAND AIRCRAFT PARKING RAMP.

MILITARY: PRIOR PERMISSION REQUIRED ALL AIRCRAFT UNITS PLANNING TO STAGE OPERATIONS FROM HICKAM AFB MUST CONTACT 15 OSS/OSX DSN 315-449-3129 NOT LATER THAN 3 WEEKS PRIOR REGARDLESS.

PERSONNEL AND EQUIPMENT WORKING 600-1300 FT EAST RUNWAY 22L & 22R THRESHOLD, 0700-1530 MON-FRI.

DUE TO LOCATION OF ATCT, CONTROLLERS UNABLE TO DETERMINE WHETHER AIRCRAFT ARE ON CORRECT FINAL APPROACH TO RUNWAYS 04L-04R AND 22L-22R.

TAXIWAYS G AND L BETWEEN TAXIWAY A AND INTER-ISLAND RAMP CLOSED TO WIDE-BODIED AND 4-ENGINE TURBO-JET AIRCRAFT UNDER POWER WITHOUT PRIOR PERMISSION FROM AIRPORT OPERATIONS MANAGER (808) 836-6428 MON-FRI 0745-1630.

RUNWAYS CLOSED 0730-0930 EVERY MONTH AS FOLLOWS; RUNWAY 04R/22L FIRST TUE; RUNWAY 08R/26L SECOND TUE; AND RUNWAY 08L/26R THIRD TUE.

CAUTION: DURING PERIODS OF REPEATED PRECIPITATION ANTICIPATE WET RUNWAY CONDITIONS, IF CURRENT CONDITIONS REQUIRE CONFIRMATION CONTACT HONOLULU TOWER ON INITIAL CONTACT.

CAUTION: RECREATIONAL BOATING ACTIVITIES ON AND IN THE VICINITY OF WATERWAYS.

MILITARY: ALL AIRCRAFT INBOUND TO HICKAM SHOULD ADDRESS FLIGHT PLAN TO PHIK.

MILITARY: ALL MILITARY AIRCRAFT WITH VIP CODE 7 OR ABOVE CONTACT 15AB COMMAND POST OR RELAY THRU HF/SSB AIRWAY 1 HOUR OUT TO CONFIRM BLOCKTIME.

TRAFFIC PATTERN OVERHEAD ALTITUDE 2000 FT, RESTRICTED TO HIANG AIRCRAFT.

MILITARY: ALL MILITARY AIRCRAFT REQUIRE CUSTOMS/AGRICULTURE/IMIGRATION INSPECTION MUST CONTACT HICKAM PILOT TO DISPATCH OR IF AIR MOBILITY COMMAND CONTACT HICKAM AMCC, NOT LATER THAN 3 HRS PRIOR TO ARR WITH ESTIMATE BLOCK TIME, NR OF CIV/MIL PAX/FOREIGN NATIONALS/AND DV CODES.*

RUNWAYS 04W/22W AND 08W/26W RECREATIONAL BOATING ACTIVITIES ON AND IN THE VICINITY OF WATERWAYS.

BIRD STRIKE HAZARD ALL RUNWAYS.

MILITARY ARRESTING GEAR: HOOK MB100(B) LOCATED 200 FT FROM THRESHOLD RUNWAY 26R.

MILITARY: TO MINIMIZE FOREIGN OBJECT DAMAGE POTENTIAL, ALL AIRCRAFT SHOULD USE MINIMUM THRUST, EXPECIALLY OUTBOARD ENGINES, WHEN TAXIING PAST THE F-15

ALERT FACILITY ON TAXIWAY TANGO.

MILITARY CAUTION: FOREIGN OBJECT DAMAGE HAZARD EXISTS ON ALL MOVEMENT AREAS EAST OF TAXIWAY SIERRA. FIGHTER AIRCRAFT EXERCISE EXTREME CAUTION WHEN TAXING.

MILITARY CAUTION: A FOREIGN OBJECT DAMAGE HAZARD EXISTS ON ALL TAXIWAYS AND RUNWAYS BUT ESPECIALLY ON RUNWAY 4L/22R AND TAXIWAYS NORTH OF RUNWAY 8L/26R.

TAXIWAY L LIGHTS BETWEEN GATE 50 AND GATE 59 OUT OF SERVICE INDEFINITELY.

MILITARY CAUTION: NO F-16 TRANSIENT SUPPORT AVAILABLE IN ACCORDANCE WITH AREA CONTROL CENTER LSET FLASH SAFETY 06-02. TRANSIENT F-16 UNITS SHOULD PROVIDE THEIR OWN MAINTENANCE SUPPORT.

MILITARY RESTRICTED: ALL TRANSIENT AIRCRAFT, NOT ON AN AIR MOBILITY COMMAND MSN, WILL PROVIDE A 2-3 HR OUT CALL, AS WELL AS 20-30 MIN OUT CALL ON 292.5 TO THE 15 AW/CP (KOA CONTROL). UPON ARRIVAL, CREWS WILL PROCEED DIRECTLY TO COMMAND POST (BLDG 2050) AND COMPLETE AN OUTBOUND SETUP SHEET TO FACILITATE DEPARTURE REQUIREMENTS.

MILITARY/COMMUNICATIONS: BEDTIME "(613AOC/AMD CORONET MSN COMMANDER WILL MEET AIRCRAFT UPON ARR; ALL CORONET W TANKERS USE 311.0 FOR TANKER-FIGHTER INTER-PLANE ON LAUNCH DAY. AFTER DUTY HR DSN 448-8888 613AOC/AMD, FLIGHT MANAGEMENT.)

CRANE 280 FT AGL 300 FT NORTH TERMINAL CENTRAL CONCOURSE UNTIL 01 JAN 2009.

TAXIWAY G LIGHTED SIGN OUT OF SERVICE AT RUNWAY 8L/26R TAXIWAY G INTERSECTION.

MILITARY MISC (1 OF 2): HICKAM BASE WX STATION OPEN MON-FRI 1400Z-0800Z; CLOSED WEEKENDS/HOL EXCEPT DUR LOCAL FLYING, AS MANNING PERMITS.

MILITARY MISC (2 OF 2 CONT'D): LIMITED WX BRIEF SUPPORT. REMOTE FLIGHT WX BRIEFINGS CONTACT 17TH WX SQUALL 24 HR, DSN 315-449-7950/8333/8335, FAX DSN 315-449-8336; 2 HR PRIOR NOTICE REQUIRE FOR TIMELY BRIEF. OFFICIAL OBSN TAKEN BY FAA. COOPERATIVE WX WATCH PROCEDURES DO NOT EXIST BETWEEN WX AND ATC.

MILITARY MISC: NO COMSEC MATERIAL AVAILABLE THRU HICKAM AIRFIELD OPERATIONS. TRANSIENT AIRCREWS SHOULD PLAN TO ARR WITH APPROPRIATE AMOUNT OF COMSEC TO COMPLETE ENTIRE MSN.

MILITARY REMARKS: SEE FLIGHT INFORMATION PUBLICATION AP/3 SUPPLEMENTARY AIRPORT INFORMATION, ROUTE AND AREA RESTRICTED, AND OAKLAND FIR FLIGHT HAZARD.

ASDE-X SURVEILLANCE SYSTEM IN USE: PILOTS SHOULD OPERATE TRANSPONDERS WITH MODE C ON ALL TAXIWAYS AND RUNWAYS.

MILITARY CAUTION: USE CAUTION FOR OBST 76_i FR TAXIWAY "M" CENTERLINE ON OCEANSIDE, APPROXIMATELY 200_i FR PARK APRON.

MILITARY MISC: AIRFIELD OPERATIONS DSN 449-0046/0048 FAX DSN 449-7624.

MILITARY RESTRICTED: WIDE BODY AND 4 ENGINE TURBO-JETS LANDING ON RUNWAY 04R
ROLL TO END OF RUNWAY, NO LEFT TURN AT TAXIWAY K WITHOUT TOWER APPROVAL.
TAXIWAY K NOT A HIGH SPEED EXIT TAXIWAY. TAXIWAY RA HOLD SHORT APPROACH ZONE
RUNWAY 04L/R AT HOLD LINE. TAXIWAY P CLOSED TO AIRCRAFT OVER 12,500 LB.

Kahului, Hawaii
Kahului
ICAO Identifier PHOG

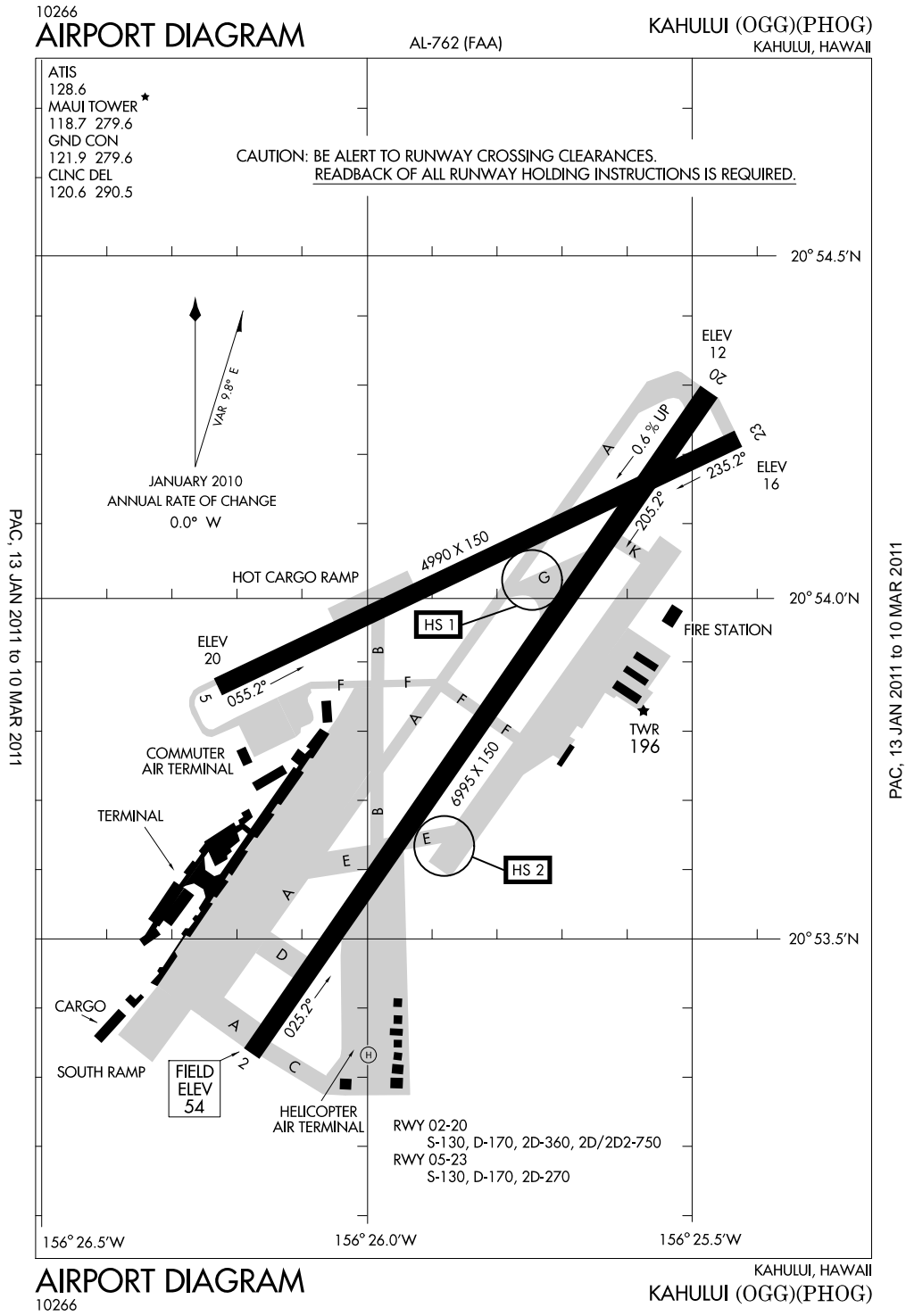

Kahului, HI
Kahului
ICAO Identifier PHOG

AD 2.2 Aerodrome geographical and administrative data

- 2.2.1 Reference Point: 20-53-55.14N / 156-25-49.65W
- 2.2.2 From City: 3 Miles E Of Kahului, HI
- 2.2.3 Elevation: 54 ft
- 2.2.5 Magnetic variation: 11E (1990)
- 2.2.6 Airport Contact: Marvin Moniz
1 KAHULUI AIRPORT ROAD, UNIT 5
Kahului, HI 96732 (808-872-3808)
- 2.2.7 Traffic: IFR/VFR

AD 2.3 Operational hours

- 2.3.1 - 2.3.11: ALL Months, ALL Days, ALL Hours

AD 2.4 Handling services and facilities

- 2.4.1 Cargo handling facilities: No
- 2.4.2 Fuel types: 100,A
- 2.4.4 De-icing facilities: None
- 2.4.5 Hangar space: No
- 2.4.6 Repair facilities: Minor

AD 2.6 Rescue and firefighting services

- 2.6.1 Aerodrome category for firefighting: ARFF Index I D certified on 5/1/1973

AD 2.10 Aerodrome obstacles

- 2.10.1.a. Runway designation: 02
- 2.10.1.b Type of obstacle: Stack (198 ft). Lighted
- 2.10.1.c Location of obstacle: 500 ft from Centerline

- 2.10.1.a. Runway designation: 20
- 2.10.1.b Type of obstacle: Bldg (5 ft). Marked
- 2.10.1.c Location of obstacle: 250 ft from Centerline

- 2.10.1.a. Runway designation: 05
- 2.10.1.b Type of obstacle: Trees (31 ft). Not Lighted or Marked

- 2.10.1.a. Runway designation: 23
- 2.10.1.b Type of obstacle: Pole (35 ft). Not Lighted or Marked

AD 2.12 Runway physical characteristics

- 2.12.1 Designation: 02
- 2.12.2 True Bearing: 35
- 2.12.3 Dimensions: 6995 ft x 150 ft
- 2.12.5 Coordinates: 20-53-20.90N / 156-26-10.75W
- 2.12.6 Threshold elevation: 54 ft
- 2.12.6 Touchdown zone elevation: 54 ft

- 2.12.1 Designation: 20
- 2.12.2 True Bearing: 215
- 2.12.3 Dimensions: 6995 ft x 150 ft
- 2.12.5 Coordinates: 20-54-17.71N / 156-25-28.47W
- 2.12.6 Threshold elevation: 12 ft
- 2.12.6 Touchdown zone elevation: 25 ft

- 2.12.1 Designation: H1
- 2.12.3 Dimensions: 125 ft x 125 ft

- 2.12.1 Designation: 05
- 2.12.2 True Bearing: 65
- 2.12.3 Dimensions: 4990 ft x 150 ft
- 2.12.5 Coordinates: 20-53-52.88N / 156-26-13.56W
- 2.12.6 Threshold elevation: 20 ft
- 2.12.6 Touchdown zone elevation: 20 ft

- 2.12.1 Designation: 23
- 2.12.2 True Bearing: 245
- 2.12.3 Dimensions: 4990 ft x 150 ft
- 2.12.5 Coordinates: 20-54-13.75N / 156-25-25.85W
- 2.12.6 Threshold elevation: 16 ft
- 2.12.6 Touchdown zone elevation: 17 ft

AD 2.14 Approach and runway lighting

- 2.14.1 Designation: 02
- 2.14.2 Approach lighting system: MALSR: 1400 feet medium intensity approach lighting system with runway alignment indicator lights
- 2.14.4 Visual approach slope indicator system: 4-box VASI on left

- 2.14.1 Designation: 20
- 2.14.4 Visual approach slope indicator system: 4-light PAPI on left

- 2.14.1 Designation: 05
- 2.14.4 Visual approach slope indicator system: 4-box VASI on left

2.14.10 Remarks: VASI Unusable Beyond 4 Nm From Threshold Due To Rapidly Rising Terrain.

CLASS C IC
2.18.3 Service designation: 322.4 MHz

AD 2.18 Air traffic services communication facilities

2.18.1 Service designation: LCL/P
2.18.3 Service designation: 118.7 MHz

2.18.1 Service designation: APCH/P DEP/P CLASS C IC
2.18.3 Service designation: 225.4 MHz

2.18.1 Service designation: APCH/P DEP/P CLASS C IC
2.18.3 Service designation: 119.5 MHz

AD 2.19 Radio navigation and landing aids

2.19.1 ILS type: Localizer for runway 02. Magnetic variation: 11E

2.18.1 Service designation: APCH/P DEP/P CLASS C IC
2.18.3 Service designation: 120.2 MHz

2.19.2 ILS identification: OGG
2.19.5 Coordinates: 20-54-22.18N / 156-25-25.15W

2.18.1 Service designation: CD
2.18.3 Service designation: 120.6 MHz

2.19.6 Site elevation: 6 ft

2.18.1 Service designation: EMERG
2.18.3 Service designation: 121.5 MHz

2.19.1 ILS type: Glide Slope for runway 02. Magnetic variation: 11E

2.18.1 Service designation: GND/P
2.18.3 Service designation: 121.9 MHz

2.19.2 ILS identification: OGG
2.19.5 Coordinates: 20-53-29.55N / 156-25-59.23W

2.18.1 Service designation: ATIS
2.18.3 Service designation: 128.6 MHz
2.18.4 Hours of operation: 24

2.19.6 Site elevation: 48 ft

2.18.1 Service designation: EMERG
2.18.3 Service designation: 243 MHz

2.19.1 ILS type: Middle Marker for runway 02. Magnetic variation: 11E

2.18.1 Service designation: LCL/P
2.18.3 Service designation: 279.6 MHz

2.19.2 ILS identification: OGG
2.19.5 Coordinates: 20-52-59.70N / 156-26-26.50W
2.19.6 Site elevation: 66 ft

2.18.1 Service designation: GND/P
2.18.3 Service designation: 279.6 MHz

2.19.1 ILS type: Outer Marker for runway 02. Magnetic variation: 11E

2.18.1 Service designation: CD/P
2.18.3 Service designation: 290.5 MHz

2.19.2 ILS identification: OGG
2.19.5 Coordinates: 20-48-13.30N / 156-29-59.30W
2.19.6 Site elevation: 39 ft

2.18.1 Service designation: APCH/P DEP/P

2.19.1 ILS type: DME for runway 02. Magnetic variation: 11E

General Remarks:

570' LIGHTED TOWER APPROXIMATE 3 MI. W.

24 HRS PRIOR PERMISSION REQUIRED FOR CLASS A & B EXPLOSIVES AND 4 HRS PRIOR PERMISSION REQUIRED FOR OTHER HAZARDOUS CARGO IN/OUT OF AIRPORT; CONTACT (808) 872-3830 0745-1630 OTHER TIMES (808) 872-3888.

RAMP AREA E SIDE RUNWAY 02 UNDER STATE AUTHORITY. FAA NOT RESPONSIBLE FOR

DIRECTION & CONTROL GROUND TRAFFIC IN AREA.

MIGRATORY BIRD ACTIVITY BELOW 1500 FT WITHIN 5 NAUTICAL MILE RADIUS OF AIRPORT DURING AUG-MAY.

MILITARY HELICOPTER OPERATIONS RESTRICTED TO HAZMAT AREA N OF RUNWAY 05/23.

COMMUTER TERMINAL RAMP RESTRICTED TO AIRCRAFT 140000 LBS OR LESS.

AREA E OF APPROACH END RUNWAY 02 DESIGNATED AS HELICOPTER OPER AREA. NO FIXED WING AIRCRAFT MAY OPER ON HELIPAD DURING OPERATIONAL HRS SR-SS.

PRIOR PERMISSION REQUIRED FOR FIXED WING AIRCRAFT OPERATIONS ON HELIPAD DURING NON-OPERATIONAL HRS CALL (808) 872-3880 5:15A-10:00P.

ACCESS TO HELIPAD FROM TAXIWAY C ONLY.

DUE TO NONVISIBILITY ATCT UNABLE TO DETERMINE IF FOLLOWING AREA IS CLEAR OF OBSTRUCTIONS AND/OR TRAFFIC: PORTION OF TAXIWAY F BETWEEN THE COMMUTER AIR TERMINAL & APPROACH END RUNWAY 05.

DUE TO NONVISIBILITY ATCT UNABLE TO PROVIDE ATC SERVICE BETWEEN AIRCRAFT & GROUND VEHICLES ON THE COMMUTER AIR TERMINAL S OF TAXIWAY F AND THE HELICOPTER AIR TERMINAL E OF APPROACH END RUNWAY 02.

TRANSIENT PARKING LOCATED ON NE SECTION OF E RAMP.

RUNWAY 02/20 SINGLE-BELLY TWIN TANDEM (SBTT) GROSS WEIGHT 460,000 LBS.

TAXIWAY G CLOSED TO AIRCRAFT OVER 30,000 LBS.

AIRCRAFT ABOVE 80,000 LBS LANDING RUNWAY 02 UNABLE TO TURN OFF ONTO RUNWAY 05 DUE TO RUNWAY 05 PAVEMENT CONDITION.

TAXIWAY F CLOSED TO LEFT TURNS FROM RUNWAY 02 AIRCRAFT ABOVE 80,000 LBS.

Chicago, Illinois
Chicago-O'Hare International
ICAO Identifier KORD

11013 AIRPORT DIAGRAM AL-166 (FAA) CHICAGO-O'HARE INTL (ORD) CHICAGO, ILLINOIS

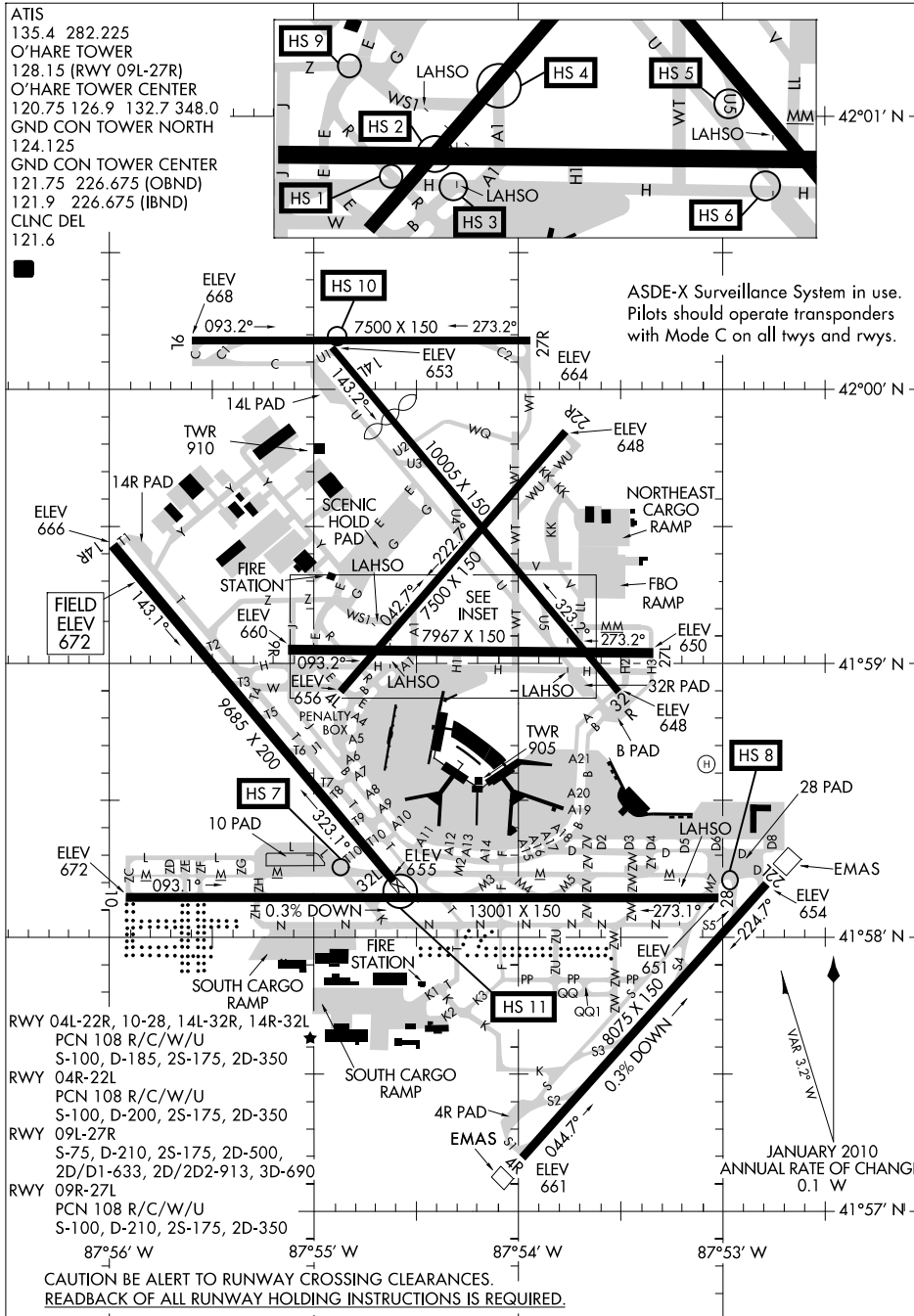

EC-3, 13 JAN 2011 to 10 FEB 2011

EC-3, 13 JAN 2011 to 10 FEB 2011

AIRPORT DIAGRAM CHICAGO, ILLINOIS CHICAGO-O'HARE INTL (ORD) 11013

Chicago, IL
Chicago O'Hare Intl
ICAO Identifier KORD

AD 2.2 Aerodrome geographical and administrative data

- 2.2.1 Reference Point: 41-58-53.94N / 87-54-24.02W
- 2.2.2 From City: 14 Miles NW Of Chicago, IL
- 2.2.3 Elevation: 672 ft
- 2.2.5 Magnetic variation: 3W (1980)
- 2.2.7 Traffic: IFR/VFR
- 2.2.8 Remarks: And Du Page Co.

AD 2.3 Operational hours

- 2.3.1 - 2.3.11: ALL Months, ALL Days, ALL Hours

AD 2.4 Handling services and facilities

- 2.4.1 Cargo handling facilities: No
- 2.4.2 Fuel types: 100LL,A1
- 2.4.4 De-icing facilities: None
- 2.4.5 Hangar space: No
- 2.4.6 Repair facilities: Major

AD 2.6 Rescue and firefighting services

- 2.6.1 Aerodrome category for firefighting: ARFF Index I E certified on 5/1/1973

AD 2.10 Aerodrome obstacles

- 2.10.1.a. Runway designation: 14R
- 2.10.1.b Type of obstacle: Trees (63 ft). Not Lighted or Marked
- 2.10.1.c Location of obstacle: 56 ft from Centerline

- 2.10.1.a. Runway designation: 32R
- 2.10.1.b Type of obstacle: Pole (43 ft). Not Lighted or Marked
- 2.10.1.c Location of obstacle: 725 ft from Centerline

- 2.10.1.a. Runway designation: 09L
- 2.10.1.b Type of obstacle: Ant (743 ft). Marked and Lighted
- 2.10.1.c Location of obstacle: 4443 ft from Centerline

- 2.10.1.a. Runway designation: 27R
- 2.10.1.b Type of obstacle: Ant (87 ft). Marked and Lighted
- 2.10.1.c Location of obstacle: 118 ft from

Centerline

- 2.10.1.a. Runway designation: 04L
- 2.10.1.b Type of obstacle: Lt Std (29 ft). Not Lighted or Marked
- 2.10.1.c Location of obstacle: 411 ft from Centerline

- 2.10.1.a. Runway designation: 22L
- 2.10.1.b Type of obstacle: Ant (109 ft). Not Lighted or Marked
- 2.10.1.c Location of obstacle: 545 ft from Centerline

- 2.10.1.a. Runway designation: 27L
- 2.10.1.b Type of obstacle: Ant (24 ft). Not Lighted or Marked
- 2.10.1.c Location of obstacle: 587 ft from Centerline

- 2.10.1.a. Runway designation: 10
- 2.10.1.b Type of obstacle: Pole (42 ft). Not Lighted or Marked
- 2.10.1.c Location of obstacle: 629 ft from Centerline

- 2.10.1.a. Runway designation: 28
- 2.10.1.b Type of obstacle: Sign (56 ft). Lighted
- 2.10.1.c Location of obstacle: 723 ft from Centerline

- AD 2.12 Runway physical characteristics**
- 2.12.1 Designation: 14R
- 2.12.2 True Bearing: 140
- 2.12.3 Dimensions: 9685 ft x 200 ft
- 2.12.4 PCN: 108 R/C/W/U
- 2.12.5 Coordinates: 41-59-25.57N / 87-55-59.30W
- 2.12.6 Threshold elevation: 666 ft
- 2.12.6 Touchdown zone elevation: 668 ft

- 2.12.1 Designation: 32L
- 2.12.2 True Bearing: 320
- 2.12.3 Dimensions: 9685 ft x 200 ft
- 2.12.4 PCN: 108 R/C/W/U
- 2.12.5 Coordinates: 41-58-12.30N / 87-54-36.84W
- 2.12.6 Threshold elevation: 655 ft

- 2.12.1 Designation: 14L
- 2.12.2 True Bearing: 140

2.12.3 Dimensions: 10005 ft x 150 ft
2.12.4 PCN: 108 R/C/W/U
2.12.5 Coordinates: 42-00-00.00N /
87-54-55.33W
2.12.6 Threshold elevation: 653 ft
2.12.6 Touchdown zone elevation: 653 ft

2.12.1 Designation: 32R
2.12.2 True Bearing: 320
2.12.3 Dimensions: 10005 ft x 150 ft
2.12.4 PCN: 108 R/C/W/U
2.12.5 Coordinates: 41-58-53.06N /
87-53-30.17W
2.12.6 Threshold elevation: 648 ft
2.12.6 Touchdown zone elevation: 653 ft

2.12.1 Designation: 09L
2.12.2 True Bearing: 90
2.12.3 Dimensions: 7500 ft x 150 ft
2.12.5 Coordinates: 42-00-10.19N /
87-55-36.03W
2.12.6 Threshold elevation: 668 ft
2.12.6 Touchdown zone elevation: 668 ft
2.12.7 Slope: 0.1DOWN

2.12.1 Designation: 27R
2.12.2 True Bearing: 270
2.12.3 Dimensions: 7500 ft x 150 ft
2.12.5 Coordinates: 42-00-10.19N /
87-53-56.70W
2.12.6 Threshold elevation: 664 ft
2.12.6 Touchdown zone elevation: 664 ft
2.12.7 Slope: 0.1UP

2.12.1 Designation: 04L
2.12.2 True Bearing: 39
2.12.3 Dimensions: 7500 ft x 150 ft
2.12.4 PCN: 108 R/C/W/U
2.12.5 Coordinates: 41-58-53.96N /
87-54-50.10W
2.12.6 Threshold elevation: 656 ft
2.12.6 Touchdown zone elevation: 658 ft

2.12.1 Designation: 22R
2.12.2 True Bearing: 219
2.12.3 Dimensions: 7500 ft x 150 ft
2.12.4 PCN: 108 R/C/W/U
2.12.5 Coordinates: 41-59-51.13N /
87-53-46.94W
2.12.6 Threshold elevation: 648 ft
2.12.6 Touchdown zone elevation: 651 ft

2.12.1 Designation: 04R
2.12.2 True Bearing: 42
2.12.3 Dimensions: 8075 ft x 150 ft
2.12.4 PCN: 108 R/C/W/U
2.12.5 Coordinates: 41-57-11.98N /
87-53-57.91W
2.12.6 Threshold elevation: 661 ft
2.12.6 Touchdown zone elevation: 661 ft

2.12.1 Designation: 22L
2.12.2 True Bearing: 222
2.12.3 Dimensions: 8075 ft x 150 ft
2.12.4 PCN: 108 R/C/W/U
2.12.5 Coordinates: 41-58-11.72N /
87-52-47.08W
2.12.6 Threshold elevation: 654 ft
2.12.6 Touchdown zone elevation: 654 ft

2.12.1 Designation: 09R
2.12.2 True Bearing: 90
2.12.3 Dimensions: 7967 ft x 150 ft
2.12.4 PCN: 108 R/C/W/U
2.12.5 Coordinates: 41-59-00.00N /
87-55-00.00W
2.12.6 Threshold elevation: 660 ft
2.12.6 Touchdown zone elevation: 660 ft

2.12.1 Designation: 27L
2.12.2 True Bearing: 270
2.12.3 Dimensions: 7967 ft x 150 ft
2.12.4 PCN: 108 R/C/W/U
2.12.5 Coordinates: 41-59-00.00N /
87-53-20.58W
2.12.6 Threshold elevation: 650 ft
2.12.6 Touchdown zone elevation: 653 ft

2.12.1 Designation: H1
2.12.3 Dimensions: 200 ft x 100 ft

2.12.1 Designation: 10
2.12.2 True Bearing: 90
2.12.3 Dimensions: 13001 ft x 150 ft
2.12.4 PCN: 108 R/C/W/U
2.12.5 Coordinates: 41-58-00.00N /
87-55-53.51W
2.12.6 Threshold elevation: 672 ft
2.12.6 Touchdown zone elevation: 672 ft

2.12.1 Designation: 28
2.12.2 True Bearing: 270
2.12.3 Dimensions: 13001 ft x 150 ft

2.12.4 PCN: 108 R/C/W/U
2.12.5 Coordinates: 41-58-00.00N /
87-53-00.00W
2.12.6 Threshold elevation: 651 ft
2.12.6 Touchdown zone elevation: 652 ft

AD 2.13 Declared distances

2.13.1 Designation: 14R
2.13.2 Takeoff run available: 9685
2.13.3 Takeoff distance available: 9685
2.13.4 Accelerate-stop distance available: 9662
2.13.5 Landing distance available: 8650

2.13.1 Designation: 32L
2.13.2 Takeoff run available: 9685
2.13.3 Takeoff distance available: 9685
2.13.4 Accelerate-stop distance available: 9685

2.13.1 Designation: 14L
2.13.2 Takeoff run available: 10005
2.13.3 Takeoff distance available: 10005
2.13.4 Accelerate-stop distance available: 10005
2.13.5 Landing distance available: 8007

2.13.1 Designation: 32R
2.13.2 Takeoff run available: 10005
2.13.3 Takeoff distance available: 10005
2.13.4 Accelerate-stop distance available: 10005
2.13.5 Landing distance available: 10005

2.13.1 Designation: 09L
2.13.2 Takeoff run available: 7500
2.13.3 Takeoff distance available: 7500
2.13.4 Accelerate-stop distance available: 7500
2.13.5 Landing distance available: 7500

2.13.1 Designation: 27R
2.13.2 Takeoff run available: 7500
2.13.3 Takeoff distance available: 7500
2.13.4 Accelerate-stop distance available: 7500
2.13.5 Landing distance available: 7500

2.13.1 Designation: 04L
2.13.2 Takeoff run available: 7500
2.13.3 Takeoff distance available: 7500
2.13.4 Accelerate-stop distance available: 7500
2.13.5 Landing distance available: 7500

2.13.1 Designation: 22R
2.13.2 Takeoff run available: 7500
2.13.3 Takeoff distance available: 7500

2.13.4 Accelerate-stop distance available: 7500
2.13.5 Landing distance available: 7500

2.13.1 Designation: 04R
2.13.2 Takeoff run available: 8075
2.13.3 Takeoff distance available: 8075
2.13.4 Accelerate-stop distance available: 8075
2.13.5 Landing distance available: 8075

2.13.1 Designation: 22L
2.13.2 Takeoff run available: 8075
2.13.3 Takeoff distance available: 8075
2.13.4 Accelerate-stop distance available: 8075
2.13.5 Landing distance available: 8075

2.13.1 Designation: 09R
2.13.2 Takeoff run available: 7967
2.13.3 Takeoff distance available: 7967
2.13.4 Accelerate-stop distance available: 7967
2.13.5 Landing distance available: 7967

2.13.1 Designation: 27L
2.13.2 Takeoff run available: 7967
2.13.3 Takeoff distance available: 7967
2.13.4 Accelerate-stop distance available: 7967
2.13.5 Landing distance available: 7967

2.13.1 Designation: 10
2.13.2 Takeoff run available: 13000
2.13.3 Takeoff distance available: 13000
2.13.4 Accelerate-stop distance available: 13000
2.13.5 Landing distance available: 12246

2.13.1 Designation: 28
2.13.2 Takeoff run available: 13000
2.13.3 Takeoff distance available: 13000
2.13.4 Accelerate-stop distance available: 13000
2.13.5 Landing distance available: 13000

AD 2.14 Approach and runway lighting

2.14.1 Designation: 14R
2.14.2 Approach lighting system: ALSF2: Standard
2400 feet high intensity approach lighting system
with sequenced flashers, category II or III
configuration
2.14.4 Visual approach slope indicator system:
4-light PAPI on right

2.14.1 Designation: 14L
2.14.2 Approach lighting system: ALSF2: Standard
2400 feet high intensity approach lighting system

with sequenced flashers, category II or III configuration

2.14.4 Visual approach slope indicator system:
4-light PAPI on left

2.14.1 Designation: 32R

2.14.2 Approach lighting system: MALSR: 1400 feet medium intensity approach lighting system with runway alignment indicator lights

2.14.1 Designation: 09L

2.14.2 Approach lighting system: ALSF2: Standard 2400 feet high intensity approach lighting system with sequenced flashers, category II or III configuration

2.14.1 Designation: 27R

2.14.2 Approach lighting system: ALSF2: Standard 2400 feet high intensity approach lighting system with sequenced flashers, category II or III configuration

2.14.1 Designation: 22R

2.14.2 Approach lighting system: MALSR: 1400 feet medium intensity approach lighting system with runway alignment indicator lights

2.14.4 Visual approach slope indicator system:
4-light PAPI on left

2.14.1 Designation: 04R

2.14.2 Approach lighting system: MALSR: 1400 feet medium intensity approach lighting system with runway alignment indicator lights

2.14.1 Designation: 22L

2.14.2 Approach lighting system: MALSR: 1400 feet medium intensity approach lighting system with runway alignment indicator lights

2.14.1 Designation: 09R

2.14.2 Approach lighting system: MALSR: 1400 feet medium intensity approach lighting system with runway alignment indicator lights

2.14.4 Visual approach slope indicator system:
4-light PAPI on left

2.14.1 Designation: 27L

2.14.2 Approach lighting system: ALSF2: Standard 2400 feet high intensity approach lighting system with sequenced flashers, category II or III configuration

2.14.4 Visual approach slope indicator system:
4-light PAPI on right

2.14.1 Designation: 10

2.14.2 Approach lighting system: ALSF2: Standard 2400 feet high intensity approach lighting system with sequenced flashers, category II or III configuration

2.14.4 Visual approach slope indicator system:
4-light PAPI on left

2.14.1 Designation: 28

2.14.2 Approach lighting system: ALSF2: Standard 2400 feet high intensity approach lighting system with sequenced flashers, category II or III configuration

2.14.4 Visual approach slope indicator system:
4-light PAPI on left

AD 2.18 Air traffic services communication facilities

2.18.1 Service designation: APCH/P CLASS B IC

2.18.3 Service designation: 119 MHz

2.18.1 Service designation: CD/S PTC/S

2.18.3 Service designation: 119.25 MHz

2.18.1 Service designation: CLASS B

2.18.3 Service designation: 120.55 MHz

2.18.1 Service designation: APCH/S

2.18.3 Service designation: 121.15 MHz

2.18.1 Service designation: EMERG

2.18.3 Service designation: 121.5 MHz

2.18.1 Service designation: GND METERING

2.18.3 Service designation: 121.675 MHz

2.18.1 Service designation: DEP/P

2.18.3 Service designation: 125.4 MHz

2.18.1 Service designation: VFR ADV

2.18.3 Service designation: 126.8 MHz

2.18.1 Service designation: CLASS B

2.18.3 Service designation: 133.5 MHz

2.18.1 Service designation: CLASS B/S

2.18.3 Service designation: 134.4 MHz

2.18.1 Service designation: D-ATIS
2.18.3 Service designation: 135.4 MHz
2.18.4 Hours of operation: 24

2.18.1 Service designation: EMERG
2.18.3 Service designation: 243 MHz

2.18.1 Service designation: ALCP
2.18.3 Service designation: 252.1 MHz

2.18.1 Service designation: DEP/P
2.18.3 Service designation: 269.5 MHz

2.18.1 Service designation: APCH/P CLASS B
2.18.3 Service designation: 284 MHz

2.18.1 Service designation: CLASS B
2.18.3 Service designation: 290.2 MHz

2.18.1 Service designation: DEP/P
2.18.3 Service designation: 307.2 MHz

2.18.1 Service designation: DEP/P
2.18.3 Service designation: 337.4 MHz

2.18.1 Service designation: APCH/P CLASS B IC
2.18.3 Service designation: 393.1 MHz

2.18.1 Service designation: APCH/P DEP/P
2.18.3 Service designation: 349 MHz

2.18.1 Service designation: APCH/P CLASS B
2.18.3 Service designation: 133.625 MHz

2.18.1 Service designation: APCH/S
2.18.3 Service designation: 124.35 MHz

2.18.1 Service designation: DEP/P
2.18.3 Service designation: 125 MHz

2.18.1 Service designation: APCH/S
2.18.3 Service designation: 125.7 MHz

2.18.1 Service designation: O'HARE TWR
CENTER LCL/P
2.18.3 Service designation: 126.9 MHz

2.18.1 Service designation: O'HARE TWR
CENTER LCL/P
2.18.3 Service designation: 120.75 MHz

2.18.1 Service designation: O'HARE TWR
CENTER LCL/P
2.18.3 Service designation: 132.7 MHz

2.18.1 Service designation: LCL/S
2.18.3 Service designation: 127.925 MHz

2.18.1 Service designation: CLNC DEL/P
2.18.3 Service designation: 121.6 MHz

2.18.1 Service designation: O'HARE TWR
NORTH GC/P
2.18.3 Service designation: 124.125 MHz

2.18.1 Service designation: O'HARE TWR LCL/P
2.18.3 Service designation: 128.15 MHz

2.18.1 Service designation: DEP/P
2.18.3 Service designation: 126.625 MHz

2.18.1 Service designation: D-ATIS
2.18.3 Service designation: 282.225 MHz
2.18.4 Hours of operation: 24

2.18.1 Service designation: GND CON CENTER
(INBOUND)
2.18.3 Service designation: 121.9 MHz

2.18.1 Service designation: GND CON CENTER
(OUTBOUND)
2.18.3 Service designation: 121.75 MHz

2.18.1 Service designation: O'HARE TWR
CENTER GND/P
2.18.3 Service designation: 226.675 MHz

2.18.1 Service designation: O'HARE TWR
CENTER LCL/P
2.18.3 Service designation: 348 MHz

AD 2.19 Radio navigation and landing aids

2.19.1 ILS type: DME for runway 14R. Magnetic
variation: 3W
2.19.2 ILS identification: ORD
2.19.5 Coordinates: 41-57-37.71N /
87-54-00.00W
2.19.6 Site elevation: 665 ft

2.19.1 ILS type: Glide Slope for runway 14R.
Magnetic variation: 3W
2.19.2 ILS identification: ORD

2.19.5 Coordinates: 41-59-15.81N /
87-55-55.22W
2.19.6 Site elevation: 662 ft

2.19.1 ILS type: Outer Marker for runway 14R.
Magnetic variation: 3W
2.19.2 ILS identification: ORD
2.19.5 Coordinates: 42-03-21.36N /
88-00-28.05W
2.19.6 Site elevation: 693 ft

2.19.1 ILS type: Inner Marker for runway 14R.
Magnetic variation: 3W
2.19.2 ILS identification: ORD
2.19.5 Coordinates: 41-59-32.74N /
87-56-00.00W
2.19.6 Site elevation: 659 ft

2.19.1 ILS type: Localizer for runway 14R.
Magnetic variation: 3W
2.19.2 ILS identification: ORD
2.19.5 Coordinates: 41-57-38.76N /
87-53-59.11W
2.19.6 Site elevation: 651 ft

2.19.1 ILS type: Middle Marker for runway 14R.
Magnetic variation: 3W
2.19.2 ILS identification: ORD
2.19.5 Coordinates: 41-59-46.54N /
87-56-22.90W
2.19.6 Site elevation: 674 ft

2.19.1 ILS type: Localizer for runway 32L.
Magnetic variation: 3W
2.19.2 ILS identification: RVG
2.19.5 Coordinates: 41-59-30.50N /
87-56-00.00W
2.19.6 Site elevation: 663 ft

2.19.1 ILS type: DME for runway 32L. Magnetic
variation: 3W
2.19.2 ILS identification: RVG
2.19.5 Coordinates: 41-59-34.48N /
87-56-00.00W
2.19.6 Site elevation: 677 ft

2.19.1 ILS type: Glide Slope for runway 32L.
Magnetic variation: 3W
2.19.2 ILS identification: RVG
2.19.5 Coordinates: 41-57-52.64N /
87-54-21.11W

2.19.6 Site elevation: 648 ft

2.19.1 ILS type: Outer Marker for runway 32L.
Magnetic variation: 3W
2.19.2 ILS identification: RVG
2.19.5 Coordinates: 41-53-39.91N /
87-49-34.69W
2.19.6 Site elevation: 99999 ft

2.19.1 ILS type: Middle Marker for runway 32L.
Magnetic variation: 3W
2.19.2 ILS identification: RVG
2.19.5 Coordinates: 41-57-22.13N /
87-53-40.44W
2.19.6 Site elevation: 653 ft

2.19.1 ILS type: DME for runway 14L. Magnetic
variation: 3W
2.19.2 ILS identification: OHA
2.19.5 Coordinates: 41-58-43.19N /
87-53-23.65W
2.19.6 Site elevation: 665 ft

2.19.1 ILS type: Inner Marker for runway 14L.
Magnetic variation: 3W
2.19.2 ILS identification: OHA
2.19.5 Coordinates: 42-00-00.00N /
87-54-43.27W
2.19.6 Site elevation: 99999 ft

2.19.1 ILS type: Glide Slope for runway 14L.
Magnetic variation: 3W
2.19.2 ILS identification: OHA
2.19.5 Coordinates: 41-59-48.18N /
87-54-25.13W
2.19.6 Site elevation: 648 ft

2.19.1 ILS type: Middle Marker for runway 14L.
Magnetic variation: 3W
2.19.2 ILS identification: OHA
2.19.5 Coordinates: 42-00-29.46N /
87-55-18.64W
2.19.6 Site elevation: 99999 ft

2.19.1 ILS type: Outer Marker for runway 14L.
Magnetic variation: 3W
2.19.2 ILS identification: OHA
2.19.5 Coordinates: 42-04-00.00N /
87-59-27.18W
2.19.6 Site elevation: 99999 ft

2.19.1 ILS type: Localizer for runway 14L.

Magnetic variation: 3W

2.19.2 ILS identification: OHA

2.19.5 Coordinates: 41-58-44.36N /

87-53-20.39W

2.19.6 Site elevation: 650 ft

2.19.1 ILS type: Glide Slope for runway 32R.

Magnetic variation: 0E

2.19.2 ILS identification: IDN

2.19.5 Coordinates: 41-59-00.00N /

87-53-36.78W

2.19.6 Site elevation: 646 ft

2.19.1 ILS type: Outer Marker for runway 32R.

Magnetic variation: 0E

2.19.2 ILS identification: IDN

2.19.5 Coordinates: 41-54-17.50N /

87-48-24.90W

2.19.6 Site elevation: 99999 ft

2.19.1 ILS type: Inner Marker for runway 32R.

Magnetic variation: 0E

2.19.2 ILS identification: IDN

2.19.5 Coordinates: 42-00-16.11N /

87-55-00.00W

2.19.6 Site elevation: 99999 ft

2.19.1 ILS type: Localizer for runway 32R.

Magnetic variation: 0E

2.19.2 ILS identification: IDN

2.19.5 Coordinates: 42-00-17.04N /

87-55-00.00W

2.19.6 Site elevation: 649 ft

2.19.1 ILS type: Middle Marker for runway 32R.

Magnetic variation: 0E

2.19.2 ILS identification: IDN

2.19.5 Coordinates: 41-58-33.83N /

87-53-00.00W

2.19.6 Site elevation: 645 ft

2.19.1 ILS type: DME for runway 09L. Magnetic

variation: 3W

2.19.2 ILS identification: SAJ

2.19.5 Coordinates: 42-00-14.10N /

87-55-48.23W

2.19.6 Site elevation: 670 ft

2.19.1 ILS type: Glide Slope for runway 09L.

Magnetic variation: 3W

2.19.2 ILS identification: SAJ

2.19.5 Coordinates: 42-00-14.22N /

87-55-20.67W

2.19.6 Site elevation: 651 ft

2.19.1 ILS type: Localizer for runway 09L.

Magnetic variation: 3W

2.19.2 ILS identification: SAJ

2.19.5 Coordinates: 42-00-10.19N /

87-53-43.32W

2.19.6 Site elevation: 661 ft

2.19.1 ILS type: Inner Marker for runway 09L.

Magnetic variation: 3W

2.19.2 ILS identification: SAJ

2.19.5 Coordinates: 42-00-10.18N /

87-55-47.42W

2.19.6 Site elevation: 668 ft

2.19.1 ILS type: Inner Marker for runway 27R.

Magnetic variation: 3W

2.19.2 ILS identification: ABU

2.19.5 Coordinates: 42-00-10.20N /

87-53-44.38W

2.19.6 Site elevation: 663 ft

2.19.1 ILS type: Localizer for runway 27R.

Magnetic variation: 3W

2.19.2 ILS identification: ABU

2.19.5 Coordinates: 42-00-10.19N /

87-55-50.20W

2.19.6 Site elevation: 668 ft

2.19.1 ILS type: Glide Slope for runway 27R.

Magnetic variation: 3W

2.19.2 ILS identification: ABU

2.19.5 Coordinates: 42-00-14.21N /

87-54-11.75W

2.19.6 Site elevation: 648 ft

2.19.1 ILS type: DME for runway 27R. Magnetic

variation: 3W

2.19.2 ILS identification: ABU

2.19.5 Coordinates: 42-00-14.10N /

87-55-48.23W

2.19.6 Site elevation: 670 ft

2.19.1 ILS type: Localizer for runway 04L.

Magnetic variation: 3W

2.19.2 ILS identification: HNA

2.19.5 Coordinates: 41-59-56.39N /

87-53-41.13W
2.19.6 Site elevation: 644 ft

2.19.1 ILS type: Outer Marker for runway 04L.
Magnetic variation: 3W
2.19.2 ILS identification: HNA
2.19.5 Coordinates: 41-54-51.77N /
87-59-19.46W
2.19.6 Site elevation: 99999 ft

2.19.1 ILS type: Localizer for runway 22R.
Magnetic variation: 3W
2.19.2 ILS identification: RXZ
2.19.5 Coordinates: 41-58-46.49N /
87-54-58.36W
2.19.6 Site elevation: 662 ft

2.19.1 ILS type: Glide Slope for runway 22R.
Magnetic variation: 3W
2.19.2 ILS identification: RXZ
2.19.5 Coordinates: 41-59-45.44N /
87-53-58.39W
2.19.6 Site elevation: 645 ft

2.19.1 ILS type: Outer Marker for runway 22R.
Magnetic variation: 3W
2.19.2 ILS identification: RXZ
2.19.5 Coordinates: 42-03-20.68N /
87-50-00.00W
2.19.6 Site elevation: 665 ft

2.19.1 ILS type: Middle Marker for runway 22R.
Magnetic variation: 3W
2.19.2 ILS identification: RXZ
2.19.5 Coordinates: 42-00-10.86N /
87-53-25.14W
2.19.6 Site elevation: 636 ft

2.19.1 ILS type: Glide Slope for runway 04R.
Magnetic variation: 3W
2.19.2 ILS identification: FJU
2.19.5 Coordinates: 41-57-17.12N /
87-53-44.75W
2.19.6 Site elevation: 654 ft

2.19.1 ILS type: Middle Marker for runway 04R.
Magnetic variation: 3W
2.19.2 ILS identification: FJU
2.19.5 Coordinates: 41-56-48.83N /
87-54-28.68W
2.19.6 Site elevation: 655 ft

2.19.1 ILS type: Outer Marker for runway 04R.
Magnetic variation: 3W
2.19.2 ILS identification: FJU
2.19.5 Coordinates: 41-53-54.57N /
87-57-51.36W
2.19.6 Site elevation: 99999 ft

2.19.1 ILS type: Localizer for runway 04R.
Magnetic variation: 3W
2.19.2 ILS identification: FJU
2.19.5 Coordinates: 41-58-16.20N /
87-52-41.76W
2.19.6 Site elevation: 647 ft

2.19.1 ILS type: Outer Marker for runway 22L.
Magnetic variation: 3W
2.19.2 ILS identification: LQQ
2.19.5 Coordinates: 42-02-16.02N /
87-47-46.00W
2.19.6 Site elevation: 629 ft

2.19.1 ILS type: Localizer for runway 22L.
Magnetic variation: 3W
2.19.2 ILS identification: LQQ
2.19.5 Coordinates: 41-57-00.00N /
87-54-00.00W
2.19.6 Site elevation: 653 ft

2.19.1 ILS type: Glide Slope for runway 22L.
Magnetic variation: 3W
2.19.2 ILS identification: LQQ
2.19.5 Coordinates: 41-58-00.00N /
87-52-52.61W
2.19.6 Site elevation: 646 ft

2.19.1 ILS type: Middle Marker for runway 22L.
Magnetic variation: 3W
2.19.2 ILS identification: LQQ
2.19.5 Coordinates: 41-58-34.71N /
87-52-19.73W
2.19.6 Site elevation: 642 ft

2.19.1 ILS type: Glide Slope for runway 27L.
Magnetic variation: 3W
2.19.2 ILS identification: IAC
2.19.5 Coordinates: 41-59-00.00N /
87-53-34.35W
2.19.6 Site elevation: 646 ft

2.19.1 ILS type: Outer Marker for runway 27L.
Magnetic variation: 3W

2.19.2 ILS identification: IAC
2.19.5 Coordinates: 41-59-00.00N /
87-47-20.48W
2.19.6 Site elevation: 99999 ft

2.19.1 ILS type: Middle Marker for runway 27L.
Magnetic variation: 3W
2.19.2 ILS identification: IAC
2.19.5 Coordinates: 41-59-00.00N /
87-52-41.36W
2.19.6 Site elevation: 99999 ft

2.19.1 ILS type: Localizer for runway 27L.
Magnetic variation: 3W
2.19.2 ILS identification: IAC
2.19.5 Coordinates: 41-59-00.00N /
87-55-17.98W
2.19.6 Site elevation: 664 ft

2.19.1 ILS type: DME for runway 27L. Magnetic
variation: 3W
2.19.2 ILS identification: IAC
2.19.5 Coordinates: 41-59-00.00N /
87-53-10.21W
2.19.6 Site elevation: 654 ft

2.19.1 ILS type: Inner Marker for runway 27L.
Magnetic variation: 3W
2.19.2 ILS identification: IAC
2.19.5 Coordinates: 41-59-00.00N /
87-53-00.00W
2.19.6 Site elevation: 642 ft

2.19.1 ILS type: Localizer for runway 09R.
Magnetic variation: 3W
2.19.2 ILS identification: JAV
2.19.5 Coordinates: 41-59-00.00N /
87-53-10.49W
2.19.6 Site elevation: 643 ft

2.19.1 ILS type: Outer Marker for runway 09R.
Magnetic variation: 3W
2.19.2 ILS identification: JAV
2.19.5 Coordinates: 41-59-00.00N /
88-01-39.29W
2.19.6 Site elevation: 717 ft

2.19.1 ILS type: DME for runway 09R. Magnetic
variation: 3W
2.19.2 ILS identification: JAV
2.19.5 Coordinates: 41-59-00.00N /

87-53-10.21W
2.19.6 Site elevation: 654 ft

2.19.1 ILS type: Glide Slope for runway 09R.
Magnetic variation: 3W
2.19.2 ILS identification: JAV
2.19.5 Coordinates: 41-59-00.00N /
87-54-51.31W
2.19.6 Site elevation: 658 ft

2.19.1 ILS type: Middle Marker for runway 09R.
Magnetic variation: 3W
2.19.2 ILS identification: JAV
2.19.5 Coordinates: 41-59-00.00N /
87-55-54.53W
2.19.6 Site elevation: 659 ft

2.19.1 ILS type: Localizer for runway 10. Magnetic
variation: 3W
2.19.2 ILS identification: MED
2.19.5 Coordinates: 41-58-00.00N /
87-52-39.69W
2.19.6 Site elevation: 645 ft

2.19.1 ILS type: DME for runway 10. Magnetic
variation: 3W
2.19.2 ILS identification: MED
2.19.5 Coordinates: 41-58-00.00N /
87-52-41.69W
2.19.6 Site elevation: 656 ft

2.19.1 ILS type: Middle Marker for runway 10.
Magnetic variation: 3W
2.19.2 ILS identification: MED
2.19.5 Coordinates: 41-58-00.00N /
87-55-52.10W
2.19.6 Site elevation: 99999 ft

2.19.1 ILS type: Outer Marker for runway 10.
Magnetic variation: 3W
2.19.2 ILS identification: MED
2.19.5 Coordinates: 41-58-00.00N /
88-01-35.55W
2.19.6 Site elevation: 99999 ft

2.19.1 ILS type: Glide Slope for runway 10.
Magnetic variation: 3W
2.19.2 ILS identification: MED
2.19.5 Coordinates: 41-58-00.00N /
87-55-38.76W
2.19.6 Site elevation: 665 ft

2.19.1 ILS type: DME for runway 28. Magnetic variation: 3W
2.19.2 ILS identification: TSL
2.19.5 Coordinates: 41-58-00.00N / 87-52-41.69W
2.19.6 Site elevation: 656 ft

2.19.1 ILS type: Inner Marker for runway 28. Magnetic variation: 3W
2.19.2 ILS identification: TSL
2.19.5 Coordinates: 41-58-00.00N / 87-52-49.13W
2.19.6 Site elevation: 649 ft

2.19.1 ILS type: Glide Slope for runway 28. Magnetic variation: 3W
2.19.2 ILS identification: TSL
2.19.5 Coordinates: 41-58-00.00N / 87-53-15.05W
2.19.6 Site elevation: 648 ft

2.19.1 ILS type: Middle Marker for runway 28. Magnetic variation: 3W
2.19.2 ILS identification: TSL
2.19.5 Coordinates: 41-58-00.00N / 87-52-23.76W
2.19.6 Site elevation: 99999 ft

2.19.1 ILS type: Outer Marker for runway 28. Magnetic variation: 3W
2.19.2 ILS identification: TSL
2.19.5 Coordinates: 41-58-00.00N / 87-47-22.63W
2.19.6 Site elevation: 99999 ft

2.19.1 ILS type: Localizer for runway 28. Magnetic variation: 3W
2.19.2 ILS identification: TSL
2.19.5 Coordinates: 41-58-00.00N / 87-56-00.00W
2.19.6 Site elevation: 661 ft

General Remarks:

AIRPORT NIGHTTIME NOISE ABATEMENT PROCEDURES ARE IN EFFECT FROM 2200 TO 0700; CONTACT AIRPORT MANAGER ON 773-686-2255.

BIRDS ON & IN THE VICINITY OF AIRPORT. PYROTECHNICS & BIRD CANNONS IN USE FOR BIRD CONTROL.

AIRCRAFT WITH WINGSPAN GREATER THAN 214 FT REQUIRE 48 HRS PRIOR PERMISSION REQUIRED - CALL 773-686-2255.

SEE LAND AND HOLD SHORT OPERATIONS SECTION.

DURING PERIODS OF COLD WEATHER; THE APPROACH CONTROL END OF RUNWAY 32R MAY NOT BE VISIBLE FROM THE ATCT DUE TO STEAM PLUME FROM AIRPORT HEATING PLANT.

BE ALERT: OF DUPLICATE ALPHA-NUMERIC TAXIWAY DESIGNATORS & TERMINAL GATE DESIGNATIONS INVOLVING THE LETTERS G, H, K L & M.

MAGNETIC DEVIATION POSSIBLE IMMEDIATELY WEST OF TAXIWAY M7 & RUNWAY 22L APPROACH ON TAXIWAY M.

PERSONNEL AND EQUIPMENT WORKING NEAR VARIOUS TAXIWAYS.

PERIODIC FIRE DEPT TRAINING AT N SECTOR OF THE AIRPORT.

PRIMARY RUN-UP LOCATION GROUND RUN UP ENCLOSURE; SECONDARY RUN UP LOCATIONS AVAILABLE UPON REQ CONTACT CITY OPERATIONS 773-686-2255.

LINE UP & WAIT WAIVER IN EFFECT AFTER DARK AT THE FOLLOWING INTERSECTIONS;

RUNWAY 32L AT TAXIWAYS T-10 AND, RUNWAY 28 AT TAXIWAY ZW AND ZV, RUNWAY 14L AT TAXIWAYS U2 & V & RUNWAY 32R AT TAXIWAY V AND RUNWAY 10 AT TAXIWAY ZH. THESE RUNWAYS WILL BE USED FOR DEPS ONLY WHEN EXERCISING THE PROVISIONS OF THIS WAIVER.

ALL PART 91 & UNSCHEDULED PART 125, 133 & 135 CHARTER OPERATORS CONTACT SIGNATURE FLIGHT SUPPORT AT 773-686-7000 REGARDING NEW SECURITY REGULATIONS PRIOR TO DEP.

RUNWAY H1 APPROACH DEP PATHS ARE E & W.

B747-400, B777-300ER, B777-200LR(F), A340-600 OR A340-500 CANNOT PASS ON TAXIWAYS 'A' & 'B' INSUFFICIENT WINGTIP CLEARANCE.

BE ALERT: THE NORTHEAST/SOUTHWEST PORTION OF TAXIWAY Y IS NOT VISIBLE FROM THE CENTER ATCT.

GENERAL AVIATION RAMP AND FBO LOCATED AT THE NORTH EAST RAMP VICINITY OF 27L APPROACH

ATCT IS AUTHORIZED TO CONDUCT ARRS TO RUNWAYS 14L & 14R WHILE CONDUCTING SIMULTANEOUS OPPOSITE DIRECTION DEPS OFF OF RUNWAYS 09R & 28 DURING IFR WEATHER CONDITIONS. ATCT IS AUTHORIZED TO CONDUCT SIMULTANEOUS CONVERGING INSTRUMENT APPROACHES TO RUNWAYS 14R & 22R WHILE CONDUCTING SIMULTANEOUS OPPOSITE DIRECTION DEPS OFF OF RUNWAYS 09R & 28 DURING IFR WEATHER CONDITIONS.

TAXIWAY V RESTRICTED TO AIRCRAFT LESS THAN 117 FT WINGSPAN OR WHEELBASE LESS THAN 30 FT (DESIGN GROUP 4-5-6) BETWEEN TAXIWAY KK & TAXIWAY LL.

ATCT IS AUTHORIZED TO CONDUCT SIMULTANEOUS OPPOSITE DIRECTION DEPS ON RUNWAYS 09R AND 28 DURING INSTRUMENT FLIGHT RULES (IFR) WX CONDITIONS.

ASDE-X SURVEILLANCE SYSTEM IN USE: PILOTS SHOULD OPERATE TRANSPONDERS WITH MODE C ON ALL TAXIWAYS & RUNWAYS.

RUNWAY 9L/27R TRIPLE DUAL TANDEM 690,000; DUAL TANDUM W/DUAL WHEEL (2D/D1) 633,000

YANKEE ECHO GATE IS MANNED 24 HRS A DAY. YANKEE TANGO GATE IS MANNED 24 HRS A DAY.

RUNWAY 32L CLOSED TO ARRIVALS.

ATC IS AUTHORIZED TO CONDUCT SIMULTANEOUS DEPS FROM RUNWAYS 14R/14L, 32L/32R, 4L/4R, 22R/22L, 9R WITH 9L OR 10, AND 27L WITH 28 OR 27R WITH COURSE DIVERGENCE BEGINNING NO LATER THAN 4 MILES FROM RUNWAY END.

Indianapolis, Indiana Indianapolis International ICAO Identifier KIND

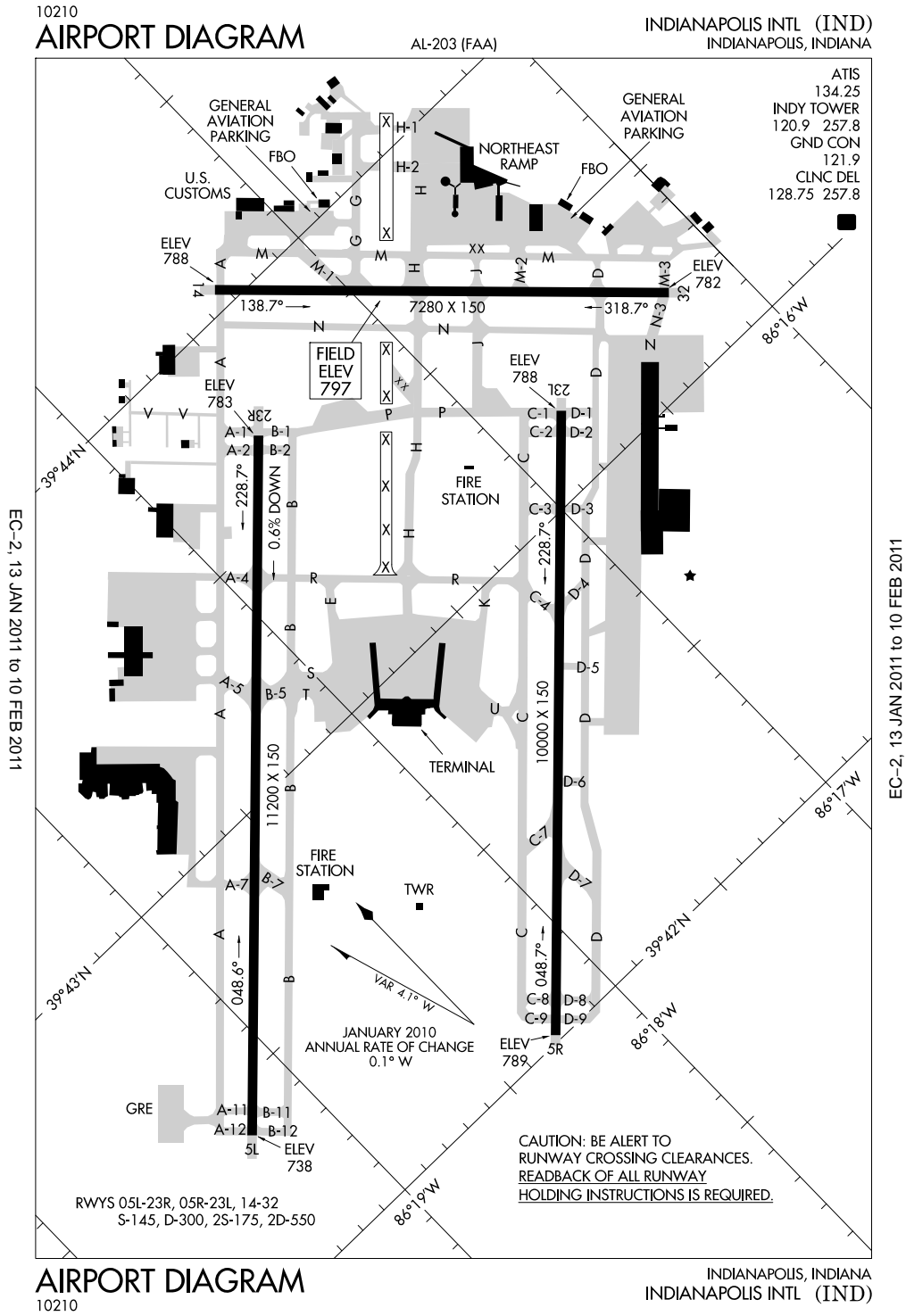

Indianapolis, IN
Indianapolis Intl
ICAO Identifier KIND

AD 2.2 Aerodrome geographical and administrative data

- 2.2.1 Reference Point: 39-43-00.00N / 86-17-40.78W
- 2.2.2 From City: 7 Miles SW Of Indianapolis, IN
- 2.2.3 Elevation: 797 ft
- 2.2.5 Magnetic variation: 2W (1985)
- 2.2.6 Airport Contact: John Clark
7800 COL. H. WEIR COOK MEMORIAL DR.
Indianapolis, IN 46241 (317-487-9594)
- 2.2.7 Traffic: IFR/VFR

AD 2.3 Operational hours

- 2.3.1 - 2.3.11: ALL Months, ALL Days, ALL Hours

AD 2.4 Handling services and facilities

- 2.4.1 Cargo handling facilities: No
- 2.4.2 Fuel types: 100LL,A,A1+
- 2.4.4 De-icing facilities: None
- 2.4.5 Hangar space: No
- 2.4.6 Repair facilities: Major

AD 2.6 Rescue and firefighting services

- 2.6.1 Aerodrome category for firefighting: ARFF Index I D certified on 5/1/1973

AD 2.10 Aerodrome obstacles

- 2.10.1.a. Runway designation: 23R
- 2.10.1.b Type of obstacle: Ant (140 ft). Lighted
- 2.10.1.c Location of obstacle: 138 ft from Centerline

- 2.10.1.a. Runway designation: 23L
- 2.10.1.b Type of obstacle: Ant (78 ft). Not Lighted or Marked
- 2.10.1.c Location of obstacle: 484 ft from Centerline

- 2.10.1.a. Runway designation: 14
- 2.10.1.b Type of obstacle: Ant (61 ft). Not Lighted or Marked
- 2.10.1.c Location of obstacle: 756 ft from Centerline

- 2.10.1.a. Runway designation: 32
- 2.10.1.b Type of obstacle: Trees (56 ft). Not

Lighted or Marked

- 2.10.1.c Location of obstacle: 391 ft from Centerline

AD 2.12 Runway physical characteristics

- 2.12.1 Designation: 05L
- 2.12.2 True Bearing: 45
- 2.12.3 Dimensions: 11200 ft x 150 ft
- 2.12.5 Coordinates: 39-42-23.03N / 86-19-14.94W
- 2.12.6 Threshold elevation: 738 ft
- 2.12.6 Touchdown zone elevation: 748 ft

- 2.12.1 Designation: 23R
- 2.12.2 True Bearing: 225
- 2.12.3 Dimensions: 11200 ft x 150 ft
- 2.12.5 Coordinates: 39-43-41.91N / 86-17-34.40W
- 2.12.6 Threshold elevation: 783 ft
- 2.12.6 Touchdown zone elevation: 783 ft

- 2.12.1 Designation: 05R
- 2.12.2 True Bearing: 45
- 2.12.3 Dimensions: 10000 ft x 150 ft
- 2.12.5 Coordinates: 39-42-00.00N / 86-18-15.94W
- 2.12.6 Threshold elevation: 789 ft
- 2.12.6 Touchdown zone elevation: 791 ft

- 2.12.1 Designation: 23L
- 2.12.2 True Bearing: 225
- 2.12.3 Dimensions: 10000 ft x 150 ft
- 2.12.5 Coordinates: 39-43-11.28N / 86-16-46.17W
- 2.12.6 Threshold elevation: 788 ft
- 2.12.6 Touchdown zone elevation: 790 ft

- 2.12.1 Designation: 14
- 2.12.2 True Bearing: 135
- 2.12.3 Dimensions: 7280 ft x 150 ft
- 2.12.5 Coordinates: 39-44-00.00N / 86-17-19.81W
- 2.12.6 Threshold elevation: 788 ft
- 2.12.6 Touchdown zone elevation: 797 ft

- 2.12.1 Designation: 32
- 2.12.2 True Bearing: 315
- 2.12.3 Dimensions: 7280 ft x 150 ft
- 2.12.5 Coordinates: 39-43-12.73N / 86-16-13.42W
- 2.12.6 Threshold elevation: 782 ft

2.12.6 Touchdown zone elevation: 792 ft

AD 2.13 Declared distances

2.13.1 Designation: 05L

2.13.2 Takeoff run available: 11200

2.13.3 Takeoff distance available: 11200

2.13.4 Accelerate-stop distance available: 11200

2.13.5 Landing distance available: 11200

2.13.1 Designation: 23R

2.13.2 Takeoff run available: 11200

2.13.3 Takeoff distance available: 11200

2.13.4 Accelerate-stop distance available: 11200

2.13.5 Landing distance available: 11200

2.13.1 Designation: 05R

2.13.2 Takeoff run available: 10000

2.13.3 Takeoff distance available: 10000

2.13.4 Accelerate-stop distance available: 10000

2.13.5 Landing distance available: 10000

2.13.1 Designation: 23L

2.13.2 Takeoff run available: 10000

2.13.3 Takeoff distance available: 10000

2.13.4 Accelerate-stop distance available: 10000

2.13.5 Landing distance available: 10000

2.13.1 Designation: 14

2.13.2 Takeoff run available: 7280

2.13.3 Takeoff distance available: 7280

2.13.4 Accelerate-stop distance available: 7280

2.13.5 Landing distance available: 7280

2.13.1 Designation: 32

2.13.2 Takeoff run available: 7280

2.13.3 Takeoff distance available: 7280

2.13.4 Accelerate-stop distance available: 7280

2.13.5 Landing distance available: 7280

AD 2.14 Approach and runway lighting

2.14.1 Designation: 05L

2.14.2 Approach lighting system: ALSF2: Standard 2400 feet high intensity approach lighting system with sequenced flashers, category II or III configuration

2.14.4 Visual approach slope indicator system: 4-light PAPI on left

2.14.1 Designation: 23R

2.14.2 Approach lighting system: MALSR: 1400 feet medium intensity approach lighting system

with runway alignment indicator lights

2.14.4 Visual approach slope indicator system: 4-light PAPI on left

2.14.1 Designation: 05R

2.14.2 Approach lighting system: ALSF2: Standard 2400 feet high intensity approach lighting system with sequenced flashers, category II or III configuration

2.14.4 Visual approach slope indicator system: 4-light PAPI on left

2.14.1 Designation: 23L

2.14.2 Approach lighting system: MALSR: 1400 feet medium intensity approach lighting system with runway alignment indicator lights

2.14.4 Visual approach slope indicator system: 4-light PAPI on right

2.14.1 Designation: 14

2.14.2 Approach lighting system: MALSR: 1400 feet medium intensity approach lighting system with runway alignment indicator lights

2.14.4 Visual approach slope indicator system: 4-light PAPI on left

2.14.10 Remarks: Unusable Beyond 8 Degrees Right Of Course.

2.14.1 Designation: 32

2.14.2 Approach lighting system: MALSR: 1400 feet medium intensity approach lighting system with runway alignment indicator lights

2.14.4 Visual approach slope indicator system: 4-light PAPI on right

AD 2.18 Air traffic services communication facilities

2.18.1 Service designation: APCH/P IC

2.18.3 Service designation: 119.3 MHz

2.18.1 Service designation: EMERG

2.18.3 Service designation: 121.5 MHz

2.18.1 Service designation: GND/S

2.18.3 Service designation: 121.8 MHz

2.18.1 Service designation: GND/P

2.18.3 Service designation: 121.9 MHz

2.18.1 Service designation: APCH/P CLASS C

2.18.3 Service designation: 124.65 MHz

2.18.1 Service designation: APCH/P CLASS C
2.18.3 Service designation: 127.15 MHz

2.18.1 Service designation: CD PRE TAXI CLNC
2.18.3 Service designation: 128.75 MHz

2.18.1 Service designation: EMERG
2.18.3 Service designation: 243 MHz

2.18.1 Service designation: CD LCL/P
2.18.3 Service designation: 257.8 MHz

2.18.1 Service designation: APCH/P DEP/P
CLASS C
2.18.3 Service designation: 317.8 MHz

2.18.1 Service designation: DEP/P
2.18.3 Service designation: 119.05 MHz

2.18.1 Service designation: D-ATIS
2.18.3 Service designation: 134.25 MHz
2.18.4 Hours of operation: 24

2.18.1 Service designation: DEP/P CLASS C
2.18.3 Service designation: 124.95 MHz

2.18.1 Service designation: LCL/P
2.18.3 Service designation: 120.9 MHz

AD 2.19 Radio navigation and landing aids

2.19.1 ILS type: Glide Slope for runway 05L.
Magnetic variation: 2W
2.19.2 ILS identification: IND
2.19.5 Coordinates: 39-42-32.78N /
86-19-00.00W
2.19.6 Site elevation: 735 ft

2.19.1 ILS type: Outer Marker for runway 05L.
Magnetic variation: 2W
2.19.2 ILS identification: IND
2.19.5 Coordinates: 39-37-44.40N /
86-25-00.00W
2.19.6 Site elevation: 689 ft

2.19.1 ILS type: DME for runway 05L. Magnetic
variation: 2W
2.19.2 ILS identification: IND
2.19.5 Coordinates: 39-43-51.36N /
86-17-27.60W
2.19.6 Site elevation: 784 ft

2.19.1 ILS type: Inner Marker for runway 05L.
Magnetic variation: 2W
2.19.2 ILS identification: IND
2.19.5 Coordinates: 39-42-15.71N /
86-19-24.44W
2.19.6 Site elevation: 736 ft

2.19.1 ILS type: Localizer for runway 05L.
Magnetic variation: 2W
2.19.2 ILS identification: IND
2.19.5 Coordinates: 39-43-49.02N /
86-17-25.33W
2.19.6 Site elevation: 788 ft

2.19.1 ILS type: Middle Marker for runway 05L.
Magnetic variation: 2W
2.19.2 ILS identification: IND
2.19.5 Coordinates: 39-42-00.00N /
86-19-43.10W
2.19.6 Site elevation: 726 ft

2.19.1 ILS type: Localizer for runway 23R.
Magnetic variation: 2W
2.19.2 ILS identification: UZK
2.19.5 Coordinates: 39-42-15.92N /
86-19-24.00W
2.19.6 Site elevation: 737 ft

2.19.1 ILS type: Glide Slope for runway 23R.
Magnetic variation: 2W
2.19.2 ILS identification: UZK
2.19.5 Coordinates: 39-43-36.51N /
86-17-48.46W
2.19.6 Site elevation: 772 ft

2.19.1 ILS type: Outer Marker for runway 23R.
Magnetic variation: 2W
2.19.2 ILS identification: UZK
2.19.5 Coordinates: 39-47-44.67N /
86-12-24.00W
2.19.6 Site elevation: 731 ft

2.19.1 ILS type: Middle Marker for runway 23R.
Magnetic variation: 2W
2.19.2 ILS identification: UZK
2.19.5 Coordinates: 39-44-24.76N /
86-16-00.00W
2.19.6 Site elevation: 789 ft

2.19.1 ILS type: DME for runway 23R. Magnetic
variation: 2W

2.19.2 ILS identification: UZK
2.19.5 Coordinates: 39-43-51.36N /
86-17-27.60W
2.19.6 Site elevation: 784 ft

2.19.1 ILS type: Outer Marker for runway 05R.
Magnetic variation: 2W
2.19.2 ILS identification: OQV
2.19.5 Coordinates: 39-37-00.00N /
86-24-28.30W
2.19.6 Site elevation: 710 ft

2.19.1 ILS type: Middle Marker for runway 05R.
Magnetic variation: 2W
2.19.2 ILS identification: OQV
2.19.5 Coordinates: 39-42-00.00N /
86-19-43.10W
2.19.6 Site elevation: 770 ft

2.19.1 ILS type: DME for runway 05R. Magnetic
variation: 2W
2.19.2 ILS identification: OQV
2.19.5 Coordinates: 39-43-20.20N /
86-16-39.55W
2.19.6 Site elevation: 788 ft

2.19.1 ILS type: Inner Marker for runway 05R.
Magnetic variation: 2W
2.19.2 ILS identification: OQV
2.19.5 Coordinates: 39-41-54.66N /
86-18-23.77W
2.19.6 Site elevation: 778 ft

2.19.1 ILS type: Localizer for runway 05R.
Magnetic variation: 2W
2.19.2 ILS identification: OQV
2.19.5 Coordinates: 39-43-18.37N /
86-16-37.12W
2.19.6 Site elevation: 785 ft

2.19.1 ILS type: Glide Slope for runway 05R.
Magnetic variation: 2W
2.19.2 ILS identification: OQV
2.19.5 Coordinates: 39-42-00.00N /
86-18-00.00W
2.19.6 Site elevation: 789 ft

2.19.1 ILS type: Localizer for runway 23L.
Magnetic variation: 2W
2.19.2 ILS identification: FVJ
2.19.5 Coordinates: 39-41-54.18N /

86-18-24.47W
2.19.6 Site elevation: 779 ft

2.19.1 ILS type: Glide Slope for runway 23L.
Magnetic variation: 2W
2.19.2 ILS identification: FVJ
2.19.5 Coordinates: 39-43-00.00N /
86-16-54.54W
2.19.6 Site elevation: 785 ft

2.19.1 ILS type: Middle Marker for runway 23L.
Magnetic variation: 2W
2.19.2 ILS identification: FVJ
2.19.5 Coordinates: 39-43-30.36N /
86-16-21.76W
2.19.6 Site elevation: 785 ft

2.19.1 ILS type: DME for runway 23L. Magnetic
variation: 2W
2.19.2 ILS identification: FVJ
2.19.5 Coordinates: 39-43-20.20N /
86-16-39.55W
2.19.6 Site elevation: 788 ft

2.19.1 ILS type: Outer Marker for runway 23L.
Magnetic variation: 2W
2.19.2 ILS identification: FVJ
2.19.5 Coordinates: 39-47-11.15N /
86-11-46.46W
2.19.6 Site elevation: 710 ft

2.19.1 ILS type: Middle Marker for runway 14.
Magnetic variation: 2W
2.19.2 ILS identification: BJP
2.19.5 Coordinates: 39-44-19.96N /
86-17-42.27W
2.19.6 Site elevation: 776 ft

2.19.1 ILS type: Outer Marker for runway 14.
Magnetic variation: 2W
2.19.2 ILS identification: BJP
2.19.5 Coordinates: 39-47-34.36N /
86-22-00.00W
2.19.6 Site elevation: 865 ft

2.19.1 ILS type: Glide Slope for runway 14.
Magnetic variation: 2W
2.19.2 ILS identification: BJP
2.19.5 Coordinates: 39-43-59.30N /
86-17-00.00W
2.19.6 Site elevation: 792 ft

2.19.1 ILS type: Localizer for runway 14. Magnetic variation: 2W

2.19.2 ILS identification: BJP

2.19.5 Coordinates: 39-43-00.00N / 86-16-00.00W

2.19.6 Site elevation: 764 ft

2.19.1 ILS type: Glide Slope for runway 32. Magnetic variation: 2W

2.19.2 ILS identification: COA

2.19.5 Coordinates: 39-43-14.60N / 86-16-23.17W

2.19.6 Site elevation: 782 ft

2.19.1 ILS type: Outer Marker for runway 32. Magnetic variation: 2W

2.19.2 ILS identification: COA

2.19.5 Coordinates: 39-39-24.86N / 86-11-00.00W

2.19.6 Site elevation: 99999 ft

2.19.1 ILS type: Middle Marker for runway 32. Magnetic variation: 2W

2.19.2 ILS identification: COA

2.19.5 Coordinates: 39-42-52.06N / 86-15-44.56W

2.19.6 Site elevation: 752 ft

2.19.1 ILS type: Localizer for runway 32. Magnetic variation: 2W

2.19.2 ILS identification: COA

2.19.5 Coordinates: 39-44-00.00N / 86-17-28.59W

2.19.6 Site elevation: 783 ft

General Remarks:

PRIMARY STUDENT TOUCH AND GO LANDING NOT PERMITTED.

LARGE FLOCKS OF BIRDS ON & IN THE VICINITY OF AIRPORT.

NOISE ABATEMENT PROCEDURES IN EFFECT CONTACT AIRPORT MANAGEMENT ON 317-487-9594.

TAXIWAY V CLOSED TO AIR CARRIER OPERATIONS WITH MORE THAN 30 PASSENGER SEATS.

BE ALERT TO CLOSE PROXIMITY OF RUNWAY 14/32 TO NORTHEAST RAMP.

TAXIWAY 'H' RUNS CONTIGUOUS AT NORTHEAST RAMP.

TAXIWAY H NE OF TAXIWAY M NOT AVAILABLE FOR GROUP V AIRCRAFT.

RUNWAY 05R/23L & RUNWAY 14/32 HAVE 200 FT BLAST PADS BOTH ENDS. RUNWAY 5L/23R HAS 400 FT BLAST PAD AT BOTH ENDS.

Johnston Island
Johnston Atoll
ICAO Identifier PJON

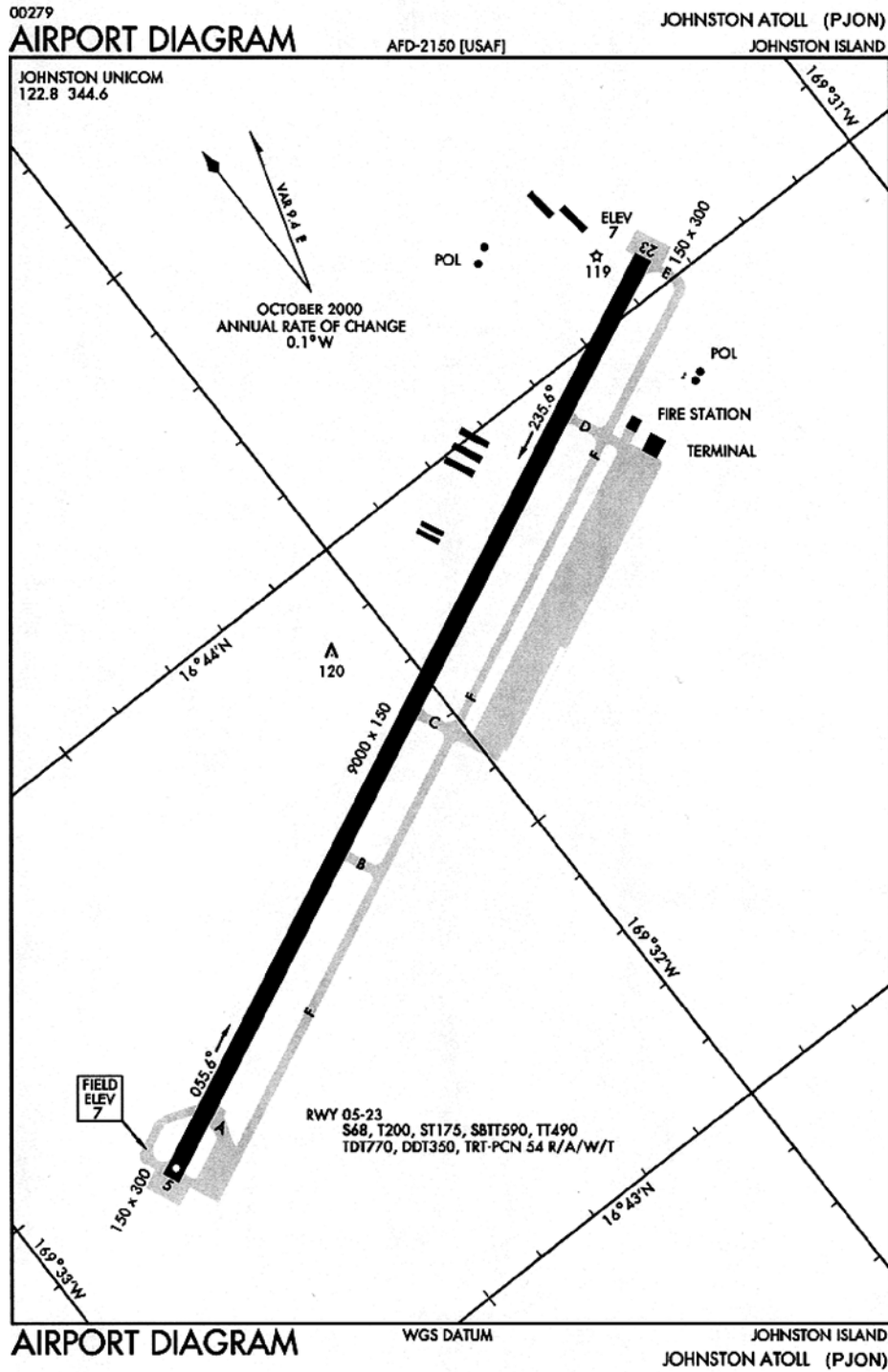

Wichita, Kansas
Wichita Mid-Continent
ICAO Identifier KICT

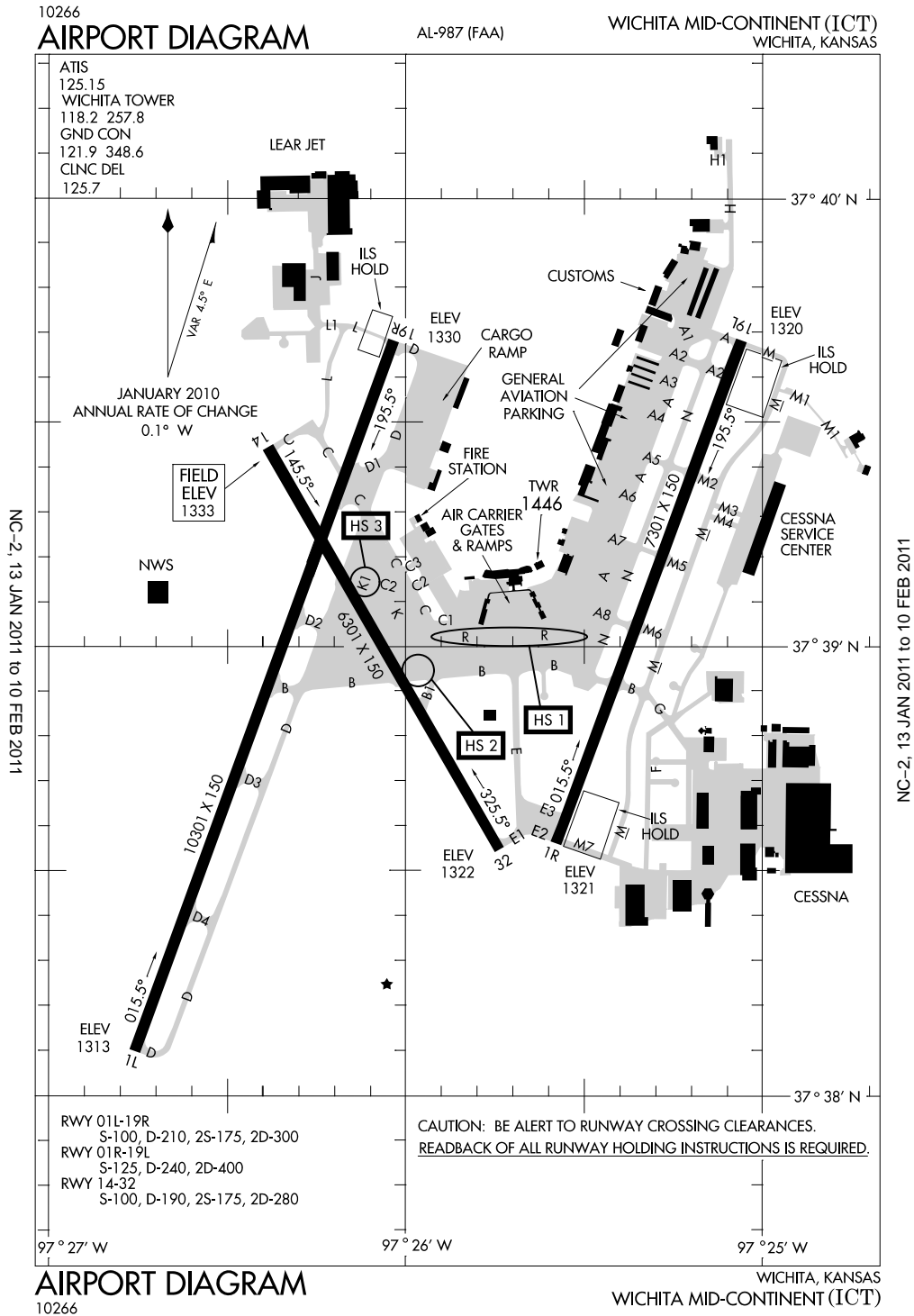

Wichita, KS
Wichita Mid-Continent
ICAO Identifier KICT

AD 2.2 Aerodrome geographical and administrative data

- 2.2.1 Reference Point: 37-38-59.80N / 97-25-59.00W
- 2.2.2 From City: 5 Miles SW Of Wichita, KS
- 2.2.3 Elevation: 1333 ft
- 2.2.5 Magnetic variation: 7E (1985)
- 2.2.6 Airport Contact: Mr. Victor White, A.A.E.
2173 AIR CARGO ROAD
Wichita, KS 67209
(316-946-4700)
- 2.2.7 Traffic: IFR/VFR

AD 2.3 Operational hours

- 2.3.1 - 2.3.11: ALL Months, ALL Days, ALL Hours

AD 2.4 Handling services and facilities

- 2.4.1 Cargo handling facilities: No
- 2.4.2 Fuel types: 100LL,A
- 2.4.4 De-icing facilities: None
- 2.4.5 Hangar space: Yes
- 2.4.6 Repair facilities: Major

AD 2.6 Rescue and firefighting services

- 2.6.1 Aerodrome category for firefighting: ARFF Index I C certified on 5/1/1973

AD 2.12 Runway physical characteristics

- 2.12.1 Designation: 01L
- 2.12.2 True Bearing: 20
- 2.12.3 Dimensions: 10301 ft x 150 ft
- 2.12.5 Coordinates: 37-38-00.00N / 97-26-45.59W
- 2.12.6 Threshold elevation: 1313 ft
- 2.12.6 Touchdown zone elevation: 1314 ft

- 2.12.1 Designation: 19R
- 2.12.2 True Bearing: 200
- 2.12.3 Dimensions: 10301 ft x 150 ft
- 2.12.5 Coordinates: 37-39-41.76N / 97-26-00.00W
- 2.12.6 Threshold elevation: 1330 ft
- 2.12.6 Touchdown zone elevation: 1330 ft

- 2.12.1 Designation: 01R
- 2.12.2 True Bearing: 20

- 2.12.3 Dimensions: 7301 ft x 150 ft
- 2.12.5 Coordinates: 37-38-33.95N / 97-25-34.63W
- 2.12.6 Threshold elevation: 1321 ft
- 2.12.6 Touchdown zone elevation: 1321 ft

- 2.12.1 Designation: 19L
- 2.12.2 True Bearing: 200
- 2.12.3 Dimensions: 7301 ft x 150 ft
- 2.12.5 Coordinates: 37-39-41.77N / 97-25-00.00W
- 2.12.6 Threshold elevation: 1320 ft
- 2.12.6 Touchdown zone elevation: 1320 ft

- 2.12.1 Designation: 14
- 2.12.2 True Bearing: 150
- 2.12.3 Dimensions: 6301 ft x 150 ft
- 2.12.5 Coordinates: 37-39-27.16N / 97-26-24.27W
- 2.12.6 Threshold elevation: 1332 ft
- 2.12.6 Touchdown zone elevation: 1333 ft

- 2.12.1 Designation: 32
- 2.12.2 True Bearing: 330
- 2.12.3 Dimensions: 6301 ft x 150 ft
- 2.12.5 Coordinates: 37-38-33.22N / 97-25-45.10W
- 2.12.6 Threshold elevation: 1322 ft
- 2.12.6 Touchdown zone elevation: 1322 ft

AD 2.14 Approach and runway lighting

- 2.14.1 Designation: 01L
- 2.14.2 Approach lighting system: ALSF2: Standard 2400 feet high intensity approach lighting system with sequenced flashers, category II or III configuration

- 2.14.1 Designation: 19R
- 2.14.2 Approach lighting system: MALSR: 1400 feet medium intensity approach lighting system with runway alignment indicator lights

- 2.14.1 Designation: 01R
- 2.14.2 Approach lighting system: MALSR: 1400 feet medium intensity approach lighting system with runway alignment indicator lights

- 2.14.1 Designation: 19L
- 2.14.2 Approach lighting system: MALSR: 1400 feet medium intensity approach lighting system with runway alignment indicator lights

2.14.4 Visual approach slope indicator system:
4-light PAPI on left

2.14.1 Designation: 14

2.14.4 Visual approach slope indicator system:
4-light PAPI on left

2.14.1 Designation: 32

2.14.4 Visual approach slope indicator system:
4-light PAPI on left

2.14.10 Remarks: PAPI Out Of Service Indefinitely.

AD 2.18 Air traffic services communication facilities

2.18.1 Service designation: LCL/P

2.18.3 Service designation: 118.2 MHz

2.18.1 Service designation: EMERG

2.18.3 Service designation: 121.5 MHz

2.18.1 Service designation: GND/P

2.18.3 Service designation: 121.9 MHz

2.18.1 Service designation: APCH/P

2.18.3 Service designation: 125.5 MHz

2.18.1 Service designation: CD/P

2.18.3 Service designation: 125.7 MHz

2.18.1 Service designation: APCH/P DEP/P
CLASS C IC

2.18.3 Service designation: 126.7 MHz

2.18.1 Service designation: CLASS C

2.18.3 Service designation: 134.85 MHz

2.18.1 Service designation: APCH/P DEP/P

2.18.3 Service designation: 134.85 MHz

2.18.1 Service designation: EMERG

2.18.3 Service designation: 243 MHz

2.18.1 Service designation: LCL/P

2.18.3 Service designation: 257.8 MHz

2.18.1 Service designation: APCH/P

2.18.3 Service designation: 269.1 MHz

2.18.1 Service designation: APCH/P

2.18.3 Service designation: 325.8 MHz

2.18.1 Service designation: APCH/S DEP/S

2.18.3 Service designation: 327.1 MHz

2.18.1 Service designation: GND/P

2.18.3 Service designation: 348.6 MHz

2.18.1 Service designation: APCH/P DEP/P
CLASS C IC

2.18.3 Service designation: 353.5 MHz

2.18.1 Service designation: APCH/P DEP/P

2.18.3 Service designation: 385.55 MHz

2.18.1 Service designation: CLASS C

2.18.3 Service designation: 385.55 MHz

2.18.1 Service designation: CLASS C

2.18.3 Service designation: 134.8 MHz

2.18.1 Service designation: ATIS

2.18.3 Service designation: 125.15 MHz

2.18.4 Hours of operation: 24

AD 2.19 Radio navigation and landing aids

2.19.1 ILS type: Glide Slope for runway 01L.
Magnetic variation: 7E

2.19.2 ILS identification: TWI

2.19.5 Coordinates: 37-38-16.71N /
97-26-46.01W

2.19.6 Site elevation: 1310 ft

2.19.1 ILS type: Middle Marker for runway 01L.
Magnetic variation: 7E

2.19.2 ILS identification: TWI

2.19.5 Coordinates: 37-37-39.47N /
97-26-57.83W

2.19.6 Site elevation: 1323 ft

2.19.1 ILS type: Outer Marker for runway 01L.
Magnetic variation: 7E

2.19.2 ILS identification: TWI

2.19.5 Coordinates: 37-33-33.95N /
97-28-51.78W

2.19.6 Site elevation: 1310 ft

2.19.1 ILS type: Inner Marker for runway 01L.
Magnetic variation: 7E

2.19.2 ILS identification: TWI

2.19.5 Coordinates: 37-37-57.14N /
97-26-49.69W

2.19.6 Site elevation: 1317 ft

2.19.1 ILS type: Localizer for runway 01L.
Magnetic variation: 7E
2.19.2 ILS identification: TWI
2.19.5 Coordinates: 37-39-51.34N /
97-25-57.41W
2.19.6 Site elevation: 1320 ft

2.19.1 ILS type: Localizer for runway 19R.
Magnetic variation: 7E
2.19.2 ILS identification: HOV
2.19.5 Coordinates: 37-37-55.48N /
97-26-50.44W
2.19.6 Site elevation: 1320 ft

2.19.1 ILS type: Glide Slope for runway 19R.
Magnetic variation: 7E
2.19.2 ILS identification: HOV
2.19.5 Coordinates: 37-39-33.83N /
97-26-10.72W
2.19.6 Site elevation: 1327 ft

2.19.1 ILS type: Middle Marker for runway 19R.
Magnetic variation: 7E
2.19.2 ILS identification: HOV
2.19.5 Coordinates: 37-40-00.00N /
97-25-49.89W
2.19.6 Site elevation: 99999 ft

2.19.1 ILS type: Outer Marker for runway 19R.
Magnetic variation: 7E
2.19.2 ILS identification: HOV
2.19.5 Coordinates: 37-44-16.61N /
97-24-00.00W
2.19.6 Site elevation: 99999 ft

2.19.1 ILS type: Localizer for runway 01R.
Magnetic variation: 7E
2.19.2 ILS identification: ICT
2.19.5 Coordinates: 37-39-50.13N /
97-24-59.73W
2.19.6 Site elevation: 1312 ft

2.19.1 ILS type: DME for runway 01R. Magnetic
variation: 7E
2.19.2 ILS identification: ICT
2.19.5 Coordinates: 37-39-52.04N /

97-25-00.00W
2.19.6 Site elevation: 1327 ft

2.19.1 ILS type: Glide Slope for runway 01R.
Magnetic variation: 7E
2.19.2 ILS identification: ICT
2.19.5 Coordinates: 37-38-42.64N /
97-25-24.70W
2.19.6 Site elevation: 1315 ft

2.19.1 ILS type: Middle Marker for runway 01R.
Magnetic variation: 7E
2.19.2 ILS identification: ICT
2.19.5 Coordinates: 37-38-00.00N /
97-25-49.07W
2.19.6 Site elevation: 99999 ft

2.19.1 ILS type: Outer Marker for runway 01R.
Magnetic variation: 7E
2.19.2 ILS identification: ICT
2.19.5 Coordinates: 37-34-41.50N /
97-27-21.09W
2.19.6 Site elevation: 99999 ft

2.19.1 ILS type: DME for runway 19L. Magnetic
variation: 7E
2.19.2 ILS identification: MVP
2.19.5 Coordinates: 37-38-21.53N /
97-25-43.26W
2.19.6 Site elevation: 1320 ft

2.19.1 ILS type: Glide Slope for runway 19L.
Magnetic variation: 7E
2.19.2 ILS identification: MVP
2.19.5 Coordinates: 37-39-30.78N /
97-25-00.00W
2.19.6 Site elevation: 1312 ft

2.19.1 ILS type: Localizer for runway 19L.
Magnetic variation: 7E
2.19.2 ILS identification: MVP
2.19.5 Coordinates: 37-38-21.32N /
97-25-40.42W
2.19.6 Site elevation: 1318 ft

General Remarks:

MIGRATORY BIRDS ON & IN THE VICINITY OF AIRPORT.

PRIOR PERMISSION REQUIRED FOR AIRCRAFT CARRYING CLASS 1 – DIVISION 1.1; 1.2 OR 1.3 EXPLOSIVES AS DEFINED BY 49 CODE OF FEDERAL REGULATIONS 173.50.

TAXIWAYS F, G, H, J, M1 AND ALL PARKING RAMPS ARE NON-MOVEMENT AREAS.

Covington, Kentucky Cincinnati/Northern Kentucky International ICAO Identifier KCVG

10210 AIRPORT DIAGRAM COVINGTON/ CINCINNATI/NORTHERN KENTUCKY INTL (CVG)
AL-655 (FAA) COVINGTON, KENTUCKY

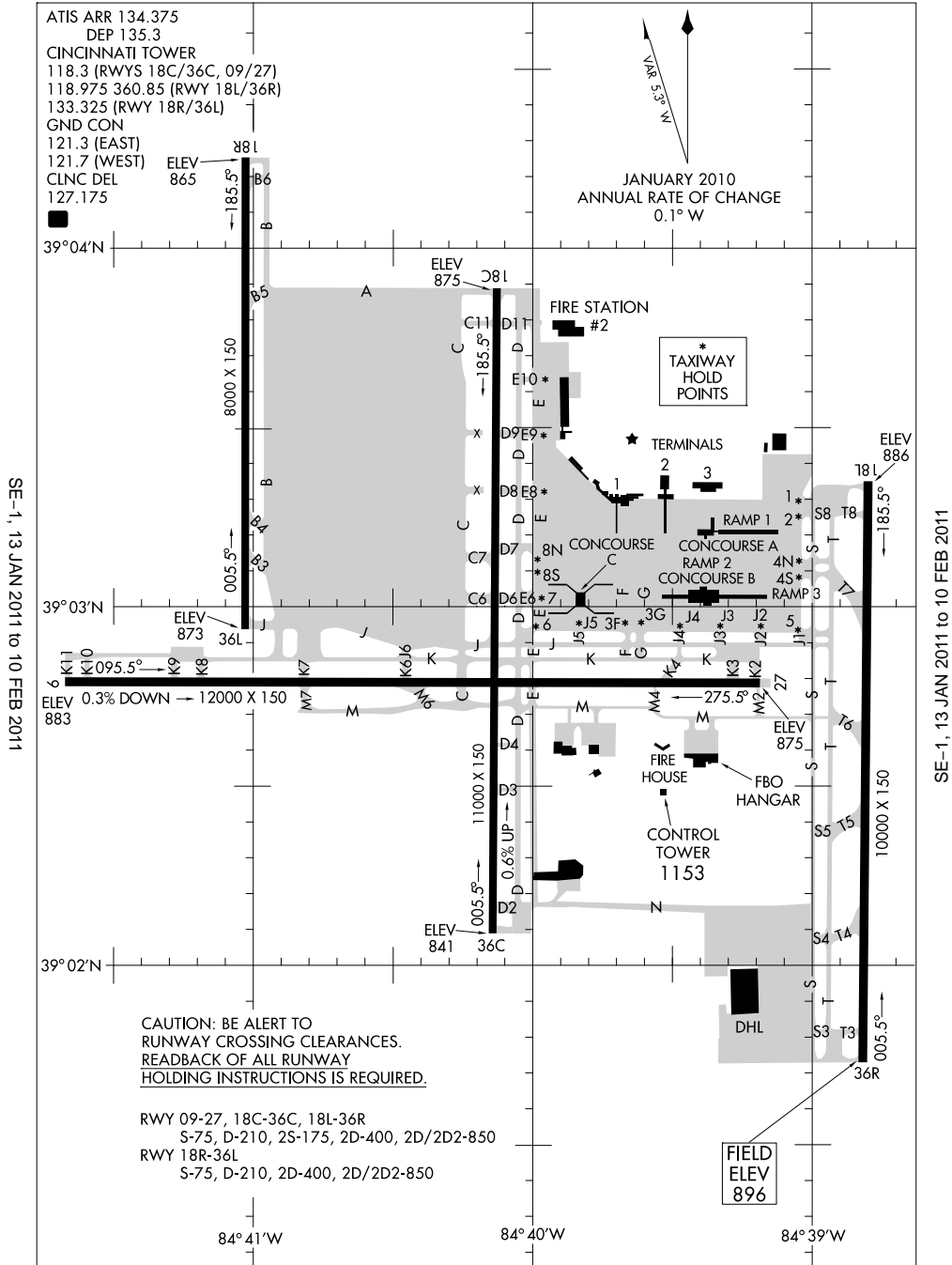

AIRPORT DIAGRAM COVINGTON, KENTUCKY
10210 COVINGTON/ CINCINNATI/NORTHERN KENTUCKY INTL (CVG)

Covington, KY
Cincinnati/Northern Kentucky Intl
ICAO Identifier KCVG

AD 2.2 Aerodrome geographical and administrative data

- 2.2.1 Reference Point: 39-02-55.81N / 84-40-00.00W
- 2.2.2 From City: 8 Miles SW Of Covington, KY
- 2.2.3 Elevation: 896 ft
- 2.2.5 Magnetic variation: 4W (1995)
- 2.2.6 Airport Contact: Mr. John C. Mok
PO BOX 752000
Cincinnati, OH 45275
(859-767-3151)
- 2.2.7 Traffic: IFR/VFR

AD 2.3 Operational hours

- 2.3.1 - 2.3.11: ALL Months, ALL Days, ALL Hours

AD 2.4 Handling services and facilities

- 2.4.1 Cargo handling facilities: No
- 2.4.2 Fuel types: 100LL,A
- 2.4.4 De-icing facilities: None
- 2.4.5 Hangar space: Yes
- 2.4.6 Repair facilities: Major

AD 2.6 Rescue and firefighting services

- 2.6.1 Aerodrome category for firefighting: ARFF Index I D certified on 5/1/1973

AD 2.10 Aerodrome obstacles

- 2.10.1.a. Runway designation: 36L
- 2.10.1.b Type of obstacle: Tree (91 ft). Not Lighted or Marked
- 2.10.1.c Location of obstacle: 895 ft from Centerline

AD 2.12 Runway physical characteristics

- 2.12.1 Designation: 18L
- 2.12.2 True Bearing: 180
- 2.12.3 Dimensions: 10000 ft x 150 ft
- 2.12.5 Coordinates: 39-03-21.08N / 84-38-48.00W
- 2.12.6 Threshold elevation: 886 ft
- 2.12.6 Touchdown zone elevation: 889 ft

- 2.12.1 Designation: 36R
- 2.12.2 True Bearing: 0
- 2.12.3 Dimensions: 10000 ft x 150 ft

- 2.12.5 Coordinates: 39-01-42.24N / 84-38-48.46W
- 2.12.6 Threshold elevation: 896 ft
- 2.12.6 Touchdown zone elevation: 896 ft

- 2.12.1 Designation: 18C
- 2.12.2 True Bearing: 180
- 2.12.3 Dimensions: 11000 ft x 150 ft
- 2.12.5 Coordinates: 39-03-53.07N / 84-40-00.00W
- 2.12.6 Threshold elevation: 875 ft
- 2.12.6 Touchdown zone elevation: 875 ft

- 2.12.1 Designation: 36C
- 2.12.2 True Bearing: 0
- 2.12.3 Dimensions: 11000 ft x 150 ft
- 2.12.5 Coordinates: 39-02-00.00N / 84-40-00.00W
- 2.12.6 Threshold elevation: 841 ft
- 2.12.6 Touchdown zone elevation: 851 ft

- 2.12.1 Designation: 09
- 2.12.2 True Bearing: 90
- 2.12.3 Dimensions: 12000 ft x 150 ft
- 2.12.5 Coordinates: 39-02-46.91N / 84-41-42.36W
- 2.12.6 Threshold elevation: 883 ft
- 2.12.6 Touchdown zone elevation: 883 ft

- 2.12.1 Designation: 27
- 2.12.2 True Bearing: 270
- 2.12.3 Dimensions: 12000 ft x 150 ft
- 2.12.5 Coordinates: 39-02-46.54N / 84-39-10.26W
- 2.12.6 Threshold elevation: 875 ft
- 2.12.6 Touchdown zone elevation: 875 ft

- 2.12.1 Designation: 18R
- 2.12.2 True Bearing: 180
- 2.12.3 Dimensions: 8000 ft x 150 ft
- 2.12.5 Coordinates: 39-04-15.18N / 84-41-00.00W
- 2.12.6 Threshold elevation: 865 ft
- 2.12.6 Touchdown zone elevation: 868 ft

- 2.12.1 Designation: 36L
- 2.12.2 True Bearing: 0
- 2.12.3 Dimensions: 8000 ft x 150 ft
- 2.12.5 Coordinates: 39-02-56.11N / 84-41-00.00W
- 2.12.6 Threshold elevation: 873 ft

2.12.6 Touchdown zone elevation: 873 ft

AD 2.13 Declared distances

- 2.13.1 Designation: 09
- 2.13.2 Takeoff run available: 12000
- 2.13.3 Takeoff distance available: 12000
- 2.13.4 Accelerate-stop distance available: 11880
- 2.13.5 Landing distance available: 11880

- 2.13.1 Designation: 27
- 2.13.2 Takeoff run available: 12000
- 2.13.3 Takeoff distance available: 12000
- 2.13.4 Accelerate-stop distance available: 12000
- 2.13.5 Landing distance available: 12000

AD 2.14 Approach and runway lighting

- 2.14.1 Designation: 18L
- 2.14.2 Approach lighting system: MALSR: 1400 feet medium intensity approach lighting system with runway alignment indicator lights
- 2.14.4 Visual approach slope indicator system: 4-light PAPI on right
- 2.14.1 Designation: 36R
- 2.14.2 Approach lighting system: ALSF2: Standard 2400 feet high intensity approach lighting system with sequenced flashers, category II or III configuration
- 2.14.4 Visual approach slope indicator system: 4-light PAPI on right
- 2.14.1 Designation: 18C
- 2.14.2 Approach lighting system: SSALR: Simplified short approach lighting system with runway alignment indicator lights
- 2.14.4 Visual approach slope indicator system: 4-box VASI on right

- 2.14.1 Designation: 36C
- 2.14.2 Approach lighting system: ALSF2: Standard 2400 feet high intensity approach lighting system with sequenced flashers, category II or III configuration
- 2.14.4 Visual approach slope indicator system: 4-light PAPI on left

- 2.14.1 Designation: 09
- 2.14.2 Approach lighting system: MALSR: 1400 feet medium intensity approach lighting system with runway alignment indicator lights
- 2.14.4 Visual approach slope indicator system:

4-light PAPI on left

- 2.14.1 Designation: 27
- 2.14.2 Approach lighting system: MALSR: 1400 feet medium intensity approach lighting system with runway alignment indicator lights
- 2.14.4 Visual approach slope indicator system: 4-box VASI on left

- 2.14.1 Designation: 18R
- 2.14.2 Approach lighting system: ALSF2: Standard 2400 feet high intensity approach lighting system with sequenced flashers, category II or III configuration

- 2.14.1 Designation: 36L
- 2.14.2 Approach lighting system: ALSF2: Standard 2400 feet high intensity approach lighting system with sequenced flashers, category II or III configuration

AD 2.18 Air traffic services communication facilities

- 2.18.1 Service designation: LCL/P
- 2.18.3 Service designation: 118.975 MHz
- 2.18.1 Service designation: APCH/P CLASS B
- 2.18.3 Service designation: 119.7 MHz
- 2.18.1 Service designation: GND/P
- 2.18.3 Service designation: 121.3 MHz
- 2.18.1 Service designation: EMERG
- 2.18.3 Service designation: 121.5 MHz
- 2.18.1 Service designation: GND/P
- 2.18.3 Service designation: 121.7 MHz
- 2.18.1 Service designation: APCH/P CLASS B
- 2.18.3 Service designation: 123.875 MHz
- 2.18.1 Service designation: (001-180)
- 2.18.3 Service designation: 126.65 MHz
- 2.18.1 Service designation: CD/P
- 2.18.3 Service designation: 127.175 MHz
- 2.18.1 Service designation: DEP/P CLASS B
- 2.18.3 Service designation: 128.7 MHz
- 2.18.1 Service designation: D-ATIS

2.18.3 Service designation: 134.375 MHz
2.18.4 Hours of operation: 24

84-38-48.51W
2.19.6 Site elevation: 872 ft

2.18.1 Service designation: D-ATIS
2.18.3 Service designation: 135.3 MHz
2.18.4 Hours of operation: 24

2.19.1 ILS type: DME for runway 36R. Magnetic variation: 4W
2.19.2 ILS identification: EEI
2.19.5 Coordinates: 39-03-30.88N / 84-38-51.18W
2.19.6 Site elevation: 905 ft

2.18.1 Service designation: EMERG
2.18.3 Service designation: 243 MHz

2.18.1 Service designation: LCL/P
2.18.3 Service designation: 360.85 MHz

2.19.1 ILS type: Middle Marker for runway 36R. Magnetic variation: 4W
2.19.2 ILS identification: EEI
2.19.5 Coordinates: 39-01-16.54N / 84-38-48.58W
2.19.6 Site elevation: 915 ft

2.18.1 Service designation: APCH/P CLASS B
2.18.3 Service designation: 254.25 MHz

2.18.1 Service designation: APCH/P CLASS B
2.18.3 Service designation: 363.15 MHz

2.19.1 ILS type: Localizer for runway 36R. Magnetic variation: 4W
2.19.2 ILS identification: EEI
2.19.5 Coordinates: 39-03-31.50N / 84-38-47.96W
2.19.6 Site elevation: 892 ft

2.18.1 Service designation: LCL/P
2.18.3 Service designation: 118.3 MHz

2.18.1 Service designation: LCL/P
2.18.3 Service designation: 133.325 MHz

AD 2.19 Radio navigation and landing aids

2.19.1 ILS type: DME for runway 18L. Magnetic variation: 4W
2.19.2 ILS identification: CIZ
2.19.5 Coordinates: 39-01-31.58N / 84-38-45.41W
2.19.6 Site elevation: 915 ft

2.19.1 ILS type: Glide Slope for runway 36R. Magnetic variation: 4W
2.19.2 ILS identification: EEI
2.19.5 Coordinates: 39-01-52.80N / 84-38-43.34W
2.19.6 Site elevation: 890 ft

2.19.1 ILS type: Localizer for runway 18L. Magnetic variation: 4W
2.19.2 ILS identification: CIZ
2.19.5 Coordinates: 39-01-31.79N / 84-38-48.50W
2.19.6 Site elevation: 899 ft

2.19.1 ILS type: Inner Marker for runway 36R. Magnetic variation: 4W
2.19.2 ILS identification: EEI
2.19.5 Coordinates: 39-01-33.56N / 84-38-48.50W
2.19.6 Site elevation: 899 ft

2.19.1 ILS type: Glide Slope for runway 18L. Magnetic variation: 4W
2.19.2 ILS identification: CIZ
2.19.5 Coordinates: 39-03-10.88N / 84-38-42.98W
2.19.6 Site elevation: 881 ft

2.19.1 ILS type: Localizer for runway 18C. Magnetic variation: 4W
2.19.2 ILS identification: SIC
2.19.5 Coordinates: 39-01-59.67N / 84-40-00.00W
2.19.6 Site elevation: 839 ft

2.19.1 ILS type: Middle Marker for runway 18L. Magnetic variation: 4W
2.19.2 ILS identification: CIZ
2.19.5 Coordinates: 39-03-47.57N /

2.19.1 ILS type: Middle Marker for runway 18C. Magnetic variation: 4W
2.19.2 ILS identification: SIC
2.19.5 Coordinates: 39-04-10.50N / 84-40-00.00W
2.19.6 Site elevation: 99999 ft

2.19.1 ILS type: DME for runway 18C. Magnetic variation: 4W
2.19.2 ILS identification: SIC
2.19.5 Coordinates: 39-01-59.68N / 84-40-00.00W
2.19.6 Site elevation: 845 ft

2.19.1 ILS type: Outer Marker for runway 18C. Magnetic variation: 4W
2.19.2 ILS identification: SIC
2.19.5 Coordinates: 39-07-30.20N / 84-40-00.00W
2.19.6 Site elevation: 99999 ft

2.19.1 ILS type: Glide Slope for runway 18C. Magnetic variation: 4W
2.19.2 ILS identification: SIC
2.19.5 Coordinates: 39-03-42.65N / 84-40-12.14W
2.19.6 Site elevation: 868 ft

2.19.1 ILS type: Localizer for runway 36C. Magnetic variation: 4W
2.19.2 ILS identification: CVG
2.19.5 Coordinates: 39-04-00.00N / 84-40-00.00W
2.19.6 Site elevation: 882 ft

2.19.1 ILS type: DME for runway 36C. Magnetic variation: 4W
2.19.2 ILS identification: CVG
2.19.5 Coordinates: 39-04-00.00N / 84-40-10.17W
2.19.6 Site elevation: 886 ft

2.19.1 ILS type: Glide Slope for runway 36C. Magnetic variation: 4W
2.19.2 ILS identification: CVG
2.19.5 Coordinates: 39-02-15.48N / 84-40-12.49W
2.19.6 Site elevation: 834 ft

2.19.1 ILS type: Inner Marker for runway 36C. Magnetic variation: 4W
2.19.2 ILS identification: CVG
2.19.5 Coordinates: 39-01-54.05N / 84-40-00.00W
2.19.6 Site elevation: 956 ft

2.19.1 ILS type: Middle Marker for runway 36C. Magnetic variation: 4W

2.19.2 ILS identification: CVG
2.19.5 Coordinates: 39-01-31.79N / 84-40-00.00W
2.19.6 Site elevation: 99999 ft

2.19.1 ILS type: Glide Slope for runway 09. Magnetic variation: 4W
2.19.2 ILS identification: URN
2.19.5 Coordinates: 39-02-42.92N / 84-41-28.27W
2.19.6 Site elevation: 874 ft

2.19.1 ILS type: Outer Marker for runway 09. Magnetic variation: 4W
2.19.2 ILS identification: URN
2.19.5 Coordinates: 39-02-44.69N / 84-46-22.67W
2.19.6 Site elevation: 99999 ft

2.19.1 ILS type: Middle Marker for runway 09. Magnetic variation: 4W
2.19.2 ILS identification: URN
2.19.5 Coordinates: 39-02-46.92N / 84-41-27.61W
2.19.6 Site elevation: 99999 ft

2.19.1 ILS type: Localizer for runway 09. Magnetic variation: 4W
2.19.2 ILS identification: URN
2.19.5 Coordinates: 39-02-46.53N / 84-39-00.00W
2.19.6 Site elevation: 874 ft

2.19.1 ILS type: DME for runway 09. Magnetic variation: 4W
2.19.2 ILS identification: URN
2.19.5 Coordinates: 39-02-43.95N / 84-39-00.00W
2.19.6 Site elevation: 872 ft

2.19.1 ILS type: Localizer for runway 27. Magnetic variation: 4W
2.19.2 ILS identification: JDP
2.19.5 Coordinates: 39-02-46.94N / 84-41-55.34W
2.19.6 Site elevation: 884 ft

2.19.1 ILS type: Middle Marker for runway 27. Magnetic variation: 4W
2.19.2 ILS identification: JDP
2.19.5 Coordinates: 39-02-46.46N /

84-38-37.56W
2.19.6 Site elevation: 890 ft

2.19.1 ILS type: Outer Marker for runway 27.
Magnetic variation: 4W
2.19.2 ILS identification: JDP
2.19.5 Coordinates: 39-02-46.53N /
84-32-59.24W
2.19.6 Site elevation: 860 ft

2.19.1 ILS type: Glide Slope for runway 27.
Magnetic variation: 4W
2.19.2 ILS identification: JDP
2.19.5 Coordinates: 39-02-46.58N /
84-39-25.15W
2.19.6 Site elevation: 867 ft

2.19.1 ILS type: DME for runway 36L. Magnetic
variation: 4W
2.19.2 ILS identification: VAC
2.19.5 Coordinates: 39-04-25.03N /
84-41-00.00W
2.19.6 Site elevation: 848 ft

2.19.1 ILS type: Localizer for runway 36L.
Magnetic variation: 4W
2.19.2 ILS identification: VAC
2.19.5 Coordinates: 39-04-25.49N /
84-41-00.00W
2.19.6 Site elevation: 855 ft

2.19.1 ILS type: Glide Slope for runway 36L.
Magnetic variation: 4W

2.19.2 ILS identification: VAC
2.19.5 Coordinates: 39-03-00.00N /
84-41-00.00W
2.19.6 Site elevation: 867 ft

2.19.1 ILS type: Localizer for runway 18R.
Magnetic variation: 4W
2.19.2 ILS identification: CJN
2.19.5 Coordinates: 39-02-41.27N /
84-41-00.00W
2.19.6 Site elevation: 878 ft

2.19.1 ILS type: Inner Marker for runway 18R.
Magnetic variation: 4W
2.19.2 ILS identification: CJN
2.19.5 Coordinates: 39-04-23.57N /
84-41-00.00W
2.19.6 Site elevation: 860 ft

2.19.1 ILS type: Glide Slope for runway 18R.
Magnetic variation: 4W
2.19.2 ILS identification: CJN
2.19.5 Coordinates: 39-04-00.00N /
84-41-00.00W
2.19.6 Site elevation: 861 ft

2.19.1 ILS type: DME for runway 18R. Magnetic
variation: 4W
2.19.2 ILS identification: CJN
2.19.5 Coordinates: 39-02-41.52N /
84-41-00.00W
2.19.6 Site elevation: 869 ft

General Remarks:

NOISE SENSITIVE AREAS NORTH & SOUTH OF AIRPORT. RUNWAY ASSIGNMENTS BETWEEN 2200-0700 WILL BE PREDICATED ON NOISE ABATEMENT CONSIDERATIONS.

FOR ALL RUNWAYS GROSS WEIGHT STRENGTH FOR 777 AIRCRAFT IS 595,000 LBS.

FOR ALL RUNWAYS GROSS WEIGHT STRENGTH FOR MD11 AIRCRAFT IS 605,000 LBS.

SUCCESSIVE OR SIMULTANEOUS DEPS FROM RUNWAYS 18L/R ARE APPROVED WITH COURSE DIVERGENCE BEGINNING NO FURTHER THAN 2 MILES FROM END OF RUNWAY DUE TO NOISE ABATEMENT RESTRICTIONS.

RUNWAY 09/27 WEST 4200 FT CONCRETE; EAST 750 FT CONCRETE; REMAINDER ASPHALT OVERLAY.

SUCCESSIVE OR SIMULTANEOUS DEPS FROM RUNWAY 36L & RUNWAY 36R ARE APPROVED WITH COURSE DIVERGENCE BEGINNING NO FURTHER THAN 2 MILES FROM END OF RUNWAY DUE TO NOISE ABATEMENT RESTRICTIONS.

New Orleans, Louisiana Louis Armstrong New Orleans International ICAO Identifier KMSY

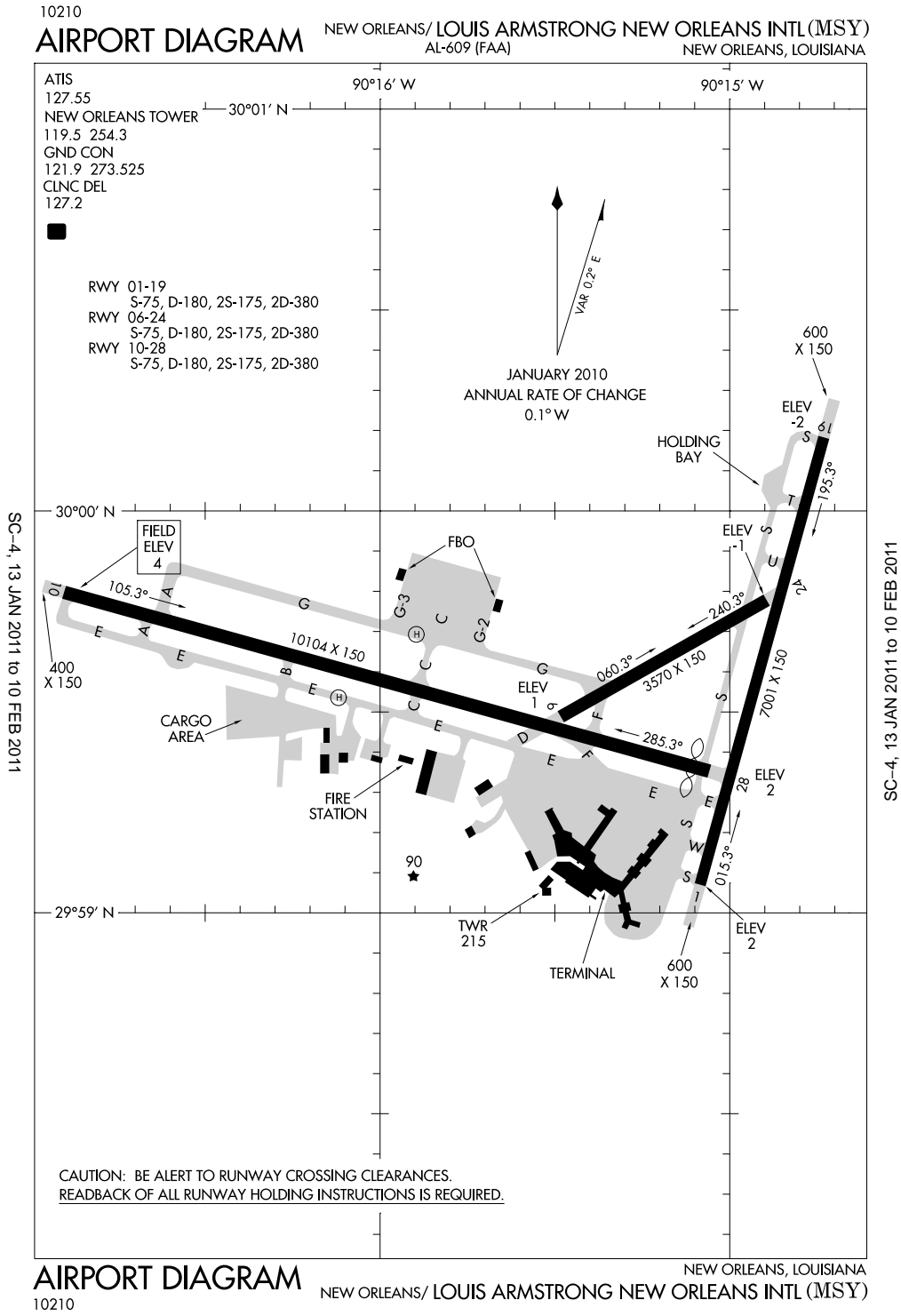

New Orleans, LA
Louis Armstrong New Orleans Intl
ICAO Identifier KMSY

AD 2.2 Aerodrome geographical and administrative data

- 2.2.1 Reference Point: 29-59-36.20N / 90-15-28.90W
- 2.2.2 From City: 10 Miles W Of New Orleans, LA
- 2.2.3 Elevation: 4 ft
- 2.2.5 Magnetic variation: 2E (1990)
- 2.2.6 Airport Contact: Iftekar Ahmad
PO BOX 20007
New Orleans, LA 70141
(504-628-2426)
- 2.2.7 Traffic: IFR/VFR

AD 2.3 Operational hours

- 2.3.1 - 2.3.11: ALL Months, ALL Days, ALL Hours

AD 2.4 Handling services and facilities

- 2.4.1 Cargo handling facilities: No
- 2.4.2 Fuel types: 100LL,A
- 2.4.4 De-icing facilities: None
- 2.4.5 Hangar space: No
- 2.4.6 Repair facilities: None

AD 2.6 Rescue and firefighting services

- 2.6.1 Aerodrome category for firefighting: ARFF Index I D certified on 5/1/1973

AD 2.10 Aerodrome obstacles

- 2.10.1.a. Runway designation: 01
- 2.10.1.b Type of obstacle: Road (12 ft). Lighted
- 2.10.1.c Location of obstacle: 365 ft from Centerline

- 2.10.1.a. Runway designation: 19
- 2.10.1.b Type of obstacle: Road (13 ft). Lighted
- 2.10.1.c Location of obstacle: 289 ft from Centerline

- 2.10.1.a. Runway designation: 06
- 2.10.1.b Type of obstacle: Pole (30 ft). Lighted
- 2.10.1.c Location of obstacle: 343 ft from Centerline

- 2.10.1.a. Runway designation: 24
- 2.10.1.b Type of obstacle: Tree (33 ft). Not Lighted or Marked

- 2.10.1.c Location of obstacle: 315 ft from Centerline

- 2.10.1.a. Runway designation: 28
- 2.10.1.b Type of obstacle: Tree (53 ft). Not Lighted or Marked
- 2.10.1.c Location of obstacle: 694 ft from Centerline

AD 2.12 Runway physical characteristics

- 2.12.1 Designation: 01
- 2.12.2 True Bearing: 15
- 2.12.3 Dimensions: 7001 ft x 150 ft
- 2.12.5 Coordinates: 29-59-00.00N / 90-15-00.00W
- 2.12.6 Threshold elevation: 2 ft
- 2.12.6 Touchdown zone elevation: 3 ft

- 2.12.1 Designation: 19
- 2.12.2 True Bearing: 195
- 2.12.3 Dimensions: 7001 ft x 150 ft
- 2.12.5 Coordinates: 30-00-10.99N / 90-14-43.84W
- 2.12.6 Threshold elevation: -2 ft
- 2.12.6 Touchdown zone elevation: 0 ft

- 2.12.1 Designation: 06
- 2.12.2 True Bearing: 60
- 2.12.3 Dimensions: 3570 ft x 150 ft
- 2.12.5 Coordinates: 29-59-29.27N / 90-15-28.99W
- 2.12.6 Threshold elevation: 1 ft
- 2.12.6 Touchdown zone elevation: 1 ft

- 2.12.1 Designation: 24
- 2.12.2 True Bearing: 240
- 2.12.3 Dimensions: 3570 ft x 150 ft
- 2.12.5 Coordinates: 29-59-46.68N / 90-14-53.67W
- 2.12.6 Threshold elevation: -1 ft
- 2.12.6 Touchdown zone elevation: 1 ft

- 2.12.1 Designation: 10
- 2.12.2 True Bearing: 105
- 2.12.3 Dimensions: 10104 ft x 150 ft
- 2.12.5 Coordinates: 29-59-47.86N / 90-16-54.22W
- 2.12.6 Threshold elevation: 4 ft
- 2.12.6 Touchdown zone elevation: 4 ft

- 2.12.1 Designation: 28

- 2.12.2 True Bearing: 285
- 2.12.3 Dimensions: 10104 ft x 150 ft
- 2.12.5 Coordinates: 29-59-21.17N / 90-15-00.00W
- 2.12.6 Threshold elevation: 2 ft
- 2.12.6 Touchdown zone elevation: 3 ft

AD 2.13 Declared distances

- 2.13.1 Designation: 01
- 2.13.2 Takeoff run available: 7001
- 2.13.3 Takeoff distance available: 7001
- 2.13.4 Accelerate-stop distance available: 7001
- 2.13.5 Landing distance available: 7001

- 2.13.1 Designation: 19
- 2.13.2 Takeoff run available: 7001
- 2.13.3 Takeoff distance available: 7001
- 2.13.4 Accelerate-stop distance available: 7001
- 2.13.5 Landing distance available: 7001

- 2.13.1 Designation: 06
- 2.13.2 Takeoff run available: 3570
- 2.13.3 Takeoff distance available: 3570
- 2.13.4 Accelerate-stop distance available: 3570
- 2.13.5 Landing distance available: 3570

- 2.13.1 Designation: 24
- 2.13.2 Takeoff run available: 3570
- 2.13.3 Takeoff distance available: 3570
- 2.13.4 Accelerate-stop distance available: 3570
- 2.13.5 Landing distance available: 3570

- 2.13.1 Designation: 10
- 2.13.2 Takeoff run available: 10104
- 2.13.3 Takeoff distance available: 10104
- 2.13.4 Accelerate-stop distance available: 10104
- 2.13.5 Landing distance available: 10104

- 2.13.1 Designation: 28
- 2.13.2 Takeoff run available: 10104
- 2.13.3 Takeoff distance available: 10104
- 2.13.4 Accelerate-stop distance available: 10104
- 2.13.5 Landing distance available: 9800

AD 2.14 Approach and runway lighting

- 2.14.1 Designation: 01
- 2.14.2 Approach lighting system: LDIN: Lead-in light system
- 2.14.4 Visual approach slope indicator system: 4-light PAPI on left

- 2.14.1 Designation: 19
- 2.14.2 Approach lighting system: MALS: 1400 feet medium intensity approach lighting system
- 2.14.4 Visual approach slope indicator system: 4-light PAPI on left

- 2.14.1 Designation: 10
- 2.14.2 Approach lighting system: ALSF2: Standard 2400 feet high intensity approach lighting system with sequenced flashers, category II or III configuration
- 2.14.4 Visual approach slope indicator system: 4-light PAPI on right

- 2.14.1 Designation: 28
- 2.14.2 Approach lighting system: MALSR: 1400 feet medium intensity approach lighting system with runway alignment indicator lights
- 2.14.4 Visual approach slope indicator system: 4-light PAPI on right

AD 2.18 Air traffic services communication facilities

- 2.18.1 Service designation: LCL/P
- 2.18.3 Service designation: 119.5 MHz

- 2.18.1 Service designation: APCH/P
- 2.18.3 Service designation: 120.1 MHz

- 2.18.1 Service designation: EMERG
- 2.18.3 Service designation: 121.5 MHz

- 2.18.1 Service designation: GND/P
- 2.18.3 Service designation: 121.9 MHz

- 2.18.1 Service designation: APCH/P DEP/P CLASS B
- 2.18.3 Service designation: 123.85 MHz

- 2.18.1 Service designation: APCH/P DEP/P CLASS B
- 2.18.3 Service designation: 125.5 MHz

- 2.18.1 Service designation: IC
- 2.18.3 Service designation: 125.5 MHz

- 2.18.1 Service designation: CD/P PTC
- 2.18.3 Service designation: 127.2 MHz

- 2.18.1 Service designation: D-ATIS
- 2.18.3 Service designation: 127.55 MHz

2.18.4 Hours of operation: 24

2.18.1 Service designation: APCH/P DEP/P
CLASS B

2.18.3 Service designation: 133.15 MHz

2.18.1 Service designation: EMERG

2.18.3 Service designation: 243 MHz

2.18.1 Service designation: LCL/P

2.18.3 Service designation: 254.3 MHz

2.18.1 Service designation: APCH/P DEP/P
CLASS B

2.18.3 Service designation: 256.9 MHz

2.18.1 Service designation: APCH/S

2.18.3 Service designation: 269.2 MHz

2.18.1 Service designation: IC

2.18.3 Service designation: 284.7 MHz

2.18.1 Service designation: APCH/P DEP/P
CLASS B

2.18.3 Service designation: 290.3 MHz

2.18.1 Service designation: APCH/P DEP/P
CLASS B

2.18.3 Service designation: 350.35 MHz

2.18.1 Service designation: GND/P

2.18.3 Service designation: 273.525 MHz

AD 2.19 Radio navigation and landing aids

2.19.1 ILS type: DME for runway 01. Magnetic
variation: 2E

2.19.2 ILS identification: JFI

2.19.5 Coordinates: 30-00-21.65N /
90-14-43.24W

2.19.6 Site elevation: 10 ft

2.19.1 ILS type: Glide Slope for runway 01.
Magnetic variation: 2E

2.19.2 ILS identification: JFI

2.19.5 Coordinates: 29-59-13.61N /
90-14-58.55W

2.19.6 Site elevation: 0 ft

2.19.1 ILS type: Outer Marker for runway 01.
Magnetic variation: 2E

2.19.2 ILS identification: JFI

2.19.5 Coordinates: 29-54-53.36N /
90-16-26.35W

2.19.6 Site elevation: 99999 ft

2.19.1 ILS type: Localizer for runway 01. Magnetic
variation: 2E

2.19.2 ILS identification: JFI

2.19.5 Coordinates: 30-00-20.51N /
90-14-40.81W

2.19.6 Site elevation: -4 ft

2.19.1 ILS type: Middle Marker for runway 01.
Magnetic variation: 2E

2.19.2 ILS identification: JFI

2.19.5 Coordinates: 29-58-28.53N /
90-15-15.88W

2.19.6 Site elevation: 99999 ft

2.19.1 ILS type: DME for runway 19. Magnetic
variation: 2E

2.19.2 ILS identification: ONW

2.19.5 Coordinates: 30-00-21.65N /
90-14-43.24W

2.19.6 Site elevation: 10 ft

2.19.1 ILS type: Localizer for runway 19. Magnetic
variation: 2E

2.19.2 ILS identification: ONW

2.19.5 Coordinates: 29-58-56.76N /
90-15-00.00W

2.19.6 Site elevation: 2 ft

2.19.1 ILS type: Glide Slope for runway 10.
Magnetic variation: 2E

2.19.2 ILS identification: MSY

2.19.5 Coordinates: 29-59-48.61N /
90-16-39.25W

2.19.6 Site elevation: 3 ft

2.19.1 ILS type: Outer Marker for runway 10.
Magnetic variation: 2E

2.19.2 ILS identification: MSY

2.19.5 Coordinates: 30-01-30.85N /
90-23-59.58W

2.19.6 Site elevation: 99999 ft

2.19.1 ILS type: Inner Marker for runway 10.
Magnetic variation: 2E

2.19.2 ILS identification: MSY

2.19.5 Coordinates: 29-59-50.26N /
90-17-00.00W

2.19.6 Site elevation: 99999 ft

2.19.1 ILS type: DME for runway 10. Magnetic variation: 2E

2.19.2 ILS identification: MSY

2.19.5 Coordinates: 29-59-17.34N / 90-14-56.02W

2.19.6 Site elevation: 13 ft

2.19.1 ILS type: Localizer for runway 10. Magnetic variation: 2E

2.19.2 ILS identification: MSY

2.19.5 Coordinates: 29-59-19.32N / 90-14-55.85W

2.19.6 Site elevation: 0 ft

2.19.1 ILS type: Middle Marker for runway 10. Magnetic variation: 2E

2.19.2 ILS identification: MSY

2.19.5 Coordinates: 29-59-56.63N / 90-17-22.12W

2.19.6 Site elevation: 99999 ft

2.19.1 ILS type: DME for runway 28. Magnetic variation: 2E

2.19.2 ILS identification: HOX

2.19.5 Coordinates: 29-59-17.34N / 90-14-56.02W

2.19.6 Site elevation: 13 ft

2.19.1 ILS type: Glide Slope for runway 28.

Magnetic variation: 2E

2.19.2 ILS identification: HOX

2.19.5 Coordinates: 29-59-27.97N / 90-15-16.78W

2.19.6 Site elevation: 1 ft

2.19.1 ILS type: Middle Marker for runway 28.

Magnetic variation: 2E

2.19.2 ILS identification: HOX

2.19.5 Coordinates: 29-59-15.11N / 90-14-37.70W

2.19.6 Site elevation: 1 ft

2.19.1 ILS type: Outer Marker for runway 28.

Magnetic variation: 2E

2.19.2 ILS identification: HOX

2.19.5 Coordinates: 29-58-12.35N / 90-10-27.99W

2.19.6 Site elevation: 5 ft

2.19.1 ILS type: Localizer for runway 28. Magnetic variation: 2E

2.19.2 ILS identification: HOX

2.19.5 Coordinates: 29-59-50.53N / 90-17-00.00W

2.19.6 Site elevation: 5 ft

General Remarks:

180 DEGREE & LOCKED WHEEL TURNS PROHIBITED ON ASPHALT SURFACE AIRCRAFT 12500 LBS & OVER.

FLOCKS OF BIRDS ON & IN VICINITY OF AIRPORT.

RUNWAY 10 NOISE SENSITIVE FOR DEP; AVAILABLE FOR OPERATIONAL NECESSITY. ALL RUNWAYS NOISE SENSITIVE FOR ARR. ARRIVING TURBOJETS MUST MAKE 5 MILE FINAL APPROACH TO MINIMIZE NOISE.

RUNWAY 06/24 CLOSED TO TAKEOFFS AND LANDINGS INDEFINITELY.

Bangor, Maine Bangor International ICAO Identifier KBGR

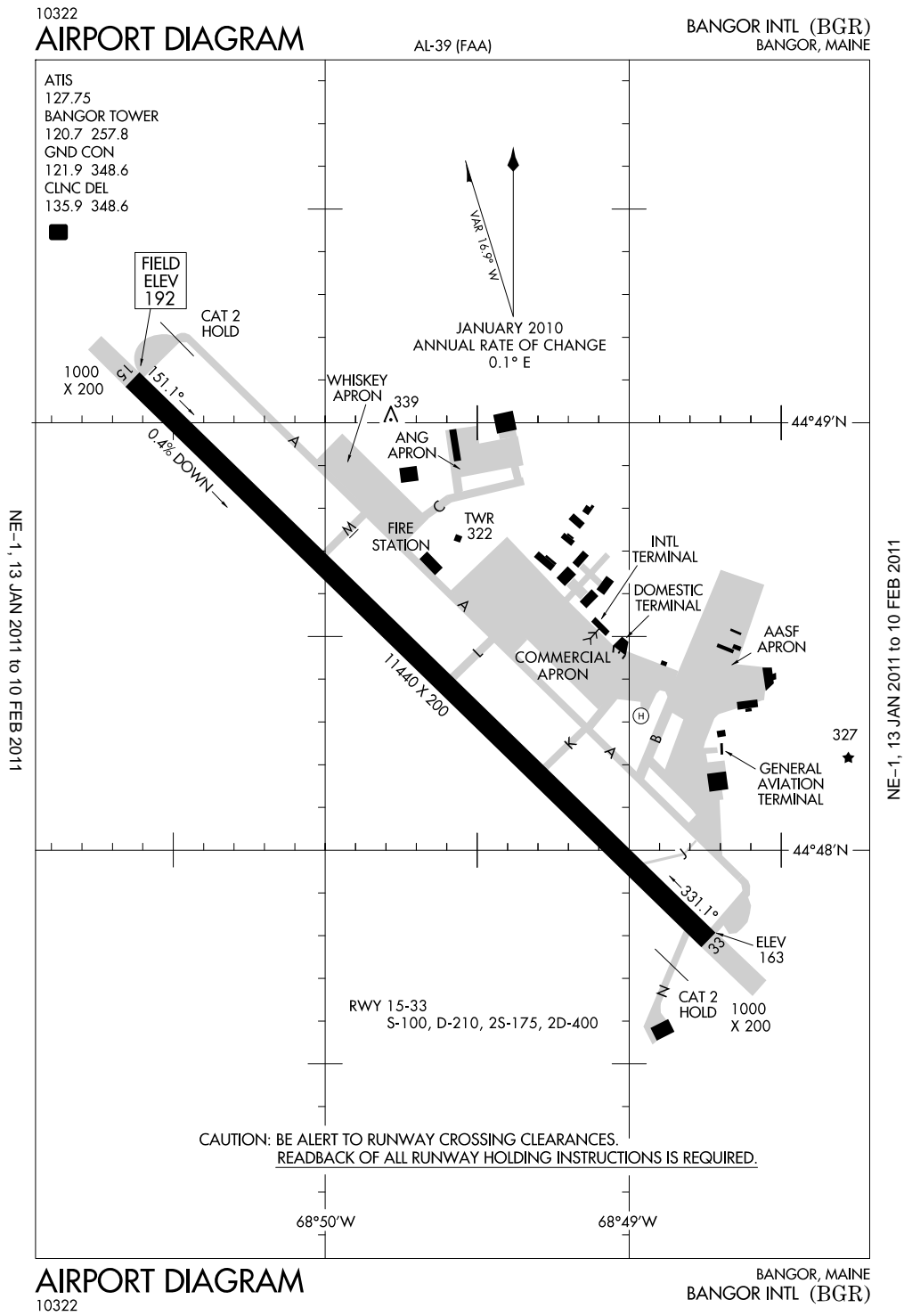

Bangor, ME
Bangor Intl
ICAO Identifier KBGR

AD 2.2 Aerodrome geographical and administrative data

- 2.2.1 Reference Point: 44-48-26.80N / 68-49-41.30W
- 2.2.2 From City: 3 Miles W Of Bangor, ME
- 2.2.3 Elevation: 192 ft
- 2.2.5 Magnetic variation: 19W (1985)
- 2.2.6 Airport Contact: Rebecca Hupp
BANGOR INTERNATIONAL ARPT
Bangor, ME 4401 (207-992-4600)
- 2.2.7 Traffic: IFR/VFR

AD 2.3 Operational hours

- 2.3.1 - 2.3.11: ALL Months, ALL Days, ALL Hours

AD 2.4 Handling services and facilities

- 2.4.1 Cargo handling facilities: No
- 2.4.2 Fuel types: 100LL,A
- 2.4.4 De-icing facilities: None
- 2.4.5 Hangar space: Yes
- 2.4.6 Repair facilities: Major

AD 2.6 Rescue and firefighting services

- 2.6.1 Aerodrome category for firefighting: ARFF Index I E certified on 5/1/1973

AD 2.10 Aerodrome obstacles

- 2.10.1.a. Runway designation: 33
- 2.10.1.b Type of obstacle: Trees (76 ft). Not Lighted or Marked
- 2.10.1.c Location of obstacle: 0 ft from Centerline

AD 2.12 Runway physical characteristics

- 2.12.1 Designation: H1
- 2.12.3 Dimensions: 100 ft x 100 ft

- 2.12.1 Designation: 15
- 2.12.2 True Bearing: 134
- 2.12.3 Dimensions: 11440 ft x 200 ft
- 2.12.5 Coordinates: 44-49-00.00N / 68-50-38.15W
- 2.12.6 Threshold elevation: 192 ft
- 2.12.6 Touchdown zone elevation: 192 ft

- 2.12.1 Designation: 33
- 2.12.2 True Bearing: 314

- 2.12.3 Dimensions: 11440 ft x 200 ft
- 2.12.5 Coordinates: 44-47-47.41N / 68-48-44.36W
- 2.12.6 Threshold elevation: 163 ft
- 2.12.6 Touchdown zone elevation: 163 ft

AD 2.13 Declared distances

- 2.13.1 Designation: 15
- 2.13.2 Takeoff run available: 11440
- 2.13.3 Takeoff distance available: 11440
- 2.13.4 Accelerate-stop distance available: 11440
- 2.13.5 Landing distance available: 11440

AD 2.14 Approach and runway lighting

- 2.14.1 Designation: 15
- 2.14.2 Approach lighting system: ALSF2: Standard 2400 feet high intensity approach lighting system with sequenced flashers, category II or III configuration
- 2.14.4 Visual approach slope indicator system: 4-light PAPI on left

- 2.14.1 Designation: 33
- 2.14.2 Approach lighting system: MALSR: 1400 feet medium intensity approach lighting system with runway alignment indicator lights
- 2.14.4 Visual approach slope indicator system: 4-light PAPI on left

AD 2.18 Air traffic services communication facilities

- 2.18.1 Service designation: LCL/P
- 2.18.3 Service designation: 120.7 MHz

- 2.18.1 Service designation: EMERG
- 2.18.3 Service designation: 121.5 MHz

- 2.18.1 Service designation: GND/P
- 2.18.3 Service designation: 121.9 MHz

- 2.18.1 Service designation: APCH/P DEP/P CLASS C IC
- 2.18.3 Service designation: 124.5 MHz

- 2.18.1 Service designation: ATIS
- 2.18.3 Service designation: 127.75 MHz
- 2.18.4 Hours of operation: 24

- 2.18.1 Service designation: CD/P
- 2.18.3 Service designation: 135.9 MHz

2.18.1 Service designation: APCH/P DEP/P
CLASS C
2.18.3 Service designation: 239.3 MHz

68-48-59.71W
2.19.6 Site elevation: 149 ft

2.18.1 Service designation: APCH/P DEP/P
CLASS C IC
2.18.3 Service designation: 239.3 MHz

2.19.1 ILS type: DME for runway 33. Magnetic
variation: 19W
2.19.2 ILS identification: BGR
2.19.5 Coordinates: 44-47-42.50N /
68-48-31.81W

2.18.1 Service designation: EMERG
2.18.3 Service designation: 243 MHz

2.19.6 Site elevation: 166 ft

2.18.1 Service designation: LCL/P
2.18.3 Service designation: 257.8 MHz

2.19.1 ILS type: Localizer for runway 15. Magnetic
variation: 19W
2.19.2 ILS identification: JVH
2.19.5 Coordinates: 44-47-40.37N /

2.18.1 Service designation: GND/P CD/P
2.18.3 Service designation: 348.6 MHz

68-48-34.19W
2.19.6 Site elevation: 166 ft

2.18.1 Service designation: NG OPS
2.18.3 Service designation: 41.2 MHz

2.19.1 ILS type: Glide Slope for runway 15.
Magnetic variation: 19W
2.19.2 ILS identification: JVH

2.18.1 Service designation: APCH/P DEP/P
CLASS C
2.18.3 Service designation: 118.925 MHz

2.19.5 Coordinates: 44-49-00.00N /
68-50-22.48W
2.19.6 Site elevation: 188 ft

AD 2.19 Radio navigation and landing aids

2.19.1 ILS type: Localizer for runway 33. Magnetic
variation: 19W
2.19.2 ILS identification: BGR
2.19.5 Coordinates: 44-49-13.62N /
68-50-48.98W
2.19.6 Site elevation: 182 ft

2.19.1 ILS type: Inner Marker for runway 15.
Magnetic variation: 19W
2.19.2 ILS identification: JVH
2.19.5 Coordinates: 44-49-12.06N /
68-50-46.72W
2.19.6 Site elevation: 184 ft

2.19.1 ILS type: Middle Marker for runway 33.
Magnetic variation: 19W
2.19.2 ILS identification: BGR
2.19.5 Coordinates: 44-47-30.62N /
68-48-20.24W
2.19.6 Site elevation: 99999 ft

2.19.1 ILS type: DME for runway 15. Magnetic
variation: 19W
2.19.2 ILS identification: JVH
2.19.5 Coordinates: 44-47-42.50N /
68-48-31.81W
2.19.6 Site elevation: 166 ft

2.19.1 ILS type: Outer Marker for runway 33.
Magnetic variation: 19W
2.19.2 ILS identification: BGR
2.19.5 Coordinates: 44-43-39.19N /
68-42-46.33W
2.19.6 Site elevation: 99999 ft

2.19.1 ILS type: Outer Marker for runway 15.
Magnetic variation: 19W
2.19.2 ILS identification: JVH
2.19.5 Coordinates: 44-52-49.62N /
68-55-59.54W
2.19.6 Site elevation: 129 ft

2.19.1 ILS type: Glide Slope for runway 33.
Magnetic variation: 19W
2.19.2 ILS identification: BGR
2.19.5 Coordinates: 44-47-53.70N /

2.19.1 ILS type: Middle Marker for runway 15.
Magnetic variation: 19W
2.19.2 ILS identification: JVH
2.19.5 Coordinates: 44-49-23.69N /
68-51-00.00W

2.19.6 Site elevation: 158 ft

General Remarks:

TAXIWAY J LIMITED TO AIRCRAFT 75000 LBS GROSS TAKEOFF WEIGHT

TRANSIENT AIRCRAFT MAY BE DIVERTED TO CIVILIAN SIDE DURING NON-DUTY HRS & WEEKENDS. FEE REQUIRED; NO ANG TRANSIENT ALERT.

RESTRICTED: TAXIWAY 'J' CLOSED DURING WINTER.

TRAFFIC PATTERN: RUNWAY 33 LEFT TRAFFIC, TURBO JET TRAFFIC 2000' MSL UNLESS OTHERWISE INSTR.

MISC: RUNWAY 15-33 GROOVED.

ANG: PRIOR PERMISSION REQUIRED DSN 698-7232 (COMM 207-990-7232), 3 HR OUT CALL (HF 6761) & 30 MIN OUT CALL (311.0) REQUIRED TO ENSURE CUSTOMS/AG AVAIL & TIMELY TRANSIENT SERVICE. TRANSIENT MAINT AVAILABLE BY PRIOR PERMISSION REQUIRED. TRANSIENT AIRCRAFT MAY BE DIVERTED TO CIVIL SIDE DUR OPERATING HRS.

ANG: FEE REQUIRE. ANG NOT EQUIPMENT OR MANNED WITH AN AERIAL PORT FLIGHT 30 OR MORE PASSENGER WILL BE SENT TO CITY FOR PROCESSING. CAN HANDLE ALL AIR MOBILITY COMMAND AIRCRAFT. SERVICE AVAILABLE 24/7. ALL HAZARD CARGO SHOULD BE PRE-COORD FOR SAFETY REASONS, NO HOT CARGO PAD AVAILABLE.

ARRANGE: OPR 1230-2100Z++ MON-FRI EXCEPT HOLIDAY. LIMITED MAINT. J8. PRIOR PERMISSION REQUIRED MAY-OCT SERVICE DSN 626-1100.

CAUTION: DEER HAZARD.

CAUTION: BASH PHASE II PERIOD OCT-NOV, APR-MAY. EXPECT INCREASED BIRD ACTIVITY. CONTACT BASE OPS/COMMAND POST/SOF FOR CURRENT BIRDWATCH CONDITION.

SERVICE-FLUID: REMARKS: FOREIGN MILITARY ONLY: ON BASE LOX SERVICE UNAVAILABLE. OFF-BASE CONTRACTED LOX AVAILABLE 24/7, CONTACT ADVANTAGE GAS (207-942-6393) FOR PRECOORDINATION.

ANG: LIMITED TRANSIENT AIRCRAFT RAMP SPACE AVAILABLE MAY 08 THRU OCT 09 DUE TO RAMP CONSTRUCTION. CIVIL RAMP SPACE FOR MILITARY AIRCRAFT MAY ALSO BE AFFECT.

Baltimore, Maryland Baltimore-Washington International Thurgood Marshall ICAO Identifier KBWI

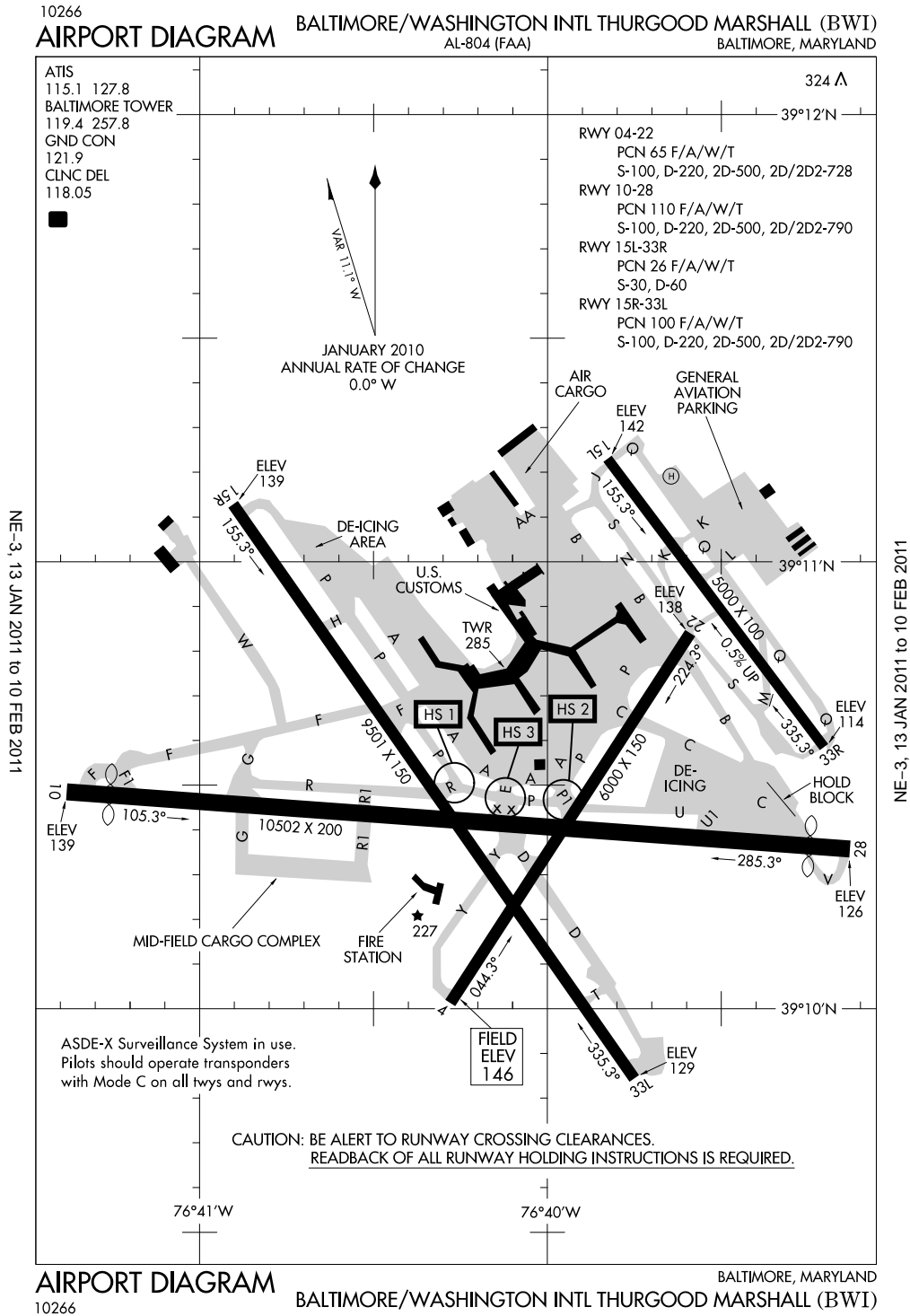

Baltimore, MD
Baltimore/Washington Intl Thurgood Marshal
ICAO Identifier KBWI

AD 2.2 Aerodrome geographical and administrative data

- 2.2.1 Reference Point: 39-10-31.30N / 76-40-00.00W
- 2.2.2 From City: 9 Miles S Of Baltimore, MD
- 2.2.3 Elevation: 146 ft
- 2.2.5 Magnetic variation: 11W (2000)
- 2.2.6 Airport Contact: John Stewart
PO BOX 8766
BWI Airport, MD 21240
(410-859-7018)
- 2.2.7 Traffic: IFR/VFR

AD 2.3 Operational hours

- 2.3.1 - 2.3.11: ALL Months, ALL Days, ALL Hours

AD 2.4 Handling services and facilities

- 2.4.1 Cargo handling facilities: No
- 2.4.2 Fuel types: 100LL,A
- 2.4.4 De-icing facilities: RWY 28 De-Ice Pad Lane 1 R Standard To Aircraft With Wingspan 171 Ft Or Less, Lane 2 R Standard To Aircraft With Wingspan 135 Ft Or Less, Lane 3 Is Used By Large Aircraft Max Wingspan 215 Ft And When In Use-Lanes 2 And 4 Are Unavailable. Lanes 4, 5 And 6 Are R Standard To Aircraft Wingspan 135 Ft Or Less.
- 2.4.5 Hangar space: Yes
- 2.4.6 Repair facilities: Major

AD 2.6 Rescue and firefighting services

- 2.6.1 Aerodrome category for firefighting: ARFF Index I D certified on 5/1/1973

AD 2.10 Aerodrome obstacles

- 2.10.1.a. Runway designation: 15L
- 2.10.1.b Type of obstacle: Pole (31 ft). Not Lighted or Marked
- 2.10.1.c Location of obstacle: 615 ft from Centerline

- 2.10.1.a. Runway designation: 33R
- 2.10.1.b Type of obstacle: Tree (39 ft). Not Lighted or Marked
- 2.10.1.c Location of obstacle: 585 ft from Centerline

- 2.10.1.a. Runway designation: 15R
- 2.10.1.b Type of obstacle: Ant (126 ft). Lighted
- 2.10.1.c Location of obstacle: 908 ft from Centerline

- 2.10.1.a. Runway designation: 33L
- 2.10.1.b Type of obstacle: Tower (154 ft). Not Lighted or Marked
- 2.10.1.c Location of obstacle: 906 ft from Centerline

- 2.10.1.a. Runway designation: 10
- 2.10.1.b Type of obstacle: Tree (35 ft). Not Lighted or Marked
- 2.10.1.c Location of obstacle: 305 ft from Centerline

- 2.10.1.a. Runway designation: 28
- 2.10.1.b Type of obstacle: Tree (31 ft). Not Lighted or Marked
- 2.10.1.c Location of obstacle: 425 ft from Centerline

- 2.10.1.a. Runway designation: 04
- 2.10.1.b Type of obstacle: Tree (51 ft). Not Lighted or Marked
- 2.10.1.c Location of obstacle: 500 ft from Centerline

- 2.10.1.a. Runway designation: 22
- 2.10.1.b Type of obstacle: Pole (60 ft). Lighted
- 2.10.1.c Location of obstacle: 328 ft from Centerline

AD 2.12 Runway physical characteristics

- 2.12.1 Designation: H1
- 2.12.3 Dimensions: 100 ft x 100 ft

- 2.12.1 Designation: 15L
- 2.12.2 True Bearing: 144
- 2.12.3 Dimensions: 5000 ft x 100 ft
- 2.12.4 PCN: 26 F/A/W/T
- 2.12.5 Coordinates: 39-11-14.54N / 76-39-48.74W
- 2.12.6 Threshold elevation: 142 ft
- 2.12.6 Touchdown zone elevation: 142 ft

- 2.12.1 Designation: 33R
- 2.12.2 True Bearing: 324
- 2.12.3 Dimensions: 5000 ft x 100 ft
- 2.12.4 PCN: 26 F/A/W/T

2.12.5 Coordinates: 39-10-34.45N /
76-39-11.63W
2.12.6 Threshold elevation: 114 ft
2.12.6 Touchdown zone elevation: 124 ft

2.12.1 Designation: 15R
2.12.2 True Bearing: 144
2.12.3 Dimensions: 9501 ft x 150 ft
2.12.4 PCN: 100 F/A/W/T
2.12.5 Coordinates: 39-11-00.00N /
76-40-55.14W
2.12.6 Threshold elevation: 139 ft
2.12.6 Touchdown zone elevation: 139 ft

2.12.1 Designation: 33L
2.12.2 True Bearing: 324
2.12.3 Dimensions: 9501 ft x 150 ft
2.12.4 PCN: 100 F/A/W/T
2.12.5 Coordinates: 39-09-51.15N /
76-39-44.58W
2.12.6 Threshold elevation: 129 ft
2.12.6 Touchdown zone elevation: 142 ft

2.12.1 Designation: 10
2.12.2 True Bearing: 94
2.12.3 Dimensions: 10502 ft x 200 ft
2.12.4 PCN: 110 F/A/W/T
2.12.5 Coordinates: 39-10-29.09N /
76-41-22.63W
2.12.6 Threshold elevation: 139 ft
2.12.6 Touchdown zone elevation: 143 ft

2.12.1 Designation: 28
2.12.2 True Bearing: 274
2.12.3 Dimensions: 10502 ft x 200 ft
2.12.4 PCN: 110 F/A/W/T
2.12.5 Coordinates: 39-10-21.48N /
76-39-00.00W
2.12.6 Threshold elevation: 126 ft
2.12.6 Touchdown zone elevation: 142 ft

2.12.1 Designation: 04
2.12.2 True Bearing: 33
2.12.3 Dimensions: 6000 ft x 150 ft
2.12.4 PCN: 65 F/A/W/T
2.12.5 Coordinates: 39-10-00.00N /
76-40-16.92W
2.12.6 Threshold elevation: 146 ft
2.12.6 Touchdown zone elevation: 146 ft

2.12.1 Designation: 22

2.12.2 True Bearing: 213
2.12.3 Dimensions: 6000 ft x 150 ft
2.12.4 PCN: 65 F/A/W/T
2.12.5 Coordinates: 39-10-50.38N /
76-39-35.21W
2.12.6 Threshold elevation: 138 ft
2.12.6 Touchdown zone elevation: 143 ft

AD 2.13 Declared distances

2.13.1 Designation: 15L
2.13.2 Takeoff run available: 5000
2.13.3 Takeoff distance available: 5000
2.13.4 Accelerate-stop distance available: 5000
2.13.5 Landing distance available: 5000

2.13.1 Designation: 33R
2.13.2 Takeoff run available: 5000
2.13.3 Takeoff distance available: 5000
2.13.4 Accelerate-stop distance available: 5000
2.13.5 Landing distance available: 5000

2.13.1 Designation: 15R
2.13.2 Takeoff run available: 9501
2.13.3 Takeoff distance available: 9501
2.13.4 Accelerate-stop distance available: 9501
2.13.5 Landing distance available: 9501

2.13.1 Designation: 33L
2.13.2 Takeoff run available: 9501
2.13.3 Takeoff distance available: 9501
2.13.4 Accelerate-stop distance available: 9501
2.13.5 Landing distance available: 9501

2.13.1 Designation: 10
2.13.2 Takeoff run available: 10502
2.13.3 Takeoff distance available: 10502
2.13.4 Accelerate-stop distance available: 10502
2.13.5 Landing distance available: 9952

2.13.1 Designation: 28
2.13.2 Takeoff run available: 10502
2.13.3 Takeoff distance available: 10502
2.13.4 Accelerate-stop distance available: 10502
2.13.5 Landing distance available: 10002

2.13.1 Designation: 04
2.13.2 Takeoff run available: 6000
2.13.3 Takeoff distance available: 6000
2.13.4 Accelerate-stop distance available: 6000
2.13.5 Landing distance available: 6000

- 2.13.1 Designation: 22
- 2.13.2 Takeoff run available: 6000
- 2.13.3 Takeoff distance available: 6000
- 2.13.4 Accelerate-stop distance available: 6000
- 2.13.5 Landing distance available: 6000

AD 2.14 Approach and runway lighting

- 2.14.1 Designation: 15L
- 2.14.4 Visual approach slope indicator system:
4-light PAPI on left

- 2.14.1 Designation: 33R
- 2.14.2 Approach lighting system: MALSR: 1400 feet medium intensity approach lighting system with runway alignment indicator lights
- 2.14.4 Visual approach slope indicator system:
4-light PAPI on left

- 2.14.1 Designation: 15R
- 2.14.2 Approach lighting system: MALSR: 1400 feet medium intensity approach lighting system with runway alignment indicator lights

- 2.14.1 Designation: 33L
- 2.14.2 Approach lighting system: MALSR: 1400 feet medium intensity approach lighting system with runway alignment indicator lights
- 2.14.4 Visual approach slope indicator system:
4-box VASI on left

- 2.14.1 Designation: 10
- 2.14.2 Approach lighting system: ALSF2: Standard 2400 feet high intensity approach lighting system with sequenced flashers, category II or III configuration

- 2.14.1 Designation: 28
- 2.14.2 Approach lighting system: MALSR: 1400 feet medium intensity approach lighting system with runway alignment indicator lights
- 2.14.4 Visual approach slope indicator system:
4-box VASI on left

- 2.14.1 Designation: 04
- 2.14.4 Visual approach slope indicator system:
4-box VASI on left

- 2.14.1 Designation: 22
- 2.14.4 Visual approach slope indicator system:
4-box VASI on left

AD 2.18 Air traffic services communication facilities

- 2.18.1 Service designation: D-ATIS
- 2.18.3 Service designation: 115.1 MHz
- 2.18.4 Hours of operation: 24

- 2.18.1 Service designation: CD/P
- 2.18.3 Service designation: 118.05 MHz

- 2.18.1 Service designation: LCL/P
- 2.18.3 Service designation: 119.4 MHz

- 2.18.1 Service designation: EMERG
- 2.18.3 Service designation: 121.5 MHz

- 2.18.1 Service designation: GND/P
- 2.18.3 Service designation: 121.9 MHz

- 2.18.1 Service designation: D-ATIS
- 2.18.3 Service designation: 127.8 MHz
- 2.18.4 Hours of operation: 24

- 2.18.1 Service designation: EMERG
- 2.18.3 Service designation: 243 MHz

- 2.18.1 Service designation: LCL/P
- 2.18.3 Service designation: 257.8 MHz

AD 2.19 Radio navigation and landing aids

- 2.19.1 ILS type: Localizer for runway 15L.
Magnetic variation: 11W
- 2.19.2 ILS identification: UQC
- 2.19.5 Coordinates: 39-10-31.22N / 76-39-00.00W
- 2.19.6 Site elevation: 102 ft

- 2.19.1 ILS type: Outer Marker for runway 15L.
Magnetic variation: 11W
- 2.19.2 ILS identification: UQC
- 2.19.5 Coordinates: 39-14-55.34N / 76-43-16.63W
- 2.19.6 Site elevation: 301 ft

- 2.19.1 ILS type: Glide Slope for runway 15L.
Magnetic variation: 11W
- 2.19.2 ILS identification: UQC
- 2.19.5 Coordinates: 39-11-00.00N / 76-39-44.24W
- 2.19.6 Site elevation: 138 ft

- 2.19.1 ILS type: Middle Marker for runway 15L.

Magnetic variation: 11W
2.19.2 ILS identification: UQC
2.19.5 Coordinates: 39-11-37.14N /
76-40-00.00W
2.19.6 Site elevation: 180 ft

2.19.1 ILS type: Localizer for runway 33R.
Magnetic variation: 11W
2.19.2 ILS identification: BWI
2.19.5 Coordinates: 39-11-16.97N /
76-39-50.99W
2.19.6 Site elevation: 135 ft

2.19.1 ILS type: Glide Slope for runway 33R.
Magnetic variation: 11W
2.19.2 ILS identification: BWI
2.19.5 Coordinates: 39-10-40.05N /
76-39-21.19W
2.19.6 Site elevation: 110 ft

2.19.1 ILS type: Middle Marker for runway 33R.
Magnetic variation: 11W
2.19.2 ILS identification: BWI
2.19.5 Coordinates: 39-10-00.00N /
76-38-48.58W
2.19.6 Site elevation: 80 ft

2.19.1 ILS type: DME for runway 33R. Magnetic
variation: 11W
2.19.2 ILS identification: BWI
2.19.5 Coordinates: 39-11-18.90N /
76-39-48.50W
2.19.6 Site elevation: 129 ft

2.19.1 ILS type: Localizer for runway 15R.
Magnetic variation: 11W
2.19.2 ILS identification: FND
2.19.5 Coordinates: 39-09-36.97N /
76-39-31.44W
2.19.6 Site elevation: 102 ft

2.19.1 ILS type: Glide Slope for runway 15R.
Magnetic variation: 11W
2.19.2 ILS identification: FND
2.19.5 Coordinates: 39-10-56.54N /
76-40-49.44W
2.19.6 Site elevation: 132 ft

2.19.1 ILS type: Middle Marker for runway 15R.
Magnetic variation: 11W
2.19.2 ILS identification: FND

2.19.5 Coordinates: 39-11-33.15N /
76-41-19.11W
2.19.6 Site elevation: 99999 ft

2.19.1 ILS type: Outer Marker for runway 15R.
Magnetic variation: 11W
2.19.2 ILS identification: FND
2.19.5 Coordinates: 39-14-13.45N /
76-43-52.10W
2.19.6 Site elevation: 99999 ft

2.19.1 ILS type: Localizer for runway 33L.
Magnetic variation: 11W
2.19.2 ILS identification: RUX
2.19.5 Coordinates: 39-11-10.77N /
76-40-58.34W
2.19.6 Site elevation: 132 ft

2.19.1 ILS type: Glide Slope for runway 33L.
Magnetic variation: 11W
2.19.2 ILS identification: RUX
2.19.5 Coordinates: 39-10-00.00N /
76-39-48.83W
2.19.6 Site elevation: 129 ft

2.19.1 ILS type: Outer Marker for runway 33L.
Magnetic variation: 11W
2.19.2 ILS identification: RUX
2.19.5 Coordinates: 39-06-36.92N /
76-36-43.69W
2.19.6 Site elevation: 151 ft

2.19.1 ILS type: Middle Marker for runway 33L.
Magnetic variation: 11W
2.19.2 ILS identification: RUX
2.19.5 Coordinates: 39-09-29.15N /
76-39-26.74W
2.19.6 Site elevation: 92 ft

2.19.1 ILS type: DME for runway 33L. Magnetic
variation: 11W
2.19.2 ILS identification: RUX
2.19.5 Coordinates: 39-11-00.00N /
76-41-00.00W
2.19.6 Site elevation: 127 ft

2.19.1 ILS type: Localizer for runway 10. Magnetic
variation: 11W
2.19.2 ILS identification: BAL
2.19.5 Coordinates: 39-10-20.59N /
76-38-54.29W

2.19.6 Site elevation: 138 ft

2.19.1 ILS type: Glide Slope for runway 10.
Magnetic variation: 11W

2.19.2 ILS identification: BAL

2.19.5 Coordinates: 39-10-24.02N /
76-41-00.00W

2.19.6 Site elevation: 138 ft

2.19.1 ILS type: Outer Marker for runway 10.
Magnetic variation: 11W

2.19.2 ILS identification: BAL

2.19.5 Coordinates: 39-10-45.89N /
76-46-00.00W

2.19.6 Site elevation: 99999 ft

2.19.1 ILS type: Inner Marker for runway 10.
Magnetic variation: 11W

2.19.2 ILS identification: BAL

2.19.5 Coordinates: 39-10-31.24N /
76-41-27.11W

2.19.6 Site elevation: 131 ft

2.19.1 ILS type: Middle Marker for runway 10.
Magnetic variation: 11W

2.19.2 ILS identification: BAL

2.19.5 Coordinates: 39-10-30.85N /
76-41-53.99W

2.19.6 Site elevation: 99999 ft

2.19.1 ILS type: Localizer for runway 28. Magnetic
variation: 11W

2.19.2 ILS identification: OEH

2.19.5 Coordinates: 39-10-29.45N /
76-41-28.96W

2.19.6 Site elevation: 137 ft

2.19.1 ILS type: Middle Marker for runway 28.
Magnetic variation: 11W

2.19.2 ILS identification: OEH

2.19.5 Coordinates: 39-10-18.69N /
76-38-22.68W

2.19.6 Site elevation: 55 ft

2.19.1 ILS type: Outer Marker for runway 28.
Magnetic variation: 11W

2.19.2 ILS identification: OEH

2.19.5 Coordinates: 39-09-56.02N /
76-31-00.00W

2.19.6 Site elevation: 39 ft

2.19.1 ILS type: Glide Slope for runway 28.
Magnetic variation: 11W

2.19.2 ILS identification: OEH

2.19.5 Coordinates: 39-10-18.84N /
76-39-28.42W

2.19.6 Site elevation: 130 ft

General Remarks:

AIRCRAFT PARKED AT GATE POSITIONS D-15; 16; ENCROACH RUNWAY 04/22 7:1 (FAR 77) TO HEIGHT OF 58'.

PRACTICE LANDING & APPROACH BY TURBO-POWERED AIRCRAFT PROHIBITED 2200-0600; PRACTICE LANDING & TAKE-OFF BY B-747 AIRCRAFT PROHIBITED RUNWAY 15R/33L.

CONT MOWING OPERATIONS ADJACENT ALL RUNWAYS & TAXIWAYS - APR THRU NOV.

NO APRON PARKING FOR UNSCHEDULED AIR CARRIER.

DEER & BIRDS OCCASIONALLY ON & IN THE VICINITY OF AIRPORT.

DISTRACTING LIGHTS (GOLF DRIVING RANGE) RIGHT SIDE EXTENDED CENTERLINE RUNWAY 33L FROM APPROACH END RUNWAY TO 1/4 MI FINAL.

NOISE ABATEMENT PROCEDURES IN EFFECT - RESTRICTION FOR RUNWAY 15L/33R EXCEPT FOR EMERGENCIES OR MERCY FLIGHTS CONTACT AIRPORT MANAGER FOR INFORMATION.

MAJOR CONSTRUCTION ON AIRPORT DAILY; AIRCRAFT MOVEMENT & PARKING AREAS

SUBJECT TO SHORT NOTICE CHANGE/CLOSURE. FOR CURRENT INFORMATION PHONE BWI OPERATIONS CENTER 410-859-7018.

AIRCRAFT ON VISUAL APPROACHES EXPECT TO MAINTAIN 3000 FT UNTIL 10 DME FROM BWI; DEPARTURE AIRCRAFT SHOULD EXPECT TURNS BASED ON BALTIMORE DME.

TAXIING PROHIBITED BETWEEN GATE C16 & ADJACENT BUILDING STRUCTURE SW OF PIER C.

RUNWAY 15R DEICE PAD, POSITION # 1, 2 & 3 ARE RESTRICTED TO AIRCRAFT WITH A WINGSPAN OF 135 FT OR LESS, POSITION #4 IS RESTRICTED TO AIRCRAFT WITH A WINGSPAN OF 156 FT OR LESS & POSITION #5 IS RESTRICTED TO AIRCRAFT WITH 214 FT OR LESS.

TAXIWAY "S", SOUTH OF RUNWAY 22, RESTRICTED TO AIRCRAFT 60000 LBS. & LESS

GENERAL AVIATION AIRCRAFT CONTACT UNICOM PRIOR TO ARRIVING AT GENERAL AVIATION RAMP FOR SECURITY PURPOSES.

RUNWAYS 04/22, 10/28, 15L/33R: PAVEMENT CONDITION IS FAIR WITH NUMEROUS CRACKS ON ALL SURFACES.

TAXIWAY "A" RESTRICTED TO AIRCRAFT WITH WINGSPAN OF 171 FT OR LESS. DESIGN GROUP IV.

TAXILANES A-1 AND H, RESTRICTED TO GROUP III AIRCRAFT WITH MAX WINGSPAN OF 118 FEET.

CONCOURSE A - ALTERNATE DEICING AREA IS RESTRICTED TO B737-800 SIZE AIRCRAFT WITH WINGLETS OR SMALLER ON SPOTS 6, 7A, AND 8A. B737-700 SIZE AIRCRAFT WITH WINGLETS OR SMALLER ARE RESTRICTED TO SPOTS 7B AND 8B.

RUNWAY 28 DE-ICE PAD LANE 1 RESTRICTED TO AIRCRAFT WITH WINGSPAN 171 FT OR LESS, LANE 2 RESTRICTED TO AIRCRAFT WITH WINGSPAN 135 FT OR LESS, LANE 3 IS USED BY LARGE AIRCRAFT MAX WINGSPAN 215 FT AND WHEN IN USE- LANES 2 AND 4 ARE UNAVAILABLE. LANES 4, 5 AND 6 ARE RESTRICTED TO AIRCRAFT WINGSPAN 135 FT OR LESS.

TAXIWAY "P" BETWEEN TAXIWAY "P1" & TAXIWAY "C" RESTRICTED TO WINGSPANS OF 171 FT OR LESS.

RUNWAY 04/22 CLOSED EXCEPT FOR TAXI. RUNWAY 04/22 RESTRICTIONS APPLY EXCEPT FOR EXCESSIVE CROSSWINDS; EMERGENCIES; OR NON-AVAILABILITY OF OTHER RUNWAYS.

ASDE-X SURVEILLANCE SYSTEM IN USE: PILOTS SHOULD OPERATE TRANSPONDERS WITH MODE-C ON ALL TAXIWAYS AND RUNWAYS.

Boston, Massachusetts
General Edward Lawrence Logan International
ICAO Identifier KBOS

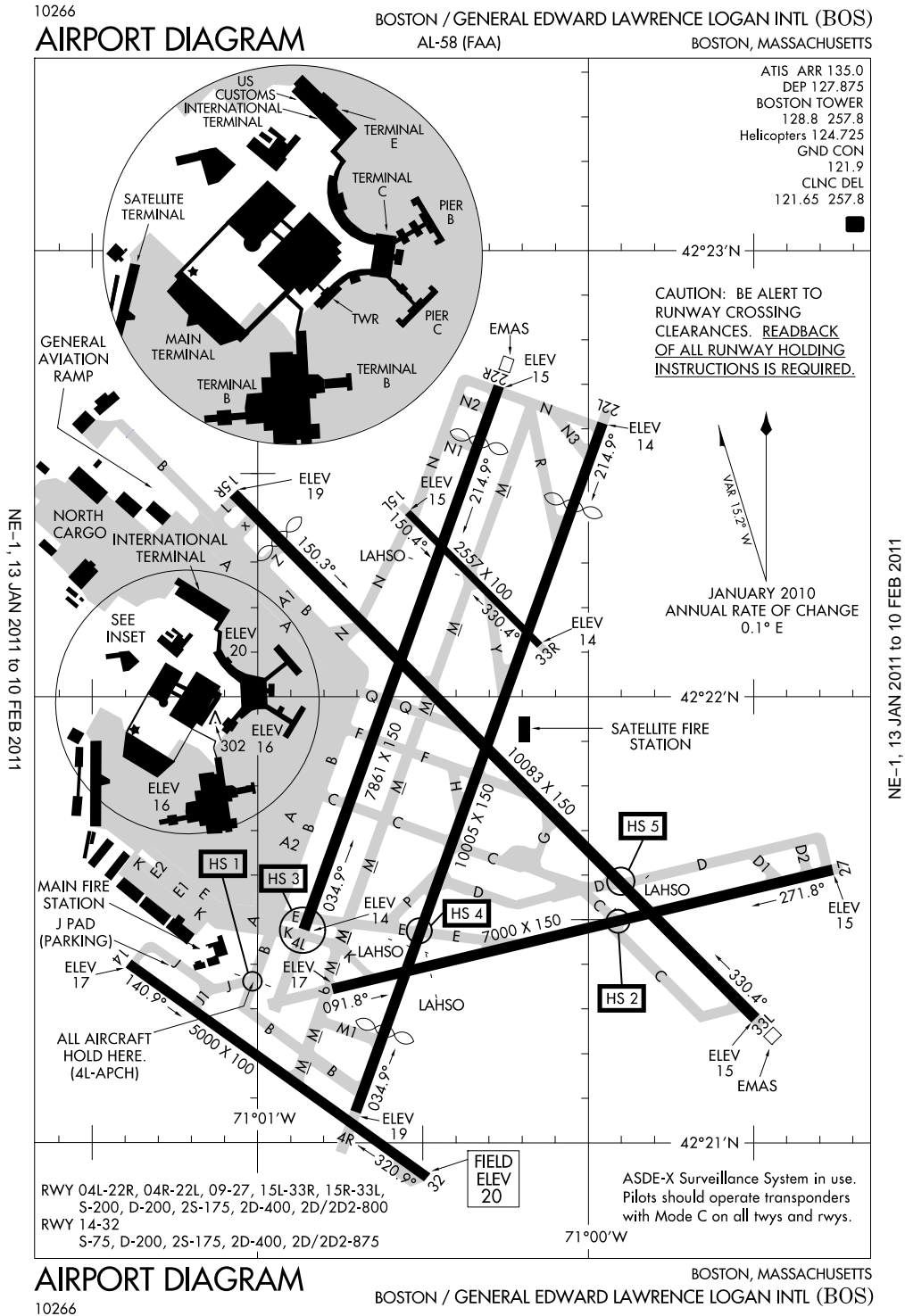

Boston, MA
General Edward Lawrence Logan Intl
ICAO Identifier KBOS

AD 2.2 Aerodrome geographical and administrative data

- 2.2.1 Reference Point: 42-21-46.70N / 71-00-23.10W
- 2.2.2 From City: 1 Miles E Of Boston, MA
- 2.2.3 Elevation: 20 ft
- 2.2.5 Magnetic variation: 16W (1995)
- 2.2.6 Airport Contact: Edward Freni
LOGAN INTERNATIONAL AIRPORT
East Boston, MA 2128
(617-567-5400)
- 2.2.7 Traffic: IFR/VFR

AD 2.3 Operational hours

- 2.3.1 - 2.3.11: ALL Months, ALL Days, ALL Hours

AD 2.4 Handling services and facilities

- 2.4.1 Cargo handling facilities: No
- 2.4.2 Fuel types: 100LL,A
- 2.4.4 De-icing facilities: None
- 2.4.5 Hangar space: No
- 2.4.6 Repair facilities: Major

AD 2.6 Rescue and firefighting services

- 2.6.1 Aerodrome category for firefighting: ARFF Index I E certified on 9/1/1972

AD 2.10 Aerodrome obstacles

- 2.10.1.a. Runway designation: 09
- 2.10.1.b Type of obstacle: Boat (158 ft). Lighted

- 2.10.1.a. Runway designation: 27
- 2.10.1.b Type of obstacle: Boat (45 ft). Lighted

- 2.10.1.a. Runway designation: 04L
- 2.10.1.b Type of obstacle: Boat (161 ft). Not Lighted or Marked

- 2.10.1.a. Runway designation: 22R
- 2.10.1.b Type of obstacle: Boat (44 ft). Not Lighted or Marked

- 2.10.1.a. Runway designation: 04R
- 2.10.1.b Type of obstacle: Boat (157 ft). Lighted

- 2.10.1.a. Runway designation: 22L

- 2.10.1.b Type of obstacle: Boat (45 ft). Not Lighted or Marked

- 2.10.1.a. Runway designation: 15R
- 2.10.1.b Type of obstacle: Trees (62 ft). Not Lighted or Marked
- 2.10.1.c Location of obstacle: 140 ft from Centerline

- 2.10.1.a. Runway designation: 33L
- 2.10.1.b Type of obstacle: Boat (160 ft). Not Lighted or Marked

- 2.10.1.a. Runway designation: 14
- 2.10.1.b Type of obstacle: Bldg (174 ft). Lighted
- 2.10.1.c Location of obstacle: 70 ft from Centerline

AD 2.12 Runway physical characteristics

- 2.12.1 Designation: 09
- 2.12.2 True Bearing: 77
- 2.12.3 Dimensions: 7000 ft x 150 ft
- 2.12.5 Coordinates: 42-21-20.72N / 71-00-46.42W
- 2.12.6 Threshold elevation: 17 ft
- 2.12.6 Touchdown zone elevation: 17 ft

- 2.12.1 Designation: 27
- 2.12.2 True Bearing: 257
- 2.12.3 Dimensions: 7000 ft x 150 ft
- 2.12.5 Coordinates: 42-21-36.78N / 70-59-15.73W
- 2.12.6 Threshold elevation: 14 ft
- 2.12.6 Touchdown zone elevation: 17 ft

- 2.12.1 Designation: 04L
- 2.12.2 True Bearing: 20
- 2.12.3 Dimensions: 7861 ft x 150 ft
- 2.12.5 Coordinates: 42-21-28.76N / 71-00-51.62W
- 2.12.6 Threshold elevation: 14 ft
- 2.12.6 Touchdown zone elevation: 14 ft

- 2.12.1 Designation: 22R
- 2.12.2 True Bearing: 200
- 2.12.3 Dimensions: 7861 ft x 150 ft
- 2.12.5 Coordinates: 42-22-41.85N / 71-00-16.26W
- 2.12.6 Threshold elevation: 15 ft
- 2.12.6 Touchdown zone elevation: 15 ft

- 2.12.1 Designation: 04R

2.12.2 True Bearing: 20
2.12.3 Dimensions: 10005 ft x 150 ft
2.12.5 Coordinates: 42-21-00.00N /
71-00-42.46W
2.12.6 Threshold elevation: 19 ft
2.12.6 Touchdown zone elevation: 18 ft

2.12.1 Designation: 22L
2.12.2 True Bearing: 200
2.12.3 Dimensions: 10005 ft x 150 ft
2.12.5 Coordinates: 42-22-36.84N /
70-59-57.45W
2.12.6 Threshold elevation: 14 ft
2.12.6 Touchdown zone elevation: 16 ft

2.12.1 Designation: 15L
2.12.2 True Bearing: 135
2.12.3 Dimensions: 2557 ft x 100 ft
2.12.5 Coordinates: 42-22-24.89N /
71-00-32.86W
2.12.6 Threshold elevation: 15 ft
2.12.6 Touchdown zone elevation: 15 ft

2.12.1 Designation: 33R
2.12.2 True Bearing: 315
2.12.3 Dimensions: 2557 ft x 100 ft
2.12.5 Coordinates: 42-22-00.00N /
71-00-00.00W
2.12.6 Threshold elevation: 14 ft
2.12.6 Touchdown zone elevation: 14 ft

2.12.1 Designation: 15R
2.12.2 True Bearing: 135
2.12.3 Dimensions: 10083 ft x 150 ft
2.12.5 Coordinates: 42-22-27.38N /
71-01-00.00W
2.12.6 Threshold elevation: 19 ft
2.12.6 Touchdown zone elevation: 17 ft

2.12.1 Designation: 33L
2.12.2 True Bearing: 315
2.12.3 Dimensions: 10083 ft x 150 ft
2.12.5 Coordinates: 42-21-16.74N /
70-59-29.71W
2.12.6 Threshold elevation: 15 ft
2.12.6 Touchdown zone elevation: 16 ft

2.12.1 Designation: 14
2.12.2 True Bearing: 125
2.12.3 Dimensions: 5000 ft x 100 ft
2.12.5 Coordinates: 42-21-23.75N /

71-01-23.79W
2.12.6 Threshold elevation: 17 ft

2.12.1 Designation: 32
2.12.2 True Bearing: 305
2.12.3 Dimensions: 5000 ft x 100 ft
2.12.5 Coordinates: 42-20-54.96N /
71-00-29.69W
2.12.6 Threshold elevation: 20 ft
2.12.6 Touchdown zone elevation: 20 ft

AD 2.13 Declared distances

2.13.1 Designation: 09
2.13.2 Takeoff run available: 7000
2.13.3 Takeoff distance available: 7000
2.13.4 Accelerate-stop distance available: 7000
2.13.5 Landing distance available: 7000

2.13.1 Designation: 27
2.13.2 Takeoff run available: 7000
2.13.3 Takeoff distance available: 7000
2.13.4 Accelerate-stop distance available: 7000
2.13.5 Landing distance available: 7000

2.13.1 Designation: 04L
2.13.2 Takeoff run available: 7861
2.13.3 Takeoff distance available: 7861
2.13.4 Accelerate-stop distance available: 7861
2.13.5 Landing distance available: 7861

2.13.1 Designation: 22R
2.13.2 Takeoff run available: 7861
2.13.3 Takeoff distance available: 7861
2.13.4 Accelerate-stop distance available: 7861
2.13.5 Landing distance available: 7046

2.13.1 Designation: 04R
2.13.2 Takeoff run available: 10005
2.13.3 Takeoff distance available: 10005
2.13.4 Accelerate-stop distance available: 10005
2.13.5 Landing distance available: 8851

2.13.1 Designation: 22L
2.13.2 Takeoff run available: 10005
2.13.3 Takeoff distance available: 10005
2.13.4 Accelerate-stop distance available: 10005
2.13.5 Landing distance available: 8806

2.13.1 Designation: 15L
2.13.2 Takeoff run available: 2557
2.13.3 Takeoff distance available: 2557

2.13.4 Accelerate–stop distance available: 2557
2.13.5 Landing distance available: 2557

2.13.1 Designation: 33R
2.13.2 Takeoff run available: 2557
2.13.3 Takeoff distance available: 2557
2.13.4 Accelerate–stop distance available: 2557
2.13.5 Landing distance available: 2557

2.13.1 Designation: 15R
2.13.2 Takeoff run available: 10083
2.13.3 Takeoff distance available: 10083
2.13.4 Accelerate–stop distance available: 10083
2.13.5 Landing distance available: 9203

2.13.1 Designation: 33L
2.13.2 Takeoff run available: 10083
2.13.3 Takeoff distance available: 10083
2.13.4 Accelerate–stop distance available: 10083
2.13.5 Landing distance available: 10083

2.13.1 Designation: 14
2.13.2 Takeoff run available: 5000
2.13.3 Takeoff distance available: 5000
2.13.4 Accelerate–stop distance available: 5000
2.13.5 Landing distance available: 5000

2.13.1 Designation: 32
2.13.2 Takeoff run available: 5000
2.13.3 Takeoff distance available: 5000
2.13.4 Accelerate–stop distance available: 5000
2.13.5 Landing distance available: 5000

AD 2.14 Approach and runway lighting

2.14.1 Designation: 27
2.14.4 Visual approach slope indicator system:
4–light PAPI on left

2.14.1 Designation: 04L
2.14.4 Visual approach slope indicator system:
4–light PAPI on left

2.14.1 Designation: 22R
2.14.4 Visual approach slope indicator system:
4–light PAPI on left

2.14.1 Designation: 04R
2.14.2 Approach lighting system: ALSF2: Standard
2400 feet high intensity approach lighting system
with sequenced flashers, category II or III
configuration

2.14.4 Visual approach slope indicator system:
4–light PAPI on left

2.14.1 Designation: 22L
2.14.4 Visual approach slope indicator system:
4–light PAPI on right

2.14.1 Designation: 15R
2.14.2 Approach lighting system: MALSR: 1400
feet medium intensity approach lighting system
with runway alignment indicator lights
2.14.4 Visual approach slope indicator system:
4–light PAPI on left

2.14.1 Designation: 33L
2.14.2 Approach lighting system: MALSR: 1400
feet medium intensity approach lighting system
with runway alignment indicator lights
2.14.4 Visual approach slope indicator system:
4–light PAPI on right

2.14.1 Designation: 32
2.14.4 Visual approach slope indicator system:
4–light PAPI on left

AD 2.18 Air traffic services communication facilities

2.18.1 Service designation: EMERG
2.18.3 Service designation: 121.5 MHz

2.18.1 Service designation: CD/P PRE TAXI
CLNC
2.18.3 Service designation: 121.65 MHz

2.18.1 Service designation: LCL/P
2.18.3 Service designation: 124.725 MHz

2.18.1 Service designation: GND/P
2.18.3 Service designation: 121.9 MHz

2.18.1 Service designation: LCL/P (ARR/DEP RYS
04R/22L 09/27)
2.18.3 Service designation: 128.8 MHz

2.18.1 Service designation: LCL/P (ARR/DEP RYS
4L/22R 15R/33L 15L/33R)
2.18.3 Service designation: 128.8 MHz

2.18.1 Service designation: LCL/P (ARR/DEP RY
14/32)
2.18.3 Service designation: 128.8 MHz

2.18.1 Service designation: GATE CTL
2.18.3 Service designation: 134.05 MHz

2.18.1 Service designation: EMERG
2.18.3 Service designation: 243 MHz

2.18.1 Service designation: LCL/P CD/P
2.18.3 Service designation: 257.8 MHz

2.18.1 Service designation: GND CTL/S
2.18.3 Service designation: 121.75 MHz

2.18.1 Service designation: LCL/S (ARR/DEP RYS
04R/22L, 09/27)
2.18.3 Service designation: 132.225 MHz

2.18.1 Service designation: D-ATIS
2.18.3 Service designation: 127.875 MHz
2.18.4 Hours of operation: 24

2.18.1 Service designation: D-ATIS
2.18.3 Service designation: 135 MHz
2.18.4 Hours of operation: 24

AD 2.19 Radio navigation and landing aids

2.19.1 ILS type: Localizer for runway 27. Magnetic
variation: 16W
2.19.2 ILS identification: DGU
2.19.5 Coordinates: 42-21-16.64N /
71-01-00.00W
2.19.6 Site elevation: 18 ft

2.19.1 ILS type: DME for runway 27. Magnetic
variation: 16W
2.19.2 ILS identification: DGU
2.19.5 Coordinates: 42-21-15.70N /
71-00-55.78W
2.19.6 Site elevation: 28 ft

2.19.1 ILS type: Glide Slope for runway 27.
Magnetic variation: 16W
2.19.2 ILS identification: DGU
2.19.5 Coordinates: 42-21-31.48N /
70-59-28.43W
2.19.6 Site elevation: 13 ft

2.19.1 ILS type: Localizer for runway 04R.
Magnetic variation: 16W
2.19.2 ILS identification: BOS
2.19.5 Coordinates: 42-22-55.97N /
70-59-48.19W

2.19.6 Site elevation: 18 ft

2.19.1 ILS type: Glide Slope for runway 04R.
Magnetic variation: 16W
2.19.2 ILS identification: BOS
2.19.5 Coordinates: 42-21-21.82N /
71-00-24.55W
2.19.6 Site elevation: 10 ft

2.19.1 ILS type: Outer Marker for runway 04R.
Magnetic variation: 16W
2.19.2 ILS identification: BOS
2.19.5 Coordinates: 42-16-25.52N /
71-02-56.95W
2.19.6 Site elevation: 6 ft

2.19.1 ILS type: Inner Marker for runway 04R.
Magnetic variation: 16W
2.19.2 ILS identification: BOS
2.19.5 Coordinates: 42-21-00.00N /
71-00-39.91W
2.19.6 Site elevation: 118 ft

2.19.1 ILS type: Middle Marker for runway 04R.
Magnetic variation: 16W
2.19.2 ILS identification: BOS
2.19.5 Coordinates: 42-20-53.18N /
71-00-47.62W
2.19.6 Site elevation: 12 ft

2.19.1 ILS type: DME for runway 04R. Magnetic
variation: 16W
2.19.2 ILS identification: BOS
2.19.5 Coordinates: 42-22-57.54N /
70-59-51.06W
2.19.6 Site elevation: 35 ft

2.19.1 ILS type: Localizer for runway 22L.
Magnetic variation: 16W
2.19.2 ILS identification: LQN
2.19.5 Coordinates: 42-21-00.00N /
71-00-44.24W
2.19.6 Site elevation: 15 ft

2.19.1 ILS type: DME for runway 22L. Magnetic
variation: 16W
2.19.2 ILS identification: LQN
2.19.5 Coordinates: 42-22-57.54N /
70-59-51.06W
2.19.6 Site elevation: 35 ft

2.19.1 ILS type: Outer Marker for runway 22L.
Magnetic variation: 16W
2.19.2 ILS identification: LQN
2.19.5 Coordinates: 42-27-00.00N /
70-57-47.83W
2.19.6 Site elevation: 8 ft

2.19.1 ILS type: Glide Slope for runway 22L.
Magnetic variation: 16W
2.19.2 ILS identification: LQN
2.19.5 Coordinates: 42-22-17.00N /
71-00-11.99W
2.19.6 Site elevation: 11 ft

2.19.1 ILS type: Localizer for runway 15R.
Magnetic variation: 16W
2.19.2 ILS identification: MDC
2.19.5 Coordinates: 42-21-24.31N /
70-59-34.15W
2.19.6 Site elevation: 10 ft

2.19.1 ILS type: Glide Slope for runway 15R.
Magnetic variation: 16W
2.19.2 ILS identification: MDC
2.19.5 Coordinates: 42-22-14.70N /
71-00-42.42W
2.19.6 Site elevation: 11 ft

2.19.1 ILS type: DME for runway 15R. Magnetic
variation: 16W
2.19.2 ILS identification: MDC
2.19.5 Coordinates: 42-21-27.28N /
70-59-32.94W
2.19.6 Site elevation: 27 ft

2.19.1 ILS type: DME for runway 33L. Magnetic
variation: 16W
2.19.2 ILS identification: LIP
2.19.5 Coordinates: 42-21-27.28N /
70-59-32.94W
2.19.6 Site elevation: 27 ft

2.19.1 ILS type: Middle Marker for runway 33L.
Magnetic variation: 16W
2.19.2 ILS identification: LIP
2.19.5 Coordinates: 42-20-58.45N /
70-59-00.00W
2.19.6 Site elevation: 20 ft

2.19.1 ILS type: Localizer for runway 33L.
Magnetic variation: 16W
2.19.2 ILS identification: LIP
2.19.5 Coordinates: 42-22-37.57N /
71-01-18.09W
2.19.6 Site elevation: 16 ft

2.19.1 ILS type: Glide Slope for runway 33L.
Magnetic variation: 16W
2.19.2 ILS identification: LIP
2.19.5 Coordinates: 42-21-26.64N /
70-59-34.71W
2.19.6 Site elevation: 11 ft

2.19.1 ILS type: Outer Marker for runway 33L.
Magnetic variation: 16W
2.19.2 ILS identification: LIP
2.19.5 Coordinates: 42-18-11.14N /
70-55-18.75W
2.19.6 Site elevation: 99999 ft

General Remarks:

BIRDS ON & IN THE VICINITY OF AIRPORT.

NOISE SENSITIVE AREA – HELICOPTERS OPERATING WITHIN THE CONTROL ZONE ARE
REQUIRED TO MAINT THE HIGHEST POSSIBLE ALTITUDE.

BETWEEN 0000-0600 – RUNWAY 15R IS PREFERENTIAL NIGHT RUNWAY FOR TAKE-OFF &
RUNWAY 33L IS PREFERENTIAL NIGHT RUNWAY FOR LANDING.

FOR NOISE ABATEMENT PROCEDURES CALL 617-561-1636 0900-1700 MON-FRI.

NO REMAINING OVERNIGHT PARKING FOR NON-TENANT CHARTER AIRCRAFT WITHOUT
PRIOR MASSPORT PERMISSION.

TERMINAL E; NORTH & SOUTH CARGO ARRIVALS CONTACT MASSPORT GATE CONTROL ON

FREQ 131.1 BEFORE ENTERING/DEPARTING RAMP AREA.

NUMEROUS CRANES ON & IN THE VICINITY OF OF AIRPORT UP TO & INCLUDING 250 FT.
MSL.

RY14/32 UNIDIRECTIONAL; NO LANDINGS RUNWAY 14; NO TAKEOFFS RUNWAY 32.

ASDE-X SURVEILLANCE SYSTEM IN USE: PILOTS SHOULD OPERATE TRANSPONDERS WITH
MODE C ON ALL TAXIWAYS AND RUNWAYS.

PILOTS SHOULD COMPLETE ALL CALCULATIONS PRIOR TO PUSHBACK FROM GATE.

Detroit, Michigan
Detroit Metropolitan Wayne County
ICAO Identifier KDTW

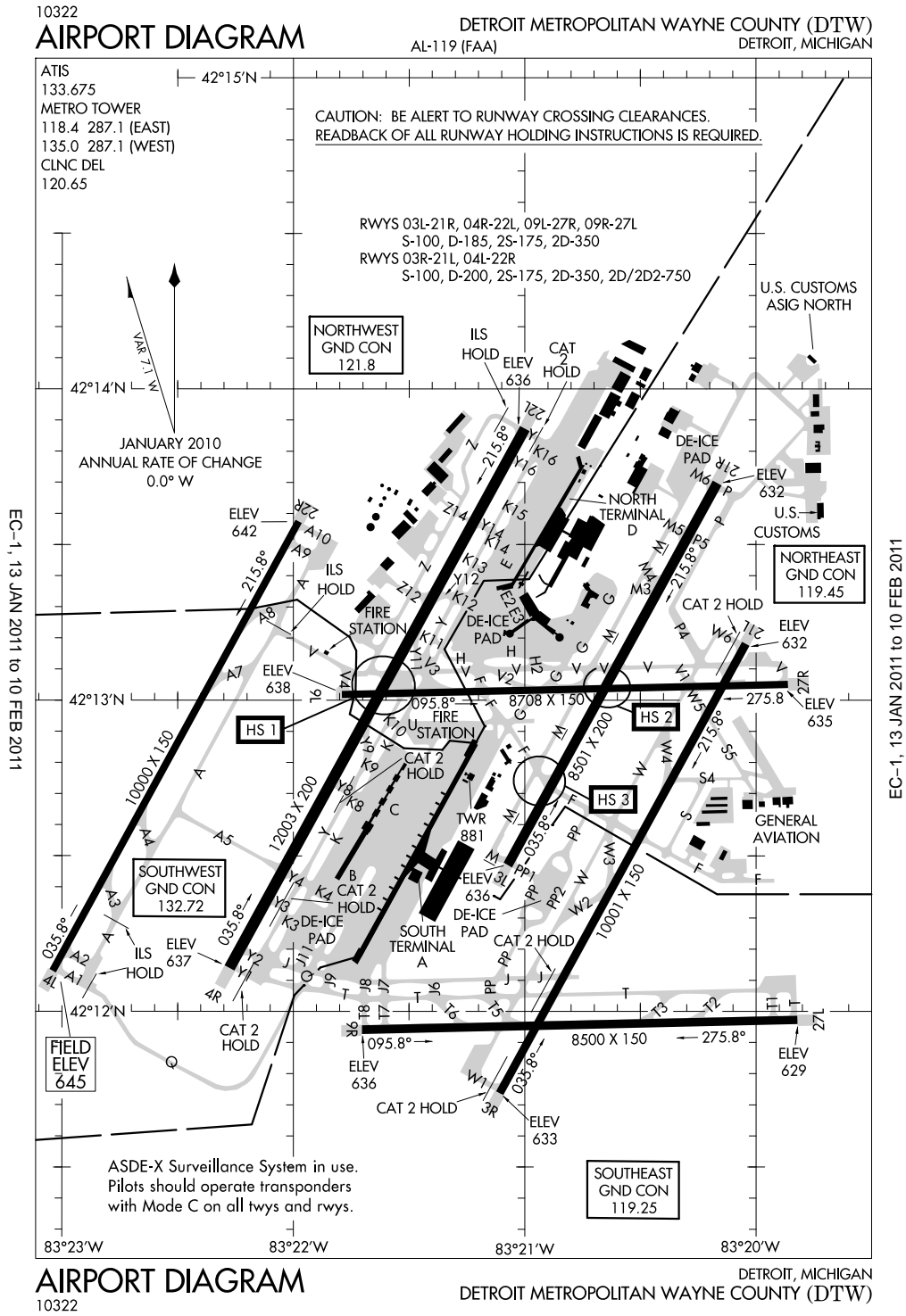

Detroit, MI
Detroit Metropolitan Wayne County
ICAO Identifier KDTW

AD 2.2 Aerodrome geographical and administrative data

- 2.2.1 Reference Point: 42-12-44.80N / 83-21-12.20W
- 2.2.2 From City: 15 Miles S Of Detroit, MI
- 2.2.3 Elevation: 645 ft
- 2.2.5 Magnetic variation: 6W (1990)
- 2.2.6 Airport Contact: Genelle Allen
L C SMITH TERMINAL MEZZANINE
Detroit, MI 48242 (734-942-3550)
- 2.2.7 Traffic: IFR/VFR

AD 2.3 Operational hours

- 2.3.1 - 2.3.11: ALL Months, ALL Days, ALL Hours

AD 2.4 Handling services and facilities

- 2.4.1 Cargo handling facilities: No
- 2.4.2 Fuel types: 100LL,A
- 2.4.4 De-icing facilities: None
- 2.4.5 Hangar space: Yes
- 2.4.6 Repair facilities: Minor

AD 2.6 Rescue and firefighting services

- 2.6.1 Aerodrome category for firefighting: ARFF
Index I E certified on 5/1/1973

AD 2.10 Aerodrome obstacles

- 2.10.1.a. Runway designation: 04R
- 2.10.1.b Type of obstacle: Tree (88 ft). Not Lighted or Marked
- 2.10.1.c Location of obstacle: 1059 ft from Centerline

- 2.10.1.a. Runway designation: 22L
- 2.10.1.b Type of obstacle: Rr (26 ft). Not Lighted or Marked
- 2.10.1.c Location of obstacle: 632 ft from Centerline

- 2.10.1.a. Runway designation: 03R
- 2.10.1.b Type of obstacle: Trees (69 ft). Not Lighted or Marked
- 2.10.1.c Location of obstacle: 935 ft from Centerline

- 2.10.1.a. Runway designation: 21L

- 2.10.1.b Type of obstacle: Berm (5 ft). Not Lighted or Marked
- 2.10.1.c Location of obstacle: 496 ft from Centerline

- 2.10.1.a. Runway designation: 03L
- 2.10.1.b Type of obstacle: Pole (21 ft). Not Lighted or Marked
- 2.10.1.c Location of obstacle: 576 ft from Centerline

- 2.10.1.a. Runway designation: 21R
- 2.10.1.b Type of obstacle: Pole (74 ft). Not Lighted or Marked
- 2.10.1.c Location of obstacle: 557 ft from Centerline

- 2.10.1.a. Runway designation: 09L
- 2.10.1.b Type of obstacle: Ant (116 ft). Not Lighted or Marked
- 2.10.1.c Location of obstacle: 459 ft from Centerline

- 2.10.1.a. Runway designation: 04L
- 2.10.1.b Type of obstacle: Pole (60 ft). Not Lighted or Marked
- 2.10.1.c Location of obstacle: 372 ft from Centerline

- 2.10.1.a. Runway designation: 22R
- 2.10.1.b Type of obstacle: Ant (73 ft). Not Lighted or Marked
- 2.10.1.c Location of obstacle: 831 ft from Centerline

- AD 2.12 Runway physical characteristics**
- 2.12.1 Designation: 04R
- 2.12.2 True Bearing: 29
- 2.12.3 Dimensions: 12003 ft x 200 ft
- 2.12.5 Coordinates: 42-12-00.00N / 83-22-16.57W
- 2.12.6 Threshold elevation: 637 ft
- 2.12.6 Touchdown zone elevation: 638 ft

- 2.12.1 Designation: 22L
- 2.12.2 True Bearing: 209
- 2.12.3 Dimensions: 12003 ft x 200 ft
- 2.12.5 Coordinates: 42-13-52.37N / 83-20-59.97W
- 2.12.6 Threshold elevation: 636 ft
- 2.12.6 Touchdown zone elevation: 637 ft

2.12.1 Designation: 03R
2.12.2 True Bearing: 29
2.12.3 Dimensions: 10001 ft x 150 ft
2.12.5 Coordinates: 42-11-44.21N /
83-21-00.00W
2.12.6 Threshold elevation: 633 ft
2.12.6 Touchdown zone elevation: 633 ft

2.12.1 Designation: 21L
2.12.2 True Bearing: 209
2.12.3 Dimensions: 10001 ft x 150 ft
2.12.5 Coordinates: 42-13-10.86N /
83-20-00.00W
2.12.6 Threshold elevation: 632 ft
2.12.6 Touchdown zone elevation: 632 ft

2.12.1 Designation: 03L
2.12.2 True Bearing: 29
2.12.3 Dimensions: 8501 ft x 200 ft
2.12.5 Coordinates: 42-12-28.20N /
83-21-00.00W
2.12.6 Threshold elevation: 636 ft
2.12.6 Touchdown zone elevation: 636 ft

2.12.1 Designation: 21R
2.12.2 True Bearing: 209
2.12.3 Dimensions: 8501 ft x 200 ft
2.12.5 Coordinates: 42-13-41.85N /
83-20-10.11W
2.12.6 Threshold elevation: 632 ft
2.12.6 Touchdown zone elevation: 634 ft

2.12.1 Designation: 09L
2.12.2 True Bearing: 89
2.12.3 Dimensions: 8708 ft x 150 ft
2.12.5 Coordinates: 42-13-00.00N /
83-21-47.40W
2.12.6 Threshold elevation: 638 ft
2.12.6 Touchdown zone elevation: 640 ft

2.12.1 Designation: 27R
2.12.2 True Bearing: 269
2.12.3 Dimensions: 8708 ft x 150 ft
2.12.5 Coordinates: 42-13-00.00N /
83-19-51.71W
2.12.6 Threshold elevation: 635 ft
2.12.6 Touchdown zone elevation: 635 ft

2.12.1 Designation: 09R
2.12.2 True Bearing: 89
2.12.3 Dimensions: 8500 ft x 150 ft

2.12.5 Coordinates: 42-11-56.46N /
83-21-42.22W
2.12.6 Threshold elevation: 636 ft
2.12.6 Touchdown zone elevation: 636 ft

2.12.1 Designation: 27L
2.12.2 True Bearing: 269
2.12.3 Dimensions: 8500 ft x 150 ft
2.12.5 Coordinates: 42-11-58.34N /
83-19-49.33W
2.12.6 Threshold elevation: 629 ft
2.12.6 Touchdown zone elevation: 630 ft

2.12.1 Designation: 04L
2.12.2 True Bearing: 29
2.12.3 Dimensions: 10000 ft x 150 ft
2.12.5 Coordinates: 42-12-00.00N /
83-23-00.00W
2.12.6 Threshold elevation: 645 ft
2.12.6 Touchdown zone elevation: 645 ft

2.12.1 Designation: 22R
2.12.2 True Bearing: 209
2.12.3 Dimensions: 10000 ft x 150 ft
2.12.5 Coordinates: 42-13-34.48N /
83-21-58.61W
2.12.6 Threshold elevation: 642 ft
2.12.6 Touchdown zone elevation: 642 ft

2.12.1 Designation: 04X
2.12.2 True Bearing: 29
2.12.3 Dimensions: 0 ft x 0 ft

2.12.1 Designation: 22X
2.12.2 True Bearing: 209
2.12.3 Dimensions: 0 ft x 0 ft

AD 2.13 Declared distances

2.13.1 Designation: 04R
2.13.2 Takeoff run available: 12003
2.13.3 Takeoff distance available: 12003
2.13.4 Accelerate-stop distance available: 12003
2.13.5 Landing distance available: 12003

2.13.1 Designation: 22L
2.13.2 Takeoff run available: 12003
2.13.3 Takeoff distance available: 12003
2.13.4 Accelerate-stop distance available: 12003
2.13.5 Landing distance available: 12003

2.13.1 Designation: 03R

2.13.2 Takeoff run available: 10001
2.13.3 Takeoff distance available: 10001
2.13.4 Accelerate-stop distance available: 10001
2.13.5 Landing distance available: 10001

2.13.1 Designation: 21L
2.13.2 Takeoff run available: 10001
2.13.3 Takeoff distance available: 10001
2.13.4 Accelerate-stop distance available: 10001
2.13.5 Landing distance available: 10001

2.13.1 Designation: 03L
2.13.2 Takeoff run available: 8501
2.13.3 Takeoff distance available: 8501
2.13.4 Accelerate-stop distance available: 8501
2.13.5 Landing distance available: 8501

2.13.1 Designation: 21R
2.13.2 Takeoff run available: 8501
2.13.3 Takeoff distance available: 8501
2.13.4 Accelerate-stop distance available: 8501
2.13.5 Landing distance available: 8501

2.13.1 Designation: 09L
2.13.2 Takeoff run available: 8708
2.13.3 Takeoff distance available: 8708
2.13.4 Accelerate-stop distance available: 8618
2.13.5 Landing distance available: 8618

2.13.1 Designation: 27R
2.13.2 Takeoff run available: 8708
2.13.3 Takeoff distance available: 8708
2.13.4 Accelerate-stop distance available: 8708
2.13.5 Landing distance available: 8708

2.13.1 Designation: 09R
2.13.2 Takeoff run available: 8500
2.13.3 Takeoff distance available: 8500
2.13.4 Accelerate-stop distance available: 8500
2.13.5 Landing distance available: 8500

2.13.1 Designation: 27L
2.13.2 Takeoff run available: 8500
2.13.3 Takeoff distance available: 8500
2.13.4 Accelerate-stop distance available: 8500
2.13.5 Landing distance available: 8500

2.13.1 Designation: 04L
2.13.2 Takeoff run available: 10000
2.13.3 Takeoff distance available: 10000
2.13.4 Accelerate-stop distance available: 10000

2.13.5 Landing distance available: 10000

2.13.1 Designation: 22R
2.13.2 Takeoff run available: 10000
2.13.3 Takeoff distance available: 10000
2.13.4 Accelerate-stop distance available: 10000
2.13.5 Landing distance available: 10000

AD 2.14 Approach and runway lighting

2.14.1 Designation: 04R
2.14.2 Approach lighting system: ALSF2: Standard 2400 feet high intensity approach lighting system with sequenced flashers, category II or III configuration

2.14.10 Remarks: Also Has SSALR.

2.14.1 Designation: 22L
2.14.2 Approach lighting system: MALSR: 1400 feet medium intensity approach lighting system with runway alignment indicator lights

2.14.1 Designation: 03R
2.14.2 Approach lighting system: ALSF2: Standard 2400 feet high intensity approach lighting system with sequenced flashers, category II or III configuration

2.14.4 Visual approach slope indicator system: 4-light PAPI on right
2.14.10 Remarks: ALSF2 Required When RVR/Visibility Is 6000/1 Mile Or Less. SSALR Operated When RVR/Visibility Is 6000/1 Mile.

2.14.1 Designation: 21L
2.14.2 Approach lighting system: MALSR: 1400 feet medium intensity approach lighting system with runway alignment indicator lights
2.14.4 Visual approach slope indicator system: 4-light PAPI on left

2.14.1 Designation: 03L
2.14.4 Visual approach slope indicator system: 4-light PAPI on right

2.14.1 Designation: 21R
2.14.4 Visual approach slope indicator system: 4-light PAPI on left

2.14.1 Designation: 27R
2.14.2 Approach lighting system: MALSR: 1400 feet medium intensity approach lighting system with runway alignment indicator lights

2.14.4 Visual approach slope indicator system:
4-light PAPI on left

2.14.1 Designation: 27L

2.14.2 Approach lighting system: MALSR: 1400
feet medium intensity approach lighting system
with runway alignment indicator lights

2.14.4 Visual approach slope indicator system:
4-light PAPI on left

2.14.1 Designation: 04L

2.14.2 Approach lighting system: ALSF2: Standard
2400 feet high intensity approach lighting system
with sequenced flashers, category II or III
configuration

2.14.1 Designation: 22R

2.14.2 Approach lighting system: MALSR: 1400
feet medium intensity approach lighting system
with runway alignment indicator lights

**AD 2.18 Air traffic services communication
facilities**

2.18.1 Service designation: APCH/S DEP/S

2.18.3 Service designation: 118.575 MHz

2.18.1 Service designation: CLASS B

2.18.3 Service designation: 118.95 MHz

2.18.1 Service designation: DEP/P

2.18.3 Service designation: 118.95 MHz

2.18.1 Service designation: CD PRE TAXI CLNC

2.18.3 Service designation: 120.65 MHz

2.18.1 Service designation: EMERG

2.18.3 Service designation: 121.5 MHz

2.18.1 Service designation: GND/P

2.18.3 Service designation: 121.8 MHz

2.18.1 Service designation: APCH/P

2.18.3 Service designation: 124.05 MHz

2.18.1 Service designation: APCH/P

2.18.3 Service designation: 125.15 MHz

2.18.1 Service designation: DEP/P

2.18.3 Service designation: 125.525 MHz

2.18.1 Service designation: CLASS B

2.18.3 Service designation: 126.85 MHz

2.18.1 Service designation: RDR

2.18.3 Service designation: 128.75 MHz

2.18.1 Service designation: DEP/P

2.18.3 Service designation: 132.025 MHz

2.18.1 Service designation: GND/P

2.18.3 Service designation: 132.72 MHz

2.18.1 Service designation: D-ATIS

2.18.3 Service designation: 133.675 MHz

2.18.4 Hours of operation: 24

2.18.1 Service designation: CLASS B

2.18.3 Service designation: 134.3 MHz

2.18.1 Service designation: DEP/P

2.18.3 Service designation: 134.3 MHz

2.18.1 Service designation: EMERG

2.18.3 Service designation: 243 MHz

2.18.1 Service designation: AIR-EVAC

2.18.3 Service designation: 259.6 MHz

2.18.1 Service designation: APCH/P

2.18.3 Service designation: 363.2 MHz

2.18.1 Service designation: GND/P

2.18.3 Service designation: 119.25 MHz

2.18.1 Service designation: GND/P

2.18.3 Service designation: 119.45 MHz

2.18.1 Service designation: CLASS B

2.18.3 Service designation: 127.5 MHz

2.18.1 Service designation: DEP/P CLASS B

2.18.3 Service designation: 239.275 MHz

2.18.1 Service designation: APCH/P

2.18.3 Service designation: 124.975 MHz

2.18.1 Service designation: APCH/S

2.18.3 Service designation: 124.25 MHz

2.18.1 Service designation: PRM RY 4L/22R

2.18.3 Service designation: 127.05 MHz

2.18.1 Service designation: PRM RY 4R/22L
2.18.3 Service designation: 135.775 MHz

83-22-14.84W
2.19.6 Site elevation: 634 ft

2.18.1 Service designation: PRM RY 3R/21L
2.18.3 Service designation: 128.35 MHz

2.19.1 ILS type: Inner Marker for runway 04R.
Magnetic variation: 6W

2.18.1 Service designation: LCL/P
2.18.3 Service designation: 287.1 MHz

2.19.2 ILS identification: DTW
2.19.5 Coordinates: 42-12-00.00N /
83-22-22.38W
2.19.6 Site elevation: 636 ft

2.18.1 Service designation: LCL/P
2.18.3 Service designation: 118.4 MHz

2.19.1 ILS type: Localizer for runway 22L.
Magnetic variation: 6W

2.18.1 Service designation: LCL/P
2.18.3 Service designation: 135 MHz

2.19.2 ILS identification: DWC
2.19.5 Coordinates: 42-11-59.54N /
83-22-23.06W
2.19.6 Site elevation: 636 ft

2.18.1 Service designation: LCL/P
2.18.3 Service designation: 128.125 MHz

2.19.1 ILS type: DME for runway 22L. Magnetic
variation: 6W

AD 2.19 Radio navigation and landing aids

2.19.1 ILS type: Outer Marker for runway 04R.
Magnetic variation: 6W

2.19.2 ILS identification: DWC
2.19.5 Coordinates: 42-13-59.69N /
83-20-50.40W
2.19.6 Site elevation: 652 ft

2.19.2 ILS identification: DTW
2.19.5 Coordinates: 42-07-12.37N /
83-25-54.19W
2.19.6 Site elevation: 631 ft

2.19.1 ILS type: DME for runway 04R. Magnetic
variation: 6W

2.19.1 ILS type: Outer Marker for runway 22L.
Magnetic variation: 6W

2.19.2 ILS identification: DTW
2.19.5 Coordinates: 42-13-59.69N /
83-20-50.36W
2.19.6 Site elevation: 650 ft

2.19.2 ILS identification: DWC
2.19.5 Coordinates: 42-18-20.74N /
83-17-40.65W
2.19.6 Site elevation: 626 ft

2.19.1 ILS type: Middle Marker for runway 04R.
Magnetic variation: 6W

2.19.1 ILS type: Glide Slope for runway 22L.
Magnetic variation: 6W

2.19.2 ILS identification: DTW
2.19.5 Coordinates: 42-11-44.10N /
83-22-34.50W
2.19.6 Site elevation: 642 ft

2.19.2 ILS identification: DWC
2.19.5 Coordinates: 42-13-43.86N /
83-21-12.29W
2.19.6 Site elevation: 636 ft

2.19.1 ILS type: Localizer for runway 04R.
Magnetic variation: 6W

2.19.1 ILS type: Middle Marker for runway 22L.
Magnetic variation: 6W

2.19.2 ILS identification: DTW
2.19.5 Coordinates: 42-14-00.00N /
83-20-53.38W
2.19.6 Site elevation: 636 ft

2.19.2 ILS identification: DWC
2.19.5 Coordinates: 42-14-21.64N /
83-20-38.75W
2.19.6 Site elevation: 99999 ft

2.19.1 ILS type: Glide Slope for runway 04R.
Magnetic variation: 6W

2.19.1 ILS type: Localizer for runway 03R.
Magnetic variation: 6W

2.19.2 ILS identification: DTW
2.19.5 Coordinates: 42-12-18.94N /

2.19.2 ILS identification: HUU
2.19.5 Coordinates: 42-13-19.27N /
83-19-56.47W
2.19.6 Site elevation: 634 ft

2.19.1 ILS type: Glide Slope for runway 03R.
Magnetic variation: 6W
2.19.2 ILS identification: HUU
2.19.5 Coordinates: 42-11-51.13N /
83-20-54.98W
2.19.6 Site elevation: 630 ft

2.19.1 ILS type: Outer Marker for runway 03R.
Magnetic variation: 6W
2.19.2 ILS identification: HUU
2.19.5 Coordinates: 42-06-27.60N /
83-24-57.66W
2.19.6 Site elevation: 625 ft

2.19.1 ILS type: Middle Marker for runway 03R.
Magnetic variation: 6W
2.19.2 ILS identification: HUU
2.19.5 Coordinates: 42-11-20.09N /
83-21-24.29W
2.19.6 Site elevation: 633 ft

2.19.1 ILS type: Inner Marker for runway 03R.
Magnetic variation: 6W
2.19.2 ILS identification: HUU
2.19.5 Coordinates: 42-11-36.55N /
83-21-12.14W
2.19.6 Site elevation: 630 ft

2.19.1 ILS type: DME for runway 03R. Magnetic
variation: 6W
2.19.2 ILS identification: HUU
2.19.5 Coordinates: 42-11-34.31N /
83-21-00.00W
2.19.6 Site elevation: 630 ft

2.19.1 ILS type: Localizer for runway 21L.
Magnetic variation: 6W
2.19.2 ILS identification: EJR
2.19.5 Coordinates: 42-11-34.94N /
83-21-13.32W
2.19.6 Site elevation: 631 ft

2.19.1 ILS type: Glide Slope for runway 21L.
Magnetic variation: 6W
2.19.2 ILS identification: EJR
2.19.5 Coordinates: 42-12-58.50N /
83-20-00.00W
2.19.6 Site elevation: 630 ft

2.19.1 ILS type: Middle Marker for runway 21L.
Magnetic variation: 6W

2.19.2 ILS identification: EJR
2.19.5 Coordinates: 42-13-38.34N /
83-19-46.25W
2.19.6 Site elevation: 630 ft

2.19.1 ILS type: Outer Marker for runway 21L.
Magnetic variation: 6W
2.19.2 ILS identification: EJR
2.19.5 Coordinates: 42-18-00.00N /
83-16-20.34W
2.19.6 Site elevation: 604 ft

2.19.1 ILS type: DME for runway 21L. Magnetic
variation: 6W
2.19.2 ILS identification: EJR
2.19.5 Coordinates: 42-11-34.31N /
83-21-00.00W
2.19.6 Site elevation: 630 ft

2.19.1 ILS type: Localizer for runway 27R.
Magnetic variation: 6W
2.19.2 ILS identification: DMI
2.19.5 Coordinates: 42-13-00.00N /
83-22-00.00W
2.19.6 Site elevation: 639 ft

2.19.1 ILS type: Middle Marker for runway 27R.
Magnetic variation: 6W
2.19.2 ILS identification: DMI
2.19.5 Coordinates: 42-13-00.00N /
83-19-10.55W
2.19.6 Site elevation: 99999 ft

2.19.1 ILS type: Outer Marker for runway 27R.
Magnetic variation: 6W
2.19.2 ILS identification: DMI
2.19.5 Coordinates: 42-13-12.02N /
83-12-11.92W
2.19.6 Site elevation: 99999 ft

2.19.1 ILS type: Glide Slope for runway 27R.
Magnetic variation: 6W
2.19.2 ILS identification: DMI
2.19.5 Coordinates: 42-12-58.36N /
83-20-00.00W
2.19.6 Site elevation: 630 ft

2.19.1 ILS type: Outer Marker for runway 27L.
Magnetic variation: 6W
2.19.2 ILS identification: EPA
2.19.5 Coordinates: 42-12-00.00N /

83-12-39.63W
2.19.6 Site elevation: 600 ft

2.19.1 ILS type: Localizer for runway 27L.
Magnetic variation: 6W
2.19.2 ILS identification: EPA
2.19.5 Coordinates: 42-11-56.23N /
83-21-55.64W
2.19.6 Site elevation: 635 ft

2.19.1 ILS type: Middle Marker for runway 27L.
Magnetic variation: 6W
2.19.2 ILS identification: EPA
2.19.5 Coordinates: 42-11-59.00N /
83-19-11.92W
2.19.6 Site elevation: 626 ft

2.19.1 ILS type: Glide Slope for runway 27L.
Magnetic variation: 6W
2.19.2 ILS identification: EPA
2.19.5 Coordinates: 42-11-54.66N /
83-20-00.00W
2.19.6 Site elevation: 626 ft

2.19.1 ILS type: DME for runway 04L. Magnetic
variation: 6W
2.19.2 ILS identification: HJT
2.19.5 Coordinates: 42-13-41.90N /
83-21-48.73W
2.19.6 Site elevation: 650 ft

2.19.1 ILS type: Localizer for runway 04L.
Magnetic variation: 6W
2.19.2 ILS identification: HJT
2.19.5 Coordinates: 42-13-43.23N /
83-21-52.16W
2.19.6 Site elevation: 642 ft

2.19.1 ILS type: Glide Slope for runway 04L.
Magnetic variation: 6W
2.19.2 ILS identification: HJT
2.19.5 Coordinates: 42-12-18.95N /
83-23-00.00W
2.19.6 Site elevation: 641 ft

2.19.1 ILS type: Inner Marker for runway 04L.
Magnetic variation: 6W
2.19.2 ILS identification: HJT
2.19.5 Coordinates: 42-12-00.00N /
83-23-00.00W
2.19.6 Site elevation: 646 ft

2.19.1 ILS type: DME for runway 22R. Magnetic
variation: 6W
2.19.2 ILS identification: JKI
2.19.5 Coordinates: 42-13-41.92N /
83-21-48.73W
2.19.6 Site elevation: 638 ft

2.19.1 ILS type: Localizer for runway 22R.
Magnetic variation: 6W
2.19.2 ILS identification: JKI
2.19.5 Coordinates: 42-11-59.07N /
83-23-00.00W
2.19.6 Site elevation: 645 ft

2.19.1 ILS type: Glide Slope for runway 22R.
Magnetic variation: 6W
2.19.2 ILS identification: JKI
2.19.5 Coordinates: 42-13-27.23N /
83-22-10.00W
2.19.6 Site elevation: 637 ft

2.19.1 ILS type: DME for runway 04X. Magnetic
variation: 6W
2.19.2 ILS identification: ALA
2.19.5 Coordinates: 42-11-57.11N /
83-23-00.00W
2.19.6 Site elevation: 643 ft

2.19.1 ILS type: Glide Slope for runway 04X.
Magnetic variation: 6W
2.19.2 ILS identification: ALA
2.19.5 Coordinates: 42-12-19.05N /
83-23-00.00W
2.19.6 Site elevation: 640 ft

2.19.1 ILS type: Localizer for runway 04X.
Magnetic variation: 6W
2.19.2 ILS identification: ALA
2.19.5 Coordinates: 42-13-33.40N /
83-21-50.94W
2.19.6 Site elevation: 639 ft

2.19.1 ILS type: Localizer for runway 22X.
Magnetic variation: 6W
2.19.2 ILS identification: BZB
2.19.5 Coordinates: 42-11-56.26N /
83-23-00.00W
2.19.6 Site elevation: 642 ft

2.19.1 ILS type: Glide Slope for runway 22X.
Magnetic variation: 6W

2.19.2 ILS identification: BZB
2.19.5 Coordinates: 42-13-27.35N /
83-22-10.30W
2.19.6 Site elevation: 638 ft

2.19.2 ILS identification: BZB
2.19.5 Coordinates: 42-11-57.11N /
83-23-00.00W
2.19.6 Site elevation: 643 ft

2.19.1 ILS type: DME for runway 22X. Magnetic
variation: 6W

General Remarks:

BRIGHTLY LIGHTED PARKING LOT 2.6 NAUTICAL MILE SW OF AIRPORT.

BE ALERT BIRDS, WATERFOWL, ON & IN THE VICINITY OF AIRPORT.

RUNWAY 21R DEPS BE ALERT FOR 'OPTICAL ILLUSION', AIRCRAFT TAXIING ON TAXIWAY 'T'
MAY APPEAR AS THOUGH CROSSING RUNWAY 21R CENTERLINE.

AIRCRAFT ON TAXIWAY 'F' AND TAXIWAY 'V' DO NOT BLOCK FIRE STATION EXITS.

TAXIWAY 'G' N OF TAXIWAY 'V' IS A NON-MOVEMENT AREA.

RUNWAY 22L DEPS BE ALERT FOR OPTICAL ILLUSION, AIRCRAFT TAXIING ON TAXIWAY Q
MAY APPEAR AS THOUGH CROSSING RUNWAY 22L CENTERLINE.

ASDE-X SURVEILLANCE SYSTEM IN USE: PILOTS SHOULD OPERATE TRANSPONDERS WITH
MODE C ON ALL TAXIWAYS & RUNWAYS.

UNIDIRECTIONAL STOPBARS ON RUNWAY 27R WHEN BEING USED FOR TAXI.

Minneapolis, Minnesota Minneapolis-St. Paul International (Wold-Chamberlain) ICAO Identifier KMSP

11013

AIRPORT DIAGRAM

MINNEAPOLIS-ST PAUL INTL/WOLD-CHAMBERLAIN (MSP)
AL-264 (FAA) MINNEAPOLIS, MINNESOTA

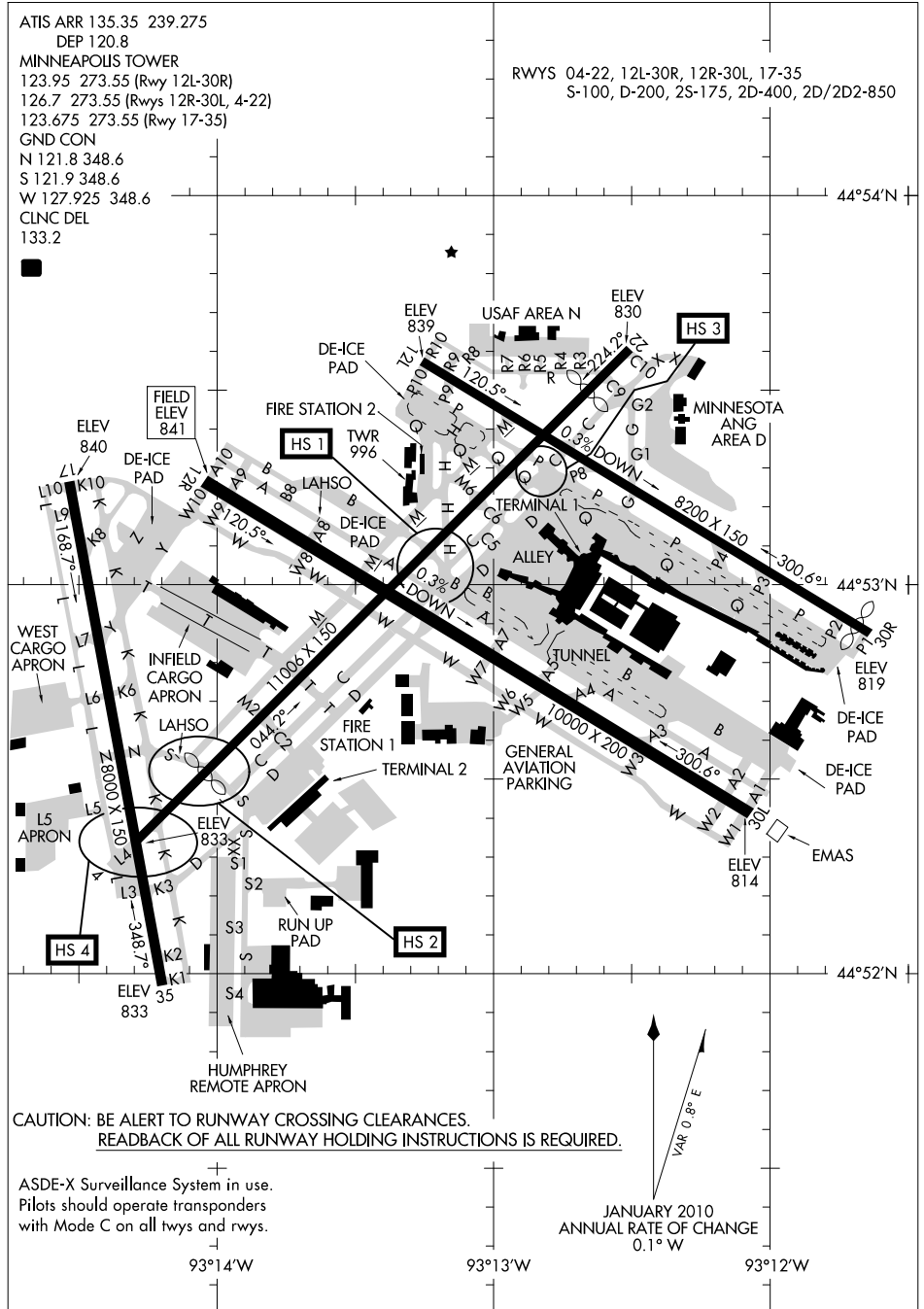

NC-1, 13 JAN 2011 to 10 FEB 2011

NC-1, 13 JAN 2011 to 10 FEB 2011

AIRPORT DIAGRAM

MINNEAPOLIS, MINNESOTA
MINNEAPOLIS-ST PAUL INTL/WOLD-CHAMBERLAIN (MSP)

11013

Minneapolis, MN
Minneapolis-St Paul Intl/Wold-Chamberlain
ICAO Identifier KMSP

AD 2.2 Aerodrome geographical and administrative data

- 2.2.1 Reference Point: 44-52-55.04N / 93-13-18.36W
- 2.2.2 From City: 6 Miles SW Of Minneapolis, MN
- 2.2.3 Elevation: 841 ft
- 2.2.5 Magnetic variation: 2E (1995)
- 2.2.6 Airport Contact: Steve Wareham
4300 GLUMACK SUITE 3000
St Paul, MN 55111
(612-725-6464)
- 2.2.7 Traffic: IFR/VFR

AD 2.3 Operational hours

- 2.3.1 - 2.3.11: ALL Months, ALL Days, ALL Hours

AD 2.4 Handling services and facilities

- 2.4.1 Cargo handling facilities: No
- 2.4.2 Fuel types: 100LL,A
- 2.4.4 De-icing facilities: None
- 2.4.5 Hangar space: Yes
- 2.4.6 Repair facilities: Major

AD 2.6 Rescue and firefighting services

- 2.6.1 Aerodrome category for firefighting: ARFF Index I E certified on 5/1/1973

AD 2.10 Aerodrome obstacles

- 2.10.1.a. Runway designation: 12L
- 2.10.1.b Type of obstacle: Tree (61 ft). Not Lighted or Marked
- 2.10.1.c Location of obstacle: 667 ft from Centerline

- 2.10.1.a. Runway designation: 30R
- 2.10.1.b Type of obstacle: Tree (13 ft). Not Lighted or Marked
- 2.10.1.c Location of obstacle: 272 ft from Centerline

- 2.10.1.a. Runway designation: 12R
- 2.10.1.b Type of obstacle: Tree (36 ft). Not Lighted or Marked
- 2.10.1.c Location of obstacle: 634 ft from Centerline

- 2.10.1.a. Runway designation: 30L
- 2.10.1.b Type of obstacle: Tree (36 ft). Lighted
- 2.10.1.c Location of obstacle: 562 ft from Centerline

- 2.10.1.a. Runway designation: 04
- 2.10.1.b Type of obstacle: Tree (101 ft). Not Lighted or Marked
- 2.10.1.c Location of obstacle: 834 ft from Centerline

- 2.10.1.a. Runway designation: 22
- 2.10.1.b Type of obstacle: Tree (66 ft). Not Lighted or Marked
- 2.10.1.c Location of obstacle: 636 ft from Centerline

- 2.10.1.a. Runway designation: 17
- 2.10.1.b Type of obstacle: Tree (52 ft). Not Lighted or Marked
- 2.10.1.c Location of obstacle: 732 ft from Centerline

AD 2.12 Runway physical characteristics

- 2.12.1 Designation: 12L
- 2.12.2 True Bearing: 121
- 2.12.3 Dimensions: 8200 ft x 150 ft
- 2.12.5 Coordinates: 44-53-34.62N / 93-13-15.55W
- 2.12.6 Threshold elevation: 838 ft
- 2.12.6 Touchdown zone elevation: 839 ft

- 2.12.1 Designation: 30R
- 2.12.2 True Bearing: 301
- 2.12.3 Dimensions: 8200 ft x 150 ft
- 2.12.5 Coordinates: 44-52-52.51N / 93-11-38.27W
- 2.12.6 Threshold elevation: 819 ft
- 2.12.6 Touchdown zone elevation: 823 ft

- 2.12.1 Designation: 12R
- 2.12.2 True Bearing: 121
- 2.12.3 Dimensions: 10000 ft x 200 ft
- 2.12.5 Coordinates: 44-53-16.04N / 93-14-00.00W
- 2.12.6 Threshold elevation: 841 ft
- 2.12.6 Touchdown zone elevation: 841 ft

- 2.12.1 Designation: 30L
- 2.12.2 True Bearing: 301
- 2.12.3 Dimensions: 10000 ft x 200 ft

2.12.5 Coordinates: 44-52-24.67N /
93-12-00.00W
2.12.6 Threshold elevation: 814 ft
2.12.6 Touchdown zone elevation: 823 ft

2.12.1 Designation: 04
2.12.2 True Bearing: 45
2.12.3 Dimensions: 11006 ft x 150 ft
2.12.5 Coordinates: 44-52-20.15N /
93-14-17.92W
2.12.6 Threshold elevation: 833 ft
2.12.6 Touchdown zone elevation: 832 ft

2.12.1 Designation: 22
2.12.2 True Bearing: 225
2.12.3 Dimensions: 11006 ft x 150 ft
2.12.5 Coordinates: 44-53-36.98N /
93-12-29.83W
2.12.6 Threshold elevation: 830 ft
2.12.6 Touchdown zone elevation: 828 ft

2.12.1 Designation: 17
2.12.2 True Bearing: 170
2.12.3 Dimensions: 8000 ft x 150 ft
2.12.5 Coordinates: 44-53-15.91N /
93-14-32.10W
2.12.6 Threshold elevation: 840 ft
2.12.6 Touchdown zone elevation: 840 ft
2.12.7 Slope: 0.1DOWN

2.12.1 Designation: 35
2.12.2 True Bearing: 350
2.12.3 Dimensions: 8000 ft x 150 ft
2.12.5 Coordinates: 44-51-58.24N /
93-14-11.92W
2.12.6 Threshold elevation: 833 ft
2.12.6 Touchdown zone elevation: 834 ft
2.12.7 Slope: 0.1UP

AD 2.13 Declared distances

2.13.1 Designation: 12L
2.13.2 Takeoff run available: 8200
2.13.3 Takeoff distance available: 8200
2.13.4 Accelerate-stop distance available: 7620
2.13.5 Landing distance available: 7620

2.13.1 Designation: 30R
2.13.2 Takeoff run available: 8200
2.13.3 Takeoff distance available: 8200
2.13.4 Accelerate-stop distance available: 8200
2.13.5 Landing distance available: 8000

AD 2.14 Approach and runway lighting

2.14.1 Designation: 12L
2.14.2 Approach lighting system: ALSF2: Standard
2400 feet high intensity approach lighting system
with sequenced flashers, category II or III
configuration

2.14.4 Visual approach slope indicator system:
4-light PAPI on left

2.14.1 Designation: 30R
2.14.4 Visual approach slope indicator system:
4-light PAPI on left

2.14.1 Designation: 12R
2.14.2 Approach lighting system: ALSF2: Standard
2400 feet high intensity approach lighting system
with sequenced flashers, category II or III
configuration

2.14.4 Visual approach slope indicator system:
4-light PAPI on left

2.14.1 Designation: 30L
2.14.2 Approach lighting system: ALSF2: Standard
2400 feet high intensity approach lighting system
with sequenced flashers, category II or III
configuration

2.14.4 Visual approach slope indicator system:
4-light PAPI on left

2.14.1 Designation: 04
2.14.2 Approach lighting system: MALSR: 1400
feet medium intensity approach lighting system
with runway alignment indicator lights
2.14.4 Visual approach slope indicator system:
4-light PAPI on left

2.14.1 Designation: 22
2.14.2 Approach lighting system: MALSR: 1400
feet medium intensity approach lighting system
with runway alignment indicator lights
2.14.4 Visual approach slope indicator system:
4-light PAPI on left

2.14.1 Designation: 17
2.14.4 Visual approach slope indicator system:
4-light PAPI on right

2.14.1 Designation: 35
2.14.2 Approach lighting system: ALSF2: Standard
2400 feet high intensity approach lighting system
with sequenced flashers, category II or III

configuration
2.14.4 Visual approach slope indicator system:
4-light PAPI on left

AD 2.18 Air traffic services communication facilities

2.18.1 Service designation: APCH/P
2.18.3 Service designation: 119.3 MHz

2.18.1 Service designation: D-ATIS
2.18.3 Service designation: 120.8 MHz
2.18.4 Hours of operation: 24

2.18.1 Service designation: CLASS B IC
2.18.3 Service designation: 121.2 MHz

2.18.1 Service designation: EMERG
2.18.3 Service designation: 121.5 MHz

2.18.1 Service designation: GND/P
2.18.3 Service designation: 121.8 MHz

2.18.1 Service designation: GND/P
2.18.3 Service designation: 121.9 MHz

2.18.1 Service designation: LCL/P
2.18.3 Service designation: 123.95 MHz

2.18.1 Service designation: CLASS B IC
2.18.3 Service designation: 126.5 MHz

2.18.1 Service designation: LCL/P
2.18.3 Service designation: 126.7 MHz

2.18.1 Service designation: CD/P PRE TAXI
CLNC
2.18.3 Service designation: 133.2 MHz

2.18.1 Service designation: D-ATIS
2.18.3 Service designation: 135.35 MHz
2.18.4 Hours of operation: 24

2.18.1 Service designation: EMERG
2.18.3 Service designation: 243 MHz

2.18.1 Service designation: LCL/P
2.18.3 Service designation: 273.55 MHz

2.18.1 Service designation: DEP/S
2.18.3 Service designation: 284.7 MHz

2.18.1 Service designation: APCH/P
2.18.3 Service designation: 335.5 MHz

2.18.1 Service designation: GND/P
2.18.3 Service designation: 348.6 MHz

2.18.1 Service designation: DEP/P
2.18.3 Service designation: 357.4 MHz

2.18.1 Service designation: GND METERING
2.18.3 Service designation: 133.57 MHz

2.18.1 Service designation: DEP/P
2.18.3 Service designation: 124.7 MHz

2.18.1 Service designation: GND/P
2.18.3 Service designation: 127.925 MHz

2.18.1 Service designation: DEP/P
2.18.3 Service designation: 125.75 MHz

2.18.1 Service designation: PTD
2.18.3 Service designation: 282.675 MHz

2.18.1 Service designation: APCH/P
2.18.3 Service designation: 118.72 MHz

2.18.1 Service designation: LCL/P
2.18.3 Service designation: 123.675 MHz

2.18.1 Service designation: DEP/P
2.18.3 Service designation: 132.975 MHz

2.18.1 Service designation: APCH/P
2.18.3 Service designation: 126.95 MHz

2.18.1 Service designation: PTD
2.18.3 Service designation: 324.3 MHz

2.18.1 Service designation: CLASS B IC
2.18.3 Service designation: 134.7 MHz

2.18.1 Service designation: ATIS
2.18.3 Service designation: 239.275 MHz
2.18.4 Hours of operation: 24

2.18.1 Service designation: ARS CMD POST
2.18.3 Service designation: 138.6 MHz

AD 2.19 Radio navigation and landing aids

2.19.1 ILS type: Localizer for runway 12L.

Magnetic variation: 2E
2.19.2 ILS identification: PJJ
2.19.5 Coordinates: 44-52-50.33N /
93-11-33.25W
2.19.6 Site elevation: 813 ft

2.19.1 ILS type: Outer Marker for runway 12L.
Magnetic variation: 2E
2.19.2 ILS identification: PJJ
2.19.5 Coordinates: 44-56-37.77N /
93-20-26.52W
2.19.6 Site elevation: 900 ft

2.19.1 ILS type: Glide Slope for runway 12L.
Magnetic variation: 2E
2.19.2 ILS identification: PJJ
2.19.5 Coordinates: 44-53-30.64N /
93-12-57.01W
2.19.6 Site elevation: 830 ft

2.19.1 ILS type: DME for runway 12L. Magnetic
variation: 2E
2.19.2 ILS identification: PJJ
2.19.5 Coordinates: 44-53-00.00N /
93-11-47.05W
2.19.6 Site elevation: 813 ft

2.19.1 ILS type: Inner Marker for runway 12L.
Magnetic variation: 2E
2.19.2 ILS identification: PJJ
2.19.5 Coordinates: 44-53-39.68N /
93-13-25.89W
2.19.6 Site elevation: 833 ft

2.19.1 ILS type: Middle Marker for runway 12L.
Magnetic variation: 2E
2.19.2 ILS identification: PJJ
2.19.5 Coordinates: 44-53-47.98N /
93-13-46.30W
2.19.6 Site elevation: 832 ft

2.19.1 ILS type: Outer Marker for runway 30R.
Magnetic variation: 2E
2.19.2 ILS identification: INN
2.19.5 Coordinates: 44-49-57.40N /
93-05-00.00W
2.19.6 Site elevation: 821 ft

2.19.1 ILS type: DME for runway 30R. Magnetic
variation: 2E
2.19.2 ILS identification: INN

2.19.5 Coordinates: 44-53-00.00N /
93-11-48.84W
2.19.6 Site elevation: 813 ft

2.19.1 ILS type: Glide Slope for runway 30R.
Magnetic variation: 2E
2.19.2 ILS identification: INN
2.19.5 Coordinates: 44-53-00.00N /
93-11-48.83W
2.19.6 Site elevation: 813 ft

2.19.1 ILS type: Middle Marker for runway 30R.
Magnetic variation: 2E
2.19.2 ILS identification: INN
2.19.5 Coordinates: 44-52-38.68N /
93-11-00.00W
2.19.6 Site elevation: 705 ft

2.19.1 ILS type: Localizer for runway 30R.
Magnetic variation: 2E
2.19.2 ILS identification: INN
2.19.5 Coordinates: 44-53-39.81N /
93-13-27.53W
2.19.6 Site elevation: 846 ft

2.19.1 ILS type: Glide Slope for runway 12R.
Magnetic variation: 2E
2.19.2 ILS identification: HKZ
2.19.5 Coordinates: 44-53-00.00N /
93-13-53.53W
2.19.6 Site elevation: 835 ft

2.19.1 ILS type: Outer Marker for runway 12R.
Magnetic variation: 2E
2.19.2 ILS identification: HKZ
2.19.5 Coordinates: 44-56-14.87N /
93-21-00.00W
2.19.6 Site elevation: 99999 ft

2.19.1 ILS type: Middle Marker for runway 12R.
Magnetic variation: 2E
2.19.2 ILS identification: HKZ
2.19.5 Coordinates: 44-53-29.37N /
93-14-33.50W
2.19.6 Site elevation: 819 ft

2.19.1 ILS type: DME for runway 12R. Magnetic
variation: 2E
2.19.2 ILS identification: HKZ
2.19.5 Coordinates: 44-52-28.40N /
93-12-23.96W

2.19.6 Site elevation: 830 ft

2.19.1 ILS type: Localizer for runway 12R.
Magnetic variation: 2E

2.19.2 ILS identification: HKZ

2.19.5 Coordinates: 44-52-20.74N /
93-11-55.17W

2.19.6 Site elevation: 813 ft

2.19.1 ILS type: Inner Marker for runway 12R.
Magnetic variation: 2E

2.19.2 ILS identification: HKZ

2.19.5 Coordinates: 44-53-20.87N /
93-14-12.67W

2.19.6 Site elevation: 839 ft

2.19.1 ILS type: Glide Slope for runway 30L.
Magnetic variation: 2E

2.19.2 ILS identification: MSP

2.19.5 Coordinates: 44-52-26.97N /
93-12-20.22W

2.19.6 Site elevation: 812 ft

2.19.1 ILS type: Inner Marker for runway 30L.
Magnetic variation: 2E

2.19.2 ILS identification: MSP

2.19.5 Coordinates: 44-52-19.78N /
93-11-52.60W

2.19.6 Site elevation: 809 ft

2.19.1 ILS type: Localizer for runway 30L.
Magnetic variation: 2E

2.19.2 ILS identification: MSP

2.19.5 Coordinates: 44-53-19.63N /
93-14-11.16W

2.19.6 Site elevation: 838 ft

2.19.1 ILS type: DME for runway 30L. Magnetic
variation: 2E

2.19.2 ILS identification: MSP

2.19.5 Coordinates: 44-52-28.40N /
93-12-23.96W

2.19.6 Site elevation: 830 ft

2.19.1 ILS type: Middle Marker for runway 30L.
Magnetic variation: 2E

2.19.2 ILS identification: MSP

2.19.5 Coordinates: 44-52-10.08N /
93-11-30.30W

2.19.6 Site elevation: 698 ft

2.19.1 ILS type: Outer Marker for runway 30L.
Magnetic variation: 2E

2.19.2 ILS identification: MSP

2.19.5 Coordinates: 44-49-32.68N /
93-05-28.78W

2.19.6 Site elevation: 880 ft

2.19.1 ILS type: Glide Slope for runway 04.
Magnetic variation: 2E

2.19.2 ILS identification: APL

2.19.5 Coordinates: 44-52-40.53N /
93-13-55.93W

2.19.6 Site elevation: 826 ft

2.19.1 ILS type: Outer Marker for runway 04.
Magnetic variation: 2E

2.19.2 ILS identification: APL

2.19.5 Coordinates: 44-49-26.67N /
93-18-21.81W

2.19.6 Site elevation: 99999 ft

2.19.1 ILS type: Localizer for runway 04. Magnetic
variation: 2E

2.19.2 ILS identification: APL

2.19.5 Coordinates: 44-53-40.12N /
93-12-25.40W

2.19.6 Site elevation: 830 ft

2.19.1 ILS type: Middle Marker for runway 04.
Magnetic variation: 2E

2.19.2 ILS identification: APL

2.19.5 Coordinates: 44-52-19.77N /
93-14-18.50W

2.19.6 Site elevation: 99999 ft

2.19.1 ILS type: Localizer for runway 22. Magnetic
variation: 2E

2.19.2 ILS identification: SIJ

2.19.5 Coordinates: 44-52-13.10N /
93-14-27.83W

2.19.6 Site elevation: 830 ft

2.19.1 ILS type: Outer Marker for runway 22.
Magnetic variation: 2E

2.19.2 ILS identification: SIJ

2.19.5 Coordinates: 44-57-00.00N /
93-07-23.39W

2.19.6 Site elevation: 99999 ft

2.19.1 ILS type: Middle Marker for runway 22.
Magnetic variation: 2E

2.19.2 ILS identification: SIJ
2.19.5 Coordinates: 44-53-55.58N /
93-12-00.00W
2.19.6 Site elevation: 821 ft

2.19.1 ILS type: Localizer for runway 17. Magnetic
variation: 3E
2.19.2 ILS identification: TJZ
2.19.5 Coordinates: 44-51-48.38N /
93-14-00.00W
2.19.6 Site elevation: 830 ft

2.19.1 ILS type: DME for runway 17. Magnetic
variation: 3E
2.19.2 ILS identification: TJZ
2.19.5 Coordinates: 44-53-25.29N /
93-14-38.30W
2.19.6 Site elevation: 822 ft

2.19.1 ILS type: Localizer for runway 35. Magnetic
variation: 2E
2.19.2 ILS identification: BMA
2.19.5 Coordinates: 44-53-25.72N /
93-14-34.65W

2.19.6 Site elevation: 840 ft

2.19.1 ILS type: Inner Marker for runway 35.
Magnetic variation: 2E
2.19.2 ILS identification: BMA
2.19.5 Coordinates: 44-51-48.33N /
93-14-00.00W
2.19.6 Site elevation: 833 ft

2.19.1 ILS type: DME for runway 35. Magnetic
variation: 2E
2.19.2 ILS identification: BMA
2.19.5 Coordinates: 44-53-25.29N /
93-14-38.30W
2.19.6 Site elevation: 822 ft

2.19.1 ILS type: Glide Slope for runway 35.
Magnetic variation: 2E
2.19.2 ILS identification: BMA
2.19.5 Coordinates: 44-52-00.00N /
93-14-19.75W
2.19.6 Site elevation: 832 ft

General Remarks:

TRAINING FLIGHTS PROHIBITED. GA FLIGHTS MUST TERMINATE AT THE FBO OR US
CUSTOMS UNLESS APPROVED BY AIRPORT MANAGER.

FOR NOISE ABATEMENT PROCEDURES CALL (612) 726-9411; NO STAGE 1 CATEGORY CIVIL
AIRCRAFT; NIGHTTIME HRS ARE 2230-0600.

BIRDS ON & IN THE VICINITY OF AIRPORT.

SIGNATURE FLIGHT SUPPORT 128.95

MILITARY REMARKS: ARFC 934 AW: OPR 1300--400Z++ MON-THU, 1300-2230Z++ FRI, CLOSED
WEEKEND AND HOLIDAY, CONTACT BASE OPERATIONS FOR OPR HRS DURING UNIT
TRAINING ASSEMBLY WEEKEND. TRANSMIT AIRCRAFT MUST OPR 1300-2145Z++ MON-FRI,
EXCEPT HOLIDAY UNLESS DIRECTLY SUPPORTING 934 AW OR OTHER SPECIAL
CIRCUMSTANCES.

MILITARY RESTRICTED: NO HAZARD CL/DIV1.1 OR 1.2 EXPLOSIVES PERMITTED. LOADING
OR UNLOADING OF HAZARD CL/DIV 1.3, 1.4, 1.5 OR 1.6 MUST BE APPROVE BY AIRPORT
DIRECT PRIOR TO FLIGHT.

COMPLEX GEOMETRY AT RUNWAY 04 APPROACH END. RUNWAY 04 DEPARTURES CHECK
COMPASS TO VERIFY CORRECT RUNWAY HEADING.

VEHICLES PARKED ALONG SOUTH END OF TAXIWAY 'S'.

133 AW BASE OPERATIONS – 324.3 REMARKS: (CALL LIGHTHOUSE).

COMMUNICATIONS: MINNEAPOLIS AIR RESERVE STATION JOINT COMMAND POST – 252.1
REMARKS: CALL NORTHSTAR.

934 AW BASE OPERATIONS – PILOT TO DISPATCH 282.675 REMARKS: (CALL VIKING OPS).

REMARKS: AFRC 934 AW: CONTACT PILOT TO DISPATCH (VIKING OPS) 20 MIN PRIOR
LANDING.

ASDE-X SURVEILLANCE SYSTEM IN USE. PILOTS SHOULD OPERATE TRANSPONDERS WITH
MODE C ON ALL TAXIWAYS AND RUNWAYS

ALL UNSCHEDULED AIRCRAFT AT TERMINAL 2-HUMPHREY ARE REQUIRED TO CONTACT
TERMINAL 2 GATE CONTROL ON 122.95 OR CALL 612-726-5742 PRIOR TO ARR.

**Kansas City, Missouri
Kansas City International
ICAO Identifier KMCI**

10266 AIRPORT DIAGRAM AL-780 (FAA) KANSAS CITY INTL (MCI) KANSAS CITY, MISSOURI

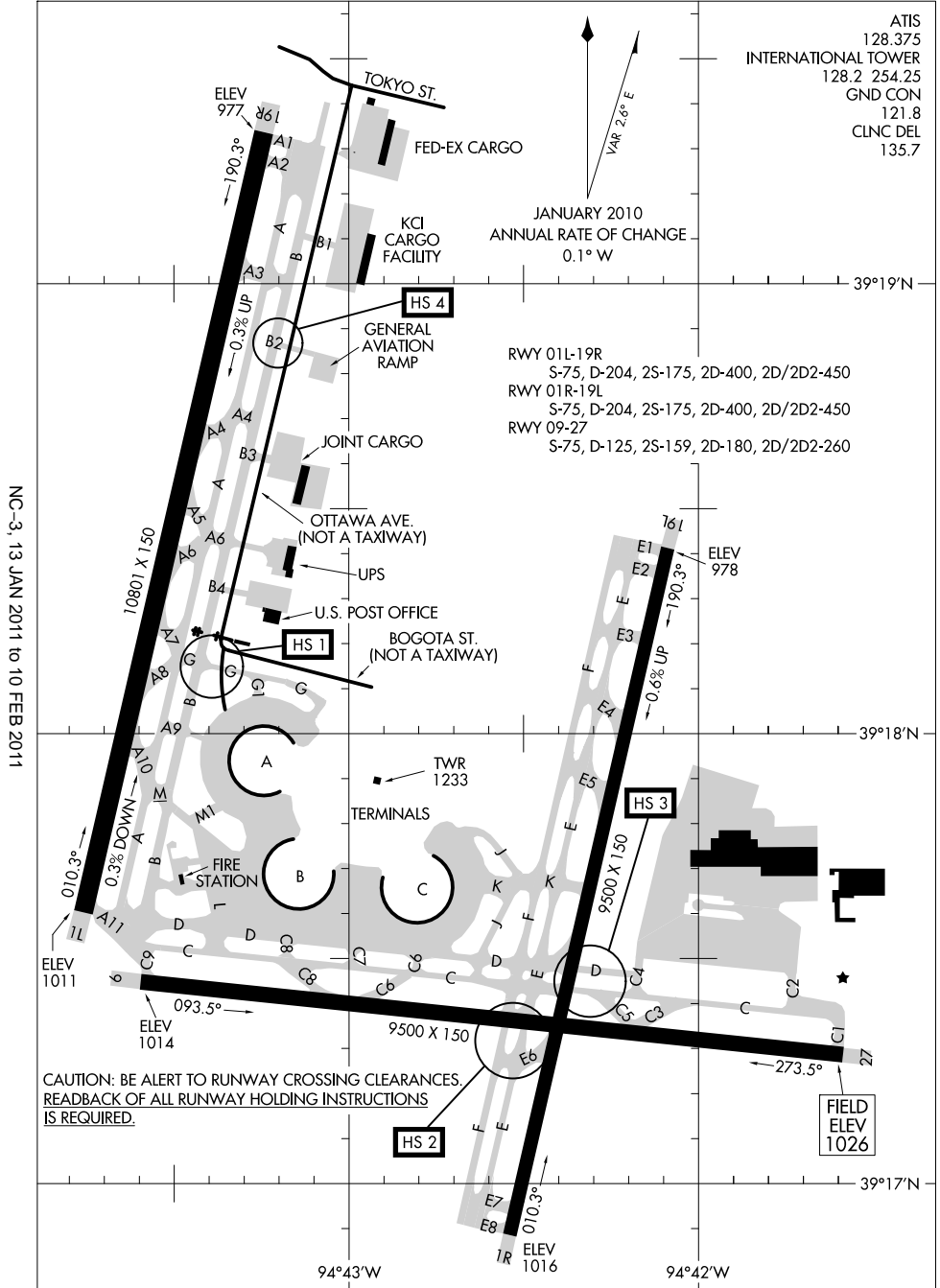

AIRPORT DIAGRAM KANSAS CITY, MISSOURI KANSAS CITY INTL (MCI)

Kansas City, MO
Kansas City Intl
ICAO Identifier KMCI

AD 2.2 Aerodrome geographical and administrative data

- 2.2.1 Reference Point: 39-17-51.38N / 94-42-50.06W
- 2.2.2 From City: 15 Miles NW Of Kansas City, MO
- 2.2.3 Elevation: 1026 ft
- 2.2.5 Magnetic variation: 5E (1990)
- 2.2.6 Airport Contact: Mr. David W. Bowen
P.O. BOX 20047
Kansas City, MO 64195
(816-243-5248)
- 2.2.7 Traffic: IFR/VFR

AD 2.3 Operational hours

- 2.3.1 - 2.3.11: ALL Months, ALL Days, ALL Hours

AD 2.4 Handling services and facilities

- 2.4.1 Cargo handling facilities: No
- 2.4.2 Fuel types: 100LL,A
- 2.4.4 De-icing facilities: None
- 2.4.5 Hangar space: No
- 2.4.6 Repair facilities: None

AD 2.6 Rescue and firefighting services

- 2.6.1 Aerodrome category for firefighting: ARFF Index I C certified on 5/1/1973

AD 2.12 Runway physical characteristics

- 2.12.1 Designation: 09
- 2.12.2 True Bearing: 96
- 2.12.3 Dimensions: 9500 ft x 150 ft
- 2.12.5 Coordinates: 39-17-27.10N / 94-43-35.73W
- 2.12.6 Threshold elevation: 1014 ft
- 2.12.6 Touchdown zone elevation: 1015 ft

- 2.12.1 Designation: 27
- 2.12.2 True Bearing: 276
- 2.12.3 Dimensions: 9500 ft x 150 ft
- 2.12.5 Coordinates: 39-17-17.08N / 94-41-35.59W
- 2.12.6 Threshold elevation: 1026 ft
- 2.12.6 Touchdown zone elevation: 1026 ft

- 2.12.1 Designation: 01L
- 2.12.2 True Bearing: 13

- 2.12.3 Dimensions: 10801 ft x 150 ft
- 2.12.5 Coordinates: 39-17-36.01N / 94-43-45.54W
- 2.12.6 Threshold elevation: 1011 ft
- 2.12.6 Touchdown zone elevation: 1011 ft

- 2.12.1 Designation: 19R
- 2.12.2 True Bearing: 193
- 2.12.3 Dimensions: 10801 ft x 150 ft
- 2.12.5 Coordinates: 39-19-20.05N / 94-43-14.79W
- 2.12.6 Threshold elevation: 977 ft
- 2.12.6 Touchdown zone elevation: 989 ft

- 2.12.1 Designation: 01R
- 2.12.2 True Bearing: 13
- 2.12.3 Dimensions: 9500 ft x 150 ft
- 2.12.5 Coordinates: 39-16-53.24N / 94-42-32.39W
- 2.12.6 Threshold elevation: 1016 ft
- 2.12.6 Touchdown zone elevation: 1016 ft

- 2.12.1 Designation: 19L
- 2.12.2 True Bearing: 193
- 2.12.3 Dimensions: 9500 ft x 150 ft
- 2.12.5 Coordinates: 39-18-24.74N / 94-42-00.00W
- 2.12.6 Threshold elevation: 978 ft
- 2.12.6 Touchdown zone elevation: 994 ft

AD 2.14 Approach and runway lighting

- 2.14.1 Designation: 09
- 2.14.2 Approach lighting system: MALSR: 1400 feet medium intensity approach lighting system with runway alignment indicator lights

- 2.14.1 Designation: 27
- 2.14.2 Approach lighting system: MALSR: 1400 feet medium intensity approach lighting system with runway alignment indicator lights
- 2.14.4 Visual approach slope indicator system: 4-light PAPI on left

- 2.14.1 Designation: 01L
- 2.14.2 Approach lighting system: MALSR: 1400 feet medium intensity approach lighting system with runway alignment indicator lights
- 2.14.4 Visual approach slope indicator system: 4-light PAPI on left

- 2.14.1 Designation: 19R

2.14.2 Approach lighting system: ALSF2: Standard
2400 feet high intensity approach lighting system
with sequenced flashers, category II or III
configuration

2.14.4 Visual approach slope indicator system:
4-light PAPI on right

2.14.1 Designation: 01R

2.14.2 Approach lighting system: ALSF2: Standard
2400 feet high intensity approach lighting system
with sequenced flashers, category II or III
configuration

2.14.4 Visual approach slope indicator system:
4-light PAPI on right

2.14.1 Designation: 19L

2.14.2 Approach lighting system: MALSR: 1400
feet medium intensity approach lighting system
with runway alignment indicator lights

**AD 2.18 Air traffic services communication
facilities**

2.18.1 Service designation: CLASS B
2.18.3 Service designation: 118.9 MHz

2.18.1 Service designation: EMERG
2.18.3 Service designation: 121.5 MHz

2.18.1 Service designation: GND/S
2.18.3 Service designation: 121.65 MHz

2.18.1 Service designation: GND/P
2.18.3 Service designation: 121.8 MHz

2.18.1 Service designation: CLASS B
2.18.3 Service designation: 124.7 MHz

2.18.1 Service designation: DEP/P
2.18.3 Service designation: 124.7 MHz

2.18.1 Service designation: LCL/S
2.18.3 Service designation: 125.75 MHz

2.18.1 Service designation: LCL/P
2.18.3 Service designation: 128.2 MHz

2.18.1 Service designation: CD/P
2.18.3 Service designation: 135.7 MHz

2.18.1 Service designation: EMERG
2.18.3 Service designation: 243 MHz

2.18.1 Service designation: LCL/P

2.18.3 Service designation: 254.25 MHz

2.18.1 Service designation: APCH/P DEP/P

2.18.3 Service designation: 284.7 MHz

2.18.1 Service designation: CLASS B

2.18.3 Service designation: 294.7 MHz

2.18.1 Service designation: CLASS B

2.18.3 Service designation: 294.7 MHz

2.18.1 Service designation: CLASS B

2.18.3 Service designation: 318.1 MHz

2.18.1 Service designation: APCH/P DEP/P

2.18.3 Service designation: 318.1 MHz

2.18.1 Service designation: APCH/P

2.18.3 Service designation: 120.95 MHz

2.18.1 Service designation: DEP/P IC

2.18.3 Service designation: 123.95 MHz

2.18.1 Service designation: CLASS B

2.18.3 Service designation: 118.4 MHz

2.18.1 Service designation: D-ATIS

2.18.3 Service designation: 128.375 MHz

2.18.4 Hours of operation: 24

AD 2.19 Radio navigation and landing aids

2.19.1 ILS type: Localizer for runway 09. Magnetic
variation: 5E

2.19.2 ILS identification: RNI

2.19.5 Coordinates: 39-17-16.02N /
94-41-22.95W

2.19.6 Site elevation: 1020 ft

2.19.1 ILS type: DME for runway 09. Magnetic
variation: 5E

2.19.2 ILS identification: RNI

2.19.5 Coordinates: 39-17-18.91N /
94-41-21.70W

2.19.6 Site elevation: 1032 ft

2.19.1 ILS type: Middle Marker for runway 09.
Magnetic variation: 5E

2.19.2 ILS identification: RNI

2.19.5 Coordinates: 39-17-30.00N /
94-44-10.10W

2.19.6 Site elevation: 99999 ft

2.19.1 ILS type: Glide Slope for runway 09.
Magnetic variation: 5E

2.19.2 ILS identification: RNI

2.19.5 Coordinates: 39-17-21.08N /
94-43-22.95W

2.19.6 Site elevation: 1010 ft

2.19.1 ILS type: Outer Marker for runway 09.
Magnetic variation: 5E

2.19.2 ILS identification: RNI

2.19.5 Coordinates: 39-18-00.00N /
94-51-00.00W

2.19.6 Site elevation: 99999 ft

2.19.1 ILS type: Localizer for runway 27. Magnetic
variation: 5E

2.19.2 ILS identification: UQY

2.19.5 Coordinates: 39-17-28.63N /
94-43-54.07W

2.19.6 Site elevation: 1014 ft

2.19.1 ILS type: Glide Slope for runway 27.
Magnetic variation: 5E

2.19.2 ILS identification: UQY

2.19.5 Coordinates: 39-17-15.72N /
94-41-50.27W

2.19.6 Site elevation: 1016 ft

2.19.1 ILS type: DME for runway 27. Magnetic
variation: 5E

2.19.2 ILS identification: UQY

2.19.5 Coordinates: 39-17-25.69N /
94-43-54.58W

2.19.6 Site elevation: 1014 ft

2.19.1 ILS type: Localizer for runway 01L.
Magnetic variation: 5E

2.19.2 ILS identification: DOT

2.19.5 Coordinates: 39-19-29.68N /
94-43-11.95W

2.19.6 Site elevation: 972 ft

2.19.1 ILS type: Glide Slope for runway 01L.
Magnetic variation: 5E

2.19.2 ILS identification: DOT

2.19.5 Coordinates: 39-17-48.27N /
94-43-47.13W

2.19.6 Site elevation: 1002 ft

2.19.1 ILS type: Outer Marker for runway 01L.
Magnetic variation: 5E

2.19.2 ILS identification: DOT

2.19.5 Coordinates: 39-13-15.20N /
94-44-59.70W

2.19.6 Site elevation: 99999 ft

2.19.1 ILS type: Middle Marker for runway 01L.
Magnetic variation: 5E

2.19.2 ILS identification: DOT

2.19.5 Coordinates: 39-17-00.00N /
94-43-53.30W

2.19.6 Site elevation: 99999 ft

2.19.1 ILS type: DME for runway 01L. Magnetic
variation: 5E

2.19.2 ILS identification: DOT

2.19.5 Coordinates: 39-19-30.05N /
94-43-00.00W

2.19.6 Site elevation: 976 ft

2.19.1 ILS type: Localizer for runway 19R.
Magnetic variation: 5E

2.19.2 ILS identification: PAJ

2.19.5 Coordinates: 39-17-23.80N /
94-43-49.14W

2.19.6 Site elevation: 1017 ft

2.19.1 ILS type: Glide Slope for runway 19R.
Magnetic variation: 5E

2.19.2 ILS identification: PAJ

2.19.5 Coordinates: 39-19-11.06N /
94-43-22.67W

2.19.6 Site elevation: 976 ft

2.19.1 ILS type: Outer Marker for runway 19R.
Magnetic variation: 5E

2.19.2 ILS identification: PAJ

2.19.5 Coordinates: 39-24-51.80N /
94-41-36.10W

2.19.6 Site elevation: 893 ft

2.19.1 ILS type: Inner Marker for runway 19R.
Magnetic variation: 5E

2.19.2 ILS identification: PAJ

2.19.5 Coordinates: 39-19-30.10N /
94-43-11.80W

2.19.6 Site elevation: 969 ft

2.19.1 ILS type: Middle Marker for runway 19R.
Magnetic variation: 5E

2.19.2 ILS identification: PAJ
2.19.5 Coordinates: 39-19-49.40N /
94-43-00.00W
2.19.6 Site elevation: 960 ft

2.19.1 ILS type: DME for runway 19R. Magnetic
variation: 5E
2.19.2 ILS identification: PAJ
2.19.5 Coordinates: 39-17-25.77N /
94-43-51.97W
2.19.6 Site elevation: 1011 ft

2.19.1 ILS type: Localizer for runway 01R.
Magnetic variation: 3E
2.19.2 ILS identification: PVL
2.19.5 Coordinates: 39-18-34.40N /
94-42-00.00W
2.19.6 Site elevation: 963 ft

2.19.1 ILS type: Middle Marker for runway 01R.
Magnetic variation: 3E
2.19.2 ILS identification: PVL
2.19.5 Coordinates: 39-16-27.60N /
94-42-40.00W
2.19.6 Site elevation: 993 ft

2.19.1 ILS type: DME for runway 01R. Magnetic
variation: 3E
2.19.2 ILS identification: PVL
2.19.5 Coordinates: 39-18-35.63N /
94-42-00.00W
2.19.6 Site elevation: 969 ft

2.19.1 ILS type: Inner Marker for runway 01R.
Magnetic variation: 3E
2.19.2 ILS identification: PVL
2.19.5 Coordinates: 39-16-45.10N /
94-42-34.80W
2.19.6 Site elevation: 1010 ft

2.19.1 ILS type: Glide Slope for runway 01R.

General Remarks:

WATERFOWL ON AND IN THE VICINITY OF AIRPORT.

WINDSHEAR ALERT SYSTEM ON AIRPORT.

NOISE ABATEMENT PROCEDURES IN EFFECT 2200-0600 WITH LANDING ON RUNWAYS 01L &
19L; TAKEOFFS ON RUNWAYS 01R & 19R.

MILITARY AIRCRAFT MAY BE CHARGED RAMP/PARKING FEES.

Magnetic variation: 3E
2.19.2 ILS identification: PVL
2.19.5 Coordinates: 39-17-00.00N /
94-42-24.22W
2.19.6 Site elevation: 1010 ft

2.19.1 ILS type: Localizer for runway 19L.
Magnetic variation: 5E
2.19.2 ILS identification: DYH
2.19.5 Coordinates: 39-16-43.59N /
94-42-35.24W
2.19.6 Site elevation: 1011 ft

2.19.1 ILS type: DME for runway 19L. Magnetic
variation: 5E
2.19.2 ILS identification: DYH
2.19.5 Coordinates: 39-16-43.62N /
94-42-38.55W
2.19.6 Site elevation: 1016 ft

2.19.1 ILS type: Glide Slope for runway 19L.
Magnetic variation: 5E
2.19.2 ILS identification: DYH
2.19.5 Coordinates: 39-18-13.95N /
94-42-00.00W
2.19.6 Site elevation: 977 ft

2.19.1 ILS type: Middle Marker for runway 19L.
Magnetic variation: 5E
2.19.2 ILS identification: DYH
2.19.5 Coordinates: 39-18-51.60N /
94-41-57.40W
2.19.6 Site elevation: 958 ft

2.19.1 ILS type: Outer Marker for runway 19L.
Magnetic variation: 5E
2.19.2 ILS identification: DYH
2.19.5 Coordinates: 39-23-12.92N /
94-40-37.14W
2.19.6 Site elevation: 830 ft

FLIGHT NOTIFICATION SERVICE (ADCUS) AVAILABLE AT GATE 90.

COYOTE ON & IN THE VICINITY OF AIRPORT.

PRIOR PERMISSION REQUIRED TO PARK AT AIRLINE GATES CONTACT RESPECTIVE AIRLINE.

WHEN USING HIGH-SPEED EXITS C5 & C6 CONTINUE UNTIL FIRST PARALLEL TAXIWAY,
THEN USE EXTREME CAUTION WHEN TURNING IN EXCESS OF 90 DEGREES.

NO AIRCRAFT PARKING ON POSTAL APRON.

PUSHBACK CLEARANCE REQUIRED AT GATES 45 THRU 52 IN TERMINAL B AND GATES 72, 73
AND 76 IN TERMINAL C, PUSHBACK FROM THESE GATES ENTERS TAXIWAY D.

**St. Louis, Missouri
Lambert-St. Louis International
ICAO Identifier KSTL**

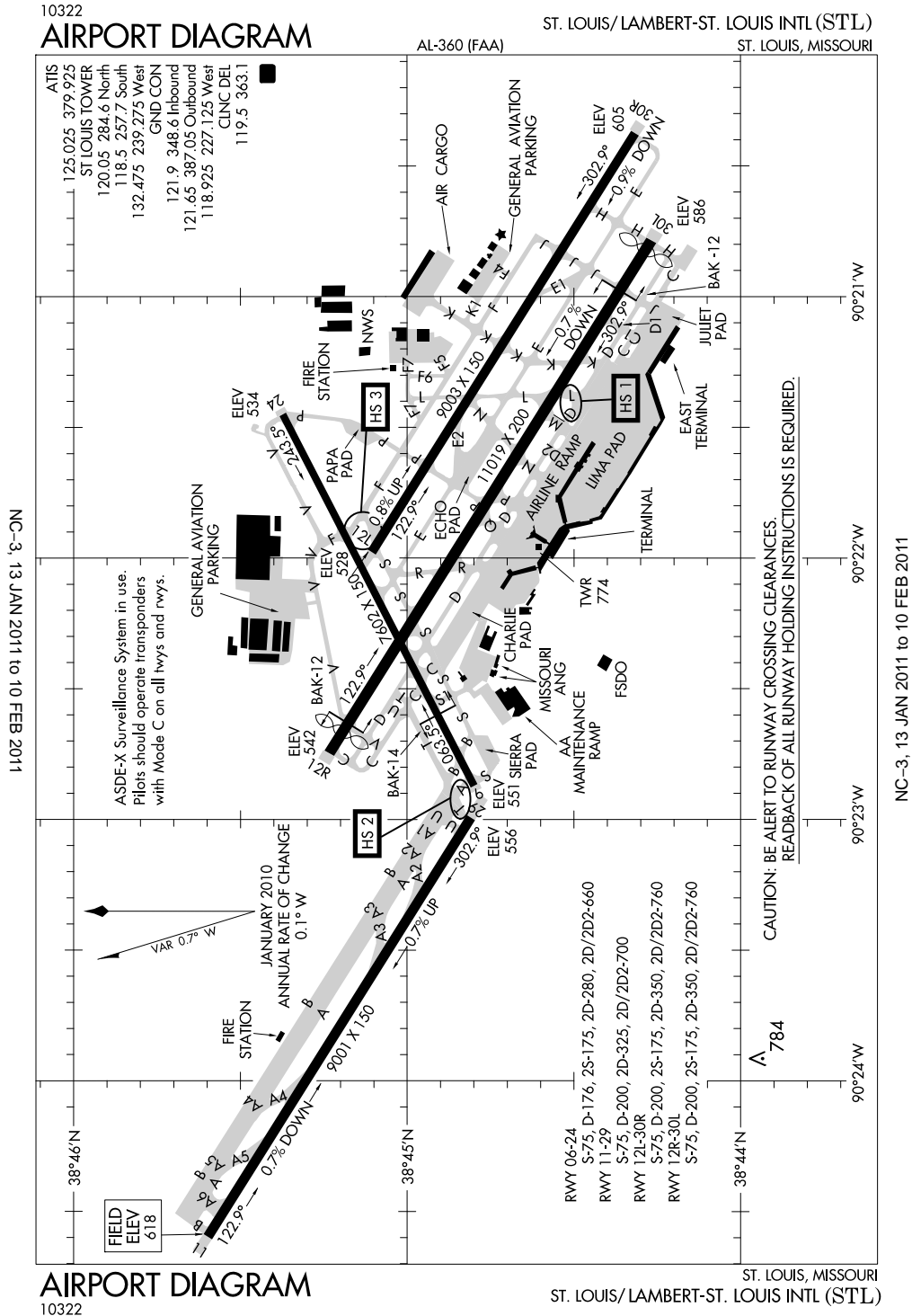

St Louis, MO
Lambert-St Louis Intl
ICAO Identifier KSTL

AD 2.2 Aerodrome geographical and administrative data

- 2.2.1 Reference Point: 38-44-55.31N / 90-22-12.10W
- 2.2.2 From City: 10 Miles NW Of St Louis, MO
- 2.2.3 Elevation: 618 ft
- 2.2.5 Magnetic variation: 0E (2000)
- 2.2.6 Airport Contact: Ms. Rhonda Hamm-Niebruegge
BOX 10212
St Louis, MO 63145
(314-426-8000)
- 2.2.7 Traffic: IFR/VFR

AD 2.3 Operational hours

- 2.3.1 - 2.3.11: ALL Months, ALL Days, ALL Hours

AD 2.4 Handling services and facilities

- 2.4.1 Cargo handling facilities: No
- 2.4.2 Fuel types: 100LL,A
- 2.4.4 De-icing facilities: None
- 2.4.5 Hangar space: Yes
- 2.4.6 Repair facilities: Major

AD 2.6 Rescue and firefighting services

- 2.6.1 Aerodrome category for firefighting: ARFF Index I D certified on 5/1/1973

AD 2.10 Aerodrome obstacles

- 2.10.1.a. Runway designation: 06
- 2.10.1.b Type of obstacle: Tree (31 ft). Not Lighted or Marked
- 2.10.1.c Location of obstacle: 250 ft from Centerline

- 2.10.1.a. Runway designation: 24
- 2.10.1.b Type of obstacle: Sign (18 ft). Not Lighted or Marked
- 2.10.1.c Location of obstacle: 450 ft from Centerline

- 2.10.1.a. Runway designation: 12L
- 2.10.1.b Type of obstacle: Bldg (54 ft). Not Lighted or Marked
- 2.10.1.c Location of obstacle: 600 ft from Centerline

- 2.10.1.a. Runway designation: 30R
- 2.10.1.b Type of obstacle: Twr (42 ft). Not Lighted or Marked
- 2.10.1.c Location of obstacle: 580 ft from Centerline

- 2.10.1.a. Runway designation: 12R
- 2.10.1.b Type of obstacle: Road (30 ft). Not Lighted or Marked
- 2.10.1.c Location of obstacle: 500 ft from Centerline

- 2.10.1.a. Runway designation: 30L
- 2.10.1.b Type of obstacle: Sign (86 ft). Not Lighted or Marked
- 2.10.1.c Location of obstacle: 900 ft from Centerline

AD 2.12 Runway physical characteristics

- 2.12.1 Designation: 06
- 2.12.2 True Bearing: 63
- 2.12.3 Dimensions: 7602 ft x 150 ft
- 2.12.5 Coordinates: 38-44-48.04N / 90-22-52.43W
- 2.12.6 Threshold elevation: 551 ft
- 2.12.6 Touchdown zone elevation: 551 ft

- 2.12.1 Designation: 24
- 2.12.2 True Bearing: 243
- 2.12.3 Dimensions: 7602 ft x 150 ft
- 2.12.5 Coordinates: 38-45-22.38N / 90-21-27.02W
- 2.12.6 Threshold elevation: 534 ft
- 2.12.6 Touchdown zone elevation: 534 ft

- 2.12.1 Designation: 30X
- 2.12.3 Dimensions: 0 ft x 0 ft

- 2.12.1 Designation: 12X
- 2.12.3 Dimensions: 0 ft x 0 ft

- 2.12.1 Designation: 11
- 2.12.2 True Bearing: 122
- 2.12.3 Dimensions: 9001 ft x 150 ft
- 2.12.5 Coordinates: 38-45-35.83N / 90-24-35.55W
- 2.12.6 Threshold elevation: 618 ft
- 2.12.6 Touchdown zone elevation: 618 ft

- 2.12.1 Designation: 29
- 2.12.2 True Bearing: 302

2.12.3 Dimensions: 9001 ft x 150 ft
2.12.5 Coordinates: 38-44-48.46N /
90-22-59.39W
2.12.6 Threshold elevation: 556 ft
2.12.6 Touchdown zone elevation: 580 ft

2.12.1 Designation: 12L
2.12.2 True Bearing: 122
2.12.3 Dimensions: 9003 ft x 150 ft
2.12.5 Coordinates: 38-45-00.00N /
90-21-58.66W
2.12.6 Threshold elevation: 528 ft
2.12.6 Touchdown zone elevation: 541 ft

2.12.1 Designation: 30R
2.12.2 True Bearing: 302
2.12.3 Dimensions: 9003 ft x 150 ft
2.12.5 Coordinates: 38-44-18.99N /
90-20-22.51W
2.12.6 Threshold elevation: 604 ft
2.12.6 Touchdown zone elevation: 605 ft

2.12.1 Designation: 12R
2.12.2 True Bearing: 122
2.12.3 Dimensions: 11019 ft x 200 ft
2.12.5 Coordinates: 38-45-14.05N /
90-22-44.97W
2.12.6 Threshold elevation: 542 ft
2.12.6 Touchdown zone elevation: 540 ft

2.12.1 Designation: 30L
2.12.2 True Bearing: 302
2.12.3 Dimensions: 11019 ft x 200 ft
2.12.5 Coordinates: 38-44-16.01N /
90-20-47.27W
2.12.6 Threshold elevation: 586 ft
2.12.6 Touchdown zone elevation: 583 ft

AD 2.13 Declared distances

2.13.1 Designation: 06
2.13.2 Takeoff run available: 7602
2.13.3 Takeoff distance available: 7602
2.13.4 Accelerate-stop distance available: 7352
2.13.5 Landing distance available: 7352

2.13.1 Designation: 24
2.13.2 Takeoff run available: 7602
2.13.3 Takeoff distance available: 7602
2.13.4 Accelerate-stop distance available: 7602
2.13.5 Landing distance available: 7602

2.13.1 Designation: 11
2.13.2 Takeoff run available: 9001
2.13.3 Takeoff distance available: 9001
2.13.4 Accelerate-stop distance available: 9001
2.13.5 Landing distance available: 9001

2.13.1 Designation: 29
2.13.2 Takeoff run available: 9001
2.13.3 Takeoff distance available: 9001
2.13.4 Accelerate-stop distance available: 9001
2.13.5 Landing distance available: 9001

2.13.1 Designation: 12L
2.13.2 Takeoff run available: 9003
2.13.3 Takeoff distance available: 9003
2.13.4 Accelerate-stop distance available: 9003
2.13.5 Landing distance available: 9003

2.13.1 Designation: 30R
2.13.2 Takeoff run available: 9003
2.13.3 Takeoff distance available: 9003
2.13.4 Accelerate-stop distance available: 9003
2.13.5 Landing distance available: 9003

2.13.1 Designation: 12R
2.13.2 Takeoff run available: 11019
2.13.3 Takeoff distance available: 11019
2.13.4 Accelerate-stop distance available: 11019
2.13.5 Landing distance available: 10562

2.13.1 Designation: 30L
2.13.2 Takeoff run available: 11019
2.13.3 Takeoff distance available: 11019
2.13.4 Accelerate-stop distance available: 11019
2.13.5 Landing distance available: 10819

AD 2.14 Approach and runway lighting

2.14.1 Designation: 06
2.14.2 Approach lighting system: MALSR: 1400 feet medium intensity approach lighting system with runway alignment indicator lights
2.14.4 Visual approach slope indicator system: 4-light PAPI on right

2.14.1 Designation: 24
2.14.2 Approach lighting system: MAL: 1400 feet medium intensity approach lighting system
2.14.4 Visual approach slope indicator system: 4-light PAPI on left

2.14.1 Designation: 11

2.14.2 Approach lighting system: ALSF2: Standard 2400 feet high intensity approach lighting system with sequenced flashers, category II or III configuration

2.14.4 Visual approach slope indicator system: 4-light PAPI on right

2.14.1 Designation: 29

2.14.2 Approach lighting system: ALSF2: Standard 2400 feet high intensity approach lighting system with sequenced flashers, category II or III configuration

2.14.4 Visual approach slope indicator system: 4-light PAPI on left

2.14.1 Designation: 12L

2.14.2 Approach lighting system: ALSF2: Standard 2400 feet high intensity approach lighting system with sequenced flashers, category II or III configuration

2.14.4 Visual approach slope indicator system: 4-light PAPI on right

2.14.1 Designation: 30R

2.14.2 Approach lighting system: ALSF2: Standard 2400 feet high intensity approach lighting system with sequenced flashers, category II or III configuration

2.14.4 Visual approach slope indicator system: 4-light PAPI on right

2.14.10 Remarks: ALSF2 Unmonitored Except When RVR Visbelow 1800 Ft.

2.14.1 Designation: 12R

2.14.2 Approach lighting system: MALSR: 1400 feet medium intensity approach lighting system with runway alignment indicator lights

2.14.4 Visual approach slope indicator system: 4-light PAPI on left

2.14.1 Designation: 30L

2.14.2 Approach lighting system: MALSR: 1400 feet medium intensity approach lighting system with runway alignment indicator lights

2.14.4 Visual approach slope indicator system: 4-light PAPI on right

2.14.10 Remarks: PAPI Offset 5 Degrees S To Accommodate LDA/DME Approach To Runway 30L.

AD 2.18 Air traffic services communication facilities

2.18.1 Service designation: LCL/P IC

2.18.3 Service designation: 118.5 MHz

2.18.1 Service designation: DEP/P

2.18.3 Service designation: 128.1 MHz

2.18.1 Service designation: DEP/P

2.18.3 Service designation: 119.15 MHz

2.18.1 Service designation: DEP/S

2.18.3 Service designation: 126.55 MHz

2.18.1 Service designation: LCL/P

2.18.3 Service designation: 120.05 MHz

2.18.1 Service designation: EMERG

2.18.3 Service designation: 121.5 MHz

2.18.1 Service designation: GND CTL OUTBOUND/P

2.18.3 Service designation: 121.65 MHz

2.18.1 Service designation: GND CTL INBOUND/P

2.18.3 Service designation: 121.9 MHz

2.18.1 Service designation: APCH/S

2.18.3 Service designation: 123.7 MHz

2.18.1 Service designation: CLASS B

2.18.3 Service designation: 124.2 MHz

2.18.1 Service designation: DEP/S

2.18.3 Service designation: 124.25 MHz

2.18.1 Service designation: APCH/P

2.18.3 Service designation: 132.125 MHz

2.18.1 Service designation: APCH/P IC

2.18.3 Service designation: 133.55 MHz

2.18.1 Service designation: CLASS B

2.18.3 Service designation: 126.5 MHz

2.18.1 Service designation: EMERG

2.18.3 Service designation: 243 MHz

2.18.1 Service designation: CLASS B

2.18.3 Service designation: 254.3 MHz

2.18.1 Service designation: LCL/P IC
2.18.3 Service designation: 257.7 MHz

2.18.1 Service designation: LCL/P
2.18.3 Service designation: 284.6 MHz

2.18.1 Service designation: DEP/P
2.18.3 Service designation: 307.05 MHz

2.18.1 Service designation: GND/S
2.18.3 Service designation: 306.2 MHz

2.18.1 Service designation: APCH/P IC
2.18.3 Service designation: 338.25 MHz

2.18.1 Service designation: DEP/P
2.18.3 Service designation: 335.5 MHz

2.18.1 Service designation: GND CTL
INBOUND/P
2.18.3 Service designation: 348.6 MHz

2.18.1 Service designation: APCH/P
2.18.3 Service designation: 360.6 MHz

2.18.1 Service designation: CD/P
2.18.3 Service designation: 363.1 MHz

2.18.1 Service designation: DEP/S
2.18.3 Service designation: 270.35 MHz

2.18.1 Service designation: CLASS B
2.18.3 Service designation: 353.9 MHz

2.18.1 Service designation: GND METER EAST
2.18.3 Service designation: 127.55 MHz

2.18.1 Service designation: CD/P
2.18.3 Service designation: 119.5 MHz

2.18.1 Service designation: D-ATIS
2.18.3 Service designation: 125.025 MHz
2.18.4 Hours of operation: 24

2.18.1 Service designation: D-ATIS
2.18.3 Service designation: 379.925 MHz
2.18.4 Hours of operation: 24

2.18.1 Service designation: GND CTL
OUTBOUND/P
2.18.3 Service designation: 387.05 MHz

2.18.1 Service designation: GND METER EAST
2.18.3 Service designation: 360.2 MHz

2.18.1 Service designation: GND METER WEST
2.18.3 Service designation: 121.075 MHz

2.18.1 Service designation: GND METER WEST
2.18.3 Service designation: 346.35 MHz

2.18.1 Service designation: LCL/P
2.18.3 Service designation: 132.475 MHz

2.18.1 Service designation: LCL/P
2.18.3 Service designation: 239.275 MHz

2.18.1 Service designation: GND CTL/P
2.18.3 Service designation: 118.925 MHz

2.18.1 Service designation: GND CTL/P
2.18.3 Service designation: 227.125 MHz

2.18.1 Service designation: PRM
2.18.3 Service designation: 278.3 MHz

2.18.1 Service designation: PRM
2.18.3 Service designation: 351.9 MHz

AD 2.19 Radio navigation and landing aids

2.19.1 ILS type: Glide Slope for runway 06.
Magnetic variation: 0E
2.19.2 ILS identification: JAK
2.19.5 Coordinates: 38-44-54.80N /
90-22-39.84W
2.19.6 Site elevation: 536 ft

2.19.1 ILS type: Localizer for runway 06. Magnetic
variation: 0E
2.19.2 ILS identification: JAK
2.19.5 Coordinates: 38-45-25.79N /
90-21-18.61W
2.19.6 Site elevation: 541 ft

2.19.1 ILS type: DME for runway 06. Magnetic
variation: 0E
2.19.2 ILS identification: JAK
2.19.5 Coordinates: 38-44-39.67N /
90-23-00.00W
2.19.6 Site elevation: 556 ft

2.19.1 ILS type: Localizer for runway 24. Magnetic
variation: 0E

2.19.2 ILS identification: STL
2.19.5 Coordinates: 38-44-43.52N /
90-23-00.00W
2.19.6 Site elevation: 545 ft

2.19.1 ILS type: DME for runway 24. Magnetic
variation: 0E
2.19.2 ILS identification: STL
2.19.5 Coordinates: 38-44-39.67N /
90-23-00.00W
2.19.6 Site elevation: 540 ft

2.19.1 ILS type: Glide Slope for runway 24.
Magnetic variation: 0E
2.19.2 ILS identification: STL
2.19.5 Coordinates: 38-45-13.62N /
90-21-37.59W
2.19.6 Site elevation: 529 ft

2.19.1 ILS type: Middle Marker for runway 24.
Magnetic variation: 0E
2.19.2 ILS identification: STL
2.19.5 Coordinates: 38-45-37.15N /
90-20-50.60W
2.19.6 Site elevation: 99999 ft

2.19.1 ILS type: Outer Marker for runway 24.
Magnetic variation: 0E
2.19.2 ILS identification: STL
2.19.5 Coordinates: 38-47-16.98N /
90-16-43.91W
2.19.6 Site elevation: 99999 ft

2.19.1 ILS type: Localizer for runway 30X.
Magnetic variation: 0E
2.19.2 ILS identification: RMK
2.19.5 Coordinates: 38-45-33.46N /
90-23-28.96W
2.19.6 Site elevation: 580 ft

2.19.1 ILS type: DME for runway 30X. Magnetic
variation: 0E
2.19.2 ILS identification: RMK
2.19.5 Coordinates: 38-45-34.14N /
90-23-30.20W
2.19.6 Site elevation: 583 ft

2.19.1 ILS type: Glide Slope for runway 30X.
Magnetic variation: 0E
2.19.2 ILS identification: RMK
2.19.5 Coordinates: 38-44-28.10N /

90-21-00.00W
2.19.6 Site elevation: 564 ft

2.19.1 ILS type: DME for runway 12X. Magnetic
variation: 0E
2.19.2 ILS identification: LDZ
2.19.5 Coordinates: 38-44-10.39N /
90-20-12.05W
2.19.6 Site elevation: 616 ft

2.19.1 ILS type: Glide Slope for runway 12X.
Magnetic variation: 0E
2.19.2 ILS identification: LDZ
2.19.5 Coordinates: 38-44-58.22N /
90-21-50.34W
2.19.6 Site elevation: 534 ft

2.19.1 ILS type: Inner Marker for runway 12X.
Magnetic variation: 0E
2.19.2 ILS identification: LDZ
2.19.5 Coordinates: 38-45-11.93N /
90-22-00.00W
2.19.6 Site elevation: 530 ft

2.19.1 ILS type: Middle Marker for runway 12X.
Magnetic variation: 0E
2.19.2 ILS identification: LDZ
2.19.5 Coordinates: 38-45-21.22N /
90-22-28.71W
2.19.6 Site elevation: 545 ft

2.19.1 ILS type: Localizer for runway 12X.
Magnetic variation: 0E
2.19.2 ILS identification: LDZ
2.19.5 Coordinates: 38-44-13.67N /
90-20-11.72W
2.19.6 Site elevation: 602 ft

2.19.1 ILS type: Outer Marker for runway 12X.
Magnetic variation: 0E
2.19.2 ILS identification: LDZ
2.19.5 Coordinates: 38-48-00.00N /
90-28-29.10W
2.19.6 Site elevation: 446 ft

2.19.1 ILS type: Inner Marker for runway 11.
Magnetic variation: 0E
2.19.2 ILS identification: OGZ
2.19.5 Coordinates: 38-45-40.35N /
90-24-44.74W
2.19.6 Site elevation: 614 ft

2.19.1 ILS type: DME for runway 11. Magnetic variation: 0E
2.19.2 ILS identification: OGZ
2.19.5 Coordinates: 38-44-36.71N / 90-22-41.69W
2.19.6 Site elevation: 548 ft

2.19.1 ILS type: Glide Slope for runway 11. Magnetic variation: 0E
2.19.2 ILS identification: OGZ
2.19.5 Coordinates: 38-45-26.04N / 90-24-25.38W
2.19.6 Site elevation: 598 ft

2.19.1 ILS type: Localizer for runway 11. Magnetic variation: 0E
2.19.2 ILS identification: OGZ
2.19.5 Coordinates: 38-44-38.72N / 90-22-39.63W
2.19.6 Site elevation: 545 ft

2.19.1 ILS type: Inner Marker for runway 29. Magnetic variation: 0E
2.19.2 ILS identification: RQN
2.19.5 Coordinates: 38-44-41.36N / 90-22-44.97W
2.19.6 Site elevation: 541 ft

2.19.1 ILS type: Localizer for runway 29. Magnetic variation: 0E
2.19.2 ILS identification: RQN
2.19.5 Coordinates: 38-45-41.35N / 90-24-46.77W
2.19.6 Site elevation: 613 ft

2.19.1 ILS type: DME for runway 29. Magnetic variation: 0E
2.19.2 ILS identification: RQN
2.19.5 Coordinates: 38-45-43.83N / 90-24-44.64W
2.19.6 Site elevation: 608 ft

2.19.1 ILS type: Glide Slope for runway 29. Magnetic variation: 0E
2.19.2 ILS identification: RQN
2.19.5 Coordinates: 38-44-49.83N / 90-23-11.86W
2.19.6 Site elevation: 556 ft

2.19.1 ILS type: Localizer for runway 12L. Magnetic variation: 0E

2.19.2 ILS identification: ABW
2.19.5 Coordinates: 38-45-20.83N / 90-21-11.28W
2.19.6 Site elevation: 566 ft

2.19.1 ILS type: DME for runway 12L. Magnetic variation: 0E
2.19.2 ILS identification: ABW
2.19.5 Coordinates: 38-45-23.25N / 90-21-00.00W
2.19.6 Site elevation: 563 ft

2.19.1 ILS type: DME for runway 30R. Magnetic variation: 0E
2.19.2 ILS identification: SJW
2.19.5 Coordinates: 38-45-14.12N / 90-22-00.00W
2.19.6 Site elevation: 546 ft

2.19.1 ILS type: Middle Marker for runway 30R. Magnetic variation: 0E
2.19.2 ILS identification: SJW
2.19.5 Coordinates: 38-44-00.00N / 90-19-57.56W
2.19.6 Site elevation: 534 ft

2.19.1 ILS type: Outer Marker for runway 30R. Magnetic variation: 0E
2.19.2 ILS identification: SJW
2.19.5 Coordinates: 38-41-46.48N / 90-15-44.59W
2.19.6 Site elevation: 530 ft

2.19.1 ILS type: Inner Marker for runway 30R. Magnetic variation: 0E
2.19.2 ILS identification: SJW
2.19.5 Coordinates: 38-44-14.66N / 90-20-13.78W
2.19.6 Site elevation: 576 ft

2.19.1 ILS type: Localizer for runway 30R. Magnetic variation: 0E
2.19.2 ILS identification: SJW
2.19.5 Coordinates: 38-45-11.41N / 90-22-00.00W
2.19.6 Site elevation: 530 ft

2.19.1 ILS type: Glide Slope for runway 30R. Magnetic variation: 0E
2.19.2 ILS identification: SJW
2.19.5 Coordinates: 38-44-21.96N /

90-20-38.02W
2.19.6 Site elevation: 592 ft

2.19.1 ILS type: Localizer for runway 12R.
Magnetic variation: 0E
2.19.2 ILS identification: LMR
2.19.5 Coordinates: 38-44-11.62N /
90-20-38.31W
2.19.6 Site elevation: 589 ft

2.19.1 ILS type: Outer Marker for runway 12R.
Magnetic variation: 0E
2.19.2 ILS identification: LMR
2.19.5 Coordinates: 38-48-00.00N /
90-28-29.10W
2.19.6 Site elevation: 446 ft

2.19.1 ILS type: Glide Slope for runway 12R.
Magnetic variation: 0E
2.19.2 ILS identification: LMR
2.19.5 Coordinates: 38-45-00.00N /
90-22-24.90W
2.19.6 Site elevation: 528 ft

2.19.1 ILS type: Middle Marker for runway 12R.
Magnetic variation: 0E
2.19.2 ILS identification: LMR
2.19.5 Coordinates: 38-45-32.78N /
90-23-23.72W
2.19.6 Site elevation: 99999 ft

2.19.1 ILS type: DME for runway 12R. Magnetic
variation: 0E
2.19.2 ILS identification: LMR

2.19.5 Coordinates: 38-44-10.45N /
90-20-42.27W
2.19.6 Site elevation: 597 ft

2.19.1 ILS type: Localizer for runway 30L.
Magnetic variation: 0E
2.19.2 ILS identification: BKY
2.19.5 Coordinates: 38-45-17.29N /
90-22-51.53W
2.19.6 Site elevation: 549 ft

2.19.1 ILS type: Glide Slope for runway 30L.
Magnetic variation: 0E
2.19.2 ILS identification: BKY
2.19.5 Coordinates: 38-44-27.94N /
90-21-00.00W
2.19.6 Site elevation: 564 ft

2.19.1 ILS type: Middle Marker for runway 30L.
Magnetic variation: 0E
2.19.2 ILS identification: BKY
2.19.5 Coordinates: 38-44-00.00N /
90-20-20.21W
2.19.6 Site elevation: 590 ft

2.19.1 ILS type: Outer Marker for runway 30L.
Magnetic variation: 0E
2.19.2 ILS identification: BKY
2.19.5 Coordinates: 38-41-45.98N /
90-15-44.21W
2.19.6 Site elevation: 530 ft

General Remarks:

NO DESIGNATED TAXILANES OR APRON TAXIWAYS LOCATED ON AIR CARRIER RAMPS.

WAIVER TO CONDUCT SIMULTANEOUS APPROACHES TO PARALLEL RUNWAYS SEPARATED BY 1,300 FT IN EFFECT.

WG TIP CLEARANCE WITH GROUND VEH NOT ADEQUATE ALONG N SIDE OF MAIN TERMINAL APRON.

MISC: MILITARY AIRCRAFT PLANNING TO ARR WHEN WX IS ANTICIPATED TO BE LESS THAN 1200'5 MUST FILE F;T PLAN BEFORE 0900Z++.

ASDE-X SURVEILLANCE SYSTEM I USE: PILOTS SHOULD OPERATE TRANSPONDERS WITH MODE C ON ALL TAXIWAYS AND RUNWAYS.

NO SERVICE AT MISSOURI ANG RAMP. BASE RE-ALIGNMENT IN PROCESS.

ARRESTING GEAR: A-G ARE KEPT IN RECESSED POSITION UNTIL REQ FOR USE. TOWER MUST BE NOTIFIED AT LEAST 5 SECOND PRIOR TO ENGAGEMENT SO THAT CABLE MAY BE RAISED.

ARRESTING GEAR: RUNWAY 06 1450 FT; RUNWAY 12R 1090 FT & RUNWAY 30L 1300 FT FROM THR.

Las Vegas, Nevada
McCarran International
ICAO Identifier KLAS

10322
AIRPORT DIAGRAM

AL-662 (FAA)

LAS VEGAS/McCARRAN INTL (LAS)
LAS VEGAS, NEVADA

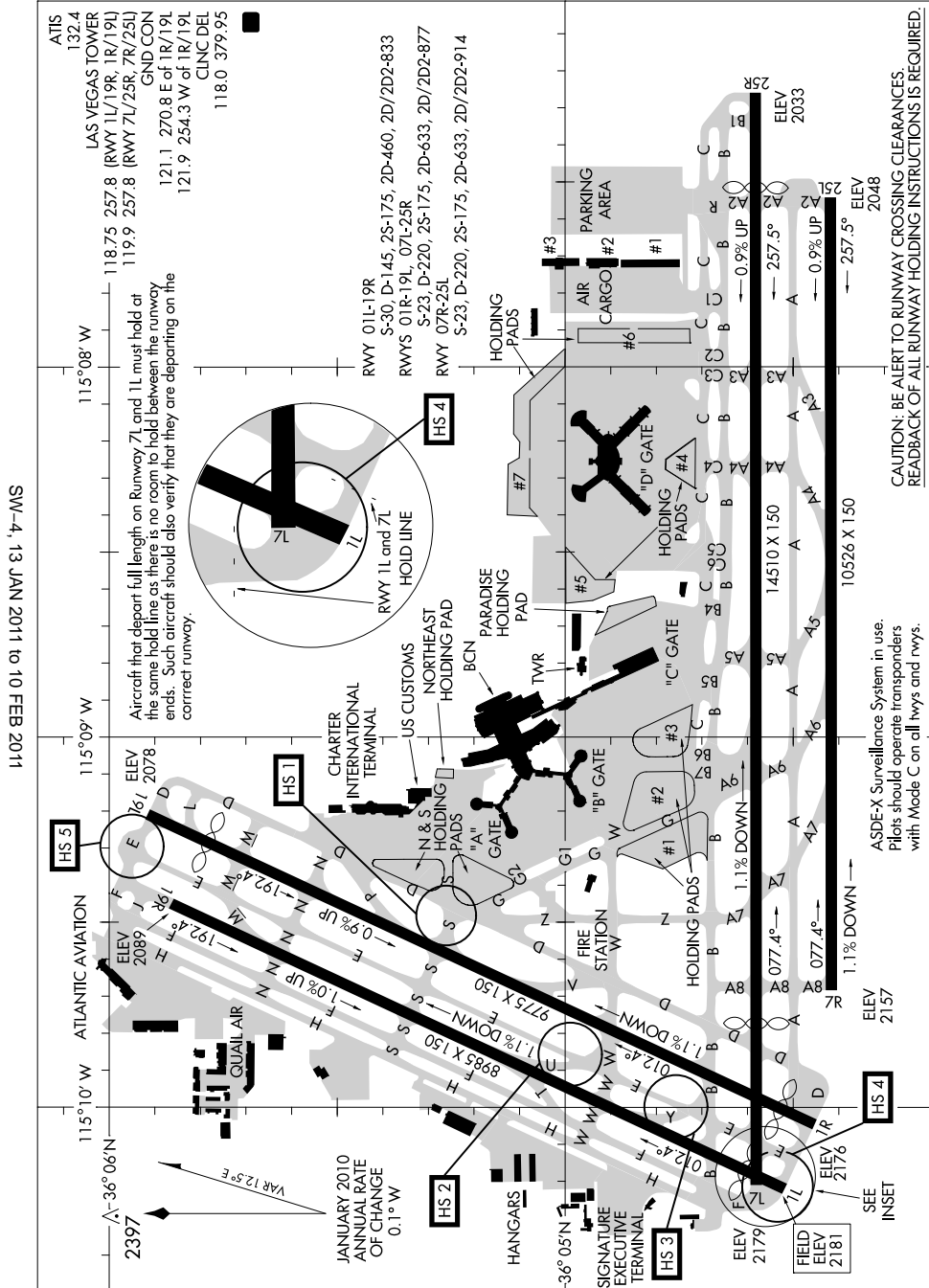

SW-4, 13 JAN 2011 to 10 FEB 2011

CAUTION: BE ALERT TO RUNWAY CROSSING CLEARANCES.
READBACK OF ALL RUNWAY HOLDING INSTRUCTIONS IS REQUIRED.

ASDE-X Surveillance System in use.
Pilots should operate transponders with Mode C on all hwy and rwy.

SW-4, 13 JAN 2011 to 10 FEB 2011

AIRPORT DIAGRAM
10322

LAS VEGAS, NEVADA
LAS VEGAS/McCARRAN INTL (LAS)

Las Vegas, NV
Mc Carran Intl
ICAO Identifier KLAS

AD 2.2 Aerodrome geographical and administrative data

- 2.2.1 Reference Point: 36-04-48.20N / 115-09-00.00W
- 2.2.2 From City: 5 Miles S Of Las Vegas, NV
- 2.2.3 Elevation: 2181 ft
- 2.2.5 Magnetic variation: 15E (1980)
- 2.2.6 Airport Contact: Randall H. Walker
5757 WAYNE NEWTON BLVD
Las Vegas, NV 89119
(702-261-5211)
- 2.2.7 Traffic: IFR/VFR

AD 2.3 Operational hours

- 2.3.1 - 2.3.11: ALL Months, ALL Days, ALL Hours

AD 2.4 Handling services and facilities

- 2.4.1 Cargo handling facilities: No
- 2.4.2 Fuel types: 100,100LL,A1+
- 2.4.4 De-icing facilities: None
- 2.4.5 Hangar space: Yes
- 2.4.6 Repair facilities: Major

AD 2.6 Rescue and firefighting services

- 2.6.1 Aerodrome category for firefighting: ARFF Index I E certified on 5/1/1973

AD 2.10 Aerodrome obstacles

- 2.10.1.a. Runway designation: 07L
- 2.10.1.b Type of obstacle: Hangar (25 ft). Not Lighted or Marked
- 2.10.1.c Location of obstacle: 500 ft from Centerline

- 2.10.1.a. Runway designation: 07R
- 2.10.1.b Type of obstacle: Pole (53 ft). Not Lighted or Marked
- 2.10.1.c Location of obstacle: 540 ft from Centerline

- 2.10.1.a. Runway designation: 01L
- 2.10.1.b Type of obstacle: Rr (48 ft). Not Lighted or Marked
- 2.10.1.c Location of obstacle: 500 ft from Centerline

- 2.10.1.a. Runway designation: 19R
- 2.10.1.b Type of obstacle: Fence (25 ft). Not Lighted or Marked
- 2.10.1.c Location of obstacle: 150 ft from Centerline

- 2.10.1.a. Runway designation: 01R
- 2.10.1.b Type of obstacle: Rr (41 ft). Not Lighted or Marked
- 2.10.1.c Location of obstacle: 600 ft from Centerline

- 2.10.1.a. Runway designation: 19L
- 2.10.1.b Type of obstacle: Pole (17 ft). Not Lighted or Marked
- 2.10.1.c Location of obstacle: 17 ft from Centerline

AD 2.12 Runway physical characteristics

- 2.12.1 Designation: 07L
- 2.12.2 True Bearing: 90
- 2.12.3 Dimensions: 14510 ft x 150 ft
- 2.12.5 Coordinates: 36-04-34.92N / 115-10-12.68W
- 2.12.6 Threshold elevation: 2179 ft
- 2.12.6 Touchdown zone elevation: 2155 ft
- 2.12.7 Slope: 1.1DOWN

- 2.12.1 Designation: 25R
- 2.12.2 True Bearing: 270
- 2.12.3 Dimensions: 14510 ft x 150 ft
- 2.12.5 Coordinates: 36-04-35.06N / 115-07-15.96W
- 2.12.6 Threshold elevation: 2033 ft
- 2.12.6 Touchdown zone elevation: 2067 ft
- 2.12.7 Slope: 1.9UP

- 2.12.1 Designation: 07R
- 2.12.2 True Bearing: 90
- 2.12.3 Dimensions: 10526 ft x 150 ft
- 2.12.5 Coordinates: 36-04-25.06N / 115-09-41.16W
- 2.12.6 Threshold elevation: 2157 ft
- 2.12.6 Touchdown zone elevation: 2157 ft
- 2.12.7 Slope: 1.1DOWN

- 2.12.1 Designation: 25L
- 2.12.2 True Bearing: 270
- 2.12.3 Dimensions: 10526 ft x 150 ft
- 2.12.5 Coordinates: 36-04-25.16N / 115-07-32.96W
- 2.12.6 Threshold elevation: 2048 ft

2.12.6 Touchdown zone elevation: 2069 ft
2.12.7 Slope: 0.9UP

2.12.1 Designation: 01L
2.12.2 True Bearing: 25
2.12.3 Dimensions: 8985 ft x 150 ft
2.12.5 Coordinates: 36-04-31.20N /
115-10-13.29W
2.12.6 Threshold elevation: 2181 ft
2.12.6 Touchdown zone elevation: 2176 ft
2.12.7 Slope: 1.1DOWN

2.12.1 Designation: 19R
2.12.2 True Bearing: 205
2.12.3 Dimensions: 8985 ft x 150 ft
2.12.5 Coordinates: 36-05-51.76N /
115-09-27.19W
2.12.6 Threshold elevation: 2089 ft
2.12.6 Touchdown zone elevation: 2117 ft
2.12.7 Slope: 1UP

2.12.1 Designation: 01R
2.12.2 True Bearing: 25
2.12.3 Dimensions: 9775 ft x 150 ft
2.12.5 Coordinates: 36-04-27.28N /
115-10-00.00W
2.12.6 Threshold elevation: 2176 ft
2.12.6 Touchdown zone elevation: 2170 ft
2.12.7 Slope: 1.1DOWN

2.12.1 Designation: 19L
2.12.2 True Bearing: 205
2.12.3 Dimensions: 9775 ft x 150 ft
2.12.5 Coordinates: 36-05-54.93N /
115-09-12.78W
2.12.6 Threshold elevation: 2078 ft
2.12.6 Touchdown zone elevation: 2113 ft
2.12.7 Slope: 0.9UP

AD 2.13 Declared distances

2.13.1 Designation: 07L
2.13.2 Takeoff run available: 14510
2.13.3 Takeoff distance available: 15099
2.13.4 Accelerate-stop distance available: 14099
2.13.5 Landing distance available: 11966

2.13.1 Designation: 25R
2.13.2 Takeoff run available: 14510
2.13.3 Takeoff distance available: 15155
2.13.4 Accelerate-stop distance available: 14155
2.13.5 Landing distance available: 12755

2.13.1 Designation: 01L
2.13.2 Takeoff run available: 8985
2.13.3 Takeoff distance available: 8985
2.13.4 Accelerate-stop distance available: 8985
2.13.5 Landing distance available: 8401

2.13.1 Designation: 19R
2.13.2 Takeoff run available: 8985
2.13.3 Takeoff distance available: 9397
2.13.4 Accelerate-stop distance available: 8397
2.13.5 Landing distance available: 8397

2.13.1 Designation: 01R
2.13.2 Takeoff run available: 9775
2.13.3 Takeoff distance available: 10172
2.13.4 Accelerate-stop distance available: 9441
2.13.5 Landing distance available: 8681

2.13.1 Designation: 19L
2.13.2 Takeoff run available: 9775
2.13.3 Takeoff distance available: 10175
2.13.4 Accelerate-stop distance available: 9685
2.13.5 Landing distance available: 8745

AD 2.14 Approach and runway lighting

2.14.1 Designation: 07L
2.14.4 Visual approach slope indicator system:
4-light PAPI on left

2.14.1 Designation: 25R
2.14.2 Approach lighting system: MALSR: 1400
feet medium intensity approach lighting system
with runway alignment indicator lights
2.14.4 Visual approach slope indicator system:
4-light PAPI on left

2.14.1 Designation: 07R
2.14.4 Visual approach slope indicator system:
4-light PAPI on left

2.14.1 Designation: 25L
2.14.4 Visual approach slope indicator system:
4-light PAPI on left

2.14.1 Designation: 01L
2.14.4 Visual approach slope indicator system:
4-light PAPI on left

2.14.1 Designation: 19R
2.14.4 Visual approach slope indicator system:
4-light PAPI on left

2.14.1 Designation: 01R
2.14.4 Visual approach slope indicator system:
4-light PAPI on left

2.14.1 Designation: 19L
2.14.4 Visual approach slope indicator system:
4-light PAPI on left

AD 2.18 Air traffic services communication facilities

2.18.1 Service designation: CD
2.18.3 Service designation: 118 MHz

2.18.1 Service designation: CLASS B
2.18.3 Service designation: 118.4 MHz

2.18.1 Service designation: LCL/P
2.18.3 Service designation: 118.75 MHz

2.18.1 Service designation: LCL/P
2.18.3 Service designation: 119.9 MHz

2.18.1 Service designation: VFR FINAL APCH
2.18.3 Service designation: 120.45 MHz

2.18.1 Service designation: GND/P
2.18.3 Service designation: 121.1 MHz

2.18.1 Service designation: EMERG
2.18.3 Service designation: 121.5 MHz

2.18.1 Service designation: GND/P
2.18.3 Service designation: 121.9 MHz

2.18.1 Service designation: RAMP CON
2.18.3 Service designation: 124.4 MHz

2.18.1 Service designation: DEP/P
2.18.3 Service designation: 125.9 MHz

2.18.1 Service designation: CLASS B
2.18.3 Service designation: 125.9 MHz

2.18.1 Service designation: RAMP CON
2.18.3 Service designation: 127.9 MHz

2.18.1 Service designation: D-ATIS
2.18.3 Service designation: 132.4 MHz
2.18.4 Hours of operation: 24

2.18.1 Service designation: EMERG

2.18.3 Service designation: 243 MHz

2.18.1 Service designation: LCL/P
2.18.3 Service designation: 257.8 MHz

2.18.1 Service designation: CLASS B
2.18.3 Service designation: 379.15 MHz

2.18.1 Service designation: APCH/P
2.18.3 Service designation: 379.15 MHz

2.18.1 Service designation: CLASS B
2.18.3 Service designation: 379.15 MHz

2.18.1 Service designation: DEP/P
2.18.3 Service designation: 379.15 MHz

2.18.1 Service designation: CD
2.18.3 Service designation: 379.95 MHz

2.18.1 Service designation: APCH/P
2.18.3 Service designation: 125.025 MHz

2.18.1 Service designation: DEP/P
2.18.3 Service designation: 125.02 MHz

2.18.1 Service designation: CLASS B
2.18.3 Service designation: 125.02 MHz

2.18.1 Service designation: CLASS B
2.18.3 Service designation: 125.02 MHz

2.18.1 Service designation: CLASS B
2.18.3 Service designation: 353.7 MHz

2.18.1 Service designation: CLASS B
2.18.3 Service designation: 353.7 MHz

2.18.1 Service designation: GND/P
2.18.3 Service designation: 254.3 MHz

2.18.1 Service designation: DEP/P
2.18.3 Service designation: 307.25 MHz

2.18.1 Service designation: GND/P
2.18.3 Service designation: 270.8 MHz

2.18.1 Service designation: RAMP CON
2.18.3 Service designation: 129.175 MHz

AD 2.19 Radio navigation and landing aids

2.19.1 ILS type: Glide Slope for runway 25R.
Magnetic variation: 15E

2.19.2 ILS identification: LAS

2.19.5 Coordinates: 36-04-32.08N /
115-07-46.67W

2.19.6 Site elevation: 2046 ft

2.19.1 ILS type: Outer Marker for runway 25R.

Magnetic variation: 15E

2.19.2 ILS identification: LAS

2.19.5 Coordinates: 36-04-35.71N /
115-01-16.98W

2.19.6 Site elevation: 99999 ft

2.19.1 ILS type: Middle Marker for runway 25R.

Magnetic variation: 15E

2.19.2 ILS identification: LAS

2.19.5 Coordinates: 36-04-35.10N /
115-06-44.40W

2.19.6 Site elevation: 99999 ft

2.19.1 ILS type: DME for runway 25R. Magnetic
variation: 15E

2.19.2 ILS identification: LAS

2.19.5 Coordinates: 36-04-30.52N /
115-10-19.17W

2.19.6 Site elevation: 2203 ft

2.19.1 ILS type: Localizer for runway 25R.

Magnetic variation: 15E

2.19.2 ILS identification: LAS

2.19.5 Coordinates: 36-04-34.91N /
115-10-19.18W

2.19.6 Site elevation: 2187 ft

2.19.1 ILS type: Localizer for runway 25L.

Magnetic variation: 15E

2.19.2 ILS identification: RLE

2.19.5 Coordinates: 36-04-25.05N /
115-09-53.34W

2.19.6 Site elevation: 2168 ft

2.19.1 ILS type: Glide Slope for runway 25L.

Magnetic variation: 15E

2.19.2 ILS identification: RLE

2.19.5 Coordinates: 36-04-21.99N /
115-07-46.66W

2.19.6 Site elevation: 2051 ft

2.19.1 ILS type: DME for runway 01L. Magnetic
variation: 15E

2.19.2 ILS identification: CUA

2.19.5 Coordinates: 36-06-00.00N /
115-09-25.07W

2.19.6 Site elevation: 2092 ft

2.19.1 ILS type: Glide Slope for runway 01L.
Magnetic variation: 15E

2.19.2 ILS identification: CUA

2.19.5 Coordinates: 36-04-49.14N /
115-10-00.00W

2.19.6 Site elevation: 2159 ft

2.19.1 ILS type: Localizer for runway 01L.

Magnetic variation: 15E

2.19.2 ILS identification: CUA

2.19.5 Coordinates: 36-06-00.00N /
115-09-21.99W

2.19.6 Site elevation: 2079 ft

General Remarks:

EXTENSIVE GLIDER/SOARING OPERATIONS WEEKENDS & HOLS; SR-SS; LAS R187/020;
ALTITUDES UP TO BUT NOT INCLUDING FL180. GLIDERS REMAIN CLEAR OF THE TCA BUT
OTHERWISE OPERATE WITHIN THE ENTIRE SW QUADRANT OF THE TCA VEIL.

ALL NON-STD RUNWAY OPERATIONS PRIOR PERMISSION REQUIRED FROM DEPT OF
AVIATION.

TURBOJET DEPS NOT PERMITTED ON RUNWAY 01R/19L OR RUNWAY 01L/19R 2000-0800.
EXCEPTIONS FOR WX OR OPERATIONAL NECESSITY.

AIRCRAFT MAY EXPERIENCE REFLECTION OF SUN FROM GLASS HOTELS LOCATED NW OF
AIRPORT. REFLECTION MAY OCCUR AT VARIOUS ALTITUDES HEADINGS & DISTANCES FROM
AIRPORT.

DIRECTIONAL TAXIWAY SIGNS WILL BE INCOMPLETE DUE TO CONSTRUCTION.

GENERAL AVIATION PARKING VERY LIMITED. FOR PARKING AVAILABILITY CONTACT EITHER FBO (702) 736-1830 OR (702) 739-1100.

RUNWAY 01L/19R 496000 LBS GROSS WEIGHT FOR L-1011; 555000 LBS GROSS WEIGHT FOR DC-10; 602500 LBS GROSS WEIGHT FOR MD-11.

RUNWAY 07L 589 FT CLEARWAY; RUNWAY 25R 645 FT CLEARWAY.

LIGHTED GOLF RANGE 1400 FT SOUTH OF RUNWAYS 01L/19R AND 01R/19L.

TIEDOWN FEE.

(E98) PLUS 64 SHELTERS & 24 SHEDS.

AIRCRAFT USING FULL LENGTH DEP ON RUNWAY 07L USE MINIMAL POWER UNTIL PASSING THE POWER-UP POINT ON RUNWAY. POWER-UP POINT IS 348 FT EAST OF BALST PAD AND MARKED WITH SIGN AND STANDARD MARKINGS FOR BEGINNING OF RUNWAY.

TAXIWAY C NO CENTERLINE LIGHTS WEST OF TAXIWAY B4, HAS EDGE LIGHTS ON SOUTH SIDE OF TAXIWAY IN THIS AREA.

LARGE NUMBERS OF BIRDS AND BATS IN THE VICINITY OF OF AIRPORT BETWEEN SUNSET AND SUNRISE.

GENERAL AVIATION AIRCRAFT REQUIRING IMMIGRATION/CUSTOMS SERVICES MUST CONTACT DEPT AVIATION FOR PARKING ARRANGEMENTS MIN 2 HRS PRIOR TO ARR (702) 261-3500 0700-1600, ALL OTHER TIMES (702) 261-4411. GENERAL AVIATION AIRCRAFT USING THE WEST SIDE CUSTOMS FACILITY MUST CONTACT RAMP CONTROL 124.4.

AIRCRAFT DEPARTING RUNWAY 19R USE MINIMAL POWER UNTIL PASSING THE RUNWAY THRESHOLD. RUNWAY 19R THRESHOLD HAS STANDARD RUNWAY MARKINGS AND IS 780 FT SOUTH OF THE BLAST PAD.

AIRCRAFT OPER NEAR THE INTERSECTION OF TAXIWAYS S, D, G AND THE NORTH END OF TAXIWAY Z SHOULD BE ALERT AS THERE ARE CLOSELY ALIGNED TAXIWAY CENTERLINES AND RADIUS TURNS.

AIRCRAFT THAT DEPART FULL LENGTH OF RUNWAYS 01L AND 07L MUST HOLD AT THE SAME HOLD LINE AS THERE IS NO ROOM TO HOLD BETWEEN THE RUNWAY ENDS AND SUCH AIRCRAFT SHOULD VERIFY THAT THEY ARE ON THE CORRECT RUNWAY.

GENERAL AVIATION CUSTOMS AND IMMIGRATION LOCATED WEST SIDE OF AIRFIELD BETWEEN FBO'S.

AIRCRAFT LARGER THAN B757 PRIOR PERMISSION REQUIRED FROM DEPT OF AVIATION TO USE TAXIWAY H.

NUMEROUS HELICOPTER OPERATIONS ON WEST SIDE OF AIRPORT.

AIRCRAFT TAXIING WESTBOUND ON TAXIWAY B NEAR TAXIWAY E USE CAUTION NOT TO ENTER THE RUNWAY ON TAXIWAY Y. AIRCRAFT TAXIING WESTBOUND ON TAXIWAY W NEAR TAXIWAY E USE CAUTION NOT TO ENTER THE RUNWAY ON TAXIWAY U.

ASDE-X SURVEILLANCE SYSTEM IN USE: PILOTS SHOULD OPERATE TRANSPONDERS WITH MODE C ON ALL TAXIWAYS AND RUNWAYS.

Reno, Nevada
Reno/Tahoe International
ICAO Identifier KRNO

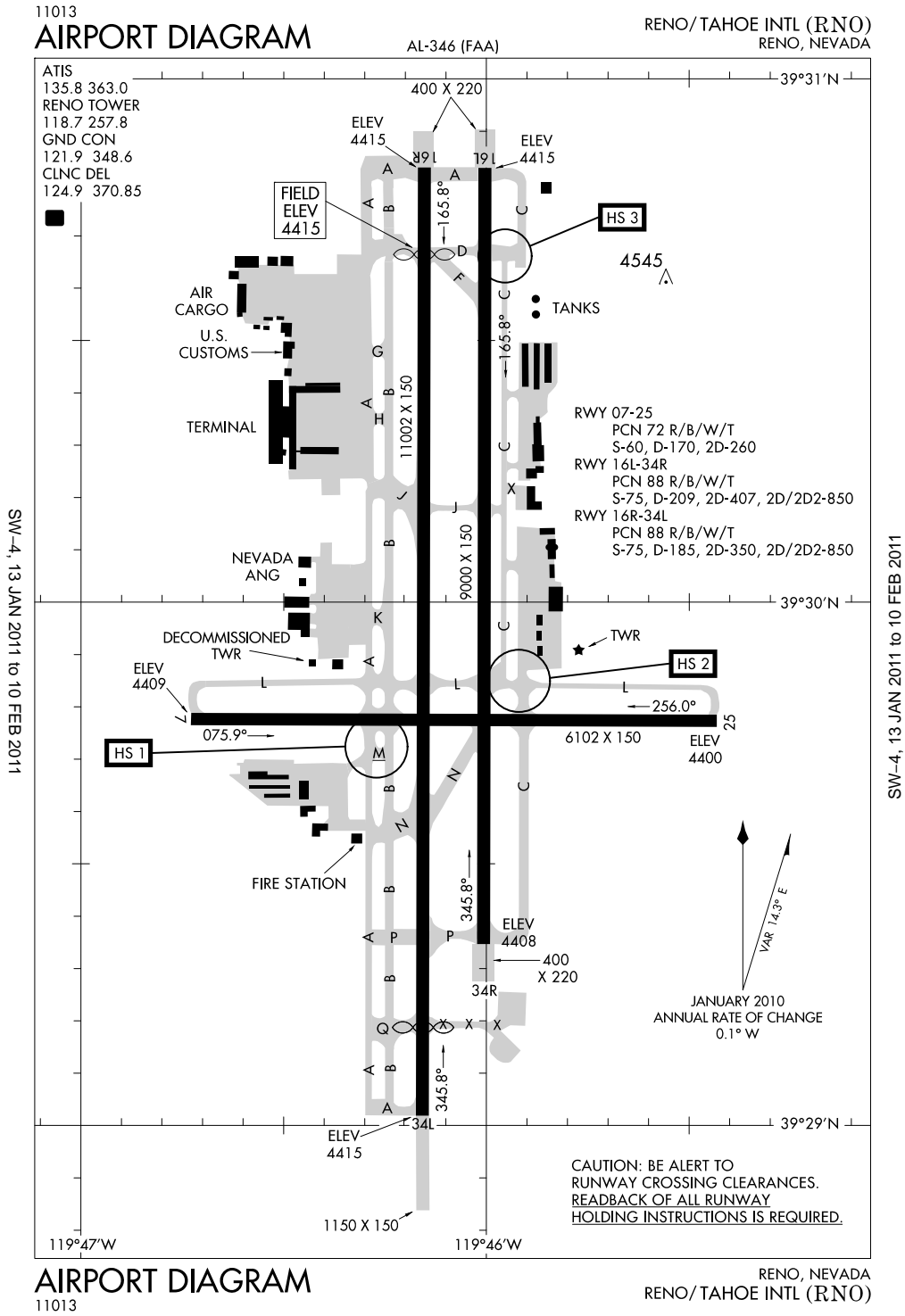

Reno, NV
Reno/Tahoe Intl
ICAO Identifier KRNO

AD 2.2 Aerodrome geographical and administrative data

- 2.2.1 Reference Point: 39-29-56.80N / 119-46-00.00W
- 2.2.2 From City: 3 Miles SE Of Reno, NV
- 2.2.3 Elevation: 4415 ft
- 2.2.5 Magnetic variation: 16E (1985)
- 2.2.6 Airport Contact: Krys T. Bart
P O BOX 12490
Reno, NV 89510
(775-328-6400)
- 2.2.7 Traffic: IFR/VFR

AD 2.3 Operational hours

- 2.3.1 - 2.3.11: ALL Months, ALL Days, ALL Hours

AD 2.4 Handling services and facilities

- 2.4.1 Cargo handling facilities: No
- 2.4.2 Fuel types: 100LL,A1+
- 2.4.4 De-icing facilities: None
- 2.4.5 Hangar space: No
- 2.4.6 Repair facilities: Major

AD 2.6 Rescue and firefighting services

- 2.6.1 Aerodrome category for firefighting: ARFF Index I C certified on 5/1/1973

AD 2.10 Aerodrome obstacles

- 2.10.1.a. Runway designation: 07
- 2.10.1.b Type of obstacle: Pole (118 ft). Not Lighted or Marked
- 2.10.1.c Location of obstacle: 500 ft from Centerline

- 2.10.1.a. Runway designation: 25
- 2.10.1.b Type of obstacle: Tree (44 ft). Not Lighted or Marked
- 2.10.1.c Location of obstacle: 275 ft from Centerline

- 2.10.1.a. Runway designation: 34L
- 2.10.1.b Type of obstacle: Gnd (243 ft). Not Lighted or Marked
- 2.10.1.c Location of obstacle: 1500 ft from Centerline

AD 2.12 Runway physical characteristics

- 2.12.1 Designation: 07
- 2.12.2 True Bearing: 90
- 2.12.3 Dimensions: 6102 ft x 150 ft
- 2.12.4 PCN: 72 R/B/W/T
- 2.12.5 Coordinates: 39-29-46.63N / 119-46-43.82W
- 2.12.6 Threshold elevation: 4409 ft
- 2.12.6 Touchdown zone elevation: 4409 ft

- 2.12.1 Designation: 25
- 2.12.2 True Bearing: 270
- 2.12.3 Dimensions: 6102 ft x 150 ft
- 2.12.4 PCN: 72 R/B/W/T
- 2.12.5 Coordinates: 39-29-46.37N / 119-45-25.99W
- 2.12.6 Threshold elevation: 4400 ft
- 2.12.6 Touchdown zone elevation: 4402 ft

- 2.12.1 Designation: 16L
- 2.12.2 True Bearing: 180
- 2.12.3 Dimensions: 9000 ft x 150 ft
- 2.12.4 PCN: 88 R/B/W/T
- 2.12.5 Coordinates: 39-30-49.82N / 119-46-00.00W
- 2.12.6 Threshold elevation: 4415 ft
- 2.12.6 Touchdown zone elevation: 4415 ft

- 2.12.1 Designation: 34R
- 2.12.2 True Bearing: 0
- 2.12.3 Dimensions: 9000 ft x 150 ft
- 2.12.4 PCN: 88 R/B/W/T
- 2.12.5 Coordinates: 39-29-20.89N / 119-46-00.00W
- 2.12.6 Threshold elevation: 4408 ft
- 2.12.6 Touchdown zone elevation: 4408 ft

- 2.12.1 Designation: 16R
- 2.12.2 True Bearing: 180
- 2.12.3 Dimensions: 11002 ft x 150 ft
- 2.12.4 PCN: 88 R/B/W/T
- 2.12.5 Coordinates: 39-30-49.84N / 119-46-00.00W
- 2.12.6 Threshold elevation: 4415 ft
- 2.12.6 Touchdown zone elevation: 4415 ft

- 2.12.1 Designation: 34L
- 2.12.2 True Bearing: 0
- 2.12.3 Dimensions: 11002 ft x 150 ft
- 2.12.4 PCN: 88 R/B/W/T
- 2.12.5 Coordinates: 39-29-00.00N /

119-46-00.00W
2.12.6 Threshold elevation: 4415 ft
2.12.6 Touchdown zone elevation: 4410 ft

AD 2.13 Declared distances

2.13.1 Designation: 07
2.13.2 Takeoff run available: 6102
2.13.3 Takeoff distance available: 6102
2.13.4 Accelerate-stop distance available: 5854
2.13.5 Landing distance available: 5854

2.13.1 Designation: 25
2.13.2 Takeoff run available: 6102
2.13.3 Takeoff distance available: 6102
2.13.4 Accelerate-stop distance available: 6102
2.13.5 Landing distance available: 6102

AD 2.14 Approach and runway lighting

2.14.1 Designation: 07
2.14.4 Visual approach slope indicator system:
4-light PAPI on left

2.14.1 Designation: 25
2.14.4 Visual approach slope indicator system:
4-light PAPI on left
2.14.10 Remarks: PAPI Not To Be Used Beyond 2
Nm Due To Rapidly Rising Mountainous Terrain

2.14.1 Designation: 16L
2.14.4 Visual approach slope indicator system:
4-light PAPI on left

2.14.1 Designation: 34R
2.14.4 Visual approach slope indicator system:
4-light PAPI on left
2.14.10 Remarks: PAPI Not To Be Used Beyond 6
Nm Due To High Terrain.

2.14.1 Designation: 16R
2.14.2 Approach lighting system: MALSR: 1400
feet medium intensity approach lighting system
with runway alignment indicator lights
2.14.4 Visual approach slope indicator system:
4-light PAPI on left

2.14.1 Designation: 34L
2.14.2 Approach lighting system: MALSR: 1400
feet medium intensity approach lighting system
with runway alignment indicator lights
2.14.4 Visual approach slope indicator system:
4-light PAPI on left

2.14.10 Remarks: PAPI Not To Be Used Beyond 6
Nm Due To High Terrain.

AD 2.18 Air traffic services communication facilities

2.18.1 Service designation: LCL/P
2.18.3 Service designation: 118.7 MHz

2.18.1 Service designation: EMERG
2.18.3 Service designation: 121.5 MHz

2.18.1 Service designation: GND/P
2.18.3 Service designation: 121.9 MHz

2.18.1 Service designation: CD/P
2.18.3 Service designation: 124.9 MHz

2.18.1 Service designation: D-ATIS
2.18.3 Service designation: 135.8 MHz
2.18.4 Hours of operation: 24

2.18.1 Service designation: EMERG
2.18.3 Service designation: 243 MHz

2.18.1 Service designation: LCL/P
2.18.3 Service designation: 257.8 MHz

2.18.1 Service designation: ANG/OPS
2.18.3 Service designation: 280 MHz

2.18.1 Service designation: GND/P
2.18.3 Service designation: 348.6 MHz

2.18.1 Service designation: ANG COMD
POST/BASEOPS
2.18.3 Service designation: 8780 MHz
2.18.6 Remarks: Callsign - Caprock.

2.18.1 Service designation: D-ATIS
2.18.3 Service designation: 363 MHz
2.18.4 Hours of operation: 24

2.18.1 Service designation: CD/P
2.18.3 Service designation: 370.85 MHz

2.18.1 Service designation: ANG COMD
POST/BASEOPS
2.18.3 Service designation: 378.4 MHz
2.18.6 Remarks: Callsign - Caprock.

AD 2.19 Radio navigation and landing aids

2.19.1 ILS type: DME for runway 16R. Magnetic variation: 16E

2.19.2 ILS identification: RNO

2.19.5 Coordinates: 39-28-48.05N / 119-46-00.00W

2.19.6 Site elevation: 4410 ft

2.19.1 ILS type: Glide Slope for runway 16R.

Magnetic variation: 16E

2.19.2 ILS identification: RNO

2.19.5 Coordinates: 39-30-28.10N / 119-46-00.00W

2.19.6 Site elevation: 4408 ft

2.19.1 ILS type: Outer Marker for runway 16R.

Magnetic variation: 16E

2.19.2 ILS identification: RNO

2.19.5 Coordinates: 39-36-27.48N / 119-46-00.00W

2.19.6 Site elevation: 99999 ft

2.19.1 ILS type: Middle Marker for runway 16R.

Magnetic variation: 16E

2.19.2 ILS identification: RNO

2.19.5 Coordinates: 39-31-10.35N / 119-46-00.00W

2.19.6 Site elevation: 99999 ft

2.19.1 ILS type: Localizer for runway 16R.

Magnetic variation: 16E

2.19.2 ILS identification: RNO

2.19.5 Coordinates: 39-28-49.52N / 119-46-00.00W

2.19.6 Site elevation: 4420 ft

2.19.1 ILS type: Localizer for runway 34L.

Magnetic variation: 16E

2.19.2 ILS identification: AGY

2.19.5 Coordinates: 39-30-59.98N / 119-46-00.00W

2.19.6 Site elevation: 4418 ft

2.19.1 ILS type: DME for runway 34L. Magnetic variation: 16E

2.19.2 ILS identification: AGY

2.19.5 Coordinates: 39-31-00.00N / 119-46-12.58W

2.19.6 Site elevation: 4419 ft

2.19.1 ILS type: Glide Slope for runway 34L.

Magnetic variation: 16E

2.19.2 ILS identification: AGY

2.19.5 Coordinates: 39-29-19.55N / 119-46-00.00W

2.19.6 Site elevation: 4402 ft

General Remarks:

WATERFOWL ALL QUADRANTS ALL SEASONS. CONCENTRATED NW OF RUNWAY 16R AND E OF RUNWAY 16L.

24 HRS PRIOR PERMISSION REQUIRED FOR TRANSIENT AIRCRAFT PARKING WITH WINGSPANS GREATER THAN 75'.

TAXIWAY C BETWEEN TAXIWAY L & TAXIWAY D RESTRICTED TO AIRCRAFT 60000 LBS OR LESS.

NOISE SENSITIVE AREA ALL QUADS. PILOTS OF TURBOJET AIRCRAFT USE RECOMMENDED NOISE ABATEMENT PROCS; AVAILABLE ON REQUEST.

NOISE NOTE CONT: PILOTS OF NON-TURBOJET AIRCRAFT USE BEST ABATEMENT PROCS AND SETTINGS. AVOID AS MUCH AS FEASIBLE FLYING OVER POPULATED AREAS.

MILITARY AIRCRAFT: TRANSIENT AIRCRAFT EXECUTE STRAIGHT-IN FULL STOP APPROACH. OVERHEAD PATTERN NOT AUTH FOR TRANSIENT AIRCRAFT.

MILITARY AIRCRAFT: NOISE ABATEMENT CRITICAL TERMINATE AFTERBURNER ASAP THEN CLIMB TO 6500 FT MSL ASAP.

GLIDER/SOARING OPER 30-50 MILES SOUTH OF AIRPORT DURING VFR WEATHER & MOUNTAIN WAVE WIND CONDITIONS 1100 TO SS.

PURE JET TOUCH & GO LOW APPROACH & PRACTICE INSTRUMENT APPROACHES ARE PROHIBITED; AIRCRAFT OVER 12500 LBS REQUIRE PRIOR WRITTEN APPROVAL FOR TRAINING FLIGHTS; FOR FURTHER INFORMATION CONTACT AIRPORT OPERATIONS 1-877-736-6359.

TAXIWAY C BETWEEN TAXIWAY L AND TAXIWAY D CLOSED TO AIR CARRIER AIRCRAFT.

TAXIWAY A BETWEEN NORTH TAXIWAY B AND TAXIWAY D CLOSED TO AIRCRAFT WITH WINGSPAN GREATER THAN 149 FT.

ALL COMMERCIAL AIRCRAFT CONTACT GROUND CONTROL FOR ADVISORIES PRIOR TO PUSH BACK ON THE TERMINAL RAMP.

INTENSIVE GLIDER ACTIVITY IN THE VICINITY OF AIRPORT AND SURROUNDING AREAS UP TO 18,000 FT.

Newark, New Jersey
Newark Liberty International
ICAO Identifier KEWR

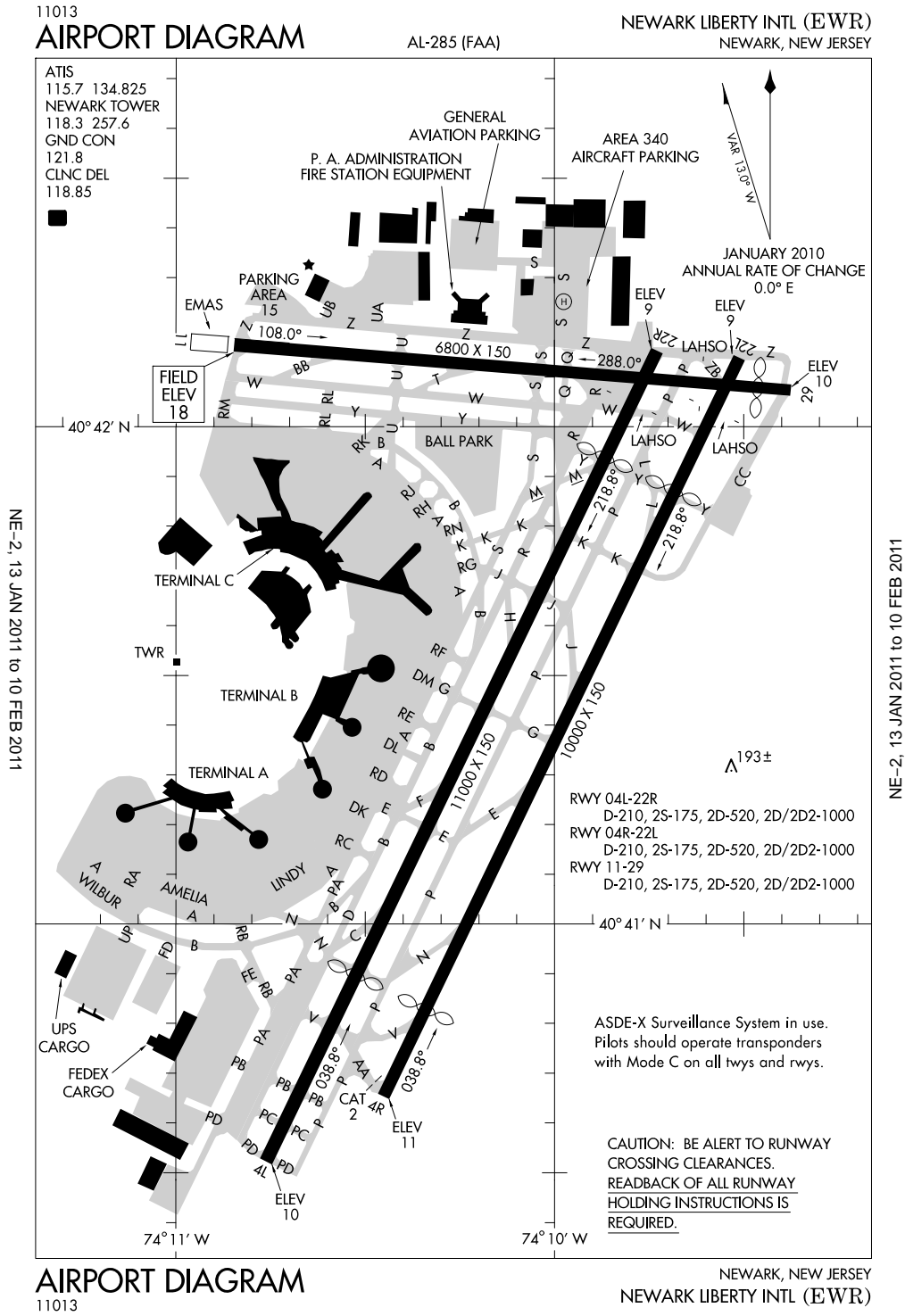

Newark, NJ
Newark Liberty Intl
ICAO Identifier KEWR

AD 2.2 Aerodrome geographical and administrative data

- 2.2.1 Reference Point: 40-41-33.00N / 74-10-00.00W
- 2.2.2 From City: 3 Miles S Of Newark, NJ
- 2.2.3 Elevation: 18 ft
- 2.2.5 Magnetic variation: 13W (1985)
- 2.2.6 Airport Contact: John S. Jacoby
BUILDING #1- CONRAD ROAD
Newark, NJ 7114 (973-961-6000)
- 2.2.7 Traffic: IFR/VFR

AD 2.3 Operational hours

- 2.3.1 - 2.3.11: ALL Months, ALL Days, ALL Hours

AD 2.4 Handling services and facilities

- 2.4.1 Cargo handling facilities: No
- 2.4.2 Fuel types: 100LL,A
- 2.4.4 De-icing facilities: None
- 2.4.5 Hangar space: Yes
- 2.4.6 Repair facilities: Major

AD 2.6 Rescue and firefighting services

- 2.6.1 Aerodrome category for firefighting: ARFF Index I E certified on 5/1/1973

AD 2.10 Aerodrome obstacles

- 2.10.1.a. Runway designation: 11
- 2.10.1.b Type of obstacle: Ant (81 ft). Lighted
- 2.10.1.c Location of obstacle: 550 ft from Centerline

- 2.10.1.a. Runway designation: 29
- 2.10.1.b Type of obstacle: Bldg (24 ft). Lighted
- 2.10.1.c Location of obstacle: 450 ft from Centerline

- 2.10.1.a. Runway designation: 04L
- 2.10.1.b Type of obstacle: Tree (59 ft). Not Lighted or Marked
- 2.10.1.c Location of obstacle: 550 ft from Centerline

- 2.10.1.a. Runway designation: 22R
- 2.10.1.b Type of obstacle: Pole (30 ft). Not Lighted or Marked

- 2.10.1.c Location of obstacle: 400 ft from Centerline

- 2.10.1.a. Runway designation: 22L
- 2.10.1.b Type of obstacle: Pole (32 ft). Not Lighted or Marked
- 2.10.1.c Location of obstacle: 500 ft from Centerline

- 2.10.1.a. Runway designation: 04R
- 2.10.1.b Type of obstacle: Pole (51 ft). Lighted
- 2.10.1.c Location of obstacle: 575 ft from Centerline

AD 2.12 Runway physical characteristics

- 2.12.1 Designation: H1
- 2.12.3 Dimensions: 40 ft x 40 ft

- 2.12.1 Designation: 11
- 2.12.2 True Bearing: 95
- 2.12.3 Dimensions: 6800 ft x 150 ft
- 2.12.5 Coordinates: 40-42-10.10N / 74-10-50.55W
- 2.12.6 Threshold elevation: 18 ft
- 2.12.6 Touchdown zone elevation: 18 ft

- 2.12.1 Designation: 29
- 2.12.2 True Bearing: 275
- 2.12.3 Dimensions: 6800 ft x 150 ft
- 2.12.5 Coordinates: 40-42-00.00N / 74-09-22.59W
- 2.12.6 Threshold elevation: 10 ft
- 2.12.6 Touchdown zone elevation: 10 ft

- 2.12.1 Designation: 04L
- 2.12.2 True Bearing: 26
- 2.12.3 Dimensions: 11000 ft x 150 ft
- 2.12.5 Coordinates: 40-40-31.37N / 74-10-46.02W
- 2.12.6 Threshold elevation: 10 ft
- 2.12.6 Touchdown zone elevation: 10 ft

- 2.12.1 Designation: 22R
- 2.12.2 True Bearing: 206
- 2.12.3 Dimensions: 11000 ft x 150 ft
- 2.12.5 Coordinates: 40-42-00.00N / 74-09-43.83W
- 2.12.6 Threshold elevation: 9 ft
- 2.12.6 Touchdown zone elevation: 10 ft

- 2.12.1 Designation: 04R

- 2.12.2 True Bearing: 26
- 2.12.3 Dimensions: 10000 ft x 150 ft
- 2.12.5 Coordinates: 40-40-39.30N / 74-10-27.28W
- 2.12.6 Threshold elevation: 11 ft
- 2.12.6 Touchdown zone elevation: 11 ft

- 2.12.1 Designation: 22L
- 2.12.2 True Bearing: 206
- 2.12.3 Dimensions: 10000 ft x 150 ft
- 2.12.5 Coordinates: 40-42-00.00N / 74-09-30.73W
- 2.12.6 Threshold elevation: 9 ft
- 2.12.6 Touchdown zone elevation: 10 ft

AD 2.13 Declared distances

- 2.13.1 Designation: 11
- 2.13.2 Takeoff run available: 6800
- 2.13.3 Takeoff distance available: 6800
- 2.13.4 Accelerate-stop distance available: 6800
- 2.13.5 Landing distance available: 6800

- 2.13.1 Designation: 29
- 2.13.2 Takeoff run available: 6800
- 2.13.3 Takeoff distance available: 6800
- 2.13.4 Accelerate-stop distance available: 6800
- 2.13.5 Landing distance available: 6502

- 2.13.1 Designation: 04L
- 2.13.2 Takeoff run available: 11000
- 2.13.3 Takeoff distance available: 11000
- 2.13.4 Accelerate-stop distance available: 11000
- 2.13.5 Landing distance available: 8460

- 2.13.1 Designation: 22R
- 2.13.2 Takeoff run available: 11000
- 2.13.3 Takeoff distance available: 11000
- 2.13.4 Accelerate-stop distance available: 11000
- 2.13.5 Landing distance available: 9560

- 2.13.1 Designation: 04R
- 2.13.2 Takeoff run available: 10000
- 2.13.3 Takeoff distance available: 10000
- 2.13.4 Accelerate-stop distance available: 10000
- 2.13.5 Landing distance available: 8810

- 2.13.1 Designation: 22L
- 2.13.2 Takeoff run available: 10000
- 2.13.3 Takeoff distance available: 10000
- 2.13.4 Accelerate-stop distance available: 10000
- 2.13.5 Landing distance available: 8206

AD 2.14 Approach and runway lighting

- 2.14.1 Designation: 11
- 2.14.4 Visual approach slope indicator system: 4-box VASI on left

- 2.14.1 Designation: 29
- 2.14.4 Visual approach slope indicator system: 4-light PAPI on right

- 2.14.1 Designation: 04L
- 2.14.2 Approach lighting system: MALSR: 1400 feet medium intensity approach lighting system with runway alignment indicator lights
- 2.14.4 Visual approach slope indicator system: 4-light PAPI on left
- 2.14.10 Remarks: Runway 04L P4L Unusable 5 Degs L Of Centerline .

- 2.14.1 Designation: 22R
- 2.14.2 Approach lighting system: MALSR: 1400 feet medium intensity approach lighting system with runway alignment indicator lights
- 2.14.4 Visual approach slope indicator system: 4-light PAPI on left

- 2.14.1 Designation: 04R
- 2.14.2 Approach lighting system: ALSF2: Standard 2400 feet high intensity approach lighting system with sequenced flashers, category II or III configuration
- 2.14.4 Visual approach slope indicator system: 4-light PAPI on left

- 2.14.1 Designation: 22L
- 2.14.2 Approach lighting system: MALSR: 1400 feet medium intensity approach lighting system with runway alignment indicator lights
- 2.14.4 Visual approach slope indicator system: 4-light PAPI on left

AD 2.18 Air traffic services communication facilities

- 2.18.1 Service designation: D-ATIS
- 2.18.3 Service designation: 115.7 MHz
- 2.18.4 Hours of operation: 24

- 2.18.1 Service designation: LCL/P
- 2.18.3 Service designation: 118.3 MHz

- 2.18.1 Service designation: CD/P PRE TAXI CLNC

2.18.3 Service designation: 118.85 MHz

2.18.1 Service designation: EMERG

2.18.3 Service designation: 121.5 MHz

2.18.1 Service designation: GND/P

2.18.3 Service designation: 121.8 MHz

2.18.1 Service designation: CLASS B

2.18.3 Service designation: 127.85 MHz

2.18.1 Service designation: LCL/S

2.18.3 Service designation: 134.05 MHz

2.18.1 Service designation: EMERG

2.18.3 Service designation: 243 MHz

2.18.1 Service designation: LCL/P CLASS B

2.18.3 Service designation: 257.6 MHz

2.18.1 Service designation: D-ATIS

2.18.3 Service designation: 134.825 MHz

2.18.4 Hours of operation: 24

2.18.1 Service designation: GND/S

2.18.3 Service designation: 126.15 MHz

2.18.1 Service designation: GATE HOLD

2.18.3 Service designation: 132.45 MHz

AD 2.19 Radio navigation and landing aids

2.19.1 ILS type: Localizer for runway 11. Magnetic variation: 13W

2.19.2 ILS identification: GPR

2.19.5 Coordinates: 40-42-00.00N / 74-10-00.00W

2.19.6 Site elevation: 8 ft

2.19.1 ILS type: Glide Slope for runway 11.

Magnetic variation: 13W

2.19.2 ILS identification: GPR

2.19.5 Coordinates: 40-42-10.84N / 74-10-35.03W

2.19.6 Site elevation: 10 ft

2.19.1 ILS type: DME for runway 11. Magnetic variation: 13W

2.19.2 ILS identification: GPR

2.19.5 Coordinates: 40-42-00.00N / 74-10-00.00W

2.19.6 Site elevation: 7 ft

2.19.1 ILS type: Outer Marker for runway 04L. Magnetic variation: 13W

2.19.2 ILS identification: EWR

2.19.5 Coordinates: 40-35-37.20N / 74-13-48.00W

2.19.6 Site elevation: 99999 ft

2.19.1 ILS type: Middle Marker for runway 04L.

Magnetic variation: 13W

2.19.2 ILS identification: EWR

2.19.5 Coordinates: 40-40-21.10N / 74-10-52.50W

2.19.6 Site elevation: 99999 ft

2.19.1 ILS type: Localizer for runway 04L.

Magnetic variation: 13W

2.19.2 ILS identification: EWR

2.19.5 Coordinates: 40-42-17.37N / 74-09-38.64W

2.19.6 Site elevation: 11 ft

2.19.1 ILS type: DME for runway 04L. Magnetic variation: 13W

2.19.2 ILS identification: EWR

2.19.5 Coordinates: 40-42-15.25N / 74-09-33.96W

2.19.6 Site elevation: 11 ft

2.19.1 ILS type: Glide Slope for runway 04L.

Magnetic variation: 13W

2.19.2 ILS identification: EWR

2.19.5 Coordinates: 40-41-00.00N / 74-10-22.50W

2.19.6 Site elevation: 9 ft

2.19.1 ILS type: Localizer for runway 22R.

Magnetic variation: 13W

2.19.2 ILS identification: JNN

2.19.5 Coordinates: 40-40-23.38N / 74-10-51.10W

2.19.6 Site elevation: 11 ft

2.19.1 ILS type: Glide Slope for runway 22R.

Magnetic variation: 13W

2.19.2 ILS identification: JNN

2.19.5 Coordinates: 40-41-47.33N / 74-09-54.13W

2.19.6 Site elevation: 9 ft

2.19.1 ILS type: Outer Marker for runway 22R.

Magnetic variation: 13W
2.19.2 ILS identification: JNN
2.19.5 Coordinates: 40-45-54.50N /
74-07-16.70W
2.19.6 Site elevation: 5 ft

2.19.1 ILS type: DME for runway 22R. Magnetic
variation: 13W
2.19.2 ILS identification: JNN
2.19.5 Coordinates: 40-42-15.25N /
74-09-33.96W
2.19.6 Site elevation: 11 ft

2.19.1 ILS type: Localizer for runway 22L.
Magnetic variation: 13W
2.19.2 ILS identification: LSQ
2.19.5 Coordinates: 40-40-31.65N /
74-10-32.15W
2.19.6 Site elevation: 8 ft

2.19.1 ILS type: DME for runway 22L. Magnetic
variation: 13W
2.19.2 ILS identification: LSQ
2.19.5 Coordinates: 40-41-43.55N /
74-09-41.63W
2.19.6 Site elevation: 24 ft

2.19.1 ILS type: Glide Slope for runway 22L.
Magnetic variation: 13W
2.19.2 ILS identification: LSQ
2.19.5 Coordinates: 40-41-43.69N /
74-09-41.73W
2.19.6 Site elevation: 9 ft

2.19.1 ILS type: Middle Marker for runway 22L.
Magnetic variation: 13W
2.19.2 ILS identification: LSQ
2.19.5 Coordinates: 40-42-23.50N /
74-09-20.90W
2.19.6 Site elevation: 8 ft

2.19.1 ILS type: Outer Marker for runway 22L.
Magnetic variation: 13W
2.19.2 ILS identification: LSQ
2.19.5 Coordinates: 40-45-54.50N /

74-07-16.70W
2.19.6 Site elevation: 99999 ft

2.19.1 ILS type: Glide Slope for runway 04R.
Magnetic variation: 13W
2.19.2 ILS identification: EZA
2.19.5 Coordinates: 40-40-57.59N /
74-10-00.00W
2.19.6 Site elevation: 8 ft

2.19.1 ILS type: Middle Marker for runway 04R.
Magnetic variation: 13W
2.19.2 ILS identification: EZA
2.19.5 Coordinates: 40-40-26.62N /
74-10-35.32W
2.19.6 Site elevation: 11 ft

2.19.1 ILS type: Inner Marker for runway 04R.
Magnetic variation: 13W
2.19.2 ILS identification: EZA
2.19.5 Coordinates: 40-40-41.50N /
74-10-23.20W
2.19.6 Site elevation: 99999 ft

2.19.1 ILS type: Outer Marker for runway 04R.
Magnetic variation: 13W
2.19.2 ILS identification: EZA
2.19.5 Coordinates: 40-36-26.40N /
74-13-00.00W
2.19.6 Site elevation: 10 ft

2.19.1 ILS type: Localizer for runway 04R.
Magnetic variation: 13W
2.19.2 ILS identification: EZA
2.19.5 Coordinates: 40-42-15.94N /
74-09-25.84W
2.19.6 Site elevation: 9 ft

2.19.1 ILS type: DME for runway 04R. Magnetic
variation: 13W
2.19.2 ILS identification: EZA
2.19.5 Coordinates: 40-41-43.55N /
74-09-41.63W
2.19.6 Site elevation: 24 ft

General Remarks:

FLOCKS OF BIRDS ON & IN THE VICINITY OF AIRPORT.

FOR NOISE RESTRICTIONS CALL 212-435-3779 DURING NORMAL BUSINESS HOURS.

PARA-SAIL & BANNER TOWING OPERATIONS 1000 FT & BELOW IN UPPER & LOWER NEW YORK BAYS INCLUDING ROCKAWAY INLET INDEFINITELY.

TAXIWAY Z BETWEEN TAXIWAY U & UB RESTRICTED TO NARROW BODY AIRCRAFT INDEFINITELY.

ASDE-X SURVEILLANCE SYSTEM IN USE: PILOTS SHOULD OPERATE TRANSPONDERS WITH MODE C ON ALL TAXIWAYS AND RUNWAYS.

RUNWAYS 04R & 04L DEPARTURES USE UPPER ANTENNA FOR ATC COMMUNICATIONS.

New York, New York
John F. Kennedy International
ICAO Identifier KJFK

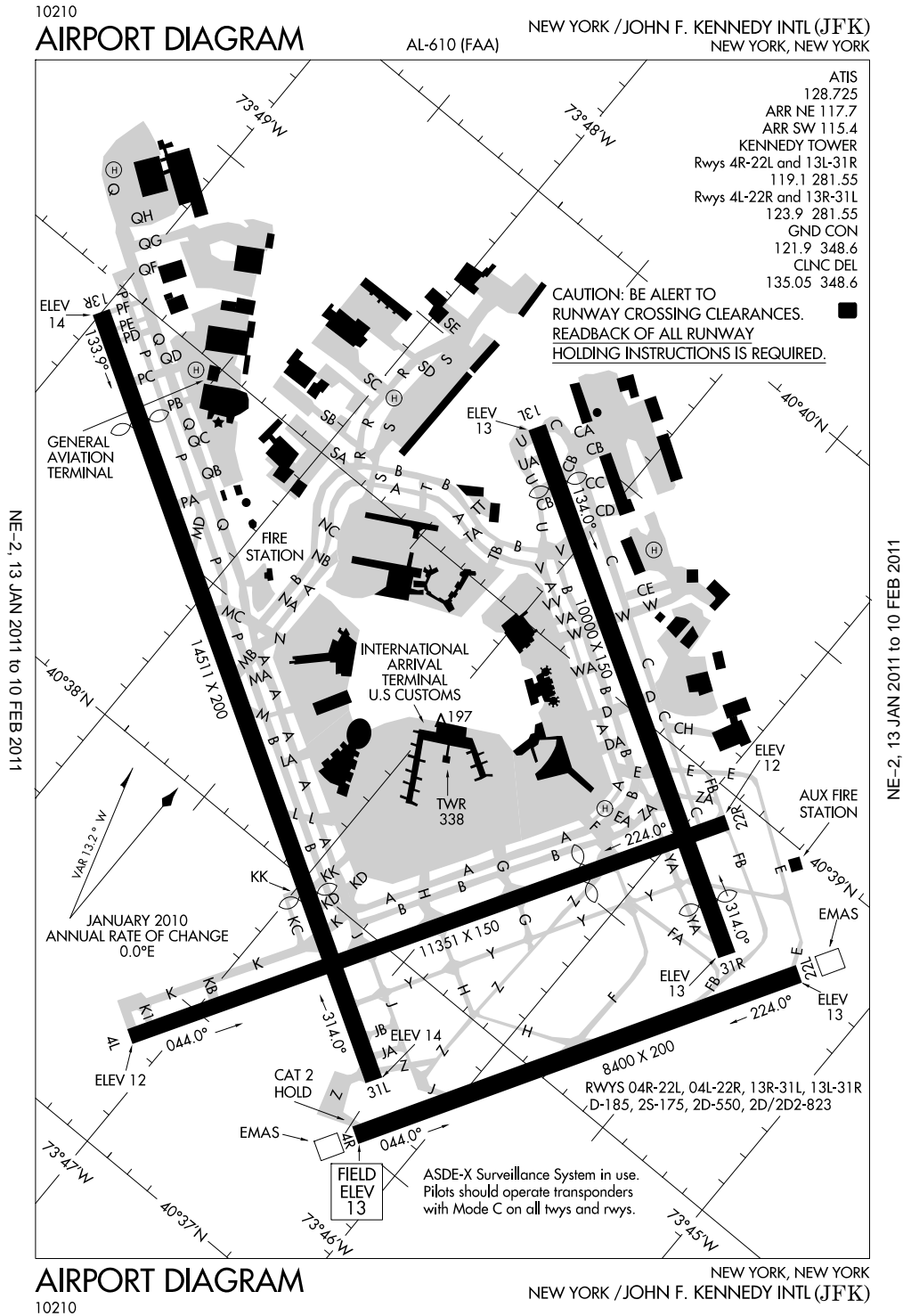

New York, NY
John F Kennedy Intl
ICAO Identifier KJFK

AD 2.2 Aerodrome geographical and administrative data

- 2.2.1 Reference Point: 40-38-23.10N / 73-46-44.13W
- 2.2.2 From City: 13 Miles SE Of New York, NY
- 2.2.3 Elevation: 13 ft
- 2.2.5 Magnetic variation: 14W (2000)
- 2.2.6 Airport Contact: Jerry Spampinato
BLDG 14
Jamaica, NY 11430
(718-244-3501)
- 2.2.7 Traffic: IFR/VFR

AD 2.3 Operational hours

- 2.3.1 - 2.3.11: ALL Months, ALL Days, ALL Hours

AD 2.4 Handling services and facilities

- 2.4.1 Cargo handling facilities: No
- 2.4.2 Fuel types: 100LL,A
- 2.4.4 De-icing facilities: None
- 2.4.5 Hangar space: Yes
- 2.4.6 Repair facilities: Major

AD 2.6 Rescue and firefighting services

- 2.6.1 Aerodrome category for firefighting: ARFF Index I E certified on 5/1/1973

AD 2.10 Aerodrome obstacles

- 2.10.1.a. Runway designation: 22R
- 2.10.1.b Type of obstacle: Fence (10 ft). Lighted
- 2.10.1.c Location of obstacle: 300 ft from Centerline

- 2.10.1.a. Runway designation: 13L
- 2.10.1.b Type of obstacle: Road (14 ft). Not Lighted or Marked
- 2.10.1.c Location of obstacle: 0 ft from Centerline

AD 2.12 Runway physical characteristics

- 2.12.1 Designation: 04L
- 2.12.2 True Bearing: 31
- 2.12.3 Dimensions: 11351 ft x 150 ft
- 2.12.5 Coordinates: 40-37-19.26N / 73-47-00.00W
- 2.12.6 Threshold elevation: 12 ft
- 2.12.6 Touchdown zone elevation: 12 ft

- 2.12.1 Designation: 22R
- 2.12.2 True Bearing: 211
- 2.12.3 Dimensions: 11351 ft x 150 ft
- 2.12.5 Coordinates: 40-38-55.65N / 73-45-52.80W
- 2.12.6 Threshold elevation: 12 ft
- 2.12.6 Touchdown zone elevation: 13 ft

- 2.12.1 Designation: 04R
- 2.12.2 True Bearing: 31
- 2.12.3 Dimensions: 8400 ft x 200 ft
- 2.12.5 Coordinates: 40-37-31.53N / 73-46-13.25W
- 2.12.6 Threshold elevation: 13 ft
- 2.12.6 Touchdown zone elevation: 13 ft

- 2.12.1 Designation: 22L
- 2.12.2 True Bearing: 211
- 2.12.3 Dimensions: 8400 ft x 200 ft
- 2.12.5 Coordinates: 40-38-42.85N / 73-45-17.51W
- 2.12.6 Threshold elevation: 13 ft
- 2.12.6 Touchdown zone elevation: 13 ft

- 2.12.1 Designation: H1
- 2.12.3 Dimensions: 60 ft x 60 ft

- 2.12.1 Designation: 13R
- 2.12.2 True Bearing: 121
- 2.12.3 Dimensions: 14511 ft x 200 ft
- 2.12.5 Coordinates: 40-38-54.10N / 73-49-00.00W
- 2.12.6 Threshold elevation: 14 ft
- 2.12.6 Touchdown zone elevation: 13 ft

- 2.12.1 Designation: 31L
- 2.12.2 True Bearing: 301
- 2.12.3 Dimensions: 14511 ft x 200 ft
- 2.12.5 Coordinates: 40-37-40.78N / 73-46-18.41W
- 2.12.6 Threshold elevation: 14 ft
- 2.12.6 Touchdown zone elevation: 13 ft

- 2.12.1 Designation: H2
- 2.12.3 Dimensions: 60 ft x 60 ft

- 2.12.1 Designation: H3
- 2.12.3 Dimensions: 60 ft x 60 ft

- 2.12.1 Designation: H4
- 2.12.3 Dimensions: 60 ft x 60 ft

2.12.1 Designation: 13L
2.12.2 True Bearing: 121
2.12.3 Dimensions: 10000 ft x 150 ft
2.12.5 Coordinates: 40-39-27.95N /
73-47-24.86W
2.12.6 Threshold elevation: 13 ft
2.12.6 Touchdown zone elevation: 13 ft

2.12.1 Designation: 31R
2.12.2 True Bearing: 301
2.12.3 Dimensions: 10000 ft x 150 ft
2.12.5 Coordinates: 40-38-37.41N /
73-45-33.40W
2.12.6 Threshold elevation: 12 ft
2.12.6 Touchdown zone elevation: 13 ft

AD 2.13 Declared distances

2.13.1 Designation: 04L
2.13.2 Takeoff run available: 11351
2.13.3 Takeoff distance available: 11351
2.13.4 Accelerate-stop distance available: 11351
2.13.5 Landing distance available: 11351

2.13.1 Designation: 22R
2.13.2 Takeoff run available: 11351
2.13.3 Takeoff distance available: 11351
2.13.4 Accelerate-stop distance available: 11351
2.13.5 Landing distance available: 8655

2.13.1 Designation: 04R
2.13.2 Takeoff run available: 8400
2.13.3 Takeoff distance available: 8400
2.13.4 Accelerate-stop distance available: 8400
2.13.5 Landing distance available: 8400

2.13.1 Designation: 22L
2.13.2 Takeoff run available: 8400
2.13.3 Takeoff distance available: 8400
2.13.4 Accelerate-stop distance available: 8400
2.13.5 Landing distance available: 8400

2.13.1 Designation: 13R
2.13.2 Takeoff run available: 11248
2.13.3 Takeoff distance available: 11248
2.13.4 Accelerate-stop distance available: 11052
2.13.5 Landing distance available: 9009

2.13.1 Designation: 31L
2.13.2 Takeoff run available: 10925
2.13.3 Takeoff distance available: 10925
2.13.4 Accelerate-stop distance available: 10925

2.13.1 Designation: 13L
2.13.2 Takeoff run available: 10000
2.13.3 Takeoff distance available: 10000
2.13.4 Accelerate-stop distance available: 10000
2.13.5 Landing distance available: 9095

2.13.1 Designation: 31R
2.13.2 Takeoff run available: 10000
2.13.3 Takeoff distance available: 10000
2.13.4 Accelerate-stop distance available: 10000
2.13.5 Landing distance available: 8976

AD 2.14 Approach and runway lighting

2.14.1 Designation: 04L
2.14.4 Visual approach slope indicator system:
4-light PAPI on left

2.14.1 Designation: 04R
2.14.2 Approach lighting system: ALSF2: Standard
2400 feet high intensity approach lighting system
with sequenced flashers, category II or III
configuration

2.14.1 Designation: 22L
2.14.2 Approach lighting system: ALSF2: Standard
2400 feet high intensity approach lighting system
with sequenced flashers, category II or III
configuration
2.14.4 Visual approach slope indicator system:
4-light PAPI on left
2.14.10 Remarks: Runway 22L PAPI Horizontal
Offset 4 Degrees To Left. Non Standard Light
Spacing.

2.14.1 Designation: 13R
2.14.2 Approach lighting system: LDIN: Lead-in
light system
2.14.4 Visual approach slope indicator system:
4-light PAPI on left
2.14.10 Remarks: Runway 13R First P4L
Horizontal Offset 22 Degs Left.
Runway 13R Has Second P4L With Transitional
Threshold Crossing Height And 3.00 Degrees Vgsi.

2.14.1 Designation: 31L
2.14.4 Visual approach slope indicator system:
4-light PAPI on left

2.14.1 Designation: 13L
2.14.2 Approach lighting system: ALSF2: Standard
2400 feet high intensity approach lighting system

with sequenced flashers, category II or III configuration

2.14.4 Visual approach slope indicator system: 12-box VASI on both sides

2.14.10 Remarks: Runway 13L VASI Unusable Left Of Centerline .

2.14.1 Designation: 31R

2.14.2 Approach lighting system: MALSR: 1400 feet medium intensity approach lighting system with runway alignment indicator lights

AD 2.18 Air traffic services communication facilities

2.18.1 Service designation: D-ATIS

2.18.3 Service designation: 115.4 MHz

2.18.4 Hours of operation: 24

2.18.1 Service designation: D-ATIS

2.18.3 Service designation: 117.7 MHz

2.18.4 Hours of operation: 24

2.18.1 Service designation: LCL/P

2.18.3 Service designation: 119.1 MHz

2.18.1 Service designation: EMERG

2.18.3 Service designation: 121.5 MHz

2.18.1 Service designation: GND/S

2.18.3 Service designation: 121.65 MHz

2.18.1 Service designation: GND/P

2.18.3 Service designation: 121.9 MHz

2.18.1 Service designation: LCL/P

2.18.3 Service designation: 123.9 MHz

2.18.1 Service designation: GATE HOLD

2.18.3 Service designation: 125.05 MHz

2.18.1 Service designation: D-ATIS

2.18.3 Service designation: 128.725 MHz

2.18.4 Hours of operation: 24

2.18.1 Service designation: CD/P PRE TAXI CLNC

2.18.3 Service designation: 135.05 MHz

2.18.1 Service designation: EMERG

2.18.3 Service designation: 243 MHz

2.18.1 Service designation: LCL/P

2.18.3 Service designation: 281.55 MHz

2.18.1 Service designation: LCL/P

2.18.3 Service designation: 281.55 MHz

2.18.1 Service designation: CLASS B

2.18.3 Service designation: 281.55 MHz

2.18.1 Service designation: GND/P CD/P PRE TAXI CLNC

2.18.3 Service designation: 348.6 MHz

2.18.1 Service designation: CLASS B

2.18.3 Service designation: 125.25 MHz

AD 2.19 Radio navigation and landing aids

2.19.1 ILS type: Localizer for runway 04L.

Magnetic variation: 14W

2.19.2 ILS identification: HIQ

2.19.5 Coordinates: 40-39-00.00N / 73-45-46.62W

2.19.6 Site elevation: 13 ft

2.19.1 ILS type: DME for runway 04L. Magnetic variation: 14W

2.19.2 ILS identification: HIQ

2.19.5 Coordinates: 40-37-43.82N / 73-46-40.58W

2.19.6 Site elevation: 24 ft

2.19.1 ILS type: Outer Marker for runway 04L.

Magnetic variation: 14W

2.19.2 ILS identification: HIQ

2.19.5 Coordinates: 40-35-00.00N / 73-48-56.17W

2.19.6 Site elevation: 9 ft

2.19.1 ILS type: Glide Slope for runway 04L.

Magnetic variation: 14W

2.19.2 ILS identification: HIQ

2.19.5 Coordinates: 40-37-27.27N / 73-46-58.14W

2.19.6 Site elevation: 10 ft

2.19.1 ILS type: Middle Marker for runway 22R.

Magnetic variation: 14W

2.19.2 ILS identification: JOC

2.19.5 Coordinates: 40-39-00.00N / 73-45-46.80W

2.19.6 Site elevation: 99999 ft

2.19.1 ILS type: Localizer for runway 22R.

Magnetic variation: 14W
2.19.2 ILS identification: JOC
2.19.5 Coordinates: 40-37-44.50N /
73-46-43.09W
2.19.6 Site elevation: 9 ft

2.19.1 ILS type: Glide Slope for runway 22R.
Magnetic variation: 14W
2.19.2 ILS identification: JOC
2.19.5 Coordinates: 40-38-21.28N /
73-46-13.92W
2.19.6 Site elevation: 10 ft

2.19.1 ILS type: DME for runway 22R. Magnetic
variation: 14W
2.19.2 ILS identification: JOC
2.19.5 Coordinates: 40-38-53.29N /
73-45-12.18W
2.19.6 Site elevation: 29 ft

2.19.1 ILS type: Localizer for runway 04R.
Magnetic variation: 14W
2.19.2 ILS identification: JFK
2.19.5 Coordinates: 40-38-51.57N /
73-45-10.68W
2.19.6 Site elevation: 13 ft

2.19.1 ILS type: DME for runway 04R. Magnetic
variation: 14W
2.19.2 ILS identification: JFK
2.19.5 Coordinates: 40-38-53.29N /
73-45-13.18W
2.19.6 Site elevation: 29 ft

2.19.1 ILS type: Glide Slope for runway 04R.
Magnetic variation: 14W
2.19.2 ILS identification: JFK
2.19.5 Coordinates: 40-37-42.10N /
73-46-11.03W
2.19.6 Site elevation: 14 ft

2.19.1 ILS type: Inner Marker for runway 04R.
Magnetic variation: 14W
2.19.2 ILS identification: JFK
2.19.5 Coordinates: 40-37-23.90N /
73-46-19.10W
2.19.6 Site elevation: 12 ft

2.19.1 ILS type: Middle Marker for runway 04R.
Magnetic variation: 14W
2.19.2 ILS identification: JFK

2.19.5 Coordinates: 40-37-00.00N /
73-46-30.60W
2.19.6 Site elevation: 12 ft

2.19.1 ILS type: Localizer for runway 22L.
Magnetic variation: 14W
2.19.2 ILS identification: IWY
2.19.5 Coordinates: 40-37-27.51N /
73-46-16.39W
2.19.6 Site elevation: 11 ft

2.19.1 ILS type: Outer Marker for runway 22L.
Magnetic variation: 14W
2.19.2 ILS identification: IWY
2.19.5 Coordinates: 40-43-31.10N /
73-41-35.40W
2.19.6 Site elevation: 99999 ft

2.19.1 ILS type: Glide Slope for runway 22L.
Magnetic variation: 14W
2.19.2 ILS identification: IWY
2.19.5 Coordinates: 40-38-33.32N /
73-45-20.81W
2.19.6 Site elevation: 14 ft

2.19.1 ILS type: DME for runway 22L. Magnetic
variation: 14W
2.19.2 ILS identification: IWY
2.19.5 Coordinates: 40-37-43.82N /
73-46-40.58W
2.19.6 Site elevation: 24 ft

2.19.1 ILS type: Inner Marker for runway 22L.
Magnetic variation: 14W
2.19.2 ILS identification: IWY
2.19.5 Coordinates: 40-38-51.13N /
73-45-11.04W
2.19.6 Site elevation: 12 ft

2.19.1 ILS type: Middle Marker for runway 22L.
Magnetic variation: 14W
2.19.2 ILS identification: IWY
2.19.5 Coordinates: 40-39-12.30N /
73-44-54.50W
2.19.6 Site elevation: 99999 ft

2.19.1 ILS type: Outer Marker for runway 31L.
Magnetic variation: 14W
2.19.2 ILS identification: MOH
2.19.5 Coordinates: 40-35-27.30N /
73-41-00.00W

2.19.6 Site elevation: 6 ft

2.19.1 ILS type: Localizer for runway 31L.
Magnetic variation: 14W

2.19.2 ILS identification: MOH

2.19.5 Coordinates: 40-38-59.65N /
73-49-12.42W

2.19.6 Site elevation: 14 ft

2.19.1 ILS type: Glide Slope for runway 31L.
Magnetic variation: 14W

2.19.2 ILS identification: MOH

2.19.5 Coordinates: 40-37-59.87N /
73-47-00.00W

2.19.6 Site elevation: 10 ft

2.19.1 ILS type: Middle Marker for runway 31L.
Magnetic variation: 14W

2.19.2 ILS identification: MOH

2.19.5 Coordinates: 40-37-39.50N /
73-46-15.80W

2.19.6 Site elevation: 12 ft

2.19.1 ILS type: Localizer for runway 13L.
Magnetic variation: 14W

2.19.2 ILS identification: TLK

2.19.5 Coordinates: 40-38-30.69N /
73-45-18.57W

2.19.6 Site elevation: 14 ft

2.19.1 ILS type: Glide Slope for runway 13L.
Magnetic variation: 14W

2.19.2 ILS identification: TLK

2.19.5 Coordinates: 40-39-14.74N /
73-47-00.00W

2.19.6 Site elevation: 11 ft

2.19.1 ILS type: Outer Marker for runway 13L.
Magnetic variation: 14W

2.19.2 ILS identification: TLK

2.19.5 Coordinates: 40-41-40.70N /
73-52-00.00W

2.19.6 Site elevation: 126 ft

2.19.1 ILS type: Middle Marker for runway 13L.
Magnetic variation: 14W

2.19.2 ILS identification: TLK

2.19.5 Coordinates: 40-39-37.10N /
73-47-44.80W

2.19.6 Site elevation: 11 ft

2.19.1 ILS type: DME for runway 13L. Magnetic
variation: 14W

2.19.2 ILS identification: TLK

2.19.5 Coordinates: 40-38-33.37N /
73-45-18.32W

2.19.6 Site elevation: 13 ft

2.19.1 ILS type: Middle Marker for runway 31R.
Magnetic variation: 14W

2.19.2 ILS identification: RTH

2.19.5 Coordinates: 40-38-25.00N /
73-45-00.00W

2.19.6 Site elevation: 99999 ft

2.19.1 ILS type: DME for runway 31R. Magnetic
variation: 14W

2.19.2 ILS identification: RTH

2.19.5 Coordinates: 40-38-33.37N /
73-45-18.32W

2.19.6 Site elevation: 13 ft

2.19.1 ILS type: Outer Marker for runway 31R.
Magnetic variation: 14W

2.19.2 ILS identification: RTH

2.19.5 Coordinates: 40-35-50.70N /
73-39-26.60W

2.19.6 Site elevation: 99999 ft

2.19.1 ILS type: Localizer for runway 31R.
Magnetic variation: 14W

2.19.2 ILS identification: RTH

2.19.5 Coordinates: 40-39-30.78N /
73-47-31.09W

2.19.6 Site elevation: 12 ft

2.19.1 ILS type: Glide Slope for runway 31R.
Magnetic variation: 14W

2.19.2 ILS identification: RTH

2.19.5 Coordinates: 40-38-50.33N /
73-45-51.02W

2.19.6 Site elevation: 11 ft

General Remarks:

FLOCKS OF BIRDS ON & IN THE VICINITY OF AIRPORT.

LDIN RUNWAY 13L USES 1000' LIGHT STATION OF THE APPROACH LIGHT SYSTEM ONLY WITH CRI VOR APPROACHES & IS ANGLED TOWARD AQUEDUCT; ALSO 5 SEQUENCE FLASHING LIGHTS FROM 1200-2000' & A 5 SEQUENCE FLASHING LIGHTS GROUPING APPROXIMATELY 1 MI FROM RUNWAY +1 ADJACENT FORMING APPROACH. APPROACH GATE ANGLED 35 DEGS S OF RUNWAY 13L CENTERLINE DESIGNED TO PROVIDE EARLIER IDENT OF RUNWAY ENVI.

FOR NOISE RESTRICTIONS CALL 212-435-3685 DURING NORMAL BUSINESS HOURS.

AIRCRAFT PROHIBITED IN THE RUNUP BLOCK AREAS AT TAXIWAY Z. TO BE USED FOR TURN AROUND ONLY.

PARA-SAIL & BANNER TOWING OPERATIONS 1000 FT & BELOW IN UPPER & LOWER NEW YORK BAYS INCLUDING ROCKAWAY INLET INDEFINITELY..

SPECIAL AIR TRAFFIC RULES-PART 93 HIGH DENSITY AIRPORT. PRIOR RESERVATION REQUIRED. SEE AERONAUTICAL INFORMATION MANUAL.

GA TRAFFIC CONTACT AIRPORT OPERATIONS ON UNICOM FOR PARKING DIRECTIONS

ASDE-X SURVEILLANCE SYSTEM IN USE: PILOTS SHOULD OPERATE TRANSPONDERS WITH MODE C ON ALL TAXIWAYS AND RUNWAYS.

TAXIWAY Q AT HANGAR 19 TOW IN/OUT ONLY.

RUNWAY 13R HAS TWO (2) PAPI - P4L SYSTEMS.

**Niagara Falls, New York
Niagara Falls International
ICAO Identifier KIAG**

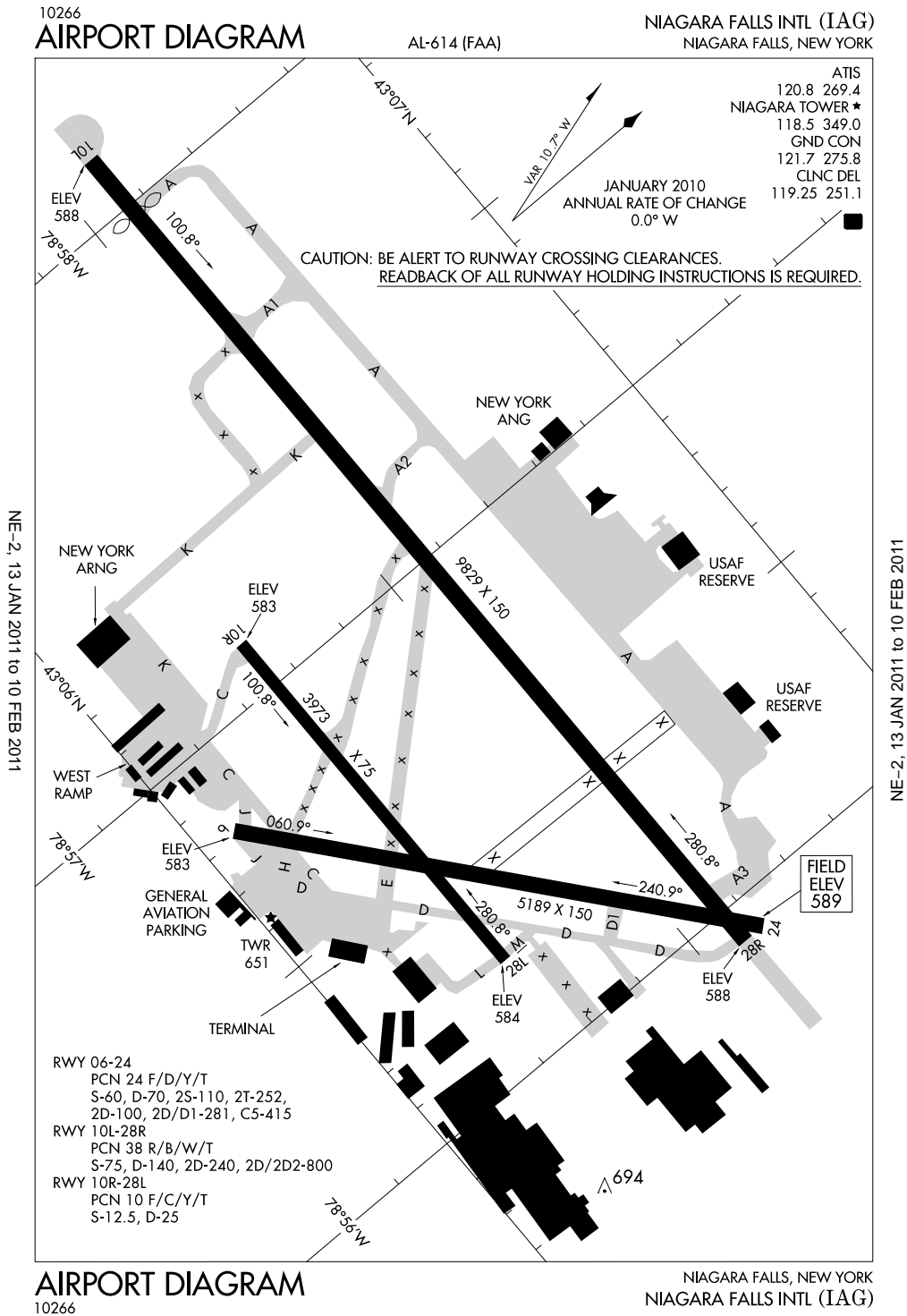

Niagara Falls, NY
Niagara Falls Intl
ICAO Identifier KIAG

AD 2.2 Aerodrome geographical and administrative data

- 2.2.1 Reference Point: 43-06-26.40N / 78-56-46.30W
- 2.2.2 From City: 4 Miles E Of Niagara Falls, NY
- 2.2.3 Elevation: 589 ft
- 2.2.5 Magnetic variation: 10W (1985)
- 2.2.6 Airport Contact: Mr. Pascal Cohen
2035 NIAGARA FALL BLVD
Niagara Falls, NY 14304
(716-855-6450)
- 2.2.7 Traffic: IFR/VFR

AD 2.3 Operational hours

- 2.3.1 - 2.3.11: ALL Months, ALL Days, ALL Hours

AD 2.4 Handling services and facilities

- 2.4.1 Cargo handling facilities: No
- 2.4.2 Fuel types: 100LL,A
- 2.4.4 De-icing facilities: None
- 2.4.5 Hangar space: No
- 2.4.6 Repair facilities: Minor

AD 2.6 Rescue and firefighting services

- 2.6.1 Aerodrome category for firefighting: ARFF Index I B certified on 7/1/1974
- 2.6.4 Remarks: ARFF Index E Equipment Coverage Provided.

AD 2.10 Aerodrome obstacles

- 2.10.1.a. Runway designation: 06
- 2.10.1.b Type of obstacle: Tree (46 ft). Not Lighted or Marked
- 2.10.1.c Location of obstacle: 290 ft from Centerline

- 2.10.1.a. Runway designation: 24
- 2.10.1.b Type of obstacle: Tree (59 ft). Not Lighted or Marked
- 2.10.1.c Location of obstacle: 320 ft from Centerline

- 2.10.1.a. Runway designation: 10L
- 2.10.1.b Type of obstacle: Tree (52 ft). Not Lighted or Marked
- 2.10.1.c Location of obstacle: 480 ft from

Centerline

- 2.10.1.a. Runway designation: 28R
- 2.10.1.b Type of obstacle: Tree (37 ft). Not Lighted or Marked
- 2.10.1.c Location of obstacle: 400 ft from Centerline

- 2.10.1.a. Runway designation: 10R
- 2.10.1.b Type of obstacle: Tree (64 ft). Not Lighted or Marked
- 2.10.1.c Location of obstacle: 60 ft from Centerline

- 2.10.1.a. Runway designation: 28L
- 2.10.1.b Type of obstacle: Stack (59 ft). Lighted
- 2.10.1.c Location of obstacle: 120 ft from Centerline

AD 2.12 Runway physical characteristics

- 2.12.1 Designation: 06
- 2.12.2 True Bearing: 50
- 2.12.3 Dimensions: 5189 ft x 150 ft
- 2.12.4 PCN: 24 F/D/Y/T
- 2.12.5 Coordinates: 43-06-00.00N / 78-56-48.96W
- 2.12.6 Threshold elevation: 582 ft
- 2.12.6 Touchdown zone elevation: 584 ft

- 2.12.1 Designation: 24
- 2.12.2 True Bearing: 230
- 2.12.3 Dimensions: 5189 ft x 150 ft
- 2.12.4 PCN: 24 F/D/Y/T
- 2.12.5 Coordinates: 43-06-36.35N / 78-55-55.26W
- 2.12.6 Threshold elevation: 589 ft
- 2.12.6 Touchdown zone elevation: 589 ft

- 2.12.1 Designation: 10L
- 2.12.2 True Bearing: 90
- 2.12.3 Dimensions: 9829 ft x 150 ft
- 2.12.4 PCN: 38 R/B/W/T
- 2.12.5 Coordinates: 43-06-34.35N / 78-58-00.00W
- 2.12.6 Threshold elevation: 588 ft
- 2.12.6 Touchdown zone elevation: 589 ft

- 2.12.1 Designation: 28R
- 2.12.2 True Bearing: 270
- 2.12.3 Dimensions: 9829 ft x 150 ft
- 2.12.4 PCN: 38 R/B/W/T
- 2.12.5 Coordinates: 43-06-34.16N /

78-55-55.28W
2.12.6 Threshold elevation: 588 ft
2.12.6 Touchdown zone elevation: 588 ft

2.12.1 Designation: 10R
2.12.2 True Bearing: 90
2.12.3 Dimensions: 3973 ft x 75 ft
2.12.4 PCN: 10 F/C/Y/T
2.12.5 Coordinates: 43-06-15.60N /
78-57-00.00W
2.12.6 Threshold elevation: 583 ft
2.12.6 Touchdown zone elevation: 584 ft

2.12.1 Designation: 28L
2.12.2 True Bearing: 270
2.12.3 Dimensions: 3973 ft x 75 ft
2.12.4 PCN: 10 F/C/Y/T
2.12.5 Coordinates: 43-06-15.51N /
78-56-13.46W
2.12.6 Threshold elevation: 584 ft
2.12.6 Touchdown zone elevation: 585 ft

AD 2.13 Declared distances

2.13.1 Designation: 06
2.13.2 Takeoff run available: 5189
2.13.3 Takeoff distance available: 5189
2.13.4 Accelerate-stop distance available: 5189
2.13.5 Landing distance available: 5189

2.13.1 Designation: 24
2.13.2 Takeoff run available: 5189
2.13.3 Takeoff distance available: 5189
2.13.4 Accelerate-stop distance available: 5189
2.13.5 Landing distance available: 5189

2.13.1 Designation: 10L
2.13.2 Takeoff run available: 9829
2.13.3 Takeoff distance available: 10829
2.13.4 Accelerate-stop distance available: 9829
2.13.5 Landing distance available: 9129

2.13.1 Designation: 28R
2.13.2 Takeoff run available: 9829
2.13.3 Takeoff distance available: 10529
2.13.4 Accelerate-stop distance available: 9129
2.13.5 Landing distance available: 9129

2.13.1 Designation: 10R
2.13.2 Takeoff run available: 3973
2.13.3 Takeoff distance available: 3973
2.13.4 Accelerate-stop distance available: 3973

2.13.5 Landing distance available: 3973

2.13.1 Designation: 28L
2.13.2 Takeoff run available: 3973
2.13.3 Takeoff distance available: 3973
2.13.4 Accelerate-stop distance available: 3973
2.13.5 Landing distance available: 3973

AD 2.14 Approach and runway lighting

2.14.1 Designation: 06
2.14.4 Visual approach slope indicator system:
4-light PAPI on left

2.14.1 Designation: 24
2.14.4 Visual approach slope indicator system:
4-light PAPI on left

2.14.1 Designation: 10L
2.14.4 Visual approach slope indicator system:
4-box VASI on left

2.14.1 Designation: 28R
2.14.2 Approach lighting system: MALSR: 1400
feet medium intensity approach lighting system
with runway alignment indicator lights

2.14.1 Designation: 10R
2.14.4 Visual approach slope indicator system:
2-light PAPI on left

2.14.1 Designation: 28L
2.14.4 Visual approach slope indicator system:
2-light PAPI on left

AD 2.18 Air traffic services communication facilities

2.18.1 Service designation: LCL/P
2.18.3 Service designation: 118.5 MHz

2.18.1 Service designation: CD/P
2.18.3 Service designation: 119.25 MHz

2.18.1 Service designation: ATIS
2.18.3 Service designation: 120.8 MHz
2.18.4 Hours of operation: 24

2.18.1 Service designation: EMERG
2.18.3 Service designation: 121.5 MHz

2.18.1 Service designation: GND/P
2.18.3 Service designation: 121.7 MHz

2.18.1 Service designation: EMERG
2.18.3 Service designation: 243 MHz

2.18.1 Service designation: CD/P
2.18.3 Service designation: 251.1 MHz

2.18.1 Service designation: ATIS
2.18.3 Service designation: 269.4 MHz
2.18.4 Hours of operation: 24

2.18.1 Service designation: GND/P
2.18.3 Service designation: 275.8 MHz

2.18.1 Service designation: LCL/P
2.18.3 Service designation: 349 MHz

2.18.1 Service designation: NG-OPNS
2.18.3 Service designation: 41 MHz

2.18.1 Service designation: AFR-OPS
2.18.3 Service designation: 340.24 MHz

2.18.1 Service designation: 914 AG COMD POST
2.18.3 Service designation: 340.025 MHz

2.19.2 ILS identification: IAG
2.19.5 Coordinates: 43-06-34.36N /
78-58-18.82W
2.19.6 Site elevation: 586 ft

2.19.1 ILS type: Outer Marker for runway 28R.
Magnetic variation: 10W
2.19.2 ILS identification: IAG
2.19.5 Coordinates: 43-06-32.53N /
78-50-18.16W
2.19.6 Site elevation: 99999 ft

2.19.1 ILS type: Glide Slope for runway 28R.
Magnetic variation: 10W
2.19.2 ILS identification: IAG
2.19.5 Coordinates: 43-06-30.09N /
78-56-16.64W
2.19.6 Site elevation: 583 ft

2.19.1 ILS type: Middle Marker for runway 28R.
Magnetic variation: 10W
2.19.2 ILS identification: IAG
2.19.5 Coordinates: 43-06-33.97N /
78-55-00.00W
2.19.6 Site elevation: 587 ft

AD 2.19 Radio navigation and landing aids

2.19.1 ILS type: Localizer for runway 28R.
Magnetic variation: 10W

General Remarks:

EXTENSIVE AIRCRAFT ACTIVITY OPERATING IN THE VICINITY OF US/CANADIAN FALLS ALL ALTITUDES.

HEAVY CONCENTRATIONS OF GULLS-BLACKBIRDS-STARLINGS UP TO 5000 AGL ON & IN THE VICINITY OF AIRPORT.

AIRCRAFT WITH SEATING CAPACITY IN EXCESS OF 30 PASSENGERS AUTH ONLY USE OF RUNWAY 10L/28R.

TAXIWAY E RESTRICTED TO 12500 LBS OR LESS.

TAXIWAY "E" CLOSED PERMANENTLY BETWEEN TAXIWAYS "C" AND "D".

TAXIWAY "E" CLOSED INDEFINITELY FROM RUNWAY 10L/28R TO RUNWAY 06/24.

ALL MILITARY AIRCRAFT ONLY OPERATIONS RESTRICTED DURING BIRD WATCH CONDITIONS. MODERATE - TAKE-OFF & LANDING PERMISSION ONLY WHEN DEP/ARR ROUTE AVOIDS IDENTIFIED BIRD ACTIVITY; NO LOCAL IFR/VFR TRAFFIC PATTERN ACTIVITY. SEVERE - TAKE-OFF & LANDING PROHIBITED WO OG/CC APPROVAL; CONTACT COMMAND POST FOR CURRENT BIRD WATCH CONDITIONS.

ALL MILITARY AIRCRAFT ONLY MINIMAL CLASSIFIED MATERIALS AVAILABLE; AIRCREWS SHOULD ARRIVE WITH APPROPRIATE AMOUNT TO COMPLETE THEIR MISSION.

BEARING STRENGTH RUNWAY 06/24: ST110 TT145 SBTT281 TDT415 TRT252.

JASU: 2(A/M32A-86) 1(AM32A-60) 1(MA-1A).

FUEL: J8(MIL) A, A+.

FLUID: SP LOX.

OIL: O-148(MIL).

REMARKS: SEE FLIGHT INFORMATION PUBLICATION AP/1 SUPPLEMENTARY AIRPORT REMARK.

MISC: LOCAL MISSION AIRCRAFT HAVE PRIORITY FOR DEICING; FULL AIRCRAFT DEICING FOR C-17 AND C-5 AIRCRAFT NOT AVAILABLE.

REMARKS-CAUTION: NIGHT VISION DEVICE OPERATIONS PERIODICALLY CONDUCTED IN THE AIRPORT TRAFFIC AREA.

CUSTOMS/AGRICULTURE/IMIGRATION -: AVAILABLE FOR ALL MILITARY WITH 72 HR PRIOR NOTICE. CREW, PASSENGER, CARGO ORGIN, DESTINATION AND PRE-CLEARED INFORMATION REQUIRE 1 HR PRIOR LANDING. CONTACT 914TH OSF, SSI/OSA DSN 238-2176, C717-236-2176,FAX DSN 238-2380, C716-236-2380 FOR RESTRICTED INFORMATION AND REQUIRE PRIOR PERMISSION REQUIRED.

REMARKS - MISC: FOR CURRENT MILITARY RUNWAY CONDITION READING (RCR) CALL OR CONTACT 914 AW COMMAND POST, 914 AW BASE OPERATIONS, OR 107 ANG COMMAND POST.

Syracuse, New York
Syracuse Hancock International
ICAO Identifier KSYR

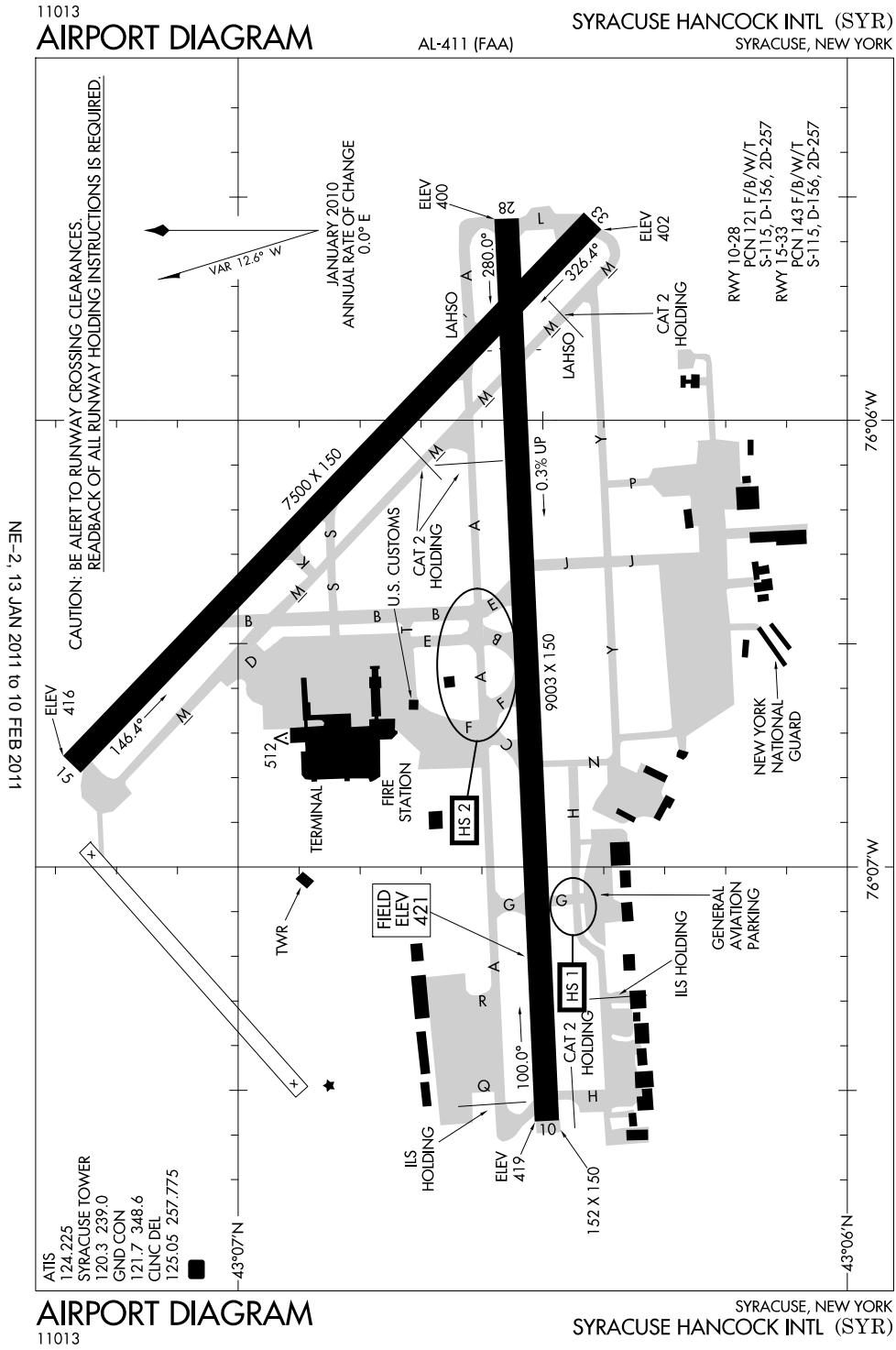

Syracuse, NY
Syracuse Hancock Intl
ICAO Identifier KSYR

AD 2.2 Aerodrome geographical and administrative data

- 2.2.1 Reference Point: 43-06-40.27N / 76-06-22.72W
- 2.2.2 From City: 4 Miles NE Of Syracuse, NY
- 2.2.3 Elevation: 421 ft
- 2.2.5 Magnetic variation: 13W (2000)
- 2.2.6 Airport Contact: Rory McMahon
1000 COL EILEEN COLLINS BLVD
Syracuse, NY 13212 (315-454-3263)
- 2.2.7 Traffic: IFR/VFR

AD 2.3 Operational hours

- 2.3.1 - 2.3.11: ALL Months, ALL Days, ALL Hours

AD 2.4 Handling services and facilities

- 2.4.1 Cargo handling facilities: No
- 2.4.2 Fuel types: 100LL,A
- 2.4.4 De-icing facilities: None
- 2.4.5 Hangar space: Yes
- 2.4.6 Repair facilities: Major

AD 2.6 Rescue and firefighting services

- 2.6.1 Aerodrome category for firefighting: ARFF Index I C certified on 5/1/1973

AD 2.10 Aerodrome obstacles

- 2.10.1.a. Runway designation: 15
- 2.10.1.b Type of obstacle: Trees (51 ft). Not Lighted or Marked
- 2.10.1.c Location of obstacle: 380 ft from Centerline

- 2.10.1.a. Runway designation: 33
- 2.10.1.b Type of obstacle: Tree (34 ft). Not Lighted or Marked
- 2.10.1.c Location of obstacle: 520 ft from Centerline

- 2.10.1.a. Runway designation: 28
- 2.10.1.b Type of obstacle: Trees (80 ft). Not Lighted or Marked
- 2.10.1.c Location of obstacle: 287 ft from Centerline

- 2.10.1.a. Runway designation: 10

- 2.10.1.b Type of obstacle: Trees (64 ft). Not Lighted or Marked
- 2.10.1.c Location of obstacle: 686 ft from Centerline

AD 2.12 Runway physical characteristics

- 2.12.1 Designation: 15
- 2.12.2 True Bearing: 134
- 2.12.3 Dimensions: 7500 ft x 150 ft
- 2.12.4 PCN: 143 F/B/W/T
- 2.12.5 Coordinates: 43-07-16.43N / 76-06-46.21W
- 2.12.6 Threshold elevation: 416 ft
- 2.12.6 Touchdown zone elevation: 417 ft

- 2.12.1 Designation: 33
- 2.12.2 True Bearing: 314
- 2.12.3 Dimensions: 7500 ft x 150 ft
- 2.12.4 PCN: 143 F/B/W/T
- 2.12.5 Coordinates: 43-06-25.13N / 76-05-33.28W
- 2.12.6 Threshold elevation: 402 ft
- 2.12.6 Touchdown zone elevation: 409 ft

- 2.12.1 Designation: 10
- 2.12.2 True Bearing: 87
- 2.12.3 Dimensions: 9003 ft x 150 ft
- 2.12.4 PCN: 121 F/B/W/T
- 2.12.5 Coordinates: 43-06-29.52N / 76-07-34.15W
- 2.12.6 Threshold elevation: 419 ft
- 2.12.6 Touchdown zone elevation: 421 ft

- 2.12.1 Designation: 28
- 2.12.2 True Bearing: 267
- 2.12.3 Dimensions: 9003 ft x 150 ft
- 2.12.4 PCN: 121 F/B/W/T
- 2.12.5 Coordinates: 43-06-33.51N / 76-05-32.91W
- 2.12.6 Threshold elevation: 400 ft
- 2.12.6 Touchdown zone elevation: 413 ft
- 2.12.7 Slope: 0.3UP

- AD 2.13 Declared distances**
- 2.13.1 Designation: 15
- 2.13.2 Takeoff run available: 7500
- 2.13.3 Takeoff distance available: 7500
- 2.13.4 Accelerate-stop distance available: 7500
- 2.13.5 Landing distance available: 7500

- 2.13.1 Designation: 33

2.13.2 Takeoff run available: 7500
2.13.3 Takeoff distance available: 7500
2.13.4 Accelerate-stop distance available: 7500
2.13.5 Landing distance available: 7500

2.13.1 Designation: 10
2.13.2 Takeoff run available: 9003
2.13.3 Takeoff distance available: 9003
2.13.4 Accelerate-stop distance available: 9003
2.13.5 Landing distance available: 9003

2.13.1 Designation: 28
2.13.2 Takeoff run available: 9003
2.13.3 Takeoff distance available: 9003
2.13.4 Accelerate-stop distance available: 9003
2.13.5 Landing distance available: 9003

AD 2.14 Approach and runway lighting

2.14.1 Designation: 15
2.14.2 Approach lighting system: MALS: 1400 feet medium intensity approach lighting system
2.14.4 Visual approach slope indicator system: 4-box VASI on left

2.14.1 Designation: 33
2.14.4 Visual approach slope indicator system: 4-light PAPI on left

2.14.1 Designation: 10
2.14.2 Approach lighting system: MALSR: 1400 feet medium intensity approach lighting system with runway alignment indicator lights
2.14.4 Visual approach slope indicator system: 4-box VASI on left

2.14.1 Designation: 28
2.14.2 Approach lighting system: ALSF2: Standard 2400 feet high intensity approach lighting system with sequenced flashers, category II or III configuration

AD 2.18 Air traffic services communication facilities

2.18.1 Service designation: AS ASGND
2.18.3 Service designation: 118.85 MHz

2.18.1 Service designation: LCL/P
2.18.3 Service designation: 120.3 MHz

2.18.1 Service designation: EMERG
2.18.3 Service designation: 121.5 MHz

2.18.1 Service designation: GND/P
2.18.3 Service designation: 121.7 MHz

2.18.1 Service designation: CD/P
2.18.3 Service designation: 125.05 MHz

2.18.1 Service designation: APCH/P DEP/P CLASS C
2.18.3 Service designation: 126.125 MHz

2.18.1 Service designation: APCH/P DEP/P CLASS C IC
2.18.3 Service designation: 134.275 MHz

2.18.1 Service designation: LCL/P
2.18.3 Service designation: 239 MHz

2.18.1 Service designation: EMERG
2.18.3 Service designation: 243 MHz

2.18.1 Service designation: AR OPS
2.18.3 Service designation: 245.3 MHz

2.18.1 Service designation: APCH/P DEP/P CLASS C IC
2.18.3 Service designation: 279.6 MHz

2.18.1 Service designation: IC
2.18.3 Service designation: 279.6 MHz

2.18.1 Service designation: GND/P
2.18.3 Service designation: 348.6 MHz

2.18.1 Service designation: ANG OPS
2.18.3 Service designation: 379.5 MHz

2.18.1 Service designation: CD/P
2.18.3 Service designation: 257.775 MHz

2.18.1 Service designation: APCH/P DEP/P CLASS C
2.18.3 Service designation: 269.125 MHz

2.18.1 Service designation: ATIS
2.18.3 Service designation: 124.225 MHz
2.18.4 Hours of operation: 24

AD 2.19 Radio navigation and landing aids

2.19.1 ILS type: Localizer for runway 28. Magnetic variation: 13W
2.19.2 ILS identification: SYR

2.19.5 Coordinates: 43-06-28.94N /
76-07-51.66W
2.19.6 Site elevation: 417 ft

2.19.1 ILS type: DME for runway 28. Magnetic
variation: 13W

2.19.2 ILS identification: SYR
2.19.5 Coordinates: 43-06-31.84N /
76-05-20.74W
2.19.6 Site elevation: 406 ft

2.19.1 ILS type: Glide Slope for runway 28.

Magnetic variation: 13W
2.19.2 ILS identification: SYR
2.19.5 Coordinates: 43-06-39.47N /
76-05-46.43W
2.19.6 Site elevation: 404 ft

2.19.1 ILS type: Outer Marker for runway 28.

Magnetic variation: 13W
2.19.2 ILS identification: SYR
2.19.5 Coordinates: 43-06-43.94N /
76-00-00.00W
2.19.6 Site elevation: 403 ft

2.19.1 ILS type: Inner Marker for runway 28.

Magnetic variation: 13W
2.19.2 ILS identification: SYR
2.19.5 Coordinates: 43-06-34.10N /
76-05-18.52W
2.19.6 Site elevation: 395 ft

2.19.1 ILS type: Middle Marker for runway 28.

Magnetic variation: 13W

General Remarks:

NO CHARTER OPER THRU PASSENGER TERMINAL BUILDING WITHOUT PRIOR PERMISSION.

NOISE ABATEMENT PROCEDURES IN EFFECT.

DEER/COYOTE/BIRDS ON IN THE VICINITY OF AIRPORT.

NO JET ENGINE MAINT RUNS ABOVE IDLE BETWEEN 2300-0600.

NO TRANSIENT AIRCRAFT PARKING ON MAIN TERMINAL RAMP.

DIRECT CUSTOM NOTIFICATION IS REQUIRED. HOURS OF NOTIFICATION ARE MON-SAT
0800-1700. ARRIVALS OUTSIDE OF THESE HRS MUST MAKE ARRANGEMENTS DURING
REGULAR WORK HRS; CALL 315-455-2271.

AIRPORT SURFACE DETECTION EQUIPMENT (ASDE) BEING TESTED AT SYRACUSE AIRPORT;

ALL AIRCRAFT REQUESTED TO OPR TRANSPONDERS WHILE ON AIRPORT SURFACE.

FIELD CONDITION REPORTS RECORDING AVAILABLE CALL 315-455-3444.

HEAVY AIRCRAFT CONTACT AIRPORT COMMISSIONER FOR PARK AVAILABLE AT C315-455-3263. MILITARY PARK RAMP UNLIGHTED. LIMITED METRO AVAIL AT DSN 243-2185. C315-233-2185 OR CONTACT OWS DSN 576-9755/9702. ALL TRANSIENT AIRCRAFT REQ NOISE ABATEMENT BRIEFING.

RESTRICTED - TAXI U NOT USED. USE TAXI J TO ENTER ANG RAMP.

COMMUNICATIONS - ANG - OPERATIONS - 139.625 379.5 REMARKS: (COBRA OPS) CONTACT ANG OPERATIONS 15 MIN PRIOR TO ARR.

RESTRICTED: TAXIWAY J AND P SOUTH OF TAXIWAY Y CLOSED TO CIVIL OPERATIONS.

CAUTION: TAXIWAY J AND P SOUTH OF TAXIWAY Y AND ANG RAMP HAVE UNCTL VEH AND EQUIPMENT TRAFFIC.

ANG: OPR 1100-2000Z++ WEEKEND EXCEPT HOLIDAY. PRIOR PERMISSION REQUIRED TRANSMIT AIRCRAFT OFFICIAL BUSINESS ONLY. AIRFIELD MANAGER DSN 243-2208, AFTER DUTY HR CONTACT C315-530-2520. PRIOR PERMISSION REQUIRED FOR ALL TRANSIENT AIRCRAFT DUE LIMITED TRANSMIT SERVICE. NOTIFY AIRFIELD MANAGER OF ESTIMATED TIME OF ARRIVAL DELAY OVER 30 MIN OR MSN CANCEL IS REQUIRE.

ANG: HEAVY AIRCRAFT CONTACT AIRPORT COMMISSIONER FOR PARK AVAILABLE AT C315-455-3666. MILITARY PARK RAMP UNLIGHTED. ALL TRANSIENT AIRCRAFT REQUIRE NS ABATEMENT BRIEFING.

Charlotte, North Carolina Charlotte/Douglas International ICAO Identifier KCLT

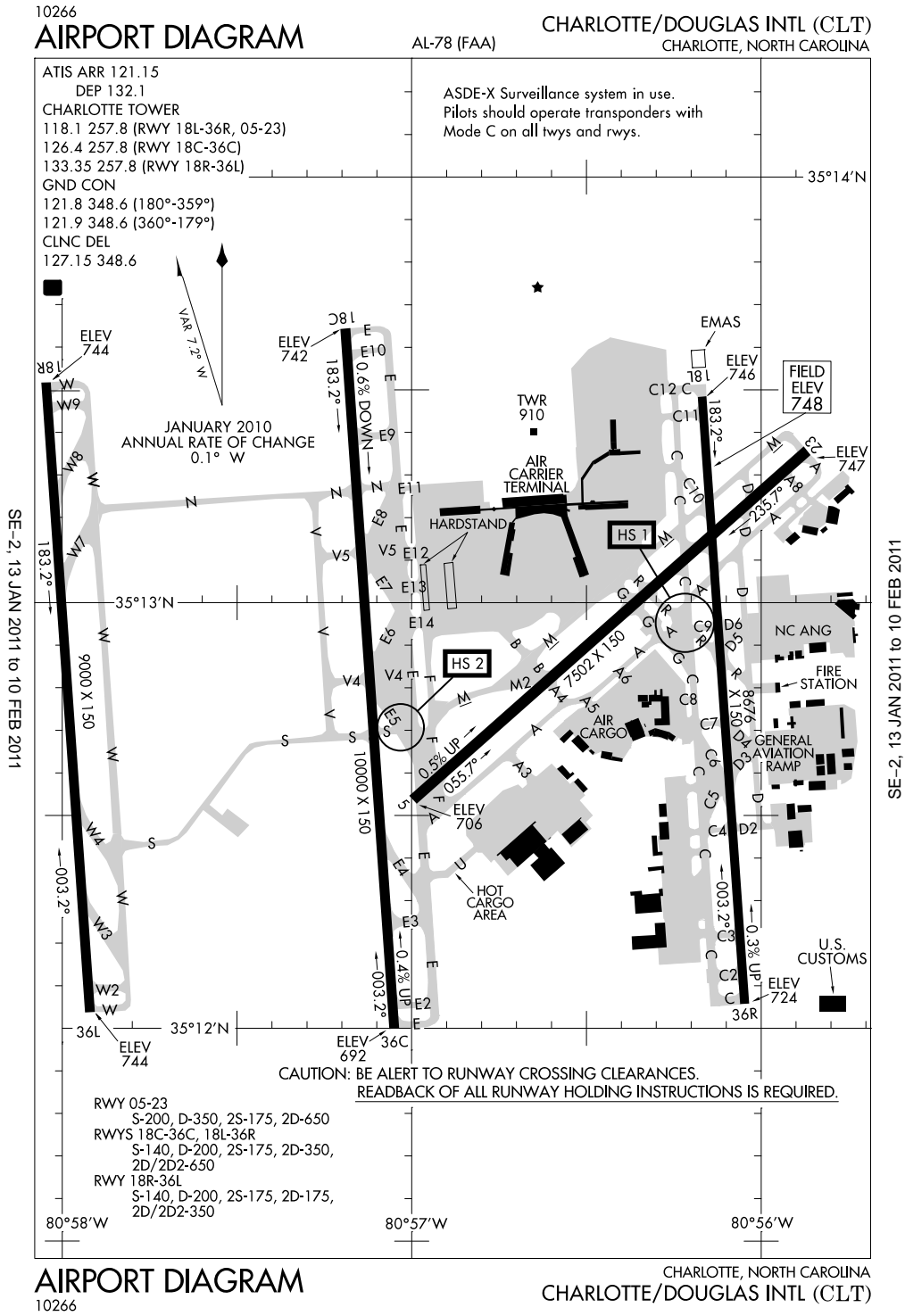

Charlotte, NC
Charlotte/Douglas Intl
ICAO Identifier KCLT

AD 2.2 Aerodrome geographical and administrative data

- 2.2.1 Reference Point: 35-12-49.47N / 80-56-56.65W
- 2.2.2 From City: 4 Miles W Of Charlotte, NC
- 2.2.3 Elevation: 748 ft
- 2.2.5 Magnetic variation: 7W (2000)
- 2.2.6 Airport Contact: Jerry Orr
PO BOX 19066
Charlotte, NC 28219
(704-359-4000)
- 2.2.7 Traffic: IFR/VFR

AD 2.3 Operational hours

- 2.3.1 - 2.3.11: ALL Months, ALL Days, ALL Hours

AD 2.4 Handling services and facilities

- 2.4.1 Cargo handling facilities: No
- 2.4.2 Fuel types: 100LL,A
- 2.4.4 De-icing facilities: None
- 2.4.5 Hangar space: No
- 2.4.6 Repair facilities: Major

AD 2.6 Rescue and firefighting services

- 2.6.1 Aerodrome category for firefighting: ARFF Index I D certified on 5/1/1973

AD 2.10 Aerodrome obstacles

- 2.10.1.a. Runway designation: 18L
- 2.10.1.b Type of obstacle: Rr (19 ft). Not Lighted or Marked
- 2.10.1.c Location of obstacle: 0 ft from Centerline

- 2.10.1.a. Runway designation: 18C
- 2.10.1.b Type of obstacle: Road (25 ft). Not Lighted or Marked
- 2.10.1.c Location of obstacle: 425 ft from Centerline

- 2.10.1.a. Runway designation: 05
- 2.10.1.b Type of obstacle: Trees (38 ft). Not Lighted or Marked
- 2.10.1.c Location of obstacle: 300 ft from Centerline

AD 2.12 Runway physical characteristics

- 2.12.1 Designation: 18L
- 2.12.2 True Bearing: 176
- 2.12.3 Dimensions: 8676 ft x 150 ft
- 2.12.5 Coordinates: 35-13-29.04N / 80-56-10.17W
- 2.12.6 Threshold elevation: 746 ft
- 2.12.6 Touchdown zone elevation: 748 ft
- 2.12.7 Slope: 0.2DOWN

- 2.12.1 Designation: 36R
- 2.12.2 True Bearing: 356
- 2.12.3 Dimensions: 8676 ft x 150 ft
- 2.12.5 Coordinates: 35-12-00.00N / 80-56-00.00W
- 2.12.6 Threshold elevation: 724 ft
- 2.12.6 Touchdown zone elevation: 727 ft
- 2.12.7 Slope: 0.3UP

- 2.12.1 Designation: 18C
- 2.12.2 True Bearing: 176
- 2.12.3 Dimensions: 10000 ft x 150 ft
- 2.12.5 Coordinates: 35-13-38.63N / 80-57-11.41W
- 2.12.6 Threshold elevation: 742 ft
- 2.12.6 Touchdown zone elevation: 742 ft
- 2.12.7 Slope: 0.6DOWN

- 2.12.1 Designation: 36C
- 2.12.2 True Bearing: 356
- 2.12.3 Dimensions: 10000 ft x 150 ft
- 2.12.5 Coordinates: 35-11-59.97N / 80-57-00.00W
- 2.12.6 Threshold elevation: 692 ft
- 2.12.6 Touchdown zone elevation: 707 ft
- 2.12.7 Slope: 0.4UP

- 2.12.1 Designation: 05
- 2.12.2 True Bearing: 48
- 2.12.3 Dimensions: 7502 ft x 150 ft
- 2.12.5 Coordinates: 35-12-32.23N / 80-56-59.81W
- 2.12.6 Threshold elevation: 706 ft
- 2.12.6 Touchdown zone elevation: 716 ft
- 2.12.7 Slope: 0.5DOWN

- 2.12.1 Designation: 23
- 2.12.2 True Bearing: 228
- 2.12.3 Dimensions: 7502 ft x 150 ft
- 2.12.5 Coordinates: 35-13-21.42N / 80-55-52.12W

2.12.6 Threshold elevation: 747 ft
2.12.6 Touchdown zone elevation: 747 ft
2.12.7 Slope: 0.5UP

2.12.1 Designation: 18R
2.12.2 True Bearing: 176
2.12.3 Dimensions: 9000 ft x 150 ft
2.12.5 Coordinates: 35-13-31.02N /
80-58-00.00W
2.12.6 Threshold elevation: 744 ft
2.12.6 Touchdown zone elevation: 744 ft

2.12.1 Designation: 36L
2.12.2 True Bearing: 356
2.12.3 Dimensions: 9000 ft x 150 ft
2.12.5 Coordinates: 35-12-00.00N /
80-57-55.07W
2.12.6 Threshold elevation: 744 ft
2.12.6 Touchdown zone elevation: 744 ft

AD 2.13 Declared distances

2.13.1 Designation: 18L
2.13.2 Takeoff run available: 8676
2.13.3 Takeoff distance available: 8676
2.13.4 Accelerate-stop distance available: 8676
2.13.5 Landing distance available: 8676

2.13.1 Designation: 36R
2.13.2 Takeoff run available: 8676
2.13.3 Takeoff distance available: 8676
2.13.4 Accelerate-stop distance available: 8676
2.13.5 Landing distance available: 8676

2.13.1 Designation: 18C
2.13.2 Takeoff run available: 10000
2.13.3 Takeoff distance available: 10000
2.13.4 Accelerate-stop distance available: 10000
2.13.5 Landing distance available: 10000

2.13.1 Designation: 36C
2.13.2 Takeoff run available: 10000
2.13.3 Takeoff distance available: 10000
2.13.4 Accelerate-stop distance available: 10000
2.13.5 Landing distance available: 10000

2.13.1 Designation: 05
2.13.2 Takeoff run available: 7502
2.13.3 Takeoff distance available: 7502
2.13.4 Accelerate-stop distance available: 7092
2.13.5 Landing distance available: 7092

2.13.1 Designation: 23
2.13.2 Takeoff run available: 7502
2.13.3 Takeoff distance available: 7502
2.13.4 Accelerate-stop distance available: 7502
2.13.5 Landing distance available: 7502

2.13.1 Designation: 18R
2.13.2 Takeoff run available: 9000
2.13.3 Takeoff distance available: 9000
2.13.4 Accelerate-stop distance available: 9000
2.13.5 Landing distance available: 9000

2.13.1 Designation: 36L
2.13.2 Takeoff run available: 9000
2.13.3 Takeoff distance available: 9000
2.13.4 Accelerate-stop distance available: 9000
2.13.5 Landing distance available: 9000

AD 2.14 Approach and runway lighting

2.14.1 Designation: 18L
2.14.4 Visual approach slope indicator system:
6-box VASI on right
2.14.10 Remarks: VASI Upwind Threshold
Crossing Height 90.9' GA 3.25 Deg; Dwnd
Threshold Crossing Height 52.4' GA 2.75 Deg.

2.14.1 Designation: 36R
2.14.2 Approach lighting system: ALSF2: Standard
2400 feet high intensity approach lighting system
with sequenced flashers, category II or III
configuration
2.14.4 Visual approach slope indicator system:
4-light PAPI on right

2.14.1 Designation: 18C
2.14.2 Approach lighting system: MALSR: 1400
feet medium intensity approach lighting system
with runway alignment indicator lights
2.14.4 Visual approach slope indicator system:
4-light PAPI on right

2.14.1 Designation: 36C
2.14.2 Approach lighting system: ALSF2: Standard
2400 feet high intensity approach lighting system
with sequenced flashers, category II or III
configuration
2.14.4 Visual approach slope indicator system:
4-light PAPI on left

2.14.1 Designation: 05
2.14.2 Approach lighting system: MALSR: 1400

feet medium intensity approach lighting system with runway alignment indicator lights
2.14.4 Visual approach slope indicator system: 4-light PAPI on left

2.14.1 Designation: 23
2.14.4 Visual approach slope indicator system: 4-box VASI on right
2.14.10 Remarks: VASI Upwind Threshold Crossing Height 93.7' GA 3.25 Deg; Downwind Threshold Crossing Height 55.8' GA 3.00 Deg.

2.14.1 Designation: 18R
2.14.2 Approach lighting system: ALSF2: Standard 2400 feet high intensity approach lighting system with sequenced flashers, category II or III configuration
2.14.4 Visual approach slope indicator system: 4-light PAPI on right

2.14.1 Designation: 36L
2.14.2 Approach lighting system: ALSF2: Standard 2400 feet high intensity approach lighting system with sequenced flashers, category II or III configuration
2.14.4 Visual approach slope indicator system: 4-light PAPI on left

AD 2.18 Air traffic services communication facilities

2.18.1 Service designation: LCL/P (RYS 18L/36R & 05/23)
2.18.3 Service designation: 118.1 MHz

2.18.1 Service designation: APCH/P DEP/P CLASS B IC
2.18.3 Service designation: 120.05 MHz

2.18.1 Service designation: APCH/P DEP/P CLASS B IC
2.18.3 Service designation: 120.5 MHz

2.18.1 Service designation: D-ATIS
2.18.3 Service designation: 121.15 MHz
2.18.4 Hours of operation: 24

2.18.1 Service designation: EMERG
2.18.3 Service designation: 121.5 MHz

2.18.1 Service designation: GND/P

2.18.3 Service designation: 121.8 MHz

2.18.1 Service designation: GND/P
2.18.3 Service designation: 121.9 MHz

2.18.1 Service designation: APCH/P DEP/P CLASS B IC
2.18.3 Service designation: 124 MHz

2.18.1 Service designation: LCL/P (RY 18C-36C)
2.18.3 Service designation: 126.4 MHz

2.18.1 Service designation: CD/P
2.18.3 Service designation: 127.15 MHz

2.18.1 Service designation: D-ATIS
2.18.3 Service designation: 132.1 MHz
2.18.4 Hours of operation: 24

2.18.1 Service designation: APCH/P DEP/P CLASS B IC
2.18.3 Service designation: 134.75 MHz

2.18.1 Service designation: EMERG
2.18.3 Service designation: 243 MHz

2.18.1 Service designation: APCH/P DEP/P CLASS B IC
2.18.3 Service designation: 257.2 MHz

2.18.1 Service designation: LCL/P
2.18.3 Service designation: 257.8 MHz

2.18.1 Service designation: ALCP
2.18.3 Service designation: 292.2 MHz

2.18.1 Service designation: GND/P CD/P
2.18.3 Service designation: 348.6 MHz

2.18.1 Service designation: APCH/P DEP/P CLASS B IC
2.18.3 Service designation: 128.32 MHz

2.18.1 Service designation: APCH/P DEP/P CLASS B IC
2.18.3 Service designation: 307.8 MHz

2.18.1 Service designation: LC/P
2.18.3 Service designation: 133.35 MHz

AD 2.19 Radio navigation and landing aids

2.19.1 ILS type: Localizer for runway 18L.

Magnetic variation: 7W

2.19.2 ILS identification: VKQ

2.19.5 Coordinates: 35-11-50.60N /
80-56-00.00W

2.19.6 Site elevation: 719 ft

2.19.1 ILS type: Glide Slope for runway 18L.

Magnetic variation: 7W

2.19.2 ILS identification: VKQ

2.19.5 Coordinates: 35-13-19.26N /
80-56-00.00W

2.19.6 Site elevation: 744 ft

2.19.1 ILS type: Outer Marker for runway 18L.

Magnetic variation: 7W

2.19.2 ILS identification: VKQ

2.19.5 Coordinates: 35-20-19.08N /
80-56-41.44W

2.19.6 Site elevation: 717 ft

2.19.1 ILS type: Middle Marker for runway 18L.

Magnetic variation: 7W

2.19.2 ILS identification: VKQ

2.19.5 Coordinates: 35-14-00.00N /
80-56-14.34W

2.19.6 Site elevation: 739 ft

2.19.1 ILS type: Localizer for runway 36R.

Magnetic variation: 7W

2.19.2 ILS identification: BQC

2.19.5 Coordinates: 35-13-33.71N /
80-56-10.57W

2.19.6 Site elevation: 741 ft

2.19.1 ILS type: Glide Slope for runway 36R.

Magnetic variation: 7W

2.19.2 ILS identification: BQC

2.19.5 Coordinates: 35-12-14.00N /
80-55-58.90W

2.19.6 Site elevation: 717 ft

2.19.1 ILS type: Inner Marker for runway 36R.

Magnetic variation: 7W

2.19.2 ILS identification: BQC

2.19.5 Coordinates: 35-11-54.22N /
80-56-00.00W

2.19.6 Site elevation: 710 ft

2.19.1 ILS type: Middle Marker for runway 36R.

Magnetic variation: 7W

2.19.2 ILS identification: BQC

2.19.5 Coordinates: 35-11-40.26N /
80-56-00.00W

2.19.6 Site elevation: 700 ft

2.19.1 ILS type: DME for runway 36R. Magnetic
variation: 7W

2.19.2 ILS identification: BQC

2.19.5 Coordinates: 35-13-33.74N /
80-56-13.65W

2.19.6 Site elevation: 744 ft

2.19.1 ILS type: Outer Marker for runway 36R.

Magnetic variation: 7W

2.19.2 ILS identification: BQC

2.19.5 Coordinates: 35-05-26.62N /
80-55-33.97W

2.19.6 Site elevation: 616 ft

2.19.1 ILS type: Middle Marker for runway 18C.

Magnetic variation: 7W

2.19.2 ILS identification: PEP

2.19.5 Coordinates: 35-14-00.00N /
80-57-13.65W

2.19.6 Site elevation: 703 ft

2.19.1 ILS type: Outer Marker for runway 18C.

Magnetic variation: 7W

2.19.2 ILS identification: PEP

2.19.5 Coordinates: 35-20-12.02N /
80-57-48.14W

2.19.6 Site elevation: 737 ft

2.19.1 ILS type: Localizer for runway 18C.

Magnetic variation: 7W

2.19.2 ILS identification: PEP

2.19.5 Coordinates: 35-11-50.60N /
80-57-00.00W

2.19.6 Site elevation: 687 ft

2.19.1 ILS type: Glide Slope for runway 18C.

Magnetic variation: 7W

2.19.2 ILS identification: PEP

2.19.5 Coordinates: 35-13-26.91N /
80-57-15.23W

2.19.6 Site elevation: 731 ft

2.19.1 ILS type: Outer Marker for runway 36C.

Magnetic variation: 7W

2.19.2 ILS identification: DQG

2.19.5 Coordinates: 35-05-43.52N /
80-56-26.77W

2.19.6 Site elevation: 593 ft

2.19.1 ILS type: Localizer for runway 36C.
Magnetic variation: 7W

2.19.2 ILS identification: DQG

2.19.5 Coordinates: 35-13-53.95N /
80-57-12.73W

2.19.6 Site elevation: 750 ft

2.19.1 ILS type: Inner Marker for runway 36C.
Magnetic variation: 7W

2.19.2 ILS identification: DQG

2.19.5 Coordinates: 35-11-48.73N /
80-57-00.00W

2.19.6 Site elevation: 680 ft

2.19.1 ILS type: Glide Slope for runway 36C.
Magnetic variation: 7W

2.19.2 ILS identification: DQG

2.19.5 Coordinates: 35-12-00.00N /
80-57-00.00W

2.19.6 Site elevation: 691 ft

2.19.1 ILS type: Middle Marker for runway 36C.
Magnetic variation: 7W

2.19.2 ILS identification: DQG

2.19.5 Coordinates: 35-11-34.90N /
80-57-00.00W

2.19.6 Site elevation: 679 ft

2.19.1 ILS type: Localizer for runway 05. Magnetic
variation: 7W

2.19.2 ILS identification: CLT

2.19.5 Coordinates: 35-13-24.50N /
80-55-47.88W

2.19.6 Site elevation: 738 ft

2.19.1 ILS type: Outer Marker for runway 05.
Magnetic variation: 7W

2.19.2 ILS identification: CLT

2.19.5 Coordinates: 35-09-29.30N /
81-01-14.12W

2.19.6 Site elevation: 691 ft

2.19.1 ILS type: Middle Marker for runway 05.
Magnetic variation: 7W

2.19.2 ILS identification: CLT

2.19.5 Coordinates: 35-12-10.91N /
80-57-29.16W

2.19.6 Site elevation: 732 ft

2.19.1 ILS type: Glide Slope for runway 05.
Magnetic variation: 7W

2.19.2 ILS identification: CLT

2.19.5 Coordinates: 35-12-43.05N /
80-56-52.18W

2.19.6 Site elevation: 695 ft

2.19.1 ILS type: DME for runway 23. Magnetic
variation: 7W

2.19.2 ILS identification: APU

2.19.5 Coordinates: 35-12-21.29N /
80-57-10.05W

2.19.6 Site elevation: 706 ft

2.19.1 ILS type: Localizer for runway 23. Magnetic
variation: 7W

2.19.2 ILS identification: APU

2.19.5 Coordinates: 35-12-24.08N /
80-57-11.02W

2.19.6 Site elevation: 704 ft

2.19.1 ILS type: Glide Slope for runway 23.
Magnetic variation: 7W

2.19.2 ILS identification: APU

2.19.5 Coordinates: 35-13-12.15N /
80-56-00.00W

2.19.6 Site elevation: 738 ft

2.19.1 ILS type: DME for runway 18R. Magnetic
variation: 7W

2.19.2 ILS identification: RGS

2.19.5 Coordinates: 35-12-13.28N /
80-58-00.00W

2.19.6 Site elevation: 732 ft

2.19.1 ILS type: Glide Slope for runway 18R.
Magnetic variation: 7W

2.19.2 ILS identification: RGS

2.19.5 Coordinates: 35-13-20.08N /
80-58-00.00W

2.19.6 Site elevation: 733 ft

2.19.1 ILS type: Localizer for runway 18R.
Magnetic variation: 7W

2.19.2 ILS identification: RGS

2.19.5 Coordinates: 35-11-51.86N /
80-57-54.19W

2.19.6 Site elevation: 738 ft

2.19.1 ILS type: Inner Marker for runway 18R.
Magnetic variation: 7W
2.19.2 ILS identification: RGS
2.19.5 Coordinates: 35-13-38.82N /
80-58-00.00W
2.19.6 Site elevation: 739 ft

80-58-00.00W
2.19.6 Site elevation: 732 ft

2.19.1 ILS type: DME for runway 36L. Magnetic
variation: 7W
2.19.2 ILS identification: XUU
2.19.5 Coordinates: 35-13-19.81N /
80-58-00.00W
2.19.6 Site elevation: 733 ft

2.19.1 ILS type: Localizer for runway 36L.
Magnetic variation: 7W
2.19.2 ILS identification: XUU
2.19.5 Coordinates: 35-13-41.39N /
80-58-00.00W
2.19.6 Site elevation: 738 ft

2.19.1 ILS type: Glide Slope for runway 36L.
Magnetic variation: 7W
2.19.2 ILS identification: XUU
2.19.5 Coordinates: 35-12-12.99N /

2.19.1 ILS type: Inner Marker for runway 36L.
Magnetic variation: 7W
2.19.2 ILS identification: XUU
2.19.5 Coordinates: 35-11-54.43N /
80-57-54.41W
2.19.6 Site elevation: 739 ft

General Remarks:

RUNWAY SURFACE CONDITION INFORMATION DURING DUTY HRS PHONE ANG OPERATIONS
V583-9177/9144 OR AIRBORNE 292.2.

NOISE ABATEMENT PROCEDURE IN EFFECT 2300-0700; LAND ON RUNWAY 05 TAKE-OFF
RUNWAY 23.

BE ALERT FOR FLOCKS OF MIGRATORY BIRDS ON & IN THE VICINITY OF AIRPORT.

TAXIWAY E13 CLOSED INDEFINITELY.

ASDE-X SURVEILLANCE SYSTEM IN USE: PILOTS SHOULD OPERATE TRANSPONDERS WITH
MODE C ON ALL TAXIWAYS AND RUNWAYS.

Raleigh-Durham, North Carolina
Raleigh-Durham International
ICAO Identifier KRDU

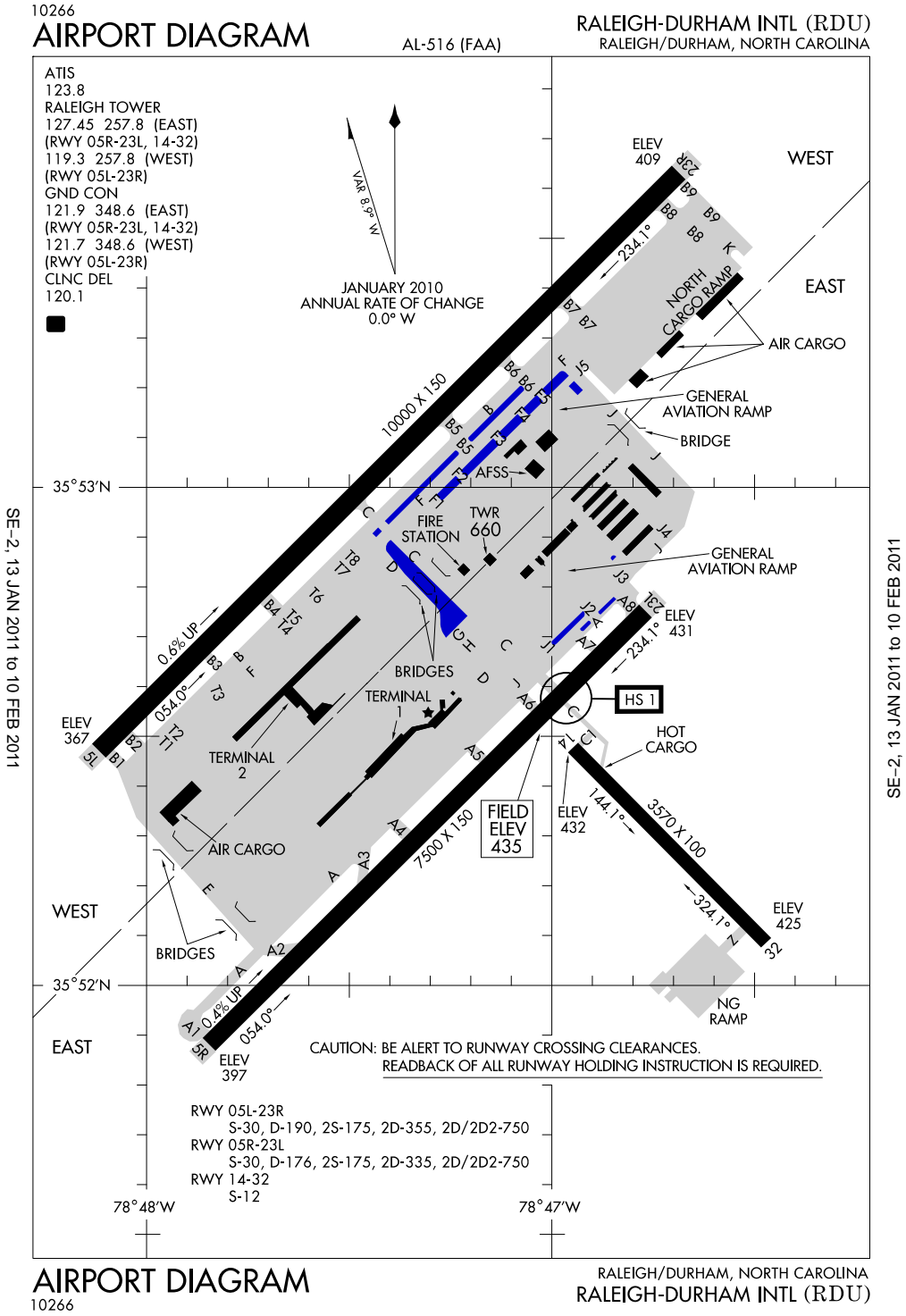

Raleigh/Durham, NC
Raleigh-Durham Intl
ICAO Identifier KRDU

AD 2.2 Aerodrome geographical and administrative data

- 2.2.1 Reference Point: 35-52-39.50N / 78-47-14.90W
- 2.2.2 From City: 9 Miles NW Of Raleigh/Durham, NC
- 2.2.3 Elevation: 435 ft
- 2.2.5 Magnetic variation: 7W (1985)
- 2.2.6 Airport Contact: John C. Brantley
P.O. BOX 80001
Rdu Airport, NC 27623
(919-840-7702)
- 2.2.7 Traffic: IFR/VFR

AD 2.3 Operational hours

- 2.3.1 - 2.3.11: ALL Months, ALL Days, ALL Hours

AD 2.4 Handling services and facilities

- 2.4.1 Cargo handling facilities: No
- 2.4.2 Fuel types: 100LL,A
- 2.4.4 De-icing facilities: None
- 2.4.5 Hangar space: Yes
- 2.4.6 Repair facilities: Major

AD 2.6 Rescue and firefighting services

- 2.6.1 Aerodrome category for firefighting: ARFF Index I D certified on 5/1/1973

AD 2.10 Aerodrome obstacles

- 2.10.1.a. Runway designation: 32
- 2.10.1.b Type of obstacle: Trees (120 ft). Not Lighted or Marked
- 2.10.1.c Location of obstacle: 1 ft from Centerline

AD 2.12 Runway physical characteristics

- 2.12.1 Designation: 05L
- 2.12.2 True Bearing: 45
- 2.12.3 Dimensions: 10000 ft x 150 ft
- 2.12.5 Coordinates: 35-52-28.02N / 78-48-00.00W
- 2.12.6 Threshold elevation: 367 ft
- 2.12.6 Touchdown zone elevation: 385 ft

- 2.12.1 Designation: 23R
- 2.12.2 True Bearing: 225
- 2.12.3 Dimensions: 10000 ft x 150 ft

- 2.12.5 Coordinates: 35-53-37.76N / 78-46-40.92W
- 2.12.6 Threshold elevation: 409 ft
- 2.12.6 Touchdown zone elevation: 409 ft

- 2.12.1 Designation: 05R
- 2.12.2 True Bearing: 45
- 2.12.3 Dimensions: 7500 ft x 150 ft
- 2.12.5 Coordinates: 35-51-52.67N / 78-47-50.42W
- 2.12.6 Threshold elevation: 397 ft
- 2.12.6 Touchdown zone elevation: 420 ft

- 2.12.1 Designation: 23L
- 2.12.2 True Bearing: 225
- 2.12.3 Dimensions: 7500 ft x 150 ft
- 2.12.5 Coordinates: 35-52-44.98N / 78-46-45.82W
- 2.12.6 Threshold elevation: 431 ft
- 2.12.6 Touchdown zone elevation: 435 ft

- 2.12.1 Designation: 14
- 2.12.2 True Bearing: 135
- 2.12.3 Dimensions: 3570 ft x 100 ft
- 2.12.5 Coordinates: 35-52-30.11N / 78-46-57.64W
- 2.12.6 Threshold elevation: 432 ft
- 2.12.6 Touchdown zone elevation: 432 ft

- 2.12.1 Designation: 32
- 2.12.2 True Bearing: 315
- 2.12.3 Dimensions: 3570 ft x 100 ft
- 2.12.5 Coordinates: 35-52-00.00N / 78-46-27.05W
- 2.12.6 Threshold elevation: 425 ft
- 2.12.6 Touchdown zone elevation: 429 ft

AD 2.13 Declared distances

- 2.13.1 Designation: 05L
- 2.13.2 Takeoff run available: 10000
- 2.13.3 Takeoff distance available: 10000
- 2.13.4 Accelerate-stop distance available: 10000
- 2.13.5 Landing distance available: 10000

- 2.13.1 Designation: 23R
- 2.13.2 Takeoff run available: 10000
- 2.13.3 Takeoff distance available: 10000
- 2.13.4 Accelerate-stop distance available: 10000
- 2.13.5 Landing distance available: 10000

- 2.13.1 Designation: 05R

2.13.2 Takeoff run available: 7500
2.13.3 Takeoff distance available: 7500
2.13.4 Accelerate-stop distance available: 7500
2.13.5 Landing distance available: 7500

2.13.1 Designation: 23L
2.13.2 Takeoff run available: 7500
2.13.3 Takeoff distance available: 7500
2.13.4 Accelerate-stop distance available: 7500
2.13.5 Landing distance available: 7500

AD 2.14 Approach and runway lighting

2.14.1 Designation: 05L
2.14.2 Approach lighting system: MALSR: 1400 feet medium intensity approach lighting system with runway alignment indicator lights
2.14.4 Visual approach slope indicator system: 4-light PAPI on left

2.14.1 Designation: 23R
2.14.2 Approach lighting system: ALSF2: Standard 2400 feet high intensity approach lighting system with sequenced flashers, category II or III configuration
2.14.4 Visual approach slope indicator system: 4-light PAPI on left

2.14.1 Designation: 05R
2.14.2 Approach lighting system: MALSR: 1400 feet medium intensity approach lighting system with runway alignment indicator lights
2.14.4 Visual approach slope indicator system: 4-light PAPI on left

2.14.1 Designation: 23L
2.14.2 Approach lighting system: MALSR: 1400 feet medium intensity approach lighting system with runway alignment indicator lights
2.14.4 Visual approach slope indicator system: 4-box VASI on left

2.14.1 Designation: 32
2.14.4 Visual approach slope indicator system: 4-box VASI on left

AD 2.18 Air traffic services communication facilities

2.18.1 Service designation: LCL/P
2.18.3 Service designation: 119.3 MHz

2.18.1 Service designation: CD/P

2.18.3 Service designation: 120.1 MHz

2.18.1 Service designation: EMERG
2.18.3 Service designation: 121.5 MHz

2.18.1 Service designation: GND/P
2.18.3 Service designation: 121.7 MHz

2.18.1 Service designation: GND/P
2.18.3 Service designation: 121.9 MHz

2.18.1 Service designation: D-ATIS
2.18.3 Service designation: 123.8 MHz
2.18.4 Hours of operation: 24

2.18.1 Service designation: FINAL CTL
2.18.3 Service designation: 124.8 MHz

2.18.1 Service designation: APCH/P
2.18.3 Service designation: 124.95 MHz

2.18.1 Service designation: CLASS C
2.18.3 Service designation: 125.3 MHz

2.18.1 Service designation: DEP/P
2.18.3 Service designation: 125.3 MHz

2.18.1 Service designation: LCL/P
2.18.3 Service designation: 127.45 MHz

2.18.1 Service designation: APCH/P IC
2.18.3 Service designation: 128.3 MHz

2.18.1 Service designation: CLASS C
2.18.3 Service designation: 132.35 MHz

2.18.1 Service designation: DEP/P
2.18.3 Service designation: 132.35 MHz

2.18.1 Service designation: RDR
2.18.3 Service designation: 134.3 MHz

2.18.1 Service designation: CLASS C
2.18.3 Service designation: 256.9 MHz

2.18.1 Service designation: DEP/P
2.18.3 Service designation: 256.9 MHz

2.18.1 Service designation: LCL/P
2.18.3 Service designation: 257.8 MHz

2.18.1 Service designation: APCH/P IC
2.18.3 Service designation: 307.9 MHz

2.18.1 Service designation: GND/P
2.18.3 Service designation: 348.6 MHz

2.18.1 Service designation: APCH/P
2.18.3 Service designation: 392.1 MHz

2.18.1 Service designation: FINAL CTL
2.18.3 Service designation: 395 MHz

2.18.1 Service designation: CLASS C
2.18.3 Service designation: 353.675 MHz

2.18.1 Service designation: DEP/P
2.18.3 Service designation: 353.675 MHz

AD 2.19 Radio navigation and landing aids

2.19.1 ILS type: DME for runway 05L. Magnetic variation: 7W
2.19.2 ILS identification: GKK
2.19.5 Coordinates: 35-53-47.52N / 78-46-27.57W
2.19.6 Site elevation: 411 ft

2.19.1 ILS type: Localizer for runway 05L. Magnetic variation: 7W
2.19.2 ILS identification: GKK
2.19.5 Coordinates: 35-53-48.07N / 78-46-28.19W
2.19.6 Site elevation: 409 ft

2.19.1 ILS type: Glide Slope for runway 05L. Magnetic variation: 7W
2.19.2 ILS identification: GKK
2.19.5 Coordinates: 35-52-37.80N / 78-48-00.00W
2.19.6 Site elevation: 366 ft

2.19.1 ILS type: Middle Marker for runway 05L. Magnetic variation: 7W
2.19.2 ILS identification: GKK
2.19.5 Coordinates: 35-52-00.00N / 78-48-41.35W
2.19.6 Site elevation: 334 ft

2.19.1 ILS type: DME for runway 23R. Magnetic variation: 9W
2.19.2 ILS identification: DMP
2.19.5 Coordinates: 35-52-19.51N /

78-48-13.82W
2.19.6 Site elevation: 370 ft

2.19.1 ILS type: Middle Marker for runway 23R. Magnetic variation: 9W
2.19.2 ILS identification: DMP
2.19.5 Coordinates: 35-53-54.73N / 78-46-19.97W
2.19.6 Site elevation: 410 ft

2.19.1 ILS type: Inner Marker for runway 23R. Magnetic variation: 9W
2.19.2 ILS identification: DMP
2.19.5 Coordinates: 35-53-43.88N / 78-46-33.36W
2.19.6 Site elevation: 402 ft

2.19.1 ILS type: Localizer for runway 23R. Magnetic variation: 9W
2.19.2 ILS identification: DMP
2.19.5 Coordinates: 35-52-21.03N / 78-48-15.70W
2.19.6 Site elevation: 359 ft

2.19.1 ILS type: Glide Slope for runway 23R. Magnetic variation: 9W
2.19.2 ILS identification: DMP
2.19.5 Coordinates: 35-53-32.48N / 78-46-54.35W
2.19.6 Site elevation: 396 ft

2.19.1 ILS type: Localizer for runway 05R. Magnetic variation: 7W
2.19.2 ILS identification: RDU
2.19.5 Coordinates: 35-52-47.95N / 78-46-42.16W
2.19.6 Site elevation: 417 ft

2.19.1 ILS type: Glide Slope for runway 05R. Magnetic variation: 7W
2.19.2 ILS identification: RDU
2.19.5 Coordinates: 35-51-57.02N / 78-47-38.17W
2.19.6 Site elevation: 400 ft

2.19.1 ILS type: Middle Marker for runway 05R. Magnetic variation: 7W
2.19.2 ILS identification: RDU
2.19.5 Coordinates: 35-51-26.40N / 78-48-22.84W
2.19.6 Site elevation: 99999 ft

2.19.1 ILS type: Outer Marker for runway 05R.
Magnetic variation: 7W
2.19.2 ILS identification: RDU
2.19.5 Coordinates: 35-47-48.98N /
78-52-58.70W
2.19.6 Site elevation: 99999 ft

2.19.1 ILS type: Localizer for runway 23L.
Magnetic variation: 7W
2.19.2 ILS identification: LEI
2.19.5 Coordinates: 35-51-48.70N /
78-47-55.32W
2.19.6 Site elevation: 365 ft

2.19.1 ILS type: Outer Marker for runway 23L.
Magnetic variation: 7W
2.19.2 ILS identification: LEI

2.19.5 Coordinates: 35-55-38.51N /
78-43-19.67W
2.19.6 Site elevation: 500 ft

2.19.1 ILS type: Middle Marker for runway 23L.
Magnetic variation: 7W
2.19.2 ILS identification: LEI
2.19.5 Coordinates: 35-53-00.00N /
78-46-24.99W
2.19.6 Site elevation: 376 ft

2.19.1 ILS type: Glide Slope for runway 23L.
Magnetic variation: 7W
2.19.2 ILS identification: LEI
2.19.5 Coordinates: 35-52-36.26N /
78-46-52.29W
2.19.6 Site elevation: 430 ft

General Remarks:

NO JET ENGINE MAINTENANCE RUNS BETWEEN 0000-0600.

NATIONAL GUARD PRIOR PERMISSION REQUIRED FOR LANDING CONTACT V582-9181
C(919)664-9181.

NATIONAL GUARD 24 HR PRIOR PERMISSION REQUIRED FOR JET AIRCRAFT & TRANSMIT
MILITARY AIRCRAFT - 919-840-2111.

FOUR ENGINE AIRCRAFT WITH WINGSPAN OVER 171 FT & GROUP V MUST USE RUNWAY
05L/23R.

NO APPROVAL REQUIRED FOR PUSHBACK AT TERMINAL GATES UNLESS AIRCRAFT
REQUIRES USE OF TAXIWAY. CONTACT ATC PRIOR TO PUSHING ONTO TAXIWAY.

PRIOR PERMISSION REQUIRED FOR ALL MILITARY AIRCRAFT F/W - R/W & UNSCHEDULED
CHARTER FLIGHTS WITH 30 OR MORE PASSENGERS. MILITARY PRACTICE APPROACHES
REQUIRE APPROVAL. 24 HOURS PRIOR NOTICE REQUIRED. CONTACT AIRPORT OPERATIONS
DSN 528-9181, C919-664-6181/ 919-840-2111.

AIRPORT CLOSED TO AIRSHIPS.

TAXIWAY E BEHIND SOUTH CARGO 4 & TAXIWAY J BEHIND CORPORATE HANGARS NOT
VISIBLE FROM ATCT.

CRAN 75 FT AGL.76 NAUTICAL MILE FROM APPROACH END RUNWAY 05R.

ARRANGE: LIMITED PARK. ARRANGE OPERATIONS DSN 582-9181 C919-664-6181. RAMP
CLOSED TO ALL F/W EXCEPT ARMY & MILITARY TRANSPORT WITH PRIOR PERMISSION
REQUIRED, FACILITY HRS 1300-2130Z++ MON=FRI EXCEPT HOLIDAY. MAKE APPT FOR AFTER
DUTY HRS. NO FUEL EXCARNG FERRY AIRCRAFT. OSACOM FLIGHT DET DSN 582-9248,
C919-664-6248.

North Mariana Islands
Saipan Island
Francisco C. Ada/Saipan International
ICAO Identifier PGSN

11013 AIRPORT DIAGRAM FRANCISCO C. ADA/SAIPAN INTL (GSN)(PGSN)
AL-6293 (FAA) SAIPAN, CQ

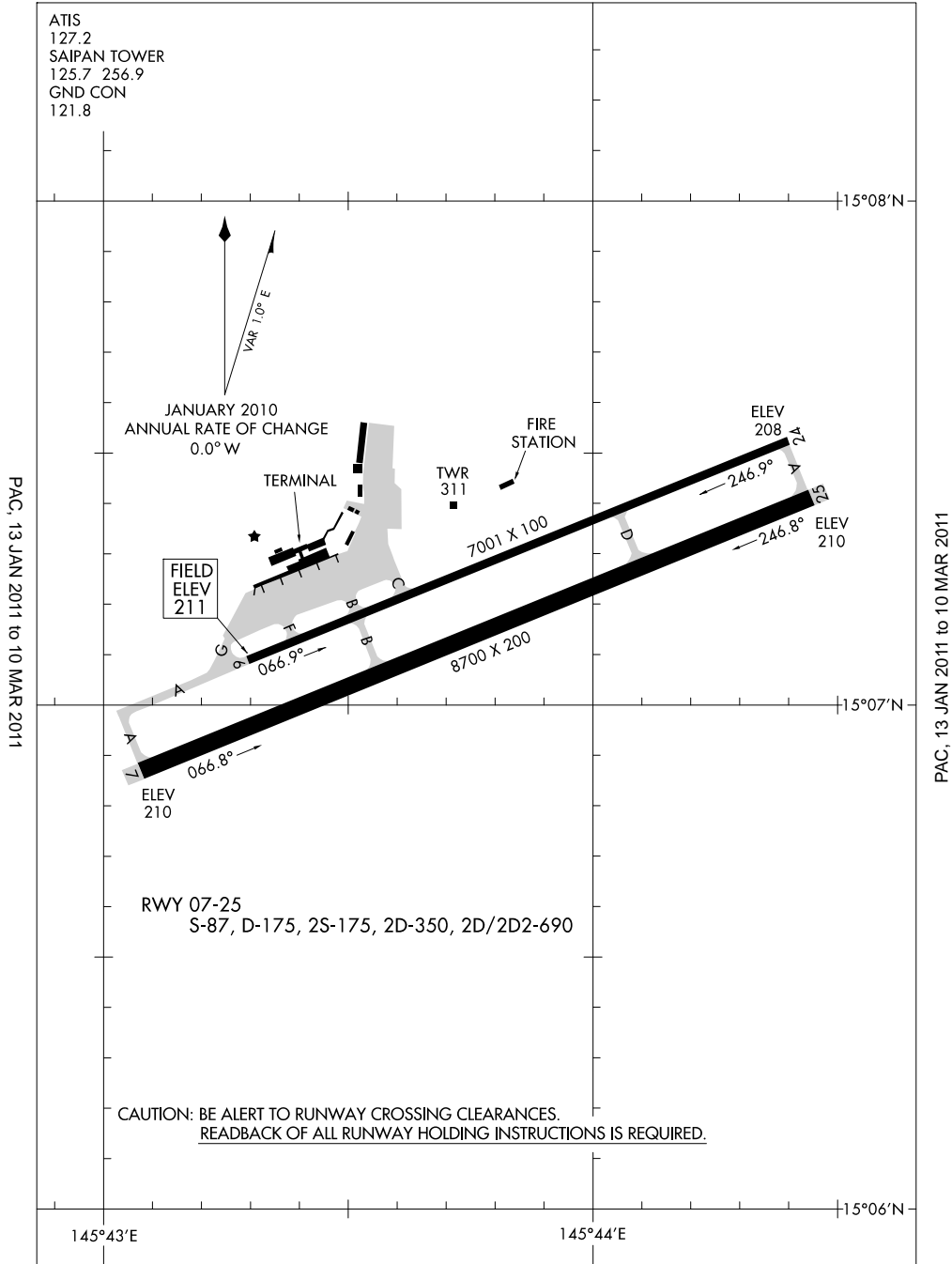

AIRPORT DIAGRAM SAIPAN, CQ
11013 FRANCISCO C. ADA/SAIPAN INTL (GSN)(PGSN)

Saipan Island, CQ
Francisco C. Ada/Saipan Intl
ICAO Identifier PGSN

AD 2.2 Aerodrome geographical and administrative data

- 2.2.1 Reference Point: 15-07-12.92N / 145-43-47.94E
- 2.2.2 From City: 4 Miles SW Of Saipan Island, Cq
- 2.2.3 Elevation: 211 ft
- 2.2.5 Magnetic variation: 2E (1985)
- 2.2.6 Airport Contact: Efrain F. Camacho, Pe
PO BOX 501055
Saipan, MP 96950
(670-237-6500/01)
- 2.2.7 Traffic: IFR/VFR

AD 2.3 Operational hours

- 2.3.1 - 2.3.11: ALL Months, ALL Days, ALL Hours

AD 2.4 Handling services and facilities

- 2.4.1 Cargo handling facilities: No
- 2.4.2 Fuel types: 100,100LL,A1+
- 2.4.4 De-icing facilities: None
- 2.4.5 Hangar space: No
- 2.4.6 Repair facilities: None

AD 2.6 Rescue and firefighting services

- 2.6.1 Aerodrome category for firefighting: ARFF Index I D certified on 1/1/1978
- 2.6.4 Remarks: Closed To Unscheduled Aircraft Operations With More Than 30 Passenger Seats Except Prior Permission Required Call Or Write Airport Manager
670-237-6500/670-483-1512(Cell); P.O. Box 501055 Saipan Mp 96950.

AD 2.12 Runway physical characteristics

- 2.12.1 Designation: 07
- 2.12.2 True Bearing: 68
- 2.12.3 Dimensions: 8700 ft x 200 ft
- 2.12.5 Coordinates: 15-06-52.11N / 145-43-00.00E
- 2.12.6 Threshold elevation: 210 ft
- 2.12.6 Touchdown zone elevation: 215 ft

- 2.12.1 Designation: 25
- 2.12.2 True Bearing: 248
- 2.12.3 Dimensions: 8700 ft x 200 ft
- 2.12.5 Coordinates: 15-07-24.70N /

- 145-44-26.79E
- 2.12.6 Threshold elevation: 210 ft
- 2.12.6 Touchdown zone elevation: 210 ft

- 2.12.1 Designation: 06
- 2.12.2 True Bearing: 68
- 2.12.3 Dimensions: 7001 ft x 100 ft
- 2.12.5 Coordinates: 15-07-00.00N / 145-43-17.64E
- 2.12.6 Threshold elevation: 211 ft
- 2.12.6 Touchdown zone elevation: 211 ft

- 2.12.1 Designation: 24
- 2.12.2 True Bearing: 248
- 2.12.3 Dimensions: 7001 ft x 100 ft
- 2.12.5 Coordinates: 15-07-31.57N / 145-44-23.86E
- 2.12.6 Threshold elevation: 208 ft
- 2.12.6 Touchdown zone elevation: 208 ft

AD 2.14 Approach and runway lighting

- 2.14.1 Designation: 07
- 2.14.2 Approach lighting system: MALSR: 1400 feet medium intensity approach lighting system with runway alignment indicator lights
- 2.14.4 Visual approach slope indicator system: 4-box VASI on left
- 2.14.10 Remarks: Restricted To 2.5nm & 5 Degrees Left & Right Of Runway Centerline Due To Intensity.

- 2.14.1 Designation: 25
- 2.14.4 Visual approach slope indicator system: 6-box VASI on left
- 2.14.10 Remarks: Restricted Beyond 2.5 Nm Due To Intensity.
vasi Upwind Threshold Crossing Height 105 Ft Glide Angle 3.25; Downwind Threshold Crossing Height 60 Ft Glide Angle 3.00. Threshold Crossing Height 105 Ft Applies To VASI 6 High Angle.

- 2.14.1 Designation: 06
- 2.14.4 Visual approach slope indicator system: PVASI on left

- 2.14.1 Designation: 24
- 2.14.4 Visual approach slope indicator system: PVASI on left

AD 2.19 Radio navigation and landing aids

- 2.19.1 ILS type: Localizer for runway 07. Magnetic

variation: 2E
2.19.2 ILS identification: GSN
2.19.5 Coordinates: 15-07-26.58N /
145-44-31.52E
2.19.6 Site elevation: 211 ft

Magnetic variation: 2E
2.19.2 ILS identification: GSN
2.19.5 Coordinates: 15-06-58.69N /
145-43-13.05E
2.19.6 Site elevation: 208 ft

2.19.1 ILS type: DME for runway 07. Magnetic
variation: 2E
2.19.2 ILS identification: GSN
2.19.5 Coordinates: 15-07-29.14N /
145-44-30.86E
2.19.6 Site elevation: 223 ft

2.19.1 ILS type: Middle Marker for runway 07.
Magnetic variation: 2E
2.19.2 ILS identification: GSN
2.19.5 Coordinates: 15-06-41.60N /
145-42-38.10E
2.19.6 Site elevation: 86 ft

2.19.1 ILS type: Glide Slope for runway 07.

General Remarks:

IMMIGRATION & CUSTOMS AVAILABLE DURING SCHEDULED OPERATIONS. OTHER TIMES
PRIOR ARRANGEMENTS MUST BE MADE WITH CHIEF IMMIGRATION SAIPAN CALL 664-3131/32.

FOR AIRPORT SECURITY CALL (670) 237-6529.

RUNWAY 07/25 CLOSED 1600 - 0000 AND 0500 - 1300.

RUNWAY 06/24 OPEN FOR TAXIING ONLY (NOT AVABL FOR LANDING & TKOFF) 1300 - 1600 AND
0000 - 0500 OTHER TIMES BY NOTAM.

Cleveland, Ohio
Cleveland-Hopkins International
ICAO Identifier KCLE

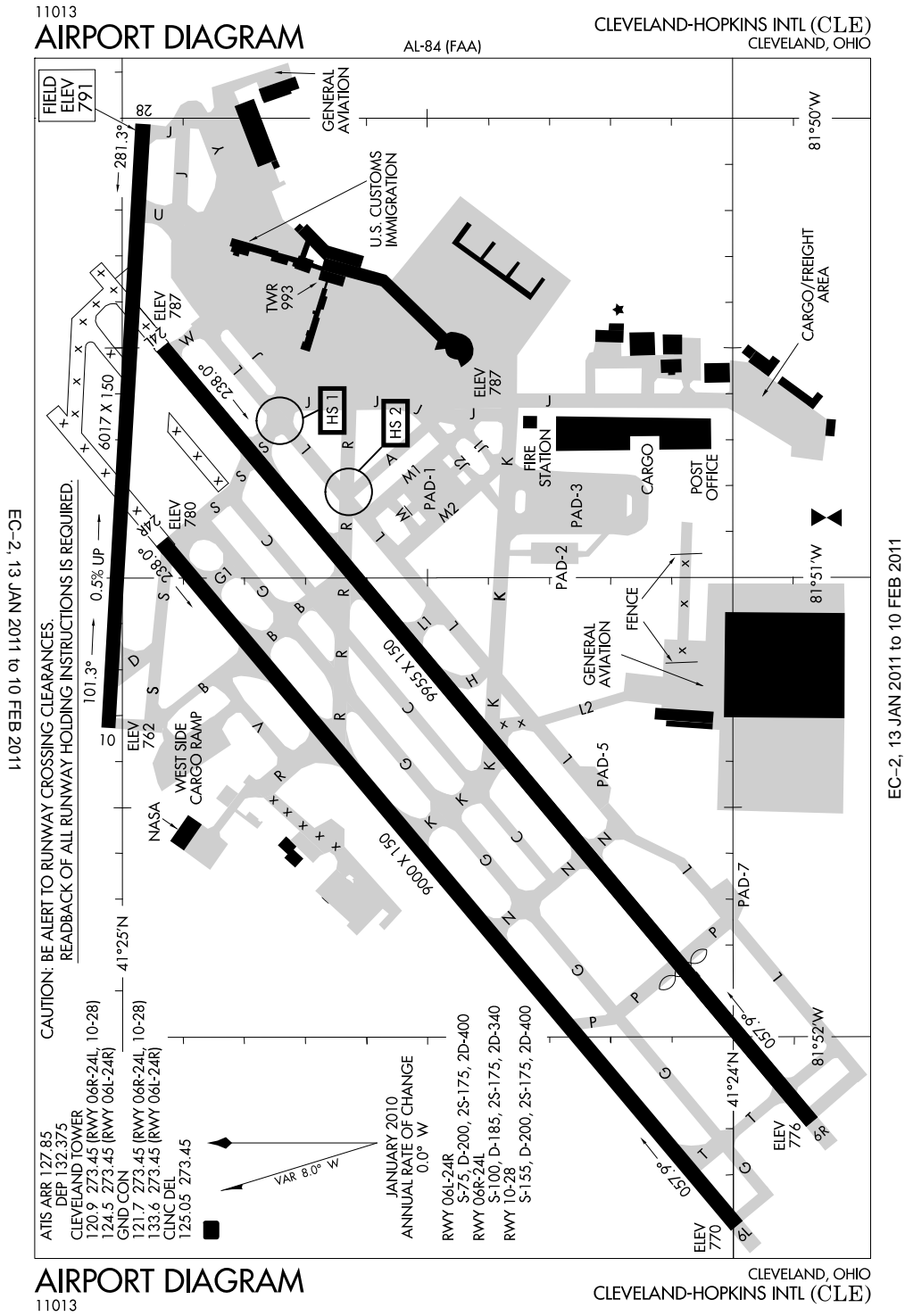

Cleveland, OH
Cleveland-Hopkins Intl
ICAO Identifier KCLE

AD 2.2 Aerodrome geographical and administrative data

- 2.2.1 Reference Point: 41-24-33.90N / 81-51-17.93W
- 2.2.2 From City: 9 Miles SW Of Cleveland, OH
- 2.2.3 Elevation: 791 ft
- 2.2.5 Magnetic variation: 7W (1990)
- 2.2.6 Airport Contact: Ricky Smith
5300 RIVERSIDE DR
Cleveland, OH 44135
(216-265-6000)
- 2.2.7 Traffic: IFR/VFR

AD 2.3 Operational hours

- 2.3.1 - 2.3.11: ALL Months, ALL Days, ALL Hours

AD 2.4 Handling services and facilities

- 2.4.1 Cargo handling facilities: No
- 2.4.2 Fuel types: 100LL,A1+
- 2.4.4 De-icing facilities: None
- 2.4.5 Hangar space: Yes
- 2.4.6 Repair facilities: Major

AD 2.6 Rescue and firefighting services

- 2.6.1 Aerodrome category for firefighting: ARFF Index I C certified on 5/1/1973

AD 2.10 Aerodrome obstacles

- 2.10.1.a. Runway designation: 06R
- 2.10.1.b Type of obstacle: Trees (80 ft). Not Lighted or Marked
- 2.10.1.c Location of obstacle: 370 ft from Centerline

- 2.10.1.a. Runway designation: 10
- 2.10.1.b Type of obstacle: Road (6 ft). Not Lighted or Marked
- 2.10.1.c Location of obstacle: 0 ft from Centerline

- 2.10.1.a. Runway designation: 28
- 2.10.1.b Type of obstacle: Pole (25 ft). Not Lighted or Marked
- 2.10.1.c Location of obstacle: 630 ft from Centerline

- 2.10.1.a. Runway designation: 06L

- 2.10.1.b Type of obstacle: Trees (97 ft). Not Lighted or Marked
- 2.10.1.c Location of obstacle: 847 ft from Centerline

AD 2.12 Runway physical characteristics

- 2.12.1 Designation: 06R
- 2.12.2 True Bearing: 50
- 2.12.3 Dimensions: 9955 ft x 150 ft
- 2.12.5 Coordinates: 41-23-51.85N / 81-52-11.38W
- 2.12.6 Threshold elevation: 776 ft
- 2.12.6 Touchdown zone elevation: 777 ft

- 2.12.1 Designation: 24L
- 2.12.2 True Bearing: 230
- 2.12.3 Dimensions: 9955 ft x 150 ft
- 2.12.5 Coordinates: 41-24-55.14N / 81-50-31.37W
- 2.12.6 Threshold elevation: 786 ft
- 2.12.6 Touchdown zone elevation: 787 ft

- 2.12.1 Designation: 10
- 2.12.2 True Bearing: 93
- 2.12.3 Dimensions: 6017 ft x 150 ft
- 2.12.5 Coordinates: 41-25-00.00N / 81-51-19.61W
- 2.12.6 Threshold elevation: 762 ft
- 2.12.6 Touchdown zone elevation: 782 ft

- 2.12.1 Designation: 28
- 2.12.2 True Bearing: 273
- 2.12.3 Dimensions: 6017 ft x 150 ft
- 2.12.5 Coordinates: 41-24-58.01N / 81-50-00.00W
- 2.12.6 Threshold elevation: 791 ft
- 2.12.6 Touchdown zone elevation: 791 ft

- 2.12.1 Designation: 06L
- 2.12.2 True Bearing: 50
- 2.12.3 Dimensions: 9000 ft x 150 ft
- 2.12.5 Coordinates: 41-23-59.53N / 81-52-24.56W
- 2.12.6 Threshold elevation: 770 ft
- 2.12.6 Touchdown zone elevation: 773 ft

- 2.12.1 Designation: 24R
- 2.12.2 True Bearing: 230
- 2.12.3 Dimensions: 9000 ft x 150 ft
- 2.12.5 Coordinates: 41-24-56.75N / 81-50-54.14W

2.12.6 Threshold elevation: 780 ft
2.12.6 Touchdown zone elevation: 780 ft

2.12.1 Designation: 06X
2.12.3 Dimensions: 0 ft x 0 ft

2.12.1 Designation: 24X
2.12.3 Dimensions: 0 ft x 0 ft

AD 2.13 Declared distances

2.13.1 Designation: 06R
2.13.5 Landing distance available: 8029

AD 2.14 Approach and runway lighting

2.14.1 Designation: 06R
2.14.2 Approach lighting system: MALSR: 1400 feet medium intensity approach lighting system with runway alignment indicator lights
2.14.4 Visual approach slope indicator system: 4–light PAPI on left

2.14.1 Designation: 24L
2.14.2 Approach lighting system: MALSR: 1400 feet medium intensity approach lighting system with runway alignment indicator lights
2.14.4 Visual approach slope indicator system: 4–light PAPI on right

2.14.1 Designation: 10
2.14.4 Visual approach slope indicator system: 4–light PAPI on left

2.14.1 Designation: 28
2.14.2 Approach lighting system: MALSR: 1400 feet medium intensity approach lighting system with runway alignment indicator lights
2.14.4 Visual approach slope indicator system: 4–light PAPI on right

2.14.1 Designation: 06L
2.14.2 Approach lighting system: ALSF2: Standard 2400 feet high intensity approach lighting system with sequenced flashers, category II or III configuration
2.14.4 Visual approach slope indicator system: 4–light PAPI on left

2.14.1 Designation: 24R
2.14.2 Approach lighting system: ALSF2: Standard 2400 feet high intensity approach lighting system with sequenced flashers, category II or III

configuration
2.14.4 Visual approach slope indicator system: 4–light PAPI on right

AD 2.18 Air traffic services communication facilities

2.18.1 Service designation: EMERG
2.18.3 Service designation: 121.5 MHz

2.18.1 Service designation: CD/P PTC
2.18.3 Service designation: 125.05 MHz

2.18.1 Service designation: EMERG
2.18.3 Service designation: 243 MHz

2.18.1 Service designation: RAMP CONTROL
2.18.3 Service designation: 129.17 MHz

2.18.1 Service designation: DEP/P
2.18.3 Service designation: 118.15 MHz

2.18.1 Service designation: CLASS B
2.18.3 Service designation: 125.35 MHz

2.18.1 Service designation: DEP S
2.18.3 Service designation: 125.85 MHz

2.18.1 Service designation: DEP/P
2.18.3 Service designation: 128.25 MHz

2.18.1 Service designation: D–ATIS
2.18.3 Service designation: 127.85 MHz
2.18.4 Hours of operation: 24

2.18.1 Service designation: D–ATIS
2.18.3 Service designation: 132.375 MHz
2.18.4 Hours of operation: 24

2.18.1 Service designation: LCL/S
2.18.3 Service designation: 135.225 MHz

2.18.1 Service designation: LCL/P
2.18.3 Service designation: 124.5 MHz

2.18.1 Service designation: APCH/P
2.18.3 Service designation: 119.625 MHz

2.18.1 Service designation: GROUND METERING
2.18.3 Service designation: 127.275 MHz

2.18.1 Service designation: APCH/P IC

2.18.3 Service designation: 124 MHz

2.18.1 Service designation: APCH/P IC
2.18.3 Service designation: 126.55 MHz

2.18.1 Service designation: LCL/P
2.18.3 Service designation: 120.9 MHz

2.18.1 Service designation: GND/P
2.18.3 Service designation: 133.6 MHz

2.18.1 Service designation: CLASS B
2.18.3 Service designation: 126.35 MHz

2.18.1 Service designation: LDA PRM RY
06L/24R
2.18.3 Service designation: 118.975 MHz

2.18.1 Service designation: LDA PRM RY
06R/24L
2.18.3 Service designation: 135.875 MHz

2.18.1 Service designation: GND/P
2.18.3 Service designation: 121.7 MHz

2.18.1 Service designation: APCH/P IC
2.18.3 Service designation: 354.025 MHz

2.18.1 Service designation: DEP/P
2.18.3 Service designation: 346.325 MHz

2.18.1 Service designation: LCL/P GND/P CD/P
2.18.3 Service designation: 273.45 MHz

AD 2.19 Radio navigation and landing aids

2.19.1 ILS type: Outer Marker for runway 24L.
Magnetic variation: 7W
2.19.2 ILS identification: HPI
2.19.5 Coordinates: 41-28-00.00N /
81-43-35.83W
2.19.6 Site elevation: 736 ft

2.19.1 ILS type: Localizer for runway 24L.
Magnetic variation: 7W
2.19.2 ILS identification: HPI
2.19.5 Coordinates: 41-24-00.00N /
81-51-57.82W
2.19.6 Site elevation: 765 ft

2.19.1 ILS type: Glide Slope for runway 24L.
Magnetic variation: 7W

2.19.2 ILS identification: HPI
2.19.5 Coordinates: 41-24-52.35N /
81-50-30.48W
2.19.6 Site elevation: 782 ft

2.19.1 ILS type: Middle Marker for runway 24L.
Magnetic variation: 7W
2.19.2 ILS identification: HPI
2.19.5 Coordinates: 41-25-22.70N /
81-49-43.90W
2.19.6 Site elevation: 99999 ft

2.19.1 ILS type: DME for runway 24L. Magnetic
variation: 7W
2.19.2 ILS identification: HPI
2.19.5 Coordinates: 41-23-44.36N /
81-52-17.92W
2.19.6 Site elevation: 772 ft

2.19.1 ILS type: Glide Slope for runway 06R.
Magnetic variation: 7W
2.19.2 ILS identification: CLE
2.19.5 Coordinates: 41-24-00.00N /
81-51-38.41W
2.19.6 Site elevation: 765 ft

2.19.1 ILS type: Inner Marker for runway 06R.
Magnetic variation: 7W
2.19.2 ILS identification: CLE
2.19.5 Coordinates: 41-23-57.23N /
81-52-00.00W
2.19.6 Site elevation: 760 ft

2.19.1 ILS type: Middle Marker for runway 06R.
Magnetic variation: 7W
2.19.2 ILS identification: CLE
2.19.5 Coordinates: 41-23-44.19N /
81-52-23.50W
2.19.6 Site elevation: 768 ft

2.19.1 ILS type: Outer Marker for runway 06R.
Magnetic variation: 7W
2.19.2 ILS identification: CLE
2.19.5 Coordinates: 41-20-19.06N /
81-57-51.96W
2.19.6 Site elevation: 800 ft

2.19.1 ILS type: DME for runway 06R. Magnetic
variation: 7W
2.19.2 ILS identification: CLE
2.19.5 Coordinates: 41-25-00.00N /

81-50-11.59W
2.19.6 Site elevation: 786 ft

2.19.1 ILS type: Localizer for runway 06R.
Magnetic variation: 7W
2.19.2 ILS identification: CLE
2.19.5 Coordinates: 41-25-00.00N /
81-50-15.50W
2.19.6 Site elevation: 786 ft

2.19.1 ILS type: Localizer for runway 28. Magnetic
variation: 7W
2.19.2 ILS identification: PXP
2.19.5 Coordinates: 41-25-00.00N /
81-51-21.25W
2.19.6 Site elevation: 756 ft

2.19.1 ILS type: Glide Slope for runway 28.
Magnetic variation: 7W
2.19.2 ILS identification: PXP
2.19.5 Coordinates: 41-25-00.00N /
81-50-12.31W
2.19.6 Site elevation: 786 ft

2.19.1 ILS type: Outer Marker for runway 28.
Magnetic variation: 7W
2.19.2 ILS identification: PXP
2.19.5 Coordinates: 41-24-34.70N /
81-42-32.40W
2.19.6 Site elevation: 99999 ft

2.19.1 ILS type: Middle Marker for runway 28.
Magnetic variation: 7W
2.19.2 ILS identification: PXP
2.19.5 Coordinates: 41-24-55.88N /
81-49-10.69W
2.19.6 Site elevation: 99999 ft

2.19.1 ILS type: DME for runway 28. Magnetic
variation: 7W
2.19.2 ILS identification: PXP
2.19.5 Coordinates: 41-24-58.45N /
81-51-23.43W
2.19.6 Site elevation: 760 ft

2.19.1 ILS type: DME for runway 06L. Magnetic
variation: 7W
2.19.2 ILS identification: LIZ
2.19.5 Coordinates: 41-25-11.94N /
81-50-35.68W
2.19.6 Site elevation: 783 ft

2.19.1 ILS type: Glide Slope for runway 06L.
Magnetic variation: 7W
2.19.2 ILS identification: LIZ
2.19.5 Coordinates: 41-24-00.00N /
81-52-17.53W
2.19.6 Site elevation: 764 ft

2.19.1 ILS type: Localizer for runway 06L.
Magnetic variation: 7W
2.19.2 ILS identification: LIZ
2.19.5 Coordinates: 41-25-10.19N /
81-50-32.90W
2.19.6 Site elevation: 779 ft

2.19.1 ILS type: Inner Marker for runway 06L.
Magnetic variation: 7W
2.19.2 ILS identification: LIZ
2.19.5 Coordinates: 41-23-53.93N /
81-52-33.42W
2.19.6 Site elevation: 781 ft

2.19.1 ILS type: DME for runway 24R. Magnetic
variation: 7W
2.19.2 ILS identification: PVY
2.19.5 Coordinates: 41-25-11.94N /
81-50-35.68W
2.19.6 Site elevation: 783 ft

2.19.1 ILS type: Localizer for runway 24R.
Magnetic variation: 7W
2.19.2 ILS identification: PVY
2.19.5 Coordinates: 41-23-53.08N /
81-52-34.75W
2.19.6 Site elevation: 760 ft

2.19.1 ILS type: Glide Slope for runway 24R.
Magnetic variation: 7W
2.19.2 ILS identification: PVY
2.19.5 Coordinates: 41-24-53.01N /
81-51-00.00W
2.19.6 Site elevation: 768 ft

2.19.1 ILS type: Inner Marker for runway 24R.
Magnetic variation: 7W
2.19.2 ILS identification: PVY
2.19.5 Coordinates: 41-25-00.00N /
81-50-47.32W
2.19.6 Site elevation: 777 ft

2.19.1 ILS type: Glide Slope for runway 06X.
Magnetic variation: 7W

2.19.2 ILS identification: EYU
2.19.5 Coordinates: 41-24-00.00N /
81-51-38.26W
2.19.6 Site elevation: 765 ft

2.19.1 ILS type: DME for runway 06X. Magnetic
variation: 7W
2.19.2 ILS identification: EYU
2.19.5 Coordinates: 41-25-00.00N /
81-50-00.00W
2.19.6 Site elevation: 786 ft

2.19.1 ILS type: Localizer for runway 06X.
Magnetic variation: 7W
2.19.2 ILS identification: EYU
2.19.5 Coordinates: 41-25-00.00N /
81-50-00.00W
2.19.6 Site elevation: 786 ft

2.19.1 ILS type: DME for runway 24X. Magnetic

General Remarks:

DEER & BIRDS INCLUDING WATERFOWL ON & IN THE VICINITY OF AIRPORT.

ADVISE CUSTOMS AVAILABLE MON-FRI 0700-2100; SAT/SUN 0900-1700; ALL REQUEST FOR SERVICE MUST BE MADE WITH THE U.S. CUSTOMS SERVICE OFFICE LOCATED AT GATE A-14 CALL (216) 267-3600 DURING LISTED HOURS.

NASA GLENN RESEARCH CENTER; NASA RAMP PRIOR PERMISSION REQUIRED CALL 216-433-2020; 0800-1730 MON-FRI. CONTACT NASA OPERATIONS ON FREQ 122.925 WITHIN 50 NAUTICAL MILE.

TAXIWAY 'L2' CLOSED BETWEEN RUNWAY 06R/24L & TAXIWAY 'L'. AREA MARKED WITH LIGHTED BARRICADES & REFLECTORS.

PAD 2 RESTRICTED TO GROUP II AIRCRAFT, LESS THAN 79 FT WINGSPAN.

ALL APPROACHES ARE OVER NOISE SENSITIVE AREAS. AIRPORT LATE NIGHT NOISE ABATEMENT PROCEDURES ARE IN EFFECT 2300-0600. ADDITIONAL NOISE ABATEMENT PROCEDURES ARE IN EFFECT CALL AIRPORT MANAGER NORMAL BUSINESS HRS AT 216-265-6090.

THE FOLLOWING TAXIWAYS ARE CLOSED ANNUALLY FR 15 OCT THRU 15 APR TO SUPPORT DEICING OPERATIONS AT CLE: TAXIWAY M; TAXIWAY M1 BETWEEN TAXIWAY L & TAXIWAY J1; TAXIWAY M2 BETWEEN TAXIWAY L & TAXIWAY J1; TAXIWAY J2 BETWEEN TAXIWAY A & TAXIWAY K.

RAMP AREA NORTH CONCOURSE B BETWEEN GATES D1, D28 CLOSED EXCEPT AIRCRAFT WINGSPAN LESS THAN 86 FT.

variation: 7W
2.19.2 ILS identification: FVZ
2.19.5 Coordinates: 41-25-00.00N /
81-50-00.00W
2.19.6 Site elevation: 786 ft

2.19.1 ILS type: Localizer for runway 24X.
Magnetic variation: 7W
2.19.2 ILS identification: FVZ
2.19.5 Coordinates: 41-23-56.45N /
81-51-51.38W
2.19.6 Site elevation: 764 ft

2.19.1 ILS type: Glide Slope for runway 24X.
Magnetic variation: 7W
2.19.2 ILS identification: FVZ
2.19.5 Coordinates: 41-24-52.26N /
81-50-30.45W
2.19.6 Site elevation: 782 ft

Columbus, Ohio
Port Columbus International
ICAO Identifier KCMH

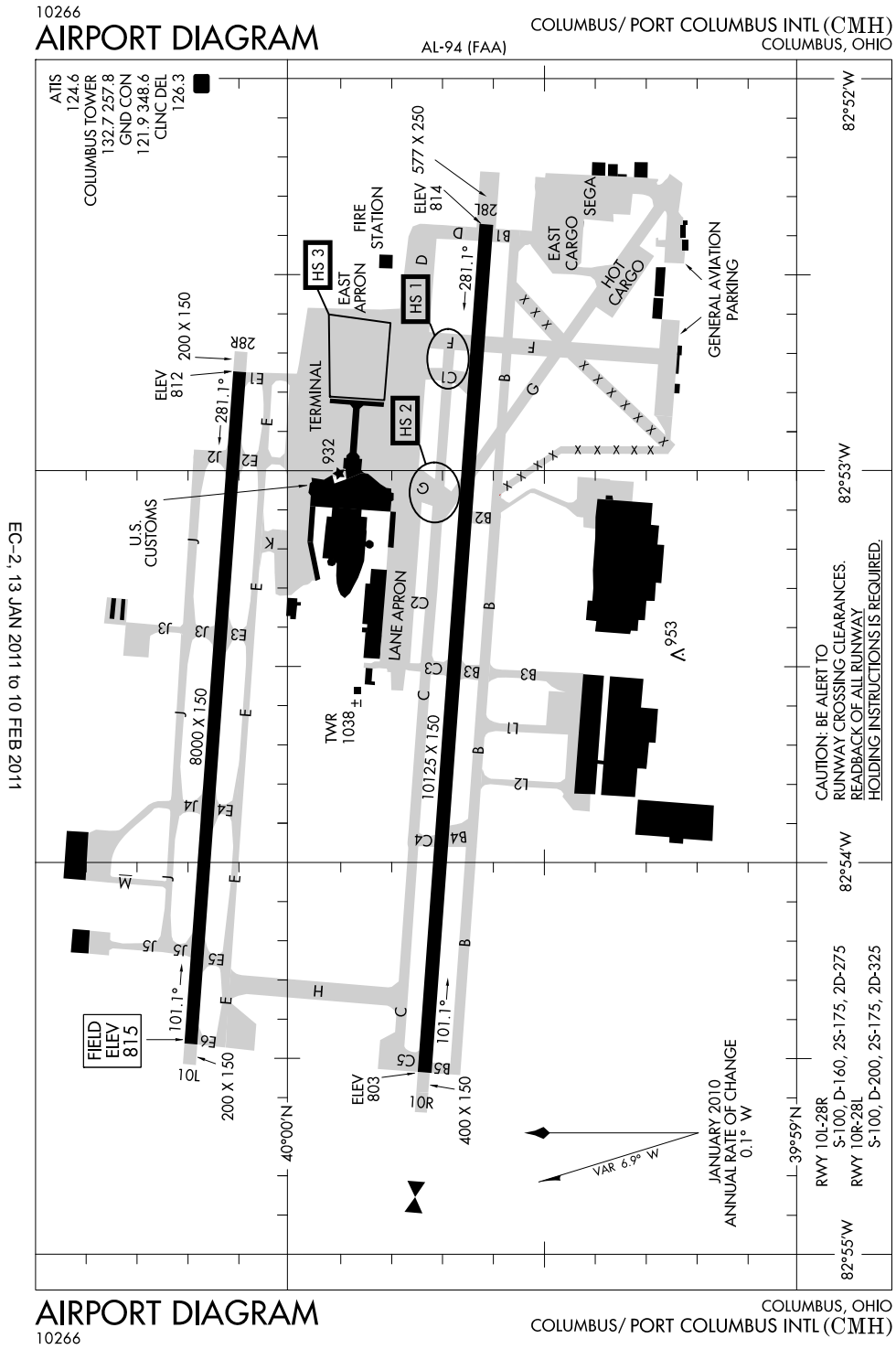

Columbus, OH
Port Columbus Intl
ICAO Identifier KCMH

AD 2.2 Aerodrome geographical and administrative data

- 2.2.1 Reference Point: 39-59-52.70N / 82-53-30.80W
- 2.2.2 From City: 6 Miles E Of Columbus, OH
- 2.2.3 Elevation: 815 ft
- 2.2.5 Magnetic variation: 5W (1990)
- 2.2.6 Airport Contact: Elaine Roberts, A.A.E.
COLUMBUS RGNL ARPT AUTH
Columbus, OH 43219 (614-239-4000)
- 2.2.7 Traffic: IFR/VFR

AD 2.3 Operational hours

- 2.3.1 - 2.3.11: ALL Months, ALL Days, ALL Hours

AD 2.4 Handling services and facilities

- 2.4.1 Cargo handling facilities: No
- 2.4.2 Fuel types: 100,A1+
- 2.4.4 De-icing facilities: None
- 2.4.5 Hangar space: Yes
- 2.4.6 Repair facilities: Major

AD 2.6 Rescue and firefighting services

- 2.6.1 Aerodrome category for firefighting: ARFF Index I C certified on 5/1/1973

AD 2.12 Runway physical characteristics

- 2.12.1 Designation: 10L
- 2.12.2 True Bearing: 94
- 2.12.3 Dimensions: 8000 ft x 150 ft
- 2.12.5 Coordinates: 40-00-11.53N / 82-54-27.49W
- 2.12.6 Threshold elevation: 815 ft
- 2.12.6 Touchdown zone elevation: 815 ft

- 2.12.1 Designation: 28R
- 2.12.2 True Bearing: 274
- 2.12.3 Dimensions: 8000 ft x 150 ft
- 2.12.5 Coordinates: 40-00-00.00N / 82-52-44.97W
- 2.12.6 Threshold elevation: 812 ft
- 2.12.6 Touchdown zone elevation: 813 ft

- 2.12.1 Designation: 10R
- 2.12.2 True Bearing: 94
- 2.12.3 Dimensions: 10125 ft x 150 ft

- 2.12.5 Coordinates: 39-59-44.05N / 82-54-32.18W
- 2.12.6 Threshold elevation: 803 ft
- 2.12.6 Touchdown zone elevation: 810 ft

- 2.12.1 Designation: 28L
- 2.12.2 True Bearing: 274
- 2.12.3 Dimensions: 10125 ft x 150 ft
- 2.12.5 Coordinates: 39-59-36.71N / 82-52-22.43W
- 2.12.6 Threshold elevation: 814 ft
- 2.12.6 Touchdown zone elevation: 814 ft

AD 2.13 Declared distances

- 2.13.1 Designation: 10L
- 2.13.2 Takeoff run available: 8000
- 2.13.3 Takeoff distance available: 8000
- 2.13.4 Accelerate-stop distance available: 8000
- 2.13.5 Landing distance available: 8000

- 2.13.1 Designation: 28R
- 2.13.2 Takeoff run available: 8000
- 2.13.3 Takeoff distance available: 8000
- 2.13.4 Accelerate-stop distance available: 8000
- 2.13.5 Landing distance available: 8000

- 2.13.1 Designation: 10R
- 2.13.2 Takeoff run available: 10125
- 2.13.3 Takeoff distance available: 10125
- 2.13.4 Accelerate-stop distance available: 10125
- 2.13.5 Landing distance available: 10125

- 2.13.1 Designation: 28L
- 2.13.2 Takeoff run available: 10125
- 2.13.3 Takeoff distance available: 10125
- 2.13.4 Accelerate-stop distance available: 10125
- 2.13.5 Landing distance available: 10125

AD 2.14 Approach and runway lighting

- 2.14.1 Designation: 10L
- 2.14.2 Approach lighting system: MALSR: 1400 feet medium intensity approach lighting system with runway alignment indicator lights
- 2.14.4 Visual approach slope indicator system: 4-light PAPI on left

- 2.14.1 Designation: 28R
- 2.14.2 Approach lighting system: MALSR: 1400 feet medium intensity approach lighting system with runway alignment indicator lights
- 2.14.4 Visual approach slope indicator system:

4-light PAPI on right

2.14.1 Designation: 10R

2.14.2 Approach lighting system: MALSR: 1400 feet medium intensity approach lighting system with runway alignment indicator lights

2.14.4 Visual approach slope indicator system: 4-light PAPI on right

2.14.1 Designation: 28L

2.14.2 Approach lighting system: MALSR: 1400 feet medium intensity approach lighting system with runway alignment indicator lights

AD 2.18 Air traffic services communication facilities

2.18.1 Service designation: APCH/S

2.18.3 Service designation: 118.2 MHz

2.18.1 Service designation: APCH/P DEP/P

2.18.3 Service designation: 119.15 MHz

2.18.1 Service designation: APCH/S

2.18.3 Service designation: 119.65 MHz

2.18.1 Service designation: CLASS C

2.18.3 Service designation: 120.2 MHz

2.18.1 Service designation: EMERG

2.18.3 Service designation: 121.5 MHz

2.18.1 Service designation: GND/P

2.18.3 Service designation: 121.9 MHz

2.18.1 Service designation: D-ATIS

2.18.3 Service designation: 124.6 MHz

2.18.4 Hours of operation: 24

2.18.1 Service designation: APCH/P DEP/P IC

2.18.3 Service designation: 125.95 MHz

2.18.1 Service designation: CD/P

2.18.3 Service designation: 126.3 MHz

2.18.1 Service designation: CLASS C

2.18.3 Service designation: 132.3 MHz

2.18.1 Service designation: LCL/P

2.18.3 Service designation: 132.7 MHz

2.18.1 Service designation: EMERG

2.18.3 Service designation: 243 MHz

2.18.1 Service designation: LCL/P

2.18.3 Service designation: 257.8 MHz

2.18.1 Service designation: CLASS C

2.18.3 Service designation: 279.6 MHz

2.18.1 Service designation: GND/P

2.18.3 Service designation: 348.6 MHz

2.18.1 Service designation: APCH/S

2.18.3 Service designation: 353.9 MHz

2.18.1 Service designation: CLASS C

2.18.3 Service designation: 317.775 MHz

2.18.1 Service designation: APCH/P DEP/P

2.18.3 Service designation: 338.225 MHz

2.18.1 Service designation: APCH/P DEP/P IC

2.18.3 Service designation: 371.975 MHz

AD 2.19 Radio navigation and landing aids

2.19.1 ILS type: Localizer for runway 10L.

Magnetic variation: 5W

2.19.2 ILS identification: CBP

2.19.5 Coordinates: 40-00-00.00N /

82-52-32.03W

2.19.6 Site elevation: 799 ft

2.19.1 ILS type: Glide Slope for runway 10L.

Magnetic variation: 5W

2.19.2 ILS identification: CBP

2.19.5 Coordinates: 40-00-14.28N /

82-54-14.87W

2.19.6 Site elevation: 810 ft

2.19.1 ILS type: Outer Marker for runway 10L.

Magnetic variation: 5W

2.19.2 ILS identification: CBP

2.19.5 Coordinates: 40-00-36.46N /

83-01-44.26W

2.19.6 Site elevation: 99999 ft

2.19.1 ILS type: Middle Marker for runway 10L.

Magnetic variation: 5W

2.19.2 ILS identification: CBP

2.19.5 Coordinates: 40-00-12.93N /

82-54-52.25W

2.19.6 Site elevation: 99999 ft

2.19.1 ILS type: DME for runway 10L. Magnetic variation: 5W
2.19.2 ILS identification: CBP
2.19.5 Coordinates: 40-00-00.00N / 82-54-41.03W
2.19.6 Site elevation: 822 ft

2.19.1 ILS type: DME for runway 28R. Magnetic variation: 5W
2.19.2 ILS identification: ONB
2.19.5 Coordinates: 40-00-00.00N / 82-54-41.03W
2.19.6 Site elevation: 822 ft

2.19.1 ILS type: Localizer for runway 28R. Magnetic variation: 5W
2.19.2 ILS identification: ONB
2.19.5 Coordinates: 40-00-12.27N / 82-54-40.56W
2.19.6 Site elevation: 812 ft

2.19.1 ILS type: Glide Slope for runway 28R. Magnetic variation: 5W
2.19.2 ILS identification: ONB
2.19.5 Coordinates: 40-00-00.00N / 82-52-56.99W
2.19.6 Site elevation: 808 ft

2.19.1 ILS type: Outer Marker for runway 28R. Magnetic variation: 5W
2.19.2 ILS identification: ONB
2.19.5 Coordinates: 39-59-46.26N / 82-46-18.93W
2.19.6 Site elevation: 1040 ft

2.19.1 ILS type: Outer Marker for runway 10R. Magnetic variation: 5W
2.19.2 ILS identification: AQI
2.19.5 Coordinates: 40-00-00.00N / 83-01-45.46W
2.19.6 Site elevation: 748 ft

2.19.1 ILS type: Middle Marker for runway 10R. Magnetic variation: 5W
2.19.2 ILS identification: AQI
2.19.5 Coordinates: 39-59-46.12N / 82-55-00.00W
2.19.6 Site elevation: 812 ft

2.19.1 ILS type: DME for runway 10R. Magnetic variation: 5W

2.19.2 ILS identification: AQI
2.19.5 Coordinates: 39-59-47.82N / 82-54-46.60W
2.19.6 Site elevation: 820 ft

2.19.1 ILS type: Localizer for runway 10R. Magnetic variation: 5W
2.19.2 ILS identification: AQI
2.19.5 Coordinates: 39-59-35.98N / 82-52-00.00W
2.19.6 Site elevation: 811 ft

2.19.1 ILS type: Glide Slope for runway 10R. Magnetic variation: 5W
2.19.2 ILS identification: AQI
2.19.5 Coordinates: 39-59-39.93N / 82-54-20.65W
2.19.6 Site elevation: 805 ft

2.19.1 ILS type: DME for runway 28L. Magnetic variation: 5W
2.19.2 ILS identification: CMH
2.19.5 Coordinates: 39-59-47.82N / 82-54-46.60W
2.19.6 Site elevation: 820 ft

2.19.1 ILS type: Glide Slope for runway 28L. Magnetic variation: 5W
2.19.2 ILS identification: CMH
2.19.5 Coordinates: 39-59-41.39N / 82-52-35.19W
2.19.6 Site elevation: 812 ft

2.19.1 ILS type: Outer Marker for runway 28L. Magnetic variation: 5W
2.19.2 ILS identification: CMH
2.19.5 Coordinates: 39-59-10.25N / 82-45-15.67W
2.19.6 Site elevation: 99999 ft

2.19.1 ILS type: Localizer for runway 28L. Magnetic variation: 5W
2.19.2 ILS identification: CMH
2.19.5 Coordinates: 39-59-44.78N / 82-54-45.21W
2.19.6 Site elevation: 804 ft

2.19.1 ILS type: Middle Marker for runway 28L. Magnetic variation: 5W
2.19.2 ILS identification: CMH
2.19.5 Coordinates: 39-59-34.84N /

82-51-48.16W
2.19.6 Site elevation: 787 ft

General Remarks:

MODEL AIRCRAFT TRAFFIC WITHIN A 1 NAUTICAL MILE RADIUS OF A POINT 8 NAUTICAL MILE ON A 010 DEGREE BEARING FROM THE AIRPORT; SURFACE - 5000 FT AGL; SR-SS DAILY.

BIRDS IN THE VICINITY OF AIRPORT.

C-3 PAVEMENT (NORTH OF TAXIWAY C) IS 35 FT WIDE; RESTRICTED TO AIRCRAFT 50000 LBS OR LESS WITH WINGSPAN LESS THAN 79 FT.

BE ALERT: RUNWAY 10L/28R RESTRICTIONS ON STAGE I & II TURBOJET AIRCRAFT 2200-0800 & ON STAGE III TURBOJET AIRCRAFT 2200-0700. PRACTICE APPROACHES FOR HIGH NOISE LEVEL TYPE AIRCRAFT INCLUDING NON-STAGE III MILITARY JET AIRCRAFT SHALL NOT BE APPROVED UNLESS RUNWAY 10R/28L IS IN USE & THE APPROACH TERMINATES IN A FULL STOP TAXI-BACK OPN.

ALL SURFACES AROUND TERMINAL; NORTH OF TAXIWAY 'C' & SOUTH OF TAXIWAY 'E' ARE NON-MOVEMENT AREAS.

TAXIWAY 'F' LIGHTS SOUTH OF TAXIWAY 'G' OUT OF SERVICE INDEFINITELY.

NOISE BARRIER LOCATED AT SE SIDE OF AIRFIELD RESTRICTED TO AIRCRAFT WITH WINGSPAN LESS THAN 79 FT.

PERSONNEL AND EQUIPMENT WORKING ADJACENT ALL RUNWAYS AND TAXIWAYS.

TO REQUEST LANDING RIGHTS CONTACT US CUSTOMS BETWEEN 1230-0300Z, MON-FRI AT 614-497-1865.

FLIGHT NOTIFICATION SERVICE (ADCUS) AVAILABLE.

TAXIWAY L1 RESTRICTED TO AIRCRAFT WITH WINGSPAN LESS THAN 118 FT.

TAXIWAY L2 RESTRICTED TO AIRCRAFT WITH WINGSPAN LESS THAN 118 FT.

TAXIWAY B3 S OF TAXIWAY B RESTRICTED TO AIRCRAFT WITH WINGSPAN LESS THAN 79 FT.

TAXIWAY J2 RESTRICTED TO AIRCRAFT WITH WINGSPAN LESS THAN 120 FT.

TAXIWAY B BETWEEN TAXIWAYS B4 AND B5 RESTRICTED TO AIRCRAFT WITH WINGSPAN LESS THAN 126 FT.

TAXIWAYS F AND G, SOUTH OF TAXIWAY B, RESTRICTED TO AIRCRAFT WEIGHING 45000 LBS OR LESS.

**Portland, Oregon
Portland International
ICAO Identifier KPDX**

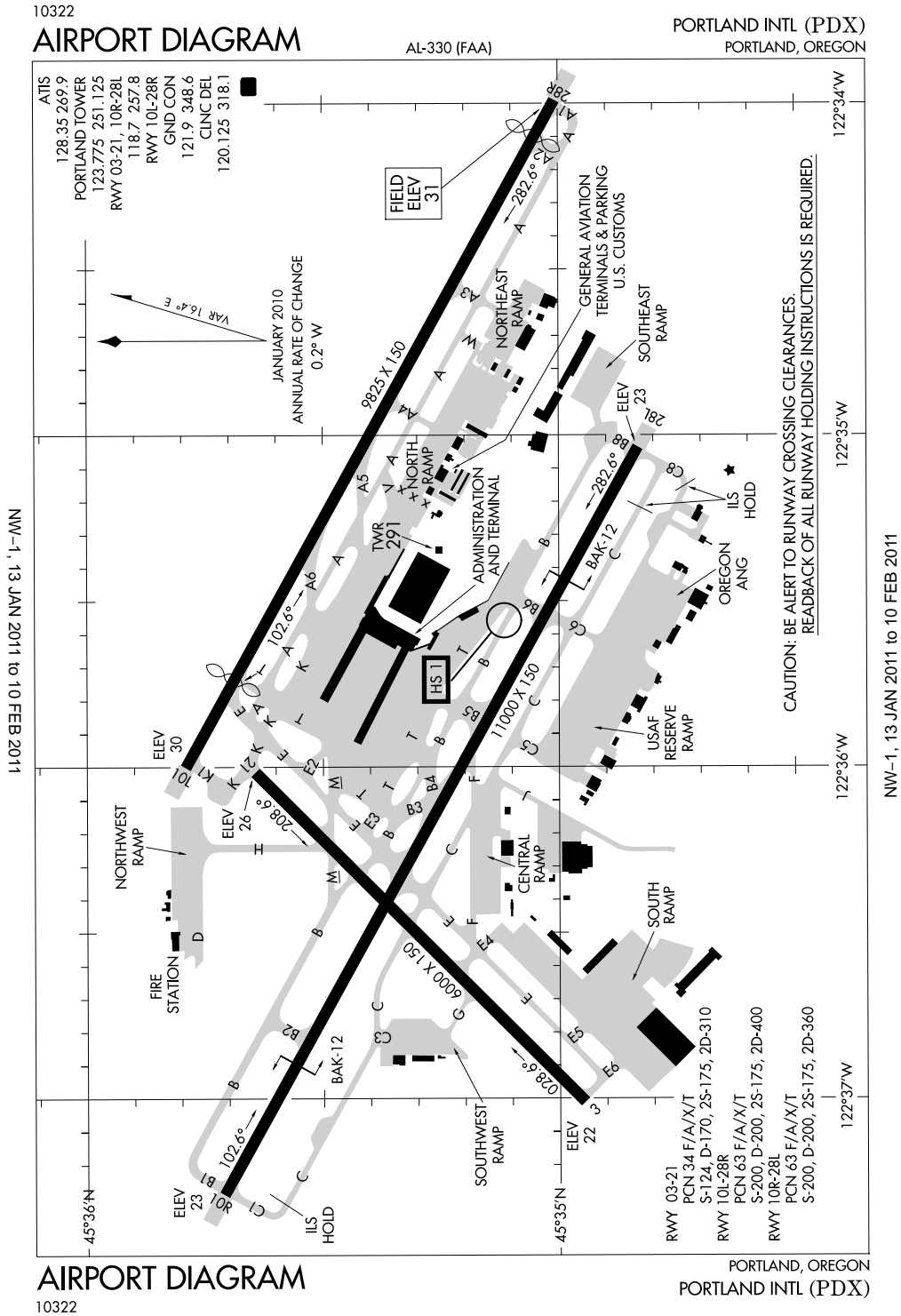

Portland, OR
Portland Intl
ICAO Identifier KPDX

AD 2.2 Aerodrome geographical and administrative data

- 2.2.1 Reference Point: 45-35-19.35N / 122-35-48.73W
- 2.2.2 From City: 4 Miles NE Of Portland, OR
- 2.2.3 Elevation: 31 ft
- 2.2.5 Magnetic variation: 20E (1980)
- 2.2.6 Airport Contact: Daren Griffin
7000 NE AIRPORT WAY
Portland, OR 97218
(503-460-4125)
- 2.2.7 Traffic: IFR/VFR

AD 2.3 Operational hours

- 2.3.1 - 2.3.11: ALL Months, ALL Days, ALL Hours

AD 2.4 Handling services and facilities

- 2.4.1 Cargo handling facilities: No
- 2.4.2 Fuel types: 100LL,A
- 2.4.4 De-icing facilities: None
- 2.4.5 Hangar space: Yes
- 2.4.6 Repair facilities: Major

AD 2.6 Rescue and firefighting services

- 2.6.1 Aerodrome category for firefighting: ARFF Index I E certified on 5/1/1973

AD 2.10 Aerodrome obstacles

- 2.10.1.a. Runway designation: 21
- 2.10.1.b Type of obstacle: Road (19 ft). Not Lighted or Marked
- 2.10.1.c Location of obstacle: 0 ft from Centerline
- 2.10.1.a. Runway designation: 28R
- 2.10.1.b Type of obstacle: Road (32 ft). Not Lighted or Marked
- 2.10.1.c Location of obstacle: 408 ft from Centerline

AD 2.12 Runway physical characteristics

- 2.12.1 Designation: 03
- 2.12.2 True Bearing: 45
- 2.12.3 Dimensions: 6000 ft x 150 ft
- 2.12.4 PCN: 34 F/A/X/T
- 2.12.5 Coordinates: 45-34-56.73N / 122-37-00.00W

- 2.12.6 Threshold elevation: 22 ft
- 2.12.6 Touchdown zone elevation: 23 ft

- 2.12.1 Designation: 21
- 2.12.2 True Bearing: 225
- 2.12.3 Dimensions: 6000 ft x 150 ft
- 2.12.4 PCN: 34 F/A/X/T
- 2.12.5 Coordinates: 45-35-38.61N / 122-36-00.00W
- 2.12.6 Threshold elevation: 26 ft
- 2.12.6 Touchdown zone elevation: 26 ft

- 2.12.1 Designation: 10R
- 2.12.2 True Bearing: 119
- 2.12.3 Dimensions: 11000 ft x 150 ft
- 2.12.4 PCN: 63 F/A/X/T
- 2.12.5 Coordinates: 45-35-42.53N / 122-37-17.30W
- 2.12.6 Threshold elevation: 23 ft
- 2.12.6 Touchdown zone elevation: 24 ft

- 2.12.1 Designation: 28L
- 2.12.2 True Bearing: 299
- 2.12.3 Dimensions: 11000 ft x 150 ft
- 2.12.4 PCN: 63 F/A/X/T
- 2.12.5 Coordinates: 45-34-49.85N / 122-35-00.00W
- 2.12.6 Threshold elevation: 23 ft
- 2.12.6 Touchdown zone elevation: 23 ft

- 2.12.1 Designation: 10L
- 2.12.2 True Bearing: 119
- 2.12.3 Dimensions: 9825 ft x 150 ft
- 2.12.4 PCN: 63 F/A/X/T
- 2.12.5 Coordinates: 45-35-47.45N / 122-36-00.00W
- 2.12.6 Threshold elevation: 30 ft
- 2.12.6 Touchdown zone elevation: 30 ft

- 2.12.1 Designation: 28R
- 2.12.2 True Bearing: 299
- 2.12.3 Dimensions: 9825 ft x 150 ft
- 2.12.4 PCN: 63 F/A/X/T
- 2.12.5 Coordinates: 45-35-00.00N / 122-33-59.26W
- 2.12.6 Threshold elevation: 31 ft
- 2.12.6 Touchdown zone elevation: 31 ft

AD 2.13 Declared distances

- 2.13.1 Designation: 03
- 2.13.2 Takeoff run available: 6000

2.13.3 Takeoff distance available: 6000
2.13.4 Accelerate-stop distance available: 6000
2.13.5 Landing distance available: 6000

2.13.1 Designation: 21
2.13.2 Takeoff run available: 6000
2.13.3 Takeoff distance available: 6000
2.13.4 Accelerate-stop distance available: 6000
2.13.5 Landing distance available: 6000

2.13.1 Designation: 10R
2.13.2 Takeoff run available: 11000
2.13.3 Takeoff distance available: 11000
2.13.4 Accelerate-stop distance available: 11000
2.13.5 Landing distance available: 11000

2.13.1 Designation: 28L
2.13.2 Takeoff run available: 11000
2.13.3 Takeoff distance available: 11000
2.13.4 Accelerate-stop distance available: 11000
2.13.5 Landing distance available: 11000

2.13.1 Designation: 10L
2.13.2 Takeoff run available: 9825
2.13.3 Takeoff distance available: 9825
2.13.4 Accelerate-stop distance available: 9825
2.13.5 Landing distance available: 8535

2.13.1 Designation: 28R
2.13.2 Takeoff run available: 9825
2.13.3 Takeoff distance available: 9825
2.13.4 Accelerate-stop distance available: 9825
2.13.5 Landing distance available: 9290

AD 2.14 Approach and runway lighting

2.14.1 Designation: 03
2.14.4 Visual approach slope indicator system:
4-light PAPI on left

2.14.1 Designation: 21
2.14.4 Visual approach slope indicator system:
4-light PAPI on right

2.14.1 Designation: 10R
2.14.2 Approach lighting system: ALSF2: Standard
2400 feet high intensity approach lighting system
with sequenced flashers, category II or III
configuration
2.14.4 Visual approach slope indicator system:
4-light PAPI on right

2.14.1 Designation: 28L
2.14.2 Approach lighting system: MALSR: 1400
feet medium intensity approach lighting system
with runway alignment indicator lights
2.14.4 Visual approach slope indicator system:
4-light PAPI on left

2.14.1 Designation: 10L
2.14.2 Approach lighting system: MALSR: 1400
feet medium intensity approach lighting system
with runway alignment indicator lights
2.14.4 Visual approach slope indicator system:
4-light PAPI on left

2.14.1 Designation: 28R
2.14.2 Approach lighting system: MALSR: 1400
feet medium intensity approach lighting system
with runway alignment indicator lights
2.14.4 Visual approach slope indicator system:
4-light PAPI on right

AD 2.18 Air traffic services communication facilities

2.18.1 Service designation: DEP/P CLASS C
2.18.3 Service designation: 118.1 MHz

2.18.1 Service designation: APCH/P DEP/P
CLASS C
2.18.3 Service designation: 118.1 MHz

2.18.1 Service designation: CD/P
2.18.3 Service designation: 120.125 MHz

2.18.1 Service designation: EMERG
2.18.3 Service designation: 121.5 MHz

2.18.1 Service designation: GND/P
2.18.3 Service designation: 121.9 MHz

2.18.1 Service designation: APCH/P DEP/P
CLASS C IC DEP/S
2.18.3 Service designation: 124.35 MHz

2.18.1 Service designation: APCH FINAL CTL
2.18.3 Service designation: 126.9 MHz

2.18.1 Service designation: DEP/S RDR
2.18.3 Service designation: 127.85 MHz

2.18.1 Service designation: AFR OPNS
2.18.3 Service designation: 138.45 MHz

2.18.1 Service designation: EMERG
2.18.3 Service designation: 243 MHz

2.18.1 Service designation: AFR OPNS
2.18.3 Service designation: 252.8 MHz

2.18.1 Service designation: ANG OPNS
2.18.3 Service designation: 280.5 MHz

2.18.1 Service designation: APCH/P DEP/P
CLASS C
2.18.3 Service designation: 284.6 MHz

2.18.1 Service designation: COMD POST
2.18.3 Service designation: 288.9 MHz

2.18.1 Service designation: DEP/S
2.18.3 Service designation: 290.3 MHz

2.18.1 Service designation: APCH/S RDR
2.18.3 Service designation: 294.7 MHz

2.18.1 Service designation: CD/P
2.18.3 Service designation: 318.1 MHz

2.18.1 Service designation: GND/P
2.18.3 Service designation: 348.6 MHz

2.18.1 Service designation: APCH/P DEP/P
CLASS C IC
2.18.3 Service designation: 299.2 MHz

2.18.1 Service designation: LCL/P
2.18.3 Service designation: 118.7 MHz

2.18.1 Service designation: LCL/P
2.18.3 Service designation: 123.775 MHz

2.18.1 Service designation: LCL/P
2.18.3 Service designation: 251.125 MHz

2.18.1 Service designation: LCL/P
2.18.3 Service designation: 257.8 MHz

2.18.1 Service designation: GND/S
2.18.3 Service designation: 132.275 MHz

2.18.1 Service designation: D-ATIS
2.18.3 Service designation: 128.35 MHz
2.18.4 Hours of operation: 24

2.18.1 Service designation: D-ATIS
2.18.3 Service designation: 269.9 MHz
2.18.4 Hours of operation: 24

2.18.1 Service designation: ANG OPS/COMD
POST
2.18.3 Service designation: 281.2 MHz

AD 2.19 Radio navigation and landing aids

2.19.1 ILS type: DME for runway 21. Magnetic
variation: 20E
2.19.2 ILS identification: GPO
2.19.5 Coordinates: 45-34-52.48N /
122-37-00.00W
2.19.6 Site elevation: 33 ft

2.19.1 ILS type: Localizer for runway 21. Magnetic
variation: 20E
2.19.2 ILS identification: GPO
2.19.5 Coordinates: 45-34-54.38N /
122-37-00.00W
2.19.6 Site elevation: 16 ft

2.19.1 ILS type: Localizer for runway 10R.
Magnetic variation: 16E
2.19.2 ILS identification: PDX
2.19.5 Coordinates: 45-34-43.53N /
122-34-45.82W
2.19.6 Site elevation: 20 ft

2.19.1 ILS type: DME for runway 10R. Magnetic
variation: 16E
2.19.2 ILS identification: PDX
2.19.5 Coordinates: 45-34-46.74N /
122-34-45.23W
2.19.6 Site elevation: 36 ft

2.19.1 ILS type: Glide Slope for runway 10R.
Magnetic variation: 16E
2.19.2 ILS identification: PDX
2.19.5 Coordinates: 45-35-33.90N /
122-37-00.00W
2.19.6 Site elevation: 16 ft

2.19.1 ILS type: Outer Marker for runway 10R.
Magnetic variation: 16E
2.19.2 ILS identification: PDX
2.19.5 Coordinates: 45-37-24.12N /
122-41-48.15W
2.19.6 Site elevation: 26 ft

2.19.1 ILS type: Middle Marker for runway 10R.
Magnetic variation: 16E
2.19.2 ILS identification: PDX
2.19.5 Coordinates: 45-35-58.13N /
122-37-57.39W
2.19.6 Site elevation: 25 ft

2.19.1 ILS type: Inner Marker for runway 10R.
Magnetic variation: 16E
2.19.2 ILS identification: PDX
2.19.5 Coordinates: 45-35-46.71N /
122-37-28.03W
2.19.6 Site elevation: 17 ft

2.19.1 ILS type: Localizer for runway 28L.
Magnetic variation: 20E
2.19.2 ILS identification: JMJ
2.19.5 Coordinates: 45-35-50.52N /
122-37-37.81W
2.19.6 Site elevation: 25 ft

2.19.1 ILS type: DME for runway 28L. Magnetic
variation: 20E
2.19.2 ILS identification: JMJ
2.19.5 Coordinates: 45-34-46.74N /
122-34-45.23W
2.19.6 Site elevation: 36 ft

2.19.1 ILS type: Glide Slope for runway 28L.
Magnetic variation: 20E
2.19.2 ILS identification: JMJ
2.19.5 Coordinates: 45-34-52.63N /
122-35-16.71W
2.19.6 Site elevation: 20 ft

2.19.1 ILS type: Localizer for runway 10L.
Magnetic variation: 20E
2.19.2 ILS identification: VDG
2.19.5 Coordinates: 45-34-55.53N /
122-33-46.85W
2.19.6 Site elevation: 29 ft

2.19.1 ILS type: DME for runway 10L. Magnetic
variation: 20E
2.19.2 ILS identification: VDG
2.19.5 Coordinates: 45-35-47.95N /

122-36-13.55W
2.19.6 Site elevation: 26 ft

2.19.1 ILS type: Glide Slope for runway 10L.
Magnetic variation: 20E
2.19.2 ILS identification: VDG
2.19.5 Coordinates: 45-35-10.93N /
122-34-16.40W
2.19.6 Site elevation: 31 ft

2.19.1 ILS type: Glide Slope for runway 28R.
Magnetic variation: 20E
2.19.2 ILS identification: IAP
2.19.5 Coordinates: 45-35-00.00N /
122-34-25.01W
2.19.6 Site elevation: 23 ft

2.19.1 ILS type: Outer Marker for runway 28R.
Magnetic variation: 20E
2.19.2 ILS identification: IAP
2.19.5 Coordinates: 45-32-28.06N /
122-27-44.78W
2.19.6 Site elevation: 99999 ft

2.19.1 ILS type: Middle Marker for runway 28R.
Magnetic variation: 20E
2.19.2 ILS identification: IAP
2.19.5 Coordinates: 45-34-44.97N /
122-33-19.90W
2.19.6 Site elevation: 99999 ft

2.19.1 ILS type: Localizer for runway 28R.
Magnetic variation: 20E
2.19.2 ILS identification: IAP
2.19.5 Coordinates: 45-35-52.30N /
122-36-12.47W
2.19.6 Site elevation: 26 ft

2.19.1 ILS type: DME for runway 28R. Magnetic
variation: 20E
2.19.2 ILS identification: IAP
2.19.5 Coordinates: 45-35-47.95N /
122-36-13.55W
2.19.6 Site elevation: 27 ft

General Remarks:

AIRPORT CLOSED TO NON-POWERED AIRCRAFT EXCEPT IN EMERGENCY.

TAXIWAY T BETWEEN EXITS B5 & B6 CLOSED TO AIRCRAFT WITH WINGSPAN OF 118 FT AND

GREATER.

MIGRATORY & WINTERING FLOCKS OF LARGE WATERFOWL ON & IN THE VICINITY OF AIRPORT. HEAVY SEAGULL ACTIVITY SEP THRU APR; EXPECT HIGH NUMBER OF BIRDS YEAR AROUND; CHECK LOCAL ADVISORIES.

NOISE ABATEMENT PROCEDURES IN EFFECT; CALL NOISE OFFICE AT 503-460-4100. RUNWAY 28L ARRIVALS ARE NOISE SENSITIVE, EXPECT APPROACH TO 28R WITH TRANSITION TO 28L.

180 DEGREE TURNS BY AIRCRAFT WEIGHING IN EXCESS OF 12500 LBS PROHIBITED ON ALL RUNWAYS & TAXIWAYS.

UNCONTROLLED TRAFFIC AT PEARSON FIELD VANCOUVER AIRMET 3 NAUTICAL MILE W OF RUNWAY 10L THRESHOLD ON EXTENDED CENTERLINE.

(E143-20) LOCALIZER ONLY.RWY 21.

(E94) WSFO/WSO/FW/RFC.

AREA OF TAXIWAY T BETWEEN M AND E3 NOT VISIBLE FROM TOWER.

TAXIWAY F BETWEEN RUNWAY 10R/28L AND TAXIWAY C CLOSED TO AIRCRAFT OVER 65,000 LBS.

TAXIWAY F CLOSED TO NON PART 139 AIRCRAFT WITH WINGSPAN GREATER THAN 194 FT.

TAXIWAY F CLOSED TO PART 139 AIRCRAFT WITH WINGSPAN GREATER THAN 108 FT.

AIRCRAFT AUTHORIZE TO UTILIZE THE NORTHWEST RAMP OR THE NORTH RAMP WILL BE TOWED TO/FROM THESE RAMPS.

AT THE WEST END ARM/DEARM AREA ON TAXIWAY C NO AIRCRAFT OF ANY TYPE MAY TAXI PAST THE ARM/DEARM AREA WHILE IT IS BEING USED.

BEARING STRENGTH: RUNWAY 03-21 ST 175, RUNWAY 10L-28R ST175, RUNWAY 10R-28L ST175.

ARRESTING GEAR - BAK-12A(B) RUNWAY 10R AND 28L CABLE RAISED BY BAK-14 DEVICE ON REQUEST TO TOWER. NOT INSPECTED FOR OPR CAPABILITY WEEKEND OR HOLIDAY.

JASU - (AM32A-60) 4(A/M32A-86) (MC-11) 1(MA-1A).

FUEL - A (AIR BP - FLIGHTCRAFT INC., C503-331-4220) J8(MIL) (NC-100LL, A)

FLUID - LHOXRB.

OIL - O-128-133-148(MIL).

MISC: FLIGHT NOTIFICATION SERVICE, ADVISE CUSTOMS, AVAILABLE.

ANG: PRIOR PERMISSION REQUIRED/OFFICIAL BUSINESS ONLY. BASE OPERATIONS OPR

1500-2300Z++ MON-FRI EXCEPT HOLIDAY.; DSN 638-4390, C503-335-4390. CONTACT BASE OPERATIONS 15 MIN PRIOR TO LANDING AND AFTER DEP ON 281.2. TRANSIENT QUARTERS NOT AVAILABLE.

TAXIWAY V CLOSED TO AIRCRAFT WITH WINGSPAN GREATER THAN 135 FT. AIRCRAFT WITH WINGSPAN GREATER THAN 91 FT PROHIBITED FROM TURNING WESTBOUND ONTO TAXIWAY A FROM TAXIWAY V UNLESS UNDER TOW.

ANG: SEE FLIGHT INFORMATION PUBLICATION AP/1 FOR SUPPLEMENTARY AIRPORT INFORMATION. HAZARDOUS BIRD CONDITION EXIST. PHASE I MAY-OCT, PHASE II NOV-APR. CURRENT BIRD WATCH CONDITIONS ARE NOT REPORTED ON AUTOMATIC TERMINAL INFORMATION SERVICE.

TAXIWAY W BETWEEN TAXIWAY A & THE GENERAL AVIATION RAMP CLOSED TO AIRCRAFT WITH WINGSPAN GREATER THAN 95 FT. AIRCRAFT WITH WINGSPAN BETWEEN 79 FT AND 95 FT MUST BE TOWED. TAXIWAY K BETWEEN THE NORTH RAMP AND THE GENERAL AVIATION RAMP CLOSED TO THROUGH TRAFFIC.

CONSTRUCTION ON RUNWAY 10L-28R IN PROGRESS. SEE NOTAMS FOR CURRENT INFORMATION.

NONSTANDARD A-G MRK - BARRIERS MRK BY 4 FT LIGHTED ORANGE BALLS (WHEN RAISED) AND 7 YELLOW PAINTED CIRCLES ON RUNWAY SURFACE. A-G MRK NOT IN LINE WITH DIST REMAINING MRK.

NONSTANDARD YELLOW PARK SPOT DESIGNATORS AND EQUIPMENT TOOL BOX LOCATION PAINTED ON RAMP. LOAD BEARING EDGE ON EAST RAMP NOT MRK. PLEASE CONTACT BASE OPERATIONS OR REQ FOLLOW ME IF NOT FAMILIAR WITH PANGB PARK PROCEDURES.

Babelthuap Island Babelthuap/Koror ICAO Identifier PTRO

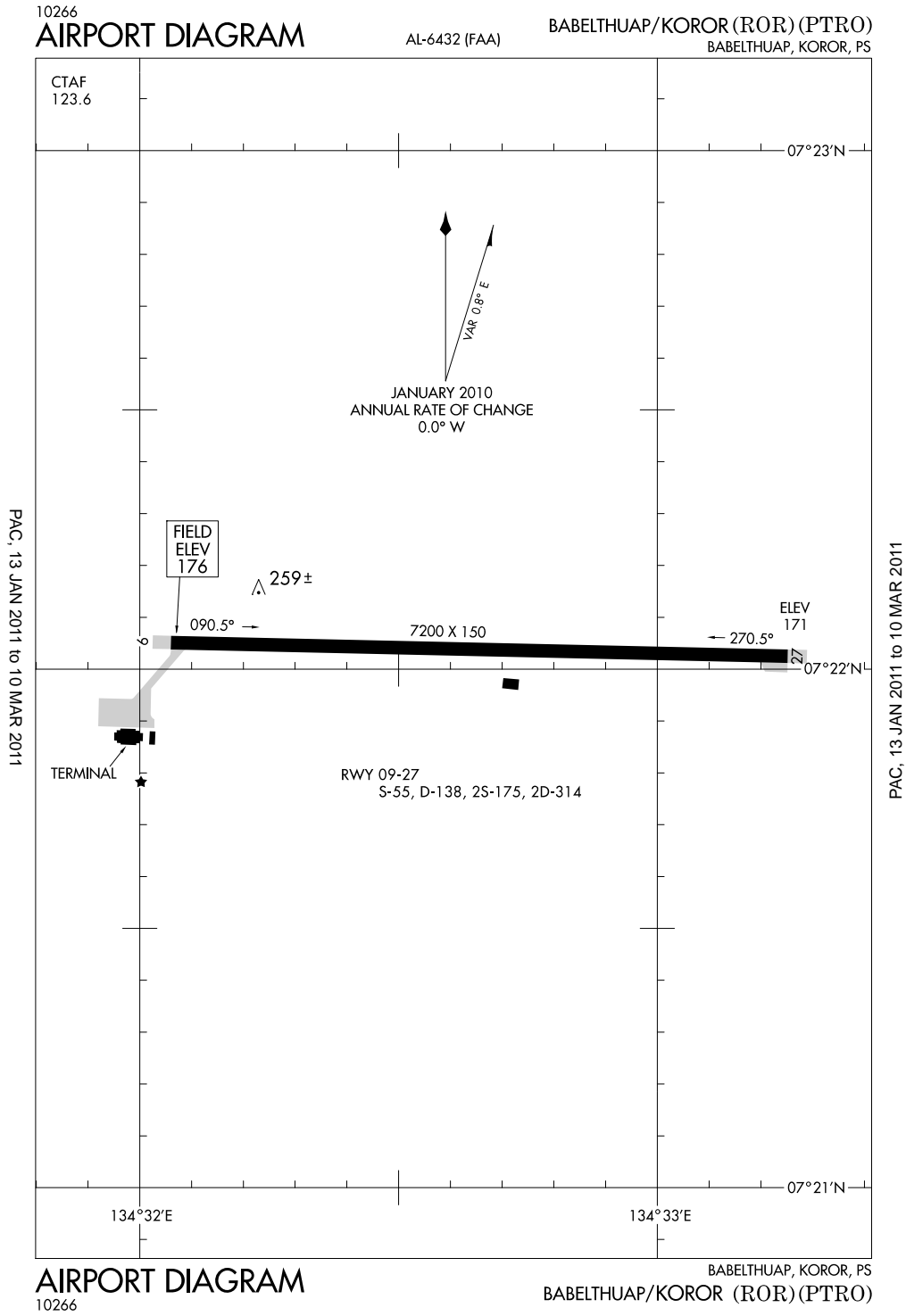

Babelthuap Island, PW
Babelthuap/Koror
ICAO Identifier PTRO

2.10.1.b Type of obstacle: Trees (11 ft). Not
Lighted or Marked
2.10.1.c Location of obstacle: 75 ft from Centerline

**AD 2.2 Aerodrome geographical and
administrative data**

2.2.1 Reference Point: 07-22-00.00N /
134-32-39.40E
2.2.2 From City: 4 Miles NE Of Babelthuap Island,
Pw
2.2.3 Elevation: 176 ft
2.2.5 Magnetic variation: 1E (1990)
2.2.7 Traffic: IFR/VFR

AD 2.3 Operational hours

2.3.1 - 2.3.11: ALL Months, ALL Days, ALL
Hours

AD 2.4 Handling services and facilities

2.4.1 Cargo handling facilities: No
2.4.2 Fuel types: 115,A1
2.4.4 De-icing facilities: None
2.4.5 Hangar space: No
2.4.6 Repair facilities: None

AD 2.6 Rescue and firefighting services

2.6.1 Aerodrome category for firefighting: None

AD 2.10 Aerodrome obstacles

2.10.1.a. Runway designation: 27

AD 2.12 Runway physical characteristics

2.12.1 Designation: 09
2.12.2 True Bearing: 91
2.12.3 Dimensions: 7200 ft x 150 ft
2.12.5 Coordinates: 07-22-00.00N /
134-32-00.00E
2.12.6 Threshold elevation: 176 ft
2.12.6 Touchdown zone elevation: 176 ft

2.12.1 Designation: 27
2.12.2 True Bearing: 271
2.12.3 Dimensions: 7200 ft x 150 ft
2.12.5 Coordinates: 07-22-00.00N /
134-33-15.17E
2.12.6 Threshold elevation: 171 ft
2.12.6 Touchdown zone elevation: 176 ft

AD 2.14 Approach and runway lighting

2.14.1 Designation: 09
2.14.4 Visual approach slope indicator system:
4-light PAPI on left

2.14.1 Designation: 27
2.14.4 Visual approach slope indicator system:
4-light PAPI on left

General Remarks:

ALL UNSCHEDULED FLIGHTS MUST FILE A FLIGHT PLAN AT LEAST 7 DAYS PRIOR TO
ARRIVAL AND ALL FLIGHTS MUST CONTACT KOROR COMMUNICATIONS ON 123.6 AT LEAST
20 MINUTES PRIOR TO ARRIVAL.

AIRCRAFT RESCUE AND FIRE FIGHTING AVAILABLE 2 HRS PRIOR TO SCHEDULE AIRCRAFT
ARR AND UNTIL 1 HR AFTER DEP.

CAUTION: LARGE NUMBER OF BIRDS ON RUNWAY AT NIGHT.

ALL AIRCRAFT EXCEEDING 100000 LBS GROSS WEIGHT TAXI TO THR TURN AROUND
BEFORE TAXING TO APRON. AIRCRAFT UNDER 100000 LBS GROSS WEIGHT MAY MAKE A
TURN AROUND WHERE FEASIBLE.

ENTRY PERMIT REQUIRED CALL 011-680-488-2498 FAX 011-680-488-4385; LANDING PERMIT
REQUIRED MUST GIVE SEVEN DAYS NOTICE CALL 011-680-488-2111 FAX 011-680-488-3207.

(E94) WX STATION 5 MI FROM AIRPORT.

Philadelphia, Pennsylvania
Philadelphia International
ICAO Identifier KPHL

10266

AIRPORT DIAGRAM

AL-320 (FAA)

PHILADELPHIA INTL (PHL)
PHILADELPHIA, PENNSYLVANIA

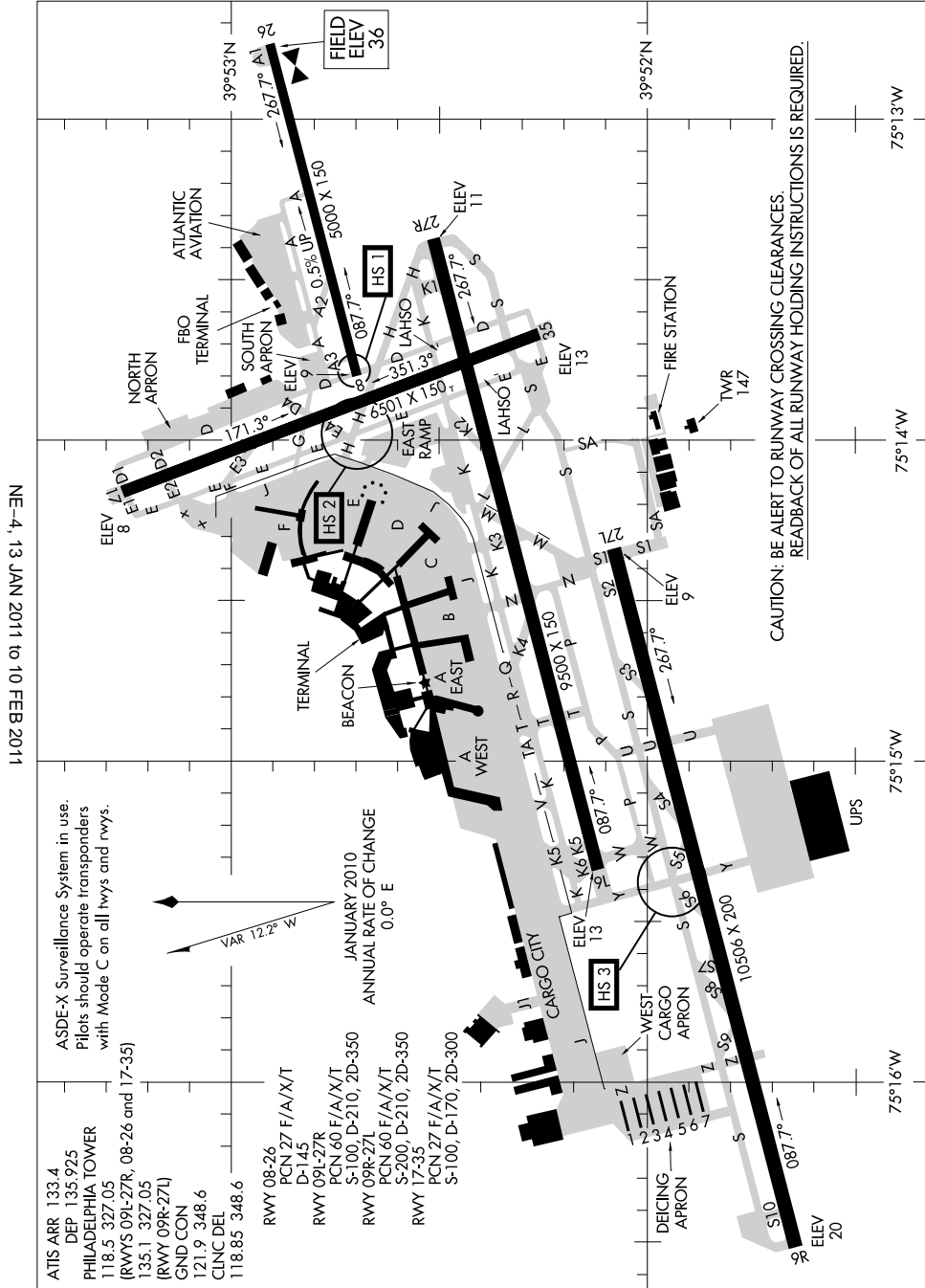

NE-4, 13 JAN 2011 to 10 FEB 2011

NE-4, 13 JAN 2011 to 10 FEB 2011

AIRPORT DIAGRAM

10266

PHILADELPHIA, PENNSYLVANIA
PHILADELPHIA INTL (PHL)

Philadelphia, PA
Philadelphia Intl
ICAO Identifier KPHL

AD 2.2 Aerodrome geographical and administrative data

- 2.2.1 Reference Point: 39-52-20.10N / 75-14-27.12W
- 2.2.2 From City: 5 Miles SW Of Philadelphia, PA
- 2.2.3 Elevation: 36 ft
- 2.2.5 Magnetic variation: 10W (1980)
- 2.2.6 Airport Contact: Mark Gale
DIV OF AVIATION TERMINAL E
Philadelphia, PA 19153
(215-937-6914)
- 2.2.7 Traffic: IFR/VFR

AD 2.3 Operational hours

- 2.3.1 - 2.3.11: ALL Months, ALL Days, ALL Hours

AD 2.4 Handling services and facilities

- 2.4.1 Cargo handling facilities: No
- 2.4.2 Fuel types: 100LL,A
- 2.4.4 De-icing facilities: None
- 2.4.5 Hangar space: Yes
- 2.4.6 Repair facilities: Major

AD 2.6 Rescue and firefighting services

- 2.6.1 Aerodrome category for firefighting: ARFF Index I E certified on 5/1/1973

AD 2.10 Aerodrome obstacles

- 2.10.1.a. Runway designation: 09L
- 2.10.1.b Type of obstacle: Gnd (17 ft). Not Lighted or Marked
- 2.10.1.c Location of obstacle: 460 ft from Centerline

- 2.10.1.a. Runway designation: 27R
- 2.10.1.b Type of obstacle: Boat (189 ft). Not Lighted or Marked
- 2.10.1.c Location of obstacle: 0 ft from Centerline

- 2.10.1.a. Runway designation: 09R
- 2.10.1.b Type of obstacle: Trees (11 ft). Not Lighted or Marked
- 2.10.1.c Location of obstacle: 360 ft from Centerline

- 2.10.1.a. Runway designation: 27L

- 2.10.1.b Type of obstacle: Boat (189 ft). Not Lighted or Marked
- 2.10.1.c Location of obstacle: 0 ft from Centerline

- 2.10.1.a. Runway designation: 17
- 2.10.1.b Type of obstacle: Pole (49 ft). Not Lighted or Marked
- 2.10.1.c Location of obstacle: 560 ft from Centerline

- 2.10.1.a. Runway designation: 35
- 2.10.1.b Type of obstacle: Boat (189 ft). Not Lighted or Marked
- 2.10.1.c Location of obstacle: 0 ft from Centerline

- 2.10.1.a. Runway designation: 08
- 2.10.1.b Type of obstacle: Bldg (190 ft). Lighted
- 2.10.1.c Location of obstacle: 200 ft from Centerline

- 2.10.1.a. Runway designation: 26
- 2.10.1.b Type of obstacle: Fence (5 ft). Lighted
- 2.10.1.c Location of obstacle: 280 ft from Centerline

AD 2.12 Runway physical characteristics

- 2.12.1 Designation: 09L
- 2.12.2 True Bearing: 75
- 2.12.3 Dimensions: 9500 ft x 150 ft
- 2.12.4 PCN: 60 F/A/X/T
- 2.12.5 Coordinates: 39-52-00.00N / 75-15-20.39W
- 2.12.6 Threshold elevation: 13 ft
- 2.12.6 Touchdown zone elevation: 13 ft

- 2.12.1 Designation: 27R
- 2.12.2 True Bearing: 255
- 2.12.3 Dimensions: 9500 ft x 150 ft
- 2.12.4 PCN: 60 F/A/X/T
- 2.12.5 Coordinates: 39-52-30.79N / 75-13-22.44W
- 2.12.6 Threshold elevation: 11 ft
- 2.12.6 Touchdown zone elevation: 11 ft

- 2.12.1 Designation: 09R
- 2.12.2 True Bearing: 75
- 2.12.3 Dimensions: 10506 ft x 200 ft
- 2.12.4 PCN: 60 F/A/X/T
- 2.12.5 Coordinates: 39-51-38.92N / 75-16-30.70W
- 2.12.6 Threshold elevation: 20 ft

2.12.6 Touchdown zone elevation: 21 ft

2.12.1 Designation: 27L

2.12.2 True Bearing: 255

2.12.3 Dimensions: 10506 ft x 200 ft

2.12.4 PCN: 60 F/A/X/T

2.12.5 Coordinates: 39-52-00.00N /
75-14-20.27W

2.12.6 Threshold elevation: 9 ft

2.12.6 Touchdown zone elevation: 10 ft

2.12.1 Designation: 17

2.12.2 True Bearing: 159

2.12.3 Dimensions: 6501 ft x 150 ft

2.12.4 PCN: 27 F/A/X/T

2.12.5 Coordinates: 39-53-15.57N /
75-14-00.00W

2.12.6 Threshold elevation: 8 ft

2.12.6 Touchdown zone elevation: 10 ft

2.12.1 Designation: 35

2.12.2 True Bearing: 339

2.12.3 Dimensions: 6501 ft x 150 ft

2.12.4 PCN: 27 F/A/X/T

2.12.5 Coordinates: 39-52-15.57N /
75-13-40.13W

2.12.6 Threshold elevation: 13 ft

2.12.6 Touchdown zone elevation: 10 ft

2.12.1 Designation: 08

2.12.2 True Bearing: 75

2.12.3 Dimensions: 5000 ft x 150 ft

2.12.4 PCN: 27 F/A/X/T

2.12.5 Coordinates: 39-52-42.02N /
75-13-48.04W

2.12.6 Threshold elevation: 9 ft

2.12.6 Touchdown zone elevation: 20 ft

2.12.1 Designation: 26

2.12.2 True Bearing: 256

2.12.3 Dimensions: 5000 ft x 150 ft

2.12.4 PCN: 27 F/A/X/T

2.12.5 Coordinates: 39-52-54.38N /
75-12-45.94W

2.12.6 Threshold elevation: 36 ft

2.12.6 Touchdown zone elevation: 36 ft

AD 2.14 Approach and runway lighting

2.14.1 Designation: 09L

2.14.2 Approach lighting system: MALSR: 1400
feet medium intensity approach lighting system

with runway alignment indicator lights

2.14.4 Visual approach slope indicator system:
4-light PAPI on left

2.14.1 Designation: 27R

2.14.2 Approach lighting system: MALSR: 1400
feet medium intensity approach lighting system
with runway alignment indicator lights

2.14.4 Visual approach slope indicator system:
4-light PAPI on left

2.14.1 Designation: 09R

2.14.2 Approach lighting system: ALSF2: Standard
2400 feet high intensity approach lighting system
with sequenced flashers, category II or III
configuration

2.14.1 Designation: 27L

2.14.2 Approach lighting system: MALSR: 1400
feet medium intensity approach lighting system
with runway alignment indicator lights

2.14.4 Visual approach slope indicator system:
4-light PAPI on right

2.14.1 Designation: 17

2.14.4 Visual approach slope indicator system:
4-light PAPI on left

2.14.1 Designation: 26

2.14.2 Approach lighting system: MALSR: 1400
feet medium intensity approach lighting system
with runway alignment indicator lights

2.14.4 Visual approach slope indicator system:
4-light PAPI on right

AD 2.18 Air traffic services communication facilities

2.18.1 Service designation: CLASS B

2.18.3 Service designation: 118.35 MHz

2.18.1 Service designation: CD/P

2.18.3 Service designation: 118.85 MHz

2.18.1 Service designation: CLASS B

2.18.3 Service designation: 119.75 MHz

2.18.1 Service designation: CLASS B

2.18.3 Service designation: 119.75 MHz

2.18.1 Service designation: DEP/P

2.18.3 Service designation: 119.75 MHz

2.18.1 Service designation: EMERG
2.18.3 Service designation: 121.5 MHz

2.18.1 Service designation: GND/S
2.18.3 Service designation: 121.65 MHz

2.18.1 Service designation: GND/P
2.18.3 Service designation: 121.9 MHz

2.18.1 Service designation: CLASS B
2.18.3 Service designation: 123.8 MHz

2.18.1 Service designation: APCH/P AT OR
BELOW 5000 FT.
2.18.3 Service designation: 123.8 MHz

2.18.1 Service designation: CLASS B
2.18.3 Service designation: 124.35 MHz

2.18.1 Service designation: CLASS B
2.18.3 Service designation: 124.35 MHz

2.18.1 Service designation: CLASS B
2.18.3 Service designation: 124.35 MHz

2.18.1 Service designation: CLASS B
2.18.3 Service designation: 124.35 MHz

2.18.1 Service designation: DEP/P
2.18.3 Service designation: 124.35 MHz

2.18.1 Service designation: APCH/P DEP/P
2.18.3 Service designation: 124.35 MHz

2.18.1 Service designation: FINAL APCH
2.18.3 Service designation: 125.4 MHz

2.18.1 Service designation: APCH/P ABOVE 5000
FT
2.18.3 Service designation: 126.6 MHz

2.18.1 Service designation: CLASS B
2.18.3 Service designation: 126.85 MHz

2.18.1 Service designation: APCH/P AT OR
BELOW 5000 FT.
2.18.3 Service designation: 126.85 MHz

2.18.1 Service designation: CLASS B
2.18.3 Service designation: 127.35 MHz

2.18.1 Service designation: CLASS B
2.18.3 Service designation: 127.35 MHz

2.18.1 Service designation: APCH/P AT OR
BELOW 5000 FT.
2.18.3 Service designation: 127.35 MHz

2.18.1 Service designation: CLASS B
2.18.3 Service designation: 128.4 MHz

2.18.1 Service designation: CLASS B
2.18.3 Service designation: 128.4 MHz

2.18.1 Service designation: CLASS B
2.18.3 Service designation: 128.4 MHz

2.18.1 Service designation: CLASS B
2.18.3 Service designation: 128.4 MHz

2.18.1 Service designation: APCH/P ABOVE 5000
FT.
2.18.3 Service designation: 128.4 MHz

2.18.1 Service designation: EMERG
2.18.3 Service designation: 243 MHz

2.18.1 Service designation: CLASS B
2.18.3 Service designation: 263.125 MHz

2.18.1 Service designation: CLASS B
2.18.3 Service designation: 263.125 MHz

2.18.1 Service designation: CLASS B
2.18.3 Service designation: 263.125 MHz

2.18.1 Service designation: APCH/P AT OR BLO
5000 FT.
2.18.3 Service designation: 263.125 MHz

2.18.1 Service designation: APCH/P AT OR BLO
5000 FT.
2.18.3 Service designation: 263.125 MHz

2.18.1 Service designation: CLASS B
2.18.3 Service designation: 269.25 MHz

2.18.1 Service designation: CLASS B
2.18.3 Service designation: 269.25 MHz

2.18.1 Service designation: DEP/P
2.18.3 Service designation: 269.25 MHz

2.18.1 Service designation: CLASS B
2.18.3 Service designation: 273.575 MHz

2.18.1 Service designation: CLASS B
2.18.3 Service designation: 273.575 MHz

2.18.1 Service designation: CLASS B
2.18.3 Service designation: 273.575 MHz

2.18.1 Service designation: APCH/P ABOVE 5000
FT
2.18.3 Service designation: 273.575 MHz

2.18.1 Service designation: CLASS B
2.18.3 Service designation: 291.7 MHz

2.18.1 Service designation: APCH/P AT OR BLO
5000 FT.
2.18.3 Service designation: 291.7 MHz

2.18.1 Service designation: CLASS B
2.18.3 Service designation: 317.55 MHz

2.18.1 Service designation: CLASS B
2.18.3 Service designation: 317.55 MHz

2.18.1 Service designation: APCH/P ABOVE 5000
FT IC
2.18.3 Service designation: 317.55 MHz

2.18.1 Service designation: CLASS B
2.18.3 Service designation: 319.15 MHz

2.18.1 Service designation: IC
2.18.3 Service designation: 319.15 MHz

2.18.1 Service designation: CLASS B
2.18.3 Service designation: 320.1 MHz

2.18.1 Service designation: CLASS B
2.18.3 Service designation: 320.1 MHz

2.18.1 Service designation: CLASS B
2.18.3 Service designation: 320.1 MHz

2.18.1 Service designation: DEP/P
2.18.3 Service designation: 320.1 MHz

2.18.1 Service designation: CLASS B
2.18.3 Service designation: 323.1 MHz

2.18.1 Service designation: CD/P GND/P
2.18.3 Service designation: 348.6 MHz

2.18.1 Service designation: D-ATIS
2.18.3 Service designation: 133.4 MHz
2.18.4 Hours of operation: 24

2.18.1 Service designation: D-ATIS
2.18.3 Service designation: 135.925 MHz
2.18.4 Hours of operation: 24

2.18.1 Service designation: ILS PRM LCL/P
2.18.3 Service designation: 118.5 MHz

2.18.1 Service designation: LCL/P
2.18.3 Service designation: 118.5 MHz

2.18.1 Service designation: ILS PRM LCL/P
2.18.3 Service designation: 135.1 MHz

2.18.1 Service designation: LCL/P
2.18.3 Service designation: 135.1 MHz

2.18.1 Service designation: ILS PRM LCL/P
2.18.3 Service designation: 327.05 MHz

2.18.1 Service designation: LCL/P
2.18.3 Service designation: 327.05 MHz

2.18.1 Service designation: ILS PRM MONITOR/P
2.18.3 Service designation: 123.6 MHz

2.18.1 Service designation: ILS PRM MONITOR/P
2.18.3 Service designation: 120.425 MHz

2.18.1 Service designation: CLASS B
2.18.3 Service designation: 133.875 MHz

2.18.1 Service designation: CLASS B
2.18.3 Service designation: 133.875 MHz

AD 2.19 Radio navigation and landing aids

2.19.1 ILS type: DME for runway 09L. Magnetic
variation: 10W

2.19.2 ILS identification: VII

2.19.5 Coordinates: 39-52-35.47N /
75-13-11.51W

2.19.6 Site elevation: 20 ft

2.19.1 ILS type: Outer Marker for runway 09L.
Magnetic variation: 10W

2.19.2 ILS identification: VII

2.19.5 Coordinates: 39-50-29.30N /
75-22-57.40W

2.19.6 Site elevation: 47 ft

2.19.1 ILS type: Middle Marker for runway 09L.
Magnetic variation: 10W
2.19.2 ILS identification: VII
2.19.5 Coordinates: 39-52-00.00N /
75-15-55.00W
2.19.6 Site elevation: 9 ft

2.19.1 ILS type: Localizer for runway 09L.
Magnetic variation: 10W
2.19.2 ILS identification: VII
2.19.5 Coordinates: 39-52-33.38N /
75-13-00.00W
2.19.6 Site elevation: 9 ft

2.19.1 ILS type: Glide Slope for runway 09L.
Magnetic variation: 10W
2.19.2 ILS identification: VII
2.19.5 Coordinates: 39-52-00.00N /
75-15-00.00W
2.19.6 Site elevation: 10 ft

2.19.1 ILS type: DME for runway 27R. Magnetic
variation: 10W
2.19.2 ILS identification: PDP
2.19.5 Coordinates: 39-52-35.46N /
75-13-11.51W
2.19.6 Site elevation: 22 ft

2.19.1 ILS type: Glide Slope for runway 27R.
Magnetic variation: 10W
2.19.2 ILS identification: PDP
2.19.5 Coordinates: 39-52-24.05N /
75-13-35.81W
2.19.6 Site elevation: 8 ft

2.19.1 ILS type: Localizer for runway 27R.
Magnetic variation: 10W
2.19.2 ILS identification: PDP
2.19.5 Coordinates: 39-52-00.00N /
75-15-32.93W
2.19.6 Site elevation: 10 ft

2.19.1 ILS type: Outer Marker for runway 27R.
Magnetic variation: 10W
2.19.2 ILS identification: PDP
2.19.5 Coordinates: 39-54-00.00N /
75-05-41.51W
2.19.6 Site elevation: 99999 ft

2.19.1 ILS type: Middle Marker for runway 27R.
Magnetic variation: 10W
2.19.2 ILS identification: PDP
2.19.5 Coordinates: 39-52-38.00N /
75-12-46.40W
2.19.6 Site elevation: 99999 ft

2.19.1 ILS type: Outer Marker for runway 09R.
Magnetic variation: 12W
2.19.2 ILS identification: PHL
2.19.5 Coordinates: 39-50-29.30N /
75-22-57.40W
2.19.6 Site elevation: 99999 ft

2.19.1 ILS type: Inner Marker for runway 09R.
Magnetic variation: 12W
2.19.2 ILS identification: PHL
2.19.5 Coordinates: 39-51-36.74N /
75-16-41.58W
2.19.6 Site elevation: 99999 ft

2.19.1 ILS type: Middle Marker for runway 09R.
Magnetic variation: 12W
2.19.2 ILS identification: PHL
2.19.5 Coordinates: 39-51-31.82N /
75-17-00.00W
2.19.6 Site elevation: 99999 ft

2.19.1 ILS type: Localizer for runway 09R.
Magnetic variation: 12W
2.19.2 ILS identification: PHL
2.19.5 Coordinates: 39-52-00.00N /
75-14-00.00W
2.19.6 Site elevation: 8 ft

2.19.1 ILS type: DME for runway 09R. Magnetic
variation: 12W
2.19.2 ILS identification: PHL
2.19.5 Coordinates: 39-52-00.00N /
75-14-00.00W
2.19.6 Site elevation: 18 ft

2.19.1 ILS type: Glide Slope for runway 09R.
Magnetic variation: 12W
2.19.2 ILS identification: PHL
2.19.5 Coordinates: 39-51-37.82N /
75-16-15.73W
2.19.6 Site elevation: 15 ft

2.19.1 ILS type: Localizer for runway 27L.
Magnetic variation: 10W

2.19.2 ILS identification: GLC
2.19.5 Coordinates: 39-51-36.27N /
75-16-43.95W
2.19.6 Site elevation: 7 ft

2.19.1 ILS type: Glide Slope for runway 27L.
Magnetic variation: 10W
2.19.2 ILS identification: GLC
2.19.5 Coordinates: 39-51-58.71N /
75-14-31.14W
2.19.6 Site elevation: 9 ft

2.19.1 ILS type: Middle Marker for runway 27L.
Magnetic variation: 10W
2.19.2 ILS identification: GLC
2.19.5 Coordinates: 39-52-12.91N /
75-13-40.55W
2.19.6 Site elevation: 21 ft

2.19.1 ILS type: DME for runway 27L. Magnetic
variation: 10W
2.19.2 ILS identification: GLC
2.19.5 Coordinates: 39-52-00.00N /
75-14-00.00W
2.19.6 Site elevation: 19 ft

2.19.1 ILS type: Outer Marker for runway 17.
Magnetic variation: 10W
2.19.2 ILS identification: MYY
2.19.5 Coordinates: 39-58-30.97N /
75-16-44.21W
2.19.6 Site elevation: 99999 ft

2.19.1 ILS type: Localizer for runway 17. Magnetic
variation: 10W
2.19.2 ILS identification: MYY
2.19.5 Coordinates: 39-52-00.00N /
75-13-35.55W
2.19.6 Site elevation: 12 ft

2.19.1 ILS type: Glide Slope for runway 17.

General Remarks:

BIRDS ON & IN THE VICINITY OF AIRPORT.

RUNWAYS 27L, 27R & 35 SHIP CHANNEL (DELAWARE RIVER) MAX HEIGHT OF SHIPS 189 FT.
RUNWAY 26 SHIP CHANNEL (SCHUYLKILL) MAX HEIGHT OF SHIPS 149 FT.

AIRPORT IS LOCATED IN A NOISE SENSITIVE AREA. AIRPORT NOISE ABATEMENT TAKEOFF
PROCEDURES ARE TO BE USED.

Magnetic variation: 10W
2.19.2 ILS identification: MYY
2.19.5 Coordinates: 39-53-00.00N /
75-14-00.00W
2.19.6 Site elevation: 6 ft

2.19.1 ILS type: Middle Marker for runway 17.
Magnetic variation: 10W
2.19.2 ILS identification: MYY
2.19.5 Coordinates: 39-53-43.20N /
75-14-27.10W
2.19.6 Site elevation: 99999 ft

2.19.1 ILS type: DME for runway 17. Magnetic
variation: 10W
2.19.2 ILS identification: MYY
2.19.5 Coordinates: 39-52-00.00N /
75-13-39.56W
2.19.6 Site elevation: 11 ft

2.19.1 ILS type: DME for runway 26. Magnetic
variation: 10W
2.19.2 ILS identification: LLH
2.19.5 Coordinates: 39-52-42.22N /
75-13-32.38W
2.19.6 Site elevation: 8 ft

2.19.1 ILS type: Glide Slope for runway 26.
Magnetic variation: 10W
2.19.2 ILS identification: LLH
2.19.5 Coordinates: 39-52-49.37N /
75-12-58.35W
2.19.6 Site elevation: 23 ft

2.19.1 ILS type: Localizer for runway 26. Magnetic
variation: 10W
2.19.2 ILS identification: LLH
2.19.5 Coordinates: 39-52-42.38N /
75-13-31.83W
2.19.6 Site elevation: 8 ft

TRAFFIC ALERT AND COLLISION AVOIDANCE SYSTEM EQUIPPED ACFT-TCAS ALERT MAY BE CAUSED BY TRANSPONDER EQUIPPED SHIPS LOCATED PHL NAVAL BASE 3 NAUTICAL MILE E.

UNLIGHTED STACK 288 FT MSL (271 FT AGL) 2.3 NAUTICAL MILE SW OF AIRPORT.

RUNWAY 09R ROLLOUT RUNWAY VISUAL RANGE USED FOR RUNWAY 09L MIDPOINT RUNWAY VISUAL RANGE.

ALL ENGINE RUNUPS REQUIRE PRIOR PERMISSION REQUIRED FROM DUTY OPERATIONS OFFICER AT 937-6914/6800; RUNUPS 20 MIN MAXIMUM.

ALL AIRCRAFT TRAVELING ON TAXIWAY J MUST USE MINIMUM POWER WHEN TURNING SOUTH DUE TO JETBLAST CONCERNS.

TAXIWAY J BETWEEN TAXIWAYS K3 AND Q RESTRICTED TO AIRCRAFT WITH WINGSPANS 171 FT AND LESS.

ONLY NOSE-IN PARKING PERMITTED ON NORTH & EAST REMOTE APRONS. PRIOR PERMISSION REQUIRED FROM AIRPORT OPERATIONS FOR ALL AIRCRAFT PARKING ON NORTH & EAST REMOTE APRONS; CONTACT 215-937-6914/6800.

POSSIBLE UNMARKED SHIP OBSTRUCTION TRANSITING EAST OR WESTBOUND ALONG THE DELAWARE RIVER REACHING HEIGHTS OF 189' - BE ALERT WHEN APPROACHING PHL RUNWAY 35 AND WHENEVER CIRCLING OR VISUALLY APPROACHING ALL OTHER RUNWAYS.

ROUGH, UNEVEN PAVEMENT ON TAXIWAY "S" BETWEEN TAXIWAY "L" & "S1".

ASDE-X SURVEILLANCE SYSTEM IN USE: PILOTS SHOULD OPERATE TRANSPONDERS WITH MODE C ON ALL TAXIWAYS AND RUNWAYS.

Pittsburgh, PA
Pittsburgh Intl
ICAO Identifier KPIT

AD 2.2 Aerodrome geographical and administrative data

- 2.2.1 Reference Point: 40-29-29.30N / 80-13-58.30W
- 2.2.2 From City: 12 Miles NW Of Pittsburgh, PA
- 2.2.3 Elevation: 1203 ft
- 2.2.5 Magnetic variation: 8W (1995)
- 2.2.6 Airport Contact: Bradley D. Penrod
PO BOX 12370, SUITE. 4000
Pittsburgh, PA 15231
(412-472-3510)
- 2.2.7 Traffic: IFR/VFR

AD 2.3 Operational hours

- 2.3.1 - 2.3.11: ALL Months, ALL Days, ALL Hours

AD 2.4 Handling services and facilities

- 2.4.1 Cargo handling facilities: No
- 2.4.2 Fuel types: 100LL,A
- 2.4.4 De-icing facilities: None
- 2.4.5 Hangar space: Yes
- 2.4.6 Repair facilities: Minor

AD 2.6 Rescue and firefighting services

- 2.6.1 Aerodrome category for firefighting: ARFF Index I D certified on 5/1/1973

AD 2.10 Aerodrome obstacles

- 2.10.1.a. Runway designation: 28C
- 2.10.1.b Type of obstacle: Trees (130 ft). Not Lighted or Marked
- 2.10.1.c Location of obstacle: 980 ft from Centerline

- 2.10.1.a. Runway designation: 14
- 2.10.1.b Type of obstacle: Pole (26 ft). Not Lighted or Marked
- 2.10.1.c Location of obstacle: 500 ft from Centerline

- 2.10.1.a. Runway designation: 28R
- 2.10.1.b Type of obstacle: Trees (38 ft). Not Lighted or Marked
- 2.10.1.c Location of obstacle: 680 ft from Centerline

- 2.10.1.a. Runway designation: 10L
- 2.10.1.b Type of obstacle: Trees (55 ft). Not Lighted or Marked
- 2.10.1.c Location of obstacle: 500 ft from Centerline

- 2.10.1.a. Runway designation: 10R
- 2.10.1.b Type of obstacle: Trees (166 ft). Not Lighted or Marked
- 2.10.1.c Location of obstacle: 700 ft from Centerline

- 2.10.1.a. Runway designation: 28L
- 2.10.1.b Type of obstacle: Trees (78 ft). Not Lighted or Marked
- 2.10.1.c Location of obstacle: 680 ft from Centerline

AD 2.12 Runway physical characteristics

- 2.12.1 Designation: 10C
- 2.12.2 True Bearing: 92
- 2.12.3 Dimensions: 9708 ft x 150 ft
- 2.12.4 PCN: 47 R/B/X/T
- 2.12.5 Coordinates: 40-29-23.54N / 80-14-46.54W
- 2.12.6 Threshold elevation: 1141 ft
- 2.12.6 Touchdown zone elevation: 1141 ft

- 2.12.1 Designation: 28C
- 2.12.2 True Bearing: 272
- 2.12.3 Dimensions: 9708 ft x 150 ft
- 2.12.4 PCN: 47 R/B/X/T
- 2.12.5 Coordinates: 40-29-20.25N / 80-12-40.96W
- 2.12.6 Threshold elevation: 1134 ft
- 2.12.6 Touchdown zone elevation: 1134 ft

- 2.12.1 Designation: 14
- 2.12.2 True Bearing: 136
- 2.12.3 Dimensions: 8101 ft x 150 ft
- 2.12.4 PCN: 48 R/B/X/T
- 2.12.5 Coordinates: 40-29-45.65N / 80-13-29.52W
- 2.12.6 Threshold elevation: 1148 ft
- 2.12.6 Touchdown zone elevation: 1148 ft
- 2.12.7 Slope: 0.5DOWN

- 2.12.1 Designation: 32
- 2.12.2 True Bearing: 316
- 2.12.3 Dimensions: 8101 ft x 150 ft
- 2.12.4 PCN: 48 R/B/X/T

2.12.5 Coordinates: 40-28-47.69N /
80-12-17.22W
2.12.6 Threshold elevation: 1114 ft
2.12.6 Touchdown zone elevation: 1123 ft
2.12.7 Slope: 0.3UP

2.12.1 Designation: 10L
2.12.2 True Bearing: 92
2.12.3 Dimensions: 10502 ft x 150 ft
2.12.4 PCN: 49 R/B/X/T
2.12.5 Coordinates: 40-30-00.00N /
80-16-16.26W
2.12.6 Threshold elevation: 1203 ft
2.12.6 Touchdown zone elevation: 1203 ft

2.12.1 Designation: 28R
2.12.2 True Bearing: 272
2.12.3 Dimensions: 10502 ft x 150 ft
2.12.4 PCN: 49 R/B/X/T
2.12.5 Coordinates: 40-30-00.00N /
80-14-00.00W
2.12.6 Threshold elevation: 1174 ft
2.12.6 Touchdown zone elevation: 1174 ft
2.12.7 Slope: 0.3UP

2.12.1 Designation: 10R
2.12.2 True Bearing: 92
2.12.3 Dimensions: 11500 ft x 200 ft
2.12.4 PCN: 48 R/B/X/T
2.12.5 Coordinates: 40-29-12.22N /
80-15-00.00W
2.12.6 Threshold elevation: 1135 ft
2.12.6 Touchdown zone elevation: 1135 ft

2.12.1 Designation: 28L
2.12.2 True Bearing: 272
2.12.3 Dimensions: 11500 ft x 200 ft
2.12.4 PCN: 48 R/B/X/T
2.12.5 Coordinates: 40-29-00.00N /
80-12-38.13W
2.12.6 Threshold elevation: 1122 ft
2.12.6 Touchdown zone elevation: 1125 ft
2.12.7 Slope: 0.3UP

2.12.1 Designation: H1
2.12.3 Dimensions: 60 ft x 60 ft

AD 2.13 Declared distances

2.13.1 Designation: 10C
2.13.2 Takeoff run available: 9708
2.13.3 Takeoff distance available: 9708

2.13.4 Accelerate-stop distance available: 9708
2.13.5 Landing distance available: 9708

2.13.1 Designation: 28C
2.13.2 Takeoff run available: 9708
2.13.3 Takeoff distance available: 9708
2.13.4 Accelerate-stop distance available: 9708
2.13.5 Landing distance available: 9708

2.13.1 Designation: 14
2.13.2 Takeoff run available: 8101
2.13.3 Takeoff distance available: 8101
2.13.4 Accelerate-stop distance available: 7366
2.13.5 Landing distance available: 7366

2.13.1 Designation: 32
2.13.2 Takeoff run available: 8101
2.13.3 Takeoff distance available: 8101
2.13.4 Accelerate-stop distance available: 7801
2.13.5 Landing distance available: 7466

2.13.1 Designation: 10L
2.13.2 Takeoff run available: 10502
2.13.3 Takeoff distance available: 10502
2.13.4 Accelerate-stop distance available: 10502
2.13.5 Landing distance available: 10502

2.13.1 Designation: 28R
2.13.2 Takeoff run available: 10502
2.13.3 Takeoff distance available: 10502
2.13.4 Accelerate-stop distance available: 10102
2.13.5 Landing distance available: 10102

2.13.1 Designation: 10R
2.13.2 Takeoff run available: 11500
2.13.3 Takeoff distance available: 11500
2.13.4 Accelerate-stop distance available: 11500
2.13.5 Landing distance available: 11500

2.13.1 Designation: 28L
2.13.2 Takeoff run available: 11500
2.13.3 Takeoff distance available: 11500
2.13.4 Accelerate-stop distance available: 11500
2.13.5 Landing distance available: 11500

AD 2.14 Approach and runway lighting

2.14.1 Designation: 10C
2.14.4 Visual approach slope indicator system:
4-light PAPI on left

2.14.1 Designation: 28C

2.14.4 Visual approach slope indicator system:
4-light PAPI on left

2.14.1 Designation: 14

2.14.4 Visual approach slope indicator system:
4-light PAPI on left

2.14.1 Designation: 32

2.14.2 Approach lighting system: MALS: 1400 feet
medium intensity approach lighting system

2.14.4 Visual approach slope indicator system:
4-light PAPI on left

2.14.1 Designation: 10L

2.14.2 Approach lighting system: ALSF2: Standard
2400 feet high intensity approach lighting system
with sequenced flashers, category II or III
configuration

2.14.4 Visual approach slope indicator system:
4-light PAPI on left

2.14.10 Remarks: ALSF2/SSALR Is A Dual Mode
System & Controlled By ATCt & Remote
Monitored.

2.14.1 Designation: 28R

2.14.2 Approach lighting system: MALSR: 1400
feet medium intensity approach lighting system
with runway alignment indicator lights

2.14.4 Visual approach slope indicator system:
4-light PAPI on left

2.14.1 Designation: 10R

2.14.2 Approach lighting system: ALSF2: Standard
2400 feet high intensity approach lighting system
with sequenced flashers, category II or III
configuration

2.14.4 Visual approach slope indicator system:
4-light PAPI on left

2.14.1 Designation: 28L

2.14.2 Approach lighting system: MALSR: 1400
feet medium intensity approach lighting system
with runway alignment indicator lights

2.14.4 Visual approach slope indicator system:
4-light PAPI on left

**AD 2.18 Air traffic services communication
facilities**

2.18.1 Service designation: LCL/P IC

2.18.3 Service designation: 119.1 MHz

2.18.1 Service designation: DEP/P

2.18.3 Service designation: 119.35 MHz

2.18.1 Service designation: APCH/P CLASS B

2.18.3 Service designation: 121.25 MHz

2.18.1 Service designation: EMERG

2.18.3 Service designation: 121.5 MHz

2.18.1 Service designation: GND/P

2.18.3 Service designation: 121.9 MHz

2.18.1 Service designation: APCH/P CLASS B IC

2.18.3 Service designation: 123.95 MHz

2.18.1 Service designation: APCH/P CLASS B

2.18.3 Service designation: 124.15 MHz

2.18.1 Service designation: DEP/P

2.18.3 Service designation: 124.75 MHz

2.18.1 Service designation: CD/P PRE TAXI
CLNC

2.18.3 Service designation: 126.75 MHz

2.18.1 Service designation: GND/P

2.18.3 Service designation: 127.8 MHz

2.18.1 Service designation: LCL/P

2.18.3 Service designation: 128.3 MHz

2.18.1 Service designation: LCL/P

2.18.3 Service designation: 135.025 MHz

2.18.1 Service designation: LCL/P

2.18.3 Service designation: 270.325 MHz

2.18.1 Service designation: EMERG

2.18.3 Service designation: 243 MHz

2.18.1 Service designation: CP

2.18.3 Service designation: 252.1 MHz

2.18.1 Service designation: LCL/P

2.18.3 Service designation: 291.7 MHz

2.18.1 Service designation: DEP/P

2.18.3 Service designation: 338.2 MHz

2.18.1 Service designation: GND/P

2.18.3 Service designation: 348.6 MHz

2.18.1 Service designation: CD/P
2.18.3 Service designation: 353.7 MHz

2.18.1 Service designation: OPS
2.18.3 Service designation: 36.35 MHz

2.18.1 Service designation: APCH/P CLASS B
2.18.3 Service designation: 360.8 MHz

2.18.1 Service designation: APCH/P CLASS B
2.18.3 Service designation: 279.625 MHz

2.18.1 Service designation: DEP/P
2.18.3 Service designation: 285.575 MHz

2.18.1 Service designation: APCH/P DEP/P
2.18.3 Service designation: 336.2 MHz

2.18.1 Service designation: ANG-OPS
2.18.3 Service designation: 311 MHz

2.18.1 Service designation: DEP/S
2.18.3 Service designation: 125.275 MHz

2.18.1 Service designation: D-ATIS
2.18.3 Service designation: 135.9 MHz
2.18.4 Hours of operation: 24

2.18.1 Service designation: D-ATIS
2.18.3 Service designation: 127.25 MHz
2.18.4 Hours of operation: 24

2.18.1 Service designation: APCH/P CLASS B
2.18.3 Service designation: 133.7 MHz

AD 2.19 Radio navigation and landing aids

2.19.1 ILS type: Localizer for runway 10C.
Magnetic variation: 8W
2.19.2 ILS identification: BGY
2.19.5 Coordinates: 40-29-19.91N /
80-12-28.02W
2.19.6 Site elevation: 1136 ft

2.19.1 ILS type: Glide Slope for runway 10C.
Magnetic variation: 8W
2.19.2 ILS identification: BGY
2.19.5 Coordinates: 40-29-19.33N /
80-14-32.79W
2.19.6 Site elevation: 1134 ft

2.19.1 ILS type: Localizer for runway 28C.

Magnetic variation: 8W
2.19.2 ILS identification: XXX
2.19.5 Coordinates: 40-29-23.76N /
80-14-54.62W
2.19.6 Site elevation: 1136 ft

2.19.1 ILS type: Glide Slope for runway 28C.
Magnetic variation: 8W
2.19.2 ILS identification: XXX
2.19.5 Coordinates: 40-29-25.79N /
80-12-54.47W
2.19.6 Site elevation: 1131 ft

2.19.1 ILS type: Localizer for runway 32. Magnetic
variation: 7W
2.19.2 ILS identification: TQW
2.19.5 Coordinates: 40-29-50.41N /
80-13-35.46W
2.19.6 Site elevation: 1139 ft

2.19.1 ILS type: Glide Slope for runway 32.
Magnetic variation: 7W
2.19.2 ILS identification: TQW
2.19.5 Coordinates: 40-28-52.66N /
80-12-29.14W
2.19.6 Site elevation: 1112 ft

2.19.1 ILS type: Middle Marker for runway 32.
Magnetic variation: 7W
2.19.2 ILS identification: TQW
2.19.5 Coordinates: 40-28-25.30N /
80-11-49.10W
2.19.6 Site elevation: 1100 ft

2.19.1 ILS type: Outer Marker for runway 32.
Magnetic variation: 7W
2.19.2 ILS identification: TQW
2.19.5 Coordinates: 40-25-53.20N /
80-08-44.60W
2.19.6 Site elevation: 1180 ft

2.19.1 ILS type: Glide Slope for runway 28R.
Magnetic variation: 8W
2.19.2 ILS identification: HFE
2.19.5 Coordinates: 40-30-00.00N /
80-14-14.60W
2.19.6 Site elevation: 1166 ft

2.19.1 ILS type: Outer Marker for runway 28R.
Magnetic variation: 8W
2.19.2 ILS identification: HFE

2.19.5 Coordinates: 40-29-58.85N /
80-07-00.00W
2.19.6 Site elevation: 938 ft

2.19.1 ILS type: Localizer for runway 28R.
Magnetic variation: 8W
2.19.2 ILS identification: HFE
2.19.5 Coordinates: 40-30-00.00N /
80-16-31.33W
2.19.6 Site elevation: 1214 ft

2.19.1 ILS type: Middle Marker for runway 28R.
Magnetic variation: 8W
2.19.2 ILS identification: HFE
2.19.5 Coordinates: 40-30-00.00N /
80-13-26.81W
2.19.6 Site elevation: 1164 ft

2.19.1 ILS type: Glide Slope for runway 10L.
Magnetic variation: 8W
2.19.2 ILS identification: LXB
2.19.5 Coordinates: 40-30-11.93N /
80-15-59.90W
2.19.6 Site elevation: 1200 ft

2.19.1 ILS type: Inner Marker for runway 10L.
Magnetic variation: 8W
2.19.2 ILS identification: LXB
2.19.5 Coordinates: 40-30-00.00N /
80-16-27.00W
2.19.6 Site elevation: 1172 ft

2.19.1 ILS type: Outer Marker for runway 10L.
Magnetic variation: 8W
2.19.2 ILS identification: LXB
2.19.5 Coordinates: 40-30-17.54N /
80-21-59.03W
2.19.6 Site elevation: 99999 ft

2.19.1 ILS type: Middle Marker for runway 10L.
Magnetic variation: 8W
2.19.2 ILS identification: LXB
2.19.5 Coordinates: 40-30-00.00N /
80-16-48.80W
2.19.6 Site elevation: 99999 ft

2.19.1 ILS type: Localizer for runway 10L.
Magnetic variation: 8W
2.19.2 ILS identification: LXB
2.19.5 Coordinates: 40-30-00.00N /
80-13-47.19W

2.19.6 Site elevation: 1170 ft

2.19.1 ILS type: Glide Slope for runway 10R.
Magnetic variation: 8W
2.19.2 ILS identification: GUT
2.19.5 Coordinates: 40-29-15.34N /
80-14-53.77W
2.19.6 Site elevation: 1130 ft

2.19.1 ILS type: Outer Marker for runway 10R.
Magnetic variation: 8W
2.19.2 ILS identification: GUT
2.19.5 Coordinates: 40-29-14.90N /
80-22-13.90W
2.19.6 Site elevation: 1081 ft

2.19.1 ILS type: Middle Marker for runway 10R.
Magnetic variation: 8W
2.19.2 ILS identification: GUT
2.19.5 Coordinates: 40-29-13.15N /
80-15-42.43W
2.19.6 Site elevation: 1155 ft

2.19.1 ILS type: Localizer for runway 10R.
Magnetic variation: 8W
2.19.2 ILS identification: GUT
2.19.5 Coordinates: 40-29-00.00N /
80-12-34.12W
2.19.6 Site elevation: 1117 ft

2.19.1 ILS type: Inner Marker for runway 10R.
Magnetic variation: 8W
2.19.2 ILS identification: GUT
2.19.5 Coordinates: 40-29-12.54N /
80-15-18.88W
2.19.6 Site elevation: 99999 ft

2.19.1 ILS type: Localizer for runway 28L.
Magnetic variation: 8W
2.19.2 ILS identification: PFS
2.19.5 Coordinates: 40-29-12.64N /
80-15-23.03W
2.19.6 Site elevation: 1141 ft

2.19.1 ILS type: Middle Marker for runway 28L.
Magnetic variation: 8W
2.19.2 ILS identification: PFS
2.19.5 Coordinates: 40-29-00.00N /
80-12-00.00W
2.19.6 Site elevation: 1069 ft

2.19.1 ILS type: Glide Slope for runway 28L.
Magnetic variation: 8W
2.19.2 ILS identification: PFS
2.19.5 Coordinates: 40-29-00.00N /
80-12-51.24W
2.19.6 Site elevation: 1118 ft

2.19.1 ILS type: Outer Marker for runway 28L.
Magnetic variation: 8W
2.19.2 ILS identification: PFS
2.19.5 Coordinates: 40-29-00.00N /
80-06-00.00W
2.19.6 Site elevation: 1043 ft

General Remarks:

DEER & BIRDS ON & IN THE VICINITY OF AIRPORT.

ALL JETS DEPARTING RUNWAY 28R MUST BE ALIGNED WITHIN RUNWAY PRIOR TO APPLYING TAKE-OFF POWER.

AIRCRAFT USING TAXIWAY 'N' PROHIBITED TO STOP ON OVERPASS AREA DUE TO POSSIBLE EMERGENCY EVACUATION HAZARD.

ANG AIRCRAFT MUST CONTACT TANKER 303.0/FTR OPERATIONS 293.7 BEFORE CROSSING RUNWAY 28L TO OBTAIN CLEARANCE TO ENTER.

TERMINAL TAXILANES E OF CONCOURSES A & B RESTRD TO GROUP 3 AIRCRAFT & SMALLER.

RUNWAY 10C & 28C DEPARTURES: DO NOT APPLY TAKEOFF THRUST PRIOR TO RUNWAY THRESHOLD.

TERMINAL APRON CONTROL FREQS ARE 130.77 FOR NORTH APRON; 131.37 FOR SOUTH APRON.

ATCT IS AUTHORIZED TO HAVE AIRCRAFT LINE-UP & WAIT ON RUNWAYS 28L AT TAXIWAY 'P' DURING HRS OF DARKNESS. THE SPECIFIC RUNWAY SHALL BE USED ONLY FOR DEPARTURES & THE INTERSECTION MUST BE VISIBLE FROM ATCT.

TAXIWAY F CLOSED INDEFINITELY FROM TAXIWAY P TO RUNWAY 32.

SERVICE-JASU: (ANG) (A/M32A-86) (AM 32-95; (AFRC - 2(A/M32-86 (AM32-95).

SERVICE-FLUID: LPOX L/H NIT.

SERVICE-OIL: O-156.

SERVICE-TRAN ALERT: NO PRIORITY BASIS.

TAXIWAY "Y" CLOSED INDEFINITE; ACCESS TO COMMUTER APRON AVAILABLE BY WAY OF TAXIWAY "Y1" AND "Y2".

AFRC: CALL PITT COMMAND POST PRIOR TO ENTRY TO S RAMP, MAIN RAMP.

ANG: OPR 1130-2030Z++ MON-FRI EXCEPT HOLIDAY (CLOSED EVERY OTH MON).

ANG: OPR 1130-2030Z++MON-FRI EXCEPT HOLIDAY. CLOSED EVERY OTHER MON. OFFICIAL

BUSINESS ONLY. PRIOR PERMISSION REQUIRED 48 HR PRIOR NOTICE REQUIRE. CALL DSN 294-7374/7260, C412-776-7374/7260.

AFRC: MIN 48HR PRIOR NOTICE REQUIRE FOR C5, C141 DUE TO LIMITED PARKING, LIGHT, AND SERVICE. NO TRANSIENT SERVICE. TRANSIENT AIRCRAFT CALL FBO AVIATION CENTER C412-472-6700. NORMAL DUTY HR 1330-0400Z++ EXCEPT HOLIDAY. UNIT TRAINING ASSEMBLY 1300-2100Z++ SAT. AND SUN.

PERSONNEL AND EQUIPMENT WORKING ADJACENT ALL RUNWAYS.

TAXIWAY G INTERSECTION AT RUNWAY 10L/28R RIGHT TURN NOT AUTHORIZED.

**Mayaguez, Puerto Rico
Eugenio Maria De Hostos
ICAO Identifier TJMZ**

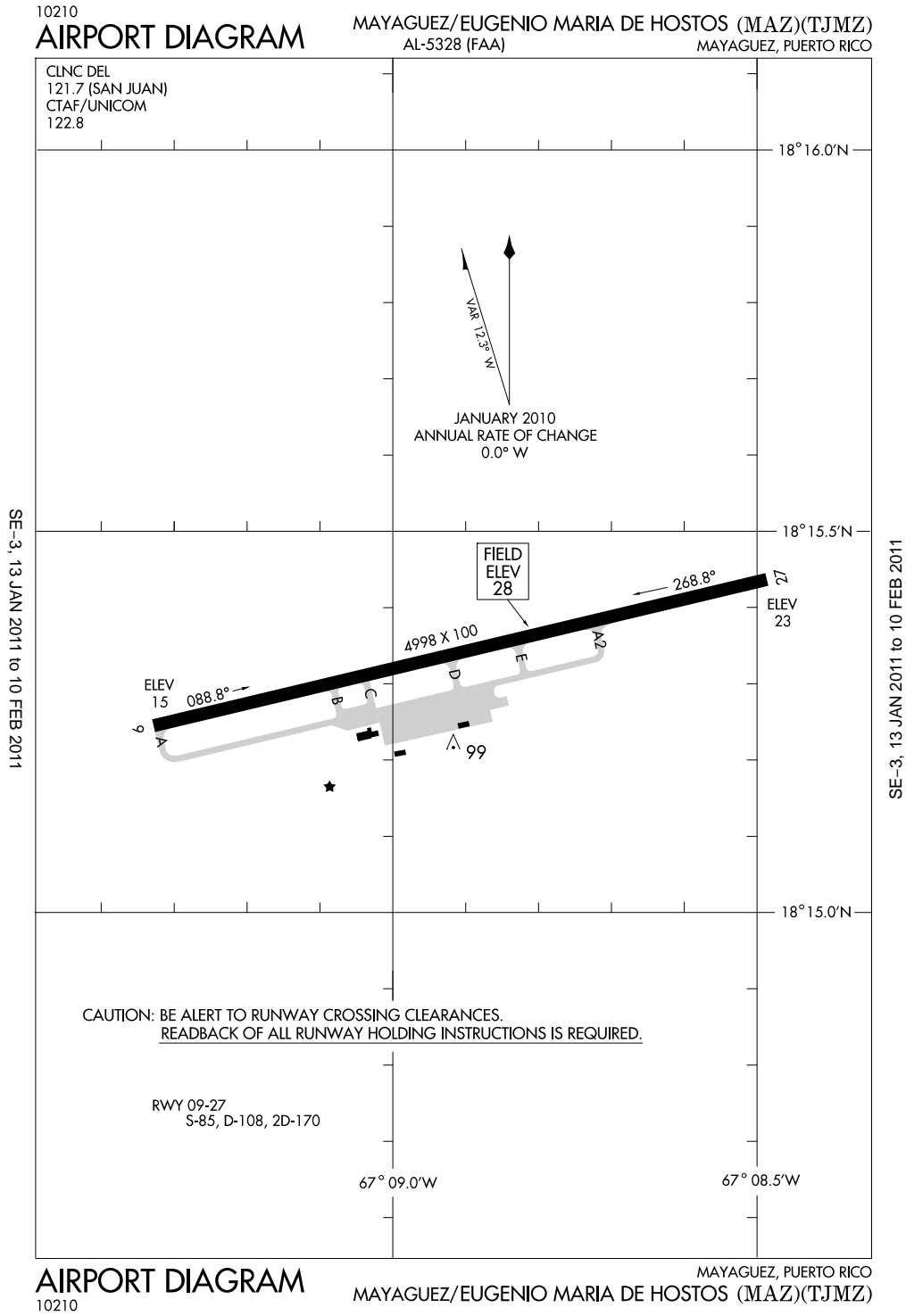

Mayaguez, PR
Eugenio Maria De Hostos
ICAO Identifier TJMZ

AD 2.2 Aerodrome geographical and administrative data

- 2.2.1 Reference Point: 18-15-20.50N / 67-08-54.50W
- 2.2.2 From City: 3 Miles N Of Mayaguez, PR
- 2.2.3 Elevation: 28 ft
- 2.2.5 Magnetic variation: 10W (1985)
- 2.2.6 Airport Contact: Lelis Suarez
BOX 710
Mayaguez, PR 709
(787-832-3390)
- 2.2.7 Traffic: IFR/VFR

AD 2.3 Operational hours

- 2.3.1 - 2.3.11: ALL Months, ALL Days, 1030-0230 Hours

AD 2.4 Handling services and facilities

- 2.4.1 Cargo handling facilities: No
- 2.4.2 Fuel types: None
- 2.4.4 De-icing facilities: None
- 2.4.5 Hangar space: Yes
- 2.4.6 Repair facilities: None

AD 2.6 Rescue and firefighting services

- 2.6.1 Aerodrome category for firefighting: None
- 2.6.4 Remarks: No ARFF Services Provided To Unscheduled Aircraft 0 Operations With More Than 30 Passenger Seats 2300-0600 Except 24 Hr Prior Permission Required; Call Airport Manager 787-832-3390 Or 787-833-0148.

General Remarks:

1200' TOWER /1207' MSL/ 9 NAUTICAL MILE NNW.

BIRDS ON AND IN THE VICINITY OF RUNWAY CAUTION ADVISED UNTIL FURTHER NOTICE.

CRANE 70 FT AGL SOUTH APPROACH END RUNWAY 9.

AVIATION GASOLINE UNAVAILABLE.

PERSONNEL AND EQUIPMENT WORKING RUNWAY 09/27 1100-2100Z DAILY.

AD 2.10 Aerodrome obstacles

- 2.10.1.a Runway designation: 09
- 2.10.1.b Type of obstacle: Poles (44 ft). Lighted
- 2.10.1.c Location of obstacle: 75 ft from Centerline

- 2.10.1.a Runway designation: 27
- 2.10.1.b Type of obstacle: Trees (65 ft). Not Lighted or Marked
- 2.10.1.c Location of obstacle: 450 ft from Centerline

AD 2.12 Runway physical characteristics

- 2.12.1 Designation: 09
- 2.12.2 True Bearing: 76
- 2.12.3 Dimensions: 4998 ft x 100 ft
- 2.12.5 Coordinates: 18-15-14.68N / 67-09-19.73W
- 2.12.6 Threshold elevation: 15 ft
- 2.12.6 Touchdown zone elevation: 28 ft

- 2.12.1 Designation: 27
- 2.12.2 True Bearing: 256
- 2.12.3 Dimensions: 4998 ft x 100 ft
- 2.12.5 Coordinates: 18-15-26.25N / 67-08-29.30W
- 2.12.6 Threshold elevation: 23 ft
- 2.12.6 Touchdown zone elevation: 28 ft

AD 2.14 Approach and runway lighting

- 2.14.1 Designation: 09
- 2.14.4 Visual approach slope indicator system: 4-light PAPI on left

- 2.14.1 Designation: 27
- 2.14.4 Visual approach slope indicator system: 4-light PAPI on left

San Juan, Puerto Rico
Luis Munoz Marin International
ICAO Identifier TJSJ

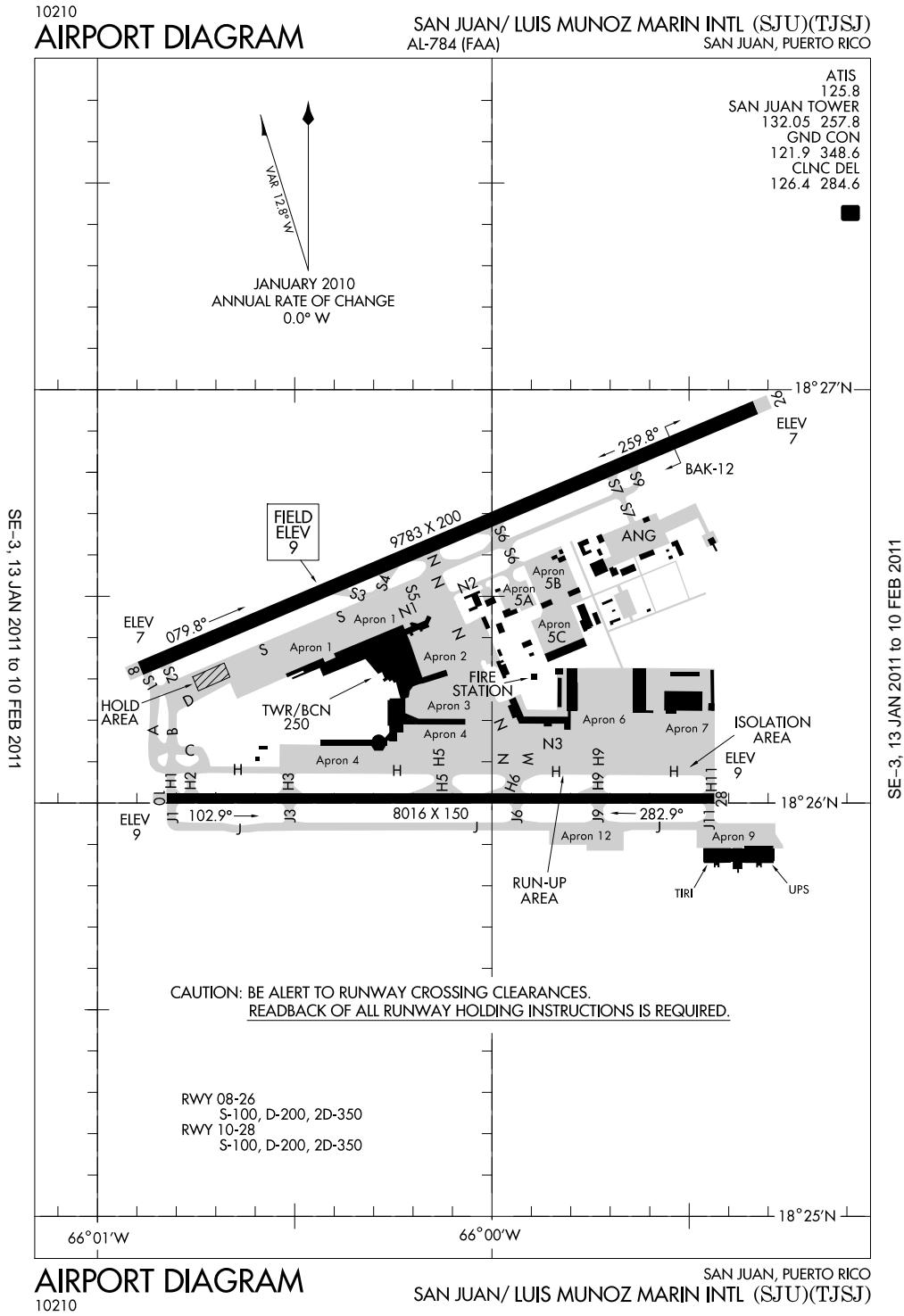

San Juan, PR
Luis Munoz Marin Intl
ICAO Identifier TJSJ

Lighted or Marked
2.10.1.c Location of obstacle: 800 ft from
Centerline

**AD 2.2 Aerodrome geographical and
administrative data**

- 2.2.1 Reference Point: 18-26-21.46N /
66-00-00.00W
- 2.2.2 From City: 3 Miles SE Of San Juan, PR
- 2.2.3 Elevation: 9 ft
- 2.2.5 Magnetic variation: 11W (1985)
- 2.2.6 Airport Contact: Arnaldo Deleo
GPO BOX 362829
San Juan, PR 936
(787-791-3840)
- 2.2.7 Traffic: IFR/VFR

AD 2.3 Operational hours

- 2.3.1 - 2.3.11: ALL Months, ALL Days, ALL
Hours

AD 2.4 Handling services and facilities

- 2.4.1 Cargo handling facilities: No
- 2.4.2 Fuel types: 100,115,A1+
- 2.4.4 De-icing facilities: None
- 2.4.5 Hangar space: Yes
- 2.4.6 Repair facilities: Major

AD 2.6 Rescue and firefighting services

- 2.6.1 Aerodrome category for firefighting: ARFF
Index I D certified on 5/1/2005

AD 2.10 Aerodrome obstacles

- 2.10.1.a. Runway designation: 10
- 2.10.1.b Type of obstacle: Tree (50 ft). Not
Lighted or Marked
- 2.10.1.c Location of obstacle: 300 ft from
Centerline

- 2.10.1.a. Runway designation: 28
- 2.10.1.b Type of obstacle: Trees (24 ft). Not
Lighted or Marked

- 2.10.1.a. Runway designation: 08
- 2.10.1.b Type of obstacle: Tree (59 ft). Not
Lighted or Marked
- 2.10.1.c Location of obstacle: 300 ft from
Centerline

- 2.10.1.a. Runway designation: 26
- 2.10.1.b Type of obstacle: Tree (72 ft). Not

AD 2.12 Runway physical characteristics

- 2.12.1 Designation: 10
- 2.12.2 True Bearing: 90
- 2.12.3 Dimensions: 8016 ft x 150 ft
- 2.12.5 Coordinates: 18-26-00.00N /
66-00-49.42W
- 2.12.6 Threshold elevation: 9 ft
- 2.12.6 Touchdown zone elevation: 9 ft

- 2.12.1 Designation: 28
- 2.12.2 True Bearing: 270
- 2.12.3 Dimensions: 8016 ft x 150 ft
- 2.12.5 Coordinates: 18-26-00.00N /
65-59-26.16W
- 2.12.6 Threshold elevation: 9 ft
- 2.12.6 Touchdown zone elevation: 9 ft

- 2.12.1 Designation: 08
- 2.12.2 True Bearing: 67
- 2.12.3 Dimensions: 9783 ft x 200 ft
- 2.12.5 Coordinates: 18-26-19.50N /
66-00-53.50W
- 2.12.6 Threshold elevation: 7 ft
- 2.12.6 Touchdown zone elevation: 9 ft

- 2.12.1 Designation: 26
- 2.12.2 True Bearing: 247
- 2.12.3 Dimensions: 9783 ft x 200 ft
- 2.12.5 Coordinates: 18-26-57.42N /
65-59-19.98W
- 2.12.6 Threshold elevation: 7 ft
- 2.12.6 Touchdown zone elevation: 7 ft

AD 2.13 Declared distances

- 2.13.1 Designation: 10
- 2.13.2 Takeoff run available: 8016
- 2.13.3 Takeoff distance available: 8016
- 2.13.4 Accelerate-stop distance available: 8016
- 2.13.5 Landing distance available: 8016

- 2.13.1 Designation: 28
- 2.13.2 Takeoff run available: 8016
- 2.13.3 Takeoff distance available: 8016
- 2.13.4 Accelerate-stop distance available: 8016
- 2.13.5 Landing distance available: 8016

AD 2.14 Approach and runway lighting

2.14.1 Designation: 10
2.14.4 Visual approach slope indicator system:
4-light PAPI on left

2.14.1 Designation: 28
2.14.4 Visual approach slope indicator system:
4-light PAPI on left

2.14.1 Designation: 08
2.14.2 Approach lighting system: MALSR: 1400
feet medium intensity approach lighting system
with runway alignment indicator lights
2.14.4 Visual approach slope indicator system:
4-light PAPI on left

AD 2.18 Air traffic services communication facilities

2.18.1 Service designation: APCH/P DEP/P
CLASS C
2.18.3 Service designation: 119.4 MHz

2.18.1 Service designation: APCH/P DEP/P
CLASS C IC
2.18.3 Service designation: 120.9 MHz

2.18.1 Service designation: EMERG
2.18.3 Service designation: 121.5 MHz

2.18.1 Service designation: GND/P
2.18.3 Service designation: 121.9 MHz

2.18.1 Service designation: D-ATIS
2.18.3 Service designation: 125.8 MHz
2.18.4 Hours of operation: 24

2.18.1 Service designation: CD PRE TAXI CLNC
2.18.3 Service designation: 126.4 MHz

2.18.1 Service designation: LCL/P
2.18.3 Service designation: 257.8 MHz

2.18.1 Service designation: APCH/P DEP/P
CLASS C
2.18.3 Service designation: 269.2 MHz

2.18.1 Service designation: CD
2.18.3 Service designation: 284.6 MHz

2.18.1 Service designation: APCH/P DEP/P
CLASS C IC

2.18.3 Service designation: 290.2 MHz

2.18.1 Service designation: GND/P
2.18.3 Service designation: 348.6 MHz

2.18.1 Service designation: LCL/P
2.18.3 Service designation: 132.05 MHz

AD 2.19 Radio navigation and landing aids

2.19.1 ILS type: Localizer for runway 10. Magnetic
variation: 11W

2.19.2 ILS identification: CLA
2.19.5 Coordinates: 18-26-00.00N /
65-59-15.53W
2.19.6 Site elevation: 9 ft

2.19.1 ILS type: Glide Slope for runway 10.
Magnetic variation: 11W
2.19.2 ILS identification: CLA
2.19.5 Coordinates: 18-25-57.56N /
66-00-39.05W
2.19.6 Site elevation: 5 ft

2.19.1 ILS type: Middle Marker for runway 10.
Magnetic variation: 11W
2.19.2 ILS identification: CLA
2.19.5 Coordinates: 18-26-00.00N /
66-01-15.39W
2.19.6 Site elevation: 1 ft

2.19.1 ILS type: Outer Marker for runway 10.
Magnetic variation: 11W
2.19.2 ILS identification: CLA
2.19.5 Coordinates: 18-26-00.00N /
66-05-00.00W
2.19.6 Site elevation: 6 ft

2.19.1 ILS type: Localizer for runway 08. Magnetic
variation: 11W
2.19.2 ILS identification: SJU
2.19.5 Coordinates: 18-27-00.00N /
65-59-11.41W
2.19.6 Site elevation: 5 ft

2.19.1 ILS type: Glide Slope for runway 08.
Magnetic variation: 11W
2.19.2 ILS identification: SJU
2.19.5 Coordinates: 18-26-27.04N /
66-00-45.58W
2.19.6 Site elevation: 4 ft

2.19.1 ILS type: Middle Marker for runway 08.
Magnetic variation: 11W
2.19.2 ILS identification: SJU
2.19.5 Coordinates: 18-26-00.00N /
66-01-24.60W
2.19.6 Site elevation: 99999 ft

Magnetic variation: 11W
2.19.2 ILS identification: SJU
2.19.5 Coordinates: 18-24-31.82N /
66-05-21.83W
2.19.6 Site elevation: 10 ft

2.19.1 ILS type: Outer Marker for runway 08.

General Remarks:

NOT LATER THAN 48 HR PRIOR PERMISSION REQUIRED FOR PARKING OF MILITARY, GENERAL AVIATION & DC3 AIRCRAFT OR LARGER. SEND PRIOR PERMISSION REQUIRED TO PUERTO RICO PORT AUTH AT 787-253-0979, 787-791-2908, 939-630-8862. AIRCRAFT WITHOUT CREDIT W PRPA MUST PAY ALL CHARGES BEFORE DEPARTURE.

24 HR PRIOR PERMISSION REQUIRED FOR ALL MILITARY TRANSPORT AIRCRAFT. C5'S NOT AUTHORIZED DUE TO CONSTRUCTION.

TAXIWAY JULIET CLOSED TO AIRCRAFT WITH GREATER THAN 118 FT WINGSPAN.

PERSONNEL AND EQUIPMENT WORKING N RUNWAY 8/26 ALONG TREE AREA. OBST CRANE 50 FT AGL 300 FT N RUNWAY 8/26 CL 1100-1800 MON-FRI.

APRON 12 AVAILABLE FOR GA AIRCRAFT ONLY.

Memphis, Tennessee
Memphis International
ICAO Identifier KMEM

10322 AIRPORT DIAGRAM AL-253 (FAA) MEMPHIS INTL (MEM) MEMPHIS, TENNESSEE

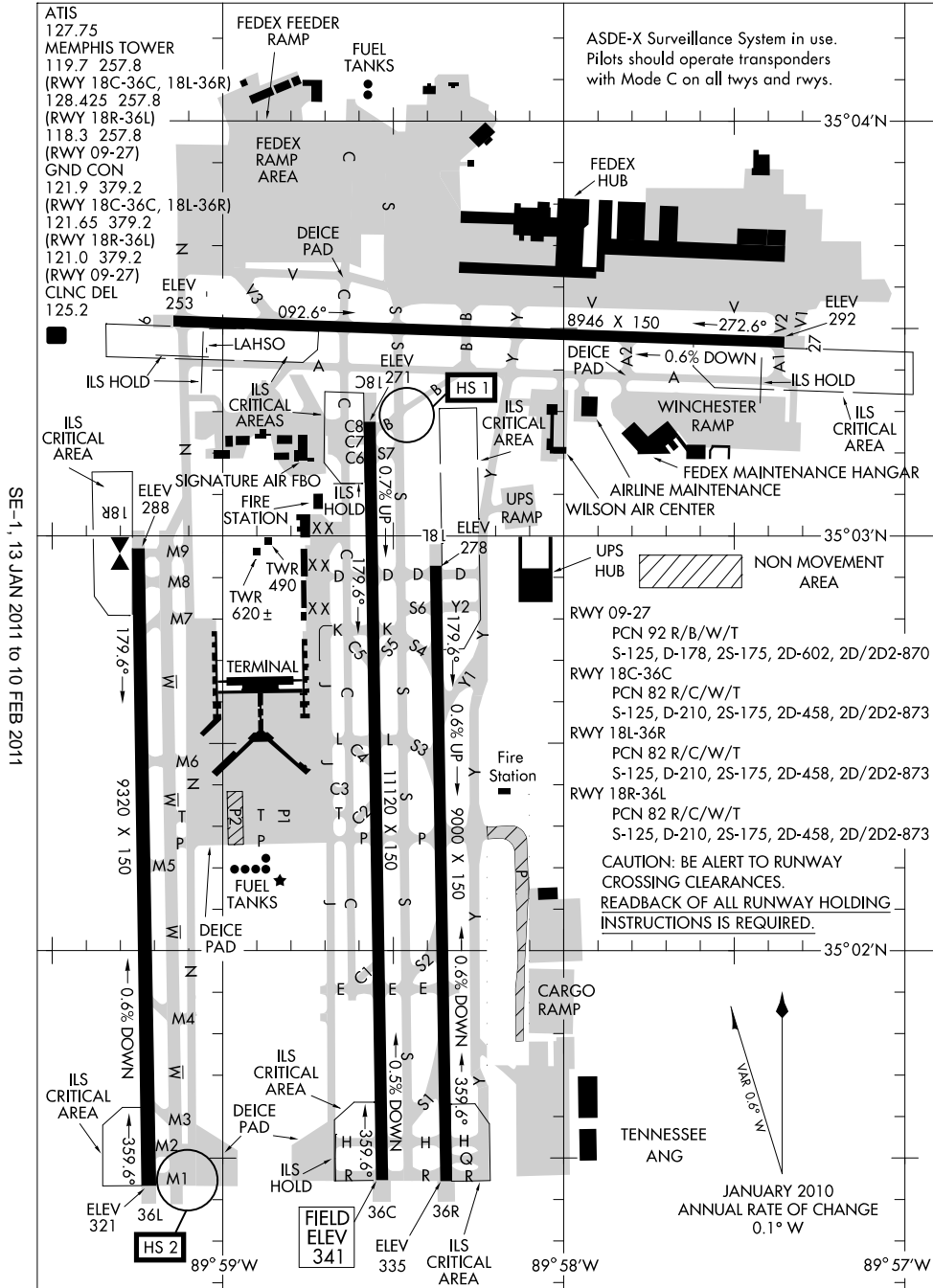

SE-1, 13 JAN 2011 to 10 FEB 2011

SE-1, 13 JAN 2011 to 10 FEB 2011

AIRPORT DIAGRAM MEMPHIS, TENNESSEE MEMPHIS INTL (MEM) 10322

Memphis, TN
Memphis Intl
ICAO Identifier KMEM

AD 2.2 Aerodrome geographical and administrative data

- 2.2.1 Reference Point: 35-02-32.70N / 89-58-36.00W
- 2.2.2 From City: 3 Miles S Of Memphis, TN
- 2.2.3 Elevation: 341 ft
- 2.2.5 Magnetic variation: 1E (2000)
- 2.2.6 Airport Contact: Larry D Cox
2491 WINCHESTER RD.
Memphis, TN 38116
(901-922-8000)
- 2.2.7 Traffic: IFR/VFR

AD 2.3 Operational hours

- 2.3.1 - 2.3.11: ALL Months, ALL Days, ALL Hours

AD 2.4 Handling services and facilities

- 2.4.1 Cargo handling facilities: No
- 2.4.2 Fuel types: 100LL,A
- 2.4.4 De-icing facilities: None
- 2.4.5 Hangar space: Yes
- 2.4.6 Repair facilities: Major

AD 2.6 Rescue and firefighting services

- 2.6.1 Aerodrome category for firefighting: ARFF Index I C certified on 5/21/1973
- 2.6.4 Remarks: Index D ARFF Equipment Available 24 Hours Per Day, 7 Days Per Week.

AD 2.10 Aerodrome obstacles

- 2.10.1.a. Runway designation: 09
- 2.10.1.b Type of obstacle: Pole (28 ft). Not Lighted or Marked
- 2.10.1.c Location of obstacle: 600 ft from Centerline

- 2.10.1.a. Runway designation: 27
- 2.10.1.b Type of obstacle: Pole (34 ft). Not Lighted or Marked
- 2.10.1.c Location of obstacle: 300 ft from Centerline

- 2.10.1.a. Runway designation: 36R
- 2.10.1.b Type of obstacle: Ant (18 ft). Lighted
- 2.10.1.c Location of obstacle: 400 ft from Centerline

- 2.10.1.a. Runway designation: 36L
- 2.10.1.b Type of obstacle: Road (21 ft). Not Lighted or Marked
- 2.10.1.c Location of obstacle: 600 ft from Centerline

- 2.10.1.a. Runway designation: 18C
- 2.10.1.b Type of obstacle: Pole (65 ft). Not Lighted or Marked
- 2.10.1.c Location of obstacle: 803 ft from Centerline

AD 2.12 Runway physical characteristics

- 2.12.1 Designation: 09
- 2.12.2 True Bearing: 92
- 2.12.3 Dimensions: 8946 ft x 150 ft
- 2.12.4 PCN: 92 R/B/W/T
- 2.12.5 Coordinates: 35-03-31.04N / 89-59-00.00W
- 2.12.6 Threshold elevation: 253 ft
- 2.12.6 Touchdown zone elevation: 259 ft
- 2.12.7 Slope: 0.1UP

- 2.12.1 Designation: 27
- 2.12.2 True Bearing: 272
- 2.12.3 Dimensions: 8946 ft x 150 ft
- 2.12.4 PCN: 92 R/B/W/T
- 2.12.5 Coordinates: 35-03-28.01N / 89-57-21.08W
- 2.12.6 Threshold elevation: 292 ft
- 2.12.6 Touchdown zone elevation: 292 ft
- 2.12.7 Slope: 0.6DOWN

- 2.12.1 Designation: 18L
- 2.12.2 True Bearing: 179
- 2.12.3 Dimensions: 9000 ft x 150 ft
- 2.12.4 PCN: 82 R/C/W/T
- 2.12.5 Coordinates: 35-02-55.74N / 89-58-22.63W
- 2.12.6 Threshold elevation: 278 ft
- 2.12.6 Touchdown zone elevation: 301 ft

- 2.12.1 Designation: 36R
- 2.12.2 True Bearing: 359
- 2.12.3 Dimensions: 9000 ft x 150 ft
- 2.12.4 PCN: 82 R/C/W/T
- 2.12.5 Coordinates: 35-01-26.74N / 89-58-20.75W
- 2.12.6 Threshold elevation: 335 ft
- 2.12.6 Touchdown zone elevation: 335 ft

2.12.1 Designation: 18R
2.12.2 True Bearing: 179
2.12.3 Dimensions: 9320 ft x 150 ft
2.12.4 PCN: 82 R/C/W/T
2.12.5 Coordinates: 35-02-58.16N /
89-59-14.79W
2.12.6 Threshold elevation: 288 ft
2.12.6 Touchdown zone elevation: 295 ft

2.12.1 Designation: 36L
2.12.2 True Bearing: 359
2.12.3 Dimensions: 9320 ft x 150 ft
2.12.4 PCN: 82 R/C/W/T
2.12.5 Coordinates: 35-01-25.98N /
89-59-12.81W
2.12.6 Threshold elevation: 321 ft
2.12.6 Touchdown zone elevation: 321 ft

2.12.1 Designation: 18C
2.12.2 True Bearing: 179
2.12.3 Dimensions: 11120 ft x 150 ft
2.12.4 PCN: 82 R/C/W/T
2.12.5 Coordinates: 35-03-16.54N /
89-58-34.21W
2.12.6 Threshold elevation: 271 ft
2.12.6 Touchdown zone elevation: 290 ft

2.12.1 Designation: 36C
2.12.2 True Bearing: 359
2.12.3 Dimensions: 11120 ft x 150 ft
2.12.4 PCN: 82 R/C/W/T
2.12.5 Coordinates: 35-01-26.58N /
89-58-31.90W
2.12.6 Threshold elevation: 341 ft
2.12.6 Touchdown zone elevation: 341 ft

AD 2.13 Declared distances

2.13.1 Designation: 09
2.13.2 Takeoff run available: 8946
2.13.3 Takeoff distance available: 8946
2.13.4 Accelerate-stop distance available: 8946
2.13.5 Landing distance available: 8946

2.13.1 Designation: 27
2.13.2 Takeoff run available: 8946
2.13.3 Takeoff distance available: 8946
2.13.4 Accelerate-stop distance available: 8946
2.13.5 Landing distance available: 8946

2.13.1 Designation: 18L
2.13.2 Takeoff run available: 9000

2.13.3 Takeoff distance available: 9000
2.13.4 Accelerate-stop distance available: 9000
2.13.5 Landing distance available: 9000

2.13.1 Designation: 36R
2.13.2 Takeoff run available: 9000
2.13.3 Takeoff distance available: 9000
2.13.4 Accelerate-stop distance available: 9000
2.13.5 Landing distance available: 9000

2.13.1 Designation: 18R
2.13.2 Takeoff run available: 9320
2.13.3 Takeoff distance available: 9320
2.13.4 Accelerate-stop distance available: 9320
2.13.5 Landing distance available: 9127

2.13.1 Designation: 36L
2.13.2 Takeoff run available: 9320
2.13.3 Takeoff distance available: 9320
2.13.4 Accelerate-stop distance available: 9320
2.13.5 Landing distance available: 9320

2.13.1 Designation: 18C
2.13.2 Takeoff run available: 11120
2.13.3 Takeoff distance available: 11120
2.13.4 Accelerate-stop distance available: 11120
2.13.5 Landing distance available: 11120

2.13.1 Designation: 36C
2.13.2 Takeoff run available: 11120
2.13.3 Takeoff distance available: 11120
2.13.4 Accelerate-stop distance available: 11120
2.13.5 Landing distance available: 11120

AD 2.14 Approach and runway lighting

2.14.1 Designation: 09
2.14.2 Approach lighting system: MALSR: 1400 feet medium intensity approach lighting system with runway alignment indicator lights

2.14.1 Designation: 27
2.14.2 Approach lighting system: MALSR: 1400 feet medium intensity approach lighting system with runway alignment indicator lights
2.14.4 Visual approach slope indicator system: 4-light PAPI on left

2.14.1 Designation: 18L
2.14.2 Approach lighting system: MALSR: 1400 feet medium intensity approach lighting system with runway alignment indicator lights

2.14.4 Visual approach slope indicator system:
4-light PAPI on left

2.14.1 Designation: 36R

2.14.2 Approach lighting system: ALSF2: Standard
2400 feet high intensity approach lighting system
with sequenced flashers, category II or III
configuration

2.14.4 Visual approach slope indicator system:
4-light PAPI on right

2.14.10 Remarks: ALSF2 Unmonitored.

2.14.1 Designation: 18R

2.14.2 Approach lighting system: MALSR: 1400
feet medium intensity approach lighting system
with runway alignment indicator lights

2.14.1 Designation: 36L

2.14.2 Approach lighting system: ALSF2: Standard
2400 feet high intensity approach lighting system
with sequenced flashers, category II or III
configuration

2.14.4 Visual approach slope indicator system:
4-light PAPI on left

2.14.1 Designation: 18C

2.14.2 Approach lighting system: MALSR: 1400
feet medium intensity approach lighting system
with runway alignment indicator lights

2.14.1 Designation: 36C

2.14.2 Approach lighting system: ALSF2: Standard
2400 feet high intensity approach lighting system
with sequenced flashers, category II or III
configuration

**AD 2.18 Air traffic services communication
facilities**

2.18.1 Service designation: LCL/P

2.18.3 Service designation: 118.3 MHz

2.18.1 Service designation: APCH/P CLASS B IC

2.18.3 Service designation: 119.1 MHz

2.18.1 Service designation: IC

2.18.3 Service designation: 119.1 MHz

2.18.1 Service designation: EMERG

2.18.3 Service designation: 121.5 MHz

2.18.1 Service designation: DEP/P

2.18.3 Service designation: 124.15 MHz

2.18.1 Service designation: DEP/P

2.18.3 Service designation: 124.65 MHz

2.18.1 Service designation: CD/P PTC

2.18.3 Service designation: 125.2 MHz

2.18.1 Service designation: APCH/P CLASS B IC

2.18.3 Service designation: 125.8 MHz

2.18.1 Service designation: FINAL

2.18.3 Service designation: 126.7 MHz

2.18.1 Service designation: D-ATIS

2.18.3 Service designation: 127.75 MHz

2.18.4 Hours of operation: 24

2.18.1 Service designation: ANG CP

2.18.3 Service designation: 138.1 MHz

2.18.1 Service designation: EMERG

2.18.3 Service designation: 243 MHz

2.18.1 Service designation: LCL/P

2.18.3 Service designation: 257.8 MHz

2.18.1 Service designation: FINAL

2.18.3 Service designation: 263.6 MHz

2.18.1 Service designation: DEP/P

2.18.3 Service designation: 284.7 MHz

2.18.1 Service designation: APCH/P CLASS B IC

2.18.3 Service designation: 291.6 MHz

2.18.1 Service designation: IC

2.18.3 Service designation: 291.6 MHz

2.18.1 Service designation: APCH/P CLASS B IC

2.18.3 Service designation: 338.3 MHz

2.18.1 Service designation: DEP/P

2.18.3 Service designation: 385.45 MHz

2.18.1 Service designation: GND/P

2.18.3 Service designation: 379.2 MHz

2.18.1 Service designation: LCL/P

2.18.3 Service designation: 119.7 MHz

2.18.1 Service designation: LCL/P
2.18.3 Service designation: 128.425 MHz

2.18.1 Service designation: GND/P
2.18.3 Service designation: 121.65 MHz

2.18.1 Service designation: GND/P
2.18.3 Service designation: 121.9 MHz

2.18.1 Service designation: GND/P
2.18.3 Service designation: 121 MHz

2.18.1 Service designation: FINAL
2.18.3 Service designation: 120.925 MHz

2.18.1 Service designation: FINAL RADAR 9/27
2.18.3 Service designation: 126.05 MHz

2.18.1 Service designation: SATELLITE
2.18.3 Service designation: 134.2 MHz

2.18.1 Service designation: ANG CP
2.18.3 Service designation: 353.45 MHz

AD 2.19 Radio navigation and landing aids

2.19.1 ILS type: Localizer for runway 09. Magnetic variation: 1E
2.19.2 ILS identification: MEM
2.19.5 Coordinates: 35-03-27.64N / 89-57-00.00W
2.19.6 Site elevation: 297 ft

2.19.1 ILS type: Glide Slope for runway 09. Magnetic variation: 1E
2.19.2 ILS identification: MEM
2.19.5 Coordinates: 35-03-27.21N / 89-58-56.22W
2.19.6 Site elevation: 253 ft

2.19.1 ILS type: Outer Marker for runway 09. Magnetic variation: 1E
2.19.2 ILS identification: MEM
2.19.5 Coordinates: 35-03-42.16N / 90-04-17.75W
2.19.6 Site elevation: 99999 ft

2.19.1 ILS type: Middle Marker for runway 09. Magnetic variation: 1E
2.19.2 ILS identification: MEM
2.19.5 Coordinates: 35-03-32.06N / 89-59-45.42W

2.19.6 Site elevation: 99999 ft

2.19.1 ILS type: Glide Slope for runway 27. Magnetic variation: 1E
2.19.2 ILS identification: JIM
2.19.5 Coordinates: 35-03-24.48N / 89-57-36.25W
2.19.6 Site elevation: 277 ft

2.19.1 ILS type: Outer Marker for runway 27. Magnetic variation: 1E
2.19.2 ILS identification: JIM
2.19.5 Coordinates: 35-03-21.52N / 89-51-53.89W
2.19.6 Site elevation: 326 ft

2.19.1 ILS type: Localizer for runway 27. Magnetic variation: 1E
2.19.2 ILS identification: JIM
2.19.5 Coordinates: 35-03-31.29N / 89-59-17.56W
2.19.6 Site elevation: 253 ft

2.19.1 ILS type: Middle Marker for runway 27. Magnetic variation: 1E
2.19.2 ILS identification: JIM
2.19.5 Coordinates: 35-03-27.13N / 89-56-49.73W
2.19.6 Site elevation: 304 ft

2.19.1 ILS type: Localizer for runway 18L. Magnetic variation: 1E
2.19.2 ILS identification: EXS
2.19.5 Coordinates: 35-01-16.82N / 89-58-20.55W
2.19.6 Site elevation: 315 ft

2.19.1 ILS type: DME for runway 18L. Magnetic variation: 1E
2.19.2 ILS identification: EXS
2.19.5 Coordinates: 35-01-16.86N / 89-58-19.30W
2.19.6 Site elevation: 382 ft

2.19.1 ILS type: Glide Slope for runway 18L. Magnetic variation: 1E
2.19.2 ILS identification: EXS
2.19.5 Coordinates: 35-02-46.77N / 89-58-17.63W
2.19.6 Site elevation: 279 ft

2.19.1 ILS type: Localizer for runway 36R.
Magnetic variation: 1E
2.19.2 ILS identification: MYO
2.19.5 Coordinates: 35-03-00.00N /
89-58-22.84W
2.19.6 Site elevation: 279 ft

2.19.1 ILS type: DME for runway 36R. Magnetic
variation: 1E
2.19.2 ILS identification: MYO
2.19.5 Coordinates: 35-03-00.00N /
89-58-19.67W
2.19.6 Site elevation: 281 ft

2.19.1 ILS type: Glide Slope for runway 36R.
Magnetic variation: 1E
2.19.2 ILS identification: MYO
2.19.5 Coordinates: 35-01-37.99N /
89-58-16.18W
2.19.6 Site elevation: 324 ft

2.19.1 ILS type: Inner Marker for runway 36R.
Magnetic variation: 1E
2.19.2 ILS identification: MYO
2.19.5 Coordinates: 35-01-18.39N /
89-58-20.58W
2.19.6 Site elevation: 324 ft

2.19.1 ILS type: Middle Marker for runway 36R.
Magnetic variation: 1E
2.19.2 ILS identification: MYO
2.19.5 Coordinates: 35-01-00.00N /
89-58-20.21W
2.19.6 Site elevation: 305 ft

2.19.1 ILS type: DME for runway 36L. Magnetic
variation: 1E
2.19.2 ILS identification: OHN
2.19.5 Coordinates: 35-03-00.00N /
89-59-17.33W
2.19.6 Site elevation: 286 ft

2.19.1 ILS type: Glide Slope for runway 36L.
Magnetic variation: 1E
2.19.2 ILS identification: OHN
2.19.5 Coordinates: 35-01-38.77N /
89-59-17.90W
2.19.6 Site elevation: 307 ft

2.19.1 ILS type: Middle Marker for runway 36L.
Magnetic variation: 1E

2.19.2 ILS identification: OHN
2.19.5 Coordinates: 35-00-55.71N /
89-59-12.14W
2.19.6 Site elevation: 99999 ft

2.19.1 ILS type: Outer Marker for runway 36L.
Magnetic variation: 1E
2.19.2 ILS identification: OHN
2.19.5 Coordinates: 34-57-13.77N /
89-59-00.00W
2.19.6 Site elevation: 320 ft

2.19.1 ILS type: Inner Marker for runway 36L.
Magnetic variation: 1E
2.19.2 ILS identification: OHN
2.19.5 Coordinates: 35-01-17.41N /
89-59-12.63W
2.19.6 Site elevation: 321 ft

2.19.1 ILS type: Localizer for runway 36L.
Magnetic variation: 1E
2.19.2 ILS identification: OHN
2.19.5 Coordinates: 35-03-00.00N /
89-59-14.98W
2.19.6 Site elevation: 276 ft

2.19.1 ILS type: Glide Slope for runway 18R.
Magnetic variation: 1E
2.19.2 ILS identification: OOI
2.19.5 Coordinates: 35-02-48.70N /
89-59-18.49W
2.19.6 Site elevation: 285 ft

2.19.1 ILS type: Middle Marker for runway 18R.
Magnetic variation: 1E
2.19.2 ILS identification: OOI
2.19.5 Coordinates: 35-03-24.11N /
89-59-15.34W
2.19.6 Site elevation: 251 ft

2.19.1 ILS type: Outer Marker for runway 18R.
Magnetic variation: 1E
2.19.2 ILS identification: OOI
2.19.5 Coordinates: 35-07-44.20N /
89-59-23.09W
2.19.6 Site elevation: 306 ft

2.19.1 ILS type: Localizer for runway 18R.
Magnetic variation: 1E
2.19.2 ILS identification: OOI
2.19.5 Coordinates: 35-01-19.31N /

- 89-59-12.67W
2.19.6 Site elevation: 325 ft
- 2.19.1 ILS type: Glide Slope for runway 18C.
Magnetic variation: 1E
2.19.2 ILS identification: SDU
2.19.5 Coordinates: 35-03-00.00N /
89-58-37.51W
2.19.6 Site elevation: 273 ft
- 2.19.1 ILS type: Outer Marker for runway 18C.
Magnetic variation: 1E
2.19.2 ILS identification: SDU
2.19.5 Coordinates: 35-07-45.23N /
89-58-37.90W
2.19.6 Site elevation: 99999 ft
- 2.19.1 ILS type: Localizer for runway 18C.
Magnetic variation: 1E
2.19.2 ILS identification: SDU
2.19.5 Coordinates: 35-01-10.23N /
89-58-31.56W
2.19.6 Site elevation: 346 ft
- 2.19.1 ILS type: Middle Marker for runway 18C.
Magnetic variation: 1E
2.19.2 ILS identification: SDU
2.19.5 Coordinates: 35-03-51.13N /
89-58-34.92W
2.19.6 Site elevation: 99999 ft
- 2.19.1 ILS type: Inner Marker for runway 36C.
Magnetic variation: 1E
- 2.19.2 ILS identification: TSE
2.19.5 Coordinates: 35-01-17.65N /
89-58-31.71W
2.19.6 Site elevation: 318 ft
- 2.19.1 ILS type: Middle Marker for runway 36C.
Magnetic variation: 1E
2.19.2 ILS identification: TSE
2.19.5 Coordinates: 35-01-00.00N /
89-58-31.42W
2.19.6 Site elevation: 326 ft
- 2.19.1 ILS type: DME for runway 36C. Magnetic
variation: 1E
2.19.2 ILS identification: TSE
2.19.5 Coordinates: 35-03-22.23N /
89-58-37.26W
2.19.6 Site elevation: 253 ft
- 2.19.1 ILS type: Localizer for runway 36C.
Magnetic variation: 1E
2.19.2 ILS identification: TSE
2.19.5 Coordinates: 35-03-22.50N /
89-58-34.34W
2.19.6 Site elevation: 261 ft
- 2.19.1 ILS type: Glide Slope for runway 36C.
Magnetic variation: 1E
2.19.2 ILS identification: TSE
2.19.5 Coordinates: 35-01-38.08N /
89-58-36.94W
2.19.6 Site elevation: 330 ft

General Remarks:

ALL TRANSIENT AIRCRAFT REQUIRE -FOLLOW ME- ASSIST ENTERING ANG RAMP. USE OF ANG RAMP REQUIRES PRIOR PERMISSION REQUIRED V966-8131 -FOR OFFICIAL BUSINESS ONLY-.

HELICOPTER OPERATIONS PROHIBITED TO/FROM TERMINAL BUILDING.

LARGE FLOCKS OF BIRDS IN THE VICINITY OF AIRPORT.

PORTIONS OF TAXIWAY A EAST OF TAXIWAY A1 NOT VISIBLE FROM ATCT.

TAXIWAY N NORTH OF TAXIWAY V, TAXIWAY C NORTH OF TAXIWAY V AND TAXIWAY S NORTH OF TAXIWAY V DESIGNATED AS NON-MOVEMENT AREAS.

LARGE & HEAVY EASTBOUND AIRCRAFT ON TAXIWAY V FOR RUNWAY 27 HOLD SHORT AT MINIMUM THRUST AREA SIGN.

PRIOR PERMISSION REQUIRED FOR TAXI CLEARANCE ON TAXIWAY 'N' NORTH OF TAXIWAY 'V', TAXIWAY 'S' NORTH TAXIWAY 'V', AND TAXIWAY 'C' NORTH OF TAXIWAY 'V' CONTACT FEDEX RAMP ATCT ON FREQ 131.5.

IF POSSIBLE ALL AIRCRAFT CONDUCT GROUND OPERATIONS WITH TRANSPONDERS ON.

TAXIWAY V BETWEEN TAXIWAY B AND APPROACH END RUNWAY 27 RESTRICTED TO AIRCRAFT WITH WINGSPANS OF 171 FT 6 INCHES OR LESS.

TAXIWAY V BETWEEN TAXIWAY S TAXIWAY Y RESTRICTED TO AIRCRAFT WITH TAIL HEIGHTS LESS THAN 65 FT 10 INCHES.

ANG-PRIOR PERMISSION REQUIRED DSN 726-7131, C901-291-7131. OPER 1245-2215Z MON - FRI AND CLOSED ALTITUDE MON & HOLIDAY DUE TO ALTERNATE WORK SCHEDULE. TRANSIENT AIRCRAFT MAINT NOT AVAILABLE. REFUEL SERVICE FOR OTHER THAN C5 AIRCRAFT REQUIRE QUALIFIED CREW CHIEF OR CREWMEMBERS. NON-C5 AIRCRAFT SUPPORT PROVIDED BY CONTRACT FBO ON FIELD.

CONTACT RAMP CONTROL ON 121.8 FOR ENTRY ON TO ANG RAMP. ANG FREQS 138.95 341.75. AFTER HRS CONTACT COMMAND POST AT DSN 726-7148 OR SECURITY FORCES AT DSN 726-7101.

READ BACK ALL HOLD SHORT INSTRUCTIONS REQUIRED.

MILITARY AIRCRAFT WITH WINGSPANS GREATER THAN 171 FT SHOULD NOT TAXI ON TAXIWAY N BETWEEN TAXIWAY M7 AND TAXIWAY T NOR ON TAXIWAY J NORTH OF TAXIWAY C3.

AIRPORT CLOSED TO C5 AND LARGER EXCEPT PRIOR PERMISSION REQUIRED AIRPORT MANAGER 901-922-8117.

ANG: BASH PHASE TWO PERIOD ACTIVE FROM SEPTEMBER THROUGH MARCH.

ASDE-X SURVEILLANCE SYSTEM IN USE: PILOTS SHOULD OPERATE TRANSPONDERS WITH MODE C ON ALL TAXIWAYS AND RUNWAYS.

Nashville, Tennessee Nashville International ICAO Identifier KBNA

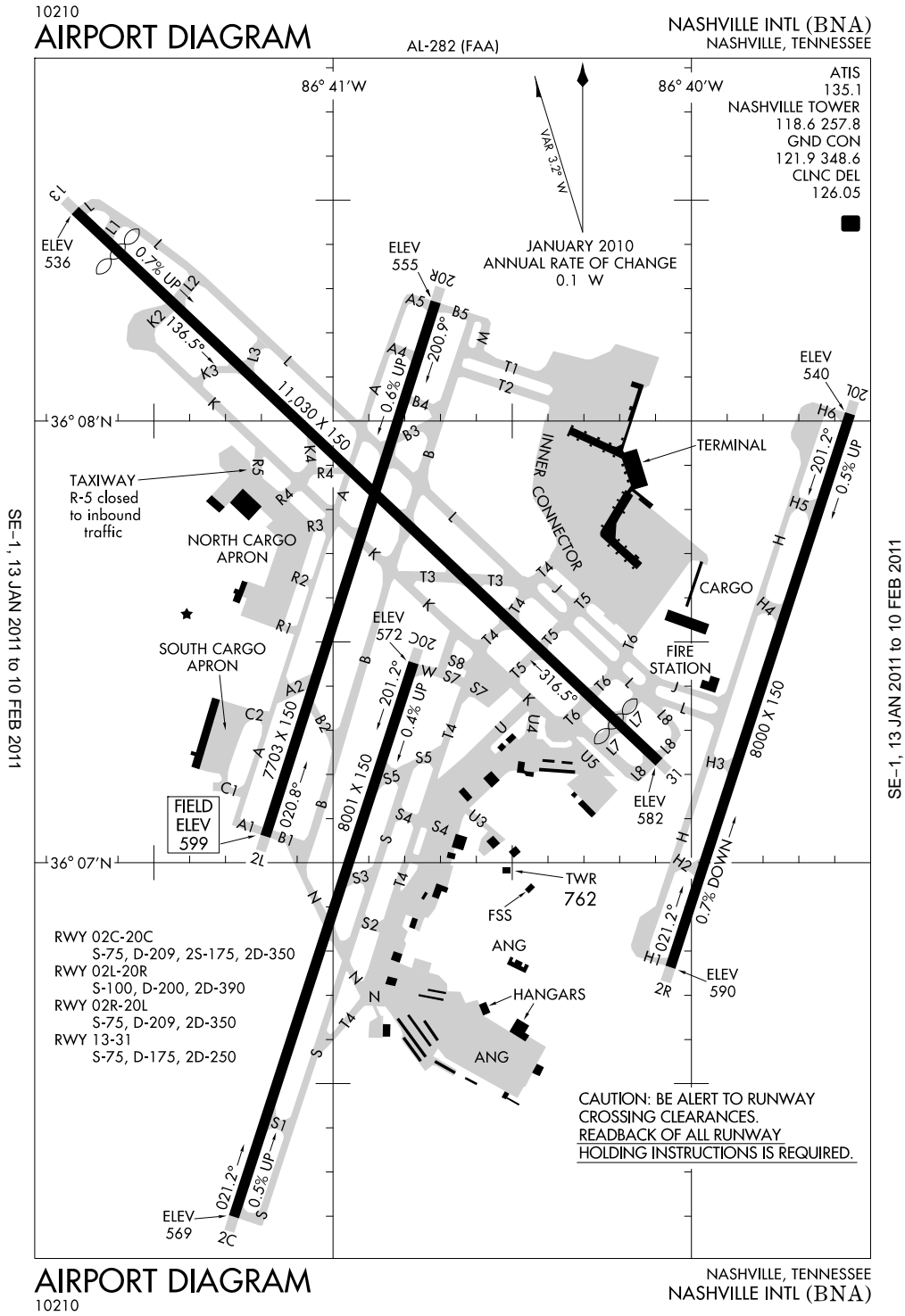

Nashville, TN
Nashville Intl
ICAO Identifier KBNA

AD 2.2 Aerodrome geographical and administrative data

- 2.2.1 Reference Point: 36-07-28.10N / 86-40-41.50W
- 2.2.2 From City: 5 Miles SE Of NASHville, TN
- 2.2.3 Elevation: 599 ft
- 2.2.5 Magnetic variation: 3W (2010)
- 2.2.6 Airport Contact: Raul Regalado
ONE TERMINAL DR. SUITE 501
Nashville, TN 37214
(615-275-1600)
- 2.2.7 Traffic: IFR/VFR

AD 2.3 Operational hours

- 2.3.1 - 2.3.11: ALL Months, ALL Days, ALL Hours

AD 2.4 Handling services and facilities

- 2.4.1 Cargo handling facilities: No
- 2.4.2 Fuel types: 100LL,A
- 2.4.4 De-icing facilities: None
- 2.4.5 Hangar space: Yes
- 2.4.6 Repair facilities: Major

AD 2.6 Rescue and firefighting services

- 2.6.1 Aerodrome category for firefighting: ARFF Index I C certified on 5/1/1973

AD 2.10 Aerodrome obstacles

- 2.10.1.a. Runway designation: 13
- 2.10.1.b Type of obstacle: Trees. Not Lighted or Marked

- 2.10.1.a. Runway designation: 31
- 2.10.1.b Type of obstacle: Tree. Not Lighted or Marked

AD 2.12 Runway physical characteristics

- 2.12.1 Designation: 13
- 2.12.2 True Bearing: 133
- 2.12.3 Dimensions: 11030 ft x 150 ft
- 2.12.5 Coordinates: 36-08-28.60N / 86-41-43.28W
- 2.12.6 Threshold elevation: 536 ft
- 2.12.6 Touchdown zone elevation: 567 ft

- 2.12.1 Designation: 31

- 2.12.2 True Bearing: 313
- 2.12.3 Dimensions: 11030 ft x 150 ft
- 2.12.5 Coordinates: 36-07-13.79N / 86-40-00.00W
- 2.12.6 Threshold elevation: 582 ft
- 2.12.6 Touchdown zone elevation: 577 ft

- 2.12.1 Designation: 02C
- 2.12.2 True Bearing: 18
- 2.12.3 Dimensions: 8001 ft x 150 ft
- 2.12.5 Coordinates: 36-06-11.99N / 86-41-16.66W
- 2.12.6 Threshold elevation: 569 ft
- 2.12.6 Touchdown zone elevation: 587 ft

- 2.12.1 Designation: 20C
- 2.12.2 True Bearing: 198
- 2.12.3 Dimensions: 8001 ft x 150 ft
- 2.12.5 Coordinates: 36-07-27.24N / 86-40-46.55W
- 2.12.6 Threshold elevation: 572 ft
- 2.12.6 Touchdown zone elevation: 588 ft

- 2.12.1 Designation: 02L
- 2.12.2 True Bearing: 18
- 2.12.3 Dimensions: 7703 ft x 150 ft
- 2.12.5 Coordinates: 36-07-00.00N / 86-41-11.31W
- 2.12.6 Threshold elevation: 598 ft
- 2.12.6 Touchdown zone elevation: 599 ft

- 2.12.1 Designation: 20R
- 2.12.2 True Bearing: 198
- 2.12.3 Dimensions: 7703 ft x 150 ft
- 2.12.5 Coordinates: 36-08-16.23N / 86-40-42.84W
- 2.12.6 Threshold elevation: 555 ft
- 2.12.6 Touchdown zone elevation: 578 ft

- 2.12.1 Designation: 02R
- 2.12.2 True Bearing: 18
- 2.12.3 Dimensions: 8000 ft x 150 ft
- 2.12.5 Coordinates: 36-06-45.77N / 86-40-00.00W
- 2.12.6 Threshold elevation: 590 ft
- 2.12.6 Touchdown zone elevation: 590 ft

- 2.12.1 Designation: 20L
- 2.12.2 True Bearing: 198
- 2.12.3 Dimensions: 8000 ft x 150 ft
- 2.12.5 Coordinates: 36-08-00.00N /

86-39-33.40W

2.12.6 Threshold elevation: 540 ft

2.12.6 Touchdown zone elevation: 551 ft

AD 2.13 Declared distances

2.13.1 Designation: 13

2.13.2 Takeoff run available: 10288

2.13.3 Takeoff distance available: 11029

2.13.4 Accelerate-stop distance available: 10288

2.13.5 Landing distance available: 9487

2.13.1 Designation: 31

2.13.2 Takeoff run available: 10228

2.13.3 Takeoff distance available: 11029

2.13.4 Accelerate-stop distance available: 10228

2.13.5 Landing distance available: 9487

2.13.1 Designation: 02C

2.13.2 Takeoff run available: 8000

2.13.3 Takeoff distance available: 8000

2.13.4 Accelerate-stop distance available: 8000

2.13.5 Landing distance available: 8000

2.13.1 Designation: 20C

2.13.2 Takeoff run available: 8000

2.13.3 Takeoff distance available: 8000

2.13.4 Accelerate-stop distance available: 8000

2.13.5 Landing distance available: 8000

2.13.1 Designation: 02L

2.13.2 Takeoff run available: 7702

2.13.3 Takeoff distance available: 7702

2.13.4 Accelerate-stop distance available: 7702

2.13.5 Landing distance available: 7702

2.13.1 Designation: 20R

2.13.2 Takeoff run available: 7702

2.13.3 Takeoff distance available: 7702

2.13.4 Accelerate-stop distance available: 7702

2.13.5 Landing distance available: 7702

2.13.1 Designation: 02R

2.13.2 Takeoff run available: 8000

2.13.3 Takeoff distance available: 8000

2.13.4 Accelerate-stop distance available: 8000

2.13.5 Landing distance available: 8000

2.13.1 Designation: 20L

2.13.2 Takeoff run available: 8000

2.13.3 Takeoff distance available: 8000

2.13.4 Accelerate-stop distance available: 8000

2.13.5 Landing distance available: 8000

AD 2.14 Approach and runway lighting

2.14.1 Designation: 13

2.14.4 Visual approach slope indicator system:
6-box VASI on left

2.14.1 Designation: 02C

2.14.2 Approach lighting system: MALSR: 1400
feet medium intensity approach lighting system
with runway alignment indicator lights

2.14.1 Designation: 20C

2.14.4 Visual approach slope indicator system:
4-light PAPI on left

2.14.1 Designation: 02L

2.14.2 Approach lighting system: ALSF2: Standard
2400 feet high intensity approach lighting system
with sequenced flashers, category II or III
configuration

2.14.1 Designation: 20R

2.14.4 Visual approach slope indicator system:
4-light PAPI on right

2.14.1 Designation: 02R

2.14.2 Approach lighting system: ALSF2: Standard
2400 feet high intensity approach lighting system
with sequenced flashers, category II or III
configuration

2.14.4 Visual approach slope indicator system:
4-light PAPI on right

2.14.1 Designation: 20L

2.14.2 Approach lighting system: MALSR: 1400
feet medium intensity approach lighting system
with runway alignment indicator lights

AD 2.18 Air traffic services communication facilities

2.18.1 Service designation: CLASS C IC

2.18.3 Service designation: 118.4 MHz

2.18.1 Service designation: DEP/P

2.18.3 Service designation: 118.4 MHz

2.18.1 Service designation: DEP/P CLASS C

2.18.3 Service designation: 119.35 MHz

2.18.1 Service designation: APCH/P

2.18.3 Service designation: 120.6 MHz

2.18.1 Service designation: EMERG
2.18.3 Service designation: 121.5 MHz

2.18.1 Service designation: CD/P PTC
2.18.3 Service designation: 126.05 MHz

2.18.1 Service designation: APCH/P
2.18.3 Service designation: 127.175 MHz

2.18.1 Service designation: EMERG
2.18.3 Service designation: 243 MHz

2.18.1 Service designation: ALCP
2.18.3 Service designation: 314.4 MHz

2.18.1 Service designation: DEP/P
2.18.3 Service designation: 317.45 MHz

2.18.1 Service designation: APCH/P CLASS C IC
2.18.3 Service designation: 360.7 MHz

2.18.1 Service designation: DEP/P CLASS C
2.18.3 Service designation: 385.55 MHz

2.18.1 Service designation: APCH/P
2.18.3 Service designation: 387 MHz

2.18.1 Service designation: LCL/P
2.18.3 Service designation: 118.6 MHz

2.18.1 Service designation: GND/P
2.18.3 Service designation: 121.9 MHz

2.18.1 Service designation: LCL/P
2.18.3 Service designation: 257.8 MHz

2.18.1 Service designation: GND/P
2.18.3 Service designation: 348.6 MHz

2.18.1 Service designation: D-ATIS
2.18.3 Service designation: 135.1 MHz
2.18.4 Hours of operation: 24

AD 2.19 Radio navigation and landing aids

2.19.1 ILS type: Localizer for runway 31. Magnetic variation: 3W
2.19.2 ILS identification: PNO
2.19.5 Coordinates: 36-08-30.65N / 86-41-45.97W

2.19.6 Site elevation: 540 ft

2.19.1 ILS type: Middle Marker for runway 31. Magnetic variation: 3W
2.19.2 ILS identification: PNO
2.19.5 Coordinates: 36-06-57.26N / 86-39-44.59W
2.19.6 Site elevation: 547 ft

2.19.1 ILS type: Outer Marker for runway 31. Magnetic variation: 3W
2.19.2 ILS identification: PNO
2.19.5 Coordinates: 36-03-16.09N / 86-34-51.59W
2.19.6 Site elevation: 520 ft

2.19.1 ILS type: Glide Slope for runway 31. Magnetic variation: 3W
2.19.2 ILS identification: PNO
2.19.5 Coordinates: 36-07-28.27N / 86-40-18.60W
2.19.6 Site elevation: 566 ft

2.19.1 ILS type: Localizer for runway 02C. Magnetic variation: 3W
2.19.2 ILS identification: EZN
2.19.5 Coordinates: 36-07-31.97N / 86-40-44.66W
2.19.6 Site elevation: 574 ft

2.19.1 ILS type: Glide Slope for runway 02C. Magnetic variation: 3W
2.19.2 ILS identification: EZN
2.19.5 Coordinates: 36-06-22.64N / 86-41-16.89W
2.19.6 Site elevation: 571 ft

2.19.1 ILS type: Localizer for runway 02L. Magnetic variation: 3W
2.19.2 ILS identification: BNA
2.19.5 Coordinates: 36-08-24.27N / 86-40-39.69W
2.19.6 Site elevation: 548 ft

2.19.1 ILS type: DME for runway 02L. Magnetic variation: 3W
2.19.2 ILS identification: BNA
2.19.5 Coordinates: 36-08-26.46N / 86-40-42.35W
2.19.6 Site elevation: 548 ft

2.19.1 ILS type: Glide Slope for runway 02L.
Magnetic variation: 3W
2.19.2 ILS identification: BNA
2.19.5 Coordinates: 36-07-12.95N /
86-41-00.00W
2.19.6 Site elevation: 591 ft

2.19.1 ILS type: Outer Marker for runway 02L.
Magnetic variation: 3W
2.19.2 ILS identification: BNA
2.19.5 Coordinates: 36-01-51.60N /
86-43-18.44W
2.19.6 Site elevation: 985 ft

2.19.1 ILS type: Middle Marker for runway 02L.
Magnetic variation: 3W
2.19.2 ILS identification: BNA
2.19.5 Coordinates: 36-06-35.04N /
86-41-22.51W
2.19.6 Site elevation: 99999 ft

2.19.1 ILS type: Inner Marker for runway 02L.
Magnetic variation: 3W
2.19.2 ILS identification: BNA
2.19.5 Coordinates: 36-06-54.83N /
86-41-14.80W
2.19.6 Site elevation: 595 ft

2.19.1 ILS type: Outer Marker for runway 20R.
Magnetic variation: 3W
2.19.2 ILS identification: VIY
2.19.5 Coordinates: 36-12-13.70N /
86-39-00.00W
2.19.6 Site elevation: 433 ft

2.19.1 ILS type: Glide Slope for runway 20R.
Magnetic variation: 3W
2.19.2 ILS identification: VIY
2.19.5 Coordinates: 36-08-00.00N /
86-40-42.76W
2.19.6 Site elevation: 555 ft

2.19.1 ILS type: Localizer for runway 20R.
Magnetic variation: 3W
2.19.2 ILS identification: VIY
2.19.5 Coordinates: 36-06-49.68N /
86-41-16.79W
2.19.6 Site elevation: 587 ft

2.19.1 ILS type: Glide Slope for runway 02R.
Magnetic variation: 3W

2.19.2 ILS identification: UQU
2.19.5 Coordinates: 36-06-56.01N /
86-39-54.74W
2.19.6 Site elevation: 577 ft

2.19.1 ILS type: Inner Marker for runway 02R.
Magnetic variation: 3W
2.19.2 ILS identification: UQU
2.19.5 Coordinates: 36-06-37.69N /
86-40-00.00W
2.19.6 Site elevation: 569 ft

2.19.1 ILS type: Middle Marker for runway 02R.
Magnetic variation: 3W
2.19.2 ILS identification: UQU
2.19.5 Coordinates: 36-06-19.86N /
86-40-13.85W
2.19.6 Site elevation: 607 ft

2.19.1 ILS type: DME for runway 02R. Magnetic
variation: 3W
2.19.2 ILS identification: UQU
2.19.5 Coordinates: 36-08-00.00N /
86-39-34.22W
2.19.6 Site elevation: 545 ft

2.19.1 ILS type: Localizer for runway 02R.
Magnetic variation: 3W
2.19.2 ILS identification: UQU
2.19.5 Coordinates: 36-08-00.00N /
86-39-31.13W
2.19.6 Site elevation: 536 ft

2.19.1 ILS type: Localizer for runway 20L.
Magnetic variation: 3W
2.19.2 ILS identification: SSX
2.19.5 Coordinates: 36-06-30.06N /
86-40-00.00W
2.19.6 Site elevation: 614 ft

2.19.1 ILS type: Middle Marker for runway 20L.
Magnetic variation: 3W
2.19.2 ILS identification: SSX
2.19.5 Coordinates: 36-08-25.51N /
86-39-23.69W
2.19.6 Site elevation: 610 ft

2.19.1 ILS type: DME for runway 20L. Magnetic
variation: 3W
2.19.2 ILS identification: SSX
2.19.5 Coordinates: 36-06-30.96N /

86-40-12.89W

2.19.6 Site elevation: 621 ft

2.19.1 ILS type: Glide Slope for runway 20L.

Magnetic variation: 3W

2.19.2 ILS identification: SSX

2.19.5 Coordinates: 36-07-50.03N /
86-39-33.12W

2.19.6 Site elevation: 534 ft

General Remarks:

AIRCRAFT CONDUCTING VISUAL APPROACH TO RUNWAYS 20R 20C 20L OR 13 AVOID CORNELIA FORT AIRPARK (5 MILES NW OF NASHVILLE INTL ARPT) BELOW 2000 FT MSL.

READ BACK OF ALL RUNWAY HOLDING INSTRUCTIONS IS REQUIRED.

FLIGHT NOTIFICATION SERVICE (ADCUS) AVAILABLE.

PILOTS COMPLY WITH ALL HOLD SHORT INSTRUCTIONS PARTICULARLY AT TAXIWAY K & RUNWAY 20C APPROACH; TAXIWAY L8 & RUNWAY 31 APPROACH; TAXIWAY L AT RUNWAY 13 APPROACH; AND TAXIWAY H AT RUNWAY 31 APPROACH.

ALL TURBOJET RUNWAYS HAVE NOISE ABATEMENT PROCEDURES. MILITARY FIGHTER/ATTACK/TRAINER TURBOJETS USE RUNWAY 13/31 FOR ARRIVAL & DEPARTURE.

LIGHTED JET BLAST FENCE 598 MSL 1100 FT SE OF RUNWAY 31 THRESHOLD.

LIGHTED JET BLAST FENCE 568 FT MSL 1167 FT NW RUNWAY 13 THRESHOLD.

NO UNAUTHORIZED 180 DEGREE TURNS FOR AIRCRAFT OVER 12500 LBS ON ASPHALT SURFACES.

NO FLIGHT OVER MAIN TERMINAL BUILDING IS PERMITTED.

BIRD ACTIVITY ON & IN THE VICINITY OF AIRPORT.

DO NOT CONFUSE 150 FT WIDE TAXIWAY S FOR RUNWAY 20C.

'C' CONCOURSE TAXILANES ARE; INNER TAXILANE FOR OUTBOUND TRAFFIC & OUTER TAXILANE FOR INBOUND TRAFFIC.

TAXIWAY 'S' BETWEEN TAXIWAY 'S5' & 'S7' INCLUDING TAXIWAY 'S6' CLOSED INDEFINITELY.

FENCE CONSTRUCTION NE RAMP APRON 'D' CONCOURSE LIGHTED.

(A89) FOR LOCAL CALL TO FSS DIAL 695-6624.

NO FLIGHTS OVER AIR NATIONAL GUARD RAMP.

CAUTION: BASH PHASE I: RUNS FROM 1 APRIL THROUGH 30 SEPTEMBER EACH YEAR. PHASE II RUNS FROM 1 OCTOBER THROUGH 31 MARCH EACH YEAR DUE TO ITS PROXIMITY TO THE FOUR MAJOR MIGRATORY FLYWAYS. SEE AP/1 FOR MORE INFORMATION.

ANG: OFFICIAL BUSINESS ONLY, PRIOR PERMISSION REQUIRED DSN 844-8119.

ANG: CALL SIGN MUSIC CITY OPERATIONS.

Dallas, Texas Dallas-Fort Worth International ICAO Identifier KDFW

10210 AIRPORT DIAGRAM DALLAS-FORT WORTH INTL (DFW)
AL-6039 (FAA) DALLAS-FORT WORTH, TEXAS

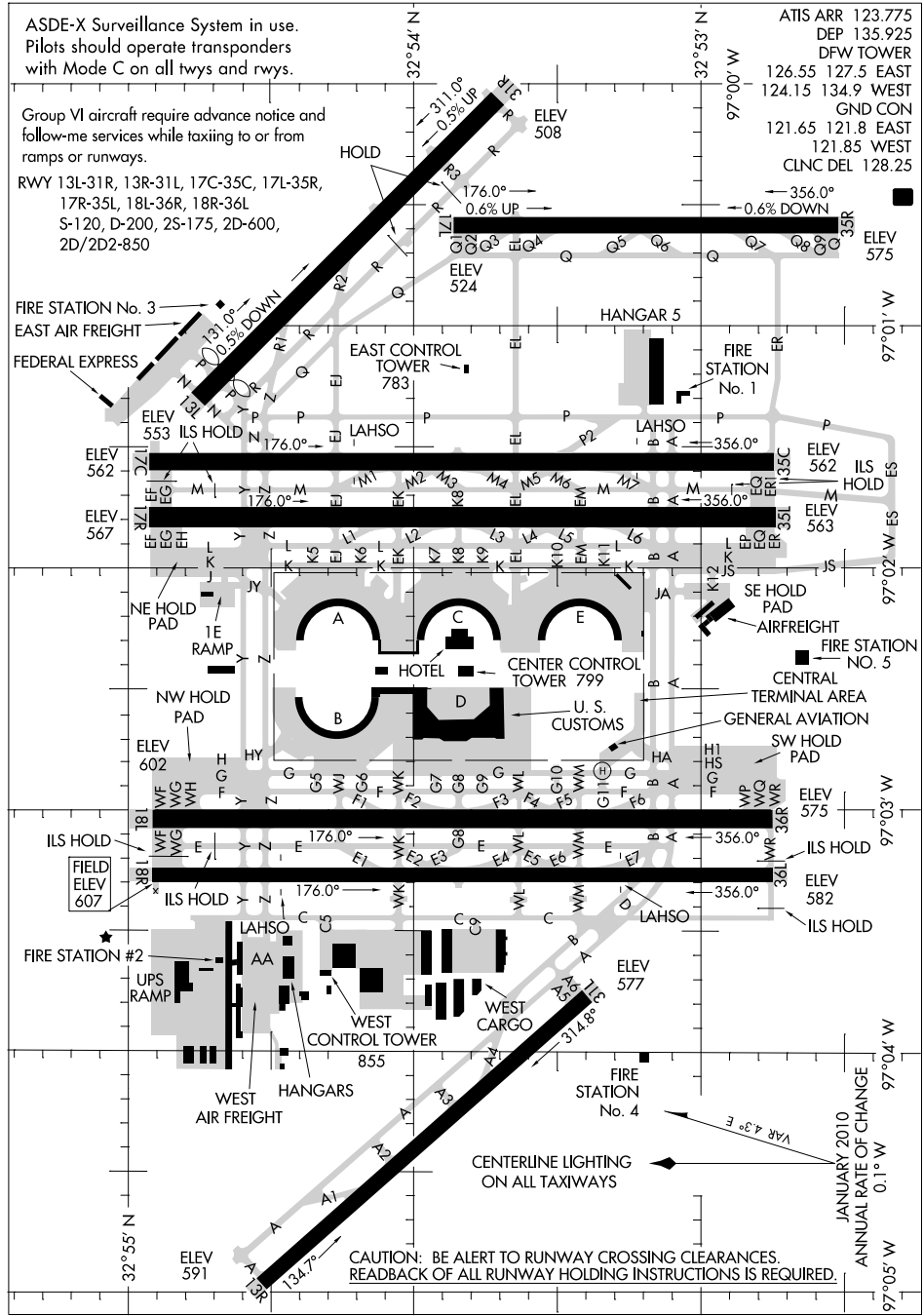

SC-2, 13 JAN 2011 to 10 FEB 2011

SC-2, 13 JAN 2011 to 10 FEB 2011

AIRPORT DIAGRAM DALLAS-FORT WORTH, TEXAS
10210 DALLAS-FORT WORTH INTL (DFW)

Dallas-Fort Worth, TX
Dallas/Fort Worth Intl
ICAO Identifier KDFW

AD 2.2 Aerodrome geographical and administrative data

- 2.2.1 Reference Point: 32-53-48.58N / 97-02-16.79W
- 2.2.2 From City: 12 Miles NW Of Dallas-Fort Worth, TX
- 2.2.3 Elevation: 607 ft
- 2.2.5 Magnetic variation: 6E (2000)
- 2.2.6 Airport Contact: Jeffrey Fegan
CHIEF EXECUTIVE OFFICER
Dallas-Ft Worth, TX 75261
(972-973-3112)
- 2.2.7 Traffic: IFR/VFR
- 2.2.8 Remarks: And Dallas Co.

AD 2.3 Operational hours

- 2.3.1 - 2.3.11: ALL Months, ALL Days, ALL Hours

AD 2.4 Handling services and facilities

- 2.4.1 Cargo handling facilities: No
- 2.4.2 Fuel types: 100LL,A
- 2.4.4 De-icing facilities: None
- 2.4.5 Hangar space: No
- 2.4.6 Repair facilities: None

AD 2.6 Rescue and firefighting services

- 2.6.1 Aerodrome category for firefighting: ARFF Index I E certified on 7/1/1973

AD 2.10 Aerodrome obstacles

- 2.10.1.a. Runway designation: 17L
- 2.10.1.b Type of obstacle: Ant (150 ft). Lighted
- 2.10.1.c Location of obstacle: 798 ft from Centerline

AD 2.12 Runway physical characteristics

- 2.12.1 Designation: 18L
- 2.12.2 True Bearing: 180
- 2.12.3 Dimensions: 13400 ft x 200 ft
- 2.12.5 Coordinates: 32-54-56.88N / 97-03-00.00W
- 2.12.6 Threshold elevation: 602 ft
- 2.12.6 Touchdown zone elevation: 602 ft

- 2.12.1 Designation: 36R
- 2.12.2 True Bearing: 0

- 2.12.3 Dimensions: 13400 ft x 200 ft
- 2.12.5 Coordinates: 32-52-44.30N / 97-03-00.00W
- 2.12.6 Threshold elevation: 575 ft
- 2.12.6 Touchdown zone elevation: 581 ft

- 2.12.1 Designation: 18R
- 2.12.2 True Bearing: 180
- 2.12.3 Dimensions: 13400 ft x 150 ft
- 2.12.5 Coordinates: 32-54-56.93N / 97-03-16.71W
- 2.12.6 Threshold elevation: 607 ft
- 2.12.6 Touchdown zone elevation: 607 ft

- 2.12.1 Designation: 36L
- 2.12.2 True Bearing: 0
- 2.12.3 Dimensions: 13400 ft x 150 ft
- 2.12.5 Coordinates: 32-52-44.35N / 97-03-17.40W
- 2.12.6 Threshold elevation: 582 ft
- 2.12.6 Touchdown zone elevation: 588 ft

- 2.12.1 Designation: 17C
- 2.12.2 True Bearing: 180
- 2.12.3 Dimensions: 13401 ft x 150 ft
- 2.12.5 Coordinates: 32-54-56.55N / 97-01-33.49W
- 2.12.6 Threshold elevation: 562 ft
- 2.12.6 Touchdown zone elevation: 562 ft

- 2.12.1 Designation: 35C
- 2.12.2 True Bearing: 0
- 2.12.3 Dimensions: 13401 ft x 150 ft
- 2.12.5 Coordinates: 32-52-43.96N / 97-01-34.22W
- 2.12.6 Threshold elevation: 562 ft
- 2.12.6 Touchdown zone elevation: 563 ft

- 2.12.1 Designation: 13L
- 2.12.2 True Bearing: 135
- 2.12.3 Dimensions: 9000 ft x 200 ft
- 2.12.5 Coordinates: 32-54-45.20N / 97-01-17.32W
- 2.12.6 Threshold elevation: 553 ft
- 2.12.6 Touchdown zone elevation: 553 ft

- 2.12.1 Designation: 31R
- 2.12.2 True Bearing: 315
- 2.12.3 Dimensions: 9000 ft x 200 ft
- 2.12.5 Coordinates: 32-53-41.93N / 97-00-00.00W

2.12.6 Threshold elevation: 508 ft
2.12.6 Touchdown zone elevation: 523 ft

2.12.1 Designation: 13R
2.12.2 True Bearing: 139
2.12.3 Dimensions: 9301 ft x 150 ft
2.12.5 Coordinates: 32-54-34.47N /
97-04-59.28W
2.12.6 Threshold elevation: 591 ft
2.12.6 Touchdown zone elevation: 591 ft

2.12.1 Designation: 31L
2.12.2 True Bearing: 319
2.12.3 Dimensions: 9301 ft x 150 ft
2.12.5 Coordinates: 32-53-24.97N /
97-03-47.79W
2.12.6 Threshold elevation: 577 ft
2.12.6 Touchdown zone elevation: 581 ft

2.12.1 Designation: 17L
2.12.2 True Bearing: 180
2.12.3 Dimensions: 8500 ft x 150 ft
2.12.5 Coordinates: 32-53-53.95N /
97-00-35.20W
2.12.6 Threshold elevation: 524 ft
2.12.6 Touchdown zone elevation: 545 ft

2.12.1 Designation: 35R
2.12.2 True Bearing: 0
2.12.3 Dimensions: 8500 ft x 150 ft
2.12.5 Coordinates: 32-52-29.85N /
97-00-35.67W
2.12.6 Threshold elevation: 575 ft
2.12.6 Touchdown zone elevation: 575 ft

2.12.1 Designation: 17R
2.12.2 True Bearing: 180
2.12.3 Dimensions: 13401 ft x 200 ft
2.12.5 Coordinates: 32-54-56.60N /
97-01-47.58W
2.12.6 Threshold elevation: 566 ft
2.12.6 Touchdown zone elevation: 567 ft

2.12.1 Designation: 35L
2.12.2 True Bearing: 0
2.12.3 Dimensions: 13401 ft x 200 ft
2.12.5 Coordinates: 32-52-44.02N /
97-01-48.29W
2.12.6 Threshold elevation: 563 ft
2.12.6 Touchdown zone elevation: 564 ft

2.12.1 Designation: H1
2.12.3 Dimensions: 158 ft x 158 ft

AD 2.13 Declared distances

2.13.1 Designation: 18L
2.13.2 Takeoff run available: 13400
2.13.3 Takeoff distance available: 13400
2.13.4 Accelerate-stop distance available: 13400
2.13.5 Landing distance available: 13400

2.13.1 Designation: 36R
2.13.2 Takeoff run available: 13400
2.13.3 Takeoff distance available: 13400
2.13.4 Accelerate-stop distance available: 13400
2.13.5 Landing distance available: 13400

2.13.1 Designation: 18R
2.13.2 Takeoff run available: 13400
2.13.3 Takeoff distance available: 13400
2.13.4 Accelerate-stop distance available: 13400
2.13.5 Landing distance available: 13400

2.13.1 Designation: 36L
2.13.2 Takeoff run available: 13400
2.13.3 Takeoff distance available: 13400
2.13.4 Accelerate-stop distance available: 13400
2.13.5 Landing distance available: 13400

2.13.1 Designation: 17C
2.13.2 Takeoff run available: 13401
2.13.3 Takeoff distance available: 13401
2.13.4 Accelerate-stop distance available: 13401
2.13.5 Landing distance available: 13401

2.13.1 Designation: 35C
2.13.2 Takeoff run available: 13401
2.13.3 Takeoff distance available: 13401
2.13.4 Accelerate-stop distance available: 13401
2.13.5 Landing distance available: 13401

2.13.1 Designation: 13L
2.13.2 Takeoff run available: 9000
2.13.3 Takeoff distance available: 9000
2.13.4 Accelerate-stop distance available: 9000
2.13.5 Landing distance available: 8375

2.13.1 Designation: 31R
2.13.2 Takeoff run available: 8375
2.13.3 Takeoff distance available: 8375
2.13.4 Accelerate-stop distance available: 8375
2.13.5 Landing distance available: 8375

2.13.1 Designation: 13R
2.13.2 Takeoff run available: 9301
2.13.3 Takeoff distance available: 9301
2.13.4 Accelerate-stop distance available: 9301
2.13.5 Landing distance available: 9301

2.13.1 Designation: 31L
2.13.2 Takeoff run available: 9301
2.13.3 Takeoff distance available: 9301
2.13.4 Accelerate-stop distance available: 9301
2.13.5 Landing distance available: 9301

2.13.1 Designation: 17L
2.13.2 Takeoff run available: 8500
2.13.3 Takeoff distance available: 8500
2.13.4 Accelerate-stop distance available: 8500
2.13.5 Landing distance available: 8500

2.13.1 Designation: 35R
2.13.2 Takeoff run available: 8500
2.13.3 Takeoff distance available: 8500
2.13.4 Accelerate-stop distance available: 8500
2.13.5 Landing distance available: 8500

2.13.1 Designation: 17R
2.13.2 Takeoff run available: 13401
2.13.3 Takeoff distance available: 13401
2.13.4 Accelerate-stop distance available: 13401
2.13.5 Landing distance available: 13401

2.13.1 Designation: 35L
2.13.2 Takeoff run available: 13401
2.13.3 Takeoff distance available: 13401
2.13.4 Accelerate-stop distance available: 13401
2.13.5 Landing distance available: 13401

AD 2.14 Approach and runway lighting

2.14.1 Designation: 18L
2.14.2 Approach lighting system: MALSR: 1400 feet medium intensity approach lighting system with runway alignment indicator lights
2.14.4 Visual approach slope indicator system: 4-light PAPI on left

2.14.1 Designation: 36R
2.14.2 Approach lighting system: MALSR: 1400 feet medium intensity approach lighting system with runway alignment indicator lights
2.14.4 Visual approach slope indicator system: 4-light PAPI on left

2.14.1 Designation: 18R

2.14.2 Approach lighting system: ALSF2: Standard 2400 feet high intensity approach lighting system with sequenced flashers, category II or III configuration

2.14.4 Visual approach slope indicator system: 4-light PAPI on left

2.14.1 Designation: 36L
2.14.2 Approach lighting system: MALSR: 1400 feet medium intensity approach lighting system with runway alignment indicator lights
2.14.4 Visual approach slope indicator system: 4-light PAPI on left

2.14.1 Designation: 17C
2.14.2 Approach lighting system: ALSF2: Standard 2400 feet high intensity approach lighting system with sequenced flashers, category II or III configuration
2.14.4 Visual approach slope indicator system: 4-light PAPI on left

2.14.1 Designation: 35C
2.14.2 Approach lighting system: ALSF2: Standard 2400 feet high intensity approach lighting system with sequenced flashers, category II or III configuration
2.14.4 Visual approach slope indicator system: 4-light PAPI on left

2.14.1 Designation: 13L
2.14.4 Visual approach slope indicator system: 4-light PAPI on left

2.14.1 Designation: 31R
2.14.2 Approach lighting system: MALSR: 1400 feet medium intensity approach lighting system with runway alignment indicator lights
2.14.4 Visual approach slope indicator system: 4-light PAPI on left

2.14.1 Designation: 13R
2.14.2 Approach lighting system: MALSR: 1400 feet medium intensity approach lighting system with runway alignment indicator lights
2.14.4 Visual approach slope indicator system: 4-light PAPI on left

2.14.1 Designation: 31L
2.14.4 Visual approach slope indicator system: 4-light PAPI on left

2.14.1 Designation: 17L
2.14.2 Approach lighting system: ALSF2: Standard
2400 feet high intensity approach lighting system
with sequenced flashers, category II or III
configuration
2.14.4 Visual approach slope indicator system:
4-light PAPI on left

2.14.1 Designation: 35R
2.14.2 Approach lighting system: ALSF2: Standard
2400 feet high intensity approach lighting system
with sequenced flashers, category II or III
configuration
2.14.4 Visual approach slope indicator system:
4-light PAPI on right

2.14.1 Designation: 17R
2.14.2 Approach lighting system: MALSR: 1400
feet medium intensity approach lighting system
with runway alignment indicator lights
2.14.4 Visual approach slope indicator system:
4-light PAPI on left

2.14.1 Designation: 35L
2.14.2 Approach lighting system: MALSR: 1400
feet medium intensity approach lighting system
with runway alignment indicator lights
2.14.4 Visual approach slope indicator system:
4-light PAPI on left

AD 2.18 Air traffic services communication facilities

2.18.1 Service designation: CLASS B NW
2.18.3 Service designation: 118.1 MHz

2.18.1 Service designation: DEP/P
2.18.3 Service designation: 118.55 MHz

2.18.1 Service designation: APCH/P IC
2.18.3 Service designation: 119.875 MHz

2.18.1 Service designation: GND/P IC
2.18.3 Service designation: 121.65 MHz

2.18.1 Service designation: GND/P IC
2.18.3 Service designation: 121.8 MHz

2.18.1 Service designation: GND/P
2.18.3 Service designation: 121.85 MHz

2.18.1 Service designation: LCL/P IC

2.18.3 Service designation: 124.15 MHz

2.18.1 Service designation: CLASS B NE
2.18.3 Service designation: 124.3 MHz

2.18.1 Service designation: DEP/P
2.18.3 Service designation: 124.825 MHz

2.18.1 Service designation: APCH/P IC
2.18.3 Service designation: 125.025 MHz

2.18.1 Service designation: DEP/P
2.18.3 Service designation: 125.125 MHz

2.18.1 Service designation: CLASS B SE
2.18.3 Service designation: 125.2 MHz

2.18.1 Service designation: DEP/P
2.18.3 Service designation: 126.475 MHz

2.18.1 Service designation: LCL/P IC
2.18.3 Service designation: 126.55 MHz

2.18.1 Service designation: LCL/P IC
2.18.3 Service designation: 127.5 MHz

2.18.1 Service designation: CD/P
2.18.3 Service designation: 128.25 MHz

2.18.1 Service designation: APCH/S
2.18.3 Service designation: 133.525 MHz

2.18.1 Service designation: APCH/S
2.18.3 Service designation: 133.625 MHz

2.18.1 Service designation: LCL/P IC
2.18.3 Service designation: 134.9 MHz

2.18.1 Service designation: CLASS B SW
2.18.3 Service designation: 135.975 MHz

2.18.1 Service designation: EMERG
2.18.3 Service designation: 243 MHz

2.18.1 Service designation: APCH/P
2.18.3 Service designation: 284.65 MHz

2.18.1 Service designation: DEP/P
2.18.3 Service designation: 290.35 MHz

2.18.1 Service designation: CLASS B NW

2.18.3 Service designation: 306.95 MHz

2.18.1 Service designation: DEP/P

2.18.3 Service designation: 319.85 MHz

2.18.1 Service designation: DEP/P

2.18.3 Service designation: 323.05 MHz

2.18.1 Service designation: CLASS B SE

2.18.3 Service designation: 343.65 MHz

2.18.1 Service designation: DEP/P

2.18.3 Service designation: 363.15 MHz

2.18.1 Service designation: CLASS B SW

2.18.3 Service designation: 379.9 MHz

2.18.1 Service designation: APCH/P

2.18.3 Service designation: 263.025 MHz

2.18.1 Service designation: CLASS B NE

2.18.3 Service designation: 282.275 MHz

2.18.1 Service designation: D-ATIS

2.18.3 Service designation: 123.775 MHz

2.18.4 Hours of operation: 24

2.18.1 Service designation: D-ATIS

2.18.3 Service designation: 135.925 MHz

2.18.4 Hours of operation: 24

AD 2.19 Radio navigation and landing aids

2.19.1 ILS type: Localizer for runway 18L.

Magnetic variation: 6E

2.19.2 ILS identification: CIX

2.19.5 Coordinates: 32-52-33.61N /

97-03-00.00W

2.19.6 Site elevation: 570 ft

2.19.1 ILS type: Middle Marker for runway 18L.

Magnetic variation: 6E

2.19.2 ILS identification: CIX

2.19.5 Coordinates: 32-55-00.00N /

97-03-00.00W

2.19.6 Site elevation: 600 ft

2.19.1 ILS type: DME for runway 18L. Magnetic

variation: 6E

2.19.2 ILS identification: CIX

2.19.5 Coordinates: 32-55-00.00N /

97-03-00.00W

2.19.6 Site elevation: 0 ft

2.19.1 ILS type: Outer Marker for runway 18L.

Magnetic variation: 6E

2.19.2 ILS identification: CIX

2.19.5 Coordinates: 32-59-42.30N /

97-02-58.02W

2.19.6 Site elevation: 571 ft

2.19.1 ILS type: Glide Slope for runway 18L.

Magnetic variation: 6E

2.19.2 ILS identification: CIX

2.19.5 Coordinates: 32-54-26.25N /

97-03-00.00W

2.19.6 Site elevation: 593 ft

2.19.1 ILS type: Localizer for runway 36R.

Magnetic variation: 6E

2.19.2 ILS identification: FJN

2.19.5 Coordinates: 32-55-00.00N /

97-03-00.00W

2.19.6 Site elevation: 595 ft

2.19.1 ILS type: Glide Slope for runway 36R.

Magnetic variation: 6E

2.19.2 ILS identification: FJN

2.19.5 Coordinates: 32-52-54.85N /

97-03-00.00W

2.19.6 Site elevation: 577 ft

2.19.1 ILS type: Outer Marker for runway 36R.

Magnetic variation: 6E

2.19.2 ILS identification: FJN

2.19.5 Coordinates: 32-47-34.94N /

97-03-00.00W

2.19.6 Site elevation: 523 ft

2.19.1 ILS type: DME for runway 36R. Magnetic

variation: 6E

2.19.2 ILS identification: FJN

2.19.5 Coordinates: 32-55-00.00N /

97-03-00.00W

2.19.6 Site elevation: 0 ft

2.19.1 ILS type: Middle Marker for runway 36R.

Magnetic variation: 6E

2.19.2 ILS identification: FJN

2.19.5 Coordinates: 32-52-17.10N /

97-03-00.00W

2.19.6 Site elevation: 560 ft

2.19.1 ILS type: Localizer for runway 18R.

Magnetic variation: 6E

2.19.2 ILS identification: VYN

2.19.5 Coordinates: 32-52-33.93N /
97-03-17.46W

2.19.6 Site elevation: 580 ft

2.19.1 ILS type: Glide Slope for runway 18R.

Magnetic variation: 6E

2.19.2 ILS identification: VYN

2.19.5 Coordinates: 32-54-25.17N /
97-03-21.58W

2.19.6 Site elevation: 598 ft

2.19.1 ILS type: Inner Marker for runway 18R.

Magnetic variation: 6E

2.19.2 ILS identification: VYN

2.19.5 Coordinates: 32-54-44.35N /
97-03-16.79W

2.19.6 Site elevation: 604 ft

2.19.1 ILS type: DME for runway 18R. Magnetic
variation: 6E

2.19.2 ILS identification: VYN

2.19.5 Coordinates: 32-52-34.09N /
97-03-12.60W

2.19.6 Site elevation: 584 ft

2.19.1 ILS type: Outer Marker for runway 18R.

Magnetic variation: 6E

2.19.2 ILS identification: VYN

2.19.5 Coordinates: 32-59-42.30N /
97-02-58.02W

2.19.6 Site elevation: 571 ft

2.19.1 ILS type: Middle Marker for runway 18R.

Magnetic variation: 6E

2.19.2 ILS identification: VYN

2.19.5 Coordinates: 32-55-00.00N /
97-03-16.70W

2.19.6 Site elevation: 600 ft

2.19.1 ILS type: Outer Marker for runway 36L.

Magnetic variation: 6E

2.19.2 ILS identification: BXN

2.19.5 Coordinates: 32-47-34.94N /
97-03-00.00W

2.19.6 Site elevation: 523 ft

2.19.1 ILS type: Middle Marker for runway 36L.

Magnetic variation: 6E

2.19.2 ILS identification: BXN

2.19.5 Coordinates: 32-52-15.86N /
97-03-17.54W

2.19.6 Site elevation: 542 ft

2.19.1 ILS type: DME for runway 36L. Magnetic
variation: 6E

2.19.2 ILS identification: BXN

2.19.5 Coordinates: 32-52-34.09N /
97-03-12.60W

2.19.6 Site elevation: 585 ft

2.19.1 ILS type: Glide Slope for runway 36L.
Magnetic variation: 6E

2.19.2 ILS identification: BXN

2.19.5 Coordinates: 32-52-54.41N /
97-03-22.04W

2.19.6 Site elevation: 580 ft

2.19.1 ILS type: Localizer for runway 36L.
Magnetic variation: 6E

2.19.2 ILS identification: BXN

2.19.5 Coordinates: 32-54-23.19N /
97-03-21.01W

2.19.6 Site elevation: 598 ft

2.19.1 ILS type: Localizer for runway 17C.
Magnetic variation: 6E

2.19.2 ILS identification: FLQ

2.19.5 Coordinates: 32-52-33.15N /
97-01-34.28W

2.19.6 Site elevation: 563 ft

2.19.1 ILS type: DME for runway 17C. Magnetic
variation: 6E

2.19.2 ILS identification: FLQ

2.19.5 Coordinates: 32-52-34.13N /
97-01-39.65W

2.19.6 Site elevation: 560 ft

2.19.1 ILS type: Inner Marker for runway 17C.
Magnetic variation: 6E

2.19.2 ILS identification: FLQ

2.19.5 Coordinates: 32-55-00.00N /
97-01-33.46W

2.19.6 Site elevation: 562 ft

2.19.1 ILS type: Middle Marker for runway 17C.
Magnetic variation: 6E

2.19.2 ILS identification: FLQ

2.19.5 Coordinates: 32-55-00.00N /

97-01-33.35W
2.19.6 Site elevation: 561 ft

2.19.1 ILS type: Outer Marker for runway 17C.
Magnetic variation: 6E
2.19.2 ILS identification: FLQ
2.19.5 Coordinates: 32-59-44.75N /
97-01-46.52W
2.19.6 Site elevation: 525 ft

2.19.1 ILS type: Glide Slope for runway 17C.
Magnetic variation: 6E
2.19.2 ILS identification: FLQ
2.19.5 Coordinates: 32-54-45.64N /
97-01-28.77W
2.19.6 Site elevation: 558 ft

2.19.1 ILS type: DME for runway 35C. Magnetic
variation: 6E
2.19.2 ILS identification: PKQ
2.19.5 Coordinates: 32-52-34.13N /
97-01-39.65W
2.19.6 Site elevation: 575 ft

2.19.1 ILS type: Outer Marker for runway 35C.
Magnetic variation: 6E
2.19.2 ILS identification: PKQ
2.19.5 Coordinates: 32-48-00.00N /
97-01-38.86W
2.19.6 Site elevation: 480 ft

2.19.1 ILS type: Inner Marker for runway 35C.
Magnetic variation: 6E
2.19.2 ILS identification: PKQ
2.19.5 Coordinates: 32-52-35.30N /
97-01-34.26W
2.19.6 Site elevation: 563 ft

2.19.1 ILS type: Glide Slope for runway 35C.
Magnetic variation: 6E
2.19.2 ILS identification: PKQ
2.19.5 Coordinates: 32-52-54.33N /
97-01-29.47W
2.19.6 Site elevation: 557 ft

2.19.1 ILS type: Localizer for runway 35C.
Magnetic variation: 6E
2.19.2 ILS identification: PKQ
2.19.5 Coordinates: 32-55-00.00N /
97-01-33.45W
2.19.6 Site elevation: 558 ft

2.19.1 ILS type: Middle Marker for runway 35C.
Magnetic variation: 6E
2.19.2 ILS identification: PKQ
2.19.5 Coordinates: 32-52-16.34N /
97-01-34.37W
2.19.6 Site elevation: 559 ft

2.19.1 ILS type: Localizer for runway 31R.
Magnetic variation: 6E
2.19.2 ILS identification: RRA
2.19.5 Coordinates: 32-54-47.86N /
97-01-20.46W
2.19.6 Site elevation: 552 ft

2.19.1 ILS type: Glide Slope for runway 31R.
Magnetic variation: 6E
2.19.2 ILS identification: RRA
2.19.5 Coordinates: 32-53-51.74N /
97-00-00.00W
2.19.6 Site elevation: 509 ft

2.19.1 ILS type: DME for runway 31R. Magnetic
variation: 6E
2.19.2 ILS identification: RRA
2.19.5 Coordinates: 32-54-46.09N /
97-01-22.58W
2.19.6 Site elevation: 548 ft

2.19.1 ILS type: Outer Marker for runway 31R.
Magnetic variation: 6E
2.19.2 ILS identification: RRA
2.19.5 Coordinates: 32-49-51.37N /
96-55-27.13W
2.19.6 Site elevation: 99999 ft

2.19.1 ILS type: Middle Marker for runway 31R.
Magnetic variation: 6E
2.19.2 ILS identification: RRA
2.19.5 Coordinates: 32-53-20.76N /
96-59-38.13W
2.19.6 Site elevation: 99999 ft

2.19.1 ILS type: Glide Slope for runway 13R.
Magnetic variation: 6E
2.19.2 ILS identification: LWN
2.19.5 Coordinates: 32-54-24.13N /
97-04-54.08W
2.19.6 Site elevation: 588 ft

2.19.1 ILS type: Outer Marker for runway 13R.
Magnetic variation: 6E

2.19.2 ILS identification: LWN
2.19.5 Coordinates: 32-58-20.35N /
97-08-45.76W
2.19.6 Site elevation: 605 ft

2.19.1 ILS type: DME for runway 13R. Magnetic
variation: 6E
2.19.2 ILS identification: LWN
2.19.5 Coordinates: 32-53-16.07N /
97-03-42.77W
2.19.6 Site elevation: 590 ft

2.19.1 ILS type: Middle Marker for runway 13R.
Magnetic variation: 6E
2.19.2 ILS identification: LWN
2.19.5 Coordinates: 32-54-55.16N /
97-05-20.58W
2.19.6 Site elevation: 610 ft

2.19.1 ILS type: Localizer for runway 13R.
Magnetic variation: 6E
2.19.2 ILS identification: LWN
2.19.5 Coordinates: 32-53-17.78N /
97-03-40.40W
2.19.6 Site elevation: 577 ft

2.19.1 ILS type: Localizer for runway 17L.
Magnetic variation: 6E
2.19.2 ILS identification: PPZ
2.19.5 Coordinates: 32-52-19.44N /
97-00-35.73W
2.19.6 Site elevation: 584 ft

2.19.1 ILS type: DME for runway 17L. Magnetic
variation: 6E
2.19.2 ILS identification: PPZ
2.19.5 Coordinates: 32-52-18.74N /
97-00-40.18W
2.19.6 Site elevation: 577 ft

2.19.1 ILS type: Glide Slope for runway 17L.
Magnetic variation: 6E
2.19.2 ILS identification: PPZ
2.19.5 Coordinates: 32-53-45.23N /
97-00-31.14W
2.19.6 Site elevation: 526 ft

2.19.1 ILS type: Outer Marker for runway 17L.
Magnetic variation: 6E
2.19.2 ILS identification: PPZ
2.19.5 Coordinates: 32-58-00.00N /

97-00-26.70W
2.19.6 Site elevation: 99999 ft

2.19.1 ILS type: Inner Marker for runway 17L.
Magnetic variation: 6E
2.19.2 ILS identification: PPZ
2.19.5 Coordinates: 32-54-00.00N /
97-00-35.26W
2.19.6 Site elevation: 99999 ft

2.19.1 ILS type: Middle Marker for runway 17L.
Magnetic variation: 6E
2.19.2 ILS identification: PPZ
2.19.5 Coordinates: 32-54-24.15N /
97-00-35.04W
2.19.6 Site elevation: 99999 ft

2.19.1 ILS type: Localizer for runway 35R.
Magnetic variation: 6E
2.19.2 ILS identification: AJQ
2.19.5 Coordinates: 32-54-00.00N /
97-00-35.15W
2.19.6 Site elevation: 519 ft

2.19.1 ILS type: DME for runway 35R. Magnetic
variation: 6E
2.19.2 ILS identification: AJQ
2.19.5 Coordinates: 32-52-18.74N /
97-00-40.18W
2.19.6 Site elevation: 577 ft

2.19.1 ILS type: Middle Marker for runway 35R.
Magnetic variation: 6E
2.19.2 ILS identification: AJQ
2.19.5 Coordinates: 32-52-00.00N /
97-00-35.82W
2.19.6 Site elevation: 99999 ft

2.19.1 ILS type: Outer Marker for runway 35R.
Magnetic variation: 6E
2.19.2 ILS identification: AJQ
2.19.5 Coordinates: 32-48-20.28N /
97-00-26.58W
2.19.6 Site elevation: 99999 ft

2.19.1 ILS type: Inner Marker for runway 35R.
Magnetic variation: 6E
2.19.2 ILS identification: AJQ
2.19.5 Coordinates: 32-52-22.61N /
97-00-35.71W
2.19.6 Site elevation: 99999 ft

2.19.1 ILS type: Glide Slope for runway 35R.
Magnetic variation: 6E
2.19.2 ILS identification: AJQ
2.19.5 Coordinates: 32-52-43.44N /
97-00-30.90W
2.19.6 Site elevation: 559 ft

2.19.1 ILS type: Glide Slope for runway 17R.
Magnetic variation: 6E
2.19.2 ILS identification: JHZ
2.19.5 Coordinates: 32-54-45.82N /
97-01-43.06W
2.19.6 Site elevation: 562 ft

2.19.1 ILS type: Outer Marker for runway 17R.
Magnetic variation: 6E
2.19.2 ILS identification: JHZ
2.19.5 Coordinates: 32-59-44.75N /
97-01-46.52W
2.19.6 Site elevation: 525 ft

2.19.1 ILS type: Localizer for runway 17R.
Magnetic variation: 6E
2.19.2 ILS identification: JHZ
2.19.5 Coordinates: 32-52-34.13N /
97-01-48.35W
2.19.6 Site elevation: 558 ft

2.19.1 ILS type: Middle Marker for runway 17R.
Magnetic variation: 6E
2.19.2 ILS identification: JHZ
2.19.5 Coordinates: 32-55-26.68N /
97-01-47.42W
2.19.6 Site elevation: 561 ft

2.19.1 ILS type: DME for runway 17R. Magnetic
variation: 6E
2.19.2 ILS identification: JHZ

2.19.5 Coordinates: 32-52-33.67N /
97-01-53.66W
2.19.6 Site elevation: 0 ft

2.19.1 ILS type: Glide Slope for runway 35L.
Magnetic variation: 6E
2.19.2 ILS identification: UWX
2.19.5 Coordinates: 32-52-54.98N /
97-01-43.53W
2.19.6 Site elevation: 559 ft

2.19.1 ILS type: Middle Marker for runway 35L.
Magnetic variation: 6E
2.19.2 ILS identification: UWX
2.19.5 Coordinates: 32-52-17.25N /
97-01-48.43W
2.19.6 Site elevation: 554 ft

2.19.1 ILS type: Localizer for runway 35L.
Magnetic variation: 6E
2.19.2 ILS identification: UWX
2.19.5 Coordinates: 32-55-00.00N /
97-01-47.52W
2.19.6 Site elevation: 566 ft

2.19.1 ILS type: DME for runway 35L. Magnetic
variation: 6E
2.19.2 ILS identification: UWX
2.19.5 Coordinates: 32-52-33.67N /
97-01-53.66W
2.19.6 Site elevation: 0 ft

2.19.1 ILS type: Outer Marker for runway 35L.
Magnetic variation: 6E
2.19.2 ILS identification: UWX
2.19.5 Coordinates: 32-48-00.00N /
97-01-38.86W
2.19.6 Site elevation: 499 ft

General Remarks:

BIRDS ON & IN THE VICINITY OF AIRPORT.

PRIOR PERMISSION REQUIRED FROM THE PRIMARY TENANT AIRLINES TO OPERATE WITHIN THE CENTRAL TERMINAL AREA. PROPER MINIMUM OBJECT FREE AREA DISTANCES MAY NOT BE MAINTAINED FOR RAMP/APRON TAXILANES.

PRIOR PERMISSION REQUIRED FROM AIRPORT OPERATIONS FOR GENERAL AVIATION AIRCRAFT TO PROCEED TO AIRLINE TERMINAL GATE EXCEPT GENERAL AVIATION FACILITY.

STANDARD SAWED GROOVING 160 FT WIDE FULL LENGTH RUNWAYS 13L/31R; 18L/36R &

17R/35L. STANDARD GROOVING 130 FT WIDE FULL LENGTH RUNWAYS 17L/35R; 18R/36L; 13R/31L & 17C/35C.

AIRPORT UNDER CONSTRUCTION; PERSONNEL AND EQUIPMENT WORKING IN MOVEMENT AREAS.

TAKE-OFF DISTANCE FOR RUNWAY 17R FROM TAXIWAY EMERGENCY GEAR IS 13082 FT & FROM TAXIWAY EH IS 12816 FT.

LAND & HOLD SHORT SIGNS ON RUNWAY 17C AT TAXIWAY 'B' 10,460 FT S OF RUNWAY 17C THRESHOLD; RUNWAY 18R AT TAXIWAY 'B' 10,100 FT S OF RUNWAY 18R THRESHOLD; RUNWAY 35C AT TAXIWAY 'EJ' 9050 FT N OF RUNWAY 35C THRESHOLD; RUNWAY 36L AT TAXIWAY 'Z' 10,650 FT N OF RUNWAY 36L THRESHOLD; LIGHTED & MARKED WITH IN-PAVEMENT PULSATING WHITE LIGHTS.

TAKE-OFF DISTANCE FOR RUNWAY 36R FROM TAXIWAY WAYPOINT IS 12,815 FT; FROM TAXIWAY WQ IS 13,082 FT.

TAKE-OFF DISTANCE FOR RUNWAY 17L FROM TAXIWAY Q2 IS 8196 FT.

TAXIWAYS MAY REQUIRE JUDGMENTAL OVERSTEERING FOR LARGE AIRCRAFT.

TAKE-OFF DISTANCE FOR RUNWAY 35R FROM TAXIWAY Q9 IS 8196 FT.

TAKE-OFF DISTANCE FOR RUNWAY 35L FROM TAXIWAY EQ IS 13084 FT & FROM TAXIWAY EN ROUTE PENETRATION IS 12811 FT.

AIRCRAFT EXITING BY WAY OF APRON ENTRANCE/EXIT POINTS 42; 43 & 44 CONTACT GROUND CONTROL PRIOR TO TAXIING.

APRON ENTRANCE/EXIT POINTS 22, 24, 105, 107, & 122 CLOSED TO AIRCRAFT WITH WINGSPAN 125 FT & GREATER.

APRON ENTRANCE/EXIT POINTS 5, 7, 42 & 44 CLOSED TO AIRCRAFT WITH WINGSPAN 118 FT & GREATER.

FREQUENT GROUND SUPPORT EQUIPMENT UNDER ESCORT CROSSING TAXIWAYS A & B AT TAXIWAY HA.

AIRCRAFT PUSHING BACK OR POWERING BACK ON TERMINAL B APRON HAVE RIGHT OF WAY.

TAXIWAY EDGE REFLECTORS ALONG ALL TAXIWAYS.

TERMINAL B APRON TAXILANE BETWEEN APRON ENTRANCE/EXIT POINT TAXILANES 110 & 115 CLOSED TO AIRCRAFT WITH WINGSPAN 118 FT AND GREATER.

TAKE-OFF DISTANCE FOR RUNWAY 18L FROM TAXIWAY WG IS 13,082; FROM TAXIWAY WH IS 12,815.

PRIOR PERMISSION REQUIRED GA OPERATIONS 2200-0600; CALL AIRPORT OPERATIONS 972-973-3112.

TAXIWAY G11 EAST OF TAXIWAY G CLOSED TO AIRCRAFT WITH WINGSPAN 125 FT & GREATER.

APRON ENTRANCE/EXIT POINT 124 CLOSED TO AIRCRAFT WITH WINGSPAN 200 FT AND GREATER.

TAXIWAY A5 CLOSED TO AIRCRAFT WITH WINGSPAN 171 FT AND GREATER.

TAKE-OFF DISTANCE FOR RUNWAY 17C FROM TAXIWAY EMERGENCY GEAR IS 13,082 FT.

TAKE-OFF DISTANCE FOR RUNWAY 18R FROM TAXIWAY WG IS 13,082 FT.

APRON ENTRANCE/EXIT POINTS 52 & 53 CLOSED TO AIRCRAFT WITH WINGSPAN 171 FT & GREATER.

AIRCRAFT USING GATES D6-D17 MUST OBTAIN APPROVAL FROM DFW RAMP TOWER 129.95 PRIOR TO ENTERING RAMP & PRIOR TO PUSHBACK 0530-2230. USE EXTREME CARE AT OTHER TIMES.

APRON ENTRANCE/EXIT POINT 45 CLOSED 2200-0800.

APRON ENTRANCE/EXIT POINTS 32, 33, 34, 35, 36, 37, 38 & 39 CLOSED TO AIRCRAFT WITH WINGSPAN GREATER THAN 135 FT.

ASDE-X SURVEILLANCE SYSTEM IN USE: PILOTS SHOULD OPERATE TRANSPONDERS WITH MODE C ON ALL TAXIWAYS AND RUNWAYS.

PRIOR PERMISSION REQUIRED AIRCRAFT WITH WINGSPAN 215 FT OR GREATER (GROUP VI) CALL AIRPORT OPERATIONS 972-973-3112 FOR FOLLOW-ME SERVICES WHILE TAXIING TO & FROM RAMP & RUNWAYS.

RAMP AREA 1E CLOSED EXCEPT PRIOR PERMISSION REQUIRED CALL 972-973-3121.

RUNWAY VISUAL SCREEN 20 FT AGL 1180 FT S APPROACH END RUNWAY 35C.

RUNWAY VISUAL SCREEN 22 FT AGL 1179 FT S APPROACH END RUNWAY 35L.

RUNWAY STATUS LIGHTS LOCATED ON RUNWAYS 18L/36R, 17R/35L & 17C/35C.

El Paso, Texas
El Paso International
ICAO Identifier KELP

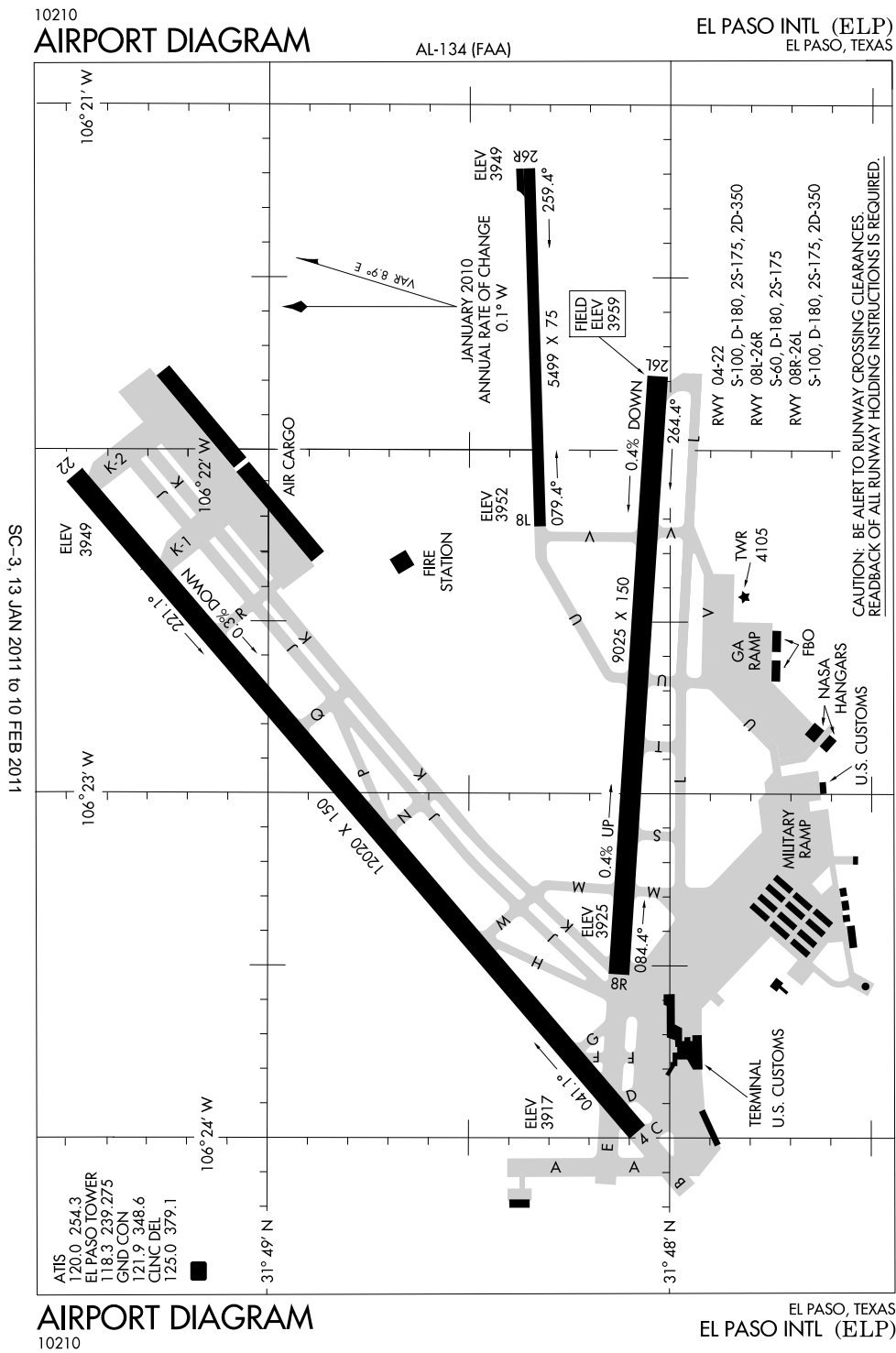

El Paso, TX
El Paso Intl
ICAO Identifier KELP

AD 2.2 Aerodrome geographical and administrative data

- 2.2.1 Reference Point: 31-48-26.10N / 106-22-39.20W
- 2.2.2 From City: 4 Miles NE Of El Paso, TX
- 2.2.3 Elevation: 3959 ft
- 2.2.5 Magnetic variation: 11E (1985)
- 2.2.6 Airport Contact: Monica Lombrana
6701 CONVAIR RD
El Paso, TX 79925
(915-780-4749)
- 2.2.7 Traffic: IFR/VFR

AD 2.3 Operational hours

- 2.3.1 - 2.3.11: ALL Months, ALL Days, ALL Hours

AD 2.4 Handling services and facilities

- 2.4.1 Cargo handling facilities: No
- 2.4.2 Fuel types: 100LL,A1+,B+
- 2.4.4 De-icing facilities: None
- 2.4.5 Hangar space: Yes
- 2.4.6 Repair facilities: Major

AD 2.6 Rescue and firefighting services

- 2.6.1 Aerodrome category for firefighting: ARFF Index I C certified on 5/1/1973

AD 2.12 Runway physical characteristics

- 2.12.1 Designation: 04
- 2.12.2 True Bearing: 50
- 2.12.3 Dimensions: 12020 ft x 150 ft
- 2.12.5 Coordinates: 31-48-00.00N / 106-23-59.46W
- 2.12.6 Threshold elevation: 3917 ft
- 2.12.6 Touchdown zone elevation: 3923 ft

- 2.12.1 Designation: 22
- 2.12.2 True Bearing: 230
- 2.12.3 Dimensions: 12020 ft x 150 ft
- 2.12.5 Coordinates: 31-49-22.01N / 106-22-12.78W
- 2.12.6 Threshold elevation: 3949 ft
- 2.12.6 Touchdown zone elevation: 3949 ft

- 2.12.1 Designation: 08R
- 2.12.2 True Bearing: 93

- 2.12.3 Dimensions: 9025 ft x 150 ft
- 2.12.5 Coordinates: 31-48-00.00N / 106-23-31.85W
- 2.12.6 Threshold elevation: 3925 ft
- 2.12.6 Touchdown zone elevation: 3937 ft

- 2.12.1 Designation: 26L
- 2.12.2 True Bearing: 273
- 2.12.3 Dimensions: 9025 ft x 150 ft
- 2.12.5 Coordinates: 31-48-00.00N / 106-21-47.47W
- 2.12.6 Threshold elevation: 3958 ft
- 2.12.6 Touchdown zone elevation: 3959 ft

- 2.12.1 Designation: 08L
- 2.12.2 True Bearing: 88
- 2.12.3 Dimensions: 5499 ft x 75 ft
- 2.12.5 Coordinates: 31-48-20.58N / 106-22-11.46W
- 2.12.6 Threshold elevation: 3952 ft
- 2.12.6 Touchdown zone elevation: 3957 ft

- 2.12.1 Designation: 26R
- 2.12.2 True Bearing: 268
- 2.12.3 Dimensions: 5499 ft x 75 ft
- 2.12.5 Coordinates: 31-48-22.17N / 106-21-00.00W
- 2.12.6 Threshold elevation: 3949 ft
- 2.12.6 Touchdown zone elevation: 3951 ft

AD 2.13 Declared distances

- 2.13.1 Designation: 04
- 2.13.2 Takeoff run available: 12020
- 2.13.3 Takeoff distance available: 12020
- 2.13.4 Accelerate-stop distance available: 12020
- 2.13.5 Landing distance available: 12020

- 2.13.1 Designation: 22
- 2.13.2 Takeoff run available: 12020
- 2.13.3 Takeoff distance available: 12020
- 2.13.4 Accelerate-stop distance available: 12449
- 2.13.5 Landing distance available: 12020

- 2.13.1 Designation: 08R
- 2.13.2 Takeoff run available: 9025
- 2.13.3 Takeoff distance available: 9025
- 2.13.4 Accelerate-stop distance available: 9025
- 2.13.5 Landing distance available: 9025

- 2.13.1 Designation: 26L
- 2.13.2 Takeoff run available: 9025

2.13.3 Takeoff distance available: 9025
2.13.4 Accelerate-stop distance available: 9025
2.13.5 Landing distance available: 9025

2.13.1 Designation: 08L
2.13.2 Takeoff run available: 5493
2.13.3 Takeoff distance available: 5493
2.13.4 Accelerate-stop distance available: 5493
2.13.5 Landing distance available: 5493

2.13.1 Designation: 26R
2.13.2 Takeoff run available: 5493
2.13.3 Takeoff distance available: 5493
2.13.4 Accelerate-stop distance available: 5493
2.13.5 Landing distance available: 5493

AD 2.14 Approach and runway lighting

2.14.1 Designation: 04
2.14.4 Visual approach slope indicator system:
4-light PAPI on left

2.14.1 Designation: 22
2.14.2 Approach lighting system: MALSR: 1400
feet medium intensity approach lighting system
with runway alignment indicator lights

2.14.1 Designation: 08R
2.14.4 Visual approach slope indicator system:
4-light PAPI on left

2.14.1 Designation: 26L
2.14.2 Approach lighting system: Omnidirectional
approach lighting system
2.14.4 Visual approach slope indicator system:
4-light PAPI on left

**AD 2.18 Air traffic services communication
facilities**

2.18.1 Service designation: LCL/P
2.18.3 Service designation: 118.3 MHz

2.18.1 Service designation: D-ATIS
2.18.3 Service designation: 120 MHz
2.18.4 Hours of operation: 24

2.18.1 Service designation: UTILITY
2.18.3 Service designation: 121.3 MHz

2.18.1 Service designation: EMERG
2.18.3 Service designation: 121.5 MHz

2.18.1 Service designation: GND/P
2.18.3 Service designation: 121.9 MHz

2.18.1 Service designation: CD/P PTC
2.18.3 Service designation: 125 MHz

2.18.1 Service designation: EMERG
2.18.3 Service designation: 243 MHz

2.18.1 Service designation: D-ATIS
2.18.3 Service designation: 254.3 MHz
2.18.4 Hours of operation: 24

2.18.1 Service designation: DEP/P
2.18.3 Service designation: 263 MHz

2.18.1 Service designation: GND/P
2.18.3 Service designation: 348.6 MHz

2.18.1 Service designation: APCH/P CLASS C
2.18.3 Service designation: 353.5 MHz

2.18.1 Service designation: CD/P
2.18.3 Service designation: 379.1 MHz

2.18.1 Service designation: APCH/P CLASS C
2.18.3 Service designation: 119.15 MHz

2.18.1 Service designation: DEP/P CLASS C
2.18.3 Service designation: 119.15 MHz

2.18.1 Service designation: APCH/P CLASS C IC
2.18.3 Service designation: 124.25 MHz

2.18.1 Service designation: APCH/P CLASS C IC
2.18.3 Service designation: 298.85 MHz

2.18.1 Service designation: LCL/P
2.18.3 Service designation: 239.275 MHz

AD 2.19 Radio navigation and landing aids

2.19.1 ILS type: DME for runway 04. Magnetic
variation: 11E

2.19.2 ILS identification: ETF
2.19.5 Coordinates: 31-47-58.72N /
106-24-13.53W

2.19.6 Site elevation: 3926 ft

2.19.1 ILS type: Localizer for runway 04. Magnetic
variation: 11E

2.19.2 ILS identification: ETF

2.19.5 Coordinates: 31-49-28.45N /
106-22-00.00W
2.19.6 Site elevation: 3950 ft

2.19.1 ILS type: Localizer for runway 22. Magnetic
variation: 11E

2.19.2 ILS identification: ELP
2.19.5 Coordinates: 31-47-55.92N /
106-24-12.90W
2.19.6 Site elevation: 3911 ft

2.19.1 ILS type: Middle Marker for runway 22.

Magnetic variation: 11E
2.19.2 ILS identification: ELP
2.19.5 Coordinates: 31-49-33.88N /
106-21-56.93W
2.19.6 Site elevation: 3947 ft

2.19.1 ILS type: Glide Slope for runway 22.
Magnetic variation: 11E

General Remarks:

24 HR PRIOR PERMISSION REQUIRED CLASS A EXPLOSIVES CONTACT 915-780-4749.

CAUTION: BIGGS AAF 2NM NW RUNWAY 21 CAN BE MISTAKEN FOR ELP RUNWAY 22.

SAILPLANE & ULTRALIGHT OPERATIONS IN THE VICINITY OF HORIZON AIRPORT 8
NAUTICAL MILE ESE.

NORTH BOUND TRAFFIC PROHIBITED ON TAXIWAY F SOUTH OF TAXIWAY E.

TAXIWAY A SOUTH OF TAXIWAY E; TAXIWAYS B & C; TAXIWAY J NE OF TAXIWAY K1;
TAXIWAY K NE OF TAXIWAY K1 BETWEEN TAXIWAY J & NORTH CARGO RAMP; TAXIWAYS U
& V SOUTH OF TAXIWAY L; & TAXIWAY K2 NOT VISIBLE FROM ATCT.

HOLDING POSITION MARKINGS FOR RUNWAY 8R APPROACH AND RUNWAY 4/22 ARE IN
CLOSE PROXIMITY TO THE TERMINAL APRON; REVIEW AIRPORT DIAGRAM PRIOR TO
PUSHBACK FROM THE GATE.

MILITARY USERS SHOULD REVIEW NOISE ABATEMENT PROCEDURES LISTED FOR BIGGS
AAF.

NOISE ABATEMENT PROCEDURES IN EFFECT, CONTACT ATCT FOR DETAILS.

ENGINE POWER IS RESTRICTED TO IDLE POWER ON ONE ENGINE AT A TIME FOR MAX 5 MIN
ON ANY TERMINAL OR PARKING APRONS, CROSS-BLEED STARTS OR OTHER PRE DEP
ACTIVITY ON MOVEMENT AREAS ONLY, MAINT OR OTHER REQUIREMENT NEEDING
LONGER OR HIGHER POWER CONTACT TOWER FOR DIRECTIONS TO DESIGNATED RUNUP
AREAS.

611 FT AGL UNLIGHTED SMOKESTACK 8 MILES WSW OF AIRPORT.

Houston, Texas George Bush Intercontinental/Houston ICAO Identifier KIAH

10210 AIRPORT DIAGRAM HOUSTON/GEORGE BUSH INTERCONTINENTAL/HOUSTON (IAH)
AL-5461 (FAA) HOUSTON, TEXAS

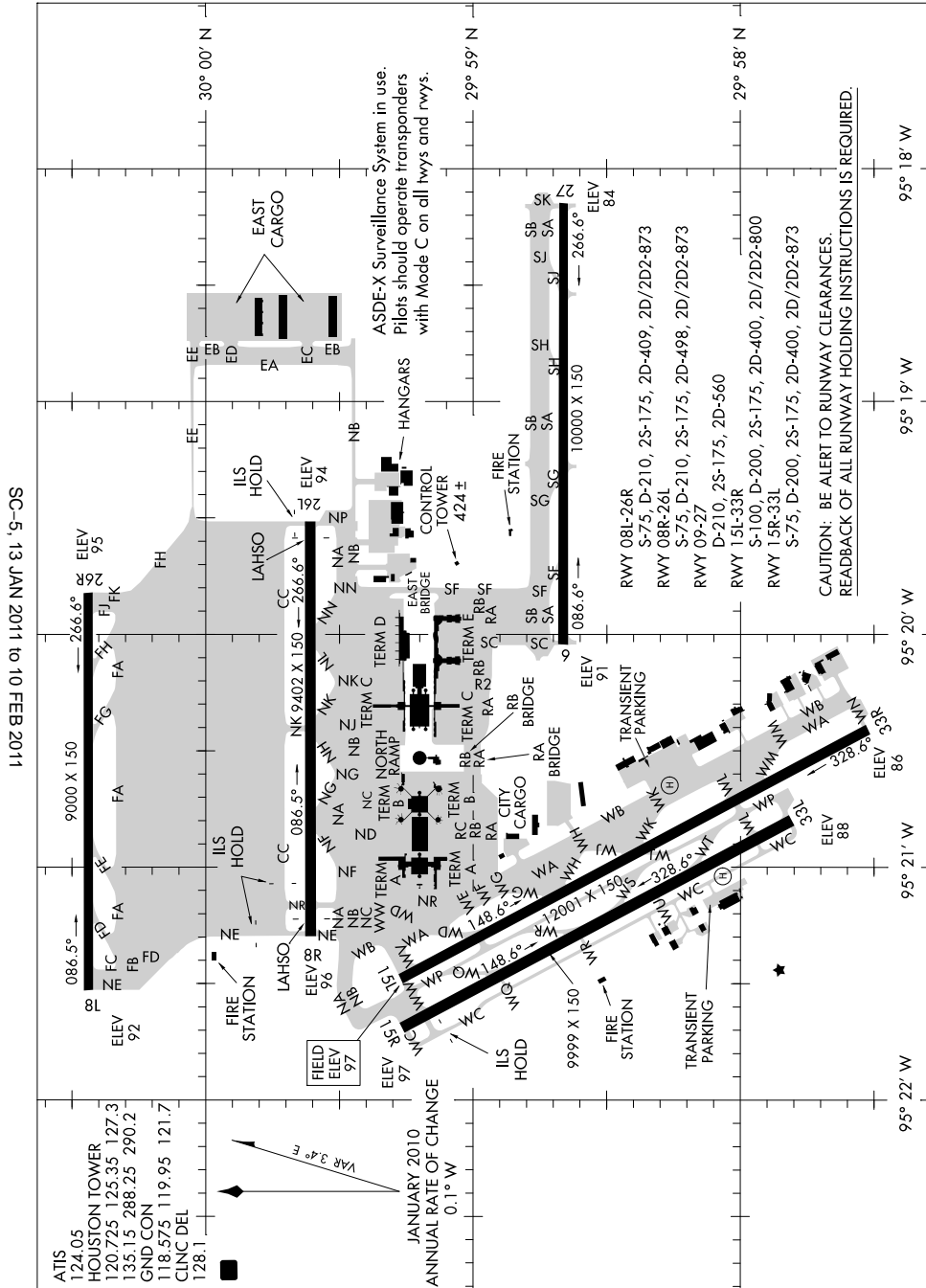

SC-5, 13 JAN 2011 to 10 FEB 2011

SC-5, 13 JAN 2011 to 10 FEB 2011

10210 AIRPORT DIAGRAM HOUSTON, TEXAS
HOUSTON/GEORGE BUSH INTERCONTINENTAL/HOUSTON (IAH)

Houston, TX
George Bush Intercontinental/Houston
ICAO Identifier KIAH

AD 2.2 Aerodrome geographical and administrative data

- 2.2.1 Reference Point: 29-59-00.00N / 95-20-29.19W
- 2.2.2 From City: 15 Miles N Of Houston, TX
- 2.2.3 Elevation: 97 ft
- 2.2.5 Magnetic variation: 5E (2000)
- 2.2.6 Airport Contact: Charles T Wall
PO BOX 60106
Houston, TX 77205
(281-230-3100)
- 2.2.7 Traffic: IFR/VFR

AD 2.3 Operational hours

- 2.3.1 - 2.3.11: ALL Months, ALL Days, ALL Hours

AD 2.4 Handling services and facilities

- 2.4.1 Cargo handling facilities: No
- 2.4.2 Fuel types: 100LL,A
- 2.4.4 De-icing facilities: None
- 2.4.5 Hangar space: Yes
- 2.4.6 Repair facilities: Major

AD 2.6 Rescue and firefighting services

- 2.6.1 Aerodrome category for firefighting: ARFF Index I E certified on 5/1/1973

AD 2.12 Runway physical characteristics

- 2.12.1 Designation: 15L
- 2.12.2 True Bearing: 152
- 2.12.3 Dimensions: 12001 ft x 150 ft
- 2.12.5 Coordinates: 29-59-16.40N / 95-21-28.33W
- 2.12.6 Threshold elevation: 96 ft
- 2.12.6 Touchdown zone elevation: 97 ft

- 2.12.1 Designation: 33R
- 2.12.2 True Bearing: 332
- 2.12.3 Dimensions: 12001 ft x 150 ft
- 2.12.5 Coordinates: 29-57-31.55N / 95-20-24.19W
- 2.12.6 Threshold elevation: 86 ft
- 2.12.6 Touchdown zone elevation: 89 ft

- 2.12.1 Designation: 15R
- 2.12.2 True Bearing: 152

- 2.12.3 Dimensions: 9999 ft x 150 ft
- 2.12.5 Coordinates: 29-59-16.10N / 95-21-41.03W
- 2.12.6 Threshold elevation: 97 ft
- 2.12.6 Touchdown zone elevation: 97 ft

- 2.12.1 Designation: 33L
- 2.12.2 True Bearing: 332
- 2.12.3 Dimensions: 9999 ft x 150 ft
- 2.12.5 Coordinates: 29-57-48.75N / 95-20-47.58W
- 2.12.6 Threshold elevation: 88 ft
- 2.12.6 Touchdown zone elevation: 91 ft

- 2.12.1 Designation: 08R
- 2.12.2 True Bearing: 90
- 2.12.3 Dimensions: 9402 ft x 150 ft
- 2.12.5 Coordinates: 29-59-36.30N / 95-21-17.87W
- 2.12.6 Threshold elevation: 96 ft
- 2.12.6 Touchdown zone elevation: 97 ft

- 2.12.1 Designation: 26L
- 2.12.2 True Bearing: 270
- 2.12.3 Dimensions: 9402 ft x 150 ft
- 2.12.5 Coordinates: 29-59-36.38N / 95-19-30.95W
- 2.12.6 Threshold elevation: 94 ft
- 2.12.6 Touchdown zone elevation: 97 ft

- 2.12.1 Designation: 09
- 2.12.2 True Bearing: 90
- 2.12.3 Dimensions: 10000 ft x 150 ft
- 2.12.5 Coordinates: 29-58-39.33N / 95-20-00.00W
- 2.12.6 Threshold elevation: 91 ft
- 2.12.6 Touchdown zone elevation: 91 ft

- 2.12.1 Designation: 27
- 2.12.2 True Bearing: 270
- 2.12.3 Dimensions: 10000 ft x 150 ft
- 2.12.5 Coordinates: 29-58-39.41N / 95-18-00.00W
- 2.12.6 Threshold elevation: 84 ft
- 2.12.6 Touchdown zone elevation: 86 ft

- 2.12.1 Designation: 08L
- 2.12.2 True Bearing: 90
- 2.12.3 Dimensions: 9000 ft x 150 ft
- 2.12.5 Coordinates: 30-00-25.78N / 95-21-31.65W

2.12.6 Threshold elevation: 92 ft
2.12.6 Touchdown zone elevation: 96 ft

2.12.1 Designation: 26R
2.12.2 True Bearing: 270
2.12.3 Dimensions: 9000 ft x 150 ft
2.12.5 Coordinates: 30-00-25.86N /
95-19-49.29W
2.12.6 Threshold elevation: 95 ft
2.12.6 Touchdown zone elevation: 97 ft

AD 2.13 Declared distances

2.13.1 Designation: 15L
2.13.2 Takeoff run available: 12001
2.13.3 Takeoff distance available: 12001
2.13.4 Accelerate-stop distance available: 12001
2.13.5 Landing distance available: 12001

2.13.1 Designation: 33R
2.13.2 Takeoff run available: 12001
2.13.3 Takeoff distance available: 12001
2.13.4 Accelerate-stop distance available: 12001
2.13.5 Landing distance available: 12001

2.13.1 Designation: 15R
2.13.2 Takeoff run available: 9999
2.13.3 Takeoff distance available: 9999
2.13.4 Accelerate-stop distance available: 9999
2.13.5 Landing distance available: 9999

2.13.1 Designation: 33L
2.13.2 Takeoff run available: 9999
2.13.3 Takeoff distance available: 9999
2.13.4 Accelerate-stop distance available: 9999
2.13.5 Landing distance available: 9999

2.13.1 Designation: 08R
2.13.2 Takeoff run available: 9402
2.13.3 Takeoff distance available: 9402
2.13.4 Accelerate-stop distance available: 9402
2.13.5 Landing distance available: 9402

2.13.1 Designation: 26L
2.13.2 Takeoff run available: 9402
2.13.3 Takeoff distance available: 9402
2.13.4 Accelerate-stop distance available: 9402
2.13.5 Landing distance available: 9402

2.13.1 Designation: 09
2.13.2 Takeoff run available: 10000
2.13.3 Takeoff distance available: 10000

2.13.4 Accelerate-stop distance available: 10000
2.13.5 Landing distance available: 10000

2.13.1 Designation: 27
2.13.2 Takeoff run available: 10000
2.13.3 Takeoff distance available: 10000
2.13.4 Accelerate-stop distance available: 10000
2.13.5 Landing distance available: 10000

2.13.1 Designation: 08L
2.13.2 Takeoff run available: 9000
2.13.3 Takeoff distance available: 9000
2.13.4 Accelerate-stop distance available: 9000
2.13.5 Landing distance available: 9000

2.13.1 Designation: 26R
2.13.2 Takeoff run available: 9000
2.13.3 Takeoff distance available: 9000
2.13.4 Accelerate-stop distance available: 9000
2.13.5 Landing distance available: 9000

AD 2.14 Approach and runway lighting

2.14.1 Designation: 15L
2.14.4 Visual approach slope indicator system:
4-light PAPI on right

2.14.1 Designation: 33R
2.14.2 Approach lighting system: MALSR: 1400
feet medium intensity approach lighting system
with runway alignment indicator lights

2.14.1 Designation: 15R
2.14.2 Approach lighting system: MALSR: 1400
feet medium intensity approach lighting system
with runway alignment indicator lights
2.14.4 Visual approach slope indicator system:
4-light PAPI on left

2.14.1 Designation: 33L
2.14.4 Visual approach slope indicator system:
4-light PAPI on right

2.14.1 Designation: 08R
2.14.2 Approach lighting system: MALSR: 1400
feet medium intensity approach lighting system
with runway alignment indicator lights
2.14.4 Visual approach slope indicator system:
4-light PAPI on left

2.14.1 Designation: 26L
2.14.2 Approach lighting system: ALSF2: Standard

2400 feet high intensity approach lighting system with sequenced flashers, category II or III configuration

2.14.4 Visual approach slope indicator system: 4-light PAPI on right

2.14.1 Designation: 09

2.14.2 Approach lighting system: MALSR: 1400 feet medium intensity approach lighting system with runway alignment indicator lights

2.14.4 Visual approach slope indicator system: 4-light PAPI on right

2.14.1 Designation: 27

2.14.2 Approach lighting system: ALSF2: Standard 2400 feet high intensity approach lighting system with sequenced flashers, category II or III configuration

2.14.4 Visual approach slope indicator system: 4-light PAPI on left

2.14.1 Designation: 08L

2.14.2 Approach lighting system: ALSF2: Standard 2400 feet high intensity approach lighting system with sequenced flashers, category II or III configuration

2.14.1 Designation: 26R

2.14.2 Approach lighting system: ALSF2: Standard 2400 feet high intensity approach lighting system with sequenced flashers, category II or III configuration

AD 2.18 Air traffic services communication facilities

2.18.1 Service designation: GND/P IC

2.18.3 Service designation: 118.575 MHz

2.18.1 Service designation: DEP/P

2.18.3 Service designation: 119.7 MHz

2.18.1 Service designation: CLASS B

2.18.3 Service designation: 119.7 MHz

2.18.1 Service designation: APCH/P IC

2.18.3 Service designation: 120.05 MHz

2.18.1 Service designation: EMERG

2.18.3 Service designation: 121.5 MHz

2.18.1 Service designation: GND/P IC

2.18.3 Service designation: 121.7 MHz

2.18.1 Service designation: CLASS B

2.18.3 Service designation: 123.8 MHz

2.18.1 Service designation: DEP/P

2.18.3 Service designation: 123.8 MHz

2.18.1 Service designation: D-ATIS

2.18.3 Service designation: 124.05 MHz

2.18.4 Hours of operation: 24

2.18.1 Service designation: APCH/P IC

2.18.3 Service designation: 124.35 MHz

2.18.1 Service designation: LCL/P IC

2.18.3 Service designation: 125.35 MHz

2.18.1 Service designation: LCL/P IC

2.18.3 Service designation: 127.3 MHz

2.18.1 Service designation: CD/P

2.18.3 Service designation: 128.1 MHz

2.18.1 Service designation: DEP/P

2.18.3 Service designation: 133.6 MHz

2.18.1 Service designation: CLASS B

2.18.3 Service designation: 133.6 MHz

2.18.1 Service designation: CLASS B

2.18.3 Service designation: 134.45 MHz

2.18.1 Service designation: LCL/P IC

2.18.3 Service designation: 135.15 MHz

2.18.1 Service designation: CLASS B

2.18.3 Service designation: 257.2 MHz

2.18.1 Service designation: DEP/P

2.18.3 Service designation: 257.2 MHz

2.18.1 Service designation: CLASS B

2.18.3 Service designation: 257.7 MHz

2.18.1 Service designation: DEP/P

2.18.3 Service designation: 257.7 MHz

2.18.1 Service designation: CLASS B

2.18.3 Service designation: 281.4 MHz

2.18.1 Service designation: DEP/P
2.18.3 Service designation: 281.4 MHz

2.18.1 Service designation: CLASS B
2.18.3 Service designation: 284 MHz

2.18.1 Service designation: APCH/P IC
2.18.3 Service designation: 316.15 MHz

2.18.1 Service designation: APCH/P IC
2.18.3 Service designation: 379.1 MHz

2.18.1 Service designation: GND/P IC
2.18.3 Service designation: 119.95 MHz

2.18.1 Service designation: LCL/P IC
2.18.3 Service designation: 288.25 MHz

2.18.1 Service designation: LCL/P IC
2.18.3 Service designation: 290.2 MHz

2.18.1 Service designation: LCL/P IC
2.18.3 Service designation: 120.725 MHz

AD 2.19 Radio navigation and landing aids

2.19.1 ILS type: Middle Marker for runway 15L.
Magnetic variation: 5E
2.19.2 ILS identification: HSQ
2.19.5 Coordinates: 29-59-44.91N /
95-21-45.76W
2.19.6 Site elevation: 99999 ft

2.19.1 ILS type: Localizer for runway 15L.
Magnetic variation: 5E
2.19.2 ILS identification: HSQ
2.19.5 Coordinates: 29-57-22.82N /
95-20-18.86W
2.19.6 Site elevation: 83 ft

2.19.1 ILS type: Outer Marker for runway 15L.
Magnetic variation: 5E
2.19.2 ILS identification: HSQ
2.19.5 Coordinates: 30-04-29.27N /
95-24-46.16W
2.19.6 Site elevation: 99999 ft

2.19.1 ILS type: Middle Marker for runway 33R.
Magnetic variation: 5E
2.19.2 ILS identification: CDG
2.19.5 Coordinates: 29-57-00.00N /
95-20-00.00W

2.19.6 Site elevation: 99999 ft

2.19.1 ILS type: Outer Marker for runway 33R.
Magnetic variation: 5E
2.19.2 ILS identification: CDG
2.19.5 Coordinates: 29-53-33.65N /
95-17-56.01W
2.19.6 Site elevation: 99999 ft

2.19.1 ILS type: Localizer for runway 33R.
Magnetic variation: 5E
2.19.2 ILS identification: CDG
2.19.5 Coordinates: 29-59-23.39N /
95-21-32.60W
2.19.6 Site elevation: 94 ft

2.19.1 ILS type: Glide Slope for runway 33R.
Magnetic variation: 5E
2.19.2 ILS identification: CDG
2.19.5 Coordinates: 29-57-38.81N /
95-20-33.46W
2.19.6 Site elevation: 81 ft

2.19.1 ILS type: Glide Slope for runway 15R.
Magnetic variation: 5E
2.19.2 ILS identification: LKM
2.19.5 Coordinates: 29-59-00.00N /
95-21-39.03W
2.19.6 Site elevation: 91 ft

2.19.1 ILS type: Localizer for runway 15R.
Magnetic variation: 5E
2.19.2 ILS identification: LKM
2.19.5 Coordinates: 29-57-39.40N /
95-20-41.87W
2.19.6 Site elevation: 84 ft

2.19.1 ILS type: DME for runway 08R. Magnetic
variation: 3E
2.19.2 ILS identification: IAH
2.19.5 Coordinates: 29-59-38.92N /
95-21-31.30W
2.19.6 Site elevation: 109 ft

2.19.1 ILS type: Outer Marker for runway 08R.
Magnetic variation: 3E
2.19.2 ILS identification: IAH
2.19.5 Coordinates: 29-59-36.55N /
95-28-20.43W
2.19.6 Site elevation: 117 ft

2.19.1 ILS type: Glide Slope for runway 08R.
Magnetic variation: 3E
2.19.2 ILS identification: IAH
2.19.5 Coordinates: 29-59-40.32N /
95-21-00.00W
2.19.6 Site elevation: 90 ft

2.19.1 ILS type: Inner Marker for runway 08R.
Magnetic variation: 3E
2.19.2 ILS identification: IAH
2.19.5 Coordinates: 29-59-36.29N /
95-21-29.37W
2.19.6 Site elevation: 94 ft

2.19.1 ILS type: Middle Marker for runway 08R.
Magnetic variation: 3E
2.19.2 ILS identification: IAH
2.19.5 Coordinates: 29-59-36.24N /
95-21-51.93W
2.19.6 Site elevation: 94 ft

2.19.1 ILS type: Localizer for runway 08R.
Magnetic variation: 3E
2.19.2 ILS identification: IAH
2.19.5 Coordinates: 29-59-36.39N /
95-19-19.59W
2.19.6 Site elevation: 91 ft

2.19.1 ILS type: Outer Marker for runway 26L.
Magnetic variation: 3E
2.19.2 ILS identification: JYV
2.19.5 Coordinates: 29-59-36.04N /
95-12-54.15W
2.19.6 Site elevation: 75 ft

2.19.1 ILS type: DME for runway 26L. Magnetic
variation: 3E
2.19.2 ILS identification: JYV
2.19.5 Coordinates: 29-59-38.92N /
95-21-31.30W
2.19.6 Site elevation: 109 ft

2.19.1 ILS type: Glide Slope for runway 26L.
Magnetic variation: 3E
2.19.2 ILS identification: JYV
2.19.5 Coordinates: 29-59-39.54N /
95-19-42.80W
2.19.6 Site elevation: 88 ft

2.19.1 ILS type: Localizer for runway 26L.
Magnetic variation: 3E

2.19.2 ILS identification: JYV
2.19.5 Coordinates: 29-59-36.29N /
95-21-31.28W
2.19.6 Site elevation: 93 ft

2.19.1 ILS type: Middle Marker for runway 26L.
Magnetic variation: 3E
2.19.2 ILS identification: JYV
2.19.5 Coordinates: 29-59-36.42N /
95-18-57.72W
2.19.6 Site elevation: 91 ft

2.19.1 ILS type: Inner Marker for runway 26L.
Magnetic variation: 3E
2.19.2 ILS identification: JYV
2.19.5 Coordinates: 29-59-36.39N /
95-19-20.60W
2.19.6 Site elevation: 93 ft

2.19.1 ILS type: Glide Slope for runway 09.
Magnetic variation: 3E
2.19.2 ILS identification: UYO
2.19.5 Coordinates: 29-58-35.39N /
95-19-50.68W
2.19.6 Site elevation: 86 ft

2.19.1 ILS type: Middle Marker for runway 09.
Magnetic variation: 3E
2.19.2 ILS identification: UYO
2.19.5 Coordinates: 29-58-39.36N /
95-20-32.49W
2.19.6 Site elevation: 92 ft

2.19.1 ILS type: Outer Marker for runway 09.
Magnetic variation: 3E
2.19.2 ILS identification: UYO
2.19.5 Coordinates: 29-58-44.10N /
95-26-00.00W
2.19.6 Site elevation: 105 ft

2.19.1 ILS type: Localizer for runway 09. Magnetic
variation: 3E
2.19.2 ILS identification: UYO
2.19.5 Coordinates: 29-58-39.41N /
95-17-57.58W
2.19.6 Site elevation: 81 ft

2.19.1 ILS type: DME for runway 09. Magnetic
variation: 3E
2.19.2 ILS identification: UYO
2.19.5 Coordinates: 29-58-35.38N /

95-20-13.58W

2.19.6 Site elevation: 100 ft

2.19.1 ILS type: Localizer for runway 27. Magnetic variation: 3E

2.19.2 ILS identification: GHI

2.19.5 Coordinates: 29-58-39.33N / 95-20-15.29W

2.19.6 Site elevation: 87 ft

2.19.1 ILS type: DME for runway 27. Magnetic variation: 3E

2.19.2 ILS identification: GHI

2.19.5 Coordinates: 29-58-35.38N / 95-20-13.58W

2.19.6 Site elevation: 100 ft

2.19.1 ILS type: Outer Marker for runway 27. Magnetic variation: 3E

2.19.2 ILS identification: GHI

2.19.5 Coordinates: 29-58-41.04N / 95-13-20.44W

2.19.6 Site elevation: 80 ft

2.19.1 ILS type: Inner Marker for runway 27. Magnetic variation: 3E

2.19.2 ILS identification: GHI

2.19.5 Coordinates: 29-58-39.41N / 95-17-59.16W

2.19.6 Site elevation: 85 ft

2.19.1 ILS type: Glide Slope for runway 27. Magnetic variation: 3E

2.19.2 ILS identification: GHI

2.19.5 Coordinates: 29-58-35.44N / 95-18-20.86W

2.19.6 Site elevation: 81 ft

2.19.1 ILS type: Middle Marker for runway 27. Magnetic variation: 3E

2.19.2 ILS identification: GHI

2.19.5 Coordinates: 29-58-39.42N / 95-17-37.46W

2.19.6 Site elevation: 83 ft

2.19.1 ILS type: Glide Slope for runway 08L. Magnetic variation: 3E

2.19.2 ILS identification: BZU

2.19.5 Coordinates: 30-00-29.75N / 95-21-18.69W

2.19.6 Site elevation: 88 ft

2.19.1 ILS type: Localizer for runway 08L.

Magnetic variation: 3E

2.19.2 ILS identification: BZU

2.19.5 Coordinates: 30-00-25.87N / 95-19-37.01W

2.19.6 Site elevation: 94 ft

2.19.1 ILS type: DME for runway 08L. Magnetic variation: 3E

2.19.2 ILS identification: BZU

2.19.5 Coordinates: 30-00-30.07N / 95-19-37.07W

2.19.6 Site elevation: 90 ft

2.19.1 ILS type: Inner Marker for runway 08L. Magnetic variation: 3E

2.19.2 ILS identification: BZU

2.19.5 Coordinates: 30-00-25.77N / 95-21-40.86W

2.19.6 Site elevation: 92 ft

2.19.1 ILS type: Glide Slope for runway 26R. Magnetic variation: 3E

2.19.2 ILS identification: OND

2.19.5 Coordinates: 30-00-29.81N / 95-20-00.00W

2.19.6 Site elevation: 91 ft

2.19.1 ILS type: Localizer for runway 26R. Magnetic variation: 3E

2.19.2 ILS identification: OND

2.19.5 Coordinates: 30-00-25.78N / 95-21-43.93W

2.19.6 Site elevation: 91 ft

2.19.1 ILS type: DME for runway 26R. Magnetic variation: 3E

2.19.2 ILS identification: OND

2.19.5 Coordinates: 30-00-21.58N / 95-21-44.35W

2.19.6 Site elevation: 84 ft

2.19.1 ILS type: Inner Marker for runway 26R. Magnetic variation: 3E

2.19.2 ILS identification: OND

2.19.5 Coordinates: 30-00-25.87N / 95-19-40.42W

2.19.6 Site elevation: 96 ft

General Remarks:

BIRDS ON & IN VICINITY OF AIRPORT.

TAXIWAYS 'RA', 'RB' & 'SC' NORTH OF TAXIWAY 'SB' ARE DESIGNATED NON-MOVEMENT AREAS OPERATED BY COA RAMP CONTROL.

CAUTION: APPROACH END RUNWAY 26L BRIGHT LIGHTS APPROXIMATELY ONE MILE FROM THRESHOLD & 900 FT S OF CENTERLINE.

9 FT AGL UNMARKED SECURITY FENCE ADJACENT TO FBO & CORPORATE BASE OPERATOR RAMPS AND NONMOVEMENT AREA TAXILANES. HELICOPTER HOVER/TAXI RESTRICTED TO HARD SURFACE MOVEMENT AREAS ONLY.

TAXIWAY 'NR' CLOSED TO AIRCRAFT WITH WINGSPANS GREATER THAN 125 FT BETWEEN TAXIWAY 'WD' & TAXIWAY 'WB'.

TAXIWAY 'SF' BETWEEN THE SOUTH RAMP & TAXIWAY 'NB' IS DESIGNATED NON-MOVEMENT AREAS.

FOR FLIGHT PLAN FILING CALL 1-800-WX-BRIEF.

DUAL TAXIWAY OPERATIONS TAXIWAY NK BETWEEN TAXIWAY NB & NORTH RAMP; WEST CENTERLINE RESTRICTED TO AIRCRAFT MAX WINGSPANS 125 FT & EAST CENTERLINE MAX WINGSPANS 214 FT.

THE FOLLOWING MOVEMENT AREAS ARE NOT VISIBLE FROM THE ATCT: PORTIONS OF TAXIWAYS 'WA' & 'WB' FROM TAXIWAY 'WH' TO THE APPROACH END RUNWAY 33R; TAXIWAYS 'WA' & 'WB' FROM TAXIWAY 'WD' NORTH FOR 400 FT; TAXIWAY 'WD' FROM TAXIWAY 'WA' TO TAXIWAY 'NR'; TAXIWAY 'NR'; TAXIWAY 'WL' FROM RUNWAY 15L TO TAXIWAY 'WB' & TAXIWAY 'WM'.

NORTH RAMP NORTH & SOUTH TAXI LANES CLOSED TO AIRCRAFT WITH WINGSPANS GREATER THAN 125 FT.

NORTH RAMP CONNECTOR RESTRICTED TO AIRCRAFT WITH WINGSPAN 125 FT AND BELOW.

RUNWAY 15L/33R MAGNETIC ANOMALIES MAY AFFECT COMPASS HEADING FOR TAKE-OFF.

TAXIWAYS AIRMET & WESTBOUND MAGNETIC ANOMALIES MAY AFFECT COMPASS HEADING.

NORTH RAMP NORTH TAXILANE BETWEEN TAXIWAY NG/SPOT 6 CLOSED FROM 2100-0800.

NORTH RAMP TAXILANE BETWEEN TAXIWAYS NF & NR RESTRICTED TO AIRCRAFT WITH WINGSPAN 125 FT & BELOW.

TAXIWAY WC WEST OF RUNWAY 15R/33L RESTRICTED TO AIRCRAFT WITH 118 FT WINGSPAN AND BELOW.

ASDE-X SURVEILLANCE SYSTEM IN USE: PILOTS SHOULD OPERATE TRANSPONDERS WITH

MODE C ON ALL TAXIWAYS AND RUNWAYS.

NOISE SENSITIVE AREA NORTH, EAST AND WEST OF AIRPORT.

TAXIWAY LANE RC CLOSED TO AIRCRAFT WITH WINGSPAN GREATER THAN 135 FT.

NJ TAXILANE BETWEEN SPOT 10 AND THE NORTH RAMP CONNECTOR CLOSED TO WINGSPANS OVER 135 FT.

Laredo, Texas
Laredo International
ICAO Identifier KLRD

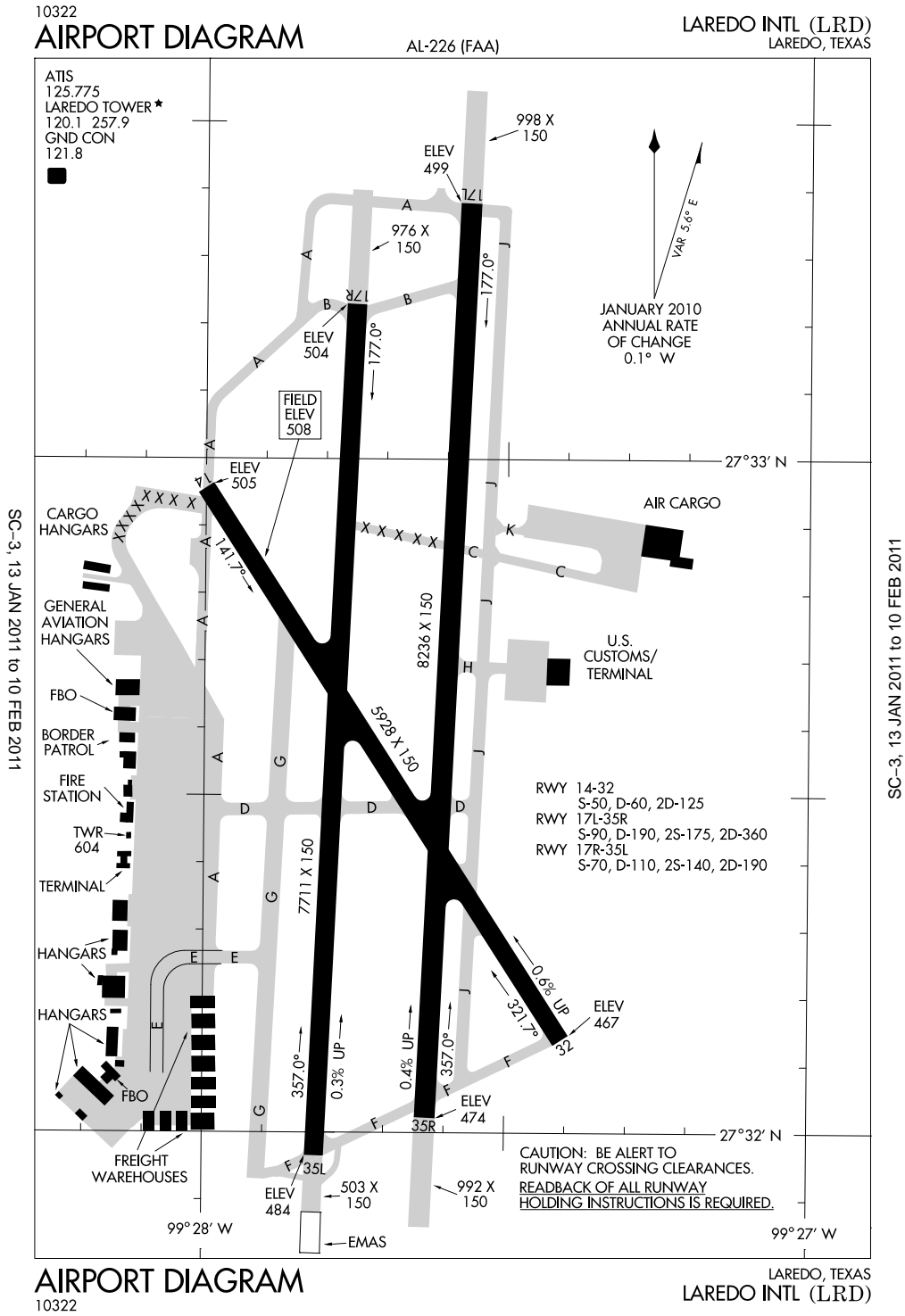

Laredo, TX
Laredo Intl
ICAO Identifier KLRD

AD 2.2 Aerodrome geographical and administrative data

- 2.2.1 Reference Point: 27-32-37.68N / 99-27-41.52W
- 2.2.2 From City: 3 Miles NE Of Laredo, TX
- 2.2.3 Elevation: 508 ft
- 2.2.5 Magnetic variation: 8E (1985)
- 2.2.6 Airport Contact: Jose Flores
5210 BOB BULLOCK LOOP
Laredo, TX 78041
(956-795-2000)
- 2.2.7 Traffic: IFR/VFR

AD 2.3 Operational hours

- 2.3.1 - 2.3.11: ALL Months, ALL Days, ALL Hours

AD 2.4 Handling services and facilities

- 2.4.1 Cargo handling facilities: No
- 2.4.2 Fuel types: 100LL,A
- 2.4.4 De-icing facilities: None
- 2.4.5 Hangar space: Yes
- 2.4.6 Repair facilities: None

AD 2.6 Rescue and firefighting services

- 2.6.1 Aerodrome category for firefighting: ARFF Index I B certified on 7/1/1975

AD 2.10 Aerodrome obstacles

- 2.10.1.a. Runway designation: 32
- 2.10.1.b Type of obstacle: Road (12 ft). Not Lighted or Marked
- 2.10.1.c Location of obstacle: 250 ft from Centerline

AD 2.12 Runway physical characteristics

- 2.12.1 Designation: 14
- 2.12.2 True Bearing: 147
- 2.12.3 Dimensions: 5928 ft x 150 ft
- 2.12.5 Coordinates: 27-32-58.03N / 99-28-00.00W
- 2.12.6 Threshold elevation: 505 ft
- 2.12.6 Touchdown zone elevation: 508 ft

- 2.12.1 Designation: 32
- 2.12.2 True Bearing: 327
- 2.12.3 Dimensions: 5928 ft x 150 ft

- 2.12.5 Coordinates: 27-32-00.00N / 99-27-24.66W
- 2.12.6 Threshold elevation: 467 ft
- 2.12.6 Touchdown zone elevation: 494 ft
- 2.12.7 Slope: 0.6UP

- 2.12.1 Designation: 17R
- 2.12.2 True Bearing: 183
- 2.12.3 Dimensions: 7711 ft x 150 ft
- 2.12.5 Coordinates: 27-33-14.34N / 99-27-45.16W
- 2.12.6 Threshold elevation: 504 ft
- 2.12.6 Touchdown zone elevation: 504 ft

- 2.12.1 Designation: 35L
- 2.12.2 True Bearing: 3
- 2.12.3 Dimensions: 7711 ft x 150 ft
- 2.12.5 Coordinates: 27-31-58.06N / 99-27-48.99W
- 2.12.6 Threshold elevation: 484 ft
- 2.12.6 Touchdown zone elevation: 497 ft
- 2.12.7 Slope: 0.3UP

- 2.12.1 Designation: 17L
- 2.12.2 True Bearing: 183
- 2.12.3 Dimensions: 8236 ft x 150 ft
- 2.12.5 Coordinates: 27-33-22.93N / 99-27-33.60W
- 2.12.6 Threshold elevation: 499 ft
- 2.12.6 Touchdown zone elevation: 499 ft
- 2.12.7 Slope: 0.2DOWN

- 2.12.1 Designation: 35R
- 2.12.2 True Bearing: 3
- 2.12.3 Dimensions: 8236 ft x 150 ft
- 2.12.5 Coordinates: 27-32-00.00N / 99-27-37.69W
- 2.12.6 Threshold elevation: 474 ft
- 2.12.6 Touchdown zone elevation: 487 ft
- 2.12.7 Slope: 0.4UP

AD 2.13 Declared distances

- 2.13.1 Designation: 14
- 2.13.2 Takeoff run available: 5928
- 2.13.3 Takeoff distance available: 5928
- 2.13.4 Accelerate-stop distance available: 5928
- 2.13.5 Landing distance available: 5928

- 2.13.1 Designation: 32
- 2.13.2 Takeoff run available: 5928
- 2.13.3 Takeoff distance available: 5928

2.13.4 Accelerate-stop distance available: 5928
2.13.5 Landing distance available: 5928

2.13.1 Designation: 17R
2.13.2 Takeoff run available: 7711
2.13.3 Takeoff distance available: 7711
2.13.4 Accelerate-stop distance available: 7711
2.13.5 Landing distance available: 7711

2.13.1 Designation: 35L
2.13.2 Takeoff run available: 7711
2.13.3 Takeoff distance available: 7711
2.13.4 Accelerate-stop distance available: 7711
2.13.5 Landing distance available: 7711

2.13.1 Designation: 17L
2.13.2 Takeoff run available: 8236
2.13.3 Takeoff distance available: 8236
2.13.4 Accelerate-stop distance available: 8236
2.13.5 Landing distance available: 8236

2.13.1 Designation: 35R
2.13.2 Takeoff run available: 8236
2.13.3 Takeoff distance available: 8236
2.13.4 Accelerate-stop distance available: 8236
2.13.5 Landing distance available: 8236

AD 2.14 Approach and runway lighting

2.14.1 Designation: 14
2.14.4 Visual approach slope indicator system:
4-box VASI on left

2.14.1 Designation: 32
2.14.4 Visual approach slope indicator system:
4-box VASI on left

2.14.1 Designation: 17R
2.14.2 Approach lighting system: MALSR: 1400
feet medium intensity approach lighting system
with runway alignment indicator lights
2.14.4 Visual approach slope indicator system:
4-box VASI on left

2.14.1 Designation: 35L
2.14.4 Visual approach slope indicator system:
4-box VASI on left

2.14.1 Designation: 17L
2.14.4 Visual approach slope indicator system:
4-light PAPI on left

AD 2.18 Air traffic services communication facilities

2.18.1 Service designation: LCL/P
2.18.3 Service designation: 120.1 MHz

2.18.1 Service designation: GND/P
2.18.3 Service designation: 121.8 MHz

2.18.1 Service designation: EMERG
2.18.3 Service designation: 243 MHz

2.18.1 Service designation: LCL/P
2.18.3 Service designation: 257.9 MHz

2.18.1 Service designation: ATIS
2.18.3 Service designation: 125.775 MHz
2.18.4 Hours of operation: 24

AD 2.19 Radio navigation and landing aids

2.19.1 ILS type: Glide Slope for runway 17R.
Magnetic variation: 8E
2.19.2 ILS identification: LRD
2.19.5 Coordinates: 27-33-00.00N /
99-27-41.22W
2.19.6 Site elevation: 498 ft

2.19.1 ILS type: Middle Marker for runway 17R.
Magnetic variation: 8E
2.19.2 ILS identification: LRD
2.19.5 Coordinates: 27-33-41.55N /
99-27-43.80W
2.19.6 Site elevation: 484 ft

2.19.1 ILS type: Localizer for runway 17R.
Magnetic variation: 8E
2.19.2 ILS identification: LRD
2.19.5 Coordinates: 27-31-51.74N /
99-27-49.30W
2.19.6 Site elevation: 476 ft

2.19.1 ILS type: Outer Marker for runway 17R.
Magnetic variation: 8E
2.19.2 ILS identification: LRD
2.19.5 Coordinates: 27-38-32.52N /
99-27-29.32W
2.19.6 Site elevation: 675 ft

2.19.1 ILS type: DME for runway 17R. Magnetic
variation: 8E
2.19.2 ILS identification: LRD
2.19.5 Coordinates: 27-31-50.97N /

99-27-46.56W
2.19.6 Site elevation: 476 ft

General Remarks:

5' LINE OF SIGHT NOT AVAILABLE BETWEEN ENDS OF RUNWAY 14/32.

RUNWAY 14/32 RESTRICTED TO AIRCRAFT LESS THAN 60,000 LBS DTW.

TAXIWAY C CLOSED BETWEEN RUNWAY 17L/35R & RUNWAY 17R INDEFINITELY.

EMAS ARRESTOR BED PARTIALLY DAMAGED, POTENTIAL DEGRADED PERFORMANCE FOR OFF RUNWAY CENTERLINE ENGAGEMENT.

San Antonio, Texas San Antonio International ICAO Identifier KSAT

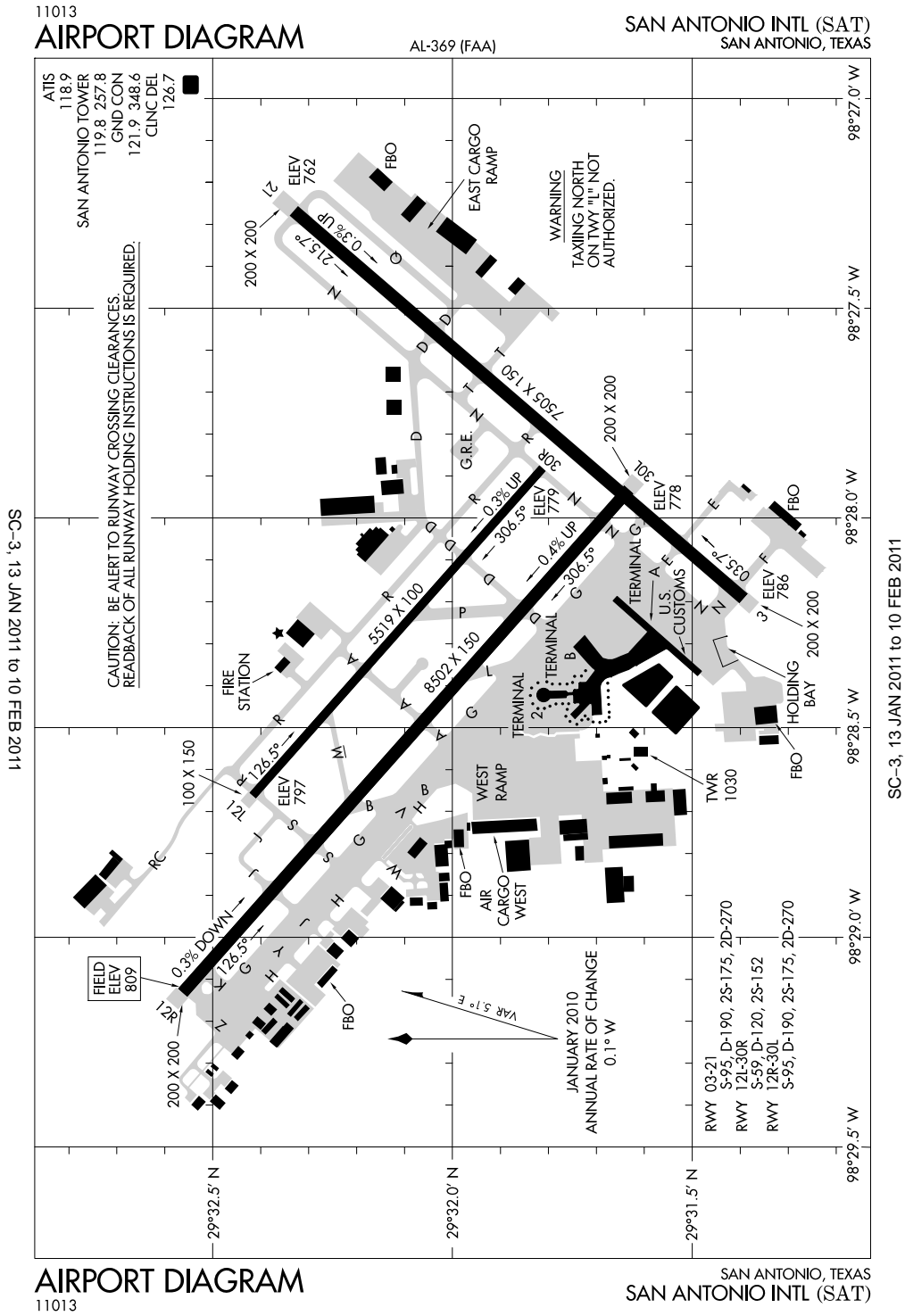

San Antonio, TX
San Antonio Intl
ICAO Identifier KSAT

AD 2.2 Aerodrome geographical and administrative data

- 2.2.1 Reference Point: 29-32-00.00N / 98-28-11.20W
- 2.2.2 From City: 7 Miles N Of San Antonio, TX
- 2.2.3 Elevation: 809 ft
- 2.2.5 Magnetic variation: 8E (1980)
- 2.2.6 Airport Contact: Frank R. Miller
9800 AIRPORT BLVD
San Antonio, TX 78216
(210-207-3450)
- 2.2.7 Traffic: IFR/VFR

AD 2.3 Operational hours

- 2.3.1 - 2.3.11: ALL Months, ALL Days, ALL Hours

AD 2.4 Handling services and facilities

- 2.4.1 Cargo handling facilities: No
- 2.4.2 Fuel types: 100LL,A
- 2.4.4 De-icing facilities: None
- 2.4.5 Hangar space: Yes
- 2.4.6 Repair facilities: Major

AD 2.6 Rescue and firefighting services

- 2.6.1 Aerodrome category for firefighting: ARFF Index I C certified on 5/1/1973

AD 2.10 Aerodrome obstacles

- 2.10.1.a. Runway designation: 30L
- 2.10.1.b Type of obstacle: Bldg (79 ft). Not Lighted or Marked
- 2.10.1.c Location of obstacle: 300 ft from Centerline

- 2.10.1.a. Runway designation: 03
- 2.10.1.b Type of obstacle: Pole (46 ft). Lighted
- 2.10.1.c Location of obstacle: 225 ft from Centerline

AD 2.12 Runway physical characteristics

- 2.12.1 Designation: 12L
- 2.12.2 True Bearing: 132
- 2.12.3 Dimensions: 5519 ft x 100 ft
- 2.12.5 Coordinates: 29-32-25.07N / 98-28-39.71W
- 2.12.6 Threshold elevation: 797 ft

- 2.12.6 Touchdown zone elevation: 797 ft

- 2.12.1 Designation: 30R
- 2.12.2 True Bearing: 312
- 2.12.3 Dimensions: 5519 ft x 100 ft
- 2.12.5 Coordinates: 29-31-48.78N / 98-27-53.02W
- 2.12.6 Threshold elevation: 779 ft
- 2.12.6 Touchdown zone elevation: 788 ft

- 2.12.1 Designation: 12R
- 2.12.2 True Bearing: 132
- 2.12.3 Dimensions: 8502 ft x 150 ft
- 2.12.5 Coordinates: 29-32-33.89N / 98-29-00.00W
- 2.12.6 Threshold elevation: 809 ft
- 2.12.6 Touchdown zone elevation: 809 ft

- 2.12.1 Designation: 30L
- 2.12.2 True Bearing: 312
- 2.12.3 Dimensions: 8502 ft x 150 ft
- 2.12.5 Coordinates: 29-31-38.00N / 98-27-55.99W
- 2.12.6 Threshold elevation: 778 ft
- 2.12.6 Touchdown zone elevation: 790 ft

- 2.12.1 Designation: 03
- 2.12.2 True Bearing: 41
- 2.12.3 Dimensions: 7505 ft x 150 ft
- 2.12.5 Coordinates: 29-31-23.64N / 98-28-11.66W
- 2.12.6 Threshold elevation: 786 ft
- 2.12.6 Touchdown zone elevation: 786 ft

- 2.12.1 Designation: 21
- 2.12.2 True Bearing: 221
- 2.12.3 Dimensions: 7505 ft x 150 ft
- 2.12.5 Coordinates: 29-32-19.90N / 98-27-16.17W
- 2.12.6 Threshold elevation: 762 ft
- 2.12.6 Touchdown zone elevation: 773 ft

AD 2.13 Declared distances

- 2.13.1 Designation: 12L
- 2.13.2 Takeoff run available: 5519
- 2.13.3 Takeoff distance available: 5519
- 2.13.4 Accelerate-stop distance available: 5519
- 2.13.5 Landing distance available: 5519

- 2.13.1 Designation: 30R
- 2.13.2 Takeoff run available: 5519

2.13.3 Takeoff distance available: 5519
2.13.4 Accelerate-stop distance available: 5519
2.13.5 Landing distance available: 5519

2.13.1 Designation: 12R
2.13.2 Takeoff run available: 8502
2.13.3 Takeoff distance available: 8502
2.13.4 Accelerate-stop distance available: 8502
2.13.5 Landing distance available: 8502

2.13.1 Designation: 30L
2.13.2 Takeoff run available: 8502
2.13.3 Takeoff distance available: 8502
2.13.4 Accelerate-stop distance available: 8502
2.13.5 Landing distance available: 8502

2.13.1 Designation: 03
2.13.2 Takeoff run available: 7505
2.13.3 Takeoff distance available: 7505
2.13.4 Accelerate-stop distance available: 7505
2.13.5 Landing distance available: 7505

2.13.1 Designation: 21
2.13.2 Takeoff run available: 7505
2.13.3 Takeoff distance available: 7505
2.13.4 Accelerate-stop distance available: 7505
2.13.5 Landing distance available: 7505

AD 2.14 Approach and runway lighting

2.14.1 Designation: 12L
2.14.4 Visual approach slope indicator system:
4-light PAPI on left

2.14.1 Designation: 30R
2.14.4 Visual approach slope indicator system:
4-light PAPI on left

2.14.1 Designation: 12R
2.14.2 Approach lighting system: ALSF2: Standard
2400 feet high intensity approach lighting system
with sequenced flashers, category II or III
configuration
2.14.4 Visual approach slope indicator system:
4-light PAPI on left

2.14.1 Designation: 30L
2.14.2 Approach lighting system: MALSR: 1400
feet medium intensity approach lighting system
with runway alignment indicator lights
2.14.4 Visual approach slope indicator system:
4-light PAPI on left

2.14.1 Designation: 03
2.14.2 Approach lighting system: MALS: 1400 feet
medium intensity approach lighting system
2.14.4 Visual approach slope indicator system:
4-light PAPI on left

2.14.1 Designation: 21
2.14.4 Visual approach slope indicator system:
4-light PAPI on left

AD 2.18 Air traffic services communication facilities

2.18.1 Service designation: APCH/P DEP/P
CLASS C

2.18.3 Service designation: 118.05 MHz

2.18.1 Service designation: D-ATIS
2.18.3 Service designation: 118.9 MHz
2.18.4 Hours of operation: 24

2.18.1 Service designation: LCL/P
2.18.3 Service designation: 119.8 MHz

2.18.1 Service designation: AS ASGND
2.18.3 Service designation: 120.3 MHz

2.18.1 Service designation: AS ASGND
2.18.3 Service designation: 121.2 MHz

2.18.1 Service designation: EMERG
2.18.3 Service designation: 121.5 MHz

2.18.1 Service designation: GND/P
2.18.3 Service designation: 121.9 MHz

2.18.1 Service designation: APCH/P DEP/P
CLASS C
2.18.3 Service designation: 124.45 MHz

2.18.1 Service designation: APCH/P DEP/P
CLASS C IC
2.18.3 Service designation: 125.1 MHz

2.18.1 Service designation: APCH/S DEP/S
2.18.3 Service designation: 125.7 MHz

2.18.1 Service designation: CD/P
2.18.3 Service designation: 126.7 MHz

2.18.1 Service designation: APCH/S DEP/S
2.18.3 Service designation: 127.1 MHz

2.18.1 Service designation: APCH/P DEP/P
CLASS C
2.18.3 Service designation: 128.05 MHz

2.18.1 Service designation: EMERG
2.18.3 Service designation: 243 MHz

2.18.1 Service designation: APCH/S DEP/S
2.18.3 Service designation: 251.125 MHz

2.18.1 Service designation: LCL/P
2.18.3 Service designation: 257.8 MHz

2.18.1 Service designation: AS ASGND
2.18.3 Service designation: 269.1 MHz

2.18.1 Service designation: APCH/P DEP/P
CLASS C IC
2.18.3 Service designation: 307 MHz

2.18.1 Service designation: AS ASGND
2.18.3 Service designation: 317.5 MHz

2.18.1 Service designation: APCH/P DEP/P
CLASS C
2.18.3 Service designation: 318.1 MHz

2.18.1 Service designation: GND/P
2.18.3 Service designation: 348.6 MHz

2.18.1 Service designation: APCH/P DEP/P
CLASS C
2.18.3 Service designation: 353.5 MHz

2.18.1 Service designation: AS ASGND
2.18.3 Service designation: 285.45 MHz

2.18.1 Service designation: AS ASGND
2.18.3 Service designation: 239.025 MHz

2.18.1 Service designation: APCH/P DEP/P
CLASS C
2.18.3 Service designation: 335.625 MHz

2.18.1 Service designation: APCH/S DEP/S
2.18.3 Service designation: 290.225 MHz

AD 2.19 Radio navigation and landing aids

2.19.1 ILS type: DME for runway 12R. Magnetic
variation: 5E
2.19.2 ILS identification: ANT

2.19.5 Coordinates: 29-31-29.11N /
98-27-49.94W
2.19.6 Site elevation: 791 ft

2.19.1 ILS type: Glide Slope for runway 12R.
Magnetic variation: 5E
2.19.2 ILS identification: ANT
2.19.5 Coordinates: 29-32-28.99N /
98-28-54.82W
2.19.6 Site elevation: 801 ft

2.19.1 ILS type: Middle Marker for runway 12R.
Magnetic variation: 5E
2.19.2 ILS identification: ANT
2.19.5 Coordinates: 29-32-55.58N /
98-29-35.87W
2.19.6 Site elevation: 99999 ft

2.19.1 ILS type: Outer Marker for runway 12R.
Magnetic variation: 5E
2.19.2 ILS identification: ANT
2.19.5 Coordinates: 29-36-27.45N /
98-34-10.92W
2.19.6 Site elevation: 99999 ft

2.19.1 ILS type: Localizer for runway 12R.
Magnetic variation: 5E
2.19.2 ILS identification: ANT
2.19.5 Coordinates: 29-31-31.31N /
98-27-47.38W
2.19.6 Site elevation: 771 ft

2.19.1 ILS type: Inner Marker for runway 12R.
Magnetic variation: 5E
2.19.2 ILS identification: ANT
2.19.5 Coordinates: 29-32-38.99N /
98-29-14.51W
2.19.6 Site elevation: 99999 ft

2.19.1 ILS type: Localizer for runway 30L.
Magnetic variation: 8E
2.19.2 ILS identification: IZR
2.19.5 Coordinates: 29-32-37.61N /
98-29-12.74W
2.19.6 Site elevation: 809 ft

2.19.1 ILS type: DME for runway 30L. Magnetic
variation: 8E
2.19.2 ILS identification: IZR
2.19.5 Coordinates: 29-31-29.11N /
98-27-49.94W

2.19.6 Site elevation: 791 ft

2.19.1 ILS type: Outer Marker for runway 30L.
Magnetic variation: 8E

2.19.2 ILS identification: IZR

2.19.5 Coordinates: 29-28-00.00N /
98-23-19.32W

2.19.6 Site elevation: 692 ft

2.19.1 ILS type: Glide Slope for runway 30L.
Magnetic variation: 8E

2.19.2 ILS identification: IZR

2.19.5 Coordinates: 29-31-47.90N /
98-28-00.00W

2.19.6 Site elevation: 778 ft

2.19.1 ILS type: Middle Marker for runway 30L.
Magnetic variation: 8E

2.19.2 ILS identification: IZR

2.19.5 Coordinates: 29-31-20.34N /
98-27-33.19W

2.19.6 Site elevation: 761 ft

2.19.1 ILS type: Outer Marker for runway 03.
Magnetic variation: 8E

2.19.2 ILS identification: SAT

2.19.5 Coordinates: 29-28-28.61N /
98-31-00.00W

2.19.6 Site elevation: 99999 ft

2.19.1 ILS type: Localizer for runway 03. Magnetic
variation: 8E

2.19.2 ILS identification: SAT

2.19.5 Coordinates: 29-32-33.45N /
98-27-00.00W

2.19.6 Site elevation: 749 ft

2.19.1 ILS type: Glide Slope for runway 03.
Magnetic variation: 8E

2.19.2 ILS identification: SAT

2.19.5 Coordinates: 29-31-27.70N /
98-28-00.00W

2.19.6 Site elevation: 777 ft

2.19.1 ILS type: Middle Marker for runway 03.
Magnetic variation: 8E

2.19.2 ILS identification: SAT

2.19.5 Coordinates: 29-31-00.00N /
98-28-35.26W

2.19.6 Site elevation: 99999 ft

General Remarks:

TAXIWAY L CLOSED NORTHBOUND.

NUMEROUS FLOCKS OF BIRDS IN THE VICINITY OF AIRPORT.

GLIDER/SOARING OPERATIONS APPROXIMATELY 17 MILES NW OF AIRPORT DURING VFR.

TAXIWAY D NON-MOVEMENT AREA FROM TAXIWAY N TO 500 FT W OF TAXIWAY N.

NOISE SENSITIVE AREAS EXIST ON ALL SIDES OF THE AIRPORT: AT THE PILOT'S DISCRETION CLIMB AS QUICKLY & QUIETLY AS SAFELY POSSIBLE ON DEP & USE CONSIDERATION WHEN FLYING OVER POPULATED AREAS BY MINIMIZING FLIGHT & HIGH POWER SETTINGS. ENGINE-UPS ARE PERMITTED BETWEEN 0600-2300.

AIRCRAFT TAXIING ON RUNWAY 03 NE BOUND LOOK FOR HOLD SHORT TO RUNWAY 30L.

AIRCRAFT TAXIING ON TAXIWAY N SW BOUND LOOK FOR HOLD SHORT TO RUNWAY 30R.

PERSONNEL AND EQUIPMENT WORKING ON & ALONG TAXIWAYS AND RAMPS AREAS AT VARIOUS TIMES.

GROUND RUN-UP ENCLOSURE AVAILABLE 24 HRS.

TERMINAL GATE A1 USE ONLY WITH PRIOR PERMISSION REQUIRED CALL OPERATIONS
210-413-4928.

RUNWAY 12L NOT AVAILABLE FOR AIR CARRIER OPERATIONS.

THE FOLLOWING TAXIWAYS ARE NOT AVAILABLE FOR AIRCRAFT 59,000 LBS OR OVER:
TAXIWAYS A & J NORTH OF RUNWAY 12R/30L; TAXIWAYS W, M, P, TAXIWAY H NW OF
TAXIWAY Z AND TAXIWAY E EAST OF RUNWAY 03/21.

TAXIWAY Z CLOSED TO AIRCRAFT WITH WINGSPAN GREATER THAN 118 FT.

C130 AND C141 TYPE AIRCRAFT SHALL PARK ON WEST RAMP TO CLEAR CUSTOMS.

GA AIRCRAFT CLEARING U.S. CUSTOMS AT TERMINAL A BE ALERT FOR PERSONNEL &
EQUIPMENT WHILE TAXIING TO AND FROM THE ASSIGNED CUSTOMS CLEARANCE
LOCATIONS.

TAXIWAY Q ENTRANCE/EXIT AT AIR CARGO EAST CLOSED TO AIRCRAFT WITH WINGSPAN
GREATER THAN 118 FT.

INNER RAMP TAXILANE NORTH & EAST OF TERMINAL A IS CLOSED TO AIRCRAFT WITH
WINGSPAN GREATER THAN 118 FT EXCEPT FOR AIRCRAFT CROSSING THE INNER RAMP TO
GATES A12 TO A16.

PRIOR PERMISSION REQUIRED WITH AIRPORT OPERATIONS FOR AIRCRAFT POWERING
BACK FROM TERMINAL GATES.

TAXIWAYS L & B CLOSED TO AIRCRAFT WITH WINGSPANS GREATER THAN 118 FT EXITING
RUNWAY 30L.

A BARRICADED PAVEMENT ELEVATION CHANGE EXISTS ALONG THE EASTERN SIDE OF THE
WEST RAMP.

FREQUENT RUBBER ACCUMULATION NW 2500 RUNWAY 12R/30L

AIRCRAFT TRANSITIONING TO OR FROM THE INNER RAMP NORTH OF TERMINAL B BE
ALERT FOR VEHICLE LANE.

Salt Lake City, Utah
Salt Lake City International
ICAO Identifier KSLC

11013 AIRPORT DIAGRAM AL-365 (FAA) SALT LAKE CITY INTL (SLC) SALT LAKE CITY, UTAH

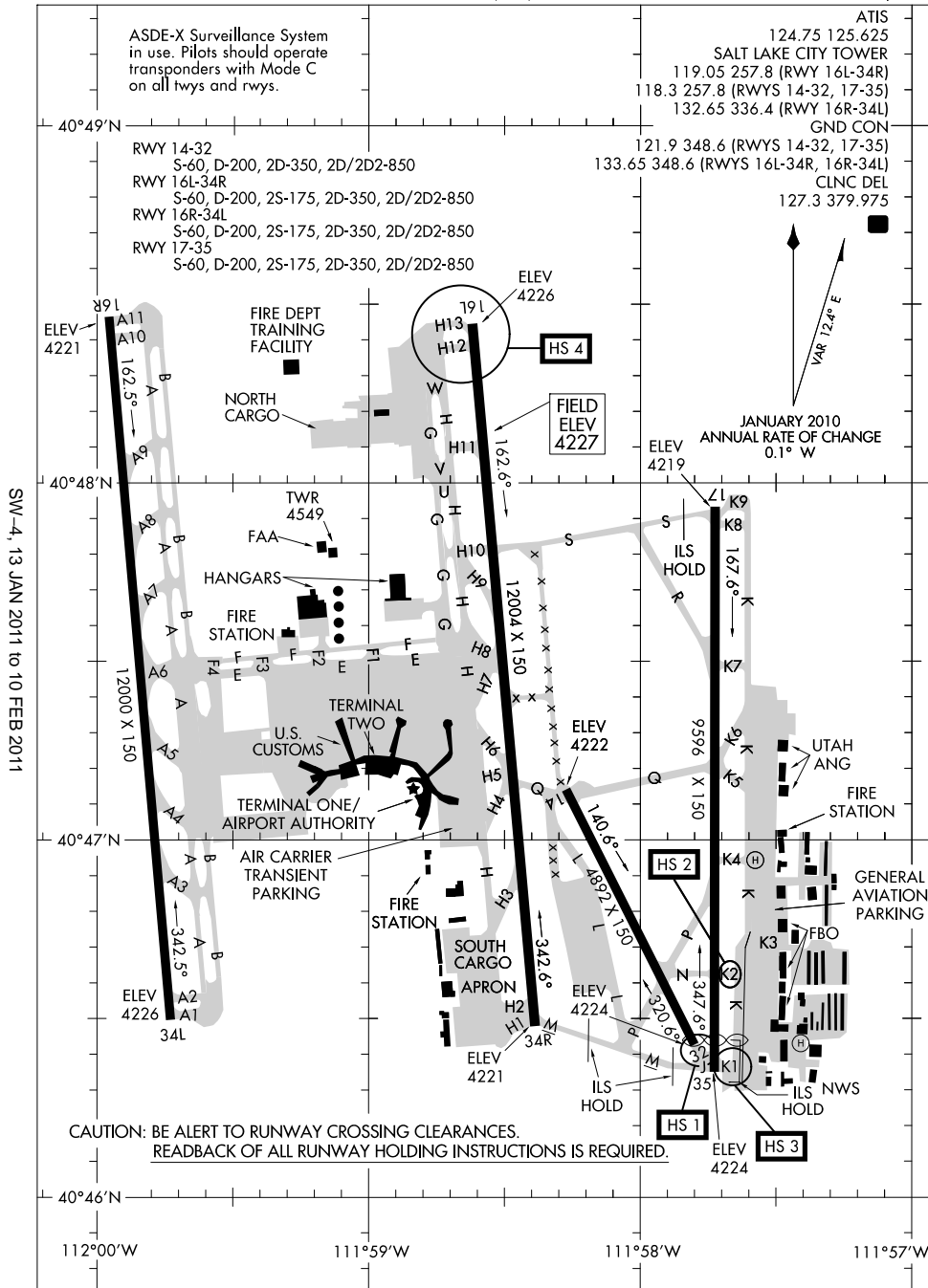

SW-4, 13 JAN 2011 to 10 FEB 2011

SW-4, 13 JAN 2011 to 10 FEB 2011

AIRPORT DIAGRAM SALT LAKE CITY, UTAH
11013 SALT LAKE CITY INTL (SLC)

Salt Lake City, UT
Salt Lake City Intl
ICAO Identifier KSLC

AD 2.2 Aerodrome geographical and administrative data

- 2.2.1 Reference Point: 40-47-18.20N / 111-58-39.98W
- 2.2.2 From City: 3 Miles W Of Salt Lake City, UT
- 2.2.3 Elevation: 4227 ft
- 2.2.5 Magnetic variation: 14E (1995)
- 2.2.6 Airport Contact: Maureen Riley
P.O. BOX 145550
Salt Lake City, UT 84114
(801-575-2401)
- 2.2.7 Traffic: IFR/VFR

AD 2.3 Operational hours

- 2.3.1 - 2.3.11: ALL Months, ALL Days, ALL Hours

AD 2.4 Handling services and facilities

- 2.4.1 Cargo handling facilities: No
- 2.4.2 Fuel types: 100,100LL,80,A1+
- 2.4.4 De-icing facilities: None
- 2.4.5 Hangar space: Yes
- 2.4.6 Repair facilities: Major

AD 2.6 Rescue and firefighting services

- 2.6.1 Aerodrome category for firefighting: ARFF Index I E certified on 5/1/1973

AD 2.10 Aerodrome obstacles

- 2.10.1.a. Runway designation: 35
- 2.10.1.b Type of obstacle: Road (13 ft). Not Lighted or Marked
- 2.10.1.c Location of obstacle: 519 ft from Centerline

AD 2.12 Runway physical characteristics

- 2.12.1 Designation: 16L
- 2.12.2 True Bearing: 175
- 2.12.3 Dimensions: 12004 ft x 150 ft
- 2.12.5 Coordinates: 40-48-26.80N / 111-58-36.97W
- 2.12.6 Threshold elevation: 4226 ft
- 2.12.6 Touchdown zone elevation: 4227 ft

- 2.12.1 Designation: 34R
- 2.12.2 True Bearing: 355
- 2.12.3 Dimensions: 12004 ft x 150 ft

- 2.12.5 Coordinates: 40-46-28.68N / 111-58-23.25W
- 2.12.6 Threshold elevation: 4221 ft
- 2.12.6 Touchdown zone elevation: 4222 ft

- 2.12.1 Designation: 16R
- 2.12.2 True Bearing: 175
- 2.12.3 Dimensions: 12000 ft x 150 ft
- 2.12.5 Coordinates: 40-48-27.99N / 111-59-57.42W
- 2.12.6 Threshold elevation: 4221 ft
- 2.12.6 Touchdown zone elevation: 4223 ft

- 2.12.1 Designation: 34L
- 2.12.2 True Bearing: 355
- 2.12.3 Dimensions: 12000 ft x 150 ft
- 2.12.5 Coordinates: 40-46-29.90N / 111-59-43.69W
- 2.12.6 Threshold elevation: 4226 ft
- 2.12.6 Touchdown zone elevation: 4226 ft

- 2.12.1 Designation: 17
- 2.12.2 True Bearing: 180
- 2.12.3 Dimensions: 9596 ft x 150 ft
- 2.12.5 Coordinates: 40-47-56.10N / 111-57-43.46W
- 2.12.6 Threshold elevation: 4218 ft
- 2.12.6 Touchdown zone elevation: 4219 ft

- 2.12.1 Designation: 35
- 2.12.2 True Bearing: 360
- 2.12.3 Dimensions: 9596 ft x 150 ft
- 2.12.5 Coordinates: 40-46-21.29N / 111-57-43.44W
- 2.12.6 Threshold elevation: 4224 ft
- 2.12.6 Touchdown zone elevation: 4224 ft

- 2.12.1 Designation: 14
- 2.12.2 True Bearing: 153
- 2.12.3 Dimensions: 4892 ft x 150 ft
- 2.12.5 Coordinates: 40-47-00.00N / 111-58-16.45W
- 2.12.6 Threshold elevation: 4222 ft
- 2.12.6 Touchdown zone elevation: 4222 ft

- 2.12.1 Designation: 32
- 2.12.2 True Bearing: 333
- 2.12.3 Dimensions: 4892 ft x 150 ft
- 2.12.5 Coordinates: 40-46-25.51N / 111-57-47.58W
- 2.12.6 Threshold elevation: 4224 ft

2.12.6 Touchdown zone elevation: 4224 ft

2.12.1 Designation: HF

2.12.3 Dimensions: 60 ft x 60 ft

2.12.1 Designation: HB

2.12.3 Dimensions: 60 ft x 60 ft

2.12.5 Coordinates: 40-46-27.08N /
111-57-24.06W

2.12.6 Threshold elevation: 4220 ft

AD 2.13 Declared distances

2.13.1 Designation: 16L

2.13.2 Takeoff run available: 12004

2.13.3 Takeoff distance available: 12004

2.13.4 Accelerate-stop distance available: 12004

2.13.5 Landing distance available: 12004

2.13.1 Designation: 34R

2.13.2 Takeoff run available: 12004

2.13.3 Takeoff distance available: 12004

2.13.4 Accelerate-stop distance available: 12004

2.13.5 Landing distance available: 12004

2.13.1 Designation: 16R

2.13.2 Takeoff run available: 12000

2.13.3 Takeoff distance available: 12000

2.13.4 Accelerate-stop distance available: 12000

2.13.5 Landing distance available: 12000

2.13.1 Designation: 34L

2.13.2 Takeoff run available: 12000

2.13.3 Takeoff distance available: 12000

2.13.4 Accelerate-stop distance available: 12000

2.13.5 Landing distance available: 12000

2.13.1 Designation: 17

2.13.2 Takeoff run available: 9597

2.13.3 Takeoff distance available: 9597

2.13.4 Accelerate-stop distance available: 9597

2.13.5 Landing distance available: 9597

2.13.1 Designation: 35

2.13.2 Takeoff run available: 9597

2.13.3 Takeoff distance available: 9597

2.13.4 Accelerate-stop distance available: 9597

2.13.5 Landing distance available: 9273

2.13.1 Designation: 14

2.13.2 Takeoff run available: 4892

2.13.3 Takeoff distance available: 4892

2.13.4 Accelerate-stop distance available: 4892

2.13.5 Landing distance available: 4892

2.13.1 Designation: 32

2.13.2 Takeoff run available: 4892

2.13.3 Takeoff distance available: 4892

2.13.4 Accelerate-stop distance available: 4892

2.13.5 Landing distance available: 4892

AD 2.14 Approach and runway lighting

2.14.1 Designation: 16L

2.14.2 Approach lighting system: ALSF2: Standard
2400 feet high intensity approach lighting system
with sequenced flashers, category II or III
configuration

2.14.4 Visual approach slope indicator system:
4-light PAPI on left

2.14.1 Designation: 34R

2.14.2 Approach lighting system: ALSF2: Standard
2400 feet high intensity approach lighting system
with sequenced flashers, category II or III
configuration

2.14.4 Visual approach slope indicator system:
4-light PAPI on left

2.14.1 Designation: 16R

2.14.2 Approach lighting system: ALSF2: Standard
2400 feet high intensity approach lighting system
with sequenced flashers, category II or III
configuration

2.14.4 Visual approach slope indicator system:
4-light PAPI on left

2.14.1 Designation: 34L

2.14.2 Approach lighting system: ALSF2: Standard
2400 feet high intensity approach lighting system
with sequenced flashers, category II or III
configuration

2.14.4 Visual approach slope indicator system:
4-light PAPI on left

2.14.1 Designation: 17

2.14.2 Approach lighting system: MALSR: 1400
feet medium intensity approach lighting system
with runway alignment indicator lights

2.14.4 Visual approach slope indicator system:
4-light PAPI on right

2.14.1 Designation: 35

2.14.2 Approach lighting system: MALSR: 1400

feet medium intensity approach lighting system
with runway alignment indicator lights
2.14.4 Visual approach slope indicator system:
4-light PAPI on left

2.14.1 Designation: 14

2.14.4 Visual approach slope indicator system:
4-light PAPI on left

2.14.1 Designation: 32

2.14.4 Visual approach slope indicator system:
4-light PAPI on left

**AD 2.18 Air traffic services communication
facilities**

2.18.1 Service designation: LCL/P

2.18.3 Service designation: 118.3 MHz

2.18.1 Service designation: LCL/P

2.18.3 Service designation: 119.05 MHz

2.18.1 Service designation: CLASS B

2.18.3 Service designation: 120.9 MHz

2.18.1 Service designation: APCH/P DEP/P

2.18.3 Service designation: 120.9 MHz

2.18.1 Service designation: CLASS B

2.18.3 Service designation: 121.1 MHz

2.18.1 Service designation: APCH/P DEP/P

2.18.3 Service designation: 121.1 MHz

2.18.1 Service designation: EMERG

2.18.3 Service designation: 121.5 MHz

2.18.1 Service designation: APCH/P DEP P IC

2.18.3 Service designation: 124.3 MHz

2.18.1 Service designation: D-ATIS

2.18.3 Service designation: 124.75 MHz

2.18.4 Hours of operation: 24

2.18.1 Service designation: APCH/P DEP/P

2.18.3 Service designation: 124.9 MHz

2.18.1 Service designation: APCH/P DEP/P

2.18.3 Service designation: 126.25 MHz

2.18.1 Service designation: CD/P PRE-TAXI
CLNC PRE-DEP CLNC

2.18.3 Service designation: 127.3 MHz

2.18.1 Service designation: APCH/P DEP/P

2.18.3 Service designation: 128.1 MHz

2.18.1 Service designation: LCL/P

2.18.3 Service designation: 132.65 MHz

2.18.1 Service designation: APCH/P DEP/P

2.18.3 Service designation: 135.5 MHz

2.18.1 Service designation: EMERG

2.18.3 Service designation: 243 MHz

2.18.1 Service designation: CLASS B

2.18.3 Service designation: 257.2 MHz

2.18.1 Service designation: LCL/P

2.18.3 Service designation: 257.8 MHz

2.18.1 Service designation: APCH/S DEP/S

2.18.3 Service designation: 284.6 MHz

2.18.1 Service designation: CLASS B

2.18.3 Service designation: 319.25 MHz

2.18.1 Service designation: ANG-OPNS

2.18.3 Service designation: 303 MHz

2.18.1 Service designation: APCH/P DEP/P

2.18.3 Service designation: 307.05 MHz

2.18.1 Service designation: ANG-OPNS

2.18.3 Service designation: 311 MHz

2.18.1 Service designation: APCH/P DEP/P IC

2.18.3 Service designation: 322.3 MHz

2.18.1 Service designation: GND/P

2.18.3 Service designation: 348.6 MHz

2.18.1 Service designation: APCH/P DEP/P

2.18.3 Service designation: 353.6 MHz

2.18.1 Service designation: LCL/P

2.18.3 Service designation: 336.4 MHz

2.18.1 Service designation: AS ASGND

2.18.3 Service designation: 377.2 MHz

2.18.1 Service designation: GND/P

2.18.3 Service designation: 121.9 MHz
2.18.1 Service designation: GND/P
2.18.3 Service designation: 133.65 MHz
2.18.1 Service designation: CD/P
2.18.3 Service designation: 379.975 MHz
2.18.1 Service designation: D-ATIS
2.18.3 Service designation: 125.625 MHz
2.18.4 Hours of operation: 24

AD 2.19 Radio navigation and landing aids

2.19.1 ILS type: Localizer for runway 16L.
Magnetic variation: 14E
2.19.2 ILS identification: MOY
2.19.5 Coordinates: 40-46-18.49N /
111-58-22.06W
2.19.6 Site elevation: 4222 ft
2.19.1 ILS type: DME for runway 16L. Magnetic
variation: 14E
2.19.2 ILS identification: MOY
2.19.5 Coordinates: 40-46-18.71N /
111-58-18.11W
2.19.6 Site elevation: 4236 ft
2.19.1 ILS type: Glide Slope for runway 16L.
Magnetic variation: 14E
2.19.2 ILS identification: MOY
2.19.5 Coordinates: 40-48-17.80N /
111-58-30.70W
2.19.6 Site elevation: 4222 ft
2.19.1 ILS type: Middle Marker for runway 16L.
Magnetic variation: 14E
2.19.2 ILS identification: MOY
2.19.5 Coordinates: 40-48-55.10N /
111-58-40.28W
2.19.6 Site elevation: 4217 ft
2.19.1 ILS type: Inner Marker for runway 16L.
Magnetic variation: 14E
2.19.2 ILS identification: MOY
2.19.5 Coordinates: 40-48-35.68N /
111-58-38.00W
2.19.6 Site elevation: 4223 ft
2.19.1 ILS type: Localizer for runway 34R.
Magnetic variation: 14E
2.19.2 ILS identification: SLC

2.19.5 Coordinates: 40-48-36.65N /
111-58-38.11W
2.19.6 Site elevation: 4221 ft
2.19.1 ILS type: Glide Slope for runway 34R.
Magnetic variation: 14E
2.19.2 ILS identification: SLC
2.19.5 Coordinates: 40-46-39.32N /
111-58-19.28W
2.19.6 Site elevation: 4217 ft
2.19.1 ILS type: Inner Marker for runway 34R.
Magnetic variation: 14E
2.19.2 ILS identification: SLC
2.19.5 Coordinates: 40-46-20.33N /
111-58-22.29W
2.19.6 Site elevation: 4222 ft
2.19.1 ILS type: Outer Marker for runway 34R.
Magnetic variation: 14E
2.19.2 ILS identification: SLC
2.19.5 Coordinates: 40-40-52.21N /
111-57-46.57W
2.19.6 Site elevation: 4310 ft
2.19.1 ILS type: DME for runway 34R. Magnetic
variation: 14E
2.19.2 ILS identification: SLC
2.19.5 Coordinates: 40-46-22.87N /
111-58-25.99W
2.19.6 Site elevation: 99999 ft
2.19.1 ILS type: Middle Marker for runway 34R.
Magnetic variation: 14E
2.19.2 ILS identification: SLC
2.19.5 Coordinates: 40-46-00.00N /
111-58-18.28W
2.19.6 Site elevation: 4221 ft
2.19.1 ILS type: DME for runway 16R. Magnetic
variation: 14E
2.19.2 ILS identification: UAT
2.19.5 Coordinates: 40-46-19.62N /
111-59-46.36W
2.19.6 Site elevation: 99999 ft
2.19.1 ILS type: Glide Slope for runway 16R.
Magnetic variation: 14E
2.19.2 ILS identification: UAT
2.19.5 Coordinates: 40-48-17.29N /
112-00-00.00W

2.19.6 Site elevation: 4216 ft

2.19.1 ILS type: Inner Marker for runway 16R.
Magnetic variation: 14E

2.19.2 ILS identification: UAT

2.19.5 Coordinates: 40-48-37.20N /
111-59-58.20W

2.19.6 Site elevation: 4218 ft

2.19.1 ILS type: Middle Marker for runway 16R.
Magnetic variation: 14E

2.19.2 ILS identification: UAT

2.19.5 Coordinates: 40-48-56.30N /
112-00-00.00W

2.19.6 Site elevation: 4215 ft

2.19.1 ILS type: Localizer for runway 16R.
Magnetic variation: 14E

2.19.2 ILS identification: UAT

2.19.5 Coordinates: 40-46-19.93N /
111-59-42.52W

2.19.6 Site elevation: 4225 ft

2.19.1 ILS type: Localizer for runway 34L.
Magnetic variation: 14E

2.19.2 ILS identification: UUH

2.19.5 Coordinates: 40-48-36.86N /
112-00-00.00W

2.19.6 Site elevation: 4216 ft

2.19.1 ILS type: DME for runway 34L. Magnetic
variation: 14E

2.19.2 ILS identification: UUH

2.19.5 Coordinates: 40-46-19.62N /
111-59-46.36W

2.19.6 Site elevation: 99999 ft

2.19.1 ILS type: Glide Slope for runway 34L.
Magnetic variation: 14E

2.19.2 ILS identification: UUH

2.19.5 Coordinates: 40-46-38.78N /
111-59-53.04W

2.19.6 Site elevation: 4218 ft

2.19.1 ILS type: Localizer for runway 17. Magnetic
variation: 14E

2.19.2 ILS identification: BNT

2.19.5 Coordinates: 40-46-10.06N /
111-57-43.44W

2.19.6 Site elevation: 4225 ft

2.19.1 ILS type: DME for runway 17. Magnetic
variation: 14E

2.19.2 ILS identification: BNT

2.19.5 Coordinates: 40-46-10.06N /
111-57-46.86W

2.19.6 Site elevation: 4238 ft

2.19.1 ILS type: Glide Slope for runway 17.
Magnetic variation: 14E

2.19.2 ILS identification: BNT

2.19.5 Coordinates: 40-47-45.73N /
111-57-49.95W

2.19.6 Site elevation: 4214 ft

2.19.1 ILS type: Middle Marker for runway 17.
Magnetic variation: 14E

2.19.2 ILS identification: BNT

2.19.5 Coordinates: 40-48-23.40N /
111-57-43.40W

2.19.6 Site elevation: 99999 ft

2.19.1 ILS type: Glide Slope for runway 35.
Magnetic variation: 14E

2.19.2 ILS identification: UTJ

2.19.5 Coordinates: 40-46-35.13N /
111-57-48.64W

2.19.6 Site elevation: 4219 ft

2.19.1 ILS type: Localizer for runway 35. Magnetic
variation: 14E

2.19.2 ILS identification: UTJ

2.19.5 Coordinates: 40-48-00.00N /
111-57-43.46W

2.19.6 Site elevation: 4218 ft

2.19.1 ILS type: DME for runway 35. Magnetic
variation: 14E

2.19.2 ILS identification: UTJ

2.19.5 Coordinates: 40-46-10.06N /
111-57-46.86W

2.19.6 Site elevation: 4238 ft

2.19.1 ILS type: Outer Marker for runway 35.
Magnetic variation: 14E

2.19.2 ILS identification: UTJ

2.19.5 Coordinates: 40-40-52.21N /
111-57-46.57W

2.19.6 Site elevation: 4310 ft

General Remarks:

CAUTION: FLOCK OF BIRDS ON AND IN VICINITY OF AIRPORT.

HELIPADS B AND F LOCATED ON GENERAL AVIATION APRONS.

SURFACE MOVEMENT GUIDANCE CONTROL SYSTEM & LOW VISIBILITY TAXI PROCEDURES.

DUE TO TRAFFIC VOLUME, LOCAL DEPARTURE AND ARR OPERATIONS ARE DISCOURAGED AND DELAYS CAN BE EXPECTED BETWEEN 1000-1200 AND 2000-2300.

SPECIAL VFR IS NOT RECOMMEND AT THE AIRPORT, IF REQUIRED, EXPECT DELAYS.

ANG RAMP - OPR 1430-2230Z++ MON-THU. CLOSED FRI-SUN AND HOLIDAY. OFFICIAL BUSINESS ONLY PRIOR PERMISSION REQUIRED ALL AIRCRAFT 48 HR PRIOR NOTICE (PPR VALID 1HR +/- ETA). TRANSIENT PRK/SVC EXTREMELY LIMITED. BASE OPERATIONS DSN 245-2274, C801-245-2274; CIRCULAR POLARIZATION DSN 245-2416/2417, C801-245-2416/2417. ALL AIRCRAFT CONTACT ANG OPERATIONS (UTAH CONTROL) 20 MIN OUT WTH ESTIMATED TIME OF ARRIVAL AND REQ.

ANG RAMP - ALL AIRCRAFT CONTACT UTAH CONTROL WITH LANDING & DEP TIMES. PHASE II WILDLIFE ACT DURING MIGRATION/MORNING/EVENING HRS FR OCT-APR. CONTACT CIRCULAR POLARIZATION FOR CURRENT BIRD-WATCH CONDITION. MILITARY ALTITUDE HILL AFB (KHIF) 25 NAUTICAL MILE NORTH.

ASDE-X SURVEILLANCE SYSTEM IN USE: PILOTS SHOULD OPERATE TRANSPONDERS WITH MODE C ON ALL TAXIWAYS AND RUNWAYS.

SEE FLIGHT INFORMATION PUBLICATION AP/1 SUPPLEMENTARY AIRPORT INFORMATION.

COMMUNICATIONS-ANG OPERATIONS: CALL UTAH CONTROL.

USE CAUTION FOR EXTENSIVE PARAGLIDING OPERATIONS IN THE VICINITY OF POINT OF THE MOUNTAIN.

Charlotte Amalie St. Thomas, Virgin Islands
Cyril E. King
ICAO Identifier TIST

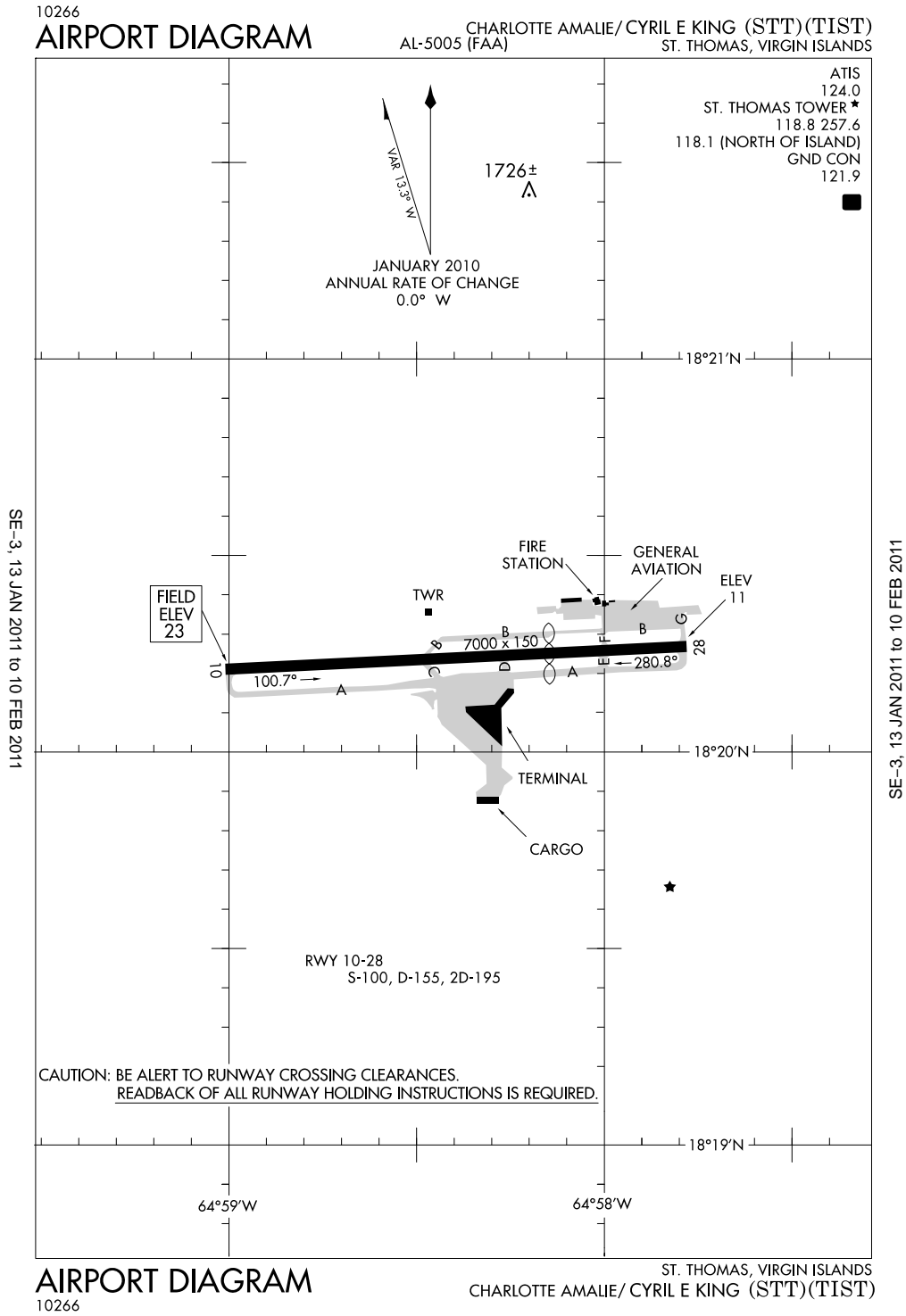

**Charlotte Amalie, VI
Cyril E King
ICAO Identifier TIST**

AD 2.2 Aerodrome geographical and administrative data

- 2.2.1 Reference Point: 18-20-14.30N / 64-58-24.10W
- 2.2.2 From City: 2 Miles W Of Charlotte Amalie, VI
- 2.2.3 Elevation: 23 ft
- 2.2.5 Magnetic variation: 13W (2000)
- 2.2.6 Airport Contact: Mr. Jose Nazario
CYRIL E. KING AIRPORT
St Thomas, VI 802
(340-774-5100)
- 2.2.7 Traffic: IFR/VFR

AD 2.3 Operational hours

- 2.3.1 - 2.3.11: ALL Months, ALL Days, 0700-2300 Hours

AD 2.4 Handling services and facilities

- 2.4.1 Cargo handling facilities: No
- 2.4.2 Fuel types: 100LL,A
- 2.4.4 De-icing facilities: None
- 2.4.5 Hangar space: Yes
- 2.4.6 Repair facilities: Minor

AD 2.6 Rescue and firefighting services

- 2.6.1 Aerodrome category for firefighting: ARFF Index I C certified on 5/1/1973
- 2.6.4 Remarks: Closed To Unscheduled Aircraft Operations With More Than 30 Passenger Seats Except 24 Hrs Prior Permission Required Call Airport Manager 340-774-5100.

AD 2.10 Aerodrome obstacles

- 2.10.1.a. Runway designation: 28
- 2.10.1.b Type of obstacle: Pole (28 ft). Not Lighted or Marked
- 2.10.1.c Location of obstacle: 400 ft from Centerline

AD 2.12 Runway physical characteristics

- 2.12.1 Designation: 10
- 2.12.2 True Bearing: 87
- 2.12.3 Dimensions: 7000 ft x 150 ft
- 2.12.5 Coordinates: 18-20-12.72N / 64-59-00.00W
- 2.12.6 Threshold elevation: 23 ft

- 2.12.6 Touchdown zone elevation: 23 ft

- 2.12.1 Designation: 28
- 2.12.2 True Bearing: 267
- 2.12.3 Dimensions: 7000 ft x 150 ft
- 2.12.5 Coordinates: 18-20-15.81N / 64-57-47.75W
- 2.12.6 Threshold elevation: 11 ft
- 2.12.6 Touchdown zone elevation: 15 ft

AD 2.13 Declared distances

- 2.13.1 Designation: 10
- 2.13.2 Takeoff run available: 7000
- 2.13.3 Takeoff distance available: 7000
- 2.13.4 Accelerate-stop distance available: 7000
- 2.13.5 Landing distance available: 7000

- 2.13.1 Designation: 28
- 2.13.2 Takeoff run available: 7000
- 2.13.3 Takeoff distance available: 7000
- 2.13.4 Accelerate-stop distance available: 6000
- 2.13.5 Landing distance available: 3700

AD 2.14 Approach and runway lighting

- 2.14.1 Designation: 10
- 2.14.4 Visual approach slope indicator system: 4-light PAPI on left

AD 2.18 Air traffic services communication facilities

- 2.18.1 Service designation: LCL/P
- 2.18.3 Service designation: 118.1 MHz

- 2.18.1 Service designation: LCL/P
- 2.18.3 Service designation: 118.8 MHz

- 2.18.1 Service designation: EMERG
- 2.18.3 Service designation: 121.5 MHz

- 2.18.1 Service designation: GND/P
- 2.18.3 Service designation: 121.9 MHz

- 2.18.1 Service designation: ATIS
- 2.18.3 Service designation: 124 MHz
- 2.18.4 Hours of operation: 24

- 2.18.1 Service designation: EMERG
- 2.18.3 Service designation: 243 MHz

- 2.18.1 Service designation: LCL/P
- 2.18.3 Service designation: 257.6 MHz

AD 2.19 Radio navigation and landing aids

2.19.1 ILS type: DME for runway 10. Magnetic variation: 13W

2.19.2 ILS identification: TMN

2.19.5 Coordinates: 18-20-18.76N / 64-57-39.49W

2.19.6 Site elevation: 22 ft

2.19.1 ILS type: Localizer for runway 10. Magnetic variation: 13W

2.19.2 ILS identification: TMN

2.19.5 Coordinates: 18-20-16.17N / 64-57-39.21W

2.19.6 Site elevation: 15 ft

2.19.1 ILS type: Glide Slope for runway 10. Magnetic variation: 13W

2.19.2 ILS identification: TMN

2.19.5 Coordinates: 18-20-10.74N / 64-58-48.30W

2.19.6 Site elevation: 14 ft

General Remarks:

AIRCRAFT THAT BACK TAXI FOR DEP ON RUNWAY 28 SHALL MAKE THEIR 180 DEGREE TURN COUNTERCLOCKWISE.

NOISE SENSITIVE AREA: AVOID OVERFLIGHTS OF WATER ISLAND LOCATED 2 MI SE OF AIRPORT.

PILOTS MAY ENCOUNTER FALSE ILLUSORY INDICATIONS DURING NIGHT VISUAL APPROACHES TO RUNWAY 10 WHEN USING VISUAL CUES FOR VERTICAL GUIDANCE; RECOMMEND USE OF THE ILS GS & FREQUENT CROSS REFERENCE WITH THE AIRCRAFT ALTITUDE TO MAINTAIN THE PROPER APPROACH PROFILE.

LIGHTS ON HILL 4 NAUTICAL MILE SE OF AIRPORT MAY BE MISTAKEN FOR RUNWAY 10/28 WHEN MAKING A VISUAL APPROACH FROM THE SOUTH.

RUNWAY 10 DEPS MAINTAIN RUNWAY HEADING UNTIL REACHING DEP END OF RUNWAY BEFORE TURNING ON COURSE OR ASSIGNED HEADING UNLESS OTHERWISE AUTHORIZED BY ATCT.

AIRCRAFT RESCUE AND FIRE FIGHTING UNAVAILABLE 2300-0630.

PILOTS CONTACT GROUND CONTROL PRIOR TO PUSHBACK.

**Christiansted St. Croix
Henry E Rohlsen
ICAO Identifier TISX**

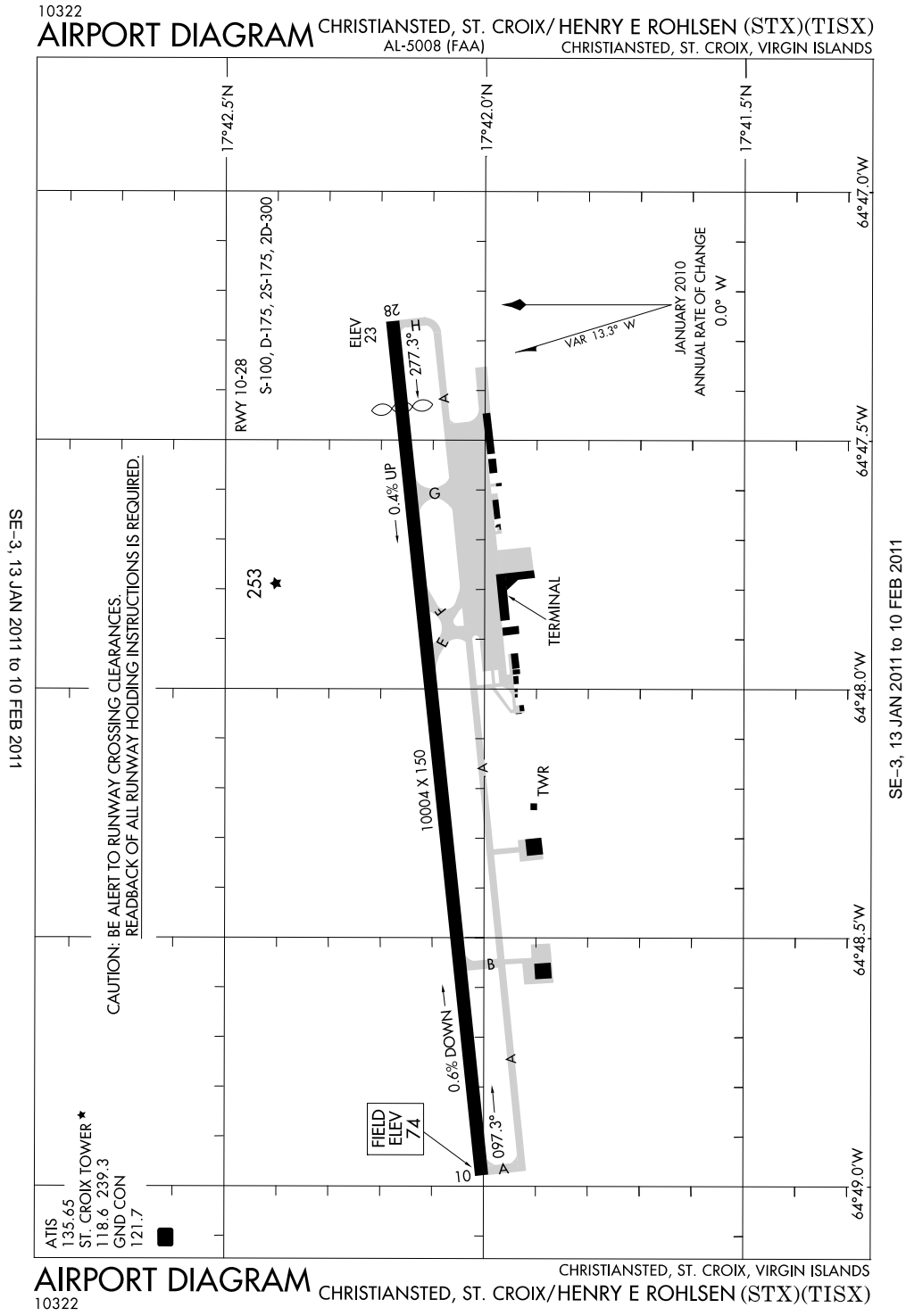

Christiansted, VI
Henry E Rohlsen
ICAO Identifier TISX

AD 2.2 Aerodrome geographical and administrative data

- 2.2.1 Reference Point: 17-42-00.00N / 64-48-00.00W
- 2.2.2 From City: 6 Miles SW Of Christiansted, VI
- 2.2.3 Elevation: 74 ft
- 2.2.5 Magnetic variation: 13W (2000)
- 2.2.6 Airport Contact: Mr. David Mapp
P.O. BOX 1134
St Croix, VI 821
(340-778-1012)
- 2.2.7 Traffic: IFR/VFR

AD 2.3 Operational hours

- 2.3.1 - 2.3.11: ALL Months, ALL Days, 0500-2300 Hours

AD 2.4 Handling services and facilities

- 2.4.1 Cargo handling facilities: No
- 2.4.2 Fuel types: 100LL,A1+
- 2.4.4 De-icing facilities: None
- 2.4.5 Hangar space: Yes
- 2.4.6 Repair facilities: Major

AD 2.6 Rescue and firefighting services

- 2.6.1 Aerodrome category for firefighting: ARFF Index I C certified on 5/1/1973
- 2.6.4 Remarks: Closed To Unscheduled Aircraft Operations With More Than 30 Passenger Seats Except 24 Hrs Prior Permission Required Contact Airport Manager 340-778-1012 Or 340-778-1033(Fax). ARFF Service Unavailable 2300-0500.

AD 2.10 Aerodrome obstacles

- 2.10.1.a. Runway designation: 28
- 2.10.1.b Type of obstacle: Bldg (217 ft). Marked
- 2.10.1.c Location of obstacle: 800 ft from Centerline

AD 2.12 Runway physical characteristics

- 2.12.1 Designation: 10
- 2.12.2 True Bearing: 84
- 2.12.3 Dimensions: 10004 ft x 150 ft
- 2.12.5 Coordinates: 17-42-00.00N / 64-48-58.45W
- 2.12.6 Threshold elevation: 74 ft

- 2.12.6 Touchdown zone elevation: 74 ft

- 2.12.1 Designation: 28
- 2.12.2 True Bearing: 264
- 2.12.3 Dimensions: 10004 ft x 150 ft
- 2.12.5 Coordinates: 17-42-10.62N / 64-47-15.54W
- 2.12.6 Threshold elevation: 22 ft
- 2.12.6 Touchdown zone elevation: 40 ft

AD 2.13 Declared distances

- 2.13.1 Designation: 10
- 2.13.2 Takeoff run available: 10004
- 2.13.3 Takeoff distance available: 10004
- 2.13.4 Accelerate-stop distance available: 9000
- 2.13.5 Landing distance available: 9000

- 2.13.1 Designation: 28
- 2.13.2 Takeoff run available: 10004
- 2.13.3 Takeoff distance available: 10004
- 2.13.4 Accelerate-stop distance available: 10004
- 2.13.5 Landing distance available: 9000

AD 2.14 Approach and runway lighting

- 2.14.1 Designation: 10
- 2.14.2 Approach lighting system: MALSR: 1400 feet medium intensity approach lighting system with runway alignment indicator lights
- 2.14.4 Visual approach slope indicator system: 4-light PAPI on left

- 2.14.1 Designation: 28
- 2.14.4 Visual approach slope indicator system: 4-light PAPI on left

AD 2.18 Air traffic services communication facilities

- 2.18.1 Service designation: LCL/P
- 2.18.3 Service designation: 118.6 MHz

- 2.18.1 Service designation: EMERG
- 2.18.3 Service designation: 121.5 MHz

- 2.18.1 Service designation: GND/P
- 2.18.3 Service designation: 121.7 MHz

- 2.18.1 Service designation: ATIS
- 2.18.3 Service designation: 135.65 MHz
- 2.18.4 Hours of operation: 24

- 2.18.1 Service designation: LCL/P

2.18.3 Service designation: 239.3 MHz

64-48-21.03W

2.19.6 Site elevation: 48 ft

2.18.1 Service designation: EMERG

2.18.3 Service designation: 243 MHz

2.19.1 ILS type: Outer Marker for runway 10.

Magnetic variation: 10W

AD 2.19 Radio navigation and landing aids

2.19.1 ILS type: Localizer for runway 10. Magnetic variation: 10W

2.19.2 ILS identification: STX

2.19.2 ILS identification: STX

2.19.5 Coordinates: 17-41-30.90N / 64-53-00.00W

2.19.5 Coordinates: 17-42-11.44N /

2.19.6 Site elevation: 99999 ft

64-47-00.00W

2.19.6 Site elevation: 23 ft

2.19.1 ILS type: Middle Marker for runway 10.

Magnetic variation: 10W

2.19.1 ILS type: Glide Slope for runway 10.

Magnetic variation: 10W

2.19.2 ILS identification: STX

2.19.2 ILS identification: STX

2.19.5 Coordinates: 17-41-59.40N /

2.19.5 Coordinates: 17-42-00.00N /

64-49-00.00W

2.19.6 Site elevation: 99999 ft

General Remarks:

APPROACH TO RUNWAY 28 SOMETIMES OBSCURED BY SMOKE FROM LANDFILL LOCATED E OF AIRPORT.

RUNWAY 10 AND 28 100' X 200' BLAST PAD.

BIRDS & WILDLIFE ON & IN THE VICINITY OF AIRPORT.

TAXI INTO POSITION AND HOLD PROCEDURES NO LONGER IN EFFECT.

Everett, Washington
Snohomish County (Paine Field)
ICAO Identifier KPAE

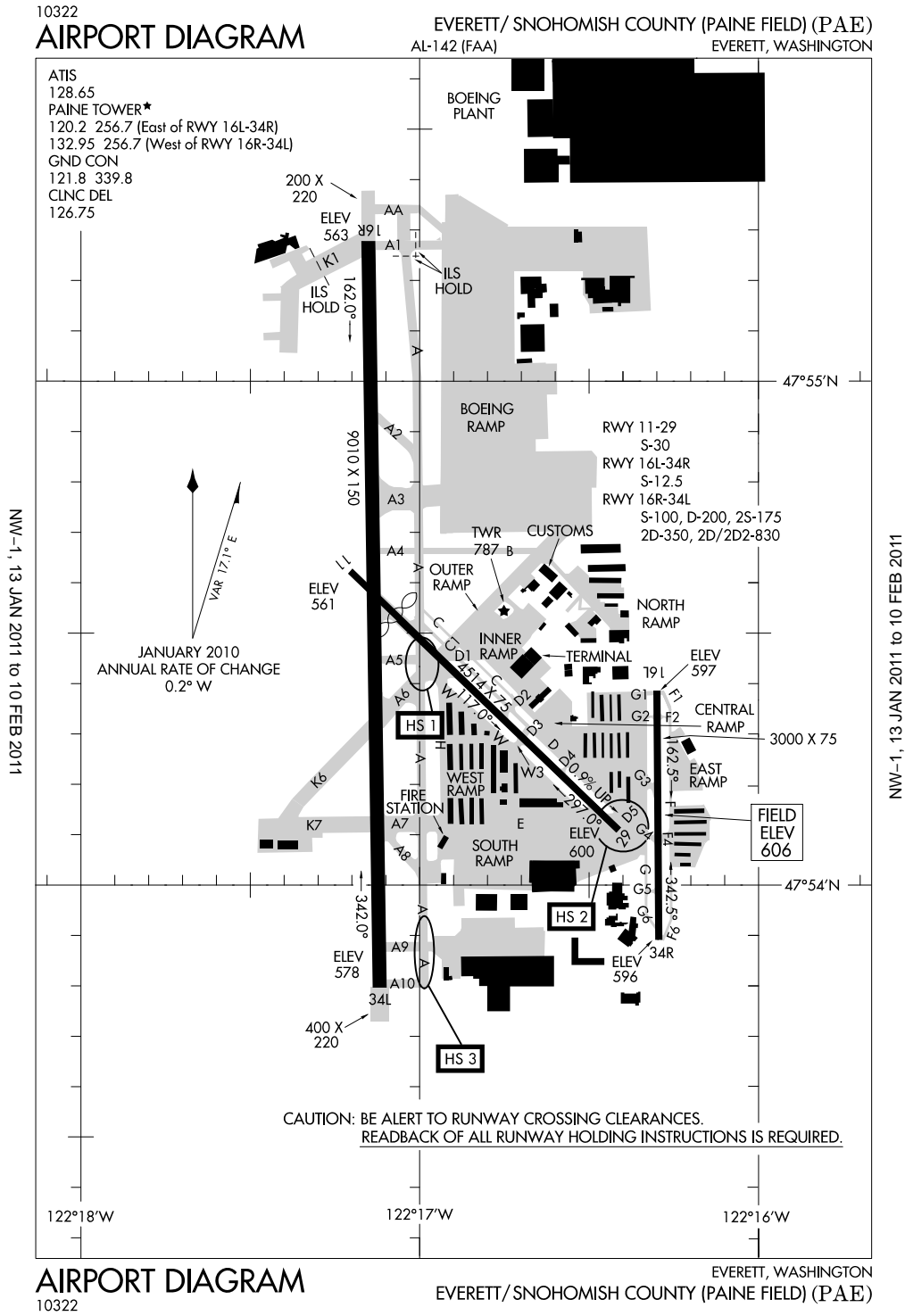

Everett, WA
Snohomish County (Paine Fld)
ICAO Identifier KPAE

AD 2.2 Aerodrome geographical and administrative data

- 2.2.1 Reference Point: 47-54-25.15N / 122-16-53.66W
- 2.2.2 From City: 6 Miles SW Of Everett, WA
- 2.2.3 Elevation: 606 ft
- 2.2.5 Magnetic variation: 20E (1990)
- 2.2.6 Airport Contact: David T Waggoner
3220 100TH ST SW
Everett, WA 98204
(425-388-5125)
- 2.2.7 Traffic: IFR/VFR

AD 2.3 Operational hours

- 2.3.1 - 2.3.11: MAY-OCT Months, ALL Days, 0700-2100 Hours

AD 2.4 Handling services and facilities

- 2.4.1 Cargo handling facilities: No
- 2.4.2 Fuel types: 100LL,A
- 2.4.4 De-icing facilities: None
- 2.4.5 Hangar space: Yes
- 2.4.6 Repair facilities: Major

AD 2.6 Rescue and firefighting services

- 2.6.1 Aerodrome category for firefighting: ARFF Index I B certified on 11/1/1974
- 2.6.4 Remarks: Airport Closed To Aircraft Operations With More Than 30 Passenger Seats 2100-0700 Except Prior Permission Required Contact Airport Operations 425-388-5110/5480. For Addl ARFF Capability Contact Airport Operations 425-388-5110.

AD 2.10 Aerodrome obstacles

- 2.10.1.a. Runway designation: 11
- 2.10.1.b Type of obstacle: Trees (9 ft). Not Lighted or Marked
- 2.10.1.c Location of obstacle: 100 ft from Centerline

- 2.10.1.a. Runway designation: 29
- 2.10.1.b Type of obstacle: Trees (46 ft). Not Lighted or Marked
- 2.10.1.c Location of obstacle: 0 ft from Centerline

- 2.10.1.a. Runway designation: 16L

- 2.10.1.b Type of obstacle: Pole (9 ft). Not Lighted or Marked
- 2.10.1.c Location of obstacle: 100 ft from Centerline

- 2.10.1.a. Runway designation: 34R
- 2.10.1.b Type of obstacle: Pole (25 ft). Not Lighted or Marked
- 2.10.1.c Location of obstacle: 125 ft from Centerline

- 2.10.1.a. Runway designation: 34L
- 2.10.1.b Type of obstacle: Trees (125 ft). Not Lighted or Marked
- 2.10.1.c Location of obstacle: 930 ft from Centerline

AD 2.12 Runway physical characteristics

- 2.12.1 Designation: 11
- 2.12.2 True Bearing: 134
- 2.12.3 Dimensions: 4514 ft x 75 ft
- 2.12.5 Coordinates: 47-54-37.49N / 122-17-12.38W
- 2.12.6 Threshold elevation: 561 ft
- 2.12.6 Touchdown zone elevation: 603 ft

- 2.12.1 Designation: 29
- 2.12.2 True Bearing: 314
- 2.12.3 Dimensions: 4514 ft x 75 ft
- 2.12.5 Coordinates: 47-54-00.00N / 122-16-24.84W
- 2.12.6 Threshold elevation: 600 ft
- 2.12.6 Touchdown zone elevation: 603 ft

- 2.12.1 Designation: 16L
- 2.12.2 True Bearing: 180
- 2.12.3 Dimensions: 3000 ft x 75 ft
- 2.12.5 Coordinates: 47-54-23.12N / 122-16-18.12W
- 2.12.6 Threshold elevation: 597 ft
- 2.12.6 Touchdown zone elevation: 606 ft

- 2.12.1 Designation: 34R
- 2.12.2 True Bearing: 360
- 2.12.3 Dimensions: 3000 ft x 75 ft
- 2.12.5 Coordinates: 47-53-53.52N / 122-16-17.78W
- 2.12.6 Threshold elevation: 596 ft
- 2.12.6 Touchdown zone elevation: 606 ft

- 2.12.1 Designation: 16R

2.12.2 True Bearing: 179
2.12.3 Dimensions: 9010 ft x 150 ft
2.12.5 Coordinates: 47-55-16.80N /
122-17-00.00W
2.12.6 Threshold elevation: 563 ft
2.12.6 Touchdown zone elevation: 570 ft

2.12.1 Designation: 34L
2.12.2 True Bearing: 359
2.12.3 Dimensions: 9010 ft x 150 ft
2.12.5 Coordinates: 47-53-47.90N /
122-17-00.00W
2.12.6 Threshold elevation: 578 ft
2.12.6 Touchdown zone elevation: 584 ft

AD 2.14 Approach and runway lighting

2.14.1 Designation: 11
2.14.4 Visual approach slope indicator system:
2-box VASI on left

2.14.1 Designation: 29
2.14.4 Visual approach slope indicator system:
2-box VASI on right

2.14.1 Designation: 16L
2.14.4 Visual approach slope indicator system:
2-light PAPI on left

2.14.1 Designation: 34R
2.14.4 Visual approach slope indicator system:
2-light PAPI on right

2.14.1 Designation: 16R
2.14.2 Approach lighting system: MALSR: 1400
feet medium intensity approach lighting system
with runway alignment indicator lights
2.14.4 Visual approach slope indicator system:
4-light PAPI on right

2.14.1 Designation: 34L
2.14.4 Visual approach slope indicator system:
4-light PAPI on left

AD 2.18 Air traffic services communication facilities

2.18.1 Service designation: LCL/P(ACFT ARR E
OF CNTRLN OR DEP RY 16L/34R)
2.18.3 Service designation: 120.2 MHz

2.18.1 Service designation: LCL/P(ACFT ARR W

OF CNTRLN OR DEP RY 16R/34L)
2.18.3 Service designation: 132.95 MHz

2.18.1 Service designation: GND/P
2.18.3 Service designation: 121.8 MHz

2.18.1 Service designation: CD/P
2.18.3 Service designation: 126.75 MHz

2.18.1 Service designation: ATIS (425-355-9797)
2.18.3 Service designation: 128.65 MHz
2.18.4 Hours of operation: 24

2.18.1 Service designation: LCL/P
2.18.3 Service designation: 256.7 MHz

2.18.1 Service designation: GND/P
2.18.3 Service designation: 339.8 MHz

2.18.1 Service designation: AR-OPNS
2.18.3 Service designation: 34.1 MHz

AD 2.19 Radio navigation and landing aids

2.19.1 ILS type: Localizer for runway 16R.
Magnetic variation: 20E
2.19.2 ILS identification: PAE
2.19.5 Coordinates: 47-53-33.98N /
122-17-00.00W
2.19.6 Site elevation: 565 ft

2.19.1 ILS type: Glide Slope for runway 16R.
Magnetic variation: 20E
2.19.2 ILS identification: PAE
2.19.5 Coordinates: 47-55-00.00N /
122-17-13.66W
2.19.6 Site elevation: 562 ft

2.19.1 ILS type: Outer Marker for runway 16R.
Magnetic variation: 20E
2.19.2 ILS identification: PAE
2.19.5 Coordinates: 48-03-10.00N /
122-17-19.50W
2.19.6 Site elevation: 99999 ft

2.19.1 ILS type: Middle Marker for runway 16R.
Magnetic variation: 20E
2.19.2 ILS identification: PAE
2.19.5 Coordinates: 47-55-53.80N /
122-17-00.00W
2.19.6 Site elevation: 99999 ft

General Remarks:

RUNWAYS 11/29 & 16L/34R CLOSED BETWEEN 2100-0700; LARGE AIRCRAFT FLY W PATTERN OVER WATER; SMALL AIRCRAFT FLY E PATTERN OVER AIRPORT.

NOISE SENSITIVE AIRPORT; FOR NOISE ABATEMENT PROCEDURES & TRAFFIC PROCEDURES CALL AIRPORT OPERATIONS 425-388-5125.

IF ACCESS TO BOEING RAMP REQUIRE CONTACT BOEING FLIGHT DISPATCH (206) 655-3421 FOR APPROVAL DURING NORMAL DUTY HRS.

IT IS REQUESTED THAT PILOTS ADHERE TO THE FOLLOWING NOISE ABATEMENT PROCEDURES UNLESS OTHERWISE INSTRUCTED BY ATCT, ITINERANT ARRIVAL AND LOW APPROACH OF SMALL AIRCRAFT OVER 250 HORSEPOWER AUTHORIZED ON RUNWAYS 29, 16L AND 34R.

BE ALERT TO CONVERGE TRAFFIC ON BASE TO FINAL LEGS RUNWAYS 16R/34L 2100-0700.

AVOID OVERFLIGHT OF BOEING RAMP - NE CORNER OF AIRPORT DUE TO JET BLAST.

TRAINING FLIGHTS DISCOURAGED AFTER 2200. RUNWAY 16R-34L TOUCH AND GO LANDING PROHIBITED MON-FRI FORM 0700-0900.

TAXIWAY ECHO LIGHTS OUT OF SERVICE INDEFINITELY.

AVOID INTERSECTION DEPS FROM RUNWAYS 16L/34R & 29. AVOID INTERSECTION DEPS FROM RUNWAY 11 EXCEPT FROM TAXIWAY DELTA 1 INTERSECTION.

FLOCKS OF LARGE & SMALL BIRDS IN THE VICINITY OF AIRPORT.

RUNWAY 34L DEPS DISCOURAGED IN CALM WIND CONDITIONS.

ITINERANT DEP OF SMALL AIRCRAFT OVER 250 HORSEPOWER ON RUNWAYS 11 AND 34R.

TAXIWAY A-2 RESTRICTED TO 30,000 LBS.

AREAS NOT VISIBLE FROM ATCT INCLUDE E EDGE OF S 1200 FT OF TAXIWAY A, TAXIWAY E FROM SE CORNER OF WEST HANGARS TO TAXIWAY A, MID SECTION OF OUTER TERMINAL RAMP, TAXIWAY H FROM NW EDGE OF WEST HANGARS TO TAXIWAY E, NE EDGE OF INNER TERMINAL RAMP.

RUNWAYS 16L/34R AND 11/29 LIMITED TO HELIPORT 8,000 LBS OR LESS.

Seattle, Washington
Seattle-Tacoma International
ICAO Identifier KSEA

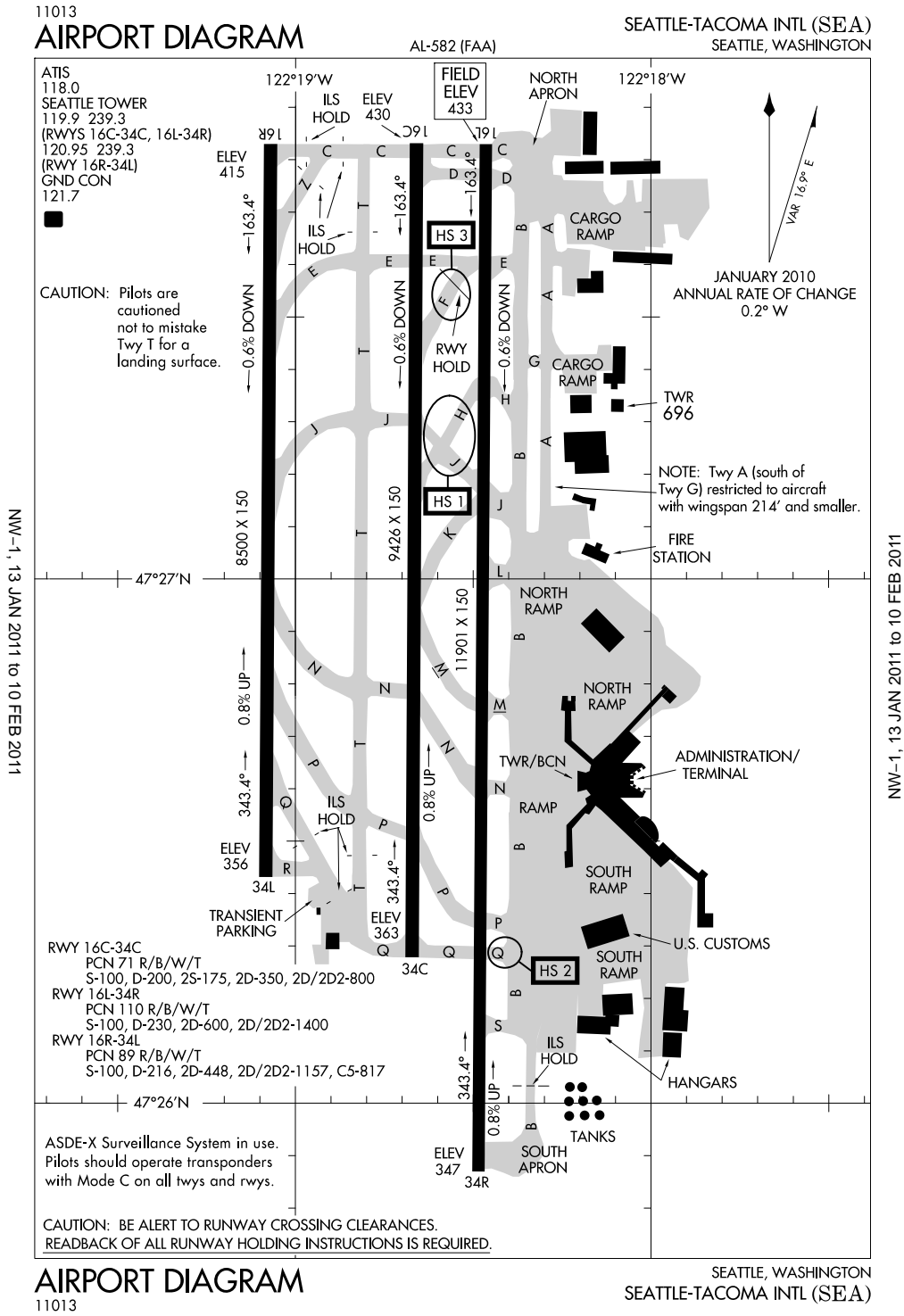

Seattle, WA
Seattle-Tacoma Intl
ICAO Identifier KSEA

AD 2.2 Aerodrome geographical and administrative data

- 2.2.1 Reference Point: 47-26-59.60N / 122-18-42.40W
- 2.2.2 From City: 10 Miles S Of Seattle, WA
- 2.2.3 Elevation: 433 ft
- 2.2.5 Magnetic variation: 17E (2010)
- 2.2.6 Airport Contact: Mark Reis
BOX 68727
Seattle, WA 98168
(206-787-4682)
- 2.2.7 Traffic: IFR/VFR

AD 2.3 Operational hours

- 2.3.1 - 2.3.11: ALL Months, ALL Days, ALL Hours

AD 2.4 Handling services and facilities

- 2.4.1 Cargo handling facilities: No
- 2.4.2 Fuel types: 100LL,A,A1
- 2.4.4 De-icing facilities: None
- 2.4.5 Hangar space: No
- 2.4.6 Repair facilities: None

AD 2.6 Rescue and firefighting services

- 2.6.1 Aerodrome category for firefighting: ARFF Index I E certified on 5/1/1973

AD 2.10 Aerodrome obstacles

- 2.10.1.a. Runway designation: 34C
- 2.10.1.b Type of obstacle: Tree (131 ft). Not Lighted or Marked
- 2.10.1.c Location of obstacle: 700 ft from Centerline

AD 2.12 Runway physical characteristics

- 2.12.1 Designation: 16R
- 2.12.2 True Bearing: 180
- 2.12.3 Dimensions: 8500 ft x 150 ft
- 2.12.4 PCN: 89 R/B/W/T
- 2.12.5 Coordinates: 47-27-49.81N / 122-19-00.00W
- 2.12.6 Threshold elevation: 415 ft
- 2.12.6 Touchdown zone elevation: 415 ft
- 2.12.7 Slope: 0.6DOWN

- 2.12.1 Designation: 34L

- 2.12.2 True Bearing: 0
- 2.12.3 Dimensions: 8500 ft x 150 ft
- 2.12.4 PCN: 89 R/B/W/T
- 2.12.5 Coordinates: 47-26-25.92N / 122-19-00.00W
- 2.12.6 Threshold elevation: 356 ft
- 2.12.6 Touchdown zone elevation: 379 ft
- 2.12.7 Slope: 0.8UP

- 2.12.1 Designation: 16L
- 2.12.2 True Bearing: 180
- 2.12.3 Dimensions: 11901 ft x 150 ft
- 2.12.4 PCN: 110 R/B/W/T
- 2.12.5 Coordinates: 47-27-49.66N / 122-18-27.90W
- 2.12.6 Threshold elevation: 432 ft
- 2.12.6 Touchdown zone elevation: 433 ft
- 2.12.7 Slope: 0.6DOWN

- 2.12.1 Designation: 34R
- 2.12.2 True Bearing: 0
- 2.12.3 Dimensions: 11901 ft x 150 ft
- 2.12.4 PCN: 110 R/B/W/T
- 2.12.5 Coordinates: 47-25-52.22N / 122-18-28.94W
- 2.12.6 Threshold elevation: 347 ft
- 2.12.6 Touchdown zone elevation: 372 ft
- 2.12.7 Slope: 0.8UP

- 2.12.1 Designation: 16C
- 2.12.2 True Bearing: 180
- 2.12.3 Dimensions: 9426 ft x 150 ft
- 2.12.4 PCN: 71 R/B/W/T
- 2.12.5 Coordinates: 47-27-49.71N / 122-18-39.55W
- 2.12.6 Threshold elevation: 430 ft
- 2.12.6 Touchdown zone elevation: 430 ft
- 2.12.7 Slope: 0.6DOWN

- 2.12.1 Designation: 34C
- 2.12.2 True Bearing: 0
- 2.12.3 Dimensions: 9426 ft x 150 ft
- 2.12.4 PCN: 71 R/B/W/T
- 2.12.5 Coordinates: 47-26-16.69N / 122-18-40.36W
- 2.12.6 Threshold elevation: 363 ft
- 2.12.6 Touchdown zone elevation: 387 ft
- 2.12.7 Slope: 0.8UP

AD 2.13 Declared distances

- 2.13.1 Designation: 16R

2.13.2 Takeoff run available: 8500
2.13.3 Takeoff distance available: 8500
2.13.4 Accelerate-stop distance available: 8500
2.13.5 Landing distance available: 8500

2.13.1 Designation: 34L
2.13.2 Takeoff run available: 8500
2.13.3 Takeoff distance available: 8500
2.13.4 Accelerate-stop distance available: 8500
2.13.5 Landing distance available: 8500

2.13.1 Designation: 16L
2.13.2 Takeoff run available: 11901
2.13.3 Takeoff distance available: 11901
2.13.4 Accelerate-stop distance available: 11901
2.13.5 Landing distance available: 11901

2.13.1 Designation: 34R
2.13.2 Takeoff run available: 11901
2.13.3 Takeoff distance available: 11901
2.13.4 Accelerate-stop distance available: 11901
2.13.5 Landing distance available: 11901

2.13.1 Designation: 16C
2.13.2 Takeoff run available: 9426
2.13.3 Takeoff distance available: 9426
2.13.4 Accelerate-stop distance available: 9426
2.13.5 Landing distance available: 9426

2.13.1 Designation: 34C
2.13.2 Takeoff run available: 9426
2.13.3 Takeoff distance available: 9426
2.13.4 Accelerate-stop distance available: 9426
2.13.5 Landing distance available: 9426

AD 2.14 Approach and runway lighting

2.14.1 Designation: 16R
2.14.2 Approach lighting system: ALSF2: Standard 2400 feet high intensity approach lighting system with sequenced flashers, category II or III configuration
2.14.4 Visual approach slope indicator system: 4-light PAPI on right

2.14.1 Designation: 34L
2.14.2 Approach lighting system: MALSR: 1400 feet medium intensity approach lighting system with runway alignment indicator lights
2.14.4 Visual approach slope indicator system: 4-light PAPI on left

2.14.1 Designation: 16L
2.14.2 Approach lighting system: ALSF2: Standard 2400 feet high intensity approach lighting system with sequenced flashers, category II or III configuration

2.14.4 Visual approach slope indicator system: 4-light PAPI on left

2.14.1 Designation: 34R
2.14.2 Approach lighting system: MALSR: 1400 feet medium intensity approach lighting system with runway alignment indicator lights
2.14.4 Visual approach slope indicator system: 4-light PAPI on left

2.14.1 Designation: 16C
2.14.2 Approach lighting system: ALSF2: Standard 2400 feet high intensity approach lighting system with sequenced flashers, category II or III configuration
2.14.4 Visual approach slope indicator system: 4-light PAPI on left

2.14.1 Designation: 34C
2.14.2 Approach lighting system: MALSR: 1400 feet medium intensity approach lighting system with runway alignment indicator lights
2.14.4 Visual approach slope indicator system: 4-light PAPI on left

AD 2.18 Air traffic services communication facilities

2.18.1 Service designation: D-ATIS
2.18.3 Service designation: 118 MHz
2.18.4 Hours of operation: 24

2.18.1 Service designation: DEP/P
2.18.3 Service designation: 119.2 MHz

2.18.1 Service designation: CLASS B
2.18.3 Service designation: 119.2 MHz

2.18.1 Service designation: CLASS B
2.18.3 Service designation: 119.2 MHz

2.18.1 Service designation: APCH/P DEP/P
2.18.3 Service designation: 120.1 MHz

2.18.1 Service designation: CLASS B
2.18.3 Service designation: 120.1 MHz

2.18.1 Service designation: CLASS B 2.18.3 Service designation: 120.4 MHz	2.18.1 Service designation: APCH/P DEP/P 2.18.3 Service designation: 290.9 MHz
2.18.1 Service designation: APCH/P DEP/P 2.18.3 Service designation: 120.4 MHz	2.18.1 Service designation: CLASS B 2.18.3 Service designation: 290.9 MHz
2.18.1 Service designation: EMERG 2.18.3 Service designation: 121.5 MHz	2.18.1 Service designation: CLASS B 2.18.3 Service designation: 290.9 MHz
2.18.1 Service designation: APCH/S DEP/S 2.18.3 Service designation: 123.9 MHz	2.18.1 Service designation: APCH/P DEP/P 2.18.3 Service designation: 290.9 MHz
2.18.1 Service designation: APCH/P DEP/P 2.18.3 Service designation: 125.9 MHz	2.18.1 Service designation: APCH/S DEP/S 2.18.3 Service designation: 338.2 MHz
2.18.1 Service designation: CLASS B 2.18.3 Service designation: 125.9 MHz	2.18.1 Service designation: CLASS B 2.18.3 Service designation: 269.125 MHz
2.18.1 Service designation: APCH/P DEP/P 2.18.3 Service designation: 125.9 MHz	2.18.1 Service designation: APCH/P DEP/P 2.18.3 Service designation: 269.125 MHz
2.18.1 Service designation: CLASS B 2.18.3 Service designation: 125.9 MHz	2.18.1 Service designation: APCH/S DEP/S 2.18.3 Service designation: 269.125 MHz
2.18.1 Service designation: GATE CTL 2.18.3 Service designation: 126.25 MHz	2.18.1 Service designation: APCH/P DEP/P 2.18.3 Service designation: 125.6 MHz
2.18.1 Service designation: APCH/P DEP/P 2.18.3 Service designation: 126.5 MHz	2.18.1 Service designation: GND CON 2.18.3 Service designation: 121.7 MHz
2.18.1 Service designation: CLASS B 2.18.3 Service designation: 126.5 MHz	2.18.1 Service designation: NORTH RAMP/CARGO 2.18.3 Service designation: 126.87 MHz
2.18.1 Service designation: EMERG 2.18.3 Service designation: 243 MHz	2.18.1 Service designation: SOUTH RAMP 2.18.3 Service designation: 122.27 MHz
2.18.1 Service designation: DEP/P 2.18.3 Service designation: 284.7 MHz	2.18.1 Service designation: APCH/P 2.18.3 Service designation: 133.65 MHz
2.18.1 Service designation: CLASS B 2.18.3 Service designation: 284.7 MHz	2.18.1 Service designation: APCH/P 2.18.3 Service designation: 273.45 MHz
2.18.1 Service designation: CLASS B 2.18.3 Service designation: 284.7 MHz	2.18.1 Service designation: LCL/P 2.18.3 Service designation: 120.95 MHz
2.18.1 Service designation: CLASS B 2.18.3 Service designation: 290.9 MHz	2.18.1 Service designation: LCL/P 2.18.3 Service designation: 119.9 MHz
2.18.1 Service designation: APCH/P DEP/P 2.18.3 Service designation: 290.9 MHz	2.18.1 Service designation: LCL/P 2.18.3 Service designation: 239.3 MHz

2.18.1 Service designation: LCL/P
2.18.3 Service designation: 239.3 MHz

2.18.1 Service designation: APCH/P DEP/P
2.18.3 Service designation: 377.15 MHz

2.18.1 Service designation: CLASS B
2.18.3 Service designation: 377.15 MHz

AD 2.19 Radio navigation and landing aids

2.19.1 ILS type: Inner Marker for runway 16R.
Magnetic variation: 17E
2.19.2 ILS identification: CJL
2.19.5 Coordinates: 47-27-58.22N /
122-19-00.00W
2.19.6 Site elevation: 379 ft

2.19.1 ILS type: Localizer for runway 16R.
Magnetic variation: 17E
2.19.2 ILS identification: CJL
2.19.5 Coordinates: 47-26-15.92N /
122-19-00.00W
2.19.6 Site elevation: 344 ft

2.19.1 ILS type: Glide Slope for runway 16R.
Magnetic variation: 17E
2.19.2 ILS identification: CJL
2.19.5 Coordinates: 47-27-38.46N /
122-19-00.00W
2.19.6 Site elevation: 406 ft

2.19.1 ILS type: DME for runway 16R. Magnetic
variation: 17E
2.19.2 ILS identification: CJL
2.19.5 Coordinates: 47-26-15.62N /
122-18-59.94W
2.19.6 Site elevation: 364 ft

2.19.1 ILS type: Localizer for runway 34L.
Magnetic variation: 17E
2.19.2 ILS identification: BEJ
2.19.5 Coordinates: 47-27-59.78N /
122-19-00.00W
2.19.6 Site elevation: 371 ft

2.19.1 ILS type: Glide Slope for runway 34L.
Magnetic variation: 17E
2.19.2 ILS identification: BEJ
2.19.5 Coordinates: 47-26-34.93N /
122-18-59.99W
2.19.6 Site elevation: 359 ft

2.19.1 ILS type: DME for runway 34L. Magnetic
variation: 17E
2.19.2 ILS identification: BEJ
2.19.5 Coordinates: 47-26-15.62N /
122-18-59.94W
2.19.6 Site elevation: 364 ft

2.19.1 ILS type: Localizer for runway 16L.
Magnetic variation: 17E
2.19.2 ILS identification: SNQ
2.19.5 Coordinates: 47-25-45.81N /
122-18-29.00W
2.19.6 Site elevation: 338 ft

2.19.1 ILS type: Glide Slope for runway 16L.
Magnetic variation: 17E
2.19.2 ILS identification: SNQ
2.19.5 Coordinates: 47-27-38.94N /
122-18-33.82W
2.19.6 Site elevation: 425 ft

2.19.1 ILS type: Middle Marker for runway 16L.
Magnetic variation: 17E
2.19.2 ILS identification: SNQ
2.19.5 Coordinates: 47-28-20.04N /
122-18-39.69W
2.19.6 Site elevation: 99999 ft

2.19.1 ILS type: Outer Marker for runway 16L.
Magnetic variation: 17E
2.19.2 ILS identification: SNQ
2.19.5 Coordinates: 47-31-56.60N /
122-18-25.00W
2.19.6 Site elevation: 99999 ft

2.19.1 ILS type: DME for runway 16L. Magnetic
variation: 17E
2.19.2 ILS identification: SNQ
2.19.5 Coordinates: 47-26-00.00N /
122-18-22.68W
2.19.6 Site elevation: 369 ft

2.19.1 ILS type: DME for runway 34R. Magnetic
variation: 17E
2.19.2 ILS identification: SEA
2.19.5 Coordinates: 47-26-00.00N /
122-18-22.68W
2.19.6 Site elevation: 369 ft

2.19.1 ILS type: Glide Slope for runway 34R.
Magnetic variation: 17E

2.19.2 ILS identification: SEA
2.19.5 Coordinates: 47-26-00.00N /
122-18-23.03W
2.19.6 Site elevation: 355 ft

2.19.1 ILS type: Middle Marker for runway 34R.
Magnetic variation: 17E
2.19.2 ILS identification: SEA
2.19.5 Coordinates: 47-25-18.10N /
122-18-29.30W
2.19.6 Site elevation: 99999 ft

2.19.1 ILS type: Localizer for runway 34R.
Magnetic variation: 17E
2.19.2 ILS identification: SEA
2.19.5 Coordinates: 47-27-54.27N /
122-18-27.86W
2.19.6 Site elevation: 428 ft

2.19.1 ILS type: Localizer for runway 16C.
Magnetic variation: 17E
2.19.2 ILS identification: SZI
2.19.5 Coordinates: 47-26-00.00N /
122-18-40.43W
2.19.6 Site elevation: 355 ft

2.19.1 ILS type: DME for runway 16C. Magnetic
variation: 17E
2.19.2 ILS identification: SZI
2.19.5 Coordinates: 47-26-00.00N /
122-18-44.23W
2.19.6 Site elevation: 370 ft

2.19.1 ILS type: Glide Slope for runway 16C.
Magnetic variation: 17E
2.19.2 ILS identification: SZI
2.19.5 Coordinates: 47-27-38.69N /
122-18-45.46W
2.19.6 Site elevation: 418 ft

2.19.1 ILS type: Outer Marker for runway 16C.
Magnetic variation: 17E
2.19.2 ILS identification: SZI
2.19.5 Coordinates: 47-31-56.59N /
122-18-25.04W

2.19.6 Site elevation: 99999 ft

2.19.1 ILS type: Inner Marker for runway 16C.
Magnetic variation: 17E
2.19.2 ILS identification: SZI
2.19.5 Coordinates: 47-27-58.58N /
122-18-39.29W
2.19.6 Site elevation: 99999 ft

2.19.1 ILS type: Middle Marker for runway 16C.
Magnetic variation: 17E
2.19.2 ILS identification: SZI
2.19.5 Coordinates: 47-28-20.04N /
122-18-39.69W
2.19.6 Site elevation: 99999 ft

2.19.1 ILS type: Localizer for runway 34C.
Magnetic variation: 17E
2.19.2 ILS identification: TUC
2.19.5 Coordinates: 47-27-54.35N /
122-18-39.51W
2.19.6 Site elevation: 422 ft

2.19.1 ILS type: DME for runway 34C. Magnetic
variation: 17E
2.19.2 ILS identification: TUC
2.19.5 Coordinates: 47-26-00.00N /
122-18-44.23W
2.19.6 Site elevation: 370 ft

2.19.1 ILS type: Glide Slope for runway 34C.
Magnetic variation: 17E
2.19.2 ILS identification: TUC
2.19.5 Coordinates: 47-26-25.60N /
122-18-46.17W
2.19.6 Site elevation: 367 ft

2.19.1 ILS type: Middle Marker for runway 34C.
Magnetic variation: 17E
2.19.2 ILS identification: TUC
2.19.5 Coordinates: 47-25-49.76N /
122-18-42.14W
2.19.6 Site elevation: 289 ft

General Remarks:

BIRD FLOCKS WITHIN AIRPORT VICINITY – CHECK LOCAL ADVISORYS.

FLIGHT NOTIFICATION SERVICE (ADCUS) AVAILABLE.

BETWEEN THE HRS OF 2200-0700 THE USE OF EXTENDED REVERSE THRUST IS DISCOURAGED BEYOND WHAT IS NECESSARY FOR OPERATIONAL OR SAFETY REASONS. NOISE ABATEMENT PROCEDURES IN EFFECT BETWEEN 2200-0600. FOR FURTHER INFORMATION CONTACT SEA NOISE ABATEMENT OFFICE AT 206-787-7496.

HELICOPTERS LANDING & DEPARTING AVOID OVERFLYING FUEL FARM LOCATED AT THE SE CORNER OF THE AIRPORT.

(E110) CONTINUOUS POWER AIRPORT.

(E94) WSO/WSFO.

TAXIWAY A SOUTH OF TAXIWAY G RESTRICTED TO AIRCRAFT WITH WINGSPAN 225 FT AND SMALLER.

DO NOT MISTAKE TAXIWAY T FOR LANDING SURFACE.

ACCESS TO AIR CARGO 4 PARKING AND CARGO AREAS RESTRICTED TO AIRCRAFT WITH WINGSPANS OF 118 FT OR LESS.

TAXIWAY FOR CORPORATE HANGAR RAMP LIMITED TO AIRCRAFT WITH 104 FT OR LESS WINGSPAN FOR TAXI OPERATIONS. GA CUSTOMS PARKING IS VERY LIMITED.

ASDE-X SURVEILLANCE SYSTEM IN USE: PILOTS SHOULD OPERATE TRANSPONDERS WITH MODE C ON ALL TAXIWAYS AND RUNWAYS.

PRIOR PERMISSION REQUIRED FOR ALL GENERAL AVIATION PARKING AND SERVICES, CONTACT 206-433-5481.

Spokane, Washington Spokane International ICAO Identifier KEGG

10322

AIRPORT DIAGRAM

AL-403 (FAA)

SPOKANE INTL (GEG)
SPOKANE, WASHINGTON

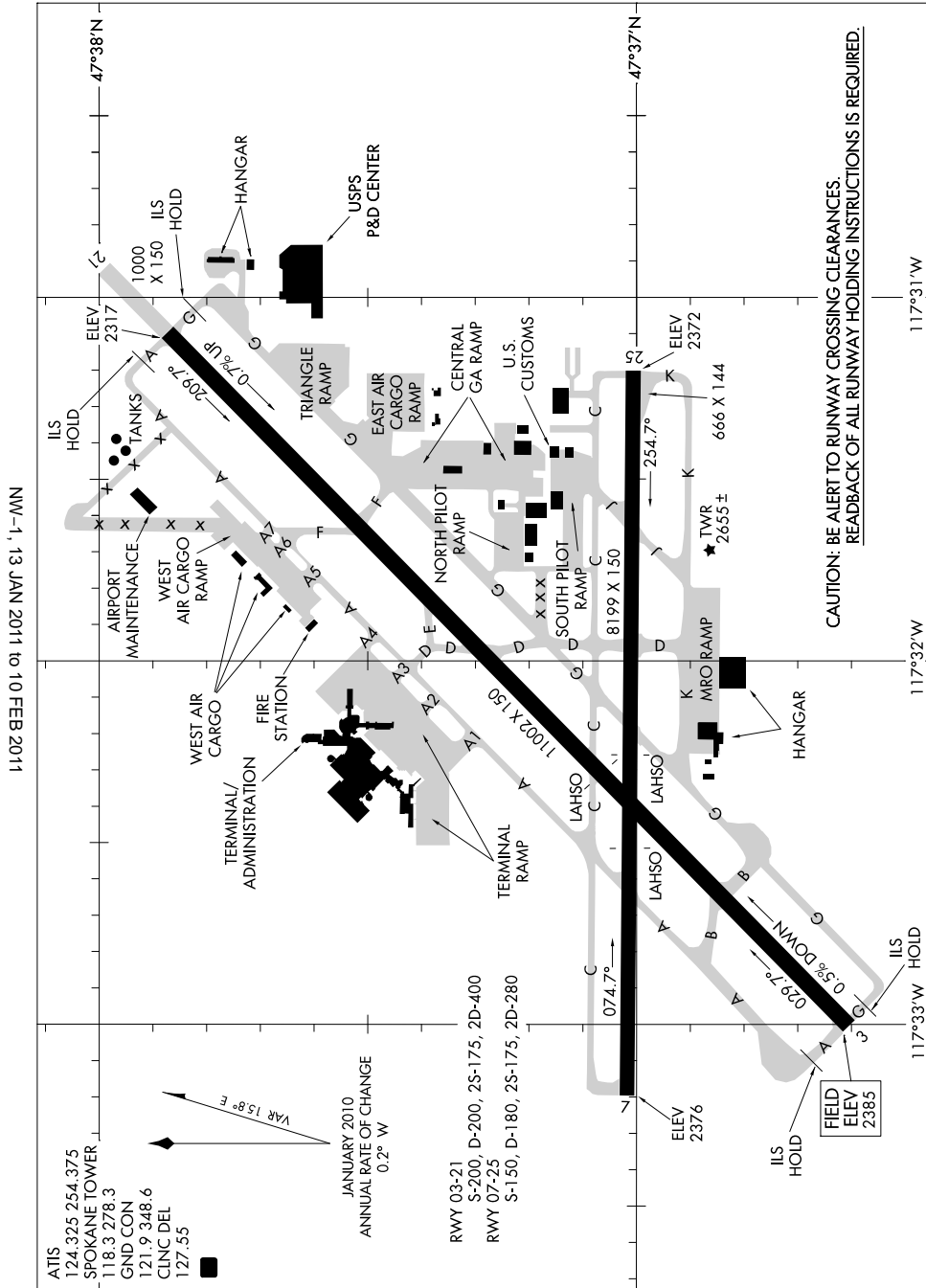

NW-1, 13 JAN 2011 to 10 FEB 2011

NW-1, 13 JAN 2011 to 10 FEB 2011

AIRPORT DIAGRAM

SPOKANE, WASHINGTON
SPOKANE INTL (GEG)

10322

Spokane, WA
Spokane Intl
ICAO Identifier KEGG

AD 2.2 Aerodrome geographical and administrative data

- 2.2.1 Reference Point: 47-37-00.00N / 117-32-00.00W
- 2.2.2 From City: 5 Miles SW Of Spokane, WA
- 2.2.3 Elevation: 2385 ft
- 2.2.5 Magnetic variation: 18E (2000)
- 2.2.6 Airport Contact: Neal Sealock
9000 W AIRPORT DR.
Spokane, WA 99224
(509-455-6455)
- 2.2.7 Traffic: IFR/VFR

AD 2.3 Operational hours

- 2.3.1 - 2.3.11: ALL Months, ALL Days, 0600-2200 Hours

AD 2.4 Handling services and facilities

- 2.4.1 Cargo handling facilities: No
- 2.4.2 Fuel types: 100,100LL,A
- 2.4.4 De-icing facilities: None
- 2.4.5 Hangar space: Yes
- 2.4.6 Repair facilities: Major

AD 2.6 Rescue and firefighting services

- 2.6.1 Aerodrome category for firefighting: ARFF Index I B certified on 5/1/1973

AD 2.10 Aerodrome obstacles

- 2.10.1.a. Runway designation: 21
- 2.10.1.b Type of obstacle: Gnd (9 ft). Not Lighted or Marked
- 2.10.1.c Location of obstacle: 500 ft from Centerline
- 2.10.1.a. Runway designation: 25
- 2.10.1.b Type of obstacle: Tree (69 ft). Not Lighted or Marked
- 2.10.1.c Location of obstacle: 365 ft from Centerline

AD 2.12 Runway physical characteristics

- 2.12.1 Designation: 03
- 2.12.2 True Bearing: 45
- 2.12.3 Dimensions: 11002 ft x 150 ft
- 2.12.5 Coordinates: 47-36-36.29N / 117-33-00.00W

- 2.12.6 Threshold elevation: 2385 ft
- 2.12.6 Touchdown zone elevation: 2385 ft
- 2.12.7 Slope: 0.7DOWN

- 2.12.1 Designation: 21
- 2.12.2 True Bearing: 225
- 2.12.3 Dimensions: 11002 ft x 150 ft
- 2.12.5 Coordinates: 47-37-52.38N / 117-31-00.00W
- 2.12.6 Threshold elevation: 2317 ft
- 2.12.6 Touchdown zone elevation: 2346 ft
- 2.12.7 Slope: 0.7UP

- 2.12.1 Designation: 07
- 2.12.2 True Bearing: 90
- 2.12.3 Dimensions: 8199 ft x 150 ft
- 2.12.5 Coordinates: 47-37-00.00N / 117-33-11.76W
- 2.12.6 Threshold elevation: 2376 ft
- 2.12.6 Touchdown zone elevation: 2376 ft

- 2.12.1 Designation: 25
- 2.12.2 True Bearing: 270
- 2.12.3 Dimensions: 8199 ft x 150 ft
- 2.12.5 Coordinates: 47-37-00.00N / 117-31-12.10W
- 2.12.6 Threshold elevation: 2372 ft
- 2.12.6 Touchdown zone elevation: 2373 ft

AD 2.13 Declared distances

- 2.13.1 Designation: 21
- 2.13.2 Takeoff run available: 11002
- 2.13.3 Takeoff distance available: 11002
- 2.13.4 Accelerate-stop distance available: 11002
- 2.13.5 Landing distance available: 11002

- 2.13.1 Designation: 07
- 2.13.2 Takeoff run available: 8199
- 2.13.3 Takeoff distance available: 8199
- 2.13.4 Accelerate-stop distance available: 8199
- 2.13.5 Landing distance available: 8199

- 2.13.1 Designation: 25
- 2.13.2 Takeoff run available: 8199
- 2.13.3 Takeoff distance available: 8199
- 2.13.4 Accelerate-stop distance available: 8199
- 2.13.5 Landing distance available: 8199

AD 2.14 Approach and runway lighting

- 2.14.1 Designation: 03
- 2.14.2 Approach lighting system: ALSF2: Standard

2400 feet high intensity approach lighting system with sequenced flashers, category II or III configuration

2.14.4 Visual approach slope indicator system: 4-light PAPI on left

2.14.1 Designation: 21

2.14.2 Approach lighting system: ALSF2: Standard 2400 feet high intensity approach lighting system with sequenced flashers, category II or III configuration

2.14.4 Visual approach slope indicator system: 4-light PAPI on left

2.14.10 Remarks: ALSF 2 May Be Operated As SSALR During Favorable Wx Conditions.

2.14.1 Designation: 07

2.14.4 Visual approach slope indicator system: 4-box VASI on left

2.14.1 Designation: 25

2.14.4 Visual approach slope indicator system: 4-light PAPI on left

AD 2.18 Air traffic services communication facilities

2.18.1 Service designation: LCL/P

2.18.3 Service designation: 118.3 MHz

2.18.1 Service designation: EMERG

2.18.3 Service designation: 121.5 MHz

2.18.1 Service designation: GND/P

2.18.3 Service designation: 121.9 MHz

2.18.1 Service designation: APCH/P DEP/P CLASS C IC

2.18.3 Service designation: 123.75 MHz

2.18.1 Service designation: ATIS

2.18.3 Service designation: 124.325 MHz

2.18.4 Hours of operation: 24

2.18.1 Service designation: CD/P

2.18.3 Service designation: 127.55 MHz

2.18.1 Service designation: APCH/P DEP/P CLASS C IC

2.18.3 Service designation: 133.35 MHz

2.18.1 Service designation: EMERG

2.18.3 Service designation: 243 MHz

2.18.1 Service designation: ATIS

2.18.3 Service designation: 254.375 MHz

2.18.4 Hours of operation: 24

2.18.1 Service designation: APCH/P DEP/P CLASS C IC

2.18.3 Service designation: 263 MHz

2.18.1 Service designation: APCH/P DEP/P CLASS C IC

2.18.3 Service designation: 282.25 MHz

2.18.1 Service designation: GND/P

2.18.3 Service designation: 348.6 MHz

2.18.1 Service designation: APCH/S DEP/S

2.18.3 Service designation: 372.9 MHz

2.18.1 Service designation: LCL/P

2.18.3 Service designation: 278.3 MHz

AD 2.19 Radio navigation and landing aids

2.19.1 ILS type: DME for runway 03. Magnetic variation: 16E

2.19.2 ILS identification: OIJ

2.19.5 Coordinates: 47-36-32.05N / 117-33-15.10W

2.19.6 Site elevation: 2371 ft

2.19.1 ILS type: Inner Marker for runway 03. Magnetic variation: 16E

2.19.2 ILS identification: OIJ

2.19.5 Coordinates: 47-36-30.06N / 117-33-00.00W

2.19.6 Site elevation: 2381 ft

2.19.1 ILS type: Localizer for runway 03. Magnetic variation: 16E

2.19.2 ILS identification: OIJ

2.19.5 Coordinates: 47-37-59.15N / 117-30-55.57W

2.19.6 Site elevation: 2313 ft

2.19.1 ILS type: Middle Marker for runway 03. Magnetic variation: 16E

2.19.2 ILS identification: OIJ

2.19.5 Coordinates: 47-36-29.40N / 117-33-10.64W

2.19.6 Site elevation: 2378 ft

2.19.1 ILS type: Glide Slope for runway 03.
Magnetic variation: 16E

117-30-49.60W
2.19.6 Site elevation: 96 ft

2.19.2 ILS identification: OLJ
2.19.5 Coordinates: 47-36-47.56N /
117-32-51.88W
2.19.6 Site elevation: 2372 ft

2.19.1 ILS type: Outer Marker for runway 21.
Magnetic variation: 16E
2.19.2 ILS identification: GEG
2.19.5 Coordinates: 47-40-37.34N /
117-27-00.00W
2.19.6 Site elevation: 99999 ft

2.19.1 ILS type: Localizer for runway 21. Magnetic
variation: 16E
2.19.2 ILS identification: GEG
2.19.5 Coordinates: 47-36-29.20N /
117-33-10.95W
2.19.6 Site elevation: 2380 ft

2.19.1 ILS type: DME for runway 21. Magnetic
variation: 16E
2.19.2 ILS identification: GEG
2.19.5 Coordinates: 47-36-32.05N /
117-33-15.10W
2.19.6 Site elevation: 2381 ft

2.19.1 ILS type: Glide Slope for runway 21.
Magnetic variation: 16E
2.19.2 ILS identification: GEG
2.19.5 Coordinates: 47-37-48.69N /
117-31-19.65W
2.19.6 Site elevation: 2322 ft

2.19.1 ILS type: Middle Marker for runway 21.
Magnetic variation: 16E
2.19.2 ILS identification: GEG
2.19.5 Coordinates: 47-38-17.00N /
117-30-28.90W
2.19.6 Site elevation: 99999 ft

2.19.1 ILS type: Inner Marker for runway 21.
Magnetic variation: 16E
2.19.2 ILS identification: GEG
2.19.5 Coordinates: 47-38-00.00N /

General Remarks:

BE ALERT TO TURBULENCE OVER SMOKE STACKS 1 MILE EAST OF AIRPORT.

WATERFOWL & BIRDS ON & IN THE VICINITY OF AIRPORT.

TAXIWAY K UNLIGHTED ON RAMP SIDE ALONG MAINTENANCE RAMP AND IS
UNAVAILABLE BELOW 1200 RUNWAY VISUAL RANGE UNLESS UNDER ESCORT BY "FOLLOW
ME".

TAXIWAY "H" RESTRICTED TO WINGSPAN OF 75 FT OR LESS.

Milwaukee, WI
General Mitchell Intl
ICAO Identifier KMKE

AD 2.2 Aerodrome geographical and administrative data

- 2.2.1 Reference Point: 42-56-49.96N / 87-53-48.23W
- 2.2.2 From City: 5 Miles S Of Milwaukee, WI
- 2.2.3 Elevation: 723 ft
- 2.2.5 Magnetic variation: 2W (1995)
- 2.2.6 Airport Contact: C.B. Bateman
5300 S HOWELL AVE
Milwaukee, WI 53207
(414-747-5300)
- 2.2.7 Traffic: IFR/VFR

AD 2.3 Operational hours

- 2.3.1 - 2.3.11: ALL Months, ALL Days, ALL Hours

AD 2.4 Handling services and facilities

- 2.4.1 Cargo handling facilities: No
- 2.4.2 Fuel types: 100LL,A
- 2.4.4 De-icing facilities: None
- 2.4.5 Hangar space: Yes
- 2.4.6 Repair facilities: Major

AD 2.6 Rescue and firefighting services

- 2.6.1 Aerodrome category for firefighting: ARFF Index I C certified on 5/1/1973
- 2.6.4 Remarks: ARFF Index D Equip Available Upon Request.

AD 2.10 Aerodrome obstacles

- 2.10.1.a. Runway designation: 13
- 2.10.1.b Type of obstacle: Pole (33 ft). Lighted
- 2.10.1.c Location of obstacle: 69 ft from Centerline

- 2.10.1.a. Runway designation: 31
- 2.10.1.b Type of obstacle: Rr (42 ft). Lighted
- 2.10.1.c Location of obstacle: 295 ft from Centerline

- 2.10.1.a. Runway designation: 07L
- 2.10.1.b Type of obstacle: Tree (44 ft). Not Lighted or Marked
- 2.10.1.c Location of obstacle: 187 ft from Centerline

- 2.10.1.a. Runway designation: 25R

- 2.10.1.b Type of obstacle: Pole (77 ft). Lighted
- 2.10.1.c Location of obstacle: 195 ft from Centerline

- 2.10.1.a. Runway designation: 07R
- 2.10.1.b Type of obstacle: Tree (80 ft). Not Lighted or Marked
- 2.10.1.c Location of obstacle: 305 ft from Centerline

- 2.10.1.a. Runway designation: 25L
- 2.10.1.b Type of obstacle: Pole (41 ft). Lighted
- 2.10.1.c Location of obstacle: 464 ft from Centerline

- 2.10.1.a. Runway designation: 19L
- 2.10.1.b Type of obstacle: Tree (125 ft). Not Lighted or Marked
- 2.10.1.c Location of obstacle: 463 ft from Centerline

- 2.10.1.a. Runway designation: 01L
- 2.10.1.b Type of obstacle: Tree (82 ft). Not Lighted or Marked
- 2.10.1.c Location of obstacle: 985 ft from Centerline

- 2.10.1.a. Runway designation: 19R
- 2.10.1.b Type of obstacle: Fence (6 ft). Not Lighted or Marked
- 2.10.1.c Location of obstacle: 404 ft from Centerline

AD 2.12 Runway physical characteristics

- 2.12.1 Designation: 13
- 2.12.2 True Bearing: 132
- 2.12.3 Dimensions: 5538 ft x 150 ft
- 2.12.5 Coordinates: 42-57-29.28N / 87-54-12.33W
- 2.12.6 Threshold elevation: 671 ft
- 2.12.6 Touchdown zone elevation: 670 ft

- 2.12.1 Designation: 31
- 2.12.2 True Bearing: 312
- 2.12.3 Dimensions: 5538 ft x 150 ft
- 2.12.5 Coordinates: 42-56-52.50N / 87-53-17.21W
- 2.12.6 Threshold elevation: 670 ft
- 2.12.6 Touchdown zone elevation: 670 ft

- 2.12.1 Designation: 07L

2.12.2 True Bearing: 72
2.12.3 Dimensions: 4800 ft x 100 ft
2.12.5 Coordinates: 42-57-00.00N /
87-54-19.15W
2.12.6 Threshold elevation: 672 ft
2.12.6 Touchdown zone elevation: 672 ft

2.12.1 Designation: 25R
2.12.2 True Bearing: 252
2.12.3 Dimensions: 4800 ft x 100 ft
2.12.5 Coordinates: 42-57-24.81N /
87-53-17.88W
2.12.6 Threshold elevation: 674 ft
2.12.6 Touchdown zone elevation: 674 ft

2.12.1 Designation: 07R
2.12.2 True Bearing: 72
2.12.3 Dimensions: 7761 ft x 150 ft
2.12.5 Coordinates: 42-56-22.34N /
87-54-57.05W
2.12.6 Threshold elevation: 723 ft
2.12.6 Touchdown zone elevation: 723 ft

2.12.1 Designation: 25L
2.12.2 True Bearing: 252
2.12.3 Dimensions: 7761 ft x 150 ft
2.12.5 Coordinates: 42-56-46.46N /
87-53-18.02W
2.12.6 Threshold elevation: 670 ft
2.12.6 Touchdown zone elevation: 683 ft

2.12.1 Designation: 01R
2.12.2 True Bearing: 7
2.12.3 Dimensions: 4183 ft x 150 ft
2.12.5 Coordinates: 42-56-21.76N /
87-53-32.51W
2.12.6 Threshold elevation: 677 ft
2.12.6 Touchdown zone elevation: 677 ft

2.12.1 Designation: 19L
2.12.2 True Bearing: 187
2.12.3 Dimensions: 4183 ft x 150 ft
2.12.5 Coordinates: 42-57-00.00N /
87-53-25.49W
2.12.6 Threshold elevation: 670 ft
2.12.6 Touchdown zone elevation: 674 ft

2.12.1 Designation: 01L
2.12.2 True Bearing: 7
2.12.3 Dimensions: 9690 ft x 200 ft
2.12.5 Coordinates: 42-55-52.73N /

87-53-51.02W
2.12.6 Threshold elevation: 704 ft
2.12.6 Touchdown zone elevation: 704 ft

2.12.1 Designation: 19R
2.12.2 True Bearing: 187
2.12.3 Dimensions: 9690 ft x 200 ft
2.12.5 Coordinates: 42-57-27.70N /
87-53-34.78W
2.12.6 Threshold elevation: 673 ft
2.12.6 Touchdown zone elevation: 672 ft

AD 2.13 Declared distances

2.13.1 Designation: 13
2.13.2 Takeoff run available: 5538
2.13.3 Takeoff distance available: 5538
2.13.4 Accelerate-stop distance available: 5538
2.13.5 Landing distance available: 4797

2.13.1 Designation: 31
2.13.2 Takeoff run available: 5538
2.13.3 Takeoff distance available: 5538
2.13.4 Accelerate-stop distance available: 5538
2.13.5 Landing distance available: 5334

2.13.1 Designation: 07R
2.13.2 Takeoff run available: 7761
2.13.3 Takeoff distance available: 7761
2.13.4 Accelerate-stop distance available: 7761
2.13.5 Landing distance available: 7761

2.13.1 Designation: 25L
2.13.2 Takeoff run available: 7761
2.13.3 Takeoff distance available: 7761
2.13.4 Accelerate-stop distance available: 7761
2.13.5 Landing distance available: 7328

2.13.1 Designation: 19R
2.13.2 Takeoff run available: 690
2.13.3 Takeoff distance available: 9690
2.13.4 Accelerate-stop distance available: 9690
2.13.5 Landing distance available: 8950

AD 2.14 Approach and runway lighting

2.14.1 Designation: 13
2.14.4 Visual approach slope indicator system:
4-light PAPI on left

2.14.1 Designation: 31
2.14.4 Visual approach slope indicator system:
4-light PAPI on right

2.14.1 Designation: 07L
2.14.4 Visual approach slope indicator system:
4-box VASI on left

2.14.1 Designation: 25R
2.14.4 Visual approach slope indicator system:
4-light PAPI on right

2.14.1 Designation: 07R
2.14.2 Approach lighting system: MALSR: 1400
feet medium intensity approach lighting system
with runway alignment indicator lights
2.14.4 Visual approach slope indicator system:
4-light PAPI on left

2.14.1 Designation: 25L
2.14.4 Visual approach slope indicator system:
4-light PAPI on left

2.14.1 Designation: 01L
2.14.2 Approach lighting system: ALSF2: Standard
2400 feet high intensity approach lighting system
with sequenced flashers, category II or III
configuration
2.14.4 Visual approach slope indicator system:
4-light PAPI on right

2.14.1 Designation: 19R
2.14.2 Approach lighting system: MALSR: 1400
feet medium intensity approach lighting system
with runway alignment indicator lights
2.14.4 Visual approach slope indicator system:
4-light PAPI on right

AD 2.18 Air traffic services communication facilities

2.18.1 Service designation: APCH/P CLASS C
2.18.3 Service designation: 118 MHz

2.18.1 Service designation: LCL/P
2.18.3 Service designation: 119.1 MHz

2.18.1 Service designation: DEP/P
2.18.3 Service designation: 119.65 MHz

2.18.1 Service designation: CD/P
2.18.3 Service designation: 120.8 MHz

2.18.1 Service designation: EMERG
2.18.3 Service designation: 121.5 MHz

2.18.1 Service designation: GND/P
2.18.3 Service designation: 121.8 MHz

2.18.1 Service designation: DEP/P
2.18.3 Service designation: 125.35 MHz

2.18.1 Service designation: D-ATIS
2.18.3 Service designation: 126.4 MHz
2.18.4 Hours of operation: 24

2.18.1 Service designation: APCH/P CLASS C IC
2.18.3 Service designation: 126.5 MHz

2.18.1 Service designation: AS ASSIGNED
2.18.3 Service designation: 127.85 MHz

2.18.1 Service designation: OPNS
2.18.3 Service designation: 139.5 MHz

2.18.1 Service designation: EMERG
2.18.3 Service designation: 243 MHz

2.18.1 Service designation: APCH/P DEP/P
CLASS C IC
2.18.3 Service designation: 307 MHz

2.18.1 Service designation: LCL/P
2.18.3 Service designation: 325.8 MHz

2.18.1 Service designation: GND/P
2.18.3 Service designation: 263.125 MHz

2.18.1 Service designation: APCH/P DEP/P
CLASS C
2.18.3 Service designation: 317.725 MHz

2.18.1 Service designation: OPNS
2.18.3 Service designation: 311 MHz

2.18.1 Service designation: 128ARW (ANG) CMD
POST
2.18.3 Service designation: 321 MHz

2.18.1 Service designation: UPSET CTL
2.18.3 Service designation: 6761 MHz

2.18.1 Service designation: APCH/P DEP/P
2.18.3 Service designation: 127 MHz

2.18.1 Service designation: APCH/P DEP/P
2.18.3 Service designation: 263.075 MHz

AD 2.19 Radio navigation and landing aids

2.19.1 ILS type: DME for runway 07R. Magnetic variation: 2W

2.19.2 ILS identification: GMF

2.19.5 Coordinates: 42-56-22.80N / 87-55-00.00W

2.19.6 Site elevation: 730 ft

2.19.1 ILS type: Glide Slope for runway 07R. Magnetic variation: 2W

2.19.2 ILS identification: GMF

2.19.5 Coordinates: 42-56-22.25N / 87-54-40.36W

2.19.6 Site elevation: 706 ft

2.19.1 ILS type: Outer Marker for runway 07R. Magnetic variation: 2W

2.19.2 ILS identification: GMF

2.19.5 Coordinates: 42-54-32.56N / 88-02-27.51W

2.19.6 Site elevation: 99999 ft

2.19.1 ILS type: Middle Marker for runway 07R. Magnetic variation: 2W

2.19.2 ILS identification: GMF

2.19.5 Coordinates: 42-56-12.13N / 87-55-35.49W

2.19.6 Site elevation: 744 ft

2.19.1 ILS type: Localizer for runway 07R. Magnetic variation: 2W

2.19.2 ILS identification: GMF

2.19.5 Coordinates: 42-56-48.89N / 87-53-00.00W

2.19.6 Site elevation: 668 ft

2.19.1 ILS type: DME for runway 25L. Magnetic variation: 2W

2.19.2 ILS identification: PXY

2.19.5 Coordinates: 42-56-22.86N / 87-55-00.00W

2.19.6 Site elevation: 720 ft

2.19.1 ILS type: Localizer for runway 25L. Magnetic variation: 2W

2.19.2 ILS identification: PXY

2.19.5 Coordinates: 42-56-19.99N / 87-55-00.00W

2.19.6 Site elevation: 720 ft

2.19.1 ILS type: Localizer for runway 01L.

Magnetic variation: 2W

2.19.2 ILS identification: MKE

2.19.5 Coordinates: 42-57-49.95N / 87-53-30.97W

2.19.6 Site elevation: 713 ft

2.19.1 ILS type: Glide Slope for runway 01L. Magnetic variation: 2W

2.19.2 ILS identification: MKE

2.19.5 Coordinates: 42-56-00.00N / 87-53-43.04W

2.19.6 Site elevation: 691 ft

2.19.1 ILS type: Outer Marker for runway 01L. Magnetic variation: 2W

2.19.2 ILS identification: MKE

2.19.5 Coordinates: 42-50-22.60N / 87-54-46.83W

2.19.6 Site elevation: 678 ft

2.19.1 ILS type: Inner Marker for runway 01L. Magnetic variation: 2W

2.19.2 ILS identification: MKE

2.19.5 Coordinates: 42-55-44.65N / 87-53-52.40W

2.19.6 Site elevation: 99999 ft

2.19.1 ILS type: Middle Marker for runway 01L. Magnetic variation: 2W

2.19.2 ILS identification: MKE

2.19.5 Coordinates: 42-55-26.50N / 87-53-55.50W

2.19.6 Site elevation: 701 ft

2.19.1 ILS type: DME for runway 01L. Magnetic variation: 2W

2.19.2 ILS identification: MKE

2.19.5 Coordinates: 42-57-50.93N / 87-53-27.40W

2.19.6 Site elevation: 714 ft

2.19.1 ILS type: Localizer for runway 19R. Magnetic variation: 2W

2.19.2 ILS identification: BLY

2.19.5 Coordinates: 42-55-38.30N / 87-53-53.48W

2.19.6 Site elevation: 710 ft

2.19.1 ILS type: Glide Slope for runway 19R. Magnetic variation: 2W

2.19.2 ILS identification: BLY

2.19.5 Coordinates: 42-57-00.00N /
87-53-32.52W
2.19.6 Site elevation: 666 ft

2.19.1 ILS type: Middle Marker for runway 19R.
Magnetic variation: 2W
2.19.2 ILS identification: BLY
2.19.5 Coordinates: 42-57-46.59N /
87-53-31.53W

2.19.6 Site elevation: 99999 ft

2.19.1 ILS type: Outer Marker for runway 19R.
Magnetic variation: 2W
2.19.2 ILS identification: BLY
2.19.5 Coordinates: 43-03-36.06N /
87-52-36.26W
2.19.6 Site elevation: 99999 ft

General Remarks:

RUNWAY 07L/25R CLOSED TO ALL JET AIRCRAFT.

TAXIWAY 'A' CLOSED FROM TAXIWAY 'R' TO 'E' & TAXIWAY 'E' CLOSED FROM TAXIWAY 'T' TO 'M' AND TAXIWAY 'T' CLOSED NORTH RUNWAY 07R/25L AIRCRAFT WITH TAIL HEIGHT GREATER THAN 54.5 FT DURING CAT II & III OPERATIONS.

RUNWAY 13/31 CLOSED JET AIRCRAFT WITHOUT PRIOR PERMISSION REQUIRED AIRPORT MANAGER - CALL 414-747-5325.

TRAINING FLIGHTS INVOLVING SUCCESSIVE USE OF ANY RUNWAY PROHIBITED 2200-0600.

RUNWAYS 13/31 & 01R/19L & 07L/25R CLOSED EXCEPT LIGHT WEIGHT SINGLE ENGINE AIRCRAFT 2200-0600 DAILY.

BIRDS ON & IN THE VICINITY OF AIRPORT.

PREFERRED USAGE BY AIRCRAFT BETWEEN 2200-0600 IS TAKE-OFF RUNWAY 19R & LANDING RUNWAY 01L.

ALL APPROACHES ARE OVER NOISE SENSITIVE AREAS; ALL TURBOJET AIRCRAFT SHOULD REFRAIN FROM CONDUCTING MULTI VFR TRAFFIC PATTERN APPROACHES & DEPS WITHOUT PRIOR APPROVAL FROM AIRPORT MANAGER CALL C414-747-5325.

ANG: PRIOR PERMISSION REQUIRED ALL AIRCRAFT, 48HR PRIOR NOTICE, CONTACT AIRFIELD OPERATIONS DSN 580-8241, C414-944-8241. 128ARW IS A FULLY OPERATIONAL KC-135R BASE WITH HRS OF OPERATION MON-FRI 1200Z-1930Z. CLOSED HOLIDAYS, SAT-SUN (EXCEPT UTA'S), CALL FOR AVAILABILITY.

ANG: ANY MDS'S (OTHER THAN KC-135) IS LIMITED TO STANDARD TRANSIENT MARSHALLING AND PARKING. NO TECHNICAL DATA AVAILABLE FOR TRANSIENT MAINTENANCE. FUEL AND AGE EQUIPMENT SUPPORT AVAILABLE FOR SELF-SERVICE. THERE ARE NO ADDITIONAL CONFIGURATION ITEMS SUPPORTED SUCH AS LANTIRN PODS, EDM PODS, ETC.

ANG: END OF RUNWAY FACILITIES, AIRCRAFT SHELTERS/REVTMENTS, AND ALERT FACILITIES ARE NOT AVAILABLE. AIRFIELD/AIRCRAFT PARKING CONCERNS INCLUDE: LIMITED STATIC GROUNDING POINTS AND NO AIRCRAFT TIE DOWN POINTS.

ANG: NO FLEET SERVICE/HOT CARGO PARKING AVAILABLE. CONTACT UPSET CTRL 20 MIN PRIOR TO ARR TO RECEIVE CURRENT BIRD WATCH CONDITION AND PARKING

INFORMATION.

ASDE-X SURVEILLANCE SYSTEM IN USE: PILOTS SHOULD OPERATE TRANSPONDERS WITH MODE 'C' ON ALL TAXIWAYS & RUNWAYS.

AIRCRAFT WITH WINGSPAN GREATER THAN 158 FT CANNOT PASS SIMULTANEOUSLY ON TAXIWAY 'A' & TAXIWAY 'B' BETWEEN TAXIWAY 'A1' & TAXIWAY 'A2'.

TAXIWAY 'S' & 'T' CLOSED BETWEEN RUNWAY 7R/25L & TAXIWAY 'R' DURING CAT II & CAT III OPERATIONS.

AIRCRAFT WITH WINGSPAN GREATER THAN 175 FT CANNOT PASS SIMULTANEOUSLY ON TAXIWAY 'E' & TAXIWAY 'Z'.

TAXIWAY B CLOSED BETWEEN TAXIWAY R AND TAXIWAY A1 TO AIRCRAFT WITH WINGSPAN GREATER THAN 117 FT WITHOUT PERMISSION FROM AIRPORT DIRECTOR AT 414-747-5325.

TAXIWAYS D1, F2, H, J, F1, P AND F (EAST OF RUNWAY 19R) CLOSED TO AIRCRAFT WITH WINGSPAN GREATER THAN 78 FT.

TAXIWAY F (WEST OF TAXIWAY Z) CLOSED TO AIRCRAFT WITH WINGSPAN GREATER THAN 117 FT UNLESS PERMISSION FROM AIRPORT DIRECTOR AT 414-747-5325.

RUNWAY 19R TAKE-OFF DISTANCE AVAILABLE 8,450 FT FROM INTERSECTION TAXIWAY V.

TAXIWAY V BETWEEN TAXIWAY D AND RUNWAY 7L/25R CLOSED TO AIRCRAFT WITH WINGSPAN GREATER THAN 170 FT WHEN RUNWAY 7L/25R IN USE.

TAXIWAY B BETWEEN TAXIWAY V AND TAXIWAY R CLOSED TO AFFECT WITH WINGSPAN GREATER THAN 170 FT.

HOLDING BAYS AT RUNWAYS 1L & 7R ARE IN USE, ASSOCIATED TAXIWAY ADJACENT TO BAY IS LIMITED TO AIRCRAFT WINGSPAN UP TO 137 FT

HOLDING BAY AT RUNWAY 19R WHEN IN USE, TAXIWAY Z ADJACENT TO BAY IS LIMITED TO AIRCRAFT WITH WINGSPAN UP TO 170 FT.

RUNWAY 07L/25R NO AIRCRAFT 65,000 LBS OR GREATER ALLOWED TAXI BETWEEN TAXIWAY 'C' & TAXIWAY 'E'.

RUNWAY 01R-19L AVAILABLE TO AIR CARRIERS FOR TAXI ONLY.

INDEX

[References are to page numbers]

A

- Abbreviations, GEN 2.2-1
- Accident and Incident Reporting , ENR 1.16-1
 - Items To Be Reported, ENR 1.16-2
- Actual Navigation Performance (ANP), ENR 4.1-40
- Aerodrome Forecast (TAF), GEN 3.5-72
- Aeronautical Charts, GEN 3.2-1
- Aeronautical Fixed Telecommunications Network (AFTN), GEN 3.4-5
- Aeronautical Information Publication (AIP)
 - Publication Schedule, GEN 0.1-2
 - Structure, GEN 0.1-1
 - Subscription Information, GEN 0.1-3
- Aeronautical Publications, Distribution of, GEN 3.1-1
- AFTN. *See* Aeronautical Fixed Telecommunications Network (AFTN)
- AHRS. *See* Attitude Heading Reference System
- Air Defense Identification Zone (ADIZ), ENR 1.12-1
- Air Defense Identification Zone, L and-Based, ENR 1.12-1
- Air Route Traffic Control Center (ARTCC), GEN 3.3-2
 - ARTCC Communications, GEN 3.3-2
 - ARTCC Radio Frequency Outage, GEN 3.3-3
- Air Traffic Clearance. *See* Clearance
- Air Traffic Control, Pilot/Controller Roles and Responsibilities, ENR 1.1-62
- Aircraft
 - Lights, Use of, ENR 1.1-25
 - Unmanned, ENR 5.7-2
- Aircraft Suffixes, ENR 1.10-11
- Airport
 - Airport Advisory/Information Services, ENR 1.4-12
 - Aircraft Arresting Devices, AD 1.1-27
 - Fees and Charges, GEN 4.1-1
 - Fire Fighting Requirements, AD 1.1-3
 - Local Airport Advisory (LAA), GEN 3.3-8
 - Operations, ENR 1.1-1
 - Exiting the Runway after Landing, ENR 1.1-21
 - VFR Flights in Terminal Areas, ENR 1.1-16
 - Low Level Wind Shear/Microburst Detection Systems, ENR 1.1-12
 - Signals, Hand, ENR 1.1-21
 - Taxiing, ENR 1.1-14
 - Traffic Pattern, ENR 1.1-1, ENR 1.1-2, ENR 1.1-6
 - With Operating Control Tower, ENR 1.1-1
 - Without Operating Control Tower, GEN 3.3-7, GEN 3.3-17, ENR 1.1-6,
 - Remote Airport Advisory (RAA), GEN 3.3-8, ENR 1.4-13
 - Remote Airport Information Service (RAIS), GEN 3.3-8, ENR 1.4-13
 - Reservations Procedures, GEN 3.3-15
 - Using Enhanced Computer Voice Reservation System (e-CVRS), GEN 3.3-15
 - Airport Lighting, AD 1.1-4
 - Airport Beacons, AD 1.1-16, AD 1.1-18
 - Approach Light Systems, AD 1.1-4
 - Obstruction Lighting, AD 1.1-18
 - Pilot-controlled Lighting, AD 1.1-13
 - Precision Approach Path Indicator (PAPI), AD 1.1-4
 - Runway Lighting, AD 1.1-5
 - Taxiway Lighting, AD 1.1-17
 - Visual Approach Slope Indicator (VASI), AD 1.1-4
 - Airport Markings, AD 1.1-19
 - Colors, AD 1.1-19
 - Holding Position Markings, AD 1.1-22
 - Other Markings, AD 1.1-23
 - Nonmovement Area Boundary Markings, AD 1.1-24
 - Temporarily Closed Runways and Taxiways, AD 1.1-24
 - VOR Checkpoint Markings, AD 1.1-24
 - Runway Markings, AD 1.1-20
 - Taxiway Markings, AD 1.1-21
 - Airport Operations
 - Intersection Takeoffs, ENR 1.1-16
 - Land and Hold Short , ENR 1.1-18
 - Airport Signs, AD 1.1-24
 - Destination Signs, AD 1.1-26
 - Direction Signs, AD 1.1-26
 - Information Signs, AD 1.1-26
 - Location Signs, AD 1.1-25
 - ILS Critical Area Boundary Sign, AD 1.1-26
 - Runway Boundary Sign, AD 1.1-26
 - Runway Location Sign, AD 1.1-25
 - Taxiway Location Sign, AD 1.1-25

[References are to page numbers]

- Mandatory Instruction Signs, AD 1.1-24
ILS Critical Area Holding Position Sign, AD 1.1-25
No Entry Sign, AD 1.1-25
Runway Approach Area Holding Position Sign, AD 1.1-25
Runway Holding Position Sign, AD 1.1-25
Runway Distance Remaining Signs, AD 1.1-27
- Airport Surface Detection Equipment - Model X (ASDE-X), ENR 1.1-42
- Airports, Designated To Serve International Operations, AD 2-1
Diagrams of, AD 2-3
- Airport Use, AD 1.1-1
See also Airport, Reservations Procedures
- Airspace, ENR 1.4-1
Classes, ENR 1.4-1, ENR 1.4-3, ENR 1.4-4
Controlled, ENR 1.4-3
IFR Requirements, ENR 1.4-3
VFR Requirements, ENR 1.4-3
Operating Rules and Requirements, ENR 1.4-4 , ENR 1.4-6, ENR 1.4-11
Radar Vectors in, ENR 1.1-65, ENR 3.5-2
Speed Adjustments in, ENR 1.1-65
VFR Corridors, ENR 1.4-14
VFR Transition Routes, ENR 1.4-14
- Flights Over Charted U.S. Wildlife Refuges, Parks and Forest Service Areas, ENR 5.6-2
- National Security Area, ENR 5.1-2
- Obstructions to Flight. *See* Flight Hazards, Potential
- Parachute Jump Aircraft Operations, ENR 5.1-4
- Special Use, ENR 5.1-1
Alert Areas, ENR 5.2-1
Controlled Firing Areas, ENR 5.2-1
Military Operations Area (MOA), ENR 5.2-1
Military Training Routes, ENR 5.2-1
Prohibited Areas, ENR 5.1-1
Restricted Areas, ENR 5.1-1
Warning Areas, ENR 5.1-2
- Temporary Flight Restriction, ENR 5.1-2
- Terminal Radar Service Area, ENR 1.1-60
- Terminal Radar Service Area (TRSA), ENR 1.4-15
- VFR Flyways, ENR 1.4-13
VFR Routes, Published, ENR 1.4-13
VFR Weather Minimums, ENR 1.4-2
- Airways and Route Systems. *See* Navigation
- Altimeter Setting Procedures, ENR 1.7-1
- Altitude
Mandatory, ENR 1.5-21
- Maximum, ENR 1.5-21
Minimum, ENR 1.5-21
- ANP. *See* Actual Navigation Performance
- Approach Control Service for VFR Arriving Aircraft, GEN 3.3-7
- Approaches, ENR 1.5-7, ENR 1.5-41
Approach and Landing Minimums, ENR 1.5-16
Approach Clearance, ENR 1.5-10
Contact Approach, ENR 1.1-63
Differences between ILS and ILS/PRM Approaches, ENR 1.5-54
ILS Minimums, ENR 4.1-8
ILS/MLS Approaches to Parallel Runways, ENR 1.5-43 , ENR 1.5-46, ENR 1.5-47
Instrument Approach, ENR 1.1-64
Instrument Approach Procedure Charts, ENR 1.5-19
See also Aeronautical Charts
Minimum Vectoring Altitudes, ENR 1.5-34
Missed Approach, ENR 1.1-64, ENR 1.5-61
Missed Approach, GPS, ENR 4.1-33
Monitoring of Instrument Approaches, ENR 1.5-43
No-Gyro Approach, ENR 1.5-43
Overhead Approach Maneuver, ENR 1.5-65
Practice Instrument Approaches, ENR 1.1-17
Precision Approach, ENR 1.5-42
Side-step Maneuver, ENR 1.5-15
Simultaneous Close Parallel ILS PRM Approaches, ENR 1.5-49
Simultaneous Converging Instrument Approaches, ENR 1.5-55
Surveillance Approach, ENR 1.5-42
Timed Approaches From a Holding Fix, ENR 1.5-55
Vertical Descent Angle (VDA), ENR 1.5-35
Visual, ENR 1.1-67
Visual Descent Points, ENR 1.5-34, ENR 1.5-60
- Area Navigation (RNAV), ENR 1.19-1, ENR 4.1-39 , ENR 4.1-41
- Area Navigation (RNAV) Routes, ENR 3.3-1
- Area Navigation (RNAV) Standard Terminal Arrival (STAR), ENR 1.5-7
- ARFF (Aircraft Rescue and Fire Fighting)
Emergency Hand Signals, GEN 3.7-1
- ARFF (Aircraft Rescue and Fire Fighting) R radio Call Sign, GEN 3.7-1
- ARTCC. *See* Air Route Traffic Control Center (ARTCC)

[References are to page numbers]

ATS Routes, ENR 3.1-1, AD 2-1
 Lower ATS Routes, ENR 3.1-1
 Upper ATS Routes, ENR 3.2-1
Attitude Heading Reference System (AHRS), ENR 4.1-22
Automated Terminal Information Service (ATIS).
 See Meteorological Services
Automated Weather Observation System (AWOS).
 See AWOS
Automated Weather Sensor System (AWSS), GEN 3.3-17, GEN 3.5-29
Automatic Flight Information Service (AFIS) -
 Alaska FSSs Only. *See* AFIS
Aviation Safety Reporting Program, ENR 1.16-1

B

Bird Activity, ENR 5.6-1
 Reporting Bird and Other Wildlife Activities,
 ENR 5.6-1
 Reporting Bird Strikes, ENR 5.6-1

C

Call Signs
 Aircraft, GEN 3.4-6
 Ground Station, GEN 3.4-8
Charts. *See* Aeronautical Charts
Class C Airspace, Outer Area, ENR 1.4-6
Clearance
 Adherence to, ENR 1.1-30
 Air Traffic Control, ENR 1.1-26
 Amended, ENR 1.1-27
 Clearance Items, ENR 1.1-26
 Pilot Responsibilities, ENR 1.1-29
 Special VFR, ENR 1.1-28
 VFR-On-Trip, ENR 1.1-29
 VFR/IFR Flights, ENR 1.1-30
CNF. *See* Computer Navigation Fix
Collision Avoidance, ENR 1.15-8
Common Traffic Advisory Frequency (CTAF). *See*
 Radio Communications
Communications. *See* Radio Communications
Computer Navigation Fix (CNF), ENR 4.1-30
Controlled Airspace. *See* Airspace, Controlled

Conversion Tables, GEN 2.6-1
Cruising Altitudes, ENR 1.4-2, ENR 1.4-13
Customs. *See* U.S. Customs

D

Declared Distances, ENR 1.1-8
Density Altitude. *See* Flight Hazards, Potential
Departure Control, ENR 1.5-68
 Abbreviated IFR Departure Clearance
 Procedures, ENR 1.5-68
Departure Procedures, ENR 1.5-65
 See also Global Positioning System (GPS)
 Clearance Void Times, ENR 1.5-67
 Departure Restrictions, ENR 1.5-66, ENR
 1.5-67
 Hold for Release, ENR 1.5-67
 Instrument Departure Procedures (DP), ENR
 1.5-69
 Pre-Taxi Clearance Procedures, ENR 1.5-65
 Release Times, ENR 1.5-67
 Taxi Clearance, ENR 1.5-66
Departure, Instrument, ENR 1.1-68
Differences From ICAO Standards, Recommended
 Practices and Procedures, GEN 1.7-1
Discrete Emergency Frequency, GEN 3.7-1
DUATS. *See* Meteorological Services

E

EFVS. *See* Enhanced Flight Vision Systems
ELT. *See* Emergency Locator Transmitters
Emergency
 Aircraft Rescue and Fire Fighting
 Communications, GEN 3.7-1
 Aircraft, Overdue, GEN 3.6-5
 Body Signals, GEN 3.6-6
 Direction Finding Instrument Approach
 Procedure, GEN 3.6-14
 Distress and Urgency Communications, GEN
 3.6-12
 Ditching Procedures, GEN 3.6-15
 Fuel Dumping, GEN 3.6-19
 Obtaining Assistance, GEN 3.6-13
 VFR Search and Rescue Protection, GEN 3.6-5
Emergency Locator Transmitters, GEN 3.6-2
Enhanced Flight Vision Systems, ENR 1.5-57

[References are to page numbers]

EPE. *See* Estimate of Position Error

Estimate of Position Error (EPE), ENR 4.1-40

F

Fees and Charges. *See* Airport

Final Guard, ENR 1.4-13

FIS. *See* Flight Information Services

Flight Hazards, Potential, ENR 5.7-1

Density Altitude, ENR 5.7-4

Laser Operations, ENR 5.7-10

Mountain Flying, ENR 5.7-3

Mountain Wave, ENR 5.7-5

Obstructions, ENR 5.7-1

VFR in Congested Area, ENR 5.7-1

Flight Information Services, GEN 3.5-23

Flight Service Station (FSS), GEN 3.1-5

Flight Management System (FMS), ENR 1.19-3

Flight Management System Procedures, ENR 1.5-7

Flight Plan, ENR 1.10-1, ENR 1.11-1

Aircraft Suffixes, ENR 1.10-11

Airways/Jet Routes Depiction, ENR 1.10-13

Area Navigation (RNAV), ENR 1.10-14

Canceling, ENR 1.10-18

Change, ENR 1.10-18, ENR 1.10-21

Composite (VFR/IFR Flights), ENR 1.10-17

Direct Flights, ENR 1.10-14

Flight Plan Form, ENR 1.10-16

Flight Plan Requirements, ENR 1.10-8

Defense VFR, ENR 1.10-12

IFR, ENR 1.10-12

VFR, ENR 1.10-8

International Flight Plan, ENR 1.10-20

Operations Associated with ADIZ, ENR 1.12-1

Preflight Preparation, ENR 1.10-1

Fly Visual to Airport, ENR 1.5-35

FMSP. *See* Flight Management System Procedures

Forms, Bird Strike Incident/Ingestion Report, ENR 5.6-3

Frequencies. *See* Radio Communications

FSS. *See* Flight Service Station (FSS)

Fuel Advisory, Minimum, ENR 1.1-68

G

GBAS. *See* Ground Based Augmentation System

GBAS Landing System (GLS), ENR 4.1-38

Global Navigation Satellite System (GNSS), ENR 4.1-38

Global Positioning System, GPS Approach Procedures, ENR 4.1-29

Global Positioning System (GPS), ENR 4.1-22
Departures, ENR 4.1-31

Missed Approach, ENR 4.1-33

Receiver Autonomous Integrity Monitoring (RAIM), ENR 4.1-29

GLS. *See* GNSS Landing System

GPS Approach Procedures, ENR 4.1-29

GPS IFR Equipment Classes/Categories, ENR 4.1-27

GPS NOTAM's/Aeronautical Information, ENR 4.1-29

Ground Based Augmentation System (GBAS), ENR 4.1-39

Gulf of Mexico Grid System, ENR 6.1-6

H

Half-Way Signs, ENR 5.7-4

Hazard, Thermal Plumes, ENR 5.7-14

Hazardous Area Reporting Service, GEN 3.4-13

Block Island, GEN 3.4-14

Cape Cod, GEN 3.4-15

Great Lakes, GEN 3.4-15

Long Island Sound, GEN 3.4-13

HDTA. *See* High Density Traffic Airports

Helicopter

IFR Operations, ENR 6.1-1

Special Operations, ENR 6.2-1

High Altitude Destinations. *See* IFR Operations to High Altitude Destinations

High Density Traffic Airports, GEN 3.3-15

Holding Instructions. *See* Clearance Items

Holding Pattern

Airspeeds, ENR 1.5-1

ATC Holding Instructions, ENR 1.5-1

Distance Measuring Equipment (DME), ENR 1.5-4

[References are to page numbers]

Entry Procedures, ENR 1.5-4
Nonstandard, ENR 1.5-6
Timing, ENR 1.5-4

I

ICAO Standards, Recommended Practices and Procedures. *See* Differences From ICAO Standards, Recommended Practices and Procedures

Icing Terms, GEN 3.5-43

IFR Operations to High Altitude Destinations, ENR 1.10-17

Inertial Navigation System, ENR 4.1-22

Inertial Reference Unit (IRU), ENR 4.1-22

INS. *See* Internal Navigation System

Instrument Departure. *See* Departure, Instrument

Instrument Departure Procedures (DP), ENR 1.5-69

Instrument Landing System, Locators, Compass, ENR 4.1-4

Instrument Landing System (ILS), ENR 4.1-4
See also Approaches
Frequency Table, ENR 4.1-7

Instrument Meteorological Conditions (IMC), ENR 1.5-70

Integrated Terminal Weather System, ENR 1.1-12

International Airports. *See* Airports, Designated To Serve International Operations

Intersection Takeoffs. *See* Airport Operations

IRU. *See* Inertial Reference Unit

ITWS. *See* Integrated Terminal Weather System

J

Jet Route System. *See* Navigation

L

Land and Hold Short Operations. *See* Airport Operations

Law Enforcement Operations by Civil and Military Organizations, ENR 1.12-5

Light Amplification by Stimulated Emission of Radiation (Laser) Operations. *See* Flight Hazards, Potential

Lighting. *See* Airport Lighting

Line Up and Wait, ENR 1.5-66

LLWAS. *See* Low Level Wind Shear Alert System

Local Airport Advisory (LAA), GEN 3.3-8, ENR 1.4-13

Localizer Performance with Vertical Guidance, ENR 4.1-35

LORAN, ENR 4.1-14

LORAN Status Information, ENR 4.1-21

Low Level Wind Shear Alert System (LLWAS), ENR 1.1-12

Low Level Wind Shear/Microburst Detection Systems, ENR 1.1-12

Lower ATS Routes, ENR 3.1-1

Low Altitude ATS Route Structure, ENR 3.1-1

LPV. *See* Localizer Performance with Vertical Guidance

LUAW, ENR 1.5-66

M

Medical Facts for Pilots, ENR 1.15-1

Carbon Monoxide Poisoning in Flight, ENR 1.15-5

Certification, ENR 1.15-1

Decompression Sickness after Scuba Diving, ENR 1.15-4

Effects of Altitude, ENR 1.15-3

Ear Block, ENR 1.15-4

Hypoxia, ENR 1.15-3

Sinus Block, ENR 1.15-4

Hyperventilation in Flight, ENR 1.15-4

Illusions, ENR 1.15-5

Personal Checklist, ENR 1.15-2

Scanning for Other Aircraft, ENR 1.15-7

Vision in Flight, ENR 1.15-6

Meteorological Services, GEN 3.5-1, GEN 3.5-33

Automatic Terminal Information Service (ATIS), GEN 3.3-14

Categorical Outlook, GEN 3.5-20

Cloud Heights, Reporting, GEN 3.5-37

Direct User Access System (DUATS), GEN 3.5-4

En Route Flight Advisory Service (EFAS), GEN 3.5-9

Hazardous In-flight Weather Advisory Service (HIWAS), GEN 3.5-22, GEN 3.5-77

[References are to page numbers]

ICAO Weather Formats, GEN 3.5-65
Inflight Aviation Weather Advisories, GEN 3.5-10
Inflight Weather Broadcasts, GEN 3.5-22
Low Level Wind Shear Alert System (LLWAS), GEN 3.5-50
Meteorological Broadcasts, GEN 3.5-77
Pilot Weather Report (PIREP), GEN 3.5-39
Prevailing Visibility, Reporting, GEN 3.5-38
Runway Visual Range (RVR), GEN 3.5-36
Telephone Information Briefing Service (TIBS), GEN 3.5-22
Terminal Doppler Weather Radar (TDWR), GEN 3.5-51
Terminal Weather Information for Pilots (TWIP), GEN 3.5-55
Weather Briefings
 Abbreviated, GEN 3.5-8
 Inflight, GEN 3.5-9
 Outlook, GEN 3.5-9
 Preflight, GEN 3.5-7
 Standard, GEN 3.5-7
Weather Deviations and Other Contingencies in Oceanic Controlled Airspace, GEN 3.5-35
Weather Observation Service Standards, GEN 3.5-30, GEN 3.5-32
Weather Observing Programs, GEN 3.5-31
 Automated Surface Observation System (ASOS), GEN 3.5-29
 Automated Weather Observing System (AWOS), GEN 3.5-27
 Manual Observations, GEN 3.5-26
Microwave Landing System (MLS), ENR 4.1-11
 See also Approaches
Military NOTAMs, ENR 1.10-7
Military Training Routes. *See* Airspace, Special Use
Minimum Navigation Performance Specifications (MNPS) Airspace, ENR 1.17-1
Minimum Safe Altitudes, ENR 1.5-22
Mountain Flying. *See* Flight Hazards, Potential
Mountain Wave. *See* Flight Hazards, Potential
MSA. *See* Minimum Safe Altitudes

N

National Security and Interception Procedures, ENR 1.12-1, ENR 1.12-4
National Security Area. *See* Airspace

NAVAID Identifier Removal During Maintenance, ENR 4.1-42
NAVAID User Reports, ENR 4.1-42
Navigation
 See also Global Positioning System (GPS) Adhering to Airways or Routes, ENR 3.5-3
 Airway or Route Course Changes, ENR 3.5-2
 Airways and Route Systems, ENR 3.5-1
 Changeover Points, ENR 3.5-2
 LORAN, ENR 4.1-14
Navigation Aids, ENR 4.1-1
Navigation, Radio, GEN 3.4-1
 Nondirectional Radio Beacon, GEN 3.4-3
Navigation Reference System (NRS), ENR 1.10-15
Navigational, Inertial Navigation System, ENR 4.1-22
Near Midair Collision Reporting, ENR 1.16-2
 Investigation, ENR 1.16-3
Notice to Airmen
 NOTAM Contractions, ENR 1.10-3
 NOTAM D, ENR 1.10-6
Notices To Airmen (NOTAM) Service, GEN 3.1-2, ENR 1.10-2

O

Operational Information System (OIS), ENR 1.10-12
Overhead Approach Maneuver. *See* Approaches

P

Parachute Jump Aircraft Operations. *See* Airspace
Phonetic Alphabet. *See* Radio Communications, Phonetic Alphabet
Pilot Visits to Air Traffic Facilities, GEN 3.3-2
PIREP. *See* Meteorological Services, Pilot Weather Report
Pointer NOTAMs, ENR 1.10-7
Position Reporting, GEN 3.3-4
Position Reporting Requirements, GEN 3.3-4
Pre-departure Clearance Procedures, ENR 1.5-65
Precipitation Static, ENR 5.7-9
Precision Approach Systems, ENR 4.1-38

[References are to page numbers]

Procedure Turns, ENR 1.5-10
Published Instrument Approach Procedure Visual Segment, ENR 1.5-35

R

Radar, ENR 1.1-35
Air Traffic Control Radar Beacon System, ENR 1.1-36
Capabilities, ENR 1.1-35
Precision Approach, ENR 1.1-37
Surveillance, ENR 1.1-37

Radar Services Provided by ATC, ENR 1.1-46
Aircraft Conflict Alert, ENR 1.1-46
Offshore Controlled Airspace, ENR 1.1-62
Radar Assistance to VFR Aircraft, ENR 1.1-48
Radar Traffic Information Service, ENR 1.1-47
Terrain/Obstruction Alert, ENR 1.1-46

Radio Communications, GEN 3.4-6
Common Traffic Advisory Frequency (CTAF), GEN 3.3-7
Contact Procedures, GEN 3.4-11
Directions, GEN 3.4-10
Failure, GEN 3.4-10, GEN 3.4-21
For Aircraft on International or Overseas Flights, GEN 3.4-17, GEN 3.4-21
Phonetic Alphabet, GEN 3.4-8
Phraseology, GEN 3.4-8
Radio Technique, GEN 3.4-6
Speed, GEN 3.4-10
UNICOM/MULTICOM, GEN 3.3-12, GEN 3.3-13

Radio Navigation Aids
Distance Measuring Equipment, ENR 4.1-3, ENR 4.1-6
Nondirectional Radio Beacon, ENR 4.1-1
Tactical Air Navigation, ENR 4.1-4
VHF Direction Finder, ENR 4.1-1
VHF Omni-directional Radio Range, ENR 4.1-1

Receiver Autonomous Integrity Monitoring (RAIM). *See* Global Positioning System (GPS)

REL. *See* Runway Entrance Lights

Remote Airport Advisory (RAA), GEN 3.3-8, ENR 1.4-13

Remote Airport Information Service (RAIS), GEN 3.3-8, ENR 1.4-13

Required Navigation Performance (RNP), ENR 1.19-1, ENR 4.1-39

Required Navigation Performance (RNP) Operations, ENR 1.10-19, ENR 4.1-41

Reservations. *See* Airport, Reservations Procedures

RNAV. *See* Area Navigation

RNP. *See* Required Navigation Performance; Required Navigation Performance (RNP)

Runway
Entrance Lights, AD 1.1-10, AD 1.1-11
Status Light (RWSL) System, AD 1.1-12, AD 1.1-13

Runway Intersection Lights (RIL), AD 1.1-11

RWSL System, Runway Status Light (RWSL) System. *See* Runway Status Light (RWSL) System

S

SCAT-I DGPS. *See* Special Category I Differential GPS

Seaplane Safety, ENR 5.7-6

Search and Rescue, GEN 3.6-1

Security Identification Display Area, AD 1.1-27

Separation
IFR, Standards, ENR 1.1-32
Runway, ENR 1.1-34
Visual, ENR 1.1-34, ENR 1.1-67

SIDA. *See* Security Identifications Display Area

Signs, Half-Way, ENR 5.7-4

Special Category I Differential GPS (SCAT-I DGPS), ENR 4.1-39

Special Instrument Approach Procedures, ENR 1.5-41

Special Use Airspace (SUA) NOTAMs, ENR 1.10-7

Standard Terminal Arrival, ENR 1.5-7

STAR. *See* Standard Terminal Arrival

T

Takeoff Hold Lights (THL), AD 1.1-11

TDWR. *See* Terminal Doppler Weather Radar

Temporary Flight Restrictions. *See* Airspace

[References are to page numbers]

Terminal Arrival Area (TAA), ENR 1.5-22
THL. *See* Takeoff Hold Lights
Time, Conversion from UTC to Standard Time, GEN 3.4-10
Terminal Doppler Weather Radar, ENR 1.1-12
Timekeeping Procedures, ENR 1.17-1, ENR 1.18-1
TLS. *See* Transponder Landing System
Tower En Route Control (TEC), ENR 1.1-61
Traffic Advisories, ENR 1.1-66
Traffic Advisories, At Airports Without Operating Control Towers, GEN 3.3-7
Traffic Alert and Collision Avoidance System (TCAS I & II), ENR 1.1-69
Traffic Information Service (TIS), ENR 1.1-70, ENR 1.1-77
Traffic Pattern. *See* Airport, Operations
Transponder Landing System (TLS), ENR 4.1-39
Transponder Operation, ENR 1.1-43
Automatic Altitude Reporting, ENR 1.1-43
Code Changes, ENR 1.1-44
Emergency, ENR 1.1-45
Ident Feature, ENR 1.1-44
Mode C Requirements, ENR 1.1-44
Under Visual Flight Rules, ENR 1.1-45
TRSA. *See* Airspace, Terminal Radar Service Area

U

Unidentified Flying Objects (UFO), ENR 1.16-3
Unmanned Aircraft, ENR 5.7-2
Upper ATS Routes, ENR 3.2-1
High Altitude ATS Route Structure, ENR 3.2-1
U.S. Customs Requirements
Entry, Transit, and Departure of Aircraft, GEN 1.2-1
Entry, Transit, and Departure of Cargo, GEN 1.4-1
Entry, Transit, and Departure of Passengers and Crew, GEN 1.3-1
U.S. Customs Service, Locations, GEN 1.1-2

U.S. Differences From ICAO Standards. *See* Differences From ICAO Standards, Recommended Practices and Procedures
Units of Measurement, GEN 2.1-1

V

VCOA. *See* Visual Climb Over the Airport
VFR Flyways. *See* Airspace
VFR-on-top, ENR 1.1-68
Visual Approach. *See* Approaches
Visual Climb Over the Airport (VCOA), ENR 1.5-72
Visual Meteorological Conditions (VMC), ENR 1.5-70
Visual Segment, ENR 1.5-35
Visual Separation, ENR 1.1-67
Volcanic Ash, Flight Operations in, ENR 5.7-7
Volcanic Ash, Reporting, GEN 3.5-56
Form, GEN 3.5-85
VOR Receiver Check, ENR 4.1-2
Vortex Avoidance Procedures, GEN 3.5-62

W

Wake Turbulence, GEN 3.5-58
Weather Briefings. *See* Meteorological Services
Weather Conversion Table, GEN 3.5-3
Weather Hazards
Microbursts, GEN 3.5-46
Thunderstorm Flying, GEN 3.5-57
Thunderstorms, GEN 3.5-56
Weather Minimums. *See* Airspace, VFR Weather Minimums
Weather Radar Services, GEN 3.5-33
Weather System Processor, ENR 1.1-12
Wide Area Augmentation System (WAAS), ENR 4.1-34
Wildlife Refuges, Parks, and Forest Service Areas. *See* Airspace
WSP, ENR 1.1-12

Appendix 1. ATS Routes

MINIMUM ENROUTE IFR ALTITUDES OVER PARTICULAR ROUTES AND INTERSECTIONS

This is a consolidation of all data in Subparts C and D of Federal Aviation Regulation (FAR) Part 95 – Subchapter F. For updates to these routes and access to additional data products, please visit <http://nfdc.faa.gov/fadds/index.jsp>.

TABLE OF CONTENTS

Contents	Page
Colored Federal Airways	1
Direct Routes – U.S.	9
(1) Puerto Rico	22
(2) Bahama	24
(3) Atlantic	28
Low Altitude RNAV Routes	38
High Altitude RNAV Routes	49
Ground-Based High Altitude RNAV Routes	58
VOR Federal Airways	59
Alaska VOR Federal Airways	259
Hawaii VOR Federal Airways	277
Jet Routes	283
VOR Federal Airway Changeover Points	333
(1) Alaska VOR Federal Airway Changeover Points	357
(2) Hawaii VOR Federal Airway Changeover Points	361
Jet Route Changeover Points	362

FROM TO MEA

95.0040 COLORED FEDERAL AIRWAYS

95.41 GREEN FEDERAL AIRWAY G1

MOUNT MOFFETT, AK NDB/DME HORTH, AK FIX 8000
HORTH, AK FIX MORDI, AK FIX *8000
*2500 - MOCA
*5000 - GNSS MEA

MORDI, AK FIX ELFEE, AK NDB *8000
*5300 - MOCA
*7000 - GNSS MEA

95.42 GREEN FEDERAL AIRWAY G2

BORLAND, AK NDB/DME WOODY ISLAND, AK NDB *10000
*6600 - MOCA

95.44 GREEN FEDERAL AIRWAY G4

WOOD RIVER, AK NDB ILIAMNA, AK NDB/DME *4500
*3000 - MOCA

95.46 GREEN FEDERAL AIRWAY G6

ST MARYS, AK NDB ANIAK, AK NDB 4000

95.47 GREEN FEDERAL AIRWAY G7

GAMBELL, AK NDB/DME FORT DAVIS, AK NDB 3000
FORT DAVIS, AK NDB NORTON BAY, AK NDB *5000
*4200 - MOCA

95.48 GREEN FEDERAL AIRWAY G8

SHEMYA, AK NDB MOUNT MOFFETT, AK NDB/DME #*8000
*6300 - MOCA
#HF COMMS REQUIRED.
MOUNT MOFFETT, AK NDB/DME DUTCH HARBOR, AK NDB/DME #*9000
*8000 - MOCA
#HF COMMUNICATIONS REQUIRED
DUTCH HARBOR, AK NDB/DME MORDI, AK FIX *9000
*5700 - MOCA
*6000 - GNSS MEA

MORDI, AK FIX ELFEE, AK NDB *8000
*5300 - MOCA
*7000 - GNSS MEA

FROM	TO	MEA
------	----	-----

95.48 GREEN FEDERAL AIRWAY G8 - CONTINUED

ELFEE, AK NDB *4100 - MOCA #HF COMMS ONLY BELOW 5000 MSL #VHF COMMS AVBL 5000 MSL AND ABOVE.	CRACK, AK FIX	#*5000
CRACK, AK FIX *2300 - MOCA #VHF/UHF COMMS AVBL 9000 MSL AND BELOW #HF COMMS ONLY BELOW 9000 MSL	CHINOOK, AK NDB	#*3000
CHINOOK, AK NDB *4900 - MOCA	NOSKY, AK FIX	*6000
NOSKY, AK FIX	KACHEMAK, AK NDB	6100

95.49 GREEN FEDERAL AIRWAY G9

OSCARVILLE, AK NDB	CAIRN MOUNTAIN, AK NDB	6000
--------------------	------------------------	------

95.50 GREEN FEDERAL AIRWAY G10

CAPE NEWENHAM, AK NDB/DME #HF COMMS REQUIRED BELOW 8000	ST PAUL ISLAND, AK NDB/DME	#4600
ST PAUL ISLAND, AK NDB/DME	BILBE, AK FIX	3000
BILBE, AK FIX *3800 - MOCA	ELFEE, AK NDB	*6000
ELFEE, AK NDB *4100 - MOCA	PORT HEIDEN, AK NDB/DME	*5000
PORT HEIDEN, AK NDB/DME	WIDTH, AK FIX COP 090 PDN	9000
WIDTH, AK FIX *6300 - MOCA	WOODY ISLAND, AK NDB	*9000
WOODY ISLAND, AK NDB	KACHEMAK, AK NDB	6000

95.51 GREEN FEDERAL AIRWAY G11

CAMPBELL LAKE, AK NDB	GLENNALLEN, AK NDB	10000
GLENNALLEN, AK NDB	NABESNA, AK NDB	10000

95.52 GREEN FEDERAL AIRWAY G12

CHINOOK, AK NDB	PORT HEIDEN, AK NDB/DME	2500
PORT HEIDEN, AK NDB/DME	BORLAND, AK NDB/DME	10000
BORLAND, AK NDB/DME	ELFEE, AK NDB	10000

95.53 GREEN FEDERAL AIRWAY G13

ZOLMN, NC FIX	MANTEO, NC NDB	2000
---------------	----------------	------

FROM	TO	MEA
95.55 GREEN FEDERAL AIRWAY G15		
ST MARYS, AK NDB	ANVIK, AK NDB/DME	4000
ANVIK, AK NDB/DME	TAKOTNA RIVER, AK NDB	*9000
*6000 - MOCA		
*7000 - GNSS MEA		
95.56 GREEN FEDERAL AIRWAY G16		
POINT LAY, AK NDB	WAINWRIGHT VILLAGE, AK NDB	*1700
*1200 - MOCA		
WAINWRIGHT VILLAGE, AK NDB	BROWERVILLE, AK NDB	*1600
*1100 - MOCA		
BROWERVILLE, AK NDB	NUIQSUT VILLAGE, AK NDB	1600
COP 050 VIR		
NUIQSUT VILLAGE, AK NDB	PUT RIVER, AK NDB	*1700
*1200 - MOCA		
PUT RIVER, AK NDB	BARTER ISLAND, AK NDB	2000
95.57 GREEN FEDERAL AIRWAY G17		
WAINWRIGHT VILLAGE, AK NDB	ATQASUK, AK NDB	*1600
*1100 - MOCA		
95.58 GREEN FEDERAL AIRWAY G18		
HOTHAM, AK NDB	POINT LAY, AK NDB	*10000
*6000 - MOCA		
POINT LAY, AK NDB	COP 096 HHM	
	ATQASUK, AK NDB	2300
	COP 050 PIZ	
95.101 AMBER FEDERAL AIRWAY A1		
ABBOTSFORD, CANADA NDB	VICTORIA, CANADA NDB	#2800
#FOR THAT AIRSPACE OVER U.S. TERRITORY.		
U.S. CANADIAN BORDER	SITKA, AK NDB	*5000
*2300 - MOCA		
SITKA, AK NDB	SPARL, AK FIX	5200
SPARL, AK FIX	OCEAN CAPE, AK NDB	*6000
*2200 - MOCA		
OCEAN CAPE, AK NDB	CAPEM, AK FIX	*6000
*2000 - MOCA		
CAPEM, AK FIX	CORVA, AK FIX	*6000
*4400 - MOCA		
CORVA, AK FIX	EGGER, AK FIX	2000
EGGER, AK FIX	ORCA BAY, AK NDB	5000
ORCA BAY, AK NDB	CAMPBELL LAKE, AK NDB	*9000
*8000 - MOCA		

FROM	TO	MEA
95.101 AMBER FEDERAL AIRWAY A1 - CONTINUED		
CAMPBELL LAKE, AK NDB *9500 - MOCA	TAKOTNA RIVER, AK NDB	*10000
TAKOTNA RIVER, AK NDB	NORTH RIVER, AK NDB	6000
NORTH RIVER, AK NDB	FORT DAVIS, AK NDB	3000
95.102 AMBER FEDERAL AIRWAY A2		
U.S. CANADIAN BORDER *9000 - MOCA	NABESNA, AK NDB	*9600
NABESNA, AK NDB	DELTA JUNCTION, AK NDB	8000
95.103 AMBER FEDERAL AIRWAY A3		
EVANSVILLE, AK NDB	PUT RIVER, AK NDB	10000
95.104 AMBER FEDERAL AIRWAY A4		
EVANSVILLE, AK NDB *8300 - MOCA	ANAKTUVUK PASS, AK NDB	*10000
95.105 AMBER FEDERAL AIRWAY A5		
AMBLER, AK NDB/DME *6600 - MOCA	EVANSVILLE, AK NDB	*7500
95.106 AMBER FEDERAL AIRWAY A6		
ST MARYS, AK NDB	NORTH RIVER, AK NDB	5000
95.107 AMBER FEDERAL AIRWAY A7		
CAMPBELL LAKE, AK NDB	MINERAL CREEK, AK NDB COP 069 CMQ	12000
95.109 AMBER FEDERAL AIRWAY A9		
CHENA, AK NDB	EVANSVILLE, AK NDB	5500
EVANSVILLE, AK NDB *9100 - MOCA	BROWERVILLE, AK NDB	*10000
95.115 AMBER FEDERAL AIRWAY A15		
US CANADIAN BORDER	NICHOLS, AK NDB	5000
NICHOLS, AK NDB *5100 - MOCA	SUMNER STRAIT, AK NDB	*7000
*6000 - GNSS MEA		

FROM	TO	MEA
------	----	-----

95.115 AMBER FEDERAL AIRWAY A15 - CONTINUED

SUMNER STRAIT, AK NDB	COGHLAN ISLAND, AK NDB	7000
COGHLAN ISLAND, AK NDB	HAINES, AK NDB	*9000
*8300 - MOCA		
HAINES, AK NDB	BURWASH, CANADA NDB	#11000
#FOR THAT AIRSPACE OVER U.S. TERRITORY.		
BURWASH, CANADA NDB	BEAVER CREEK, CANADA NDB	#9600
#FOR THAT AIRSPACE OVER U.S. TERRITORY.		
BEAVER CREEK, CANADA NDB	NABESNA, AK NDB	*9600
*9000 - MOCA		
NABESNA, AK NDB	DELTA JUNCTION, AK NDB	8000

95.116 AMBER FEDERAL AIRWAY A16

ACTIVE PASS, CANADA NDB	WHITE ROCK, CANADA NDB	#*3000
*2100 - MOCA		
#FOR THAT AIRSPACE OVER U.S. TERRITORY.		

95.117 AMBER FEDERAL AIRWAY A17

CHENA, AK NDB	CHANDALAR LAKE, AK NDB	7000
*CHANDALAR LAKE, AK NDB	PUT RIVER, AK NDB	10000
*10000 - MCA CHANDALAR LAKE, AK NDB , NW BND		

95.201 RED FEDERAL AIRWAY R1

ST PAUL ISLAND, AK NDB/DME	GARRS, AK FIX	*4600
*2700 - MOCA		
GARRS, AK FIX	CHINOOK, AK NDB	4600

95.202 RED FEDERAL AIRWAY R2

ELFEE, AK NDB	PORT HEIDEN, AK NDB/DME	6000
---------------	-------------------------	------

95.204 RED FEDERAL AIRWAY R4

CHENA, AK NDB	BEAR CREEK, AK NDB	5000
---------------	--------------------	------

95.239 RED FEDERAL AIRWAY R39

OSCARVILLE, AK NDB	*ANIAK, AK NDB	**2000
*3500 - MCA ANIAK, AK NDB , NE BND		
**1400 - MOCA		
ANIAK, AK NDB	TAKOTNA RIVER, AK NDB	*6000
*5400 - MOCA		
TAKOTNA RIVER, AK NDB	MINCHUMINA, AK NDB	5000
MINCHUMINA, AK NDB	ICE POOL, AK NDB	4000

FROM	TO	MEA
95.250 RED FEDERAL AIRWAY R50		
NANWAK, AK NDB/DME	OSCARVILLE, AK NDB	3000
OSCARVILLE, AK NDB	ANVIK, AK NDB/DME	4100
95.251 RED FEDERAL AIRWAY R51		
SUMNER STRAIT, AK NDB	SITKA, AK NDB	7000
95.299 RED FEDERAL AIRWAY R99		
ST PAUL ISLAND, AK NDB/DME	DUTCH HARBOR, AK NDB/DME	#4800
#HF COMMS REQUIRED BELOW 8000 MSL.		
DUTCH HARBOR, AK NDB/DME	CHINOOK, AK NDB	*9000
*6300 - MOCA		
CHINOOK, AK NDB	ILIAMNA, AK NDB/DME	*5000
*4400 - MOCA		
ILIAMNA, AK NDB/DME	KACHEMAK, AK NDB	6100
95.601 BLUE FEDERAL AIRWAY B1		
WOODY ISLAND, AK NDB	ILIAMNA, AK NDB/DME	*10000
*9100 - MOCA		
95.602 BLUE FEDERAL AIRWAY B2		
POINT LAY, AK NDB	CAPE LISBURNE, AK NDB/DME	4000
CAPE LISBURNE, AK NDB/DME	HOTHAM, AK NDB	*8000
*4100 - MOCA		
COP 057 LUR		
HOTHAM, AK NDB	TIN CITY, AK NDB/DME	*5000
*4300 - MOCA		
TIN CITY, AK NDB/DME	FORT DAVIS, AK NDB	*7000
*5900 - MOCA		
*6000 - GNSS MEA		
95.603 BLUE FEDERAL AIRWAY B3		
ANIAK, AK NDB	ANVIK, AK NDB/DME	3700
ANVIK, AK NDB/DME	NORTH RIVER, AK NDB	4600
NORTH RIVER, AK NDB	NORTON BAY, AK NDB	3000
NORTON BAY, AK NDB	HOTHAM, AK NDB	4500
HOTHAM, AK NDB	NOATAK, AK NDB/DME	3300
95.604 BLUE FEDERAL AIRWAY B4		
UTOPIA CREEK, AK NDB	EVANSVILLE, AK NDB	*8000
*6200 - MOCA		
EVANSVILLE, AK NDB	YUKON RIVER, AK NDB	*8000
*6600 - MOCA		

FROM	TO	MEA
95.605 BLUE FEDERAL AIRWAY B5		
CAPE LISBURNE, AK NDB/DME	POINT HOPE, AK NDB	4000
95.607 BLUE FEDERAL AIRWAY B7		
CAPE NEWENHAM, AK NDB/DME	OSCARVILLE, AK NDB	4600
95.608 BLUE FEDERAL AIRWAY B8		
TIN CITY, AK NDB/DME	SHISHMAREF, AK NDB	4000
95.609 BLUE FEDERAL AIRWAY B9		
*DEEDS, FL FIX	MARATHON, FL NDB	**2000
*4000 - MRA		
**1500 - MOCA		
95.6125 BLUE FEDERAL AIRWAY B25		
ORCA BAY, AK NDB	*SHOPE, AK FIX	4900
*6600 - MCA SHOPE, AK FIX, N BND		
SHOPE, AK FIX	GLENNALLEN, AK NDB	10000
GLENNALLEN, AK NDB	*DELTA JUNCTION, AK NDB	**12000
*8000 - MCA DELTA JUNCTION, AK NDB, SE BND		
**11500 - MOCA		
95.6126 BLUE FEDERAL AIRWAY B26		
CHENA, AK NDB	YUKON RIVER, AK NDB	7000
95.6127 BLUE FEDERAL AIRWAY B27		
WOODY ISLAND, AK NDB	CHINOOK, AK NDB	10000
CHINOOK, AK NDB	OSCARVILLE, AK NDB	7500
OSCARVILLE, AK NDB	ST MARYS, AK NDB	3000
ST MARYS, AK NDB	FORT DAVIS, AK NDB	3000
FORT DAVIS, AK NDB	HOTHAM, AK NDB	6000
95.6128 BLUE FEDERAL AIRWAY B28		
US CANADIAN BORDER	NICHOLS, AK NDB	5000
NICHOLS, AK NDB	SITKA, AK NDB	*6900
*6000 - MOCA		
*6000 - GNSS MEA		

FROM TO MEA

95.6137 BLUE FEDERAL AIRWAY B37

SUMNER STRAIT, AK NDB ELEPHANT, AK NDB *7000
*6400 – MOCA

ELEPHANT, AK NDB SPARL, AK FIX *6000
*5000 - MOCA
*5000 - GNSS MEA

95.6138 BLUE FEDERAL AIRWAY B38

ELEPHANT, AK NDB CHILL, AK FIX 7300
CHILL, AK FIX HAINES, AK NDB 9000

95.6140 BLUE FEDERAL AIRWAY B40

HAINES, AK NDB ROBINSON, CANADA NDB #*10000
*9800 - MOCA
#FOR THAT AIRSPACE OVER U.S. TERRITORY.

95.6179 BLUE FEDERAL AIRWAY B79

SANDSPIT, CANADA NDB NICHOLS, AK NDB #5000
#FOR THAT AIRSPACE OVER U.S. TERRITORY.

FROM TO MEA

95.1001 DIRECT ROUTES-U.S.

ABERDEEN, SD VOR/DME	FARGO, ND VORTAC	18000
		MAA - 45000
ABERDEEN, SD VOR/DME	MASON CITY, IA VORTAC	18000
		MAA - 45000
ABILENE, TX VORTAC	LLANO, TX VORTAC	7000
	COP 75 ABI	
ABILENE, TX VORTAC	WACO, TX VORTAC	*6500
*3300 - MOCA		
ALBEK, NJ FIX	INT OOD VORTAC 075 & CYN	2000
	VORTAC 042	
		MAA - 8000
ALBEK, NJ FIX	WOODSTOWN, NJ VORTAC	2000
		MAA - 7000
ALEXANDRIA, MN VOR/DME	JAMESTOWN, ND VOR/DME	18000
		MAA - 22000
ALLENDALE, SC VOR	SINCA, GA FIX	11000
		MAA - 23000
ALLENTOWN, PA VORTAC	POTTSTOWN, PA VORTAC	*2700
*2500 - MOCA		
ALLENTOWN, PA VORTAC	STILLWATER, NJ VOR/DME	*3300
*3000 - MOCA		
APPIN, TX FIX	LAKE CHARLES, LA VORTAC	*8000
*1500 - MOCA		
APPLETON, OH VORTAC	TIVERTON, OH VOR/DME	18000
		MAA - 45000
ATLANTIC CITY, NJ VORTAC	ATLANTIC CITY, NJ VORTAC	2000
	165/20	
		MAA - 4000
AUGUSTA, ME VOR/DME	SCUPP, MA FIX	13000
		MAA - 39000
BAGBY, CA FIX	CLOVIS, CA VORTAC	*7000
*5800 - MOCA		
BANGOR, ME VORTAC	*PATTA, ME FIX	**8000
*8000 - MRA		
**5000 - MOCA		
BARNES, MA VORTAC	KIBBE, MA FIX	2200
		MAA - 17500
BARRETT'S MOUNTAIN, NC	GREENSBORO, NC VORTAC	*3500
VOR/DME		
*3000 - MOCA		
BATTLE MOUNTAIN, NV	CLOVIS, CA VORTAC	24000
VORTAC		
		MAA - 45000
BATTLE MOUNTAIN, NV	TWIN FALLS, ID VORTAC	#18000
VORTAC		
#MEA IS ESTABLISHED WITH A GAP IN NAVIGATION SIGNAL COVERAGE.		
BAXLY, GA FIX	BRUNSWICK, GA VORTAC	*3000
*1700 - MOCA		
BERLIN, NH VOR/DME	SUGRR, ME FIX	6000
		MAA - 17000
BERLIN, NH VOR/DME	NERNY, ME FIX	*6000
*4300 - MOCA		MAA - 17000
BESGE, NC FIX	CAPEX, NC FIX	6000
		MAA - 10000

FROM	TO	MEA
BIG SUR, CA VORTAC VIA BSR VORTAC 85 & AVE VORTAC 304 *7900 - MOCA	AVENAL, CA VORTAC	*11000
BISMARCK, ND VOR/DME	DICKINSON, ND VORTAC	MAA - 35000 18000 MAA - 24000
BISMARCK, ND VOR/DME	HUMBOLDT, MN VORTAC	18000
BLALY, GA FIX	FLINN, GA FIX	2000
BOOIE, TN NDB	YUMMY, VA FIX	4500
BOWLING GREEN, KY VORTAC	LEXINGTON, KY VORTAC	18000 MAA - 41000
BOZEMAN, MT VOR/DME	BOYSEN RESERVOIR, WY VOR/DME	19000 MAA - 35000
BOZEMAN, MT VOR/DME	DUBOIS, ID VORTAC	18000 MAA - 25000
BRADFORD, IL VORTAC	DES MOINES, IA VORTAC	18000 MAA - 41000
BRILO, CA FIX	YAGER, CA FIX	7000
BROOKLEY, AL VORTAC	SEMMES, AL VORTAC	2000 MAA - 17500
BRUSE, FL FIX *1700 - MOCA	DEFUN, FL FIX	*2000
BULLION, NV VOR/DME	BOISE, ID VORTAC	18000
BUTLER, MO VORTAC VIA BUM VORTAC 84 & VIH VOR/DME 268	VICHY, MO VOR/DME	18000 MAA - 41000
BUTLER, MO VORTAC	KANSAS CITY, MO VORTAC	3100 MAA - 35000
CAJON, CA FIX	HITOP, CA FIX	8000
CALBE, CA FIX VIA PDZ VORTAC 306 & PMD VORTAC 142	PALMDALE, CA VORTAC	10000 MAA - 17500
*CAMARILLO, CA VOR/DME *3600 - MCA CAMARILLO, CA	SANTA MONICA, CA VOR/DME VOR/DME , E BND	5000
CAPE GIRARDEAU, MO VOR/DME 221	INT CGI VOR 149 & CNG VORTAC	2000 MAA - 12000
CARRA, FL FIX	ORMOND BEACH, FL VORTAC	2000 MAA - 17500
*CHARM, CO FIX *10000 - MCA CHARM, CO FIX , S BND **7200 - MCA PUEBLO, CO VORTAC , S BND	**PUEBLO, CO VORTAC	8000 MAA - 45000
CHICO, CA VOR/DME	RED BLUFF, CA VORTAC	3000 MAA - 12000
CHISUM, NM VORTAC *11000 - MCA TRACC, NM FIX , N BND	*TRACC, NM FIX	10000
CLARKSVILLE, TN VOR/DME *1700 - MOCA	CLERK, TN FIX	*3000
COALDALE, NV VORTAC	SQUAW VALLEY, CA VOR/DME	15000 MAA - 39000
COALDALE, NV VORTAC *15100 - MOCA	WOODSIDE, CA VORTAC COP 68 OAL	*18000 MAA - 45000
COCHISE, AZ VORTAC	DOUGLAS, AZ VORTAC	8200
COLLI, CA FIX	SCAGGS ISLAND, CA VORTAC	3500
COLOM, CA FIX	FRIANT, CA VORTAC	18000 MAA - 45000

FROM	TO	MEA
COLOM, CA FIX	MINA, NV VORTAC	28000
COLUMBIA, MO VOR/DME	SEDALIA, MO NDB	4000
COLUMBIA, SC VORTAC	CHARLESTON, WV VORTAC	18000
		MAA - 45000
CONCORD, NH VORTAC	KHRIS, NH FIX	3000
		MAA - 8000
CORONA, NM VORTAC	TRACC, NM FIX	12000
CORTEZ, CO VOR/DME	PUEBLO, CO VORTAC	#22000
	COP 80 CEZ	
		MAA - 45000
#MEA IS ESTABLISHED WITH A GAP IN NAVIGATION SIGNAL COVERAGE.		
COVEX, LA FIX	APPIN, TX FIX	*8000
*1800 - MOCA		
COVEX, LA FIX	BELCHER, LA VORTAC	*3500
*1900 - MOCA		
CRAIG, FL VORTAC	LEE COUNTY, FL VORTAC	24000
		MAA - 45000
CRAIG, FL VORTAC	VALDOSTA, GA VOR/DME	*4000
*1500 - MOCA		
CRAIG, FL VORTAC	GATORS, FL VORTAC	24000
		MAA - 45000
CRESTVIEW, FL VORTAC	IDGES, FL FIX	2000
VIA 1500 FLOOR CEW VORTAC R-131.		
		MAA - 17500
CUNNEY, TX FIX	NACOGDOCHES, TX NDB	*4000
*3000 - MOCA		
CUNNINGHAM, KY VORTAC	NIKEL, IL FIX	*4500
	COP 74 CNG	
*3000 - MOCA		
CUNNINGHAM, KY VORTAC	AIRBE, KY NDB	*3000
*2100 - MOCA		
DAGGETT, CA VORTAC	PALMDALE, CA VORTAC	7000
DAYTON, OH VOR/DME	APPLETON, OH VORTAC	18000
		MAA - 45000
DAYTON, OH VOR/DME	GUNNE, OH FIX	18000
		MAA - 39000
DAYTON, OH VOR/DME	FORT WAYNE, IN VORTAC	18000
		MAA - 43000
DECATUR, AL VOR/DME	ROME, GA VORTAC	3800
DELLS, WI VORTAC	EAU CLAIRE, WI VORTAC	18000
		MAA - 29000
DES MOINES, IA VORTAC	IOWA CITY, IA VORTAC	2700
		MAA - 35000
DESTN, FL FIX	VARRE, FL FIX	*2000
VIA 1500 FLOOR. NUN VOR R-095.		
*1500 - MOCA		
DETROIT LAKES, MN VOR/DME	THIEF RIVER FALLS, MN	*3300
	VOR/DME	
*2700 - MOCA		
DICKINSON, ND VORTAC	MINOT, ND VORTAC	18000
		MAA - 35000
DICKINSON, ND VORTAC	U.S. CANADIAN BORDER	18000
VIA DIK VORTAC 31		
DILLON, MT VOR/DME	SHERIDAN, WY VORTAC	#33000
		MAA - 45000
#MEA IS ESTABLISHED WITH A GAP IN NAVIGATION SIGNAL COVERAGE.		
DUBOIS, ID VORTAC	BOZEMAN, MT VOR/DME	18000
		MAA - 35000
DULUTH, MN VORTAC	U.S. CANADIAN BORDER	#*18000
*3100 - MOCA		
#FOR THAT AIRSPACE OVER U.S. TERRITORY.		
DULUTH, MN VORTAC	TRAVERSE CITY, MI VORTAC	24000

FROM	TO	MEA
*DUNOIR, WY VOR/DME	WORLAND, WY VOR/DME COP 40 DNW	**16000
*12200 - MCA DUNOIR, WY VOR/DME , E BND		
**15200 - MOCA		
DUNOIR, WY VOR/DME	BILLINGS, MT VORTAC	18000 MAA - 45000
DUPREE, SD VORTAC	BISMARCK, ND VOR/DME	18000 MAA - 35000
DYERSBURG, TN VORTAC	CUNNINGHAM, KY VORTAC	2000 MAA - 17500
EATON, MS VORTAC	JACKSON, MS VORTAC	3400 MAA - 17500
EAU CLAIRE, WI VORTAC	DULUTH, MN VORTAC	18000 MAA - 29000
EEDEN, AK FIX	FRIED, AK FIX	10000 MAA - 45000
ELLWOOD CITY, PA VORTAC	INT EWC VORTAC 050 & BFD VORTAC 246	4000
EPHRATA, WA VORTAC	OMAK, WA NDB	*8000
*6700 - MOCA		
EVELETH, MN VOR/DME	ELY, MN VOR/DME	3400
FARGO, ND VORTAC	WILLISTON, ND VORTAC	23000
FARMINGTON, MO VORTAC	FLIPPIN, AR VOR/DME	*5000
*2900 - MOCA		
FAYETTEVILLE, NC VOR/DME	TAR RIVER, NC VORTAC	*3000
*1600 - MOCA		
FAYETTEVILLE, NC VOR/DME	KINSTON, NC VORTAC	2000
FELLOWS, CA VORTAC	SHAFTER, CA VORTAC	6400
FELLOWS, CA VORTAC	GUADALUPE, CA VOR	7000
FELLOWS, CA VORTAC	FILLMORE, CA VORTAC COP 42 FLW	9500
FELLOWS, CA VORTAC	GORMAN, CA VORTAC	11000
FELLOWS, CA VORTAC	GAVIOTA, CA VORTAC	8000
FELLOWS, CA VORTAC	SAN MARCUS, CA VORTAC	9000
FILLMORE, CA VORTAC	CLOVIS, CA VORTAC COP 60 FIM	18000
FILLMORE, CA VORTAC	FELLOWS, CA VORTAC	9500
FLINT, MI VORTAC	OLTOE, IA FIX	2600
FLIPPIN, AR VOR/DME	GILMORE, AR VOR/DME	*5000
*2100 - MOCA		
FLIPPIN, AR VOR/DME	MAPLES, MO VORTAC	*4000 MAA - 23000
*2800 - MOCA		
FLYING CLOUD, MN VOR/DME	SIOUX FALLS, SD VORTAC	17000 MAA - 25000
FORNEY, MO VOR	COLUMBIA, MO VOR/DME	2900 MAA - 17500
FORT DODGE, IA VORTAC	BRADFORD, IL VORTAC	18000 MAA - 45000
FORT SMITH, AR VORTAC	WESTY, AR FIX	4500
FORT SMITH, AR VORTAC	SUMMO, AR FIX	*4000 MAA - 17500
*3000 - MOCA		
FORT STOCKTON, TX VORTAC	SAN ANGELO, TX VORTAC	7000
FORT STOCKTON, TX VORTAC	ROCKSPRINGS, TX VORTAC	*8000
*6000 - MOCA		
FORT WAYNE, IN VORTAC	KALAMAZOO, MI VOR/DME	18000 MAA - 43000
GATORS, FL VORTAC	BASSS, FL FIX	3000 MAA - 17500
GATORS, FL VORTAC	ROYES, FL FIX	*3000
*1700 - MOCA		
GATORS, FL VORTAC	CARRA, FL FIX	3000 MAA - 17500
GEORGETOWN, NY VORTAC	VASTS, NY FIX	3900
GINNA, CA FIX	CAMARILLO, CA VOR/DME	4000

FROM	TO	MEA
GIPPER, MI VORTAC	LITCHFIELD, MI VOR/DME COP 49 GIJ	#18000 MAA - 41000
#MAXIMUM CROSSING ALT SBN 075/49 33000.		
GLINA, NM FIX VIA BWS VOR/DME 351	BOLES, NM VOR/DME	#*13000 MAA - 24000
*9900 - MOCA #RADAR REQUIRED WHEN IN HOLLOWMAN APCH CTL ARSPC.		
GOOCH SPRINGS, TX VORTAC	COLLEGE STATION, TX VORTAC	*4000
*3000 - MOCA		
GOPHER, MN VORTAC	CEDAR RAPIDS, IA VOR/DME	14500 MAA - 35000
GOPHER, MN VORTAC	MOLINE, IL VORTAC	13000 MAA - 35000
GOREY, CO FIX	RLG*C*128/10	16000 MAA - 14700
GRAHAM, TN VORTAC	FIDDS, TN FIX	*2800
*2500 - MOCA		
GRAND ISLAND, NE VORTAC	LINCOLN, NE VORTAC	*4000 MAA - 35000
*2900 - MOCA		
GRAND ISLAND, NE VORTAC	SALINA, KS VORTAC	*7000 MAA - 17500
*3800 - MOCA		
GRAND STRAND, SC VORTAC	KINSTON, NC VORTAC	18000 MAA - 45000
GROTON, CT VOR/DME	FLIBB, CT FIX	*2000 MAA - 17500
*1500 - MOCA		
GUADALUPE, CA VOR	HABUT, CA FIX	5000
GUANTANAMO BAY, CU UHF/NDB	INT NBW NDB 078 & GT NDB 243	2400
GULFPORT, MS VORTAC	*PLUGG, MS FIX	**2000
*5000 - MRA **1700 - MOCA		
GUNNE, OH FIX	TIVERTON, OH VOR/DME	18000 MAA - 39000
HARRISON, AR VOR/DME	FORNEY, MO VOR	*4000 MAA - 23000
*2800 - MOCA		
HOLSTON MOUNTAIN, TN VORTAC	LONDON, KY VORTAC	18000 MAA - 45000
HOMEE, PA FIX	JOHNSTOWN, PA VORTAC	4200
HOMEE, PA FIX	REVLOC, PA VOR/DME	4000
HONEZ, CA FIX	MODESTO, CA VOR/DME	2200
HORIG, TN FIX	KIMGE, TN FIX	5500 MAA - 10000
HOSSY, AR NDB	LITTLE ROCK, AR VORTAC	2500
HOVEL, ID FIX	ONTARIO, OR NDB SE BND NW BND	7000 9000
HUDSPETH, TX VORTAC	MARFA, TX VOR/DME	9400
HUMBLE, TX VORTAC	QUITMAN, TX VOR/DME	*9000 MAA - 41000
*2200 - MOCA		
HURON, SD VORTAC	REDWOOD FALLS, MN VOR/DME COP 40 HON	31000 MAA - 37000
INT ADW VORTAC 067 & OTT VORTAC 037	BOAST, MD FIX	2200
INT CNX VORTAC 315 & OTO VOR 168 VIA OTO VOR 168	GLINA, NM FIX	*12000
*9000 - MOCA		
INT EWC VORTAC 050 & BFD VOR/DME 246	BRADFORD, PA VOR/DME	4000
INT MGY VOR 234 & MXE VORTAC 113	MODENA, PA VORTAC	2000

FROM	TO	MEA
INT NBW NDB 078 & GT NDB 243 *1300 - MOCA	GRAND TURK, TC NDB	*2000
INT TUL VORTAC 097 & RZC VORTAC 240 *2900 - MOCA	RAZORBACK, AR VORTAC	*3000
JACKS CREEK, TN VOR/DME *2100 - MOCA	CUNNINGHAM, KY VORTAC	*2400
JAMESTOWN, ND VOR/DME	BISMARCK, ND VOR/DME	18000 MAA - 24000
JAMESTOWN, ND VOR/DME	GRAND FORKS, ND VOR/DME	18000 MAA - 35000
JIMMY, VA FIX	INT HPW VORTAC 105 & HCM VORTAC 134	2000
JULIAN, CA VORTAC	PARADISE, CA VORTAC	8000 MAA - 41000
KAISER, MO NDB *2400 - MOCA	FORNEY, MO VOR	*3000
KALAMAZOO, MI VOR/DME	GRAND RAPIDS, MI VOR/DME	18000 MAA - 43000
KALISPELL, MT VOR/DME *11400 - MOCA	HELENA, MT VORTAC COP 50 FCA	*15500
KALISPELL, MT VOR/DME	U.S. CANADIAN BORDER COP 82 FCA	18000 MAA - 45000
KANSAS CITY, MO VORTAC	ST JOSEPH, MO VORTAC	2900 MAA - 35000
KANSAS CITY, MO VORTAC *2900 - MOCA	LINCOLN, NE VORTAC	*3500 MAA - 35000
KEARNEY, NE VOR	MANKATO, KS VORTAC	4200
KENNEDY, NY VOR/DME	COLTS NECK, NJ VOR/DME	2000 MAA - 5000
KHRIS, NH FIX	LAWRENCE, MA VOR/DME	3000 MAA - 8000
KILMA, NJ FIX	COLTS NECK, NJ VOR/DME	2000 MAA - 6000
KIRKSVILLE, MO VORTAC	SPINNER, IL VORTAC	18000 MAA - 41000
LAFAYETTE, LA VORTAC	ORICH, LA FIX	1600
LAKE CHARLES, LA VORTAC *1600 - MOCA	LUFKIN, TX VORTAC	*3000 MAA - 1700
LAKE CHARLES, LA VORTAC *1600 - MOCA	APPIN, TX FIX	*8000
LAKE HUGHES, CA VORTAC	FILLMORE, CA VORTAC	8000
LAMONI, IA VORTAC	IOWA CITY, IA VORTAC	18000 MAA - 42000
LAUGHLIN, TX VORTAC *3000 - MOCA	SAN ANTONIO, TX VORTAC	*5000
LAWTON, OK VOR/DME VIA LAW VOR/DME 71 & MLC VORTAC 254 *2700 - MOCA	MC ALESTER, OK VORTAC	*6000
LEONA, TX VORTAC *1900 - MOCA	GREGG COUNTY, TX VORTAC	MAA - 24000 *2500
LINCOLN, NE VORTAC	OMAHA, IA VORTAC	3700 MAA - 35000
LINCOLN, NE VORTAC *2700 - MOCA	DES MOINES, IA VORTAC	*5000 MAA - 45000
LONDON, KY VORTAC	HOLSTON MOUNTAIN, TN VORTAC	18000 MAA - 43000
LUFKIN, TX VORTAC *2000 - MOCA	MONROE, LA VORTAC COP 82 LFK	*8000

FROM	TO	MEA
LUFKIN, TX VORTAC	PALESTINE, TX NDB COP 53 LFK	*3200
*2100 - MOCA MADISON, WI VORTAC	DELLS, WI VORTAC	18000 MAA - 29000
MANHATTAN, KS VOR/DME	FORBES FIELD, KS- RIPLY LOM COP 35 MHK	3500
MANKATO, KS VORTAC *3100 - MOCA	SALINA, KS VORTAC	*3400
MANTECA, CA VORTAC	SAN JOSE, CA VOR/DME COP 30 ECA	6000 MAA - 30000
MANTECA, CA VORTAC	BUSHY, CA FIX	6000
MAPLES, MO VORTAC *2800 - MOCA	WALNUT RIDGE, AR VORTAC	*3500
MARATHON, FL NDB VIA CONTROL 1233	TADPO, FL FIX	2500
*MARIC, CA FIX VIA AVE VORTAC 109 & LHS VORTAC 305 *3400 - MCA MARIC, CA FIX, E BND	LAKE HUGHES, CA VORTAC	7800
MARSH HARBOUR, BS NDB *1300 - MOCA	ANGLL, BS FIX	*2000
MARYSVILLE, CA VOR/DME	CHICO, CA VOR/DME	3000 MAA - 12000
MC ALESTER, OK VORTAC *2700 - MOCA	TULSA, OK VORTAC	*3000
MC GUIRE, NJ VORTAC	INT GXU VORTAC 234 & MXE VORTAC 113	2000 MAA - 8000
MC GUIRE, NJ VORTAC	ROBBINSVILLE, NJ VORTAC	2000 MAA - 7000
MEEKER, CO VOR/DME *16500 - MRA **15500 - MOCA	*FUNDS, CO FIX	**24000 MAA - 37000
MENDOCINO, CA VORTAC	POINT REYES, CA VORTAC	5000 MAA - 39000
MENDOCINO, CA VORTAC *7500 - MOCA	BRILO, CA FIX	*11000 MAA - 24000
MERIDIAN, MS VORTAC	NASHVILLE, TN VORTAC	24000 MAA - 45000
MINA, NV VORTAC	BATTLE MOUNTAIN, NV VORTAC	18000
MINOT, ND VORTAC	U.S. CANADIAN BORDER	18000 MAA - 45000
MISSOULA, MT VOR/DME	GREAT FALLS, MT VORTAC	18000 MAA - 24000
MISSOULA, MT VOR/DME	BOZEMAN, MT VOR/DME	20000 MAA - 35000
MISSOULA, MT VOR/DME	DILLON, MT VOR/DME	16500 MAA - 35000
MISSOULA, MT VOR/DME	KALISPELL, MT VOR/DME	18000 MAA - 45000
MONTEBELLO, VA VOR/DME	ELKINS, WV VORTAC	6600
MONTOUR, PA VORTAC	DU BOIS, PA LOM COP 65 MMJ	5000
MORGANTOWN, WV VORTAC	INT AGC VORTAC 237 & EWC VORTAC 190	3800
MORMON MESA, NV VORTAC	WILSON CREEK, NV VORTAC	18000
MORRO BAY, CA VORTAC	FILLMORE, CA VORTAC	9500
MORRO BAY, CA VORTAC	FELLOWS, CA VORTAC	6400
MORRO BAY, CA VORTAC	SHAFTER, CA VORTAC	6000
MOULTRIE, GA VOR/DME	VALDOSTA, GA VOR/DME	2000 MAA - 7000
MUDDY MOUNTAIN, WY VORTAC	DICKINSON, ND VORTAC	18000

FROM	TO	MEA
		MAA - 35000
MUSCLE SHOALS, AL VORTAC	ROME, GA VORTAC	3800
MUSCLE SHOALS, AL VORTAC	NASHVILLE, TN VORTAC	*3000
VIA MSL VORTAC 24		
& BNA VORTAC 205		
*2500 - MOCA		
MUSTANG, NV VORTAC	TROSE, CA FIX	22000
NAPOLEON, MO VORTAC	KAISER, MO NDB	*5000
	COP 70 ANX	
*2400 - MOCA		
NERNY, ME FIX	AUGUSTA, ME VOR/DME	6000
		MAA - 17000
NEWMAN, TX VORTAC	TURQE, NM FIX	*8000
*6700 - MOCA		MAA - 17500
NORTH BEND, OR VORTAC	EUGENE, OR VORTAC	18000
		MAA - 41000
NORTH BEND, OR VORTAC	NEWPORT, OR VORTAC	18000
		MAA - 45000
NORTH PHILADELPHIA, PA	ROBBINSVILLE, NJ VORTAC	2000
VOR		
		MAA - 7000
NORTH PHILADELPHIA, PA	NORTH PHILADELPHIA, PA VOR	*4000
VOR 100/40		
*1700 - MOCA		MAA - 5000
NORTH PLATTE, NE VORTAC	KEARNEY, NE VOR	*5000
*4200 - MOCA		
NORTHBROOK, IL VOR/DME	DES MOINES, IA VORTAC	18000
		MAA - 41000
NORWICH, CT VOR/DME	LAFAY, RI FIX	2000
		MAA - 17500
O'NEILL, NE VORTAC	MASON CITY, IA VORTAC	24000
VIA ONL VORTAC 68		
& MCW VORTAC 257		
		MAA - 41000
OAKLAND, CA VORTAC	SCAGGS ISLAND, CA VORTAC	4000
OMAHA, IA VORTAC	HILL CITY, KS VORTAC	18000
		MAA - 45000
ONTARIO, OR NDB	PARMO, ID FIX	5000
PACIF, CA FIX	SEAL BEACH, CA VORTAC	3000
PANAMA CITY, FL VORTAC	PHIPS, FL FIX	*2000
VIA 1500 FLOOR. PFN VORTAC R-284.		
*1500 - MOCA		MAA - 17500
PANAMA CITY, FL VORTAC	BRUSE, FL FIX	1800
PANAMA CITY, FL VORTAC	WILME, FL FIX	1800
PANAMA CITY, FL VORTAC	BRITS, FL FIX	2500
PANAMA CITY, FL VORTAC	PARER, FL FIX	*1800
*1400 - MOCA		
PANOCH, CA VORTAC	GORMAN, CA VORTAC	24000
PANOCH, CA VORTAC	*HENCE, CA FIX	**9000
*9000 - MCA HENCE, CA FIX , E BND		
**5800 - MOCA		
PANOCH, CA VORTAC	SUNOL, CA FIX	18000
		MAA - 31000
PARADISE, CA VORTAC	*CALBE, CA FIX	6000
*8500 - MCA CALBE, CA FIX , NW BND		
		MAA - 17500
PARER, FL FIX	CRESS, FL FIX	*2000
*1400 - MOCA		
PAWNEE CITY, NE VORTAC	KIRKSVILLE, MO VORTAC	18000
VIA PWE VORTAC 81		
& IRK VORTAC 266		
		MAA - 41000
PAWNEE CITY, NE VORTAC	KANSAS CITY, MO VORTAC	18000
		MAA - 45000

FROM	TO	MEA
PEACH SPRINGS, AZ VORTAC VIA PGS VORTAC 43 & DVC VORTAC 226	DOVE CREEK, CO VORTAC COP 100 PGS	18000 MAA - 41000
PECAN, GA VORTAC *1900 - MOCA	OMAHO, AL FIX	*2500
PECAN, GA VORTAC	MOULTRIE, GA VOR/DME	2500 MAA - 7000
PENDLETON, OR VORTAC #MEA IS ESTABLISHED WITH A GAP IN NAVIGATION SIGNAL COVERAGE.	DILLON, MT VOR/DME	#24000
PHIPS, FL FIX VIA 1500 FLOOR. PFN VORTAC R-284. *1500 - MOCA	DESTN, FL FIX	*3000 MAA - 17500
PINON, NM VOR/DME *11000 - MCA TRACC, NM FIX, N BND	*TRACC, NM FIX	10000
POINT REYES, CA VORTAC *4400 - MOCA	WOODSIDE, CA VORTAC	*5000 MAA - 17000
POTTSTOWN, PA VORTAC	BOYER, PA FIX	5000 MAA - 7000
*PRYOR, OK FIX *2900 - MRA **3000 - MOCA	DRAKE, AR VOR/DME	**4000 MAA - 23000
PUEBLO CO LOM PUEBLO, CO VORTAC	PYNON, CO FIX HILL CITY, KS VORTAC	7600 18000 MAA - 45000
PUEBLO, CO VORTAC VIA PUB VORTAC 37 & HCT VORTAC 221	HAYES CENTER, NE VORTAC	18000 MAA - 41000
PUT RIVER, AK NDB *1200 - MOCA	BARTER ISLAND, AK NDB	*2000
PYNON, CO FIX QUITMAN, TX VOR/DME *3000 - MOCA	BLACK FOREST, CO VORTAC TULSA, OK VORTAC	9400 *9000
RAPID CITY, SD VORTAC	HURON, SD VORTAC COP 165 RAP	31000 MAA - 37000
RAPID CITY, SD VORTAC	DUPREE, SD VORTAC	18000 MAA - 35000
RAPID CITY, SD VORTAC RAPID CITY, SD VORTAC #MEA IS ESTABLISHED WITH A GAP IN NAVIGATION SIGNAL COVERAGE.	FARGO, ND VORTAC MINOT, ND VORTAC	24000 #18000
RAVINE, PA VORTAC RAVINE, PA VORTAC *3900 - MOCA	HAILS, PA FIX WILKES-BARRE, PA VORTAC	3400 *4000
RAZORBACK, AR VORTAC *3100 - MOCA	MADES, AR FIX	*3600
RED BLUFF, CA VORTAC RED BLUFF, CA VORTAC *9000 - MOCA	REDDING, CA VOR/DME SCAGGS ISLAND, CA VORTAC COP 60 RBL	3000 *6000
*REDDING, CA VOR/DME	**TOMAD, CA FIX NE BND SW BND	6000 9000
**7000 - MRA *5000 - MCA REDDING, CA VOR/DME, SW BND	CHICO, CA VOR/DME	5000 MAA - 12000
REDDING, CA VOR/DME	GRACE, PA FIX	4000 MAA - 17000
REVLOC, PA VOR/DME	HOT SPRINGS, AR VOR/DME	4000
RICH MOUNTAIN, OK VORTAC RICHY, CA FIX	MARRI, CA FIX	13000

FROM	TO	MEA
RIVERTON, WY VOR/DME *14800 - MOCA #35000 MRA AT COP.	GREAT FALLS, MT VORTAC	#*35000
RIVERTON, WY VOR/DME	LARAMIE, WY VOR/DME	18000 MAA - 35000
ROCK SPRINGS, WY VOR/DME *13200 - MOCA	JACKSON, WY VOR/DME COP 118 OCS	*18000 MAA - 45000
ROCK SPRINGS, WY VOR/DME *14000 - MOCA	LARAMIE, WY VOR/DME	*18000 MAA - 45000
ROCKET, AL VORTAC	ROME, GA VORTAC	6000
ROGUE VALLEY, OR VORTAC *11000 - MRA	*ROOTY, OR FIX	11000
ROLLS, OK FIX *3300 - MOCA	INT GAG VORTAC 143 & SYO VORTAC 079	*6000 MAA - 17500
ROME, OR VORTAC	DONNELLY, ID VORTAC	24000 MAA - 45000
ROME, OR VORTAC	DUBOIS, ID VORTAC COP 144 REO	31000 MAA - 45000
SACRAMENTO, CA VORTAC	KLAMATH FALLS, OR VORTAC COP 130 SAC	18000
SALEM, OR LOM	BATTLE GROUND, WA VORTAC	3000
SALINA, KS VORTAC *2800 - MOCA	FORBES KS LOM	*4500
SALINAS, CA VORTAC	LICKE, CA FIX	6000 MAA - 17500
SALINAS, CA VORTAC	GILRO, CA FIX	5000
SALMON, ID VOR/DME	MISSOULA, MT VOR/DME	18000 MAA - 45000
SALT FLAT, TX VORTAC	MARFA, TX VOR/DME	10400
SAN ANGELO, TX VORTAC	GOOCH SPRINGS, TX VORTAC	5000
SAN ANGELO, TX VORTAC	ROCKSPRINGS, TX VORTAC	4200
SAN ANGELO, TX VORTAC	BROWNWOOD, TX VOR/DME	3500
SAN ANGELO, TX VORTAC VIA SJT VORTAC 73 & BWD VOR/DME 224	BROWNWOOD, TX VOR/DME	4500
SAN JOSE, CA VOR/DME	COLLI, CA FIX	4000
SAN MARCUS, CA VORTAC	GUADALUPE, CA VOR	6700
SAN MARCUS, CA VORTAC	MORRO BAY, CA VORTAC	6800
SANTA CATALINA, CA VORTAC	GAVIOTA, CA VORTAC	6400
*SANTY, CA FIX *7000 - MRA **7000 - MRA	**TAILS, CA FIX	5000
SAUFLEY, FL VOR VIA NUN VOR 104	VARRE, FL FIX	2000 MAA - 17500
SCAPA, PR FIX	CRSTL, PR FIX	6000
SCOTTSBLUFF, NE VORTAC	ABERDEEN, SD VOR/DME	26000 MAA - 45000
SCOTTSBLUFF, NE VORTAC VIA BFF VORTAC 83 & OBH VORTAC 269	WOLBACH, NE VORTAC	18000 MAA - 45000
SEAL BEACH, CA VORTAC *2400 - MOCA	ELMOO, CA FIX	*5000
SEMMES, AL VORTAC	GREENE COUNTY, MS VORTAC	2000 MAA - 17500
*SHAFTER, CA VORTAC *3300 - MCA SHAFTER, CA VORTAC, NE BND **5400 - MCA WRING, CA FIX, SE BND	**WRING, CA FIX	5000
SHELBYVILLE, TN VOR/DME *2400 - MOCA	INT BNA VORTAC 130 & SYI VOR/DME 040	*3000

FROM	TO	MEA
SHERIDAN, WY VORTAC	RAPID CITY, SD VORTAC	18000 MAA - 45000
SIDNEY, NE VORTAC	ABERDEEN, SD VOR/DME	29000 MAA - 45000
SILVER CITY, NM VORTAC	ALBUQUERQUE, NM VORTAC COP 50 SVC	14500
SIoux FALLS, SD VORTAC SNOUT, AK FIX	FARGO, ND VORTAC EEDEN, AK FIX	15000 10000 MAA - 45000
SNOWBIRD, TN VORTAC	LONDON, KY VORTAC	18000 MAA - 45000
SPOKANE, WA VORTAC	U.S. CANADIAN BORDER	#18000 MAA - 45000
#MEA IS ESTABLISHED WITH A GAP IN NAVIGATION SIGNAL COVERAGE.		
SPOKANE, WA VORTAC VIA GEG VORTAC 139 & DNJ VORTAC 322	DONNELLY, ID VORTAC	18000 MAA - 41000
SPOKANE, WA VORTAC	MISSOULA, MT VOR/DME	18000 MAA - 35000
SPRINGFIELD, MO VORTAC	NASHVILLE, TN VORTAC	18000 MAA - 41000
SQUAW VALLEY, CA VOR/DME	KLAMATH FALLS, OR VORTAC	28000 MAA - 45000
SQUAW VALLEY, CA VOR/DME *12000 - MCA RICHY, CA FIX , *21000 - MCA RICHY, CA FIX , SE BND	*RICHY, CA FIX	11000
ST JEAN, CANADA VORTAC VIA YJN VORTAC 160 & LEB VOR/DME 360	LEBANON, NH VOR/DME	#18000 MAA - 26000
#FOR THAT AIRSPACE OVER U.S. TERRITORY.		
ST LOUIS, MO VORTAC *3200 - MOCA	MOLINE, IL VORTAC	*8000 MAA - 30000
ST LOUIS, MO VORTAC *2100 - MOCA	PEORIA, IL VORTAC	*7000
ST PETERSBURG, FL VORTAC	ATLANTA, GA VORTAC	30000 MAA - 41000
SUGRR, ME FIX	AUGUSTA, ME VOR/DME	6000 MAA - 17000
SUMMO, AR FIX *2800 - MOCA	NEOSHO, MO VOR/DME	*3500
TAOS, NM VORTAC *10000 - MCA CHARM, CO FIX , S BND	*CHARM, CO FIX	15000 MAA - 45000
TIVERTON, OH VOR/DME	AKRON, OH VOR/DME	18000 MAA - 39000
TIVERTON, OH VOR/DME	WILMO, OH FIX	18000 MAA - 41000
TONOPAH, NV VORTAC VIA TPH VORTAC 77 & BCE VORTAC 262	BRYCE CANYON, UT VORTAC	23000 MAA - 45000
TOPEKA, KS VORTAC *3000 - MOCA	NEOSHO, MO VOR/DME	*5000 MAA - 35000
TROSE, CA FIX	MODESTO, CA VOR/DME SW BND NE BND	5000 22000 MAA - 39000
TRUER, PA FIX	ELMIRA, NY VOR/DME	4000
TULSA, OK VORTAC *3900 - MOCA	RICH MOUNTAIN, OK VORTAC	*4600
TULSA, OK VORTAC	INT TUL VORTAC 189 & OKM VOR	*2500

FROM	TO	MEA
	208	
*2200 - MOCA TULSA, OK VORTAC	BARTLESVILLE, OK VOR/DME	2500
TULSA, OK VORTAC	DRAKE, AR VOR/DME	*4000
*3000 - MOCA		MAA - 23000
TUPELO, MS VOR/DME	CRIMSON, AL VORTAC	*3000
*1800 - MOCA		
TURQE, NM FIX	BOLES, NM VOR/DME	#*8000
*6600 - MOCA		MAA - 17500
#MAA 11000 MSL WHEN R-5103C IN USE		
#ROUTE NOT USABLE WHEN R-5103A OR R-5103B IN USE.		
RADAR RQRD WHEN IN HOLLOMAN APCH CTL AIRSPACE.		
TUSCOLA, TX VOR/DME	LLANO, TX VORTAC	*4500
*3900 - MOCA		
TUTTS, VA FIX	AZALEA PARK, VA NDB	4000
TWENTYNINE PALMS, CA VORTAC	GOFFS, CA VORTAC	18000
	COP 17 TNP	
VIA TNP VORTAC 28 & GFS VORTAC 185		MAA - 45000
UNBAR, MI FIX	SALEM, MI VORTAC	18000
		MAA - 45000
VALDOSTA, GA VOR/DME	WAYCROSS, GA VORTAC	2300
		MAA - 7000
VALER, TN FIX	CLARKSVILLE, TN VOR/DME	*2300
*2000 - MOCA		MAA - 6000
*VAN NUYS, CA VOR/DME	**PALMDALE, CA VORTAC	7800
*6000 - MCA VAN NUYS, CA VOR/DME , NE BND		
**5800 - MCA PALMDALE, CA VORTAC , SW BND		MAA - 17500
VAN NUYS, CA VOR/DME	STABO, CA FIX	4000
	COP 18 VNY	
VARRE, FL FIX	SAUFLEY, FL VOR	2000
VIA 1500 FLOOR. NUN VOR R-095.		MAA - 17500
VEERS, CT FIX	BARNES, MA VORTAC	3300
		MAA - 17500
VERO BEACH, FL VORTAC	LUCYS, FL FIX	1500
		MAA - 17500
VICHY, MO VOR/DME	POCKET CITY, IN VORTAC	18000
VIA VIH VOR/DME 87 & PXV VORTAC 272		MAA - 41000
WAKER, CA FIX	FILLMORE, CA VORTAC	4800
*WESLA, CA FIX	FILLMORE, CA VORTAC	4800
*4100 - MCA WESLA, CA FIX , N BND		
WICHITA FALLS, TX VORTAC	ARDMORE, OK VORTAC	*4000
*2500 - MOCA		
WICHITA, KS VORTAC	WALNUT RIDGE, AR VORTAC	18000
		MAA - 45000
WICHITA, KS VORTAC	WILL ROGERS, OK VORTAC	*6000
*3600 - MOCA		MAA - 17500
WILKES-BARRE, PA VORTAC	LATTY, NY FIX	4000
		MAA - 10000
WILL ROGERS, OK VORTAC	MEMPHIS, TN VORTAC	27000
		MAA - 45000
WILL ROGERS, OK VORTAC	WICHITA, KS VORTAC	*6000
*3600 - MOCA		MAA - 17500
WILLISTON, ND VORTAC	U.S. CANADIAN BORDER	*8000
VIA ISN VORTAC 340		
*3400 - MOCA		MAA - 17500

FROM	TO	MEA
WILME, FL FIX *7000 - MCA TERES, FL FIX , E BND **1400 - MOCA	*TERES, FL FIX	**7000
WILMO, OH FIX	AKRON, OH VOR/DME	18000 MAA - 41000
WILSON CREEK, NV VORTAC	BULLION, NV VOR/DME	20000
WINDOM, MN NDB *2900 - MOCA	WORTHINGTON, MN VOR/DME	*3400
WINDOM, MN NDB	REDWOOD FALLS, MN VOR/DME	3300
WIREGRASS, AL VORTAC	BLALY, GA FIX	2500
WOLBACH, NE VORTAC	DES MOINES, IA VORTAC	10000 MAA - 17500
WOLBACH, NE VORTAC	OMAHA, IA VORTAC	3800 MAA - 35000
WOLBACH, NE VORTAC	PAWNEE CITY, NE VORTAC	18000 MAA - 45000
WOODRING, OK VOR/DME *2700 - MOCA	STILLWATER, OK VOR/DME	*2900
WOODSIDE, CA VORTAC *7000 - MRA **4400 - MOCA	*EUGEN, CA FIX	**6000
WRAPS, CA FIX *2600 - MOCA	SACRAMENTO, CA VORTAC	*3000

FROM TO MEA

PUERTO RICO ROUTES

ROUTE 1

UTAHS, PR FIX *1300 - MOCA	BORINQUEN, PR VORTAC	*4000
BORINQUEN, PR VORTAC	MAYAGUEZ, PR VOR/DME	2500

ROUTE 2

FAJAR, PR FIX	TOURO, PR FIX	2000
TOURO, PR FIX	MALIE, VI FIX	2000

ROUTE 3

UTAHS, PR FIX *7000 - MRA	*JAAWS, PR FIX	12000
JAAWS, PR FIX	SAN JUAN, PR VORTAC	3000

ROUTE 4

*IDAHO, PR FIX *15000 - MRA **1800 - MOCA	BORINQUEN, PR VORTAC	**2500
BORINQUEN, PR VORTAC	JOSHE, PR FIX	6000
JOSHE, PR FIX	MIGHT, PR FIX	6000
MIGHT, PR FIX	TUUNA, PR FIX	6000
TUUNA, PR FIX	VEDAS, PR FIX	5000
VEDAS, PR FIX	SNOOZ, VI FIX	4000
SNOOZ, VI FIX	ST CROIX, VI VOR/DME	2400

ROUTE 5

BORINQUEN, PR VORTAC *6000 - MRA **1800 - MOCA	*ROBLL, PR FIX	**3000
ROBLL, PR FIX *1300 - MOCA	PLING, PR FIX	*6000

ROUTE 6

*IDAHO, PR FIX *15000 - MRA **6000 - MRA	**ROBLL, PR FIX	15000
ROBLL, PR FIX	BEANO, PR FIX	6000
BEANO, PR FIX *1300 - MOCA	CORAF, PR FIX	*3000
CORAF, PR FIX	SAN JUAN, PR VORTAC	1500
SAN JUAN, PR VORTAC	CHAKA, PR FIX	2500
CHAKA, PR FIX	PALCO, PR FIX	3000
PALCO, PR FIX	ST THOMAS, VI VOR/DME	2700
		MAA - 45000

FROM	TO	MEA
ROUTE 7		
PLING, PR FIX	SAALR, PR FIX	12000
SAALR, PR FIX	DONKE, PR FIX	3000
DONKE, PR FIX	SAN JUAN, PR VORTAC	3000
SAN JUAN, PR VORTAC	SANLO, PR FIX	4000
SANLO, PR FIX	TUUNA, PR FIX	4000
TUUNA, PR FIX	GESSO, PR FIX	9000
ROUTE 8		
*PONCE, PR VOR/DME	TUUNA, PR FIX	**6000
*13000 - MCA PONCE, PR VOR/DME , W BND		
**4500 - MOCA		
ROUTE 9		
VERMO, PR FIX	*DEEDY, PR FIX	12000
*2500 - MRA		
DEEDY, PR FIX	WALNA, PR FIX	12000
PONCE, PR VOR/DME	*DAKES, PR FIX	6000
*9000 - MRA		
ROUTE 10		
SAN JUAN, PR VORTAC	VARNA, PR FIX	3700
VARNA, PR FIX	JOSHE, PR FIX	6000
JOSHE, PR FIX	PONCE, PR VOR/DME	6000
PONCE, PR VOR/DME	KYAAK, PR FIX	6000
KYAAK, PR FIX	ALASK, PR FIX	6000
ROUTE 12		
MAYAGUEZ, PR VOR/DME	JOSHE, PR FIX	6000
JOSHE, PR FIX	*VARNA, PR FIX	6000
*5000 - MCA VARNA, PR FIX , SW BND		
VARNA, PR FIX	SAN JUAN, PR VORTAC	3700
SAN JUAN, PR VORTAC	JETSS, PR FIX	2000
JETSS, PR FIX	ST THOMAS, VI VOR/DME	2800

FROM TO MEA

BAHAMA ROUTES

1L

SATELLITE, FL NDB *1500 - MOCA	JOLTS, BS FIX	*2000
JOLTS, BS FIX *1500 - MOCA	FREEPORT, BS VOR/DME	*2000
FREEPORT, BS VOR/DME *1300 - MOCA	BARTS, BS FIX	*2000
BARTS, BS FIX *1200 - MOCA	MAMML, BS FIX	*2000
MAMML, BS FIX *1200 - MOCA	DIAZZ, OA FIX	*2000
DIAZZ, OA FIX	COBBL, BS FIX	
COBBL, BS FIX *1200 - MOCA	LOGVN, OA FIX	*2000
LOGVN, OA FIX	BRRGO, BS FIX	2000
BRRGO, BS FIX *1200 - MOCA	AVNEY, OA FIX	*2000
AVNEY, OA FIX *1200 - MOCA	BENIE, IB FIX	*2000
BENIE, IB FIX *1200 - MOCA	OREDE, BS FIX	*2000
OREDE, BS FIX *1200 - MOCA	RAHAM, IB FIX	*2000
RAHAM, IB FIX *1300 - MOCA	STRUD, OA FIX	*2000
STRUD, OA FIX	BIKIN, IB FIX	
BIKIN, IB FIX *1300 - MOCA	GRAND TURK, TC VORTAC	*2000

7L

NASSAU, BS NDB *1500 - MOCA	HIROC, BS FIX	*2000
HIROC, BS FIX *1400 - MOCA	FREEPORT, BS NDB	MAA - 45000 *2000 MAA - 45000

9L

GRAND TURK, TC VORTAC	TOMAZ, IB FIX	
TOMAZ, IB FIX *1300 - MOCA	CARAH, OA FIX	*2000
CARAH, OA FIX *1300 - MOCA	SKHOT, OA FIX	*2000

10L

FREEPORT, BS VOR/DME	HAANA, BS FIX	
HAANA, BS FIX	MRRSH, BS FIX	3000

FROM	TO	MEA
 21V		
FREEPOR, BS VOR/DME	ULAMA, BS FIX	2000
ULAMA, BS FIX	WALIK, FL FIX	
WALIK, FL FIX	PALM BEACH, FL VORTAC	2000
 22V		
FORT LAUDERDALE, FL VOR/DME	DEKAL, OA FIX	6000
DEKAL, OA FIX	WIERS, BS FIX	6000
WIERS, BS FIX	OYSTA, BS FIX	10000
OYSTA, BS FIX	CAREY, BS FIX	6000
CAREY, BS FIX	MAJUR, OA FIX	2000
MAJUR, OA FIX	NASSAU, BS VOR/DME	*2000
*1500 - MOCA		
 49V		
DOLPHIN, FL VORTAC	LUVLY, FL FIX	2000
LUVLY, FL FIX	JUNUR, FL FIX	2000
JUNUR, FL FIX	FOWEE, OA FIX	6000
FOWEE, OA FIX	LUCSS, BS FIX	12000
LUCSS, BS FIX	*TINKY, OA FIX	
*8000 - MRA		
TINKY, OA FIX	NICKO, BS FIX	4000
NICKO, BS FIX	NASSAU, BS VOR/DME	4000
 53V		
VIRGINIA KEY, FL VOR/DME	SKIPS, BS FIX	4000
SKIPS, BS FIX	LEEVI, BS FIX	5000
LEEVI, BS FIX	SWIMM, BS FIX	5000
SWIMM, BS FIX	WOOZE, BS FIX	9000
WOOZE, BS FIX	*RAJAY, BS FIX	11000
*11000 - MRA		
RAJAY, BS FIX	PRUNE, BS FIX	4000
PRUNE, BS FIX	HINZY, BS FIX	2000
HINZY, BS FIX	NASSAU, BS VOR/DME	2000
NASSAU, BS VOR/DME	GUAVA, BS FIX	3000
GUAVA, BS FIX	BNTTZ, BS FIX	3000
 54V		
PALM BEACH, FL VORTAC	MRLIN, FL FIX	2000
MRLIN, FL FIX	PREDA, FL FIX	4000
PREDA, FL FIX	ISAAC, BS FIX	6000
ISAAC, BS FIX	OYSTA, BS FIX	8000
OYSTA, BS FIX	CAREY, BS FIX	6000
CAREY, BS FIX	MAJUR, OA FIX	2000
MAJUR, OA FIX	NASSAU, BS VOR/DME	*2000
*1500 - MOCA		

FROM	TO	MEA
55V		
PALM BEACH, FL VORTAC	MRLIN, FL FIX	2000
MRLIN, FL FIX	PREDA, FL FIX	4000
PREDA, FL FIX	BEECH, BS FIX	4000
BEECH, BS FIX	BIMINI, BS VORTAC	4000
BIMINI, BS VORTAC	*RAJAY, BS FIX	4000
*11000 - MRA		
RAJAY, BS FIX	PRUNE, BS FIX	4000
PRUNE, BS FIX	HINZY, BS FIX	2000
HINZY, BS FIX	NASSAU, BS VOR/DME	
NASSAU, BS VOR/DME	BURRL, BS FIX	*3000
*1500 - MOCA		
BURRL, BS FIX	SEAAN, BS FIX	*3000
*1300 - MOCA		
SEAAN, BS FIX	MUVOD, BS FIX	*10000
*1300 - MOCA		
MUVOD, BS FIX	BRRGO, BS FIX	*16000
*1300 - MOCA		
57V		
FORT LAUDERDALE, FL VOR/DME	DEKAL, OA FIX	6000
DEKAL, OA FIX	WIERS, BS FIX	6000
WIERS, BS FIX	BIMINI, BS VORTAC	3000
BIMINI, BS VORTAC	CAREY, BS FIX	*2000
*1300 - MOCA		
CAREY, BS FIX	MAJUR, OA FIX	2000
MAJUR, OA FIX	NASSAU, BS VOR/DME	*2000
*1500 - MOCA		
58V		
NASSAU, BS VOR/DME	KURAY, BS FIX	*2000
*1500 - MOCA		
KURAY, BS FIX	*MELON, BS FIX	**2000
*8000 - MRA		
**1300 - MOCA		
MELON, BS FIX	HANKX, BS FIX	*2000
*1300 - MOCA		
HANKX, BS FIX	BARTS, BS FIX	*4000
*1300 - MOCA		
BARTS, BS FIX	ANGLL, BS FIX	10000
62V		
VERO BEACH, FL VORTAC	ANGEE, FL FIX	2000
ANGEE, FL FIX	FORNL, FL FIX	2000
FORNL, FL FIX	SURFN, FL FIX	2000
SURFN, FL FIX	BERTH, BS FIX	*4000
*1300 - MOCA		
BERTH, BS FIX	JAKEL, BS FIX	*4000
*1300 - MOCA		
JAKEL, BS FIX	FREEPORT, BS VOR/DME	*4000
*1400 - MOCA		

FROM	TO	MEA
63V		
PALM BEACH, FL VORTAC	TURPS, FL FIX	2000
TURPS, FL FIX	MIXAE, BS FIX	3000
MIXAE, BS FIX	HALBI, BS FIX	4000
HALBI, BS FIX	ULAMA, BS FIX	2000
ULAMA, BS FIX	FREPORT, BS VOR/DME	
FREPORT, BS VOR/DME	CEGUR, BS FIX	*2000
*1400 - MOCA		
CEGUR, BS FIX	BURBO, BS FIX	*2000
*1300 - MOCA		
BURBO, BS FIX	BAYRU, BS FIX	*10000
*1300 - MOCA		
BAYRU, BS FIX	HANKX, BS FIX	*10000
*1300 - MOCA		
HANKX, BS FIX	*MELON, BS FIX	**2000
*8000 - MRA		
**1300 - MOCA		
MELON, BS FIX	KURAY, BS FIX	*2000
*1300 - MOCA		
KURAY, BS FIX	NASSAU, BS VOR/DME	*2000
*1500 - MOCA		

64V		
VIRGINIA KEY, FL VOR/DME	HEATT, FL FIX	5000
HEATT, FL FIX	MRLIN, FL FIX	5000
MRLIN, FL FIX	MUNRO, BS FIX	5000
MUNRO, BS FIX	FREPORT, BS VOR/DME	2000

65V		
NASSAU, BS VOR/DME	PEACH, BS FIX	*2000
*1500 - MOCA		
PEACH, BS FIX	*SYDNY, BS FIX	**2000
*5000 - MRA		
**1300 - MOCA		
SYDNY, BS FIX	LAUTH, BS FIX	*5000
*1300 - MOCA		
LAUTH, BS FIX	FREPORT, BS VOR/DME	*2000
*1400 - MOCA		
FREPORT, BS VOR/DME	RAPPS, BS FIX	3000
RAPPS, BS FIX	STIFF, BS FIX	8000
STIFF, BS FIX	ELDER, FL FIX	8000
ELDER, FL FIX	ADOOR, FL FIX	25000

66V		
VIRGINIA KEY, FL VOR/DME	JANUS, FL FIX	2000
JANUS, FL FIX	PADUS, BS FIX	4000
PADUS, BS FIX	FREPORT, BS VOR/DME	2000

68V		
FORT LAUDERDALE, FL VOR/DME	MRLIN, FL FIX	6000
MRLIN, FL FIX	MUNRO, BS FIX	5000
MUNRO, BS FIX	FREPORT, BS VOR/DME	2000

FROM	TO	MEA
69V		
BIMINI, BS VORTAC	BAHMA, BS FIX	3000
BAHMA, BS FIX	MAYKO, OA FIX	3000
MAYKO, OA FIX	FREEPOR, BS VOR/DME	3000
FREEPOR, BS VOR/DME	JAMAX, BS FIX	*2000
*1400 - MOCA		
JAMAX, BS FIX	BENZI, BS FIX	*3000
*1200 - MOCA		
BENZI, BS FIX	JOLTS, BS FIX	4000
JOLTS, BS FIX	BERTH, BS FIX	4000
BERTH, BS FIX	KIXAL, OA FIX	4000
KIXAL, OA FIX	WALIK, FL FIX	
WALIK, FL FIX	PALM BEACH, FL VORTAC	2000

70V		
FORT LAUDERDALE, FL VOR/DME	TURBO, OA FIX	2000
TURBO, OA FIX	PADUS, BS FIX	7000
PADUS, BS FIX	FREEPOR, BS VOR/DME	2000
FREEPOR, BS VOR/DME	GRREG, BS FIX	3500
GRREG, BS FIX	MRRSH, BS FIX	3500

71V		
FREEPOR, BS VOR/DME	WOPOP, BS FIX	*2000
*1400 - MOCA		
WOPOP, BS FIX	WLKER, BS FIX	*3000
*1200 - MOCA		

ATLANTIC ROUTES

A300		
KIKER, OA FIX	RAYAS, OA FIX	#6000
#NAVIGATION EQUIPMENT OTHER THAN LF OR VHF REQUIRED		
RAYAS, OA FIX	DORADO, PR NDB	6000
PLING, PR FIX	LENNT, OA FIX	*3000
*1200 - MOCA		

A301		
*URSUS, OA FIX	ZOLLA, OA FIX	10000
*16000 - MRA		
ZOLLA, OA FIX	FOWEE, OA FIX	10000
FOWEE, OA FIX	SKIPS, BS FIX	5000
SKIPS, BS FIX	BIMINI, BS VORTAC	4000

FROM	TO	MEA
A315		
BIMINI, BS VORTAC	SWIMM, BS FIX	5000
SWIMM, BS FIX	*TINKY, OA FIX	8000
*8000 - MRA		
TINKY, OA FIX	*PEKRE, BS FIX	12500
*12500 - MRA		
PEKRE, BS FIX	*JAYEE, BS FIX	14000
*14000 - MRA		
JAYEE, BS FIX	*HODGY, BS FIX	7000
*16500 - MRA		
HODGY, BS FIX	*AMBIS, BS FIX	7000
*16500 - MRA		
AMBIS, BS FIX	DUNNO, BS FIX	7000
A509		
*URSUS, OA FIX	ELLEE, BS FIX	16000
*16000 - MRA		
ELLEE, BS FIX	EONNS, FL FIX	5000
EONNS, FL FIX	DOLPHIN, FL VORTAC	3000
DOLPHIN, FL VORTAC	MARCI, FL FIX	8000
MARCI, FL FIX	EPSON, OG FIX	6000
EPSON, OG FIX	MINOW, OG FIX	*7000
*1200 - MOCA		
MINOW, OG FIX	ELIOM, OG FIX	*7000
*1200 - MOCA		
A516		
MILOK, OA FIX	RAYAS, OA FIX	#9000
#MEA EA IS ESTABLISHED WITH A GAP IN NAVIGATION SIGNAL COVERAGE.		
NAVIGATION EQUIPMENT OTHER THAN LF OF VHF REQUIRED.		
RAYAS, OA FIX	RAFEE, OA FIX	#9000
#MEA IS ESTABLISHED WITH A GAP IN NAVIGATION SIGNAL COVERAGE.		
NAVIGATION EQUIPMENT OTHER THAN LF OR VHF REQUIRED.		
ANNER, OA FIX	*PORQE, VI FIX	#9000
*8000 - MRA		
#MEA IS ESTABLISHED WITH A GAP IN NAVIGATIONAL SIGNAL COVERAGE.		
NAVIGATION EQUIPMENT OTHER THAN LF OR VHF REQUIRED.		
PORQE, VI FIX	*DANDE, VI FIX	6000
*3500 - MRA		
DANDE, VI FIX	SAINT MAARTEN, AN VOR/DME	2500
A523		
DORADO, PR NDB	CORAF, PR FIX	*2000
*1500 - MOCA		
CORAF, PR FIX	SAALR, PR FIX	*2000
*1500 - MOCA		
VERMO, PR FIX	THANK, PR FIX	*2000
*1300 - MOCA		

FROM	TO	MEA
A555		
ILURI, OA FIX	*PORQE, VI FIX	#12000
*8000 - MRA		
#MEA IS ESTABLISHED WITH A GAP IN NAVIGATION SIGNAL COVERAGE.		
NAVIGATION EQUIPMENT OTHER THAN LF OR VHF REQUIRED.		
PORQE, VI FIX	ST CROIX, VI VOR/DME	6000
DORADO, PR NDB	*IDAHO, PR FIX	2000
*15000 - MRA		
IDAHO, PR FIX	HARDE, PR FIX	*2000
*1300 - MOCA		
HARDE, PR FIX	GRADI, IB FIX	*2000
*1300 - MOCA		
GRADI, IB FIX	KARRN, OA FIX	*2000
*1300 - MOCA		
COCBU, IB FIX	GRAND TURK, TC VORTAC	*2000
*1500 - MOCA		
GRAND TURK, TC VORTAC	MAYAG, IB FIX	2000
BTLER, OA FIX	GUANA, OA FIX	2000
GUANA, OA FIX	INDEE, BS FIX	2000
INDEE, BS FIX	DUKKY, BS FIX	2000
DUKKY, BS FIX	EVETS, BS FIX	3000
EVETS, BS FIX	GEROT, OA FIX	3000
GEROT, OA FIX	DONEZ, OA FIX	3000
DONEZ, OA FIX	BOSAR, BS FIX	3000
BOSAR, BS FIX	LEPAS, BS FIX	*3000
*1300 - MOCA		
LEPAS, BS FIX	NASSAU, BS VOR/DME	*1500
*1500 - MOCA		
NASSAU, BS VOR/DME	HINZY, BS FIX	2000
HINZY, BS FIX	PRUNE, BS FIX	2000
PRUNE, BS FIX	*RAJAY, BS FIX	4000
*11000 - MRA		
RAJAY, BS FIX	BIMINI, BS VORTAC	4000
A636		
BORINQUEN, PR VORTAC	KATOK, PR FIX	2000
		MAA - 45000
ALBBE, BS FIX	GREAT INAGUA, BS NDB	4000
A638		
ST THOMAS, VI VOR/DME	GUYRO, VI FIX	4000
GUYRO, VI FIX	SLUGO, VI FIX	4000
SLUGO, VI FIX	SAINT MAARTEN, AN VOR/DME	3000
A699		
NUCAR, BS FIX	STIFF, BS FIX	8000
STIFF, BS FIX	RAMJT, OA FIX	8000
PERMT, FL FIX	PALM BEACH, FL VORTAC	6000

FROM	TO	MEA
 A756		
BODLO, OA FIX	GREAT INAGUA, BS NDB	3000
GREAT INAGUA, BS NDB	ROSEA, OA FIX	3000
ROSEA, OA FIX	DUKKY, BS FIX	3000
 AR3		
NASSAU, BS NDB	HANKX, BS FIX	*2000
*1400 - MOCA		MAA - 45000
ANGLL, BS FIX	NUCAR, BS FIX	2500
		MAA - 45000
CARPX, OA FIX	PERIE, OA FIX	2500
		MAA - 45000
PERIE, OA FIX	OLDEY, SC FIX	2500
		MAA - 45000
OLDEY, SC FIX	PANAL, OA FIX	2500
		MAA - 45000
PANAL, OA FIX	CAROLINA BEACH, NC NDB	2500
		MAA - 45000
 AR4		
ASHLY, SC NDB	METTA, OA FIX	9000
 AR5		
DINNS, FL NDB	JAWSS, FL FIX	2500
		MAA - 45000
 AR6		
ORLANDO, FL VORTAC	MALET, FL FIX	2700
		MAA - 45000
MALET, FL FIX	*APOLO, FL FIX	4000
*4000 - MRA		MAA - 45000
APOLO, FL FIX	PETEE, OA FIX	24000
		MAA - 45000
 AR8		
ELIZABETH CITY, NC VOR/DME	OHPEA, NC FIX	21000
		MAA - 41000
OHPEA, NC FIX	TOMMZ, OA FIX	21000
		MAA - 41000
TOMMZ, OA FIX	OXANA, OA FIX	21000
		MAA - 41000

FROM	TO	MEA
AR10		
DOLPHIN, FL VORTAC	TURBO, OA FIX	6000
TURBO, OA FIX	PRED, FL FIX	6000
PRED, FL FIX	ZAPPA, BS FIX	10000
AR11		
VIRGINIA KEY, FL VOR/DME	JANUS, FL FIX	#2000
#VIRGINIA KEY R-058 UNUSABLE JANUS TO VALLY		
JANUS, FL FIX	VALLY, FL FIX	*5000
*5000 - GNSS MEA		
B24		
SEA ISLE, NJ VORTAC	FISSH, NJ FIX	15000
		MAA - 45000
FISSH, NJ FIX	DASHA, OA FIX	15000
		MAA - 45000
B503		
ENAMO, OA FIX	*HODGY, BS FIX	6000
*16500 - MRA		
HODGY, BS FIX	NASSAU, BS VOR/DME	7000
B646		
CANO, FL FIX	FISH HOOK, FL NDB	2000
		MAA - 45000
FISH HOOK, FL NDB	JOVCU, FL FIX	2000
		MAA - 45000
MARATHON, FL NDB	AVION, FL FIX	*6000
*1400 - MOCA		
AVION, FL FIX	ELLE, BS FIX	6000
		MAA - 45000
ELLE, BS FIX	FOWEE, OA FIX	*6000
*1400 - MOCA		
FOWEE, OA FIX	JERRE, OA FIX	*6000
VIA CHANGE OVER PT FOWEE		
*1400 - MOCA		
NASSAU, BS NDB	OHBE, BS FIX	*6000
*1200 - MOCA		
MAMML, BS FIX	EXTER, OA FIX	*6000
*1200 - MOCA		
		MAA - 45000
B760		
BIMINI, BS VORTAC	LEVI, BS FIX	4000
LEVI, BS FIX	MENDL, BS FIX	8000
MENDL, BS FIX	BORDO, BS FIX	12000
BORDO, BS FIX	IMELA, OA FIX	12000

FROM	TO	MEA
 B891		
POKEG, IB FIX	MACKI, OA FIX	4000
GRADI, IB FIX	NOPIT, OA FIX	10000
 B892		
MAYAGUEZ, PR VOR/DME	ANTEX, PR FIX	4000
 G430		
VIRGINIA KEY, FL VOR/DME	EONNS, FL FIX	3000
EONNS, FL FIX	AVION, FL FIX	4000
 G432		
ARMUR, PR FIX	CRSTL, PR FIX	6000
CRSTL, PR FIX	ALASK, PR FIX	6000
ALASK, PR FIX	CLAYO, PR FIX	6000
CLAYO, PR FIX	DORADO, PR NDB	6000
DORADO, PR NDB	CORAF, PR FIX	*2000
*1500 – MOCA		
CORAF, PR FIX	SAALR, PR FIX	*2000
*1500 - MOCA		
SAALR, PR FIX	VERMO, PR FIX	*2000
*1500 - MOCA		
VERMO, PR FIX	THANK, PR FIX	*2000
*1300 - MOCA		
 G437		
CIEGO DE AVILA, CU	IMELA, OA FIX	14000
VOR/DME		
DYNAH, OA FIX	*JAYEE, BS FIX	6000
*14000 - MRA		
JAYEE, BS FIX	BRONO, BS FIX	5000
BRONO, BS FIX	WELKS, BS FIX	2000
WELKS, BS FIX	NASSAU, BS VOR/DME	2000
NASSAU, BS VOR/DME	INGRA, BS FIX	2000
INGRA, BS FIX	ELBOW, BS FIX	8000
 G439		
DOLPHIN, FL VORTAC	MNATE, FL FIX	3000
MNATE, FL FIX	TWNNS, FL FIX	5000
TWNNS, FL FIX	*DROWN, FL FIX	5000
*5000 - MRA		

FROM	TO	MEA
G446		
OLDEY, SC FIX	PERIE, OA FIX	2500
PERIE, OA FIX	CARPX, OA FIX	2500
CARPX, OA FIX	SCOBY, OA FIX	2500
SCOBY, OA FIX	CASPR, OA FIX	2500
CASPR, OA FIX	NUCAR, BS FIX	2500
NUCAR, BS FIX	OMALY, OA FIX	5500
OMALY, OA FIX	SLEMA, OA FIX	5500
LASEE, OA FIX	ALUTE, OA FIX	5500
ALUTE, OA FIX	RENAH, OA FIX	5500
GRAND TURK, TC VORTAC	PAMMS, IB FIX	2000
PAMMS, IB FIX	BESAS, IB FIX	6000
G449		
DORADO, PR NDB	VARNA, PR FIX	#6000
#NAVIGATION EQUIPMENT OTHER THAN LF OR VHF REQUIRED.		
HENLI, PR FIX	ANNER, OA FIX	#6000
#NAVIGATION EQUIPMENT OTHER THAN LF OR VHF REQUIRED.		
ANNER, OA FIX	ANADA, OA FIX	#6000
#NAVIGATION EQUIPMENT OTHER THAN LF OF VHF REQUIRED.		
G629		
GREAT INAGUA, BS NDB	RAPPR, OA FIX	3000
CATHI, OA FIX	PROVIDENCIALES, TC VOR/DME	1500
PROVIDENCIALES, TC VOR/DME	EGANN, IB FIX	1500
EGANN, IB FIX	RAHAM, IB FIX	2000
RAHAM, IB FIX	LYMIN, OA FIX	2000
G648		
GRAND TURK, TC VORTAC	PROVIDENCIALES, TC VOR/DME	1500
PROVIDENCIALES, TC VOR/DME	MICAS, IB FIX	2000
G765		
MAXIM, FL FIX	FISH HOOK, FL NDB	*3000
*1300 - MOCA		MAA - 45000
L454		
KENNEDY, NY VOR/DME	BOUNO, NY FIX	6000
BOUNO, NY FIX	GEDIC, NJ FIX	6000
GEDIC, NJ FIX	TAAPS, OA FIX	6000
TAAPS, OA FIX	GLINN, OA FIX	6000
VOGEL, OA FIX	GEENE, OA FIX	6000
GEENE, OA FIX	OWENZ, OA FIX	6000

FROM	TO	MEA
L454 CONTINUED		
OWENZ, OA FIX	FONDE, OA FIX	6000
FONDE, OA FIX	ELCAM, OA FIX	21000
ELCAM, OA FIX	WUZYU, OA FIX	21000
WUZYU, OA FIX	ANNGO, OA FIX	21000
ANNGO, OA FIX	BERGH, OA FIX	21000
BERGH, OA FIX	WEBBB, OA FIX	21000

L455

KENNEDY, NY VOR/DME	BOUNO, NY FIX	6000
BOUNO, NY FIX	GEDIC, NJ FIX	6000
GEDIC, NJ FIX	TAAPS, OA FIX	6000
TAAPS, OA FIX	GLINN, OA FIX	6000
GLINN, OA FIX	VOGEL, OA FIX	6000
VOGEL, OA FIX	GEENE, OA FIX	6000
GEENE, OA FIX	OWENZ, OA FIX	6000
OWENZ, OA FIX	FONDE, OA FIX	6000
FONDE, OA FIX	ELCAM, OA FIX	21000
ELCAM, OA FIX	WUZYU, OA FIX	21000
WUZYU, OA FIX	ANNGO, OA FIX	21000
ANNGO, OA FIX	BERGH, OA FIX	21000
BERGH, OA FIX	SAVIK, OA FIX	21000

L456

KENNEDY, NY VOR/DME	SHERL, NY FIX	15000
SHERL, NY FIX	FATON, OA FIX	15000
FATON, OA FIX	THROP, OA FIX	15000
THROP, OA FIX	SEIFF, OA FIX	15000
SEIFF, OA FIX	GRAPT, OA FIX	15000
GRAPT, OA FIX	LEOES, OA FIX	15000
LEOES, OA FIX	FINIT, OA FIX	15000

L457

KENNEDY, NY VOR/DME	BOUNO, NY FIX	6000
BOUNO, NY FIX	GEDIC, NJ FIX	6000
GEDIC, NJ FIX	TAAPS, OA FIX	6000
TAAPS, OA FIX	GLINN, OA FIX	6000
GLINN, OA FIX	VOGEL, OA FIX	6000
VOGEL, OA FIX	GEENE, OA FIX	6000
GEENE, OA FIX	OWENZ, OA FIX	6000
OWENZ, OA FIX	FONDE, OA FIX	6000
FONDE, OA FIX	ELCAM, OA FIX	21000
ELCAM, OA FIX	WUZYU, OA FIX	21000
WUZYU, OA FIX	ANNGO, OA FIX	21000
ANNGO, OA FIX	BERGH, OA FIX	21000
BERGH, OA FIX	WEBBB, OA FIX	21000

FROM	TO	MEA
L459		
KENNEDY, NY VOR/DME	BOUNO, NY FIX	6000
BOUNO, NY FIX	GEDIC, NJ FIX	6000
GEDIC, NJ FIX	TAAPS, OA FIX	6000
TAAPS, OA FIX	GLINN, OA FIX	6000
GLINN, OA FIX	VOGEL, OA FIX	6000
VOGEL, OA FIX	GEENE, OA FIX	6000
GEENE, OA FIX	OWENZ, OA FIX	6000
OWENZ, OA FIX	FONDE, OA FIX	6000
FONDE, OA FIX	ELCAM, OA FIX	21000
ELCAM, OA FIX	WUZYU, OA FIX	21000
WUZYU, OA FIX	ANNGO, OA FIX	21000
ANNGO, OA FIX	BERGH, OA FIX	21000
BERGH, OA FIX	SAVIK, OA FIX	21000
L461		
KENNEDY, NY VOR/DME	SHERL, NY FIX	15000
SHERL, NY FIX	FATON, OA FIX	15000
FATON, OA FIX	THROP, OA FIX	15000
THROP, OA FIX	SEIFF, OA FIX	15000
SEIFF, OA FIX	GRAPT, OA FIX	15000
GRAPT, OA FIX	LEOES, OA FIX	15000
LEOES, OA FIX	FINIT, OA FIX	15000
Q100		
LEEVILLE, LA VORTAC *1500 - MOCA	REDFN, OG FIX	*6000
REDFN, OG FIX *1500 - MOCA	ROZZI, OG FIX	*6000
ROZZI, OG FIX *1500 - MOCA	REMIS, OG FIX	*6000
REMIS, OG FIX *1500 - MOCA	SARASOTA, FL VORTAC	*6000
Q102		
LEEVILLE, LA VORTAC *1500 - MOCA	BLVNS, OG FIX	*6000
BLVNS, OG FIX *1500 - MOCA	BUNNZ, OG FIX	*6000
BUNNZ, OG FIX *1500 - MOCA	BACCA, OG FIX	*6000
BACCA, OG FIX *1500 - MOCA	CIGAR, OG FIX	*6000
CIGAR, OG FIX *1500 - MOCA	BAGGS, OG FIX	*6000
BAGGS, OG FIX *1500 - MOCA	CYPRESS, FL VOR/DME	*6000

FROM	TO	MEA
Q105		
HARVEY, LA VORTAC *1500 - MOCA	FATSO, OG FIX	*6000
FATSO, OG FIX *1500 - MOCA	REDFN, OG FIX	*6000
REDFN, OG FIX *1500 - MOCA	BLVNS, OG FIX	*6000
R507		
SAPPO, OA FIX *24000 - MRA	*CONCH, OA FIX	#24000
#NAVIGATION EQUIPMENT OTHER THAN LF OR VHF REQUIRED.		
CONCH, OA FIX	UTAHNS, PR FIX	24000
R628		
TANIA, OA FIX	ZOLLA, OA FIX	12000
ZOLLA, OA FIX	MENDL, BS FIX	10000
MENDL, BS FIX *12500 - MRA	*PEKRE, BS FIX	8000
PEKRE, BS FIX	NASSAU, BS NDB	6000
R760		
ST CROIX, VI VOR/DME	GOUDA, VI FIX	5000
GOUDA, VI FIX	SAINT MAARTEN, AN VOR/DME	3000
R763		
GRAND TURK, TC VORTAC *1200 - MOCA	RNTRY, OA FIX	*14000 MAA - 45000
R888		
ST CROIX, VI VOR/DME	MODUX, VI FIX	14000
MODUX, VI FIX	POINTE A PITRE, GP VOR/DME	14000

FROM

TO

MEA

MAA

&95.3000 LOW ALTITUDE RNAV ROUTES

95.3200 RNAV ROUTE T200

FOOTHILLS, GA VORTAC
#EASTBOUND EXPECT 5000
WESTBOUND EXPECT 6000

RICHE, SC FIX

#4800 8000

RICHE, SC FIX
#EASTBOUND EXPECT 5000
WESTBOUND EXPECT 6000

FLORENCE, SC VORTAC

#2500 8000

95.3201 RNAV ROUTE T201

COLUMBIA, SC VORTAC
#NORTHBOUND EXPECT 5000
SOUTHBOUND EXPECT 6000

LOCAS, NC FIX

#2500 7000

LOCAS, NC FIX
#NORTHBOUND EXPECT 5000
SOUTHBOUND EXPECT 6000

JOTTA, NC FIX

#4400 7000

95.3202 RNAV ROUTE T202

RICHE, SC FIX
#NORTHBOUND EXPECT 5000
SOUTHBOUND EXPECT 6000

HUSTN, NC FIX

#2500 8000

HUSTN, NC FIX
#NORTHBOUND EXPECT 5000
SOUTHBOUND EXPECT 6000

GANTS, NC FIX

#2600 8000

95.3203 RNAV ROUTE T203

COLUMBIA, SC VORTAC
#NORTHBOUND EXPECT 6000
SOUTHBOUND EXPECT 7000

LOCKS, SC FIX

#2500 7000

LOCKS, SC FIX
#NORTHBOUND EXPECT 6000
SOUTHBOUND EXPECT 7000

BARRETTS MOUNTAIN, NC VOR/DME

#4900 7000

BARRETTS MOUNTAIN, NC VOR/DME
#NORTHBOUND EXPECT 6000
SOUTHBOUND EXPECT 7000

PULASKI, VA VORTAC

#6000 7000

FROM	TO	MEA	MAA
95.3204 RNAV ROUTE T204 TAYLOR, FL VORTAC	BRUNSWICK, GA VORTAC	2100	15000
95.3205 RNAV ROUTE T205 OCALA, FL VORTAC *2500 - MOCA	VALDOSTA, GA VOR/DME	*3000	15000
95.3207 RNAV ROUTE T207 ORMOND BEACH, FL VORTAC CARRA, FL FIX MONIA, GA FIX	CARRA, FL FIX MONIA, GA FIX WAYCROSS, GA VORTAC	2300 1900 2300	15000 15000 15000
95.3208 RNAV ROUTE T208 GATORS, FL VORTAC CARRA, FL FIX	CARRA, FL FIX ORMOND BEACH, FL VORTAC	2100 2300	15000 15000
95.3209 RNAV ROUTE T209 EHEJO, GA FIX JAMTA, GA FIX	JAMTA, GA FIX COLLIERS, SC VORTAC	2000 2500	17500 17500
95.3210 RNAV ROUTE T210 TAYLOR, FL VORTAC	BRADO, FL FIX	1900	9000
95.3211 RNAV ROUTE T211 OCALA, FL VORTAC JUTTS, FL FIX CARRA, FL FIX	JUTTS, FL FIX CARRA, FL FIX CRAIG, FL VORTAC	2500 1900 2100	15000 15000 15000
95.3213 RNAV ROUTE T213 LOUISVILLE, KY VORTAC #NORTHBOUND EXPECT 7000 SOUTHBOUND EXPECT 6000	GAMKE, IN FIX	#3600	8000
GAMKE, IN FIX #NORTHBOUND EXPECT 7000 SOUTHBOUND EXPECT 6000	RICHMOND, IN VORTAC	#2800	8000
95.3215 RNAV ROUTE T215 LEXINGTON, KY VORTAC #NORTHBOUND EXPECT 6000 SOUTHBOUND EXPECT 5000	GAMKE, IN FIX	#3000	8000

FROM	TO	MEA	MAA
95.3217 RNAV ROUTE T217			
LEXINGTON, KY VORTAC #NORTHBOUND EXPECT 7000 SOUTHBOUND EXPECT 6000	BOSTR, OH FIX	#3000	8000
BOSTR, OH FIX #NORTHBOUND EXPECT 7000 SOUTHBOUND EXPECT 6000	HEDEN, OH FIX	#2700	8000
HEDEN, OH FIX #NORTHBOUND EXPECT 7000 SOUTHBOUND EXPECT 6000	SPRINGFIELD, OH VOR/DME	#2800	8000
SPRINGFIELD, OH VOR/DME #NORTHBOUND EXPECT 7000 SOUTHBOUND EXPECT 6000	BONEE, OH FIX	#2900	8000
95.3219 RNAV ROUTE T219			
NANWAK, AK NDB/DME *1700 - MOCA	RUFVY, AK FIX	*2300	17500
RUFVY, AK FIX *1300 - MOCA	ACATE, AK FIX	*2000	17500
ACATE, AK FIX *5400 - MOCA	BROUS, AK FIX	*6000	17500
BROUS, AK FIX *5000 - MOCA	DILLINGHAM, AK VOR/DME	*6000	17500
95.3222 RNAV ROUTE T222			
BAERE, AK FIX	ST PAUL ISLAND, AK NDB/DME	3600	17500
ST PAUL ISLAND, AK NDB/DME *1800 - MOCA	RUFVY, AK FIX	*3000	17500
RUFVY, AK FIX *1400 - MOCA	BETHEL, AK VORTAC	*3000	17500
BETHEL, AK VORTAC	MC GRATH, AK VORTAC	5000	17500
MC GRATH, AK VORTAC	NENANA, AK VORTAC	5000	17500
NENANA, AK VORTAC *3200 - MOCA	FAIRBANKS, AK VORTAC	*4000	17500
95.3223 RNAV ROUTE T223			
CAPE NEWENHAM, AK NDB/DME	DILLINGHAM, AK VOR/DME	4400	17500
DILLINGHAM, AK VOR/DME	FAGIN, AK FIX	4400	17500
FAGIN, AK FIX	NONDA, AK FIX	8400	17500
NONDA, AK FIX	BLUGA, AK FIX	12000	17500
BLUGA, AK FIX	AMOTT, AK FIX	3000	17500
95.3225 RNAV ROUTE T225			
HOOPER BAY, AK VOR/DME	AKELT, AK FIX	4600	17500
AKELT, AK FIX	ALMOT, AK FIX	4400	17500
ALMOT, AK FIX	UNALAKLEET, AK VOR/DME	3700	17500
UNALAKLEET, AK VOR/DME	EDMON, AK FIX	5000	17500

FROM	TO	MEA	MAA
95.3225 RNAV ROUTE T225 - CONTINUED			
EDMON, AK FIX	VENCE, AK FIX	5900	17500
VENCE, AK FIX	GALENA, AK VOR/DME	3400	17500
GALENA, AK VOR/DME	KUHZE, AK FIX	3400	17500
KUHZE, AK FIX	CHOKK, AK FIX	6800	17500
CHOKK, AK FIX	TANANA, AK VOR/DME	4000	17500
TANANA, AK VOR/DME	*REEBA, AK FIX	4000	17500
*7000 - MRA			
REEBA, AK FIX	FAIRBANKS, AK VORTAC	5000	17500
*4700 - MCA FAIRBANKS, AK VORTAC , W BND			
95.3226 RNAV ROUTE T226			
JOHNSTONE POINT, AK VOR/DME	FIDAL, AK FIX	5000	17500
*7000 - MCA FIDAL, AK FIX , N BND			
FIDAL, AK FIX	ROBES, AK FIX	8000	17500
*8900 - MCA ROBES, AK FIX , N BND			
ROBES, AK FIX	KLUNG, AK FIX	10000	17500
*KLUNG, AK FIX	GULKANA, AK VOR/DME	7000	17500
*7100 - MCA KLUNG, AK FIX , S BND			
GULKANA, AK VOR/DME	DOZEY, AK FIX	5000	17500
DOZEY, AK FIX	PAXON, AK FIX	**8000	17500
*9500 - MCA PAXON, AK FIX , N BND			
*7300 - MOCA			
PAXON, AK FIX	DONEL, AK FIX	*12000	17500
*11500 - MOCA			
*DONEL, AK FIX	BIG DELTA, AK VORTAC	7000	17500
*10600 - MCA DONEL, AK FIX , S BND			
BIG DELTA, AK VORTAC	HUTIL, AK FIX	7000	17500
HEXAX, AK FIX	FORT YUKON, AK VORTAC	*4000	17500
*3100 - MOCA			
95.3227 RNAV ROUTE T227			
SHEMYA, AK VORTAC	JANNT, AK FIX	3400	17500
JANNT, AK FIX	BAERE, AK FIX	2900	17500
BAERE, AK FIX	ALEUT, AK FIX	3300	17500
ALEUT, AK FIX	MORDI, AK FIX	2500	17500
MORDI, AK FIX	BINAL, AK FIX	4900	17500
BINAL, AK FIX	PORT HEIDEN, AK NDB/DME	3800	17500
PORT HEIDEN, AK NDB/DME	CULTI, AK FIX	*3700	17500
*1900 - MOCA			
CULTI, AK FIX	BATTY, AK FIX	*6100	17500
*5400 - MOCA			
BATTY, AK FIX	AMOTT, AK FIX	**13000	17500
*5200 - MCA AMOTT, AK FIX , SE BND			
*12300 - MOCA			
AMOTT, AK FIX	ANCHORAGE, AK VOR/DME	4000	17500
ANCHORAGE, AK VOR/DME	FAIRBANKS, AK VORTAC	9700	17500
FAIRBANKS, AK VORTAC	PESGE, AK FIX	5500	17500
PESGE, AK FIX	FIPSU, AK FIX	8400	17500
FIPSU, AK FIX	CUGOB, AK FIX	**11000	17500
*7000 - MCA CUGOB, AK FIX , S BND			
*10300 - MOCA			
CUGOB, AK FIX	SIKLV, AK FIX	4500	17500
SIKLV, AK FIX	DEADHORSE, AK VOR/DME	2200	17500

FROM	TO	MEA	MAA
95.3228 RNAV ROUTE T228			
CAPE NEWENHAM, AK NDB/DME	KUCYE, AK FIX	4600	17500
KUCYE, AK FIX	RUFVY, AK FIX	2000	17500
RUFVY, AK FIX	HOOPER BAY, AK VOR/DME	3000	17500
HOOPER BAY, AK VOR/DME	NOME, AK VOR/DME	*5000	17500
*4400 - MOCA			
NOME, AK VOR/DME	HIKAX, AK FIX	7000	17500
HIKAX, AK FIX	SHISHMAREF, AK NDB	4000	17500
SHISHMAREF, AK NDB	ECIPI, AK FIX	*10000	17500
*2000 - MOCA			
ECIPI, AK FIX	JAPKI, AK FIX	*8000	17500
*3800 - MOCA			
JAPKI, AK FIX	PODKE, AK FIX	*13000	17500
*4200 - MOCA			
PODKE, AK FIX	CIRSU, AK FIX	3800	17500
CIRSU, AK FIX	BARROW, AK VOR/DME	2000	17500
BARROW, AK VOR/DME	DEADHORSE, AK VOR/DME	*2000	17500
*1500 - MOCA			
DEADHORSE, AK VOR/DME	ROCES, AK FIX	*2000	17500
*1300 - MOCA			
95.3229 RNAV ROUTE T229			
*FAIRBANKS, AK VORTAC	*REEBA, AK FIX	5000	17500
*7000 - MRA			
*4700 - MCA FAIRBANKS, AK VORTAC , W BND			
REEBA, AK FIX	TANANA, AK VOR/DME	4000	17500
TANANA, AK VOR/DME	HUSLIA, AK VOR/DME	*6000	17500
*5500 - MOCA			
HUSLIA, AK VOR/DME	DESOY, AK FIX	4000	17500
DESOY, AK FIX	SELAWIK, AK VOR/DME	2500	
SELAWIK, AK VOR/DME	KOTZEBUE, AK VOR/DME	*3000	17500
*2500 - MOCA			
KOTZEBUE, AK VOR/DME	POINT HOPE, AK NDB	4000	17500
95.3230 RNAV ROUTE T230			
ST PAUL ISLAND, AK NDB/DME	CHINOOK, AK NDB	*3000	17500
*2700 - MOCA			
95.3231 RNAV ROUTE T231			
FAIRBANKS, AK VORTAC	HOBOM, AK FIX	4700	17500
HOBOM, AK FIX	MIPMY, AK FIX	6300	17500
MIPMY, AK FIX	SELAWIK, AK VOR/DME	3300	17500
SELAWIK, AK VOR/DME	KOTZEBUE, AK VOR/DME	3400	17500
95.3232 RNAV ROUTE T232			
NORTHWAY, AK VORTAC	BIG DELTA, AK VORTAC	8000	
BIG DELTA, AK VORTAC	FAIRBANKS, AK VORTAC	*5000	17500
*4300 - MOCA			
FAIRBANKS, AK VORTAC	BETTLES, AK VOR/DME	*6000	17500
*5200 - MOCA			
BETTLES, AK VOR/DME	BRONX, AK FIX	9000	17500
BRONX, AK FIX	BARROW, AK VOR/DME	*4000	17500
*1200 - MOCA			

FROM	TO	MEA	MAA
95.3233 RNAV ROUTE T233			
AMBLER, AK NDB/DME	KORKY, AK FIX	5000	17500
KORKY, AK FIX	ENCOR, AK FIX	7000	17500
ENCOR, AK FIX	EVANSVILLE, AK NDB	5000	17500
95.3234 RNAV ROUTE T234			
*FAIRBANKS, AK VORTAC	TOLLO, AK FIX	5000	17500
TOLLO, AK FIX	RAMPA, AK FIX	7000	17500
95.3235 RNAV ROUTE T235			
ATQASUK, AK NDB	NUIQSUT VILLAGE, AK NDB	*3000	17500
*1300 - MOCA			
95.3236 RNAV ROUTE T236			
NENANA, AK VORTAC	RAMPA, AK FIX	7000	17500
95.3237 RNAV ROUTE T237			
*HOMER, AK VOR/DME	WUXAN, AK FIX	**9000	17500
*4800 - MCA HOMER, AK VOR/DME , E BND			
*8500 - MOCA			
WUXAN, AK FIX	MIDDLETON ISLAND, AK VOR/DME	*5000	17500
*4100 - MOCA			
95.3238 RNAV ROUTE T238			
RAMPA, AK FIX	BETTLES, AK VOR/DME	7000	17500
95.3240 RNAV ROUTE T240			
BETTLES, AK VOR/DME	TEGDE, AK FIX	7800	17500
TEGDE, AK FIX	DERIK, AK FIX	9700	17500
DERIK, AK FIX	SHELO, AK FIX	3600	17500
SHELO, AK FIX	DEADHORSE, AK VOR/DME	2000	17500
95.3241 RNAV ROUTE T241			
LATCH, AK FIX	LEVEL ISLAND, AK VOR/DME	5000	17500
95.3242 RNAV ROUTE T242			
*TALKEETNA, AK VOR/DME	JOKAP, AK FIX	**16000	17500
*12100 - MCA TALKEETNA, AK VOR/DME , N BND			
*15300 - MOCA			
*JOKAP, AK FIX	KUTDE, AK FIX	6000	17500
*11500 - MCA JOKAP, AK FIX , S BND			
KUTDE, AK FIX	LACIL, AK FIX	*15000	17500
*9400 - MOCA			
LACIL, AK FIX	BARROW, AK VOR/DME	*8000	17500
*1800 - MOCA			

FROM	TO	MEA	MAA
95.3243 RNAV ROUTE T243			
PUNGO, NC FIX *1500 - MOCA	ZOLMN, NC FIX	*4000	17000
95.3244 RNAV ROUTE T244			
ANCHORAGE, AK VOR/DME *3500 - MCA CAKAD, AK FIX , NW BND *1400 - MOCA	CAKAD, AK FIX	**2000	17500
CAKAD, AK FIX *7400 - MCA CEXIX, AK FIX , NW BND	CEXIX, AK FIX	5000	17500
CEXIX, AK FIX *BETPE, AK FIX *7400 - MCA BETPE, AK FIX , SE BND	BETPE, AK FIX CHEFF, AK FIX	10000 6000	17500 17500
*CHEFF, AK FIX *5300 - MCA CHEFF, AK FIX , SE BND	CONFI, AK FIX	5000	17500
CONFI, AK FIX	NOME, AK VOR/DME	3000	17500
95.3245 RNAV ROUTE T245			
SEAL BEACH, CA VORTAC SANTA MONICA, CA VOR/DME	SANTA MONICA, CA VOR/DME SILEX, CA FIX	2500 4000	17500 17500
95.3246 RNAV ROUTE T246			
BARROW, AK VOR/DME GALENA, AK VOR/DME MC GRATH, AK VORTAC	GALENA, AK VOR/DME MC GRATH, AK VORTAC ANCHORAGE, AK VOR/DME	9200 5800 8700	17500 17500 17500
95.3247 RNAV ROUTE T247			
SEAL BEACH, CA VORTAC SANTA MONICA, CA VOR/DME	SANTA MONICA, CA VOR/DME CANOG, CA FIX	2500 5000	17500 17500
95.3248 RNAV ROUTE T248			
GAMBELL, AK NDB/DME QAYAQ, AK FIX	QAYAQ, AK FIX EMMONAK, AK VOR/DME	3600 3000	17500 17500
95.3249 RNAV ROUTE T249			
VAN NUYS, CA VOR/DME SANTA MONICA, CA VOR/DME	SANTA MONICA, CA VOR/DME SEAL BEACH, CA VORTAC	4700 2500	17500 17500
95.3250 RNAV ROUTE T250			
BETHEL, AK VORTAC AKELT, AK FIX QAYAQ, AK FIX	AKELT, AK FIX QAYAQ, AK FIX KUKULIAK, AK VOR/DME	3800 3000 3700	17500 17500 17500
95.3251 RNAV ROUTE T251			
FARMINGTON, MO VORTAC FORISTELL, MO VORTAC *6000 - MRA	FORISTELL, MO VORTAC *RIVRS, IL FIX	3000 2700	6000 6000

FROM	TO	MEA	MAA
95.3252 RNAV ROUTE T252			
NOME, AK VOR/DME	KOTZEBUE, AK VOR/DME	5900	17500
KOTZEBUE, AK VOR/DME	PERCI, AK FIX	3000	17500
PERCI, AK FIX	WARRT, AK FIX	7000	17500
WARRT, AK FIX	DEADHORSE, AK VOR/DME	3000	17500
95.3254 RNAV ROUTE T254			
COLLEGE STATION, TX VORTAC	EAKES, TX FIX	3000	15000
EAKES, TX FIX	CREPO, TX FIX	3100	15000
CREPO, TX FIX	LAKE CHARLES, LA VORTAC	2200	15000
95.3257 RNAV ROUTE T257			
BIG SUR, CA VORTAC	ISIFU, CA FIX	7300	17500
ISIFU, CA FIX	SUTRO, CA FIX	4900	17500
SUTRO, CA FIX	POINT REYES, CA VORTAC	4000	17500
95.3259 RNAV ROUTE T259			
SAN JOSE, CA VOR/DME	CEDES, CA FIX	6200	17500
CEDES, CA FIX	MOVDD, CA FIX	5900	17500
MOVDD, CA FIX	SACRAMENTO, CA VORTAC	3200	17500
95.3260 RNAV ROUTE T260			
NOME, AK VOR/DME	TIN CITY, AK NDB/DME	6900	17500
TIN CITY, AK NDB/DME	COGNU, AK FIX	5300	17500
COGNU, AK FIX	POINT HOPE, AK NDB	3000	17500
95.3261 RNAV ROUTE T261			
WOODSIDE, CA VORTAC	ALTAM, CA FIX	5000	17500
95.3262 RNAV ROUTE T262			
KODIAK, AK VOR/DME	WUXAN, AK FIX	**6000	17500
*5200 - MCA WUXAN, AK FIX , E BND			
*3800 - MOCA			
WUXAN, AK FIX	JOHNSTONE POINT, AK VOR/DME	7000	17500
95.3263 RNAV ROUTE T263			
SUNOL, CA FIX	SCAGGS ISLAND, CA VORTAC	4600	17500
95.3264 RNAV ROUTE T264			
KODIAK, AK VOR/DME	ZAXUM, AK FIX	*6000	17500
*4000 - MOCA			
ZAXUM, AK FIX	MIDDLETON ISLAND, AK VOR/DME	*3000	17500
*2200 - MOCA			
95.3265 RNAV ROUTE T265			
KELSI, IL FIX	BULLZ, IL FIX	*4000	8000
*2300 - MOCA			
BULLZ, IL FIX	VEENA, WI FIX	*4000	8000
*2600 - MOCA			

FROM	TO	MEA	MAA
95.3266 RNAV ROUTE T266			
COGLAN ISLAND, AK NDB	FREDERICKS POINT, AK NDB	6500	17500
FREDERICKS POINT, AK NDB	ANNETTE ISLAND, AK VOR/DME	6200	17500
95.3267 RNAV ROUTE T267			
NOME, AK VOR/DME	JIKSA, AK FIX	*6700	17500
*6000 - MOCA			
JIKSA, AK FIX	BALIN, AK FIX	*3400	17500
*2700 - MOCA			
BALIN, AK FIX	KOTZEBUE, AK VOR/DME	*3300	17500
*2600 - MOCA			
95.3269 RNAV ROUTE T269			
ANNETTE ISLAND, AK VOR/DME	TOKEE, AK FIX	5700	17500
TOKEE, AK FIX	FLIPS, AK FIX	6300	17500
FLIPS, AK FIX	BIORKA ISLAND, AK VORTAC	6000	17500
BIORKA ISLAND, AK VORTAC	SALIS, AK FIX	5100	17500
SALIS, AK FIX	CENTA, AK FIX	*6200	17500
*2000 - MOCA			
CENTA, AK FIX	YAKUTAT, AK VOR/DME	2000	17500
YAKUTAT, AK VOR/DME	MALAS, AK FIX	2400	17500
MALAS, AK FIX	KATAT, AK FIX	*9000	17500
*5300 - MOCA			
KATAT, AK FIX	CASEL, AK FIX	*7000	17500
*3400 - MOCA			
CASEL, AK FIX	JOHNSTONE POINT, AK VOR/DME	4800	17500
*4800 - MCA JOHNSTONE POINT, AK VOR/DME, E BND			
JOHNSTONE POINT, AK VOR/DME	FIMIB, AK FIX	3200	17500
*4500 - MCA FIMIB, AK FIX, W BND			
FIMIB, AK FIX	ANCHORAGE, AK VOR/DME	8200	17500
ANCHORAGE, AK VOR/DME	YONEK, AK FIX	3000	17500
YONEK, AK FIX	TORTE, AK FIX	4200	17500
*10000 - MCA TORTE, AK FIX, W BND			
TORTE, AK FIX	VEILL, AK FIX	10600	17500
*10000 - MCA VEILL, AK FIX, E BND			
VEILL, AK FIX	SPARREVOHN, AK VOR/DME	6000	17500
SPARREVOHN, AK VOR/DME	ACRAN, AK FIX	5200	17500
ACRAN, AK FIX	VIDDA, AK FIX	6000	17500
VIDDA, AK FIX	BETHEL, AK VORTAC	2100	17500
95.3270 RNAV ROUTE T270			
NORTON BAY, AK NDB	HEXOG, AK FIX	*6000	17500
*5400 - MOCA			
HEXOG, AK FIX	SHISHMAREF, AK NDB	5000	17500
95.3271 RNAV ROUTE T271			
COLD BAY, AK VORTAC	BINAL, AK FIX	4400	17500
BINAL, AK FIX	KING SALMON, AK VORTAC	2700	17500
KING SALMON, AK VORTAC	JIVCO, AK FIX	3000	17500
JIVCO, AK FIX	WOLCI, AK FIX	4000	17500

FROM	TO	MEA	MAA
95.3271 RNAV ROUTE T271 CONTINUED			
WOLCI, AK FIX *8000 - MCA WIDVA, AK FIX , NE BND	WIDVA, AK FIX	7000	17500
WIDVA, AK FIX *10700 - MCA ZINAM, AK FIX , SW BND	ZINAM, AK FIX	11800	17500
ZINAM, AK FIX	AMOTT, AK FIX	2500	17500
95.3272 RNAV ROUTE T272			
HALLSVILLE, MO VORTAC	VANDALIA, IL VORTAC	2700	6000
95.3273 RNAV ROUTE T273			
FAIRBANKS, AK VORTAC	AYKID, AK FIX	6700	17500
AYKID, AK FIX	TUVVO, AK FIX	6000	17500
TUVVO, AK FIX *8000 - MCA SOTGE, AK FIX , S BND	SOTGE, AK FIX	11300	17500
SOTGE, AK FIX *2800 - MOCA	ROCES, AK FIX	*4000	17500
95.3274 RNAV ROUTE T274			
NEWPORT, OR VORTAC *5000 - MCA CRAAF, OR FIX , SW BND	CRAAF, OR FIX	5500	17500
95.3275 RNAV ROUTE T275			
BETHEL, AK VORTAC	UNALAKLEET, AK VOR/DME	5900	17500
95.3276 RNAV ROUTE T276			
COUGA, WA FIX	CARBY, WA FIX	6500	17500
95.3277 RNAV ROUTE T277			
BETTLES, AK VOR/DME *4000 - MOCA	JIGTI, AK FIX	*6000	17500
JIGTI, AK FIX *7000 - MOCA	NOKFE, AK FIX	*8000	17500
NOKFE, AK FIX *9400 - MOCA	VOVUY, AK FIX	*10300	17500
VOVUY, AK FIX *9500 - MOCA	EPEHO, AK FIX	*16000	17500
EPEHO, AK FIX *5500 - MOCA	POINT LAY, AK NDB	*6400	17500
95.3278 RNAV ROUTE T278			
*HAPIT, AK FIX *15000 - MRA	SISTERS ISLAND, AK VORTAC	6100	17500
95.3279 RNAV ROUTE T279			
ALEUT, AK FIX	BETHEL, AK VORTAC	3200	17500

FROM	TO	MEA	MAA
95.3280 RNAV ROUTE T280			
FLIPS, AK FIX	LEVEL ISLAND, AK VOR/DME	*7000	17500
*6300 - MOCA			
95.3282 RNAV ROUTE T282			
VENCE, AK FIX	HORSI, AK FIX	5000	17500
HORSI, AK FIX	PERZO, AK FIX	4700	17500
PERZO, AK FIX	FAIRBANKS, AK VORTAC	4300	17500

FROM	TO	MEA	MAA
------	----	-----	-----

&95.4000 HIGH ALTITUDE RNAV ROUTES

95.4001 RNAV ROUTE Q1

ELMAA, WA FIX *18000 - GNSS MEA #*DME/DME/IRU MEA	POINT REYES, CA VORTAC	#*24000	45000
---	------------------------	---------	-------

95.4002 RNAV ROUTE Q2

BOILE, CA FIX *18000 - GNSS MEA #DME/DME/IRU RNAV MEA	HEDVI, AZ FIX	#*24000	45000
---	---------------	---------	-------

ITUCO, AZ FIX *18000 - GNSS MEA #DME/DME/IRU RNAV MEA	NEWMAN, TX VORTAC	#*26000	45000
---	-------------------	---------	-------

95.4003 RNAV ROUTE Q3

FEPOT, WA FIX *18000 - GNSS MEA #DME/DME/IRU RNAV MEA	POINT REYES, CA VORTAC	#*24000	45000
---	------------------------	---------	-------

95.4004 RNAV ROUTE Q4

BOILE, CA FIX *18000 - GNSS MEA #DME/DME/IRU RNAV MEA	SKTTR, AZ FIX	#*24000	45000
---	---------------	---------	-------

SKTTR, AZ FIX *18000 - GNSS MEA #DME/DME/IRU RNAV MEA	EL PASO, TX VORTAC	#*26000	45000
---	--------------------	---------	-------

95.4005 RNAV ROUTE Q5

HAROB, WA FIX *18000 - GNSS MEA #DME/DME/IRU RNAV MEA	STIKM, CA FIX	#*26000	45000
---	---------------	---------	-------

95.4006 RNAV ROUTE Q6

TALKEETNA, AK VOR/DME *GNSS REQUIRED	BARROW, AK VOR/DME	*18000	45000
---	--------------------	--------	-------

FROM	TO	MEA	MAA
95.4007 RNAV ROUTE Q7			
JINMO, WA FIX *18000 - GNSS MEA #DME/DME/IRU RNAV MEA	AVENAL, CA VORTAC	**24000	45000
95.4008 RNAV ROUTE Q8			
GALENA, AK VORTAC * GNSS REQUIRED	ANCHORAGE, AK VOR/DME	*18000	45000
95.4009 RNAV ROUTE Q9			
SUMMA, WA FIX *18000 - GNSS MEA #DME/DME/IRU RNAV MEA	DERBB, CA FIX	**24000	45000
95.4010 RNAV ROUTE Q10			
KUKULIAK, AK VOR/DME * GNSS REQUIRED	EMMONAK, AK VOR/DME	*18000	45000
95.4011 RNAV ROUTE Q11			
PAAGE, WA FIX *18000 - GNSS MEA #DME/DME/IRU RNAV MEA	LOS ANGELES, CA VORTAC	**26000	45000
95.4012 RNAV ROUTE Q12			
KOTZEBUE, AK VOR/DME *GNSS REQUIRED	DEADHORSE, AK VOR/DME	*18000	45000
95.4013 RNAV ROUTE Q13			
PRFUM, AZ FIX *GNSS REQUIRED	PAWLI, OR FIX	*18000	45000
95.4014 RNAV ROUTE Q14			
KODIAK, AK VOR/DME *GNSS REQUIRED	JOHNSTONE POINT, AK VOR/DME	*18000	45000
95.4015 RNAV ROUTE Q15			
CHILY, AZ FIX *GNSS REQUIRED	LOMIA, NV FIX	**18000	45000

FROM	TO	MEA	MAA
95.4016 RNAV ROUTE Q16			
KODIAK, AK VOR/DME *GNSS REQUIRED	MIDDLETON ISLAND, AK VOR/DME	*18000	45000
MIDDLETON ISLAND, AK VOR/DME *GNSS REQUIRED	YAKUTAT, AK VOR/DME	* 18000	45000
95.4017 RNAV ROUTE Q17			
HOMER, AK VOR/DME *GNSS REQUIRED	MIDDLETON ISLAND, AK VOR/DME	*18000	45000
95.4018 RNAV ROUTE Q18			
GALENA, AK VORTAC *GNSS REQUIRED	BARROW, AK VOR/DME	*18000	45000
95.4019 RNAV ROUTE Q19			
NASHVILLE, TN VORTAC *18000 - GNSS MEA #DME/DME/IRU RNAV MEA	PLESS, IL FIX	##*20000	4500
95.4020 RNAV ROUTE Q20			
CORONA, NM VORTAC *18000 - GNSS MEA #DME/DME/IRU RNAV MEA	JUNCTION, TX VORTAC	##*24000	45000
95.4021 RNAV ROUTE Q21			
JONEZ, OK FIX *18000 - GNSS MEA #DME/DME/IRU RNAV MEA	RAZORBACK, AR VORTAC	##*18000	45000
95.4022 RNAV ROUTE Q22			
GUSTI, LA FIX *18000 - GNSS MEA #DME/DME/IRU RNAV MEA	CATLN, AL FIX	##*18000	45000
95.4023 RNAV ROUTE Q23			
FORT SMITH, AR VORTAC *18000 - GNSS MEA #DME/DME/IRU RNAV MEA	RAZORBACK, AR VORTAC	##*18000	45000

FROM	TO	MEA	MAA
95.4024 RNAV ROUTE Q24			
LAKE CHARLES, LA VORTAC *18000 - GNSS MEA #DME/DME/IRU RNAV MEA	PAYTN, AL FIX	#*20000	45000
95.4025 RNAV ROUTE Q25			
MEEOW, AR FIX *18000 - GNSS MEA #DME/DME/IRU RNAV MEA	WALNUT RIDGE, AR VORTAC	#*20000	45000
WALNUT RIDGE, AR VORTAC *18000 - GNSS MEA #DME/DME/IRU RNAV MEA	POCKET CITY, IN VORTAC	#*20000	45000
95.4026 RNAV ROUTE Q26			
WALNUT RIDGE, AR VORTAC *18000 - GNSS MEA #DME/DME/IRU RNAV MEA	DEVAC, AL FIX	#*20000	45000
95.4027 RNAV ROUTE Q27			
FORT SMITH, AR VORTAC *18000 - GNSS MEA #DME/DME/IRU RNAV MEA	ZALDA, AR FIX	#*18000	45000
95.4028 RNAV ROUTE Q28			
GRAZN, AR FIX *18000 - GNSS MEA #DME/DME/IRU RNAV MEA	POCKET CITY, IN VORTAC	#*20000	45000
95.4029 RNAV ROUTE Q29			
HARES, LA FIX *18000 - GNSS MEA #DME/DME/IRU ME	MEMPHIS, TN VORTAC	#*18000	45000
MEMPHIS, TN VORTAC *18000 - GNSS MEA #DME/DME/IRU RNAV MEA	POCKET CITY, IN VORTAC	#*18000	45000
95.4030 RNAV ROUTE Q30			
SIDON, MS VORTAC *18000 - GNSS MEA #DME/DME/IRU RNAV MEA	VULCAN, AL VORTAC	#*18000	45000

FROM	TO	MEA	MAA
95.4031 RNAV ROUTE Q31			
DHART, AR FIX *18000 - GNSS MEA #DME/DME/IRU RNAV MEA	MARVELL, AR VOR/DME	#*18000	45000
MARVELL, AR VOR/DME *18000 - GNSS MEA #DME/DME/IRU RNAV MEA	POCKET CITY, IN VORTAC	#*18000	45000
95.4032 RNAV ROUTE Q32			
EL DORADO, AR VORTAC *18000 - GNSS MEA #DME/DME/IRU RNAV MEA	NASHVILLE, TN VORTAC	#*20000	45000
NASHVILLE, TN VORTAC *18000 - GNSS MEA #DME/DME/IRU RNAV MEA	SWAPP, TN FIX	#*20000	45000
95.4033 RNAV ROUTE Q33			
DHART, AR FIX *18000 - GNSS MEA #DME/DME/IRU RNAV MEA	LITTLE ROCK, AR VORTAC	#*20000	45000
LITTLE ROCK, AR VORTAC *18000 - GNSS MEA #DME/DME/IRU RNAV MEA	PROWL, MO FIX	#*20000	45000
95.4034 RNAV ROUTE Q34			
TEXARKANA, AR VORTAC *18000 - GNSS MEA #DME/DME/IRU RNAV MEA	MEMPHIS, TN VORTAC	#*24000	45000
MEMPHIS, TN VORTAC *18000 - GNSS MEA #DME/DME/IRU RNAV MEA	SWAPP, TN FIX	#*24000	45000
95.4035 RNAV ROUTE Q35			
KIMBERLY, OR VORTAC *DME/DME/IRU MEA	CORKR, AZ FIX	*29000	45000
CORKR, AZ FIX *DME/DME/IRU MEA	DRAKE, AZ VORTAC	*22000	45000
95.4036 RNAV ROUTE Q36			
RAZORBACK, AR VORTAC *18000 - GNSS MEA #DME/DME/IRU RNAV MEA	NASHVILLE, TN VORTAC	#*20000	45000
NASHVILLE, TN VORTAC *18000 - GNSS MEA #DME/DME/IRU RNAV MEA	SWAPP, TN FIX	#*20000	45000

FROM	TO	MEA	MAA
 95.4038 RNAV ROUTE Q38			
ROKIT, TX FIX *18000 - GNSS MEA #DME/DME/IRU RNAV MEA	BESOM, AL FIX	#*18000	45000
 95.4040 RNAV ROUTE Q40			
ALEXANDRIA, LA VORTAC *18000 - GNSS MEA #DME/DME/IRU RNAV MEA	MISLE, AL FIX	#*18000	45000
 95.4041 RNAV ROUTE Q41			
CAWIN, AK FIX *GNSS REQUIRED	DEADHORSE, AK VOR/DME	*18000	45000
 95.4042 RNAV ROUTE Q42			
KIRKSVILLE, MO VORTAC *18000 GNSS MEA #DME/DME/IRU RNAV MEA	DANVILLE, IL VORTAC	#*34000	45000
DANVILLE, IL VORTAC *18000 GNSS MEA #DME/DME/IRU RNAV MEA	MUNCIE, IN VOR/DME	#*34000	45000
MUNCIE, IN VOR/DME *18000 - GNSS MEA #DME/DME/IRU RNAV MEA	BRNAN, PA FIX	#*24000	45000
BRNAN, PA FIX *18000 - GNSS MEA #DME/DME/IRU RNAV MEA	NAALS, PA FIX	#*26000	45000
NAALS, PA FIX *18000 - GNSS MEA #DME/DME/IRU RNAV MEA	EAST TEXAS, PA VOR/DME	#*24000	45000
EAST TEXAS, PA VOR/DME *18000 - GNSS MEA #DME/DME/IRU RNAV MEA	ELIOT, PA IX	#*24000	45000

FROM	TO	MEA	MAA
95.4043 RNAV ROUTE Q43			
ANCHORAGE, AK VOR/DME * GNSS REQUIRED	FAIRBANKS, AK VORTAC	*18000	45000
95.4044 RNAV ROUTE Q44			
NOME, AK VOR/DME *GNSS REQUIRED	ANCHORAGE, AK VOR/DME	*18000	45000
95.4045 RNAV ROUTE Q45			
DILLINGHAM, AK VOR/DME *GNSS REQUIRED	AMOTT, AK FIX	*18000	45000
95.4046 RNAV ROUTE Q46			
POINT HOPE, AK NDB * GNSS REQUIRED	BARROW, AK VOR/DME	*18000	45000
95.4047 RNAV ROUTE Q47			
KING SALMON, AK VORTAC *GNSS REQUIRED	AMOTT, AK FIX	*18000	45000
95.4048 RNAV ROUTE Q48			
BARROW, AK VOR/DME *GNSS REQUIRED	DEADHORSE, AK VOR/DME	*18000	45000
DEADHORSE, AK VOR/DME *GNSS REQUIRED	ROCES, AK FIX	*18000	45000
95.4049 RNAV ROUTE Q49			
KODIAK, AK VOR/DME *GNSS REQUIRED	AMOTT, AK FIX	*18000	45000
95.4051 RNAV ROUTE Q51			
KING SALMON, AK VORTAC *GNSS REQUIRED	KOTZEBUE, AK VOR/DME	*18000	45000
95.4053 RNAV ROUTE Q53			
KODIAK, AK VOR/DME *GNSS REQUIRED	ILIAMNA, AK NDB/DME	*18000	45000
ILIAMNA, AK NDB/DME *GNSS REQUIRED	KOTZEBUE, AK VOR/DME	*18000	45000
95.4055 RNAV ROUTE Q55			
KODIAK, AK VOR/DME *GNSS REQUIRED	NOME, AK VOR/DME	*18000	45000

FROM	TO	MEA	MAA
95.4057 RNAV ROUTE Q57			
KING SALMON, AK VORTAC *GNSS REQUIRED	MC GRATH, AK VORTAC	*18000	45000
95.4059 RNAV ROUTE Q59			
COLD BAY, AK VORTAC *GNSS REQUIRED	BETHEL, AK VORTAC	*18000	45000
95.4061 RNAV ROUTE Q61			
FAIRBANKS, AK VORTAC *GNSS REQUIRED	BARROW, AK VOR/DME	*18000	45000
95.4104 RNAV ROUTE Q104			
DEFUN, FL FIX *18000 - GNSS MEA #DME/DME/IRU RNAV MEA	ST PETERSBURG, FL VORTAC	#*18000	45000
ST PETERSBURG, FL VORTAC *18000 - GNSS MEA #DME/DME/IRU RNAV MEA	CYPRESS, FL VOR/DME	#*18000	45000
95.4106 RNAV ROUTE Q106			
SME LZ, FL FIX *18000 - GNSS MEA #DME/DME/IRU RNAV MEA	GADAY, AL FIX	#*18000	45000
95.4108 RNAV ROUTE Q108			
GADAY, AL FIX *18000 - GNSS MEA #DME/DME/IRU RNAV MEA	HKUNA, FL FIX	#*18000	45000
95.4110 RNAV ROUTE Q110			
THNDR, FL FIX *18000 - GNSS MEA #DME/DME/IRU RNAV MEA	KPASA, FL FIX	#*18000	45000
KPASA, FL FIX *18000 - GNSS MEA #DME/DME/IRU RNAV MEA	FEONA, GA FIX	#*18000	45000

FROM	TO	MEA	MAA
95.4112 RNAV ROUTE Q112			
INPIN, FL FIX *18000 - GNSS MEA #DME/DME/IRU RNAV MEA	DEFUN, FL FIX	#*18000	45000
95.4116 RNAV ROUTE Q116			
KPASA, FL FIX *18000 - GNSS MEA #DME/DME/IRU RNAV MEA	CEEYA, GA FIX	#*18000	45000
95.4118 RNAV ROUTE Q118			
KPASA, FL FIX *18000 - GNSS MEA #DME/DME/IRU RNAV MEA	LENIE, GA FIX	#*18000	45000
95.4501 RNAV ROUTE Q501			
SOBME, SD FIX *18000 - GNSS MEA #DME/DME/IRU RNAV MEA	GOPHER, MN VORTAC	#*24000	45000
GOPHER, MN VORTAC *18000 - GNSS MEA #DME/DME/IRU RNAV MEA #EXCLUDES THE PORTION WITHIN CANADA	VIXIS, CANADA FIX	#*24000	45000
95.4502 RNAV ROUTE Q502			
SOBME, SD FIX *18000 - GNSS MEA #DME/DME/IRU RNAV MEA	GOPHER, MN VORTAC	#*24000	45000
GOPHER, MN VORTAC *18000 - GNSS MEA #DME/DME/IRU RNAV MEA #EXCLUDES THE PORTION WITHIN CANADA	KENPA, CANADA FIX	#*24000	45000
95.4504 RNAV ROUTE Q504			
HEMDI, SD FIX *18000 - GNSS MEA #DME/DME/IRU RNAV MEA #EXCLUDES THE PORTION WITHIN CANADA	NOTAP, CANADA FIX	#*24000	45000
95.4505 RNAV ROUTE Q505			
HEMDI, SD FIX *18000 - GNSS MEA #DME/DME/IRU RNAV MEA #EXCLUDES THE PORTION WITHIN CANADA	OMAGA, CANADA FIX	#*24000	45000

&95.5000 GROUND-BASED HIGH ALTITUDE RNAV ROUTES

FROM/TO	TOTAL DISTANCE	CHANGEOVER DISTANCE	POINT FROM	TRACK ANGLE	MEA	MAA
J804R						
ANCHORAGE, AK VOR/DME	61.2				18000	45000
NOWEL, AK RP				130/310 TO NOWEL		
NOWEL, AK RP	94.0				18000	45000
MIDDLETON ISLAND, AK VOR/DME				131/311 TO MIDDLETON ISLAND		
MIDDLETON ISLAND, AK VOR/DME ISLAND	170.9	121	MIDDLETON	095/275 TO COP	24000	45000
SNOUT, AK RP				120/300 TO SNOUT		
SNOUT, AK RP	196.9	197	SNOUT	096/276 TO COP	24000	45000
EEDEN, AK RP				125/305 TO EEDEN		
EEDEN, AK RP	153.9	112	EEDEN	102/282 TO COP	24000	45000
FRIED, AK RP				129/309 TO FRIED		
 J889R						
NOWEL, AK RP	79.0	10	NOWEL	110/290 TO COP	18000	45000
ARISE, AK RP				003/183 TO ARISE		
ARISE, AK RP	70.0			111/291 TO KONKS	18000	45000
KONKS, AK WP				293/113 TO KONKS		
KONKS, AK WP	116.0	40	KONKS	111/291 TO COP	18000	45000
LAIRE, AK RP				294/114 TO LAIRE		

FROM TO MEA

&95.6001 VOR FEDERAL AIRWAYS

95.6001 VOR FEDERAL AIRWAY V1

CRAIG, FL VORTAC *2100 - MOCA	STARY, GA FIX	*4000
STARY, GA FIX *1200 - MOCA	RUBYS, SC FIX	*11000
RUBYS, SC FIX *3000 - MRA **2300 - MOCA	*BASSO, SC FIX	**11000
BASSO, SC FIX	CHARLESTON, SC VORTAC	2000
CHARLESTON, SC VORTAC *3000 - MRA	*INLET, SC FIX	2000
INLET, SC FIX	GRAND STRAND, SC VORTAC	2000
GRAND STRAND, SC VORTAC	ASHES, NC FIX	2000
ASHES, NC FIX	LAYZE, NC FIX	5000
LAYZE, NC FIX *1600 - MOCA	WALLO, NC FIX	*7000
WALLO, NC FIX	KINSTON, NC VORTAC	2000
KINSTON, NC VORTAC *7000 - MRA	*ZAGGY, NC FIX	2000
ZAGGY, NC FIX *1500 - MOCA	COFIELD, NC VORTAC	*3000
COFIELD, NC VORTAC	DRONE, NC FIX	2000
DRONE, NC FIX *1600 - MOCA	NORFOLK, VA VORTAC	*2500
NORFOLK, VA VORTAC *1800 - MOCA	CAPE CHARLES, VA VORTAC	*2500
CAPE CHARLES, VA VORTAC	SALISBURY, MD VORTAC	2000
SALISBURY, MD VORTAC *1500 - MOCA	WATERLOO, DE VOR/DME	#*2000
#SALISBURY R-039 UNUSABLE BELOW 5000 MSL		
WATERLOO, DE VOR/DME	COYLE, NJ VORTAC	1800
COYLE, NJ VORTAC *1600 - MOCA	DIXIE, NJ FIX	*2500
DIXIE, NJ FIX *1600 - MOCA	KENNEDY, NY VOR/DME	*2500
KENNEDY, NY VOR/DME	DEER PARK, NY VOR/DME	1800
DEER PARK, NY VOR/DME	MADISON, CT VOR/DME	2000
MADISON, CT VOR/DME	HARTFORD, CT VOR/DME	2500
HARTFORD, CT VOR/DME *2500 - MOCA	GRAYM, MA FIX	*3000
GRAYM, MA FIX *2500 - MOCA	BOSTON, MA VOR/DME	*4000
*3000 - GNSS MEA		

95.6002 VOR FEDERAL AIRWAY V2

*SEATTLE, WA VORTAC	VAMPS, WA FIX E BND W BND	**8000 **4000
*4300 - MCA SEATTLE, WA VORTAC, E BND **3100 - MOCA		
VAMPS, WA FIX *9000 - MRA	*BEEZR, WA FIX	8000
BEEZR, WA FIX *6800 - MOCA	ELLENSBURG, WA VORTAC	*8000
ELLENSBURG, WA VORTAC	EDSEW, WA FIX	7000
EDSEW, WA FIX	MOSES LAKE, WA VOR/DME	4000

FROM TO MEA

95.6002 VOR FEDERAL AIRWAY V2 - CONTINUED

MOSES LAKE, WA VOR/DME	BATUM, WA FIX	4000
BATUM, WA FIX	SUBDY, WA FIX	5000
SUBDY, WA FIX	*SPOKANE, WA VORTAC	5000
*5200 - MCA SPOKANE, WA VORTAC , E BND		
SPOKANE, WA VORTAC	ROPES, WA FIX	7100
ROPES, WA FIX	MULLAN PASS, ID VOR/DME	9100
MULLAN PASS, ID VOR/DME	ALTON, MT FIX	9600
ALTON, MT FIX	MISSOULA, MT VOR/DME	
	SE BND	*9000
	NW BND	*9600
*8500 - MOCA		
MISSOULA, MT VOR/DME	HELENA, MT VORTAC	*13000
*10300 - MOCA		
HELENA, MT VORTAC	SWEDD, MT FIX	10000
SWEDD, MT FIX	CONNS, MT FIX	10800
CONNS, MT FIX	LIVINGSTON, MT VOR/DME	10000
LIVINGSTON, MT VOR/DME	REEPO, MT FIX	*9000
*8300 - MOCA		
REEPO, MT FIX	COLUS, MT FIX	
	W BND	9000
	E BND	7000
COLUS, MT FIX	BILLINGS, MT VORTAC	
	W BND	9000
	E BND	6000
BILLINGS, MT VORTAC	MILES CITY, MT VOR/DME	6000
MILES CITY, MT VOR/DME	DICKINSON, ND VORTAC	6000
DICKINSON, ND VORTAC	BISMARCK, ND VOR/DME	4600
BISMARCK, ND VOR/DME	JAMESTOWN, ND VOR/DME	4000
JAMESTOWN, ND VOR/DME	*CHAFE, ND FIX	3300
*6000 - MRA		
CHAFE, ND FIX	FARGO, ND VORTAC	
	W BND	3300
	E BND	2700
FARGO, ND VORTAC	ALEXANDRIA, MN VOR/DME	*3500
*3000 - MOCA		
ALEXANDRIA, MN VOR/DME	GOPHER, MN VORTAC	3400
GOPHER, MN VORTAC	PEGGS, MN FIX	3400
PEGGS, MN FIX	NODINE, MN VORTAC	3000
NODINE, MN VORTAC	LONE ROCK, WI VOR/DME	3000
LONE ROCK, WI VOR/DME	MADISON, WI VORTAC	3000
MADISON, WI VORTAC	*WAITS, WI FIX	2800
*4000 - MRA		
WAITS, WI FIX	BADGER, WI VORTAC	2800
BADGER, WI VORTAC	*SUDDS, WI FIX	2900
*3500 - MRA		
SUDDS, WI FIX	MUSKEGON, MI VORTAC	2500
MUSKEGON, MI VORTAC	LANSING, MI VORTAC	2600
#LANSING, MI VORTAC	SALEM, MI VORTAC	*5000
*3000 - MOCA		
*3000 - GNSS MEA		
#LANSING R-115 UNUSABLE BELOW 5000.		
SALEM, MI VORTAC	DELOW, MI FIX	3000
DELOW, MI FIX	U.S. CANADIAN BORDER	*4000
*2800 - MOCA		
U.S. CANADIAN BORDER	BUFFALO, NY VOR/DME	*3000
*2400 - MOCA		
BUFFALO, NY VOR/DME	#ROCHESTER, NY VOR/DME	#2800
#ROCHESTER R-083 UNUSABLE BELOW 11000.		
ROCHESTER, NY VOR/DME	MAGEN, NY FIX	2300
MAGEN, NY FIX	*KONDO, NY FIX	2300
*4800 - MRA		
KONDO, NY FIX	*WIFFY, NY FIX	2300
*3000 - MRA		
WIFFY, NY FIX	SYRACUSE, NY VORTAC	2300
SYRACUSE, NY VORTAC	STODA, NY FIX	2400

FROM TO MEA

95.6002 VOR FEDERAL AIRWAY V2 - CONTINUED

STODA, NY FIX	VASTS, NY FIX	3000
VASTS, NY FIX	UTICA, NY VORTAC	3400
UTICA, NY VORTAC	MARIA, NY FIX	3500
MARIA, NY FIX	ALBANY, NY VORTAC	3000
ALBANY, NY VORTAC	WARIC, MA FIX	5000
WARIC, MA FIX	GARDNER, MA VOR/DME	*4000
*3500 - MOCA		

95.6003 VOR FEDERAL AIRWAY V3

KEY WEST, FL VORTAC	*BIPIN, FL FIX	15000
*14100 - MCA BIPIN, FL FIX , W BND		
BIPIN, FL FIX	*DROWN, FL FIX	**5000
*5000 - MRA		
**1400 - MOCA		
DROWN, FL FIX	MNATE, FL FIX	5000
MNATE, FL FIX	DOLPHIN, FL VORTAC	*5000
*2800 - MOCA		
DOLPHIN, FL VORTAC	FORT LAUDERDALE, FL VOR/DME	#2100
#FORT LAUDERDALE R-213 UNUSABLE, USE DOLPHIN R-037		
FORT LAUDERDALE, FL VOR/DME	PALM BEACH, FL VORTAC	#2000
#FORT LAUDERDALE R-006 UNUSABLE, USE PALM BEACH R-189		
PALM BEACH, FL VORTAC	VERO BEACH, FL VORTAC	*3000
*2000 - MOCA		
VERO BEACH, FL VORTAC	MELBOURNE, FL VOR/DME	2000
MELBOURNE, FL VOR/DME	MALET, FL FIX	2000
MALET, FL FIX	ORMOND BEACH, FL VORTAC	*4000
*1600 - MOCA		
ORMOND BEACH, FL VORTAC	*SEBAG, FL FIX	**2000
*3000 - MRA		
**1400 - MOCA		
SEBAG, FL FIX	BRUNSWICK, GA VORTAC	*2000
*1400 - MOCA		
BRUNSWICK, GA VORTAC	*BROUN, GA FIX	**3000
*11000 - MRA		
**2200 - MOCA		
BROUN, GA FIX	*HARPS, GA FIX	**3000
*3800 - MRA		
**2200 - MOCA		
HARPS, GA FIX	KELER, GA FIX	*3000
*2200 - MOCA		
KELER, GA FIX	SAVANNAH, GA VORTAC	*3000
*1900 - MOCA		
SAVANNAH, GA VORTAC	OWENS, SC FIX	*3000
*1500 - MOCA		
OWENS, SC FIX	VANCE, SC VORTAC	2000
VANCE, SC VORTAC	FLORENCE, SC VORTAC	2000
FLORENCE, SC VORTAC	TOWEY, SC FIX	2000
TOWEY, SC FIX	SANDHILLS, NC VORTAC	*8000
*1900 - MOCA		
SANDHILLS, NC VORTAC	RALEIGH/DURHAM, NC VORTAC	2500
RALEIGH/DURHAM, NC VORTAC	*HARVY, VA FIX	3000
*3000 - MRA		
HARVY, VA FIX	*NUTTS, VA FIX	**6000
*9000 - MRA		
**4000 - GNSS MEA		

FROM TO MEA

95.6003 VOR FEDERAL AIRWAY V3 – CONTINUED

NUTTS, VA FIX *4000 - GNSS MEA #FLAT ROCK R-220 UNUSABLE	FLAT ROCK, VA VORTAC	#*6000
FLAT ROCK, VA VORTAC	GORDONSVILLE, VA VORTAC	2500
GORDONSVILLE, VA VORTAC	LURAY, VA FIX	6100
LURAY, VA FIX *7000 - MRA **5000 - MOCA	*KERRE, VA FIX	**6000
KERRE, VA FIX *5000 - MOCA	MARTINSBURG, WV VORTAC	*6000
MARTINSBURG, WV VORTAC *3300 - MOCA	WESTMINSTER, MD VORTAC	*4000
WESTMINSTER, MD VORTAC	VINNY, PA FIX	3000
VINNY, PA FIX	MODENA, PA VORTAC	3500
MODENA, PA VORTAC *2500 - GNSS MEA #MODENA R-056 UNUSABLE.	BIGGY, NJ FIX	#*2500
BIGGY, NJ FIX	SOLBERG, NJ VOR/DME	2000
SOLBERG, NJ VOR/DME *2500 - MOCA	CARMEL, NY VOR/DME	*3000
CARMEL, NY VOR/DME	RACEY, CT FIX	2100
RACEY, CT FIX	HARTFORD, CT VOR/DME	3000
HARTFORD, CT VOR/DME *2100 - MOCA	JEWIT, CT FIX	*2600
JEWIT, CT FIX	WOONS, RI FIX	2500
WOONS, RI FIX	BOSTON, MA VOR/DME	2000
BOSTON, MA VOR/DME	PEASE, NH VOR/DME	3000
PEASE, NH VOR/DME *5500 - MRA **2400 - MOCA	*YUKES, NH FIX	**3500
YUKES, NH FIX *2400 - MOCA	PARSO, ME FIX	*3500
PARSO, ME FIX	AUGUSTA, ME VOR/DME	3500
AUGUSTA, ME VOR/DME	BANGOR, ME VORTAC	3000
BANGOR, ME VORTAC *1600 - MOCA	NIELD, ME FIX	*2700
NIELD, ME FIX *2100 - MOCA	LAUDS, ME FIX	*2700
LAUDS, ME FIX *1900 - MOCA	HOULTON, ME VOR/DME	*2700
HOULTON, ME VOR/DME *2700 - MOCA	PRESQUE ISLE, ME VOR/DME	*3400
PRESQUE ISLE, ME VOR/DME *3500 - MOCA	U.S. CANADIAN BORDER	*6000

95.6004 VOR FEDERAL AIRWAY V4

TATOOSH, WA VORTAC *4600 - MOCA	DIGGN, WA FIX	*5400
DIGGN, WA FIX *4300 - MOCA	LOFAL, WA FIX	*5400
LOFAL, WA FIX *5200 - MCA SEATTLE, WA VORTAC, E BND **2800 – MOCA	*SEATTLE, WA VORTAC	**4000

FROM TO MEA

95.6004 VOR FEDERAL AIRWAY V4 -CONTINUED

SEATTLE, WA VORTAC	*BLAKO, WA FIX E BND W BND	**6000 **4000
*7500 - MCA BLAKO, WA FIX , E BND		
**3100 - MOCA		
BLAKO, WA FIX	HUMPP, WA FIX E BND W BND	*10000 *6400
*6200 - MOCA		
HUMPP, WA FIX	CHINS, WA FIX	*10000
*9000 - MOCA		
CHINS, WA FIX	TITON, WA FIX E BND W BND	*7000 *10000
*7000 - MOCA		
TITON, WA FIX	GLEED, WA FIX W BND E BND	*7000 *5500
*5000 - MOCA		
GLEED, WA FIX	YAKIMA, WA VORTAC E BND W BND	5000 5500
YAKIMA, WA VORTAC	AMPLE, WA FIX	5000
AMPLE, WA FIX	PENDLETON, OR VORTAC	4000
PENDLETON, OR VORTAC	PIANO, OR FIX SE BND NW BND	7000 6000
PIANO, OR FIX	LACED, OR FIX NW BND SE BND	7000 10000
LACED, OR FIX	BAKER CITY, OR VOR/DME	10000
BAKER CITY, OR VOR/DME	PAYET, ID FIX	9000
PAYET, ID FIX	*EMETT, ID FIX SE BND NW BND	5600 9000
*9400 - MRA		
EMETT, ID FIX	BOISE, ID VORTAC	5600
BOISE, ID VORTAC	CANEK, ID FIX	7000
CANEK, ID FIX	ALKAL, ID FIX	*9500
*8500 - MOCA		
ALKAL, ID FIX	GOODE, ID FIX E BND W BND	*8000 *9500
*6200 - MOCA		
GOODE, ID FIX	JEROT, ID FIX	*8000
*6500 - MOCA		
JEROT, ID FIX	BURLEY, ID VOR/DME	6500
BURLEY, ID VOR/DME	MEDEA, ID FIX	*8400
*7800 - MOCA		
MEDEA, ID FIX	MALAD CITY, ID VOR/DME	9400
MALAD CITY, ID VOR/DME	GRIPS, WY FIX	#*14000
*11500 - MOCA		
#MEA IS ESTABLISHED WITH A GAP IN NAVIGATION SIGNAL COVERAGE.		
GRIPS, WY FIX	ROCK SPRINGS, WY VOR/DME	10000
ROCK SPRINGS, WY VOR/DME	CHEROKEE, WY VOR/DME	10000
CHEROKEE, WY VOR/DME	KLASH, WY FIX E BND W BND	13000 11000
KLASH, WY FIX	*LARAMIE, WY VOR/DME	13000
*10600 - MCA LARAMIE, WY VOR/DME , W BND		
LARAMIE, WY VOR/DME	FLEMS, WY FIX	11000

FROM	TO	MEA
95.6004 VOR FEDERAL AIRWAY V4		
FLEMS, WY FIX *10000 - MOCA	BARGR, CO FIX	*11000
BARGR, CO FIX	WISER, CO FIX	8400
WISER, CO FIX	GILL, CO VOR/DME	8000
GILL, CO VOR/DME	THURMAN, CO VORTAC	7000
THURMAN, CO VORTAC *6300 - MOCA	GOODLAND, KS VORTAC	*7000
GOODLAND, KS VORTAC	HILL CITY, KS VORTAC	5500
HILL CITY, KS VORTAC *4000 - MOCA	WESAL, KS FIX	*5500
WESAL, KS FIX *2900 - MOCA	SALINA, KS VORTAC	*4000
SALINA, KS VORTAC *5000 - MRA	*VASCO, KS FIX	3000
VASCO, KS FIX	ALMAS, KS FIX	3000
ALMAS, KS FIX	TOPEKA, KS VORTAC	3600
TOPEKA, KS VORTAC	KANSAS CITY, MO VORTAC	2700
KANSAS CITY, MO VORTAC	LEXIN, MO FIX	2600
LEXIN, MO FIX *3000 - GNSS MEA	HALLSVILLE, MO VORTAC	*6000
HALLSVILLE, MO VORTAC	SADEN, MO FIX	2600
SADEN, MO FIX *1700 - MOCA	ST LOUIS, MO VORTAC	*2400
ST LOUIS, MO VORTAC	TROY, IL VORTAC	2400
TROY, IL VORTAC	CENTRALIA, IL VORTAC	2300
CENTRALIA, IL VORTAC	POCKET CITY, IN VORTAC	3000
POCKET CITY, IN VORTAC	LAMBS, IN FIX	2500
LAMBS, IN FIX *4500 - MRA **2400 - MOCA	*APALO, IN FIX	**3000
APALO, IN FIX *2400 - MOCA	DOWNNS, KY FIX	*3000
DOWNNS, KY FIX *2300 - MOCA	LOUISVILLE, KY VORTAC	*2600
LOUISVILLE, KY VORTAC	FEDRA, KY FIX	2600
FEDRA, KY FIX	LEXINGTON, KY VORTAC	2800
LEXINGTON, KY VORTAC	CODEL, KY FIX	3000
CODEL, KY FIX *2500 - MOCA	MASSE, KY FIX	*5000
MASSE, KY FIX *2900 - MOCA	CICKE, KY FIX	*5000
CICKE, KY FIX	NEWCOMBE, KY VORTAC	3100
NEWCOMBE, KY VORTAC	CHARLESTON, WV VORTAC	3000
CHARLESTON, WV VORTAC *4000 - MRA	*ITALY, WV FIX	3000
ITALY, WV FIX	REACH, WV FIX	4000
REACH, WV FIX	ELKINS, WV VORTAC	4400
ELKINS, WV VORTAC	KESSEL, WV VOR/DME	6400
KESSEL, WV VOR/DME	ARMEL, VA VORTAC	5000

95.6005 VOR FEDERAL AIRWAY V5

PECAN, GA VORTAC	VIENNA, GA VORTAC	2000
VIENNA, GA VORTAC	DUBLIN, GA VORTAC	2100
DUBLIN, GA VORTAC *2200 - MOCA	ATHENS, GA VORTAC	*3000
ATHENS, GA VORTAC	IRMOS, GA FIX	3000
IRMOS, GA FIX	CORCE, GA FIX	3800
CORCE, GA FIX *5000 - MRA	*AWSON, GA FIX	4600
AWSON, GA FIX	NELLO, GA FIX	5400

FROM TO MEA

95.6005 VOR FEDERAL AIRWAY V5 - CONTINUED

NELLO, GA FIX *4000 - MCA HOCHE, GA FIX , SE BND	*HOCHE, GA FIX	5400
HOCHE, GA FIX CHOO CHOO, TN VORTAC	CHOO CHOO, TN VORTAC	3000
MCMIN, TN FIX *3700 - MOCA	MCMIN, TN FIX	4000
HARME, TN FIX *2300 - MOCA	HARME, TN FIX	*6000
BOWLING GREEN, KY VORTAC *2300 - MOCA	BOWLING GREEN, KY VORTAC	*2800
NEW HOPE, KY VOR/DME *2700 - GNSS MEA	NEW HOPE, KY VOR/DME	*2900
LOUISVILLE, KY VORTAC *2700 - GNSS MEA	LOUISVILLE, KY VORTAC	2700
NERVE, KY FIX CINCINNATI, KY VORTAC	NERVE, KY FIX	*10000
MOAKS, OH FIX *2300 - MOCA	CINCINNATI, KY VORTAC	2700
PRUDE, OH FIX *2500 - MOCA	MOAKS, OH FIX	2800
SHIRT, OH FIX *4000 - MRA	PRUDE, OH FIX	*3000
GLOOM, OH FIX APPLETON, OH VORTAC	SHIRT, OH FIX	*4000
MANSFIELD, OH VORTAC DRYER, OH VOR/DME	*GLOOM, OH FIX	3000
DRYER, OH VOR/DME	APPLETON, OH VORTAC	3000
	MANSFIELD, OH VORTAC	3000
	DRYER, OH VOR/DME	3000
	U.S. CANADIAN BORDER	2500

95.6006 VOR FEDERAL AIRWAY V6

OAKLAND, CA VORTAC COLLI, CA FIX *3800 - MCA PITTS, CA FIX , S BND	COLLI, CA FIX	4000
PITTS, CA FIX *2800 - MCA REJOY, CA FIX , S BND	*PITTS, CA FIX	5000
**2300 - MOCA	*REJOY, CA FIX	**4000
REJOY, CA FIX SACRAMENTO, CA VORTAC	SACRAMENTO, CA VORTAC	2000
FOLLY, CA FIX *9500 - MCA COLOM, CA FIX , NE BND	FOLLY, CA FIX	3000
COLOM, CA FIX SQUAW VALLEY, CA VOR/DME	*COLOM, CA FIX	5000
*12000 - MCA MUSTANG, NV VORTAC , SW BND	SQUAW VALLEY, CA VOR/DME	11000
MUSTANG, NV VORTAC WADDS, NV FIX	*MUSTANG, NV VORTAC	13000
WADDS, NV FIX *8500 - MCA LOVELOCK, NV VORTAC , NE BND	WADDS, NV FIX	10300
**9500 - MOCA	*LOVELOCK, NV VORTAC	**10000
LOVELOCK, NV VORTAC BATTLE MOUNTAIN, NV VORTAC	BATTLE MOUNTAIN, NV VORTAC	12000
BATTLE MOUNTAIN, NV VORTAC *10100 - MOCA	WELLS, NV VOR	*11000
WELLS, NV VOR LUCIN, UT VORTAC	LUCIN, UT VORTAC	10300
*OGDEN, UT VORTAC	OGDEN, UT VORTAC	9000
	EVIEW, UT FIX	12000
	E BND	7000
	W BND	7000
*10700 - MCA OGDEN, UT VORTAC , E BND		
EVIEW, UT FIX FORT BRIDGER, WY VOR/DME	FORT BRIDGER, WY VOR/DME	12000
ROCK SPRINGS, WY VOR/DME	ROCK SPRINGS, WY VOR/DME	10000
CHEROKEE, WY VOR/DME	CHEROKEE, WY VOR/DME	10000
MEDICINE BOW, WY VOR/DME	MEDICINE BOW, WY VOR/DME	10000
MEDICINE BOW, WY VOR/DME	MOIST, WY FIX	9500

FROM	TO	MEA
95.6006 VOR FEDERAL AIRWAY V6 - CONTINUED		
MOIST, WY FIX *10500 - MCA LITER, WY FIX , W BND **9500 - MOCA	*LITER, WY FIX	**10500
LITER, WY FIX *7600 - MOCA	SIDNEY, NE VORTAC	*9500
SIDNEY, NE VORTAC NORTH PLATTE, NE VORTAC *4300 - MOCA	NORTH PLATTE, NE VORTAC RAGAR, NE FIX	6000 *5000
RAGAR, NE FIX *3600 - MOCA	GRAND ISLAND, NE VORTAC	*5000
GRAND ISLAND, NE VORTAC *3100 - MOCA	HUSKR, NE FIX	*4000
HUSKR, NE FIX OMAHA, IA VORTAC *4500 - MRA	OMAHA, IA VORTAC *LYMAN, IA FIX	4000 3000
LYMAN, IA FIX DES MOINES, IA VORTAC IOWA CITY, IA VORTAC DAVENPORT, IA VORTAC LEECS, IL FIX *2700 - GNSS MEA	DES MOINES, IA VORTAC IOWA CITY, IA VORTAC DAVENPORT, IA VORTAC LEECS, IL FIX DUPAGE, IL VOR/DME	3000 2700 2600 2500 *4000
NILES, IL FIX *2500 - MOCA	CHETT, MI FIX	*3500
CHETT, MI FIX *2200 - MOCA	GIPPER, MI VORTAC	*3000
GIPPER, MI VORTAC *2300 - MOCA	BRYTO, IN FIX	*3000
BRYTO, IN FIX *4000 - MRA **2400 - MOCA	*PIONS, OH FIX	**4000
PIONS, OH FIX *2200 - MOCA	WATERVILLE, OH VOR/DME	*3300
WATERVILLE, OH VOR/DME SANDUSKY, OH VOR/DME DRYER, OH VOR/DME MOROW, OH FIX *2700 - MOCA *3000 - GNSS MEA	SANDUSKY, OH VOR/DME DRYER, OH VOR/DME MOROW, OH FIX HIRES, OH FIX	3000 3000 3100 *5000
HIRES, OH FIX YOUNGSTOWN, OH VORTAC *3000 - MOCA *3000 - GNSS MEA	YOUNGSTOWN, OH VORTAC MERCY, PA FIX	2900 *5000
MERCY, PA FIX CLARION, PA VOR/DME PHILIPSBURG, PA VORTAC SELINGSGROVE, PA VORTAC *3500 - MOCA *4000 - GNSS MEA	CLARION, PA VOR/DME PHILIPSBURG, PA VORTAC SELINGSGROVE, PA VORTAC SNOWY, PA FIX	3600 4000 4000 *5000
SNOWY, PA FIX *3300 - MOCA	ALLENTOWN, PA VORTAC	*4000
ALLENTOWN, PA VORTAC *2200 - MOCA # FJC R-115 UNUSABLE. USE SBJ R-295.	SOLBERG, NJ VOR/DME	#*3000
SOLBERG, NJ VOR/DME EMPYR, NY FIX NANCI, NY FIX	EMPYR, NY FIX NANCI, NY FIX LA GUARDIA, NY VOR/DME	2300 2700 2600

FROM	TO	MEA
95.6007 VOR FEDERAL AIRWAY V7		
DOLPHIN, FL VORTAC *1500 - MOCA	SWAGS, FL FIX	*2000
SWAGS, FL FIX	LEE COUNTY, FL VORTAC	2200
LEE COUNTY, FL VORTAC	JOCKS, FL FIX	2600
JOCKS, FL FIX	*CROWD, FL FIX	**2300
*5000 - MRA		
**1600 - MOCA		
CROWD, FL FIX	LAKELAND, FL VORTAC	2300
LAKELAND, FL VORTAC	DADES, FL FIX	1800
DADES, FL FIX	*NITTS, FL FIX	2300
*3000 - MRA		
NITTS, FL FIX	*ORATE, FL FIX	**3000
*3000 - MRA		
**1600 - MOCA		
ORATE, FL FIX	CROSS CITY, FL VORTAC	*2000
*1500 - MOCA		
CROSS CITY, FL VORTAC	SEMINOLE, FL VORTAC	2000
SEMINOLE, FL VORTAC	OALDY, AL FIX	2000
OALDY, AL FIX	WIREGRASS, AL VORTAC	2500
WIREGRASS, AL VORTAC	CLIOS, AL FIX	2200
CLIOS, AL FIX	BANBI, AL FIX	*2400
*2400 - GNSS MEA		
BANBI, AL FIX	MONTGOMERY, AL VORTAC	2400
MONTGOMERY, AL VORTAC	BOWIN, AL FIX	2000
BOWIN, AL FIX	VULCAN, AL VORTAC	3000
VULCAN, AL VORTAC	MUSCLE SHOALS, AL VORTAC	*2800
*2200 - MOCA		
MUSCLE SHOALS, AL VORTAC	GILLE, AL FIX	2500
GILLE, AL FIX	GRAHAM, TN VORTAC	*3000
*2400 - MOCA		
GRAHAM, TN VORTAC	VALER, TN FIX	3000
VALER, TN FIX	CENTRAL CITY, KY VORTAC	*3000
*2200 - MOCA		
CENTRAL CITY, KY VORTAC	POCKET CITY, IN VORTAC	2300
POCKET CITY, IN VORTAC	PRINC, IN FIX	2300
PRINC, IN FIX	LISLE, IN FIX	4500
LISLE, IN FIX	TERRE HAUTE, IN VORTAC	3000
TERRE HAUTE, IN VORTAC	*POTES, IN FIX	2500
*4000 - MRA		
POTES, IN FIX	BOILER, IN VORTAC	2500
BOILER, IN VORTAC	CHICAGO HEIGHTS, IL VORTAC	2700
CHICAGO HEIGHTS, IL VORTAC	*NILES, IL FIX	2100
*3500 - MRA		
*3000 - MCA NILES, IL FIX , N BND		
NILES, IL FIX	LAIRD, IL FIX	3300
*LAIRD, IL FIX	THORR, IL FIX	2500
*3000 - MCA LAIRD, IL FIX , S BND		
THORR, IL FIX	PAPPI, IL FIX	*2500
*1700 - MOCA		
PAPPI, IL FIX	TALOR, WI FIX	*4000
*1700 - MOCA		
TALOR, WI FIX	PETTY, WI FIX	*6000
*1800 - MOCA		
PETTY, WI FIX	PROOT, WI FIX	*4500
*1700 - MOCA		
PROOT, WI FIX	FALLS, WI VOR/DME	*3000
*2100 - MOCA		
FALLS, WI VOR/DME	GREEN BAY, WI VORTAC	3000
GREEN BAY, WI VORTAC	MENOMINEE, MI VOR/DME	2600
MENOMINEE, MI VOR/DME	SAWYER, MI VOR/DME	2900

FROM	TO	MEA
95.6008 VOR FEDERAL AIRWAY V8		
DOYLE, CA FIX	LIMBO, CA FIX	3000
LIMBO, CA FIX	*WILMA, CA FIX	3200
*2800 - MCA WILMA, CA FIX , W BND		
WILMA, CA FIX	SEAL BEACH, CA VORTAC	2300
SEAL BEACH, CA VORTAC	AHEIM, CA FIX	*3000
*2200 - MOCA		
AHEIM, CA FIX	*OLLIE, CA FIX	3000
*4000 - MRA		
*4100 - MCA OLLIE, CA FIX , NE BND		
OLLIE, CA FIX	PARADISE, CA VORTAC	5000
PARADISE, CA VORTAC	*RAVON, CA FIX	4500
*8800 - MCA RAVON, CA FIX , NE BND		
RAVON, CA FIX	GAREY, CA FIX	
	SW BND	8000
	NE BND	10500
GAREY, CA FIX	*LUCER, CA FIX	10500
*9300 - MCA LUCER, CA FIX , SW BND		
LUCER, CA FIX	BULGY, CA FIX	*9000
*8000 - MOCA		
BULGY, CA FIX	HECTOR, CA VORTAC	*9000
*7000 - MOCA		
HECTOR, CA VORTAC	GOFFS, CA VORTAC	*9000
*8200 - MOCA		
GOFFS, CA VORTAC	LYNSY, NV FIX	7600
LYNSY, NV FIX	MEADS, NV FIX	7500
MEADS, NV FIX	MORMON MESA, NV VORTAC	6000
MORMON MESA, NV VORTAC	MATZO, UT FIX	
	NE BND	12000
	SW BND	9000
MATZO, UT FIX	BRYCE CANYON, UT VORTAC	12300
BRYCE CANYON, UT VORTAC	HANKSVILLE, UT VORTAC	13300
HANKSVILLE, UT VORTAC	GRAND JUNCTION, CO VOR/DME	10000
GRAND JUNCTION, CO VOR/DME	*SQUAT, CO FIX	**10500
*11700 - MRA		
*11700 - MCA SQUAT, CO FIX , NE BND		
**9600 - MOCA		
SQUAT, CO FIX	RIFLE, CO VOR/DME	13200
RIFLE, CO VOR/DME	KREMMLING, CO VOR/DME	13400
KREMMLING, CO VOR/DME	MILE HIGH, CO VORTAC	15500
*MILE HIGH, CO VORTAC	HOYTT, CO FIX	7600
*10300 - MCA MILE HIGH, CO VORTAC , W BND		
HOYTT, CO FIX	AKRON, CO VOR/DME	7000
AKRON, CO VOR/DME	HAYES CENTER, NE VORTAC	6500
HAYES CENTER, NE VORTAC	GRAND ISLAND, NE VORTAC	*5500
*4900 - MOCA		
GRAND ISLAND, NE VORTAC	HUSKR, NE FIX	*4000
*3100 - MOCA		
HUSKR, NE FIX	OMAHA, IA VORTAC	4000
OMAHA, IA VORTAC	*LYMAN, IA FIX	3000
*4500 - MRA		
LYMAN, IA FIX	DES MOINES, IA VORTAC	3000
DES MOINES, IA VORTAC	IOWA CITY, IA VORTAC	2700
IOWA CITY, IA VORTAC	MOLINE, IL VORTAC	2700
MOLINE, IL VORTAC	TRIDE, IL FIX	3300
TRIDE, IL FIX	JOLIET, IL VORTAC	2600
JOLIET, IL VORTAC	CHICAGO HEIGHTS, IL VORTAC	2500
CHICAGO HEIGHTS, IL VORTAC	HALIE, IN FIX	2600
HALIE, IN FIX	INKEN, IN FIX	*4000
*2300 - MOCA		
INKEN, IN FIX	GOSHEN, IN VORTAC	2600
GOSHEN, IN VORTAC	GAREN, IN FIX	3000

FROM	TO	MEA
------	----	-----

95.6008 VOR FEDERAL AIRWAY V8 - CONTINUED

GAREN, IN FIX *4000 - MRA **2200 - MOCA	*GRABI, IN FIX	**4000
GRABI, IN FIX *2200 - MOCA	TWERP, OH FIX	*4000
TWERP, OH FIX FLAG CITY, OH VORTAC DUSKY, OH FIX MANSFIELD, OH VORTAC BRIGGS, OH VOR/DME *3100 - MOCA *3100 - GNSS MEA	FLAG CITY, OH VORTAC DUSKY, OH FIX MANSFIELD, OH VORTAC BRIGGS, OH VOR/DME ATWOO, OH FIX	2600 2600 3000 3000 *4000
ATWOO, OH FIX *3000 - MOCA	BELLAIRE, OH VOR/DME	*6000
BELLAIRE, OH VOR/DME *3100 - MOCA	GALLS, PA FIX	*3600
GALLS, PA FIX GRANTSVILLE, MD VOR/DME *4500 - MOCA	GRANTSVILLE, MD VOR/DME MARTINSBURG, WV VORTAC	5000 *5000
MARTINSBURG, WV VORTAC	WASHINGTON, DC VOR/DME	3300

95.6009 VOR FEDERAL AIRWAY V9

LEEVILLE, LA VORTAC *1400 - MOCA	SAFES, LA FIX	*2000
SAFES, LA FIX *1600 - MOCA	WAVEZ, LA FIX	*4000
WAVEZ, LA FIX *1800 - MOCA	OYSTY, LA FIX	*3000
OYSTY, LA FIX MC COMB, MS VORTAC *4000 - MRA	MC COMB, MS VORTAC *ROMAR, MS FIX	2000 2100
ROMAR, MS FIX JACKSON, MS VORTAC *4000 - MRA	JACKSON, MS VORTAC *BERRA, MS FIX	2000 2000
BERRA, MS FIX SIDON, MS VORTAC MARVELL, AR VOR/DME GILMORE, AR VOR/DME *2300 - MOCA	SIDON, MS VORTAC MARVELL, AR VOR/DME GILMORE, AR VOR/DME MALDEN, MO VORTAC	2000 2100 1900 *3000
MALDEN, MO VORTAC *2300 - MOCA	FARMINGTON, MO VORTAC	*3000
FARMINGTON, MO VORTAC *2500 - MOCA	ARNOL, IL FIX	*3000
ARNOL, IL FIX IMPER, MO FIX ST LOUIS, MO VORTAC *2100 - MOCA	IMPER, MO FIX ST LOUIS, MO VORTAC SPINNER, IL VORTAC	2800 2600 *2700
SPINNER, IL VORTAC *2300 - MOCA	PONTIAC, IL VOR/DME	*3000
PONTIAC, IL VOR/DME KELSI, IL FIX ROCKFORD, IL VOR/DME JANESVILLE, WI VOR/DME MADISON, WI VORTAC OSHKOSH, WI VORTAC *2300 - MOCA	KELSI, IL FIX ROCKFORD, IL VOR/DME JANESVILLE, WI VOR/DME MADISON, WI VORTAC OSHKOSH, WI VORTAC GREEN BAY, WI VORTAC	3000 2700 2700 3000 3000 *3000
GREEN BAY, WI VORTAC IRON MOUNTAIN, MI VOR/DME *3300 - MOCA	IRON MOUNTAIN, MI VOR/DME HOUGHTON, MI VOR/DME	2900 *3800

FROM	TO	MEA
95.6010 VOR FEDERAL AIRWAY V10		
PUEBLO, CO VORTAC	LAMAR, CO VORTAC	7000
LAMAR, CO VORTAC	ADEER, KS FIX	*5600
*5200 - MOCA		
ADEER, KS FIX	GARDEN CITY, KS VORTAC	*5000
*4400 - MOCA		
GARDEN CITY, KS VORTAC	DODGE CITY, KS VORTAC	4600
DODGE CITY, KS VORTAC	*STAFF, KS FIX	4300
*4200 - MRA		
STAFF, KS FIX	HUTCHINSON, KS VOR/DME	3700
HUTCHINSON, KS VOR/DME	WAIVE, KS FIX	4000
WAIVE, KS FIX	*FLOSS, KS FIX	3300
*5000 - MRA		
FLOSS, KS FIX	EMPORIA, KS VORTAC	3300
EMPORIA, KS VORTAC	JOHNSON COUNTY, KS VOR/DME	2700
JOHNSON COUNTY, KS	NAPOLEON, MO VORTAC	3000
VOR/DME		
NAPOLEON, MO VORTAC	KIRKSVILLE, MO VORTAC	3000
KIRKSVILLE, MO VORTAC	LOAMY, MO FIX	3000
LOAMY, MO FIX	BURLINGTON, IA VORTAC	*2700
*2200 - MOCA		
BURLINGTON, IA VORTAC	BRADFORD, IL VORTAC	2600
BRADFORD, IL VORTAC	PLANO, IL FIX	3000
NILES, IL FIX	CHETT, MI FIX	*3500
*2500 - MOCA		
CHETT, MI FIX	GIPPER, MI VORTAC	*3000
*2200 - MOCA		
GIPPER, MI VORTAC	LITCHFIELD, MI VOR/DME	2800
LITCHFIELD, MI VOR/DME	*CRUXX, MI FIX	3000
*7500 - MRA		
CRUXX, MI FIX	CARLETON, MI VORTAC	*3000
*2200 - MOCA		
CARLETON, MI VORTAC	U.S. CANADIAN BORDER	*3000
*2100 - MOCA		
U.S. CANADIAN BORDER	FAILS, OH FIX	*4000
*1800 - MOCA		
*2300 - GNSS MEA		
FAILS, OH FIX	*WONOP, OH FIX	**3000
*5000 - MRA		
**2000 - MOCA		
WONOP, OH FIX	YOUNGSTOWN, OH VORTAC	*5000
*2700 - MOCA		
*3000 - GNSS MEA		
YOUNGSTOWN, OH VORTAC	VOLAN, PA FIX	*5000
*3000 - MOCA		
*3000 - GNSS MEA		
VOLAN, PA FIX	TALLS, PA FIX	*5000
*3200 - MOCA		
*3300 - GNSS MEA		
TALLS, PA FIX	REVLOC, PA VOR/DME	4100
REVLOC, PA VOR/DME	LANCASTER, PA VORTAC	5000

FROM	TO	MEA
95.6011 VOR FEDERAL AIRWAY V11		
BROOKLEY, AL VORTAC	GREENE COUNTY, MS VORTAC	2000
GREENE COUNTY, MS VORTAC	SOSOE, MS FIX	*4000
*1800 - MOCA		
*3000 - GNSS MEA		
SOSOE, MS FIX	*RAKIN, MS FIX	**3000
*3000 - MRA		
**2400 - MOCA		
RAKIN, MS FIX	JACKSON, MS VORTAC	2400
JACKSON, MS VORTAC	*BERRA, MS FIX	2000
*4000 - MRA		
BERRA, MS FIX	SIDON, MS VORTAC	2000
SIDON, MS VORTAC	HOLLY SPRINGS, MS VORTAC	3000
HOLLY SPRINGS, MS VORTAC	DYERSBURG, TN VORTAC	*2500
*2000 - MOCA		
DYERSBURG, TN VORTAC	CUNNINGHAM, KY VORTAC	2400
CUNNINGHAM, KY VORTAC	WESON, KY FIX	2600
WESON, KY FIX	POCKET CITY, IN VORTAC	2200
POCKET CITY, IN VORTAC	MACKY, IN FIX	2300
MACKY, IN FIX	CLOWN, IN FIX	*3000
*2100 - MOCA		
CLOWN, IN FIX	SCOTO, IN FIX	*6000
*2100 - MOCA		
SCOTO, IN FIX	BRICKYARD, IN VORTAC	*2900
*2200 - MOCA		
BRICKYARD, IN VORTAC	WELDO, IN FIX	2900
WELDO, IN FIX	MARION, IN VOR/DME	2800
MARION, IN VOR/DME	FORT WAYNE, IN VORTAC	2600
FORT WAYNE, IN VORTAC	*GRABI, IN FIX	3000
*4000 - MRA		
GRABI, IN FIX	EDGE, OH FIX	3000
EDGE, OH FIX	*PIONS, OH FIX	4000
*4000 - MRA		
PIONS, OH FIX	*HIRED, MI FIX	6000
*6000 - MRA		
HIRED, MI FIX	*CRUXX, MI FIX	7500
*7500 - MRA		

95.6012 VOR FEDERAL AIRWAY V12

GAVIOTA, CA VORTAC	SAN MARCUS, CA VORTAC	6400
SAN MARCUS, CA VORTAC	*PALMDALE, CA VORTAC	9000
*6000 - MCA PALMDALE, CA VORTAC , W BND		
PALMDALE, CA VORTAC	HELDE, CA FIX	
	E BND	7500
	W BND	6000
HELDE, CA FIX	HECTOR, CA VORTAC	7500
HECTOR, CA VORTAC	CLIPP, CA FIX	9000
CLIPP, CA FIX	NEEDLES, CA VORTAC	*8000
*5300 - MOCA		
NEEDLES, CA VORTAC	DRAKE, AZ VORTAC	10000
DRAKE, AZ VORTAC	OATES, AZ FIX	10100
OATES, AZ FIX	WINSLOW, AZ VORTAC	10800
WINSLOW, AZ VORTAC	ZUNI, NM VORTAC	9000
ZUNI, NM VORTAC	*CARTY, NM FIX	11000
*10000 - MCA CARTY, NM FIX , W BND		
CARTY, NM FIX	*ALBUQUERQUE, NM VORTAC	9000
*10700 - MCA ALBUQUERQUE, NM VORTAC , E BND		
ALBUQUERQUE, NM VORTAC	OTTO, NM VOR	12000
OTTO, NM VOR	ANTON CHICO, NM VORTAC	*10000
*9400 - MOCA		
ANTON CHICO, NM VORTAC	TUCUMCARI, NM VORTAC	7700
TUCUMCARI, NM VORTAC	PANHANDLE, TX VORTAC	6000

FROM	TO	MEA
95.60012 VOR FEDERAL AIRWAY V12 CONTINUED		
PANHANDLE, TX VORTAC *5000 - MOCA	MITBEE, OK VORTAC	*5500
MITBEE, OK VORTAC *5000 - MRA **3700 - MOCA	*CARON, OK FIX	**5000
CARON, OK FIX	ANTHONY, KS VORTAC	3000
ANTHONY, KS VORTAC	WICHITA, KS VORTAC	3600
WICHITA, KS VORTAC	EMPORIA, KS VORTAC	3600
EMPORIA, KS VORTAC	JOHNSON COUNTY, KS VOR/DME	2700
JOHNSON COUNTY, KS VOR/DME	NAPOLEON, MO VORTAC	3000
NAPOLEON, MO VORTAC	FRANC, MO FIX	3000
FRANC, MO FIX	COLUMBIA, MO VOR/DME	2600
COLUMBIA, MO VOR/DME *2100 - MOCA	STITH, MO FIX	*2600
STITH, MO FIX	FORISTELL, MO VORTAC	2600
FORISTELL, MO VORTAC	TROY, IL VORTAC	2500
TROY, IL VORTAC	BIBLE GROVE, IL VORTAC	2300
BIBLE GROVE, IL VORTAC	WORKE, IL FIX	2300
WORKE, IL FIX *2600 - MOCA	OZMOE, IN FIX	*6000
OZMOE, IN FIX	SHELBYVILLE, IN VORTAC	2500
SHELBYVILLE, IN VORTAC	RICHMOND, IN VORTAC	2800
RICHMOND, IN VORTAC	DAYTON, OH VOR/DME	2900
DAYTON, OH VOR/DME *5000 - MRA	*PIZZA, OH FIX	3000
PIZZA, OH FIX	APPLETON, OH VORTAC	3000
APPLETON, OH VORTAC	NEWCOMERSTOWN, OH VOR/DME	3000
NEWCOMERSTOWN, OH VOR/DME	ALLEGHENY, PA VOR/DME	3300
ALLEGHENY, PA VOR/DME	MILWO, PA FIX	4000
MILWO, PA FIX	JOHNSTOWN, PA VORTAC	4900
JOHNSTOWN, PA VORTAC	HARRISBURG, PA VORTAC	5000
HARRISBURG, PA VORTAC	POTTSTOWN, PA VORTAC	3000

95.6013 VOR FEDERAL AIRWAY V13

MC ALLEN, TX VOR/DME *1600 - MOCA	MANNY, TX FIX	*5000
MANNY, TX FIX *1500 - MOCA	ASCOT, TX FIX	*5000
ASCOT, TX FIX *1500 - MOCA	SOLON, TX FIX	*4000
SOLON, TX FIX	CORPUS CHRISTI, TX VORTAC	1600
CORPUS CHRISTI, TX VORTAC *2100 - MRA	*WORRY, TX FIX	1700
WORRY, TX FIX *2300 - MRA	*AUSTS, TX FIX	1700
AUSTS, TX FIX	PALACIOS, TX VORTAC	1700
PALACIOS, TX VORTAC	HUMBLE, TX VORTAC	2000
HUMBLE, TX VORTAC	CLEEP, TX FIX	3000
CLEEP, TX FIX *3000 - MRA	*LEGGE, TX FIX	3100
LEGGE, TX FIX	LUFKIN, TX VORTAC	2100
LUFKIN, TX VORTAC *2400 - MOCA	CARTH, TX FIX	*3800
CARTH, TX FIX	BELCHER, LA VORTAC	3100
BELCHER, LA VORTAC *3000 - MRA	*IDDAS, LA FIX	2000
IDDAS, LA FIX *4000 - MRA	*DUBOW, AR FIX	2000
DUBOW, AR FIX	TEXARKANA, AR VORTAC	2000
TEXARKANA, AR VORTAC	DEENS, AR FIX	2300

FROM	TO	MEA
95.60013 VOR FEDERAL AIRWAY V13 CONTINUED		
DEENS, AR FIX *4000 - MOCA	RICH MOUNTAIN, OK VORTAC	*4600
RICH MOUNTAIN, OK VORTAC *5000 - MRA **3900 - MOCA	*HADES, AR FIX	**4600
HADES, AR FIX	FORT SMITH, AR VORTAC	2000
FORT SMITH, AR VORTAC *5000 - MRA	*CHESO, AR FIX	3400
CHESO, AR FIX	RAZORBACK, AR VORTAC	3700
RAZORBACK, AR VORTAC *4500 - MRA	*PINNE, MO FIX	3000
PINNE, MO FIX	NEOSHO, MO VOR/DME	3000
NEOSHO, MO VOR/DME	NASHE, MO FIX	2900
NASHE, MO FIX *3000 - MRA	*DIZZI, MO FIX	2700
DIZZI, MO FIX *2000 - MOCA	BUTLER, MO VORTAC	*2600
BUTLER, MO VORTAC	NAPOLEON, MO VORTAC	2900
NAPOLEON, MO VORTAC	LAMONI, IA VORTAC	2900
LAMONI, IA VORTAC *4300 - MRA	*WIVEY, IA FIX	3000
WIVEY, IA FIX	DES MOINES, IA VORTAC	3000
DES MOINES, IA VORTAC *3500 - MCA ANKEN, IA FIX, N BND	*ANKEN, IA FIX	2700
ANKEN, IA FIX	NEVAD, IA FIX	4000
NEVAD, IA FIX *2700 - MOCA	ALOCK, IA FIX	*3300
ALOCK, IA FIX	MASON CITY, IA VORTAC	3000
MASON CITY, IA VORTAC	FARMINGTON, MN VORTAC	3000
FARMINGTON, MN VORTAC *5500 - MRA **3400 - MOCA	*WAGNR, MN FIX	**5500
WAGNR, MN FIX *3400 - MOCA	CINCI, MN FIX	*5500
CINCI, MN FIX *2700 - MOCA	SIREN, WI VOR/DME	*3400
SIREN, WI VOR/DME	DULUTH, MN VORTAC	4000
DULUTH, MN VORTAC	WEMAN, MN FIX	4000
WEMAN, MN FIX	BYPOR, MN FIX	5000
BYPOR, MN FIX	U.S. CANADIAN BORDER	4000

95.6014 VOR FEDERAL AIRWAY V14

CHISUM, NM VORTAC	ONSOM, NM FIX E BND W BND	*7000 *7500
*6000 - MOCA	WINNS, TX FIX	*8000
ONSOM, NM FIX *6300 - MOCA	FLATT, TX FIX	*8000
WINNS, TX FIX *5200 - MOCA	SHALO, TX FIX	5100
FLATT, TX FIX	LUBBOCK, TX VORTAC	*5100
SHALO, TX FIX *5000 - GNSS MEA	CHILDRESS, TX VORTAC	5000
LUBBOCK, TX VORTAC	HOBART, OK VORTAC	3700
CHILDRESS, TX VORTAC	CARFF, OK FIX	3600
HOBART, OK VORTAC	WILL ROGERS, OK VORTAC	3000
CARFF, OK FIX	TOTES, OK FIX	*3700
WILL ROGERS, OK VORTAC *3000 - MOCA	DROPS, OK FIX	*3700
TOTES, OK FIX *2500 - MOCA		

FROM TO MEA

95.6014 VOR FEDERAL AIRWAY V14 CONTINUED

DROPS, OK FIX	TULSA, OK VORTAC	2600
TULSA, OK VORTAC	ADAIR, OK FIX	2500
ADAIR, OK FIX	NEOSHO, MO VOR/DME	3000
NEOSHO, MO VOR/DME	SPRINGFIELD, MO VORTAC	3000
SPRINGFIELD, MO VORTAC	LANEZ, MO FIX	3000
LANEZ, MO FIX	STOUT, MO FIX	3000
STOUT, MO FIX	REBBS, MO FIX	3000
REBBS, MO FIX	VICHY, MO VOR/DME	3000
VICHY, MO VOR/DME	STEER, MO FIX	*3000
*2300 - MOCA		
STEER, MO FIX	ST LOUIS, MO VORTAC	2600
ST LOUIS, MO VORTAC	VANDALIA, IL VORTAC	2500
VANDALIA, IL VORTAC	TERRE HAUTE, IN VORTAC	2400
TERRE HAUTE, IN VORTAC	BRICKYARD, IN VORTAC	2700
BRICKYARD, IN VORTAC	MUNCIE, IN VOR/DME	2900
MUNCIE, IN VOR/DME	FLAG CITY, OH VORTAC	3000
FLAG CITY, OH VORTAC	OBRLN, OH FIX	*3500
*2400 - MOCA		
OBRLN, OH FIX	DRYER, OH VOR/DME	*3000
*2400 - MOCA		
DRYER, OH VOR/DME	JEFFERSON, OH VOR/DME	3000
JEFFERSON, OH VOR/DME	ERIE, PA VORTAC	2700
ERIE, PA VORTAC	HAMIT, PA FIX	3200
HAMIT, PA FIX	DUNKIRK, NY VORTAC	3300
DUNKIRK, NY VORTAC	BUFFALO, NY VOR/DME	3000
#BUFFALO, NY VOR/DME	GENESEO, NY VOR/DME	#4000
#BUF FALO R-106 UNUSABLE.		
GENESEO, NY VOR/DME	BEEPS, NY FIX	*4000
*3300 - MOCA		
BEEPS, NY FIX	SCIPO, NY FIX	*4000
*3400 - MOCA		
SCIPO, NY FIX	VESPE, NY FIX	4000
VESPE, NY FIX	GEORGETOWN, NY VORTAC	4000
GEORGETOWN, NY VORTAC	SHERB, NY FIX	4000
SHERB, NY FIX	COBIA, NY FIX	5000
COBIA, NY FIX	CASIL, NY FIX	*5000
*3800 - MOCA		
CASIL, NY FIX	ALBANY, NY VORTAC	3600
ALBANY, NY VORTAC	WARIC, MA FIX	5000
WARIC, MA FIX	GARDNER, MA VOR/DME	*4000
*3500 - MOCA		
GARDNER, MA VOR/DME	GRAYM, MA FIX	3000
GRAYM, MA FIX	NORWICH, CT VOR/DME	*3000
*2200 - MOCA		

95.6015 VOR FEDERAL AIRWAY V15

HOBBY, TX VOR/DME	NAVASOTA, TX VORTAC	2100
NAVASOTA, TX VORTAC	COLLEGE STATION, TX VORTAC	2000
COLLEGE STATION, TX VORTAC	SATTY, TX FIX	2200
SATTY, TX FIX	WACO, TX VORTAC	2000
WACO, TX VORTAC	CEDAR CREEK, TX VORTAC	2500
CEDAR CREEK, TX VORTAC	BONHAM, TX VORTAC	*3500
*2200 - MOCA		
BONHAM, TX VORTAC	*PRIZZ, OK FIX	**3600
*7000 - MRA		
**2100 - MOCA		
PRIZZ, OK FIX	MC ALESTER, OK VORTAC	*3000
*2500 - MOCA		

FROM TO MEA

95.60015 VOR FEDERAL AIRWAY V15 CONTINUED

MC ALESTER, OK VORTAC *4700 - MRA	*HOFFE, OK FIX	2700
HOFFE, OK FIX	OKMULGEE, OK VOR/DME	2600
OKMULGEE, OK VOR/DME	MALTS, OK FIX	3500
MALTS, OK FIX	*PRYOR, OK FIX	**2900
*2900 - MRA		
**2200 - MOCA		
PRYOR, OK FIX	NEOSHO, MO VOR/DME	3000
SIoux CITY, IA VORTAC	SIoux FALLS, SD VORTAC	3400
SIoux FALLS, SD VORTAC	HURON, SD VORTAC	3700
HURON, SD VORTAC	ABERDEEN, SD VOR/DME	3000
ABERDEEN, SD VOR/DME	BISMARCK, ND VOR/DME	*4700
*3500 - MOCA		
BISMARCK, ND VOR/DME	MINOT, ND VORTAC	4100

95.6016 VOR FEDERAL AIRWAY V16

LOS ANGELES, CA VORTAC	PRADO, CA FIX	4000
PRADO, CA FIX	PARADISE, CA VORTAC	4000
PARADISE, CA VORTAC	*SETER, CA FIX	5500
*12000 - MCA SETER, CA FIX , E BND		
SETER, CA FIX	*BANDS, CA FIX	
	E BND	13000
	W BND	9000
*13000 - MRA		
BANDS, CA FIX	GARNE, CA FIX	13000
GARNE, CA FIX	*PALM SPRINGS, CA VORTAC	
	E BND	8000
	W BND	12000
*11600 - MCA PALM SPRINGS, CA VORTAC , W BND		
PALM SPRINGS, CA VORTAC	BLYTHE, CA VORTAC	*8000
*7500 - MOCA		
BLYTHE, CA VORTAC	*VICKO, AZ FIX	6000
*9000 - MRA		
VICKO, AZ FIX	BUCKEYE, AZ VORTAC	6000
BUCKEYE, AZ VORTAC	PERKY, AZ FIX	5000
PERKY, AZ FIX	PHOENIX, AZ VORTAC	
	E BND	4000
	W BND	5000
PHOENIX, AZ VORTAC	*TOTEK, AZ FIX	5000
*5500 - MCA TOTEK, AZ FIX , E BND		
TOTEK, AZ FIX	*TUCSON, AZ VORTAC	6500
*8700 - MCA TUCSON, AZ VORTAC , E BND		
TUCSON, AZ VORTAC	COCHISE, AZ VORTAC	10500
COCHISE, AZ VORTAC	ANIMA, NM FIX	11000
ANIMA, NM FIX	*DARCE, NM FIX	
	E BND	9000
	W BND	11000
*11000 - MCA DARCE, NM FIX , W BND		
DARCE, NM FIX	COLUMBUS, NM VOR/DME	*9000
*8200 - MOCA		
COLUMBUS, NM VOR/DME	EL PASO, TX VORTAC	9000
EL PASO, TX VORTAC	SALT FLAT, TX VORTAC	*8000
*7400 - MOCA		
SALT FLAT, TX VORTAC	DILLI, TX FIX	8000
DILLI, TX FIX	CAVRN, TX FIX	*10000
*7500 - MOCA		
CAVRN, TX FIX	WINK, TX VORTAC	*10000
*5300 - MOCA		
WINK, TX VORTAC	GOMIT, TX FIX	5500

FROM TO MEA

95.60016 VOR FEDERAL AIRWAY V16 - CONTINUED

GOMIT, TX FIX	PIZON, TX FIX	5000
PIZON, TX FIX	MERGE, TX FIX	*7000
*4400 - MOCA		
MERGE, TX FIX	BIG SPRING, TX VORTAC	4400
BIG SPRING, TX VORTAC	WEEPE, TX FIX	4200
WEEPE, TX FIX	*LORAN, TX FIX	4500
*6500 - MRA		
LORAN, TX FIX	MERKE, TX FIX	4500
MERKE, TX FIX	ABILENE, TX VORTAC	*4000
*3200 - MOCA		
ABILENE, TX VORTAC	*ROGEE, TX FIX	3600
*5000 - MRA		
ROGEE, TX FIX	BOWIE, TX VORTAC	*4500
*2900 - MOCA		
BOWIE, TX VORTAC	BONHAM, TX VORTAC	4000
BONHAM, TX VORTAC	PARIS, TX VOR/DME	2400
PARIS, TX VOR/DME	TEXARKANA, AR VORTAC	2000
TEXARKANA, AR VORTAC	*HOSES, AR FIX	2000
*3000 - MRA		
HOSES, AR FIX	SPARO, AR FIX	*4000
*2300 - MOCA		
SPARO, AR FIX	BUNNS, AR FIX	*6000
*1900 - MOCA		
BUNNS, AR FIX	PINE BLUFF, AR VOR/DME	2000
PINE BLUFF, AR VOR/DME	MARVELL, AR VOR/DME	1900
MARVELL, AR VOR/DME	HOLLY SPRINGS, MS VORTAC	2200
HOLLY SPRINGS, MS VORTAC	JACKS CREEK, TN VOR/DME	*2500
*2000 - MOCA		
JACKS CREEK, TN VOR/DME	SHELBYVILLE, TN VOR/DME	*3000
*2500 - MOCA		
SHELBYVILLE, TN VOR/DME	HINCH MOUNTAIN, TN VORTAC	5000
HINCH MOUNTAIN, TN VORTAC	BUCKY, TN FIX	5000
BUCKY, TN FIX	VOLUNTEER, TN VORTAC	3500
VOLUNTEER, TN VORTAC	*PENICE, TN FIX	3000
*4000 - MCA PENICE, TN FIX, NE BND		
PENICE, TN FIX	TAKEN, TN FIX	4000
TAKEN, TN FIX	HOLSTON MOUNTAIN, TN VORTAC	6000
HOLSTON MOUNTAIN, TN VORTAC	DAMAS, TN FIX	6000
DAMAS, TN FIX	*STOVE, VA FIX	7500
*7500 - MCA STOVE, VA FIX, SW BND		
STOVE, VA FIX	SPEEL, VA FIX	6000
SPEEL, VA FIX	PULASKI, VA VORTAC	5400
PULASKI, VA VORTAC	ROANOKE, VA VORTAC	5300
ROANOKE, VA VORTAC	GOOZE, VA FIX	5000
GOOZE, VA FIX	LYNCHBURG, VA VORTAC	
	W BND	*5000
	E BND	*3000
*2900 - MOCA		
LYNCHBURG, VA VORTAC	FLAT ROCK, VA VORTAC	3000
FLAT ROCK, VA VORTAC	RICHMOND, VA VORTAC	2600
RICHMOND, VA VORTAC	TAPPA, VA FIX	1900
TAPPA, VA FIX	COLIN, VA FIX	*5000
*1500 - MOCA		
*2000 - GNSS MEA		
COLIN, VA FIX	PATUXENT, MD VORTAC	*5000
*1400 - MOCA		
*2000 - GNSS MEA		
PATUXENT, MD VORTAC	*GARED, MD FIX	**4500
*8000 - MRA		
**1500 - MOCA		
**4000 - GNSS MEA		

FROM	TO	MEA
------	----	-----

95.60016 VOR FEDERAL AIRWAY V16 - CONTINUED

GARED, MD FIX *1500 - MOCA *4000 - GNSS MEA	CHOPS, MD FIX	*4500
CHOPS, MD FIX *1500 - MOCA	SMYRNA, DE VORTAC	*2000
SMYRNA, DE VORTAC	CEDAR LAKE, NJ VORTAC	1800
CEDAR LAKE, NJ VORTAC *1300 - MOCA	COYLE, NJ VORTAC	*1900
COYLE, NJ VORTAC *1600 - MOCA	DIXIE, NJ FIX	*2500
DIXIE, NJ FIX *1600 - MOCA	KENNEDY, NY VOR/DME	*2500
KENNEDY, NY VOR/DME	DEER PARK, NY VOR/DME	1800
DEER PARK, NY VOR/DME	CALVERTON, NY VOR/DME	1900
CALVERTON, NY VOR/DME	CREAM, NY FIX	2000
CREAM, NY FIX	NORWICH, CT VOR/DME	2500
NORWICH, CT VOR/DME	WOONS, RI FIX	2500
WOONS, RI FIX	BOSTON, MA VOR/DME	2000

95.6017 VOR FEDERAL AIRWAY V17

BROWNSVILLE, TX VORTAC	HARLINGEN, TX VOR/DME	1600
HARLINGEN, TX VOR/DME	MC ALLEN, TX VOR/DME	2400
MC ALLEN, TX VOR/DME *1700 - MOCA	FATOR, TX FIX	*2500
FATOR, TX FIX *5500 - MRA **2400 - MOCA	*NELEE, TX FIX	**4000
NELEE, TX FIX	LAREDO, TX VORTAC	2500
LAREDO, TX VORTAC *5000 - MRA	*KAHAN, TX FIX	2400
KAHAN, TX FIX *1800 - MOCA	COTULLA, TX VORTAC	*2400
COTULLA, TX VORTAC	MILET, TX FIX	2500
MILET, TX FIX *2500 - MOCA	SOMER, TX FIX	*4000
SOMER, TX FIX *2400 - MOCA	SAN ANTONIO, TX VORTAC	*3000
SAN ANTONIO, TX VORTAC	CENTEX, TX VORTAC	3500
CENTEX, TX VORTAC	WACO, TX VORTAC	3500
WACO, TX VORTAC *4000 - MRA **2500 - MOCA	*GAINS, TX FIX	**3000
GAINS, TX FIX *5000 - MRA	*BRIAN, TX FIX	3000
BRIAN, TX FIX	GLEN ROSE, TX VORTAC	3000
GLEN ROSE, TX VORTAC	MILLSAP, TX VORTAC	3000
MILLSAP, TX VORTAC	BOWIE, TX VORTAC	3000
BOWIE, TX VORTAC	ARDMORE, OK VORTAC	3000
ARDMORE, OK VORTAC	WILL ROGERS, OK VORTAC	3100
WILL ROGERS, OK VORTAC	ODINS, OK FIX	3300
ODINS, OK FIX *3600 - MOCA	CAMAR, OK FIX	*4900
CAMAR, OK FIX	MITBEE, OK VORTAC	4300
MITBEE, OK VORTAC *3900 - MOCA	FLACK, KS FIX	*4400
FLACK, KS FIX	GARDEN CITY, KS VORTAC	4700
GARDEN CITY, KS VORTAC *9000 - MRA **4600 - MOCA	*COFFE, KS FIX	**5500
COFFE, KS FIX	GOODLAND, KS VORTAC	5500

FROM	TO	MEA
95.6018 VOR FEDERAL AIRWAY V18		
GUTHRIE, TX VORTAC *3300 - MOCA	BEKLE, TX FIX	*6000
BEKLE, TX FIX *3500 - MOCA	MILLSAP, TX VORTAC	*8000
MILLSAP, TX VORTAC GLEN ROSE, TX VORTAC *2200 - MOCA	GLEN ROSE, TX VORTAC CEDAR CREEK, TX VORTAC	3000 *3000
CEDAR CREEK, TX VORTAC QUITMAN, TX VOR/DME CADOZ, TX FIX BELCHER, LA VORTAC MONROE, LA VORTAC *3000 - MRA	QUITMAN, TX VOR/DME CADOZ, TX FIX BELCHER, LA VORTAC MONROE, LA VORTAC *RINKY, LA FIX	2500 2400 2500 2000 2000
RINKY, LA FIX *3800 - MRA	*SIGNS, MS FIX	2000
SIGNS, MS FIX *3600 - MRA	*BLAKY, MS FIX	2000
BLAKY, MS FIX JACKSON, MS VORTAC *3500 - MRA	JACKSON, MS VORTAC *BAETT, MS FIX	2000 2500
BAETT, MS FIX CONEE, MS FIX MERIDIAN, MS VORTAC CRIMSON, AL VORTAC CRIMSON, AL VORTAC VULCAN, AL VORTAC TRUST, AL FIX TALLADEGA, AL VOR/DME ATLANTA, GA VORTAC *2500 - MOCA	CONEE, MS FIX MERIDIAN, MS VORTAC CRIMSON, AL VORTAC VULCAN, AL VORTAC TRUST, AL FIX TALLADEGA, AL VOR/DME ATLANTA, GA VORTAC CONNI, GA FIX	2500 2500 2000 2400 3500 3700 4000 *3000
CONNI, GA FIX *2300 - MOCA	MADDI, GA FIX	*4000
MADDI, GA FIX *2000 - MOCA	CORVI, GA FIX	*5000
CORVI, GA FIX *2200 - MOCA	RAFFE, GA FIX	*6000
RAFFE, GA FIX *2000 - MOCA	COLLIERS, SC VORTAC	*2500
COLLIERS, SC VORTAC LASHE, SC FIX *2200 - MOCA	LASHE, SC FIX NORMS, SC FIX	2400 *3000
NORMS, SC FIX *1700 - MOCA	SACKS, SC FIX	*4000
SACKS, SC FIX	CHARLESTON, SC VORTAC	2100

95.6019 VOR FEDERAL AIRWAY V19

CINCINNATI, KY VORTAC *2800 - MOCA	APPLETON, OH VORTAC	*4000
---------------------------------------	---------------------	-------

95.6020 VOR FEDERAL AIRWAY V20

MC ALLEN, TX VOR/DME LATEX, TX FIX *1900 - MOCA	LATEX, TX FIX ASCOT, TX FIX	1700 *4000
ASCOT, TX FIX *1500 - MOCA	SOLON, TX FIX	*4000

FROM TO MEA

95.6020 VOR FEDERAL AIRWAY V20 - CONTINUED

SOLON, TX FIX	CORPUS CHRISTI, TX VORTAC	1600
CORPUS CHRISTI, TX VORTAC	COPAN, TX FIX	1800
COPAN, TX FIX	BETZY, TX FIX	1700
BETZY, TX FIX	PALACIOS, TX VORTAC	2000
PALACIOS, TX VORTAC	*MAGUS, TX FIX	1800
*3000 - MRA		
MAGUS, TX FIX	KEEDS, TX FIX	1700
KEEDS, TX FIX	HOBBY, TX VOR/DME	2500
HOBBY, TX VOR/DME	BEAUMONT, TX VOR/DME	2100
BEAUMONT, TX VOR/DME	LAKE CHARLES, LA VORTAC	2000
LAKE CHARLES, LA VORTAC	LAFAYETTE, LA VORTAC	1800
LAFAYETTE, LA VORTAC	RESERVE, LA VOR/DME	2000
RESERVE, LA VOR/DME	*SLIDD, LA FIX	2000
*5000 - MCA SLIDD, LA FIX, NE BND		
SLIDD, LA FIX	GULFPORT, MS VORTAC	*5000
*2000 - GNSS MEA		
GULFPORT, MS VORTAC	SEMMES, AL VORTAC	2000
SEMMES, AL VORTAC	MONROEVILLE, AL VORTAC	2000
MONROEVILLE, AL VORTAC	*PICKS, AL FIX	2300
*3500 - MRA		
PICKS, AL FIX	MONTGOMERY, AL VORTAC	2300
MONTGOMERY, AL VORTAC	TUSKEGEE, AL VOR/DME	2000
TUSKEGEE, AL VOR/DME	MARVO, AL FIX	2100
MARVO, AL FIX	COLUMBUS, GA VORTAC	*2600
*2000 - MOCA		
COLUMBUS, GA VORTAC	GRANT, GA FIX	2800
GRANT, GA FIX	SMARR, GA FIX	*4000
*2500 - MOCA		
*2500 - GNSS MEA		
SMARR, GA FIX	SINCA, GA FIX	*4500
*2500 - MOCA		
*2500 - GNSS MEA		
SINCA, GA FIX	*GLOSS, GA FIX	**3000
*3500 - MRA		
**2000 - MOCA		
GLOSS, GA FIX	MADDI, GA FIX	*3000
*2200 - MOCA		
MADDI, GA FIX	ATHENS, GA VORTAC	*3000
*2100 - MOCA		
ATHENS, GA VORTAC	ELECTRIC CITY, SC VORTAC	*2800
*2200 - MOCA		
ELECTRIC CITY, SC VORTAC	ELLID, SC FIX	3000
ELLID, SC FIX	CLEVA, SC FIX	3400
CLEVA, SC FIX	TUXDO, NC FIX	5000
TUXDO, NC FIX	SUGARLOAF MOUNTAIN, NC VORTAC	6000
SUGARLOAF MOUNTAIN, NC VORTAC	VAESE, NC FIX	6000
VAESE, NC FIX	BARRETTS MOUNTAIN, NC VOR/DME	*5000
*3600 - MOCA		
BARRETTS MOUNTAIN, NC VOR/DME	PROVE, NC FIX	3500
PROVE, NC FIX	LEAKS, NC FIX	3500
LEAKS, NC FIX	SOUTH BOSTON, VA VORTAC	3000
SOUTH BOSTON, VA VORTAC	*NUTTS, VA FIX	**3000
*9000 - MRA		
**2000 - MOCA		
NUTTS, VA FIX	MELIA, VA FIX	*3000
*2400 - MOCA		
MELIA, VA FIX	RICHMOND, VA VORTAC	2000
RICHMOND, VA VORTAC	TAPPA, VA FIX	1900

FROM TO MEA

95.6020 VOR FEDERAL AIRWAY V20 - CONTINUED

TAPPA, VA FIX *1500 - MOCA *2000 - GNSS MEA	COLIN, VA FIX	*5000
COLIN, VA FIX *1800 - MOCA *2000 - GNSS MEA	NOTTINGHAM, MD VORTAC	*10000

95.6021 VOR FEDERAL AIRWAY V21

SANTA CATALINA, CA VORTAC SEAL BEACH, CA VORTAC *2200 - MOCA	SEAL BEACH, CA VORTAC AHEIM, CA FIX	4000 *3000
AHEIM, CA FIX *4000 - MRA *4100 - MCA OLLIE, CA FIX , NE BND	*OLLIE, CA FIX	3000
OLLIE, CA FIX PARADISE, CA VORTAC *8800 - MCA RAVON, CA FIX , NE BND	PARADISE, CA VORTAC *RAVON, CA FIX	5000 4500
RAVON, CA FIX	GAREY, CA FIX NE BND SW BND	10500 8000
GAREY, CA FIX *9300 - MCA LUCER, CA FIX , SW BND	*LUCER, CA FIX	10500
LUCER, CA FIX *8000 - MOCA	BULGY, CA FIX	*9000
BULGY, CA FIX *7000 - MOCA	HECTOR, CA VORTAC	*9000
HECTOR, CA VORTAC *12000 - MRA	*WHIGG, CA FIX	10000
WHIGG, CA FIX BOULDER CITY, NV VORTAC MORMON MESA, NV VORTAC BERYL, UT FIX MILFORD, UT VORTAC DELTA, UT VORTAC FAIRFIELD, UT VORTAC *8000 - MCA WASATCH, UT VORTAC , S BND	BOULDER CITY, NV VORTAC MORMON MESA, NV VORTAC BERYL, UT FIX MILFORD, UT VORTAC DELTA, UT VORTAC FAIRFIELD, UT VORTAC *WASATCH, UT VORTAC OGDEN, UT VORTAC *CORIN, UT FIX N BND S BND	10000 7500 9800 10000 9600 10300 9600 7000
WASATCH, UT VORTAC OGDEN, UT VORTAC		
*13000 - MRA		
CORIN, UT FIX MALAD CITY, ID VOR/DME BANNO, ID FIX *8000 - MCA POCATELLO, ID VORTAC , SE BND	MALAD CITY, ID VOR/DME BANNO, ID FIX *POCATELLO, ID VORTAC	10000 10000 9000
POCATELLO, ID VORTAC IDAHO FALLS, ID VOR/DME *8600 - MCA DUBOIS, ID VORTAC , N BND	IDAHO FALLS, ID VOR/DME *DUBOIS, ID VORTAC	7000 7600
DUBOIS, ID VORTAC *11100 - MOCA	DILLON, MT VOR/DME	*12000
DILLON, MT VOR/DME *9300 - MCA WHITEHALL, MT VOR/DME , N BND **9000 - MOCA	*WHITEHALL, MT VOR/DME	**10000
WHITEHALL, MT VOR/DME *10000 - MCA HELENA, MT VORTAC , SE BND	*HELENA, MT VORTAC	10600
HELENA, MT VORTAC GREAT FALLS, MT VORTAC CUT BANK, MT VORTAC	GREAT FALLS, MT VORTAC CUT BANK, MT VORTAC U.S. CANADIAN BORDER	10000 6000 6200

FROM	TO	MEA
95.6023 VOR FEDERAL AIRWAY V23		
MISSION BAY, CA VORTAC	OCEANSIDE, CA VORTAC	3000
OCEANSIDE, CA VORTAC	BALBO, CA FIX	4000
BALBO, CA FIX	SEAL BEACH, CA VORTAC	
	NW BND	3000
	SE BND	4000
SEAL BEACH, CA VORTAC	LOS ANGELES, CA VORTAC	2500
LOS ANGELES, CA VORTAC	*CHATY, CA FIX	4000
*5400 - MCA CHATY, CA FIX , NW BND		
CHATY, CA FIX	*CASTA, CA FIX	6000
*8300 - MCA CASTA, CA FIX , NW BND		
CASTA, CA FIX	GORMAN, CA VORTAC	9500
GORMAN, CA VORTAC	*GRAPE, CA FIX	9500
*9500 - MCA GRAPE, CA FIX , S BND		
GRAPE, CA FIX	*LAMPE, CA FIX	
	NW BND	5000
	SE BND	9500
*7800 - MCA LAMPE, CA FIX , SE BND		
LAMPE, CA FIX	SHAFTER, CA VORTAC	
	NW BND	3000
	SE BND	6000
SHAFTER, CA VORTAC	DELNO, CA FIX	3000
DELNO, CA FIX	LATON, CA FIX	*3000
*2000 - MOCA		
LATON, CA FIX	CLOVIS, CA VORTAC	2000
CLOVIS, CA VORTAC	BEREN, CA FIX	2100
BEREN, CA FIX	WRAPS, CA FIX	*4000
*3000 - MOCA		
WRAPS, CA FIX	LINDEN, CA VORTAC	3000
LINDEN, CA VORTAC	SACRAMENTO, CA VORTAC	2000
SACRAMENTO, CA VORTAC	GRIME, CA FIX	*2000
*1600 - MOCA		
GRIME, CA FIX	YUBBA, CA FIX	*4000
*2000 - MOCA		
YUBBA, CA FIX	*GRIDD, CA FIX	**4000
*4000 - MRA		
**3400 - MOCA		
GRIDD, CA FIX	RED BLUFF, CA VORTAC	*3000
*1700 - MOCA		
RED BLUFF, CA VORTAC	BEIRA, CA FIX	
	NW BND	8000
	SE BND	3000
BEIRA, CA FIX	*SHATA, CA FIX	
	NW BND	**8000
	SE BND	**6500
*8000 - MCA SHATA, CA FIX , NW BND		
**5500 - MOCA		
SHATA, CA FIX	FORT JONES, CA VOR/DME	10000
FORT JONES, CA VOR/DME	TALEM, OR FIX	*10000
*9400 - MOCA		
TALEM, OR FIX	*ROGUE VALLEY, OR VORTAC	
	NW BND	8000
	SE BND	10000
*7000 - MCA ROGUE VALLEY, OR VORTAC , SE BND		
ROGUE VALLEY, OR VORTAC	MOURN, OR FIX	7000
MOURN, OR FIX	*CURTI, OR FIX	**8000
*7000 - MRA		
**6500 - MOCA		
CURTI, OR FIX	EUGENE, OR VORTAC	
	SE BND	*6000
	NW BND	*4000
*4000 - MOCA		
EUGENE, OR VORTAC	TURNO, OR FIX	3000
TURNO, OR FIX	RAWER, OR FIX	5000

FROM TO MEA

95.6023 VOR FEDERAL AIRWAY V23 - CONTINUED

RAWER, OR FIX	BATTLE GROUND, WA VORTAC	4000
BATTLE GROUND, WA VORTAC	*MALAY, WA FIX	
	NW BND	6000
	SE BND	5000
*9500 - MRA		
MALAY, WA FIX	*MCKEN, WA FIX	
	S BND	6000
	N BND	5000
*4100 - MCA MCKEN, WA FIX , S BND		
MCKEN, WA FIX	SEATTLE, WA VORTAC	3000
SEATTLE, WA VORTAC	PAINE, WA VOR/DME	3000
PAINE, WA VOR/DME	EGRET, WA FIX	4500
EGRET, WA FIX	ACORD, WA FIX	3500
ACORD, WA FIX	WHATCOM, WA VORTAC	*3000
*2200 - MOCA		
WHATCOM, WA VORTAC	U.S. CANADIAN BORDER	3000

95.6024 VOR FEDERAL AIRWAY V24

ABERDEEN, SD VOR/DME	WATERTOWN, SD VORTAC	3600
WATERTOWN, SD VORTAC	REDWOOD FALLS, MN VOR/DME	3800
REDWOOD FALLS, MN VOR/DME	*ALMAY, MN FIX	**3400
*5000 - MRA		
**2700 - MOCA		
ALMAY, MN FIX	KASPR, MN FIX	*3400
*2700 - MOCA		
KASPR, MN FIX	ROCHESTER, MN VOR/DME	3000
ROCHESTER, MN VOR/DME	LONE ROCK, WI VOR/DME	3000
LONE ROCK, WI VOR/DME	GLARS, WI FIX	*3400
*2800 - MOCA		
GLARS, WI FIX	JANESVILLE, WI VOR/DME	*2800
*2300 - MOCA		
JANESVILLE, WI VOR/DME	FARMM, IL FIX	2900
FARMM, IL FIX	NORTHBROOK, IL VOR/DME	2700
PEOTONE, IL VORTAC	KENLA, IN FIX	2400
KENLA, IN FIX	VAGES, IN FIX	2600
VAGES, IN FIX	*POTES, IN FIX	**4000
*4000 - MRA		
**2300 - MOCA		
POTES, IN FIX	JAKKS, IN FIX	*4000
*2300 - MOCA		
JAKKS, IN FIX	BRICKYARD, IN VORTAC	2700

95.6025 VOR FEDERAL AIRWAY V25

MISSION BAY, CA VORTAC	REDIN, CA FIX	3000
REDIN, CA FIX	PACIF, CA FIX	*6000
*2000 - MOCA		
PACIF, CA FIX	ALBAS, CA FIX	*3000
*2000 - MOCA		
ALBAS, CA FIX	*FERMY, CA FIX	2100
*2700 - MCA FERMY, CA FIX , NW BND		
FERMY, CA FIX	*HERMO, CA FIX	3200
*2700 - MCA HERMO, CA FIX , SE BND		
HERMO, CA FIX	LOS ANGELES, CA VORTAC	2500
LOS ANGELES, CA VORTAC	*MERMA, CA FIX	2000
*3000 - MRA		
MERMA, CA FIX	EXERT, CA FIX	2000
EXERT, CA FIX	VENTURA, CA VOR/DME	5000

FROM TO MEA

95.6025 VOR FEDERAL AIRWAY V25 - CONTINUED

VENTURA, CA VOR/DME *7600 - MCA SAN MARCUS, CA	*SAN MARCUS, CA VORTAC VORTAC , NW BND	6000
SAN MARCUS, CA VORTAC POZOE, CA FIX	POZOE, CA FIX PASO ROBLES, CA VORTAC	8600
	NW BND	6000
	SE BND	7000
PASO ROBLES, CA VORTAC SALINAS, CA VORTAC	SALINAS, CA VORTAC *SANTY, CA FIX	5500 **5000
*7000 - MRA **4000 - MOCA		
SANTY, CA FIX WOODSIDE, CA VORTAC	WOODSIDE, CA VORTAC SAN FRANCISCO, CA VOR/DME	5000 4500
SAN FRANCISCO, CA VOR/DME SUTRO, CA FIX	SUTRO, CA FIX GOBBS, CA FIX	3500 3000
GOBBS, CA FIX POINT REYES, CA VORTAC	POINT REYES, CA VORTAC FREES, CA FIX	3500 3500
FREES, CA FIX *12000 - MCA GETER, CA FIX , N BND	*GETER, CA FIX *LAPED, CA FIX	6000 **12000
GETER, CA FIX *9000 - MRA *11000 - MCA LAPED, CA FIX , S BND **6300 - MOCA		
LAPED, CA FIX *5500 - MCA GRENY, CA FIX , S BND	*GRENY, CA FIX RED BLUFF, CA VORTAC	9000 3000
GRENY, CA FIX RED BLUFF, CA VORTAC	HOMAN, CA FIX	*4000
*4000 - MOCA HOMAN, CA FIX	*ITMOR, CA FIX	**5000
*7000 - MCA ITMOR, CA FIX , N BND **4000 - MOCA **4000 - GNSS MEA		
ITMOR, CA FIX *9600 - MOCA *10000 - GNSS MEA	MUREX, CA FIX	*11000
MUREX, CA FIX	KLAMATH FALLS, OR VORTAC	
	N BND	*8500
	S BND	*11000
*8500 - MOCA KLAMATH FALLS, OR VORTAC	SPRAG, OR FIX	*12000
*9500 - MOCA *10000 - GNSS MEA		
SPRAG, OR FIX *9500 - MOCA *10000 - GNSS MEA	OCTAD, OR FIX	*12000
OCTAD, OR FIX	DESCHUTES, OR VORTAC	
	S BND	*12000
	N BND	*7000
*6700 - MOCA *10000 - GNSS MEA, S BND		
DESCHUTES, OR VORTAC *10000 - MRA **6500 - MOCA	*GASHE, OR FIX	**7000
GASHE, OR FIX *5400 - MCA KCLICKITAT, OR VOR/DME , N BND **6500 - MOCA	*KCLICKITAT, OR VOR/DME	**7000
KCLICKITAT, OR VOR/DME GUBSE, WA FIX	GUBSE, WA FIX YAKIMA, WA VORTAC	7800
	N BND	*5000
	S BND	*7800
*4500 - MOCA		

FROM TO MEA

95.6025 VOR FEDERAL AIRWAY V25 - CONTINUED

YAKIMA, WA VORTAC	*ELLENSBURG, WA VORTAC	5600
*6800 - MCA ELLENSBURG, WA VORTAC , N BND		
ELLENSBURG, WA VORTAC	*WENATCHEE, WA VOR/DME	8600
*7400 - MCA WENATCHEE, WA VOR/DME , S BND		

95.6026 VOR FEDERAL AIRWAY V26

BLUE MESA, CO VOR/DME	MONTROSE, CO VOR/DME	12500
MONTROSE, CO VOR/DME	GRAND JUNCTION, CO VOR/DME	11000
GRAND JUNCTION, CO VOR/DME	RAYMN, CO FIX	
	NE BND	11000
	SW BND	10000
RAYMN, CO FIX	MEEKER, CO VOR/DME	11000
MEEKER, CO VOR/DME	STRIM, CO FIX	11000
STRIM, CO FIX	CHEROKEE, WY VOR/DME	10000
CHEROKEE, WY VOR/DME	*ALCOS, WY FIX	11600
*9900 - MRA		
ALCOS, WY FIX	MUDDY MOUNTAIN, WY VORTAC	
	NE BND	*8400
	SW BND	*9700
*7900 - MOCA		
MUDDY MOUNTAIN, WY VORTAC	SALON, WY FIX	8000
SALON, WY FIX	*RULER, SD FIX	**13000
*9000 - MRA		
**9200 - MOCA		
RULER, SD FIX	*RAPID CITY, SD VORTAC	
	E BND	8000
	W BND	13000
*6500 - MCA RAPID CITY, SD VORTAC , W BND		
RAPID CITY, SD VORTAC	PHILIP, SD VOR/DME	5000
PHILIP, SD VOR/DME	PIERRE, SD VORTAC	*4400
*3700 - MOCA		
PIERRE, SD VORTAC	HURON, SD VORTAC	4000
HURON, SD VORTAC	*OBITT, SD FIX	**5000
*5000 - MRA		
**4000 - GNSS MEA		
OBITT, SD FIX	GHENT, MN FIX	*6000
*3400 - MOCA		
*4000 - GNSS MEA		
GHENT, MN FIX	REDWOOD FALLS, MN VOR/DME	*5000
*4000 - GNSS MEA		
REDWOOD FALLS, MN VOR/DME	BEEGR, MN FIX	*3000
*2500 - MOCA		
BEEGR, MN FIX	LYDIA, MN FIX	*5500
*2400 - MOCA		
LYDIA, MN FIX	FARMINGTON, MN VORTAC	*3500
*2500 - MOCA		
FARMINGTON, MN VORTAC	PRESS, WI FIX	*3500
*2800 - MOCA		
PRESS, WI FIX	ELPAS, WI FIX	*5500
*2600 - MOCA		
ELPAS, WI FIX	EAU CLAIRE, WI VORTAC	*3500
*2800 - MOCA		
EAU CLAIRE, WI VORTAC	EDGRR, WI FIX	3000
EDGRR, WI FIX	WAUSAU, WI VORTAC	3600
WAUSAU, WI VORTAC	WOVET, WI FIX	3000
WOVET, WI FIX	GREEN BAY, WI VORTAC	2600
GREEN BAY, WI VORTAC	NEROE, WI FIX	3000

FROM TO MEA

95.6026 VOR FEDERAL AIRWAY V26 - CONTINUED

NEROE, WI FIX *2400 - MOCA	WELKO, MI FIX	*5000
WELKO, MI FIX	WHITE CLOUD, MI VOR/DME	2700
WHITE CLOUD, MI VOR/DME	LANSING, MI VORTAC	3000
#LANSING, MI VORTAC *3000 - GNSS MEA #LANSING R-115 UNUSABLE BELOW 5000.	SALEM, MI VORTAC	#*5000
SALEM, MI VORTAC	DETROIT, MI VOR/DME	2900
DETROIT, MI VOR/DME *2300 - MOCA	U.S. CANADIAN BORDER	*3400
U.S. CANADIAN BORDER *2300 - MOCA	GEMNI, OH FIX	*3400
GEMNI, OH FIX *2200 - MOCA	DRYER, OH VOR/DME	*3000

95.6027 VOR FEDERAL AIRWAY V27

MISSION BAY, CA VORTAC	REDIN, CA FIX	3000
REDIN, CA FIX *2000 - MOCA	PACIF, CA FIX	*6000
PACIF, CA FIX *2000 - MOCA	AVOLS, CA FIX	*3000
AVOLS, CA FIX	SANTA CATALINA, CA VORTAC	4000
SANTA CATALINA, CA VORTAC	EXERT, CA FIX	4000
EXERT, CA FIX	VENTURA, CA VOR/DME	5000
VENTURA, CA VOR/DME	KWANG, CA FIX	5000
KWANG, CA FIX *5000 - MCA GOLET, CA FIX , NW BND **2300 - MOCA	*GOLET, CA FIX	**4000
GOLET, CA FIX	GAVIOTA, CA VORTAC	6400
GAVIOTA, CA VORTAC *6000 - MCA ORCUT, CA FIX , S BND	*ORCUT, CA FIX	6000
ORCUT, CA FIX	MORRO BAY, CA VORTAC	4000
MORRO BAY, CA VORTAC	BLANC, CA FIX	4000
BLANC, CA FIX	BIG SUR, CA VORTAC	7000
BIG SUR, CA VORTAC	CARME, CA FIX	7000
CARME, CA FIX *5200 - MOCA	SHOEY, CA FIX	*6000
SHOEY, CA FIX *7000 - MRA **3000 - MOCA	*EUGEN, CA FIX	**6000
EUGEN, CA FIX *7000 - MRA **3000 - MOCA	*TAILS, CA FIX	**6000
TAILS, CA FIX *3000 - MOCA	HADLY, CA FIX	*6000
HADLY, CA FIX *3000 - MOCA	SEEMS, CA FIX	*4000
SEEMS, CA FIX *3000 - MOCA	STINS, CA FIX	*3500
STINS, CA FIX	POINT REYES, CA VORTAC	3500
POINT REYES, CA VORTAC	FREES, CA FIX	3500
FREES, CA FIX	MENDOCINO, CA VORTAC	6000
MENDOCINO, CA VORTAC	OLRIO, CA FIX	6700
OLRIO, CA FIX	FORTUNA, CA VORTAC	
	NW BND	4000
	SE BND	6700
FORTUNA, CA VORTAC *1700 - MOCA	CRESCENT CITY, CA VORTAC	*3000

FROM TO MEA

95.6027 VOR FEDERAL AIRWAY V27 - CONTINUED

CRESCENT CITY, CA VORTAC *11000 - MRA	*ROOTY, OR FIX	6400
ROOTY, OR FIX	LEDGE, OR FIX	6400
LEDGE, OR FIX	NORTH BEND, OR VORTAC	
	S BND	6400
	N BND	4000
NORTH BEND, OR VORTAC	*GAMMA, OR FIX	
	S BND	4000
	N BND	4500
*6200 - MRA		
GAMMA, OR FIX	NEWPORT, OR VORTAC	4500
NEWPORT, OR VORTAC	CUTEL, OR FIX	
	N BND	*8000
	S BND	*3000
*3000 - MOCA		
*4000 - GNSS MEA, N BND		
CUTEL, OR FIX	DANES, OR FIX	
	N BND	*8000
	S BND	*5000
*3600 - MOCA		
*4000 - GNSS MEA		
DANES, OR FIX	ASTORIA, OR VOR/DME	*8000
*5000 - MOCA		
*5000 - GNSS MEA		
ASTORIA, OR VOR/DME	HOQUIAM, WA VORTAC	3700
HOQUIAM, WA VORTAC	*CARRO, WA FIX	3200
*4000 - MRA		
CARRO, WA FIX	SEATTLE, WA VORTAC	3000

95.6028 VOR FEDERAL AIRWAY V28

OAKLAND, CA VORTAC	*SALAD, CA FIX	4000
*4700 - MCA SALAD, CA FIX , NE BND		
SALAD, CA FIX	ALTAM, CA FIX	5000
ALTAM, CA FIX	HAIRE, CA FIX	4500
HAIRE, CA FIX	LINDEN, CA VORTAC	*3000
*2000 - MOCA		
*LINDEN, CA VORTAC	KATSO, CA FIX	5000
*4000 - MCA LINDEN, CA VORTAC , NE BND		
*KATSO, CA FIX	SPOOK, CA FIX	10500
*9000 - MCA KATSO, CA FIX , NE BND		
*SPOOK, CA FIX	RICHY, CA FIX	**15000
*15000 - MCA SPOOK, CA FIX , N BND		
**12000 - MOCA		
RICHY, CA FIX	*MUSTANG, NV VORTAC	13000
*10500 - MCA MUSTANG, NV VORTAC , S BND		

95.6029 VOR FEDERAL AIRWAY V29

SNOW HILL, MD VORTAC	*SALISBURY, MD VORTAC	**2000
*5000 - MCA SALISBURY, MD VORTAC , N BND		
**1500 - MOCA		
SALISBURY, MD VORTAC	*EZIZI, DE FIX	5000
*7000 - MCA EZIZI, DE FIX , N BND		
EZIZI, DE FIX	*LAFLN, DE FIX	**7000
*7000 - MCA LAFLN, DE FIX , S BND		
**5000 - GNSS MEA		

FROM TO MEA

95.6029 VOR FEDERAL AIRWAY V29 - CONTINUED

LAF LN, DE FIX	SMYRNA, DE VORTAC	1800
SMYRNA, DE VORTAC	#DUPONT, DE VORTAC	*10000
*1800 - GNSS MEA		
#DUPONT R-181 UNUSABLE BELOW 10000.		
#DUPONT, DE VORTAC	MODENA, PA VORTAC	*6000
*1800 - MOCA		
*2000 - GNSS MEA		
#DUPONT R-358 UNUSABLE		
MODENA, PA VORTAC	POTTSTOWN, PA VORTAC	2400
POTTSTOWN, PA VORTAC	*HIKES, PA FIX	2900
*4000 - MRA		
HIKES, PA FIX	EAST TEXAS, PA VOR/DME	2900
EAST TEXAS, PA VOR/DME	SLATT, PA FIX	4000
SLATT, PA FIX	WILKES-BARRE, PA VORTAC	4000
WILKES-BARRE, PA VORTAC	SCOFF, PA FIX	4000
SCOFF, PA FIX	BINGHAMTON, NY VORTAC	3600
BINGHAMTON, NY VORTAC	CORTA, NY FIX	*4000
*3600 - MOCA		
CORTA, NY FIX	VESPE, NY FIX	4500
VESPE, NY FIX	SYRACUSE, NY VORTAC	*4000
*3600 - MOCA		
SYRACUSE, NY VORTAC	PAGER, NY FIX	*2400
*1800 - MOCA		
PAGER, NY FIX	WATERTOWN, NY VORTAC	*2600
*2000 - MOCA		
WATERTOWN, NY VORTAC	*LETUS, NY FIX	**3000
*4000 - MRA		
**1900 - MOCA		
LETUS, NY FIX	#MASSENA, NY VORTAC	*3000
*GNSS MEA ONLY		
#MASSENA R-255 UNUSABLE. GNSS REQUIRED		

95.6030 VOR FEDERAL AIRWAY V30

BADGER, WI VORTAC	SQUIB, MI FIX	2900
SQUIB, MI FIX	PULLMAN, MI VOR/DME	3500
PULLMAN, MI VOR/DME	LITCHFIELD, MI VOR/DME	2800
LITCHFIELD, MI VOR/DME	*HIRED, MI FIX	3000
*6000 - MRA		
HIRED, MI FIX	WATERVILLE, OH VOR/DME	3000
WATERVILLE, OH VOR/DME	SANDUSKY, OH VOR/DME	3000
SANDUSKY, OH VOR/DME	DRYER, OH VOR/DME	3000
DRYER, OH VOR/DME	AKRON, OH VOR/DME	3000
AKRON, OH VOR/DME	CAPEL, OH FIX	3600
CAPEL, OH FIX	VOLAN, PA FIX	*3600
*2800 - MOCA		
VOLAN, PA FIX	CLARION, PA VOR/DME	3600
CLARION, PA VOR/DME	PHILIPSBURG, PA VORTAC	4000
PHILIPSBURG, PA VORTAC	SELINGSGROVE, PA VORTAC	4000
SELINGSGROVE, PA VORTAC	EAST TEXAS, PA VOR/DME	4000
EAST TEXAS, PA VOR/DME	LANNA, NJ FIX	2600
LANNA, NJ FIX	SOLBERG, NJ VOR/DME	2000

FROM TO MEA

95.6031 VOR FEDERAL AIRWAY V31

PATUXENT, MD VORTAC	*ARUYE, MD FIX	2500
*6000 - MRA		
ARUYE, MD FIX	#NOTTINGHAM, MD VORTAC	*6000
*3000 - GNSS MEA		
#NOTTINGHAM R-138 UNUSABLE BELOW 6000'.		
BALTIMORE, MD VORTAC	VINNY, PA FIX	3000
VINNY, PA FIX	*SUEDE, PA FIX	**12000
*4500 - MRA		
**5000 - GNSS MEA		
SUEDE, PA FIX	GRAMO, PA FIX	*12000
*5000 - GNSS MEA		
GRAMO, PA FIX	HARRISBURG, PA VORTAC	*7000
*5000 - GNSS MEA		
HARRISBURG, PA VORTAC	*MORTO, PA FIX	3000
*5000 - MRA		
MORTO, PA FIX	SELINGSGROVE, PA VORTAC	5000
SELINGSGROVE, PA VORTAC	WATSO, PA FIX	*3500
*3000 - MOCA		
WATSO, PA FIX	WILLIAMSPORT, PA VOR/DME	3800
WILLIAMSPORT, PA VOR/DME	ELMIRA, NY VOR/DME	4000
ELMIRA, NY VOR/DME	GIBBE, NY FIX	3800
GIBBE, NY FIX	BEEPS, NY FIX	3500
BEEPS, NY FIX	ROCHESTER, NY VOR/DME	4000
ROCHESTER, NY VOR/DME	AIRCO, NY FIX	4000
AIRCO, NY FIX	U.S. CANADIAN BORDER	*8000
*4000 - GNSS MEA		
U.S. CANADIAN BORDER	LINNG, CANADA FIX	6000

95.6032 VOR FEDERAL AIRWAY V32

MUSTANG, NV VORTAC	HAZEN, NV VORTAC	*10000
*9200 - MOCA		
HAZEN, NV VORTAC	LOVELOCK, NV VORTAC	8000
LOVELOCK, NV VORTAC	BATTLE MOUNTAIN, NV VORTAC	11000
BATTLE MOUNTAIN, NV VORTAC	*BULLION, NV VOR/DME	**10000
*10800 - MCA BULLION, NV VOR/DME , E BND		
**9400 - MOCA		
BULLION, NV VOR/DME	SPATS, NV FIX	13000
SPATS, NV FIX	BONNEVILLE, UT VORTAC	*11000
*10000 - MOCA		
BONNEVILLE, UT VORTAC	*WASATCH, UT VORTAC	9000
*10400 - MCA WASATCH, UT VORTAC , NE BND		
WASATCH, UT VORTAC	FORT BRIDGER, WY VOR/DME	12000

95.6033 VOR FEDERAL AIRWAY V33

HARCUM, VA VORTAC	COLIN, VA FIX	4000
COLIN, VA FIX	NOTTINGHAM, MD VORTAC	*10000
*1800 - MOCA		
*2000 - GNSS MEA		

FROM TO MEA

95.6033 VOR FEDERAL AIRWAY V33 - CONTINUED

BALTIMORE, MD VORTAC	VINNY, PA FIX	3000
VINNY, PA FIX	*SUEDE, PA FIX	**12000
*4500 - MRA		
**5000 - GNSS MEA		
SUEDE, PA FIX	GRAMO, PA FIX	*12000
*5000 - GNSS MEA		
GRAMO, PA FIX	HARRISBURG, PA VORTAC	*7000
*5000 - GNSS MEA		
HARRISBURG, PA VORTAC	PHILIPSBURG, PA VORTAC	4000
PHILIPSBURG, PA VORTAC	KEATING, PA VORTAC	4000
KEATING, PA VORTAC	BRADFORD, PA VOR/DME	4000
BRADFORD, PA VOR/DME	BUFFALO, NY VOR/DME	*11000
*5000 - GNSS MEA		
#BRADFORD R-006 UNUSABLE USE BUF R-187		

95.6034 VOR FEDERAL AIRWAY V34

ROCHESTER, NY VOR/DME	HANCOCK, NY VOR/DME	4000
HANCOCK, NY VOR/DME	*WEETS, NY FIX	6000
*6000 - MRA		
WEETS, NY FIX	PAWLING, NY VOR/DME	4000
PAWLING, NY VOR/DME	MADISON, CT VOR/DME	3000
MADISON, CT VOR/DME	SANDY POINT, RI VOR/DME	*2000
*1400 - MOCA		
SANDY POINT, RI VOR/DME	NANTUCKET, MA VOR/DME	2000

95.6035 VOR FEDERAL AIRWAY V35

DOLPHIN, FL VORTAC	CURVE, FL FIX	*2000
*1500 - MOCA		
CURVE, FL FIX	*DEEDS, FL FIX	**5000
*4000 - MRA		
**1300 - MOCA		
DEEDS, FL FIX	LEE COUNTY, FL VORTAC	2200
LEE COUNTY, FL VORTAC	ST PETERSBURG, FL VORTAC	2000
ST PETERSBURG, FL VORTAC	ENDED, FL FIX	2500
ENDED, FL FIX	CROSS CITY, FL VORTAC	*3000
*1500 - MOCA		
CROSS CITY, FL VORTAC	GREENVILLE, FL VORTAC	2000
GREENVILLE, FL VORTAC	*SALER, GA FIX	2500
*3000 - MRA		
SALER, GA FIX	PECAN, GA VORTAC	2000
PECAN, GA VORTAC	MACON, GA VORTAC	2000
MACON, GA VORTAC	SINCA, GA FIX	2500
SINCA, GA FIX	*GLOSS, GA FIX	**3000
*3500 - MRA		
**2000 - MOCA		
GLOSS, GA FIX	MADDI, GA FIX	*3000
*2200 - MOCA		
MADDI, GA FIX	ATHENS, GA VORTAC	*3000
*2100 - MOCA		
ATHENS, GA VORTAC	ELECTRIC CITY, SC VORTAC	*2800
*2200 - MOCA		
ELECTRIC CITY, SC VORTAC	ELLID, SC FIX	3000

FROM TO MEA

95.6035 VOR FEDERAL AIRWAY V35 - CONTINUED

ELLID, SC FIX	CLEVA, SC FIX	3400
CLEVA, SC FIX	TUXDO, NC FIX	5000
TUXDO, NC FIX	SUGARLOAF MOUNTAIN, NC VORTAC	6000
SUGARLOAF MOUNTAIN, NC VORTAC	*BUSIC, NC FIX	8000
*9000 - MCA BUSIC, NC FIX , N BND		
BUSIC, NC FIX	*ROANS, TN FIX	**9000
*9000 - MCA ROANS, TN FIX , S BND		
**8200 - MOCA		
ROANS, TN FIX	HOLSTON MOUNTAIN, TN VORTAC	7000
HOLSTON MOUNTAIN, TN VORTAC	GLADE SPRING, VA VOR/DME	6000
GLADE SPRING, VA VOR/DME	STACY, VA FIX	6000
STACY, VA FIX	CHARLESTON, WV VORTAC	*4500
*4000 - MOCA		
CHARLESTON, WV VORTAC	BENZO, WV FIX	*4000
*3000 - MOCA		
BENZO, WV FIX	CLARKSBURG, WV VOR/DME	3200
CLARKSBURG, WV VOR/DME	MORGANTOWN, WV VORTAC	4000
MORGANTOWN, WV VORTAC	INDIAN HEAD, PA VORTAC	*5000
*4400 - MOCA		
INDIAN HEAD, PA VORTAC	JOHNSTOWN, PA VORTAC	*5000
*4500 - MOCA		
JOHNSTOWN, PA VORTAC	TYRONE, PA VORTAC	4500
TYRONE, PA VORTAC	PHILIPSBURG, PA VORTAC	4500
PHILIPSBURG, PA VORTAC	STONYFORK, PA VOR/DME	4500
STONYFORK, PA VOR/DME	ELMIRA, NY VOR/DME	*4500
*3900 - MOCA		
ELMIRA, NY VOR/DME	SCIPO, NY FIX	*3700
*3100 - MOCA		
SCIPO, NY FIX	SYRACUSE, NY VORTAC	3500

95.6036 VOR FEDERAL AIRWAY V36

U.S. CANADIAN BORDER	SAULT STE MARIE, MI VOR/DME	*4600
*3100 - MOCA		
SAULT STE MARIE, MI VOR/DME	U.S. CANADIAN BORDER	*5000
*2800 - MOCA		
U.S. CANADIAN BORDER	U.S. CANADIAN BORDER	*6000
*2700 - MOCA		
U.S. CANADIAN BORDER	BUFFALO, NY VOR/DME	#*6000
*2700 - MOCA		
*3000 - GNSS MEA		
#BUFFALO R-314 UNUSABLE BELOW 6000		
BUFFALO, NY VOR/DME	*BURST, NY FIX	**11000
*11000 - MCA BURST, NY FIX , NW BND		
**4000 - GNSS MEA		
BURST, NY FIX	THINK, NY FIX	4000
THINK, NY FIX	ELMIRA, NY VOR/DME	3500
ELMIRA, NY VOR/DME	HAWLY, PA FIX	#4500
#GNSS MEA.		
ELMIRA R-122 UNUSABLE BELOW FL180.		
HAWLY, PA FIX	HOPCE, NJ FIX	*15500
*3600 - MOCA		
*4000 - GNSS MEA		
HOPCE, NJ FIX	NEION, NJ FIX	*13500
*3600 - MOCA		
*4000 - GNSS MEA		

FROM	TO	MEA
95.6037 VOR FEDERAL AIRWAY V37		
CRAIG, FL VORTAC	CARVL, FL FIX	2100
CARVL, FL FIX	BRUNSWICK, GA VORTAC	2000
BRUNSWICK, GA VORTAC	*BROUN, GA FIX	**3000
*11000 - MRA		
**2200 - MOCA		
BROUN, GA FIX	*HARPS, GA FIX	**3000
*3800 - MRA		
**2200 - MOCA		
HARPS, GA FIX	KELER, GA FIX	*3000
*2200 - MOCA		
SAVANNAH, GA VORTAC	ALLENDALE, SC VOR	*6000
*1600 - MOCA		
*4000 - GNSS MEA		
ALLENDALE, SC VOR	COLUMBIA, SC VORTAC	*3000
*2000 - GNSS MEA		
COLUMBIA, SC VORTAC	RICHE, SC FIX	*4000
*2400 - MOCA		
*2400 - GNSS MEA		
RICHE, SC FIX	CHARLOTTE, NC VOR/DME	2500
CHARLOTTE, NC VOR/DME	OWALT, NC FIX	3000
OWALT, NC FIX	JOTTA, NC FIX	*6000
*3500 - MOCA		
JOTTA, NC FIX	DOILY, VA FIX	*7000
*5100 - MOCA		
DOILY, VA FIX	PULASKI, VA VORTAC	*6000
*5000 - MOCA		
PULASKI, VA VORTAC	HAWKI, WV FIX	8000
HAWKI, WV FIX	ELKINS, WV VORTAC	6000
ELKINS, WV VORTAC	CLARKSBURG, WV VOR/DME	*5000
*3900 - MOCA		
CLARKSBURG, WV VOR/DME	TEDDS, WV FIX	#*4000
*3200 - MOCA		
#CLARKSBURG R-003 UNUSABLE BYD 23NM		
TEDDS, WV FIX	AKSAR, PA FIX	*4000
*4000 - GNSS MEA		
AKSAR, PA FIX	ELLWOOD CITY, PA VORTAC	*4000
*3200 - MOCA		
ELLWOOD CITY, PA VORTAC	ERIE, PA VORTAC	3000
ERIE, PA VORTAC	U.S. CANADIAN BORDER	3000
U.S. CANADIAN BORDER	FOWEL, CANADA FIX	3000

95.6038 VOR FEDERAL AIRWAY V38

MOLINE, IL VORTAC	TRIDE, IL FIX	3300
TRIDE, IL FIX	MEDAN, IL FIX	*4000
*2200 - MOCA		
MEDAN, IL FIX	PEOTONE, IL VORTAC	2400
PEOTONE, IL VORTAC	LUCIT, IN FIX	2500
LUCIT, IN FIX	CLEFT, IN FIX	*4000
*2400 - MOCA		
CLEFT, IN FIX	FORT WAYNE, IN VORTAC	2800
FORT WAYNE, IN VORTAC	FLAG CITY, OH VORTAC	2500
FLAG CITY, OH VORTAC	APPLETON, OH VORTAC	3000
APPLETON, OH VORTAC	ZANESVILLE, OH VOR/DME	3000
ZANESVILLE, OH VOR/DME	PARKERSBURG, WV VORTAC	3000
PARKERSBURG, WV VORTAC	SACKY, WV FIX	3000
SACKY, WV FIX	*JULEA, WV FIX	3000
*5000 - MRA		
JULEA, WV FIX	BENZO, WV FIX	3300
BENZO, WV FIX	ELKINS, WV VORTAC	4000

FROM TO MEA

95.6038 VOR FEDERAL AIRWAY V38 – CONTINUED

ELKINS, WV VORTAC *9500 - MRA	*DEKAY, WV FIX	9000
DEKAY, WV FIX	CEROL, VA FIX	9000
CEROL, VA FIX	GORDONSVILLE, VA VORTAC	6000
GORDONSVILLE, VA VORTAC *2500 - MRA	*ROOKY, VA FIX	2500
ROOKY, VA FIX	RICHMOND, VA VORTAC	2100
RICHMOND, VA VORTAC	HARCUM, VA VORTAC	2000
HARCUM, VA VORTAC	CAPE CHARLES, VA VORTAC	2000

95.6039 VOR FEDERAL AIRWAY V39

SANDHILLS, NC VORTAC	SOUTH BOSTON, VA VORTAC	2500
SOUTH BOSTON, VA VORTAC *2000 - MOCA	SHEPS, VA FIX	*3000
SHEPS, VA FIX	GORDONSVILLE, VA VORTAC	3000
GORDONSVILLE, VA VORTAC	LURAY, VA FIX	6100
LURAY, VA FIX *7000 - MRA **5000 - MOCA	*KERRE, VA FIX	**6000
KERRE, VA FIX *5000 - MOCA	MARTINSBURG, WV VORTAC	*6000
MARTINSBURG, WV VORTAC *3900 - MOCA	HYPER, MD FIX	*5000
HYPER, MD FIX	BINNS, PA FIX	4000
BINNS, PA FIX *4500 - MRA	*SUEDE, PA FIX	4500
SUEDE, PA FIX	DELRO, PA FIX	4500
DELRO, PA FIX	LANCASTER, PA VORTAC	3000
LANCASTER, PA VORTAC *2400 - MOCA	BOYER, PA FIX	*2900
BOYER, PA FIX *2400 - MOCA	EAST TEXAS, PA VOR/DME	*3000
EAST TEXAS, PA VOR/DME	SPARTA, NJ VORTAC	2700
SPARTA, NJ VORTAC	CARMEL, NY VOR/DME	2600
CARMEL, NY VOR/DME	SOARS, CT FIX	3000
SOARS, CT FIX *4100 - MOCA	STUBY, CT FIX	*6000
STUBY, CT FIX	CHESTER, MA VOR/DME	4000
CHESTER, MA VOR/DME *3200 - MOCA	VAPER, MA FIX	*3700
VAPER, MA FIX *2900 - MOCA	GARDNER, MA VOR/DME	*3500
GARDNER, MA VOR/DME	CONCORD, NH VORTAC	4000
CONCORD, NH VORTAC	AUGUSTA, ME VOR/DME	3500
AUGUSTA, ME VOR/DME *2000 - MOCA	RINTH, ME FIX	*3000
RINTH, ME FIX *2400 - MOCA	MILLINOCKET, ME VOR/DME	*3000
MILLINOCKET, ME VOR/DME *2500 - MOCA	PRESQUE ISLE, ME VOR/DME	*3000
PRESQUE ISLE, ME VOR/DME *3000 - MOCA	GRINS, ME FIX	*5000
GRINS, ME FIX	U.S. CANADIAN BORDER	3000

FROM	TO	MEA
------	----	-----

95.6040 VOR FEDERAL AIRWAY V40

DRYER, OH VOR/DME	BRIGGS, OH VOR/DME	3000
BRIGGS, OH VOR/DME	CUTTA, OH FIX	3000

95.6041 VOR FEDERAL AIRWAY V41

CUTTA, OH FIX	YOUNGSTOWN, OH VORTAC	*5000
*3600 - GNSS MEA		

95.6043 VOR FEDERAL AIRWAY V43

APPLETON, OH VORTAC	TIVERTON, OH VOR/DME	#3000
#R-055 UNUSABLE.		
TIVERTON, OH VOR/DME	BRIGGS, OH VOR/DME	3000
BRIGGS, OH VOR/DME	YOUNGSTOWN, OH VORTAC	3000
YOUNGSTOWN, OH VORTAC	ERIE, PA VORTAC	*5000
*3000 - GNSS MEA		
ERIE, PA VORTAC	U.S. CANADIAN BORDER	3000
U.S. CANADIAN BORDER	BUFFALO, NY VOR/DME	*3000
*2400 - MOCA		

95.6044 VOR FEDERAL AIRWAY V44

COLUMBIA, MO VOR/DME	HODGS, MO FIX	2800
HODGS, MO FIX	FORISTELL, MO VORTAC	*2800
*2200 - MOCA		
FORISTELL, MO VORTAC	MOODS, IL FIX	2600
MOODS, IL FIX	CENTRALIA, IL VORTAC	2300
CENTRALIA, IL VORTAC	SAMSVILLE, IL VOR/DME	2400
SAMSVILLE, IL VOR/DME	NABB, IN VORTAC	3000
NABB, IN VORTAC	FALMOUTH, KY VOR/DME	2700
FALMOUTH, KY VOR/DME	YORK, KY VORTAC	3300
YORK, KY VORTAC	PARKERSBURG, WV VORTAC	3300
PARKERSBURG, WV VORTAC	BENDS, WV FIX	3000
BENDS, WV FIX	RANDE, WV FIX	4000
RANDE, WV FIX	MORGANTOWN, WV VORTAC	4000
MORGANTOWN, WV VORTAC	KEYER, WV FIX	5000
KEYER, WV FIX	MARTINSBURG, WV VORTAC	*5000
*4100 - MOCA		
MARTINSBURG, WV VORTAC	WOOLY, MD FIX	3200
WOOLY, MD FIX	BALTIMORE, MD VORTAC	2600
BALTIMORE, MD VORTAC	PALEO, MD FIX	*2200
*1700 - MOCA		
PALEO, MD FIX	SPEAK, MD FIX	*13500
*2000 - GNSS MEA		
SPEAK, MD FIX	SEA ISLE, NJ VORTAC	*7000
*1500 - MOCA		
*2000 - GNSS MEA		
SEA ISLE, NJ VORTAC	*KARRS, NJ FIX	**6000
*7000 - MRA		
**1500 - MOCA		
**2000 - GNSS MEA		

FROM	TO	MEA
------	----	-----

95.6044 VOR FEDERAL AIRWAY V44 – CONTINUED

KARRS, NJ FIX *6000 - MRA **1300 - MOCA **2000 - GNSS MEA	*GAMBY, NJ FIX	**7000
GAMBY, NJ FIX *6000 - MRA **1300 - MOCA **2000 - GNSS MEA	*SATES, NJ FIX	**5000
SATES, NJ FIX *1600 - MOCA *2000 - GNSS MEA	DEER PARK, NY VOR/DME	*5000
DEER PARK, NY VOR/DME *4000 - MRA	*NESSI, CT FIX	2000
NESSI, CT FIX	BRIDGEPORT, CT VOR/DME	2000
BRIDGEPORT, CT VOR/DME	PAWLING, NY VOR/DME	3000
PAWLING, NY VOR/DME	ATHOS, NY FIX	3100
ATHOS, NY FIX *3000 - GNSS MEA	GROUP, NY FIX	*8000
GROUP, NY FIX *2300 - MOCA *2800 - GNSS MEA	ALBANY, NY VORTAC	*6000

95.6045 VOR FEDERAL AIRWAY V45

NEW BERN, NC VOR/DME	KINSTON, NC VORTAC	2500
KINSTON, NC VORTAC	WENDI, NC FIX	2000
WENDI, NC FIX	RALEIGH/DURHAM, NC VORTAC	2600
RALEIGH/DURHAM, NC VORTAC	CHAPL, NC FIX	2000
CHAPL, NC FIX	GREENSBORO, NC VORTAC	3000
GREENSBORO, NC VORTAC	PROVE, NC FIX	2500
PROVE, NC FIX	FREON, NC FIX	4100
FREON, NC FIX *5500 - MOCA	PULASKI, VA VORTAC	*6000
PULASKI, VA VORTAC	BLUEFIELD, WV VORTAC	6000
BLUEFIELD, WV VORTAC *5000 - MOCA	CHARLESTON, WV VORTAC	*6000
CHARLESTON, WV VORTAC	HENDERSON, WV VORTAC	3000
HENDERSON, WV VORTAC *10000 - MCA BREMN, OH FIX , S BND **3000 - GNSS MEA	*BREMN, OH FIX	**10000
BREMN, OH FIX	APPLETON, OH VORTAC	3000
APPLETON, OH VORTAC	DUSKY, OH FIX	3000
DUSKY, OH FIX	WATERVILLE, OH VOR/DME	2600
WATERVILLE, OH VOR/DME *6000 - MRA	*HIRED, MI FIX	3000
HIRED, MI FIX	JACKSON, MI VOR/DME	3000
JACKSON, MI VOR/DME	LANSING, MI VORTAC	3000
LANSING, MI VORTAC	SAGINAW, MI VOR/DME	2600
SAGINAW, MI VOR/DME	SEEKS, MI FIX	2200
SEEKS, MI FIX *2600 - MOCA	ALPENA, MI VORTAC	*3500
ALPENA, MI VORTAC	SAULT STE MARIE, MI VOR/DME	2900

FROM	TO	MEA
------	----	-----

95.6046 VOR FEDERAL AIRWAY V46

DEER PARK, NY VOR/DME	CALVERTON, NY VOR/DME	1900
CALVERTON, NY VOR/DME	HAMPTON, NY VORTAC	1900
HAMPTON, NY VORTAC	LIBBE, NY FIX	*2500
*1800 - MOCA		
LIBBE, NY FIX	CLAMY, MA FIX	*3000
*2000 - MOCA		
CLAMY, MA FIX	NANTUCKET, MA VOR/DME	2000

95.6047 VOR FEDERAL AIRWAY V47

PINE BLUFF, AR VOR/DME	GILMORE, AR VOR/DME	*4000
*1800 - MOCA		
GILMORE, AR VOR/DME	DYERSBURG, TN VORTAC	2500
DYERSBURG, TN VORTAC	CUNNINGHAM, KY VORTAC	2400
CUNNINGHAM, KY VORTAC	WESON, KY FIX	2600
WESON, KY FIX	POCKET CITY, IN VORTAC	2200
POCKET CITY, IN VORTAC	*HOLAN, IN FIX	2500
*2600 - MRA		
HOLAN, IN FIX	SACKO, IN FIX	*3500
*2000 - MOCA		
SACKO, IN FIX	*HEALS, IN FIX	**3500
*10000 - MRA		
**2200 - MOCA		
HEALS, IN FIX	NABB, IN VORTAC	*3000
*2300 - MOCA		
NABB, IN VORTAC	CINCINNATI, KY VORTAC	2700
CINCINNATI, KY VORTAC	MIZZA, OH FIX	2800
MIZZA, OH FIX	ROSEWOOD, OH VORTAC	3000
ROSEWOOD, OH VORTAC	FLAG CITY, OH VORTAC	3000
FLAG CITY, OH VORTAC	WATERVILLE, OH VOR/DME	2500

95.6048 VOR FEDERAL AIRWAY V48

OTTUMWA, IA VOR/DME	BURLINGTON, IA VORTAC	2500
BURLINGTON, IA VORTAC	PEORIA, IL VORTAC	2400
PEORIA, IL VORTAC	MAROC, IL FIX	*3000
*2300 - MOCA		
MAROC, IL FIX	PONTIAC, IL VOR/DME	2400

95.6049 VOR FEDERAL AIRWAY V49

VULCAN, AL VORTAC	*BOUNT, AL FIX	3100
*4200 - MRA		
BOUNT, AL FIX	*FOLSO, AL FIX	**3100
*7000 - MRA		
**2400 - MOCA		
FOLSO, AL FIX	MASHA, AL FIX	*3000
*2400 - MOCA		
MASHA, AL FIX	DECATUR, AL VOR/DME	*3000
*2200 - MOCA		
DECATUR, AL VOR/DME	ELKED, AL FIX	2500
ELKED, AL FIX	NASHVILLE, TN VORTAC	*3500
*2700 - MOCA		
NASHVILLE, TN VORTAC	*TANDS, TN FIX	2700
*3000 - MRA		
TANDS, TN FIX	BOWLING GREEN, KY VORTAC	2700
BOWLING GREEN, KY VORTAC	MYSTIC, KY VOR	2700
MYSTIC, KY VOR	NABB, IN VORTAC	3000

FROM TO MEA

95.6050 VOR FEDERAL AIRWAY V50

HASTINGS, NE VOR/DME	PAWNEE CITY, NE VORTAC	4000
PAWNEE CITY, NE VORTAC	ST JOSEPH, MO VORTAC	4000
ST JOSEPH, MO VORTAC	KIRKSVILLE, MO VORTAC	3000
KIRKSVILLE, MO VORTAC	QUINCY, IL VORTAC	2700
QUINCY, IL VORTAC	SPINNER, IL VORTAC	*3000
*2100 - MOCA		
SPINNER, IL VORTAC	ADDERS, IL VORTAC	3000
ADDERS, IL VORTAC	TERRE HAUTE, IN VORTAC	2500
TERRE HAUTE, IN VORTAC	BRICKYARD, IN VORTAC	2700
BRICKYARD, IN VORTAC	DAYTON, OH VOR/DME	3000

95.6051 VOR FEDERAL AIRWAY V51

PAHOKEE, FL VORTAC	*SHEDS, FL FIX	2000
*3000 - MRA		
SHEDS, FL FIX	VERO BEACH, FL VORTAC	2000
VERO BEACH, FL VORTAC	OVIDO, FL FIX	4000
OVIDO, FL FIX	ORMOND BEACH, FL VORTAC	3000
ORMOND BEACH, FL VORTAC	*BULLI, FL FIX	**2000
*3000 - MRA		
**1400 - MOCA		
BULLI, FL FIX	*ASTOR, FL FIX	**2000
*3000 - MRA		
**1400 - MOCA		
ASTOR, FL FIX	CRAIG, FL VORTAC	2100
CRAIG, FL VORTAC	#ALMA, GA VORTAC	*5000
*1700 - MOCA		
*4000 - GNSS MEA		
#ALMA R-144 NA BELOW 10000		
#ALMA, GA VORTAC	DUBLIN, GA VORTAC	*3000
*2000 - GNSS MEA		
#ALMA R-345 UNUSABLE, USE DUBLIN R-170		
DUBLIN, GA VORTAC	ATHENS, GA VORTAC	*3000
*2200 - MOCA		
ATHENS, GA VORTAC	IRMOS, GA FIX	3000
IRMOS, GA FIX	CORCE, GA FIX	3800
CORCE, GA FIX	TALLE, GA FIX	5300
TALLE, GA FIX	HARRIS, GA VORTAC	7000
HARRIS, GA VORTAC	ETOWA, TN FIX	7000
ETOWA, TN FIX	HINCH MOUNTAIN, TN VORTAC	5000
HINCH MOUNTAIN, TN VORTAC	LIVINGSTON, TN VORTAC	5000
LIVINGSTON, TN VORTAC	LOUISVILLE, KY VORTAC	3200
LOUISVILLE, KY VORTAC	NABB, IN VORTAC	*10000
*2300 - MOCA		
NABB, IN VORTAC	SHELBYVILLE, IN VORTAC	*3000
*2300 - MOCA		
SHELBYVILLE, IN VORTAC	OCKEL, IN FIX	3000
OCKEL, IN FIX	BOILER, IN VORTAC	*2500
*2100 - MOCA		
BOILER, IN VORTAC	CHICAGO HEIGHTS, IL VORTAC	2700

95.6052 VOR FEDERAL AIRWAY V52

DES MOINES, IA VORTAC	OTTUMWA, IA VOR/DME	2700
OTTUMWA, IA VOR/DME	QUINCY, IL VORTAC	2600
QUINCY, IL VORTAC	*RIVRS, IL FIX	2600
*6000 - MRA		
RIVRS, IL FIX	ST LOUIS, MO VORTAC	2600
ST LOUIS, MO VORTAC	TROY, IL VORTAC	2400
TROY, IL VORTAC	CRATS, IL FIX	2600

FROM TO MEA

95.6052 VOR FEDERAL AIRWAY V52 - CONTINUED

CRATS, IL FIX *2100 - MOCA	POCKET CITY, IN VORTAC	*4500
POCKET CITY, IN VORTAC	CENTRAL CITY, KY VORTAC	2300
CENTRAL CITY, KY VORTAC	BOWLING GREEN, KY VORTAC	2400
BOWLING GREEN, KY VORTAC	LIVINGSTON, TN VORTAC	2900

95.6053 VOR FEDERAL AIRWAY V53

CHARLESTON, SC VORTAC	COLUMBIA, SC VORTAC	2000
COLUMBIA, SC VORTAC	WILLS, SC FIX	4000
WILLS, SC FIX	SPARTANBURG, SC VORTAC	2700
SPARTANBURG, SC VORTAC *2300 - MOCA	CARTT, SC FIX	*3000
CARTT, SC FIX	SUGARLOAF MOUNTAIN, NC VORTAC	6000
SUGARLOAF MOUNTAIN, NC VORTAC	*BUSIC, NC FIX	8000
*9000 - MCA BUSIC, NC FIX , N BND		
BUSIC, NC FIX	*ROANS, TN FIX	**9000
*9000 - MCA ROANS, TN FIX , S BND		
**8200 - MOCA		
ROANS, TN FIX	HOLSTON MOUNTAIN, TN VORTAC	7000
HOLSTON MOUNTAIN, TN VORTAC	HAZARD, KY VOR/DME	6400
HAZARD, KY VOR/DME	IRVIN, KY FIX	4000
IRVIN, KY FIX	LEXINGTON, KY VORTAC	3000
LEXINGTON, KY VORTAC	FEDRA, KY FIX	2800
FEDRA, KY FIX	LOUISVILLE, KY VORTAC	2600
LOUISVILLE, KY VORTAC *3000 - MOCA	HOUSE, IN FIX	*10000
HOUSE, IN FIX	MOUTH, IN FIX	*2800
*2300 - MOCA		
MOUTH, IN FIX	BRICKYARD, IN VORTAC	2700

95.6054 VOR FEDERAL AIRWAY V54

WACO, TX VORTAC	CEDAR CREEK, TX VORTAC	2500
CEDAR CREEK, TX VORTAC	QUITMAN, TX VOR/DME	2500
QUITMAN, TX VOR/DME	TEXARKANA, AR VORTAC	2300
TEXARKANA, AR VORTAC *4000 - MRA	*WASHO, AR FIX	2200
WASHO, AR FIX	CANEY, AR FIX	*3500
*1800 - MOCA		
CANEY, AR FIX	MALVE, AR FIX	*3500
*1900 - MOCA		
MALVE, AR FIX	LITTLE ROCK, AR VORTAC	2000
LITTLE ROCK, AR VORTAC	MARVELL, AR VOR/DME	1900
MARVELL, AR VOR/DME	HOLLY SPRINGS, MS VORTAC	2200
HOLLY SPRINGS, MS VORTAC	MUSCLE SHOALS, AL VORTAC	3000
MUSCLE SHOALS, AL VORTAC	TANNE, AL FIX	2400
TANNE, AL FIX	ROCKET, AL VORTAC	2900
ROCKET, AL VORTAC	CHOO CHOO, TN VORTAC	4000
CHOO CHOO, TN VORTAC	*CRAND, GA FIX	3000
*4500 - MCA CRAND, GA FIX , E BND		
CRAND, GA FIX	MELLS, GA FIX	6000
MELLS, GA FIX	HARRIS, GA VORTAC	*6000
*5200 - MOCA		
HARRIS, GA VORTAC	DILLA, GA FIX	7500

FROM	TO	MEA
------	----	-----

95.6054 VOR FEDERAL AIRWAY V54 - CONTINUED

DILLA, GA FIX *6800 - MOCA	RESTS, SC FIX	*8000
RESTS, SC FIX	CLEVA, SC FIX	5000
CLEVA, SC FIX *3300 - GNSS MEA	SPARTANBURG, SC VORTAC	*4000
SPARTANBURG, SC VORTAC #CHARLOTTE R-081 UNUSABLE BELOW 15000	CHARLOTTE, NC VOR/DME	#4000
CHARLOTTE, NC VOR/DME	LOCAS, NC FIX	3000
LOCAS, NC FIX	SANDHILLS, NC VORTAC	2500
SANDHILLS, NC VORTAC *2000 - MOCA	RAEFO, NC FIX	*6000
*3000 - GNSS MEA		
RAEFO, NC FIX *2400 - GNSS MEA	FAYETTEVILLE, NC VOR/DME	*5000
FAYETTEVILLE, NC VOR/DME *5000 - MRA	*JOSCH, NC FIX	2000
JOSCH, NC FIX	KINSTON, NC VORTAC	2000

95.6055 VOR FEDERAL AIRWAY V55

DAYTON, OH VOR/DME	FORT WAYNE, IN VORTAC	2800
FORT WAYNE, IN VORTAC	GOSHEN, IN VORTAC	2700
GOSHEN, IN VORTAC	GIPPER, MI VORTAC	2900
GIPPER, MI VORTAC *2300 - MOCA	KEELER, MI VOR/DME	*4000
KEELER, MI VOR/DME	PULLMAN, MI VOR/DME	4000
PULLMAN, MI VOR/DME	MUSKEGON, MI VORTAC	2500
MUSKEGON, MI VORTAC	WHALL, MI FIX	2400
WHALL, MI FIX *2400 - MOCA	NEROE, WI FIX	*5000
NEROE, WI FIX	GREEN BAY, WI VORTAC	3000
GREEN BAY, WI VORTAC	STEVENS POINT, WI VORTAC	3000
STEVENS POINT, WI VORTAC	EAU CLAIRE, WI VORTAC	3000
EAU CLAIRE, WI VORTAC *2800 - MOCA	SIREN, WI VOR/DME	*5000
*3000 - GNSS MEA		
SIREN, WI VOR/DME *2800 - MOCA	BRAINERD, MN VORTAC	*6000
*3000 - GNSS MEA		
BRAINERD, MN VORTAC	PARK RAPIDS, MN VOR/DME	3300
PARK RAPIDS, MN VOR/DME *3000 - MOCA	BETRA, MN FIX	*4500
BETRA, MN FIX *2300 - MOCA	GRAND FORKS, ND VOR/DME	*3300
GRAND FORKS, ND VOR/DME *12000 - MRA	*BEHQY, ND FIX	**8000
**3600 - MOCA		
BEHQY, ND FIX	BISMARCK, ND VOR/DME	3900

95.6056 VOR FEDERAL AIRWAY V56

MERIDIAN, MS VORTAC	KEWANEE, MS VORTAC	2000
KEWANEE, MS VORTAC *2300 - MOCA	MONTGOMERY, AL VORTAC	*5500
MONTGOMERY, AL VORTAC	TUSKEGEE, AL VOR/DME	2000
TUSKEGEE, AL VOR/DME	MARVO, AL FIX	2100

FROM	TO	MEA
------	----	-----

95.6056 VOR FEDERAL AIRWAY V56 - CONTINUED

MARVO, AL FIX *2000 - MOCA	COLUMBUS, GA VORTAC	*2600
COLUMBUS, GA VORTAC	TALBO, GA FIX	2500
TALBO, GA FIX *3000 - MRA	*PRATZ, GA FIX	2500
PRATZ, GA FIX	ROBBS, GA FIX	2500
ROBBS, GA FIX	MACON, GA VORTAC	2000
MACON, GA VORTAC *2200 - MOCA	MISTY, GA FIX	*6000
MISTY, GA FIX	COLLIERS, SC VORTAC	2300
COLLIERS, SC VORTAC	COLUMBIA, SC VORTAC	3000
COLUMBIA, SC VORTAC	FLORENCE, SC VORTAC	2000
FLORENCE, SC VORTAC	FAYETTEVILLE, NC VOR/DME	2200
FAYETTEVILLE, NC VOR/DME *3100 - MRA	*ROZBO, NC FIX	2000
ROZBO, NC FIX	WALLO, NC FIX	2000
WALLO, NC FIX *2400 - MOCA	KROVE, NC FIX	*3000
KROVE, NC FIX	NEW BERN, NC VOR/DME	2400

95.6057 VOR FEDERAL AIRWAY V57

LEXINGTON, KY VORTAC	FALMOUTH, KY VOR/DME	3000
----------------------	----------------------	------

95.6058 VOR FEDERAL AIRWAY V58

GRACE, PA FIX *4000 - MRA	*EARED, PA FIX	3400
EARED, PA FIX *4100 - MOCA	PHILIPSBURG, PA VORTAC	*6000
*5000 - GNSS MEA		
PHILIPSBURG, PA VORTAC	WILLIAMSPORT, PA VOR/DME	4000
WILLIAMSPORT, PA VOR/DME	LOPEZ, PA FIX	4500
LOPEZ, PA FIX	LAKE HENRY, PA VORTAC	4000
LAKE HENRY, PA VORTAC	KINGSTON, NY VOR/DME	4000
KINGSTON, NY VOR/DME	HARTFORD, CT VOR/DME	3200
HARTFORD, CT VOR/DME	GROTON, CT VOR/DME	2500
GROTON, CT VOR/DME *1500 - MOCA	SANDY POINT, RI VOR/DME	*2000
SANDY POINT, RI VOR/DME	NANTUCKET, MA VOR/DME	2000

95.6059 VOR FEDERAL AIRWAY V59

PULASKI, VA VORTAC	BECKLEY, WV VORTAC	6000
BECKLEY, WV VORTAC *4000 - MRA	*ITALY, WV FIX	**5000
**4300 - MOCA		
ITALY, WV FIX *4300 - MOCA	WARDO, WV FIX	*5000
WARDO, WV FIX	PARKERSBURG, WV VORTAC	3000
PARKERSBURG, WV VORTAC	NEWCOMERSTOWN, OH VOR/DME	3000
NEWCOMERSTOWN, OH VOR/DME	BRIGGS, OH VOR/DME	3000

FROM TO MEA

95.6060 VOR FEDERAL AIRWAY V60

GALLUP, NM VORTAC	*CUBBA, NM FIX	11000
*10000 - MCA CUBBA, NM FIX, W BND		
CUBBA, NM FIX	ALBUQUERQUE, NM VORTAC	8600
ALBUQUERQUE, NM VORTAC	OTTO, NM VOR	10000
OTTO, NM VOR	FORT UNION, NM VORTAC	10000

95.6061 VOR FEDERAL AIRWAY V61

GRAND ISLAND, NE VORTAC	PAWNEE CITY, NE VORTAC	*4000
*3200 - MOCA		
PAWNEE CITY, NE VORTAC	ROBINSON, KS VOR/DME	2800
ROBINSON, KS VOR/DME	BOWLR, KS FIX	2600

95.6062 VOR FEDERAL AIRWAY V62

GALLUP, NM VORTAC	CABZO, NM FIX	11000
CABZO, NM FIX	ZIASE, NM FIX	10000
ZIASE, NM FIX	SANTA FE, NM VORTAC	9000
SANTA FE, NM VORTAC	ANTON CHICO, NM VORTAC	10000
ANTON CHICO, NM VORTAC	FLUTY, NM FIX	8000
FLUTY, NM FIX	TEXICO, TX VORTAC	6500
TEXICO, TX VORTAC	SPADE, TX FIX	5700
SPADE, TX FIX	LUBBOCK, TX VORTAC	*5700
*4800 - MOCA		
*5000 - GNSS MEA		
LUBBOCK, TX VORTAC	*ROTAN, TX FIX	**6000
*4500 - MRA		
**5000 - MOCA		
ROTAN, TX FIX	ABILENE, TX VORTAC	3700
ABILENE, TX VORTAC	FLECK, TX FIX	3300
FLECK, TX FIX	GEENI, TX FIX	*4000
*3300 - MOCA		
GEENI, TX FIX	GLEN ROSE, TX VORTAC	*3500
*3000 - MOCA		

95.6063 VOR FEDERAL AIRWAY V63

BOWIE, TX VORTAC	TEXOMA, OK VOR/DME	3000
TEXOMA, OK VOR/DME	MC ALESTER, OK VORTAC	2800
MC ALESTER, OK VORTAC	RAZORBACK, AR VORTAC	*4000
*3000 - MOCA		
RAZORBACK, AR VORTAC	GAMPS, AR FIX	3500
GAMPS, AR FIX	JENKY, MO FIX	*4000
*3100 - MOCA		
JENKY, MO FIX	BILIE, MO FIX	3300
BILIE, MO FIX	SPRINGFIELD, MO VORTAC	3000
SPRINGFIELD, MO VORTAC	PLADD, MO FIX	3000
PLADD, MO FIX	ROACH, MO FIX	*4000
*2400 - MOCA		
ROACH, MO FIX	BARTI, MO FIX	*4000
*2500 - MOCA		
BARTI, MO FIX	GIBSN, MO FIX	3000
GIBSN, MO FIX	HALLSVILLE, MO VORTAC	2900
HALLSVILLE, MO VORTAC	QUINCY, IL VORTAC	2900
QUINCY, IL VORTAC	BURLINGTON, IA VORTAC	2600
BURLINGTON, IA VORTAC	MOLINE, IL VORTAC	2600
MOLINE, IL VORTAC	DAVENPORT, IA VORTAC	3000
DAVENPORT, IA VORTAC	ROCKFORD, IL VOR/DME	2700

FROM TO MEA

95.6063 VOR FEDERAL AIRWAY V63 - CONTINUED

ROCKFORD, IL VOR/DME	JANESVILLE, WI VOR/DME	2700
#JANESVILLE, WI VOR/DME	*DEBOW, WI FIX	**4000
*10000 - MRA		
**3000 - GNSS MEA		
#JANESVILLE R-044 UNUSABLE, USE BADGER R-226		
DEBOW, WI FIX	RASTT, WI FIX	*4000
*4000 - GNSS MEA		
RASTT, WI FIX	BADGER, WI VORTAC	*3000
*3000 - GNSS MEA		
BADGER, WI VORTAC	OSHKOSH, WI VORTAC	3000
OSHKOSH, WI VORTAC	#STEVENS POINT, WI VORTAC	*4000
*3000 - MOCA		
*3000 - GNSS MEA		
#WAUSAU R-171 UNUSABLE BYD 8 NM, USE STEVENS POINT R-354		
STEVENS POINT, WI VORTAC	TAYUY, WI FIX	3100
TAYUY, WI FIX	#WAUSAU, WI VORTAC	3100
#WAUSAU R-171 UNUSABLE BYD 8 NM, USE STEVENS POINT R-354		
#WAUSAU, WI VORTAC	#RHINELANDER, WI VORTAC	*4000
*4000 - GNSS MEA		
#WAUSAU R-005 UNUSABLE BYD 10 NM. GNSS REQUIRED BEYOND 10 NM.		
RHINELANDER R-185 UNUSABLE BYD 10 NM. GNSS REQUIRED BEYOND 10 NM.		
RHINELANDER, WI VORTAC	HOUGHTON, MI VOR/DME	3500

95.6064 VOR FEDERAL AIRWAY V64

LOS ANGELES, CA VORTAC	LIMBO, CA FIX	3000
LIMBO, CA FIX	*WILMA, CA FIX	3200
*2800 - MCA WILMA, CA FIX, W BND		
WILMA, CA FIX	SEAL BEACH, CA VORTAC	2300
SEAL BEACH, CA VORTAC	TUSTI, CA FIX	
	E BND	3000
	W BND	2500
TUSTI, CA FIX	*COREL, CA FIX	6000
*7400 - MCA COREL, CA FIX, E BND		
COREL, CA FIX	PERIS, CA FIX	8000
PERIS, CA FIX	HEMET, CA FIX	
	E BND	*11000
	W BND	*10000
*6600 - MOCA		
HEMET, CA FIX	HAPPE, CA FIX	*11000
*10200 - MOCA		
HAPPE, CA FIX	BALDI, CA FIX	10500
BALDI, CA FIX	CORLA, CA FIX	
	W BND	9700
	E BND	8000
CORLA, CA FIX	*THERMAL, CA VORTAC	
	W BND	8400
	E BND	6000
*7700 - MCA THERMAL, CA VORTAC, W BND		
THERMAL, CA VORTAC	BLYTHE, CA VORTAC	7000

95.6065 VOR FEDERAL AIRWAY V65

DRYER, OH VOR/DME	SANDUSKY, OH VOR/DME	*3000
*2100 - MOCA		
SANDUSKY, OH VOR/DME	CARLETON, MI VORTAC	*3000
*2400 - MOCA		

FROM	TO	MEA
95.6066 VOR FEDERAL AIRWAY V66		
MISSION BAY, CA VORTAC	*RYAHH, CA FIX	4000
*6200 - MCA RYAHH, CA FIX ,	E BND	
RYAHH, CA FIX	BARET, CA FIX	
	E BND	8000
	W BND	5500
BARET, CA FIX	*KUMBA, CA FIX	8000
*6700 - MCA KUMBA, CA FIX ,	W BND	
KUMBA, CA FIX	IMPERIAL, CA VORTAC	4100
IMPERIAL, CA VORTAC	BARD, AZ VORTAC	3600
BARD, AZ VORTAC	*MOHAK, AZ FIX	
	W BND	4000
	E BND	6000
*6000 - MCA MOHAK, AZ FIX ,	E BND	
MOHAK, AZ FIX	*JUDTH, AZ FIX	**6000
*6000 - MCA JUDTH, AZ FIX ,	W BND	
**4000 - MOCA		
JUDTH, AZ FIX	GILA BEND, AZ VORTAC	
	W BND	6000
	E BND	4000
GILA BEND, AZ VORTAC	FLIER, AZ FIX	6500
FLIER, AZ FIX	TUCSON, AZ VORTAC	*8000
*6700 - MOCA		
TUCSON, AZ VORTAC	SULLI, AZ FIX	8000
SULLI, AZ FIX	MESCA, AZ FIX	
	SE BND	9500
	NW BND	8000
MESCA, AZ FIX	DOUGLAS, AZ VORTAC	9500
DOUGLAS, AZ VORTAC	ANIMA, NM FIX	*11000
*8700 - MOCA		
ANIMA, NM FIX	*DARCE, NM FIX	
	E BND	9000
	W BND	11000
*11000 - MCA DARCE, NM FIX ,	W BND	
DARCE, NM FIX	COLUMBUS, NM VOR/DME	*9000
*8200 - MOCA		
COLUMBUS, NM VOR/DME	EL PASO, TX VORTAC	9000
EL PASO, TX VORTAC	HUDSPETH, TX VORTAC	7500
HUDSPETH, TX VORTAC	PECOS, TX VOR/DME	*9000
*8000 - MOCA		
PECOS, TX VOR/DME	MIDLAND, TX VORTAC	5000
MIDLAND, TX VORTAC	BYPAS, TX FIX	*5000
*4400 - MOCA		
BYPAS, TX FIX	*HYMAN, TX FIX	**6000
*5000 - MRA		
**4300 - MOCA		
HYMAN, TX FIX	TYEES, TX FIX	*7000
*4500 - MOCA		
TYEES, TX FIX	ABILENE, TX VORTAC	*7000
*4300 - MOCA		
ABILENE, TX VORTAC	TRUSS, TX FIX	3500
TRUSS, TX FIX	MILLSAP, TX VORTAC	3700
CRIMSON, AL VORTAC	BROOKWOOD, AL VORTAC	*2500
*2000 - MOCA		
BROOKWOOD, AL VORTAC	KYLEE, AL FIX	3000
KYLEE, AL FIX	LAGRANGE, GA VORTAC	3400
LAGRANGE, GA VORTAC	CANER, GA FIX	3500
CANER, GA FIX	GRANT, GA FIX	2800

FROM	TO	MEA
------	----	-----

95.6066 VOR FEDERAL AIRWAY V66 - CONTINUED

GRANT, GA FIX *2500 - MOCA *2500 - GNSS MEA	SMARR, GA FIX	*4000
SMARR, GA FIX *2500 - MOCA *2500 - GNSS MEA	SINCA, GA FIX	*4500
SINCA, GA FIX *3500 - MRA **2000 - MOCA	*GLOSS, GA FIX	**3000
GLOSS, GA FIX *2200 - MOCA	MADDI, GA FIX	*3000
MADDI, GA FIX *2100 - MOCA	ATHENS, GA VORTAC	*3000
ATHENS, GA VORTAC GREENWOOD, SC VORTAC *2100 - MOCA *2500 - GNSS MEA	GREENWOOD, SC VORTAC RICHE, SC FIX	2500 *4000
RICHE, SC FIX *2300 - MOCA *2500 - GNSS MEA	SANDHILLS, NC VORTAC	*8000
SANDHILLS, NC VORTAC RALEIGH/DURHAM, NC VORTAC	RALEIGH/DURHAM, NC VORTAC FRANKLIN, VA VORTAC	2500 2500

95.6067 VOR FEDERAL AIRWAY V67

CHOO CHOO, TN VORTAC SHELBYVILLE, TN VOR/DME *2500 - MOCA	SHELBYVILLE, TN VOR/DME GRAHAM, TN VORTAC	4000 *4000
GRAHAM, TN VORTAC *2200 - MOCA	LANKY, TN FIX	*4000
LANKY, TN FIX *2200 - MOCA	CUNNINGHAM, KY VORTAC	*3000
CUNNINGHAM, KY VORTAC MARION, IL VOR/DME CENTRALIA, IL VORTAC VANDALIA, IL VORTAC SPINNER, IL VORTAC BURLINGTON, IA VORTAC IOWA CITY, IA VORTAC CEDAR RAPIDS, IA VOR/DME WATERLOO, IA VORTAC FOYDE, IA FIX	MARION, IL VOR/DME CENTRALIA, IL VORTAC VANDALIA, IL VORTAC SPINNER, IL VORTAC BURLINGTON, IA VORTAC IOWA CITY, IA VORTAC CEDAR RAPIDS, IA VOR/DME WATERLOO, IA VORTAC FOYDE, IA FIX ROCHESTER, MN VOR/DME	2600 2300 2500 2500 2500 2600 2700 2900 3000 3500

95.6068 VOR FEDERAL AIRWAY V68

MONTROSE, CO VOR/DME CONES, CO VOR/DME DOVE CREEK, CO VORTAC CORTEZ, CO VOR/DME PLATA, NM FIX RATTLESNAKE, NM VORTAC OTINS, NM FIX *10000 - MOCA	CONES, CO VOR/DME DOVE CREEK, CO VORTAC CORTEZ, CO VOR/DME PLATA, NM FIX RATTLESNAKE, NM VORTAC OTINS, NM FIX PEDRA, NM FIX	12000 12000 9800 10600 10000 9000 *11500
PEDRA, NM FIX *ALBUQUERQUE, NM VORTAC *10000 - MCA ALBUQUERQUE, NM VORTAC, SE BND	ALBUQUERQUE, NM VORTAC CORONA, NM VORTAC	9000 12000
CORONA, NM VORTAC HONDS, NM FIX	HONDS, NM FIX CHISUM, NM VORTAC NW BND SE BND	9000 9000 6500

FROM	TO	MEA
------	----	-----

95.6068 VOR FEDERAL AIRWAY V68 - CONTINUED

CHISUM, NM VORTAC *5000 - MOCA	HAGER, NM FIX	*6000
HAGER, NM FIX	HOBBS, NM VORTAC	6500
HOBBS, NM VORTAC	ANEEL, TX FIX	5200
ANEEL, TX FIX	MIDLAND, TX VORTAC	5000
MIDLAND, TX VORTAC	JOKES, TX FIX	4500
JOKES, TX FIX *4200 - MOCA	STEEP, TX FIX	*5000
STEEP, TX FIX	TANKR, TX FIX	4400
TANKR, TX FIX	SAN ANGELO, TX VORTAC	3700
SAN ANGELO, TX VORTAC	JUNCTION, TX VORTAC	4000
JUNCTION, TX VORTAC	CENTER POINT, TX VORTAC	3800
CENTER POINT, TX VORTAC	SAN ANTONIO, TX VORTAC	4000
SAN ANTONIO, TX VORTAC *5500 - MRA	*BRAUN, TX FIX	3100
BRAUN, TX FIX	MARCS, TX FIX	3100
MARCS, TX FIX *2000 - MOCA	CRAYS, TX FIX	*2900
CRAYS, TX FIX	INDUSTRY, TX VORTAC	2500
INDUSTRY, TX VORTAC	SEALY, TX FIX	2100
SEALY, TX FIX	HOBBY, TX VOR/DME	2000

95.6069 VOR FEDERAL AIRWAY V69

EL DORADO, AR VORTAC	PINE BLUFF, AR VOR/DME	2000
PINE BLUFF, AR VOR/DME	BILLI, AR FIX	2000
BILLI, AR FIX *6000 - MRA	*HILLE, AR FIX	**6000
**1500 - MOCA		
HILLE, AR FIX *3000 - MOCA	WALNUT RIDGE, AR VORTAC	*4000
WALNUT RIDGE, AR VORTAC	FARMINGTON, MO VORTAC	3000
FARMINGTON, MO VORTAC *2500 - MOCA	TROY, IL VORTAC	*3000
TROY, IL VORTAC	SPINNER, IL VORTAC	2500
SPINNER, IL VORTAC *2300 - MOCA	PONTIAC, IL VOR/DME	*3000
PONTIAC, IL VOR/DME *2200 - MOCA	JOLIET, IL VORTAC	*3000

95.6070 VOR FEDERAL AIRWAY V70

U.S. MEXICAN BORDER *1500 - MOCA	BROWNSVILLE, TX VORTAC	*5000
BROWNSVILLE, TX VORTAC *5000 - MRA	*MADRE, TX FIX	1600
MADRE, TX FIX *5000 - MRA	*RAYMO, TX FIX	1600
RAYMO, TX FIX *1600 - MOCA	JIMIE, TX FIX	*4000
JIMIE, TX FIX *1800 - MOCA	JETTY, TX FIX	*4000
JETTY, TX FIX	CORPUS CHRISTI, TX VORTAC	2000
CORPUS CHRISTI, TX VORTAC	COPAN, TX FIX	1800
COPAN, TX FIX	BETZY, TX FIX	1700
BETZY, TX FIX	PALACIOS, TX VORTAC	2000
PALACIOS, TX VORTAC	SCHOLES, TX VORTAC	2600
SCHOLES, TX VORTAC	SABINE PASS, TX VOR/DME	2000
SABINE PASS, TX VOR/DME	LAKE CHARLES, LA VORTAC	1700
LAKE CHARLES, LA VORTAC	LAFAYETTE, LA VORTAC	1800

FROM TO MEA

95.6070 VOR FEDERAL AIRWAY V70 - CONTINUED

LAFAYETTE, LA VORTAC *5000 - MRA	*ROSEY, LA FIX	2000
ROSEY, LA FIX	BATON ROUGE, LA VORTAC	2000
BATON ROUGE, LA VORTAC	PICAYUNE, MS VOR/DME	2000
PICAYUNE, MS VOR/DME	GREENE COUNTY, MS VORTAC	2000
GREENE COUNTY, MS VORTAC	MONROEVILLE, AL VORTAC	2000
MONROEVILLE, AL VORTAC	CHAFF, AL FIX	2000
CHAFF, AL FIX	RUTEL, AL FIX	*2500
*1800 - MOCA		
RUTEL, AL FIX	CRENS, AL FIX	*4500
*1800 - MOCA		
CRENS, AL FIX	EUFAULA, AL VORTAC	2400
EUFAULA, AL VORTAC	VIENNA, GA VORTAC	2400
VIENNA, GA VORTAC	*OCONE, GA FIX	**3000
*3000 - MRA		
**2100 - MOCA		
OCONE, GA FIX	MILEN, GA FIX	*3000
*1800 - MOCA		MAA - 9000
MILEN, GA FIX	ALLENDALE, SC VOR	*3000
*1800 - MOCA		
GRAND STRAND, SC VORTAC	WILMINGTON, NC VORTAC	##*3100
*3100 - GNSS MEA		
#WILMINGTON R-240 UNUSABLE		
WILMINGTON, NC VORTAC	BEULA, NC FIX	*8000
*5000 - GNSS MEA		
BEULA, NC FIX	KINSTON, NC VORTAC	2000
KINSTON, NC VORTAC	PEARS, NC FIX	*2500
*1600 - MOCA		
PEARS, NC FIX	COFIELD, NC VORTAC	*3000
*2000 - MOCA		

95.6071 VOR FEDERAL AIRWAY V71

BATON ROUGE, LA VORTAC	RELAY, LA FIX	2000
RELAY, LA FIX	*WRACK, LA FIX	**2200
*4000 - MRA		
**1700 - MOCA		
WRACK, LA FIX	WILIN, MS FIX	2200
WILIN, MS FIX	NATCHEZ, MS VOR/DME	2200
NATCHEZ, MS VOR/DME	MONROE, LA VORTAC	2000
MONROE, LA VORTAC	EL DORADO, AR VORTAC	2100
EL DORADO, AR VORTAC	SPARO, AR FIX	
	S BND	*2500
	N BND	*4000
*1800 - MOCA		
SPARO, AR FIX	CANEY, AR FIX	*4000
*1700 - MOCA		
CANEY, AR FIX	HOT SPRINGS, AR VOR/DME	
	N BND	2500
	S BND	3000
HOT SPRINGS, AR VOR/DME	OLLAS, AR FIX	*3600
*3100 - MOCA		
OLLAS, AR FIX	HAAWK, AR FIX	*4500
*2500 - MOCA		
HAAWK, AR FIX	HARRISON, AR VOR/DME	*10000
*3700 - MOCA		
*4000 - GNSS MEA		
HARRISON, AR VOR/DME	RASON, MO FIX	3200
RASON, MO FIX	SPRINGFIELD, MO VORTAC	3000

FROM TO MEA

95.6071 VOR FEDERAL AIRWAY V71 - CONTINUED

SPRINGFIELD, MO VORTAC *4000 - MRA **2500 - MOCA	*SHIRE, MO FIX	**3000
SHIRE, MO FIX *2500 - MOCA	BUTLER, MO VORTAC	*3000
BUTLER, MO VORTAC	TOPEKA, KS VORTAC	3100
TOPEKA, KS VORTAC *2800 - MOCA	PAWNEE CITY, NE VORTAC	*4000
PAWNEE CITY, NE VORTAC	LINCOLN, NE VORTAC	3000
LINCOLN, NE VORTAC *2600 - MOCA	DWELL, NE FIX	*3300
DWELL, NE FIX *3000 - MOCA	COLUMBUS, NE VOR/DME	*3500
COLUMBUS, NE VOR/DME	O'NEILL, NE VORTAC	4000
O'NEILL, NE VORTAC	WINNER, SD VOR	4000
WINNER, SD VOR	PIERRE, SD VORTAC	4100
PIERRE, SD VORTAC *3600 - MOCA	LINTN, ND FIX	*5500
LINTN, ND FIX	BISMARCK, ND VOR/DME	
	S BND	5500
	N BND	3600
BISMARCK, ND VOR/DME	CENTR, ND FIX	
	W BND	5600
	E BND	4000
CENTR, ND FIX *3900 - MOCA	WILLISTON, ND VORTAC	*5600

95.6072 VOR FEDERAL AIRWAY V72

RAZORBACK, AR VORTAC	EDUGE, AR FIX	3500
EDUGE, AR FIX *2900 - MOCA	REEDS, MO FIX	*4000
REEDS, MO FIX *2900 - MOCA	DOGWOOD, MO VORTAC	*3400
DOGWOOD, MO VORTAC	GOBEY, MO FIX	3400
GOBEY, MO FIX	MAPLES, MO VORTAC	3400
MAPLES, MO VORTAC	BUNKS, MO FIX	3000
BUNKS, MO FIX	FARMINGTON, MO VORTAC	3500
FARMINGTON, MO VORTAC *2500 - MOCA	NIKEL, IL FIX	*3000
NIKEL, IL FIX	CENTRALIA, IL VORTAC	2300
CENTRALIA, IL VORTAC	BIBLE GROVE, IL VORTAC	2600
BIBLE GROVE, IL VORTAC	MATTOON, IL VOR/DME	2500
MATTOON, IL VOR/DME	BLOOMINGTON, IL VOR/DME	2700

95.6073 VOR FEDERAL AIRWAY V73

TULSA, OK VORTAC	FRAKS, OK FIX	3000
FRAKS, OK FIX	WICHITA, KS VORTAC	4000
WICHITA, KS VORTAC	HUTCHINSON, KS VOR/DME	3600
HUTCHINSON, KS VOR/DME	SALINA, KS VORTAC	3400

95.6074 VOR FEDERAL AIRWAY V74

GARDEN CITY, KS VORTAC	DODGE CITY, KS VORTAC	4600
DODGE CITY, KS VORTAC *4000 - MRA	*SAFER, KS FIX	4300
SAFER, KS FIX	ANTHONY, KS VORTAC	3400

FROM TO MEA

95.6074 VOR FEDERAL AIRWAY V74 - CONTINUED

ANTHONY, KS VORTAC	PIONEER, OK VORTAC	3000
PIONEER, OK VORTAC	MANON, OK FIX	2700
MANON, OK FIX	TULSA, OK VORTAC	2500
TULSA, OK VORTAC	OWETA, OK FIX	3200
OWETA, OK FIX	MALTS, OK FIX	*2800
*1900 - MOCA		
MALTS, OK FIX	FORT SMITH, AR VORTAC	3000
FORT SMITH, AR VORTAC	CHARR, AR FIX	2500
CHARR, AR FIX	MAGGA, AR FIX	4000
MAGGA, AR FIX	DANIL, AR FIX	*4500
*4000 - MOCA		
DANIL, AR FIX	OLLAS, AR FIX	*4500
*2600 - MOCA		
OLLAS, AR FIX	MAUME, AR FIX	*4500
*2700 - MOCA		
MAUME, AR FIX	LITTLE ROCK, AR VORTAC	3500
LITTLE ROCK, AR VORTAC	PINE BLUFF, AR VOR/DME	2500
PINE BLUFF, AR VOR/DME	GREENVILLE, MS VOR/DME	2000
GREENVILLE, MS VOR/DME	JACKSON, MS VORTAC	*2500
*1800 - MOCA		

95.6075 VOR FEDERAL AIRWAY V75

MORGANTOWN, WV VORTAC	BELLAIRE, OH VOR/DME	4000
BELLAIRE, OH VOR/DME	ATWOO, OH FIX	*6000
*3000 - MOCA		
ATWOO, OH FIX	BRIGGS, OH VOR/DME	*4000
*3100 - MOCA		
*3100 - GNSS MEA		
BRIGGS, OH VOR/DME	DRYER, OH VOR/DME	3000
DRYER, OH VOR/DME	U.S. CANADIAN BORDER	*4000
*2200 - MOCA		
U.S. CANADIAN BORDER	LLEEO, CANADA FIX	4000

95.6076 VOR FEDERAL AIRWAY V76

LUBBOCK, TX VORTAC	*WELCH, TX FIX	5200
*7000 - MRA		
WELCH, TX FIX	PATTS, TX FIX	*6100
*5200 - MOCA		
PATTS, TX FIX	BIG SPRING, TX VORTAC	4700
BIG SPRING, TX VORTAC	*HYMAN, TX FIX	4500
*5000 - MRA		
HYMAN, TX FIX	*WATOR, TX FIX	4500
*7000 - MRA		
WATOR, TX FIX	SAN ANGELO, TX VORTAC	4500
SAN ANGELO, TX VORTAC	EVILE, TX FIX	3700
EVILE, TX FIX	BREDY, TX FIX	3800
BREDY, TX FIX	LLANO, TX VORTAC	3500
LLANO, TX VORTAC	CENTEX, TX VORTAC	3200
CENTEX, TX VORTAC	MOUZE, TX FIX	2200
MOUZE, TX FIX	INDUSTRY, TX VORTAC	2100
INDUSTRY, TX VORTAC	SEALY, TX FIX	2100
SEALY, TX FIX	HOBBY, TX VOR/DME	2000

FROM	TO	MEA
95.6077 VOR FEDERAL AIRWAY V77		
SAN ANGELO, TX VORTAC	ABILENE, TX VORTAC	4000
ABILENE, TX VORTAC	WICHITA FALLS, TX VORTAC	*3900
*3400 - MOCA		
WICHITA FALLS, TX VORTAC	FOYER, OK FIX	2900
FOYER, OK FIX	*FLECH, OK FIX	3000
*4900 - MRA		
FLECH, OK FIX	*NEADS, OK FIX	**3800
*5400 - MRA		
**2800 - MOCA		
NEADS, OK FIX	WILL ROGERS, OK VORTAC	3000
WILL ROGERS, OK VORTAC	CASTN, OK FIX	3500
CASTN, OK FIX	WENDY, OK FIX	4000
WENDY, OK FIX	PIONEER, OK VORTAC	2900
PIONEER, OK VORTAC	WICHITA, KS VORTAC	3600
WICHITA, KS VORTAC	*FLOSS, KS FIX	3600
*5000 - MRA		
FLOSS, KS FIX	*WILSY, KS FIX	**5000
*5000 - MRA		
**2800 - MOCA		
WILSY, KS FIX	HEYDN, KS FIX	*4500
*2900 - MOCA		
HEYDN, KS FIX	TOPEKA, KS VORTAC	3700
TOPEKA, KS VORTAC	ST JOSEPH, MO VORTAC	3000
ST JOSEPH, MO VORTAC	LAMONI, IA VORTAC	2900
LAMONI, IA VORTAC	*WIVEY, IA FIX	3000
*4300 - MRA		
WIVEY, IA FIX	DES MOINES, IA VORTAC	3000
DES MOINES, IA VORTAC	*MIXIN, IA FIX	3000
*4000 - MRA		
MIXIN, IA FIX	NEWTON, IA VOR/DME	3000
NEWTON, IA VOR/DME	WATERLOO, IA VORTAC	2800
WATERLOO, IA VORTAC	WAUKON, IA VORTAC	*3000
*2400 - MOCA		

95.6078 VOR FEDERAL AIRWAY V78

HURON, SD VORTAC	WATERTOWN, SD VORTAC	*3700
*3100 - MOCA		
WATERTOWN, SD VORTAC	CLAPS, MN FIX	*5500
*3300 - MOCA		
CLAPS, MN FIX	DARWIN, MN VORTAC	3000
DARWIN, MN VORTAC	GOPHER, MN VORTAC	3000
GOPHER, MN VORTAC	EAU CLAIRE, WI VORTAC	3400
EAU CLAIRE, WI VORTAC	RHINELANDER, WI VORTAC	3700
RHINELANDER, WI VORTAC	IRON MOUNTAIN, MI VOR/DME	4300
IRON MOUNTAIN, MI VOR/DME	VUKFI, MI FIX	3100
VUKFI, MI FIX	ESCANABA, MI VOR/DME	*3000
*2200 - MOCA		
ESCANABA, MI VOR/DME	SCHOOLCRAFT COUNTY, MI VOR/DME	2500
SCHOOLCRAFT COUNTY, MI VOR/DME	PELLSTON, MI VORTAC	2600
PELLSTON, MI VORTAC	*RABBO, MI FIX	2600
*3500 - MRA		
RABBO, MI FIX	ALPENA, MI VORTAC	2600
ALPENA, MI VORTAC	ZABLE, MI FIX	3000
ZABLE, MI FIX	BANJO, MI FIX	*5000
*2900 - MOCA		
BANJO, MI FIX	BENNY, MI FIX	*3000
*2200 - MOCA		
BENNY, MI FIX	SAGINAW, MI VOR/DME	2200

FROM	TO	MEA
------	----	-----

95.6079 VOR FEDERAL AIRWAY V79

HASTINGS, NE VOR/DME	LINCOLN, NE VORTAC	4000
----------------------	--------------------	------

95.6080 VOR FEDERAL AIRWAY V80

AKRON, CO VOR/DME	HOLYO, CO FIX	6400
HOLYO, CO FIX	NORTH PLATTE, NE VORTAC	*6500
*5000 - MOCA		
NORTH PLATTE, NE VORTAC	O'NEILL, NE VORTAC	*5400
*4400 - MOCA		
O'NEILL, NE VORTAC	TYNDA, SD FIX	*4000
*3500 - MOCA		
TYNDA, SD FIX	DOLTS, SD FIX	*4000
*3200 - MOCA		
DOLTS, SD FIX	SIOUX FALLS, SD VORTAC	3400

95.6081 VOR FEDERAL AIRWAY V81

DUSVI, MX FIX	MARFA, TX VOR/DME	10000
MARFA, TX VOR/DME	FORT STOCKTON, TX VORTAC	9000
FORT STOCKTON, TX VORTAC	MIDLAND, TX VORTAC	4500
MIDLAND, TX VORTAC	PATTS, TX FIX	4500
PATTS, TX FIX	*WELCH, TX FIX	**6100
*7000 - MRA		
**5200 - MOCA		
WELCH, TX FIX	LUBBOCK, TX VORTAC	5200
LUBBOCK, TX VORTAC	PLAINVIEW, TX VOR/DME	5000
PLAINVIEW, TX VOR/DME	*YOCAN, TX FIX	**5400
*6500 - MRA		
**4900 - MOCA		
YOCAN, TX FIX	PANHANDLE, TX VORTAC	5400
PANHANDLE, TX VORTAC	LANTT, TX FIX	6100
LANTT, TX FIX	EXELL, TX FIX	5400
EXELL, TX FIX	DALHART, TX VORTAC	5900
DALHART, TX VORTAC	TOBE, CO VORTAC	8800
TOBE, CO VORTAC	PUEBLO, CO VORTAC	7700
PUEBLO, CO VORTAC	*BLACK FOREST, CO VORTAC	9500
*10000 - MCA BLACK FOREST, CO VORTAC, N BND		
BLACK FOREST, CO VORTAC	*HOHUM, CO FIX	#10000
*9500 - MRA		
#GNSS MEA		
BLACK FOREST R-325 UNUSABLE		
HOHUM, CO FIX	SIGNE, CO FIX	9200
SIGNE, CO FIX	JEFFCO, CO VOR/DME	*9200
*8600 - MOCA		
JEFFCO, CO VOR/DME	WISER, CO FIX	8000
WISER, CO FIX	CHEYENNE, WY VORTAC	9000
CHEYENNE, WY VORTAC	SCOTTSBLUFF, NE VORTAC	8000
SCOTTSBLUFF, NE VORTAC	CHADRON, NE VOR/DME	7000

95.6082 VOR FEDERAL AIRWAY V82

BAUDETTE, MN VOR/DME	BRAINERD, MN VORTAC	*7000
*3400 - MOCA		
*3500 - GNSS MEA		

FROM TO MEA

95.6082 VOR FEDERAL AIRWAY V82 - CONTINUED

BRAINERD, MN VORTAC	GOPHER, MN VORTAC	3000
GOPHER, MN VORTAC	FARMINGTON, MN VORTAC	*3500
*2700 - MOCA		
FARMINGTON, MN VORTAC	*CORDY, MN FIX	3000
*4000 - MRA		
CORDY, MN FIX	ROCHESTER, MN VOR/DME	3000
ROCHESTER, MN VOR/DME	NODINE, MN VORTAC	3000
NODINE, MN VORTAC	DELLS, WI VORTAC	3000

95.6083 VOR FEDERAL AIRWAY V83

CARLSBAD, NM VORTAC	CHISUM, NM VORTAC	5900
CHISUM, NM VORTAC	HONDS, NM FIX	
	NW BND	9000
	SE BND	6500
HONDS, NM FIX	CORONA, NM VORTAC	9000
CORONA, NM VORTAC	OTTO, NM VOR	9000
OTTO, NM VOR	*LACRO, NM FIX	9000
*10500 - MRA		
LACRO, NM FIX	SANTA FE, NM VORTAC	9000
SANTA FE, NM VORTAC	NAMBE, NM FIX	
	N BND	11000
	S BND	9000
NAMBE, NM FIX	TAOS, NM VORTAC	11000
TAOS, NM VORTAC	*ALAMOSA, CO VORTAC	11600
*10400 - MCA ALAMOSA, CO	VORTAC , S BND	
ALAMOSA, CO VORTAC	GOSIP, CO FIX	
	E BND	*14000
	W BND	*10400
*10100 - MOCA		
GOSIP, CO FIX	PUEBLO, CO VORTAC	8300
PUEBLO, CO VORTAC	DRAKE, CO FIX	7600
DRAKE, CO FIX	BLACK FOREST, CO VORTAC	9000

95.6084 VOR FEDERAL AIRWAY V84

NORTHBROOK, IL VOR/DME	*KUBBS, IL FIX	**2500
*4000 - MRA		
**1900 - MOCA		
KUBBS, IL FIX	*STORY, IL FIX	**2500
*3500 - MRA		
**1900 - MOCA		
STORY, IL FIX	PIVOT, MI FIX	*2500
*1900 - MOCA		
PIVOT, MI FIX	*JYBEE, MI FIX	**4000
*4000 - MRA		
**1900 - MOCA		
JYBEE, MI FIX	PULLMAN, MI VOR/DME	*4000
*2200 - MOCA		
PULLMAN, MI VOR/DME	LANSING, MI VORTAC	3000
LANSING, MI VORTAC	FLINT, MI VORTAC	2700
FLINT, MI VORTAC	PECK, MI VORTAC	2800
PECK, MI VORTAC	U.S. CANADIAN BORDER	*3500
*2900 - MOCA		

FROM TO MEA

95.6084 VOR FEDERAL AIRWAY V84 - CONTINUED

U.S. CANADIAN BORDER	#BUFFALO, NY VOR/DME	*6000
*2400 - MOCA		
*3000 - GNSS MEA		
#BUFFALO R-282 UNUSABLE	BELOW 6000	
BUFFALO, NY VOR/DME	GENESE0, NY VOR/DME	#4000
#BUF R-106 UNUSABLE.		
GENESE0, NY VOR/DME	BEEPS, NY FIX	*4000
*3300 - MOCA		
BEEPS, NY FIX	SYRACUSE, NY VORTAC	*3500
*2600 - MOCA		

95.6085 VOR FEDERAL AIRWAY V85

FALCON, CO VORTAC	*HYGEN, CO FIX	8000
*11300 - MCA HYGEN, CO FIX , NW BND		
HYGEN, CO FIX	*ALLAN, CO FIX	**13500
*16000 - MRA		
*15400 - MCA ALLAN, CO FIX , NW BND		
**12600 - MOCA		
ALLAN, CO FIX	LARAMIE, WY VOR/DME	16000
LARAMIE, WY VOR/DME	MEDICINE BOW, WY VOR/DME	9400
MEDICINE BOW, WY VOR/DME	MULTI, WY FIX	10800
MULTI, WY FIX	MUDDY MOUNTAIN, WY VORTAC	
	N BND	8000
	S BND	10800
MUDDY MOUNTAIN, WY VORTAC	RIVERTON, WY VOR/DME	8500
RIVERTON, WY VOR/DME	BOYSEN RESERVOIR, WY VOR/DME	9600
BOYSEN RESERVOIR, WY VOR/DME	CODY, WY VOR/DME	9600
CODY, WY VOR/DME	EDDAR, MT FIX	8400
EDDAR, MT FIX	BILLINGS, MT VORTAC	
	S BND	8400
	N BND	7000

95.6086 VOR FEDERAL AIRWAY V86

MISSOULA, MT VOR/DME	COPPERTOWN, MT VOR/DME	*13000
*11300 - MOCA		
*12000 - GNSS MEA		
COPPERTOWN, MT VOR/DME	*WHITEHALL, MT VOR/DME	10500
*9100 - MCA WHITEHALL, MT VOR/DME , W BND		
WHITEHALL, MT VOR/DME	*BOZEMAN, MT VOR/DME	8500
*9300 - MCA BOZEMAN, MT VOR/DME , SE BND		
BOZEMAN, MT VOR/DME	LIVINGSTON, MT VOR/DME	10400
LIVINGSTON, MT VOR/DME	REEPO, MT FIX	*9000
*8300 - MOCA		
REEPO, MT FIX	COLUS, MT FIX	
	W BND	9000
	E BND	7000
COLUS, MT FIX	BILLINGS, MT VORTAC	
	W BND	9000
	E BND	6000
BILLINGS, MT VORTAC	KRONA, MT FIX	
	NW BND	6200
	SE BND	8000
KRONA, MT FIX	SHERIDAN, WY VORTAC	8000

FROM	TO	MEA
------	----	-----

95.6086 VOR FEDERAL AIRWAY V86 - CONTINUED

SHERIDAN, WY VORTAC *7000 - MOCA *7000 - GNSS MEA #MEA IS ESTABLISHED WITH A GAP IN NAVIGATION SIGNAL COVERAGE.	WETON, WY FIX	#*10900
WETON, WY FIX *15000 - MRA **7000 - MOCA **7000 - GNSS MEA	*KOCYE, WY FIX	**13000
KOCYE, WY FIX *8600 - MOCA *9000 - GNSS MEA	KARAS, WY FIX	*13000
KARAS, WY FIX *9700 - MRA **9400 - MOCA **10000 - GNSS MEA	*PACTO, SD FIX	**11100
PACTO, SD FIX *7100 - MOCA	RAPID CITY, SD VORTAC E BND W BND	*8000 *9700

95.6087 VOR FEDERAL AIRWAY V87

PANOCHÉ, CA VORTAC SALINAS, CA VORTAC *7000 - MRA **4000 - MOCA	SALINAS, CA VORTAC *SANTY, CA FIX	6000 **5000
SANTY, CA FIX WOODSIDE, CA VORTAC SAN FRANCISCO, CA VOR/DME SCAGGS ISLAND, CA VORTAC MAXWELL, CA VORTAC	WOODSIDE, CA VORTAC SAN FRANCISCO, CA VOR/DME SCAGGS ISLAND, CA VORTAC MAXWELL, CA VORTAC RED BLUFF, CA VORTAC	5000 4500 4000 5000 3000

95.6088 VOR FEDERAL AIRWAY V88

TULSA, OK VORTAC VINTA, OK FIX *2300 - MOCA *4000 - GNSS MEA	VINTA, OK FIX NARCI, OK FIX	2600 *4500
NARCI, OK FIX *3100 - MOCA *4000 - GNSS MEA	WACCO, MO FIX	*8000
WACCO, MO FIX *3700 - MRA	*MIRTH, MO FIX	3000
MIRTH, MO FIX SPRINGFIELD, MO VORTAC VICHY, MO VOR/DME VICHY, MO VOR/DME *2300 - MOCA	SPRINGFIELD, MO VORTAC VICHY, MO VOR/DME STEER, MO FIX	3000 3000 *3000
STEER, MO FIX	TROY, IL VORTAC	2700

95.6089 VOR FEDERAL AIRWAY V89

GILL, CO VOR/DME HAMER, WY FIX CHEYENNE, WY VORTAC LITER, WY FIX	HAMER, WY FIX CHEYENNE, WY VORTAC LITER, WY FIX CHADRON, NE VOR/DME	8000 8500 8000 7800
---	--	------------------------------

FROM	TO	MEA
------	----	-----

95.6090 VOR FEDERAL AIRWAY V90

SALEM, MI VORTAC *2700 - MOCA	U.S. CANADIAN BORDER	*4000
BEWEL, OH FIX	DUNKIRK, NY VORTAC	3000

95.6091 VOR FEDERAL AIRWAY V91

SARDI, NY FIX *1900 - MOCA	CALVERTON, NY VOR/DME	*2500
CALVERTON, NY VOR/DME *4000 - MRA	*NESSI, CT FIX	2000
NESSI, CT FIX	BRIDGEPORT, CT VOR/DME	2000
BRIDGEPORT, CT VOR/DME *4100 - MOCA	ALBANY, NY VORTAC	*6000
ALBANY, NY VORTAC *5000 - GNSS MEA	GLENS FALLS, NY VORTAC	*7000
GLENS FALLS, NY VORTAC *5000 - GNSS MEA	ENSON, VT FIX	*10000
ENSON, VT FIX *2800 - MOCA	WEIGH, VT FIX	*4000
WEIGH, VT FIX	BURLINGTON, VT VOR/DME	3000
BURLINGTON, VT VOR/DME	PLATTSBURGH, NY VORTAC	2600
PLATTSBURGH, NY VORTAC *3200 - MOCA	U.S. CANADIAN BORDER	*6000
*3500 - GNSS MEA		
U.S. CANADIAN BORDER	ABCOT, CANADA FIX	6000

95.6092 VOR FEDERAL AIRWAY V92

BEBEE, IL FIX *3500 - MRA *3000 - MCA NILES, IL FIX , N BND	*NILES, IL FIX	3300
NILES, IL FIX	CHICAGO HEIGHTS, IL VORTAC	2100
CHICAGO HEIGHTS, IL VORTAC	HALIE, IN FIX	2600
HALIE, IN FIX *2300 - MOCA	INKEN, IN FIX	*4000
INKEN, IN FIX	GOSHEN, IN VORTAC	2600
GOSHEN, IN VORTAC	BAGEL, IN FIX	2700
BAGEL, IN FIX *2400 - MOCA	EDGE, OH FIX	*3000
EDGE, OH FIX	WATERVILLE, OH VOR/DME	3000
WATERVILLE, OH VOR/DME	MANSFIELD, OH VORTAC	2900
MANSFIELD, OH VORTAC	TIVERTON, OH VOR/DME	3000
TIVERTON, OH VOR/DME	NEWCOMERSTOWN, OH VOR/DME	3000
NEWCOMERSTOWN, OH VOR/DME	BELLAIRE, OH VOR/DME	3000
BELLAIRE, OH VOR/DME *3100 - MOCA	GALLS, PA FIX	*3600
GALLS, PA FIX	GRANTSVILLE, MD VOR/DME	5000
GRANTSVILLE, MD VOR/DME	ARMEL, VA VORTAC	5000

FROM TO MEA

95.6093 VOR FEDERAL AIRWAY V93

PATUXENT, MD VORTAC *10000 - MRA **1700 - MOCA	*GRACO, MD FIX	**2500
GRACO, MD FIX *1600 - MOCA	PALEO, MD FIX	*10000
PALEO, MD FIX *1700 - MOCA	BALTIMORE, MD VORTAC	*2200
BALTIMORE, MD VORTAC VINNY, PA FIX *10000 - MRA **2600 - MOCA	VINNY, PA FIX *ROAST, PA FIX	3000 **4500
ROAST, PA FIX *2600 - MOCA	LANCASTER, PA VORTAC	*4500
LANCASTER, PA VORTAC HAILS, PA FIX SNOWY, PA FIX SNOWY, PA FIX LYTEL, PA FIX WILKES-BARRE, PA VORTAC LAKE HENRY, PA VORTAC HELON, NY FIX KINGSTON, NY VOR/DME PAWLING, NY VOR/DME CHESTER, MA VOR/DME *3500 - GNSS MEA	HAILS, PA FIX SNOWY, PA FIX LYTEL, PA FIX WILKES-BARRE, PA VORTAC LAKE HENRY, PA VORTAC HELON, NY FIX SPECL, NY FIX PAWLING, NY VOR/DME CHESTER, MA VOR/DME KEENE, NH VORTAC	3400 4000 4000 4000 4000 4000 4000 3000 4000 *4000
KEENE, NH VORTAC CONCORD, NH VORTAC KENNEBUNK, ME VORTAC *1600 - MOCA	CONCORD, NH VORTAC KENNEBUNK, ME VORTAC BRNNS, ME FIX	5000 3000 *3000
BRNNS, ME FIX BANGOR, ME VORTAC PRINCETON, ME VOR/DME *1500 - MOCA	BANGOR, ME VORTAC PRINCETON, ME VOR/DME U.S. CANADIAN BORDER	3000 3000 *2500

95.6094 VOR FEDERAL AIRWAY V94

BLYTHE, CA VORTAC *9000 - MRA	*VICKO, AZ FIX	6000
VICKO, AZ FIX *5200 - MOCA	GILA BEND, AZ VORTAC	*9000
GILA BEND, AZ VORTAC *8000 - MRA	*POTER, AZ FIX	5000
POTER, AZ FIX STANFIELD, AZ VORTAC *5500 - MCA TOTEC, AZ FIX, E BND **4300 - MOCA	STANFIELD, AZ VORTAC *TOTEC, AZ FIX	5000 **5000
TOTEC, AZ FIX	CROME, AZ FIX E BND W BND	8000 6500
CROME, AZ FIX SAN SIMON, AZ VORTAC *8100 - MOCA	SAN SIMON, AZ VORTAC DEMING, NM VORTAC	10000 *9000
DEMING, NM VORTAC *10000 - MRA **7700 - MOCA	*MOLLY, NM FIX	**9000
MOLLY, NM FIX NEWMAN, TX VORTAC SALT FLAT, TX VORTAC DILLI, TX FIX *7500 - MOCA	NEWMAN, TX VORTAC SALT FLAT, TX VORTAC DILLI, TX FIX CAVRN, TX FIX	9000 8800 8000 *10000

FROM	TO	MEA
95.6094 VOR FEDERAL AIRWAY V94 - CONTINUED		
CAVRN, TX FIX *5300 - MOCA	WINK, TX VORTAC	*10000
WINK, TX VORTAC	NOTES, TX FIX	5500
NOTES, TX FIX	MIDLAND, TX VORTAC	5000
MIDLAND, TX VORTAC *4400 - MOCA	BYPAS, TX FIX	*5000
BYPAS, TX FIX *5000 - MRA **4300 - MOCA	*HYMAN, TX FIX	**6000
HYMAN, TX FIX *4100 - MOCA	TUSCOLA, TX VOR/DME	*6000
TUSCOLA, TX VOR/DME	GEENI, TX FIX	4000
GEENI, TX FIX *3000 - MOCA	GLEN ROSE, TX VORTAC	*3500
GLEN ROSE, TX VORTAC *2200 - MOCA	CEDAR CREEK, TX VORTAC	*3000
CEDAR CREEK, TX VORTAC	GREGG COUNTY, TX VORTAC	2500
GREGG COUNTY, TX VORTAC	ELM GROVE, LA VORTAC	2000
ELM GROVE, LA VORTAC *3000 - MRA	*WETER, LA FIX	2400
WETER, LA FIX *1800 - MOCA	MONROE, LA VORTAC	*2400
MONROE, LA VORTAC	GREENVILLE, MS VOR/DME	2100
GREENVILLE, MS VOR/DME *2000 - MOCA	HOLLY SPRINGS, MS VORTAC	*3000
HOLLY SPRINGS, MS VORTAC *2000 - MOCA	JACKS CREEK, TN VOR/DME	*2500
JACKS CREEK, TN VOR/DME *2200 - MOCA	VALER, TN FIX	*3000
VALER, TN FIX *2500 - MOCA	TEACH, TN FIX	*4000
TEACH, TN FIX	BOWLING GREEN, KY VORTAC	2600

95.6095 VOR FEDERAL AIRWAY V95

GILA BEND, AZ VORTAC *8000 - MRA	*POTER, AZ FIX	5000
POTER, AZ FIX	PHOENIX, AZ VORTAC	8000
PHOENIX, AZ VORTAC	WINSLOW, AZ VORTAC	10000
WINSLOW, AZ VORTAC	*BUTTE, AZ FIX	
	NE BND	11000
	SW BND	8700
*9600 - MRA		
BUTTE, AZ FIX	CASTI, AZ FIX	
	NE BND	11000
	SW BND	8700
CASTI, AZ FIX *11400 - MOCA	DERMA, NM FIX	*13000
DERMA, NM FIX	RATTLESNAKE, NM VORTAC	
	E BND	8300
	W BND	13000
RATTLESNAKE, NM VORTAC	*DURANGO, CO VOR/DME	9700
*13200 - MCA DURANGO, CO VOR/DME, N BND		
DURANGO, CO VOR/DME	ZEANS, CO FIX	
	S BND	12000
	N BND	16100
ZEANS, CO FIX	LAZON, CO FIX	16100
LAZON, CO FIX	POWES, CO FIX	
	N BND	15000
	S BND	16100

FROM TO MEA

95.6095 VOR FEDERAL AIRWAY V95 - CONTINUED

POWES, CO FIX	*BLUE MESA, CO VOR/DME	
	SW BND	16100
	NE BND	12800
*12600 - MCA BLUE MESA, CO	VOR/DME , S BND	
*12900 - MCA BLUE MESA, CO	VOR/DME , NE BND	
BLUE MESA, CO VOR/DME	ROMLY, CO FIX	
	NE BND	16200
	SW BND	12000
ROMLY, CO FIX	*GORJE, CO FIX	16200
*17000 - MRA		
GORJE, CO FIX	*HOHUM, CO FIX	**17000
*9500 - MRA		
*13100 - MCA HOHUM, CO FIX ,	S BND	
**16200 - MOCA		
HOHUM, CO FIX	FALCON, CO VORTAC	9000

95.6096 VOR FEDERAL AIRWAY V96

BRICKYARD, IN VORTAC	KOKOMO, IN VORTAC	2700
KOKOMO, IN VORTAC	FORT WAYNE, IN VORTAC	2600
FORT WAYNE, IN VORTAC	ILLIE, OH FIX	*5000
*2200 - MOCA		
ILLIE, OH FIX	ANNTS, OH FIX	*16000
*2100 - MOCA		
ANNTS, OH FIX	DETROIT, MI VOR/DME	*3000
*2000 - MOCA		

95.6097 VOR FEDERAL AIRWAY V97

DOLPHIN, FL VORTAC	LA BELLE, FL VORTAC	*3000
*1500 - MOCA		
LA BELLE, FL VORTAC	ST PETERSBURG, FL VORTAC	2000
ST PETERSBURG, FL VORTAC	DARBS, FL FIX	2000
DARBS, FL FIX	PLYER, FL FIX	*6000
*4000 - GNSS MEA		
PLYER, FL FIX	CLAMP, FL FIX	*7000
*1400 - MOCA		
*4000 - GNSS MEA		
CLAMP, FL FIX	HEVVN, FL FIX	*6000
*1400 - MOCA		
*4000 - GNSS MEA		
HEVVN, FL FIX	ADDAX, FL FIX	*3000
*1400 - MOCA		
*2000 - GNSS MEA		
ADDAX, FL FIX	SEMINOLE, FL VORTAC	2000
SEMINOLE, FL VORTAC	PECAN, GA VORTAC	2000
PECAN, GA VORTAC	AMAPO, GA FIX	2000
AMAPO, GA FIX	*PRATZ, GA FIX	**3000
*3000 - MRA		
**2000 - MOCA		
PRATZ, GA FIX	GRANT, GA FIX	*4000
*2000 - MOCA		
GRANT, GA FIX	ATLANTA, GA VORTAC	3000
ATLANTA, GA VORTAC	BAPPY, GA FIX	*4000
*3300 - MOCA		
BAPPY, GA FIX	NELLO, GA FIX	5000
NELLO, GA FIX	MELLS, GA FIX	*10000
*5800 - GNSS MEA		

FROM	TO	MEA
------	----	-----

95.6097 VOR FEDERAL AIRWAY V97 - CONTINUED

MELLS, GA FIX *6600 - MCA HINDE, TN FIX , S BND	*HINDE, TN FIX	7400
HINDE, TN FIX	TALLA, TN FIX	6600
TALLA, TN FIX	VOLUNTEER, TN VORTAC	4200
VOLUNTEER, TN VORTAC	NOISE, TN FIX	3800
NOISE, TN FIX	LONDON, KY VORTAC	5000
LONDON, KY VORTAC *2800 - MOCA	REBEL, KY FIX	*3400
REBEL, KY FIX	LEXINGTON, KY VORTAC	2800
LEXINGTON, KY VORTAC	DARKS, KY FIX	3000
DARKS, KY FIX	CINCINNATI, KY VORTAC	2700
CINCINNATI, KY VORTAC	SHELBYVILLE, IN VORTAC	2800
SHELBYVILLE, IN VORTAC	OCKEL, IN FIX	3000
OCKEL, IN FIX *2100 - MOCA	BOILER, IN VORTAC	*2500
BOILER, IN VORTAC	CHICAGO HEIGHTS, IL VORTAC	2700
CHICAGO HEIGHTS, IL VORTAC *3500 - MRA *3000 - MCA NILES, IL FIX , N BND	*NILES, IL FIX	2100
NILES, IL FIX	BEBEE, IL FIX	3300
FARMM, IL FIX	JANESVILLE, WI VOR/DME	2900
JANESVILLE, WI VOR/DME	THEBO, WI FIX	3000
THEBO, WI FIX *2800 - MOCA	LONE ROCK, WI VOR/DME	*3400
LONE ROCK, WI VOR/DME	NODINE, MN VORTAC	3000
NODINE, MN VORTAC	PEGGS, MN FIX	3000
PEGGS, MN FIX	GOPHER, MN VORTAC	3400

95.6098 VOR FEDERAL AIRWAY V98

DAYTON, OH VOR/DME	HINES, OH FIX	3000
HINES, OH FIX *7000 - MRA *7000 - MCA WOCKY, OH FIX , S BND	*WOCKY, OH FIX	7000
WOCKY, OH FIX *4000 - MRA *10000 - MCA PIONS, OH FIX , S BND	*PIONS, OH FIX	10000
PIONS, OH FIX	MIZAR, MI FIX	3000
U.S. CANADIAN BORDER	MASSENA, NY VORTAC	2100
#MASSENA, NY VORTAC *2100 - GNSS MEA #GNSS MEA ONLY	U.S. CANADIAN BORDER	*2100
U.S. CANADIAN BORDER	MASSENA R-085 UNUSABLE. GNSS REQUIRED	
U.S. CANADIAN BORDER	17057, CANADA FIX	#2100
#MEA IS ESTABLISHED WITH A GAP IN NAVIGATION SIGNAL COVERAGE.		

95.6099 VOR FEDERAL AIRWAY V99

LA GUARDIA, NY VOR/DME *1700 - MOCA	OUTTE, CT FIX	*4000
OUTTE, CT FIX *2600 - MOCA	SORRY, CT FIX	*4000
SORRY, CT FIX	HARTFORD, CT VOR/DME	3000

FROM TO MEA

95.6100 VOR FEDERAL AIRWAY V100

MEDICINE BOW, WY VOR/DME	SCOTTSBLUFF, NE VORTAC	9500
SCOTTSBLUFF, NE VORTAC	ALLIANCE, NE VOR/DME	6300
ALLIANCE, NE VOR/DME	AINSWORTH, NE VOR/DME	*7500
*5600 - MOCA		
AINSWORTH, NE VOR/DME	O'NEILL, NE VORTAC	4500
O'NEILL, NE VORTAC	SIoux CITY, IA VORTAC	3700
SIoux CITY, IA VORTAC	FORT DODGE, IA VORTAC	3000
FORT DODGE, IA VORTAC	WATERLOO, IA VORTAC	3000
WATERLOO, IA VORTAC	DUBUQUE, IA VORTAC	2900
DUBUQUE, IA VORTAC	ROCKFORD, IL VOR/DME	2900
ROCKFORD, IL VOR/DME	FARMM, IL FIX	2800
FARMM, IL FIX	NORTHBROOK, IL VOR/DME	2700
NORTHBROOK, IL VOR/DME	*MINCE, MI FIX	2500
*3500 - MRA		
MINCE, MI FIX	MUSKY, MI FIX	2500
MUSKY, MI FIX	KEELER, MI VOR/DME	2400
KEELER, MI VOR/DME	LITCHFIELD, MI VOR/DME	2600

95.6101 VOR FEDERAL AIRWAY V101

GILL, CO VOR/DME	LIBEL, CO FIX	*10000
*8900 - MOCA		
LIBEL, CO FIX	BROCC, CO FIX	16000
BROCC, CO FIX	LORIN, CO FIX	13000
LORIN, CO FIX	HAYDEN, CO VOR/DME	
	E BND	13000
	W BND	11000
HAYDEN, CO VOR/DME	STRIM, CO FIX	10000
STRIM, CO FIX	*RENAE, CO FIX	11000
*13000 - MRA		
RENAE, CO FIX	VERNAL, UT VOR/DME	11000
VERNAL, UT VOR/DME	*NEOLA, UT FIX	10000
*12000 - MCA NEOLA, UT FIX , W BND		
NEOLA, UT FIX	*WASATCH, UT VORTAC	15000
*11000 - MCA WASATCH, UT VORTAC , E BND		
WASATCH, UT VORTAC	OGDEN, UT VORTAC	7000
OGDEN, UT VORTAC	*KREBS, UT FIX	9400
*13000 - MRA		
KREBS, UT FIX	BLIDA, UT FIX	9400
BLIDA, UT FIX	MALTT, ID FIX	11400
MALTT, ID FIX	*BURLEY, ID VOR/DME	
	NW BND	**8000
	SE BND	**11400
*9300 - MCA BURLEY, ID VOR/DME , SE BND		
**7400 - MOCA		
BURLEY, ID VOR/DME	*REAPS, ID FIX	7000
*8600 - MCA REAPS, ID FIX , NW BND		
REAPS, ID FIX	HAILEY, ID NDB/DME	8600
HAILEY, ID NDB/DME	SOLDE, ID FIX	8600

95.6102 VOR FEDERAL AIRWAY V102

*SALT FLAT, TX VORTAC	CARLSBAD, NM VORTAC	10800
*10000 - MCA SALT FLAT, TX VORTAC , NE BND		
*CARLSBAD, NM VORTAC	HOBBS, NM VORTAC	5600
*7000 - MCA CARLSBAD, NM VORTAC , SW BND		
HOBBS, NM VORTAC	LUBBOCK, TX VORTAC	*6000
*5400 - MOCA		
LUBBOCK, TX VORTAC	RALLS, TX FIX	5000
RALLS, TX FIX	GUTHRIE, TX VORTAC	*5000
*4500 - MOCA		

FROM	TO	MEA
------	----	-----

95.6102 VOR FEDERAL AIRWAY V102 - CONTINUED

GUTHRIE, TX VORTAC *4000 - MRA **3000 - MOCA	*SNEED, TX FIX	**3700
SNEED, TX FIX *3500 - MRA	*ELECT, TX FIX	2700
ELECT, TX FIX	WICHITA FALLS, TX VORTAC	2700

95.6103 VOR FEDERAL AIRWAY V103

CHESTERFIELD, SC VOR/DME	GREENSBORO, NC VORTAC	2500
GREENSBORO, NC VORTAC	HENBY, VA FIX	3500
HENBY, VA FIX	TABER, VA FIX	5100
TABER, VA FIX	ROANOKE, VA VORTAC	5600
ROANOKE, VA VORTAC *6000 - MRA	*NATTS, WV FIX	5600
NATTS, WV FIX	VELLI, WV FIX	7000
VELLI, WV FIX *6400 - MOCA	ELKINS, WV VORTAC	*7000
ELKINS, WV VORTAC *3900 - MOCA	CLARKSBURG, WV VOR/DME	*5000
CLARKSBURG, WV VOR/DME	BELLAIRE, OH VOR/DME	#3400
#CKB R-335 UNUSABLE BELOW 9000, USE AIR R-158.		
BELLAIRE, OH VOR/DME *3000 - MOCA	ATWOO, OH FIX	*6000
ATWOO, OH FIX	AKRON, OH VOR/DME	3000
AKRON, OH VOR/DME *2700 - MOCA	U.S. CANADIAN BORDER	*9000
U.S. CANADIAN BORDER *2700 - MOCA	DETROIT, MI VOR/DME	*4000
DETROIT, MI VOR/DME *2400 - MOCA	PONTIAC, MI VORTAC	*3000
PONTIAC, MI VORTAC	LANSING, MI VORTAC	3000

95.6104 VOR FEDERAL AIRWAY V104

U.S. CANADIAN BORDER *1600 - MOCA	MASSENA, NY VORTAC	#*2100
#GNSS MEA ONLY		
MASSENA R-314 UNUSABLE GNSS REQUIRED		
MASSENA, NY VORTAC *2700 - MOCA	MALAE, NY FIX	#*3500
#GNSS MEA ONLY		
MASSENA R-119 UNUSABLE. GNSS REQUIRED		
MALAE, NY FIX	PLATTSBURGH, NY VORTAC	6100
PLATTSBURGH, NY VORTAC	BURLINGTON, VT VOR/DME	2600
BURLINGTON, VT VOR/DME	MONTPELIER, VT VOR/DME	6000
MONTPELIER, VT VOR/DME *4800 - MOCA	AYZOO, NH FIX	*5400
AYZOO, NH FIX *5600 - MOCA	BERLIN, NH VOR/DME	*7000
BERLIN, NH VOR/DME	ANSYN, ME FIX	6500
ANSYN, ME FIX	BANGOR, ME VORTAC	4000

FROM	TO	MEA
95.6105 VOR FEDERAL AIRWAY V105		
TUCSON, AZ VORTAC *6700 - MOCA	STANFIELD, AZ VORTAC	*8000
STANFIELD, AZ VORTAC	PHOENIX, AZ VORTAC	5000
PHOENIX, AZ VORTAC	KARLO, AZ FIX	10000
KARLO, AZ FIX *10000 - MOCA	DRAKE, AZ VORTAC	*12000
*10000 - GNSS MEA		
DRAKE, AZ VORTAC	WINDS, AZ FIX	10000
WINDS, AZ FIX *6000 - MOCA	BOULDER CITY, NV VORTAC	*7000
BOULDER CITY, NV VORTAC	*LAS VEGAS, NV VORTAC	6000
*8500 - MCA LAS VEGAS, NV	VORTAC, W BND	
LAS VEGAS, NV VORTAC	*HARLS, NV FIX W BND	10500
	E BND	7000
*11000 - MRA		
HARLS, NV FIX	LUCKY, NV FIX	10500
LUCKY, NV FIX *14000 - MRA	*HIDEN, CA FIX	14000
HIDEN, CA FIX	BEATTY, NV VORTAC NW BND	*11000
	SE BND	*12000
*8400 - MOCA		
BEATTY, NV VORTAC	COALDALE, NV VORTAC	*11000
*9600 - MOCA		
COALDALE, NV VORTAC	*YERIN, NV FIX	**14000
*12500 - MCA YERIN, NV FIX	SE BND	
**11200 - MOCA		
YERIN, NV FIX	CHIME, NV FIX NW BND	10000
	SE BND	11500
CHIME, NV FIX	MUSTANG, NV VORTAC	10000

95.6106 VOR FEDERAL AIRWAY V106

JOHNSTOWN, PA VORTAC *4500 - MOCA	HUDON, PA FIX	*5000
HUDON, PA FIX *4000 - MOCA	RASHE, PA FIX	*7000
*4000 - GNSS MEA		
RASHE, PA FIX *4000 - GNSS MEA	SELINGROVE, PA VORTAC	*14000
SELINGROVE, PA VORTAC	DIANO, PA FIX	3700
DIANO, PA FIX	WILKES-BARRE, PA VORTAC	4000
WILKES-BARRE, PA VORTAC	LAKE HENRY, PA VORTAC	4000
LAKE HENRY, PA VORTAC	WEARD, NY FIX	4000
WEARD, NY FIX *6000 - MRA	*WEETS, NY FIX	6000
		MAA - 14500
WEETS, NY FIX	PAWLING, NY VOR/DME	4000
PAWLING, NY VOR/DME *3500 - MOCA	COBOL, MA FIX	*4000
COBOL, MA FIX *3000 - MOCA	BARNES, MA VORTAC	*3500
BARNES, MA VORTAC *3000 - MOCA	GARDNER, MA VOR/DME	*3500
GARDNER, MA VOR/DME	MANCHESTER, NH VOR/DME	4000
MANCHESTER, NH VOR/DME *2100 - MOCA	RAYMY, NH FIX	*2600

FROM TO MEA

95.6106 VOR FEDERAL AIRWAY V106 - CONTINUED

RAYMY, NH FIX KENNEBUNK, ME VORTAC *5500
 *2200 - MOCA
 *3000 - GNSS MEA

95.6107 VOR FEDERAL AIRWAY V107

LOS ANGELES, CA VORTAC STABO, CA FIX 2500
 STABO, CA FIX *SANTA MONICA, CA VOR/DME 3000
 *3700 - MCA SANTA MONICA, CA VOR/DME , W BND
 SANTA MONICA, CA VOR/DME *FILLMORE, CA VORTAC 5000
 *7500 - MCA FILLMORE, CA VORTAC , NW BND
 FILLMORE, CA VORTAC PIRUE, CA FIX
 SE BND *8000
 NW BND *9000
 *7200 - MOCA
 PIRUE, CA FIX REYES, CA FIX *11000
 *9200 - MOCA
 REYES, CA FIX DERBB, CA FIX 11000
 DERBB, CA FIX AVENAL, CA VORTAC *7000
 *6500 - MOCA
 AVENAL, CA VORTAC *PANOCHÉ, CA VORTAC 7000
 *5500 - MCA PANOCHÉ, CA VORTAC , SE BND
 PANOCHÉ, CA VORTAC *CATHE, CA FIX **7000
 *7000 - MCA CATHE, CA FIX , NW BND
 **5700 - MOCA
 CATHE, CA FIX VINCO, CA FIX *7000
 *6400 - MOCA
 VINCO, CA FIX MABRY, CA FIX
 S BND 7000
 N BND 6000
 MABRY, CA FIX MISON, CA FIX
 N BND 5500
 S BND 7000
 MISON, CA FIX IMPLY, CA FIX
 SE BND 7000
 NW BND 4500
 IMPLY, CA FIX OAKLAND, CA VORTAC
 SE BND 7000
 NW BND 4000
 OAKLAND, CA VORTAC COMMO, CA FIX *5000
 *4000 - MOCA
 COMMO, CA FIX POINT REYES, CA VORTAC 5000
 POINT REYES, CA VORTAC BOARS, CA FIX 5000

95.6108 VOR FEDERAL AIRWAY V108

SANTA ROSA, CA VOR/DME SCAGGS ISLAND, CA VORTAC 4500
 SCAGGS ISLAND, CA VORTAC CONCORD, CA VOR/DME 3000
 CONCORD, CA VOR/DME OAKEY, CA FIX 3500
 OAKEY, CA FIX LINDEN, CA VORTAC 2000
 MEEKER, CO VOR/DME RED TABLE, CO VOR/DME *14000
 *12800 - MOCA
 RED TABLE, CO VOR/DME BLACK FOREST, CO VORTAC 16000
 *BLACK FOREST, CO VORTAC ADANE, CO FIX 9500
 *10400 - MCA BLACK FOREST, CO VORTAC , W BND
 ADANE, CO FIX HUGO, CO VORTAC 9000

FROM	TO	MEA
95.6108 VOR FEDERAL AIRWAY V108 - CONTINUED		
HUGO, CO VORTAC *6300 - MOCA	GOODLAND, KS VORTAC	*7000
GOODLAND, KS VORTAC	HILL CITY, KS VORTAC	5500
95.6109 VOR FEDERAL AIRWAY V109		
PANOCHÉ, CA VORTAC VOLTA, CA FIX *3000 - GNSS MEA #MANTRCA R-147 UNUSABLE	VOLTA, CA FIX #MANTECA, CA VORTAC	5000 *3000
MANTECA, CA VORTAC BYRON, CA FIX	BYRON, CA FIX ALTAM, CA FIX	2000
	W BND E BND	4500 3500
ALTAM, CA FIX *4700 - MCA	*SALAD, CA FIX SALAD, CA FIX , NE BND	5000
SALAD, CA FIX	OAKLAND, CA VORTAC	4000
95.6110 VOR FEDERAL AIRWAY V110		
DEMING, NM VORTAC	TRUTH OR CONSEQUENCES, NM VORTAC	8000
95.6111 VOR FEDERAL AIRWAY V111		
BIG SUR, CA VORTAC SALINAS, CA VORTAC CATHE, CA FIX KARNN, CA FIX PATYY, CA FIX *1500 - MOCA	SALINAS, CA VORTAC CATHE, CA FIX KARNN, CA FIX PATYY, CA FIX MODESTO, CA VOR/DME	7000 5500 5500 5000 *3000
95.6112 VOR FEDERAL AIRWAY V112		
HOQUIAM, WA VORTAC ILWAC, WA FIX ASTORIA, OR VOR/DME PITER, OR FIX	ILWAC, WA FIX ASTORIA, OR VOR/DME PITER, OR FIX BATTLE GROUND, WA VORTAC E BND W BND	2500 3000 5000 4000 5000
*BATTLE GROUND, WA VORTAC	GYMME, WA FIX E BND W BND	7000 6500
*4700 - MCA	BATTLE GROUND, WA VORTAC , E BND	
GYMME, WA FIX *6400 - MOCA	KLICKITAT, OR VOR/DME	*7000
KLICKITAT, OR VOR/DME *6000 - MRA	*LOAMS, OR FIX	5300
LOAMS, OR FIX *6000 - MRA	*ECHOD, OR FIX	4000
ECHOD, OR FIX	PENDLETON, OR VORTAC	4000

FROM	TO	MEA
95.6112 VOR FEDERAL AIRWAY V112 - CONTINUED		
PENDLETON, OR VORTAC	LYLES, WA FIX	4000
LYLES, WA FIX	*RODNA, WA FIX	**5000
*6000 - MRA		
**4400 - MOCA		
RODNA, WA FIX	SPOKANE, WA VORTAC	5000
SPOKANE, WA VORTAC	DIANN, WA FIX	
	SW BND	*7000
	NE BND	*11000
*5500 - MOCA		
DIANN, WA FIX	U.S. CANADIAN BORDER	*11000
*9700 - MOCA		

95.6113 VOR FEDERAL AIRWAY V113

MORRO BAY, CA VORTAC	PASO ROBLES, CA VORTAC	5000
PASO ROBLES, CA VORTAC	PRIEST, CA VOR	6000
PRIEST, CA VOR	*PANOCHÉ, CA VORTAC	7000
*5500 - MCA PANOCHÉ, CA VORTAC , SE BND		
PANOCHÉ, CA VORTAC	VOLTA, CA FIX	5000
VOLTA, CA FIX	#MANTECA, CA VORTAC	*3000
*3000 - GNSS MEA		
#MANTECA R-147 UNUSABLE		
MANTECA, CA VORTAC	LINDEN, CA VORTAC	2000
*LINDEN, CA VORTAC	KATSO, CA FIX	5000
*4000 - MCA LINDEN, CA VORTAC , NE BND		
*KATSO, CA FIX	SPOOK, CA FIX	10500
*9000 - MCA KATSO, CA FIX , NE BND		
*SPOOK, CA FIX	RICHY, CA FIX	**15000
*15000 - MCA SPOOK, CA FIX , N BND		
**12000 - MOCA		
RICHY, CA FIX	*MUSTANG, NV VORTAC	13000
*10500 - MCA MUSTANG, NV VORTAC , S BND		
MUSTANG, NV VORTAC	NICER, NV FIX	10300
NICER, NV FIX	ROBUD, NV FIX	*12000
*10600 - MOCA		
ROBUD, NV FIX	SOD HOUSE, NV VORTAC	*10000
*9000 - MOCA		
SOD HOUSE, NV VORTAC	ROME, OR VORTAC	10000
ROME, OR VORTAC	*RENOL, ID FIX	9400
*7300 - MCA RENOL, ID FIX , SW BND		
RENOL, ID FIX	*BOISE, ID VORTAC	6000
*8200 - MCA BOISE, ID VORTAC , NE BND		
BOISE, ID VORTAC	SALMON, ID VOR/DME	16500
SALMON, ID VOR/DME	SLIPP, MT FIX	13000
SLIPP, MT FIX	*COPPERTOWN, MT VOR/DME	
	SW BND	13000
	NE BND	11000
*10200 - MCA COPPERTOWN, MT VOR/DME , SW BND		
COPPERTOWN, MT VOR/DME	HELENA, MT VORTAC	*13000
*10800 - MOCA		
HELENA, MT VORTAC	LEWISTOWN, MT VOR/DME	10200

95.6114 VOR FEDERAL AIRWAY V114

PANHANDLE, TX VORTAC	CAUDE, TX FIX	*5400
*4900 - MOCA		
CAUDE, TX FIX	*DOGIN, TX FIX	5000
*6500 - MRA		
DOGIN, TX FIX	CHILDRESS, TX VORTAC	*5000
*4500 - MOCA		

FROM TO MEA

95.6114 VOR FEDERAL AIRWAY V114 - CONTINUED

CHILDRESS, TX VORTAC	VASTY, TX FIX	3700
VASTY, TX FIX	WICHITA FALLS, TX VORTAC	3200
WICHITA FALLS, TX VORTAC	BONHAM, TX VORTAC	3000
BONHAM, TX VORTAC	QUITMAN, TX VOR/DME	2500
QUITMAN, TX VOR/DME	GREGG COUNTY, TX VORTAC	2400
GREGG COUNTY, TX VORTAC	CARTH, TX FIX	2300
CARTH, TX FIX	EXITE, LA FIX	*3000
*1700 - MOCA		
EXITE, LA FIX	COVEX, LA FIX	*3500
*1700 - MOCA		
COVEX, LA FIX	*NUBOY, LA FIX	**4500
*6000 - MRA		
**1700 - MOCA		
NUBOY, LA FIX	BOYCE, LA FIX	
	SE BND	2000
	NW BND	4500
BOYCE, LA FIX	ALEXANDRIA, LA VORTAC	2000
ALEXANDRIA, LA VORTAC	*MIKLE, LA FIX	2000
*3000 - MRA		
MIKLE, LA FIX	BATON ROUGE, LA VORTAC	2000
BATON ROUGE, LA VORTAC	VEILS, LA FIX	2800
VEILS, LA FIX	RESERVE, LA VOR/DME	2000
RESERVE, LA VOR/DME	*SLIDD, LA FIX	2000
*5000 - MCA SLIDD, LA FIX, NE BND		
SLIDD, LA FIX	GULFPORT, MS VORTAC	*5000
*2000 - GNSS MEA		
GULFPORT, MS VORTAC	*MINDO, MS FIX	**6000
*6000 - MRA		
**2000 - GNSS MEA		
MINDO, MS FIX	EATON, MS VORTAC	*6000
*2000 - GNSS MEA		

95.6115 VOR FEDERAL AIRWAY V115

CRESTVIEW, FL VORTAC	PIGON, AL FIX	2500
PIGON, AL FIX	*REDDI, AL FIX	2500
*5500 - MRA		
REDDI, AL FIX	MONTGOMERY, AL VORTAC	2500
MONTGOMERY, AL VORTAC	BEING, AL FIX	2000
BEING, AL FIX	VULCAN, AL VORTAC	3000
VULCAN, AL VORTAC	WILED, AL FIX	3500
WILED, AL FIX	CHOO CHOO, TN VORTAC	4000
CHOO CHOO, TN VORTAC	ETOWA, TN FIX	3000
ETOWA, TN FIX	GROSS, TN FIX	3100
GROSS, TN FIX	VOLUNTEER, TN VORTAC	3000
VOLUNTEER, TN VORTAC	MALIN, TN FIX	4500
MALIN, TN FIX	ROSAR, KY FIX	5000
ROSAR, KY FIX	HAZARD, KY VOR/DME	5200
HAZARD, KY VOR/DME	WHIRL, WV FIX	4000
WHIRL, WV FIX	CHARLESTON, WV VORTAC	3000
CHARLESTON, WV VORTAC	*MORAN, WV FIX	3000
*3500 - MRA		
MORAN, WV FIX	PARKERSBURG, WV VORTAC	3000
PARKERSBURG, WV VORTAC	NEWCOMERSTOWN, OH VOR/DME	3000
NEWCOMERSTOWN, OH VOR/DME	ATWOO, OH FIX	3000
ATWOO, OH FIX	CAPEL, OH FIX	*6000
*3500 - MOCA		
CAPEL, OH FIX	FRANKLIN, PA VOR	3500
FRANKLIN, PA VOR	TIDIOUTE, PA VORTAC	3800
TIDIOUTE, PA VORTAC	JAMESTOWN, NY VOR/DME	*4000
*3400 - MOCA		
JAMESTOWN, NY VOR/DME	LANGS, NY FIX	3900

FROM	TO	MEA
------	----	-----

95.6115 VOR FEDERAL AIRWAY V115 - CONTINUED

LANGS, NY FIX *3500 - MOCA *5000 - GNSS MEA	BUFFALO, NY VOR/DME	*11000
---	---------------------	--------

95.6116 VOR FEDERAL AIRWAY V116

WILLA, IL FIX *3000 - MRA **1800 - MOCA	*NEPTS, MI FIX	**4000
NEPTS, MI FIX KEELER, MI VOR/DME KALAMAZOO, MI VOR/DME JACKSON, MI VOR/DME JACKSON, MI VOR/DME SALEM, MI VORTAC *2400 - MOCA	KEELER, MI VOR/DME KALAMAZOO, MI VOR/DME JACKSON, MI VOR/DME SALEM, MI VORTAC U.S. CANADIAN BORDER	2400 2600 2700 3000 *3000
U.S. CANADIAN BORDER U.S. CANADIAN BORDER *11000 - MRA **1900 - MOCA	WINDSOR, CANADA VOR/DME *TRACE, OH FIX	3000 **7000
TRACE, OH FIX *2200 - MOCA	ERIE, PA VORTAC	*3000
ERIE, PA VORTAC BRADFORD, PA VOR/DME STONYFORK, PA VOR/DME WILKES-BARRE, PA VORTAC	BRADFORD, PA VOR/DME STONYFORK, PA VOR/DME WILKES-BARRE, PA VORTAC SPARTA, NJ VORTAC	4000 4500 4000 4000

95.6117 VOR FEDERAL AIRWAY V117

PARKERSBURG, WV VORTAC BELLAIRE, OH VOR/DME	BELLAIRE, OH VOR/DME WISKE, WV FIX	3000 3300
--	---------------------------------------	--------------

95.6118 VOR FEDERAL AIRWAY V118

MEDICINE BOW, WY VOR/DME LARAMIE, WY VOR/DME *9900 - MCA SENSE, WY FIX , W BND	LARAMIE, WY VOR/DME *SENSE, WY FIX CHEYENNE, WY VORTAC	9400 11000 8800
--	--	-----------------------

95.6119 VOR FEDERAL AIRWAY V119

NEWCOMBE, KY VORTAC HENDERSON, WV VORTAC *3500 - MRA	HENDERSON, WV VORTAC *JACEE, WV FIX	2800 2700
JACEE, WV FIX PARKERSBURG, WV VORTAC ANTIO, OH FIX ANTIO, OH FIX BURGS, WV FIX *3100 - MOCA	PARKERSBURG, WV VORTAC ANTIO, OH FIX BURGS, WV FIX OTOWN, PA FIX	2700 3000 3400 *3700
OTOWN, PA FIX *4400 - MOCA	INDIAN HEAD, PA VORTAC	*5000
INDIAN HEAD, PA VORTAC *4500 - MOCA	QUARY, PA FIX	*5000
QUARY, PA FIX TALLS, PA FIX *3200 - MOCA	TALLS, PA FIX CLARION, PA VOR/DME	4000 *3700

FROM TO MEA

95.6119 VOR FEDERAL AIRWAY V119 - CONTINUED

CLARION, PA VOR/DME # BFD R-232 UNUSABLE. USE CIP R-050.	BRADFORD, PA VOR/DME	#4200
BRADFORD, PA VOR/DME *4000 - MOCA	WELLSVILLE, NY VORTAC	*4500
WELLSVILLE, NY VORTAC	BURST, NY FIX	4500
BURST, NY FIX	GENESE0, NY VOR/DME	4000
GENESE0, NY VOR/DME	ROCHESTER, NY VOR/DME	2800

95.6120 VOR FEDERAL AIRWAY V120

*SEATTLE, WA VORTAC *6300 - MCA SEATTLE, WA VORTAC , E BND **5000 - MOCA	TAGOR, WA FIX E BND W BND	**8500 **5000
TAGOR, WA FIX *11400 - MOCA	CASHS, WA FIX	*12000
CASHS, WA FIX	*WENATCHEE, WA VOR/DME E BND W BND	**7500 **12000
*8200 - MCA WENATCHEE, WA VOR/DME , W BND **6700 - MOCA		
WENATCHEE, WA VOR/DME	EPHRATA, WA VORTAC	5500
EPHRATA, WA VORTAC	WIPES, WA FIX	4000
WIPES, WA FIX	*SPOKANE, WA VORTAC	5000
*5200 - MCA SPOKANE, WA VORTAC , E BND		
SPOKANE, WA VORTAC	KARPS, ID FIX E BND W BND	*9000 *8000
*7200 - MOCA		
KARPS, ID FIX	MULLAN PASS, ID VOR/DME	9100
MULLAN PASS, ID VOR/DME *9600 - MOCA	CHARL, MT FIX	*13000
CHARL, MT FIX *7000 - MRA *7900 - MCA SHIMY, MT FIX , W BND **12100 - MOCA	*SHIMY, MT FIX	**13000
SHIMY, MT FIX	GREAT FALLS, MT VORTAC	6800
GREAT FALLS, MT VORTAC	LEWISTOWN, MT VOR/DME	8400
LEWISTOWN, MT VOR/DME	ESTRO, MT FIX	7700
ESTRO, MT FIX *7500 - MOCA	MILES CITY, MT VOR/DME	*9000
MILES CITY, MT VOR/DME *6600 - MOCA	DUPREE, SD VORTAC	*10000
DUPREE, SD VORTAC *3700 - MOCA	PIERRE, SD VORTAC	*4300
PIERRE, SD VORTAC *3400 - MOCA	MITCHELL, SD VOR/DME	*3900
MITCHELL, SD VOR/DME	FRYRE, SD FIX	3700
FRYRE, SD FIX	SIOUX FALLS, SD VORTAC	3700
SIOUX FALLS, SD VORTAC	BILOO, IA FIX	3600
BILOO, IA FIX *8000 - MRA **2900 - MOCA	*GRUVE, IA FIX	**6800
GRUVE, IA FIX	BANCO, IA FIX	6800
BANCO, IA FIX	MASON CITY, IA VORTAC	3000
MASON CITY, IA VORTAC *3500 - MRA	*AREDA, IA FIX	3000
AREDA, IA FIX *3500 - MRA	*SEATS, IA FIX	3000
SEATS, IA FIX	WATERLOO, IA VORTAC	3000

FROM	TO	MEA
95.6121 VOR FEDERAL AIRWAY V121		
FORT JONES, CA VOR/DME *10000 - MRA *9000 - MCA BAYTS, OR FIX , S BND **9400 - MOCA	*BAYTS, OR FIX	**10000
BAYTS, OR FIX *7500 - MOCA	ROGUE VALLEY, OR VORTAC	*8000
ROGUE VALLEY, OR VORTAC MOURN, OR FIX	MOURN, OR FIX *ROSEBURG, OR VOR/DME W BND E BND	7000 5500 7000
	*5700 - MCA ROSEBURG, OR VOR/DME , E BND	
ROSEBURG, OR VOR/DME NORTH BEND, OR VORTAC	NORTH BEND, OR VORTAC *SCOTY, OR FIX NE BND SW BND	5000 5000 4200
	*5500 - MRA	
SCOTY, OR FIX *7000 - MRA **4500 - MOCA	*VAUGN, OR FIX	**5000
VAUGN, OR FIX	*EUGENE, OR VORTAC NE BND SW BND	4000 5000
	*3700 - MCA EUGENE, OR VORTAC , NE BND	
EUGENE, OR VORTAC	DOSEE, OR FIX NE BND SW BND	6000 5200
DOSEE, OR FIX	*VIDAS, OR FIX NE BND SW BND	8000 6000
	*8800 - MCA VIDAS, OR FIX , NE BND	
VIDAS, OR FIX	WHIFF, OR FIX NE BND SW BND	*13000 *9000
	*7500 - MOCA	
	*8000 - GNSS MEA	
WHIFF, OR FIX *12200 - MOCA	SNOKY, OR FIX	*13000
SNOKY, OR FIX	*DESCHUTES, OR VORTAC NE BND SW BND	8000 13000
	*10000 - MCA DESCHUTES, OR VORTAC , SW BND	
DESCHUTES, OR VORTAC	JABOT, OR FIX NE BND SW BND	9000 7000
JABOT, OR FIX	KIMBERLY, OR VORTAC	9000
KIMBERLY, OR VORTAC *10000 - MCA BAKER CITY, OR	*BAKER CITY, OR VOR/DME VOR/DME , SW BND	12000
BAKER CITY, OR VOR/DME	DONNELLY, ID VORTAC	11000
DONNELLY, ID VORTAC	SALMON, ID VOR/DME	12000
SALMON, ID VOR/DME	NOSEY, MT FIX	12000
NOSEY, MT FIX	DILLON, MT VOR/DME E BND W BND	*10000 *12000
	*9100 - MOCA	

FROM	TO	MEA
95.6122 VOR FEDERAL AIRWAY V122		
CRESCENT CITY, CA VORTAC	REFIX, CA FIX	
	SW BND	4000
	NE BND	8000
REFIX, CA FIX	OBRIN, OR FIX	
	NE BND	8000
	SW BND	6000
OBRIN, OR FIX	*PAPLE, OR FIX	8000
*10100 - MRA		
PAPLE, OR FIX	GNATS, OR FIX	8000
GNATS, OR FIX	ROGUE VALLEY, OR VORTAC	
	SW BND	8000
	NE BND	5500
ROGUE VALLEY, OR VORTAC	BRUTE, OR FIX	
	E BND	9000
	W BND	5000
BRUTE, OR FIX	LANKS, OR FIX	
	W BND	*6500
	E BND	*9000
*5800 - MOCA		
LANKS, OR FIX	KLAMATH FALLS, OR VORTAC	*9000
*8500 - MOCA		
KLAMATH FALLS, OR VORTAC	LAKEVIEW, OR VORTAC	9600
LAKEVIEW, OR VORTAC	ROME, OR VORTAC	12000

95.6123 VOR FEDERAL AIRWAY V123

MITCH, MD FIX	SWANN, MD FIX	*5500
*3000 - GNSS MEA		
SWANN, MD FIX	TACKS, MD FIX	*7000
*4000 - GNSS MEA		
TACKS, MD FIX	WOODSTOWN, NJ VORTAC	*2000
*1500 - MOCA		
WOODSTOWN, NJ VORTAC	ROBBINSVILLE, NJ VORTAC	*3000
*2000 - MOCA		
ROBBINSVILLE, NJ VORTAC	MINKS, NJ FIX	2000
MINKS, NJ FIX	LA GUARDIA, NY VOR/DME	2600
LA GUARDIA, NY VOR/DME	FAMMA, NY FIX	2000
FAMMA, NY FIX	HAARP, CT FIX	3000
HAARP, CT FIX	*RYMES, CT FIX	**5000
*5000 - MRA		
**2000 - MOCA		
**3000 - GNSS MEA		
RYMES, CT FIX	CARMEL, NY VOR/DME	2500
CARMEL, NY VOR/DME	*WIGAN, NY FIX	3000
*4500 - MRA		
WIGAN, NY FIX	GROUP, NY FIX	*8000
*3000 - GNSS MEA		
GROUP, NY FIX	ALBANY, NY VORTAC	*6000
*2300 - MOCA		
*2800 - GNSS MEA		
ALBANY, NY VORTAC	*CAMBRIDGE, NY VOR/DME	***4000
*4500 - MCA CAMBRIDGE, NY	VOR/DME , N BND	
**3000 - MOCA		
#ALB R-067 UNUSABLE.		
CAMBRIDGE, NY VOR/DME	GLENS FALLS, NY VORTAC	4500

FROM	TO	MEA
------	----	-----

95.6124 VOR FEDERAL AIRWAY V124

BONHAM, TX VORTAC	PARIS, TX VOR/DME	2400
PARIS, TX VOR/DME	DEENS, AR FIX	*4000
*2000 - MOCA		
DEENS, AR FIX	HOT SPRINGS, AR VOR/DME	*5000
*2600 - MOCA		
HOT SPRINGS, AR VOR/DME	LONNS, AR FIX	3000
LONNS, AR FIX	LITTLE ROCK, AR VORTAC	*2500
*1900 - MOCA		
LITTLE ROCK, AR VORTAC	TAFTE, AR FIX	*4000
*1600 - MOCA		
TAFTE, AR FIX	*HILLE, AR FIX	**6000
*6000 - MRA		
**1500 - MOCA		
HILLE, AR FIX	GILMORE, AR VOR/DME	*4000
*1700 - MOCA		
GILMORE, AR VOR/DME	JACKS CREEK, TN VOR/DME	*3000
*2300 - MOCA		
JACKS CREEK, TN VOR/DME	GRAHAM, TN VORTAC	2500

95.6125 VOR FEDERAL AIRWAY V125

CAPE GIRARDEAU, MO	NIKEL, IL FIX	3500
VOR/DME	BURCK, IL FIX	*4500
NIKEL, IL FIX		
*2300 - MOCA		
BURCK, IL FIX	ST LOUIS, MO VORTAC	*3500
*2600 - MOCA		

95.6126 VOR FEDERAL AIRWAY V126

BEARZ, IN FIX	HALIE, IN FIX	3000
HALIE, IN FIX	INKEN, IN FIX	*4000
*2300 - MOCA		
INKEN, IN FIX	GOSHEN, IN VORTAC	2600
GOSHEN, IN VORTAC	BAGEL, IN FIX	2700
BAGEL, IN FIX	EDGE, OH FIX	*3000
*2400 - MOCA		
EDGE, OH FIX	WATERVILLE, OH VOR/DME	3000
WATERVILLE, OH VOR/DME	SANDUSKY, OH VOR/DME	3000
SANDUSKY, OH VOR/DME	DRYER, OH VOR/DME	3000
DRYER, OH VOR/DME	JEFFERSON, OH VOR/DME	3000
JEFFERSON, OH VOR/DME	ERIE, PA VORTAC	2700
ERIE, PA VORTAC	BRADFORD, PA VOR/DME	4000
BRADFORD, PA VOR/DME	STONYFORK, PA VOR/DME	4500
STONYFORK, PA VOR/DME	LAKE HENRY, PA VORTAC	4000
LAKE HENRY, PA VORTAC	SPARTA, NJ VORTAC	4000

95.6127 VOR FEDERAL AIRWAY V127

BRADFORD, IL VORTAC	*WYNET, IL FIX	2700
*3300 - MRA		
WYNET, IL FIX	POLO, IL VOR/DME	2600
POLO, IL VOR/DME	ROCKFORD, IL VOR/DME	2700

FROM	TO	MEA
------	----	-----

95.6128 VOR FEDERAL AIRWAY V128

JANESVILLE, WI VOR/DME	ROCKFORD, IL VOR/DME	2700
ROCKFORD, IL VOR/DME	KELSI, IL FIX	2700
KELSI, IL FIX	SMARS, IL FIX	3000
SMARS, IL FIX	KANKAKEE, IL VOR/DME	2700
KANKAKEE, IL VOR/DME	KENLA, IN FIX	2400
KENLA, IN FIX	VAGES, IN FIX	2600
VAGES, IN FIX	*POTES, IN FIX	**4000
*4000 - MRA		
**2300 - MOCA		
POTES, IN FIX	JAKKS, IN FIX	*4000
*2300 - MOCA		
JAKKS, IN FIX	BRICKYARD, IN VORTAC	2700
BRICKYARD, IN VORTAC	DECEE, IN FIX	2600
DECEE, IN FIX	CINCINNATI, KY VORTAC	2800
CINCINNATI, KY VORTAC	CALIF, KY FIX	2600
CALIF, KY FIX	YORK, KY VORTAC	4000
YORK, KY VORTAC	CROUP, OH FIX	3300
CROUP, OH FIX	RULEY, WV FIX	3100
RULEY, WV FIX	CHARLESTON, WV VORTAC	3500
CHARLESTON, WV VORTAC	SWIFT, WV FIX	3400
SWIFT, WV FIX	BITES, WV FIX	*5000
*4400 - MOCA		
*4400 - GNSS MEA		
BITES, WV FIX	VELLI, WV FIX	7000
VELLI, WV FIX	BOIER, WV FIX	*8000
*7100 - MOCA		
*7100 - GNSS MEA		
BOIER, WV FIX	LURAY, VA FIX	*10000
*6900 - MOCA		
*6900 - GNSS MEA		
LURAY, VA FIX	CASANOVA, VA VORTAC	6300

95.6129 VOR FEDERAL AIRWAY V129

SPINNER, IL VORTAC	PEORIA, IL VORTAC	*2500
*2000 - MOCA		
PEORIA, IL VORTAC	GENSO, IL FIX	2500
GENSO, IL FIX	DAVENPORT, IA VORTAC	3000
DAVENPORT, IA VORTAC	DUBUQUE, IA VORTAC	*2900
*2300 - MOCA		
DUBUQUE, IA VORTAC	QUEST, WI FIX	*3100
*2600 - MOCA		
QUEST, WI FIX	NODINE, MN VORTAC	3000
NODINE, MN VORTAC	EAU CLAIRE, WI VORTAC	3000
EAU CLAIRE, WI VORTAC	DULUTH, MN VORTAC	*4000
*3100 - MOCA		
DULUTH, MN VORTAC	HIBBING, MN VOR/DME	3300
HIBBING, MN VOR/DME	INTERNATIONAL FALLS, MN VORTAC	*3600
*3100 - MOCA		
INTERNATIONAL FALLS, MN VORTAC	U.S. CANADIAN BORDER	2500
U.S. CANADIAN BORDER	BOFIN, CANADA FIX	2500

FROM	TO	MEA
------	----	-----

95.6130 VOR FEDERAL AIRWAY V130

ALBANY, NY VORTAC *3900 - MOCA *4000 - GNSS MEA	STELA, MA FIX	*6000
STELA, MA FIX	BRADLEY, CT VORTAC	3900
BRADLEY, CT VORTAC	NORWICH, CT VOR/DME	2600
NORWICH, CT VOR/DME	MINNK, RI FIX	2000
MINNK, RI FIX	FALMA, RI FIX	3000
FALMA, RI FIX	MARTHAS VINEYARD, MA VOR/DME	3000

95.6131 VOR FEDERAL AIRWAY V131

OKMULGEE, OK VOR/DME	TULSA, OK VORTAC	2700
TULSA, OK VORTAC	TYROE, KS FIX	3000
TYROE, KS FIX	CHANUTE, KS VOR/DME	2800
CHANUTE, KS VOR/DME	TOPEKA, KS VORTAC	2900

95.6132 VOR FEDERAL AIRWAY V132

MEDICINE BOW, WY VOR/DME	MOIST, WY FIX	9500
MOIST, WY FIX	CHEYENNE, WY VORTAC	9000
CHEYENNE, WY VORTAC	RAYME, CO FIX	8500
RAYME, CO FIX	AKRON, CO VOR/DME	6800
AKRON, CO VOR/DME	GOODLAND, KS VORTAC	6400
GOODLAND, KS VORTAC	ORION, KS FIX	5500
ORION, KS FIX	*RANSO, KS FIX	**10000
*10000 - MRA **4200 - MOCA		
RANSO, KS FIX	DISKS, KS FIX	*10000
*4400 - MOCA		
DISKS, KS FIX	*SPELT, KS FIX	**5000
*5000 - MRA **3300 - MOCA		
SPELT, KS FIX	HUTCHINSON, KS VOR/DME	3200
HUTCHINSON, KS VOR/DME	WAIVE, KS FIX	4000
WAIVE, KS FIX	*FLOSS, KS FIX	3300
*5000 - MRA		
FLOSS, KS FIX	CHANUTE, KS VOR/DME	*5000
*2800 - MOCA		
CHANUTE, KS VOR/DME	NALLY, KS FIX	2800
NALLY, KS FIX	NASHE, MO FIX	2700
NASHE, MO FIX	SPRINGFIELD, MO VORTAC	3000
SPRINGFIELD, MO VORTAC	FORNEY, MO VOR	3000
FORNEY, MO VOR	LENOX, MO FIX	3000

95.6133 VOR FEDERAL AIRWAY V133

LINCO, NC FIX	BARRETT'S MOUNTAIN, NC VOR/DME	4000
BARRETT'S MOUNTAIN, NC VOR/DME	MULBE, NC FIX	5400
MULBE, NC FIX	STOVE, VA FIX	7200
STOVE, VA FIX	PINEE, WV FIX	*13000
*7000 - MOCA		
*7000 - GNSS MEA		
PINEE, WV FIX	CHARLESTON, WV VORTAC	*7000
*5000 - MOCA		
*5000 - GNSS MEA		

FROM TO MEA

95.6133 VOR FEDERAL AIRWAY V133 - CONTINUED

CHARLESTON, WV VORTAC	ZANESVILLE, OH VOR/DME	3000
ZANESVILLE, OH VOR/DME	TIVERTON, OH VOR/DME	3000
TIVERTON, OH VOR/DME	MANSFIELD, OH VORTAC	3000
MANSFIELD, OH VORTAC	SANDUSKY, OH VOR/DME	3000
SANDUSKY, OH VOR/DME	GEMNI, OH FIX	*3000
*2000 - MOCA		
GEMNI, OH FIX	U.S. CANADIAN BORDER	3400
U.S. CANADIAN BORDER	DETROIT, MI VOR/DME	*3400
*2300 - MOCA		
DETROIT, MI VOR/DME	SALEM, MI VORTAC	*3000
*2300 - MOCA		
SALEM, MI VORTAC	SAGINAW, MI VOR/DME	3000
SAGINAW, MI VOR/DME	WHIPP, MI FIX	2400
WHIPP, MI FIX	*LADIN, MI FIX	**5000
*5000 - MRA		
**2800 - MOCA		
LADIN, MI FIX	BORIN, MI FIX	*5000
*2700 - MOCA		
BORIN, MI FIX	TRAVERSE CITY, MI VORTAC	*5000
*2500 - MOCA		
TRAVERSE CITY, MI VORTAC	ESCANABA, MI VOR/DME	*5000
*2700 - MOCA		
ESCANABA, MI VOR/DME	SAWYER, MI VOR/DME	2800
SAWYER, MI VOR/DME	HOUGHTON, MI VOR/DME	*4500
*3400 - MOCA		
HOUGHTON, MI VOR/DME	U.S. CANADIAN BORDER	*3100
*2500 - MOCA		
U.S. CANADIAN BORDER	U.S. CANADIAN BORDER	#2800
#FOR THAT AIRSPACE OVER U.S. TERRITORY.		
U.S. CANADIAN BORDER	INTERNATIONAL FALLS, MN VORTAC	*3000
*2500 - MOCA		
INTERNATIONAL FALLS, MN VORTAC	RED LAKE, CANADA VOR/DME	##6500
*2800 - MOCA		
#FOR THAT AIRSPACE OVER U.S. TERRITORY.		

95.6134 VOR FEDERAL AIRWAY V134

*FAIRFIELD, UT VORTAC	CARBON, UT VOR/DME	#13000
*10800 - MCA	FAIRFIELD, UT VORTAC, E BND	
#MEA IS ESTABLISHED WITH A GAP IN NAVIGATION SIGNAL COVERAGE.		
*CARBON, UT VOR/DME	GRAND JUNCTION, CO VOR/DME	
	W BND	11900
*10200 - MCA	CARBON, UT VOR/DME, W BND	
GRAND JUNCTION, CO VOR/DME	PACES, CO FIX	11500
PACES, CO FIX	SLOLM, CO FIX	13000
SLOLM, CO FIX	*GLENO, CO FIX	14000
*16000 - MRA		
GLENO, CO FIX	RED TABLE, CO VOR/DME	14000
RED TABLE, CO VOR/DME	HERLS, CO FIX	16000
	E BND	14000
	W BND	16000
HERLS, CO FIX	*FUNDS, CO FIX	16000
*16500 - MRA		
FUNDS, CO FIX	BREWS, CO FIX	16500
BREWS, CO FIX	*FALCON, CO VORTAC	
	W BND	16500
	E BND	10000
*11600 - MCA	FALCON, CO VORTAC, W BND	

FROM TO MEA

95.6135 VOR FEDERAL AIRWAY V135

BARD, AZ VORTAC *3900 - MOCA	BLYTHE, CA VORTAC	*5000
BLYTHE, CA VORTAC	PARKER, CA VORTAC	5400
PARKER, CA VORTAC	NEEDLES, CA VORTAC	6000
NEEDLES, CA VORTAC	*GOFFS, CA VORTAC	
	NW BND	8000
	SE BND	6300
*8600 - MCA GOFFS, CA VORTAC , NW BND		
GOFFS, CA VORTAC	*WHIGG, CA FIX	**12000
*12000 - MRA		
**9500 - MOCA		
WHIGG, CA FIX	CLARR, CA FIX	*12000
*9900 - MOCA		
CLARR, CA FIX	*HIDEN, CA FIX	**12000
*14000 - MRA		
**8500 - MOCA		
HIDEN, CA FIX	BEATTY, NV VORTAC	
	NW BND	*11000
	SE BND	*12000
*8400 - MOCA		
BEATTY, NV VORTAC	TEZUM, NV FIX	*11000
*9600 - MOCA		
TEZUM, NV FIX	TONOPAH, NV VORTAC	11000

95.6136 VOR FEDERAL AIRWAY V136

HINCH MOUNTAIN, TN VORTAC	SWELL, TN FIX	5000
SWELL, TN FIX	VOLUNTEER, TN VORTAC	3000
VOLUNTEER, TN VORTAC	AUBRY, TN FIX	5000
AUBRY, TN FIX	*PITTE, TN FIX	6000
*7000 - MCA PITTE, TN FIX , E BND		
PITTE, TN FIX	AFTEN, TN FIX	7000
AFTEN, TN FIX	HOLSTON MOUNTAIN, TN VORTAC	6000
HOLSTON MOUNTAIN, TN VORTAC	DAMAS, TN FIX	6000
DAMAS, TN FIX	STOVE, VA FIX	7500
STOVE, VA FIX	SPEEL, VA FIX	6000
SPEEL, VA FIX	PULASKI, VA VORTAC	5400
PULASKI, VA VORTAC	PIGGS, VA FIX	5500
PIGGS, VA FIX	DUNCE, VA FIX	3500
DUNCE, VA FIX	SOUTH BOSTON, VA VORTAC	2800
SOUTH BOSTON, VA VORTAC	*ALDAN, NC FIX	2600
*3000 - MRA		
ALDAN, NC FIX	RALEIGH/DURHAM, NC VORTAC	2600
RALEIGH/DURHAM, NC VORTAC	LANHO, NC FIX	3000
LANHO, NC FIX	FAYETTEVILLE, NC VOR/DME	2000
FAYETTEVILLE, NC VOR/DME	GRAND STRAND, SC VORTAC	*3000
*2100 - MOCA		

95.6137 VOR FEDERAL AIRWAY V137

IMPERIAL, CA VORTAC	*BRAWL, CA FIX	**3700
*4500 - MRA		
**2300 - MOCA		
BRAWL, CA FIX	HENOM, CA FIX	3700
HENOM, CA FIX	THERMAL, CA VORTAC	3900
THERMAL, CA VORTAC	*PALM SPRINGS, CA VORTAC	4000
*11200 - MCA PALM SPRINGS, CA VORTAC , NW BND		

FROM TO MEA

95.6137 VOR FEDERAL AIRWAY V137 - CONTINUED

PALM SPRINGS, CA VORTAC	*WHETO, CA FIX NW BND SE BND	**12000 **7000
*12400 - MCA WHETO, CA FIX , NW BND		
**6000 - MOCA		
WHETO, CA FIX	MORON, CA FIX SE BND NW BND	12000 13500
MORON, CA FIX	*ARRAN, CA FIX	13500
*12000 - MCA ARRAN, CA FIX , E BND		
ARRAN, CA FIX	*PALMDALE, CA VORTAC	10700
*7000 - MCA PALMDALE, CA VORTAC , E BND		
PALMDALE, CA VORTAC	VICKY, CA FIX W BND E BND	7000 5000
VICKY, CA FIX	JEFFY, CA FIX	8000
JEFFY, CA FIX	GORMAN, CA VORTAC E BND W BND	8000 9000
GORMAN, CA VORTAC	*TAFTO, CA FIX	10000
*9000 - MCA TAFTO, CA FIX , SE BND		
TAFTO, CA FIX	AVENAL, CA VORTAC SE BND NW BND	5500 4500
AVENAL, CA VORTAC	PRIEST, CA VOR	6500
PRIEST, CA VOR	SALINAS, CA VORTAC	6000

95.6138 VOR FEDERAL AIRWAY V138

RIVERTON, WY VOR/DME	HUNTZ, WY FIX	9000
HUNTZ, WY FIX	MEDICINE BOW, WY VOR/DME	11200
MEDICINE BOW, WY VOR/DME	MILKY, WY FIX	10600
MILKY, WY FIX	CHEYENNE, WY VORTAC	9200
CHEYENNE, WY VORTAC	PIETY, WY FIX	8000
PIETY, WY FIX	SIDNEY, NE VORTAC	7600
GRAND ISLAND, NE VORTAC	BRADY, NE FIX	3600
BRADY, NE FIX	GAMBL, NE FIX	4100
GAMBL, NE FIX	LINCOLN, NE VORTAC	3300
LINCOLN, NE VORTAC	OMAHA, IA VORTAC	4000
OMAHA, IA VORTAC	*MADUP, IA FIX	**4500
*5500 - MRA		
**2900 - MOCA		
**3000 - GNSS MEA		
MADUP, IA FIX	FORT DODGE, IA VORTAC	*3900
*2900 - MOCA		
*3000 - GNSS MEA		
FORT DODGE, IA VORTAC	MASON CITY, IA VORTAC	3000
MASON CITY, IA VORTAC	WAUKON, IA VORTAC	3000

95.6139 VOR FEDERAL AIRWAY V139

FLORENCE, SC VORTAC	*DELKO, NC FIX	2000
*2500 - MRA		
DELKO, NC FIX	WILMINGTON, NC VORTAC	2000
WILMINGTON, NC VORTAC	*KOBBY, NC FIX	2000
*4000 - MRA		

FROM	TO	MEA
------	----	-----

95.6139 VOR FEDERAL AIRWAY V139 - CONTINUED

KOBBY, NC FIX *4000 - MRA	*WIDGE, NC FIX	2000
WIDGE, NC FIX	NEW BERN, NC VOR/DME	2000
NEW BERN, NC VOR/DME *4000 - MCA	*PEARS, NC FIX	2000
PEARS, NC FIX *5000 - MCA	*SUNNS, NC FIX	**6000
*2000 - MOCA		
SUNNS, NC FIX *1600 - MOCA	NORFOLK, VA VORTAC	*2000
NORFOLK, VA VORTAC *1800 - MOCA	CAPE CHARLES, VA VORTAC	*2500
CAPE CHARLES, VA VORTAC	SNOW HILL, MD VORTAC	2000
SNOW HILL, MD VORTAC	CBEAV, MD FIX	2000
CBEAV, MD FIX *1700 - MOCA	SEA ISLE, NJ VORTAC	*2500
SEA ISLE, NJ VORTAC *4000 - GNSS MEA	AVALO, NJ FIX	*4500
AVALO, NJ FIX *4000 - GNSS MEA	HARBO, NJ FIX	*6000
HARBO, NJ FIX *6000 - MRA	*DRIFT, NJ FIX	**7500
**3000 - GNSS MEA		
DRIFT, NJ FIX *3000 - GNSS MEA	MANTA, NJ FIX	*12000
MANTA, NJ FIX *2000 - MOCA	PLUME, NJ FIX	*7000
*3000 - GNSS MEA		
PLUME, NJ FIX *5000 - MRA	*KOPPY, NY FIX	**4000
**3000 - MOCA		
**3000 - GNSS MEA		
KOPPY, NY FIX *3000 - MOCA	BEADS, NY FIX	*4000
*3000 - GNSS MEA		
BEADS, NY FIX *1600 - MOCA	HAMPTON, NY VORTAC	*2500
HAMPTON, NY VORTAC	PROVIDENCE, RI VORTAC	2000
PROVIDENCE, RI VORTAC *2000 - GNSS MEA	INNDY, MA FIX	*3000
INNDY, MA FIX *6000 - MRA	*TONNI, MA FIX	6000
TONNI, MA FIX *4000 - GNSS MEA	SEEDY, NH FIX	*5000
SEEDY, NH FIX *1800 - MOCA	KENNEBUNK, ME VORTAC	*2500

95.6140 VOR FEDERAL AIRWAY V140

PANHANDLE, TX VORTAC	SAYRE, OK VORTAC	5000
SAYRE, OK VORTAC *5000 - MRA	*WAXEY, OK FIX	4000
WAXEY, OK FIX *3300 - MOCA	ODINS, OK FIX	*4000

FROM TO MEA

95.6140 VOR FEDERAL AIRWAY V140 - CONTINUED

ODINS, OK FIX *3100 - MOCA	KINGFISHER, OK VORTAC	*3500
KINGFISHER, OK VORTAC	LASTS, OK FIX	3000
LASTS, OK FIX *3100 - MOCA	IBA AH, OK FIX	*4500
IBA AH, OK FIX	TULSA, OK VORTAC	3300
TULSA, OK VORTAC *2900 - MRA	*PRYOR, OK FIX	2700
PRYOR, OK FIX *2800 - MOCA	RAZORBACK, AR VORTAC	*3400
RAZORBACK, AR VORTAC *2900 - MOCA	SPRAY, AR FIX	*3400
SPRAY, AR FIX *3500 - MOCA	HARRISON, AR VOR/DME	*4000
HARRISON, AR VOR/DME	VILLO, AR FIX	3000
VILLO, AR FIX	WALNUT RIDGE, AR VORTAC	
	W BND	3000
	E BND	2500
WALNUT RIDGE, AR VORTAC	HELMS, MO FIX	2400
HELMS, MO FIX	DYERSBURG, TN VORTAC	2000
DYERSBURG, TN VORTAC *2300 - MOCA	GOSH N, TN FIX	*3500
GOSH N, TN FIX	NASHVILLE, TN VORTAC	3000
NASHVILLE, TN VORTAC *2400 - MOCA	HARME, TN FIX	*3000
HARME, TN FIX	LIVINGSTON, TN VORTAC	3000
LIVINGSTON, TN VORTAC	LONDON, KY VORTAC	3900
LONDON, KY VORTAC	HAZARD, KY VOR/DME	4000
HAZARD, KY VOR/DME *4200 - MOCA	STACY, VA FIX	*5000
*4200 - GNSS MEA		
STACY, VA FIX *13000 - MRA	*KENYA, WV FIX	5000
KENYA, WV FIX	BLUEFIELD, WV VORTAC	5400
BLUEFIELD, WV VORTAC	OBERS, WV FIX	5600
OBERS, WV FIX	MONTEBELLO, VA VOR/DME	6000
MONTEBELLO, VA VOR/DME	HOODE, VA FIX	6100
HOODE, VA FIX	CASANOVA, VA VORTAC	3200

95.6141 VOR FEDERAL AIRWAY V141

NANTUCKET, MA VOR/DME	GAILS, MA FIX	1700
GAILS, MA FIX *2500 - MRA	*CELTS, MA FIX	**3000
**2000 - MOCA		
CELTS, MA FIX	BOSTON, MA VOR/DME	2000
MANCHESTER, NH VOR/DME *2000 - MOCA	CONCORD, NH VORTAC	*2900
CONCORD, NH VORTAC *4400 - MOCA	KELLI, NH FIX	*5000
KELLI, NH FIX *3600 - MOCA	LEBANON, NH VOR/DME	*4000
LEBANON, NH VOR/DME *5500 - MRA	*RUCKY, VT FIX	**6000
**4000 - MOCA		
RUCKY, VT FIX	GREEK, VT FIX	6000
GREEK, VT FIX	*BURLINGTON, VT VOR/DME	6000
*4100 - MCA BURLINGTON, VT VOR/DME, SE BND		

FROM TO MEA

95.6141 VOR FEDERAL AIRWAY V141 - CONTINUED

BURLINGTON, VT VOR/DME	BUGSY, NY FIX	*9000
*5100 - MOCA		
*5500 - GNSS MEA		
#MASSENA R-129 UNSABLE USE BURLINGTON R-311		
BUGSY, NY FIX	#MASSENA, NY VORTAC	*9000
*4000 - MOCA		
*4000 - GNSS MEA		
#MASSENA R-129 UNUSABLE USE BURLINGTON R-311		

95.6142 VOR FEDERAL AIRWAY V142

*TWIN FALLS, ID VORTAC	MURTH, ID FIX	
	E BND	13000
	W BND	7800
*12000 - MCA TWIN FALLS, ID VORTAC , E BND		
MURTH, ID FIX	OCLEY, ID FIX	
	E BND	15000
	W BND	9500
OCLEY, ID FIX	*SHEAR, UT FIX	**16500
*16500 - MCA SHEAR, UT FIX , W BND		
**12400 - MOCA		
SHEAR, UT FIX	*MALAD CITY, ID VOR/DME	
	SW BND	11000
	NE BND	10000
*13500 - MCA MALAD CITY, ID VOR/DME , SW BND		
MALAD CITY, ID VOR/DME	*ORNEY, UT FIX	10000
*11100 - MCA ORNEY, UT FIX , E BND		
ORNEY, UT FIX	FORT BRIDGER, WY VOR/DME	12000
FORT BRIDGER, WY VOR/DME	ROCK SPRINGS, WY VOR/DME	10000

95.6143 VOR FEDERAL AIRWAY V143

GIZMO, NC FIX	GREENSBORO, NC VORTAC	3000
GREENSBORO, NC VORTAC	LEAKS, NC FIX	3000
LEAKS, NC FIX	LYNCHBURG, VA VORTAC	3000
LYNCHBURG, VA VORTAC	*ELLON, VA FIX	
	N BND	5000
	S BND	3200
*4100 - MCA ELLON, VA FIX , N BND		
ELLON, VA FIX	*CLYFF, VA FIX	4600
*6000 - MCA CLYFF, VA FIX , N BND		
CLYFF, VA FIX	MONTEBELLO, VA VOR/DME	6400
MONTEBELLO, VA VOR/DME	LURAY, VA FIX	6000
LURAY, VA FIX	*KERRE, VA FIX	**6000
*7000 - MRA		
**5000 - MOCA		
KERRE, VA FIX	MARTINSBURG, WV VORTAC	*6000
*5000 - MOCA		
MARTINSBURG, WV VORTAC	HYPER, MD FIX	*5000
*3900 - MOCA		
HYPER, MD FIX	BINNS, PA FIX	4000
BINNS, PA FIX	*SUEDE, PA FIX	4500
*4500 - MRA		
SUEDE, PA FIX	DELRO, PA FIX	4500
DELRO, PA FIX	LANCASTER, PA VORTAC	3000
LANCASTER, PA VORTAC	POTTSTOWN, PA VORTAC	4500
POTTSTOWN, PA VORTAC	YARDLEY, PA VOR/DME	*6900
*4000 - GNSS MEA		

FROM	TO	MEA
------	----	-----

95.6144 VOR FEDERAL AIRWAY V144

BRADFORD, IL VORTAC	KANKAKEE, IL VOR/DME	2700
KANKAKEE, IL VOR/DME	RODNY, IN FIX	2400
RODNY, IN FIX	MAPPS, IN FIX	*3000
*2200 - MOCA		
MAPPS, IN FIX	CLEFT, IN FIX	*4000
*2400 - MOCA		
CLEFT, IN FIX	FORT WAYNE, IN VORTAC	2800
FORT WAYNE, IN VORTAC	*BUZZI, OH FIX	**6000
*4000 - MCA BUZZI, OH FIX , E BND		
**3000 - MOCA		
BUZZI, OH FIX	APPLETON, OH VORTAC	*4000
*2600 - MOCA		
APPLETON, OH VORTAC	ZANESVILLE, OH VOR/DME	3000
ZANESVILLE, OH VOR/DME	BEALL, OH FIX	3000
BEALL, OH FIX	MORGANTOWN, WV VORTAC	4000
MORGANTOWN, WV VORTAC	KESSEL, WV VOR/DME	5700
KESSEL, WV VOR/DME	LINDEN, VA VORTAC	5000

95.6145 VOR FEDERAL AIRWAY V145

UTICA, NY VORTAC	WEEPY, NY FIX	*3400
*2800 - MOCA		
WEEPY, NY FIX	FLOOR, NY FIX	*3000
*2000 - MOCA		
FLOOR, NY FIX	WATERTOWN, NY VORTAC	*3000
*2500 - MOCA		
WATERTOWN, NY VORTAC	U.S. CANADIAN BORDER	*3000
*1600 - MOCA		

95.6146 VOR FEDERAL AIRWAY V146

ALBANY, NY VORTAC	CHESTER, MA VOR/DME	4100
CHESTER, MA VOR/DME	BARNES, MA VORTAC	*4000
*3200 - MOCA		
BARNES, MA VORTAC	PUTNAM, CT VOR/DME	*3000
*2500 - MOCA		
PUTNAM, CT VOR/DME	PROVIDENCE, RI VORTAC	3000
PROVIDENCE, RI VORTAC	MARTHAS VINEYARD, MA VOR/DME	2000
MARTHAS VINEYARD, MA VOR/DME	NANTUCKET, MA VOR/DME	2000

95.6147 VOR FEDERAL AIRWAY V147

YARDLEY, PA VOR/DME	EAST TEXAS, PA VOR/DME	2500
EAST TEXAS, PA VOR/DME	SLATT, PA FIX	4000
SLATT, PA FIX	WILKES-BARRE, PA VORTAC	4000
WILKES-BARRE, PA VORTAC	ELMIRA, NY VOR/DME	4000
ELMIRA, NY VOR/DME	GENESE0, NY VOR/DME	4000
GENESE0, NY VOR/DME	ROCHESTER, NY VOR/DME	2800

FROM TO MEA

95.6148 VOR FEDERAL AIRWAY V148

FALCON, CO VORTAC *9000 - MRA	*LIMEX, CO FIX	8500
LIMEX, CO FIX	THURMAN, CO VORTAC	7500
THURMAN, CO VORTAC *6500 - MOCA	MCJEF, NE FIX	*7000
MCJEF, NE FIX *5600 - MOCA	HAYES CENTER, NE VORTAC	*7000
HAYES CENTER, NE VORTAC *4500 - MOCA	NORTH PLATTE, NE VORTAC	*4900
NORTH PLATTE, NE VORTAC *4400 - MOCA	O'NEILL, NE VORTAC	*5400
O'NEILL, NE VORTAC *3500 - MOCA	TYNDA, SD FIX	*4000
TYNDA, SD FIX *3200 - MOCA	DOLTS, SD FIX	*4000
DOLTS, SD FIX	SIOUX FALLS, SD VORTAC	3400
SIOUX FALLS, SD VORTAC	REDWOOD FALLS, MN VOR/DME	3700
REDWOOD FALLS, MN VOR/DME	MAYER, MN FIX	2800
MAYER, MN FIX	GOPHER, MN VORTAC	3000
GOPHER, MN VORTAC *2700 - MOCA	ALEEN, WI FIX	*5000
ALEEN, WI FIX *2800 - MOCA	HAYWARD, WI VOR/DME	*10000
HAYWARD, WI VOR/DME *3000 - MOCA	IRONWOOD, MI VORTAC	*10000
IRONWOOD, MI VORTAC *3100 - MOCA	HOUGHTON, MI VOR/DME	*3700

95.6149 VOR FEDERAL AIRWAY V149

MAZIE, PA FIX *3000 - GNSS MEA #ALLENTOWN R-157 UNUSABLE.	#ALLENTOWN, PA VORTAC	*6000
ALLENTOWN, PA VORTAC	LAKE HENRY, PA VORTAC	4000
LAKE HENRY, PA VORTAC	BINGHAMTON, NY VORTAC	4000

95.6150 VOR FEDERAL AIRWAY V150

SAN FRANCISCO, CA VOR/DME	SUTRO, CA FIX	3500
SUTRO, CA FIX	GOBBS, CA FIX	3000
GOBBS, CA FIX	SAUSALITO, CA VORTAC	4000
SAUSALITO, CA VORTAC	COMMO, CA FIX	4000
COMMO, CA FIX	REBAS, CA FIX	
	SW BND	4000
	NE BND	3000
REBAS, CA FIX	EMBER, CA FIX	3000
EMBER, CA FIX	SACRAMENTO, CA VORTAC	
	NE BND	2000
	SW BND	3000

95.6151 VOR FEDERAL AIRWAY V151

GAILS, MA FIX *2000 - GNSS MEA	PROVIDENCE, RI VORTAC	*3000
PROVIDENCE, RI VORTAC	PUTNAM, CT VOR/DME	3000
PUTNAM, CT VOR/DME	GARDNER, MA VOR/DME	3000
GARDNER, MA VOR/DME	KEENE, NH VORTAC	3600
KEENE, NH VORTAC	STRUM, NH FIX	3600

FROM	TO	MEA
------	----	-----

95.6151 VOR FEDERAL AIRWAY V151 -CONTINUED

STRUM, NH FIX *6000 - MRA	*UNKER, NH FIX	6000
UNKER, NH FIX MCADM, NH FIX *3500 - MOCA	MCADM, NH FIX LEBANON, NH VOR/DME	4500 *4000
LEBANON, NH VOR/DME *3600 - MOCA	ZIECH, VT FIX	*4000
ZIECH, VT FIX *3900 - MOCA	MONTPELIER, VT VOR/DME	*4400
MONTPELIER, VT VOR/DME	BURLINGTON, VT VOR/DME	6000

95.6152 VOR FEDERAL AIRWAY V152

ST PETERSBURG, FL VORTAC *2500 - MOCA *2500 - GNSS MEA	JENSN, FL FIX	*4000
JENSN, FL FIX KIZER, FL FIX	KIZER, FL FIX ORMOND BEACH, FL VORTAC	2900 2700

95.6153 VOR FEDERAL AIRWAY V153

LAKE HENRY, PA VORTAC GROWS, NY FIX *3800 - MOCA *4000 - GNSS MEA	GROWS, NY FIX GEORGETOWN, NY VORTAC	4500 *4500
GEORGETOWN, NY VORTAC	SYRACUSE, NY VORTAC	4000

95.6154 VOR FEDERAL AIRWAY V154

ROME, GA VORTAC *3400 - MOCA	MACON, GA VORTAC	*4000 MAA - 7000
MACON, GA VORTAC DUBLIN, GA VORTAC *3000 - MRA	DUBLIN, GA VORTAC *OCONE, GA FIX	2100 2000
OCONE, GA FIX *1800 - MOCA	SAVANNAH, GA VORTAC	*3000

95.6155 VOR FEDERAL AIRWAY V155

COLUMBUS, GA VORTAC GRANT, GA FIX *2500 - MOCA *2500 - GNSS MEA	GRANT, GA FIX SMARR, GA FIX	2800 *4000
SMARR, GA FIX *2500 - MOCA *2500 - GNSS MEA	SINCA, GA FIX	*4500
SINCA, GA FIX *2400 - MOCA *2400 - GNSS MEA	BEYLO, GA FIX	*5000
BEYLO, GA FIX *2100 - MOCA	COLLIERS, SC VORTAC	*3000
COLLIERS, SC VORTAC *4000 - MRA	*WIDER, SC FIX	2500

FROM TO MEA

95.6155 VOR FEDERAL AIRWAY V155 - CONTINUED

WIDER, SC FIX *4000 - MRA	*BLOTS, SC FIX	2500
BLOTS, SC FIX	CHESTERFIELD, SC VOR/DME	2300
CHESTERFIELD, SC VOR/DME	LILLS, NC FIX	2000
LILLS, NC FIX *2100 - MOCA	SANDHILLS, NC VORTAC	*8000
SANDHILLS, NC VORTAC	RALEIGH/DURHAM, NC VORTAC	2500
RALEIGH/DURHAM, NC VORTAC	WIPER, NC FIX	2300
WIPER, NC FIX *2000 - MOCA	LAWRENCEVILLE, VA VORTAC	*9000
*2300 - GNSS MEA		
LAWRENCEVILLE, VA VORTAC	*MANGE, VA FIX	##*4000
*5000 - MRA		
**2000 - GNSS MEA		
#LAWRENCEVILLE R-042 UNUSABLE.		
MANGE, VA FIX	MELIA, VA FIX	*5000
*1800 - MOCA		
*2000 - GNSS MEA		
MELIA, VA FIX	FLAT ROCK, VA VORTAC	2000
FLAT ROCK, VA VORTAC	BROOKE, VA VORTAC	2000

95.6156 VOR FEDERAL AIRWAY V156

CEDAR RAPIDS, IA VOR/DME	MOSCO, IA FIX	3200
MOSCO, IA FIX	MOLINE, IL VORTAC	2600
MOLINE, IL VORTAC	BRADFORD, IL VORTAC	2800
BRADFORD, IL VORTAC	PEOTONE, IL VORTAC	2700
PEOTONE, IL VORTAC	LUCIT, IN FIX	2500
LUCIT, IN FIX *2400 - MOCA	MAPPS, IN FIX	*4000
MAPPS, IN FIX	KNOX, IN VOR/DME	*3000
*2200 - MOCA		
KNOX, IN VOR/DME	GIPPER, MI VORTAC	2600
GIPPER, MI VORTAC	KALAMAZOO, MI VOR/DME	3000

95.6157 VOR FEDERAL AIRWAY V157

KEY WEST, FL VORTAC *5700 - MRA **1300 - MOCA	*FAMIN, FL FIX	**5000
FAMIN, FL FIX *1500 - MOCA	DOLPHIN, FL VORTAC	*5000
DOLPHIN, FL VORTAC *1500 - MOCA	THNDR, FL FIX	*3000
THNDR, FL FIX *1600 - MOCA	LA BELLE, FL VORTAC	*3000
LA BELLE, FL VORTAC *1400 - MOCA	RINSE, FL FIX	*2000
RINSE, FL FIX	LAKELAND, FL VORTAC	2200
LAKELAND, FL VORTAC	OCALA, FL VORTAC	2000
OCALA, FL VORTAC	TAYLOR, FL VORTAC	2000
TAYLOR, FL VORTAC	WAYCROSS, GA VORTAC	2300
WAYCROSS, GA VORTAC	ALMA, GA VORTAC	2300
ALMA, GA VORTAC *1800 - MOCA	LOTTS, GA FIX	*10000
*2000 - GNSS MEA		

FROM	TO	MEA
95.6157 VOR FEDERAL AIRWAY V157 - CONTINUED		
LOTTS, GA FIX *1700 - MOCA	ALLENDALE, SC VOR	*9000
ALLENDALE, SC VOR *2000 - GNSS MEA	VANCE, SC VORTAC	*6000
VANCE, SC VORTAC	FLORENCE, SC VORTAC	2000
FLORENCE, SC VORTAC	FAYETTEVILLE, NC VOR/DME	2200
FAYETTEVILLE, NC VOR/DME *5000 - MRA	*JOSCH, NC FIX	2000
JOSCH, NC FIX	KINSTON, NC VORTAC	2000
KINSTON, NC VORTAC	TAR RIVER, NC VORTAC	2200
TAR RIVER, NC VORTAC *2500 - MOCA	#LAWRENCEVILLE, VA VORTAC	*4500
#LAWRENCEVILLE R-177 UNUSABLE BELOW 6000, USE TAR RIVER R-354.		
#LAWRENCEVILLE, VA VORTAC	DALTO, VA FIX	*4000
*2000 - GNSS MEA		
#LAWRENCEVILLE R-042 UNUSABLE.		
DALTO, VA FIX	RICHMOND, VA VORTAC	2000
RICHMOND, VA VORTAC	TAPPA, VA FIX	1900
TAPPA, VA FIX *1500 - MOCA	COLIN, VA FIX	*5000
*2000 - GNSS MEA		
COLIN, VA FIX *1400 - MOCA	PATUXENT, MD VORTAC	*5000
*2000 - GNSS MEA		
PATUXENT, MD VORTAC *8000 - MRA	*GARED, MD FIX	**4500
**1500 - MOCA		
**4000 - GNSS MEA		
GARED, MD FIX *1500 - MOCA	CHOPS, MD FIX	*4500
*4000 - GNSS MEA		
CHOPS, MD FIX *1500 - MOCA	SMYRNA, DE VORTAC	*2000
SMYRNA, DE VORTAC	WOODSTOWN, NJ VORTAC	*1900
*1500 - MOCA		
WOODSTOWN, NJ VORTAC *2000 - MOCA	ROBBINSVILLE, NJ VORTAC	*3000
ROBBINSVILLE, NJ VORTAC	MINKS, NJ FIX	2000
MINKS, NJ FIX	LA GUARDIA, NY VOR/DME	2600
LA GUARDIA, NY VOR/DME	FAMMA, NY FIX	2000
FAMMA, NY FIX	HAARP, CT FIX	3000
HAARP, CT FIX *2800 - MOCA	KINGSTON, NY VOR/DME	*7000
*4000 - GNSS MEA		
KINGSTON, NY VOR/DME *4500 - MRA	*WIGAN, NY FIX	3000
WIGAN, NY FIX	GROUP, NY FIX	*8000
*3000 - GNSS MEA		
GROUP, NY FIX *2300 - MOCA	ALBANY, NY VORTAC	*6000
*2800 - GNSS MEA		

FROM	TO	MEA
------	----	-----

95.6158 VOR FEDERAL AIRWAY V158

MASON CITY, IA VORTAC	POUND, IA FIX	3000
POUND, IA FIX	DUBUQUE, IA VORTAC	*6000
*3100 - MOCA		
DUBUQUE, IA VORTAC	POLO, IL VOR/DME	2800
POLO, IL VOR/DME	SHOOF, IL FIX	2700

95.6159 VOR FEDERAL AIRWAY V159

VIRGINIA KEY, FL VOR/DME	NITNY, FL FIX	2000
NITNY, FL FIX	VERO BEACH, FL VORTAC	2500
VERO BEACH, FL VORTAC	*PRESK, FL FIX	3000
*2500 - MRA		
PRESK, FL FIX	ORLANDO, FL VORTAC	2000
ORLANDO, FL VORTAC	*SHIMM, FL FIX	2000
*3000 - MRA		
SHIMM, FL FIX	OCALA, FL VORTAC	2000
OCALA, FL VORTAC	CROSS CITY, FL VORTAC	2000
CROSS CITY, FL VORTAC	GREENVILLE, FL VORTAC	2000
GREENVILLE, FL VORTAC	*SALER, GA FIX	2500
*3000 - MRA		
SALER, GA FIX	PECAN, GA VORTAC	2000
PECAN, GA VORTAC	*SHANY, GA FIX	2000
*2800 - MRA		
SHANY, GA FIX	EUFAULA, AL VORTAC	2100
EUFAULA, AL VORTAC	TUSKEGEE, AL VOR/DME	2000
TUSKEGEE, AL VOR/DME	KENTT, AL FIX	*2600
*1900 - MOCA		
KENTT, AL FIX	KYLEE, AL FIX	3800
KYLEE, AL FIX	VULCAN, AL VORTAC	3800
VULCAN, AL VORTAC	HAMILTON, AL VORTAC	*2600
*2200 - MOCA		
HAMILTON, AL VORTAC	HOLLY SPRINGS, MS VORTAC	2300
HOLLY SPRINGS, MS VORTAC	GILMORE, AR VOR/DME	2500
GILMORE, AR VOR/DME	WALNUT RIDGE, AR VORTAC	2800
WALNUT RIDGE, AR VORTAC	DOGWOOD, MO VORTAC	*3400
*2800 - MOCA		
DOGWOOD, MO VORTAC	SPRINGFIELD, MO VORTAC	4300
SPRINGFIELD, MO VORTAC	*OLIVA, MO FIX	**3000
*6000 - MRA		
**2500 - MOCA		
OLIVA, MO FIX	TRALE, MO FIX	*3000
*2500 - MOCA		
TRALE, MO FIX	AUGIE, MO FIX	*3000
*2500 - MOCA		
AUGIE, MO FIX	HODEN, MO FIX	2700
HODEN, MO FIX	NAPOLEON, MO VORTAC	*3000
*2400 - MOCA		
NAPOLEON, MO VORTAC	ST JOSEPH, MO VORTAC	2900
ST JOSEPH, MO VORTAC	VIKKI, IA FIX	3000
VIKKI, IA FIX	OMAHA, IA VORTAC	3400
OMAHA, IA VORTAC	BECOM, IA FIX	3000
BECOM, IA FIX	SIoux CITY, IA VORTAC	3000
SIoux CITY, IA VORTAC	OBERT, NE FIX	*4500
*2700 - MOCA		
OBERT, NE FIX	YANKTON, SD VOR/DME	3400
YANKTON, SD VOR/DME	MITCHELL, SD VOR/DME	3300
MITCHELL, SD VOR/DME	HURON, SD VORTAC	3000

FROM TO MEA

95.6160 VOR FEDERAL AIRWAY V160

*BLUE MESA, CO VOR/DME **15600 - MRA *12900 - MCA BLUE MESA, CO VOR/DME , NE BND	**MURFE, CO FIX	16200
MURFE, CO FIX *15600 - MRA **14400 - MOCA	*LARKS, CO FIX	**15000
LARKS, CO FIX *13800 - MOCA	SIGNE, CO FIX	*14400
*SIGNE, CO FIX *11500 - MCA SIGNE, CO FIX , SW BND	FALCON, CO VORTAC	8800
FALCON, CO VORTAC WITNE, CO FIX *7200 - MOCA	WITNE, CO FIX SAYGE, CO FIX	8000 *8000
SAYGE, CO FIX *6800 - MOCA	TUMBL, CO FIX	*8000
TUMBL, CO FIX *6800 - MOCA	SIDNEY, NE VORTAC	*8000

95.6161 VOR FEDERAL AIRWAY V161

THREE RIVERS, TX VORTAC LEMIG, TX FIX CENTER POINT, TX VORTAC LLANO, TX VORTAC *6000 - MRA **2800 - MOCA	LEMIG, TX FIX CENTER POINT, TX VORTAC LLANO, TX VORTAC *BUILT, TX FIX	2000 4000 4000 **6000
BUILT, TX FIX *2700 - MOCA	DUFFA, TX FIX	*6000
DUFFA, TX FIX MILLSAP, TX VORTAC BOWIE, TX VORTAC ARDMORE, OK VORTAC PHARA, OK FIX *2300 - MOCA	MILLSAP, TX VORTAC BOWIE, TX VORTAC ARDMORE, OK VORTAC PHARA, OK FIX OKMULGEE, OK VOR/DME	3000 3000 3000 3000 *3000
OKMULGEE, OK VOR/DME TULSA, OK VORTAC NOVEL, OK FIX OSWEGO, KS VORTAC *2400 - MOCA	TULSA, OK VORTAC NOVEL, OK FIX OSWEGO, KS VORTAC NALLY, KS FIX	2700 3000 2800 *3000
NALLY, KS FIX *2500 - MOCA	BUTLER, MO VORTAC	*3000
BUTLER, MO VORTAC NAPOLEON, MO VORTAC LAMONI, IA VORTAC *4300 - MRA	NAPOLEON, MO VORTAC LAMONI, IA VORTAC *WIVEY, IA FIX	2900 2900 3000
WIVEY, IA FIX DES MOINES, IA VORTAC *3500 - MCA ANKEN, IA FIX , N BND	DES MOINES, IA VORTAC *ANKEN, IA FIX	3000 2700
ANKEN, IA FIX NEVAD, IA FIX *2700 - MOCA	NEVAD, IA FIX ALOCK, IA FIX	4000 *3300
ALOCK, IA FIX MASON CITY, IA VORTAC ROCHESTER, MN VOR/DME *4000 - MRA	MASON CITY, IA VORTAC ROCHESTER, MN VOR/DME *CORDY, MN FIX	3000 3000 3000
CORDY, MN FIX FARMINGTON, MN VORTAC *2700 - MOCA	FARMINGTON, MN VORTAC GOPHER, MN VORTAC	3000 *3500

FROM	TO	MEA
------	----	-----

95.6161 VOR FEDERAL AIRWAY V161 - CONTINUED

GOPHER, MN VORTAC	BRAINERD, MN VORTAC	3000
BRAINERD, MN VORTAC	GRAND RAPIDS, MN VOR/DME	3400
GRAND RAPIDS, MN VOR/DME	SQEAK, MN FIX	*5000
*3100 - MOCA		
SQEAK, MN FIX	*BEBEL, MN FIX	5000
*4000 - MRA		
BEBEL, MN FIX	INTERNATIONAL FALLS, MN VORTAC	3000
INTERNATIONAL FALLS, MN VORTAC	U.S. CANADIAN BORDER	3000
U.S. CANADIAN BORDER	KRANG, CANADA FIX	3000

95.6162 VOR FEDERAL AIRWAY V162

HARRISBURG, PA VORTAC	BOBSS, PA FIX	3000
BOBSS, PA FIX	EAST TEXAS, PA VOR/DME	3000
EAST TEXAS, PA VOR/DME	ALLENTOWN, PA VORTAC	3000
ALLENTOWN, PA VORTAC	HUGUENOT, NY VOR/DME	3500

95.6163 VOR FEDERAL AIRWAY V163

U.S. MEXICAN BORDER	BROWNSVILLE, TX VORTAC	*2000
*1400 - MOCA		
BROWNSVILLE, TX VORTAC	MANNY, TX FIX	1500
MANNY, TX FIX	ASCOT, TX FIX	*5000
*1500 - MOCA		
ASCOT, TX FIX	SOLON, TX FIX	*4000
*1500 - MOCA		
SOLON, TX FIX	CORPUS CHRISTI, TX VORTAC	1600
CORPUS CHRISTI, TX VORTAC	SINTO, TX FIX	1700
SINTO, TX FIX	THREE RIVERS, TX VORTAC	1900
THREE RIVERS, TX VORTAC	*YENNS, TX FIX	2000
*3000 - MRA		
YENNS, TX FIX	SAN ANTONIO, TX VORTAC	*3000
*2500 - MOCA		
SAN ANTONIO, TX VORTAC	SLIMM, TX FIX	*3500
*2900 - MOCA		
SLIMM, TX FIX	GOOCH SPRINGS, TX VORTAC	*3500
*3000 - MOCA		
GOOCH SPRINGS, TX VORTAC	*TENAT, TX FIX	**3500
*4000 - MRA		
**2700 - MOCA		
TENAT, TX FIX	GLEN ROSE, TX VORTAC	*3500
*2700 - MOCA		

95.6164 VOR FEDERAL AIRWAY V164

U.S. CANADIAN BORDER	*BULGE, NY FIX	3100
*6000 - MCA BULGE, NY FIX , S BND		
BULGE, NY FIX	BUFFALO, NY VOR/DME	*6000
*2100 - MOCA		
*3000 - GNSS MEA		
BUFFALO, NY VOR/DME	*BENEE, NY FIX	**11000
*11000 - MRA		
**4400 - MOCA		
**5000 - GNSS MEA		

FROM TO MEA

95.6164 VOR FEDERAL AIRWAY V164 - CONTINUED

BENEE, NY FIX *4500 - MOCA *5000 - GNSS MEA	WELLSVILLE, NY VORTAC	*6000
WELLSVILLE, NY VORTAC	STONYFORK, PA VOR/DME	4500
STONYFORK, PA VOR/DME	WILLIAMSPORT, PA VOR/DME	4000
WILLIAMSPORT, PA VOR/DME	DIANO, PA FIX	4000
DIANO, PA FIX *3500 - MOCA	EAST TEXAS, PA VOR/DME	*4000

95.6165 VOR FEDERAL AIRWAY V165

MISSION BAY, CA VORTAC	SARGS, CA FIX	3000
SARGS, CA FIX	OCEANSIDE, CA VORTAC	2500
OCEANSIDE, CA VORTAC	BALBO, CA FIX	4000
BALBO, CA FIX	SEAL BEACH, CA VORTAC	
	NW BND	3000
	SE BND	4000
SEAL BEACH, CA VORTAC	LOS ANGELES, CA VORTAC	2500
LOS ANGELES, CA VORTAC	*VALEY, CA FIX	4000
*5600 - MCA VALEY, CA FIX , N BND		
VALEY, CA FIX	*SAUGS, CA FIX	6000
*6600 - MCA SAUGS, CA FIX , NW BND		
SAUGS, CA FIX	LAKE HUGHES, CA VORTAC	8000
LAKE HUGHES, CA VORTAC	JEFFY, CA FIX	8000
JEFFY, CA FIX	*LOPES, CA FIX	9000
*8400 - MCA LOPES, CA FIX , S BND		
LOPES, CA FIX	*ARVIN, CA FIX	7800
*6900 - MCA ARVIN, CA FIX , SE BND		
ARVIN, CA FIX	SHAFTER, CA VORTAC	3000
SHAFTER, CA VORTAC	TULE, CA VOR/DME	3000
TULE, CA VOR/DME	DINUB, CA FIX	3500
DINUB, CA FIX	SELMA, CA FIX	
	NW BND	2500
	SE BND	3500
SELMA, CA FIX	*CLOVIS, CA VORTAC	2000
*4000 - MCA CLOVIS, CA VORTAC , N BND		
CLOVIS, CA VORTAC	*COGOL, CA FIX	
	N BND	6500
	S BND	5000
*8500 - MCA COGOL, CA FIX , N BND		
COGOL, CA FIX	MARRI, CA FIX	##16000
*13600 - MOCA		
#MEA IS ESTABLISHED WITH A GAP IN NAVIGATION SIGNAL COVERAGE.		
MARRI, CA FIX	*MUSTANG, NV VORTAC	**13000
*10000 - MCA MUSTANG, NV VORTAC , S BND		
**11000 - MOCA		
MUSTANG, NV VORTAC	PYRAM, NV FIX	*11000
*9700 - MOCA		
*10000 - GNSS MEA		
PYRAM, NV FIX	BINNZ, NV FIX	
	NW BND	*14000
	SE BND	*12000
*11000 - MOCA		
*11000 - GNSS MEA		
BINNZ, NV FIX	CHOIR, CA FIX	*14000
*12200 - MOCA		
CHOIR, CA FIX	LAKEVIEW, OR VORTAC	
	SE BND	*14000
	NW BND	*11000
*10500 - MOCA		

FROM	TO	MEA
------	----	-----

95.6165 VOR FEDERAL AIRWAY V165 - CONTINUED

LAKEVIEW, OR VORTAC	URBIA, OR FIX	9500
URBIA, OR FIX	*DESCHUTES, OR VORTAC	
	SE BND	9500
	NW BND	7000
*9300 - MCA DESCHUTES, OR	VORTAC, NW BND	
DESCHUTES, OR VORTAC	BOTTL, OR FIX	
	NW BND	12500
	SE BND	7000
BOTTL, OR FIX	WALDO, OR FIX	12500
WALDO, OR FIX	ELKES, OR FIX	
	NW BND	7800
	SE BND	12500
ELKES, OR FIX	*MAVER, OR FIX	
	SE BND	12500
	NW BND	7000
*9400 - MCA MAVER, OR FIX,	SE BND	
MAVER, OR FIX	RAWER, OR FIX	*5000
*3600 - MOCA		
RAWER, OR FIX	NEWBERG, OR VOR/DME	4000
NEWBERG, OR VOR/DME	PITER, OR FIX	4000
PITER, OR FIX	CETRA, WA FIX	6000
CETRA, WA FIX	OLYMPIA, WA VORTAC	
	N BND	4000
	S BND	6000
OLYMPIA, WA VORTAC	*CARRO, WA FIX	**4000
*4000 - MRA		
**1900 - MOCA		
CARRO, WA FIX	ARPEE, WA FIX	*6000
*5200 - MOCA		
ARPEE, WA FIX	DIGGN, WA FIX	*5000
*2700 - MOCA		
DIGGN, WA FIX	PENN COVE, WA VOR/DME	*5000
*2100 - MOCA		
PENN COVE, WA VOR/DME	ISLND, WA FIX	*5000
*1500 - MOCA		
ISLND, WA FIX	CANDL, WA FIX	*5000
*2800 - MOCA		
CANDL, WA FIX	WHATCOM, WA VORTAC	*4000
*1900 - MOCA		

95.6166 VOR FEDERAL AIRWAY V166

PARKERSBURG, WV VORTAC	MOSIC, WV FIX	3000
MOSIC, WV FIX	CLARKSBURG, WV VOR/DME	*3600
*3100 - MOCA		
CLARKSBURG, WV VOR/DME	TYGAR, WV FIX	3600
TYGAR, WV FIX	UGJOB, WV FIX	4700
UGJOB, WV FIX	KESSEL, WV VOR/DME	6300
KESSEL, WV VOR/DME	CAPON, WV FIX	*5000
*4500 - MOCA		
CAPON, WV FIX	MARTINSBURG, WV VORTAC	*5000
*3500 - MOCA		
MARTINSBURG, WV VORTAC	WESTMINSTER, MD VORTAC	*4000
*3300 - MOCA		
WESTMINSTER, MD VORTAC	BELAY, MD FIX	*3000
*2500 - MOCA		
BELAY, MD FIX	*BAINS, MD FIX	2000
*6000 - MRA		
BAINS, MD FIX	DUPONT, DE VORTAC	2000
DUPONT, DE VORTAC	WOODSTOWN, NJ VORTAC	2000
		MAA - 8000

FROM	TO	MEA
------	----	-----

95.6166 VOR FEDERAL AIRWAY V166 - CONTINUED

WOODSTOWN, NJ VORTAC	BRIEF, NJ FIX	1900
BRIEF, NJ FIX	LEEAH, NJ FIX	7000
LEEAH, NJ FIX	SEA ISLE, NJ VORTAC	3000

95.6167 VOR FEDERAL AIRWAY V167

HANCOCK, NY VOR/DME	HELON, NY FIX	4100
HELON, NY FIX	KINGSTON, NY VOR/DME	4000
KINGSTON, NY VOR/DME	HARTFORD, CT VOR/DME	3200
HARTFORD, CT VOR/DME	JEWIT, CT FIX	*2600
*2100 - MOCA		
JEWIT, CT FIX	PROVIDENCE, RI VORTAC	*2500
*2000 - MOCA		
PROVIDENCE, RI VORTAC	PEAKE, MA FIX	*2500
*1800 - MOCA		
PEAKE, MA FIX	MARCONI, MA VOR/DME	*3000
*1600 - MOCA		
MARCONI, MA VOR/DME	KENNEBUNK, ME VORTAC	*5000
*1600 - MOCA		
*4000 - GNSS MEA		

95.6168 VOR FEDERAL AIRWAY V168

VULCAN, AL VORTAC	LAGRANGE, GA VORTAC	4000
LAGRANGE, GA VORTAC	MILER, AL FIX	2600
MILER, AL FIX	EFORD, AL FIX	*3000
*2400 - MOCA		
*3000 - GNSS MEA		
EFORD, AL FIX	WIREGRASS, AL VORTAC	#2400
#WIREGRASS R-360 UNUSABLE BEYOND EFORD		

95.6169 VOR FEDERAL AIRWAY V169

TOBE, CO VORTAC	HUGO, CO VORTAC	8000
HUGO, CO VORTAC	THURMAN, CO VORTAC	*7200
*6600 - MOCA		
THURMAN, CO VORTAC	AKRON, CO VOR/DME	*7000
*6200 - MOCA		
AKRON, CO VOR/DME	SIDNEY, NE VORTAC	6400
SIDNEY, NE VORTAC	SCOTTSBLUFF, NE VORTAC	*7000
*6000 - MOCA		
SCOTTSBLUFF, NE VORTAC	CHADRON, NE VOR/DME	7000
CHADRON, NE VOR/DME	WAXER, NE FIX	*7000
*6000 - MOCA		
WAXER, NE FIX	RAPID CITY, SD VORTAC	6000
RAPID CITY, SD VORTAC	DUPREE, SD VORTAC	5000
DUPREE, SD VORTAC	BISMARCK, ND VOR/DME	4700
BISMARCK, ND VOR/DME	DEVILS LAKE, ND VOR/DME	4000

95.6170 VOR FEDERAL AIRWAY V170

DEVILS LAKE, ND VOR/DME	JAMESTOWN, ND VOR/DME	3500
JAMESTOWN, ND VOR/DME	ABERDEEN, SD VOR/DME	3300

FROM TO MEA

95.6170 VOR FEDERAL AIRWAY V170 - CONTINUED

ABERDEEN, SD VOR/DME *3300 - MOCA	SIoux FALLS, SD VORTAC	*5000
SIoux FALLS, SD VORTAC	WORTHINGTON, MN VOR/DME	3400
WORTHINGTON, MN VOR/DME	FAIRMONT, MN VOR/DME	3300
FAIRMONT, MN VOR/DME	ROCHESTER, MN VOR/DME	3000
ROCHESTER, MN VOR/DME	NODINE, MN VORTAC	3000
NODINE, MN VORTAC	DELLS, WI VORTAC	3000
DELLS, WI VORTAC	BADGER, WI VORTAC	3000
BADGER, WI VORTAC	PETTY, WI FIX	2700
PETTY, WI FIX	RAINE, MI FIX	4000
RAINE, MI FIX	PULLMAN, MI VOR/DME	2200
PULLMAN, MI VOR/DME	HEBEL, MI FIX	3000
HEBEL, MI FIX	LESSY, MI FIX	*4500
*3000 - MOCA		
LESSY, MI FIX	SALEM, MI VORTAC	3000
ERIE, PA VORTAC	BRADFORD, PA VOR/DME	4000
BRADFORD, PA VOR/DME	SLATE RUN, PA VORTAC	4000
SLATE RUN, PA VORTAC	SELINGSGROVE, PA VORTAC	4000
SELINGSGROVE, PA VORTAC	RAVINE, PA VORTAC	*4000
*3300 - MOCA		
RAVINE, PA VORTAC	BOYER, PA FIX	3500
BOYER, PA FIX	MODENA, PA VORTAC	*3000
*2400 - MOCA		
MODENA, PA VORTAC	DUPONT, DE VORTAC	##*6000
*1800 - MOCA		
*2000 - GNSS MEA		
#DUPONT R-358 UNUSABLE		
DUPONT, DE VORTAC	KERNO, MD FIX	##*2000
*2000 - GNSS MEA		
#DUPONT R-233 UNUSABLE BEYOND 22NM.		
KERNO, MD FIX	SWANN, MD FIX	*2500
*1500 - MOCA		
*2500 - GNSS MEA		
SWANN, MD FIX	PALEO, MD FIX	2500
PALEO, MD FIX	POLLA, MD FIX	2200
		MAA - 13000

95.6171 VOR FEDERAL AIRWAY V171

LEXINGTON, KY VORTAC	MCFEE, KY FIX	3000
MCFEE, KY FIX	LOUISVILLE, KY VORTAC	2600
LOUISVILLE, KY VORTAC	SCOTO, IN FIX	*10000
*3000 - MOCA		
SCOTO, IN FIX	TERRE HAUTE, IN VORTAC	*4000
*3000 - MOCA		
TERRE HAUTE, IN VORTAC	DANVILLE, IL VORTAC	2500
DANVILLE, IL VORTAC	PEOTONE, IL VORTAC	2500
PEOTONE, IL VORTAC	MEDAN, IL FIX	2400
MEDAN, IL FIX	JOLIET, IL VORTAC	2400
JOLIET, IL VORTAC	NOAHE, IL FIX	2700
NOAHE, IL FIX	ROCKFORD, IL VOR/DME	2700
ROCKFORD, IL VOR/DME	GLARS, WI FIX	2900
GLARS, WI FIX	LONE ROCK, WI VOR/DME	*3400
*2800 - MOCA		
LONE ROCK, WI VOR/DME	NODINE, MN VORTAC	3000
NODINE, MN VORTAC	EMILS, MN FIX	3000
EMILS, MN FIX	FARMINGTON, MN VORTAC	*5500
*3000 - GNSS MEA		
FARMINGTON, MN VORTAC	JONNA, MN FIX	*3500
*2500 - MOCA		
*3000 - GNSS MEA		
JONNA, MN FIX	DARWIN, MN VORTAC	2900
DARWIN, MN VORTAC	ALEXANDRIA, MN VOR/DME	3000

FROM TO MEA

95.6171 VOR FEDERAL AIRWAY V171 - CONTINUED

ALEXANDRIA, MN VOR/DME *3000 - MOCA	STARR, MN FIX	*3500
STARR, MN FIX *4000 - MRA **3500 - MOCA	*SHELS, MN FIX	**6000
SHELS, MN FIX	GRAND FORKS, ND VOR/DME	3000
GRAND FORKS, ND VOR/DME	ROSEAU, MN VOR/DME	2900

95.6172 VOR FEDERAL AIRWAY V172

NORTH PLATTE, NE VORTAC *4500 - MOCA	WOLBACH, NE VORTAC	*5400
WOLBACH, NE VORTAC	COLUMBUS, NE VOR/DME	3800
COLUMBUS, NE VOR/DME	OMAHA, IA VORTAC	3700
OMAHA, IA VORTAC	WUNOT, IA FIX	3800
WUNOT, IA FIX *5500 - MRA **3800 - MOCA	*LINDE, IA FIX	**5500
LINDE, IA FIX	GUMBO, IA FIX	3500
GUMBO, IA FIX	NEWTON, IA VOR/DME	3300
NEWTON, IA VOR/DME	CEDAR RAPIDS, IA VOR/DME	2800
CEDAR RAPIDS, IA VOR/DME	LISBO, IA FIX	2700
LISBO, IA FIX	LOTTE, IA FIX	3300
LOTTE, IA FIX	POLO, IL VOR/DME	2700
POLO, IL VOR/DME	DUPAGE, IL VOR/DME	2600

95.6173 VOR FEDERAL AIRWAY V173

SPINNER, IL VORTAC *2300 - MOCA	PEOTONE, IL VORTAC	*4500
------------------------------------	--------------------	-------

95.6174 VOR FEDERAL AIRWAY V174

YORK, KY VORTAC	HENDERSON, WV VORTAC	3300
HENDERSON, WV VORTAC *2700 - MOCA	GAYED, WV FIX	*4000
GAYED, WV FIX *5500 - MRA	*CARLA, WV FIX	5500
CARLA, WV FIX	ELKINS, WV VORTAC	5500

95.6175 VOR FEDERAL AIRWAY V175

MALDEN, MO VORTAC *2600 - MOCA	BUNKS, MO FIX	*4000
BUNKS, MO FIX	VICHY, MO VOR/DME	3000
VICHY, MO VOR/DME	ZIPUR, MO FIX	3000
ZIPUR, MO FIX	HALLSVILLE, MO VORTAC	2600
HALLSVILLE, MO VORTAC	MACON, MO VOR/DME	2600
MACON, MO VOR/DME	KIRKSVILLE, MO VORTAC	2700
KIRKSVILLE, MO VORTAC	DES MOINES, IA VORTAC	2800
DES MOINES, IA VORTAC *5500 - MRA	*LINDE, IA FIX	3500
LINDE, IA FIX *5500 - MRA **2900 - MOCA	*MADUP, IA FIX	**5500

FROM TO MEA

95.6175 VOR FEDERAL AIRWAY V175 - CONTINUED

MADUP, IA FIX	*WELTE, IA FIX	5500
*3900 - MRA		
WELTE, IA FIX	SIoux CITY, IA VORTAC	3000
SIoux CITY, IA VORTAC	OYENS, IA FIX	4400
OYENS, IA FIX	WORTHINGTON, MN VOR/DME	3600
WORTHINGTON, MN VOR/DME	REDWOOD FALLS, MN VOR/DME	3400
REDWOOD FALLS, MN VOR/DME	ALEXANDRIA, MN VOR/DME	3500
ALEXANDRIA, MN VOR/DME	PARK RAPIDS, MN VOR/DME	3000
PARK RAPIDS, MN VOR/DME	BLUOX, MN FIX	
	S BND	3500
	NW BND	7000
BLUOX, MN FIX	ROSEAU, MN VOR/DME	*7000
*2800 - MOCA		
*3300 - GNSS MEA		
ROSEAU, MN VOR/DME	U.S. CANADIAN BORDER	*3600
*2500 - MOCA		

95.6176 VOR FEDERAL AIRWAY V176

CARLETON, MI VORTAC	U.S. CANADIAN BORDER	*3000
*2100 - MOCA		

95.6177 VOR FEDERAL AIRWAY V177

JOLIET, IL VORTAC	NUELG, IL FIX	2600
NUELG, IL FIX	JANESVILLE, WI VOR/DME	*4000
*2300 - MOCA		
JANESVILLE, WI VOR/DME	MADISON, WI VORTAC	3000
MADISON, WI VORTAC	STEVENS POINT, WI VORTAC	2800
STEVENS POINT, WI VORTAC	TAYUY, WI FIX	#3100
#WAUSAU R-171 UNUSABLE BEYOND 8 NM, USE STEVENS POINT R-354	WAUSAU, WI VORTAC	#3100
TAYUY, WI FIX	#WAUSAU R-171 UNUSABLE BYD 8 NM, USE STEVENS POINT R-354	
WAUSAU, WI VORTAC	BAITS, WI FIX	##4500
*3600 - MOCA		
*4500 - GNSS MEA		
#WAUSAU R-310 UNUSABLE BYD 10 NM, GNSS REQUIRED BYD 10 NM	HAYWARD, WI VOR/DME	*10000
BAITS, WI FIX		
*3100 - MOCA		
*10000 - GNSS MEA		
HAYWARD, WI VOR/DME	DULUTH, MN VORTAC	*10000
*3000 - MOCA		
DULUTH, MN VORTAC	ELY, MN VOR/DME	3600

95.6178 VOR FEDERAL AIRWAY V178

HALLSVILLE, MO VORTAC	BNTON, MO FIX	2800
BNTON, MO FIX	VICHY, MO VOR/DME	*2800
*2200 - MOCA		
VICHY, MO VOR/DME	FARMINGTON, MO VORTAC	3300
FARMINGTON, MO VORTAC	CAPE GIRARDEAU, MO VOR/DME	3000
CAPE GIRARDEAU, MO VOR/DME	CUNNINGHAM, KY VORTAC	2400
CUNNINGHAM, KY VORTAC	CENTRAL CITY, KY VORTAC	2600
CENTRAL CITY, KY VORTAC	NEW HOPE, KY VOR/DME	2700
NEW HOPE, KY VOR/DME	MAUDD, KY FIX	2700
MAUDD, KY FIX	MCFEE, KY FIX	5000

FROM	TO	MEA
------	----	-----

95.6178 VOR FEDERAL AIRWAY V178 - CONTINUED

MCFEE, KY FIX	LEXINGTON, KY VORTAC	3000
LEXINGTON, KY VORTAC	TRENT, KY FIX	3400
TRENT, KY FIX	SLINK, WV FIX	*8000
*4200 - GNSS MEA		
SLINK, WV FIX	BLUEFIELD, WV VORTAC	*6000
*5400 - GNSS MEA		

95.6179 VOR FEDERAL AIRWAY V179

BRUNSWICK, GA VORTAC	DUBLIN, GA VORTAC	2000
DUBLIN, GA VORTAC	HUSKY, GA FIX	*3000
*2100 - MOCA		

95.6180 VOR FEDERAL AIRWAY V180

INTERNATIONAL FALLS, MN VORTAC	U.S. CANADIAN BORDER	2900
--------------------------------	----------------------	------

95.6181 VOR FEDERAL AIRWAY V181

KIRKSVILLE, MO VORTAC	LAMONI, IA VORTAC	2900
LAMONI, IA VORTAC	OMAHA, IA VORTAC	3000
OMAHA, IA VORTAC	NORFOLK, NE VOR/DME	3500
NORFOLK, NE VOR/DME	YANKTON, SD VOR/DME	3700
YANKTON, SD VOR/DME	SIoux FALLS, SD VORTAC	3400
SIoux FALLS, SD VORTAC	*OBITT, SD FIX	**4000
*5000 - MRA		
**3500 - MOCA		
#SIoux FALLS R-340 UNUSABLE BELOW 4000.		
OBITT, SD FIX	WATERTOWN, SD VORTAC	*4000
*3200 - MOCA		
WATERTOWN, SD VORTAC	BANEY, ND FIX	4500
BANEY, ND FIX	FARGO, ND VORTAC	
	N BND	2800
	S BND	3900
FARGO, ND VORTAC	GRAND FORKS, ND VOR/DME	2600
GRAND FORKS, ND VOR/DME	HUMBOLDT, MN VORTAC	2600
HUMBOLDT, MN VORTAC	U.S. CANADIAN BORDER	2800

95.6182 VOR FEDERAL AIRWAY V182

NORTH BEND, OR VORTAC	*GAMMA, OR FIX	
	S BND	4000
	N BND	4500
*6200 - MRA		
GAMMA, OR FIX	NEWPORT, OR VORTAC	4500
NEWPORT, OR VORTAC	NEWBERG, OR VOR/DME	6000
NEWBERG, OR VOR/DME	BATTLE GROUND, WA VORTAC	4000
*BATTLE GROUND, WA VORTAC	GYMME, WA FIX	
	E BND	7000
	W BND	6500
*4700 - MCA BATTLE GROUND, WA VORTAC , E BND		
GYMME, WA FIX	KLICKITAT, OR VOR/DME	*7000
*6400 - MOCA		
KLICKITAT, OR VOR/DME	*BREED, OR FIX	5300
*5700 - MRA		
BREED, OR FIX	*UKIAH, OR FIX	8000
*9400 - MCA UKIAH, OR FIX , E BND		

FROM TO MEA

95.6182 VOR FEDERAL AIRWAY V182 - CONTINUED

UKIAH, OR FIX	*BAKER CITY, OR VOR/DME	**13000
*10000 - MCA BAKER CITY, OR VOR/DME , W BND		
**11000 - MOCA		
BAKER CITY, OR VOR/DME	*IBEAM, OR FIX	9000
*12000 - MCA IBEAM, OR FIX , NE BND		
IBEAM, OR FIX	LEZLE, WA FIX	*12000
*8100 - MOCA		
LEZLE, WA FIX	NEZ PERCE, ID VOR/DME	*7000
*6200 - MOCA		

95.6183 VOR FEDERAL AIRWAY V183

*SAN MARCUS, CA VORTAC	TAFTO, CA FIX	9000
*7500 - MCA SAN MARCUS, CA VORTAC , N BND		
*TAFTO, CA FIX	MARIC, CA FIX	**6000
*6000 - MCA TAFTO, CA FIX , S BND		
**4500 - MOCA		
*MARIC, CA FIX	SHAFTER, CA VORTAC	3000
*5000 - MCA MARIC, CA FIX , S BND		

95.6184 VOR FEDERAL AIRWAY V184

ERIE, PA VORTAC	TIDIOUTE, PA VORTAC	3500
TIDIOUTE, PA VORTAC	PHILIPSBURG, PA VORTAC	*5000
*4000 - MOCA		
PHILIPSBURG, PA VORTAC	HARRISBURG, PA VORTAC	4000
HARRISBURG, PA VORTAC	DELRO, PA FIX	3000
DELRO, PA FIX	MODENA, PA VORTAC	*10000
*3900 - MOCA		
*4000 - GNSS MEA		
MODENA, PA VORTAC	WOODSTOWN, NJ VORTAC	2000
WOODSTOWN, NJ VORTAC	CEDAR LAKE, NJ VORTAC	1900
CEDAR LAKE, NJ VORTAC	ATLANTIC CITY, NJ VORTAC	1800
ATLANTIC CITY, NJ VORTAC	PANZE, NJ FIX	*2000
*1500 - MOCA		
PANZE, NJ FIX	FALON, NJ FIX	*5000
*1500 - MOCA		
*2000 - GNSS MEA		
FALON, NJ FIX	ZIGGI, NJ FIX	*2500
*1600 - MOCA		

95.6185 VOR FEDERAL AIRWAY V185

SAVANNAH, GA VORTAC	*SPONG, GA FIX	**3000
*5000 - MRA		
**2200 - MOCA		
SPONG, GA FIX	COLLIERS, SC VORTAC	*3000
*2200 - MOCA		
COLLIERS, SC VORTAC	GREENWOOD, SC VORTAC	2400
GREENWOOD, SC VORTAC	*UNMAN, SC FIX	3000
*4000 - MCA UNMAN, SC FIX , N BND		
UNMAN, SC FIX	SUGARLOAF MOUNTAIN, NC VORTAC	6000
SUGARLOAF MOUNTAIN, NC	MUMMI, NC FIX	7000

FROM TO MEA

95.6185 VOR FEDERAL AIRWAY V185 - CONTINUED

VORTAC		
MUMMI, NC FIX	SNOWBIRD, TN VORTAC	8000
SNOWBIRD, TN VORTAC	*PENGE, TN FIX	7000
*4000 - MCA PENGE, TN FIX , SE BND		
PENGE, TN FIX	VOLUNTEER, TN VORTAC	3000

95.6186 VOR FEDERAL AIRWAY V186

SAN MARCUS, CA VORTAC	DEANO, CA FIX	6000
DEANO, CA FIX	HENER, CA FIX	5000
HENER, CA FIX	FILLMORE, CA VORTAC	6000
FILLMORE, CA VORTAC	VAN NUYS, CA VOR/DME	5500
VAN NUYS, CA VOR/DME	TIFNI, CA FIX	5000
TIFNI, CA FIX	PARADISE, CA VORTAC	4000
PARADISE, CA VORTAC	TANNR, CA FIX	5500
TANNR, CA FIX	POGGI, CA VORTAC	5000

95.6187 VOR FEDERAL AIRWAY V187

SOCORRO, NM VORTAC	ALBUQUERQUE, NM VORTAC	8000
ALBUQUERQUE, NM VORTAC	*CURLY, NM FIX	9000
*9500 - MCA CURLY, NM FIX , NW BND		
CURLY, NM FIX	*MISSY, NM FIX	11000
*9000 - MRA		
MISSY, NM FIX	RATTLESNAKE, NM VORTAC	8700
RATTLESNAKE, NM VORTAC	RIZAL, CO FIX	9100
RIZAL, CO FIX	MANCA, CO FIX	10900
MANCA, CO FIX	HERRM, CO FIX	*15000
*12200 - MOCA		
HERRM, CO FIX	*GRAND JUNCTION, CO VOR/DME	12100
*10700 - MCA GRAND JUNCTION, CO VOR/DME , S BND		
GRAND JUNCTION, CO	*TESSY, CO FIX	10000
VOR/DME		
*10500 - MRA		
*10700 - MCA TESSY, CO FIX , N BND		
TESSY, CO FIX	RACER, CO FIX	*12000
*11000 - MOCA		
RACER, CO FIX	*RENAE, CO FIX	**13000
*13000 - MRA		
**10700 - MOCA		
RENAE, CO FIX	ROCK SPRINGS, WY VOR/DME	*13000
*11700 - MOCA		
ROCK SPRINGS, WY VOR/DME	RIVERTON, WY VOR/DME	*12000
*10000 - MOCA		
*10000 - GNSS MEA		
RIVERTON, WY VOR/DME	BOYSEN RESERVOIR, WY VOR/DME	9600
BOYSEN RESERVOIR, WY	PRYER, MT FIX	11000
VOR/DME		
PRYER, MT FIX	*BILLINGS, MT VORTAC	
SE BND		
NW BND		
*6500 - MCA BILLINGS, MT VORTAC , S BND		
BILLINGS, MT VORTAC	TASSE, MT FIX	
SE BND		
NW BND		
TASSE, MT FIX	*JUGAP, MT FIX	8000
*9500 - MCA JUGAP, MT FIX , NW BND		

FROM	TO	MEA
95.6187 VOR FEDERAL AIRWAY V187 - CONTINUED		
JUGAP, MT FIX *10300 - MOCA	GREAT FALLS, MT VORTAC	*11000
GREAT FALLS, MT VORTAC	ABARN, MT FIX NE BND SW BND	8000 10000
ABARN, MT FIX *11400 - MOCA	MISSOULA, MT VOR/DME	*13000
MISSOULA, MT VOR/DME	LOLLO, MT FIX NE BND SW BND	*10000 *13000
*9300 - MOCA		
LOLLO, MT FIX	RIVAL, MT FIX NE BND SW BND	*12000 *13000
*9000 - MOCA		
RIVAL, MT FIX *9900 - MOCA	OFINO, ID FIX	*13000
OFINO, ID FIX	NEZ PERCE, ID VOR/DME SW BND NE BND	5500 10000
NEZ PERCE, ID VOR/DME	DATES, WA FIX	7000
DATES, WA FIX	PASCO, WA VOR/DME	4000
PASCO, WA VOR/DME	NIALS, WA FIX	3500
NIALS, WA FIX	FEBUS, WA FIX	4700
FEBUS, WA FIX	*ELLENSBURG, WA VORTAC	6000
*6700 - MCA ELLENSBURG, WA VORTAC		
ELLENSBURG, WA VORTAC	THICK, WA FIX E BND W BND	7700 10000
THICK, WA FIX	MOUNT, WA FIX	10000
MOUNT, WA FIX	ORTIN, WA FIX W BND E BND	8000 10000
ORTIN, WA FIX	MCCHORD, WA VORTAC	6000
MCCHORD, WA VORTAC	OLYMPIA, WA VORTAC	6000
OLYMPIA, WA VORTAC	RINDS, WA FIX	4000
RINDS, WA FIX	ASTORIA, OR VOR/DME	5000

95.6188 VOR FEDERAL AIRWAY V188

CARLETON, MI VORTAC *2200 - MOCA	U.S. CANADIAN BORDER	*3000
U.S. CANADIAN BORDER *1800 - MOCA	FAILS, OH FIX	*4000
*2300 - GNSS MEA		
FAILS, OH FIX *5000 - MRA **2000 - MOCA	*WONOP, OH FIX	**3000
WONOP, OH FIX *2200 - MOCA	CLERI, OH FIX	*3000
CLERI, OH FIX *2400 - MOCA	JEFFERSON, OH VOR/DME	*3000
JEFFERSON, OH VOR/DME	TIDIOUTE, PA VORTAC	3500
TIDIOUTE, PA VORTAC	SLATE RUN, PA VORTAC	4000
SLATE RUN, PA VORTAC	WILLIAMSPORT, PA VOR/DME	4000
WILLIAMSPORT, PA VOR/DME	SWANK, PA FIX	4500
SWANK, PA FIX	WILKES-BARRE, PA VORTAC	4000
WILKES-BARRE, PA VORTAC	SPARTA, NJ VORTAC	4000
SPARTA, NJ VORTAC *2500 - MOCA	CARMEL, NY VOR/DME	*3000
CARMEL, NY VOR/DME	GROTON, CT VOR/DME	3000

FROM TO MEA

95.6189 VOR FEDERAL AIRWAY V189

WRIGHT BROTHERS, NC VOR/DME *8000 - MCA DAREZ, NC FIX , E BND **3000 - GNSS MEA	*DAREZ, NC FIX	**8000
DAREZ, NC FIX *3000 - MOCA *4000 - GNSS MEA	TAR RIVER, NC VORTAC	*6000
TAR RIVER, NC VORTAC	FRANKLIN, VA VORTAC	2000
FRANKLIN, VA VORTAC	HOPEWELL, VA VORTAC	3000

95.6190 VOR FEDERAL AIRWAY V190

PHOENIX, AZ VORTAC *7800 - MCA LAKEY, AZ FIX , NE BND	*LAKEY, AZ FIX	5000
LAKEY, AZ FIX *5300 - MOCA	GRINE, AZ FIX NE BND SW BND	*9000 *6000
GRINE, AZ FIX *6700 - MOCA	PEAKS, AZ FIX	*10000
PEAKS, AZ FIX	TEDDI, AZ FIX NE BND SW BND	13000 10000
TEDDI, AZ FIX *11000 - MOCA *11000 - GNSS MEA	ST JOHNS, AZ VORTAC	*13000
ST JOHNS, AZ VORTAC *10800 - MOCA	ACOMA, NM FIX	*11500
ACOMA, NM FIX *11500 - MCA ALBUQUERQUE, NM VORTAC , NE BND	*ALBUQUERQUE, NM VORTAC	9000
ALBUQUERQUE, NM VORTAC	RENCO, NM FIX	13000
RENCO, NM FIX *11300 - MCA FORT UNION, NM VORTAC , SW BND	*FORT UNION, NM VORTAC	12000
FORT UNION, NM VORTAC *9200 - MOCA	DALHART, TX VORTAC	*10000
DALHART, TX VORTAC *5400 - MOCA	MITBEE, OK VORTAC	*7000
MITBEE, OK VORTAC *5000 - MRA **3700 - MOCA	*CARON, OK FIX	**5000
CARON, OK FIX *2700 - MOCA	PIONEER, OK VORTAC	*5000
PIONEER, OK VORTAC	BARTLESVILLE, OK VOR/DME	3000
BARTLESVILLE, OK VOR/DME	OSWEGO, KS VORTAC	2500
OSWEGO, KS VORTAC	WACCO, MO FIX	3000
WACCO, MO FIX *3700 - MRA	*MIRTH, MO FIX	3000
MIRTH, MO FIX	SPRINGFIELD, MO VORTAC	3000
SPRINGFIELD, MO VORTAC	MAPLES, MO VORTAC	3000
MAPLES, MO VORTAC	BUNKS, MO FIX	3000
BUNKS, MO FIX	FARMINGTON, MO VORTAC	3500
FARMINGTON, MO VORTAC	MARION, IL VOR/DME	3000
MARION, IL VOR/DME *2500 - MRA	*TEXAS, IL FIX	2000
TEXAS, IL FIX	POCKET CITY, IN VORTAC	2200

FROM TO MEA

95.6191 VOR FEDERAL AIRWAY V191

TROY, IL VORTAC	ADDERS, IL VORTAC	2500
ADDERS, IL VORTAC	ROBERTS, IL VOR/DME	2800
ROBERTS, IL VOR/DME	NEWT, IL FIX	2500
NEWT, IL FIX	*BOJAK, IL FIX	**5000
*5000 - MRA		
**2100 - MOCA		
BOJAK, IL FIX	NORTHBROOK, IL VOR/DME	2500
NORTHBROOK, IL VOR/DME	BADGER, WI VORTAC	2900
BADGER, WI VORTAC	OSHKOSH, WI VORTAC	3000
OSHKOSH, WI VORTAC	RHINELANDER, WI VORTAC	*4500
*3000 - MOCA		
RHINELANDER, WI VORTAC	IRONWOOD, MI VORTAC	*8000
*3100 - MOCA		
IRONWOOD, MI VORTAC	DULUTH, MN VORTAC	3500
DULUTH, MN VORTAC	HIBBING, MN VOR/DME	3300
HIBBING, MN VOR/DME	GRAND RAPIDS, MN VOR/DME	3000

95.6192 VOR FEDERAL AIRWAY V192

CHAMPAIGN, IL VORTAC	TERRE HAUTE, IN VORTAC	2500
TERRE HAUTE, IN VORTAC	BRICKYARD, IN VORTAC	2700
BRICKYARD, IN VORTAC	MUNCIE, IN VOR/DME	2900
MUNCIE, IN VOR/DME	DAYTON, OH VOR/DME	2800

95.6193 VOR FEDERAL AIRWAY V193

MUSKY, MI FIX	PULLMAN, MI VOR/DME	2400
PULLMAN, MI VOR/DME	CLOCK, MI FIX	2700
CLOCK, MI FIX	WHITE CLOUD, MI VOR/DME	2800
WHITE CLOUD, MI VOR/DME	TRAVERSE CITY, MI VORTAC	3200
TRAVERSE CITY, MI VORTAC	PELLSTON, MI VORTAC	3000
PELLSTON, MI VORTAC	SAULT STE MARIE, MI VOR/DME	3000

95.6194 VOR FEDERAL AIRWAY V194

CEDAR CREEK, TX VORTAC	KISER, TX FIX	2100
KISER, TX FIX	COLLEGE STATION, TX VORTAC	4000
COLLEGE STATION, TX VORTAC	PRARI, TX FIX	2000
PRARI, TX FIX	SEALY, TX FIX	3500
SEALY, TX FIX	HOBBY, TX VOR/DME	2000
HOBBY, TX VOR/DME	SABINE PASS, TX VOR/DME	3000
SABINE PASS, TX VOR/DME	GUSTI, LA FIX	*4000
*1600 - MOCA		
GUSTI, LA FIX	LAFAYETTE, LA VORTAC	2800
LAFAYETTE, LA VORTAC	*ROSEY, LA FIX	2000
*5000 - MRA		
ROSEY, LA FIX	BATON ROUGE, LA VORTAC	2000
BATON ROUGE, LA VORTAC	MC COMB, MS VORTAC	2200
MC COMB, MS VORTAC	MIZZE, MS FIX	*3000
*2000 - MOCA		
MIZZE, MS FIX	*PAULD, MS FIX	3000
*5000 - MRA		
*3000 - MCA PAULD, MS FIX , SW BND		
PAULD, MS FIX	MERIDIAN, MS VORTAC	2100
LIBERTY, NC VORTAC	RALEIGH/DURHAM, NC VORTAC	3000
RALEIGH/DURHAM, NC VORTAC	TAR RIVER, NC VORTAC	2500
TAR RIVER, NC VORTAC	COFIELD, NC VORTAC	1800
COFIELD, NC VORTAC	SUNNS, NC FIX	*2000
*1600 - MOCA		

FROM TO MEA

95.6195 VOR FEDERAL AIRWAY V195

MANTECA, CA VORTAC	TRACY, CA FIX E BND W BND	2000 4000
TRACY, CA FIX	SUNOL, CA FIX	5000
SUNOL, CA FIX	OAKLAND, CA VORTAC	4000
OAKLAND, CA VORTAC	CROIT, CA FIX	4000
CROIT, CA FIX	*CORDD, CA FIX	5000
*6200 - MCA CORDD, CA FIX , N BND		
CORDD, CA FIX	*RAGGS, CA FIX	**8500
*8500 - MRA		
**5000 - MOCA		
RAGGS, CA FIX	*BESSA, CA FIX	**7500
*7500 - MCA BESSA, CA FIX , S BND		
**4800 - MOCA		
BESSA, CA FIX	WILLIAMS, CA VORTAC	5300
WILLIAMS, CA VORTAC	RED BLUFF, CA VORTAC	*3000
*1700 - MOCA		
RED BLUFF, CA VORTAC	BURRS, CA FIX	3000
BURRS, CA FIX	*TOMAD, CA FIX	6000
*7000 - MRA		
*7000 - MCA TOMAD, CA FIX , W BND		
TOMAD, CA FIX	*YAGER, CA FIX	**9500
*7700 - MCA YAGER, CA FIX , E BND		
**7900 - MOCA		
YAGER, CA FIX	FORTUNA, CA VORTAC	6000

95.6196 VOR FEDERAL AIRWAY V196

UTICA, NY VORTAC	*BECKS, NY FIX	**5000
*10000 - MRA		
**4500 - MOCA		
BECKS, NY FIX	SARANAC LAKE, NY VOR/DME	5000
SARANAC LAKE, NY VOR/DME	PLATTSBURGH, NY VORTAC	5000

95.6197 VOR FEDERAL AIRWAY V197

PARADISE, CA VORTAC	POMONA, CA VORTAC	#4500
#MTA V264 E TO V197 NW 11800		
POMONA, CA VORTAC	*HASSA, CA FIX	6500
*10000 - MCA HASSA, CA FIX , NW BND		
HASSA, CA FIX	*PALMDALE, CA VORTAC	10500
*8700 - MCA PALMDALE, CA VORTAC , SE BND		
PALMDALE, CA VORTAC	*FISCH, CA FIX	5000
*8100 - MCA FISCH, CA FIX , NW BND		
FISCH, CA FIX	*KELEN, CA FIX	10000
*9100 - MCA KELEN, CA FIX , SE BND		
KELEN, CA FIX	*ARVIN, CA FIX	7800
*6900 - MCA ARVIN, CA FIX , SE BND		
ARVIN, CA FIX	SHAFTER, CA VORTAC	3000

FROM	TO	MEA
95.6198 VOR FEDERAL AIRWAY V198		
SAN SIMON, AZ VORTAC	COLUMBUS, NM VOR/DME	8700
COLUMBUS, NM VOR/DME	EL PASO, TX VORTAC	9000
EL PASO, TX VORTAC	HUDSPETH, TX VORTAC	7500
HUDSPETH, TX VORTAC	AGAZY, TX FIX	*11000
*8900 - MOCA		
AGAZY, TX FIX	DOWES, TX FIX	*8000
*6400 - MOCA		
DOWES, TX FIX	FORT STOCKTON, TX VORTAC	5000
FORT STOCKTON, TX VORTAC	JUNCTION, TX VORTAC	*8000
*5500 - MOCA		
JUNCTION, TX VORTAC	DOSSY, TX FIX	3800
DOSSY, TX FIX	*COMFY, TX FIX	4000
*4000 - MRA		
COMFY, TX FIX	SAN ANTONIO, TX VORTAC	4000
SAN ANTONIO, TX VORTAC	SEEDS, TX FIX	2900
SEEDS, TX FIX	WEMAR, TX FIX	*2500
*1800 - MOCA		
WEMAR, TX FIX	EAGLE LAKE, TX VOR/DME	2000
EAGLE LAKE, TX VOR/DME	BLUMS, TX FIX	*2100
*1500 - MOCA		
BLUMS, TX FIX	HOBBY, TX VOR/DME	2400
HOBBY, TX VOR/DME	SABINE PASS, TX VOR/DME	3000
SABINE PASS, TX VOR/DME	WHITE LAKE, LA VOR/DME	*4000
*1700 - MOCA		
*2000 - GNSS MEA		
WHITE LAKE, LA VOR/DME	TIBBY, LA VORTAC	2000
TIBBY, LA VORTAC	HARVEY, LA VORTAC	2000
HARVEY, LA VORTAC	PEARL, LA FIX	2000
PEARL, LA FIX	DOGMA, MS FIX	*2300
*1300 - MOCA		
DOGMA, MS FIX	*ROMMY, MS FIX	**2800
*4000 - MRA		
**1300 - MOCA		
ROMMY, MS FIX	BROOKLEY, AL VORTAC	2000
BROOKLEY, AL VORTAC	CRESTVIEW, FL VORTAC	3000
CRESTVIEW, FL VORTAC	DEFUN, FL FIX	2000
DEFUN, FL FIX	CHEWS, FL FIX	*3000
*1600 - MOCA		
CHEWS, FL FIX	MARIANNA, FL VORTAC	2000
MARIANNA, FL VORTAC	*SNEAD, FL FIX	2000
*3000 - MRA		
SNEAD, FL FIX	SEMINOLE, FL VORTAC	2000
SEMINOLE, FL VORTAC	*LLOYD, FL FIX	2000
*5000 - MRA		
LLOYD, FL FIX	GREENVILLE, FL VORTAC	2000
GREENVILLE, FL VORTAC	TAYLOR, FL VORTAC	2000
TAYLOR, FL VORTAC	CRAIG, FL VORTAC	*3000
*2100 - MOCA		

95.6199 VOR FEDERAL AIRWAY V199

SAN FRANCISCO, CA VOR/DME	SUTRO, CA FIX	3500
SUTRO, CA FIX	GOBBS, CA FIX	3000
GOBBS, CA FIX	STINS, CA FIX	3500
STINS, CA FIX	DUBRY, CA FIX	4500
DUBRY, CA FIX	MENDOCINO, CA VORTAC	6000
MENDOCINO, CA VORTAC	*HENLE, CA FIX	**9000
*5000 - MCA HENLE, CA FIX , S BND		
**8300 - MOCA		
HENLE, CA FIX	RED BLUFF, CA VORTAC	3000

FROM	TO	MEA
95.6200 VOR FEDERAL AIRWAY V200		
MENDOCINO, CA VORTAC *9000 - MRA	*LAPED, CA FIX	6000
LAPED, CA FIX	WILLIAMS, CA VORTAC	6000
WILLIAMS, CA VORTAC	YUBBA, CA FIX	4000
YUBBA, CA FIX	*RANGO, CA FIX	5000
*8500 - MCA RANGO, CA FIX , E BND		
RANGO, CA FIX	SIGNA, CA FIX	*11000
*10000 - MOCA		
SIGNA, CA FIX	MUSTANG, NV VORTAC	11500
BONNEVILLE, UT VORTAC	*STACO, UT FIX	9000
*11000 - MCA STACO, UT FIX , SE BND		
STACO, UT FIX	*FAIRFIELD, UT VORTAC	12000
*10500 - MCA FAIRFIELD, UT VORTAC , NW BND		
*12000 - MCA FAIRFIELD, UT VORTAC , E BND		
FAIRFIELD, UT VORTAC	PANEL, UT FIX	
	E BND	13000
	W BND	11000
PANEL, UT FIX	MYTON, UT VORTAC	13000
MYTON, UT VORTAC	RACER, CO FIX	*10000
*8600 - MOCA		
RACER, CO FIX	MEEKER, CO VOR/DME	10500
MEEKER, CO VOR/DME	KREMMLING, CO VOR/DME	14500

95.6201 VOR FEDERAL AIRWAY V201

LOS ANGELES, CA VORTAC *7500 - MCA BERRI, CA FIX , N BND	*BERRI, CA FIX	5000
BERRI, CA FIX	SOLED, CA FIX	8500
SOLED, CA FIX	*PALMDALE, CA VORTAC	
	SW BND	8500
	NE BND	7000
*6900 - MCA PALMDALE, CA VORTAC , S BND		

95.6202 VOR FEDERAL AIRWAY V202

TUCSON, AZ VORTAC	SULLI, AZ FIX	8000
SULLI, AZ FIX	MESCA, AZ FIX	
	SE BND	9500
	NW BND	8000
MESCA, AZ FIX	COCHISE, AZ VORTAC	9500
COCHISE, AZ VORTAC	SAN SIMON, AZ VORTAC	10000
SAN SIMON, AZ VORTAC	SILVER CITY, NM VORTAC	10000
SILVER CITY, NM VORTAC	*KEAPS, NM FIX	10000
*11600 - MCA KEAPS, NM FIX , NE BND		
KEAPS, NM FIX	TRUTH OR CONSEQUENCES, NM VORTAC	12000

95.6203 VOR FEDERAL AIRWAY V203

ALBANY, NY VORTAC *2200 - MOCA	OTOLE, NY FIX	*6000
*3000 - GNSS MEA		
OTOLE, NY FIX	DINNY, NY FIX	*10000
*6900 - MOCA		
*7000 - GNSS MEA		
DINNY, NY FIX	SARANAC LAKE, NY VOR/DME	6700

FROM TO MEA

95.6203 VOR FEDERAL AIRWAY V203 - CONTINUED

SARANAC LAKE, NY VOR/DME	#MASSENA, NY VORTAC	*10000
*4500 - MOCA		
*5000 - GNSS MEA		
#MASSENA R-159 UNUSABLE. USE SARANAC R-339		
MASSENA, NY VORTAC	U.S. CANADIAN BORDER	*14000
*1500 - MOCA		
*2000 - GNSS MEA		

95.6204 VOR FEDERAL AIRWAY V204

HOQUIAM, WA VORTAC	*OLYMPIA, WA VORTAC	4500
*3200 - MCA OLYMPIA, WA VORTAC , W BND		
OLYMPIA, WA VORTAC	*MCKEN, WA FIX	4000
*5000 - MCA MCKEN, WA FIX , E BND		
MCKEN, WA FIX	*ALDER, WA FIX	5800
*5800 - MCA ALDER, WA FIX , E BND		
ALDER, WA FIX	TAMPO, WA FIX	10000
TAMPO, WA FIX	*YAKIMA, WA VORTAC	
W BND		8000
E BND		6000
*5300 - MCA YAKIMA, WA VORTAC , W BND		
YAKIMA, WA VORTAC	*PAIDS, WA FIX	6000
*5200 - MCA PAIDS, WA FIX , W BND		
PAIDS, WA FIX	PASCO, WA VOR/DME	4000
PASCO, WA VOR/DME	WATSY, WA FIX	3500
WATSY, WA FIX	*GRAPH, WA FIX	5000
*6000 - MRA		
GRAPH, WA FIX	SPOKANE, WA VORTAC	5000

95.6205 VOR FEDERAL AIRWAY V205

COATE, NJ FIX	HUGUENOT, NY VOR/DME	*4000
*3300 - MOCA		
HUGUENOT, NY VOR/DME	WEARD, NY FIX	*4000
*3500 - MOCA		
WEARD, NY FIX	*WEETS, NY FIX	6000
*6000 - MRA		
WEETS, NY FIX	STUBY, CT FIX	MAA - 14500
*5000 - GNSS MEA		*8500
STUBY, CT FIX	VEERS, CT FIX	3500
VEERS, CT FIX	RONGE, CT FIX	3500
BRADLEY, CT VORTAC	PUTNAM, CT VOR/DME	3000

95.6206 VOR FEDERAL AIRWAY V206

NAPOLEON, MO VORTAC	KIRKSVILLE, MO VORTAC	3000
KIRKSVILLE, MO VORTAC	OTTUMWA, IA VOR/DME	3000

FROM	TO	MEA
------	----	-----

95.6207 VOR FEDERAL AIRWAY V207

GILL, CO VOR/DME	SCOTTSBLUFF, NE VORTAC	7500
------------------	------------------------	------

95.6208 VOR FEDERAL AIRWAY V208

VENTURA, CA VOR/DME	WEEZL, CA FIX	5000
WEEZL, CA FIX	SANTA CATALINA, CA VORTAC	4000
SANTA CATALINA, CA VORTAC	AVOLS, CA FIX	4000
AVOLS, CA FIX	PACIF, CA FIX	*3000
*2000 - MOCA		
PACIF, CA FIX	OCEANSIDE, CA VORTAC	3000
OCEANSIDE, CA VORTAC	*VISTA, CA FIX	3000
*5000 - MCA VISTA, CA FIX , E BND		
VISTA, CA FIX	JULIAN, CA VORTAC	7700
JULIAN, CA VORTAC	WARNE, CA FIX	
	SW BND	8000
	NE BND	9000
WARNE, CA FIX	*THERMAL, CA VORTAC	9000
*5600 - MCA THERMAL, CA VORTAC , N BND		
*7000 - MCA THERMAL, CA VORTAC , S BND		
THERMAL, CA VORTAC	TWENTYNINE PALMS, CA VORTAC	7000
TWENTYNINE PALMS, CA VORTAC	NEEDLES, CA VORTAC	7800
NEEDLES, CA VORTAC	PEACH SPRINGS, AZ VORTAC	9000
PEACH SPRINGS, AZ VORTAC	GRAND CANYON, AZ VOR/DME	10000
GRAND CANYON, AZ VOR/DME	TUBA CITY, AZ VORTAC	9500
TUBA CITY, AZ VORTAC	PAGE, AZ VOR/DME	9000
PAGE, AZ VOR/DME	*HANKSVILLE, UT VORTAC	14000
*11500 - MCA HANKSVILLE, UT VORTAC , S BND		
HANKSVILLE, UT VORTAC	CARBON, UT VOR/DME	10000
CARBON, UT VOR/DME	MYTON, UT VORTAC	11300
MYTON, UT VORTAC	VERNAL, UT VOR/DME	8400
VERNAL, UT VOR/DME	CHEROKEE, WY VOR/DME	11700

95.6209 VOR FEDERAL AIRWAY V209

SEMMES, AL VORTAC	JANES, AL FIX	*2300
*1800 - MOCA		
*2000 - GNSS MEA		
JANES, AL FIX	KEWANEE, MS VORTAC	2300
KEWANEE, MS VORTAC	MOVIL, AL FIX	2000
MOVIL, AL FIX	BROOKWOOD, AL VORTAC	2400
BROOKWOOD, AL VORTAC	VULCAN, AL VORTAC	2500
VULCAN, AL VORTAC	TRUST, AL FIX	3500
TRUST, AL FIX	GADSDEN, AL VOR/DME	3600
GADSDEN, AL VOR/DME	*MENLA, AL FIX	**5000
*5000 - MCA MENLA, AL FIX , SW BND		
**3700 - MOCA		
MENLA, AL FIX	CHOO CHOO, TN VORTAC	4000

95.6210 VOR FEDERAL AIRWAY V210

LOS ANGELES, CA VORTAC	PIRRO, CA FIX	3500
PIRRO, CA FIX	*POMONA, CA VORTAC	4500
*10300 - MCA POMONA, CA VORTAC , NE BND		

FROM TO MEA

95.6210 VOR FEDERAL AIRWAY V210 - CONTINUED

POMONA, CA VORTAC	CALBE, CA FIX	
	NE BND	10800
	SW BND	5300
CALBE, CA FIX	MEANT, CA FIX	
	NE BND	11500
	SW BND	10700
MEANT, CA FIX	*APLES, CA FIX	11500
*9100 - MCA	APLES, CA FIX , SW BND	
APLES, CA FIX	HECTOR, CA VORTAC	7500
HECTOR, CA VORTAC	GOFFS, CA VORTAC	*9000
*8200 - MOCA		
GOFFS, CA VORTAC	UNPAS, NV FIX	8000
UNPAS, NV FIX	PEACH SPRINGS, AZ VORTAC	9000
PEACH SPRINGS, AZ VORTAC	*GRAND CANYON, AZ VOR/DME	10000
*14500 - MCA	GRAND CANYON, AZ VOR/DME , E BND	
GRAND CANYON, AZ VOR/DME	*TUBA CITY, AZ VORTAC	**14500
*14500 - MCA	TUBA CITY, AZ VORTAC , W BND	
**9600 - MOCA		
TUBA CITY, AZ VORTAC	*FULLY, NM FIX	12000
*10500 - MRA		
FULLY, NM FIX	RATTLESNAKE, NM VORTAC	8300
RATTLESNAKE, NM VORTAC	RESER, NM FIX	9000
RESER, NM FIX	MRKKO, CO FIX	15000
MRKKO, CO FIX	*ALAMOSA, CO VORTAC	
	W BND	14800
	E BND	10000
*11200 - MCA	ALAMOSA, CO VORTAC , W BND	
ALAMOSA, CO VORTAC	GOSIP, CO FIX	
	NE BND	*14000
	SW BND	*10400
*10100 - MOCA		
GOSIP, CO FIX	*RADIO, CO FIX	**12000
*10900 - MCA	RADIO, CO FIX , SW BND	
**8500 - MOCA		
RADIO, CO FIX	BLOOM, CO FIX	*9400
*8000 - MOCA		
BLOOM, CO FIX	LAMAR, CO VORTAC	7000
LAMAR, CO VORTAC	LIBERAL, KS VORTAC	*6000
*5300 - MOCA		
LIBERAL, KS VORTAC	ROLLS, OK FIX	*12000
*4400 - MOCA		
ROLLS, OK FIX	*WAXEY, OK FIX	**8400
*5000 - MRA		
**3500 - MOCA		
WAXEY, OK FIX	WILL ROGERS, OK VORTAC	*4000
*3200 - MOCA		
WILL ROGERS, OK VORTAC	MINGG, OK FIX	*4000
*3000 - MOCA		
MINGG, OK FIX	OKMULGEE, OK VOR/DME	*4000
*2500 - MOCA		
BRICKYARD, IN VORTAC	MUNCIE, IN VOR/DME	2900
MUNCIE, IN VOR/DME	ROSEWOOD, OH VORTAC	2800
ROSEWOOD, OH VORTAC	TIVERTON, OH VOR/DME	3000
TIVERTON, OH VOR/DME	BRIGGS, OH VOR/DME	3000
BRIGGS, OH VOR/DME	SEING, OH FIX	3000
SEING, OH FIX	CAPEL, OH FIX	3600
CAPEL, OH FIX	VOLAN, PA FIX	*3600
*2800 - MOCA		
VOLAN, PA FIX	TALLS, PA FIX	*5000
*3200 - MOCA		
*3300 - GNSS MEA		

FROM	TO	MEA
------	----	-----

95.6210 VOR FEDERAL AIRWAY V210 - CONTINUED

TALLS, PA FIX	REVLOC, PA VOR/DME	4100
REVLOC, PA VOR/DME	BLINK, PA FIX	4500
BLINK, PA FIX	HARRISBURG, PA VORTAC	4000
HARRISBURG, PA VORTAC	LANCASTER, PA VORTAC	3000
LANCASTER, PA VORTAC	SPERY, PA FIX	2800
SPERY, PA FIX	YARDLEY, PA VOR/DME	*3000
*2200 - MOCA		

95.6211 VOR FEDERAL AIRWAY V211

BRAZO, NM FIX	*DURANGO, CO VOR/DME	
	W BND	11200
	E BND	13000
*9000 - MCA DURANGO, CO VOR/DME , E BND		
*9100 - MCA DURANGO, CO VOR/DME , W BND		
DURANGO, CO VOR/DME	CORTEZ, CO VOR/DME	11000

95.6212 VOR FEDERAL AIRWAY V212

SAN ANTONIO, TX VORTAC	SEEDS, TX FIX	2900
SEEDS, TX FIX	WEMAR, TX FIX	*2500
*1800 - MOCA		
WEMAR, TX FIX	INDUSTRY, TX VORTAC	2000
INDUSTRY, TX VORTAC	NAVASOTA, TX VORTAC	2000
NAVASOTA, TX VORTAC	OSKER, TX FIX	3000
OSKER, TX FIX	LUFKIN, TX VORTAC	*4000
*2000 - MOCA		
LUFKIN, TX VORTAC	COSGO, LA FIX	*4000
*1900 - MOCA		
COSGO, LA FIX	COCOS, LA FIX	*3000
*1700 - MOCA		
COCOS, LA FIX	ALEXANDRIA, LA VORTAC	2000
ALEXANDRIA, LA VORTAC	JOHON, LA FIX	2000
JOHON, LA FIX	MC COMB, MS VORTAC	*3000
*2000 - MOCA		

95.6213 VOR FEDERAL AIRWAY V213

GRAND STRAND, SC VORTAC	WILMINGTON, NC VORTAC	#*3100
*3100 - GNSS MEA		
#WILMINGTON R-240 UNUSABLE		
WILMINGTON, NC VORTAC	WALLO, NC FIX	*8000
*5000 - GNSS MEA		
WALLO, NC FIX	*JOSCH, NC FIX	**5000
*5000 - MRA		
**1700 - MOCA		
JOSCH, NC FIX	ESTER, NC FIX	*5000
*1700 - MOCA		
ESTER, NC FIX	TAR RIVER, NC VORTAC	2000
TAR RIVER, NC VORTAC	GUMBE, NC FIX	2000
GUMBE, NC FIX	HOPEWELL, VA VORTAC	*2000
*1500 - MOCA		
HOPEWELL, VA VORTAC	TAPPA, VA FIX	2000
TAPPA, VA FIX	COLIN, VA FIX	*5000
*1500 - MOCA		
*2000 - GNSS MEA		

FROM TO MEA

95.6213 VOR FEDERAL AIRWAY V213 - CONTINUED

COLIN, VA FIX *1400 - MOCA *2000 - GNSS MEA	PATUXENT, MD VORTAC	*5000
PATUXENT, MD VORTAC *8000 - MRA **1500 - MOCA **4000 - GNSS MEA	*GARED, MD FIX	**4500
GARED, MD FIX *1500 - MOCA *4000 - GNSS MEA	CHOPS, MD FIX	*4500
CHOPS, MD FIX *1500 - MOCA	SMYRNA, DE VORTAC	*2000
SMYRNA, DE VORTAC *1600 - MOCA	HOLEY, NJ FIX	*3000
HOLEY, NJ FIX *2000 - MOCA	ROBBINSVILLE, NJ VORTAC	*3000
ROBBINSVILLE, NJ VORTAC *1900 - MOCA	WARRD, NJ FIX	*3000 MAA - 10000
WARRD, NJ FIX *2500 - MOCA	SHOTT, NJ FIX	*3000 MAA - 10000
SHOTT, NJ FIX *2600 - MOCA	SPARTA, NJ VORTAC	*3500 MAA - 10000
SPARTA, NJ VORTAC *3200 - MOCA	FLOSI, NY FIX	*4000
FLOSI, NY FIX *6000 - MRA **4000 - MOCA	*WEETS, NY FIX	**5500
WEETS, NY FIX *6100 - MOCA *8000 - GNSS MEA	ALBANY, NY VORTAC	*10000

95.6214 VOR FEDERAL AIRWAY V214

KOKOMO, IN VORTAC	MARION, IN VOR/DME	2600
MARION, IN VOR/DME	MUNCIE, IN VOR/DME	2800
MUNCIE, IN VOR/DME	RICHMOND, IN VORTAC	2900
GLOOM, OH FIX *2600 - MOCA *3000 - GNSS MEA	ZANESVILLE, OH VOR/DME	*4000
ZANESVILLE, OH VOR/DME	BELLAIRE, OH VOR/DME	3000
BELLAIRE, OH VOR/DME *3100 - MOCA	GALLS, PA FIX	*3600
GALLS, PA FIX	GRANTSVILLE, MD VOR/DME	5000
GRANTSVILLE, MD VOR/DME *4500 - MOCA	MARTINSBURG, WV VORTAC	*5000
MARTINSBURG, WV VORTAC	WOOLY, MD FIX	3200
WOOLY, MD FIX	BALTIMORE, MD VORTAC	2600
BALTIMORE, MD VORTAC	SWANN, MD FIX	2000
SWANN, MD FIX *1500 - MOCA *2500 - GNSS MEA	KERNO, MD FIX	*2500
KERNO, MD FIX *2000 - GNSS MEA #DUPONT R-233 UNUSABLE BEYOND 22NM.	#DUPONT, DE VORTAC	*2000
DUPONT, DE VORTAC	YARDLEY, PA VOR/DME	*6000
*3000 - GNSS MEA	TETERBORO, NJ VOR/DME	*3000
YARDLEY, PA VOR/DME *2000 - MOCA		MAA - 10000

FROM TO MEA

95.6215 VOR FEDERAL AIRWAY V215

*JYBEE, MI FIX *4000 - MRA **1700 - MOCA	SALES, MI FIX	**3500
SALES, MI FIX *2300 - MOCA	MUSKEGON, MI VORTAC	*3000
MUSKEGON, MI VORTAC	WHITE CLOUD, MI VOR/DME	2800
WHITE CLOUD, MI VOR/DME *5000 - MRA	*LADIN, MI FIX	4000
LADIN, MI FIX *5000 - MRA **2600 - MOCA	*CARGA, MI FIX	**4000
CARGA, MI FIX *2900 - MOCA	GAYLORD, MI VOR/DME	*3000

95.6216 VOR FEDERAL AIRWAY V216

LAMAR, CO VORTAC *5200 - MOCA	ORION, KS FIX	*6300
ORION, KS FIX *4100 - MOCA	HILL CITY, KS VORTAC	*5000
HILL CITY, KS VORTAC *3900 - MOCA	MANKATO, KS VORTAC	*4500
MANKATO, KS VORTAC	PAWNEE CITY, NE VORTAC	3600
PAWNEE CITY, NE VORTAC	LAMONI, IA VORTAC	3400
LAMONI, IA VORTAC	OTTUMWA, IA VOR/DME	2900
OTTUMWA, IA VOR/DME	IOWA CITY, IA VORTAC	3000
IOWA CITY, IA VORTAC *2500 - MOCA	LOTTE, IA FIX	*3500
LOTTE, IA FIX *2200 - MOCA	WACKS, IL FIX	*4000
WACKS, IL FIX	JANESVILLE, WI VOR/DME	2800
JANESVILLE, WI VOR/DME #GNSS MEA, GNSS REQUIRED. JANESVILLE R-073 UNUSABLE	WIPED, WI FIX	#3000
WIPED, WI FIX #GNSS MEA, GNSS REQUIRED.	PETTY, WI FIX	#4000
PETTY, WI FIX #GNSS MEA, GNSS REQUIRED.	SQUIB, MI FIX	#7000
SQUIB, MI FIX *3000 - GNSS MEA	MUSKEGON, MI VORTAC	*4000
MUSKEGON, MI VORTAC	SAGINAW, MI VOR/DME	3000
SAGINAW, MI VOR/DME	PECK, MI VORTAC	3000
PECK, MI VORTAC *2200 - MOCA	U.S. CANADIAN BORDER	*5000

95.6217 VOR FEDERAL AIRWAY V217

FARMM, IL FIX	BESIE, IL FIX	2500
BESIE, IL FIX	BADGER, WI VORTAC	2700
BADGER, WI VORTAC	CHING, WI FIX	3000
CHING, WI FIX	SHOOD, WI FIX	2700
SHOOD, WI FIX	GREEN BAY, WI VORTAC	2500
GREEN BAY, WI VORTAC *2200 - MOCA	CECIL, WI FIX	*2700
CECIL, WI FIX	RHINELANDER, WI VORTAC	3600

FROM TO MEA

95.6217 VOR FEDERAL AIRWAY V217 - CONTINUED

RHINELANDER, WI VORTAC *4000 - MOCA	DULUTH, MN VORTAC	*6000
DULUTH, MN VORTAC	HIBBING, MN VOR/DME	3300
HIBBING, MN VOR/DME *3100 - MOCA	BAUDETTE, MN VOR/DME	*5000
BAUDETTE, MN VOR/DME	U.S. CANADIAN BORDER	2800

95.6218 VOR FEDERAL AIRWAY V218

GRAND RAPIDS, MN VOR/DME *3000 - MOCA	GOPHER, MN VORTAC	*5500
GOPHER, MN VORTAC *3200 - MOCA	DLANY, MN FIX	*4800
DLANY, MN FIX *2500 - MOCA	WAUKON, IA VORTAC	*3000
WAUKON, IA VORTAC *4000 - MRA **3000 - MOCA	*BAULK, WI FIX	**4000
BAULK, WI FIX *2500 - MOCA	ROCKFORD, IL VOR/DME	*4000
KEELER, MI VOR/DME	HEBEL, MI FIX	4000
HEBEL, MI FIX *2400 - MOCA	LANSING, MI VORTAC	*3000

95.6219 VOR FEDERAL AIRWAY V219

HAYES CENTER, NE VORTAC *4500 - MOCA	WOLBACH, NE VORTAC	*5000
WOLBACH, NE VORTAC	NORFOLK, NE VOR/DME	4000
NORFOLK, NE VOR/DME	SIOUX CITY, IA VORTAC	3600
SIOUX CITY, IA VORTAC *3200 - MOCA	RITTA, IA FIX	*4500
RITTA, IA FIX	MILSS, IA FIX	9000
MILSS, IA FIX *8000 - MRA	*GRUVE, IA FIX	8000
GRUVE, IA FIX	FAIRMONT, MN VOR/DME	8000
FAIRMONT, MN VOR/DME *2500 - MOCA	MANKATO, MN VOR/DME	*3000

95.6220 VOR FEDERAL AIRWAY V220

GRAND JUNCTION, CO VOR/DME	PACES, CO FIX	11500
PACES, CO FIX	SLOLM, CO FIX	13000
SLOLM, CO FIX	RIFLE, CO VOR/DME	12400
RIFLE, CO VOR/DME	MEEKER, CO VOR/DME	12400
MEEKER, CO VOR/DME	AXIAL, CO FIX	11000
AXIAL, CO FIX	HAYDEN, CO VOR/DME	
	SW BND	11000
	NE BND	10000
HAYDEN, CO VOR/DME	HABRO, CO FIX	10000
HABRO, CO FIX	KREMMLING, CO VOR/DME	13000
KREMMLING, CO VOR/DME	*HYGEN, CO FIX	**17000
*17000 - MCA HYGEN, CO FIX , SW BND		
**15600 - MOCA		

FROM	TO	MEA
------	----	-----

95.6220 VOR FEDERAL AIRWAY V220 - CONTINUED

HYGEN, CO FIX	NIWOT, CO FIX NE BND SW BND	9000 12500
NIWOT, CO FIX	GILL, CO VOR/DME NE BND SW BND	7400 10000
GILL, CO VOR/DME AKRON, CO VOR/DME *6000 - MOCA	AKRON, CO VOR/DME MCJEF, NE FIX	7000 *7000
MCJEF, NE FIX *5000 - MOCA	MC COOK, NE VOR/DME	*7500
MC COOK, NE VOR/DME *4100 - MOCA	SPRIT, NE FIX	*5000
SPRIT, NE FIX *3700 - MOCA	KEARNEY, NE VOR	*5000
KEARNEY, NE VOR HASTINGS, NE VOR/DME	HASTINGS, NE VOR/DME COLUMBUS, NE VOR/DME	4300 4000

95.6221 VOR FEDERAL AIRWAY V221

BIBLE GROVE, IL VORTAC HOOSIER, IN VORTAC *3100 - MOCA *4000 - GNSS MEA #HOOSIER R-053 UNUSABLE.	HOOSIER, IN VORTAC SHELBYVILLE, IN VORTAC	3000 #*6000
SHELBYVILLE, IN VORTAC MUNCIE, IN VOR/DME FORT WAYNE, IN VORTAC GAREN, IN FIX LITCHFIELD, MI VOR/DME *2500 - MOCA	MUNCIE, IN VOR/DME FORT WAYNE, IN VORTAC GAREN, IN FIX LITCHFIELD, MI VOR/DME JACKSON, MI VOR/DME	2800 2700 2600 3000 *3000
JACKSON, MI VOR/DME SALEM, MI VORTAC DELOW, MI FIX *2800 - MOCA	SALEM, MI VORTAC DELOW, MI FIX U.S. CANADIAN BORDER	3000 3000 *4000

95.6222 VOR FEDERAL AIRWAY V222

EL PASO, TX VORTAC *7400 - MOCA	SALT FLAT, TX VORTAC	*8000
SALT FLAT, TX VORTAC HOBAN, TX FIX FORT STOCKTON, TX VORTAC *5500 - MOCA	HOBAN, TX FIX FORT STOCKTON, TX VORTAC KEMPL, TX FIX	8000 5000 *8000
JUNCTION, TX VORTAC STONEWALL, TX VORTAC *4000 - MOCA	STONEWALL, TX VORTAC MARCS, TX FIX	4000 *4500
MARCS, TX FIX *2000 - MOCA	CRAYS, TX FIX	*2900
CRAYS, TX FIX INDUSTRY, TX VORTAC SEALY, TX FIX HUMBLE, TX VORTAC HUMBLE, TX VORTAC BEAUMONT, TX VOR/DME BEAUMONT, TX VOR/DME LAKE CHARLES, LA VORTAC LAKE CHARLES, LA VORTAC	INDUSTRY, TX VORTAC SEALY, TX FIX HUMBLE, TX VORTAC BEAUMONT, TX VOR/DME LAKE CHARLES, LA VORTAC MAXON, LA FIX	2500 2100 2000 3100 2000 2000

FROM TO MEA

95.6222 VOR FEDERAL AIRWAY V222 - CONTINUED

MAXON, LA FIX *4000 - MRA **1800 - MOCA **2000 - GNSS MEA	*WRACK, LA FIX	**6000
WRACK, LA FIX *2000 - MOCA *2000 - GNSS MEA	MC COMB, MS VORTAC	*4000
MC COMB, MS VORTAC	EATON, MS VORTAC	2000
EATON, MS VORTAC	PICAN, MS FIX	2300
PICAN, MS FIX	MONROEVILLE, AL VORTAC	2000
MONROEVILLE, AL VORTAC	MONTGOMERY, AL VORTAC	2300
MONTGOMERY, AL VORTAC *3500 - MRA	*MARST, AL FIX	2300
MARST, AL FIX	KENTT, AL FIX	2100
KENTT, AL FIX	LAGRANGE, GA VORTAC	2500
LAGRANGE, GA VORTAC *4000 - MRA	*TIROE, GA FIX	2600
LOGEN, GA FIX	CORCE, GA FIX	4000
CORCE, GA FIX	FOOTHILLS, GA VORTAC	3400
FOOTHILLS, GA VORTAC	SUNET, SC FIX	6100
SUNET, SC FIX	SUGARLOAF MOUNTAIN, NC VORTAC	6100
SUGARLOAF MOUNTAIN, NC VORTAC	VAESE, NC FIX	6000
VAESE, NC FIX *3600 - MOCA	BARRETTS MOUNTAIN, NC VOR/DME	*5000
BARRETTS MOUNTAIN, NC VOR/DME	HENBY, VA FIX	5000
HENBY, VA FIX	LYNCHBURG, VA VORTAC	4000

95.6223 VOR FEDERAL AIRWAY V223

FLAT ROCK, VA VORTAC *7000 - MRA	*HANEY, VA FIX	2800
HANEY, VA FIX	FLUKY, VA FIX	2600

95.6224 VOR FEDERAL AIRWAY V224

SAWYER, MI VOR/DME *2600 - MOCA	SCHOOLCRAFT COUNTY, MI VOR/DME	*3500
------------------------------------	--------------------------------	-------

95.6225 VOR FEDERAL AIRWAY V225

KEY WEST, FL VORTAC	RIGOR, FL FIX	1700
RIGOR, FL FIX *1400 - MOCA *1700 - GNSS MEA	MARCI, FL FIX	*4000
MARCI, FL FIX	LEE COUNTY, FL VORTAC	2100
LEE COUNTY, FL VORTAC *1400 - MOCA	LA BELLE, FL VORTAC	*2000
LA BELLE, FL VORTAC *1400 - MOCA	DIDDY, FL FIX	*2000
DIDDY, FL FIX	VERO BEACH, FL VORTAC	2000

FROM	TO	MEA
------	----	-----

95.6226 VOR FEDERAL AIRWAY V226

GRACE, PA FIX *4000 - MRA	*EARED, PA FIX	3400
EARED, PA FIX	CLARION, PA VOR/DME	3400
CLARION, PA VOR/DME	KEATING, PA VORTAC	4000
KEATING, PA VORTAC *3900 - MOCA	WILLIAMSPORT, PA VOR/DME	*4500
WILLIAMSPORT, PA VOR/DME	SWANK, PA FIX	4500
SWANK, PA FIX	WILKES-BARRE, PA VORTAC	4000
WILKES-BARRE, PA VORTAC	STILLWATER, NJ VOR/DME	4000

95.6227 VOR FEDERAL AIRWAY V227

BOILER, IN VORTAC	ROBERTS, IL VOR/DME	2600
ROBERTS, IL VOR/DME	PONTIAC, IL VOR/DME	3000
PONTIAC, IL VOR/DME	PLANO, IL FIX	3000

95.6228 VOR FEDERAL AIRWAY V228

STEVENS POINT, WI VORTAC	DELLS, WI VORTAC	3000
DELLS, WI VORTAC	MADISON, WI VORTAC	3300
MADISON, WI VORTAC *10000 - MRA	*DEBOW, WI FIX	10000
DEBOW, WI FIX	BESIE, IL FIX	10000
BESIE, IL FIX	FARMM, IL FIX	2500
FARMM, IL FIX	NORTHBROOK, IL VOR/DME	2700
NORTHBROOK, IL VOR/DME *3000 - MRA	*NEPTS, MI FIX	2500
NEPTS, MI FIX	GIPPER, MI VORTAC	2600

95.6229 VOR FEDERAL AIRWAY V229

PATUXENT, MD VORTAC *8000 - MRA **1500 - MOCA **4000 - GNSS MEA	*GARED, MD FIX	**4500
GARED, MD FIX *1600 - MOCA *4000 - GNSS MEA	DONIL, DE FIX	*8000
DONIL, DE FIX *1500 - MOCA	ATLANTIC CITY, NJ VORTAC	*2000
ATLANTIC CITY, NJ VORTAC *1500 - MOCA	PANZE, NJ FIX	*2000
PANZE, NJ FIX	DIXIE, NJ FIX	2500
DIXIE, NJ FIX *1600 - MOCA	KENNEDY, NY VOR/DME	*2500
KENNEDY, NY VOR/DME	BRIDGEPORT, CT VOR/DME	2000
BRIDGEPORT, CT VOR/DME	HARTFORD, CT VOR/DME	2000
HARTFORD, CT VOR/DME *2500 - MOCA	GARDNER, MA VOR/DME	*3000
GARDNER, MA VOR/DME	KEENE, NH VORTAC	3600
KEENE, NH VORTAC	JAMMA, VT FIX	4000
JAMMA, VT FIX	EBERT, VT FIX	5500
EBERT, VT FIX	MUDDI, VT FIX	5900
MUDDI, VT FIX *5300 - MOCA	BURLINGTON, VT VOR/DME	*5800

FROM TO MEA

95.6230 VOR FEDERAL AIRWAY V230

SHOEY, CA FIX	*SALINAS, CA VORTAC	**5000
*6000 - MCA SALINAS, CA VORTAC , E BND		
**4100 - MOCA		
SALINAS, CA VORTAC	*PANOS, CA FIX	**6500
*8000 - MCA PANOS, CA FIX , E BND		
**5500 - MOCA		
PANOS, CA FIX	*FIDDO, CA FIX	**9000
*9000 - MCA FIDDO, CA FIX , W BND		
**5700 - MOCA		
FIDDO, CA FIX	PANOCHE, CA VORTAC	*7000
*5700 - MOCA		
PANOCHE, CA VORTAC	*MENDO, CA FIX	4500
*3000 - MCA MENDO, CA FIX , SW BND		
MENDO, CA FIX	*CLOVIS, CA VORTAC	2000
*4000 - MCA CLOVIS, CA VORTAC , NE BND		
CLOVIS, CA VORTAC	*FRIANT, CA VORTAC	5000
*9000 - MCA FRIANT, CA VORTAC , NE BND		
FRIANT, CA VORTAC	*CAINS, CA FIX	11000
*13000 - MCA CAINS, CA FIX , NE BND		
CAINS, CA FIX	NIKOL, CA FIX	14300
NIKOL, CA FIX	MINA, NV VORTAC	11000

95.6231 VOR FEDERAL AIRWAY V231

BURLEY, ID VOR/DME	*MENIN, ID FIX	
	S BND	**7000
	N BND	**9500
*10600 - MCA MENIN, ID FIX , N BND		
**7000 - MOCA		
MENIN, ID FIX	SALMON, ID VOR/DME	14000
SALMON, ID VOR/DME	TUFFY, MT FIX	*12000
*11300 - MOCA		
TUFFY, MT FIX	*MISSOULA, MT VOR/DME	
	S BND	12000
	N BND	9000
*10000 - MCA MISSOULA, MT VOR/DME , S BND		
MISSOULA, MT VOR/DME	ARLEE, MT FIX	9200
ARLEE, MT FIX	*JESSY, MT FIX	**11000
*13000 - MCA JESSY, MT FIX , N BND		
**9200 - MOCA		
JESSY, MT FIX	*SKOTT, MT FIX	**13000
*12000 - MRA		
**8700 - MOCA		
SKOTT, MT FIX	KALISPELL, MT VOR/DME	
	N BND	*8500
	S BND	*10000
*6900 - MOCA		

95.6232 VOR FEDERAL AIRWAY V232

CHARDON, OH VOR/DME	FRANKLIN, PA VOR	3300
		MAA - 15000
FRANKLIN, PA VOR	COOBE, PA FIX	3500

FROM	TO	MEA
95.6232 VOR FEDERAL AIRWAY V232 – CONTINUED		
COOBE, PA FIX	KEATING, PA VORTAC	4000
KEATING, PA VORTAC	WATSO, PA FIX	4000
WATSO, PA FIX	MILTON, PA VORTAC	*4000
*2900 - MOCA		
MILTON, PA VORTAC	SOLBERG, NJ VOR/DME	*4000
*3500 - MOCA		
SOLBERG, NJ VOR/DME	COLTS NECK, NJ VOR/DME	2000

95.6233 VOR FEDERAL AIRWAY V233

SPINNER, IL VORTAC	ROBERTS, IL VOR/DME	2600
ROBERTS, IL VOR/DME	KNOX, IN VOR/DME	*3000
*2200 - MOCA		
KNOX, IN VOR/DME	GOSHEN, IN VORTAC	2600
GOSHEN, IN VORTAC	LITCHFIELD, MI VOR/DME	3000
LITCHFIELD, MI VOR/DME	LANSING, MI VORTAC	3000
LANSING, MI VORTAC	MOUNT PLEASANT, MI VOR/DME	3000
MOUNT PLEASANT, MI VOR/DME	*CARGA, MI FIX	5500
*5000 - MRA		
CARGA, MI FIX	GAYLORD, MI VOR/DME	3000
GAYLORD, MI VOR/DME	PELLSTON, MI VORTAC	3200

95.6234 VOR FEDERAL AIRWAY V234

ST JOHNS, AZ VORTAC	*STONY, NM FIX	**12000
*9500 - MCA STONY, NM FIX, SW BND		
**10500 - MOCA		
STONY, NM FIX	ALBUQUERQUE, NM VORTAC	9000
ALBUQUERQUE, NM VORTAC	ANTON CHICO, NM VORTAC	10000
ANTON CHICO, NM VORTAC	DALHART, TX VORTAC	*8500
*7500 - MOCA		
DALHART, TX VORTAC	BRAKR, OK FIX	5700
BRAKR, OK FIX	LIBERAL, KS VORTAC	*5700
*4700 - MOCA		
LIBERAL, KS VORTAC	FLACK, KS FIX	4600
FLACK, KS FIX	KRIER, KS FIX	*5000
*3900 - MOCA		
KRIER, KS FIX	BYWAY, KS FIX	*7100
*3700 - MOCA		
BYWAY, KS FIX	GABIE, KS FIX	4300
GABIE, KS FIX	HUTCHINSON, KS VOR/DME	3700
HUTCHINSON, KS VOR/DME	WAIVE, KS FIX	4000
WAIVE, KS FIX	*FLOSS, KS FIX	3300
*5000 - MRA		
FLOSS, KS FIX	EMPORIA, KS VORTAC	3300
EMPORIA, KS VORTAC	BUTLER, MO VORTAC	3000
BUTLER, MO VORTAC	AUGIE, MO FIX	2700
AUGIE, MO FIX	VICHY, MO VOR/DME	*3200
*2400 - MOCA		
VICHY, MO VOR/DME	DELMA, MO FIX	3000
DELMA, MO FIX	*GLASS, MO FIX	**3500
*4500 - MRA		
**2800 - MOCA		
GLASS, MO FIX	CENTRALIA, IL VORTAC	*3000
*2200 - MOCA		

FROM TO MEA

95.6235 VOR FEDERAL AIRWAY V235

PEACH SPRINGS, AZ VORTAC	MORMON MESA, NV VORTAC	10000
MORMON MESA, NV VORTAC	MATZO, UT FIX	
	NE BND	12000
	SW BND	9000
MATZO, UT FIX	*CEDAR CITY, UT VOR/DME	12400
*11400 - MCA CEDAR CITY, UT	VOR/DME, S BND	
CEDAR CITY, UT VOR/DME	MILFORD, UT VORTAC	10000
MILFORD, UT VORTAC	DELTA, UT VORTAC	9600
DELTA, UT VORTAC	FAIRFIELD, UT VORTAC	10300
*FAIRFIELD, UT VORTAC	GRODI, WY FIX	14000
*12500 - MCA FAIRFIELD, UT	VORTAC, NE BND	
GRODI, WY FIX	FORT BRIDGER, WY VOR/DME	11000
ROCK SPRINGS, WY VOR/DME	BORGG, WY FIX	9500
BORGG, WY FIX	OILLY, WY FIX	11200
OILLY, WY FIX	MUDDY MOUNTAIN, WY VORTAC	9000
MUDDY MOUNTAIN, WY VORTAC	NEWCASTLE, WY VOR	8300

95.6236 VOR FEDERAL AIRWAY V236

CEVAR, UT FIX	EMONT, UT FIX	9000
EMONT, UT FIX	OGDEN, UT VORTAC	#*8000
*7000 - MOCA		
#MTA V236 NE TO V21-101 SE 12000		

95.6237 VOR FEDERAL AIRWAY V237

NEEDLES, CA VORTAC	BOULDER CITY, NV VORTAC	7600
BOULDER CITY, NV VORTAC	LAS VEGAS, NV VORTAC	6000

95.6238 VOR FEDERAL AIRWAY V238

MAPLES, MO VORTAC	IMPER, MO FIX	3000
IMPER, MO FIX	TROY, IL VORTAC	2600

95.6239 VOR FEDERAL AIRWAY V239

FORNEY, MO VOR	BNTON, MO FIX	2900
BNTON, MO FIX	HALLSVILLE, MO VORTAC	2800

95.6240 VOR FEDERAL AIRWAY V240

HARVEY, LA VORTAC	PEARL, LA FIX	2000
PEARL, LA FIX	DOGMA, MS FIX	*2300
*1300 - MOCA		
DOGMA, MS FIX	*ROMMY, MS FIX	**2800
*4000 - MRA		
**1300 - MOCA		
ROMMY, MS FIX	SEMMES, AL VORTAC	2000

95.6241 VOR FEDERAL AIRWAY V241

SEMMES, AL VORTAC	CRESTVIEW, FL VORTAC	3000
CRESTVIEW, FL VORTAC	WIREGRASS, AL VORTAC	2000

FROM	TO	MEA
------	----	-----

95.6241 VOR FEDERAL AIRWAY V241 – CONTINUED

WIREGRASS, AL VORTAC *2500 - MRA	*HAVSO, AL FIX	2000
HAVSO, AL FIX	EUFAULA, AL VORTAC	2000
EUFAULA, AL VORTAC	COLUMBUS, GA VORTAC	2400
COLUMBUS, GA VORTAC *4000 - MRA	*TIROE, GA FIX	3000

95.6242 VOR FEDERAL AIRWAY V242

INTERNATIONAL FALLS, MN VORTAC	YUPNU, MN FIX	3000
-----------------------------------	---------------	------

95.6243 VOR FEDERAL AIRWAY V243

CRAIG, FL VORTAC *2300 - MOCA	WAYCROSS, GA VORTAC	*3000
WAYCROSS, GA VORTAC	VIENNA, GA VORTAC	2300
VIENNA, GA VORTAC *3000 - MRA **2000 - MOCA	*PRATZ, GA FIX	**3000
PRATZ, GA FIX	LAGRANGE, GA VORTAC	3500
LAGRANGE, GA VORTAC *3200 - MOCA	HEFIN, AL FIX	*4000
HEFIN, AL FIX *3400 - MOCA	FELTO, GA FIX	*6000
FELTO, GA FIX *4000 - MOCA	GORGO, GA FIX	*5000
GORGO, GA FIX	CHOO CHOO, TN VORTAC	4000
CHOO CHOO, TN VORTAC	MCMIN, TN FIX	4000
MCMIN, TN FIX *3700 - MOCA	HARME, TN FIX	*6000
HARME, TN FIX *2300 - MOCA	BOWLING GREEN, KY VORTAC	*2800
BOWLING GREEN, KY VORTAC *2400 - MOCA	RENRO, KY FIX	*3000
RENRO, KY FIX *4500 - MRA **2100 - MOCA	*APALO, IN FIX	**4500
APALO, IN FIX *2100 - MOCA	HUNTINGBURG, IN VOR/DME	*4500
HUNTINGBURG, IN VOR/DME *2000 - MOCA	TERRE HAUTE, IN VORTAC	*2400

95.6244 VOR FEDERAL AIRWAY V244

OAKLAND, CA VORTAC *4700 - MCA	*SALAD, CA FIX	4000
SALAD, CA FIX	ALTAM, CA FIX	5000
ALTAM, CA FIX	BYRON, CA FIX	
	W BND	4500
	E BND	3500
BYRON, CA FIX	MANTECA, CA VORTAC	2000
MANTECA, CA VORTAC	WRAPS, CA FIX	
	E BND	3000
	W BND	2000

FROM TO MEA

95.6244 VOR FEDERAL AIRWAY V244 – CONTINUED

WRAPS, CA FIX	*DUCKE, CA FIX	8000
*12000 - MCA DUCKE, CA FIX , E BND		
DUCKE, CA FIX	*NIKOL, CA FIX	15100
*13000 - MCA NIKOL, CA FIX , W BND		
NIKOL, CA FIX	COALDALE, NV VORTAC	12500
COALDALE, NV VORTAC	TONOPAH, NV VORTAC	11000
TONOPAH, NV VORTAC	WILSON CREEK, NV VORTAC	12200
WILSON CREEK, NV VORTAC	*MILFORD, UT VORTAC	12000
*12000 - MCA MILFORD, UT VORTAC , E BND		
MILFORD, UT VORTAC	DETAN, UT FIX	14000
DETAN, UT FIX	HANKSVILLE, UT VORTAC	*16000
*14200 - MOCA		
HANKSVILLE, UT VORTAC	*ANIUM, UT FIX	**10500
*12300 - MCA ANIUM, UT FIX , E BND		
**8500 - MOCA		
ANIUM, UT FIX	*PAROX, CO FIX	**15500
*13300 - MCA PAROX, CO FIX , W BND		
**14800 - MOCA		
PAROX, CO FIX	*NADIN, CO FIX	**13000
*12000 - MCA NADIN, CO FIX , W BND		
**12000 - MOCA		
NADIN, CO FIX	MONTROSE, CO VOR/DME	11000
MONTROSE, CO VOR/DME	BLUE MESA, CO VOR/DME	12500
BLUE MESA, CO VOR/DME	DUFEL, CO FIX	
	E BND	16000
	W BND	12000
DUFEL, CO FIX	*FLOOD, CO FIX	16000
*10000 - MRA		
FLOOD, CO FIX	STANO, CO FIX	
	W BND	12000
	E BND	9000
STANO, CO FIX	PUEBLO, CO VORTAC	7800
PUEBLO, CO VORTAC	LAMAR, CO VORTAC	7000
LAMAR, CO VORTAC	*COFFE, KS FIX	**9000
*9000 - MRA		
**5400 - MOCA		
COFFE, KS FIX	*RANSO, KS FIX	**10000
*10000 - MRA		
**4400 - MOCA		
RANSO, KS FIX	HAYS, KS VORTAC	*5000
*3900 - MOCA		
HAYS, KS VORTAC	*GLIDE, KS FIX	3900
*4000 - MRA		
GLIDE, KS FIX	SALINA, KS VORTAC	*3600
*2900 - MOCA		

95.6245 VOR FEDERAL AIRWAY V245

ALEXANDRIA, LA VORTAC	NATCHEZ, MS VOR/DME	2000
NATCHEZ, MS VOR/DME	JACKSON, MS VORTAC	3000
JACKSON, MS VORTAC	BIGBEE, MS VORTAC	##*5000
		MAA - 7000
*3000 - GNSS MEA		
#BIGBEE R-231 UNUSABLE BELOW 5000		
BIGBEE, MS VORTAC	MINIM, AL FIX	2000
MINIM, AL FIX	CRIMSON, AL VORTAC	2400

FROM	TO	MEA
------	----	-----

95.6246 VOR FEDERAL AIRWAY V246

JANESVILLE, WI VOR/DME	DUBUQUE, IA VORTAC	3000
DUBUQUE, IA VORTAC	WAUKON, IA VORTAC	3000
WAUKON, IA VORTAC	NODINE, MN VORTAC	3000
NODINE, MN VORTAC	MILTO, WI FIX	3000
MILTO, WI FIX	STEVENS POINT, WI VORTAC	2900

95.6247 VOR FEDERAL AIRWAY V247

SCOTTSBLUFF, NE VORTAC	HIPSHER, WY VOR/DME	8100
HIPSHER, WY VOR/DME	CRAZY WOMAN, WY VOR/DME	8000
CRAZY WOMAN, WY VOR/DME	SHERIDAN, WY VORTAC	7000
SHERIDAN, WY VORTAC	ARDMO, MT FIX	8000
ARDMO, MT FIX	BILLINGS, MT VORTAC	
	E BND	8000
	W BND	6000
BILLINGS, MT VORTAC	PELJE, MT FIX	
	W BND	7000
	E BND	6000
PELJE, MT FIX	BAXTA, MT FIX	
	E BND	7000
	W BND	10500
BAXTA, MT FIX	WAUTS, MT FIX	*13000
*10900 - MOCA		
*WAUTS, MT FIX	HELENA, MT VORTAC	9400
*10700 - MCA WAUTS, MT FIX , E BND		

95.6248 VOR FEDERAL AIRWAY V248

SALINAS, CA VORTAC	*SARDO, CA FIX	5500
*5500 - MRA		
*5500 - MCA SARDO, CA FIX , N BND		
SARDO, CA FIX	PASO ROBLES, CA VORTAC	5000
PASO ROBLES, CA VORTAC	AVENAL, CA VORTAC	4500
AVENAL, CA VORTAC	SCRAP, CA FIX	4000
SCRAP, CA FIX	SHAFTER, CA VORTAC	
	W BND	4000
	E BND	2500

95.6249 VOR FEDERAL AIRWAY V249

ROBBINSVILLE, NJ VORTAC	JERYY, NJ FIX	4000
JERYY, NJ FIX	SOLBERG, NJ VOR/DME	*3000
*2000 - MOCA		
SOLBERG, NJ VOR/DME	SPARTA, NJ VORTAC	3000
SPARTA, NJ VORTAC	FLOSI, NY FIX	*4000
*3200 - MOCA		
FLOSI, NY FIX	*WEETS, NY FIX	**5500
*6000 - MRA		
**4000 - MOCA		
WEETS, NY FIX	RIMBA, NY FIX	6000
RIMBA, NY FIX	DELANCEY, NY VOR/DME	5500
DELANCEY, NY VOR/DME	MILID, NY FIX	4300
MILID, NY FIX	UTICA, NY VORTAC	3700

FROM	TO	MEA
------	----	-----

95.6250 VOR FEDERAL AIRWAY V250

O'NEILL, NE VORTAC	YANKTON, SD VOR/DME	3700
YANKTON, SD VOR/DME	WORTHINGTON, MN VOR/DME	3400
WORTHINGTON, MN VOR/DME	MANKATO, MN VOR/DME	3400

95.6251 VOR FEDERAL AIRWAY V251

ADDERS, IL VORTAC	CHAMPAIGN, IL VORTAC	2500
CHAMPAIGN, IL VORTAC	DANVILLE, IL VORTAC	2500
DANVILLE, IL VORTAC	BOILER, IN VORTAC	2500

95.6252 VOR FEDERAL AIRWAY V252

U.S. CANADIAN BORDER *2500 - MOCA	BULGE, NY FIX	*3100
BULGE, NY FIX *2400 - MOCA	GENESE0, NY VOR/DME	*4000
GENESE0, NY VOR/DME	GIBBE, NY FIX	4000
GIBBE, NY FIX	BINGHAMTON, NY VORTAC	3800
BINGHAMTON, NY VORTAC	HUGIE, PA FIX	4000
HUGIE, PA FIX	RAGER, NY FIX	4400
RAGER, NY FIX	HUGUENOT, NY VOR/DME	4000
HUGUENOT, NY VOR/DME *3300 - MOCA	COATE, NJ FIX	*4000
COATE, NJ FIX *2700 - MOCA	SLYNG, NJ FIX	*5000
SLYNG, NJ FIX	ROBBINSVILLE, NJ VORTAC	2600
ROBBINSVILLE, NJ VORTAC	DUPONT, DE VORTAC	2000

95.6253 VOR FEDERAL AIRWAY V253

LUCIN, UT VORTAC	ROGET, ID FIX	11000
ROGET, ID FIX	*TWIN FALLS, ID VORTAC	
	NW BND	9000
	SE BND	11000
*9000 - MCA TWIN FALLS, ID VORTAC , SE BND		
TWIN FALLS, ID VORTAC	LITKE, ID FIX	6000
LITKE, ID FIX	ALKAL, ID FIX	
	SE BND	*6000
	NW BND	*9500
*5700 - MOCA		
ALKAL, ID FIX	CANEK, ID FIX	*9500
*8500 - MOCA		
CANEK, ID FIX	BOISE, ID VORTAC	7000
*BOISE, ID VORTAC	BANGS, ID FIX	9000
*7400 - MCA BOISE, ID VORTAC , N BND		
BANGS, ID FIX	DONNELLY, ID VORTAC	10400
DONNELLY, ID VORTAC	OXLEY, ID FIX	12000
OXLEY, ID FIX	*NEZ PERCE, ID VOR/DME	
	SE BND	12000
	NW BND	7400
*6400 - MCA NEZ PERCE, ID VOR/DME , SE BND		
NEZ PERCE, ID VOR/DME	PULLMAN, WA VOR/DME	6000
PULLMAN, WA VOR/DME	SPOKANE, WA VORTAC	*6000
*5600 - MOCA		

FROM	TO	MEA
------	----	-----

95.6254 VOR FEDERAL AIRWAY V254

HIPSHER, WY VOR/DME *7500 - MOCA	TOOKE, WY FIX	*10000
TOOKE, WY FIX	GILLETTE, WY VOR/DME	7000
GILLETTE, WY VOR/DME *6900 - MOCA	MILES CITY, MT VOR/DME	*9000
MILES CITY, MT VOR/DME	GLASGOW, MT VOR/DME	6000

95.6255 VOR FEDERAL AIRWAY V255

GARDEN CITY, KS VORTAC	HAYS, KS VORTAC	4600
------------------------	-----------------	------

95.6256 VOR FEDERAL AIRWAY V256

TULSA, OK VORTAC	PIONEER, OK VORTAC	3000
PIONEER, OK VORTAC	HUTCHINSON, KS VOR/DME	3300

95.6257 VOR FEDERAL AIRWAY V257

PHOENIX, AZ VORTAC	*AVENT, AZ FIX NW BND SE BND	7000 5000
*7000 - MRA		
AVENT, AZ FIX	*BANYO, AZ FIX NW BND SE BND	7000 5000
*6000 - MRA		
BANYO, AZ FIX *8100 - MOCA	COYOT, AZ FIX	*9000
COYOT, AZ FIX *9000 - GNSS MEA	MAIER, AZ FIX	*10000
MAIER, AZ FIX	DRAKE, AZ VORTAC	10000
DRAKE, AZ VORTAC *11000 - MRA **8400 - MOCA **9000 - GNSS MEA	*BISOP, AZ FIX	**10000
BISOP, AZ FIX	*GRAND CANYON, AZ VOR/DME	10000
*14500 - MCA GRAND CANYON, AZ VOR/DME, N BND		
GRAND CANYON, AZ VOR/DME	*DOZIT, AZ FIX	**14500
*14500 - MCA DOZIT, AZ FIX, S BND **11200 - MOCA		
DOZIT, AZ FIX *11200 - MOCA	JALMA, AZ FIX	*14500
JALMA, AZ FIX *11000 - MOCA	KACIR, AZ FIX	*13000
KACIR, AZ FIX	BRYCE CANYON, UT VORTAC	11600
BRYCE CANYON, UT VORTAC	DELTA, UT VORTAC	12000
DELTA, UT VORTAC *12200 - MCA VERNE, UT FIX, N BND	*VERNE, UT FIX	11500
VERNE, UT FIX *10500 - MCA STACO, UT FIX, S BND	*STACO, UT FIX	13000
STACO, UT FIX *8900 - MOCA	MOINT, UT FIX	*13000

FROM	TO	MEA
------	----	-----

95.6257 VOR FEDERAL AIRWAY V257 – CONTINUED

MOINT, UT FIX *13000 - MRA **9600 - MOCA	*KREBS, UT FIX	**13000
KREBS, UT FIX *10000 - MOCA	MALAD CITY, ID VOR/DME	*11000
MALAD CITY, ID VOR/DME	BANNO, ID FIX	10000
BANNO, ID FIX *8000 - MCA POCATELLO, ID VORTAC , SE BND	*POCATELLO, ID VORTAC	9000
POCATELLO, ID VORTAC	ROCCA, ID FIX	7000
ROCCA, ID FIX *8600 - MCA DUBOIS, ID VORTAC , N BND	*DUBOIS, ID VORTAC	7500
DUBOIS, ID VORTAC *11200 - MOCA	DILLON, MT VOR/DME	*12000
DILLON, MT VOR/DME	DIVID, MT FIX	11000
DIVID, MT FIX *10000 - MCA COPPERTOWN, MT VOR/DME , SE BND	*COPPERTOWN, MT VOR/DME	10000
COPPERTOWN, MT VOR/DME	GLUES, MT FIX	9200
GLUES, MT FIX *9200 - MOCA	SCAAT, MT FIX	*16000
SCAAT, MT FIX *9800 - MOCA *9800 - GNSS MEA	SIEBE, MT FIX	*13000
SIEBE, MT FIX	WOKEN, MT FIX	9000
WOKEN, MT FIX	GREAT FALLS, MT VORTAC	8800
GREAT FALLS, MT VORTAC	SHONK, MT FIX	6200
SHONK, MT FIX	HAVRE, MT VOR/DME	6000

95.6258 VOR FEDERAL AIRWAY V258

CHARLESTON, WV VORTAC *4100 - MCA SCRIB, WV FIX , SE BND	*SCRIB, WV FIX	4000
SCRIB, WV FIX	BECKLEY, WV VORTAC	5000
BECKLEY, WV VORTAC *6300 - MOCA *6300 - GNSS MEA	ZOOMS, WV FIX	*10000
ZOOMS, WV FIX	ROANOKE, VA VORTAC	6400
ROANOKE, VA VORTAC	PIGGS, VA FIX	5000
PIGGS, VA FIX *3400 - MOCA	ENTUK, VA FIX	*4000
ENTUK, VA FIX	DANVILLE, VA VOR	3000

95.6259 VOR FEDERAL AIRWAY V259

GRAND STRAND, SC VORTAC *3000 - MRA	*CLETA, SC FIX	2000
CLETA, SC FIX	FLORENCE, SC VORTAC	2000
FLORENCE, SC VORTAC	CHESTERFIELD, SC VOR/DME	2000
CHESTERFIELD, SC VOR/DME	HUSTN, NC FIX	2500
MOPED, NC FIX	BARRETT'S MOUNTAIN, NC VOR/DME	4000
BARRETT'S MOUNTAIN, NC VOR/DME	GOWBE, NC FIX	5000
*GOWBE, NC FIX *6000 - MCA GOWBE, NC FIX , N BND	HOLSTON MOUNTAIN, TN VORTAC	7500

FROM	TO	MEA
------	----	-----

95.6260 VOR FEDERAL AIRWAY V260

CHARLESTON, WV VORTAC	MONTS, WV FIX	3400
MONTS, WV FIX	RAINELLE, WV VOR	5100
RAINELLE, WV VOR	ROANOKE, VA VORTAC	*6000
*5400 - MOCA		
ROANOKE, VA VORTAC	GOOZE, VA FIX	5000
GOOZE, VA FIX	LYNCHBURG, VA VORTAC	
	W BND	*5000
	E BND	*3000
*2900 - MOCA		
LYNCHBURG, VA VORTAC	FLAT ROCK, VA VORTAC	3000
FLAT ROCK, VA VORTAC	RICHMOND, VA VORTAC	2600
RICHMOND, VA VORTAC	HOPEWELL, VA VORTAC	1900
HOPEWELL, VA VORTAC	FRANKLIN, VA VORTAC	3000
FRANKLIN, VA VORTAC	COFIELD, NC VORTAC	1800

95.6261 VOR FEDERAL AIRWAY V261

WICHITA, KS VORTAC	CEKIS, KS FIX	3600
CEKIS, KS FIX	MANHATTAN, KS VOR/DME	3000

95.6262 VOR FEDERAL AIRWAY V262

PEORIA, IL VORTAC	*DULAP, IL FIX	2700
*3000 - MRA		
DULAP, IL FIX	BRADFORD, IL VORTAC	2700
BRADFORD, IL VORTAC	MOTIF, IL FIX	2700

95.6263 VOR FEDERAL AIRWAY V263

CORONA, NM VORTAC	ENCIA, NM FIX	9700
ENCIA, NM FIX	ALBUQUERQUE, NM VORTAC	8000
ALBUQUERQUE, NM VORTAC	*ZIASSE, NM FIX	9000
*11600 - MCA ZIASSE, NM FIX , E BND		
ZIASSE, NM FIX	SANTA FE, NM VORTAC	9000
SANTA FE, NM VORTAC	*FORT UNION, NM VORTAC	12500
*10900 - MCA FORT UNION, NM VORTAC , N BND		
*11300 - MCA FORT UNION, NM VORTAC , W BND		
FORT UNION, NM VORTAC	CIMARRON, NM VORTAC	*12000
*11100 - MOCA		
CIMARRON, NM VORTAC	TOBE, CO VORTAC	*11600
*10700 - MOCA		
TOBE, CO VORTAC	LAMAR, CO VORTAC	*7400
*6700 - MOCA		
LAMAR, CO VORTAC	HUGO, CO VORTAC	*6900
*6200 - MOCA		
HUGO, CO VORTAC	*LIMEX, CO FIX	9000
*9000 - MRA		
LIMEX, CO FIX	AKRON, CO VOR/DME	7000
PIERRE, SD VORTAC	ABERDEEN, SD VOR/DME	4000

95.6264 VOR FEDERAL AIRWAY V264

LOS ANGELES, CA VORTAC	STABO, CA FIX	2500
STABO, CA FIX	AMTRA, CA FIX	3000
AMTRA, CA FIX	*POMONA, CA VORTAC	4500
*5600 - MCA POMONA, CA VORTAC , E BND		
POMONA, CA VORTAC	*RAVON, CA FIX	6000
*11400 - MCA RAVON, CA FIX , E BND		

FROM TO MEA

95.6264 VOR FEDERAL AIRWAY V264 – CONTINUED

RAVON, CA FIX	REANS, CA FIX	
	E BND	12800
	W BND	9000
REANS, CA FIX	*YUCCA, CA FIX	13500
*12000 - MCA	YUCCA, CA FIX , W BND	
YUCCA, CA FIX	TWENTYNINE PALMS, CA VORTAC	*8500
*7700 - MOCA		
TWENTYNINE PALMS, CA VORTAC	PARKER, CA VORTAC	6000
DRAKE, AZ VORTAC	OATES, AZ FIX	10100
OATES, AZ FIX	WINSLOW, AZ VORTAC	10800
WINSLOW, AZ VORTAC	ST JOHNS, AZ VORTAC	8900
ST JOHNS, AZ VORTAC	*SOCORRO, NM VORTAC	**12000
*10000 - MCA	SOCORRO, NM VORTAC , W BND	
**11100 - MOCA		
SOCORRO, NM VORTAC	CORONA, NM VORTAC	9500
CORONA, NM VORTAC	TUCUMCARI, NM VORTAC	*11000
*9000 - MOCA		

95.6265 VOR FEDERAL AIRWAY V265

KRANT, MD FIX	WESTMINSTER, MD VORTAC	2600
WESTMINSTER, MD VORTAC	HARRISBURG, PA VORTAC	3400
HARRISBURG, PA VORTAC	PHILIPSBURG, PA VORTAC	4000
PHILIPSBURG, PA VORTAC	KEATING, PA VORTAC	4000
KEATING, PA VORTAC	BRADFORD, PA VOR/DME	4000
BRADFORD, PA VOR/DME	JAMESTOWN, NY VOR/DME	4000
JAMESTOWN, NY VOR/DME	DUNKIRK, NY VORTAC	4000
DUNKIRK, NY VORTAC	U.S. CANADIAN BORDER	2400
U.S. CANADIAN BORDER	THORL, CANADA FIX	2400

95.6266 VOR FEDERAL AIRWAY V266

ELECTRIC CITY, SC VORTAC	PELZE, SC FIX	2800
PELZE, SC FIX	SPARTANBURG, SC VORTAC	2900
GREENSBORO, NC VORTAC	SOUTH BOSTON, VA VORTAC	2500
SOUTH BOSTON, VA VORTAC	LAWRENCEVILLE, VA VORTAC	#*3000
*2000 - MOCA		
*2300 - GNSS MEA		
#LAWRENCEVILLE R-269 UNUSABLE BELOW 9000.		
LAWRENCEVILLE, VA VORTAC	FRANKLIN, VA VORTAC	#2000
#LAWRENCEVILLE R-106 UNSUABLE BELOW 7500.		
FRANKLIN, VA VORTAC	SUNNS, NC FIX	*2000
*1500 - MOCA		
SUNNS, NC FIX	ELIZABETH CITY, NC VOR/DME	*5000
*4000 - MOCA		
ELIZABETH CITY, NC VOR/DME	WRIGHT BROTHERS, NC VOR/DME	4000

95.6267 VOR FEDERAL AIRWAY V267

DOLPHIN, FL VORTAC	PAHOKEE, FL VORTAC	*2000
*1500 - MOCA		
PAHOKEE, FL VORTAC	DIDDY, FL FIX	*2000

FROM	TO	MEA
------	----	-----

95.6267 VOR FEDERAL AIRWAY V267 - CONTINUED

*1400 - MOCA		
DIDDY, FL FIX	BAIRN, FL FIX	2600
BAIRN, FL FIX	ORLANDO, FL VORTAC	2000
ORLANDO, FL VORTAC	PAOLA, FL FIX	1700
PAOLA, FL FIX	WORMS, FL FIX	2700
WORMS, FL FIX	CRAIG, FL VORTAC	*3000
*2100 - MOCA		
CRAIG, FL VORTAC	BAXLY, GA FIX	3000
BAXLY, GA FIX	DUBLIN, GA VORTAC	*3000
*2300 - MOCA		
DUBLIN, GA VORTAC	ATHENS, GA VORTAC	*3000
*2200 - MOCA		
ATHENS, GA VORTAC	IRMOS, GA FIX	3000
IRMOS, GA FIX	CORCE, GA FIX	3800
CORCE, GA FIX	TALLE, GA FIX	5300
TALLE, GA FIX	HARRIS, GA VORTAC	7000
HARRIS, GA VORTAC	FORMS, NC FIX	7800
FORMS, NC FIX	*KNITS, TN FIX	7000
*6000 - MCA KNITS, TN FIX, S BND		
KNITS, TN FIX	VOLUNTEER, TN VORTAC	4200

95.6268 VOR FEDERAL AIRWAY V268

NESTO, PA FIX	PLEEZ, PA FIX	*4000
*3100 - MOCA		
PLEEZ, PA FIX	INDIAN HEAD, PA VORTAC	*5000
*4500 - MOCA		
INDIAN HEAD, PA VORTAC	HAGERSTOWN, MD VOR	*12000
*4600 - MOCA		
*4700 - GNSS MEA		
HAGERSTOWN, MD VOR	KEMAR, MD FIX	5000
KEMAR, MD FIX	WESTMINSTER, MD VORTAC	*4000
*2600 - MOCA		
*2700 - GNSS MEA		
WESTMINSTER, MD VORTAC	BALTIMORE, MD VORTAC	2500
BALTIMORE, MD VORTAC	SMYRNA, DE VORTAC	2000
SMYRNA, DE VORTAC	LEEAH, NJ FIX	*1800
*1300 - MOCA		
LEEAH, NJ FIX	AVALO, NJ FIX	2000
AVALO, NJ FIX	HARBO, NJ FIX	*6000
*4000 - GNSS MEA		
HARBO, NJ FIX	*DRIFT, NJ FIX	**7500
*6000 - MRA		
**3000 - GNSS MEA		
DRIFT, NJ FIX	MANTA, NJ FIX	*12000
*3000 - GNSS MEA		
MANTA, NJ FIX	PLUME, NJ FIX	*7000
*2000 - MOCA		
*3000 - GNSS MEA		
PLUME, NJ FIX	*KOPPY, NY FIX	**4000
*5000 - MRA		
**3000 - MOCA		
**3000 - GNSS MEA		

FROM	TO	MEA
95.6268 VOR FEDERAL AIRWAY V268 - CONTINUED		
KOPPY, NY FIX *3000 - MOCA *3000 - GNSS MEA	BEADS, NY FIX	*4000
BEADS, NY FIX *1600 - MOCA	HAMPTON, NY VORTAC	*2500
HAMPTON, NY VORTAC	SANDY POINT, RI VOR/DME	2000
SANDY POINT, RI VOR/DME	INNDY, MA FIX	2000
INNDY, MA FIX *6000 - MRA	*TONNI, MA FIX	6000
TONNI, MA FIX *5000 - MRA **4000 - GNSS MEA	*MESHL, ME FIX	**5000
MESHL, ME FIX	SAPPE, ME FIX	3000
SAPPE, ME FIX *1800 - MOCA	AUGUSTA, ME VOR/DME	*3000

95.6269 VOR FEDERAL AIRWAY V269

ELY, NV VOR/DME *13000 - MCA SPATS, NV FIX , S BND **12200 - MOCA	*SPATS, NV FIX	**13000
SPATS, NV FIX	WELLS, NV VOR	11000
WELLS, NV VOR *7500 - MCA TWIN FALLS, ID VORTAC , S BND **11000 - MOCA **11000 - GNSS MEA	*TWIN FALLS, ID VORTAC	**13000
TWIN FALLS, ID VORTAC	BURLEY, ID VOR/DME	7000
BURLEY, ID VOR/DME	POCATELLO, ID VORTAC	7000
POCATELLO, ID VORTAC	*JATTS, ID FIX NW BND SE BND	**8000 **7700
*10100 - MCA JATTS, ID FIX , NW BND **7700 - MOCA		
JATTS, ID FIX	SALMON, ID VOR/DME	14000
SALMON, ID VOR/DME	DONNELLY, ID VORTAC	12000
DONNELLY, ID VORTAC	HOVEL, ID FIX	12000
HOVEL, ID FIX *8700 - MOCA *9000 - GNSS MEA	FONNA, OR FIX	*12000
FONNA, OR FIX	WILDHORSE, OR VOR/DME	9000
WILDHORSE, OR VOR/DME	DESCHUTES, OR VORTAC	9500
DESCHUTES, OR VORTAC	MANTE, OR FIX	10000
MANTE, OR FIX *7600 - MOCA *8000 - GNSS MEA	MOBIL, OR FIX	*10000
MOBIL, OR FIX	COBUR, OR FIX NE BND SW BND	7000 5200
COBUR, OR FIX	*EUGENE, OR VORTAC NE BND SW BND	5000 4400
*3800 - MCA EUGENE, OR VORTAC , NE BND		

FROM	TO	MEA
------	----	-----

95.6270 VOR FEDERAL AIRWAY V270

ERIE, PA VORTAC	JAMESTOWN, NY VOR/DME	4000
JAMESTOWN, NY VOR/DME	*VAIRS, NY FIX	4000
*11000 - MRA		
VAIRS, NY FIX	WELLSVILLE, NY VORTAC	*4500
*4000 - MOCA		
WELLSVILLE, NY VORTAC	WOMAN, NY FIX	*4500
*4000 - MOCA		
WOMAN, NY FIX	ELMIRA, NY VOR/DME	*4000
*3400 - MOCA		
ELMIRA, NY VOR/DME	BINGHAMTON, NY VORTAC	3500
BINGHAMTON, NY VORTAC	ARMON, NY FIX	3600
ARMON, NY FIX	DELANCEY, NY VOR/DME	4500
DELANCEY, NY VOR/DME	TUSON, NY FIX	*6000
*5100 - MOCA		
TUSON, NY FIX	ATHOS, NY FIX	*6000
*5600 - MOCA		
ATHOS, NY FIX	CHESTER, MA VOR/DME	4000
CHESTER, MA VOR/DME	GLYDE, MA FIX	4000
GLYDE, MA FIX	BOSTON, MA VOR/DME	*4000
*3000 - MOCA		

95.6271 VOR FEDERAL AIRWAY V271

MUSKEGON, MI VORTAC	WELKO, MI FIX	*3000
*2400 - MOCA		
WELKO, MI FIX	MANISTEE, MI VOR/DME	*4000
*2100 - MOCA		
MANISTEE, MI VOR/DME	ESCANABA, MI VOR/DME	*3000
*2100 - MOCA		

95.6272 VOR FEDERAL AIRWAY V272

DALHART, TX VORTAC	BORGER, TX VORTAC	5700
BORGER, TX VORTAC	*BRISC, TX FIX	4800
*7000 - MRA		
BRISC, TX FIX	SAYRE, OK VORTAC	4700
SAYRE, OK VORTAC	SERTS, OK FIX	3900
SERTS, OK FIX	LIONS, OK FIX	*3700
*3100 - MOCA		
LIONS, OK FIX	WILL ROGERS, OK VORTAC	3100
WILL ROGERS, OK VORTAC	MINGG, OK FIX	*4000
*3000 - MOCA		
MINGG, OK FIX	HOLLE, OK FIX	*4000
*2600 - MOCA		
HOLLE, OK FIX	MC ALESTER, OK VORTAC	*3000
*2500 - MOCA		
MC ALESTER, OK VORTAC	FORT SMITH, AR VORTAC	*3500
*2900 - MOCA		

95.6273 VOR FEDERAL AIRWAY V273

FALLZ, NJ FIX	HUGUENOT, NY VOR/DME	3000
HUGUENOT, NY VOR/DME	HANCOCK, NY VOR/DME	4000
HANCOCK, NY VOR/DME	OXFOR, NY FIX	4000
OXFOR, NY FIX	GEORGETOWN, NY VORTAC	4000
GEORGETOWN, NY VORTAC	SYRACUSE, NY VORTAC	4000

FROM	TO	MEA
------	----	-----

95.6274 VOR FEDERAL AIRWAY V274

PULLMAN, MI VOR/DME	GRAND RAPIDS, MI VOR/DME	3000
GRAND RAPIDS, MI VOR/DME	SAGINAW, MI VOR/DME	2600

95.6275 VOR FEDERAL AIRWAY V275

CINCINNATI, KY VORTAC	DAYTON, OH VOR/DME	2900
DAYTON, OH VOR/DME	KLINE, OH FIX	*6000
*3000 - MOCA		

95.6276 VOR FEDERAL AIRWAY V276

ERIE, PA VORTAC	FRANKLIN, PA VOR	3600
FRANKLIN, PA VOR	CLARION, PA VOR/DME	*3700
*3200 - MOCA		
CLARION, PA VOR/DME	TYRONE, PA VORTAC	4600
TYRONE, PA VORTAC	RASHE, PA FIX	4500
RASHE, PA FIX	*MORTO, PA FIX	4000
*5000 - MRA		
MORTO, PA FIX	RAVINE, PA VORTAC	4000
RAVINE, PA VORTAC	*HIKES, PA FIX	**4000
*4000 - MRA		
**3500 - MOCA		
HIKES, PA FIX	YARDLEY, PA VOR/DME	*4000
*2300 - MOCA		
YARDLEY, PA VOR/DME	ROBBINSVILLE, NJ VORTAC	2100
ROBBINSVILLE, NJ VORTAC	CASVI, NJ FIX	1900
CASVI, NJ FIX	*GAMBY, NJ FIX	**3000
*6000 - MRA		
**1400 - MOCA		
GAMBY, NJ FIX	MANTA, NJ FIX	*6000
*2000 - MOCA		
*2000 - GNSS MEA		
MANTA, NJ FIX	*PREPI, OA FIX	**3000
*8000 - MRA		
**2000 - MOCA		

95.6277 VOR FEDERAL AIRWAY V277

ROSEWOOD, OH VORTAC	FORT WAYNE, IN VORTAC	3000
FORT WAYNE, IN VORTAC	BAGEL, IN FIX	2800
BAGEL, IN FIX	KEELER, MI VOR/DME	4000

95.6278 VOR FEDERAL AIRWAY V278

TEXICO, TX VORTAC	PLAINVIEW, TX VOR/DME	5800
PLAINVIEW, TX VOR/DME	GUTHRIE, TX VORTAC	*5100
*4600 - MOCA		
GUTHRIE, TX VORTAC	*NIFDE, TX FIX	**4500
*6500 - MRA		
**3300 - MOCA		
NIFDE, TX FIX	BOWIE, TX VORTAC	*4500
*2600 - MOCA		
*3300 - GNSS MEA		

FROM	TO	MEA
------	----	-----

95.6278 VOR FEDERAL AIRWAY V278 - CONTINUED

BOWIE, TX VORTAC	BONHAM, TX VORTAC	4000
BONHAM, TX VORTAC	PARIS, TX VOR/DME	2400
PARIS, TX VOR/DME	TEXARKANA, AR VORTAC	2000
TEXARKANA, AR VORTAC	WARLO, AR FIX	2200
WARLO, AR FIX	LOCUS, AR FIX	*3000
*1700 - MOCA		
LOCUS, AR FIX	MONTICELLO, AR VOR/DME	*2500
*1600 - MOCA		
MONTICELLO, AR VOR/DME	GREENVILLE, MS VOR/DME	*2000
*1500 - MOCA		
GREENVILLE, MS VOR/DME	SIDON, MS VORTAC	2000
SIDON, MS VORTAC	BIGBEE, MS VORTAC	2400
BIGBEE, MS VORTAC	MINIM, AL FIX	2000
MINIM, AL FIX	VULCAN, AL VORTAC	2600

95.6279 VOR FEDERAL AIRWAY V279

GUNNE, OH FIX	FLAG CITY, OH VORTAC	3000
---------------	----------------------	------

95.6280 VOR FEDERAL AIRWAY V280

U.S. MEXICAN BORDER	EL PASO, TX VORTAC	*8000
*6300 - MOCA		
EL PASO, TX VORTAC	PINON, NM VOR/DME	8800
PINON, NM VOR/DME	*HOPET, NM FIX	8800
*7400 - MCA HOPET, NM FIX, SW BND		
HOPET, NM FIX	CHISUM, NM VORTAC	7000
CHISUM, NM VORTAC	*FRAIZ, NM FIX	**6500
*6700 - MRA		
**5700 - MOCA		
FRAIZ, NM FIX	*DEBRA, NM FIX	**7500
*7500 - MRA		
**5700 - MOCA		
DEBRA, NM FIX	TEXICO, TX VORTAC	*6500
*5600 - MOCA		
TEXICO, TX VORTAC	PANHANDLE, TX VORTAC	*5900
*5600 - MOCA		
PANHANDLE, TX VORTAC	MITBEE, OK VORTAC	*5500
*5000 - MOCA		
MITBEE, OK VORTAC	CARKO, KS FIX	4000
CARKO, KS FIX	WIPET, KS FIX	*8000
*3500 - MOCA		
WIPET, KS FIX	HUTCHINSON, KS VOR/DME	3300
HUTCHINSON, KS VOR/DME	BUHLS, KS FIX	4000
BUHLS, KS FIX	*WILSY, KS FIX	**4500
*5000 - MRA		
**2800 - MOCA		
WILSY, KS FIX	HEYDN, KS FIX	*4500
*2900 - MOCA		
HEYDN, KS FIX	TOPEKA, KS VORTAC	3700

95.6281 VOR FEDERAL AIRWAY V281

MOSES LAKE, WA VOR/DME	PASCO, WA VOR/DME	4000
------------------------	-------------------	------

FROM TO MEA

95.6282 VOR FEDERAL AIRWAY V282

SARANAC LAKE, NY VOR/DME *FAWNS, NY FIX 5000
 *5000 - MCA FAWNS, NY FIX , S BND
 FAWNS, NY FIX U.S. CANADIAN BORDER #5000
 #FIX OVERLIES U.S. CANADIAN BORDER.

95.6283 VOR FEDERAL AIRWAY V283

SEAL BEACH, CA VORTAC *JOGIT, CA FIX 4000
 *6000 - MCA JOGIT, CA FIX , E BND
 JOGIT, CA FIX *KAYOH, CA FIX 6000
 *7400 - MCA KAYOH, CA FIX , E BND
 KAYOH, CA FIX HOMELAND, CA VOR 8000
 HOMELAND, CA VOR *LUCER, CA FIX 10500
 *9300 - MCA LUCER, CA FIX , SW BND
 LUCER, CA FIX BULGY, CA FIX *9000
 *8000 - MOCA
 BULGY, CA FIX HECTOR, CA VORTAC *9000
 *7000 - MOCA
 HECTOR, CA VORTAC *WHIGG, CA FIX 10000
 *12000 - MRA
 WHIGG, CA FIX BOULDER CITY, NV VORTAC 10000

95.6284 VOR FEDERAL AIRWAY V284

SEA ISLE, NJ VORTAC AZXEW, NJ FIX *2500
 *1500 - MOCA
 AZXEW, NJ FIX CEDAR LAKE, NJ VORTAC *2500
 *1600 - MOCA

95.6285 VOR FEDERAL AIRWAY V285

BRICKYARD, IN VORTAC KOKOMO, IN VORTAC 2700
 KOKOMO, IN VORTAC GOSHEN, IN VORTAC 2600
 GOSHEN, IN VORTAC KALAMAZOO, MI VOR/DME 2600
 KALAMAZOO, MI VOR/DME GRAND RAPIDS, MI VOR/DME 3000
 GRAND RAPIDS, MI VOR/DME CLOCK, MI FIX 2600
 CLOCK, MI FIX WHITE CLOUD, MI VOR/DME 2800
 WHITE CLOUD, MI VOR/DME MANISTEE, MI VOR/DME *4000
 *2400 - MOCA
 MANISTEE, MI VOR/DME TRAVERSE CITY, MI VORTAC 2800

95.6286 VOR FEDERAL AIRWAY V286

ELKINS, WV VORTAC DERIN, WV FIX #5700
 #ELKINS R-105 UNUSABLE BYD 32 BLW 9000
 DERIN, WV FIX TEAKK, VA FIX *9000
 *6900 - MOCA
 *6900 - GNSS MEA

FROM TO MEA

95.6286 VOR FEDERAL AIRWAY V286 - CONTINUED

TEAKK, VA FIX *5800 - MOCA *5800 - GNSS MEA	CASANOVA, VA VORTAC	*6500
CASANOVA, VA VORTAC *2300 - MOCA	FLUKY, VA FIX	*3000
FLUKY, VA FIX BROOKE, VA VORTAC *5000 - MCA ZUNAR, VA FIX , SE BND **2000 - GNSS MEA	BROOKE, VA VORTAC *ZUNAR, VA FIX	2000 **3000
ZUNAR, VA FIX *2000 - GNSS MEA	FAGED, VA FIX	*5000
FAGED, VA FIX GWYNN, VA FIX *1500 - MOCA	GWYNN, VA FIX CAPE CHARLES, VA VORTAC	2000 *2000

95.6287 VOR FEDERAL AIRWAY V287

FORT JONES, CA VOR/DME *9700 - MOCA	KLAMA, OR FIX	*10000
KLAMA, OR FIX	*ROGUE VALLEY, OR VORTAC SE BND NW BND *7000 - MCA ROGUE VALLEY, OR VORTAC , SE BND **8000 - MOCA	**10000 **8000
ROGUE VALLEY, OR VORTAC *7400 - MOCA	KOLER, OR FIX	*8000
KOLER, OR FIX *6000 - MOCA	CAMAS, OR FIX	*8500
CAMAS, OR FIX	DEROY, OR FIX NW BND SE BND	5500 8000
DEROY, OR FIX	NORTH BEND, OR VORTAC NW BND SE BND	4000 8000
NORTH BEND, OR VORTAC	*RARES, OR FIX N BND S BND *5500 - MRA	6000 3700
RARES, OR FIX CRAAF, OR FIX *3400 - MOCA	CRAAF, OR FIX MCCOY, OR FIX	6000 *4000
MCCOY, OR FIX NEWBERG, OR VOR/DME BATTLE GROUND, WA VORTAC	NEWBERG, OR VOR/DME BATTLE GROUND, WA VORTAC *MALAY, WA FIX NW BND SE BND	3600 4000 6000 5000
*9500 - MRA MALAY, WA FIX *5000 - MRA	*TONNO, WA FIX	6000
TONNO, WA FIX OLYMPIA, WA VORTAC *4000 - MRA **1900 - MOCA	OLYMPIA, WA VORTAC *CARRO, WA FIX	4000 **4000
CARRO, WA FIX *4700 - MCA ARPEE, WA FIX , S BND **5200 - MOCA	*ARPEE, WA FIX	**6000
ARPEE, WA FIX LOFAL, WA FIX *1800 - MOCA	LOFAL, WA FIX PAINE, WA VOR/DME	4000 *3000
PAINE, WA VOR/DME *1800 - MOCA	PENN COVE, WA VOR/DME	*3000

FROM TO MEA

95.6288 VOR FEDERAL AIRWAY V288

LUCIN, UT VORTAC *13000 - MRA *16000 - MCA CORIN, UT FIX , E BND **9400 - MOCA	*CORIN, UT FIX	**13000
*CORIN, UT FIX *16000 - MCA CORIN, UT FIX , E BND **11600 - MOCA **12000 - GNSS MEA	FORT BRIDGER, WY VOR/DME	**16000

95.6289 VOR FEDERAL AIRWAY V289

BEAUMONT, TX VOR/DME HONEE, TX FIX *1900 - MOCA	HONEE, TX FIX LUFKIN, TX VORTAC	2000 *3000
LUFKIN, TX VORTAC *2400 - MRA	*PIPES, TX FIX	2400
PIPES, TX FIX GREGG COUNTY, TX VORTAC TEXARKANA, AR VORTAC *4500 - MRA **1700 - MOCA	GREGG COUNTY, TX VORTAC TEXARKANA, AR VORTAC *PROVO, AR FIX	2000 2000 **2200
PROVO, AR FIX *3400 - MOCA	UMPIR, AR FIX	*3900
UMPIR, AR FIX *3800 - MOCA	BATEZ, AR FIX	*4300
BATEZ, AR FIX *3600 - MOCA	FORT SMITH, AR VORTAC	*4100
FORT SMITH, AR VORTAC *1800 - MOCA	MULBY, AR FIX SW BND NE BND	*3000 *4000
MULBY, AR FIX HARRISON, AR VOR/DME DOGWOOD, MO VORTAC GOBEY, MO FIX PEKLE, MO FIX	HARRISON, AR VOR/DME DOGWOOD, MO VORTAC GOBEY, MO FIX PEKLE, MO FIX VICHY, MO VOR/DME	4000 3400 3400 3400 3000

95.6290 VOR FEDERAL AIRWAY V290

RAINELLE, WV VOR *6000 - MRA	*NATTS, WV FIX	6000
NATTS, WV FIX *MONTEBELLO, VA VOR/DME *6000 - MCA MONTEBELLO, VA VOR/DME , SE BND	MONTEBELLO, VA VOR/DME ROMAN, VA FIX	6000 6300
ROMAN, VA FIX ARVON, VA FIX *2200 - GNSS MEA #FLAT ROCK R-297 UNUSABLE.	ARVON, VA FIX #FLAT ROCK, VA VORTAC	4000 *5000
TAR RIVER, NC VORTAC *1500 - MOCA	KENIR, NC FIX	*4000
KENIR, NC FIX *1500 - MOCA	PUNGO, NC FIX	*5000

FROM TO MEA

95.6291 VOR FEDERAL AIRWAY V291

HOBBS, NM VORTAC *5500 - MOCA	CHISUM, NM VORTAC	*6000
CHISUM, NM VORTAC	DUPAL, NM FIX NW BND	9000
	SE BND	6000
DUPAL, NM FIX	CORONA, NM VORTAC	9000
CORONA, NM VORTAC	ALBUQUERQUE, NM VORTAC	10000
ALBUQUERQUE, NM VORTAC	AROYO, NM FIX	8300
AROYO, NM FIX	*LORAT, NM FIX	9500
*12400 - MCA LORAT, NM FIX ,	W BND	
LORAT, NM FIX	BLINI, NM FIX	13300
BLINI, NM FIX	GALLUP, NM VORTAC	11000
GALLUP, NM VORTAC	FORAN, AZ FIX	9400
FORAN, AZ FIX	WINSLOW, AZ VORTAC	9000
WINSLOW, AZ VORTAC	FLAGSTAFF, AZ VOR/DME	*10100
*10100 - MOCA		
FLAGSTAFF, AZ VOR/DME	KACEE, AZ FIX	11000
KACEE, AZ FIX	PEACH SPRINGS, AZ VORTAC	10000

95.6292 VOR FEDERAL AIRWAY V292

HANCOCK, NY VOR/DME	SAGES, NY FIX	6000
SAGES, NY FIX	*WIGAN, NY FIX	**10000
*4500 - MRA		
**6400 - MOCA		
**7000 - GNSS MEA		
WIGAN, NY FIX	#BARNES, MA VORTAC	*10000
*4900 - MOCA		
*5000 - GNSS MEA		
#BARNES R-279 UNUSABLE.		
BARNES, MA VORTAC	GLYDE, MA FIX	*7000
*2700 - MOCA		
*4000 - GNSS MEA		
GLYDE, MA FIX	BOSTON, MA VOR/DME	*4000
*3000 - MOCA		

95.6293 VOR FEDERAL AIRWAY V293

*GRAND CANYON, AZ VOR/DME	KLIFF, AZ FIX	**14500
*14500 - MCA GRAND CANYON, AZ VOR/DME ,	N BND	
**10900 - MOCA		
*KLIFF, AZ FIX	PAGE, AZ VOR/DME	8700
*14500 - MCA KLIFF, AZ FIX ,	S BND	
PAGE, AZ VOR/DME	CABER, UT FIX	8500
CABER, UT FIX	BRYCE CANYON, UT VORTAC	11000
BRYCE CANYON, UT VORTAC	*CEDAR CITY, UT VOR/DME	13000
*12000 - MCA CEDAR CITY, UT VOR/DME ,	E BND	
CEDAR CITY, UT VOR/DME	BERYL, UT FIX	*9000
*8400 - MOCA		
BERYL, UT FIX	WILSON CREEK, NV VORTAC	11300
WILSON CREEK, NV VORTAC	ELY, NV VOR/DME	12000
ELY, NV VOR/DME	*BULLION, NV VOR/DME	***14000
*12000 - MCA BULLION, NV VOR/DME ,	S BND	
**13100 - MOCA		
#MEA IS ESTABLISHED WITH A GAP IN NAVIGATION SIGNAL COVERAGE.		

FROM TO MEA

95.6293 VOR FEDERAL AIRWAY V293 - CONTINUED

BULLION, NV VOR/DME	SAMAN, ID FIX	10600
SAMAN, ID FIX	*TWIN FALLS, ID VORTAC	
	N BND	7500
	S BND	8600
*6500 - MCA TWIN FALLS, ID VORTAC , S BND		
TWIN FALLS, ID VORTAC	GOODE, ID FIX	6000
GOODE, ID FIX	*TORIN, ID FIX	6600
*8700 - MCA TORIN, ID FIX , NW BND		
TORIN, ID FIX	DERSO, ID FIX	
	NW BND	11500
	SE BND	9200
DERSO, ID FIX	DONNELLY, ID VORTAC	11700

95.6294 VOR FEDERAL AIRWAY V294

DES MOINES, IA VORTAC	CEDAR RAPIDS, IA VOR/DME	2700
CEDAR RAPIDS, IA VOR/DME	DAVENPORT, IA VORTAC	2600

95.6295 VOR FEDERAL AIRWAY V295

VIRGINIA KEY, FL VOR/DME	STOOP, FL FIX	*5000
*1800 - MOCA		
STOOP, FL FIX	VERO BEACH, FL VORTAC	*2000
*1500 - MOCA		
VERO BEACH, FL VORTAC	ORLANDO, FL VORTAC	2600
ORLANDO, FL VORTAC	*SHIMM, FL FIX	2000
*3000 - MRA		
SHIMM, FL FIX	OCALA, FL VORTAC	2000
OCALA, FL VORTAC	CROSS CITY, FL VORTAC	2000
CROSS CITY, FL VORTAC	SEMINOLE, FL VORTAC	2000

95.6296 VOR FEDERAL AIRWAY V296

HUSTN, NC FIX	RAEFO, NC FIX	*5000
*2300 - MOCA		
RAEFO, NC FIX	FAYETTEVILLE, NC VOR/DME	*5000
*2400 - GNSS MEA		
FAYETTEVILLE, NC VOR/DME	RAPVY, NC FIX	*3000
*2100 - MOCA		
RAPVY, NC FIX	WILMINGTON, NC VORTAC	*8000
*5000 - GNSS MEA		

95.6297 VOR FEDERAL AIRWAY V297

JOHNSTOWN, PA VORTAC	TALLS, PA FIX	4200
TALLS, PA FIX	VOLAN, PA FIX	*5000
*3200 - MOCA		
*3300 - GNSS MEA		
VOLAN, PA FIX	CAPEL, OH FIX	*3600
*2800 - MOCA		
CAPEL, OH FIX	AKRON, OH VOR/DME	3600
AKRON, OH VOR/DME	U.S. CANADIAN BORDER	*6000
*3000 - MOCA		
U.S. CANADIAN BORDER	LLEEO, CANADA FIX	#4000
#FOR THAT AIRSPACE OVER U.S. TERRITORY.		

FROM TO MEA

95.6298 VOR FEDERAL AIRWAY V298

*SEATTLE, WA VORTAC	VAMPS, WA FIX W BND E BND	**4000 **8000
*4300 - MCA SEATTLE, WA VORTAC , E BND		
**3100 - MOCA		
VAMPS, WA FIX	*BEEZR, WA FIX	8000
*9000 - MRA		
BEEZR, WA FIX	PERTT, WA FIX	*9000
*7500 - MOCA		
PERTT, WA FIX	YAKIMA, WA VORTAC	6500
YAKIMA, WA VORTAC	BENTY, WA FIX	5000
BENTY, WA FIX	PASCO, WA VOR/DME	4000
PASCO, WA VOR/DME	PENDLETON, OR VORTAC	4400
PENDLETON, OR VORTAC	CABAN, OR FIX	6000
CABAN, OR FIX	IBEAM, OR FIX	8300
IBEAM, OR FIX	DONNELLY, ID VORTAC	12000
DONNELLY, ID VORTAC	*DUBOIS, ID VORTAC	**16000
*9800 - MCA DUBOIS, ID VORTAC , W BND		
**13600 - MOCA		
DUBOIS, ID VORTAC	*SABAT, ID FIX W BND E BND	**9000 **13000
*10000 - MRA		
*11100 - MCA SABAT, ID FIX , E BND		
**8100 - MOCA		
SABAT, ID FIX	LAMON, ID FIX W BND E BND	*10000 *13000
*8100 - MOCA		
LAMON, ID FIX	*QUIRT, WY FIX	15000
*14100 - MCA QUIRT, WY FIX , W BND		
QUIRT, WY FIX	DUNOIR, WY VOR/DME	*12000
*10800 - MOCA		
DUNOIR, WY VOR/DME	*BOYSEN RESERVOIR, WY VOR/DME	14000
*11000 - MCA BOYSEN RESERVOIR, WY VOR/DME , W BND		
BOYSEN RESERVOIR, WY VOR/DME	MUDDY MOUNTAIN, WY VORTAC	*11000
*10300 - MOCA		
MUDDY MOUNTAIN, WY VORTAC	CHANG, WY FIX	8500
CHANG, WY FIX	GILLETTE, WY VOR/DME	7200

95.6299 VOR FEDERAL AIRWAY V299

*LOS ANGELES, CA VORTAC	VENTURA, CA VOR/DME	5000
*3200 - MCA LOS ANGELES, CA VORTAC , W BND		
VENTURA, CA VOR/DME	FILLMORE, CA VORTAC	5000
FILLMORE, CA VORTAC	GORMAN, CA VORTAC	9500

95.6300 VOR FEDERAL AIRWAY V300

U.S. CANADIAN BORDER	AVALE, MI FIX	#*9000
*2400 - MOCA		
#MEA IS ESTABLISHED WITH A GAP IN NAVIGATION SIGNAL COVERAGE.		

FROM	TO	MEA
------	----	-----

95.6300 VOR FEDERAL AIRWAY V300 - CONTINUED

AVALE, MI FIX *2400 - MOCA #FOR THAT AIRSPACE OVER U.S. TERRITORY.	SAULT STE MARIE, MI VOR/DME	#*3000
SAULT STE MARIE, MI VOR/DME *2500 - MOCA	ALVUS, MI FIX	*3000
ALVUS, MI FIX *2500 - MOCA	RIBIR, CANADA FIX	*3000
U.S. CANADIAN BORDER *2500 - MOCA	NAASH, MI FIX	*3000
NAASH, MI FIX *2500 - MOCA	MKPDG, MI FIX	*6000
U.S. CANADIAN BORDER *5900 - MOCA *5900 - GNSS MEA	CAMPO, ME FIX	*9000
CAMPO, ME FIX *6000 - MOCA *6000 - GNSS MEA	WRAPT, ME FIX	*9000
WRAPT, ME FIX *5900 - MOCA *5900 - GNSS MEA	MILLINOCKET, ME VOR/DME	*7000
MILLINOCKET, ME VOR/DME *2200 - MOCA	U.S. CANADIAN BORDER	*3000

95.6301 VOR FEDERAL AIRWAY V301

PANOCHE, CA VORTAC *6500 - MCA SUNOL, CA FIX , SE BND	*SUNOL, CA FIX	6500
SUNOL, CA FIX	OAKLAND, CA VORTAC	4000
OAKLAND, CA VORTAC *4000 - MOCA	COMMO, CA FIX	*5000
COMMO, CA FIX	POINT REYES, CA VORTAC	5000
POINT REYES, CA VORTAC	SANTA ROSA, CA VOR/DME	3500
SANTA ROSA, CA VOR/DME *6000 - MCA KLOGE, CA FIX , NE BND	*KLOGE, CA FIX	5000
KLOGE, CA FIX	RUMSY, CA FIX	7000
RUMSY, CA FIX	WILLIAMS, CA VORTAC	5000

95.6302 VOR FEDERAL AIRWAY V302

AUGUSTA, ME VOR/DME *3000 - GNSS MEA	ANCOR, ME FIX	*5000
---	---------------	-------

95.6303 VOR FEDERAL AIRWAY V303

HOT SPRINGS, AR VOR/DME *3000 - MOCA	BLURB, AR FIX	*3500
BLURB, AR FIX *3600 - MOCA	BLIMP, AR FIX	*4100
BLIMP, AR FIX *2400 - MOCA	FORT SMITH, AR VORTAC	*2900

FROM TO MEA

95.6304 VOR FEDERAL AIRWAY V304

PANHANDLE, TX VORTAC	BORGER, TX VORTAC	5000
BORGER, TX VORTAC	LIBERAL, KS VORTAC	4800
LIBERAL, KS VORTAC	LAMAR, CO VORTAC	*6000
*5300 - MOCA		

95.6305 VOR FEDERAL AIRWAY V305

EL DORADO, AR VORTAC	BUNNS, AR FIX	2200
BUNNS, AR FIX	HERID, AR FIX	2000
HERID, AR FIX	LITTLE ROCK, AR VORTAC	3300
LITTLE ROCK, AR VORTAC	DUMPI, AR FIX	
	S BND	2000
	N BND	4000
DUMPI, AR FIX	WALNUT RIDGE, AR VORTAC	*4000
*2200 - MOCA		
WALNUT RIDGE, AR VORTAC	MALDEN, MO VORTAC	2300
MALDEN, MO VORTAC	CUNNINGHAM, KY VORTAC	2500
CUNNINGHAM, KY VORTAC	WESON, KY FIX	2600
WESON, KY FIX	POCKET CITY, IN VORTAC	2200
POCKET CITY, IN VORTAC	*AUGUS, IN FIX	2400
*2600 - MRA		
AUGUS, IN FIX	*WEGEE, IN FIX	**3500
*3500 - MRA		
**1900 - MOCA		
WEGEE, IN FIX	HOOSIER, IN VORTAC	2700
HOOSIER, IN VORTAC	BRICKYARD, IN VORTAC	#*2700
*2700 - GNSS MEA		
#HOOSIER R-027 UNUSABLE.		
BRICKYARD, IN VORTAC	WELDO, IN FIX	2900
WELDO, IN FIX	KOKOMO, IN VORTAC	2700

95.6306 VOR FEDERAL AIRWAY V306

JUNCTION, TX VORTAC	AMUSE, TX FIX	3800
AMUSE, TX FIX	CENTEX, TX VORTAC	3100
CENTEX, TX VORTAC	NAVASOTA, TX VORTAC	2300
NAVASOTA, TX VORTAC	ZMSKL, TX FIX	2000
ZMSKL, TX FIX	CLEEP, TX FIX	*5000
*2300 - MOCA		
CLEEP, TX FIX	DAISETTA, TX VORTAC	3000
DAISETTA, TX VORTAC	SILBE, TX FIX	2000
SILBE, TX FIX	OFERS, LA FIX	2200
OFERS, LA FIX	LAKE CHARLES, LA VORTAC	2000

95.6307 VOR FEDERAL AIRWAY V307

HARRISON, AR VOR/DME	NEOSHO, MO VOR/DME	*3400
*2800 - MOCA		
NEOSHO, MO VOR/DME	OSWEGO, KS VORTAC	3000
OSWEGO, KS VORTAC	CHANUTE, KS VOR/DME	*3000
*2400 - MOCA		
CHANUTE, KS VOR/DME	EMPORIA, KS VORTAC	3000
EMPORIA, KS VORTAC	ALMAS, KS FIX	3000
ALMAS, KS FIX	PAWNEE CITY, NE VORTAC	*5000
*2800 - MOCA		
PAWNEE CITY, NE VORTAC	OMAHA, IA VORTAC	3000
OMAHA, IA VORTAC	*DECKA, NE FIX	3000
*3500 - MRA		
DECKA, NE FIX	SIoux CITY, IA VORTAC	3000

FROM	TO	MEA
95.6308 VOR FEDERAL AIRWAY V308		
NOTTINGHAM, MD VORTAC	*BILIT, MD FIX	**6000
*6000 - MCA BILIT, MD FIX , W BND		
**1600 - MOCA		
**2000 - GNSS MEA		
BILIT, MD FIX	WATERLOO, DE VOR/DME	*2000
*1500 - MOCA		
WATERLOO, DE VOR/DME	SEA ISLE, NJ VORTAC	*2000
*1500 - MOCA		
SEA ISLE, NJ VORTAC	AVALO, NJ FIX	*4500
*4000 - GNSS MEA		
AVALO, NJ FIX	HARBO, NJ FIX	*6000
*4000 - GNSS MEA		
HARBO, NJ FIX	*DRIFT, NJ FIX	**7500
*6000 - MRA		
**3000 - GNSS MEA		
DRIFT, NJ FIX	MANTA, NJ FIX	*12000
*3000 - GNSS MEA		
MANTA, NJ FIX	PLUME, NJ FIX	*7000
*2000 - MOCA		
*3000 - GNSS MEA		
PLUME, NJ FIX	*KOPPY, NY FIX	**4000
*5000 - MRA		
**3000 - MOCA		
**3000 - GNSS MEA		
KOPPY, NY FIX	BEADS, NY FIX	*4000
*3000 - MOCA		
*3000 - GNSS MEA		
BEADS, NY FIX	HAMPTON, NY VORTAC	*2500
*1600 - MOCA		
HAMPTON, NY VORTAC	GROTON, CT VOR/DME	2000

95.6309 VOR FEDERAL AIRWAY V309

CHARLESTON, WV VORTAC	RANDE, WV FIX	*5000
*3200 - MOCA		
*3200 - GNSS MEA		
RANDE, WV FIX	BURGS, WV FIX	*7000
*3300 - MOCA		
*3400 - GNSS MEA		
BURGS, WV FIX	BELLAIRE, OH VOR/DME	3400

95.6310 VOR FEDERAL AIRWAY V310

LOUISVILLE, KY VORTAC	LONDON, KY VORTAC	3300
LONDON, KY VORTAC	ROSAR, KY FIX	5500
ROSAR, KY FIX	HOLSTON MOUNTAIN, TN VORTAC	6400
HOLSTON MOUNTAIN, TN VORTAC	*STAIN, TN FIX	6000
*7100 - MCA STAIN, TN FIX , E BND		
STAIN, TN FIX	*MULBE, NC FIX	7500
*7100 - MCA MULBE, NC FIX , W BND		
MULBE, NC FIX	BURCH, NC FIX	6000
BURCH, NC FIX	GREENSBORO, NC VORTAC	3500
GREENSBORO, NC VORTAC	CHAPL, NC FIX	3000
CHAPL, NC FIX	RALEIGH/DURHAM, NC VORTAC	2000
RALEIGH/DURHAM, NC VORTAC	TAR RIVER, NC VORTAC	2500
TAR RIVER, NC VORTAC	ELIZABETH CITY, NC VOR/DME	4000

FROM TO MEA

95.6311 VOR FEDERAL AIRWAY V311

HINCH MOUNTAIN, TN VORTAC	DUBBS, TN FIX	5000
DUBBS, TN FIX	NELLO, GA FIX	*7000
*5600 - MOCA		
NELLO, GA FIX	*AWSON, GA FIX	5400
*5000 - MRA		
AWSON, GA FIX	CORCE, GA FIX	4600
CORCE, GA FIX	ELECTRIC CITY, SC VORTAC	3800
ELECTRIC CITY, SC VORTAC	GREENWOOD, SC VORTAC	2500
GREENWOOD, SC VORTAC	COLUMBIA, SC VORTAC	2300
COLUMBIA, SC VORTAC	*ERNIE, SC FIX	2000
*2500 - MRA		
ERNIE, SC FIX	SACKS, SC FIX	2000
SACKS, SC FIX	CHARLESTON, SC VORTAC	2100

95.6312 VOR FEDERAL AIRWAY V312

POLLA, MD FIX	TACKS, MD FIX	2200
		MAA - 13000
TACKS, MD FIX	WOODSTOWN, NJ VORTAC	*2000
*1500 - MOCA		
WOODSTOWN, NJ VORTAC	COYLE, NJ VORTAC	2000
		MAA - 8000
COYLE, NJ VORTAC	*DRIFT, NJ FIX	2000
*6000 - MRA		
DRIFT, NJ FIX	*PREPI, OA FIX	**4800
*8000 - MRA		
**2000 - GNSS MEA		

95.6313 VOR FEDERAL AIRWAY V313

MALDEN, MO VORTAC	CAPE GIRARDEAU, MO VOR/DME	2300
CAPE GIRARDEAU, MO	GENTS, IL FIX	3500
VOR/DME		
GENTS, IL FIX	CENTRALIA, IL VORTAC	*3000
*2400 - MOCA		
CENTRALIA, IL VORTAC	ADDERS, IL VORTAC	2500
ADDERS, IL VORTAC	PONTIAC, IL VOR/DME	3000

95.6314 VOR FEDERAL AIRWAY V314

U.S. CANADIAN BORDER	*PATTA, ME FIX	**6000
*8000 - MRA		
**3900 - MOCA		
PATTA, ME FIX	MILLINOCKET, ME VOR/DME	*6000
*3900 - MOCA		
MILLINOCKET, ME VOR/DME	PRINCETON, ME VOR/DME	2900
PRINCETON, ME VOR/DME	U.S. CANADIAN BORDER	*2500
*1800 - MOCA		

95.6315 VOR FEDERAL AIRWAY V315

PARIS, TX VOR/DME	RICH MOUNTAIN, OK VORTAC	4200
-------------------	--------------------------	------

FROM	TO	MEA
------	----	-----

95.6316 VOR FEDERAL AIRWAY V316

IRONWOOD, MI VORTAC *3600 - MOCA	SAWYER, MI VOR/DME	*6000
SAWYER, MI VOR/DME *2600 - MOCA	UZMEF, MI FIX	*3500
UZMEF, MI FIX *2500 - MOCA	NEWBERRY, MI VOR/DME	*6000
NEWBERRY, MI VOR/DME *2300 - MOCA	SAULT STE MARIE, MI VOR/DME	*3000
SAULT STE MARIE, MI VOR/DME *2800 - MOCA	U.S. CANADIAN BORDER	*5000

95.6317 VOR FEDERAL AIRWAY V317

MISSION BAY, CA VORTAC	POGGI, CA VORTAC	4500
POGGI, CA VORTAC	IMPERIAL, CA VORTAC	7000

95.6318 VOR FEDERAL AIRWAY V318

U.S. CANADIAN BORDER *3900 - MOCA	HOULTON, ME VOR/DME	*9000
HOULTON, ME VOR/DME	U.S. CANADIAN BORDER	1900

95.6319 VOR FEDERAL AIRWAY V319

BOYSEN RESERVOIR, WY VOR/DME	WORLAND, WY VOR/DME	9600
WORLAND, WY VOR/DME	ALVIL, WY FIX	7000
ALVIL, WY FIX	CODY, WY VOR/DME	8500

95.6320 VOR FEDERAL AIRWAY V320

PELLSTON, MI VORTAC	TRAVERSE CITY, MI VORTAC	3000
TRAVERSE CITY, MI VORTAC *3000 - MOCA	MOUNT PLEASANT, MI VOR/DME	*5000
MOUNT PLEASANT, MI VOR/DME	SAGINAW, MI VOR/DME	2600
SAGINAW, MI VOR/DME	PECK, MI VORTAC	3000
PECK, MI VORTAC *2000 - MOCA	U.S. CANADIAN BORDER	*6000

95.6321 VOR FEDERAL AIRWAY V321

PECAN, GA VORTAC	KUTVE, GA FIX	2000
KUTVE, GA FIX	PREST, GA FIX	2600

FROM TO MEA

95.6321 VOR FEDERAL AIRWAY V321 - CONTINUED

PREST, GA FIX	*COLUMBUS, GA VORTAC	**5000
*5000 - MCA COLUMBUS, GA VORTAC , SE BND		
*5000 - MCA COLUMBUS, GA VORTAC , NW BND		
**3300 - MOCA		
COLUMBUS, GA VORTAC	LAGRANGE, GA VORTAC	2500
LAGRANGE, GA VORTAC	HEFIN, AL FIX	*4000
*3200 - MOCA		
HEFIN, AL FIX	GADSDEN, AL VOR/DME	4000
GADSDEN, AL VOR/DME	OWENT, AL FIX	3000
OWENT, AL FIX	ROCKET, AL VORTAC	3700
ROCKET, AL VORTAC	SHELBYVILLE, TN VOR/DME	3000
SHELBYVILLE, TN VOR/DME	LIVINGSTON, TN VORTAC	3400

95.6322 VOR FEDERAL AIRWAY V322

CONCORD, NH VORTAC	GRUMP, NH FIX	4000
GRUMP, NH FIX	*NOTTY, NH FIX	5000
*6000 - MCA NOTTY, NH FIX , N BND		
NOTTY, NH FIX	WYLIE, NH FIX	*7000
*5600 - MOCA		
WYLIE, NH FIX	BUKER, NH FIX	*7000
*6000 - MOCA		
BUKER, NH FIX	BERLIN, NH VOR/DME	*6000
*5100 - MOCA		
BERLIN, NH VOR/DME	U.S. CANADIAN BORDER	#6500
#FOR THAT AIRSPACE OVER U.S. TERRITORY.		

95.6323 VOR FEDERAL AIRWAY V323

MONTGOMERY, AL VORTAC	PEECH, AL FIX	2400
PEECH, AL FIX	EUFAULA, AL VORTAC	2000
EUFAULA, AL VORTAC	BYROE, GA FIX	*3000
*2000 - MOCA		
BYROE, GA FIX	MACON, GA VORTAC	2000
MACON, GA VORTAC	NALIZ, GA FIX	*3000
*2500 - MOCA		
NALIZ, GA FIX	HUSKY, GA FIX	*3000
*2100 - MOCA		

95.6324 VOR FEDERAL AIRWAY V324

GILLETTE, WY VOR/DME	*CRAZY WOMAN, WY VOR/DME	7500
*9500 - MCA CRAZY WOMAN, WY VOR/DME , W BND		
CRAZY WOMAN, WY VOR/DME	CHAPY, WY FIX	12000
CHAPY, WY FIX	WORLAND, WY VOR/DME	12000
E BND		
W BND		
		8000

95.6325 VOR FEDERAL AIRWAY V325

COLUMBIA, SC VORTAC	VESTO, GA FIX	2400
VESTO, GA FIX	ATHENS, GA VORTAC	2500
ATHENS, GA VORTAC	WOMAC, GA FIX	3700
WOMAC, GA FIX	LOGEN, GA FIX	4000

FROM	TO	MEA
------	----	-----

95.6325 VOR FEDERAL AIRWAY V325 – CONTINUED

DALAS, GA FIX *3700 - MOCA	GADSDEN, AL VOR/DME	*5000
GADSDEN, AL VOR/DME	MASHA, AL FIX	3500
MASHA, AL FIX	MUSCLE SHOALS, AL VORTAC	2500

95.6326 VOR FEDERAL AIRWAY V326

FILLMORE, CA VORTAC	VAN NUYS, CA VOR/DME	5000
---------------------	----------------------	------

95.6327 VOR FEDERAL AIRWAY V327

PHOENIX, AZ VORTAC	KNOBB, AZ FIX	8000
KNOBB, AZ FIX	RADOM, AZ FIX	
	S BND	8000
	N BND	11000
RADOM, AZ FIX	*FERER, AZ FIX	
	N BND	**12000
	S BND	**11000

*12000 - MRA
*11000 - MCA FERER, AZ FIX , S BND
**8400 - MOCA
**9000 - GNSS MEA

FERER, AZ FIX	OATES, AZ FIX	**12000
**9400 - MOCA		
**10000 - GNSS MEA		

OATES, AZ FIX	FLAGSTAFF, AZ VOR/DME	
	N BND	10500
	S BND	10000

95.6328 VOR FEDERAL AIRWAY V328

JACKSON, WY VOR/DME	BIG PINEY, WY VOR/DME	13500
BIG PINEY, WY VOR/DME	ROCK SPRINGS, WY VOR/DME	*10000
*9700 - MOCA		
ROCK SPRINGS, WY VOR/DME	SNAKY, WY FIX	11000
SNAKY, WY FIX	CELIA, CO FIX	*12000
*10000 - GNSS MEA		

CELIA, CO FIX	HAYDEN, CO VOR/DME	10000
HAYDEN, CO VOR/DME	HABRO, CO FIX	10000
HABRO, CO FIX	KREMMLING, CO VOR/DME	13000
KREMMLING, CO VOR/DME	*SKEED, CO FIX	**16500
*16500 - MRA		
**15800 - MOCA		
SKEED, CO FIX	*POWDR, CO FIX	14500
*15600 - MRA		
POWDR, CO FIX	MILE HIGH, CO VORTAC	14000

FROM	TO	MEA
------	----	-----

95.6330 VOR FEDERAL AIRWAY V330

WILDHORSE, OR VOR/DME	BOISE, ID VORTAC	8000
BOISE, ID VORTAC	CANEK, ID FIX	7000
CANEK, ID FIX	ALKAL, ID FIX	*9500
*8500 - MOCA		
ALKAL, ID FIX	TORIN, ID FIX	
	E BND	*8000
	W BND	*9500
*6700 - MOCA		
TORIN, ID FIX	*KINZE, ID FIX	8000
*8000 - MCA KINZE, ID FIX , W BND		
*IDAHO FALLS, ID VOR/DME	OSITY, ID FIX	
	W BND	8000
	E BND	10000
*7500 - MCA IDAHO FALLS, ID VOR/DME , E BND		
OSITY, ID FIX	*JACKSON, WY VOR/DME	14000
*13200 - MCA JACKSON, WY VOR/DME , W BND		
JACKSON, WY VOR/DME	DUNOIR, WY VOR/DME	13000
DUNOIR, WY VOR/DME	*ROWEY, WY FIX	**14000
*11000 - MCA ROWEY, WY FIX , W BND		
**13500 - MOCA		
ROWEY, WY FIX	RIVERTON, WY VOR/DME	8800
RIVERTON, WY VOR/DME	MUDDY MOUNTAIN, WY VORTAC	8500

95.6331 VOR FEDERAL AIRWAY V331

HAZARD, KY VOR/DME	NEWCOMBE, KY VORTAC	*4000
*3500 - MOCA		

95.6332 VOR FEDERAL AIRWAY V332

FRIANT, CA VORTAC	HANGTOWN, CA VOR/DME	8500
HANGTOWN, CA VOR/DME	RED BLUFF, CA VORTAC	6000

95.6333 VOR FEDERAL AIRWAY V333

DALAS, GA FIX	ROME, GA VORTAC	*4000
*3200 - MOCA		
ROME, GA VORTAC	CHOO CHOO, TN VORTAC	4000
CHOO CHOO, TN VORTAC	*BOOPS, TN FIX	3500
*4500 - MRA		
BOOPS, TN FIX	HINCH MOUNTAIN, TN VORTAC	5000
HINCH MOUNTAIN, TN VORTAC	JELLO, TN FIX	5000
JELLO, TN FIX	DOLLY, KY FIX	4000
DOLLY, KY FIX	LEXINGTON, KY VORTAC	3800

95.6334 VOR FEDERAL AIRWAY V334

SAN JOSE, CA VOR/DME	*OAKEY, CA FIX	5000
*3000 - MCA OAKEY, CA FIX , S BND		
OAKEY, CA FIX	SACRAMENTO, CA VORTAC	2500

FROM	TO	MEA
------	----	-----

95.6335 VOR FEDERAL AIRWAY V335

ST LOUIS, MO VORTAC	IMPER, MO FIX	2600
IMPER, MO FIX	ARNOL, IL FIX	2800
ARNOL, IL FIX	*GLASS, MO FIX	**3000
*4500 - MRA		
**2100 - MOCA		
GLASS, MO FIX	NIKEL, IL FIX	*4500
*2200 - MOCA		
*3500 - GNSS MEA		
NIKEL, IL FIX	MARION, IL VOR/DME	2400

95.6336 VOR FEDERAL AIRWAY V336

ELLENSBURG, WA VORTAC	*QUINT, WA FIX	7000
*6500 - MCA QUINT, WA FIX , SW BND		
QUINT, WA FIX	EPHRATA, WA VORTAC	5000

95.6337 VOR FEDERAL AIRWAY V337

CUTTA, OH FIX	AKRON, OH VOR/DME	3000
AKRON, OH VOR/DME	U.S. CANADIAN BORDER	5000
U.S. CANADIAN BORDER	PECK, MI VORTAC	*7000
*2700 - MOCA		
PECK, MI VORTAC	SAGINAW, MI VOR/DME	3000
SAGINAW, MI VOR/DME	MOUNT PLEASANT, MI VOR/DME	2600
MOUNT PLEASANT, MI VOR/DME	WHITE CLOUD, MI VOR/DME	*3000
*2400 - MOCA		

95.6338 VOR FEDERAL AIRWAY V338

LINDEN, CA VORTAC	*HANGTOWN, CA VOR/DME	5000
*7000 - MCA HANGTOWN, CA VOR/DME , NE BND		
HANGTOWN, CA VOR/DME	SQUAW VALLEY, CA VOR/DME	11000

95.6339 VOR FEDERAL AIRWAY V339

HAZARD, KY VOR/DME	TRENT, KY FIX	4000
TRENT, KY FIX	FALMOUTH, KY VOR/DME	3500

95.6340 VOR FEDERAL AIRWAY V340

BEARZ, IN FIX	KNOX, IN VOR/DME	3000
KNOX, IN VOR/DME	FORT WAYNE, IN VORTAC	3000
FORT WAYNE, IN VORTAC	RICHMOND, IN VORTAC	3000

FROM TO MEA

95.6341 VOR FEDERAL AIRWAY V341

CEDAR RAPIDS, IA VOR/DME	DUBUQUE, IA VORTAC	2900
DUBUQUE, IA VORTAC	*BAULK, WI FIX	3600
*4000 - MRA		
BAULK, WI FIX	MADISON, WI VORTAC	3600
MADISON, WI VORTAC	OSHKOSH, WI VORTAC	3000
OSHKOSH, WI VORTAC	GREEN BAY, WI VORTAC	*3000
*2300 - MOCA		
GREEN BAY, WI VORTAC	MENOMINEE, MI VOR/DME	2600
MENOMINEE, MI VOR/DME	HAVEL, MI FIX	2500
HAVEL, MI FIX	IRON MOUNTAIN, MI VOR/DME	3300
IRON MOUNTAIN, MI VOR/DME	SAWYER, MI VOR/DME	3100
SAWYER, MI VOR/DME	HOUGHTON, MI VOR/DME	*4500
*3400 - MOCA		

95.6343 VOR FEDERAL AIRWAY V343

*DUBOIS, ID VORTAC	RANEY, MT FIX	**15000
*8500 - MCA DUBOIS, ID VORTAC , N BND		
**13200 - MOCA		
RANEY, MT FIX	*GATEY, MT FIX	
	S BND	14000
	N BND	10200
*11500 - MCA GATEY, MT FIX , S BND		
GATEY, MT FIX	*BOZEMAN, MT VOR/DME	
	S BND	11500
	N BND	8000
*10500 - MCA BOZEMAN, MT VOR/DME , S BND		
BOZEMAN, MT VOR/DME	THESE, MT FIX	8000
THESE, MT FIX	SUZZY, MT FIX	
	E BND	8300
	W BND	10800
SUZZY, MT FIX	EVVER, MT FIX	11000

95.6344 VOR FEDERAL AIRWAY V344

DUPREE, SD VORTAC	ABERDEEN, SD VOR/DME	*6500
*4100 - MOCA		
ABERDEEN, SD VOR/DME	FARGO, ND VORTAC	*3900
*3000 - MOCA		

95.6345 VOR FEDERAL AIRWAY V345

DELLS, WI VORTAC	MILTO, WI FIX	*3500
*2800 - MOCA		
MILTO, WI FIX	EAU CLAIRE, WI VORTAC	3500
EAU CLAIRE, WI VORTAC	*HOMLO, WI FIX	**5200
*10000 - MRA		
**3100 - MOCA		
**4000 - GNSS MEA		
HOMLO, WI FIX	HAYWARD, WI VOR/DME	*10000
*3100 - MOCA		
*4000 - GNSS MEA		

FROM	TO	MEA
------	----	-----

95.6345 VOR FEDERAL AIRWAY V345 –CONTINUED

#HAYWARD, WI VOR/DME *6000 - MRA *10000 - MCA GRASS, WI FIX , SW BND **3000 - MOCA **4000 - GNSS MEA #HAYWARD UNUSABLE BELOW 10000	*GRASS, WI FIX	***10000
GRASS, WI FIX *2900 - MOCA *3000 - GNSS MEA	ASHLAND, WI VOR/DME	*4000

95.6346 VOR FEDERAL AIRWAY V346

U.S. CANADIAN BORDER *5100 - MOCA	MILLINOCKET, ME VOR/DME	*6000
--------------------------------------	-------------------------	-------

95.6347 VOR FEDERAL AIRWAY V347

LONDON, KY VORTAC	HINCH MOUNTAIN, TN VORTAC	4700
-------------------	---------------------------	------

95.6348 VOR FEDERAL AIRWAY V348

THUNDER BAY, CANADA VORTAC *2800 - MOCA #FOR THAT AIRSPACE OVER U.S. TERRITORY.	SAULT STE MARIE, MI VOR/DME	#*15000
--	-----------------------------	---------

95.6349 VOR FEDERAL AIRWAY V349

WHATCOM, WA VORTAC *2600 - MOCA	U.S. CANADIAN BORDER	*3000
------------------------------------	----------------------	-------

95.6350 VOR FEDERAL AIRWAY V350

LIBERAL, KS VORTAC *4500 - MOCA	WICHITA, KS VORTAC	*8000
WICHITA, KS VORTAC	CHANUTE, KS VOR/DME	3600

95.6352 VOR FEDERAL AIRWAY V352

U.S. CANADIAN BORDER *8000 - MRA	*PATTA, ME FIX	6300
PATTA, ME FIX	HOULTON, ME VOR/DME	6300
HOULTON, ME VOR/DME	U.S. CANADIAN BORDER	2000

FROM TO MEA

95.6353 VOR FEDERAL AIRWAY V353

JACKSON, MI VOR/DME FLINT, MI VORTAC 2800

95.6354 VOR FEDERAL AIRWAY V354

WILL ROGERS, OK VORTAC PIONEER, OK VORTAC 4000
 PIONEER, OK VORTAC EMPORIA, KS VORTAC 3500

95.6355 VOR FEDERAL AIRWAY V355

BOWIE, TX VORTAC WICHITA FALLS, TX VORTAC 3100

95.6356 VOR FEDERAL AIRWAY V356

RED TABLE, CO VOR/DME FISTR, CO FIX 15200
 NE BND 14000
 SW BND 15200
 FISTR, CO FIX FIDLE, CO FIX *16500
 FIDLE, CO FIX ELORE, CO FIX
 *15600 - MOCA
 *ELORE, CO FIX MILE HIGH, CO VORTAC 7800
 *12400 - MCA ELORE, CO FIX, W BND

95.6357 VOR FEDERAL AIRWAY V357

LAKEVIEW, OR VORTAC WILDHORSE, OR VOR/DME *10000
 *9500 - MOCA
 WILDHORSE, OR VOR/DME POTSY, OR FIX 10000
 POTSY, OR FIX BAKER CITY, OR VOR/DME 12000
 BAKER CITY, OR VOR/DME TOLGA, OR FIX 9000
 TOLGA, OR FIX *WALLA WALLA, WA VOR/DME 6000
 *5000 - MCA WALLA WALLA, WA VOR/DME, SE BND
 WALLA WALLA, WA VOR/DME MOSES LAKE, WA VOR/DME 4000
 MOSES LAKE, WA VOR/DME QUINT, WA FIX 4000
 QUINT, WA FIX WENATCHEE, WA VOR/DME 5500

95.6358 VOR FEDERAL AIRWAY V358

SAN ANTONIO, TX VORTAC GUADA, TX FIX *4000
 *2800 - MOCA
 GUADA, TX FIX STONEWALL, TX VORTAC 4000
 STONEWALL, TX VORTAC GOOCH SPRINGS, TX VORTAC *3800
 *3200 - MOCA
 GOOCH SPRINGS, TX VORTAC SONET, TX FIX 3000
 SONET, TX FIX WACO, TX VORTAC 2700

FROM TO MEA

95.6359 VOR FEDERAL AIRWAY V359

U.S. MEXICAN BORDER LAREDO, TX VORTAC *3000
 *2500 - MOCA

95.6360 VOR FEDERAL AIRWAY V360

SAULT STE MARIE, MI U.S. CANADIAN BORDER *6000
 VOR/DME
 *2600 - MOCA

95.6361 VOR FEDERAL AIRWAY V361

RATTLESNAKE, NM VORTAC	MARKE, CO FIX	
	NE BND	16300
	SW BND	9500
MARKE, CO FIX	UNLAP, CO FIX	
	NE BND	*16300
	SW BND	*11000
*10400 - MOCA		
UNLAP, CO FIX	SCRUB, CO FIX	16300
SCRUB, CO FIX	LYZZA, CO FIX	
	SW BND	16300
	NE BND	12400
LYZZA, CO FIX	MONTROSE, CO VOR/DME	
	SW BND	16300
	NE BND	9600
MONTROSE, CO VOR/DME	ICIES, CO FIX	
	SW BND	10000
	NE BND	15000
ICIES, CO FIX	RED TABLE, CO VOR/DME	15000
RED TABLE, CO VOR/DME	KREMMLING, CO VOR/DME	14000
KREMMLING, CO VOR/DME	*ALLAN, CO FIX	15200
*16000 - MRA		
ALLAN, CO FIX	*BARGR, CO FIX	15000
*11700 - MCA BARGR, CO FIX ,	SW BND	
BARGR, CO FIX	CHEYENNE, WY VORTAC	9000

95.6362 VOR FEDERAL AIRWAY V362

BRUNSWICK, GA VORTAC	*HABLE, GA FIX	**3000
*10000 - MCA HABLE, GA FIX ,	NW BND	
**1700 - MOCA		
HABLE, GA FIX	ALMA, GA VORTAC	*10000
*1700 - MOCA		
*3000 - GNSS MEA		
ALMA, GA VORTAC	VIENNA, GA VORTAC	*3000
*1900 - MOCA		
VIENNA, GA VORTAC	MACON, GA VORTAC	2000

95.6363 VOR FEDERAL AIRWAY V363

MISSION BAY, CA VORTAC	HURSI, CA FIX	3000
HURSI, CA FIX	OORAH, CA FIX	*4000
*2600 - MOCA		

FROM	TO	MEA
------	----	-----

95.6363 VOR FEDERAL AIRWAY V363 - CONTINUED

OORAH, CA FIX *2300 - MOCA	OFREE, CA FIX	*4000
OFREE, CA FIX EL TORO, CA VOR/DME	EL TORO, CA VOR/DME POMONA, CA VORTAC	4000 4000

95.6364 VOR FEDERAL AIRWAY V364

LINCO, NC FIX	SUGARLOAF MOUNTAIN, NC VORTAC	6000
SUGARLOAF MOUNTAIN, NC VORTAC	WEAKS, NC FIX	8000
WEAKS, NC FIX *7700 - MOCA	UNICO, TN FIX	*9000
*7700 - GNSS MEA UNICO, TN FIX	HOLSTON MOUNTAIN, TN VORTAC	7000

95.6365 VOR FEDERAL AIRWAY V365

BURLEY, ID VOR/DME IDAHO FALLS, ID VOR/DME	IDAHO FALLS, ID VOR/DME RIGBY, ID FIX	8000 7600
RIGBY, ID FIX *10000 - MRA	*SABAT, ID FIX	8000
LIVINGSTON, MT VOR/DME *9300 - MCA BOZEMAN, MT VOR/DME , SE BND	*BOZEMAN, MT VOR/DME	10400
BOZEMAN, MT VOR/DME *9200 - MCA MENAR, MT FIX , NW BND	*MENAR, MT FIX	8700
MENAR, MT FIX *9400 - MOCA	SWEDD, MT FIX	*10000
SWEDD, MT FIX HELENA, MT VORTAC	HELENA, MT VORTAC WOKEN, MT FIX	10000 9000
WOKEN, MT FIX *7000 - MRA **7500 - MOCA	*SHIMY, MT FIX	**9500
SHIMY, MT FIX *7000 - MOCA	CHOTE, MT FIX	*9500
CHOTE, MT FIX *6400 - MOCA	CUT BANK, MT VORTAC	*7000

95.6366 VOR FEDERAL AIRWAY V366

HUGO, CO VORTAC *9500 - MRA	*QUAIL, CO FIX	8500
QUAIL, CO FIX *10500 - MRA	*JEFEL, CO FIX	8500
JEFEL, CO FIX	FALCON, CO VORTAC	8500

95.6367 VOR FEDERAL AIRWAY V367

INTERNATIONAL FALLS, MN VORTAC	U.S. CANADIAN BORDER	3000
-----------------------------------	----------------------	------

FROM	TO	MEA
95.6368 VOR FEDERAL AIRWAY V368		
ALAMOSA, CO VORTAC	RODDS, CO FIX	
	W BND	13000
	E BND	10000
RODDS, CO FIX	*WAPRE, CO FIX	13000
*14000 - MRA		
WAPRE, CO FIX	MANUL, NM FIX	13000
MANUL, NM FIX	TURLY, NM FIX	
	E BND	11000
	W BND	9700
TURLY, NM FIX	RATTLESNAKE, NM VORTAC	9000

95.6369 VOR FEDERAL AIRWAY V369

NAVASOTA, TX VORTAC	GROESBECK, TX VOR/DME	2300
GROESBECK, TX VOR/DME	MAVERICK, TX VOR/DME	3600

95.6370 VOR FEDERAL AIRWAY V370

LOS ANGELES, CA VORTAC	PRADO, CA FIX	4000
PRADO, CA FIX	PARADISE, CA VORTAC	4000
PARADISE, CA VORTAC	*SETER, CA FIX	5500
*12000 - MCA SETER, CA FIX, E BND		
SETER, CA FIX	*BANDS, CA FIX	
	E BND	13000
	W BND	9000
*13000 - MRA		
BANDS, CA FIX	GARNE, CA FIX	13000
GARNE, CA FIX	*PALM SPRINGS, CA VORTAC	
	W BND	12000
	E BND	8000
*11600 - MCA PALM SPRINGS, CA VORTAC, W BND		
*6200 - MCA PALM SPRINGS, CA VORTAC, NE BND		
PALM SPRINGS, CA VORTAC	TWENTYNINE PALMS, CA VORTAC	7600

95.6371 VOR FEDERAL AIRWAY V371

BOILER, IN VORTAC	KNOX, IN VOR/DME	2500
-------------------	------------------	------

95.6372 VOR FEDERAL AIRWAY V372

SEAL BEACH, CA VORTAC	*JOGIT, CA FIX	4000
*6000 - MCA JOGIT, CA FIX, E BND		
JOGIT, CA FIX	*KAYOH, CA FIX	6000
*7400 - MCA KAYOH, CA FIX, E BND		
KAYOH, CA FIX	*HOMELAND, CA VOR	8000
*11200 - MCA HOMELAND, CA VOR, NE BND		
HOMELAND, CA VOR	*BANDS, CA FIX	
	E BND	13000
	W BND	8000
*13000 - MRA		
BANDS, CA FIX	GARNE, CA FIX	13000
GARNE, CA FIX	*PALM SPRINGS, CA VORTAC	
	W BND	12000
	E BND	8000
*11600 - MCA PALM SPRINGS, CA VORTAC, W BND		
PALM SPRINGS, CA VORTAC	BLYTHE, CA VORTAC	*8000
*7500 - MOCA		

FROM	TO	MEA
------	----	-----

95.6373 VOR FEDERAL AIRWAY V373

GREENSBORO, NC VORTAC	SANDHILLS, NC VORTAC	3600
-----------------------	----------------------	------

95.6374 VOR FEDERAL AIRWAY V374

MARTHAS VINEYARD, MA VOR/DME	FALMA, RI FIX	3000
FALMA, RI FIX	MINNK, RI FIX	3000
MINNK, RI FIX	GROTON, CT VOR/DME	3000
GROTON, CT VOR/DME	KURTY, CT FIX	3000
KURTY, CT FIX	CREAM, NY FIX	2500
CREAM, NY FIX	*BETHA, CT FIX	2500
*8000 - MRA		
BETHA, CT FIX	CARMEL, NY VOR/DME	2500
CARMEL, NY VOR/DME	VOLLU, NY FIX	2600
VOLLU, NY FIX	*GAYEL, NY FIX	**5000
*5500 - MRA		
**3200 - MOCA		
GAYEL, NY FIX	#BINGHAMTON, NY VORTAC	*6000
*4300 - MOCA		
#GNSS MEA, GNSS REQUIRED		
BINGHAMTON R-129 UNUSABLE. GNSS REQUIRED		

95.6375 VOR FEDERAL AIRWAY V375

ROANOKE, VA VORTAC	PROSE, VA FIX	5000
PROSE, VA FIX	ROMAN, VA FIX	6500
ROMAN, VA FIX	GORDONSVILLE, VA VORTAC	4000
GORDONSVILLE, VA VORTAC	*HANEY, VA FIX	2800
*7000 - MRA		
HANEY, VA FIX	FLUKY, VA FIX	2600

95.6376 VOR FEDERAL AIRWAY V376

RICHMOND, VA VORTAC	GRUBY, VA FIX	2000
GRUBY, VA FIX	IRONS, MD FIX	*2500
*1700 - MOCA		

95.6377 VOR FEDERAL AIRWAY V377

MONTEBELLO, VA VOR/DME	KESSEL, WV VOR/DME	*6000
*5500 - MOCA		
KESSEL, WV VOR/DME	TOMAC, MD FIX	4300
TOMAC, MD FIX	HAGERSTOWN, MD VOR	4000
HAGERSTOWN, MD VOR	HARRISBURG, PA VORTAC	*5000
*3800 - MOCA		
*4000 - GNSS MEA		

95.6378 VOR FEDERAL AIRWAY V378

BALTIMORE, MD VORTAC	BELAY, MD FIX	2300
BELAY, MD FIX	TROY, MD FIX	*9500
*4000 - GNSS MEA		

FROM	TO	MEA
------	----	-----

95.6378 VOR FEDERAL AIRWAY V378 - CONTINUED

TROYZ, MD FIX *4000 - GNSS MEA	NUGGY, PA FIX	*7500
NUGGY, PA FIX *2000 - MOCA *4000 - GNSS MEA	MODENA, PA VORTAC	*6000

95.6379 VOR FEDERAL AIRWAY V379

NOTTINGHAM, MD VORTAC	JETTA, MD FIX	1900 MAA - 17500
JETTA, MD FIX *10000 - MRA **1600 - MOCA	*GRACO, MD FIX	**3000 MAA - 17500
GRACO, MD FIX	SMYRNA, DE VORTAC	1800 MAA - 17500

95.6380 VOR FEDERAL AIRWAY V380

O'NEILL, NE VORTAC *3500 - MOCA	WOLBACH, NE VORTAC	*4000
WOLBACH, NE VORTAC *3200 - MOCA	GRAND ISLAND, NE VORTAC	*4000
GRAND ISLAND, NE VORTAC	HASTINGS, NE VOR/DME	4000
HASTINGS, NE VOR/DME	MANKATO, KS VORTAC	3900

95.6381 VOR FEDERAL AIRWAY V381

BISHOP, CA VOR/DME *13000 - MCA NIKOL, CA FIX , SE BND **12300 - MOCA	*NIKOL, CA FIX	**13000
---	----------------	---------

95.6382 VOR FEDERAL AIRWAY V382

GRAND JUNCTION, CO VOR/DME *14000 - MCA CONES, CO VOR/DME , SE BND	*CONES, CO VOR/DME	12000
CONES, CO VOR/DME *12000 - MCA DURANGO, CO VOR/DME , NW BND	*DURANGO, CO VOR/DME	15300

95.6383 VOR FEDERAL AIRWAY V383

ROSEWOOD, OH VORTAC	DETROIT, MI VOR/DME	3100
---------------------	---------------------	------

95.6384 VOR FEDERAL AIRWAY V384

LIVINGSTON, TN VORTAC	VOLUNTEER, TN VORTAC	5500
-----------------------	----------------------	------

FROM TO MEA

95.6385 VOR FEDERAL AIRWAY V385

LUBBOCK, TX VORTAC *8000 - MRA **4600 - MOCA	*WAGUN, TX FIX	**8000
WAGUN, TX FIX *3800 - MOCA	ABILENE, TX VORTAC	*8000

95.6386 VOR FEDERAL AIRWAY V386

SAN MARCUS, CA VORTAC *9000 - MRA	*OHIGH, CA FIX	8000
OHIGH, CA FIX *6100 - MCA FILLMORE, CA VORTAC , W BND	*FILLMORE, CA VORTAC	8000
FILLMORE, CA VORTAC *6300 - MCA SAUGS, CA FIX , NE BND	*SAUGS, CA FIX	6000
SAUGS, CA FIX	PALMDALE, CA VORTAC	7000
PALMDALE, CA VORTAC	APLES, CA FIX	7000
APLES, CA FIX	SOGGI, CA FIX E BND	11000
	W BND	9000
SOGGI, CA FIX *9400 - MOCA	YUCCA, CA FIX	*11000
YUCCA, CA FIX *7600 - MCA PALM SPRINGS, CA VORTAC , NW BND **8200 - MOCA	*PALM SPRINGS, CA VORTAC	**9000

95.6387 VOR FEDERAL AIRWAY V387

MC ALLEN, TX VOR/DME	U.S. MEXICAN BORDER	2000
----------------------	---------------------	------

95.6388 VOR FEDERAL AIRWAY V388

PARADISE, CA VORTAC	ACINS, CA FIX E BND	7000
	W BND	5000
ACINS, CA FIX	DEWAY, CA FIX	9500
DEWAY, CA FIX *6300 - MCA PALM SPRINGS, CA VORTAC , W BND	*PALM SPRINGS, CA VORTAC	9500

95.6389 VOR FEDERAL AIRWAY V389

CIMARRON, NM VORTAC *15600 - MRA **10700 - MOCA	*FOGLE, NM FIX	**11600
FOGLE, NM FIX *11600 - MRA **12000 - MOCA	*EARLS, CO FIX	**15600
EARLS, CO FIX *8500 - MOCA	RADIO, CO FIX	*11600
RADIO, CO FIX	PUEBLO, CO VORTAC	8200
PUEBLO, CO VORTAC	DRAKE, CO FIX	7600
DRAKE, CO FIX	FALCON, CO VORTAC	9000

FROM	TO	MEA
------	----	-----

95.6390 VOR FEDERAL AIRWAY V390

TUCUMCARI, NM VORTAC	BORGER, TX VORTAC	6500
BORGER, TX VORTAC	MITBEE, OK VORTAC	4800

95.6391 VOR FEDERAL AIRWAY V391

RATTLESNAKE, NM VORTAC	PLATA, NM FIX	10000
PLATA, NM FIX	CORTEZ, CO VOR/DME	10600
CORTEZ, CO VOR/DME	DOVE CREEK, CO VORTAC	9800
DOVE CREEK, CO VORTAC	PAROX, CO FIX	*12000
*10500 - MOCA		
PAROX, CO FIX	*GRAND JUNCTION, CO VOR/DME	12000
*10700 - MCA GRAND JUNCTION, CO VOR/DME , S BND		
GRAND JUNCTION, CO VOR/DME	BONGO, UT FIX	10800
BONGO, UT FIX	*VERNAL, UT VOR/DME	8400
*9500 - MCA VERNAL, UT VOR/DME , N BND		
VERNAL, UT VOR/DME	ROCK SPRINGS, WY VOR/DME	11800

95.6392 VOR FEDERAL AIRWAY V392

OAKLAND, CA VORTAC	*SALAD, CA FIX	4000
*4700 - MCA SALAD, CA FIX , NE BND		
SALAD, CA FIX	*OAKEY, CA FIX	5000
*3000 - MCA OAKEY, CA FIX , S BND		
OAKEY, CA FIX	SACRAMENTO, CA VORTAC	2500
SACRAMENTO, CA VORTAC	ROZZY, CA FIX	*3000
*1600 - MOCA		
ROZZY, CA FIX	HAGAN, CA FIX	4000
HAGAN, CA FIX	*AUDIO, CA FIX	**6000
*9000 - MCA AUDIO, CA FIX , NE BND		
**4500 - MOCA		
AUDIO, CA FIX	CONYO, CA FIX	
	N BND	10000
	S BND	8000
CONYO, CA FIX	SIGNA, CA FIX	11000
SIGNA, CA FIX	MUSTANG, NV VORTAC	11500

95.6393 VOR FEDERAL AIRWAY V393

*TUCSON, AZ VORTAC	NOGALES, AZ VOR/DME	11500
*9000 - MCA TUCSON, AZ VORTAC , S BND		
NOGALES, AZ VOR/DME	U.S. MEXICAN BORDER	*13000
*8800 - MOCA		

95.6394 VOR FEDERAL AIRWAY V394

SEAL BEACH, CA VORTAC	AHEIM, CA FIX	*3000
*2200 - MOCA		
AHEIM, CA FIX	*POMONA, CA VORTAC	4000
*10300 - MCA POMONA, CA VORTAC , NE BND		

FROM	TO	MEA
------	----	-----

95.6394 VOR FEDERAL AIRWAY V394 – CONTINUED

POMONA, CA VORTAC	CALBE, CA FIX	
	SW BND	5300
	NE BND	10800
CALBE, CA FIX	MEANT, CA FIX	
	SW BND	10700
	NE BND	11500
MEANT, CA FIX	*APLES, CA FIX	11500
*9100 - MCA	APLES, CA FIX, SW BND	
APLES, CA FIX	DAGGETT, CA VORTAC	7500
DAGGETT, CA VORTAC	OASYS, NV FIX	*12000
*9500 - MOCA		
*10000 - GNSS MEA		
OASYS, NV FIX	LAS VEGAS, NV VORTAC	7500
LAS VEGAS, NV VORTAC	MORMON MESA, NV VORTAC	*7500
*6500 - MOCA		

95.6395 VOR FEDERAL AIRWAY V395

*TUCSON, AZ VORTAC	NOGALES, AZ VOR/DME	10000
*9000 - MCA	TUCSON, AZ VORTAC, S BND	
NOGALES, AZ VOR/DME	U.S. MEXICAN BORDER	*10000
*6500 - MOCA		

95.6396 VOR FEDERAL AIRWAY V396

U.S. CANADIAN BORDER	CHARDON, OH VOR/DME	*8000
*2700 - MOCA		

95.6397 VOR FEDERAL AIRWAY V397

MONROE, LA VORTAC	RUTTS, AR FIX	*6000
*1600 - MOCA		
RUTTS, AR FIX	GREENVILLE, MS VOR/DME	2000
GREENVILLE, MS VOR/DME	MARVELL, AR VOR/DME	1900

95.6398 VOR FEDERAL AIRWAY V398

ABERDEEN, SD VOR/DME	WATERTOWN, SD VORTAC	3600
WATERTOWN, SD VORTAC	REDWOOD FALLS, MN VOR/DME	3800
REDWOOD FALLS, MN VOR/DME	*ALMAY, MN FIX	**3400
*5000 - MRA		
**2700 - MOCA		
ALMAY, MN FIX	KASPR, MN FIX	*3400
*2700 - MOCA		
KASPR, MN FIX	ROCHESTER, MN VOR/DME	3000
ROCHESTER, MN VOR/DME	WAUKON, IA VORTAC	3000
WAUKON, IA VORTAC	LONE ROCK, WI VOR/DME	3000

FROM	TO	MEA
------	----	-----

95.6399 VOR FEDERAL AIRWAY V399

BRICKYARD, IN VORTAC	JAKKS, IN FIX	2700
JAKKS, IN FIX	BOILER, IN VORTAC	2500
BOILER, IN VORTAC	KENLA, IN FIX	2600
KENLA, IN FIX	PEOTONE, IL VORTAC	2400

95.6400 VOR FEDERAL AIRWAY V400

PRESQUE ISLE, ME VOR/DME *4000 - MOCA	U.S. CANADIAN BORDER	*6000
--	----------------------	-------

95.6401 VOR FEDERAL AIRWAY V401

WORLAND, WY VOR/DME	RANKK, WY FIX	
	SE BND	11000
	NW BND	7000
RANKK, WY FIX	MUDDY MOUNTAIN, WY VORTAC	11000

95.6402 VOR FEDERAL AIRWAY V402

TUCUMCARI, NM VORTAC *5400 - MOCA	MOSER, TX FIX	*6000
MOSER, TX FIX *5200 - MOCA	PANHANDLE, TX VORTAC	*6000
PANHANDLE, TX VORTAC *7000 - MRA **4800 - MOCA	*BRISC, TX FIX	**7000
BRISC, TX FIX *4400 - MOCA	MITBEE, OK VORTAC	*5000

95.6403 VOR FEDERAL AIRWAY V403

SOLBERG, NJ VOR/DME	POTTSTOWN, PA VORTAC	5000
POTTSTOWN, PA VORTAC *2100 - MOCA	SPERY, PA FIX	*3000
SPERY, PA FIX *2100 - MOCA *3000 - GNSS MEA	BELAY, MD FIX	*10000

95.6404 VOR FEDERAL AIRWAY V404

CHILDRESS, TX VORTAC *4000 - MRA	*SNEED, TX FIX	4000
SNEED, TX FIX *3500 - MRA	*ELECT, TX FIX	2700
ELECT, TX FIX	WICHITA FALLS, TX VORTAC	2700

95.6405 VOR FEDERAL AIRWAY V405

BELAY, MD FIX *2100 - MOCA *3000 - GNSS MEA	SPERY, PA FIX	*10000
---	---------------	--------

FROM	TO	MEA
------	----	-----

95.6405 VOR FEDERAL AIRWAY V405 - CONTINUED

SPERY, PA FIX *2100 - MOCA	POTTSTOWN, PA VORTAC	*3000
POTTSTOWN, PA VORTAC	LANNA, NJ FIX	5000
LANNA, NJ FIX	SOLBERG, NJ VOR/DME	2000
SOLBERG, NJ VOR/DME	CARMEL, NY VOR/DME	2500
CARMEL, NY VOR/DME	PAWLING, NY VOR/DME	3000
PAWLING, NY VOR/DME *3500 - MOCA	VEERS, CT FIX	*4000
VEERS, CT FIX	BRADLEY, CT VORTAC	3500
BRADLEY, CT VORTAC *2200 - MOCA	PROVIDENCE, RI VORTAC	*3000
PROVIDENCE, RI VORTAC *1400 - MOCA	FALMA, RI FIX	*3000
FALMA, RI FIX	MARTHAS VINEYARD, MA VOR/DME	3000

95.6406 VOR FEDERAL AIRWAY V406

SALEM, MI VORTAC *2700 - MOCA	U.S. CANADIAN BORDER	*4000
U.S. CANADIAN BORDER	FINGL, CANADA FIX	4000

95.6407 VOR FEDERAL AIRWAY V407

BROWNSVILLE, TX VORTAC	HARLINGEN, TX VOR/DME	1600
HARLINGEN, TX VOR/DME	JIMIE, TX FIX	1700
JIMIE, TX FIX *1800 - MOCA	JETTY, TX FIX	*4000
JETTY, TX FIX	CORPUS CHRISTI, TX VORTAC	2000
CORPUS CHRISTI, TX VORTAC *2100 - MRA	*WORRY, TX FIX	1700
WORRY, TX FIX *2300 - MRA	*AUSTS, TX FIX	1700
AUSTS, TX FIX	PALACIOS, TX VORTAC	1700
PALACIOS, TX VORTAC *1600 - MOCA	GLAND, TX FIX	*4000
GLAND, TX FIX *1900 - MOCA	HUMBLE, TX VORTAC	*2500
HUMBLE, TX VORTAC	DAISETTA, TX VORTAC	2000
DAISETTA, TX VORTAC	LUFKIN, TX VORTAC	2000
LUFKIN, TX VORTAC *2000 - MOCA	ELM GROVE, LA VORTAC	*4000
ELM GROVE, LA VORTAC	EL DORADO, AR VORTAC	2000

95.6408 VOR FEDERAL AIRWAY V408

ROBRT, MD FIX	VINNY, PA FIX	5000
VINNY, PA FIX	MODENA, PA VORTAC	3500
MODENA, PA VORTAC	POTTSTOWN, PA VORTAC	2400
POTTSTOWN, PA VORTAC *4000 - MRA	*HIKES, PA FIX	2900
HIKES, PA FIX	EAST TEXAS, PA VOR/DME	2900

FROM	TO	MEA
------	----	-----

95.6408 VOR FEDERAL AIRWAY V408 - CONTINUED

EAST TEXAS, PA VOR/DME	ALLENTOWN, PA VORTAC	3000
ALLENTOWN, PA VORTAC	LAKE HENRY, PA VORTAC	4000
LAKE HENRY, PA VORTAC	PRNCE, NY FIX	6000
		MAA - 15000
PRNCE, NY FIX	SAGES, NY FIX	6400
		MAA - 15000

95.6409 VOR FEDERAL AIRWAY V409

CHARLOTTE, NC VOR/DME	LOCAS, NC FIX	3000
LOCAS, NC FIX	LIBERTY, NC VORTAC	2500
LIBERTY, NC VORTAC	RALEIGH/DURHAM, NC VORTAC	3000

95.6410 VOR FEDERAL AIRWAY V410

PONTIAC, MI VORTAC	U.S. CANADIAN BORDER	*4000
*2500 - MOCA		
U.S. CANADIAN BORDER	AXXIS, CANADA FIX	4000

95.6411 VOR FEDERAL AIRWAY V411

LONE ROCK, WI VOR/DME	WAUKON, IA VORTAC	3000
WAUKON, IA VORTAC	ROCHESTER, MN VOR/DME	3000
ROCHESTER, MN VOR/DME	FARMINGTON, MN VORTAC	3000

95.6412 VOR FEDERAL AIRWAY V412

REDWOOD FALLS, MN VOR/DME	FLYING CLOUD, MN VOR/DME	2800
---------------------------	--------------------------	------

95.6413 VOR FEDERAL AIRWAY V413

IRONWOOD, MI VORTAC	*RUSSH, WI FIX	8000
*10000 - MRA		
RUSSH, WI FIX	EAU CLAIRE, WI VORTAC	*6000
*2900 - MOCA		
EAU CLAIRE, WI VORTAC	BITLR, WI FIX	*3500
*2800 - MOCA		
BITLR, WI FIX	GOPHER, MN VORTAC	3400
GOPHER, MN VORTAC	BRAINERD, MN VORTAC	4000

95.6415 VOR FEDERAL AIRWAY V415

MONTGOMERY, AL VORTAC	SEMAN, AL FIX	2300
SEMAN, AL FIX	GIFFY, AL FIX	*4000
*3300 - MOCA		
GIFFY, AL FIX	FELTO, GA FIX	*6000
*3400 - MOCA		
FELTO, GA FIX	GORGO, GA FIX	*5000
*4000 - MOCA		
GORGO, GA FIX	ROME, GA VORTAC	4000
ROME, GA VORTAC	NELLO, GA FIX	5600
NELLO, GA FIX	ANNYE, GA FIX	6000

FROM	TO	MEA
------	----	-----

95.6415 VOR FEDERAL AIRWAY V415 - CONTINUED

ANNYE, GA FIX	FOOTHILLS, GA VORTAC	5000
FOOTHILLS, GA VORTAC	PELAM, SC FIX	4000
PELAM, SC FIX	SPARTANBURG, SC VORTAC	*3000
*2400 - MOCA		
SPARTANBURG, SC VORTAC	LOCKS, SC FIX	2300

95.6416 VOR FEDERAL AIRWAY V416

ROSEWOOD, OH VORTAC	*LAWTO, OH FIX	**4000
*4000 - MRA		
**2500 - MOCA		
LAWTO, OH FIX	MANSFIELD, OH VORTAC	*4000
*2500 - MOCA		
MANSFIELD, OH VORTAC	JAKEE, OH FIX	3000

95.6417 VOR FEDERAL AIRWAY V417

MONROE, LA VORTAC	*BOLTS, MS FIX	**5000
*3400 - MRA		
**1900 - MOCA		
BOLTS, MS FIX	JACKSON, MS VORTAC	2000
JACKSON, MS VORTAC	*FANEN, MS FIX	**3000
*3300 - MRA		
**2000 - MOCA		
FANEN, MS FIX	MERIDIAN, MS VORTAC	3000
MERIDIAN, MS VORTAC	CRIMSON, AL VORTAC	2000
CRIMSON, AL VORTAC	VULCAN, AL VORTAC	2400
VULCAN, AL VORTAC	ROME, GA VORTAC	4000
ROME, GA VORTAC	NELLO, GA FIX	5600
NELLO, GA FIX	*AWSON, GA FIX	5400
*5000 - MRA		
AWSON, GA FIX	CORCE, GA FIX	4600
CORCE, GA FIX	IRMOS, GA FIX	3800
IRMOS, GA FIX	ATHENS, GA VORTAC	3000
ATHENS, GA VORTAC	COLLIERS, SC VORTAC	2500
COLLIERS, SC VORTAC	ALLENDALE, SC VOR	3000
ALLENDALE, SC VOR	*STOAS, SC FIX	**6000
*6000 - MCA STOAS, SC FIX, W BND		
**2000 - GNSS MEA		
STOAS, SC FIX	CHARLESTON, SC VORTAC	2000

95.6418 VOR FEDERAL AIRWAY V418

SALEM, MI VORTAC	U.S. CANADIAN BORDER	*4000
*2700 - MOCA		
U.S. CANADIAN BORDER	BEWEL, OH FIX	*4000
*2700 - MOCA		
BEWEL, OH FIX	JAMESTOWN, NY VOR/DME	*4000
*3300 - MOCA		

95.6419 VOR FEDERAL AIRWAY V419

BOSTON, MA VOR/DME	BRADLEY, CT VORTAC	*4000
*2500 - MOCA		
*3000 - GNSS MEA		

FROM	TO	MEA
------	----	-----

95.6419 VOR FEDERAL AIRWAY V419 - CONTINUED

BRADLEY, CT VORTAC CARMEL, NY VOR/DME *2500 - MOCA	CARMEL, NY VOR/DME SOLBERG, NJ VOR/DME	3000 *3000
SOLBERG, NJ VOR/DME BIGGY, NJ FIX *2500 - GNSS MEA #MODENA R-056 UNUSABLE.	BIGGY, NJ FIX #MODENA, PA VORTAC	2000 *2500
MODENA, PA VORTAC *2400 - MOCA	WESTMINSTER, MD VORTAC	*3000

95.6420 VOR FEDERAL AIRWAY V420

GREEN BAY, WI VORTAC *2600 - MOCA	TRAVERSE CITY, MI VORTAC	*3500
TRAVERSE CITY, MI VORTAC GAYLORD, MI VOR/DME	GAYLORD, MI VOR/DME ALPENA, MI VORTAC	3000 3000

95.6421 VOR FEDERAL AIRWAY V421

ZUNI, NM VORTAC GALLUP, NM VORTAC RATTLESNAKE, NM VORTAC *13200 - MCA DURANGO, CO VOR/DME , N BND	GALLUP, NM VORTAC RATTLESNAKE, NM VORTAC *DURANGO, CO VOR/DME	9000 10000 9700
DURANGO, CO VOR/DME	ZEANS, CO FIX S BND N BND	12000 16100
ZEANS, CO FIX LAZON, CO FIX	LAZON, CO FIX POWES, CO FIX S BND N BND	16100 16100 15000
POWES, CO FIX	*BLUE MESA, CO VOR/DME SW BND NE BND	16100 12800
*12600 - MCA BLUE MESA, CO VOR/DME , S BND *12900 - MCA BLUE MESA, CO VOR/DME , N BND		
BLUE MESA, CO VOR/DME	WENDT, CO FIX N BND S BND	16300 13000
WENDT, CO FIX *14600 - MOCA	CAZUU, CO FIX	*16300
CAZUU, CO FIX SKIER, CO FIX *14900 - MOCA	SKIER, CO FIX RED TABLE, CO VOR/DME	16300 *16300
RED TABLE, CO VOR/DME KREMMLING, CO VOR/DME ROBERT, CO VOR/DME	KREMMLING, CO VOR/DME ROBERT, CO VOR/DME HAHNS, CO FIX	14000 12900 12600

95.6422 VOR FEDERAL AIRWAY V422

BEBEE, IL FIX *3500 - MRA *3000 - MCA NILES, IL FIX , N BND	*NILES, IL FIX	3300
NILES, IL FIX	CHICAGO HEIGHTS, IL VORTAC	2100
CHICAGO HEIGHTS, IL VORTAC	KNOX, IN VOR/DME	2800
KNOX, IN VOR/DME	WEBSTER LAKE, IN VOR	2700

FROM	TO	MEA
------	----	-----

95.6422 VOR FEDERAL AIRWAY V422 - CONTINUED

WEBSTER LAKE, IN VOR	TWERP, OH FIX	2700
TWERP, OH FIX	FLAG CITY, OH VORTAC	2600

95.6423 VOR FEDERAL AIRWAY V423

WILLIAMSPORT, PA VOR/DME *3800 - MOCA	BINGHAMTON, NY VORTAC	*4300
BINGHAMTON, NY VORTAC	ITHACA, NY VOR/DME	3700
ITHACA, NY VOR/DME *3100 - MOCA	SYRACUSE, NY VORTAC	*4000
SYRACUSE, NY VORTAC *1800 - MOCA	PAGER, NY FIX	*2400
PAGER, NY FIX *2000 - MOCA	WATERTOWN, NY VORTAC	*2600
WATERTOWN, NY VORTAC *1800 - MOCA	U.S. CANADIAN BORDER	*3000

95.6424 VOR FEDERAL AIRWAY V424

NAPOLEON, MO VORTAC	MACON, MO VOR/DME	2900
---------------------	-------------------	------

95.6425 VOR FEDERAL AIRWAY V425

BROOKLEY, AL VORTAC	AXSIS, AL FIX	2000
---------------------	---------------	------

95.6426 VOR FEDERAL AIRWAY V426

CARLETON, MI VORTAC *4000 - MRA **3000 - GNSS MEA	*AMRST, OH FIX	**4000
AMRST, OH FIX *2200 - MOCA	DRYER, OH VOR/DME	*3000

95.6427 VOR FEDERAL AIRWAY V427

MONROE, LA VORTAC *2800 - MRA **1900 - MOCA **2000 - GNSS MEA	*PECKS, MS FIX	**5000
PECKS, MS FIX #JACKSON R-281 UNUSABLE BEYOND 40 NM	#JACKSON, MS VORTAC	2000

95.6428 VOR FEDERAL AIRWAY V428

ELMIRA, NY VOR/DME	ITHACA, NY VOR/DME	3800
ITHACA, NY VOR/DME	CORTA, NY FIX	3600
CORTA, NY FIX *3600 - MOCA	GEORGETOWN, NY VORTAC	*5000
GEORGETOWN, NY VORTAC	EATEN, NY FIX	4000
EATEN, NY FIX	UTICA, NY VORTAC	3500

FROM	TO	MEA
------	----	-----

95.6429 VOR FEDERAL AIRWAY V429

CAPE GIRARDEAU, MO VOR/DME	MARION, IL VOR/DME	3000
MARION, IL VOR/DME	BIBLE GROVE, IL VORTAC	2300
BIBLE GROVE, IL VORTAC	MATTOON, IL VOR/DME	2500
MATTOON, IL VOR/DME	CHAMPAIGN, IL VORTAC	2400
CHAMPAIGN, IL VORTAC	ROBERTS, IL VOR/DME	2600
ROBERTS, IL VOR/DME	MEDAN, IL FIX	2500
MEDAN, IL FIX	JOLIET, IL VORTAC	2400

95.6430 VOR FEDERAL AIRWAY V430

CUT BANK, MT VORTAC	HAVRE, MT VOR/DME	6200
HAVRE, MT VOR/DME	GLASGOW, MT VOR/DME	*6500
*5500 - MOCA		
GLASGOW, MT VOR/DME	WILLISTON, ND VORTAC	*6000
*5000 - MOCA		
WILLISTON, ND VORTAC	MINOT, ND VORTAC	*4500
*3900 - MOCA		
MINOT, ND VORTAC	DEVILS LAKE, ND VOR/DME	3600
DEVILS LAKE, ND VOR/DME	GRAND FORKS, ND VOR/DME	3300
GRAND FORKS, ND VOR/DME	THIEF RIVER FALLS, MN VOR/DME	2900
THIEF RIVER FALLS, MN VOR/DME	GRAND RAPIDS, MN VOR/DME	*7000
*3400 - GNSS MEA		
GRAND RAPIDS, MN VOR/DME	DULUTH, MN VORTAC	3000
DULUTH, MN VORTAC	IRONWOOD, MI VORTAC	3500
IRONWOOD, MI VORTAC	DINER, MI FIX	*3500
*3400 - MOCA		
DINER, MI FIX	IRON MOUNTAIN, MI VOR/DME	*5000
*3500 - MOCA		
*4000 - GNSS MEA		
IRON MOUNTAIN, MI VOR/DME	VUKFI, MI FIX	3100
VUKFI, MI FIX	ESCANABA, MI VOR/DME	*3000
*2200 - MOCA		

95.6431 VOR FEDERAL AIRWAY V431

REVER, MA FIX	LOBBY, MA FIX	2000
LOBBY, MA FIX	GARDNER, MA VOR/DME	3500
GARDNER, MA VOR/DME	KEENE, NH VORTAC	3600
KEENE, NH VORTAC	BRATS, VT FIX	*4400
*3600 - MOCA		
BRATS, VT FIX	GLENS FALLS, NY VORTAC	7000
GLENS FALLS, NY VORTAC	*GASSY, NY FIX	**10000
*10000 - MRA		
**6000 - GNSS MEA		

95.6432 VOR FEDERAL AIRWAY V432

*THERMAL, CA VORTAC	PARKER, CA VORTAC	**9000
*4500 - MCA THERMAL, CA VORTAC, NE BND		
**7300 - MOCA		

FROM TO MEA

95.6433 VOR FEDERAL AIRWAY V433

NOTTINGHAM, MD VORTAC	SWANN, MD FIX	2500
SWANN, MD FIX	KERNO, MD FIX	*2500
*1500 - MOCA		
*2500 - GNSS MEA		
KERNO, MD FIX	#DUPONT, DE VORTAC	*2000
*2000 - GNSS MEA		
#DUPONT R-233 UNUSABLE BEYOND 22 NM.		
DUPONT, DE VORTAC	YARDLEY, PA VOR/DME	*6000
*3000 - GNSS MEA		
YARDLEY, PA VOR/DME	METRO, NJ FIX	*3000
*2000 - MOCA		
		MAA - 10000
METRO, NJ FIX	GRITY, NJ FIX	*4000
*1700 - MOCA		
GRITY, NJ FIX	TICKL, NY FIX	4000
TICKL, NY FIX	LA GUARDIA, NY VOR/DME	2600
LA GUARDIA, NY VOR/DME	DUNBO, NY FIX	2000
DUNBO, NY FIX	BRIDGEPORT, CT VOR/DME	*2000
*1500 - MOCA		
BRIDGEPORT, CT VOR/DME	PAWLING, NY VOR/DME	3000
PAWLING, NY VOR/DME	*CYPER, NY FIX	6100
*10000 - MRA		
CYPER, NY FIX	#ROCKDALE, NY VOR/DME	*10000
*6100 - GNSS MEA		
#ROCKDALE R-127 UNUSABLE BELOW 10000'.		
ROCKDALE, NY VOR/DME	STODA, NY FIX	4000
STODA, NY FIX	SYRACUSE, NY VORTAC	2400

95.6434 VOR FEDERAL AIRWAY V434

OTTUMWA, IA VOR/DME	MOLINE, IL VORTAC	*3000
*2500 - MOCA		
MOLINE, IL VORTAC	PEORIA, IL VORTAC	2600
PEORIA, IL VORTAC	CHAMPAIGN, IL VORTAC	2800
CHAMPAIGN, IL VORTAC	BRICKYARD, IN VORTAC	2700

95.6435 VOR FEDERAL AIRWAY V435

ROSEWOOD, OH VORTAC	OBRLN, OH FIX	*5000
*2700 - MOCA		
OBRLN, OH FIX	DRYER, OH VOR/DME	*3000
*2400 - MOCA		

95.6436 VOR FEDERAL AIRWAY V436

HOBART, OK VORTAC	*NEADS, OK FIX	**5400
*5400 - MRA		
**3500 - MOCA		
NEADS, OK FIX	WILL ROGERS, OK VORTAC	3000
WILL ROGERS, OK VORTAC	BARNS, OK FIX	*4500
*3000 - MOCA		
BARNS, OK FIX	SAPPA, OK FIX	*4000
*2400 - MOCA		
SAPPA, OK FIX	TULSA, OK VORTAC	2500

FROM TO MEA

95.6437 VOR FEDERAL AIRWAY V437

DOLPHIN, FL VORTAC *1500 - MOCA	PAHOKEE, FL VORTAC	*2000
PAHOKEE, FL VORTAC	MELBOURNE, FL VOR/DME	2100
MELBOURNE, FL VOR/DME	KIZER, FL FIX	3000
KIZER, FL FIX	ORMOND BEACH, FL VORTAC	2700
ORMOND BEACH, FL VORTAC *1300 - MOCA	JETSO, FL FIX	*3000
JETSO, FL FIX *1200 - MOCA	HOTAR, FL FIX	*5000
HOTAR, FL FIX *1200 - MOCA	STARY, GA FIX	*8000
STARY, GA FIX *1900 - MOCA	SAVANNAH, GA VORTAC	*3000
SAVANNAH, GA VORTAC	CHARLESTON, SC VORTAC	2000
CHARLESTON, SC VORTAC	WESEL, SC FIX	1800
WESEL, SC FIX *1900 - MOCA	FLORENCE, SC VORTAC	*4000

95.6438 VOR FEDERAL AIRWAY V438

GRANTSVILLE, MD VOR/DME *4400 - MOCA	FLINT, MD FIX	*5000
FLINT, MD FIX *3300 - MOCA	TOMAC, MD FIX	*4000
TOMAC, MD FIX	HAGERSTOWN, MD VOR	4000
HAGERSTOWN, MD VOR *3300 - MOCA	LUCKE, VA FIX	*3800

95.6439 VOR FEDERAL AIRWAY V439

DICKINSON, ND VORTAC	WILLISTON, ND VORTAC	4500
----------------------	----------------------	------

95.6440 VOR FEDERAL AIRWAY V440

PANHANDLE, TX VORTAC *7000 - MRA **4800 - MOCA	*BRISC, TX FIX	**7000
BRISC, TX FIX *4400 - MOCA	SAYRE, OK VORTAC	*4700
SAYRE, OK VORTAC	CARFF, OK FIX	4000
CARFF, OK FIX	WILL ROGERS, OK VORTAC	3000

95.6441 VOR FEDERAL AIRWAY V441

MELBOURNE, FL VOR/DME	LAKELAND, FL VORTAC	2600
LAKELAND, FL VORTAC	ST PETERSBURG, FL VORTAC	2000
ST PETERSBURG, FL VORTAC	BAYPO, FL FIX	2000
BAYPO, FL FIX *3000 - MRA **1700 - MOCA	*NITTS, FL FIX	**4000
NITTS, FL FIX	OCALA, FL VORTAC	2000
OCALA, FL VORTAC *3000 - MRA	*LEJKO, FL FIX	2000
LEJKO, FL FIX	GATORS, FL VORTAC	2000
GATORS, FL VORTAC	BRUNSWICK, GA VORTAC	3000

FROM TO MEA

95.6441 VOR FEDERAL AIRWAY V441 -CONTINUED

BRUNSWICK, GA VORTAC *1500 - MOCA	STARY, GA FIX	*3000
STARY, GA FIX *1900 - MOCA	SAVANNAH, GA VORTAC	*3000

95.6442 VOR FEDERAL AIRWAY V442

PARADISE, CA VORTAC *8000 - MOCA	APLES, CA FIX	*9000
APLES, CA FIX *8300 - MOCA	HECTOR, CA VORTAC	*10000
HECTOR, CA VORTAC	CLIPP, CA FIX	9000
CLIPP, CA FIX	PARKER, CA VORTAC	8000

95.6443 VOR FEDERAL AIRWAY V443

WISKE, WV FIX	NEWCOMERSTOWN, OH VOR/DME	3300
NEWCOMERSTOWN, OH VOR/DME	TIVERTON, OH VOR/DME	3000
TIVERTON, OH VOR/DME	DRYER, OH VOR/DME	3000
DRYER, OH VOR/DME	FAILS, OH FIX	2500
FAILS, OH FIX *1700 - MOCA	U.S. CANADIAN BORDER	*3000
*FOR THAT AIRSPACE OVER U.S. TERRITORY.		

95.6444 VOR FEDERAL AIRWAY V444

BURLEY, ID VOR/DME *11200 - MCA KINZE, ID FIX , NW BND **7000 - MOCA	*KINZE, ID FIX	**8000
KINZE, ID FIX	*SOLDE, ID FIX NW BND SE BND	12500 8000
*12500 - MCA SOLDE, ID FIX , W BND		
SOLDE, ID FIX *12500 - MCA DERSO, ID FIX , W BND **9200 - MOCA	*DERSO, ID FIX	**17000
DERSO, ID FIX *9700 - MOCA	AROWS, ID FIX	*12500
AROWS, ID FIX	*BOISE, ID VORTAC E BND W BND	9000 8000
*7000 - MCA BOISE, ID VORTAC , E BND		
BOISE, ID VORTAC *9400 - MRA	*EMETT, ID FIX	5600
EMETT, ID FIX	PAYET, ID FIX SE BND NW BND	5600 9000
PAYET, ID FIX	BAKER CITY, OR VOR/DME	9000
WALLA WALLA, WA VOR/DME	DATES, WA FIX	4000
DATES, WA FIX	SPOKANE, WA VORTAC	5000

FROM	TO	MEA
95.6445 VOR FEDERAL AIRWAY V445		
MITCH, MD FIX	SWANN, MD FIX	*5500
*3000 - GNSS MEA		
SWANN, MD FIX	KERNO, MD FIX	*2500
*1500 - MOCA		
*2500 - GNSS MEA		
KERNO, MD FIX	#DUPONT, DE VORTAC	*2000
*2000 - GNSS MEA		
#DUPONT R-233 UNUSABLE BEYOND 22 NM.		
DUPONT, DE VORTAC	YARDLEY, PA VOR/DME	*6000
*3000 - GNSS MEA		
YARDLEY, PA VOR/DME	EMPYR, NY FIX	2100
EMPYR, NY FIX	NANCI, NY FIX	2700
NANCI, NY FIX	LA GUARDIA, NY VOR/DME	2600
95.6446 VOR FEDERAL AIRWAY V446		
TROY, IL VORTAC	SAMSVILLE, IL VOR/DME	2600
95.6447 VOR FEDERAL AIRWAY V447		
CAMBRIDGE, NY VOR/DME	KERST, VT FIX	*5900
*5400 - MOCA		
KERST, VT FIX	MUDDI, VT FIX	*6000
*5500 - MOCA		
MUDDI, VT FIX	*RUCKY, VT FIX	5200
*5500 - MRA		
RUCKY, VT FIX	MONTPELIER, VT VOR/DME	*4500
*3900 - MOCA		
MONTPELIER, VT VOR/DME	*PLOTT, VT FIX	4800
*8000 - MRA		
PLOTT, VT FIX	*HURDS, VT FIX	5000
*6500 - MRA		
HURDS, VT FIX	U.S. CANADIAN BORDER	5000
95.6448 VOR FEDERAL AIRWAY V448		
ROGUE VALLEY, OR VORTAC	ROSEBURG, OR VOR/DME	7000
ROSEBURG, OR VOR/DME	*DRAIN, OR FIX	5000
*6000 - MRA		
DRAIN, OR FIX	EUGENE, OR VORTAC	
	N BND	*4000
	S BND	*5000
*3900 - MOCA		
EUGENE, OR VORTAC	GLORR, OR FIX	4000
GLORR, OR FIX	MAVER, OR FIX	6000
MAVER, OR FIX	BATTLE GROUND, WA VORTAC	5000
*BATTLE GROUND, WA VORTAC	LEARN, WA FIX	
	SW BND	**10500
	NE BND	**14500
*9400 - MCA BATTLE GROUND, WA VORTAC, NE BND		
**8000 - MOCA		
LEARN, WA FIX	ANGOO, WA FIX	14500
ANGOO, WA FIX	SIMCO, WA FIX	
	SW BND	*14500
	NE BND	*8500
*7500 - MOCA		

FROM TO MEA

95.6448 VOR FEDERAL AIRWAY V448 –CONTINUED

SIMCO, WA FIX	*YAKIMA, WA VORTAC	
	SW BND	12000
	NE BND	6300
*9500 - MCA YAKIMA, WA VORTAC , SW BND		
YAKIMA, WA VORTAC	RUBEL, WA FIX	6000
RUBEL, WA FIX	MOSES LAKE, WA VOR/DME	
	SW BND	6000
	NE BND	4000
MOSES LAKE, WA VOR/DME	BATUM, WA FIX	4000
BATUM, WA FIX	*SPOKANE, WA VORTAC	5000
*5200 - MCA SPOKANE, WA VORTAC , NE BND		
SPOKANE, WA VORTAC	CLASS, ID FIX	
	NE BND	*9000
	SW BND	*8000
*7200 - MOCA		
CLASS, ID FIX	*OLIBY, MT FIX	**12000
*13000 - MCA OLIBY, MT FIX , NE BND		
**9900 - MOCA		
**10000 - GNSS MEA		
OLIBY, MT FIX	KILLY, MT FIX	*13000
*9000 - GNSS MEA		
KILLY, MT FIX	KALISPELL, MT VOR/DME	*12000
*7600 - MOCA		
*8000 - GNSS MEA		

95.6449 VOR FEDERAL AIRWAY V449

LAKE HENRY, PA VORTAC	DELANCEY, NY VOR/DME	4300
DELANCEY, NY VOR/DME	OAKIL, NY FIX	5000
OAKIL, NY FIX	ALBANY, NY VORTAC	4400

95.6450 VOR FEDERAL AIRWAY V450

ESCANABA, MI VOR/DME	MENOMINEE, MI VOR/DME	2500
MENOMINEE, MI VOR/DME	GREEN BAY, WI VORTAC	2600
GREEN BAY, WI VORTAC	MUSKEGON, MI VORTAC	3000
MUSKEGON, MI VORTAC	FLINT, MI VORTAC	*3000
*2400 - MOCA		
FLINT, MI VORTAC	KATTY, MI FIX	3000
KATTY, MI FIX	U.S. CANADIAN BORDER	*4000
*2800 - MOCA		

95.6451 VOR FEDERAL AIRWAY V451

LA GUARDIA, NY VOR/DME	*NESSI, CT FIX	**4000
*4000 - MRA		
**1700 - MOCA		
**2000 - GNSS MEA		
NESSI, CT FIX	KEYED, NY FIX	2500
KEYED, NY FIX	CREAM, NY FIX	2000
CREAM, NY FIX	GROTON, CT VOR/DME	*6000
*4000 - GNSS MEA		

FROM	TO	MEA
------	----	-----

95.6452 VOR FEDERAL AIRWAY V452

NEWPORT, OR VORTAC *4300 - MCA HORTE, OR FIX , W BND	*HORTE, OR FIX	6000
HORTE, OR FIX	EUGENE, OR VORTAC	4000
EUGENE, OR VORTAC	CHEEZ, OR FIX SE BND	7000
	NW BND	5200
CHEEZ, OR FIX	MANSN, OR FIX SE BND	#*11000
	NW BND	#*8000
*7400 - MOCA		
#MEA IS ESTABLISHED WITH A GAP IN NAVIGATION SIGNAL COVERAGE.		
MANSN, OR FIX *9800 - MOCA	MIXUP, OR FIX	*11000
MIXUP, OR FIX	KLAMATH FALLS, OR VORTAC NW BND	11000
	SE BND	9100
KLAMATH FALLS, OR VORTAC	TULIP, CA FIX	9000
TULIP, CA FIX	BACHS, CA FIX S BND	*14000
	N BND	*9000
*11000 - GNSS MEA		
BACHS, CA FIX *10200 - MOCA	HALLE, NV FIX	*14000
*11000 - GNSS MEA		
HALLE, NV FIX *9600 - MOCA	MUSTANG, NV VORTAC	*11000

95.6453 VOR FEDERAL AIRWAY V453

GORDONSVILLE, VA VORTAC	CASANOVA, VA VORTAC	4500
CASANOVA, VA VORTAC	LINDEN, VA VORTAC	5000

95.6454 VOR FEDERAL AIRWAY V454

BROOKLEY, AL VORTAC	MONROEVILLE, AL VORTAC	2000
MONROEVILLE, AL VORTAC	CHAFF, AL FIX	2000
CHAFF, AL FIX *1800 - MOCA	RUTEL, AL FIX	*2500
RUTEL, AL FIX *1800 - MOCA	CRENS, AL FIX	*4500
CRENS, AL FIX	BANBI, AL FIX	2400
BANBI, AL FIX *2000 - MOCA	COLUMBUS, GA VORTAC	*2400
COLUMBUS, GA VORTAC	GRANT, GA FIX	2800
GRANT, GA FIX *2500 - MOCA	SMARR, GA FIX	*4000
*2500 - GNSS MEA		
SMARR, GA FIX *2500 - MOCA	SINCA, GA FIX	*4500
*2500 - GNSS MEA		
SINCA, GA FIX *3500 - MRA **2000 - MOCA	*GLOSS, GA FIX	**3000
GLOSS, GA FIX *2200 - MOCA	MADDI, GA FIX	*3000

FROM TO MEA

95.6454 VOR FEDERAL AIRWAY V454 - CONTINUED

MADDI, GA FIX *2100 - MOCA	VESTO, GA FIX	*4000
VESTO, GA FIX	GREENWOOD, SC VORTAC	2500
GREENWOOD, SC VORTAC	LOCKS, SC FIX	2300
GIZMO, NC FIX	LIBERTY, NC VORTAC	3000
LIBERTY, NC VORTAC	*NOKIY, VA FIX	**6000
*9000 - MCA NOKIY, VA FIX , NE BND		
**3000 - GNSS MEA		
NOKIY, VA FIX	LAWRENCEVILLE, VA VORTAC	*9000
*3000 - GNSS MEA		
#LAWRENCEVILLE, VA VORTAC	JUNKI, VA FIX	*6000
*1900 - MOCA		
*2000 - GNSS MEA		
#LAWRENCEVILLE R-059 UNUSABLE, USE HOPEWELL R-237.		
JUNKI, VA FIX	HOPEWELL, VA VORTAC	2000

95.6455 VOR FEDERAL AIRWAY V455

RESERVE, LA VOR/DME	PICAYUNE, MS VOR/DME	2000
PICAYUNE, MS VOR/DME	*PLUGG, MS FIX	2000
*5000 - MRA		
PLUGG, MS FIX	EATON, MS VORTAC	2000
EATON, MS VORTAC	MERIDIAN, MS VORTAC	2300

95.6456 VOR FEDERAL AIRWAY V456

FORT DODGE, IA VORTAC	MANKATO, MN VOR/DME	3000
MANKATO, MN VOR/DME	FLYING CLOUD, MN VOR/DME	*2900
*2400 - MOCA		

95.6457 VOR FEDERAL AIRWAY V457

BROADWAY, NJ VOR/DME	LANCASTER, PA VORTAC	*3000
*2600 - MOCA		
LANCASTER, PA VORTAC	*ROAST, PA FIX	**4500
*10000 - MRA		
**2600 - MOCA		
ROAST, PA FIX	VINNY, PA FIX	*4500
*2600 - MOCA		
VINNY, PA FIX	WESTMINSTER, MD VORTAC	3000
WESTMINSTER, MD VORTAC	MARTINSBURG, WV VORTAC	*4000
*3300 - MOCA		

95.6458 VOR FEDERAL AIRWAY V458

SANTA CATALINA, CA VORTAC	AVOLS, CA FIX	4000
AVOLS, CA FIX	PACIF, CA FIX	*3000
*2000 - MOCA		
PACIF, CA FIX	OCEANSIDE, CA VORTAC	3000
OCEANSIDE, CA VORTAC	*VISTA, CA FIX	3000
*5000 - MCA VISTA, CA FIX , E BND		
VISTA, CA FIX	JULIAN, CA VORTAC	7700
JULIAN, CA VORTAC	*KUMBA, CA FIX	7700
*5600 - MCA KUMBA, CA FIX , NW BND		

FROM	TO	MEA
------	----	-----

95.6458 VOR FEDERAL AIRWAY V458 - CONTINUED

KUMBA, CA FIX	IMPERIAL, CA VORTAC	4100
IMPERIAL, CA VORTAC	BARD, AZ VORTAC	3600

95.6459 VOR FEDERAL AIRWAY V459

SEAL BEACH, CA VORTAC	DARTS, CA FIX	
	SE BND	4000
	NW BND	6000
DARTS, CA FIX	*SAUGS, CA FIX	7000
*6600 - MCA SAUGS, CA FIX , NW BND		
SAUGS, CA FIX	LAKE HUGHES, CA VORTAC	8000
LAKE HUGHES, CA VORTAC	JEFFY, CA FIX	8000
JEFFY, CA FIX	*LOPES, CA FIX	9000
*8400 - MCA LOPES, CA FIX , S BND		
LOPES, CA FIX	*WRING, CA FIX	7800
*5400 - MCA WRING, CA FIX , SE BND		
WRING, CA FIX	TULE, CA VOR/DME	5000
TULE, CA VOR/DME	EXTRA, CA FIX	3500
EXTRA, CA FIX	FRIANT, CA VORTAC	5000
FRIANT, CA VORTAC	LINDEN, CA VORTAC	*7000
*6200 - MOCA		

95.6460 VOR FEDERAL AIRWAY V460

MISSION BAY, CA VORTAC	RYAHH, CA FIX	4000
*RYAHH, CA FIX	BARET, CA FIX	
	E BND	8000
	W BND	5500
*6200 - MCA RYAHH, CA FIX , E BND		
BARET, CA FIX	CANNO, CA FIX	8000
CANNO, CA FIX	JULIAN, CA VORTAC	8500
JULIAN, CA VORTAC	*HENOM, CA FIX	8500
*7300 - MCA HENOM, CA FIX , SW BND		
HENOM, CA FIX	MOMAR, CA FIX	3900
MOMAR, CA FIX	SHADI, CA FIX	7000
SHADI, CA FIX	BLYTHE, CA VORTAC	7000

95.6461 VOR FEDERAL AIRWAY V461

GILA BEND, AZ VORTAC	BUCKEYE, AZ VORTAC	4000
----------------------	--------------------	------

95.6462 VOR FEDERAL AIRWAY V462

FORT DODGE, IA VORTAC	SIOUX FALLS, SD VORTAC	4400
-----------------------	------------------------	------

95.6463 VOR FEDERAL AIRWAY V463

WOMAC, GA FIX	*ANNYE, GA FIX	**5000
*5900 - MCA ANNYE, GA FIX , N BND		
**4100 - MOCA		
ANNYE, GA FIX	HARRIS, GA VORTAC	7000

FROM	TO	MEA
------	----	-----

95.6464 VOR FEDERAL AIRWAY V464

SALEM, MI VORTAC	DELOW, MI FIX	3000
U.S. CANADIAN BORDER	DUNKIRK, NY VORTAC	3300
DUNKIRK, NY VORTAC	LANGS, NY FIX	3300
LANGS, NY FIX	GENESE0, NY VOR/DME	4000

95.6465 VOR FEDERAL AIRWAY V465

BULLION, NV VOR/DME	*WELLS, NV VOR	13000
*11800 - MCA WELLS, NV VOR	, SW BND	
WELLS, NV VOR	SHEAR, UT FIX	12000
SHEAR, UT FIX	*MALAD CITY, ID VOR/DME	
	SW BND	11000
	NE BND	10000
*10300 - MCA MALAD CITY, ID VOR/DME	, NE BND	
MALAD CITY, ID VOR/DME	LUNDI, ID FIX	
	SW BND	11400
	NE BND	14000
LUNDI, ID FIX	JACKSON, WY VOR/DME	#*15000
*13100 - MOCA		

#MEA IS ESTABLISHED WITH A GAP IN NAVIGATION SIGNAL COVERAGE.

JACKSON, WY VOR/DME	DUNOIR, WY VOR/DME	13000
DUNOIR, WY VOR/DME	REDLO, MT FIX	*17000
*14200 - MOCA		
REDLO, MT FIX	LAREI, MT FIX	
	N BND	7200
	S BND	16000
LAREI, MT FIX	BILLINGS, MT VORTAC	
	S BND	16000
	N BND	6000
BILLINGS, MT VORTAC	MILES CITY, MT VOR/DME	6000
MILES CITY, MT VOR/DME	WILLISTON, ND VORTAC	*6000
*5200 - MOCA		

95.6466 VOR FEDERAL AIRWAY V466

VOLUNTEER, TN VORTAC	TAMPI, TN FIX	3500
TAMPI, TN FIX	YUMMY, VA FIX	4500
YUMMY, VA FIX	GLADE SPRING, VA VOR/DME	6000
GLADE SPRING, VA VOR/DME	*DORFF, VA FIX	6600
*7000 - MRA		
DORFF, VA FIX	PULASKI, VA VORTAC	6000

95.6467 VOR FEDERAL AIRWAY V467

RICHMOND, IN VORTAC	WATERVILLE, OH VOR/DME	*10000
*3000 - MOCA		
WATERVILLE, OH VOR/DME	DETROIT, MI VOR/DME	*3000
*2100 - MOCA		

95.6468 VOR FEDERAL AIRWAY V468

*BATTLE GROUND, WA VORTAC	TROTS, WA FIX	**10000
*5000 - MCA BATTLE GROUND, WA VORTAC	, NE BND	
**7200 - MOCA		
**8000 - GNSS MEA		
*TROTS, WA FIX	SWANY, WA FIX	**11500
*11500 - MCA TROTS, WA FIX	, NE BND	
**6800 - MOCA		
**7000 - GNSS MEA		

FROM	TO	MEA
------	----	-----

95.6468 VOR FEDERAL AIRWAY V468 - CONTINUED

SWANY, WA FIX *6800 - MOCA *7000 - GNSS MEA	HITCH, WA FIX	*8500
HITCH, WA FIX	YAKIMA, WA VORTAC SE BND NW BND	*8500 *5000
*4300 - MOCA *5000 - GNSS MEA, SW BND		
YAKIMA, WA VORTAC	GLEED, WA FIX W BND E BND	5500 5000
GLEED, WA FIX	ELLENSBURG, WA VORTAC	5500

95.6469 VOR FEDERAL AIRWAY V469

DANVILLE, VA VOR LYNCHBURG, VA VORTAC RADIA, VA FIX RELEE, VA FIX *5100 - MOCA *5200 - GNSS MEA	LYNCHBURG, VA VORTAC RADIA, VA FIX RELEE, VA FIX EXRAS, VA FIX	3000 4600 6000 *8000
EXRAS, VA FIX *6900 - MOCA *6900 - GNSS MEA	BOIER, WV FIX	*10000
BOIER, WV FIX ELKINS, WV VORTAC *4400 - MOCA	ELKINS, WV VORTAC TYGAR, WV FIX	6800 *5000
TYGAR, WV FIX MORGANTOWN, WV VORTAC *4100 - MOCA	MORGANTOWN, WV VORTAC OTOWN, PA FIX	4000 *5000
OTOWN, PA FIX *3100 - MOCA	NESTO, PA FIX	*4000
NESTO, PA FIX QUARY, PA FIX *4400 - MOCA	QUARY, PA FIX JOHNSTOWN, PA VORTAC	4000 *5000
#JOHNSTOWN, PA VORTAC *5000 - GNSS MEA #JOHNSTOWN R-125 UNUSABLE.	ST THOMAS, PA VORTAC	*5000
ST THOMAS, PA VORTAC *4000 - MOCA	BADDI, PA FIX	*5000
BADDI, PA FIX HARRISBURG, PA VORTAC JOANE, PA FIX DUPONT, DE VORTAC	HARRISBURG, PA VORTAC JOANE, PA FIX DUPONT, DE VORTAC WOODSTOWN, NJ VORTAC	4000 4000 3000 2000 MAA - 8000

95.6470 VOR FEDERAL AIRWAY V470

PULASKI, VA VORTAC TABER, VA FIX *4000 - MRA **5100 - MOCA	TABER, VA FIX *MONAT, VA FIX	5500 **5600
MONAT, VA FIX	LYNCHBURG, VA VORTAC W BND E BND	*4000 *3000
*2900 - MOCA		

FROM	TO	MEA
------	----	-----

95.6471 VOR FEDERAL AIRWAY V471

BARHA, ME FIX *2500 - MOCA	BANGOR, ME VORTAC	*3000
BANGOR, ME VORTAC *2100 - MOCA	MILLINOCKET, ME VOR/DME	*2500
MILLINOCKET, ME VOR/DME *2000 - MOCA	HOULTON, ME VOR/DME	*2600
HOULTON, ME VOR/DME *2100 - MOCA	U.S. CANADIAN BORDER	*2600

95.6472 VOR FEDERAL AIRWAY V472

FROM	TO	MEA
------	----	-----

95.6472 VOR FEDERAL AIRWAY V472 - CONTINUED

ELIZABETH CITY, NC VOR/DME	BERTI, NC FIX	4000
BERTI, NC FIX *7000 - MRA **2000 - MOCA	*ZAGGY, NC FIX	**7000
ZAGGY, NC FIX	KINSTON, NC VORTAC	2000

95.6473 VOR FEDERAL AIRWAY V473

ROANOKE, VA VORTAC *5100 - MOCA	HOBOS, VA FIX	*6000
HOBOS, VA FIX MONTEBELLO, VA VOR/DME *5500 - MOCA	MONTEBELLO, VA VOR/DME GORDONSVILLE, VA VORTAC	6000 *6000

95.6474 VOR FEDERAL AIRWAY V474

NESTO, PA FIX *3100 - MOCA	PLEEZ, PA FIX	*4000
PLEEZ, PA FIX *4500 - MOCA	INDIAN HEAD, PA VORTAC	*5000
INDIAN HEAD, PA VORTAC *4500 - MOCA	ST THOMAS, PA VORTAC	*5000
ST THOMAS, PA VORTAC *4000 - MOCA	NOENO, PA FIX	*5000
NOENO, PA FIX DELRO, PA FIX *3900 - MOCA *4000 - GNSS MEA	DELRO, PA FIX MODENA, PA VORTAC	3000 *10000

95.6475 VOR FEDERAL AIRWAY V475

LA GUARDIA, NY VOR/DME DUNBO, NY FIX *1500 - MOCA	DUNBO, NY FIX BRIDGEPORT, CT VOR/DME	2000 *2000
---	---	---------------

FROM	TO	MEA
95.6475 VOR FEDERAL AIRWAY V475 - CONTINUED		
BRIDGEPORT, CT VOR/DME *1500 - MOCA	MADISON, CT VOR/DME	*2000
MADISON, CT VOR/DME	NORWICH, CT VOR/DME	2300
NORWICH, CT VOR/DME *1900 - MOCA	PROVIDENCE, RI VORTAC	*2400
95.6476 VOR FEDERAL AIRWAY V476		
LYNCHBURG, VA VORTAC	GORDONSVILLE, VA VORTAC	3300
95.6477 VOR FEDERAL AIRWAY V477		
HUMBLE, TX VORTAC *2000 - MOCA	LEONA, TX VORTAC	*3000
LEONA, TX VORTAC	CEDAR CREEK, TX VORTAC	2100
95.6478 VOR FEDERAL AIRWAY V478		
FALMOUTH, KY VOR/DME	NEWCOMBE, KY VORTAC	3100
NEWCOMBE, KY VORTAC	BECKLEY, WV VORTAC	5900
95.6479 VOR FEDERAL AIRWAY V479		
DUPONT, DE VORTAC	YARDLEY, PA VOR/DME	2000
95.6481 VOR FEDERAL AIRWAY V481		
EUGENE, OR VORTAC	CORVALLIS, OR VOR/DME	3500
CORVALLIS, OR VOR/DME	CRAAF, OR FIX	4000
95.6483 VOR FEDERAL AIRWAY V483		
DEER PARK, NY VOR/DME *5000 - MRA **2000 - MOCA	*RYMES, CT FIX	**2500
RYMES, CT FIX	CARMEL, NY VOR/DME	2500
CARMEL, NY VOR/DME	KINGSTON, NY VOR/DME	3000
KINGSTON, NY VOR/DME *6000 - MRA **3000 - GNSS MEA	*WEETS, NY FIX	**4000
WEETS, NY FIX	RIMBA, NY FIX	6000
RIMBA, NY FIX	DELANCEY, NY VOR/DME	5500
DELANCEY, NY VOR/DME	ROCKDALE, NY VOR/DME	4200
ROCKDALE, NY VOR/DME	STODA, NY FIX	4000
STODA, NY FIX	SYRACUSE, NY VORTAC	2400
SYRACUSE, NY VORTAC *3000 - MRA	*LYSAN, NY FIX	2300
LYSAN, NY FIX	ROCHESTER, NY VOR/DME	2300

FROM TO MEA

95.6484 VOR FEDERAL AIRWAY V484

HAILEY, ID NDB/DME	KINZE, ID FIX	8600
KINZE, ID FIX	*TWIN FALLS, ID VORTAC	7000
*8000 - MCA TWIN FALLS, ID VORTAC , E BND		
TWIN FALLS, ID VORTAC	WODEN, ID FIX	8800
WODEN, ID FIX	*DRYAD, ID FIX	**12000
*13000 - MCA DRYAD, ID FIX , SE BND		
**9500 - MOCA		
DRYAD, ID FIX	SWITZ, UT FIX	##16000
*11900 - MOCA		
#MEA IS ESTABLISHED WITH A GAP IN NAVIGATION SIGNAL COVERAGE.		
SWITZ, UT FIX	CAUSE, UT FIX	*11500
*8600 - MOCA		
CAUSE, UT FIX	*WASATCH, UT VORTAC	8600
*11000 - MCA WASATCH, UT VORTAC , E BND		
WASATCH, UT VORTAC	PARLE, UT FIX	11500
PARLE, UT FIX	MYTON, UT VORTAC	13000
MYTON, UT VORTAC	*WINDO, UT FIX	**10500
*13000 - MRA		
**9000 - MOCA		
WINDO, UT FIX	GRAND JUNCTION, CO VOR/DME	10500
GRAND JUNCTION, CO VOR/DME	BATTZ, CO FIX	12300
BATTZ, CO FIX	BLUE MESA, CO VOR/DME	14000
BLUE MESA, CO VOR/DME	HOMME, CO FIX	14600
HOMME, CO FIX	ALAMOSA, CO VORTAC	
	S BND	10000
	N BND	14600

95.6485 VOR FEDERAL AIRWAY V485

VENTURA, CA VOR/DME	*HENER, CA FIX	5000
*6200 - MCA HENER, CA FIX , NW BND		
HENER, CA FIX	FELLOWS, CA VORTAC	9000
FELLOWS, CA VORTAC	*REDDE, CA FIX	**7000
*7000 - MCA REDDE, CA FIX , SE BND		
**6000 - MOCA		
REDDE, CA FIX	PRIEST, CA VOR	6000
PRIEST, CA VOR	PANOS, CA FIX	6500
PANOS, CA FIX	HENCE, CA FIX	*6500
*5600 - MOCA		
HENCE, CA FIX	SAN JOSE, CA VOR/DME	4600

95.6486 VOR FEDERAL AIRWAY V486

LEBRN, OH FIX	CHARDON, OH VOR/DME	3000
CHARDON, OH VOR/DME	ALLCO, PA FIX	3300
ALLCO, PA FIX	JAMESTOWN, NY VOR/DME	*3700
*3200 - MOCA		

95.6487 VOR FEDERAL AIRWAY V487

LA GUARDIA, NY VOR/DME	DUNBO, NY FIX	2000
DUNBO, NY FIX	BRIDGEPORT, CT VOR/DME	*2000
*1500 - MOCA		
BRIDGEPORT, CT VOR/DME	BOWAN, NY FIX	*6000
*4100 - MOCA		

FROM	TO	MEA
------	----	-----

95.6487 VOR FEDERAL AIRWAY V487 - CONTINUED

BOWAN, NY FIX *4300 - MOCA	CAMBRIDGE, NY VOR/DME	*5000
CAMBRIDGE, NY VOR/DME *10000 - MRA	*GRISS, NY FIX	4000
GRISS, NY FIX *2700 - MOCA	ENSON, VT FIX	*4000
ENSON, VT FIX *2800 - MOCA	WEIGH, VT FIX	*4000
WEIGH, VT FIX	BURLINGTON, VT VOR/DME	3000
BURLINGTON, VT VOR/DME	U.S. CANADIAN BORDER	2800

95.6489 VOR FEDERAL AIRWAY V489

COATE, NJ FIX *3300 - MOCA	HUGUENOT, NY VOR/DME	*4000
HUGUENOT, NY VOR/DME *3500 - MOCA	WEARD, NY FIX	*4000
WEARD, NY FIX *5700 - MOCA	SAGES, NY FIX	*7000
SAGES, NY FIX	ALBANY, NY VORTAC	6000
ALBANY, NY VORTAC *5000 - GNSS MEA	GLENS FALLS, NY VORTAC	*7000
GLENS FALLS, NY VORTAC *8000 - MRA	*FAIRB, NY FIX	6000
FAIRB, NY FIX *6000 - GNSS MEA	LEAFY, NY FIX	*8000
LEAFY, NY FIX	KEESE, NY FIX	4000
KEESE, NY FIX	PLATTSBURGH, NY VORTAC	3300

95.6490 VOR FEDERAL AIRWAY V490

UTICA, NY VORTAC *6000 - MRA **3300 - MOCA	*GALWA, NY FIX	**4000
GALWA, NY FIX *3300 - MOCA	CAMBRIDGE, NY VOR/DME	*4000
CAMBRIDGE, NY VOR/DME *5300 - MOCA	STRUM, NH FIX	*6000
STRUM, NH FIX	DUBIN, NH FIX	5000
DUBIN, NH FIX	LURCH, NH FIX	4000
LURCH, NH FIX *4000 - MCA	*MUGGY, NH FIX	4000
MUGGY, NH FIX	MUGGY, NH FIX, W BND	
	MANCHESTER, NH VOR/DME	3000

95.6491 VOR FEDERAL AIRWAY V491

RAPID CITY, SD VORTAC	UNION, SD FIX	5000
UNION, SD FIX *5000 - MOCA	HAYNI, ND FIX	*9000
HAYNI, ND FIX *4500 - MOCA	DICKINSON, ND VORTAC	*5000
DICKINSON, ND VORTAC *4300 - MOCA	MINOT, ND VORTAC	*6000

FROM	TO	MEA
------	----	-----

95.6492 VOR FEDERAL AIRWAY V492

ST PETERSBURG, FL VORTAC	LA BELLE, FL VORTAC	2000
LA BELLE, FL VORTAC *1500 - MOCA	PALM BEACH, FL VORTAC	*2000
PALM BEACH, FL VORTAC *2000 - MOCA	STOOP, FL FIX	*3000
STOOP, FL FIX	MELBOURNE, FL VOR/DME	3000

95.6493 VOR FEDERAL AIRWAY V493

LIVINGSTON, TN VORTAC	LEXINGTON, KY VORTAC	3500
LEXINGTON, KY VORTAC	BEAER, KY FIX	3000
BEAER, KY FIX	YORK, KY VORTAC	3300
YORK, KY VORTAC	TARTO, OH FIX	3300
TARTO, OH FIX	APPLETON, OH VORTAC	3000
APPLETON, OH VORTAC	DUSKY, OH FIX	3000
DUSKY, OH FIX	WATERVILLE, OH VOR/DME	2600
WATERVILLE, OH VOR/DME *2100 - MOCA	CARLETON, MI VORTAC	*3000
MENOMINEE, MI VOR/DME	RHINELANDER, WI VORTAC	3500

95.6494 VOR FEDERAL AIRWAY V494

CRESCENT CITY, CA VORTAC *3500 - MOCA	FORTUNA, CA VORTAC	*6000
FORTUNA, CA VORTAC *6100 - MOCA	MENDOCINO, CA VORTAC	*13000
MENDOCINO, CA VORTAC	SANTA ROSA, CA VOR/DME	6000
SANTA ROSA, CA VOR/DME *8500 - MRA	*RAGGS, CA FIX	5000
RAGGS, CA FIX	SACRAMENTO, CA VORTAC	5000
SACRAMENTO, CA VORTAC *1600 - MOCA	ROZZY, CA FIX	*3000
ROZZY, CA FIX	HAGAN, CA FIX	4000
HAGAN, CA FIX *9000 - MCA AUDIO, CA FIX , NE BND **4500 - MOCA	*AUDIO, CA FIX	**6000
AUDIO, CA FIX	SQUAW VALLEY, CA VOR/DME	11000
SQUAW VALLEY, CA VOR/DME *11000 - MCA VIKES, NV FIX , SW BND	*VIKES, NV FIX	12000
VIKES, NV FIX	*HAZEN, NV VORTAC	**10000
*9000 - MCA HAZEN, NV VORTAC , SW BND **9300 - MOCA		

95.6495 VOR FEDERAL AIRWAY V495

ABBOTSFORD, CANADA NDB	U.S. CANADIAN BORDER	3000
U.S. CANADIAN BORDER *1900 - MOCA	WHATCOM, WA VORTAC	*3000
WHATCOM, WA VORTAC	U.S. CANADIAN BORDER	3000
U.S. CANADIAN BORDER *2800 - MOCA	VICTORIA, CANADA VOR/DME	*3000
VICTORIA, CANADA VOR/DME	CONDI, CANADA FIX	4500

FROM	TO	MEA
95.6495 VOR FEDERAL AIRWAY V495 - CONTINUED		
CONDI, CANADA FIX	DISCO, CANADA FIX	4000
DISCO, CANADA FIX	DIGGN, WA FIX	*5400
*4300 - MOCA		
DIGGN, WA FIX	LOFAL, WA FIX	*5400
*4300 - MOCA		
LOFAL, WA FIX	SEATTLE, WA VORTAC	*4000
*2800 - MOCA		
SEATTLE, WA VORTAC	CIDUG, WA FIX	*5000
*3000 - MOCA		
*3000 - GNSS MEA		
CIDUG, WA FIX	ALDER, WA FIX	
	S BND	*9000
	N BND	*5000
*4000 - MOCA		
*4000 - GNSS MEA		
ALDER, WA FIX	*TOUTL, WA FIX	**9000
*8500 - MRA		
*5900 - MCA TOUTL, WA FIX, N BND		
**6800 - MOCA		
**7000 - GNSS MEA		
TOUTL, WA FIX	BATTLE GROUND, WA VORTAC	
	N BND	*9000
	S BND	*5000
*5000 - MOCA		
*5000 - GNSS MEA, N BND		
BATTLE GROUND, WA VORTAC	NEWBERG, OR VOR/DME	4000
NEWBERG, OR VOR/DME	CORVALLIS, OR VOR/DME	*4000
*3400 - MOCA		
CORVALLIS, OR VOR/DME	HORTE, OR FIX	4000
HORTE, OR FIX	*VAUGN, OR FIX	
	S BND	7000
	N BND	4000
*7000 - MRA		
VAUGN, OR FIX	ROSEBURG, OR VOR/DME	*7000
*4400 - MOCA		
ROSEBURG, OR VOR/DME	MERLI, OR FIX	*8000
*7500 - MOCA		
MERLI, OR FIX	*PAPLE, OR FIX	**9000
*10100 - MRA		
**6500 - MOCA		
PAPLE, OR FIX	*BAYTS, OR FIX	**10100
*10000 - MRA		
**7300 - MOCA		
BAYTS, OR FIX	FORT JONES, CA VOR/DME	*10000
*9400 - MOCA		

95.6496 VOR FEDERAL AIRWAY V496

UTICA, NY VORTAC	MALLO, NY FIX	4500
MALLO, NY FIX	GLENS FALLS, NY VORTAC	*7000
*6000 - GNSS MEA		
GLENS FALLS, NY VORTAC	KERST, VT FIX	*10000
*6000 - GNSS MEA		
KERST, VT FIX	LEBANON, NH VOR/DME	5900
LEBANON, NH VOR/DME	GRUMP, NH FIX	5000
GRUMP, NH FIX	NEETS, NH FIX	4000
NEETS, NH FIX	KENNEBUNK, ME VORTAC	3600

FROM TO MEA

95.6497 VOR FEDERAL AIRWAY V497

ROME, OR VORTAC	WILDHORSE, OR VOR/DME	9000
WILDHORSE, OR VOR/DME	KIMBERLY, OR VORTAC	9000
KIMBERLY, OR VORTAC	KLICKITAT, OR VOR/DME	7300
KLICKITAT, OR VOR/DME	SUNED, WA FIX	7000
SUNED, WA FIX	MOSES LAKE, WA VOR/DME	6000
MOSES LAKE, WA VOR/DME	EPHRATA, WA VORTAC	4000

95.6499 VOR FEDERAL AIRWAY V499

BALTIMORE, MD VORTAC	BELAY, MD FIX	2300
BELAY, MD FIX	LANCASTER, PA VORTAC	2500
LANCASTER, PA VORTAC	BINGHAMTON, NY VORTAC	*4500
*3900 - MOCA		

95.6500 VOR FEDERAL AIRWAY V500

BATTLE GROUND, WA VORTAC	NEWBERG, OR VOR/DME	4000
NEWBERG, OR VOR/DME	GLARA, OR FIX	4000
GLARA, OR FIX	*HARZL, OR FIX	
	W BND	**7200
	E BND	**10000
*7200 - MRA		
**6600 - MOCA		
**7000 - GNSS MEA		
HARZL, OR FIX	RATZZ, OR FIX	
	E BND	*10000
	W BND	*8000
*7400 - MOCA		
*8000 - GNSS MEA		
RATZZ, OR FIX	*GASHE, OR FIX	**10000
*10000 - MRA		
**8000 - MOCA		
**8000 - GNSS MEA		
GASHE, OR FIX	KIMBERLY, OR VORTAC	*9200
*8200 - MOCA		
KIMBERLY, OR VORTAC	*HOSTS, OR FIX	11000
*11700 - MRA		
HOSTS, OR FIX	PARMO, ID FIX	
	E BND	6000
	W BND	11000
PARMO, ID FIX	*BOISE, ID VORTAC	5000
*7000 - MCA BOISE, ID VORTAC, E BND		
BOISE, ID VORTAC	AROWS, ID FIX	
	E BND	9000
	W BND	8000
AROWS, ID FIX	*DERSO, ID FIX	**12500
*12500 - MCA DERSO, ID FIX, E BND		
**9700 - MOCA		
DERSO, ID FIX	*SOLDE, ID FIX	**17000
*12500 - MCA SOLDE, ID FIX, E BND		
**9200 - MOCA		
SOLDE, ID FIX	*REAPS, ID FIX	**12500
*9500 - MCA REAPS, ID FIX, E BND		
*9500 - MCA REAPS, ID FIX, W BND		
**8000 - MOCA		
REAPS, ID FIX	BETRE, ID FIX	*9500
*7000 - MOCA		
BETRE, ID FIX	POCATELLO, ID VORTAC	7500

FROM TO MEA

95.6501 VOR FEDERAL AIRWAY V501

MARTINSBURG, WV VORTAC	HAGERSTOWN, MD VOR	3500
HAGERSTOWN, MD VOR	ST THOMAS, PA VORTAC	4000
ST THOMAS, PA VORTAC	PHILIPSBURG, PA VORTAC	*4500
*4000 - MOCA		
WELLSVILLE, NY VORTAC	BEEPS, NY FIX	*4500
*4000 - MOCA		

95.6502 VOR FEDERAL AIRWAY V502

DODGE CITY, KS VORTAC	DISKS, KS FIX	*4500
*4000 - MOCA		
DISKS, KS FIX	*SPELT, KS FIX	**5000
*5000 - MRA		
**3300 - MOCA		
SPELT, KS FIX	HUTCHINSON, KS VOR/DME	3200
HUTCHINSON, KS VOR/DME	WAIVE, KS FIX	4000
WAIVE, KS FIX	*FLOSS, KS FIX	3300
*5000 - MRA		
FLOSS, KS FIX	EMPORIA, KS VORTAC	3300
EMPORIA, KS VORTAC	KANSAS CITY, MO VORTAC	3100
KANSAS CITY, MO VORTAC	BRAYMER, MO VOR/DME	2600
BRAYMER, MO VOR/DME	KIRKSVILLE, MO VORTAC	2900

95.6503 VOR FEDERAL AIRWAY V503

ROCHESTER, MN VOR/DME	CEDAR RAPIDS, IA VOR/DME	*4500
*3600 - MOCA		

95.6505 VOR FEDERAL AIRWAY V505

DES MOINES, IA VORTAC	GUMBO, IA FIX	2700
GUMBO, IA FIX	FORT DODGE, IA VORTAC	3000
FORT DODGE, IA VORTAC	MASON CITY, IA VORTAC	3000
MASON CITY, IA VORTAC	FREED, MN FIX	3000
FREED, MN FIX	*ALMAY, MN FIX	**4600
*5000 - MRA		
**2800 - MOCA		
ALMAY, MN FIX	PRAGS, MN FIX	*5000
*2500 - MOCA		
PRAGS, MN FIX	GOPHER, MN VORTAC	3000
GOPHER, MN VORTAC	SIREN, WI VOR/DME	3000
SIREN, WI VOR/DME	DULUTH, MN VORTAC	4000
DULUTH, MN VORTAC	HIBBING, MN VOR/DME	3300
HIBBING, MN VOR/DME	SQEAK, MN FIX	*5000
*3100 - MOCA		
SQEAK, MN FIX	*BEBEL, MN FIX	5000
*4000 - MRA		
BEBEL, MN FIX	INTERNATIONAL FALLS, MN VORTAC	3000

FROM	TO	MEA
------	----	-----

95.6506 VOR FEDERAL AIRWAY V506

TULSA, OK VORTAC	VINTA, OK FIX	2600
VINTA, OK FIX	NEOSHO, MO VOR/DME	3000
NEOSHO, MO VOR/DME	BILIE, MO FIX	3000
BILIE, MO FIX	SPRINGFIELD, MO VORTAC	3000

95.6507 VOR FEDERAL AIRWAY V507

ARDMORE, OK VORTAC	WILL ROGERS, OK VORTAC	3100
WILL ROGERS, OK VORTAC	*WAXEY, OK FIX	**4000
*5000 - MRA		
**3200 - MOCA		
WAXEY, OK FIX	ROLLS, OK FIX	*8400
*3500 - MOCA		
ROLLS, OK FIX	MITBEE, OK VORTAC	4000
MITBEE, OK VORTAC	LIBERAL, KS VORTAC	4700
LIBERAL, KS VORTAC	GARDEN CITY, KS VORTAC	4700

95.6508 VOR FEDERAL AIRWAY V508

HILL CITY, KS VORTAC	HAYS, KS VORTAC	*4500
*3900 - MOCA		
HAYS, KS VORTAC	*GLIDE, KS FIX	3900
*4000 - MRA		
GLIDE, KS FIX	SALINA, KS VORTAC	*3600
*2900 - MOCA		
SALINA, KS VORTAC	*VASCO, KS FIX	3000
*5000 - MRA		
VASCO, KS FIX	MANHATTAN, KS VOR/DME	3000
MANHATTAN, KS VOR/DME	TOPEKA, KS VORTAC	3000
TOPEKA, KS VORTAC	RUGBB, KS FIX	2800
RUGBB, KS FIX	JOHNSON COUNTY, KS VOR/DME	2600

95.6509 VOR FEDERAL AIRWAY V509

ST PETERSBURG, FL VORTAC	*CROWD, FL FIX	**5000
*5000 - MRA		
**2600 - MOCA		
CROWD, FL FIX	HALLR, FL FIX	*6000
*1800 - MOCA		

95.6510 VOR FEDERAL AIRWAY V510

DICKINSON, ND VORTAC	BISMARCK, ND VOR/DME	4600
BISMARCK, ND VOR/DME	*BEHQY, ND FIX	3900
*12000 - MRA		
BEHQY, ND FIX	JAMESTOWN, ND VOR/DME	3900
JAMESTOWN, ND VOR/DME	*CHAFE, ND FIX	3300
*6000 - MRA		
CHAFE, ND FIX	FARGO, ND VORTAC	
	W BND	3300
	E BND	2700
FARGO, ND VORTAC	STARR, MN FIX	3500
STARR, MN FIX	ALEXANDRIA, MN VOR/DME	*3500
*3000 - MOCA		
ALEXANDRIA, MN VOR/DME	*DAYLE, MN FIX	5000
*5000 - MCA DAYLE, MN FIX	NW BND	
DAYLE, MN FIX	GOPHER, MN VORTAC	4000

FROM TO MEA

95.6510 VOR FEDERAL AIRWAY V510 - CONTINUED

GOPHER, MN VORTAC	*BITLR, WI FIX	3400
*5500 - MCA BITLR, WI FIX , SE BND		
BITLR, WI FIX	NODINE, MN VORTAC	5500
NODINE, MN VORTAC	DELLS, WI VORTAC	3000
OSHKOSH, WI VORTAC	FALLS, WI VOR/DME	3000
FALLS, WI VOR/DME	*GAYLE, MI FIX	3500
*3500 - MRA		
GAYLE, MI FIX	MUSKEGON, MI VORTAC	3500
MUSKEGON, MI VORTAC	GRAND RAPIDS, MI VOR/DME	2700
GRAND RAPIDS, MI VOR/DME	LANSING, MI VORTAC	2700
BUFFALO, NY VOR/DME	*EHMAN, NY FIX	##*11000
*11000 - MCA EHMAN, NY FIX , SW BND		
**3000 - GNSS MEA		
#BUFFALO R-053 UNUSABLE BELOW 11000.		
EHMAN, NY FIX	ROCHESTER, NY VOR/DME	2400

95.6511 VOR FEDERAL AIRWAY V511

LAKELAND, FL VORTAC	HALLR, FL FIX	*4000
*2200 - MOCA		
HALLR, FL FIX	THNDR, FL FIX	*7000
*1700 - MOCA		
*5000 - GNSS MEA		
THNDR, FL FIX	DOLPHIN, FL VORTAC	*3000
*1500 - MOCA		

95.6512 VOR FEDERAL AIRWAY V512

POCKET CITY, IN VORTAC	*HOLAN, IN FIX	2500
*2600 - MRA		
HOLAN, IN FIX	SACKO, IN FIX	*3500
*2000 - MOCA		
SACKO, IN FIX	LOUISVILLE, KY VORTAC	2700
LOUISVILLE, KY VORTAC	CLEGG, KY FIX	*10000
*2700 - MOCA		
CLEGG, KY FIX	LEXINGTON, KY VORTAC	2800

95.6513 VOR FEDERAL AIRWAY V513

LIVINGSTON, TN VORTAC	NEW HOPE, KY VOR/DME	3000
NEW HOPE, KY VOR/DME	LOUISVILLE, KY VORTAC	2700

95.6514 VOR FEDERAL AIRWAY V514

MISSION BAY, CA VORTAC	RYAHH, CA FIX	4000
*RYAHH, CA FIX	BARET, CA FIX	
	E BND	8000
	W BND	5500
*6200 - MCA RYAHH, CA FIX , E BND		
BARET, CA FIX	CANNO, CA FIX	8000
CANNO, CA FIX	JULIAN, CA VORTAC	8500
JULIAN, CA VORTAC	WARNE, CA FIX	
	SW BND	8000
	NE BND	9000

FROM TO MEA

95.6514 VOR FEDERAL AIRWAY V514 - CONTINUED

WARNE, CA FIX	*THERMAL, CA VORTAC	9000
*5600 - MCA THERMAL, CA VORTAC , N BND		
THERMAL, CA VORTAC	*TWENTYNINE PALMS, CA VORTAC	7000
*10200 - MCA TWENTYNINE PALMS, CA VORTAC , NE BND		
*TWENTYNINE PALMS, CA VORTAC	GOFFS, CA VORTAC	**12000
*10200 - MCA TWENTYNINE PALMS, CA VORTAC , NE BND		
**7900 - MOCA		
**8000 - GNSS MEA		
GOFFS, CA VORTAC	BOULDER CITY, NV VORTAC	7600

95.6516 VOR FEDERAL AIRWAY V516

LIBERAL, KS VORTAC	ANTHONY, KS VORTAC	*6000
*4500 - MOCA		
ANTHONY, KS VORTAC	PIONEER, OK VORTAC	3000
PIONEER, OK VORTAC	TYROE, KS FIX	*3100
*2600 - MOCA		
TYROE, KS FIX	OSWEGO, KS VORTAC	2700

95.6517 VOR FEDERAL AIRWAY V517

SNOWBIRD, TN VORTAC	MIAMI, TN FIX	6900
MIAMI, TN FIX	LONDON, KY VORTAC	*5500
*4700 - MOCA		
LONDON, KY VORTAC	LOGIC, KY FIX	3300
LOGIC, KY FIX	FALMOUTH, KY VOR/DME	2800
FALMOUTH, KY VOR/DME	CINCINNATI, KY VORTAC	2700
CINCINNATI, KY VORTAC	RICHMOND, IN VORTAC	2800
RICHMOND, IN VORTAC	DAYTON, OH VOR/DME	2900

95.6518 VOR FEDERAL AIRWAY V518

FILLMORE, CA VORTAC	TWINE, CA FIX	5500
TWINE, CA FIX	*LANGE, CA FIX	7000
*7000 - MCA LANGE, CA FIX , NE BND		
LANGE, CA FIX	*PALMDALE, CA VORTAC	7000
*6300 - MCA PALMDALE, CA VORTAC , SW BND		

95.6519 VOR FEDERAL AIRWAY V519

VOLUNTEER, TN VORTAC	TAMPI, TN FIX	3500
TAMPI, TN FIX	YUMMY, VA FIX	4500
YUMMY, VA FIX	GLADE SPRING, VA VOR/DME	6000
GLADE SPRING, VA VOR/DME	*TELOC, VA FIX	6900
*13000 - MRA		
TELOC, VA FIX	BLUEFIELD, WV VORTAC	6100
BLUEFIELD, WV VORTAC	BECKLEY, WV VORTAC	##9000
*5900 - MOCA		
*5900 - GNSS MEA		
#BECKLEY R-193 UNUSABLE BELOW 9000.		

FROM TO MEA

95.6520 VOR FEDERAL AIRWAY V520

*BATTLE GROUND, WA VORTAC	KLICKITAT, OR VOR/DME	7000
*4700 - MCA BATTLE GROUND, WA VORTAC , E BND		
KLICKITAT, OR VOR/DME	AMPLE, WA FIX	6000
AMPLE, WA FIX	VIRTU, WA FIX	
	NE BND	4000
	SW BND	5000
VIRTU, WA FIX	PASCO, WA VOR/DME	4000
PASCO, WA VOR/DME	*WALLA WALLA, WA VOR/DME	3200
*5500 - MCA WALLA WALLA, WA VOR/DME , NE BND		
WALLA WALLA, WA VOR/DME	CLOVA, WA FIX	8000
CLOVA, WA FIX	NEZ PERCE, ID VOR/DME	
	NE BND	5500
	SW BND	8000
NEZ PERCE, ID VOR/DME	FERDI, ID FIX	
	W BND	6700
	E BND	12000
FERDI, ID FIX	SALMON, ID VOR/DME	12000
SALMON, ID VOR/DME	*DUBOIS, ID VORTAC	13500
*10500 - MCA DUBOIS, ID VORTAC , W BND		
*8900 - MCA DUBOIS, ID VORTAC , E BND		
DUBOIS, ID VORTAC	*JACKSON, WY VOR/DME	15000
*14600 - MCA JACKSON, WY VOR/DME , W BND		

95.6521 VOR FEDERAL AIRWAY V521

DOLPHIN, FL VORTAC	RUTHY, FL FIX	*3000
*1500 - MOCA		
RUTHY, FL FIX	LEE COUNTY, FL VORTAC	2000
LEE COUNTY, FL VORTAC	QUNCY, FL FIX	2500
QUNCY, FL FIX	RINSE, FL FIX	2200
RINSE, FL FIX	LAKELAND, FL VORTAC	2200
LAKELAND, FL VORTAC	DADES, FL FIX	1800
DADES, FL FIX	*NITTS, FL FIX	2300
*3000 - MRA		
NITTS, FL FIX	*ORATE, FL FIX	**3000
*3000 - MRA		
**1600 - MOCA		
ORATE, FL FIX	*CROSS CITY, FL VORTAC	**2000
*5000 - MCA CROSS CITY, FL VORTAC , W BND		
**1500 - MOCA		
CROSS CITY, FL VORTAC	*HEVVN, FL FIX	**5000
*7000 - MCA HEVVN, FL FIX , W BND		
**1400 - MOCA		
HEVVN, FL FIX	*TERES, FL FIX	**7000
*7000 - MCA TERES, FL FIX , E BND		
**1300 - MOCA		
TERES, FL FIX	CRESS, FL FIX	*4000
*1400 - MOCA		
CRESS, FL FIX	MARIANNA, FL VORTAC	2000
MARIANNA, FL VORTAC	*MALON, FL FIX	2000
*3000 - MRA		
MALON, FL FIX	WIREGRASS, AL VORTAC	2000
#WIREGRASS, AL VORTAC	CLIOS, AL FIX	#2200
#WIREGRASS -331 NA BEYOND CLIOS		
CLIOS, AL FIX	BANBI, AL FIX	*2400
*2400 - GNSS MEA		
BANBI, AL FIX	MONTGOMERY, AL VORTAC	2400
MONTGOMERY, AL VORTAC	KYLEE, AL FIX	3000
KYLEE, AL FIX	VULCAN, AL VORTAC	3800

FROM	TO	MEA
------	----	-----

95.6522 VOR FEDERAL AIRWAY V522

DRYER, OH VOR/DME	FAILS, OH FIX	2500
FAILS, OH FIX	ERIE, PA VORTAC	2700
ERIE, PA VORTAC	HAMIT, PA FIX	3200
HAMIT, PA FIX	DUNKIRK, NY VORTAC	3300
DUNKIRK, NY VORTAC	U.S. CANADIAN BORDER	3000

95.6523 VOR FEDERAL AIRWAY V523

#APPLETON, OH VORTAC	TIVERTON, OH VOR/DME	3000
#APPLETON R-055 UNUSABLE.		
TIVERTON, OH VOR/DME	AKRON, OH VOR/DME	3000
AKRON, OH VOR/DME	YOUNGSTOWN, OH VORTAC	3000
YOUNGSTOWN, OH VORTAC	ERIE, PA VORTAC	*5000
*3000 - GNSS MEA		

95.6524 VOR FEDERAL AIRWAY V524

HAYDEN, CO VOR/DME	LARAMIE, WY VOR/DME	14200
LARAMIE, WY VOR/DME	SCOTTSBLUFF, NE VORTAC	10700
SCOTTSBLUFF, NE VORTAC	NORTH PLATTE, NE VORTAC	7000

95.6525 VOR FEDERAL AIRWAY V525

#APPLETON, OH VORTAC	TIVERTON, OH VOR/DME	#3000
#APPLETON R-055 UNUSABLE.		
TIVERTON, OH VOR/DME	DRYER, OH VOR/DME	3000

95.6526 VOR FEDERAL AIRWAY V526

NORTHBROOK, IL VOR/DME	*MINCE, MI FIX	2500
*3500 - MRA		
MINCE, MI FIX	MUSKY, MI FIX	2500
MUSKY, MI FIX	GIPPER, MI VORTAC	2600

95.6527 VOR FEDERAL AIRWAY V527

HOT SPRINGS, AR VOR/DME	HIDER, AR FIX	3000
HIDER, AR FIX	ROVER, AR FIX	*5500
*3100 - MOCA		
ROVER, AR FIX	DANIL, AR FIX	*9500
*2500 - MOCA		
DANIL, AR FIX	*SCRAN, AR FIX	**9500
*3300 - MRA		
**3100 - MOCA		
SCRAN, AR FIX	CASKS, AR FIX	*6500
*3500 - MOCA		
CASKS, AR FIX	RAZORBACK, AR VORTAC	4000
RAZORBACK, AR VORTAC	GAMPS, AR FIX	3500
GAMPS, AR FIX	JENKY, MO FIX	*4000
*3100 - MOCA		

FROM	TO	MEA
------	----	-----

95.6527 VOR FEDERAL AIRWAY V527 - CONTINUED

JENKY, MO FIX	BILIE, MO FIX	3300
BILIE, MO FIX	SPRINGFIELD, MO VORTAC	3000

95.6528 VOR FEDERAL AIRWAY V528

*PHOENIX, AZ VORTAC	EAGUL, AZ FIX	**14500
*8000 - MCA PHOENIX, AZ VORTAC , NE BND		
**9400 - MOCA		
**10000 - GNSS MEA		
EAGUL, AZ FIX	*PAYSO, AZ FIX	**16000
*16000 - MRA		
**9800 - MOCA		
PAYSO, AZ FIX	ST JOHNS, AZ VORTAC	*13000
*9800 - MOCA		

95.6529 VOR FEDERAL AIRWAY V529

*FAMIN, FL FIX	SWAGS, FL FIX	**5700
*5700 - MRA		
**1500 - MOCA		
SWAGS, FL FIX	LA BELLE, FL VORTAC	*2000
*1400 - MOCA		

95.6530 VOR FEDERAL AIRWAY V530

TEXICO, TX VORTAC	CHILDRESS, TX VORTAC	6000
-------------------	----------------------	------

95.6531 VOR FEDERAL AIRWAY V531

PALM BEACH, FL VORTAC	*SHEDS, FL FIX	**3000
*3000 - MRA		
**2500 - MOCA		
SHEDS, FL FIX	BAIRN, FL FIX	*6000
*2000 - MOCA		
BAIRN, FL FIX	ORLANDO, FL VORTAC	2600

95.6532 VOR FEDERAL AIRWAY V532

LITTLE ROCK, AR VORTAC	*PARON, AR FIX	2600
*3500 - MRA		
PARON, AR FIX	GATZY, AR FIX	*3700
*3100 - MOCA		
GATZY, AR FIX	BLURB, AR FIX	*5500
*3200 - MOCA		
BLURB, AR FIX	BLIMP, AR FIX	*4100
*3600 - MOCA		
BLIMP, AR FIX	FORT SMITH, AR VORTAC	*2900
*2400 - MOCA		
FORT SMITH, AR VORTAC	*AKINS, OK FIX	2500
*3000 - MRA		

FROM	TO	MEA
------	----	-----

95.6532 VOR FEDERAL AIRWAY V532 - CONTINUED

AKINS, OK FIX *2200 - MOCA	OKMULGEE, OK VOR/DME	*3000
OKMULGEE, OK VOR/DME	PIONEER, OK VORTAC	3000
PIONEER, OK VORTAC	WICHITA, KS VORTAC	3600
WICHITA, KS VORTAC	SALINA, KS VORTAC	3600
SALINA, KS VORTAC *3000 - MOCA	LINCOLN, NE VORTAC	*5000

95.6533 VOR FEDERAL AIRWAY V533

ST PETERSBURG, FL VORTAC	LAKELAND, FL VORTAC	2000
LAKELAND, FL VORTAC *3000 - MRA	*CAMBE, FL FIX	1700
CAMBE, FL FIX	ORLANDO, FL VORTAC	1700
ORLANDO, FL VORTAC	OAKIE, FL FIX	2000
OAKIE, FL FIX *1600 - MOCA	ORMOND BEACH, FL VORTAC	*4000

95.6534 VOR FEDERAL AIRWAY V534

LITTLE ROCK, AR VORTAC	BIBBS, AR FIX	3500
BIBBS, AR FIX *2500 - MOCA	HAAWK, AR FIX	*4500
HAAWK, AR FIX *3300 - MRA **3100 - MOCA	*SCRAN, AR FIX	**4500
SCRAN, AR FIX *3000 - MRA **3000 - MOCA	*DRANO, AR FIX	**3500
DRANO, AR FIX *2100 - MOCA	FORT SMITH, AR VORTAC	*2600

95.6535 VOR FEDERAL AIRWAY V535

SIDON, MS VORTAC *2000 - MOCA	HOLLY SPRINGS, MS VORTAC	*3000
----------------------------------	--------------------------	-------

95.6536 VOR FEDERAL AIRWAY V536

NORTH BEND, OR VORTAC	*RARES, OR FIX N BND S BND	6000 3700
*5500 - MRA		
RARES, OR FIX	CORVALLIS, OR VOR/DME	6000
CORVALLIS, OR VOR/DME	SHEDD, OR FIX	3000
SHEDD, OR FIX	LATHE, OR FIX	4000
LATHE, OR FIX *8300 - MCA	*JAIME, OR FIX	6000
JAIME, OR FIX *7800 - MOCA	MANTE, OR FIX	*10000
MANTE, OR FIX	DESCHUTES, OR VORTAC	10000

FROM	TO	MEA
95.6536 VOR FEDERAL AIRWAY V536 – CONTINUED		
DESCHUTES, OR VORTAC	ZORNS, OR FIX NE BND SW BND	10000 7000
ZORNS, OR FIX *10000 - MRA **7700 - MOCA	*RENCE, OR FIX	**10000
RENCE, OR FIX *7700 - MOCA	HEPPE, OR FIX	*10000
HEPPE, OR FIX	PENDLETON, OR VORTAC NE BND SW BND	6000 10000
PENDLETON, OR VORTAC	WALLA WALLA, WA VOR/DME	4000
WALLA WALLA, WA VOR/DME *5700 - MOCA	PULLMAN, WA VOR/DME	*6000
PULLMAN, WA VOR/DME	MULLAN PASS, ID VOR/DME	9000
MULLAN PASS, ID VOR/DME *9000 - MCA KALISPELL, MT VOR/DME , E BND **9400 - MOCA	*KALISPELL, MT VOR/DME	**11500
KALISPELL, MT VOR/DME *10900 - MOCA	GAPAR, MT FIX	*13000
GAPAR, MT FIX *10600 - MCA PIKUN, MT FIX , W BND **11400 - MOCA	*PIKUN, MT FIX	**12000
PIKUN, MT FIX	*CHOTE, MT FIX W BND E BND	**10000 **9000
*9200 - MCA CHOTE, MT FIX , W BND **6900 - MOCA		
CHOTE, MT FIX	GREAT FALLS, MT VORTAC	7000
GREAT FALLS, MT VORTAC *9700 - MOCA	SWEDD, MT FIX	*12000
SWEDD, MT FIX *9200 - MCA MENAR, MT FIX , NW BND **9400 - MOCA	*MENAR, MT FIX	**10000
MENAR, MT FIX *9300 - MCA BOZEMAN, MT VOR/DME , SE BND	*BOZEMAN, MT VOR/DME	8700
SHERIDAN, WY VORTAC	GILLETTE, WY VOR/DME	7000
GILLETTE, WY VOR/DME	NEWCASTLE, WY VOR	7500
NEWCASTLE, WY VOR *9300 - MRA	*ZAMBI, SD FIX	9300
ZAMBI, SD FIX	*RAPID CITY, SD VORTAC E BND W BND	8000 9300
*6500 - MCA RAPID CITY, SD VORTAC , W BND		

95.6537 VOR FEDERAL AIRWAY V537

PALM BEACH, FL VORTAC *2000 - MOCA	STOOP, FL FIX	*3000
STOOP, FL FIX *1500 - MOCA	VERO BEACH, FL VORTAC	*2000
VERO BEACH, FL VORTAC *2500 - MRA	*PRESK, FL FIX	3000
PRESK, FL FIX *2000 - MOCA	CERMO, FL FIX	*8000
CERMO, FL FIX	OCALA, FL VORTAC	2000
OCALA, FL VORTAC *3000 - MRA	*LEJKO, FL FIX	2000
LEJKO, FL FIX	GATORS, FL VORTAC	2000
GATORS, FL VORTAC *2000 - MOCA	ALVIN, FL FIX	*3000

FROM	TO	MEA
95.6537 VOR FEDERAL AIRWAY V537 - CONTINUED		
ALVIN, FL FIX	GREENVILLE, FL VORTAC	2000
GREENVILLE, FL VORTAC	MOULTRIE, GA VOR/DME	*5000
*1600 - MOCA		
*2000 - GNSS MEA		
MOULTRIE, GA VOR/DME	MACON, GA VORTAC	*3000
*2400 - MOCA		
95.6538 VOR FEDERAL AIRWAY V538		
*TWENTYNINE PALMS, CA VORTAC	GOFFS, CA VORTAC	**12000
VORTAC		
*10200 - MCA TWENTYNINE PALMS, CA VORTAC , NE BND		
**7900 - MOCA		
**8000 - GNSS MEA		
GOFFS, CA VORTAC	LAS VEGAS, NV VORTAC	9000
95.6539 VOR FEDERAL AIRWAY V539		
KEY WEST, FL VORTAC	CORGI, FL FIX	1500
CORGI, FL FIX	GOODY, FL FIX	*4000
*1200 - MOCA		
GOODY, FL FIX	LEE COUNTY, FL VORTAC	2000
95.6540 VOR FEDERAL AIRWAY V540		
CUNNINGHAM, KY VORTAC	TAMMS, IL FIX	2800
TAMMS, IL FIX	FARMINGTON, MO VORTAC	3500
95.6541 VOR FEDERAL AIRWAY V541		
GADSDEN, AL VOR/DME	HOBBI, AL FIX	*3600
*2800 - MOCA		
HOBBI, AL FIX	DECATUR, AL VOR/DME	3000
DECATUR, AL VOR/DME	MUSCLE SHOALS, AL VORTAC	2500
95.6542 VOR FEDERAL AIRWAY V542		
ROSEWOOD, OH VORTAC	*LAWTO, OH FIX	4000
*4000 - MRA		
LAWTO, OH FIX	MANSFIELD, OH VORTAC	*4000
*2500 - MOCA		
MANSFIELD, OH VORTAC	AKRON, OH VOR/DME	3000
AKRON, OH VOR/DME	YOUNGSTOWN, OH VORTAC	*3000
*2600 - MOCA		
YOUNGSTOWN, OH VORTAC	HAGAR, PA FIX	3000
HAGAR, PA FIX	TIDIOUTE, PA VORTAC	3600
TIDIOUTE, PA VORTAC	BRADFORD, PA VOR/DME	*4000
*3500 - MOCA		
BRADFORD, PA VOR/DME	EXALL, PA FIX	4500
EXALL, PA FIX	ELMIRA, NY VOR/DME	4000
ELMIRA, NY VOR/DME	BINGHAMTON, NY VORTAC	3500
BINGHAMTON, NY VORTAC	OXFOR, NY FIX	3500
OXFOR, NY FIX	ROCKDALE, NY VOR/DME	4000
ROCKDALE, NY VOR/DME	ALBANY, NY VORTAC	4000

FROM	TO	MEA
------	----	-----

95.6542 VOR FEDERAL AIRWAY V542 - CONTINUED

ALBANY, NY VORTAC *3000 - MOCA #ALB R-067 UNUSABLE.	CAMBRIDGE, NY VOR/DME	#*4000
CAMBRIDGE, NY VOR/DME *5000 - MCA JAMMA, VT FIX , W BND	*JAMMA, VT FIX	6200
JAMMA, VT FIX	LEBANON, NH VOR/DME	5000

95.6543 VOR FEDERAL AIRWAY V543

LEEVILLE, LA VORTAC *1400 - MOCA	SAFES, LA FIX	*2000
SAFES, LA FIX *1600 - MOCA	WAVEZ, LA FIX	*4000
WAVEZ, LA FIX *1800 - MOCA	OYSTY, LA FIX	*3000
OYSTY, LA FIX RYTHM, LA FIX *2000 - MOCA	RYTHM, LA FIX EATON, MS VORTAC	2000 *4200
EATON, MS VORTAC *2000 - MOCA	BAING, MS FIX	*3000
BAING, MS FIX *5000 - MRA *3000 - MCA PAULD, MS FIX , SW BND	*PAULD, MS FIX	3000
PAULD, MS FIX	MERIDIAN, MS VORTAC	2100

95.6545 VOR FEDERAL AIRWAY V545

MILES CITY, MT VOR/DME *5200 - MOCA	WILLISTON, ND VORTAC	*6000
--	----------------------	-------

95.6546 VOR FEDERAL AIRWAY V546

WINK, TX VORTAC	NOTES, TX FIX	5500
NOTES, TX FIX	MIDLAND, TX VORTAC	5000
MIDLAND, TX VORTAC	BIG SPRING, TX VORTAC	4400

95.6547 VOR FEDERAL AIRWAY V547

CHEYENNE, WY VORTAC	HIPSHER, WY VOR/DME	9000
HIPSHER, WY VOR/DME	MUDDY MOUNTAIN, WY VORTAC	7900

95.6548 VOR FEDERAL AIRWAY V548

HOBBY, TX VOR/DME	SEALY, TX FIX	2000
SEALY, TX FIX	PRARI, TX FIX	3500
PRARI, TX FIX	COLLEGE STATION, TX VORTAC	2000
COLLEGE STATION, TX VORTAC	BARBA, TX FIX	2500
BARBA, TX FIX	BOSEL, TX FIX	3600
BOSEL, TX FIX	WACO, TX VORTAC	2800

FROM	TO	MEA
------	----	-----

95.6549 VOR FEDERAL AIRWAY V549

HAYS, KS VORTAC	MANKATO, KS VORTAC	4100
-----------------	--------------------	------

95.6550 VOR FEDERAL AIRWAY V550

COTULLA, TX VORTAC	LEMIG, TX FIX	2500
LEMIG, TX FIX	SAN ANTONIO, TX VORTAC	3000
SAN ANTONIO, TX VORTAC	*PINCH, TX FIX	3300
*3300 - MRA		
PINCH, TX FIX	CENTEX, TX VORTAC	3000

95.6551 VOR FEDERAL AIRWAY V551

SALINA, KS VORTAC	MANKATO, KS VORTAC	*4500
*3100 - MOCA		

95.6552 VOR FEDERAL AIRWAY V552

BEAUMONT, TX VOR/DME	LAKE CHARLES, LA VORTAC	2000
LAKE CHARLES, LA VORTAC	HATHA, LA FIX	2000
HATHA, LA FIX	LAFAYETTE, LA VORTAC	2800
LAFAYETTE, LA VORTAC	*GRICE, LA FIX	**2000
*4000 - MRA		
**1500 - MOCA		
GRICE, LA FIX	TIBBY, LA VORTAC	*2000
*1500 - MOCA		
TIBBY, LA VORTAC	HARVEY, LA VORTAC	2000
HARVEY, LA VORTAC	PICAYUNE, MS VOR/DME	2000
PICAYUNE, MS VOR/DME	*MINDO, MS FIX	2000
*6000 - MRA		
MINDO, MS FIX	SEMMES, AL VORTAC	2000
SEMMES, AL VORTAC	MONROEVILLE, AL VORTAC	2000

95.6553 VOR FEDERAL AIRWAY V553

SALINA, KS VORTAC	PAWNEE CITY, NE VORTAC	3400
-------------------	------------------------	------

95.6554 VOR FEDERAL AIRWAY V554

NATCHEZ, MS VOR/DME	*TULLO, LA FIX	**6000
*6000 - MCA TULLO, LA FIX , SE BND		
**1800 - MOCA		
TULLO, LA FIX	MONROE, LA VORTAC	2000

95.6555 VOR FEDERAL AIRWAY V555

PICAYUNE, MS VOR/DME	MC COMB, MS VORTAC	2000
MC COMB, MS VORTAC	*BANDO, MS FIX	2100
*3400 - MRA		
BANDO, MS FIX	JACKSON, MS VORTAC	2000

FROM	TO	MEA
------	----	-----

95.6555 VOR FEDERAL AIRWAY V555 - CONTINUED

JACKSON, MS VORTAC *3500 - MRA	*VAHNS, MS FIX	2000
VAHNS, MS FIX	SIDON, MS VORTAC	2000

95.6556 VOR FEDERAL AIRWAY V556

SAN ANGELO, TX VORTAC	JUNCTION, TX VORTAC	4000
JUNCTION, TX VORTAC	STONEWALL, TX VORTAC	4000
STONEWALL, TX VORTAC *4000 - MOCA	MARCS, TX FIX	*4500
MARCS, TX FIX *1900 - MOCA	SEEDS, TX FIX	*7500
SEEDS, TX FIX *1800 - MOCA	WEMAR, TX FIX	*2500
WEMAR, TX FIX	EAGLE LAKE, TX VOR/DME	2000
EAGLE LAKE, TX VOR/DME	KEEDS, TX FIX	2500
KEEDS, TX FIX	SCHOLES, TX VORTAC	3100
SCHOLES, TX VORTAC	SABINE PASS, TX VOR/DME	2000

95.6557 VOR FEDERAL AIRWAY V557

MC COMB, MS VORTAC *4200 - MRA	*BYRAM, MS FIX	2900
BYRAM, MS FIX	JACKSON, MS VORTAC	2900
JACKSON, MS VORTAC	SIDON, MS VORTAC	2000

95.6558 VOR FEDERAL AIRWAY V558

LLANO, TX VORTAC	SLIMM, TX FIX	3100
SLIMM, TX FIX	CENTEX, TX VORTAC	4100
CENTEX, TX VORTAC	MOUZE, TX FIX	2200
MOUZE, TX FIX	INDUSTRY, TX VORTAC	2100
INDUSTRY, TX VORTAC	EAGLE LAKE, TX VOR/DME	2000
EAGLE LAKE, TX VOR/DME *1500 - MOCA	BLUMS, TX FIX	*2100
BLUMS, TX FIX	HOBBY, TX VOR/DME	2400

95.6559 VOR FEDERAL AIRWAY V559

LAFAYETTE, LA VORTAC	BATON ROUGE, LA VORTAC	2000
----------------------	------------------------	------

95.6560 VOR FEDERAL AIRWAY V560

NEWMAN, TX VORTAC	MAYFY, TX FIX	9000
MAYFY, TX FIX *10500 - MRA **9000 - MOCA	*CONNE, TX FIX	**10500
CONNE, TX FIX	SALT FLAT, TX VORTAC	9000
SALT FLAT, TX VORTAC	CARLSBAD, NM VORTAC	8000

FROM	TO	MEA
------	----	-----

95.6561 VOR FEDERAL AIRWAY V561

GRAND FORKS, ND VOR/DME *3000 - MOCA	JAMESTOWN, ND VOR/DME	*4000
JAMESTOWN, ND VOR/DME *3400 - MOCA	PIERRE, SD VORTAC	*10000

95.6562 VOR FEDERAL AIRWAY V562

PHOENIX, AZ VORTAC	KNOBB, AZ FIX	8000
KNOBB, AZ FIX	RADOM, AZ FIX S BND	8000
	N BND	11000
RADOM, AZ FIX	*FERER, AZ FIX N BND	**12000
	S BND	**11000
*12000 - MRA		
*11000 - MCA FERER, AZ FIX, S BND		
**8400 - MOCA		
**9000 - GNSS MEA		

FERER, AZ FIX **9200 - MOCA	DRAKE, AZ VORTAC	**10000
DRAKE, AZ VORTAC *8900 - MOCA	PEACH SPRINGS, AZ VORTAC	*9000
PEACH SPRINGS, AZ VORTAC	*MEADS, NV FIX	9000
*9000 - MCA MEADS, NV FIX, SE BND		
MEADS, NV FIX	LAS VEGAS, NV VORTAC	6000

95.6563 VOR FEDERAL AIRWAY V563

LUBBOCK, TX VORTAC	BIG SPRING, TX VORTAC	5200
--------------------	-----------------------	------

95.6564 VOR FEDERAL AIRWAY V564

COALDALE, NV VORTAC	MINA, NV VORTAC	11500
MINA, NV VORTAC	YERIN, NV FIX	11500
YERIN, NV FIX	CHIME, NV FIX NW BND	10000
	SE BND	11500
CHIME, NV FIX	MUSTANG, NV VORTAC	10000

95.6565 VOR FEDERAL AIRWAY V565

LLANO, TX VORTAC	AMUSE, TX FIX	3300
AMUSE, TX FIX	CENTEX, TX VORTAC	3100
CENTEX, TX VORTAC	COLLEGE STATION, TX VORTAC	2200
COLLEGE STATION, TX VORTAC	LUFKIN, TX VORTAC	*4000
*2000 - MOCA		

FROM	TO	MEA
95.6566 VOR FEDERAL AIRWAY V566		
GREGG COUNTY, TX VORTAC *3000 - MRA	*WORKS, TX FIX	2300
WORKS, TX FIX	BELCHER, LA VORTAC	3100
BELCHER, LA VORTAC	KNELT, LA FIX	2300
KNELT, LA FIX *1800 - MOCA	COVEX, LA FIX	*3500
COVEX, LA FIX *6000 - MRA **1700 - MOCA	*NUBOY, LA FIX	**4500
NUBOY, LA FIX	BOYCE, LA FIX SE BND	2000
	NW BND	4500
BOYCE, LA FIX	ALEXANDRIA, LA VORTAC	2000
ALEXANDRIA, LA VORTAC *1700 - MOCA	MUSHE, LA FIX	*3000
MUSHE, LA FIX *4000 - MRA **1700 - MOCA	*WRACK, LA FIX	**4000
WRACK, LA FIX *2100 - MOCA	VEILS, LA FIX	*3000
VEILS, LA FIX *1500 - MOCA	RESERVE, LA VOR/DME	*2000

95.6567 VOR FEDERAL AIRWAY V567

PHOENIX, AZ VORTAC	KNOBB, AZ FIX	8000
KNOBB, AZ FIX	RADOM, AZ FIX S BND	8000
	N BND	11000
RADOM, AZ FIX	*FERER, AZ FIX N BND	**12000
	S BND	**11000
*12000 - MRA		
*14000 - MCA FERER, AZ FIX , NE BND		
*11000 - MCA FERER, AZ FIX , S BND		
**8400 - MOCA		
**9000 - GNSS MEA		
FERER, AZ FIX	WINSLOW, AZ VORTAC	*14000
*10000 - GNSS MEA		

95.6568 VOR FEDERAL AIRWAY V568

CORPUS CHRISTI, TX VORTAC	THREE RIVERS, TX VORTAC	1800
THREE RIVERS, TX VORTAC	LEMIG, TX FIX	2000
LEMIG, TX FIX	SAN ANTONIO, TX VORTAC	3000
SAN ANTONIO, TX VORTAC *2800 - MOCA	GUADA, TX FIX	*4000
GUADA, TX FIX	STONEWALL, TX VORTAC	4000
STONEWALL, TX VORTAC	LLANO, TX VORTAC	3700
LLANO, TX VORTAC *6000 - MRA **2800 - MOCA	*BUILT, TX FIX	**6000
BUILT, TX FIX *3000 - MOCA	GLEN ROSE, TX VORTAC	*3500
GLEN ROSE, TX VORTAC	MILLSAP, TX VORTAC	3000
MILLSAP, TX VORTAC	KARYN, TX FIX	3000
KARYN, TX FIX	WICHITA FALLS, TX VORTAC	3100

FROM	TO	MEA
------	----	-----

95.6569 VOR FEDERAL AIRWAY V569

BEAUMONT, TX VOR/DME	SILBE, TX FIX	2000
SILBE, TX FIX	LUFKIN, TX VORTAC	2500
LUFKIN, TX VORTAC	FRANKSTON, TX VOR/DME	2300
FRANKSTON, TX VOR/DME	CEDAR CREEK, TX VORTAC	2000

95.6570 VOR FEDERAL AIRWAY V570

ALEXANDRIA, LA VORTAC	NATCHEZ, MS VOR/DME	2000
NATCHEZ, MS VOR/DME	MC COMB, MS VORTAC	2000

95.6571 VOR FEDERAL AIRWAY V571

HUMBLE, TX VORTAC	NAVASOTA, TX VORTAC	2000
NAVASOTA, TX VORTAC	LEONA, TX VORTAC	3000
LEONA, TX VORTAC	ALLMO, TX FIX	2100
ALLMO, TX FIX	CEDAR CREEK, TX VORTAC	*2300
*1700 - MOCA		

95.6572 VOR FEDERAL AIRWAY V572

WINSLOW, AZ VORTAC	*FRISY, AZ FIX	10000
*10500 - MCA FRISY, AZ FIX , W BND		
FRISY, AZ FIX	FLAGSTAFF, AZ VOR/DME	11500

95.6573 VOR FEDERAL AIRWAY V573

WILL ROGERS, OK VORTAC	*ALEXX, OK FIX	3100
*7000 - MRA		
ALEXX, OK FIX	ARDMORE, OK VORTAC	*4000
*2900 - MOCA		
ARDMORE, OK VORTAC	BONHAM, TX VORTAC	3600
BONHAM, TX VORTAC	SULPHUR SPRINGS, TX VOR/DME	2500
SULPHUR SPRINGS, TX VOR/DME	TEXARKANA, AR VORTAC	2000
TEXARKANA, AR VORTAC	PIKES, AR FIX	*3500
*1800 - MOCA		
PIKES, AR FIX	MARKI, AR FIX	*3500
*2100 - MOCA		
MARKI, AR FIX	HOT SPRINGS, AR VOR/DME	*3500
*2500 - MOCA		
HOT SPRINGS, AR VOR/DME	LONNS, AR FIX	3000
LONNS, AR FIX	LITTLE ROCK, AR VORTAC	*2500
*1900 - MOCA		

FROM	TO	MEA
------	----	-----

95.6574 VOR FEDERAL AIRWAY V574

CENTEX, TX VORTAC	MOUZE, TX FIX	2200
MOUZE, TX FIX	NAVASOTA, TX VORTAC	2100
NAVASOTA, TX VORTAC	HUMBLE, TX VORTAC	2000
HUMBLE, TX VORTAC	DAISETTA, TX VORTAC	2000
DAISETTA, TX VORTAC	BEAUMONT, TX VOR/DME	2300
BEAUMONT, TX VOR/DME	LAKE CHARLES, LA VORTAC	2000

95.6575 VOR FEDERAL AIRWAY V575

LARAMIE, WY VOR/DME	*NIWOT, CO FIX	11300
*9500 - MCA NIWOT, CO FIX , NW BND		
NIWOT, CO FIX	MILE HIGH, CO VORTAC	8000

95.6576 VOR FEDERAL AIRWAY V576

PHILIPSBURG, PA VORTAC	WILLIAMSPORT, PA VOR/DME	4000
WILLIAMSPORT, PA VOR/DME	HANCOCK, NY VOR/DME	4000
HANCOCK, NY VOR/DME	DELANCEY, NY VOR/DME	4000

95.6577 VOR FEDERAL AIRWAY V577

CEDAR LAKE, NJ VORTAC	BRIGS, NJ FIX	1700
-----------------------	---------------	------

95.6578 VOR FEDERAL AIRWAY V578

PECAN, GA VORTAC	TIFT MYERS, GA VOR	2500
TIFT MYERS, GA VOR	ALMA, GA VORTAC	*3000
*1900 - MOCA		
ALMA, GA VORTAC	SAVANNAH, GA VORTAC	*10000
*2600 - MOCA		
*3000 - GNSS MEA		

95.6579 VOR FEDERAL AIRWAY V579

LEE COUNTY, FL VORTAC	VIOLA, FL FIX	2000
VIOLA, FL FIX	SARASOTA, FL VORTAC	3000
SARASOTA, FL VORTAC	ST PETERSBURG, FL VORTAC	2000
ST PETERSBURG, FL VORTAC	BAYPO, FL FIX	2000
BAYPO, FL FIX	*NITTS, FL FIX	**4000
*3000 - MRA		
**1700 - MOCA		
NITTS, FL FIX	GATORS, FL VORTAC	*3000
*2000 - MOCA		
GATORS, FL VORTAC	CROSS CITY, FL VORTAC	2000
CROSS CITY, FL VORTAC	VALDOSTA, GA VOR/DME	2000
VALDOSTA, GA VOR/DME	TIFT MYERS, GA VOR	2200
TIFT MYERS, GA VOR	VIENNA, GA VORTAC	2100

FROM	TO	MEA
------	----	-----

95.6580 VOR FEDERAL AIRWAY V580

ST LOUIS, MO VORTAC *2200 - MOCA	LEBOY, IL FIX	*3000
LEBOY, IL FIX	SEXTN, IL FIX	4500
SEXTN, IL FIX	BURLINGTON, IA VORTAC	3000

95.6581 VOR FEDERAL AIRWAY V581

ST PETERSBURG, FL VORTAC	TUMPY, FL FIX	2000
TUMPY, FL FIX	DADES, FL FIX	*5000
*2000 - GNSS MEA		
DADES, FL FIX	OCALA, FL VORTAC	2000

95.6582 VOR FEDERAL AIRWAY V582

ST LOUIS, MO VORTAC *2200 - MOCA	LEBOY, IL FIX	*3000
LEBOY, IL FIX	QUINCY, IL VORTAC	3000

95.6583 VOR FEDERAL AIRWAY V583

CENTEX, TX VORTAC	TOAMY, TX FIX	2200
TOAMY, TX FIX	COLLEGE STATION, TX VORTAC	2200
COLLEGE STATION, TX VORTAC	LEONA, TX VORTAC	2000
LEONA, TX VORTAC	FRANKSTON, TX VOR/DME	2300
FRANKSTON, TX VOR/DME	QUITMAN, TX VOR/DME	2300
QUITMAN, TX VOR/DME	PARIS, TX VOR/DME	2100
PARIS, TX VOR/DME	MC ALESTER, OK VORTAC	*3000
*2500 - MOCA		

95.6584 VOR FEDERAL AIRWAY V584

WATERVILLE, OH VOR/DME *2200 - MOCA	DRYER, OH VOR/DME	*3000
--	-------------------	-------

95.6585 VOR FEDERAL AIRWAY V585

CLOVIS, CA VORTAC	*MENDO, CA FIX	2000
*3000 - MCA MENDO, CA FIX , SW BND		
MENDO, CA FIX	PANOCHÉ, CA VORTAC	4500
PANOCHÉ, CA VORTAC	VOLTA, CA FIX	5000
VOLTA, CA FIX	#MANTECA, CA VORTAC	*3000
*3000 - GNSS MEA		
#MANTECA R-147 UNUSABLE		
MANTECA, CA VORTAC	LODDI, CA FIX	2000
LODDI, CA FIX	SACRAMENTO, CA VORTAC	3000

FROM	TO	MEA
95.6586 VOR FEDERAL AIRWAY V586		
EXCEL, MO FIX *2300 - MOCA	MACON, MO VOR/DME	*3000
MACON, MO VOR/DME *2100 - MOCA	QUINCY, IL VORTAC	*2700
QUINCY, IL VORTAC *2000 - MOCA	PEORIA, IL VORTAC	*2500
PEORIA, IL VORTAC *2300 - MOCA	MAROC, IL FIX	*3000
MAROC, IL FIX	PONTIAC, IL VOR/DME	2400
PONTIAC, IL VOR/DME *2200 - MOCA	JOLIET, IL VORTAC	*3000

95.6587 VOR FEDERAL AIRWAY V587

HOMELAND, CA VOR *9300 - MCA LUCER, CA FIX , SW BND	*LUCER, CA FIX	10500
LUCER, CA FIX *8000 - MOCA	BULGY, CA FIX	*9000
BULGY, CA FIX	DAGGETT, CA VORTAC	8000
DAGGETT, CA VORTAC *12000 - MRA	*WHIGG, CA FIX	10000
WHIGG, CA FIX	BOULDER CITY, NV VORTAC	10000

95.6589 VOR FEDERAL AIRWAY V589

MEDICINE BOW, WY VOR/DME *9900 - MRA	*ALCOS, WY FIX	9900
ALCOS, WY FIX	MUDDY MOUNTAIN, WY VORTAC NE BND	*8400
	SW BND	*9700
*7900 - MOCA		

95.6591 VOR FEDERAL AIRWAY V591

GRAND JUNCTION, CO VOR/DME	PACES, CO FIX	11500
PACES, CO FIX	SLOLM, CO FIX	13000
SLOLM, CO FIX *16000 - MRA	*GLENO, CO FIX	14000
GLENO, CO FIX	SNOW, CO VOR/DME	14000
SNOW, CO VOR/DME	KREMMLING, CO VOR/DME	14500

95.6595 VOR FEDERAL AIRWAY V595

*ROGUE VALLEY, OR VORTAC	CUTTR, OR FIX NE BND	10500
	SW BND	6100
*5100 - MCA ROGUE VALLEY, OR	VORTAC , NE BND	
CUTTR, OR FIX	COPPR, OR FIX	10500
COPPR, OR FIX	DRACK, OR FIX	
	NE BND	9900
	SW BND	10500

FROM TO MEA

95.6595 VOR FEDERAL AIRWAY V595 - CONTINUED

DRACK, OR FIX	*DESCHUTES, OR VORTAC NE BND SW BND	6200 10500
*7900 - MCA	DESCHUTES, OR VORTAC , SW BND	
*9300 - MCA	DESCHUTES, OR VORTAC , NW BND	
DESCHUTES, OR VORTAC	JAYTE, OR FIX NW BND SE BND	12600 9000
JAYTE, OR FIX	JEFSN, OR FIX	12600
JEFSN, OR FIX	*HARZL, OR FIX NW BND SE BND	8000 12600
*7200 - MRA		
*9300 - MCA	HARZL, OR FIX , SE BND	
HARZL, OR FIX	*PORTLAND, OR VOR/DME	7000
*5500 - MCA	PORTLAND, OR VOR/DME , SE BND	

95.6597 VOR FEDERAL AIRWAY V597

SAN MARCUS, CA VORTAC	*OHIGH, CA FIX	8000
*9000 - MRA		
OHIGH, CA FIX	*FILLMORE, CA VORTAC	8000
*6100 - MCA	FILLMORE, CA VORTAC , W BND	
FILLMORE, CA VORTAC	VAN NUYS, CA VOR/DME	5500
VAN NUYS, CA VOR/DME	DARTS, CA FIX	5000
DARTS, CA FIX	SEAL BEACH, CA VORTAC NW BND SE BND	6000 4000
SEAL BEACH, CA VORTAC	BALBO, CA FIX NW BND SE BND	3000 4000
BALBO, CA FIX	OCEANSIDE, CA VORTAC	4000
OCEANSIDE, CA VORTAC	MISSION BAY, CA VORTAC	3000

95.6599 VOR FEDERAL AIRWAY V599

LEE COUNTY, FL VORTAC	THNDR, FL FIX	*3000
*1500 - MOCA		
THNDR, FL FIX	DOLPHIN, FL VORTAC	*3000
*1500 - MOCA		

95.6601 VOR FEDERAL AIRWAY V601

PAHOKEE, FL VORTAC	*DEEDS, FL FIX	**3000
*4000 - MRA		
**1600 - MOCA		
**2000 - GNSS MEA		
DEEDS, FL FIX	KEY WEST, FL VORTAC	*7000
*1400 - MOCA		
*2000 - GNSS MEA		

FROM	TO	MEA
------	----	-----

95.6605 VOR FEDERAL AIRWAY V605

HOLSTON MOUNTAIN, TN VORTAC *15000 - MRA	*GENOD, NC FIX	8500
GENOD, NC FIX *4200 - MOCA *5000 - GNSS MEA	SPARTANBURG, SC VORTAC	*15000

95.6607 VOR FEDERAL AIRWAY V607

MENDOCINO, CA VORTAC	YAGER, CA FIX	9000
YAGER, CA FIX	ARCATA, CA VOR/DME	8000

95.6609 VOR FEDERAL AIRWAY V609

SAGINAW, MI VOR/DME	BENNY, MI FIX	2200
BENNY, MI FIX *2200 - MOCA	BANJO, MI FIX	*3000
BANJO, MI FIX *2900 - MOCA	ZABLE, MI FIX	*5000
ZABLE, MI FIX *5000 - MRA	*RONDO, MI FIX	3000
RONDO, MI FIX *2400 - MOCA	OTREE, MI FIX	*3000
OTREE, MI FIX *2400 - MOCA	PELLSTON, MI VORTAC	*3000

95.6611 VOR FEDERAL AIRWAY V611

NEWMAN, TX VORTAC *10000 - MRA	*MOLLY, NM FIX	9000
MOLLY, NM FIX	TRUTH OR CONSEQUENCES, NM VORTAC	10000
TRUTH OR CONSEQUENCES, NM VORTAC	SOCORRO, NM VORTAC	9000
SOCORRO, NM VORTAC	ALBUQUERQUE, NM VORTAC	8000
ALBUQUERQUE, NM VORTAC *11600 - MCA SANTA FE, NM VORTAC , E BND	*SANTA FE, NM VORTAC	9000
SANTA FE, NM VORTAC *10900 - MCA FORT UNION, NM VORTAC , N BND *11300 - MCA FORT UNION, NM VORTAC , W BND	*FORT UNION, NM VORTAC	12500
FORT UNION, NM VORTAC *11100 - MOCA	CIMARRON, NM VORTAC	*12000
CIMARRON, NM VORTAC *10200 - MOCA	GOSIP, CO FIX	*11000
GOSIP, CO FIX	PUEBLO, CO VORTAC	8300
PUEBLO, CO VORTAC *10000 - MCA BLACK FOREST, CO VORTAC , NE BND	*BLACK FOREST, CO VORTAC	9500
BLACK FOREST, CO VORTAC #GNSS MEA #BLACK FOREST R-023 UNUSABLE	LUFSE, CO FIX	#10000
LUFSE, CO FIX *10500 - MRA #GNSS MEA	*JEFEL, CO FIX	#10500
JEFEL, CO FIX *9000 - MRA #GNSS MEA	*LIMEX, CO FIX	#8500

FROM TO MEA

95.6611 VOR FEDERAL AIRWAY V611 -CONTINUED

*LIMEX, CO FIX	GILL, CO VOR/DME	7600
*16000 - MCA LIMEX, CO FIX , SW BND		
GILL, CO VOR/DME	CHEYENNE, WY VORTAC	8500
CHEYENNE, WY VORTAC	MOIST, WY FIX	9000
MOIST, WY FIX	DEALT, WY FIX	11500
DEALT, WY FIX	MUDDY MOUNTAIN, WY VORTAC	
	NW BND	9000
	SE BND	10000
MUDDY MOUNTAIN, WY VORTAC	CRAZY WOMAN, WY VOR/DME	7600
CRAZY WOMAN, WY VOR/DME	SHERIDAN, WY VORTAC	9000
SHERIDAN, WY VORTAC	KRONA, MT FIX	8000
KRONA, MT FIX	BILLINGS, MT VORTAC	
	SE BND	8000
	NW BND	6200
BILLINGS, MT VORTAC	*SHELA, MT FIX	
	SE BND	6100
	NW BND	7700
*9700 - MRA		
SHELA, MT FIX	LEWISTOWN, MT VOR/DME	7700
LEWISTOWN, MT VOR/DME	SHONK, MT FIX	7700
SHONK, MT FIX	HAVRE, MT VOR/DME	6000

95.6613 VOR FEDERAL AIRWAY V613

ALLENTOWN, PA VORTAC	WILKES-BARRE, PA VORTAC	4000
----------------------	-------------------------	------

95.6615 VOR FEDERAL AIRWAY V615

RALEIGH/DURHAM, NC VORTAC	DUFFI, NC FIX	2500
DUFFI, NC FIX	HOPEWELL, VA VORTAC	*5000
*2500 - MOCA		
*2500 - GNSS MEA		

95.6623 VOR FEDERAL AIRWAY V623

SPARTA, NJ VORTAC	CARMEL, NY VOR/DME	3000
-------------------	--------------------	------

95.6625 VOR FEDERAL AIRWAY V625

U.S. MEXICAN BORDER	NOGALES, AZ VOR/DME	*10000
*9500 - MOCA		

95.6626 VOR FEDERAL AIRWAY V626

MYTON, UT VORTAC	YMONT, UT FIX	*15000
*12600 - MOCA		
*12600 - GNSS MEA		

FROM TO MEA

&95.6301 ALASKA VOR FEDERAL AIRWAYS

95.6301 ALASKA VOR FEDERAL AIRWAY V301

FAIRBANKS, AK VORTAC *7300 - MOCA	DIFER, AK FIX	*8000
DIFER, AK FIX	FORT YUKON, AK VORTAC SE BND NW BND	8000 2300

95.6302 ALASKA VOR FEDERAL AIRWAY V302

FAIRBANKS, AK VORTAC	MAYPO, AK FIX	7000
MAYPO, AK FIX	FORT YUKON, AK VORTAC SW BND NE BND	7000 2300

95.6308 ALASKA VOR FEDERAL AIRWAY V308

BETHEL, AK VORTAC	FISHH, AK FIX E BND W BND	*8000 *2000
*1400 - MOCA FISHH, AK FIX *6000 - MOCA *6000 - GNSS MEA	SPARREVOHN, AK VOR/DME	*8000

95.6309 ALASKA VOR FEDERAL AIRWAY V309

U.S. CANADIAN BORDER *4900 - MOCA	ANNETTE ISLAND, AK VOR/DME	*5000
--------------------------------------	----------------------------	-------

95.6311 ALASKA VOR FEDERAL AIRWAY V311

ANNETTE ISLAND, AK VOR/DME	TOKEE, AK FIX	6000
TOKEE, AK FIX *6300 - MOCA	FLIPS, AK FIX	#*7500
#MEA IS ESTABLISHED WITH A GAP IN NAVIGATION SIGNAL COVERAGE.		
FLIPS, AK FIX	BIORKA ISLAND, AK VORTAC	6000

FROM	TO	MEA
95.6317 ALASKA VOR FEDERAL AIRWAY V317		
U.S. CANADIAN BORDER	ANNETTE ISLAND, AK VOR/DME	5000
ANNETTE ISLAND, AK VOR/DME	GESTI, AK FIX	5000
GESTI, AK FIX *5000 - MOCA *5000 - GNSS MEA	LEVEL ISLAND, AK VOR/DME	*7000
LEVEL ISLAND, AK VOR/DME *5900 - MOCA *7000 - GNSS MEA	HOODS, AK FIX	*9000
HOODS, AK FIX *5500 - MOCA *6000 - GNSS MEA	SISTERS ISLAND, AK VORTAC	*7000
SISTERS ISLAND, AK VORTAC *5000 - MOCA *5000 - GNSS MEA	CSPER, AK FIX	*7000
CSPER, AK FIX *15000 - MRA **4100 - MOCA **5000 - GNSS MEA	*HAPIT, AK FIX	**15000
95.6318 ALASKA VOR FEDERAL AIRWAY V318		
ANNETTE ISLAND, AK VOR/DME	LEVEL ISLAND, AK VOR/DME	6000
95.6319 ALASKA VOR FEDERAL AIRWAY V319		
YAKUTAT, AK VOR/DME	MALAS, AK FIX E BND	2400
	W BND	10000
MALAS, AK FIX *5600 - MOCA	KATAT, AK FIX	#*10000
	#MEA IS ESTABLISHED WITH A GAP IN NAVIGATION SIGNAL COVERAGE.	
KATAT, AK FIX *3400 - MOCA	CASEL, AK FIX	*7000
CASEL, AK FIX *4800 - MCA	*JOHNSTONE POINT, AK VOR/DME	4800
JOHNSTONE POINT, AK VOR/DME	*EDELE, AK FIX	4400
*8000 - MCA EDELE, AK FIX , W BND		
EDELE, AK FIX *7500 - MOCA *7500 - GNSS MEA	ANCHORAGE, AK VOR/DME	*13000
ANCHORAGE, AK VOR/DME	YONEK, AK FIX	3000
YONEK, AK FIX	*TORTE, AK FIX SW BND	**12000
	NE BND	**6000
*8100 - MCA TORTE, AK FIX , W BND **4200 - MOCA		
TORTE, AK FIX	*VEILL, AK FIX	**12000
*10000 - MCA VEILL, AK FIX , E BND **10600 - MOCA		

FROM TO MEA

95.6319 ALASKA VOR FEDERAL AIRWAY V319 - CONTINUED

VEILL, AK FIX	SPARREVOHN, AK VOR/DME	
	E BND	12000
	W BND	6200
SPARREVOHN, AK VOR/DME	ACRAN, AK FIX	
	W BND	*6000
	E BND	*5200
*5200 - MOCA		
ACRAN, AK FIX	VIDDA, AK FIX	6000
VIDDA, AK FIX	WEEKE, AK FIX	
	SW BND	*6000
	NE BND	*3000
*2100 - MOCA		
WEEKE, AK FIX	BETHEL, AK VORTAC	2000
BETHEL, AK VORTAC	ARSEN, AK FIX	2000
ARSEN, AK FIX	FANCI, AK FIX	*4000
*2000 - MOCA		
*2000 - GNSS MEA		
FANCI, AK FIX	HOOPER BAY, AK VOR/DME	2000
HOOPER BAY, AK VOR/DME	NANWAK, AK NDB/DME	2300

95.6320 ALASKA VOR FEDERAL AIRWAY V320

JOHNSTONE POINT, AK	KEBAB, AK FIX	5000
VOR/DME		
KEBAB, AK FIX	NELLI, AK FIX	*5000
*4400 - MOCA		
NELLI, AK FIX	NOWEL, AK FIX	*10000
*8500 - MOCA		
NOWEL, AK FIX	HOPER, AK FIX	*8500
* GNSS MEA		
HOPER, AK FIX	*ANCHORAGE, AK VOR/DME	**7000
*5000 - MCA ANCHORAGE, AK	VOR/DME , E BND	
**6000 - MOCA		
**6000 - GNSS MEA		

95.6321 ALASKA VOR FEDERAL AIRWAY V321

CAPE NEWENHAM, AK NDB/DME	KING SALMON, AK VORTAC	*5000
*4300 - MOCA		
KING SALMON, AK VORTAC	BATTY, AK FIX	
	NE BND	7000
	SW BND	6000
BATTY, AK FIX	AUGEY, AK FIX	7000
AUGEY, AK FIX	HOMER, AK VOR/DME	*4000
*3000 - MOCA		

95.6322 ALASKA VOR FEDERAL AIRWAY V322

KING SALMON, AK VORTAC	KONIC, AK FIX	*5000
*5000 - MOCA		
KONIC, AK FIX	WORRI, AK FIX	*9000
*7700 - MOCA		
*7700 - GNSS MEA		

FROM	TO	MEA
------	----	-----

95.6322 ALASKA VOR FEDERAL AIRWAY V322 - CONTINUED

WORRI, AK FIX *8500 - MOCA	MALLT, AK FIX	*9000
MALLT, AK FIX	HOMER, AK VOR/DME SW BND NE BND	9000 4000

95.6333 ALASKA VOR FEDERAL AIRWAY V333

HOOPER BAY, AK VOR/DME	HALEM, AK FIX	4500
HALEM, AK FIX *2300 - MOCA	FAIRE, AK FIX	*8000
FAIRE, AK FIX	NOME, AK VOR/DME	3000
NOME, AK VOR/DME	GAITS, AK FIX N BND S BND	10000 4000
GAITS, AK FIX *6700 - MOCA	SHISHMAREF, AK NDB	*10000

95.6334 ALASKA VOR FEDERAL AIRWAY V334

AUGEY, AK FIX *2000 - MOCA *2000 - GNSS MEA	CLAMS, AK FIX	*7000
CLAMS, AK FIX	KENAI, AK VOR/DME	2000
KENAI, AK VOR/DME	ANCHORAGE, AK VOR/DME	2000

95.6350 ALASKA VOR FEDERAL AIRWAY V350

DILLINGHAM, AK VOR/DME	TOGIAK, AK NDB/DME	5000
TOGIAK, AK NDB/DME	BAFIN, AK FIX	5000
BAFIN, AK FIX	BETHEL, AK VORTAC E BND W BND	5000 2000
BETHEL, AK VORTAC	DAHLS, AK FIX W BND E BND	3600 2000
DAHLS, AK FIX *3000 - MOCA *3000 - GNSS MEA	EMMONAK, AK VOR/DME	*3600
EMMONAK, AK VOR/DME	NOME, AK VOR/DME	3000

95.6351 ALASKA VOR FEDERAL AIRWAY V351

DILLINGHAM, AK VOR/DME	PORT HEIDEN, AK NDB/DME	3000
------------------------	-------------------------	------

95.6357 ALASKA VOR FEDERAL AIRWAY V357

KODIAK, AK VOR/DME	INNOL, AK FIX	3500
INNOL, AK FIX *3000 - MOCA	MOCHO, AK FIX	*4000
MOCHO, AK FIX *2300 - MOCA *7000 - GNSS MEA	GERKS, AK FIX	*7500

FROM	TO	MEA
95.6357 ALASKA VOR FEDERAL AIRWAY V357 - CONTINUED		
GERKS, AK FIX *3700 - MOCA *7000 - GNSS MEA	SANER, AK FIX	*9000
SANER, AK FIX	HOMER, AK VOR/DME	6000
95.6385 ALASKA VOR FEDERAL AIRWAY V385		
HOOPER BAY, AK VOR/DME EMMONAK, AK VOR/DME *2800 - MOCA *3000 - GNSS MEA	EMMONAK, AK VOR/DME UNALAKLEET, AK VOR/DME	4500 *3500
95.6388 ALASKA VOR FEDERAL AIRWAY V388		
ANCHORAGE, AK VOR/DME NAPTO, AK FIX	NAPTO, AK FIX KENAI, AK VOR/DME	2400 2500
95.6401 ALASKA VOR FEDERAL AIRWAY V401		
AMBLER, AK NDB/DME *4700 - MOCA FARME, AK FIX KOTZEBUE, AK VOR/DME *2000 - MOCA	FARME, AK FIX KOTZEBUE, AK VOR/DME SHISHMAREF, AK NDB	*5500 2000 *2500
95.6414 ALASKA VOR FEDERAL AIRWAY V414		
GAMBELL, AK NDB/DME	KUKULIAK, AK VOR/DME	3000
95.6427 ALASKA VOR FEDERAL AIRWAY V427		
KING SALMON, AK VORTAC TOMMY, AK FIX *5300 - MOCA *6000 - GNSS MEA RINGO, AK FIX *9000 - MOCA *9000 - GNSS MEA	TOMMY, AK FIX RINGO, AK FIX NONDA, AK FIX	3000 *7000 *14000
95.6428 ALASKA VOR FEDERAL AIRWAY V428		
BIORKA ISLAND, AK VORTAC *6000 - MOCA *6000 - GNSS MEA	SISTERS ISLAND, AK VORTAC	*7000

FROM TO MEA

95.6428 ALASKA VOR FEDERAL AIRWAY V428 - CONTINUED

SISTERS ISLAND, AK VORTAC *8500 - MOCA *8500 - GNSS MEA #MEA IS ESTABLISHED WITH A GAP IN NAVIGATION SIGNAL COVERAGE.	HAINES, AK NDB	#*10000
HAINES, AK NDB *9600 - MOCA	U.S. CANADIAN BORDER	*10000

95.6435 ALASKA VOR FEDERAL AIRWAY V435

HOMER, AK VOR/DME	KASSI, AK FIX	4400
KASSI, AK FIX	KENAI, AK VOR/DME	2000

95.6436 ALASKA VOR FEDERAL AIRWAY V436

ANCHORAGE, AK VOR/DME *3800 - MCA TALKEETNA, AK VOR/DME , N BND	*TALKEETNA, AK VOR/DME	3000
TALKEETNA, AK VOR/DME *7600 - MCA EGRAM, AK FIX , N BND	*EGRAM, AK FIX	6000
EGRAM, AK FIX	NENANA, AK VORTAC	10000
NENANA, AK VORTAC	GOLLY, AK FIX	4000
GOLLY, AK FIX *3400 - MOCA	TOLLO, AK FIX	*4000
TOLLO, AK FIX	LIVEN, AK FIX	5000
LIVEN, AK FIX *5500 - MOCA	BEETE, AK FIX	*10000
BEETE, AK FIX *6900 - MOCA	CHANDALAR LAKE, AK NDB	*10000
CHANDALAR LAKE, AK NDB *7000 - MCA ARTIC, AK FIX , S BND	*ARTIC, AK FIX	10000
ARTIC, AK FIX **4500 - MOCA **5000 - GNSS MEA	PIPET, AK FIX	**6000
PIPET, AK FIX *3700 - MOCA *4000 - GNSS MEA	BIXER, AK FIX	*5000
BIXER, AK FIX	ARCON, AK FIX	3000
ARCON, AK FIX *1300 - MOCA	DEADHORSE, AK VOR/DME	*2000

95.6438 ALASKA VOR FEDERAL AIRWAY V438

KODIAK, AK VOR/DME	SHUYA, AK FIX	4000
SHUYA, AK FIX *5900 - MOCA	HOMER, AK VOR/DME	*6000
HOMER, AK VOR/DME *4900 - MOCA	SKILA, AK FIX	*5000
SKILA, AK FIX	NAPTO, AK FIX	2500
NAPTO, AK FIX	ANCHORAGE, AK VOR/DME	2400
ANCHORAGE, AK VOR/DME *4700 - MCA BIG LAKE, AK VORTAC , N BND	*BIG LAKE, AK VORTAC	2000
BIG LAKE, AK VORTAC	SURES, AK FIX	#7500
#MEA IS ESTABLISHED WITH A GAP IN NAVIGATION SIGNAL COVERAGE.		
SURES, AK FIX *12000 - MRA **8700 - MOCA	*CAWIN, AK FIX	**10000
CAWIN, AK FIX *8700 - MOCA	LIBER, AK FIX	*10000

FROM TO MEA

95.6438 ALASKA VOR FEDERAL AIRWAY V438 – CONTINUED

LIBER, AK FIX	*GLOWS, AK FIX	**7500
*4800 - MCA GLOWS, AK FIX , S BND		
**6800 - MOCA		
GLOWS, AK FIX	FAIRBANKS, AK VORTAC	2600
FAIRBANKS, AK VORTAC	*CHATA, AK FIX	**7000
*7000 - MRA		
**5000 - MOCA		
CHATA, AK FIX	BURMA, AK FIX	*8000
*7200 - MOCA		
BURMA, AK FIX	BIJOU, AK FIX	5000
BIJOU, AK FIX	FORT YUKON, AK VORTAC	2300
FORT YUKON, AK VORTAC	RIGGS, AK FIX	#*10000
*9500 - MOCA		
#MEA IS ESTABLISHED WITH A GAP IN NAVIGATION SIGNAL COVERAGE.		
RIGGS, AK FIX	*OILEE, AK FIX	**8000
*6500 - MCA OILEE, AK FIX , S BND		
**7500 - MOCA		
OILEE, AK FIX	WIMAN, AK FIX	**5000
**4400 - MOCA		
WIMAN, AK FIX	UVALL, AK FIX	*4000
*3200 - MOCA		
UVALL, AK FIX	DEADHORSE, AK VOR/DME	*2000
*1400 - MOCA		
DEADHORSE, AK VOR/DME	OOSIK, AK FIX	*2000
*1300 - MOCA		
OOSIK, AK FIX	TUNDA, AK FIX	*6000
*1300 - MOCA		
TUNDA, AK FIX	BARROW, AK VOR/DME	*3000
*1200 - MOCA		

95.6439 ALASKA VOR FEDERAL AIRWAY V439

KODIAK, AK VOR/DME	BAREL, AK FIX	*6000
*4200 - MOCA		
BAREL, AK FIX	OTONY, AK FIX	*6000
*5300 - MOCA		
OTONY, AK FIX	HOMER, AK VOR/DME	*6000
*5300 - MOCA		

95.6440 ALASKA VOR FEDERAL AIRWAY V440

SANDSPIT, CANADA VORTAC	U.S. CANADIAN BORDER	
#FOR THAT AIRSPACE OVER U.S. TERRITORY.		
U.S. CANADIAN BORDER	LATCH, AK FIX	*12000
*4200 - MOCA		
*8000 - GNSS MEA		
LATCH, AK FIX	BIORKA ISLAND, AK VORTAC	
	NW BND	4500
	SW BND	12000
BIORKA ISLAND, AK VORTAC	SALIS, AK FIX	
	SE BND	5100
	NW BND	9000
SALIS, AK FIX	CENTA, AK FIX	#*9000
*2000 - MOCA		
#MEA IS ESTABLISHED WITH A GAP IN NAVIGATION SIGNAL COVERAGE.		
CENTA, AK FIX	YAKUTAT, AK VOR/DME	
	SE BND	9000
	NW BND	2000
YAKUTAT, AK VOR/DME	OCULT, AK FIX	2000

FROM	TO	MEA
95.6440 ALASKA VOR FEDERAL AIRWAY V440 – CONTINUED		
OCULT, AK FIX *2000 - MOCA *7000 - GNSS MEA	MIDDLETON ISLAND, AK VOR/DME	*8000
MIDDLETON ISLAND, AK VOR/DME *8500 - MOCA *8500 - GNSS MEA	NOWEL, AK FIX	*10000
NOWEL, AK FIX * GNSS MEA	HOPER, AK FIX	*8500
HOPER, AK FIX *6000 - MOCA *6000 - GNSS MEA	ANCHORAGE, AK VOR/DME	*7000
ANCHORAGE, AK VOR/DME *5000 - MCA IVANN, AK FIX , W BND	*IVANN, AK FIX	2000
IVANN, AK FIX *7000 - MCA FRIDA, AK FIX , W BND **6000 - MOCA	*FRIDA, AK FIX	**6500
FRIDA, AK FIX *9400 - MOCA	MIGAN, AK FIX	*10000
MIGAN, AK FIX *8600 - MCA WINOR, AK FIX , E BND **8900 - MOCA **9000 - GNSS MEA	*WINOR, AK FIX	**10000
WINOR, AK FIX	MC GRATH, AK VORTAC SE BND NW BND	*10000 *5000
*4000 - MOCA		
MC GRATH, AK VORTAC	GANES, AK FIX E BND W BND	*6000 *8000
*5600 - MOCA		
GANES, AK FIX *5600 - MOCA *7000 - GNSS MEA	YUCON, AK FIX	*8000
YUCON, AK FIX	UNALAKLEET, AK VOR/DME	4500
UNALAKLEET, AK VOR/DME	NOME, AK VOR/DME	3000

95.6441 ALASKA VOR FEDERAL AIRWAY V441

MIDDLETON ISLAND, AK VOR/DME *9500 - MRA **8200 - MOCA	*SEWAR, AK FIX	**9000
SEWAR, AK FIX *7700 - MOCA	BROIL, AK FIX	*9500
BROIL, AK FIX *6800 - MOCA *7000 - GNSS MEA	CHICK, AK FIX	*9000
*CHICK, AK FIX *5300 - MCA CHICK, AK FIX , SE BND	ANCHORAGE, AK VOR/DME	3500

95.6444 ALASKA VOR FEDERAL AIRWAY V444

BARROW, AK VOR/DME *1200 - MOCA	CHIPS, AK FIX	*2000
CHIPS, AK FIX *1200 - MOCA	BRONX, AK FIX	*5000

FROM TO MEA

95.6444 ALASKA VOR FEDERAL AIRWAY V444 -CONTINUED

BRONX, AK FIX *9100 - MOCA	EVANSVILLE, AK NDB	*10000
EVANSVILLE, AK NDB	BETTLES, AK VOR/DME	3500
BETTLES, AK VOR/DME *4400 - MCA	*CYCLE, AK FIX	3500
CYCLE, AK FIX *5200 - MOCA	BRION, AK FIX	*6000
BRION, AK FIX *5200 - MOCA	LIVEN, AK FIX	*9000
LIVEN, AK FIX *4400 - MOCA	HESSE, AK FIX	*5000
HESSE, AK FIX *4900 - MOCA	FAIRBANKS, AK VORTAC	*5000
FAIRBANKS, AK VORTAC *4200 - MOCA	BIG DELTA, AK VORTAC	*5000
BIG DELTA, AK VORTAC *7800 - MOCA	NORTHWAY, AK VORTAC	*8000
NORTHWAY, AK VORTAC *8900 - MOCA	BURWASH, CANADA NDB	#*9600
#FOR THAT AIRSPACE OVER U.S. TERRITORY.		

95.6445 ALASKA VOR FEDERAL AIRWAY V445

BETTLES, AK VOR/DME	KANUT, AK FIX NW BND	3500
	SE BND	7000
KANUT, AK FIX	RAMPA, AK FIX	7000
RAMPA, AK FIX	TOLLO, AK FIX	7000
TOLLO, AK FIX *4200 - MOCA	WILTS, AK FIX	*5000
WILTS, AK FIX *4000 - MCA	*FAIRBANKS, AK VORTAC	5000
FAIRBANKS, AK VORTAC	W BND	

95.6447 ALASKA VOR FEDERAL AIRWAY V447

FAIRBANKS, AK VORTAC *7000 - MRA **4400 - MOCA	*DOMEY, AK FIX	**5000
DOMEY, AK FIX *5200 - MOCA	TATTA, AK FIX	*7000
TATTA, AK FIX *8000 - MOCA	CHANDALAR LAKE, AK NDB	#*11000
#MEA IS ESTABLISHED WITH A GAP IN NAVIGATION SIGNAL COVERAGE.		

95.6452 ALASKA VOR FEDERAL AIRWAY V452

KUKULIAK, AK VOR/DME	NOME, AK VOR/DME	3000
NOME, AK VOR/DME *4200 - MOCA	MOSES POINT, AK VOR/DME	*5000
MOSES POINT, AK VOR/DME *5200 - MOCA	JAYQE, AK FIX	*6000
JAYQE, AK FIX *6000 - MRA	*DIBVY, AK FIX	
DIBVY, AK FIX	GALENA, AK VOR/DME	3000
GALENA, AK VOR/DME *3300 - MOCA	ZOMBY, AK FIX	*4000
*3300 - GNSS MEA		

FROM TO MEA

95.6452 ALASKA VOR FEDERAL AIRWAY V452 - CONTINUED

ZOMBY, AK FIX	*HORSI, AK FIX	
	E BND	**8000
	W BND	**4000
*8000 - MRA		
**4000 - MOCA		
**4000 - GNSS MEA		
HORSI, AK FIX	BONET, AK FIX	*8000
*4000 - MOCA		
*4000 - GNSS MEA		
BONET, AK FIX	NENANA, AK VORTAC	*7000
*4400 - MOCA		
*4400 - GNSS MEA		

95.6453 ALASKA VOR FEDERAL AIRWAY V453

KING SALMON, AK VORTAC	DILLINGHAM, AK VOR/DME	2100
DILLINGHAM, AK VOR/DME	EDUCE, AK FIX	*7000
*6500 - MOCA		
EDUCE, AK FIX	BETHEL, AK VORTAC	
	S BND	*7000
	N BND	*4000
*2500 - MOCA		
*3000 - GNSS MEA		
BETHEL, AK VORTAC	WAPRO, AK FIX	*9000
*4300 - MOCA		
WAPRO, AK FIX	UNALAKLEET, AK VOR/DME	*11000
*5100 - MOCA		

95.6454 ALASKA VOR FEDERAL AIRWAY V454

KING SALMON, AK VORTAC	DILLINGHAM, AK VOR/DME	*5000
*4300 - MOCA		

95.6456 ALASKA VOR FEDERAL AIRWAY V456

COLD BAY, AK VORTAC	BINAL, AK FIX	*4000
*3400 - MOCA		
BINAL, AK FIX	TANIE, AK FIX	#*14000
*3400 - MOCA		
*8000 - GNSS MEA		
#MEA IS ESTABLISHED WITH A GAP IN NAVIGATION SIGNAL COVERAGE.		
TANIE, AK FIX	KING SALMON, AK VORTAC	#*3000
*1300 - MOCA		
*2000 - GNSS MEA		
#14000 SW WHEN DLG FSS SHUT DOWN		
KING SALMON, AK VORTAC	STREW, AK FIX	
	SW BND	*3000
	NE BND	*9000
*2300 - MOCA		
STREW, AK FIX	BITOP, AK FIX	*9000
	NE BND	
	SW BND	*5000
*5000 - GNSS MEA		

FROM TO MEA

95.6456 ALASKA VOR FEDERAL AIRWAY V456 - CONTINUED

BITOP, AK FIX *5200 - MOCA *8000 - GNSS MEA, NE BND *6000 - OPPOSITE GNSS MEA, SW BND	NOSKY, AK FIX	*9000
NOSKY, AK FIX *10300 - MCA TUCKS, AK FIX , SW BND **12300 - MOCA	*TUCKS, AK FIX	**13000
TUCKS, AK FIX *3300 - MOCA	KENAI, AK VOR/DME	*5000
KENAI, AK VOR/DME ANCHORAGE, AK VOR/DME *5000 - MCA BIG LAKE, AK VORTAC , NE BND	ANCHORAGE, AK VOR/DME *BIG LAKE, AK VORTAC	2000 2000
BIG LAKE, AK VORTAC MATTA, AK FIX *9100 - MOCA	MATTA, AK FIX UREKA, AK FIX	7000 *10000
UREKA, AK FIX *6100 - MOCA	SMOKY, AK FIX	*7000
SMOKY, AK FIX GULKANA, AK VOR/DME *7800 - MCA SANKA, AK FIX , NE BND	GULKANA, AK VOR/DME *SANKA, AK FIX	5000 6000
SANKA, AK FIX *10400 - MOCA	NORTHWAY, AK VORTAC	*11000

95.6457 ALASKA VOR FEDERAL AIRWAY V457

ILIAMNA, AK NDB/DME *7000 - MCA AWOMY, AK FIX , E BND **5300 - MOCA	*AWOMY, AK FIX W BND E BND	**5300 **9000
AWOMY, AK FIX *7000 - MCA MOFOF, AK FIX , W BND	*MOFOF, AK FIX	9000
MOFOF, AK FIX *2700 - MOCA	KENAI, AK VOR/DME W BND E BND	*9000 *3000

95.6459 ALASKA VOR FEDERAL AIRWAY V459

EMMONAK, AK VOR/DME	ST MARYS, AK NDB	3000
---------------------	------------------	------

95.6462 ALASKA VOR FEDERAL AIRWAY V462

CAPE NEWENHAM, AK NDB/DME *4300 - MOCA	DILLINGHAM, AK VOR/DME	*5000
DILLINGHAM, AK VOR/DME *2500 - MOCA	KOWOK, AK FIX	*3000
KOWOK, AK FIX *3800 - MOCA	SAHOK, AK FIX	*5000
SAHOK, AK FIX *8800 - MOCA #MEA IS ESTABLISHED WITH A GAP IN NAVIGATION SIGNAL COVERAGE.	NONDA, AK FIX	#*14000
NONDA, AK FIX *12200 - MOCA	BLUGA, AK FIX	*14000
BLUGA, AK FIX *2500 - MOCA	ANCHORAGE, AK VOR/DME	*3000

FROM	TO	MEA
95.6473 ALASKA VOR FEDERAL AIRWAY V473		
LEVEL ISLAND, AK VOR/DME *6300 - MOCA	FLIPS, AK FIX	*7000
FLIPS, AK FIX	BIORKA ISLAND, AK VORTAC	6000
95.6477 ALASKA VOR FEDERAL AIRWAY V477		
GALENA, AK VOR/DME	HUSLIA, AK VOR/DME	3000
HUSLIA, AK VOR/DME	ATAGO, AK FIX	
	W BND	*4000
	E BND	*3500
*2500 - MOCA		
ATAGO, AK FIX	DESOY, AK FIX	4000
DESOY, AK FIX	SELAWIK, AK VOR/DME	
	W BND	2500
	E BND	4000
SELAWIK, AK VOR/DME	JELLE, AK FIX	3500
JELLE, AK FIX	AMBLER, AK NDB/DME	
	NE BND	5000
	SW BND	4000
95.6480 ALASKA VOR FEDERAL AIRWAY V480		
MOUNT MOFFETT, AK NDB/DME	ST PAUL ISLAND, AK NDB/DME	6000
ST PAUL ISLAND, AK NDB/DME	ZESKA, AK FIX	*10000
*1800 - MOCA		
ZESKA, AK FIX	BETHEL, AK VORTAC	
	SW BND	*10000
	NE BND	*2000
*1400 - MOCA		
BETHEL, AK VORTAC	CABOT, AK FIX	
	W BND	*2000
	E BND	*4000
*1400 - MOCA		
CABOT, AK FIX	ANIAK, AK FIX	*4000
*2300 - MOCA		
ANIAK, AK FIX	JOANY, AK FIX	#*8000
*5600 - MOCA		
#MEA IS ESTABLISHED WITH A GAP IN NAVIGATION SIGNAL COVERAGE.		
#CONTINUOUS NAV SIGNAL COVERAGE DOES NOT EXIST BETWEEN BET 110 NM & MCG 60 NM		
JOANY, AK FIX	MC GRATH, AK VORTAC	
	W BND	*8000
	E BND	*6000
*5200 - MOCA		
MC GRATH, AK VORTAC	MEFRA, AK FIX	
	W BND	4000
	E BND	8000
MEFRA, AK FIX	NENANA, AK VORTAC	*8000
*5000 - MOCA		
NENANA, AK VORTAC	FAIRBANKS, AK VORTAC	*4000
*2700 - MOCA		

FROM TO MEA

95.6481 ALASKA VOR FEDERAL AIRWAY V481

JOHNSTONE POINT, AK VOR/DME	FIDAL, AK FIX S BND N BND	5000 10000
FIDAL, AK FIX	ROBES, AK FIX S BND N BND	8000 10000
ROBES, AK FIX KLUNG, AK FIX	KLUNG, AK FIX GULKANA, AK VOR/DME N BND S BND	10000 6500 10000
GULKANA, AK VOR/DME	DOZEY, AK FIX N BND S BND	12000 4000
DOZEY, AK FIX	PAXON, AK FIX S BND N BND	7000 12000
PAXON, AK FIX *10500 - MCA **11500 - MOCA	*DONEL, AK FIX DONEL, AK FIX, S BND	**12000
DONEL, AK FIX	BIG DELTA, AK VORTAC N BND S BND	7000 12000
BIG DELTA, AK VORTAC	FORT YUKON, AK VORTAC	#7000

#MEA IS ESTABLISHED WITH A GAP IN NAVIGATION SIGNAL COVERAGE.

95.6482 ALASKA VOR FEDERAL AIRWAY V482

JOHNSTONE POINT, AK VOR/DME *9300 - MOCA	TOSIN, AK FIX	*10000
TOSIN, AK FIX RIVVA, AK FIX *4500 - MOCA	RIVVA, AK FIX GULKANA, AK VOR/DME	6000 *5000

95.6488 ALASKA VOR FEDERAL AIRWAY V488

HOOPER BAY, AK VOR/DME	AKELT, AK FIX NE BND SW BND	10000 4000
AKELT, AK FIX *4000 - MOCA	ALMOT, AK FIX	*10000
ALMOT, AK FIX	UNALAKLEET, AK VOR/DME SW BND NE BND	10000 3000
UNALAKLEET, AK VOR/DME	EDMON, AK FIX NE BND SW BND	*5500 *4000
*4000 - MOCA EDMON, AK FIX *4900 - MOCA	VENCE, AK FIX	*5500

FROM	TO	MEA
95.6488 ALASKA VOR FEDERAL AIRWAY V488 – CONTINUED		
VENGE, AK FIX	GALENA, AK VOR/DME	
	SW BND	*5500
	NE BND	*3000
*2500 - MOCA		
GALENA, AK VOR/DME	KUHZE, AK FIX	*5000
*4400 - MOCA		
KUHZE, AK FIX	CHOKK, AK FIX	6000
CHOKK, AK FIX	TANANA, AK VOR/DME	
	SW BND	6000
	NE BND	3000
TANANA, AK VOR/DME	*REEBA, AK FIX	
	E BND	**7000
	W BND	**4000
*7000 - MRA		
**4000 - MOCA		
REEBA, AK FIX	GOLLY, AK FIX	*7000
*5000 - MOCA		
GOLLY, AK FIX	*FAIRBANKS, AK VORTAC	5000
*4700 - MCA FAIRBANKS, AK VORTAC , W BND		

95.6489 ALASKA VOR FEDERAL AIRWAY V489

GALENA, AK VOR/DME	ZOMBY, AK FIX	*4000
*3300 - MOCA		
*3300 - GNSS MEA		
ZOMBY, AK FIX	*HORSI, AK FIX	
	E BND	**8000
	W BND	**4000
*8000 - MRA		
**4000 - MOCA		
**4000 - GNSS MEA		
HORSI, AK FIX	ROSII, AK FIX	*6000
*4000 - MOCA		
ROSII, AK FIX	TANANA, AK VOR/DME	3400

95.6491 ALASKA VOR FEDERAL AIRWAY V491

BIG LAKE, AK VORTAC	TALKEETNA, AK VOR/DME	3000
---------------------	-----------------------	------

95.6496 ALASKA VOR FEDERAL AIRWAY V496

HOOPER BAY, AK VOR/DME	ST MARYS, AK NDB	3500
------------------------	------------------	------

95.6498 ALASKA VOR FEDERAL AIRWAY V498

MC GRATH, AK VORTAC	NIXON, AK FIX	
	NW BND	*6000
	SE BND	*4500
*4500 - MOCA		
NIXON, AK FIX	AHVUH, AK FIX	*6000
*5500 - MOCA		

FROM TO MEA

95.6498 ALASKA VOR FEDERAL AIRWAY V498 – CONTINUED

AHVUH, AK FIX	GALENA, AK VOR/DME SE BND	*6000
	NW BND	*4000
*4000 - MOCA		
GALENA, AK VOR/DME	EBIKY, AK FIX	*3000
*2500 - MOCA		
EBIKY, AK FIX	*KATEL, AK FIX NW BND	**8000
	SE BND	**4000
*8000 - MRA		
**4000 - MOCA		
KATEL, AK FIX	BALIN, AK FIX	*8000
*5300 - MOCA		
BALIN, AK FIX	KOTZEBUE, AK VOR/DME SE BND	*8000
	NW BND	*2000
*2000 - MOCA		

95.6504 ALASKA VOR FEDERAL AIRWAY V504

NENANA, AK VORTAC	KANUT, AK FIX	7000
KANUT, AK FIX	BETTLES, AK VOR/DME NW BND	3500
	SE BND	7000
BETTLES, AK VOR/DME	EVANSVILLE, AK NDB	3500
EVANSVILLE, AK NDB	DERIK, AK FIX	*10000
*9500 - MOCA		
DERIK, AK FIX	MUKTU, AK FIX	*7000
*3700 - MOCA		
MUKTU, AK FIX	SHELO, AK FIX	*5000
*3000 - MOCA		
SHELO, AK FIX	DEADHORSE, AK VOR/DME	*2000
*1300 - MOCA		

95.6506 ALASKA VOR FEDERAL AIRWAY V506

MARLO, AK FIX	KODIAK, AK VOR/DME	4000
*KODIAK, AK VOR/DME	BAILY, AK FIX W BND	##*1200
		0
	E BND	##*7000
**4900 - MOCA		
#MEA IS ESTABLISHED WITH A GAP IN NAVIGATION SIGNAL COVERAGE.		
BAILY, AK FIX	BREMI, AK FIX	*12000
*9700 - MOCA		
*10000 - GNSS MEA		
BREMI, AK FIX	*KING SALMON, AK VORTAC E BND	**12000
	W BND	**5000
*2400 - MCA KING SALMON, AK VORTAC , E BND		
**4600 - MOCA		
KING SALMON, AK VORTAC	KOWOK, AK FIX	*3000
*2400 - MOCA		
KOWOK, AK FIX	CAYON, AK FIX	*8000
*7000 - MOCA		
*7000 - GNSS MEA		
CAYON, AK FIX	BETHEL, AK VORTAC E BND	8000
	W BND	4000

FROM TO MEA

95.6506 ALASKA VOR FEDERAL AIRWAY V506 – CONTINUED

BETHEL, AK VORTAC	MARSI, AK FIX W BND	16000
	E BND	2000
MARSI, AK FIX	JOHNI, AK FIX	#*16000
*3200 - MOCA		
*4000 - GNSS MEA		
#MEA IS ESTABLISHED WITH A GAP IN NAVIGATION SIGNAL COVERAGE.		
JOHNI, AK FIX	DACIA, AK FIX	*8000
*3200 - MOCA		
*4000 - GNSS MEA		
DACIA, AK FIX	NOME, AK VOR/DME S BND	*8000
	N BND	*4000
*3200 - MOCA		
NOME, AK VOR/DME	BAIME, AK FIX N BND	7000
	S BND	6000
BAIME, AK FIX	SETUP, AK FIX	*7000
*5700 - MOCA		
*6000 - GNSS MEA		
SETUP, AK FIX	KOTZEBUE, AK VOR/DME S BND	7000
	N BND	2000
KOTZEBUE, AK VOR/DME	HOTHAM, AK NDB	2000
HOTHAM, AK NDB	SHOKK, AK FIX	*6000
*5000 - MOCA		
*5000 - GNSS MEA		
SHOKK, AK FIX	MEADE, AK FIX	*10000
*7000 - MOCA		
*8000 - GNSS MEA		
MEADE, AK FIX	BARROW, AK VOR/DME S BND	*10000
	N BND	*2000
*1100 - MOCA		

95.6507 ALASKA VOR FEDERAL AIRWAY V507

NOME, AK VOR/DME	PHOTO, AK FIX NW BND	*13000
	SE BND	*6000
*5700 - MOCA		
PHOTO, AK FIX	ESKAR, AK FIX	*13000
*6000 - MOCA		
*6000 - GNSS MEA		
ESKAR, AK FIX	KOTZEBUE, AK VOR/DME SW BND	*13000
	NE BND	*2100
*2100 - MOCA		

95.6508 ALASKA VOR FEDERAL AIRWAY V508

MIDDLETON ISLAND, AK VOR/DME	*SEWAR, AK FIX	**9000
*9500 - MRA		
**8200 - MOCA		

FROM	TO	MEA
95.6508 ALASKA VOR FEDERAL AIRWAY V508 – CONTINUED		
SEWAR, AK FIX	*SKILA, AK FIX	**9000
*5800 - MCA SKILA, AK FIX , E BND		
**7500 - MOCA		
**8000 - GNSS MEA		
SKILA, AK FIX	KENAI, AK VOR/DME	2000
KENAI, AK VOR/DME	*NEARR, AK FIX	3000
*7600 - MCA NEARR, AK FIX , W BND		
NEARR, AK FIX	SPARREVOHN, AK VOR/DME	12000
SPARREVOHN, AK VOR/DME	EBSIH, AK FIX	6000

95.6510 ALASKA VOR FEDERAL AIRWAY V510

EMMONAK, AK VOR/DME	ANVIK, AK NDB/DME	3900
ANVIK, AK NDB/DME	SABOC, AK FIX	
	E BND	*10000
	W BND	*9000
*6200 - MOCA		
*7000 - GNSS MEA		
SABOC, AK FIX	MC GRATH, AK VORTAC	*10000
*6200 - MOCA		
*7000 - GNSS MEA		
MC GRATH, AK VORTAC	*WINOR, AK FIX	
	SE BND	**10000
	NW BND	**5000
*8600 - MCA WINOR, AK FIX , E BND		
**4000 - MOCA		
WINOR, AK FIX	MIGAN, AK FIX	*10000
*8900 - MOCA		
MIGAN, AK FIX	KLART, AK FIX	*10000
*8800 - MOCA		
*9000 - GNSS MEA		
KLART, AK FIX	BIG LAKE, AK VORTAC	
	W BND	*10000
	E BND	*6000
*2500 - MOCA		

95.6515 ALASKA VOR FEDERAL AIRWAY V515

GULKANA, AK VOR/DME	MERIE, AK FIX	5000
MERIE, AK FIX	*BIG DELTA, AK VORTAC	12000
*8100 - MCA BIG DELTA, AK VORTAC , S BND		

95.6531 ALASKA VOR FEDERAL AIRWAY V531

*FAIRBANKS, AK VORTAC	GOLLY, AK FIX	5000
*4700 - MCA FAIRBANKS, AK VORTAC , W BND		
GOLLY, AK FIX	*REEBA, AK FIX	**7000
*7000 - MRA		
**5000 - MOCA		
REEBA, AK FIX	TANANA, AK VOR/DME	
	E BND	*7000
	W BND	*4000
*4000 – MOCA		

FROM	TO	MEA
------	----	-----

95.6531 ALASKA VOR FEDERAL AIRWAY V531 – CONTINUED

TANANA, AK VOR/DME	ELCON, AK FIX W BND	*6500
	E BND	*5400
*5400 - MOCA		
ELCON, AK FIX	CENSE, AK FIX	*6500
*5700 - MOCA		
CENSE, AK FIX	HUSLIA, AK VOR/DME W BND	*3500
	E BND	*6500
*3000 - MOCA		
HUSLIA, AK VOR/DME	ATAGO, AK FIX W BND	*4000
	E BND	*3500
*2500 - MOCA		
ATAGO, AK FIX	DESOY, AK FIX	*4000
*3900 - MOCA		
DESOY, AK FIX	SELAWIK, AK VOR/DME BND	*2500
W	E BND	*4000
*2500 - MOCA		
SELAWIK, AK VOR/DME	KOTZEBUE, AK VOR/DME	2500
KOTZEBUE, AK VOR/DME	BERJO, AK FIX SE BND	*2500
	NW BND	*8000
*2500 - MOCA		
BERJO, AK FIX	POINT HOPE, AK NDB	*8000
*4000 - MOCA		

95.6593 ALASKA VOR FEDERAL AIRWAY V593

SISTERS ISLAND, AK VORTAC	*LYRIC, AK FIX	**8000
*8000 - MRA		
**5800 - MOCA		
**5800 - GNSS MEA		
LYRIC, AK FIX	BIORKA ISLAND, AK VORTAC	5000

95.6603 ALASKA VOR FEDERAL AIRWAY V603

ELFEE, AK NDB	DILLINGHAM, AK VOR/DME	2700
---------------	------------------------	------

95.6617 ALASKA VOR FEDERAL AIRWAY V617

HOMER, AK VOR/DME	JOHNSTONE POINT, AK VOR/DME	*12000
*8600 - MOCA		
*9000 - GNSS MEA		

95.6619 ALASKA VOR FEDERAL AIRWAY V619

PORT HEIDEN, AK NDB/DME	CHINOOK, AK NDB	4000
CHINOOK, AK NDB	DILLINGHAM, AK VOR/DME	3000

FROM

TO

MEA

95.6621 ALASKA VOR FEDERAL AIRWAY V621

BARROW, AK VOR/DME ATQASUK, AK NDB 2000

&95.6401 HAWAII VOR FEDERAL AIRWAYS

95.6401 HAWAII VOR FEDERAL AIRWAY V1

KONA, HI VORTAC	*REEFS, HI FIX	5000
*3600 - MCA REEFS, HI FIX , SE BND		
REEFS, HI FIX	MOANA, HI FIX	2000
MOANA, HI FIX	*ROWIN, HI FIX	4000
*5500 - MCA ROWIN, HI FIX , N BND		
ROWIN, HI FIX	*LAVAS, HI FIX	**7000
*7000 - MRA		
**1200 - MOCA		
LAVAS, HI FIX	MAKEN, HI FIX	*7000
*5000 - MOCA		
MAKEN, HI FIX	HARPO, HI FIX	5000
HARPO, HI FIX	MAUI, HI VORTAC	6000

95.6402 HAWAII VOR FEDERAL AIRWAY V2

HONOLULU, HI VORTAC	PALAY, HI FIX	3500
PALAY, HI FIX	LANAI, HI VORTAC	4000
LANAI, HI VORTAC	KEIKI, HI FIX	5000
KEIKI, HI FIX	HARPO, HI FIX	*5000
*1200 - MOCA		
HARPO, HI FIX	UPOLU POINT, HI VORTAC	5000
UPOLU POINT, HI VORTAC	WAPIO, HI FIX	*7000
*6000 - MOCA		
WAPIO, HI FIX	PARIS, HI FIX	
	E BND	*4500
	W BND	*6000
*4000 - MOCA		
PARIS, HI FIX	*ARBOR, HI FIX	**4000
*8000 - MRA		
**3000 - MOCA		
ARBOR, HI FIX	HILO, HI VORTAC	3000

95.6403 HAWAII VOR FEDERAL AIRWAY V3

MYNAH, HI FIX	*JASON, HI FIX	3500
*4700 - MCA JASON, HI FIX , NE BND		
JASON, HI FIX	KAMUELA, HI VOR/DME	6500
KAMUELA, HI VOR/DME	TIGAH, HI FIX	6500
TIGAH, HI FIX	PARIS, HI FIX	5000

FROM	TO	MEA
95.6404 HAWAII VOR FEDERAL AIRWAY V4		
HONOLULU, HI VORTAC	*GECKO, HI FIX	**4000
*10000 - MRA		
**2800 - MOCA		
GECKO, HI FIX	*ZUKEY, HI FIX	
	W BND	16000
	E BND	4000
*16000 - MRA		
ZUKEY, HI FIX	BINJO, HI FIX	
	W BND	29000
	E BND	16000
 95.6405 HAWAII VOR FEDERAL AIRWAY V5		
KONA, HI VORTAC	*MYNAH, HI FIX	5000
*3500 - MCA MYNAH, HI FIX , SE BND		
MYNAH, HI FIX	HEFTI, HI FIX	2000
HEFTI, HI FIX	MAKEN, HI FIX	
	NW BND	*8000
	SE BND	*7000
*5500 - MOCA		
 95.6406 HAWAII VOR FEDERAL AIRWAY V6		
BLUSH, HI FIX	PLUMB, HI FIX	*5000
*1200 - MOCA		
PLUMB, HI FIX	MAUI, HI VORTAC	5000
 95.6407 HAWAII VOR FEDERAL AIRWAY V7		
KONA, HI VORTAC	*REEFS, HI FIX	5000
*3600 - MCA REEFS, HI FIX , SE BND		
REEFS, HI FIX	MOANA, HI FIX	2000
MOANA, HI FIX	*ROWIN, HI FIX	4000
*5500 - MCA ROWIN, HI FIX , N BND		
ROWIN, HI FIX	LANAI, HI VORTAC	4000
LANAI, HI VORTAC	MOLOKAI, HI VORTAC	4000
ATINE, HI FIX	BERLE, HI FIX	7000
BERLE, HI FIX	ZIGIE, OP FIX	22000
 95.6408 HAWAII VOR FEDERAL AIRWAY V8		
HONOLULU, HI VORTAC	*ALANA, HI FIX	3000
*5000 - MRA		
ALANA, HI FIX	HAUNA, HI FIX	3000
HAUNA, HI FIX	LOKIE, HI FIX	2000
LOKIE, HI FIX	MOLOKAI, HI VORTAC	3500
MOLOKAI, HI VORTAC	BLUSH, HI FIX	5000
BLUSH, HI FIX	FISHE, HI FIX	*4000
*1200 - MOCA		

FROM	TO	MEA
95.6411 HAWAII VOR FEDERAL AIRWAY V11		
REEFS, HI FIX	MYNAH, HI FIX	2000
MYNAH, HI FIX	*FLITT, HI FIX	2000
*4500 - MCA FLITT, HI FIX , N BND		
FLITT, HI FIX	UPOLU POINT, HI VORTAC	5400
UPOLU POINT, HI VORTAC	BARBY, HI FIX	5400
BARBY, HI FIX	OPANA, HI FIX	*5000
*3000 - MOCA		
OPANA, HI FIX	MAUI, HI VORTAC	5000

95.6412 HAWAII VOR FEDERAL AIRWAY V12		
*KATHS, HI FIX	**NONNI, HI FIX	29000
*29000 - MRA		
**29000 - MRA		
NONNI, HI FIX	*LEANE, HI FIX	
	W BND	29000
	E BND	16000
*16000 - MRA		
LEANE, HI FIX	*KEOLA, HI FIX	
	W BND	16000
	E BND	5000
*10000 - MRA		
KEOLA, HI FIX	*SHIGI, HI FIX	4000
*5000 - MRA		
SHIGI, HI FIX	HONOLULU, HI VORTAC	4000
HONOLULU, HI VORTAC	*KOKO HEAD, HI VORTAC	5000
*4500 - MCA KOKO HEAD, HI VORTAC , W BND		
KOKO HEAD, HI VORTAC	BAMBO, OP FIX	4500
BAMBO, OP FIX	MAGGI, HI FIX	5000
MAGGI, HI FIX	*SHARK, HI FIX	
	NE BND	**16000
	SW BND	**5000
*16000 - MRA		
**1200 - MOCA		

95.6413 HAWAII VOR FEDERAL AIRWAY V13		
KOKO HEAD, HI VORTAC	BAMBO, OP FIX	4500
BAMBO, OP FIX	TOADS, HI FIX	5000

95.6415 HAWAII VOR FEDERAL AIRWAY V15		
*CANON, HI FIX	LILIA, HI FIX	
	W BND	32000
	E BND	8000
*32000 - MRA		
LILIA, HI FIX	SOUTH KAUAI, HI VORTAC	*8000
*4800 - MOCA		
SOUTH KAUAI, HI VORTAC	LIHUE, HI VORTAC	5000
LIHUE, HI VORTAC	BOOKE, HI FIX	4000
BOOKE, HI FIX	*SHIGI, HI FIX	5000
*5000 - MRA		

FROM TO MEA

95.6415 HAWAII VOR FEDERAL AIRWAY V15 - CONTINUED

SHIGI, HI FIX	HONOLULU, HI VORTAC	4000
HONOLULU, HI VORTAC	*KOKO HEAD, HI VORTAC	5000
*4500 - MCA KOKO HEAD, HI VORTAC , W BND		
KOKO HEAD, HI VORTAC	MABBL, HI FIX	
	E BND	3500
	W BND	4500
MABBL, HI FIX	*MOLOKAI, HI VORTAC	
	E BND	3500
	W BND	4500
*5000 - MCA MOLOKAI, HI VORTAC , E BND		
MOLOKAI, HI VORTAC	*LORET, HI FIX	7000
*7800 - MCA LORET, HI FIX , E BND		
LORET, HI FIX	*MAUI, HI VORTAC	8000
*6800 - MCA MAUI, HI VORTAC , W BND		
MAUI, HI VORTAC	BARBY, HI FIX	7000
BARBY, HI FIX	*RABAT, HI FIX	**10000
*10000 - MRA		
**1200 - MOCA		
RABAT, HI FIX	*PUMIC, HI FIX	6000
*10000 - MRA		
PUMIC, HI FIX	PARIS, HI FIX	4000
PARIS, HI FIX	*ARBOR, HI FIX	**4000
*8000 - MRA		
**3000 - MOCA		
ARBOR, HI FIX	HILO, HI VORTAC	3000
HILO, HI VORTAC	HODAY, HI FIX	2000
HODAY, HI FIX	EELIC, HI FIX	10000
EELIC, HI FIX	KUMME, HI FIX	
	W BND	10000
	E BND	31000
KUMME, HI FIX	MAITI, HI FIX	31000

95.6416 HAWAII VOR FEDERAL AIRWAY V16

*SYVAD, HI FIX	**PUPPI, HI FIX	
	W BND	32000
	E BND	14000
*32000 - MRA		
**14000 - MRA		
PUPPI, HI FIX	*OHANA, HI FIX	
	W BND	14000
	E BND	5000
*5000 - MRA		
OHANA, HI FIX	SOUTH KAUAI, HI VORTAC	
	W BND	14000
	SE BND	5000
SOUTH KAUAI, HI VORTAC	MORKE, HI FIX	
	NW BND	5000
	SE BND	3000
MORKE, HI FIX	*NAPUA, HI FIX	3000
*6000 - MRA		
NAPUA, HI FIX	*GRAIL, HI FIX	6000
*9000 - MRA		
GRAIL, HI FIX	*KEOLA, HI FIX	9000
*10000 - MRA		

FROM TO MEA

95.6416 HAWAII VOR FEDERAL AIRWAY V16 - CONTINUED

KEOLA, HI FIX *10000 - MRA	*GECKO, HI FIX	10000
GECKO, HI FIX *5000 - MRA	*ALANA, HI FIX	7000
ALANA, HI FIX	JULLE, HI FIX	5000
JULLE, HI FIX	GRAMY, HI FIX	2000
GRAMY, HI FIX	LANAI, HI VORTAC	4000
LANAI, HI VORTAC *7000 - MRA	*LAVAS, HI FIX	4300
LAVAS, HI FIX *5800 - MCA UPOLU POINT, HI VORTAC , E BND	*UPOLU POINT, HI VORTAC	6000
UPOLU POINT, HI VORTAC	TIGAH, HI FIX	7000
TIGAH, HI FIX *6500 - MCA OKALA, HI FIX , W BND **5500 - MOCA	*OKALA, HI FIX	**8000
OKALA, HI FIX *8000 - MRA **5500 - MOCA	*ARBOR, HI FIX	**8000
ARBOR, HI FIX	HILO, HI VORTAC	3000

95.6417 HAWAII VOR FEDERAL AIRWAY V17

HARPO, HI FIX	MAUI, HI VORTAC	6000
STAIT, HI FIX *1200 - MOCA	FREDI, HI FIX	*17000
FREDI, HI FIX *1200 - MOCA	REXIE, HI FIX	*28000

95.6420 HAWAII VOR FEDERAL AIRWAY V20

HONOLULU, HI VORTAC	HAUNA, HI FIX	3000
HAUNA, HI FIX	JULLE, HI FIX	4000
JULLE, HI FIX	JORDA, HI FIX	5000
JORDA, HI FIX	FIRES, HI FIX	10000
FIRES, HI FIX	TYPHO, HI FIX	8000
TYPHO, HI FIX *1200 - MOCA	ANDES, HI FIX	*3000
ANDES, HI FIX *3800 - MCA ROBYN, HI FIX , SE BND	*ROBYN, HI FIX	3000
ROBYN, HI FIX	KONA, HI VORTAC	5000

95.6421 HAWAII VOR FEDERAL AIRWAY V21

HONOLULU, HI VORTAC *5000 - MRA	*ALANA, HI FIX	3000
ALANA, HI FIX	JULLE, HI FIX	5000
JULLE, HI FIX	GRAMY, HI FIX	2000
GRAMY, HI FIX	LANAI, HI VORTAC	4000
LANAI, HI VORTAC	KEIKI, HI FIX	5000
KEIKI, HI FIX *1200 - MOCA	CAMPS, HI FIX	*5000

FROM TO MEA

95.6421 HAWAII VOR FEDERAL AIRWAY V21 - CONTINUED

CAMPS, HI FIX	*HARPO, HI FIX	**5000
*8100 - MCA HARPO, HI FIX , E BND		
**1200 - MOCA		
HARPO, HI FIX	FUNKI, HI FIX	*10000
*9000 - MOCA		
FUNKI, HI FIX	*PUMIC, HI FIX	10000
*10000 - MRA		
PUMIC, HI FIX	BISEN, HI FIX	14000
BISEN, HI FIX	CUTLE, HI FIX	21000
CUTLE, HI FIX	OSTAH, HI FIX	24000
OSTAH, HI FIX	SCOON, HI FIX	22000

95.6422 HAWAII VOR FEDERAL AIRWAY V22

*MOLOKAI, HI VORTAC	PLUMB, HI FIX	7000
*5000 - MCA MOLOKAI, HI VORTAC , E BND		
PLUMB, HI FIX	MAUI, HI VORTAC	5000
MAUI, HI VORTAC	*BARBY, HI FIX	7000
*10500 - MCA BARBY, HI FIX , SE BND		
BARBY, HI FIX	SARDS, HI FIX	12000
SARDS, HI FIX	BONUS, HI FIX	8000
BONUS, HI FIX	HILO, HI VORTAC	6000
HILO, HI VORTAC	SESAW, HI FIX	2000
SESAW, HI FIX	BATES, HI FIX	8000
BATES, HI FIX	OSTAH, HI FIX	10000
OSTAH, HI FIX	SCOON, HI FIX	22000

95.6423 HAWAII VOR FEDERAL AIRWAY V23

UPOLU POINT, HI VORTAC	JESSI, HI FIX	*6000
*5000 - MOCA		
JESSI, HI FIX	FIRES, HI FIX	6000

95.6424 HAWAII VOR FEDERAL AIRWAY V24

*LANAI, HI VORTAC	MAUI, HI VORTAC	**9000
*5100 - MCA LANAI, HI VORTAC , NE BND		
**7800 - MOCA		

95.6425 HAWAII VOR FEDERAL AIRWAY V25

HILO, HI VORTAC	COOKE, HI FIX	3000
COOKE, HI FIX	BASSY, HI FIX	6000
BASSY, HI FIX	CODDY, HI FIX	9000
CODDY, HI FIX	ARROW, HI FIX	26000
ARROW, HI FIX	CLUTS, OP FIX	*26000
*1200 - MOCA		

FROM	TO	MEA	MAA
------	----	-----	-----

&95.7001 JET ROUTES

95.7001 JET ROUTE J1

U.S. MEXICAN BORDER	MISSION BAY, CA VORTAC	18000	45000
MISSION BAY, CA VORTAC	OCEANSIDE, CA VORTAC	18000	45000
OCEANSIDE, CA VORTAC	LOS ANGELES, CA VORTAC	18000	45000
LOS ANGELES, CA VORTAC	FILLMORE, CA VORTAC	18000	45000
FILLMORE, CA VORTAC	AVENAL, CA VORTAC	18000	45000
AVENAL, CA VORTAC	OAKLAND, CA VORTAC	18000	45000
OAKLAND, CA VORTAC	RED BLUFF, CA VORTAC	18000	45000
RED BLUFF, CA VORTAC	ROGUE VALLEY, OR VORTAC	18000	45000
ROGUE VALLEY, OR VORTAC	BATTLE GROUND, WA VORTAC	18000	45000
BATTLE GROUND, WA VORTAC	SEATTLE, WA VORTAC	18000	45000

95.7002 JET ROUTE J2

MISSION BAY, CA VORTAC	IMPERIAL, CA VORTAC	18000	45000
IMPERIAL, CA VORTAC	BARD, AZ VORTAC	18000	45000
BARD, AZ VORTAC	GILA BEND, AZ VORTAC	18000	45000
GILA BEND, AZ VORTAC	COCHISE, AZ VORTAC	18000	45000
COCHISE, AZ VORTAC	EL PASO, TX VORTAC	18000	45000
EL PASO, TX VORTAC	FORT STOCKTON, TX VORTAC	18000	45000
FORT STOCKTON, TX VORTAC	JUNCTION, TX VORTAC	18000	45000
JUNCTION, TX VORTAC	SAN ANTONIO, TX VORTAC	18000	45000
SAN ANTONIO, TX VORTAC	HUMBLE, TX VORTAC	18000	45000
HUMBLE, TX VORTAC	LAKE CHARLES, LA VORTAC	18000	45000
LAKE CHARLES, LA VORTAC	SEMMES, AL VORTAC	18000	45000
SEMMES, AL VORTAC	CRESTVIEW, FL VORTAC	18000	45000
CRESTVIEW, FL VORTAC	SEMINOLE, FL VORTAC	18000	45000
SEMINOLE, FL VORTAC	TAYLOR, FL VORTAC	18000	45000

95.7003 JET ROUTE J3

OAKLAND, CA VORTAC	RED BLUFF, CA VORTAC	18000	45000
RED BLUFF, CA VORTAC	LAKEVIEW, OR VORTAC	18000	45000
LAKEVIEW, OR VORTAC	KIMBERLY, OR VORTAC	18000	45000
KIMBERLY, OR VORTAC	SPOKANE, WA VORTAC	18000	45000

95.7004 JET ROUTE J4

LOS ANGELES, CA VORTAC	TWENTYNINE PALMS, CA VORTAC	18000	45000
TWENTYNINE PALMS, CA VORTAC	PARKER, CA VORTAC	18000	45000
PARKER, CA VORTAC	BUCKEYE, AZ VORTAC	18000	45000
BUCKEYE, AZ VORTAC	SAN SIMON, AZ VORTAC	18000	45000
SAN SIMON, AZ VORTAC	NEWMAN, TX VORTAC	18000	45000
NEWMAN, TX VORTAC	WINK, TX VORTAC	18000	45000
WINK, TX VORTAC	ABILENE, TX VORTAC	18000	45000
ABILENE, TX VORTAC	RANGER, TX VORTAC	18000	45000
RANGER, TX VORTAC	BELCHER, LA VORTAC	18000	45000
BELCHER, LA VORTAC	JACKSON, MS VORTAC	18000	45000
JACKSON, MS VORTAC	MERIDIAN, MS VORTAC	18000	45000
MERIDIAN, MS VORTAC	MONTGOMERY, AL VORTAC	18000	45000

FROM	TO	MEA	MAA
95.7005 JET ROUTE J5 – CONTINUED			
MONTGOMERY, AL VORTAC	COLLIERS, SC VORTAC	18000	45000
COLLIERS, SC VORTAC	COLUMBIA, SC VORTAC	18000	45000
COLUMBIA, SC VORTAC	FLORENCE, SC VORTAC	18000	45000
FLORENCE, SC VORTAC	WILMINGTON, NC VORTAC	18000	45000
95.7005 JET ROUTE J5			
LOS ANGELES, CA VORTAC	SHAFTER, CA VORTAC	18000	45000
SHAFTER, CA VORTAC	MUSTANG, NV VORTAC	#18000	45000
#MEA IS ESTABLISHED WITH A GAP IN NAVIGATION SIGNAL COVERAGE.			
MUSTANG, NV VORTAC	LAKEVIEW, OR VORTAC	18000	45000
LAKEVIEW, OR VORTAC	POWEL, OR FIX	18000	45000
POWEL, OR FIX	SUMMA, WA FIX	26000	45000
SUMMA, WA FIX	SEATTLE, WA VORTAC	18000	45000
SEATTLE, WA VORTAC	U.S. CANADIAN BORDER	18000	45000
95.7006 JET ROUTE J6			
SALINAS, CA VORTAC	AVENAL, CA VORTAC	18000	45000
AVENAL, CA VORTAC	PALMDALE, CA VORTAC	18000	45000
PALMDALE, CA VORTAC	HECTOR, CA VORTAC	18000	45000
HECTOR, CA VORTAC	NEEDLES, CA VORTAC	18000	45000
NEEDLES, CA VORTAC	DRAKE, AZ VORTAC	18000	45000
DRAKE, AZ VORTAC	PYRIT, AZ FIX	22000	45000
PYRIT, AZ FIX	ZUNI, NM VORTAC	18000	45000
ZUNI, NM VORTAC	ALBUQUERQUE, NM VORTAC	18000	45000
ALBUQUERQUE, NM VORTAC	TUCUMCARI, NM VORTAC	18000	45000
TUCUMCARI, NM VORTAC	PANHANDLE, TX VORTAC	18000	45000
PANHANDLE, TX VORTAC	WILL ROGERS, OK VORTAC	18000	45000
WILL ROGERS, OK VORTAC	LITTLE ROCK, AR VORTAC	18000	45000
LITTLE ROCK, AR VORTAC	BOWLING GREEN, KY VORTAC	#18000	45000
#MEA IS ESTABLISHED WITH A GAP IN NAVIGATION SIGNAL COVERAGE.			
BOWLING GREEN, KY VORTAC	CHARLESTON, WV VORTAC	18000	45000
CHARLESTON, WV VORTAC	MARTINSBURG, WV VORTAC	18000	45000
MARTINSBURG, WV VORTAC	LANCASTER, PA VORTAC	18000	32000
LANCASTER, PA VORTAC	BROADWAY, NJ VOR/DME	18000	45000
BROADWAY, NJ VOR/DME	SPARTA, NJ VORTAC	18000	45000
SPARTA, NJ VORTAC	ALBANY, NY VORTAC	18000	45000
ALBANY, NY VORTAC	PLATTSBURGH, NY VORTAC	18000	45000
95.7007 JET ROUTE J7			
LOS ANGELES, CA VORTAC	FILLMORE, CA VORTAC	18000	45000
FILLMORE, CA VORTAC	FRIANT, CA VORTAC	18000	45000
FRIANT, CA VORTAC	MUSTANG, NV VORTAC	18000	45000
MUSTANG, NV VORTAC	ROME, OR VORTAC	#19000	45000
#MEA IS ESTABLISHED WITH A GAP IN NAVIGATION SIGNAL COVERAGE.			
ROME, OR VORTAC	BOISE, ID VORTAC	18000	45000
BOISE, ID VORTAC	SALMON, ID VOR/DME	18000	45000
SALMON, ID VOR/DME	GREAT FALLS, MT VORTAC	18000	45000
GREAT FALLS, MT VORTAC	U.S. CANADIAN BORDER	18000	45000

FROM	TO	MEA	MAA
95.7008 JET ROUTE J8			
NEEDLES, CA VORTAC	FLAGSTAFF, AZ VOR/DME	18000	45000
FLAGSTAFF, AZ VOR/DME	GALLUP, NM VORTAC	18000	45000
GALLUP, NM VORTAC	FORT UNION, NM VORTAC	18000	45000
FORT UNION, NM VORTAC	BORGER, TX VORTAC	18000	45000
BORGER, TX VORTAC	KINGFISHER, OK VORTAC	18000	45000
KINGFISHER, OK VORTAC	SPRINGFIELD, MO VORTAC	18000	45000
SPRINGFIELD, MO VORTAC	ST LOUIS, MO VORTAC	18000	45000
ST LOUIS, MO VORTAC	LOUISVILLE, KY VORTAC	18000	45000
LOUISVILLE, KY VORTAC	CHARLESTON, WV VORTAC	18000	45000
CHARLESTON, WV VORTAC	CASANOVA, VA VORTAC	18000	45000

95.7009 JET ROUTE J9			
LOS ANGELES, CA VORTAC	DAGGETT, CA VORTAC	18000	45000
DAGGETT, CA VORTAC	LAS VEGAS, NV VORTAC	18000	45000
LAS VEGAS, NV VORTAC	MILFORD, UT VORTAC	18000	45000
MILFORD, UT VORTAC	FAIRFIELD, UT VORTAC	18000	45000
FAIRFIELD, UT VORTAC	WASATCH, UT VORTAC	18000	45000
WASATCH, UT VORTAC	DUBOIS, ID VORTAC	18000	45000
DUBOIS, ID VORTAC	DILLON, MT VOR/DME	18000	45000
DILLON, MT VOR/DME	GREAT FALLS, MT VORTAC	18000	45000

95.7010 JET ROUTE J10			
LOS ANGELES, CA VORTAC	TWENTYNINE PALMS, CA VORTAC	18000	45000
TWENTYNINE PALMS, CA VORTAC	HIPPI, AZ FIX	23000	40000
HIPPI, AZ FIX	FLAGSTAFF, AZ VOR/DME	23000	40000
FLAGSTAFF, AZ VOR/DME	RATTLESNAKE, NM VORTAC	18000	40000
RATTLESNAKE, NM VORTAC	BLUE MESA, CO VOR/DME	18000	45000
BLUE MESA, CO VOR/DME	FALCON, CO VORTAC	18000	45000
FALCON, CO VORTAC	NORTH PLATTE, NE VORTAC	18000	45000
NORTH PLATTE, NE VORTAC	WOLBACH, NE VORTAC	18000	41000
WOLBACH, NE VORTAC	DES MOINES, IA VORTAC	18000	45000
DES MOINES, IA VORTAC	IOWA CITY, IA VORTAC	18000	45000

95.7011 JET ROUTE J11			
TUCSON, AZ VORTAC	PHOENIX, AZ VORTAC	18000	45000
PHOENIX, AZ VORTAC	DRAKE, AZ VORTAC	18000	45000
DRAKE, AZ VORTAC	BRYCE CANYON, UT VORTAC	18000	45000
BRYCE CANYON, UT VORTAC	FAIRFIELD, UT VORTAC	18000	45000
FAIRFIELD, UT VORTAC	WASATCH, UT VORTAC	18000	45000

95.7012 JET ROUTE J12			
SEATTLE, WA VORTAC	EPHRATA, WA VORTAC	18000	45000
EPHRATA, WA VORTAC	DONNELLY, ID VORTAC	18000	45000
DONNELLY, ID VORTAC	TWIN FALLS, ID VORTAC	18000	45000
TWIN FALLS, ID VORTAC	WASATCH, UT VORTAC	22000	45000
WASATCH, UT VORTAC	FAIRFIELD, UT VORTAC	18000	45000
FAIRFIELD, UT VORTAC	GRAND JUNCTION, CO VOR/DME	18000	45000

FROM	TO	MEA	MAA
95.7013 JET ROUTE J13			
U.S. MEXICAN BORDER	TRUTH OR CONSEQUENCES, NM VORTAC	18000	45000
TRUTH OR CONSEQUENCES, NM VORTAC	ALBUQUERQUE, NM VORTAC	18000	45000
ALBUQUERQUE, NM VORTAC	ALAMOSA, CO VORTAC	18000	45000
ALAMOSA, CO VORTAC	FALCON, CO VORTAC	23000	45000
FALCON, CO VORTAC	CHEYENNE, WY VORTAC	18000	45000
CHEYENNE, WY VORTAC	MUDDY MOUNTAIN, WY VORTAC	18000	45000
MUDDY MOUNTAIN, WY VORTAC	BILLINGS, MT VORTAC	18000	45000
BILLINGS, MT VORTAC	GREAT FALLS, MT VORTAC	18000	45000
GREAT FALLS, MT VORTAC	U.S. CANADIAN BORDER	#18000	45000
#FOR THAT AIRSPACE OVER U.S. TERRITORY.			

95.7014 JET ROUTE J14

PANHANDLE, TX VORTAC	WILL ROGERS, OK VORTAC	18000	45000
WILL ROGERS, OK VORTAC	LITTLE ROCK, AR VORTAC	18000	45000
LITTLE ROCK, AR VORTAC	VULCAN, AL VORTAC	18000	45000
VULCAN, AL VORTAC	ATLANTA, GA VORTAC	18000	45000
ATLANTA, GA VORTAC	SPARTANBURG, SC VORTAC	18000	45000
SPARTANBURG, SC VORTAC	GREENSBORO, NC VORTAC	18000	45000
GREENSBORO, NC VORTAC	RICHMOND, VA VORTAC	18000	45000
RICHMOND, VA VORTAC	PATUXENT, MD VORTAC	18000	45000

95.7015 JET ROUTE J15

HUMBLE, TX VORTAC	JUNCTION, TX VORTAC	18000	45000
JUNCTION, TX VORTAC	WINK, TX VORTAC	18000	45000
WINK, TX VORTAC	CHISUM, NM VORTAC	18000	45000
CHISUM, NM VORTAC	CORONA, NM VORTAC	18000	45000
CORONA, NM VORTAC	ALBUQUERQUE, NM VORTAC	18000	45000
ALBUQUERQUE, NM VORTAC	RATTLESNAKE, NM VORTAC	18000	45000
RATTLESNAKE, NM VORTAC	GRAND JUNCTION, CO VOR/DME	18000	45000
GRAND JUNCTION, CO VOR/DME	WASATCH, UT VORTAC	#18000	45000
#MEA IS ESTABLISHED WITH A GAP IN NAVIGATION SIGNAL COVERAGE.			
WASATCH, UT VORTAC	TWIN FALLS, ID VORTAC	22000	45000
TWIN FALLS, ID VORTAC	BOISE, ID VORTAC	18000	45000
BOISE, ID VORTAC	KIMBERLY, OR VORTAC	18000	45000
KIMBERLY, OR VORTAC	BATTLE GROUND, WA VORTAC	18000	45000

95.7016 JET ROUTE J16

BATTLE GROUND, WA VORTAC	PENDLETON, OR VORTAC	18000	45000
PENDLETON, OR VORTAC	WHITEHALL, MT VOR/DME	#29000	45000
#MEA IS ESTABLISHED WITH A GAP IN NAVIGATION SIGNAL COVERAGE.			
WHITEHALL, MT VOR/DME	BILLINGS, MT VORTAC	18000	45000
BILLINGS, MT VORTAC	DUPREE, SD VORTAC	#20000	45000
#MEA IS ESTABLISHED WITH A GAP IN NAVIGATION SIGNAL COVERAGE.			
DUPREE, SD VORTAC	SIOUX FALLS, SD VORTAC	18000	45000
SIOUX FALLS, SD VORTAC	MASON CITY, IA VORTAC	18000	45000
MASON CITY, IA VORTAC	BADGER, WI VORTAC	18000	45000
BADGER, WI VORTAC	PECK, MI VORTAC	18000	45000

FROM	TO	MEA	MAA
95.7016 JET ROUTE J16 – CONTINUED			
PECK, MI VORTAC	U.S. CANADIAN BORDER	18000	45000
U.S. CANADIAN BORDER	BUFFALO, NY VOR/DME	18000	45000
BUFFALO, NY VOR/DME	ALBANY, NY VORTAC	18000	45000
ALBANY, NY VORTAC	BOSTON, MA VOR/DME	18000	45000
95.7017 JET ROUTE J17			
SAN ANTONIO, TX VORTAC	ABILENE, TX VORTAC	18000	45000
ABILENE, TX VORTAC	PANHANDLE, TX VORTAC	18000	45000
PANHANDLE, TX VORTAC	TOBE, CO VORTAC	18000	45000
TOBE, CO VORTAC	PUEBLO, CO VORTAC	18000	45000
PUEBLO, CO VORTAC	FALCON, CO VORTAC	18000	45000
FALCON, CO VORTAC	CHEYENNE, WY VORTAC	18000	45000
CHEYENNE, WY VORTAC	RAPID CITY, SD VORTAC	18000	45000
95.7018 JET ROUTE J18			
MISSION BAY, CA VORTAC	IMPERIAL, CA VORTAC	18000	45000
IMPERIAL, CA VORTAC	BARD, AZ VORTAC	18000	45000
BARD, AZ VORTAC	GILA BEND, AZ VORTAC	18000	45000
GILA BEND, AZ VORTAC	PHOENIX, AZ VORTAC	18000	45000
PHOENIX, AZ VORTAC	ST JOHNS, AZ VORTAC	18000	45000
ST JOHNS, AZ VORTAC	ALBUQUERQUE, NM VORTAC	18000	45000
ALBUQUERQUE, NM VORTAC	FORT UNION, NM VORTAC	18000	45000
FORT UNION, NM VORTAC	GARDEN CITY, KS VORTAC	18000	45000
GARDEN CITY, KS VORTAC	SALINA, KS VORTAC	18000	45000
SALINA, KS VORTAC	ST JOSEPH, MO VORTAC	18000	45000
ST JOSEPH, MO VORTAC	MOLINE, IL VORTAC	18000	35000
MOLINE, IL VORTAC	JOLIET, IL VORTAC	18000	35000
95.7019 JET ROUTE J19			
PHOENIX, AZ VORTAC	ZUNI, NM VORTAC	19000	45000
ZUNI, NM VORTAC	BUKKO, NM FIX	#18000	45000
#MEA IS ESTABLISHED WITH A GAP IN NAVIGATION SIGNAL COVERAGE.			
FORT UNION, NM VORTAC	LIBERAL, KS VORTAC	18000	45000
LIBERAL, KS VORTAC	WICHITA, KS VORTAC	18000	45000
WICHITA, KS VORTAC	BUTLER, MO VORTAC	18000	45000
BUTLER, MO VORTAC	ST LOUIS, MO VORTAC	18000	45000
ST LOUIS, MO VORTAC	ROBERTS, IL VOR/DME	18000	35000
ROBERTS, IL VOR/DME	NORTHBROOK, IL VOR/DME	18000	35000
95.7020 JET ROUTE J20			
SEATTLE, WA VORTAC	YAKIMA, WA VORTAC	18000	45000
YAKIMA, WA VORTAC	PENDLETON, OR VORTAC	18000	45000
PENDLETON, OR VORTAC	DONNELLY, ID VORTAC	18000	45000
DONNELLY, ID VORTAC	POCATELLO, ID VORTAC	18000	45000
POCATELLO, ID VORTAC	ROCK SPRINGS, WY VOR/DME	21000	45000

FROM	TO	MEA	MAA
95.7020 JET ROUTE J20 – CONTINUED			
ROCK SPRINGS, WY VOR/DME #MEA IS ESTABLISHED WITH A GAP IN NAVIGATION SIGNAL COVERAGE.	FALCON, CO VORTAC	#22000	45000
FALCON, CO VORTAC	HUGO, CO VORTAC	18000	45000
HUGO, CO VORTAC	LAMAR, CO VORTAC	18000	45000
LAMAR, CO VORTAC	LIBERAL, KS VORTAC	18000	45000
LIBERAL, KS VORTAC	WILL ROGERS, OK VORTAC	18000	45000
WILL ROGERS, OK VORTAC	BELCHER, LA VORTAC	18000	45000
BELCHER, LA VORTAC	JACKSON, MS VORTAC	18000	45000
JACKSON, MS VORTAC	MERIDIAN, MS VORTAC	18000	45000
MERIDIAN, MS VORTAC	MONTGOMERY, AL VORTAC	18000	45000
MONTGOMERY, AL VORTAC	SEMINOLE, FL VORTAC	18000	45000
SEMINOLE, FL VORTAC	ORLANDO, FL VORTAC	18000	45000
95.7021 JET ROUTE J21			
U.S. MEXICAN BORDER	LAREDO, TX VORTAC	18000	45000
LAREDO, TX VORTAC	SAN ANTONIO, TX VORTAC	18000	45000
SAN ANTONIO, TX VORTAC	CENTEX, TX VORTAC	18000	45000
CENTEX, TX VORTAC	WACO, TX VORTAC	18000	45000
WACO, TX VORTAC	RANGER, TX VORTAC	18000	45000
RANGER, TX VORTAC	ARDMORE, OK VORTAC	18000	45000
ARDMORE, OK VORTAC	WILL ROGERS, OK VORTAC	18000	45000
WILL ROGERS, OK VORTAC	WICHITA, KS VORTAC	18000	45000
WICHITA, KS VORTAC	OMAHA, IA VORTAC	18000	45000
OMAHA, IA VORTAC	GOPHER, MN VORTAC	18000	45000
GOPHER, MN VORTAC	DULUTH, MN VORTAC	18000	45000
95.7022 JET ROUTE J22			
U.S. MEXICAN BORDER	LAREDO, TX VORTAC	18000	45000
LAREDO, TX VORTAC	CORPUS CHRISTI, TX VORTAC	18000	45000
CORPUS CHRISTI, TX VORTAC	PALACIOS, TX VORTAC	18000	45000
PALACIOS, TX VORTAC	LAKE CHARLES, LA VORTAC	18000	45000
LAKE CHARLES, LA VORTAC	MC COMB, MS VORTAC	18000	45000
MC COMB, MS VORTAC	MERIDIAN, MS VORTAC	18000	45000
MERIDIAN, MS VORTAC	VULCAN, AL VORTAC	18000	45000
VULCAN, AL VORTAC	VOLUNTEER, TN VORTAC	18000	45000
VOLUNTEER, TN VORTAC	PULASKI, VA VORTAC	18000	45000
PULASKI, VA VORTAC	MONTEBELLO, VA VOR/DME	18000	45000
95.7023 JET ROUTE J23			
SAN ANTONIO, TX VORTAC	MILLSAP, TX VORTAC	18000	45000
MILLSAP, TX VORTAC	WILL ROGERS, OK VORTAC	18000	45000
WILL ROGERS, OK VORTAC	PIONEER, OK VORTAC	18000	45000
PIONEER, OK VORTAC	WICHITA, KS VORTAC	18000	45000

FROM	TO	MEA	MAA
95.7024 JET ROUTE J24			
MYTON, UT VORTAC	HAYDEN, CO VOR/DME	18000	45000
HUGO, CO VORTAC	HAYS, KS VORTAC	18000	45000
HAYS, KS VORTAC	SALINA, KS VORTAC	18000	45000
SALINA, KS VORTAC	KANSAS CITY, MO VORTAC	18000	45000
KANSAS CITY, MO VORTAC	ST LOUIS, MO VORTAC	18000	45000
ST LOUIS, MO VORTAC	BRICKYARD, IN VORTAC	18000	45000
BRICKYARD, IN VORTAC	FALMOUTH, KY VOR/DME	18000	45000
FALMOUTH, KY VOR/DME	CHARLESTON, WV VORTAC	18000	45000
CHARLESTON, WV VORTAC	MONTEBELLO, VA VOR/DME	18000	41000
MONTEBELLO, VA VOR/DME	FLAT ROCK, VA VORTAC	18000	41000
FLAT ROCK, VA VORTAC	HARCUM, VA VORTAC	18000	29000

95.7025 JET ROUTE J25

U.S. MEXICAN BORDER	BROWNSVILLE, TX VORTAC	18000	45000
BROWNSVILLE, TX VORTAC	CORPUS CHRISTI, TX VORTAC	18000	45000
CORPUS CHRISTI, TX VORTAC	SAN ANTONIO, TX VORTAC	18000	45000
SAN ANTONIO, TX VORTAC	CENTEX, TX VORTAC	18000	45000
CENTEX, TX VORTAC	WACO, TX VORTAC	18000	45000
WACO, TX VORTAC	RANGER, TX VORTAC	18000	45000
RANGER, TX VORTAC	TULSA, OK VORTAC	18000	45000
TULSA, OK VORTAC	KANSAS CITY, MO VORTAC	18000	45000
KANSAS CITY, MO VORTAC	DES MOINES, IA VORTAC	18000	45000
DES MOINES, IA VORTAC	MASON CITY, IA VORTAC	18000	45000
MASON CITY, IA VORTAC	GOPHER, MN VORTAC	18000	45000
GOPHER, MN VORTAC	BRAINERD, MN VORTAC	18000	45000
BRAINERD, MN VORTAC	U.S. CANADIAN BORDER	18000	45000
U.S. CANADIAN BORDER	WINNIPEG, CANADA VORTAC	#18000	45000
#FOR THAT AIRSPACE OVER U.S. TERRITORY.			

95.7026 JET ROUTE J26

U.S. MEXICAN BORDER	EL PASO, TX VORTAC	18000	45000
EL PASO, TX VORTAC	CHISUM, NM VORTAC	18000	45000
CHISUM, NM VORTAC	PANHANDLE, TX VORTAC	18000	45000
PANHANDLE, TX VORTAC	MITBEE, OK VORTAC	18000	45000
MITBEE, OK VORTAC	WICHITA, KS VORTAC	18000	45000
WICHITA, KS VORTAC	KANSAS CITY, MO VORTAC	18000	45000
KANSAS CITY, MO VORTAC	KIRKSVILLE, MO VORTAC	18000	45000
KIRKSVILLE, MO VORTAC	BRADFORD, IL VORTAC	18000	45000
BRADFORD, IL VORTAC	JOLIET, IL VORTAC	18000	45000

95.7027 JET ROUTE J27

SAN ANTONIO, TX VORTAC	LUFKIN, TX VORTAC	18000	45000
------------------------	-------------------	-------	-------

95.7028 JET ROUTE J28

MILFORD, UT VORTAC	HANKSVILLE, UT VORTAC	18000	45000
HANKSVILLE, UT VORTAC	BLUE MESA, CO VOR/DME	18000	45000
BLUE MESA, CO VOR/DME	PUEBLO, CO VORTAC	18000	45000

FROM	TO	MEA	MAA
95.7028 JET ROUTE J28 – CONTINUED			
PUEBLO, CO VORTAC	GARDEN CITY, KS VORTAC	18000	45000
GARDEN CITY, KS VORTAC	WICHITA, KS VORTAC	18000	45000
95.7029 JET ROUTE J29			
U.S. MEXICAN BORDER	CORPUS CHRISTI, TX VORTAC	24000	45000
CORPUS CHRISTI, TX VORTAC	PALACIOS, TX VORTAC	18000	45000
PALACIOS, TX VORTAC	HUMBLE, TX VORTAC	18000	45000
HUMBLE, TX VORTAC	EL DORADO, AR VORTAC	18000	45000
EL DORADO, AR VORTAC	MEMPHIS, TN VORTAC	18000	45000
MEMPHIS, TN VORTAC	POCKET CITY, IN VORTAC	18000	45000
POCKET CITY, IN VORTAC	ROSEWOOD, OH VORTAC	18000	45000
ROSEWOOD, OH VORTAC	DRYER, OH VOR/DME	18000	45000
DRYER, OH VOR/DME	JAMESTOWN, NY VOR/DME	18000	45000
JAMESTOWN, NY VOR/DME	SYRACUSE, NY VORTAC	18000	45000
SYRACUSE, NY VORTAC	PLATTSBURGH, NY VORTAC	18000	45000
PLATTSBURGH, NY VORTAC	BANGOR, ME VORTAC	18000	45000
BANGOR, ME VORTAC	U.S. CANADIAN BORDER	18000	45000
95.7030 JET ROUTE J30			
NODINE, MN VORTAC	JOLIET, IL VORTAC	18000	45000
JOLIET, IL VORTAC	APPLETON, OH VORTAC	18000	45000
APPLETON, OH VORTAC	BUCKO, WV FIX	20000	39000
BUCKO, WV FIX	KESSEL, WV VOR/DME	18000	45000
KESSEL, WV VOR/DME	TRIXY, VA FIX	19000	29000
95.7031 JET ROUTE J31			
LEEVILLE, LA VORTAC	HARVEY, LA VORTAC	18000	45000
HARVEY, LA VORTAC	MERIDIAN, MS VORTAC	18000	45000
MERIDIAN, MS VORTAC	VULCAN, AL VORTAC	18000	45000
95.7032 JET ROUTE J32			
OAKLAND, CA VORTAC	SACRAMENTO, CA VORTAC	18000	45000
SACRAMENTO, CA VORTAC	MUSTANG, NV VORTAC	18000	45000
MUSTANG, NV VORTAC	LOVELOCK, NV VORTAC	18000	45000
LOVELOCK, NV VORTAC	BATTLE MOUNTAIN, NV VORTAC	18000	45000
BATTLE MOUNTAIN, NV VORTAC	MALAD CITY, ID VOR/DME	#18000	45000
#MEA IS ESTABLISHED WITH A GAP IN NAVIGATION SIGNAL COVERAGE.			
MALAD CITY, ID VOR/DME	BOYSEN RESERVOIR, WY VOR/DME	18000	45000
BOYSEN RESERVOIR, WY VOR/DME	CRAZY WOMAN, WY VOR/DME	18000	45000
CRAZY WOMAN, WY VOR/DME	DUPREE, SD VORTAC	18000	45000
DUPREE, SD VORTAC	ABERDEEN, SD VOR/DME	18000	45000
ABERDEEN, SD VOR/DME	DULUTH, MN VORTAC	18000	45000

FROM	TO	MEA	MAA
95.7033 JET ROUTE J33			
HUMBLE, TX VORTAC	DONIE, TX FIX	18000	45000
DONIE, TX FIX	RANGER, TX VORTAC	18000	45000
95.7034 JET ROUTE J34			
HOQUIAM, WA VORTAC	OLYMPIA, WA VORTAC	18000	45000
OLYMPIA, WA VORTAC	MOSES LAKE, WA VOR/DME	18000	45000
MOSES LAKE, WA VOR/DME	HELENA, MT VORTAC	#28000	45000
#MEA IS ESTABLISHED WITH A GAP IN NAVIGATION SIGNAL COVERAGE.			
HELENA, MT VORTAC	BILLINGS, MT VORTAC	18000	45000
BILLINGS, MT VORTAC	DUPREE, SD VORTAC	#20000	45000
#MEA IS ESTABLISHED WITH A GAP IN NAVIGATION SIGNAL COVERAGE.			
DUPREE, SD VORTAC	REDWOOD FALLS, MN VOR/DME	18000	45000
REDWOOD FALLS, MN VOR/DME	NODINE, MN VORTAC	18000	45000
NODINE, MN VORTAC	DELLS, WI VORTAC	18000	45000
DELLS, WI VORTAC	BADGER, WI VORTAC	18000	45000
BADGER, WI VORTAC	GRAND RAPIDS, MI VOR/DME	18000	45000
GRAND RAPIDS, MI VOR/DME	CARLETON, MI VORTAC	18000	45000
CARLETON, MI VORTAC	DRYER, OH VOR/DME	18000	45000
DRYER, OH VOR/DME	BELLAIRE, OH VOR/DME	18000	45000
BELLAIRE, OH VOR/DME	BUCKO, WV FIX	18000	45000
BUCKO, WV FIX	KESSEL, WV VOR/DME	18000	45000
KESSEL, WV VOR/DME	TRIXY, VA FIX	19000	29000
95.7035 JET ROUTE J35			
LEEVILLE, LA VORTAC	MC COMB, MS VORTAC	18000	45000
MC COMB, MS VORTAC	SIDON, MS VORTAC	18000	45000
SIDON, MS VORTAC	MEMPHIS, TN VORTAC	18000	45000
MEMPHIS, TN VORTAC	FARMINGTON, MO VORTAC	18000	45000
FARMINGTON, MO VORTAC	ST LOUIS, MO VORTAC	18000	45000
ST LOUIS, MO VORTAC	SPINNER, IL VORTAC	18000	45000
SPINNER, IL VORTAC	PONTIAC, IL VOR/DME	18000	31000
PONTIAC, IL VOR/DME	JOLIET, IL VORTAC	18000	35000
JOLIET, IL VORTAC	NORTHBROOK, IL VOR/DME	18000	45000
95.7036 JET ROUTE J36			
MULLAN PASS, ID VOR/DME	GREAT FALLS, MT VORTAC	18000	45000
GREAT FALLS, MT VORTAC	HILGR, MT FIX	18000	45000
HILGR, MT FIX	DICKINSON, ND VORTAC	#28000	45000
#MEA IS ESTABLISHED WITH A GAP IN NAVIGATION SIGNAL COVERAGE.			
DICKINSON, ND VORTAC	FARGO, ND VORTAC	18000	45000
FARGO, ND VORTAC	GOPHER, MN VORTAC	18000	45000
GOPHER, MN VORTAC	NODINE, MN VORTAC	18000	45000
NODINE, MN VORTAC	BADGER, WI VORTAC	18000	45000
BADGER, WI VORTAC	FLINT, MI VORTAC	18000	45000
FLINT, MI VORTAC	U.S. CANADIAN BORDER	18000	45000
U.S. CANADIAN BORDER	DUNKIRK, NY VORTAC	18000	45000
DUNKIRK, NY VORTAC	MTCAF, PA FIX	31000	45000
MTCAF, PA FIX	LAKE HENRY, PA VORTAC	18000	37000
LAKE HENRY, PA VORTAC	COATE, NJ FIX	18000	45000

FROM	TO	MEA	MAA
95.7037 JET ROUTE J37			
HOBBY, TX VOR/DME	HARVEY, LA VORTAC	18000	45000
HARVEY, LA VORTAC	SEMMES, AL VORTAC	18000	45000
SEMMES, AL VORTAC	MONTGOMERY, AL VORTAC	18000	45000
MONTGOMERY, AL VORTAC	SPARTANBURG, SC VORTAC	18000	45000
SPARTANBURG, SC VORTAC	*SANNY, VA FIX	22000	45000
*22000 - MRA			
SANNY, VA FIX	LYNCHBURG, VA VORTAC	18000	45000
LYNCHBURG, VA VORTAC	GORDONSVILLE, VA VORTAC	18000	45000
GORDONSVILLE, VA VORTAC	BROOKE, VA VORTAC	18000	45000
BROOKE, VA VORTAC	COYLE, NJ VORTAC	18000	45000
KENNEDY, NY VOR/DME	KINGSTON, NY VOR/DME	18000	45000
KINGSTON, NY VOR/DME	ALBANY, NY VORTAC	18000	45000
ALBANY, NY VORTAC	MASSENA, NY VORTAC	18000	45000
95.7038 JET ROUTE J38			
GREEN BAY, WI VORTAC	PECK, MI VORTAC	18000	45000
95.7039 JET ROUTE J39			
CRESTVIEW, FL VORTAC	MONTGOMERY, AL VORTAC	18000	45000
MONTGOMERY, AL VORTAC	VULCAN, AL VORTAC	18000	45000
VULCAN, AL VORTAC	NASHVILLE, TN VORTAC	18000	45000
NASHVILLE, TN VORTAC	LOUISVILLE, KY VORTAC	18000	45000
LOUISVILLE, KY VORTAC	ROSEWOOD, OH VORTAC	18000	45000
95.7040 JET ROUTE J40			
MONTGOMERY, AL VORTAC	MACON, GA VORTAC	18000	45000
MACON, GA VORTAC	CHARLESTON, SC VORTAC	18000	45000
CHARLESTON, SC VORTAC	WILMINGTON, NC VORTAC	18000	45000
WILMINGTON, NC VORTAC	TAR RIVER, NC VORTAC	18000	45000
TAR RIVER, NC VORTAC	RICHMOND, VA VORTAC	18000	45000
95.7041 JET ROUTE J41			
KEY WEST, FL VORTAC	LEE COUNTY, FL VORTAC	18000	45000
LEE COUNTY, FL VORTAC	ST PETERSBURG, FL VORTAC	18000	45000
ST PETERSBURG, FL VORTAC	SEMINOLE, FL VORTAC	#*25000	45000
*18000 - GNSS MEA			
#MEA IS ESTABLISHED WITH A GAP IN NAVIGATION SIGNAL COVERAGE.			
SEMINOLE, FL VORTAC	MONTGOMERY, AL VORTAC	18000	45000
MONTGOMERY, AL VORTAC	VULCAN, AL VORTAC	18000	45000
VULCAN, AL VORTAC	MEMPHIS, TN VORTAC	18000	45000
MEMPHIS, TN VORTAC	SPRINGFIELD, MO VORTAC	18000	45000
SPRINGFIELD, MO VORTAC	KANSAS CITY, MO VORTAC	18000	45000
KANSAS CITY, MO VORTAC	OMAHA, IA VORTAC	18000	45000

FROM	TO	MEA	MAA
95.7042 JET ROUTE J42			
U.S. MEXICAN BORDER	FORT STOCKTON, TX VORTAC	18000	45000
FORT STOCKTON, TX VORTAC	ABILENE, TX VORTAC	18000	45000
ABILENE, TX VORTAC	RANGER, TX VORTAC	18000	45000
RANGER, TX VORTAC	TEXARKANA, AR VORTAC	18000	45000
TEXARKANA, AR VORTAC	MEMPHIS, TN VORTAC	18000	45000
MEMPHIS, TN VORTAC	NASHVILLE, TN VORTAC	18000	45000
NASHVILLE, TN VORTAC	FOUNT, KY FIX	18000	45000
FOUNT, KY FIX	TONIO, KY FIX	#*20000	35000
*18000 - GNSS MEA			
TONIO, KY FIX	#BECKLEY, WV VORTAC	*18000	35000
*18000 - GNSS MEA			
#BECKLEY R-257 UNSUSABLE			
BECKLEY, WV VORTAC	MONTEBELLO, VA VOR/DME	18000	41000
MONTEBELLO, VA VOR/DME	GORDONSVILLE, VA VORTAC	18000	41000
GORDONSVILLE, VA VORTAC	NOTTINGHAM, MD VORTAC	18000	45000
NOTTINGHAM, MD VORTAC	*GRACO, MD FIX	18000	35000
*10000 - MRA			
GRACO, MD FIX	WOODSTOWN, NJ VORTAC	18000	45000
WOODSTOWN, NJ VORTAC	ROBBINSVILLE, NJ VORTAC	18000	45000
ROBBINSVILLE, NJ VORTAC	HARTFORD, CT VOR/DME	18000	45000
HARTFORD, CT VOR/DME	PUTNAM, CT VOR/DME	18000	45000
PUTNAM, CT VOR/DME	BOSTON, MA VOR/DME	18000	45000
95.7043 JET ROUTE J43			
DOLPHIN, FL VORTAC	LA BELLE, FL VORTAC	18000	45000
LA BELLE, FL VORTAC	ST PETERSBURG, FL VORTAC	18000	45000
ST PETERSBURG, FL VORTAC	SEMINOLE, FL VORTAC	#*25000	45000
*18000 - GNSS MEA			
#MEA IS ESTABLISHED WITH A GAP IN NAVIGATION SIGNAL COVERAGE.			
SEMINOLE, FL VORTAC	ATLANTA, GA VORTAC	18000	45000
ATLANTA, GA VORTAC	VOLUNTEER, TN VORTAC	18000	45000
VOLUNTEER, TN VORTAC	FALMOUTH, KY VOR/DME	18000	45000
FALMOUTH, KY VOR/DME	ROSEWOOD, OH VORTAC	18000	45000
ROSEWOOD, OH VORTAC	CARLETON, MI VORTAC	18000	45000
CARLETON, MI VORTAC	SAULT STE MARIE, MI VOR/DME	18000	45000
95.7044 JET ROUTE J44			
PHOENIX, AZ VORTAC	WINSLOW, AZ VORTAC	18000	45000
WINSLOW, AZ VORTAC	RATTLESNAKE, NM VORTAC	18000	45000
RATTLESNAKE, NM VORTAC	ALAMOSA, CO VORTAC	18000	45000
ALAMOSA, CO VORTAC	FALCON, CO VORTAC	23000	45000
FALCON, CO VORTAC	MC COOK, NE VOR/DME	18000	45000
MC COOK, NE VOR/DME	LINCOLN, NE VORTAC	18000	41000
95.7045 JET ROUTE J45			
VIRGINIA KEY, FL VOR/DME	VERO BEACH, FL VORTAC	18000	45000
VERO BEACH, FL VORTAC	ORMOND BEACH, FL VORTAC	18000	45000
ORMOND BEACH, FL VORTAC	CRAIG, FL VORTAC	18000	45000
CRAIG, FL VORTAC	ALMA, GA VORTAC	18000	45000
ALMA, GA VORTAC	MACON, GA VORTAC	18000	45000

FROM	TO	MEA	MAA
95.7045 JET ROUTE J45 - CONTINUED			
MACON, GA VORTAC	ATLANTA, GA VORTAC	18000	45000
ATLANTA, GA VORTAC	NASHVILLE, TN VORTAC	18000	45000
NASHVILLE, TN VORTAC	ST LOUIS, MO VORTAC	18000	45000
ST LOUIS, MO VORTAC	DES MOINES, IA VORTAC	18000	45000
DES MOINES, IA VORTAC	SIOUX FALLS, SD VORTAC	18000	45000
SIOUX FALLS, SD VORTAC	ABERDEEN, SD VOR/DME	18000	45000
95.7046 JET ROUTE J46			
TULSA, OK VORTAC	WALNUT RIDGE, AR VORTAC	18000	45000
WALNUT RIDGE, AR VORTAC	NASHVILLE, TN VORTAC	18000	45000
NASHVILLE, TN VORTAC	VOLUNTEER, TN VORTAC	18000	45000
VOLUNTEER, TN VORTAC	ATHENS, GA VORTAC	18000	45000
ATHENS, GA VORTAC	ALMA, GA VORTAC	18000	45000
95.7047 JET ROUTE J47			
CHARLESTON, SC VORTAC	COLUMBIA, SC VORTAC	18000	45000
COLUMBIA, SC VORTAC	SPARTANBURG, SC VORTAC	18000	45000
95.7048 JET ROUTE J48			
LANNA, NJ FIX	POTTSTOWN, PA VORTAC	18000	45000
POTTSTOWN, PA VORTAC	WESTMINSTER, MD VORTAC	18000	45000
WESTMINSTER, MD VORTAC	CASANOVA, VA VORTAC	18000	45000
CASANOVA, VA VORTAC	MONTEBELLO, VA VOR/DME	18000	41000
MONTEBELLO, VA VOR/DME	FOOTHILLS, GA VORTAC	18000	41000
95.7049 JET ROUTE J49			
PHILIPSBURG, PA VORTAC	HANCOCK, NY VOR/DME	18000	45000
HANCOCK, NY VOR/DME	ALBANY, NY VORTAC	18000	45000
ALBANY, NY VORTAC	BANGOR, ME VORTAC	18000	45000
BANGOR, ME VORTAC	PRESQUE ISLE, ME VOR/DME	18000	45000
95.7050 JET ROUTE J50			
SHAFTER, CA VORTAC	PARADISE, CA VORTAC	18000	45000
PARADISE, CA VORTAC	BLYTHE, CA VORTAC	18000	45000
BLYTHE, CA VORTAC	GILA BEND, AZ VORTAC	18000	45000
GILA BEND, AZ VORTAC	STANFIELD, AZ VORTAC	18000	45000
STANFIELD, AZ VORTAC	SAN SIMON, AZ VORTAC	18000	45000
SAN SIMON, AZ VORTAC	EL PASO, TX VORTAC	18000	45000
EL PASO, TX VORTAC	WINK, TX VORTAC	18000	45000
WINK, TX VORTAC	ABILENE, TX VORTAC	18000	45000
ABILENE, TX VORTAC	WACO, TX VORTAC	18000	45000
WACO, TX VORTAC	LUFKIN, TX VORTAC	18000	45000
LUFKIN, TX VORTAC	ALEXANDRIA, LA VORTAC	18000	45000
ALEXANDRIA, LA VORTAC	MC COMB, MS VORTAC	18000	45000
MC COMB, MS VORTAC	CRESTVIEW, FL VORTAC	18000	45000

FROM	TO	MEA	MAA
95.7051 JET ROUTE J51			
CRAIG, FL VORTAC	SAVANNAH, GA VORTAC	18000	45000
SAVANNAH, GA VORTAC	COLUMBIA, SC VORTAC	18000	45000
COLUMBIA, SC VORTAC	TUBAS, NC FIX	18000	45000
TUBAS, NC FIX	#FLAT ROCK, VA VORTAC	*26000	45000
*18000 - GNSS MEA			
#FLAT ROCK R-218 UNUSABLE			
FLAT ROCK, VA VORTAC	NOTTINGHAM, MD VORTAC	18000	45000
NOTTINGHAM, MD VORTAC	PALEO, MD FIX	18000	29000
PALEO, MD FIX	DUPONT, DE VORTAC	18000	45000
DUPONT, DE VORTAC	YARDLEY, PA VOR/DME	18000	29000
95.7052 JET ROUTE J52			
U.S. CANADIAN BORDER	SPOKANE, WA VORTAC	18000	45000
SPOKANE, WA VORTAC	SALMON, ID VOR/DME	18000	45000
SALMON, ID VOR/DME	DUBOIS, ID VORTAC	18000	45000
DUBOIS, ID VORTAC	ROCK SPRINGS, WY VOR/DME	18000	45000
ROCK SPRINGS, WY VOR/DME	FALCON, CO VORTAC	#22000	45000
#MEA IS ESTABLISHED WITH A GAP IN NAVIGATION SIGNAL COVERAGE.			
FALCON, CO VORTAC	HUGO, CO VORTAC	18000	45000
HUGO, CO VORTAC	LAMAR, CO VORTAC	18000	45000
LAMAR, CO VORTAC	LIBERAL, KS VORTAC	18000	45000
LIBERAL, KS VORTAC	ARDMORE, OK VORTAC	18000	45000
ARDMORE, OK VORTAC	TEXARKANA, AR VORTAC	18000	45000
TEXARKANA, AR VORTAC	SIDON, MS VORTAC	18000	45000
SIDON, MS VORTAC	BIGBEE, MS VORTAC	18000	45000
BIGBEE, MS VORTAC	VULCAN, AL VORTAC	18000	45000
VULCAN, AL VORTAC	ATLANTA, GA VORTAC	18000	45000
ATLANTA, GA VORTAC	COLLIERS, SC VORTAC	18000	45000
COLLIERS, SC VORTAC	COLUMBIA, SC VORTAC	18000	45000
COLUMBIA, SC VORTAC	TUBAS, NC FIX	18000	45000
TUBAS, NC FIX	RALEIGH/DURHAM, NC VORTAC	18000	45000
RALEIGH/DURHAM, NC VORTAC	RICHMOND, VA VORTAC	18000	45000
95.7053 JET ROUTE J53			
DOLPHIN, FL VORTAC	PAHOKEE, FL VORTAC	18000	45000
PAHOKEE, FL VORTAC	ORLANDO, FL VORTAC	18000	45000
ORLANDO, FL VORTAC	CRAIG, FL VORTAC	18000	45000
CRAIG, FL VORTAC	COLLIERS, SC VORTAC	18000	45000
COLLIERS, SC VORTAC	SPARTANBURG, SC VORTAC	18000	45000
SPARTANBURG, SC VORTAC	PULASKI, VA VORTAC	18000	45000
PULASKI, VA VORTAC	RICCS, WV FIX	21000	45000
RICCS, WV FIX	ELLWOOD CITY, PA VORTAC	18000	45000
95.7054 JET ROUTE J54			
TATOOSH, WA VORTAC	OLYMPIA, WA VORTAC	18000	45000
OLYMPIA, WA VORTAC	BAKER CITY, OR VOR/DME	#29000	45000
#MEA IS ESTABLISHED WITH A GAP IN NAVIGATION SIGNAL COVERAGE.			
BAKER CITY, OR VOR/DME	BOISE, ID VORTAC	18000	45000
BOISE, ID VORTAC	POCATELLO, ID VORTAC	18000	45000
POCATELLO, ID VORTAC	CHEROKEE, WY VOR/DME	25000	45000
CHEROKEE, WY VOR/DME	LARAMIE, WY VOR/DME	18000	45000

FROM	TO	MEA	MAA
95.7055 JET ROUTE J55			
DOLPHIN, FL VORTAC	LLAKE, FL FIX	18000	45000
LLAKE, FL FIX	INPIN, FL FIX	23000	45000
INPIN, FL FIX	LOULO, FL FIX	18000	45000
LOULO, FL FIX	CRAIG, FL VORTAC	18000	45000
CRAIG, FL VORTAC	SAVANNAH, GA VORTAC	18000	45000
SAVANNAH, GA VORTAC	CHARLESTON, SC VORTAC	18000	45000
CHARLESTON, SC VORTAC	FLORENCE, SC VORTAC	18000	45000
FLORENCE, SC VORTAC	TUBAS, NC FIX	18000	45000
TUBAS, NC FIX	RALEIGH/DURHAM, NC VORTAC	18000	45000
RALEIGH/DURHAM, NC VORTAC	HOPEWELL, VA VORTAC	18000	45000
HOPEWELL, VA VORTAC	HUBBS, VA FIX	18000	20000
SEA ISLE, NJ VORTAC	HAMPTON, NY VORTAC	18000	45000
HAMPTON, NY VORTAC	PROVIDENCE, RI VORTAC	18000	45000
PROVIDENCE, RI VORTAC	BOSTON, MA VOR/DME	18000	45000
BOSTON, MA VOR/DME	KENNEBUNK, ME VORTAC	18000	45000
KENNEBUNK, ME VORTAC	PRESQUE ISLE, ME VOR/DME	19000	45000
95.7056 JET ROUTE J56			
MINA, NV VORTAC	WASATCH, UT VORTAC	#33000	45000
#MEA IS ESTABLISHED WITH A GAP IN NAVIGATION SIGNAL COVERAGE.			
WASATCH, UT VORTAC	HAYDEN, CO VOR/DME	25000	45000
HAYDEN, CO VOR/DME	FALCON, CO VORTAC	18000	45000
95.7057 JET ROUTE J57			
TRUTH OR CONSEQUENCES, NM VORTAC	SOCORRO, NM VORTAC	18000	45000
SOCORRO, NM VORTAC	ALBUQUERQUE, NM VORTAC	18000	45000
95.7058 JET ROUTE J58			
OAKLAND, CA VORTAC	MANTECA, CA VORTAC	18000	45000
MANTECA, CA VORTAC	COALDALE, NV VORTAC	18000	45000
COALDALE, NV VORTAC	WILSON CREEK, NV VORTAC	18000	45000
WILSON CREEK, NV VORTAC	MILFORD, UT VORTAC	18000	45000
MILFORD, UT VORTAC	RATTLESNAKE, NM VORTAC	33000	45000
RATTLESNAKE, NM VORTAC	FORT UNION, NM VORTAC	18000	45000
FORT UNION, NM VORTAC	PANHANDLE, TX VORTAC	18000	45000
PANHANDLE, TX VORTAC	WICHITA FALLS, TX VORTAC	18000	45000
WICHITA FALLS, TX VORTAC	RANGER, TX VORTAC	18000	45000
RANGER, TX VORTAC	ALEXANDRIA, LA VORTAC	18000	45000
ALEXANDRIA, LA VORTAC	HARVEY, LA VORTAC	18000	45000
95.7059 JET ROUTE J59			
PHILIPSBURG, PA VORTAC	SYRACUSE, NY VORTAC	18000	45000

FROM	TO	MEA	MAA
95.7060 JET ROUTE J60			
LOS ANGELES, CA VORTAC	PARADISE, CA VORTAC	18000	45000
PARADISE, CA VORTAC	HECTOR, CA VORTAC	18000	45000
HECTOR, CA VORTAC	BOULDER CITY, NV VORTAC	18000	45000
BOULDER CITY, NV VORTAC	BRYCE CANYON, UT VORTAC	18000	45000
BRYCE CANYON, UT VORTAC	HANKSVILLE, UT VORTAC	18000	45000
HANKSVILLE, UT VORTAC	RED TABLE, CO VOR/DME	18000	45000
RED TABLE, CO VOR/DME	MILE HIGH, CO VORTAC	18000	45000
MILE HIGH, CO VORTAC	HAYES CENTER, NE VORTAC	18000	45000
HAYES CENTER, NE VORTAC	LINCOLN, NE VORTAC	18000	45000
LINCOLN, NE VORTAC	IOWA CITY, IA VORTAC	18000	45000
IOWA CITY, IA VORTAC	JOLIET, IL VORTAC	18000	45000
JOLIET, IL VORTAC	GOSHEN, IN VORTAC	18000	45000
GOSHEN, IN VORTAC	DRYER, OH VOR/DME	18000	45000
DRYER, OH VOR/DME	PHILIPSBURG, PA VORTAC	18000	45000
PHILIPSBURG, PA VORTAC	EAST TEXAS, PA VOR/DME	18000	38000
EAST TEXAS, PA VOR/DME	SPARTA, NJ VORTAC	18000	32000
95.7061 JET ROUTE J61			
EDDYS, NC FIX	FORTS, VA FIX	31000	45000
FORTS, VA FIX	NOTTINGHAM, MD VORTAC	18000	45000
NOTTINGHAM, MD VORTAC	WESTMINSTER, MD VORTAC	18000	45000
WESTMINSTER, MD VORTAC	PHILIPSBURG, PA VORTAC	18000	45000
PHILIPSBURG, PA VORTAC	BUFFALO, NY VOR/DME	18000	45000
95.7062 JET ROUTE J62			
ROBBINSVILLE, NJ VORTAC	NANTUCKET, MA VOR/DME	18000	45000
95.7063 JET ROUTE J63			
KENNEDY, NY VOR/DME	HUGUENOT, NY VOR/DME	18000	45000
HUGUENOT, NY VOR/DME	SYRACUSE, NY VORTAC	18000	45000
SYRACUSE, NY VORTAC	U.S. CANADIAN BORDER	18000	45000
U.S. CANADIAN BORDER	AU SABLE, MI VOR/DME	18000	45000
AU SABLE, MI VOR/DME	TRAVERSE CITY, MI VORTAC	18000	45000
95.7064 JET ROUTE J64			
LOS ANGELES, CA VORTAC	HECTOR, CA VORTAC	18000	45000
HECTOR, CA VORTAC	PEACH SPRINGS, AZ VORTAC	18000	45000
PEACH SPRINGS, AZ VORTAC	TUBA CITY, AZ VORTAC	18000	45000
TUBA CITY, AZ VORTAC	RATTLESNAKE, NM VORTAC	18000	45000
RATTLESNAKE, NM VORTAC	PUEBLO, CO VORTAC	20000	45000
PUEBLO, CO VORTAC	HILL CITY, KS VORTAC	18000	45000
HILL CITY, KS VORTAC	PAWNEE CITY, NE VORTAC	18000	45000
PAWNEE CITY, NE VORTAC	LAMONI, IA VORTAC	18000	45000
LAMONI, IA VORTAC	BRADFORD, IL VORTAC	18000	45000
BRADFORD, IL VORTAC	FORT WAYNE, IN VORTAC	18000	45000
FORT WAYNE, IN VORTAC	ELLWOOD CITY, PA VORTAC	18000	45000
ELLWOOD CITY, PA VORTAC	RAVINE, PA VORTAC	18000	45000
RAVINE, PA VORTAC	ROBBINSVILLE, NJ VORTAC	18000	45000

FROM	TO	MEA	MAA
95.7065 JET ROUTE J65			
SAN ANTONIO, TX VORTAC	ABILENE, TX VORTAC	18000	45000
ABILENE, TX VORTAC	CHISUM, NM VORTAC	25000	45000
CHISUM, NM VORTAC	TRUTH OR CONSEQUENCES, NM VORTAC	24000	45000
TRUTH OR CONSEQUENCES, NM VORTAC	PHOENIX, AZ VORTAC	#23000	45000
#MEA IS ESTABLISHED WITH A GAP IN NAVIGATION SIGNAL COVERAGE.			
PHOENIX, AZ VORTAC	BLYTHE, CA VORTAC	18000	45000
BLYTHE, CA VORTAC	PALMDALE, CA VORTAC	18000	45000
PALMDALE, CA VORTAC	SHAFTER, CA VORTAC	18000	45000
SHAFTER, CA VORTAC	CLOVIS, CA VORTAC	18000	45000
CLOVIS, CA VORTAC	SACRAMENTO, CA VORTAC	18000	45000
SACRAMENTO, CA VORTAC	RED BLUFF, CA VORTAC	18000	45000
RED BLUFF, CA VORTAC	KLAMATH FALLS, OR VORTAC	18000	45000
KLAMATH FALLS, OR VORTAC	SEATTLE, WA VORTAC	#31000	45000
#MEA IS ESTABLISHED WITH A GAP IN NAVIGATION SIGNAL COVERAGE.			
95.7066 JET ROUTE J66			
NEWMAN, TX VORTAC	BIG SPRING, TX VORTAC	#19000	45000
#MEA IS ESTABLISHED WITH A GAP IN NAVIGATION SIGNAL COVERAGE.			
BIG SPRING, TX VORTAC	ABILENE, TX VORTAC	18000	45000
ABILENE, TX VORTAC	RANGER, TX VORTAC	18000	45000
RANGER, TX VORTAC	BONHAM, TX VORTAC	18000	45000
BONHAM, TX VORTAC	LITTLE ROCK, AR VORTAC	18000	45000
LITTLE ROCK, AR VORTAC	MEMPHIS, TN VORTAC	18000	45000
MEMPHIS, TN VORTAC	ROME, GA VORTAC	18000	45000
95.7067 JET ROUTE J67			
LINDEN, CA VORTAC	LAKEVIEW, OR VORTAC	18000	45000
LAKEVIEW, OR VORTAC	BATTLE GROUND, WA VORTAC	18000	45000
95.7068 JET ROUTE J68			
GOPHER, MN VORTAC	DELLS, WI VORTAC	18000	45000
DELLS, WI VORTAC	BADGER, WI VORTAC	18000	45000
BADGER, WI VORTAC	FLINT, MI VORTAC	18000	45000
FLINT, MI VORTAC	U.S. CANADIAN BORDER	18000	45000
U.S. CANADIAN BORDER	DUNKIRK, NY VORTAC	18000	45000
HANCOCK, NY VOR/DME	PUTNAM, CT VOR/DME	18000	45000
PUTNAM, CT VOR/DME	PROVIDENCE, RI VORTAC	18000	45000
PROVIDENCE, RI VORTAC	NANTUCKET, MA VOR/DME	18000	45000
95.7069 JET ROUTE J69			
SEMMES, AL VORTAC	DELBE, AL FIX	22000	45000
DELBE, AL FIX	VULCAN, AL VORTAC	18000	45000

FROM	TO	MEA	MAA
95.7070 JET ROUTE J70			
HOQUIAM, WA VORTAC	SEATTLE, WA VORTAC	18000	45000
SEATTLE, WA VORTAC	EPHRATA, WA VORTAC	18000	45000
EPHRATA, WA VORTAC	MULLAN PASS, ID VOR/DME	18000	45000
MULLAN PASS, ID VOR/DME	LEWISTOWN, MT VOR/DME	18000	45000
LEWISTOWN, MT VOR/DME	DICKINSON, ND VORTAC	18000	45000
DICKINSON, ND VORTAC	ABERDEEN, SD VOR/DME	24000	45000
ABERDEEN, SD VOR/DME	GOPHER, MN VORTAC	18000	45000
GOPHER, MN VORTAC	NICKL, WI FIX	18000	45000
NICKL, WI FIX	AUGER, WI FIX	25000	45000
*25000 - MCA AUGER, WI FIX , W BND			
AUGER, WI FIX	BADGER, WI VORTAC	18000	45000
BADGER, WI VORTAC	PULLMAN, MI VOR/DME	18000	45000
PULLMAN, MI VOR/DME	SALEM, MI VORTAC	18000	45000
SALEM, MI VORTAC	U.S. CANADIAN BORDER	18000	45000
U.S. CANADIAN BORDER	JAMESTOWN, NY VOR/DME	18000	45000
JAMESTOWN, NY VOR/DME	WILKES-BARRE, PA VORTAC	18000	45000
WILKES-BARRE, PA VORTAC	STILLWATER, NJ VOR/DME	18000	45000
STILLWATER, NJ VOR/DME	LA GUARDIA, NY VOR/DME	18000	24000
LA GUARDIA, NY VOR/DME	KENNEDY, NY VOR/DME	18000	45000
95.7071 JET ROUTE J71			
MEMPHIS, TN VORTAC	CENTRALIA, IL VORTAC	18000	45000
CENTRALIA, IL VORTAC	ROBERTS, IL VOR/DME	18000	35000
ROBERTS, IL VOR/DME	NORTHBROOK, IL VOR/DME	18000	35000
95.7072 JET ROUTE J72			
BOULDER CITY, NV VORTAC	PEACH SPRINGS, AZ VORTAC	18000	45000
PEACH SPRINGS, AZ VORTAC	GALLUP, NM VORTAC	#18000	45000
#MEA IS ESTABLISHED WITH A GAP IN NAVIGATION SIGNAL COVERAGE.			
GALLUP, NM VORTAC	ALBUQUERQUE, NM VORTAC	18000	45000
ALBUQUERQUE, NM VORTAC	TEXICO, TX VORTAC	18000	45000
TEXICO, TX VORTAC	WICHITA FALLS, TX VORTAC	18000	45000
95.7073 JET ROUTE J73			
DOLPHIN, FL VORTAC	LA BELLE, FL VORTAC	18000	45000
LA BELLE, FL VORTAC	LAKELAND, FL VORTAC	18000	45000
LAKELAND, FL VORTAC	SEMINOLE, FL VORTAC	18000	45000
SEMINOLE, FL VORTAC	LAGRANGE, GA VORTAC	18000	45000
LAGRANGE, GA VORTAC	NASHVILLE, TN VORTAC	18000	45000
NASHVILLE, TN VORTAC	POCKET CITY, IN VORTAC	18000	45000
POCKET CITY, IN VORTAC	NORTHBROOK, IL VOR/DME	18000	45000
95.7074 JET ROUTE J74			
LOS ANGELES, CA VORTAC	PARADISE, CA VORTAC	18000	45000
PARADISE, CA VORTAC	PARKER, CA VORTAC	18000	45000
PARKER, CA VORTAC	NABOB, AZ FIX	21000	45000

FROM	TO	MEA	MAA
95.7074 JET ROUTE J74 – CONTINUED			
NABOB, AZ FIX	ST JOHNS, AZ VORTAC	18000	45000
ST JOHNS, AZ VORTAC	CORONA, NM VORTAC	18000	45000
CORONA, NM VORTAC	TEXICO, TX VORTAC	18000	45000
TEXICO, TX VORTAC	WILL ROGERS, OK VORTAC	18000	45000
95.7075 JET ROUTE J75			
DOLPHIN, FL VORTAC	LEE COUNTY, FL VORTAC	18000	45000
LEE COUNTY, FL VORTAC	TAYLOR, FL VORTAC	18000	45000
TAYLOR, FL VORTAC	COLUMBIA, SC VORTAC	18000	45000
COLUMBIA, SC VORTAC	GREENSBORO, NC VORTAC	18000	45000
GREENSBORO, NC VORTAC	GORDONSVILLE, VA VORTAC	18000	45000
GORDONSVILLE, VA VORTAC	MODENA, PA VORTAC	18000	45000
MODENA, PA VORTAC	SOLBERG, NJ VOR/DME	18000	32000
SOLBERG, NJ VOR/DME	CARMEL, NY VOR/DME	18000	32000
CARMEL, NY VOR/DME	BOSTON, MA VOR/DME	18000	45000
95.7076 JET ROUTE J76			
LAS VEGAS, NV VORTAC	TUBA CITY, AZ VORTAC	18000	45000
TUBA CITY, AZ VORTAC	FORT UNION, NM VORTAC	#27000	45000
#MEA IS ESTABLISHED WITH A GAP IN NAVIGATION SIGNAL COVERAGE.			
#MEA GAP			
FORT UNION, NM VORTAC	TUCUMCARI, NM VORTAC	18000	45000
TUCUMCARI, NM VORTAC	WICHITA FALLS, TX VORTAC	18000	45000
95.7077 JET ROUTE J77			
BOSTON, MA VOR/DME	BARNES, MA VORTAC	18000	45000
BARNES, MA VORTAC	SPARTA, NJ VORTAC	18000	31000
SPARTA, NJ VORTAC	BROADWAY, NJ VOR/DME	18000	45000
BROADWAY, NJ VOR/DME	POTTSTOWN, PA VORTAC	18000	45000
POTTSTOWN, PA VORTAC	WESTMINSTER, MD VORTAC	18000	45000
95.7078 JET ROUTE J78			
LOS ANGELES, CA VORTAC	SEAL BEACH, CA VORTAC	18000	45000
SEAL BEACH, CA VORTAC	THERMAL, CA VORTAC	18000	45000
THERMAL, CA VORTAC	PARKER, CA VORTAC	18000	45000
PARKER, CA VORTAC	DRAKE, AZ VORTAC	18000	45000
DRAKE, AZ VORTAC	PYRIT, AZ FIX	22000	45000
PYRIT, AZ FIX	ZUNI, NM VORTAC	18000	45000
ZUNI, NM VORTAC	ALBUQUERQUE, NM VORTAC	18000	45000
ALBUQUERQUE, NM VORTAC	TUCUMCARI, NM VORTAC	18000	45000
TUCUMCARI, NM VORTAC	PANHANDLE, TX VORTAC	18000	45000
PANHANDLE, TX VORTAC	WILL ROGERS, OK VORTAC	18000	45000
WILL ROGERS, OK VORTAC	TULSA, OK VORTAC	18000	45000
TULSA, OK VORTAC	FARMINGTON, MO VORTAC	18000	45000
FARMINGTON, MO VORTAC	POCKET CITY, IN VORTAC	18000	45000
POCKET CITY, IN VORTAC	LOUISVILLE, KY VORTAC	18000	45000
LOUISVILLE, KY VORTAC	CHARLESTON, WV VORTAC	18000	45000

FROM	TO	MEA	MAA
95.7078 JET ROUTE J78 - CONTINUED			
CHARLESTON, WV VORTAC	PHILIPSBURG, PA VORTAC	18000	45000
PHILIPSBURG, PA VORTAC	MILTON, PA VORTAC	18000	45000
95.7079 JET ROUTE J79			
KEY WEST, FL VORTAC	DOLPHIN, FL VORTAC	18000	45000
DOLPHIN, FL VORTAC	PALM BEACH, FL VORTAC	18000	45000
PALM BEACH, FL VORTAC	VERO BEACH, FL VORTAC	18000	45000
VERO BEACH, FL VORTAC	ORMOND BEACH, FL VORTAC	18000	45000
ORMOND BEACH, FL VORTAC	CHARLESTON, SC VORTAC	18000	45000
CHARLESTON, SC VORTAC	TAR RIVER, NC VORTAC	18000	45000
TAR RIVER, NC VORTAC	FRANKLIN, VA VORTAC	18000	45000
FRANKLIN, VA VORTAC	SALISBURY, MD VORTAC	18000	45000
SALISBURY, MD VORTAC	KENNEDY, NY VOR/DME	18000	45000
KENNEDY, NY VOR/DME	MARCONI, MA VOR/DME	18000	45000
MARCONI, MA VOR/DME	BANGOR, ME VORTAC	18000	45000
95.7080 JET ROUTE J80			
OAKLAND, CA VORTAC	MANTECA, CA VORTAC	18000	45000
MANTECA, CA VORTAC	COALDALE, NV VORTAC	18000	45000
COALDALE, NV VORTAC	WILSON CREEK, NV VORTAC	18000	45000
WILSON CREEK, NV VORTAC	MILFORD, UT VORTAC	18000	45000
MILFORD, UT VORTAC	GRAND JUNCTION, CO VOR/DME	18000	45000
GRAND JUNCTION, CO VOR/DME	RED TABLE, CO VOR/DME	18000	45000
RED TABLE, CO VOR/DME	FALCON, CO VORTAC	18000	45000
FALCON, CO VORTAC	GOODLAND, KS VORTAC	18000	45000
GOODLAND, KS VORTAC	HILL CITY, KS VORTAC	18000	45000
HILL CITY, KS VORTAC	KANSAS CITY, MO VORTAC	18000	45000
KANSAS CITY, MO VORTAC	SPINNER, IL VORTAC	18000	45000
SPINNER, IL VORTAC	BRICKYARD, IN VORTAC	18000	45000
BRICKYARD, IN VORTAC	BELLAIRE, OH VOR/DME	18000	45000
BELLAIRE, OH VOR/DME	VINSE, PA FIX	18000	45000
VINSE, PA FIX	KIPPI, PA FIX	26000	45000
KIPPI, PA FIX	EAST TEXAS, PA VOR/DME	18000	38000
EAST TEXAS, PA VOR/DME	SPARTA, NJ VORTAC	18000	32000
SPARTA, NJ VORTAC	BARNES, MA VORTAC	18000	31000
BARNES, MA VORTAC	BANGOR, ME VORTAC	18000	45000
95.7081 JET ROUTE J81			
DOLPHIN, FL VORTAC	PAHOKEE, FL VORTAC	18000	45000
PAHOKEE, FL VORTAC	ORLANDO, FL VORTAC	18000	45000
ORLANDO, FL VORTAC	CECIL, FL VOR	18000	45000
CECIL, FL VOR	COLLIERS, SC VORTAC	18000	45000
95.7082 JET ROUTE J82			
BATTLE GROUND, WA VORTAC	DONNELLY, ID VORTAC	22000	45000
DONNELLY, ID VORTAC	DUBOIS, ID VORTAC	18000	45000

FROM	TO	MEA	MAA
95.7082 JET ROUTE J82 – CONTINUED			
DUBOIS, ID VORTAC #MEA IS ESTABLISHED WITH A GAP	CRAZY WOMAN, WY VOR/DME IN NAVIGATION SIGNAL COVERAGE.	#25000	45000
CRAZY WOMAN, WY VOR/DME	RAPID CITY, SD VORTAC	18000	45000
RAPID CITY, SD VORTAC	SIOUX FALLS, SD VORTAC	18000	45000
SIOUX FALLS, SD VORTAC	FORT DODGE, IA VORTAC	18000	45000
FORT DODGE, IA VORTAC	DUBUQUE, IA VORTAC	18000	45000
DUBUQUE, IA VORTAC	JOLIET, IL VORTAC	18000	45000
JOLIET, IL VORTAC	GOSHEN, IN VORTAC	18000	45000
GOSHEN, IN VORTAC	GOSHEN, OH VOR/DME	18000	45000
DRYER, OH VOR/DME	JAMESTOWN, NY VOR/DME	18000	45000
JAMESTOWN, NY VOR/DME	ALBANY, NY VORTAC	18000	40000

95.7083 JET ROUTE J83

SPARTANBURG, SC VORTAC #APPLETON, OH VORTAC #APPLETON R-021 UNUSABLE.	APPLETON, OH VORTAC DRYER, OH VOR/DME	23000 18000	45000 45000
---	--	----------------	----------------

95.7084 JET ROUTE J84

OAKLAND, CA VORTAC	LINDEN, CA VORTAC	18000	45000
LINDEN, CA VORTAC	MINA, NV VORTAC	18000	45000
MINA, NV VORTAC #MEA IS ESTABLISHED WITH A GAP	DELTA, UT VORTAC IN NAVIGATION SIGNAL COVERAGE.	#20000	45000
DELTA, UT VORTAC #MEA IS ESTABLISHED WITH A GAP	MEEKER, CO VOR/DME IN NAVIGATION SIGNAL COVERAGE.	#20000	45000
MEEKER, CO VOR/DME #MEA IS ESTABLISHED WITH A GAP	SIDNEY, NE VORTAC IN NAVIGATION SIGNAL COVERAGE.	#22000	45000
SIDNEY, NE VORTAC #MEA IS ESTABLISHED WITH A GAP	WOLBACH, NE VORTAC IN NAVIGATION SIGNAL COVERAGE.	#18000	45000
WOLBACH, NE VORTAC #MEA IS ESTABLISHED WITH A GAP	DUBUQUE, IA VORTAC IN NAVIGATION SIGNAL COVERAGE.	#21000	45000
DUBUQUE, IA VORTAC	NORTHBROOK, IL VOR/DME	18000	45000
NORTHBROOK, IL VOR/DME	DANVILLE, IL VORTAC	18000	35000

95.7085 JET ROUTE J85

DOLPHIN, FL VORTAC	LLAKE, FL FIX	18000	45000
LLAKE, FL FIX	INPIN, FL FIX	23000	45000
INPIN, FL FIX	GATORS, FL VORTAC	18000	45000
GATORS, FL VORTAC	TAYLOR, FL VORTAC	18000	45000
TAYLOR, FL VORTAC	ALMA, GA VORTAC	18000	45000
ALMA, GA VORTAC	COLLIERS, SC VORTAC	18000	45000
COLLIERS, SC VORTAC	SPARTANBURG, SC VORTAC	18000	45000
SPARTANBURG, SC VORTAC	CHARLESTON, WV VORTAC	18000	45000
CHARLESTON, WV VORTAC	DRYER, OH VOR/DME	18000	45000

FROM	TO	MEA	MAA
95.7086 JET ROUTE J86			
BEATTY, NV VORTAC	FUZZY, NV FIX	18000	45000
FUZZY, NV FIX	BOULDER CITY, NV VORTAC	29000	45000
BOULDER CITY, NV VORTAC	PEACH SPRINGS, AZ VORTAC	#18000	45000
#MEA IS ESTABLISHED WITH A GAP IN NAVIGATION SIGNAL COVERAGE.			
PEACH SPRINGS, AZ VORTAC	BAVPE, AZ FIX	18000	45000
BAVPE, AZ FIX	WINSLOW, AZ VORTAC	18000	45000
WINSLOW, AZ VORTAC	EL PASO, TX VORTAC	#27000	45000
#MEA IS ESTABLISHED WITH A GAP IN NAVIGATION SIGNAL COVERAGE.			
EL PASO, TX VORTAC	FORT STOCKTON, TX VORTAC	18000	45000
FORT STOCKTON, TX VORTAC	JUNCTION, TX VORTAC	18000	45000
JUNCTION, TX VORTAC	HUMBLE, TX VORTAC	18000	45000
HUMBLE, TX VORTAC	LEEVILLE, LA VORTAC	18000	45000

95.7087 JET ROUTE J87

HUMBLE, TX VORTAC	NAVASOTA, TX VORTAC	18000	45000
NAVASOTA, TX VORTAC	TORN, TX FIX	18000	45000
TORN, TX FIX	COWBOY, TX VOR/DME	18000	45000
COWBOY, TX VOR/DME	TULSA, OK VORTAC	18000	45000
TULSA, OK VORTAC	BUTLER, MO VORTAC	18000	45000
BUTLER, MO VORTAC	KIRKSVILLE, MO VORTAC	18000	45000
KIRKSVILLE, MO VORTAC	MOLINE, IL VORTAC	18000	35000
MOLINE, IL VORTAC	JOLIET, IL VORTAC	18000	35000
JOLIET, IL VORTAC	NORTHBROOK, IL VOR/DME	18000	45000

95.7088 JET ROUTE J88

LOS ANGELES, CA VORTAC	SAN MARCUS, CA VORTAC	18000	45000
SAN MARCUS, CA VORTAC	SALINAS, CA VORTAC	18000	45000
SALINAS, CA VORTAC	POINT REYES, CA VORTAC	18000	45000

95.7089 JET ROUTE J89

HITTR, FL FIX	VALDOSTA, GA VOR/DME	18000	45000
VALDOSTA, GA VOR/DME	ATLANTA, GA VORTAC	18000	45000
ATLANTA, GA VORTAC	LOUISVILLE, KY VORTAC	18000	45000
LOUISVILLE, KY VORTAC	BOILER, IN VORTAC	18000	45000
BOILER, IN VORTAC	NORTHBROOK, IL VOR/DME	18000	45000
NORTHBROOK, IL VOR/DME	BADGER, WI VORTAC	18000	45000
BADGER, WI VORTAC	DULUTH, MN VORTAC	18000	45000
DULUTH, MN VORTAC	U.S. CANADIAN BORDER	18000	45000

95.7090 JET ROUTE J90

SEATTLE, WA VORTAC	MOSES LAKE, WA VOR/DME	18000	45000
MOSES LAKE, WA VOR/DME	HELENA, MT VORTAC	#28000	45000
#MEA IS ESTABLISHED WITH A GAP IN NAVIGATION SIGNAL COVERAGE.			
HELENA, MT VORTAC	MILES CITY, MT VOR/DME	28000	45000
MILES CITY, MT VOR/DME	ABERDEEN, SD VOR/DME	#20000	45000
#MEA IS ESTABLISHED WITH A GAP IN NAVIGATION SIGNAL COVERAGE.			
ABERDEEN, SD VOR/DME	REDWOOD FALLS, MN VOR/DME	18000	45000
REDWOOD FALLS, MN VOR/DME	MASON CITY, IA VORTAC	18000	45000
MASON CITY, IA VORTAC	NORTHBROOK, IL VOR/DME	18000	45000

FROM	TO	MEA	MAA
95.7091 JET ROUTE J91			
INPIN, FL FIX	CROSS CITY, FL VORTAC	18000	45000
CROSS CITY, FL VORTAC	ATLANTA, GA VORTAC	24000	45000
#ATLANTA R-169 DME UNUSABLE			
ATLANTA, GA VORTAC	VOLUNTEER, TN VORTAC	18000	45000
VOLUNTEER, TN VORTAC	HENDERSON, WV VORTAC	18000	45000
HENDERSON, WV VORTAC	BELLAIRE, OH VOR/DME	18000	45000
95.7092 JET ROUTE J92			
KLAMATH FALLS, OR VORTAC	MUSTANG, NV VORTAC	18000	45000
MUSTANG, NV VORTAC	COALDALE, NV VORTAC	18000	45000
COALDALE, NV VORTAC	BEATTY, NV VORTAC	18000	45000
BEATTY, NV VORTAC	BOULDER CITY, NV VORTAC	24000	45000
BOULDER CITY, NV VORTAC	DRAKE, AZ VORTAC	18000	45000
DRAKE, AZ VORTAC	PHOENIX, AZ VORTAC	18000	45000
PHOENIX, AZ VORTAC	STANFIELD, AZ VORTAC	18000	45000
STANFIELD, AZ VORTAC	TUCSON, AZ VORTAC	18000	45000
TUCSON, AZ VORTAC	U.S. MEXICAN BORDER	18000	45000
95.7093 JET ROUTE J93			
U.S. MEXICAN BORDER	JULIAN, CA VORTAC	18000	45000
JULIAN, CA VORTAC	PARADISE, CA VORTAC	18000	45000
PARADISE, CA VORTAC	LOS ANGELES, CA VORTAC	18000	45000
95.7094 JET ROUTE J94			
OAKLAND, CA VORTAC	MANTECA, CA VORTAC	18000	45000
MANTECA, CA VORTAC	MUSTANG, NV VORTAC	19000	45000
MUSTANG, NV VORTAC	LOVELOCK, NV VORTAC	18000	45000
LOVELOCK, NV VORTAC	BATTLE MOUNTAIN, NV VORTAC	18000	45000
BATTLE MOUNTAIN, NV VORTAC	LUCIN, UT VORTAC	18000	45000
LUCIN, UT VORTAC	ROCK SPRINGS, WY VOR/DME	#18000	45000
#MEA IS ESTABLISHED WITH A GAP IN NAVIGATION SIGNAL COVERAGE.			
ROCK SPRINGS, WY VOR/DME	SCOTTSBLUFF, NE VORTAC	18000	45000
SCOTTSBLUFF, NE VORTAC	O'NEILL, NE VORTAC	18000	45000
O'NEILL, NE VORTAC	FORT DODGE, IA VORTAC	18000	45000
FORT DODGE, IA VORTAC	DUBUQUE, IA VORTAC	18000	45000
DUBUQUE, IA VORTAC	NORTHBROOK, IL VOR/DME	18000	45000
NORTHBROOK, IL VOR/DME	PULLMAN, MI VOR/DME	18000	45000
PULLMAN, MI VOR/DME	FLINT, MI VORTAC	18000	45000
FLINT, MI VORTAC	PECK, MI VORTAC	18000	45000
PECK, MI VORTAC	U.S. CANADIAN BORDER	18000	45000
U.S. CANADIAN BORDER	BUFFALO, NY VOR/DME	18000	45000
BUFFALO, NY VOR/DME	ALBANY, NY VORTAC	18000	45000
ALBANY, NY VORTAC	BOSTON, MA VOR/DME	18000	45000

FROM	TO	MEA	MAA
95.7095 JET ROUTE J95			
DEER PARK, NY VOR/DME *5500 - MRA	*GAYEL, NY FIX	18000	45000
GAYEL, NY FIX #GNSS MEA, GNSS REQUIRED	BINGHAMTON, NY VORTAC	18000	45000
BINGHAMTON, NY VORTAC BINGHAMTON R-129 UNUSABLE. GNSS REQUIRED	BUFFALO, NY VOR/DME	18000	45000
BUFFALO, NY VOR/DME	U.S. CANADIAN BORDER	18000	45000
95.7096 JET ROUTE J96			
LOS ANGELES, CA VORTAC	PARADISE, CA VORTAC	18000	45000
PARADISE, CA VORTAC	PARKER, CA VORTAC	18000	45000
PARKER, CA VORTAC	DRAKE, AZ VORTAC	18000	45000
DRAKE, AZ VORTAC	GALLUP, NM VORTAC	18000	45000
GALLUP, NM VORTAC	CIMARRON, NM VORTAC	#23000	45000
#MEA IS ESTABLISHED WITH A GAP IN NAVIGATION SIGNAL COVERAGE.			
CIMARRON, NM VORTAC	GARDEN CITY, KS VORTAC	18000	45000
GARDEN CITY, KS VORTAC	SALINA, KS VORTAC	18000	45000
SALINA, KS VORTAC	KIRKSVILLE, MO VORTAC	18000	45000
KIRKSVILLE, MO VORTAC	PEORIA, IL VORTAC	18000	35000
PEORIA, IL VORTAC	JOLIET, IL VORTAC	18000	35000
95.7097 JET ROUTE J97			
SLATON, VA FIX	NANTUCKET, MA VOR/DME	25000	45000
NANTUCKET, MA VOR/DME	BOSTON, MA VOR/DME	18000	45000
BOSTON, MA VOR/DME	PLATTSBURGH, NY VORTAC	18000	45000
95.7098 JET ROUTE J98			
LIBERAL, KS VORTAC	MITBEE, OK VORTAC	18000	45000
MITBEE, OK VORTAC	WILL ROGERS, OK VORTAC	18000	45000
WILL ROGERS, OK VORTAC	TULSA, OK VORTAC	18000	45000
TULSA, OK VORTAC	SPRINGFIELD, MO VORTAC	18000	45000
SPRINGFIELD, MO VORTAC	FARMINGTON, MO VORTAC	18000	45000
95.7099 JET ROUTE J99			
COLLIERS, SC VORTAC	VOLUNTEER, TN VORTAC	18000	45000
VOLUNTEER, TN VORTAC	LOUISVILLE, KY VORTAC	18000	45000
95.7100 JET ROUTE J100			
LOS ANGELES, CA VORTAC	DAGGETT, CA VORTAC	18000	45000
DAGGETT, CA VORTAC	LAS VEGAS, NV VORTAC	18000	45000
LAS VEGAS, NV VORTAC	BRYCE CANYON, UT VORTAC	18000	45000
BRYCE CANYON, UT VORTAC	MEEKER, CO VOR/DME	#20000	45000
#MEA IS ESTABLISHED WITH A GAP IN NAVIGATION SIGNAL COVERAGE.			
MEEKER, CO VOR/DME	SIDNEY, NE VORTAC	#22000	45000
#MEA IS ESTABLISHED WITH A GAP IN NAVIGATION SIGNAL COVERAGE.			

FROM	TO	MEA	MAA
95.7100 JET ROUTE J100 - CONTINUED			
SIDNEY, NE VORTAC	WOLBACH, NE VORTAC	18000	45000
WOLBACH, NE VORTAC	DUBUQUE, IA VORTAC	#21000	45000
#MEA IS ESTABLISHED WITH A GAP IN NAVIGATION SIGNAL COVERAGE.			
DUBUQUE, IA VORTAC	NORTHBROOK, IL VOR/DME	18000	45000
95.7101 JET ROUTE J101			
HUMBLE, TX VORTAC	LUFKIN, TX VORTAC	18000	45000
LUFKIN, TX VORTAC	LITTLE ROCK, AR VORTAC	18300	45000
LITTLE ROCK, AR VORTAC	ST LOUIS, MO VORTAC	18000	45000
ST LOUIS, MO VORTAC	SPINNER, IL VORTAC	18000	45000
SPINNER, IL VORTAC	PONTIAC, IL VOR/DME	18000	31000
PONTIAC, IL VOR/DME	JOLIET, IL VORTAC	18000	35000
JOLIET, IL VORTAC	NORTHBROOK, IL VOR/DME	18000	45000
NORTHBROOK, IL VOR/DME	BADGER, WI VORTAC	18000	45000
BADGER, WI VORTAC	GREEN BAY, WI VORTAC	18000	45000
GREEN BAY, WI VORTAC	SAULT STE MARIE, MI VOR/DME	18000	45000
95.7102 JET ROUTE J102			
PHOENIX, AZ VORTAC	ZUNI, NM VORTAC	18000	45000
ZUNI, NM VORTAC	GALLUP, NM VORTAC	18000	45000
GALLUP, NM VORTAC	ALAMOSA, CO VORTAC	18000	45000
ALAMOSA, CO VORTAC	LAMAR, CO VORTAC	18000	45000
LAMAR, CO VORTAC	SALINA, KS VORTAC	18000	45000
95.7103 JET ROUTE J103			
ORMOND BEACH, FL VORTAC	SAVANNAH, GA VORTAC	18000	45000
95.7104 JET ROUTE J104			
LOS ANGELES, CA VORTAC	TWENTYNINE PALMS, CA VORTAC	18000	45000
TWENTYNINE PALMS, CA VORTAC	PARKER, CA VORTAC	18000	45000
PARKER, CA VORTAC	GILA BEND, AZ VORTAC	18000	45000
GILA BEND, AZ VORTAC	TUCSON, AZ VORTAC	18000	45000
TUCSON, AZ VORTAC	SAN SIMON, AZ VORTAC	18000	45000
SAN SIMON, AZ VORTAC	SOCORRO, NM VORTAC	20000	45000
SOCORRO, NM VORTAC	FORT UNION, NM VORTAC	18000	45000
FORT UNION, NM VORTAC	PUEBLO, CO VORTAC	18000	45000
95.7105 JET ROUTE J105			
RANGER, TX VORTAC	MC ALESTER, OK VORTAC	18000	45000
MC ALESTER, OK VORTAC	RAZORBACK, AR VORTAC	18000	45000
RAZORBACK, AR VORTAC	SPRINGFIELD, MO VORTAC	18000	45000
SPRINGFIELD, MO VORTAC	BRADFORD, IL VORTAC	18000	45000
BRADFORD, IL VORTAC	BADGER, WI VORTAC	18000	45000

FROM	TO	MEA	MAA
95.7106 JET ROUTE J106			
GOPHER, MN VORTAC	GREEN BAY, WI VORTAC	18000	45000
GREEN BAY, WI VORTAC	FLINT, MI VORTAC	18000	45000
FLINT, MI VORTAC	U.S. CANADIAN BORDER	18000	45000
U.S. CANADIAN BORDER	JAMESTOWN, NY VOR/DME	18000	45000
JAMESTOWN, NY VOR/DME	WILKES-BARRE, PA VORTAC	18000	45000
WILKES-BARRE, PA VORTAC	STILLWATER, NJ VOR/DME	18000	45000
STILLWATER, NJ VOR/DME	LA GUARDIA, NY VOR/DME	18000	24000
95.7107 JET ROUTE J107			
LOS ANGELES, CA VORTAC	HECTOR, CA VORTAC	18000	45000
HECTOR, CA VORTAC	BOULDER CITY, NV VORTAC	18000	45000
BOULDER CITY, NV VORTAC	MILFORD, UT VORTAC	18000	45000
MILFORD, UT VORTAC	ROCK SPRINGS, WY VOR/DME	#33000	45000
#MEA IS ESTABLISHED WITH A GAP IN NAVIGATION SIGNAL COVERAGE.			
ROCK SPRINGS, WY VOR/DME	MUDDY MOUNTAIN, WY VORTAC	18000	45000
MUDDY MOUNTAIN, WY VORTAC	DUPREE, SD VORTAC	18000	45000
DUPREE, SD VORTAC	HUMBOLDT, MN VORTAC	21000	45000
HUMBOLDT, MN VORTAC	U.S. CANADIAN BORDER	18000	45000
95.7108 JET ROUTE J108			
WINSLOW, AZ VORTAC	ST JOHNS, AZ VORTAC	18000	45000
ST JOHNS, AZ VORTAC	TRUTH OR CONSEQUENCES, NM VORTAC	18000	45000
TRUTH OR CONSEQUENCES, NM VORTAC	WINK, TX VORTAC	24000	45000
95.7109 JET ROUTE J109			
WILMINGTON, NC VORTAC	FLAT ROCK, VA VORTAC	18000	45000
FLAT ROCK, VA VORTAC	LINDEN, VA VORTAC	18000	45000
LINDEN, VA VORTAC	BUFFALO, NY VOR/DME	18000	45000
95.7110 JET ROUTE J110			
OAKLAND, CA VORTAC	SALINAS, CA VORTAC	18000	45000
SALINAS, CA VORTAC	CLOVIS, CA VORTAC	18000	45000
CLOVIS, CA VORTAC	BOULDER CITY, NV VORTAC	#29000	45000
#MEA IS ESTABLISHED WITH A GAP IN NAVIGATION SIGNAL COVERAGE.			
BOULDER CITY, NV VORTAC	RATTLESNAKE, NM VORTAC	#28000	45000
#MEA IS ESTABLISHED WITH A GAP IN NAVIGATION SIGNAL COVERAGE.			
RATTLESNAKE, NM VORTAC	ALAMOSA, CO VORTAC	18000	45000
ALAMOSA, CO VORTAC	GARDEN CITY, KS VORTAC	#19000	45000
#MEA IS ESTABLISHED WITH A GAP IN NAVIGATION SIGNAL COVERAGE.			
GARDEN CITY, KS VORTAC	BUTLER, MO VORTAC	#22000	45000
#MEA IS ESTABLISHED WITH A GAP IN NAVIGATION SIGNAL COVERAGE.			
BUTLER, MO VORTAC	ST LOUIS, MO VORTAC	18000	45000
ST LOUIS, MO VORTAC	BRICKYARD, IN VORTAC	18000	45000
BRICKYARD, IN VORTAC	BELLAIRE, OH VOR/DME	18000	45000
BELLAIRE, OH VOR/DME	VINSE, PA FIX	18000	45000
VINSE, PA FIX	KIPPI, PA FIX	26000	45000
KIPPI, PA FIX	COYLE, NJ VORTAC	22000	45000

FROM	TO	MEA	MAA
95.7111 JET ROUTE J111			
NOME, AK VOR/DME	UNALAKLEET, AK VOR/DME	18000	45000
UNALAKLEET, AK VOR/DME	MC GRATH, AK VORTAC	18000	45000
MC GRATH, AK VORTAC	ANCHORAGE, AK VOR/DME	18000	45000
95.7112 JET ROUTE J112			
BUTLER, MO VORTAC	FARMINGTON, MO VORTAC	18000	45000
FARMINGTON, MO VORTAC	POCKET CITY, IN VORTAC	18000	45000
POCKET CITY, IN VORTAC	LOUISVILLE, KY VORTAC	18000	45000
95.7113 JET ROUTE J113			
VIRGINIA KEY, FL VOR/DME	CRAIG, FL VORTAC	18000	45000
95.7114 JET ROUTE J114			
MILE HIGH, CO VORTAC	SIDNEY, NE VORTAC	18000	45000
SIDNEY, NE VORTAC	O'NEILL, NE VORTAC	23000	45000
O'NEILL, NE VORTAC	SIOUX FALLS, SD VORTAC	18000	45000
SIOUX FALLS, SD VORTAC	GOPHER, MN VORTAC	18000	45000
95.7115 JET ROUTE J115			
SHEMYA, AK NDB	MOUNT MOFFETT, AK NDB/DME	18000	45000
MOUNT MOFFETT, AK NDB/DME	DUTCH HARBOR, AK NDB/DME	18000	45000
DUTCH HARBOR, AK NDB/DME	COLD BAY, AK VORTAC	18000	45000
COLD BAY, AK VORTAC	KING SALMON, AK VORTAC	#18000	45000
#MEA IS ESTABLISHED WITH A GAP IN NAVIGATION SIGNAL COVERAGE.			
KING SALMON, AK VORTAC	KENAI, AK VOR/DME	18000	45000
KENAI, AK VOR/DME	ANCHORAGE, AK VOR/DME	18000	45000
ANCHORAGE, AK VOR/DME	FAIRBANKS, AK VORTAC	18000	45000
FAIRBANKS, AK VORTAC	CHANDALAR LAKE, AK NDB	18000	45000
CHANDALAR LAKE, AK NDB	DEADHORSE, AK VOR/DME	18000	45000
95.7116 JET ROUTE J116			
WASATCH, UT VORTAC	FAIRFIELD, UT VORTAC	18000	45000
FAIRFIELD, UT VORTAC	MEEKER, CO VOR/DME	18000	45000
MEEKER, CO VOR/DME	FALCON, CO VORTAC	20000	45000
95.7117 JET ROUTE J117			
MC GRATH, AK VORTAC	GALENA, AK VOR/DME	18000	45000
GALENA, AK VOR/DME	KOTZEBUE, AK VOR/DME	18000	45000

FROM	TO	MEA	MAA
95.7118 JET ROUTE J118			
MEMPHIS, TN VORTAC	CHOO CHOO, TN VORTAC	18000	45000
CHOO CHOO, TN VORTAC	SPARTANBURG, SC VORTAC	18000	45000
95.7119 JET ROUTE J119			
ST PETERSBURG, FL VORTAC	TAYLOR, FL VORTAC	18000	45000
95.7120 JET ROUTE J120			
MOUNT MOFFETT, AK NDB/DME	ST PAUL ISLAND, AK NDB/DME	18000	45000
ST PAUL ISLAND, AK NDB/DME	BETHEL, AK VORTAC	28000	45000
BETHEL, AK VORTAC	MC GRATH, AK VORTAC	18000	45000
MC GRATH, AK VORTAC	FAIRBANKS, AK VORTAC	18000	45000
FAIRBANKS, AK VORTAC	*CHATA, AK FIX	18000	45000
*7000 - MRA			
CHATA, AK FIX	FORT YUKON, AK VORTAC	18000	45000
FORT YUKON, AK VORTAC	BARTER ISLAND, AK NDB	18000	45000
95.7121 JET ROUTE J121			
CRAIG, FL VORTAC	CHARLESTON, SC VORTAC	18000	45000
CHARLESTON, SC VORTAC	KINSTON, NC VORTAC	18000	45000
KINSTON, NC VORTAC	NORFOLK, VA VORTAC	18000	45000
NORFOLK, VA VORTAC	SNOW HILL, MD VORTAC	18000	45000
SNOW HILL, MD VORTAC	SEA ISLE, NJ VORTAC	18000	45000
SEA ISLE, NJ VORTAC	HAMPTON, NY VORTAC	18000	45000
HAMPTON, NY VORTAC	SANDY POINT, RI VOR/DME	18000	45000
SANDY POINT, RI VOR/DME	KENNEBUNK, ME VORTAC	18000	45000
95.7122 JET ROUTE J122			
FAIRBANKS, AK VORTAC	GALENA, AK VOR/DME	18000	45000
GALENA, AK VOR/DME	NOME, AK VOR/DME	18000	45000
95.7123 JET ROUTE J123			
MARLO, AK FIX	KODIAK, AK VOR/DME	18000	45000
KODIAK, AK VOR/DME	KING SALMON, AK VORTAC	18000	45000
KING SALMON, AK VORTAC	BETHEL, AK VORTAC	18000	45000
BETHEL, AK VORTAC	NOME, AK VOR/DME	18000	45000
NOME, AK VOR/DME	KOTZEBUE, AK VOR/DME	18000	45000
KOTZEBUE, AK VOR/DME	BARROW, AK VOR/DME	#21000	45000
#MEA IS ESTABLISHED WITH A GAP IN NAVIGATION SIGNAL COVERAGE.			

FROM	TO	MEA	MAA
95.7124 JET ROUTE J124			
ANCHORAGE, AK VOR/DME	BIG LAKE, AK VORTAC	18000	45000
BIG LAKE, AK VORTAC	GULKANA, AK VOR/DME	18000	45000
GULKANA, AK VOR/DME	NORTHWAY, AK VORTAC	18000	45000
95.7125 JET ROUTE J125			
KODIAK, AK VOR/DME	ANCHORAGE, AK VOR/DME	18000	45000
ANCHORAGE, AK VOR/DME	TALKEETNA, AK VOR/DME	18000	45000
TALKEETNA, AK VOR/DME	NENANA, AK VORTAC	18000	45000
95.7126 JET ROUTE J126			
LOS ANGELES, CA VORTAC	SAN MARCUS, CA VORTAC	18000	45000
SAN MARCUS, CA VORTAC	SALINAS, CA VORTAC	18000	45000
SALINAS, CA VORTAC	SACRAMENTO, CA VORTAC	18000	45000
SACRAMENTO, CA VORTAC	RED BLUFF, CA VORTAC	18000	45000
RED BLUFF, CA VORTAC	ROGUE VALLEY, OR VORTAC	18000	45000
ROGUE VALLEY, OR VORTAC	EUGENE, OR VORTAC	18000	45000
EUGENE, OR VORTAC	NEWBERG, OR VOR/DME	18000	45000
NEWBERG, OR VOR/DME	OLYMPIA, WA VORTAC	18000	45000
OLYMPIA, WA VORTAC	U.S. CANADIAN BORDER	18000	45000
95.7127 JET ROUTE J127			
KING SALMON, AK VORTAC	RINGO, AK FIX	18000	45000
RINGO, AK FIX	NONDA, AK FIX	18000	45000
95.7128 JET ROUTE J128			
LOS ANGELES, CA VORTAC	RUSTT, CA FIX	18000	45000
RUSTT, CA FIX	PEACH SPRINGS, AZ VORTAC	25000	45000
PEACH SPRINGS, AZ VORTAC	TUBA CITY, AZ VORTAC	18000	45000
TUBA CITY, AZ VORTAC	BLUE MESA, CO VOR/DME	#20000	45000
#MEA IS ESTABLISHED WITH A GAP IN NAVIGATION SIGNAL COVERAGE.			
BLUE MESA, CO VOR/DME	FALCON, CO VORTAC	18000	45000
FALCON, CO VORTAC	HAYES CENTER, NE VORTAC	18000	45000
HAYES CENTER, NE VORTAC	WOLBACH, NE VORTAC	18000	45000
WOLBACH, NE VORTAC	DUBUQUE, IA VORTAC	#21000	45000
#MEA IS ESTABLISHED WITH A GAP IN NAVIGATION SIGNAL COVERAGE.			
DUBUQUE, IA VORTAC	NORTHBROOK, IL VOR/DME	18000	45000
95.7129 JET ROUTE J129			
NOME, AK VOR/DME	KOTZEBUE, AK VOR/DME	18000	45000

FROM	TO	MEA	MAA
95.7130 JET ROUTE J130			
MC COOK, NE VOR/DME	PAWNEE CITY, NE VORTAC	18000	41000
95.7131 JET ROUTE J131			
SAN ANTONIO, TX VORTAC	EDNAS, TX FIX	18000	45000
EDNAS, TX FIX	RANGER, TX VORTAC	18000	45000
RANGER, TX VORTAC	TEXARKANA, AR VORTAC	18000	45000
TEXARKANA, AR VORTAC	LITTLE ROCK, AR VORTAC	18000	45000
LITTLE ROCK, AR VORTAC	POCKET CITY, IN VORTAC	#18000	45000
#MEA IS ESTABLISHED WITH A GAP IN NAVIGATION SIGNAL COVERAGE.			
95.7132 JET ROUTE J132			
ELMIRA, NY VOR/DME	HUGUENOT, NY VOR/DME	18000	45000
95.7133 JET ROUTE J133			
SITKA, AK NDB	ORCA BAY, AK NDB	18000	45000
ORCA BAY, AK NDB	JOHNSTONE POINT, AK VOR/DME	18000	
JOHNSTONE POINT, AK VOR/DME	ANCHORAGE, AK VOR/DME	18000	45000
ANCHORAGE, AK VOR/DME	GALENA, AK VOR/DME	#24000	45000
#MEA IS ESTABLISHED WITH A GAP IN NAVIGATION SIGNAL COVERAGE.			
95.7134 JET ROUTE J134			
LOS ANGELES, CA VORTAC	SEAL BEACH, CA VORTAC	18000	45000
SEAL BEACH, CA VORTAC	THERMAL, CA VORTAC	18000	45000
THERMAL, CA VORTAC	PARKER, CA VORTAC	18000	45000
PARKER, CA VORTAC	DRAKE, AZ VORTAC	18000	45000
DRAKE, AZ VORTAC	GALLUP, NM VORTAC	18000	45000
GALLUP, NM VORTAC	CIMARRON, NM VORTAC	#23000	45000
#MEA IS ESTABLISHED WITH A GAP IN NAVIGATION SIGNAL COVERAGE.			
CIMARRON, NM VORTAC	LIBERAL, KS VORTAC	18000	45000
LIBERAL, KS VORTAC	WICHITA, KS VORTAC	18000	45000
WICHITA, KS VORTAC	BUTLER, MO VORTAC	18000	45000
BUTLER, MO VORTAC	ST LOUIS, MO VORTAC	18000	45000
ST LOUIS, MO VORTAC	FALMOUTH, KY VOR/DME	18000	45000
FALMOUTH, KY VOR/DME	HENDERSON, WV VORTAC	18000	45000
HENDERSON, WV VORTAC	LINDEN, VA VORTAC	18000	45000
95.7135 JET ROUTE J135			
BETHEL, AK VORTAC	UNALAKLEET, AK VOR/DME	18000	45000

FROM	TO	MEA	MAA
95.7136 JET ROUTE J136			
NEWPORT, OR VORTAC	BATTLE GROUND, WA VORTAC	18000	45000
BATTLE GROUND, WA VORTAC	YAKIMA, WA VORTAC	18000	45000
YAKIMA, WA VORTAC	SPOKANE, WA VORTAC	18000	45000
SPOKANE, WA VORTAC	MULLAN PASS, ID VOR/DME	18000	45000
MULLAN PASS, ID VOR/DME	HELENA, MT VORTAC	18000	45000
HELENA, MT VORTAC	BILLINGS, MT VORTAC	18000	45000
BILLINGS, MT VORTAC	MEDICINE BOW, WY VOR/DME	28000	45000
95.7137 JET ROUTE J137			
SPINNER, IL VORTAC	FARMINGTON, MO VORTAC	18000	45000
FARMINGTON, MO VORTAC	WALNUT RIDGE, AR VORTAC	18000	45000
WALNUT RIDGE, AR VORTAC	LITTLE ROCK, AR VORTAC	18000	45000
95.7138 JET ROUTE J138			
FORT STOCKTON, TX VORTAC	CENTER POINT, TX VORTAC	18000	45000
CENTER POINT, TX VORTAC	SAN ANTONIO, TX VORTAC	18000	45000
SAN ANTONIO, TX VORTAC	HOBBY, TX VOR/DME	18000	45000
HOBBY, TX VOR/DME	LAKE CHARLES, LA VORTAC	18000	45000
LAKE CHARLES, LA VORTAC	SEMMES, AL VORTAC	18000	45000
95.7139 JET ROUTE J139			
BETTLES, AK VOR/DME	DEADHORSE, AK VOR/DME	18000	45000
95.7140 JET ROUTE J140			
FARGO, ND VORTAC	DULUTH, MN VORTAC	18000	45000
DULUTH, MN VORTAC	SAULT STE MARIE, MI VOR/DME	18000	45000
95.7141 JET ROUTE J141			
EL PASO, TX VORTAC	U.S. MEXICAN BORDER	18000	45000
95.7142 JET ROUTE J142			
SOCORRO, NM VORTAC	ANTON CHICO, NM VORTAC	18000	45000
ANTON CHICO, NM VORTAC	BORGER, TX VORTAC	18000	45000
95.7143 JET ROUTE J143			
POINT REYES, CA VORTAC	MENDOCINO, CA VORTAC	18000	45000
MENDOCINO, CA VORTAC	ROSEBURG, OR VOR/DME	18000	45000
ROSEBURG, OR VOR/DME	EUGENE, OR VORTAC	18000	45000
EUGENE, OR VORTAC	KLICKITAT, OR VOR/DME	18000	45000
KLICKITAT, OR VOR/DME	SPOKANE, WA VORTAC	18000	45000

FROM	TO	MEA	MAA
95.7144 JET ROUTE J144			
WOLBACH, NE VORTAC	DES MOINES, IA VORTAC	18000	45000
DES MOINES, IA VORTAC	DUBUQUE, IA VORTAC	18000	45000
95.7145 JET ROUTE J145			
FOOTHILLS, GA VORTAC	CHARLESTON, WV VORTAC	18000	45000
CHARLESTON, WV VORTAC	ELLWOOD CITY, PA VORTAC	18000	45000
95.7146 JET ROUTE J146			
LOS ANGELES, CA VORTAC	DAGGETT, CA VORTAC	18000	45000
DAGGETT, CA VORTAC	LAS VEGAS, NV VORTAC	18000	45000
LAS VEGAS, NV VORTAC	NOOTN, AZ FIX	18000	45000
NOOTN, AZ FIX	DOVE CREEK, CO VORTAC	#25000	45000
#MEA IS ESTABLISHED WITH A GAP	IN NAVIGATION SIGNAL COVERAGE.		
DOVE CREEK, CO VORTAC	BLUE MESA, CO VOR/DME	18000	45000
BLUE MESA, CO VOR/DME	GOODLAND, KS VORTAC	#23000	45000
#MEA IS ESTABLISHED WITH A GAP	IN NAVIGATION SIGNAL COVERAGE.		
GOODLAND, KS VORTAC	LINCOLN, NE VORTAC	18000	45000
LINCOLN, NE VORTAC	IOWA CITY, IA VORTAC	18000	45000
IOWA CITY, IA VORTAC	JOLIET, IL VORTAC	18000	45000
JOLIET, IL VORTAC	GIPPER, MI VORTAC	18000	45000
GIPPER, MI VORTAC	CHARDON, OH VOR/DME	18000	45000
CHARDON, OH VOR/DME	KEATING, PA VORTAC	18000	45000
KEATING, PA VORTAC	MILTON, PA VORTAC	18000	45000
MILTON, PA VORTAC	ALLENTOWN, PA VORTAC	18000	45000
#ALLENTOWN, PA VORTAC	#KENNEDY, NY VOR/DME	18000	45000
#ALLENTOWN R-104 UNUSABLE. USE KENNEDY R-287.			
95.7147 JET ROUTE J147			
BECKLEY, WV VORTAC	GREENBRIER, WV VOR/DME	18000	45000
GREENBRIER, WV VOR/DME	CASANOVA, VA VORTAC	18000	45000
95.7148 JET ROUTE J148			
COALDALE, NV VORTAC	DELTA, UT VORTAC	27000	45000
DELTA, UT VORTAC	MYTON, UT VORTAC	18000	45000
MYTON, UT VORTAC	CHEYENNE, WY VORTAC	#21000	45000
#MEA IS ESTABLISHED WITH A GAP	IN NAVIGATION SIGNAL COVERAGE.		
CHEYENNE, WY VORTAC	O'NEILL, NE VORTAC	#21000	45000
#MEA IS ESTABLISHED WITH A GAP	IN NAVIGATION SIGNAL COVERAGE.		
O'NEILL, NE VORTAC	MASON CITY, IA VORTAC	18000	45000
95.7149 JET ROUTE J149			
ARMEL, VA VORTAC	GEFFS, WV FIX	#*31000	41000
*18000 - GNSS MEA			
GEFFS, WV FIX	HACKS, WV FIX	#*29000	41000
*18000 - GNSS MEA			

FROM	TO	MEA	MAA
95.7149 JET ROUTE J149 - CONTINUED			
HACKS, WV FIX	ROSEWOOD, OH VORTAC	#*23000	45000
*18000 - GNSS MEA			
ROSEWOOD, OH VORTAC	FORT WAYNE, IN VORTAC	18000	45000
95.7150 JET ROUTE J150			
GORDONSVILLE, VA VORTAC	NOTTINGHAM, MD VORTAC	18000	45000
NOTTINGHAM, MD VORTAC	*GRACO, MD FIX	18000	35000
*10000 - MRA			
GRACO, MD FIX	WOODSTOWN, NJ VORTAC	18000	45000
WOODSTOWN, NJ VORTAC	COYLE, NJ VORTAC	18000	45000
COYLE, NJ VORTAC	HAMPTON, NY VORTAC	18000	45000
HAMPTON, NY VORTAC	MARCONI, MA VOR/DME	18000	45000
MARCONI, MA VOR/DME	STOOL, MA FIX	18000	45000
95.7151 JET ROUTE J151			
CROSS CITY, FL VORTAC	VULCAN, AL VORTAC	26000	45000
VULCAN, AL VORTAC	FARMINGTON, MO VORTAC	25000	41000
FARMINGTON, MO VORTAC	ST LOUIS, MO VORTAC	18000	45000
ST LOUIS, MO VORTAC	DES MOINES, IA VORTAC	18000	45000
DES MOINES, IA VORTAC	O'NEILL, NE VORTAC	18000	45000
O'NEILL, NE VORTAC	RAPID CITY, SD VORTAC	18000	45000
RAPID CITY, SD VORTAC	BILLINGS, MT VORTAC	#22000	45000
#MEA IS ESTABLISHED WITH A GAP IN NAVIGATION SIGNAL COVERAGE.			
BILLINGS, MT VORTAC	WHITEHALL, MT VOR/DME	18000	45000
95.7152 JET ROUTE J152			
ROSEWOOD, OH VORTAC	JOHNSTOWN, PA VORTAC	18000	45000
JOHNSTOWN, PA VORTAC	HARRISBURG, PA VORTAC	18000	40000
95.7153 JET ROUTE J153			
ROME, OR VORTAC	BAKER CITY, OR VOR/DME	18000	45000
BAKER CITY, OR VOR/DME	SPOKANE, WA VORTAC	18000	45000
95.7154 JET ROUTE J154			
BATTLE MOUNTAIN, NV VORTAC	BONNEVILLE, UT VORTAC	18000	45000
BONNEVILLE, UT VORTAC	WASATCH, UT VORTAC	18000	45000
WASATCH, UT VORTAC	ROCK SPRINGS, WY VOR/DME	18000	45000
ROCK SPRINGS, WY VOR/DME	MILE HIGH, CO VORTAC	#21000	45000
#MEA IS ESTABLISHED WITH A GAP IN NAVIGATION SIGNAL COVERAGE.			
MILE HIGH, CO VORTAC	GARDEN CITY, KS VORTAC	21000	45000

FROM	TO	MEA	MAA
95.7155 JET ROUTE J155			
CHANDALAR LAKE, AK NDB	NENANA, AK VORTAC	18000	45000
95.7156 JET ROUTE J156			
WILSON CREEK, NV VORTAC #MEA IS ESTABLISHED WITH A GAP IN NAVIGATION SIGNAL COVERAGE.	MEEKER, CO VOR/DME	#18000	45000
95.7157 JET ROUTE J157			
MYTON, UT VORTAC #MEA IS ESTABLISHED WITH A GAP IN NAVIGATION SIGNAL COVERAGE.	LARAMIE, WY VOR/DME	#23000	45000
LARAMIE, WY VOR/DME	SCOTTSBLUFF, NE VORTAC	18000	45000
SCOTTSBLUFF, NE VORTAC	RAPID CITY, SD VORTAC	18000	45000
95.7158 JET ROUTE J158			
MINA, NV VORTAC #MEA IS ESTABLISHED WITH A GAP IN NAVIGATION SIGNAL COVERAGE.	LUCIN, UT VORTAC	#23000	45000
LUCIN, UT VORTAC	MALAD CITY, ID VOR/DME	18000	45000
MALAD CITY, ID VOR/DME	BIG PINEY, WY VOR/DME	18000	45000
BIG PINEY, WY VOR/DME	MUDDY MOUNTAIN, WY VORTAC	18000	45000
MUDDY MOUNTAIN, WY VORTAC	RAPID CITY, SD VORTAC	18000	45000
RAPID CITY, SD VORTAC	ABERDEEN, SD VOR/DME	18000	45000
95.7159 JET ROUTE J159			
BATTLE GROUND, WA VORTAC	DESCHUTES, OR VORTAC	18000	45000
95.7160 JET ROUTE J160			
FAIRBANKS, AK VORTAC	FORT YUKON, AK VORTAC	18000	45000
FORT YUKON, AK VORTAC	ADREW, AK FIX	18000	45000
95.7161 JET ROUTE J161			
ZUNI, NM VORTAC	RATTLESNAKE, NM VORTAC	18000	45000
95.7162 JET ROUTE J162			
DRYER, OH VOR/DME	BELLAIRE, OH VOR/DME	18000	45000
BELLAIRE, OH VOR/DME	MORGANTOWN, WV VORTAC	18000	45000
MORGANTOWN, WV VORTAC	MARTINSBURG, WV VORTAC	18000	29000

FROM	TO	MEA	MAA
95.7163 JET ROUTE J163			
BAKER CITY, OR VOR/DME	BOISE, ID VORTAC	18000	45000
BOISE, ID VORTAC	POCATELLO, ID VORTAC	18000	45000
POCATELLO, ID VORTAC	ROCK SPRINGS, WY VOR/DME	21000	45000
ROCK SPRINGS, WY VOR/DME	HAYDEN, CO VOR/DME	18000	45000
95.7165 JET ROUTE J165			
CHARLESTON, SC VORTAC	RICHMOND, VA VORTAC	#18000	45000
#MEA IS ESTABLISHED WITH A GAP IN NAVIGATION SIGNAL COVERAGE.			
95.7166 JET ROUTE J166			
SAN SIMON, AZ VORTAC	TRUTH OR CONSEQUENCES, NM VORTAC	18000	45000
TRUTH OR CONSEQUENCES, NM VORTAC	CHISUM, NM VORTAC	24000	45000
CHISUM, NM VORTAC	WICHITA FALLS, TX VORTAC	#18000	45000
#MEA IS ESTABLISHED WITH A GAP IN NAVIGATION SIGNAL COVERAGE.			
95.7167 JET ROUTE J167			
JOHNSTONE POINT, AK VOR/DME	GULKANA, AK VOR/DME	18000	45000
GULKANA, AK VOR/DME	BIG DELTA, AK VORTAC	18000	45000
BIG DELTA, AK VORTAC	FORT YUKON, AK VORTAC	18000	45000
FORT YUKON, AK VORTAC	U.S. CANADIAN BORDER	18000	45000
95.7168 JET ROUTE J168			
WICHITA FALLS, TX VORTAC	LAMAR, CO VORTAC	#22000	45000
#MEA IS ESTABLISHED WITH A GAP IN NAVIGATION SIGNAL COVERAGE.			
95.7169 JET ROUTE J169			
LOS ANGELES, CA VORTAC	SEAL BEACH, CA VORTAC	18000	45000
SEAL BEACH, CA VORTAC	THERMAL, CA VORTAC	18000	45000
THERMAL, CA VORTAC	BLYTHE, CA VORTAC	18000	45000
BLYTHE, CA VORTAC	STANFIELD, AZ VORTAC	18000	45000
95.7170 JET ROUTE J170			
CRAZY WOMAN, WY VOR/DME	MUDDY MOUNTAIN, WY VORTAC	18000	45000
MUDDY MOUNTAIN, WY VORTAC	MEDICINE BOW, WY VOR/DME	18000	45000
95.7171 JET ROUTE J171			
TOBE, CO VORTAC	HUGO, CO VORTAC	18000	45000

FROM	TO	MEA	MAA
95.7173 JET ROUTE J173			
WASATCH, UT VORTAC	MEEKER, CO VOR/DME	18000	45000
95.7174 JET ROUTE J174			
CRAIG, FL VORTAC	CHARLESTON, SC VORTAC	18000	45000
CHARLESTON, SC VORTAC	WILMINGTON, NC VORTAC	18000	45000
WILMINGTON, NC VORTAC	DIXON, NC NDB/DME	18000	45000
DIXON, NC NDB/DME	NORFOLK, VA VORTAC	18000	45000
NORFOLK, VA VORTAC	SNOW HILL, MD VORTAC	18000	45000
SNOW HILL, MD VORTAC	HAMPTON, NY VORTAC	18000	45000
HAMPTON, NY VORTAC	MARCONI, MA VOR/DME	18000	45000
MARCONI, MA VOR/DME	HERIN, MA FIX	18000	45000
95.7175 JET ROUTE J175			
CHEYENNE, WY VORTAC	LARAMIE, WY VOR/DME	18000	45000
LARAMIE, WY VOR/DME	DUBOIS, ID VORTAC	#29000	45000
#MEA IS ESTABLISHED WITH A GAP IN NAVIGATION SIGNAL COVERAGE.			
95.7177 JET ROUTE J177			
HUMBLE, TX VORTAC	HOBBY, TX VOR/DME	18000	45000
HOBBY, TX VOR/DME	PALACIOS, TX VORTAC	18000	45000
PALACIOS, TX VORTAC	U.S. MEXICAN BORDER	31000	45000
95.7178 JET ROUTE J178			
FORT WAYNE, IN VORTAC	APPLETON, OH VORTAC	18000	45000
95.7179 JET ROUTE J179			
MIDDLETON ISLAND, AK VOR/DME	KENAI, AK VOR/DME	18000	45000
KENAI, AK VOR/DME	SPARREVOHN, AK VOR/DME	18000	45000
SPARREVOHN, AK VOR/DME	ANIAK, AK NDB	18000	45000
ANIAK, AK NDB	ST MARYS, AK NDB	18000	45000
ST MARYS, AK NDB	EMMONAK, AK VOR/DME	18000	45000
95.7180 JET ROUTE J180			
HUMBLE, TX VORTAC	DAISETTA, TX VORTAC	18000	45000
DAISETTA, TX VORTAC	CIDOR, LA FIX	18000	45000
CIDOR, LA FIX	FOSIN, LA FIX	19000	45000
FOSIN, LA FIX	SAWMILL, LA VOR/DME	18000	45000
SAWMILL, LA VOR/DME	LITTLE ROCK, AR VORTAC	18000	45000
LITTLE ROCK, AR VORTAC	FORISTELL, MO VORTAC	18000	45000

FROM	TO	MEA	MAA
95.7181 JET ROUTE J181			
RANGER, TX VORTAC	OKMULGEE, OK VOR/DME	18000	45000
OKMULGEE, OK VOR/DME	NEOSHO, MO VOR/DME	18000	45000
NEOSHO, MO VOR/DME	HALLSVILLE, MO VORTAC	18000	45000
HALLSVILLE, MO VORTAC	BAYLI, IL FIX	18000	23000
BAYLI, IL FIX	BRADFORD, IL VORTAC	18000	45000
95.7182 JET ROUTE J182			
GOODLAND, KS VORTAC	WICHITA, KS VORTAC	18000	45000
WICHITA, KS VORTAC	RAZORBACK, AR VORTAC	18000	45000
95.7183 JET ROUTE J183			
EL PASO, TX VORTAC	PECOS, TX VOR/DME	18000	45000
PECOS, TX VOR/DME	LLANO, TX VORTAC	20000	45000
LLANO, TX VORTAC	COLLEGE STATION, TX VORTAC	18000	45000
95.7184 JET ROUTE J184			
BUCKEYE, AZ VORTAC	DEMING, NM VORTAC	23000	45000
DEMING, NM VORTAC	NEWMAN, TX VORTAC	18000	45000
95.7185 JET ROUTE J185			
TRAVERSE CITY, MI VORTAC	FLINT, MI VORTAC	18000	45000
95.7186 JET ROUTE J186			
FOOTHILLS, GA VORTAC	SNOWBIRD, TN VORTAC	18000	45000
SNOWBIRD, TN VORTAC	APPLETON, OH VORTAC	18000	45000
95.7187 JET ROUTE J187			
MEMPHIS, TN VORTAC	FORISTELL, MO VORTAC	18000	45000
95.7188 JET ROUTE J188			
BETHEL, AK VORTAC	SPARREVOHN, AK VOR/DME	18000	45000
95.7189 JET ROUTE J189			
AVENAL, CA VORTAC	LINDEN, CA VORTAC	18000	45000
LINDEN, CA VORTAC	KLAMATH FALLS, OR VORTAC	#18000	45000
#MEA IS ESTABLISHED WITH A GAP IN NAVIGATION SIGNAL COVERAGE.			

FROM	TO	MEA	MAA
95.7189 JET ROUTE J189 - CONTINUED			
KLAMATH FALLS, OR VORTAC	BATTLE GROUND, WA VORTAC	#19000	45000
#MEA IS ESTABLISHED WITH A GAP IN NAVIGATION SIGNAL COVERAGE.			
BATTLE GROUND, WA VORTAC	SEATTLE, WA VORTAC	18000	45000
95.7190 JET ROUTE J190			
CARLETON, MI VORTAC	SLATE RUN, PA VORTAC	#18000	45000
#FOR THAT AIRSPACE OVER U.S. TERRITORY.			
SLATE RUN, PA VORTAC	BINGHAMTON, NY VORTAC	18000	38000
BINGHAMTON, NY VORTAC	ROCKDALE, NY VOR/DME	18000	45000
ROCKDALE, NY VOR/DME	ALBANY, NY VORTAC	18000	45000
95.7191 JET ROUTE J191			
ROBBINSVILLE, NJ VORTAC	DAVYS, NJ FIX	18000	45000
DAVYS, NJ FIX	SMYRNA, DE VORTAC	18000	33000
SMYRNA, DE VORTAC	PATUXENT, MD VORTAC	18000	45000
PATUXENT, MD VORTAC	HUBBS, VA FIX	18000	45000
HUBBS, VA FIX	HOPEWELL, VA VORTAC	18000	22000
HOPEWELL, VA VORTAC	WILMINGTON, NC VORTAC	18000	45000
95.7192 JET ROUTE J192			
GOODLAND, KS VORTAC	PAWNEE CITY, NE VORTAC	18000	45000
PAWNEE CITY, NE VORTAC	IOWA CITY, IA VORTAC	18000	45000
95.7193 JET ROUTE J193			
WILMINGTON, NC VORTAC	COFIELD, NC VORTAC	18000	45000
COFIELD, NC VORTAC	HARCUM, VA VORTAC	18000	29000
HARCUM, VA VORTAC	HUBBS, VA FIX	18000	28000
95.7195 JET ROUTE J195			
ANNETTE ISLAND, AK VOR/DME	BIORKA ISLAND, AK VORTAC	18000	45000
95.7196 JET ROUTE J196			
BRYCE CANYON, UT VORTAC	MEEKER, CO VOR/DME	33000	45000

FROM	TO	MEA	MAA
95.7197 JET ROUTE J197			
DOVE CREEK, CO VORTAC	HUGO, CO VORTAC	33000	45000
HUGO, CO VORTAC	GOODLAND, KS VORTAC	18000	45000
GOODLAND, KS VORTAC	WOLBACH, NE VORTAC	18000	45000
WOLBACH, NE VORTAC	SIOUX FALLS, SD VORTAC	18000	45000
95.7198 JET ROUTE J198			
MINA, NV VORTAC	WILSON CREEK, NV VORTAC	18000	45000
WILSON CREEK, NV VORTAC	MEEKER, CO VOR/DME	33000	45000
95.7199 JET ROUTE J199			
WILSON CREEK, NV VORTAC	DELTA, UT VORTAC	18000	45000
DELTA, UT VORTAC	MEEKER, CO VOR/DME	33000	45000
95.7202 JET ROUTE J202			
FAIRFIELD, UT VORTAC	ROCK SPRINGS, WY VOR/DME	20000	45000
ROCK SPRINGS, WY VOR/DME	MUDDY MOUNTAIN, WY VORTAC	18000	45000
95.7203 JET ROUTE J203			
BILLINGS, MT VORTAC	GREAT FALLS, MT VORTAC	18000	45000
95.7204 JET ROUTE J204			
DUPREE, SD VORTAC	MILES CITY, MT VOR/DME	18000	45000
MILES CITY, MT VOR/DME	GREAT FALLS, MT VORTAC	18000	45000
95.7206 JET ROUTE J206			
ALAMOSA, CO VORTAC	BLUE MESA, CO VOR/DME	18000	45000
BLUE MESA, CO VOR/DME	RED TABLE, CO VOR/DME	18000	45000
RED TABLE, CO VOR/DME	ROCK SPRINGS, WY VOR/DME	18000	45000
95.7207 JET ROUTE J207			
SAVANNAH, GA VORTAC	FLORENCE, SC VORTAC	24000	45000
FLORENCE, SC VORTAC	RALEIGH/DURHAM, NC VORTAC	31000	45000
RALEIGH/DURHAM, NC VORTAC	FRANKLIN, VA VORTAC	18000	45000
95.7208 JET ROUTE J208			
ATHENS, GA VORTAC	LIBERTY, NC VORTAC	18000	45000
LIBERTY, NC VORTAC	HOPEWELL, VA VORTAC	18000	45000

FROM	TO	MEA	MAA
95.7209 JET ROUTE J209			
GREENWOOD, SC VORTAC	RALEIGH/DURHAM, NC VORTAC	18000	45000
RALEIGH/DURHAM, NC VORTAC	TAR RIVER, NC VORTAC	18000	45000
TAR RIVER, NC VORTAC	NORFOLK, VA VORTAC	18000	45000
NORFOLK, VA VORTAC	SALISBURY, MD VORTAC	18000	45000
SALISBURY, MD VORTAC	COYLE, NJ VORTAC	18000	45000
COYLE, NJ VORTAC	WHITE, NJ FIX	18000	45000
95.7210 JET ROUTE J210			
DUNKN, GA FIX	VANCE, SC VORTAC	18000	45000
VANCE, SC VORTAC	WILMINGTON, NC VORTAC	18000	45000
95.7211 JET ROUTE J211			
#YOUNGSTOWN, OH VORTAC	JOHNSTOWN, PA VORTAC	18000	
#YOUNGSTOWN R-130 UNUSABLE ABOVE 24000.			
JOHNSTOWN, PA VORTAC	WESTMINSTER, MD VORTAC	18000	45000
95.7212 JET ROUTE J212			
STANFIELD, AZ VORTAC	BUCKEYE, AZ VORTAC	18000	45000
BUCKEYE, AZ VORTAC	PALM SPRINGS, CA VORTAC	26000	45000
95.7213 JET ROUTE J213			
ARMEL, VA VORTAC	#BECKLEY, WV VORTAC	*18000	45000
*18000 - GNSS MEA			
#BECKLEY R-072 UNUSABLE.			
95.7217 JET ROUTE J217			
HANCOCK, NY VOR/DME	KEATING, PA VORTAC	18000	45000
95.7220 JET ROUTE J220			
ARMEL, VA VORTAC	STONYFORK, PA VOR/DME	18000	23000
STONYFORK, PA VOR/DME	WELLSVILLE, NY VORTAC	18000	45000
WELLSVILLE, NY VORTAC	BUFFALO, NY VOR/DME	18000	39000
95.7222 JET ROUTE J222			
ROBBINSVILLE, NJ VORTAC	KENNEDY, NY VOR/DME	18000	45000
KENNEDY, NY VOR/DME	CAMBRIDGE, NY VOR/DME	18000	31000
CAMBRIDGE, NY VOR/DME	PLATTSBURGH, NY VORTAC	18000	45000

FROM	TO	MEA	MAA
95.7223 JET ROUTE J223			
LA GUARDIA, NY VOR/DME	CORDS, PA FIX	18000	25000
95.7225 JET ROUTE J225			
CEDAR LAKE, NJ VORTAC	KENNEDY, NY VOR/DME	18000	33000
KENNEDY, NY VOR/DME	PROVIDENCE, RI VORTAC	18000	45000
95.7227 JET ROUTE J227			
ARMEL, VA VORTAC	ELMIRA, NY VOR/DME	18000	23000
95.7230 JET ROUTE J230			
ROBBINSVILLE, NJ VORTAC	LARRI, PA FIX	18000	45000
LARRI, PA FIX	VINSE, PA FIX	26000	45000
VINSE, PA FIX	BELLAIRE, OH VOR/DME	18000	45000
95.7231 JET ROUTE J231			
TWENTYNINE PALMS, CA VORTAC	HIPPI, AZ FIX	23000	40000
HIPPI, AZ FIX	DRAKE, AZ VORTAC	18000	45000
DRAKE, AZ VORTAC	ST JOHNS, AZ VORTAC	18000	45000
ST JOHNS, AZ VORTAC	ANTON CHICO, NM VORTAC	18000	45000
ANTON CHICO, NM VORTAC	LIBERAL, KS VORTAC	18000	45000
95.7232 JET ROUTE J232			
MOLINE, IL VORTAC	KIRKSVILLE, MO VORTAC	18000	35000
95.7233 JET ROUTE J233			
WATERLOO, IA VORTAC	ST LOUIS, MO VORTAC	18000	45000
95.7236 JET ROUTE J236			
THERMAL, CA VORTAC	NEEDLES, CA VORTAC	18000	45000
NEEDLES, CA VORTAC	TUBA CITY, AZ VORTAC	18000	45000
95.7239 JET ROUTE J239			
ATLANTA, GA VORTAC	MERIDIAN, MS VORTAC	24000	45000

FROM	TO	MEA	MAA
95.7240 JET ROUTE J240			
MYTON, UT VORTAC	BLUE MESA, CO VOR/DME	19000	45000
95.7244 JET ROUTE J244			
FORT UNION, NM VORTAC	ZUNI, NM VORTAC	21000	45000
ZUNI, NM VORTAC	PHOENIX, AZ VORTAC	19000	45000
95.7477 JET ROUTE J477			
GLASGOW, MT VOR/DME	U.S. CANADIAN BORDER	18000	45000
95.7478 JET ROUTE J478			
GLASGOW, MT VOR/DME	U.S. CANADIAN BORDER	18000	45000
95.7483 JET ROUTE J483			
MINOT, ND VORTAC	U.S. CANADIAN BORDER	18000	45000
95.7488 JET ROUTE J488			
WATERTOWN, NY VORTAC	U.S. CANADIAN BORDER	18000	45000
95.7500 JET ROUTE J500			
U.S. CANADIAN BORDER	SAULT STE MARIE, MI VOR/DME	18000	45000
SAULT STE MARIE, MI VOR/DME	U.S. CANADIAN BORDER	18000	45000
U.S. CANADIAN BORDER	MILLINOCKET, ME VOR/DME	18000	45000
MILLINOCKET, ME VOR/DME	U.S. CANADIAN BORDER	18000	45000
95.7501 JET ROUTE J501			
SAN MARCUS, CA VORTAC	BIG SUR, CA VORTAC	18000	45000
BIG SUR, CA VORTAC	POINT REYES, CA VORTAC	18000	45000
POINT REYES, CA VORTAC	ROGUE VALLEY, OR VORTAC	#22000	45000
#MEA IS ESTABLISHED WITH A GAP IN NAVIGATION SIGNAL COVERAGE.			
ROGUE VALLEY, OR VORTAC	HOQUIAM, WA VORTAC	#22000	45000
#MEA IS ESTABLISHED WITH A GAP IN NAVIGATION SIGNAL COVERAGE.			
HOQUIAM, WA VORTAC	TATOOSH, WA VORTAC	18000	45000
TATOOSH, WA VORTAC	U.S. CANADIAN BORDER	18000	45000
U.S. CANADIAN BORDER	BIORKA ISLAND, AK VORTAC	18000	45000
BIORKA ISLAND, AK VORTAC	YAKUTAT, AK VOR/DME	18000	45000
YAKUTAT, AK VOR/DME	JOHNSTONE POINT, AK VOR/DME	18000	45000
JOHNSTONE POINT, AK VOR/DME	ANCHORAGE, AK VOR/DME	18000	45000
ANCHORAGE, AK VOR/DME	SPARREVOHN, AK VOR/DME	18000	45000
SPARREVOHN, AK VOR/DME	VIDDA, AK FIX	18000	45000
VIDDA, AK FIX	BETHEL, AK VORTAC	18000	45000

FROM	TO	MEA	MAA
95.7502 JET ROUTE J502			
SEATTLE, WA VORTAC	U.S. CANADIAN BORDER	18000	45000
U.S. CANADIAN BORDER	ANNETTE ISLAND, AK VOR/DME	18000	45000
ANNETTE ISLAND, AK VOR/DME	LEVEL ISLAND, AK VOR/DME	18000	45000
LEVEL ISLAND, AK VOR/DME	SISTERS ISLAND, AK VORTAC	18000	45000
SISTERS ISLAND, AK VORTAC	BURWASH, CANADA NDB	#18000	45000
#FOR THAT AIRSPACE OVER U.S. TERRITORY.			
BURWASH, CANADA NDB	NORTHWAY, AK VORTAC	#18000	45000
#FOR THAT AIRSPACE OVER U.S. TERRITORY.			
NORTHWAY, AK VORTAC	FAIRBANKS, AK VORTAC	18000	45000
FAIRBANKS, AK VORTAC	KOTZEBUE, AK VOR/DME	#27000	45000
#MEA IS ESTABLISHED WITH A GAP IN NAVIGATION SIGNAL COVERAGE.			
95.7503 JET ROUTE J503			
SEATTLE, WA VORTAC	U.S. CANADIAN BORDER	18000	45000
95.7505 JET ROUTE J505			
SEATTLE, WA VORTAC	U.S. CANADIAN BORDER	#24000	45000
#MEA IS ESTABLISHED WITH A GAP IN NAVIGATION SIGNAL COVERAGE.			
95.7506 JET ROUTE J506			
MILLINOCKET, ME VOR/DME	U.S. CANADIAN BORDER	18000	45000
95.7507 JET ROUTE J507			
DEADHORSE, AK VOR/DME	FORT YUKON, AK VORTAC	18000	45000
FORT YUKON, AK VORTAC	NORTHWAY, AK VORTAC	18000	45000
NORTHWAY, AK VORTAC	U.S. CANADIAN BORDER	#21000	45000
#FOR THAT AIRSPACE OVER U.S. TERRITORY.			
U.S. CANADIAN BORDER	YAKUTAT, AK VOR/DME	#22000	45000
#FOR THAT AIRSPACE OVER U.S. TERRITORY.			
95.7509 JET ROUTE J509			
U.S. CANADIAN BORDER	HOULTON, ME VOR/DME	18000	45000
HOULTON, ME VOR/DME	U.S. CANADIAN BORDER	18000	45000
95.7511 JET ROUTE J511			
DILLINGHAM, AK VOR/DME	ANCHORAGE, AK VOR/DME	18000	45000
ANCHORAGE, AK VOR/DME	BIG LAKE, AK VORTAC	18000	45000
BIG LAKE, AK VORTAC	GULKANA, AK VOR/DME	18000	45000
GULKANA, AK VOR/DME	U.S. CANADIAN BORDER	#18000	45000
#FOR THAT AIRSPACE OVER U.S. TERRITORY.			

FROM	TO	MEA	MAA
95.7512 JET ROUTE J512			
EMMONAK, AK VOR/DME	UNALAKLEET, AK VOR/DME	18000	45000
UNALAKLEET, AK VOR/DME	GALENA, AK VOR/DME	18000	45000
95.7513 JET ROUTE J513			
THUNDER BAY, CANADA VORTAC #FOR THAT AIRSPACE OVER U.S. TERRITORY.	U.S. CANADIAN BORDER	#18000	45000
U.S. CANADIAN BORDER #FOR THAT AIRSPACE OVER U.S. TERRITORY.	U.S. CANADIAN BORDER	#18000	45000
U.S. CANADIAN BORDER #FOR THAT AIRSPACE OVER U.S. TERRITORY.	SUDBURY, CANADA VOR/DME	#24000	45000
95.7515 JET ROUTE J515			
FARGO, ND VORTAC	HUMBOLDT, MN VORTAC	18000	45000
HUMBOLDT, MN VORTAC	U.S. CANADIAN BORDER	18000	45000
WHITEHORSE, CANADA VOR/DME #FOR THAT AIRSPACE OVER U.S. TERRITORY. #MEA IS ESTABLISHED WITH GAP 110 NM FROM NORTHWAY, 100 NM FROM WHITEHORSE.	NORTHWAY, AK VORTAC	#18000	45000
NORTHWAY, AK VORTAC	FAIRBANKS, AK VORTAC	18000	45000
FAIRBANKS, AK VORTAC	BETTLES, AK VOR/DME	18000	45000
BETTLES, AK VOR/DME #MEA IS ESTABLISHED WITH A GAP IN NAVIGATION SIGNAL COVERAGE.	BARROW, AK VOR/DME	#20000	45000
95.7516 JET ROUTE J516			
GREAT FALLS, MT VORTAC #FOR THAT AIRSPACE OVER U.S. TERRITORY.	U.S. CANADIAN BORDER	#18000	45000
95.7517 JET ROUTE J517			
BOISE, ID VORTAC	SPOKANE, WA VORTAC	18000	45000
SPOKANE, WA VORTAC	U.S. CANADIAN BORDER	18000	45000
95.7518 JET ROUTE J518			
DRYER, OH VOR/DME	INDIAN HEAD, PA VORTAC	18000	45000
INDIAN HEAD, PA VORTAC	BALTIMORE, MD VORTAC	18000	35000
95.7522 JET ROUTE J522			
BRAINERD, MN VORTAC	GREEN BAY, WI VORTAC	18000	45000
GREEN BAY, WI VORTAC	TRAVERSE CITY, MI VORTAC	18000	45000
TRAVERSE CITY, MI VORTAC	AU SABLE, MI VOR/DME	18000	45000

FROM	TO	MEA	MAA
95.7522 JET ROUTE J522 – CONTINUED			
AU SABLE, MI VOR/DME	U.S. CANADIAN BORDER	18000	45000
U.S. CANADIAN BORDER	ROCHESTER, NY VOR/DME	18000	35000
#GNSS REQUIRED ABOVE FL350.			
ROCHESTER, NY VOR/DME	HANCOCK, NY VOR/DME	18000	45000
HANCOCK, NY VOR/DME	KINGSTON, NY VOR/DME	18000	45000
95.7523 JET ROUTE J523			
BRYCE CANYON, UT VORTAC	ELY, NV VOR/DME	18000	45000
ELY, NV VOR/DME	ROME, OR VORTAC	29000	45000
ROME, OR VORTAC	KIMBERLY, OR VORTAC	18000	45000
KIMBERLY, OR VORTAC	KLICKITAT, OR VOR/DME	18000	45000
KLICKITAT, OR VOR/DME	SEATTLE, WA VORTAC	18000	45000
SEATTLE, WA VORTAC	TATOOSH, WA VORTAC	18000	45000
TATOOSH, WA VORTAC	U.S. CANADIAN BORDER	18000	45000
U.S. CANADIAN BORDER	ANNETTE ISLAND, AK VOR/DME	18000	45000
95.7524 JET ROUTE J524			
BUGSY, NY FIX	U.S. CANADIAN BORDER	18000	45000
95.7526 JET ROUTE J526			
BECKLEY, WV VORTAC	LOUISVILLE, KY VORTAC	18000	45000
95.7528 JET ROUTE J528			
WHATCOM, WA VORTAC	U.S. CANADIAN BORDER	18000	45000
95.7530 JET ROUTE J530			
GREAT FALLS, MT VORTAC	U.S. CANADIAN BORDER	18000	45000
95.7531 JET ROUTE J531			
BUFFALO, NY VOR/DME	SAULT STE MARIE, MI VOR/DME	#18000	45000
#FOR THAT AIRSPACE OVER U.S. TERRITORY.			
95.7533 JET ROUTE J533			
DULUTH, MN VORTAC	U.S. CANADIAN BORDER	18000	45000

FROM	TO	MEA	MAA
95.7534 JET ROUTE J534			
IWACK, WA FIX	WHATCOM, WA VORTAC	18000	45000
WHATCOM, WA VORTAC	U.S. CANADIAN BORDER	18000	45000
95.7536 JET ROUTE J536			
SISTERS ISLAND, AK VORTAC	U.S. CANADIAN BORDER	#18000	45000
#MEA IS ESTABLISHED WITH A GAP IN NAVIGATION SIGNAL COVERAGE.			
95.7537 JET ROUTE J537			
ROME, OR VORTAC	MULLAN PASS, ID VOR/DME	20000	45000
MULLAN PASS, ID VOR/DME	U.S. CANADIAN BORDER	18000	45000
#GNSS MEA, GNSS REQUIRED			
MULLAN PASS R-357 UNUSABLE			
95.7538 JET ROUTE J538			
U.S. CANADIAN BORDER	DULUTH, MN VORTAC	18000	45000
DULUTH, MN VORTAC	DELLS, WI VORTAC	18000	45000
DELLS, WI VORTAC	BADGER, WI VORTAC	18000	45000
95.7539 JET ROUTE J539			
GLASGOW, MT VOR/DME	U.S. CANADIAN BORDER	18000	45000
95.7540 JET ROUTE J540			
MULLAN PASS, ID VOR/DME	U.S. CANADIAN BORDER	18000	45000
95.7541 JET ROUTE J541			
YAKUTAT, AK VOR/DME	SISTERS ISLAND, AK VORTAC	18000	45000
95.7545 JET ROUTE J545			
DRYER, OH VOR/DME	U.S. CANADIAN BORDER	18000	45000
95.7546 JET ROUTE J546			
PECK, MI VORTAC	U.S. CANADIAN BORDER	18000	45000
U.S. CANADIAN BORDER	DENGA, CANADA FIX	18000	

FROM	TO	MEA	MAA
95.7547 JET ROUTE J547			
NORTHBROOK, IL VOR/DME	PULLMAN, MI VOR/DME	18000	45000
PULLMAN, MI VOR/DME	FLINT, MI VORTAC	18000	45000
FLINT, MI VORTAC	U.S. CANADIAN BORDER	18000	45000
U.S. CANADIAN BORDER	BUFFALO, NY VOR/DME	18000	45000
BUFFALO, NY VOR/DME	SYRACUSE, NY VORTAC	18000	45000
SYRACUSE, NY VORTAC	CAMBRIDGE, NY VOR/DME	18000	45000
CAMBRIDGE, NY VOR/DME	KENNEBUNK, ME VORTAC	18000	45000
95.7548 JET ROUTE J548			
PULLMAN, MI VOR/DME	TRAVERSE CITY, MI VORTAC	18000	45000
TRAVERSE CITY, MI VORTAC	SAULT STE MARIE, MI VOR/DME	18000	45000
SAULT STE MARIE, MI VOR/DME	U.S. CANADIAN BORDER	18000	45000
95.7549 JET ROUTE J549			
WILLISTON, ND VORTAC	U.S. CANADIAN BORDER	18000	45000
95.7551 JET ROUTE J551			
PECK, MI VORTAC	U.S. CANADIAN BORDER	18000	45000
95.7552 JET ROUTE J552			
SAULT STE MARIE, MI VOR/DME	U.S. CANADIAN BORDER	18000	45000
95.7553 JET ROUTE J553			
PECK, MI VORTAC	U.S. CANADIAN BORDER	18000	45000
95.7554 JET ROUTE J554			
GIPPER, MI VORTAC	CARLETON, MI VORTAC	18000	45000
CARLETON, MI VORTAC	U.S. CANADIAN BORDER	18000	45000
U.S. CANADIAN BORDER	JAMESTOWN, NY VOR/DME	18000	45000
95.7559 JET ROUTE J559			
SYRACUSE, NY VORTAC	WATERTOWN, NY VORTAC	18000	45000
WATERTOWN, NY VORTAC	U.S. CANADIAN BORDER	18000	45000
95.7560 JET ROUTE J560			
PLATTSBURGH, NY VORTAC	U.S. CANADIAN BORDER	18000	45000

FROM	TO	MEA	MAA
95.7561 JET ROUTE J561			
PRESQUE ISLE, ME VOR/DME	U.S. CANADIAN BORDER	18000	45000
95.7562 JET ROUTE J562			
DICKINSON, ND VORTAC	U.S. CANADIAN BORDER	18000	45000
95.7563 JET ROUTE J563			
ALBANY, NY VORTAC	U.S. CANADIAN BORDER	18000	45000
95.7564 JET ROUTE J564			
U.S. CANADIAN BORDER	PRESQUE ISLE, ME VOR/DME	18000	45000
PRESQUE ISLE, ME VOR/DME	U.S. CANADIAN BORDER	18000	45000
95.7566 JET ROUTE J566			
MASSENA, NY VORTAC	U.S. CANADIAN BORDER	18000	45000
95.7567 JET ROUTE J567			
PLATTSBURGH, NY VORTAC	U.S. CANADIAN BORDER	18000	45000
95.7569 JET ROUTE J569			
GREAT FALLS, MT VORTAC	U.S. CANADIAN BORDER	18000	45000
95.7570 JET ROUTE J570			
ALBANY, NY VORTAC	U.S. CANADIAN BORDER	18000	45000
95.7573 JET ROUTE J573			
KENNEBUNK, ME VORTAC	U.S. CANADIAN BORDER	18000	45000
95.7575 JET ROUTE J575			
BOSTON, MA VOR/DME	U.S. CANADIAN BORDER	18000	45000

FROM	TO	MEA	MAA
95.7581 JET ROUTE J581			
PUTNAM, CT VOR/DME	KENNEBUNK, ME VORTAC	18000	45000
KENNEBUNK, ME VORTAC	BANGOR, ME VORTAC	18000	45000
BANGOR, ME VORTAC	U.S. CANADIAN BORDER	18000	45000
95.7582 JET ROUTE J582			
PRESQUE ISLE, ME VOR/DME	U.S. CANADIAN BORDER	18000	45000
95.7584 JET ROUTE J584			
NORTHBROOK, IL VOR/DME	CARLETON, MI VORTAC	18000	45000
CARLETON, MI VORTAC	SLATE RUN, PA VORTAC	#18000	45000
#FOR THAT AIRSPACE OVER U.S. TERRITORY.			
SLATE RUN, PA VORTAC	WILLIAMSPORT, PA VOR/DME	18000	33000
WILLIAMSPORT, PA VOR/DME	BROADWAY, NJ VOR/DME	18000	31000
95.7585 JET ROUTE J585			
NANTUCKET, MA VOR/DME	U.S. CANADIAN BORDER	18000	45000
95.7586 JET ROUTE J586			
CARLETON, MI VORTAC	MASSENA, NY VORTAC	#18000	45000
#FOR THAT AIRSPACE OVER U.S. TERRITORY.			
MASSENA, NY VORTAC	U.S. CANADIAN BORDER	18000	45000
95.7587 JET ROUTE J587			
THUNDER BAY, CANADA VORTAC	WAWA, CANADA VOR/DME	#18000	45000
#FOR THAT AIRSPACE OVER U.S. TERRITORY.			
95.7588 JET ROUTE J588			
SAULT STE MARIE, MI VOR/DME	U.S. CANADIAN BORDER	25000	45000
95.7589 JET ROUTE J589			
ROSEBURG, OR VOR/DME	CORVALLIS, OR VOR/DME	18000	45000
CORVALLIS, OR VOR/DME	U.S. CANADIAN BORDER	28000	45000
95.7590 JET ROUTE J590			
LAKE CHARLES, LA VORTAC	GREENE COUNTY, MS VORTAC	18000	45000
GREENE COUNTY, MS VORTAC	MONTGOMERY, AL VORTAC	18000	45000

FROM	TO	MEA	MAA
95.7591 JET ROUTE J591			
WHATCOM, WA VORTAC	U.S. CANADIAN BORDER	18000	45000
95.7594 JET ROUTE J594			
MASSENA, NY VORTAC	U.S. CANADIAN BORDER	18000	45000
95.7595 JET ROUTE J595			
U.S. CANADIAN BORDER	WATERTOWN, NY VORTAC	18000	45000
WATERTOWN, NY VORTAC	PLATTSBURGH, NY VORTAC	18000	45000
PLATTSBURGH, NY VORTAC	BANGOR, ME VORTAC	18000	45000
BANGOR, ME VORTAC	U.S. CANADIAN BORDER	18000	45000
95.7599 JET ROUTE J599			
MULLAN PASS, ID VOR/DME	U.S. CANADIAN BORDER	18000	45000
95.7603 JET ROUTE J603			
ELFEE, AK NDB	DILLINGHAM, AK VOR/DME	18000	45000
95.7604 JET ROUTE J604			
BORLAND, AK NDB/DME	WOODY ISLAND, AK NDB	18000	45000
95.7605 JET ROUTE J605			
BIORKA ISLAND, AK VORTAC	MIDDLETON ISLAND, AK VOR/DME	23000	45000
95.7606 JET ROUTE J606			
ST PAUL ISLAND, AK NDB/DME	CHINOOK, AK NDB	18000	45000
95.7614 JET ROUTE J614			
SARASOTA, FL VORTAC	LEE COUNTY, FL VORTAC	18000	45000
LEE COUNTY, FL VORTAC	DOLPHIN, FL VORTAC	18000	45000
95.7616 JET ROUTE J616			
SARASOTA, FL VORTAC	LA BELLE, FL VORTAC	18000	45000
LA BELLE, FL VORTAC	DOLPHIN, FL VORTAC	18000	45000

FROM	TO	MEA	MAA
95.7617 JET ROUTE J617			
HOMER, AK VOR/DME	JOHNSTONE POINT, AK VOR/DME	18000	45000
95.7618 JET ROUTE J618			
MOUNT MOFFETT, AK NDB/DME	ELFEE, AK NDB	18000	45000
95.7619 JET ROUTE J619			
CAPE NEWENHAM, AK NDB/DME	ST PAUL ISLAND, AK NDB/DME	18000	45000
95.7623 JET ROUTE J623			
PORT HEIDEN, AK NDB/DME	COLD BAY, AK VORTAC	18000	45000
COLD BAY, AK VORTAC	ST PAUL ISLAND, AK NDB/DME	18000	45000
95.7713 JET ROUTE J713			
BILLINGS, MT VORTAC	BOYSEN RESERVOIR, WY VOR/DME	18000	45000
BOYSEN RESERVOIR, WY VOR/DME	BIG PINEY, WY VOR/DME	18000	45000
BIG PINEY, WY VOR/DME	WASATCH, UT VORTAC	26000	45000

AIRWAY SEGMENT

CHANGEOVER POINTS

FROM	TO	DISTANCE	FROM
------	----	----------	------

&95.8003 VOR FEDERAL AIRWAYS CHANGEOVER POINTS**V1**

CRAIG, FL VORTAC	CHARLESTON, SC VORTAC	96	CRAIG
CAPE CHARLES, VA VORTAC	WATERLOO, DE VOR/DME	31	CAPE CHARLES

V2

SPOKANE, WA VORTAC	MULLAN PASS, ID VOR/DME	32	SPOKANE
MISSOULA, MT VOR/DME	HELENA, MT VORTAC	35	MISSOULA
MILES CITY, MT VOR/DME	DICKINSON, ND VORTAC	60	MILES CITY
GOPHER, MN VORTAC	NODINE, MN VORTAC	50	GOPHER
BADGER, WI VORTAC	MUSKEGON, MI VORTAC	58	BADGER
BUFFALO, NY VOR/DME	ROCHESTER, NY VOR/DME	45	BUFFALO
ROCHESTER, NY VOR/DME	ROCHESTER, NY VOR/DME	13	ROCHESTER

V3

VERO BEACH, FL VORTAC	ORMOND BEACH, FL VORTAC	55	VERO BEACH
FLORENCE, SC VORTAC	SANDHILLS, NC VORTAC	20	FLORENCE
SANDHILLS, NC VORTAC	RALEIGH/DURHAM, NC VORTAC	10	SANDHILLS

V4

YAKIMA, WA VORTAC	PENDLETON, OR VORTAC	26	YAKIMA
BAKER CITY, OR VOR/DME	BOISE, ID VORTAC	25	BAKER CITY
LEXINGTON, KY VORTAC	NEWCOMBE, KY VORTAC	37	LEXINGTON
CHARLESTON, WV VORTAC	ELKINS, WV VORTAC	27	CHARLESTON

V5

DUBLIN, GA VORTAC	ATHENS, GA VORTAC	47	DUBLIN
CINCINNATI, KY VORTAC	APPLETON, OH VORTAC	64	CINCINNATI
APPLETON, OH VORTAC	MANSFIELD, OH VORTAC	43	APPLETON
DRYER, OH VOR/DME	LONDON, CA VORTAC	55	DRYER

V6

OAKLAND, CA VORTAC	SACRAMENTO, CA VORTAC	34	OAKLAND
SACRAMENTO, CA VORTAC	SQUAW VALLEY, CA VOR/DME	40	SACRAMENTO
OGDEN, UT VORTAC	FORT BRIDGER, WY VOR/DME	25	OGDEN
GRAND ISLAND, NE VORTAC	OMAHA, IA VORTAC	52	GRAND ISLAND
DRYER, OH VOR/DME	YOUNGSTOWN, OH VORTAC	39	DRYER
YOUNGSTOWN, OH VORTAC	CLARION, PA VOR/DME	20	YOUNGSTOWN

AIRWAY SEGMENT

CHANGEOVER POINTS

FROM	TO	DISTANCE	FROM
V7			
SEMINOLE, FL VORTAC	WIREGRASS, AL VORTAC	52	SEMINOLE
V8			
SEAL BEACH, CA VORTAC	PARADISE, CA VORTAC	13	SEAL BEACH
PARADISE, CA VORTAC	HECTOR, CA VORTAC	44	PARADISE
HECTOR, CA VORTAC	GOFFS, CA VORTAC	38	HECTOR
HANKSVILLE, UT VORTAC	GRAND JUNCTION, CO VOR/DME	40	HANKSVILLE
GRAND JUNCTION, CO VOR/DME	RIFLE, CO VOR/DME	37	GRAND JUNCTION
RIFLE, CO VOR/DME	KREMMLING, CO VOR/DME	20	RIFLE
GRAND ISLAND, NE VORTAC	OMAHA, IA VORTAC	52	GRAND ISLAND
BELLAIRE, OH VOR/DME	GRANTSVILLE, MD VOR/DME	39	BELLAIRE
MARTINSBURG, WV VORTAC	WASHINGTON, DC VOR/DME	29	MARTINSBURG
V10			
EMPORIA, KS VORTAC	EMPORIA, KS VORTAC	49	EMPORIA
V12			
PALMDALE, CA VORTAC	HECTOR, CA VORTAC	60	PALMDALE
HECTOR, CA VORTAC	NEEDLES, CA VORTAC	41	HECTOR
DRAKE, AZ VORTAC	WINSLOW, AZ VORTAC	39	DRAKE
ALBUQUERQUE, NM VORTAC	OTTO, NM VOR	23	ALBUQUERQUE
ANTON CHICO, NM VORTAC	TUCUMCARI, NM VORTAC	30	ANTON CHICO
PANHANDLE, TX VORTAC	MITBEE, OK VORTAC	46	PANHANDLE
EMPORIA, KS VORTAC	JOHNSON COUNTY, KS VOR/DME	49	EMPORIA
BIBLE GROVE, IL VORTAC	SHELBYVILLE, IN VORTAC	70	BIBLE GROVE
DAYTON, OH VOR/DME	APPLETON, OH VORTAC	41	DAYTON
APPLETON, OH VORTAC	NEWCOMERSTOWN, OH VOR/DME	26	APPLETON
JOHNSTOWN, PA VORTAC	HARRISBURG, PA VORTAC	62	JOHNSTOWN
V13			
LUFKIN, TX VORTAC	BELCHER, LA VORTAC	64	LUFKIN
NAPOLEON, MO VORTAC	LAMONI, IA VORTAC	40	NAPOLEON
V14			
MUNCIE, IN VOR/DME	FLAG CITY, OH VORTAC	44	MUNCIE
V15			
HOBBY, TX VOR/DME	NAVASOTA, TX VORTAC	38	HOBBY
CEDAR CREEK, TX VORTAC	BONHAM, TX VORTAC	20	CEDAR CREEK

AIRWAY SEGMENT

CHANGEOVER POINTS

FROM	TO	DISTANCE	FROM
V16			
LOS ANGELES, CA VORTAC	PARADISE, CA VORTAC	25	LOS ANGELES
PARADISE, CA VORTAC	PALM SPRINGS, CA VORTAC	34	PARADISE
BLYTHE, CA VORTAC	BUCKEYE, AZ VORTAC	44	BLYTHE
COCHISE, AZ VORTAC	COLUMBUS, NM VOR/DME	50	COCHISE
SALT FLAT, TX VORTAC	WINK, TX VORTAC	42	SALT FLAT
TEXARKANA, AR VORTAC	PINE BLUFF, AR VOR/DME	62	TEXARKANA
JACKS CREEK, TN VOR/DME	SHELBYVILLE, TN VOR/DME	50	JACKS CREEK
VOLUNTEER, TN VORTAC	HOLSTON MOUNTAIN, TN VORTAC	38	VOLUNTEER
V20			
PALACIOS, TX VORTAC	HOBBY, TX VOR/DME	41	PALACIOS
MONTGOMERY, AL VORTAC	TUSKEGEE, AL VOR/DME	30	MONTGOMERY
ATHENS, GA VORTAC	ELECTRIC CITY, SC VORTAC	20	ATHENS
V21			
SEAL BEACH, CA VORTAC	PARADISE, CA VORTAC	13	SEAL BEACH
PARADISE, CA VORTAC	HECTOR, CA VORTAC	44	PARADISE
HECTOR, CA VORTAC	BOULDER CITY, NV VORTAC	23	HECTOR
DUBOIS, ID VORTAC	DILLON, MT VOR/DME	46	DUBOIS
V23			
LOS ANGELES, CA VORTAC	GORMAN, CA VORTAC	36	LOS ANGELES
GORMAN, CA VORTAC	SHAFTER, CA VORTAC	10	GORMAN
SHAFTER, CA VORTAC	CLOVIS, CA VORTAC	49	SHAFTER
CLOVIS, CA VORTAC	LINDEN, CA VORTAC	42	CLOVIS
RED BLUFF, CA VORTAC	FORT JONES, CA VOR/DME	53	RED BLUFF
ROGUE VALLEY, OR VORTAC	EUGENE, OR VORTAC	40	ROGUE VALLEY
EUGENE, OR VORTAC	BATTLE GROUND, WA VORTAC	57	EUGENE
WHATCOM, WA VORTAC	VANCOUVER, CA VORTAC	10	WHATCOM
V25			
MISSION BAY, CA VORTAC	LOS ANGELES, CA VORTAC	40	MISSION BAY
KLAMATH FALLS, OR VORTAC	DESCHUTES, OR VORTAC	23	KLAMATH FALLS
V26			
MEEKER, CO VOR/DME	CHEROKEE, WY VOR/DME	35	MEEKER
MUDDY MOUNTAIN, WY VORTAC	RAPID CITY, SD VORTAC	92	MUDDY MOUNTAIN

AIRWAY SEGMENT

CHANGEOVER POINTS

FROM	TO	DISTANCE	FROM
V27			
GAVIOTA, CA VORTAC	MORRO BAY, CA VORTAC	20	GAVIOTA
MENDOCINO, CA VORTAC	FORTUNA, CA VORTAC	67	MENDOCINO
FORTUNA, CA VORTAC	CRESCENT CITY, CA VORTAC	30	FORTUNA
NEWPORT, OR VORTAC	ASTORIA, OR VOR/DME	66	NEWPORT
V30			
SELINGROVE, PA VORTAC	EAST TEXAS, PA VOR/DME	20	SELINGROVE
V31			
HARRISBURG, PA VORTAC	SELINGROVE, PA VORTAC	19	HARRISBURG
V32			
BATTLE MOUNTAIN, NV VORTAC	BULLION, NV VOR/DME	24	BATTLE MOUNTAIN
BULLION, NV VOR/DME	BONNEVILLE, UT VORTAC	40	BULLION
WASATCH, UT VORTAC	FORT BRIDGER, WY VOR/DME	17	WASATCH
V33			
HARRISBURG, PA VORTAC	PHILIPSBURG, PA VORTAC	35	HARRISBURG
KEATING, PA VORTAC	BRADFORD, PA VOR/DME	30	KEATING
V35			
PHILIPSBURG, PA VORTAC	STONYFORK, PA VOR/DME	25	PHILIPSBURG
V37			
SAVANNAH, GA VORTAC	ALLENDALE, SC VOR	36	SAVANNAH
CHARLOTTE, NC VOR/DME	PULASKI, VA VORTAC	74	CHARLOTTE
V38			
ELKINS, WV VORTAC	GORDONSVILLE, VA VORTAC	46	ELKINS
V44			
MORGANTOWN, WV VORTAC	MARTINSBURG, WV VORTAC	53	MORGANTOWN

AIRWAY SEGMENT

CHANGEOVER POINTS

FROM	TO	DISTANCE	FROM
V45			
HENDERSON, WV VORTAC	APPLETON, OH VORTAC	59	HENDERSON
V47			
PINE BLUFF, AR VOR/DME	GILMORE, AR VOR/DME	41	PINE BLUFF
V51			
VERO BEACH, FL VORTAC	ORMOND BEACH, FL VORTAC	55	VERO BEACH
CRAIG, FL VORTAC	ALMA, GA VORTAC	48	CRAIG
DUBLIN, GA VORTAC	ATHENS, GA VORTAC	47	DUBLIN
NABB, IN VORTAC	SHELBYVILLE, IN VORTAC	20	NABB
SHELBYVILLE, IN VORTAC	BOILER, IN VORTAC	50	SHELBYVILLE
V54			
CHOO CHOO, TN VORTAC	HARRIS, GA VORTAC	36	CHOO CHOO
HARRIS, GA VORTAC	SPARTANBURG, SC VORTAC	52	HARRIS
V56			
MONTGOMERY, AL VORTAC	TUSKEGEE, AL VOR/DME	30	MONTGOMERY
V59			
BECKLEY, WV VORTAC	PARKERSBURG, WV VORTAC	46	BECKLEY
V60			
ALBUQUERQUE, NM VORTAC	OTTO, NM VOR	23	ALBUQUERQUE
V62			
SANTA FE, NM VORTAC	ANTON CHICO, NM VORTAC	30	SANTA FE
ANTON CHICO, NM VORTAC	TEXICO, TX VORTAC	61	ANTON CHICO
V63			
STEVENS POINT, WI VORTAC	WAUSAU, WI VORTAC	12	STEVENS POINT

AIRWAY SEGMENT

CHANGEOVER POINTS

FROM	TO	DISTANCE	FROM
V64			
SEAL BEACH, CA VORTAC	THERMAL, CA VORTAC	59	SEAL BEACH
THERMAL, CA VORTAC	BLYTHE, CA VORTAC	29	THERMAL
V66			
MISSION BAY, CA VORTAC	IMPERIAL, CA VORTAC	39	MISSION BAY
GILA BEND, AZ VORTAC	TUCSON, AZ VORTAC	48	GILA BEND
DOUGLAS, AZ VORTAC	COLUMBUS, NM VOR/DME	#44	DOUGLAS
#UTILIZE DEMING VORTAC 233 M RAD FROM COP TO ANIMA FIX			
MIDLAND, TX VORTAC	ABILENE, TX VORTAC	51	MIDLAND
GREENWOOD, SC VORTAC	SANDHILLS, NC VORTAC	64	GREENWOOD
SANDHILLS, NC VORTAC	RALEIGH/DURHAM, NC VORTAC	10	SANDHILLS
V68			
CORONA, NM VORTAC	CHISUM, NM VORTAC	33	CORONA
SAN ANGELO, TX VORTAC	JUNCTION, TX VORTAC	25	SAN ANGELO
V71			
EL DORADO, AR VORTAC	HOT SPRINGS, AR VOR/DME	49	EL DORADO
OLLAS, AR FIX	HOT SPRINGS, AR VOR/DME	#47	OLLAS
#COP MEASURED FROM HOT VOR/DME.			
V74			
TULSA, OK VORTAC	FORT SMITH, AR VORTAC	48	TULSA
V77			
ABILENE, TX VORTAC	WICHITA FALLS, TX VORTAC	56	ABILENE
V83			
CARLSBAD, NM VORTAC	CHISUM, NM VORTAC	31	CARLSBAD
CHISUM, NM VORTAC	CORONA, NM VORTAC	48	CHISUM
CORONA, NM VORTAC	OTTO, NM VOR	20	CORONA
V86			
MISSOULA, MT VOR/DME	COPPERTOWN, MT VOR/DME	35	MISSOULA
SHERIDAN, WY VORTAC	RAPID CITY, SD VORTAC	100	SHERIDAN

AIRWAY SEGMENT

CHANGEOVER POINTS

FROM	TO	DISTANCE	FROM
V87			
SAN FRANCISCO, CA VOR/DME	SCAGGS ISLAND, CA VORTAC	19	SAN FRANCISCO
V92			
BELLAIRE, OH VOR/DME	GRANTSVILLE, MD VOR/DME	39	BELLAIRE
V94			
STANFIELD, AZ VORTAC	SAN SIMON, AZ VORTAC	82	STANFIELD
DEMING, NM VORTAC	NEWMAN, TX VORTAC	35	DEMING
SALT FLAT, TX VORTAC	WINK, TX VORTAC	42	SALT FLAT
MIDLAND, TX VORTAC	TUSCOLA, TX VOR/DME	51	MIDLAND
JACKS CREEK, TN VOR/DME	BOWLING GREEN, KY VORTAC	70	JACKS CREEK
V95			
WINSLOW, AZ VORTAC	RATTLESNAKE, NM VORTAC	91	WINSLOW
BLUE MESA, CO VOR/DME	FALCON, CO VORTAC	#77	BLUE MESA
#USE THE HUGO (HGO) VORTAC FROM THE COP TO THE GORJE INT			
V97			
ST PETERSBURG, FL VORTAC	SEMINOLE, FL VORTAC	97	ST PETERSBURG
SHELBYVILLE, IN VORTAC	BOILER, IN VORTAC	50	SHELBYVILLE
NODINE, MN VORTAC	GOPHER, MN VORTAC	60	NODINE
V101			
GILL, CO VORTAC	HAYDEN, CO VOR/DME	71	GILL
HAYDEN, CO VOR/DME	VERNAL, UT VOR/DME	56	HAYDEN
VERNAL, UT VOR/DME	WASATCH, UT VORTAC	75	VERNAL
OGDEN, UT VORTAC	BURLEY, ID VOR/DME	61	OGDEN
V102			
SALT FLAT, TX VORTAC	CARLSBAD, NM VORTAC	24	SALT FLAT
V103			
GREENSBORO, NC VORTAC	ROANOKE, VA VORTAC	28	GREENSBORO
V104			
MONTPELIER, VT VOR/DME	BERLIN, NH VOR/DME	39	MONTPELIER

AIRWAY SEGMENT

CHANGEOVER POINTS

FROM	TO	DISTANCE	FROM
BERLIN, NH VOR/DME	BANGOR, ME VORTAC	25	BERLIN
V105			
DRAKE, AZ VORTAC	BOULDER CITY, NV VORTAC	55	DRAKE
BEATTY, NV VORTAC	COALDALE, NV VORTAC	34	BEATTY
COALDALE, NV VORTAC	MUSTANG, NV VORTAC	55	COALDALE
V107			
FILLMORE, CA VORTAC	AVENAL, CA VORTAC	31	FILLMORE
AVENAL, CA VORTAC	PANOCHÉ, CA VORTAC	45	AVENAL
V111			
BIG SUR, CA VORTAC	SALINAS, CA VORTAC	21	BIG SUR
SALINAS, CA VORTAC	MODESTO, CA VOR/DME	22	SALINAS
V112			
PENDLETON, OR VORTAC	SPOKANE, WA VORTAC	57	PENDLETON
V113			
MORRO BAY, CA VORTAC	PASO ROBLES, CA VORTAC	7	MORRO BAY
MUSTANG, NV VORTAC	SOD HOUSE, NV VORTAC	48	MUSTANG
BOISE, ID VORTAC	SALMON, ID VOR/DME	45	BOISE
SALMON, ID VOR/DME	COPPERTOWN, MT VOR/DME	60	SALMON
HELENA, MT VORTAC	LEWISTOWN, MT VOR/DME	40	HELENA
V115			
VULCAN, AL VORTAC	CHOO CHOO, TN VORTAC	59	VULCAN
HAZARD, KY VOR/DME	CHARLESTON, WV VORTAC	40	HAZARD
PARKERSBURG, WV VORTAC	NEWCOMERSTOWN, OH VOR/DME	25	PARKERSBURG
V116			
KALAMAZOO, MI VOR/DME	JACKSON, MI VOR/DME	36	KALAMAZOO
V119			
INDIAN HEAD, PA VORTAC	PARKERSBURG, WV VORTAC	60	INDIAN HEAD

AIRWAY SEGMENT

CHANGEOVER POINTS

FROM	TO	DISTANCE	FROM
V120			
SEATTLE, WA VORTAC	WENATCHEE, WA VOR/DME	51	SEATTLE
WENATCHEE, WA VOR/DME	EPHRATA, WA VORTAC	10	WENATCHEE
MULLAN PASS, ID VOR/DME	GREAT FALLS, MT VORTAC	80	MULLAN PASS
LEWISTOWN, MT VOR/DME	MILES CITY, MT VOR/DME	74	LEWISTOWN
MILES CITY, MT VOR/DME	DUPREE, SD VORTAC	90	MILES CITY
SIOUX FALLS, SD VORTAC	MASON CITY, IA VORTAC	82	SIOUX FALLS
V121			
KIMBERLY, OR VORTAC	BAKER CITY, OR VOR/DME	67	KIMBERLY
V123			
WOODSTOWN, NJ VORTAC	ROBBINSVILLE, NJ VORTAC	19	WOODSTOWN
V124			
PARIS, TX VOR/DME	HOT SPRINGS, AR VOR/DME	75	PARIS
HOT SPRINGS, AR VOR/DME	LITTLE ROCK, AR VORTAC	14	HOT SPRINGS
V128			
SMARS, IL FIX	KANKAKEE, IL VOR/DME	#44	SMARS
#COP MEASURED FROM BDF VORTAC.			
CINCINNATI, KY VORTAC	YORK, KY VORTAC	38	CINCINNATI
YORK, KY VORTAC	CHARLESTON, WV VORTAC	29	YORK
CHARLESTON, WV VORTAC	CASANOVA, VA VORTAC	114	CHARLESTON
V133			
BARRETT'S MOUNTAIN, NC VOR/DME	CHARLESTON, WV VORTAC	77	BARRETT'S MOUNTAIN
CHARLESTON, WV VORTAC	ZANESVILLE, OH VOR/DME	52	CHARLESTON
V134			
FAIRFIELD, UT VORTAC	CARBON, UT VOR/DME	20	FAIRFIELD
GRAND JUNCTION, CO VOR/DME	RED TABLE, CO VOR/DME	#56	GRAND JUNCTION
#THE COP IS AT THE SLOLM INT.			
V135			
GOFFS, CA VORTAC	BEATTY, NV VORTAC	31	GOFFS
BEATTY, NV VORTAC	COALDALE, NV VORTAC	#34	BEATTY
#COP 53 NM FROM AND UTILIZES COALDALE, NV VORTAC ON THE 129 M RAD.			

AIRWAY SEGMENT

CHANGEOVER POINTS

FROM	TO	DISTANCE	FROM
V136			
VOLUNTEER, TN VORTAC	SNOWBIRD, TN VORTAC	25	VOLUNTEER
V137			
PALM SPRINGS, CA VORTAC	PALMDALE, CA VORTAC	30	PALM SPRINGS
GORMAN, CA VORTAC	AVENAL, CA VORTAC	31	GORMAN
V139			
CAPE CHARLES, VA VORTAC	SNOW HILL, MD VORTAC	38	CAPE CHARLES
SNOW HILL, MD VORTAC	SEA ISLE, NJ VORTAC	25	SNOW HILL
V140			
BLUEFIELD, WV VORTAC	MONTEBELLO, VA VOR/DME	44	BLUEFIELD
V142			
MALAD CITY, ID VOR/DME	FORT BRIDGER, WY VOR/DME	32	MALAD CITY
V144			
BRADFORD, IL VORTAC	KANKAKEE, IL VOR/DME	44	BRADFORD
V146			
ALBANY, NY VORTAC	CHESTER, MA VOR/DME	8	ALBANY
V148			
THURMAN, CO VORTAC	HAYES CENTER, NE VORTAC	65	THURMAN
GOPHER, MN VORTAC	HAYWARD, WI VOR/DME	65	GOPHER
V153			
LAKE HENRY, PA VORTAC	GEORGETOWN, NY VORTAC	60	LAKE HENRY
V155			
SANDHILLS, NC VORTAC	RALEIGH/DURHAM, NC VORTAC	10	SANDHILLS

AIRWAY SEGMENT

CHANGEOVER POINTS

FROM	TO	DISTANCE	FROM
V157			
WOODSTOWN, NJ VORTAC	ROBBINSVILLE, NJ VORTAC	19	WOODSTOWN
V159			
VERO BEACH, FL VORTAC	ORLANDO, FL VORTAC	32	VERO BEACH
V161			
NAPOLEON, MO VORTAC	LAMONI, IA VORTAC	40	NAPOLEON
INTERNATIONAL FALLS, MN VORTAC	WINNIPEG, CA VORTAC	77	INTERNATIONAL FALLS
V162			
ALLENTOWN, PA VORTAC	HUGUENOT, NY VOR/DME	10	ALLENTOWN
V163			
BROWNSVILLE, TX VORTAC	CORPUS CHRISTI, TX VORTAC	71	BROWNSVILLE
V165			
CLOVIS, CA VORTAC	MUSTANG, NV VORTAC	94	CLOVIS
MUSTANG, NV VORTAC	LAKEVIEW, OR VORTAC	70	MUSTANG
LAKEVIEW, OR VORTAC	DESCHUTES, OR VORTAC	73	LAKEVIEW
DESCHUTES, OR VORTAC	NEWBERG, OR VOR/DME	43	DESCHUTES
V166			
WESTMINSTER, MD VORTAC	DUPONT, DE VORTAC	40	WESTMINSTER
V170			
PULLMAN, MI VOR/DME	SALEM, MI VORTAC	61	PULLMAN

AIRWAY SEGMENT

CHANGEOVER POINTS

FROM	TO	DISTANCE	FROM
V177			
JOLIET, IL VORTAC	JANESVILLE, WI VOR/DME	40	JOLIET
STEVENS POINT, WI VORTAC	WAUSAU, WI VORTAC	12	STEVENS POINT
WAUSAU, WI VORTAC	HAYWARD, WI VOR/DME	59	WAUSAU
HAYWARD, WI VOR/DME	DULUTH, MN VORTAC	42	HAYWARD
V182			
NEWPORT, OR VORTAC	NEWBERG, OR VOR/DME	29	NEWPORT
KLICKITAT, OR VOR/DME	BAKER CITY, OR VOR/DME	119	KLICKITAT
V183			
SAN MARCUS, CA VORTAC	SHAFTER, CA VORTAC	20	SAN MARCUS
V184			
PHILIPSBURG, PA VORTAC	HARRISBURG, PA VORTAC	21	PHILIPSBURG
V186			
VAN NUYS, CA VOR/DME	PARADISE, CA VORTAC	39	VAN NUYS
V187			
ALBUQUERQUE, NM VORTAC	RATTLESNAKE, NM VORTAC	58	ALBUQUERQUE
RATTLESNAKE, NM VORTAC	GRAND JUNCTION, CO VOR/DME	90	RATTLESNAKE
GRAND JUNCTION, CO VOR/DME	ROCK SPRINGS, WY VOR/DME	86	GRAND JUNCTION
BOYSEN RESERVOIR, WY VOR/DME	BILLINGS, MT VORTAC	97	BOYSEN RESERVOIR
GREAT FALLS, MT VORTAC	MISSOULA, MT VOR/DME	84	GREAT FALLS
MISSOULA, MT VOR/DME	NEZ PERCE, ID VOR/DME	35	MISSOULA
V189			
WRIGHT BROTHERS, NC VOR/DME	TAR RIVER, NC VORTAC	25	WRIGHT BROTHERS
V190			
PHOENIX, AZ VORTAC	ST JOHNS, AZ VORTAC	67	PHOENIX
ALBUQUERQUE, NM VORTAC	FORT UNION, NM VORTAC	38	ALBUQUERQUE
V191			
IRONWOOD, MI VORTAC	DULUTH, MN VORTAC	32	IRONWOOD

AIRWAY SEGMENT

CHANGEOVER POINTS

FROM	TO	DISTANCE	FROM
V194			
SABINE PASS, TX VOR/DME	LAFAYETTE, LA VORTAC	50	SABINE PASS
V198			
JUNCTION, TX VORTAC	SAN ANTONIO, TX VORTAC	51	JUNCTION
HARVEY, LA VORTAC	BROOKLEY, AL VORTAC	61	HARVEY
V200			
MENDOCINO, CA VORTAC	WILLIAMS, CA VORTAC	22	MENDOCINO
WILLIAMS, CA VORTAC	MUSTANG, NV VORTAC	84	WILLIAMS
FAIRFIELD, UT VORTAC	MYTON, UT VORTAC	32	FAIRFIELD
V201			
LOS ANGELES, CA VORTAC	PALMDALE, CA VORTAC	19	LOS ANGELES
V203			
ALBANY, NY VORTAC	SARANAC LAKE, NY VOR/DME	60	ALBANY
SARANAC LAKE, NY VOR/DME	MASSENA, NY VORTAC	11	SARANAC LAKE
V204			
HOQUIAM, WA VORTAC	OLYMPIA, WA VORTAC	31	HOQUIAM
V208			
THERMAL, CA VORTAC	TWENTYNINE PALMS, CA VORTAC	20	THERMAL
NEEDLES, CA VORTAC	PEACH SPRINGS, AZ VORTAC	39	NEEDLES
PEACH SPRINGS, AZ VORTAC	GRAND CANYON, AZ VOR/DME	57	PEACH SPRINGS
PAGE, AZ VOR/DME	HANKSVILLE, UT VORTAC	61	PAGE
CARBON, UT VOR/DME	MYTON, UT VORTAC	17	CARBON
VERNAL, UT VOR/DME	CHEROKEE, WY VOR/DME	54	VERNAL
V209			
SEMMES, AL VORTAC	KEWANEE, MS VORTAC	50	SEMMES

AIRWAY SEGMENT

CHANGEOVER POINTS

FROM	TO	DISTANCE	FROM
V210			
POMONA, CA VORTAC	HECTOR, CA VORTAC	16	POMONA
HECTOR, CA VORTAC	GOFFS, CA VORTAC	38	HECTOR
GOFFS, CA VORTAC	PEACH SPRINGS, AZ VORTAC	42	GOFFS
PEACH SPRINGS, AZ VORTAC	GRAND CANYON, AZ VOR/DME	57	PEACH SPRINGS
ALAMOSA, CO VORTAC	LAMAR, CO VORTAC	60	ALAMOSA
V212			
LUFKIN, TX VORTAC	ALEXANDRIA, LA VORTAC	65	LUFKIN
V213			
TAR RIVER, NC VORTAC	HOPEWELL, VA VORTAC	43	TAR RIVER
V214			
BELLAIRE, OH VOR/DME	GRANTSVILLE, MD VOR/DME	39	BELLAIRE
V216			
JANESVILLE, WI VOR/DME	MUSKEGON, MI VORTAC	92	JANESVILLE
SAGINAW, MI VOR/DME	MUSKEGON, MI VORTAC	48	SAGINAW
V217			
RHINELANDER, WI VORTAC	DULUTH, MN VORTAC	49	RHINELANDER
V218			
GRAND RAPIDS, MN VOR/DME	GOPHER, MN VORTAC	46	GRAND RAPIDS
KEELER, MI VOR/DME	LANSING, MI VORTAC	39	KEELER
V219			
SIOUX CITY, IA VORTAC	FAIRMONT, MN VOR/DME	74	SIOUX CITY
V220			
GRAND JUNCTION, CO VOR/DME	RIFLE, CO VOR/DME	#56	GRAND JUNCTION
#COP- THE COP IS AT THE SLOLM INT			

AIRWAY SEGMENT

CHANGEOVER POINTS

FROM	TO	DISTANCE	FROM
V222			
SALT FLAT, TX VORTAC	FORT STOCKTON, TX VORTAC	52	SALT FLAT
BARRETT'S MOUNTAIN, NC VOR/DME	LYNCHBURG, VA VORTAC	62	BARRETT'S MOUNTAIN
V228			
MADISON, WI VORTAC	NORTHBROOK, IL VOR/DME	56	MADISON
V229			
BRIDGEPORT, CT VOR/DME	HARTFORD, CT VOR/DME	19	BRIDGEPORT
V230			
SALINAS, CA VORTAC	PANOCHÉ, CA VORTAC	30	SALINAS
FRIANT, CA VORTAC	MINA, NV VORTAC	40	FRIANT
V231			
MISSOULA, MT VOR/DME	KALISPELL, MT VOR/DME	29	MISSOULA
V234			
DALHART, TX VORTAC	LIBERAL, KS VORTAC	45	DALHART
V235			
FAIRFIELD, UT VORTAC	FORT BRIDGER, WY VOR/DME	32	FAIRFIELD
ROCK SPRINGS, WY VOR/DME	MUDDY MOUNTAIN, WY VORTAC	65	ROCK SPRINGS
V237			
NEEDLES, CA VORTAC	BOULDER CITY, NV VORTAC	60	NEEDLES
V240			
HARVEY, LA VORTAC	BROOKLEY, AL VORTAC	61	HARVEY
V243			
WAYCROSS, GA VORTAC	VIENNA, GA VORTAC	30	WAYCROSS
HUNTINGBURG, IN VOR/DME	TERRE HAUTE, IN VORTAC	36	HUNTINGBURG

AIRWAY SEGMENT

CHANGEOVER POINTS

FROM	TO	DISTANCE	FROM
V244			
MANTECA, CA VORTAC	COALDALE, NV VORTAC	96	MANTECA
COALDALE, NV VORTAC	TONOPAH, NV VORTAC	14	COALDALE
TONOPAH, NV VORTAC	WILSON CREEK, NV VORTAC	50	TONOPAH
WILSON CREEK, NV VORTAC	MILFORD, UT VORTAC	40	WILSON CREEK
MILFORD, UT VORTAC	HANKSVILLE, UT VORTAC	40	MILFORD
BLUE MESA, CO VOR/DME	PUEBLO, CO VORTAC	53	BLUE MESA
V252			
GENESE0, NY VOR/DME	BINGHAMTON, NY VORTAC	34	GENESE0
V253			
LUCIN, UT VORTAC	TWIN FALLS, ID VORTAC	40	LUCIN
TWIN FALLS, ID VORTAC	BOISE, ID VORTAC	48	TWIN FALLS
NEZ PERCE, ID VOR/DME	PULLMAN, WA VOR/DME	13	NEZ PERCE
V257			
GRAND CANYON, AZ VOR/DME	BRYCE CANYON, UT VORTAC	36	GRAND CANYON
DELTA, UT VORTAC	MALAD CITY, ID VOR/DME	63	DELTA
DUBOIS, ID VORTAC	DILLON, MT VOR/DME	46	DUBOIS
DILLON, MT VOR/DME	COPPERTOWN, MT VOR/DME	27	DILLON
V259			
GRAND STRAND, SC VORTAC	FLORENCE, SC VORTAC	25	GRAND STRAND
V263			
SANTA FE, NM VORTAC	FORT UNION, NM VORTAC	21	SANTA FE
FORT UNION, NM VORTAC	CIMARRON, NM VORTAC	28	FORT UNION
V264			
LOS ANGELES, CA VORTAC	POMONA, CA VORTAC	25	LOS ANGELES
POMONA, CA VORTAC	TWENTYNINE PALMS, CA VORTAC	37	POMONA
DRAKE, AZ VORTAC	WINSLOW, AZ VORTAC	39	DRAKE
V265			
HARRISBURG, PA VORTAC	PHILIPSBURG, PA VORTAC	35	HARRISBURG
KEATING, PA VORTAC	BRADFORD, PA VOR/DME	30	KEATING

AIRWAY SEGMENT

CHANGEOVER POINTS

FROM	TO	DISTANCE	FROM
V266			
SOUTH BOSTON, VA VORTAC	LAWRENCEVILLE, VA VORTAC	32	SOUTH BOSTON
V267			
DUBLIN, GA VORTAC	ATHENS, GA VORTAC	47	DUBLIN
V268			
WESTMINSTER, MD VORTAC	BALTIMORE, MD VORTAC	12	WESTMINSTER
V269			
WELLS, NV VOR	TWIN FALLS, ID VORTAC	33	WELLS
V270			
JAMESTOWN, NY VOR/DME	WELLSVILLE, NY VORTAC	22	JAMESTOWN
V273			
HANCOCK, NY VOR/DME	GEORGETOWN, NY VORTAC	31	HANCOCK
V276			
TYRONE, PA VORTAC	RAVINE, PA VORTAC	31	TYRONE
V277			
FORT WAYNE, IN VORTAC	KEELER, MI VOR/DME	38	FORT WAYNE
V278			
GUTHRIE, TX VORTAC	BOWIE, TX VORTAC	64	GUTHRIE
V280			
PANHANDLE, TX VORTAC	MITBEE, OK VORTAC	46	PANHANDLE

AIRWAY SEGMENT

CHANGEOVER POINTS

FROM	TO	DISTANCE	FROM
V282			
SARANAC LAKE, NY VOR/DME	MONTREAL, CA VOR/DME	37	SARANAC LAKE
V283			
SEAL BEACH, CA VORTAC	HOMELAND, CA VOR	24	SEAL BEACH
HECTOR, CA VORTAC	BOULDER CITY, NV VORTAC	23	HECTOR
V285			
WHITE CLOUD, MI VOR/DME	MANISTEE, MI VOR/DME	28	WHITE CLOUD
V286			
BROOKE, VA VORTAC	CAPE CHARLES, VA VORTAC	22	BROOKE
V287			
BATTLE GROUND, WA VORTAC	OLYMPIA, WA VORTAC	41	BATTLE GROUND
V291			
ALBUQUERQUE, NM VORTAC	GALLUP, NM VORTAC	44	ALBUQUERQUE
V293			
ELY, NV VOR/DME	BULLION, NV VOR/DME	26	ELY
BULLION, NV VOR/DME	TWIN FALLS, ID VORTAC	66	BULLION
V298			
DONNELLY, ID VORTAC	DUBOIS, ID VORTAC	109	DONNELLY
DUNOIR, WY VOR/DME	BOYSEN RESERVOIR, WY VOR/DME	15	DUNOIR
V299			
LOS ANGELES, CA VORTAC	VENTURA, CA VOR/DME	18	LOS ANGELES

AIRWAY SEGMENT

CHANGEOVER POINTS

FROM	TO	DISTANCE	FROM
V300			
THUNDER BAY, CANADA VORTAC	SAULT STE MARIE, MI VOR/DME	142	THUNDER BAY
SHERBROOKE, CANADA VORTAC	MILLINOCKET, ME VOR/DME	61	SHERBROOKE
V306			
DAISETTA, TX VORTAC	LAKE CHARLES, LA VORTAC	30	DAISETTA
V316			
IRONWOOD, MI VORTAC	SAWYER, MI VOR/DME	64	IRONWOOD
SAWYER, MI VOR/DME	NEWBERRY, MI VOR/DME	50	SAWYER
V317			
POGGI, CA VORTAC	IMPERIAL, CA VORTAC	25	POGGI
V319			
WORLAND, WY VOR/DME	CODY, WY VOR/DME	39	WORLAND
V323			
MONTGOMERY, AL VORTAC	EUFAULA, AL VORTAC	32	MONTGOMERY
V324			
CRAZY WOMAN, WY VOR/DME	WORLAND, WY VOR/DME	15	CRAZY WOMAN
V328			
JACKSON, WY VOR/DME	BIG PINEY, WY VOR/DME	20	JACKSON
V330			
IDAHO FALLS, ID VOR/DME	JACKSON, WY VOR/DME	48	IDAHO FALLS
DUNOIR, WY VOR/DME	RIVERTON, WY VOR/DME	15	DUNOIR
V336			
ELLENSBURG, WA VORTAC	EPHRATA, WA VORTAC	19	ELLENSBURG

AIRWAY SEGMENT

CHANGEOVER POINTS

FROM	TO	DISTANCE	FROM
V343			
DUBOIS, ID VORTAC	BOZEMAN, MT VOR/DME	60	DUBOIS
V361			
RATTLESNAKE, NM VORTAC	MONTROSE, CO VOR/DME	61	RATTLESNAKE
V365			
HELENA, MT VORTAC	CUT BANK, MT VORTAC	51	HELENA
V370			
LOS ANGELES, CA VORTAC	PARADISE, CA VORTAC	25	LOS ANGELES
PARADISE, CA VORTAC	PALM SPRINGS, CA VORTAC	34	PARADISE
V372			
SEAL BEACH, CA VORTAC	HOMELAND, CA VOR	24	SEAL BEACH
V373			
GREENSBORO, NC VORTAC	SANDHILLS, NC VORTAC	43	GREENSBORO
V375			
ROANOKE, VA VORTAC	GORDONSVILLE, VA VORTAC	48	ROANOKE
V382			
CONES, CO VOR/DME	DURANGO, CO VOR/DME	25	CONES
V393			
NOGALES, AZ VOR/DME	HERMOSILLO, MX VOR/DME	64	NOGALES
V394			
POMONA, CA VORTAC	DAGGETT, CA VORTAC	16	POMONA
DAGGETT, CA VORTAC	LAS VEGAS, NV VORTAC	59	DAGGETT

AIRWAY SEGMENT

CHANGEOVER POINTS

FROM	TO	DISTANCE	FROM
V401			
WORLAND, WY VOR/DME	MUDDY MOUNTAIN, WY VORTAC	35	WORLAND
V413			
IRONWOOD, MI VORTAC	EAU CLAIRE, WI VORTAC	45	IRONWOOD
V419			
BOSTON, MA VOR/DME	BRADLEY, CT VORTAC	49	BOSTON
V428			
ITHACA, NY VOR/DME	GEORGETOWN, NY VORTAC	20	ITHACA
V430			
MINOT, ND VORTAC	MINOT, ND VORTAC	56	MINOT
DULUTH, MN VORTAC	IRONWOOD, MI VORTAC	55	DULUTH
IRONWOOD, MI VORTAC	IRON MOUNTAIN, MI VOR/DME	44	IRONWOOD
V432			
THERMAL, CA VORTAC	PARKER, CA VORTAC	30	THERMAL
V433			
LA GUARDIA, NY VOR/DME	BRIDGEPORT, CT VOR/DME	9	LA GUARDIA
V437			
ORMOND BEACH, FL VORTAC	SAVANNAH, GA VORTAC	80	ORMOND BEACH
V442			
HECTOR, CA VORTAC	PARKER, CA VORTAC	#41	HECTOR
#USE THE NEEDLES (EED) VORTAC FROM THE COP TO THE CLIPP INT.			

AIRWAY SEGMENT

CHANGEOVER POINTS

FROM	TO	DISTANCE	FROM
V444			
BURLEY, ID VOR/DME	BOISE, ID VORTAC	#95	BURLEY
#COP 95 NM FROM AND UTILIZES POCATELLO, ID VORTAC ON THE 269 M RAD.			
BOISE, ID VORTAC	BAKER CITY, OR VOR/DME	77	BOISE
V448			
YAKIMA, WA VORTAC	MOSES LAKE, WA VOR/DME	15	YAKIMA
SPOKANE, WA VORTAC	KALISPELL, MT VOR/DME	105	SPOKANE
V450			
MUSKEGON, MI VORTAC	FLINT, MI VORTAC	54	MUSKEGON
V452			
EUGENE, OR VORTAC	KLAMATH FALLS, OR VORTAC	67	EUGENE
V454			
LIBERTY, NC VORTAC	LAWRENCEVILLE, VA VORTAC	82	LIBERTY
V465			
BULLION, NV VOR/DME	WELLS, NV VOR	25	BULLION
WELLS, NV VOR	MALAD CITY, ID VOR/DME	40	WELLS
MALAD CITY, ID VOR/DME	JACKSON, WY VOR/DME	#63	MALAD CITY
#MEA GAP AT COP			
DUNOIR, WY VOR/DME	BILLINGS, MT VORTAC	45	DUNOIR
V469			
HARRISBURG, PA VORTAC	DUPONT, DE VORTAC	32	HARRISBURG
V475			
LA GUARDIA, NY VOR/DME	BRIDGEPORT, CT VOR/DME	9	LA GUARDIA
V484			
TWIN FALLS, ID VORTAC	WASATCH, UT VORTAC	59	TWIN FALLS
WASATCH, UT VORTAC	MYTON, UT VORTAC	28	WASATCH

AIRWAY SEGMENT

CHANGEOVER POINTS

FROM	TO	DISTANCE	FROM
V487			
LA GUARDIA, NY VOR/DME	BRIDGEPORT, CT VOR/DME	9	LA GUARDIA
V489			
GLENS FALLS, NY VORTAC	PLATTSBURGH, NY VORTAC	21	GLENS FALLS
V490			
CAMBRIDGE, NY VOR/DME	MANCHESTER, NH VOR/DME	37	CAMBRIDGE
V493			
LEXINGTON, KY VORTAC	YORK, KY VORTAC	41	LEXINGTON
V494			
MENDOCINO, CA VORTAC	SANTA ROSA, CA VOR/DME	25	MENDOCINO
V495			
WHATCOM, WA VORTAC	VICTORIA, CA VOR/DME	10	WHATCOM
SEATTLE, WA VORTAC	VICTORIA, CA VOR/DME	50	SEATTLE
BATTLE GROUND, WA VORTAC	SEATTLE, WA VORTAC	20	BATTLE GROUND
V500			
NEWBERG, OR VOR/DME	KIMBERLY, OR VORTAC	79	NEWBERG
BOISE, ID VORTAC	POCATELLO, ID VORTAC	66	BOISE
V501			
ST THOMAS, PA VORTAC	PHILIPSBURG, PA VORTAC	22	ST THOMAS
V505			
GOPHER, MN VORTAC	SIREN, WI VOR/DME	38	GOPHER

AIRWAY SEGMENT

CHANGEOVER POINTS

FROM	TO	DISTANCE	FROM
V510			
GAYLE, MI FIX #COP MEASURED FROM MUSKEGON VORTAC.	MUSKEGON, MI VORTAC	#47	GAYLE
V514			
THERMAL, CA VORTAC GOFFS, CA VORTAC #COP MEASURED FROM NEEDLES VORTAC.	TWENTYNINE PALMS, CA VORTAC BOULDER CITY, NV VORTAC	20 #60	THERMAL GOFFS
V520			
NEZ PERCE, ID VOR/DME DUBOIS, ID VORTAC	SALMON, ID VOR/DME JACKSON, WY VOR/DME	53 60	NEZ PERCE DUBOIS
V527			
HOT SPRINGS, AR VOR/DME	RAZORBACK, AR VORTAC	42	HOT SPRINGS
V532			
SALINA, KS VORTAC	LINCOLN, NE VORTAC	51	SALINA
V536			
MULLAN PASS, ID VOR/DME KALISPELL, MT VOR/DME	KALISPELL, MT VOR/DME GREAT FALLS, MT VORTAC	45 35	MULLAN PASS KALISPELL
V542			
YOUNGSTOWN, OH VORTAC	TIDIOUTE, PA VORTAC	21	YOUNGSTOWN
V569			
FRANKSTON, TX VOR/DME	CEDAR CREEK, TX VORTAC	5	FRANKSTON
V571			
HUMBLE, TX VORTAC	NAVASOTA, TX VORTAC	24	HUMBLE

AIRWAY SEGMENT

CHANGEOVER POINTS

FROM	TO	DISTANCE	FROM
V573			
HOT SPRINGS, AR VOR/DME	LITTLE ROCK, AR VORTAC	14	HOT SPRINGS
V574			
NAVASOTA, TX VORTAC	HUMBLE, TX VORTAC	18	NAVASOTA
V578			
TIFT MYERS, GA VOR	ALMA, GA VORTAC	26	TIFT MYERS
V591			
GRAND JUNCTION, CO VOR/DME #THE COP IS AT THE SLOLM INT	SNOW, CO VOR/DME	#56	GRAND JUNCTION
V595			
DESCHUTES, OR VORTAC	PORTLAND, OR VOR/DME	42	DESCHUTES
V611			
SANTA FE, NM VORTAC	FORT UNION, NM VORTAC	21	SANTA FE
FORT UNION, NM VORTAC	CIMARRON, NM VORTAC	28	FORT UNION
CIMARRON, NM VORTAC	PUEBLO, CO VORTAC	30	CIMARRON
ALASKA V309			
PRINCE RUPERT, CANADA NDB	ANNETTE ISLAND, AK VOR/DME	26	PRINCE RUPERT
ALASKA V311			
ANNETTE ISLAND, AK VOR/DME	BIORKA ISLAND, AK VORTAC	103	ANNETTE ISLAND
ALASKA V317			
ANNETTE ISLAND, AK VOR/DME	LEVEL ISLAND, AK VOR/DME	35	ANNETTE ISLAND
LEVEL ISLAND, AK VOR/DME	SISTERS ISLAND, AK VORTAC	51	LEVEL ISLAND

AIRWAY SEGMENT

CHANGEOVER POINTS

FROM	TO	DISTANCE	FROM
ALASKA V319			
YAKUTAT, AK VOR/DME	JOHNSTONE POINT, AK VOR/DME	119	YAKUTAT
SPARREVOHN, AK VOR/DME	BETHEL, AK VORTAC	92	SPARREVOHN
ALASKA V321			
KING SALMON, AK VORTAC	HOMER, AK VOR/DME	70	KING SALMON
ALASKA V333			
HOOPER BAY, AK VOR/DME	NOME, AK VOR/DME	70	HOOPER BAY
NOME, AK VOR/DME	SHISHMAREF, AK NDB	65	NOME
ALASKA V401			
AMBLER, AK NDB/DME	KOTZEBUE, AK VOR/DME	40	AMBLER
KOTZEBUE, AK VOR/DME	SHISHMAREF, AK NDB	60	KOTZEBUE
ALASKA V428			
BIORKA ISLAND, AK VORTAC	SISTERS ISLAND, AK VORTAC	55	BIORKA ISLAND
SISTERS ISLAND, AK VORTAC	HAINES, AK NDB	21	SISTERS ISLAND
HAINES, AK NDB	WHITEHORSE, CA VOR/DME	30	HAINES
ALASKA V436			
TALKEETNA, AK VOR/DME	NENANA, AK VORTAC	50	TALKEETNA
NENANA, AK VORTAC	CHANDALAR LAKE, AK NDB	120	NENANA
CHANDALAR LAKE, AK NDB	DEADHORSE, AK VOR/DME	63	CHANDALAR LAKE
ALASKA V438			
KODIAK, AK VOR/DME	HOMER, AK VOR/DME	66	KODIAK
ALASKA V440			
SANDSPIT, CANADA VORTAC	BIORKA ISLAND, AK VORTAC	119	SANDSPIT
BIORKA ISLAND, AK VORTAC	YAKUTAT, AK VOR/DME	98	BIORKA ISLAND
YAKUTAT, AK VOR/DME	MIDDLETON ISLAND, AK VOR/DME	95	YAKUTAT
MIDDLETON ISLAND, AK VOR/DME	ANCHORAGE, AK VOR/DME	95	MIDDLETON ISLAND
UNALAKLEET, AK VOR/DME	NOME, AK VOR/DME	80	UNALAKLEET

AIRWAY SEGMENT

CHANGEOVER POINTS

FROM	TO	DISTANCE	FROM
ALASKA V441			
MIDDLETON ISLAND, AK VOR/DME	ANCHORAGE, AK VOR/DME	84	MIDDLETON ISLAND
ALASKA V444			
BARROW, AK VOR/DME	EVANSVILLE, AK NDB	105	BARROW
BETTLES, AK VOR/DME	FAIRBANKS, AK VORTAC	89	BETTLES
NORTHWAY, AK VORTAC	BURWASH, CA NDB	97	NORTHWAY
ALASKA V445			
BETTLES, AK VOR/DME	BETTLES, AK VOR/DME	#67	BETTLES
#USE THE NENANA (ENN) VORTAC FROM THE COP TO THE RAMPA INT.			
ALASKA V447			
FAIRBANKS, AK VORTAC	CHANDALAR LAKE, AK NDB	103	FAIRBANKS
ALASKA V452			
KUKULIAK, AK VOR/DME	NOME, AK VOR/DME	67	KUKULIAK
MOSES POINT, AK VOR/DME	GALENA, AK VOR/DME	70	MOSES POINT
GALENA, AK VOR/DME	NENANA, AK VORTAC	75	GALENA
ALASKA V453			
BETHEL, AK VORTAC	UNALAKLEET, AK VOR/DME	109	BETHEL
ALASKA V457			
ILIAMNA, AK NDB/DME	KENAI, AK VOR/DME	47	ILIAMNA
ALASKA V459			
EMMONAK, AK VOR/DME	ST MARYS, AK NDB	40	EMMONAK
ALASKA V480			
ST PAUL ISLAND, AK NDB/DME	BETHEL, AK VORTAC	223	ST PAUL ISLAND
BETHEL, AK VORTAC	MC GRATH, AK VORTAC	128	BETHEL
MC GRATH, AK VORTAC	NENANA, AK VORTAC	70	MC GRATH

AIRWAY SEGMENT

CHANGEOVER POINTS

FROM	TO	DISTANCE	FROM
ALASKA V481			
GULKANA, AK VOR/DME	BIG DELTA, AK VORTAC	63	GULKANA
BIG DELTA, AK VORTAC	FORT YUKON, AK VORTAC	69	BIG DELTA
ALASKA V488			
HOOPER BAY, AK VOR/DME	HOOPER BAY, AK VOR/DME	91	HOOPER BAY
TANANA, AK VOR/DME	FAIRBANKS, AK VORTAC	40	TANANA
ALASKA V496			
HOOPER BAY, AK VOR/DME	ST MARYS, AK NDB	40	HOOPER BAY
ALASKA V498			
GALENA, AK VOR/DME	KOTZEBUE, AK VOR/DME	85	GALENA
ALASKA V504			
NENANA, AK VORTAC	BETTLES, AK VOR/DME	67	NENANA
BETTLES, AK VOR/DME	DEADHORSE, AK VOR/DME	116	BETTLES
ALASKA V506			
KODIAK, AK VOR/DME	KING SALMON, AK VORTAC	55	KODIAK
KING SALMON, AK VORTAC	BETHEL, AK VORTAC	102	KING SALMON
NOME, AK VOR/DME	KOTZEBUE, AK VOR/DME	64	NOME
HOTHAM, AK NDB	BARROW, AK VOR/DME	186	HOTHAM
ALASKA V508			
MIDDLETON ISLAND, AK VOR/DME	KENAI, AK VOR/DME	84	MIDDLETON ISLAND
SPARREVOHN, AK VOR/DME	ANIAK, AK NDB	68	SPARREVOHN
ALASKA V510			
EMMONAK, AK VOR/DME	ANVIK, AK NDB/DME	69	EMMONAK
ANVIK, AK NDB/DME	MC GRATH, AK VORTAC	40	ANVIK

AIRWAY SEGMENT

CHANGEOVER POINTS

FROM	TO	DISTANCE	FROM
ALASKA V531			
FAIRBANKS, AK VORTAC	TANANA, AK VOR/DME	69	FAIRBANKS
TANANA, AK VOR/DME	HUSLIA, AK VOR/DME	40	TANANA
SELAWIK, AK VOR/DME	KOTZEBUE, AK VOR/DME	30	SELAWIK
KOTZEBUE, AK VOR/DME	POINT HOPE, AK NDB	116	KOTZEBUE
ALASKA V603			
ELFEE, AK NDB	DILLINGHAM, AK VOR/DME	55	ELFEE
ALASKA V617			
HOMER, AK VOR/DME	JOHNSTOWN POINT, AK VOR/DME	63	HOMER
HAWAII V15			
MOLOKAI, HI VORTAC	MAUI, HI VORTAC	31	MOLOKAI
HAWAII V16			
LANAI, HI VORTAC	UPOLU POINT, HI VORTAC	47	LANAI

FROM	AIRWAY SEGMENT	TO	CHANGEOVER POINTS DISTANCE	FROM
------	----------------	----	-------------------------------	------

&95.8005 JET ROUTES CHANGEOVER POINTS

J1

ROGUE VALLEY, OR VORTAC	BATTLE GROUND, WA VORTAC	90	ROGUE VALLEY
-------------------------	--------------------------	----	--------------

J2

BARD, AZ VORTAC	GILA BEND, AZ VORTAC	32	BARD
-----------------	----------------------	----	------

J5

LAKEVIEW, OR VORTAC	SEATTLE, WA VORTAC	176	LAKEVIEW
---------------------	--------------------	-----	----------

J6

DRAKE, AZ VORTAC	ZUNI, NM VORTAC	76	DRAKE
MARTINSBURG, WV VORTAC	LANCASTER, PA VORTAC	24	MARTINSBURG

J8

GALLUP, NM VORTAC	FORT UNION, NM VORTAC	101	GALLUP
-------------------	-----------------------	-----	--------

J10

BLUE MESA, CO VOR/DME	FALCON, CO VORTAC	50	BLUE MESA
-----------------------	-------------------	----	-----------

J15

RATTLESNAKE, NM VORTAC	GRAND JUNCTION, CO VOR/DME	90	RATTLESNAKE
------------------------	----------------------------	----	-------------

J16

BATTLE GROUND, WA VORTAC	PENDLETON, OR VORTAC	60	BATTLE GROUND
--------------------------	----------------------	----	---------------

AIRWAY SEGMENT		CHANGEOVER POINTS	
FROM	TO	DISTANCE	FROM
J17			
CHEYENNE, WY VORTAC	RAPID CITY, SD VORTAC	90	CHEYENNE
J18			
PHOENIX, AZ VORTAC	ST JOHNS, AZ VORTAC	88	PHOENIX
MOLINE, IL VORTAC	JOLIET, IL VORTAC	45	MOLINE
J19			
BUKKO, NM FIX	FORT UNION, NM VORTAC	82	BUKKO
ROBERTS, IL VOR/DME	NORTHBROOK, IL VOR/DME	40	ROBERTS
J20			
POCATELLO, ID VORTAC	ROCK SPRINGS, WY VOR/DME	82	POCATELLO
J21			
GOPHER, MN VORTAC	DULUTH, MN VORTAC	81	GOPHER
J24			
HUGO, CO VORTAC	HAYS, KS VORTAC	80	HUGO
CHARLESTON, WV VORTAC	MONTEBELLO, VA VOR/DME	104	CHARLESTON
J32			
ABERDEEN, SD VOR/DME	DULUTH, MN VORTAC	130	ABERDEEN
J36			
DUNKIRK, NY VORTAC	LAKE HENRY, PA VORTAC	130	DUNKIRK
J37			
KENNEDY, NY VOR/DME	KINGSTON, NY VOR/DME	37	KENNEDY

AIRWAY SEGMENT		CHANGEOVER POINTS	
FROM	TO	DISTANCE	FROM
J42			
MEMPHIS, TN VORTAC	NASHVILLE, TN VORTAC	119	MEMPHIS
J44			
FALCON, CO VORTAC	MC COOK, NE VOR/DME	90	FALCON
MC COOK, NE VOR/DME	LINCOLN, NE VORTAC	51	MC COOK
J48			
CASANOVA, VA VORTAC	MONTEBELLO, VA VOR/DME	58	CASANOVA
J52			
BIGBEE, MS VORTAC	VULCAN, AL VORTAC	25	BIGBEE
J55			
BOSTON, MA VOR/DME	KENNEBUNK, ME VORTAC	38	BOSTON
J56			
WASATCH, UT VORTAC	HAYDEN, CO VOR/DME	66	WASATCH
HAYDEN, CO VOR/DME	FALCON, CO VORTAC	#55	HAYDEN
#USE THE GILL (GLL) VORTAC FROM THE COP TO THE RIDGE INT			
J58			
COALDALE, NV VORTAC	WILSON CREEK, NV VORTAC	44	COALDALE
MILFORD, UT VORTAC	RATTLESNAKE, NM VORTAC	92	MILFORD
J60			
HANKSVILLE, UT VORTAC	RED TABLE, CO VOR/DME	75	HANKSVILLE
RED TABLE, CO VOR/DME	MILE HIGH, CO VORTAC	39	RED TABLE
GOSHEN, IN VORTAC	DRYER, OH VOR/DME	90	GOSHEN

AIRWAY SEGMENT		CHANGEOVER POINTS	
FROM	TO	DISTANCE	FROM
J64			
RATTLESNAKE, NM VORTAC	PUEBLO, CO VORTAC	93	RATTLESNAKE
PUEBLO, CO VORTAC	HILL CITY, KS VORTAC	80	PUEBLO
FORT WAYNE, IN VORTAC	ELLWOOD CITY, PA VORTAC	112	FORT WAYNE
J68			
DELLS, WI VORTAC	GOPHER, MN VORTAC	115	DELLS
J70			
DICKINSON, ND VORTAC	ABERDEEN, SD VOR/DME	60	DICKINSON
J71			
CENTRALIA, IL VORTAC	ROBERTS, IL VOR/DME	98	CENTRALIA
ROBERTS, IL VOR/DME	NORTHBROOK, IL VOR/DME	40	ROBERTS
J78			
DRAKE, AZ VORTAC	ZUNI, NM VORTAC	76	DRAKE
J79			
FRANKLIN, VA VORTAC	SALISBURY, MD VORTAC	20	FRANKLIN
J80			
COALDALE, NV VORTAC	WILSON CREEK, NV VORTAC	44	COALDALE
MILFORD, UT VORTAC	GRAND JUNCTION, CO VOR/DME	50	MILFORD
BELLAIRE, OH VOR/DME	EAST TEXAS, PA VOR/DME	132	BELLAIRE
J82			
BATTLE GROUND, WA VORTAC	DONNELLY, ID VORTAC	90	BATTLE GROUND
RAPID CITY, SD VORTAC	SIOUX FALLS, SD VORTAC	125	RAPID CITY
GOSHEN, IN VORTAC	DRYER, OH VOR/DME	90	GOSHEN
JAMESTOWN, NY VOR/DME	ALBANY, NY VORTAC	145	JAMESTOWN
J83			
APPLETON, OH VORTAC	DRYER, OH VOR/DME	75	APPLETON

AIRWAY SEGMENT		CHANGEOVER POINTS	
FROM	TO	DISTANCE	FROM
J84			
NORTHBROOK, IL VOR/DME	DANVILLE, IL VORTAC	67	NORTHBROOK
J87			
MOLINE, IL VORTAC	JOLIET, IL VORTAC	45	MOLINE
J88			
SAN MARCUS, CA VORTAC	SALINAS, CA VORTAC	71	SAN MARCUS
J89			
ATLANTA, GA VORTAC	LOUISVILLE, KY VORTAC	126	ATLANTA
J90			
HELENA, MT VORTAC	MILES CITY, MT VOR/DME	115	HELENA
J91			
VOLUNTEER, TN VORTAC	HENDERSON, WV VORTAC	135	VOLUNTEER
J92			
BEATTY, NV VORTAC	BOULDER CITY, NV VORTAC	12	BEATTY
J94			
ROCK SPRINGS, WY VOR/DME	SCOTTSBLUFF, NE VORTAC	105	ROCK SPRINGS
J96			
DRAKE, AZ VORTAC	GALLUP, NM VORTAC	77	DRAKE
GALLUP, NM VORTAC	CIMARRON, NM VORTAC	146	GALLUP

AIRWAY SEGMENT		CHANGEOVER POINTS	
FROM	TO	DISTANCE	FROM
J107			
MILFORD, UT VORTAC	ROCK SPRINGS, WY VOR/DME	120	MILFORD
J110			
BELLAIRE, OH VOR/DME	COYLE, NJ VORTAC	132	BELLAIRE
J115			
CHANDALAR LAKE, AK NDB	DEADHORSE, AK VOR/DME	15	CHANDALAR LAKE
J116			
MEEKER, CO VOR/DME	FALCON, CO VORTAC	60	MEEKER
J118			
MEMPHIS, TN VORTAC	CHOO CHOO, TN VORTAC	130	MEMPHIS
J120			
ST PAUL ISLAND, AK NDB/DME	REEVE, AK NDB	190	ST PAUL ISLAND
J121			
CHARLESTON, SC VORTAC	KINSTON, NC VORTAC	128	CHARLESTON
SNOW HILL, MD VORTAC	SEA ISLE, NJ VORTAC	20	SNOW HILL
J123			
KODIAK, AK VOR/DME	KING SALMON, AK VORTAC	60	KODIAK
J125			
KODIAK, AK VOR/DME	ANCHORAGE, AK VOR/DME	93	KODIAK
J126			
SAN MARCUS, CA VORTAC	SALINAS, CA VORTAC	71	SAN MARCUS

AIRWAY SEGMENT		CHANGEOVER POINTS	
FROM	TO	DISTANCE	FROM
J128			
BLUE MESA, CO VOR/DME	FALCON, CO VORTAC	50	BLUE MESA
J130			
MC COOK, NE VOR/DME	PAWNEE CITY, NE VORTAC	72	MC COOK
J134			
DRAKE, AZ VORTAC	GALLUP, NM VORTAC	77	DRAKE
GALLUP, NM VORTAC	CIMARRON, NM VORTAC	146	GALLUP
HENDERSON, WV VORTAC	LINDEN, VA VORTAC	133	HENDERSON
J136			
YAKIMA, WA VORTAC	SPOKANE, WA VORTAC	50	YAKIMA
MULLAN PASS, ID VOR/DME	HELENA, MT VORTAC	100	MULLAN PASS
BILLINGS, MT VORTAC	MEDICINE BOW, WY VOR/DME	149	BILLINGS
J139			
BETTLES, AK VOR/DME	DEADHORSE, AK VOR/DME	83	BETTLES
J140			
DULUTH, MN VORTAC	SAULT STE MARIE, MI VOR/DME	171	DULUTH
J143			
MENDOCINO, CA VORTAC	ROSEBURG, OR VOR/DME	150	MENDOCINO
J152			
JOHNSTOWN, PA VORTAC	HARRISBURG, PA VORTAC	62	JOHNSTOWN
J153			
BAKER CITY, OR VOR/DME	SPOKANE, WA VORTAC	60	BAKER CITY

AIRWAY SEGMENT		CHANGEOVER POINTS	
FROM	TO	DISTANCE	FROM
J154			
WASATCH, UT VORTAC	ROCK SPRINGS, WY VOR/DME	35	WASATCH
ROCK SPRINGS, WY VOR/DME	MILE HIGH, CO VORTAC	104	ROCK SPRINGS
J157			
MYTON, UT VORTAC	LARAMIE, WY VORTAC	112	MYTON
J163			
POCATELLO, ID VORTAC	ROCK SPRINGS, WY VOR/DME	82	POCATELLO
J173			
WASATCH, UT VORTAC	MEEKER, CO VOR/DME	47	WASATCH
J180			
SAWMILL, LA VOR/DME	LITTLE ROCK, AR VORTAC	105	SAWMILL
LITTLE ROCK, AR VORTAC	FORISTELL, MO VORTAC	118	LITTLE ROCK
J181			
RANGER, TX VORTAC	OKMULGEE, OK VOR/DME	139	RANGER
OKMULGEE, OK VOR/DME	NEOSHO, MO VOR/DME	58	OKMULGEE
NEOSHO, MO VOR/DME	HALLSVILLE, MO VORTAC	45	NEOSHO
J183			
LLANO, TX VORTAC	COLLEGE STATION, TX VORTAC	93	LLANO
J187			
MEMPHIS, TN VORTAC	FORISTELL, MO VORTAC	96	MEMPHIS
J189			
KLAMATH FALLS, OR VORTAC	BATTLE GROUND, WA VORTAC	78	KLAMATH FALLS

AIRWAY SEGMENT		CHANGEOVER POINTS	
FROM	TO	DISTANCE	FROM
J193			
COFIELD, NC VORTAC	HARCUM, VA VORTAC	36	COFIELD
J197			
DOVE CREEK, CO VORTAC	HUGO, CO VORTAC	105	DOVE CREEK
J209			
NORFOLK, VA VORTAC	SALISBURY, MD VORTAC	42	NORFOLK
J220			
ARMEL, VA VORTAC	STONYFORK, PA VOR/DME	122	ARMEL
J230			
LARRI, PA FIX #COP MEASURED FROM COYLE, NJ VORTAC.	BELLAIRE, OH VOR/DME	#163	LARRI
J233			
WATERLOO, IA VORTAC	ST LOUIS, MO VORTAC	55	WATERLOO
J236			
THERMAL, CA VORTAC	NEEDLES, CA VORTAC	53	THERMAL
NEEDLES, CA VORTAC	TUBA CITY, AZ VORTAC	72	NEEDLES
J240			
MYTON, UT VORTAC	BLUE MESA, CO VOR/DME	60	MYTON
J244			
FORT UNION, NM VORTAC	ZUNI, NM VORTAC	86	FORT UNION

AIRWAY SEGMENT		CHANGEOVER POINTS	
FROM	TO	DISTANCE	FROM
J501			
SANDSPIT, CANADA VORTAC	BIORKA ISLAND, AK VORTAC	99	SANDSPIT
BIORKA ISLAND, AK VORTAC	YAKUTAT, AK VOR/DME	98	BIORKA ISLAND
YAKUTAT, AK VOR/DME	JOHNSTONE POINT, AK VOR/DME	117	YAKUTAT
J502			
SEATTLE, WA VORTAC	VICTORIA, CA VOR/DME	50	SEATTLE
SISTERS ISLAND, AK VORTAC	BURWASH, CA NDB	80	SISTERS ISLAND
J505			
SEATTLE, WA VORTAC	CRANBROOK, CA VOR/DME	108	SEATTLE
J507			
NORTHWAY, AK VORTAC	YAKUTAT, AK VOR/DME	135	NORTHWAY
J511			
GULKANA, AK VOR/DME	BURWASH, CA NDB	55	GULKANA
J515			
BETTLES, AK VOR/DME	BARROW, AK VOR/DME	130	BETTLES
J517			
BOISE, ID VORTAC	SPOKANE, WA VORTAC	100	BOISE
J518			
INDIAN HEAD, PA VORTAC	BALTIMORE, MD VORTAC	20	INDIAN HEAD
J522			
ROCHESTER, NY VOR/DME	HANCOCK, NY VOR/DME	54	ROCHESTER
HANCOCK, NY VOR/DME	KINGSTON, NY VOR/DME	41	HANCOCK

FROM	AIRWAY SEGMENT	TO	DISTANCE	CHANGEOVER POINTS FROM	
				J523	
BRYCE CANYON, UT	VORTAC	ELY, NV	VOR/DME	119	BRYCE CANYON
					J537
MULLAN PASS, ID	VOR/DME	CALGARY, CA	VORTAC	95	MULLAN PASS
					J589
CORVALLIS, OR	VOR/DME	VICTORIA, CA	VOR/DME	100	CORVALLIS
					J617
HOMER, AK	VOR/DME	JOHNSTONE POINT, AK	VOR/DME	63	HOMER
					J713
BIG PINEY, WY	VOR/DME	WASATCH, UT	VORTAC	94	BIG PINEY