

# ENHANCED ACCESS PENETRATION SYSTEM (EAPS)

## DRAFT FINAL TECHNICAL REPORT

**Work Performed Under Contract:**  
DE-AC26-01NT41187

**Submitted By:**  
Applied Research Associates, Inc.  
415 Waterman Road  
South Royalton, VT 05068

**Principal Investigator:**  
James D. Shinn II  
Phone Number: 802-763-8348  
Fax Number: 802-763-8283

**Submitted To:**  
U. S. Department of Energy  
National Energy Technology Laboratory  
COR: Skip Chamberlain

**January 2004**

## **EXECUTIVE SUMMARY**

Cone Penetrometer Technology (CPT) has proven to be a cost effective alternative to conventional drilling for environmental and geotechnical site investigation. Over the past decade, the U.S. Department of Energy (DOE) and Department of Defense (DOD) have developed CPT tools and sensors that enhance the investigative capabilities of CPT. While CPT's investigative capabilities have continued to improve, the ability to achieve the depths of penetration required at many DOE sites such as the Hanford Site, Savannah River Site (SRS), and Paducah has remained a limitation.

The geology at these DOE sites can include very hard layers that will stop static penetration by conventional CPT and direct push sampling methods. These layers can be cemented soils such as the caliche typically found in arid regions, coarse-grained formations (i.e., gravel and boulders), or volcanic flow fields.

Refusal of CPT and other direct push techniques in these layers has historically resulted in the need to mobilize a drill rig to penetrate the refusal layer, followed by continued investigation through a cased borehole. This increases cost and forfeits the detailed profile of site stratigraphy that CPT provides. At highly contaminated sites, the cost of drilling and disposal of the drilling spoils can greatly increase the cost of characterization and extend the time required to conduct the investigation.

Under funding from the National Energy Technology Laboratory (NETL), Contract No. DE-AC26-01NT41187, and in cooperation with the DOE Hanford Site, Applied Research Associates, Inc. (ARA) has developed an Enhanced Access Penetration System (EAPS) that aims to extend CPT penetration depth, conduct real-time sample collection and analysis, and contain drilling waste material. EAPS consists of four major components: (1) a Wireline CPT/Gas sampling probe and wireline soil and groundwater sampling system, (2) a small diameter air rotary drilling system, (3) environmental sensors that are used to detect and characterize contamination in both real and near-real time, and (4) an integral drill spoils collection and filtration system. The Wireline CPT/Gas sampling probe is used to determine soil stratigraphy and profile contaminants in real time. Once refusal occurs, the CPT/Gas sampling probe is withdrawn, leaving the push casing in place. A small diameter air rotary drill is then lowered through the casing and locked into the bottom end. This drill is used to penetrate the refusal layer. The return air and drill cuttings are routed through a series of filters to remove the drill cuttings. Volatile organic contaminants in the air stream are retained in a Granulated Carbon Trap ensuring that only clean air is emitted into the atmosphere. Once through the refusal layer, the Wireline CPT/Gas sampling probe sounding is resumed. At any depth of special interest, the Wireline CPT/Gas sampling probe can be removed and soil or water samples collected (again, without removing the casing) for either on-site or off-site testing.

The project was divided into two Phases, with Phase I consisting of evaluating candidate drill systems to implement with EAPS, selection of the drill system and integration and testing of the EAPS at the Hanford 200 site. Phase II consisted of

implementing the lessons learned under the Phase I effort and conducting a one-month demonstration at 200 West. The results of the Phase I and II efforts are summarized below.

## **Phase I Results**

Under Phase I, we evaluated laser and conventional drill techniques that could be integrated with CPT. Recent advances in laser technology and specifically work sponsored by the Gas Technology Institute suggested that laser drilling might be a possible candidate for EAPS. We conducted both a literature review and conducted a laser drilling laboratory experimental series using rocks from the Hanford site. A parallel effort was also conducted to evaluate drilling technologies that could be integrated with EAPS. Results of these studies and the design and field tests efforts are summarized below.

### **Evaluation of Laser Assisted Drilling**

The objectives of the laser drilling study were to: (1) conduct a survey to gather historical results from past laser rock drilling efforts, (2) compile information on the features and capabilities of current, state-of-the-art high power laser system and their applicability to drilling, and (3) to conduct a laboratory tests of candidate laser systems. If the systems showed potential for outperforming overburden drilling in the EAPS, then a laser-based system was to be designed, fabricated, and fielded.

### **Laser Drilling Summary and Conclusions**

Experimentation with state-of-the art commercial lasers has provided valuable insight into the capability for drilling rocks at Hanford using CPT. The following list summarizes the key findings of the study:

- Drilling rock with lasers is difficult, but achievable for the major rock types at Hanford. Under near-optimal conditions, which we expect will be compromised to some degree when implemented in a CPT, the best anticipated laser drilling rate is just over 1 ft/hr using two, 0.5 kW Nd:YAG lasers.
- The optimal mechanisms and conditions for drilling different rocks, even within the same nominal classification, vary significantly. For optimal laser drilling, a detailed understanding of each rock in situ would be required.
- No single set of parameters can be used as a compromise to drill all rock types at less than optimal efficiency.
- Rocks such as microgranular basalts that melt easily are a major challenge for laser drilling. Pulsed lasers have a distinct advantage with those materials because continuous wave (CW) conditions promote melting.
- A pulsed Nd:YAG laser is better suited for general rock drilling than a CW CO<sub>2</sub> laser.

- Laser-rock interactions can be modeled with reasonable confidence in the sub-melt regime.

### **Laser Drilling Recommendations**

The slow drilling rates achieved under near-optimal laboratory conditions using the most powerful lasers available commercially resulted in a recommendation that no further resources be expended to assemble a CPT laser drill system under the EAPS program.

At present, the major obstacles to productive (i.e., rapid) laser drilling are (1) a lack of power available in commercial laser systems, and (2) dependence on rock type. While we believe solutions to the latter challenge can be found in the near term, the lack of power is currently insurmountable within reasonable cost and physical constraints (i.e., using multiple lasers is not feasible) with no solution on the near term horizon. However, should pulsed Nd:YAG or similar lasers with average powers in the 5-10 kW range become available commercially, we believe it would be worthwhile revisiting the laser drilling concept.

### **CPT-based Drilling Reviewed and Selected for EAPS**

A review of the various conventional drilling methods that could be used to advance the CPT probe to greater depths was conducted as the first overburden drilling task. The primary overburden drilling systems that were evaluated included the drill and drive method, the dual rotary method, and the eccentric and concentric reaming methods. Other techniques, such as cable tool and mud rotary, were not reviewed as (1) cable tool is well-known at the site and the speed of cable tool drilling is the primary limitation, and (2) mud rotary techniques are generally not acceptable at the Hanford site as the drill technique introduces significant amounts of moisture into the formation which could potentially lead to mobilization of contaminants. After testing and evaluation of several drill subsystems, two subsystems were selected for use with EAPS. The first, smaller, subsystem is used in conjunction with the Wireline CPT and consists of a concentric ring bit that is attached to the bottom of the rod string. In operation, a center bit is locked into the ring bit and rotary air drilling is used to advance through refusal layers. In highly impervious materials, the wireline-scale drill may prove ineffective at penetrating the refusal layer. For these situations, a larger size, Down-the-Hole air rotary percussion drill system was developed.

### **EAPS End-State Technology Description**

The EAPS truck and support equipment are mobilized to the penetration location. The EAPS truck is self-leveling with hydraulic jacks to compensate for uneven surface terrain. If necessary, a Starter Casing is installed first, by means of standard push, from grade level to approximately 10-ft. deep. This casing aids in containment of circulation air if shallow drilling is anticipated.

A selected means of penetration is then chosen to initiate the sounding. A variety of penetration strategies are available depending on the site and project-specific requirements. In general, pushing is typically implemented whenever possible to maximize characterization information and minimize IDW. Rods or casing segments are 3.3-ft (1.0 meter) long and in variable diameters, depending upon mode of penetration. Rods are repeatedly threaded together as the penetration advances from within the safety and comfort of the EAPS truck's enclosed van-body.

In the push mode, a single rod string is pushed into the ground by hydraulic rams and gripping clamps at a rate of about 0.1-ft/second. The typical EAPS rod diameter is 2.0-in. to facilitate wireline implements, such as CPT probes and samplers. Push tools are also available in 1.75-in. and 1.44-in. diameters. An open-center ring bit is generally used while pushing. The selected wireline implement is locked into the center space and can be retrieved for exchange with other wireline implements or a center-drill bit at any time. When refusal is encountered drilling may be undertaken to penetrate the resilient geology until either pushing may resume or the target depth is achieved.

In the drill mode, two nested rod strings (or casings) are advanced, serving two purposes: air conveyance, and bit versatility. First, the inner rod delivers compressed air to the advancing front of the penetration to sweep away drill cuttings and to power a percussion hammer, if installed. Air circulates through ports in the drill bit, where cuttings are entrained and carried away in the discharge air through the outer casing annulus. Particulates and vapors brought to the surface in the discharge are filtered out. Second, the nested casing configuration supports the use of separate, interchangeable outer and inner drill bits. The center rods and bit may be withdrawn should the geological conditions change, if the center bit becomes too worn, or if a narrower gauge drill or push method must continue without the outer rod advancing in the penetration. The drilling approach is typically initiated with the small diameter, 2.0-in., drill after refusal is encountered while pushing. In some instances, boring may begin with a 2.875-in. drill as a time saving measure. Drilling can be paused for occasional soil or vapor sampling. The discharge stream may be sampled while drilling.

An on-board, digital Data Acquisition System (DAS) electronically monitors all vital push, drill, and other sensor parameters required for geotechnical and environmental characterization. The archived data files can later be analyzed in conjunction with other penetrations or datasets.

### **Support Equipment**

A skid-based compressor mounted on a flatbed truck or trailer delivers compressed air for drilling circulation. The diesel-powered compressor uses ambient air to deliver up to 300 scfm at 200 psi to the drilling system. Operating volumes and pressures delivered down-hole, however, are usually much less, due to variables in the percussion hammer and geologic formation.

Discharge air potentially containing particulate and vapor-phase contamination is contained at the surface with an airtight swivel that enhances worker safety. The

discharge stream is diverted out of the EAPS truck to a series of filtration elements in the support trailer, which itself provides secondary containment. The filtration train includes a centrifugal separator on a standard 55-gal drum, a set of 15 parallel reusable media filter socks, a standard HEPA filter with 99.99% removal efficiency at 0.1 micron, and 70 lbs of granular activated carbon. A 20-HP electric blower augments flow through the air filtration equipment, and an 80-kW diesel-electric generator trailer supplies electrical power for the air filtration blower and other ancillary equipment.

### **Phase 1 Conclusions**

Phase 1 of the EAPS project achieved its primary objectives. The overburden drilling EAPS and sampling tools were developed and tested in and around Hanford's 200 West Area. The EAPS drill successfully penetrated the Cold Creek Caliche (Caliche) and Ringold Conglomerate, without safety concerns. Large rocks in the Ringold formation slowed the drill rate but did not prevent penetration. For most of the penetration, conventional CPT proved feasible, resulting in minimal derived waste. Also demonstrated were wireline techniques for soil sampling, CPT, and drill tool interchange, and considerable insight was gained on the efficacy of various drill bit designs in Hanford geologic materials. The ultimate goal, reaching groundwater, was achieved and a groundwater sample was collected.

### **Phase 2 Demonstration Summary**

The EAPS demonstration was conducted in the 200 West Area at Hanford, along the western end of the Plutonium Finishing Plant. The demonstration was conducted over a one-month period from September 26 to October 29, 2003. The objectives of the demonstration were two-fold; the first was to demonstrate the capabilities of the EAPS, the second was to use EAPS to characterize an area believed to have carbon tetrachloride contamination in the subsurface.

A total of six penetrations were made within the designated 60m by 600m demonstration area. Samples were collected for on-site and confirmatory off-site analysis. Data from the photoacoustic spectroscopy infra-red (PAS IR) detector, CPT probe, and other equipment were digitally recorded and monitored in real time by the DAS and EAPS operations staff. Geological grab samples were also collected.

### **Phase 2 Results**

The most significant results of the demonstration were:

- One month of continuous safe operation, minimized waste, and contained contamination.
- Six characterization tools integrated into EAPS operation.
- Enhanced the depth of every penetration in which target depths beyond pushed refusal depths were desired.

- Six penetrations completed: three above the Cold Creek Caliche and three below.
- Valuable environmental and geotechnical data collected in an area that previously lacked detail.
- Field screening analysis of gas and soil samples for in-field investigation conducted.
- Soil and gas samples for off-site laboratory analysis collected.

### **Phase 2 Lessons Learned**

As this was the first full-scale demonstration of the EAPS technology, a number of valuable lessons were learned. Primarily, additional testing and optimization of the drill bits used to penetrate refusal materials is needed to improve productivity. Bit longevity can be improved by testing alternative bit geometries to find that most appropriate for the specific site geology. Since no libraries of bit performance are available for the Hanford site, we recommend a study to evaluate different bit configurations with an aim toward improving longevity. This study would be best performed on geology analogous to that of 200 West Area.

## TABLE OF CONTENTS

1.0	Introduction	1
1.1	Background	1
1.2	Project Overview	2
2.0	Phase 1: Research, Development, and Testing	2
2.1	Laser Drilling Feasibility Study	3
2.1.1.	Literature Review and Survey of Current Technology	3
2.1.2.	Laser Selection Matrix	4
2.1.3.	Laser Equipment	5
2.1.4.	Test Specimens	5
2.1.5.	Laser Drilling and Analysis Procedures	9
2.1.6.	Laser Drilling Results	9
2.1.7.	CO <sub>2</sub> Laser Drilling Results	13
2.1.8.	Modeling of Laser-Rock Interactions	13
2.1.9.	Laser Drilling Summary and Conclusions	14
2.2	Rotary Drilling Evaluation and Testing	15
2.3	EAPS End-State Technology	17
2.3.1.	Rotary Hydraulic Drill Head	18
2.3.2.	Small Diameter Rotary-Only Drill	18
2.3.3.	Air Rotary Percussion Drilling	18
2.3.4.	Characterization Technologies	20
2.3.4.1.	Piezo-Vapor Cone	20
2.3.4.2.	Groundwater Sampler	21
2.3.4.3.	Soil Sampler	21
2.3.4.4.	Down-hole Video Camera	21
2.3.4.5.	Core Barrel Sampler	21
2.3.4.6.	Geological Sampler	22
2.3.4.7.	Particulate Sampler	22
2.3.4.8.	Field Screening Vapor Analysis	23
2.3.5.	Data Acquisition	24
2.3.6.	Waste Management	25
2.3.7.	Supporting Equipment	27
2.4	Phase 1 Testing	27
2.4.1.	Hanford On-Site Testing	27
2.4.2.	Umatilla Army Chemical Depot Testing	29
3.0	Phase 2: Field Demonstration	30
3.1	Site Conditions and Limitations	31
3.2	Field Demonstration Summary	33
3.2.1.	Boring C4241	37
3.2.2.	Boring C4242	38
3.2.3.	Boring C4243	38



3.2.4. Boring C4244.....	39
3.2.5. Boring C4245.....	39
3.2.6. Boring C4246.....	40
3.3 Percussion Hammer Experiment.....	45
3.4 Demonstration Summary .....	45
4.0 Conclusions, and Recommendations	45
4.1 Phase 1 .....	45
4.2 Phase 2 .....	46
4.2.1. Production Rate Analysis.....	46
4.2.2. Recommendations.....	49
4.2.2.1. Downtime Mitigation .....	49
4.2.2.2. Drill Bit Performance Study.....	49
4.2.2.3. Additional Characterization Tools .....	49
4.2.3. Application of EAPS.....	49

## **LIST OF ACRONYMS**

AFE	Air Filtration Equipment
ARA	Applied Research Associates, Inc.
ASTM	American Society for Testing and Materials
CCC	Cold Creek Caliche
CCS	Cold Creek Silt
CCl4	Carbon Tetrachloride
CFM	cubic feet per minute
CPT	Cone Penetrometer Technology
DOD	Department of Defense
DOE	Department of Energy
DTH	down-the-hole
EAPS	Enhanced Access Penetration System
EPA	Environmental Protection Agency
FHI	Fluor Hanford, Incorporated
HASP	Health and Safety Plan
HEPA	High Efficiency Particulate Air Filter
ID	Inner Diameter
JHA	Job Hazard Analysis
MOU	Memorandum of Understanding
NETL	National Energy Technology Laboratory
OD	Outer Diameter
OSHA	Occupational Safety and Health Administration
PAS IR	Photoacoustic Spectroscopy Infra-Red
PI	Principal Investigator
PSI	pounds per square inch
PPE	Personal Protective Equipment
P/S-ECPT	Piezo/Seismic-Electric Cone Penetration Tests
QA	Quality Assurance
QAP	Quality Assurance Program
QC	Quality Control
RMMA	Radioactive Material Management Area
SBT	Soil Behavior Type
SOP	Standard Operating Procedure
SQA	Software Quality Assurance
VOSHA	Vermont Occupational Safety and Health Administration
WAC	Washington Administrative Code

WDOE

Washington State Department of Ecology

## LIST OF FIGURES

Figure 2-1. Caliche sample ARA-23 showing laser drilled linear tracks (left) and drilled areas (right). .....	10
Figure 2-2. Laser profiles for four cuts along linear track 14 of caliche sample ARA-20. ....	11
Figure 2-3. Efficiency of laser drilling along track 14 of caliche sample ARA-20. Profiles for the numbered cuts identified on the plot are shown in Table 2-3. ....	12
Figure 2-4. Some drill bit configurations evaluated. ....	16
Figure 2-5. Center hammer bit after more than 700 feet of drilling. ....	17
Figure 2-6. EAPS drill/push apparatus .....	19
Figure 2-7. Schematic view of air circulation route (left), and exploded view of air swivel (right). ....	19
Figure 2-8. Wireline CPT <i>in situ</i> characterization and sampling tools: (a) piezo-vapor cone, (b) water sampler, and (c) soil sampler. ....	20
Figure 2-9. Cemented Cold Creek caliche core section sample collected by the core barrel sampler. ....	22
Figure 2-10. Particulate sampler (left side), geological sampler (right side) configured in series. ....	23
Figure 2-11. Field screening analytical equipment: (a) photoacoustic infra-red analyzer, and (b) gas chromatograph. ....	24
Figure 2-12. Data acquisition system laptop with software on operator control console. ....	25
Figure 2-13. Air filtration equipment in support trailer. Cyclone separator (right), bag filter (left), HEPA and carbon filters (background). ....	26
Figure 2-14. EAPS support truck, CPT truck, and waste management trailer. ....	27
Figure 2-15. Early test prototype, large ring bit showing wear and two missing carbide buttons after drilling through 145-ft. at Hanford. ....	28
Figure 2-16. Drill cuttings, showing chip size cut primarily basaltic rock. ....	30
Figure 3-1. Outcrop of the Ringold formation near Hanford. ....	32
Figure 3-2. Close-up of basaltic cobble from Ringold formation. ....	33
Figure 3-3. Map of demonstration site showing borehole locations. ....	34
Figure 3-4. North-South Geologic Cross Section Within and East of Test Site Area. ....	35
Figure 3-5. North-South Geologic Cross Section West of Test Site Area. ....	36
Figure 3-6. Profile of CCl <sub>4</sub> vapor concentrations obtained at C4241 using piezo-vapor cone .....	37
Figure 3-7. Profile of CCl <sub>4</sub> vapor concentrations obtained at C4242 using piezo-vapor cone .....	38
Figure 3-8. CPT/Gas sampler results from C4241. ....	41
Figure 3-9. Drilling parameters recorded at C4241. ....	42
Figure 3-10. Profile of first three penetrations during demonstration .....	43

Figure 3-11. Profile of final three penetrations during demonstration. .... 44

## **LIST OF TABLES**

Table 2-1. Hanford rocks used in the laser drilling experiments.....	6
Table 2-2. Summary of Lab Mechanical Testing .....	7
Table 2-3. Summary of laser drilling results for Hanford rock samples under optimal conditions. Rate assumes 1 kW avg power laser and 2 in diameter hole.....	13
Table 2-4. Summary of data types collected by EAPS data acquisition system.....	24
Table 2-5. Summary of penetrations conducted at Umatilla. ....	29
Table 4-1. Production Time Summary.....	47
Table 4-3. Evaluation of Non-Production Time .....	48
Table 4-4. Time projections of EAPS deployment scenarios.....	50

## **LIST OF APPENDICES**

- A EAPS Operating Procedures**
  - A-1 Wireline CPT Operating Procedures
  - A-2 Wireline Soil Sampling Tool Operating Procedures
  - A-3 Wireline Small-Diameter Drill Tool Operating Procedures
  - A-4 Overburden Drill and Casing Tool Operating Procedures
  - A-5 Air Filtration Equipment Operating Procedures
  - A-6 Wireline Soil Gas Sampler Operating Procedures
  - A-7 Wireline Groundwater Sampler Operating Procedures
  - A-8 Drilling Particulate Discharge Sampler Operating Procedures
  - A-9 EAPS General Operation in Contaminated Subsurface Environments
  - A-10 BHI-EE-01, Environmental Investigation Procedures – Field Cleaning and/or Decontamination of Geoprobe and Drilling Equipment
  - A-11 Environmental Investigation Procedures for Field Decontamination of Sampling Equipment
  - A-12 Rock Core Sampling SOP
  - A-13 Analysis of Perturbation and Recovery of Ambient CCl<sub>4</sub> Concentrations due to the Introduction of Drilling Air During EAPS Operations
  
- B Subsurface Conditions – (by Kennedy/Jenks Consultants, Inc.)**
  
- C Laboratory Analytical Chemistry Results – (by Severn Trent Laboratory, Inc.)**
  
- D Laser Report**
- E Quick Look Report**
- F Laser Survey**
- G Drill Survey**

## **1.0 Introduction**

With funding from the National Energy Technology Laboratory (NETL), Contract No. DE-AC26-01NT41187, and in cooperation with the DOE Hanford Site, Applied Research Associates, Inc. (ARA) has developed the Enhanced Access Penetration System (EAPS). EAPS extends CPT penetration depth through previously resistant geologies for characterization purposes.

This report summarizes the 27-month long EAPS project, including the research, development, and testing of the, followed by the final demonstration and the final down-selected EAPS technology. The report is divided into four chapters. Chapter One contains an introduction and background information on the technical challenge of site characterization that EAPS was developed to address. Chapter Two documents the 24-month Phase 1 R&D effort that included evaluation of alternative enabling technologies, followed by development and testing of a system using the selected candidate. Chapter Three details the results of the Phase 2 field demonstration of the end-state EAPS technology; and Chapter Four presents a summary, conclusions, and recommendations for the entire project. Appendix A contains the standard operating procedures developed for this project. Further appendices contain: an exposition of the geologic setting at the demonstration site; laboratory analytical reports; and interim project reports documenting various stages of the R&D effort.

### **1.1 Background**

After years of designing, manufacturing, and testing nuclear weapons, the DOE is faced with the challenge of cleaning up the hazardous waste left behind. More than 5,700 known DOE groundwater plumes have contaminated more than 475 billion gallons of water. DOE landfills contain more than 3 million cubic meters of buried waste contaminating the surrounding environment. Soil, groundwater, and landfills containing or contaminated with hazardous chemical and radioactive contaminants have special clean up needs at DOE sites throughout the country.

Cone Penetration technology (CPT) has proven to be a cost effective and safe alternative to conventional drilling techniques for environmental and geotechnical site investigation. CPT is a direct push method that displaces sediment within the formation, rather than removing it to the surface, to allow passage of an instrumented cone.

Over the past decade, ARA, in conjunction with the U.S. Department of Energy (DOE) and Department of Defense (DOD), has developed CPT tools and sensors that enhance the capabilities of CPT. CPT has been deployed at Hanford on numerous occasions with mostly successful results. Its central limitation is the inability to reach a desired depth if a refusal layer is encountered. Sites at Hanford, Pantex, Savannah River, and Oak Ridge have plumes that contaminate soil and groundwater in subsurface conditions where difficult access hampers contaminant assessment. These conditions include complex sedimentary facies, deep contamination, and soils that are difficult to penetrate with push techniques.



A number of methods to improve CPT penetration depth have been tested, including friction reducing agents, heavier weight CPT trucks, sonic vibration, percussion hammering, rod string expanders, and rotary drills - all with mixed success.

At Hanford, heavyweight (30-ton) CPT rigs have reached depths greater than 120 ft on several occasions; however, the average depth of penetration is near 70 feet. Vibratory loading of CPT at sonic frequencies has also been tried at the Hanford site. While these methods have improved certain performance aspects of the CPT they have not been able to penetrate the hardest rocks and cemented sedimentary layers at Hanford and other similar sites.

The development of EAPS enhances DOE's ability to quickly, safely, and economically characterize subsurface conditions at these difficult sites. The lessons learned over the past 10 years have led ARA to augment its conventional CPT platform with wireline tools and overburden drilling tools, including an air-rotary drilling technique. This combination allows EAPS to penetrate hard geologic layers and allow the system to reach the targeted depths with minimal investigative derived waste and a low potential for worker exposure to hazardous materials.

## **1.2 Project Overview**

The objectives of the project were to research, develop, test, and demonstrate an access enhancing technology in conditions and for purposes similar to those at the Hanford site. The technology was required to present an effective alternative to the baseline technology currently used at Hanford, and to preserve many of the benefits favored by CPT users.

The project was conducted in two phases. Phase 1 consisted of evaluation, selection, and development of depth enhancement techniques and incorporation of sampling and characterization capabilities into new equipment. Phase 1 also included field testing and further refinement of the system developed. In Phase 2 a demonstration of the end-state EAPS, including any refinements incorporated as a result of Phase 1 testing, was conducted at a contaminated site at Hanford.

## **2.0 Phase 1: Research, Development, and Testing**

Phase 1 was aimed at developing a subsurface access and characterization technology that employs a progressively invasive approach to characterization to minimize drilling spoils, potential for personnel exposure, penetration time, and costs. EAPS was designed to maintain all the advantages of conventional CPT, and resort to more invasive means of advancement only when necessary to penetrate resistive materials.

Phase 1 of the project began with evaluations of novel laser drilling and more conventional rotary drilling technologies to select the most promising approach for further development. Since laser drilling exists in a less mature state than conventional techniques, the laser drilling evaluation was more of a feasibility study, while the rock

and overburden drilling evaluation comprised more of a survey and field trial process. Following these evaluations, conventional drilling techniques were chosen for further development and integration into EAPS.

## **2.1 Laser Drilling Feasibility Study**

The objectives of the laser drilling study were to: (1) conduct a survey to gather historical results from past laser rock drilling efforts, (2) compile information on the features and capabilities of current, state-of-the-art high-power laser system and their applicability to drilling, and (3) conduct laboratory tests of candidate laser systems. If the systems showed potential for outperforming overburden drilling in EAPS, then a laser-based system was to be designed, fabricated, and fielded.

### **2.1.1. Literature Review and Survey of Current Technology**

The laser rock drilling literature is extensive, comprising close to a thousand papers dating back to the early 1960's, soon after the invention of the laser in 1960. Fortunately, an excellent review and critical evaluation of laser cutting and drilling research through 1997 has been developed for the Gas Research Institute (GRI), which is interested in lasers for drilling and completing natural gas wells. The GRI report emphasized the fundamental processes of laser energy transfer into rocks and the physical and chemical effects produced by the transfer, but concluded with a pragmatic look at rock destruction. An important observation in the report was that nearly all laser drilling investigations up to that time were conducted with continuous wave (CW) carbon dioxide (CO<sub>2</sub>) lasers. Only ruby and neodymium:yttrium aluminum garnet (Nd:YAG) lasers had been employed for a few pulsed laser experiments at low repetition rates.

Laser technology is changing rapidly, with smaller, lower-cost, higher-powered lasers appearing annually. At the end of the GRI report period and during the past four years, researchers have begun to investigate these new lasers for rock drilling and related applications (cleaning concrete, etc.). The GRI report identified the following seven lasers as having the greatest potential for gas well drilling in 1998:

- Deuterium fluoride/hydrogen fluoride (DF/HF)
- Free-electron laser (FEL)
- Chemical oxygen iodine laser (COIL)
- CO<sub>2</sub>
- Carbon monoxide (CO)
- Nd:YAG
- Excimer (e.g., KrF)

Our survey of current technologies indicated that no new laser types have emerged and the list above was still a valid starting point for CPT laser selection in early 2002.

Previous work has clearly demonstrated that laser destruction of a wide range of rock types is feasible at a variety of operating wavelengths. Most work has been conducted at wavelengths between 1 and 10  $\mu\text{m}$ , even though the absorptive properties of many rocks increases at even lower, UV wavelengths. No rigorous studies have been conducted to establish that any particular wavelength is markedly more effective at rock destruction than others, although some pulsed CO (5  $\mu\text{m}$ ) and CO<sub>2</sub> (10.6  $\mu\text{m}$ ) laser studies of supported the general assertion that lower wavelengths offer improved destruction.

Some of the most rigorous investigations of the efficiency of rock ablation versus laser intensity have been conducted with a medium repetition-rate pulsed Nd:YAG laser at Argonne National Laboratory (ANL). Working with sandstone, shale, and limestone samples, the ANL group showed that the efficiency of ablation, as represented by the specific energy ( $\text{J}/\text{cm}^3$ , where  $\text{cm}^3$  is the volume of rock removed), improves (specific energy decreases) with increasing laser intensity to an optimum just below the transition to a melting mechanism, when the specific energy increases substantially. *The important conclusion to be drawn from this work is that the most energy efficient drilling can be achieved by maintaining laser intensities below the threshold for rock melting and vaporization.* Also, it is important to note that rock properties (type, porosity, moisture content, etc.) have a strong influence on laser drilling efficacy and some rocks may have optimum (minimum) specific energies higher than those reported above the consequence of which is slower drilling. It is clear from the previous studies that careful experimentation over a wide range of parameters is necessary to establish optimal conditions for drilling rock materials of interest to the EAPS program.

The literature has demonstrated that pulsed lasers offer considerably more flexibility and capability for optimizing rock destruction than CW lasers. CW lasers provide continuous heating of the target and only power can be varied. For pulsed lasers, the energy per pulse, pulse duration, and repetition rate can all be varied to optimize drilling performance. Altogether, the results of our literature review indicated that lasers in the low kW power class, especially pulsed lasers, should be considered as potential candidates for CPT laser drilling. When applied properly, drilling rate generally scales with laser power and the power required for optimal destruction depends highly on the rock material properties (type, porosity, moisture content, etc).

### **2.1.2. Laser Selection Matrix**

There are a number of important criteria that must be considered in the selection of a laser source for implementation in CPT drilling for the EAPS Program. The most important criteria included in our evaluation and selection of candidate lasers were: *Potential Drilling Performance, Laser Power Available, Laser Size, Electrical Power and Cooling Requirements, Acquisition Cost, Operations & Maintenance Cost, Delivery Subsystem Compatibility, Duty Cycle, Safety & Environmental, Operational Considerations.* These criteria are discussed in detail in the body of this report. Candidate lasers were scored against the criteria with a weighting factor applied to each

criterion based on its criticality for success in the program. The result was a Laser Selection Matrix with a total score and ranking for each laser evaluated.

The results of the literature survey and laser selection matrix showed that modestly high-power CO<sub>2</sub>/CO and Nd:YAG lasers (<10 kW) could be successful at drilling rock when configured in the CPT system. There are many advantages to working at these power levels, including lower cost, size, weight, power consumption, as well as better safety and simpler beam delivery down-hole. Because of the very limited pulsed studies to date, the potential exists for even more efficient rock drilling via enhanced ablation, shocking, or other mechanisms outside the capabilities of CW systems. Thus, for the laboratory experimental phase of this project, we selected low-kW, pulsed Nd:YAG and CO<sub>2</sub> lasers for assessment of drilling performance on Hanford soils and rocks. Our efforts were focused primarily on the Nd:YAG laser because of its favorable wavelength for fiber optic transmission.

### **2.1.3. Laser Equipment**

An early discovery in the experimental program was the lack of kW-class, repetitive pulse Nd:YAG lasers. Realistic maximum average powers are on the order of 0.5 kW and only a few manufacturers are able to achieve even that level of performance. The 1.6 kW laser used in the aforementioned ANL experiments is no longer available. After a considerable effort, we were able to identify two, 0.5 kW class Nd:YAG lasers available for testing Hanford rocks. Both lasers employed a fiber optic cable and beam delivery system (2-in diameter optics) to focus laser energy onto test specimens along with a coaxial air purge to enhance removal of released material and prevent fouling of the beam delivery optics. In a limited series of tests at ConvergentPrima, we also used a CW CO<sub>2</sub> laser operating in the range 0.5-1.5 kW without fiber optics.

### **2.1.4. Test Specimens**

A total of 14 rocks collected from the Hanford area were tested with the laser systems. For the laser drilling tests, the rocks were cut into approximately 4-in thick slabs about 6-in x 6-in square. Table 2-1 contains a summary of rocks used in the laser drilling experiments.

Table 2-1. Hanford rocks used in the laser drilling experiments

Sample ID	Description
ARA-1 (CP)	White, coarse grained <i>Quartzite</i>
ARA-3 (CP,L)	<i>Rhyolite</i> , with phenocrysts of quartz and sodic feldspar
ARA-5 (CP)	Porphyritic <i>Rhyolite</i> (Rhyodacite)?
ARA-6 (L)	Metamorphosed arkosic <i>Sandstone</i>
ARA-8 (CP)	Medium grained, lavender/purple darker <i>Quartzite</i> , metamorphosed
ARA-10 (L)	Fine grained, light colored <i>Quartzite</i> , metamorphosed with 25% K-feldspar
ARA-13 (L)	Slightly porphyritic, mildly altered <i>Basalt</i> with dark color characteristic of Columbia River basalts common in the area
ARA-14 (CP)	<i>Basalt Breccia</i> , very fine grained to glassy
ARA-16 (CP)	Fine grained, sparsely porphyritic, crystalline Columbia River <i>Basalt</i>
ARA-20 (CP)	<i>Caliche/Calcrete</i>
ARA-22 (CP)	<i>Caliche/Calcrete</i>
ARA-23 (L)	<i>Caliche/Calcrete</i>
ARA-24 (L)	<i>Caliche/Calcrete</i>
ARA-29 (L)	Medium to coarse grained, porphyritic <i>Basalt</i> crystalline groundmass (Wanapum)

Table2-2. Summary of Lab Mechanical Testing

Sample Number	Rock Description	Bulk Density (g/cc)	Grain Density (g/cc)	Porosity (%)	Axial Compression Wavespeed (km/sec)	Transverse Compression Wavespeed (km/sec)	Unconfined Compression Strength (Mpa)	Laser Tests (No.) {136 Total}
ARA 1	White, Coarse Grained Quartzite	2.64	2.66	0.8530	5.23	5.02	353.24	22
ARA 3	Very Coarse Grained, Silicic Volcanic (Possibly Rhyolite)	2.58	2.64	1.9554	4.69	4.33	268.17	19
ARA 5	Fine Siliceous Groundmass with a few Pehnocrysts of Plagioclase and Possible Quartz (Dacite or Andesite)	2.62	2.64	0.6666	5.54	5.29	438.48	18
ARA 8	Medium Grained, Lavender/Purple Colored Quartzite	2.67	2.68	0.3654	5.46	5.04	391.21	7
ARA 14	Very Fine Grained Basalt containing a number of Xenoliths of Finer Grained Reddish Basalt and of Coarser Grained Porphyritic Basalt	2.87	2.89	0.4712	5.84	5.64	445.28	17
ARA 16	Large Pehnocrysts of Potassium Feldspar (Possibly Granitic Rock)	2.88	2.97	2.9228	5.55	5.02	238.95	22
ARA 20-1	Caliche	2.29	2.66	14.1789	3.91	3.18	40.57	17
ARA 20-2	Caliche	2.31	2.66	13.2025	5.09	1.99	58.37	X
ARA 22	Caliche							14
ARA 23	Caliche	2.26			4.11	2.65	44.62	X



### 2.1.5. Laser Drilling and Analysis Procedures

Most of the drilling experiments were of two types - linear track tests or area drilling - where the rock samples were translated in the laser beam, although a few tests were performed with a stationary sample. In most cases, to evaluate multiple laser power densities in a single run, the laser beam delivery system was simultaneously translated away from the rock surface (i.e., in the "z" direction). This defocused the laser spot incident on the material, creating a "V" shaped track along its long axis. This approach made efficient use of the available rock material. Multiple passes, usually 3 to 10, were required to remove sufficient material for subsequent laser profilometry, described below. Area drilling was performed after optimal laser parameters had been determined from the linear track experiments. Drilling out larger areas was intended to simulate the type of drilling expected to be used in our CPT application (i.e., a constantly moving beam cutting out an area the size of a CPT rod).

Upon completion of the linear track experiments, the cuts were analyzed for drilling efficiency in our laboratories using laser profilometry. A series of depth profiles was obtained across each track (i.e., orthogonal to the direction the sample was translated in the laser beam) at intervals of 0.1 in along the track. Integration of the depth in each profile provided a measure of total material removed at that "point", allowing the most favorable power density (laser spot size) to be easily identified for each track. The principle metric of merit used to compare drilling efficiencies under different laser conditions (i.e., compare the most favorable results from track-to-track) was the Specific Energy, or SE ( $\text{kJ}/\text{cm}^3$ ), which is the energy (kJ) required to remove a specified volume ( $\text{cm}^3$ ) of rock. The lower the SE value; the more efficient the drilling.

### 2.1.6. Laser Drilling Results

A photograph showing a "typical" rock sample (ARA-23, caliche) after Nd:YAG laser testing is presented in Figure 2-1. On the left side of the specimen are linear tracks of decreasing laser spot power density ( $\text{kW}/\text{cm}^2$ ) as one views the track from left to right. The broadening of the track with decreasing power density (constant power, increasing spot size) is clearly evident. Drilled areas are visible on the right side of the sample. For caliche, from which very small particles were spalled, the edges of the drilled areas were sharp and well defined as evidenced in the photograph.





**Figure 2-1. Caliche sample ARA-23 showing laser drilled linear tracks (left) and drilled areas (right).**

Typical laser profilometry results for another caliche sample are presented in Figure 2-2. The figure shows 4 of the 15 profiles collected along linear track number 14 on sample ARA-20. The pattern in the profiles is characteristic - deep and narrow at high power densities (small laser spot size ca. 1mm) and wider and shallower at lower power densities (larger laser spot size ca. 10mm). The areas under each curve can be used (along with the laser spot size) to calculate the volume of material removed in the track at each cut. In Figure 2-2, it is clear that more material was removed from cuts 1 and 4 (red and blue traces, respectively) than from cuts 8 and 12 (green and black traces, respectively). This is confirmed in Figure 2-3, which is a more comprehensive plot of drilling efficiency (SE) as a function of laser power density. For this track, which is characteristic for caliche, a power density of about  $6.5 \text{ kW/cm}^2$  (Cut 4) was most efficient, but it is clear that at power densities above  $3 \text{ kW/cm}^2$  there was little variation in drilling efficiency with laser spot size (power density).

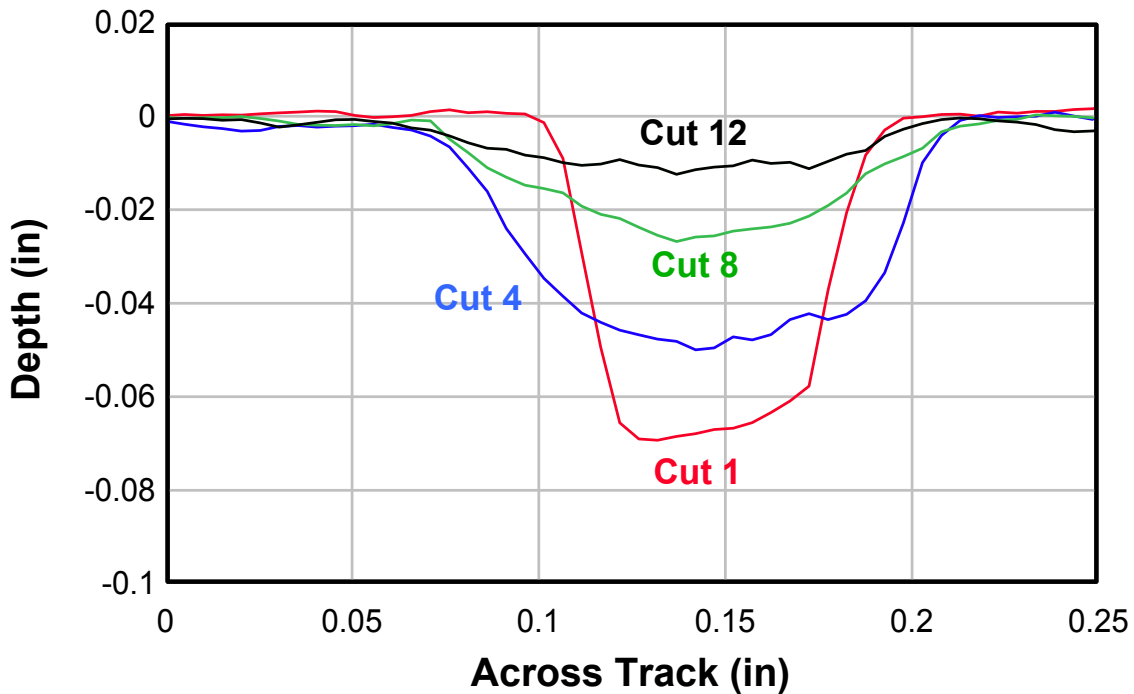

**Figure 2-2. Laser profiles for four cuts along linear track 14 of caliche sample ARA-20.**

As mentioned previously, a primary purpose for the linear track experiments was to quickly identify optimal parameters for drilling each type of rock. Once the best conditions were identified, larger areas (see Figure 2-1) were drilled in the samples to simulate CPT drilling, albeit in a largely unconfined geometry. Experiments were performed for up to several minutes duration in order to remove sufficient material for accurate determinations of rock drilling volumes. Ultimately, this provided the most reliable data on optimal laser drilling efficiency for each rock type.

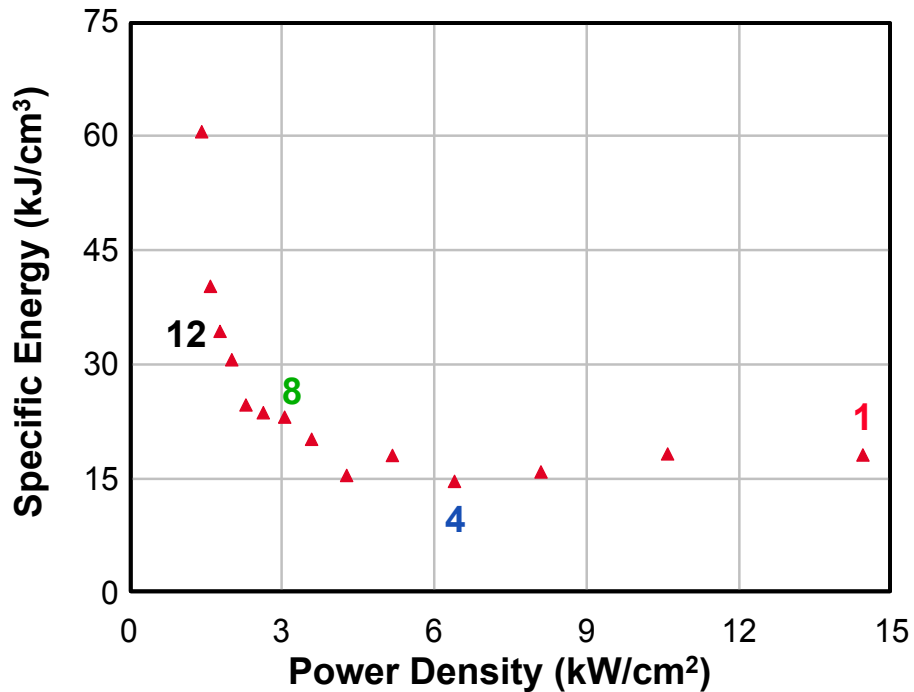

**Figure 2-3. Efficiency of laser drilling along track 14 of caliche sample ARA-20. Profiles for the numbered cuts identified on the plot are shown in Table 2-3.**

Optimal laser drilling parameters and efficiencies for the Hanford rock test samples are summarized in Table 2-3. From the table, it is clear that best achievable laser drilling efficiencies vary considerably by rock type, but are within an order of magnitude. Minimum SE values range from about 5 to 35 kJ/cm<sup>3</sup>. It is also evident, however, that the conditions for optimal drilling were significantly different for different rocks, most notably in the power density which varied over an order of magnitude. The final column in Table 2-3 gives an estimate of maximum drill rate calculated for 1 kW average laser power and a 2-in diameter hole.

**Table 2-3. Summary of laser drilling results for Hanford rock samples under optimal conditions. Rate assumes 1 kW avg power laser and 2 in diameter hole.**

Sample	Type	Min Spec. Energy, KJ/cm <sup>3</sup>	Energy, J	Width, msec	Freq, Hz	Peak Power, kW	Power Density, kW/cm <sup>2</sup>	Air Flow	Rate, ft/hr
<b>ConvergentPrima</b>									
1	Quartzite	30.0	4.7	0.5	100	9.4	12.1	Low	0.19
8	Quartzite	8.4	9.4	1.0	50	9.4	4.2	Low	0.69
3	Porphyritic Rhyolite	15.5	4.7	0.5	100	9.4	1.5	High	0.38
5	Porphyritic Rhyolite	10.5	4.7	2.0	100	2.35	2.1	High	0.56
14	Volcanic Breccia	11.4	4.7	2.0	100	2.35	1.0	High	0.51
16	Micro-granular Basalt	35.7	4.7	1.0	100	4.7	8.0	High	0.16
20/22	Caliche	15.7	9.4	1.0	50	9.4	5.7	High	0.37
<b>LASAG</b>									
10	Quartzite	12.5	75	6.0	5	12.5	2.9	Low	0.47
3A	Porphyritic Rhyolite	16.1	75	3.0	7	25	3.1	High	0.36
6	Meta-sandstone	6.5	100	6.0	5	16.7	1.9	High	0.90
13/29	Porphyritic Basalt	4.6	3.5	0.25	100	14	1.6	High	1.27
23	Caliche	13.1	45	1.0	10	45	11.3	High	0.45
24	Caliche	13.8	75	6.0	5	12.5	9.4	High	0.42

### 2.1.7. CO<sub>2</sub> Laser Drilling Results

A limited number of experiments were also performed at ConvergentPrima using a CW CO<sub>2</sub> laser operated at 0.5-1.5 kW. The primary objective of these experiments was to determine whether or not there was any obvious advantage over the Nd:YAG laser. For the quartzites, which tended not to melt and produced large chips and peels when heated, the CO<sub>2</sub> laser performed well, with SE values approaching 1 kJ/cm<sup>3</sup>. The rhyolites and basalts did not fare well under CO<sub>2</sub> laser illumination due to the formation of strongly bonded, glassy melts. Caliche was drilled slightly less efficiently with the CO<sub>2</sub> laser due to melting, which created a flaky, yellow crust in the drill area.

### 2.1.8. Modeling of Laser-Rock Interactions

There have been few attempts to model the interaction of laser beams with rocks. As an adjunct to the experimental program described in detail above, we developed a first-generation model that represents laser/rock interactions at a sub-melt condition leading to material removal. This preliminary modeling effort was directed toward the laser/caliche and laser/granitic rock interactions that are of importance at Hanford. Once the model was constructed using critical rock properties and laser drilling parameters, its

predictions were tested against the experimental data. The results were found to be in good agreement; i.e., broad trends in the most important experimental parameters were successfully predicted and approximate quantitative agreements (SE values) were obtained. The model also predicted the different behaviors of caliche and granite observed empirically under laser irradiation. With refinement, the model could be of use in future efforts to optimize laser drilling efficiencies.

### 2.1.9. Laser Drilling Summary and Conclusions

Experimentation with state-of-the art commercial lasers has provided valuable insight into the capability for drilling rocks at Hanford from CPT rig. The following list summarizes the key findings of the study:

- Drilling rock with lasers is difficult, but achievable for the major rock types at Hanford. Under near-optimal conditions, which we expect will be compromised to some degree when implemented in a CPT, the best anticipated laser drilling rate is just over 1 ft/hr using two, 0.5 kW Nd:YAG lasers.
- The optimal mechanisms and conditions for drilling different rocks, even within the same nominal classification, vary significantly. For optimal laser drilling, a detailed understanding of each rock *in situ* would be required.
- No single set of parameters can be used as a compromise to drill all rock types at less than optimal efficiency.
- Rocks such as microgranular basalts that melt easily are a major challenge for laser drilling. Pulsed lasers have a distinct advantage with those materials because CW conditions promote melting.
- A pulsed Nd:YAG laser is better suited for general rock drilling than a CW CO<sub>2</sub> laser.
- Laser-rock interactions can be modeled with reasonable confidence in the sub-melt regime.

The slow drilling rates achieved under near-optimal laboratory conditions using the most powerful lasers available commercially led us to recommend that further resources not be expended to assemble a CPT laser drill system under the EAPS program.

At present, the major obstacles to productive (i.e., rapid) laser drilling are (1) a lack of power available in commercial laser systems, and (2) dependence on rock type. While we believe solutions to the latter challenge can be found in the near term, the lack of power is currently insurmountable within reasonable cost and physical constraints (i.e., using multiple lasers is not feasible) with no solution on the near term horizon. However, should pulsed Nd:YAG or similar lasers with average powers in the 5-10 kW range become available commercially, we believe it would be worthwhile revisiting the laser drilling concept.

## **2.2 Rotary Drilling Evaluation and Testing**

Similar to and concurrent with the laser drilling research and tests, ARA engaged in analysis and evaluation of more conventional drilling technologies for use with EAPS. The first task under this evaluation was a review of the various conventional drilling methods that could be used to advance the CPT probe to greater depths. ARA began by consulting drilling industry vendors to identify prospective equipment worth testing and integrating with EAPS.

The primary drilling methods evaluated were air methods and included: the drill and drive method, the dual rotary method, and eccentric and concentric reaming methods. Other techniques, such as cable tool and mud rotary, were not reviewed as (1) cable tool is well-known at the Hanford site and the speed of cable tool drilling is the primary limitation, and (2) mud rotary techniques are generally not acceptable at the site as they introduce a significant amount of liquid into the formation which could lead to mobilization of contaminants.

Past experience informed us that refusal of direct push methods is caused not only by the bearing strength of the strata encountered at depth, but also by accumulated frictional resistance over the length of CPT rod embedded in the ground. With this in mind, we investigated methods not only for removing material in the path of the penetration, but also for advancing a casing around the CPT rod string that would eliminate friction between the formation and the CPT rod string.

Identifying and integrating drill bits, percussion hammers, and supporting equipment to suit the project's needs posed the greatest research, development, and testing challenges. Many of the drilling components underwent several research and testing evolutions to ultimately arrive at the EAPS technology end-state.

ARA's Vertek manufacturing facility in South Royalton, Vermont integrated the drilling components into one of ARA's existing, truck-based CPT systems. Testing was conducted off-site (away from Hanford), in Vermont, for general equipment shakedown during the summer of 2002. Once the general mechanics of the operations were proven in Vermont, the EAPS prototype was mobilized to the Richland, Washington Operations of ARA, near Hanford. Throughout the following year, a series of additional off-site tests were conducted in selected local geologies that posed similar challenges to those found on-site, but without concerns of environmental contamination and permit administration. Additionally, three on-site tests were conducted in late 2002 and through June of 2003. These tests provided a more realistic assessment of both the technological and administrative dimensions of operation. Several of the bits evaluated as shown in Figure 2-4.



**Figure 2-4. Some drill bit configurations evaluated.**

After testing and evaluation of several drilling subsystems, we selected two to carry forward in the final EAPS implementation. The first, smaller subsystem is used in conjunction with Wireline CPT and consists of a concentric ring bit that is attached to the bottom of the 2-in OD Wireline CPT rod string. Normally during push mode, an *in situ* characterization tool will extend through the outer bit, and both bit and characterization tool will advance together under applied static load. To engage the drilling capability, a center bit replaces the characterization tool and couples to the ring bit via a nested conical fitting arrangement. Both bits are rotated from up-hole by applying torque to a rigid rod that leads to the center bit.

In highly impervious materials, the small-bit system may fail to penetrate the refusal layer. For these situations, several larger size drill systems were evaluated, including down-the-hole air rotary percussion systems, and an air rotary two-cone system. We found an air rotary percussion system to be superior, and carried this system into the final implementation. Like the small-diameter system, this system also utilizes a concentric ring bit configuration. Unlike the smaller system, it incorporates a percussion hammer. The outer, ring portion of the concentric bit arrangement is over-reaming, meaning it is sized slightly larger than the 2-7/8-in OD casing it advances, to minimize friction between the casing and the formation. After penetrating a difficult stratum, this casing remains in the hole to provide a friction-free guide tube for the 2-inch OD wireline system to telescope through and resume characterization below.



**Figure 2-5. Center hammer bit after more than 700 feet of drilling.**

### **2.3 EAPS End-State Technology**

EAPS employs a progressively invasive approach to characterization to minimize drilling spoils, potential for personnel exposure, penetration time, and costs. Utilizing CPT as its base platform, and resorting to drilling only when necessary to penetrate resistive materials, EAPS maintains all the advantages of conventional CPT. ARA's Wireline CPT technology comprises the heart of EAPS, allowing various characterization tools and drills to be exchanged without removing the advancing rod string from the ground.

Wireline characterization tools provide real time, *in situ* characterization data in addition to a means of collecting soil and water samples. In the vadose zone a soil gas sampling CPT piezocone can be used. This tool enables profiles of both geotechnical properties and gaseous contaminant concentrations to be obtained simultaneously.

The Wireline soil sampler can be used to obtain physical samples at any depth in the profile. Once the water table is encountered, groundwater sampling can be performed using the Wireline water sampler tool, which incorporates a modified, air-actuated bladder pump.

When a geologic formation is encountered that causes refusal in the primary direct push mode, further advancement is attempted using a small-diameter, wireline deployable drill. Should the small-diameter drill meet refusal in the formation, a larger diameter drill can be deployed to penetrate the refusal layer and set a casing through which the wireline system can telescope to resume characterization below.



Each technology component in EAPS is discussed below, beginning with the drilling subsystems and progressing through to characterization tools, waste management, and supporting equipment.

### **2.3.1. Rotary Hydraulic Drill Head**

The CPT push system was modified to incorporate a rotary hydraulic drill head that can be swung out of the way during CPT sounding (see Figure 2-6). To engage drill mode, the drill head is swung into position and locked into place. An air swivel (see Figure 2-7) is attached to the casing to diver the waste stream to air filtration equipment located outside the CPT truck. Considerable effort was expended to match the hydraulic torque requirements of the drill system to the CPT push frame to ensure its stability. Also, the air swivel system developed under this effort was designed to incorporate easily replaceable seals, as the abrasive action of rock particles in the waste stream tends to rapidly erode them.

### **2.3.2. Small Diameter Rotary-Only Drill**

The small-diameter Wireline rotary drill consists of a bit attached to a 1.0-in OD rod-string, extending to the bottom of the 2-in OD (1.125-in ID) Wireline CPT rod string, which acts as a casing. The center bit nests into the ring bit and the entire assembly rotates, cutting the geologic material. Spoils are entrained in compressed air injected at the bit face and conveyed to the surface through the Wireline CPT rod string, where it is captured by the waste management system.

As a wireline tool, the small diameter drill can be used without removing the entire Wireline CPT rod string. This drill is used to penetrate the hard geologic materials that impede the static-push Wireline CPT cone.

### **2.3.3. Air Rotary Percussion Drilling**

A 2.875-in OD rotary percussion drill incorporated into EAPS is used in geologic strata the smaller tools are incapable of penetrating. This drilling subsystem incorporates a 2.0-in OD, down-the-hole (DTH) air hammer that is attached to the down-hole end of a 1.75-in OD rod-string. The 1-075-in rod string is supported within a 2.875-in OD (2.375-in ID) outer casing. The drill uses up-hole hydraulics to rotate the drive rods while the down-hole hammer is pneumatically driven to pulverize the subsurface material. The material is removed from the subsurface by entrainment in the drive air exhausted from the down-hole hammer. Non-hammering drill bits can also be used with this drilling subsystem, though hammer bits proved most effective. Drilling waste is brought to the surface through the outer casing and captured in the waste management system.

When the rotary hammer drill is used to penetrate through a refusal layer, the casing is kept in place to reduce CPT rod friction, facilitating further penetration via Wireline CPT to complete the sounding through the bottom of the embedded casing.

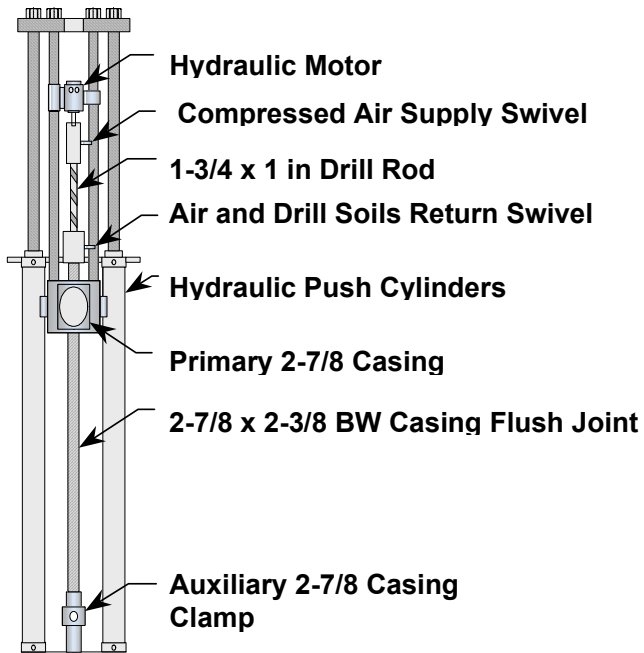

Figure 2-6. EAPS drill/push apparatus

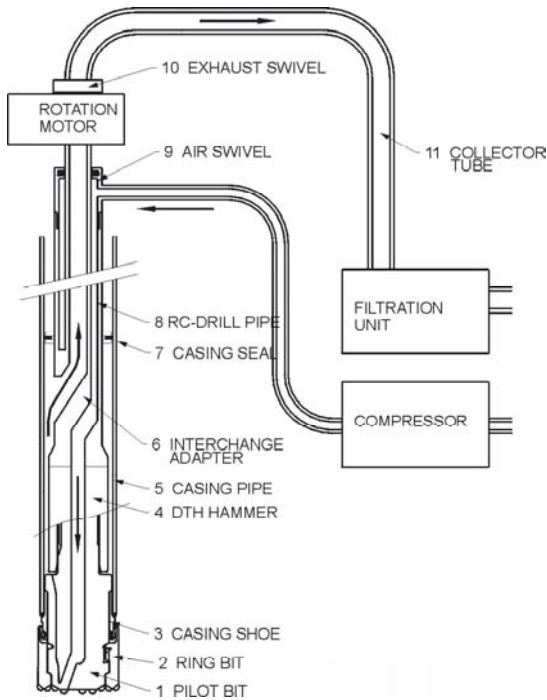

Figure 2-7. Schematic view of air circulation route (left), and exploded view of air swivel (right).

### 2.3.4. Characterization Technologies

As well as providing a basis for the smaller diameter drilling system, the Wireline CPT system also hosts most of the characterization tools. This system consists of the following components: a segmented rod string, tool/lock housing (including cutting mouth), tool locking and retrieval mechanism, piezo/vapor sampling cone, groundwater sampler, and grouting tool. The lock mechanism provides the functionality that enables deployment of multiple Wireline CPT end effectors without removing the outer rods, thereby ensuring against borehole collapse. The same lock mechanism is used for all Wireline tools, thus enabling their interchangeability. The lock mechanism is also a key component for EAPS because it allows the interchange of tools without retracting the rods from the ground.

#### 2.3.4.1. Piezo-Vapor Cone

The Wireline piezo-vapor cone incorporates geotechnical characterization and soil gas sampling capabilities into a single device, while maintaining compatibility with other Wireline CPT tools (see Figure 2-8a). Continuous or semi-continuous vertical profiles of vapor concentrations can be generated along with geotechnical Soil Behavior Type (SBT) classification derived from tip and sleeve stress measurements.

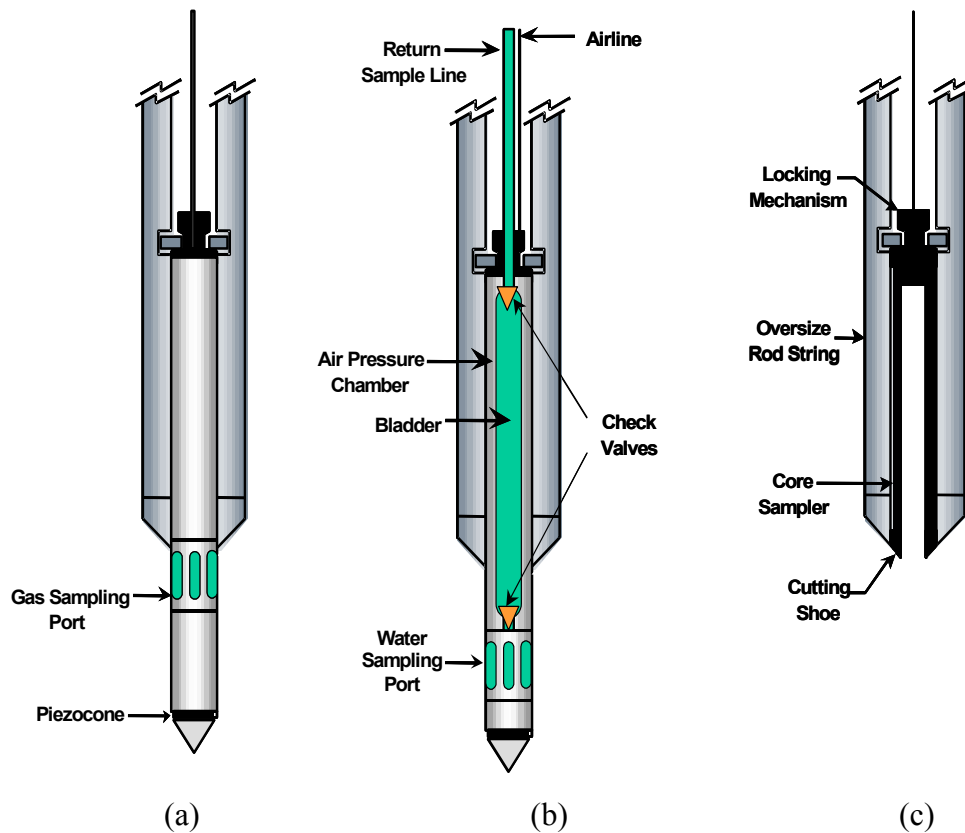

Figure 2-8. Wireline CPT *in situ* characterization and sampling tools: (a) piezo-vapor cone, (b) water sampler, and (c) soil sampler.

Vadose zone soil gas delivered by the Wireline piezo-vapor cone is analyzed via Photoacoustic Infrared spectroscopy or, optionally, collected in suitable containers for off-site analysis. The typical approach most widely used with CPT is to develop high spatial resolution contaminant profiles as a function of depth. Soil vapor is drawn into the Wireline CPT through a multi-hole screened port in the probe.

The piezo-vapor probe is Wireline CPT compatible, a key advantage of which is, in the event the filter becomes plugged, the tool can be retrieved and the screen replaced in minutes, without having to withdraw the entire rod string. Additionally, a reverse pulse of air could be used to clear the plugged port without retrieving the tool.

#### **2.3.4.2. Groundwater Sampler**

The EAPS groundwater sampler is externally similar to piezo vapor cone, but incorporates a water handling system in place of geotechnical measurement capability (see Figure 2-8b). In the saturated zone, groundwater will enter the device's sample chamber under ambient hydrostatic pressure. Once the chamber is full, the entire sample volume can be lifted to the surface using pressurized gas. An air-actuated pulsating bladder pump incorporated into the sampler pushes the sample to the surface. The bladder pump allows for the collection of a high quality sample, as it does not permit the sample to contact air or lubricated parts.

#### **2.3.4.3. Soil Sampler**

When a soil sample is required, the piezo vapor probe is temporarily swapped out for a Wireline CPT soil sampler (see Figure 2-8c). The soil sampler allows for the collection and retrieval of core samples from multiple depths during a penetration without requiring retraction of the CPT rods from the ground. The inexpensive sample barrel produces a 1-inch diameter, 12-inch long core of soil, accommodates the use of a plastic retainer basket (for loose soils), and is easily separable from the locking mechanism and basket retainer nut. Either end of the barrel connects to these other parts, or to end plugs used for sealing the sample. A replaceable cutting lip minimizes wear at the leading edge of the core barrel and holds the plastic sample retainer basket in place.

#### **2.3.4.4. Down-hole Video Camera**

A 1-in diameter down-hole video camera enables visual inspection of geological formations, and the condition of other down-hole equipment. The video camera relays a live feed connected to a color TV/VCR monitor for real-time observation and/or recording. The video camera can be deployed in both the large and small diameter rod strings. The video camera can be inserted and retracted while live.

#### **2.3.4.5. Core Barrel Sampler**

The EAPS rock core sampler enables sampling from strata that cannot be penetrated using the Wireline CPT soil sampler. The core barrel uses hydraulic rotary cutting action and bias load to penetrate resilient formations. A ring at the bit's bottom

tip captures the 5-ft long core section for retrieval to the surface. The core sampler uses a diamond faced cutting bit. Figure 2-9 shows a sample of cemented Cold Creek caliche recovered using the core barrel sampler.



**Figure 2-9. Cemented Cold Creek caliche core section sample collected by the core barrel sampler.**

#### **2.3.4.6. Geological Sampler**

The optional grab sampling module can be installed in-line to the drilling particulate handling system to permit geologic observation, archiving, and verification by operations staff (see Figure 2-10). The module is manually actuated via valves and couplings to collect particulates for geologic analysis and as a surrogate indicator of drilling efficiency. The grab sampler captures particulate in a standard one-quart glass jar. The jar is threaded to a stainless steel housing that includes a diverter for depositing sample in the jar. Particulates settle out in stratified layers, inverse to the order in which geologic horizons are penetrated.

#### **2.3.4.7. Particulate Sampler**

Similar to the geologic sampler described above, an optional particulate sampler can be installed in-line to the drilling particulate handling system, enabling collection of finer particulates and representative samples for metals or other non-volatile analyses. This filtering grab sampler is intended to augment the wireline soil sampler, which cannot be used when in the drilling mode. A stainless steel filter housing holds a bag-type filter of polypropylene or other appropriate material. The particulate sampler is depicted in Figure 2-10.



**Figure 2-10. Particulate sampler (left side), geological sampler (right side) configured in series.**

#### **2.3.4.8. Field Screening Vapor Analysis**

Soil gas samples are collected by continuously drawing vapors from the piezo-vapor cone, typically through 1/8-in ID (3/16-in OD) Teflon tubing. Samples are drawn to the surface by a 2.5-lpm diaphragm pump or similar device. Soil gas vapors pass through a sampling “tee” at the surface. One branch exits to the atmosphere through a granular activated carbon filter, while the other connects to the inlet of the Photoacoustic Infrared analyzer (PAS IR), shown in Figure 2-11a. Alternately, a Gas Chromatograph can be employed as dictated by site and project objectives (see Figure 2-11b). An in-line mass flow meter monitors gas flow to the analyzer at all times.

The internal volume of the sampling line is measured and the transit time through the tubing is calculated to ensure that analysis is correlating to the appropriate sample depth. Soil gas sampling can be conducted while in the push mode, semi-continuous, at discrete intervals. The detection system can be configured to sub-sample and perform a measurement at each rod addition (one meter intervals). Alternately, during sufficiently measured pauses in drilling to allow for formation equilibration, a tube can be lowered to target depth, with the surface annulus plugged, to collect samples while in the drilling mode. Furthermore, soil gas samples can be collected while retracting the drill string during borehole abandonment.



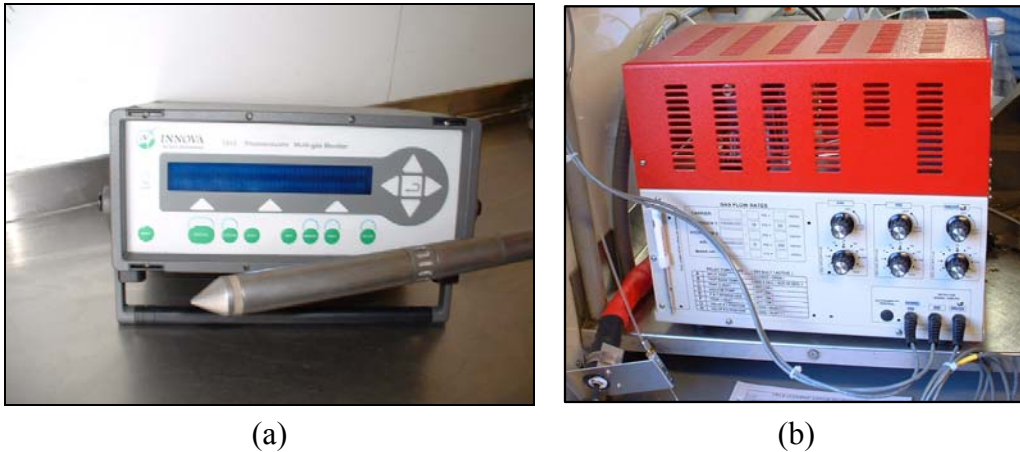

**Figure 2-11. Field screening analytical equipment: (a) photoacoustic infra-red analyzer, and (b) gas chromatograph.**

For field screening of soil and groundwater samples a headspace analysis procedure has been developed and laboratory-tested to provide rough-order estimates and confirm the presence of volatile contaminants. Total time for field analyses of soil and groundwater samples, once collected from the Wireline CPT tools or core barrel, is approximately 15 minutes.

**2.3.5. Data Acquisition**

Data measured in the field, such as drilling and pushing parameters, down-hole instrumentation output, and PAS IR (or GC) data are monitored real-time and recorded on a laptop computer. ARA developed EAPS-specific software for this function. Table 2-3 summarizes the types of data this system records. All data trends are recorded relative to both depth and time for an accurate reconstruction of the field activities. A photograph of the data acquisition system atop the EAPS operator control console appears in Figure 2-12.

**Table 2-4. Summary of data types collected by EAPS data acquisition system.**

CPT Instrumentation	Drilling Parameters	Screening Analyzer
Tip and Sleeve Stress	Total Push Force	PAS IR Output:
Pore Pressure	Rotation Speed	Carbon Dioxide
Total Push Force	Torque	Water Vapor
Depth	Hammer Blow Rate	Carbon Tetrachloride
Soil Gas Flow Rate	Supply Air Flow Rate	Chloroform
Temperature	Return Air Flow Rate	



**Figure 2-12. Data acquisition system laptop with software on operator control console.**

### **2.3.6. Waste Management**

In drilling mode, air containing entrained spoils is conveyed to the surface in the annular space between the drive rods and the outer casing. Solids, fine particulates, and possible vapor-phase contamination must be removed from this air prior to discharge into the atmosphere.

Spoils laden air exits the top of the drill casing into a main discharge line. A slipstream valve enables adjustable diversion to a bypass line for geological observation and/or environmental sampling as earlier described.

From here, a cyclone separator produces a circular airflow field that causes suspended particulates to migrate toward the low-velocity center by creating gradient aerodynamic drag. This process removes all but very fine particulate matter. The quiescent zone in the center drops into a 55-gallon drum. Approximately one 55-gallon drum is filled per borehole, depending on the volume of the borehole at target depth. The cyclone separator is affixed directly to the top of the 55-gallon drum (with a rubber gasket seal).

Air exits the cyclone with some fine particulates still entrained and passes through a bag-type after-filter, consisting of fifteen individual, parallel filters with 66 square feet



of surface area. A manual, airtight shaker arm mounted external to the bag filter containment vessel periodically agitates the filter bags to rejuvenate them.

Following the cyclone and bag filters, the discharge air stream enters a standard High Efficiency Particulate Air (HEPA) filter with an efficiency rating of 99.97 percent at 0.3 micron. The HEPA discharge is routed to the final module, an activated carbon filter. The filter cartridge holds 1.16 cubic feet of granular activated carbon that efficiently adsorbs most organic vapors of concern.

Clean air exits a rooftop vent on the Air Filtration Equipment (AFE) trailer. In addition to housing the primary filtration equipment, the AFE trailer provides secondary containment in the event a primary filtration element is breached. The air filtering equipment has two adjustable, one-way, overpressure release valves to ensure that the blower motor does not run outside of normal conditions, especially as occurs under deadheaded airflow conditions. A 20-HP electric blower augments airflow through the AFE components. Airflow is also driven on the upstream end by the air circulation drilling compressor flow.

Most of the air filtration equipment is contained in a separate trailer adjacent to the CPT truck. The photograph in Figure 2-13 shows the location of equipment within the trailer. During drilling, exhumed spoils are carried from the boring by compressed air, and captured in the air filtration equipment.



**Figure 2-13. Air filtration equipment in support trailer. Cyclone separator (right), bag filter (left), HEPA and carbon filters (background).**

Two digital flowmeters monitor airflow in standard cubic feet per minute (scfm), providing measurement of both down-hole supply from the compressor and discharge from the filtration equipment stack prior to release. Flow rate is transmitted

electronically to the on-board EAPS computer software for recording and real-time monitoring. Mass balance or volume differential calculations determine the fraction of air volume lost to the formation, if any.

### **2.3.7. Supporting Equipment**

Supply air for the drilling equipment is provided by a 300-cfm, 200-psi, diesel-powered air compressor. A diesel-driven generator provides electricity to run the air filtration equipment blower, the support trailer electricity, and other miscellaneous sources. A support truck is typically employed to move support trailers, refuel motorized equipment, and transport other consumable materials from off-site. The photograph in Figure 2-14 shows the EAPS support truck, CPT truck, and waste management trailer.



**Figure 2-14. EAPS support truck, CPT truck, and waste management trailer.**

## **2.4 Phase 1 Testing**

Three rounds of testing were conducted during the Phase 1 EAPS development effort. The first round comprised component- and system-level testing that occurred continually during integration of the various subsystems at ARA's Vertek manufacturing facility and nearby field sites in Vermont. Of greater importance were the second and third rounds of testing that involved the integrated system both on and off-site at Hanford, and at the Umatilla Army Chemical Depot in Northeast Oregon.

### **2.4.1. Hanford On-Site Testing**

We tested drill bit performance in the 200 West Area of Hanford (200W) during June 2003, culminating in a rapid penetration to 138ft bgs. Penetrations began using the piezo vapor cone in conjunction with the 2.0-in rod string and the diamond-impregnated turbine ring bit. The direct push mode consistently encountered refusal in the range of 23

to 28-ft bgs. After the second refusal in direct push mode, we re-initiated penetration in drilling mode using the 2.0-in turbine ring bit and the carbide cross as the inner pilot bit. This configuration again encountered refusal in the same range. Two pilot bits incurred significant wear during approximately four feet of penetration, apparently related to the two-part technique by which they were manufactured.

In a subsequent test, we deployed the large drill beginning at the ground surface. First using the diamond-impregnated turbine ring bit and the carbide bi-cone we penetrated to approximately 10ft bgs. We then engaged a second large-bit combination, consisting of carbide buttons with the percussion hammer, from the same location. Unlike the aforementioned bits first used at Hanford during this test, the carbide button bit design had been improved based on two previous Hanford test results. Penetration in this drill configuration progressed rapidly, at a rate of approximately one foot-per-minute in silts and sands and a half foot-per-minute in gravels and cobbles. We achieved a total depth of 138ft bgs. Progress slowed remarkably during the final foot of penetration. However, upon retrieving and examining the bits, we noted no significant wear and no missing carbide button teeth. The bit condition indicates that, for the specific geology encountered at that depth (e.g., presumably hard rock material), the bit area in contact with the formation was not optimal for rapid penetration.



**Figure 2-15. Early test prototype, large ring bit showing wear and two missing carbide buttons after drilling through 145-ft. at Hanford.**

The Phase 1 tests at Hanford were a success, showing that the primary objectives of the development effort were achieved. Specifically, EAPS successfully penetrated the Cold Creek caliche and the Ringold sand and silt conglomerate without creating any safety concerns. Large rocks in the Ringold formation slowed the drill rate via rotary air drill. For most of the penetration, conventional CPT was feasible to limited depth, generating minimal derived waste. Also demonstrated were wireline techniques for soil

sampling, CPT testing, and drill tool interchange. Insight was gained on the efficacy of various drill bit designs in Hanford geologic materials and the ultimate goal, reaching groundwater, was achieved during the first test, culminating in collection of a groundwater sample.

As this was the first full-scale testing of EAPS, a number of valuable lessons were learned. The primary improvement needed is additional testing and optimization of the drill bits used to penetrate the refusal materials. Bit longevity can be improved by altering bit geometry to find the appropriate configuration for the specific site geology. Since no libraries of bit performance are available for the Hanford site, we recommended a two-week study to evaluate different bit configurations for improving longevity. Further effort to optimize the combination of hammer and bit geometry should result in faster drilling with less bit wear in the various conditions and configurations tested. Additional effort in this area remains a recommendation.

In addition, the capacity of the air filtration system required expansion. This system was originally sized for an airflow rate of 150 scfm. However, later experimentation with the drilling system led to an increase in compressor capacity to 300 cfm. This upgrade was implemented prior to Phase 2 testing.

#### **2.4.2. Umatilla Army Chemical Depot Testing**

During July 2003, ARA conducted a field investigation at the Umatilla Army Chemical Depot in Northeast Oregon, in cooperation with the US Army Corps of Engineers.

The objective of the Umatilla investigation was to delineate the boundary of a military grade explosive contaminant (e.g., RDX) in a groundwater plume migrating from a former lagoon disposal area. The strategic technologies selected were EAPS water sampling and on-site field chemical analysis. Site conditions are described as gravel and cobbles near surface, more consolidated gravels at about 10 ft bgs, followed by silty/sandy gravels and occasional cobbles to groundwater (near 100 ft bgs). A photograph of the chips obtained from the drilling grab sampler is shown in Figure 2-16. These conditions are roughly analogous to those found within Hanford's Ringold formation. ARA used this deployment to further test and advance the operational experience of EAPS.

**Table 2-5. Summary of penetrations conducted at Umatilla.**

<b>Hole ID</b>	<b>Depth (ft)</b>	<b>Ring Bit</b>	<b>Avg. Rate (ft/hr)</b>
DP-1	98	Full	18
DP-2	79	Full	17.4
DP-3	109	Half	24
DP-4	92	Half	19.8

A combination of larger diameter hammer bit and studded ring bit proved highly effective at drilling through Umatilla gravel and cobbles at all depths. EAPS easily



reached groundwater, at approximately 100 ft bgs, within a single day of drilling at each location. Mostly rotation and bias load were applied, with hammer action being used only to penetrate boulders and cobbles.



**Figure 2-16. Drill cuttings, showing chip size cut primarily basaltic rock.**

The application of EAPS was essential, as the project could not have been executed with conventional CPT. Only minute waste quantities were generated in the Umatilla gravels, less than a 55-gallon drum per 100-ft borehole. Approximately 400 ft of penetration was completed at four locations in one week, including equipment mobilization and field analysis. The rapid investigation was enabled by the field analysis and EAPS technology; thereby, saving weeks of downtime waiting for analytical results and slower penetrating technology rates. This project successfully demonstrated several strength and revealed opportunities for improvement, especially related to drilling. Lessons learned from this project were incorporated with those from the Hanford and near-Hanford site tests.

### **3.0 Phase 2: Field Demonstration**

ARA performed the final demonstration of EAPS during September and October of 2003. The objectives of the final demonstration were to affirm safe, quick, economical, and near real-time, *in situ* geotechnical and environmental characterization of subsurface conditions at Hanford 200W down to groundwater.

Specific demonstration goals included:

- Characterizing subsurface contamination at Hanford 200 West Area in a period of 20 working days through the Hanford and Ringold formations.

- Safely and economically reaching groundwater in at least one location (approximately 250 feet below grade surface) and up to 4 other penetrations into or just below the Cold Creek caliche.
- Collecting soil gas, soil, groundwater, and drill cutting discharge samples in accordance with the Sampling and Analysis Plan.
- Collecting continuous geotechnical data by Cone Penetrometer and providing geologists interpretation of grab samples through at least one entire penetration.
- Correlating environmental and geotechnical data to quantitatively and qualitatively interpret the spatial distribution of subsurface contaminants.
- Corroborating field analytical results with those from an independent off-site laboratory.
- Comparing all facets of EAPS operation to that of conventional, baseline drilling at Hanford, with respect to factors such as time, cost, and investigative derived waste.
- Minimizing risk of hazard exposure to operations staff and preventing the release of fugitive environmental contamination by effectively containing the drilling discharge and instituting engineering controls with other operational processes.

### **3.1 Site Conditions and Limitations**

The demonstration was conducted in a portion of the 200 West Area (200W) of the Hanford site. Best available information implied this portion of the site was contaminated with carbon tetrachloride (CCl<sub>4</sub>). Appendix B contains a thorough description of the subsurface conditions, including geology, hydrogeology, and contaminants. Here we briefly discuss the geology based on available borehole logs previously drilled in the area of the Phase 2 demonstration site. The cross sections in Appendix B were generated using borehole geologic data.

The uppermost geologic unit in the demonstration site area is the Hanford formation. The Hanford formation consists of unconsolidated silt, sand, and gravel. The Hanford formation ranges in thickness from 85 ft at well 299-W15-10 to a maximum thickness of 146 ft at well 299-W18-26.

Underlying the Hanford formation is the Cold Creek silt, a unit consisting of interbedded silt and fine sand. The top of the Cold Creek silt was previously encountered at an uppermost depth of 85 ft below grade surface (bgs) at well 299-W15-10. The Cold Creek silt ranges in thickness from 6 ft at well 299-W15-18 to 13 ft at well 299-W18-23.

The Cold Creek caliche underlies the Cold Creek silt and generally consists of variably indurated carbonate rich sand, silt, and gravel. The top of this unit lies at depths ranging from 95 ft bgs at well 299-W15-10 to 155 ft bgs at well 299-W15-23. Cold

Creek caliche unit thickness ranges from 8 ft at well 299-W15-10 to 38 ft at well 299-W15-20.



**Figure 3-1. Outcrop of the Ringold formation near Hanford.**

All of the boreholes shown in the cross-sections penetrated into the top of the Ringold formation. The Ringold Formation, shown in Figure 3-1, consists of silt, sand, and gravel. At many depths, the formation can be cemented, as can be seen from the vertical faces in the photograph. Large cobble sand boulders are encountered at many depths. An example is shown in Figure 3-2. The Ringold formation lies at an uppermost depth of 10 ft bgs at well 299-W15-10 and a maximum depth of 400 ft bgs at well 299-W15-17. The Ringold formation was not fully penetrated.



**Figure 3-2. Close-up of basaltic cobble from Ringold formation.**

Carbon tetrachloride ( $\text{CCl}_4$ ) was the contaminant of interest, which we expected to encounter during the demonstration. In much of the 200 West Area  $\text{CCl}_4$  is present in multiple phases and at varying concentrations throughout the vadose zone and aquifer. Near the primary source locations, the highest concentrations are associated with the Cold Creek layers. Other contaminants detected in these areas include chloroform, trichloroethylene, iodine-129, tritium, and technetium-99. The magnitude and extent of contamination in the deep unconfined aquifer and confined aquifer are not well defined.

### **3.2 Field Demonstration Summary**

ARA performed a series of six penetrations to demonstrate of EAPS during September and October of 2003. These penetrations were performed in the 200W area at Hanford. Locations are shown on a map of the demonstration area in Figure 3-3. Geologic cross-sections developed from previous site investigations are indicated by red lines on the site map, and are shown in Figure 3-4 and Figure 3-5. Experience at each penetration location is summarized below.





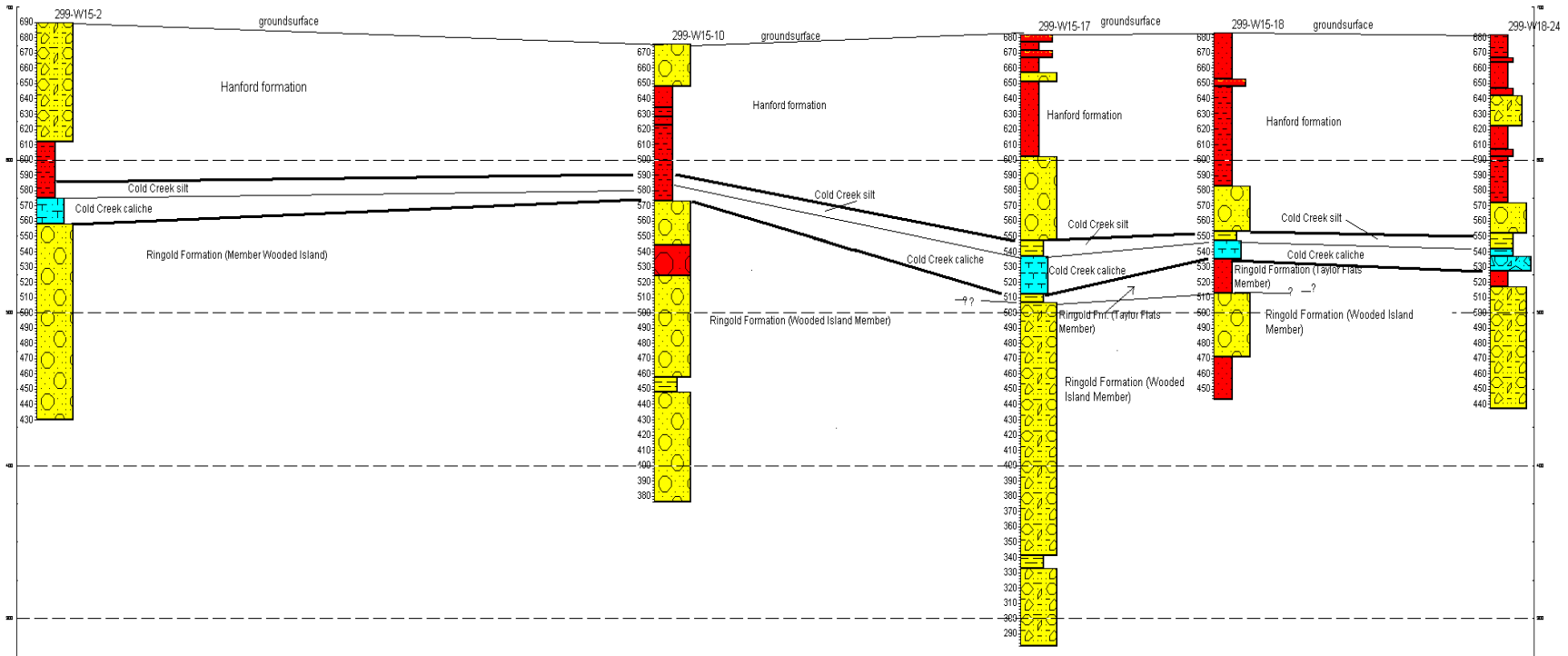

Figure 3-4. North-South Geologic Cross Section Within and East of Test Site Area

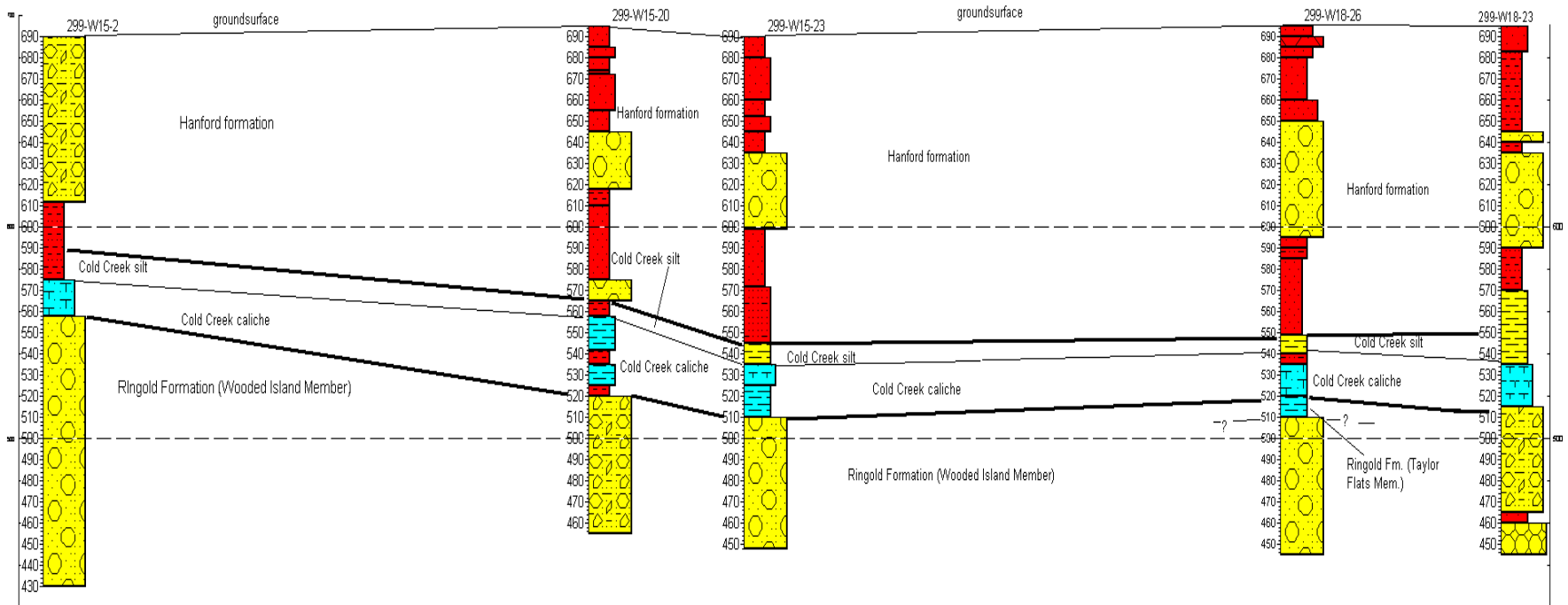
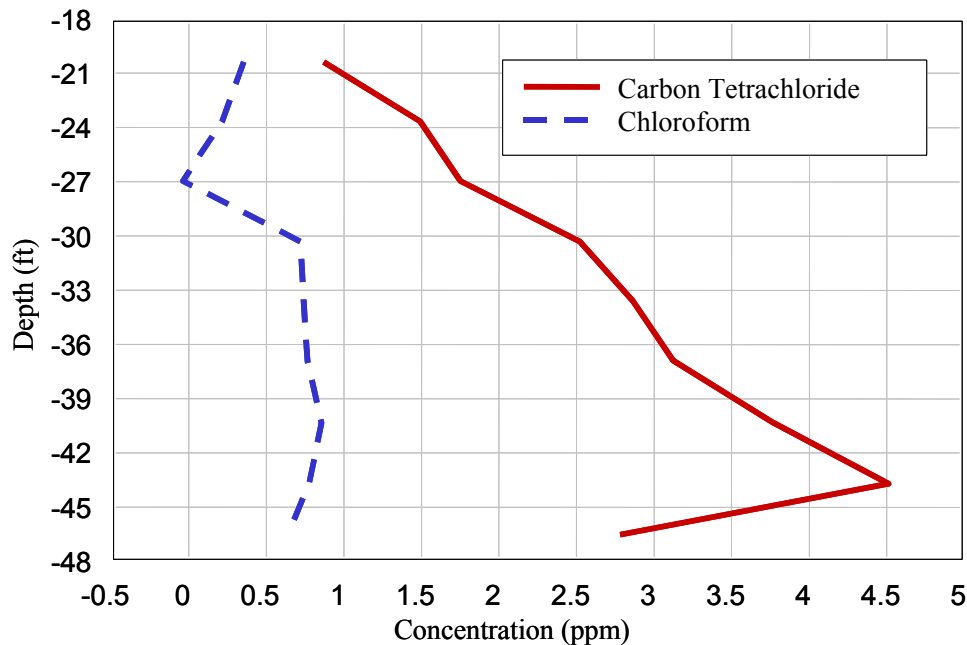

Figure 3-5. North-South Geologic Cross Section West of Test Site Area

### 3.2.1. Boring C4241

Boring C4241 was the first penetration made. This penetration was located in the southwest corner of the demonstration area and was started on September 26. A total of 4.5 days were spent at this location.

Gas sampling and CPT measurements were collected while pushing from grade to 46.5 ft bgs, where refusal was encountered. The plot in Figure 3-6 depicts vapor phase  $\text{CCl}_4$  concentration profile measured at C4241 using the piezo-vapor cone and PAS IR analyzer.

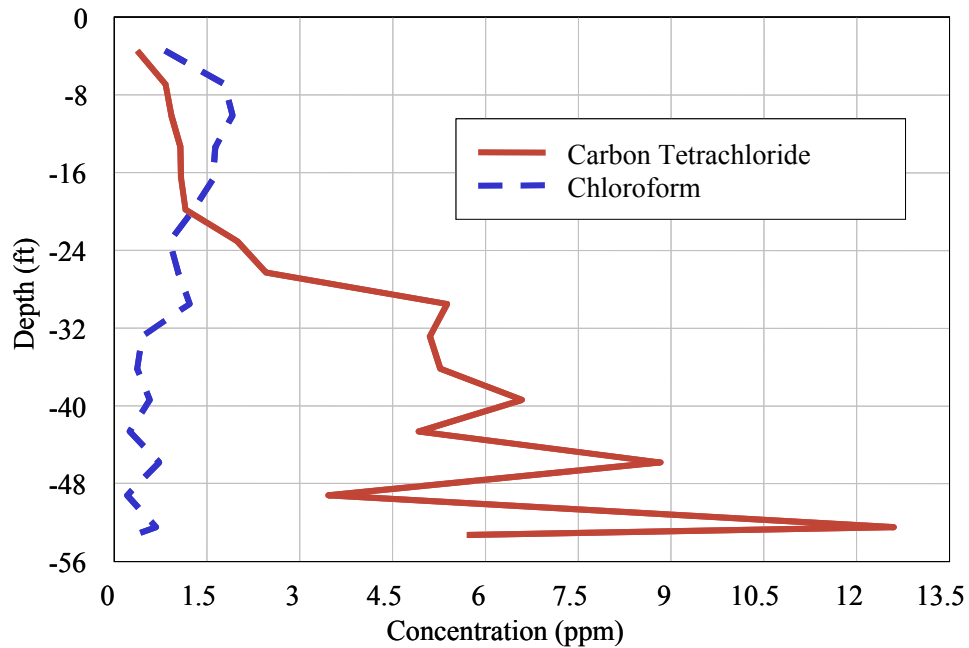

**Figure 3-6. Profile of  $\text{CCl}_4$  vapor concentrations obtained at C4241 using piezo-vapor cone**

Following direct push refusal, the 2-in drill was deployed to penetrate the resilient zone, which ended at 56.6 ft bgs. Following this drilling, we intended to continue with the wireline piezo vapor cone, but the locking mechanism did not engage due to a bent section on the threads of the wireline. Tubing and wires had also broken loose. The 2-in rods were retrieved to inspect the lower assembly. Once back in working order the wireline piezo vapor cone was redeployed and achieved a depth of 32.91 ft before refusal. The wireline locking mechanism would not disengage, so the 2-in rods were retrieved and 2-in diameter drilling was resumed to a depth of 131.2 ft, in the Cold Creek silt (CCS). Wireline soil samples and gas samples were collected down to 138.5 ft, after which drilling with the 2-in system resumed to a total penetration depth of 162 ft (see Figure 3-10). A gas sample collected at this depth on October 2 indicated 8.2 ppm  $\text{CCl}_4$  before closing the hole.

### 3.2.2. Boring C4242

Boring C4242 was located approximately 100 yards north of the C4241. Six days were spent at this location. Penetration began midday on October 2, with wireline gas sampling down to refusal at 53.7 ft bgs. CCl<sub>4</sub> gas concentrations peaked at 12.6 ppm at a depth of 52.49 ft. The plot in Figure 3-7 depicts vapor phase CCl<sub>4</sub> concentration profile measured at C4242 using the piezo-vapor cone and PAS IR analyzer.



**Figure 3-7. Profile of CCl<sub>4</sub> vapor concentrations obtained at C4242 using piezo-vapor cone**

The penetration alignment had strayed from vertical through the course of pushing; therefore, the 2-in rods were withdrawn and the 2-in drill with the wireline dummy tip was installed to try to achieve the previous refusal depth. Refusal was encountered at 32 ft bgs. The wireline threads failed, rendering the dummy tip irretrievable by wireline. The 2-in rods were extracted again, and the 2-in drill with center bit was pushed to refusal at 29.53 ft bgs. Drilling then advanced the penetration to 148 ft bgs (see Figure 3-10), during which noticeable change in the formation at 141 ft bgs indicated CCS. The gas analyzer indicated a CCl<sub>4</sub> concentration of 12.9 ppm at 148 ft bgs, so a soil sample was collected for off-site analysis. Headspace analysis of soil samples collected beneath the CCS indicated 2.09 ppm CCl<sub>4</sub>. Several gas samples were collected while withdrawing the rods from the borehole. Observed concentrations of CCl<sub>4</sub> agreed well with those obtained during penetration.

### 3.2.3. Boring C4243

Boring C4243 was located just north of the center of the demonstration area. Four and a half days were spent at this location.

Starting on October 9, the 2.875-in hammer was used to drill this penetration to 132.4 ft bgs - the top of the CCS. The entire casing and hammer required extraction when the lock and threads failed on the hammer during the center bit and hammer separation process. At 128 ft deep the operator airspace monitor detected an organic gas of unknown chemistry. The PAS IR detected no carbon tetrachloride or chloroform. A grab sample was collected and analyzed by HSC's gas chromatograph to analyze for other suspect gasses, but none were identified. The sounding was re-initiated from grade, with a different hammer for comparative purposes, and proceeded to 132.8 ft bgs. Several rods still on the hammer were accidentally dropped down-hole causing a broken ring bit. The CCS was encountered at 132.5 ft. The 2-in drill was used to drill to 134.5 to clear out soil in ring bit. The 2-in gas push then commenced to telescope through 2-7/8 casing and ring bit to a refusal depth of 142 ft (see Figure 3-10). A peak of 12.4 ppm CCl<sub>4</sub> was detected at 137.79 ft. Drilling with the 2-in setup commenced to 172 ft, approximately 10 feet below the Cold Creek Caliche (CCC). The hole was abandoned on October 17.

#### **3.2.4. Boring C4244**

Boring C4244 was located approximately 50 yards southwest of the center of the demonstration area. One day was spent at this location. This penetration was initiated on October 17 using the gas sampler. Refusal was encountered at 28-ft (see Figure 3-11). The wireline was removed and drilling commenced through the obstruction to 32.81 ft bgs where pushing with the gas sampler resumed. The center bit weld was broken during drilling of this interval. The gas sampler was pushed to refusal at 40-ft. The 2-in rod broke at grade level when refusal was encountered. The penetration would have normally continued but due to limitations in demonstration time the hole was abandoned. Gas detection was relatively low with concentrations of less than 7 ppm CCl<sub>4</sub>.

#### **3.2.5. Boring C4245**

Boring C4245 was located approximately 100 yards south of the north end of the demonstration area. Four days were spent at this location. This penetration was initiated on October 20 with the gas sampler pushed to refusal at 20.2 ft. The 2-in rods were removed and the penetration resumed from grade with the large drill and hammer to 124.7 ft bgs. Penetration rates were somewhat slowed by hydraulic cooling system problems. The 2-in drill was telescoped through the ring bit to 125 ft bgs at the top of the CCS. The wireline gas sampler was then pushed to refusal at 129 ft bgs (see Figure 3-11). The cable broke upon retrieval. The core barrel was deployed to retrieve a soil sample and remove the wireline tool obstructing further progress. The core barrel was driven to 134.5 ft., from whence the 2-in drill resumed the penetration several feet into the top of the Ringold formation. Upon reaching a total depth of 167ft bgs, the hole was abandoned.

### **3.2.6. Boring C4246**

Boring C4246 was the last penetration in the demonstration, located approximately 50 yards southwest of the center of the demonstration area (approximately 6 ft southwest of C4245). Three and a half days were spent at this location.

This penetration started with the 2.875-in hammer from grade on October 24. At 80 ft bgs, the Loric hammer and center bit was removed for inspection. High oil temperatures and bit wear were the suspected causes of slower penetration. A bi-cone bit was employed, but without better penetration rate results. The resilient formation was then penetrated with the Halco hammer and a new center bit to a terminal depth of 167 ft (see Figure 3-11). The hole was closed on October 29.

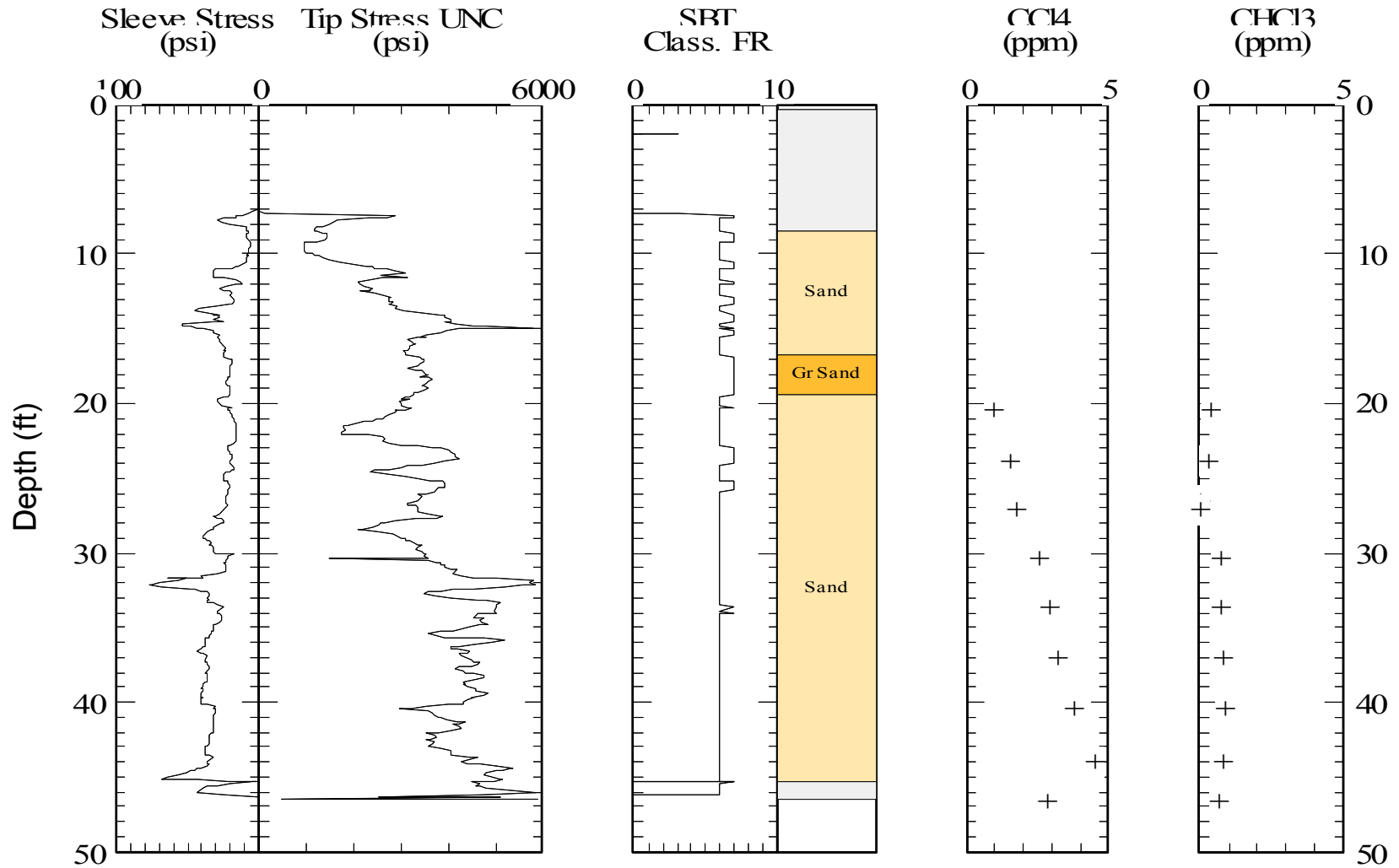

Figure 3-8. CPT/Gas sampler results from C4241.



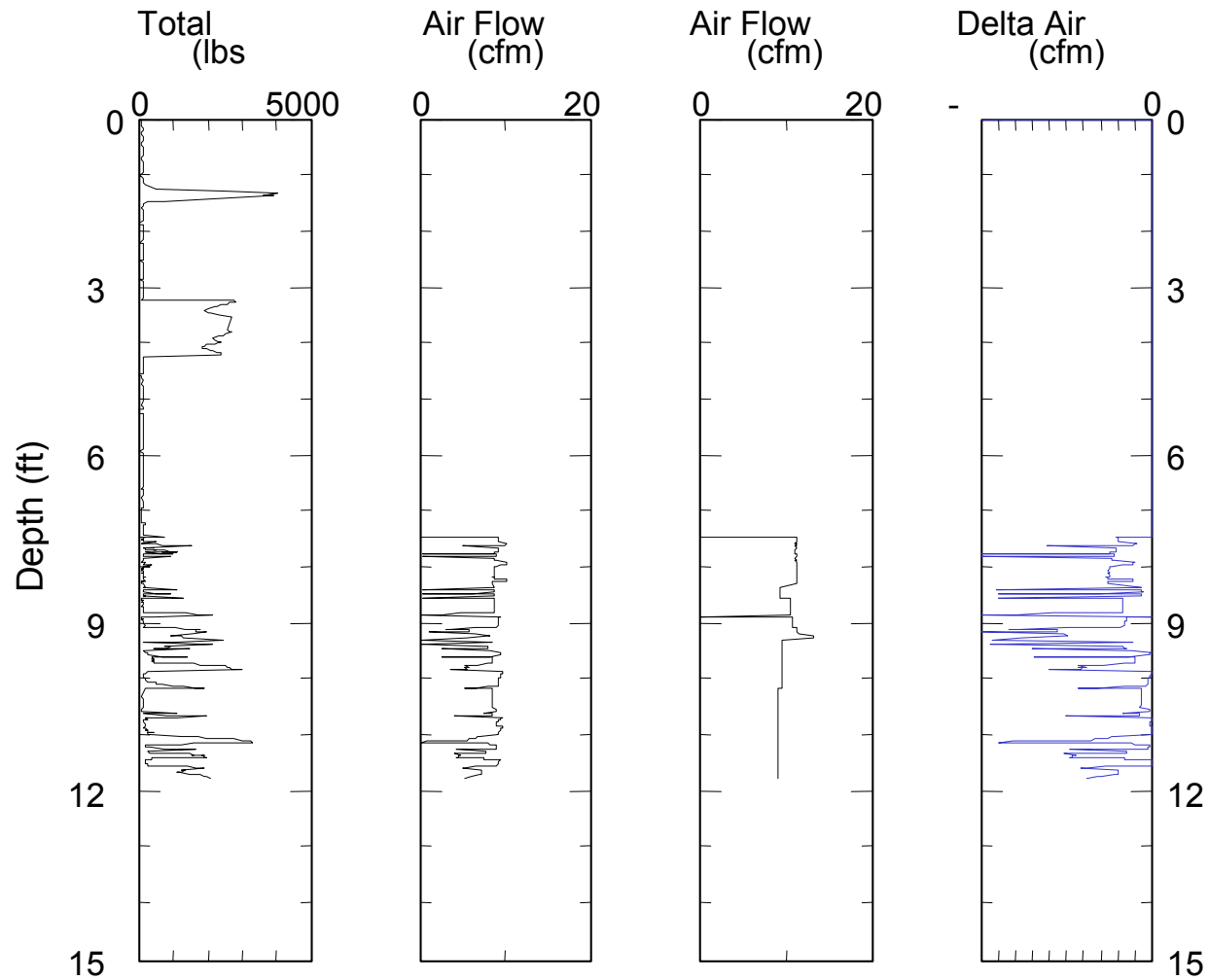

Figure 3-9. Drilling parameters recorded at C4241.

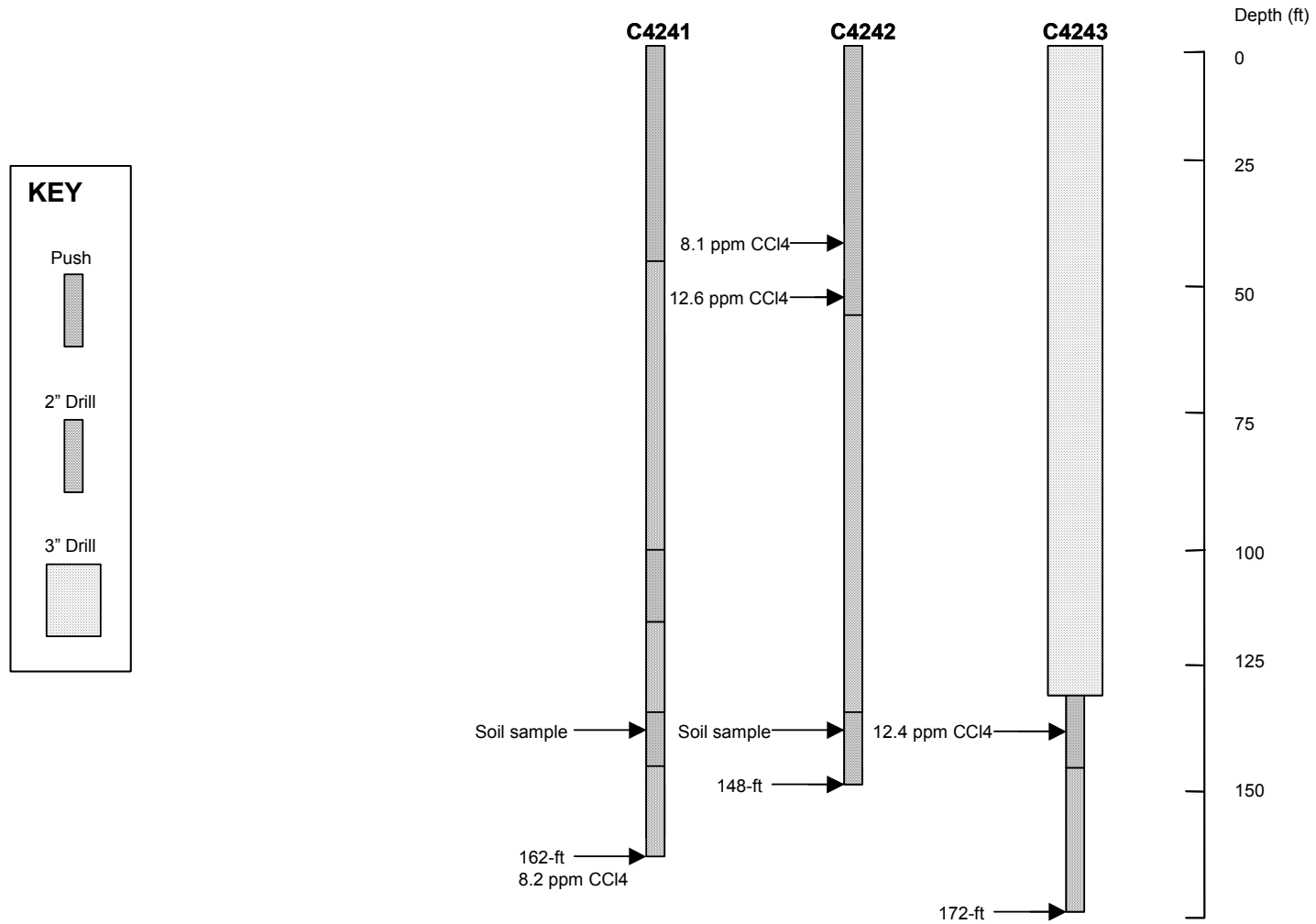

Figure 3-10. Profile of first three penetrations during demonstration

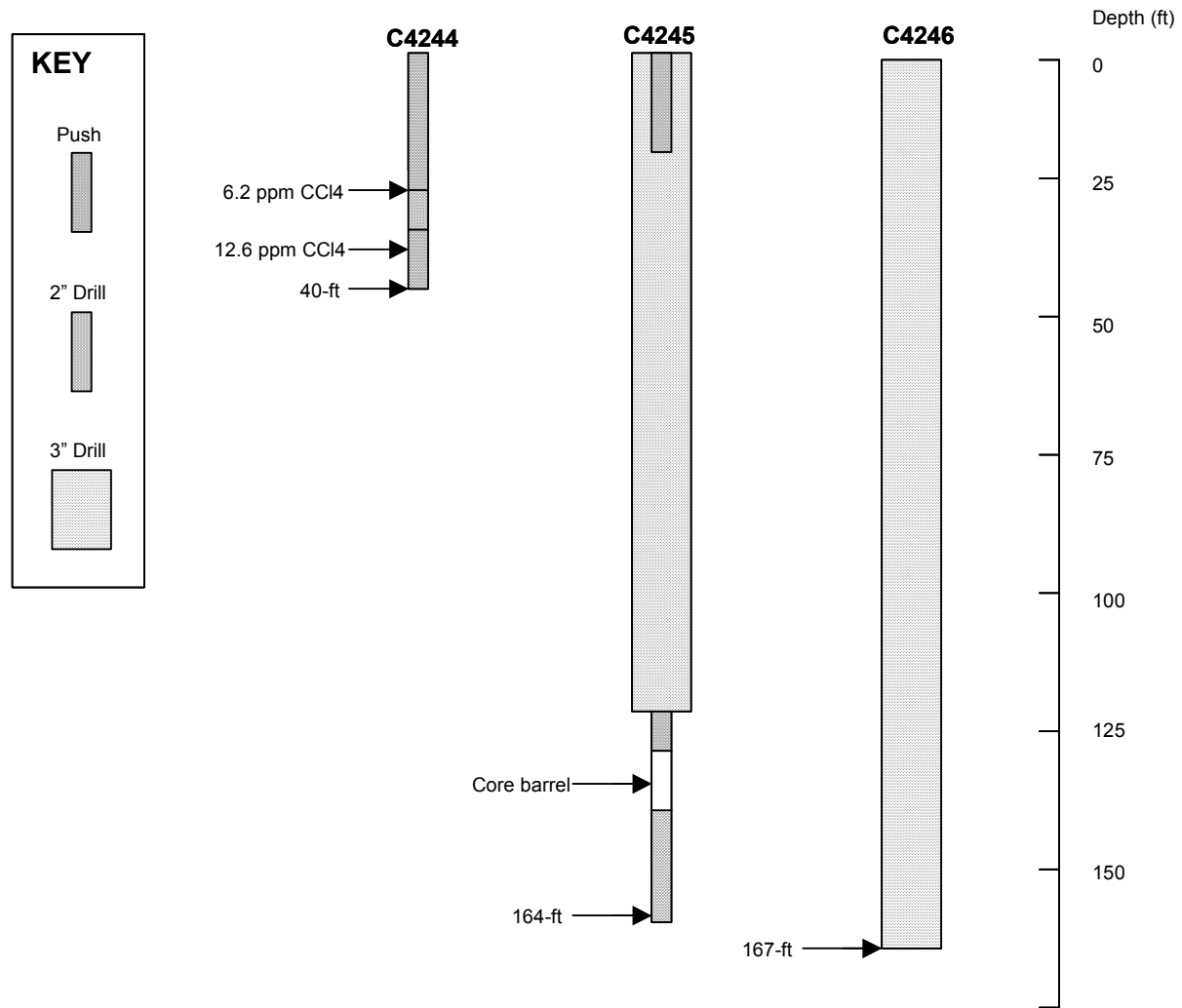

Figure 3-11. Profile of final three penetrations during demonstration.

### **3.3 Percussion Hammer Experiment**

Concurrent with the demonstration, we also conducted an experiment to compare two separate manufacturer's percussion hammers designed for the large drill set-up. Loric Tool provided several of the initial hammers tested in Phase 1, including a small diameter hammer. Loric also furnished several versions of drill bits for testing throughout Phase 1 and 2. The other manufacturer was Halco. Performance of both hammers was compared in similar geology and operational conditions. Both hammers were tested and demonstrated by penetrating hundreds of feet throughout the testing and demonstration periods of the project.

Though the Loric hammer incorporates some superior design features, such as the locking rings and a faster hammer rate, in our comparison, the Halco hammer performed better than the Loric. The Halco hammer penetrated a quartzite boulder measuring at least 2ft in diameter that had previously stopped the Loric hammer.

### **3.4 Demonstration Summary**

The month-long EAPS demonstration at Hanford represented the culmination of 27 months of research, development, and testing. Overall, the demonstration successfully satisfied the objectives set forth in the Demonstration Plan. Six penetrations were made to depths above and below the Cold Creek Caliche. Samples were collected for on and off-site analysis. Other CPT data, subsurface video, and geological samples were observed and logged throughout the demonstration. Perhaps most importantly, the dynamic ability to overcome technical, mechanical, and administrative barriers encountered in the field was demonstrated in many instances by the EAPS technology, penetration and characterization techniques employed, and the operations staff.

## **4.0 Conclusions, and Recommendations**

### **4.1 Phase 1**

The Phase 1 tests at Hanford 200W were a success, showing that the primary objectives of the development effort were achieved. Specifically, EAPS successfully penetrated the Cold Creek caliche and the Ringold sand and silt conglomerate without creating any safety concerns. Large rocks in the Ringold formation slowed the drill rate via rotary air drill. For most of the penetrations, conventional CPT proved feasible to limited depth. Derived waste was minimal. Also demonstrated were wireline techniques for soil sampling, CPT testing, and drill tool interchange. Insight was gained on the efficacy of various drill bit designs in Hanford geologic materials and the ultimate goal, reaching groundwater, was achieved during the first test, culminating in collection of a groundwater sample.

Two primary recommendations were derived from the Phase 1 experience. These included further study to compare the performance of several different bit designs in Hanford geologies, and re-sizing of the air filtration system to handle the larger volume

of air produced by the rotary hammer system. The air filtration system was expanded, and limited testing of additional bits was performed leading up to the Phase 2 demonstration, but it remains a recommendation that a more comprehensive bit study be undertaken to further improve rates of production attainable with EAPS.

## **4.2 Phase 2**

Phase 2 demonstrated that several important objectives of the EAPS development program were achieved. Specific capabilities demonstrated included:

- The ability to routinely reach, identify, and penetrate the Cold Creek Caliche layer at 200W;
- The ability to collect and conduct on-site analysis of soil gas and soil samples to support in-field decision-making; and
- The ability to resume CPT *in situ* characterization below strata that required drilling to penetrate;

Although EAPS reached and sampled groundwater adjacent 200W during the Phase 1 testing, a bit failure in the hard rocks of the Ringold formation prevented demonstration of this capability in Phase 2 (during the final penetration).

### **4.2.1. Production Rate Analysis**

Time spent on production is summarized in Table 4-1. The average rate of penetration in direct push mode (including CPT geotechnical characterization with simultaneous vapor contaminant profiling) was 20 feet per hour. The average drilling penetration rate with the 2.875-in drill is over 21 feet per hour, and with the 2-in drill is 16 feet per hour.

Factoring in setup and teardown time, discrete soil and vapor sampling, scheduled breaks (lunch, etc), and hole closure, the overall site investigation rate was 7.1 feet per hour during the demonstration. This rate does not include downtime considered to be improbable in an actual production deployment (rather than demonstration). A security restriction that prohibited leaving vehicles unattended overnight added approximately three hours per day of extra setup and teardown for half of the boreholes in the demonstration. If security restrictions could be eased or eliminated, a production rate gain may be realized. Likewise, if restrictions of this type are applied across an entire investigation site, the investigation rate would be slower.

Other contributions to downtime included: waiting for site support, interaction with demonstration visitors, and mechanical failures. These contributions added 112.5 hours to demonstration downtime, with mechanical failures being the largest contributor.

**Table 4-1. Production Time Summary**

Borehole	Total Depth (ft)	IDW (gal)	Total Push (ft)	Total 2" Drilling (ft)	Total 2.875" Drilling (ft)	Setup/Teardown (hrs)	Penetration (hrs)	Hole Closure (hrs)	Soil Sampling (hrs)	Gas Sampling (hrs)	Scheduled Breaks
C4241	162	30	63	99	0	17.0	6.5	2	2	0.5	2
C4242	148	30	54	94	0	24.5	7.5	2.5	0	0.75	3
C4243 (A)	132	40	0	0	132	2.0	7	1	0	0.25	1
C4243 (B)	173	50	9	31	133	2.0	12	1	0	1.5	1.5
C4244	40	0	40	0	0	4.0	2	1	0	0.75	0.5
C4245 (A)	20	0	20	0	0	1.5	1	0.75	0	0.5	1
C4245 (B)	163	70	4	35	124	1.5	9.5	0.75	3	0.25	1
C4246	165	100	0	0	165	3.0	7	2	0	0	2
<b>Totals</b>	<b>1003</b>	<b>320</b>	<b>190</b>	<b>259</b>	<b>554</b>	<b>55.5</b>	<b>52.5</b>	<b>11</b>	<b>5</b>	<b>4.5</b>	<b>12</b>

Table 4-2 summarizes an evaluation of downtime events that occurred during the demonstration, and presents possible remedies. These remedies are included by reference in the recommendations of section 4.2.2.1. Quantitative estimates of production time under contrasting investigation scenarios presented in section 4.2.3 assume implementation of these remedies.

**Table 4-2. Evaluation of Non-Production Time**

Incident	Description	Remedy	Non-Production Hours	
			Actual	Est. After Remedy
Wireline System	Pulled wire out of locking mechanism and locking wireline into casing rods	Increase diameter of wireline cable	16	4
Cone failure	CPT cone broke at a thread joint below the locking mechanism	Joint as been engineered out of the wireline cone	4	1
Bit Plugging/Dirt Rods	Fine grained soil accumulated in the rods, blocking the return air flow. Appears to be due to excessive moisture in the supply air	Implement a better air water separator after the compressor, for 2 in system use ADT bit design with had only minor plugging problems	20.5	5
Dropped Rods/Hyd. Clamp	Clamp shoe was not in proper place and rods were dropped	Clamp shoes have been indexed to be in proper locking position	5	0
Sand Lock between two casings	Sand collected between the 2 7/8 in and 2 in rods and eventually locked the two casing system together	Metal backed rubber rod wiper to be placed on 2 in rods to keep sand from blowing up into the annulus between the tow rods	16.5	4
Hydraulic System	Excessive heating of the hydraulic oil due to the higher thermal loads from drill motor and inadequate hydraulic torque	EAPS CPT truck is being retrofitted with a bigger hydraulic tank and cooling system and motor with twice the torque will be installed	10	0
Broken Bits	Bits broke at the connection between the retaining ring and concentric bit, with result that the 2 7/8 in concentric bit was lost	Conduct engineering analysis of threaded joint and re-engineer threaded joint	11	2
Vacuum System	Reduced flow through bags caused a minor leak	Clean bags after every sounding, this will increase non-production time, but reduce risk of a leak	0.5	2
Data Acquisition System	Computer crashed during penetrations and required rebooting. Could occur form once to several times per day	Appears to be a grounding problem between the truck and computer which causes the computer to reboot. Electrical engineers will evaluate system when truck arrives in Vermont for retro fit of hydraulic tank	19	1
<b>Total Hours</b>			<b>102.5</b>	<b>19</b>

#### **4.2.2. Recommendations**

The experience of testing multiple generations and combinations of equipment and operational techniques informs us that further improvements to EAPS may still be realized.

##### **4.2.2.1. Downtime Mitigation**

First, production downtime can be reduced to increase the effective production rate. By employing remedies outlined above in the production rate analysis, we estimate that downtime can be mitigated to roughly one-quarter of that experienced during the Phase 2 demonstration.

##### **4.2.2.2. Drill Bit Performance Study**

Next, knowledge that could be gained from a more comprehensive drill bit and percussion hammer study would help to maximize EAPS production rates as well as equipment longevity. Hanford currently has no documented history of drill bits used on-site. We recommend a brief drill bit study and testing session on or off-site in the Hanford and Ringold formations to finally define the bit configurations that are optimal for the site. We have already begun compiling a compendium of drill bit and percussion hammer performance. Additionally we have sought the advice of local and international experts who would be willing to assist in such a study. Local drilling and geological experts agree that Hanford's relatively heterogeneous sedimentary lithology poses a unique challenge for drilling. The variable mineralogy and physical rock size preclude off-the-shelf drill bits and standard penetration technique from being effective. Further performance testing of non-standard drill bit and percussion hammer designs would yield the most beneficial improvements to EAPS.

##### **4.2.2.3. Additional Characterization Tools**

For the purposes this project only several selected pre-existing CPT tools were adapted for use of the baseline EAPS technology to accomplish the project and demonstration objectives. However, a wide variety of other geotechnical and environmental tools used in conjunction with CPT have been developed and proven. Should an EAPS deployment require the use of a tool not already integrated, relatively simple modifications can adapt it for use with EAPS. Some of these tools include a membrane interface probe (MIP), seismic tools, a spectral gamma probe, etc.

#### **4.2.3. Application of EAPS**

EAPS can provide a great deal of flexibility in how an investigation is conducted. On a site-specific and project-specific basis, a wide variety of penetration strategies could be employed for geotechnical and environmental characterization. Examples of two investigation approaches ready for use in future site characterization programs are given below. Two example penetration strategies are outlined below.



**Scenario 1** - Starts with a Wireline CPT sounding conducted to refusal and then pulling the Wireline cone. The sounding is then advanced to the CCS with the large drill. The hammer is pulled and the Wireline CPT system reinserted through the open casing. Soil gas and soil samples are collected into the caliche layer. The Wireline drill is then used to penetrate the caliche if necessary. This approach ensures that any boulders encountered will be penetrated and also the coring system can be used to obtain samples of the caliche. Gas monitoring points are installed during hole closure.

**Scenario 2** - Assumes that the Wireline system is used throughout the penetration. This was successfully accomplished in Phase 2, but there is a possibility that a boulder will be encountered, necessitating use of the large drill and percussion hammer to complete the penetration.

**Table 4-3. Time projections of EAPS deployment scenarios.**

Scenario 1: Combined 2" and 2.875" Drill		Scenario 2: 2" Drill Only	
Operation	Time (hr)		Time (hr)
Site screening (1 hr/day)	5.24	Site screening (1 hr/day)	2.66
Mobilization and Setup	3.00	Mobilization and Setup	3.00
Daily calibration, tailgate safety meeting, etc. (1 hr/day)	5.24	Daily calibration, tailgate safety meeting, etc. (1 hr/day)	2.66
CPT/Gas Sample to Refusal, 0 to 55 ft	2.75	CPT/Gas Sample to Refusal	2.75
Remove 2" system and install 2.875" drill	1.75	Remove CPT cone, insert drill bit	0.50
2.875" drill to silt (55-140 ft)	4.25	2" drill to silt (55-140 ft)	4.25
Soil sampling above silt (7 samples)	10.50	Remove drill and insert CPT cone	1.00
Gas sampling above silt (7 samples)	2.10	CPT push w/gas sampling to Caliche (140-150 ft)	2.00
Remove hammer/insert CPT cone & rods	2.25	Remove piezo-vapor cone	0.50
CPT Push to Caliche and sample (140-150 ft)	2.00	Wireline soil sample silt	0.50
Wireline soil sample silt	0.30	Insert center bit & drive rods	0.75
Wireline gas sample in silt	1.50	Drill through Caliche	1.00
Remove Wireline CPT probe	0.50	Sample gas through drill	1.00
Insert 1 in Drill	0.75	Remove 2" drill and grout hole	2.50
Drill through Caliche, (150-160 ft)	1.00	Demobilization	1.50
Soil sample	1.50		
Sample gas through drill	0.30		
Remove 2" drill, install gas monitor, grout	4.00		
Remove 2.875" drill and grout	2.00		
Demobilization	1.50		
<b>Total Time</b>	<b>52.44</b>	<b>Total Time</b>	<b>26.56</b>

Since the Phase 2 field effort was aimed at demonstrating EAPS rather than site characterization, times in Table 4-1 represent a minimal amount of soil, water, and vapor sampling. In an actual field investigation, additional sampling requirements and sensor placement of permanent monitoring infrastructure (sampling ports, sensors) activity may be required. For a realistic site investigation, such as Scenario 1 summarized in Table 4-3, we approximate 50 hours of sounding per hole, or about one week of ten-hour days. Given the numerous characterization tools and modes of operation available with EAPS,

time required to complete any sounding will be highly dependent on the investigation strategy being employed.

This project has demonstrated the ability of EAPS to provide safer, lower-cost, access and characterization of the subsurface than previous baseline technologies. While further improvements to EAPS capabilities are realizable, the technology is presently mature and robust enough for immediate full-time, full-scale deployment at a number of sites.