

**NATIONAL WEATHER SERVICE MANUAL 10-1315**

**October 5, 2010**

**Operations and Services**

**Surface Observing Program (Land), NDSPD 10-13**

**Cooperative Station Observations**

---

**NOTICE:** This publication is available at: <http://www.nws.noaa.gov/directives/>.

---

**OPR:** OS7 (T. Trunk)

**Certified by:** OS7 (D. Caldwell)

**Type of Issuance:** Routine

---

**SUMMARY OF REVISIONS:** This Directive supersedes National Weather Service Manual, *Cooperative Station Observations*, dated, April 18, 2007.

- Clarified policy in the introduction, Section 4, as it concerns the procedures, forms, and policy directives which apply to the establishment, maintenance, and inspection of cooperative stations.
- Added procedures to Section 4.3.2.3, of Appendix A, to prevent ice damage to Fischer & Porter rain gauges.
- Added Section 4.3.4, to Appendix A, for procedures on operation and maintenance of the Fischer & Porter Rebuild rain gauge (FPR-D).
- Added a web link in Section 7, of Appendix A, for access to the *Measuring Snow* video, to illustrate the National Weather Service's procedures for taking snow observations.
- Added a web link to the SKYWARN program in Section 12 of Appendix A, to offer cooperative observers another opportunity to serve the Weather Forecast Offices in real time.
- Added procedures in Section 4.1, of Appendix B, for the clean-up and disposal of broken mercurial thermometers.
- Added new policy to Section 6 of Appendix B, to require the C460-5 surge protector to be installed at each new cooperative station configured with an indoor temperature display unit.

Signed

9/21/2010

David Caldwell  
Director, Office of Climate  
Water and Weather Services

Date

**Cooperative Station Observations**

<u>Table of Contents:</u>	<u>Page</u>
1 Purpose.....	3
2. Definition of a Cooperative Station.....	3
3. Reporting Elements.....	3
3.1 Precipitation.....	3
3.2 Air Temperature.....	3
3.3 River Stage.....	3
3.4 Evaporation, Wind Movement and Water Temperature.....	4
3.5 Soil Temperature.....	4
3.6 Atmospheric Phenomena.....	4
3.7 Flash Flooding.....	4
4. Establishing, Maintaining, and Inspecting Stations.....	4
4.1 Observer Training.....	5
4.2 Maintenance.....	5
4.3 Requesting Supplies.....	5
4.4 Reporting Equipment or Instrument Problems.....	5
5. Preferred Time for Taking Observations.....	5
6. Resetting Instruments.....	6
7. Forms.....	6
7.1 Legibility.....	6
7.2 Disposition of Forms.....	6
8. Paperless Data Transmission.....	6
9. Figures.....	6
 Appendices	
A. Precipitation.....	A-1
B. Air Temperature.....	B-1
C. River Stages and Related Precipitation Observations.....	C-1
D. Evaporation Station Observations.....	D-1

E. Soil Temperature Stations.....E-1  
 F. Atmospheric Phenomena ..... F-1  
 G. Flash Flooding ..... G-1

1. Purpose. The purpose of this manual is to provide guidelines for taking and reporting climate and weather observations at cooperative observer program stations. The instructions pertain to the exposure, operation, maintenance of instruments, and equipment used by the cooperative observer.

2. Definition of a Cooperative Station. A cooperative weather observing station, under the direction of the National Weather Service (NWS), is a location at which weather observations are taken or other services rendered by private citizens, institutions or by other government agencies. Services rendered usually consist of taking instrumental or visual observations, recording data and transmitting reports. The equipment is usually owned by the NWS, but may be owned by an individual company, another government agency, or privately owned by the cooperative observer.

The equipment complies with NWSI 10-1302, Requirements and Standards for Climate Observations, and the station siting complies with standards set in NWSI 10-1307, *Cooperative Program Management and Operations*.

3. Reporting Elements. Although the majority of cooperative stations record precipitation amounts and maximum and minimum temperatures, each station is unique. For example, one station may record precipitation only, while another station may record precipitation, temperature, and evaporation. One or more of the following elements may be reported:

- |                    |                          |
|--------------------|--------------------------|
| a. Precipitation   | f. Water Temperature     |
| b. Air temperature | g. Soil Temperature      |
| c. River stage     | h. Atmospheric Phenomena |
| d. Evaporation     | i. Flash Flooding        |
| e. Wind Movement   |                          |

3.1 Precipitation. Measurements are taken and recorded daily of the amount of rainfall, snowfall (new snow), depth of snow, and for other forms of precipitation. Records are kept of the character, type, and time of occurrence. Each station is usually furnished with a non-recording or a weighing-type recording gauge.

3.2 Air Temperature. Measurements of the current air temperature and the maximum and minimum temperatures between observations are taken and recorded daily. Cooperative stations are provided with maximum and minimum thermometers and an instrument shelter for housing the thermometers, or an electronic thermometer system.

3.3 River Stage. Some stations take daily observations of river stages. These stations generally record precipitation, weather conditions, depth of snow or ice, and record the status of the river (rising or falling). The NWS furnishes an appropriate river gauge for the station.

3.4 Evaporation, Wind Movement and Water Temperature. Daily measurements of the amount of evaporation observed from an open, freely exposed pan are taken and recorded. Measurements are made of wind movement over the pan, temperature of the water, and temperature of the air. The stations are provided with:

- a. An evaporation pan with stilling well and calibrated refill cylinder.
- b. A totalizing anemometer.
- c. A maximum and minimum thermometer.

3.5 Soil Temperature. Selected stations record the soil temperatures daily. These stations are provided with soil thermometers or sensing elements to be installed at selected depths under undisturbed bare soil or under grass-covered soil.

3.6 Atmospheric Phenomena. Weather occurrences such as rain, cloud cover, hail, and thunderstorms are considered to be atmospheric phenomena. Phenomena of severe enough nature to threaten life and property are usually reported when they take place, rather than waiting to report them at the scheduled time of observation.

3.7 Flash Flooding. In areas where flash flooding may occur, observations of the conditions which cause flash flooding are reported promptly. These conditions include heavy rainfall, river or creek stage, and the formation or breakup of ice jams.

4. Establishing, Maintaining, and Inspecting Stations. In the cooperative program, the NWSREP is ordinarily the Data Acquisition Program Manager (DAPM), or the Observing Program Leader (OPL) or the Hydrometeorological Technician (HMT). At times, other staff persons such as Service Hydrologist, Intern, Meteorologist in Charge, Meteorologist, regional and national personnel, etc., who operate within the scope of the cooperative program are considered an NWSREP.

The National Weather Service Representative (NWSREP) selects a site to establish a station in accordance with 10-1302, *Requirements and Standards for Climate Observations*. When a station is established – not as relocation, the NWSREP submits a WS Form B-43 to their RCPM, and if approved prepare a WS Form B44, *Station Information Report*, once the station is established. The NWSREP is responsible for the installation of all furnished instruments and equipment.

The NWSREP should visit sites twice per year only if they have a recording precipitation gauge or an evaporation pan. Otherwise, all other sites should be visited once per year. An inspection report, WS Form 10-13-6, *Cooperative Station Inspection*, (i.e., Form B-23) or a locally developed form, is prepared for the station by the person who makes the visit. The information is entered into the Station Inspection section of the Cooperative Station Service Accountability (CSSA) system. For instructions see the NWSM 10-1313, *Cooperative Station Service Accountability (CSSA)*.

4.1 Observer Training. When establishing a station, the NWSREP will train the observer in the established techniques for taking a weather observation, recording the data, and the maintenance and care of instrumentation. The NWSREP will also train the observer in the safety and environmental work practices as outlined in NWSM 50-1115, *Occupational Safety and Health*, and NWSM 50-5116, *Environmental Management*. For a new observer, the NWSREP should closely monitor WxCoderIII (the web-based remote observation reporting system) or the Interactive Voice-Remote Observation Collection System (IV-ROCS) data entries, and provide positive or constructive feedback during the first month. During each site visit the NWSREP should discuss with the observer any problems with observing and recording weather data and any lapses with respect to the care and maintenance of the instrumentation.

4.2 Maintenance. Instruments and equipment furnished to the station should be maintained in accordance with any instructions issued with the instrument. In virtually all cases, it is the NWSREP's responsibility to install replacement parts. Instruments and equipment should not be moved or relocated without the approval of the NWSREP. If immediate action is necessary to prevent damage, the cooperative observer should notify the NWSREP promptly. The cooperative observer should also inform the NWSREP when the growth of vegetation, trees, shrubs, or other changes affect the exposure of instruments or equipment. Only upon NWSREP's approval, should the observer take action to remove or cut back the obstructions.

4.3 Requesting Supplies. Instruments and equipment, report forms, envelopes, and all other supplies are furnished by the NWSREP. The cooperative observer should advise the NWSREP promptly when any forms, supplies, or services are needed. This may be communicated with a phone call, e-mail, or a printed note mailed to the attention of the NWSREP at the Weather Forecast Office (WFO). For this reason, the NWSREP provides each observer updated contact information, once per year, to quickly facilitate supply requests from observers.

4.4 Reporting Equipment or Instrument Problems. NWS equipment and instrument problems should be reported to the NWSREP, in this way repairs or replacements can be arranged. The NWSREP brings the new or replacement parts to the Observer's site and performs the installation or repair. The NWSREP saves the original shipping boxes and internal shipping containers for the site visit, in the event the NWSREP needs to ship or transport broken or obsolete equipment to the WFO.

5. Preferred Time for Taking Observations. Observations at precipitation stations should be taken at 7 a.m. local time, however any time between 6am and 8am is usually acceptable if coordinated and approved by the NWSREP. Observations should be taken at the same time every day throughout the year if at all possible using standard time in the winter and daylight saving time in the summer if applicable.

While NCDC would prefer climatological observations be taken at midnight each day, this is not feasible for the observers. Therefore, stations reporting both precipitation and temperature should report at a time agreed to with the NWSREP. Unless otherwise directed, precipitation and temperature should be observed at the same time each day. Evaporation and soil temperature stations should observe all elements in the morning.

6. Resetting Instruments. The maximum and minimum thermometers and MMTS/NIMBUS will be reset once every 24 hours. This is done manually immediately after the instruments have been read at the official time of observation. Non-recording precipitation gauges should be emptied after being read once each 24 hours. Thermometers and other temperature instruments should be reset only at the official time of observation. Instruments may be read at intermediate times, but they should not be reset.

7. Forms. The NWS will furnish all printed forms, where applicable, for recording weather data. The cover page for each pad of forms contains the reporting instructions. The cooperative observer should be instructed to enter their station name, county, state, month and year, time of observation, etc., on all forms. Existing and newly recruited observers with internet connectivity should be strongly encouraged to use WxCoderIII, and observers without an internet connection should be encouraged to use IV-ROCS to submit their daily observations. WS Form B-82 makes a convenient daily logbook for the observer's use.

7.1 Legibility. A legible record adds credibility to the historical record. A form that is difficult to read loses value. Use a black ball-point pen. The observer should draw a single line through erroneous entries. The correct entry can be written above, below, to the right or left of the line. If more space is needed, enter data in the remarks column for that day.

7.2 Disposition of Forms. The original observation form is mailed to the NWSREP, promptly. Most forms are monthly record sheets, and so this is ordinarily done in the first five days of the month. The observer should make one copy to serve as the official record if the original gets lost. The copy should be kept until the original is officially certified by NCDC. The NWS will furnish postage-paid envelopes for mailing forms.

8. Paperless Data Transmission. Paperless data transmission modes through personal computer and web-based servers (i.e., WxCoderIII) and touch tone telephone transmission (i.e., IV-ROCS) or other approved National Oceanic and Atmospheric Administration (NOAA) supported paperless systems will follow the procedures developed and updated by the NWS and the National Climatic Data Center (NCDC).

Phone or email your NWSREP if you have questions on the current status of WxCoderIII and IV-ROCS programs.

9. Figures. Some pictures in this document are for display purposes and do not necessarily meet siting or suggested criteria.

**APPENDIX A Precipitation**

<u>Table of Contents:</u>	<u>Page</u>
1. Introduction.....	A-4
2. Precipitation Gauges.....	A-5
3. Exposure of Gauges.....	A-5
4. Types of Precipitation Gauges.....	A-6
4.1 Eight-Inch Non-Recording Standard Precipitation Gauge.....	A-6
4.1.1 Installation.....	A-7
4.1.2 Maintenance.....	A-8
4.2 Four-Inch Non-Recording Gauge.....	A-8
4.2.1 Installation.....	A-9
4.2.2 Maintenance.....	A-9
4.3 Weighing Recording Gauge.....	A-9
4.3.1 Universal Weighing Precipitation Gauge.....	A-10
4.3.1.1 Calibration and Equipment Problems.....	A-10
4.3.1.2 Gaining Access to Bucket and Chart Mechanism.....	A-10
4.3.1.3 Preparation of Charts.....	A-11
4.3.1.4 Installing and Removing Charts.....	A-11
4.3.1.5 Changing Charts on Gauges.....	A-12
4.3.1.6 Completing the Charts.....	A-13
4.3.2 Fischer & Porter Punch Tape Gauge.....	A-13
4.3.2.1 Operation and Maintenance.....	A-14
4.3.2.2 Setting the Tape to the Correct Time.....	A-15
4.3.2.3 Winter Operation.....	A-16
4.3.2.4 Routine Maintenance.....	A-18
4.3.3 Fischer & Porter Upgrade (FPU) Gauge.....	A-18
4.3.3.1 Equipment Cluster.....	A-20
4.3.3.1.1 Data Logger Enclosure.....	A-20
4.3.3.1.2 Data Logger Display.....	A-21
4.3.3.2 Routine Checks.....	A-22
4.3.3.2.1 Rain Parameter.....	A-22
4.3.3.2.2 24-Hour Rain Difference Parameter (24RainDiff).....	A-23
4.3.3.3 Notation Codes Instead of “ON/OFF” Times.....	A-23
4.3.3.3.1 Notation Code List for Observer.....	A-24
4.3.3.3.2 How to Add a Notation.....	A-24
4.3.3.3.3 Checking Date or Time.....	A-25
4.3.3.4 Monthly Data Retrieval.....	A-26
4.3.3.4.1 Insert Data Key.....	A-26
4.3.3.4.2 Monitor the Display.....	A-27

<u>Table of Contents:</u>		<u>Page</u>
4.3.3.4.3	Verify the Start of Download.....	A-27
4.3.3.4.4	Remove Key.....	A-28
4.3.3.4.5	Mail the Data Key.....	A-29
4.3.3.5	FPU Bucket Draining.....	A-29
4.3.3.6	Inspect the Hardware and Visual Check List.....	A-29
4.3.3.7	NWSREP Seasonal Maintenance .....	A-29
4.3.3.7.1	Winterizing the FPU .....	A-31
4.3.3.7.2	FPU Summer Maintenance .....	A-31
4.3.4	Fischer & Porter Rebuild (FPR) Gauge.....	A-32
4.3.4.1	Equipment Cluster .....	A-32
4.3.4.1.1	Weighing Sensor.....	A-32
4.3.4.1.2	Precip Recorder Display .....	A-33
4.3.4.2	Viewing the Menus.....	A-34
4.3.4.3	Routine Checks.....	A-35
4.3.4.3.1	Precip Parameter .....	A-35
4.3.4.3.2	Date and Time.....	A-36
4.3.4.3.3	Spare Memory Card.....	A-36
4.3.4.4	Monthly Data Retrieval .....	A-36
4.3.4.4.1	Insert Memory Card.....	A-37
4.3.4.4.2	Display Responds .....	A-37
4.3.4.4.3	Verify the End of Download.....	A-37
4.3.4.4.4	Remove Card .....	A-37
4.3.4.4.5	Enclose for Mailing .....	A-38
4.3.4.5	Review the Log Sheet.....	A-38
4.3.4.6	Mail the Memory Card .....	A-38
4.3.4.7	Journal Responsibilities .....	A-39
4.3.4.7.1	Continuous Automated Logging.....	A-39
4.3.4.7.2	Bucket Maintenance Journal Entries .....	A-39
4.3.4.7.3	Log Sheet .....	A-40
4.3.4.8	NWSREP Seasonal Maintenance .....	A-40
4.3.4.8.1	FPR Bucket Draining.....	A-42
4.3.4.8.2	Winterizing the FPR .....	A-42
4.3.4.8.3	FPR Summer Maintenance .....	A-42
5.	Gauge Supplies .....	A-43
6.	How to Measure Rainfall.....	A-43
6.1	Fischer & Porter Gauge .....	A-43
6.2	Universal Weighing Gauge.....	A-43
6.3	Four-Inch Non-Recording Gauge .....	A-43
6.4	Eight-Inch Non-Recording Gauge .....	A-43
7.	Measuring the Depth of Frozen Precipitation.....	A-45



7.1	Definition .....	A-45
7.2	Snow Measurement Stick .....	A-45
7.3	Measuring New Snow Falling on Top of Old Snow.....	A-46
7.4	Snow Measurement Boards .....	A-47
7.5	Snow Measurement Stakes .....	A-48
8.	Measuring the Water Equivalent of Snowfall.....	A-48
9.	Obtaining Core Samples of Snow.....	A-49
10.	Measuring Snow Pack Water Equivalent .....	A-50
11.	Keeping and Mailing Records .....	A-51
11.1	Purpose.....	A-51
11.2	WS FORM B-82, “Official Weather Observer’s Record”.....	A-52
11.3	WS FORM B-91, “Record of River and Climatological Observations” .....	A-53
12.	Real-Time Reporting of Precipitation, Temperatures, and Hazardous Weather Events ....	A-54

Figures:

Page

A-1	Wind Shield .....	A-5
A-2	Eight Inch Gauge .....	A-5
A-3	Fischer & Porter Gauge Mounted on a Snow Tower with Wind Shield .....	A-6
A-4	Eight-Inch Precipitation Gauge Components .....	A-7
A-5	Measuring Stick Close Up .....	A-7
A-6	Eight-Inch Gauge .....	A-8
A-7	Four-Inch Plastic Gauge .....	A-8
A-8	Four-Inch Measuring Tube Close-up.....	A-8
A-9	Universal Weighing Recording Gauge .....	A-9
A-10	Fischer & Porter Recording Gauge.....	A-9
A-11	Front Open View of Universal Gauge .....	A-11
A-12	Fischer & Porter Recorder Components View with Cover Removed.....	A-16
A-13	Fischer & Porter Equipment Cluster.....	A-18
A-14	Upgraded F&P Gauge with Cover Removed.....	A-19
A-15	FPU Front View of Load Cell.....	A-19
A-16	Data Logger Box.....	A-20
A-17	Components - Data Logger Box .....	A-21
A-18	Data Logger .....	A-22
A-19	Rain Parameter.....	A-23
A-20	24-Hour Rain Difference Parameter .....	A-23
A-21	Data Logger Keypad.....	A-24
A-22	New Sensor Notation .....	A-25
A-23	Value Accepted.....	A-25
A-24	Date and Time.....	A-26

A-25	Data key Receptacle.....	A-27
A-26	Data key Activated.....	A-27
A-27	Data key Insertion.....	A-27
A-28	Transfer Data .....	A-28
A-29	Download Complete .....	A-28
A-30	F&P Access Door .....	A-32
A-31	FPR-D Logger Mounted in Shell.....	A-32
A-32	FPR-D Contained in Shell .....	A-32
A-33	Display Screen .....	A-33
A-34	Precip Recorder – Arrow Buttons Visible.....	A-33
A-35	SD Memory Card.....	A-34
A-36	Home Menu .....	A-34
A-37	Primary Menus.....	A-34
A-38	Battery Display .....	A-35
A-39	Station Name Display .....	A-35
A-40	Arrow Buttons.....	A-35
A-41	Precip Readout.....	A-36
A-42	Memory Card Slot.....	A-37
A-43	Download Start Display.....	A-37
A-44	Download Progress .....	A-37
A-45	Download Completed .....	A-37
A-46	The ‘Off’ Button .....	A-38
A-47	Memory Card Cover .....	A-38
A-48	Mailing Envelope.....	A-38
A-49	Log Sheet Required .....	A-40
A-50	Eight-Inch Gauge with Measuring Stick Inserted.....	A-44
A-51	Measuring Tube with Funnel on Top .....	A-44
A-52	40-Inch and 20-Inch Snow Stick .....	A-46
A-53	Snow Stick Graduated Scale to a Tenth of an Inch .....	A-46
A-54	Snow Measurement Board (On Old Snow).....	A-47
A-55	Snow Measurement Board.....	A-47
A-56	Snow Measurement Stake.....	A-48
A-57	WS Form B-82.....	A-52
A-58	WS Form B-91.....	A-53

**Appendix A - Precipitation**

1. Introduction. There are two basic types of precipitation; liquid and solid. Liquid precipitation includes rain and drizzle. Since precipitation, by definition, falls to the ground, dew (which forms on surfaces) is not precipitation. Solid precipitation includes snow, hail, ice pellets (sleet), snow pellets, ice crystals, and other types. Precipitation is measured in terms of its accumulation:

- a. Liquid (including the water equivalent of solid precipitation which has melted) precipitation is measured to the nearest hundredth of an inch.

b. Solid precipitation is measured to the nearest tenth of an inch.

2. Precipitation Gauges. In its simplest form, a precipitation gauge is an open-mouthed can with straight sides and the open end that faces upward with the mouth positioned level as determined by a carpenter's level. Precipitation gauges are commonly called rain gauges. Recording gauges record the amount of precipitation falling per unit time on a chart (a punch tape or rotating drum) or electronically. See Section 4, Types of Precipitation Gauges.

3. Exposure of Gauges. Accurate and consistent measurements are obtained from properly exposed precipitation gauges. Gauges should not be located close to obstructions such as trees and buildings, which may deflect precipitation due to turbulence. Gauges should not be located in wide-open spaces or on elevated sites, such as tops of buildings because of wind and the resulting turbulence. The best location is where the gauge is uniformly protected in all directions, such as an opening in a grove of trees.

As a general rule: the windier the gauge location, the greater the under catch. Gauge catch should be maximized by assuring it is unobstructed. Buildings, trees or any object that obstruct catch create a bias in the amount. Optimally when siting a precipitation gauge, the height of the obstruction should not exceed twice its distance from the gauge (not to exceed a 30° angle at the gauge).



Figure A-1. Wind Shield



Figure A-2. Eight Inch Gauge

Wind shields, also known as snow shields (Figure A-1), can minimize under catch. Because of its light weight and propensity to blow about more easily than raindrops, snow is prone to under catch more than rain. Figure A-2 is an 8-inch gauge without the wind shield.

In areas where heavy snowfall occurs; e.g., mountainous areas in the western U.S., gauges may be mounted on towers at a height considerably above the maximum level to which snow accumulates, but at or somewhat below the level of tree tops. (See Figure A-3).

Good exposures are not always permanent. Man-made alterations to the area and the growth of

vegetation may change an excellent exposure to an unsatisfactory one in a very short time. This will force the NWSREP to move the gauge to a location with a better exposure. Try to avoid this by anticipating changes when selecting a site.



Figure A-3. Fischer & Porter Gauge  
Mounted on a Snow Tower with Wind  
Shield

4. Types of Precipitation Gauges. The specific types of gauges approved for measuring precipitation are:

- |    |                             |    |                            |
|----|-----------------------------|----|----------------------------|
| a. | Non-recording               | b. | Recording (weighing type)  |
|    | (1) eight-inch gauge        |    | (1) Fischer & Porter gauge |
|    | (2) four-inch plastic gauge |    | (2) Universal gauge        |

4.1 Eight-Inch Non-Recording Standard Precipitation Gauge. This gauge (Figure A-4) consists of a support, large diameter overflow can, measuring stick, smaller diameter measuring tube inside the overflow can, a funnel that connects the overflow can and measuring tube. The overflow can and top of the funnel are eight inches in diameter. The funnel directs precipitation into the measuring tube, which is 2.53 inches in diameter. The reduction in area from 8 inch diameter of the funnel to 2.53 inches diameter of the tube results in one to ten multiplication in the height of the volume. Therefore, 2 inches of rain entering the funnel will occupy 20 linear inches in the measuring tube, making it possible and practical to read rainfall amounts to the nearest hundredth, scaled inch.

The measuring stick is marked to indicate this expansion; 20 linear inches on the stick equals 2 inches of rainfall. Therefore the smallest increments on the measuring stick, the 0.01 inch rainfall tick marks, are actually  $1/10^{\text{th}}$  linear inch apart, (See Figure A- 5). The inner measuring tube is 20 inches tall and holds exactly 2 inches of rainfall. Rainfall which overflows the measuring tube is captured by the overflow can and is measured by pouring the excess water into the measuring tube with the funnel attached, as shown - after the initial two inches gets discarded. Now use the measuring stick to read the excess water in tube and add this amount to 2.00, to get the total.



Figure A-4. Eight-Inch Precipitation Gauge Components



Figure A-5.  
Measuring  
Stick Close  
Up

4.1.1 Installation. Firmly install the metal support (Figure A-6) for the eight-inch standard precipitation gauge to prevent it from being overturned. The top of the gauge must be level. This should be checked by laying a level across the open top of the gauge in two directions, one crossing the other at right angles.



Figure A-6. Eight-Inch Gauge

4.1.2 Maintenance. If the cooperative observer re-levels the gauge, the observer should add a note to the observation form giving the date the defect was discovered and the date corrected. Leaks in the measuring tube or overflow should be reported immediately to the NWSREP. In areas that receive frozen precipitation, the funnel and inner measuring tube should be removed before any frozen precipitation event. The funnel should be inspected and cleaned before each precipitation event to ensure an accurate catch.

4.2 Four-Inch Non-Recording Gauge. The four-inch non-recording gauge (Figure A-7) consists of the outer overflow tube (lower center), measuring tube (left), a funnel (top) that catches the precipitation and directs it into the inner measuring tube, and a mounting bracket with screws (lower right). The gauge is made of clear plastic. No measuring stick is needed because the transparent inner measuring tube (Figure A-8) is graduated to hundredths of an inch. The inner measuring tube holds one inch of precipitation. Additional amounts will flow into the overflow tube and can be measured by pouring the excess into the graduated measuring tube with the funnel attached once you discard the first inch. Read the amount of excess water and add it to 1.00 inches to get the total. Repeat these steps until all the excess water gets measured to produce the total rainfall.



Figure A-7. Four-Inch Plastic Gauge



Figure A-8. Four-Inch Measuring Tube Closeup

4.2.1 Installation. The installation of the four-inch plastic gauge should follow the same guidelines as the standard eight-inch rain gauge. The gauge is installed on a bracket provided with the gauge and is held in place with screws driven into a post or similar permanent mount. The top of the funnel should be well above the top of the post or similar mount for optimum exposure.

4.2.2 Maintenance. Little maintenance of the plastic gauge is needed. The measuring tube should be easy to read. If the plastic becomes “clouded” from exposure, the measuring tube or the gauge should be replaced. In areas that receive frozen precipitation, the funnel and inner measuring tube should be removed before any frozen precipitation event.

4.3 Weighing Recording Gauge. The weighing-type recording gauge is designed to record the amount of precipitation in a capture bucket at periodic intervals; F&P usually every 15 minutes and the Universal to the nearest minute. From this time series record of gain or loss, rate and accumulation can be calculated. The precipitation mass is measured in hundredths (Universal) or tenths (F&P) of an inch per unit time. These gauges consist of a receiver with an inside diameter of exactly eight inches that funnels precipitation into a collector mounted on a weighing mechanism. There are two types of weighing gauges approved by the NWS:

- a. The Universal Gauge (Figure A-9), and
- b. The Fischer & Porter (Figure A-10) Gauge.



Figure A-9. Universal Weighing Recording Gauge



Figure A-10. Fischer & Porter Recording Gauge

4.3.1 Universal Weighing Precipitation Gauge. Precipitation falls into the Universal gauge funnel and into a collector mounted on a weighing mechanism. The weight of the precipitation in the collector compresses a spring, which is connected to a pen arm. Ink from the pen leaves a trace on a paper chart, which is wrapped around a clock-driven cylinder. The cylinder rotates continuously, making one revolution hourly, daily, weekly or monthly based on the gears of the clock. Ink tracings on the chart provide a “history” of precipitation amounts over time.

Charts are graduated to the nearest .05 inch and may be estimated to the nearest .01 inch by interpolating between the graduations. The total capacity of the gauge varies from 2.4, 6 or 12 inches, depending on the model. Each type of gauge uses a different chart graduated for its specific range

4.3.1.1 Calibration and Equipment Problems. The Universal gauge requires calibration and other adjustments semi-annually. This is completed by the NWSREP with special equipment. Clock failure, or any trouble that cannot be corrected by the cooperative observer, should be reported immediately to the NWSREP.

4.3.1.2 Gaining Access to Bucket and Chart Mechanism. Access to the chart and bucket is necessary in order to read or change the chart, wind the clock, or empty the bucket. Most universal gauges have an inspection door large enough to provide access to the clock and chart.



Figure A-11. Front Open View of Universal Gauge

4.3.1.3 Preparation of Charts. The following information is entered into the spaces provided on



the chart before placing the chart on the cylinder:

- a. Station name and station number as specified by the NWSREP.
- b. Date and local time, to the nearest minute, the pen will be placed on the new chart.

Indicate A.M. or P.M. as appropriate. When Daylight Saving Time is used locally, a “D” is entered following A.M. or P.M. For example, if the chart is changed in the morning, A.M.D. is entered.

4.3.1.4 Installing and Removing Charts. Charts should be changed on all of the following occasions:

- a. At the end of the chart (Usually once a week).
- b. On the first day of each month, and
- c. Within 24 hours after the ending of any precipitation.

Charts should not be changed during rain that is heavy enough to wet the trace and cause the ink to spread. Rather than changing the chart, the bucket should be emptied during heavy rain when it may overflow or the capacity of the chart may be exceeded.

When charts are installed or removed, a vertical mark should be inserted about 1/4 inch long on the chart (trace). This is accomplished by gently touching the weighing mechanism which moves the pen. This mark serves as a time check. If the pen does not produce a trace on the chart, a small dot should be placed on the chart to mark the position of the pen. A circle should be drawn around the dot for identification, and a note of explanation entered on the chart (e.g., “chart removed”).

4.3.1.5 Changing Charts on Gauges.

- a. Raise the sliding door and make a time check on the chart.
- b. Remove the pen from the chart by shifting the pen bar forward.
- c. Remove the upper portion of the case that includes the funnel. This is called the receiver. Also, remove the funnel for winter season.
- d. Empty and replace the bucket (this is based on the best judgment of the observer and NWSREP). Recharge with **food grade Propylene Glycol** (hereafter referred to as propylene glycol) and oil as directed by the NWSREP and for winter operation add extra propylene glycol in anticipation the expected volume of collected precipitation by winter’s end. For summer operation, the pen on the universal gauge should rest between the one and two inch lines after propylene

glycol and oil have been added.

- e. Remove the chart drum retaining nut.
- f. Grasp the cylinder at the top and gently lift it over the spindle.
- g. Release the clip holding the chart. Avoid touching or storing the chart in a way that will cause the trace to be smeared before it dries.
- h. Wind the clock. **Caution:** The clock may stop if wound too tight.
- i. Wrap the new chart around the cylinder, so it fits smoothly and snugly on the cylinder and uniformly against the flange on the bottom.
- j. The clip is a replaceable item and should be replaced if it fails to hold the end of the paper. Ensure the corresponding ends of each “inch” line coincide where they meet. The exposed end of the chart extends 1/4 inch to the right of the clip.
- k. The cylinder can be reinstalled. It should be lowered gently over the spindle until the gears mesh and replace the retaining nut.
- l. If necessary, re-ink the pen or replace it with a gas-line type pen. Return the pen almost to the surface of the chart. Ensure it reads within .025 inch of the last reading on the previous chart. The chart should read zero if the bucket is empty.
- m. With the pen almost touching the chart, the cylinder should be turned until it reads three hours fast, and then turned back so it reads the correct time. Write the start time on the chart.
- n. Return the pen to the chart. Make a time check. The weighing mechanism should be touched to make a 1/4 inch vertical time mark on the chart. The shield and receiver can be reinstalled.

4.3.1.6 Completing the Charts. After the chart has been removed from the gauge, verify the following has been entered on the chart:

- a. Station name.
- b. The local time and date of removal. (See Section 4.3.1.3)
- c. The time check mark was made when the chart was installed and removed.
- d. Notes that will explain unusual or missing parts of the trace. The gauge should be inspected daily to ensure the clock is running and the pen is making a trace. If the clock has stopped and cannot be restarted, the cylinder should be turned forward ½ inch each day until the clock is replaced. The chart should be replaced in

accordance with Section 4.3.1.4, or when the chart drive is replaced. The cooperative observer should contact the NWSREP promptly for a replacement of the chart drive.

- e By the 5<sup>th</sup> day of month, mail all of the Universal charts from the most recently completed month, to the Weather Forecast Office (WFO), to the attention of the NWSREP. Use the same type of envelope you use to mail the Fischer & Porter punch tape records.

4.3.2 Fischer & Porter Punch Tape Gauge. In the early 1980's the Belfort Instrument Company took over manufacturing of this gauge from the Fischer & Porter Company. Precipitation amounts are recorded at 0.1 inch increments. The maximum capacity is approximately 22 inches, however 19.5 inches is the maximum recorded. The F&P punches holes in a paper tape on a moving scroll every 15 minutes. Although the punch tape is designed for automatic machine processing, it may be read visually by summing the values of the holes punched. Punches are made for the following values: 0.1, 0.2, 0.4, 0.8, 1.0, 2.0, 4.0, 8.0, and 10.0 inches. For a precipitation amount of 3.7 inches, the following punches would be made: 2.0, 1.0, 0.4, 0.2 and 0.1 inches, the sum of which equals 3.7 inches.

An illustrated instruction bulletin is provided with each instrument. It should be consulted for details on any specified model. The Fischer & Porter gauge is powered by a 6 volt DC battery as illustrated in Fig A-10. The battery is recharged in the field by a solar panel. The measuring device consists of:

- a. a collection bucket for captured precipitation,
- b. a weighing device, and
- c. an indicator dial showing the amount of precipitation collected

4.3.2.1 Operation and Maintenance. The NWSREP will place the gauge in operation and explain to the observer how it operates. The cooperative observer should be instructed to do the following:

- a. Inspect the gauge weekly to ensure that the tape is positioned at the proper time. Figures on the left side of the tape indicate the days. Make a dial reading and enter it on the tape. If the time indicated on the tape is in error by more than an hour (4 spaces) from local time, reset it to the correct time. Annotate the time correction on the tape. Refer to Section 4.3.2.2 for instructions on setting the tape to the correct time. Do not force manual punches before adjusting or removing the tape.
- b. Read the dial indicator to understand the volume of collected precipitation fluid in the bucket. If freezing conditions are expected in the weeks and months ahead, the dial values of 3.5 inches, 7.0 inches, 10.5 inches, and 14.0 inches are reference levels for how much propylene glycol to add to the bucket (see next paragraph).

- c. If the reading on the indicator dial is near or exceeds 10 inches, remove the upper hood. Either, remove and empty the bucket\* or unhook the plastic drain tube from the rim of the collector bucket and lower it to drain. The fluid should be collected in a container and retained for collection in accordance with instructions provided by the NWSREP. Return the bucket\* to the force post or replace the drain tube on the collector. In warmer weather, add oil to the bucket. It is supplied by the NWSREP. For winter operation, turn to Section 4.3.2.3, and follow instructions to remove funnel, empty bucket, add propylene glycol, and add oil to the bucket. To prevent accumulating liquid from freezing and risking damage to bucket, you add propylene glycol as bucket levels rise. Maintain the concentration specified in the table in Section 4.3.2.3, by adding propylene glycol each time your dial indicator reads 3.5 inches, 7.0 inches, 10.5 inches, and 14.0 inches (i.e., 4 inches past one full revolution of the dial). Then, replace the hood. Write the date and time on the tape along with a note indicating the bucket had been emptied, and that oil/propylene glycol has been added. Contact the NWSREP for instructions.

\* Be especially careful when removing or replacing the bucket. Too much force will damage equipment.

- d. As soon as possible after the beginning of each month, remove the punched portion of the tape from the black take-up spool. Before removing the tape, draw a line along the top of the punch block for a gauge time versus local time reference. Annotate the tape with station name and number, date and time information as instructed by the NWSREP. Advance the tape to provide 20 inches of blank tape following the punched portion. Tear or cut the tape above the punch block and remove by slipping it off the end of the black take-up spool. Include any other information that may be helpful in processing the tape.
- e. Check the amount of tape remaining on the spool. Install a new roll of tape when necessary. Thread the loose end of the tape from the supply roll under the tension spring, through the punch block behind the guide bar, and onto the take-up spool. The printed side of the tape should face you and be properly threaded through the punch block and paper guides.
- f. Set the tape to the correct time (Section 4.3.2.2 below) and mark the station name, station number, start time, date and month on the tape.
- g. Remove, empty, and replace the Chad tray.
- h. Close and fasten the door with both latches to keep out dust and moisture. Insert the latch cover in its retainer on the base of the gauge. The slot near the top should be over the padlock eye on the hood. The latch cover need not be installed if it is not necessary to lock the gauge.

- i. Put the punched tape for the past month in one of the mailers supplied by the NWSREP and mail by the 5<sup>th</sup> of the month. A mailing address should be stamped on the mailer. If not, obtain the address from the NWSREP and request new mailers properly addressed.

4.3.2.2 Setting the Tape to the Correct Time. The electronic timer (Figure A-12) will trigger the gauge to punch every 15 minutes. The power switch must be “ON.” The best time to change the tape is immediately after a routine punch. This will allow 15 minutes to change the tape without missing any readings. The Model III timer has two buttons and a window on the front face. The window allows the observer to see the LED timer. The right button is pressed to light the LED while the left button is pressed to advance the time. The timer should be set to the number of minutes past the last scheduled punch time.

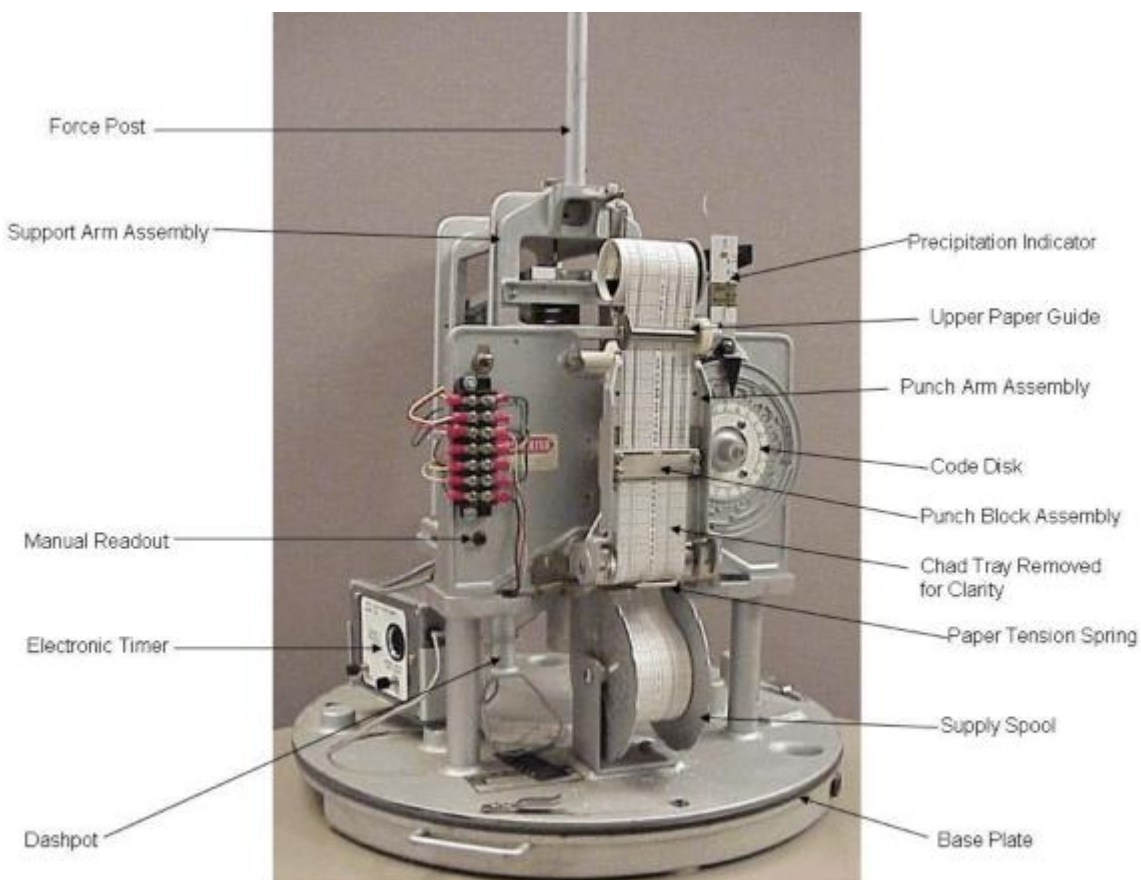

Figure A-12. Fischer & Porter Recorder Components View with Cover Removed

Set the tape to the correct time, as follows:

- a. With the power switch “OFF,” feed the tape through the punch block onto the take-up spool. Continue feeding the tape until the first time line to appear above the punch block reads two hours before the current time. (See Figure A-12).

- b. Turn the power switch to the “ON” position and push the button to advance the tape eight punches or until the time line on the tape corresponding to the next 15-minute time interval is lined up with the holes in the punch block. Next, draw a line across the tape just above the punching block, using a felt tip pen. Write the date and time on the tape above the punch block. This reference will determine the actual start of the record. The next punch should occur at the next 15-minute clock interval and it should agree with the time shown by the tape within 15 minutes. Hold the button down 5 seconds for each punch.

4.3.2.3 Winter Operation. During the season when frozen precipitation (except hail) or freezing temperatures are likely to occur; recording gauges need to be winterized, as described below:

- a. At the start of winter, remove funnel from the collector. Store it in base of gauge.
- b. Empty the collection bucket with the drain tube into a five gallon container. If there is any doubt about your ability to drain and then remove the bucket contact your NWSREP for instructions. **Caution:** a full bucket can weight 40 pounds.
- c. Return the empty bucket to its regular position to ready the bucket for its charge of propylene glycol. Following the propylene glycol you will add one quart of oil. Do not use commercial anti-freeze or add water.
- d. Initial charge: Into the empty bucket, pour an amount of propylene glycol as specified by one of the three temperature categories listed in this table. Choose the category that offers protection against the coldest condition possible for the site. Make an initial charge of 1.0 quart of propylene glycol if the coldest the site could get is 15°F.

Coldest Temperature	Initial charge and subsequent charges of propylene glycol. When dial indicator reads 3.5 inches, 7.0 inches, 10.5 inches, and 14.0 inches, add this amount of propylene glycol.	To Maintain this Concentration
+ 15° F	1.0 quart	25%
0° F	1.5 quarts	35%
- 30° F	2.0 quarts	50%

Note: An initial 2 quarts charge of propylene glycol produces a height of just one inch in bucket.

- e. Subsequent Charges: When visual inspection of dial indicator shows the level has reached 3.5 inches add the specified amount of propylene glycol; for example the coldest category sites (- 30°F) require 2 quarts be added. Always add the same amount as the initial charge. If you had not serviced the bucket at either 3.5 inches, or 7.0 inches, or 10.5 inches and now notice the bucket holds 11 inches, and you are in the coldest category, then pour six quarts of propylene glycol to

maintain the 50% concentration. To prevent the bucket contents from ever freezing add propylene glycol per the schedule in the above table at 3.5, 7.0, 10.5, and 14.0 inches.

- f. Install one quart of oil after the initial charge of propylene glycol. For sites more prone to evaporation, these include tropical sites and sites with windy conditions with low relative humidity; ensure a film of oil is visible after draining water/propylene glycol mixture. Use NWS supplies, only.
- g. Make no adjustments to the gauge after propylene glycol and/or oil has been added.
- h. Document the date and hour each time the bucket was charged with propylene glycol and/or oil. For legacy gauges mark the paper tape with a brief note (i.e., added propylene glycol and/or oil at 2PM March 16, 2010). For FPU gauges enter a notation in the data logger, see Section 4.3.3.7, NWSREP Seasonal Maintenance. For FPR gauges write Log Sheet entry, according to Section 4.3.4.7, Journal Responsibility.

4.3.2.4 Routine Maintenance. The following actions should be taken during the year:

- a. Empty or drain the F& P gauge when 15-inches are reached. The new indicated gauge level should not be adjusted. Follow the management of waste procedures in NWSM 50-5116 Section 2 (2.11.2b). **Contact the NWSREP for instructions.**
- b. Change tapes on the F&P gauge on or after the first of each month (never change the tape before the first of the month).
  - (1) The observer should notify the NWSREP when additional propylene glycol/oil or other materials are needed.
  - (2) Charts or tapes should be mailed as instructed by the NWSREP.

4.3.3 Fischer & Porter Upgrade (FPU) Gauge. This equipment replaces the paper tape mechanism and provides an electronic data record. The upgrade is comprised of three components; the new precipitation sensor located in the base of the gauge; the data logger inside the stainless steel box; and the solar power panel also mounted to the new pole (Figure A-13). The weighing sensor (load cell) is to the right with inside pictures (Figures A-14, A-15). The weighing sensor is the small block at the bottom of the frame.



Figure A-13. Fischer & Porter Equipment Cluster





Figure A-14. Upgraded F&P Gauge with Cover Removed



Figure A-15. FPU Front View of Load Cell

#### 4.3.3.1 Equipment Cluster.

4.3.3.1.1 Data Logger Enclosure. The enclosure is comprised of a stainless steel box that houses the data logger, battery, and a data key receptacle, see Figure A-16. To open the box, unfasten the spring clip located on the right-hand side of the enclosure's front panel. Your NWSREP will affix a reference card showing the notation codes to the inside of the door panel. The components of the Data Logger are highlighted in Figure A-17.



Figure A-16. Data Logger Box

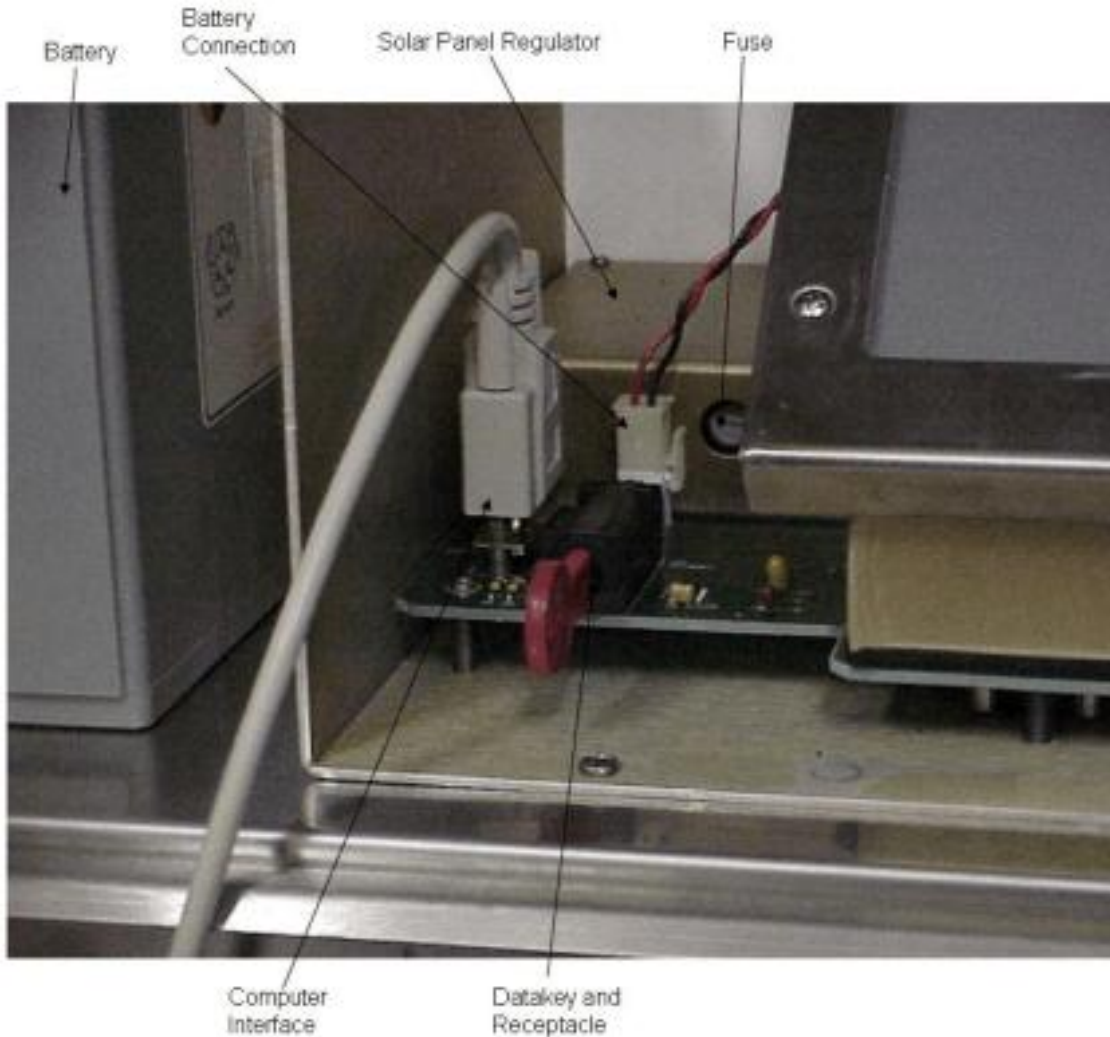

Figure A-17. Components - Data Logger Box

4.3.3.1.2 Data Logger Display. Press the <ENT> button on the data logger's keypad to wake-up the green fluorescent display. The user display (Figure A-18), is situated together with the data logger's 16-button pad. The keypad's user commands are called-up by pressing the <Up-arrow> and <Down-arrow> buttons.



Figure A-18. Data Logger

The keypad menus let you: change the date and time, change the displayed units of measurement, and enter a note into the data similar to when you drew a line and entered the “ON date/time” to an F&P paper tape. To return to the default data display, continue pressing the **<Up-arrow>** button until the current readings appear.

Data is displayed for five seconds at a time in an alternating pattern to show the current bucket level and then the precipitation for the 24 hours ending at midnight. If the keypad is not used for 5 minutes, it will return to the ‘sleep mode’, and the green fluorescent characters will not appear on the display – the screen goes dark.

4.3.3.2 Routine Checks.

4.3.3.2.1 Rain Parameter. This is the current level of liquid in the bucket, not just precipitation, from whenever the bucket was last serviced. The display (Figure A-19) updates every 10 seconds.

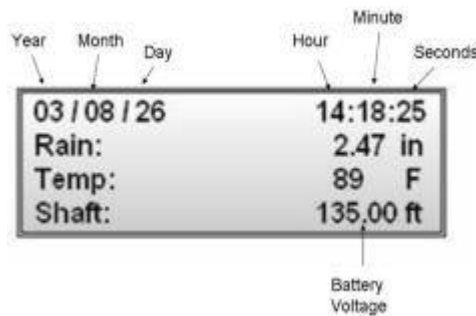

Figure A-19. ‘Rain’ Parameter

**Note:** The **Rain** parameter gives the total amount of liquid in the bucket. This includes any propylene glycol, oil, or water from collected precipitation. Special instructions apply if you have emptied the gauge bucket in the middle of the month. See Section 4.3.3.5, ‘FPU Bucket Draining’.

4.3.3.2.2 24-Hour Rain Difference Parameter (24RainDiff). This is the difference between the rain reading of the most recent midnight, and the Rain reading from the preceding day’s midnight. The **24RainDiff** display (Figure A-20) is a data reading that updates once every 24 hours.

03 / 08 / 26	14:18:25
24RainDiff:	0.04 in
Temp:	89 F
Shaft:	135.00 ft

Figure A-20 24-Hour Rain Difference Parameter

**Caution:** Never use the **24RainDiff** parameter when entering data on the B-91 report, because midnight is invalid as your station’s standard observation time. Also, there are several conditions when the **24RainDiff** will not be valid (i.e., bucket drained on same day).

4.3.3.3 Notation Codes Instead of “ON/OFF” Times. The FPU data logger continues to run un-interrupted while you perform the critical monthly task of downloading precipitation data to the red plastic data key. Therefore, you do not need to personally account for an “OFF” time, and “ON” when you collect the data. While the FPU has no punch tape for you to enter “ON/OFF” times, it does have a user interface, the keypad, where you may enter a 3-digit code for the record, to remark how a certain action interrupted the continuity of the data record!

There are FPU actions you may take, upon the direction of the NWSREP, that will affect the weight of the collection bucket, or somehow interrupt the logging of valid data. For example, any type of bucket draining or adding of propylene glycol or oil will interrupt the continuity of data. For these actions you first enter code 100, ‘End of Valid Data,’ prior to the task. This is analogous to the “OFF Date/Time” notation you entered on the F&P Punch Tape. When your task(s), are concluded you must always enter code 140, ‘Start of Valid Data’. This is analogous to the “ON Date/Time” notation.

In addition, your NWSREP will enter a Notation Code when he conducts a maintenance visit. For example, when the NWSREP partially drains the bucket, code 162, ‘partially drained bucket’ is entered but for the observer the code is 116 ‘partially emptied’. Likewise, when propylene glycol is added, code “164” is entered, but for the observer 118, and when oil is added, code “163” is entered, but the observer enters 117. See the *NWSREP’s FPU Operations Manual* for the complete list.

When a Notation Code is entered to the keypad, a valuable, unchangeable, and permanent note is entered into the electronic record. The National Climatic Data Center (NCDC) archives the Notation Code as it is embedded with the precipitation data.

4.3.3.3.1 Notation Code List For Observer. To review your list of appropriate 3-digit codes follow these descriptions for codes 100 to 140:

**Value Meaning of value**

100	End of Valid Data	117	Added Oil to bucket
103	Time is more than 15 minutes fast/slow	118	Added Propylene Glycol
104	Routine Gauge Check	125	Installed Funnel
115	Emptied bucket - bucket completely emptied	126	Removed Funnel
116	Partially emptied bucket - some liquid left in bucket	140	Start of Valid Data

4.3.3.3.2 How to Add a Notation. To enter a notation, access the FPU data logger’s keypad (Figure A-21) and press <ENT> button in lower-right corner. This wakes up the display.



Figure A-21. Data Logger Keypad

Now press either <Up-arrow> or <Down-arrow> buttons to cycle through the four menus (Sensor Notation, Current Date & Time, Current Units, Data Readings Status) until you reach the one labeled “New Sensor Notation:”. See Figure A-22.

For example: If you open the data logger enclosure to check on the health of the system, you should enter Code 104, ‘Routine Gauge Check’



Figure A-22. New Sensor Notation

Press the buttons < 1 >, < 0 >, < 4 >, and observe the numbers appear in the display. Press <ENT> button, the display will show, 'Value Accepted'. See Figure A-23.



Figure A-23. Value Accepted

This notation now becomes a permanent, irrevocable record embedded into the data file sent to the NWS and NCDC.

Notice you did not have to enter a date and time like you did on the Punch Tape, because the FPU appends date/time to every sensor notation before each is stored to memory. To return to the data readings display, a few presses of the <Up-arrow> button will cycle you back.

4.3.3.3.3 Checking Date or Time. At the keypad illustrated in Figure A-21, wake up the green florescent display by pressing the <ENT> button. View the current readings of precipitation. The precipitation appears underneath a date and time heading (Figure A-24).

The time is always kept in **Standard** time, also known as 'sun time'. Do not adjust to daylight savings time. If you notice the **minutes** are off by more than 10 minutes, phone your NWSREP. The NWSREP will analyze the system to correct the problem.

**Caution:** The date format is **YEAR / Month / Day**. Data will become useless if you accidentally input the wrong format. See Figure A-19.

**Example:**

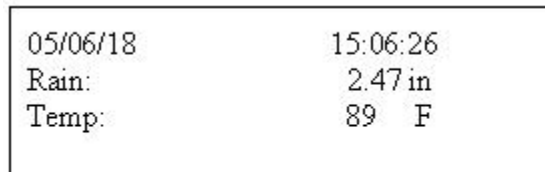

Figure A-24. Date and Time

**Explanation:** In the above example, **05/06/18**, is the proper display for June 18th, 2005. Specifically, the **05/** signifies year 2005; the **/06/** signifies month of June; and the **/18**, signifies the 18th day of June. The time, **15:06:26**, this is the proper display for 3:06 pm local Standard time in the 24 hour convention.

4.3.3.4 Monthly Data Retrieval. Download data in the first five days of each month (**but never before the first day of the month!**) on a day that is rain-free and snow-free, open the data

logger housing's door, and wake up the keypad's green fluorescent display, then insert the red plastic Data Key into the key receptacle (Figure A-25) and turn 1/4 turn clockwise until it stops. Follow the prompts that appear on the user display and then remove key when prompted. This outdoor procedure could take up to 5 minutes.

4.3.3.4.1 Insert Data Key. Insert the red plastic data key into the Data Key receptacle (Figure A-26) while the green fluorescent display is active. Turn the data key clockwise one-quarter turn (Figure A-26).



Datakey

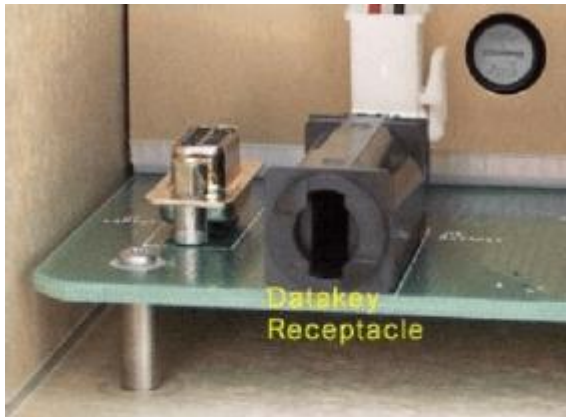

Red datakey (above) is inserted into the datakey receptacle and turned to the right in order to transfer the rain data from the Gauge Modification Assembly (GMA) into the datakey.

Figure A-25. Datakey Receptacle

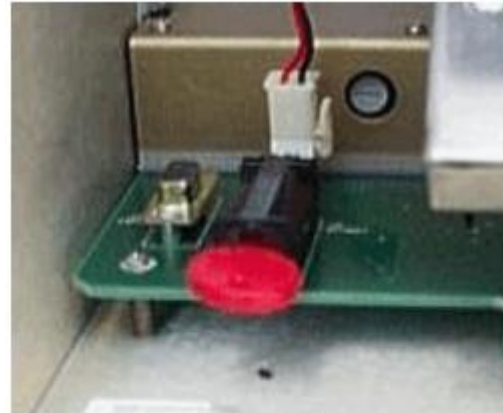

Red datakey remains in the receptacle for several minutes until data logger download completes. When keypad instructs "Please Remove Data Key" turn key to left and remove it.

Figure A-26. Datakey Activated

4.3.3.4.2 Monitor the Display. When the system recognizes that the Data Key has been inserted (Figure A-27) and turned, it automatically loads the data to it.



Figure A-27. Datakey Insertion



If the user display fails to give the message in Figure A-27 ‘data key insertion detected’, remove the red data key and wipe it clean with a paper towel, and then reinsert to the receptacle.

**Note:** If you entered the data key to the tumbler without having awakened the keypad display, remove the key, and then press the <ENT> button to wake up the display. Now reinsert the data key and turn the key one quarter turn to the right.

4.3.3.4.3 Verify the Start of Download. Monitor the display to verify a successful download to the data key. The display gives a running percentage (Figure A-28) of the portion of data copied to the data key until 100% complete. It may take 3 to 5 minutes to complete this process.



Figure A-28. Transfer Data

4.3.3.4.4 Remove Key. Monitor the display for a notice that key download is completed and that it requests removal of the data key (Figure A-29).



Figure A-29. Download Complete

**Note:** After download has completed and if you forget to remove the data key from the receptacle and 5 minutes have elapsed, you will notice the display times-out and goes dark. You will also realize that pressing the <ENT> in this state will not wake-up the display. So, first remove the data key, then press <ENT> to wake-up the display. Finally, confirm that alternating readings of rain and **24RainDiff** appear every five seconds.

4.3.3.4.5 Mail the Data Key. By the 5th day of the month the observer mails the red plastic Data Key to the Weather Forecast Office in the USPS mailing envelope supplied by the NWSREP.

**Note:** You should keep the primary Data Key inside the data logger enclosure, so it is readily available at time of download. Never leave the data key inserted in the receptacle. If you are missing your data key, phone your NWSREP.

4.3.3.5 FPU Bucket Draining. The FPU uses the same bucket as the F&P Punch Tape system. It holds the same volume of fluids, with a capacity to 22 inches. Measurement range is 0-19.5 inches of precipitation (or 4.9 gallons). When you observe that your daily rain readings exceed 15.00 inches, go to the keypad and enter Notation Code 100 (End of Valid Data). Follow instructions outlined in paragraph 4.3.2.1.c, and enter notation 115 (completely emptied), or 116 (partially drained) to the keypad. If you have questions, contact your NWSREP.

4.3.3.6 Inspect the Hardware and Visual Check List. Periodic inspection of hardware is a best practice that will help ensure good system performance and quality representation of precipitation data. Ensure there are no obstructions that block the aperture of the gauge bucket and that all access doors and their hinges, latches, and locks, are working properly. After clearing obstructions, use a damp cloth or paper towel with gloves to wipe clean exterior surfaces.

- a. FPU Hood, Funnel and Bucket: each free and clear of debris.
- b. Data Logger Access Door, hinges, latch, and lock is functional.
- c. Solar Panel, fastened tight, free and clear of debris. Ensure the cable and cable plugs are properly positioned and appear in good physical condition. Ensure the solar panel is not covered by dust, bird droppings, snow, or obstructed by any shaded objects.

4.3.3.7 NWSREP Seasonal Maintenance. Your NWSREP will plan seasonal maintenance for your site and coordinate with you in advance of his/her visit.

**Note:** The FPU Observer should not open the door to the lower bucket assembly where the gauge weighing sensor is located unless instructed by the NWSREP.

**FPU SEMIANNUAL CHECK BY OBSERVER**

What to Check	How to Check	Precautions and Remarks
1. Overall Appearance	Observe paint finish, or evidence of vandalism.	Clean oil film from the outside of gauge using nonflammable liquid detergent.

<p>2. Weather Stripping around Base Plate and Cylindrical Door.</p>	<p>Check for breaks or general deterioration. Weather stripping is used around Base Plate of the Model 1558 and 1559 gauges only.</p>	<p>Notify NWSREP.</p>
<p>3. Collection Bucket</p> <p>a. Emptying and charging collection bucket – Warm Season.</p>	<p>The collection bucket is to be emptied whenever the keypad <b>Rain</b> display gives a reading in excess of <b>15.00 inches</b>. Follow NWSREP instructions.</p> <p>Collection bucket is charged for warm weather operation by adding one quart of SAE 10 weight oil to retard evaporation. It is supplied by NWSREP.</p> <p>See NWSM 50-5116, section 2.11.1, for rules on disposal. The used-oil contractor will usually accept this oil-propylene glycol mixture.</p>	<p>Enter notation 100, ‘End of Valid Data,’ before servicing collection bucket.</p> <p>Remove any foreign material in the collection bucket and clean. Enter 140 ‘Start of Valid Data’ when actions are completed.</p> <p>SAE10, non-detergent oil available.</p> <p>Enter notation 100 ‘End of Valid Data’. Complete the actions. Enter notation 115 ‘Bucket completely emptied’; or enter 116, ‘Partially drained bucket’.</p> <p>Then enter notation 117, ‘Added oil to bucket’.</p> <p>Finally, enter notation 140, ‘Start of Valid Data,’ if you completed all actions with the bucket.</p>
<p>b. Emptying and charging collection bucket – Cold Season.</p>	<p>Collection bucket is charged for cold weather by installing up to two quarts of propylene glycol. For exact amount see table in Section 4.3.2.3. Then add one quart of oil. Use NWSREP supplies, only.</p>	<p>Use propylene glycol (D111-153). Less propylene glycol may be required in climatologically mild areas.</p>

<p>4. Funnel</p>	<p>See NWSM 50-5116, section 2.11.1, for rules on disposal. The used-oil contractor will usually accept this oil-propylene glycol mixture.</p> <p>During the period of year when snow or freezing weather is expected, remove funnel from the conical upper housing and store.</p>	<p>Enter notation ‘End of Valid Data’. Complete the actions. Enter notation 118, ‘Added propylene glycol to bucket’, and then enter notation 117, ‘Added oil to bucket.’</p> <p>Then enter notation 140, ‘Start of Valid Data’, when you have completed all re-charging actions with the bucket.</p> <p>Enter notation 126, ‘Removed Funnel’. Reinstall funnel after cold weather season ends. Enter notation 125, ‘Installed funnel’.</p>
------------------	--	--

4.3.3.7.1 Winterizing the FPU. Partially drain the FPU bucket into the dispenser provided by the NWSREP (code 116), so as to retain the oil layer in the bucket. Remember to recharge with as much as two quarts of propylene glycol (code 118). For exact amount turn to Section 4.3.2.3, and see table indexed to coldest temperatures. If necessary, add oil (code 117). You do not need more than ¼ inch surface oil layer in the Fischer Porter’s 14 inch diameter bucket. If bucket is emptied of all contents, then charge with one quart of oil.

Remove funnel: Remove the cone-shaped hood, tip it upside down and set it down. Rotate the funnel so its slots allow it to slide free from the three pins located on the base of the hood assembly. Enter notation 126, ‘Removed Funnel.’

Further Considerations: Snowfall and high-rate rainfall events can lead to a layer of snow, ice, or fresh rainwater that rests on top of the oil layer. For these events stir the bucket with a mixing stick. This will prevent freezing and possible equipment damage.

4.3.3.7.2 FPU Summer Maintenance. Remove the cone-shaped hood and inspect the contents of the bucket with a mixing stick (i.e., paint stirrer). Remove and properly dispose of any leaves or debris that might have collected when the funnel was removed at start of winter season. Then with the stick, ensure there is still a ¼ inch film of oil on the surface to inhibit evaporation. If the **Rain** value exceeds **15.00 inches** on the day you are installing the funnel then perform a partial draining of the bucket by keeping the oil from running out the drain tube. Add propylene glycol if local conditions require. Drain the contents into the dispenser provided by the NWSREP.

Install the funnel: Remove the conical housing, turn it upside down, and fasten the funnel by rotating its three slots onto the three pins of the cone shaped hood. Return this hood assembly to the gauge. Enter operator notation 125, 'Installed Funnel.' and enter code 140 'Start of Valid Data'.

**4.3.4 Fischer & Porter Rebuild (FPR) Gauge.** The new recording rain gauge instrumentation is housed entirely within the body of the original Fischer & Porter (F&P) containment shell (Fig A-30). Once you open the access door (Fig A-32) you will see a blue and white plastic box that contains the data recorder. This is the Precip Recorder and it takes the place of the paper-tape assembly for the purpose of recording the weight of the liquid in the bucket (Fig A-31).

#### 4.3.4.1 Equipment Cluster

4.3.4.1.1 Weighing Sensor: The weight of the catch bucket with liquid rests upon a metallic bar that bends with increased weight. This weighing sensor is very sensitive and can detect changes of one hundredth of an inch of precipitation in a matter of several seconds. Readings from the sensor are processed by the Precip Recorder. Fifteen minute data, based on weighing sensor measurements, are available when you insert a memory card to the slot on the right side of the Precip Recorder (Fig A-31).



Fig A-30. F&P Access Door



Fig A-31. FPR-D Mounted in Shell



Fig A-32. FPR-D Containment Shell

4.3.4.1.2. Precip Recorder Display: The Precip Recorder stays in a 'sleep' mode until you wake it up by pressing any one of the key pad's buttons. The blinking green lamp tells you the rain gauge recorder system is working properly.

The green fluorescent display communicates the running total of precipitation plus any other additive like oil or propylene glycol. It also shows the current date and time.

Your NWSREP has pre-programmed the Precip Recorder for automated operation.

The four Arrow buttons (Fig A-34) allow you to scroll through six menus to view rain gauge status and view a log of times you checked the recorder and downloaded precipitation data.



Figure A-33. Display Screen



Figure A-34. Precip Recorder - Arrow Buttons Visible

To collect data, the NWS mails you a small Memory Card, once per month. In the first few days of the month you insert the card to the slot in the right side of the Precip Recorder (Fig A-35) and download the rain gauge data.

You insert the Memory Card and the system automatically downloads data to the Memory Card.

Follow instructions in 4.3.4.4., Monthly Data Retrieval, to understand how the system responds and when to eject the Memory Card.

Expect the rain gauge to take about five minutes to download the last 60 days of data. Always wait nearby the Precip Recorder while it conducts the download – and never conduct the download when the weather is raining or snowing.



Figure A-35. SD Memory Card

4.3.4.2. Viewing the Menus

The Home Menu (Fig A-36) will always appear when you wake-up the system. It gives you the Precip value in hundredths of an inch together with the current date and time. When you press the keypad’s down arrow key ( ▼ ) you advance to the next menu of the six menus. All six menus are listed in Figure A-37.



Figure A-36. Home Menu

The menu revolves back to the Home Menu (Fig A-36) if you keep pressing the down-arrow ( ▼ ) key.

Primary Menus	Description
Precip 15.00 2009/02/13 10:52:30	This is the ‘home menu’ it appears on power-up.
Battery Now 12.6V	Battery voltage.
Logged Data	Stored 15-min data.
Station Setup	Password protected
Diagnostic	Calibration
Station Name & Time	COOP site number

Figure A-37. Primary Menus

Observers are not required to access any of these six menus however the Observer may conduct a routine check of battery voltage, or perhaps a quick check of the Logged Data. For more detailed information, see the *FPR-D Operations Manual* (Sep 2009) available on the DAD web site: <http://www.srh.noaa.gov/ohx/dad/coop/FPR.html> .

Press the ▼ (down) key twice, and you advance to the parameter ‘Battery Now’ – this informs you of the battery’s voltage.



Figure A-38. Battery Display

Press ▼ (down) four more times and your COOP station name and number appear on the screen, this is the Station Name and Time, menu (Fig A-39).

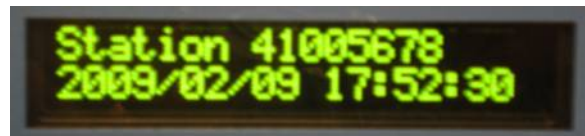

Figure A-39. Station Name Display

No action is required. To return to the home display, simply press the ▼ (down) button one more time and you revolve back to the first of the six menus.

#### 4.3.4.3. Routine Checks

Whenever you open the F&P containment shell, always wake-up the green fluorescent display. Use any of the ‘arrow buttons’ or either the ‘Set,’ or ‘Off’ button.

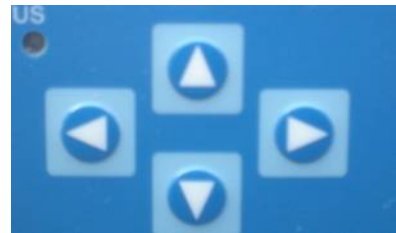

Figure A-40. Arrow Buttons

4.3.4.3.1. Precip Parameter: This **Precip** display gives the current weight of liquid in the bucket. This includes rain water, melted snow, oil, propylene glycol, and possibly anything that



fell into the bucket since it was last serviced.



Figure A-41. Precip Readout

In this example (Fig A-41) the Precip shows 15.00 inches of liquid in bucket.

If the display ever reads a negative value or reports more than 15.00 inches (bucket capacity is 20 inches), phone your NWS Representative (NWSREP) so he/she can service the gauge. Your responsibility is to journal any maintenance action or a data discrepancy, to the Log Sheet, as described in Section 4.3.4.7.

4.3.4.3.2 Date and Time: The current date and time appear in the Home Display (Fig A-36) and also appear in the last menu, the Station Name and Time (Fig A-39).

The year, month, and day, appear on the left side: **2009/02/13**. Shows Feb 13, 2009.

The time in hours, minutes, and seconds, appears next: **10:52:30**. This is 10:52am local Standard time in a 24-hour convention.

Understand that the time is always kept in **Standard** time. The NWS policy is to never adjust to daylight savings time. If you notice the **minutes** are off by more than 10 minutes, then phone your NWSREP to inform him/her of the error. Discrepancies on the display may indicate a system problem that requires a station visit by your NWSREP.

4.3.4.3.3 Spare Memory Card: You should keep a spare Memory Card in its plastic protective case resting on the support stage several inches below the memory card slot, right beside the Precip Recorder. The support stage is visible in Fig A-31.

4.3.4.4. Monthly Data Retrieval

In the first five days of each month, but never before 12am on the first day of month, at a time when it is not raining or snowing, walk out to the Fischer & Porter gauge, and retrieve the precipitation measurements. This outdoor procedure might take 5 minutes.

4.3.4.4.1. Insert Memory Card: First, wake-up the display. Then insert the Memory Card into the slot on the right side of the Precip Recorder (Fig A-42) with the card's label-side facing you. Press it in, until it clicks.



Figure A-42. Memory Card Slot

4.3.4.4.2 Display responds: Auto Log Download of 60 days in 8 seconds.



Figure A-43. Download Start Display

Then the display gives the running percentage of the portion of data copied to the memory card until 100% complete. This process might take five minutes to complete.



Figure A-44. Download Progress

4.3.4.4.3 Verify the End of Download: View the display to confirm the download has completed.

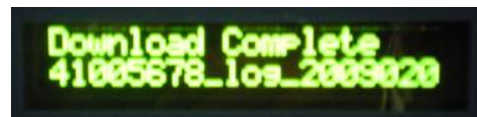

Figure A-45. Download Completed

4.3.4.4.4 Remove Card:

Press the **OFF** button three times to return to the Home Menu. Then eject the card by pressing it in and then releasing it gently. Place the plastic protective plug back into its slot.

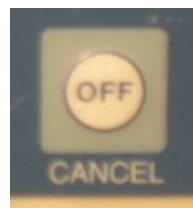

Figure A-46. The 'Off' Button

4.3.4.4.5. Enclose for Mailing: Place the plastic Memory Card into its clear plastic protective cover (Fig A-47). Then, place the memory card into the standard ten inch, yellow mailing envelope (Fig A-48), for delivery to your NWSREP at the forecast office.

#### 4.3.4.5 Review the Log Sheet

Certain Observers are given the responsibility to perform gauge/bucket maintenance. These Observers are required to review and update the Log Sheet for any performed maintenance or discrepancies that occurred since the last monthly submission.

If your Log Sheet contains any entries, then mail it to your NWSREP together with the monthly Memory Card. If maintenance was not performed in last one month, or there were no discrepancies, do not mail the Log Sheet.

#### 4.3.4.6 Mail the Memory Card

By the 5<sup>th</sup> day of month, the observer mails the Memory Card, enclosed in its plastic protective case, in a USPS mailing envelope – one that is supplied by the NWSREP. The observer mails the Memory Card to the Weather Forecast Office.



Figure A-47.

The Jiffy No. 0 (zero) padded mailing envelope (photo, right) is the appropriate envelope because you may include the log sheet and/or Form B91 if you also observe with the standard rain gauge or observe temperature. The photo shows the standard ten inch square, darker color envelope. Newer, bubble-pack square envelopes have thinner paper and tear more easily and can result in the Memory Card being lost in the mail.



Figure A-48. Mailing Envelope

Certain United States Postal Service (USPS) centers might use electro-magnetic scanning

devices to screen materials coming through the mail. To avoid potential damage to the Memory Card, the NWSREP writes: ‘**Sensitive Magnetic Media, Handle Manually**’ on the front of the Jiffy No. 0 mailing envelope.

#### 4.3.4.7 Journal Responsibility

4.3.4.7.1 Continuous Automated Logging: The FPR recorder continues to run uninterrupted while the observer performs the critical monthly task of downloading precipitation data to the Memory Card. So, there is no need for the observer to document the hour and date he/she made the monthly download.

Each time the display is woken up or data is downloaded to memory card, the Precip Recorder will self-log the date and time of the event as, ‘Display On, 09/20/2008, 10:12:54.’ This way a permanent record is made to the electronic data, and this follows the legacy policy of entering notations pen markings onto the paper tape.

Prior to the modernization, each time you suspended the gauge from its 15-minute timer for maintenance, and each month when punch tape was removed, the observer had to mark four pieces of information to the tape: the ‘OFF Date/Time’, the Station ID (i.e., 23-4652), the Station Name (i.e., Lake City), and State (i.e., MO). Then a straight line (i.e., a “time line”) was drawn across the width of the Punch Tape, to stand as an unmistakable reference to show where the interruption began. The observer would mark the ‘ON Date/Time’ when he rethreaded the tape into the gauge.

4.3.4.7.2 Bucket Maintenance – Journal Entries: When the bucket is emptied or when propylene glycol and oil are added, the weight of the collection bucket will change and produce a discontinuity in the Rain record. For these actions write a journal entry of the Date and Time when you conducted these tasks.

**Note:** Always remember to press the monitor’s OFF button once, to wake it up, this way you create an internal log entry of the date/time you added oil or propylene glycol to the bucket. Otherwise, this action may be mistaken as a valid precipitation event. Likewise wake up the system before you drain the bucket so everyone will understand the system did not experience a failure – it was simply a maintenance job.

For example, anytime you partially drain the bucket, the statement: ‘partially drained bucket’ is written into the log sheet.

Likewise, anytime propylene glycol is added, the statement: ‘propylene glycol added to bucket’ is written into the log sheet.

4.3.4.7.3 Log Sheet: You may keep the Log Sheet in a protective plastic pocket envelope within the containment shell next to the Precip Recorder. If you need a replacement Log Sheet, phone your NWSREP.

**F&P OBSERVER LOG SHEET  
REQUIRED ENTRIES**

COOP Station Number: \_\_\_\_\_ Your Name: \_\_\_\_\_ Institution Name: \_\_\_\_\_

LOG DATE	BUCKET LEVEL?	OIL ADDED?	ANTIFREEZE ADDED?	FUNNEL IN / OUT?	SPECIAL NOTES:
Date of Journal Entry	Date and time bucket was <u>partially drained</u> or completely <u>emptied</u> .	Date and time <u>oil</u> was last added. Typical is half-quart (16oz).	Date and time <u>antifreeze</u> was last added. Typical is 2 quarts (64oz).	Date and time <u>funnel</u> was removed for winter; or installed for summer.	Any <u>anomaly</u> or <u>outage</u> event? Give date and the elapsed time of outage. Describe the problem.
Apr 15, 2009	2pm Apr 15, 2009 - partially drained – New level is 2.37 inch	11am May 5, 2008	11am Oct 9, 2008, for winter.	Installed 2pm Apr 15, 2009, for summer.	This log-sheet is being mailed to NWS with memory card on or about May 3, 2009.

Figure A-49. Log Sheet Required

**4.3.4.8** NWSREP Seasonal Maintenance. Your NWSREP will plan seasonal maintenance for your site and coordinate with you in advance of his/her visit.

**FPR SEMIANNUAL CHECK BY OBSERVER**

What to Check	How to Check	Precautions and Remarks
1. Overall Appearance	Observe paint finish, or evidence of vandalism.	Clean oil film from the outside of gauge using nonflammable liquid detergent.
2. Weather Stripping around Base Plate and Cylindrical Door.	Check for breaks or general deterioration. Weather stripping is used around Base Plate of the Model 1558 and 1559 gauges only.	Notify NWSREP.
3. Collection Bucket	The collection bucket is to be emptied whenever the keypad <b>Rain</b> display gives a	Remove any foreign material in the collection bucket and clean.

	<p>reading in excess of <b>15.00 inches</b>. Follow NWSREP instructions.</p>	<p>When you have completed your actions write the new Precip value in hundredths of an inch, to the log sheet.</p>
<p>a. Emptying and charging collection bucket – Warm Season.</p>	<p>Collection bucket is charged for warm weather operation by adding one quart of SAE 10 weight oil to retard evaporation. It is supplied by NWSREP.</p> <p>See NWSM 50-5116, section 2.11.1, for rules on disposal. The used-oil contractor will usually accept this oil-propylene glycol mixture.</p>	<p>Use SAE10, non-detergent oil available. Complete the actions. Write into log sheet, ‘Bucket completely emptied’; or ‘Partially drained bucket’.</p> <p>Then write, ‘Added oil to bucket’.</p>
<p>b. Emptying and charging collection bucket – Cold Season.</p>	<p>Collection bucket is charged for cold weather by installing up to two quarts of propylene glycol. For exact amount see table in Section 4.3.2.3. Then add one quart of oil. Use NWSREP supplies, only.</p> <p>See NWSM 50-5116, section 2.11.1, for rules on disposal. The used-oil contractor will usually accept this oil-propylene glycol mixture.</p>	<p>Use propylene glycol, (D111-153). Less propylene glycol may be required in climatologically mild areas.</p> <p>Complete the actions. Write in log sheet, ‘Added propylene glycol to bucket’, and then write ‘Added oil to bucket.’</p> <p>When you have completed all re-charging actions with the bucket, write the new Precip value in hundredths of an inch, to the log sheet.</p>
<p>4. Funnel</p>		

	During the period of year when snow or freezing weather is expected, remove funnel from the conical upper housing and store.	Write into log sheet, 'Removed Funnel'. Reinstall funnel after cold weather season ends then write, 'Installed funnel'.
--	--	---

4.3.4.8.1 FPR Bucket Draining. The FPR uses the same bucket as is used in the F&P Punch Tape recording rain gauge. It holds the same volume of fluids, with a capacity to 22 inches. Measurement range is 0-19.5 inches of precipitation (or 4.9 gallons). When you observe that your daily rain readings exceed 15.00 inches, write into your Log Sheet the date and time and amount that appears on the FPR display screen. Follow instructions outlined in paragraph 4.3.2.1.c, and enter to Log Sheet whether you have completely emptied the bucket, or have partially drained the bucket and how you recharged the bucket. Turn to Section 4.3.4.7 for instructions on how to journal to Log Sheet.

4.3.4.8.2 Winterizing the FPR. Partially drain the F&P bucket into the dispenser provided by the NWSREP, so as to retain the oil layer in the bucket. Remember to recharge with two quarts of propylene glycol. For exact amount turn to Section 4.3.2.3, and see table indexed to coldest temperatures. If necessary, add oil. You do not need more than ¼ inch surface oil layer in the Fischer Porter's 14 inch diameter bucket. If bucket is emptied of all contents, then charge with one quart of oil.

Remove funnel: Remove the cone-shaped hood tip it upside down and set it down. Rotate the funnel so its slots allow it to slide free from the three pins located on the base of the hood assembly.

Further Considerations: Snowfall and high-rate rainfall events can lead to a layer of snow, ice, or fresh rainwater that rests on top of the oil layer. For these events stir the bucket with a mixing stick. This will prevent freezing and possible equipment damage.

4.3.4.8.3 FPR Summer Maintenance. Remove the cone-shaped hood and inspect the contents of the bucket with a mixing stick (i.e., paint stirrer). Remove and properly dispose of any leaves or debris that might have collected when the funnel was removed at start of winter season. Then with the stick, ensure there is still a ¼ inch film of oil on the surface to inhibit evaporation. If the **Precip** value exceeds **15.00 inches** on the day you are installing the funnel then perform a partial draining of the bucket by keeping the oil from running out the drain tube. Add propylene glycol if local conditions require. Drain the contents into the dispenser provided by the NWSREP.

Install the funnel: Remove the conical housing, turn it upside down, and fasten the funnel by rotating its three slots onto the three pins of the cone shaped hood. Return this hood assembly to the gauge.

**5. Gauge Supplies.** These quantities will vary as a function of the amount of precipitation a site receives in a given season. Please contact your NWSREP if you are responsible for keeping any of these items at your cooperative observer station.

- a. One quart of oil (SAE 10).
- b. Four 2-quart containers of Propylene Glycol (ASN part D111-153).
- c. One 5 gallon sealable plastic container available to discard bucket fluids.

**6. How to Measure Rainfall.**

6.1 Fischer & Porter Gauge. See Section 4.3.2 (Fischer & Porter Punch Tape Gauge) for instructions on reading the F&P gauge.

6.2 Universal Weighing Gauge. The Universal weighing gauge is read directly from the Trace on the drum. If the gauge did not read zero at the last observation time, the previous reading is subtracted from the current reading.

6.3. Four-Inch Non-Recording Gauge. The four-inch clear plastic gauge (Figure A-7) may be read directly by observing the marks etched on the measuring tube. The measuring tube holds up to one inch of water. If more than an inch of rain fell, then discard the water from the measuring tube, and pour the water from the overflow cylinder into the measuring tube. Measure the additional water you poured into the measuring tube and add this number to the amount already measured. This should be repeated if more than two inches fell. When finished, place the measuring tube back inside the overflow cylinder and replace the funnel.

6.4. Eight-Inch Non-Recording Gauge. This gauge is also known as the eight-inch Standard Rain Gauge (SRG). The funnel is designed to allow the measuring stick to be inserted into the top of the measuring tube (Figure A-50). This way you measure precipitation amounts of less than 2 inches. Slide the stick into the gauge, **do not bounce**, and leave it in place for two or three seconds. The water will coat the stick. Remove the stick and read the rainfall amount from the top of the coated part of the stick. Replacement sticks are available from the NWSREP.





Figure A-50. Eight-Inch Gauge with Measuring Stick Inserted

For amounts of more than 2 inches when the measuring tube is full (indicating at least two inches of rain), carefully remove the funnel and empty the measuring tube to avoid spilling water back into the overflow can. Allow a few seconds for all the water to drain from the tube. Place the funnel over the measuring tube (Figure A-51) and pour the water from the overflow can into the measuring tube. Measure this amount and add it to the two inches already emptied. This procedure should be repeated if necessary.



Figure A-51. Measuring Tube With Funnel on Top

7. Measuring the Depth of Frozen Precipitation. The Department of Atmospheric Science at Colorado State University produced a ‘Measuring Snow’ video tape for the NWS, to give the proper procedures for measuring and reporting snow. Each Weather Forecast Office was provided a copy from the Regional Headquarters. You are expected to give a copy to the Cooperative observers who are required to take snow observations. Order copies of the snow measurement video through the Regional Cooperative Program Manager (RCPM).

Snow measurement guidelines can also be accessed at: [www.weather.gov/os/coop/training.htm](http://www.weather.gov/os/coop/training.htm) .

7.1 Definition. Although frozen precipitation includes snow, ice pellets, hail, the following text will use the word “snow” for all in this paragraph.

Two types of snow measurements are reported:

- a. Snowfall- The depth of newly fallen snow (snow having fallen since the previous scheduled time of observation), reported in inches and tenths.
- b. Snow Depth- The total depth of snow on the ground (new and old), reported to the nearest whole inch.

7.2 Snow Measurement Stick. Specially designed snow measuring sticks are available from the NWSREP. Figure A-52 illustrates two sizes available: a 20 inch measuring stick for areas that climatologically receive small amounts of snow and a 40 inch stick for heavier amounts. The snow measuring stick is graduated to tenths of an inch, Figure A-53.

To measure snow with this stick, find a location where the snow appears to be near its average depth. This may be difficult if the snow has drifted. Look for a flat, somewhat open area away from buildings and trees. Some trees in the distance may be helpful in breaking the wind, preventing drifting, and thus providing for a more even distribution of the snow.

Measure the depth with the snow measuring stick. Measure the depth at several locations and use an average depth if drifting has occurred.

When snow has fallen between observation times and has been melting, measure its greatest depth on the ground while it is snowing. This greatest depth measurement is considered the snowfall for the observation period. If all snow melted as it fell, enter a trace for the snowfall on the observing form.



Figure A-52. 40-Inch and 20-Inch Snow Sticks



Figure A-53. Snow Stick Graduated Scale to One Tenth of an Inch

7.3 Measuring New Snow Falling on Top of Old Snow. When fresh snow has fallen on old snow, it is necessary to measure the depth of the new snow (tenths of inches) and the total depth of all snow (whole inches). Snow boards (Section 7.4) provide the best method of taking measurements in this case. If a snow board is not available, and if the old snow has settled or partially melted enough to develop a crust or to be noticeably denser than the new snow, it may be possible to insert a snow stick until it meets the greater resistance of the crust of old snow, and to use this depth as the amount of new snow that fell.

Sometimes pollution or partial melting will give the old snow a darker color than the new snow. If so, cut a vertical core through the snow down to the ground. Measure the new (whitest) snow depth to the nearest tenth of an inch, and the total snow depth to the nearest inch. Some cooperative observers may be asked to provide 6-hour snowfall amounts other than their scheduled time of observation.

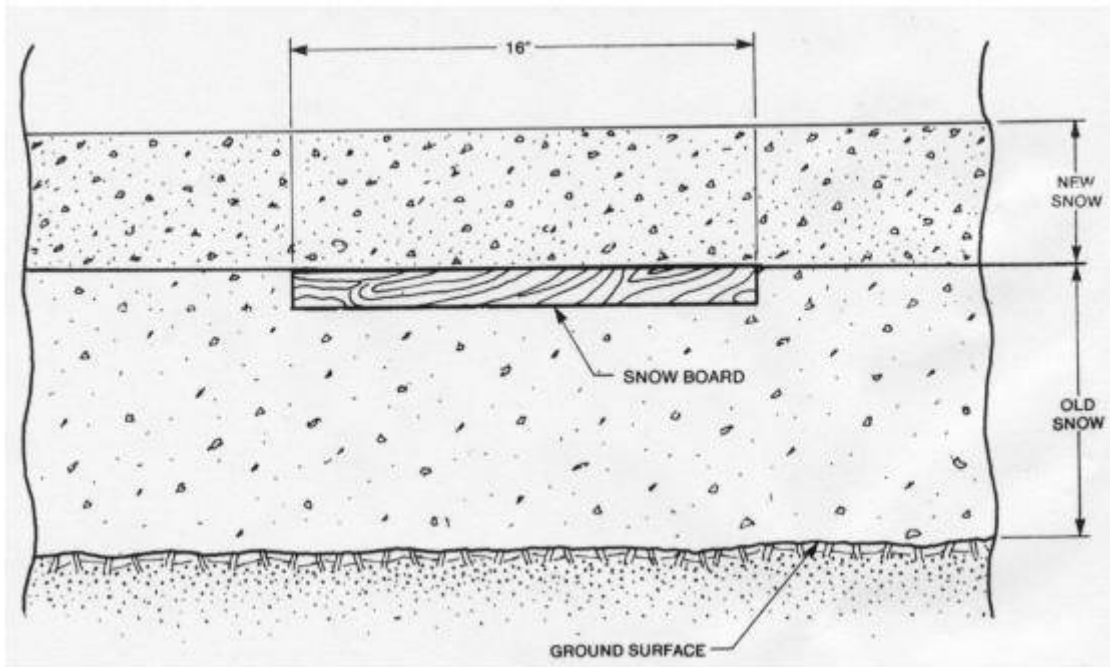

Figure A-54. Snow Measurement Board (Upon Old Snow)

7.4 Snow Measurement Boards. Snow boards provide a standard surface for measuring fresh snowfall. Inconsistent measurement surfaces from station to station or even at the same location for different snowfalls, contributes to inaccurate and incompatible snowfall measurements and an inconsistent database.

Snow boards are laid on top of the old snow (Figure A-54) when there is any possibility of new snow falling. The snow board may be comprised of thin lumber or other light material that will not sink into the snow, yet be heavy enough not to blow away. The board should be painted white. Push the board into the snow just far enough that the top of the board is level with the top of the snow. A 16" by 16" snow board will allow cutting more than one snow sample.



Figure A-55. Snow Measurement Board

Usually the NWS provided snow board (Figure A-55) is the best surface and tool used to measure snowfall. The NWS snow board measures 16 inches by 24 inches, is eight millimeters thick, and is made of the expanded PVC. These snow boards are available from the NWSREP.

After each observation, the snow board should be cleaned and placed in a new location. Because of evaporation or drifting, the board may need adjusting daily to ensure that the top of the board remains flush with the old snow.



Figure A-56. Snow Measurement Stake

7.5 Snow Measurement Stakes. Snow stakes are routinely used in geographical areas which receive deep snowfalls; such as the mountains in the Western U.S. and about the Great Lakes. Stakes should be graduated in whole inches, with numerals inscribed at 10-inch intervals. Stakes should be sturdy, water-resistant, and painted white to minimize snow melt around them. The example (Figure A-56) is a snow stake in the Eastern U.S. with numerals inscribed at 2-inch intervals.

If possible, the stake should be located on level ground where the snow depth is typical of the area. In hilly areas, select a northerly exposure in a level area if possible. The area around the stake should be free from trees, buildings and other obstructions that could seriously affect the wind flow around the stake. Low, leafless bushes, however, can be beneficial in reducing drifting. If possible, several snow stakes may be used to represent the snow depth.

8. Measuring the Water Equivalent of Snowfall. The F&P and Universal weighing gauges measure the quantity of frozen precipitation when properly serviced with a non-freezing solution such as propylene glycol. When a propylene glycol mixture is installed to the bucket, the snowfall, or sleet, or freezing rain, will melt upon contact with this mixture and the weight of the melted precipitation will be measured by the recording gauge. For non-recording gauges, remove the funnel and measuring tube from the outer overflow can during winter or whenever

snow is likely to fall. The water equivalent of frozen precipitation that has fallen into the gauge can be determined by the following:

- a. Bring the overflow container that contains the snow into a warm building.
- b. Wait for the snow to melt.
- c. Pour the melted snow into the measuring tube.
- d. Measure as you would measure rain.

Melting the snow can be accelerated by carefully measuring an amount of warm water in the measuring tube, and then pour the warm water into the overflow can with the snow. Next, let the snow melt. Once melted, pour the water into the measuring tube and measure the total amount of water. Subtract the amount of added warm water to determine the water equivalent of snow.

Do not leave water standing in the gauge if temperatures are expected to drop below freezing.

9. Obtaining Core Samples of Snow. In cases where strong winds or drifting snow prevent the gauge from receiving the correct amount of snow, or when snow overflows the gauge or clings to the top to block snow from falling inside, the measurement will likely be inaccurate. Often the best solution in these cases is to take a core sample:

- a. Find an area where drifting is minimal. This will usually be a flat area away from obstructions such as trees and buildings, although obstructions at some distance can help minimize drifting.
- b. Invert the overflow can and force it down through the snow. The rim will cut a cylindrical vertical sample. If the snow is very deep, it may be necessary to push the can part way to the ground. Then, remove and empty the snow into a container and insert the can in the same hole to obtain the rest of the snow.

Caution! Do not push the can through snow that was measured at the previous observation, or its water equivalent will be counted in both measurements.

- c. Slip a piece of sheet metal or thin wood beneath the mouth of the can to prevent the snow from falling out of the can.
- d. Take the snow indoors, melt it, and obtain the water equivalent as described in Section 8.
- e. If there is a question about the accuracy of the water equivalent of snow measured directly in the can, compare it with the amount determined by a core sample and use the larger of the two readings.

10. Measuring Snow Pack Water Equivalent. Runoff from winter snow pack has the

potential to produce flooding during warm spells or spring thaw. Measurement of the snow water equivalent helps the NWS to forecast river stages and flooding potential during rapid runoff. The snow water equivalent can be determined by the following:

- a. Determine the average snow depth as described in Section 7, for example; your morning observation snow depth measurement.
- b. Invert the overflow can at the point of the determined snow depth and force the can down through the snow. The rim will cut a cylindrical vertical sample. If the snow is very deep, it may be necessary to push the can part way to the ground. Then, remove and empty the snow into a container and insert the can in the same hole and obtain the remaining snow.

This procedure is also covered in the “Measuring Snow” video produced by Colorado State University. You may order it from NLSC as agency part number XMISC-26, or access it online, via: <http://www.weather.gov/os/coop/training.htm>

- c. Slip a piece of sheet metal or thin wood beneath the mouth of the can to prevent the snow from falling out of the can.
- d. Bring the overflow container that contains the snow into a warm building.
- e. Wait for the snow to melt. Melting the snow can be accelerated by carefully measuring an amount of warm water in the measuring tube, and then pour the water into the overflow can with the snow. Let the snow melt. Once melted, pour the water into the measuring tube and measure the total amount of water. Subtract the amount of added warm water to determine the water equivalent of snow.  
**Caution: Be very careful not to overfill the tube. The tube will fill quickly with high water content and overflow losing some of the water content.**
- f. The water content is measured to the nearest hundredth of an inch (.01) but in this case, it is reported to the nearest tenth of an inch (.1)

When measuring to the nearest hundredth of an inch and converting to the nearest tenth of an inch for reporting purposes, average up if the amount is .05 or more and average down if less than .05, for example:

(1) If you measure .65 then you will report (.7)

(2) If you measure .73 then you will report (.7)

- g. Snow water equivalent (SWE) should be reported via WXCoderIII in the Remarks section because there is no specific entry point on the form. Daily observations of SWE are encouraged after each precipitation event, or when the

snowpack is melting or evaporating noticeably. Check with the Senior Hydrologist and the local River Forecast Center (RFC) as to how often your observer should take the SWE observation. Some may require the observation only once per week.

11. Keeping and Mailing Records.

11.1 Purpose. The cooperative observer is to record precipitation and other data either electronically, by telephone, or on forms that are mailed directly by the observer to the NWSREP. The NWSREP reviews the data before s/he mails it or transmits it electronically to the National Climatic Data Center (NCDC). The NCDC archives, quality controls and publishes these records, which comprise the major part of the climate history of the United States. The monthly forms, charts, and tapes are sent to the designated NWS Office. The forms used most often by cooperative observers are WS Form B-82 and WS Form B-91. These are described in section 11.2 and 11.3.



11.2 WS FORM B-82 “Official Weather Observer’s Record”. The purpose of this handy pocket-sized pad of forms (Figure A-57) is to record observations while reading the instruments. Information recorded on WS Form B-82 is then transferred to the official permanent record, WS Form B-91 or the approved NOAA paperless systems. Each pad of WS Form B-82 is intended to last one month. WS Form B-82 contains complete instructions for recording observations. This form is not to be mailed and may be retained by the observer.

DATE \_\_\_\_\_, 20\_\_\_\_ DAY OF WEEK \_\_\_\_\_

TEMPERATURE °F			PRECIPITATION																													
24 Hrs. ending at Observation		AT. OBSN.	DRAW A STRAIGHT LINE (——) THROUGH HOURS PRECIPITATION WAS OBSERVED. AND A WAVED LINE (~~~~) THROUGH HOURS PRECIPITATION PROBABLY OCCURRED BUT WAS NOT OBSERVED.																													
MAX.	MIN.		A.M.												P.M.										Midnight							
			1	2	3	4	5	6	7	8	9	10	11	Noon	1	2	3	4	5	6	7	8	9	10	11							
			.....	.....	.....	.....	.....	.....	.....	.....	.....	.....	.....	.....	.....	.....	.....	.....	.....	.....	.....	.....	.....	.....	.....	.....						
PRECIPITATION		SNOW, ICE PELLETS, HAIL, ICE on ground at Obsn. (Inches)	WEATHER					REMARKS AND NOTES																								
24 Hr. Amounts AT OBSN.			Mark "X" for all types that occur during the calendar day																													
RAIN, MELTED SNOW, Etc. (Inches and Hundredths)	SNOW, ICE PELLETS, HAIL (Inches and tenths)		Fog	Ice Pellets	Glaze	Thunder	Hail	Damaging Wind																								
.....	.....																															

ENTER ADDITIONAL NOTES ON REVERSE SIDE

Figure A-57. WS Form B-82



12. Real-Time Reporting of Precipitation, Temperatures, and Hazardous Weather Events.

Many cooperative observers may be requested to report precipitation values (and in some cases temperature readings) to an NWS office, once per day or whenever a certain minimum amount of precipitation has fallen. If the cooperative observer agrees, the information will be vital to the NWS river and flood forecast and warning program. During the winter, the observer may be requested to measure and report the water content (water equivalent) of snow on the ground twice a week. This information helps the NWS forecast the amount of runoff and potential flooding from snow melt during warm spells or the spring thaw. Some observers maintain precipitation gauges from which the data are automatically interrogated by telephone or satellite.

The NWSREP may also ask the cooperative observer to report immediately by telephone any severe weather event that may endanger life and property. Inform the observer of the NWS SKYWARN Program, <http://www.weather.gov/skywarn/>. This information will aid in determining the need for warnings of severe weather. If the cooperative observer agrees to participate in this program, the observer should be asked to report one or more of the following types of events.

- a. Flash flooding (observer should provide the time of the observation and state if the water level is rising or falling).
- b. Severe thunderstorms with damaging winds (58 mph or stronger) or 3/4 inch or larger hail.
- c. Excessive rain; i.e., 0.50 or 1.00 inch or more per hour.
- d. Unusual snow accumulation (4 inches or more, or as instructed).

This special reporting is entirely voluntary and is not intended to interfere with the regular weather duties agreed to by the cooperative observer with the NWS. However, these extra reports can be a valuable means of saving lives and minimizing the destruction of property.

**APPENDIX B – Air Temperature**

<u>Table of Contents:</u>	<u>Page</u>
1. Definition .....	B-2
2. Types of Thermometers .....	B-2
3. Instrument Shelters .....	B-3
3.1 Shelter Placement .....	B-3
3.2 Shelter Maintenance .....	B-4
4. Liquid-in-Glass Maximum/Minimum Thermometers .....	B-4
4.1 Mercury Clean-Up .....	B-4
4.2 Maximum Thermometer - How It Works .....	B-5
4.3 Minimum Thermometer - How It Works .....	B-6
4.4 Mounting and Maintaining the Thermometer Support .....	B-6
4.5 Mounting the Thermometers .....	B-7
4.6 How to Read and Record Temperatures .....	B-7
4.6.1 Reading and Setting the Maximum Thermometer .....	B-9
4.6.2 Reading and Setting the Minimum Thermometer .....	B-11
4.6.3 Reading the Current Temperature .....	B-11
5. Correcting Thermometer Errors .....	B-11
5.1 Correcting Maximum Thermometers .....	B-11
5.2 Correcting Minimum Thermometers .....	B-12
6. Electronic Thermometers .....	B-13
6.1 Initial Checkout of Instrument .....	B-14
6.2 Calibration .....	B-15
6.3 Operation .....	B-15
6.4 Identifying and Correcting Erroneous Maximum/Minimum Temperatures .....	B-16
6.5 “Help” and Blinking Displays .....	B-17
7. Entry of Temperature Readings on WS Form B-91 .....	B-18
8. Common Errors to Avoid .....	B-18

<u>Figures:</u>	<u>Page</u>
B-1 Liquid-in-Glass Maximum and Minimum Thermometers .....	B-3
B-2 Instrument Shelters - Cotton Region Shelter and Two MMTS Shelters .....	B-3
B-3 ET Shelter .....	B-4
B-4 Liquid-in-Glass Maximum Thermometer .....	B-6
B-5 Index on Minimum Thermometer .....	B-6
B-6 Townsend Support for Maximum/Minimum Thermometers .....	B-7

<u>Figures:</u>	<u>Page</u>
B-7 Reading and Setting Thermometers.....	B-8
B-8 Reading Thermometers.....	B-9
B-9 Maximum Thermometer in Reading Position.....	B-10
B-10 Maximum Thermometer Before and After Whirling.....	B-10
B-11 Minimum Thermometer in Vertical Position During Resetting of Index.....	B-11
B-12a Joining the Alcohol Column Tapping Method .....	B-12
B-12b Joining the Alcohol Column Centrifugal Method .....	B-13
B-13 C450-1 Original .....	B-14
B-14 C450-7 Upgrade.....	B-14
B-15 C451-N1 Nimbus PL-2 .....	B-14
B-16 MMTS “Help” Display .....	B-15
B-17 WS Form B-91, Temperature Entries .....	B-19

1. Definitions. The word temperature as used in this appendix refers only to the air temperature. Temperature readings are taken from maximum and minimum thermometers, or from the digital displays of an electronic thermometer.

The minimum temperature is the lowest temperature to have occurred since the minimum thermometer or on the electronic thermometer since it was last read and reset.

The maximum temperature is the highest temperature since the maximum thermometer or electronic thermometer since it was last read and reset.

The current temperature is the temperature at the time the thermometer or electronic thermometer is read. This is read from the maximum thermometer while in a vertical position after it has been whirled.

2. Types of Thermometers. There are two types of temperature sensors approved at cooperative stations; the liquid-in-glass maximum and minimum thermometers (Figure B-1) and the electronic thermometers (seen in background of Figure B-2). Figure B-1 shows the liquid-in-glass (LIG) maximum and minimum thermometers in their correct operating or measuring positions. The LIG thermometers are required to be housed within a Cotton Region Shelter (CRS). The CRS is pictured in Figure B-2.

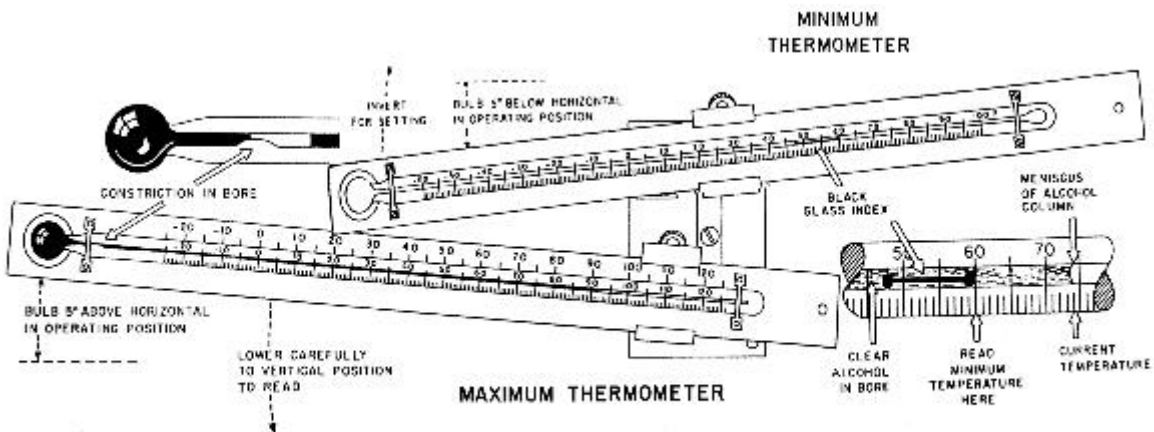

Figure B-1 - Liquid-in-Glass Maximum and Minimum Thermometers

3. Instrument Shelters. Ensure thermometers are enclosed in shelters to reduce the risk of erroneous readings. The sensors are shielded from the sun, rain, snow, and other sources of light, heat, or cold, when they are housed in a shelter. Shelters are designed to allow the maximum possible free flow of air. Ventilation is accomplished by louvers which slope downward from the inside to the outside of the shelter and with a double top. Figure B-2 shows the medium-sized cotton region shelter used most often for liquid-in-glass maximum and minimum thermometers. Liquid-in-glass thermometers are mounted on a horizontal board located in the upper middle part of the shelter. The MMTS shelters are shown behind the cotton region shelter in Figure B-2.

3.1 Shelter Placement. The ground under the shelter should be typical of the surrounding area. A level, open clearing is desirable so the thermometers are freely ventilated by the flow of air. Do not install on a steep slope or in a sheltered hollow unless it is typical of the area, or unless data from that type of topographic location is desired. When possible, the shelter should be no closer than four times the estimated height of any obstruction (tree, fence, building, etc.). Optimally it should be at least 100 feet from any paved or concrete surface. Under no circumstances should a shelter be placed on the roof of a building as this may result in extreme temperature biases.



Figure B-2 - Instrument Shelters Cotton Region Shelter and Two MMTS Shelters

All shelter supports or poles should be mounted securely enough into the earth or a concrete slab to eliminate vibrations. Strong winds can cause vibrations that will displace the indices on maximum and minimum thermometers, causing erroneous readings. Ensure the wooden shelter door faces “North” to prevent the sun from shining on the thermometers when the door is open.

3.2 Shelter Maintenance. Dust the inside of the cotton region shelter occasionally with a dry cloth. Inspect supports for a secure mounting. The cooperative observer should report any defects or changes to the NWSREP. The NWSREP is responsible for painting the cotton region shelter when needed.

Remove insect nests and other matter restricting air flow through the MMTS shelter (Figure B-3) when needed. The NWSREP should periodically disassemble the MMTS shelter and clean the plastic louvers with mild soap and water. The sensor should be cleaned with a non-abrasive cloth. Reassemble the plastic louvers in the same location before it was disassembled. Not all the plastic louvers are the same size.

**Caution:** Plastic louvers have sharp edges that may cause injury.



Figure B-3 – MMTS Shelter

#### 4. Liquid-in-Glass Maximum/Minimum Thermometers.

4.1 Mercury Clean-Up. Each cooperative observing site with mercurial thermometers will be supplied a Material Safety Data Sheet (MSDS) and one mercury clean-up kit for each mercury thermometer. The MSDS can be downloaded from the Consolidated Logistics System (CLS) inventory web site, after you type in the agency stock number: C102-1. The MSDS should be added to the kit.

Clean-up kits may be purchased by the field office or by the regional office. Two examples are: Safetec EZ Cleans Mercury Spill Kit; and LAB SAFETY SUPPLY ® Portable Mercury Spill Kit.

The kit is provided by the NWSREP to the Observer and should include a pair of gloves (rubber, polyethylene or polyvinylchloride), safety glasses, mercury absorbent sponge/sponges (e.g., Hg Absorb), mercury absorb powder, magic marker, adhesive tape (e.g., duct tape), adhesive label, and a self-sealable heavy duty plastic bag. The NWSREP will explain information on the MSDS and instruct the cooperative observer how to clean a mercury spill from a broken thermometer. If a mercurial thermometer breaks, there could be pieces of mercury contaminated glass and droplets of mercury on the floor of the Cotton Region Shelter. When a broken thermometer is discovered, the observer should follow instructions provided with the kit. If instructions are not provided, the following steps are recommended:

- Wear safety glasses and gloves before starting the cleanup.
- Collect any broken mercury contaminated glass and place it in the plastic bag. Be careful not to pierce the bag (double bagging may be necessary.)

- Place the mercury absorbent sponge with rough-side up (the rough side contains active material that will amalgamate mercury).
- Dampen the active side of the sponge with several drops of water. Spread the water evenly and wait one minute. (Excessive water may reduce the ability of the sponge to pick-up mercury).
- Slowly wipe down the mercury contaminated areas with the active side of the sponge (i.e., face down). The mercury droplets will be amalgamated by the chemical layer on the sponge.
- Use mercury absorb powder to collect remaining mercury droplets, if necessary. Sprinkle powder and wet the powder with water and scoop the residue to a disposal bag.
- Place the used sponge into the plastic bag, seal the bag closed with adhesive tape, and label the bag: “Hazardous Waste - Mercury.” The bag with the mercury waste should always be placed in the secondary container (metal or plastic with lid). The lid should be secured with an adhesive or electrician tape to prevent mercury escape in the case of accident. The secondary container should be labeled: “Waste Mercury UN 2809, RQ, UN151” to be ready for transportation.
- The cooperative observer will phone the NWSREP and request retrieval of the mercury waste. The NWSREP will responsible for transportation and disposal of the mercury waste according to instructions in NWSM 50-5116, *Environmental Management*, Sections 2 and 3, <http://www.nws.noaa.gov/directives/sym/pd05051016curr.pdf> .

4.2 Maximum Thermometer - How It Works. The maximum thermometer has a mercury filled bulb sensing element. It is exposed in a nearly horizontal position (Figure B-1). Graduations at one degree intervals are etched on the stem. The bore is constricted between the graduated portion of the stem and the bulb, as shown in Figure B-4.

As the temperature rises, some of the expanding mercury in the bulb is forced to pass through the constricted portion into the graduated portion. As soon as the temperature falls, the column of mercury breaks at the constriction leaving the thread of mercury in the graduated portion indicating its highest reading. The thermometer is turned vertical for reading. The top of the mercury column indicates the highest temperature reached. Once the maximum temperature is read, the max thermometer is spun in its mount to force the mercury in the graduated tube past the constriction until it joins the mercury in the bulb. When joined, the maximum thermometer will indicate the current air temperature.



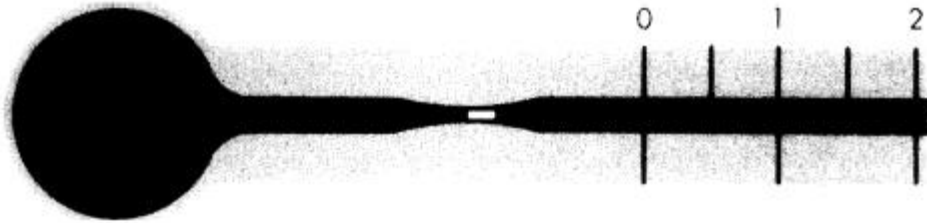

Figure B-4 - Liquid-in-Glass Maximum Thermometer

4.3 Minimum Thermometer - How It Works. The minimum thermometer has a spirit-filled bulb, graduated at one degree intervals, and exposed as shown in Figure B-1. The spirit is often colored to make it easier to read. The bore contains a dark dumbbell-shaped object called an index (Figure B-5). As the temperature rises, the spirit expands and flows around the index without displacing it. Part A of Figure B-5 shows the top of the spirit column some distance to the right of the index. In Part B, the spirit column has retreated with falling temperatures until the top just touches the index. Further cooling moves the index nearer the bulb (to the left). As the temperature rises again, the spirit column moves toward the right without moving the index. Part C in Fig B-5 shows an incorrect reading with the index trapped in the broken spirit column. Correcting this problem is described in Section 5.2.

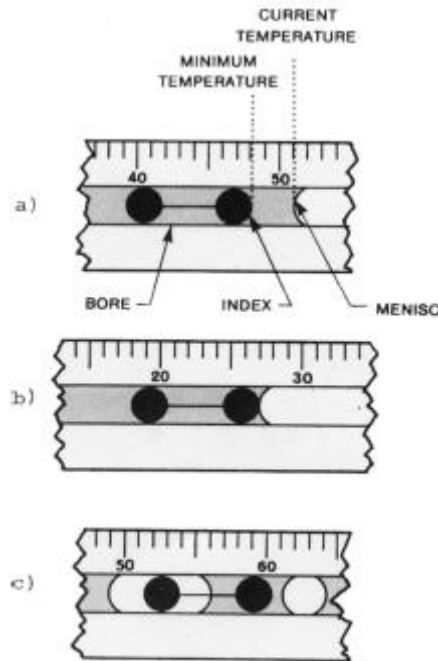

Figure B-5 - Index on Minimum Thermometer

4.4 Mounting and Maintaining the Thermometer Support. Thermometers are mounted in instrument shelters on supports such as the one shown in Figure B-6. This support is known as

the “Townsend Support”. The support makes it easy to read and reset the thermometers to the current temperature at the time of observation.

The support consists of two metal shafts fastened to a metal base plate. Clamps, which hold the thermometers, are attached to the end of the shafts. The longer shaft holds the maximum thermometer, while the shorter shaft holds the minimum thermometer. The maximum thermometer may be spun (rotated) by hand to reset the mercury column to the current temperature. A pin in the minimum thermometer shaft prevents it from rotating more than a quarter turn (about 90°). It is reset by rotating it to the vertical position.

4.5 Mounting the Thermometers. Clamp the metal back of the maximum thermometer to the lower (longer) shaft of the support at a point 3.5 inches from the high-temperature end of the back. The bulb end will be to the left when the thermometer is set.

Clamp the metal back of the minimum thermometer to the upper (shorter) shaft. The back should be clamped at a point slightly closer to the high temperature end than the bulb end. The bulb end should be to the left when the thermometer is set.

The bulbs should not touch any object when rotated or tilted vertically. When properly installed and set, the bulb end of the minimum thermometer will be raised slightly (about 5°) above the horizontal (Figure B-1).

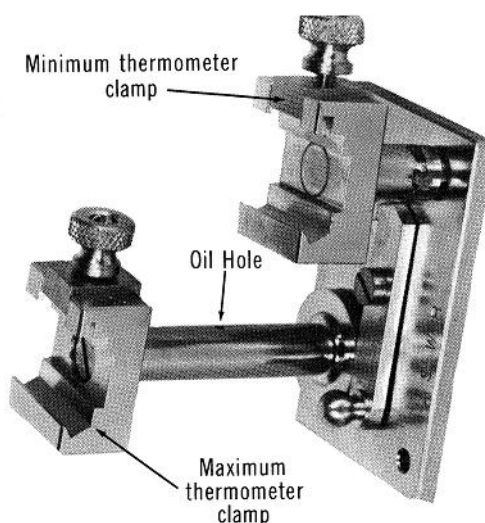
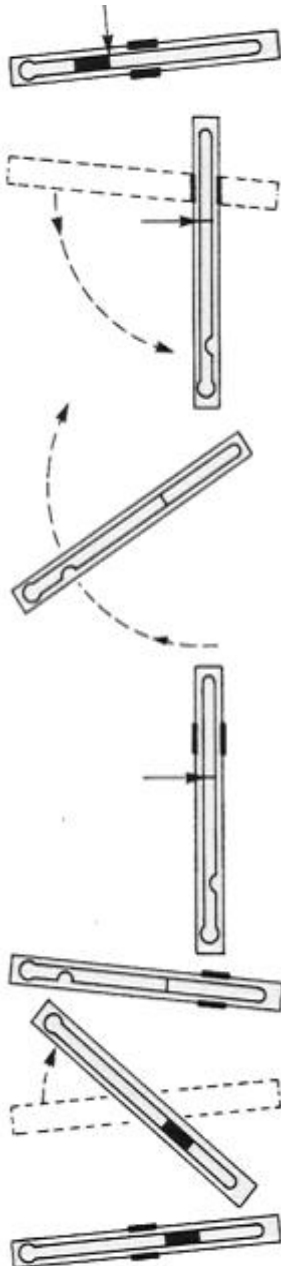

Figure B-6 - Townsend Support for Maximum/Minimum Thermometers

4.6 How to Read and Record Temperatures. Thermometers are read and recorded to the nearest whole degree Fahrenheit. Readings are usually recorded on WS Form B-82, and WS Form B-91, or WS Form B-92. Temperatures below zero are recorded with a minus (–) sign to the left of the digits; i.e., –15°F for 15°F below zero. The thermometers should be reset after they are read, as described in Sections 4.6.1, 4.6.2 and Figure B-7.

**Caution:** Stand as far from the thermometers as possible to prevent body heat from changing the readings. This is particularly important in cold weather. The bulbs of the thermometers should not be touched.



- a. Read the right end of the index on the minimum thermometer.
- b. Unlock and slowly lower the maximum thermometer and read the top of the mercury column.
- c. Whirl the maximum thermometer until its reading agrees (within 1°F) with the reading at the top of the spirit column on the minimum thermometer. When the two thermometers differ by more than 1°F, this should be reported to the NWSREP.
- d. Read the current ambient temperature from the maximum thermometer after it has been whirled, except at evaporation stations.
- e. Rotate the bulb end to the left near horizontal and lock the maximum thermometer in its set position.
- f. Invert the minimum thermometer until the index drops to the end of the spirit column.
- g. Return the minimum thermometer to its nearly horizontal position.

Figure B-7 - Reading and Setting Thermometers

The line of sight from the top of the mercury or spirit column should be level to the eyes. If not, the reading will be too high or too low, as illustrated in Figure B-8.

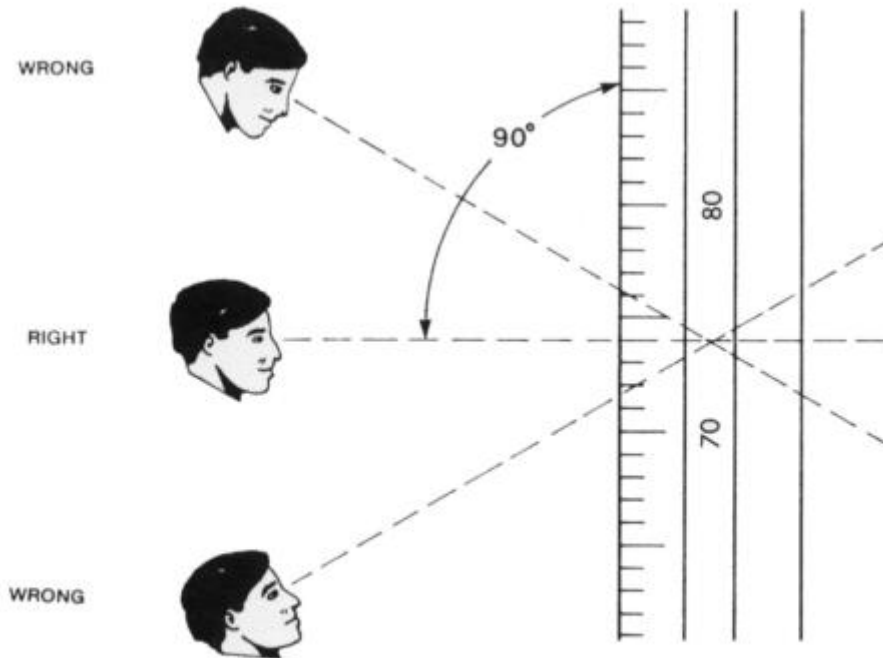

Figure B-8 - Reading Thermometers

4.6.1 Reading and Setting the Maximum Thermometer. The highest temperature occurring since the maximum temperature was previously reset is the reading at the top of the mercury column, taken with the bulb end lowered. Release the support catch on the back of the clamp and carefully lower the bulb end of the thermometer. See Figure B-9.

To reset the maximum thermometer, start with the bulb end lowered and whirl it rapidly, allowing it to spin freely until it comes to rest. Repeat the whirling if necessary until the mercury will not retreat farther into the bulb; i.e., until the column is no longer separated at or below the constriction. See Figure B-10.

Next, move the catch on the support until it touches the longer shaft. Carefully elevate the bulb end of the thermometer until the catch locks the shaft in place on the support. The thermometer is now “set” to indicate the maximum temperature that occurs before it is set again.



Figure B-9 - Maximum Thermometer  
in Reading Position

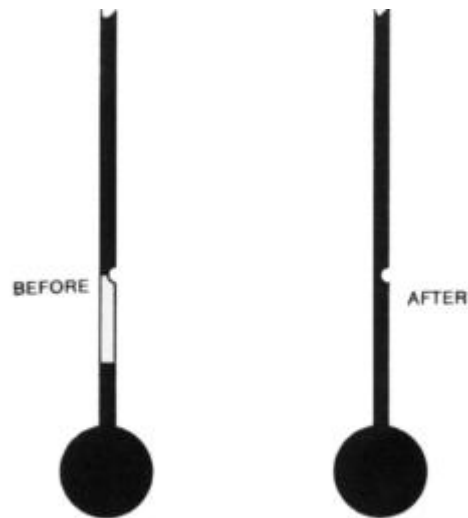

Figure B-10 - Maximum Thermometer  
Before and After Whirling

4.6.2 Reading and Setting the Minimum Thermometer. The minimum temperature is the reading at the end of the index farthest from the bulb (not the reading on the spirit column). Read the thermometer before moving it from the almost horizontal position in which it was set at the time of the last observation.

To reset the minimum thermometer, point the bulb end upward (Figure B-11). Allow the index to fall to the end of the spirit column. Then turn the thermometer counterclockwise until it stops. The bulb end will now be slightly lower than horizontal.



Figure B-11 - Minimum Thermometer  
in Vertical Position During Resetting of Index

4.6.3 Reading the Current Temperature. Read the current temperature from the maximum thermometer while it is in a vertical position after spinning. Read the temperature at the end of the mercury column farthest from the bulb. Read it immediately after resetting it. The current temperature should be within 1°F of the minimum thermometer. If the current and minimum temperatures are not within 1°F notify the NWSREP.

5. Correcting Thermometer Errors. Sometimes there may be breaks in the mercury or spirit columns, the thermometer may be too difficult to reset, or it will reset itself between readings. The following instructions explain how to correct some of these problems. If a correction is impossible, the cooperative observer should request a replacement from the NWSREP.

5.1 Correcting Maximum Thermometers. The constriction shown in Figure B-4 may not be small enough in some thermometers to prevent the mercury from withdrawing into the bulb when the temperature falls after reaching its maximum value. Sometimes rough handling will cause this problem. To test for this defect, place the thermometer in a vertical position. If the mercury withdraws into the bulb without spinning the thermometer, replace the thermometer. This defect should be reported to the NWSREP promptly.

If the constriction is too small, it may require many spins of the thermometer to get the mercury to return to the bulb, especially during low temperatures. This should be reported to the NWSREP.

Sometimes a small amount of mercury will lodge in the upper end of the bore. To correct this problem, hold the thermometer vertically with the bulb upward. Tap the metal back of the thermometer gently with a finger until the column joins the mercury at the bottom. Lower the bulb, allowing the column to slide slowly down the bore to the constriction. When the mercury cannot be united as above, remove the thermometer from its support and swing it as in Method II of Section 5.2.

5.2 Correcting Minimum Thermometers. Sometimes the spirit column of a minimum thermometer separates into small parts, causing incorrect readings. Separations may appear as small bubbles, making the column too long and readings too high, and trapping the index. Some spirits may separate completely and remain in the upper portion of the bore, resulting in readings too low. The thermometer should be inspected regularly for these problems. The methods described below may have to be repeated several times, taking 15 to 20 minutes, before the column can be joined. The thermometer should be kept in a vertical position for several hours after parts of the column have been joined, in order that spirit clinging to the sides of the bore will drain down. When repeated attempts fail to join the spirit column, replace the minimum thermometer.

#### METHOD I: TAPPING

Grasp the thermometer slightly below the middle with the bulb end down. Strike the edge of the metal back sharply against the palm of your hand as shown in Figure B-12. Repeat this procedure several times. Do not hold the thermometer so that your fingers or any part of your hand presses against the stem. The bulb end may also be tapped on an open book.

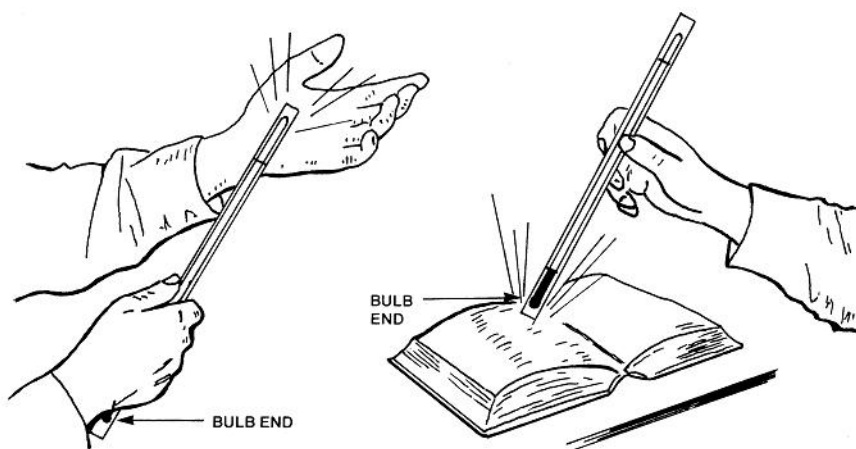

Figure B-12a. Joining the Alcohol Column Tapping Method

## METHOD II: CENTRIFUGAL FORCE

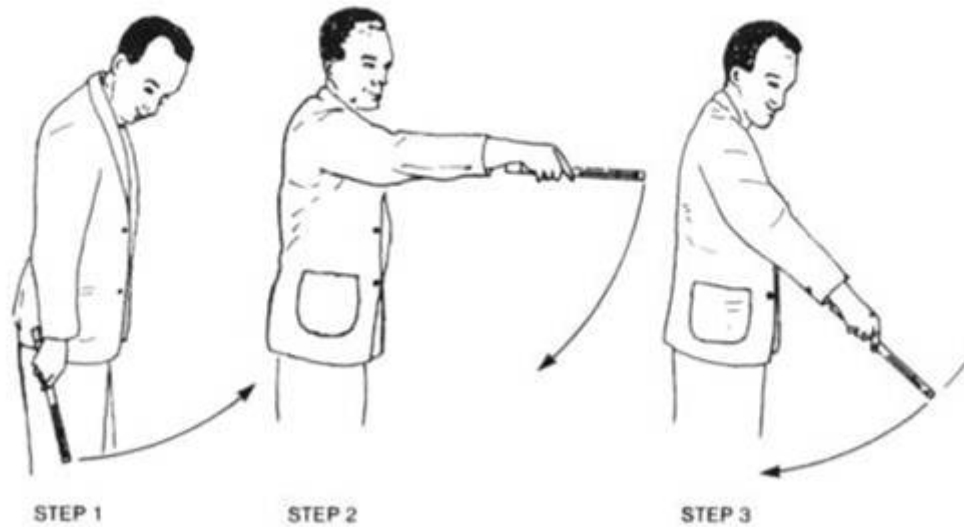

Figure B-12b. Joining the Alcohol Column – Centrifugal Method

A short, quick swing of the arm is often effective in forcing the index toward the bulb and reuniting segments of the alcohol column. Grasp the thermometer firmly by the edges of the metal back a little above the midpoint. Avoid pressure on the back. With the arm extended upward, quickly swing the thermometer downward through an arc of 3 or 4 feet, stopping the motion suddenly when the thermometer is vertical. Sometimes it will be necessary to repeat this operation several times.

The thermometer can also be whirled on a short cord. Pass a strong cord through the hole in the top of the metal back of the thermometer. Firmly grasp the cord 6 to 8 inches from the thermometer and whirl it rapidly. Stand clear of all objects the thermometer might strike while whirling. It may take considerable practice to spin the thermometer rapidly and stop it safely. This method will often bring down an entrapped index and unite detached segments of the column. Ensure the cord is not cut by the thermometer back as it is whirled.

6. Electronic Thermometers. The electronic thermometer measures the current air temperature over a range from  $-80^{\circ}\text{F}$  to  $+140^{\circ}\text{F}$  and compares it to the highest and lowest values stored in the memory of a microprocessor. If the current temperature exceeds the previous highest or lowest reading, then it becomes the newest maximum or minimum temperature.

A thermometer display unit (TDU) is supplied for the Nimbus and the MMTS models described in this manual. The display unit is installed indoors and is connected by wire to the thermometer mounted outdoors. All new and upgrade TDU installations are to be installed with a primary protector assembly (PPA). The PPA is a surge protector mounted outdoors, in the sensor line



between the thermistor/shelter and the TDU. The PPA is known as part number C460-5, and is installed according to NWS Maintenance Note, *Primary Surge Protection C460-5 Installation Instructions*, posted to: [www.nws.noaa.gov/ops2/Surface/coopmodnotes.htm](http://www.nws.noaa.gov/ops2/Surface/coopmodnotes.htm). If the observer's facility does not have an adequate grounding electrode conductor, then the OPL/DAPM is required to permanently remove the MMTS or Nimbus system from this COOP site.

6.1 Initial Checkout of Instrument. The NWS has three types of approved electronic thermometers, the NWS designed C450-1, the newer C450-7, and a commercial off the shelf unit, the Nimbus PL-2. The Nimbus unit will be referred to as the C451-N1 in this manual.



Figure B-13 - C450-1  
Original



Figure B-14 - C450-7, Upgrade



Figure B-15 - C451-N1,  
Nimbus PL-2

Important: Always turn the electronic display unit power switch “off” on the C450-1 and C450-7 when the unit is not plugged in. If the power switch is “on” and the unit is unplugged, the battery supplying the emergency backup power will severely discharge, “permanently damaging” the system. The C451-N1 does not have an on/off switch. When not in use, remove the AC adapter and the 9 Volt battery to power down the unit.

- a. Connect the instrument shelter to the display unit with the fabricated cable.
- b. C450-1 and C450-7 Plug the AC power cord of the display unit into an AC outlet.  
  
C451-N1 Plug the AC adapter into an AC outlet and into the back of the unit. Install a 9 Volt Alkaline battery into the rear compartment.
- c. C450-1 and C450-7 Turn on the power switch located on the rear panel of the display unit.  
  
C451-N1 The unit is on when either the AC adapter or or battery are connected.

- d. C450-1 and C450-7 Allow one hour for the backup nickel cadmium battery to charge and then turn the display unit off and back on to reset it. C451-N1 No action required.
- e. C450-1 and C450-7 Check to see if display shows the message, "HELP". This indicates the microprocessor is functioning properly. Figure B-16 shows the display reading "HELP."  
 C451-N1 No action required. The unit will display the current temperature.
- f. C450-1 and C450-7 Depress the button labeled "RESET". The message "HELP" will be replaced by the current temperature; e.g., 66.3.  
 C451-N1 Depress and hold the "CLEAR" button until the display reads "E2E2". This takes about 6 seconds. Then release the button. The unit will display the current temperature.
- g. C450-1 and C450-7 Press and hold the "MAX" and "MIN" buttons simultaneously to test the fluorescent display for missing segments. All segments that are not already illuminated will flash intermittently.  
 C451-N1 No action required.
- h. C450-1 and C450-7 The message "LO" or "HI" may appear indicating an open or shorted sensor or bad cable, or less likely, a temperature colder than -55°F or hotter than +125°F.
- i. C451-N1 The display "-99.9" or "255.5" may appear indicating an open or shorted sensor or bad cable, or less likely, a temperature colder than -55°F or hotter than +125°F.

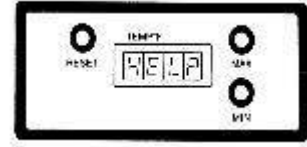

Figure B-16 – MMTS 'Help' Display

6.2 Calibration. No calibration is necessary due to the design of the MMTS. To verify proper operation, some cooperative observers may be given accuracy verification equipment by the NWSREP, who will provide instructions on its use. Temperature sensors used with all three systems are accurate within 0.4°F between -40°F and +104°F, and within 0.7°F for temperatures between -40°F and -55°F and between +104°F and 125°F if working properly.

6.3 Operation. The current temperature is displayed if no buttons are pressed.

To view the Maximum or Minimum Temperature:

- a. C450-1 and C450-7 Depress the “MAX” button to display the maximum temperature that occurred since the unit was last reset. Depress the “MIN” button to do the same for the minimum temperature.
- b. C451-N1 Verify the “MEMORY” switch is “OFF”. Depress and hold the “RECALL” button. The display will toggle back and forth showing the maximum and minimum temperatures while the button is depressed.

To reset the Maximum or Minimum Temperature:

- a. C450-1 and C450-7 Simultaneously press the “RESET” and “MAX” buttons to reset the stored maximum temperature. Do the same with the “RESET” and “MIN” buttons to reset the minimum temperature.
- b. C451-N1 Verify the “MEMORY” switch is “OFF”. Depress and hold the “CLEAR” button until the display reads “E2E2”. This takes about 6 seconds. Then release the button.

Do not reset the maximum or minimum temperatures between the scheduled times of observation. Resetting the temperatures at unscheduled times is a common cause of errors.

Record the maximum, minimum, and current temperatures on WS Form B91 or WS Form B-92 to the nearest whole degree, even though the readings are displayed to the nearest tenth degree. If the last digit is a 5 or higher (e.g., 43.5), round the temperature upward to the next higher whole degree (i.e., 44). If the last digit is 4 or lower (43.4) round the temperature downward to the whole degree (i.e., 43)

6.4 Identifying and Correcting Erroneous Maximum/Minimum Temperatures. Today’s maximum temperature is at least as high as the higher of today’s or yesterday’s temperatures at the time of their respective observations. For example, if the temperature at observation time yesterday was 64°, and today’s maximum temperature is displayed as 62°, today’s maximum temperature should be raised to 64°. See Section 8, for a description of the most frequently occurring errors.

Similarly, today’s minimum temperature should be at least as low as the lowest of today’s or yesterday’s current temperature. If not, lower it to the lower of the two readings. For example, if yesterday’s observation time temperature was 64° and today’s minimum is 65°, the minimum temperature must be lowered to 64°. Improper resetting between observation times creates more errors than all other causes combined. Persistent errors from other causes (i.e., vibrations) should be reported to the NWSREP.

6.5 “Help” and Blinking Displays. If the “HELP” message appears on the display, press the “RESET” button to clear it and to show the current temperature.

- a. C450-1      When the AC power line voltage is interrupted on a C450-1 unit; the microprocessor enters a “power down” condition in which the internal backup battery is used to preserve the maximum and minimum values stored in memory. These values are stored a minimum of two hours without power. However, no updating of new maximum and minimum temperatures occurs during the power interruption. Determine if the stored readings are still valid, based on the length of the outage.
- b. C450-7      When the AC power line voltage is interrupted on a C450-7 unit, the display is blanked to preserve battery power, but the unit continues to measure the maximum and minimum values and update them to memory. Operation of the unit will continue for several hours without AC power and is indicated by a lit decimal point in the display. If power returns before the battery is depleted, the unit will NOT display “HELP”, and no action is required of the user as the data record is continuous through the outage. If the outage is long enough to deplete the battery, the decimal point will disappear from the display. The unit will display “HELP” when the AC power returns. Any stored maximum or minimum values are not valid and they should log the daily readings accordingly. These units are identified by the markings “(ASN) C450-7” on the lower left of the front panel.
- c. C451-N1      This unit does not display “HELP” as it continues full operation on either AC power or battery. It will operate for more than 2 weeks on a fresh battery in the absence of AC power.

BLINKING:

- a. C450-1 and C450-7      Blinking of the tenths (right-most) digit on the display indicates the internal backup battery is charging. If the blinking persists and is not caused by power outages, the battery is probably defective, and the NWSREP should be informed.
- b. C451-N1      An “L” blinking on the left side of the display indicates the battery is low and should be replaced. Replace it with a 9 Volt Alkaline battery. This unit does not recharge the battery.

7. Entry of Temperature Readings on WS Form B-91. Maximum, minimum, and current temperatures are recorded to the nearest whole degree on WS Form B-91 (See Figure A-38). WS Form B-82 (Figure A-37) is designed to record readings taken outdoors, so as not to forget the values between the time the instruments are read and the time the readings are recorded on WS Form B-91. Since the electronic thermometer is read indoors, WS Form B-82 may be needed only for recording precipitation.
8. Common Errors to Avoid. Maximum and minimum temperature data are keyed into computers at NCDC. Data which are inconsistent either should be rejected or corrected. Observations are flagged most commonly for the following types of errors:
- a. Maximum temperature lower than the time-of-observation temperature at the previous observation (24 hours earlier). This error is most frequently committed by observers taking observations in the afternoon or evening.
  - b. Minimum temperature higher than the time-of-observation temperature at the previous observation (24 hours earlier). This error is most frequent among morning observers.
  - c. Maximum (and occasionally the minimum) temperature entered on the WS Form B-91 on the day it occurred rather than on the day the thermometers were read and reset. For example, a morning observer records high and low temperatures for the past 24 hours at 7 a.m. on the 25th as being 88° and 62°. The observer knows the maximum of 88° occurred on the 24th (the previous afternoon), so the observer records the high temperature on the WS Form B-91 for the 24<sup>th</sup>. It should have been recorded on the 25th; because this is the day the instruments were read and reset.

The most common cause of errors a. and b. is resetting the electronic thermometers (and for that matter, the liquid in glass thermometers) between times of observation. The maximum temperature for the past 24 hours should be at least as high as the time-of-observation temperature both today and 24 hours earlier, and the minimum at least as low as today's and 24 hours ago. This error appears to be committed because the afternoon observer wants to record this afternoon's maximum temperature when it is lower than yesterday's afternoon maximum.

This situation usually arises when it was warmer yesterday than today. Today's maximum should be recorded in the REMARKS column. For example, "PM MAX 48" or "TODAY'S MAX 48," and last night's minimum as "AM MIN 36." Figure B-17 shows the correct method of recording minima for the past night that is higher than the 24-hour minima (see the REMARKS entries on the 3rd and 4th) and 24-hour maxima that is lower than the previous afternoon's maximum (see the REMARKS entry on the 5<sup>th</sup>). Figure B-17 illustrates the date, temperature, and remarks columns associated with WS Form B-91. The scheduled time of observation for this cooperative observer is 8 A.M.

DATE	TEMPERATURE F.		AT OBSN.	REMARKS (Special observations, etc.)
	24 HRS. ENDING AT OBSERVATION			
	MAX.	MIN.		
1				
2			28	
3	44	28	39	AM MIN 36
4	65	38	62	AM MIN 55
5	62	35	35	PM MAX 58
6				

Figure B-17 - WS Form B-91, Temperature Entries

**APPENDIX C - River Stages and Related Precipitation Observations**

<u>Table of Contents:</u>	<u>Page</u>
1. Introduction.....	C-1
2. Staff River Gauge .....	C-2
3. Wire Weight Gauge .....	C-2
3.1 Description.....	C-2
3.2 Installation .....	C-3
3.3 Re-Installing a Wire Weight at an Established Site.....	C-6
3.4 Replacement of a Lost Weight.....	C-7
4. Profile Gauge .....	C-9
5. River Gauge Location.....	C-9
6. Relocating River Gauges .....	C-9
7. When to Report.....	C-9
8. What to Report.....	C-10
9. Report Forms .....	C-11

<u>Figures:</u>	<u>Page</u>
C-1 Staff Gauge .....	C-2
C-2 Left Front View of Wire Weight Gauge Components.....	C-4
C-3 Top View of Wire Weight Gauge Components.....	C-5
C-4 Installing Brass Weight Visual Instructions .....	C-7

1. Introduction. The term “stage” is the height of the water surface above an established datum or reference elevation. The term “gauge height” is used for readings from a gauge, but stage and gauge height are often used interchangeably. The datum may be a recognized elevation such as mean sea level or an arbitrary datum chosen for convenience. In either case, the gauge is adjusted for positive gauge heights. This is accomplished by setting the lowest possible gauge height (the case of no stream flow) to a value of zero. The elevation of the zero gauge height is referenced to the datum by running levels to a reference mark which has a known elevation relative to the datum. It is important that an elevation reference mark for the datum be located (or established) that is permanent even if the gauge is destroyed.

River stages are affected by many factors. Precipitation and temperature are the most commonly known causes of rises and falls in river stages, but river stages may also be affected by the

release of water from upstream reservoirs.

Precipitation readings at river cooperative stations are taken with the four-or eight-inch non-recording gauges (Appendix A). River stages are read using a staff, wire weight, or profile gauge, as described below.

\*Obtain a stage measurement at the river crest, recording the approximate time of occurrence. It is also very helpful to take observations, both as the river begins a significant rise and as it recedes from a crest\*. These reports, even when not transmitted, will be valuable input to computer models that relate precipitation to river stage, and to determine the relationships of river stages at different points on the river.

**\*Do not risk injury to collect data\***

2. Staff River Gauge. The staff river gauge (Figure C-1) is a fixed scale that can be in the form of porcelain-enameled iron sections, a wooden plank, or may be printed on available structures such as a bridge, pier, or wall. The gauge may be mounted vertically or inclined with graduations for vertical depth. The inclined gauge is used where ice or debris will not permit a permanent vertical staff to be installed. It usually consists of a heavy timber installed on the incline of the bank. The scale of the staff gauge is set so a reading can be taken at zero flow in the low-water channel. Readings are made to the nearest tenth of a foot. The staff gauge will usually have a gauge datum that will be the elevation of its zero reading referenced to mean sea level.

The gauge sections should be set so the readings are heights above the datum.

If vertical movement of the supporting structure occurs, such as settling, erroneous observations from the staff gauge will result unless levels are run from a reference of known elevation and the staff scale is reset.

If the gauge has been set with a scale that has graduations above and below zero, record the below zero readings on the report form with a minus sign; e.g.,  $-0.3$ . If possible, the gauge should be set so as to avoid negative values.



Figure C-1.  
Staff Gauge

3. Wire Weight Gauge.

3.1 Description. The wire weight gauge (Figures C-2 and C-3) is permanently mounted inside a lockable cast metal box attached to a bridge or similar structure. The gauge consists of a drum wound with a single layer of stainless steel cable, a bronze or brass weight attached to the end of the cable, a graduated disc, and a counter. The drums disk is graduated in tenths and hundredths of a foot and is connected to the counter which advances by one with each full revolution of the drum. The cable is made of 0.015 inch stainless steel wire, geometrically wound, and is guided to smoothly fill the drum by means of a threaded sheave. The wire weight reel assembly is equipped with a ratchet used to lock the drum and cable in any position by means of a pawl.



In order to check the check bar reading of the wire weight gauge, slide the check bar at the bottom fully forward toward the drum. When in this position, the cable weight when released can rest on the check bar. When the weight is resting on the bar with no slack in the cable, the combined reading from the counter and the number of graduations on the graduated disk equals the current Check-Bar reading.

The cable drum is fastened to the handle and shaft assembly by a friction clamp which, when loosened, allows the handle and shaft attached to the counter to turn independently of the cable drum. This allows the cable, weight and drum to be held in place on the check bar while the handle is turned to obtain the desired check bar reading on the counter and graduated disk. When the handle shaft assembly is released from the drum cable assembly, hold the cable drum in place by hand, to keep the weight from free falling.

3.2 Installation. It is important to note that the NWSREP is only responsible for the installation and maintenance of NWS owned wire weight river gauges. Gauges owned by another agency are the responsibility of that agency. The wire weight river gauge is traditionally mounted on the upstream side of a bridge above the main channel of the river or stream.

The wire weight can be attached to the bridge using several methods. In some cases, the gauge is mounted to the bridge with bolts or it can be mounted using straps which secure the gage to the railing. The method of mounting is dictated by the owner of the bridge.

A safety railing is required to be installed if the existing bridge railing is less than 39 inches high.

Many newer bridges have a concrete barrier on each side of the bridge which necessitates the use of a hanger strap that can be fashioned for the particular bridge. \* Consult with the owner of the bridge targeted for installation of a wire weight gauge to solicit approved methods of mounting the gauge. Never mount a wire weight gauge on a bridge without help. It is a **two person** job.

\* Get approval in writing from the bridge owner before installing gauge.

When the gauge is mounted on the bridge, levels have to be run for the gauge. Consult with the owner for benchmark/reference elevations. Often the owner will agree to run a level for the wire weight's check bar. This will save considerable work for the NWSREP. The ultimate objective of running a level on the new gauge is to develop a Check Bar setting. The process of determining the check bar elevations is calculated from the "gauge zero." Follow safety considerations outlined in Section 5.e

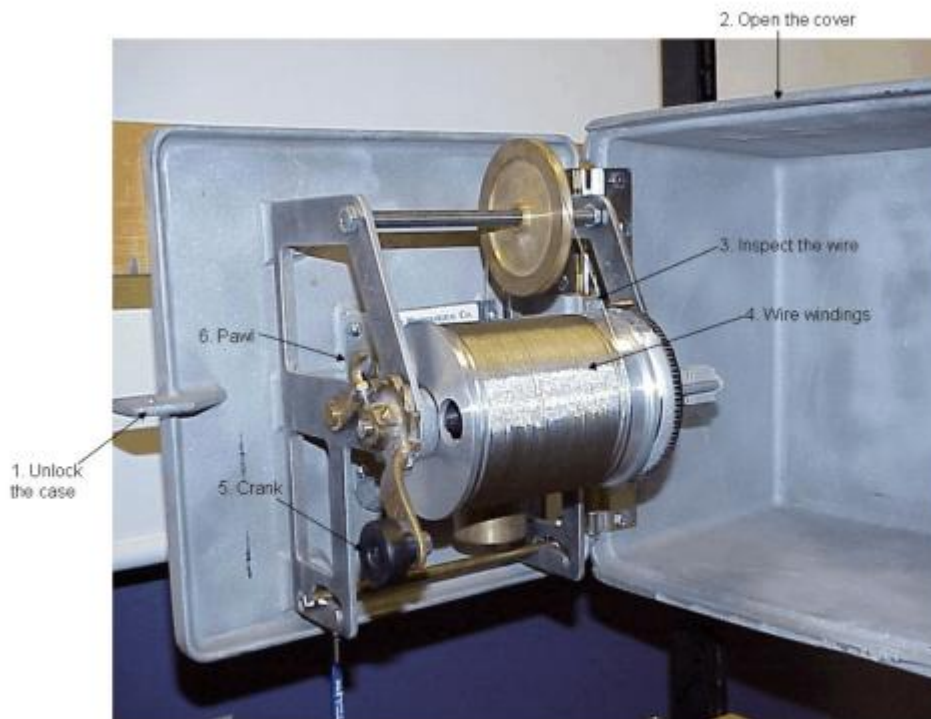

Figure C-2. Left Front View of Wire Weight Gauge Components

Take the readings as follows:

- a. Unlock the case at (1) and gently open the cover (2). If the cover jams and will not swing freely, do not force it open. Close, relock, and submit a repair order. Inspect the wire (3) on the drum (4) for even windings that touch each other.
- b. Grasp the crank handle (5) and release the pawl (6).

**Caution:** If the handle is released when the lock is not engaged the unit will backlash. Severe damage to the equipment or injury is possible.

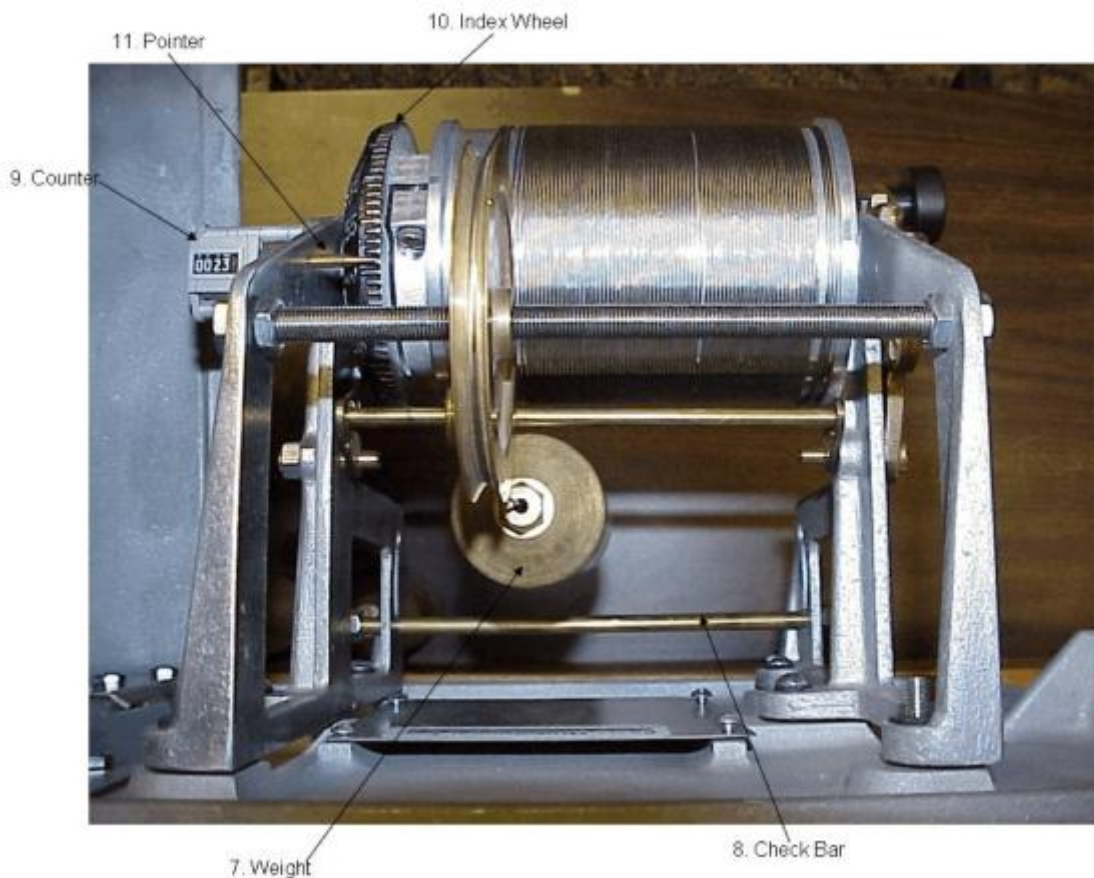

Figure C-3. Top View of Wire Weight Gauge Components

- c. Lower the weight (7) to just touch the check bar (8), which is read while in the forward position. Read the check bar elevation and record it. Enter this reading at the beginning, middle, and end of each month on WS Form B-91. The counter (9) displays units of feet. The index wheel (10) displays units of tenths and hundredths of a foot and is read at the pointer (11).
- d. Raise the weight and slide the check bar to the rear position. Lower the weight to the water surface and read this elevation just as the weight touches the water while descending. Average the peaks and troughs of elevation if the water surface is rough. Repeat this process at least once. If the point of contact with the water surface is difficult to determine, it may be necessary to strum the cable or to swing the weight in a pendulum motion up and downstream to obtain an accurate reading.
- e. Every day, record the reading obtained in step “c” in the "GAUGE READING AT" column on WS Form B-91 (Figure A-38).
- f. Engage the pawl and crank the weight to its original position within the gauge.

Slide the check bar to the forward notch. The crank handle should now be located in the rear position. This will allow the cover to close without touching the outer tip of the crank handle.

- g. Close the cover and lock the case.

3.3 Re-Installing a Wire Weight at an Established Site. When installing a wire weight gauge at an established site, the gauge zero is established. If acceptable, the established gauge zero is simply subtracted from the surveyed elevation of the newly installed wire weight's check bar. This is the distance in feet, tenths and hundredths of a foot the check bar is above the gauge zero. The distance becomes the CHECK BAR READING for the newly installed gauge. The new check bar reading should be documented on the SIR in CSSA. The new check bar setting should be immediately made available to the Service Hydrologist (SH) or focal point, the River Forecast Center (RFC) and the Cooperative Observer.

When the wire weight's observed check bar reading differs by 0.03 feet or more from the official check bar established for the station, ensure the check bar reading of the gage is brought back within tolerance. Assuming adjustment is necessary:

**Important.** Never adjust the gauge of another agency. Report any errors to the owner of the gauge.

- a. Note the difference upon inspection.
- b. Rest the weight upon the check bar assuring the cable is taught.
- c. While holding the cable and drum, loosen the 2 large screws which secure the cable drum to the graduated disk.
- d. Turn the crank handle until the counter and graduated disk indicate the desired check bar reading.
- e. Tighten the 2 large screws. Do not let go of the cable drum until both screws are tightened.
- f. Recheck starting at b. Read just as necessary.
- g. Lock the drum with the ratchet pawl.
- h. Move the check bar to the rear to allow the weight to be lowered.
- i. Lower weight to water level and rewind.
- j. Verify correct check bar reading of gauge.
- k. When the correct check bar reading is obtained, the gage crank handle may

require adjustment to permit closing of the gauge cover. This is accomplished by loosening the two small bolts which secure the handle to the shaft and repositioning the handle to allow closure of the cover. Re-tighten both bolts when repositioned.

- l. Lock gauge.
- m. Notify the SH of wire weight check bar readings before and after adjustment.

3.4 Replacement of a Lost Weight. When a weight is lost from a wire weight river gauge, determine the amount of cable remaining on the drum before deciding on the correct method of repair. This can be determined by winding the remaining cable on the drum and counting the number of feet of cable left. One complete revolution equates to one foot of cable. The condition of the remaining cable must be evaluated. If frayed or kinked, cable replacement should be considered.

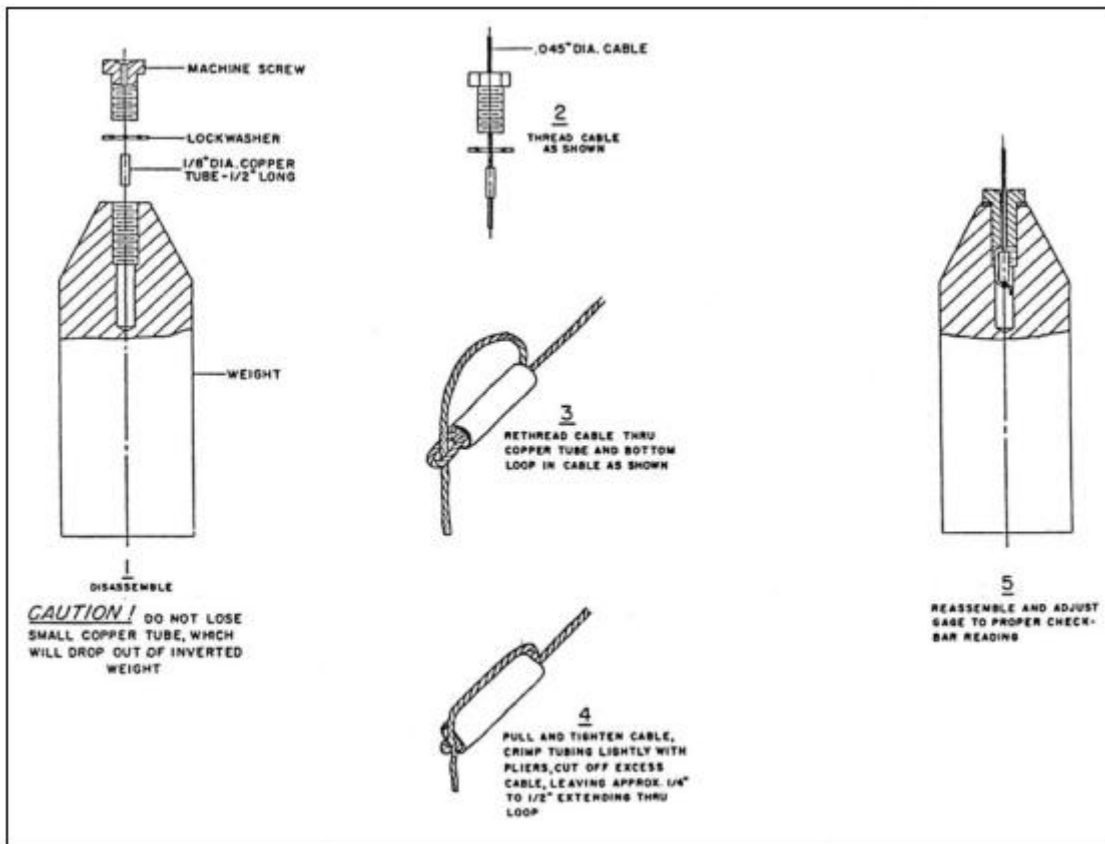

Figure C-4. Installing Brass Weight Visual Instructions

If the remaining cable on the wire weight is in acceptable condition and sufficient cable remains on the drum to allow the weight to extend several feet below gauge zero, a new brass weight can be installed on the existing cable. (See Figure C-4)

If the remaining cable on the wire weight is unacceptable or if it is too short to extend several

feet below gage zero, the cable must be replaced. When considering installation of a new cable, it is suggested that the drum be filled to near capacity (100 feet) regardless of the amount required to attain the necessary length. This process of installing a full drum of cable could allow several future weights to be replaced without adding new cable.

Cable replacement begins with the removal of the old cable. It can be easily unwound. **Note how the old cable is secured to the drum.** Attach the new cable in a similar manner. When attached to the drum, move the guide wheel on the threaded shaft to where it is directly above the point on the drum where the new cable is attached. Route the new cable over the brass guide wheel.

While continuing to hold the cable taut as it extends from the drum across the guide wheel, use the gauges crank handle and wind new cable onto the drum assuring that it fills the drum smoothly and evenly.

When sufficient cable is wound onto the drum, the weight can be installed. Tension applied while winding the cable should not be released. If the cable is released, the cable may loosen on the drum and become tangled. Keeping tension on the cable, install the new weight. When installed, route the weight between the guide wheel and gage mounting base to the normal weight position. Keep tension against cable until the weight takes over and provides tension to the cable.

The gauge should be back in operation. Lower the weight to the water level and rewind. The cable should rewind evenly on the drum. After successful installation of the new cable and weight, the wire weight's check bar reading must be set, and then the gauge is operational.

Routine use/reading of the wire weight river gauge:

- a. While holding the crank handle, release the latch pawl which locks the drum in place.
- b. Assure the check bar is moved completely to the rear (toward you).
- c. Using the crank handle, lower the weight slowly to the surface of the water so the weight is just touching the surface.

**Caution:** If the handle is released when the lock is not engaged the unit will backlash. Severe damage to the equipment or injury is possible.

- d. Read the counter for whole feet. Add hundredths of feet from the graduated wheel on the drum.

**Rough water-** if the surface is rough, average the peaks and troughs.

- e. This is the current river reading.

4. Profile Gauge. On some rivers, especially where man-made structures such as bridges are rare and where vertical or staff gauges can be damaged by ice jams and breakup, profile gauges are used. These consist of a marker, usually a brass cap benchmark, anchored in the bank above the levels of ice movement. The profile of the bank is surveyed to determine elevations to the nearest tenth of a foot and plotted on a graph. The cooperative observer, using a long surveyor's tape measure, determines the distance from the reference marker to the water's edge. From the graph, the slope distance is converted to a vertical stage. The observer always reports the slope distance to the NWS office.

5. River Gauge Location. Consider the following factors when selecting a site for the river gauge:

- a. The gauge should be located so river stages will best reflect flooding in the area of maximum damage potential.
- b. There should be access to the gauge during high water, if at all possible.
- c. The gauge should not be located in the backwater of a reservoir or of a main stem river, if possible.
- d. The river banks at the gauge site should be stable.
- e. Safety considerations require if a wire weight gauge is located on a bridge, the railing will be no lower than 42 inches. There should also be enough room for the observers to perform their job without having to worry about traffic. If either of these situations exists, the gauge should be moved or the safety of the location improved. Follow instructions in NWSM 50-1115.

6. Relocating River Gauges. A river gauge should be moved only after all other options have been exhausted. A different river gauge location is likely to change such forecast components as the relationship of the gauge reading to the discharge rate, flood wave travel time and attenuation, and flood stage. Moving the gauge may add or exclude a significant tributary from the drainage area. All users of the stage data will be informed of the change.

A new or moved river gauge location will mean establishing a new gauge datum if an arbitrary datum is used. If mean sea level is the datum, a bench mark or a new reference mark with known mean sea level will have to be located. It will then be necessary to run levels from the known elevation to the new gauge site.

A wire weight gauge will require a new check bar elevation determination, while a staff gauge will require the individual gauge sections be set to given elevations above the datum. If moving the gauge is necessary, observers should contact their NWSREP.

7. When To Report. Observations of river stage and precipitation should be taken at 7 a.m. each day unless otherwise specified by or agreed upon with the NWS. Special observations are taken at 1 p.m., 7 p.m., and 1 a.m. "only" when a report is required or when the cooperative

observer believes an emergency situation has occurred.

There are two types of reporting stations, daily and criteria. Criteria stations are sometimes called occasional stations. In many areas of the country, criteria (occasional) stations are being converted to daily stations.

At a “daily” reporting station, reports are to be sent immediately after the 7 a.m. observation. Extra reports are sent at 1 p.m., 7 p.m., and 1 a.m. when the river stage reaches a level designated by the NWSREP (the criteria level).

The reporting station should send its first report when the river stage reaches the criteria level specified by the NWS. Reports should continue daily until the stages fall below this level. If the river stage goes above a second criteria level, extra reports are to be made at 1 p.m., 7 p.m., and 1 a.m., until the stage falls below this level.

Observations of both precipitation and river stage should be recorded on WS Form B-91 at 7 a.m. every day at criteria reporting stations, even if stages are below criteria and are not sent. Always report the river stage and the precipitation together.

If no precipitation has occurred, the daily record from both types of stations should indicate 0 or 0.00.

When the rain gauge measurement reaches a criteria value (usually 0.50 inch), an initial report should be communicated to the WFO and any additional 0.50 inch amounts. The criteria are determined locally.

8. What To Report. The report should contain the following information:
  - a. Location (station name or number), date, and time of observation.
  - b. The amount of precipitation having fallen since the previous 7 a.m. observation (inches and hundredths).
  - c. Character of the precipitation (intermittent, continuous, showers).
  - d. The weather at the observation time (clear, cloudy, rain, snow, etc.).
  - e. The depth of snow and ice on the ground (nearest whole inch).
  - f. The water equivalent of snow and ice (nearest tenth inch), if agreement with the NWS.
  - g. The river stage at the observation time (feet and tenths).
  - h. The tendency of the river stage (rising, falling or stationary).



- i. The river stage at the previous 7 a.m. observation, if not previously reported.
- j. In the remarks section, enter special comments such as snow melting slowly or rapidly, unusually heavy rainfall in a short period of time (e.g., 1.54" in 30 minutes), ice breaking up or an ice jam forming on the river, etc.

When the water surface is disturbed due to turbulence or waves, record the stage as the average of the peaks and troughs.

9. Report Forms. All necessary forms will be furnished by the NWS. Each pad of forms contains detailed instructions. A sample of WS Form B-91 is shown in Figure A-38.

**APPENDIX D - Evaporation Station Observations**

<u>Table Of Contents:</u>	<u>Page</u>
1. Introduction.....	D-2
2. Setting up the Observation Site .....	D-2
2.1 Exposure of Equipment.....	D-2
2.2 Plot Layout.....	D-3
2.3 Enclosure .....	D-3
3. Evaporation Equipment .....	D-3
3.1 Evaporation Pan.....	D-4
3.1.1 Installation .....	D-4
3.1.2 Maintenance.....	D-5
3.1.3 Control of Algae .....	D-6
3.2 Fixed Point Gauge .....	D-6
3.3 Measuring the Amount of Evaporation .....	D-7
3.4 Micrometer Hook Gauge .....	D-8
3.5 Water Storage Tank .....	D-9
3.6 Anemometer.....	D-9
3.6.1 Installation .....	D-9
3.6.2 Maintenance.....	D-10
3.6.3 Wind Movement Readings .....	D-10
3.6.4 Data From 5-Digit-Counter Type Anemometers.....	D-10
3.6.5 Data From 6-Digit-Counter Type Anemometers.....	D-10
3.7 Dry and Wet Bulb Temperatures .....	D-10
3.7.1 Types of Psychrometers.....	D-10
3.7.2 Maintenance.....	D-11
3.7.3 Moistening the Wet Bulb.....	D-12
3.7.4 Taking Psychrometer Observations.....	D-12
3.8 Water Temperatures.....	D-13
3.8.1 Installation .....	D-14
3.8.1.2 Submerged-Mounted Thermometer.....	D-14
3.8.1.3 Recording Thermometers.....	D-14
3.8.2 Maintenance.....	D-14
3.8.3 Accuracy Checks .....	D-14
3.8.4 Rejoining Separated Mercury Columns.....	D-14
3.8.5 Reading and Resetting the Sixes Thermometer.....	D-14
4. Reading Observations from Evaporation Stations.....	D-15

<u>Figures:</u>	<u>Page</u>
D-1 Evaporation Station Plot Layout Example.....	D-3
D-2 Evaporation Pan.....	D-5
D-3 Stilling Well, Fixed Point Gauge and Measuring Tube.....	D-6
D-4 Transparent Measuring Tube and Stilling Well Inside the Pan.....	D-7
D-5 Evaporation Measurements.....	D-8
D-6 Hook Gauge.....	D-8
D-7 Anemometer.....	D-9
D-8 Totalizing Anemometer With 6-Digits.....	D-10
D-9 CRS With Fan.....	D-11
D-10 Sling Psychrometer.....	D-11
D-11 Sling Psychrometer (close up view).....	D-12
D-12 Sixes Thermometer.....	D-13
D-13 Submerged Mounted Thermometer.....	D-14
D-14 WS Form B-92, Record of Evaporation and Climatological Observations.....	D-15

1. Introduction. Observations of the amount of evaporation from an open pan are made to the nearest hundredth of an inch. Other elements recorded include wind movement, water and air temperatures, and precipitation. At some sites, additional parameters will be required, such as dry- and wet-bulb temperatures, humidity, and the temperature and moisture content of the soil. Appendix E contains instructions on soil temperature measurements.

2. Setting up the Observation Site.

2.1 Exposure of Equipment. The equipment site should be fairly level, sodded, and free from obstructions. It should be representative of the principal natural agricultural soils and conditions of the area.

Neither the pan nor instrument shelter should be placed over heat-absorbing surfaces such as asphalt, crushed rock, concrete slabs or pedestals. The equipment should be in full sunlight during as much of the daylight hours as possible, and be generally free of obstructions to wind flow. Obstructions that cannot be moved, such as trees, buildings, and nearby shrubs, should not be closer to the instruments than four times their heights. Shadows are permissible only near sunrise and sunset. Avoid areas subject to flooding or lawn sprinkling.

At reservoirs (flood control, water supply, and irrigation projects) the pan should be placed on the prevailing upwind side of the water. The pan site should be far enough from the water to avoid the chance of water or spray carried from a spillway, or picked up from the reservoir by a strong wind that will be deposited in the pan.

2.2 Plot Layout. The layout of the equipment on an example plot is shown in Figure D-1. The orientation of the layout is indicated by the position of the CRS and its door facing north.

Note the layout is designed to eliminate shadows from instruments at stations in the northern hemisphere. Shadows from small diameter fence posts will occur only briefly in the late afternoon. The minimum distances between instruments are illustrated.

The 16- by 20-foot plot shown allows ample room for more equipment. The size of the plot can be either smaller or larger depending on how much equipment is needed.

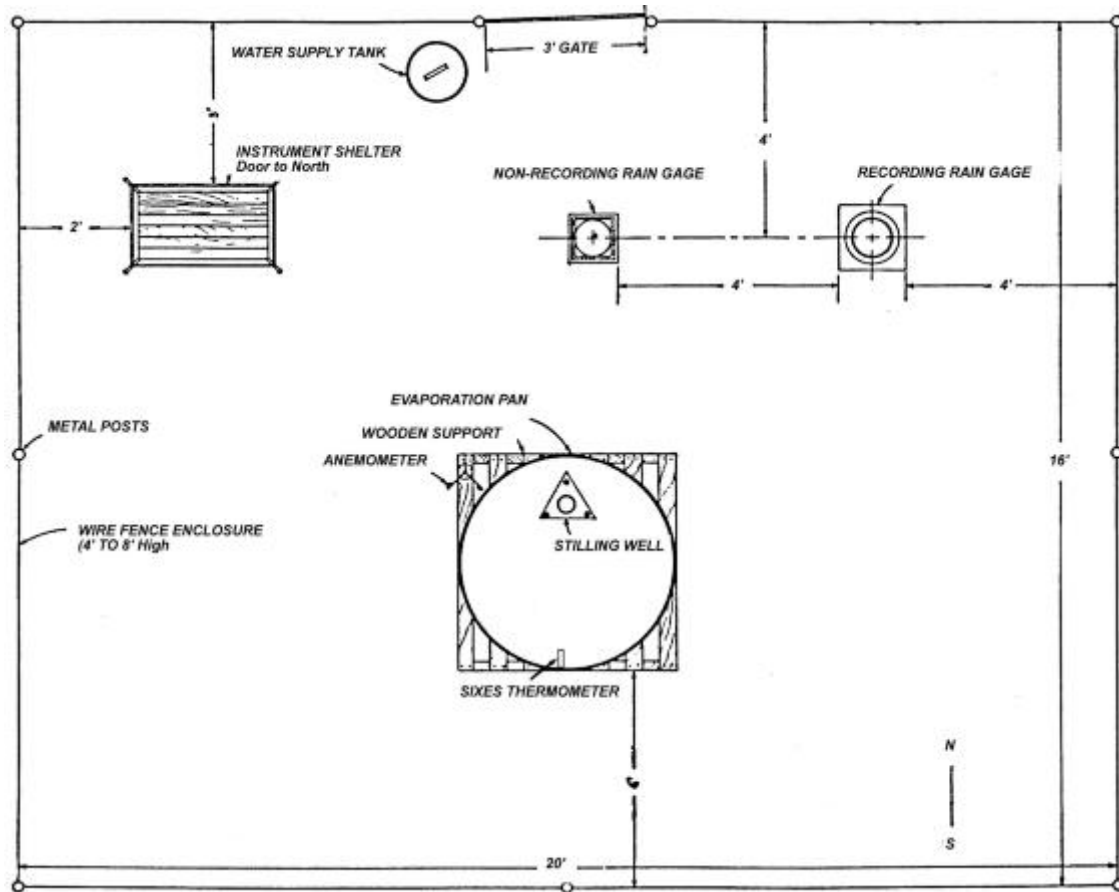

Figure D-1. Evaporation Station Plot Layout Example

2.3 Enclosure. Enclose the plot by a fence to keep out animals. A steel chain link fence (9 or 11 gauge), 4 or 5 feet high, with steel posts set in concrete is recommended. Fences of wood or other solid material will not be used. Burying a barrier underneath the fence may be necessary for protection from burrowing animals, or add 18 to 24 inches of one inch galvanized chicken mesh fence along the bottom of the chain link fence to keep out small animals.

3. Evaporation Equipment. This section describes the installation, maintenance, and method of taking observations from each instrument. Evaporation measurements are made with an evaporation pan and a fixed-point gauge with a measuring tube.

Evaporation stations have the following additional instruments:

- a. An anemometer to determine the daily wind movement over the pan and a display stand pintle (Section 3.6).
- b. A non-recording precipitation gauge with appropriate measuring stick or in some cases, a weighing-type recording precipitation gauge.
- c. A water temperature thermometer to provide maximum, minimum, and current temperatures of the water in the evaporation pan (Section 3.8).
- d. Maximum and minimum thermometers for measuring the air temperature. An MMTS system can also be used.
- e. An instrument shelter for housing the temperature (dry bulb and wet bulb) measuring instruments. From the dry bulb and wet bulb, dew point is calculated.
- f. A water storage tank (if necessary) to provide a reserve water supply for the pan (Section 3.5).

3.1 Evaporation Pan. The pan is circular, 10 inches deep, and has an inside diameter of 47.5 inches. It is constructed of stainless steel (Figure D-2). Also shown in Figure D-2 are the pan support, anemometer, stilling well, fixed point measuring tube, and sixes thermometer submerged.

3.1.1 Installation. Center the pan on a pressure treated wooden support resting on leveled ground in order to assure there is level water in the pan. Ensure that the pan is located in an area free from flooding even in heavy rains, or where runoff could wash away the support. If fill dirt is required to level the ground, it should be tamped firmly. The top of the wooden support should be a minimum ½ inch above the dirt. This will leave an air space between the bottom of the pan and the fill dirt to simplify inspecting the pan for leaks.



Figure D-2 Evaporation Pan

3.1.2 Maintenance. The pan should be routinely inspected for leaks. Leaks in an evaporation pan render measurements useless. The observer should notify the NWSREP if a leak is discovered in the pan. The observer should also record on the observing form, the date the leak was discovered and the date the pan was repaired or replaced.

Clean the pan as often as necessary to keep it free from any substance that will alter the evaporation rate, such as sediment, scum, oil films, and algae. Oil films greatly reduce evaporation.

The interior or exterior of the pan should never be painted. This would alter the evaporation characteristics. In order to compare measurements between sites, ensure all pans have identical characteristics.

Under no circumstances should the pan be lifted and emptied with a significant amount of water in it. This action can split or bend the pan. Most of the water should be siphoned or dipped out first. A length of plastic water hose can be used to siphon out the water.

During months when freezing conditions are likely, empty clean, and store the pan, preferably indoors. If the pan is left in the fenced enclosure, it should be turned upside down and secured to the support with a strong rope.

3.1.3 Control of Algae. A small amount (follow label instructions) of copper sulphate may be added to the water to discourage algae growth. The NWSREP will supply the copper sulphate. If algae is already present, remove it by thoroughly cleaning the pan. Prior to emptying the pan, remove excess copper sulphate by placing 1-3 iron penny nails\* in the pan overnight. The color of the water will change from blue, to orange, to clear with a muddy brown precipitate. Decant the water (siphon or dip out as described in 3.1.2) and rinse down the sink. Do not pour on the ground. Place precipitate in the trash.

\*Nails should not be coated or plated. The nails should be suspended on strings or placed on a plastic sheet on the bottom not directly touching the sides or the bottom of the pan. The nails can only be used once.\*

3.2 Fixed Point Gauge. The fixed point gauge consists of a pointed rod mounted in a tube called the stilling well. It is placed inside the evaporation pan, one foot from the north edge. The stilling well makes readings more precise by eliminating wind-caused surges and ripples in the water level.

The stilling well is 2.5 to 3.5 inches in diameter and 10 inches tall, and is attached to a base. All parts are made of non-corrosive metal (Figure D-3). The base is heavy enough to resist being moved by the wind. The stilling well has two small openings, 1/8 inch in diameter, located opposite each other near the base. Openings permit the flow of water in and out of the stilling well.

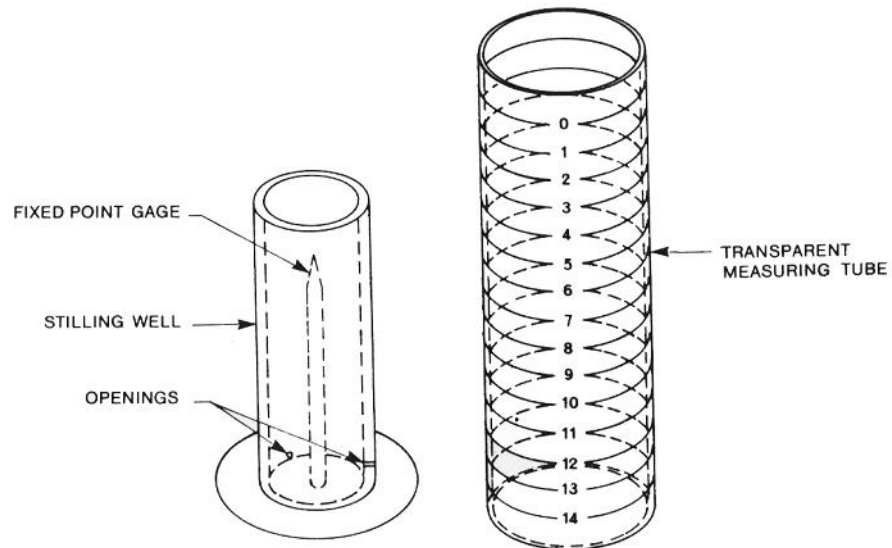

Figure D-3. Stilling Well, Fixed Point Gauge and Measuring Tube

The pointed rod is 1/4 inch in diameter. It is attached to the center of the base inside the well. The point is 7.5 inches above the bottom of the evaporation pan when in position.

Replace evaporated water. This is accomplished by using the transparent measuring tube, shown beside the stilling well in Figure D- 4. The tube is 15 inches deep with an inside diameter of 4-3/4 inches, which is one-hundredth of the surface area of the evaporation pan. The tube is graduated at one-inch intervals, with the zero mark at the top. One inch of water in the measuring tube is equivalent to .01 inch in the evaporation pan.



Figure D-4. Transparent Measuring Tube and Stilling Well Inside the Pan

3.3 Measuring the Amount of Evaporation. Evaporation is measured by determining the amount of water required to bring the water level in the stilling well exactly to the tip of the pointed rod. Use the transparent measuring tube (Figure D-4) to add or remove water from the evaporation pan. When adding water, fill the measuring tube to the zero mark (the top mark on the tube), then pour (slowly) exactly enough water into the evaporation pan (not in the stilling well) to bring the water level to the tip of the fixed point. Read the level of water remaining in the measuring tube. If this reading is closest to the 12 mark, for example, 0.12 inches of water has evaporated (or else evaporation has exceeded precipitation by 0.12 inches). See Figure D-5.

If precipitation has occurred since the previous observation, the water level may be above the tip of the fixed point. In this case, remove water by filling the measuring tube up to the zero level with water from the evaporation pan as many times as necessary to bring the water level to the fixed point. Be sure to keep track of the number of times the tube is filled. Each filling represents 0.15 inches of water. When enough water has been removed to bring the water level below the fixed point, fill the measuring tube with water from the storage tank (Section 3.5) to the zero level, and pour enough water back into the pan to bring the level to the tip of the fixed point. Deduct this amount from the total removed.

An alternative to bringing the water level below the fixed point is to remove enough water from the pan into the measuring tube to bring the water exactly to the fixed point, measuring the amount in the tube, and subtracting this from 0.15 inch. For example, if the tube is filled to the “5” level (0.05 inch), subtract 0.05 from 0.15. The amount removed by dipping is thus 0.10 inch. This is added to the amount removed (if any) by filling the tube from the pan as described in the previous paragraph.



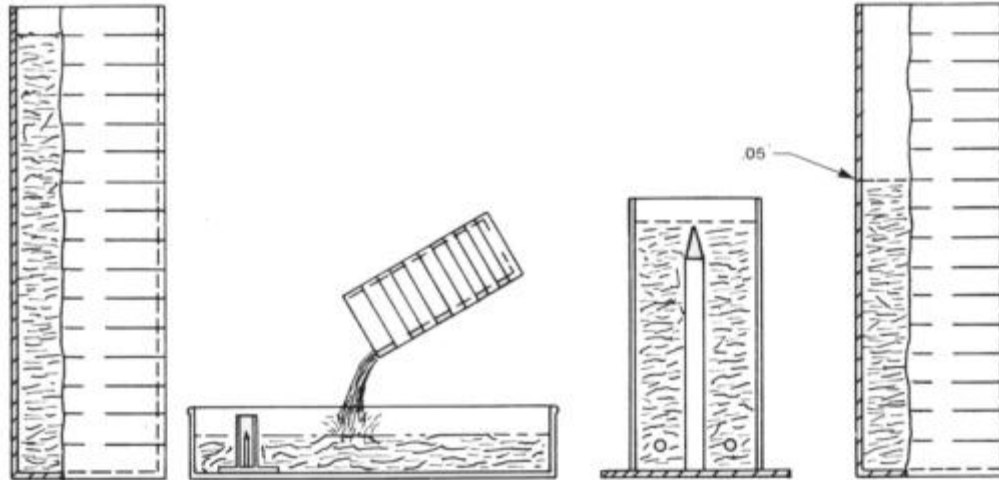

Figure D-5. Evaporation Measurements

For recording purposes, water added is positive and water removed is negative. For example, if 0.24 inches of water is added, record this as +0.24. On the other hand, if rain has fallen and the measuring tube requires filling three times to bring the level below the fixed point, then 0.45 inches is deducted. If 0.06 inch of water is then added to bring the level back to the fixed point, enter the sum of -0.45 and +0.06, or -0.39, on WS Form B-92.

3.4 Micrometer Hook Gauge. The Hook Gauge is no longer supported by NWS Logistics and measurement practices. The Hook Gauge allows the water level to drop over respective successive readings; this changes the exposure of the water surface to its surrounding environment. In contrast, the Fixed Point Gauge resets the water level to a constant exposure at each reading. In order to obtain more constant measurements and simplify operations, the NWS no longer supports use of the Hook Gauge. This section is included for historical and reference purposes.



Figure D-6. Hook Gauge

3.5 Water Storage Tank. If clean water is not available at the site, a storage tank should be installed. The tank should be placed where it will not shade or reduce wind flow over the pan. Thoroughly clean the tank at the beginning of the evaporation measuring season. Ensure the water is completely free of oil.

When the season ends, empty the tank and secure it to prevent freeze and wind damage.

3.6 Anemometer. A standard 3-cup, 5-digit counter anemometer (Figure D-7) is mounted on a wooden pan support.

3.6.1 Installation. The anemometer is mounted on a specially designed display stand pintle on the northwest projecting corner of the pan support. The center of the cups should be 6 to 8 inches above the rim of the pan. In this position, the shadow of the cup falls on the pan only during the late afternoon. The anemometer retaining screw (the knurled head set screw located in the adaptor at the bottom end of the anemometer) is used to attach the anemometer to its support base. This screw should be turned only hand-tight.



Figure D-7. Anemometer

3.6.2 Maintenance. The NWSREP will service and clean the anemometer on his/her routine inspection trips, normally twice a year. Bearings of an anemometer lacking oil will squeak and wear badly within a few hours. This problem should be reported to the NWSREP immediately.

A squeaking anemometer should be removed and replaced with a new one and sent to NRC for service.

**3.6.3 Wind Movement Readings.** The anemometer counter is read daily at the scheduled time of observation to the nearest whole mile. For example, if the counter shows a total wind movement of 9291.3 miles, 9291 is recorded.

**3.6.4 Data From 5-Digit-Counter Type Anemometers.** The five digits appearing in the window of the meter indicate the total wind movement in tenths of a mile for any total from zero to 10,000 miles. The right hand digit indicates tenths of a mile.

Generally, the cooperative observer will not have to compute the number of miles of wind movement since the previous reading. When the observer is asked to compute the miles of wind travel, the procedure is to subtract the previous day's reading from the number currently on the counter. When 10,000 miles have accumulated, the reading starts over at zero. Thus, when the current day's reading is less than the preceding reading, compute the 24-hour wind movement by adding 10,000 to the current reading. Subtract the preceding reading from this total. For example, if today's reading is 10,109 and the previous reading 9,986, subtract 9,986 from 10,109. The movement will be 123 miles.

**3.6.5 Data from 6-Digit-Counter Type Anemometers.** The Totalizing Anemometer is equipped with a built-in counter to provide a simple, yet precise, method of determining miles of wind with total air passage. An internal gear train converts cup rotation to counter input. Miles of wind accumulate the same as a 5-digit anemometer. The 6-digit counter is **not** manually re-settable. The wind can typically accumulate for a year or longer (up to 99,999.9) before it automatically rolls over to zero. See Figure D-8.

**3.7 Dry- And Wet-Bulb Temperatures.** Dry- and wet-bulb temperatures are read in order to compute a measure of humidity. Although the humidity is not a required weather element in the Cooperative Program, the NWSREP may request the dry-bulb and wet-bulb temperature data be used to compute the dew point or relative humidity when a backup observation is required. If required, calculate the dew point or relative humidity values with a psychrometric calculator. One is available online: <http://www.psychrometric-calculator.com/>



Figure D-8. Totalizing Anemometer with 6-Digits

The dry-bulb thermometer of the psychrometer gives the current air temperature. The wet-bulb temperature is the lowest temperature obtained from the moistened wick-covered thermometer of the psychrometer. The thermometer is cooled by evaporating water.

**3.7.1 Types of Psychrometers.** The psychrometer in general use consists of two identical mercury or spirit-in-glass thermometers, shown hanging from a hook above the ventilating fan of

a CRS in Figure D-9. The lower of the two thermometers (the wet-bulb thermometer) has a close fitting, loosely woven muslin wick covering the bulb. The fan is operated electrically providing forced ventilation of the thermometers. Some older instrument shelters are equipped with a hand cranked fan.



Figure D-9. Dry and Wet-bulb Thermometers in CRS

Another type of psychrometer, called the sling psychrometer, is shown in Figure D-10. Evaporation of water from the wick covering the wet-bulb thermometer is enhanced by whirling the thermometers through the air around the sling handle.



Figure D-10. Sling Psychrometer

3.7.2 Maintenance. The only additional maintenance the wet-bulb thermometer requires over

other dry-bulb thermometer is the muslin wick. Ensure the wick is close-fitting and tubular, to hold tightly over the thermometer bulb. Slip about 3 inches of wicking over the bulb until it extends beyond the narrow part of the thermometer stem. A wick should be tied in place with a piece of thread. The wicking should be changed frequently to keep it clean. A dirty wick, or one filled with mineral salts (often invisible) from evaporated water, will not allow water to evaporate as readily as a clean wick. This will result in readings being too warm.

3.7.3 Moistening the Wet Bulb. The wet-bulb should be moistened just prior to ventilation, with the following two exceptions:

- a. **High Temperature and Low Humidity.** In hot, dry weather, thoroughly moisten the wet-bulb several minutes before reading, leaving a drop of water on the end. Natural ventilation will cause partial evaporative cooling before it is ventilated. The drop of water is necessary to prevent the wick from drying before the lowest wet-bulb reading can be obtained. Nevertheless, under very low humidity conditions the wet-bulb, pre-cool the wet-bulb by one of the following methods to prevent premature drying:
  - (1) Store the moistening water in a porous jug in the shelter.
  - (2) Equip the wet-bulb with a longer wick and insert the end of the wick in a water container placed a few inches below the bulb. Move the container away before ventilating the wet-bulb.
- b. **Dry-Bulb Temperature Below 37°F.** Moisten the wick thoroughly 10-15 minutes before reading. This time interval will allow the latent heat released by possible freezing of the wet bulb wick to escape before ventilation is started. Use water at room temperature to melt any accumulation of ice. A thin coating of ice may form during the above 10 to 15 minute wait or during ventilation. Ensure the ice coating is thin in order to get accurate readings at these wet-bulb temperatures. If water remains unfrozen at wet-bulb temperatures below 32°F in spite of ventilation, freezing may be induced by touching the wick with snow or ice.

3.7.4 Taking Psychrometer Observations. Moisten the wick and turn on the ventilating fan (Figure D-9). For psychrometers with hand-cranked fans, turn the crank at least 3.5 revolutions per second to ventilate properly.

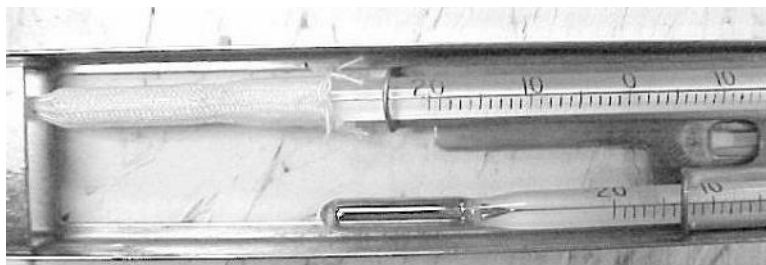

Figure D-11. Sling Psychrometer (close-up view)

For the sling Psychrometer (Figure D-11), select a shady spot with plenty of room for whirling the psychrometer. Face into the wind. Whirl the psychrometer at least two revolutions per second, as far in front of the body as possible, for at least 10 to 15 seconds between each reading. Ventilate longer if the temperature is near or below freezing.

For both types of Psychrometers, read both thermometers to the nearest tenth of a degree, two or more times immediately following each period of ventilation. Repeat the ventilation operation until two successive readings of the wet-bulb are the same. Record the lowest wet- and dry-bulb readings. Follow the procedures given in Section 3.7.3 if the air is very dry or the temperature is below 37°F.

3.8 Water Temperatures. Under standard conditions, the rate of evaporation increases rapidly with increasing water temperatures when the pan is influenced by air motion or sustained breeze.

Maximum and minimum temperatures are determined from sensing elements placed beneath the surface of the water in the evaporation pan. Evaporation occurs at the immediate surface of the water. Since warmer water is lighter than colder (if above 39°F), it will rise to the top and tend to stratify there during the day, especially with the sun shining; therefore, the thermometer should measure the water temperature preferably near the bottom of the pan.

Water temperatures can be measured with the maximum and minimum (Sixes) thermometer, as shown in Figure D-12.

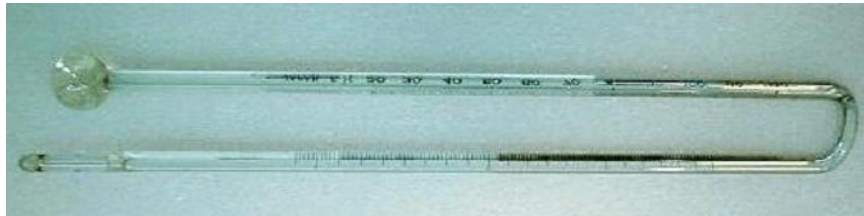

Figure D-12. Sixes Thermometer

### 3.8.1 Installation.

3.8.1.2 Submerged-Mounted Thermometer. The submerged-mount thermometer is mounted horizontally on a plastic holder which rests on the bottom of the pan (Figure D-13). A non-magnetic metal handle is fastened to the bulb end of the holder and hooks over the edge of the pan. The holder should be located on the inside bottom (south side) of the pan, to be shaded as much as possible from direct sun rays. Submerge the thermometer gently to prevent the small indices inside the tube from jarring away from the mercury column.



Figure D-13.  
Submerged  
Mount Thermometer

3.8.1.3 Recording Thermometers. Any recording thermometer with an immersible sensing element may be used. The line connecting the thermometer to the recorder should be long enough to permit installation of the recorder where it will not cast a shadow on the pan, and more than four feet from any instrument. It should be in a low housing along a fence in the northern half of the enclosure.

3.8.2 Maintenance. Keep the Sixes thermometer assembly and plastic holder free from dust and sediment. Use a soft wet cloth for cleaning the unit. A very fine grade steel wool or SOS-type cleaning pad can be used to clean salt deposits from the thermometer bulb and tube.

3.8.3 Accuracy Checks. Check the accuracy of the water temperature readings once a month when the pan is cleaned by removing the Sixes thermometer from the pan and placing it in the instrument shelter. Allow enough time for the thermometer to dry and reach the air temperature. Read the current air temperature from the minimum thermometer without resetting. Then read the temperature from the Sixes thermometer. Enter the readings in the "Remarks" column of WS Form B-92. If readings differ by 2.0°F or more, the NWSREP should be notified.

3.8.4 Rejoining Separated Mercury Columns. The mercury columns in a Sixes thermometer are subject to separation and this causes inaccurate readings. The column should be joined as soon as possible. Remove the thermometer and holder from the pan. Do not remove the thermometer from either its plastic holder or float frame. Hold the thermometer near its bulb end and swing rapidly in an arc until the mercury column is rejoined. Avoid striking objects and breaking the thermometer. Always perform maintenance on the sixes thermometer outdoors.

3.8.5 Reading and Resetting the Sixes Thermometer. Read temperatures to the nearest whole degree, as indicated by the end of the metal indices nearest the mercury columns. If possible, read while submerged. Then, remove the thermometer from the pan to reset the indices. To reset the thermometer, place a horseshoe magnet (open end down and parallel to the

thermometer tube) directly above one metal index. Move the magnet slowly toward the mercury column until the index touches the mercury. Gently lift the magnet away from the tube so the index will not spring away from its contact with the mercury. Repeat this procedure for the other index.

The submerged-mount thermometer magnet comes with a small metal strip to bridge across the poles of the magnet and keeps it from losing strength. Replace the strip after each use. If the strip is lost, a nail or small metal piece may be used.

4. Reading Observations from Evaporation Stations. Observations are recorded on WS Form B-92, "Record of Evaporation and Climatological Observations," unless instructed otherwise by an NWSREP. The cover of the form contains instructions for recording observations. If data is missing, **M** will be entered in the appropriate column(s) for the day(s). Whenever possible, the evaporation observation should be transmitted electronically via WxCoderIII system.

Note: If water freezes in the pan during the period the data will not be used.

Station		County		State		Date (Month & yr.)		Time of Complete Observation (Local time)		Standard Time in Use		RECORD OF EVAPORATION AND CLIMATOLOGICAL OBSERVATIONS									
DATE	AIR TEMPERATURE °F						PRECIPITATION				WIND		EVAPORATION (Inches & hundredths)		WATER TEMP. °F		ADDITIONAL DATA/REMARKS				
	24 Hours Ending at Observation		At Observation		Supplemental Readings at _____		Time of beginning	Time of ending	Time of beginning	Time of ending	24 Hour Amounts	At Obsn. Snow, Ice Pellets Hail, Ice on ground (in.)	Anemometer Dial Reading (Miles)	24 Hour	Gage Reading or Amount Added +	Reading When Tank Filled or Amount Removed -		Amount of Evaporation	24 Hours Ending at Observation		
	Max.	Min.	Dry-bulb	Wet-bulb	Dew Point	Dry-bulb	Wet-bulb	Dew Point			Rain, Melted Snow, etc. (in & hundredths)	Snow, Ice Pellets, Hail (in. & tenths)							Max.	Min.	
1																					
2																					
3																					
4																					
5																					
6																					
7																					
8																					
9																					
10																					
11																					
12																					
13																					
14																					
15																					
16																					
17																					
18																					
19																					
20																					
21																					
22																					
23																					
24																					
25																					
26																					
27																					
28																					
29																					
30																					
31																					
Sum																					
Avg.									Greatest							Adjusted Total					

WS FORM B-92 (5-89) U.S. DEPARTMENT OF COMMERCE NATIONAL WEATHER SERVICE OBSERVER STATION NUMBER (PRES. BY WSOM B-17)



Figure D-14. WS Form B-92, Record of Evaporation and Climatological Observations

**APPENDIX E - Soil Temperature Stations**

<u>Table of Contents:</u>	<u>Page</u>
1. Introduction.....	E-2
2. Exposure and Protection of Equipment .....	E-2
3. Size of Plot.....	E-2
4. Maintenance of Plots .....	E-2
4.1 Sod Covered Plots.....	E-2
4.2 Natural Cover.....	E-2
4.3 Bare Soil .....	E-2
4.4 Snow Cover.....	E-3
5. Types of Thermometers and Readings .....	E-3
6. Installation of Thermometers.....	E-3
7. Shelters.....	E-4
7.1 Thermometer Head Shelters .....	E-4
7.2 Location of Shelter.....	E-5
7.3 Replacing Soil In Trench .....	E-5
8. Depth of Soil Temperature Measurements .....	E-5
9. Observations .....	E-5
9.1 Type and Frequency.....	E-5
9.2 Time of Observation .....	E-6
10. Entry of Readings on Permanent Record Forms.....	E-6
11. Palmer Soil Thermometer .....	E-7
11.1 Resetting Maximum and Minimum Pointers.....	E-7
11.2 Maintenance.....	E-8
11.2.1 Loose Pointers.....	E-8
11.2.2 Frozen Pointers .....	E-8
11.2.3 Moisture in the Head.....	E-8
11.2.4 Broken Cover .....	E-8
11.3 On Site Accuracy Check by the NWSREP.....	E-8
11.3.1 In-Place Accuracy Checks by the NWSREP.....	E-8
11.3.2 Accuracy Check of Palmer Model 35B by NWSREP .....	E-9
11.3.3 The Calibration by the NWSREP .....	E-9

<u>Figures:</u>	<u>Page</u>
E-1 Installation of Soil Thermometers .....	E-4
E-2 Palmer Soil Thermometer in Shelter.....	E-4
E-3 WS Form B-83a .....	E-6
E-4 Palmer Soil Thermometer .....	E-7

1. Introduction. Soil temperatures are essential to the agricultural industry. All species of plants have a specific range of temperatures in which they will grow. Most seeds require a certain amount of warmth in order to germinate. Some vegetation will suffer if the soil temperature is too warm.

Many stations measuring soil temperature transmit their readings over nationwide communications circuits, especially during the beginning and middle portions of the growing season. Nationwide weekly average soil temperatures are published during the growing season in the Weekly Weather and Crop Bulletin, and daily readings for one or more levels are published in “Climatological Data” by the NCDC.

Soil temperature stations may have the following additional instrumentation: precipitation gauge, air temperature thermometer with shelter, evaporation pan, and anemometer.

2. Exposure and Protection of Equipment. Soil thermometers should have an exposure to represent the principal agricultural soils and conditions of the area. The site should not be subject to irrigation, overflow, or unusual ground-water conditions. The site should be open to full sunshine, with the exception of certain designated sites or where partial shade is considered typical of the area. The observing plot should be fenced or have other protection from humans and animals.

3. Size of Plot. The plot should be 10 by 10 feet or larger, with the thermometers centrally located. Where both sod and bare plots are maintained, the bare plot should also be at least 10 by 10 feet. If the location is not typical of the surroundings, the plot should be larger, at least 30 by 30 feet.

4. Maintenance of Plots.

4.1 Sod-Covered Plots. Sod-covered plots should be under bluegrass, alta fescue, perennial rye, or other grasses used for lawns or pastures in the area. The area should be trimmed and maintained at a uniform 2 or 3 inch height. No irrigation should be applied, except to start cover before beginning observations. If during extreme drought, it is necessary to irrigate, the soil temperature should be noted as not being typical and should be excluded from published data.

4.2 Natural Cover. At some locations, normal climate and soil do not permit maintenance of a sod cover. The observer should maintain the cover like the natural cover common to the area.

4.3 Bare Soil. Bare soil plots should be kept free of weeds and other vegetation at all times.

This can be done by scraping with a hoe or by chemical treatment. Shallow raking to avoid heavy crusting after precipitation is recommended. Avoid deep cultivation.

Local jurisdictions should be contacted in regard to herbicides that will be best suitable for particular type of soil and vegetation. License and/or permission to apply herbicides should also be verified with the property owner. Refer to environmental polices stated in NWSM 50-5116.

4.4 Snow Cover. Snow cover should remain natural and undisturbed. The observation site should be located to avoid or limit artificial drifting or wind scouring. The site should allow snow to fall free of obstructions and to accumulate naturally on the ground.

5. Types of Thermometers and Readings. Dial-type or digital thermometers may be used. Maximum/minimum and current temperatures are measured at the shallower depths. At greater depths where temperature changes are slower (generally, below the 8-inch level), the current temperature is usually recorded. At most observing sites, maximum and minimum air temperatures are read and recorded at the same time and location as the soil temperatures. See Section 11 for a description of the Palmer soil thermometer in use.

6. Installation of Thermometers. Sensing elements should be located in and under undisturbed soil. The sensors should be in close contact with the ambient soil, with no insulating air spaces or pockets, and without artificial channels for the entry of water. They should be in or very near the center of the observation plot. Readouts should be mounted high enough above ground to make it easy and convenient to read and reset the thermometers.

Dig a small trench just to the north of the spot where the sensors will be imbedded in the earth. This should be as small as possible without hindering the necessary work. Remove the sod carefully and set it aside on boards or a tarpaulin for replacement later. The soil should be removed in layers, as it can be replaced as close to its original condition as possible.

The trench should be slightly deeper than the assigned depth for the lowest sensor. This allows enough working space and permits a slight looping of the flexible cables to be installed. A hole should be made for the sensing elements with a rod 18 inches long and 5/16 inch in diameter for installing the 13-inch long mercury-in-steel sensors used with the Palmer soil thermometer (Section 11, Palmer Soil Thermometer). The rod should be pressed into the face of the south end of the pit at the proper depth and be driven into the soil nearly its full length. It should remain parallel to the surface above it so that it is the same depth throughout its full length. If smaller sensors (such as thermistors or thermocouples) are used, a rod with a diameter equal to or only slightly larger than the sensor should be used. See Figure E-1, which shows the instrument trench (un-shaded area) as it would appear before replacing the soil.

Press the sensing element into the hole with the least force possible. If too much resistance is met, withdraw the element and clear the hole with the rod.

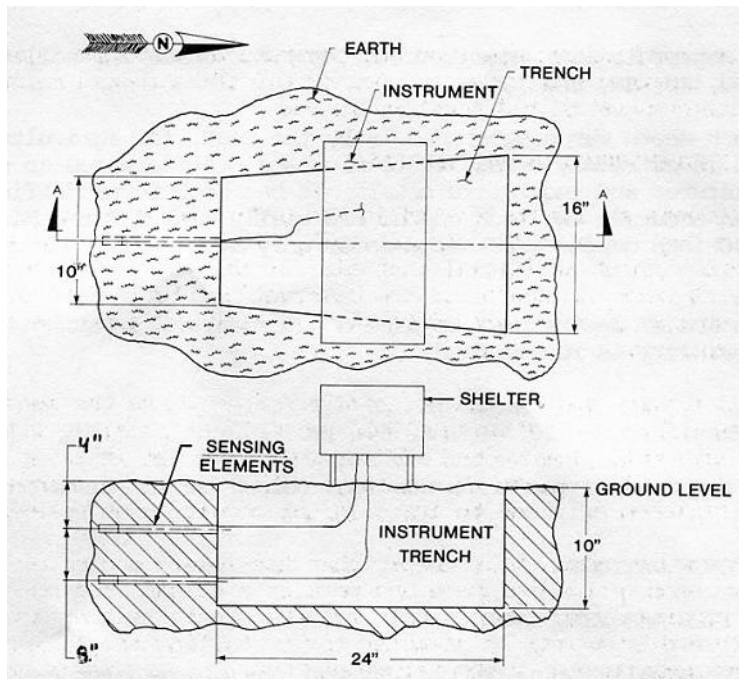

Figure E-1. Installation of Soil Thermometers

7. Shelters.

7.1 Thermometer Head Shelters. Protect soil temperature thermometer heads or recorders from the weather by a shelter, in which the access door opens from the side or top. The length of the shelter depends on the number of thermometers installed. Soil temperatures measured with an electronic thermometer will have the display mounted in or near a shelter housing of the air temperature sensor.



Figure E-2. Palmer Soil Thermometer in Shelter

7.2 Location of Shelter. The shelter should be located about one foot north of the south edge of the trench. Set the supports for the shelter in the trench before replacing the soil. The 5-foot cable will permit the shelter to be about three feet above ground. This will allow for a slight loop of the cable in the trench floor for sensors as deep as eight inches.

The shelter may be located outside and to the north of the trench, where no shadows will affect the soil above the sensors, if you have sufficiently long sensor cables to connect the thermometers to the recorders - as with the NIMBUS/MMTS. Trench the temperature cable(s) into the earth a few inches. Do not run them across the ground surface.

7.3 Replacing Soil in Trench. The soil should be replaced as nearly as possible in its original condition. This will usually require firm packing as each layer is replaced. Soak the soil as it is returned to the trench, then replace the sod. Excess moisture will assist in renewing sod growth.

8. Depth of Soil Temperature Measurements. The following depths (in inches) for observing soil temperature have been recommended by the Commission for Climatology (CCI) and the Commission for Agricultural Meteorology (CAgM) of the World Meteorological Organization (WMO): 2, 4, 8, 20, 40, 60, and 120 inches.

The two-inch depth was suggested only by the CAgM, for agricultural purposes. This depth is extremely sensitive to micro scale differences in soil type and color, moisture, and vegetative cover. It has been found difficult to maintain an accurate two-inch depth, especially with a bare soil cover. The 60- and 120-inch depths were recommended only by the CCI, for climatological purposes.

Where a choice of depths is required due to sensor limitations, the following order of priority is recommended:

Priority	1	2	3	4	5	6	7
Depth (inches)	4	8	20	40	2	60	120

Many soil temperature measuring stations record temperatures only at the 4-inch depth.

9. Observations.

9.1 Type and Frequency. The NWS requires the observer to take a daily reading of the maximum, minimum, and current soil temperature for just the 4 inch and the 20 inch depths. Daily ranges in the soil temperature can exceed air temperature ranges in the shallow layers. This amplitude diminishes rapidly to about 1°F at depths of 18 to 24 inches. Therefore, maximum and minimum temperatures are normally recorded at depths through 20 inches, while only the current temperature is recorded at greater depths.



11. Palmer Soil Thermometer. This section describes the operation, maintenance, and calibration procedures for the Palmer soil thermometer. This thermometer has been in general use for many years (Figure E-4).



Figure E.4. Palmer Soil Thermometer

11.1 Resetting Maximum and Minimum Pointers. After the maximum and minimum temperatures have been recorded; carefully reset the red (maximum) and green (minimum) pointers. The red pointer is reset first by bringing it into contact with the black (current temperature) pointer. Next, the green pointer is gently rotated to the opposite side of the black pointer. Do not press down on either pointer knob, as this will result in tension loss in the pressure washer and cause loose pointers.

During the resetting, check the “flex” of the black pointer. It should flex or move less than one degree in response to pressure from the red and green pointers. Movement in excess of this indicates either a loss of tension in the sensor system or too much drag tension in the maximum and/or minimum pointers. If lubrication does not correct the situation, replace the instrument.



11.2 Maintenance. The most common maintenance needs of the Palmer soil thermometer are as follows: loose or frozen pointers, moisture in the head, broken cover, and calibration errors.

11.2.1 Loose Pointers. This usually results from improper resetting procedures. This is corrected by removing the bezel ring and glass cover (the red and green pointers are mounted in the glass cover). Remove the Allen set-screw embedded in the green knob. The tightness of this knob controls the tension on both pointers. Hold the bottom of the connecting shaft (inside the glass cover) and carefully reset the green knob to the desired tension. Clockwise rotation increases the tension. Replace the Allen set-screw in the green knob and reassemble. Replacing the tension washer under the green knob may be necessary.

11.2.2 Frozen Pointers. Frozen pointers can often be corrected by cleaning and lubricating. Use a good silicone lubricant. It may be necessary to remove the bezel ring and glass cover to perform adequate cleaning and lubrication.

11.2.3 Moisture in the Head. This indicates the need for a new gasket. Remove the bezel ring and glass cover. Replace the sealing gasket on a day with as low humidity as possible.

11.2.4 Broken Cover. A file or hacksaw may be required to remove the bezel ring. Make a cut across the outside edge of the ring. Then use a screwdriver to press downward and outward to snap it off. A new cover and ring should be replaced with a connecting screw to fasten it in place.

11.3 On-Site Accuracy Check by the NWSREP. Verify the accuracy of the soil thermometers at least once per year. Without an accuracy check, the thermometers are likely to drift upward or downward. The following describes the verification procedures.

11.3.1 In-Place Accuracy Checks by the NWSREP. Incorrect data resulting from long-term calibration drifts can be eliminated with careful accuracy checks once per year at sites that observe only soil temperature. Thermometers should be accurate to  $\pm 2.0^{\circ}$  F at three reference temperatures of 20°F, 50°F, and 100°F. The following three procedures may be used to accomplish this.

- a. A thermometer of known accuracy (i.e., MMTS, or Nimbus) may be used for comparison. It is imperative that the sensor be pushed to the same depth as the Palmer soil thermometer sensor bulb and left there long enough to stabilize at the soil temperature (4 to 5 minutes).
- b. A less desirable technique for shallow depths is to remove soil to the level of the base of the Palmer 13-inch sensor bulb near the sensor but not directly at the sensor. The comparison thermometer sensor should then be inserted and the soil replaced above it. Ensure the thermometer remains embedded long enough for the removed and replaced soil to regain the temperature of adjacent undisturbed soil at the same depth.

- c. If the soil at the depth of a soil thermometer is in the process of freezing, the temperature will often remain at the 32°F ice-water equilibrium point for several days. Check the temperature during this period to determine the accuracy of the thermometer.

11.3.2 Accuracy Check of Palmer Model 35B by the NWSREP. The NWS recommends an accuracy check of the Palmer model 35B be performed twice a year at sites that measure soil temperatures, only.

Methods (a) and (b) in section 11.3.1 should not be used on model 35B soil thermometers between about 9 a.m. and 6 p.m. on bright, sunny days, as sensitivity to heat penetration under these conditions can make it read higher.

Make the following two allowances for discrepancies between the Palmer model 35B and the check thermometer.

- a. The tolerance of the Palmer (about 2°F) and the check thermometer (generally 1% of the scale) may be additive.
- b. A seemingly slight difference in exposure between the two may contribute to a variation in readings. A spread of up to 4°F between the two readings should be considered satisfactory. For method “C” in Section 11.3.1, a reading between 29°F and 35°F should be considered sufficiently accurate at the ice point.

Note: Never apply any allowable difference as a correction to future observations.

11.3.3 The Calibration by the NWSREP. If the checks in section 11.3.2 indicate a calibration off-set, then calibrate the thermometer as follows:

- a. Carefully slide the sensor probe out of its berthed position, by way of the instrument trench (Figure E.1).
- b. Place both the probe and the reference thermometer in the shelter housing of the dial indicator and close the door.
- c. After a minimum of 10 minutes, open the door and record both readings.
- d. Immerse both the reference thermometer and the entire probe of the Palmer thermometer in a slushy ice bath.
- e. After a minimum of 10 minutes, record the temperatures. Leave the sensors in the ice bath, in case step (g) must be used.
- f. If the difference in the readings of the two thermometers is approximately the same in steps (c) and (e), an offset is indicated. See step (g) below. If the differences are not approximately the same, the Palmer must be considered

inoperative and replaced.

- g. If an offset is indicated, turn the “reset” screw on the back of the dial head until the thermometer reads 32°F while the probe is still in the ice bath. On some older instruments an access-screw in back of the dial head must be removed first. The adjustment on these models is limited to about two degrees. If a greater adjustment is needed, remove the bezel ring and glass cover. Place a screwdriver in the center screw of the black pointer hand and loosen it. Rotate the pointer hand gently to the desired setting. Re-tighten the center screw.

**APPENDIX F - Atmospheric Phenomena**

<u>Table of Contents:</u>	<u>Page</u>
1. Introduction.....	F-2
2. Tornadoes, Waterspouts and Funnel Clouds .....	F-3
2.1 Tornado.....	F-3
2.2 Funnel Cloud.....	F-4
2.3 Waterspout.....	F-4
3. Thunderstorm.....	F-5
4. Damaging Winds, Squalls and Gusts.....	F-5
5. Hydrometeors.....	F-6
5.1 Forms of Precipitation .....	F-6
5.2 Hydrometeors Other Than Precipitation.....	F-8
6. Lithometeors .....	F-12
6.1 Haze .....	F-13
6.2 Smoke .....	F-13
6.3 Dust.....	F-13
6.4 Blowing Sand.....	F-15
7. Electrometeors .....	F-16
7.1 Aurora .....	F-16
7.2 Thunder.....	F-16
7.3 Lightning.....	F-16
8. Luminous Meteors .....	F-17
8.1 Halo Phenomena.....	F-17
8.2 Corona.....	F-17
8.3 Rainbow .....	F-18
8.4 Fog Bow.....	F-18
9. Reporting and Recording Atmospheric Phenomena.....	F-19
9.1 Real-Time Reporting .....	F-19
9.1.1 Reporting Tornadoes, Waterspouts, and Funnel Clouds .....	F-19
9.1.2 Reporting Other Phenomena.....	F-19
9.2 Recording Atmospheric Phenomena.....	F-20
9.2.1 Tornadoes, Waterspouts, and Funnel Clouds .....	F-20
9.2.2 Thunderstorms .....	F-20
9.2.3 Other Phenomena.....	F-20

<u>Figures:</u>	<u>Page</u>
F-1 Winds Associated with a Tornado .....	F-3
F-2 Tornado .....	F-3
F-3 Funnel Cloud.....	F-4
F-4 Waterspouts.....	F-4
F-5 Distant Thunderstorm .....	F-5
F-6 Microburst.....	F-6
F-7 Glaze .....	F-7
F-8 Hail.....	F-7
F-9 Snow Pellets.....	F-8
F-10 Snow Grains.....	F-8
F-11 Fog .....	F-9
F-12 Mist .....	F-9
F-13 Ice Fog .....	F-10
F-14 Dew .....	F-10
F-15 Frost Formed on Window .....	F-11
F-16 Rime.....	F-12
F-17 Blowing Snow.....	F-12
F-18 Haze .....	F-13
F-19 Smoke .....	F-13
F-20 Blowing Dust .....	F-14
F-21 Dust Storm .....	F-14
F-22 Dust Devil .....	F-15
F-23 Sandstorm .....	F-15
F-24 Northern Lights.....	F-16
F-25 Lightning.....	F-16
F-26 Halo with Sun Dogs.....	F-17
F-27 Corona.....	F-17
F-28 Double Rainbow .....	F-18
F-29 Fog Bow.....	F-19

1. Introduction. The following atmospheric phenomena should be observed and recorded on WS Form B-91 or other form designated by the NWSREP: Tornadoes, waterspouts, funnel clouds, thunderstorms, damaging winds (including squalls), fog, mist, haze, smoke, dust, frost, and any form of precipitation. Recording haze, smoke, dust and frost is optional, except when dangerous, i.e., to travelers or crops. Observations of these phenomena are an important part of the record from climatological stations, and they are often the only written account of these occurrences from the observer’s area that will be sent to NCDC. Except for precipitation, no instruments are required to record these phenomena.

Damaging and life-threatening phenomena, especially tornadoes, should be reported immediately to the NWS office or as directed by the NWSREP. A report should give at least two observations of the storm in order to determine direction and speed. State its compass location

(i.e., SSW and distance, i.e., 3miles) and current time to nearest minute; and repeat the observation in five minutes.

## 2. Tornadoes, Waterspouts and Funnel Clouds.

Tornadoes and funnel clouds are nearly always associated with intense thunderstorms. While some waterspouts may develop in the absence of thunderstorms and often are much less destructive, others are tornadoes that have formed or moved over water, and are just as dangerous over water as land.

2.1 Tornado. Tornadoes are local storms usually of short duration that consist of a violently rotating column of air extending from a thunderstorm to the ground (Figure F-2). A tornado will usually appear hanging from the bottom of the storm cloud, generally close to, but outside the area in which rain is falling.

Part, or all, of the funnel may be invisible if the air is dry, but the tornado can still often be identified by the rotating particulate matter, especially near the ground, and in intense tornadoes, by a loud roaring sound. Rotating debris not associated with clouds are whirlwinds (dust devils-see Figure F-22) rather than tornadoes.

Tornadoes do their destructive work from strong rotary winds. As a tornado passes over a building, the winds twist and rip from the outside (Figure F-1). Walls collapse or topple outward, windows explode, and the debris of this destruction is driven through the air with dangerous force. Heavy, objects like machinery and railroad cars can be lifted and carried by the wind for considerable distances.

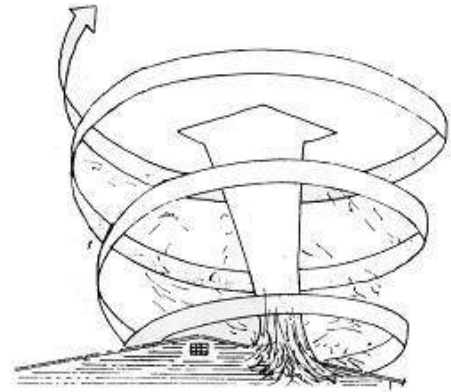

Figure F-1. Winds Associated with a Tornado



Figure F-2. Tornado

2.2 Funnel Cloud. A funnel cloud is a rotating column of air that is not in contact with the ground. Funnel clouds form at the base of dark, heavy cumulonimbus clouds and develop downward. Some never reach the ground. Others reach the ground (becoming tornadoes), then rise again or dissipate. See Figure F-3.



Figure F-3. Funnel Cloud

2.3 Waterspout. Over a large body of water, a tornado is called a waterspout. It rises from the water into the cloud in an upward spiral. Waterspouts are weaker than most tornadoes, but can still be dangerous. Waterspouts can overturn small boats, damage ships; do significant damage when hitting land, and cause fatalities. See Figure F-4.



Figure F-4. Waterspouts

3. Thunderstorm. For record purposes, a thunderstorm is considered in progress when thunder is heard, whether or not rain is falling or lightning is seen. The intensity may vary from occasional distant thunder to very frequent, sharp thunder with heavy rain, sometimes associated with strong winds and hail. See Figure F-5.



Figure F-5. Distant Thunderstorm

4. Damaging Winds, Squalls, and Gusts. Winds are considered “damaging” when crops, buildings, or other property has been injured, damaged, or destroyed. See Figure F-6.

A squall is a sudden, violent wind, often accompanied by rain or snow. Gusty winds are characterized by sudden, periodic increases in speed. There are noticeable differences in speed between the peaks and lulls. All of these often occur with thunderstorms, or they can occur alone.





Figure F-6. Microburst

5. Hydrometeors. A hydrometeor is any form of atmospheric water (liquid or frozen) or water vapor that (a) falls through the atmosphere, such as rain or snow; (b) is suspended in the atmosphere, such as fog; is blown from surfaces by the wind, such as blowing snow or blowing spray; or (d) is deposited on objects, such as freezing rain (glaze).

5.1 Forms of Precipitation. Hydrometeors include precipitation in all its forms. It may be continuous, intermittent, or showery. Dew is not considered precipitation. The intensity is classified as light, moderate, or heavy. Precipitation is observed in the following forms:

- a. Rain - Rain is drops of water in liquid form falling from the sky, the individual drops are larger than .02 inch in diameter.
- b. Drizzle - Drizzle is fairly uniform precipitation composed exclusively of fine droplets (less than .02 inch in diameter), uniformly dispersed, that may appear to float with the air currents.
- c. Ice Pellets - Ice Pellets are round or irregularly-shaped pellets of ice with a diameter of 1/5 inch or less, either transparent or translucent. Ice Pellets usually rebound when striking hard surfaces, making a sound on impact. The following two types of ice pellets are observed:
  - (1) Hard grains of ice consisting of frozen raindrops or melted and re-frozen snowflakes (often called sleet).
  - (2) Pellets of snow encased in a thin layer of ice. These rarely bounce on impact.

The first type (1) falls as continuous precipitation, the second type (2) is associated with showers.

- d. Glaze - Glaze is rain or drizzle that falls in liquid form, but freezes to objects and/or on the ground. It forms a smooth coating of transparent ice layers. Ice storms result from heavy coatings of glaze and may do great damage to trees, shrubs, and telephone and power lines, creating unsafe conditions.



Figure F-7. Glaze

- e. Hail - Hail is pieces of ice, often round or in irregularly shaped lumps, falling individually or several pieces frozen together. They range from 1/5 inch to two or more inches in diameter. Hail usually consists of alternate opaque and clear layers of ice (Figure F-8). Hail is normally associated with thunderstorms and temperatures above freezing. Hail can cause serious damage to anything it strikes. Crops may be destroyed and livestock injured.



Figure F-8. Hail

- f. Snow - Snow is white or translucent ice crystals, mostly in six-pointed star form, often mixed with simple crystals. Snow occurs under conditions similar to those of rain, but the air temperature aloft is freezing or lower.
- g. Snow Pellets - Snow Pellets are white, opaque grains of ice, round or conical, 1/16 to 1/4 inch in diameter. The pellets are crisp and easily compressed and may bounce or burst when striking hard surfaces. See Figure F-9.



Figure F-9. Snow Pellets

- h. Snow Grains (granular snow) - Snow Grains are minute opaque, branched, star like snowflakes or very fine simple crystals. They are smaller than snow pellets and usually fall in small quantities from low stratified clouds. They do not bounce or shatter on impact. See Figure F-10.



Figure F-10. Snow Grains

Both snow pellets and snow grains should be recorded.

## 5.2 Hydrometeors Other Than Precipitation.

- a. Fog - Fog is minute water droplets suspended in the atmosphere to form a cloud at

the earth's surface. There is no visible downward motion. The horizontal visibility is  $\frac{1}{2}$  mile or less. It is called ground fog if the depth is less than 20 feet. Fog differs from haze by its dampness, and gray color. See Figure F-11.



Figure F-11. Fog

- b. Mist - Mist is similar to fog except the horizontal visibility is greater than  $\frac{1}{2}$  mile, but less than 7 miles. See Figure F-12.



Figure F-12. Mist

- c. Ice Fog - Ice Fog is minute suspended particles in the form of ice crystals and/or needles. It occurs at very low temperatures ( $-20^{\circ}\text{F}$  or colder), usually in clear, calm weather at high latitudes. It does not produce rime or glaze on objects. See Figure F-13.



Figure F-13. Ice Fog

- d. Dew - Dew is liquid water that has condensed on objects on or near the surface of the earth with above freezing temperatures. Dew occurs on calm, clear nights. See Figure F-14.



Figure F-14.  
Dew

- e. Frost - Frost is thin ice crystals shaped like scales, needles, feathers or fans that form on objects with a temperature of 32°F or lower. Frost can occur on the ground when the air temperature at the instrument shelter level is several degrees above freezing. It is the same as hoarfrost. See Figure F-15.



Figure F-15. Frost Formed on Window

- f. Freeze - Freeze is the condition of the lower atmosphere when the temperature of surface objects is 32°F or lower. A freeze may or may not be accompanied by a deposit of frost (Figure F-15). When vegetation is injured by a relatively low temperature (with or without a frost), the condition is termed a freeze.

During a freeze, the air at the instrument shelter level may be above 32°F, although the ground is 32°F or colder. This occurs most frequently during calm, clear nights, with the greatest temperature difference near sunrise.

Freezes are classified as follows:

- (1) Light Freeze - Little destructive effect on vegetation, except to tender plants and vines. Shelter level temperatures are often above freezing but drop below freezing for a short period at the surface.
  - (2) Killing Freeze - Widely destructive to vegetation. It is often defined as a sufficiently severe freeze to cut short the growing season. Temperatures at thermometer level are generally below freezing. This is sometimes called a "killing frost."
  - (3) Hard Freeze - Staple vegetation is destroyed. The ground surface is frozen solid under foot, and heavy ice forms on puddles and other exposed water surfaces. It is colder and more prolonged than a killing freeze.
- g. Rime - A white or milky and opaque granular deposit of ice formed by the rapid freezing of super cooled water droplets of fog, as they impinge on exposed objects. It is denser and harder than hoar frost, but lighter and softer than glaze. See Figure F-16.



Figure F-16. Rime

- h. **Blowing Snow** - Blowing snow consists of particles of snow raised from the surface up to six feet (eye level) and higher (Figure F-17) by strong turbulent winds. It is blown about in sufficient quantities to restrict the horizontal visibility. It is called “drifting snow” if limited to below eye level. Blowing and drifting snow should be recorded when causing damage, such as blocking roads or exposing seeded fields.



Figure F-17. Blowing Snow

- 6. **Lithometeors.** Lithometeors are visible phenomena suspended in the air that are not associated with water vapor. Examples are haze and smoke.

6.1 Haze. Haze consists of fine dust or salt particles suspended in the air in sufficient quantity to reduce the visibility. It resembles a uniform veil that subdues all colors. See Figure F-18.



Figure F-18. Haze

Dark objects have a bluish tinge. Bright objects (the sun or distant lights) appear a dirty yellow or have a reddish hue. Haze may be caused by a variety of substances, including dust, salt, smoke particles from distant fires, volcanic ash, and pollen.

6.2 Smoke. Smoke is suspended particulate matter resulting from combustion. Smoke will cause the disk of the sun at sunrise and sunset to appear very red or to have a reddish tinge at other times of day. Smoke coming from a great distance, such as from forest fires or volcanoes, usually has a light grayish or bluish color. As smoke continues traveling from its source, the larger particles drop out, leaving haze. See Figure F-19.



Figure F-19. Smoke

6.3 Dust. Dust is fine particles of dust or sand suspended in the air, often as the result of a dust storm or sand storm that may have occurred at or far away from the observing site. It imparts a tan or gray hue to distant objects. The sun's disk is pale, colorless, or tinged yellow.



Dust manifests itself in the following additional forms.

- a. **Blowing Dust** - Blowing dust is dust picked up locally from the surface and blown about in clouds or sheets, reducing the horizontal visibility to 6 miles or less. See Figure F-20.



Figure F-20. Blowing Dust

- b. **Dust Storm** - A dust storm is blowing dust reducing the visibility to 1/2 mile or less. A dust storm usually arrives suddenly in the form of an advancing dust wall (Figure F-21) which may be miles long and several thousand feet high. Ahead of the dust wall the air is very hot and the wind usually light.



Figure F-21. Dust Storm

- c. Dust Devil - The dust devil is a small vigorous whirlwind, usually of short duration, made visible by dust and debris picked up (Figure F-22) from the surface. Dust devils usually occur on hot, calm afternoons with clear skies. They are seldom intense enough to cause appreciable damage.



Figure F-22. Dust Devil

6.4 Blowing Sand. This is sand that is picked up from the surface of the earth by the wind and blown about in clouds or sheets, reducing the visibility to 6 miles or less. It is called a sandstorm when the wind is very strong and the visibility is reduced to 5/8 of a mile or less. See Figure F-23.

**IMPORTANT:** Road hazards created by dust storms and sand storms should be reported immediately to the Weather Forecast Office.



Figure F-23. Sandstorm

7. Electrometeors. An electrometeor is a visible or audible display of atmospheric electricity.

7.1 Aurora. The aurora, frequently known as the “northern lights” (Figure F-24) in the northern hemisphere, is a luminous phenomenon of arcs, bands, or curtains of light in the high (and occasionally middle) latitudes and at very high altitudes. Aurora is usually white, but they may have other colors. The lower edges of the arcs or curtains are usually well defined, while the upper edges are not. The aurora is caused by electrically charged particles ejected by the sun, acting on the rarified gases of the higher atmosphere. The particles are channeled by the earth's magnetic field, so the bases of the curtains are pointed toward the earth's magnetic poles.



Figure F-24. Northern Lights

7.2 Thunder. This is a sharp rumbling sound which accompanies and follows lightning discharges. It is caused by rapidly expanding gases along the channel of a lightning discharge.

7.3 Lightning. Lightning is the flash of light from a sudden visible electrical discharge (Figure F-25) produced by thunderstorms. It takes the following forms:

- a. Cloud-to-Ground - Bolts of lightning occurring between the cloud and the ground.
- b. In-the-Cloud - Lightning within the cloud. The streaks are not visible from the ground.
- c. Cloud-to-Cloud - Streaks of lightning from one cloud to another, or from one part of a cloud through cloudless air to another. The streaks are visible from the ground.



Figure F-25. Lightning

d. Cloud-to-Air - Lightning from a cloud into the air, but not striking the ground.

8. Luminous Meteors. A luminous meteor is an atmospheric phenomenon appearing as a luminous pattern in the sky. It is produced by the reflection, refraction, diffraction, or interference of light from the sun or moon. The following types are observed:

8.1 Halo Phenomena. This is a group of phenomena in the form of rings, arcs, pillars, or bright spots produced by the reflection or refraction of sunlight or moonlight by ice crystals suspended in the atmosphere. Cirrus and cirrostratus clouds often produce halos. The rings are about 22 arc-degrees away from the sun or moon. See Figure F-26.



Figure F-26. Halo with Sun Dogs

8.2 Corona. A corona is one or more sequences of small colored rings centered on the sun or moon. A corona is usually smaller than a halo, and all colors may not be visible. Colors may be repeated irregularly, causing iridescence. Coronas are produced by sunlight or moonlight shining through thin clouds consisting of water vapor. See Figure F-27.



Figure F-27. Corona

8.3 Rainbow. A rainbow is a group of concentric arcs produced on a “screen” of falling precipitation by the light from the sun or moon. In some cases a double rainbow may be seen (Figure F-28) with the weaker bow being outside the stronger and having the sequence of colors reversed.



Figure F-28. Double Rainbow

8.4 Fog Bow. A fog bow is primarily a rainbow consisting of a white band which appears on a screen of fog. It is usually fringed with red on the outside and blue on the inside. See Figure F-29.



Figure F-29. Fog Bow

9. Reporting and Recording Atmospheric Phenomena. While all phenomena should be recorded on the forms used by the observer to record other parameters, only a few of the phenomena need to be reported in real-time.

9.1 Real-Time Reporting. Phenomena posing threats to lives and property should be reported to the Weather Forecast Office and, in many cases, to the police or other emergency preparedness offices, as soon as possible. This will greatly assist in the issuance of accurate warnings for areas in the path of the storm. The NWSREP will instruct the observer where to report and will provide information on how to be trained in the NWS SKYWARN program. The observer can review the program on: <http://www.weather.gov/skywarn/>. In addition, the NWSREP can order a 20-page booklet, *Basic Spotter's Field Guide* (1997) from the national support center, part number: YPA-97050.

9.1.1 Reporting Tornadoes, Waterspouts, and Funnel Clouds. Whenever a tornado, waterspout, or funnel cloud is observed, the observer should contact the designated NWS office immediately by telephone or other designated means, giving the following information:

- a. Distance and direction from the observing location.
- b. Direction toward which it is traveling.
- c. Time it was observed.

9.1.2 Reporting Other Phenomena. Record information in the "Remarks" of WS Form B-91 or other designated form. See Section 12 of Appendix A for real-time reporting of other phenomena.

9.2 Recording Atmospheric Phenomena.

9.2.1 Tornadoes, Waterspouts, and Funnel Clouds. Record as many of the following as possible: time of occurrence, direction and length of path, width of the path, destruction from wind and hail, injuries, deaths, and any other relevant circumstances.

9.2.2 Thunderstorms. Record the location of the thunderstorm in terms of compass bearing (i.e., WSW) and distance from the COOP site (i.e., 3 miles). Update your observation in five minutes, in order to calculate the direction and approximate speed of movement.

9.2.3 Other Phenomena. Record other phenomena in the “Remarks” of WS Form B-91 or other designated form. Include information on damage, deaths, or injuries, if any.

**APPENDIX G - Flash Flooding**

<u>Table of Contents:</u>	<u>Page</u>
1. Introduction.....	G-1
2. Areas Most Subject to Flash Flooding.....	G-1
3. Flash Flood Warnings.....	G-1
4. Role of Cooperative Observers.....	G-2
5. Supplemental Precipitation Surveys .....	G-2
5.1 Purpose of Surveys .....	G-2
5.2 How the Cooperative Observer Can Help .....	G-2

1. Introduction. Flash floods are caused mostly by sudden heavy rains filling natural and man made drainage systems beyond their capacities. Water cannot be carried away fast enough, which results in the overflowing of the drainage systems with dangerous flood waters and its deadly cargo of uprooted trees, smashed structures, boulders, mud, and other debris. Flash floods may also result from dam breaks, the buildup of water behind ice jams, and by the breakup of ice jams.

2. Areas Most Subject to Flash Flooding. Flash flooding can occur quickly in urban areas, sweeping away vehicles and damaging residential and industrial property. It can occur in and near mountainous areas where steep slopes can accelerate runoff rates, quickly changing dry or trickling brooks into dangerous raging torrents. Flash flooding is especially likely near the headwaters of river basins, where there is relatively little time between the onset of heavy rain and flood conditions in smaller basins. Sudden flash flooding is possible in areas having no rain, due to thunderstorms many miles away, out of sight and hearing range.

Even moderate rain, falling on frozen, snow- or ice-covered ground, can produce flash flooding, especially if temperatures are high enough to add melted snow to the runoff. Flash flooding occurring on streams and rivers behind ice jams and following the breakup of ice jams can cause severe devastation from chunk ice scouring and literally destroying anything along the banks of rivers.

3. Flash Flood Warnings. The NWS assigns flash flood warning responsibilities to the WFO. These offices rely on satellite, radar, observations from weather stations operating 24 hours per day, and particularly on reports from private individuals, the police, and local preparedness agencies.

Because flash floods, and particularly the thunderstorms that may cause them, can occur suddenly and in limited areas, the density of weather observations from 24-hour stations is often



inadequate to detect conditions leading to flash flooding. Therefore, the NWS also relies on observer reports to issue warnings with enough lead time to protect lives and property adequately.

4. Role of Cooperative Observers. Cooperative observers can play a vital role in protecting lives and property by being alert to and making reports of excessive rains, rapidly rising or flooding streams to the WFO and to the police or other preparedness agencies in their communities. They should be encouraged to become involved in any preparedness plans developed by their community. Observers should be certain special telephone numbers they have been given for reporting these events are current.

These flash flood reports, even when not transmitted, will be valuable input to the weather forecast offices and the river forecast centers that relate precipitation to the rapid onset of flash-flooding and river flooding conditions.

However, Cooperative observers should heed their personal safety and assess the situation and not walk into a zone that is dangerous. **\*Do not risk injury to collect data\***

5. Supplemental Precipitation Surveys. Frequently in the aftermath of flash floods or other exceptionally heavy rainfall events, the NWS or other authorities may decide to conduct supplemental precipitation surveys - popularly known as "bucket surveys." Within two or three days of the event, officials will go to the area of flooding or heavy rainfall to obtain data from citizens who do not routinely report rainfall. They will contact people who had trash cans, jars, other containers, or any type of personal rain gauge that can be used as unofficial gauges. They will also look for high water marks on buildings, trees, etc., to determine the maximum stream levels attained during flooding. Complete the surveys before subsequent rains wash away the water marks and before memories dim and records are lost. The time rain began and ended (the duration of heavy rainfall) is also very important.

5.1 Purpose of Surveys. Data obtained from bucket surveys are used to correlate heavy rainfall amounts with flood and flash flood crests. This information is vital in developing models that relate heavy rainfall to peak water levels. These relationships are used to increase the accuracy of future flash flood forecasts. Bucket surveys are also needed to justify the building of dams, the widening of drainage channels, the control of upstream urbanization (which can greatly increase future flooding risks), and to decide legal questions.

5.2 How the Cooperative Observer Can Help. Many cooperative observers routinely compare rainfall amounts with other unofficial observers. The official observer can be of great help to the bucket survey team by providing the locations and rainfall amounts recorded by others, or by informing the team how best to contact other observers for further information. They can often assist the team to identify the area(s) having received the most precipitation.

The cooperative observer can take the initiative prior to the survey team arrival. He/she can call unofficial observers to get their rainfall amounts during or promptly after the storm before the information is forgotten. Once the cooperative observer collects this information, they should notify the weather office as soon as possible. This may be the only way the weather office learns

of these extreme rainfall amounts or flood levels.