

# RECLAMATION

*Managing Water in the West*

Desalination and Water Purification Research  
and Development Program Report No. 146

## Wind Power and Water Desalination Technology Integration



U.S. Department of the Interior  
Bureau of Reclamation

July 2009

# REPORT DOCUMENTATION PAGE

Form Approved  
OMB No. 0704-0188

Public reporting burden for this collection of information is estimated to average 1 hour per response, including the time for reviewing instructions, searching existing data sources, gathering and maintaining the data needed, and completing and reviewing this collection of information. Send comments regarding this burden estimate or any other aspect of this collection of information, including suggestions for reducing this burden to Department of Defense, Washington Headquarters Services, Directorate for Information Operations and Reports (0704-0188), 1215 Jefferson Davis Highway, Suite 1204, Arlington, VA 22202-4302. Respondents should be aware that notwithstanding any other provision of law, no person shall be subject to any penalty for failing to comply with a collection of information if it does not display a currently valid OMB control number. **PLEASE DO NOT RETURN YOUR FORM TO THE ABOVE ADDRESS.**

<b>1. REPORT DATE</b> (DD-MM-YYYY) July 2008		<b>2. REPORT TYPE</b> Final		<b>3. DATES COVERED</b> (From - To) June 2005 to October 2008	
<b>4. TITLE AND SUBTITLE</b> Wind Power and Water Desalination Technology Integration				<b>5a. CONTRACT NUMBER</b> Agreement No. 05-FC-81-1173	
				<b>5b. GRANT NUMBER</b>	
				<b>5c. PROGRAM ELEMENT NUMBER</b>	
<b>6. AUTHOR(S)</b> Andy Swift, Ken Rainwater, Jamie Chapman, Dennis Noll, Andrew Jackson, Bradley Ewing, Lianfa Song, Geetha Ganesan, Ryan Marshall, Vikas Doon, Phil Nash				<b>5d. PROJECT NUMBER</b>	
				<b>5e. TASK NUMBER</b> Task C	
				<b>5f. WORK UNIT NUMBER</b>	
<b>7. PERFORMING ORGANIZATION NAME(S) AND ADDRESS(ES)</b> Texas Tech University, Wind Science and Engineering Research Center and Water Resources Center, Box 41022, Lubbock, TX 79409-1022				<b>8. PERFORMING ORGANIZATION REPORT NUMBER</b>	
<b>9. SPONSORING / MONITORING AGENCY NAME(S) AND ADDRESS(ES)</b> Bureau of Reclamation, Denver Federal Center, PO Box 25007, Denver, CO 80225-0007				<b>10. SPONSOR/MONITOR'S ACRONYM(S)</b>	
				<b>11. SPONSOR/MONITOR'S REPORT NUMBER(S)</b> DWPR Report No. 146	
<b>12. DISTRIBUTION / AVAILABILITY STATEMENT</b> Available from the National Technical Information Service Operations Division, 5285 Port Royal Road, Springfield VA 22161					
<b>13. SUPPLEMENTARY NOTES</b> Report can be downloaded from Reclamation Web site: <a href="http://www.usbr.gov/pmts/water/publications/reports.html">www.usbr.gov/pmts/water/publications/reports.html</a>					
<b>14. ABSTRACT</b> (Maximum 200 words) Many communities in the western and southwestern regions of the U.S. face both water quality and quantity issues. Depleting aquifers, and more stringent water quality standards, are contributing to the urgency of the problem. With the maturing of the wind energy industry to provide clean electric power at a firm price, significant wind and brackish water aquifer resources available throughout much of the region, and improving reverse osmosis (RO) technology at decreasing cost - the concept of providing an integrated wind-driven water desalination solution for municipalities in the region is appealing. Topics specifically addressed in this work included the following: background studies outlining previous work done in this area; a market analysis to provide an indication of the breadth and scope of the market for integrated wind-water desalination systems for municipal applications; design parameters, system sizing, and optimization to include economic analysis and cost of water estimates for a specific municipality; and control issues that address the intermittency of the wind resource, water storage, and the usual steady power utilization of current RO system operation.					
<b>15. SUBJECT TERMS</b> Wind Energy, Desalination					
<b>16. SECURITY CLASSIFICATION OF:</b>			<b>17. LIMITATION OF ABSTRACT</b> SAR	<b>18. NUMBER OF PAGES</b>	<b>19a. NAME OF RESPONSIBLE PERSON</b> Andrew Tiffenbach
<b>a. REPORT</b> U	<b>b. ABSTRACT</b> U	<b>c. THIS PAGE</b> U			<b>19b. TELEPHONE NUMBER</b> (include area code) 303-445-2393

# Wind Power and Water Desalination Technology Integration

*by*

**Andy Swift  
Ken Rainwater  
Jamie Chapman  
Dennis Noll  
Andrew Jackson  
Bradley Ewing**

**Lianfa Song  
Geetha Ganesan  
Ryan Marshall  
Vikas Doon  
Phil Nash**

**Wind Science and Engineering Research Center and  
Water Resources Center  
Texas Tech University  
Lubbock, Texas 79409**



**U.S. Department of the Interior  
Bureau of Reclamation  
Technical Service Center  
Water and Environmental Services Division  
Water Treatment Engineering Research Team  
Denver, Colorado**

**July 2009**

## **MISSION STATEMENTS**

The mission of the Department of the Interior is to protect and provide access to our Nation's natural and cultural heritage and honor our trust responsibilities to Indian tribes and our commitments to island communities.

---

The mission of the Bureau of Reclamation is to manage, develop, and protect water and related resources in an environmentally and economically sound manner in the interest of the American public.

### **Disclaimer**

The views, analysis, recommendations, and conclusions in this report are those of the authors and do not represent official or unofficial policies or opinions of the United States Government, and the United States takes no position with regard to any findings, conclusions, or recommendations made. As such, mention of trade names or commercial products does not constitute their endorsement by the United States Government.

# Acknowledgement

We would like to thank our project sponsor, the U.S. Bureau of Reclamation, and especially Kevin Price, Harry Remmers, and Andrew Tiffenbach, for providing project oversight and access to a pilot scale desalination unit, for proof of concept development related to this effort. Also, we thank our partners in the project, the Texas State Energy Conservation Office, for support related to this research; West Texas A&M University, for providing the 5 kW Enertech wind turbine for proof of concept testing; the staff of the General Electric Global Research Center, who assisted with the controls and instrumentation aspects of the project; National Instruments technical staff; as well as the students and technical support staff of the Wind Science and Engineering Research Center and the Water Resources Center.



# Glossary

## Acronyms and Abbreviations

<b>EPA</b>	Environmental Protection Agency
<b>Gpd</b>	gallons per day
<b>ICC</b>	Installed Capital Cost
<b>mg/L</b>	Milligrams per liter
<b>MGD</b>	Million Gallons per Day
<b>O&amp;M</b>	Operations & Maintenance
<b>pCi/L</b>	Picocuries Per liter
<b>PTC</b>	Production Tax Credit
<b>Q<sub>avg</sub></b>	Average Flow
<b>Q<sub>max</sub></b>	Maximum Flow
<b>REC</b>	Renewable Energy Credits
<b>RO</b>	Reverse Osmosis
<b>TDS</b>	Total Dissolved Solids

## Chemical Nomenclature

<b>As</b>	Arsenic
<b>Cl</b>	Chloride
<b>F</b>	Fluoride
<b>Fe</b>	Iron
<b>NO<sub>3</sub></b>	Nitrate
<b>Sb</b>	Antimony
<b>SO<sub>4</sub></b>	Sulfate





# Table of Contents

	<i>Page</i>
Acknowledgement .....	iii
Glossary .....	v
Acronyms and Abbreviations.....	v
Chemical Nomenclature.....	v
1. Executive Summary .....	1
2. Background .....	3
2.1 Purpose of the Study .....	4
2.2 Report Organization.....	5
2.3 Approach.....	6
3. Conclusions and Recommendations.....	9
4. Introduction .....	11
5. Survey of Municipal/Community Water Systems .....	13
6. RO System Design .....	15
7. Design and Control of an Integrated Wind-Water Desalination System for an Inland Municipality.....	17
8. Small-Scale Demonstration of an Integrated Wind-water System for Brackish Water Treatment.....	23
9. References .....	25
Appendix A.—Estimated Useable Lifetime of the Ogallala Aquifer in Texas	
Appendix B.—Report I. Reverse Osmosis Design, Geetha Ganesan and Dr. Andrew Jackson, 2007	
Appendix C.—Report II. Design and Control of an Integrated Wind-Water Desalination System for an Inland Municipality, Dennis Noll, 2008	
Appendix D.—Report III. Integrated Wind-Water System for Brackish Water Treatment, Ryan Marshall, 2008	

## List of Tables

		<i>Page</i>
1	Communities with Primary ( <i>italics</i> ) and Secondary ( <b>bold</b> ) Exceedances (blank cell = not reported).....	14
2	Summary of Component Costs/1000 Gallons .....	21

## List of Figures

		<i>Page</i>
1	Integrated Wind-RO Layout for an Inland Municipality.....	7
2	Real-Time Energy Supply/Demand Comparison .....	15
3	Turbine Array Benefit/(Loss) per 1000 Gallons.....	20
4	Distribution of Costs/1000 Gallons .....	18
5	Distribution of Monthly Average Energy Use.....	18

# 1. Executive Summary

Many communities in the western and southwestern regions of the US face both water quality and quantity issues. Depleting aquifers, and more stringent water quality standards, are contributing to the urgency of the problem. Many municipalities currently use local Ogallala aquifer water that contains total dissolved solids (TDS) above the secondary drinking water standard, as well as exceeding other primary and secondary standards. As the shallow Ogallala aquifer levels drop, the next local groundwater source is the brackish and much deeper Santa Rosa aquifer. With the maturing of the wind energy industry to provide clean electric power at a firm price, significant wind and brackish water aquifer resources available throughout much of the region, and improving reverse osmosis (RO) technology at decreasing cost, the concept of providing an integrated wind-driven water desalination solution for municipalities in the region is appealing. This concept is the focus of the project.

Topics specifically addressed in this work included the following: background studies outlining previous work done in this area; a market analysis to provide an indication of the breadth and scope of the market for integrated wind-water desalination systems for municipal applications; design parameters, system sizing, and optimization to include economic analysis and cost of water estimates for a specific municipality; and control issues that address the intermittency of the wind resource, water storage, and the usual steady power utilization of current RO system operation.

These topics are addressed in the report in detail. The market study indicated at least 39 rural municipalities in the Southern High Plains of Texas and New Mexico with water quality issues. The concept of integrating wind power and RO desalination can be an attractive option, and one municipality, Seminole, Texas, has expressed interest in a demonstration project, and is pursuing funds for such a project. Initial data collection from Seminole has resulted in detailed water use, energy use, and wind availability data for initial design studies, which are provided in the report.

A spreadsheet model was assembled to approximate the design and sizing of small municipal RO treatment systems for various TDS levels, as well as to estimate the installed capital and O&M costs. Finally, a small scale control development platform integrating a 5-kW wind turbine and a 1500-gpd RO system provided by the Bureau of Reclamation (Reclamation), was assembled, successfully tested, and provided valuable integration data for a basic on/off control strategy. That work was funded by the State of Texas, State Energy Conservation Office (Swift et al., 2008).



## 2. Background

Unchecked consumption has led to serious depletion of the slow-recharging water resource of the Ogallala aquifer in some areas of West Texas (Rainwater et al., 2005). Practical aquifer exhaustion for those areas looms on a 50-year horizon, or less, if current withdrawal rates continue (TWDB, 2007). This depletion comes largely from the continued agricultural irrigation, causing the prediction that the aquifer will be of diminished availability by the middle of the century (Rainwater et al., 2005, TWDB, 2007; Lyons, 2005). Many cities face economic distress due to lack of sustainable fresh water availability (Phillips, 2007). In order for these cities to remain economically and physically viable, alternative water resources must be utilized. The city of Seminole, population 5910 in Gaines County, Texas, is one such municipality.

Beneath the extreme southern portion of the Ogallala aquifer lays a deeper, brackish, but mostly untapped reservoir: the Santa Rosa aquifer within the Dockum formation (TWDB, 2007). The salinity of the Santa Rosa has kept it from being used for agricultural uses (Reisner, 1993). In the past, the prohibitive costs of purification have limited its use (TWDB, 2007). The capacity of the aquifer is estimated to be 66 million acre-feet of water. Seminole currently consumes approximately 1800 acre-feet of water per year (1.64 MGD). Because the aquifer cannot be used for agricultural use at its current level of salinity the aquifer lifespan is expected to be sufficient to provide Seminole, and other potential adopters of the integrated wind-water system, with potentially potable water for well over 1000 years (TWDB, 2007). Many municipal water providers, including Seminole, do not take the aforementioned economic pricing responsibility for the increasing scarcity of their fresh water resources by increasing prices as water levels continue to drop (Lyons, 2005). As a consequence, there is a large difference between the costs of producing purified water through reverse osmosis (a replacement technology) and ground water sources that require little treatment to become potable.

Through the past several years, the costs of purifying water through reverse osmosis (RO) have declined (Busch, 2004). At the same time, the modern wind turbine has emerged with predictable economics and a lack of need for water to produce energy (Lyons, 2005). The cost of energy from the wind turbines is comparable to conventional energy sources. Further, wind turbines have predictable life-cycle and 20-year fuel costs since the turbines are independent of fossil fuel pricing (Flowers, 2005). These results have led us to integrate wind energy with RO because of the significant energy requirements of the reverse osmosis process (Lyons, 2005). As a result, the integration of the two relatively mature technologies of wind energy and RO becomes an attractive match to address an emerging threat to the continuing economic viability of a region heavily dependent on affordable energy and potable water.

The management and council of the city of Seminole have recognized the need to explore the technology and economics of obtaining sources of water other than the Ogallala aquifer (Phillips, 2007). As a result, they have agreed to work with Texas Tech University for the design and possible implementation of a full-scale integrated wind-water system. This system will draw from the deeper, brackish Santa Rosa aquifer to provide a supply of potable water for the municipality. The installation of a municipal integrated wind-water system is attractive because the water distribution and storage system is already in place (Goodger, 2007). Water storage holds the ability to compensate for the time-variability of wind energy systems, and allows for the possibility of time-shifting wind generated energy.

This ability will be realized by an adaptive and intelligent control algorithm that will determine the best use of the energy produced by a wind turbine array. The algorithm will determine the use of the produced energy in three ways, listed here in order of decreasing importance:

1. Producing potable water through RO
2. Offsetting the costs of municipal electric loads, and
3. Selling excess energy to the grid.

## **2.1 Purpose of the Study**

The purpose of this study was to determine if potable water can be supplied from deep, high salinity aquifers using the RO treatment. Due to declining water levels in the southern portion of the Ogallala aquifer, many municipalities will face significant water shortages by the middle of this century. Groundwater is available in aquifers located below the Ogallala. However, the brackish nature of water in these deeper aquifers is unfit for human consumption without further, more costly treatment. RO is a common technology used worldwide for desalination. Brackish water could be pumped from deeper aquifers, treated by RO, and sold to customers. RO treatment could, also, be employed to ensure water meets EPA standards in other areas, as well. For instance, along with high salinity (TDS), some cities on the southern High Plains struggle with elevated arsenic and fluoride levels. RO technology would lower these to acceptable limits, however, RO is an energy-intensive operation. Grid-supplied electricity makes RO treatment cost-prohibitive, especially in smaller cities where revenue streams are much more limited. The key to this challenge may be in combining RO with a renewable source of energy, like wind. Fortunately, many cities on the High Plains are located in regions with high wind resource availability. Because wind power can be sold back to local utilities, an opportunity exists to harness the wind power to offset the high energy requirements of RO treatment.

Although the study originally focused on three market and application areas – (1) municipal water treatment systems; (2) ranch and farm applications; and

(3) industrial applications –, early in the study a rural community, Seminole, Texas, expressed interest in becoming the first adopter of the integrated wind-water system. With sponsor approval, the study was redirected to focus solely on development of a municipal, integrated wind-water desalination system for the inland small community.

## **2.2 Report Organization**

This report is organized to present the findings of four individual reports resulting from the research program. Chapter 3 summarizes the conclusions and recommendations from this research. Chapter 4 presents introductory thoughts about the regional groundwater issues and the value of drinking water. Chapter 5, Survey of Municipal/Community Water Systems, presents the results from the survey of existing water supply sources for 40 small communities. Primary and secondary exceedances, the amount by which components exceed a primary or secondary drinking water standard, are identified for each community.

Chapter 6 summarizes a study to create a simple model used to size and estimate the cost associated with a RO system. The study focused on small municipalities in the rural communities of the High Plains region of Texas in which the main source of water is groundwater. Investigators also present full descriptions of RO systems with details of system components and parameters important to the design and cost considerations. The full report (Ganesan and Jackson, 2007) is given in Appendix B.

A comprehensive design of an integrated wind-water desalination system for an inland municipality is summarized in Chapter 7. A specific small rural inland community was selected as a first adopter of the technology and the design concentrated on the specific attributes and needs of that community. Researchers determined the water consumption of the community, local wind energy resources, electricity available from the existing grid, and associated costs. The full report (Noll, 2008) is given in Appendix C of this report.

Reclamation provided a small RO system for a small-scale demonstration of an integrated wind-water system. Chapter 8 presents a summary of the system assembly, operation, observations, while the full report (Marshall, 2008) is given in Appendix D. Additional details of this work may be found in Chapter 9 (Swift et al., 2008).

## 2.3 Approach

An integrated wind-RO system layout for an inland municipality is illustrated in Figure 1. The system shown considers the availability of both an existing potable water source and a brackish water source. The brackish water is treated with RO techniques and blended with available potable water until regulatory requirements for water quality are met. Wind-generated, and/or grid-provided electricity provides power for the water treatment operations. Because two sources of power are available for the water treatment system, an integration and control unit is needed to manage power input to the water treatment system or return power to the grid. Concentrate from the water treatment system must be properly managed, and several options are available.

Researchers designed and evaluated each step of the integrated wind-RO system with respect to performance and economical operation. First, 40 communities were surveyed to characterize the water quality of currently used sources. Next, researchers investigated the key elements affecting costs of RO water treatment, and developed methods to calculate the cost associated with reverse osmosis water treatment based on the source water quality. Concurrently, a possible first-adopter community was selected as a candidate for an integrated wind-RO water treatment system and performed an extensive evaluation of RO water treatment for the community considering water quality, water usage, commercial energy costs and wind energy availability. In an associated study, a small scale test facility was constructed to integrate a wind-water desalination prototype and perform initial characterization tests of the small-scale system (Swift et al., 2008).



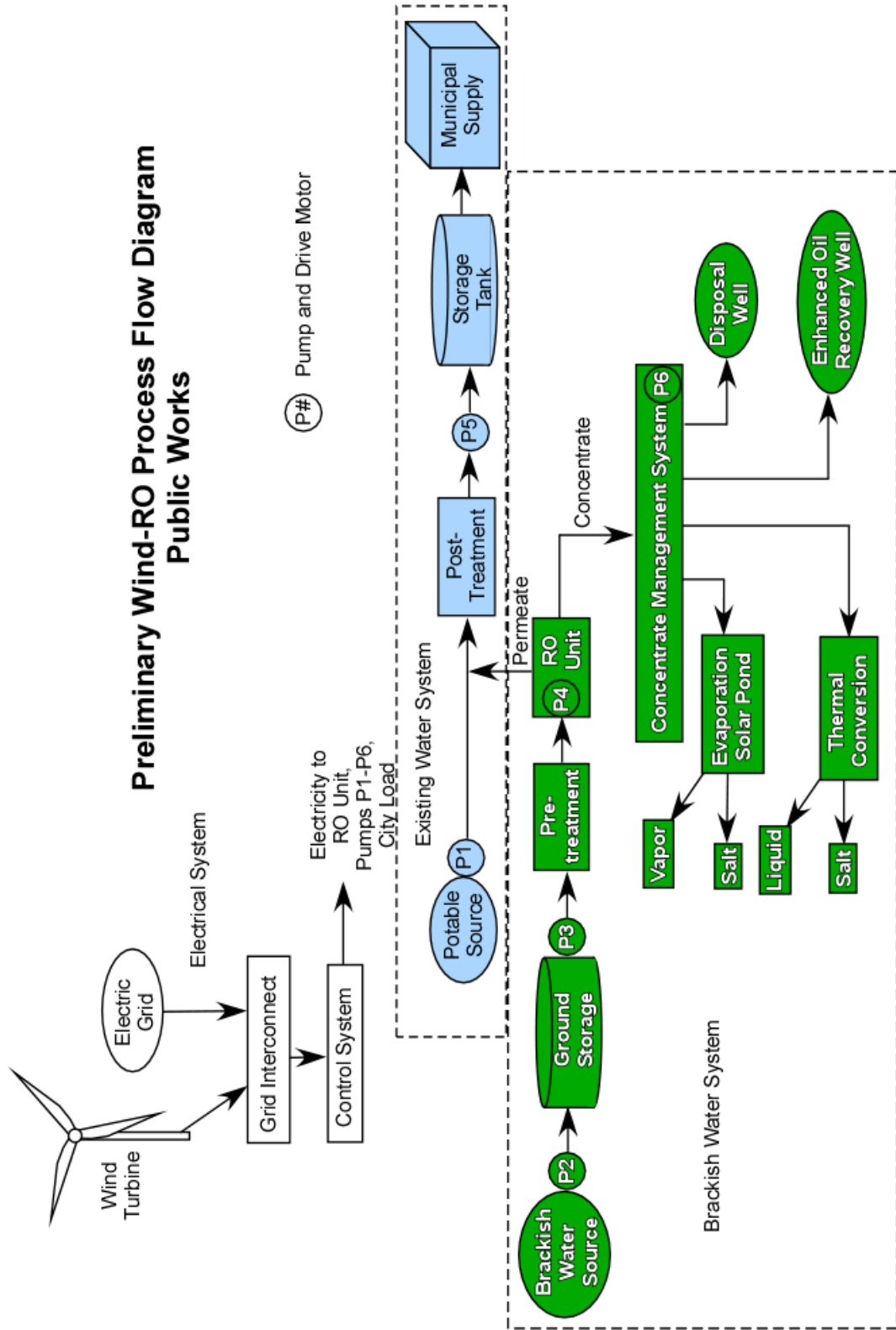


Figure 1. Integrated Wind-RO Layout for an Inland Municipality.



### 3. Conclusions and Recommendations

This project addresses the integration of wind energy systems with reverse osmosis water treatment for inland municipalities to decrease the cost of RO-treated water. Conclusions from this work are summarized below.

- The market analysis identified 39 municipalities in the Southern High Plains region that use Ogallala aquifer or other groundwater and have the need for a potable water treatment, either for primary or secondary drinking water limit exceedances. Additional communities may have declining fresh water aquifers, and could be good candidates for future integrated wind-water desalination system consideration.
- A small-scale demonstration, utilizing a 5-kW wind turbine and 1500-gpd RO desalination unit provided by Reclamation, was successfully completed using a simple control strategy. Results of the demonstration indicated that the RO system and its elements successfully treated the brackish feed water consistently throughout the test duration with no operational problems.
- A case study using data from Seminole, Texas, indicated that an optimized application of a wind turbine array and intelligent control system will improve the cost of water economics through an overall reduction of energy cost.
- Detailed electricity and water use data for the city of Seminole, Texas, have been collected and integrated into an energy and water analysis for the city.
- Seminole, Texas, is anticipating installation of a 50-kW integrated wind-water RO desalination system with funds from the Texas Water Development Board and the Office of Rural and Community Affairs, in collaboration with Texas Tech University.
- A spreadsheet-based model was assembled to approximate the design and associated costs of small community RO applications. The cost figures were based on publicly available, rather than proprietary, information.

Recommendations for further investigation include the following:

- Research with more advanced RO systems for improved membrane performance and reliability could improve the performance and economics of the system.

- Methods to reduce the risks associated with the costly drilling of wells into poorly characterized brackish aquifers could reduce costs and expand the market for these systems.
- A larger scale demonstration of the concept to optimize control strategies and determine other possible integration synergies is needed to finalize performance and cost numbers in order to attract other potential system adopters.

## 4. Introduction

Until early in the 20th century, water was a scarce resource in West Texas. Springs, streams, and rivers fed the occasional body of surface water, while indigenous grasses depended upon rainfall for survival. Some of the early settlers were quick to realize that there was an abundance of water beneath them, and began drilling wells and using windmills to pump water to the surface (Reisner, 1993). This discovery of a seemingly unending source of potable water influenced the region's population and economics. For almost a century, settlers from West Texas to South Dakota have tapped this underground sea of the High Plains, the Ogallala aquifer. Much of the land above the aquifer is used for agricultural purposes, from corn to cotton to livestock. All users have demanded their share of the water to support their families and livelihood. Consequently, the aquifer has shown signs of overuse (Reisner, 1993).

Current municipal water pricing practices do not fully recognize the dwindling availability of this undervalued resource, nor does the subsequent economic responsibility to adjust price accordingly (Lyons, 2005). Pricing mechanisms for these resources should be based on their replacement value, taking into consideration future supplies. Incorporating financial costs rather than true economic value in the pricing of these scarce water resources, and the serious depletion of these often slow-recharging groundwater resources has occurred in many areas of the United States. Many municipalities in the Southwest and elsewhere face potential water distress due to lack of sustainable fresh water availability (Reisner, 1993). In order for these cities to continue to exist, other water resources must be found.



## 5. Survey of Municipal/Community Water Systems

Table 1 shows a list of 40 cities in the Southern High Plains of Texas and New Mexico that depend on Ogallala or other groundwater for their primary municipal water supply. The data were collected from the public records of the regional offices of the Texas Commission on Environmental Quality (TCEQ) and the website of the New Mexico Environmental Department. As of 2005, when the data were collected, each of these cities only provided disinfection prior to distribution of the groundwater to their customers. Bold numbers in the cells show levels that are above primary maximum contaminant levels, shown in the column heading cells, set by the Environmental Protection Agency. Italicized text in the cells denotes concentrations that are above secondary recommended levels. Blank cells indicate that the parameter value was not available in the agency files. Secondary TDS levels were exceeded by 33 of the city supplies, 29 exceeded either the primary or secondary fluoride levels, and 24 exceeded the recent primary standard for arsenic. Sulfate (14), chloride (10), iron (2), nitrate (10), and gross  $\alpha$  (8) exceedances often accompanied high TDS levels. This table shows that 39 rural municipalities could benefit from advanced treatment of their water supplies. It should be noted that TDS values above 2000 mg/L, such as those seen at Tulia and Lefors, were most likely from the Santa Rosa, not the Ogallala. The communities in Table 1 represent the regional market for wind-water applications.

**Table 1. Communities with Primary (bold) and Secondary (*italics*) Exceedances (blank cell = not reported)**

City	County	Population	Q <sub>avg</sub> MGD	TDS mg/L <i>500</i>	As mg/L <b>0.01</b>	Cl mg/L <i>250</i>	F mg/L <b>4, 2</b>	SO <sub>4</sub> mg/L <i>250</i>	NO <sub>3</sub> mg/L <b>10</b>	Fe mg/L <i>0.3</i>	Gross α pCi/L <b>15</b>
Hereford	Deaf Smith	14,400	2.750	<i>1,150</i>	0.003	210	<b>4.2</b>	209	5.5	0.05	<b>18.7</b>
Levelland	Hockley	12,866	1.448	<i>714</i>	0.008	86.9	<b>4.4</b>	202	2.6	0.12	13.5
Lamesa	Dawson	9,942	1.570	<i>1,150</i>	<b>0.018</b>	<i>315</i>	2.2	327	5.3	0.00	7.2
Andrews	Andrews	9,652	2.388	<i>660</i>	<b>0.038</b>	157	<b>4.4</b>	116	2.2	0.00	3.4
Seminole	Gaines	5,910	1.847	<i>531</i>	<b>0.017</b>	116	<b>4.1</b>	99	3.4	0.15	5.4
Tulia	Swisher	5,200	0.795	<i>2,020</i>	0.003	389	<b>5.3</b>	436	0.4	0.13	7.1
Denver City	Yoakum	3,985	0.852	<i>948</i>	<b>0.014</b>	316	2.3	169	2.6	0.00	4.5
Crane	Crane	3,191	1.053	<i>464</i>	<b>0.013</b>	59	1.5	147	2.2	0.00	4.8
Tahoka	Lynn	2,910	0.405	<i>1,020</i>	0.003	321	1.0	225	1.0	0.01	4.8
Stanton	Martin	2,900	0.329	<i>1,111</i>	<b>0.020</b>	302	2.4	425	<b>10.1</b>	0.00	2.0
Wolfforth	Lubbock	2,710	0.442	<i>652</i>	<b>0.015</b>	76.5	<b>5.8</b>	131	2.2	0.00	10.7
Seagraves	Gaines	2,334	0.328	<i>788</i>	<b>0.049</b>	120	<b>4.7</b>	223	<b>10.9</b>	0.00	6.7
Shallowater	Lubbock	2,300	0.380	<i>725</i>	<b>0.012</b>	67	2.9	177	7.6	0.09	<b>47.3</b>
Morton	Cochran	2,245	0.379	<i>1,050</i>	<b>0.015</b>	217	3.6	342	5.1	<i>1.00</i>	6.4
Lorenzo	Crosby	1,372	0.172	<i>351</i>	<b>0.016</b>	24	2.5	32	1.5	0.00	9.8
Plains	Yoakum	1,350	0.931	<i>1,124</i>	<b>0.015</b>	184	<b>4.3</b>	446	3.2	0.01	6.3
Booker	Lipscomb	1,200	0.282	<i>785</i>	0.005	239	1.4	105	2.6	0.21	9.6
O'Donnell	Lynn	1,011	0.100	<i>1,262</i>	0.003	352	1.0	348	0.0	0.00	
Silverton	Briscoe	780	0.111	<i>358</i>	<b>0.012</b>	19	3.5	19	1.1	0.02	
Meadow	Terry	750	0.110	<i>930</i>	<b>0.028</b>	164	<b>4.8</b>	274	6.8	0.01	<b>17.9</b>
Lefors	Gray	560	0.093	<i>3,666</i>	0.010	<i>1,926</i>	0.2	4	1.5	0.07	0.0
Vaughn	Guadalupe	540	0.198		0.009		3.2				<b>50.1</b>
Wilson	Lynn	532	0.045	<i>1,336</i>	0.009	275	<b>4.0</b>	350	<b>11.0</b>	0.00	<b>16.9</b>
Turkey	Hall	500	0.065	<i>1,237</i>	0.005	157	1.5	437	<b>17.1</b>	0.01	10.8
Smyer	Hockley	480	0.053	<i>1,000</i>	<b>0.012</b>	92	<b>5.2</b>	176	3.0	0.01	<b>23.6</b>
Quitaque	Briscoe	463	0.105	<i>1,124</i>	0.004	231	1.9	286	<b>14.6</b>	0.01	
Wickett	Ward	455	0.118	<i>586</i>	0.006	83	1.9	169	1.3	0.02	6.7
New Home	Lynn	440	0.047	<i>859</i>	<b>0.026</b>	135	<b>5.0</b>	171	5.0	0.00	10.0
Texhoma	Sherman	371	0.100	<i>330</i>	0.004	11.6	2.0	72	2.1	0.01	13.8
Welch	Dawson	354	0.049	<i>1,295</i>	<b>0.027</b>	298	<b>4.6</b>	408	<b>17.2</b>	<i>4.08</i>	14.6
Floyd	Roosevelt	350		<i>657</i>	<b>0.012</b>	135	<b>4.2</b>	290	4.5	0.00	
Loop	Gaines	300	0.031	<i>654</i>	<b>0.031</b>	27	<b>4.9</b>	197	7.0	0.00	
Goldsmith	Ector	250	0.079	<i>494</i>	<b>0.017</b>	72	3.2	83	2.6	0.03	
Wellman	Terry	225	0.038	<i>823</i>	<b>0.037</b>	108	<b>5.7</b>	241	5.3	0.01	8.8
Elida	Roosevelt	189	0.022	<i>897</i>	<b>0.012</b>		2.3				
Opdyke West	Hockley	180	0.050	<i>628</i>	<b>0.014</b>	53	<b>5.9</b>	127	6.7	0.11	8.1
Whitharral	Hockley	175	0.054	<i>1,040</i>	0.007	107	<b>4.4</b>	395	<b>11.0</b>	0.16	<b>17.0</b>
Dodson	Collingsworth	120	0.030	<i>335</i>	0.002	9	0.7	40	<b>13.8</b>	0.02	2.9
Grassland	Lynn	75		<i>1,732</i>	<b>0.020</b>	659	<b>5.0</b>	332	<b>13.0</b>	0.00	<b>16.6</b>
Flomot	Motley	40		<i>749</i>	0.007	131	2.0	168	<b>19.0</b>	0.00	4.6



## 6. RO System Design

The goal of the RO system design study was to devise a simple, yet easy to use spreadsheet tool to quickly calculate the cost of an RO system based on the source water quality of the raw water. To achieve this goal, a literature review was performed considering various public and proprietary sources. Using publically available design and cost approximations, a flow chart model was created that is the basis for a spreadsheet or web-based tool. Various scenarios were tested in validating the model (Ganesan and Jackson, 2007).

The model requires the user to specify inputs such as raw water quality (TDS level), recovery, desired finished water quality, brine disposal method, and an energy unit cost. Depending on whether or not the user chooses to blend permeate water with raw water, the tool then performs mass balance calculations. The model consists of four TDS-level categories, in which each category is associated with a specified membrane, pressure, membrane area, and design flux. Each of the four categories has associated cost calculations. The higher the TDS level, the higher the pressure, which results in a greater total RO design cost. The costs are broken down into operation and maintenance (O&M), pretreatment, feed pumping, and process system) and capital costs (pretreatment, feed pumping, and process system). The outputs include the number of elements and pressure vessels required, O&M, and capital costs. Various brine disposal methods were suggested, but the actual cost calculations could be implemented in a later version.

Verification of the model is also exhibited in this report. Scenarios were created for each of the TDS levels at each of the pressures (Ganesan and Jackson, 2007, Appendix B). For each scenario, the numbers of elements and pressure vessels, as well as total costs were calculated. This task was repeated for situations in which blending also occurred at each of the TDS levels at each of the pressures. In all cases, the lower energy elements were the cheapest and then progressed on upwards such that the seawater energy configuration was the most expensive. The model validation also showed that blending decreases the cost considerably.



## **7. Design and Control of an Integrated Wind-Water Desalination System for an Inland Municipality**

Current water pricing standards do not take economic responsibility for dwindling potable water aquifer resources. By only incorporating financial, but not true economic costs of these scarce resources, serious depletion of these often slow-recharging groundwater resources has occurred in many areas in the United States. Aquifer depletion for some areas looms on a 50-year or closer horizon, and many municipalities in the Southwest and elsewhere face potential distress due to lack of sustainable fresh water availability. In order for these cities to remain economically and physically viable, alternative water resources must be found. An affected West Texas inland municipality will become the subject of research to evaluate the technology and economics of a full-scale, integrated, wind-powered RO water purification system. The integrated system will be applied to produce potable water from a brackish aquifer using renewable energy to reduce the energy costs of the system. An adaptive and intelligent control algorithm will control the integrated wind-water system.

The algorithm will process streaming real-time water use and electrical demand data in combination with wind speed measurements in order to determine the best use of the energy produced by a turbine array: either for water purification or for displacing conventional power on other municipal loads. The end product of this system is a water purification process that will utilize a brackish water aquifer, from either the Santa Rosa or the southernmost Ogallala, for all of the city's potable water needs, and wind energy for all associated pumping, reverse osmosis, distribution and other electrical loads.

Research results indicate that the economically optimized application of a wind turbine array and the intelligent control of the energy produced by that array will benefit the economics of an integrated wind-water system by reducing the energy cost of that system (Noll, 2008, Appendix C). This inland system differs from a system designed for a coastal location for several reasons. The lifting costs associated with bringing the raw water from the Santa Rosa Aquifer (assumed to be 1350 feet) to the surface add to the costs of the inland system, as coastal locations are usually located at or near sea level and have minimal lifting costs. The disposal of the brine from the RO process also adds to the cost of the inland system, as coastal locations generally pump the brine back out to sea.

There is less of an energy cost associated with the purification of Santa Rosa water than sea water (Hightower, 2005; Mickley, 2006). The economic assumptions of this report ignore any effects that the production tax credit (PTC) or the sale of renewable energy credits (REC) might have on the calculated cost of

water. Both of these benefits remain politically uncertain with an unpredictable lifespan. A detailed analysis is presented of the real-time shear exponent values that are present during different times of the day and year. This analysis challenges the conventional assumption of a constant shear exponent value throughout the year. The time-varying shear exponent values throughout the day and year contribute to the time-variation in energy supply seen in Figure 2.

Acknowledgment of these time-varying shear exponent values contributes to the potential time-shifting of the energy supplied by the wind turbine array. The analysis presents the annual average sizing procedure for different components of the integrated wind-water system. The annual average analysis is an acceptable sizing procedure for some of the components of the integrated system (wellfield, RO, distribution), but the analysis shows the difference between the low-resolution annual average analysis, and that of an analysis performed with the intent of maximizing the resource offered by the wind turbine array.

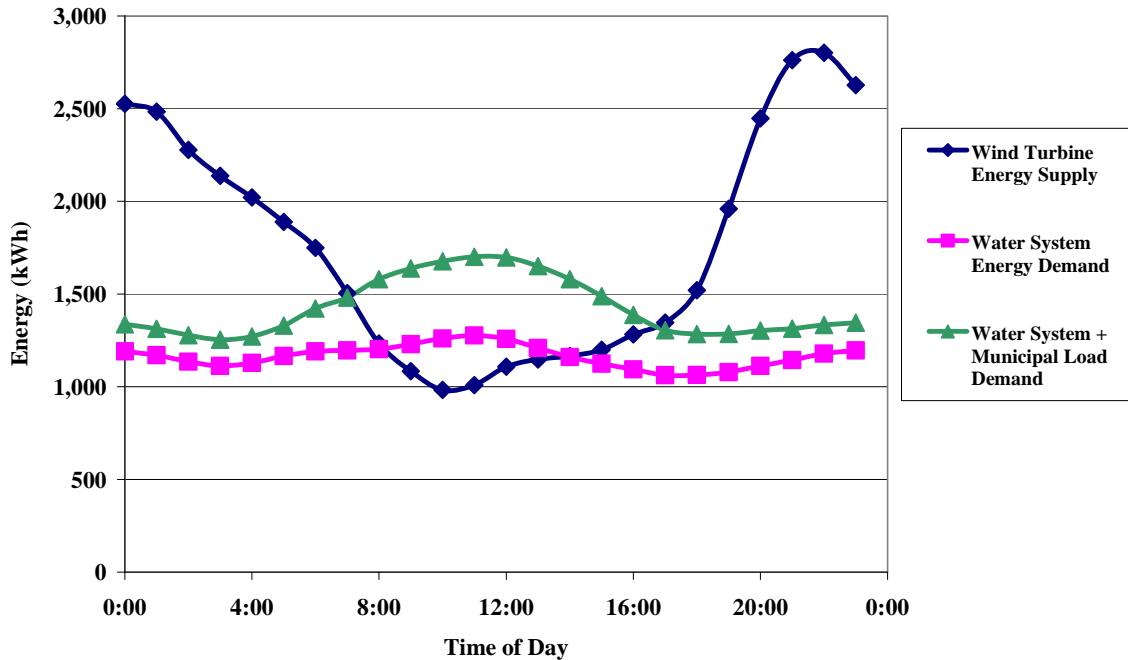
The *cost of solely providing municipal loads* represents the cost to power municipal loads at the cost of energy of \$0.08/kWh. The *cost to power the wellfield, reverse osmosis, and distribution loads without wind energy* was estimated based on the systems sized to meet the Seminole demands as shown in detail in Appendix C. The *cost to the municipality to power municipal, wellfield, reverse osmosis, and distribution loads without wind energy* is a summation of these two costs. These numbers remain the same regardless of the size of the turbine array, since the turbine array has no effect on these costs.

The *cost to power municipal, wellfield, reverse osmosis, and distribution loads with available wind energy* is the annual summation of all of the times when the wind-water system will have to purchase energy from the utility energy provider, at \$0.08/kWh, after the consideration of the benefit of the wind turbine array. This number varies with the number of turbines in the array, as their added benefit displaces more of the energy required to power the water system and municipal loads as the size of the array increases.

The *revenue from selling excess wind energy* at the selling price of \$0.04/kWh is taken from the annual positive balance and multiplied times the stated selling price. This revenue varies with the number of turbines in the array, as the excess energy produced by the turbine array goes beyond that needed by the water system and municipal loads.

The *cost to the municipality to power municipal, wellfield, reverse osmosis, and distribution loads after selling excess energy* is the net difference between the cost of powering the municipal and water system loads with wind energy, and the revenue gained by selling excess wind energy to the utility energy provider. This cost again varies with the number of turbines included in the wind turbine array.

The *annual total monetary benefit of the wind turbine array to the municipality* is the net difference between the cost to the municipality to power the municipal and

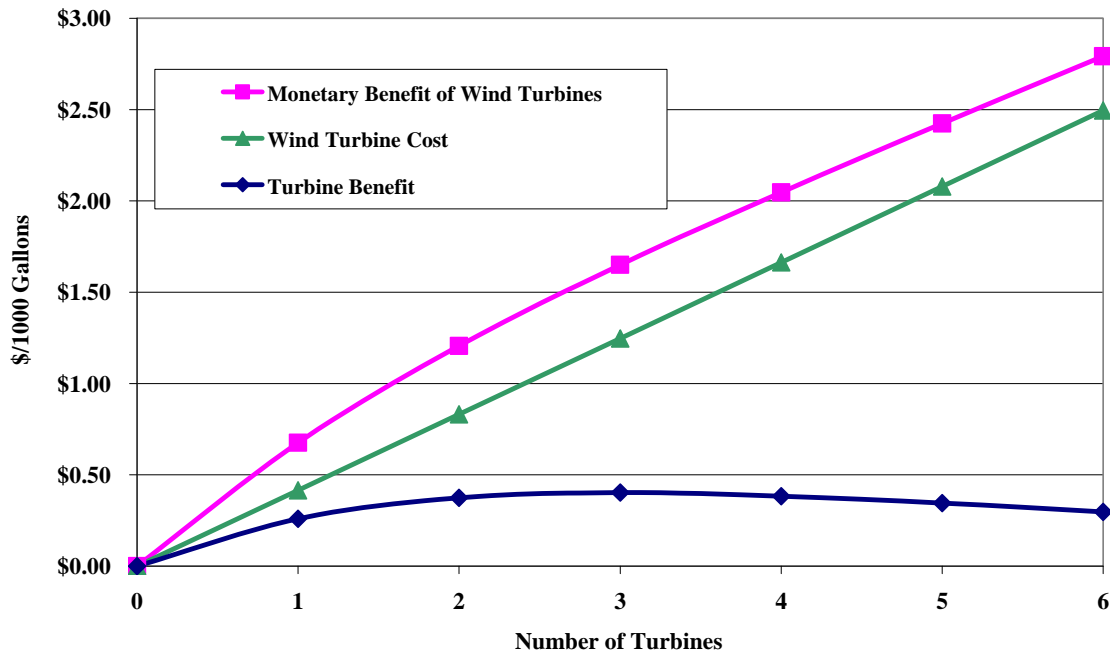


**Figure 2. Real-Time Energy Supply/Demand Comparison**

water system loads without wind energy, and the cost to the municipality to power the municipal and water system loads, considering wind energy and the sale of excess energy to the utility energy provider. The annual total monetary benefit varies with the number of turbines in the wind turbine array. This benefit is converted into a cost/1000 gallons later in the table.

The annual total monetary benefit was compared to turbine installed capital cost as well as operations and maintenance costs in order to determine the benefit that the turbine array brings to the integrated wind-water system. The wind turbine installed capital cost is \$2.4 million per turbine, and the operations and maintenance costs associated with the wind turbines is set at \$0.012/kWh produced. The turbines are to be financed with a 20-year municipal bond, at a rate of 4.65%.

The *turbine array benefit/loss* is calculated as the difference between the total monetary benefit of the wind turbine array and the total wind turbine cost/1000 gallons. Both of these costs vary with the number of turbines in the array, and when analyzed, there is a maximum benefit associated with the number of turbines. The turbine array benefit decreases after the maximum, because as the benefit of displacing water system energy runs out, the municipality sells the surplus energy to the utility energy provider at a reduced rate, placing Seminole in the business of producing wind energy. A graphical representation of the turbine array benefit/loss is presented in Figure 3. These results are presented in detail in Appendix C.



**Figure 3. Turbine Array Benefit/(Loss) per 1000 Gallons**

The high-resolution analysis represents a more comprehensive display of the times during the day and during the year where energy surpluses or deficits occur. Through the acknowledgement of these different energy values, the analysis arrives at a projected cost of water that is more accurate than the annual average analysis.

This difference stems not only from the magnitude of the surpluses or deficits, but also from the different values of energy purchased from or sold to the utility energy provider. The maximization of the benefit from the turbine array is an analysis that will vary with differences in turbine pricing (economies of scale or different installed capital cost), costs of energy, or projected energy consumption of whatever system is proposed. The maximization procedure was performed in such a manner that it could be applied to other systems with different parameters.

The sensitivity analysis (Noll, 2008) portrays the effects that different parameters have on the cost of water for the proposed system. Of note in the analysis is the sensitivity of the cost of water to parameters that affect the energy consumption of the water system, which is composed of the wellfield, RO, and distribution systems. The energy consumption of the entire system is not the parameter with the highest effect on the cost of water: that slot belongs to the capital costs and bond interest rate of the associated components. However, the emphasis on the energy efficiency of the different components will produce a lower total cost of water and make the system more economically attractive to potential adopters. An analysis of a system at a coastal location was not considered in the sensitivity

analysis because of the large differences in many of the parameters associated with coastal RO systems, mentioned earlier in this chapter. The introduction of an adaptive and intelligent control algorithm to determine the best use of the energy generated by the wind turbine array produces many opportunities for future work involving the integration of renewable energy with energy intensive processes.

A summary of the costs associated with pumping water from the Santa Rosa and purifying it via a RO system, both with and without the consideration of wind turbines is presented in Table 2. Seminole currently charges between \$1.60-2.15/1000 gallons, depending on individual consumer use. The distribution of costs/1000 gallons is presented in Figure 4, and the distribution of monthly average energy use gallons is presented in Table 2. Capital costs were amortized over a 20-year bond life at an interest rate of 4.65 percent. The total cost of the produced water is estimated at \$4.17/1000 gal. If the total energy value of the wind turbine is considered in terms of the surplus energy net metered or sold to the regional utility, the energy displacement value of the wind turbine benefit is \$0.62/1000 gal, which may be subtracted from the total cost.

**Table 2. Summary of Component Costs/1000 Gallons**

<b>Component</b>	<b>kWh/1000</b>	<b>Utility Energy</b>	<b>ICC*</b>	<b>O&amp;M</b>	<b>Totals</b>
Wellfield	10.58	\$ 0.85	\$ 0.45	–	\$ 1.30
RO (incl. Evap. Pond)	5.63	\$ 0.45	\$ 0.24	\$ 2.11	\$ 2.80
Distribution	0.86	\$ 0.07	–	–	\$ 0.07
				Total:	\$ 4.17
				Total Considering Wind Turbine Benefit:	\$ 3.55

\* ICC—Installed Captial Cost

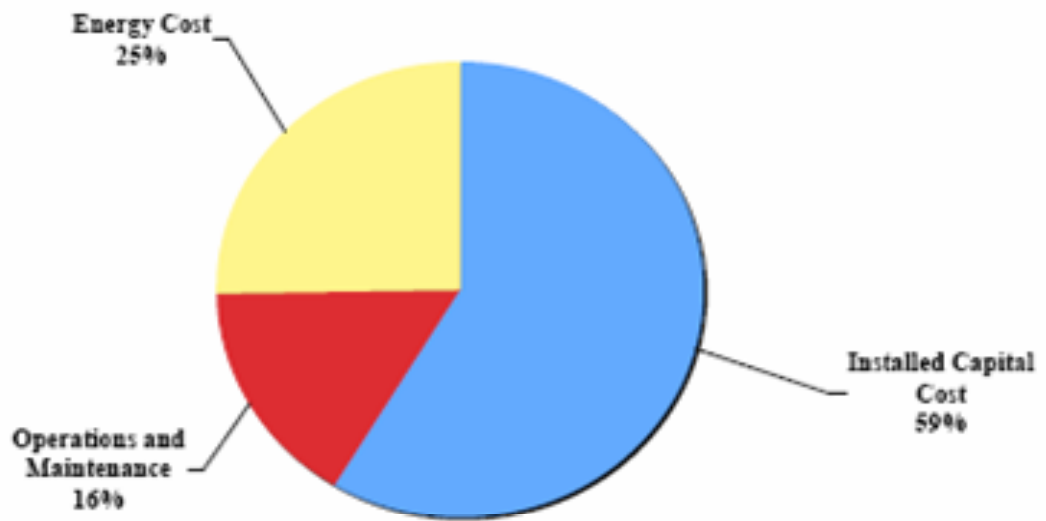


Figure 4. Distribution of Costs/1000 Gallons

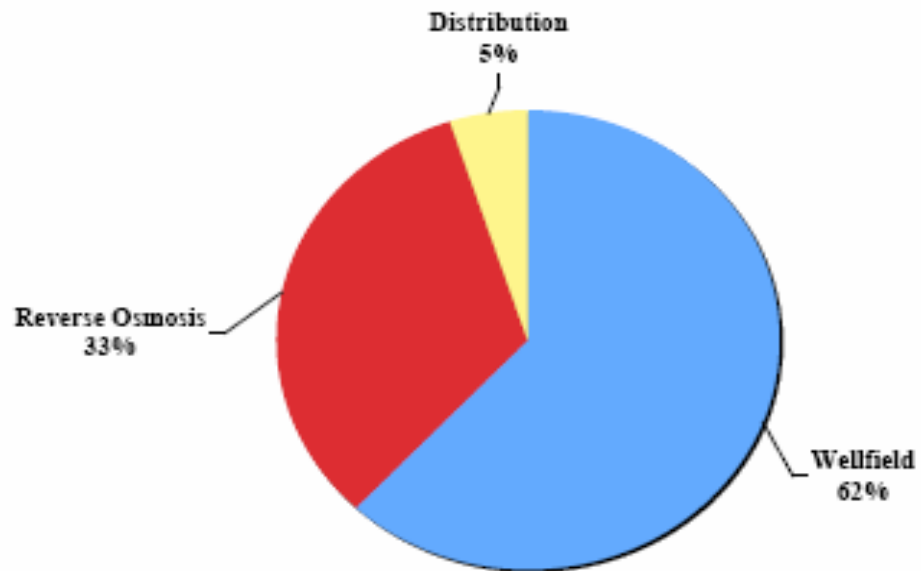


Figure 5. Distribution of Monthly Average Energy Use



## 8. Small-Scale Demonstration of an Integrated Wind-Water System for Brackish Water Treatment

The purpose of the small-scale demonstration was to provide an operational and control development platform for an integrated wind-water desalination system. The RO system operated well throughout the three-month test period. One concern was that the system would gradually produce lower quality water due to intermittent use of the RO membranes. This concern was not observed, as no increase in raw water or concentrate pressure occurred throughout the three-month period. There was a slight increase in permeate TDS by the end of the testing period. However, this was attributed to drift in the conductivity meter.

The RO membranes treated the brackish feed water, which had 2600 mg/L of TDS, to below acceptable limits. The average permeate TDS was approximately 50 mg/L, well below the secondary limit of 500 mg/L. Also, the membranes removed most of the hardness causing cations from the water. The permeate had less than 1 mg/L of  $\text{Ca}^{2+}$  and  $\text{Mg}^{2+}$ . The raw water used was already low in arsenic, so this was not a concern. However, future research could involve waters with higher amounts of arsenic to determine the removal efficiencies of RO membranes. The wind generator produced more energy than was required. The wind turbine generated 2,674 kWh, but the RO operation consumed only 110 kWh. However, this small-scaled project intended to show the validity of the concept.

Key findings included the following:

- Integration of a grid-connected wind turbine, computer control system, and RO system was successful;
- Over three months of operational data were collected and analyzed;
- The straightforward on-off control system used worked well, processing over 44,000 gal of treated water using 137 kWh of electrical energy, and returning 3,355 kWh of electrical energy to the grid; and
- After 460 on-off cycles, there was no indication of failure of the RO system or its elements.

Further details can be found in Appendix D (Marshall et al., 2008).



## 9. References

- Busch, M., Mickols, W.E. 2004. "Reducing Energy Consumption in Seawater Desalination." *Desalination*. Vol. 165. P. 299-312
- Flowers, L. 2005. "Wind Power Options and Opportunities for the Great Plains." *Proceedings of the 2005 Texas Tech University Economic Development Summit: 'Wind and Water: Redeveloping Regional Resources for the New Economy.'* Lubbock, TX, 2005.
- Goodger, Renee. 2007, 2008. (Personal communication.)
- Hightower, M. 2005. "Water Issues and Opportunities and their Connections with Renewable Energy Sources." *Proceedings of the 2005 Texas Tech University Economic Development Summit: 'Wind and Water: Redeveloping Regional Resources for the New Economy.'* Lubbock, TX, 2005.
- Lyons, J. 2005. "The Technology and Economics of Wind Power and Water Desalinization." *Proceedings of the 2005 Texas Tech University Economic Development Summit: 'Wind and Water: Redeveloping Regional Resources for the New Economy.'* Lubbock, TX, 2005.
- Mickley & Associates. 2006. "Membrane Concentrate Disposal: Practices and Regulation." *Desalination and Water Purification Research and Development Program Report No. 123 (Second Edition)*. Denver, CO: US Department of the Interior, Bureau of Reclamation.
- Noll, Dennis. Design and Control of an Integrated Wind-Water Desalination System for an Inland Municipality. Diss. Texas Tech U, 2008.  
<http://etd.lib.ttu.edu/theses/available/etd-05142008-132845/>
- Phillips, Tommy. 2007. (Personal communication.)
- Rainwater, K.A., Stovall, J.N., Frailey, S.M., and Urban, L.V. 2005. "Transboundary Impacts on Regional Groundwater Modeling in Texas," Ground Water, NGWA, Vol. 43, no. 5, pp. 706-716.
- Reisner, M. 1993. *Cadillac Desert: The American West and Its Disappearing Water*. New York: Penguin Books.
- Swift, A., Rainwater, K., Chapman, J., Doon, V., Marshall, R., Nash, P. 2008. *Integrated Wind-Water System*, State of Texas, State Energy Conservation

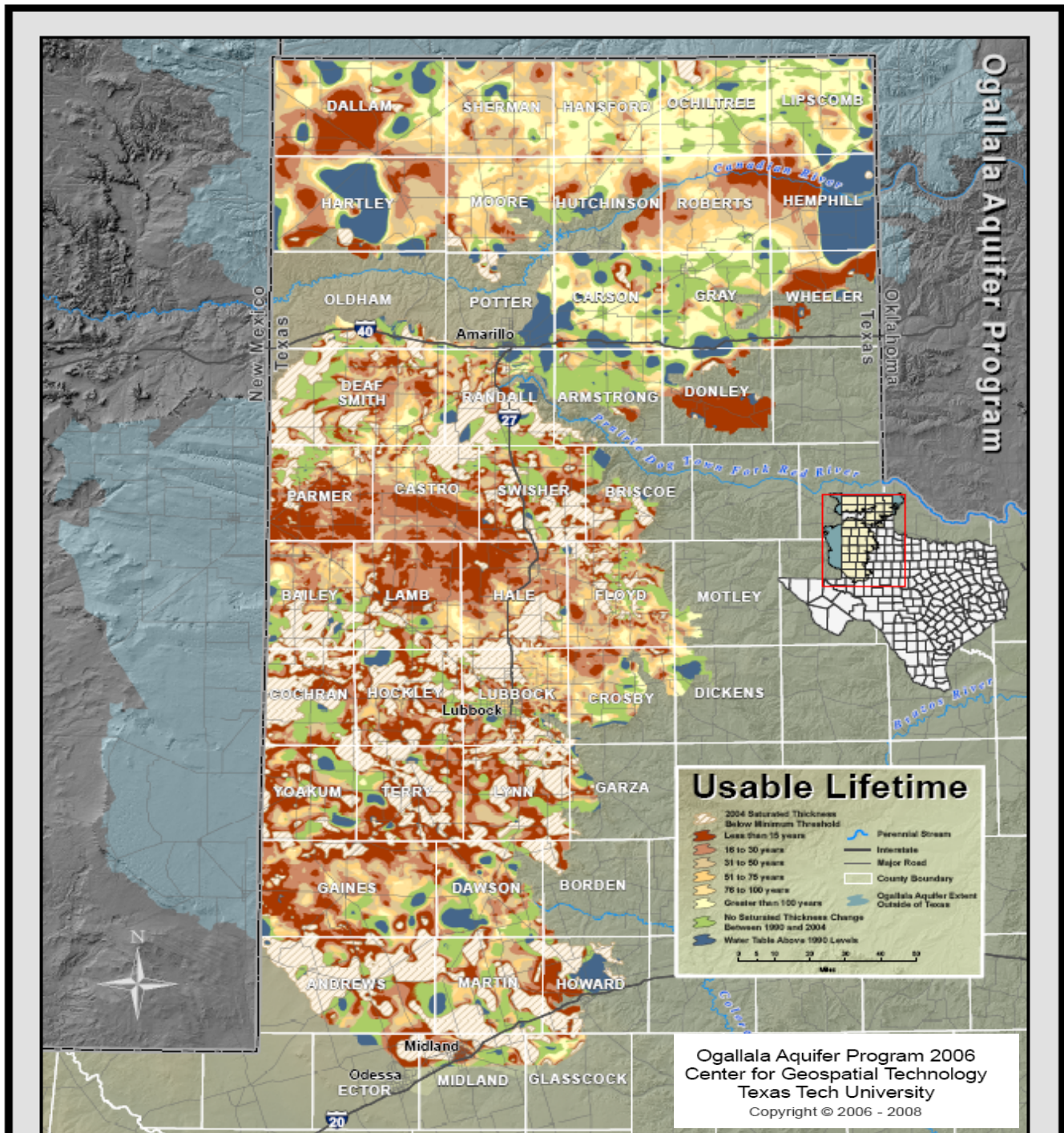
Office (SECO), Research Contract Number CM616, Wind Science and Engineering Research Center, Texas Tech University, Lubbock, TX.

Texas Water Development Board (TWDB). 2007. *2007 State Water Plan*. Austin, TX.

# Appendix A

## Estimated Useable Lifetime of the Ogallala Aquifer in Texas

(reprinted with permission of the Texas Tech University Center for Geospatial Technology)



This map shows the estimated years to depletion from 2004 over the Ogallala Aquifer in West Texas. This estimation was based on the rate of change for the saturated thickness from 1990 to 2004.



# Appendix B

## Reverse Osmosis Design and Costing

by Geetha Ganesan and Andrew Jackson

### Table of Contents

page B-

1. Introduction.....	3
2. Pretreatment .....	3
3. RO System Components and Parameters .....	6
4. RO System Design.....	12
5. Cost Analysis .....	17
6. Detailed Development of Capital Costs.....	19
7. Detailed Development of O&M Costs.....	22
8. Development of Cost Scenarios.....	31
9. Summary .....	39
10. References.....	39

### List of Figures

page B-

Figure 1. SDI Apparatus .....	4
Figure 2. Membrane construction <sup>2</sup> .....	7
Figure 3. FilmTec nomenclature <sup>2</sup> .....	9
Figure 4. Example of membrane array configuration <sup>1</sup> .....	11
Figure 5: Schematic of blending process <sup>4</sup> .....	13
Figure 6: Flowchart of RO design process .....	16
Figure 7. RO pretreatment cost vs. flow .....	19
Figure 8. RO feed pumping construction cost at medium, high, and seawater pressure .....	20
Figure 9. RO process system construction cost at medium, high, and seawater pressures .....	21
Figure 10: RO pretreatment O&M cost .....	22
Figure 11. RO pretreatment labor cost.....	22
Figure 12. Membrane feed pumping O&M including labor, materials, and energy at low pressure .....	23
Figure 13. Membrane feed pumping O&M including labor, materials, and energy at medium pressure .....	24
Figure 14: Membrane feed pumping O&M including labor, materials, and energy at high pressure .....	25
Figure 15. Membrane feed pumping O&M including labor, materials, and energy at seawater pressure .....	26
Figure 16. RO process system O&M including labor, materials, and membrane replacement at low pressure .....	27
Figure 17: RO process system O&M including labor, materials, and membrane replacement at medium pressure .....	28

Figure 18: RO process system O&M including labor, materials, and membrane replacement at high pressure .....	29
Figure 19: RO process system O&M including labor, materials, and membrane replacement at seawater pressure .....	30

## List of Tables

page B-

Table 1. Common Scalants .....	5
Table 2. Dow FilmTec Membranes .....	8
Table 3. Required Number of Stages Using Brackish Water Source Supply <sup>2</sup> .....	11
Table 4. Required Number of Stages Using Seawater Source Supply <sup>2</sup> .....	12
Table 5. Capital Costs for RO design .....	17
Table 6. O&M Costs for RO Design .....	18
Table 7. RO Pretreatment Cost <sup>3</sup> .....	19
Table 8. RO Feed Pumping Construction Cost <sup>3</sup> .....	20
Table 9. RO Process System Construction Cost <sup>3</sup> .....	21
Table 10. RO Pretreatment O&M Costs <sup>3</sup> .....	22
Table 11. Membrane Feed Pumping O&M <sup>3</sup> – Low Pressure (300 psi).....	23
Table 12. Membrane Feed Pumping O&M <sup>3</sup> – Medium Pressure (500 psi).....	24
Table 13. Membrane Feed Pumping O&M <sup>3</sup> – High Pressure (700 psi) .....	25
Table 14. Membrane Feed Pumping O&M <sup>3</sup> – Seawater Pressure (900 psi) .....	26
Table 15. RO Process System O&M <sup>3</sup> – Low Pressure (300 psi).....	27



# 1. Introduction

Texas Tech proposes to investigate using wind energy to drive reverse osmosis treatment processes for the application of three market areas: 1) municipal water treatment systems (small municipalities) 2) ranch and farm applications (irrigation and food processing), and 3) industrial applications (processes requiring pure water). For the application of municipal water treatment systems, the study will focus mainly on small municipalities in the rural communities of the High Plains region of Texas in which their main source of water is groundwater. The quality of the groundwater is of concern with regard to fluoride, arsenic, chloride, high TDS, etc and will ultimately require further treatment such as reverse osmosis, an expensive energy driven process. However, these municipalities reside in areas prone to high winds, thereby making wind driven energy a feasible opportunity in driving down reverse osmosis costs.

The following will be encompassed in the study for each of the three market areas:

- 1) Representative system designs appropriate for the demands needed
- 2) Economic trends and market forces
- 3) Estimates of the market size for each of the three market areas
- 4) Projected system economics

The motivation for this study is that people are entitled to potable drinking water at a reasonable cost. Secondly, wind energy represents a viable option for driving reverse osmosis processes – an advanced water treatment process that is also becoming more and more cost effective.

The main objective for this study, performed during spring semester 2007, was to create a spreadsheet tool that is simple to use in sizing and estimating the cost of a reverse osmosis system. The sizing and design of the system will depend mainly on the source water quality, the amount of permeate that is required, and on the desired finished TDS concentration.

The main tasks to achieving the objective were to complete a literature review of various sources, create a spreadsheet model, and create scenarios validating the model. In addition to explaining the inputs and outputs of the model, this paper also details what types of pretreatment may be required before RO, depending on the source water quality. This paper also details the RO system components and what parameters are important in RO design. The idea behind the spreadsheet tool is then explained, such as what user inputs are required, what calculations are performed, and what the outputs will be. Finally, scenarios for validating the model are given illustrating how the system design cost changes, depending on the source water quality and whether or not blending is incurred.

## 2. Pretreatment

As mentioned, the broad scope of this project focuses on using wind energy to drive reverse osmosis treatment of brackish water in small municipalities. However, reverse osmosis is sensitive with respect to membrane fouling. An accumulation of particles on the membrane results in a loss of flux and requires more pressure to maintain the water production and quality. Membrane fouling generally occurs due to 1) deposition of particles (sand or silt) not removed effectively by pretreatment 2) scale deposits and, 3) biological fouling.

## Deposition of Particles/SDI

The silt density index (SDI) is a measure of the fouling potential of the source water on the membrane. It is recommended that for using spiral wound membranes (normally used for reverse osmosis systems) the SDI should be no greater than 5. If the SDI is greater than 5, then pretreatment is required, or other filtration techniques are suggested for reducing silt densities such as ultrafiltration, microfiltration, precoat filtration, and rapid sand filters. The equipment required for evaluating the SDI of a water source is illustrated in Figure 1, and a detailed procedure of the test is mentioned in ASTM D-4189. If particles are so small that filtration is not sufficient, then coagulant chemicals may need to be added to achieve flocs of particles in order for filtration to be more effective.

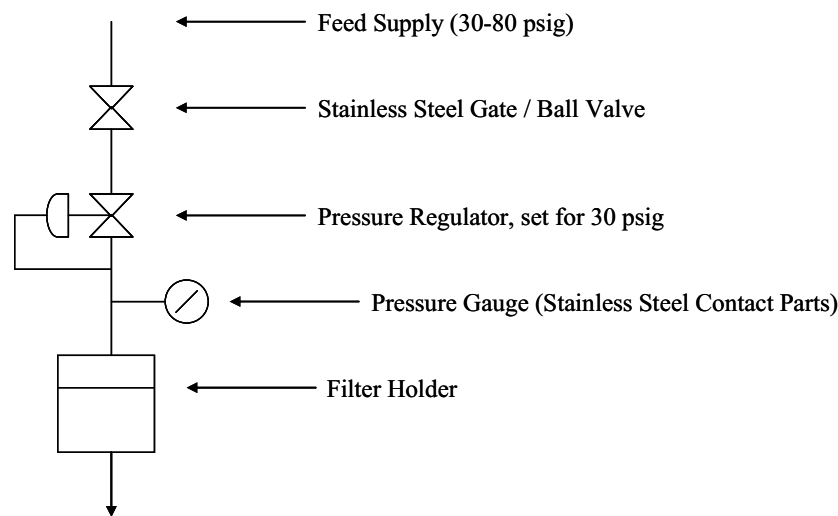


Figure 1. SDI Apparatus

## Scaling

As product water passes through the membrane, the remaining feed-water can become heavily concentrated in salts to the point where its solubility has exceeded the solubility limit, thereby causing salt precipitation. Scaling occurs when salts precipitate onto the membrane, causing membrane fouling, resulting in a decrease in flux, recovery, and overall system efficiency. Calcium sulfate is notable for its role in causing scaling problems.

The solubility product constant,  $K_{sp}$ , conveys the relative solubility of a sparingly soluble salt. For simplicity, engineers and chemists define a conditional solubility product constant ( $K_{sp}$ ) in terms of ionic strength. When the ratio of the ion product to the  $K_{sp}$  is greater than 1, then scaling can occur and pretreatment is required. For spiral wound membranes, the ratio is 0.8. The Langelier Saturation index (LSI) is used when evaluating the calcium carbonate solubility and is defined as:

$$LSI = pH - pCa - pAlk - C \quad \text{eqn. 1}$$

where

**pCa** = negative logarithm of the calcium molarity

**pAlk** = negative logarithm of the alkalinity in equivalents per liter

**C** = a constant to account for the change in calcium carbonate solubility with temperature and ionic strength (found from a nomograph).

A positive value of this index indicates scaling potential.

One way to combat scaling problems is to chemically alter the feed-stream by adding acid to convert carbonate ions to bicarbonate ions, thereby preventing the formation of calcium carbonate scales. Antiscalants can also be added to the feed-water stream to inhibit the formation of precipitate crystals. As the crystals begin to form, the velocity of the feed-water is enough to break up the salt crystals and flush them away from the membrane. Additional methods for controlling scaling are listed below:

- Ion exchange softening
- Lime softening
- Aeration and filtration
- Coagulation/filtration to reduce particle matter

Below is a table of common scales and other foulants and measures to prevent them from occurring, including acidification to remove carbonate or bicarbonate ions and limiting the permeate recovery to prevent excess salt build-up on the membrane.

Table 1. Common Scalants

Species	Method of Control	
	Primary	Secondary
Calcium carbonate, CaCO <sub>3</sub>	Mineral acid Threshold inhibitor	Soften
Calcium sulfate, CaSO <sub>4</sub>	Threshold inhibitor Soften	Limit Recovery
Barium sulfate, BaSO <sub>4</sub>	Threshold inhibitor Soften	Limit Recovery
Strontium sulfate, SrSO <sub>4</sub>	Threshold inhibitor Soften	Limit Recovery
Calcium fluoride, CaF <sub>2</sub>	Threshold inhibitor Soften	Limit Recovery
Silica, SiO <sub>2</sub>	Limit recovery	-
Ferric hydroxide, Fe(OH) <sub>3</sub>	Precipitation and filtration	Soften
Aluminum hydroxide, Al(OH) <sub>3</sub>	Precipitation and filtration	-
Sulfur, S	Exclude air and other oxidants	-

Another pretreatment method used for RO units is prefiltration. It is very common for all membrane systems to use micron-sized filters to protect the membranes downstream from fouling due to particulate matter such as sand or rust particles. The prefiltration method uses

cartridge filters in pressure vessels with a filter size of 5 microns. Selection of cartridge filters is for a maximum flow of 5 gpm per 10 inches of cartridge filter length, with the typical length being 40 inches. According to water supply practice manuals, the clean filter pressure drop is 3 psi. The cartridge should be replaced when the transfilter pressure drop is 15 psi.

## **Biofouling**

Because of its damp surface, membranes can be ideal places for microorganisms to grow. The biofilm they secrete can cover the entire membrane, thereby reducing flux and system efficiency. However, pretreatment for biofouling is not required in most brackish waters because the microorganism population in these waters is small. A good way to prevent biofouling is to size the system appropriately for the capacity needed. If the membrane is left idle for even a day or two, a small bacteria population could grow to become a nuisance, and should therefore be flushed often with pretreated water in order to prevent bacterial growth.

Surface waters need more biofouling pretreatment than brackish waters. For highly contaminated waters, continuous chlorination is recommended, if the membrane can tolerate chlorine. If the water is not so highly contaminated, then another prevention method is to use shock treatments in which high chlorine doses are used to reduce the bacteria count.

## **3. RO System Components and Parameters**

Important RO system components and parameters include membrane configuration nomenclature, number of elements and pressure vessels required, membrane flux and area, and staging ratio.

### **Membrane Configuration**

Reverse osmosis uses either a spiral wound or hollow fiber membrane configuration. Spiral wound is the most common membrane configuration used in the treatment and production of potable drinking water. Its advantages over hollow fine fiber configuration include lower replacement costs, easier to clean, and less subject to fouling. Below is a figure illustrating the configuration of Dow Chemical's FILMTEC membrane, all of which are formed in a spiral wound configuration.

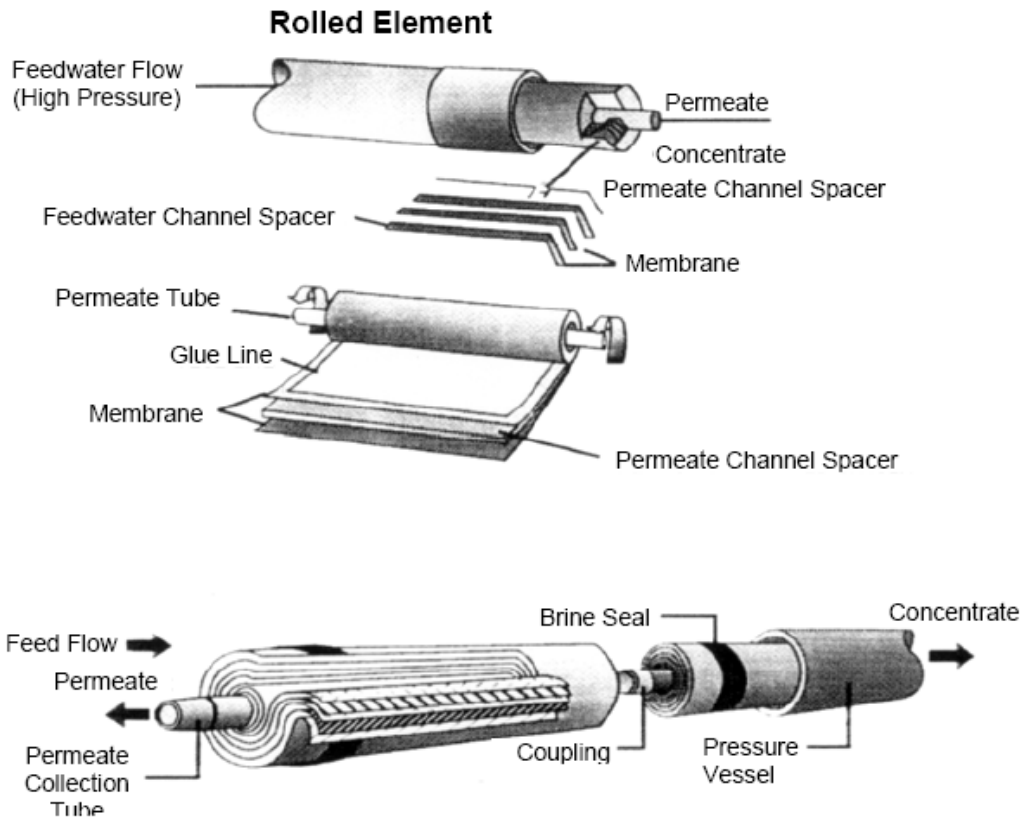


Figure 2. Membrane construction<sup>2</sup>

The standard membrane length is 40 inches but it is available in smaller sizes for compact systems. The standard element diameters are 2.5, 4, and 8 inches, designed to fit into 2.5, 4, and 8-inch pressure vessels.

The type of membrane used depends on the source water quality. Source water quality is a very important factor, because it could cause major fouling within the membrane, which is the greatest influence on membrane design. Below is an overview of the types of FILMTEC membranes suggested based on the type of water source to be treated.

Table 2. Dow FilmTec Membranes

Feed source	RO Permeate	Well Water	Surface Supply		Wastewater (Filtered Municipal Effluent)		Seawater		
			MF <sup>1</sup>	Conventional	MF <sup>1</sup>	Conventional	Well or MF <sup>1</sup>	Open intake	
Feed silt density index	SDI < 1	SDI < 3	SDI < 3	SDI < 5	SDI < 3	SDI < 5	SDI < 3	SDI < 5	
Average system flux	gfd	21-25	16-20	13-17	12-16	10-14	8-12	8-12	7-10
	l/m <sup>2</sup> h	36-43	27-34	22-29	20-27	17-24	14-20	13-20	11-17
Maximum element recovery %	30	19	17	15	14	12	15	13	

Active Membrane Area	Maximum permeate flow rate, gpd (m <sup>3</sup> /d)							
	320 ft <sup>2</sup> elements	9,000 (34)	7,500 (28)	6,500 (25)	5,900 (22)	5,300 (20)	4,700 (18)	6,700 (25)
365 ft <sup>2</sup> elements	10,000 (38)	8,300 (31)	7,200 (27)	6,500 (25)	5,900 (22)	5,200 (20)		
380 ft <sup>2</sup> elements	10,600 (40)	8,600 (33)	7,500 (28)	6,800 (26)	5,900 (22)	5,200 (20)	7,900 (30)	7,200 (27)
390 ft <sup>2</sup> elements	10,600 (40)	8,900 (34)	7,700 (29)	7,000 (26)	6,300 (24)	5,500 (21)		
400 ft <sup>2</sup> elements	11,000 (42)	9,100 (34)	7,900 (30)	7,200 (27)	6,400 (24)	5,700 (22)		
440 ft <sup>2</sup> elements	12,000 (45)	10,000 (38)	8,700 (33)	7,900 (30)	7,100 (27)	6,300 (24)		

Element type	Minimum concentrate flow rate <sup>2</sup> , gpm (m <sup>3</sup> /h)							
	BW elements (365 ft <sup>2</sup> )	10 (2.3)	13 (3.0)	13 (3.0)	15 (3.4)	16 (3.6)	18 (4.1)	
BW elements (400 ft <sup>2</sup> and 440 ft <sup>2</sup> )	10 (2.3)	13 (3.0)	13 (3.0)	15 (3.4)	18 (4.1)	20 (4.6)		
NF elements	10 (2.3)	13 (3.0)	13 (3.0)	15 (3.4)	18 (4.1)	18 (4.1)		
Full-fit elements	25 (5.7)	25 (5.7)	25 (5.7)	25 (5.7)	25 (5.7)	25 (5.7)		
SW elements	10 (2.3)	13 (3.0)	13 (3.0)	15 (3.4)	16 (3.6)	18 (4.1)	13 (3.0)	15 (3.4)

Element type	Active area ft <sup>2</sup> (m <sup>2</sup> )	Maximum feed flow rate <sup>2</sup> , gpm (m <sup>3</sup> /h)							
		BW elements	365 (33.9)	65 (15)	65 (15)	63 (14)	58 (13)	52 (12)	52 (12)
BW or NF elements	400 (37.2)	75 (17)	75 (17)	73 (17)	67 (15)	61 (14)	61 (14)		
BW elements	440 (40.9)	75 (17)	75 (17)	73 (17)	67 (15)	61 (14)	61 (14)		
Full-fit elements	390 (36.2)	85 (19)	75 (17)	73 (17)	67 (15)	61 (14)	61 (14)		
SW elements	320 (29.7)	65 (15)	65 (15)	63 (14)	58 (13)	52 (12)	52 (12)	63 (14)	56 (13)
SW elements	380 (35.3)	72 (16)	72 (16)	70 (16)	64 (15)	58 (13)	58 (13)	70 (16)	62 (14)

<sup>1</sup> MF: Microfiltration - continuous filtration process using a membrane with pore size of <0.5 micron.

<sup>2</sup> The maximum recommended pressure drop across a single element is 15 psid (1bar) or 50 psid (3.5 bar) across multiple elements in a pressure vessel, whichever value is more limiting. We recommend designing at maximum of 80% (12 psid) for any element in a system.

Note: The limiting values listed above have been incorporated into the ROSA (Reverse Osmosis System Analysis) software. Designs of systems in excess of the guidelines results in a warning on the ROSA printout.

The water source is categorized based on the silt density index (SDI). The SDI is a measure of the fouling potential on a membrane. It is recommended that the water source should not have an SDI greater than 5 when using spiral wound membranes, and an SDI no greater than 3 for hollow fiber membranes.

Examples of Dow Chemical's FILMTEC membranes include BW30, TW30, SW30, etc. Below is an example of the nomenclature that Dow uses for its FILMTEC membranes.

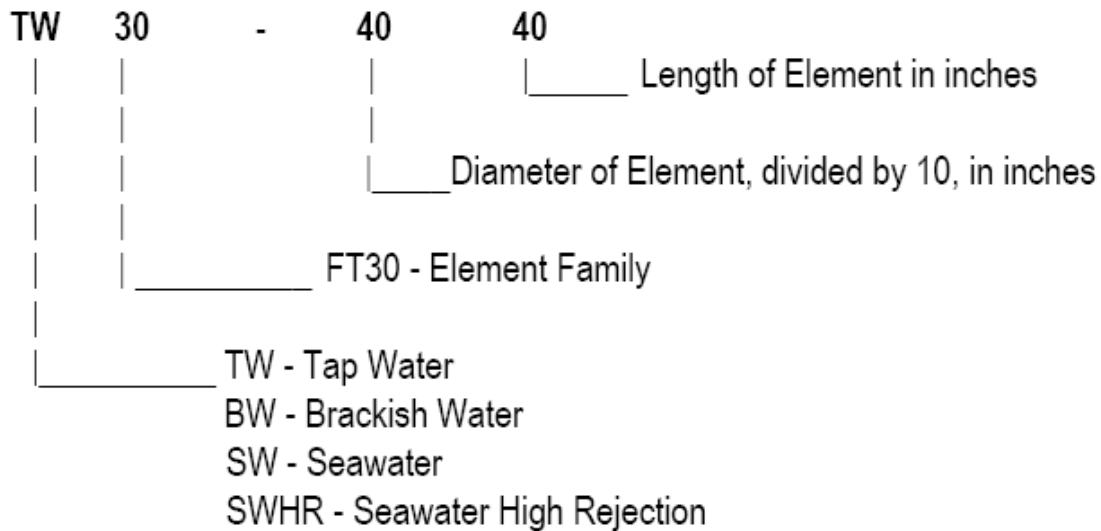


Figure 3. FilmTec nomenclature<sup>2</sup>

As mentioned, for demineralization of water for industrial purposes and for desalination, the standard membrane size is 40 inches in length and 8 inches in diameter. But what constitutes which membrane is used depends on the source water quality, specifically TDS level. Membrane manufacturing websites state that low energy membranes are used with waters having a TDS level less than 2000 mg/L. Brackish water membranes are applied to waters with a TDS level up to 10,000 mg/L, and seawater and seawater high rejection membranes are applied to waters with a TDS level up to 50,000 mg/L. The higher the TDS of the source water, the more pressure is required per membrane and the more complex the RO system will be.

## Recovery

Recovery is the ratio of the permeate flow rate to the feed water flow rate. The amount of recovery required depends on the source water quality and on drinking water standards, and is affected by membrane fouling. An increase in recovery requires an increase in membrane pressure and, ultimately, cost.

## Membrane Flux and Area

The feed pressure required to produce a certain permeate quality depends on the permeate flux, which is the volumetric flowrate of permeate through the membrane area. Table 2 specifies the average system flux and area of each membrane type. Dow defines the units as  $l/m^2/h$  or  $gfd$  ( $gpd/ft^2$ ). The flux is determined either through experimental data, manufacturer specification, or customer experience. In this study, four categories of TDS level were chosen (as mentioned above). Lists of membranes were compiled for each category. In each category, average pressures, membrane areas, and flow per membrane were calculated. An average flux was then

calculated for each TDS category by dividing the average flow rate by the average area. Once the permeate flowrate, design flux, and membrane area have been determined, the total number of elements and total number of pressure vessels can be calculated.

## Element/Pressure Vessel Configuration

Each FILMTEC membrane element consists of one to thirty membrane leaves. In RO systems, the membrane elements are placed within a pressure vessel, and each pressure vessel can contain six to eight membrane elements with typical dimensions of a diameter of 8 inches and a length of 40 inches, but are available in smaller sizes for compact systems. The standard element diameters are 2.5, 4, and 8 inches, designed to fit into 2.5, 4, and 8-inch pressure vessels.

The number of elements required is found by using equation 2 below:

$$\text{Total number of elements needed} = \frac{\text{(Required permeate flow rate)}}{\text{(design flux)} / \text{(active membrane surface area)}} \quad \text{eqn. 2}$$

The number of pressure vessels required is found by using equation 3 below:

$$\text{Total number of pressure vessels needed} = \frac{\text{(total number of elements)}}{\text{(number of elements in pressure vessel)}} \quad \text{eqn 3}$$

## Number of Stages and Staging Ratio

The membrane elements within a pressure vessel are connected with an O-ring sealed connector. The vessels are placed in a parallel configuration, forming stages. The stages are then arranged in a series formation to maintain a minimum concentrate flow. Below is a schematic of a membrane array design. It is a typical 4:2:1 array in which the first stage has four pressure vessels, the second stage has two pressure vessels, and the third stage has one pressure vessel. The number of pressure vessels decrease because most of the recovery occurs in the first stage, thereby requiring a reduction in the number of pressure vessels in the second and third stages.



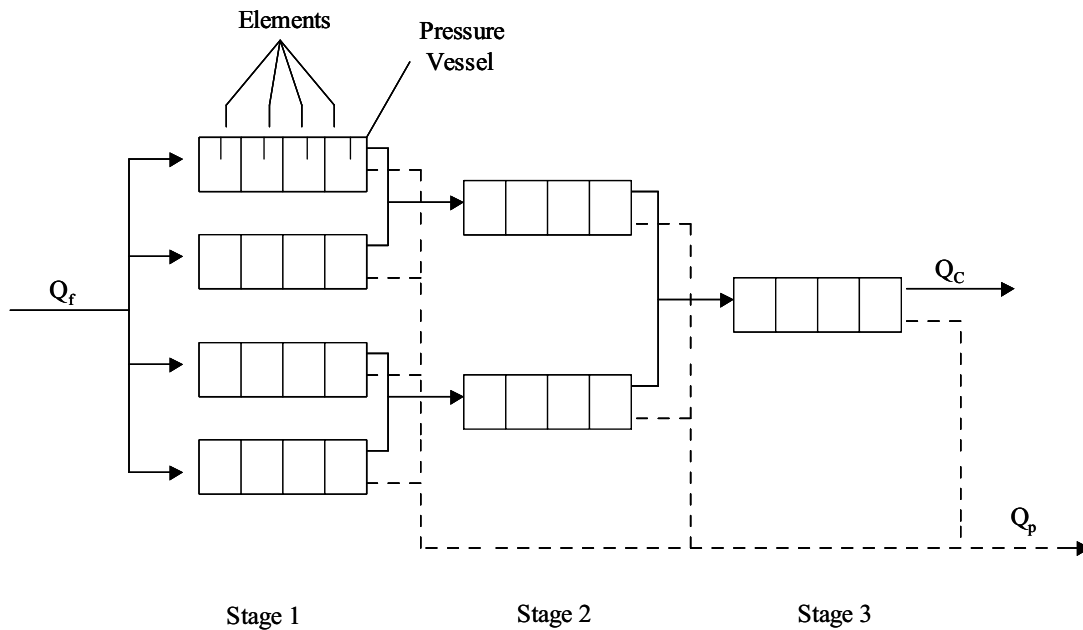


Figure 4. Example of membrane array configuration<sup>1</sup>

As the diagram shows, each stage consists of a number of pressure vessels in parallel. The pressure vessels in each parallel configuration receive a similar flow feed and operate at the same recovery. The amount of recovery depends on the number of membranes inside the vessel. In order to operate at a higher recovery, the permeate from an array is fed to another array in series, which is illustrated in the figure above. Pressure vessels arranged in two or three stages are aligned in a pyramid like structure. The number of stages is dependent upon the recovery, number of elements per vessel, and the feed water quality. The higher the recovery and the lower the feed water quality, the more stages the system will have. A criterion for pressure vessel arrangement is that the ratio of the number of pressure vessels in subsequent stages should be 2:1. Below are tables from various membrane manufacturing websites regarding the number of stages for a brackish water and seawater reverse osmosis system. For low pressure RO systems, only one stage may be required to achieve the necessary recovery.

Table 3. Required Number of Stages Using Brackish Water Source Supply<sup>2</sup>

System Recovery (%)	Number of Serial Element Positions	Number of Stages (6-element vessels)
40 - 60	6	1
70 - 80	12	2
85 - 90	18	3

Table 4. Required Number of Stages Using Seawater Source Supply<sup>2</sup>

System Recovery (%)	Number of Serial Element Positions	Number of Stages (6- element vessels)	Number of Stages (7- element vessels)	Number of Stages (8- element vessels)
35 - 40	6	1	1	----
45	7 - 12	2	1	1
50	8 - 12	2	2	1
55 - 60	12 - 14	2	2	----

## 4. RO System Design

This section details the inputs and outputs required in configuring an RO design based on the source water quality. The RO design includes user-specified inputs, which, depending on the source water quality will set the type of RO membrane that is used. This design assumes a breakdown of four categories of TDS levels that each corresponds with a specified pressure, membrane flux, and membrane area. The design also encompasses blending, which reduces the total cost of RO design because not as much feed water is required to flow into the RO unit, thereby reducing capital and O&M costs. After the user-inputs have been defined and the membrane parameters have been chosen based on TDS level, the number of elements and pressure vessels as well as costs can be calculated. This process, shown on the flowchart in Figure 5 is a very simplified process and is only meant to serve as a quick tool to estimate the cost of an RO system. If more detailed calculations are required, one is encouraged to speak to RO design manufacturers or perform more detailed research.

### Inputs

A flow chart on Figure 5 illustrates the steps, inputs, and outputs required for designing the initial RO configuration. The user-defined inputs include initial raw water TDS concentration (mg/L), required finished TDS concentration (mg/L), required finished flowrate (MGD), percent recovery, brine disposal method, and an energy cost (\$/kWh).

### Blending

The flow chart takes into account whether or not the user wants to blend source water with permeate water. In many cases, permeate from RO results in a lower TDS value than what is required by drinking water standards. Therefore, one can blend permeate with source water that results in a higher, but still acceptable TDS level in order to reduce costs. A basic schematic of the blending process is shown below.

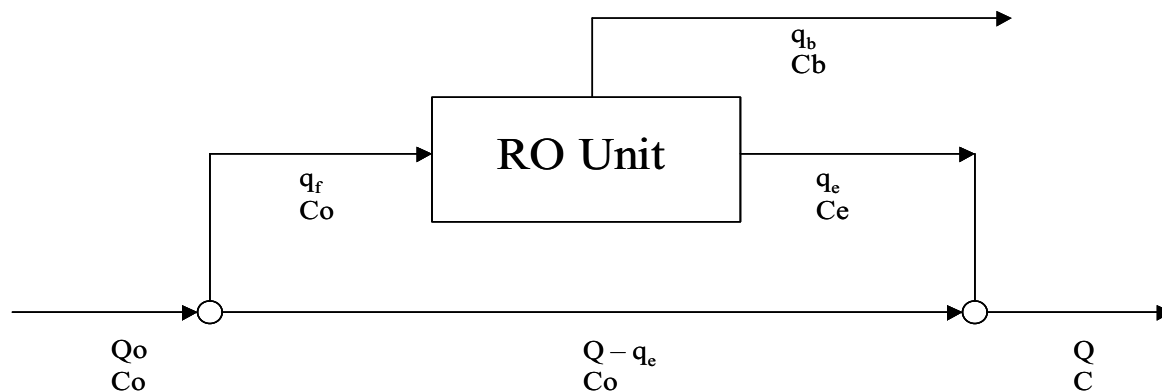


Figure 5: Schematic of blending process <sup>4</sup>

The governing equations for a mass balance in calculating flows and concentrations are as follows:

$$C_e \text{ (RO permeate concentration)} = C_o \cdot (1-S)/R \quad \text{eqn. 3}^4$$

$$C_b \text{ (Brine TDS concentration)} = C_o \cdot S/(1-R) \quad \text{eqn. 4}^4$$

$$q_e \text{ (RO permeate flow rate)} = Q \cdot (C_o - C)/(C_o - C_e) \quad \text{eqn. 5}^4$$

$$q_b \text{ (Brine flow rate)} = q_e \cdot (1/R - 1) \quad \text{eqn. 6}^4$$

$$q_f \text{ (Feed flow into RO unit)} = q_e/R \quad \text{eqn. 7}^4$$

$$Q_o \text{ (Total source water flow rate)} = (Q + q_e)/(1/R - 1) \quad \text{eqn. 8}^4$$

where S and R represent the percent salt rejection and recovery, respectively. In looking at membrane manufacturing websites, for most all membranes listed, the average salt rejection capacity was 99%. In the cost examples in Section 6, salt rejection is assumed to be 98%. Concentrations are in units of mg/L and flow rates are in units of gpd.

## Membrane Parameters

After the mass balance has been performed and the flows and concentrations have been calculated, the next step is to determine the membrane element parameters, which are determined by the source water TDS level. Depending on the TDS level of the source water, the membrane element pressure, area, and design flux can change, which affects the capital and O&M costs as well. The cost calculations, as shown on the flow chart, were formulated from data prepared by HDR engineering prepared for the Texas Water Development Board. The calculations include costs at different element pressure levels broken down into low pressure (300 psi), medium pressure (500 psi), high pressure (700 psi), and seawater pressure (900 psi). Looking at various RO membrane manufacturing websites, the consensus was that low energy membranes are applied to waters with TDS < 2,000 mg/L, brackish water membranes are applied to waters with TDS up to 10,000 mg/L, and seawater and seawater high rejection membranes are applied to waters with TDS levels up to 50,000 mg/L.

From membrane manufacturing websites, membrane elements and their corresponding characteristics (membrane area, design flux, etc) were compiled for each TDS level. Then, average membrane areas and fluxes were calculated so that a concrete number of criteria were set for each TDS level.

## Calculations and Outputs

Once the TDS level and membrane characteristics have been identified, the number of elements and pressure vessels required can be calculated as shown in equations 2 and 3. The costs associated with RO design can also be calculated. As mentioned, the cost equations came from data prepared by HDR engineering. The data was then graphed in Excel and trend line equations were formulated. The costs are broken down into O&M (pretreatment, membrane feed pumping, and process system) and capital costs (pretreatment, membrane feed pumping, and process system). The costs are also based on membrane operating pressure: low energy (300 psi), medium energy (500 psi), high energy (700 psi), and seawater energy (900 psi). The higher the membrane pressure, the higher the associated cost. Finally, the outputs of this process should be the number of elements, vessels, O&M, capital, and disposal costs.

### O&M Costs

The RO pretreatment O&M cost encompasses labor, materials, chemicals, cartridge replacement, acid chemical cost, and antiscalant cost. HDR Engineering assumes that labor requirements are based on a 24 hour chemical feed system. The acid used is sulfuric acid and the cost is based on a dosage of 20 mg/L at a cost of \$0.39/lb. The antiscalant cost is \$1.25/lb and based on a dose of 3 mg/L. It is assumed that the cartridge filters are replaced every three months.

Feed water O&M costs are based on the fact that feed water pumping is a continuous operation. Power requirements are calculated in MWh/yr due to variable energy costs. HDR assumes a pump efficiency of 75%, and labor requirements were estimated at 1hr/pump/wk with a 156 hr/yr minimum.

Labor requirements for RO membrane process train O&M costs are assumed to be 3.3 hours/train/week plus 0.1 hr/element/year. Maintenance materials were estimated to be 1% of the process system equipment cost, and the cost for membrane replacement was assumed to be the same as the original element cost calculated for construction and assumes an RO membrane life of five years.

### Capital Costs

Construction costs for pretreatment includes the cost of the cartridge filters, which are used to remove particles that may clog the membrane. It is assumed that one cartridge filter is used for every 5 MGD. A standby cartridge is implemented for capacities up to 50 MGD, and two standby cartridges are implemented for capacities greater than 50 MGD. Cost per filter ranges from \$42,000 - \$60,000. The cost also includes the equipment required for the acid and antiscalant systems.

For feed water pumping construction costs, HDR assumes that horizontal split case pumps with variable frequency drives are used. Each membrane train has a dedicated feed water pump plus one standby pump. Construction costs are estimated for discharge pressures of 300, 500, 700, and 900 psi.

Construction costs for RO membrane process trains include costs for elements as well as costs for 7 element pressure vessels.

## **Disposal Costs**

The brine concentrate stream from the RO unit needs to be disposed of somehow. Such methods include saline water discharge, deep well injection, and evaporation ponds.

Saline water discharge encompasses transporting concentrate from the treatment plant to a point of outfall, such as a bay, lake, or ocean. The concentrate discharged into the body of water must meet state water quality standards. Thus, the water may have to be treated before it is released.

In deep well injection, the waste brine stream is injected thousands of feet below the ground surface into an injection zone. The injection zone can be overlaid with impermeable layers of rock to prevent the concentrate from migrating towards the surface.

Evaporation ponds represent an established method for removing water from a concentrate solution. This method is appropriate for smaller volume flows in areas with high evaporation rates. The advantages include 1) relatively easy to design and construct 2) very little mechanical equipment required, and 3) properly constructed evaporation ponds are low maintenance and require little operator attention. The disadvantages include 1) requirements for large land areas 2) requirements for clay or synthetic liners, thereby increasing construction costs.

The broad scope of this project is concerned with small municipalities, and therefore, the more practical brine disposal method may be the method of evaporation ponds. But, this report just serves to suggest brine disposal methods, but the RO design and costing tool does not actually calculate a cost for brine disposal. This is a factor that will be added in the future.

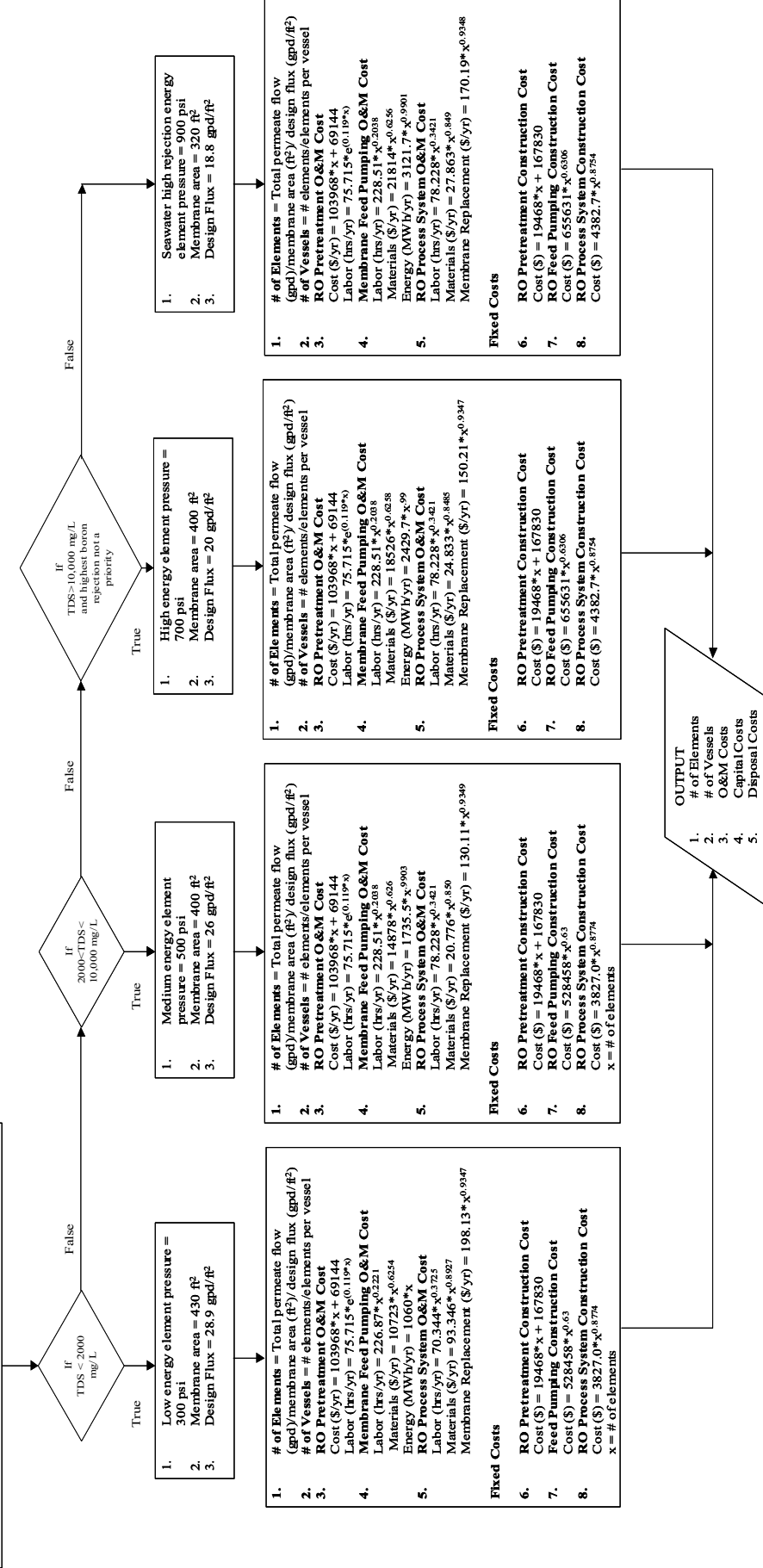
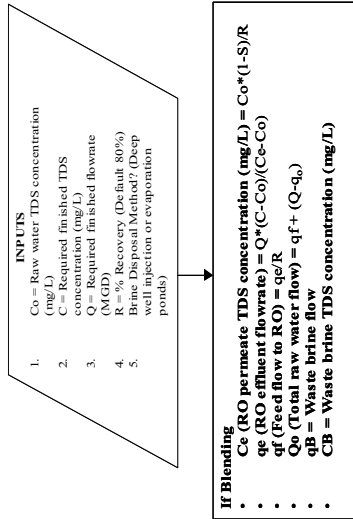


Figure 6: Flowchart of RO design process

## 5. Cost Analysis

As mentioned, the costs equations came from data prepared by HDR engineering, in which they had prepared data for the Texas Water Development Board. The data from that study were used in Excel to generate trend line cost equations, which are used for calculating the associated costs. The costs are broken down into O&M and capital costs. O&M costs include those for RO pretreatment, membrane feed pumping, and RO process system. Capital costs include construction costs for pretreatment, feed pumping, and process system construction costs. The pretreatment cost includes costs for labor, materials, chemicals, cartridge replacement, acid chemicals, and antiscalant as a function of feedwater flow. O&M costs for feed pumping and process system include labor, materials, and energy costs. Below is a table of the cost functions for capital and O&M costs at each pressure, if applicable. Cost data and graphs are also shown in Sections 6 and 7. Cost examples are shown in Section 8.

Table 5. Capital Costs for RO design

	<b>Fixed Costs/Capital Costs</b>	<b>Equation</b>
<b>1</b>	<b>RO Construction Cost vs Flow</b>	Cost (\$) = 19468*(x) + 167830
<b>2</b>	<b>RO Feed Pumping Construction</b>	
	Medium (500 psi)	Cost (\$) = 528458*x <sup>0.63</sup>
	High (700 psi)	Cost (\$) = 655631*x <sup>(0.6306)</sup>
	Seawater (900 psi)	
<b>3</b>	<b>RO Process System Construction Cost</b>	
	Medium (500 psi)	Cost (\$) = 3827*x <sup>(0.8774)</sup>
	High (700 psi)	Cost (\$) = 4382.7*x <sup>(0.8754)</sup>
	Seawater (900 psi)	

Table 6. O&M Costs for RO Design

	Variable Costs/O&M Costs	Equation
1	<b>RO Pretreatment O&amp;M Cost</b> Labor (hrs/yr)	$103968*(x) + 69144$ $75.715*e^{(0.119*x)}$ <b>x = Flow (MGD)</b>
2	<b>Membrane Feed Pumping O&amp;M</b> <b>Low (300 psi)</b> Labor (\$/yr) Materials (\$/yr) Energy (MWh/yr) <b>Medium (500 psi)</b> Labor (\$/yr) Materials (\$/yr) Energy (MWh/yr) <b>High (700 psi)</b> Labor (\$/yr) Materials (\$/yr) Energy (MWh/yr) <b>Seawater (900 psi)</b> Labor (\$/yr) Materials (\$/yr) Energy (MWh/yr)	Labor (\$/yr) = $226.87*x^{(0.2221)}$ Materials (\$/yr) = $10723*x^{(0.6254)}$ Energy (mWh/yr) = $1060*x$ <b>x = Flow (MGD)</b>  Labor (\$/yr) = $228.51*x^{(0.2038)}$ Materials (\$/yr) = $14878*x^{(0.626)}$ Energy (MWh/yr) = $1735.5*x^{(0.9903)}$ <b>x = Flow (MGD)</b>  Labor (\$/yr) = $228.51*x^{(0.2038)}$ Maerials (\$/yr) = $18526*x^{(0.6258)}$ Energy (MWh/yr) = $2429.7*x^{(.99)}$ <b>x = Flow (MGD)</b>  Labor (\$/yr) = $228.51*x^{(0.2038)}$ Materials (\$/yr) = $21814*x^{(0.6256)}$ Energy (MWh/yr) = $3121.7*x^{(0.9901)}$ <b>x = Flow (MGD)</b>
3	<b>RO Process System O&amp;M</b> <b>Low (300 psi)</b> Labor (\$/yr) Materials (\$/yr) Membrane Replacement (\$/yr) <b>Medium (500 psi)</b> Labor (\$/yr) Materials (\$/yr) Membrane Replacement (\$/yr) <b>High (700 psi)</b> Labor (\$/yr) Materials (\$/yr) Membrane Replacement (\$/yr) <b>Seawater (900 psi)</b> Labor (\$/yr) Materials (\$/yr) Membrane Replacement (\$/yr)	Labor (\$/yr) = $70.344*x^{(0.3725)}$ Materials (\$/yr) = $93.346*x^{(0.8927)}$ Membrane Replacement (\$/yr) = $198.13*x^{(0.9347)}$ <b>x = # of Elements</b>  Labor (\$/yr) = $78.228*x^{(0.3421)}$ Materials (\$/yr) = $20.776*x^{(0.850)}$ Membrane Replacement (\$/yr) = $130.11*x^{(0.9349)}$ <b>x = # of Elements</b>  Labor (\$/yr) = $78.228*x^{(0.3421)}$ Materials (\$/yr) = $24.833*x^{(0.8485)}$ Membrane Replacement (\$/yr) = $150.21*x^{(0.9347)}$ <b>x = # of Elements</b>  Labor (\$/yr) = $78.228*x^{(0.3421)}$ Materials (\$/yr) = $27.863*x^{(0.849)}$ Membrane Replacement (\$/yr) = $170.19*x^{(0.9348)}$ <b>x = # of Elements</b>



## 6. Detailed Development of Capital Costs

Table 7. RO Pretreatment Cost<sup>3</sup>

Flow (MGD)	Construct Cost (\$)
0.05	115,000.00
0.1	122,000.00
0.2	136,000.00
0.5	158,000.00
1	184,000.00
2	228,000.00
5	323,000.00
10	424,000.00
15	535,000.00
50	1,100,000.00
100	2,090,000.00
150	3,080,000.00
200	4,080,000.00

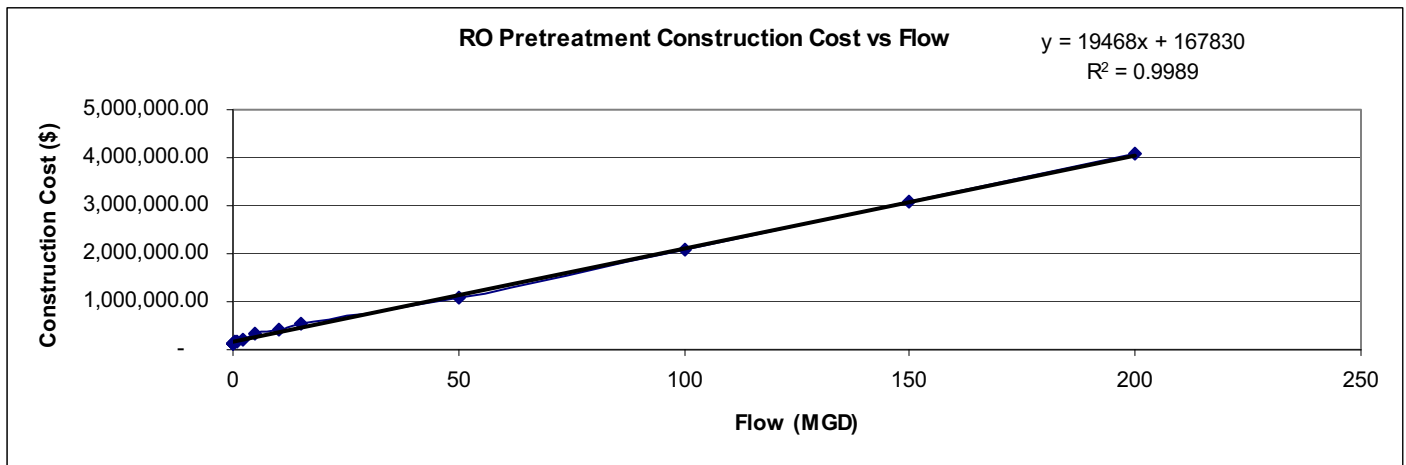


Figure 7. RO pretreatment cost vs. flow

Table 8. RO Feed Pumping Construction Cost<sup>3</sup>

Flow (MGD)	Medium (500 psi)	High (700 psi)	Seawater (900 psi)
0.05	81,900	101,000	119,000
0.1	128,000	159,000	187,000
0.2	200,000	248,000	292,000
0.5	321,000	398,000	468,000
1	514,000	639,000	751,000
2	769,000	955,000	1,120,000
5	1,450,000	1,800,000	2,110,000
10	2,260,000	2,810,000	3,310,000
15	2,940,000	3,650,000	4,300,000
50	6,430,000	7,990,000	9,400,000
100	9,720,000	12,100,000	14,200,000

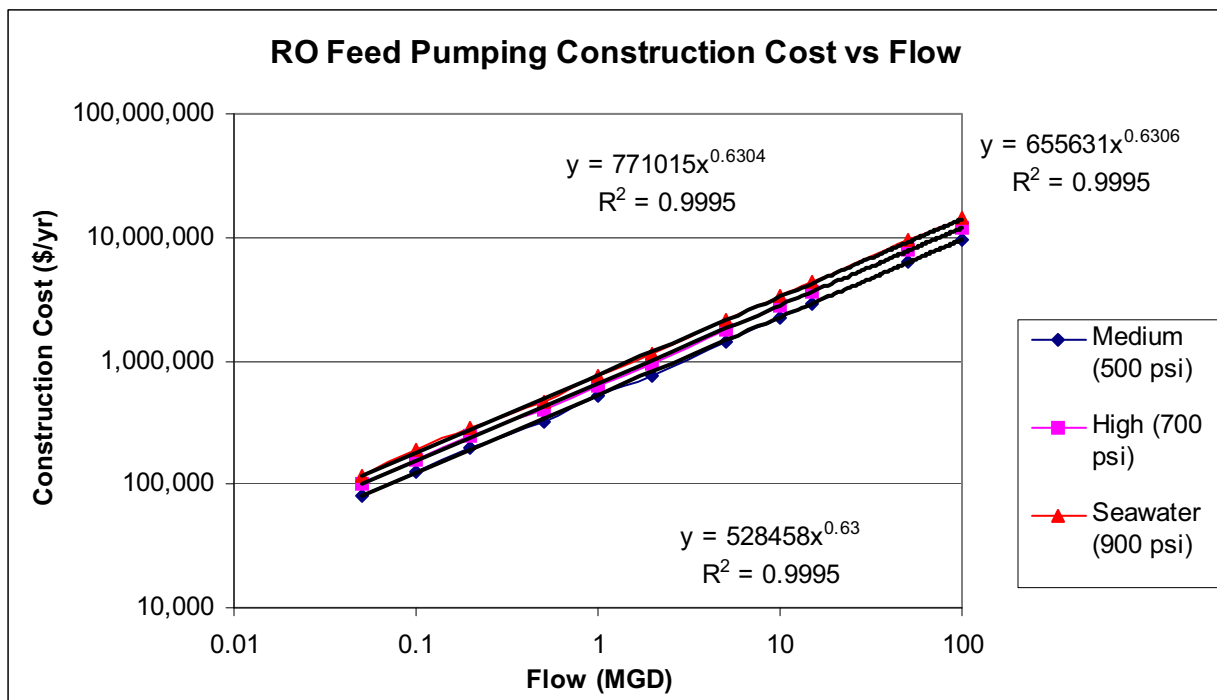


Figure 8. RO feed pumping construction cost at medium, high, and seawater pressure

Medium Pressure:  $y = 528458 * x^{0.63}$   
 Seawater Pressure:  $y = 771015 * x^{0.6304}$   
 High Pressure:  $y = 655631 * x^{0.6306}$

Table 9. RO Process System Construction Cost<sup>3</sup>

Elements	Medium (500 psi)	High (700 psi)	Seawater (900 psi)
3	17,800	20,700	22,900
6	22,300	25,700	28,200
15	34,800	39,200	42,800
35	75,000	84,900	92,900
70	128,000	144,000	157,000
98	174,000	196,000	214,000
140	242,000	273,000	298,000
196	331,000	373,000	408,000
700	1,090,000	1,230,000	1,350,000
1,400	2,100,000	2,370,000	2,590,000
2,770	3,990,000	4,510,000	4,930,000
6,900	9,510,000	10,700,000	11,700,000
13,800	18,400,000	20,700,000	22,600,000
18,300	24,200,000	27,300,000	29,800,000
27,500	35,600,000	40,100,000	43,800,000

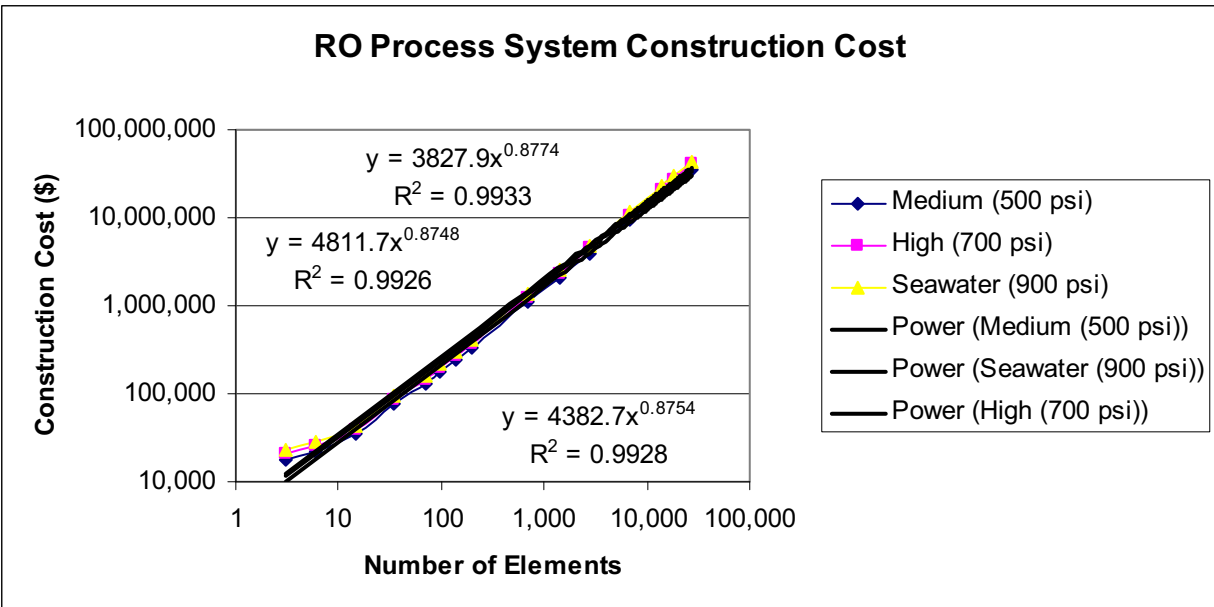


Figure 9. RO process system construction cost at medium, high, and seawater pressures

Medium pressure:  $y = 3827.9 * x^{0.8774}$   
 Seawater Pressure:  $y = 4811.7 * x^{0.8748}$   
 High Pressure:  $y = 4382.7 * x^{0.8754}$

## 7. Detailed Development of O&M Costs

Table 10. RO Pretreatment O&M Costs<sup>3</sup>

Flow (MGD)	Labor (hrs/yr)	Materials (\$/yr)	Chemicals (\$/yr)	Cartridge Replacement (\$/yr)	Acid Chemical Cost (\$/yr)	Antiscalant Cost (\$/yr)	Total Cost (\$/yr)
0.05	72	3,180	1,760	16,000	1,190	570	22,700
0.1	72	3,380	3,510	24,000	2,370	1,140	34,400
0.2	72	3,780	7,020	40,000	4,740	2,280	57,820
0.5	72	4,390	17,600	64,000	11,900	5,700	103,590
1	72	5,110	35,100	92,000	23,700	11,400	167,310
2	72	6,350	70,200	140,000	47,400	22,800	286,750
5	72	8,990	176,000	240,000	119,000	57,000	600,990
10	84	11,800	351,000	456,000	237,000	114,000	1,169,800
15	96	14,800	527,000	684,000	356,000	171,000	1,752,800
50	192	30,200	1,760,000	1,680,000	1,190,000	570,000	5,230,200
100	336	57,700	3,510,000	3,360,000	2,370,000	1,140,000	10,437,700
150	480	85,100	5,270,000	5,040,000	3,560,000	1,710,000	15,665,100
200	624	113,000	7,020,000	6,720,000	4,740,000	2,280,000	20,873,000

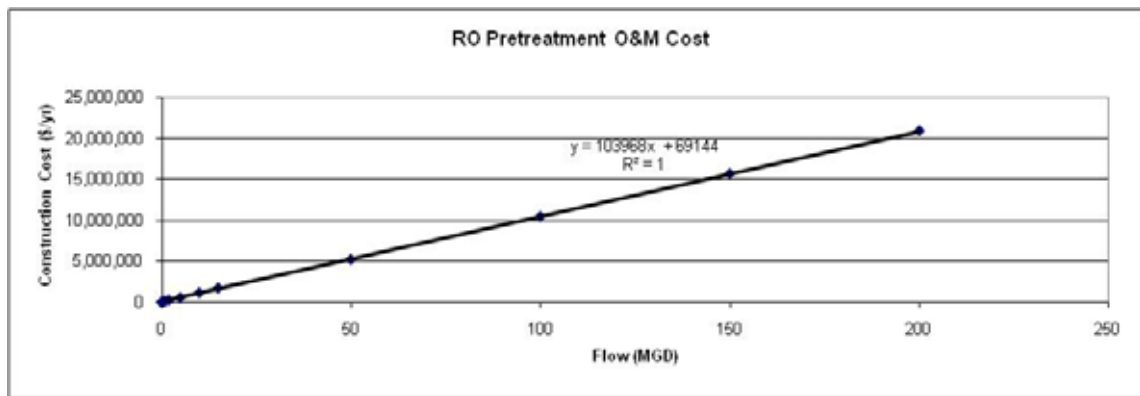


Figure 10: RO pretreatment O&M cost

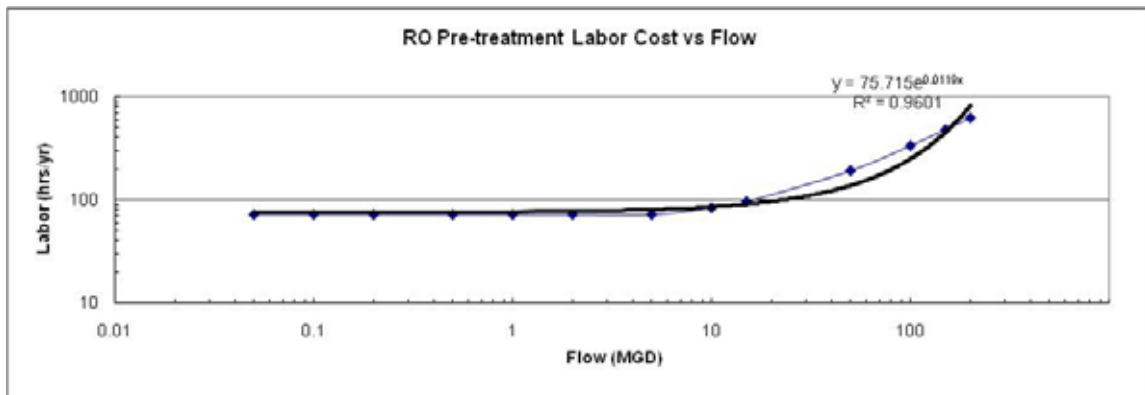


Figure 11. RO pretreatment labor cost

Table 11. Membrane Feed Pumping O&M<sup>3</sup> – Low Pressure (300 psi)

Flow (MGD)	Labor (hrs/yr)	Materials (\$/yr)	Energy Process (MWh/yr)
0.05	156	1,660	53
0.1	156	2,600	106
0.2	156	4,080	212
0.5	157	6,550	530
1	211	10,500	1,060
2	214	16,500	2,120
5	274	28,600	5,300
10	340	46,500	10,600
20	420	69,000	21,200
50	607	121,000	53,000
100	850	200,000	106,000

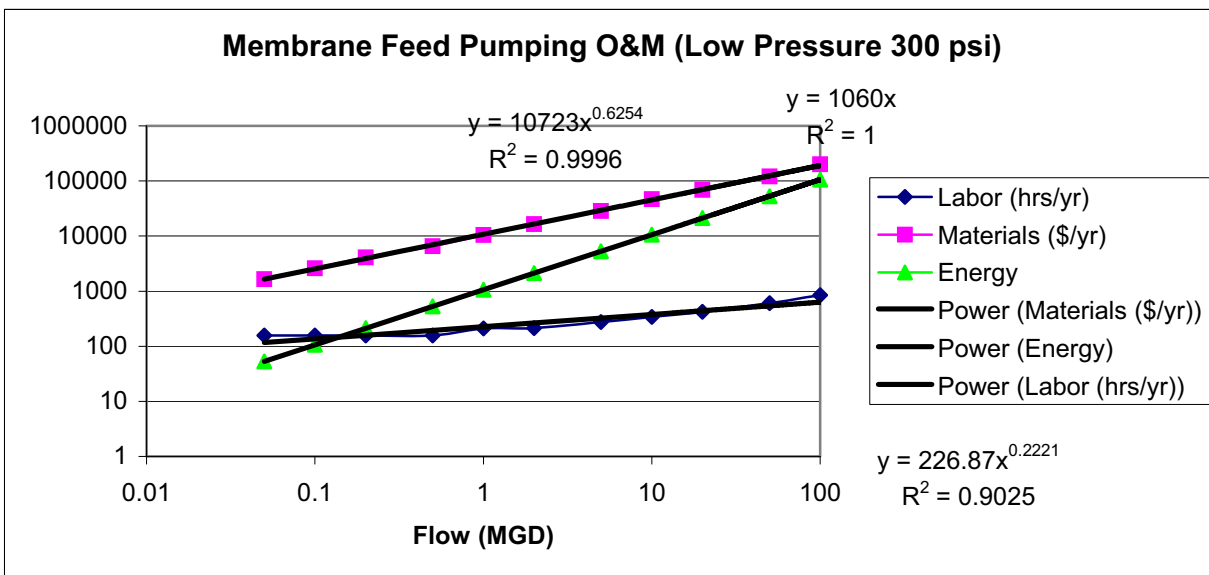


Figure 12. Membrane feed pumping O&M including labor, materials, and energy at low pressure

Materials –  $y = 10723 * x^{0.6254}$

Energy:  $y = 1060 * x$

Labor:  $y = 226.87 * x^{0.2221}$

Table 12. Membrane Feed Pumping O&M<sup>3</sup> – Medium Pressure (500 psi)

Flow (MGD)	Labor (hrs/yr)	Materials (\$/yr)	Energy Process (MWh/yr)
0.05	156	2,310	88
0.1	156	3,630	177
0.2	156	5,690	354
0.5	157	9,130	884
1	211	14,700	1,770
2	266	21,900	3,540
5	326	41,300	8,840
10	340	64,800	17,700
20	354	84,400	26,500
50	451	185,000	88,400
100	850	279,000	177,000

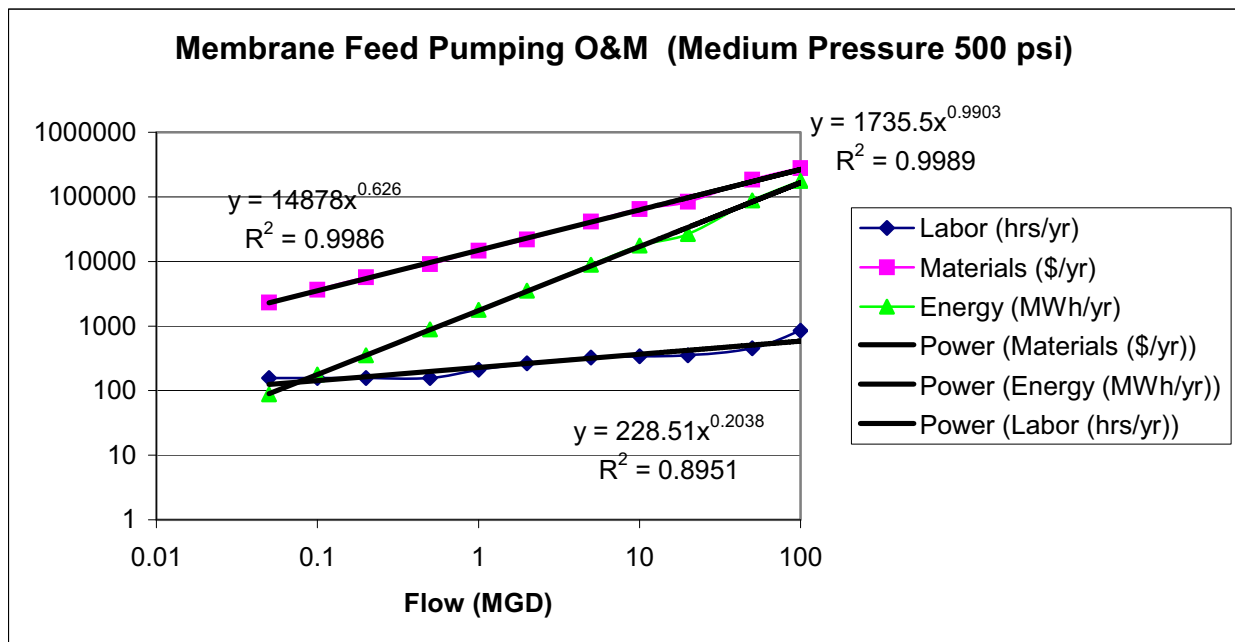


Figure 13. Membrane feed pumping O&M including labor, materials, and energy at medium pressure

Materials:  $y = 14070 * x^{0.626}$

Energy:  $y = 1735.5 * x^{0.9903}$

Labor:  $y = 228.51 * x^{0.2038}$

Table 13. Membrane Feed Pumping O&M<sup>3</sup> – High Pressure (700 psi)

Flow (MGD)	Labor (hrs/yr)	Materials (\$/yr)	Energy Process (MWh/yr)
0.05	156	2,880	124
0.1	156	4,510	247
0.2	156	7,080	495
0.5	157	11,400	1,240
1	211	18,300	2,470
2	266	27,300	4,950
5	326	51,400	12,400
10	340	80,700	24,700
20	354	105,000	37,100
50	451	230,000	124,000
100	850	347,000	247,000

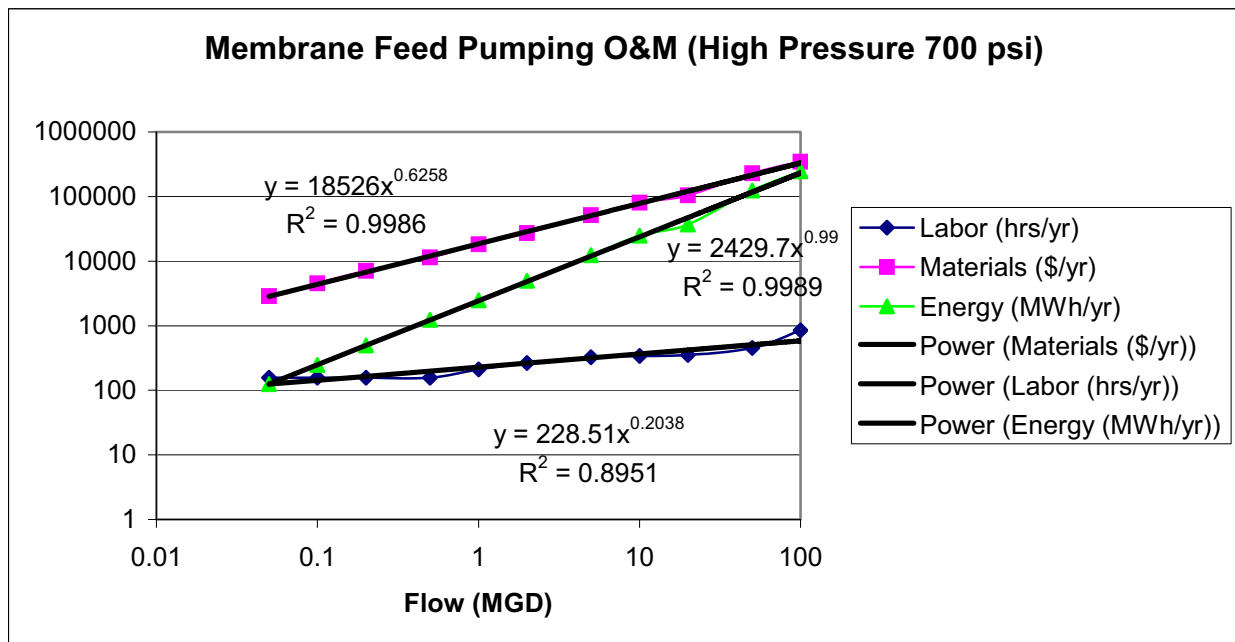


Figure 14: Membrane feed pumping O&M including labor, materials, and energy at high pressure

Materials:  $y = 18526 * x^{0.6258}$

Energy:  $y = 2429.7 * x^{0.99}$

Labor:  $y = 228.51 * x^{0.2038}$

Table 14. Membrane Feed Pumping O&M<sup>3</sup> – Seawater Pressure (900 psi)

Flow (MGD)	Labor (hrs/yr)	Materials (\$/yr)	Energy Process (MWh/yr)
0.05	156	3,390	159
0.1	156	5,320	318
0.2	156	8,340	636
0.5	157	13,400	1,590
1	211	21,500	3,180
2	266	32,200	6,360
5	326	60,600	15,900
10	340	95,000	31,800
20	354	124,000	47,700
50	451	270,000	159,000
100	850	408,000	318,000

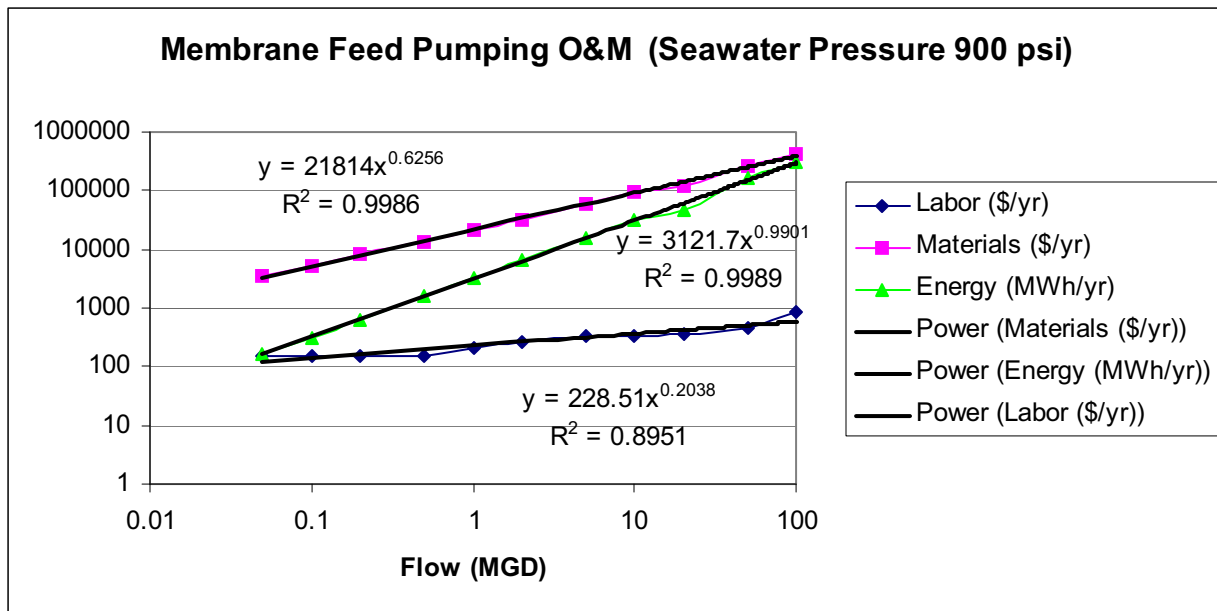


Figure 15. Membrane feed pumping O&M including labor, materials, and energy at seawater pressure

Materials:  $y = 21814 * x^{0.6256}$   
 Energy:  $y = 3121.7 * x^{0.9901}$   
 Labor:  $y = 228.51 * x^{0.2038}$



Table 15. RO Process System O&M<sup>3</sup> – Low Pressure (300 psi)

# elements	Labor (hrs/yr)	Materials (\$/yr)	Membrane Replacement (\$/yr)
3	173	409	553
6	174	535	1,060
15	175	893	2,490
35	177	1,980	5,490
70	180	3,480	10,500
98	356	4,770	14,400
140	360	6,670	20,100
196	712	9,150	27,500
280	721	12,800	38,400
700	936	30,300	90,400
1,400	1,010	58,100	173,000
2,420	1,110	96,900	288,000
4,130	1,280	180,000	475,000
9,170	1,780	340,000	1,000,000
13,800	2,240	497,000	1,460,000
18,300	3,570	651,000	1,920,000
27,500	4,480	953,000	2,800,000

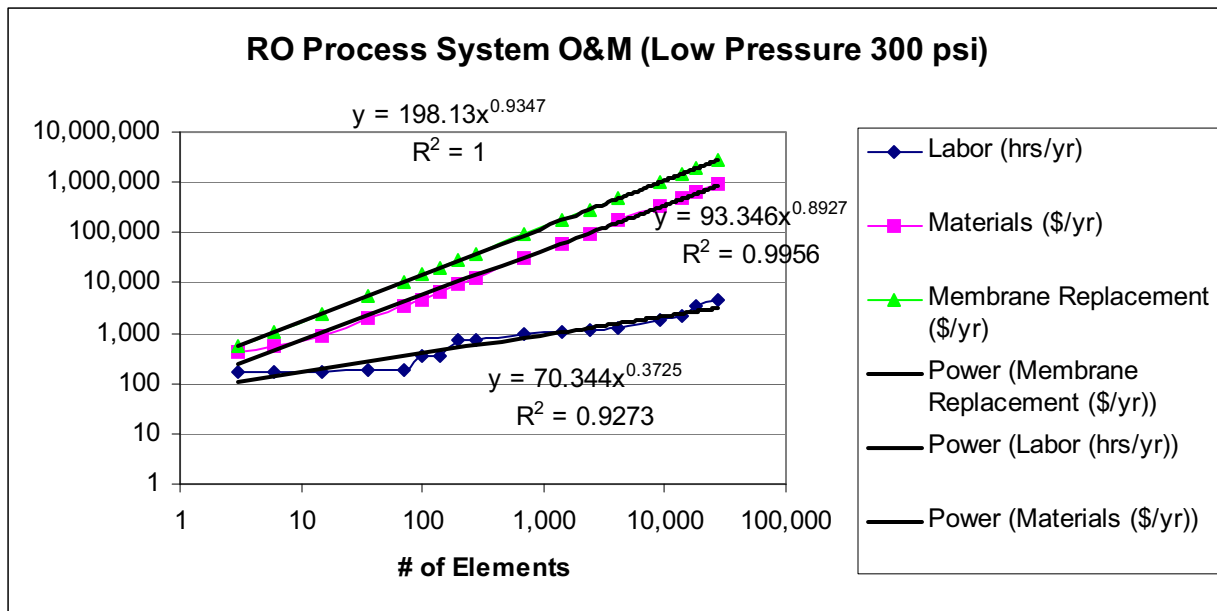


Figure 16. RO process system O&M including labor, materials, and membrane replacement at low pressure

Membrane replacement:  $y = 198.13 * x^{0.9347}$   
 Materials:  $y = 93.3467 * x^{0.8927}$   
 Labor:  $y = 70.344 * x^{0.3725}$

Table 16. RO Process System O&M<sup>3</sup> – Medium Pressure (500 psi)

# elements	Labor (hrs/yr)	Materials (\$/yr)	Membrane Replacement (\$/yr)
3	173	98	363
6	174	114	694
15	175	162	1,640
35	177	359	3,610
70	180	596	6,900
98	356	819	9,460
140	360	1,150	13,200
196	712	1,570	18,100
700	936	5,230	59,400
1,400	1,010	10,000	114,000
2,770	1,140	19,100	215,000
6,900	1,560	45,200	505,000
13,800	2,240	86,600	963,000

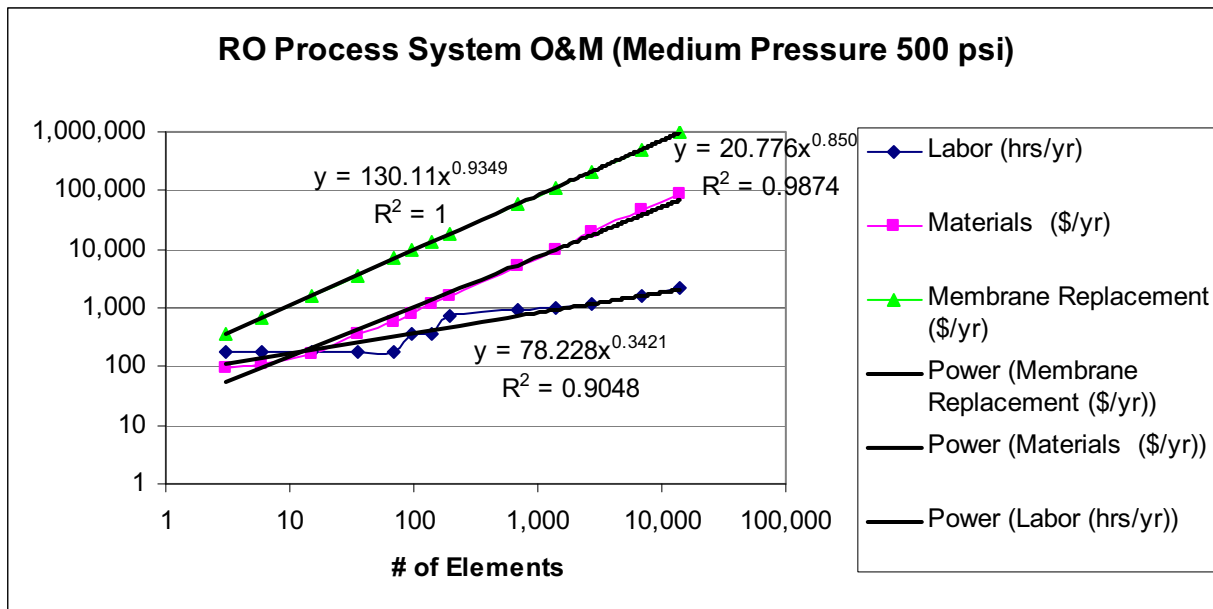


Figure 17: RO process system O&M including labor, materials, and membrane replacement at medium pressure

Membrane replacement:  $y = 130.11 * x^{0.9349}$

Materials:  $y = 20.776 * x^{0.850}$

Labor:  $y = 78.228 * x^{0.3421}$

Table 17. RO Process System O&M<sup>3</sup> – High Pressure (700 psi)

# elements	Labor (hrs/yr)	Materials (\$/yr)	Membrane Replacement (\$/yr)
3	173	118	419
6	174	137	801
15	175	191	1,890
35	177	426	4,170
70	180	703	7,970
98	356	966	10,900
140	360	1,350	15,200
196	712	1,860	20,900
700	936	6,170	68,600
1,400	1,010	11,900	131,000
2,770	1,140	22,500	248,000
6,900	1,560	53,300	582,000
13,800	2,240	102,000	1,110,000

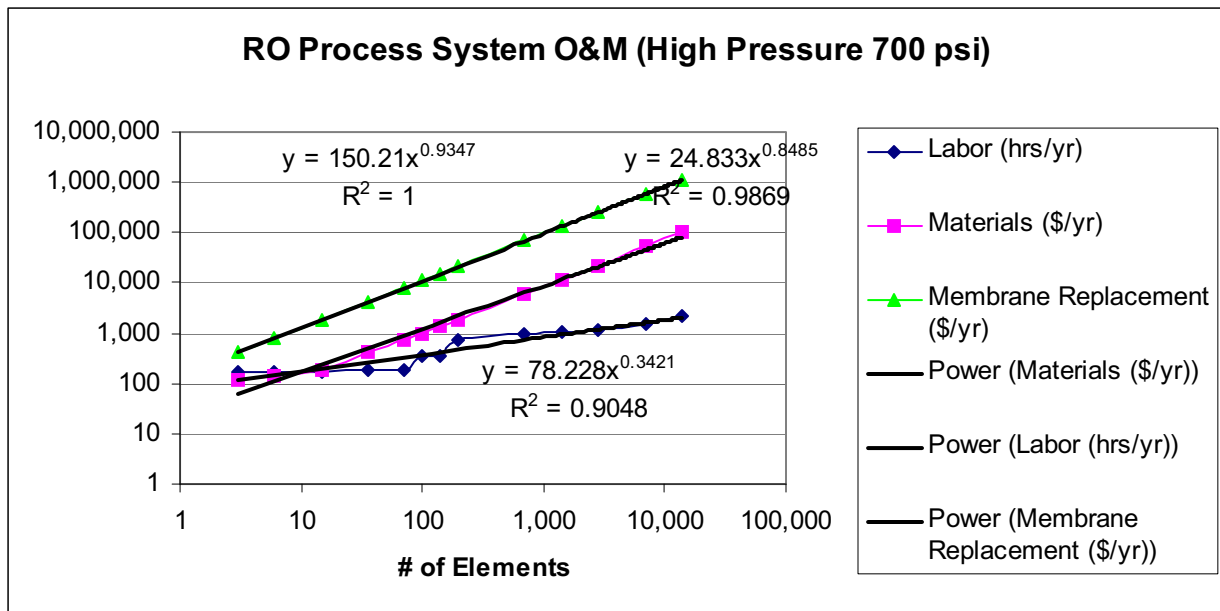


Figure 18: RO process system O&M including labor, materials, and membrane replacement at high pressure

Membrane replacement:  $y = 150.21 * x^{0.9347}$

Materials:  $y = 24.833 * x^{0.8485}$

Labor:  $y = 78.228 * x^{0.3421}$

Table 18. RO Process System O&M<sup>3</sup> – Seawater Pressure (900 psi)

# elements	Labor (hrs/yr)	Materials (\$/yr)	Membrane Replacement (\$/yr)
3	173	132	475
6	174	154	908
15	175	215	2,140
35	177	479	4,720
70	180	792	9,030
98	356	1,090	12,400
140	360	1,520	17,300
196	712	2,090	23,600
700	936	6,950	77,700
1,400	1,010	13,400	149,000
2,770	1,140	25,400	281,000
6,900	1,560	60,100	660,000
13,800	2,240	115,000	1,260,000

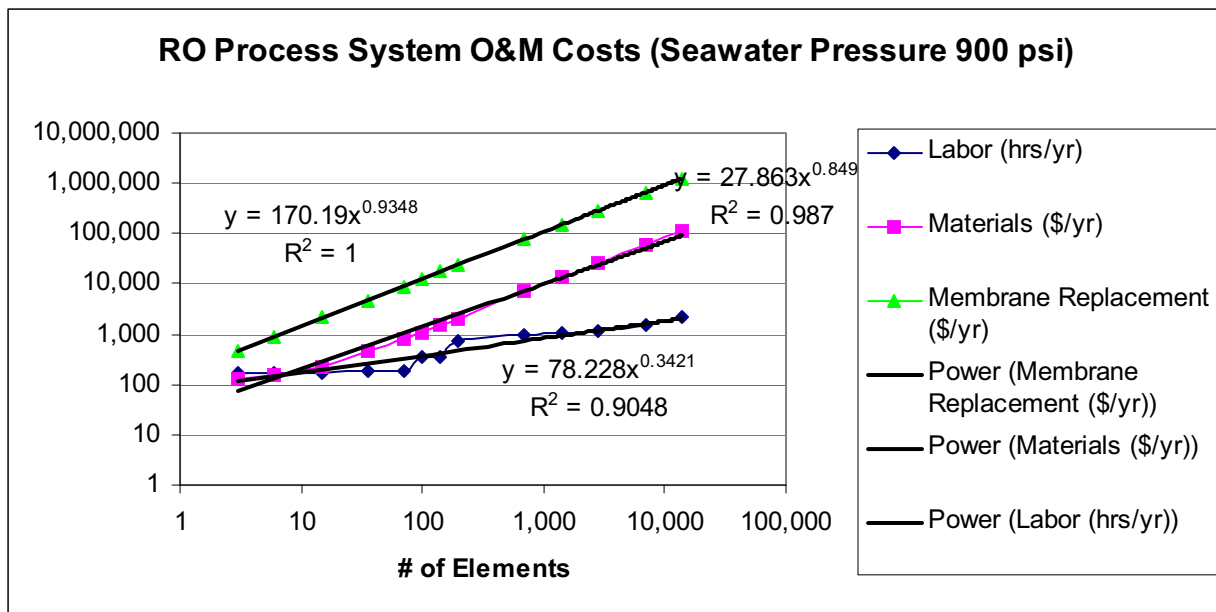


Figure 19: RO process system O&M including labor, materials, and membrane replacement at seawater pressure

Membrane replacement:  $y = 170.19 * x^{0.9348}$

Materials:  $y = 27.863 * x^{0.849}$

Labor:  $y = 78.228 * x^{0.3421}$

## 8. Development of Cost Scenarios

The examples shown in this section illustrate the total cost of an RO system based on the TDS level of the source water. The TDS levels range from 1000, 5000, 20,000, and 50,000 mg/L and correspond to pressures of 300, 500, 700, and 900 psi. The costs are also compared with those when blending is involved, again, at the same TDS and pressure levels. The costs do not include electricity costs, as the user must enter an energy cost of \$/kWh.

Table 19. Total Cost of RO Design for Low Pressure System with no Blending

<b>SCENARIO/INPUTS</b>		
Population	people	10,000
Water usage	gpd/person	75
TDS Level	mg/L or ppm	1,000
SDI	3	3
Recovery desired		0.8
Disposal Method	Surface water	
<b>Total Permeate Flow Required</b>		
	gpd	750000
<b>Total Feedwater Flow Required</b>		
	MGD	0.9375
<b>Required # of stages</b>		
		2
<b>Low energy element required</b>		
	psi	300
<b>Membrane Area/element</b>		
	ft <sup>2</sup>	430
<b>Design Flux</b>		
	gpd/ft <sup>2</sup>	28.9
<b>OUTPUTS</b>		
<b># Elements required</b>		60
<b># Vessels required</b>		10
<b>RO Pretreatment O&amp;M Costs</b>		
Cost (\$/yr)		\$166,614
Labor (hrs/yr)		85
<b>Membrane Feed Pumping O&amp;M Cost</b>		
Labor (hrs/yr)		224
Materials (\$/yr)		\$10,299
Energy (MWh/yr)		\$994
<b>RO Process System O&amp;M Cost</b>		
Labor (hrs/yr)		324
Materials (\$/yr)		\$3,628
Membrane Replacement (\$/yr)		\$9,149
<b>RO Pretreatment Construction Costs</b>		
		\$186,081
<b>RO Feed Pumping Construction Costs</b>		
		\$507,402
<b>RO Process System Construction Costs</b>		
		\$139,714
<b>Disposal Cost</b>		
<b>Total Cost</b>		\$1,023,520

Table 20. Total Cost for RO Design of Low Pressure System with Blending

<b>SCENARIO/INPUTS</b>		
Population	people	10,000
Water usage	gpd/person	75
TDS Level	mg/L or ppm	1,000
Finished water quality TDS required	mg/L or ppm	800
SDI	3	3
Recovery desired		0.8
Disposal Method	Surface water	
Total Permeate Flow Required	gpd	750000

<b>Membrane/Element Characteristics</b>		
Required # of stages		2
Low energy element required	psi	300
Membrane Area/element	ft <sup>2</sup>	430
Design Flux	gpd/ft <sup>2</sup>	28.9

<b>Mass Balance Calculations</b>		
RO permeate concentration, C <sub>e</sub>	mg/L	25
RO permeate flow rate, q <sub>e</sub>	gpd	153,846
Feed flow rate to RO system, q <sub>f</sub>	gpd	192,308
Total raw water flow rate, Q <sub>o</sub>	gpd	788,462

<b>OUTPUTS</b>	
<b># Elements required</b>	12
<b># Vessels required</b>	2
<b>RO Pretreatment O&amp;M Costs</b>	
Cost (\$/yr)	\$89,138
Labor (hrs/yr)	77
<b>Membrane Feed Pumping O&amp;M Cost</b>	
Labor (hrs/yr)	157.31
Materials (\$/yr)	3824
Energy (MWh/yr)	\$204
<b>RO Process System O&amp;M Cost</b>	
Labor (hrs/yr)	180
Materials (\$/yr)	\$882
Membrane Replacement (\$/yr)	\$2,081
<b>RO Pretreatment Construction Costs</b>	\$171,574
<b>RO Feed Pumping Construction Costs</b>	\$187,037
<b>RO Process System Construction Costs</b>	\$34,803
<b>Disposal Cost</b>	
<b>Total Cost</b>	\$489,753

Table 21 – Total Cost of RO Design of Medium Pressure System with No Blending

<b>SCENARIO/INPUTS</b>		
Population	people	10,000
Water usage	gpd/person	75
TDS Level	mg/L or ppm	5,000
SDI	3	3
Recovery desired		0.8
Disposal Method	Surface water	

<b>Total Permeate Flow Required</b>	gpd	750000
<b>Total Feedwater Flow Required</b>	MGD	0.9375
<b>Required # of stages</b>		2
<b>Medium energy element required</b>	psi	500
<b>Membrane Area/element</b>	ft <sup>2</sup>	400
<b>Design Flux</b>	gpd/ft <sup>2</sup>	26

<b>OUTPUTS</b>	
<b># Elements required</b>	72
<b># Vessels required</b>	12
<b>RO Pretreatment O&amp;M Costs</b>	
Cost (\$/yr)	\$166,614
Labor (hrs/yr)	85
<b>Membrane Feed Pumping O&amp;M Cost</b>	
Labor (hrs/yr)	224
Materials (\$/yr)	\$14,289
Energy (MWh/yr)	\$1,628
<b>RO Process System O&amp;M Cost</b>	
Labor (hrs/yr)	338
Materials (\$/yr)	\$789
Membrane Replacement (\$/yr)	\$7,102
<b>RO Pretreatment Construction Costs</b>	\$186,082
<b>RO Feed Pumping Construction Costs</b>	\$507,402
<b>RO Process System Construction Costs</b>	\$163,340
<b>Disposal Cost</b>	
<b>Total Cost</b>	\$1,046,264

Table 22. Total Cost of RO Design of Medium Pressure System with Blending

<b>SCENARIO/INPUTS</b>		
Population	people	10,000
Water usage	gpd/person	75
TDS Level	mg/L or ppm	5,000
Finished water quality TDS required	mg/L or ppm	800
SDI	3	3
Recovery desired		0.8
Disposal Method	Surface water	
Total Permeate Flow Required	gpd	750000
<b>Membrane/Element Characteristics</b>		
Required # of stages		2
Medium energy element required	psi	500
Membrane Area/element	ft <sup>2</sup>	400
Design Flux	gpd/ft <sup>2</sup>	26

**Mass Balance Calculations**

RO permeate concentration, C <sub>e</sub>	mg/L	125
RO permeate flow rate, q <sub>e</sub>	gpd	646,154
Feed flow rate to RO system, q <sub>f</sub>	gpd	807,692
Total raw water flow rate, Q <sub>o</sub>	gpd	911,538

**OUTPUTS**

<b># Elements required</b>	62
<b># Vessels required</b>	10
<b>RO Pretreatment O&amp;M Costs</b>	
Cost (\$/yr)	\$153,118
Labor (hrs/yr)	83
<b>Membrane Feed Pumping O&amp;M Cost</b>	
Labor (hrs/yr)	218.78
Materials (\$/yr)	\$13,016
Energy (MWh/yr)	\$1,402
<b>RO Process System O&amp;M Cost</b>	
Labor (hrs/yr)	321
Materials (\$/yr)	\$695
Membrane Replacement (\$/yr)	\$6,178
<b>RO Pretreatment Construction Costs</b>	\$183,554
<b>RO Feed Pumping Construction Costs</b>	\$461,929
<b>RO Process System Construction Costs</b>	\$143,318
<b>Disposal Cost</b>	
<b>Total Cost</b>	\$962,433



Table 23 – Total Cost of RO Design of High Pressure System with No Blending

**SCENARIO/INPUTS**

Population	people	10,000
Water usage	gpd/person	75
TDS Level	mg/L or ppm	20,000
SDI	3	3
Recovery desired		0.8
Disposal Method	Surface water	

<b>Total Permeate Flow Required</b>	gpd	750000
<b>Total Feedwater Flow Required</b>	MGD	0.9375
<b>Required # of stages</b>		3
<b>High energy element required</b>	psi	700
<b>Membrane Area/element</b>	ft <sup>2</sup>	400
<b>Design Flux</b>	gpd/ft <sup>2</sup>	20

**OUTPUTS**

<b># Elements required</b>	94
<b># Vessels required</b>	16
<b>RO Pretreatment O&amp;M Costs</b>	
Cost (\$/yr)	\$166,614
Labor (hrs/yr)	85
<b>Membrane Feed Pumping O&amp;M Cost</b>	
Labor (hrs/yr)	226
Materials (\$/yr)	\$17,793
Energy (MWh/yr)	\$2,279
<b>RO Process System O&amp;M Cost</b>	
Labor (hrs/yr)	370
Materials (\$/yr)	\$1,170
Membrane Replacement (\$/yr)	\$10,469
<b>RO Pretreatment Construction Costs</b>	\$186,082
<b>RO Feed Pumping Construction Costs</b>	\$629,484
<b>RO Process System Construction Costs</b>	\$233,349
<b>Disposal Cost</b>	
<b>Total Cost</b>	\$1,245,640

Table 24. Total Cost of RO Design of High Pressure System with Blending

**SCENARIO/INPUTS**

Population	people	10,000
Water usage	gpd/person	75
TDS Level	mg/L or ppm	20,000
Finished water quality TDS required	mg/L or ppm	800
SDI	3	3
Recovery desired		0.8
Disposal Method	Surface water	
Total Permeate Flow Required	gpd	750000

**Membrane/Element Characteristics**

Required # of stages		3
High energy element required	psi	700
Membrane Area/element	ft <sup>2</sup>	400
Design Flux	gpd/ft <sup>2</sup>	20

**Mass Balance Calculations**

RO permeate concentration, Ce	mg/L	500
RO permeate flow rate, qe	gpd	738,462
Feed flow rate to RO system, qf	gpd	923,077
Total raw water flow rate, Qo	gpd	934,615

**OUTPUTS**

<b># Elements required</b>	92
<b># Vessels required</b>	15
<b>RO Pretreatment O&amp;M Costs</b>	
Cost (\$/yr)	\$165,114
Labor (hrs/yr)	85
<b>Membrane Feed Pumping O&amp;M Cost</b>	
Labor (hrs/yr)	225
Materials (\$/yr)	\$17,621
Energy (MWh/yr)	\$2,245
<b>RO Process System O&amp;M Cost</b>	
Labor (hrs/yr)	368
Materials (\$/yr)	\$1,155
Membrane Replacement (\$/yr)	\$10,318
<b>RO Pretreatment Construction Costs</b>	\$185,801
<b>RO Feed Pumping Construction Costs</b>	\$623,359
<b>RO Process System Construction Costs</b>	\$230,203
<b>Disposal Cost</b>	
<b>Total Cost</b>	\$1,234,249

Table 25. Total Cost of RO Design of Seawater Pressure System with No Blending

<b>SCENARIO/INPUTS</b>		
Population	people	10,000
Water usage	gpd/person	75
TDS Level	mg/L or ppm	50,000
SDI	3	3
Recovery desired	%	0.8
Disposal Method	Surface water	

<b>Total Permeate Flow Required</b>	gpd	750000
<b>Total Feedwater Flow Required</b>	MGD	0.9375
<b>Required # of stages</b>		3
<b>SW energy element required</b>	psi	900
<b>Membrane Area/element</b>	ft <sup>2</sup>	320
<b>Design Flux</b>	gpd/ft <sup>2</sup>	18.8

<b>OUTPUTS</b>	
<b># Elements required</b>	125
<b># Vessels required</b>	21
<b>RO Pretreatment O&amp;M Costs</b>	
Cost (\$/yr)	\$166,614
Labor (hrs/yr)	85
<b>Membrane Feed Pumping O&amp;M Cost</b>	
Labor (hrs/yr)	226
Materials (\$/yr)	\$20,951
Energy (MWh/yr)	\$2,928
<b>RO Process System O&amp;M Cost</b>	
Labor (hrs/yr)	408
Materials (\$/yr)	\$1,676
Membrane Replacement (\$/yr)	\$15,482
<b>RO Pretreatment Construction Costs</b>	\$186,081
<b>RO Feed Pumping Construction Costs</b>	\$740,276
<b>RO Process System Construction Costs</b>	\$327,841
<b>Disposal Cost</b>	
<b>Total Cost</b>	\$1,459,639

Table 26. Total Cost of RO Design of Seawater Pressure System with Blending

<b>SCENARIO/INPUTS</b>		
Population	people	10,000
Water usage	gpd/person	75
TDS Level	mg/L or ppm	50,000
Finished water quality TDS required	mg/L or ppm	800
SDI	3	3
Recovery desired	%	0.8
Disposal Method	Surface water	
Total Permeate Flow Required	gpd	750000

<b>Membrane/Element Characteristics</b>		
Required # of stages		3
SW energy element required	psi	900
Membrane Area/element	ft <sup>2</sup>	320
Design Flux	gpd/ft <sup>2</sup>	18.8

<b>Mass Balance Calculations</b>		
RO permeate concentration, C <sub>e</sub>	mg/L	1250
RO permeate flow rate, q <sub>e</sub>	gpd	756,923
Feed flow rate to RO system, q <sub>f</sub>	gpd	946,154
Total raw water flow rate, Q <sub>o</sub>	gpd	939,231

<b>OUTPUTS</b>	
<b># Elements required</b>	126
<b># Vessels required</b>	21
<b>RO Pretreatment O&amp;M Costs</b>	
Cost (\$/yr)	\$167,514
Labor (hrs/yr)	85
<b>Membrane Feed Pumping O&amp;M Cost</b>	
Labor (hrs/yr)	226
Materials (\$/yr)	\$21,072
Energy (MWh/yr)	\$2,955
<b>RO Process System O&amp;M Cost</b>	
Labor (hrs/yr)	409
Materials (\$/yr)	\$1,689
Membrane Replacement (\$/yr)	\$15,615
<b>RO Pretreatment Construction Costs</b>	\$186,250
<b>RO Feed Pumping Construction Costs</b>	\$744,576
<b>RO Process System Construction Costs</b>	\$330,487
<b>Disposal Cost</b>	
<b>Total Cost</b>	\$1,467,922

## 9. Summary

The goal of the research performed during spring semester 2007 was to devise a simple, yet easy to use spreadsheet tool to quickly calculate the cost of an RO system based on the source water quality of the raw water. To achieve this goal, a literature review was performed using various sources, a flow chart model was created, which will become the basis for a spreadsheet or web based tool, and various scenarios were tested in validating the model.

The model will ask the user to specify inputs such as raw water quality (TDS level), recovery, desired finished water quality, brine disposal method, and an energy cost. Depending on whether or not the user chooses to blend permeate water with raw water, the tool will then perform mass balance calculations according to equations 3-8.

The model consists of four TDS level categories, in which each category is associated with a specified membrane, pressure, membrane area, and design flux. Each of the four categories has associated cost calculations. The higher the TDS level, the higher the pressure, which results in a greater total RO design cost. The costs are broken down into O&M (pretreatment, feed pumping, and process system) and capital costs (pretreatment, feed pumping, and process system). The outputs include the number of elements and pressure vessels required, O&M, and capital costs. Various brine disposal methods were suggested, but the actual cost calculations will be implemented in a later version.

Verification of the model is also exhibited in this report. Scenarios were created for each of the TDS levels at each of the pressures. These scenarios and inputs are shown in Section 6. For each scenario, the numbers of elements and pressure vessels, as well as total costs were calculated. This was repeated for situations in which blending also occurred at each of the TDS levels at each of the pressures. In all cases, the lower energy elements were the cheapest and then progressed on upwards such that the seawater energy configuration was the most expensive. The model validation also showed that blending decreases the cost considerably, as not as much feed water is required for input into the RO system, thereby reducing, capital, energy, and O&M costs.

## 10. References

1. American Water Works Association Manual: Manual of Water Supply Practices; Reverse Osmosis and Nanofiltration: AWWA M46; Denver, CO. 1999.
2. Dow Chemical. "Design a Reverse Osmosis System." 1995-2007.  
[http://www.dow.com/liquidseps/service/lm\\_design.htm](http://www.dow.com/liquidseps/service/lm_design.htm)
3. HDR Engineering. Desalination for Texas Water Supply. Texas, August 2000.
4. Motley, Edward and Syed Qasim, Guang Zhu. Water Works Engineering. Upper Saddle River, NJ. 2000.



## **Appendix C**

### **Design and Control of an Integrated Wind-Water Desalination System for an Inland Municipality**

by **Dennis D. Noll, B.A., M.A.**





DESIGN AND CONTROL OF AN INTEGRATED WIND-WATER DESALINATION  
SYSTEM FOR AN INLAND MUNICIPALITY

by

Dennis D. Noll, B.A., M.A.

A Dissertation

in

WIND SCIENCE AND ENGINEERING

Submitted to the Graduate Faculty  
of Texas Tech University in  
Partial Fulfillment of  
the Requirements for  
the Degree of

DOCTOR OF PHILOSOPHY

Approved

Bradley T. Ewing  
Chairperson of the Committee

Jamie C. Chapman

Andrew H.P. Swift

Lianfa Song

Accepted

Fred Hartmeister  
Dean of the Graduate School

August, 2008

Copyright 2008, Dennis D. Noll

## Acknowledgements

I would like to express my sincere gratitude to all the organizations that provided support for this dissertation. This work was funded by the National Science Foundation under Grant No. 0221688, and additional financial support was given by the Texas Tech University (TTU) Graduate School and the Wind Science and Engineering Research Center. Much support also came from the staff of the TTU WISE Center and the NSF-IGERT program.

I would also like to thank the management of the city of Seminole, Texas for their cooperation in this project. Through them, the city provided equipment, personnel, and data that were of great assistance to this report. Special thanks go to Renee Goodger, who was exceptionally helpful in my requests for the inner workings of the Seminole Public Works.

Thanks to all members who served on my dissertation committee, for all of the constructive input they had on this research. Many thanks go to my advisor, Dr. Jamie Chapman, for being a great mentor and motivator throughout this entire process. Thanks also to Wes Burgett of the West Texas Mesonet, for providing assistance with the Seminole data logger and internet interface.

Thank you to my family, friends, and dogs who were supportive of my goals.

Finally, thanks to my wife, Jennifer Noll, for always embracing my dreams.

## TABLE OF CONTENTS

Acknowledgements.....	ii
Abstract.....	vi
List of Tables.....	vii
List of Figures.....	x
Chapter 1 Introduction.....	1
1.1 Overview.....	1
1.2 Problem Statement.....	2
1.3 Research Objectives.....	3
1.4 Organization of the Dissertation.....	4
Chapter 2 Literature Review.....	5
2.1 Overview.....	5
2.2 Atmospheric Science.....	5
2.2.1 Holmes.....	5
2.2.2 Schroeder.....	6
2.2.3 Vega & Letchford.....	6
2.3 Wind Power Systems.....	7
2.3.1 American Wind Energy Association (AWEA).....	7
2.3.2 Black & Veatch <sup>a, b, c</sup> .....	8
2.3.3 Blanco.....	9
2.3.4 Flowers.....	10
2.3.5 Hightower.....	11
2.3.6 Lyons.....	12
2.3.7 Manwell.....	12
2.3.8 Nelson, Barieau, Starcher.....	13
2.3.9 Nelson & Starcher.....	13
2.3.10 Walter.....	14
2.4 Economics.....	14
2.4.1 Osborne.....	14
2.5 Statistics.....	15
2.5.1 Larsen.....	15
2.6 Information Systems.....	15
2.6.1 Simon.....	15
2.6.2 Wolf.....	15
2.7 Water Resources.....	16
2.7.1 Busch.....	16
2.7.2 Environmental Protection Agency (EPA).....	17
2.7.3 HDR Engineering.....	17
2.7.4 Mickley.....	17
2.7.5 Reisner.....	18
2.7.6 Texas Commission on Environmental Quality (TCEQ).....	18
2.7.7 Texas Water Development Board (TWDB).....	19
2.8 Renewable Energy Desalination.....	19
2.8.1 Carta.....	19
2.8.2 Garcia-Rodriguez.....	20
2.8.3 Hrayshat.....	20
2.8.4 Kiranoudis.....	20
2.8.5 Mohamed.....	21

2.8.6	Tzen.....	21
Chapter 3	Analysis of the Water Use Data .....	22
3.1	Introduction .....	22
3.2	Equipment.....	22
3.3	The Water Use Data Set .....	25
3.3.1	Manually Collected Water Use Data.....	25
3.3.2	Real-Time Water Use Data .....	25
3.4	Quality Assurance/Quality Control .....	26
3.4.1	Seminole Data .....	26
3.4.2	WTAMU and WTM data .....	26
3.5	Moving Average Filter .....	28
3.6	Distribution Fitting .....	31
Chapter 4	Daily/Monthly Wind Energy Assessment and Associated Calculations.....	34
4.1	Introduction .....	34
4.2	Adjusting the Power Curve for Air Density .....	35
4.3	Processing of the 10m Wind Data .....	36
4.4	Processing of the 50m Wind Data .....	39
4.5	Calculation of Wind Shear Exponent Values .....	42
4.6	Calculation of 100m Wind Speeds .....	45
4.7	Calculation of the Expected Power and Energy from the Wind Turbine .....	49
4.8	Capacity Factor Calculation .....	53
Chapter 5	Annual Average System Sizing Procedure .....	54
5.1	Introduction .....	54
5.2	Overview of Consumption.....	54
5.2.1	Annual Average Energy Consumption Study .....	58
5.2.2	Section Equations.....	58
5.3	Municipal Water Consumption .....	60
5.4	Municipal Electrical Consumption.....	67
5.5	Santa Rosa Well Field Energy Estimate and Capital Costs.....	72
5.5.1	Costs of Pumping Water to the Surface .....	74
5.5.2	Well Pump Information.....	77
5.6	RO System Energy Estimate and Capital Costs .....	78
5.6.1	Brine Disposal.....	82
5.7	Distribution System Energy Estimate.....	84
5.8	Total Water System Energy Estimate and Capital Costs.....	87
5.9	Wind Turbine Array Sizing .....	92
5.10	Conclusion.....	94
Chapter 6	Optimization of System Sizing and Economics .....	97
6.1	Introduction .....	97
6.1.1	Comparison of Annual Average to Real-Time Surplus/Deficit Analysis .....	98
6.2	Wind Turbine Array Energy Production Analysis .....	98
6.3	Municipal Water Use Analysis.....	102
6.4	Water System Energy Cost Analysis.....	105
6.5	Seminole Municipal Load Analysis .....	108
6.6	Energy Surplus or Deficit Analysis .....	110
6.6.1	Energy Surplus or Deficit without considering Municipal Loads.....	110
6.6.2	Energy Surplus or Deficit considering Municipal Loads.....	112
6.7	Summary of Benefits from Wind Turbine Array .....	115
6.7.1	Explanation of the Function of Turbine Array Benefit/Loss.....	116

6.8	Optimal Sizing of the Wind Turbine Array .....	118
6.8.1	Explanation of Costs/1000 Gallons .....	118
6.9	Explanation of Total System Cost Minimum .....	122
6.10	Water System Energy Consumption by Component .....	126
Chapter 7	Sensitivity Analysis.....	128
7.1	Introduction .....	128
7.2	Selling Price of Energy to the Utility Energy Provider .....	129
7.3	Wind Turbine Cost of Energy .....	130
7.4	Purchase Price of Energy from the Utility Energy Provider .....	131
7.5	Bond Interest Rate .....	132
7.6	Well Depth.....	133
7.6.1	Acknowledgement of the Effect of Head Pressure on Cost of Water .....	134
7.6.1.1	Varying Head Pressure, Holding Well Depth Constant .....	135
7.6.1.2	Varying Well Depth, Holding Head Pressure Constant .....	136
7.7	Reverse Osmosis Unit Energy Consumption .....	137
7.8	Conclusion.....	138
Chapter 8	Adaptive/Intelligent Control Algorithm.....	141
8.1	Introduction .....	141
8.2	Simplified Algorithm.....	142
8.3	Comprehensive Algorithm .....	144
8.3.1	Process Priority .....	144
8.3.2	Register Locations.....	144
8.3.3	Interrupt Service Routines.....	145
8.3.3.1	ISR0—Reset Watchdog Timer Counter .....	146
8.3.3.2	ISR1—Wind Data Acquisition.....	146
8.3.3.3	ISR2—Water Data Acquisition.....	147
8.3.3.4	ISR3—Water Remaining in Storage .....	147
8.3.3.5	ISR4—Priority Fill .....	148
8.3.3.5.1	Estimation of the Time-Varying Linear Model Parameters .....	149
8.3.3.5.1.1	Estimation of the Time-Varying Slope Variable .....	149
8.3.3.5.1.2	Estimation of the Time-Varying Y-intercept Parameter.....	152
8.3.3.5.1.3	Estimation of the Time-Varying Variance and Standard Deviation .....	153
8.3.4	Background Code.....	156
8.3.4.1	Supply.....	157
8.3.4.2	Demand .....	159
8.3.4.3	Economics .....	160
Chapter 9	Summary, Conclusions and Recommendations .....	165
9.1	Conclusion.....	165
9.2	Recommendations for Future Work .....	169
References	.....	172
Appendix A	Database for System Optimization .....	176
Appendix B	Parameter Definitions for Adaptive/Intelligent Control Algorithm.....	217
Appendix C	Background Code Block Diagram .....	231
Appendix D	Interrupt Service Routine Block Diagrams.....	241

## Abstract

Current water pricing standards do not take economic responsibility for dwindling potable water aquifer resources. By only incorporating financial, but not true economic costs of these scarce resources, serious depletion of these often slow-recharging groundwater resources has occurred in many areas in the United States. Aquifer depletion for some areas looms on a 50-year or closer horizon, and many municipalities in the Southwest and elsewhere face potential distress due to lack of sustainable fresh water availability. In order for these cities to remain economically and physically viable, alternative water resources must be found.

An affected West Texas inland municipality will become the subject of research to evaluate the technology and economics of a full-scale, integrated, wind-powered reverse osmosis water purification system. The integrated system will be applied to produce potable water from a brackish aquifer using renewable energy to reduce the energy costs of the system. An adaptive and intelligent control algorithm will control the integrated wind-water system.

The algorithm will process streaming real-time water use and electrical demand data in combination with wind speed measurements in order to determine the best use of the energy produced by a turbine array: either for water purification or for displacing conventional power on other municipal loads. The end product of this system is a water purification process that will utilize a brackish water aquifer for all of the city's potable water needs, and wind energy for all associated pumping, reverse osmosis, distribution and other electrical loads.

## List of Tables

Table 3.1. Seminole Annual Average Water Use .....	25
Table 3.2. Average Real-Time Water Flow Rate, in MGD .....	27
Table 4.1. Wind Speed at 10 Meters by Month and Hour of Day .....	37
Table 4.2. Wind Speed at 50 Meters by Month and Hour of Day .....	40
Table 4.3. Calculated Shear Exponent Values by Month and Hour of Day .....	43
Table 4.4. Calculation of Wind Speeds at 100 Meters by Month and Hour of Day .....	46
Table 4.5. Expected Energy Output Sums by Month.....	49
Table 4.6. Expected Energy Output by Month and Hour of Day .....	51
Table 5.1. Annual Water Use by Seminole.....	60
Table 5.2. Monthly and Daily Average Water Use by Seminole.....	60
Table 5.3. Scaled Monthly and Daily Average Water Use by Seminole .....	61
Table 5.4. Real-Time Water Flow Rate Data.....	63
Table 5.5. Annual Electric Use by Seminole's 64 Municipal Electric Meters .....	68
Table 5.6. Monthly, Daily, and Hourly Average Electric Use by Seminole's 64 Municipal Meters ....	68
Table 5.7. Real-Time Electric Data Profile Approximation .....	69
Table 5.8. Well Field Energy Consumption Estimate.....	73
Table 5.9. Assumptions and Calculation of the Costs of Bringing Santa Rosa Water to the Surface ....	75
Table 5.10. Sizing Protocol, Estimated Flow Rates, and Calculated Number of Wells .....	76
Table 5.11. Drilling Costs Associated With Wells and Depths .....	77
Table 5.12. Well Pump Information and Assumptions.....	77
Table 5.13. Capital Costs and Energy Requirements for Well Field (40 Wells) .....	78
Table 5.14. Seminole RO System Energy Consumption Estimate .....	79
Table 5.15. RO System Assumptions .....	79
Table 5.16. RO System Itemized Costs .....	80
Table 5.17. Labor Costs For RO System .....	80
Table 5.18. Post-Treatment Costs for RO System .....	80
Table 5.19. Itemized Costs/Per 1000 Gallons for RO System.....	81
Table 5.20. Itemized Materials Costs/1000 Gallons for RO System .....	81
Table 5.21. Seminole Distribution Energy Consumption Estimate .....	85
Table 5.22. Calculations Associated with Distribution System Energy Consumption Estimate .....	86
Table 5.23. Total Water System Energy Consumption Estimate.....	90
Table 5.24. Water System Cost by Component .....	91
Table 5.25. Wind Turbine Energy Generation Estimate.....	93
Table 5.26. Cost of System Components and Total System Cost/1000 Gallons .....	95
Table 6.1. Annual Average Analysis .....	98
Table 6.2. Real-Time Wind Energy Estimate for a Single Turbine.....	100
Table 6.3. Energy Produced by Turbine Arrays .....	101
Table 6.4. Average Real-Time Water Flow Rate.....	103
Table 6.5. Average Real-Time Water Flow Rate in Thousand Gallon Units .....	104
Table 6.6. Energy Costs for Components of Water System .....	105
Table 6.7. Average Real-Time Energy Use for Total System .....	106
Table 6.8. Real-Time Municipal Electrical Demand Data.....	109
Table 6.9. Real-Time Expected Energy Surplus or Deficit .....	111
Table 6.10. Real-Time Expected Energy Balance .....	113
Table 6.11. Expected Cost of Municipal Loads.....	114
Table 6.12. Summary of Costs/Benefits Associated with a Three Turbine Array.....	117
Table 6.13. Costs and Benefits for Different Turbine Array Sizes .....	120



Table 6.14. Total Costs of System Components/1000 Gallons for a Three Turbine Array .....	123
Table 6.15. Total Costs and Benefits for Different Turbine Array Sizes.....	124
Table 6.16. Water System Energy Consumption Estimate by Component .....	127
Table 8.1. Process Priority .....	144
Table 8.2. Register Locations .....	145
Table 9.1. Summary of Component Costs/1000 Gallons.....	167
Table A.1. Real-Time Wind Energy Estimate for a Single Turbine .....	177
Table A.2. Energy Produced by Turbine Arrays .....	178
Table A.3. Real-Time Municipal Electrical Demand Data.....	179
Table A.4. Average Real-Time Water Flow Rate.....	180
Table A.5. Average Real-Time Flow Rate in TG Units and Energy Costs for Components of Water System.....	181
Table A.6. Average Real-Time Energy Use for Total System .....	182
Table A.7. Real-Time Expected Energy Surplus or Deficit for a Single Turbine Array .....	184
Table A.8. Real-Time Expected Energy Balance for a Single Turbine Array.....	185
Table A.9. Expected Cost of Municipal Loads for a Single Turbine Array .....	186
Table A.10. Summary of Costs/Benefits Associated with a Single Turbine Array .....	187
Table A.11. Real-Time Expected Energy Surplus or Deficit for a Two Turbine Array .....	188
Table A.12. Real-Time Expected Energy Balance for a Two Turbine Array.....	189
Table A.13. Expected Cost of Municipal Loads for a Two Turbine Array .....	190
Table A.14. Summary of Costs/Benefits Associated with a Two Turbine Array .....	191
Table A.15. Real-Time Expected Energy Surplus or Deficit for a Three Turbine Array .....	192
Table A.16. Real-Time Expected Energy Balance for a Three Turbine Array.....	193
Table A.17. Expected Cost of Municipal Loads for a Three Turbine Array .....	194
Table A.18. Summary of Costs/Benefits Associated with a Three Turbine Array .....	195
Table A.19. Real-Time Expected Energy Surplus or Deficit for a Four Turbine Array.....	196
Table A.20. Real-Time Expected Energy Balance for a Four Turbine Array .....	197
Table A.21. Expected Cost of Municipal Loads for a Four Turbine Array .....	198
Table A.22. Summary of Costs/Benefits Associated with a Four Turbine Array.....	199
Table A.23. Real-Time Expected Energy Surplus or Deficit for a Five Turbine Array .....	200
Table A.24. Real-Time Expected Energy Balance for a Five Turbine Array.....	201
Table A.25. Expected Cost of Municipal Loads for a Five Turbine Array.....	202
Table A.26. Summary of Costs/Benefits Associated with a Five Turbine Array .....	203
Table A.27. Real-Time Expected Energy Surplus or Deficit for a Six Turbine Array .....	204
Table A.28. Real-Time Expected Energy Balance for a Six Turbine Array.....	205
Table A.29. Expected Cost of Municipal Loads for a Six Turbine Array .....	206
Table A.30. Summary of Costs/Benefits Associated with a Six Turbine Array .....	207
Table A.31. Costs and Benefits for Different Turbine Array Sizes .....	208
Table A.32. Total Costs and Benefits for Different Turbine Array Sizes.....	209
Table A.33. Water System Energy Consumption Estimate by Component.....	210
Table A.34. Total Costs of System Components/1000 Gallons for a Single Turbine Array .....	211
Table A.35. Total Costs of System Components/1000 Gallons for a Two Turbine Array .....	212
Table A.36. Total Costs of System Components/1000 Gallons for a Three Turbine Array .....	213
Table A.37. Total Costs of System Components/1000 Gallons for a Four Turbine Array .....	214
Table A.38. Total Costs of System Components/1000 Gallons for a Five Turbine Array .....	215
Table A.39. Total Costs of System Components/1000 Gallons for a Six Turbine Array .....	216
Table B.1. System Constant Parameters .....	218
Table B.2. System Constant Parameters (continued).....	219
Table B.3. Computational Results .....	220

Table B.4. Computational Results (Continued) .....	221
Table B.5. Computational Results (Continued) .....	222
Table B.6. Computational Results (Continued) .....	223
Table B.7. Computational Results (Continued) .....	224
Table B.8. Input Variables .....	225
Table B.9. Input Variables (Continued) .....	226
Table B.10. Output Variables .....	227
Table B.11. Output Variables (Continued) .....	228
Table B.12. Output Variables (Continued) .....	229
Table B.13. Output Variables (Continued) .....	230

## List of Figures

Figure 3.1. Circular Chart Recorder.....	22
Figure 3.2. Wellfield System Diagram .....	23
Figure 3.3. Settling Tanks at Seminole Wellfield .....	23
Figure 3.4. Eastech Badger 4400 Flow Meter/Data Logger .....	24
Figure 3.5. Circular Chart Recorder, Data Logger, and Internet Interface .....	24
Figure 3.6. 12 January 2006 Recharging Characteristics.....	29
Figure 3.7. January 2006 Real-Time Water Use, No Moving Average Calculation .....	30
Figure 3.8. January 2006 Real-Time Water Use, Moving Average Calculation .....	31
Figure 3.9. Municipal Water Use Histogram.....	32
Figure 3.10. January Municipal Water Use Histogram.....	32
Figure 3.11. June Municipal Water Use Histogram.....	33
Figure 4.1. 1.5 MW Wind Turbine Power Curve Adjusted for Air Density Change .....	36
Figure 4.2. Real-Time 10m Wind Speed by Month and Hour of Day .....	38
Figure 4.3. Real-Time 50m Wind Speed by Month and Hour of Day .....	41
Figure 4.4. Real-Time Shear Exponent Values by Month and Hour of Day .....	44
Figure 4.5. Real-Time Extrapolated 100m Wind Speed by Month and Hour of Day .....	47
Figure 4.6. Average 10m and Extrapolated 100m Wind Speeds by Month.....	48
Figure 4.7. Seminole Estimated Monthly Wind Energy Production .....	50
Figure 4.8. Real-Time Energy Production by Month and Hour of Day.....	52
Figure 5.1. 12 January 2006 Real-Time Water Use.....	55
Figure 5.2. January 2006 Real-Time Water Use, No Moving Average Calculation .....	56
Figure 5.3. January 2006 Real-Time Water Use, Moving Average Calculation .....	57
Figure 5.4. Flow Chart of Proposed Water System Processes.....	62
Figure 5.5. Scaled Daily Average Water Use by Month.....	65
Figure 5.6. Seminole Real-Time Water Use .....	66
Figure 5.7. Daily Electric Use by Month .....	70
Figure 5.8. Scaled ERCOT Real-Time Profile of Seminole Loads .....	71
Figure 5.9. Brine and Product Water from Raw Water.....	74
Figure 5.10. Distribution of Costs/1000 Gallons .....	87
Figure 5.11. Distribution of Monthly Average Energy Use.....	88
Figure 5.12. Distribution of Installed Capital Costs .....	88
Figure 5.13. Distribution of Operations and Maintenance Costs.....	89
Figure 5.14. Real-Time Energy Supply/Demand Comparison .....	96
Figure 6.1. Seminole System Energy Use.....	107
Figure 6.2. Turbine Array Benefit/Loss.....	121
Figure 6.3. Total System Cost.....	125
Figure 6.4. Distribution of Monthly Average Energy Use.....	126
Figure 7.1. Sensitivity of the Cost of Water to the Selling Price of Energy .....	129
Figure 7.2. Sensitivity of the Cost of Water to the Wind Turbine COE .....	130
Figure 7.3. Sensitivity of the Cost of Water to the Purchase Price of Energy .....	131
Figure 7.4. Sensitivity of the Cost of Water to the Bond Interest Rate.....	132
Figure 7.5. Distribution of Monthly Average Energy Use.....	133
Figure 7.6. Sensitivity of the Cost of Water to Well Depth.....	134
Figure 7.7. Sensitivity of the Cost of Water to Head Pressure .....	136
Figure 7.8. Sensitivity of the Cost of Water to Well Depth, Holding Pumping Depth Constant.....	137
Figure 7.9. Sensitivity of the Cost of Water to Reverse Osmosis Unit Energy Consumption.....	138
Figure 7.10. Sensitivity of Cost of Water to Various Parameters .....	140
Figure 8.1. Flow Chart for Simplified Algorithm.....	143

Figure 8.2. Decision Tree for Adaptive/Intelligent Control Algorithm ..... 145

Figure 8.3. General Graph of Water Use Data..... 150

Figure 9.1. Turbine Array Benefit/(Loss) per 1000 Gallons..... 166

Figure 9.2. Distribution of Costs/1000 Gallons ..... 168

Figure 9.3. Distribution of Monthly Average Energy Use..... 168

Figure 9.4. Real-Time Energy Supply/Demand Comparison ..... 170

Figure A.1. Seminole System Energy Use..... 183

Figure C.1. Background Code Block Diagram Section 1, 2 ..... 232

Figure C.2. Background Code Block Diagram Section 3, 4 ..... 233

Figure C.3. Background Code Block Diagram Section 5, 6 ..... 234

Figure C.4. Background Code Block Diagram Section 7, 8 ..... 235

Figure C.5. Background Code Block Diagram Section 9, 10, 11 ..... 236

Figure C.6. Background Code Block Diagram Section 12, 13, 14 ..... 237

Figure C.7. Background Code Block Diagram Section 15, 16, 17 ..... 238

Figure C.8. Background Code Block Diagram Section 18, 19 ..... 239

Figure C.9. Background Code Block Diagram Section 20, 21 ..... 240

Figure D.1. Block Diagrams for ISR 0 and ISR 1 ..... 242

Figure D.2. Block Diagram for ISR 2 ..... 243

Figure D.3. Block Diagram for ISR 3 ..... 244

Figure D.4. Block Diagram for ISR 4, Section 1, 2 ..... 245

Figure D.5. Block Diagram for ISR 4, Section 3, 4 ..... 246

Figure D.6. Block Diagram for ISR 4, Section 5 ..... 247

## CHAPTER 1

### INTRODUCTION

“When the well is dry, we know the worth of water.”

-Benjamin Franklin

#### 1.1 Overview

Until early in the 20<sup>th</sup> century, water was a scarce resource in West Texas (Reisner, 1993). Springs, streams, and rivers fed the occasional body of surface water, with indigenous grasses depending upon the grace of a long-awaited rainfall for survival. Some of the early settlers were quick to realize that there was an abundance of water beneath them, and began to drill wells and use windmills to pump water to the surface (Reisner, 1993). This discovery of a seemingly unending source of potable water influenced the region’s population and economics (Reisner, 1993).

For almost a century, settlers from West Texas to South Dakota have tapped this underground sea of the High Plains, the Ogallala aquifer. Much of the land over the aquifer is used for agricultural purposes, from corn to cotton to livestock. All users have demanded their share of the water to support their families and livelihood. As a consequence, the aquifer is beginning to show signs of overuse (Reisner, 1993).

Current municipal water pricing practices neither fully recognize the dwindling availability of this undervalued resource, nor their subsequent economic responsibility to adjust prices accordingly (Lyons, 2005). Pricing mechanisms for these resources should be based on their replacement value, taking into consideration future supplies. By only incorporating financial costs rather than true economic valuation in the pricing these scarce water resources, serious depletion of these often slow-recharging groundwater resources has occurred in many areas of the United States (Reisner, 1993). Many municipalities in the Southwest and elsewhere face potential water distress due to lack of sustainable fresh water availability (Reisner, 1993). In order for these cities to continue to exist, other water resources must be found.

## 1.2 Problem Statement

Unchecked consumption has led to serious exhaustion of the slow-recharging water resource of the Ogallala aquifer in some areas of West Texas (Rainwater, 2007). Aquifer depletion for those areas looms on a 50-year horizon, or less (TWDB, 2007). This depletion comes from the continued drawdown of the resource for agricultural and thermal power uses (each 39% of total use), causing the prediction that the aquifer will be of diminished availability by the middle of the century (TWDB, 2007; Lyons, 2005).

Many cities face economic distress due to lack of sustainable fresh water availability (Phillips, 2007). In order for these cities to remain economically and physically viable, alternative water resources must be utilized.

Beneath the extreme southern portion of the Ogallala aquifer lies a deeper, brackish, but mostly untapped reservoir, the Santa Rosa aquifer (TWDB, 2007). The salinity of the Santa Rosa has kept it from being used for agricultural uses (Reisner, 1993). The prohibitive costs of purification have kept it from being used for drinking or any other use (TWDB, 2007).

The capacity of the aquifer is estimated to be 66 million acre-feet of water. Seminole currently consumes approximately 1800 acre-feet of water per year (1.64 MGD). Because the aquifer cannot be used for agricultural use at its current level of salinity, the aquifer lifespan is expected to be sufficient enough to provide Seminole and other potential adopters of the integrated wind-water system with potentially potable water for well over 1000 years (TWDB, 2007).

Many municipal water providers, including Seminole, Texas, do not take the aforementioned economic pricing responsibility for the increasing scarcity of their fresh water resources by increasing prices as water levels continue to drop (Lyons, 2005). As a consequence, there is a large difference between the costs of producing purified water through reverse osmosis (a replacement technology) and ground water sources that require little treatment to become potable.

Through the past several years, the costs of purifying water through reverse osmosis have declined (Busch, 2004). At the same time, the modern wind turbine has emerged with predictable economics and a lack of need for water to produce energy (Lyons, 2005). The cost of energy from the wind turbines is comparable to conventional energy sources. Further, wind turbines have predictable life-cycle and 20-year fuel costs since the turbines are independent of fossil fuel pricing (Flowers, 2005). These results have led us to integrate wind energy with reverse osmosis because of the significant energy requirements of the reverse osmosis process (Lyons, 2005). As a result, the integration of the two relatively mature technologies of wind energy and reverse osmosis becomes an attractive match to address an emerging threat to the continuing economic viability of a region heavily dependent on affordable energy and potable water.

The management and council of the city of Seminole has recognized the need to explore the technology and economics of obtaining sources of water other than the Ogallala aquifer (Phillips, 2007). As a result, they have agreed to work with Texas Tech University for the design

and possible implementation of a full-scale integrated wind-water system. This system will draw from the deeper, brackish Santa Rosa aquifer to provide a supply of potable water for the municipality. The installation of a municipal integrated wind-water system is attractive because the water distribution and storage system is already in place (Goodger, 2007). Water storage holds the ability to compensate for the time-variability of wind energy systems and allows for the possibility of time-shifting wind generated energy. This ability will be realized by an adaptive and intelligent control algorithm that will determine the best use of the energy produced by a wind turbine array.

The algorithm will determine the use of the produced energy in three ways, listed here in order of decreasing importance:

1. Producing potable water through reverse osmosis
2. Offsetting the costs of municipal electric loads
3. Selling excess energy to the grid

This research resulted in a detailed economic model of the entire system, as well as the derivation and development of an adaptive/intelligent algorithm for system control, dispatch of electricity, and process optimization. Data have been collected for use as an input to the control algorithm to generate a real-time water use profile, on a 5-minute interval. This interval has been chosen so that periods of water demand can be met with the required amounts of produced or stored water. Excess energy will be sold to the grid for revenue to the city from the electric utility provider. The objective of this system is for the municipality to utilize the Santa Rosa aquifer for all of its water needs, rather than focusing on blending the remaining Ogallala water with purified Santa Rosa water.

### **1.3 Research Objectives**

For the research proposed here, the objectives are:

1. Determine the average use and statistical distribution of the potable water consumption for the city.
2. Determine the wind resource and wind generated energy potential of the city.
3. Perform a detailed real-time analysis (5-minute intervals) and evaluation of the available wind energy resource (energy supply), potable water consumption, water system component electrical consumption (energy demand), and municipal electrical demand. This analysis results in a 24 hour by 12 month array used in comparing energy supply and demand.
4. Determine the associated costs involved in implementing a municipal-scale reverse osmosis system powered by wind turbines.
5. Using the above parameters, create a comprehensive algorithm for the adaptive and intelligent control of the wind-water system, as well as a sensitivity analysis of the cost of water to relevant influences.

To accomplish these objectives, data from both the city's well field and a nearby mesonet station have been collected and analyzed. Appropriate energy consumption analyses for the collective parts of the system have also been generated. Vendors were contacted in order to estimate a total system capital and operating cost. A system sizing procedure for the system and wind turbines and a control algorithm for the system was developed and designed using the results from the real-time data collection and analysis.

#### **1.4 Organization of the Dissertation**

Chapter 2 presents a review of the major research results found on water purification, wind energy, and wind resource statistical distributions. Chapter 3 presents data collection methods and the results of the statistical analyses performed on Seminole water use data. Chapter 4 contains the calculations for the assessment of the wind energy resource available in Seminole. Chapter 5 describes the annual average system sizing procedure for the integrated wind-water system. Chapter 6 is the optimization of the system sizing procedure and system economics. Chapter 7 presents the sensitivity analysis of different variables and their effect on the cost of water. Chapter 8 presents the adaptive/intelligent control algorithm. Chapter 9 contains the summary, conclusions, and recommendations for future work.

Data supporting the main body of the dissertation can be found in the appendices. Appendix A consists of the database for the system optimization procedure found in Chapter 6. Appendix B contains the parameter definitions for the adaptive/intelligent control algorithm in Chapter 8. Appendices C and D are the block diagrams of the interrupt service routines and background code for the adaptive/intelligent control algorithm.



## CHAPTER 2

### LITERATURE REVIEW

#### 2.1 Overview

In this chapter, the resources used in this dissertation are discussed along with prior work performed on renewable energy systems and desalination. These publications contain analyses performed on some of the different components involved in the integrated wind-water system proposed by this dissertation.

The resources are grouped in sections according to their subject matter, and then in subsections alphabetically by the lead author or agency. The following subjects are covered in this review.

1. Atmospheric Science
2. Wind Power Systems
3. Economics
4. Statistics
5. Information Systems
6. Water Resources
7. Renewable Energy Desalination

#### 2.2 Atmospheric Science

##### 2.2.1 Holmes

Holmes and his colleagues study the time history of a rear flank downdraft event that occurred in Lubbock, Texas in 2002. The major importance of the study of this event to the authors of the resource is that the gust event was within 1 m/s of the 50-year design period regarding wind loading on structures for the West Texas area.

The importance of this resource to this dissertation is its decomposition of wind speed time histories. In the resource, Holmes, et al, discuss the decomposition of a time series into “slowly-varying deterministic ‘running-mean’, and residual random ‘turbulence’ components.”

This method, implemented in the form of a moving average filter, removes the random turbulence of the time history, while preserving “the main features of the flow represented by the main low-frequency peaks and troughs (Holmes, 2007).” In this dissertation, the above filtering technique is applied to the water use data of Seminole in order to filter out the fluctuations caused by the water system as it drains and recharges itself. Discussion of the application of this moving average filter and its resulting implications on the Seminole water use data occurs in Chapter 3.

### **2.2.2 Schroeder**

Schroeder, et al, describe installations of the West Texas Mesonet (WTM) in their resource. The resource includes site criteria, descriptions of the meteorological equipment used to collect the observations, as well as the communications system used to relay the data observations back to the WTM headquarters at Reese Technology Center in Lubbock, Texas.

Of particular importance to this dissertation is the wind speed observation data recorded at the Gaines County, Texas (Seminole) mesonet site. The wind speed observation equipment used at that site is a R. M. Young model 05103 propeller anemometer, sampling at an interval of 3 seconds, and recording at intervals of 5 minutes. The resolution and accuracy of the wind speed measurements of the anemometer are 0.03 m/s and 2%, respectively. The minimum threshold for the wind speed measurements of this anemometer is 1 m/s.

Quality Assurance/Quality Control (QA/QC) of the West Texas Mesonet data is handled by software that “flag suspect data for manual review by a decision maker.” Ten meter data sampled at 5-minute intervals from the Gaines County mesonet site is used by the adaptive/intelligent control algorithm described in Chapter 8 of this dissertation. This 10m data is extrapolated to the assumed 100m turbine hub height for real time wind energy resource estimation.

Additional information and archived data for the Gaines County site, as well as the data for all of the stations included in the West Texas Mesonet, can be found at: [www.mesonet.ttu.edu](http://www.mesonet.ttu.edu) (Schroeder, 2005).

### **2.2.3 Vega & Letchford**

Vega and Letchford expand upon the topic of including directionality in their analysis of wind speeds at different West Texas Mesonet locations. The authors use two years of continuous 5-minute mean wind speed data from the 41 available stations of the West Texas Mesonet at the time of their analysis, and report on the changes in the Weibull shape and scale parameters of the observed wind data with changes in direction.

The authors of this resource give the equations for the Weibull distribution as:

$$f_v(v_i) = P(v > 0) \cdot \left(\frac{k}{c}\right) \cdot \left(\frac{v_i}{c}\right)^{k-1} \cdot \text{EXP}\left\{-\left(\frac{v_i}{c}\right)^k\right\} \quad (1)$$

$$f_v(v_i, \theta) = P(v > 0, \theta) \cdot \left(\frac{k(\theta)}{c(\theta)}\right) \cdot \left(\frac{v_i}{c(\theta)}\right)^{k(\theta)-1} \cdot \text{EXP}\left\{-\left(\frac{v_i}{c(\theta)}\right)^{k(\theta)}\right\} \quad (2)$$

where  $k$  is the non-dimensional Weibull shape parameter,  $c$  is the Weibull scale parameter (wind speed units), and  $P(v > 0)$  is the probability that the wind comes from any direction in (1), and comes from direction  $\theta$  in (2).

The authors of this resource also include the importance of wind energy in their study by stating:

...one of the main reasons to perform the directional analysis is because the traditional isotropic analysis assumes constant shape and scale parameters for all directions while in fact they can vary significantly with direction...For wind energy applications, generally the sites with the lower values of the shape parameter and higher mean speeds will have the highest total mean power density shape parameter. Therefore careful consideration of the directionality effect in estimating wind power density is essential.

The consideration of directionality in the analysis of a wind power resource was not applied to the wind resource analysis performed in Chapter 4 of this dissertation.

The authors express the need for further work on this subject in order to overcome limitations in their data set and the uncertainties involved in predicting wind speed and direction using their current methods. Many of the results of this resource have applications in future work regarding integrated wind-water control systems, or the application of renewable energy to energy-intensive projects (Vega, 2007).

## 2.3 Wind Power Systems

### 2.3.1 American Wind Energy Association (AWEA)

The paper written by the American Wind Energy Association (AWEA) on the subject of the economics of wind energy describes some of the economic and technological advances that wind energy systems have made in the past two decades. According to the paper, “the economics of wind energy have changed dramatically over the past twenty years, as the cost of wind power has fallen approximately 90 percent during that period.” The AWEA resource also includes cost of energy estimates as a function of wind speed, given that the energy available in the wind increases proportionally to the cube of the wind speed. The resource places some

emphasis on the economies of scale associated with large turbine projects compared to small (community wind) projects, stating that “transaction costs that can be spread over more kilowatt-hours with a larger project” will make the larger project more economical than a small one.

This dissertation considers the application of a community wind project to an otherwise energy intensive application of reverse osmosis. The wind turbine array displaces higher priced utility energy with lower priced renewable energy in order to positively affect the economics of both the wind and water aspects of this project, rather than solely selling energy to the grid.

The AWEA resource also places emphasis on the financing of a wind project, stating that “the cost of financing constitutes a large variable in a wind project’s economics,” making the project proposed by this dissertation sensitive to the opportunity cost of money used in the financial assumptions. An analysis of the cost of water’s sensitivity to the cost of wind turbine energy (installed capital cost) and the opportunity cost of money (bond interest rate) is presented in Chapter 7 of this dissertation.

The AWEA resource also includes a short section on the effects of tax codes and environmental regulations on a wind project, but these items are not considered in the course of this dissertation.

Some of the benefits of wind energy are given in a list from the AWEA resource:

“Wind energy provides ancillary economic benefits:

1. Less dependence of fossil fuels, which can be subject to rapid price fluctuations and supply problems
2. Steady income for farmers or ranchers who own the land on which wind farms are built, and for the communities in which they live
3. An increase in the property tax base for rural counties”

All three of the points on the above list are relevant to this dissertation. The point regarding the independence of renewable energy from fossil fuel price fluctuations is important, as these fluctuations drive the economics of the proposed project in terms of the value of the wind energy produced (AWEA, 2005).

### **2.3.2 Black & Veatch<sup>a, b, c</sup>**

The three Black & Veatch reports outline estimates of turbine installed capital costs for small turbine arrays in several different locations. These estimates will be considered in this dissertation for the Installed Capital Cost (ICC) of each turbine in the turbine array. These references also provide an example of turbine feasibility studies inclusive of relevant variables such as cost of turbine, cost of energy, and turbine siting.

The Black & Veatch resources are essential reading for understanding the complexity of community wind projects (projects less than 10 MW). Estimates of community wind energy projects are included in these resources as examples of the benefits that accompany community wind projects.

Black & Veatch's approach to site screening, especially in their energy estimates, could be updated to include the variability of the wind shear coefficient during different times of the day or year. Data regarding which shear coefficient is used is omitted from the earliest report, as are Weibull shape and scale parameters regarding the distribution of the wind resource at the prospective site. The wind shear coefficient is stated to be constant in instances that it is explicitly stated in these references.

In the most recent resource, the site screening for the town of Eastham, MA, wind shear coefficient values are calculated for each month of the year, but an annual average coefficient is instead used for the wind resource estimates. This shows that Black & Veatch are aware of the variations in the value of the shear coefficient over the course of the year, but have chosen to only partially include this in their analyses. The evolution of the technique involved in the site screening analyses is evident when the resources are compared in chronological order (Black & Veatch<sup>a,b,c</sup>, 2005).

### **2.3.3 Blanco**

Blanco, Manwell, and McGowan focused on the feasibility of wind/hybrid power systems for several islands in New England in their work. They began with a categorization of the islands by size, then by electrical consumption, and then a classification of the islands according to their main source of power, whether grid-connected or isolated. Each island then underwent an estimation of its wind resource in order to construct a net annual energy flow analysis, which generated a year-end estimate of wind energy supply and island electric demand. A similar analysis is performed on the integrated wind-water system proposed by this dissertation in Chapter 5.

In conducting the wind energy resource assessment, Blanco, et al. used available data from National Oceanic and Atmospheric Administration (NOAA) stations and Coastal Marine Automated Network (C-MAN) buoys. The authors introduced a correction factor to adjust the data sets "for year 2000 and to adjust for coastal or island sites as compared to ocean based sites. The factor was calculated by using the ratio between the average wind speeds for year 2000 and the 10-year average both at Logan International Airport in Boston and a conservative estimate of an 8% reduction in wind speed for potential island sites." In order to extrapolate the gathered wind data from the NOAA stations and the C-MAN buoys, the authors used a power law (wind shear) coefficient of 0.12 throughout the year, not taking into consideration seasonal or real-time changes of that shear coefficient value and its subsequent effect on estimating wind turbine power output. See the resource Walter (2007), and Chapter 4 of this work for a more in-depth explanation of the effects of wind shear exponents and estimation of wind turbine energy output.

Blanco, et al. also describes the different power supply schemes of the islands isolated from the mainland grid. Most of these islands utilize stand-alone diesel generators with the cost of energy being dependent upon the fuel cost. The authors' proposition was that the application of a wind/hybrid system would produce enough economic benefit to lower the cost of electricity for those islands by offsetting some of the cost of the fuel used to produce electricity. Other islands face the proposition of replacing damaged interconnects to the mainland in order to fix their supply problems, or converting to a wind/hybrid system as well. In this aspect, this resource by Blanco reinforces the prospect of the application of renewable energy to reduce the electrical consumption (energy cost) of many different energy-intensive projects.

The authors of the resource focus on an isolated approach to wind/diesel systems in their models of capital cost and cost of energy, using the projected available wind energy to offset the projected costs of diesel fuel. The analysis of the integrated wind-water system by this dissertation uses a grid-connected approach to system sizing and operation, because of the availability of utility energy to the project.

After establishing a basis of cost using solely diesel-generated electricity, the authors used the Hybrid2 and Homer models, both developed by the National Renewable Energy Laboratories (NREL). These models were used to determine the benefit of the turbines in terms of avoided diesel cost and a cost of energy assessment. This procedure was performed on several islands in order to find the best match between expected electrical demand and fuel charges as well as the size and number of turbines in the turbine array. The authors came to the conclusion that the turbines provided enough benefit in preliminary analysis to be studied in closer detail in future analyses (Blanco, 2002).

#### **2.3.4 Flowers**

In his work, Flowers describes some of the economic impacts associated with wind power installations. He states that one of the reasons why wind power has not caught on in some areas is not because the lack of wind resource, but rather because there is the availability of cheaper carbon-based energy resources in the area.

In a short history of wind turbine technology, Flowers tells of the increases in efficiency, decreases in cost, and increases in machine availability. Machine availability measures the time that the machines are available to produce energy, and has risen from about 65 percent operational availability in the early eighties to over 98 percent currently. Flowers states, "while we have made tremendous increases in technology and machine size, we have made equally important advances in the ability to efficiently operate and maintain the turbines."

According to Flowers, turbines have important economic development aspects as well. "Construction of a wind farm creates an estimated 1 to 2 jobs per MW. When the wind farm begins production, high quality jobs in operation and maintenance remain at an estimated 2 to 5

permanent jobs per 50 to 100 MW.” This is important to note in community wind projects, especially those in small towns where quality jobs may be scarce and the addition of any new job benefits the community. The externality of the economic benefit of the additional employment associated with turbine installations is not explored by this dissertation.

Flowers also provides a list of opportunities that he sees for the application of integrated wind and water systems, stating that:

Economic and energy development are increasingly in conflict with water availability as the population in drier regions increases. Wind development works hand-in-hand with water processing and can help solve water shortages.

Integration of wind development has opportunities in the following applications:

- Stock watering
- Desalination
- Irrigation
- Thermal electric generation water treatment
- Municipal water supply
- Wind-hydro integration
- Oil, gas, coal bed methane water treatment, and
- Village power (Flowers, 2005).

### 2.3.5 Hightower

Hightower presents a short synopsis of many international water statistics as well as appropriate costs for several different solutions to those problems. He states:

International organizations increasingly recognize water as an international security problem. In 1990, poor water supply and sanitation was the second leading cause of death and disability worldwide. Currently, over 50 percent of the world’s major rivers are dry or heavily polluted. Additionally, the amount of water needed continues to grow. By 2025, 20 percent more fresh water will be needed for irrigation and 40 percent more for cities to maintain current per capita water levels. *As the need for water increases, we can no longer solely rely on traditional water resources—nontraditional resources must be used to address water shortages.* (emphasis added)

Hightower’s concentration on nontraditional energy resources should be noted, as it is also the emphasis of this dissertation. The resource shows the total freshwater withdrawal from aquifers versus 1995 available precipitation. From this, it is evidenced that much of West Texas receives the majority of its fresh water from groundwater rather than fresh water resources. This imbalance creates the situation of overdrawing the groundwater resources in order to meet the region’s municipal and agricultural needs.

Hightower's work delineates the different total dissolved solids for each type of saline water and the costs associated with the purification of some of those types. The resource also lists the characteristics of the different types of saline and brackish water, which are important delineations when referencing water types.

Hightower states in his reference that the energy costs for the reverse osmosis treatment of brackish waters would require between 1300 to 3250 kWh per acre foot (4 to 10 kWh per 1000 gallons). The costs presented by this resource will be used as a benchmark for the costs generated by this dissertation (Hightower, 2005).

### **2.3.6 Lyons**

Lyons argues that, "the cost of water does not always reflect its value, resulting in wasteful practices." This statement is in agreement with one of the main emphases of this dissertation, that water producers do not take economic responsibility for the dwindling resource of water. This lack of responsibility leads to overuse and wasteful practice in its consumption. Lyons expects the cost of fresh water to rise to \$5.00 per 1000 gallons, while the desalination of seawater should drop to \$2.50 per 1000 gallons by 2025. Lyons states that in order for the cost of desalination to decrease, "finding ways to reduce energy cost is critical." The application of wind turbines to the integrated wind-water system proposed by this dissertation is evidence of one of the ways to reduce the energy cost of desalination.

Also in his work, Lyons also puts forth a cost system for producing potable water from fresh water or seawater, which will be used in comparison to the numbers generated by this dissertation. He states that "it currently costs \$2.00 per 1000 gallons to make clean water out of fresh water, and desalination of seawater costs \$3.50 per 1000 gallons. Reverse osmosis is energy intensive, requiring 3 to 5 kWh per cubic meter [of seawater]." This translates into a purification cost of 11 to 20 kWh per 1000 gallons of seawater, with brackish water purification requiring less energy to purify.

In his resource, Lyons also offers different cost levels for wind power over the past twenty years, citing its technological development as the reason for its declining costs (Lyons, 2005).

### **2.3.7 Manwell**

Manwell, McGowan, and Rodgers' textbook on wind energy provides a comprehensive look into the history and operations of wind turbines. The aerodynamics, mechanics, and electrical design aspects of turbines are presented in an in-depth format.

Of special interest to this dissertation are the sections of this resource that cover the aerodynamics of wind turbines. These sections were the theoretical basis for the equations used



in Chapter 4 of this dissertation. One curious omission from the sections on aerodynamics and wind turbine performance is the calculation of the wind turbine capacity factor. Capacity factor is a measurement of the actual performance of a wind turbine versus its performance potential, measured over the course of a year. The expression and application of this equation can be found in Chapter 4 of this dissertation.

Manwell, et al, also take into consideration the economic performance of turbines by referencing cash flows and capital costs, and assigning a capital value to the energy produced by a turbine. The authors of this reference briefly introduce a sensitivity analysis of the sensitivity of the cost of energy from a wind turbine to different parameters that must be taken into consideration when studying the feasibility of wind turbines. A similar sensitivity analysis is performed in Chapter 7 of this dissertation in order to determine the effect that various parameters have on the cost of water (Manwell, 2002).

### **2.3.8 Nelson, Barieau, Starcher**

This report by the Alternative Energy Institute proposes supplementing the pumping efforts of Canyon, TX with various wind power systems. The proposed systems involve coupling the wind turbine either mechanically or electrically to the municipal water system's wellfield pumps. These pumps provide fresh water from a relatively shallow depth to the municipality. The proposal is hindered by the large cost of energy associated with wind turbines at the time of writing (1980), which places wind turbine cost of energy several times that which could be purchased from the utility energy provider (Nelson, 1980).

### **2.3.9 Nelson & Starcher**

In this resource, Nelson and Starcher describe the actions they took to evaluate the wind and solar resource of the State of Texas over the years 1995-1999. Descriptions of the equipment used to collect the meteorological data are also included in the resource.

This dissertation used data collected from the Denver City, TX site of the West Texas A&M University (WTAMU) Tall Tower project to perform the wind energy resource analysis presented in Chapter 4. The WTAMU Tall Tower project is part of the research done by Nelson and Starcher. The Denver City site is described as "a site on SPS property at the power substation 3 miles east of Denver City. This tower is a four sided angle iron with the vertex of the tower faces pointing to the main compass points. Access to this site must be coordinated with SPS. Tower is located in an oil field in flat terrain. There is a tree wind break (4 m evergreens) 1/8 mile to the east and an old power plant (12 m height) 140 m west." For each site in the project, "two anemometers were installed at 10, 25 and 40 m (180 deg apart), wind direction at 10, 25, and 40 m, and solar horizontal and vertical (Li-Cor) and temperature at 3 m."

The data loggers that were used in the project were NRG 9300CL loggers with 12 input channels. “Data were sampled at 1 Hz and the following were stored: 15 minute averages and standard deviation plus daily maximum/minimum and time of occurrence.”

Sensors for the sites were “Maximum #40 three cup anemometer, Maximum #200P wind vane, the Li-Cor 200S solar pyranometer, and the NRG 100 or 110S temp probe.”

Quality control of the data occurred by visually inspecting the data, marking and discarding suspect observations. Other conclusions, including graphs of wind shear and expected wind power potential were produced by this resource, but not used in this dissertation (Nelson, 2000).

### **2.3.10 Walter**

Walter’s dissertation on the effects that wind speed and directional shear have on wind power systems in the stable nocturnal boundary layer explains the derivation of those stated effects from beginning to end. His dissertation focuses on diurnal shear coefficients and their effects on systems in the Great Plains. This emphasis exists not only because of the amount of work done in this region on this subject, but also because of the assumed homogeneity of wind effects for the majority of this region.

Both wind speed and directional shear effects can have a detrimental impact on the performance of utility (megawatt) scale wind turbines. These effects stem from the difference between intended machine operating inputs versus those influenced on the machine by the surrounding atmosphere. For example, the power output of a clockwise rotating machine is negatively affected by a clockwise rotation of the wind vector with height. This negative effect occurs because of the difference between the resultant vectors (original or modified) that are influenced by the wind speeds and directions at the differing heights of the blades during their rotational path.

This work comprehensively covers many of the effect of wind on wind turbines, and is an excellent resource for the explanation of the derivation of wind speed shear exponents (Walter, 2007).

## **2.4 Economics**

### **2.4.1 Osborne**

Osborne explains many of the basic concepts of game theory in his text, as well as many of their applications. Of special importance to this dissertation are the sections describing decision trees, as these sections are used in the design of the adaptive/intelligent control algorithm described in Chapter 8 of this dissertation.

Other important sections of this reference include the explanations of Nash equilibria and their determination through both mathematical and visual (game table) means. Many of the examples of games in this reference reflect real-world decisions and the illustration of how a mathematical solution to these decisions may be concluded.

Further work could be performed using data from this dissertation to assign payoff values in order to ensure that the decisions made by the adaptive/intelligent control algorithm are theoretically optimized (Osborne, 2004).

## **2.5 Statistics**

### **2.5.1 Larsen**

Larsen explores the theory and application of statistical methods to many forms of data. Many of the expressions in this text were used in the statistical analysis of the water use data that is performed in Chapter 3 of this dissertation. The theory behind sections of the adaptive/intelligent control algorithm presented in Chapter 8 covering water use data trends and the maximum likelihood estimates for standard deviation also originated from this resource.

Other sections of this resource include hypothesis testing, probability, data distributions, and as stated in the case of the control algorithm, different methods of parameter estimation (Larsen, 2001).

## **2.6 Information Systems**

### **2.6.1 Simon**

The text written by Simon on the subject of embedded software systems contains many of the basic elements in understanding these control systems. Models of basic CPU's as well as many of the other hardware components of embedded controllers explain the applications and constraints of these devices. Fundamentals of embedded software design are presented with examples of interrupts and background code, both of which are essential to the design of the adaptive/intelligent control algorithm presented in Chapter 8 of this dissertation.

Use of this text enabled the author of this dissertation to develop an algorithm that allows accommodation into different environments while at the same time maintaining the adaptive and intelligent control that customized it to the particular application of the integrated wind-water system proposed in this dissertation (Simon, 1999).

## **2.6.2 Wolf**

The text by Wolf served this dissertation by furthering the author's knowledge of embedded computer system design. This knowledge was applied to the adaptive/intelligent control algorithm in Chapter 8 of this dissertation. Some of the more basic, yet essential lessons learned from this resource were the partitioning of the algorithm's interrupt service routines and background code into different sections to make them more manageable and comprehensible. Many other basic applications of embedded control were applied to the formulation of the control algorithm.

The structure of processors, their requirements, and limitations were also among the knowledge gained from this resource (Wolf, 2005).

## **2.7 Water Resources**

### **2.7.1 Busch**

The resource written by Busch gives a history of the evolution of the role of reverse osmosis in seawater desalination. The major technological improvements of this evolution revolve around reduction in the energy consumption of the reverse osmosis units. Busch states that "since energy cost is the single largest factor in the cost of a seawater system, it is an obvious target for cost reduction." Like wind power, increased demand for these reverse osmosis units is encouraging cost-reducing advances in their design and technology.

Busch's focus on the reduction of the energy consumption of reverse osmosis units revolves around the evolution of the filtration elements used in the purification process. The newer filtration elements require less osmotic pressure to flow through, and can deliver higher flow rates with higher rejection rates than have been historically possible. The reduction of the osmotic pressure required to overcome the membrane reduces the energy consumption of the reverse osmosis unit pumps, while the increase in the rejection rate eliminates the need for the product water to pass through a secondary membrane prior to delivery.

Reductions in the capital costs of reverse osmosis units are also mentioned by Busch in this resource. Increases in element technology have reduced the number of membrane elements, pressure vessels, and pump sizes in the unit designs. Also included in this resource are several reverse osmosis unit designs and the results of the real-world applications of the technological advances listed above (Busch, 2004).

### **2.7.2 Environmental Protection Agency (EPA)**

The drinking water quality standards set by the Environmental Protection Agency (EPA) explain the national standards that all drinking water in the United States must meet. It defines the authority that the EPA and the individual states have in the establishment and certification of these clean water standards.

Of importance to this dissertation are the standards of Maximum Contaminant Levels (MCL) allowed in drinking water. The city of Seminole has failed to meet MCL requirements for arsenic and fluoride, and is held accountable for appropriate action to correct these infractions. This infraction is one of the catalysts that caused Seminole to consider the integrated wind-water system proposed in this dissertation (EPA, 2005).

### **2.7.3 HDR Engineering**

The report prepared for Seminole by HDR Engineering outlines the possibility of processing the municipal water supply of Seminole by utilizing a municipal-scale reverse osmosis system powered by conventional utility sources. Also included in this report are population forecasts and water demand forecasts for the city of Seminole, through 2050. Because this resource assumed energy supply solely through a utility energy provider, the cost of the reverse osmosis purified water is seen as economically unfeasible. In this dissertation, the application of renewable energy in the form of wind power reduces the cost of water by displacing higher priced utility energy with lower priced wind energy in order to show that an integrated wind-water system has feasible economics.

The HDR engineers caution that the historical population of Seminole has dropped over the past two censuses, and that the projected population and water demand may differ from what is reported in the report. In light of this information, population forecasts and their subsequent effect on water demand are not considered in the analysis presented by this dissertation.

The authors also make the oversight of assuming that “the only source of water for the area surrounding Seminole, Texas is groundwater from the Ogallala aquifer.” This is a misstatement, as the Ogallala is the only source of *fresh* groundwater for the area surrounding Seminole. The Santa Rosa aquifer, which is brackish, is also available to the area (HDR, 2005).

### **2.7.4 Mickley**

The resource by Mickley and Associates covers many of the computations associated with the costs of reverse osmosis concentrate disposal. Many different methods of disposal are covered in this resource, but the section of greatest importance to this dissertation is the section on disposal by evaporation pond.

Mickley begins the section with an explanation of the major advantages and disadvantages of constructing an evaporation pond. Among the disadvantages given is that the cost of the land and the area required for an evaporation pond may be financially detrimental enough to make the project economically unfeasible. These two considerations are of lesser concern in the case of Seminole, because there is an abundance of land at a relatively low cost surrounding the city (Phillips, 2008).

Specific assumptions for dike height, fences, roads and other service related items are explained in detail in this resource. Many of the operations and maintenance costs are explained, and then bundled in a flat rate of 0.5% of total costs.

Equations on sizing of the pond area, pond depth, liner costs, and other associated costs with building an evaporation pond are generalized by Mickley in order to make the equations applicable to almost every project. The equations are simplified as a regression model, with exogenous variables being the relevant parameters associated with the construction of an evaporation pond, and the endogenous variable being the total cost of the project. These equations are explained and solved for the case of Seminole in Chapter 5 of this dissertation (Mickley, 2006).

### **2.7.5 Reisner**

In his book, Reisner gives a very detailed account of the history of water policy and action in the American West. He details the social costs and efforts by such organizations as the Bureau of Reclamation and the Sierra Club as they affect policies regarding water reclamation and distribution. Many of the under workings of water policy and distribution are revealed in this text.

Of special importance to this dissertation is the rich history written on the role water and water rights have had in the American West. This publication gives the impression that the fight for water resources has just begun (Reisner, 1993).

### **2.7.6 Texas Commission on Environmental Quality (TCEQ)**

The drinking water standards set by the Texas Commission on Environmental Quality (TCEQ) explains the maximum contaminant levels (MCL) set by the State of Texas. These MCL's must meet or exceed the levels set for drinking water by the Environmental Protection Agency.

Levels are set for contaminants such as arsenic, lead, and other metals in the drinking water. Seminole currently exceeds the MCL for both arsenic and fluoride, and is taking steps to mitigate this problem. Other water standards, such as the standard for turbidity, emphasize the appearance, taste, and smell that are acceptable for municipal drinking water.

A section included in this resource explains the steps that a municipality or water district must take to notify the public in the event that water delivered to the consumer by the water provider does not meet EPA or TCEQ standards. As the Ogallala aquifer depletes further, and contaminants become more concentrated, the expectation for these notices increases for the people of West Texas and the Great Plains.

Of importance to this dissertation are the MCL's set by the TCEQ standard, as the water from the reverse osmosis system described in this dissertation must meet these standards in order to be considered potable (TCEQ, 2005).

### **2.7.7 Texas Water Development Board (TWDB)**

The Texas Water Development Board (TWDB) 2007 State Water plan describes the different groundwater resources and possible strategies for regions in Texas. It summarizes each of the regions in the state by giving the regions' boundaries, inclusive counties, and projected growth rate for that region. Conservation recommendations for the region in question are also included in the summary. The same type of summary is given for each of the groundwater resources in the state. Individual county growth rates are also listed in this resource.

This resource also describes the water demand and population projections for the entire state of Texas. A history of water planning in the state of Texas gives the results that the active consideration of the use of groundwater resources has had on the state.

Of interest to this dissertation is the section of this resource devoted to recommended water management and cost estimates for these different strategies. These estimates show that the system proposed by this dissertation has costs comparable to those systems proposed in actual applications. This result emphasizes the legitimacy of the project proposed by this dissertation, and its application to water-scarce regions that have a complementary renewable energy resource (TWDB, 2007).

## **2.8 Renewable Energy Desalination**

### **2.8.1 Carta**

The work done by the authors of this resource is to design a seawater desalination system for several of the Canary Islands. The proposed system would be powered exclusively by wind energy. Several different desalination techniques are evaluated by their system, including reverse osmosis. The plant size is optimized with regards to the wind power resource, rather than holding the amount of purified water constant and maximizing the benefit of the turbine array, as is done in this dissertation.

The authors consider the use of a flywheel as an energy storage device, with operational parameters set by the frequency of the mechanism. An operational strategy is based on these operational parameters, as well as the modular design and control of several different sized RO units (Carta, 2003).

### **2.8.2 Garcia-Rodriguez**

This resource evaluates the effect that different parameters have on the levelized cost of water for a wind-powered reverse osmosis system. Consideration of the size of the RO plant, which affects energy consumption, and the output of the wind turbine(s) are considered with the parameters of the annual average wind speed and RO plant capacity to determine the effects that a change in the parameter has on the cost of water.

The main purpose of this resource is to evaluate the economic performance of different system designs, and to output factors that influence the cost of water associated with these designs (Garcia-Rodriguez, 2004).

### **2.8.3 Hrayshat**

The main emphasis of this resource is to evaluate the wind power potential of different sites where the produced energy would be used to power a reverse osmosis desalination unit. The energy consumption of the RO unity, the salinity of the feed water, and the estimated amount of renewable energy available at the site are used to classify different regions in the country of Jordan.

This resource shows a re-alignment in the thinking involved in the estimation and use of a renewable energy resource (Hrayshat, 2007).

### **2.8.4 Kiranoudis**

This resource takes another look at plant size optimization subject to membrane and wind turbine type, which are affected by the different capacity levels of proposed RO systems. The authors apply mathematical models of RO plant operational parameters in order to calculate a cost minimization curve for desalted water, for their assumed salinities of both brackish (2,000 ppm) and sea water (35,000 ppm). These models are also utilized in a sensitivity analysis of the minimized cost of water to the shape parameter of the Weibull distribution of the site wind resource.

The resource makes the same general conclusions as this dissertation: the application of wind power to a reverse osmosis system can reduce the cost of the desalted water (Kiranoudis, 1997).



### **2.8.5 Mohamed**

This resource is a close model to the processes used in this dissertation. However, the RO unit proposed in this resource is a hybrid wind-photovoltaic system. The methodology of the system design is similar also to this dissertation, using the steps of:

- Evaluation of water needs
- RO unit sizing
- System energy needs
- Sizing of the renewable energy systems

This proposed system is modeled using data from a single typical summer and winter day. The simulation is performed utilizing real-time data for those two days, and then a monthly economic analysis is performed on the proposed system.

This resource briefly mentions utilizing water storage as a form of energy storage, as its cost is significantly lower than comparable battery (electric) storage. However, the water storage is only utilized to mitigate the energy variability of the photovoltaic system rather than the entire renewable energy system, including wind turbines (Mohamed, 2004).

### **2.8.6 Tzen**

This resource evaluates different renewable energy resources that could be considered to power various types of desalination systems. The authors mention that the sizing of the renewable energy source relative to the desalination system demand is essential to “provide a satisfactory supply of power and water at a reasonable cost.”

Different renewable energy sources are matched with the authors’ interpretation of a suitable desalination technology, with consideration of the variability of the energy resources and the salinity of the feed water. The author acknowledges potential problems between water demand and the variability of renewable energy systems. However, this resource does not acknowledge the potential of using water storage as a form of mitigation technique to compensate for the variability of the renewable energy resource (Tzen, 2003).

## CHAPTER 3

### ANALYSIS OF THE WATER USE DATA

#### 3.1 Introduction

The real-time water use data collected from the Seminole, TX municipal water supply is a rare and valuable resource. Most municipalities only log daily totals by hand, or rely on analog representations of water demand through the use of a circular chart recorder, an example of which is photographed in Figure 3.1 (Essoree, 2007). These representations do offer some information about the water use of a municipality, but have limited usefulness in calculating water use statistics.



Figure 3.1. Circular Chart Recorder

Increased accuracy and resolution are offered by a digital flow meter and data logger that have been installed in Seminole. The data recorded by this device allow for many different analyses to be performed on the water use data. The analyses of the water use data that were used in this dissertation are presented in this chapter.

#### 3.2 Equipment

The Seminole Public Works had installed an Eastech Badger 4400 flow meter at a choke point in the Seminole municipal water supply in 1999, prior to the initial investigations of this

dissertation. This choke point occurs after the settling tanks, which is a convergence point for the Seminole wellfield, but before the water is chlorinated for distribution to consumers (Goodger, 2007). All of the water from the Seminole wellfield passes through this choke point. Figure 3.2 shows a representative diagram of the wellfield system and the choke point where the flow meter and data logger are located. Figure 3.3 shows a picture of the settling tanks at the Seminole wellfield, as well as the building that houses the flow meter.

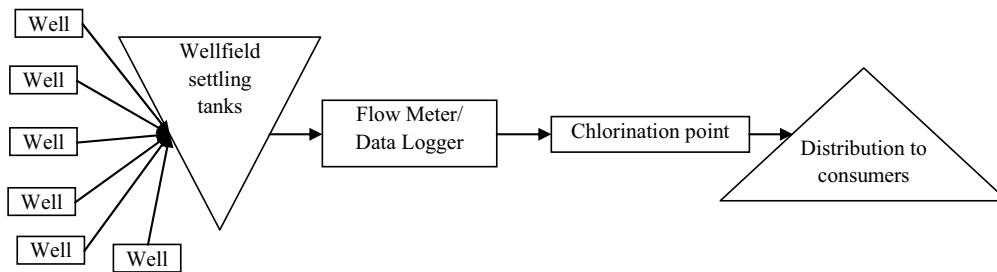


Figure 3.2. Wellfield System Diagram



Figure 3.3. Settling Tanks at Seminole Wellfield

The Eastech Badger 4400 flow meter/data logger is an ultrasonic flow meter that has the capability to both observe and record real-time water use data at a variety of intervals (Eastech, 2008). The interval has been set to record 5-minute observations of the flow rate data for this research.

The unit has several output options, but the one used to collect data for this dissertation is the RS232 serial port on the front of the unit. An internet interface and ethernet serial port have been placed at the wellfield choke point to provide remote access to the flow meter and its stored data. A picture of the flow meter and the data port are shown in Figure 3.4.

Data that was collected manually by the Seminole Public Works came from observing the display of this unit, and logging the data on a clipboard (Goodger, 2007).



Figure 3.4. Eastech Badger 4400 Flow Meter/Data Logger

The Eastech Badger 4400 flow meter has accuracy of up to +/- 0.5% of actual flow above 1 foot/second (Eastech, 2008), and its most recent annual calibration occurred in October, 2007 (Goodger, 2008). Figure 3.5 shows the arrangement of the circular chart recorder, data logger, and internet interface at the Seminole wellfield.



Figure 3.5. Circular Chart Recorder, Data Logger, and Internet Interface

The data from the Eastech flow meter is validated by Seminole Public Works comparing its recorded data to the amount of water that has flowed through flow meters located on each of the wells in the Seminole wellfield. The comparison of data from the different sources differs occasionally due to leaks in the lines from the wells to the flow meter, or when the wells are flushed (Goodger, 2008). Flushing the wells is an operation that releases water from the well that does not reach the flow meter in order to reduce the contaminants that may have collected in the well (Goodger, 2008).

Discrepancies observed between monthly observations of the summed wellfield data and the Eastech flow meter data have been reported to be less than 1% of average monthly flow (Goodger, 2008).

The data recorded by the Eastech flow meter is occasionally re-validated by a comparison of its reported flow to that recorded by the circular chart recorder (Goodger, 2008). The discrepancies between the Eastech flow meter and the circular chart recorder are reported to be minimal. Because the circular chart recorder represents a redundancy both in reporting and

quality control, the difference between its data and the data recorded by the Eastech flow meter has not been quantified. The low resolution of the chart recorded data contributes to why the data from the circular chart recorder is not considered for use in statistical analysis.

### 3.3 The Water Use Data Set

#### 3.3.1 Manually Collected Water Use Data

Daily water consumption data has been collected by hand by the Seminole Public Works department for several years (Goodger, 2007). This water use data from the years 2000 through 2006 was used to generate the monthly and annual average use of water by the city of Seminole. This data set shows the monthly and seasonal changes in water demand over the year, but does not have the resolution to show real-time changes in water use by Seminole.

The manually entered data is the record of water consumption over an approximate period of 24 hours, but is not collected at the same time every day (Goodger, 2007). Because of the variations in observation timing, the data is not a true representation of daily water use, and was not utilized in this manner for this dissertation. However, the variation in daily recording times was not expected to affect monthly or annual consumption totals, data which were utilized by this dissertation.

Annual average water consumption for the years 2000-2006 is shown in Table 3.1.

<b>Seminole Annual Water Use Over Past 7 Years</b>		
2000 Total (Jan-Dec)	670.0	Million Gallons
2001 Total (Jan-Dec)	638.6	Million Gallons
2002 Total (Jan-Dec)	634.2	Million Gallons
2003 Total (Jan-Dec)	674.0	Million Gallons
2004 Total (Jan-Dec)	585.5	Million Gallons
2005 Total (Jan-Dec)	582.4	Million Gallons
2006 Total (Jan-Dec)	598.9	Million Gallons

Table 3.1. Seminole Annual Average Water Use

#### 3.3.2 Real-Time Water Use Data

The real-time water use data from Seminole consists of 17 months of data (January 2006 through May 2007) collected at 5-minute observation periods from the choke point at the Seminole wellfield. These data were categorized by their respective months, and then by hour of the day. The raw data was subjected to a 20-period moving average filter in order to remove data flux while preserving the underlying trend of the data (Holmes, 2007). A description of the application of this low-pass filter is described in a later section of this chapter.

The data were then averaged over the days in their respective month to calculate the real-time 24 row by 12 column data archive matrix in Table 3.2. The real-time water use data is presented in the annual average analysis of Chapter 5 and used in the optimization of system sizing in Chapter 6. The data matrix is also used to compare current flow to historical flow by the adaptive/intelligent control algorithm presented in Chapter 8.

### **3.4 Quality Assurance/Quality Control**

#### **3.4.1 Seminole Data**

For quality assurance and quality control of the raw data from the Seminole data logger, the data was displayed both graphically and in array form to be visually inspected for obvious problems. Possible problems included periods where the flow meter was not operational, or missing observations. Because of the low occurrence of missing observations (less than 1%), and the small variability between the 5-minute observations, the observation for the period prior to the missing data was manually entered to replace the missing observation.

This manual entry procedure was taken to preserve the time continuity of the real-time data set. Because of the low variability between observations, the application of the moving average filter, as well as the sampling frequency, manual entry of missing data was not expected to significantly change the underlying flow characteristics.

Flow meter operational availability during the time of data observation (January 2006-May 2007) was 100% (Goodger, 2008).

#### **3.4.2 WTAMU and WTM data**

The data for the estimation of the wind resource for Seminole came from two sources. The 10 meter (surface level) data came from the Seminole station of the West Texas Mesonet. A description of this logging station can be found in Schroeder (2005). The 50m data came from the Denver City, TX site of the West Texas A&M Tall Tower project. A description of the project and its sites can be found in Nelson (2000).

Quality assurance and quality control measures were taken by the sources of the West Texas Mesonet (WTM) data, and the data from West Texas A&M University (WTAMU). Descriptions of the quality assurance and quality control steps taken by these institutions can be found in Schroeder (2005) for WTM, and Nelson (2000) for WTAMU.

**Average real-time water flow rate, in MGD, January 2006 through May 2007**  
(five minute data observation period, moving average smoothed over 20 periods)

Time of Day	Jan	Feb	Mar	Apr	May	June	July	Aug	Sept	Oct	Nov	Dec	AVERAGE
	MGD	MGD	MGD	MGD	MGD	MGD	MGD	MGD	MGD	MGD	MGD	MGD	MGD
Midnight	0.86	0.93	1.19	1.65	1.61	2.53	2.28	2.51	2.75	1.53	1.26	0.97	1.67
1:00	0.81	0.93	1.11	1.57	1.63	2.44	2.19	2.67	2.60	1.43	1.36	0.93	1.64
2:00	0.76	0.85	0.98	1.49	1.55	2.36	2.16	2.79	2.54	1.41	1.29	0.95	1.59
3:00	0.72	0.78	0.86	1.41	1.45	2.35	2.19	2.71	2.66	1.55	1.21	0.88	1.56
4:00	0.66	0.70	0.82	1.35	1.44	2.41	2.21	2.74	2.88	1.78	1.22	0.87	1.59
5:00	0.62	0.62	0.82	1.28	1.37	2.45	2.25	2.90	3.07	1.96	1.34	0.89	1.63
6:00	0.60	0.58	0.85	1.20	1.38	2.50	2.28	3.05	3.20	2.01	1.43	0.81	1.66
7:00	0.65	0.59	0.89	1.19	1.51	2.54	2.33	3.09	3.25	1.96	1.33	0.76	1.67
8:00	0.70	0.66	0.95	1.24	1.61	2.57	2.40	3.14	3.29	1.84	1.17	0.79	1.70
9:00	0.77	0.74	1.04	1.37	1.66	2.58	2.47	3.12	3.32	1.73	1.19	0.92	1.74
10:00	0.83	0.86	1.13	1.50	1.61	2.59	2.52	3.05	3.25	1.62	1.36	1.02	1.78
11:00	0.91	0.93	1.24	1.59	1.60	2.60	2.53	2.96	3.11	1.51	1.47	1.10	1.80
12:00	0.95	1.01	1.31	1.62	1.52	2.56	2.49	2.73	2.91	1.39	1.42	1.17	1.76
13:00	0.99	1.02	1.27	1.61	1.42	2.50	2.41	2.43	2.71	1.31	1.30	1.19	1.68
14:00	1.01	1.04	1.19	1.56	1.40	2.38	2.32	2.27	2.56	1.26	1.19	1.17	1.61
15:00	1.02	1.01	1.08	1.48	1.39	2.31	2.19	2.32	2.49	1.25	1.17	1.12	1.57
16:00	1.00	0.98	1.08	1.39	1.39	2.25	2.00	2.31	2.54	1.20	1.17	1.10	1.53
17:00	0.97	0.94	1.13	1.33	1.37	2.22	1.79	2.25	2.60	1.16	1.14	1.02	1.49
18:00	0.94	0.92	1.23	1.36	1.37	2.29	1.61	2.26	2.63	1.17	1.14	1.01	1.49
19:00	0.91	0.94	1.25	1.46	1.36	2.36	1.56	2.29	2.59	1.22	1.15	1.04	1.51
20:00	0.91	0.96	1.22	1.58	1.48	2.45	1.71	2.39	2.53	1.29	1.17	1.10	1.57
21:00	0.91	0.98	1.17	1.69	1.66	2.51	1.94	2.44	2.59	1.36	1.20	1.05	1.63
22:00	0.91	0.97	1.16	1.75	1.68	2.58	2.18	2.55	2.65	1.46	1.18	0.99	1.67
23:00	0.91	0.97	1.20	1.75	1.63	2.59	2.27	2.57	2.67	1.52	1.18	0.99	1.69
<b>AVERAGE</b>	0.85	0.87	1.09	1.48	1.50	2.46	2.18	2.65	2.81	1.50	1.25	0.99	<b>1.635</b>
										<b>Annual Average</b>			

Table 3.2. Average Real-Time Water Flow Rate, in MGD

Because quality assurance and quality control measures had been taken by both of the data sources for the wind measurement data, no further quality control or quality assurance steps were performed on the data by the author of this dissertation.

### **3.5 Moving Average Filter**

A moving average filter has been implemented on the raw water use data collected by the data logger at the Seminole wellfield choke point. This 20 period moving average calculation preserves underlying trend information held by the data but reduces the effect of the flux caused by the inconsistent water system demand (Holmes, 2007). The trends exposed by the moving average filter give a better representation of the actual water use of Seminole, rather than the demand by the water system's storage tanks. A similar trend analysis is performed on the water use data by the adaptive/intelligent control algorithm presented in Chapter 8.

The real-time data presented in Figure 3.6 represents raw data gathered from the Seminole wellfield. This real-time data was recorded on 12 January, 2006, and shows the regular peaks and valleys that occur within the water use data at approximately 30 minute intervals. These peaks and valleys are the result of the drain and recharge characteristics of the water system's storage tanks. The storage tank levels (and subsequent demand) are controlled by the city's Supervisory Control and Data Acquisition (SCADA) system. The SCADA system regulates the city's water pressure by keeping a set amount of water within both the elevated and on-ground storage tanks (Goodger, 2007). The elevated storage tanks operate between approximately 75-95% capacity, and the on-ground storage tanks operate between approximately 90-95% capacity (Goodger, 2008), both of which contribute to the quick cycling of demand.



**One Day: 12 January 2006 Recharging Characteristics  
of Water Storage Tanks  
Raw Data: No Moving Average Calculation  
(5-minute periods)**

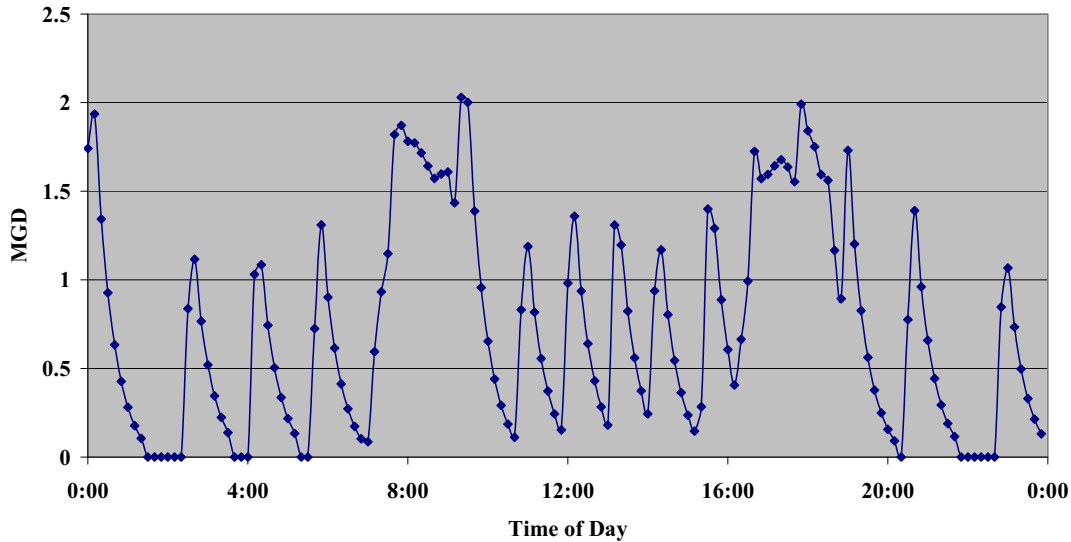


Figure 3.6. 12 January 2006 Recharging Characteristics

The average water use data for the month of January, 2006 is presented in Figure 3.7. This water use data benefits from the smoothing of some of the peaks and valleys that occur in the daily data, because the raw data has been averaged over the 31 days in January. An underlying trend can be visualized, but would not be evident to the adaptive/intelligent controller without further refinement of the data.

Figure 3.8 shows water use data after it has been subjected to the moving average low-pass filter. The raw data is smoothed using a 20 period (100 minute) moving average filter, the length of which preserves the increasing or decreasing trend features of the data while removing the water use flux caused by the system filling and draining the water storage tanks (Holmes, 2007).

The raw data presented in Figure 3.6, which represents the water system's storage tanks drain and recharge schedule, may be viewed as Seminole's current demand by the *water* system of on-ground and above-ground storage tanks. The water system has to operate under the aforementioned constraints of the setpoint margins of the SCADA system. This contrasts to the moving-average filtered data presented in Figure 3.8, which may be a better representation of the

actual *consumer* water demand. The demand of the consumers in Seminole is unlikely to hold the peaks and valleys of the raw data.

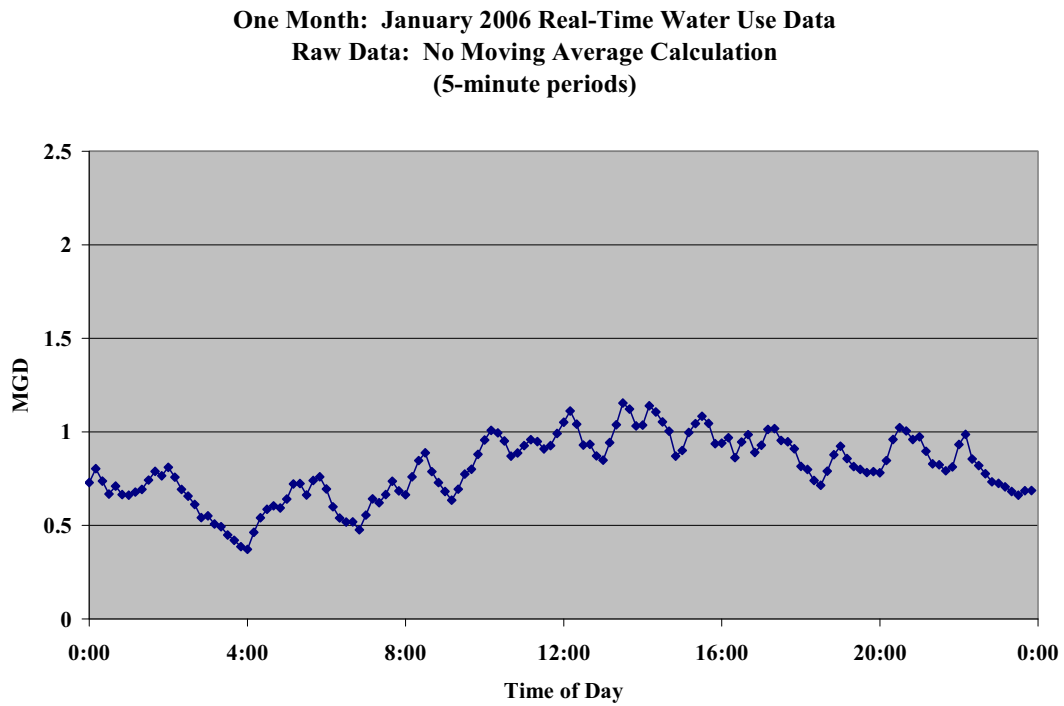


Figure 3.7. January 2006 Real-Time Water Use, No Moving Average Calculation

**One Month: January 2006 Real-Time Average Water Use Data  
20 Period Moving Average calculation  
(5-minute periods)**

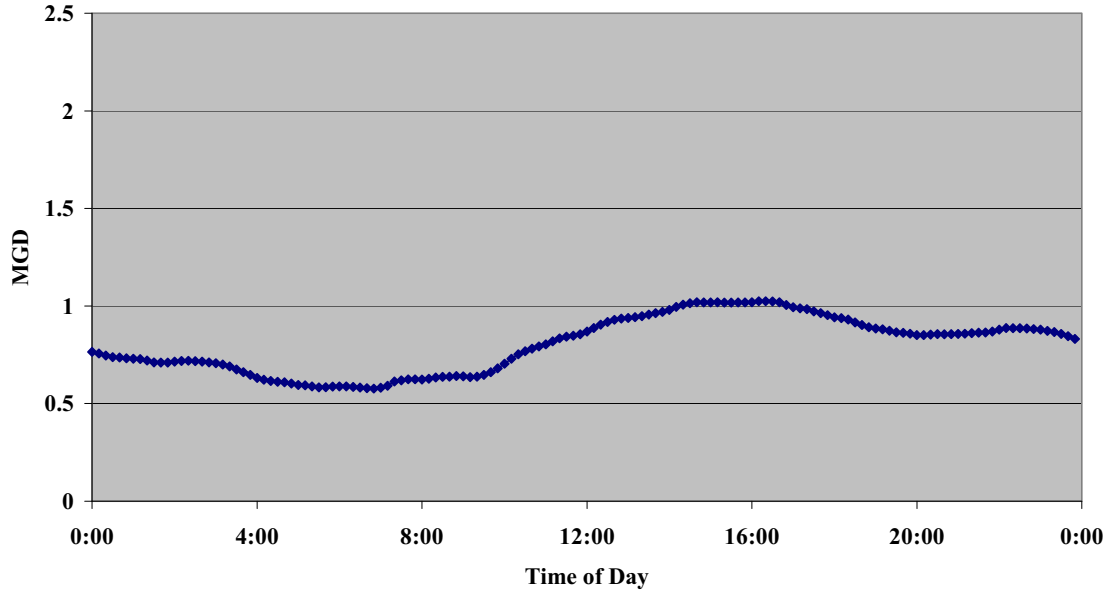


Figure 3.8. January 2006 Real-Time Water Use, Moving Average Calculation

### 3.6 Distribution Fitting

Finding an appropriate distribution to fit the Seminole water use data would be beneficial to the prediction of water use, especially to the adaptive/intelligent control algorithm presented in Chapter 8. Unfortunately, after several attempts at distribution fitting using the Matlab Statistics Toolbox and all available options within, no appropriate fit was found for the data.

By plotting the data in histograms, as shown in Figure 3.9 and Figure 3.10, it is shown that the water use data may be comprised of a multimodal probability density function. Attempts at separating the data into different modes included seasonal separations (quarterly), monthly separations (Figure 3.10 and Figure 3.11), and daily periods of high and low use (12-hour separations). These attempts proved to be fruitless, as most of the probability density functions of the different modes appeared as variations on the probability density function for the data before it was separated.

**Municipal Water Use Histogram**  
January 2006 - May 2007  
18 Bins, 0.25 MGD Bin Width

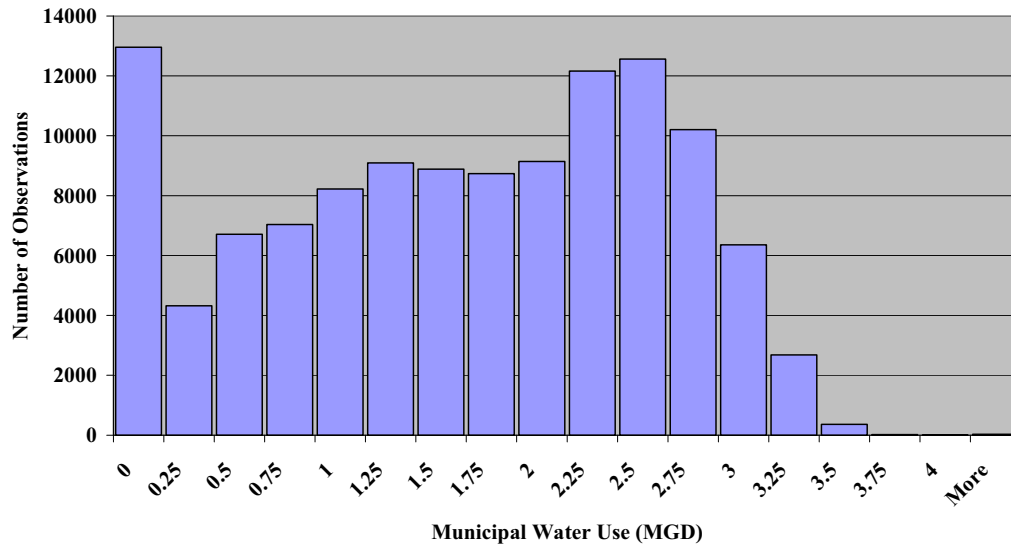


Figure 3.9. Municipal Water Use Histogram

**January Municipal Water Use Histogram**  
18 Bins, 0.25 MGD Bin Width

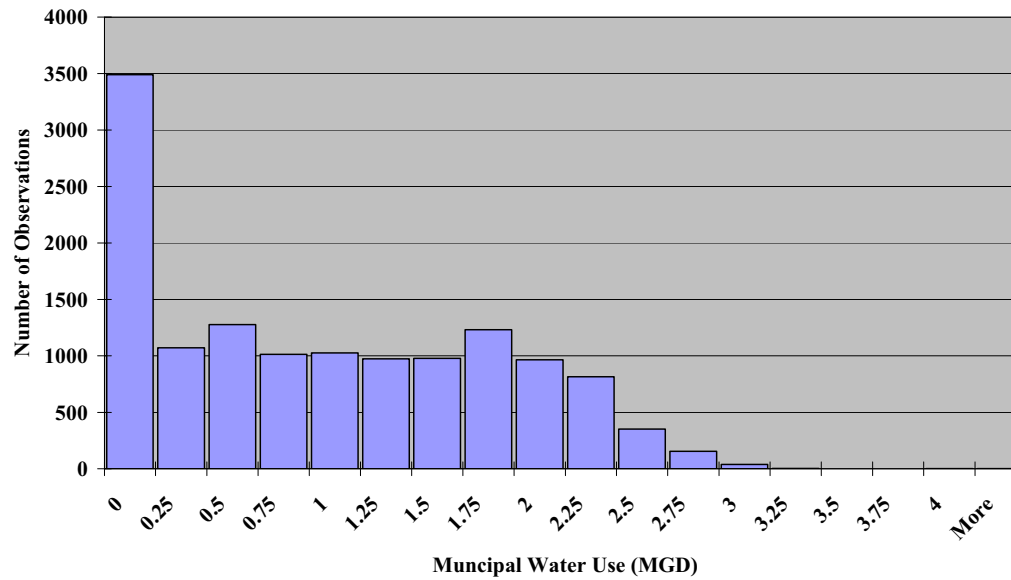


Figure 3.10. January Municipal Water Use Histogram

Of note in the histograms above are the large number of observations for the '0' bin. The reason for this spike can be evidenced in Figure 3.6, as the recharging characteristics of the water system's tanks produce many calm periods during the day. These calms occur throughout the year, excluding the high water consumption months of June-August, where the system is in a near constant cycling state.

The month of June, whose histogram is in Figure 3.11, is an exception to the rest of the water use histograms, as it appears to have a near-normal distribution. However, because this month represents only a portion of the data, assumptions of the distribution of this part cannot be applied to the rest of the data.

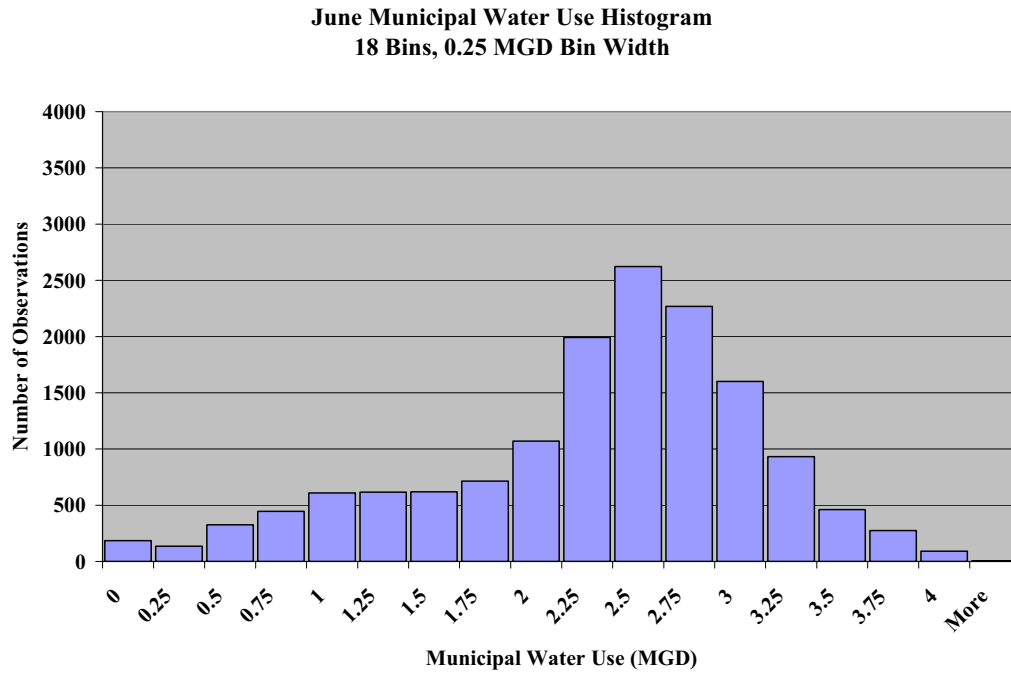


Figure 3.11. June Municipal Water Use Histogram

## CHAPTER 4

### DAILY/MONTHLY WIND ENERGY ASSESSMENT

### AND ASSOCIATED CALCULATIONS

#### 4.1 Introduction

This section of work covers the wind energy resource assessment for the city of Seminole, Texas. An array of wind turbines will provide the wind energy for the integrated wind-water system. To properly evaluate the economic impact of the wind turbine array and its benefit to the project's economics, an analysis of the city's wind resource is necessary.

Accurately estimating the wind energy assessment for Seminole is a crucial step for sizing the turbine array and projecting the benefits the array might bring to the project. The wind turbine energy estimates described here are based on data gathered from the West Texas Mesonet (<http://www.mesonet.ttu.edu/>) and from the West Texas A&M University (WTAMU) Alternative Energy Institute (AEI) Tall Tower Project.

The data from the West Texas Mesonet (WTM) is taken from the Seminole station. The station is a 10m tower located in flat terrain, and the data used spans the years 2002-2006. The data from the AEI Tall Tower project was from a 50m tower installed in Denver City, Texas, which is located approximately 21 miles NNW from Seminole. The AEI data used in this chapter spans the years 1996-2001. A full description of the West Texas Mesonet sites can be found in Schroeder, et al, 2005, and a description of the AEI Tall Tower Project can be found in Nelson, 2000.

The 10m and 50m data were averaged into hourly rows and monthly columns. Thus, each data set forms a 24 row (hour) by 12 column (month) matrix that was used to calculate an analogous 24 by 12 matrix of wind shear exponent values (power law). The wind shear exponent values were used in a power law equation to extrapolate the 10m West Texas Mesonet wind speeds to the 100m turbine hub height. The wind speeds measured by the West Texas Mesonet are sampled at 5-minute intervals, but the hourly average is used in the 24 by 12 matrix, since the values for wind speed and the shear exponent are not expected to have significant change in value over a one hour period.

The 100m hourly average wind speeds were then applied to the adjusted wind turbine power curve. This power curve has been corrected for the change in the density of the air in Seminole, which is 3313 feet (1010m) above sea level (Section 4.2). This correction is necessary

because turbine performance is negatively affected by upward changes in elevation (Manwell, 2002). The wind turbine modeled in this work was a GE 1.5sl (1.5 MW) turbine with a hub height of 100m (GE<sup>b</sup>, 2008).

These calculations will yield the expected energy output for a single turbine for the year, as well as the turbine capacity factor. The results will be used to assess the expected benefits of the turbine array in meeting the energy demands of the wellfield pumps, reverse osmosis system, distribution system, and municipal loads.

The application of the aforementioned calculations is found later in this chapter. A more rigorous explanation of the variation of wind shear with height, among other atmospheric phenomena that affect wind turbines, can be found in Walter, 2007.

## 4.2 Adjusting the Power Curve for Air Density

Differences in height above sea level affect turbine performance through changes in the density of the air (Manwell, 2002). Since Seminole is located 3313ft (1010m) above sea level, there is a change in both the standard temperature as well as the density. The international standard temperature at sea level is assumed to be 288.15 K, and from Manwell, 2002, the international standard atmospheric lapse rate (change in standard temperature per unit height) is calculated to be:

$$\left(\frac{dT}{dz}\right)_{\text{Standard}} = -\frac{0.0066^{\circ}\text{K}}{\text{m}} \quad (4.2.1)$$

Use of this equation determines the standard atmospheric temperature in Seminole to be 281.48 K. To determine the density of air at that height above sea level, the following equations are used:

$$\rho = 3.4837 \frac{p}{T} \quad (4.2.2)$$

$$p = 101.29 - (0.011837)z + (4.793 * 10^{-7})z^2 \quad (4.2.3)$$

where  $\rho$  is air density in  $\text{kg}/\text{m}^3$ ,  $p$  is pressure in kPa,  $T$  is temperature in Kelvin, and  $z$  is the site elevation in meters (Manwell, 2002). Equation 4.2.3 gives the international standard atmosphere assumption that “the sea-level temperature and pressure are 288.15 K (15 C, 59 F) and 101.325 kPa (14.696 psi), resulting in a standard sea-level density of  $1.225 \text{ kg}/\text{m}^3$ ” (Manwell, 2002). Using these equations, the corresponding air pressure in Seminole, Texas is 89.824 kPa, and the density is calculated to be  $1.111 \text{ kg}/\text{m}^3$ .

Wind power density is expressed by the equation:

$$P = \frac{1}{2} A \rho U^3 \quad (4.2.4)$$

where  $P$  is the available wind power,  $A$  is the swept area of the turbine rotor, and  $U$  is the velocity of the air. Wind power density is defined as the power available in the wind per unit of cross sectional area (Manwell, 2002).

The prior calculation of the change in air density from sea level (0m) to Seminole (1010m) calculates a 9.3% reduction in the available power of the wind. This reduction in available power will be rounded to 10% to provide a conservative estimate of the wind power potential of the site in Seminole. Figure 4.1 shows the power curve change due to air density. The original power curve was sourced from GE<sup>a</sup> (2008).

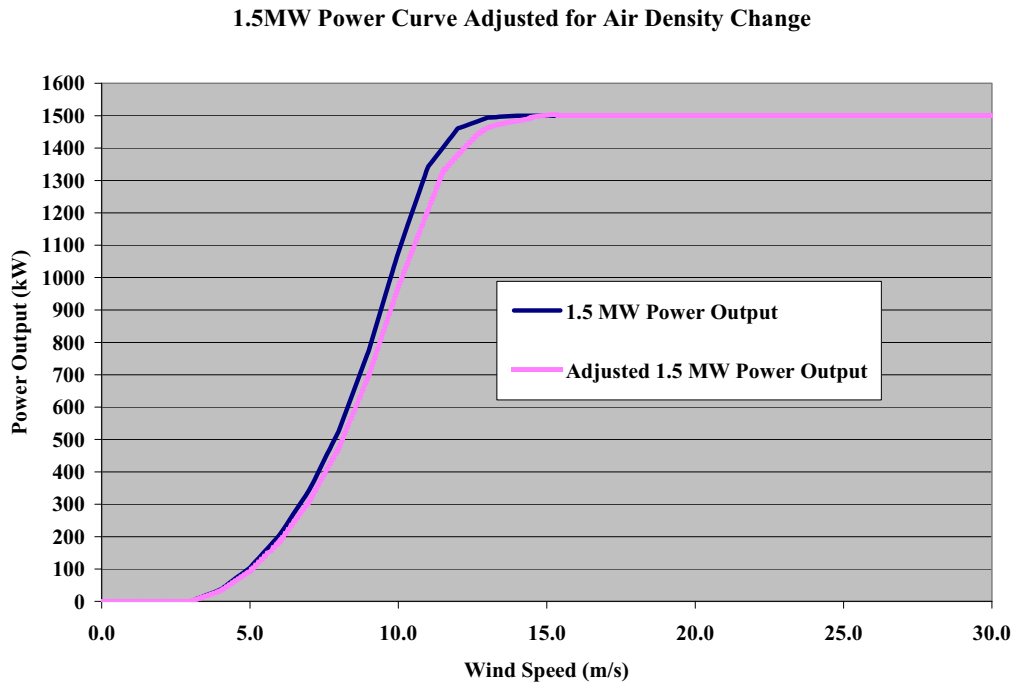


Figure 4.1. 1.5 MW Wind Turbine Power Curve Adjusted for Air Density Change

### 4.3 Processing of the 10m Wind Data

The 10m wind data comes from the West Texas Mesonet tower located near Seminole, Texas. This station measures and records a variety of atmospheric measurements; however, the only one that will be used by this research is wind speed. A complete description of the mesonet network and its associated measurements can be found in Schroeder, et al, 2005.

The 10m data is recorded as a 5-minute average of 3-second sampling intervals (Schroeder, 2005), which were categorized by month, and then averaged for each hour of the day, creating the 24 by 12 matrix of averages shown in Table 4.1. The data used spans the years 2002-2006. Figure 4.2 is a graphical representation of the data presented in Table 4.1.



**Wind Speed at 10 Meters by Month and Hour of Day**  
 (Obtained from West Texas Mesonet, Seminole Station: 2002-2006)

Hour	January	February	March	April	May	June	July	August	September	October	November	December	Average
	m/s	m/s	m/s	m/s	m/s	m/s	m/s	m/s	m/s	m/s	m/s	m/s	m/s
0:00	3.90	3.88	4.55	4.35	4.68	4.65	3.92	3.57	3.24	3.64	3.95	3.75	4.01
1:00	3.84	3.74	4.49	4.06	4.44	4.21	3.66	3.35	3.12	3.44	3.81	3.80	3.83
2:00	3.84	3.66	4.34	3.96	4.19	3.84	3.55	3.25	2.99	3.40	3.72	3.74	3.71
3:00	3.90	3.67	4.27	3.85	3.95	3.70	3.25	3.04	2.93	3.27	3.67	3.73	3.60
4:00	3.77	3.69	4.32	3.71	3.76	3.51	3.04	2.85	2.91	3.21	3.72	3.68	3.51
5:00	3.77	3.69	4.30	3.58	3.70	3.27	2.78	2.71	2.92	3.17	3.69	3.84	3.45
6:00	3.73	3.75	4.27	3.59	3.66	3.25	2.74	2.62	2.80	3.23	3.69	3.87	3.43
7:00	3.87	3.60	4.30	3.88	4.33	4.24	3.51	3.00	2.87	3.20	3.76	3.79	3.70
8:00	3.86	3.75	4.98	5.08	5.31	5.15	4.41	4.06	3.77	3.68	4.01	3.87	4.33
9:00	4.42	4.50	5.85	5.69	5.44	5.06	4.28	4.25	4.51	4.03	4.80	4.45	4.77
10:00	5.15	5.05	6.19	5.72	5.30	4.86	4.14	4.20	4.61	4.29	5.30	5.28	5.01
11:00	5.47	5.14	6.36	5.72	5.19	4.69	4.25	4.15	4.48	4.31	5.43	5.70	5.07
12:00	5.56	5.19	6.44	5.70	5.21	4.55	4.27	4.14	4.50	4.49	5.50	5.83	5.12
13:00	5.63	5.11	6.55	5.81	5.28	4.58	4.35	4.13	4.47	4.44	5.47	5.98	5.15
14:00	5.76	5.10	6.59	5.98	5.33	4.69	4.34	4.20	4.48	4.52	5.36	5.98	5.20
15:00	5.66	5.16	6.57	6.02	5.39	4.90	4.38	4.32	4.55	4.64	5.36	5.78	5.23
16:00	5.55	5.13	6.61	5.97	5.62	5.26	4.47	4.62	4.69	4.74	5.16	5.43	5.27
17:00	4.94	5.01	6.41	6.07	5.75	5.47	4.77	5.01	4.83	4.55	4.39	4.46	5.14
18:00	3.97	4.19	5.56	5.74	5.71	5.67	5.10	5.00	4.64	3.89	3.76	3.81	4.75
19:00	3.86	3.80	4.69	4.73	5.11	5.31	4.69	4.50	3.93	3.82	3.82	3.84	4.34
20:00	3.95	3.82	4.62	4.63	4.81	4.72	4.31	4.08	3.78	3.81	3.93	3.89	4.20
21:00	3.96	3.89	4.77	4.72	4.89	4.88	4.20	3.93	3.77	3.77	3.93	3.90	4.22
22:00	4.09	3.75	4.72	4.71	5.02	4.78	4.23	3.82	3.65	3.75	3.95	3.98	4.20
23:00	4.04	3.88	4.65	4.59	4.86	4.84	4.10	3.77	3.47	3.82	3.95	3.90	4.16
<b>Average</b>	4.44	4.26	5.27	4.91	4.87	4.59	4.03	3.86	3.83	3.88	4.34	4.43	<b>4.39</b>

Table 4.1. Wind Speed at 10 Meters by Month and Hour of Day

### Real-Time 10m Wind Speed by Month and Hour of Day West Texas Mesonet, Seminole Station: 2002-2006

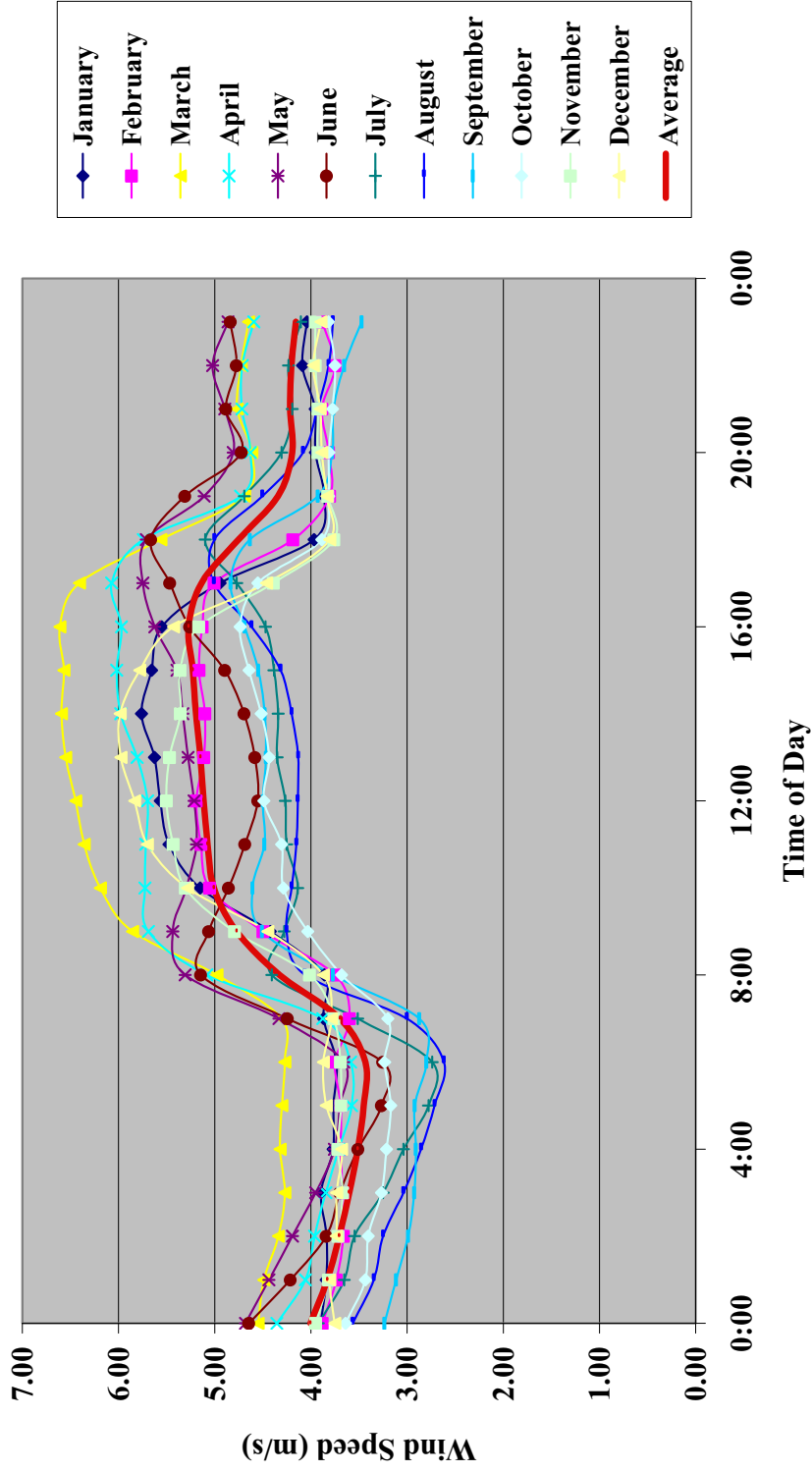


Figure 4.2. Real-Time 10m Wind Speed by Month and Hour of Day

#### **4.4 Processing of the 50m Wind Data**

The 50m wind speed data comes from the Alternative Energy Institute Tall Tower Project. The site which was used for this research was located in Denver City, Texas. The data used spans the years 1996-2001. This data was sampled at 1-second intervals, and averaged into 15-minute observations (Nelson, 2000). A complete description of the entire project can be found in Nelson, 2000. The data was categorized and averaged in the same way as the 10m data from the West Texas Mesonet, creating the 24 by 12 matrix of 50m wind speed data in Table 4.2. Figure 4.3 is a graphical representation of the data presented in Table 4.2.

**Wind Speed at 50 Meters by Month and Hour of Day**  
 (Using AEL Tall Tower Data, Denver City, TX: 1996-2001)

Hour	January	February	March	April	May	June	July	August	September	October	November	December	Average
	m/s	m/s	m/s	m/s	m/s	m/s	m/s	m/s	m/s	m/s	m/s	m/s	m/s
0:00	7.47	7.39	7.42	8.22	8.13	7.49	6.81	6.61	6.86	7.20	6.87	7.51	7.33
1:00	7.50	7.25	7.48	8.03	7.84	7.16	6.70	6.36	6.71	7.13	6.74	7.51	7.20
2:00	7.39	7.24	7.40	7.80	7.49	6.82	6.50	5.96	6.45	6.89	6.64	7.35	6.99
3:00	7.34	7.18	7.36	7.62	7.02	6.65	6.11	5.87	6.13	6.69	6.70	7.29	6.83
4:00	7.51	7.07	7.22	7.48	6.88	6.41	5.98	5.57	5.76	6.53	6.57	7.19	6.68
5:00	7.56	7.09	7.01	7.17	6.83	6.33	5.67	5.12	5.50	6.34	6.58	7.17	6.53
6:00	7.45	7.10	6.89	7.09	6.61	6.07	5.37	4.75	5.44	6.40	6.56	6.97	6.39
7:00	7.40	6.88	6.88	6.85	6.40	5.96	4.79	4.28	5.24	6.26	6.58	7.23	6.23
8:00	7.47	6.59	6.52	7.08	6.92	6.36	5.57	4.45	5.08	5.79	6.05	7.01	6.24
9:00	7.41	6.48	6.85	7.54	7.18	6.30	5.49	4.85	5.63	6.02	5.67	6.33	6.31
10:00	6.77	6.85	7.04	7.70	6.88	6.00	5.28	4.78	5.57	6.28	5.99	6.52	6.30
11:00	6.92	7.07	7.01	7.81	6.47	5.84	5.39	4.72	5.42	6.30	6.19	7.11	6.35
12:00	7.25	7.31	7.05	8.00	6.42	5.78	5.59	4.98	5.44	6.33	6.22	7.38	6.48
13:00	7.30	7.53	7.08	8.03	6.50	5.89	5.70	5.13	5.52	6.46	6.16	7.34	6.55
14:00	7.19	7.50	7.27	8.25	6.63	6.01	5.83	5.17	5.47	6.46	6.07	7.12	6.58
15:00	7.14	7.45	7.49	8.46	6.78	6.21	6.05	5.27	5.58	6.42	5.95	6.95	6.65
16:00	7.27	7.46	7.64	8.52	7.05	6.40	6.41	5.26	5.77	6.58	5.74	6.87	6.75
17:00	7.09	7.20	7.71	8.55	7.29	6.81	6.63	5.57	5.92	6.60	5.61	6.55	6.79
18:00	6.74	6.94	7.48	8.01	7.36	7.24	6.95	5.86	5.97	6.69	6.16	6.80	6.85
19:00	6.82	7.09	7.47	7.95	7.49	7.49	7.04	5.77	6.55	7.13	6.80	7.07	7.06
20:00	7.21	7.35	7.94	8.37	7.94	7.72	7.28	6.37	7.04	7.22	7.04	7.06	7.38
21:00	7.46	7.46	8.25	8.52	8.47	8.08	7.39	6.76	7.25	7.51	7.13	7.24	7.63
22:00	7.51	7.53	8.22	8.49	8.50	8.01	7.27	6.89	7.08	7.64	7.19	7.30	7.64
23:00	7.43	7.61	7.86	8.35	8.21	7.80	7.00	6.88	6.83	7.55	6.84	7.41	7.48
<b>Average</b>	7.28	7.19	7.36	7.91	7.22	6.70	6.20	5.55	6.01	6.68	6.42	7.09	<b>6.80</b>

Table 4.2. Wind Speed at 50 Meters by Month and Hour of Day

**Real-time 50m Wind Speed by Month and Hour of Day**  
**AEI Tall Tower Data, Denver City, TX: 1996-2001**

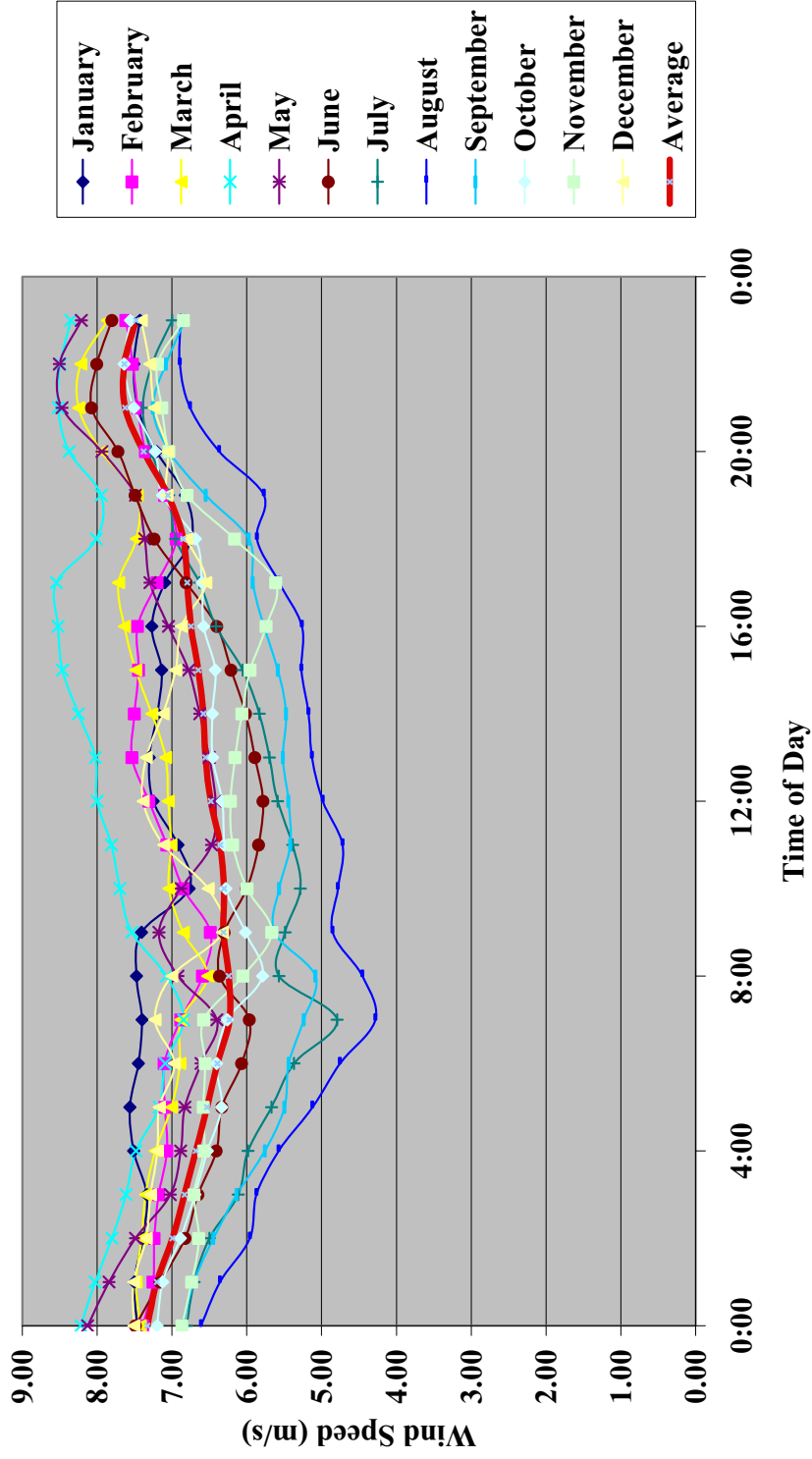


Figure 4.3. Real-Time 50m Wind Speed by Month and Hour of Day

#### 4.5 Calculation of Wind Shear Exponent Values

The basic wind shear (power law) equation is:

$$\frac{u}{u_r} = \left( \frac{z}{z_r} \right)^\alpha \quad (4.5.1)$$

where  $\alpha$  is the wind shear coefficient,  $u$  is the wind speed at height  $z$ , and  $u_r$  is the wind speed at height  $z_r$ . The height values for the variables used in this part of the research are:

$$z = 10 \text{ meters}$$

$$z_r = 50 \text{ meters}$$

In order to calculate the wind speed shear exponent from the 10m WTM and 50m AEI wind speeds, the equation must be solved for  $\alpha$ :

$$\alpha = \frac{\ln\left(\frac{u}{u_r}\right)}{\ln\left(\frac{z}{z_r}\right)} \quad (4.5.2)$$

The 24 by 12 matrices of the 10m and 50m wind data are used to create a matrix of the same dimensions, containing the values of  $\alpha$  in Table 4.3 below. Note that the commonly accepted shear exponent value of 0.14 (Blanco, 2002; Walter, 2007) for all times of the day and year is not applicable to the Seminole data. Use of this value would negatively influence the expected energy output of the turbine at hub height, as the commonly accepted value of 0.14 is below Seminole's average shear exponent value of 0.28. Therefore, in this analysis, the shear exponent values for each hour of the day, every month of the year are used. Figure 4.4 shows the changes in the shear exponent value over the hours of the day and throughout the year.

**Calculated Shear Exponent Values by Month and Hour of Day**  
 (Calculated using WTM 10m and AEI 50m Wind Speed Values)

Hour	January	February	March	April	May	June	July	August	September	October	November	December	Average
0:00	0.404	0.400	0.304	0.395	0.343	0.297	0.342	0.384	0.467	0.424	0.344	0.431	0.378
1:00	0.416	0.412	0.317	0.424	0.354	0.329	0.377	0.399	0.476	0.453	0.353	0.423	0.394
2:00	0.407	0.423	0.332	0.421	0.360	0.357	0.376	0.376	0.478	0.438	0.360	0.420	0.396
3:00	0.393	0.417	0.338	0.425	0.357	0.364	0.392	0.409	0.460	0.446	0.374	0.416	0.399
4:00	0.428	0.404	0.319	0.436	0.377	0.374	0.421	0.416	0.424	0.440	0.354	0.416	0.401
5:00	0.433	0.406	0.303	0.432	0.381	0.411	0.444	0.395	0.393	0.431	0.360	0.388	0.398
6:00	0.429	0.397	0.297	0.423	0.368	0.387	0.418	0.371	0.413	0.425	0.357	0.365	0.388
7:00	0.403	0.403	0.292	0.353	0.242	0.211	0.193	0.220	0.373	0.417	0.347	0.401	0.321
8:00	0.410	0.351	0.168	0.206	0.165	0.132	0.146	0.058	0.185	0.281	0.255	0.369	0.227
9:00	0.321	0.227	0.098	0.175	0.172	0.136	0.155	0.082	0.138	0.249	0.104	0.219	0.173
10:00	0.170	0.189	0.080	0.184	0.162	0.132	0.152	0.080	0.117	0.237	0.076	0.130	0.142
11:00	0.146	0.198	0.061	0.194	0.137	0.137	0.147	0.080	0.118	0.237	0.081	0.137	0.139
12:00	0.164	0.213	0.056	0.211	0.129	0.148	0.168	0.116	0.118	0.213	0.076	0.147	0.147
13:00	0.162	0.241	0.049	0.201	0.130	0.156	0.167	0.134	0.131	0.233	0.073	0.128	0.150
14:00	0.138	0.240	0.061	0.200	0.135	0.154	0.183	0.130	0.124	0.222	0.077	0.108	0.148
15:00	0.145	0.228	0.081	0.212	0.142	0.148	0.201	0.124	0.128	0.201	0.065	0.115	0.149
16:00	0.168	0.233	0.090	0.221	0.140	0.122	0.224	0.081	0.129	0.204	0.066	0.146	0.152
17:00	0.224	0.226	0.115	0.212	0.148	0.136	0.205	0.066	0.126	0.231	0.153	0.238	0.173
18:00	0.329	0.314	0.184	0.207	0.158	0.152	0.193	0.098	0.158	0.337	0.307	0.361	0.233
19:00	0.353	0.387	0.289	0.322	0.237	0.214	0.252	0.154	0.318	0.388	0.357	0.380	0.304
20:00	0.373	0.407	0.337	0.368	0.311	0.305	0.326	0.276	0.386	0.397	0.363	0.371	0.352
21:00	0.394	0.405	0.341	0.368	0.341	0.312	0.352	0.336	0.407	0.428	0.371	0.384	0.370
22:00	0.378	0.433	0.344	0.366	0.327	0.321	0.336	0.368	0.411	0.442	0.372	0.378	0.373
23:00	0.378	0.418	0.327	0.372	0.326	0.297	0.332	0.374	0.420	0.424	0.341	0.399	0.367
<b>Average</b>	0.315	0.332	0.216	0.305	0.248	0.239	0.271	0.230	0.287	0.342	0.249	0.303	<b>0.278</b>

Table 4.3. Calculated Shear Exponent Values by Month and Hour of Day

### Real-Time Shear Exponent Values by Month and Hour of Day Calculated Using WTM 10m and AEI 50m Wind Speed Values

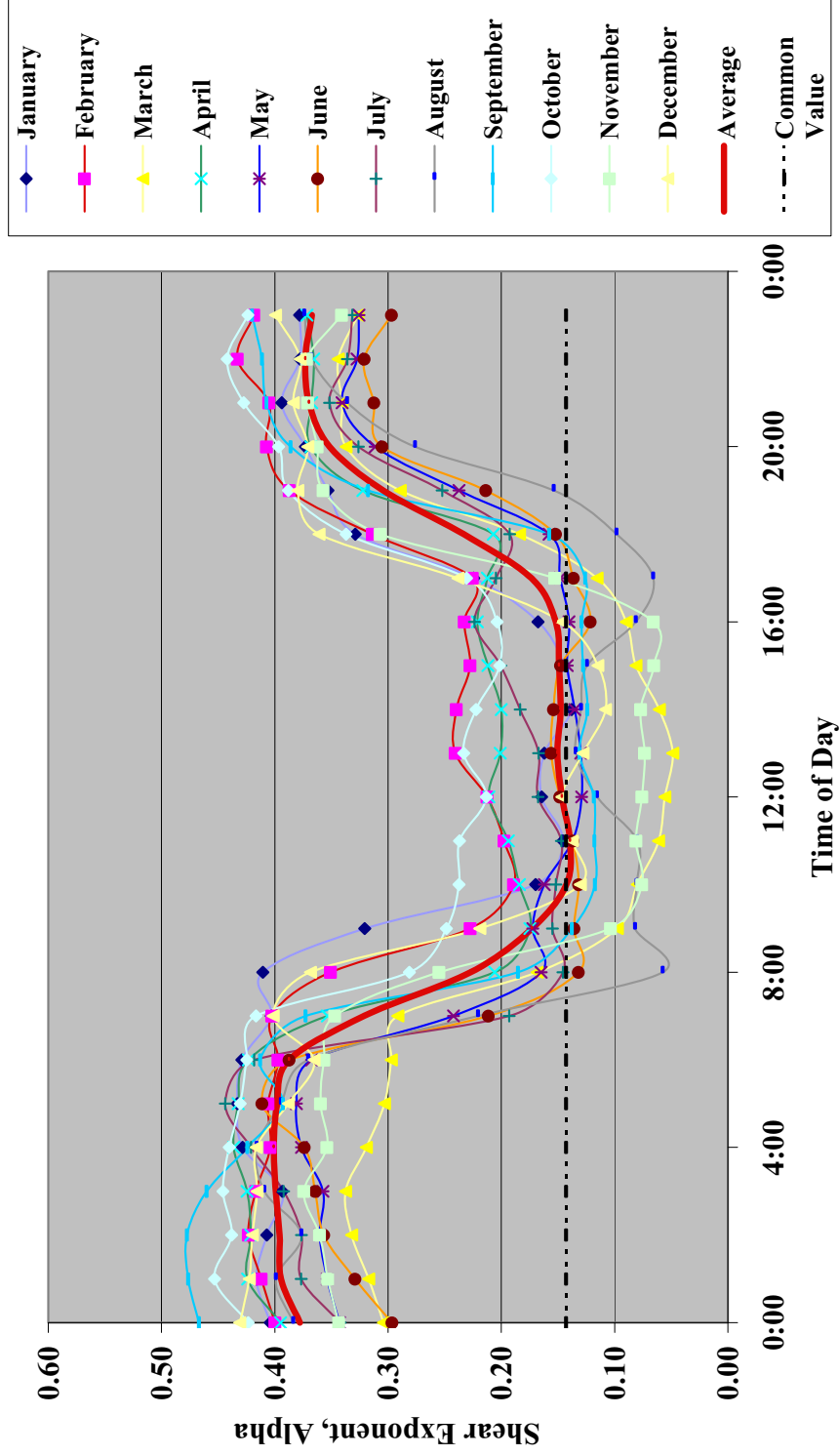


Figure 4.4. Real-Time Shear Exponent Values by Month and Hour of Day



#### 4.6 Calculation of 100m Wind Speeds

In order to calculate the 100m wind speeds from 10m data and the shear exponent values, the power law equation must be solved for  $u_r$ . By solving the wind shear power law equation for the 100m wind speed ( $u_r$ ), the following equation is formed:

$$u_r = u \left( \frac{z_r}{z} \right)^\alpha \quad (4.6.1)$$

Again, the values of the height variables used in this part of the research are:

$$z = 10 \text{ meters}$$

$$z_r = 100 \text{ meters}$$

The 100m average wind speeds above Seminole, extrapolated from the 10m data ( $u$ ), using shear exponent values calculated by observed 10m and 50m wind speeds are given in Table 4.4 below. Figure 4.5 shows a graphical representation of the data presented in Table 4.4. Figure 4.6 shows the monthly average wind speeds at both 10m (WTM) and 100m (extrapolated).

**Calculation of Wind Speeds at 100 Meters by Month and Hour of Day**  
 (Extrapolated from West Texas Mesonet 10m Wind Speeds using prior calculated shear exponents)

Hour	January	February	March	April	May	June	July	August	September	October	November	December	Average
	m/s	m/s	m/s	m/s	m/s	m/s	m/s	m/s	m/s	m/s	m/s	m/s	m/s
0:00	9.88	9.75	9.17	10.81	10.31	9.20	8.63	8.63	9.48	9.66	8.71	10.12	9.53
1:00	10.01	9.65	9.32	10.77	10.02	8.99	8.70	8.39	9.33	9.76	8.61	10.07	9.47
2:00	9.80	9.71	9.32	10.45	9.61	8.74	8.44	7.73	8.98	9.33	8.52	9.83	9.20
3:00	9.64	9.58	9.29	10.22	9.00	8.56	8.02	7.79	8.44	9.12	8.69	9.72	9.01
4:00	10.11	9.35	9.01	10.12	8.94	8.31	8.01	7.44	7.72	8.86	8.40	9.60	8.82
5:00	10.21	9.40	8.65	9.68	8.89	8.42	7.71	6.73	7.22	8.54	8.44	9.38	8.61
6:00	10.03	9.35	8.47	9.51	8.53	7.94	7.18	6.15	7.24	8.60	8.39	8.98	8.36
7:00	9.79	9.10	8.42	8.75	7.57	6.91	5.48	4.99	6.78	8.35	8.37	9.55	7.84
8:00	9.93	8.41	7.33	8.16	7.76	6.97	6.16	4.63	5.78	7.04	7.22	9.04	7.37
9:00	9.25	7.59	7.33	8.51	8.09	6.92	6.11	5.14	6.19	7.15	6.09	7.36	7.14
10:00	7.62	7.81	7.44	8.74	7.69	6.58	5.87	5.05	6.04	7.40	6.32	7.13	6.97
11:00	7.65	8.11	7.32	8.93	7.12	6.42	5.97	4.99	5.88	7.43	6.55	7.82	7.01
12:00	8.13	8.47	7.33	9.26	7.02	6.41	6.28	5.40	5.91	7.34	6.55	8.18	7.19
13:00	8.17	8.90	7.33	9.23	7.12	6.56	6.40	5.63	6.04	7.59	6.48	8.02	7.29
14:00	7.92	8.86	7.58	9.48	7.28	6.69	6.62	5.66	5.97	7.54	6.40	7.67	7.30
15:00	7.89	8.72	7.92	9.80	7.48	6.88	6.96	5.74	6.10	7.38	6.23	7.53	7.39
16:00	8.16	8.77	8.13	9.94	7.77	6.96	7.48	5.57	6.31	7.57	6.01	7.61	7.52
17:00	8.29	8.42	8.36	9.90	8.08	7.48	7.64	5.83	6.46	7.74	6.24	7.72	7.68
18:00	8.46	8.63	8.49	9.25	8.22	8.04	7.94	6.28	6.66	8.45	7.62	8.74	8.07
19:00	8.71	9.28	9.13	9.94	8.83	8.69	8.39	6.42	8.16	9.33	8.70	9.20	8.73
20:00	9.33	9.75	10.03	10.81	9.85	9.54	9.13	7.71	9.20	9.51	9.05	9.13	9.42
21:00	9.80	9.88	10.44	11.00	10.72	10.03	9.43	8.53	9.62	10.10	9.22	9.44	9.85
22:00	9.76	10.16	10.44	10.94	10.67	10.00	9.17	8.90	9.42	10.38	9.31	9.48	9.89
23:00	9.65	10.18	9.86	10.81	10.30	9.59	8.80	8.92	9.13	10.13	8.67	9.78	9.65
<b>Average</b>	9.09	9.07	8.59	9.79	8.62	7.95	7.52	6.59	7.42	8.51	7.70	8.80	<b>8.30</b>

Table 4.4. Calculation of Wind Speeds at 100 Meters by Month and Hour of Day

**Real-Time Extrapolated 100m Wind Speed by Month  
Extrapolated From 10m West Texas Mesonet Wind Speeds,  
Using Prior Calculated Shear Exponents**

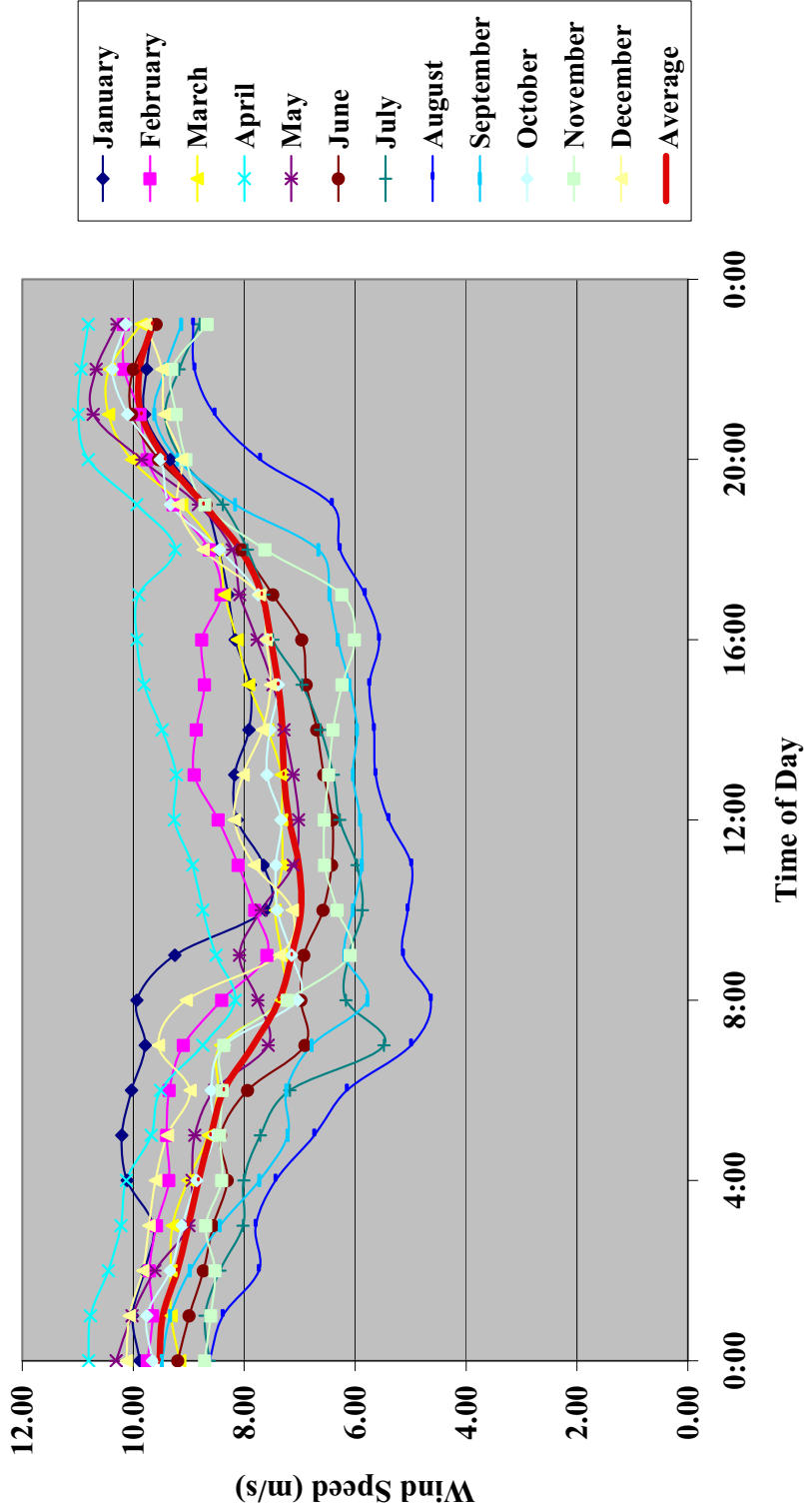


Figure 4.5. Real-Time Extrapolated 100m Wind Speed by Month and Hour of Day

### Average 10m and Extrapolated 100m Wind Speeds by Month

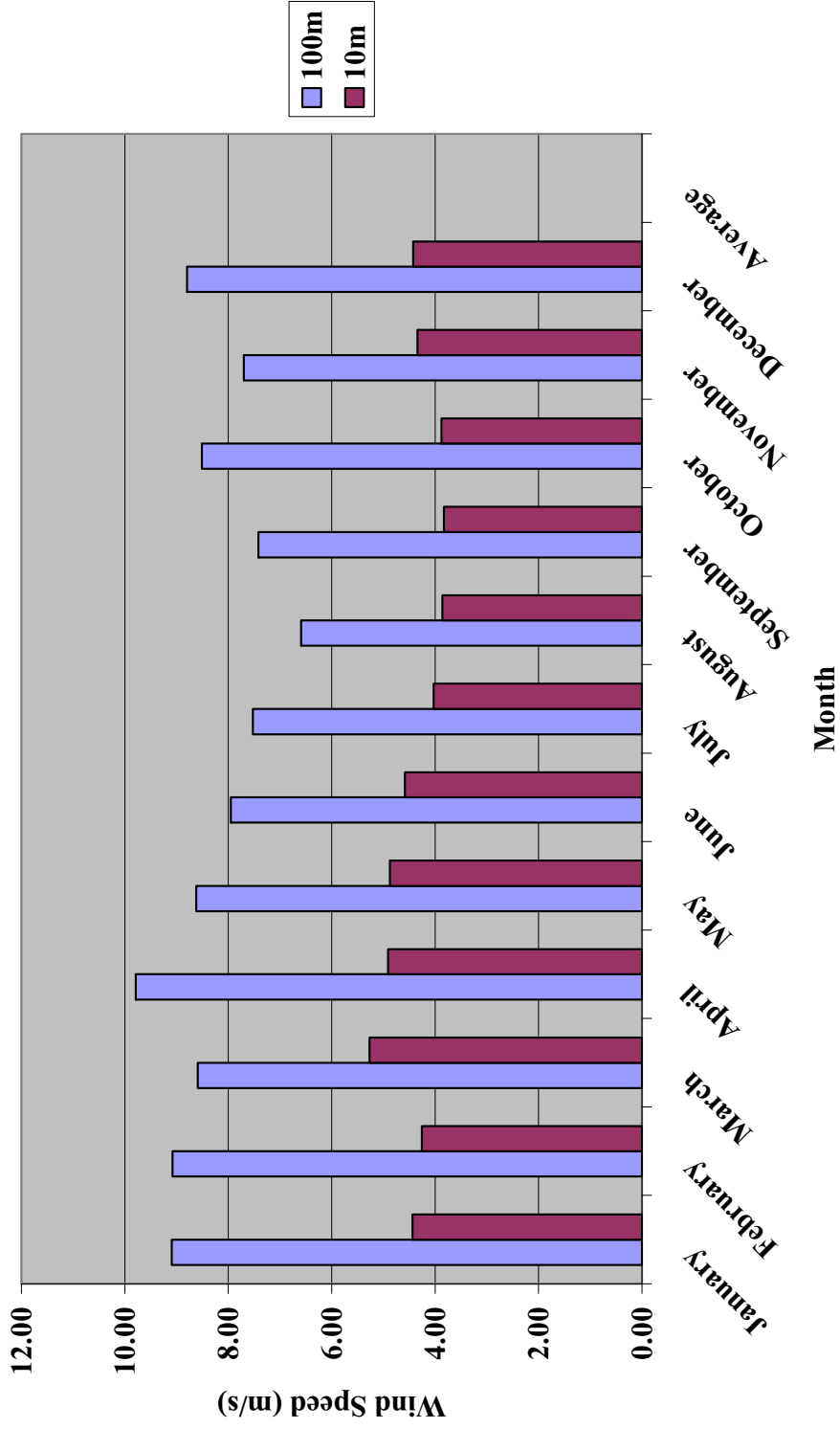


Figure 4.6. Average 10m and Extrapolated 100m Wind Speeds by Month

#### 4.7 Calculation of the Expected Power and Energy from the Wind Turbine

The 100m wind speeds in Table 4.4 were referenced to the wind turbine power curve adjusted for air density, which was shown earlier in Figure 4.1. The expected daily, monthly, and annual average energy output of a single turbine is presented in Table 4.5. The expected average energy output of a single turbine over each hour of the day, every month of the year is shown in Table 4.6. Figure 4.7 is a graphical representation of the data presented in Table 4.5. Figure 4.8 graphs the real-time expected wind speed production by month presented in Table 4.6.

<b>Expected Energy Output Sums by Month</b>			
	<b>Daily Sum</b>	<b>Monthly Sum</b>	
<b>January</b>	17,861	553,698	kWh
<b>February</b>	17,620	493,368	kWh
<b>March</b>	15,000	464,995	kWh
<b>April</b>	21,739	652,155	kWh
<b>May</b>	15,364	476,284	kWh
<b>June</b>	12,156	364,686	kWh
<b>July</b>	10,210	316,506	kWh
<b>August</b>	7,070	219,168	kWh
<b>September</b>	10,150	304,493	kWh
<b>October</b>	14,730	456,642	kWh
<b>November</b>	10,987	329,600	kWh
<b>December</b>	16,143	500,420	kWh
<b>Average</b>	14,086		kWh
<b>Annual Expected Energy Output Per Turbine</b>			
		5,132,015	kWh

Table 4.5. Expected Energy Output Sums by Month

**Seminole Estimated Monthly Wind Energy Production**  
**Total Annual Energy: 5.1 Million kWh, Capacity Factor = 0.39**

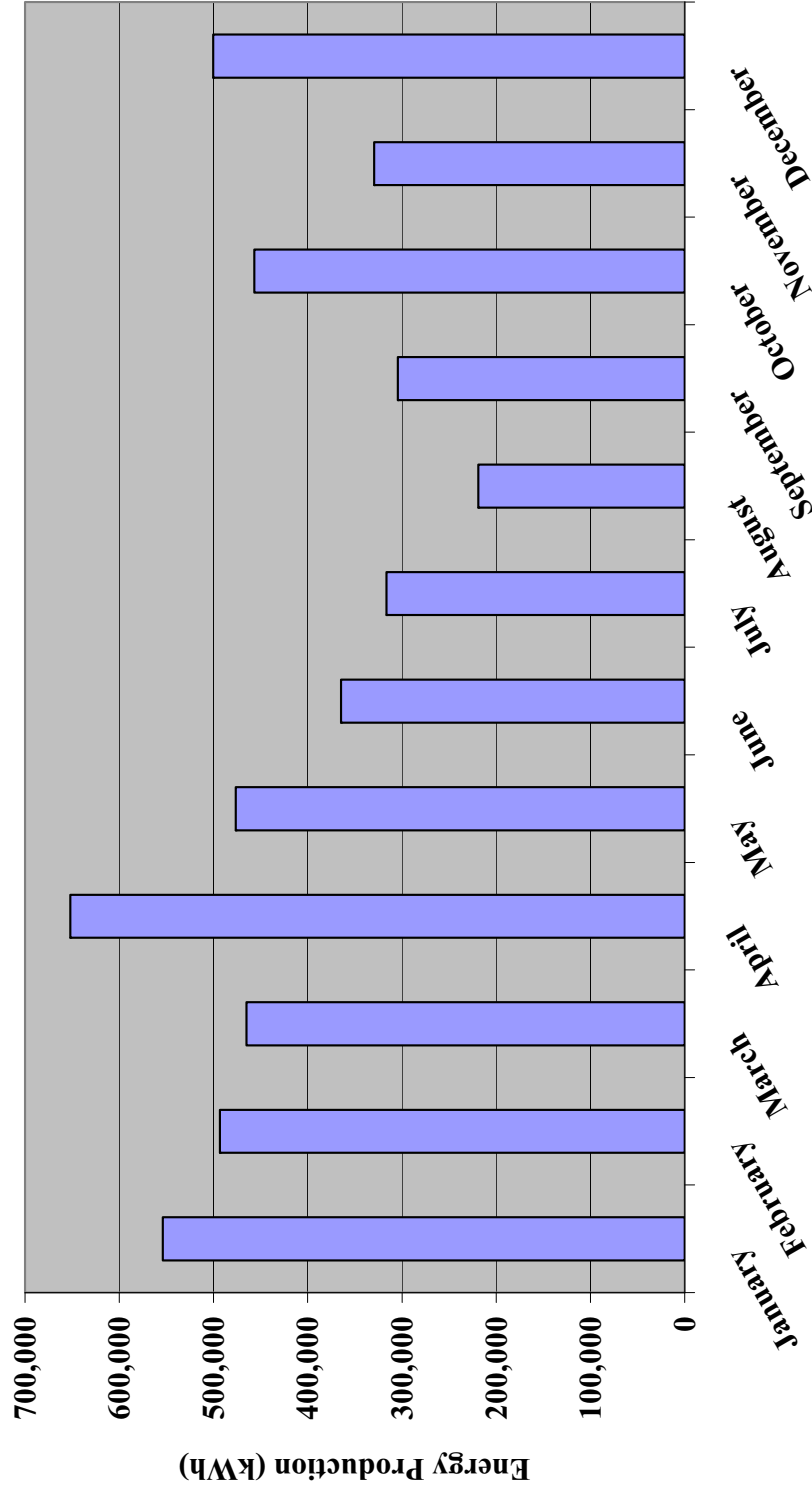


Figure 4.7. Seminole Estimated Monthly Wind Energy Production

**Expected Energy Output by Month and Hour of Day**  
(Extrapolated from WTM 10m Wind Speeds and calculated shear exponents, using power curve adjusted for air density)

Hour	January kWh	February kWh	March kWh	April kWh	May kWh	June kWh	July kWh	August kWh	September kWh	October kWh	November kWh	December kWh	Average kWh
0:00	944	889	752	1160	1042	752	608	608	834	889	630	995	842
1:00	971	861	779	1160	971	697	630	564	779	916	608	995	828
2:00	916	889	779	1066	861	630	564	426	697	779	586	916	759
3:00	861	861	779	1018	697	608	475	442	564	724	630	889	712
4:00	995	806	697	995	674	542	475	376	426	674	564	861	674
5:00	1018	806	608	889	674	564	426	272	343	586	564	806	630
6:00	971	806	586	834	586	459	343	197	343	608	564	697	583
7:00	916	724	564	630	409	297	139	94	285	564	564	834	502
8:00	944	564	359	519	442	310	210	69	166	310	343	697	411
9:00	779	409	359	586	497	297	197	103	210	326	197	376	361
10:00	409	442	376	630	426	260	175	103	185	376	222	326	327
11:00	426	497	359	674	326	235	185	94	175	376	247	442	336
12:00	497	586	359	779	310	235	222	130	175	359	260	519	369
13:00	519	674	359	752	326	260	235	148	185	409	247	475	382
14:00	459	674	409	834	359	272	260	157	185	392	235	426	388
15:00	459	630	459	916	392	297	310	157	197	376	210	392	400
16:00	519	652	497	944	442	310	392	148	222	409	185	409	427
17:00	542	564	564	944	497	392	409	166	247	426	210	426	449
18:00	586	608	586	752	519	475	459	222	272	564	409	630	507
19:00	630	779	724	944	652	630	564	235	519	779	630	752	653
20:00	779	916	971	1160	944	834	724	426	752	834	724	724	816
21:00	916	944	1066	1208	1137	971	806	586	861	995	752	806	921
22:00	916	1018	1066	1184	1137	971	752	674	806	1066	779	834	934
23:00	889	1018	944	1160	1042	861	652	674	724	995	630	916	876
<b>Monthly Average Per Day</b>	744	734	625	906	640	507	425	295	423	614	458	673	587

Table 4.6. Expected Energy Output by Month and Hour of Day

### Real-Time Expected Energy Production by Month Using Calculated 100m Wind Speed and GE 1.5 MW Adjusted Power Curve

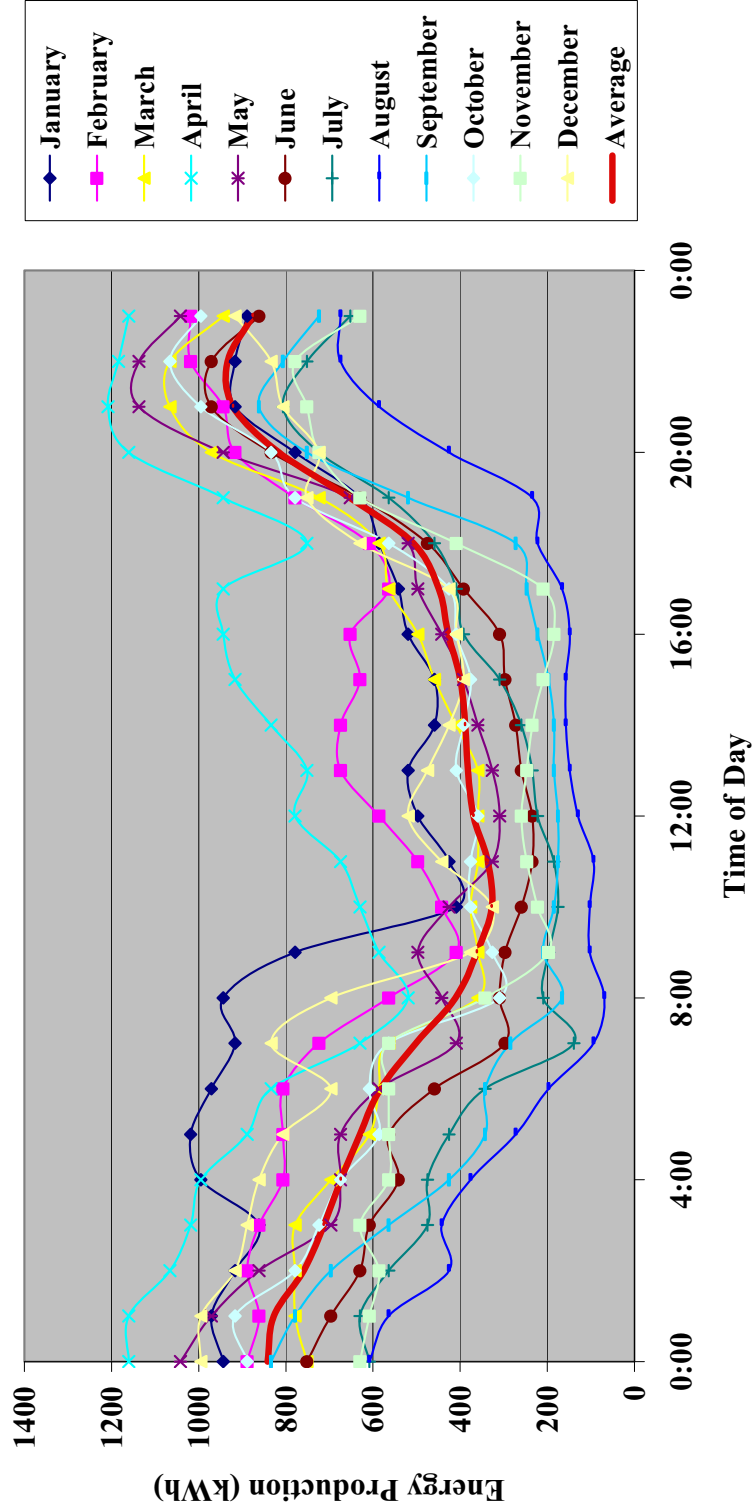


Figure 4.8. Real-Time Energy Production by Month and Hour of Day



#### 4.8 Capacity Factor Calculation

Wind turbine capacity factor is a measurement of the annual expected energy output for a turbine against the nameplate output, or rated capacity of the turbine over a year.

The equation for capacity factor (CF) is:

$$CF = \frac{\text{Annual Expected Energy Output (kWh)}}{\text{Rated Capacity (kW)} * 8760 \text{ hours}} \quad (4.8.1)$$

When this equation is applied to this research:

$$CF = \frac{5,132,015 \text{ kWh}}{1500 \text{ kW} * 8760 \text{ h}} = 39\% \quad (4.8.2)$$

## CHAPTER 5

### ANNUAL AVERAGE SYSTEM SIZING PROCEDURE

#### 5.1 Introduction

Determining consumption of both water and electricity is essential to the sizing of the reverse osmosis system as well as the wind turbine array. Daily (although not real-time) water consumption totals for the past seven years (2000-2006) were used to create annual totals, discrete monthly averages, and calculated daily averages.

The mean daily average use of the city of Seminole during this seven-year observation period is 1.712 million gallons of water per day (MGD). Seasonal and monthly variations are visible from this data period. This calculated average represents the longest time period of recorded Seminole water use data. The more comprehensive real-time consumption data for Seminole reports an average of 1.635 MGD, recorded from January 2006 through May 2007. This real-time number will be used throughout the report for calculations and analyses.

#### 5.2 Overview of Consumption

A digital data logger and internet interface have been placed on Seminole's main well field flow meter. A detailed description of this logger can be found in Chapter 3. This data logger captures instantaneous data and records 5-minute observations of real-time water use. These 5-minute observations are used in the decision making process of the control algorithm presented in Chapter 8, as well as in the optimization procedure presented in Chapter 6.

The data logged from the Seminole wellfield is unique because most municipalities do not digitally log their real-time water use data (Essoree, 2007). Most data are daily totals that are manually recorded, or are real-time water use data, recorded in analog fashion on a circular chart recorder (Essoree, 2007). Neither of these methods matches the accuracy or resolution of data recording offered by the digital data logger currently installed in Seminole.

The data presented in Figure 5.1 represents raw data gathered from the Seminole wellfield. This data was recorded on 12 January, 2006, and shows the regular peaks and valleys that occur at approximately 30 minute intervals. These peaks and valleys are the result of the drain and recharge schedule of the water system’s storage tanks. These tanks are controlled by the city’s Supervisory Control and Data Acquisition (SCADA) system. The SCADA system regulates the city’s water pressure by keeping a set amount of water within both the elevated and on-ground storage tanks (Goodger, 2007). The elevated storage tanks operate between 75-95% capacity, and the on-ground storage tanks operate between 90-95% capacity (Goodger, 2008).

**One Day: 12 January 2006 Recharging Characteristics  
of Water Storage Tanks  
Raw Data: No Moving Average Calculation  
(5-minute periods)**

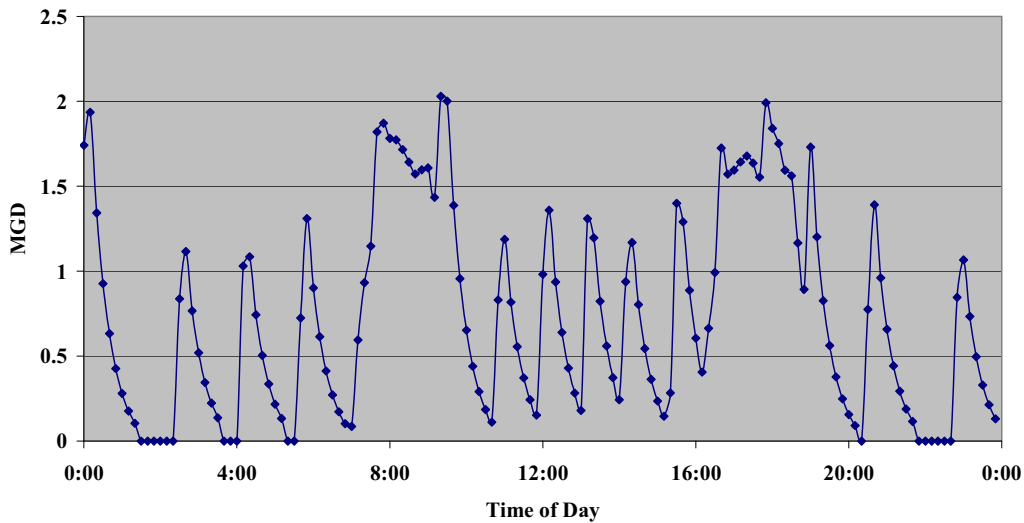


Figure 5.1. 12 January 2006 Real-Time Water Use

The average use data for the month of January, 2006 is presented in Figure 5.2. This data benefits from the smoothing of some of the peaks and valleys that are seen in the daily data, because the raw data has been averaged over the 31 days in January.

**One Month: January 2006 Real-Time Water Use Data**  
**Raw Data: No Moving Average Calculation**  
**(5-minute periods)**

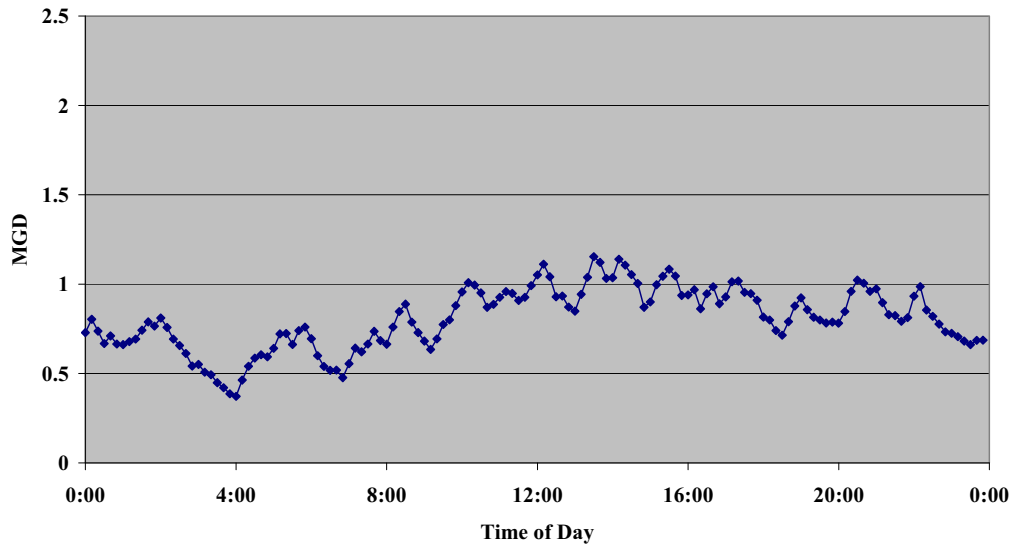


Figure 5.2. January 2006 Real-Time Water Use, No Moving Average Calculation

Figure 5.3 shows data after it has been through a moving average low-pass filter. The data is smoothed using a 20 period (100 minute) moving average filter. This low-pass moving average filter preserves the increasing or decreasing trend features of the data while removing the turbulence influenced by the SCADA system (Holmes, 2007).

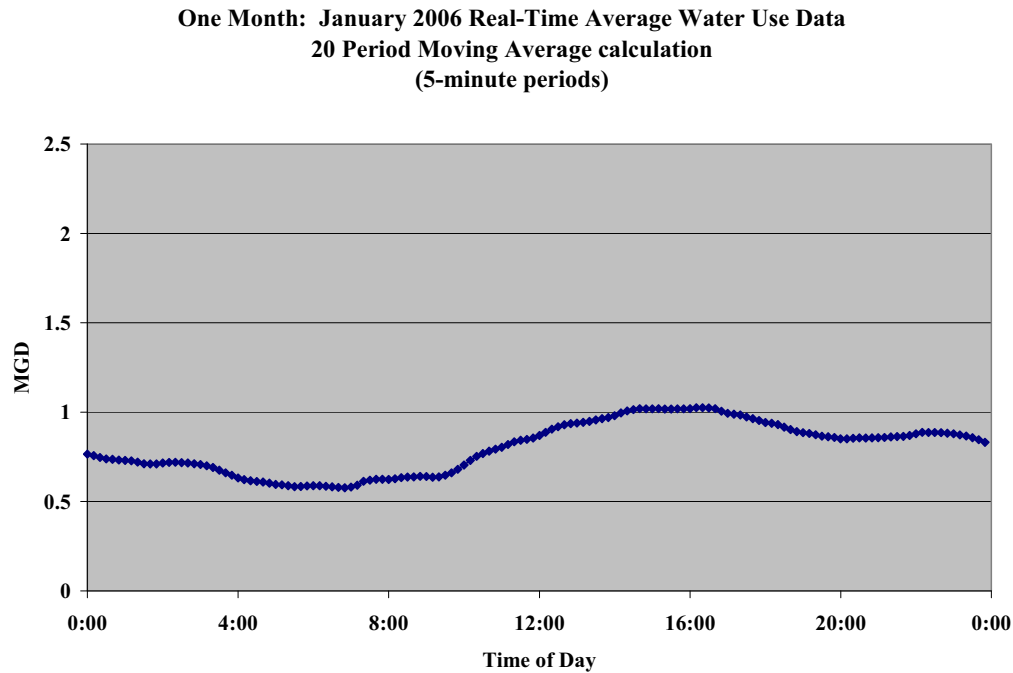


Figure 5.3. January 2006 Real-Time Water Use, Moving Average Calculation

Manipulation of the water system's operational setpoint margins may offer an opportunity to smooth out the recharge schedule of the storage tanks and operate the distribution system in a more efficient way. Increasing the efficiency of the distribution system holds the opportunity to possibly decrease the city's water system electrical demand costs by reducing electrical demand charges.

The raw data presented in Figure 5.1, which represents the water system's storage tanks drain and recharge schedule, may be viewed as Seminole's current demand by the *water* system. The water system has to operate under the constraints of the setpoint margins of the SCADA system. This contrasts to the moving-average filtered data presented in Figure 5.3, which may hold a better representation of the actual *consumer* water demand. The demand of the consumers in Seminole is unlikely to hold the peaks and valleys of the raw data, unless the citizens operate their sinks and toilets in concert.

A seventeen month analysis of this recorded and smoothed water data show mid-day and mid-night peak flow rates. The algorithm presented in Chapter 8 will take into consideration the expected water use during different time periods, which is a factor to be considered in the decision making process of whether to use the wind-generated electricity to pump water, power municipal loads, or sell excess energy to the grid. Of course, the wind-water system will use the grid as a backup in the cases where there is a wind energy deficit. However, the integrated wind-water system is expected to generate a positive return through cost minimization over a given time period, giving the system financial viability and economic sustainability.

The integrated wind-water system is based on the assumption that all of the water demanded by the city of Seminole will come from the Santa Rosa aquifer and pass through the reverse osmosis unit. Blending Santa Rosa water with Ogallala water will not be considered, although this could be considered an interim step until the current resource is depleted.

### **5.2.1 Annual Average Energy Consumption Study**

Based on an annual average energy consumption study, the turbine array cost and benefit analysis will be analyzed and rounded to the nearest whole number turbine. This calculation will come from system energy consumption as well as expected turbine array output. Excess energy from the turbine array will be considered a positive externality to the economics of the entire wind-water system. This excess energy will benefit the entire community by being routed to offset municipal loads, or in the event of a surplus, sold to the utility energy provider.

The annual average sizing procedure is appropriate for sizing some of the components of the water system. The wellfield, reverse osmosis, brine disposal, and distribution systems can all be appropriately sized by an annual average analysis, as their sizing procedures stem from annual average water use. The annual average procedure will be used for the sizing of the wind turbine array in this chapter, as the annual average energy production is a commonly accepted sizing protocol for projects (Blanco, 2002). However, the opportunity for the maximization of the benefits contributed to the project by the wind turbine array can be found in Chapter 6.

As energy costs continue to rise, the portion of municipal budgets allocated to energy obviously must increase (Phillips, 2007). This increase comes with an opportunity cost to the municipality when other budgets must be cut to compensate. The value of the offset energy will free up several hundred thousand dollars per year of municipal funds for other uses, and provide the most effective use of any surplus energy from the system in order to minimize the expected cost of water per 1000 gallons.

### **5.2.2 Section Equations**

As the Ogallala aquifer depletes, the resource becomes dearer to us. New policies on conservation and pricing will most likely occur; requiring many lifestyle and logistic changes regarding that diminishing resource. To discourage water resource abuse, the price of water will have to increase.

Current municipal water pricing practices neither fully recognize the dwindling availability of this undervalued resource, nor their subsequent economic responsibility to adjust prices accordingly (Lyons, 2005). Pricing mechanisms for these resources should be based on their replacement value, taking into consideration future supplies. By only incorporating financial, but not true economic costs of these scarce resources, serious depletion of these often slow-recharging groundwater resources has occurred in many areas of the United States (Reisner, 1993). As the price of water increases, other options that were not economically feasible now become viable alternatives to pumping Ogallala water. The remainder of this report

looks at the pumping of the alternate resource of the Santa Rosa (Dockum) aquifer to fulfill the water needs of Seminole.

The following section equations take into consideration current technology and pricing, both of which are subject to change over the life span of the project, either for the better or for the worse. The Cost of Energy (COE) purchased from the utility energy provider is assumed to be \$0.08/kWh, in accordance with information gathered from Xcel Energy as well as billing records from the Seminole Water Department (Chapman, 2007). COE is subject to change most frequently with fuel costs, which have been rising and continue to rise. Higher COE does not necessarily hurt the economics of this project (see the Sensitivity Analysis in Chapter 7), as the energy required for the entire system will be provided by wind energy on the aggregate, and the avoided cost of higher priced conventional energy will make the system more attractive. In addition, higher COE, and therefore a higher selling price to the utility energy provider (for our purposes assumed to be \$0.04/kWh, (Chapman, 2007)), will make any surplus energy more valuable in its savings to the city of Seminole, as it will provide consistently priced and relatively lower cost energy to the city.

Electrical demand charges are not considered in this work, because the electrical billing records for the city’s wellfield and distribution systems do not reflect that electrical demand charges are billed to the city. For the project, the Installed Capital Cost (ICC), associated financing, and Cost/1000 gallons all use a conservative 4.65%, 20-year municipal bond (Bloomberg, 2007).

At any point in the report where the Installed Capital Cost/1000 gallons is calculated, the following formula is used:

$$(\text{InstalledCapitalCost} / 1000\text{gallons}) = \left( \frac{iP}{1 - (1 + i)^{-n}} \right) / \text{TGUnits} \quad (5.2.1)$$

where the periods ( $n$ ) are considered to be yearly over the 20 year life of the bond, which carries a 4.65% rate ( $i$ ), as described above. The variable  $P$  is the capital cost of whichever part of the project for which the cost/1000 gallons is being calculated. The value of TG units is the actual number of Thousand Gallon (TG) units that would be pumped annually by a system continuously pumping an average of 1.635 Million Gallons per Day (597,538 TG).

To calculate TG units that would be pumped in a year from MGD, the following equation is used:

$$\text{ThousandGallonUnits} / \text{Year} = \frac{\text{MillionGallons}}{\text{Day}} \times \frac{1000\text{ThousandGallons}}{1\text{MillionGallons}} \times \frac{365\text{Days}}{\text{Year}},$$

which simplifies to:

$$\text{ThousandGallonUnits} / \text{Year} = \text{MGD} \times 365,000 \quad (5.2.2)$$

All other assumptions made are specific to the area of analysis, and will be listed accordingly.

### 5.3 Municipal Water Consumption

The longest period of monthly water use data from Seminole was collected from daily observation totals for the years 2000-2006. Annual totals are shown in Table 5.1. Average monthly use is calculated from this annual data set, and shows the variation in water use throughout the year. Average water consumption per day, by month, is calculated by dividing the monthly average use by the appropriate number of days in each month, and is shown in Table 5.2. As with the monthly average use numbers, the daily averages show which months have the highest or lowest daily use. This data is shown in a unit of measure that is of higher resolution and consistent with the units that are used subsequently (Million Gallons per Day, or MGD).

The historical water use data is then scaled to match the real-time use data in order to maintain continuity between the system sizing procedure and the real-time analysis. Since the historical data spans a longer time period than the real-time data, it contains more information on the month-to-month variation of water use by the city. The high resolution of the real-time data contains more information on the hour-to-hour variation of water use, but because of the shorter time period of its observations (17 months), it does not contain that same month-to-month information. Table 5.3 shows the scaled monthly and daily average water use by Seminole.

Year	Total (Jan-Dec)	Unit
2000	670.0	Million Gallons
2001	638.6	Million Gallons
2002	634.2	Million Gallons
2003	674.0	Million Gallons
2004	585.5	Million Gallons
2005	582.4	Million Gallons
2006	598.9	Million Gallons

Table 5.1. Annual Water Use by Seminole

<b>Monthly Average Use (Seven Year Average)</b>			<b>Average Water Consumption Per Day, by Month (Seven Year Average)</b>		
January	30.00	Million Gallons	January	0.968	Million Gallons
February	28.34	Million Gallons	February	1.001	Million Gallons
March	37.44	Million Gallons	March	1.208	Million Gallons
April	51.88	Million Gallons	April	1.729	Million Gallons
May	72.18	Million Gallons	May	2.328	Million Gallons
June	78.18	Million Gallons	June	2.606	Million Gallons
July	84.89	Million Gallons	July	2.738	Million Gallons
August	75.92	Million Gallons	August	2.449	Million Gallons
September	62.23	Million Gallons	September	2.074	Million Gallons
October	43.42	Million Gallons	October	1.401	Million Gallons
November	32.03	Million Gallons	November	1.068	Million Gallons
December	29.72	Million Gallons	December	0.959	Million Gallons
<b>AVERAGE</b>	<b>52.19</b>	<b>Million Gallons</b>	<b>AVERAGE</b>	<b>1.712</b>	<b>Million Gallons</b>

Table 5.2. Monthly and Daily Average Water Use by Seminole



Scaled Monthly Average Use (Seven Year Average)			Scaled Average Water Consumption Per Day, by Month (Seven Year Average)		
January	28.65	Million Gallons	January	0.924	Million Gallons
February	27.07	Million Gallons	February	0.967	Million Gallons
March	35.76	Million Gallons	March	1.153	Million Gallons
April	49.55	Million Gallons	April	1.652	Million Gallons
May	68.94	Million Gallons	May	2.224	Million Gallons
June	74.67	Million Gallons	June	2.489	Million Gallons
July	81.07	Million Gallons	July	2.615	Million Gallons
August	72.51	Million Gallons	August	2.339	Million Gallons
September	59.44	Million Gallons	September	1.981	Million Gallons
October	41.47	Million Gallons	October	1.338	Million Gallons
November	30.59	Million Gallons	November	1.020	Million Gallons
December	28.38	Million Gallons	December	0.916	Million Gallons
<b>AVERAGE</b>	<b>49.84</b>	<b>Million Gallons</b>	<b>AVERAGE</b>	<b>1.635</b>	<b>Million Gallons</b>

Table 5.3. Scaled Monthly and Daily Average Water Use by Seminole

In order to calculate the appropriate scaling factor, the following equation was used:

$$\text{ScalingFactor} = \frac{\text{RealTimeUseDailyAverage}}{\text{HistoricalUseDailyAverage}} \quad (5.3.1)$$

where the Real-time Use Daily Average is calculated from the collected real-time data, and the Historical Use Daily Average is calculated from the historical data in Table 5.2. The scaling factor is calculated at 95.5%.

The average real-time flow rate data in Table 5.4 shows actual recorded data from the city’s well field flow meter. This data is unusual in that most municipalities concentrate on logging only discrete daily totals, instead of hourly, or in this case, 5-minute observations (Essoree, 2007). These 5-minute observations have been averaged into hourly flows, and plotted for each hour of the day for the months listed. This data continues to be collected, and provides insight into when the city uses water, every single day of the year.

This data is also very important because of its high resolution and ability to report water demand peaks during different times of the day. Because wind, and consequently wind energy, also has peaks at time intervals, we will be able to more accurately determine when the water system would benefit from pumping. One possible solution could be pumping water at night and storing throughout the day, or another solution could be to pump water whenever wind energy is available.

Regardless of the solution chosen, the wind turbines will always produce energy when wind is available in order to maximize the electrical resource generated by them. Curtailment of wind energy production will not be considered. Water pumping decisions will be made by the algorithm presented in Chapter 8. The algorithm will maximize the wind energy resource based on the aforementioned real-time demand and cost minimization.

The average flow rate given by the real-time data differs from that given by the annual totals above because of the different time periods that the observations were recorded. The flow rate from the annual totals is calculated with data from the years 2000-2006, while the real-time data set is much smaller, and only encompasses the period January 2006 through May 2007. Table 5.4 shows the real-time flow rate data.

A flow chart of the processes of the proposed water system (wellfield, reverse osmosis (RO), and distribution systems) is presented in Figure 5.4.

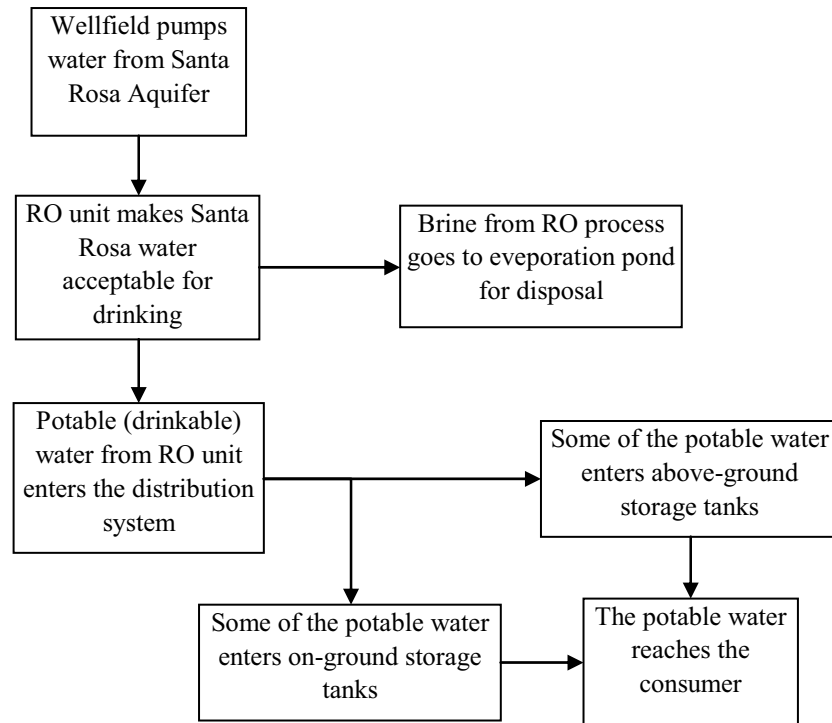


Figure 5.4. Flow Chart of Proposed Water System Processes

Average real-time water flow rate, in MGD, January 2006 through May 2007  
(five minute data observation period, moving average smoothed over 20 periods)

Time of Day	Jan	Feb	Mar	Apr	May	June	July	Aug	Sept	Oct	Nov	Dec	AVERAGE
	MGD	MGD	MGD	MGD	MGD	MGD	MGD	MGD	MGD	MGD	MGD	MGD	MGD
Midnight	0.86	0.93	1.19	1.65	1.61	2.53	2.28	2.51	2.75	1.53	1.26	0.97	1.67
1:00	0.81	0.93	1.11	1.57	1.63	2.44	2.19	2.67	2.60	1.43	1.36	0.93	1.64
2:00	0.76	0.85	0.98	1.49	1.55	2.36	2.16	2.79	2.54	1.41	1.29	0.95	1.59
3:00	0.72	0.78	0.86	1.41	1.45	2.35	2.19	2.71	2.66	1.55	1.21	0.88	1.56
4:00	0.66	0.70	0.82	1.35	1.44	2.41	2.21	2.74	2.88	1.78	1.22	0.87	1.59
5:00	0.62	0.62	0.82	1.28	1.37	2.45	2.25	2.90	3.07	1.96	1.34	0.89	1.63
6:00	0.60	0.58	0.85	1.20	1.38	2.50	2.28	3.05	3.20	2.01	1.43	0.81	1.66
7:00	0.65	0.59	0.89	1.19	1.51	2.54	2.33	3.09	3.25	1.96	1.33	0.76	1.67
8:00	0.70	0.66	0.95	1.24	1.61	2.57	2.40	3.14	3.29	1.84	1.17	0.79	1.70
9:00	0.77	0.74	1.04	1.37	1.66	2.58	2.47	3.12	3.32	1.73	1.19	0.92	1.74
10:00	0.83	0.86	1.13	1.50	1.61	2.59	2.52	3.05	3.25	1.62	1.36	1.02	1.78
11:00	0.91	0.93	1.24	1.59	1.60	2.60	2.53	2.96	3.11	1.51	1.47	1.10	1.80
12:00	0.95	1.01	1.31	1.62	1.52	2.56	2.49	2.73	2.91	1.39	1.42	1.17	1.76
13:00	0.99	1.02	1.27	1.61	1.42	2.50	2.41	2.43	2.71	1.31	1.30	1.19	1.68
14:00	1.01	1.04	1.19	1.56	1.40	2.38	2.32	2.27	2.56	1.26	1.19	1.17	1.61
15:00	1.02	1.01	1.08	1.48	1.39	2.31	2.19	2.32	2.49	1.25	1.17	1.12	1.57
16:00	1.00	0.98	1.08	1.39	1.39	2.25	2.00	2.31	2.54	1.20	1.17	1.10	1.53
17:00	0.97	0.94	1.13	1.33	1.37	2.22	1.79	2.25	2.60	1.16	1.14	1.02	1.49
18:00	0.94	0.92	1.23	1.36	1.37	2.29	1.61	2.26	2.63	1.17	1.14	1.01	1.49
19:00	0.91	0.94	1.25	1.46	1.36	2.36	1.56	2.29	2.59	1.22	1.15	1.04	1.51
20:00	0.91	0.96	1.22	1.58	1.48	2.45	1.71	2.39	2.53	1.29	1.17	1.10	1.57
21:00	0.91	0.98	1.17	1.69	1.66	2.51	1.94	2.44	2.59	1.36	1.20	1.05	1.63
22:00	0.91	0.97	1.16	1.75	1.68	2.58	2.18	2.55	2.65	1.46	1.18	0.99	1.67
23:00	0.91	0.97	1.20	1.75	1.63	2.59	2.27	2.57	2.67	1.52	1.18	0.99	1.69
<b>AVERAGE</b>	0.85	0.87	1.09	1.48	1.50	2.46	2.18	2.65	2.81	1.50	1.25	0.99	<b>1.635</b>
											<b>Annual Average</b>		

Table 5.4. Real-Time Water Flow Rate Data

This real-time water use data is invaluable in formatting operating decisions for reverse osmosis systems and all of their associated logistic items, as it reports actual water use for the city, every hour of the day. Real-time water use data will be relied upon for the analysis in Chapter 6.

The following figures report the daily average water use, by month for the city, showing the mid-year peak of water use during the hottest months as well as showing the real-time water use of the city. Figure 5.5 shows the scaled daily average water use, by month, for the city of Seminole.

The hourly water use in Figure 5.6 has been smoothed by a 20 period moving average calculation in order to preserve underlying trend information in the data but reduce the effect of the flux caused by the inconsistent demand of the water system (Holmes, 2007). The odd mid-night peaks in the high-use months of the real-time graph are reported to be times when the residents of Seminole water their lawns, in order to maximize the effectiveness of the watering times and the water used. This stems from personal choice rather than a city regulation, as Seminole currently does not ration water (Phillips, 2007).

**Seminole Scaled Daily Water Use By Month  
Scaled from Seven Year Average: 2000-2006**

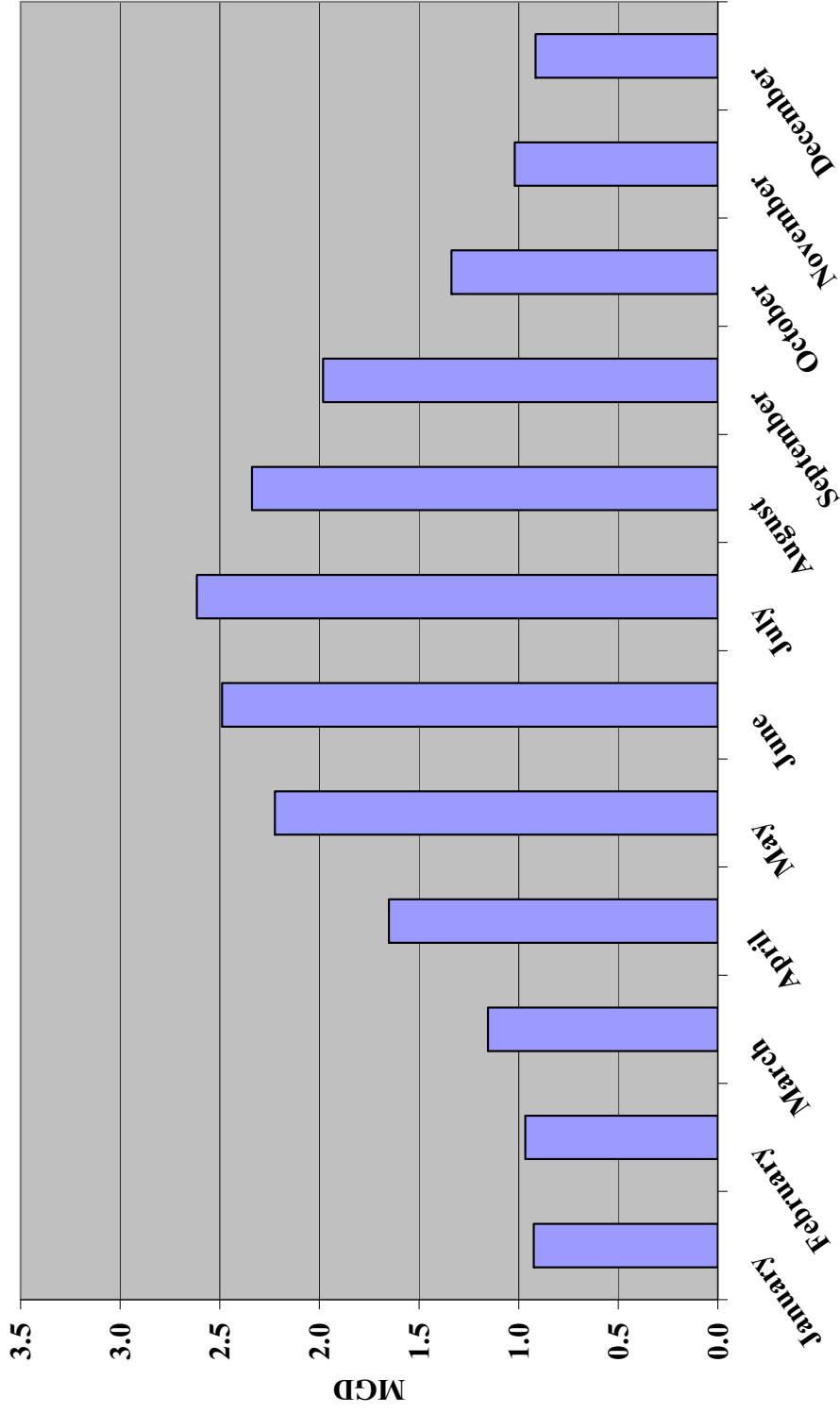


Figure 5.5. Scaled Daily Average Water Use by Month

**Seminole Real-Time Water Use  
(17 Month Average: January 2006-May 2007)  
200 Minute Moving Average Calculation  
5-minute Observations**

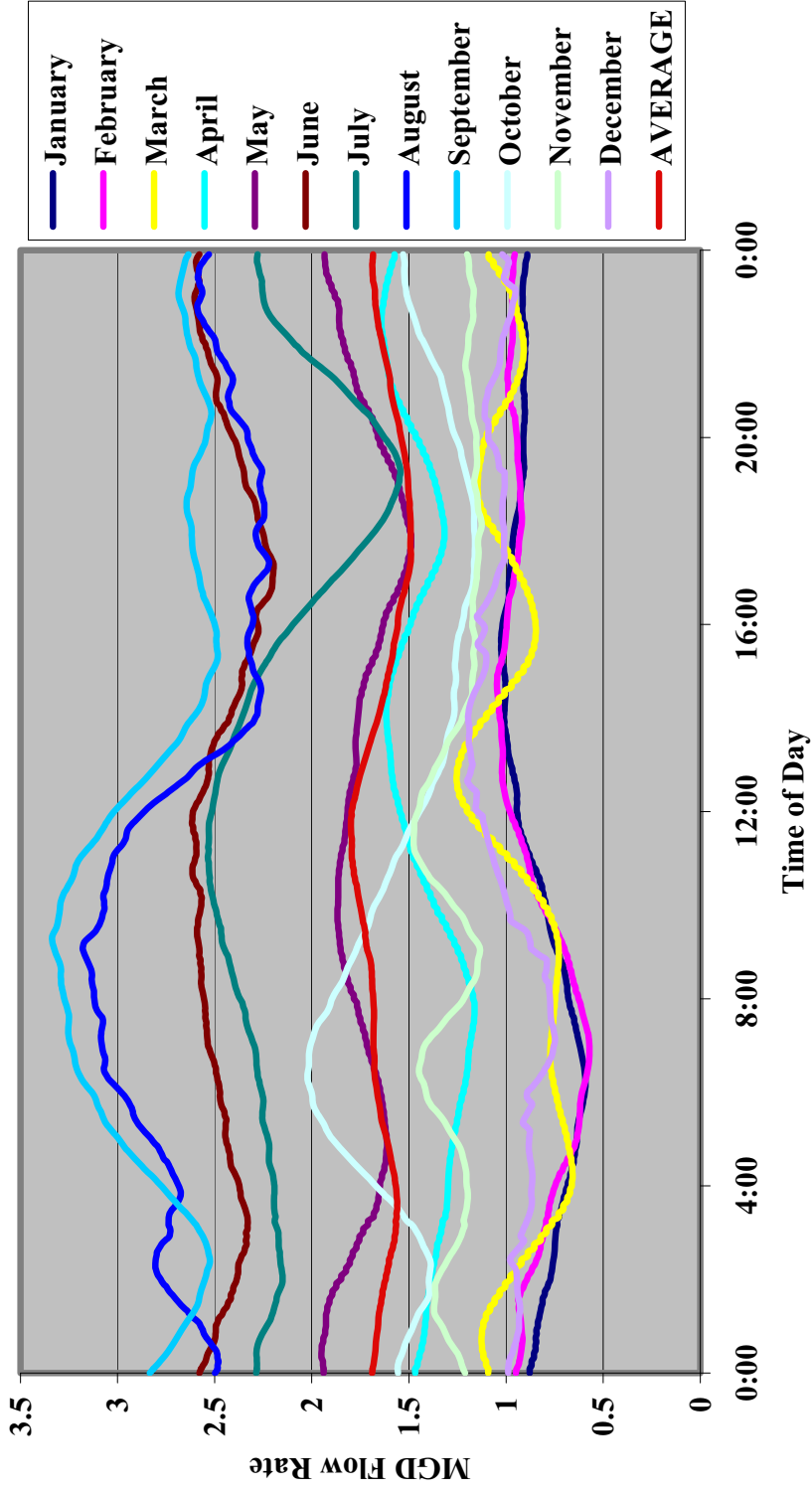


Figure 5.6. Seminole Real-Time Water Use

## 5.4 Municipal Electrical Consumption

The Seminole Electric Use data comes from three years of bills (2003-2005) from Xcel Energy showing Seminole's 64 electric meters that serve municipal loads. The annual electricity use for the city of Seminole is shown in Table 5.5. The monthly average use and daily average use shown in Table 5.6 are calculated in the same way as their respective calculations in the water use section. This daily electrical use data was coordinated with an actual real-time profile for an ERCOT (Electric Reliability Council of Texas) Business Low Load Factor consumer (collected July 1, 2005 through June 30, 2006), and then scaled to correspond with the actual Seminole use. The real-time profile shown in Table 5.7 gives an approximation of the municipal loads throughout the day. This real-time approximation is analyzed with wind turbine energy production and water system energy consumption to create a real-time energy budget for the entire system. This analysis includes the positive externality of powering municipal loads when enough excess energy is available, and will be performed in Chapter 6.

There are currently no data recording devices on the Seminole municipal electric loads, as these devices are generally cost-prohibitive, especially considering the large number of meters' worth of data to record (Chapman, 2007). By adapting an actual ERCOT business customer to the daily totals of Seminole, an acceptable approximation of the real-time loading has been developed. Figure 5.7 gives the actual daily electric use by month. Figure 5.8 shows the scaled ERCOT real-time profile of the Seminole municipal loads, with peak use occurring during normal business hours, and sloping down during the evenings.

**Seminole Annual Electricity Use**

2003 Total (Mar 03-Feb 04)	2,337,045	kWh
2004 Total (Mar 04-Feb 05)	2,296,744	kWh
2005 Total (Mar 05-Feb 06)	2,259,583	kWh

Table 5.5. Annual Electric Use by Seminole’s 64 Municipal Electric Meters

Monthly Average Use			Daily Average Use			Hourly Average Use		
January	154,962	kWh	January	4,999	kWh	January	208	kWh
February	146,029	kWh	February	5,215	kWh	February	217	kWh
March	146,473	kWh	March	4,725	kWh	March	197	kWh
April	149,048	kWh	April	4,968	kWh	April	207	kWh
May	209,405	kWh	May	6,755	kWh	May	281	kWh
June	237,398	kWh	June	7,913	kWh	June	330	kWh
July	288,201	kWh	July	9,297	kWh	July	387	kWh
August	280,643	kWh	August	9,053	kWh	August	377	kWh
September	244,719	kWh	September	8,157	kWh	September	340	kWh
October	161,562	kWh	October	5,212	kWh	October	217	kWh
November	140,951	kWh	November	4,698	kWh	November	196	kWh
December	148,795	kWh	December	4,800	kWh	December	200	kWh
<b>AVERAGE</b>	<b>192,349</b>	<b>kWh</b>	<b>AVERAGE</b>	<b>6,316</b>	<b>kWh</b>	<b>AVERAGE</b>	<b>263</b>	<b>kWh</b>

Table 5.6. Monthly, Daily, and Hourly Average Electric Use by Seminole’s 64 Municipal Meters



**Real-time Data Assumption for Seminole's 64 Electric Meters Serving Municipal Loads**  
(based on Daily Average Usage and actual ERCOT use, scaled to fit Seminole loads)

Hour	Jan kWh	Feb kWh	Mar kWh	Apr kWh	May kWh	Jun kWh	Jul kWh	Aug kWh	Sep kWh	Oct kWh	Nov kWh	Dec kWh	AVERAGE kWh
0:00	112.7	132.4	111.7	106.7	146.9	224.5	336.5	174.7	127.6	92.2	102.4	144.6	145.3
1:00	114.8	136.3	109.8	104.4	139.4	212.6	324.8	172.8	122.6	90.0	101.7	148.2	142.9
2:00	118.4	140.3	111.5	101.1	134.1	206.3	321.2	170.8	120.1	87.8	102.3	154.1	142.4
3:00	123.1	144.3	112.4	99.1	132.5	198.4	315.5	164.5	117.0	87.7	104.0	159.2	142.1
4:00	125.5	149.1	112.1	96.8	130.4	194.4	316.5	160.5	116.8	87.3	105.1	163.0	142.2
5:00	137.2	161.0	114.5	116.3	152.7	236.3	374.0	193.3	159.0	109.5	109.8	177.0	164.2
6:00	159.6	188.2	131.1	149.2	210.0	304.5	389.7	390.4	364.8	197.5	138.3	191.4	231.1
7:00	229.0	234.8	171.9	197.6	276.1	353.7	377.2	435.2	440.8	264.5	199.3	234.7	286.1
8:00	331.5	316.6	230.4	313.1	413.4	399.1	407.8	557.0	561.7	347.0	245.6	308.2	377.7
9:00	351.7	355.7	307.1	325.1	425.9	422.8	411.7	585.9	574.8	369.6	316.0	320.7	408.0
10:00	360.3	361.6	321.2	327.8	429.7	452.4	434.8	609.2	584.7	370.4	334.4	308.3	417.4
11:00	349.3	349.1	305.9	339.5	459.5	484.9	455.6	619.5	618.5	394.9	318.7	292.3	424.0
12:00	351.0	346.8	321.2	362.7	490.2	480.4	455.3	649.3	647.3	423.3	340.1	285.8	439.1
13:00	334.2	333.7	329.3	384.5	508.1	417.8	432.7	697.4	676.8	434.2	340.7	261.9	441.0
14:00	328.3	328.1	340.9	348.1	460.7	410.4	449.3	660.7	602.2	383.7	358.6	254.8	419.4
15:00	279.5	271.1	305.3	299.6	402.1	408.8	443.8	575.3	517.8	324.3	297.6	208.5	365.2
16:00	228.5	233.8	248.1	233.8	327.7	398.8	431.6	419.4	371.1	230.0	237.4	178.0	293.9
17:00	172.6	179.1	190.0	204.0	291.8	371.4	414.0	349.6	288.9	176.6	179.8	145.6	242.7
18:00	152.2	151.4	159.9	185.7	267.5	346.9	394.3	323.2	267.5	165.5	156.1	142.5	221.2
19:00	149.7	157.0	157.4	165.7	243.6	325.6	375.4	281.6	237.8	151.6	143.9	146.1	206.7
20:00	143.1	149.9	154.0	151.6	213.5	297.8	368.5	257.7	205.8	127.7	132.2	148.6	190.9
21:00	128.7	140.3	139.2	126.5	180.8	274.7	368.3	219.0	161.0	106.4	120.8	147.6	169.8
22:00	108.3	127.9	124.9	117.4	163.8	253.1	354.3	199.6	140.4	95.9	109.2	139.2	154.6
23:00	109.7	126.9	115.5	111.8	154.6	237.7	344.0	186.2	132.2	94.2	104.3	139.4	148.4
Theoretical	4998.8	5215.3	4724.9	4968.3	6755.0	7913.3	9296.8	9053.0	8157.3	5211.7	4698.4	4799.8	6316.0
Actual	4998.8	5215.3	4724.9	4968.3	6755.0	7913.3	9296.8	9053.0	8157.3	5211.7	4698.4	4799.8	6316.0
% Error	0.0	0.0	0.0	0.0	0.0	0.0	0.0	0.0	0.0	0.0	0.0	0.0	0.0
<b>Daily Total</b>	4998.8	5215.3	4724.9	4968.3	6755.0	7913.3	9296.8	9053.0	8157.3	5211.7	4698.4	4799.8	
<b>Monthly Total</b>	154,962	146,029	146,473	149,048	209,405	237,398	288,201	280,643	244,719	161,562	140,951	148,795	
<b>ERCOT Data</b>	July 1, 2005-June 30, 2006												
<b>Seminole Data</b>	March 2003-February 2006												
	COE = \$0.08												
	<b>Annual Total</b>												
	<b>2,308,187</b>												
	<b>\$184,655</b>												

Table 5.7. Real-Time Electric Data Profile Approximation

**Seminole Daily Electricity Use by Month  
Three Year Average: 2003-2005  
Sum of 64 Electric Meters Serving Municipal Loads**

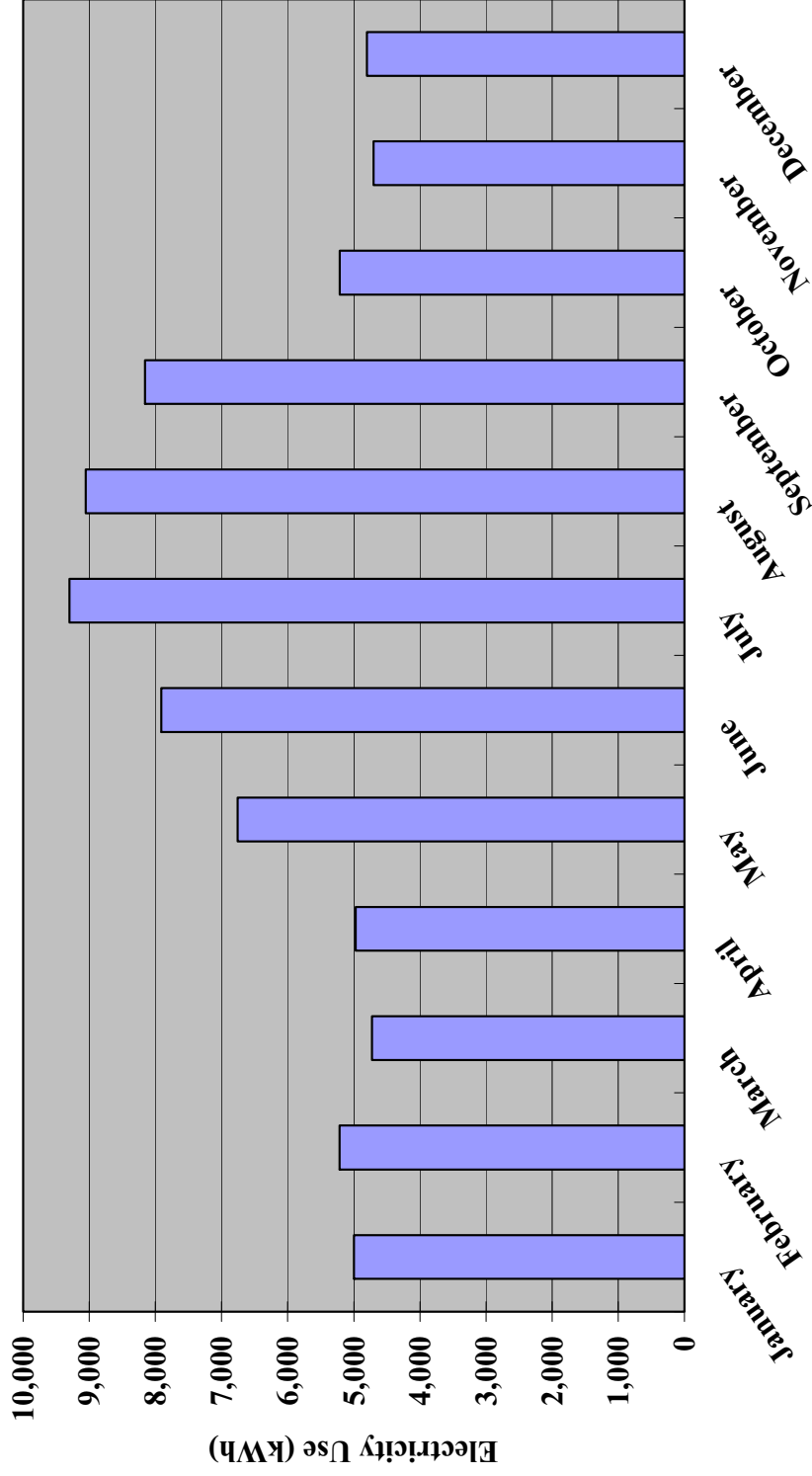


Figure 5.7. Daily Electric Use by Month

**Seminole Real-Time Municipal Electricity Use  
Data Adjusted from ERCOT Load Data for Business Low Load Factor  
Seminole Data from 64 Municipal Electric Meters 2003-2005  
ERCOT Data from 7/1/05-6/30/06**

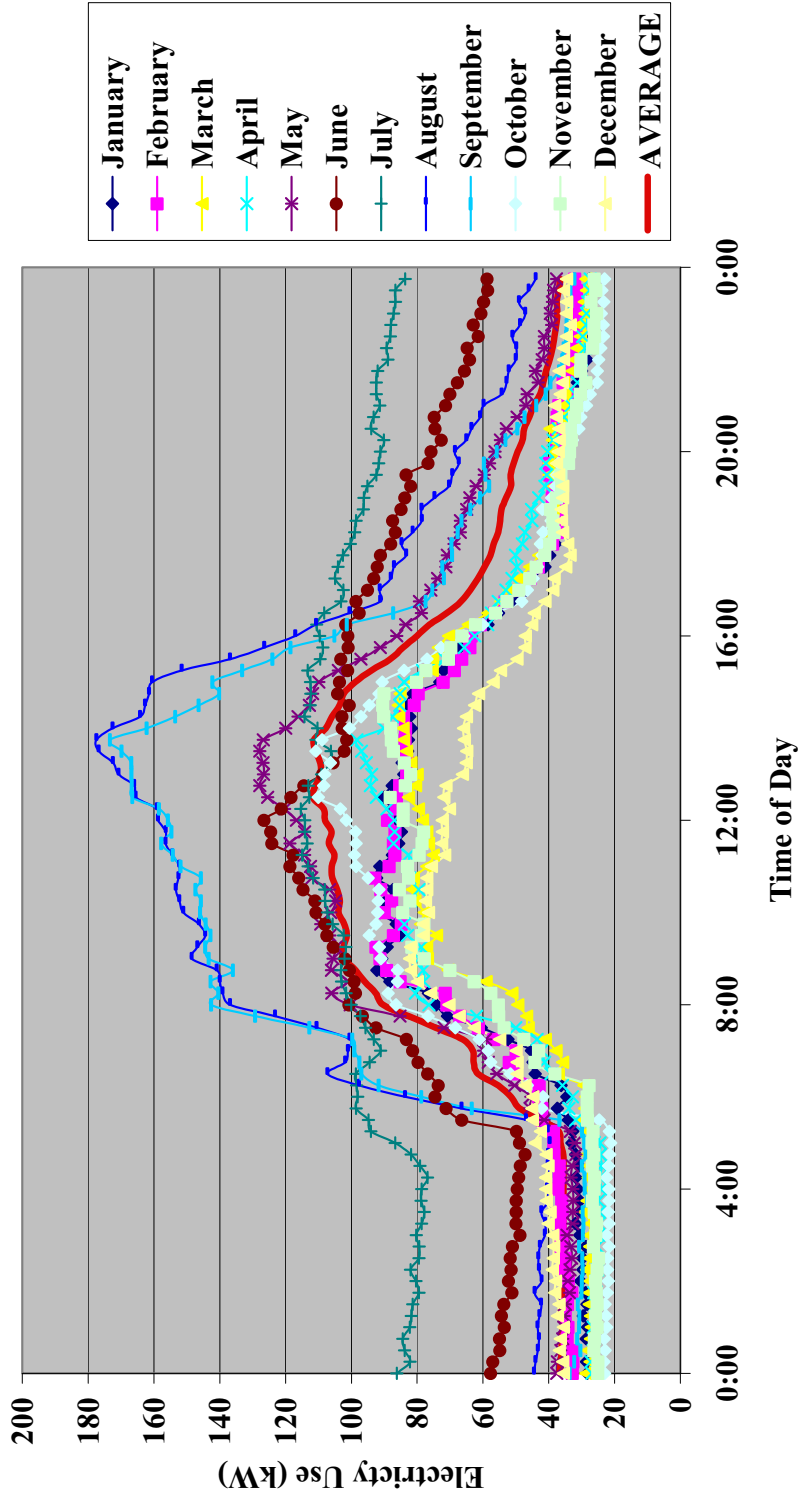


Figure 5.8. Scaled ERCOT Real-Time Profile of Seminole Loads

## 5.5 Santa Rosa Well Field Energy Estimate and Capital Costs

The calculations for the well field energy consumption estimate began by adjusting each month's average water use for the needs of the reverse osmosis (RO) unit. Due to the assumption that the water from the Santa Rosa will have a salinity of 10,000 ppm, the RO unit is expected to produce 75% product (drinkable) water and 25% brine (waste) from each unit of raw water from the Santa Rosa aquifer. Because of this ratio, each month's use must be increased 33% to account for the pumping of brine as well as the product water (Stapp, 2007). This new, adjusted monthly average use is used for the entire well field electric and equipment calculations. The assumption is made that all of the potable water for the city of Seminole will pass through the wellfield system and RO unit.

The energy cost of production in Table 5.8 is calculated from the energy requirements of the specified pumps, and the dollar energy cost is calculated using the \$0.08/kWh COE. The current comparison column is actual billing costs from Xcel Energy to the Seminole well field as the pumps draw water from the Ogallala aquifer.

When noting the large difference in cost for the two electric bills, it is good to remember that the Santa Rosa cost calculations are assuming a pumping depth of 1350 feet, while the current Ogallala wells are drilled to approximately 250 feet below the surface (Goodger, 2007). In the spirit of the conservative nature of this dissertation, the worst-case scenario that the Santa Rosa aquifer has zero head pressure is assumed.

The Santa Rosa aquifer is likely a confined aquifer, whose depth usually comes with the externality of head pressure due to the force exerted on the aquifer by the weight of the soil above it (Song, 2008). This head pressure reduces the pumping depth of the well to less than that of the physical depth by pushing water up the well to a certain depth where the weight of the water column in the well equals the head pressure of the aquifer.

Because little is known of the Santa Rosa aquifer around Seminole, no assumptions about the amount of head pressure within the aquifer are made in this chapter. The sensitivity analysis presented in Chapter 7 explores the effect of head pressure on the cost of water.

Also, note that the Seminole water system differs somewhat from that of a system at a coastal (seawater) location. Coastal locations, while having higher feed water salinity, do not have the capital and energy considerations of pumping water to the surface for purification, or the costs associated with disposal of the reverse osmosis concentrate (Swift, 2007; Chapman, 2007; Rainwater, 2007). The sensitivity of the cost of water/1000 gallons to parameters such as these is explored in Chapter 7.

Seminole Well Field System Energy Consumption Estimate From Scaled Water Use Data								
Adjusted Monthly Average Use			Energy Cost of Production		Current Comparison (June 2006)			
				\$ Energy Cost	Production Energy Cost	\$ Energy Cost		
January	38.20	Million Gallons	303,135	kWh/Month	\$ 24,250.78	/month		
February	36.09	Million Gallons	286,403	kWh/Month	\$ 22,912.27	/month		
March	47.68	Million Gallons	378,350	kWh/Month	\$ 30,268.02	/month		
April	66.07	Million Gallons	524,327	kWh/Month	\$ 41,946.14	/month		
May	91.92	Million Gallons	729,461	kWh/Month	\$ 58,356.91	/month		
June	99.56	Million Gallons	790,072	kWh/Month	\$ 63,205.72	/month		
July	108.10	Million Gallons	857,863	kWh/Month	\$ 68,629.07	/month		
August	96.68	Million Gallons	767,242	kWh/Month	\$ 61,379.36	/month		
September	79.25	Million Gallons	628,909	kWh/Month	\$ 50,312.76	/month		
October	55.30	Million Gallons	438,839	kWh/Month	\$ 35,107.12	/month		
November	40.79	Million Gallons	323,723	kWh/Month	\$ 25,897.87	/month		
December	37.85	Million Gallons	300,339	kWh/Month	\$ 24,027.10	/month		
<b>AVERAGE</b>	<b>66.46</b>	<b>Million Gallons</b>	<b>527,389</b>	<b>kWh/Month</b>	<b>\$ 42,191.09</b>	<b>/month</b>		
(based on July, 2006, pumping from Ogallala) (current billed energy price approx \$0.07)								
<b>113,893 kWh/month \$8,061.24 \$/month</b>								
Adjusted average water consumption per day, by month								
Water Consumption			Energy Cost of Production		Current Comparison (June 2006)			
				\$ Energy Cost	Production Energy Cost	\$ Energy Cost		
January	1.232	MGD	9,779	kWh/day	\$ 782.28	/day		
February	1.289	MGD	10,229	kWh/day	\$ 818.30	/day		
March	1.538	MGD	12,205	kWh/day	\$ 976.39	/day		
April	2.202	MGD	17,478	kWh/day	\$ 1,398.20	/day		
May	2.965	MGD	23,531	kWh/day	\$ 1,882.48	/day		
June	3.319	MGD	26,336	kWh/day	\$ 2,106.86	/day		
July	3.487	MGD	27,673	kWh/day	\$ 2,213.84	/day		
August	3.119	MGD	24,750	kWh/day	\$ 1,979.98	/day		
September	2.642	MGD	20,964	kWh/day	\$ 1,677.09	/day		
October	1.784	MGD	14,156	kWh/day	\$ 1,132.49	/day		
November	1.360	MGD	10,791	kWh/day	\$ 863.26	/day		
December	1.221	MGD	9,688	kWh/day	\$ 775.07	/day		
<b>AVERAGE</b>	<b>2.180</b>	<b>MGD</b>	<b>17,298</b>	<b>kWh/day</b>	<b>\$ 1,383.85</b>	<b>/day</b>		
					3673.97	kWh/day	\$ 260.04	\$/day
					COE = \$0.08/kWh			

Table 5.8. Well Field Energy Consumption Estimate

### 5.5.1 Costs of Pumping Water to the Surface

This subsection of the report provides energy consumption information for pumping enough raw water to the surface to produce 1, 3, and 5 MGD of potable water. These discrete steps are given in order to generate a cost/1000 gallons for the different flow rates, from which the appropriate flow cost can be extrapolated. Energy costs typically remain the same over the cost/1000 gallons number for each pumping capability, as do capital costs, both of which are linear in their expansion with regards to flow capability. This differentiation is primarily made because of the differences in operating costs and capital of the reverse osmosis system and its associated components, but will be carried through all parts of the water system analysis.

Energy costs will also have to be increased by 33% in order to compensate for the wellfield system pumping 33% more raw water to produce an amount of product water. This increase makes the system total calculation more comprehensive. The wellfield system costs will be presented per 1000 gallons of product water, even though it pumps 33% more raw water to the surface. Figure 5.9 shows the relationship between raw water, product water, and brine.

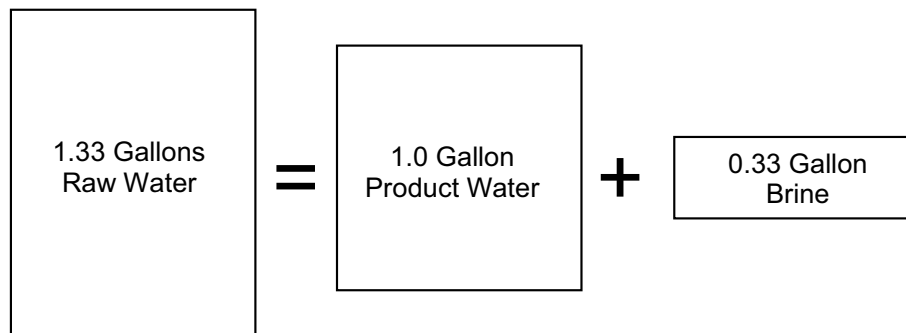


Figure 5.9. Brine and Product Water from Raw Water

Costs of Bringing Santa Rosa Water to surface						
Energy Required For Product Water Flow Rates (10 Wells/MGD Product)				Number of Wells Required for Flow Rates		
MGD	kWh/hour	kWh/day	kWh/year	MGD Product Water	Wells	Wells for calc
1	441	10,581	3,862,161	1	10	10
3	1323	31,744	11,586,484	3	28	30
5	2204	52,906	19,310,807	5	47	50

Energy Required For Product Water Flow Rates (kWh/1000gallons, 10 Wells/MGD Product)			
MGD	\$/hr	\$/day	\$/yr
1	10.58	kWh/1000 gallons	
3	10.58	kWh/1000 gallons	
5	10.58	kWh/1000 gallons	

Costs to bring brackish water to the surface to produce product water (10 Wells/MGD Product)				Well Field Relevant Costs	
MGD	\$/hr	\$/day	\$/yr	\$/1000gal	
1	35	846	308,973	0.85	Energy Cost/1000 Gallons Product Water
3	106	2,539	926,919	0.85	\$ 0.85
5	176	4,233	1,544,865	0.85	Capital Cost/1000 Gallons Product Water
					\$ 0.45
					Total Well Field Cost/1000 Gallons Product Water
					\$ 1.30

COE = \$0.08 kWh

Table 5.9. Assumptions and Calculation of the Costs of Bringing Santa Rosa Water to the Surface

The energy and dollar costs per hour, day, year, and 1000 gallons are presented in Table 5.9 above. A breakdown of the energy (\$0.85), capital (\$0.45), and total costs (\$1.30) per thousand gallons expected from this portion of the project are presented.

Because the assumption is made that the wells will come online pumping an average of 100 gallons per minute (gpm) of raw water, we will assume that 10 wells/MGD product water provides a conservative representation of well pumping capabilities (Keffler, 2007). This is also important in regard to the probability of drilling wells that may provide more or less water than expected.

Seminole uses a scaled 1.635 MGD on average throughout the year, with a maximum product flow rate of 4.09 MGD (approximately 2.5 times the average). The maximum product flow rate is calculated from sizing protocol set by State of Texas sizing guidelines (TWDB, 2007). As stated earlier, the 4.09 MGD maximum flow rate must be converted into raw water production, which would be 5.45 MGD (33% more than the max), and the expected number of wells to be drilled if they come online at an average of 100 gpm can be calculated. From this calculation, 40 wells capable of producing a total of 5.76 MGD of raw water flow are proposed. The equations below simplify this explanation. The wellfield is conservatively sized to produce more product water (4.32 MGD) than is calculated as necessary (4.09 MGD).

$$\frac{0.144\text{MGD}}{\text{Well}} * 40\text{Wells} = 5.76\text{MGD} \tag{5.5.1.1}$$

$$5.76\text{MGD} * 75\% \text{Product Water} = 4.32\text{MGD Product Water} \tag{5.5.1.2}$$

<b>Sizing Protocol, Estimated Flow rates, and Calculated Number of Wells</b>			
<b>Average Product Water Use per Year</b>	<b>Estimated Possible Well Flow Rates</b>		
1.635 MGD		<b>GPM</b>	<b>MGD</b>
<b>Maximum Product Water Flow Rate</b>	(Low end case)	50	0.072
4.09 MGD	(Case used in calcs)	100	0.144
(approximately 2.5 times the Average)	(High end case)	150	0.216
<b>Number of Wells for various flow capabilities, matching calculated maximum:</b>			
	<b>Wells</b>	<b>4.09 MGD Product Water</b>	
50 GPM	80	<b>5.45 MGD Raw Water</b>	
100 GPM	40		
150 GPM	27		
(includes 1.33 scaling factor for RO rejection rate)			

Table 5.10. Sizing Protocol, Estimated Flow Rates, and Calculated Number of Wells

The drilling costs for the well field are expected to be \$25/foot per well (Keffler, 2007), and the appropriate prices for varying depths are given. The capital cost calculations are based on a 1350-foot physical and pumping depth for all wells, and using the 40 recommended wells pumping an average of 100 gallons per minute. The actual drilling costs may vary on a per foot



basis due to competing uses of the drilling equipment (oil), and other market considerations. Drilling several wells at once would introduce economies of scale and have an effect on the estimated price of the wellfield.

<b>\$ Drilling Cost for Recommended Number of Wells (40 Wells)</b>						
	<b>1350 ft</b>	<b>1500 ft</b>	<b>1800 ft</b>	<b>1900 ft</b>	<b>2000 ft</b>	<b>2100 ft</b>
50 GPM	2,700,000	3,000,000	3,600,000	3,800,000	4,000,000	4,200,000
100 GPM	1,350,000	1,500,000	1,800,000	1,900,000	2,000,000	2,100,000
150 GPM	911,250	1,012,500	1,215,000	1,282,500	1,350,000	1,417,500

(assuming \$25/ft for 12" hole with 10.75" casing)

Table 5.11. Drilling Costs Associated With Wells and Depths

Currently the Seminole well field is controlled by a SCADA system, which pumps the wells as needed, dependent upon storage tank levels. A comparable system would be used to control the pumping of the 40 Santa Rosa wells.

### 5.5.2 Well Pump Information

The well pump information was sourced from John Keffler (2007) at Peerless Pump, and gives the horsepower, required power, and efficiency of the pumps in a real world setting. When actual Santa Rosa well depths and production capabilities are found, the appropriate pump, shaft, and motor system will be engineered to operate under these new constraints.

<b>Well Pump Information</b>			
Information based on 100 GPM/Well flow rate			
0.144 MGD/Well Flow Rate			
<b>HP required/Well</b>	<b>Power required (kW/Well)</b>	<b>Pump Efficiency</b>	
59.1	44.09	0.701	
<b>Capital Cost/Well</b>			
<b>Description</b>	<b>Amount / Length</b>	<b>Price</b>	
6LB, 26 stage bowl assembly, 1403ft TDH at 100GPM	1	\$ 9,719.00	
4" sch 40 steel column pipe, 1" dia 416ss line shaft	1330ft	\$ 40,000.00	
60hp, 3545 RPM, 3PH, 60HZ, 460/230V motor	1	\$ 2,449.00	
4X4X10C discharge head	1	\$ 630.00	
<b>Total per Well</b>		<b>\$ 52,798.00</b>	

Table 5.12. Well Pump Information and Assumptions

The remainder of the well pump information in Table 5.13 lists the total flow rate, capital costs, energy requirement, and total costs for those 40 wells that the project anticipates to be drilled, with final ICC/1000 gallons calculated at \$0.45.

<b>Capital Costs and Energy Requirements for Well Field (40 Wells)</b>		
<b>Total Well Flow Rate (40 wells)</b>	5.76 MGD	<b>Capital Costs Associated With Well Field</b>
		<b>Expected Well Drilling Costs</b>
		\$1,350,000
<b>Total Equipment Cost for Pumping 40 wells</b>	\$2,111,920	(1350ft well depth, 40 total wells drilled)
		<b>Well Pump Costs</b>
		\$2,111,920
<b>Total Horsepower Requirement for 40 wells</b>	2,364 HP	(40 pumps and motors, calculated to meet the flow requirements based on average use of: 1.635 MGD)
<b>Energy Required for pumping 40 wells using maximum flow of 5.76 MGD</b>	1,764 kW	<b>Total Well Field Capital Costs</b>
		\$3,461,920
	<b>Annual Payment at Bond Rate, 20-year bond</b>	<b>Bond Rate 4.65%</b>
	\$269,609	
	<b>Well Field \$/1000 gallons ICC</b>	
	\$0.45	

Table 5.13. Capital Costs and Energy Requirements for Well Field (40 Wells)

## 5.6 RO System Energy Estimate and Capital Costs

This section of the report focuses on the monthly and daily average use of product water (scaled, but non-adjusted, as the energy consumption of the RO unit is calculated per unit *output* of produced purified water (Stapp, 2007)) by the city of Seminole, as well as the expected costs of operation associated with the RO system. RO system installed capital and maintenance costs were sourced from Eldon Stapp (2007) from GE Betz Labs. Listed in the appropriate columns of Table 5.14 are the expected energy and capital costs of the RO system. Table 5.15 following provides a breakdown of the assumptions made for the RO system, such as the expected labor costs and membrane life, as well as a list of the financial costs of the associated parts of the system.

The capital cost recorded in Table 5.16 is calculated as the cost of the RO unit(s) per 1000 gallons at a product water rate of 1, 3, and 5 MGD. These delineations are relevant especially to this section because of the increase in labor and capital costs for the different flow rates of the reverse osmosis units. Operation of the 1 and 3 MGD units would only take a single worker, while the 5 MGD unit requires two workers (Stapp, 2007). Therefore, the addition of another worker doubles the labor costs for achieving that flow rate. These labor costs are shown in Table 5.17. Included in the material costs are the cost of the appropriate filters and additions that would be necessary to treat the raw water stream; the additions are itemized in Table 5.20. Brine disposal represents a significant cost to the project and will be discussed in greater detail in a separate subsection of this report (Section 5.6.1).

**Seminole RO System Energy Consumption Estimate**

Scaled Monthly Average Use			Energy Cost of Production		\$ Energy Cost	
January	28.65	Million Gallons	161,147	kWh/Month	\$12,891.75	/month
February	27.07	Million Gallons	152,244	kWh/Month	\$12,179.51	/month
March	35.76	Million Gallons	201,132	kWh/Month	\$16,090.52	/month
April	49.55	Million Gallons	278,733	kWh/Month	\$22,298.63	/month
May	68.94	Million Gallons	387,783	kWh/Month	\$31,022.62	/month
June	74.67	Million Gallons	420,003	kWh/Month	\$33,600.26	/month
July	81.07	Million Gallons	456,041	kWh/Month	\$36,483.31	/month
August	72.51	Million Gallons	407,867	kWh/Month	\$32,629.36	/month
September	59.44	Million Gallons	334,329	kWh/Month	\$26,746.34	/month
October	41.47	Million Gallons	233,287	kWh/Month	\$18,663.00	/month
November	30.59	Million Gallons	172,092	kWh/Month	\$13,767.35	/month
December	28.38	Million Gallons	159,661	kWh/Month	\$12,772.84	/month
<b>AVERAGE</b>	<b>49.84</b>	<b>Million Gallons</b>	<b>280,360</b>	<b>kWh/Month</b>	<b>\$22,428.79</b>	<b>/month</b>

Scaled Average water consumption per day, by month						
Water Consumption			Energy Cost of Production		\$ Energy Cost	
January	0.924	MGD	5,198	kWh/Day	\$ 415.86	/day
February	0.967	MGD	5,437	kWh/Day	\$ 434.98	/day
March	1.153	MGD	6,488	kWh/Day	\$ 519.05	/day
April	1.652	MGD	9,291	kWh/Day	\$ 743.29	/day
May	2.224	MGD	12,509	kWh/Day	\$ 1,000.73	/day
June	2.489	MGD	14,000	kWh/Day	\$ 1,120.01	/day
July	2.615	MGD	14,711	kWh/Day	\$ 1,176.88	/day
August	2.339	MGD	13,157	kWh/Day	\$ 1,052.56	/day
September	1.981	MGD	11,144	kWh/Day	\$ 891.54	/day
October	1.338	MGD	7,525	kWh/Day	\$ 602.03	/day
November	1.020	MGD	5,736	kWh/Day	\$ 458.91	/day
December	0.916	MGD	5,150	kWh/Day	\$ 412.03	/day
<b>AVERAGE</b>	<b>1.635</b>	<b>MGD</b>	<b>9,196</b>	<b>kWh/Day</b>	<b>\$ 735.66</b>	<b>/day</b>

Energy Cost of RO System Production = 5.63 kWh/1000 Gallons

COE = \$0.08

Table 5.14. Seminole RO System Energy Consumption Estimate

<b>RO System Assumptions:</b>	
TDS =	10,000 ppm
Recovery =	75%
Interest rate =	4.65%
Investment years =	20 years
Electrical rate =	\$0.08 per kWh
Labor rate =	\$20.00 per hour
Membrane life =	4 years

Table 5.15. RO System Assumptions

The post treatment cost to the product water stream represents a pH adjustment made to the water to protect the downstream pipes and faucets (Stapp, 2007). The RO process turns the water more acidic than the approximate pH of 8.1 that is acceptable by drinking water standards (TWDB, 2007). Chlorination is not considered in this post-treatment analysis, as it is pre-

<b>RO System Itemized Costs</b>									
<b>MGD</b>			<b>\$ / 1000 gallons</b>						
<b>Feed (raw)</b>	<b>Product</b>	<b>Brine</b>	<b>Capital</b>	<b>Materials</b>	<b>Energy</b>	<b>Labor</b>	<b>Post Treat</b>	<b>Brine Disposal</b>	<b>Total</b>
1.33	1	0.33	\$0.08	\$0.36	\$0.45	\$0.10	\$0.01	\$1.64	\$2.64
4.00	3	1.00	\$0.24	\$0.36	\$0.45	\$0.10	\$0.01	\$1.64	\$2.80
6.67	5	1.67	\$0.40	\$0.36	\$0.45	\$0.20	\$0.01	\$1.64	\$3.06
<b>RO Costs w/o Energy</b>									
			\$2.19	/1000 gallons		1 MGD			
			\$2.35	/1000 gallons		3 MGD			
			\$2.61	/1000 gallons		5 MGD			

Table 5.16. RO System Itemized Costs

<b>Labor Costs for different RO System Flow Capabilities</b>			
<b>1 and 3 MGD</b>			
Unit cost of labor =	\$20.00	per hour	
Man hours worked per day =	8	hrs per day	
Cost of labor =	\$160	per day	
	\$58,400	per year	
	\$0.09	/ 1000 gallons	
<b>5 MGD</b>			
Unit cost of labor =	\$20.00	per hour	
Man hours worked per day =	16	hrs per day	
Cost of labor =	\$320	per day	
	\$116,800	per year	
	\$0.20	/ 1000 gallons	

Table 5.17. Labor Costs For RO System

existing in the Seminole water system. Table 5.18 shows the breakdown of post treatment costs.

Table 5.19 delineates the total costs of the RO system mentioned above in costs per hour, day, and 1000 gallons. Table 5.20 shows the itemized materials cost per 1000 gallons for the RO system.

<b>RO System Post Treatment Cost Calculations</b>			
<b>Product flow = 1 MGD</b>			
Permeate pH adjustment chemical cost =	0.15	per lb	
Permeate pH adjustment concentration =	8	ppm	
Chemical cost =	\$9.99	per day	\$0.01 /1000 gallons
	\$3,647.23	per year	
<b>Product flow = 3 MGD</b>			
Permeate pH adjustment chemical cost =	\$0.15	per lb	
Permeate pH adjustment concentration =	8	ppm	
Chemical cost =	\$29.98	per day	\$0.01 /1000 gallons
	\$10,941.68	per year	
<b>Product flow = 5 MGD</b>			
Permeate pH adjustment chemical cost =	\$0.15	per lb	
Permeate pH adjustment concentration =	8	ppm	
Chemical cost =	\$49.96	per day	\$0.01 /1000 gallons
	\$18,236.13	per year	

Table 5.18. Post-Treatment Costs for RO System

**Itemized RO System Cost Estimates**

RO Capital Cost Estimates			RO Labor Cost Estimates						
MGD	\$/1000gal	\$/yr	\$/day	\$/hr	MGD	\$/1000gal	\$/yr	\$/day	\$/hr
1	\$0.08	\$29,518.02	\$80.87	\$3.37	1	\$0.10	\$35,673.05	\$97.73	\$4.07
3	\$0.24	\$265,662.17	\$727.84	\$30.33	3	\$0.10	\$107,019.14	\$293.20	\$12.22
5	\$0.40	\$737,950.47	\$2,021.78	\$84.24	5	\$0.20	\$356,730.45	\$977.34	\$40.72

RO Materials Cost Estimates			RO Post Treatment Cost Estimates						
MGD	\$/1000gal	\$/yr	\$/day	\$/hr	MGD	\$/1000gal	\$/yr	\$/day	\$/hr
1	\$0.36	\$131,400.00	\$360.00	\$15.00	1	\$0.01	\$3,647.23	\$9.99	\$0.42
3	\$0.36	\$394,200.00	\$1,080.00	\$45.00	3	\$0.01	\$10,941.68	\$29.98	\$1.25
5	\$0.36	\$657,000.00	\$1,800.00	\$75.00	5	\$0.01	\$18,236.13	\$49.96	\$2.08

RO Energy Cost Estimates			RO System Energy Use Estimates						
MGD	\$/1000gal	\$/yr	\$/day	\$/hr	MGD	kWh/1000gal	kWh/yr	kWh/day	kWh/hour
1	\$0.45	\$164,250.00	\$450.00	\$18.75	1	5.63	2,053,125	5,625	234
3	\$0.45	\$492,750.00	\$1,350.00	\$56.25	3	5.63	6,159,375	16,875	703
5	\$0.45	\$821,250.00	\$2,250.00	\$93.75	5	5.63	10,265,625	28,125	1,172

Table 5.19. Itemized Costs/Per 1000 Gallons for RO System

Materials Cost	
	\$/1000 gal
Acid	\$ 0.03
Cleanings	\$ 0.17
Antiscalant	\$ 0.08
Filters	\$ 0.02
Membranes	\$ 0.06
<b>TOTAL</b>	<b>\$ 0.36</b>

Table 5.20. Itemized Materials Costs/1000 Gallons for RO System

### 5.6.1 Brine Disposal

In order to dispose of the brine (concentrate) that is a result of the reverse osmosis process, a cost effective and environmentally stable disposal method must be used in order for the project to maintain its legitimacy. By using an evaporation pond for disposal, the project takes advantage of both a relatively high evaporation rate for the region as well as a relatively low cost land resource, both which add to the feasibility of this part of the project (TWDB, 2007; Mickley, 2006; Phillips, 2007).

The costs for the purchase and clearing of nearly 372 acres of land containing 289 acres of evaporative area are paltry sums compared to the cost of the pond liner, which constitutes 64% of the total cost. The pond liner is made of a thick membrane that keeps the brine, considered a toxic substance, out of the surrounding ecosphere and water table (Rainwater, 2007). The total capital cost of the evaporation pond and liner is included in the RO system section as part of the cost of that complete system.

The following equation gives the method for finding the total area required by the evaporation pond, including the area of the dike and perimeter of the pond:

$$A_t = (1.2A_e) \left( 1 + \frac{0.155dh}{\sqrt{A_e}} \right) \quad (5.6.1.1)$$

where  $A_t$  is the total area required for the evaporation pond in acres,  $A_e$  is the evaporative area (TWDB, 2007) in acres, and  $dh$  is the height of the surrounding dike, in feet.

The equation for the evaporative area,  $A_e$ , is:

$$A_e = \frac{\text{Concentrate Flow Rate}}{\text{Evaporation Rate}} \quad (5.6.1.2)$$

For a maximum flow rate of 5.76 MGD of raw water (from equation 5.5.1.1), the concentrate flow rate is 1.44 MGD of brine. Solving equation 5.6.1.2 for  $A_e$ :

$$A_e = \frac{1.44 \text{ Million Gallons/Day} * 365 \text{ Days} * \frac{1 \text{ ft}^3}{7.48 \text{ gallons}} * \frac{12 \text{ in}}{1 \text{ ft}} * \frac{1 \text{ acre}}{43560 \text{ ft}^2}}{67.09 \text{ in/yr}} \quad (5.6.1.3)$$

$$A_e = 289 \text{ acres}$$

Using the value of  $A_e$  in equation 5.6.1.1 to find the value of  $A_t$ :

$$A_t = 371.49 \text{ acres} \quad (5.6.1.4)$$

Making the assumptions that the dike height will be 8 ft (Mickley, 2006), the liner thickness will be 50 mils, the cost of the land is \$500/acre, and the cost to clear the land is \$1000/acre (Phillips, 2007), the following equation is used. This regression equation calculates the cost of constructing the evaporation pond, and takes into account land purchase, land clearing, pond excavation, the construction of the dike, installing the liner, installing fencing around the pond, and constructing an access road (Mickley, 2006).

$$CC_u = 5406 + 465t_1 + 1.07Cl + 0.93Cc + 217.5dh \quad (5.6.1.5)$$

where  $CC_u$  is the \$/acre cost of constructing the pond,  $t_1$  is the thickness of the liner, in mils,  $Cl$  is the land cost (\$/acre),  $Cc$  is the land clearing cost (\$/acre), and  $dh$  is the height of the surrounding dike, in feet. Solving for  $CC_u$ :

$$CC_u = \$31,862/\text{acre} \quad (5.6.1.6)$$

To find the total cost of the pond, the cost per acre is multiplied by the number of acres of the pond:

$$\text{TotalCost} = CC_u * A_t = \$11,836,406 \quad (5.6.1.7)$$

The per year operations and maintenance (O&M) costs of the liner are expected to be 0.5% of the total capital costs (Mickley, 2006). Therefore, the O&M costs/year are expected to be:

$$O \& M = 0.5\% * \$11,836,406 = \$59,182/\text{year} \quad (5.6.1.8)$$

The present value of the O&M payments over 20 years is equal to:

$$PV(4.65\%, 20\text{years}, \$59,182) = \$759,927 \quad (5.6.1.9)$$

Therefore the total capital cost of the evaporation pond, including O&M costs, is:

$$\text{Total Capital Cost} = \text{Total Cost} + O \& M = \$12,596,333 \quad (5.6.1.10)$$

The annual equivalent Total Capital Cost of the evaporation pond is:

$$\text{Annual Equivalent TCC} = \$980,985 \quad (5.6.1.11)$$

The Installed Capital Cost of the evaporation pond is expected to be (from equation 5.2.1):

$$\text{InstalledCapitalCost}/1000\text{gallons} = \$1.64/1000\text{gallons} \quad (5.6.1.12)$$

To determine the cost of the liner, and its percentage of the total cost, the following equation is used:

$$\text{LinerCost} = \$0.50 / \text{ft}^2 * 371.49 \text{ Acres} = \$8,091,052 \quad (5.6.1.12)$$

This makes the liner 64% of the total cost of the evaporation pond. The cost/1000 gallons for the evaporation pond is calculated at \$1.64/1000 gallons.

## 5.7 Distribution System Energy Estimate

The cost estimates for the distribution system of the project do not include any capital costs because the system of water mains, pumps, and storage tanks is already in place and operational (Goodger, 2007). The energy costs for distribution are included in this section of the report to determine the energy consumption based on current water demand. The costs per month and costs per day in Table 5.21 are presented in the general format of this report.

The energy demand for the distribution system is calculated by summing the potential pumping capability and energy consumption of all of the pumps and motors, and then determining a ratio of HP/MGD for the system. This HP/MGD ratio is then used to generate general numbers again for a 1, 3, and 5 MGD system. The calculations for average MGD/day, and a cost/1000 gallons to determine distribution system energy consumption are also calculated. The distribution energy costs are quite low compared to other parts of the system, mainly because the pumps only have to raise a percentage of the water to the height of the elevated storage (approximately 120 feet), in order to maintain acceptable water pressure levels (Goodger, 2007). The remainder of the water is stored in on-ground storage tanks throughout the city, currently with a total holding capacity of approximately 2.5 million gallons.

Table 5.22 itemizes the different calculations and values associated with the distribution energy cost estimate presented in the table.



Seminole Distribution System Energy Consumption Estimate

	Scaled Monthly Average Use			Current Comparison With Actual Costs		
	Million Gallons	Energy Cost of Production	\$ Energy Cost	Energy Cost of Production	\$ Energy Cost	\$ Energy Cost
January	28.65	24,530	\$1,962.42 /month	43602	kWh/month	\$3,488.16
February	27.07	23,176	\$1,854.11 /month	32857	kWh/month	\$2,628.52
March	35.76	30,617	\$2,449.35 /month	32960	kWh/month	\$2,636.80
April	49.55	42,430	\$3,394.37 /month	37120	kWh/month	\$2,969.60
May	68.94	59,030	\$4,722.36 /month	45002	kWh/month	\$3,600.16
June	74.67	63,934	\$5,114.74 /month	N/A	N/A	N/A
July	81.07	69,420	\$5,553.61 /month	47720	kWh/month	\$3,817.60
August	72.51	62,087	\$4,966.95 /month	77200	kWh/month	\$6,176.00
September	59.44	50,893	\$4,071.41 /month	46200	kWh/month	\$3,696.00
October	41.47	35,512	\$2,840.94 /month	35880	kWh/month	\$2,870.40
November	30.59	26,196	\$2,095.71 /month	36720	kWh/month	\$2,937.60
December	28.38	24,304	\$1,944.32 /month	35854	kWh/month	\$2,868.32
<b>AVERAGE</b>	<b>49.84</b>	<b>42,677</b>	<b>\$3,414.19 /month</b>	(Current Comparison based on 2 year average: 2004-2005)		

Scaled Average water consumption per day, by month

	Water Consumption			Current Comparison With Actual Costs		
	MGD	Energy Cost of Production	\$ Energy Cost	Energy Cost of Production	\$ Energy Cost	\$ Energy Cost
January	0.924	791	\$ 63.30 /day	1557	kWh/day	\$124.58
February	0.967	828	\$ 66.22 /day	1173	kWh/day	\$93.88
March	1.153	988	\$ 79.01 /day	1063	kWh/day	\$85.06
April	1.652	1,414	\$ 13.15 /day	1237	kWh/day	\$98.99
May	2.224	1,904	\$ 152.33 /day	1452	kWh/day	\$116.13
June	2.489	2,131	\$ 70.49 /day	N/A	N/A	N/A
July	2.615	2,239	\$ 79.15 /day	1539	kWh/day	\$123.15
August	2.339	2,003	\$ 60.22 /day	2490	kWh/day	\$199.23
September	1.981	1,696	\$ 135.71 /day	1540	kWh/day	\$123.20
October	1.338	1,146	\$ 91.64 /day	1157	kWh/day	\$92.59
November	1.020	873	\$ 69.86 /day	1224	kWh/day	\$97.92
December	0.916	784	\$ 62.72 /day	1157	kWh/day	\$92.53
<b>AVERAGE</b>	<b>1.635</b>	<b>1,400</b>	<b>\$ 111.98 /day</b>	(based on month/appropriate days)		

COE = 0.08

Table 5.21. Seminole Distribution Energy Consumption Estimate

**Calculations Associated with Distribution System Energy Consumption Estimate**

<u>Pump Station 1</u>		<u>5300 GPM to MGD</u>	
<b>Pump 1</b>	300 gpm	7.632 HP/MGD	MGD
<b>Pump 2</b>	1000 gpm		
<b>Pump 3</b>	600 gpm	47.82	
<b>Pump 4</b>	600 gpm		
<u>Pump Station 2</u>			
<b>Pump 1</b>	1100 gpm	47.82 hp	This is the expected hp requirements for the listed MGD flow rates
<b>Pump 2</b>	600 gpm	143.47 hp	
<b>Pump 3</b>	1100 gpm	239.12 hp	
<b>Totals</b>		5300	365
<b>Distribution</b>			
\$ 0.07			
<b>hp to kW conversion:</b>			
		HP =	0.746 kW
		COE =	\$0.08 /kWh
<b>Energy Required For Flow Rates (kWh/1000gallons)</b>			
<b>MGD</b>	<b>1</b>	0.86	
	<b>3</b>	0.86	
	<b>5</b>	0.86	
<b>Energy Consumption For Flow Rates</b>			
<b>MGD</b>	<b>kWh/hr</b>	<b>kWh/day</b>	<b>kWh/yr</b>
<b>1</b>	36	856	312,534
<b>3</b>	107	2,569	937,602
<b>5</b>	178	4,281	1,562,671
<b>Costs for Distribution Pumps for Associated Flow rates</b>			
<b>MGD</b>	<b>\$/hr</b>	<b>\$/day</b>	<b>\$/yr</b>
<b>1</b>	2.85	68.50	25,002.73
<b>3</b>	8.56	205.50	75,008.19
<b>5</b>	14.27	342.50	125,013.65
			0.07

Table 5.22. Calculations Associated with Distribution System Energy Consumption Estimate

## 5.8 Total Water System Energy Estimate and Capital Costs

This section of the report presents the average water consumption per month and per day for the city of Seminole, as well as the aggregate energy consumption for all of the water system components for those set time periods. The energy aggregation includes the adjusted well field energy consumption, the RO system energy consumption, and the distribution system energy consumption. The expected energy cost per 1000 gallons is given for each component. A total annual energy sum is also calculated, which represents entire system annual energy demand. This demand will be compared to the expected energy supply from the wind turbine array in the decision-making process of the control algorithm, which is described in Chapter 8.

Table 5.23 shows average monthly and daily energy consumption for all of the system segments. The table also shows total system energy consumption. The dollar cost associated with that energy consumption, at the assumed \$0.08/kWh cost of energy is also presented.

Figure 5.10 shows a pie graph of the distribution of total water cost/1000 gallons. Figure 5.11 shows a pie graph of the distribution of monthly average energy use for each of the water system components of the wellfield, reverse osmosis, and distribution systems. Figure 5.12 shows a pie graph of the distribution of capital costs for the water system components. Figure 5.13 shows a pie graph of the distribution of operations and maintenance costs for different components of the water system.

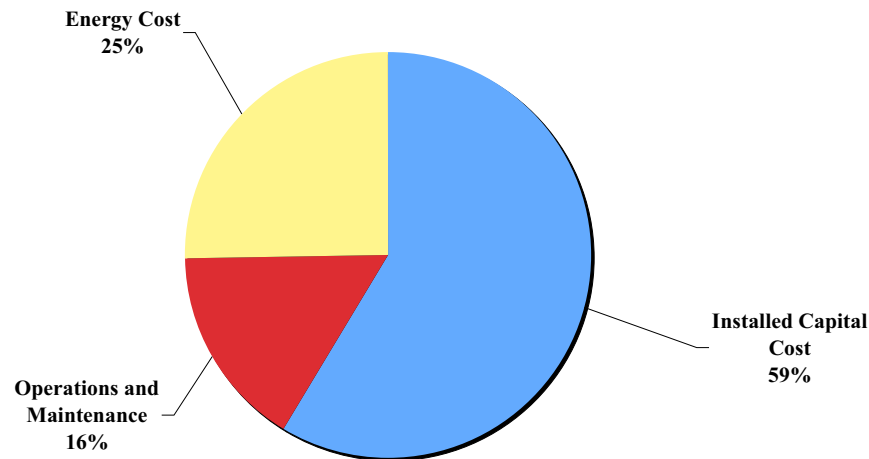


Figure 5.10. Distribution of Costs/1000 Gallons

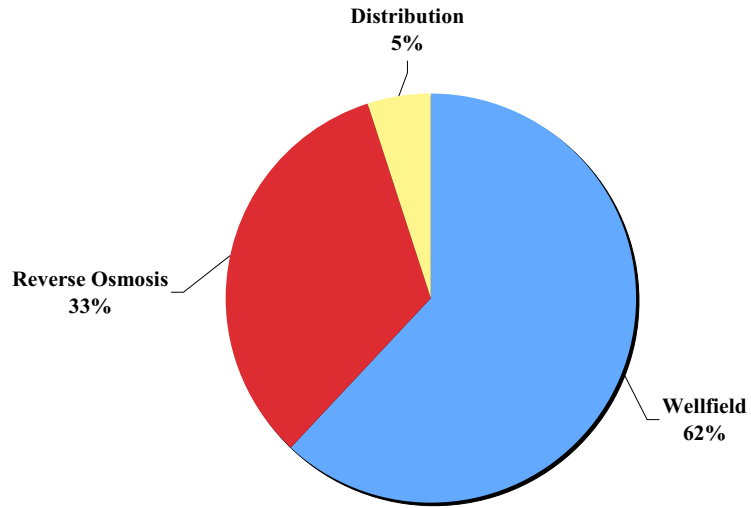


Figure 5.11. Distribution of Monthly Average Energy Use

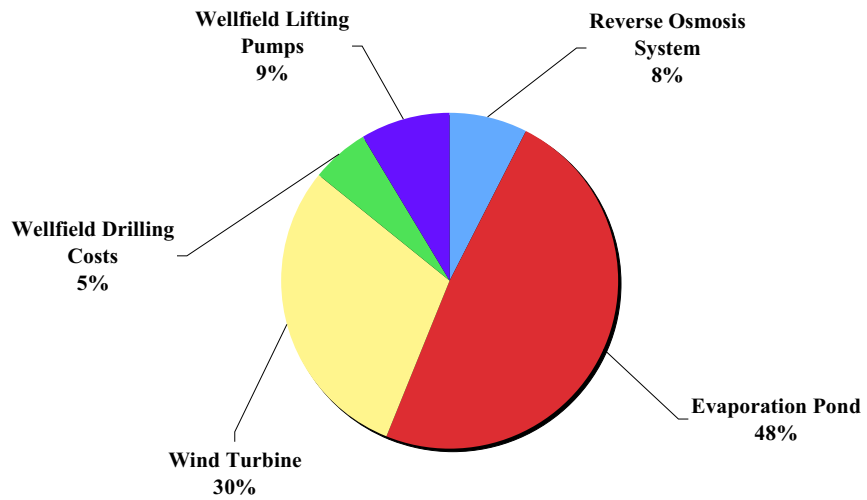


Figure 5.12. Distribution of Installed Capital Costs

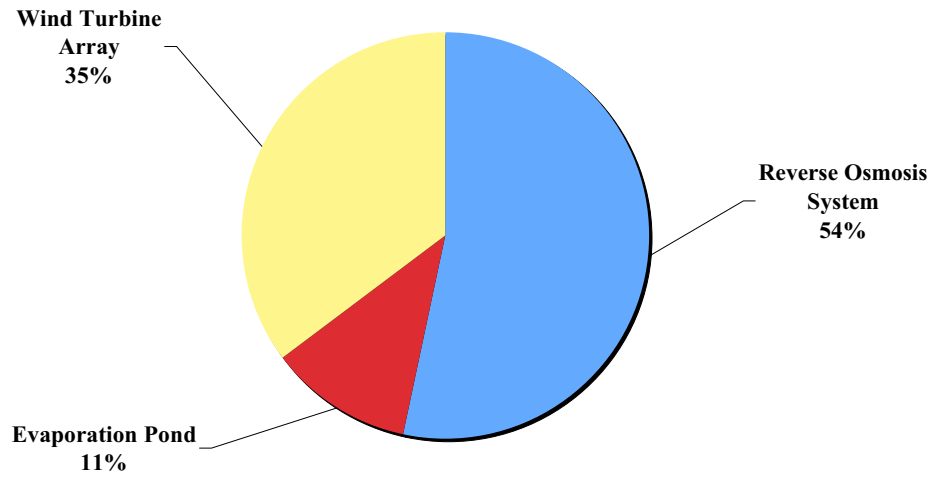


Figure 5.13. Distribution of Operations and Maintenance Costs

Total Water System Energy Consumption Estimate			
Scaled Monthly Average Use	Total Energy Cost of Production	\$ Energy Cost	
January	28.65 Million Gallons	488,811 kWh/month	\$ 39,104.92
February	27.07 Million Gallons	461,832 kWh/month	\$ 36,946.55
March	35.76 Million Gallons	610,098 kWh/month	\$ 48,807.85
April	49.55 Million Gallons	845,488 kWh/month	\$ 67,639.08
May	68.94 Million Gallons	1,176,273 kWh/month	\$ 94,101.81
June	74.67 Million Gallons	1,274,008 kWh/month	\$ 101,920.63
July	81.07 Million Gallons	1,383,324 kWh/month	\$ 110,665.88
August	72.51 Million Gallons	1,237,195 kWh/month	\$ 98,975.57
September	59.44 Million Gallons	1,014,130 kWh/month	\$ 81,130.44
October	41.47 Million Gallons	707,638 kWh/month	\$ 56,611.00
November	30.59 Million Gallons	522,011 kWh/month	\$ 41,760.89
December	28.38 Million Gallons	484,303 kWh/month	\$ 38,744.22
Sum of Monthly Uses			\$ 816,408.84
Sum of Monthly Uses			10,205,110 Average Annual Energy Cost
Scaled Average water consumption per day, by month			
Water Consumption	Energy Cost of Production	\$ Energy Cost	
January	0.924 MGD	15,768 kWh/day	\$ 1,261.45
February	0.967 MGD	16,494 kWh/day	\$ 1,319.52
March	1.153 MGD	19,681 kWh/day	\$ 1,574.45
April	1.652 MGD	28,183 kWh/day	\$ 2,254.64
May	2.224 MGD	37,944 kWh/day	\$ 3,035.54
June	2.489 MGD	42,467 kWh/day	\$ 3,397.35
July	2.615 MGD	44,623 kWh/day	\$ 3,569.87
August	2.339 MGD	39,910 kWh/day	\$ 3,192.76
September	1.981 MGD	33,804 kWh/day	\$ 2,704.35
October	1.338 MGD	22,827 kWh/day	\$ 1,826.16
November	1.020 MGD	17,400 kWh/day	\$ 1,392.03
December	0.916 MGD	15,623 kWh/day	\$ 1,249.81
Daily Average Use		27,894 Average Monthly Energy Cost	\$ 2,231.49

Well	Energy Costs/1000 Gallons		
	Reverse Osmosis	Distribution	Total
kWh/1000	\$/1000	kWh/1000	\$/1000
10.58	0.85	0.45	1.37
COE = \$0.08	5.63	0.86	17.06
		0.07	

Table 5.23. Total Water System Energy Consumption Estimate

Water System Energy Consumption Estimate by Component

Monthly Average Use	Well		RO		Distribution		Total	
	Million Gallons	kWh	kWh	\$	kWh	\$	kWh	\$
January	28.65	303,135	161,146	12,891.71	24,530	1,962.42	488,811	39,104.92
February	27.07	286,403	152,252	12,180.17	23,176	1,854.11	461,832	36,946.55
March	35.76	378,350	201,131	16,090.48	30,617	2,449.35	610,098	48,807.85
April	49.55	524,327	278,732	22,298.57	42,430	3,394.37	845,488	67,639.08
May	68.94	729,461	387,782	31,022.53	59,030	4,722.36	1,176,273	94,101.81
June	74.67	790,072	420,002	33,600.16	63,934	5,114.74	1,274,008	101,920.63
July	81.07	857,863	456,040	36,483.21	69,420	5,553.61	1,383,324	110,665.88
August	72.51	767,242	407,866	32,629.27	62,087	4,966.95	1,237,195	98,975.57
September	59.44	628,909	334,328	26,746.26	50,893	4,071.41	1,014,130	81,130.44
October	41.47	438,839	233,287	18,662.94	35,512	2,840.94	707,638	56,611.00
November	30.59	323,723	172,091	13,767.31	26,196	2,095.71	522,011	41,760.89
December	28.38	300,339	159,660	12,772.80	24,304	1,944.32	484,303	38,744.22
							10,205,110	816,408.84

Average Water Consumption per Day	Well		RO		Distribution		Total	
	MGD	kWh	kWh	\$	kWh	\$	kWh	\$
January	0.924	9,779	5,198	415.86	791	63.30	15,768	1,261.45
February	0.967	10,229	5,438	435.01	828	66.22	16,494	1,319.52
March	1.153	12,205	6,488	519.05	988	79.01	19,681	1,574.45
April	1.652	17,478	9,291	743.29	1,414	113.15	28,183	2,254.64
May	2.224	23,531	12,509	1,000.73	1,904	152.33	37,944	3,035.54
June	2.489	26,336	14,000	1,120.01	2,131	170.49	42,467	3,397.35
July	2.615	27,673	14,711	1,176.88	2,239	179.15	44,623	3,569.87
August	2.339	24,750	13,157	1,052.56	2,003	160.22	39,910	3,192.76
September	1.981	20,964	11,144	891.54	1,696	135.71	33,804	2,704.35
October	1.338	14,156	7,525	602.03	1,146	91.64	22,827	1,826.16
November	1.020	10,791	5,736	458.91	873	69.86	17,400	1,392.03
December	0.916	9,688	5,150	412.03	784	62.72	15,623	1,249.81

Table 5.24. Water System Cost by Component

## 5.9 Wind Turbine Array Sizing

The wind turbine array energy production estimate in this section is an application of the data presented in Chapter 4. The sizing protocol used for the wind turbine array in this section is the annual average sizing protocol (Blanco, 2002). This protocol simply uses the annual average expected energy demand of the water system (wellfield, reverse osmosis, distribution) to determine the number of turbines needed in the wind turbine array to cover water system electrical demand. A more accurate and optimized sizing protocol is introduced in Chapter 6.

The cost per 1000 gallons of ICC is calculated assuming a 4.65%, 20-year bond (Bloomberg, 2007), at an assumed average water pumping rate of 1.635 MGD, as described in the initial assumptions of this section. The operational and maintenance costs for the turbine are assumed to be \$0.012 per produced kWh (Swift, 2007; Chapman, 2007).

The energy required by the water system (wellfield, reverse osmosis system and distribution system) is then compared to the expected annual energy production by the wind turbine array. This comparison is used to calculate the required number of turbines in the array to provide enough wind energy to power the entire water system, on the aggregate.

Turbine ICC is assumed to be \$2.4 million per turbine for an array this size (Chapman, 2007; Black & Veatch<sup>a,b,c</sup>).



Wind Turbine Energy Generation Estimate				
Monthly Wind Speed and Energy Generation for a Single Turbine				
	Average Wind Speed (m/s)	Average Monthly Wind Turbine Energy Production	Total Energy Cost of Water Production	O&M Costs Per Wind Turbine
January	10.57	553,698 kWh/month	488,811 kWh/month	\$6,644.37 /Month
February	9.53	493,368 kWh/month	461,832 kWh/month	\$5,920.42 /Month
March	10.90	464,995 kWh/month	610,098 kWh/month	\$5,579.94 /Month
April	9.97	652,155 kWh/month	845,488 kWh/month	\$7,825.86 /Month
May	9.73	476,284 kWh/month	1,176,273 kWh/month	\$5,715.40 /Month
June	8.55	364,686 kWh/month	1,274,008 kWh/month	\$4,376.24 /Month
July	8.79	316,506 kWh/month	1,383,324 kWh/month	\$3,798.07 /Month
August	9.50	219,168 kWh/month	1,237,195 kWh/month	\$2,630.02 /Month
September	9.02	304,493 kWh/month	1,014,130 kWh/month	\$3,653.91 /Month
October	8.56	456,642 kWh/month	707,638 kWh/month	\$5,479.71 /Month
November	10.68	329,600 kWh/month	522,011 kWh/month	\$3,955.20 /Month
December	9.87	500,420 kWh/month	484,303 kWh/month	\$6,005.04 /Month
Average Annual Sum		5,132,015 kWh/year	10,205,110 kWh/year	\$61,584.18 Average Annual Sum
<b>Total Energy Cost of Water Production Per Year</b>				
	\$ 816,408.84			Turbine O&M = \$0.012 /kWh
<b>Avoided Cost From Wind Generated Electricity (Per Turbine, O&amp;M Included)</b>				
	\$ 348,977.02			
<b>Wind Turbine Capacity Factor</b>				
	0.39			
<b>Recommended Number of Turbines</b>				
	3			
<b>Wind Turbine Installed Capital Cost (ICC)</b>				
\$ 2.4 Million/each				
<b>Total ICC</b>	\$ 7.20 Million Dollars			
<b>Energy Produced by Turbine Array</b>				
	15,396,045 kWh/year			
<b>Energy Cost of Water Production</b>				
	10,205,110 kWh/year			
<b>Energy Surplus From Turbine Array</b>				
	5,190,935 kWh/year			
<b>Monetary Value of Surplus Energy if Net Metered</b>				
	2,308,187 kWh			
\$ 184,654.96				COE \$0.08
<b>Value of Surplus Energy if sold to Energy Provider</b>				
	2,882,748 kWh			
\$115,309.90				Sale Price \$0.04

Table 5.25. Wind Turbine Energy Generation Estimate

## 5.10 Conclusion

Table 5.26 of this section of the report shows the expected energy costs, capital costs, and operational costs where applicable per 1000 gallons for each individual element of the wind-water system (wellfield system, reverse osmosis system, distribution system, and wind turbine array). These elements are then summed to calculate a total wind-water system cost to produce 1000 gallons of potable water. This cost represents all of the costs associated with pumping and purifying brackish water from the Santa Rosa aquifer and distributing that purified water to the city of Seminole, Texas.

The effect of the addition of three wind turbines to the system should be noted. The turbine array is not only a significant addition to the cost of the project, but also holds a significant benefit that offsets a portion of the energy consumption of the water system. As can be seen, the contribution of the turbine array more than makes up for its own capital and O&M costs per 1000 gallons.

The sections of this chapter are designed to give a comprehensive overview of a system sizing procedure for an integrated wind-water system. Each component has been outlined with estimates for energy consumption, capital costs, and operation and maintenance costs where applicable. These calculations are easily adaptable to different demands for water, sources of renewable energy, turbine design, reverse osmosis unit, method of brine disposal, or any other variables. Adaptability is the key to the versatility of this study and its application to different markets.

Technological advances that lower the cost of reverse osmosis water as well as increases in the price of Ogallala fresh water will make the wind-water system more economically feasible and attractive to potential adopters. Raising the price of one of the most basic of our resources will eventually have a large economic impact on cities in the same predicament as Seminole, Texas. This increase in water prices is a crucial step in order to prevent total depletion of this dear resource.

Figure 5.14 shows the real-time energy supply/demand comparison of the integrated wind-water system, municipal loads, and wind turbine array. The figure highlights the times of day when there is excess energy supply, and the time-shifting of energy could be considered. A detailed analysis of energy supply and demand is performed in Chapter 6, and recommendations on the time-shifting of energy are explored in Chapter 9.

Costs of System Components/1000 gallons	
<b>Well Field Relevant Costs</b>	
Energy Cost/1000 Gallons	\$ 0.85
Capital Cost/1000 Gallons	\$ 0.45
<b>Total Well Field Cost/1000 Gallons</b>	<b>\$ 1.30</b>
<b>RO System Relevant Costs</b>	
Energy Cost/1000 Gallons	\$ 0.45
RO System Operational and Capital Cost	\$ 2.35
<b>Total RO System Cost/1000 Gallons</b>	<b>\$ 2.80</b>
<b>Distribution System Relevant Costs</b>	
Energy Cost/1000 Gallons	\$ 0.07
<b>Total Distribution System Cost/1000 Gallons</b>	<b>\$ 0.07</b>
<b>Wind Turbine Relevant Costs (Three Turbines)</b>	
ICC \$/1000 Gallons	\$ 0.94
O&M Cost \$/1000 Gallons	\$ 0.31
<b>Total Wind Turbine Cost \$/1000 Gallons</b>	<b>\$ 1.25</b>
<b>Total Water System Cost/1000 Gallons</b>	
Energy Cost/1000 Gallons	\$ 1.37
Operations Cost/1000 Gallons (including capital)	\$ 2.80
<b>Total Water System Cost/1000 Gallons</b>	<b>\$ 4.17</b>
<b>Energy Costs Avoided by Wind Turbine/1000 Gallons</b>	
Value of Surplus Energy Produced by Wind Turbine/1000 Gallons	\$ 0.31 Net Metered
Total Energy Value of Wind Turbine	\$ 0.19 Sold to Utility Energy Provider
<b>Total Wind Turbine Cost \$/1000 Gallons</b>	<b>\$ 1.87 (Assuming net metered surplus)</b>
Actual Wind Turbine Benefit, Considering Energy Displacement	\$ 1.25
	\$ 0.62 /1000 gallons
<b>Total System Cost/1000 Gallons After Considering Wind Energy Benefit</b>	
	<b>\$ 3.55</b>

Table 5.26. Cost of System Components and Total System Cost/1000 Gallons

### Real-Time Energy Supply/Demand Comparison

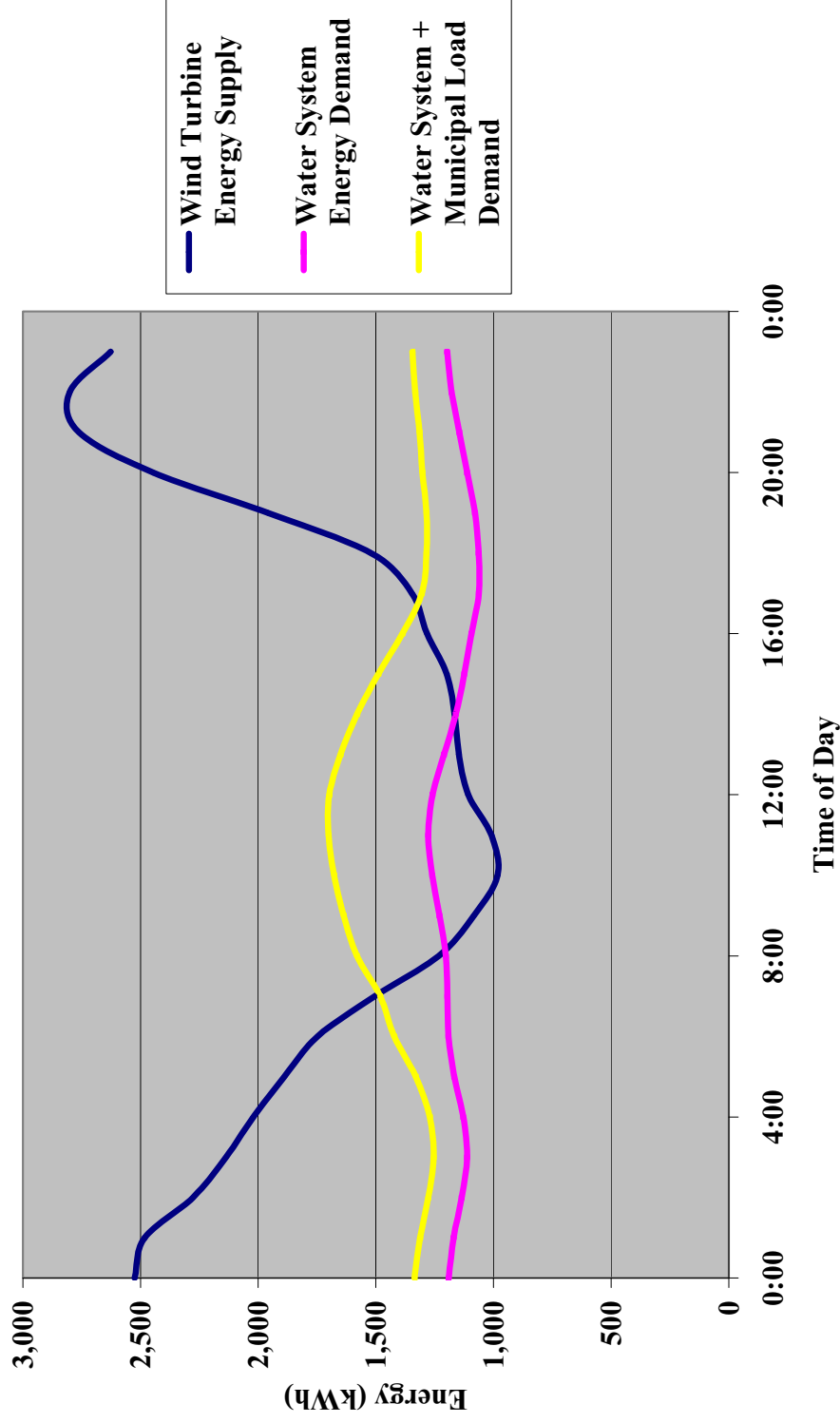


Figure 5.14. Real-Time Energy Supply/Demand Comparison

## CHAPTER 6

### OPTIMIZATION OF SYSTEM SIZING AND ECONOMICS

#### 6.1 Introduction

The purpose of performing an optimization of system sizing and economics on the proposed wind-water system is to minimize the cost of water by maximizing the benefit introduced by the wind turbine array. This optimized analysis also calculates a cost of water/1000 gallons somewhat in the same way as the annual average analysis performed in Chapter 5. However, since this optimized analysis contains more opportunities for surplus or deficit decision making, this optimization represents a more accurate and higher resolution cost analysis. However, the emphasis of this analysis is not accuracy, but rather the optimization of the sizing of the wind turbine array and its effect on system economics.

For the purposes of this analysis, energy can hold three values:

1. Energy purchased from the utility energy provider
2. Wind turbine cost of energy
3. Energy sold to the utility energy provider

Each of these values can be implemented at optimal times, in order to affect different economic results on the integrated wind-water system.

In instances where there is not enough energy produced from the wind turbine array to power the water system, energy must be purchased from the utility energy provider at the cost of energy of \$0.08/kWh (Chapman, 2007). The wind turbine array displaces higher cost energy (\$0.08/kWh) from the utility energy provider with lower cost energy (\$0.05-0.07/kWh) (Chapman, 2007). Wind turbine cost of energy incorporates the capital and operations and maintenance costs of the wind turbine array. In other instances where there is excess wind turbine array energy over that which the water system is consuming, the excess energy will be sold to the utility energy provider at a price of \$0.04/kW (Chapman, 2007).

Curtailed wind turbine production is not considered in this analysis, even though wind turbine cost of energy is greater than that of the price of energy sold back to the utility energy provider.

### 6.1.1 Comparison of Annual Average to Real-Time Surplus/Deficit Analysis

The annual average analysis performed in Chapter 5 compared the annual average energy production of the turbine array to the annual average energy consumption of the water system (wellfield, RO, distribution). The results from this analysis are presented in Table 6.1, which has been reproduced from data from Chapter 5. The number of turbines recommended by the annual average analysis produces enough energy to compensate for the energy cost of producing potable water with the integrated wind-water system. Another consideration for the number of recommended turbines from the annual average analysis is the opportunity of net metering municipal loads, to further benefit the economics of the integrated wind-water system.

The annual average sizing process is not optimal, as it does not consider either maximizing the benefit of the turbine array, or minimizing the cost/1000 gallons of water. Both of these factors are considered later in this chapter.

<b>Annual Average Analysis</b>		
<b>Energy Produced by Turbine Array</b>		
15,396,045	kWh/year	
<b>Energy Cost of Water Production</b>		
10,205,110	kWh/year	<b>Recommended Number of Turbines</b>
<b>Energy Surplus From Turbine Array</b>		<b>3</b>
5,190,935	kWh/year	
<b>Net Metering Monetary Value of Surplus Energy</b>		
2,308,187	kWh	
\$ 184,654.96		COE = \$0.08/kWh
		Sale Price = \$0.04/kWh
<b>Value of Surplus Energy sold to Utility Energy Provider</b>		
2,882,748	kWh	(Energy surplus minus net metered energy)
\$115,309.90		

Table 6.1. Annual Average Analysis

### 6.2 Wind Turbine Array Energy Production Analysis

The estimated output for a single wind turbine was calculated in Chapter 4. In the following tables, the output of a single turbine is presented along with the expected annual output of turbine arrays ranging in size from a single turbine up to six turbines. Table 6.2 shows the real-time wind energy estimate for a single turbine. Table 6.3 shows the monthly and annual expected output of the different sized turbine arrays.

The example of using only energy from the utility energy provider (at the cost of energy of \$0.08/kWh) is not included in this section, as the cost for powering the water system with zero wind turbines is constant.

The costs and benefits of the different sized turbine arrays (zero turbines through six turbines) will be considered later in the chapter, when the contribution that the turbine array makes to the integrated wind-water system is calculated. The application of too many turbines reduces their benefit, as the turbine array would no longer only displace the energy demanded by the wind-water system.

When the benefit of energy displacement becomes marginalized, the municipality sells the surplus energy to the utility energy provider at a reduced rate (\$0.04/kWh), essentially placing Seminole in the business of producing wind energy. This outcome is not optimal, as the project places more value on retail-priced energy that is displaced by the wind turbine array than what is sold back to the utility energy provider. Too few turbines would not minimize the cost/1000 gallons of water.

**Real-Time Wind Energy at 100 Meters by Month for a Single 1.5 MW Wind Turbine**  
(Calculated using West Texas Mesonet 100m Extrapolated Wind Speeds and GE 1.5 MW Machine Adjusted Power Curve)

Hour	January kWh	February kWh	March kWh	April kWh	May kWh	June kWh	July kWh	August kWh	September kWh	October kWh	November kWh	December kWh	Average kWh
0:00	944	889	752	1160	1042	752	608	608	834	889	630	995	842
1:00	971	861	779	1160	971	697	630	564	779	916	608	995	828
2:00	916	889	779	1066	861	630	564	426	697	779	586	916	759
3:00	861	861	779	1018	697	608	475	442	564	724	630	889	712
4:00	995	806	697	995	674	542	475	376	426	674	564	861	674
5:00	1018	806	608	889	674	564	426	272	343	586	564	806	630
6:00	971	806	586	834	586	459	343	197	343	608	564	697	583
7:00	916	724	564	630	409	297	139	94	285	564	564	834	502
8:00	944	564	359	519	442	310	210	69	166	310	343	697	411
9:00	779	409	359	586	497	297	197	103	210	326	197	376	361
10:00	409	442	376	630	426	260	175	103	185	376	222	326	327
11:00	426	497	359	674	326	235	185	94	175	376	247	442	336
12:00	497	586	359	779	310	235	222	130	175	359	260	519	369
13:00	519	674	359	752	326	260	235	148	185	409	247	475	382
14:00	459	674	409	834	359	272	260	157	185	392	235	426	388
15:00	459	630	459	916	392	297	310	157	197	376	210	392	400
16:00	519	652	497	944	442	310	392	148	222	409	185	409	427
17:00	542	564	564	944	497	392	409	166	247	426	210	426	449
18:00	586	608	586	752	519	475	459	222	272	564	409	630	507
19:00	630	779	724	944	652	630	564	235	519	779	630	752	653
20:00	779	916	971	1160	944	834	724	426	752	834	724	724	816
21:00	916	944	1066	1208	1137	971	806	586	861	995	752	806	921
22:00	916	1018	1066	1184	1137	971	752	674	806	1066	779	834	934
23:00	889	1018	944	1160	1042	861	652	674	724	995	630	916	876
<b>Daily Total</b>	17,861	17,620	15,000	21,739	15,364	12,156	10,210	7,070	10,150	14,730	10,987	16,143	14,086
<b>Monthly Total</b>	553,698	493,368	464,995	652,155	476,284	364,686	316,506	219,168	304,493	456,642	329,600	500,420	5,132,015
<b>Annual Total</b>													5,132,015

Table 6.2. Real-Time Wind Energy Estimate for a Single Turbine



Energy Produced by Turbine Arrays, in kWh													
	January	February	March	April	May	June	July	August	September	October	November	December	Average
	kWh	kWh	kWh	kWh	kWh	kWh	kWh	kWh	kWh	kWh	kWh	kWh	kWh
<b>Energy from 1 Turbine:</b>													
Daily Total	17,861	17,620	15,000	21,739	15,364	12,156	10,210	7,070	10,150	14,730	10,987	16,143	14,086
Monthly Total	553,698	493,368	464,995	652,155	476,284	364,686	316,506	219,168	304,493	456,642	329,600	500,420	5,132,015
<b>Annual Total</b>													
<b>Energy from 2 Turbines:</b>													
Daily Total	35,722	35,241	30,000	43,477	30,728	24,312	20,420	14,140	20,300	29,461	21,973	32,285	28,172
Monthly Total	1,107,396	986,736	929,991	1,304,311	952,567	729,373	633,012	438,337	608,985	913,284	659,200	1,000,840	10,264,031
<b>Annual Total</b>													
<b>Energy from 3 Turbines:</b>													
Daily Total	53,584	52,861	45,000	65,216	46,092	36,469	30,630	21,210	30,449	44,191	32,960	48,428	42,257
Monthly Total	1,661,093	1,480,104	1,394,986	1,956,466	1,428,851	1,094,059	949,518	657,505	913,478	1,369,926	988,799	1,501,260	15,396,046
<b>Annual Total</b>													
<b>Energy from 4 Turbines:</b>													
Daily Total	71,445	70,481	59,999	86,954	61,456	48,625	40,839	28,280	40,599	58,922	43,947	64,570	56,343
Monthly Total	2,214,791	1,973,472	1,859,981	2,608,621	1,905,135	1,458,745	1,266,024	876,674	1,217,970	1,826,568	1,318,399	2,001,680	20,528,061
<b>Annual Total</b>													
<b>Energy from 5 Turbines:</b>													
Daily Total	89,306	88,101	74,999	108,693	76,820	60,781	51,049	35,350	50,749	73,652	54,933	80,713	70,429
Monthly Total	2,768,489	2,466,841	2,324,977	3,260,777	2,381,418	1,823,432	1,582,530	1,095,842	1,522,463	2,283,210	1,647,999	2,502,100	25,660,077
<b>Annual Total</b>													
<b>Energy from 6 Turbines:</b>													
Daily Total	107,167	105,722	89,999	130,431	92,184	72,937	61,259	42,420	60,899	88,382	65,920	96,855	84,515
Monthly Total	3,322,187	2,960,209	2,789,972	3,912,932	2,857,702	2,188,118	1,899,036	1,315,011	1,826,955	2,739,853	1,977,599	3,002,520	30,792,092
<b>Annual Total</b>													

Table 6.3. Energy Produced by Turbine Arrays

### **6.3 Municipal Water Use Analysis**

The procedure for the analysis of the water use data is presented in Chapter 5. Table 6.4 shows the average real-time water flow rate by month and hour of the day, and is a reproduction of a table in Chapter 5. Table 6.5 shows the average real-time water flow rate converted to thousand gallon (TG) units. Thousand gallon units are used in the remainder of this analysis in order to maintain consistency between calculations. The output of this analysis will be to calculate the minimized cost/1000 gallons of potable water.

Matching the expected electrical demand of the water system with the available wind energy on an annual average basis was the output of the system sizing procedure in Chapter 5. The real-time data presented in this chapter proposes a different approach to the sizing of the turbine array. This approach uses real-time data of both wind turbine energy supply and water system energy demand to determine when there will be surplus energy from the turbine array, and whether that surplus energy will go to municipal loads or to the utility energy provider.

Average Real-Time Water Flow Rate, in MGD (One Hour Averages)  
Using Real-Time data from January 2006-May 2007

Hour	January		February		March		April		May		June		July		August		September		October		November		December		AVERAGE	
	MGD	MGD	MGD	MGD	MGD	MGD	MGD	MGD	MGD	MGD	MGD	MGD	MGD	MGD	MGD	MGD	MGD	MGD	MGD	MGD	MGD	MGD	MGD	MGD	MGD	MGD
0:00	0.86	0.93	1.19	1.65	1.61	2.53	2.28	2.51	2.75	1.53	1.26	0.97	1.68													
1:00	0.81	0.93	1.11	1.57	1.63	2.44	2.19	2.67	2.60	1.43	1.36	0.93	1.65													
2:00	0.76	0.85	0.98	1.49	1.55	2.36	2.16	2.79	2.54	1.41	1.29	0.95	1.60													
3:00	0.72	0.78	0.86	1.41	1.45	2.35	2.19	2.71	2.66	1.55	1.21	0.88	1.56													
4:00	0.66	0.70	0.82	1.35	1.44	2.41	2.21	2.74	2.88	1.78	1.22	0.87	1.59													
5:00	0.62	0.62	0.82	1.28	1.37	2.45	2.25	2.90	3.07	1.96	1.34	0.89	1.64													
6:00	0.60	0.58	0.85	1.20	1.38	2.50	2.28	3.05	3.20	2.01	1.43	0.81	1.68													
7:00	0.65	0.59	0.89	1.19	1.51	2.54	2.33	3.09	3.25	1.96	1.33	0.76	1.68													
8:00	0.70	0.66	0.95	1.24	1.61	2.57	2.40	3.14	3.29	1.84	1.17	0.79	1.69													
9:00	0.77	0.74	1.04	1.37	1.66	2.58	2.47	3.12	3.32	1.73	1.19	0.92	1.73													
10:00	0.83	0.86	1.13	1.50	1.61	2.59	2.52	3.05	3.25	1.62	1.36	1.02	1.77													
11:00	0.91	0.93	1.24	1.59	1.60	2.60	2.53	2.96	3.11	1.51	1.47	1.10	1.80													
12:00	0.95	1.01	1.31	1.62	1.52	2.56	2.49	2.73	2.91	1.39	1.42	1.17	1.77													
13:00	0.99	1.02	1.27	1.61	1.42	2.50	2.41	2.43	2.71	1.31	1.30	1.19	1.70													
14:00	1.01	1.04	1.19	1.56	1.40	2.38	2.32	2.27	2.56	1.26	1.19	1.17	1.63													
15:00	1.02	1.01	1.08	1.48	1.39	2.31	2.19	2.32	2.49	1.25	1.17	1.12	1.58													
16:00	1.00	0.98	1.08	1.39	1.39	2.25	2.00	2.31	2.54	1.20	1.17	1.10	1.54													
17:00	0.97	0.94	1.13	1.33	1.37	2.22	1.79	2.25	2.60	1.16	1.14	1.02	1.49													
18:00	0.94	0.92	1.23	1.36	1.37	2.29	1.61	2.26	2.63	1.17	1.14	1.01	1.50													
19:00	0.91	0.94	1.25	1.46	1.36	2.36	1.56	2.29	2.59	1.22	1.15	1.04	1.52													
20:00	0.91	0.96	1.22	1.58	1.48	2.45	1.71	2.39	2.53	1.29	1.17	1.10	1.56													
21:00	0.91	0.98	1.17	1.69	1.66	2.51	1.94	2.44	2.59	1.36	1.20	1.05	1.61													
22:00	0.91	0.97	1.16	1.75	1.68	2.58	2.18	2.55	2.65	1.46	1.18	0.99	1.66													
23:00	0.91	0.97	1.20	1.75	1.63	2.59	2.27	2.57	2.67	1.52	1.18	0.99	1.68													
<b>Daily Average</b>	0.85	0.87	1.09	1.48	1.50	2.46	2.18	2.65	2.81	1.50	1.25	0.99	1.635													
	<b>Annual Average</b>																						1.635			

Table 6.4. Average Real-Time Water Flow Rate

Hour	Average Real-Time Water Use, From Real-Time Flow Rate, By Hour, in Thousand Gallon Units (TG)												AVERAGE TG
	January TG	February TG	March TG	April TG	May TG	June TG	July TG	August TG	September TG	October TG	November TG	December TG	
0:00	35.70	38.63	49.47	68.77	67.29	105.43	94.82	104.58	114.42	63.74	52.59	40.22	69.80
1:00	33.91	38.55	46.43	65.39	67.73	101.68	91.25	111.28	108.27	59.49	56.69	38.94	68.55
2:00	31.52	35.21	40.76	62.15	64.74	98.41	90.10	116.08	105.82	58.66	53.91	39.42	66.54
3:00	29.98	32.55	35.89	58.96	60.40	97.75	91.21	112.99	110.84	64.56	50.33	36.82	65.18
4:00	27.43	28.99	33.99	56.24	60.13	100.40	92.13	114.32	120.03	73.96	50.74	36.37	66.14
5:00	25.82	25.96	33.98	53.34	56.89	102.20	93.60	120.95	127.78	81.48	55.69	36.98	68.34
6:00	24.97	24.32	35.55	50.10	57.47	104.01	94.91	127.00	133.15	83.95	59.71	33.82	69.80
7:00	26.93	24.67	37.19	49.52	62.75	105.99	97.13	128.76	135.57	81.66	55.32	31.74	70.07
8:00	29.05	27.39	39.69	51.80	67.01	107.02	100.18	130.68	137.16	76.59	48.68	32.89	70.50
9:00	31.99	30.98	43.30	57.05	69.23	107.65	102.94	130.07	138.26	71.96	49.51	38.30	72.05
10:00	34.39	35.68	47.05	62.58	67.27	108.00	105.02	127.29	135.46	67.65	56.67	42.69	73.84
11:00	38.05	38.73	51.53	66.28	66.74	108.51	105.42	123.30	129.57	63.06	61.26	45.68	74.84
12:00	39.62	41.95	54.68	67.31	63.30	106.77	103.96	113.68	121.40	57.97	58.99	48.71	73.75
13:00	41.40	42.55	53.03	66.99	59.13	103.98	100.55	101.13	112.72	54.41	54.07	49.41	70.89
14:00	41.89	43.38	49.45	64.83	58.22	99.34	96.70	94.78	106.76	52.71	49.58	48.56	68.00
15:00	42.55	42.25	44.89	61.66	58.10	96.35	91.38	96.65	103.87	52.19	48.55	46.51	65.86
16:00	41.53	40.97	45.02	58.07	57.75	93.68	83.37	96.17	105.87	49.98	48.64	45.83	64.09
17:00	40.51	39.23	46.90	55.51	56.99	92.46	74.38	93.90	108.47	48.45	47.70	42.47	62.26
18:00	39.09	38.46	51.20	56.77	57.00	95.37	67.06	94.09	109.75	48.74	47.52	42.29	62.32
19:00	37.98	39.01	51.88	60.99	56.66	98.53	65.19	95.22	108.03	50.84	48.09	43.20	63.21
20:00	37.76	40.08	50.76	66.00	61.72	102.22	71.26	99.39	105.49	53.71	48.83	45.82	65.17
21:00	37.76	41.02	48.76	70.38	69.09	104.54	81.02	101.68	107.95	56.64	50.02	43.76	67.07
22:00	37.82	40.27	48.54	72.91	69.97	107.50	90.86	106.23	110.50	61.04	49.13	41.30	69.08
23:00	37.73	40.22	49.87	72.79	68.06	107.93	94.43	107.02	111.15	63.36	49.29	41.14	70.13
<b>Daily Total</b>	845	871	1,090	1,476	1,504	2,456	2,179	2,647	2,808	1,497	1,252	993	1,637
<b>Monthly Total</b>	26,208	24,389	33,784	44,292	46,613	73,671	67,545	82,064	84,249	46,400	37,545	30,779	59,538
<b>Annual Average Sum</b>													<b>597,538</b>

Table 6.5. Average Real-Time Water Flow Rate in Thousand Gallon Units

### 6.4 Water System Energy Cost Analysis

The total system energy cost was calculated in Chapter 5. The calculated total system energy cost/1000 gallons is 17.06 kWh, as seen in Table 6.6 below. The energy costs for each of the water system components of the wellfield system, the reverse osmosis system, and the distribution system are also given.

This total system energy cost/1000 gallons from Table 6.6 is multiplied by the municipal water flow rate in thousand gallon units presented in Table 6.5, to produce the costs in Table 6.7.

Table 6.7 below shows the real-time estimate for total system (wellfield system, reverse osmosis system, distribution system) energy use. Figure 6.1 below is a graphical representation of the data in Table 6.7. This real-time estimate will be matched up with the expected output of the different sized turbine arrays, shown in Table 6.2 and Table 6.3.

Energy Costs/1000 Gallons at COE = \$0.08/kWh							
Well (1350 ft)		RO System		Distribution		Total	
kWh/1000	\$/1000	kWh/1000	\$/1000	kWh/1000	\$/1000	kWh/1000	\$/1000
10.58	\$0.85	5.63	\$0.45	0.86	\$0.07	17.06	\$1.36

Table 6.6. Energy Costs for Components of Water System

Average Real-Time Energy Use (kWh) for Total System (Well+RO System+Distribution)  
 Real-Time Water Use Multiplied by the Total System Energy Cost of 17.06 kWh/1000 gallon

Hour	January kWh	February kWh	March kWh	April kWh	May kWh	June kWh	July kWh	August kWh	September kWh	October kWh	November kWh	December kWh	AVERAGE kWh
0:00	609	659	844	1,173	1,148	1,799	1,618	1,784	1,952	1,087	897	686	1,191
1:00	579	658	792	1,116	1,156	1,735	1,557	1,898	1,847	1,015	967	664	1,169
2:00	538	601	695	1,060	1,105	1,679	1,537	1,980	1,805	1,001	920	672	1,135
3:00	511	555	612	1,006	1,030	1,668	1,556	1,928	1,891	1,101	859	628	1,112
4:00	468	495	580	959	1,026	1,713	1,572	1,950	2,048	1,262	866	620	1,128
5:00	441	443	580	910	971	1,744	1,597	2,063	2,180	1,390	950	631	1,166
6:00	426	415	606	855	980	1,774	1,619	2,167	2,272	1,432	1,019	577	1,191
7:00	460	421	634	845	1,071	1,808	1,657	2,197	2,313	1,393	944	541	1,195
8:00	496	467	677	884	1,143	1,826	1,709	2,229	2,340	1,307	830	561	1,203
9:00	546	529	739	973	1,181	1,837	1,756	2,219	2,359	1,228	845	653	1,229
10:00	587	609	803	1,068	1,148	1,842	1,792	2,171	2,311	1,154	967	728	1,260
11:00	649	661	879	1,131	1,139	1,851	1,799	2,103	2,211	1,076	1,045	779	1,277
12:00	676	716	933	1,148	1,080	1,822	1,773	1,939	2,071	989	1,006	831	1,258
13:00	706	726	905	1,143	1,009	1,774	1,715	1,725	1,923	928	922	843	1,209
14:00	715	740	844	1,106	993	1,695	1,650	1,617	1,821	899	846	828	1,160
15:00	726	721	766	1,052	991	1,644	1,559	1,649	1,772	890	828	793	1,124
16:00	708	699	768	991	985	1,598	1,422	1,641	1,806	853	830	782	1,093
17:00	691	669	800	947	972	1,577	1,269	1,602	1,850	826	814	724	1,062
18:00	667	656	874	969	972	1,627	1,144	1,605	1,872	831	811	721	1,063
19:00	648	665	885	1,040	967	1,681	1,112	1,624	1,843	867	820	737	1,078
20:00	644	684	866	1,126	1,053	1,744	1,216	1,696	1,800	916	833	782	1,112
21:00	644	700	832	1,201	1,179	1,783	1,382	1,735	1,842	966	853	746	1,144
22:00	645	687	828	1,244	1,194	1,834	1,550	1,812	1,885	1,041	838	705	1,179
23:00	644	686	851	1,242	1,161	1,841	1,611	1,826	1,896	1,081	841	702	1,196
<b>Daily Total</b>	14,423	14,860	18,592	25,187	25,652	41,894	37,172	45,162	47,909	25,535	21,351	16,938	27,935
<b>Monthly Total</b>	447,103	416,081	576,349	755,613	795,209	1,256,830	1,152,317	1,400,012	1,437,282	791,590	640,521	525,084	
<b>Monthly Cost</b>	7,627,574	7,098,347	9,832,520	12,890,764	13,566,271	21,441,517	19,658,532	23,884,204	24,520,027	13,504,520	10,927,297	8,957,927	10,193,992
<b>Annual Total</b>													8815,519,34
<b>Annual Cost</b>													\$815,519,34

Table 6.7. Average Real-Time Energy Use for Total System

COE = \$0.08/kWh

**Seminole System Energy Use  
(Well+RO System+Distribution)  
Based on Water Consumption Data  
13 Month Average: January 2006-May 2007  
20 Period Moving Average Calculation  
5-minute Observation Period**

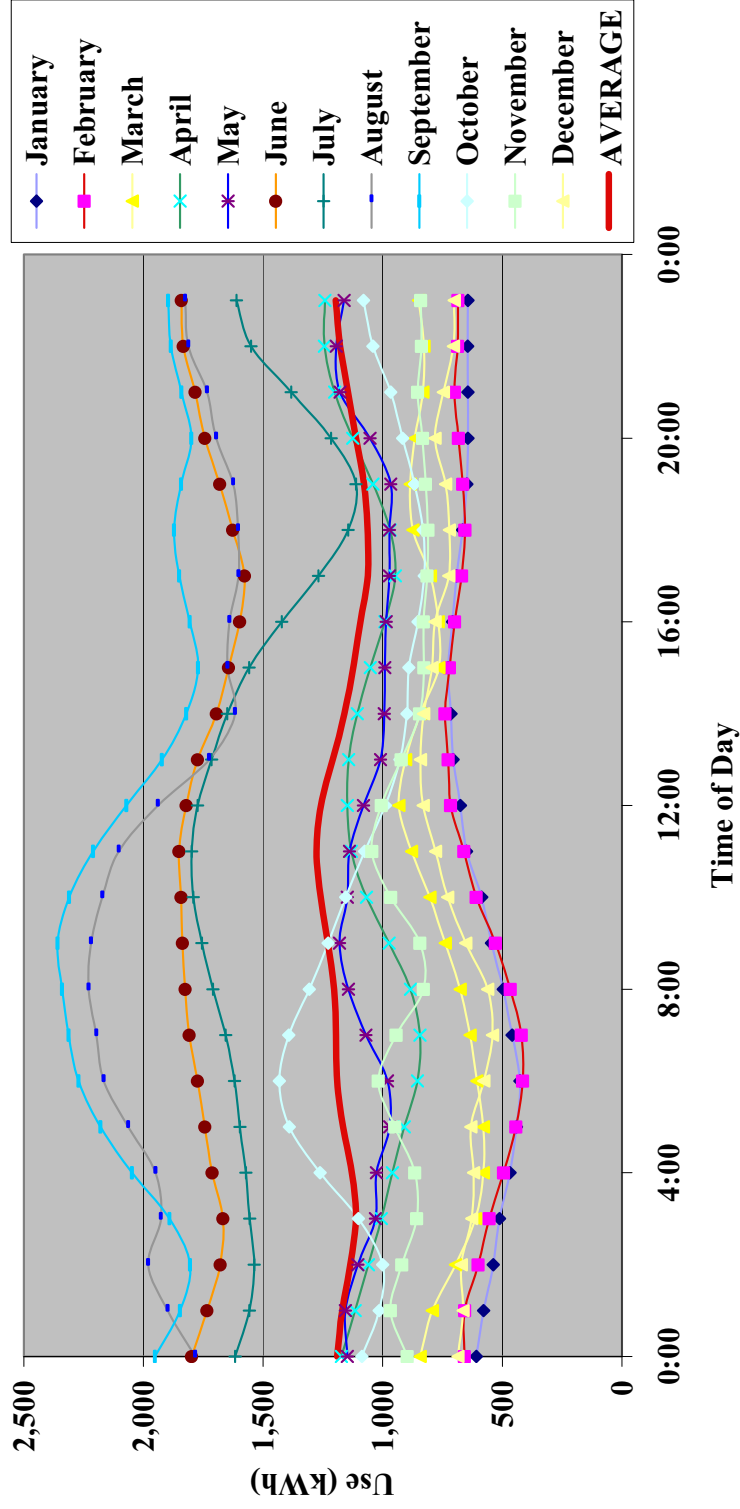


Figure 6.1. Seminole System Energy Use

## **6.5 Seminole Municipal Load Analysis**

The analysis of the municipal electrical loads for Seminole, Texas is discussed in Chapter 5. Table 6.8 shows the reproduction of the real-time municipal electrical demand data. The real-time electrical demand data will be matched with the corresponding wind energy availability of the different sized turbine arrays in an attempt to maximize both the benefit of the turbine array and also minimize the cost of water. This analysis (and definition of these terms) occurs later in this chapter.

The annual cost of powering the municipal loads is an essential number in the calculation of both the benefit of the different sized turbine arrays, as well as the final cost of water. In the event that there is excess energy beyond that demanded by the water system (wellfield, reverse osmosis, distribution), that energy will be applied to the municipal loads in order to increase the economic advantage of adding wind turbines to the system.



Real-Time Municipal Electrical Demand Data (64 electric meters' load on grid)													
(Based on Daily Average Usage and actual ERCOT Business Customer Profile, scaled to fit Seminole Loads)													
Hour	January kWh	February kWh	March kWh	April kWh	May kWh	June kWh	July kWh	August kWh	September kWh	October kWh	November kWh	December kWh	AVERAGE kWh
0:00	113	132	112	107	147	224	336	175	128	92	102	145	145
1:00	115	136	110	104	139	213	325	173	123	90	102	148	143
2:00	118	140	111	101	134	206	321	171	120	88	102	154	142
3:00	123	144	112	99	132	198	316	164	117	88	104	159	142
4:00	125	149	112	97	130	194	316	161	117	87	105	163	142
5:00	137	161	114	116	153	236	374	193	159	109	110	177	164
6:00	160	188	131	149	210	305	390	390	365	197	138	191	231
7:00	229	235	172	198	276	354	377	435	441	264	199	235	286
8:00	331	317	230	313	413	399	408	557	562	347	246	308	378
9:00	352	356	307	325	426	423	412	586	575	370	316	321	408
10:00	360	362	321	328	430	452	435	609	585	370	334	308	417
11:00	349	349	306	339	460	485	456	619	618	319	319	292	424
12:00	351	347	321	363	490	480	455	649	647	423	340	286	439
13:00	334	334	329	385	508	418	433	697	677	434	341	262	441
14:00	328	328	341	348	461	410	449	661	602	384	359	255	419
15:00	279	271	305	300	402	409	444	575	518	324	298	208	365
16:00	229	234	248	234	328	399	432	419	371	230	237	178	294
17:00	173	179	190	204	292	371	414	350	289	177	180	146	243
18:00	152	151	160	186	267	347	394	323	267	165	156	143	221
19:00	150	157	157	166	244	326	375	282	238	152	144	146	207
20:00	143	150	154	152	214	298	368	258	206	128	132	149	191
21:00	129	140	139	127	181	275	368	219	161	106	121	148	170
22:00	108	128	125	117	164	253	354	200	140	96	109	139	155
23:00	110	127	116	112	155	238	344	186	132	94	104	139	148
<b>Daily Total</b>	4,999	5,215	4,725	4,968	6,755	7,913	9,297	9,053	8,157	5,212	4,698	4,800	6,316
<b>Monthly Total</b>	154,962	146,029	146,473	149,048	209,405	237,398	288,201	280,643	244,719	161,562	140,951	148,795	2,308,187
<b>ERCOT Data</b>													<b>Annual Total</b>
<b>Seminole Data</b>													<b>Annual Cost</b>
												\$184,654.96	

COE = \$0.08/kWh

Table 6.8. Real-Time Municipal Electrical Demand Data

## 6.6 Energy Surplus or Deficit Analysis

This section calculates the energy surplus or deficit of the system, using the recommended array of three turbines, as calculated in Chapter 5 by the annual average analysis. Surplus or deficit calculation for other turbine arrays ranging in size from one to six can be found in Appendix A. The energy supplies from the wind turbine arrays in Table 6.2 and Table 6.3 are compared against the total water system energy demand presented in Table 6.7 to determine the times of surplus or deficit energy. Municipal loads are considered later in this analysis (Section 6.6.2). In that section of the analysis, the energy loads presented in Table 6.8 will be compared to those presented in the analysis of Section 6.6.1.

### 6.6.1 Energy Surplus or Deficit without considering Municipal Loads

Table 6.9 shows the monthly and hourly difference between expected wind energy supply, from Table 6.2, and expected water system energy demand, from Table 6.7.

Positive values in the table represent periods when the energy produced from the wind turbine array exceeds the energy needed to produce the amount of potable water to meet the municipality's water demand for that period. These positive periods are opportunities for the surplus energy generated from the wind turbine array to be used to power municipal loads or to be sold to the utility energy provider.

Negative values, colored red and in parenthesis, represent periods when the energy demanded from the water system exceeds that produced by the wind turbine array. Additional energy demanded by the water system will have to be purchased from the utility energy provider at a higher cost than what can be produced by the wind turbine array. Cost of energy from the utility energy provider for this report is \$0.08/kWh.

The average values of surplus or deficit energy per day and month, as well as the annual average values are given in Table 6.9 below. The table shows the surplus or deficit analysis for three wind turbines. The surplus or deficit analyses for turbine arrays ranging in size from a single turbine up to six wind turbines is presented in Appendix A.

Real-Time Expected Energy Surplus or (Deficit), Without Including Municipal Loads for an array size of Three Wind Turbines  
(electrical cost of powering entire system with wind turbines; negative periods will indicate energy purchased from utility)

Hour	January kWh	February kWh	March kWh	April kWh	May kWh	June kWh	July kWh	August kWh	September kWh	October kWh	November kWh	December kWh	AVERAGE kWh
0:00	2,222	2,007	1,411	2,308	1,978	456	207	40	550	1,579	993	2,298	1,335
1:00	2,355	1,926	1,545	2,366	1,758	355	334	(207)	490	1,734	857	2,320	1,313
2:00	2,211	2,066	1,642	2,137	1,479	212	154	(704)	285	1,336	838	2,076	1,142
3:00	2,072	2,029	1,725	2,050	1,059	156	(131)	(601)	(200)	1,071	1,032	2,038	1,025
4:00	2,516	1,925	1,510	2,025	998	(88)	(146)	(771)	(771)	762	826	1,963	893
5:00	2,615	1,976	1,244	1,756	1,053	(52)	(320)	(1,247)	(1,152)	368	741	1,788	723
6:00	2,487	2,004	1,151	1,647	777	(398)	(591)	(1,576)	(1,243)	392	673	1,513	557
7:00	2,289	1,751	1,057	1,046	156	(917)	(1,240)	(1,916)	(1,459)	298	748	1,960	309
8:00	2,335	1,224	401	675	183	(897)	(1,081)	(2,022)	(1,841)	(378)	198	1,529	30
9:00	1,791	698	339	784	311	(945)	(1,165)	(1,911)	(1,730)	(249)	(254)	474	(145)
10:00	640	717	325	823	129	(1,064)	(1,265)	(1,863)	(1,757)	52	(301)	250	(277)
11:00	627	831	199	893	(160)	(1,148)	(1,245)	(1,823)	(1,684)	89	(228)	547	(268)
12:00	816	1,042	145	1,189	(151)	(1,118)	(1,107)	(1,549)	(1,545)	299	(181)	583	(62)
13:00	852	1,298	173	1,112	(30)	(995)	(1,012)	(1,281)	(1,370)	278	(142)	448	5
14:00	661	1,283	383	1,396	85	(879)	(871)	(1,145)	(1,268)	237	(200)	384	75
15:00	650	1,170	610	1,697	186	(753)	(630)	(1,177)	(1,181)	374	(276)	445	189
16:00	850	1,258	724	1,840	341	(669)	(245)	(1,196)	(1,140)	450	(185)	552	284
17:00	934	1,022	891	1,884	520	(400)	(42)	(1,103)	(1,109)	860	416	1,169	457
18:00	1,091	1,168	884	1,286	586	(201)	232	(939)	(285)	1,470	1,070	1,517	881
19:00	1,243	1,671	1,287	1,791	990	210	579	(921)	455	1,585	1,339	1,391	1,335
20:00	1,693	2,065	2,047	2,355	1,778	758	956	(419)	742	2,018	1,401	1,673	1,618
21:00	2,104	2,131	2,366	2,423	2,232	1,130	1,037	23	534	2,156	1,499	1,797	1,622
22:00	2,103	2,368	2,369	2,309	2,217	1,079	704	211	276	1,903	1,050	2,047	1,430
23:00	2,023	2,369	1,980	2,240	1,965	743	346	198	331	19,310	13,680	31,490	15,225
Daily Total (+)	39,161	38,001	26,408	40,028	20,781	5,098	4,549	472	3,331	19,310	13,680	31,490	15,225
Daily Total (-)	0	0	0	0	(341)	(10,524)	(11,091)	(24,424)	(20,791)	(654)	(2,071)	0	(903)
Positive Total	1,213,991	1,064,023	818,637	1,200,853	644,225	152,953	141,028	14,628	99,927	598,600	410,397	976,176	7,335,437
Negative Total	0	0	0	0	(10,583)	(315,723)	(343,828)	(757,135)	(623,731)	(20,263)	(62,119)	0	(2,133,383)
(By Month)													
Annual Positive Balance													7,335,437
Annual Negative Balance													(2,133,383)

(Red) values represent energy drawn from electric utility  
Black values represent excess energy produced by Wind Turbine array

Table 6.9. Real-Time Expected Energy Surplus or Deficit

### **6.6.2 Energy Surplus or Deficit Considering Municipal Loads**

Table 6.10 below shows the surplus or deficit analysis presented in Table 6.9, with the extra consideration of the municipal loads presented in Table 6.8. The purpose of this analysis is to determine the contribution of the wind turbine array to both the water system (wellfield, reverse osmosis, distribution) as well as the municipal loads. This allows for the use of the surplus energy produced by the wind turbine array to offset some of the costs to power municipal loads. A calculation of the total expected energy cost for both the water system and municipal loads are produced from this analysis.

Positive values in the table below represent periods when the wind turbine array produces a surplus of energy over the amount demanded by both the water system and municipal loads. The energy values in these positive periods are amounts of energy that will be sold back to the utility energy provider. The price of energy sold to the utility energy provider is \$0.04/kWh.

Negative values, colored red and in parenthesis, are periods when the electrical demands of the water system and the municipal loads exceed the energy generated by the wind turbine array. The energy values in the negative periods are amounts of energy that will have to be purchased from the utility energy provider. The cost of energy from the utility energy provider is \$0.08/kWh.

Daily and monthly, as well as annual average values are presented. Also presented are the dollar values of the annual average negative and positive periods of energy use.

The data presented in Table 6.11 are simply the negative energy periods presented in Table 6.10, with the purpose of separating and showing the periods where the municipality will have to purchase energy from the utility energy provider at the higher cost of energy of \$0.08/kWh. Further data for the different sized turbine arrays, ranging in size from a single turbine up to six turbines are presented in Appendix A.

**Real-Time Expected Energy Balance, Including Municipal Loads for an array size of Three Wind Turbines**  
(electrical cost of powering entire system with wind turbines; negative periods indicate energy purchased from utility)

Hour	January kWh	February kWh	March kWh	April kWh	May kWh	June kWh	July kWh	August kWh	September kWh	October kWh	November kWh	December kWh	AVERAGE kWh
0:00	2,109	1,875	1,299	2,201	1,831	231	(130)	(135)	422	1,487	891	2,154	1,189
1:00	2,220	1,790	1,435	2,261	1,618	143	9	(380)	367	1,644	755	2,172	1,170
2:00	2,092	1,925	1,530	2,036	1,345	5	(167)	(875)	164	1,248	736	1,922	999
3:00	1,949	1,884	1,612	1,950	927	(42)	(446)	(766)	(317)	983	928	1,879	883
4:00	2,391	1,776	1,398	1,928	867	(282)	(463)	(983)	(888)	674	721	1,800	751
5:00	2,478	1,815	1,130	1,640	900	(288)	(694)	(1,441)	(1,311)	258	631	1,611	559
6:00	2,328	1,816	1,020	1,498	567	(703)	(981)	(1,966)	(1,608)	194	534	1,322	326
7:00	2,060	1,517	885	848	(120)	(1,271)	(1,617)	(2,351)	(1,900)	34	548	1,725	23
8:00	2,004	907	170	362	(230)	(1,296)	(1,488)	(2,579)	(2,403)	(725)	(48)	1,221	(347)
9:00	1,439	343	32	459	(115)	(1,368)	(1,577)	(2,497)	(2,305)	(619)	(570)	153	(553)
10:00	280	356	4	495	(301)	(1,516)	(1,700)	(2,473)	(2,342)	(397)	(635)	(58)	(695)
11:00	278	482	(107)	553	(620)	(1,632)	(1,701)	(2,442)	(2,303)	(343)	(623)	255	(692)
12:00	465	695	(176)	826	(641)	(1,598)	(1,563)	(2,199)	(2,192)	(334)	(568)	442	(590)
13:00	518	964	(156)	727	(538)	(1,413)	(1,445)	(1,978)	(2,046)	(136)	(522)	321	(503)
14:00	333	955	42	1,047	(376)	(1,289)	(1,320)	(1,806)	(1,870)	(106)	(501)	193	(414)
15:00	371	899	305	1,397	(216)	(1,161)	(1,074)	(1,699)	(1,699)	(87)	(497)	175	(290)
16:00	621	1,024	476	1,606	13	(1,068)	(677)	(1,616)	(1,511)	144	(514)	267	(105)
17:00	761	843	701	1,680	228	(772)	(456)	(1,453)	(1,398)	274	(365)	406	42
18:00	939	1,017	724	1,100	319	(548)	(162)	(1,262)	(1,324)	694	260	1,027	236
19:00	1,093	1,514	1,130	1,625	747	(116)	204	(1,202)	(522)	1,318	926	1,371	674
20:00	1,549	1,915	1,893	2,204	1,564	460	588	(677)	249	1,458	1,207	1,242	1,144
21:00	1,976	1,991	2,226	2,296	2,051	855	669	(196)	581	1,912	1,280	1,525	1,448
22:00	1,995	2,240	2,244	2,191	2,053	826	350	12	394	2,060	1,389	1,658	1,468
23:00	1,913	2,242	1,865	2,128	1,811	505	2	11	144	1,809	945	1,907	1,282
<b>Daily Total (+)</b>	34,162	32,786	22,122	35,060	16,842	3,026	1,821	23	2,321	16,191	11,753	26,748	12,195
<b>Daily Total (-)</b>	0	0	(439)	0	(3,157)	(16,365)	(17,660)	(33,028)	(27,939)	(2,747)	(4,842)	(58)	(4,189)
<b>Positive Total</b>	1,059,028	917,994	685,785	1,051,805	522,111	90,770	56,466	714	69,638	501,919	352,581	829,185	
<b>Negative Total</b>	0	0	(13,621)	0	(97,875)	(490,939)	(547,467)	(1,023,863)	(838,162)	(85,144)	(145,255)	(1,804)	
<b>(By Month)</b>													
													<b>Annual Positive Balance</b>
													<b>6,137,997</b>
													<b>Annual Negative Balance</b>
													<b>(3,244,130)</b>
													<b>Sell Price = \$0.04</b>
													<b>COE = \$0.08</b>

Revenue from selling excess wind energy (balance) at sell price **\$245,520**  
 Cost of purchasing negative balance at COE **(\$259,530)**

Table 6.10. Real-Time Expected Energy Balance

**Expected Energy Cost of Municipal Loads, After Considering Wind Energy for an array size of Three Wind Turbines**  
 (expected energy outlay for municipal loads after net metering with wind energy)  
*this is a reproduction of the negative values of the previous chart, showing expected energy purchase times*

Hour	January kWh	February kWh	March kWh	April kWh	May kWh	June kWh	July kWh	August kWh	September kWh	October kWh	November kWh	December kWh	AVERAGE kWh
0:00	0	0	0	0	0	0	(130)	(135)	0	0	0	0	0
1:00	0	0	0	0	0	0	0	(380)	0	0	0	0	0
2:00	0	0	0	0	0	0	(167)	(875)	0	0	0	0	0
3:00	0	0	0	0	0	(42)	(446)	(766)	(317)	0	0	0	0
4:00	0	0	0	0	0	(282)	(463)	(983)	(888)	0	0	0	0
5:00	0	0	0	0	0	(288)	(694)	(1,441)	(1,311)	0	0	0	0
6:00	0	0	0	0	0	(703)	(981)	(1,966)	(1,608)	0	0	0	0
7:00	0	0	0	0	(120)	(1,271)	(1,617)	(2,351)	(1,900)	0	0	0	0
8:00	0	0	0	0	(230)	(1,296)	(1,488)	(2,579)	(2,403)	(725)	(48)	0	(347)
9:00	0	0	0	0	(115)	(1,368)	(1,577)	(2,497)	(2,305)	(619)	(570)	0	(553)
10:00	0	0	0	0	(301)	(1,516)	(1,700)	(2,473)	(2,342)	(397)	(635)	(58)	(695)
11:00	0	0	(107)	0	(620)	(1,632)	(1,701)	(2,442)	(2,303)	(343)	(623)	0	(692)
12:00	0	0	(176)	0	(641)	(1,598)	(1,563)	(2,199)	(2,192)	(334)	(568)	0	(590)
13:00	0	0	(156)	0	(538)	(1,413)	(1,445)	(1,978)	(2,046)	(136)	(522)	0	(503)
14:00	0	0	0	0	(376)	(1,289)	(1,320)	(1,806)	(1,870)	(106)	(501)	0	(414)
15:00	0	0	0	0	(216)	(1,161)	(1,074)	(1,752)	(1,699)	(87)	(497)	0	(290)
16:00	0	0	0	0	0	(1,068)	(677)	(1,616)	(1,511)	0	(514)	0	(105)
17:00	0	0	0	0	0	(772)	(456)	(1,453)	(1,398)	0	(365)	0	0
18:00	0	0	0	0	0	(548)	(162)	(1,262)	(1,324)	0	0	0	0
19:00	0	0	0	0	0	(116)	0	(1,202)	(522)	0	0	0	0
20:00	0	0	0	0	0	0	0	(677)	0	0	0	0	0
21:00	0	0	0	0	0	0	0	(196)	0	0	0	0	0
22:00	0	0	0	0	0	0	0	0	0	0	0	0	0
23:00	0	0	0	0	0	0	0	0	0	0	0	0	0
<b>Daily Total</b>	0	0	(439)	0	(3,157)	(16,365)	(17,660)	(33,028)	(27,939)	(2,747)	(4,842)	(58)	(4,189)
<b>Monthly Total</b>	0	0	(13,621)	0	(97,875)	(490,939)	(547,467)	(1,023,863)	(838,162)	(85,144)	(145,255)	(1,804)	(3,244,130)
												<b>Annual Balance</b>	(3,244,130)
												<b>Annual Cost</b>	(\$259,530)

COE = \$0.08/kWh

Table 6.11. Expected Cost of Municipal Loads

## 6.7 Summary of Benefits from Wind Turbine Array

The following data presented in Table 6.12 below shows the itemized costs of powering municipal loads, powering municipal and water system loads without any wind energy, and the cost to the municipality to power those loads with available wind energy. Also presented in the table is the expected revenue from selling excess energy to the utility energy provider. This revenue is then subtracted from the cost to the municipality to power the water system and municipal loads with available wind energy. This calculated difference is considered the cost to the municipality to power the water system and municipal loads, after the excess energy is sold. This section is a description of the calculations used in generating Table 6.8.

The *cost of solely providing municipal loads* is a cost taken from Table 6.8, and represents the cost to power municipal loads at the cost of energy of \$0.08/kWh. The *cost to the municipality to power municipal, wellfield, reverse osmosis, and distribution loads without wind energy* is a summation of the total cost numbers from Table 6.7 and Table 6.8.

The *cost to power municipal, wellfield, reverse osmosis, and distribution loads with available wind energy* is the annual negative balance presented in Table 6.10 and Table 6.11. This number represents the summation of all of the times when the wind-water system will have to purchase energy from the utility energy provider, at \$0.08/kWh, after the consideration of the benefit of the wind turbine array.

The *revenue from selling excess wind energy* at the selling price of \$0.04/kWh is taken from the annual positive balance in Table 6.10, and multiplied times the stated selling price. The *cost to the municipality to power municipal, wellfield, reverse osmosis, and distribution loads after selling excess energy* is the net difference between the cost of powering the municipal and water system loads with wind energy, and the revenue gained by selling excess wind energy to the utility energy provider.

The *annual total monetary benefit of the wind turbine array to the municipality* is the net difference between the cost to the municipality to power the municipal and water system loads without wind energy, and the cost to the municipality to power the municipal and water system loads, considering wind energy and the sale of excess energy to the utility energy provider. This annual total monetary benefit will be compared to turbine installed capital cost as well as operations and maintenance costs in order to determine the benefit that the turbine array brings to the integrated wind-water system.

The remaining calculations in Table 6.12 show the energy consumption information specific to the application of three turbines to the wind-water system. Additional information on the application of turbine arrays ranging in size from a single turbine up to six turbines can be found in Appendix A.

### 6.7.1 Explanation of the Function of Turbine Array Benefit/Loss

The turbine array benefit/loss can be explained by condensing into a function:

$$\text{Benefit} = f(\beta, \omega)$$

$$\omega = f(n) = \text{wind turbine capital cost} = \$2.4 \text{ million} * n$$

$n$  = number of turbines in array

$$\beta = \text{monetary benefit} = \alpha - \rho$$

$\alpha$  = annual average energy cost to power municipal and water system loads using electricity from the utility energy provider

$\rho = f(n)$  = cost to power municipal and water system loads using wind energy first, and then selling any surplus energy to the utility energy provider.

These variables are shown by the tables in this chapter, and would vary when designing systems that differ than described by this work.



Summary of the Costs/Benefits associated with an array of Three Wind Turbines	
Cost of providing solely municipal loads; no Wells, no RO, no Wind Energy (business as usual, which includes distribution)	(\$184,655)
Cost to municipality to power municipal, Well, RO System, and Distribution loads <i>without wind energy</i>	Cost of Energy from utility = \$0.08
Cost to municipality to power municipal, Well, RO System, and Distribution loads <i>with available wind energy</i>	Selling Price of Energy to Utility = \$0.04
Revenue from selling excess wind energy at Selling Price	\$245,520
Cost to municipality to power municipal, Well, RO System, and Distribution loads after selling excess energy	(\$14,011)
Annual total monetary benefit of wind turbine to municipality, yearly	\$986,164
<hr/>	
Total energy produced by turbine	15,396,046 kWh
Energy used by water system (Wells+RO System+Distribution)	10,193,992 kWh
Energy used by municipal loads	2,308,187 kWh
Excess energy sold to utility grid	6,137,997 kWh

Table 6.12. Summary of Costs/Benefits Associated with a Three Turbine Array

## 6.8 Optimal Sizing of the Wind Turbine Array

Different turbine arrays will contribute different costs and benefits to the entire wind-water system. The tables below present the differences in cost and benefits for each of the different sized turbine arrays, ranging in size from zero turbines up to six turbines. Table 6.13 also presents the maximization of the turbine benefit. A graphical representation of the maximization of turbine benefit is presented in Figure 6.2. This section is a description of the calculations used in generating Table 6.13.

### 6.8.1 Explanation of Costs/1000 Gallons

The equation for converting the capital costs of components into a cost/1000 gallon unit was presented in Chapter 5 (equation 5.2.1). A reproduction of that equation is presented here:

$$(\text{CapitalCost} / 1000\text{gallons}) = \left( \frac{iP}{1 - (1 + i)^{-n}} \right) / \text{TGUnits}$$

The *cost of solely providing municipal loads* is taken from Table 6.8, and represents the cost to power municipal loads at the cost of energy of \$0.08/kWh. The *cost to power the wellfield, reverse osmosis, and distribution loads without wind energy* is taken from Table 6.7. The *cost to the municipality to power municipal, wellfield, reverse osmosis, and distribution loads without wind energy* is a summation of the total cost numbers from Table 6.7 and Table 6.8, and a summation of the two costs mentioned in this paragraph. These numbers remain the same regardless of the size of the turbine array, since the turbine array has no effect on these costs.

The *cost to power municipal, wellfield, reverse osmosis, and distribution loads with available wind energy* is the annual negative balance presented in Table 6.10 and Table 6.11. This number represents the summation of all of the times when the wind-water system will have to purchase energy from the utility energy provider, at \$0.08/kWh, after the consideration of the benefit of the wind turbine array. This number varies with the number of turbines in the array, as their added benefit displaces more of the energy required to power the water system and municipal loads as the size of the array increases.

The *revenue from selling excess wind energy* at the selling price of \$0.04/kWh is taken from the annual positive balance in Table 6.10, and multiplied times the stated selling price. This revenue varies with the number of turbines in the array, as the excess energy produced by the turbine array goes beyond that needed by the water system and municipal loads.

The *cost to the municipality to power municipal, wellfield, reverse osmosis, and distribution loads after selling excess energy* is the net difference between the cost of powering the municipal and water system loads with wind energy, and the revenue gained by selling excess wind energy to the utility energy provider. This again varies with the number of turbines included in the wind turbine array.

The *annual total monetary benefit of the wind turbine array to the municipality* is the net difference between the cost to the municipality to power the municipal and water system loads without wind energy, and the cost to the municipality to power the municipal and water system loads, considering wind energy and the sale of excess energy to the utility energy provider. The annual total monetary benefit varies with the number of turbines in the wind turbine array. This benefit is converted into a cost/1000 gallons later in the table.

The annual total monetary benefit will be compared to turbine installed capital cost as well as operations and maintenance costs in order to determine the benefit that the turbine array brings to the integrated wind-water system. The wind turbine installed capital cost is \$2.4 million per turbine, and the operations and maintenance costs associated with the wind turbines is set at \$0.012/kWh produced (Chapman, 2007). The turbines are to be financed with a 20-year municipal bond, at a rate of 4.65% (Bloomberg, 2007).

The *turbine array benefit/loss* is calculated as the difference between the total monetary benefit of the wind turbine array and the total wind turbine cost/1000 gallons. Both of these costs vary with the number of turbines in the array, and when analyzed, there is a maximum benefit associated with the number of turbines. The turbine array benefit decreases after the maximum, because as the benefit of displacing water system energy runs out, the municipality sells the surplus energy to the utility energy provider at a reduced rate, placing Seminole in the business of producing wind energy. A graphical representation of the turbine array benefit/loss is presented in Figure 6.2.

Costs and Benefits for Different Turbine Array Sizes							
Number of Turbines	0	1	2	3	4	5	6
Cost of providing solely municipal loads; no Wells, no RO, no Wind Energy	(\$184,655)	(\$184,655)	(\$184,655)	(\$184,655)	(\$184,655)	(\$184,655)	(\$184,655)
Cost of solely providing system loads (Wells, RO System, Distribution); no Wind Energy	(\$815,519)	(\$815,519)	(\$815,519)	(\$815,519)	(\$815,519)	(\$815,519)	(\$815,519)
Cost to municipality to power municipal, Well, RO System, and Distribution loads <i>without wind energy</i>	(\$1,000,174) (\$1.67)	(\$1,000,174) (\$1.67)	(\$1,000,174) (\$1.67)	(\$1,000,174) (\$1.67)	(\$1,000,174) (\$1.67)	(\$1,000,174) (\$1.67)	(\$1,000,174) (\$1.67)
Cost to municipality to power municipal, Well, RO System, and Distribution loads <i>with available wind energy</i>	(\$1,000,174) (\$1.67)	(\$603,389) (\$1.01)	(\$380,155) (\$0.64)	(\$259,530) (\$0.43)	(\$196,713) (\$0.33)	(\$155,174) (\$0.26)	(\$126,638) (\$0.21)
Revenue from selling excess wind energy at selling price	\$0	\$6,888	\$100,552	\$245,520	\$419,392	\$603,903	\$794,916
Cost to municipality to power municipal, Well, RO System, and Distribution loads after selling excess energy	(\$1,000,174) (\$1.67)	(\$596,501) (\$1.00)	(\$279,604) (\$0.47)	(\$14,011) (\$0.02)	\$222,679 \$0.37	\$448,729 \$0.75	\$668,277 \$1.12
Annual total monetary benefit of wind turbine to municipality, yearly (difference between loads prior to net metering and after selling excess energy)	(\$1,000,174) (\$1,000,174)	(\$1,000,174) (\$596,501)	(\$1,000,174) (\$279,604)	(\$1,000,174) (\$14,011)	(\$1,000,174) \$222,679	(\$1,000,174) \$448,729	(\$1,000,174) \$668,277
ICC of Turbine Array (using 1.5 MW Turbines) at \$2.4 million each	\$0	\$403,673	\$720,571	\$986,164	\$1,222,853	\$1,448,903	\$1,668,452
ICC \$/1000 Gallons (20-year note at 20-yr Bond Rate)	\$0	\$0.31	\$0.63	\$0.94	\$1.25	\$1.56	\$1.88
O&M Cost \$/1000 Gallons Assuming O&M = 0.012 kWh	\$0	\$0.10	\$0.21	\$0.31	\$0.41	\$0.52	\$0.62
Total Wind Turbine Cost \$/1000 Gallons	\$0	\$0.42	\$0.83	\$1.25	\$1.66	\$2.08	\$2.50
Total Monetary Benefit of Wind Turbines to Municipality/1000 Gallons	\$0	\$0.68	\$1.21	\$1.65	\$2.05	\$2.42	\$2.79
Turbine Array Benefit/(Loss) per 1000 Gallons	\$0	\$0.26	\$0.37	\$0.40	\$0.38	\$0.35	\$0.30

Table 6.13. Costs and Benefits for Different Turbine Array Sizes

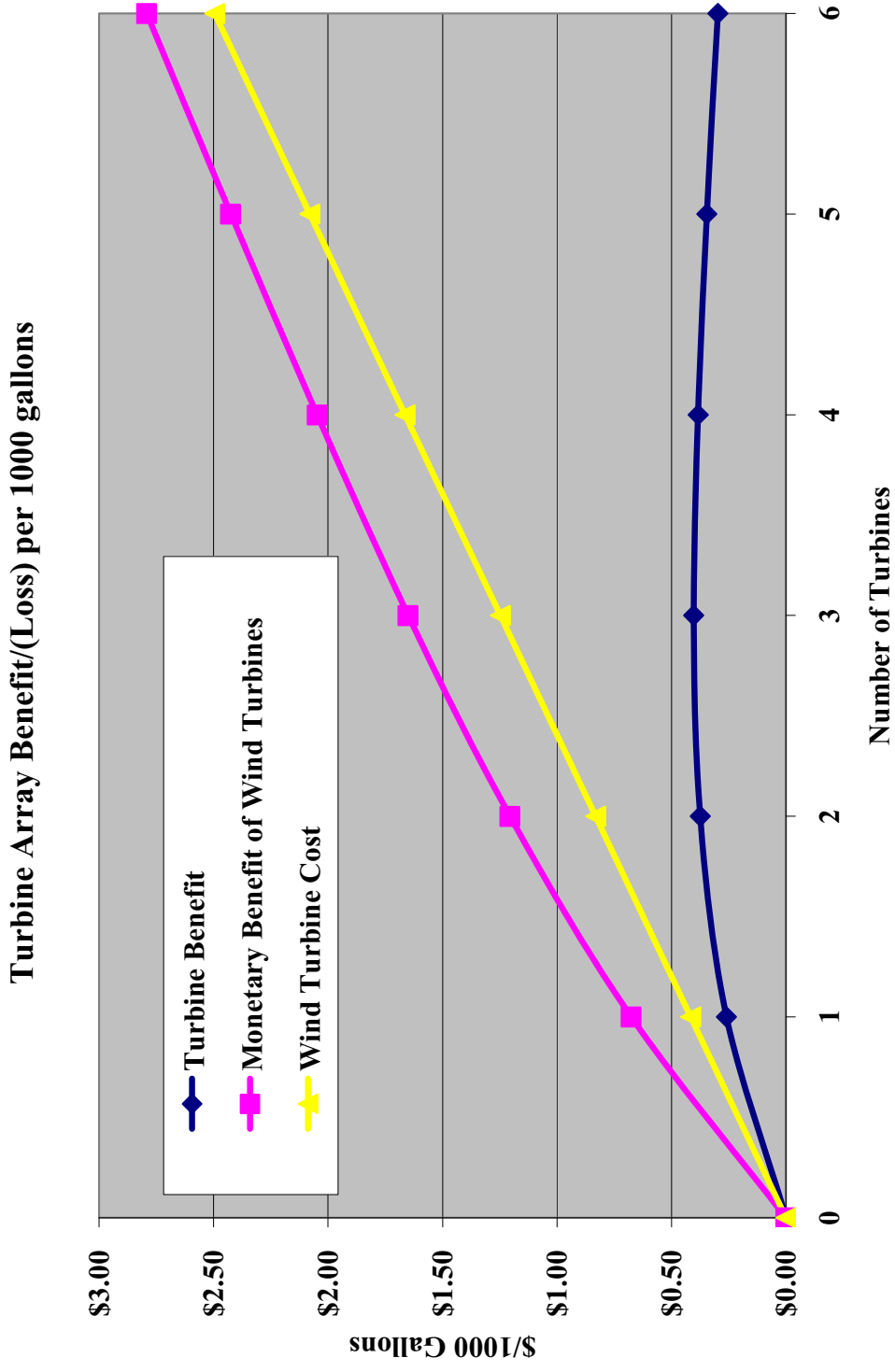


Figure 6.2. Turbine Array Benefit/Loss

## 6.9 Explanation of Total System Cost Minimum

Table 6.14 shows the total costs of different parts of the water system (wellfield, reverse osmosis, distribution), presented in the style of Chapter 5. Table 6.15 shows the total system costs associated with the different sized turbine arrays, ranging in size from zero turbines to six turbines. The total cost/1000 gallons presented for a three-turbine array is a summation of the costs and benefits associated with the entire water system presented in Table 6.14.

The total system cost reaches a minimum at the application of three turbines in the turbine array, as can be seen graphically in Figure 6.3. This minimum occurs as the benefit of additional turbines to the turbine array diminishes due to the decreased displacement of water system loads, and the increased sale of energy to the utility energy provider.

It is important to note the difference in cost of water when energy is only purchased from the utility energy provider (zero turbines), and when wind turbine generated energy is applied to the water system (one through six turbines). This shows that the application of wind turbines to the energy intensive reverse osmosis process has economic benefit. Further economic benefit is realized when the benefit from the wind turbine array is maximized at an array size of three turbines.

It should be noted that the total water system cost/1000 gallons is different than the cost presented in Chapter 5. This discrepancy exists because of the differences in analyzing the water system electrical use on an annual average analysis (Chapter 5) or a real-time analysis (Chapter 6). It is the intent of this chapter to show the increase in accuracy when the opportunity to make more data-related decisions is increased. Annual average analyses offer only a single opportunity: once a year. The real-time analysis of this chapter offers 288 opportunities (12 months, 24 hours/day) for data-related decisions. The difference in the purchase price of energy from the utility energy provider (\$0.08/kWh), and the selling price to the utility energy provider (\$0.04/kWh), compounds the discrepancies.

The adaptive/intelligent control algorithm presented in Chapter 8 explores the scenario of offering data-related decision opportunities on a 5-minute interval to control the integrated wind-water system. The increase in the number of data-related decisions, which is 288 decisions in the real-time analysis rather than 1 decision in the annual average analysis, explains the differences in the calculated cost of water between the two different types of analyses.

<u>Costs of System Components/1000 gallons for an array size of Three Wind Turbines</u>		
<b>Well Field Relevant Costs</b>		
Energy Cost/1000 Gallons	\$ 0.85	
Capital Cost/1000 Gallons	\$ 0.45	
Total Well Field Cost/1000 Gallons	\$ 1.30	
<b>RO System Relevant Costs</b>		
Energy Cost/1000 Gallons	\$ 0.45	
RO System Operational Cost	\$ 2.35	
Total RO System Cost/1000 Gallons	\$ 2.80	
<b>Distribution System Relevant Costs</b>		
Energy Cost/1000 Gallons	\$ 0.07	
Total Distribution System Cost/1000 Gallons	\$ 0.07	
<b>Wind Turbine Relevant Costs, assuming 3 turbines</b>		
ICC \$/1000 Gallons	\$ 0.94	
O&M Cost \$/1000 Gallons	\$ 0.31	
Total Wind Turbine Cost \$/1000 Gallons	\$ 1.25	
<b>Total Water System Cost/1000 Gallons</b>		
Energy Cost/1000 Gallons	\$ 1.37	
Operations Cost of Water Systems/1000 Gallons (including capital)	\$ 2.80	
Total Water System Cost/1000 Gallons	\$ 4.17	
<b>Total Monetary value produced by Wind Turbine (energy)</b>		
/1000 gallons	\$ 1.65	
<b>Total Wind Turbine Cost/1000 gallons</b>		
/1000 gallons	\$ 1.25	
<b>Actual Wind Turbine Benefit, Considering Energy Displacement</b>		
/1000 gallons	\$ 0.40	
<table border="1" style="margin: auto;"> <tr> <td style="padding: 5px;"> <b>Total System Cost/1000 Gallons</b>  <b>\$ 3.76</b> </td> </tr> </table>		<b>Total System Cost/1000 Gallons</b> <b>\$ 3.76</b>
<b>Total System Cost/1000 Gallons</b> <b>\$ 3.76</b>		

Table 6.14. Total Costs of System Components/1000 Gallons for a Three Turbine Array

Total Costs and Benefits for Different Turbine Array Sizes							
Number of Turbines	0	1	2	3	4	5	6
<b>Total System Cost (Wells+RO System+Distribution) \$/1000 gallons Including Capital, O&amp;M, Energy and Other Relevant Costs</b>	\$4.17	\$3.91	\$3.79	\$3.76	\$3.78	\$3.82	\$3.87
<b>Cost to Municipality to Power RO system Loads with No Wind Turbines, Not Including Capital Costs of Any Components</b>	<b>(\$1.36)</b>	<b>/1000 Gallons</b>					<b>(\$4.17)</b>
<b>Energy used by system (kW/h) (Wells+RO System+Distribution)</b>	10,193,992	10,193,992	10,193,992	10,193,992	10,193,992	10,193,992	10,193,992
<b>Energy used by municipal loads (kW/h)</b>	2,308,187	2,308,187	2,308,187	2,308,187	2,308,187	2,308,187	2,308,187
<b>Excess energy sold to utility grid (kW/h)</b>	0	172,203	2,513,795	6,137,997	10,484,790	15,097,569	19,872,894
				<b>Total Water System Cost/1000 Gallons Including Capital Costs of Components, But Not Including Any Turbines</b>			

Table 6.15. Total Costs and Benefits for Different Turbine Array Sizes



**Total System Cost  
(Wells+RO System+Distribution) \$/1000 Gallons  
Including Capital, O&M, Energy,  
and Other Relevant Costs**

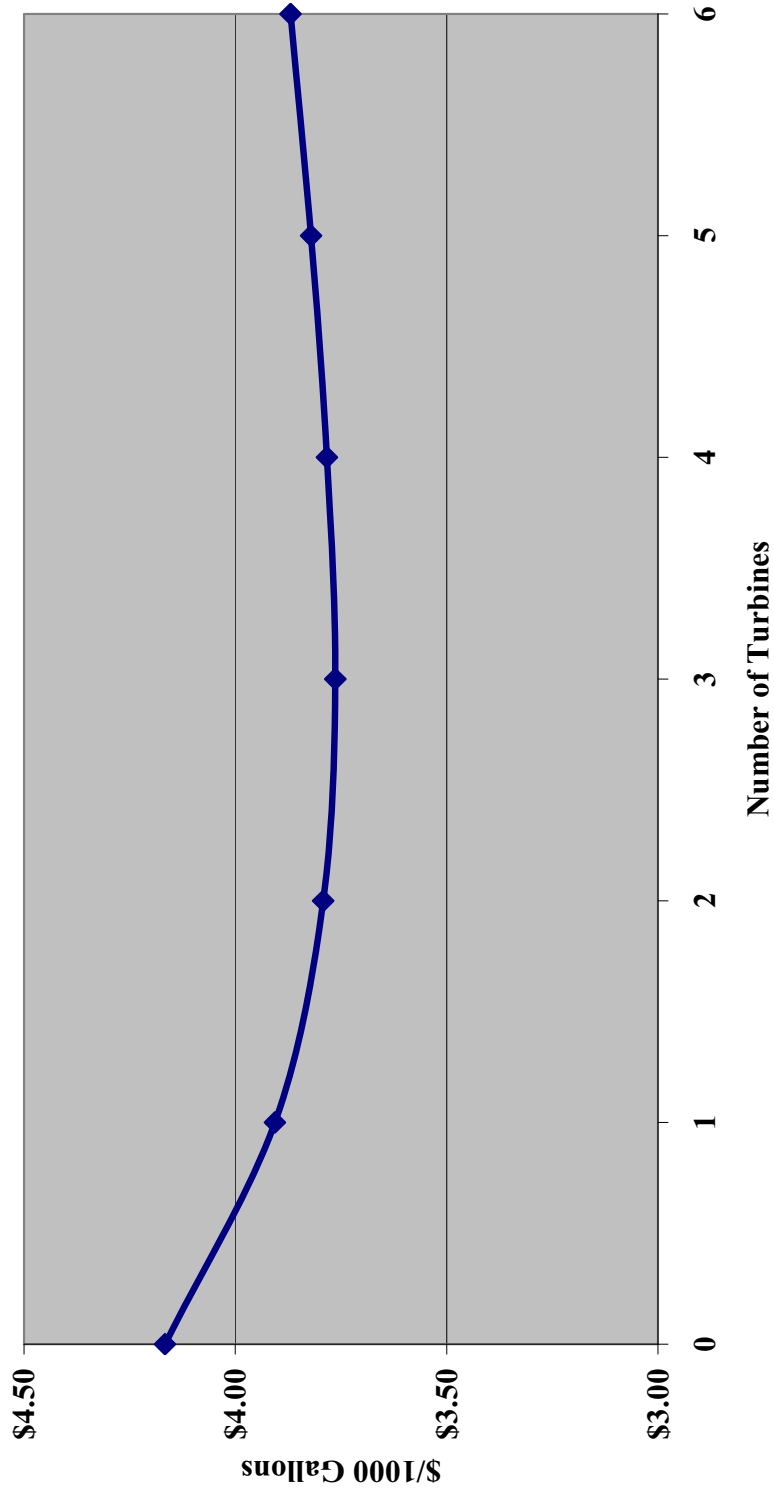


Figure 6.3. Total System Cost

## 6.10 Water System Energy Consumption by Component

This section is a reproduction of the data presented in Chapter 5. Continued analysis of different sized wind turbine arrays and their contribution to the water system can be found in Appendix A.

Figure 6.4 shows a pie graph of the distribution of monthly average energy use for each of the water system components of the wellfield, reverse osmosis, and distribution systems. Figure 6.4 shows the water system energy consumption estimate by component, both on a monthly and daily basis. Dollar amounts of the energy costs are also included, at the utility energy provider cost of energy of \$0.08/kWh.

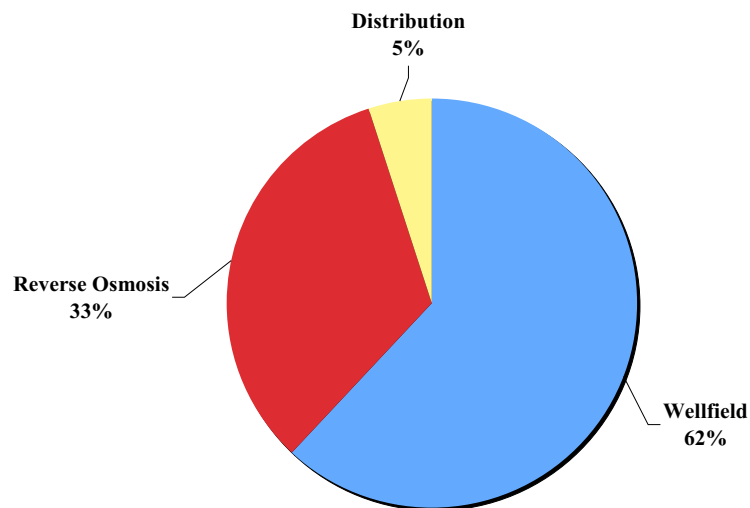


Figure 6.4. Distribution of Monthly Average Energy Use

<b>Water System Energy Consumption Estimate by Component</b>										
<b>Monthly Average Consumption</b>			<b>Well</b>		<b>RO</b>		<b>Distribution</b>		<b>Total</b>	
			<b>kWh</b>	<b>\$</b>	<b>kWh</b>	<b>\$</b>	<b>kWh</b>	<b>\$</b>	<b>kWh</b>	<b>\$</b>
January	28.65	Million Gallons	303,099	24,248	161,290	12,903	24,637	1,971	489,026	39,122
February	27.07	Million Gallons	286,369	22,910	152,387	12,191	23,278	1,862	462,034	36,963
March	35.76	Million Gallons	378,305	30,264	201,310	16,105	30,751	2,460	610,365	48,829
April	49.55	Million Gallons	524,264	41,941	278,980	22,318	42,615	3,409	845,859	67,669
May	68.94	Million Gallons	729,374	58,350	388,126	31,050	59,288	4,743	1,176,788	94,143
June	74.67	Million Gallons	789,977	63,198	420,375	33,630	64,214	5,137	1,274,566	101,965
July	81.07	Million Gallons	857,761	68,621	456,446	36,516	69,723	5,578	1,383,930	110,714
August	72.51	Million Gallons	767,150	61,372	408,228	32,658	62,358	4,989	1,237,737	99,019
September	59.44	Million Gallons	628,834	50,307	334,625	26,770	51,115	4,089	1,014,575	81,166
October	41.47	Million Gallons	438,787	35,103	233,494	18,680	35,667	2,853	707,948	56,636
November	30.59	Million Gallons	323,685	25,895	172,244	13,780	26,311	2,105	522,240	41,779
December	28.38	Million Gallons	300,303	24,024	159,802	12,784	24,410	1,953	484,515	38,761
									<b>Annual Sum</b>	<b>\$816,767</b>

<b>Average Water Consumption per Day</b>			<b>Well</b>		<b>RO</b>		<b>Distribution</b>		<b>Total</b>	
			<b>kWh</b>	<b>\$</b>	<b>kWh</b>	<b>\$</b>	<b>kWh</b>	<b>\$</b>	<b>kWh</b>	<b>\$</b>
January	0.924	MGD	9,777	782	5,203	416	795	64	15,775	1,262
February	0.967	MGD	10,227	818	5,442	435	831	67	16,501	1,320
March	1.153	MGD	12,203	976	6,494	520	992	79	19,689	1,575
April	1.652	MGD	17,475	1,398	9,299	744	1,421	114	28,195	2,256
May	2.224	MGD	23,528	1,882	12,520	1,002	1,913	153	37,961	3,037
June	2.489	MGD	26,333	2,107	14,013	1,121	2,140	171	42,486	3,399
July	2.615	MGD	27,670	2,214	14,724	1,178	2,249	180	44,643	3,571
August	2.339	MGD	24,747	1,980	13,169	1,053	2,012	161	39,927	3,194
September	1.981	MGD	20,961	1,677	11,154	892	1,704	136	33,819	2,706
October	1.338	MGD	14,154	1,132	7,532	603	1,151	92	22,837	1,827
November	1.020	MGD	10,789	863	5,741	459	877	70	17,408	1,393
December	0.916	MGD	9,687	775	5,155	412	787	63	15,630	1,250

COE = \$0.08/kWh

Table 6.16. Water System Energy Consumption Estimate by Component

## CHAPTER 7

### SENSITIVITY ANALYSIS

#### 7.1 Introduction

The cost of water from the integrated wind-water system proposed in earlier chapters is sensitive to various parameters. The exploration of this sensitivity to relevant parameters and their influence on the cost of water/1000 gallons is the purpose of the analysis performed in this chapter. The sensitivity analysis is performed on the following parameters:

1. Selling price of energy to the utility energy provider
2. Wind turbine cost of energy
3. Purchase price of energy from the utility energy provider
4. Bond interest rate
5. Well depth
6. Reverse osmosis unit energy consumption

The sensitivity analysis is performed on these parameters one at a time, varying the parameter in question, and holding all other variables constant. This isolates the effect of the parameter in question on the cost of water. Each of the components of the integrated wind-water system (wellfield, reverse osmosis, distribution, wind turbine array) are affected by more than one of these varied parameters, which contributed to their selection to test their influence on the cost of water/1000 gallons.

For each parameter, the initial (unchanged) value is represented graphically by the point (100%, 100%). The initial value for the cost of water is \$3.55/1000 gallons, and will vary by percentage from that value. Each parameter that will be varied has its initial value stated in the appropriate section, along with a restatement of the initial value for the cost of water, for a point of reference. The rate of change (slope) that the parameter has on the initial value of the cost of water will also be presented.

The parameters have been varied from the lower limit of 25% (one quarter of the initial value) to the upper limit of 200% (double the initial value). This encompasses many of the realistic values that these parameters may hold, as well as providing enough data points for a reasonable approximation of the calculated rate of change.

Because of the linear nature of the sensitivity analysis, all rates of change are statistically significant at the 99% level. Therefore, individual p-values are not presented with each parameter's effect on the cost of water.

## 7.2 Selling Price of Energy to the Utility Energy Provider

The initial selling price of energy to the utility energy provider is assumed to be \$0.04/kWh (Chapman, 2007), which contributes to the initial cost of water of \$3.55/1000 gallons. This parameter affects the sale of surplus energy back to the utility energy provider, and is influential only when the wind turbine array produces more energy than the integrated wind-water system can consume at a certain time period. Energy will be sold to the utility energy provider when the turbine array output exceeds the energy demand of the water system and municipal loads.

The effect that the selling price of energy has on the cost of water appears to be linear. In terms of the change shown by the line in Figure 7.1 below, an increase in the selling price of electricity negatively affects (lowers) the cost of water. The rate of change that varying the selling price of energy to the utility energy provider has on the cost of water is -0.0542 times the percent change from the initial value of the selling price of energy to the utility energy provider.

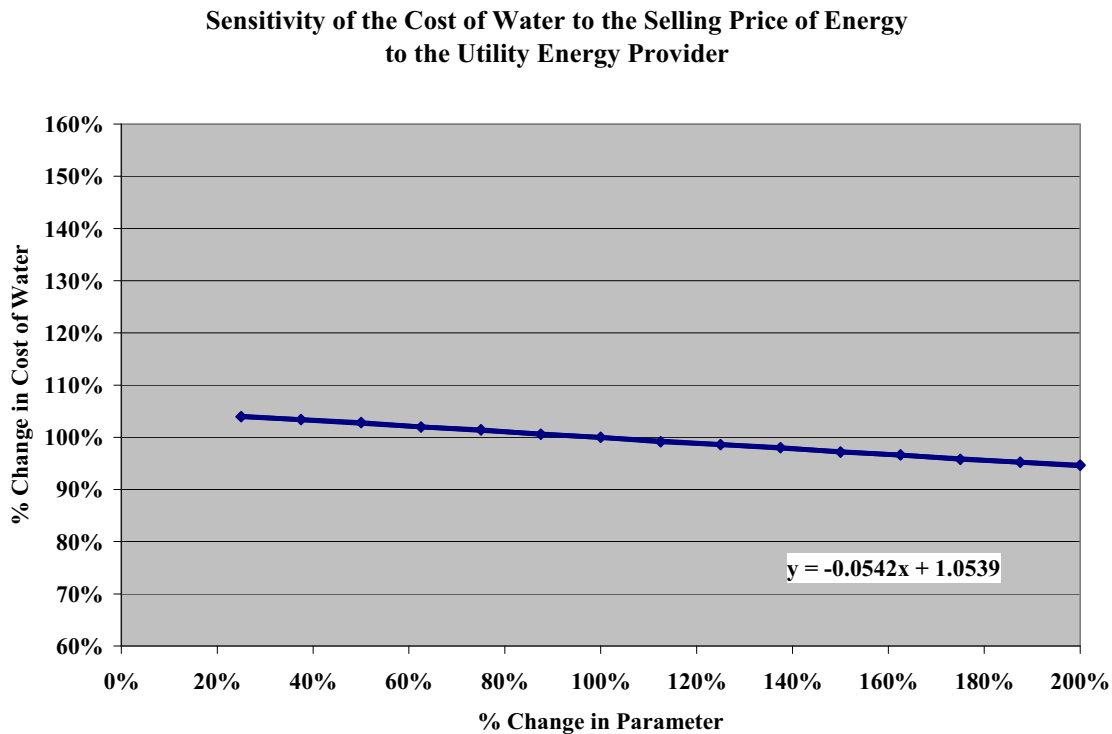


Figure 7.1. Sensitivity of the Cost of Water to the Selling Price of Energy

### 7.3 Wind Turbine Cost of Energy

The wind turbine cost of energy is a function of both the operations and maintenance (O&M) costs of the turbine as well as the wind turbine installed capital costs (ICC). For the purpose of this sensitivity analysis, the ICC for the turbines is varied, while the O&M costs are held constant. The turbine array is held constant at a size of three turbines, whose maximized benefit was presented in Chapter 6. The initial cost of the wind turbines was stated at \$2.4 million/turbine (Chapman, 2007; Black & Veatch<sup>a,b,c</sup>), and resulted in an initial cost of water of \$3.55/1000 gallons. The ICC of the turbine array affects the capital costs associated with the integrated wind-water system, which in turn has an effect on the cost of water.

The energy generated by the wind turbine array displaces the need to purchase retail-priced energy from the utility energy provider. This energy holds a value less than the \$0.08/kWh charged by the utility energy provider (Chapman, 2007). Wind turbine cost of energy holds an estimated value of \$0.05-0.07/kWh (Chapman, 2007).

The effect that varying the wind turbine ICC has on the cost of water appears to be linear. In terms of the change shown by the line in Figure 7.2 below, an increase in the ICC of the wind turbine positively affects (increases) the cost of water. The rate of change that varying wind turbine ICC has on the cost of water is 0.2643 times the percent change from the initial value of the wind turbine ICC.

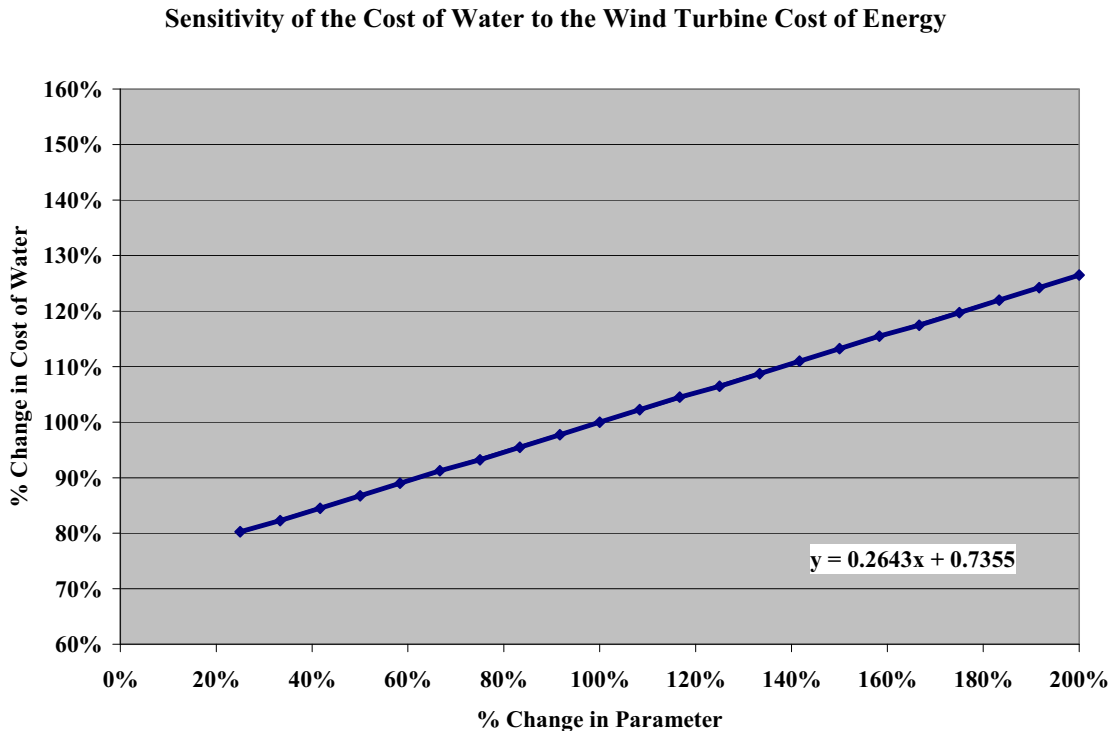


Figure 7.2. Sensitivity of the Cost of Water to the Wind Turbine COE

### 7.4 Purchase Price of Energy from the Utility Energy Provider

The initial purchase price of energy from the utility energy provider is assumed to be \$0.08/kWh (Chapman, 2007), which contributes to the initial cost of water of \$3.55/1000 gallons. Energy must be purchased from the utility energy provider when the energy supplied by the turbine array does not meet the energy demand of the water system (wellfield, reverse osmosis system, and distribution system) and municipal loads. This parameter affects the economic value of energy at those times when there is a wind energy deficit, and the integrated wind-water system purchases energy from the utility energy provider at the set price of \$0.08/kWh.

The effect that the purchase price of energy from the utility energy provider has on the cost of water appears to be linear. In terms of the change shown by the line in Figure 7.3, an increase in the purchase price of energy has a negative (lowering) effect on the cost of water. The rate of change that varying the purchase price of energy from the utility energy provider has on the cost of water is -0.0866 times the percent change from the initial value of that energy purchase price. The decrease in the cost of water with an increase in the purchase price of energy from the utility energy provider may seem counter-intuitive, but the value of retail priced energy that is displaced by the wind turbine array causes the price of water to drop. A summary of the value of the displaced energy, as well as energy that is sold to the grid can be found in Table 5.26.

**Sensitivity of the Cost of Water to the Purchase Price of Energy from the Utility Energy Provider**

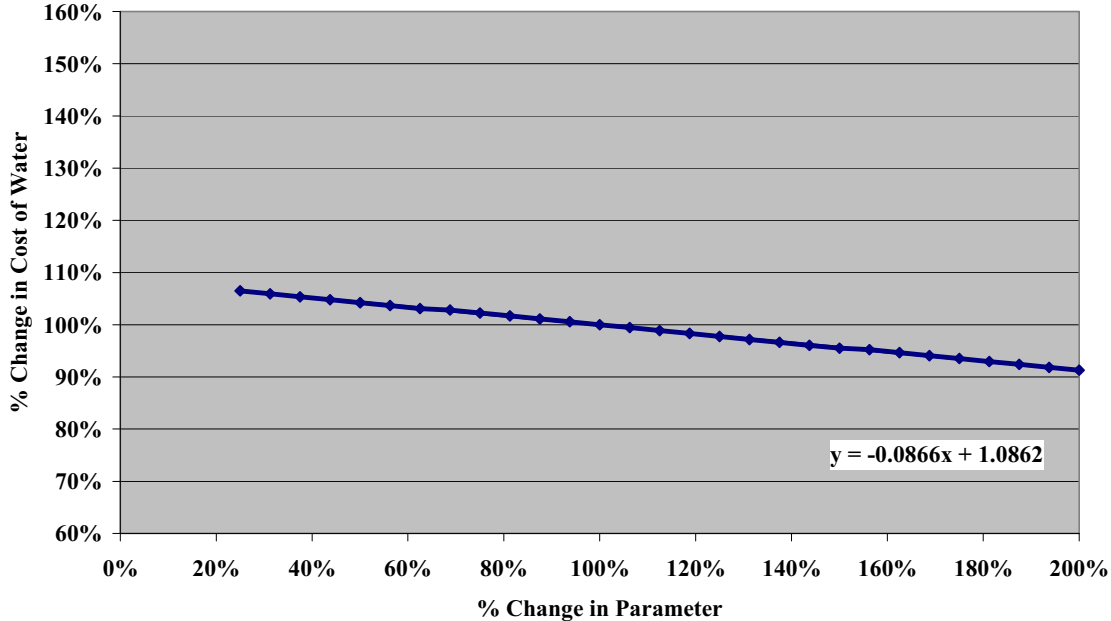


Figure 7.3. Sensitivity of the Cost of Water to the Purchase Price of Energy

### 7.5 Bond Interest Rate

The initial 20-year municipal bond interest rate used in the cost of water calculation is assumed to be 4.65% (Bloomberg, 2007), which contributes to the initial cost of water of \$3.55/1000 gallons. This parameter affects the payments to the municipal bonds used to fund the installed capital costs of the components of the integrated wind-water system. The equation below (initially presented in Chapter 5) shows the effect the bond interest rate has on the ICC/1000 gallons of the integrated wind-water system components.

$$(\text{InstalledCapitalCost}/1000\text{gallons}) = \left( \frac{iP}{1 - (1 + i)^{-n}} \right) / \text{TGUnits}$$

When analyzing the graph in Figure 7.4, the effect of the bond interest rate on the cost of water appears to be non-linear. However, the curvature in the sensitivity analysis that occurs when varying the bond interest rate is minimal. For the purposes of this analysis, the effect of the bond interest rate will be considered linear, as shown by the trend line in Figure 7.4. In terms of the rate of change shown in Figure 7.4, an increase in the bond interest rate has a positive (increasing) effect on the cost of water. The rate of change that varying the bond interest rate has on the cost of water is 0.3658 times the percent change from the initial value of the bond interest rate.

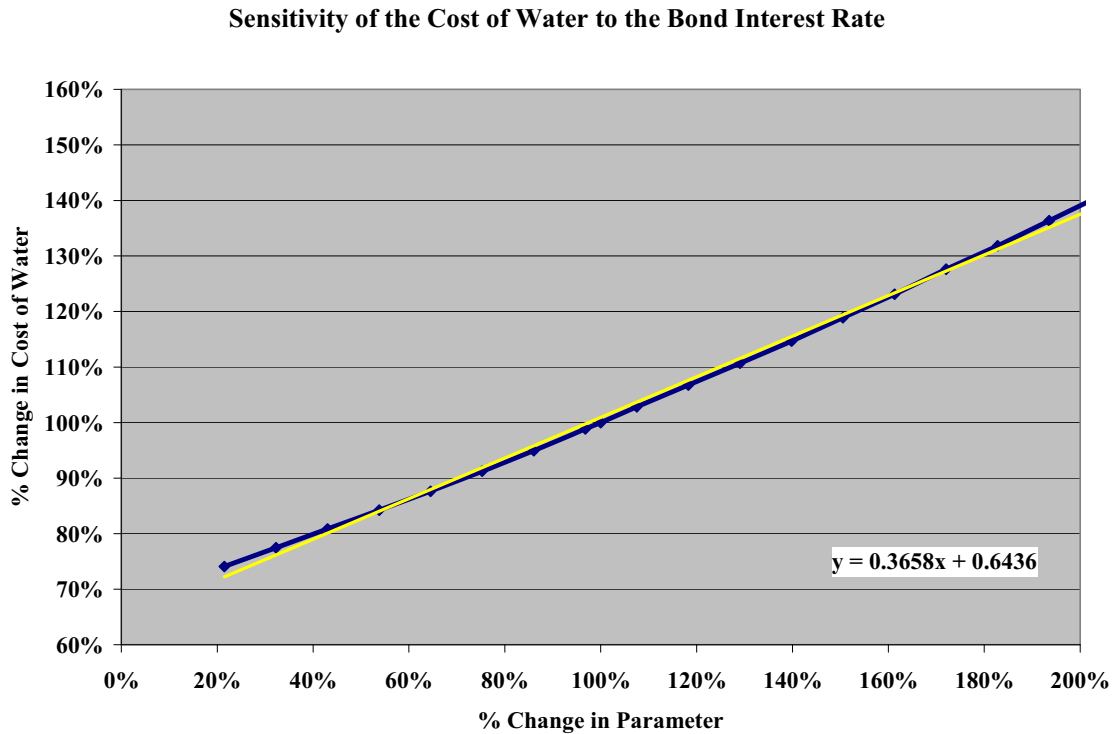


Figure 7.4. Sensitivity of the Cost of Water to the Bond Interest Rate



## 7.6 Well Depth

In this report, the assumed depth of the wells drilled to produce water from the Santa Rosa aquifer is 1350 feet (Chapman, 2007), contributing to the initial cost of water of \$3.55/1000 gallons. The parameter of well depth includes both the cost per foot of drilling the well (installed capital cost) and the energy requirement of the pumps that lift water to the surface. The capital cost of drilling the well was assumed to be \$25/foot (Keffler, 2007), and was held constant while the well depth was varied for this analysis.

The processes used to calculate the energy required to operate the wellfield lift pumps are included in Chapter 5. Figure 7.5 (reproduced from Chapter 5) below shows the distribution of the monthly average energy use by the different components of the integrated wind-water system (wellfield, reverse osmosis, and distribution). The overwhelming contribution of the wellfield pumps to the total energy cost should be noted.

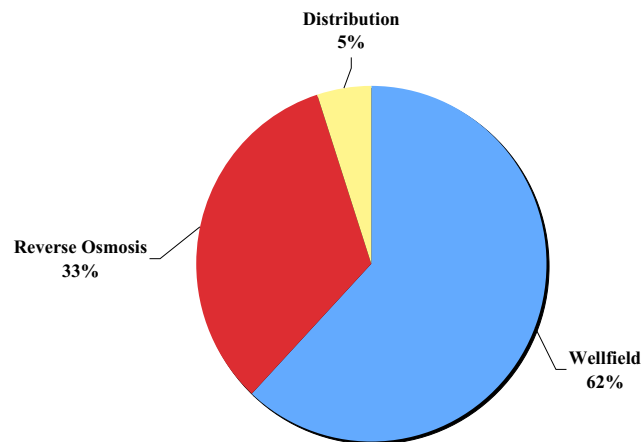


Figure 7.5. Distribution of Monthly Average Energy Use

Because of the large cost of energy required to lift enough raw water to the surface to meet Seminole's average daily potable water consumption, there are two interesting effects that occur when varying the depth of the Santa Rosa wells. Both of these effects stem from the increase in energy consumption of the wellfield lifting pumps as the well depths are deepened.

At a certain depth, the value of energy required to lift water to the surface by the wellfield lifting pumps causes the benefit of selling surplus energy to the utility energy provider to expire. This benefit is defined and explored in Chapter 6. The expiration of the benefit causes an increase in the percentage effect that well depth has on the cost of water, as the revenue generated by the surplus energy disappears. The increase is shown graphically in Figure 7.6 by an increase in the slope of the percent change at approximately 150% of the initial value of the well depth (2000 feet).

The second effect that the varying well depth has on the cost of water occurs at a deeper depth than that which caused the earlier effect. At a depth of approximately 180% of the initial value of the well depth (2400 feet), the benefit of the wind turbine array’s displacement of energy purchased from the utility energy provider expires. This benefit is explored and defined in Chapter 6. This effect essentially causes the total energy requirement of the components of the integrated wind-water system (wellfield, reverse osmosis, distribution) to outgrow the recommended turbine array, sized at three turbines. The effect is shown by a subtle change in the slope of the percent change that well depth has on the cost of water.

Both of these points are shown in Figure 7.6 below and are circled and labeled in the figure. Because of the non-continuous linearity of the effect well depth has on the cost of water, no rate of change (slope) is given.

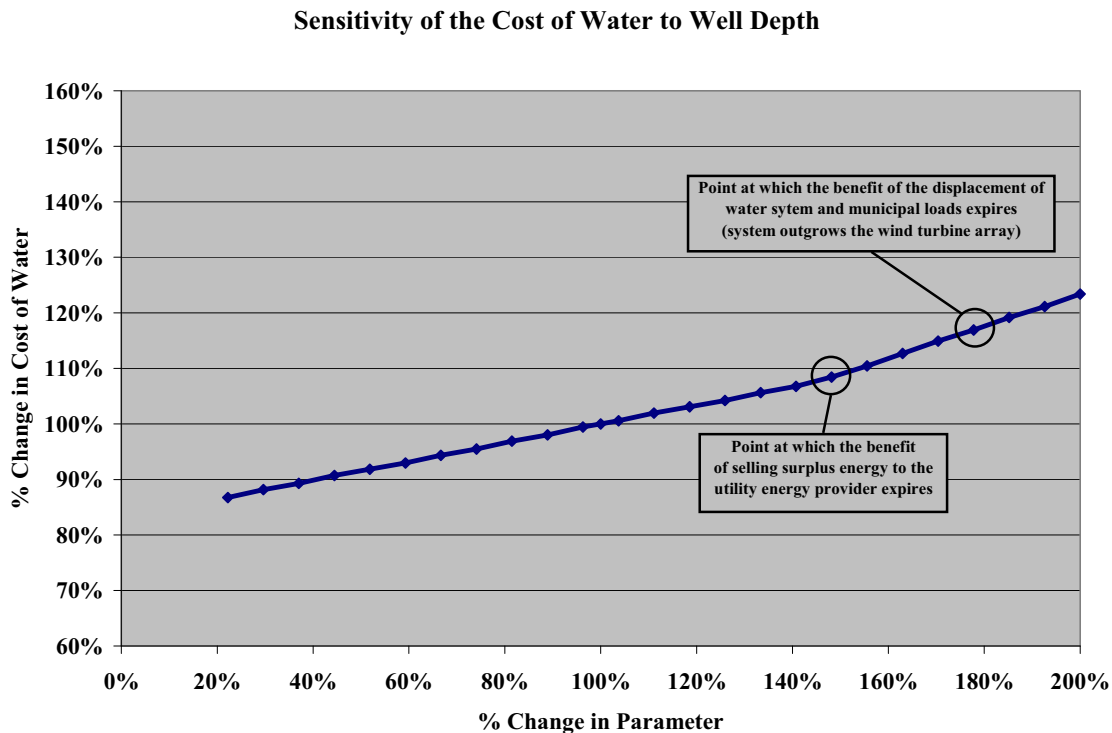


Figure 7.6. Sensitivity of the Cost of Water to Well Depth

### 7.6.1 Acknowledgement of the Effect of Head Pressure on Cost of Water

The Santa Rosa aquifer is likely a confined aquifer, whose depth usually comes with the externality of head pressure due to the force exerted on the aquifer by the weight of the soil above it (Song, 2008). This head pressure reduces the pumping depth of the well to less than that of the physical depth by pushing water up the well to a certain point where the pressure that the weight of the water column in the well equals the internal pressure of the aquifer.

In this section, two analyses of the effect of head pressure on the cost of water are performed. Because of the lack of knowledge about the characteristics of the Santa Rosa aquifer, the assumptions made for these analyses come from the resource (Song, 2008).

#### **7.6.1.1 Varying Head Pressure, Holding Well Depth Constant**

In the first analysis, the physical depth of the wells drilled to the Santa Rosa aquifer is held constant at 1350 feet, while the effect of the head pressure is varied. The effect of varying the head pressure varies the pumping depth of the wells, which in turn affects the energy required to pump the Santa Rosa aquifer water to the surface. The pumping depth will be varied from 150 feet to 1350 feet (approximately 10-100% of the initial physical depth of the wells). This analysis essentially holds the capital (drilling) costs of the wells constant while varying the amount of energy required to pump water from the Santa Rosa aquifer to the surface.

The initial cost of water for this analysis is \$3.55/1000 gallons, as the initial value of the physical depth and pumping depth of the well are both 1350 feet. The effect of holding the physical depth constant at 1350 feet and varying the pumping depth can be seen in Figure 7.7.

When analyzing Figure 7.7, the effect that varying head pressure has on the cost of water appears to be linear. In terms of the rate of change shown in the figure, a decrease in the pumping depth of the wells has a negative (decreasing) effect on the cost of water. The rate of change that varying the pumping depth of the Santa Rosa wells has on the cost of water is 0.1192 times the percent change from the initial value of the pumping depth.

**Sensitivity of the Cost of Water to Head Pressure**

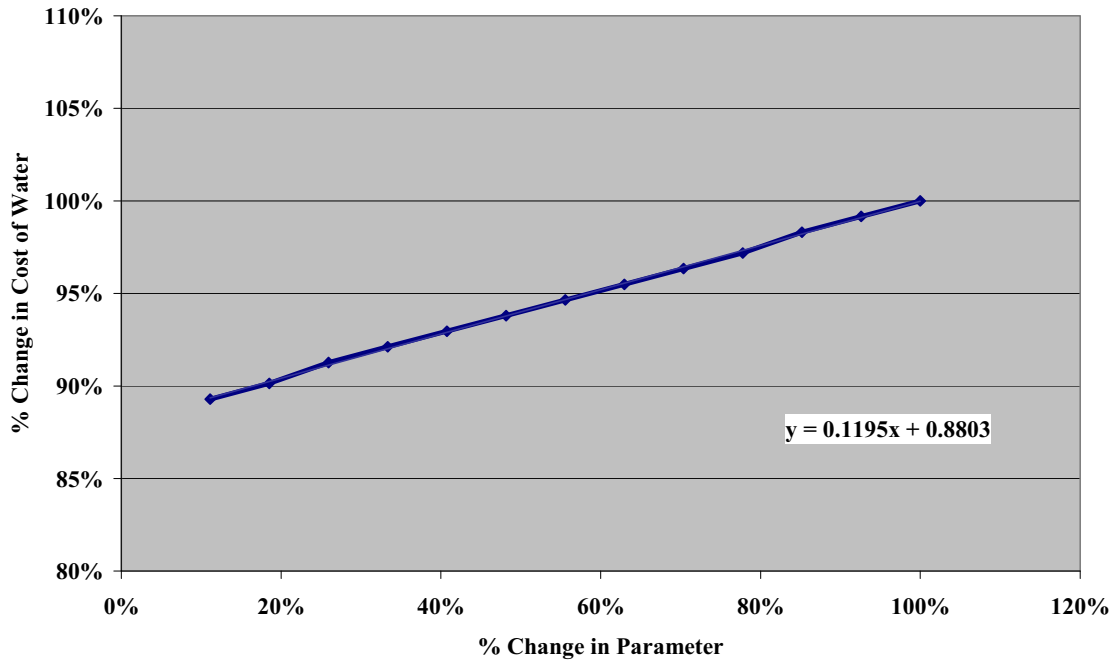


Figure 7.7. Sensitivity of the Cost of Water to Head Pressure

**7.6.1.2 Varying Well Depth, Holding Head Pressure Constant**

The second analysis performed on the effect of head pressure on the cost of water will hold the pumping depth of the wells to 600 feet, while varying the physical well depth from 600 to 1350 feet. This analysis essentially holds constant the energy costs of lifting water from the Santa Rosa aquifer to the surface, while varying the capital costs of the wells.

The initial cost of water for this analysis, with a 1350 foot well depth, but a 600 foot pumping depth is \$3.31/1000 gallons. The effect of holding the pumping depth at 600 feet, but varying the physical depth of the wells can be seen in Figure 7.8.

When analyzing Figure 7.8 below, the effect on the cost of water that varying the well depths while holding pumping depth constant appears to be linear. In terms of the rate of change shown in the figure, a decrease in the physical depth of the wells, while holding pumping depth constant, has a negative (decreasing) effect on the cost of water. The rate of change that varying the physical depth of the Santa Rosa wells has on the cost of water is 0.0493 times the percent change from the initial value of the pumping depth.

**Sensitivity of the Cost of Water to Well Depth  
Holding Pumping Depth Constant at 600 ft.**

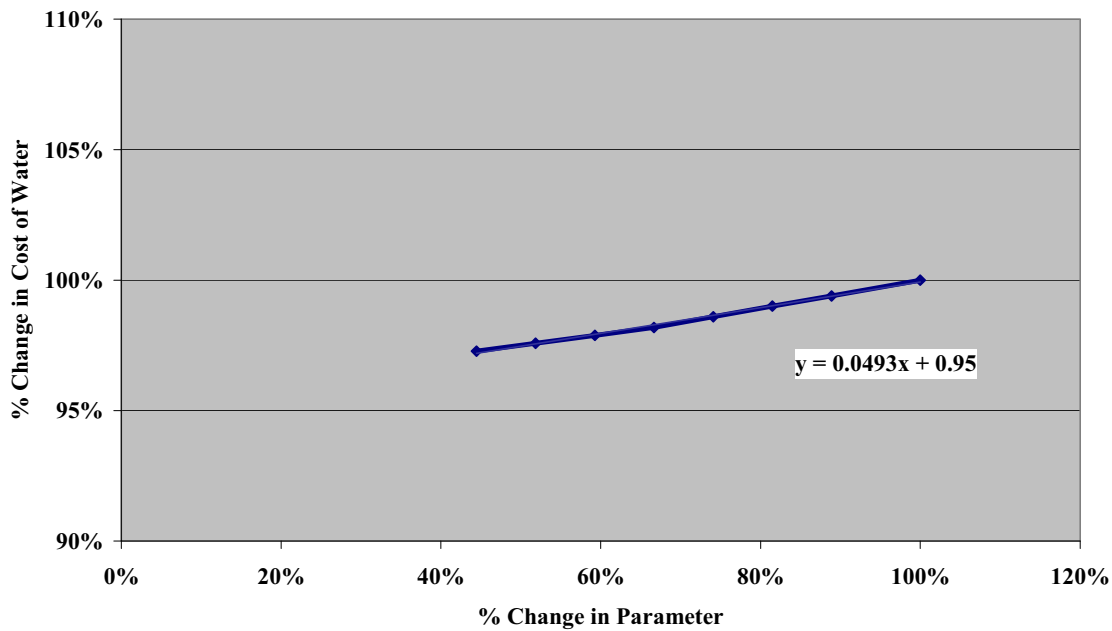


Figure 7.8. Sensitivity of the Cost of Water to Well Depth, Holding Pumping Depth Constant

## 7.7 Reverse Osmosis Unit Energy Consumption

The reverse osmosis unit energy consumption varies with the salinity of the feed water, the efficiency of the unit, and the recovery rate of the process. Many of these variables are extremely non-linear in their expansion and are site-specific. Some of the operating pressures of the machines can only be found through a physical application of the reverse osmosis technology to the system in question (Song, 2008). Because of these many complex constraints, the simplest way to conduct a reasonably accurate sensitivity analysis of the cost of water to feed water salinity is to vary the energy consumption of the reverse osmosis unit.

The initial energy consumption of the reverse osmosis unit is 5.63 kWh/1000 gallons, at a feed water salinity of 10,000 ppm, and a recovery rate of 75% (Stapp, 2007). The reverse osmosis energy consumption parameter affects the total water system energy consumption, and thus influences the price of water from its \$3.55/1000 gallons starting point.

The effect of varying the energy consumption of the reverse osmosis unit is linear, but also shares one of the interesting effects observed when varying the well depth. At a certain point, approximately 185% of the initial value of energy consumption (10.5 kWh/1000 gallons), the benefit of selling surplus energy to the utility energy provider expires. This benefit is discussed in Chapter 6. This effect is shown in Figure 7.9 as a change in the slope of the effect the reverse

osmosis unit energy consumption has on the cost of water. This point is circled and labeled in the figure. Because of the non-continuous linearity of the effect, no rate of change (slope) is given.

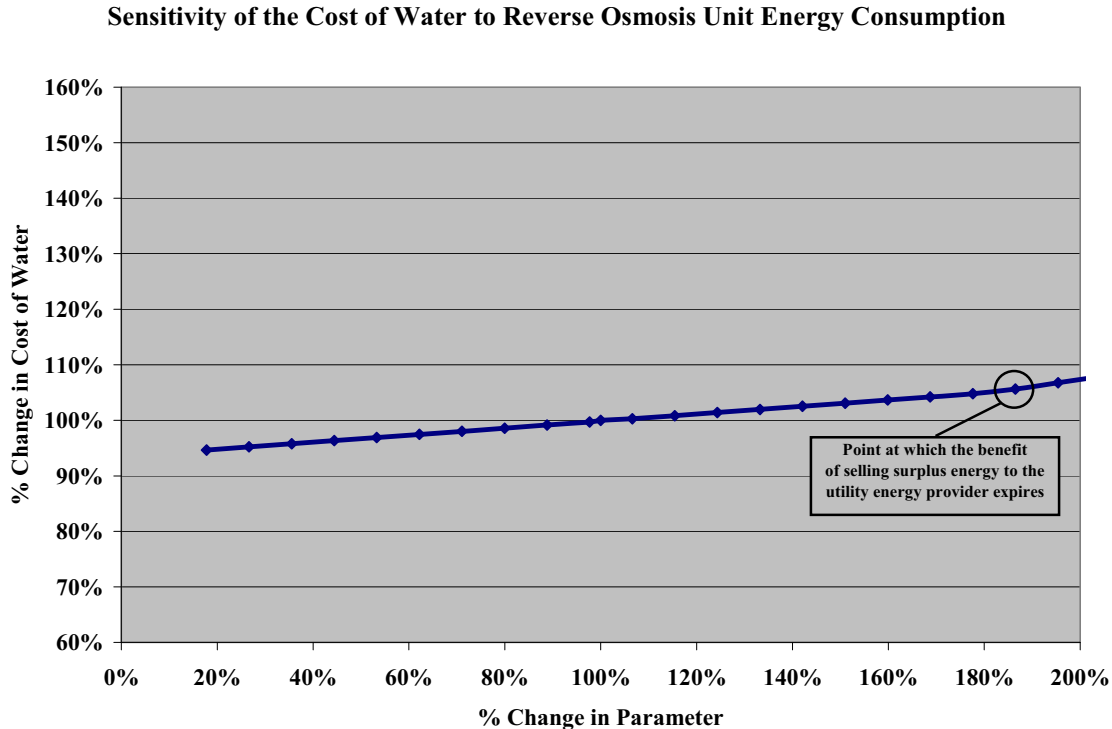


Figure 7.9. Sensitivity of the Cost of Water to Reverse Osmosis Unit Energy Consumption

### 7.8 Conclusion

A graphical representation of all of the effects that the different parameters have on the cost of water/1000 gallons is presented in Figure 7.10 below. The initial values that these parameters hold when calculating the initial cost of water at \$3.55/1000 gallons are given next to the data labels in the figure’s legend.

The integrated wind-water system appears to be sensitive not only to changes in energy prices, but also energy consumption. Actual system design thus should emphasize energy efficiency. As the wellfield system and reverse osmosis unit energy consumptions increased, they outgrow the benefits introduced by the wind turbine array at its current recommended size of three turbines. By emphasizing the minimization of the energy consumption of the components of the integrated wind-water system (wellfield, reverse osmosis, distribution), the capital costs of the proposed system can be somewhat mitigated from sensitivity to the bond interest rate and the installed capital costs associated with various components.

Because the cost of water is most sensitive to the municipal bond interest rate presented in Section 7.5, an accurate estimation of this parameter is essential to ensure that the economics of the proposed integrated wind-water system are legitimate. This parameter should be defined first by a potential adopter, as it will have the most impact on the value of the final cost of water.

### Sensitivity of Cost of Water to Various Parameters

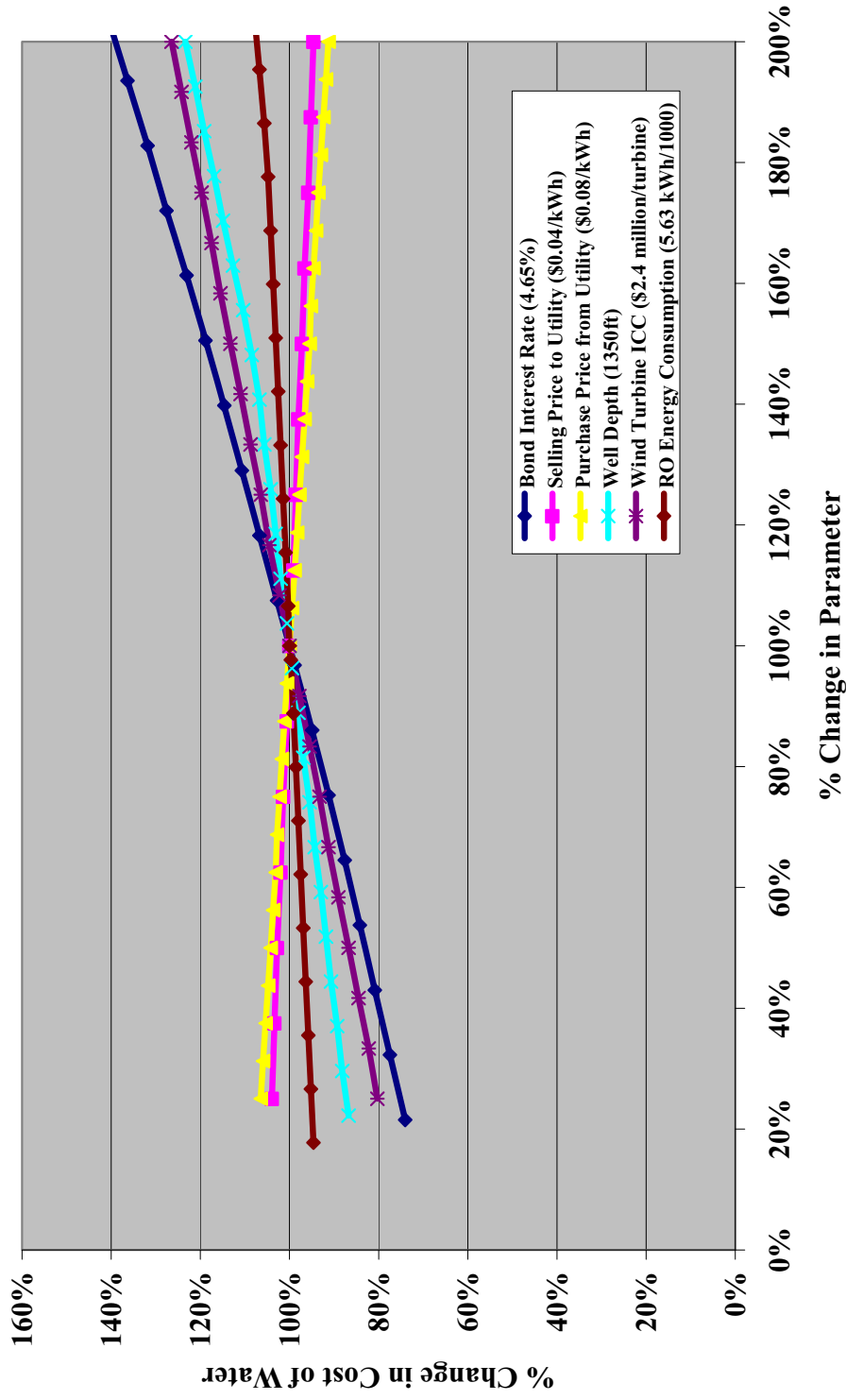


Figure 7.10. Sensitivity of Cost of Water to Various Parameters



## CHAPTER 8

### ADAPTIVE/INTELLIGENT CONTROL ALGORITHM

#### 8.1 Introduction

The economics of the wind-water system described in earlier chapters is especially sensitive to the cost of energy, as illustrated in Chapter 7. The energy produced by the wind turbine array has a predictable cost of energy, independent from fossil fuel pricing (Flowers, 2005). In order to get the most value out of the energy produced by the turbine array, intelligent decisions must be made regarding the optimal use and dispatch of that energy. These decisions will be based on available data: statistics from historical data and short-term trend resources, so that the produced energy is utilized where it has the highest value.

The purpose of the control algorithm is to dispatch the wind-generated energy in such a way that the benefit received from the use of the energy is maximized.

For the purpose of this analysis, energy can have three separate values:

1. Energy purchased from the utility energy provider
2. Wind turbine cost of energy
3. Energy sold to the utility energy provider

Energy must be purchased from the utility energy provider when the turbine array cannot meet the energy demand of the water system (wellfield, reverse osmosis system, and distribution system) and municipal loads. For the purposes of this research, the cost of energy from the utility energy provider is priced at \$0.08/kWh (Chapman, 2007). Energy will be sold to the utility energy provider when the turbine array output exceeds the energy demand of the water system and municipal loads. In this work, the selling price of wind-generated energy to the utility is assumed to be \$0.04/kWh (Chapman, 2007).

The energy generated by the wind turbine array displaces the need to purchase retail-priced energy from the utility energy provider. This energy holds a value less than the \$0.08/kWh charged by the utility energy provider. The wind turbine cost of energy incorporates the installed capital cost as well as the operations and maintenance costs of the wind turbine array. Wind turbine cost of energy is valued at \$0.05-0.07/kWh (Chapman, 2007, Swift, 2007).

## 8.2 Simplified Algorithm

Figure 8.1 portrays the simplified control algorithm's processes. The simplified algorithm exists to create a general understanding of the algorithm's processes for the reader, and is organized from the point of view of how it will be implemented in an industrial controller.

The software interrupts below are designed for processes that have to be computed with little time lag between initialization and execution. The name for these software interrupts is an Interrupt Service Routine (ISR). When the processor is operating in its normal, non-interrupted state, it is running background code. Background code is defined in this work as processes that have no specified time urgency to their execution.

The first of the algorithm's interrupt service routines (ISR1) will retrieve measurements from anemometers at heights of 10m and 60m. These measurement data will be used to calculate the vertical wind shear coefficient and extrapolate the 10m wind speeds to the turbine hub height of 100m. The 100m wind speed will then be used to calculate the expected wind turbine energy output from the turbine power curve. The power curve has been adjusted for the changes in air density with height above sea level as described in Chapter 4.

The second interrupt service routine (ISR2) will retrieve the water use measurements from the flow meter located at the Seminole wellfield. These data will be used to produce the energy requirement for the water system. The energy requirement is calculated at a rate of a certain kWh/MGD (over a 5-minute period) for each component of the water system (wellfield system, reverse osmosis system, distribution system) as described in Chapter 5. The components' energy requirements will be summed for the next segment of the code.

The third segment of the simplified control algorithm (an example of background code) compares the energy supply from the wind turbines to the energy demand of the water system. This segment of the code can only be completed after the first two ISR's have completed their run. Upon reaching the conclusion as to whether supply or demand is greater, the algorithm will then make the decision whether to purchase electricity from the grid, or sell electricity to the grid.

This simplified algorithm illustrated in Figure 8.1 ignores any water use statistics based on new or historical data, or short-term trends in water use by the municipality. These additional refinements will be incorporated in the comprehensive control algorithm described in the next section (Section 8.3). Again, the simplified algorithm is presented to instill understanding of the algorithm's basic processes in the reader.

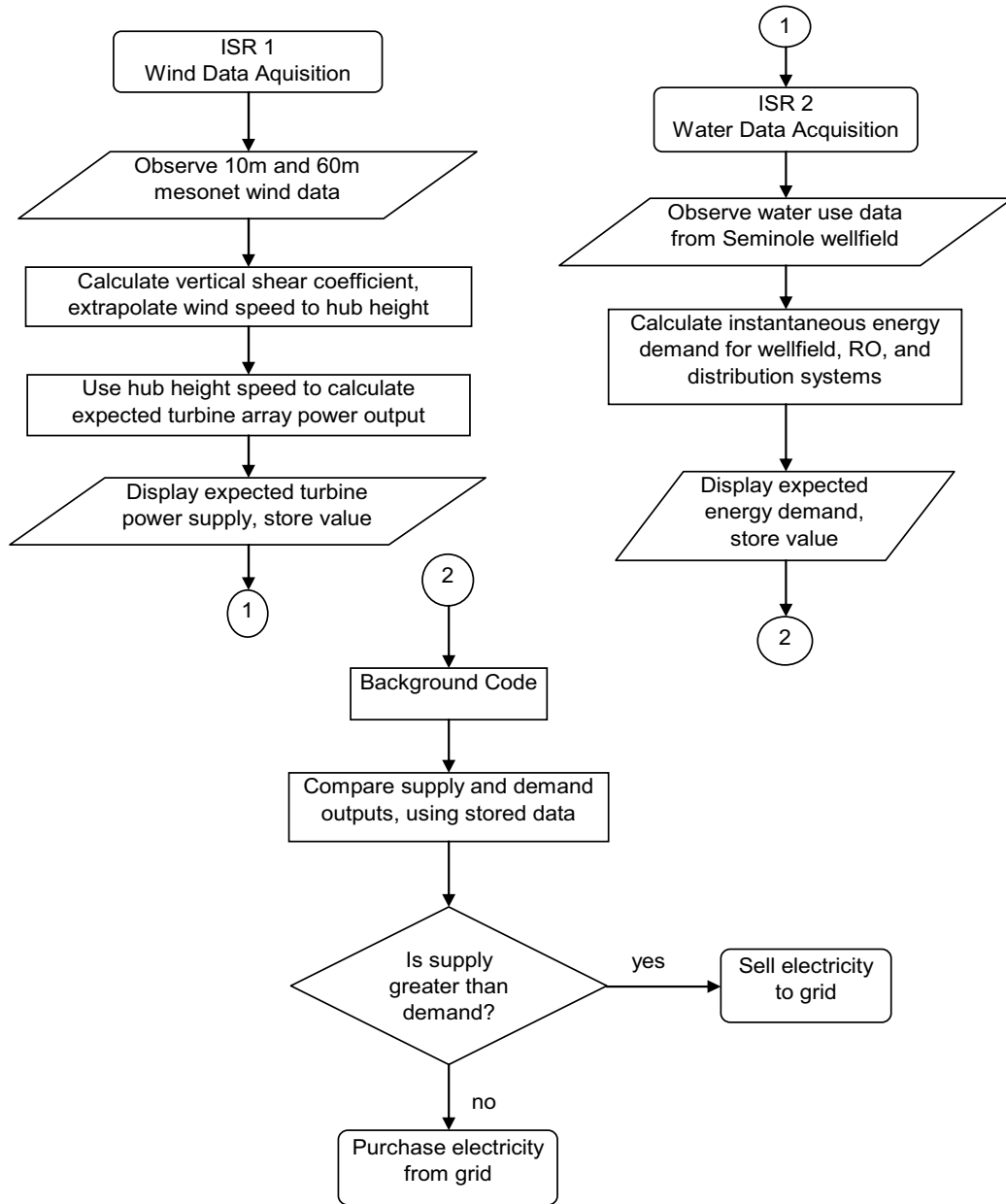


Figure 8.1. Flow Chart for Simplified Algorithm

### 8.3 Comprehensive Algorithm

The comprehensive control algorithm incorporates statistics from historical data and short-term trends into the decision-making process of adaptive and intelligent control of the energy from the wind turbine array. This comprehensive algorithm is much more in depth than the simplified algorithm, and will be broken into several segments. The segments of this algorithm will be described in the next several sections.

#### 8.3.1 Process Priority

The first section is the process priority, which is partitioned into interrupt service routines and the background code. The process priority gives the hierarchy of the ISR's, as well as the placement of the background code in that hierarchy. The first ISR will receive top priority, while the others will follow suit in their respective priorities. The ISR's interrupt the background code to perform their specific duties when triggered, and the background code then resumes.

Table 1 shows the process priorities. Parameter definitions for the control algorithm are located in Appendix B. Block diagrams for the background code can be found in Appendix C, and block diagrams for the ISR's are in Appendix D.

##### **Process Priority**

1. ISR0 – Reset Watchdog Timer Counter
2. ISR4 – Priority Fill
3. ISR1 – Wind Data Acquisition
4. ISR2 – Water Data Acquisition
5. ISR3 – Water Remaining in Storage
6. Background Code

Table 8.1. Process Priority

#### 8.3.2 Register Locations

The register locations are internal memory locations into which the microprocessor writes data that need to be retrieved quickly (Simon, 1999). In the control algorithm, the register locations are reserved for data that are used for computations, either in an ISR or in the background code. Table 8.2 shows the defined register locations, their code segment, and their definitions.

---

##### Register Locations

NUMBER	SYMBOL	MEM	CODE	DEFINITION
		<b>LOCS.</b>	<b>SEGMENT</b>	<b>DEFINITION</b>
1	$x$	REG	supply	10m wind data
2	$y$	REG	supply	60m wind data
3	$\gamma$	REG	demand	array of MA calculations from sample n
4	$\eta$	REG	econ	<supply>, in kW, of wind energy
5	$\lambda$	REG	econ	<demand>, in kW, of water system (summation of WEL, RO, and DIST)
6-27	$\delta$	REG	ISR2	prior MA data points for new MA calculation
28	<i>SETP</i>	REG	ISR3	setpoint recall for time remaining calculation
29	$\delta$	REG	ISR3, ISR4	current water use data
30	$\iota$	REG	ISR3	tank level data
31	$\iota_1$	REG	ISR4	tank #1 level data
32	$\iota_2$	REG	ISR4	tank #2 level data
33	$\iota_3$	REG	ISR4	tank #3 level data
34	$\iota_4$	REG	ISR4	tank #4 level data
35	$\iota_5$	REG	ISR4	tank #5 level data
36	<i>REMA</i>	REG	ISR4	hours of water remaining
37	$\delta_{ij}$	REG	ISR4	calculated average water use matrix location
38	<i>pint105</i>	REG	ISR4	integer 10.5 for water trend analysis
39-58	<i>p20</i>	REG	ISR4	array of numbers 1-20
59-78	$\delta_{20}$	REG	ISR4	array of past 20 water use values
79	$\alpha$	REG	supply	100m calculated wind data
80	$\alpha_{ij}$	REG	supply	average wind data matrix location
81-104	$\alpha_{24}$	REG	supply	array of past 24 wind data values
105	UseSigma	REG	ISR4	standard deviation setpoint input by user
106-129	<i>p24</i>	REG	supply	array of numbers 1-24
130	<i>pint12</i>	REG	supply	integer 12.5 for wind trend analysis

Table 8.2. Register Locations

### 8.3.3 Interrupt Service Routines

The interrupt service routines are pieces of software that interrupt the microprocessor's current activity, and tell it to run a section of code (Simon, 1999). The ISR's in the comprehensive algorithm were written in pseudo code in order to facilitate understanding by the reader. In the sections below are the ISR pseudo code, their explanations, and their triggers (software or hardware) for the comprehensive algorithm.

Figure 8.2 shows the decision tree scheme the control algorithm uses to control the actions of the integrated wind-water system. This decision tree will be referenced frequently in explanations of the decisions made by the adaptive/intelligent control algorithm.

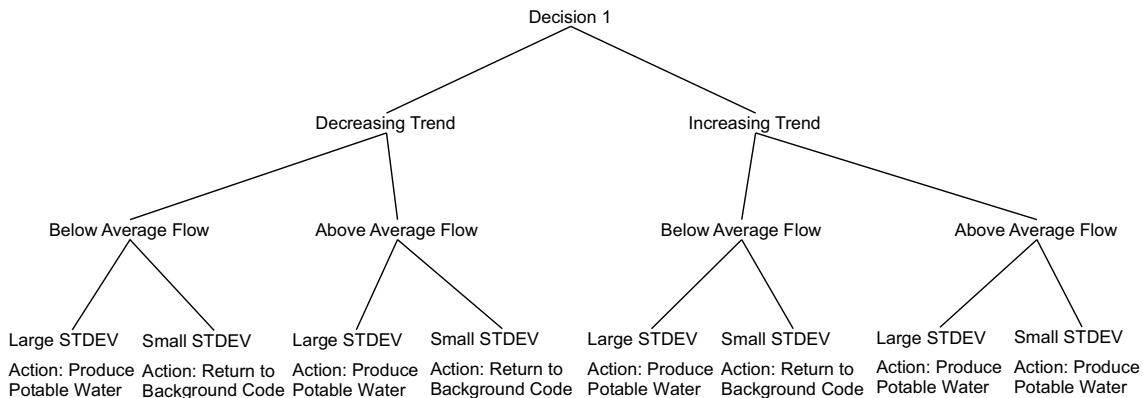


Figure 8.2. Decision Tree for Adaptive/Intelligent Control Algorithm

### 8.3.3.1 ISR0—Reset Watchdog Timer Counter

Resetting the watchdog timer is an essential function to the operation of the microprocessor, as it ensures that the operations do not crash (indefinitely stall) the processor. The watchdog timer “contains a timer that expires after a certain interval unless it is restarted...If the timer is allowed to expire, the presumption is that the software failed to restart it often enough because the software has crashed” (Simon, 1999). This is the reason that resetting the watchdog timer has first priority. ISR0 is listed below.

#### **ISR0 – Reset Watchdog Timer Counter      Triggered by Software      Priority 1**

Store program counter value

Reset watchdog timer

Restore program counter

Return to background code

### 8.3.3.2 ISR1—Wind Data Acquisition

The first of the algorithm’s interrupt service routines (ISR1) will retrieve measurements from anemometers at heights of 10m and 60m. These measurement data will be used to calculate the vertical wind shear coefficient, and to extrapolate the 10m wind speeds to the turbine hub height of 100m. The 100m wind speed will then be used to calculate the expected wind turbine energy output from the turbine power curve, a calculation which occurs in the background code. ISR1 is listed below.

#### **ISR1- Wind Data Acquisition      Triggered by Software      Priority 3**

Store program counter value

Select multiplexer channel

Store wind data 1 in memory location  $x$

Set pointer  $xPNT$  to next value in memory location  $x$

Select multiplexer channel

Store wind data 2 in memory location  $y$

Set pointer  $yPNT$  to next value in memory location  $y$

Restore program counter

Return to background code

### 8.3.3.3 ISR2—Water Data Acquisition

The second interrupt service routine will retrieve the water use measurements from the flow meter located at the Seminole wellfield. The 20 period moving average filter is also performed in this interrupt service routine. These data will be used to produce the energy requirement for the water system. ISR2 is listed below.

#### ISR2 – Water Data Acquisition                      Triggered by Software    Priority 4

Store program counter value

Select multiplexer channel

Store water data in memory location  $\delta$

Set pointer  $\delta$ PNT to next value in memory location  $\delta$

Recall prior data points into register locations 6 through 27 (*Sample<sub>n</sub> through Sample<sub>n-21</sub>*)

Recall prior moving average value from memory location  $\beta$  (*Average<sub>n-1</sub>*)

Perform operation:  $Average_n = Average_{n-1} + \frac{Sample_n - Sample_{n-21}}{p}$

Store new moving average value (*Average<sub>n</sub>*) in memory location  $\gamma$

Set pointer  $\gamma$ PNT to next value in memory location  $\gamma$

Store new moving average value (*Average<sub>n</sub>*) in memory location  $\delta 20$

Set pointer  $\delta 20$ PNT to next value in memory location  $\delta 20$

Store new data point (*Sample<sub>n</sub>*) into memory location  $\kappa$

Set pointer  $\kappa$ PNT to next value in memory location  $\kappa$

Restore program counter

Return to background code

### 8.3.3.4 ISR3—Water Remaining in Storage

The fifth ISR in the process priority calculates the water remaining in the storage tanks. The ISR calculates the sum of the tank levels and compares that sum to the current water use, in MGD, to determine the chronological amount of potable water remaining at the rate of current water consumption. This calculation is made for the water remaining until the tank levels reach a preset minimum setpoint, and also the water remaining until the system is completely empty. ISR3 is listed below.

**ISR3 –Water Remaining in Storage      Triggered by Software      Priority 5**

Store program counter value

Select multiplexer channel

Recall memory location  $\delta$  (water use data) into register location 29

Recall memory location  $\iota$  (tank level data) into register location 30

Recall SETP into register location 28

Perform operation:  $REMG = \frac{TLVL}{WATER} * 24$

Store REMG into memory location REMG

Perform operation:  $REMA = \frac{TLVL - SETP}{WATER} * 24$

Store REMA into memory location REMA

Restore program counter

Return to background code

**8.3.3.5 ISR4—Priority Fill**

The second priority ISR is the priority filling of the water storage tanks. The algorithm will first check the current tank levels against the user-defined presets, and fill the tanks as needed. The first two tanks to be checked are the water towers in Seminole, which provide water pressure to their water distribution system (Goodger, 2007). The other three tanks to be checked are on-ground storage tanks.

The second operation of the ISR is to evaluate the trend of the water use over 20 periods, as well as comparing the current water use to the stored average water use. The time-varying trend will be used in the decision tree defined in Figure 8.2. The third operation of the ISR is to calculate an estimate of the time-varying standard deviation, which will also be used in the decision tree. The equations in the following sections are used in this time-varying trend and standard deviation analysis.

As the historical data set for water use becomes more comprehensive, the user-input standard deviation setpoint should reflect understanding of the trend expectations gained from observing Seminole's water use information.



### 8.3.3.5.1 Estimation of the Time-Varying Linear Model Parameters

The general equation of a line is:

$$Y = \beta_1 x + \beta_0$$

Or in linear algebra form:

$$y = X\beta + u$$

with matrix dimensions  $y = n \times 1$ ,  $u = n \times 1$ ,  $X = n \times k$ , and  $\beta = k \times 1$ . In the general form,  $\beta_1$  is the slope and  $\beta_0$  is the y-intercept. The relevant portion of this equation for estimating the trend parameter is the sign (+/-) of the slope variable,  $\beta_1$ . Determining the sign of the  $\beta_1$  variable over the time period of 20 observations ( $n=20$ ) will tell if the trend of water use is increasing ( $\beta_1 > 0$ ) or decreasing ( $\beta_1 < 0$ ) (Larsen, 2001).

#### 8.3.3.5.1.1 Estimation of the Time-Varying Slope Variable

To determine the slope of the  $\beta_1$  variable from the 20 period analysis, the following regression equation is used to find the maximum-likelihood estimator for  $\beta_1$  (Larsen, 2001):

$$\hat{\beta}_1 = \frac{n \sum_{i=1}^n (x_i Y_i) - \left( \sum_{i=1}^n x_i \right) \left( \sum_{i=1}^n Y_i \right)}{n \left( \sum_{i=1}^n x_i^2 \right) - \left( \sum_{i=1}^n x_i \right)^2}$$

Where the  $x$  values are the time indices integers and the  $Y$  values are water use observations, in MGD.

The general graph of the water use data is presented in Figure 8.3.

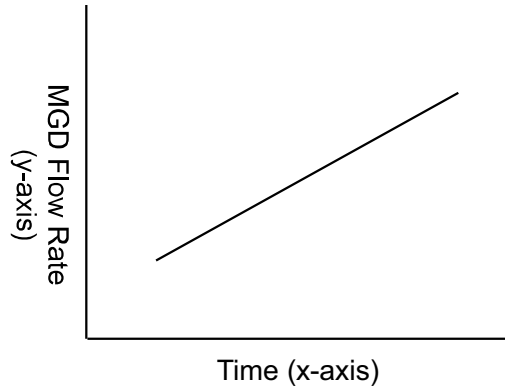


Figure 8.3. General Graph of Water Use Data

Since the x variables of the estimate will be constant (time indices 1-20), all of the terms in the equation involving x will also be constant, and can be substituted into the equation. The following values are constant:

$$n = 20$$

$$\sum_{i=1}^n x_i = 210$$

$$\sum_{i=1}^n (x_i^2) = 2,870$$

$$\left( \sum_{i=1}^n x_i \right)^2 = 44,100$$

The denominator does not carry any y variables, so the values for the x terms can be inserted to determine the sign of the denominator. The denominator is equal to:

$$n \left( \sum_{i=1}^n x_i^2 \right) - \left( \sum_{i=1}^n x_i \right)^2$$

Inserting the known constants from calculations above:

$$20(2,870) - (44,100) = 13,300$$

Therefore:

$$n\left(\sum_{i=1}^n x_i^2\right) - \left(\sum_{i=1}^n x_i\right)^2 > 0$$

The denominator of the equation for the slope variable  $\beta_1$  can then be resolved:

$$\hat{\beta}_1 = \frac{n\sum_{i=1}^n (x_i Y_i) - \left(\sum_{i=1}^n x_i\right)\left(\sum_{i=1}^n Y_i\right)}{(+)}$$

Again, inserting known constants from calculations above:

$$\hat{\beta}_1 = \frac{20\sum_{i=1}^n (x_i Y_i) - 210\sum_{i=1}^n Y_i}{(+)}$$

Logically, if the water use observations yield the inequality:

$$20\sum_{i=1}^n (x_i Y_i) > 210\left(\sum_{i=1}^n Y_i\right)$$

The numerator will be positive, and the value for  $\beta_1$  will also be positive, signifying an increasing trend ( $\beta_1 > 0$ ).

$$\hat{\beta}_1 = \frac{(+)}{(+)} > 0$$

However, if the water use observations yield the inequality:

$$20\sum_{i=1}^n (x_i Y_i) < 210\left(\sum_{i=1}^n Y_i\right)$$

The numerator will be negative, and the value for  $\beta_1$  will also be negative, signifying a decreasing trend ( $\beta_1 < 0$ ).

$$\hat{\beta}_1 = \frac{(-)}{(+)} < 0$$

These operations are performed to determine the direction of the trend in the ISR below. By summing the observations of the flow rate over the past 20 periods, the terms containing the

Y variables in the numerator can be signed (+/-), and the sign of the entire equation can be determined from that analysis.

### 8.3.3.5.1.2 Estimation of the Time-Varying Y-intercept Parameter

The next step in estimating the linear model parameters is to determine the value of the Y-intercept,  $\beta_0$ , which has the following equation:

$$\hat{\beta}_0 = \bar{Y} - \hat{\beta}_1 \bar{x}$$

Where  $\bar{x}$  is the average value of the x observations observed over the past 20 periods. The sum of the values of x was calculated in an earlier section, so the calculated value of  $\bar{x}$  can be resolved as:

$$\bar{x} = \frac{210}{20} = 10.5$$

$\bar{Y}$  is the calculated average of the past 20 water observations, and can be resolved as:

$$\bar{Y} = \frac{\sum_{i=1}^n Y_i}{20}$$

$\beta_1$  is the slope estimate calculated earlier, and still holds the equation:

$$\hat{\beta}_1 = \frac{n \sum_{i=1}^n (x_i Y_i) - \left( \sum_{i=1}^n x_i \right) \left( \sum_{i=1}^n Y_i \right)}{n \left( \sum_{i=1}^n x_i^2 \right) - \left( \sum_{i=1}^n x_i \right)^2}$$

Solving  $\beta_1$  for known parameters (given earlier):

$$\hat{\beta}_1 = \frac{20 \sum_{i=1}^n (x_i Y_i) - 210 \sum_{i=1}^n Y_i}{(13,300)}$$

Substituting these calculations into the equation for  $\beta_0$ :

$$\hat{\beta}_0 = \bar{Y} - \hat{\beta}_1 \bar{x}$$

$$\hat{\beta}_0 = \left( \frac{\sum_{i=1}^n Y_i}{20} \right) - \left( \frac{20 \sum_{i=1}^n (x_i Y_i) - 210 \sum_{i=1}^n Y_i}{(13,300)} \right) * 10.5$$

### 8.3.3.5.1.3 Estimation of the Time-Varying Variance and Standard Deviation

The maximum-likelihood estimator for the variance ( $\sigma^2$ ) is calculated by:

$$\hat{\sigma}^2 = \frac{1}{n} \sum_{i=1}^n (Y_i - \hat{Y}_i)^2$$

Where  $\hat{Y}_i = \hat{\beta}_0 + \hat{\beta}_1 x_i$ ,  $i = 1, \dots, n$ . The array of estimates for  $Y_i$  will be found using the estimates for  $\beta_0$  and  $\beta_1$  above, along with the array of time indices 1 through 20. The maximum-likelihood estimator for the variance ( $\sigma^2$ ) equation simplifies to:

$$\hat{\sigma}^2 = \frac{1}{20} \sum_{i=1}^n (Y_i - \hat{Y}_i)^2$$

From the variance ( $\sigma^2$ ), the standard deviation ( $\sigma$ ) can be calculated:

$$\sigma = \sqrt{\sigma^2}$$

The standard deviation of the estimates will be used to determine the accuracy of the estimates, which will be compared against a constant value defined by the user. The comparison of whether the standard deviation is relatively small or large will be used in the decision tree given in Figure 8.2 above. Relatively large standard deviations indicate a certain unacceptable degree of uncertainty, and will result in the water system producing potable water.

A relatively small standard deviation is defined as:

$$\sigma < \text{User Preset}$$

A relatively large standard deviation is defined as:

$$\sigma > \text{User Preset}$$

The final operation of the ISR is to compare the current flow rate to that of the stored average flow rate. This will tell if the city is currently flowing above or below a historical average.

The decision tree for the final part of the algorithm is given in Figure 8.2. The stored average water use table can be found in Chapter 5. ISR4 is listed below.

**ISR4 – Priority Fill** **Triggered by Software** **Priority 2**

Store program counter value

Select multiplexer channel

Recall  $t_1$  into register location 31

Recall  $t_2$  into register location 32

Recall  $t_3$  into register location 33

Recall  $t_4$  into register location 34

Recall  $t_5$  into register location 35

<fill if low>

If  $t_1 < SETP1$ , then  $PROD = 1$ , otherwise  $PROD = 0$

If  $t_2 < SETP2$ , then  $PROD = 1$ , otherwise  $PROD = 0$

If  $t_3 < SETP3$ , then  $PROD = 1$ , otherwise  $PROD = 0$

If  $t_4 < SETP4$ , then  $PROD = 1$ , otherwise  $PROD = 0$

If  $t_5 < SETP5$ , then  $PROD = 1$ , otherwise  $PROD = 0$

<trend analysis>

Recall  $\delta$  from register location 29

Recall  $REMA$  into register location 36

Recall appropriate value from  $\delta_{ij}$  into register location 37

Recall  $pint105$  into register location 38

Recall  $p_{20}$  into register locations 39-58

Recall  $\delta_{20}$  into register locations 59-78

Perform operation:  $p\delta = p_{20} * \delta_{20}$

Store  $p\delta$  in memory location  $p\delta$

Perform operation:  $\text{sum}p\delta = \sum p\delta$

Store  $\text{sum}p\delta$  into memory location  $\text{sum}p\delta$

Perform operation:  $\delta\text{sum} = \sum \delta 20$

Store  $\delta\text{sum}$  in memory location  $\delta\text{sum}$

<slope parameter estimate>

Perform operation:  $\text{Bhat}\delta = \frac{20(\text{sum}p\delta) - 210(\delta\text{sum})}{13,300}$

Store  $\text{Bhat}\delta$  in memory location  $\text{Bhat}\delta$

<Y-average parameter estimate>

Perform operation:  $\text{Ybar}\delta = \frac{\delta\text{sum}}{20}$

Store  $\text{Ybar}\delta$  in memory location  $\text{Ybar}\delta$

<Y-intercept parameter estimate>

Perform operation:  $\text{Bnot}\delta = \text{Ybar}\delta - (\text{Bhat}\delta * 10.5)$

Store  $\text{Bnot}\delta$  in memory location  $\text{Bnot}\delta$

<Y-value parameter estimate>

Perform operation:  $\text{Yhat}\delta = \text{Bnot}\delta + \text{Bhat}\delta * p20$

Store  $\text{Yhat}\delta$  in memory location  $\text{Yhat}\delta$

<Variance parameter estimate>

Perform operation:  $\text{SumHat}\delta = \sum (\delta 20 - \text{Yhat}\delta)^2$

Store  $\text{SumHat}\delta$  into memory location  $\text{SumHat}\delta$

Perform operation:  $\text{Var}\delta = \frac{\text{SumHat}\delta}{24}$

Store  $\text{Var}\delta$  into memory location  $\text{Var}\delta$

Perform operation:  $\text{Sigma}\delta = \sqrt{\text{Var}\delta}$

Store  $\text{Sigma}\delta$  into memory location  $\text{Sigma}\delta$

<comparison of small and large standard deviation to user setpoint>

Recall parameter UseSigma into register location 105

Perform Operation:                    If:  
                                                $\text{Sigma}\delta > \text{UseSigma}$ , then  $\text{PROD} = 1$   
                                                $\text{Sigma}\delta < \text{UseSigma}$ , then: perform operation:

                                              If:  $\text{sump}\delta > \text{pint}105 * \delta\text{sum}$ ,  
                                                                                                   Then,  $\text{Trend} > 0$

                                              If:  $\text{sump}\delta < \text{pint}105 * \delta\text{sum}$ ,  
                                                                                                   Then,  $\text{Trend} < 0$

Perform Operation                    If:  
                                                                                                    $\text{Trend} < 0$        $\text{Trend} > 0$   
                                                $\delta < \delta_{ij}$   $\text{PROD} = 0$        $\text{PROD} = 0$   
                                                $\delta > \delta_{ij}$   $\text{PROD} = 0$        $\text{PROD} = 1$

Restore program counter

Return to background code

### 8.3.4 Background Code

The background code contains the computations that are essential to the operation of the algorithm, but have no time urgency assigned to them. The background code is placed at the bottom of the process priority because of this. Below is the pseudo-code for the operational sections of the background code.



### 8.3.4.1 Supply

The supply portion of the background code calculates the expected energy supply from the wind turbine array. The output from ISR1 is used in this calculation, and is extrapolated to the 100m hub height of the turbine array. The expected output of a single turbine is multiplied by the number of turbines in the array to determine the output of the array, in kW. The power curve has been adjusted for the changes in air density with height above sea level as described in Chapter 4.

The final operation of the supply portion of the background code is to evaluate the trend and standard deviation estimate of the wind data over the past 2 hours, which will be stored for further applications not explored by this work. The equations described in Section 8.3.3.5 are adapted for use in this trend analysis, with appropriate variable substitutions of wind data instead of water data.

<b>&lt;SUPPLY&gt;</b>	<b>Background Code</b>	<b>Priority 6</b>
-----------------------	------------------------	-------------------

Recall memory location  $x$  into register location 1

Recall memory location  $y$  into register location 2

Perform operation: 
$$\alpha = \frac{\ln\left(\frac{x}{y}\right)}{\ln\left(\frac{10}{60}\right)}$$

Store  $\alpha$  in memory location  $\alpha$

Store  $\alpha$  in register location 79

Store  $\alpha$  in memory location  $\alpha HR$

Set pointer  $\alpha HRPNT$  to next value in memory location  $\alpha HR$

Store  $\alpha$  in memory location  $\alpha 24$

Set pointer  $\alpha 24PNT$  to next value in memory location  $\alpha 24$

Perform operation: if  $\alpha HR$  holds 12 values, then 
$$\alpha AVG = \frac{\alpha HR}{12}$$

Store  $\alpha AVG$  in appropriate memory location of  $\alpha_{ij}$

Set pointer  $\alpha_{ij}PNTRW$  to next value in memory location  $\alpha_{ij}$

Set pointer  $\alpha_{ij}PNTCLM$  to next value in memory location  $\alpha_{ij}$  when month changes

Perform operation: 
$$100m = y * \left(\frac{60}{100}\right)^{1/\alpha}$$

Store  $100m$  in memory location  $\epsilon$

Set pointer  $\epsilon PNT$  to next value in memory location  $\epsilon$

Use memory location  $\epsilon$  to point at appropriate memory location  $\tau$  via *PWRPNT*

Perform operation:  $\langle \text{supply} \rangle = NOT * \tau * \epsilon$

Store  $\langle \text{supply} \rangle$  in memory location  $\eta$

$\langle \text{wind data trend analysis} \rangle$

Recall  $\alpha$  from register location 79

Recall appropriate value from  $\alpha_{ij}$  into register location 80

Recall *pint12* into register location 130

Recall  $p24$  into register locations 106-129

Recall  $\alpha24$  into register locations 81-104

Perform operation:  $p\alpha = p24 * \alpha24$

Store  $p\alpha$  in memory location  $p\alpha$

Perform operation:  $\text{sum}p\alpha = \sum p\alpha$

Store  $\text{sum}p\alpha$  into memory location  $\text{sum}p\alpha$

Perform operation:  $\alpha\text{sum} = \sum \alpha24$

Store  $\alpha\text{sum}$  in memory location  $\alpha$

Perform operation: If:  $\text{sum}p\alpha > \text{pint12} * \alpha\text{sum}$ ,  
Then,  $\text{Trend} > 0$

Perform operation: If:  $\text{sum}p\alpha < \text{pint12} * \alpha\text{sum}$ ,  
Then,  $\text{Trend} < 0$

$\langle \text{slope parameter estimate} \rangle$

Perform operation:  $\text{Bhat}\alpha = \frac{24(\text{sum}p\alpha) - 300(\alpha\text{sum})}{27,600}$

Store  $\text{Bhat}\alpha$  in memory location  $\text{Bhat}\alpha$

$\langle \text{Y-average parameter estimate} \rangle$

Perform operation:  $Ybar\alpha = \frac{\alpha sum}{24}$

Store  $Ybar\alpha$  in memory location  $Ybar\alpha$

<Y-intercept parameter estimate>

Perform operation:  $Bnot\alpha = Ybar\alpha - (Bhat\alpha * 12.5)$

Store  $Bnot\alpha$  in memory location  $Bnot\alpha$

<Y-value parameter estimate>

Perform operation:  $Yhat\alpha = Bnot\alpha + Bhat\alpha * p24$

Store  $Yhat\alpha$  in memory location  $Yhat\alpha$

<Variance parameter estimate>

Perform operation:  $SumHat\alpha = \sum (\alpha 24 - Yhat\alpha)^2$

Store  $SumHat\alpha$  into memory location  $SumHat\alpha$

Perform operation:  $Var\alpha = \frac{SumHat\alpha}{24}$

Store  $Var\alpha$  into memory location  $Var\alpha$

Perform operation:  $Sigma\alpha = \sqrt{Var\alpha}$

Store  $Sigma\alpha$  into memory location  $Sigma\alpha$

### 8.3.4.2 Demand

The demand portion of the background code calculates the expected energy demand from the water system components (wellfield system, reverse osmosis system, and distribution system). The output from ISR2 is used in this calculation, as are the expected kWh/MGD consumptions of the individual components, as calculated in Chapter 5. The output for the demand portion of the algorithm is in kW.

**<DEMAND>** **Background Code** **Priority 6**

Recall memory location  $\gamma$  into register location 3

Perform operation:  $WEL = WE\theta * \gamma$

Set pointer *WELPNT* to next value in memory location *WEL*

Perform operation:  $RO = RO\theta * \gamma$

Set pointer *ROPNT* to next value in memory location *RO*

Perform operation:  $DIST = DIST\theta * \gamma$

Set pointer *DISTPNT* to next value in memory location *DIST*

Perform operation:  $\langle \text{demand} \rangle = \theta * \gamma$

Store  $\langle \text{demand} \rangle$  in memory location  $\lambda$

### 8.3.4.3 Economics

The economics section of the background code calculates the three separate values that energy holds in this analysis, as stated earlier in this chapter. Supply and demand estimates are checked against each other in order to evaluate the energy balance of the system. These amounts of each of the separate energy values are aggregated in daily, weekly, monthly, yearly, and lifetime storage arrays. Profit ( $\pi$ ) aggregate (which for this analysis is equal to  $\pi = (\text{Revenue} - \text{Cost})$ ) is also calculated in storage arrays. The  $\langle \text{COMPARE} \rangle$  section of the background code is redundant for the purpose of displaying the results from ISR4.

<u><math>\langle \text{ECONOMICS} \rangle</math></u>	<u>Background Code</u>	<u>Priority 6</u>
------------------------------------------------------	------------------------	-------------------

Recall memory location  $\eta$  into register location 4

Recall memory location  $\lambda$  into register location 5

Perform operation: If  $\eta > \lambda$ , then  $\eta - \lambda = s$

Store  $s$  in memory location  $s$

Set pointer *sPNT* to next value in memory location  $s$

Perform operation: If  $\eta > \lambda$ , then  $\lambda = m$

Store  $m$  in memory location  $m$

Set pointer *mPNT* to next value in memory location  $m$

Perform operation: If  $\eta < \lambda$ , then  $\lambda - \eta = d$

Store  $d$  in memory location  $d$

Set pointer *dPNT* to next value in memory location  $d$

Perform operation: If  $\eta < \lambda$ , then  $\eta = m$

Store  $m$  in memory location  $m$

Set pointer  $mPNT$  to next value in memory location  $m$

-----

Perform operation: sum memory location  $m$

Perform operation:  $m_{coe} = m * coe * tod$

Store  $m_{coe}$  in memory location  $m_{coe}$

Store last value of  $m_{coe}$  in memory array  $m_{storD}$

Set pointer  $m_{storDPNT}$  to next value in memory location  $m_{storD}$

Sum and export values of  $m_{storD}$  when array is full

Reset pointer  $m_{storDPNT}$  to beginning value in memory location  $m_{storD}$  when day changes

Store last value of  $m_{storD}$  in memory array  $m_{storW}$

Set pointer  $m_{storWPNT}$  to next value in memory location  $m_{storW}$

Sum and export values of  $m_{storW}$  when array is full

Reset pointer  $m_{storWPNT}$  to beginning value in memory location  $m_{storW}$  when week changes

Store last value of  $m_{storW}$  in memory array  $m_{storM}$

Set pointer  $m_{storMPNT}$  to next value in memory location  $m_{storM}$

Sum and export values of  $m_{storM}$  when array is full

Reset pointer  $m_{storMPNT}$  to beginning value in memory location  $m_{storM}$  when month changes

Store last value of  $m_{storM}$  in memory array  $m_{storY}$

Set pointer  $m_{storYPNT}$  to next value in memory location  $m_{storY}$

Sum and export values of  $m_{storY}$  when array is full

Reset pointer  $m_{storYPNT}$  to beginning value in memory location  $m_{storY}$  when year changes

Store last value of  $m_{storY}$  in memory array  $m_{storL}$

-----

Perform operation: sum memory location  $d$

Perform operation:  $d_{coe} = d * coe * tod$

Store  $d_{coe}$  in memory location  $d_{coe}$

Store last value of  $d_{coe}$  in memory array  $d_{storD}$

Set pointer  $d_{storDPNT}$  to next value in memory location  $d_{storD}$

Sum and export values of  $d_{storD}$  when array is full

Reset pointer  $d_{storDPNT}$  to beginning value in memory location  $d_{storD}$  when day changes

Store last value of  $d_{storD}$  in memory array  $d_{storW}$

Set pointer  $d_{storWPNT}$  to next value in memory location  $d_{storW}$

Sum and export values of  $d_{storW}$  when array is full

Reset pointer  $d_{storWPNT}$  to beginning value in memory location  $d_{storW}$  when week changes

Store last value of  $d_{storW}$  in memory array  $d_{storM}$

Set pointer  $d_{storMPNT}$  to next value in memory location  $d_{storM}$

Sum and export values of  $d_{storM}$  when array is full

Reset pointer  $d_{storMPNT}$  to beginning value in memory location  $d_{storM}$  when month changes

Store last value of  $d_{storM}$  in memory array  $d_{storY}$

Set pointer  $d_{storYPNT}$  to next value in memory location  $d_{storY}$

Sum and export values of  $d_{storY}$  when array is full

Reset pointer  $d_{storYPNT}$  to beginning value in memory location  $d_{storY}$  when year changes

Store last value of  $d_{storY}$  in memory array  $d_{storL}$

-----

Perform operation: sum memory location  $s$

Perform operation:  $s_{poe} = s * poe * todp$

Store  $s_{coe}$  in memory location  $s_{coe}$

Store last value of  $s_{coe}$  in memory array  $s_{storD}$

Set pointer  $s_{storDPNT}$  to next value in memory location  $s_{storD}$

Sum and export values of  $s_{storD}$  when array is full

Reset pointer  $s_{storDPNT}$  to beginning value in memory location  $s_{storD}$  when day changes

Store last value of  $s_{storD}$  in memory array  $s_{storW}$

Set pointer  $s_{storWPNT}$  to next value in memory location  $s_{storW}$

Sum and export values of  $s_{storW}$  when array is full

Reset pointer  $s_{storWPNT}$  to beginning value in memory location  $s_{storW}$  when week changes

Store last value of  $s_{storW}$  in memory array  $s_{storM}$

Set pointer  $s_{storMPNT}$  to next value in memory location  $s_{storM}$

Sum and export values of  $s_{storM}$  when array is full

Reset pointer  $s_{storMPNT}$  to beginning value in memory location  $s_{storM}$  when month changes

Store last value of  $s_{storM}$  in memory array  $s_{storY}$

Set pointer  $s_{storYPNT}$  to next value in memory location  $s_{storY}$

Sum and export values of  $s_{storY}$  when array is full

Reset pointer  $s_{storYPNT}$  to beginning value in memory location  $s_{storY}$  when year changes

Store last value of  $s_{storY}$  in memory array  $s_{storL}$

Perform operation:  $\pi = (m_{coe} + s_{poe}) - (d_{coe}) \quad [(Revenue) - (Cost)]$

Store  $\pi$  in memory location  $\pi$

Perform operation:  $\pi_{stor} = (m_{stor} + s_{stor}) - (d_{stor}) \quad [(Revenue) - (Cost)]$

Store last value of  $\pi_{coe}$  in memory array  $\pi_{storD}$

Set pointer  $\pi_{storDPNT}$  to next value in memory location  $\pi_{storD}$

Sum and export values of  $\pi_{storD}$  when array is full

Reset pointer  $\pi_{storDPNT}$  to beginning value in memory location  $\pi_{storD}$  when day changes

Store last value of  $\pi_{storD}$  in memory array  $\pi_{storW}$

Set pointer  $\pi_{storWPNT}$  to next value in memory location  $\pi_{storW}$

Sum and export values of  $\pi_{storW}$  when array is full

Reset pointer  $\pi_{storWPNT}$  to beginning value in memory location  $\pi_{storW}$  when week changes

Store last value of  $\pi_{storW}$  in memory array  $\pi_{storM}$

Set pointer  $\pi_{storMPNT}$  to next value in memory location  $\pi_{storM}$

Sum and export values of  $\pi_{storM}$  when array is full

Reset pointer  $\pi_{storMPNT}$  to beginning value in memory location  $\pi_{storM}$  when month changes

Store last value of  $\pi_{storM}$  in memory array  $\pi_{storY}$

Set pointer  $\pi_{storYPNT}$  to next value in memory location  $\pi_{storY}$

Sum and export values of  $\pi_{storY}$  when array is full

Reset pointer  $\pi_{storYPNT}$  to beginning value in memory location  $\pi_{storY}$  when year changes

Store last value of  $\pi_{storY}$  in memory array  $\pi_{storL}$

Display memory location  $\pi$

Display memory location  $\pi_{stor}$

**<COMPARE>**

Recall register location 4

Recall register location 5

Perform operation: If  $\eta > \lambda$ , then display:  $B/S = 0$  (*Sell*)

Perform operation: If  $\eta < \lambda$ , then display:  $B/S = 1$  (*Buy*)



## CHAPTER 9

### SUMMARY, CONCLUSIONS AND RECOMMENDATIONS

#### 9.1 Conclusion

The chapters prior to this describe the steps involved in the design and control of an integrated wind-water system for an inland municipality. A primary objective of this dissertation is to show that the economically optimized application of a wind turbine array and the intelligent control of the energy produced by that array will benefit the economics of an integrated wind-water system by reducing the energy cost of that system.

This inland system differs from a system designed for a coastal location for several reasons. The lifting costs associated with bringing the raw water from the Santa Rosa Aquifer (assumed to be 1350 feet) to the surface add to the costs of the inland system, as coastal locations are usually located at or near sea level and have minimal lifting costs. The disposal of the brine from the reverse osmosis process also adds to the cost of the inland system, as coastal locations generally pump the brine back out to sea. On the other hand, because the salinity of the water coming from the Santa Rosa Aquifer (assumed to be 10,000 ppm) is less than that of seawater (approximately 35,000 ppm) there is less of an energy cost associated with the purification of Santa Rosa water than sea water (Hightower, 2005; Mickley, 2006).

The economic assumptions of this report ignore any effects that the production tax credit (PTC) or the sale of renewable energy credits (REC) might have on the calculated cost of water. At the time of the writing of this dissertation, both of these benefits remain politically uncertain with an unpredictable lifespan.

Chapter 4 of this dissertation presents a detailed analysis of the real-time shear exponent values that are present during different times of the day and year. This analysis challenges the conventional assumption of a constant shear exponent value throughout the year. The time-varying shear exponent values throughout the day and year contribute to the time-variation in energy supply seen in Figure 9.4. Acknowledgment of these time-varying shear exponent values contributes to the potential time-shifting of the energy supplied by the wind turbine array.

The analysis performed in Chapter 5 presents the annual average sizing procedure for different components of the integrated wind-water system. The annual average analysis is an acceptable sizing procedure for some of the components of the integrated system (wellfield,

reverse osmosis, distribution), but the analysis in Chapter 6 shows the difference between the low-resolution annual average analysis, and that of an analysis performed with the intent of maximizing the resource offered by the wind turbine array.

The cost of water/1000 gallons presented in Chapter 6 represents the result of a high-resolution analysis of the energy dispatched from the wind turbine array for use by the different components of the water system, in order to maximize the benefit of that produced energy. Also included in that chapter is the economic maximization of the benefit of the wind turbine array, as well as the contribution of that benefit to the minimization of the cost of water for the entire system. The graph of turbine benefit maximization is reproduced in Figure 9.1. It should be noted that the application of a single turbine has a positive benefit, showing that wind turbines have benefit beyond the costs associated with their installed capital costs and operations and maintenance costs.

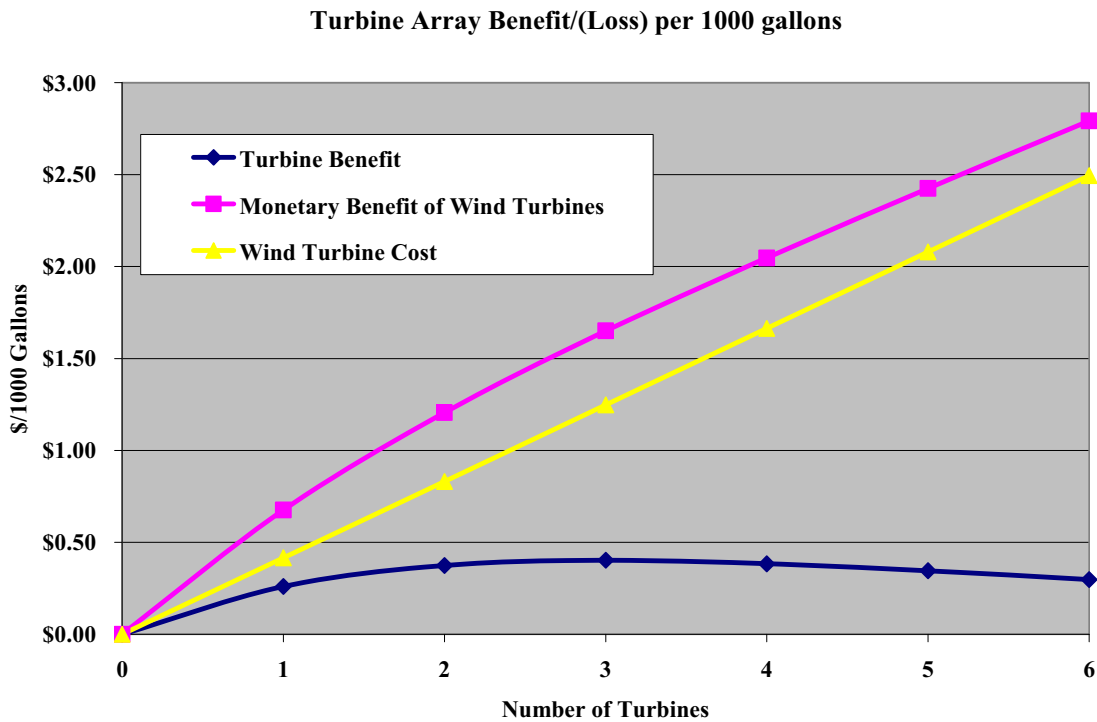


Figure 9.1. Turbine Array Benefit/(Loss) per 1000 Gallons

The high-resolution analysis in Chapter 6 represents a more comprehensive display of the times during the day and during the year where energy surpluses or deficits occur. Through the acknowledgement of these different energy values, the analysis arrives at a projected cost of water that is more accurate than the annual average analysis. This difference stems not only from the magnitude of the surpluses or deficits, but also from the different values of energy purchased from or sold to the utility energy provider.

The maximization of the benefit from the turbine array is an analysis that will vary with differences in turbine pricing (economies of scale or different installed capital cost), costs of energy, or projected energy consumption of whatever system is proposed. The maximization procedure was performed in such a manner that it could be applied to other systems with different parameters.

The sensitivity analysis presented in Chapter 7 portrays the effects that different parameters have on the cost of water for the proposed system. Of note in the information presented in Chapter 7 is the sensitivity of the cost of water to parameters that affect the energy consumption of the water system, which is composed of the wellfield, reverse osmosis, and distribution systems. The energy consumption of the entire system is not the parameter with the highest effect on the cost of water: that slot belongs to the capital costs and bond interest rate of the associated components. However, the emphasis on the energy efficiency of the different components will produce a lower total cost of water and make the system more economically attractive to potential adopters.

An analysis of a system at a coastal location was not considered in the sensitivity analysis because of the large differences in many of the parameters associated with coastal reverse osmosis systems, mentioned earlier in this chapter.

The introduction of an adaptive and intelligent control algorithm to determine the best use of the energy generated by the wind turbine array produces many opportunities for future work involving the integration of renewable energy with energy intensive processes. Many of these unexplored possibilities are presented in the next section.

A summary of the costs associated with pumping water from the Santa Rosa and purifying it via a reverse osmosis system, both with and without the consideration of wind turbines is presented in Table 9.1. Seminole currently charges between \$1.60-2.15/1000 gallons, depending on individual consumer use. The distribution of costs/1000 gallons is presented in Figure 9.2, and the distribution of monthly average energy use gallons is presented in Figure 9.3. Both figures were initially presented in Chapter 5.

<b>Summary of Component Costs/1000 Gallons</b>						
<b>Component</b>	<b>kWh/1000</b>	<b>Utility Energy</b>	<b>ICC</b>	<b>O&amp;M</b>	<b>Totals</b>	
Wellfield	10.58	\$ 0.85	\$ 0.45	---	\$ 1.30	
Reverse Osmosis (including Evap. Pond)	5.63	\$ 0.45	\$ 0.24	\$ 2.56	\$ 2.80	
Distribution	0.86	\$ 0.07	---	---	\$ 0.07	
Total					\$ 4.17	
Total Considering Wind Turbine Benefit					\$ 3.55	

Table 9.1. Summary of Component Costs/1000 Gallons

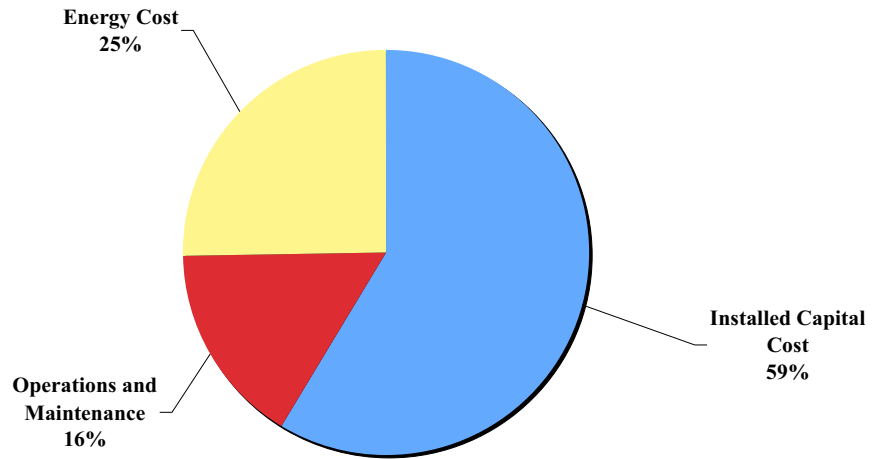


Figure 9.2. Distribution of Costs/1000 Gallons

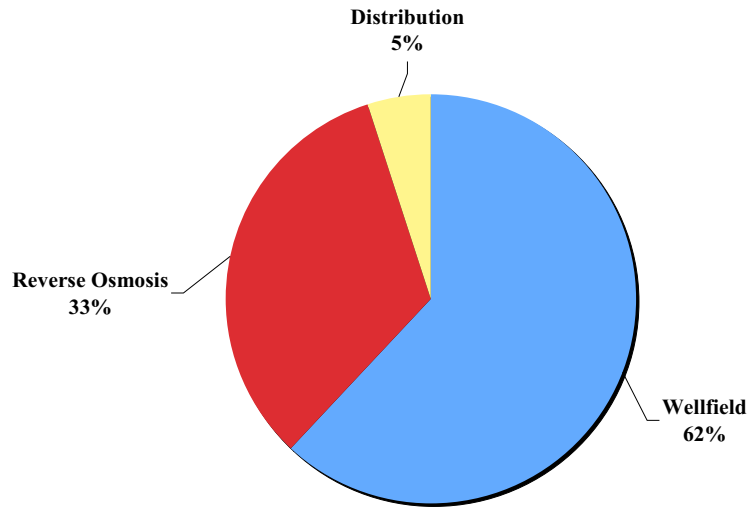


Figure 9.3. Distribution of Monthly Average Energy Use

## 9.2 Recommendations for Future Work

Some of the further applications of the adaptive/intelligent control algorithm explore the unintended synergisms of an integrated wind-water system that evolved during the course of this investigation. Among these synergisms is the opportunity for a municipal water supplier, such as Seminole, to apply the computational power of the algorithm to their currently heuristic approach to managing the municipality's water supply, i.e. to take advantage of using different storage tank setpoints in order to gain the benefit of time-shifting water demand.

A re-evaluation of how the city of Seminole manages their re-schedulable municipal loads would possibly curtail energy use at certain times of the day to a level which could be more easily displaced by the wind turbine array. Typical re-scheduling of loads includes practices such as pre-heating or pre-cooling buildings. The beneficial times exist when the water system and municipal loads exceed the amount of energy produced by the wind turbine array. Figure 9.4 shows times of day, approximately 8:00 am to 5:00 pm, which could benefit from a re-evaluation of load scheduling.

As discussed in Chapters 3 and 5, the current raw data stream recorded from the wellfield flow meter represents the recharging characteristics of the storage tanks of Seminole's current water system rather than what could be considered actual consumer water demand. By evaluating the real-time data stream and applying a moving average filter to the water use data, an opportunity presents itself to more efficiently operate the water system. The filtering of the incoming data stream through a moving-average filter could possibly reduce demand charges (in a system where they are applicable) by applying a more intelligent operation scheme to the storage and distribution system. The reduction in demand charges would be attained from the operation of a minimal amount of lifting and distribution pumps in order to reduce the instantaneous power (kW) demand of the distribution system.

Although electrical demand charges were not considered by this research, re-scheduling municipal loads could lessen the impact that demand charges would have on the cost of water. Also, using water storage to re-schedule water pumping times also presents an opportunity to diminish demand charges. However, because of the modularity of the system of wellfield pumps, the reverse osmosis system, and the distribution system, an adopter of the system is able to schedule power draw to minimize costs of these different systems, as well as to add components as the adopter sees fit.

The system modeled in this research is not readily adaptable to include demand charges or time-varying energy charges, as it has made the assumption of infinitely variable pump control for all components of the integrated wind-water system and a constant energy charge throughout the day and year.

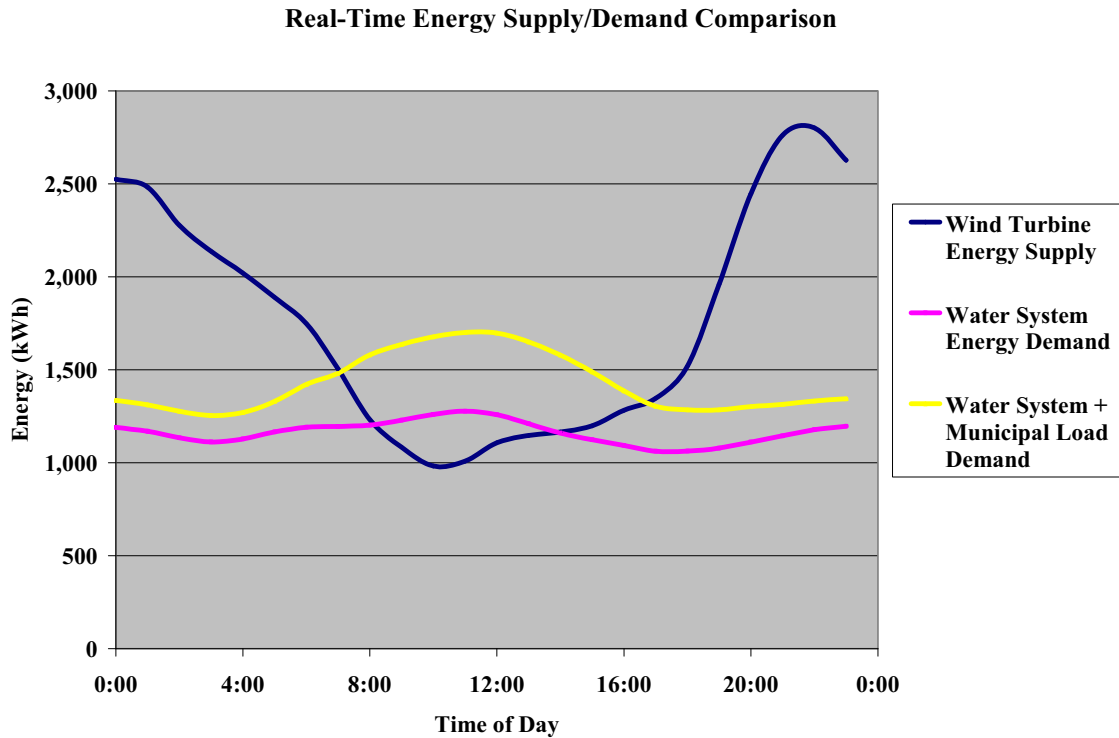


Figure 9.4. Real-Time Energy Supply/Demand Comparison

Intelligent control of the pumping and distribution system also introduces the benefit of storing water during times of low water system demand and high wind turbine array energy availability. When referencing Figure 9.4, it is easy to visualize time-shifting the energy produced by the wind turbine array by producing and storing fresh water during times of wind power surplus. Storing produced water in above or on-ground tanks effectively acts as energy storage, and allows the system to reap the benefit of time-shifting water system energy demand, which allows for the sale of surplus energy or further displacement of municipal loads at times where there would otherwise be a wind power deficit.

Further analysis needs to be performed on utilizing the algorithm to determine the economic impact of changes in the storage tank setpoints, or the impact of additional fresh water storage, as these changes may impact the times of the day when there is a wind power surplus or deficit. The elevated storage tanks operate between approximately 75-95% capacity, and the on-ground storage tanks operate between approximately 90-95% capacity (Goodger, 2008). By adjusting these margins to allow for a wider range between the top and bottom setpoints, the city may further recognize the benefit of time-shifting the energy produced by the wind turbine array.

By more accurately matching supply and demand throughout the day by analyzing water storage capabilities, the maximized value (displacing energy purchased from the utility energy provider) of the wind turbines can further be realized. Further utilization of historical water use

data in the decision making process of the algorithm would potentially allow for the forecasting of water use, and further optimization of system operation.

The ability to adapt the control algorithm allows for many of these different synergisms to be applied to the city's water and electrical load management. As more data is gathered about the characteristics of the Santa Rosa aquifer and the water demand by the city of Seminole, the algorithm can be reprogrammed for this additional knowledge.

The time-shifting of renewable energy acknowledges other potential synergisms between renewable energy and energy intensive technologies that are not explored by this dissertation. By using a medium that can be stored in its useable form (e.g. water) rather than a medium that has to be transferred to a different form before use (e.g. batteries, compressed air), the benefit of time-shifting renewable energy is fully realized. Technologies that do require changes in medium before use can also benefit from the application of the adaptive/intelligent control algorithm in order to optimize the use of the energy generated by that system.

Most importantly, the recognition of the positive economics of the integration of wind energy to a municipal scale reverse osmosis system addresses the water shortage needs of West Texas, as well as water scarce regions worldwide.

## References

- American Wind Energy Association (AWEA). 2005. "The Economics of Wind Energy." Washington, DC: AWEA.
- Black & Veatch<sup>a</sup>. 2005. "Town of Eastham: Wind Energy Site Screening and Development Options Analysis." Boston, MA: Black & Veatch.
- Black & Veatch<sup>b</sup>. 2005. "Town of Lenox: Site Screening and Development Options Analysis Report." Boston, MA: Black & Veatch.
- Black & Veatch<sup>c</sup>. 2005. "Town of Winthrop: Site Screening and Development Options Analysis Report." Boston, MA: Black & Veatch.
- Blanco, G., Manwell, J.F., McGowan, J.G. 2002. "A Feasibility Study for Wind/Hybrid Power System Applications for New England Islands." *Proceedings of the AWEA Annual Conference*. Portland, OR, June, 2002.
- Bloomberg.com. "Municipal Bonds, 20-year." <http://www.bloomberg.com/markets/rates/index.html>, November 13, 2007.
- Busch, M., Mickols, W.E. 2004. "Reducing Energy Consumption in Seawater Desalination." *Desalination*. Vol. 165. p. 299-312.
- Carta, J.A., Gonzalez, J., Subiela, V. 2003. "The SDAWES project: An ambitious R and D prototype for wind-powered desalination." *Desalination*. Vol. 161. p. 33-48.
- Chapman, Jamie. 2006, 2007, 2008. (personal communication).
- Eastech Flow Controls. "Vantage 4400 Technical Brief." <http://www.eastechflow.com/pdf/4400TB.pdf>, January 4, 2008.
- Environmental Protection Agency (EPA). 2005. "Water Quality Standards: CFR Title 40 Part 131." Washington, DC: EPA.
- Essoree, Gary. 2007. (personal communication).
- Flowers, L. 2005. "Wind Power Options and Opportunities for the Great Plains." *Proceedings of the 2005 Texas Tech University Economic Development Summit: 'Wind and Water: Redeveloping Regional Resources for the New Economy.'* Lubbock, TX 2005.



- Garcia-Rodriguez, L., Romero-Ternero, V., Gomez-Camacho, C. 2004. "Economic analysis of wind-powered desalination." *Desalination*. Vol. 137. p. 259-265.
- GE<sup>a</sup>. "1.5 MW Wind Turbine Technical Data."  
[http://www.gepower.com/prod\\_serv/products/wind\\_turbines/en/15mw/tech\\_data.htm](http://www.gepower.com/prod_serv/products/wind_turbines/en/15mw/tech_data.htm),  
February 13, 2008.
- GE<sup>b</sup>. "1.5 MW Wind Turbine Technical Specifications."  
[http://www.gepower.com/prod\\_serv/products/wind\\_turbines/en/15mw/specs.htm](http://www.gepower.com/prod_serv/products/wind_turbines/en/15mw/specs.htm),  
February 13, 2008.
- Goodger, Renee. 2007, 2008. (personal communication).
- HDR Engineering, Inc. 2005. "Evaluation of Alternative Sources and Treatment Technologies: Prepared for The City of Seminole, Texas." Austin, TX: HDR Engineering, Inc.
- Hightower, M. 2005. "Water Issues and Opportunities and their Connections with Renewable Energy Sources." *Proceedings of the 2005 Texas Tech University Economic Development Summit: 'Wind and Water: Redeveloping Regional Resources for the New Economy.'* Lubbock, TX 2005.
- Holmes, J.D., Hangan, H.M., Schroeder, J.L., Letchford, C.W., Orwig, K.D. 2007. "A Forensic Study of the Lubbock-Reese Downdraft of 2002." *Proceedings of the 12<sup>th</sup> International Conference on Wind Engineering*, Cairns, Australia, 2007.
- Hrayshat, E.S. 2007. "A Wind-Powered System for Water Desalination." *International Journal of Green Energy*. Vol. 4. p. 471-481.
- Keffler, John. 2007. (personal communication).
- Kiranoudis, C.T., Voros, N.G., Maroulis, Z.B. 1997. "Wind energy exploitation for reverse osmosis desalination plants. *Desalination*. Vol. 109. p. 195-209
- Larsen, R.J., Marx, M.L. 2001. *An Introduction to Mathematical Statistics and Its Applications, Third Edition*. Upper Saddle River, NJ: Prentice-Hall.
- Lyons, J. 2005. "The Technology and Economics of Wind Power and Water Desalinization." *Proceedings of the 2005 Texas Tech University Economic Development Summit: 'Wind and Water: Redeveloping Regional Resources for the New Economy.'* Lubbock, TX 2005.
- Manwell, J.F., McGowan, J.G., Rogers, A.L. 2002. *Wind Energy Explained*. West Sussex, England: John Wiley & Sons.

- Mickley & Associates. 2006. "Membrane Concentrate Disposal: Practices and Regulation." *Desalination and Water Purification Research and Development Program Report No. 123 (Second Edition)*. Denver, CO: U.S. Department of the Interior, Bureau of Reclamation.
- Mohamed, E.S., Papadakis, G. 2004. "Design, simulation and economic analysis of a stand-alone reverse osmosis desalination unit powered by wind turbines and photovoltaics." *Desalination*. Vol. 164. p. 87-97.
- Nelson, V., Barieau, R., Starcher, K. 1980. "Wind energy for municipal water systems." AEI Report 80-1, February 1980, Alternative Energy Institute, West Texas A&M University.
- Nelson, V., Starcher, K. 2000. "Wind/Solar Resource Assessment State of Texas, 1995-1999." AEI Report 2000-2, March 2000, Alternative Energy Institute, West Texas A&M University.
- Osborne, M.J. 2004. *An Introduction to Game Theory*. New York, New York: Oxford University Press.
- Phillips, Tommy. 2007. (personal communication).
- Rainwater, Ken. 2007. (personal communication).
- Reisner, Marc. 1993. *Cadillac Desert: The American West and Its Disappearing Water*. New York: Penguin Books.
- Schroeder, J.L., Burgett, W.S., Haynie, K.B., Sonmez, I. 2005. "The West Texas Mesonet: A Technical Overview," *Journal of Atmospheric and Oceanic Technology*. 22:211-22.
- Simon, David E. 1999. *An Embedded Software Primer*. Reading, MA: Addison-Wesley.
- Song, Lianfa. 2008. (personal communication).
- Stapp, Eldon. 2007. (personal communication).
- Swift, Andy. 2007, 2008. (personal communication).
- Texas Commission on Environmental Quality (TCEQ). 2005. "Drinking Water Standards Governing Drinking Water Quality and Reporting Requirements for Public Water Systems." Austin, TX: TCEQ.

- Texas Water Development Board (TWDB). 2007. "2007 State Water Plan." Austin, TX: TWDB.
- Tzen, E., Morris, R. 2003. "Renewable energy sources for desalination." *Solar Energy*. Vol. 75. P. 375-379.
- Vega R.E., Letchford C.W. 2007. "On directional Weibull probability distribution functions for mean wind speeds." *Proceedings of the 12th International Conference on Wind Engineering*. Cairns, Australia. July 1 - 7, 2007.
- Walter, K. 2007. "Wind Power Systems in the Stable Nocturnal Boundary Layer." Ph.D. Dissertation, Texas Tech University, Lubbock, TX.  
<http://etd.lib.ttu.edu/theses/available/etd-06292007-100356>. April 3, 2008.
- Wolf, Wayne. 2005. *Computers as Components: Principles of Embedded Computer System Design*. San Francisco, CA: Elsevier.



APPENDIX A  
DATABASE FOR SYSTEM OPTIMIZATION

Real-Time Wind Energy at 100 Meters by Month for a Single 1.5 MW Wind Turbine

(Calculated using 100m Extrapolated Wind Speeds and GE 1.5 MW Machine Adjusted Power Curve)

Hour	Jan kWh	Feb kWh	Mar kWh	Apr kWh	May kWh	Jun kWh	Jul kWh	Aug kWh	Sep kWh	Oct kWh	Nov kWh	Dec kWh	Average kWh
0:00	944	889	752	1160	1042	752	608	608	834	889	630	995	842
1:00	971	861	779	1160	971	697	630	564	779	916	608	995	828
2:00	916	889	779	1066	861	630	564	426	697	779	586	916	759
3:00	861	861	779	1018	697	608	475	442	564	724	630	889	712
4:00	995	806	697	995	674	542	475	376	426	674	564	861	674
5:00	1018	806	608	889	674	564	426	272	343	586	564	806	630
6:00	971	806	586	834	586	459	343	197	343	608	564	697	583
7:00	916	724	564	630	409	297	139	94	285	564	564	834	502
8:00	944	564	359	519	442	310	210	69	166	310	343	697	411
9:00	779	409	359	586	497	297	197	103	210	326	197	376	361
10:00	409	442	376	630	426	260	175	103	185	376	222	326	327
11:00	426	497	359	674	326	235	185	94	175	376	247	442	336
12:00	497	586	359	779	310	235	222	130	175	359	260	519	369
13:00	519	674	359	752	326	260	235	148	185	409	247	475	382
14:00	459	674	409	834	359	272	260	157	185	392	235	426	388
15:00	459	630	459	916	392	297	310	157	197	376	210	392	400
16:00	519	652	497	944	442	310	392	148	222	409	185	409	427
17:00	542	564	564	944	497	392	409	166	247	426	210	426	449
18:00	586	608	586	752	519	475	459	222	272	564	409	630	507
19:00	630	779	724	944	652	630	564	235	519	779	630	752	653
20:00	779	916	971	1160	944	834	724	426	752	834	724	724	816
21:00	916	944	1066	1208	1137	971	806	586	861	995	752	806	921
22:00	916	1018	1066	1184	1137	971	752	674	806	1066	779	834	934
23:00	889	1018	944	1160	1042	861	652	724	724	995	630	916	876
<b>Daily Total</b>	17,861	17,620	15,000	21,739	15,364	12,156	10,210	7,070	10,150	14,730	10,987	16,143	14,086
<b>Monthly Total</b>	553,698	493,368	464,995	652,155	476,284	364,686	316,506	219,168	304,493	456,642	329,600	500,420	5,132,015
													<b>Annual Total</b>

Table A.1. Real-Time Wind Energy Estimate for a Single Turbine

Energy Produced by Turbine Arrays, in kWh													
	Jan	Feb	Mar	Apr	May	Jun	Jul	Aug	Sep	Oct	Nov	Dec	Average
	kWh	kWh	kWh	kWh	kWh	kWh	kWh	kWh	kWh	kWh	kWh	kWh	kWh
<b>Energy from 1 Turbines:</b>													
Daily Total	17,861	17,620	15,000	21,739	15,364	12,156	10,210	7,070	10,150	14,730	10,987	16,143	14,086
Monthly Total	553,698	493,368	464,995	652,155	476,284	364,686	316,506	219,168	304,493	456,642	329,600	500,420	Annual Total
													5,132,015
<b>Energy from 2 Turbines:</b>													
Daily Total	35,722	35,241	30,000	43,477	30,728	24,312	20,420	14,140	20,300	29,461	21,973	32,285	28,172
Monthly Total	1,107,396	986,736	929,991	1,304,311	952,567	729,373	633,012	438,337	608,985	913,284	659,200	1,000,840	Annual Total
													10,264,031
<b>Energy from 3 Turbines:</b>													
Daily Total	53,584	52,861	45,000	65,216	46,092	36,469	30,630	21,210	30,449	44,191	32,960	48,428	42,257
Monthly Total	1,661,093	1,480,104	1,394,986	1,956,466	1,428,851	1,094,059	949,518	657,505	913,478	1,369,926	988,799	1,501,260	Annual Total
													15,396,046
<b>Energy from 4 Turbines:</b>													
Daily Total	71,445	70,481	59,999	86,954	61,456	48,625	40,839	28,280	40,599	58,922	43,947	64,570	56,343
Monthly Total	2,214,791	1,973,472	1,859,981	2,608,621	1,905,135	1,458,745	1,266,024	876,674	1,217,970	1,826,568	1,318,399	2,001,680	Annual Total
													20,528,061
<b>Energy from 5 Turbines:</b>													
Daily Total	89,306	88,101	74,999	108,693	76,820	60,781	51,049	35,350	50,749	73,652	54,933	80,713	70,429
Monthly Total	2,768,489	2,466,841	2,324,977	3,260,777	2,381,418	1,823,432	1,582,530	1,095,842	1,522,463	2,283,210	1,647,999	2,502,100	Annual Total
													25,660,077
<b>Energy from 6 Turbines:</b>													
Daily Total	107,167	105,722	89,999	130,431	92,184	72,937	61,259	42,420	60,899	88,382	65,920	96,855	84,515
Monthly Total	3,322,187	2,960,209	2,789,972	3,912,932	2,857,702	2,188,118	1,899,036	1,315,011	1,826,955	2,739,853	1,977,599	3,002,520	Annual Total
													30,792,092

Table A.2. Energy Produced by Turbine Arrays

**Real-Time Municipal Electrical Demand Data**

**64 electric meters' load on grid**

(Based on Daily Average Usage and actual ERCOT Business Customer Profile, scaled to fit Seminole Loads)

Hour	Jan kWh	Feb kWh	Mar kWh	Apr kWh	May kWh	Jun kWh	Jul kWh	Aug kWh	Sep kWh	Oct kWh	Nov kWh	Dec kWh	AVERAGE kWh
0:00	113	132	112	107	147	224	336	175	128	92	102	145	145
1:00	115	136	110	104	139	213	325	173	123	90	102	148	143
2:00	118	140	111	101	134	206	321	171	120	88	102	154	142
3:00	123	144	112	99	132	198	316	164	117	88	104	159	142
4:00	125	149	112	97	130	194	316	161	117	87	105	163	142
5:00	137	161	114	116	153	236	374	193	159	109	110	177	164
6:00	160	188	131	149	210	305	390	390	365	197	138	191	231
7:00	229	235	172	198	276	354	377	435	441	264	199	235	286
8:00	331	317	230	313	413	399	408	557	562	347	246	308	378
9:00	352	356	307	325	426	423	412	586	575	370	316	321	408
10:00	360	362	321	328	430	452	435	609	585	370	334	308	417
11:00	349	349	306	339	460	485	456	619	618	395	319	292	424
12:00	351	347	321	363	490	480	455	649	647	423	340	286	439
13:00	334	334	329	385	508	418	433	697	677	434	341	262	441
14:00	328	328	341	348	461	410	449	661	602	384	359	255	419
15:00	279	271	305	300	402	409	444	575	518	324	298	208	365
16:00	229	234	248	234	328	399	432	419	371	230	237	178	294
17:00	173	179	190	204	292	371	414	350	289	177	180	146	243
18:00	152	151	160	186	267	347	394	323	267	165	156	143	221
19:00	150	157	157	166	244	326	375	282	238	152	144	146	207
20:00	143	150	154	152	214	298	368	258	206	128	132	149	191
21:00	129	140	139	127	181	275	368	219	161	106	121	148	170
22:00	108	128	125	117	164	253	354	200	140	96	109	139	155
23:00	110	127	116	112	155	238	344	186	132	94	104	139	148
<b>Daily Total</b>	4,999	5,215	4,725	4,968	6,755	7,913	9,297	9,053	8,157	5,212	4,698	4,800	6,316
<b>Monthly Total</b>	154,962	146,029	146,473	149,048	209,405	237,398	288,201	280,643	244,719	161,562	140,951	148,795	
<b>ERCOT Data</b>													<b>Annual Total</b>
<b>Seminole Data</b>													<b>Annual Cost</b>
July 1, 2005-June 30, 2006													2,308,187
March 2003-February 2006													\$184,654.96
													COE = \$0.08/kWh

Table A.3. Real-Time Municipal Electrical Demand Data



**Hourly Average Real-Time Water Flow Rate, in MGD Using Real-Time data from January 2006-May 2007**

Hour	Jan MGD	Feb MGD	Mar MGD	Apr MGD	May MGD	Jun MGD	Jul MGD	Aug MGD	Sep MGD	Oct MGD	Nov MGD	Dec MGD	AVERAGE MGD
0:00	0.86	0.93	1.19	1.65	1.61	2.53	2.28	2.51	2.75	1.53	1.26	0.97	1.68
1:00	0.81	0.93	1.11	1.57	1.63	2.44	2.19	2.67	2.60	1.43	1.36	0.93	1.65
2:00	0.76	0.85	0.98	1.49	1.55	2.36	2.16	2.79	2.54	1.41	1.29	0.95	1.60
3:00	0.72	0.78	0.86	1.41	1.45	2.35	2.19	2.71	2.66	1.55	1.21	0.88	1.56
4:00	0.66	0.70	0.82	1.35	1.44	2.41	2.21	2.74	2.88	1.78	1.22	0.87	1.59
5:00	0.62	0.62	0.82	1.28	1.37	2.45	2.25	2.90	3.07	1.96	1.34	0.89	1.64
6:00	0.60	0.58	0.85	1.20	1.38	2.50	2.28	3.05	3.20	2.01	1.43	0.81	1.68
7:00	0.65	0.59	0.89	1.19	1.51	2.54	2.33	3.09	3.25	1.96	1.33	0.76	1.68
8:00	0.70	0.66	0.95	1.24	1.61	2.57	2.40	3.14	3.29	1.84	1.17	0.79	1.69
9:00	0.77	0.74	1.04	1.37	1.66	2.58	2.47	3.12	3.32	1.73	1.19	0.92	1.73
10:00	0.83	0.86	1.13	1.50	1.61	2.59	2.52	3.05	3.25	1.62	1.36	1.02	1.77
11:00	0.91	0.93	1.24	1.59	1.60	2.60	2.53	2.96	3.11	1.51	1.47	1.10	1.80
12:00	0.95	1.01	1.31	1.62	1.52	2.56	2.49	2.73	2.91	1.39	1.42	1.17	1.77
13:00	0.99	1.02	1.27	1.61	1.42	2.50	2.41	2.43	2.71	1.31	1.30	1.19	1.70
14:00	1.01	1.04	1.19	1.56	1.40	2.38	2.32	2.27	2.56	1.26	1.19	1.17	1.63
15:00	1.02	1.01	1.08	1.48	1.39	2.31	2.19	2.32	2.49	1.25	1.17	1.12	1.58
16:00	1.00	0.98	1.08	1.39	1.39	2.25	2.00	2.31	2.54	1.20	1.17	1.10	1.54
17:00	0.97	0.94	1.13	1.33	1.37	2.22	1.79	2.25	2.60	1.16	1.14	1.02	1.49
18:00	0.94	0.92	1.23	1.36	1.37	2.29	1.61	2.26	2.63	1.17	1.14	1.01	1.50
19:00	0.91	0.94	1.25	1.46	1.36	2.36	1.56	2.29	2.59	1.22	1.15	1.04	1.52
20:00	0.91	0.96	1.22	1.58	1.48	2.45	1.71	2.39	2.53	1.29	1.17	1.10	1.56
21:00	0.91	0.98	1.17	1.69	1.66	2.51	1.94	2.44	2.59	1.36	1.20	1.05	1.61
22:00	0.91	0.97	1.16	1.75	1.68	2.58	2.18	2.55	2.65	1.46	1.18	0.99	1.66
23:00	0.91	0.97	1.20	1.75	1.63	2.59	2.27	2.57	2.67	1.52	1.18	0.99	1.68
<b>Daily Average</b>	0.85	0.87	1.09	1.48	1.50	2.46	2.18	2.65	2.81	1.50	1.25	0.99	<b>Annual Average</b> 1.635

Table A.4. Average Real-Time Water Flow Rate

Hour	Average Real-Time Water Use, From Real-Time Flow Rate, By Hour, in Thousand Gallon Units (TG)												AVERAGE TG
	Jan TG	Feb TG	Mar TG	Apr TG	May TG	Jun TG	Jul TG	Aug TG	Sep TG	Oct TG	Nov TG	Dec TG	
0:00	35.70	38.63	49.47	68.77	67.29	105.43	94.82	104.58	114.42	63.74	52.59	40.22	69.80
1:00	33.91	38.55	46.43	65.39	67.73	101.68	91.25	111.28	108.27	59.49	56.69	38.94	68.55
2:00	31.52	35.21	40.76	62.15	64.74	98.41	90.10	116.08	105.82	58.66	53.91	39.42	66.54
3:00	29.98	32.55	35.89	58.96	60.40	97.75	91.21	112.99	110.84	64.56	50.33	36.82	65.18
4:00	27.43	28.99	33.99	56.24	60.13	100.40	92.13	114.32	120.03	73.96	50.74	36.37	66.14
5:00	25.82	25.96	33.98	53.34	56.89	102.20	93.60	120.95	127.78	81.48	55.69	36.98	68.34
6:00	24.97	24.32	35.55	50.10	57.47	104.01	94.91	127.00	133.15	83.95	59.71	33.82	69.80
7:00	26.93	24.67	37.19	49.52	62.75	105.99	97.13	128.76	135.57	81.66	55.32	31.74	70.07
8:00	29.05	27.39	39.69	51.80	67.01	107.02	100.18	130.68	137.16	76.59	48.68	32.89	70.50
9:00	31.99	30.98	43.30	57.05	69.23	107.65	102.94	130.07	138.26	71.96	49.51	38.30	72.05
10:00	34.39	35.68	47.05	62.58	67.27	108.00	105.02	127.29	135.46	67.65	56.67	42.69	73.84
11:00	38.05	38.73	51.53	66.28	66.74	108.51	105.42	123.30	129.57	63.06	61.26	45.68	74.84
12:00	39.62	41.95	54.68	67.31	63.30	106.77	103.96	113.68	121.40	57.97	58.99	48.71	73.75
13:00	41.40	42.55	53.03	66.99	59.13	103.98	100.55	101.13	112.72	54.41	54.07	49.41	70.89
14:00	41.89	43.38	49.45	64.83	58.22	99.34	96.70	94.78	106.76	52.71	49.58	48.56	68.00
15:00	42.55	42.25	44.89	61.66	58.10	96.35	91.38	96.65	103.87	52.19	48.55	46.51	65.86
16:00	41.53	40.97	45.02	58.07	57.75	93.68	83.37	96.17	105.87	49.98	48.64	45.83	64.09
17:00	40.51	39.23	46.90	55.51	56.99	92.46	74.38	93.90	108.47	48.45	47.70	42.47	62.26
18:00	39.09	38.46	51.20	56.77	57.00	95.37	67.06	94.09	109.75	48.74	47.52	42.29	62.32
19:00	37.98	39.01	51.88	60.99	56.66	98.53	65.19	95.22	108.03	50.84	48.09	43.20	63.21
20:00	37.76	40.08	50.76	66.00	61.72	102.22	71.26	99.39	105.49	53.71	48.83	45.82	65.17
21:00	37.76	41.02	48.76	70.38	69.09	104.54	81.02	101.68	107.95	56.64	50.02	43.76	67.07
22:00	37.82	40.27	48.54	72.91	69.97	107.50	90.86	106.23	110.50	61.04	49.13	41.30	69.08
23:00	37.73	40.22	49.87	72.79	68.06	107.93	94.43	107.02	111.15	63.36	49.29	41.14	70.13
<b>Daily Total</b>	845	871	1,090	1,476	1,504	2,456	2,179	2,647	2,808	1,497	1,252	993	1,637
<b>Monthly Total</b>	26,208	24,389	33,784	44,292	46,613	73,671	67,545	82,064	84,249	46,400	37,545	30,779	597,538
<b>Annual Average Sum</b>													

Energy Costs/1000 Gallons at COE							
Well (1350 ft)		Ro System		Distribution		Total	
kWh/1000	\$/1000	kWh/1000	\$/1000	kWh/1000	\$/1000	kWh/1000	\$/1000
10.58	\$0.85	\$0.45	\$0.45	0.86	\$0.07	17.06	\$1.36
<b>Total System Energy Cost/1000 Gallons = 17.06 kWh/1000 gallons</b>						COE = \$0.08	

Table A.5. Average Real-Time Flow Rate in TG Units and Energy Costs for Components of Water System



**Seminole System Energy Use  
(Well+RO System+Distribution)  
Based on Water Consumption Data  
13 Month Average: January 2006-May 2007  
20 Period Moving Average Calculation  
5-minute Observation Period**

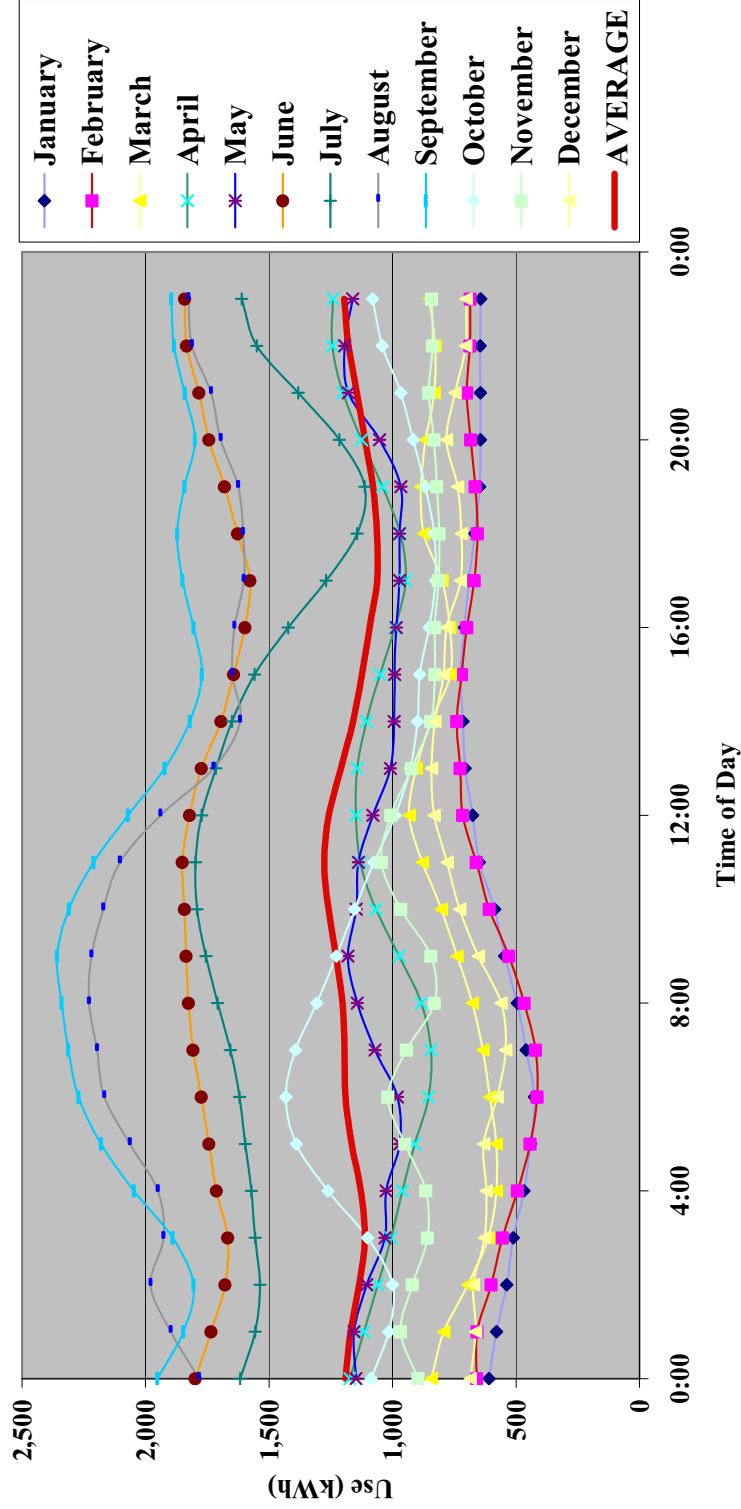


Figure A.1. Seminole System Energy Use

One Wind Turbine													
Real-Time Expected Energy Surplus or (Deficit), Without Including Municipal Loads													
(electrical cost of powering entire system with wind turbines; negative periods indicate energy purchased from utility)													
Hour	Jan kWh	Feb kWh	Mar kWh	Apr kWh	May kWh	Jun kWh	Jul kWh	Aug kWh	Sep kWh	Oct kWh	Nov kWh	Dec kWh	AVERAGE kWh
0:00	335	230	(92)	(13)	(106)	(1,047)	(1,010)	(1,176)	(1,118)	(199)	(267)	309	(349)
1:00	393	204	(13)	45	(184)	(1,038)	(927)	(1,335)	(1,068)	(99)	(359)	330	(342)
2:00	378	288	84	5	(243)	(1,049)	(973)	(1,555)	(1,109)	(222)	(334)	244	(376)
3:00	350	306	167	13	(334)	(1,060)	(1,081)	(1,486)	(1,327)	(377)	(229)	261	(400)
4:00	527	312	117	35	(351)	(1,171)	(1,097)	(1,574)	(1,622)	(587)	(302)	241	(455)
5:00	578	364	28	(21)	(296)	(1,180)	(1,171)	(1,791)	(1,837)	(804)	(386)	175	(536)
6:00	545	391	(21)	(21)	(394)	(1,316)	(1,276)	(1,970)	(1,929)	(824)	(455)	120	(608)
7:00	457	303	(71)	(215)	(662)	(1,511)	(1,518)	(2,103)	(2,028)	(829)	(380)	292	(694)
8:00	448	97	(318)	(364)	(701)	(1,516)	(1,500)	(2,160)	(2,174)	(997)	(488)	136	(792)
9:00	233	(120)	(379)	(387)	(684)	(1,539)	(1,559)	(2,116)	(2,149)	(897)	(488)	136	(792)
10:00	(178)	(167)	(427)	(438)	(722)	(1,583)	(1,616)	(2,069)	(2,126)	(778)	(745)	(402)	(932)
11:00	(224)	(163)	(520)	(456)	(812)	(1,617)	(1,614)	(2,010)	(2,035)	(700)	(798)	(337)	(940)
12:00	(179)	(130)	(573)	(369)	(770)	(1,587)	(1,551)	(1,809)	(1,896)	(630)	(747)	(312)	(889)
13:00	(187)	(51)	(545)	(391)	(683)	(1,514)	(1,481)	(1,577)	(1,739)	(519)	(675)	(368)	(827)
14:00	(256)	(66)	(435)	(272)	(634)	(1,423)	(1,390)	(1,460)	(1,637)	(507)	(611)	(403)	(772)
15:00	(267)	(91)	(307)	(136)	(599)	(1,347)	(1,249)	(1,492)	(1,575)	(515)	(619)	(401)	(724)
16:00	(189)	(47)	(271)	(47)	(543)	(1,289)	(1,030)	(1,493)	(1,584)	(444)	(604)	(373)	(666)
17:00	(149)	(106)	(236)	(3)	(475)	(1,185)	(860)	(1,436)	(1,603)	(401)	(604)	(299)	(613)
18:00	(81)	(48)	(288)	(217)	(453)	(1,152)	(685)	(1,383)	(1,600)	(268)	(402)	(91)	(556)
19:00	(18)	114	(161)	(97)	(314)	(1,051)	(548)	(1,390)	(1,324)	(88)	(190)	14	(425)
20:00	135	232	105	35	(109)	(910)	(492)	(1,270)	(1,048)	(82)	(109)	(58)	(296)
21:00	272	244	234	7	(42)	(812)	(576)	(1,149)	(980)	29	(102)	60	(224)
22:00	271	332	238	(60)	(57)	(863)	(799)	(1,138)	(1,079)	24	(59)	129	(245)
23:00	245	332	93	(81)	(119)	(980)	(959)	(1,151)	(1,172)	(86)	(211)	214	(321)
Daily Total (+)	5,166	3,747	1,065	140	0	0	0	0	0	53	0	2,525	0
Daily Total (-)	(1,727)	(987)	(4,657)	(3,589)	(10,288)	(29,738)	(26,962)	(38,092)	(37,760)	(10,858)	(10,364)	(3,321)	(13,849)
Positive Total	160,144	104,929	33,020	4,203	0	0	0	0	0	1,641	0	78,283	
Negative Total	(53,549)	(27,643)	(144,374)	(107,661)	(318,926)	(892,144)	(835,811)	(1,180,843)	(1,132,789)	(336,588)	(310,922)	(102,946)	
(By Month)													
Annual Positive Balance													382,219
Annual Negative Balance													(5,444,195)

Table A.7. Real-Time Expected Energy Surplus or Deficit for a Single Turbine Array

One Wind Turbine													
Real-Time Expected Energy Balance, Including Municipal Loads													
(electrical cost of powering entire system with wind turbines; negative periods indicate energy purchased from utility)													
Hour	Jan	Feb	Mar	Apr	May	Jun	Jul	Aug	Sep	Oct	Nov	Dec	AVERAGE
	kWh	kWh	kWh	kWh	kWh	kWh	kWh	kWh	kWh	kWh	kWh	kWh	kWh
0:00	222	97	(204)	(120)	(253)	(1,272)	(1,346)	(1,351)	(1,246)	(291)	(369)	164	(494)
1:00	278	67	(123)	(59)	(324)	(1,251)	(1,251)	(1,508)	(1,191)	(189)	(461)	182	(485)
2:00	260	148	(28)	(96)	(377)	(1,255)	(1,294)	(1,726)	(1,229)	(310)	(436)	90	(519)
3:00	227	162	54	(86)	(466)	(1,258)	(1,396)	(1,650)	(1,444)	(465)	(333)	101	(542)
4:00	401	163	5	(62)	(482)	(1,366)	(1,413)	(1,735)	(1,739)	(675)	(407)	78	(597)
5:00	441	203	(86)	(137)	(449)	(1,416)	(1,545)	(1,985)	(1,996)	(914)	(496)	(2)	(700)
6:00	386	203	(152)	(170)	(605)	(1,620)	(1,666)	(2,360)	(2,294)	(1,022)	(593)	(72)	(839)
7:00	228	68	(243)	(412)	(938)	(1,865)	(1,895)	(2,538)	(2,469)	(1,094)	(579)	58	(980)
8:00	117	(220)	(548)	(677)	(1,114)	(1,915)	(1,907)	(2,717)	(2,735)	(1,344)	(733)	(173)	(1,169)
9:00	(119)	(475)	(686)	(713)	(1,110)	(1,962)	(1,971)	(2,702)	(2,724)	(1,271)	(964)	(598)	(1,276)
10:00	(538)	(528)	(748)	(765)	(1,152)	(2,035)	(2,051)	(2,678)	(2,711)	(1,149)	(1,079)	(711)	(1,350)
11:00	(573)	(512)	(826)	(796)	(1,272)	(2,102)	(2,070)	(2,629)	(2,654)	(1,095)	(1,117)	(630)	(1,364)
12:00	(530)	(477)	(895)	(732)	(1,260)	(2,067)	(2,007)	(2,459)	(2,543)	(1,053)	(1,087)	(597)	(1,328)
13:00	(521)	(385)	(875)	(776)	(1,191)	(1,932)	(1,914)	(2,415)	(2,415)	(1,016)	(1,016)	(630)	(1,268)
14:00	(584)	(394)	(776)	(620)	(1,095)	(1,833)	(1,840)	(2,120)	(2,239)	(890)	(970)	(658)	(1,191)
15:00	(547)	(362)	(613)	(435)	(1,001)	(1,756)	(1,693)	(2,067)	(2,093)	(839)	(916)	(610)	(1,089)
16:00	(417)	(280)	(519)	(281)	(871)	(1,687)	(1,461)	(1,912)	(1,955)	(674)	(883)	(551)	(960)
17:00	(322)	(285)	(426)	(207)	(767)	(1,556)	(1,274)	(1,785)	(1,892)	(578)	(784)	(445)	(856)
18:00	(233)	(200)	(448)	(403)	(720)	(1,499)	(1,080)	(1,706)	(1,868)	(433)	(558)	(234)	(778)
19:00	(168)	(43)	(319)	(263)	(558)	(1,376)	(924)	(1,671)	(1,561)	(240)	(334)	(132)	(632)
20:00	(8)	82	(49)	(117)	(323)	(1,208)	(860)	(1,528)	(1,254)	(210)	(241)	(206)	(487)
21:00	143	104	95	(119)	(223)	(1,087)	(944)	(1,368)	(1,141)	(78)	(223)	(88)	(393)
22:00	163	204	113	(177)	(221)	(1,116)	(1,153)	(1,337)	(1,219)	(72)	(168)	(10)	(399)
23:00	135	205	(23)	(193)	(274)	(1,218)	(1,303)	(1,337)	(1,304)	(180)	(315)	75	(469)
Daily Total	3,000	1,706	267	0	0	0	0	0	0	0	0	748	0
Daily Total (+)													
Daily Total (-)	(4,560)	(4,161)	(8,584)	(8,417)	(17,043)	(37,651)	(36,258)	(47,145)	(45,917)	(16,016)	(15,062)	(6,343)	(20,165)
Positive Total	92,988	47,772	8,264	0	0	0	0	0	0	0	0	23,179	
Negative Total	(141,356)	(116,513)	(266,091)	(252,506)	(528,331)	(1,129,542)	(1,124,013)	(1,461,486)	(1,377,508)	(496,510)	(451,873)	(196,638)	172,203
(By Month)													(7,542,366)
Annual Positive Balance													\$6,888
Annual Negative Balance													(\$603,389)
Revenue from selling excess wind energy at sell price													\$0.04
Cost of purchasing negative balance at COE													\$0.08

Table A.8. Real-Time Expected Energy Balance for a Single Turbine Array

One Wind Turbine

**Expected Energy Cost of Municipal Loads, After Considering Wind Energy**  
 (expected energy outlay for municipal loads after net metering with wind energy)

*this is a reproduction of the negative values of the previous chart, showing expected energy purchase times*

Hour	Jan kWh	Feb kWh	Mar kWh	Apr kWh	May kWh	Jun kWh	Jul kWh	Aug kWh	Sep kWh	Oct kWh	Nov kWh	Dec kWh	AVERAGE kWh
0:00	0	0	(204)	(120)	(253)	(1,272)	(1,346)	(1,351)	(1,246)	(291)	(369)	0	(494)
1:00	0	0	(123)	(59)	(324)	(1,251)	(1,251)	(1,508)	(1,191)	(189)	(461)	0	(485)
2:00	0	0	(28)	(96)	(377)	(1,258)	(1,294)	(1,294)	(1,229)	(310)	(436)	0	(519)
3:00	0	0	0	(86)	(466)	(1,258)	(1,396)	(1,650)	(1,444)	(465)	(333)	0	(542)
4:00	0	0	0	(62)	(482)	(1,366)	(1,413)	(1,735)	(1,739)	(675)	(407)	0	(597)
5:00	0	0	(86)	(137)	(449)	(1,416)	(1,545)	(1,985)	(1,996)	(914)	(496)	(2)	(700)
6:00	0	0	(152)	(170)	(605)	(1,620)	(1,666)	(2,360)	(2,294)	(1,022)	(593)	(72)	(839)
7:00	0	0	(243)	(412)	(938)	(1,865)	(1,895)	(2,538)	(2,469)	(1,094)	(579)	0	(980)
8:00	0	(220)	(548)	(677)	(1,114)	(1,915)	(1,907)	(2,717)	(2,735)	(1,344)	(733)	(173)	(1,169)
9:00	(119)	(475)	(686)	(713)	(1,110)	(1,962)	(1,971)	(2,702)	(2,724)	(1,271)	(964)	(598)	(1,276)
10:00	(538)	(528)	(748)	(765)	(1,152)	(2,035)	(2,051)	(2,678)	(2,711)	(1,149)	(1,079)	(711)	(1,350)
11:00	(573)	(512)	(826)	(796)	(1,272)	(2,102)	(2,070)	(2,629)	(2,654)	(1,095)	(1,117)	(630)	(1,364)
12:00	(530)	(477)	(895)	(732)	(1,260)	(2,067)	(2,007)	(2,459)	(2,543)	(1,053)	(1,087)	(597)	(1,328)
13:00	(521)	(385)	(875)	(776)	(1,191)	(1,932)	(1,914)	(2,275)	(2,415)	(953)	(1,016)	(630)	(1,268)
14:00	(584)	(394)	(776)	(620)	(1,095)	(1,833)	(1,840)	(2,120)	(2,239)	(890)	(970)	(658)	(1,191)
15:00	(547)	(362)	(613)	(435)	(1,001)	(1,756)	(1,693)	(2,067)	(2,093)	(839)	(916)	(610)	(1,089)
16:00	(417)	(280)	(519)	(281)	(871)	(1,687)	(1,461)	(1,912)	(1,955)	(674)	(883)	(551)	(960)
17:00	(322)	(285)	(426)	(207)	(767)	(1,536)	(1,274)	(1,785)	(1,892)	(578)	(784)	(445)	(856)
18:00	(233)	(200)	(448)	(403)	(720)	(1,499)	(1,080)	(1,706)	(1,868)	(433)	(558)	(234)	(778)
19:00	(168)	(43)	(319)	(263)	(538)	(1,376)	(924)	(1,671)	(1,561)	(240)	(334)	(132)	(632)
20:00	(8)	0	(49)	(117)	(323)	(1,208)	(860)	(1,528)	(1,254)	(210)	(241)	(206)	(487)
21:00	0	0	0	(119)	(223)	(1,087)	(944)	(1,368)	(1,141)	(78)	(223)	(88)	(393)
22:00	0	0	0	(177)	(221)	(1,116)	(1,153)	(1,337)	(1,219)	(72)	(168)	(10)	(399)
23:00	0	0	(23)	(193)	(274)	(1,218)	(1,303)	(1,337)	(1,304)	(180)	(315)	0	(469)
<b>Daily Total</b>	<b>(4,560)</b>	<b>(4,161)</b>	<b>(8,584)</b>	<b>(8,417)</b>	<b>(17,043)</b>	<b>(37,651)</b>	<b>(36,258)</b>	<b>(47,145)</b>	<b>(45,917)</b>	<b>(16,016)</b>	<b>(15,062)</b>	<b>(6,343)</b>	<b>(20,165)</b>
<b>Monthly Total</b>	<b>(141,356)</b>	<b>(116,513)</b>	<b>(266,091)</b>	<b>(252,506)</b>	<b>(528,331)</b>	<b>(1,129,542)</b>	<b>(1,124,013)</b>	<b>(1,461,486)</b>	<b>(1,377,508)</b>	<b>(496,510)</b>	<b>(451,873)</b>	<b>(196,638)</b>	<b>(7,542,366)</b>
<b>Annual Balance</b>													<b>(603,389)</b>
<b>Annual Cost</b>													

COE = \$0.08/kWh

Table A.9. Expected Cost of Municipal Loads for a Single Turbine Array

Summary of Costs/Benefits Associated with a Single Turbine Array	
Cost of providing solely municipal loads; no Wells, no RO, no Wind Energy (business as usual, which includes distribution)	(\$184,655)
Cost to municipality to power municipal, Well, RO System, and Distribution loads <i>without wind energy</i>	Cost of Energy from utility = \$0.08
Cost to municipality to power municipal, Well, RO System, and Distribution loads <i>with available wind energy</i>	Selling Price of Energy to Utility = \$0.04
Revenue from selling excess wind energy at Selling Price	\$6,888
Cost to municipality to power municipal, Well, RO System, and Distribution loads after selling excess energy	(\$596,501)
Annual total monetary benefit of wind turbine to municipality, yearly	\$403,673
<hr/>	
Total energy produced by turbine	5,132,015 kWh
Energy used by system (Wells+RO System+Distribution)	10,193,992 kWh
Energy used by municipal loads	2,308,187 kWh
Excess energy sold to utility grid	172,203 kWh

Table A.10. Summary of Costs/Benefits Associated with a Single Turbine Array



Two Wind Turbines													
Real-Time Expected Energy Surplus or (Deficit), Without Including Municipal Loads													
(electrical cost of powering entire system with wind turbines; negative periods indicate energy purchased from utility)													
Hour	Jan	Feb	Mar	Apr	May	Jun	Jul	Aug	Sep	Oct	Nov	Dec	AVERAGE
	kWh	kWh	kWh	kWh	kWh	kWh	kWh	kWh	kWh	kWh	kWh	kWh	kWh
0:00	1,278	1,118	659	1,148	936	(296)	(402)	(568)	(284)	690	363	1,303	493
1:00	1,364	1,065	766	1,205	787	(341)	(296)	(771)	(289)	817	249	1,325	486
2:00	1,295	1,177	863	1,071	618	(418)	(410)	(1,129)	(412)	557	252	1,160	383
3:00	1,211	1,167	946	1,031	363	(452)	(606)	(1,044)	(763)	347	402	1,149	313
4:00	1,522	1,118	813	1,030	323	(630)	(621)	(1,199)	(1,197)	87	262	1,102	219
5:00	1,596	1,170	636	868	378	(616)	(746)	(1,519)	(1,494)	(218)	177	982	94
6:00	1,516	1,198	565	813	191	(857)	(934)	(1,773)	(1,586)	(216)	109	816	(25)
7:00	1,373	1,027	493	416	(253)	(1,214)	(1,379)	(2,009)	(1,744)	(266)	184	1,126	(192)
8:00	1,392	660	41	155	(259)	(1,207)	(1,290)	(2,091)	(2,007)	(687)	(145)	832	(381)
9:00	1,012	289	(20)	198	(186)	(1,242)	(1,362)	(2,014)	(1,940)	(575)	(451)	98	(507)
10:00	231	275	(51)	193	(297)	(1,323)	(1,441)	(1,966)	(1,942)	(403)	(523)	(76)	(605)
11:00	202	334	(160)	218	(486)	(1,382)	(1,430)	(1,916)	(1,860)	(324)	(551)	105	(604)
12:00	319	456	(214)	410	(461)	(1,352)	(1,329)	(1,679)	(1,720)	(270)	(487)	208	(520)
13:00	333	623	(186)	360	(356)	(1,255)	(1,246)	(1,429)	(1,554)	(110)	(428)	108	(445)
14:00	203	609	(26)	562	(275)	(1,151)	(1,131)	(1,302)	(1,452)	(114)	(377)	23	(383)
15:00	191	540	151	780	(206)	(1,050)	(940)	(1,334)	(1,378)	(139)	(409)	(9)	(325)
16:00	331	606	227	897	(101)	(979)	(637)	(1,344)	(1,362)	(35)	(461)	36	(238)
17:00	392	458	327	940	22	(793)	(451)	(1,269)	(1,356)	25	(395)	127	(165)
18:00	505	560	298	534	67	(677)	(227)	(1,161)	(1,328)	296	7	539	(50)
19:00	612	892	563	847	338	(421)	15	(1,155)	(804)	691	440	766	228
20:00	914	1,149	1,076	1,195	834	(76)	232	(845)	(297)	751	615	666	519
21:00	1,188	1,188	1,300	1,215	1,095	159	231	(563)	(119)	1,023	650	866	697
22:00	1,187	1,350	1,303	1,124	1,080	108	(47)	(463)	(272)	1,090	720	963	689
23:00	1,134	1,351	1,037	1,079	923	(119)	(306)	(477)	(448)	909	420	1,131	555
Daily Total (+)	21,300	20,381	12,065	18,290	7,956	267	478	0	0	7,284	4,849	15,432	4,675
Daily Total (-)	0	0	(658)	0	(2,880)	(17,849)	(17,230)	(31,022)	(27,610)	(3,358)	(4,226)	(85)	(4,438)
Positive Total	660,293	570,655	374,028	548,697	246,638	8,008	14,828	0	0	225,790	145,470	478,382	
Negative Total	0	0	(20,387)	0	(89,280)	(535,466)	(534,134)	(961,675)	(828,297)	(104,095)	(126,792)	(2,626)	
(By Month)													
Annual Positive Balance													3,272,790
Annual Negative Balance													(3,202,750)

Table A.1.1. Real-Time Expected Energy Surplus or Deficit for a Two Turbine Array

Two Wind Turbines													
Real-Time Expected Energy Balance, Including Municipal Loads													
(electrical cost of powering entire system with wind turbines; negative periods indicate energy purchased from utility)													
Hour	Jan	Feb	Mar	Apr	May	Jun	Jul	Aug	Sep	Oct	Nov	Dec	AVERAGE
	kWh	kWh	kWh	kWh	kWh	kWh	kWh	kWh	kWh	kWh	kWh	kWh	kWh
0:00	1,166	986	547	1,041	789	(520)	(738)	(743)	(412)	598	261	1,159	348
1:00	1,249	929	656	1,101	647	(554)	(621)	(944)	(412)	728	147	1,177	343
2:00	1,176	1,036	751	970	484	(625)	(731)	(1,300)	(532)	469	150	1,006	240
3:00	1,088	1,023	833	932	230	(650)	(921)	(1,208)	(880)	259	298	990	171
4:00	1,396	969	701	933	193	(824)	(938)	(1,359)	(1,314)	(0)	157	939	77
5:00	1,459	1,009	522	751	226	(852)	(1,120)	(1,713)	(1,653)	(328)	68	805	(71)
6:00	1,357	1,010	434	664	(19)	(1,162)	(1,323)	(2,163)	(1,951)	(414)	(30)	625	(256)
7:00	1,144	792	321	218	(529)	(1,568)	(1,756)	(2,445)	(2,184)	(530)	(16)	892	(478)
8:00	1,060	344	(189)	(158)	(672)	(1,606)	(1,698)	(2,648)	(2,569)	(1,034)	(391)	524	(758)
9:00	660	(66)	(327)	(127)	(612)	(1,665)	(1,774)	(2,600)	(2,515)	(945)	(767)	(222)	(915)
10:00	(129)	(86)	(372)	(135)	(726)	(1,776)	(1,876)	(2,575)	(2,527)	(773)	(857)	(384)	(1,022)
11:00	(147)	(15)	(466)	(121)	(946)	(1,867)	(1,885)	(2,536)	(2,478)	(719)	(870)	(187)	(1,028)
12:00	(32)	109	(535)	47	(951)	(1,833)	(1,785)	(2,329)	(2,368)	(694)	(827)	(78)	(959)
13:00	(1)	289	(516)	(24)	(865)	(1,679)	(1,679)	(2,126)	(2,231)	(544)	(769)	(154)	(886)
14:00	(126)	281	(367)	214	(735)	(1,561)	(1,580)	(1,963)	(2,054)	(498)	(735)	(232)	(803)
15:00	(88)	268	(154)	481	(609)	(1,458)	(1,384)	(1,910)	(1,896)	(463)	(707)	(217)	(690)
16:00	102	372	(21)	663	(429)	(1,378)	(1,069)	(1,764)	(1,733)	(265)	(698)	(142)	(532)
17:00	219	279	137	736	(269)	(1,164)	(865)	(1,619)	(1,645)	(152)	(574)	(19)	(407)
18:00	353	408	138	349	(201)	(1,023)	(621)	(1,484)	(1,596)	131	(149)	396	(271)
19:00	463	736	406	681	95	(746)	(360)	(1,437)	(1,042)	539	296	620	21
20:00	771	999	922	1,043	621	(374)	(136)	(1,102)	(502)	624	483	518	329
21:00	1,059	1,047	1,161	1,088	914	(116)	(138)	(782)	(280)	917	529	719	527
22:00	1,079	1,222	1,179	1,007	916	(145)	(401)	(663)	(413)	994	610	824	534
23:00	1,024	1,224	921	967	768	(356)	(650)	(663)	(580)	814	315	991	406
Daily Total (+)	16,825	15,333	9,630	13,887	5,883	0	0	0	0	6,073	3,314	12,184	2,996
Daily Total (-)	(524)	(168)	(2,947)	(565)	(7,562)	(25,495)	(26,049)	(40,075)	(35,767)	(7,359)	(7,389)	(1,637)	(9,076)
Positive Total	521,573	429,323	298,537	416,609	182,383	0	0	0	0	188,260	99,405	377,705	
Negative Total	(16,243)	(4,696)	(91,369)	(16,959)	(234,430)	(764,856)	(807,507)	(1,242,318)	(1,073,016)	(228,127)	(221,678)	(50,743)	
(By Month)													
Annual Positive Balance													2,513,795
Annual Negative Balance													(4,751,943)
Revenue from selling excess wind energy at sell price													\$100,552
Cost of purchasing negative balance at COE													(5380,155)
Sell Price =													\$0.04
COE =													\$0.08

Table A.12. Real-Time Expected Energy Balance for a Two Turbine Array

**Two Wind Turbines**

**Expected Energy Cost of Municipal Loads, After Considering Wind Energy**  
 (expected energy outlay for municipal loads after net metering with wind energy)  
*this is a reproduction of the negative values of the previous chart, showing expected energy purchase times*

Hour	Jan kWh	Feb kWh	Mar kWh	Apr kWh	May kWh	Jun kWh	Jul kWh	Aug kWh	Sep kWh	Oct kWh	Nov kWh	Dec kWh	AVERAGE kWh
0:00	0	0	0	0	0	(520)	(738)	(743)	(412)	0	0	0	0
1:00	0	0	0	0	0	(554)	(621)	(944)	(412)	0	0	0	0
2:00	0	0	0	0	0	(625)	(731)	(1,300)	(532)	0	0	0	0
3:00	0	0	0	0	0	(650)	(921)	(1,208)	(880)	0	0	0	0
4:00	0	0	0	0	0	(824)	(938)	(1,359)	(1,314)	(0)	0	0	0
5:00	0	0	0	0	0	(852)	(1,120)	(1,713)	(1,653)	(328)	0	0	(71)
6:00	0	0	0	0	(19)	(1,162)	(1,323)	(2,163)	(1,951)	(414)	(30)	0	(256)
7:00	0	0	0	0	(529)	(1,568)	(1,756)	(2,445)	(2,184)	(530)	(16)	0	(478)
8:00	0	0	(189)	(158)	(672)	(1,606)	(1,698)	(2,648)	(2,569)	(1,034)	(391)	0	(758)
9:00	0	(66)	(327)	(127)	(612)	(1,665)	(1,774)	(2,600)	(2,515)	(945)	(767)	(222)	(915)
10:00	(129)	(86)	(372)	(135)	(726)	(1,776)	(1,876)	(2,575)	(2,527)	(773)	(857)	(384)	(1,022)
11:00	(147)	(15)	(466)	(121)	(946)	(1,867)	(1,885)	(2,536)	(2,478)	(719)	(870)	(187)	(1,028)
12:00	(32)	0	(535)	0	(951)	(1,833)	(1,785)	(2,329)	(2,368)	(694)	(827)	(78)	(959)
13:00	(1)	0	(516)	(24)	(865)	(1,673)	(1,679)	(2,126)	(2,231)	(544)	(769)	(154)	(886)
14:00	(126)	0	(367)	0	(735)	(1,561)	(1,580)	(1,963)	(2,054)	(498)	(735)	(232)	(803)
15:00	(88)	0	(154)	0	(609)	(1,458)	(1,384)	(1,910)	(1,896)	(463)	(707)	(217)	(690)
16:00	0	0	(21)	0	(429)	(1,378)	(1,069)	(1,764)	(1,733)	(265)	(698)	(142)	(532)
17:00	0	0	0	0	(269)	(1,164)	(865)	(1,619)	(1,645)	(152)	(574)	(19)	(407)
18:00	0	0	0	0	(201)	(1,023)	(621)	(1,484)	(1,596)	0	(149)	0	(271)
19:00	0	0	0	0	0	(746)	(360)	(1,437)	(1,042)	0	0	0	0
20:00	0	0	0	0	0	(374)	(136)	(1,102)	(502)	0	0	0	0
21:00	0	0	0	0	0	(116)	(782)	(782)	(280)	0	0	0	0
22:00	0	0	0	0	0	(145)	(401)	(663)	(413)	0	0	0	0
23:00	0	0	0	0	0	(356)	(650)	(663)	(580)	0	0	0	0
<b>Daily Total</b>	<b>(524)</b>	<b>(168)</b>	<b>(2,947)</b>	<b>(565)</b>	<b>(7,562)</b>	<b>(25,495)</b>	<b>(26,049)</b>	<b>(40,075)</b>	<b>(35,767)</b>	<b>(7,359)</b>	<b>(7,389)</b>	<b>(1,637)</b>	<b>(9,076)</b>
<b>Monthly Total</b>	<b>(16,243)</b>	<b>(4,696)</b>	<b>(91,369)</b>	<b>(16,959)</b>	<b>(234,430)</b>	<b>(764,856)</b>	<b>(807,507)</b>	<b>(1,242,318)</b>	<b>(1,073,016)</b>	<b>(228,127)</b>	<b>(221,678)</b>	<b>(50,743)</b>	<b>(4,751,943)</b>
<b>Annual Balance</b>												<b>(4,751,943)</b>	
<b>Annual Cost</b>												<b>(\$380,155)</b>	

COE = \$0.08/kWh

Table A.13. Expected Cost of Municipal Loads for a Two Turbine Array

Summary of Costs/Benefits Associated with a Two Turbine Array	
Cost of providing solely municipal loads; no Wells, no RO, no Wind Energy (business as usual, which includes distribution)	(\$184,655)
Cost to municipality to power municipal, Well, RO System, and Distribution loads <i>without wind energy</i>	Cost of Energy from utility = \$0.08
Cost to municipality to power municipal, Well, RO System, and Distribution loads <i>with available wind energy</i>	Selling Price of Energy to Utility = (\$380,155) \$0.04
Revenue from selling excess wind energy at Selling Price	\$100,552
Cost to municipality to power municipal, Well, RO System, and Distribution loads after selling excess energy	(\$279,604)
Annual total monetary benefit of wind turbine to municipality, yearly	\$720,571
Total energy produced by turbine	10,264,031 kWh
Energy used by water system (Wells+RO System+Distribution)	10,193,992 kWh
Energy used by municipal loads	2,308,187 kWh
Excess energy sold to utility grid	2,513,795 kWh

Table A.14. Summary of Costs/Benefits Associated with a Two Turbine Array

Three Wind Turbines

Real-Time Expected Energy Surplus or (Deficit), Without Including Municipal Loads

(electrical cost of powering entire system with wind turbines; negative periods indicate energy purchased from utility)

Hour	Jan kWh	Feb kWh	Mar kWh	Apr kWh	May kWh	Jun kWh	Jul kWh	Aug kWh	Sep kWh	Oct kWh	Nov kWh	Dec kWh	AVERAGE kWh
0:00	2,222	2,007	1,411	2,308	1,978	456	207	40	550	1,579	993	2,298	1,335
1:00	2,335	1,926	1,545	2,366	1,758	355	334	(207)	490	1,734	857	2,320	1,313
2:00	2,211	2,066	1,642	2,137	1,479	212	154	(704)	285	1,336	838	2,076	1,142
3:00	2,072	2,029	1,725	2,050	1,059	156	(131)	(601)	(200)	1,071	1,032	2,038	1,025
4:00	2,516	1,925	1,510	2,025	998	(88)	(146)	(823)	(771)	762	826	1,963	893
5:00	2,615	1,976	1,244	1,756	1,053	(398)	(320)	(1,247)	(1,152)	368	741	1,788	723
6:00	2,487	2,004	1,151	1,647	777	(917)	(591)	(1,576)	(1,243)	392	673	1,513	557
7:00	2,289	1,751	1,057	1,046	156	(975)	(1,081)	(1,916)	(1,459)	298	748	1,960	309
8:00	2,335	1,224	401	675	183	(897)	(1,165)	(2,022)	(1,841)	(378)	198	1,529	30
9:00	1,791	698	339	784	311	(945)	(1,107)	(1,911)	(1,730)	(249)	(254)	474	(145)
10:00	640	717	325	823	129	(1,064)	(1,265)	(1,863)	(1,757)	(27)	(301)	250	(277)
11:00	816	1,042	145	1,189	893	(1,148)	(1,245)	(1,823)	(1,684)	52	(304)	547	(268)
12:00	852	1,298	173	1,112	(30)	(1,118)	(1,107)	(1,549)	(1,545)	89	(228)	727	(150)
13:00	661	1,283	383	1,396	85	(879)	(871)	(1,145)	(1,370)	278	(142)	583	5
14:00	650	1,170	610	1,697	186	(753)	(630)	(1,177)	(1,181)	237	(200)	384	75
15:00	850	1,258	724	1,840	341	(669)	(425)	(1,196)	(1,140)	374	(276)	445	189
16:00	934	1,022	891	1,884	520	(400)	(45)	(1,103)	(1,109)	450	(185)	552	284
17:00	1,091	1,168	884	1,286	586	(201)	232	(939)	(1,056)	860	416	1,169	457
18:00	1,243	1,671	1,287	1,791	990	210	579	(921)	(285)	1,470	1,070	1,517	881
19:00	1,693	2,065	2,047	2,355	1,778	758	956	(419)	455	1,585	1,339	1,391	1,335
20:00	2,104	2,131	2,366	2,423	2,232	1,130	1,037	742	742	2,018	1,401	1,673	1,618
21:00	2,103	2,368	2,369	2,309	2,217	1,079	704	211	534	2,156	1,499	1,797	1,622
22:00	2,023	2,369	1,980	2,240	1,965	743	346	198	276	1,903	1,050	2,047	1,430
23:00	39,161	38,001	26,408	40,028	20,781	5,098	4,549	472	3,331	19,310	13,680	31,490	15,225
Daily Total (+)	0	0	0	0	(341)	(10,524)	(11,091)	(24,424)	(20,791)	(654)	(2,071)	0	(903)
Daily Total (-)	1,213,991	1,064,023	818,637	1,200,853	644,225	152,953	141,028	14,628	99,927	598,600	410,397	976,176	7,335,437
Positive Total	0	0	0	0	(10,583)	(315,723)	(343,828)	(757,135)	(623,731)	(20,263)	(62,119)	0	Annual Positive Balance
Negative Total													(2,133,383)
(By Month)													Annual Negative Balance

Table A.15. Real-Time Expected Energy Surplus or Deficit for a Three Turbine Array

Three Wind Turbines													
Real-Time Expected Energy Balance, Including Municipal Loads													
(electrical cost of powering entire system with wind turbines; negative periods indicate energy purchased from utility)													
Hour	Jan	Feb	Mar	Apr	May	Jun	Jul	Aug	Sep	Oct	Nov	Dec	AVERAGE
	kWh	kWh	kWh	kWh	kWh	kWh	kWh	kWh	kWh	kWh	kWh	kWh	kWh
0:00	2,109	1,875	1,299	2,201	1,831	231	(130)	(135)	422	1,487	891	2,154	1,189
1:00	2,220	1,790	1,435	2,220	1,618	143	9	(380)	367	1,644	755	2,172	1,170
2:00	2,092	1,925	1,530	2,036	1,345	5	(167)	(875)	164	1,248	736	1,922	999
3:00	1,949	1,884	1,612	1,950	927	(42)	(446)	(766)	(317)	983	928	1,879	883
4:00	2,391	1,776	1,398	1,928	867	(282)	(463)	(983)	(888)	674	721	1,800	751
5:00	2,478	1,815	1,130	1,640	900	(288)	(694)	(1,441)	(1,311)	258	631	1,611	559
6:00	2,328	1,816	1,020	1,498	567	(703)	(981)	(1,966)	(1,608)	194	534	1,322	326
7:00	2,060	1,517	885	848	(120)	(1,271)	(1,617)	(2,351)	(1,900)	34	548	1,725	23
8:00	2,004	907	170	362	(230)	(1,296)	(1,488)	(2,579)	(2,403)	(725)	(48)	1,221	(347)
9:00	1,439	343	32	459	(115)	(1,368)	(1,577)	(2,497)	(2,305)	(619)	(570)	153	(553)
10:00	280	356	4	495	(301)	(1,516)	(1,700)	(2,473)	(2,342)	(397)	(635)	(58)	(695)
11:00	278	482	(107)	553	(620)	(1,632)	(1,701)	(2,442)	(2,303)	(343)	(623)	255	(692)
12:00	465	695	(176)	826	(641)	(1,598)	(1,563)	(2,199)	(2,192)	(334)	(568)	442	(590)
13:00	518	964	(156)	1,047	(538)	(1,413)	(1,445)	(1,978)	(2,046)	(136)	(522)	321	(503)
14:00	333	955	42	1,047	(376)	(1,289)	(1,320)	(1,806)	(1,870)	(106)	(501)	193	(414)
15:00	371	899	305	1,397	(216)	(1,161)	(1,074)	(1,752)	(1,699)	(87)	(497)	175	(290)
16:00	621	1,024	476	1,606	13	(1,068)	(677)	(1,616)	(1,511)	144	(514)	267	(105)
17:00	761	843	701	1,680	228	(772)	(456)	(1,453)	(1,398)	274	(365)	406	42
18:00	939	1,017	724	1,100	319	(548)	(162)	(1,262)	(1,324)	694	260	1,027	236
19:00	1,093	1,514	1,130	1,625	747	(116)	204	(1,202)	(522)	1,318	926	1,371	674
20:00	1,549	1,915	1,893	2,204	1,564	460	588	(677)	249	1,458	1,207	1,242	1,144
21:00	1,976	1,991	2,226	2,296	2,051	855	669	(196)	581	1,912	1,280	1,525	1,448
22:00	1,995	2,240	2,244	2,191	2,053	826	350	12	394	2,060	1,389	1,658	1,468
23:00	1,913	2,242	1,865	2,128	1,811	505	2	11	144	1,809	945	1,907	1,282
Daily Total (+)	34,162	32,786	22,122	35,060	16,842	3,026	1,821	23	2,321	16,191	11,753	26,748	12,195
Daily Total (-)	0	0	(439)	0	(3,157)	(16,365)	(17,660)	(33,028)	(27,939)	(2,747)	(4,842)	(58)	(4,189)
Positive Total	1,059,028	917,994	685,785	1,051,805	522,111	90,770	56,466	714	69,638	501,919	352,581	829,185	
Negative Total	0	0	(13,621)	0	(97,875)	(490,939)	(547,467)	(1,023,863)	(838,162)	(85,144)	(145,255)	(1,804)	
(By Month)													
Annual Positive Balance													6,137,997
Annual Negative Balance													(3,244,130)
Revenue from selling excess wind energy at sell price									\$245,520				
Cost of purchasing negative balance at COE									(\$259,530)				
Sell Price =													\$0.04
COE =													\$0.08

Table A.16. Real-Time Expected Energy Balance for a Three Turbine Array

**Three Wind Turbines**

**Expected Energy Cost of Municipal Loads, After Considering Wind Energy**  
 (expected energy outlay for municipal loads after net metering with wind energy)  
*this is a reproduction of the negative values of the previous chart, showing expected energy purchase times*

Hour	Jan kWh	Feb kWh	Mar kWh	Apr kWh	May kWh	Jun kWh	Jul kWh	Aug kWh	Sep kWh	Oct kWh	Nov kWh	Dec kWh	AVERAGE kWh
0:00	0	0	0	0	0	0	(130)	(135)	0	0	0	0	0
1:00	0	0	0	0	0	0	0	(380)	0	0	0	0	0
2:00	0	0	0	0	0	0	(167)	(875)	0	0	0	0	0
3:00	0	0	0	0	0	(42)	(446)	(766)	(317)	0	0	0	0
4:00	0	0	0	0	0	(282)	(463)	(983)	(888)	0	0	0	0
5:00	0	0	0	0	0	(288)	(694)	(1,441)	(1,311)	0	0	0	0
6:00	0	0	0	0	0	(703)	(981)	(1,966)	(1,608)	0	0	0	0
7:00	0	0	0	0	(120)	(1,271)	(1,617)	(2,351)	(1,900)	0	0	0	0
8:00	0	0	0	0	(230)	(1,296)	(1,488)	(2,579)	(2,403)	(725)	(48)	0	(347)
9:00	0	0	0	0	(115)	(1,368)	(1,577)	(2,497)	(2,305)	(619)	(570)	0	(553)
10:00	0	0	0	0	(301)	(1,516)	(1,700)	(2,473)	(2,342)	(397)	(635)	(58)	(695)
11:00	0	0	(107)	0	(620)	(1,632)	(1,701)	(2,442)	(2,303)	(343)	(623)	0	(692)
12:00	0	0	(176)	0	(641)	(1,598)	(1,563)	(2,199)	(2,192)	(334)	(568)	0	(590)
13:00	0	0	(156)	0	(538)	(1,413)	(1,445)	(1,978)	(2,046)	(136)	(522)	0	(503)
14:00	0	0	0	0	(376)	(1,289)	(1,320)	(1,806)	(1,870)	(106)	(501)	0	(414)
15:00	0	0	0	0	(216)	(1,161)	(1,074)	(1,752)	(1,699)	(87)	(497)	0	(290)
16:00	0	0	0	0	0	(1,068)	(677)	(1,616)	(1,511)	0	(514)	0	(105)
17:00	0	0	0	0	0	(772)	(456)	(1,453)	(1,398)	0	(365)	0	0
18:00	0	0	0	0	0	(548)	(162)	(1,262)	(1,324)	0	0	0	0
19:00	0	0	0	0	0	(116)	0	(1,202)	(522)	0	0	0	0
20:00	0	0	0	0	0	0	0	(677)	0	0	0	0	0
21:00	0	0	0	0	0	0	0	(196)	0	0	0	0	0
22:00	0	0	0	0	0	0	0	0	0	0	0	0	0
23:00	0	0	0	0	0	0	0	0	0	0	0	0	0
<b>Daily Total</b>	0	0	(439)	0	(3,157)	(16,365)	(17,660)	(33,028)	(27,939)	(2,747)	(4,842)	(58)	(4,189)
<b>Monthly Total</b>	0	0	(13,621)	0	(97,875)	(490,939)	(547,467)	(1,023,863)	(838,162)	(85,144)	(145,255)	(1,804)	(3,244,130)
<b>Annual Cost</b>													
Annual Cost (\$259,530)													

COE = \$.08/kWh

Table A.17. Expected Cost of Municipal Loads for a Three Turbine Array

Summary of Costs/Benefits Associated with a Three Turbine Array	
Cost of providing solely municipal loads; no Wells, no RO, no Wind Energy (business as usual, which includes distribution)	(\$184,655)
Cost to municipality to power municipal, Well, RO System, and Distribution loads <i>without wind energy</i>	Cost of Energy from utility = \$0.08
Cost to municipality to power municipal, Well, RO System, and Distribution loads <i>with available wind energy</i>	Selling Price of Energy to Utility = (\$259,550) \$0.04
Revenue from selling excess wind energy at Selling Price	\$245,520
Cost to municipality to power municipal, Well, RO System, and Distribution loads after selling excess energy	(\$14,011)
Annual total monetary benefit of wind turbine to municipality, yearly	\$986,164
Total energy produced by turbine	15,396,046 kWh
Energy used by water system (Wells+RO System+Distribution)	10,193,992 kWh
Energy used by municipal loads	2,308,187 kWh
Excess energy sold to utility grid	6,137,997 kWh

Table A.18. Summary of Costs/Benefits Associated with a Three Turbine Array



**Real-Time Expected Energy Surplus or (Deficit), Without Including Municipal Loads** **Four Wind Turbines**

(electrical cost of powering entire system with wind turbines; negative periods indicate energy purchased from utility)

Hour	Jan	Feb	Mar	Apr	May	Jun	Jul	Aug	Sep	Oct	Nov	Dec	AVERAGE
	kWh	kWh	kWh	kWh	kWh	kWh	kWh	kWh	kWh	kWh	kWh	kWh	kWh
0:00	3,166	2,896	2,162	3,469	3,020	1,207	815	648	1,383	2,468	1,624	3,293	2,176
1:00	3,306	2,787	2,324	3,526	2,729	1,052	964	357	1,269	2,650	1,465	3,315	2,141
2:00	3,127	2,954	2,420	3,203	2,341	842	718	(278)	981	2,115	1,424	2,992	1,901
3:00	2,934	2,890	2,504	3,068	1,756	765	345	(159)	364	1,795	1,662	2,927	1,738
4:00	3,511	2,731	2,207	3,020	1,672	454	329	(447)	(346)	1,436	1,389	2,825	1,567
5:00	3,633	2,783	1,853	2,645	1,727	512	105	(975)	(809)	954	1,305	2,595	1,353
6:00	3,458	2,811	1,737	2,481	1,363	60	(248)	(1,379)	(901)	1,000	1,236	2,209	1,140
7:00	3,205	2,475	1,621	1,676	565	(620)	(1,101)	(1,822)	(1,174)	862	1,311	2,794	811
8:00	3,279	1,788	760	1,194	625	(587)	(871)	(1,953)	(1,675)	(68)	540	2,225	441
9:00	2,570	1,107	698	1,370	808	(648)	(968)	(1,808)	(1,521)	77	(57)	850	216
10:00	1,049	1,160	701	1,453	554	(804)	(1,090)	(1,761)	(1,573)	349	(79)	576	50
11:00	1,053	1,329	558	1,567	166	(913)	(1,061)	(1,729)	(1,509)	428	(57)	989	69
12:00	1,313	1,628	504	1,967	159	(883)	(885)	(1,419)	(1,369)	448	32	1,247	219
13:00	1,372	1,972	532	1,863	296	(736)	(777)	(1,133)	(1,185)	708	66	1,058	320
14:00	1,120	1,958	792	2,229	444	(606)	(611)	(988)	(1,083)	670	92	874	394
15:00	1,109	1,800	1,069	2,613	578	(455)	(320)	(1,020)	(984)	613	10	776	475
16:00	1,369	1,910	1,221	2,784	783	(360)	147	(1,048)	(918)	783	(92)	854	616
17:00	1,475	1,586	1,455	2,828	1,017	(8)	367	(937)	(862)	876	24	978	733
18:00	1,677	1,776	1,470	2,037	1,106	274	690	(717)	(784)	1,424	825	1,799	964
19:00	1,873	2,450	2,011	2,734	1,643	840	1,143	(686)	235	2,249	1,700	2,269	1,534
20:00	2,472	2,981	3,018	3,516	2,722	1,592	1,680	6	1,206	2,419	2,063	2,115	2,151
21:00	3,021	3,075	3,431	3,631	3,369	2,101	1,843	609	1,604	3,013	2,153	2,479	2,538
22:00	3,020	3,387	3,435	3,493	3,353	2,050	1,456	886	1,340	3,222	2,278	2,631	2,556
23:00	2,911	3,388	2,924	3,400	3,007	1,604	998	872	1,000	2,898	1,680	2,963	2,306
Daily Total (+)	57,022	55,621	41,407	61,767	35,804	13,352	11,601	3,378	9,383	33,455	22,880	47,632	28,408
Daily Total (-)	0	0	0	0	0	(6,621)	(7,933)	(20,260)	(16,693)	(68)	(284)	0	0
Positive Total	1,767,688	1,557,391	1,283,632	1,853,008	1,109,925	400,547	359,635	104,712	281,479	1,037,094	686,400	1,476,596	
Negative Total	0	0	0	0	0	(198,631)	(245,929)	(628,050)	(500,790)	(2,115)	(8,522)	0	
(By Month)													
Annual Positive Balance													11,918,107
Annual Negative Balance													(1,584,037)

Table A.19. Real-Time Expected Energy Surplus or Deficit for a Four Turbine Array

Four Wind Turbines

Real-Time Expected Energy Balance, Including Municipal Loads

(electrical cost of powering entire system with wind turbines; negative periods indicate energy purchased from utility)

Hour	Jan	Feb	Mar	Apr	May	Jun	Jul	Aug	Sep	Oct	Nov	Dec	AVERAGE
	kWh	kWh	kWh	kWh	kWh	kWh	kWh	kWh	kWh	kWh	kWh	kWh	kWh
0:00	3,053	2,764	2,050	3,362	2,874	983	478	473	1,256	2,375	1,521	3,148	2,031
1:00	3,191	2,651	2,214	3,422	2,589	839	639	184	1,146	2,560	1,363	3,167	1,998
2:00	3,009	2,814	2,309	3,102	2,207	636	397	(449)	861	2,027	1,322	2,838	1,758
3:00	2,811	2,746	2,391	2,969	1,623	566	29	(324)	247	1,707	1,558	2,768	1,596
4:00	3,386	2,582	2,095	2,923	1,542	259	13	(607)	(463)	1,349	1,284	2,662	1,424
5:00	3,496	2,622	1,738	2,529	1,575	275	(269)	(1,168)	(968)	844	1,195	2,418	1,189
6:00	3,299	2,622	1,606	2,331	1,153	(244)	(638)	(1,769)	(1,265)	803	1,098	2,018	909
7:00	2,976	2,241	1,449	1,478	289	(973)	(1,478)	(2,257)	(1,615)	597	1,112	2,559	525
8:00	2,948	1,471	530	881	212	(986)	(1,279)	(2,510)	(2,236)	(415)	295	1,917	64
9:00	2,218	752	391	1,045	382	(1,071)	(1,380)	(2,394)	(2,096)	(293)	(373)	529	(192)
10:00	689	798	380	1,125	125	(1,257)	(1,525)	(2,370)	(2,158)	(21)	(413)	268	(367)
11:00	704	980	252	1,228	(293)	(1,398)	(1,516)	(2,349)	(2,127)	33	(376)	697	(355)
12:00	962	1,281	183	1,605	(332)	(1,364)	(1,341)	(2,069)	(2,017)	25	(308)	961	(220)
13:00	1,037	1,638	203	1,479	(212)	(1,153)	(1,210)	(1,830)	(1,862)	273	(266)	796	(121)
14:00	792	1,630	451	1,881	(17)	(1,017)	(1,061)	(1,649)	(1,685)	287	(266)	619	(26)
15:00	829	1,529	763	2,313	176	(864)	(764)	(1,595)	(1,502)	289	(288)	568	109
16:00	1,141	1,677	973	2,550	455	(759)	(284)	(1,468)	(1,289)	553	(329)	676	323
17:00	1,303	1,407	1,265	2,624	725	(379)	(47)	(1,286)	(1,151)	699	(155)	832	490
18:00	1,524	1,625	1,310	1,852	838	(73)	296	(1,040)	(1,052)	1,258	669	1,657	743
19:00	1,723	2,293	1,854	2,568	1,399	514	767	(968)	(3)	2,097	1,556	2,123	1,328
20:00	2,328	2,831	2,864	3,364	2,508	1,294	1,312	(251)	1,001	2,291	1,931	1,966	1,960
21:00	2,892	2,935	3,292	3,504	3,188	1,826	1,475	390	1,443	2,906	2,032	2,332	2,369
22:00	2,911	3,259	3,310	3,375	3,190	1,797	1,102	686	1,200	3,126	2,168	2,492	2,401
23:00	2,802	3,261	2,808	3,288	2,853	1,366	654	686	868	2,804	1,576	2,824	2,157
Daily Total (+)	52,023	50,406	36,683	56,799	29,903	10,356	7,163	2,419	8,021	28,904	20,681	42,832	23,374
Daily Total (-)	0	0	0	0	(854)	(11,539)	(12,791)	(28,354)	(23,489)	(729)	(2,783)	0	(1,282)
Positive Total	1,612,726	1,411,363	1,137,159	1,703,960	926,998	310,683	222,039	74,989	240,631	896,017	620,423	1,327,801	10,484,790
Negative Total	0	0	0	0	(26,477)	(346,166)	(396,534)	(878,970)	(704,662)	(22,600)	(83,497)	0	(2,458,907)
(By Month)													
Annual Positive Balance													10,484,790
Annual Negative Balance													(2,458,907)
Sell Price =													\$0.04
COE =													\$0.08
Revenue from selling excess wind energy at sell price													\$419,392
Cost of purchasing negative balance at COE													(\$196,713)

Table A.20. Real-Time Expected Energy Balance for a Four Turbine Array

Four Wind Turbines

Expected Energy Cost of Municipal Loads, After Considering Wind Energy  
 (expected energy outlay for municipal loads after net metering with wind energy)

*this is a reproduction of the negative values of the previous chart, showing expected energy purchase times*

Hour	Jan kWh	Feb kWh	Mar kWh	Apr kWh	May kWh	Jun kWh	Jul kWh	Aug kWh	Sep kWh	Oct kWh	Nov kWh	Dec kWh	AVERAGE kWh
0:00	0	0	0	0	0	0	0	0	0	0	0	0	0
1:00	0	0	0	0	0	0	0	0	0	0	0	0	0
2:00	0	0	0	0	0	0	0	(449)	0	0	0	0	0
3:00	0	0	0	0	0	0	0	(324)	0	0	0	0	0
4:00	0	0	0	0	0	0	0	(607)	(463)	0	0	0	0
5:00	0	0	0	0	0	0	(269)	(1,168)	(968)	0	0	0	0
6:00	0	0	0	0	0	(244)	(638)	(1,769)	(1,265)	0	0	0	0
7:00	0	0	0	0	0	(973)	(1,478)	(2,257)	(1,615)	0	0	0	0
8:00	0	0	0	0	0	(986)	(1,279)	(2,510)	(2,236)	(415)	0	0	0
9:00	0	0	0	0	0	(1,071)	(1,380)	(2,394)	(2,096)	(293)	(373)	0	(192)
10:00	0	0	0	0	0	(1,257)	(1,525)	(2,370)	(2,158)	(21)	(413)	0	(367)
11:00	0	0	0	0	(293)	(1,398)	(1,516)	(2,349)	(2,127)	0	(376)	0	(355)
12:00	0	0	0	0	(332)	(1,364)	(1,341)	(2,069)	(2,017)	0	(308)	0	(220)
13:00	0	0	0	0	(212)	(1,153)	(1,210)	(1,830)	(1,862)	0	(275)	0	(121)
14:00	0	0	0	0	(17)	(1,017)	(1,061)	(1,649)	(1,685)	0	(266)	0	(26)
15:00	0	0	0	0	0	(864)	(764)	(1,595)	(1,502)	0	(288)	0	0
16:00	0	0	0	0	0	(759)	(284)	(1,468)	(1,289)	0	(329)	0	0
17:00	0	0	0	0	0	(379)	(47)	(1,286)	(1,151)	0	(155)	0	0
18:00	0	0	0	0	0	(73)	0	(1,040)	(1,052)	0	0	0	0
19:00	0	0	0	0	0	0	0	(968)	(3)	0	0	0	0
20:00	0	0	0	0	0	0	0	(251)	0	0	0	0	0
21:00	0	0	0	0	0	0	0	0	0	0	0	0	0
22:00	0	0	0	0	0	0	0	0	0	0	0	0	0
23:00	0	0	0	0	0	0	0	0	0	0	0	0	0
Daily Total	0	0	0	0	(854)	(11,539)	(12,791)	(28,354)	(23,489)	(729)	(2,783)	0	(1,282)
Monthly Total	0	0	0	0	(26,477)	(346,166)	(396,534)	(878,970)	(704,662)	(22,600)	(83,497)	0	(2,458,907)
												Annual Balance	(2,458,907)
												Annual Cost	(\$196,713)

COE = \$0.08/kWh

Table A.21. Expected Cost of Municipal Loads for a Four Turbine Array

Summary of Costs/Benefits Associated with a Four Turbine Array	
Cost of providing solely municipal loads; no Wells, no RO, no Wind Energy (business as usual, which includes distribution)	(\$184,655)
Cost to municipality to power municipal, Well, RO System, and Distribution loads <i>without wind energy</i>	Cost of Energy from utility = \$0.08
Cost to municipality to power municipal, Well, RO System, and Distribution loads <i>with available wind energy</i>	Selling Price of Energy to Utility = \$0.04
Revenue from selling excess wind energy at Selling Price	\$419,392
Cost to municipality to power municipal, Well, RO System, and Distribution loads after selling excess energy	\$222,679
Annual total monetary benefit of wind turbine to municipality, yearly	\$1,222,853
<hr/>	
Total energy produced by turbine	20,528,061 kWh
Energy used by water system (Wells+RO System+Distribution)	10,193,992 kWh
Energy used by municipal loads	2,308,187 kWh
Excess energy sold to utility grid	10,484,790 kWh

Table A.22. Summary of Costs/Benefits Associated with a Four Turbine Array

Hour	Five Wind Turbines												
	Jan kWh	Feb kWh	Mar kWh	Apr kWh	May kWh	Jun kWh	Jul kWh	Aug kWh	Sep kWh	Oct kWh	Nov kWh	Dec kWh	AVERAGE kWh
0:00	4,109	3,785	2,914	4,629	4,063	1,959	1,423	1,256	2,217	3,356	2,254	4,288	3,018
1:00	4,277	3,649	3,103	4,687	3,700	1,748	1,594	920	2,048	3,566	2,073	4,309	2,969
2:00	4,043	3,843	3,199	4,269	3,202	1,472	1,282	147	1,678	2,894	2,010	3,909	2,660
3:00	3,795	3,751	3,282	4,086	2,453	1,373	820	283	928	2,519	2,292	3,816	2,450
4:00	4,506	3,537	2,903	4,014	2,346	995	804	(71)	80	2,111	1,953	3,686	2,240
5:00	4,652	3,589	2,461	3,534	2,402	1,075	531	(703)	(466)	1,539	1,869	3,401	1,983
6:00	4,430	3,617	2,323	3,314	1,949	519	94	(1,182)	(558)	1,608	1,800	2,906	1,723
7:00	4,121	3,199	2,184	2,306	974	(323)	(962)	(1,729)	(890)	1,426	1,875	3,628	1,312
8:00	4,223	2,352	1,119	1,714	1,067	(278)	(661)	(1,884)	(1,508)	241	883	2,922	852
9:00	3,349	1,516	1,058	1,956	1,306	(351)	(771)	(1,706)	(1,311)	403	140	1,226	577
10:00	1,458	1,602	1,077	2,083	980	(545)	(915)	(1,658)	(1,388)	725	143	902	377
11:00	1,478	1,826	917	2,242	492	(678)	(876)	(1,635)	(1,333)	803	190	1,431	405
12:00	1,811	2,214	864	2,746	468	(649)	(663)	(1,290)	(1,194)	807	291	1,766	588
13:00	1,891	2,646	892	2,615	622	(476)	(543)	(985)	(1,001)	1,117	313	1,533	703
14:00	1,578	2,632	1,201	3,063	803	(334)	(352)	(831)	(899)	1,063	327	1,299	782
15:00	1,567	2,430	1,527	3,529	971	(158)	(11)	(863)	(787)	989	219	1,169	874
16:00	1,889	2,563	1,719	3,728	1,225	(50)	540	(900)	(696)	1,192	93	1,263	1,044
17:00	2,017	2,149	2,019	3,771	1,515	385	776	(770)	(615)	1,301	234	1,403	1,182
18:00	2,263	2,384	2,056	2,789	1,625	749	1,149	(495)	(512)	1,987	1,234	2,430	1,471
19:00	2,503	3,229	2,735	3,678	2,295	1,470	1,707	(452)	754	3,027	2,331	3,020	2,187
20:00	3,251	3,897	3,990	4,676	3,665	2,425	2,404	432	1,958	3,253	2,787	2,839	2,966
21:00	3,937	4,019	4,497	4,838	4,505	3,072	2,650	1,195	2,465	4,008	2,904	3,286	3,459
22:00	3,936	4,405	4,501	4,677	4,490	3,021	2,207	1,560	2,147	4,288	3,057	3,465	3,490
23:00	3,800	4,406	3,867	4,561	4,049	2,465	1,651	1,547	1,724	3,893	2,310	3,879	3,181
<b>Daily Total (+)</b>	74,883	73,241	56,407	83,505	51,168	22,729	19,632	7,340	15,998	48,117	33,583	63,775	42,494
<b>Daily Total (-)</b>	0	0	0	0	0	(3,842)	(5,754)	(17,152)	(13,159)	0	0	0	0
<b>Positive Total</b>	2,321,386	2,050,759	1,748,627	2,505,163	1,586,209	681,876	608,577	227,539	479,950	1,491,621	1,007,478	1,977,016	1,686,203
<b>Negative Total</b>	0	0	0	0	0	(115,274)	(178,365)	(531,709)	(394,770)	0	0	0	0
<b>(By Month)</b>													
													<b>Annual Positive Balance</b>
													<b>Annual Negative Balance</b>
													<b>(1,220,118)</b>

Table A.23. Real-Time Expected Energy Surplus or Deficit for a Five Turbine Array

Five Wind Turbines

Real-Time Expected Energy Balance, Including Municipal Loads

(electrical cost of powering entire system with wind turbines; negative periods indicate energy purchased from utility)

Hour	Jan kWh	Feb kWh	Mar kWh	Apr kWh	May kWh	Jun kWh	Jul kWh	Aug kWh	Sep kWh	Oct kWh	Nov kWh	Dec kWh	AVERAGE kWh
0:00	3,996	3,652	2,802	4,522	3,916	1,734	1,086	1,081	2,090	3,264	2,151	4,143	2,873
1:00	4,162	3,513	2,993	4,582	3,561	1,536	1,269	748	1,925	3,476	1,971	4,161	2,826
2:00	3,925	3,703	3,088	4,167	3,068	1,266	961	(24)	1,558	2,806	1,907	3,754	2,517
3:00	3,672	3,607	3,170	3,987	2,320	1,174	504	118	811	2,431	2,188	3,656	2,308
4:00	4,380	3,388	2,791	3,918	2,216	801	488	(232)	(37)	2,023	1,848	3,523	2,098
5:00	4,515	3,428	2,346	3,418	2,249	839	157	(896)	(625)	1,430	1,759	3,224	1,818
6:00	4,270	3,429	2,192	3,165	1,739	214	(295)	(1,572)	(923)	1,411	1,662	2,715	1,492
7:00	3,893	2,965	2,012	2,109	698	(676)	(1,339)	(2,164)	(1,331)	1,161	1,676	3,393	1,026
8:00	3,891	2,035	889	1,401	654	(677)	(1,069)	(2,441)	(2,070)	(106)	638	2,614	475
9:00	2,997	1,161	751	1,631	880	(774)	(1,183)	(2,292)	(1,886)	34	(176)	905	169
10:00	1,098	1,240	755	1,755	550	(997)	(1,349)	(2,267)	(1,973)	355	(191)	594	(40)
11:00	1,129	1,477	611	1,902	33	(1,163)	(1,332)	(2,255)	(1,952)	409	(129)	1,139	(19)
12:00	1,460	1,867	542	2,384	(22)	(1,129)	(1,119)	(1,939)	(1,841)	384	(49)	1,481	149
13:00	1,557	2,313	562	2,230	114	(894)	(975)	(1,682)	(1,677)	682	(28)	1,271	262
14:00	1,250	2,304	860	2,715	342	(745)	(801)	(1,492)	(1,501)	679	(32)	1,044	363
15:00	1,288	2,159	1,222	3,230	569	(567)	(455)	(1,438)	(1,305)	664	(78)	960	509
16:00	1,660	2,329	1,471	3,494	898	(449)	108	(1,319)	(1,067)	962	(145)	1,085	750
17:00	1,844	1,970	1,829	3,567	1,223	13	362	(1,120)	(904)	1,125	54	1,258	939
18:00	2,110	2,233	1,896	2,603	1,358	402	755	(818)	(779)	1,822	1,078	2,287	1,250
19:00	2,353	3,072	2,578	3,512	2,051	1,144	1,331	(733)	517	2,876	2,187	2,874	1,981
20:00	3,107	3,747	3,836	4,525	3,452	2,128	2,036	174	1,752	3,125	2,655	2,690	2,775
21:00	3,808	3,878	4,358	4,712	4,325	2,797	2,282	976	2,304	3,901	2,783	3,138	3,289
22:00	3,828	4,277	4,376	4,559	4,326	2,768	1,853	1,360	2,007	4,192	2,947	3,325	3,335
23:00	3,690	4,279	3,752	4,449	3,895	2,228	1,307	1,360	1,592	3,799	2,206	3,740	3,033
Daily Total (+)	69,885	68,026	51,682	78,537	44,435	19,045	14,498	5,818	14,554	43,011	29,711	58,975	36,237
Daily Total (-)	0	0	0	0	(22)	(8,072)	(9,917)	(24,683)	(19,872)	(106)	(827)	0	(59)
Positive Total	2,166,424	1,904,731	1,602,154	2,356,115	1,377,489	571,351	449,445	180,362	436,621	1,333,334	891,321	1,828,221	15,097,569
Negative Total	0	0	0	0	(685)	(242,148)	(307,434)	(765,175)	(596,159)	(3,275)	(24,795)	0	(1,939,671)
(By Month)													
Annual Positive Balance									\$603,903				
Annual Negative Balance									(\$155,174)				
Sell Price =													\$0.04
COE =													\$0.08

Table A.24. Real-Time Expected Energy Balance for a Five Turbine Array

Five Wind Turbines													
Expected Energy Cost of Municipal Loads, After Considering Wind Energy													
(expected energy outlay for municipal loads after net metering with wind energy)													
<i>this is a reproduction of the negative values of the previous chart, showing expected energy purchase times</i>													
Hour	Jan	Feb	Mar	Apr	May	Jun	Jul	Aug	Sep	Oct	Nov	Dec	AVERAGE
kWh	kWh	kWh	kWh	kWh	kWh	kWh	kWh	kWh	kWh	kWh	kWh	kWh	kWh
0:00	0	0	0	0	0	0	0	0	0	0	0	0	0
1:00	0	0	0	0	0	0	0	0	0	0	0	0	0
2:00	0	0	0	0	0	0	0	(24)	0	0	0	0	0
3:00	0	0	0	0	0	0	0	0	0	0	0	0	0
4:00	0	0	0	0	0	0	0	(232)	(37)	0	0	0	0
5:00	0	0	0	0	0	0	0	(896)	(625)	0	0	0	0
6:00	0	0	0	0	0	0	(295)	(1,572)	(923)	0	0	0	0
7:00	0	0	0	0	0	(676)	(1,339)	(2,164)	(1,331)	0	0	0	0
8:00	0	0	0	0	0	(677)	(1,069)	(2,441)	(2,070)	(106)	0	0	0
9:00	0	0	0	0	0	(774)	(1,183)	(2,292)	(1,886)	0	(176)	0	0
10:00	0	0	0	0	0	(977)	(1,349)	(2,267)	(1,973)	0	(191)	0	(40)
11:00	0	0	0	0	0	(1,163)	(1,332)	(2,255)	(1,952)	0	(129)	0	(19)
12:00	0	0	0	0	(22)	(1,129)	(1,119)	(1,939)	(1,841)	0	(49)	0	0
13:00	0	0	0	0	0	(894)	(975)	(1,682)	(1,677)	0	(28)	0	0
14:00	0	0	0	0	0	(745)	(801)	(1,492)	(1,501)	0	(32)	0	0
15:00	0	0	0	0	0	(567)	(455)	(1,438)	(1,305)	0	(78)	0	0
16:00	0	0	0	0	0	(449)	0	(1,319)	(1,067)	0	(145)	0	0
17:00	0	0	0	0	0	0	0	(1,120)	(904)	0	0	0	0
18:00	0	0	0	0	0	0	0	(818)	(779)	0	0	0	0
19:00	0	0	0	0	0	0	0	(733)	0	0	0	0	0
20:00	0	0	0	0	0	0	0	0	0	0	0	0	0
21:00	0	0	0	0	0	0	0	0	0	0	0	0	0
22:00	0	0	0	0	0	0	0	0	0	0	0	0	0
23:00	0	0	0	0	0	0	0	0	0	0	0	0	0
Daily Total	0	0	0	0	(22)	(8,072)	(9,917)	(24,683)	(19,872)	(106)	(827)	0	(59)
Monthly Total	0	0	0	0	(685)	(242,148)	(307,434)	(765,175)	(596,159)	(3,275)	(24,795)	0	(1,939,671)
												Annual Balance	(1,939,671)
												Annual Cost	(\$155,174)

COE = \$0.08/kWh

Table A.25. Expected Cost of Municipal Loads for a Five Turbine Array

Summary of Costs/Benefits Associated with a Five Turbine Array	
Cost of providing solely municipal loads; no Wells, no RO, no Wind Energy (business as usual, which includes distribution)	(\$184,655)
Cost to municipality to power municipal, Well, RO System, and Distribution loads <i>without wind energy</i>	Cost of Energy from utility = \$0.08
Cost to municipality to power municipal, Well, RO System, and Distribution loads <i>with available wind energy</i>	Selling Price of Energy to Utility = \$0.04 (\$155,174)
Revenue from selling excess wind energy at Selling Price	\$603,903
Cost to municipality to power municipal, Well, RO System, and Distribution loads after selling excess energy	\$448,729
Annual total monetary benefit of wind turbine to municipality, yearly	\$1,448,903
<hr/>	
Total energy produced by turbine	25,660,077 kWh
Energy used by water system (Wells+RO System+Distribution)	10,193,992 kWh
Energy used by municipal loads	2,308,187 kWh
Excess energy sold to utility grid	15,097,569 kWh

Table A.26. Summary of Costs/Benefits Associated with a Five Turbine Array



Real-Time Expected Energy Surplus or (Deficit), Without Including Municipal Loads Six Wind Turbines

Hour	Jan kWh	Feb kWh	Mar kWh	Apr kWh	May kWh	Jun kWh	Jul kWh	Aug kWh	Sep kWh	Oct kWh	Nov kWh	Dec kWh	AVERAGE kWh
0:00	5,053	4,673	3,665	5,790	5,105	2,710	2,031	1,864	3,051	4,245	2,884	5,282	3,860
1:00	5,248	4,510	3,882	5,847	4,671	2,445	2,224	1,484	2,827	4,482	2,681	5,304	3,796
2:00	4,959	4,732	3,978	5,334	4,063	2,102	1,846	573	2,374	3,673	2,596	4,825	3,419
3:00	4,656	4,612	4,061	5,105	3,149	1,981	1,295	725	1,492	3,243	2,922	4,704	3,162
4:00	5,501	4,344	3,600	5,009	3,021	1,537	1,279	305	505	2,785	2,517	4,547	2,914
5:00	5,670	4,396	3,069	4,423	3,076	1,639	956	(431)	(124)	2,125	2,433	4,207	2,612
6:00	5,401	4,423	2,909	4,148	2,535	977	437	(985)	(215)	2,216	2,364	3,603	2,306
7:00	5,038	3,923	2,748	2,936	1,383	(26)	(823)	(1,635)	(605)	1,989	2,439	4,462	1,814
8:00	5,166	2,915	1,479	2,233	1,509	32	(452)	(1,815)	(1,342)	551	1,226	3,619	1,263
9:00	4,128	1,925	1,417	2,542	1,803	(54)	(574)	(1,603)	(1,102)	729	337	1,602	939
10:00	1,867	2,044	1,452	2,713	1,405	(285)	(739)	(1,555)	(1,204)	1,101	365	1,229	705
11:00	1,904	2,323	1,277	2,916	818	(444)	(692)	(1,542)	(1,158)	1,179	437	1,873	741
12:00	2,308	2,800	1,223	3,525	778	(414)	(441)	(1,160)	(1,019)	1,167	551	2,286	957
13:00	2,411	3,321	1,251	3,366	948	(217)	(308)	(837)	(816)	1,526	560	2,008	1,085
14:00	2,037	3,307	1,610	3,897	1,162	(62)	(92)	(674)	(714)	1,455	561	1,725	1,170
15:00	2,026	3,060	1,986	4,445	1,363	139	299	(705)	(590)	1,365	429	1,561	1,274
16:00	2,408	3,215	2,216	4,671	1,667	259	932	(752)	(474)	1,601	277	1,672	1,471
17:00	2,559	2,713	2,582	4,715	2,012	777	1,185	(604)	(368)	1,727	443	1,829	1,631
18:00	2,848	2,992	2,642	3,540	2,144	1,224	1,608	(273)	(240)	2,551	1,643	3,060	1,978
19:00	3,133	4,008	3,459	4,621	2,947	2,100	2,270	(217)	1,274	3,806	2,961	3,772	2,841
20:00	4,029	4,813	4,961	5,837	4,609	3,259	3,129	858	2,709	4,087	3,511	3,563	3,782
21:00	4,853	4,962	5,563	6,046	5,642	4,043	3,456	1,781	3,326	5,002	3,656	4,092	4,380
22:00	4,852	5,424	5,567	5,861	5,627	3,993	2,959	2,234	2,953	5,353	3,835	4,299	4,423
23:00	4,689	5,425	4,811	5,721	5,092	3,327	2,303	2,221	2,448	4,888	2,940	4,795	4,057
Daily Total (+)	92,745	90,862	71,407	105,244	66,532	32,545	28,209	12,044	22,960	62,847	44,569	79,917	56,580
Daily Total (-)	0	0	0	0	0	(1,502)	(4,121)	(14,786)	(9,971)	0	0	0	0
Positive Total	2,875,084	2,544,127	2,213,623	3,157,318	2,062,493	976,342	874,476	373,379	688,793	1,948,263	1,337,077	2,477,436	
Negative Total	0	0	0	0	0	(45,054)	(127,758)	(458,381)	(299,120)	0	0	0	
(By Month)													
Annual Positive Balance													21,528,413
Annual Negative Balance													(930,312)

Table A.27. Real-Time Expected Energy Surplus or Deficit for a Six Turbine Array

Six Wind Turbines

Real-Time Expected Energy Balance, Including Municipal Loads

(electrical cost of powering entire system with wind turbines; negative periods indicate energy purchased from utility)

Hour	Jan kWh	Feb kWh	Mar kWh	Apr kWh	May kWh	Jun kWh	Jul kWh	Aug kWh	Sep kWh	Oct kWh	Nov kWh	Dec kWh	AVERAGE kWh
0:00	4,940	4,541	3,553	5,683	4,958	2,486	1,694	1,689	2,923	4,153	2,782	5,138	3,715
1:00	5,133	4,374	3,772	5,743	4,532	2,232	1,900	1,311	2,704	4,392	2,579	5,156	3,653
2:00	4,841	4,591	3,867	5,233	3,929	1,896	1,524	402	2,254	3,585	2,493	4,671	3,276
3:00	4,533	4,468	3,949	5,006	3,017	1,785	980	560	1,375	3,155	2,818	4,545	3,020
4:00	5,375	4,195	3,488	4,912	2,891	1,343	963	144	389	2,698	2,412	4,384	2,772
5:00	5,533	4,235	2,954	4,306	2,924	1,403	582	(624)	(283)	2,016	2,323	4,030	2,448
6:00	5,241	4,235	2,778	3,999	2,325	673	47	(1,375)	(580)	2,019	2,226	3,411	2,074
7:00	4,809	3,689	2,576	2,739	1,107	(379)	(1,200)	(2,070)	(1,046)	1,725	2,239	4,227	1,528
8:00	4,835	2,599	1,248	1,920	1,096	(367)	(860)	(2,372)	(1,904)	204	980	3,310	886
9:00	3,776	1,569	1,110	2,217	1,377	(477)	(986)	(2,189)	(1,676)	360	21	1,281	531
10:00	1,507	1,682	1,131	2,386	976	(737)	(1,174)	(2,165)	(1,789)	730	31	920	287
11:00	1,555	1,974	971	2,577	359	(929)	(1,147)	(2,161)	(1,777)	784	118	1,581	317
12:00	1,957	2,453	902	3,163	288	(895)	(897)	(1,809)	(1,666)	743	211	2,000	518
13:00	2,076	2,987	922	2,982	440	(634)	(741)	(1,534)	(1,493)	1,091	219	1,746	644
14:00	1,709	2,979	1,269	3,549	702	(473)	(542)	(1,334)	(1,316)	1,072	203	1,470	751
15:00	1,746	2,789	1,681	4,146	961	(270)	(145)	(1,281)	(1,108)	1,040	131	1,352	909
16:00	2,180	2,981	1,968	4,437	1,340	(139)	501	(1,171)	(845)	1,371	40	1,494	1,177
17:00	2,386	2,534	2,392	4,511	1,720	406	771	(954)	(657)	1,550	264	1,683	1,388
18:00	2,696	2,841	2,482	3,355	1,877	877	1,213	(596)	(507)	2,386	1,487	2,917	1,756
19:00	2,983	3,851	3,302	4,456	2,704	1,774	1,895	(499)	1,036	3,655	2,817	3,626	2,634
20:00	3,886	4,663	4,807	5,685	4,395	2,961	2,760	600	2,504	3,959	3,379	3,414	3,591
21:00	4,724	4,822	5,424	5,920	5,461	3,768	3,088	1,562	3,165	4,896	3,535	3,944	4,210
22:00	4,744	5,296	5,442	5,744	5,463	3,739	2,605	2,035	2,813	5,257	3,726	4,159	4,269
23:00	4,579	5,298	4,696	5,609	4,937	3,089	1,959	2,035	2,316	4,794	2,836	4,656	3,909
Daily Total (+)	87,746	85,646	66,682	100,276	59,777	28,431	22,482	10,339	21,478	57,636	39,871	75,117	50,264
Daily Total (-)	0	0	0	0	0	(5,301)	(7,691)	(22,134)	(16,647)	0	0	0	0
Positive Total	2,720,122	2,398,099	2,067,150	3,008,270	1,853,088	852,915	696,931	320,497	644,354	1,786,701	1,196,126	2,328,641	19,872,894
Negative Total	0	0	0	0	0	(159,026)	(238,414)	(686,141)	(499,399)	0	0	0	(1,582,980)
(By Month)									\$794,916	Annual Positive Balance	Annual Positive Balance	Annual Positive Balance	19,872,894
									(\$126,638)	Cost of purchasing negative balance at COE	Sell Price =	COE =	(1,582,980)
													\$0.04
													\$0.08

Table A.28. Real-Time Expected Energy Balance for a Six Turbine Array

Six Wind Turbines													
Expected Energy Cost of Municipal Loads, After Considering Wind Energy													
(expected energy outlay for municipal loads after net metering with wind energy)													
<i>this is a reproduction of the negative values of the previous chart, showing expected energy purchase times</i>													
Hour	Jan	Feb	Mar	Apr	May	Jun	Jul	Aug	Sep	Oct	Nov	Dec	AVERAGE
	kWh	kWh	kWh	kWh	kWh	kWh	kWh	kWh	kWh	kWh	kWh	kWh	kWh
0:00	0	0	0	0	0	0	0	0	0	0	0	0	0
1:00	0	0	0	0	0	0	0	0	0	0	0	0	0
2:00	0	0	0	0	0	0	0	0	0	0	0	0	0
3:00	0	0	0	0	0	0	0	0	0	0	0	0	0
4:00	0	0	0	0	0	0	0	0	0	0	0	0	0
5:00	0	0	0	0	0	0	0	(624)	(283)	0	0	0	0
6:00	0	0	0	0	0	0	0	(1,375)	(580)	0	0	0	0
7:00	0	0	0	0	0	(379)	(1,200)	(2,070)	(1,046)	0	0	0	0
8:00	0	0	0	0	0	(860)	(860)	(2,372)	(1,904)	0	0	0	0
9:00	0	0	0	0	0	(477)	(986)	(2,189)	(1,676)	0	0	0	0
10:00	0	0	0	0	0	(737)	(1,174)	(2,165)	(1,789)	0	0	0	0
11:00	0	0	0	0	0	(929)	(1,147)	(2,161)	(1,777)	0	0	0	0
12:00	0	0	0	0	0	(895)	(897)	(1,809)	(1,666)	0	0	0	0
13:00	0	0	0	0	0	(634)	(741)	(1,534)	(1,493)	0	0	0	0
14:00	0	0	0	0	0	(473)	(542)	(1,334)	(1,316)	0	0	0	0
15:00	0	0	0	0	0	(270)	(145)	(1,281)	(1,108)	0	0	0	0
16:00	0	0	0	0	0	(139)	0	(1,171)	(845)	0	0	0	0
17:00	0	0	0	0	0	0	0	(954)	(657)	0	0	0	0
18:00	0	0	0	0	0	0	0	(596)	(507)	0	0	0	0
19:00	0	0	0	0	0	0	0	(499)	0	0	0	0	0
20:00	0	0	0	0	0	0	0	0	0	0	0	0	0
21:00	0	0	0	0	0	0	0	0	0	0	0	0	0
22:00	0	0	0	0	0	0	0	0	0	0	0	0	0
23:00	0	0	0	0	0	0	0	0	0	0	0	0	0
<b>Daily Total</b>	0	0	0	0	0	(5,301)	(7,691)	(22,134)	(16,647)	0	0	0	0
<b>Monthly Total</b>	0	0	0	0	0	(159,026)	(238,414)	(686,141)	(499,399)	0	0	0	0
												<b>Annual Balance</b>	(1,582,980)
												<b>Annual Cost</b>	(\$126,638)

COE = \$0.08/kWh

Table A.29. Expected Cost of Municipal Loads for a Six Turbine Array

Summary of Costs/Benefits Associated with a Six Turbine Array	
Cost of providing solely municipal loads; no Wells, no RO, no Wind Energy (business as usual, which includes distribution)	(\$184,655)
Cost to municipality to power municipal, Well, RO System, and Distribution loads <i>without wind energy</i>	Cost of Energy from utility = 0.08
Cost to municipality to power municipal, Well, RO System, and Distribution loads <i>with available wind energy</i>	Selling Price of Energy to Utility = 0.04
Revenue from selling excess wind energy at Selling Price	\$794,916
Cost to municipality to power municipal, Well, RO System, and Distribution loads after selling excess energy	\$668,277
Annual total monetary benefit of wind turbine to municipality, yearly	\$1,668,452
<hr/>	
Total energy produced by turbine	30,792,092 kWh
Energy used by water system (Wells+RO System+Distribution)	10,193,992 kWh
Energy used by municipal loads	2,308,187 kWh
Excess energy sold to utility grid	19,872,894 kWh

Table A.30. Summary of Costs/Benefits Associated with a Six Turbine Array

Costs and Benefits for Different Turbine Array Sizes							
Number of Turbines	0	1	2	3	4	5	6
Cost of providing solely municipal loads; no Wells, no RO, no Wind Energy	(\$184,655)	(\$184,655)	(\$184,655)	(\$184,655)	(\$184,655)	(\$184,655)	(\$184,655)
Cost of solely providing system loads (Wells, RO System, Distribution); no Wind Energy	(\$815,519)	(\$815,519)	(\$815,519)	(\$815,519)	(\$815,519)	(\$815,519)	(\$815,519)
Cost to municipality to power municipal, Well, RO System, and Distribution loads <i>without wind energy</i>	(\$1,000,174) (\$1.67)	(\$1,000,174) (\$1.67)	(\$1,000,174) (\$1.67)	(\$1,000,174) (\$1.67)	(\$1,000,174) (\$1.67)	(\$1,000,174) (\$1.67)	(\$1,000,174) (\$1.67)
Cost to municipality to power municipal, Well, RO System, and Distribution loads <i>with available wind energy</i>	(\$1,000,174)	(\$603,389) (\$1.01)	(\$380,155) (\$0.64)	(\$259,530) (\$0.43)	(\$196,713) (\$0.33)	(\$155,174) (\$0.26)	(\$126,638) (\$0.21)
Revenue from selling excess wind energy at selling price	\$0	\$6,888	\$100,552	\$245,520	\$419,392	\$603,903	\$794,916
Cost to municipality to power municipal, Well, RO System, and Distribution loads after selling excess energy	(\$1,000,174) (\$1.67)	(\$596,501) (\$1.00)	(\$279,604) (\$0.47)	(\$14,011) (\$0.02)	\$222,679 \$0.37	\$448,729 \$0.75	\$668,277 \$1.12
Annual total monetary benefit of wind turbine to municipality, yearly (difference between loads prior to net metering and after selling excess energy)	(\$1,000,174) (\$1,000,174) (\$596,501)	(\$1,000,174) (\$596,501)	(\$1,000,174) (\$279,604)	(\$1,000,174) (\$14,011)	(\$1,000,174) \$222,679	(\$1,000,174) \$448,729	(\$1,000,174) \$668,277
ICC of Turbine Array (using 1.5 MW Turbines) at \$2.4 million each	\$0	\$403,673	\$720,571	\$986,164	\$1,222,853	\$1,448,903	\$1,668,452
ICC \$/1000 Gallons (20-year note at 20-yr Bond Rate)	\$0	\$2,400,000	\$4,800,000	\$7,200,000	\$9,600,000	\$12,000,000	\$14,400,000
O&M Cost \$/1000 Gallons Assuming O&M = 0.012 kWh	\$0	\$0.31	\$0.63	\$0.94	\$1.25	\$1.56	\$1.88
Total Wind Turbine Cost \$/1000 Gallons	\$0	\$0.10	\$0.21	\$0.31	\$0.41	\$0.52	\$0.62
Total Monetary Benefit of Wind Turbines to Municipality/1000 Gallons	\$0	\$0.42	\$0.83	\$1.25	\$1.66	\$2.08	\$2.50
Turbine Array Benefit/(Loss) per 1000 Gallons	\$0	\$0.26	\$0.37	\$0.40	\$0.38	\$0.35	\$0.30

Table A.3.1. Costs and Benefits for Different Turbine Array Sizes



Water System Energy Consumption Estimate by Component										
Monthly Average Consumption	Well		RO		Distribution		Total			
		kWh	\$	kWh	\$	kWh	\$	kWh	\$	
January	28.65	Million Gallons	303,099	24,248	161,290	12,903	24,637	1,971	489,026	39,122
February	27.07	Million Gallons	286,369	22,910	152,387	12,191	23,278	1,862	462,034	36,963
March	35.76	Million Gallons	378,305	30,264	201,310	16,105	30,751	2,460	610,365	48,829
April	49.55	Million Gallons	524,264	41,941	278,980	22,318	42,615	3,409	845,859	67,669
May	68.94	Million Gallons	729,374	58,350	388,126	31,050	59,288	4,743	1,176,788	94,143
June	74.67	Million Gallons	789,977	63,198	420,375	33,630	64,214	5,137	1,274,566	101,965
July	81.07	Million Gallons	857,761	68,621	456,446	36,516	69,723	5,578	1,383,930	110,714
August	72.51	Million Gallons	767,150	61,372	408,228	32,658	62,358	4,989	1,237,737	99,019
September	59.44	Million Gallons	628,834	50,307	334,625	26,770	51,115	4,089	1,014,575	81,166
October	41.47	Million Gallons	438,787	35,103	233,494	18,680	35,667	2,853	707,948	56,636
November	30.59	Million Gallons	323,685	25,895	172,244	13,780	26,311	2,105	522,240	41,779
December	28.38	Million Gallons	300,303	24,024	159,802	12,784	24,410	1,953	484,515	38,761
									<b>Annual Sum</b>	<b>816,767</b>

Average Water Consumption per Day										
Average Water Consumption per Day	Well		RO		Distribution		Total			
		kWh	\$	kWh	\$	kWh	\$	kWh	\$	
January	0.924	MGD	9,777	782	5,203	416	795	64	15,775	1,262
February	0.967	MGD	10,227	818	5,442	435	831	67	16,501	1,320
March	1.153	MGD	12,203	976	6,494	520	992	79	19,689	1,575
April	1.652	MGD	17,475	1,398	9,299	744	1,421	114	28,195	2,256
May	2.224	MGD	23,528	1,882	12,520	1,002	1,913	153	37,961	3,037
June	2.489	MGD	26,333	2,107	14,013	1,121	2,140	171	42,486	3,399
July	2.615	MGD	27,670	2,214	14,724	1,178	2,249	180	44,643	3,571
August	2.339	MGD	24,747	1,980	13,169	1,053	2,012	161	39,927	3,194
September	1.981	MGD	20,961	1,677	11,154	892	1,704	136	33,819	2,706
October	1.338	MGD	14,154	1,132	7,532	603	1,151	92	22,837	1,827
November	1.020	MGD	10,789	863	5,741	459	877	70	17,408	1,393
December	0.916	MGD	9,687	775	5,155	412	787	63	15,630	1,250

Table A.33. Water System Energy Consumption Estimate by Component

Costs of System Components/1000 gallons		One Wind Turbine Array	
<b>Well Field Relevant Costs</b>			
Energy Cost/1000 Gallons	\$ 0.85	Total Water System Cost/1000 Gallons	
Capital Cost/1000 Gallons	\$ 0.45	Energy Cost/1000 Gallons	\$ 1.37
Total Well Field Cost/1000 Gallons	\$ 1.30	Operations Cost of Water Systems/1000 Gallons (including capital)	\$ 2.80
		Total Water System Cost/1000 Gallons	\$ 4.17
<b>RO System Relevant Costs</b>			
Energy Cost/1000 Gallons	\$ 0.45	Total Monetary value produced by Wind Turbine (energy)	
RO System Operational Cost	\$ 2.35	/1000 gallons	\$ 0.68
Total RO System Cost/1000 Gallons	\$ 2.80	Total Wind Turbine Cost/1000 gallons	\$ 0.42
		Actual Wind Turbine Benefit, Considering Energy Displacement	\$ 0.26
		/1000 gallons	
<b>Distribution System Relevant Costs</b>			
Energy Cost/1000 Gallons	\$ 0.07	Total System Cost/1000 Gallons \$ 3.91	
Total Distribution System Cost/1000 Gallons	\$ 0.07		
<b>Wind Turbine Relevant Costs, assuming 1 turbine</b>			
ICC \$/1000 Gallons	\$ 0.31		
O&M Cost \$/1000 Gallons	\$ 0.10		
Total Wind Turbine Cost \$/1000 Gallons	\$ 0.42		

Table A.34. Total Costs of System Components/1000 Gallons for a Single Turbine Array



Costs of System Components/1000 gallons		Two Wind Turbine Array	
<b>Well Field Relevant Costs</b>			
Energy Cost/1000 Gallons	\$ 0.85	Total Water System Cost/1000 Gallons	
Capital Cost/1000 Gallons	\$ 0.45	Energy Cost/1000 Gallons	\$ 1.37
Total Well Field Cost/1000 Gallons	\$ 1.30	Operations Cost of Water Systems/1000 Gallons (including capital)	\$ 2.80
		Total Water System Cost/1000 Gallons	\$ 4.17
<b>RO System Relevant Costs</b>			
Energy Cost/1000 Gallons	\$ 0.45	Total Monetary value produced by Wind Turbine (energy)	\$ 1.21 /1000 gallons
RO System Operational Cost	\$ 2.35	Total Wind Turbine Cost/1000 gallons	\$ 0.83 /1000 gallons
Total RO System Cost/1000 Gallons	\$ 2.80	Actual Wind Turbine Benefit, Considering Energy Displacement	\$ 0.37 /1000 gallons
<b>Distribution System Relevant Costs</b>			
Energy Cost/1000 Gallons	\$ 0.07	Total System Cost/1000 Gallons \$ 3.79	
Total Distribution System Cost/1000 Gallons	\$ 0.07		
<b>Wind Turbine Relevant Costs, assuming 2 turbines</b>			
ICC \$/1000 Gallons	\$ 0.63		
O&M Cost \$/1000 Gallons	\$ 0.21		
Total Wind Turbine Cost \$/1000 Gallons	\$ 0.83		

Table A.35. Total Costs of System Components/1000 Gallons for a Two Turbine Array

Costs of System Components/1000 gallons		Three Wind Turbine Array	
<b>Well Field Relevant Costs</b>			
Energy Cost/1000 Gallons	\$ 0.85	Total Water System Cost/1000 Gallons	
Capital Cost/1000 Gallons	\$ 0.45	Energy Cost/1000 Gallons	\$ 1.37
Total Well Field Cost/1000 Gallons	\$ 1.30	Operations Cost of Water Systems/1000 Gallons (including capital)	\$ 2.80
		Total Water System Cost/1000 Gallons	\$ 4.17
<b>RO System Relevant Costs</b>			
Energy Cost/1000 Gallons	\$ 0.45	Total Monetary value produced by Wind Turbine (energy)	
RO System Operational Cost	\$ 2.35	/1000 gallons	\$ 1.65
Total RO System Cost/1000 Gallons	\$ 2.80	Total Wind Turbine Cost/1000 gallons	\$ 1.25
		/1000 gallons	
<b>Distribution System Relevant Costs</b>			
Energy Cost/1000 Gallons	\$ 0.07	Actual Wind Turbine Benefit, Considering Energy Displacement	
Total Distribution System Cost/1000 Gallons	\$ 0.07	/1000 gallons	\$ 0.40
<b>Wind Turbine Relevant Costs, assuming 3 turbines</b>			
ICC \$/1000 Gallons	\$ 0.94	Total System Cost/1000 Gallons \$ 3.76	
O&M Cost \$/1000 Gallons	\$ 0.31		
Total Wind Turbine Cost \$/1000 Gallons	\$ 1.25		

Table A.36. Total Costs of System Components/1000 Gallons for a Three Turbine Array

Costs of System Components/1000 gallons		Four Wind Turbine Array	
<b>Well Field Relevant Costs</b>			
Energy Cost/1000 Gallons	\$ 0.85	Total Water System Cost/1000 Gallons	
Capital Cost/1000 Gallons	\$ 0.45	Energy Cost/1000 Gallons	\$ 1.37
Total Well Field Cost/1000 Gallons	\$ 1.30	Operations Cost of Water Systems/1000 Gallons (including capital)	\$ 2.80
		Total Water System Cost/1000 Gallons	\$ 4.17
<b>RO System Relevant Costs</b>			
Energy Cost/1000 Gallons	\$ 0.45	Total Monetary value produced by Wind Turbine (energy)	\$ 2.05 /1000 gallons
RO System Operational Cost	\$ 2.35	Total Wind Turbine Cost/1000 gallons	\$ 1.66 /1000 gallons
Total RO System Cost/1000 Gallons	\$ 2.80	Actual Wind Turbine Benefit, Considering Energy Displacement	\$ 0.38 /1000 gallons
<b>Distribution System Relevant Costs</b>			
Energy Cost/1000 Gallons	\$ 0.07	Total System Cost/1000 Gallons \$ 3.78	
Total Distribution System Cost/1000 Gallons	\$ 0.07		
<b>Wind Turbine Relevant Costs, assuming 4 turbines</b>			
ICC \$/1000 Gallons	\$ 1.25		
O&M Cost \$/1000 Gallons	\$ 0.41		
Total Wind Turbine Cost \$/1000 Gallons	\$ 1.66		

Table A.37. Total Costs of System Components/1000 Gallons for a Four Turbine Array

Costs of System Components/1000 gallons		Five Wind Turbine Array	
<b>Well Field Relevant Costs</b>			
Energy Cost/1000 Gallons	\$ 0.85	Total Water System Cost/1000 Gallons	
Capital Cost/1000 Gallons	\$ 0.45	Energy Cost/1000 Gallons	\$ 1.37
Total Well Field Cost/1000 Gallons	\$ 1.30	Operations Cost of Water Systems/1000 Gallons (including capital)	\$ 2.80
		Total Water System Cost/1000 Gallons	\$ 4.17
<b>RO System Relevant Costs</b>			
Energy Cost/1000 Gallons	\$ 0.45	Total Monetary value produced by Wind Turbine (energy)	\$ 2.42 /1000 gallons
RO System Operational Cost	\$ 2.35	Total Wind Turbine Cost/1000 gallons	\$ 2.08 /1000 gallons
Total RO System Cost/1000 Gallons	\$ 2.80	Actual Wind Turbine Benefit, Considering Energy Displacement	\$ 0.35 /1000 gallons
<b>Distribution System Relevant Costs</b>			
Energy Cost/1000 Gallons	\$ 0.07	Total System Cost/1000 Gallons \$ 3.82	
Total Distribution System Cost/1000 Gallons	\$ 0.07		
<b>Wind Turbine Relevant Costs, assuming 5 turbines</b>			
ICC\$/1000 Gallons	\$ 1.56		
O&M Cost\$/1000 Gallons	\$ 0.52		
Total Wind Turbine Cost\$/1000 Gallons	\$ 2.08		

Table A.38. Total Costs of System Components/1000 Gallons for a Five Turbine Array

Costs of System Components/1000 gallons		Six Wind Turbine Array	
<b>Well Field Relevant Costs</b>			
Energy Cost/1000 Gallons	\$ 0.85	Total Water System Cost/1000 Gallons	
Capital Cost/1000 Gallons	\$ 0.45	Energy Cost/1000 Gallons	\$ 1.37
Total Well Field Cost/1000 Gallons	\$ 1.30	Operations Cost of Water Systems/1000 Gallons (including capital)	\$ 2.80
		Total Water System Cost/1000 Gallons	\$ 4.17
<b>RO System Relevant Costs</b>			
Energy Cost/1000 Gallons	\$ 0.45	Total Monetary value produced by Wind Turbine (energy)	
RO System Operational Cost	\$ 2.35	/1000 gallons	\$ 2.79
Total RO System Cost/1000 Gallons	\$ 2.80	Total Wind Turbine Cost/1000 gallons	\$ 2.50
		/1000 gallons	
<b>Distribution System Relevant Costs</b>			
Energy Cost/1000 Gallons	\$ 0.07	Actual Wind Turbine Benefit, Considering Energy Displacement	
Total Distribution System Cost/1000 Gallons	\$ 0.07	/1000 gallons	\$ 0.30
<b>Wind Turbine Relevant Costs, assuming 6 turbines</b>			
ICC\$/1000 Gallons	\$ 1.88	Total System Cost/1000 Gallons \$ 3.87	
O&M Cost\$/1000 Gallons	\$ 0.62		
Total Wind Turbine Cost\$/1000 Gallons	\$ 2.50		

Table A.39. Total Costs of System Components/1000 Gallons for a Six Turbine Array



APPENDIX B  
PARAMETER DEFINITIONS  
FOR ADAPTIVE/INTELLIGENT CONTROL ALGORITHM

<u>System Constant Parameters</u>									
<u>SYMBOL</u>	<u>CODE</u>	<u># OF VALUES</u>	<u>TYPE</u>	<u>SEGMENT</u>	<u>UNITS</u>	<u>RANGE</u>	<u>NUMBER OF BITS/BYTES</u>	<u>DEFINITION</u>	
$\tau$	PWRCRV	301	---	supply	kW	0-1500	16 bit	reference constant array of turbine power curve (adjusted for appropriate number of turbines in array, and appropriate number of bins for resolution of 0.1 m/s, with a range from 0.0-30.0 m/s)	
<i>PWRPNT</i>	PWRPNT	301	---	supply	---	0-301	16 bit	pointer for PWRRCRV	
<i>NOT</i>	NOT	1	---	supply	---	0-10	8 bit	number of turbines in array	
$\theta$	SYSUSE	1	---	demand	kWh	4 sigdig 0-9999	16 bit	reference constant of expected energy demand by entire water system for given MGD value, to be loaded into register for demand calculation (slope of linear expansion of kWh/MGD)	
								(sum of wells, RO, distribution) (kWh/MGD)	
<i>WEL0</i>	WELUSE	1	---	demand	kWh	4 sigdig 0-9999	16 bit	wellfield reference constant of expected energy demand for given MGD, (kWh/MGD)	
<i>RO0</i>	ROUSE	1	---	demand	kWh	4 sigdig 0-9999	16 bit	reverse osmosis system reference constant of expected energy demand for given MGD (kWh/MGD)	
<i>DIS0</i>	DISUSE	1	---	demand	kWh	4 sigdig 0-9999	16 bit	distribution system reference constant of expected energy demand for given MGD (kWh/MGD)	
<i>coe</i>	COE	1	---	demand	\$	3 sigdig 0-999	16 bit	cost of energy purchased from grid (assumed to be \$0.08)	
<i>poe</i>	POE	1	---	demand	\$	3 sigdig 0-999	16 bit	price of energy sold to grid (assumed to be \$0.04)	
<i>tod</i>	TOD	3	---	demand	%	3 sigdig 0-999	16 bit	time of day integer array to adjust <i>coe</i> for appropriate time of day pricing (percentages)	
<i>todp</i>	TODP	3	---	demand	%	3 sigdig 0-999	16 bit	time of day integer array to adjust <i>poe</i> for appropriate time of day pricing (percentages)	

Table B.1. System Constant Parameters



<u>System Constant Parameters</u>		(continued)						
<u>SYMBOL</u>	<u>CODE</u>	<u>MEM LOCS.</u>	<u>TYPE</u>	<u>SEGMENT</u>	<u>UNITS</u>	<u>RANGE</u>	<u>NUMBER OF BITS/BYTES</u>	<u>DEFINITION</u>
<i>p</i>	MALEN	1	---	ISR2	---	20	8 bit	length of moving average calculation
<i>p24</i>	REGLEN	24	---	supply	---	1-24	8 bit	array of integers 1-24 for wind trend analysis
<i>a24</i>	WNDSTR	24	---	supply	---	1-20	8 bit	array of last 24 wind values
<i>p20</i>	WREGLN	20	---	ISR4	---	1-24	8 bit	array of integers 1-20 for water trend analysis
<i>a20</i>	WATSTR	20	---	ISR4	---	1-20	8 bit	array of last 20 water values
<i>pint12</i>	PINT12	1	---	ISR4	---	12.5	8 bit	number 12.5 for wind trend analysis
<i>pint105</i>	PINT105	1	---	ISR4	---	10.5	8 bit	number 10.5 for water trend analysis
<i>SETP</i>	SETP	1	---	ISR3 ISR4	ft OR %	3 sigdig 0-999	16 bit	minimum setpoint integer for all tank levels, (sum of SETP1 through SETP5)
<i>SETP1</i>	SETP1	1	---	ISR5	ft OR %	3 sigdig 0-999	16 bit	minimum setpoint integer for tank level 1
<i>SETP2</i>	SETP2	1	---	ISR5	ft OR %	3 sigdig 0-999	16 bit	minimum setpoint integer for tank level 2
<i>SETP3</i>	SETP3	1	---	ISR5	ft OR %	3 sigdig 0-999	16 bit	minimum setpoint integer for tank level 3
<i>SETP4</i>	SETP4	1	---	ISR5	ft OR %	3 sigdig 0-999	16 bit	minimum setpoint integer for tank level 4
<i>SETP5</i>	SETP5	1	---	ISR5	ft OR %	3 sigdig 0-999	16 bit	minimum setpoint integer for tank level 5
<i>USESIGMA</i>	USESIGMA	1	---	ISR4	---	3 sigdig 0-999	16 bit	standard deviation setpoint

Table B.2. System Constant Parameters (continued)

<b>Computational Results SYMBOL</b>	<b>CODE</b>	<b>MEM LOCS.</b>	<b>TYPE</b>	<b>CODE SEGMENT</b>	<b>UNITS</b>	<b>RANGE</b>	<b>NUMBER OF BITS/BYTES</b>	<b>DEFINITION</b>
$\alpha$	ALPHA	1	CR	supply	dmsnles	3 sigdig 0-999	16 bit	shear exponent value calculated from 5-minute measurements of the wind speeds recorded at 10m by the west texas mesonet, and at 60m by a wind resource measurement tower
$\alpha_{HR}$	AHR	12	CR	supply	dmsnles	3 sigdig 0-999	16 bit	hour array of alpha, to be averaged in AAVG when full
$\alpha_{HRPNT}$	AHRPNT	12	CR	supply	---	0-12	8 bit	pointer for alpha
$\alpha_{AVG}$	AAVG	1	CR	supply	dmsnles	3 sigdig 0-999	16 bit	hour average of alpha, to be placed in ALPIJ
$\alpha_{ij}$	ALPIJ	288	CR	supply	dmsnles	3 sigdig 0-999	16 bit	calculated average shear exponent storage matrix for month and hour data, updated with new average numbers as new data becomes. available 24 by 12 matrix, with months in columns, and hours of the day in rows
$\alpha_{ijPNTRW}$	AIJPNTRW	24	CR	supply	---	0-24	8 bit	row pointer for ALPIJ
$\alpha_{ijPNTCLM}$	AIJNTCLM	12	CR	supply	---	0-12	8 bit	column pointer for ALPIJ
$\epsilon$	100M	24	CR	supply	m/s	3 sigdig 0-999	16 bit	array of 100m wind speeds, calculated from 10 meter west texas mesonet wind speeds and ALPHA, stored for the past 2 hours
$\epsilon_{PNT}$	100PNT	24	CR	supply	---	0-24	8 bit	pointer for 100m
$\eta$	SUPP	1	CR	supply econ	kWh	3 sigdig 0-999	16 bit	<supply>, in kWh, of wind energy, calculated from 100 meter wind speeds and turbine power curve
$\lambda$	DEMAND	1	CR	demand econ	kWh	3 sigdig 0-999	16 bit	<demand>, in kWh, of water system (summation of WEL, RO, and DIST), over 5 minutes

Table B.3. Computational Results

Computational Results		(continued)						
SYMBOL	CODE	MEM LOCS.	TYPE	SEGMENT	UNITS	RANGE	NUMBER OF BITS/BYTES	DEFINITION
<i>m</i>	MENG	24	CR	econ	kWh	3 sigdig 0-999	16 bit	avoided energy calculated array, calculated when wind energy is used to net meter either system or municipal loads, stored over the past 2 hours, to export to long-term storage
<i>mPNT</i>	MENGPNT	24	CR	econ	---	0-24	8 bit	pointer for MENG
<i>m<sub>coe</sub></i>	MCOE	1	CR	econ	\$	3 sigdig 0-999	16 bit	avoided cost of energy, the value of the energy avoided in the MENG calculation, valued at <i>coe</i>
<i>d</i>	DENG	24	CR	econ	kWh	3 sigdig 0-999	16 bit	deficit energy calculated array, calculated when there is not enough wind energy to cover the entire system or municipal loads, stored over the past 2 hours, to export to long-term storage (energy purchased from utility)
<i>dPNT</i>	DENGPNT	24	CR	econ	---	0-24	8 bit	pointer for DENG
<i>d<sub>coe</sub></i>	DCOE	1	CR	econ	\$	3 sigdig 0-999	16 bit	the value of the energy purchased from the DENG calculation, valued at <i>coe</i>
<i>s</i>	SENG	24	CR	econ	kWh	3 sigdig 0-999	16 bit	surplus energy calculated array, calculated when there is surplus wind energy that is to be sold to the grid, valued at <i>poe</i> , stored over the past 2 hours, to export to long-term storage
<i>sPNT</i>	SENGPNT	24	CR	econ	---	0-24	8 bit	pointer for SENG
<i>s<sub>poe</sub></i>	SPOE	1	CR	econ	\$	3 sigdig 0-999	16 bit	the value of the energy sold to the grid from the SENG calculation, valued at <i>poe</i>
$\pi$	PROFIT	1	CR	econ	\$	3 sigdig 0-999	16 bit	profit of system economics, calculated as revenue – cost, which is (MCOE + SPOE) - DCOE
<i>REMG</i>	REMG	1	CR	ISR4	hours	3 sigdig 0-999	16 bit	hours of water remaining in storage tanks before depletion

Table B.4. Computational Results (Continued)

<u>Computational Results</u>		(continued)									
<u>SYMBOL</u>	<u>CODE</u>	<u>MEM</u> <u>LOCS.</u>	<u>TYPE</u>	<u>CODE</u> <u>SEGMENT</u>	<u>UNITS</u>	<u>RANGE</u>	<u>NUMBER OF</u> <u>BITS/BYTES</u>	<u>DEFINITION</u>			
<i>REMA</i>	<i>REMA</i>	1	CR	ISR4	hours	3 sigdig 0-999	16 bit	hours of water remaining in storage tanks before system alert, and activation of PROD variable (PROD = 1)			
<i>t</i>	<i>TLVL</i>	1	CR	ISR3	ft OR %	3 sigdig 0-999	16 bit	sum of all five storage tank levels, from above- and on-ground storage			
<i>DISTPNT</i>	<i>DISTPNT</i>	24	CR	demand	---	0-24	8 bit	pointer for DIST			
<i>WEL</i>	<i>WEL</i>	24	CR	demand	kWh	3 sigdig 0-999	16 bit	storage array of the wellfield consumption over 5 minutes of energy, calculated from water use (MGD) and expected energy consumption per MGD, stored for the past 2 hours, to export to long-term storage			
<i>WELPNT</i>	<i>WELPNT</i>	24	CR	demand	---	0-24	8 bit	pointer for WEL			
<i>RO</i>	<i>RO</i>	24	CR	demand	kWh	3 sigdig 0-999	16 bit	storage array of the reverse osmosis system consumption over 5 minutes of energy, calculated from water use (MGD) and expected energy consumption per MGD, stored for the past 2 hours, to export to long-term storage			
<i>ROPNT</i>	<i>ROPNT</i>	24	CR	demand	---	0-24	8 bit	pointer for RO			
<i>DIST</i>	<i>DIST</i>	24	CR	demand	kWh	3 sigdig 0-999	16 bit	storage array of the distribution system consumption over 5 minutes of energy, calculated from water use (MGD) and expected energy consumption per MGD, stored for the past 2 hours, to export to long-term storage			
<i>DISTPNT</i>	<i>DISTPNT</i>	24	CR	demand	---	0-24	8 bit	pointer for DIST			
<i>δ20</i>	<i>24SUM</i>	20	CR	ISR4	---	3 sigdig 0-999	16 bit	Array of the past 20 values of water use			
<i>δ20PNT</i>	<i>24SUMPNT</i>	20	CR	ISR4	---	0-20	8 bit	pointer for 20SUM			
<i>δsum</i>	<i>WATSUM</i>	1	CR	ISR4	---	3 sigdig	16 bit	Sum of the array δ20			

Table B.5. Computational Results (Continued)

<u>Computational Results</u>		(continued)									
<u>SYMBOL</u>	<u>CODE</u>	<u>MEM LOCS.</u>	<u>TYPE</u>	<u>SEGMENT</u>	<u>UNITS</u>	<u>RANGE</u>	<u>NUMBER OF BITS/BYTES</u>	<u>DEFINITION</u>			
Yhat $\delta$	YHATWAT	20	CR	ISR4	---	3 sigdig 0-999	16 bit	Y-value parameter estimate for water			
SumHat $\delta$	SUMHATWAT	1	CR	ISR4	---	3 sigdig 0-999	16 bit	Interior value for variance parameter estimate for water			
Var $\delta$	VARWAT	1	CR	ISR4	---	3 sigdig 0-999	16 bit	Variance parameter estimate for water			
Sigma $\delta$	SIGWAT	1	CR	ISR4	---	3 sigdig 0-999	16 bit	Standard deviation parameter estimate for water			
Bhat $\alpha$	BHATWND	1	CR	supply	---	3 sigdig 0-999	16 bit	Slope parameter estimate for wind			
Ybar $\alpha$	YBARWND	1	CR	supply	---	3 sigdig 0-999	16 bit	Y-average parameter estimate for wind			
Bnot $\alpha$	BNOTWND	1	CR	supply	---	3 sigdig 0-999	16 bit	Y-intercept parameter estimate for wind			
Yhat $\alpha$	YHATWND	24	CR	supply	---	3 sigdig 0-999	16 bit	Y-value parameter estimate for wind			
SumHat $\alpha$	SUMHATWND	1	CR	supply	---	3 sigdig 0-999	16 bit	Interior value for variance parameter estimate for wind			
Var $\alpha$	VARWND	1	CR	supply	---	3 sigdig 0-999	16 bit	Variance parameter estimate for wind			
Sigma $\alpha$	SIGWND	1	CR	supply	---	3 sigdig 0-999	16 bit	Standard deviation parameter estimate for wind			

Table B.6. Computational Results (Continued)

Computational Results		(continued)								
SYMBOL	CODE	MEM LOCS.	TYPE	SEGMENT	UNITS	RANGE	NUMBER OF BITS/BYTES	DEFINITION		
$\gamma$	MA	24	CR	ISR2	---	3 sigdig 0-999	16 bit	array of moving average calculations from present sample (n) of water use data, and past samples, stored for the past 20 periods		
$p\delta$	PRDPWAT	20	CR	ISR4	---	3 sigdig 0-999	16 bit	Product of the arrays p20 and $\alpha 20$		
sump $\delta$	SUMPWT	1	CR	ISR4	---	3 sigdig 0-999	16 bit	Sum of the array p $\delta$		
$\alpha 24$	ALSUM	24	CR	supply	---	3 sigdig 0-999	16 bit	Array of the past 24 values of wind data		
$\alpha 24PNT$	24ALPNT	24	CR	supply	---	0-24	8 bit	pointer for 24ALSUM		
$\alpha sum$	WINDSUM	1	CR	supply	---	3 sigdig 0-999	16 bit	Sum of the array $\alpha 24$		
$p\alpha$	PRDPWND	24	CR	supply	---	3 sigdig 0-999	16 bit	Product of the arrays p24 and $\alpha 24$		
sump $\alpha$	SUMPWND	1	CR	supply	---	3 sigdig 0-999	16 bit	Sum of the array p $\alpha$		
Bhat $\delta$	BHATWAT	1	CR	ISR4	---	3 sigdig 0-999	16 bit	Slope parameter estimate for water		
Ybar $\delta$	YBARWAT	1	CR	ISR4	---	3 sigdig 0-999	16 bit	Y-average parameter estimate for water		
Bnot $\delta$	BNOTWAT	1	CR	ISR4	---	3 sigdig 0-999	16 bit	Y-intercept parameter estimate for water		

Table B.7. Computational Results (Continued)

<u>Input Variables</u>													
SYMBOL	CODE	MEM LOCS.	TYPE	CODE SEGMENT	UNITS	RANGE	NUMBER OF BITS/BYTES	DEFINITION					
$x$	10M	24	I	ISR1	m/s	3 sigdig 0-999	16 bit	array of 5-minute measurements of 10 meter wind speed from the west texas mesonet, using the most recent value in array for calculations, stored for the past 2 hours, to export to long-term storage					
$xPNT$	10MPNT	24	I	ISR1	---	0-24	8 bit	pointer for 10M					
$y$	60M	24	I	ISR1	m/s	3 sigdig 0-999	16 bit	array of 5-minute measurements of 60 meter wind speed from a yet to be installed wind resource tower, using the most recent value in array for calculations, stored for the past 2 hours, to export to long-term storage					
$yPNT$	60MPNT	24	I	ISR1	---	0-24	8 bit	pointer for 60M					
$\delta$	WATER	24	I	ISR2 ISR4	MGD	3 sigdig 0-999	16 bit	array of 5-minute measurements of water use from the Seminole wellfield, using the most recent value in array for calculations, stored for the past 2 hours, to export to long-term storage					
$\delta PNT$	WATERPNT	24	I	ISR2	---	0-24	8 bit	pointer for WATER					
$\delta_{ij}$	WATIJ	288	I	ISR5	dmsnles	3 sigdig 0-999	16 bit	calculated average water use storage matrix for month and hour data, updated with new average numbers as new data becomes available. 24 by 12 matrix, with months in columns, and hours of the day in rows.					
$\delta_{ijPNTRW}$	WATIJRW	24	I	ISR5	---	0-24	8 bit	row pointer for WATIJ					
$\delta_{ijPNTCLM}$	WATIJCLM	12	I	ISR5	---	0-12	8 bit	column pointer for WATIJ					

Table B.8. Input Variables

<u>Input Variables</u> SYMBOL	CODE	MEM LOCS.	(continued) TYPE	CODE SEGMENT	UNITS	RANGE	NUMBER OF BITS/BYTES	DEFINITION
i1	TLVL1	1	I	ISR5	ft OR %	3 sigdig 0-999	16 bit	level of tank 1 (water tower 1)
i2	TLVL2	1	I	ISR5	ft OR %	3 sigdig 0-999	16 bit	level of tank 2 (water tower 2)
i3	TLVL3	1	I	ISR5	ft OR %	3 sigdig 0-999	16 bit	level of tank 3 (on-ground 1)
i4	TLVL4	1	I	ISR5	ft OR %	3 sigdig 0-999	16 bit	level of tank 4 (on-ground 2)
i5	TLVL5	1	I	ISR5	ft OR %	3 sigdig 0-999	16 bit	level of tank 5 (on ground 3)

Table B.9. Input Variables (Continued)



<u>Output Variables</u>		MEM LOCS.	TYPE	CODE SEGMENT	UNITS	RANGE	NUMBER OF BITS/BYTES	DEFINITION
SYMBOL	CODE							
$m_{storD}$	MSTORD	7	O	econ	kWh	3 sigdig 0-999	16 bit	storage array of avoided energy, organized by day
$m_{storDPNT}$	MSTORDP	7	O	econ	---	0-7	8 bit	pointer for MSTORD
$m_{storW}$	MSTORW	4	O	econ	kWh	3 sigdig 0-999	16 bit	storage array of avoided energy, organized by week
$m_{storWPN}$	MSTORWP	4	O	econ	---	0-4	8 bit	pointer for MSTORW
$m_{storM}$	MSTORM	12	O	econ	kWh	3 sigdig 0-999	16 bit	storage array of avoided energy, organized by month
$m_{storMPNT}$	MSTORMP	12	O	econ	---	0-12	8 bit	pointer for MSTORM
$m_{storY}$	MSTORY	100	O	econ	kWh	3 sigdig 0-999	16 bit	storage array of avoided energy, organized by year
$m_{storYPNT}$	MSTORYP	100	O	econ	---	0-100	8 bit	pointer for MSTORY
$m_{storL}$	MSTORL	1	O	econ	kWh	3 sigdig 0-999	16 bit	storage array of avoided energy, organized by lifespan
$d_{storD}$	DSTORD	7	O	econ	kWh	3 sigdig 0-999	16 bit	storage array of purchased energy, organized by day
$d_{storDPNT}$	DSTORDP	7	O	econ	---	0-7	8 bit	pointer for DSTORD
$d_{storW}$	DSTORW	4	O	econ	kWh	3 sigdig 0-999	16 bit	storage array of purchased energy, organized by week
$d_{storWPN}$	DSTORWP	4	O	econ	---	0-4	8 bit	pointer for DSTORW

Table B.10. Output Variables

<b>Output Variables</b>		<b>(continued)</b>							
<b>SYMBOL</b>	<b>CODE</b>	<b>MEM LOCS.</b>	<b>TYPE</b>	<b>SEGMENT</b>	<b>UNITS</b>	<b>RANGE</b>	<b>NUMBER OF BITS/BYTES</b>	<b>DEFINITION</b>	
<i>d<sub>storM</sub></i>	DSTORM	12	O	econ	kWh	3 sigdig 0-999	16 bit	storage array of purchased energy, organized by month	
<i>d<sub>storMPNT</sub></i>	DSTORMP	12	O	econ	---	0-12	8 bit	pointer for DSTORM	
<i>d<sub>storY</sub></i>	DSTORY	100	O	econ	kWh	3 sigdig 0-999	16 bit	storage array of purchased energy, organized by year	
<i>d<sub>storYPNT</sub></i>	DSTORYP	100	O	econ	---	0-100	8 bit	pointer for DSTORY	
<i>d<sub>storL</sub></i>	DSTORL	1	O	econ	kWh	3 sigdig 0-999	16 bit	storage array of purchased energy, organized by lifespan	
<i>S<sub>storD</sub></i>	SSTORD	7	O	econ	kWh	3 sigdig 0-999	16 bit	storage array of surplus energy, organized by day	
<i>S<sub>storDPNT</sub></i>	SSTORDP	7	O	econ	---	0-7	8 bit	pointer for SSTORD	
<i>S<sub>storW</sub></i>	SSTORW	4	O	econ	kWh	3 sigdig 0-999	16 bit	storage array of surplus energy, organized by week	
<i>S<sub>storWPNT</sub></i>	SSTORWP	4	O	econ	---	0-4	8 bit	pointer for SSTORW	
<i>S<sub>storM</sub></i>	SSTORM	12	O	econ	kWh	3 sigdig 0-999	16 bit	storage array of surplus energy, organized by month	
<i>S<sub>storMPNT</sub></i>	SSTORMP	12	O	econ	---	0-12	8 bit	pointer for SSTORM	
<i>S<sub>storY</sub></i>	SSTORY	100	O	econ	kWh	3 sigdig 0-999	16 bit	storage array of surplus energy, organized by year	
<i>S<sub>storYPNT</sub></i>	SSTORYP	100	O	econ	---	0-100	8 bit	pointer for SSTORY	

Table B.11. Output Variables (Continued)

Output Variables		(continued)						
SYMBOL	CODE	MEM LOCS.	MEM TYPE	CODE SEGMENT	UNITS	RANGE	NUMBER OF BITS/BYTES	DEFINITION
$S_{storL}$	SSTORL	1	O	econ	kWh	3 sigdig 0-999	16 bit	storage array of surplus energy, organized by lifespan
$\pi_{storD}$	PRSTORD	7	O	econ	kWh	3 sigdig 0-999	16 bit	storage array of the profit of the system economics, organized by day
$\pi_{storDPNT}$	PRSTORDP	7	O	econ	---	0-7	8 bit	pointer for PSTORD
$\pi_{storW}$	PRSTORW	4	O	econ	kWh	3 sigdig 0-999	16 bit	storage array of the profit of the system economics, organized by week
$\pi_{storWPNT}$	PRSTORWP	4	O	econ	---	0-4	8 bit	pointer for PRSTORW
$\pi_{storM}$	PRSTORM	12	O	econ	kWh	3 sigdig 0-999	16 bit	storage array of the profit of the system economics, organized by month
$\pi_{storY}$	PRSTORY	100	O	econ	---	0-12	8 bit	pointer for PRSTORM
$\pi_{storY}$	PRSTORY	100	O	econ	kWh	3 sigdig 0-999	16 bit	storage array of the profit of the system economics, organized by year
$\pi_{storL}$	PRSTORL	1	O	econ	---	0-100	8 bit	pointer for PRSTORY
$B/S$	BS	2	O	compare	---	1 digit	1 bit	operation to buy or sell energy from/to the grid, based on memory location <i>s</i> . single register of binary operation (buy = 1, sell = 0)
$PROD$	PROD	2	O	ISR3	---	1 digit	1 bit	binary variable to force production of potable water (produce = 1, return to background code = 0)

Table B.12. Output Variables (Continued)

<u>Output Variables</u>		(continued)						
<u>SYMBOL</u>	<u>CODE</u>	<u>MEM</u> <u>LOCS.</u>	<u>TYPE</u>	<u>CODE</u> <u>SEGMENT</u>	<u>UNITS</u>	<u>RANGE</u>	<u>NUMBER OF</u> <u>BITS/BYTES</u>	<u>DEFINITION</u>
$\gamma$ PNT	MAPNT	24	O	ISR2	---	0-24	8 bit	pointer for MA
$\beta$	PREMA	1	O	ISR2	---	3 sigdig 0-999	16 bit	single value moving average calculation from sample (n-1), which is the second-newest MA value, upon the arrival of the newest
$\kappa$	POSTMA	21	O	ISR2	---	3 sigdig 0-999	16 bit	array of the past 21 water data points, using a FIFO scheme of renewal
$\kappa$ PNT	POSTMAPNT	21	O	ISR2	---	0-21	8 bit	pointer for POSTMA

Table B.13. Output Variables (Continued)

## APPENDIX C

### BACKGROUND CODE BLOCK DIAGRAM

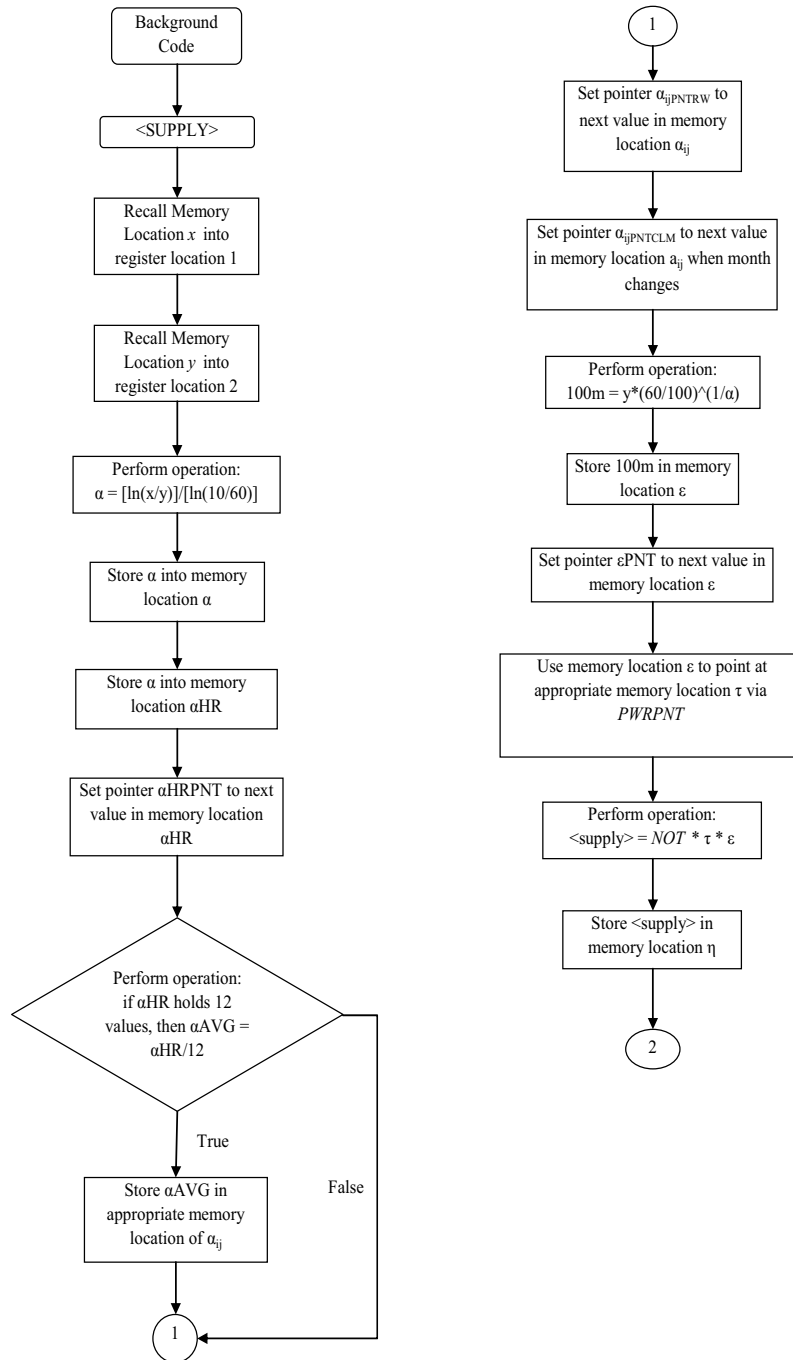


Figure C.1. Background Code Block Diagram Section 1, 2

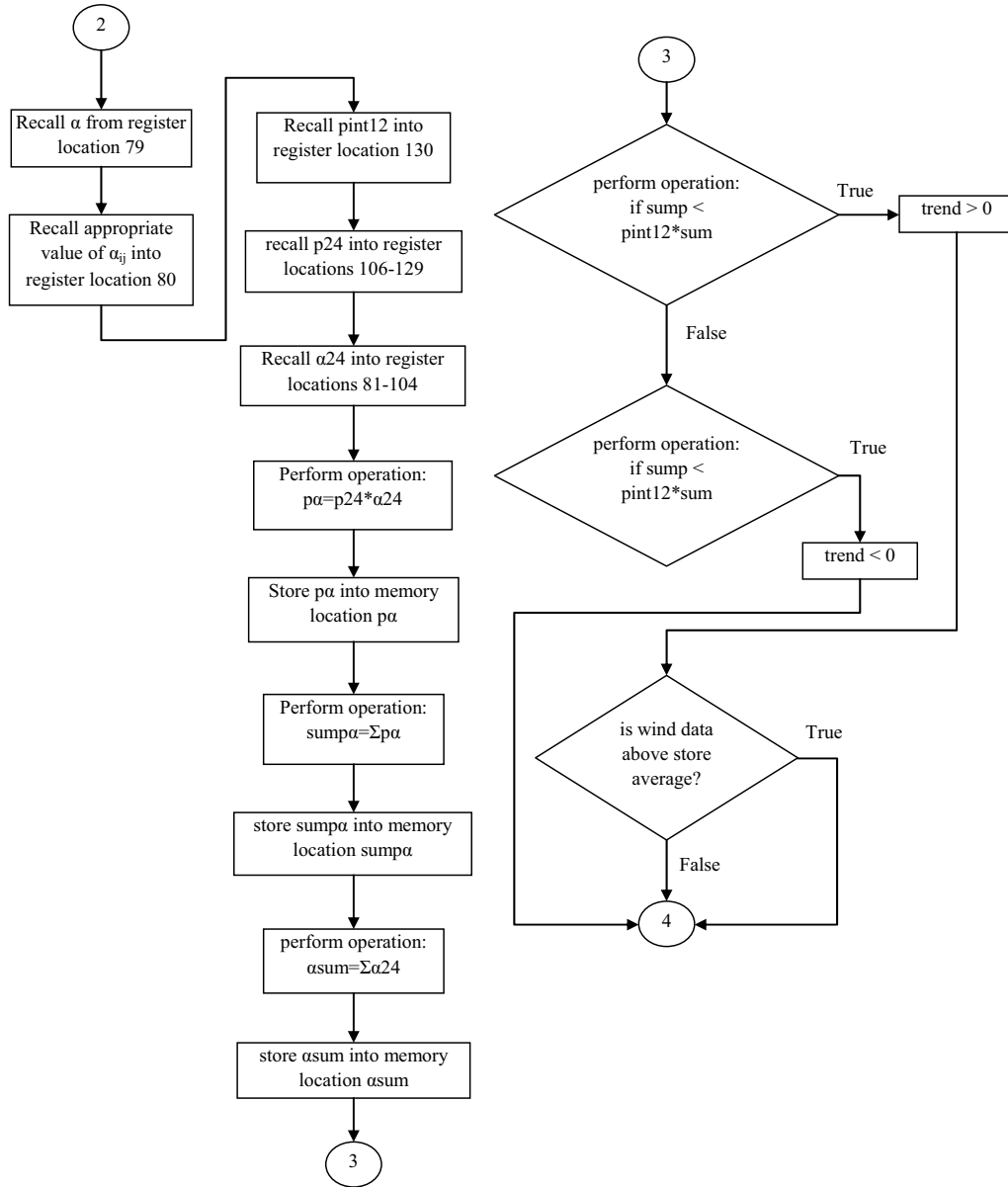


Figure C.2. Background Code Block Diagram Section 3, 4

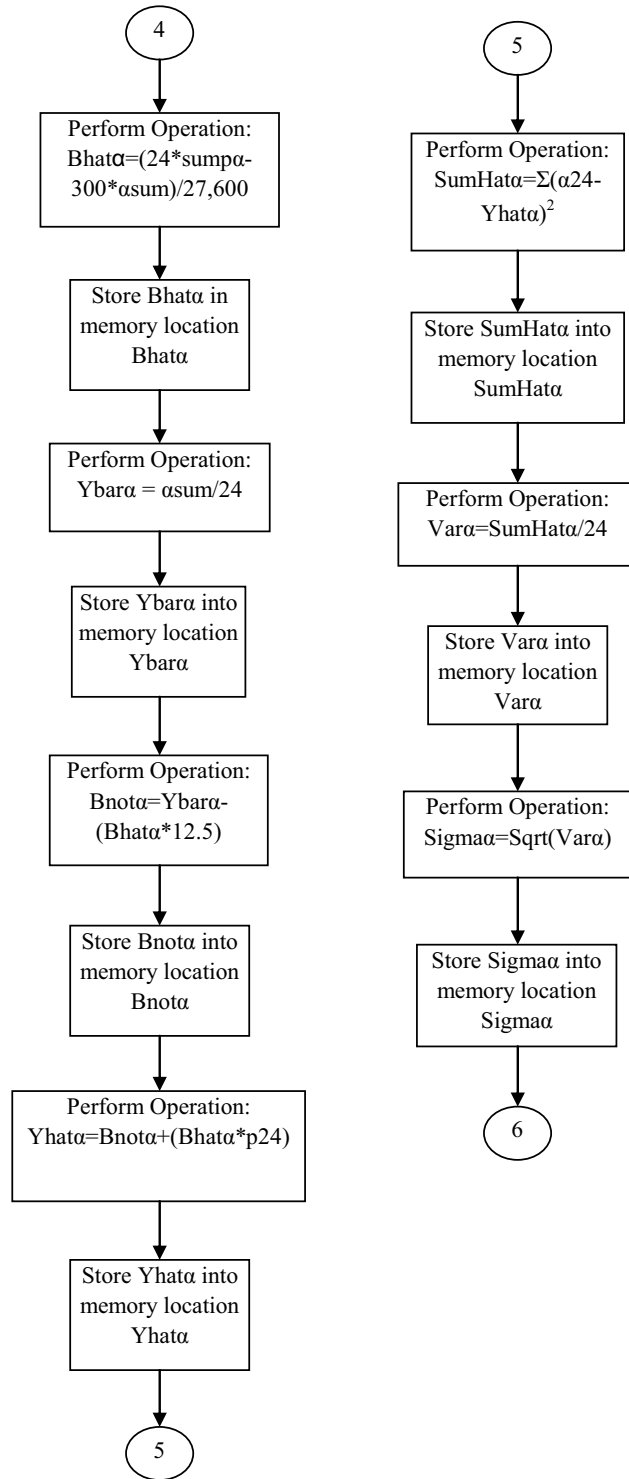


Figure C.3. Background Code Block Diagram Section 5, 6



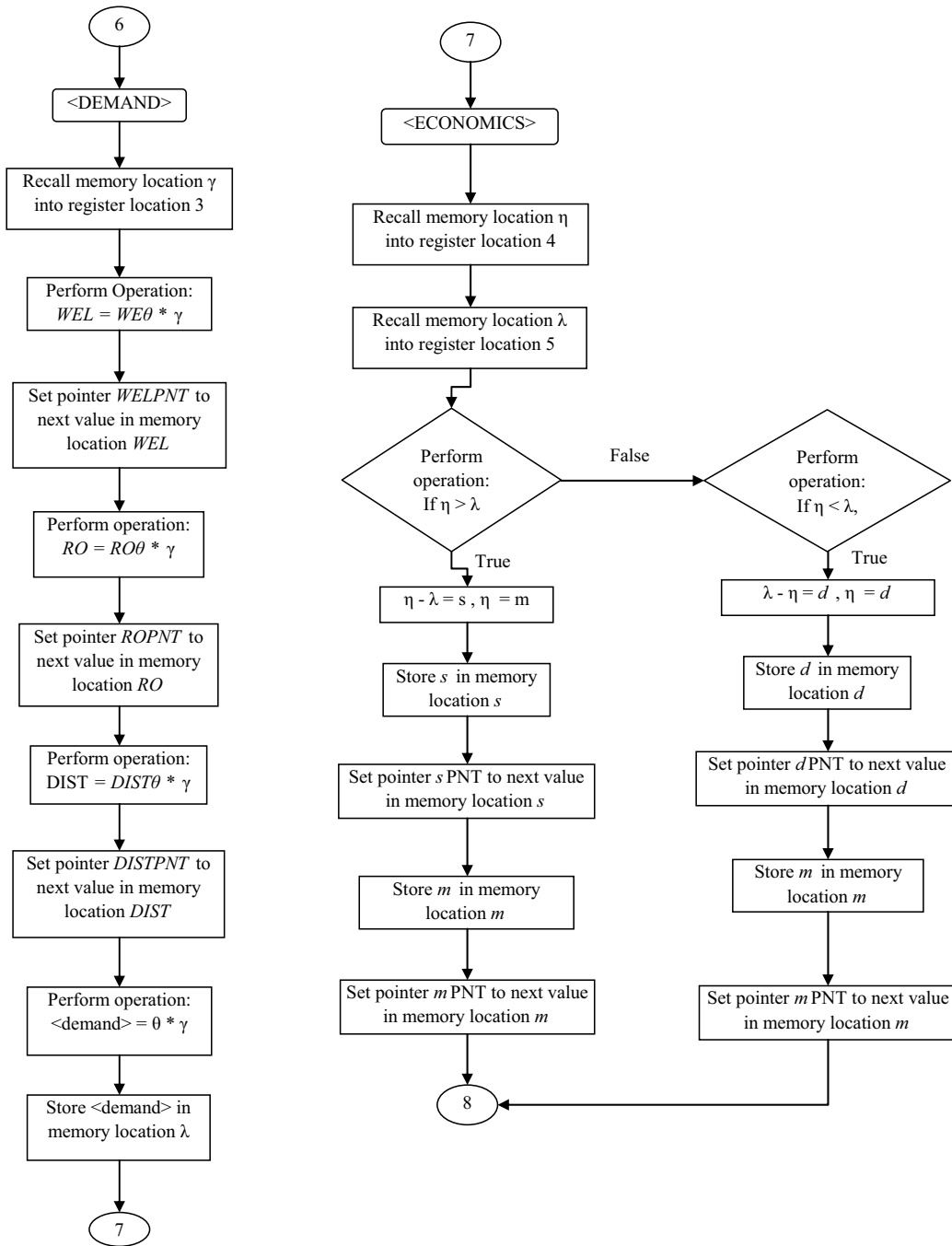


Figure C.4. Background Code Block Diagram Section 7, 8

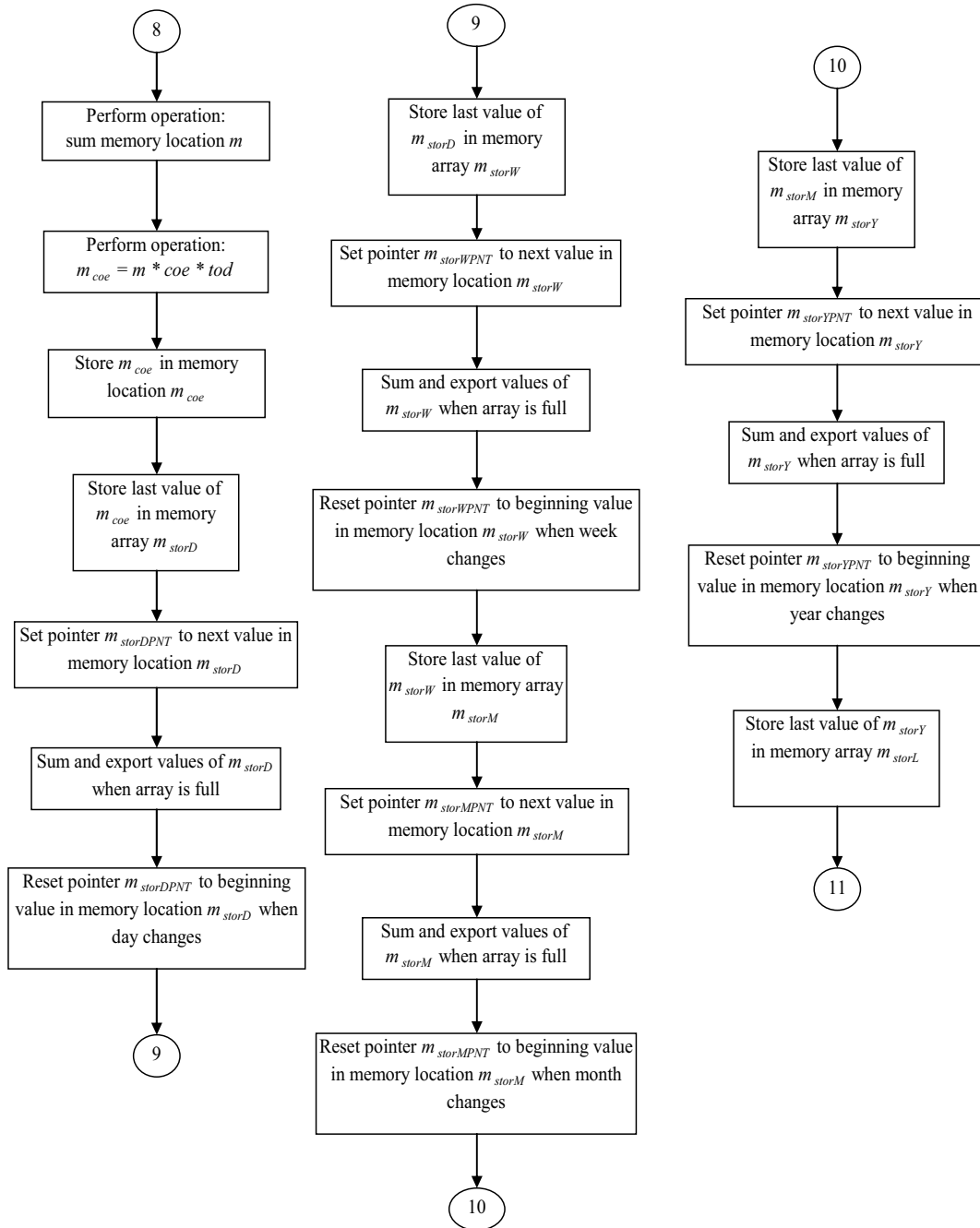


Figure C.5. Background Code Block Diagram Section 9, 10, 11

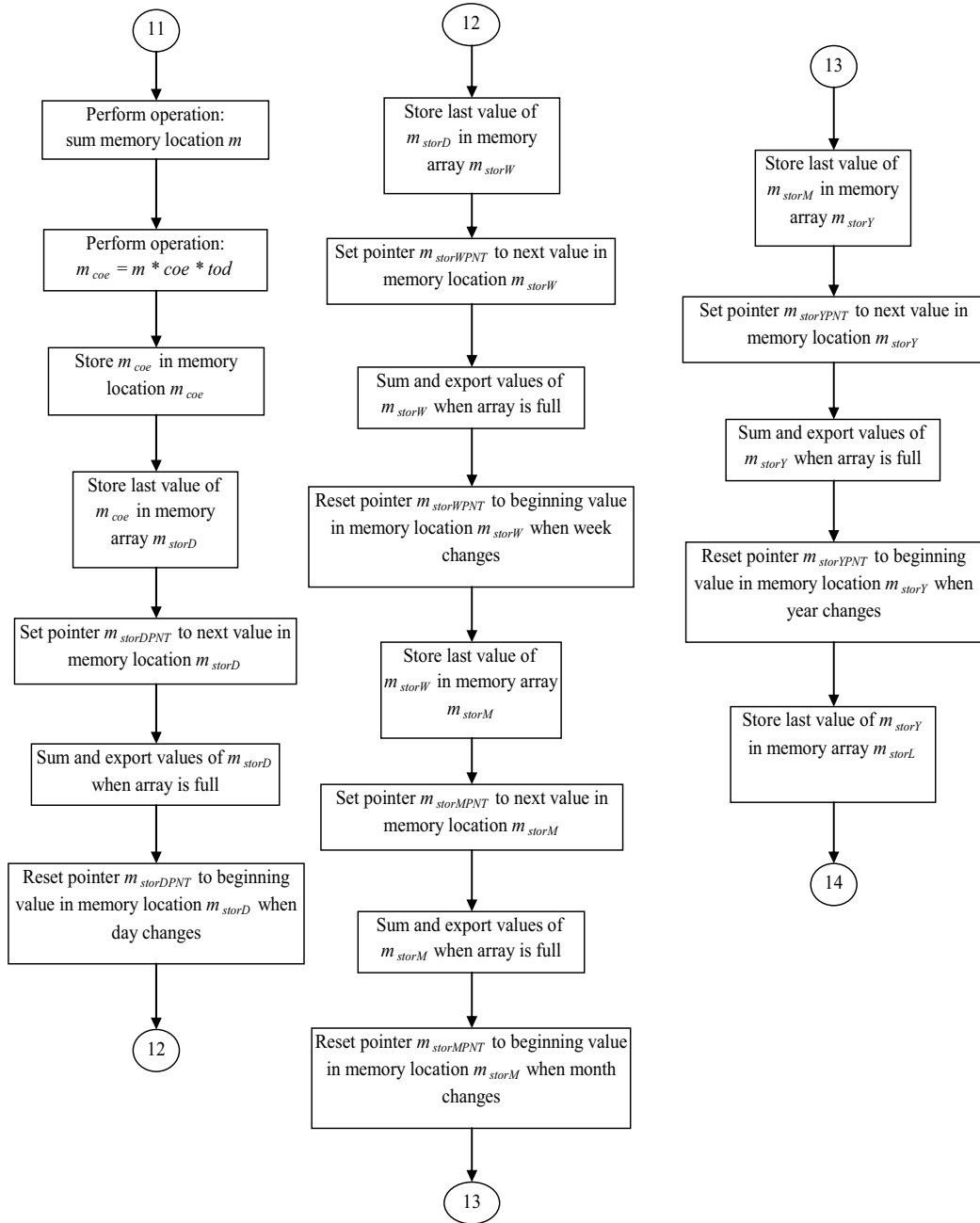


Figure C.6. Background Code Block Diagram Section 12, 13, 14

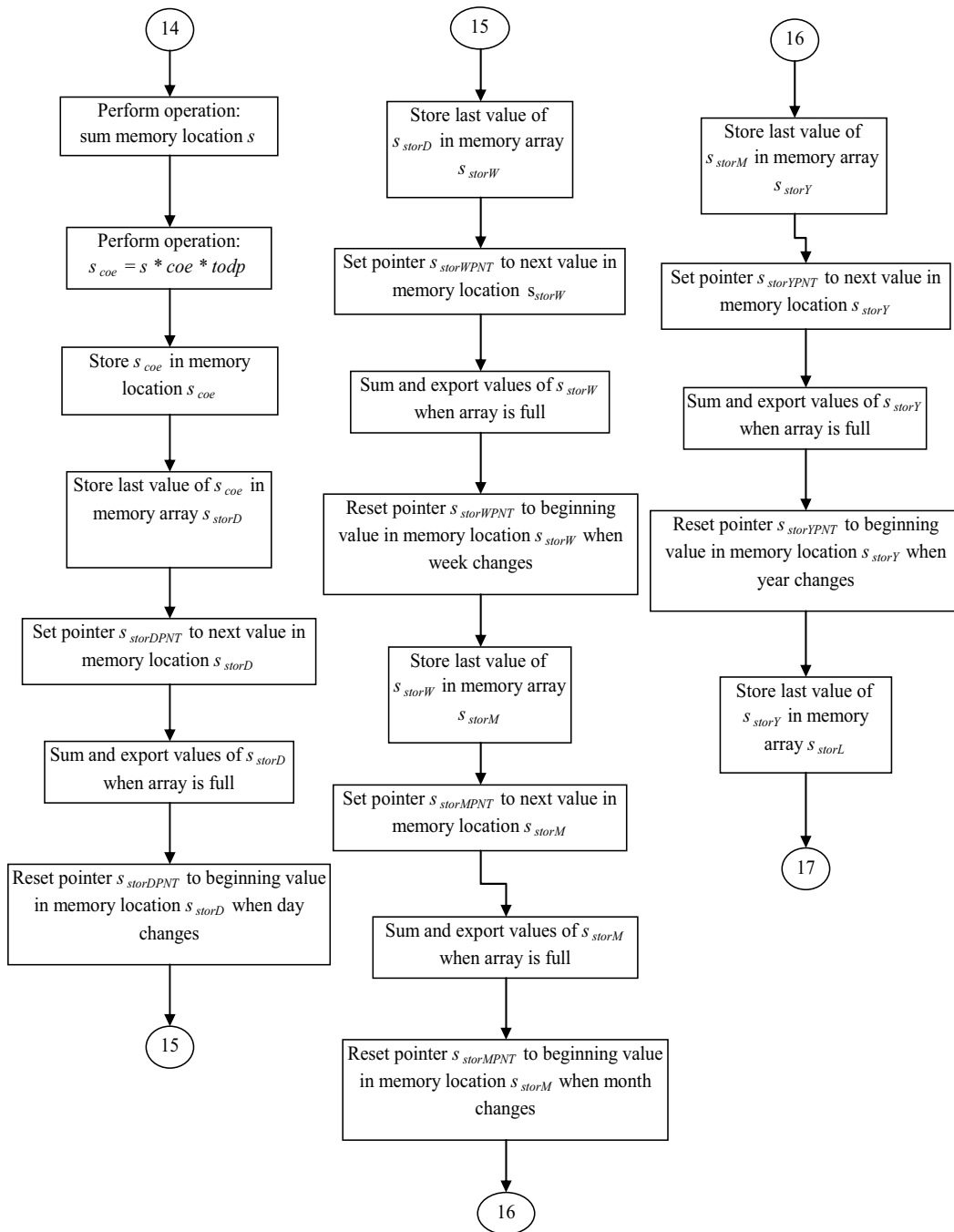


Figure C.7. Background Code Block Diagram Section 15, 16, 17

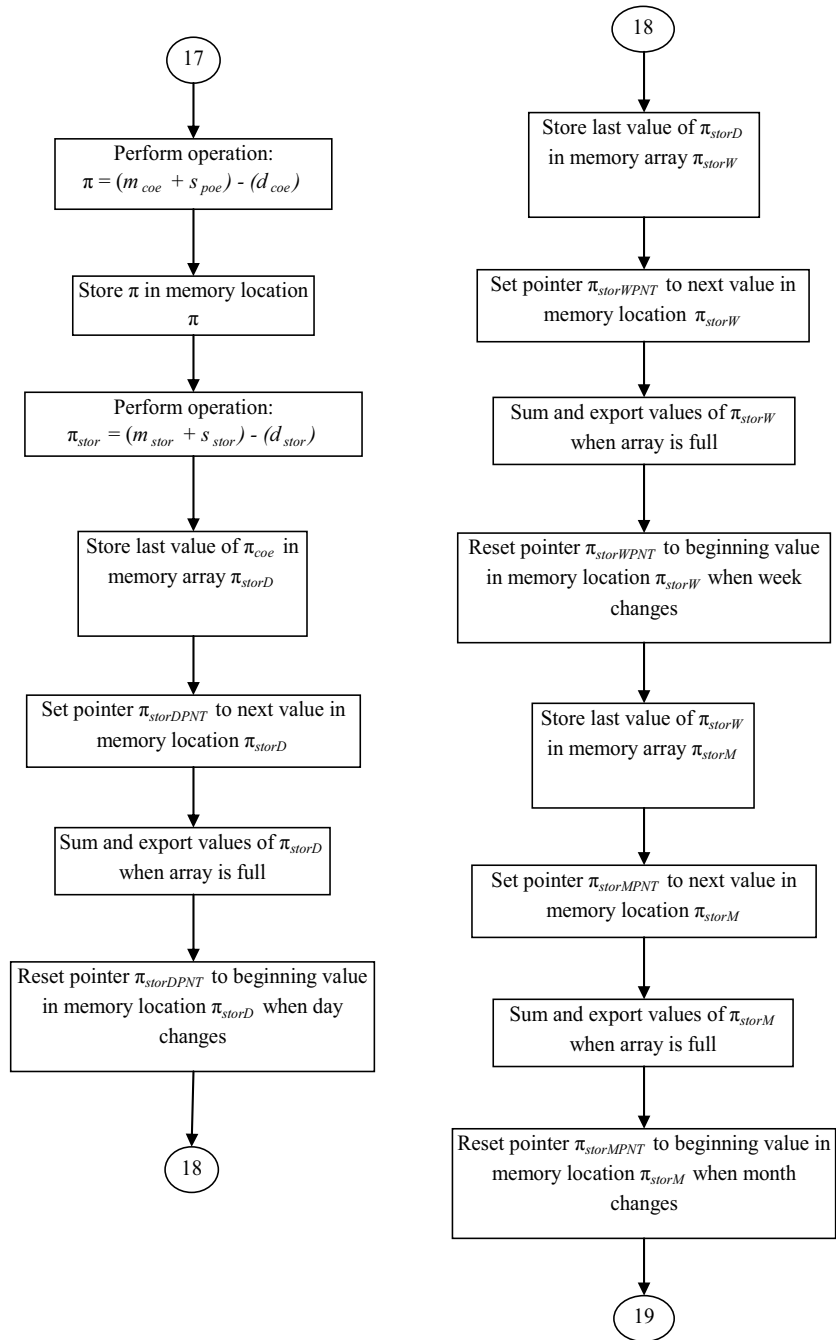


Figure C.8. Background Code Block Diagram Section 18, 19

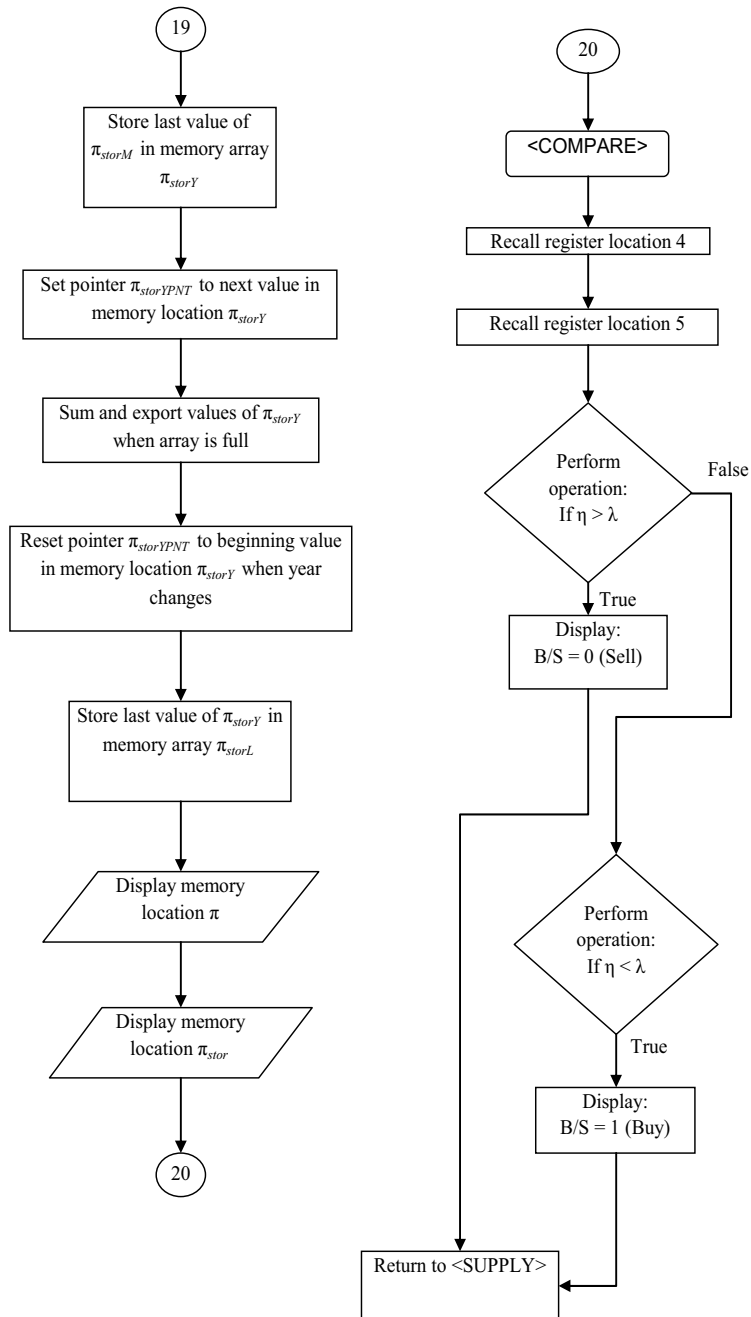


Figure C.9. Background Code Block Diagram Section 20, 21

APPENDIX D  
INTERRUPT SERVICE ROUTINE  
BLOCK DIAGRAMS

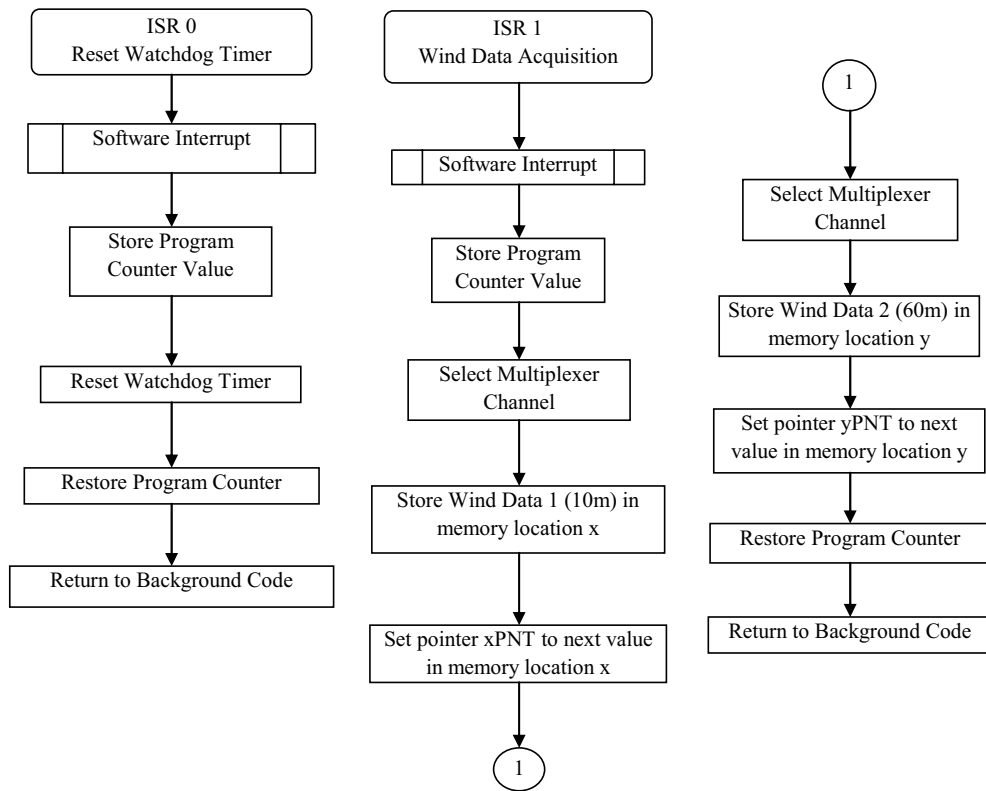


Figure D.1. Block Diagrams for ISR 0 and ISR 1



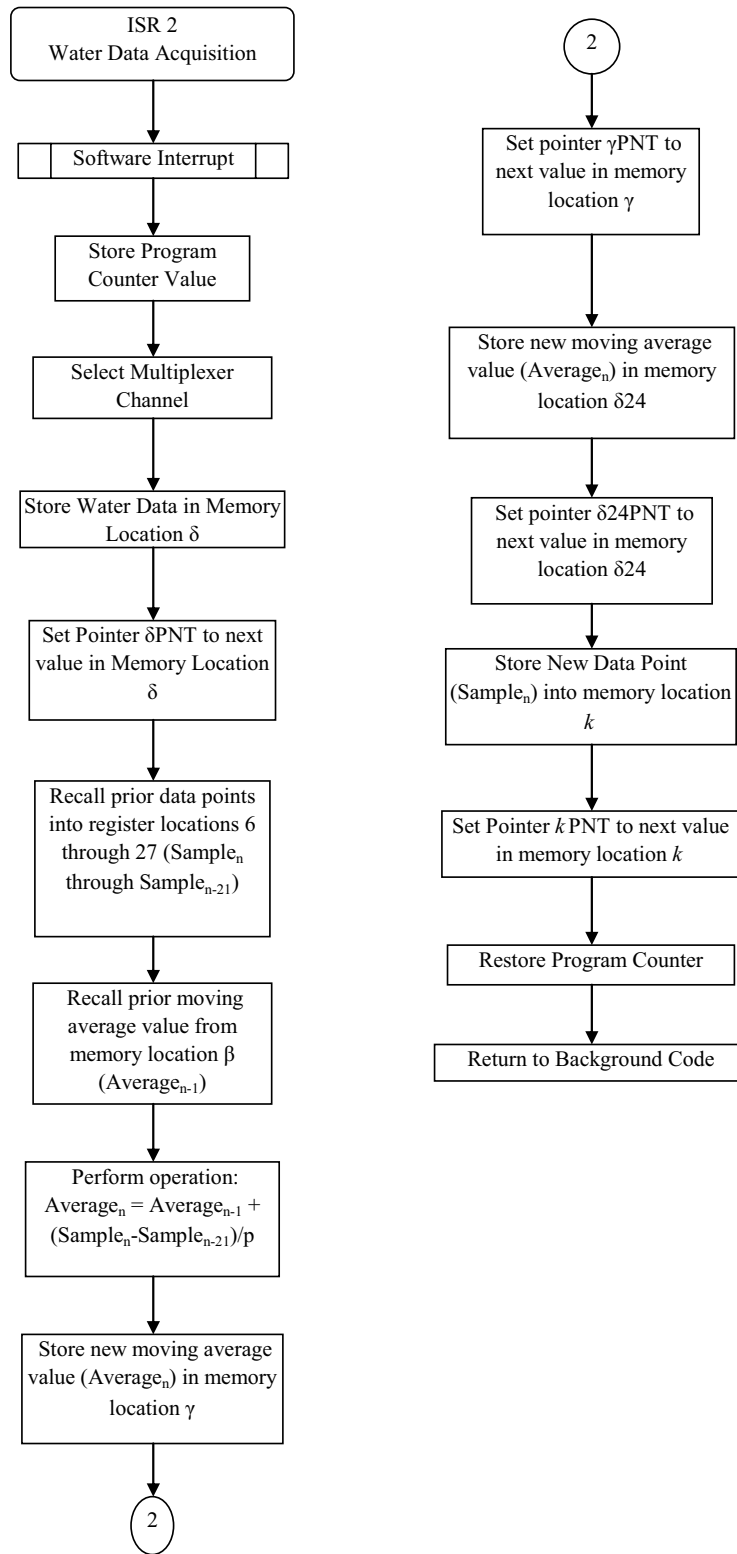


Figure D.2. Block Diagram for ISR 2

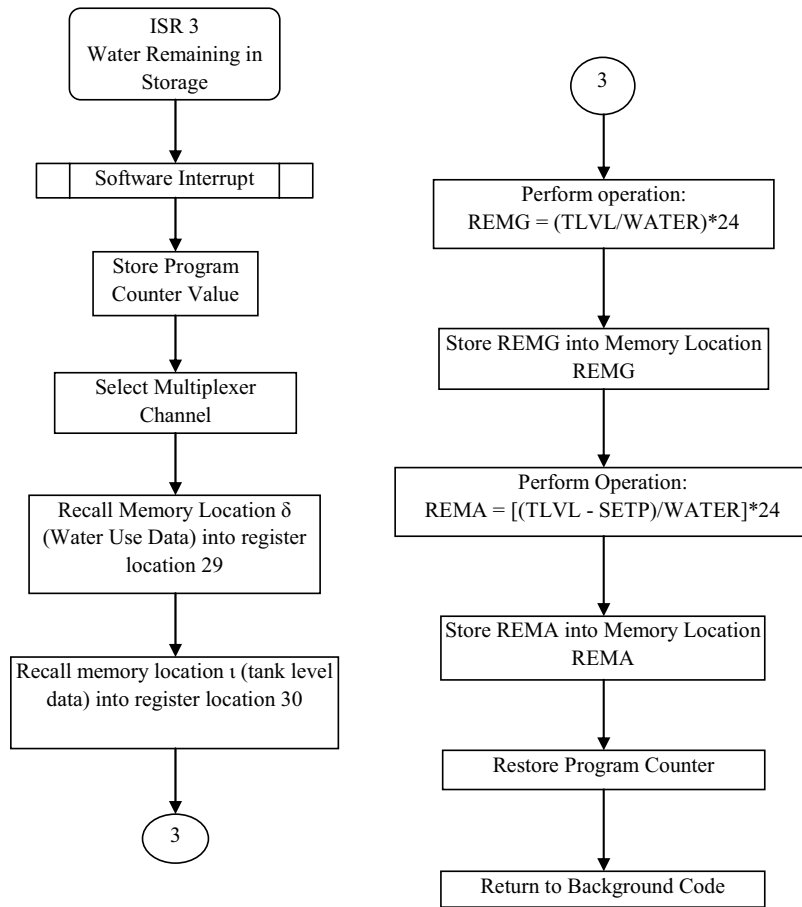


Figure D.3. Block Diagram for ISR 3

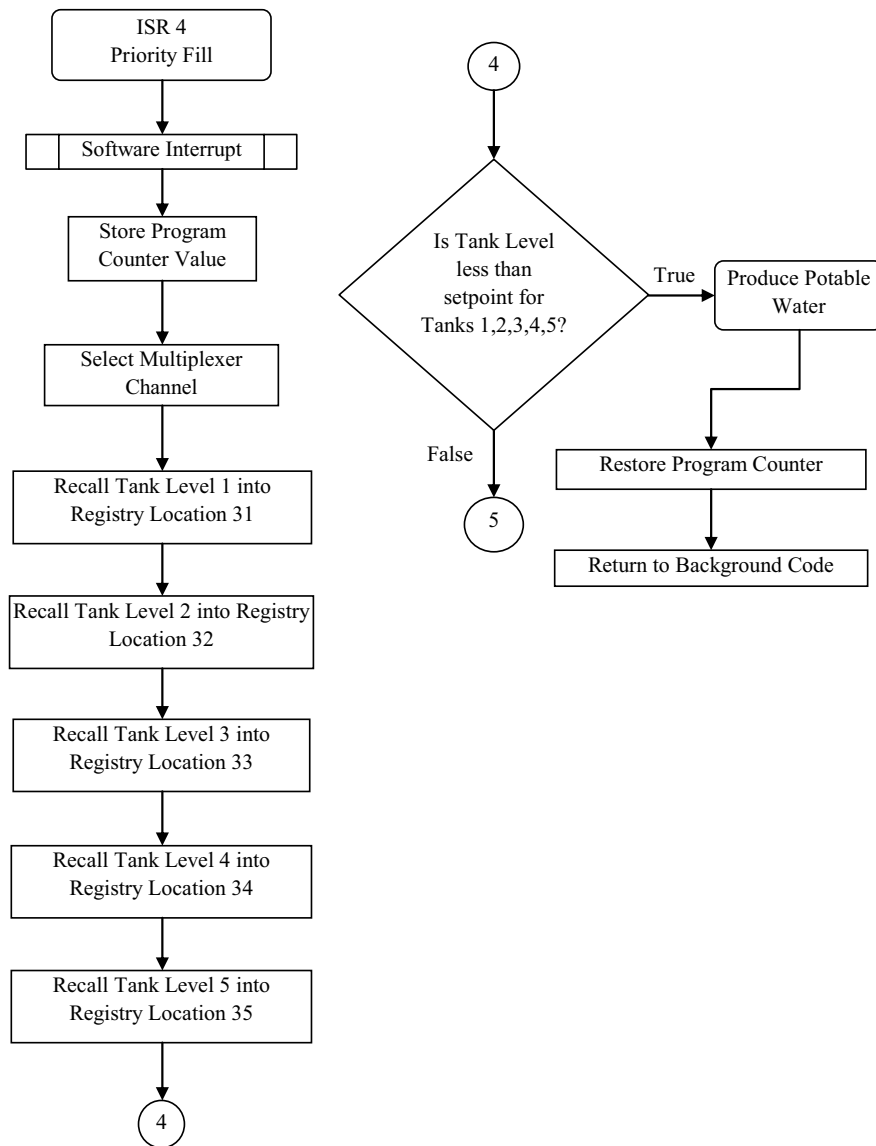


Figure D.4. Block Diagram for ISR 4, Section 1, 2

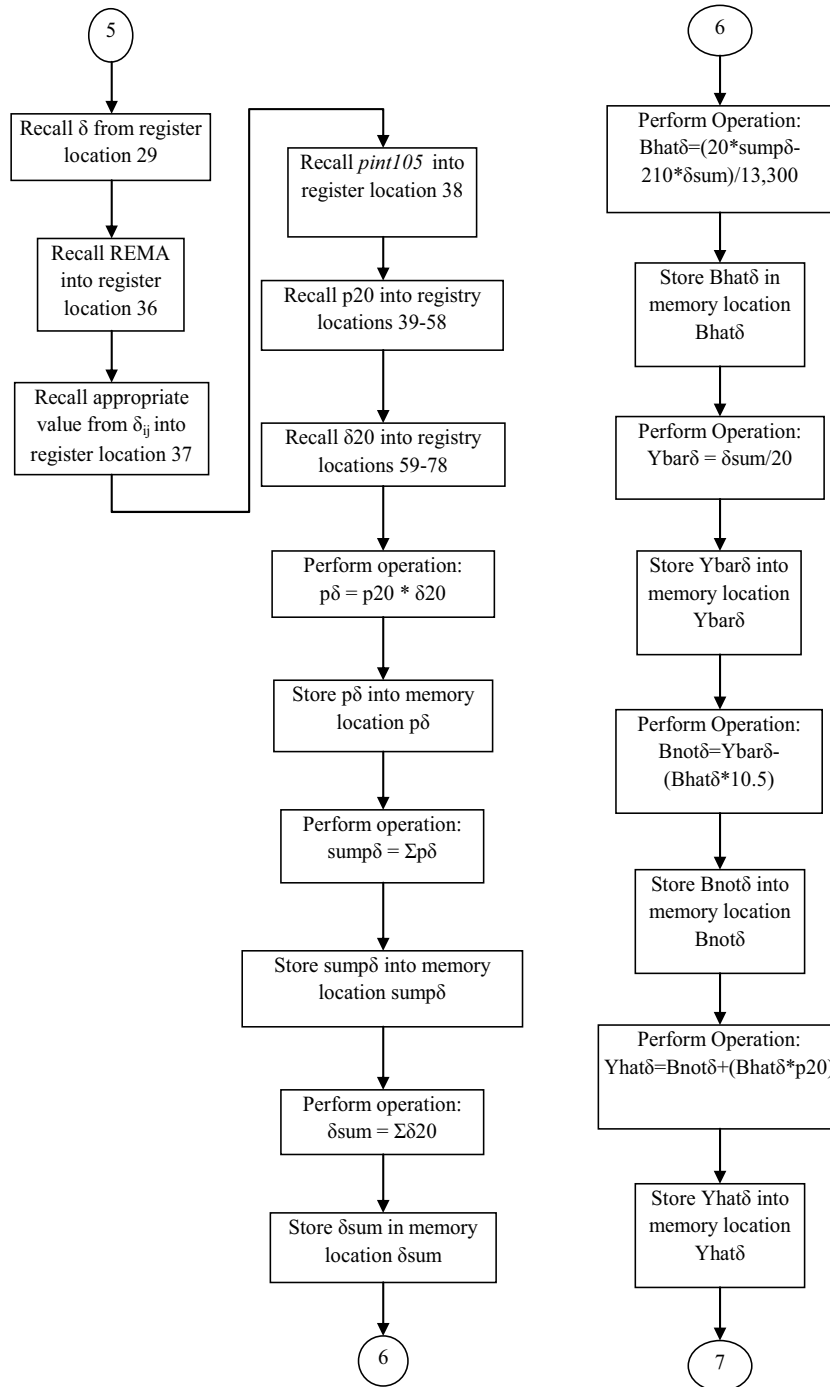


Figure D.5. Block Diagram for ISR 4, Section 3, 4

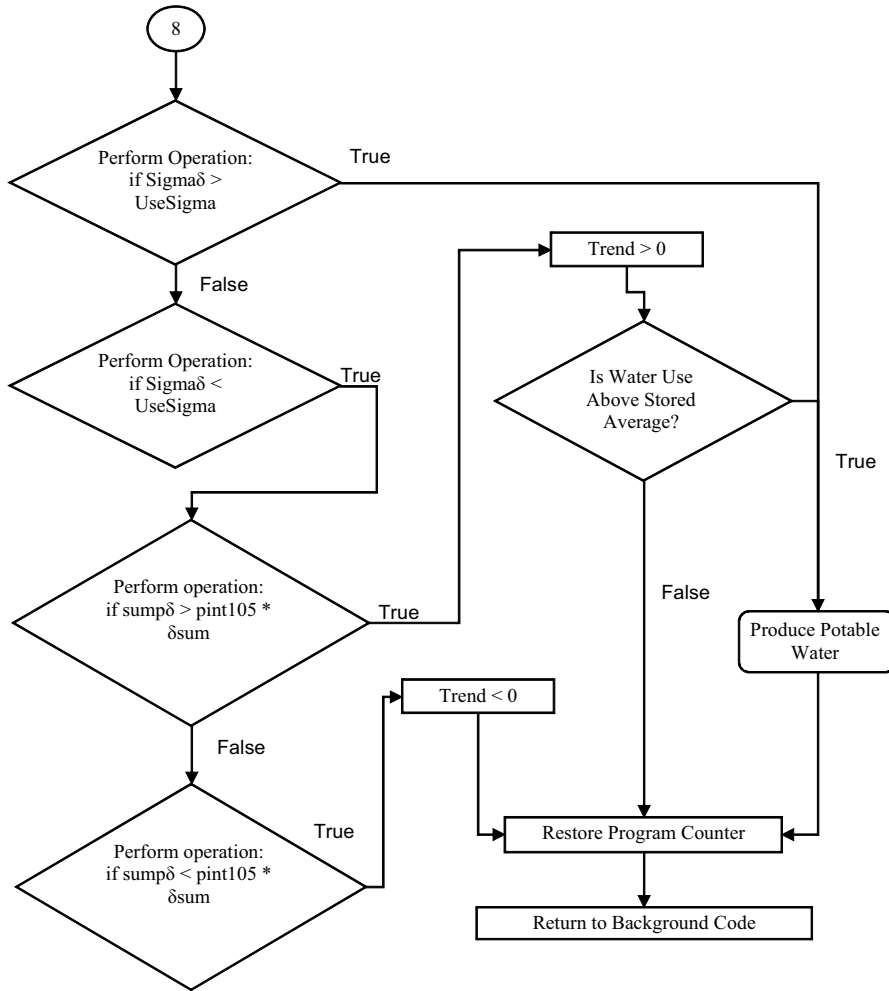


Figure D.6. Block Diagram for ISR 4, Section 5



# Appendix D

## Pilot Testing of a Small-Scale Integrated Wind-Water System

by Ryan Marshall, Ken Rainwater, Lianfa Song, and Vikas Doon

### Table of Contents

page D-

1. Problem Statement.....	1
1.1 Background.....	1
1.2 Objectives.....	2
2. Methods and Procedures.....	2
2.1 Wind Turbine System Description.....	3
2.2 RO System Description.....	3
2.2.2 RO Pump.....	3
2.2.3 RO Membranes.....	3
2.2.4 Disinfection.....	4
3. Results.....	4
4. Conclusions and Recommendations.....	5

### List of Figures

page D-

Figure 1. Photographs of 5 kW Wind Turbine, RO unit, and Controller.....	8
Figure 2. Wind-Water System Diagram.....	8
Figure 3. 5 kW Turbine System and Integrated RO.....	9
Figure 4. Integrated Wind-Water Test Facility.....	9
Figure 5: RO Unit Flow Schematic.....	10
Figure 6: Wind Speed, March 30 <sup>th</sup> - April 5 <sup>th</sup> .....	10
Figure 7. RO Power, March 30 <sup>th</sup> - April 5 <sup>th</sup> .....	11
Figure 8. Wind Power, March 30 <sup>th</sup> - April 5 <sup>th</sup> .....	11
Figure 9. Feed/Concentrate Pressure, March 30 <sup>th</sup> - April 5 <sup>th</sup> .....	12
Figure 10. Feed TDS, March 30 <sup>th</sup> - April 5 <sup>th</sup> .....	12
Figure 11. Permeate TDS, March 30 <sup>th</sup> - April 5 <sup>th</sup> .....	13
Figure 12. Permeate Produced, March 30 <sup>th</sup> - April 5 <sup>th</sup> .....	13
Figure 13. Kilowatt Hours Used By RO, March 30 <sup>th</sup> - April 5 <sup>th</sup> .....	14
Figure 14: Kilowatt Hours Generated/Delivered to Utility, March 30 <sup>th</sup> - April 5 <sup>th</sup> .....	14
Figure 15. Wind Speed, April 6 <sup>th</sup> - 12 <sup>th</sup> .....	15
Figure 16. RO Power, April 6 <sup>th</sup> - 12 <sup>th</sup> .....	15
Figure 17. Wind Power, April 6 <sup>th</sup> - 12 <sup>th</sup> .....	16
Figure 18. Feed/Concentrate Pressure, April 6 <sup>th</sup> - 12 <sup>th</sup> .....	16
Figure 19. Feed TDS, April 6 <sup>th</sup> - 12 <sup>th</sup> .....	17
Figure 20. Permeate TDS, April 6 <sup>th</sup> - 12 <sup>th</sup> .....	17
Figure 21. Permeate Produced, April 6 <sup>th</sup> - 12 <sup>th</sup> .....	18

Figure 22. Kilowatt Hours Used By RO, April 6 <sup>th</sup> - 12 <sup>th</sup> .....	18
Figure 23. Kilowatt Hours Generated/Delivered To Utility, April 6 <sup>th</sup> - 12 <sup>th</sup> .....	19
Figure 24. Wind Speed, April 13 <sup>th</sup> - 19 <sup>th</sup> .....	19
Figure 25. RO Power, April 13 <sup>th</sup> - 19 <sup>th</sup> .....	20
Figure 26. Wind Power, April 13 <sup>th</sup> - 19 <sup>th</sup> .....	20
Figure 27. Feed/Concentrate Pressure, April 13 <sup>th</sup> - 19 <sup>th</sup> .....	21
Figure 28. Feed TDS, April 13 <sup>th</sup> - 19 <sup>th</sup> .....	21
Figure 29. Permeate TDS, April 13 <sup>th</sup> - 19 <sup>th</sup> .....	22
Figure 30. Permeate Produced, April 13 <sup>th</sup> - 19 <sup>th</sup> .....	22
Figure 31. Kilowatt Hours Used By RO, April 13 <sup>th</sup> - 19 <sup>th</sup> .....	23
Figure 32. Kilowatt Hours Generated/Delivered To Utility, April 13 <sup>th</sup> - 19 <sup>th</sup> .....	23
Figure 33. Wind Speed, April 20 <sup>th</sup> - 25 <sup>th</sup> .....	24
Figure 34. RO Power, April 20 <sup>th</sup> - 25 <sup>th</sup> .....	24
Figure 35. Wind Power, April 20 <sup>th</sup> - 25 <sup>th</sup> .....	25
Figure 36. Feed/Concentrate Pressure, April 20 <sup>th</sup> - 25 <sup>th</sup> .....	25
Figure 37. Feed TDS, April 20 <sup>th</sup> - 25 <sup>th</sup> .....	26
Figure 38. Permeate TDS, April 20 <sup>th</sup> - 25 <sup>th</sup> .....	26
Figure 39. Permeate Produced, April 20 <sup>th</sup> - 25 <sup>th</sup> .....	27
Figure 40. Kilowatt Hours Generated/Delivered, April 20 <sup>th</sup> - 25 <sup>th</sup> .....	27
Figure 41. Kilowatt Hours Used By RO, April 20 <sup>th</sup> - 25 <sup>th</sup> .....	28
Figure 42. Wind Speed, May 13 <sup>th</sup> - 17 <sup>th</sup> .....	28
Figure 43. RO Power, May 13 <sup>th</sup> - 17 <sup>th</sup> .....	29
Figure 44. Wind Power, May 13 <sup>th</sup> - 17 <sup>th</sup> .....	29
Figure 45. Feed/Concentrate Pressure, May 13 <sup>th</sup> - 17 <sup>th</sup> .....	30
Figure 46. Feed TDS, May 13 <sup>th</sup> - 17 <sup>th</sup> .....	30
Figure 47. Permeate TDS, May 13 <sup>th</sup> - 17 <sup>th</sup> .....	31
Figure 48. Permeate Produced, May 13 <sup>th</sup> - 17 <sup>th</sup> .....	31
Figure 49. Kilowatt Hours Generated/Delivered to Utility, May 13 <sup>th</sup> - 17 <sup>th</sup> .....	32
Figure 50. Kilowatt Hours Used By RO, May 13 <sup>th</sup> - 17 <sup>th</sup> .....	32
Figure 51. Wind Speed, May 21 <sup>st</sup> - 24 <sup>th</sup> .....	33
Figure 52. RO Power, May 21 <sup>st</sup> - 24 <sup>th</sup> .....	33
Figure 53. Wind Power, May 21 <sup>st</sup> - 24 <sup>th</sup> .....	34
Figure 54. Feed/Concentrate Pressure, May 21 <sup>st</sup> - 24 <sup>th</sup> .....	34
Figure 55. Feed TDS, May 21 <sup>st</sup> - 24 <sup>th</sup> .....	35
Figure 56. Permeate TDS, May 21 <sup>st</sup> - 24 <sup>th</sup> .....	35
Figure 57. Permeate Produced, May 21 <sup>st</sup> - 24 <sup>th</sup> .....	36
Figure 58. Kilowatt Hours Generated/Delivered To Utility, May 21 <sup>st</sup> - 24 <sup>th</sup> .....	36
Figure 59. Kilowatt Hours Used By RO, May 21 <sup>st</sup> - 24 <sup>th</sup> .....	37
Figure 60. Wind Speed, May 21 <sup>st</sup> - 24 <sup>th</sup> .....	37
Figure 61. RO Power, May 25 <sup>th</sup> - 31 <sup>st</sup> .....	38
Figure 62. Wind Power, May 25 <sup>th</sup> - 31 <sup>st</sup> .....	38
Figure 63. Feed/Concentrate Pressure, May 25 <sup>th</sup> - 31 <sup>st</sup> .....	39
Figure 64. Permeate TDS, May 25 <sup>th</sup> - 31 <sup>st</sup> .....	39
Figure 65. Permeate Produced, May 25 <sup>th</sup> - 31 <sup>st</sup> .....	40
Figure 66. Kilowatt Hours Generated/Delivered To Utility, May 25 <sup>th</sup> - 31 <sup>st</sup> .....	40
Figure 67. Kilowatt Hours Used By RO, May 25 <sup>th</sup> - 31 <sup>st</sup> .....	41



Figure 68. Wind Speed, June 1 <sup>st</sup> - 7 <sup>th</sup> .....	41
Figure 69. RO Power, June 1 <sup>st</sup> - 7 <sup>th</sup> .....	42
Figure 70. Wind Power, June 1 <sup>st</sup> - 7 <sup>th</sup> .....	42
Figure 71. Feed/Concentrate Pressure, June 1 <sup>st</sup> - 7 <sup>th</sup> .....	43
Figure 72. Feed TDS, June 1 <sup>st</sup> - 7 <sup>th</sup> .....	43
Figure 73. Permeate TDS, June 1 <sup>st</sup> - 7 <sup>th</sup> .....	44
Figure 74. Permeate Produced, June 1 <sup>st</sup> - 7 <sup>th</sup> .....	44
Figure 75. Kilowatt Hours Generated/Delivered To Utility, June 1 <sup>st</sup> - 7 <sup>th</sup> .....	45
Figure 76. Kilowatt Hours Used By RO, June 1 <sup>st</sup> - 7 <sup>th</sup> .....	45
Figure 77. Wind Speed, June 8 <sup>th</sup> - 14 <sup>th</sup> .....	46
Figure 78. RO Power, June 8 <sup>th</sup> - 14 <sup>th</sup> .....	46
Figure 79. Wind Power, June 8 <sup>th</sup> - 14 <sup>th</sup> .....	47
Figure 80. Feed/Concentrate Pressure, June 8 <sup>th</sup> - 14 <sup>th</sup> .....	47
Figure 81. Feed TDS, June 8 <sup>th</sup> - 14 <sup>th</sup> .....	48
Figure 82. Permeate TDS, June 8 <sup>th</sup> - 14 <sup>th</sup> .....	48
Figure 83. Permeate Produced, June 8 <sup>th</sup> - 14 <sup>th</sup> .....	49
Figure 84. Kilowatt Hours Generated/Delivered to Utility, June 8 <sup>th</sup> - 14 <sup>th</sup> .....	49
Figure 85. Kilowatt Hours Used By RO, June 8 <sup>th</sup> - 14 <sup>th</sup> .....	50
Figure 86. Wind Speed, June 15 <sup>th</sup> - 21 <sup>st</sup> .....	50
Figure 87. RO Power, June 15 <sup>th</sup> - 21 <sup>st</sup> .....	51
Figure 88. Wind Power, June 15 <sup>th</sup> - 21 <sup>st</sup> .....	51
Figure 89. Feed/Concentrate Pressure, June 15 <sup>th</sup> - 21 <sup>st</sup> .....	52
Figure 90. Feeds TDS, June 15 <sup>th</sup> - 21 <sup>st</sup> .....	52
Figure 91. Permeate TDS, June 15 <sup>th</sup> - 21 <sup>st</sup> .....	53
Figure 92. Permeate Produced, June 15 <sup>th</sup> - 21 <sup>st</sup> .....	53
Figure 93. Kilowatt Hours Generated/Delivered to Utility, June 15 <sup>th</sup> - 21 <sup>st</sup> .....	54
Figure 94. Kilowatt Hours Used By RO, June 15 <sup>th</sup> - 21 <sup>st</sup> .....	54

## List of Tables

page D-

Table 1. Water Quality of Raw and Permeate Water.....	7
Table 2. Three-Month Average of Collected Data .....	7
Table 3. Cumulative Three-Month Totals .....	7



# 1. Problem Statement

The purpose of this field experiment was to determine if potable water can be supplied from deep, high salinity aquifers using reverse osmosis (RO) treatment powered by wind energy. Due to declining water levels in the southern portion of the Ogallala aquifer, many municipalities will face significant water shortages by the middle of this century. Groundwater is available in aquifers located below the Ogallala, however, the brackish nature of water in these deeper aquifers are unfit for human consumption without further, more costly treatment.

RO is a common technology used worldwide for desalination. Brackish water could be pumped from deeper aquifers, treated by RO, and sold to customers. RO treatment could, also, be employed to ensure water meets EPA standards in other areas, as well. For instance, along with high salinity (TDS), some cities on the southern High Plains may struggle with elevated arsenic and fluoride levels. RO technology would lower these to acceptable limits. However, RO is an energy-intensive operation. Grid supplied electricity makes RO treatment cost prohibitive, especially in smaller cities where revenue streams are much more limited. The key to this challenge may be in combining RO with a renewable source of energy, like wind. Fortunately, many cities on the High Plains are located in regions with chronic high winds. Because wind power can be sold to local utilities, an opportunity exists to harness the wind power to offset the high energy requirements of RO treatment.

## 1.1 Background

Table 1 shown previously in the main report shows a list of 40 cities in the Southern High Plains of Texas and New Mexico that depend on Ogallala or other groundwater for their primary municipal water supply. The data were collected from the public records of the regional offices of the Texas Commission on Environmental Quality (TCEQ) and the website of the New Mexico Environmental Department. As of 2005, when the data were collected, each of these cities only provided disinfection prior to distribution of the groundwater to their customers. Italicized bold numbers in the cells show levels that are above primary maximum contaminant levels, shown in the column heading cells, set by the Environmental Protection Agency. Bold text in the cells denotes concentrations that are above secondary recommended levels. Blank cells indicate that the parameter value was not available in the agency files. Secondary TDS levels were exceeded by 33 of the city supplies, 29 exceeded either the primary or secondary fluoride levels, and 24 exceeded the recent primary standard for As. Sulfate (14), chloride (10), iron (2), nitrate (10), and gross  $\alpha$  (8) exceedances often accompanied high TDS levels. This table shows that 39 rural municipalities could benefit from advanced treatment of their water supplies. It should be noted that TDS values above 2000 mg/L, such as those seen at Tulia and Lefors, were most likely from the Santa Rosa, not the Ogallala.

A map of the Ogallala aquifer in Texas provided by the TTU Center for Geospatial Technology is shown in Appendix A. The map illustrates estimated usable life on a regional basis. Dark red areas are regions with less than 15 years of aquifer usage. The

areas denoted with the cross-hatchings are places where the 2004 saturated thickness was too low to make reasonable predictions. These areas may have a lower lifetime than the dark red areas. Areas in green and blue are regions where aquifer levels in 2004 were either the same as 1990 (green) or above 1990 levels (blue). Tan regions indicate an estimated lifetime of greater than 100 years. While 95% of the aquifer usage is due to irrigation of farmland, as levels in the aquifer continually decline, municipalities will have to look elsewhere for public water supplies. The water quality data indicated that the Ogallala water used by 39 cities already has high enough TDS and other constituents to justify RO treatment. Local Santa Rosa groundwater, if producible, would also require desalination prior to potable use.

## **1.2 Objectives**

This appendix describes the assembly and three-month operational study of an integrated wind powered RO system for brackish water treatment. The specific objects included:

1. Set up wind-powered RO system,
2. Observe operation for as long as project duration allowed, and
3. Analyze system performance.

## **2. Methods and Procedures**

A small-scale test facility was constructed to house the integrated system. The system included a RO unit with a capacity of 1500 gpd and an Enertech 4000 5-kW wind turbine to provide power needed for the system. The RO system was provided by Reclamation. Figure 1 shows a photograph of the test facility. A power distribution controller was developed in conjunction with General Electric (GE). The power controller was designed to manage energy flow between the wind turbine, the RO unit and the electrical grid. Data were collected for a three-month period: April, May, and June of 2008. The software used for data collection was Labview™. Labview™ was programmed to average the data collected over ten-minute intervals. The data collected included power requirements, feed and concentrate pressure, and TDS in the feed, permeate, and concentrate. Data were also collected showing the use and generation of energy at the site. The raw brackish water was taken from a WRC monitoring well in central Gaines County.

Figure 2 shows a diagram for the wind/water system. Power can either be provided directly from the wind turbine or from the electric grid. The controller selects where power comes from based on wind forecasts, current price of electricity, current water demand, and power needed to meet the current water demand.

## **2.1 Wind Turbine System Description**

The wind turbine used in this study was an Enertech 4000 5-kW horizontal axis, fixed pitch wind turbine. The unit had a cut-in wind speed of 8 mph, a cut-out speed of 45 mph, and a survival speed of 120 mph. The generator was a 4-pole squirrel cage induction generator (230 VAC, 60 Hz).

## **2.2 RO System Description**

### **2.2.1 Pre-filters**

The RO system used in the study included three micro-filters for raw water pretreatment. The first was a 50 micron cartridge filter placed upstream of the RO pump. This filter removed suspended solids, primarily sand, due to the pump's low tolerance for suspended solids in the feed water. The second and third filters were downstream of the pump and directly upstream of the RO membranes. The second filter was 10 microns, while the third was 5 microns. These filters further removed suspended particles and help extend the life of the RO membranes.

### **2.2.2 RO Pump**

The pump used in this application was a Dankoff Solar series 2600 slow pump. The pump was originally used in a photovoltaic application that ran at 48 V DC. Since grid power was used in this study, a converter was used to transform the 110 V AC to 48 V DC. The pump had a capacity of 2.2 gpm and provided a pressure of 250 psi. The feed water was first drawn through the suction line and the 50 micron pre-filter. After filtration the feed water passes through the pump, the flow rate was measured using a 2500 series continuous output Roto-Flow Sensor flow meter. The conductivity of the feed water was measured using Oakton Conductivity/TDS transmitters with a 4-20 milliamp output. The pressure of the feed water was monitored using a series PG1000DR Falcon Retransmitting Digital Pressure Gage. The range for this series was 0-200 psig with an output of 4-20 milliamps.

### **2.2.3 RO Membranes**

GE Osmonics Duraslick 2540 F membranes were used. Duraslick 2540 are thin film membranes specifically engineered for fouling prone brackish water applications. The membranes have high salt rejection (98% Avg.), require less cleaning, and have lower energy requirements than typical membranes. The membrane had a capacity of 675 gpd. For this study, four Duraslick membranes were arranged in series. The first element was directly downstream of the 5 micron pre-filter. The concentrate from each upstream membrane became the feed water for the next, downstream, membrane. Permeate was collected from each membrane and combined. The pressure and conductivity were monitored using Series PG1000DR Falcon Digital Pressure Gages and Oakton Conductivity/TDS Transmitters. Permeate was pumped through an ultraviolet water

purifier and in to a storage tank. The concentrate was pumped through a throttle valve, where an Oakton Conductivity/TDS probe measured conductivity. The concentrate pressure was monitored using a 0-300 psig Falcon Digital Pressure Gage. The concentrate was then pumped to a separate storage tank.

## **2.2.4 Disinfection**

The last stage of RO filtration is pathogen inactivation by ultraviolet light. The ultraviolet water purifier was an Atlantic Ultraviolet Minipure model MIN-1.5. This model provided a level of 2,537 Angstrom units applied at a dosage of 16,000 micro-watt seconds per square centimeter at all points throughout the disinfection chamber. The ultraviolet tubes were quartz jacketed to ensure the proper operating temperature of 105°F.

## **2.2.5 Data Logger and Display Units**

All recorded data, such as pressure, flow rate, and conductivity, were recorded using MadgeTech 8 channel data loggers. The data were accessed using MadgeTech 2.0 software. The display panels located on the membrane control station were Red Lion 1/8 DIN Analog Input Panel Meters.

## **3. Results**

Table 1 shows the results of major ion water analyses conducted on both the influent raw water used in the project and effluent permeate collected from the RO unit. The triplicate samples were collected at the beginning of the test operation of the RO system, prior to the connection to the wind turbine. These analyses were performed at a commercial laboratory, TraceAnalysis, Inc., in Lubbock. “Alk” represents alkalinity. The raw water had total TDS of approximately 2500 mg/L, with particularly high chloride, sulfate, and fluoride, all above secondary levels. The permeate had average TDS of about 54 mg/L, with concentrations of all components greatly reduced. It should be noted that the RO unit operation was set so that the flows recycled, such that the permeate and concentrate flows were mixed and then recycled through the treatment device. The lab results proved that the RO unit delivered excellent product water. The permeate flow rate was maintained at approximately 1 gpm, with approximately 1 gpm concentrate flow.

It should be noted that the TDS measurements made by the commercial laboratory were more precise than the estimates from the conductivity based TDS readings at the field site. A relatively coarse screw adjustment was all that was available to calibrate the meters against a standard. Both the feed and permeate TDS readings were subject to significant shifts over the three-month operational period. The data plots of these field TDS often deviate significantly from the lab values, with the feed TDS typically around 1600 mg/L at the site rather than the 2500 mg/L lab value. There is no chemical reason for losses of TDS due to the RO unit operation, so the field TDS values are recognized as inaccurate, but still useful when comparing feed to permeate.

The following graphs show weekly changes in wind speed, RO power, wind- power, feed and concentrate pressures, field feed and permeate TDS, cumulative permeate produced, cumulative energy produced by the wind turbine, cumulative energy used by the RO system, and cumulative energy sold back to the utility company. The complete 3-month data-set can be obtained from the WRC if needed. The off-on cycles for the wind turbine and RO unit are easily seen in the figures as times with no zero values of the abscissa. Table 2 shows the three-month averages for the raw data collected at the test facility.

The TDS figures show that the RO unit was always able to deliver permeate water at TDS levels well below the feed TDS. The initial permeate TDS typically spiked upward by about 10 to 20 percent for just one reading, then subsided back downward. This finding demonstrated that the Duraslick elements were well suited to the brackish feed water. In addition, the feed pressure never indicated fouling of the membranes, as there was no consistent upward trend in the pressure values. Table 3 shows the cumulative kilowatt hours generated by the wind turbine, the total kilowatt hours sold back to the utility, the cumulative amount of kilowatt hours consumed by the RO operation, and the total amount of permeate produces for the three-month period.

## **4. Conclusions and Recommendations**

Raw water supply quality data were collected from the TCEQ for 40 cities in the Southern High Plains in Texas that depend on groundwater for their primary municipal water supply. These cities currently only provide disinfection prior to distribution of the water to their customers. Secondary TDS levels were exceeded by 33 of the city supplies, 29 exceeded either the primary or secondary fluoride levels, and 24 exceeded the recent primary standard for As. Sulfate, chloride, iron, nitrate, and gross exceedances often accompanied high TDS levels. The water quality data indicated that the groundwater currently used by 39 cities already has high enough TDS and other constituents to justify RO treatment. Local Santa Rosa groundwater, if producible, would also require desalination prior to potable use.

The RO unit was capable of providing about 1 gpm of 50 mg/L permeate from a 2 gpm feed rate at about 2500 mg/L TDS. The RO unit fared well throughout the three-month testing period. One concern was that the system would gradually produce lower quality water due to intermittent use of the RO membranes. This concern was not observed, as no increase in raw water or concentrate pressure occurred throughout the three-month period. The wind generator produced much more energy than was required. The wind turbine generated 2,674 kWh, but the RO operation consumed only 110 kWh. However, this small-scale project was only intended to show the viability of the concept. More research is required with a large-scale wind-powered RO system at the municipal level.

A number of recommendations for future work can be identified. Based on the needs of the rural municipalities, it would valuable to demonstrate the removal of As by the RO membranes. Monitoring of As was not included in the scope and budget of this project. Another future related topic would be to test the behavior of the RO unit with higher TDS water with greater fouling potential. Finally, a larger-scale system should be developed

and demonstrated at an actual municipality. A large-scale demonstration is necessary to get realistic experience on capital and operation and maintenance costs, as well as operational logistics.



**Table 1: Water Quality of Raw and Permeate Water  
(all concentrations ins mg/L except pH)**

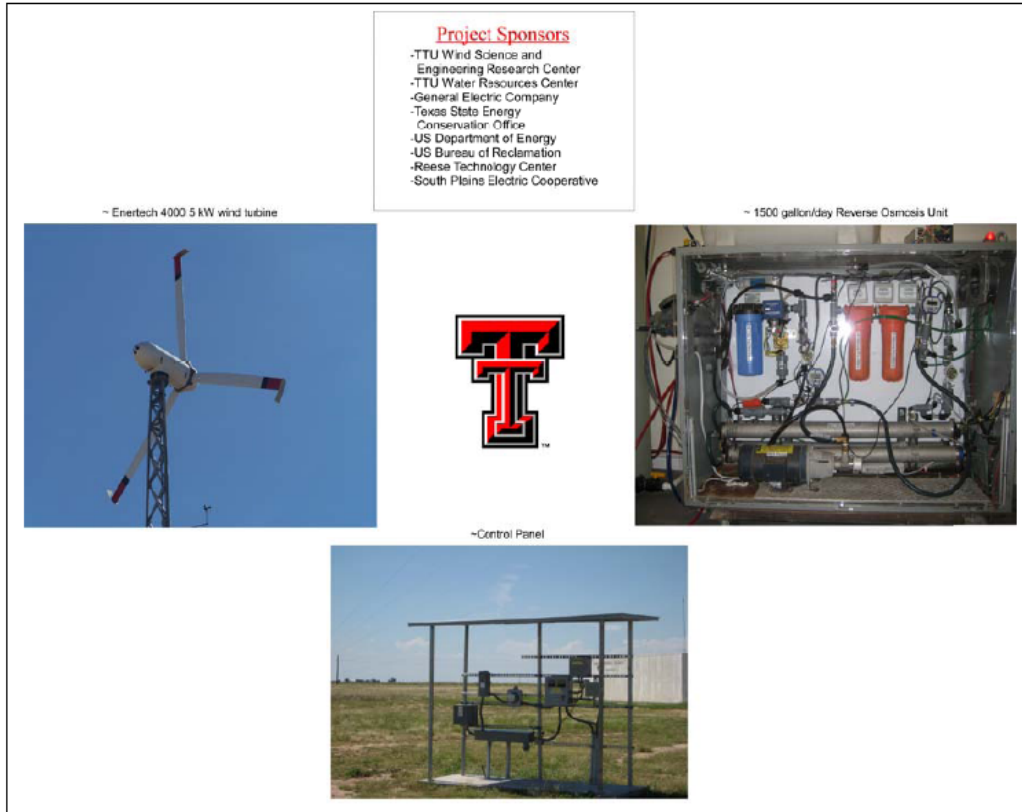
Sample	Alk	Ca	K	Mg	Na	Fe	Cl	F	SO <sub>4</sub>	Mn	NO <sub>3</sub>	pH	TDS
Raw 1	336	88	16.4	113	616	0.03	513	4.8	1080	0.06	15.8	8.0	2455
Raw 2	334	92	15	110	620	0.03	527	5.2	1073	0.05	15.2	8.0	2467
Raw 3	334	85	17.3	112	614	0.03	524	4.5	1069	0.05	14.9	8.0	2446
Raw Avg	335	88	16	112	617	0.03	521	4.8	1074	0.05	15.3	8.0	2456
Permeate 1	32	<0.50	0.71	<0.50	13.1	<0.010	4.5	<0.20	2.3	<0.025	0.56	8.0	53
Permeate 2	31	<0.50	0.74	<0.50	13.8	<0.010	4.6	<0.20	3.4	<0.025	0.55	8.0	54
Permeate 3	32	<0.50	0.77	<0.50	14.3	<0.010	4.6	<0.20	2.9	<0.025	0.53	8.0	55
Permeate Avg	32	<0.50	0.74	<0.50	13.7	<0.010	4.6	<0.20	2.9	<0.025	0.55	8.0	54

**Table 2: Three-Month Average of Collected Data**

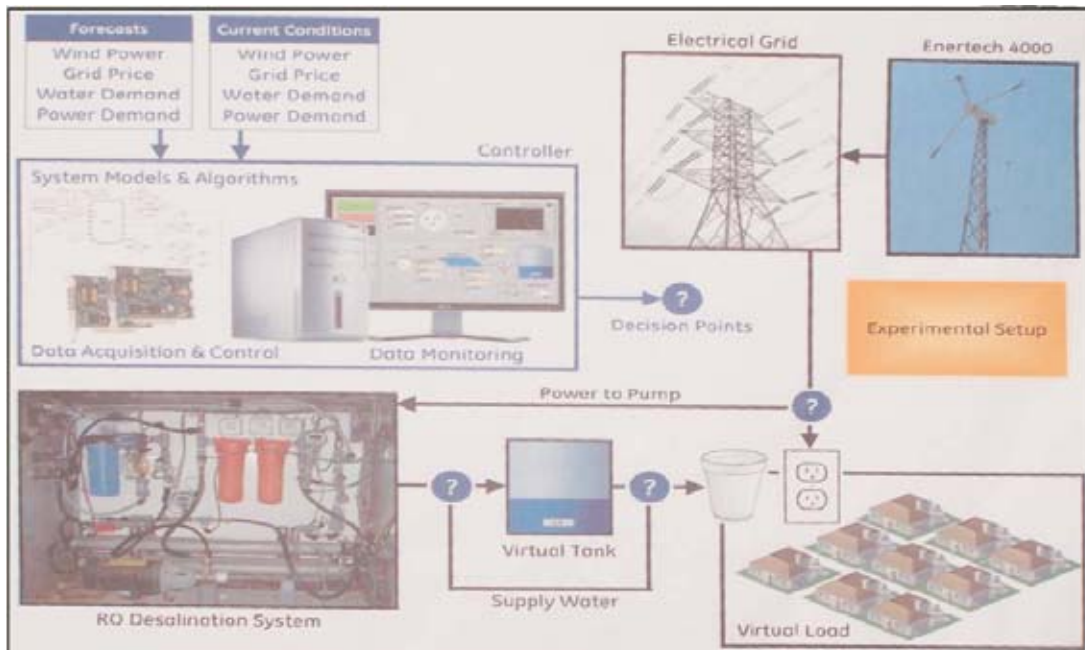
Parameter	Value
Wind Speed (mph)	16.73
Feed Pressure (psi)	186
Concentrate Pressure (psi)	175
Feed TDS (mg/L)	1540
Permeate TDS (mg/L)	45
RO Power (kW)	0.14
Wind Power (kW)	3.14

**Table 3: Cumulative Three-Month Totals**

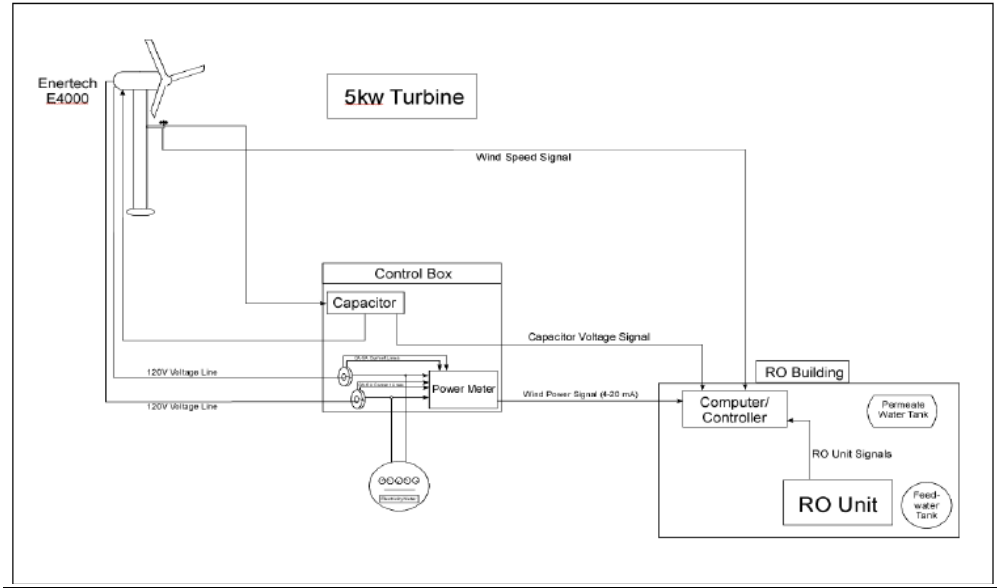
Time, weeks	Volume of Water, kgal	kWh from Turbine	kWh Used by RO	kWh Delivered To Utility
1	2.3	165	8	158
2	4.7	387	16	372
3	3.4	214	11	203
4	4.9	333	14	318
5	2.0	143	6	137
6	2.5	180	7	172
7	4.4	333	13	320
8	3.7	308	11	297
9	4.4	388	13	375
10	3.2	222	10	212
<b>Total</b>	<b>35.5</b>	<b>2674</b>	<b>110</b>	<b>2563</b>



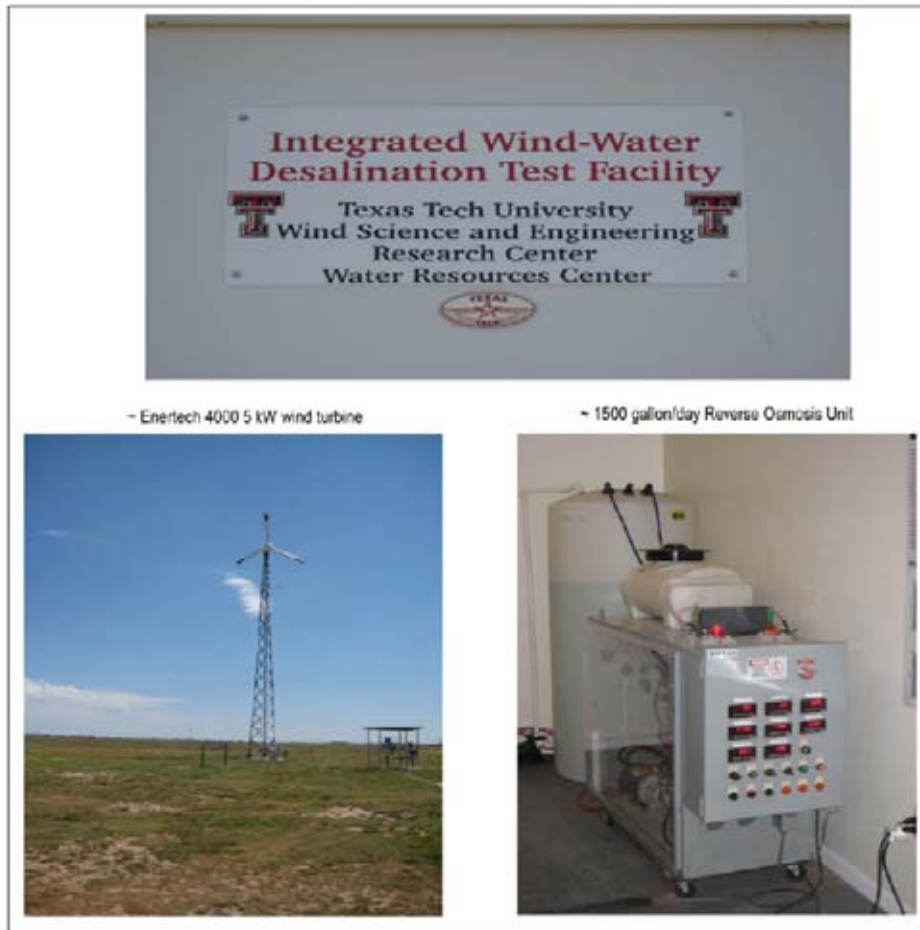
**Figure 1: Photographs of 5 kW Wind Turbine, RO unit, and Controller**



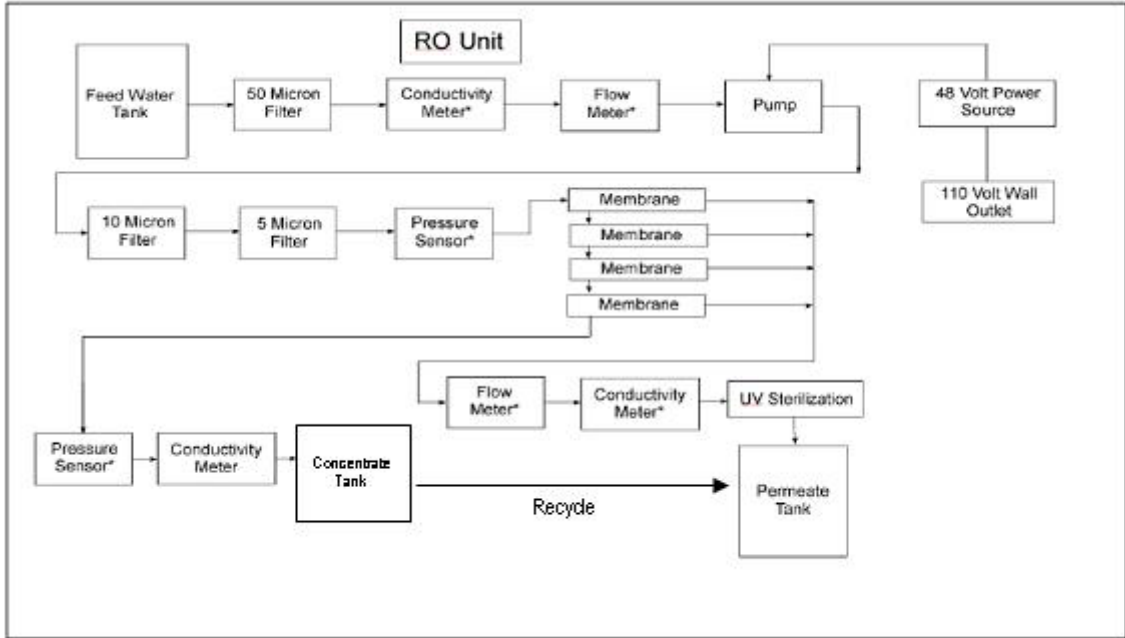
**Figure 2: Wind-Water System Diagram**



**Figure 3: 5 kW Turbine System and Integrated RO**

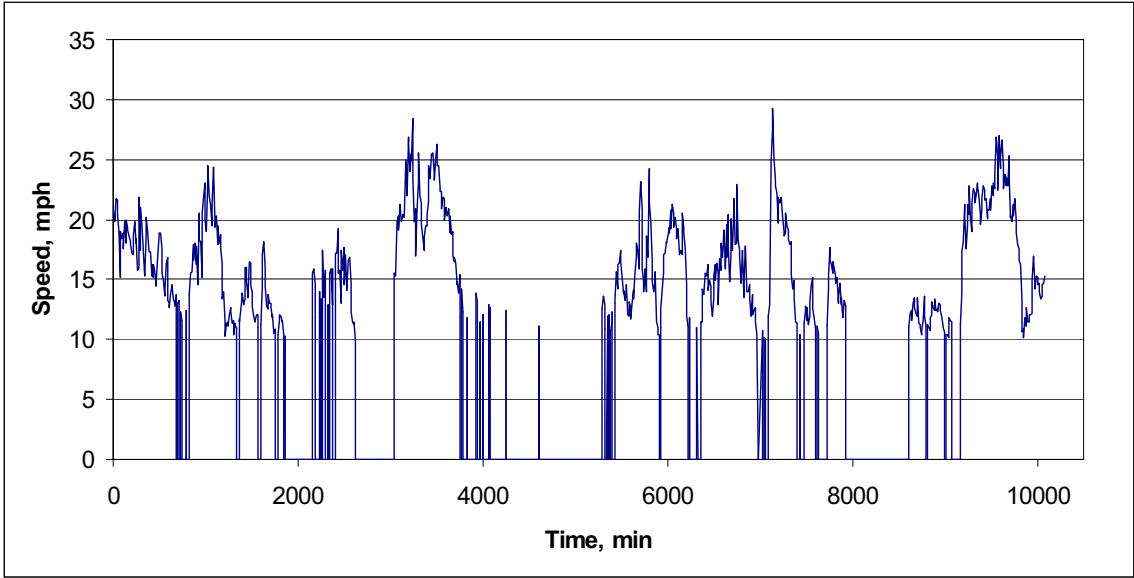


**Figure 4: Integrated Wind/Water Test Facility**

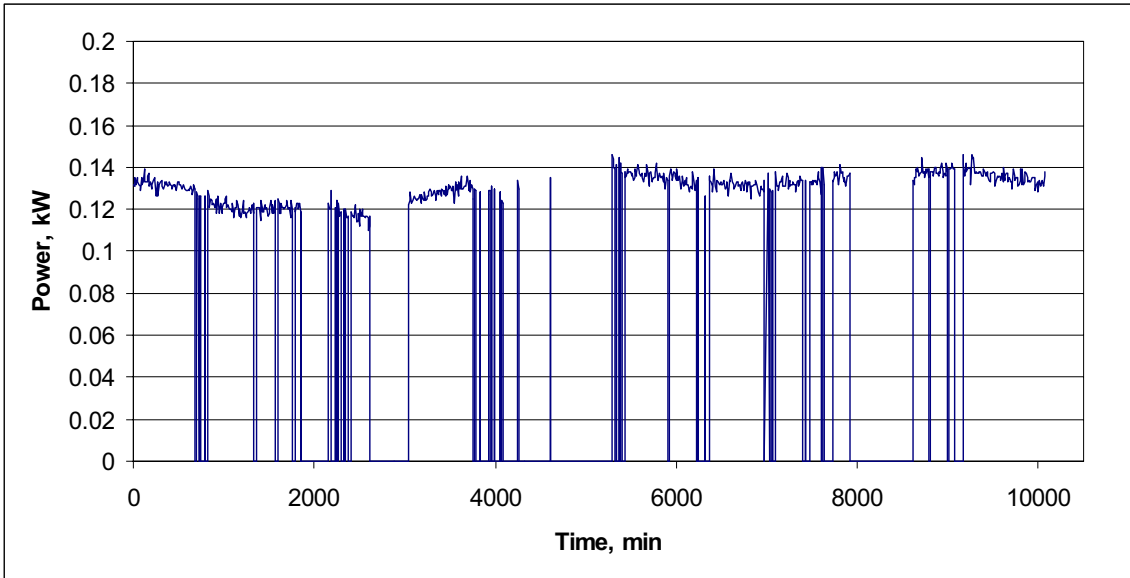


**Figure 5: RO Flow Schematic**

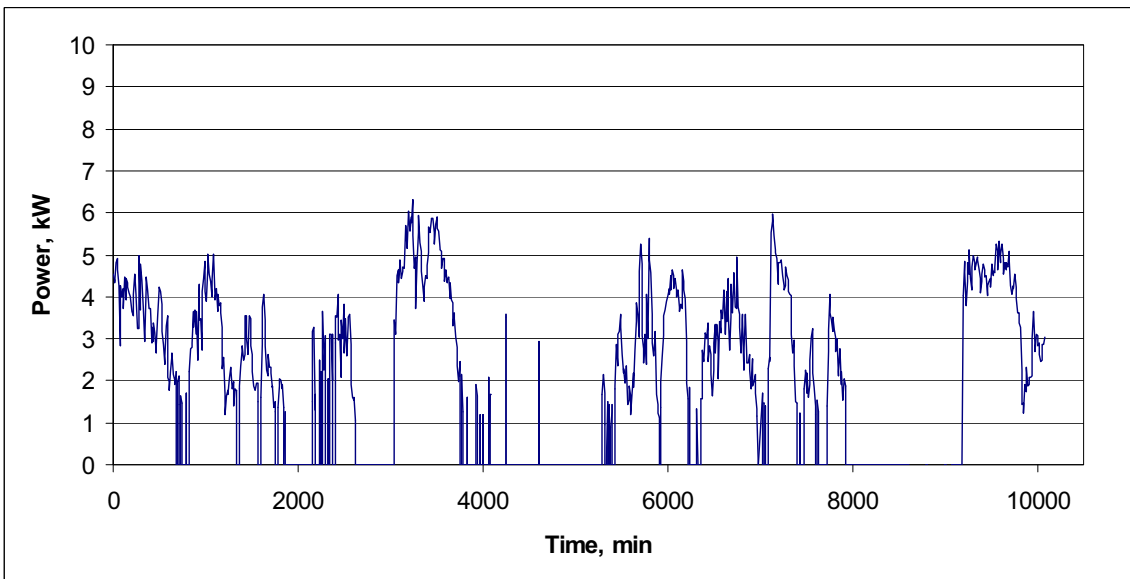
**Week #1 (March 30<sup>th</sup> – April 5<sup>th</sup>)**



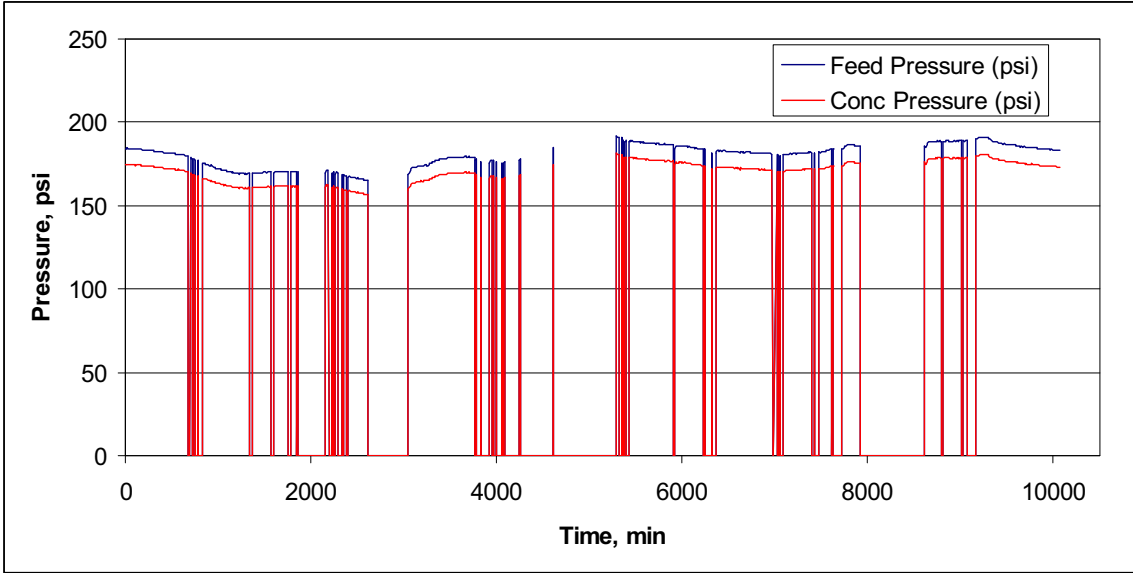
**Figure 6: Wind Speed, March 30<sup>th</sup> – April 5<sup>th</sup>**



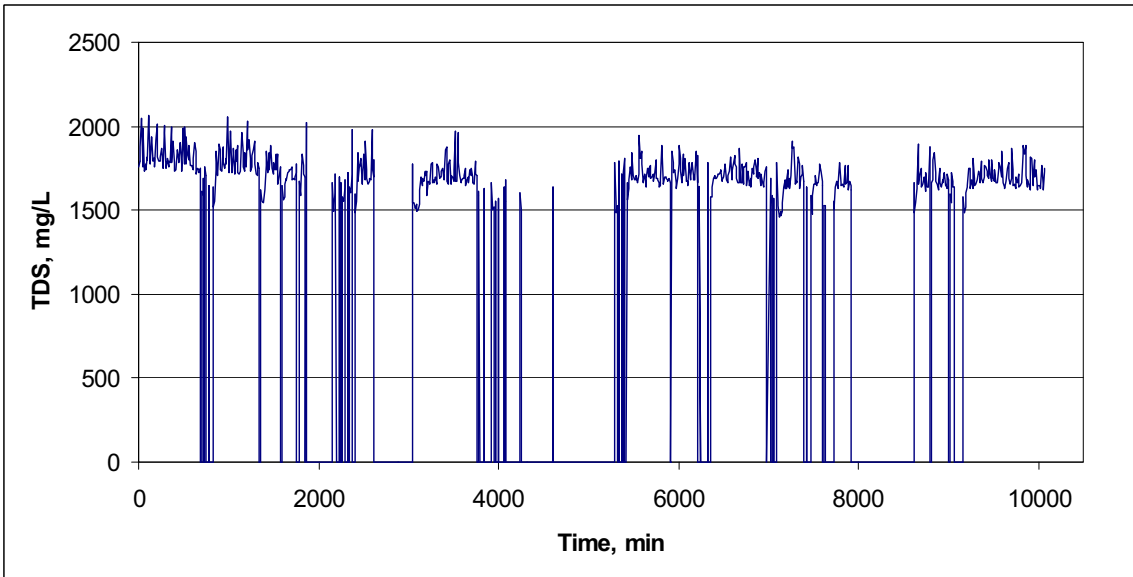
**Figure 7: RO Power, March 30<sup>th</sup> – April 5<sup>th</sup>**



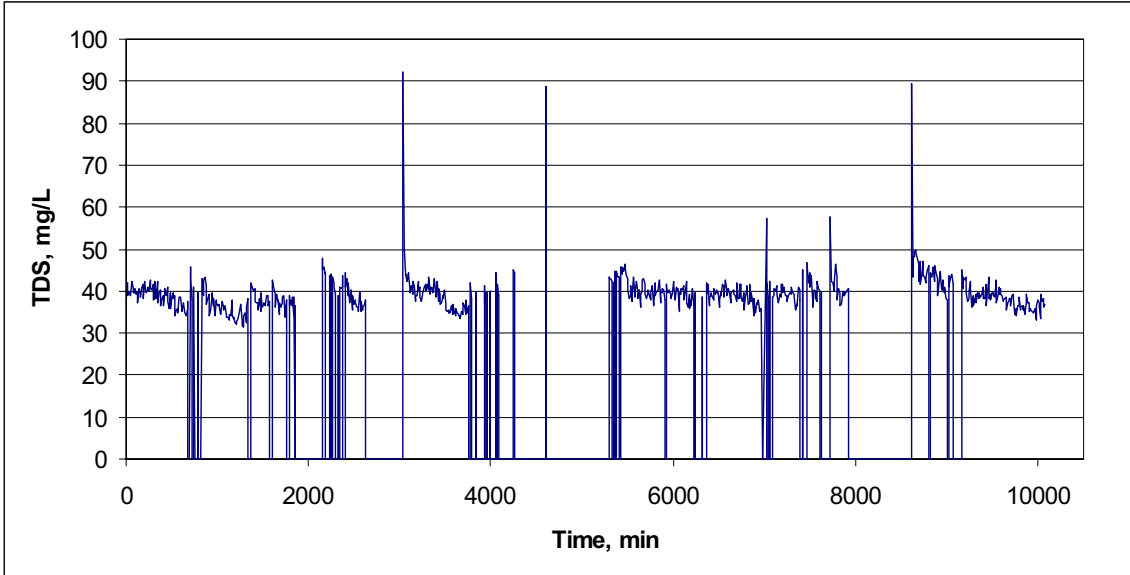
**Figure 8: Wind Power, March 30<sup>th</sup> – April 5<sup>th</sup>**



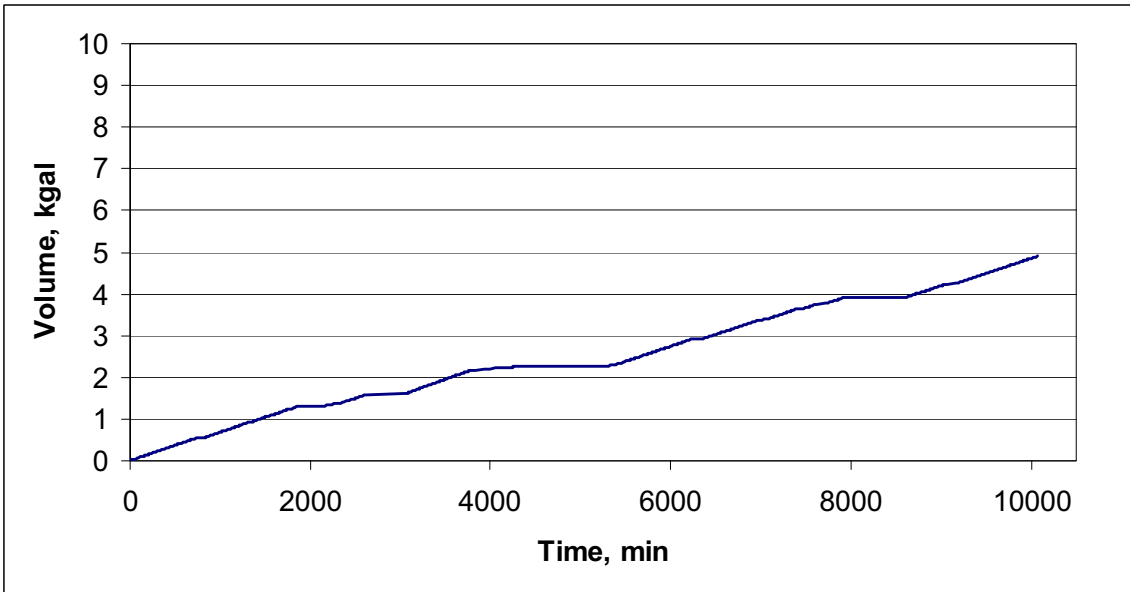
**Figure 9: Feed/Concentrate pressure, March 30<sup>th</sup> – April 5<sup>th</sup>**



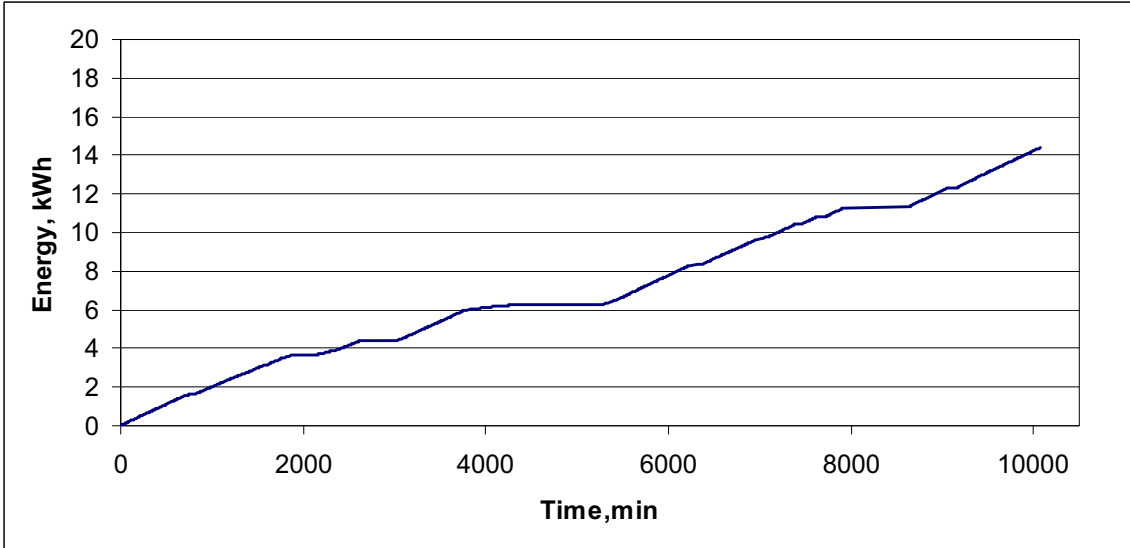
**Figure 10: Feed TDS, March 30<sup>th</sup> – April 5<sup>th</sup>**



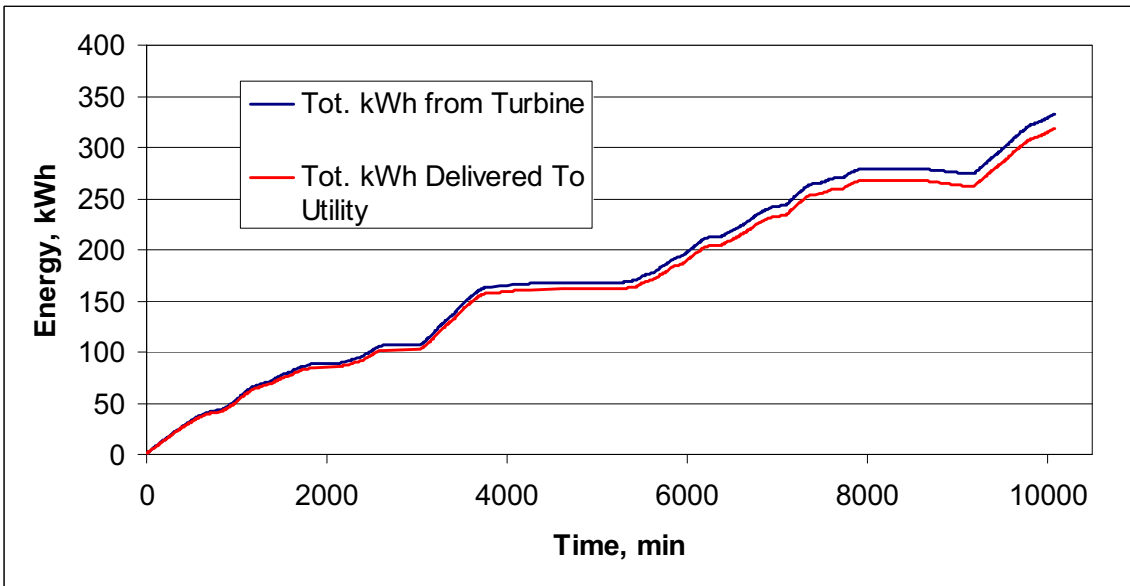
**Figure 11: Permeate TDS, March 30<sup>th</sup> – April 5<sup>th</sup>**



**Figure 12: Permeate produced, March 30<sup>th</sup> – April 5<sup>th</sup>**



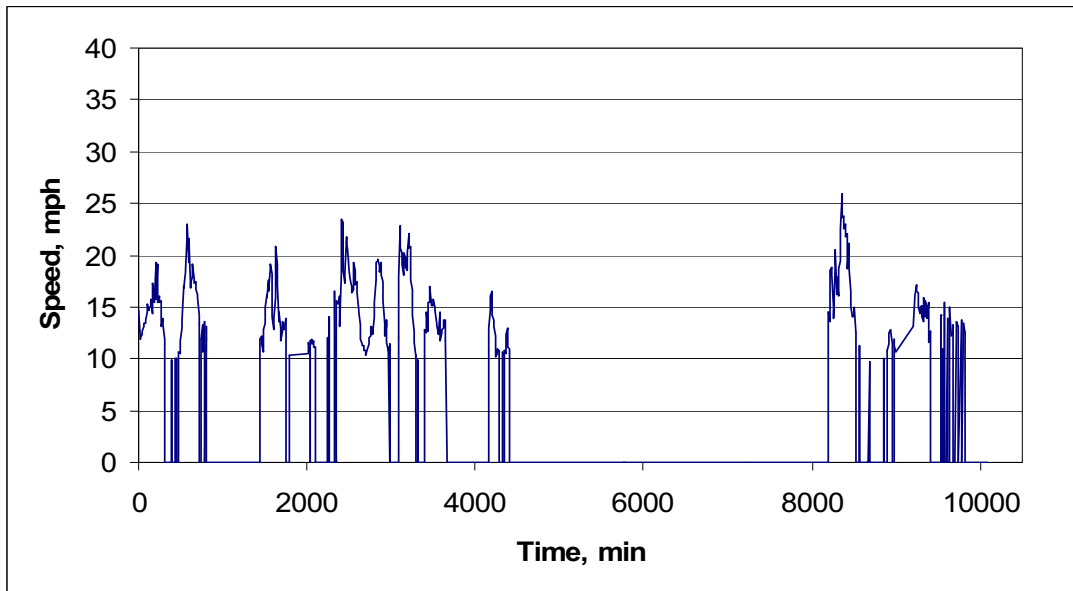
**Figure 13: Kilowatt hours used by RO, March 30<sup>th</sup> – April 5<sup>th</sup>**



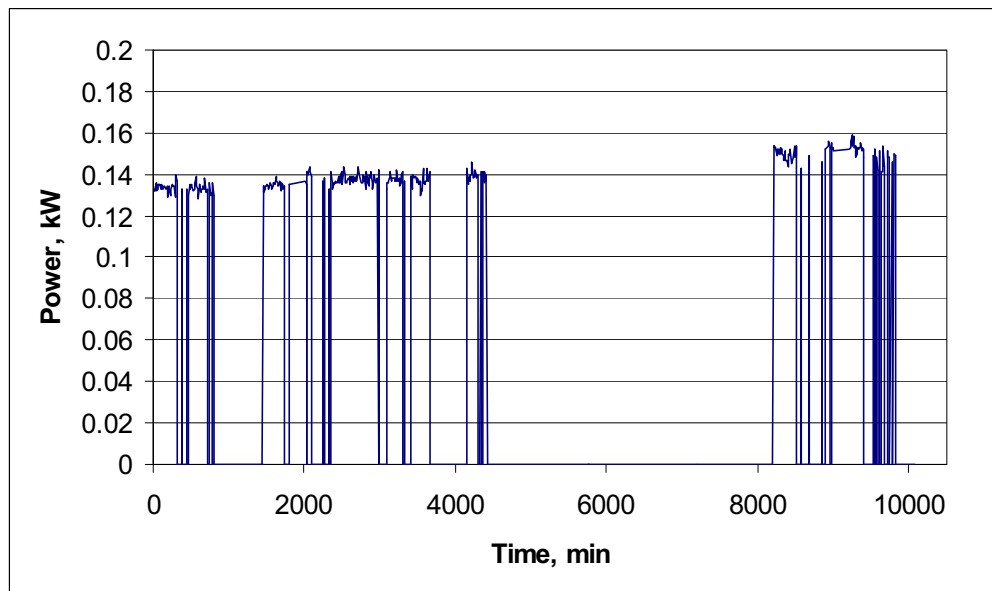
**Figure 14: Kilowatt hours generated/delivered to utility, March 30<sup>th</sup>-April 5<sup>th</sup>**



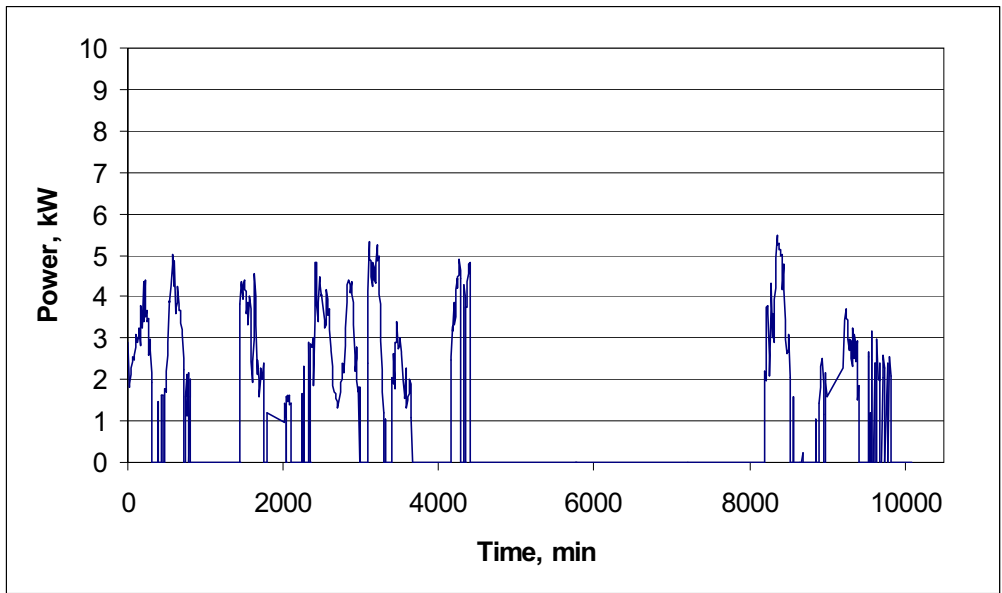
**Week #2 (April 6- 12<sup>th</sup>)**



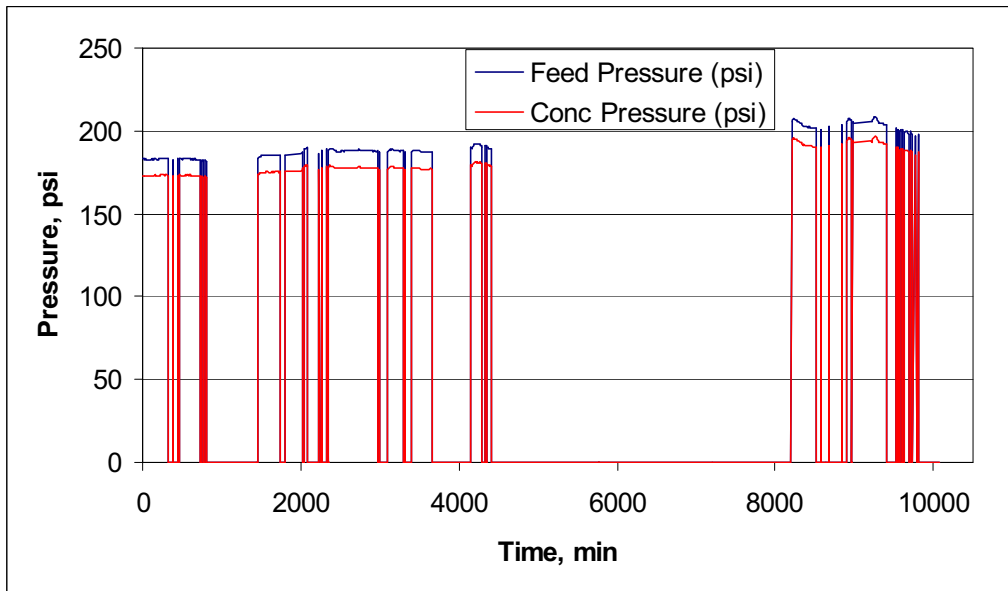
**Figure 15: Wind Speed, April 6-12<sup>th</sup>**



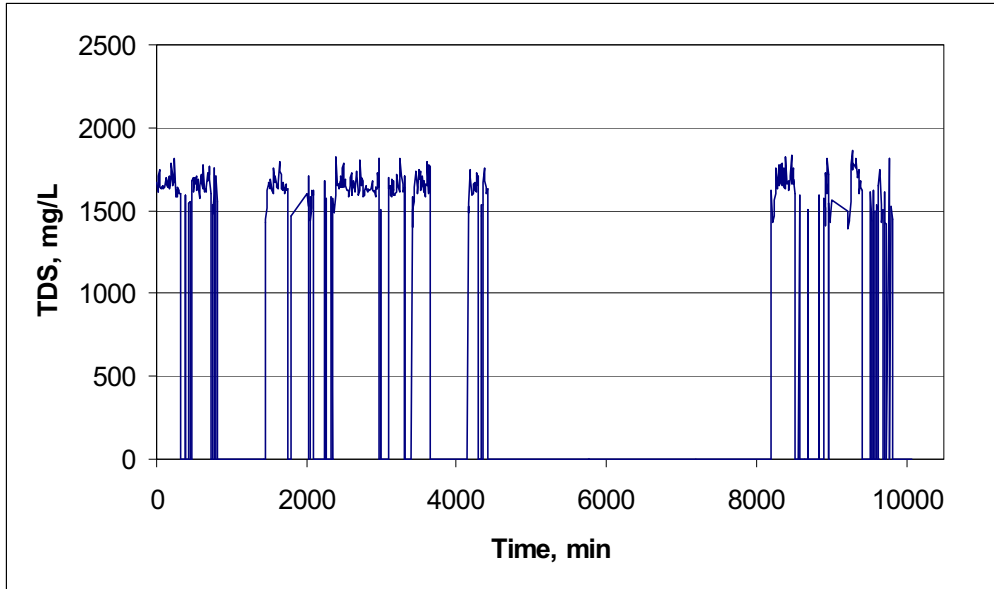
**Figure 16: RO Power, April 6-12<sup>th</sup>**



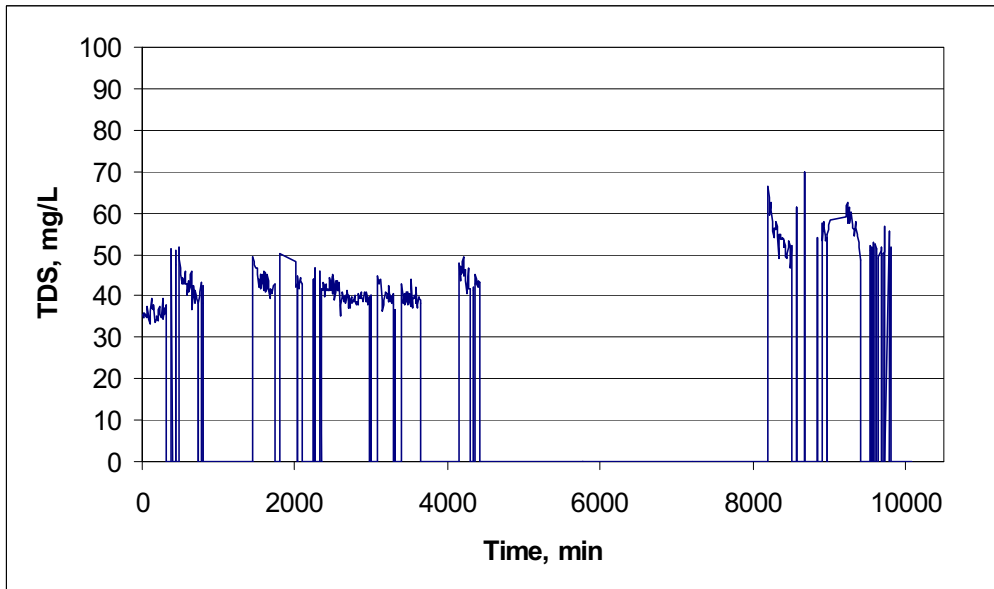
**Figure 17: Wind Power, April 6-12<sup>th</sup>**



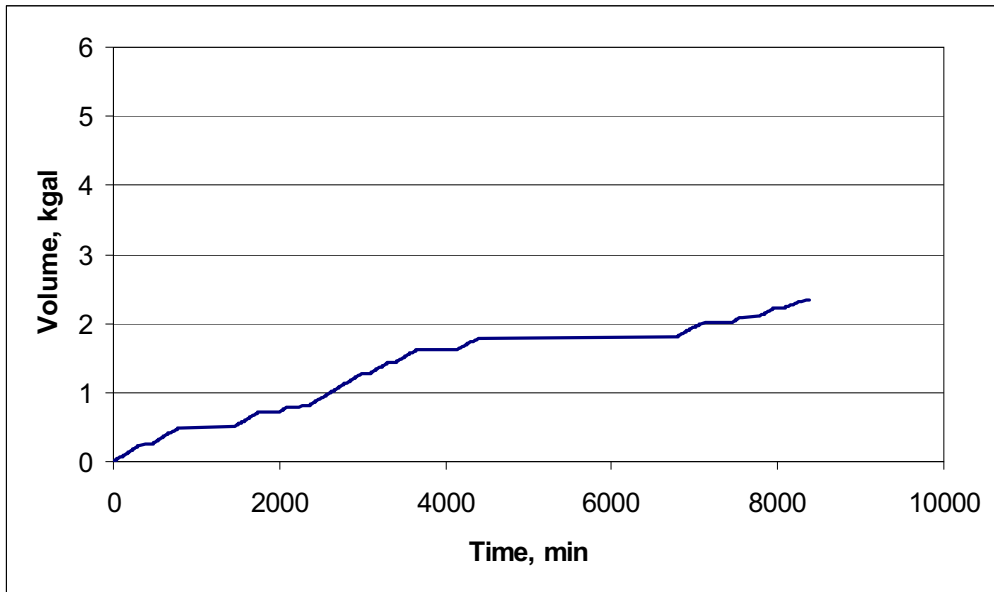
**Figure 18: Feed/Concentrate Pressure, April 6-12<sup>th</sup>**



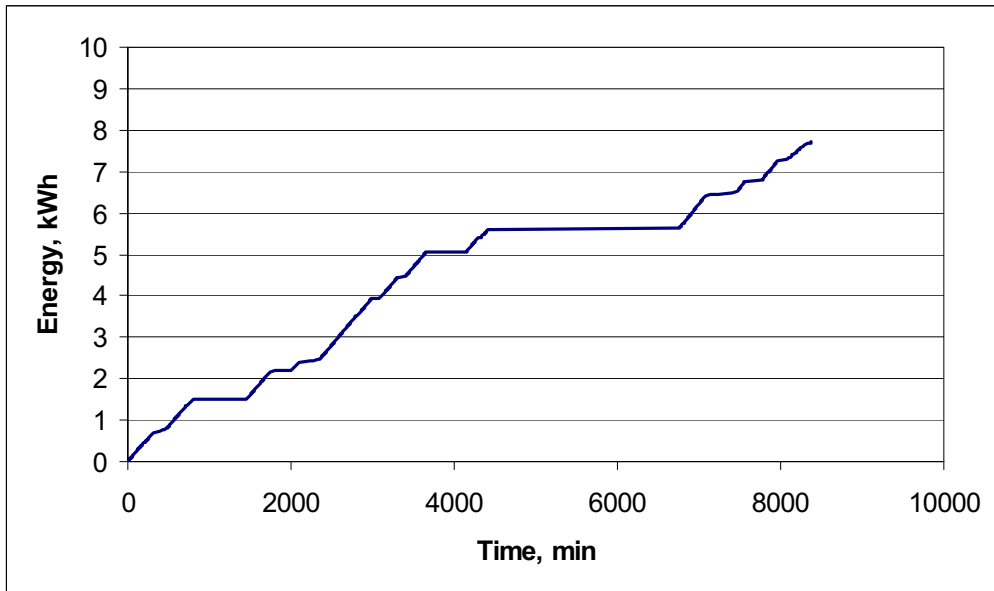
**Figure 19: Feed TDS, April 6-12<sup>th</sup>**



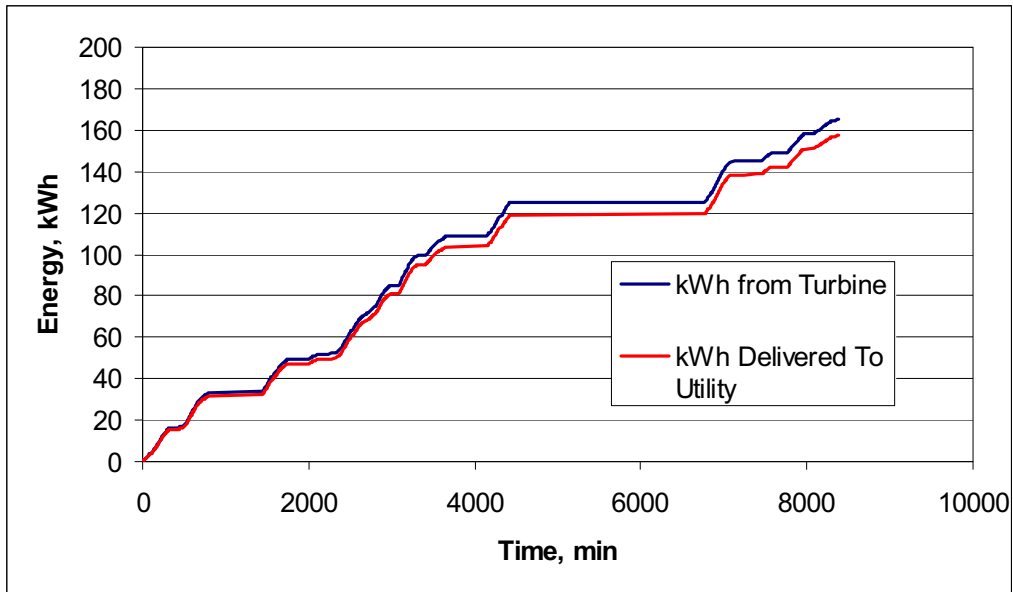
**Figure 20: Permeate TDS, April 6-12<sup>th</sup>**



**Figure 21: Permeate produced, April 6-12<sup>th</sup>**

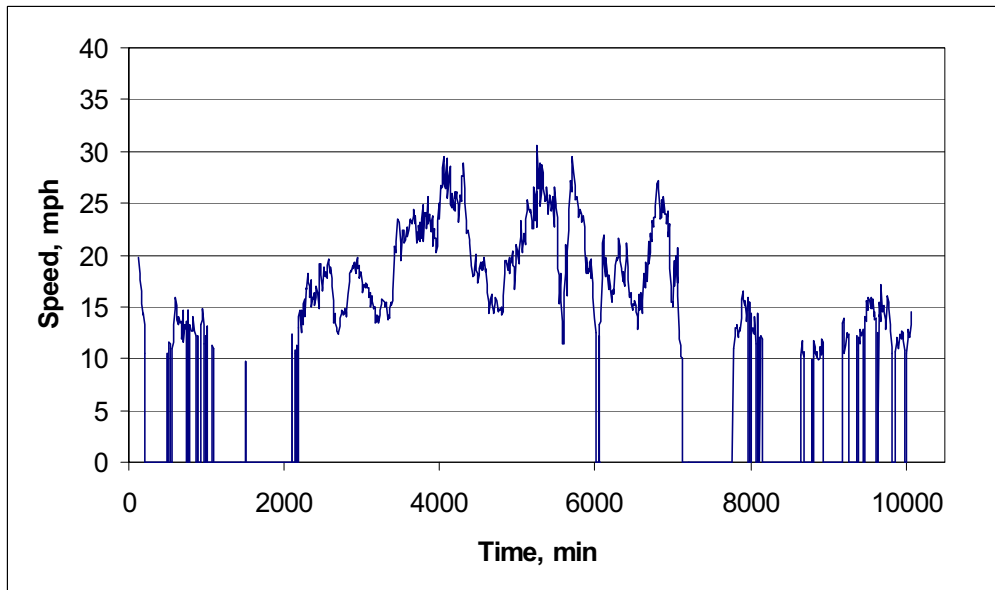


**Figure 22: Kilowatt hours used by RO, April 6-12<sup>th</sup>**

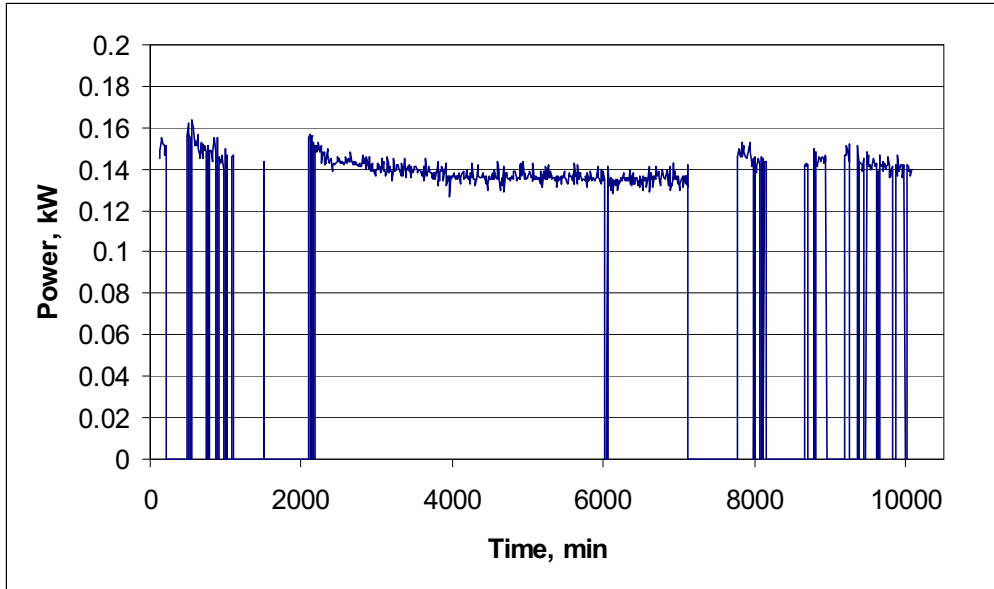


**Figure 23: Kilowatt hours generated/delivered to utility, April 6-12<sup>th</sup>**

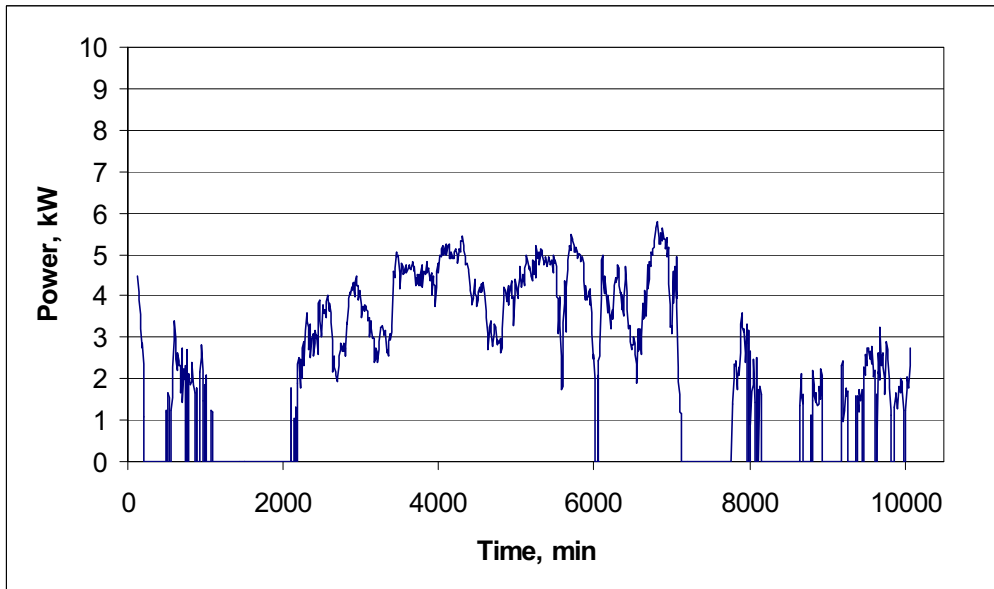
**Week #3 (April 13<sup>th</sup>-19<sup>th</sup>)**



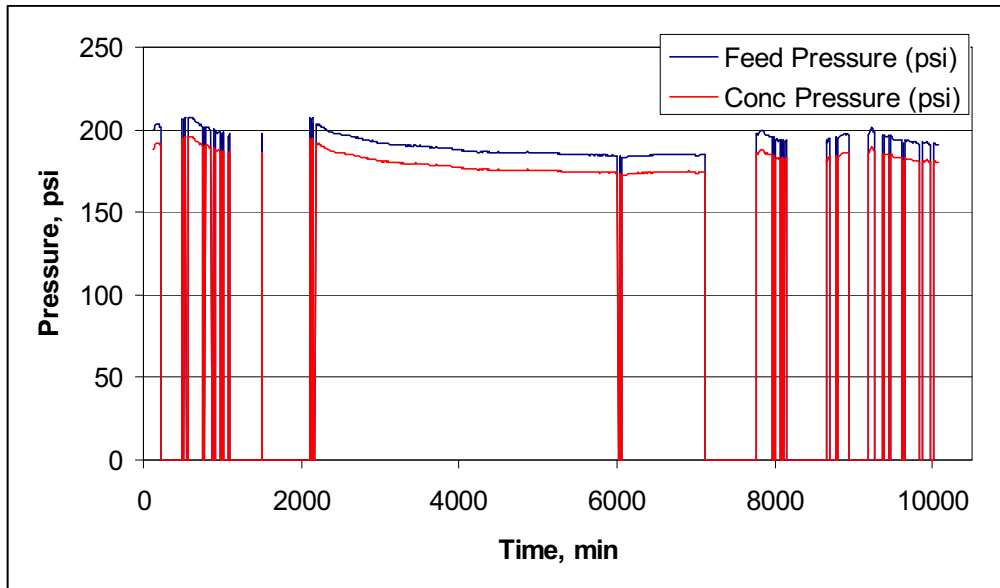
**Figure 24: Wind Speed, April 13-19<sup>th</sup>**



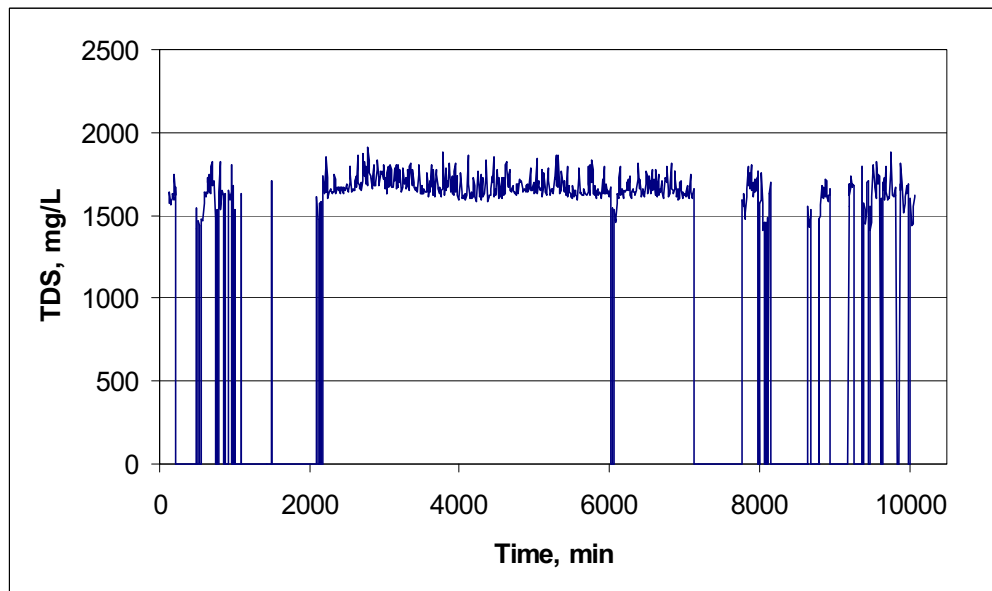
**Figure 25: RO Power, April 13-19<sup>th</sup>**



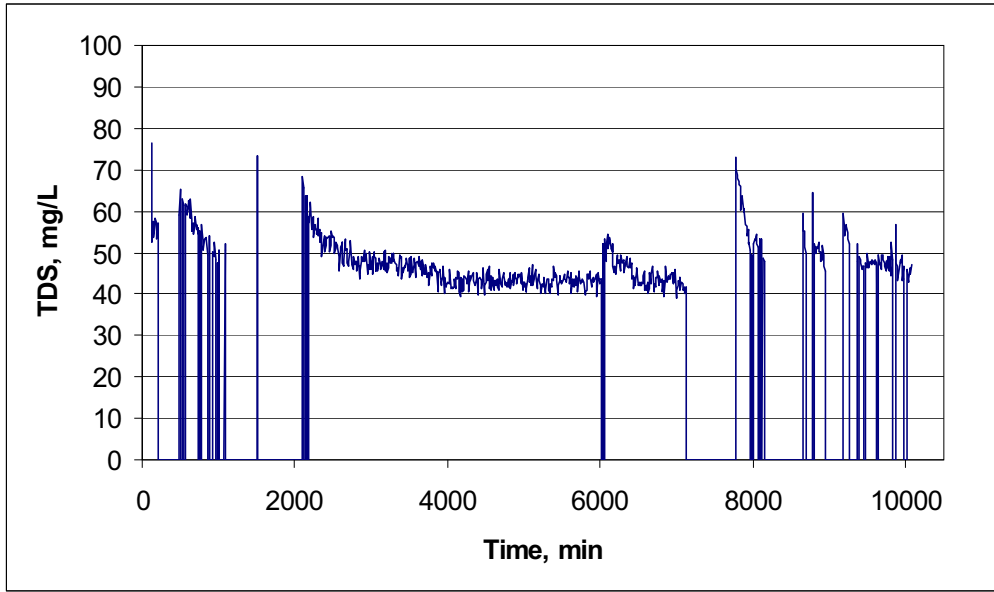
**Figure 26: Wind Power, April 13-19<sup>th</sup>**



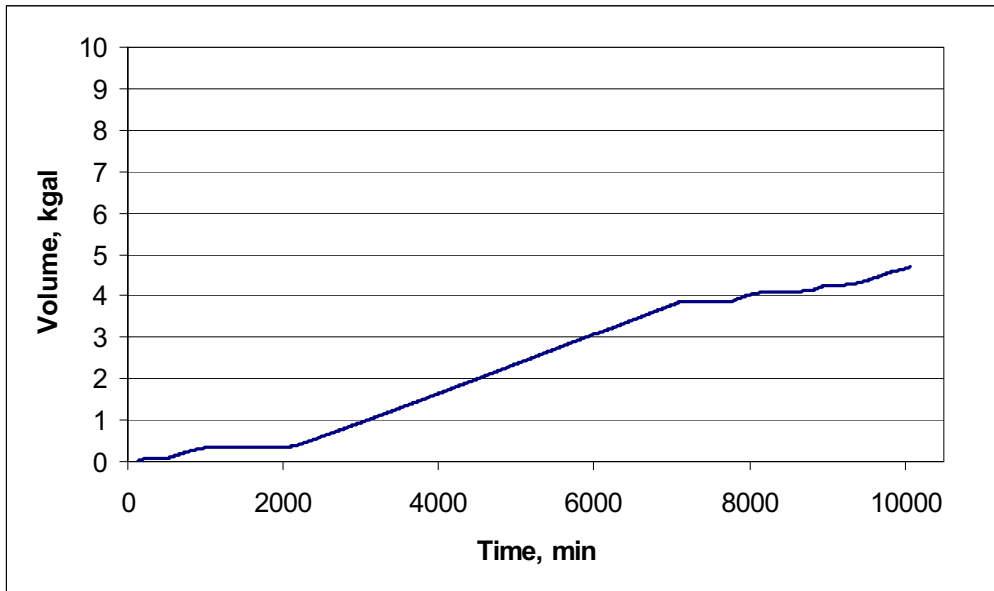
**Figure 27: Feed/Concentrate pressure, April 13-19<sup>th</sup>**



**Figure 28: Feed TDS, April 13-19<sup>th</sup>**

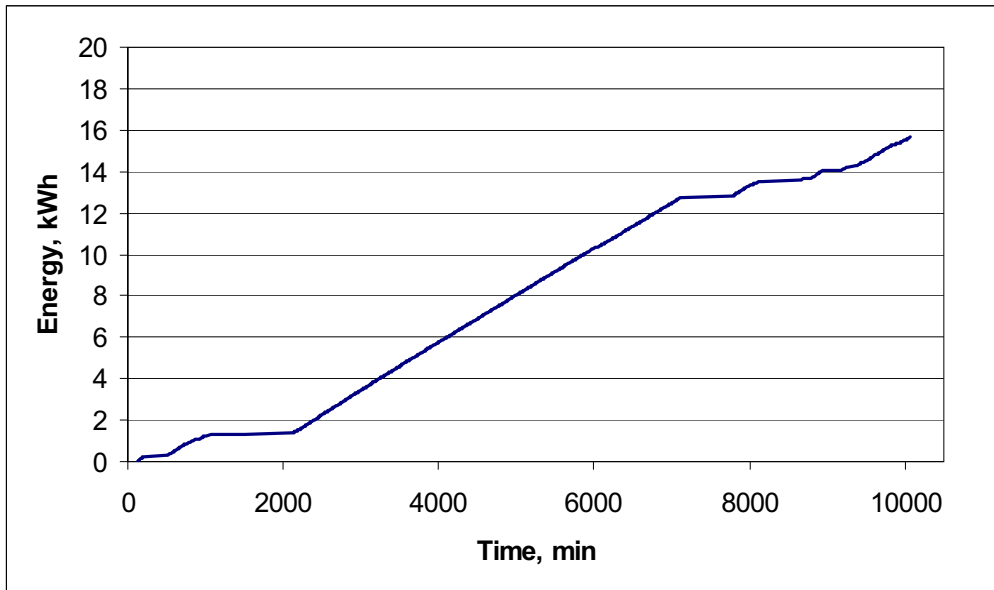


**Figure 29: Permeate TDS, April 13-19<sup>th</sup>**

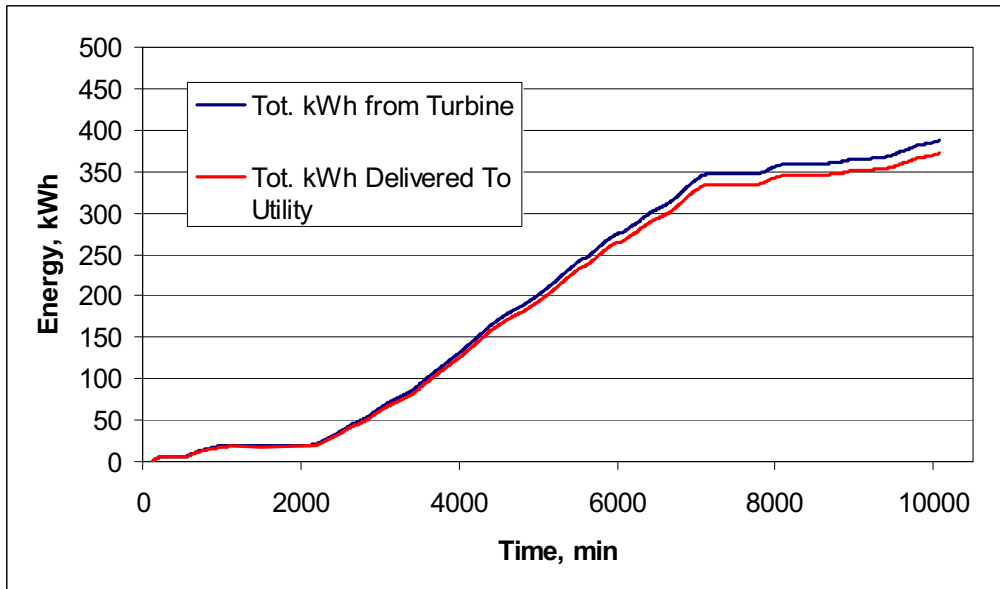


**Figure 30: Permeate Produced, April 13-19<sup>th</sup>**



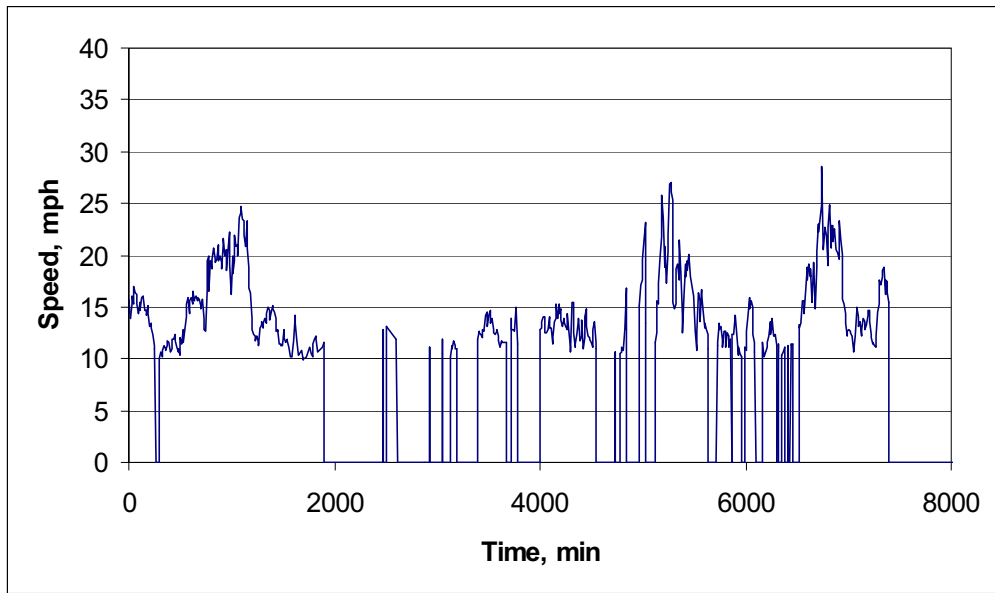


**Figure 31: Kilowatt hours used by RO, April 13-19<sup>th</sup>**

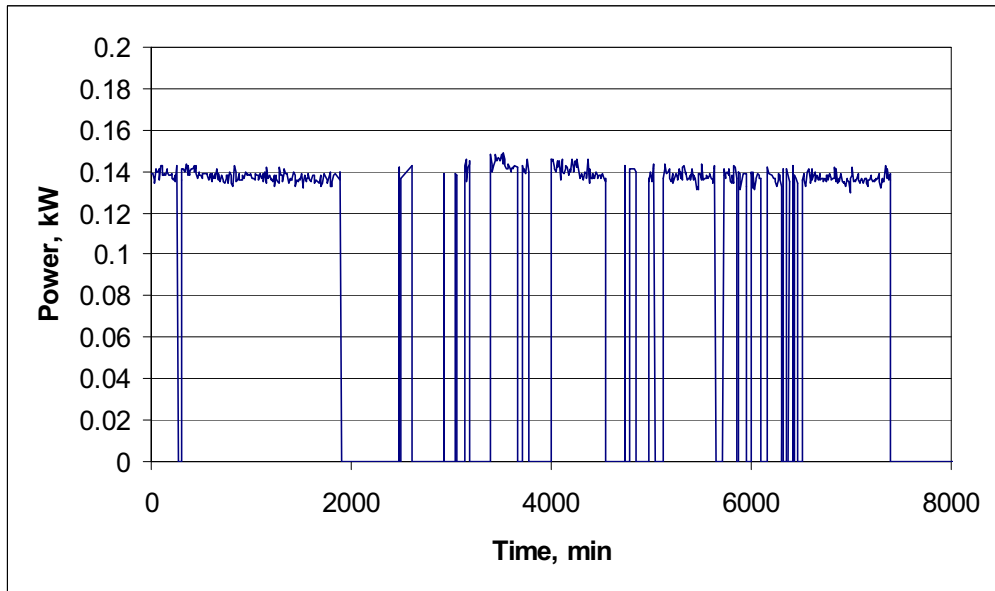


**Figure 32: Kilowatt hours generated/delivered to utility, April 13-19<sup>th</sup>**

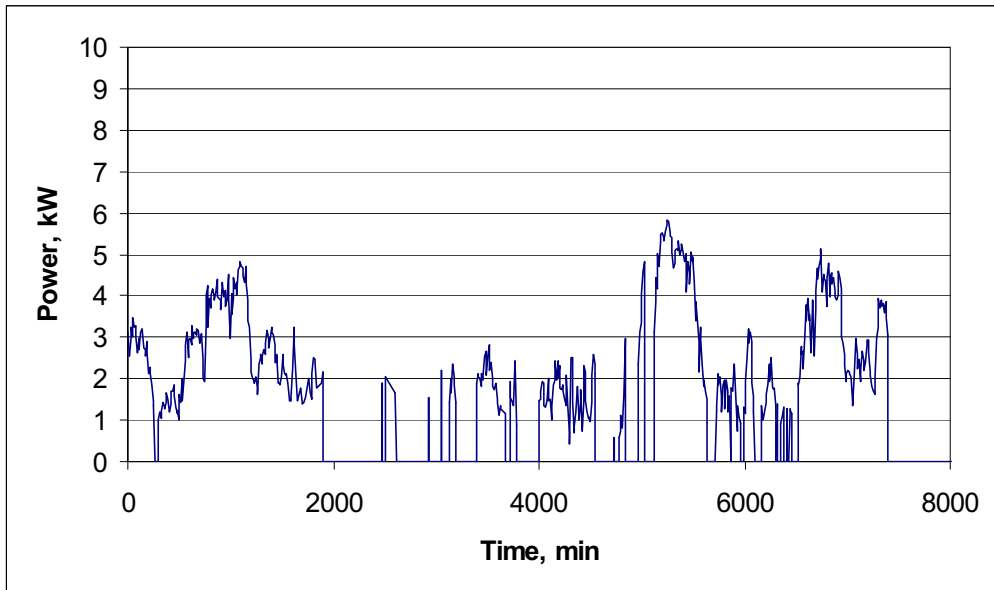
**Week #4 (April 20-25<sup>th</sup>)**



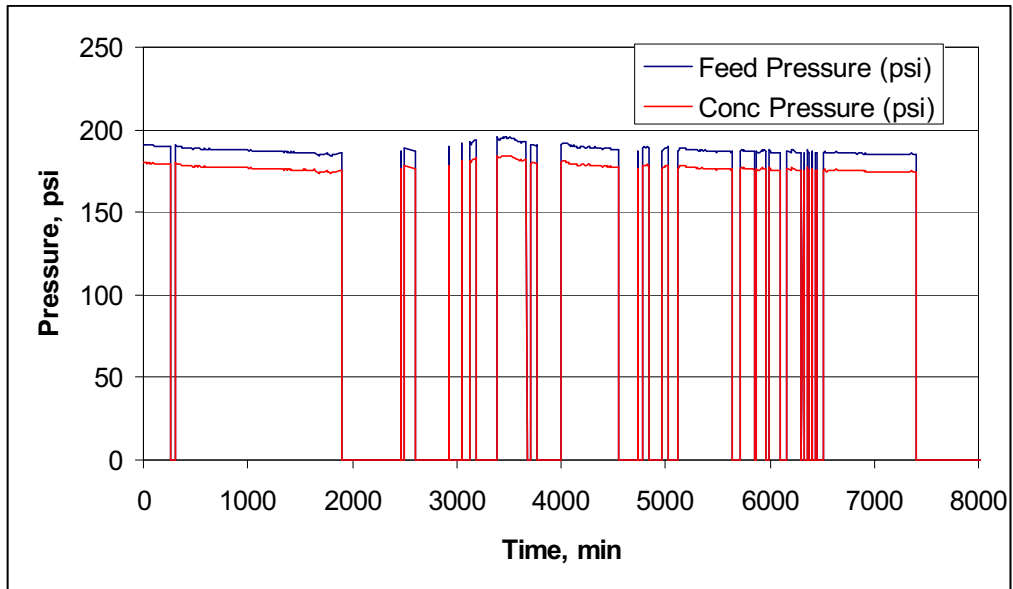
**Figure 33: Wind Speed, April 20-25<sup>th</sup>**



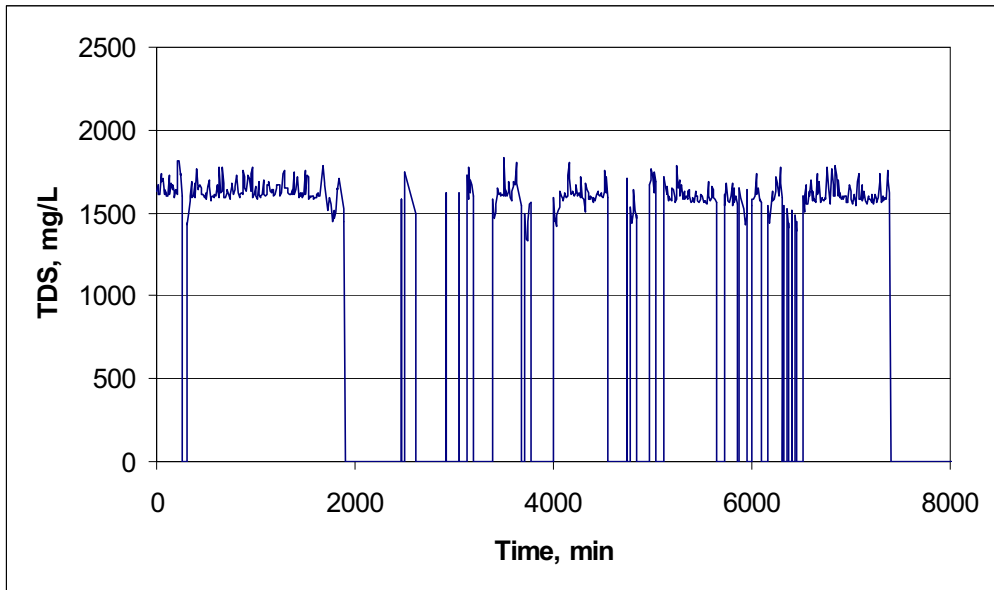
**Figure 34: RO Power, April 20-25<sup>th</sup>**



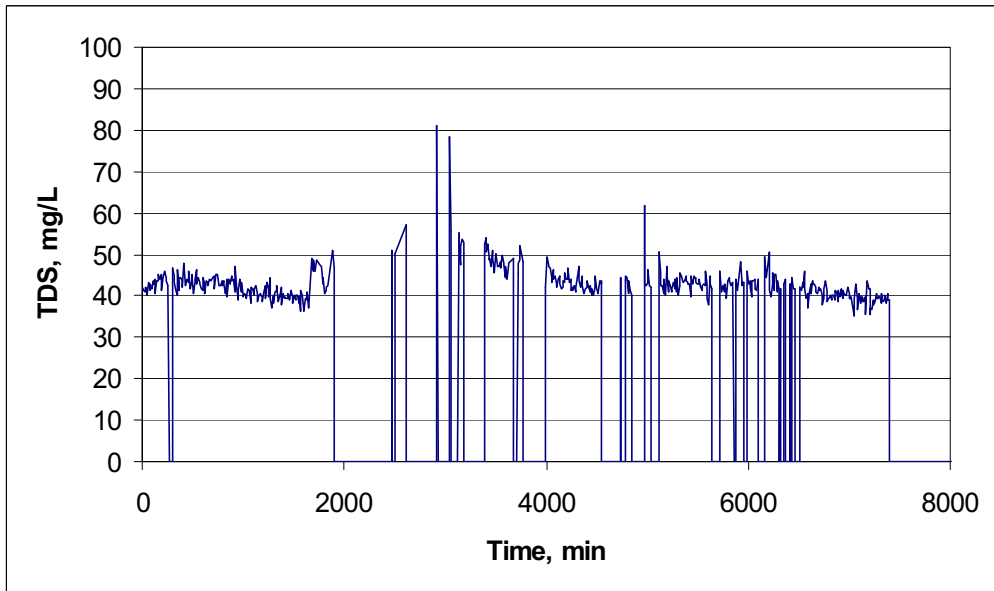
**Figure 35: Wind Power, April 20-25<sup>th</sup>**



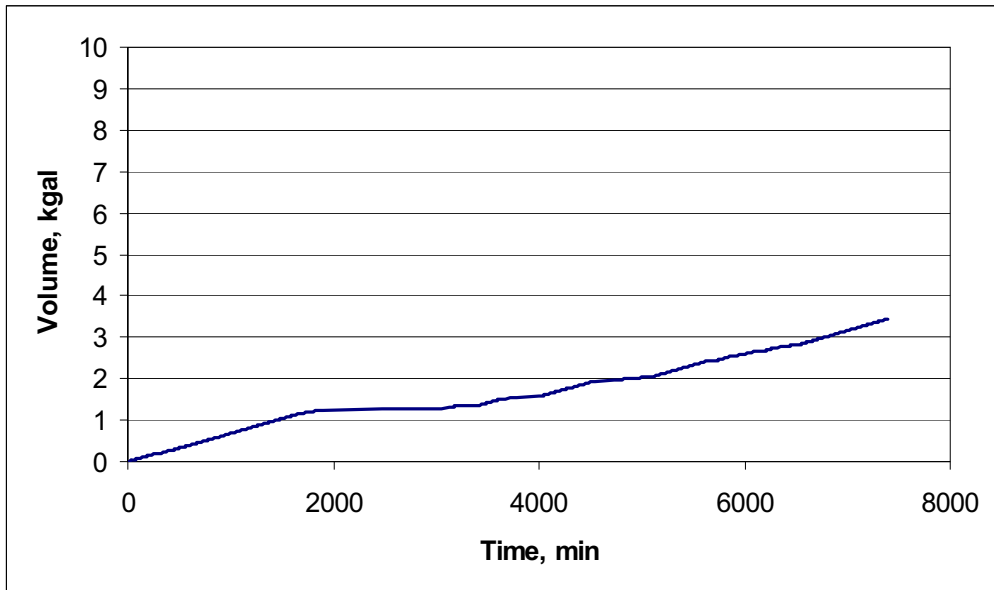
**Figure 36: Feed/Concentrate pressure, April 20-25<sup>th</sup>**



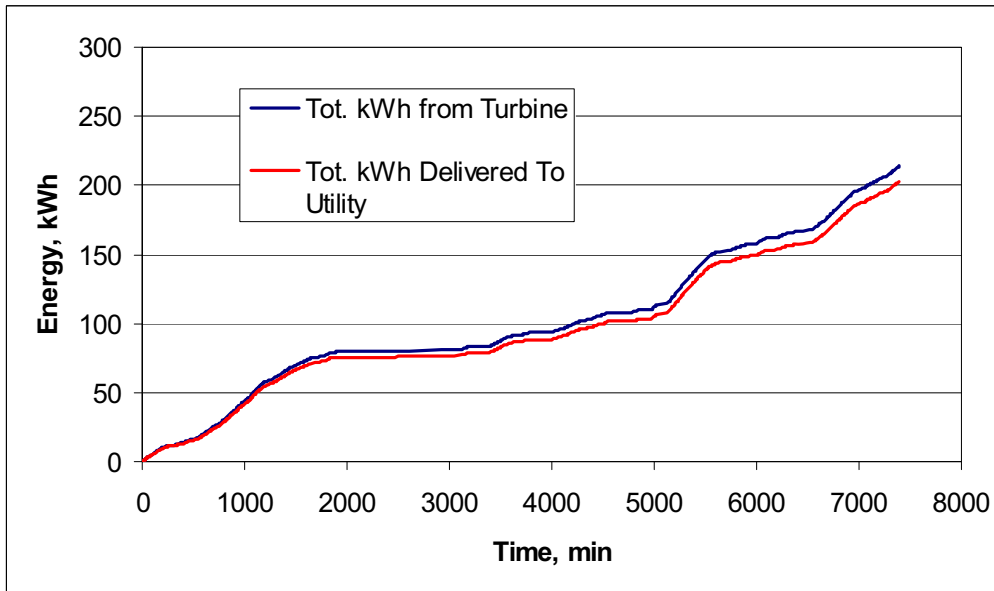
**Figure 37: Feed TDS, April 20-25<sup>th</sup>**



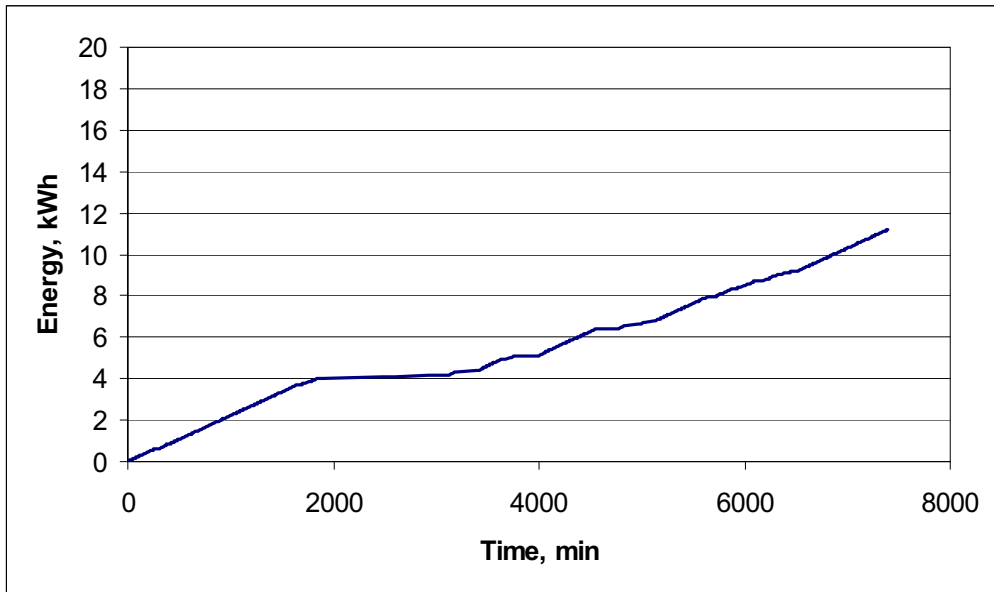
**Figure 38: Permeate TDS, April 20-25<sup>th</sup>**



**Figure 39: Permeate Produced, April 20-25<sup>th</sup>**

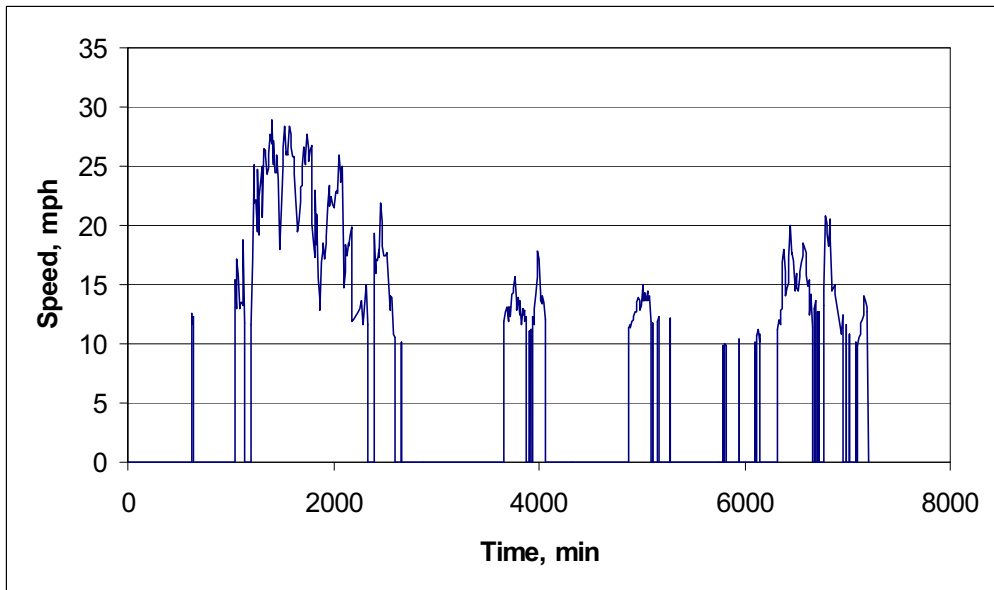


**Figure 40: Kilowatt hours generated/delivered, April 20-25<sup>th</sup>**

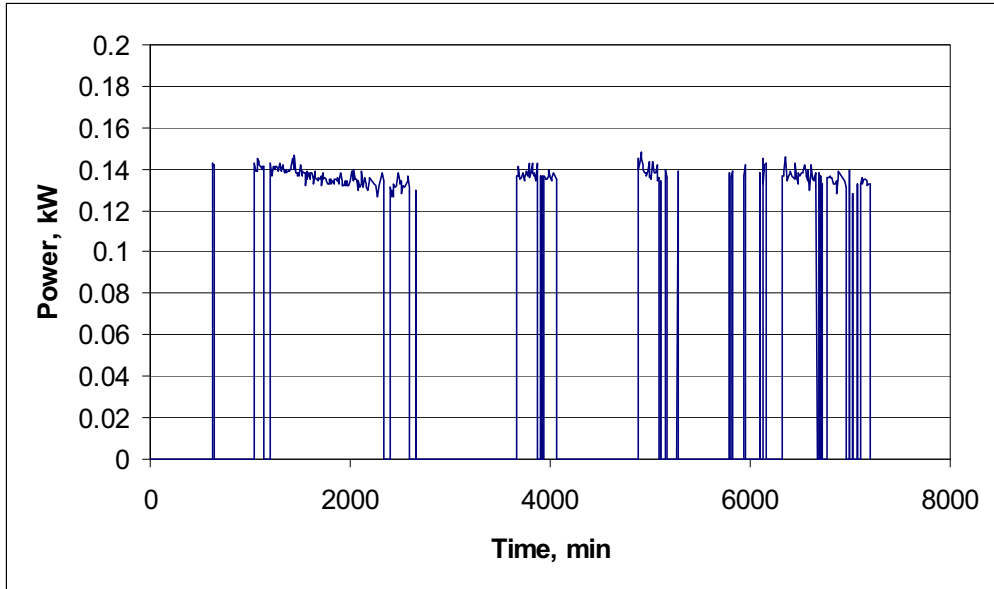


**Figure 41: Kilowatt hours used by RO, April 20-25<sup>th</sup>**

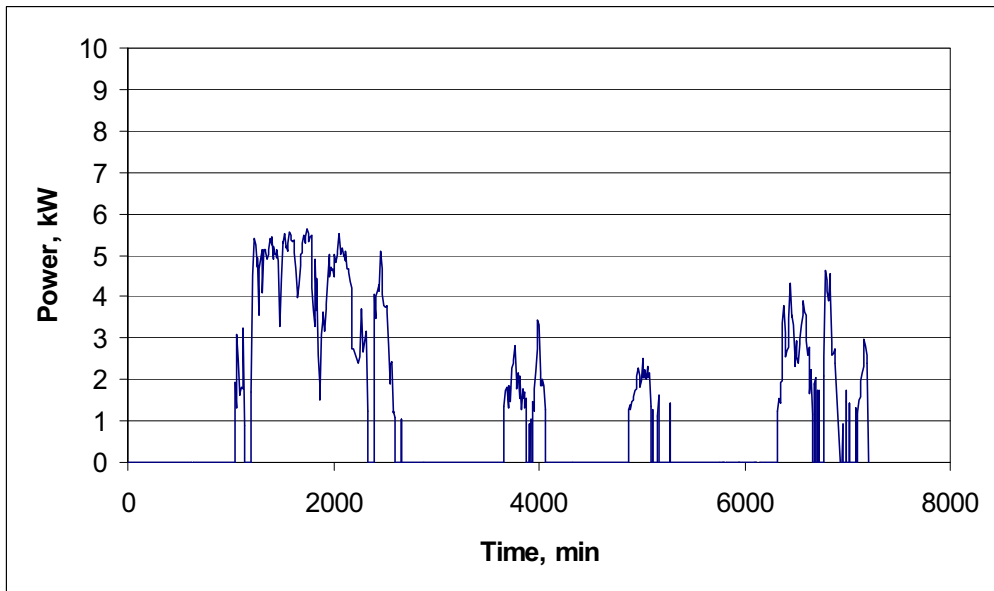
**Week #5 (May 13-17<sup>th</sup>)**



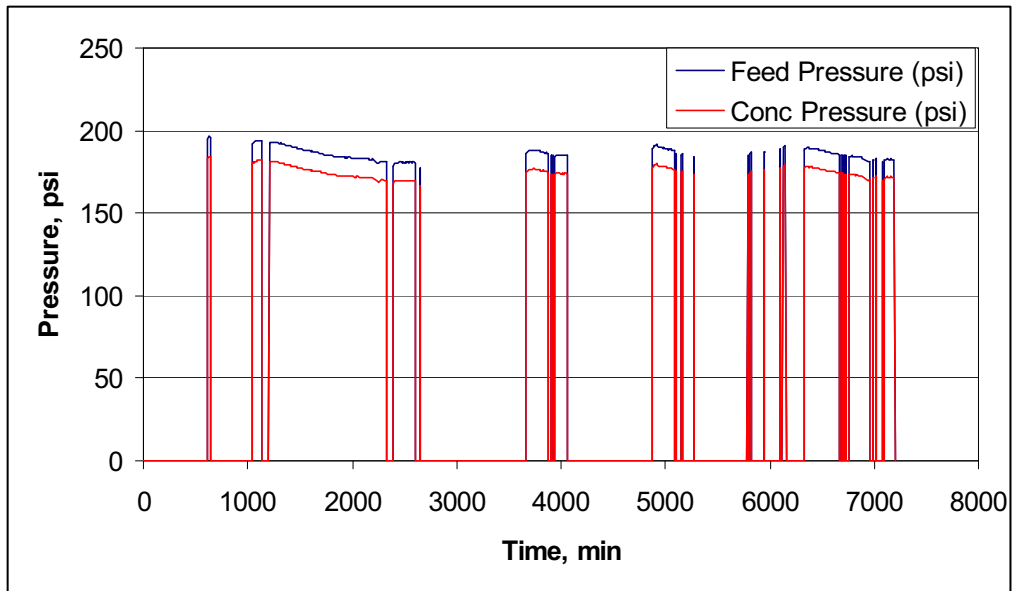
**Figure 42: Wind Speed, May 13-17<sup>th</sup>**



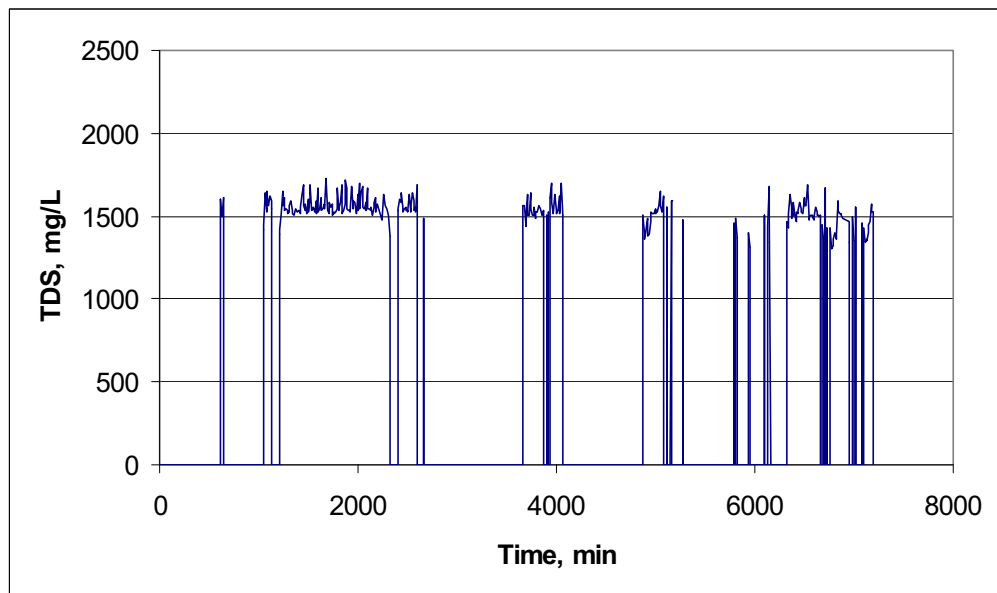
**Figure 43: RO Power, May 13-17<sup>th</sup>**



**Figure 44: Wind Power, May 13-17<sup>th</sup>**

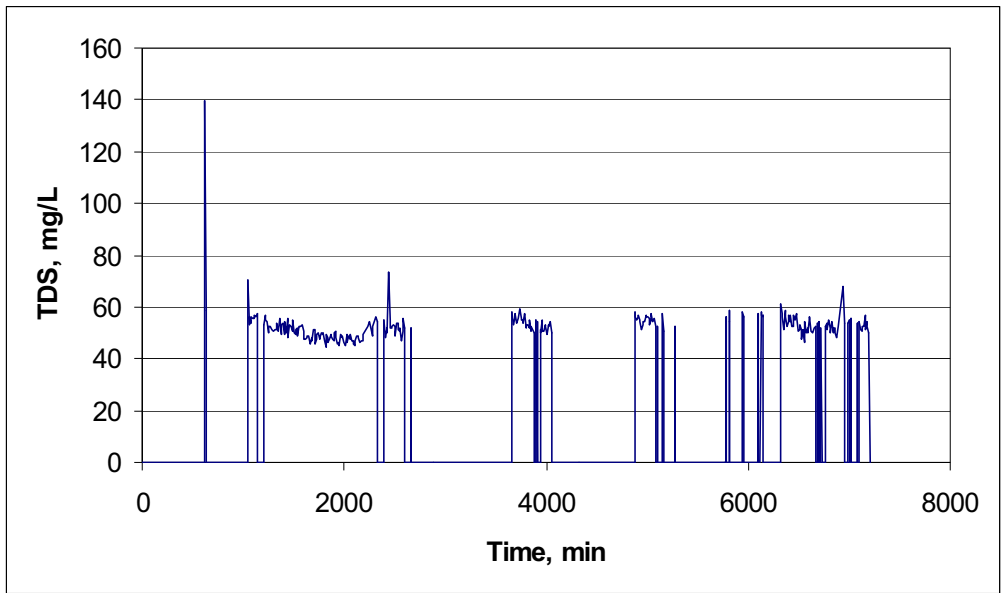


**Figure 45: Feed/Concentrate Pressure, May 13-17<sup>th</sup>**

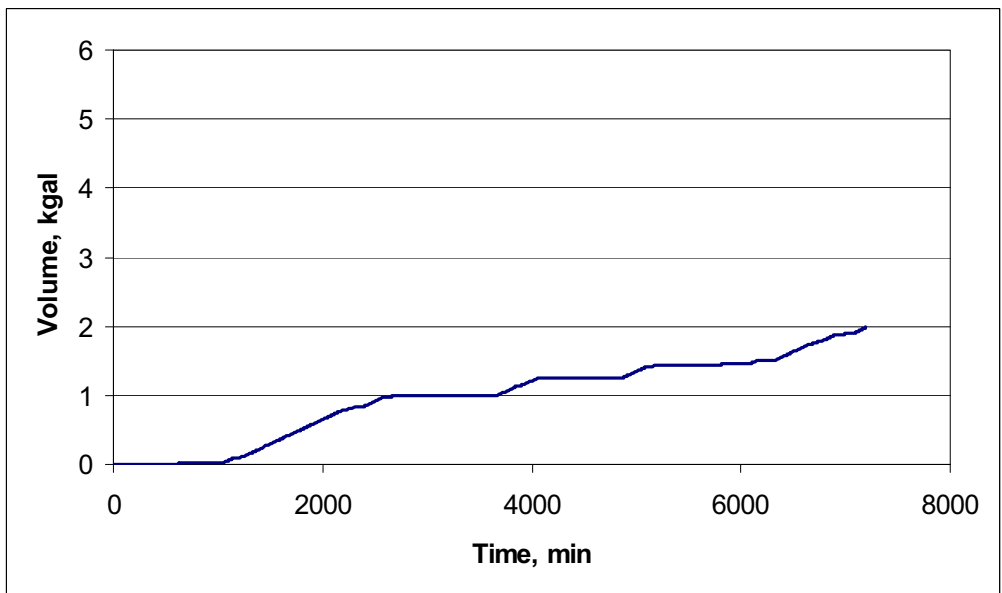


**Figure 46: Feed TDS, May 13-17<sup>th</sup>**

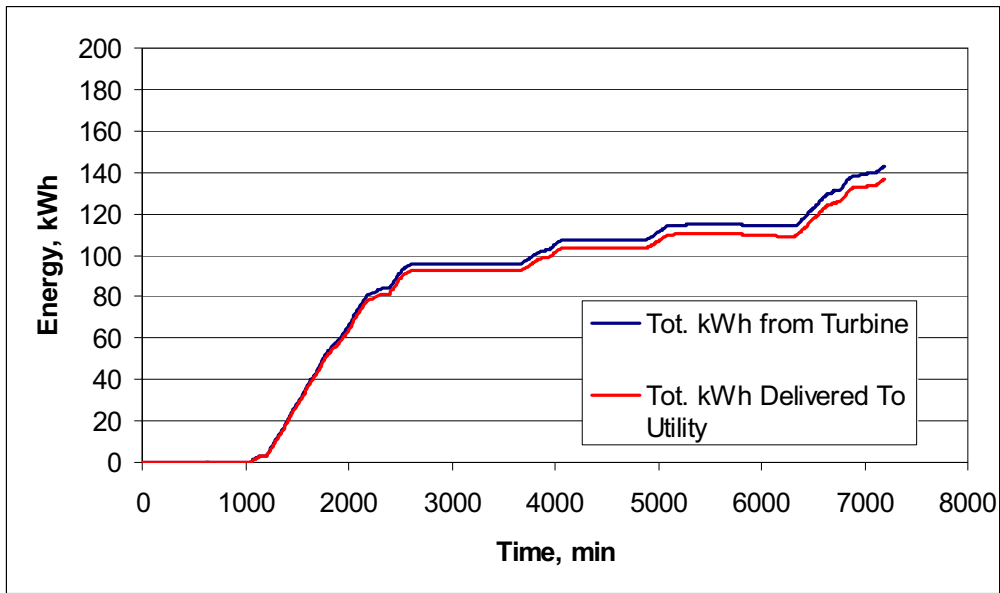




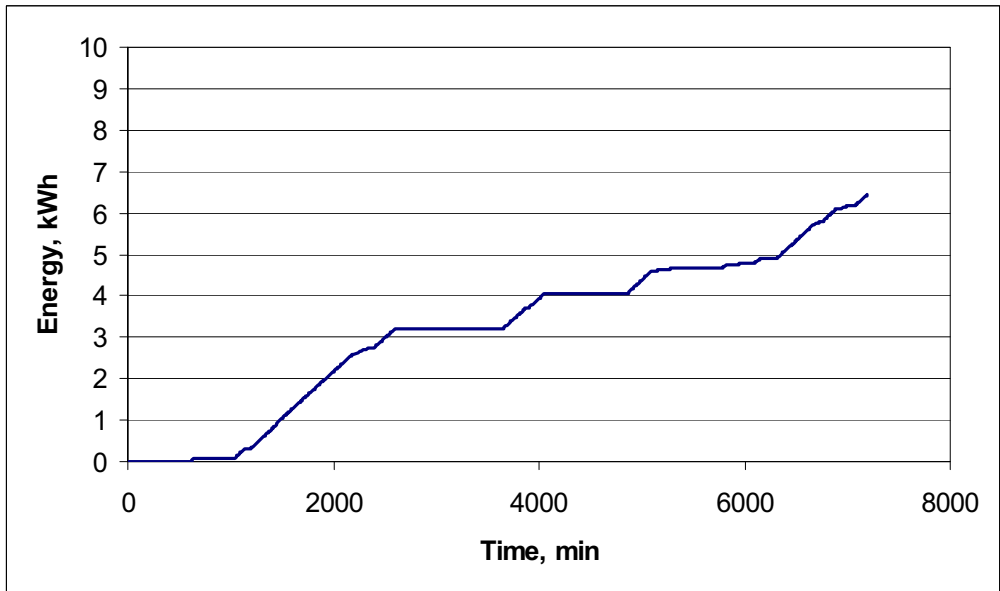
**Figure 47: Permeate TDS, May 13-17<sup>th</sup>**



**Figure 48: Permeate Produced, May 13-17<sup>th</sup>**

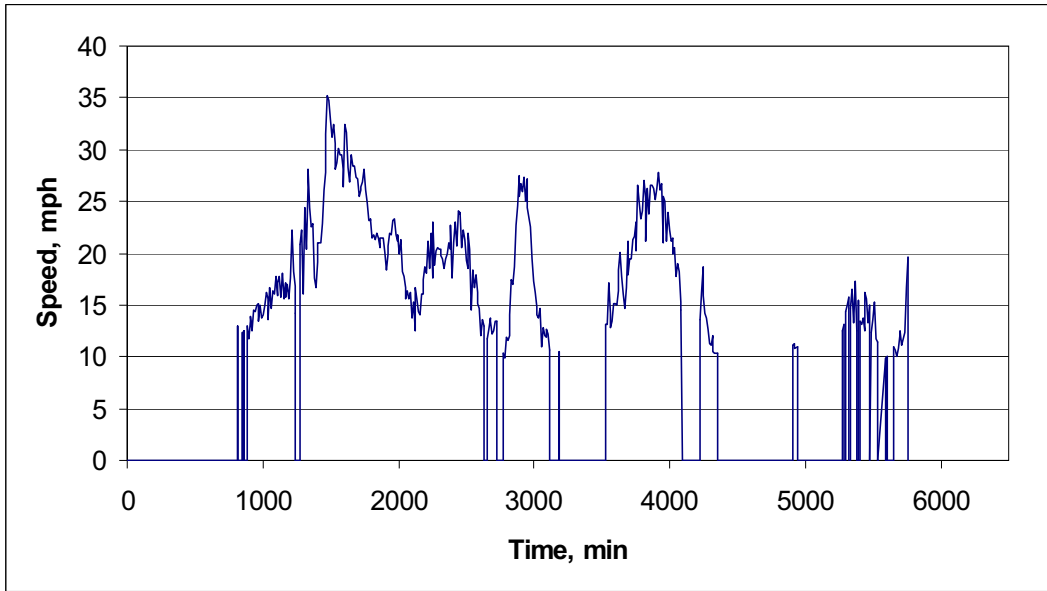


**Figure 49: Kilowatt hours generated/delivered to utility, May 13-17<sup>th</sup>**

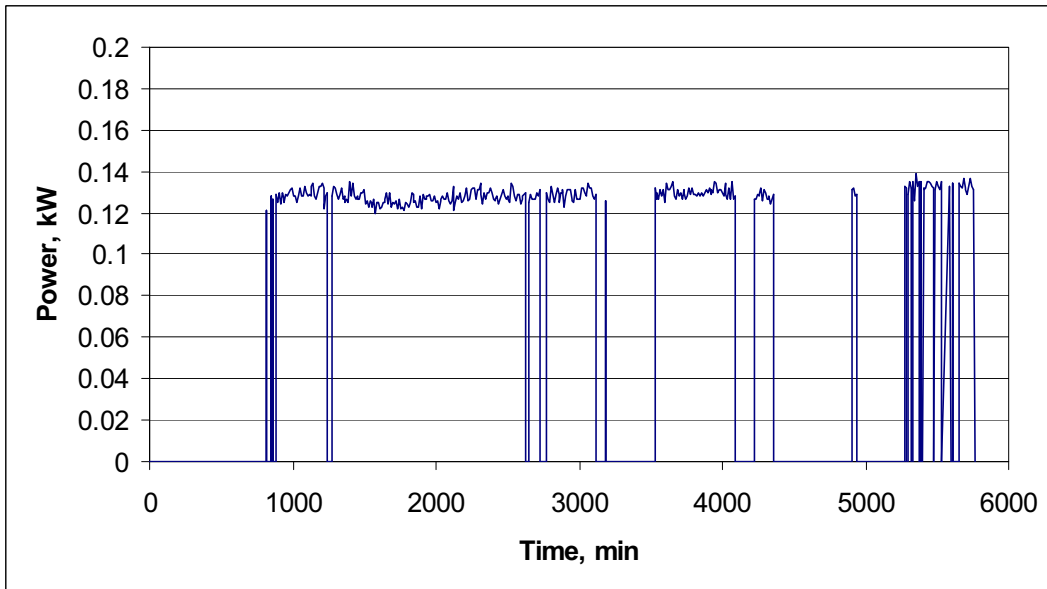


**Figure 50: Kilowatt hours used by RO, May 13-17<sup>th</sup>**

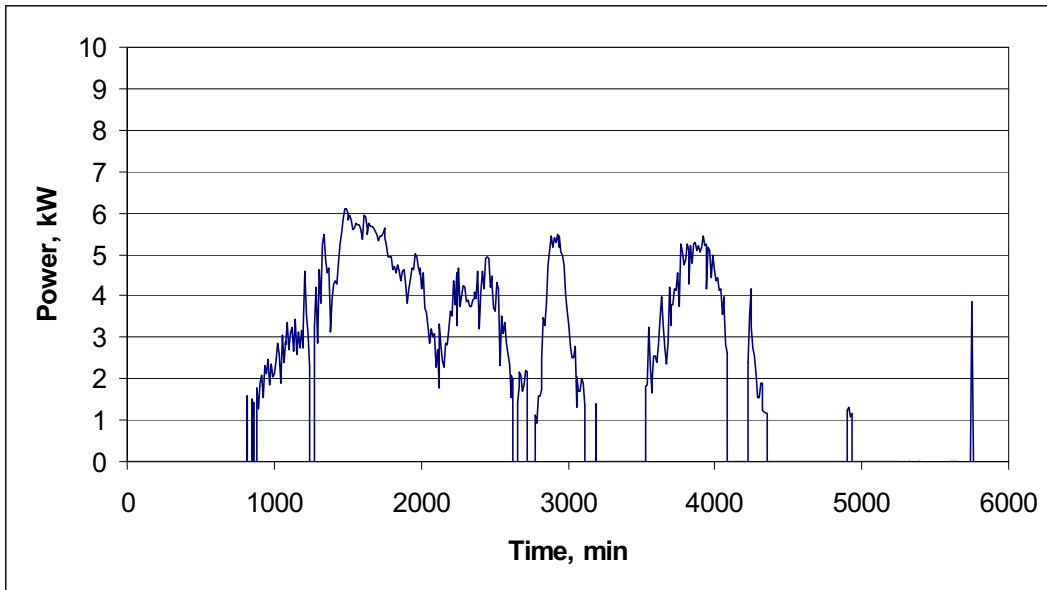
**Week #6 (May 21-24<sup>th</sup>)**



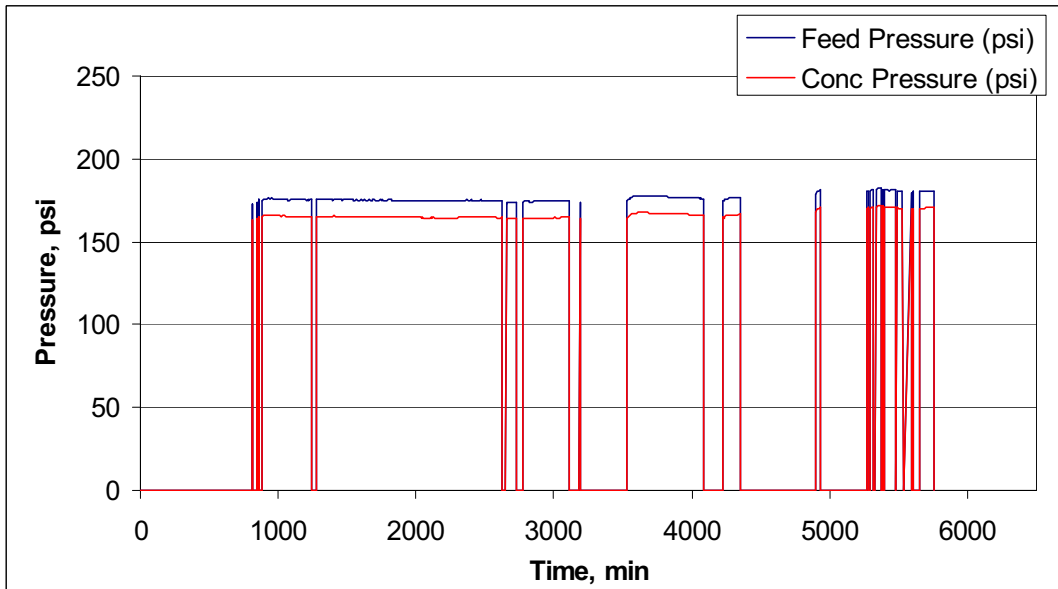
**Figure 51: Wind Speed, May 21-24<sup>th</sup>**



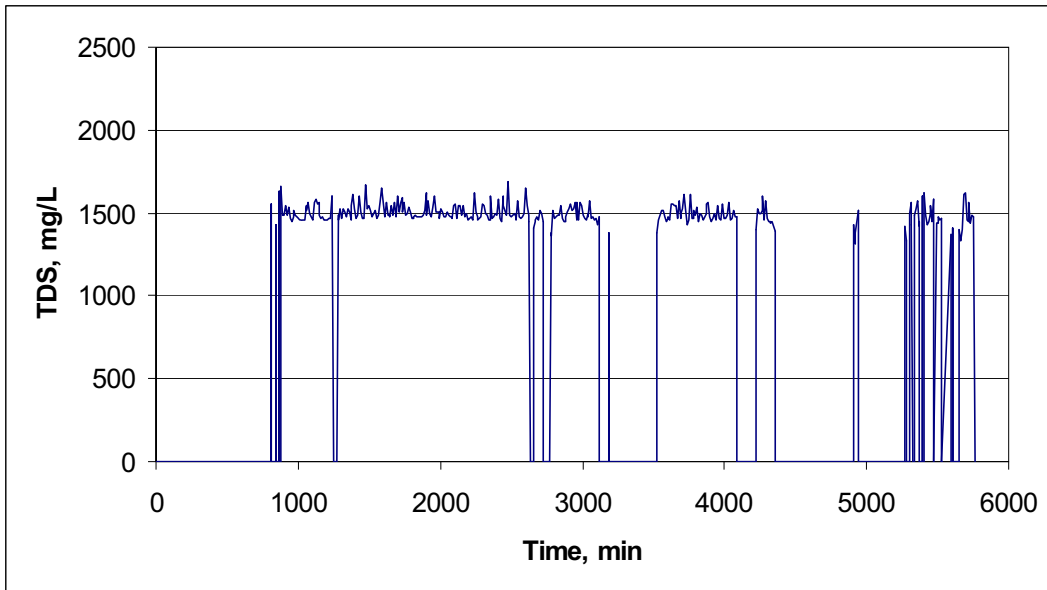
**Figure 52: RO Power, May 21-24<sup>th</sup>**



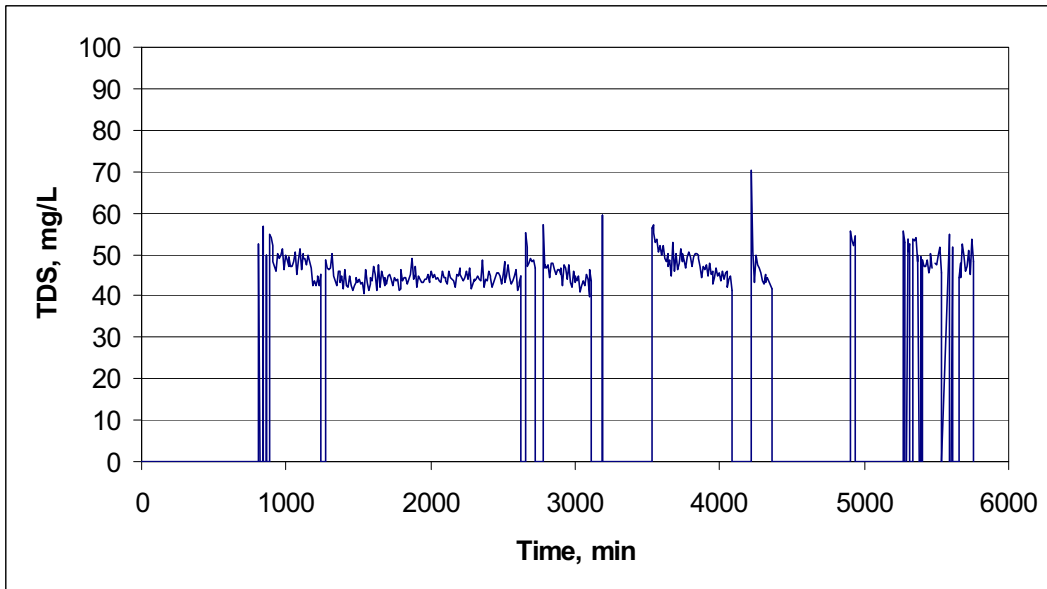
**Figure 53: Wind Power, May 21-24<sup>th</sup>**



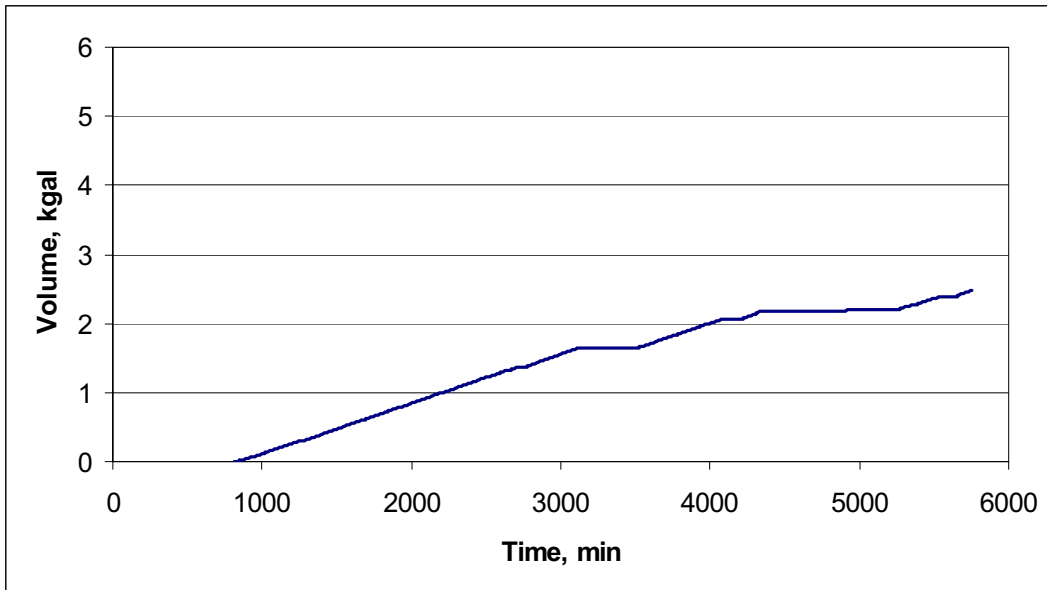
**Figure 54: Feed/Concentrate pressure, May 21-24<sup>th</sup>**



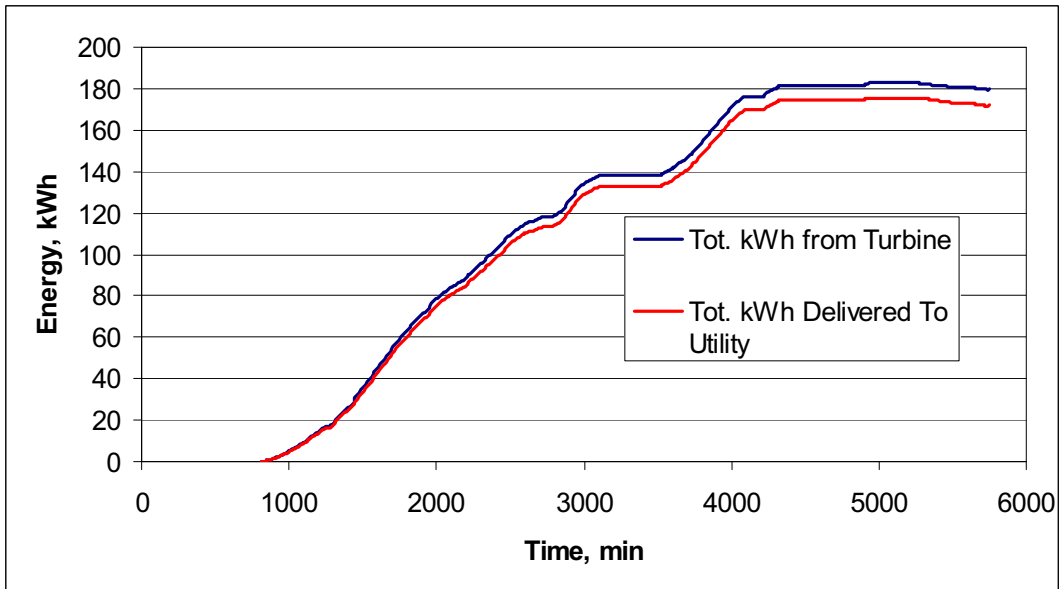
**Figure 55: Feed TDS, May 21-24<sup>th</sup>**



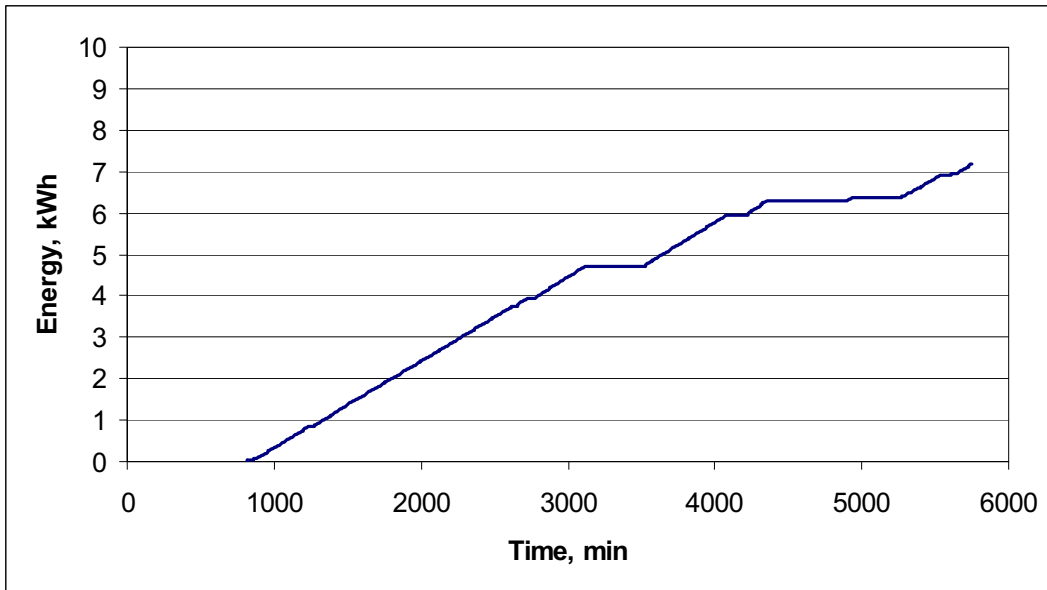
**Figure 56: Permeate TDS, May 21-24<sup>th</sup>**



**Figure 57: Permeate Produced, May 21-24<sup>th</sup>**

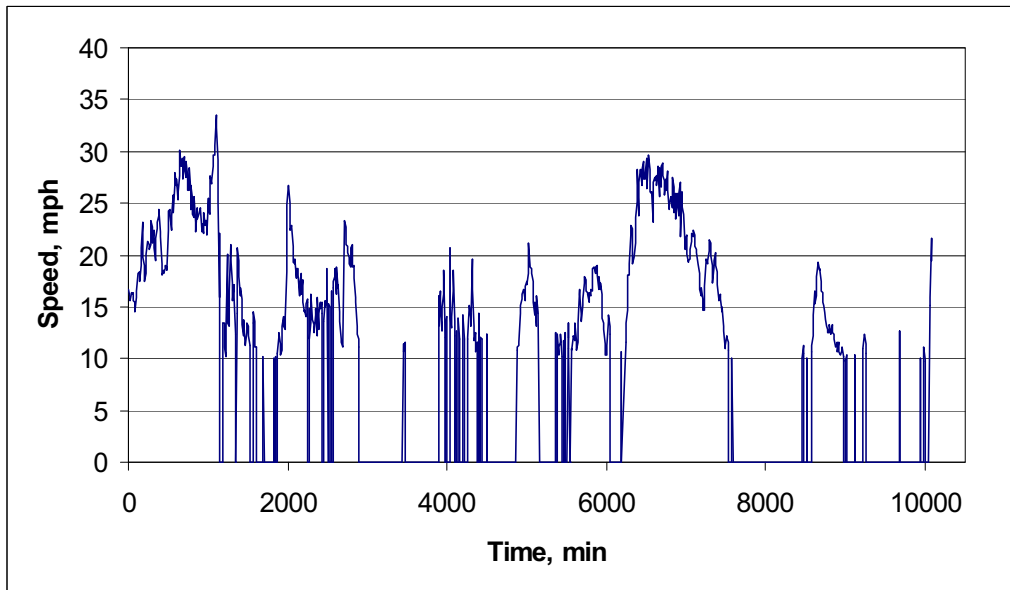


**Figure 58: Kilowatt hours generated/delivered to utility, May 21-24<sup>th</sup>**

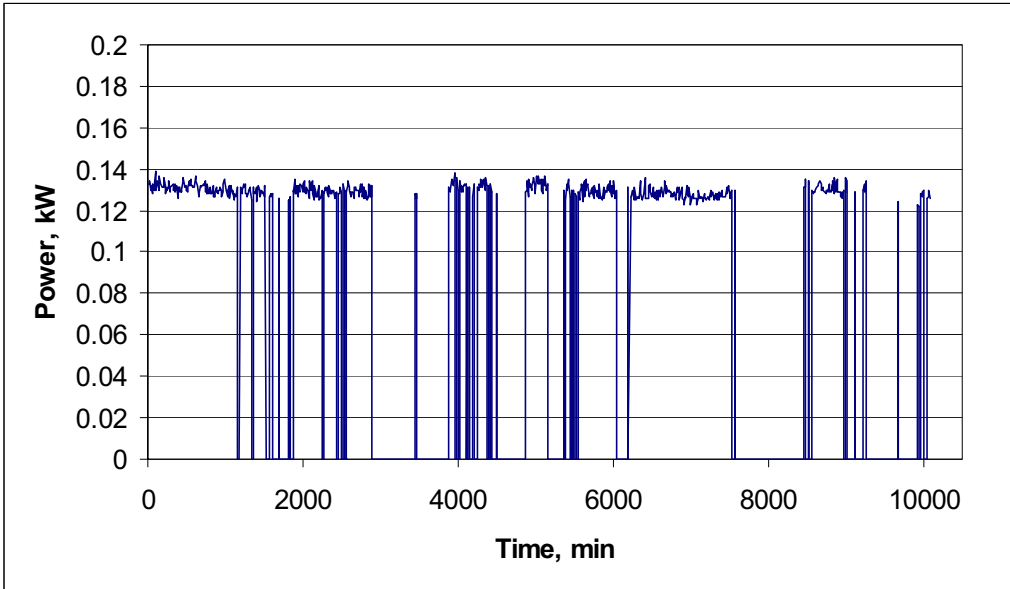


**Figure 59: Kilowatt hours used by RO, May 21-24<sup>th</sup>**

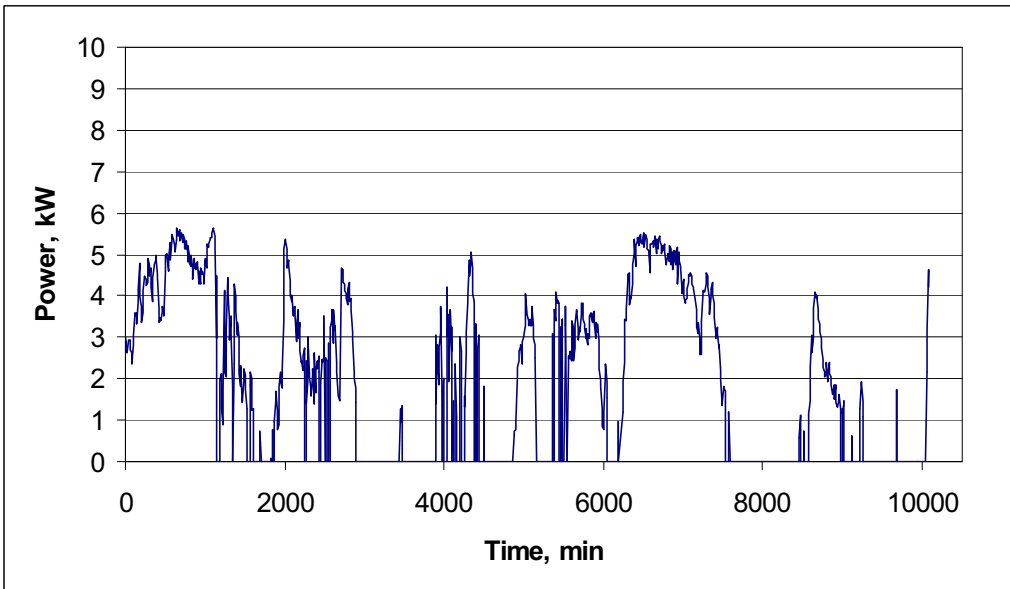
**Week #8 (May 25-31<sup>st</sup>)**



**Figure 60: Wind Speed, May 25-31<sup>st</sup>**

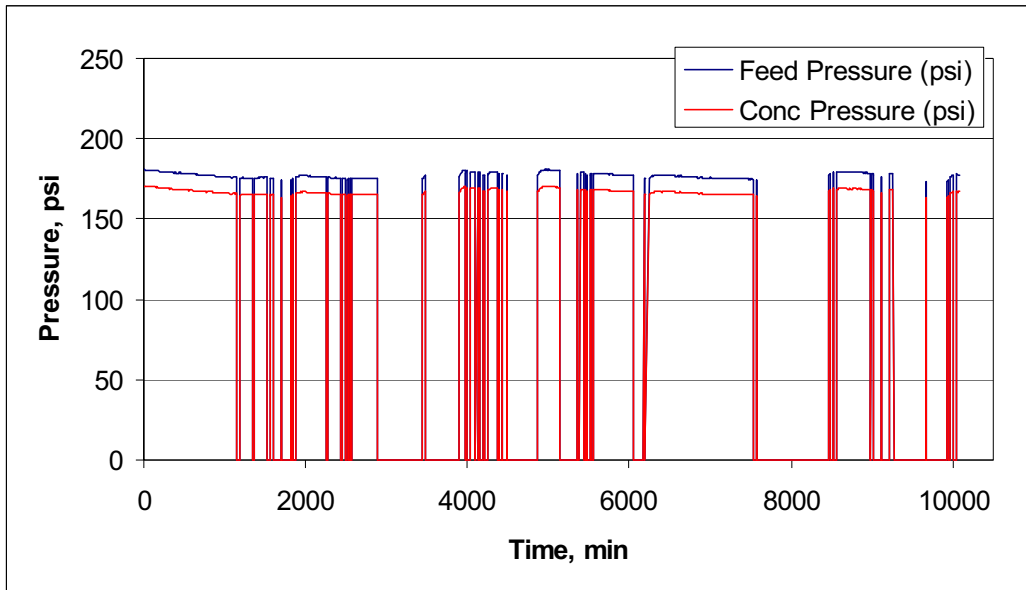


**Figure 61: RO Power, May 25-31<sup>st</sup>**

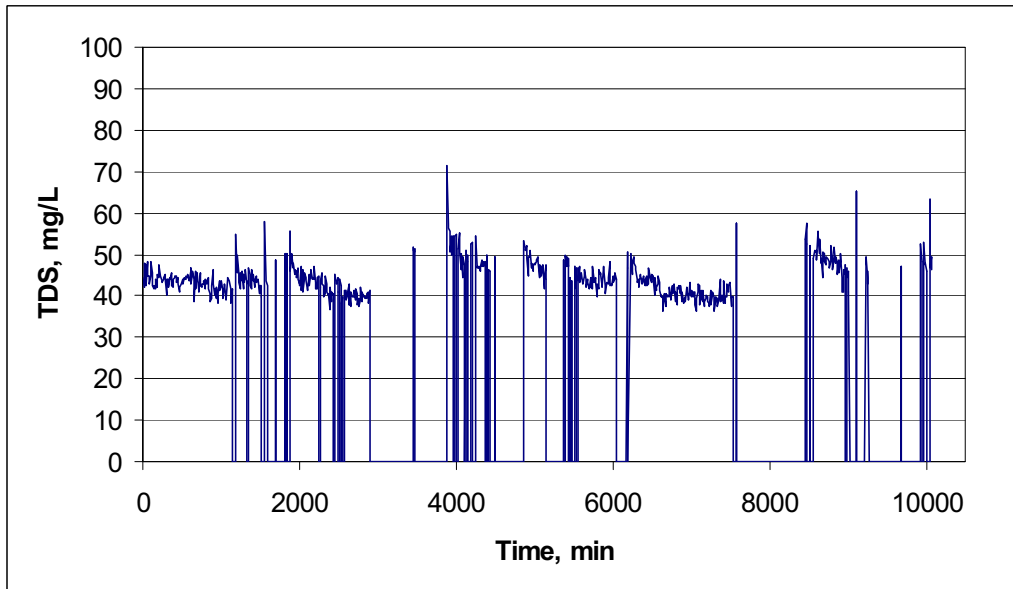


**Figure 62: Wind Power, May 25-31<sup>st</sup>**

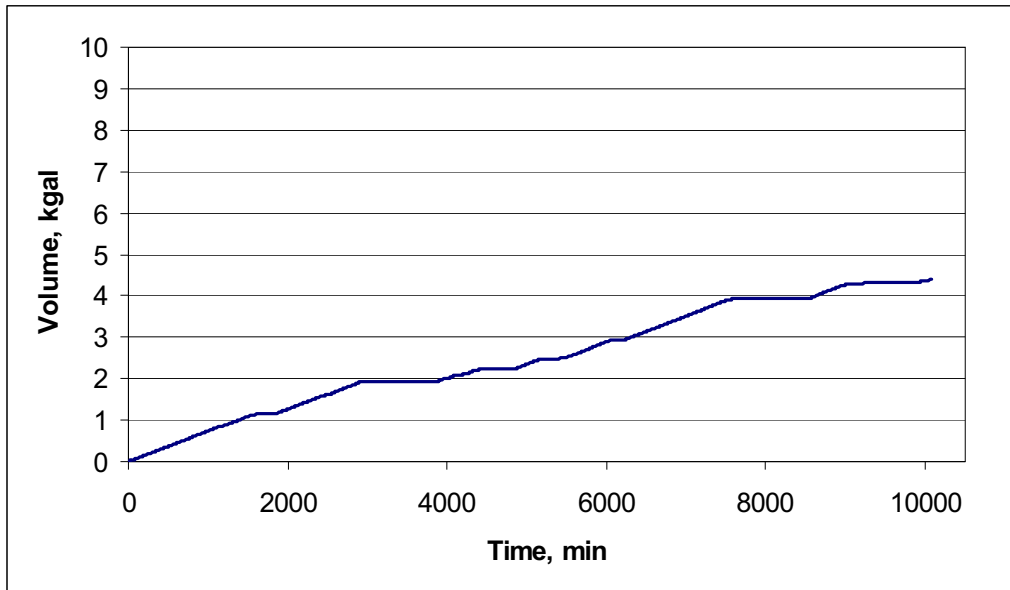




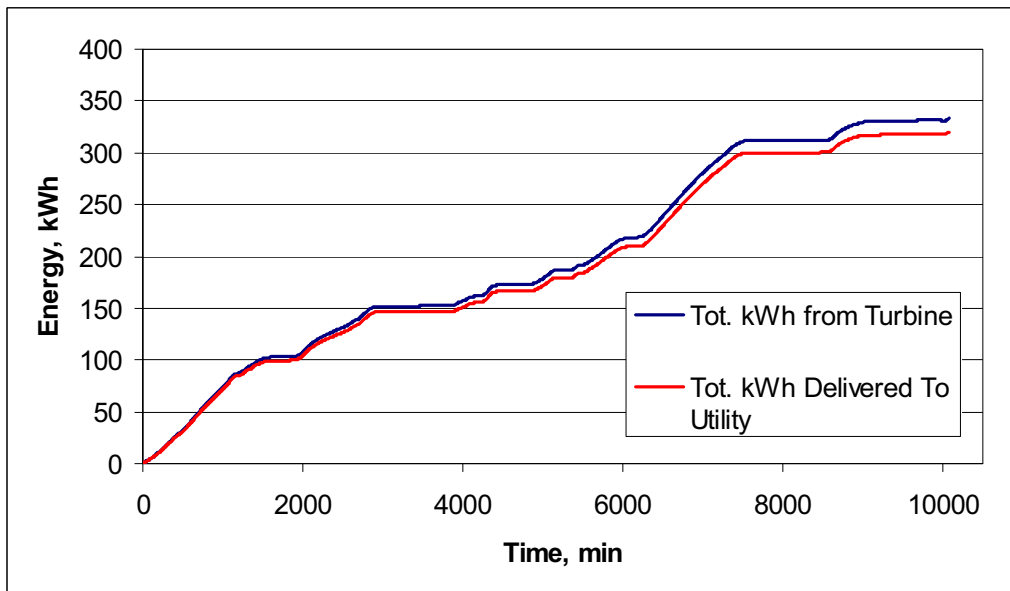
**Figure 63: Feed/Concentrate pressure, May 25-31<sup>st</sup>**



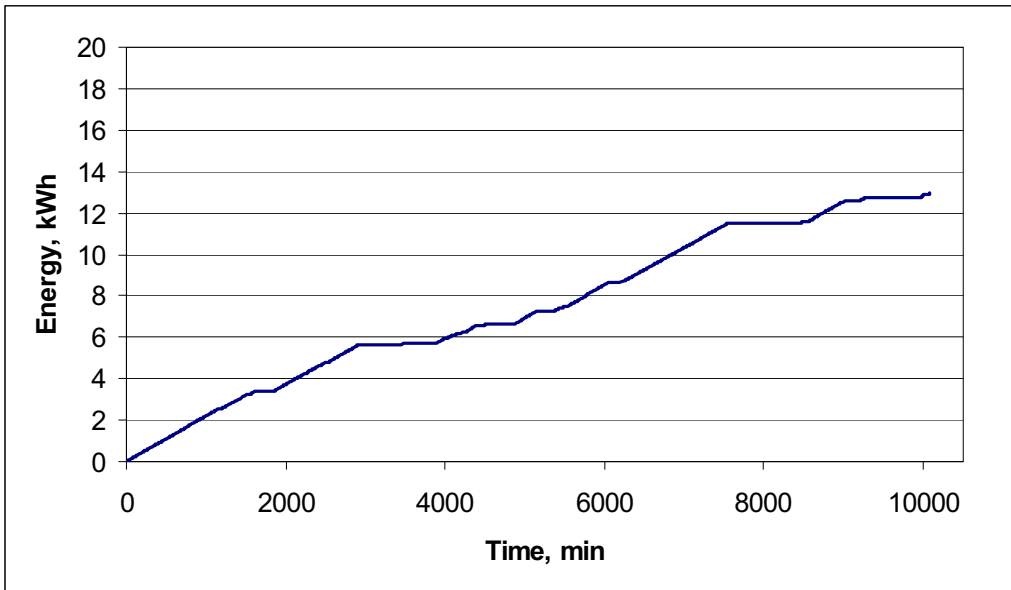
**Figure 64: Permeate TDS, May 25-31<sup>st</sup>**



**Figure 65: Permeate Produced, May 25-31<sup>st</sup>**

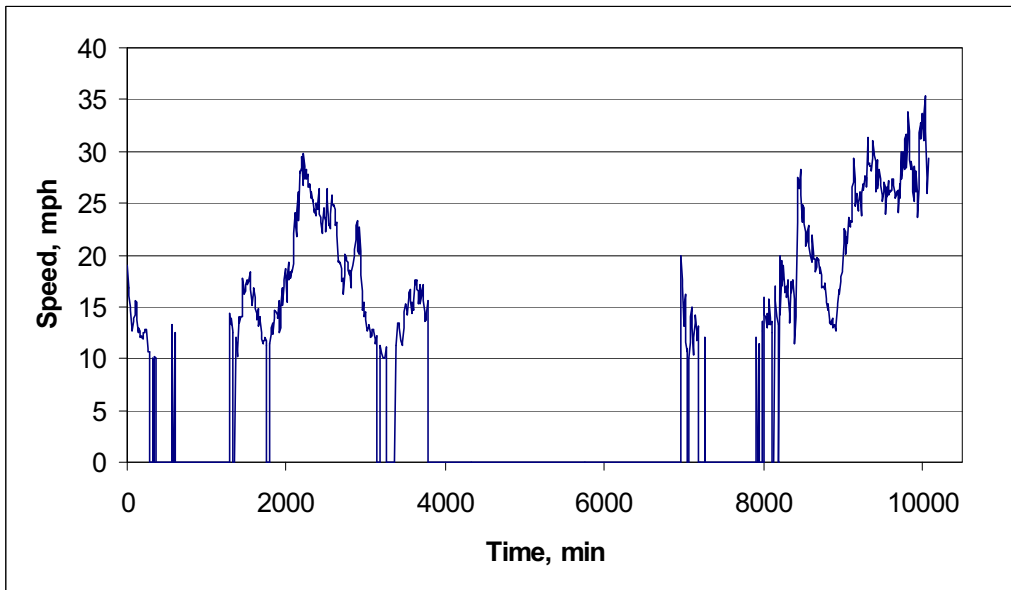


**Figure 66: Kilowatt hours generated /delivered to utility, May 25-31<sup>st</sup>**

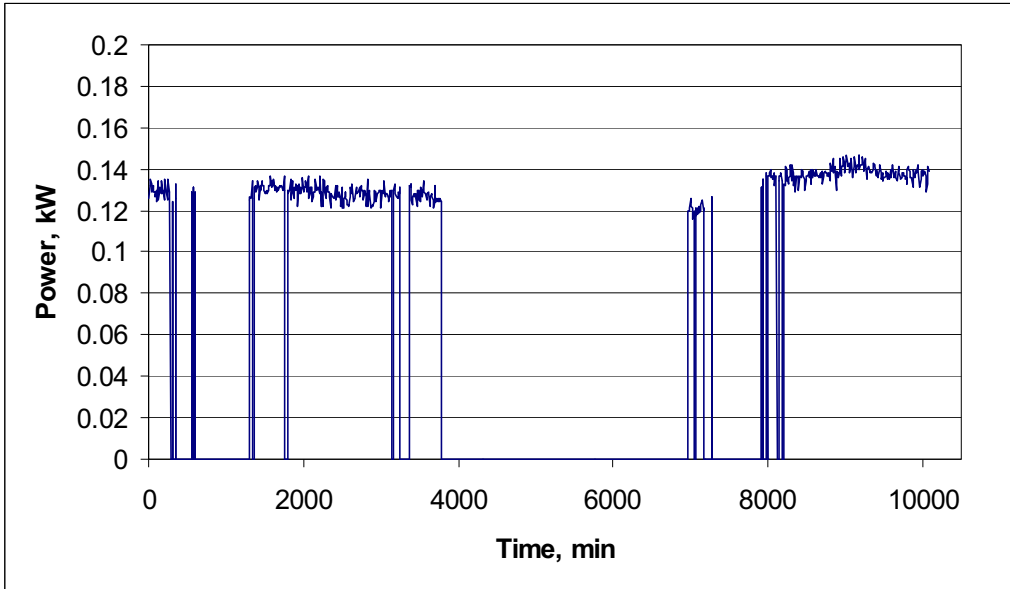


**Figure 67: Kilowatt hours used by RO, May 25-31<sup>st</sup>**

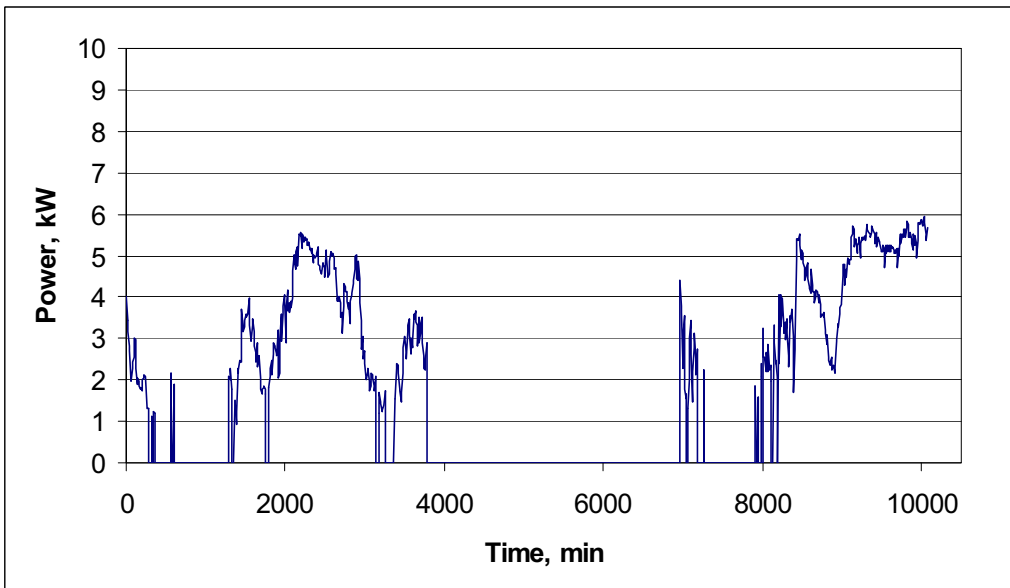
**Week #9 (June 1-7<sup>th</sup>)**



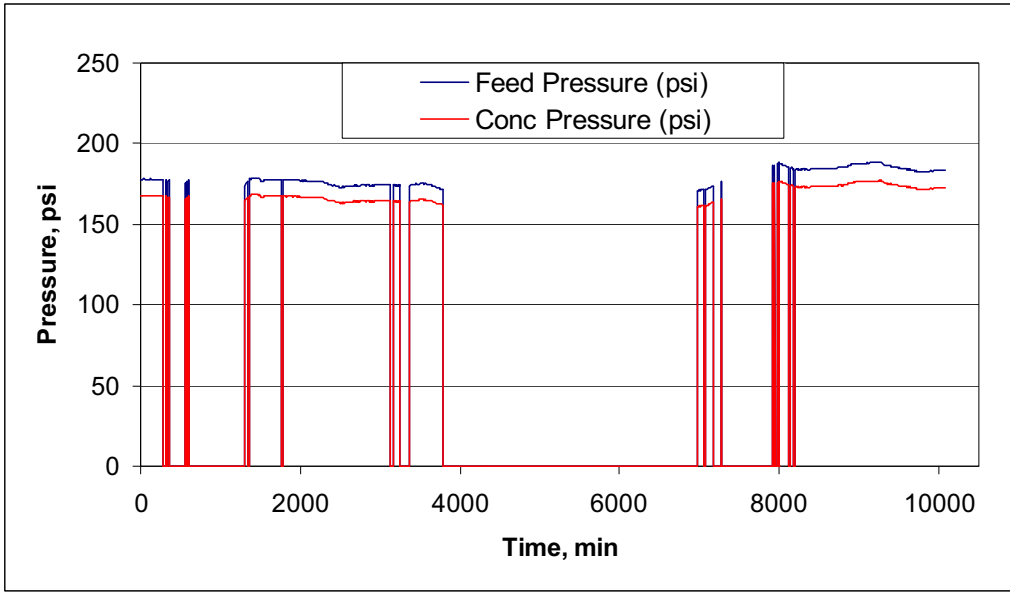
**Figure 68: Wind Speed, June 1-7<sup>th</sup>**



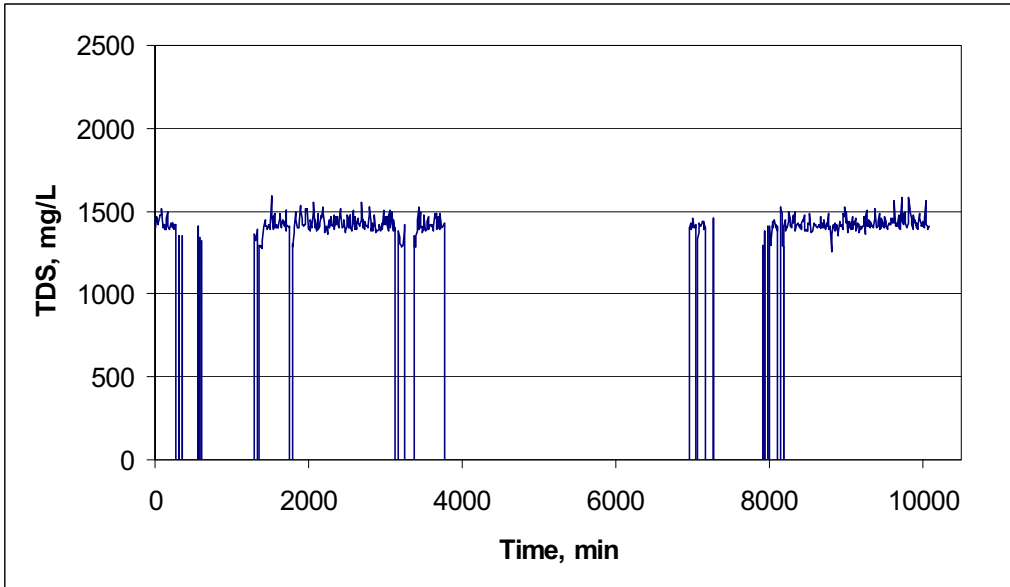
**Figure 69: RO Power, June 1-7<sup>th</sup>**



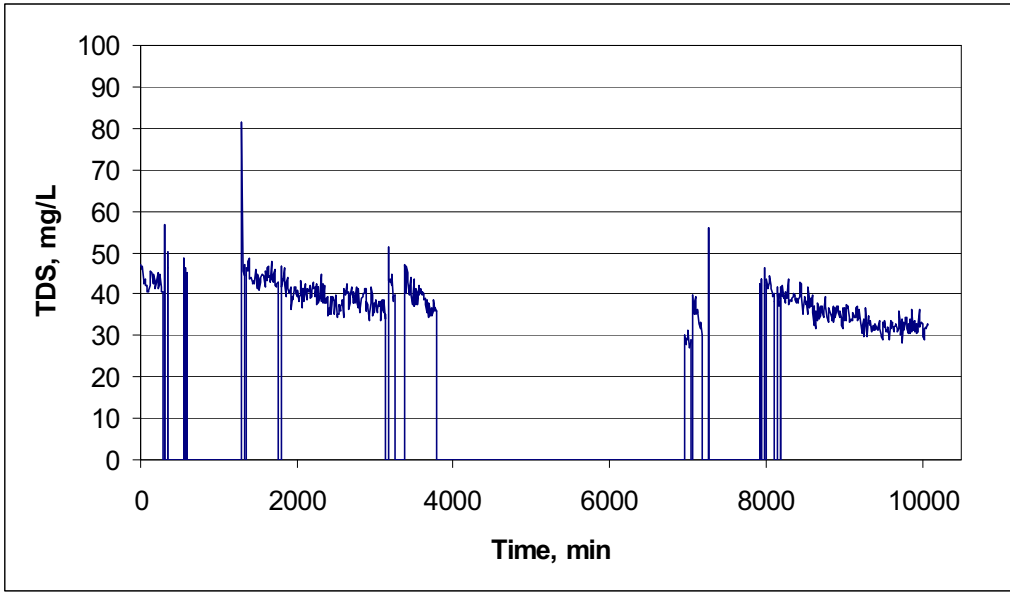
**Figure 70: Wind Power, June 1-7<sup>th</sup>**



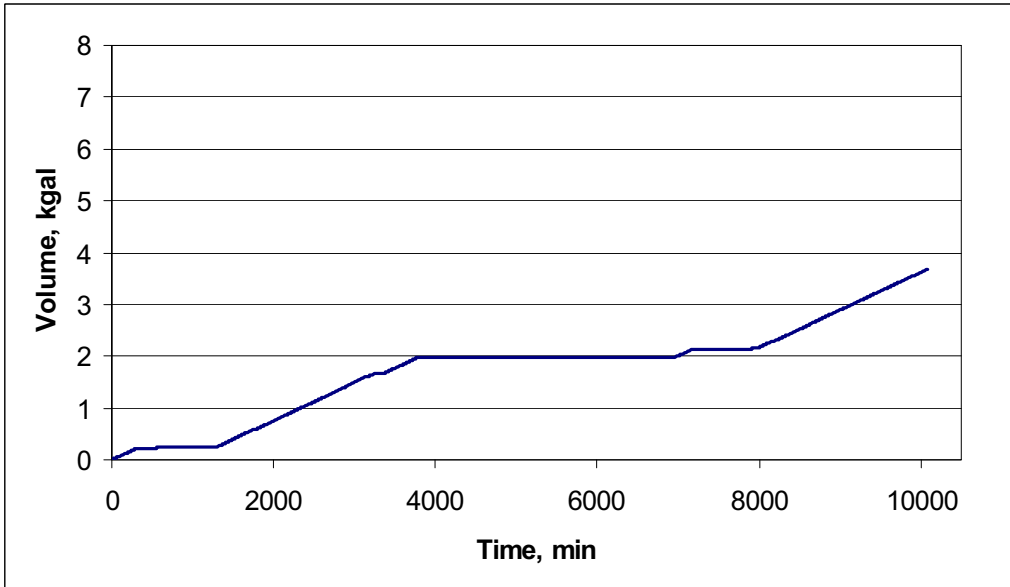
**Figure 71: Feed/Concentrate pressure, June 1-7<sup>th</sup>**



**Figure 72: Feed TDS, June 1-7<sup>th</sup>**



**Figure 73: Permeate TDS, June 1-7<sup>th</sup>**



**Figure 74: Permeate Produced, June 1-7<sup>th</sup>**

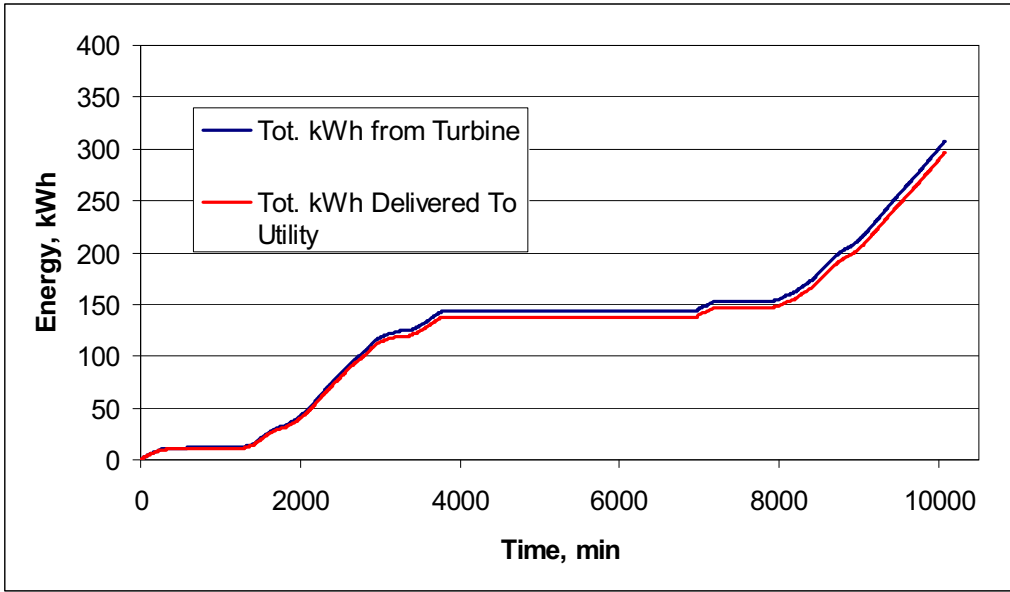


Figure 75: Kilowatt hours generated/delivered to utility, June 1-7<sup>th</sup>

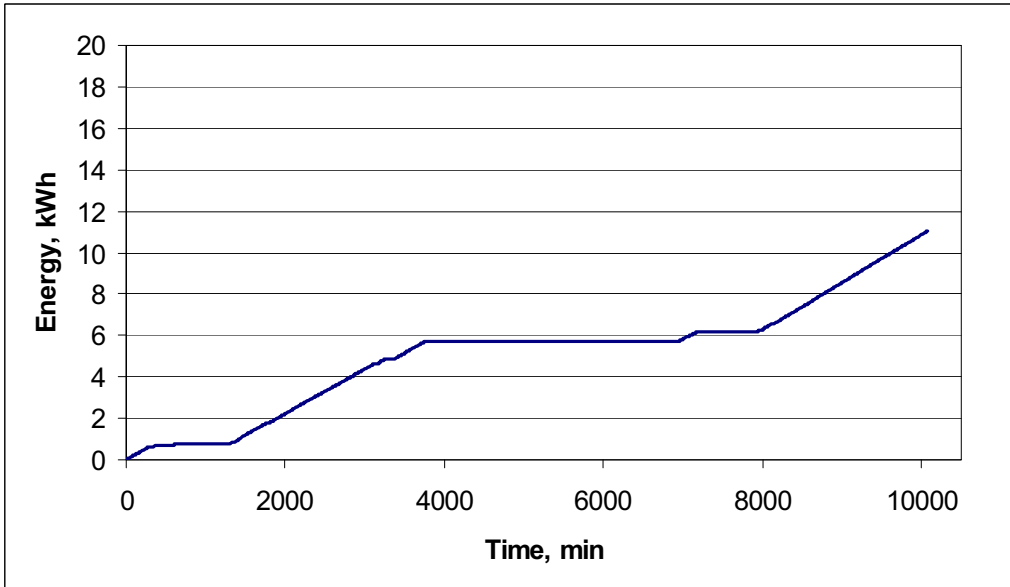
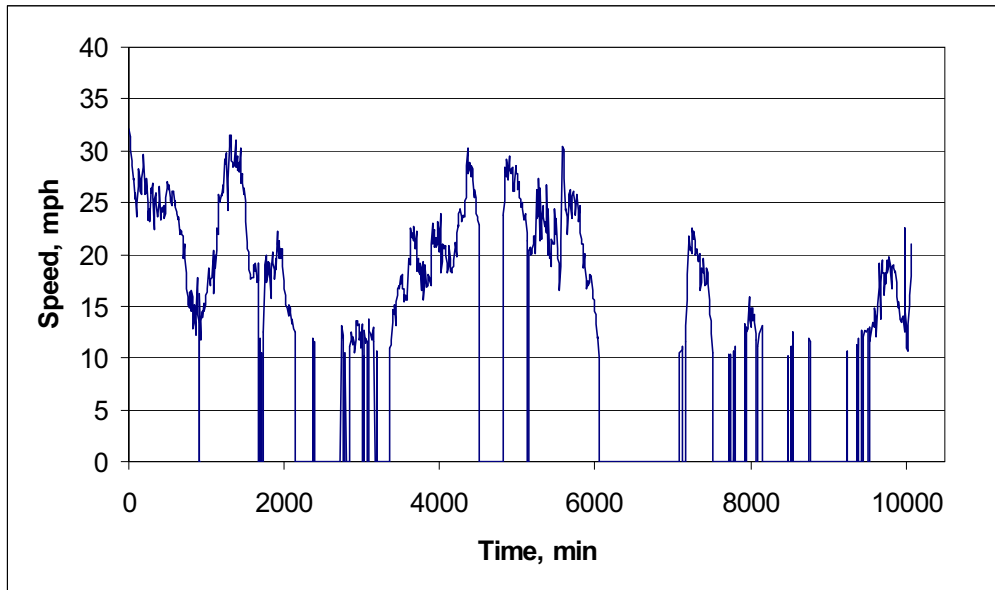
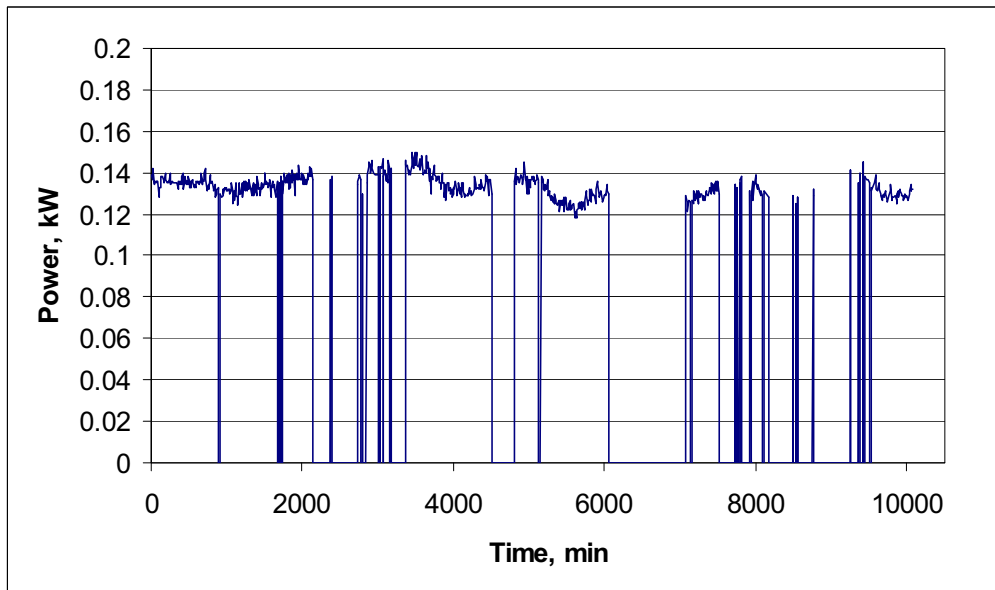


Figure 76: Kilowatt hours used by RO, June 1-7<sup>th</sup>

**Week #10 (June 8-14<sup>th</sup>)**

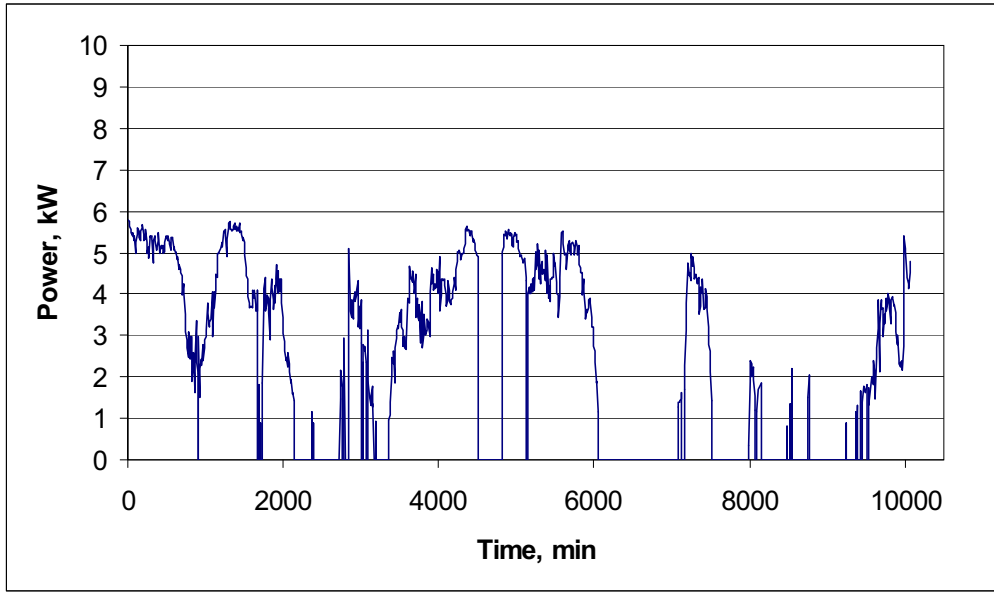


**Figure 77: Wind Speed, June 8-14<sup>th</sup>**

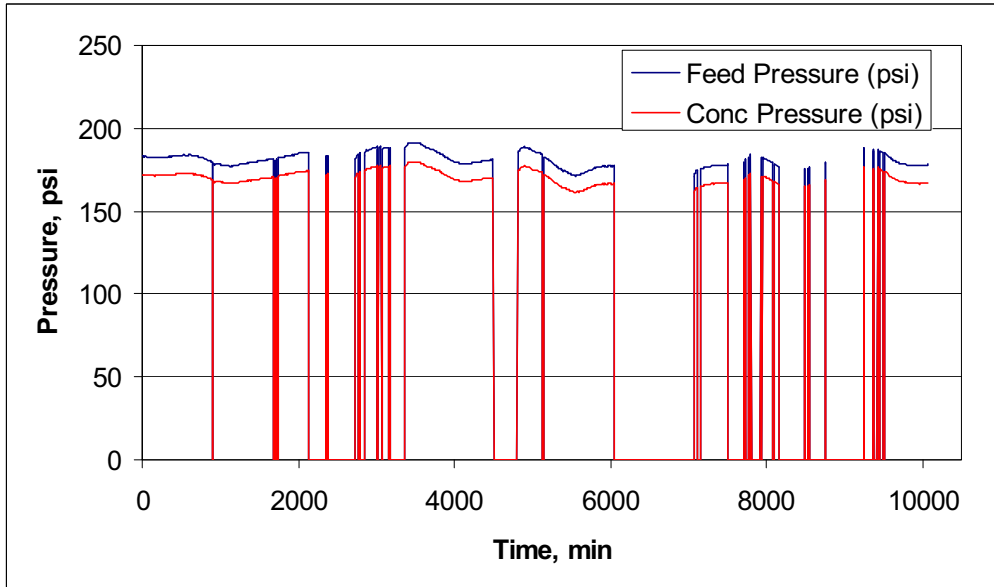


**Figure 78: RO Power, June 8-14<sup>th</sup>**

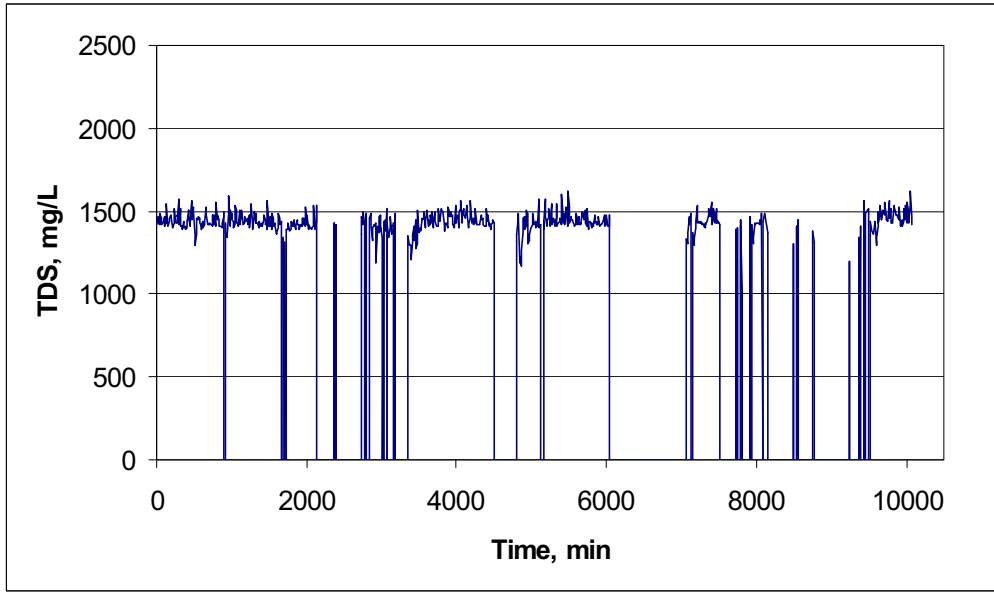




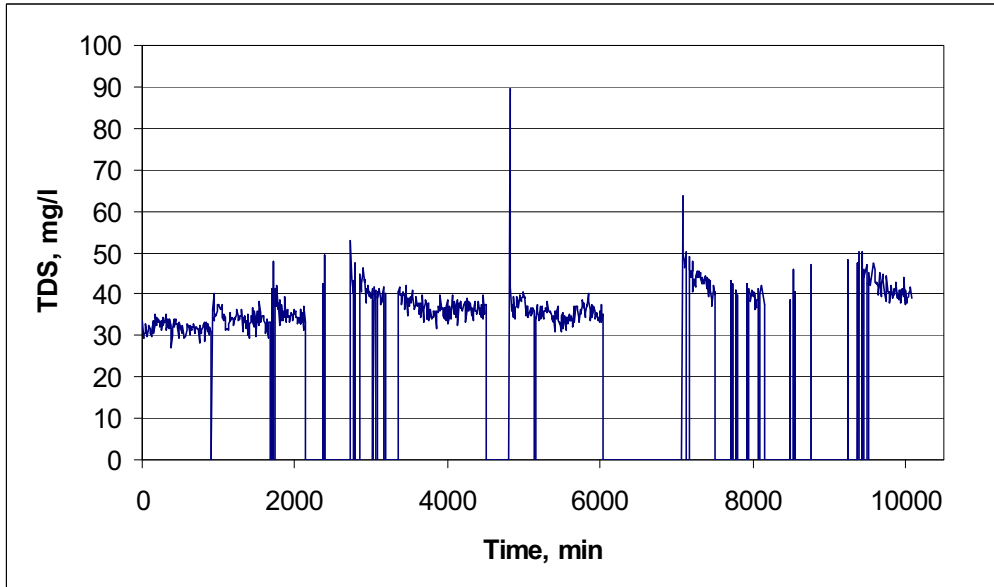
**Figure 79: Wind Power, June 8-14<sup>th</sup>**



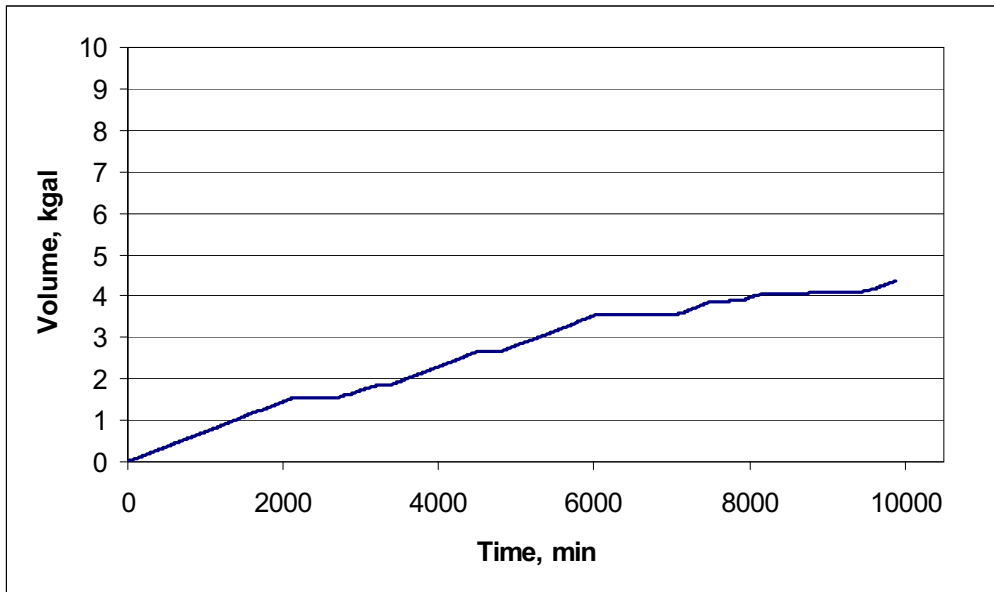
**Figure 80: Feed/Concentrate pressure, June 8-14<sup>th</sup>**



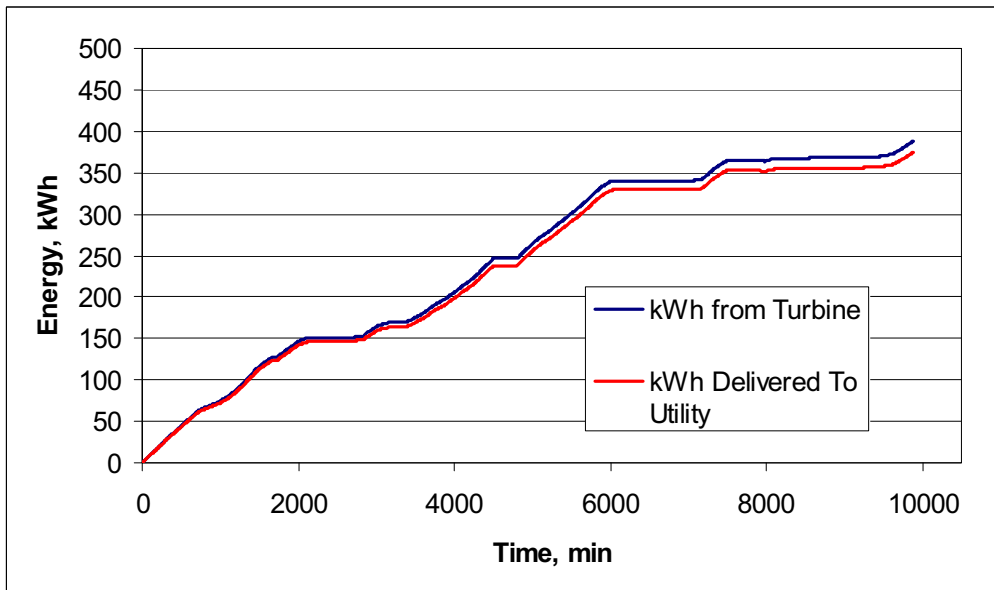
**Figure 81: Feed TDS, June 8-14<sup>th</sup>**



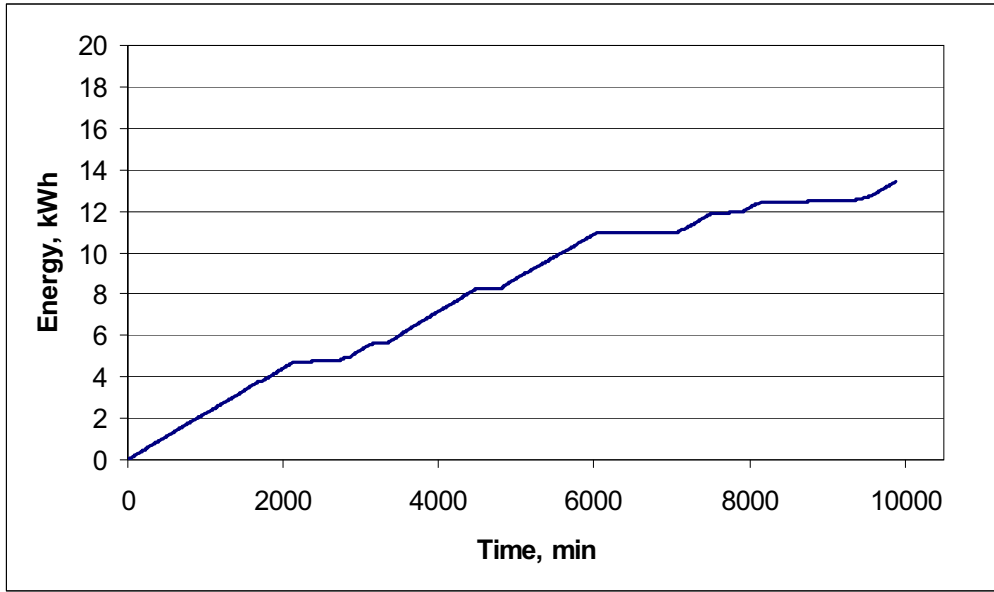
**Figure 82: Permeate TDS, June 8-14<sup>th</sup>**



**Figure 83: Permeate Produced, June 8-14<sup>th</sup>**

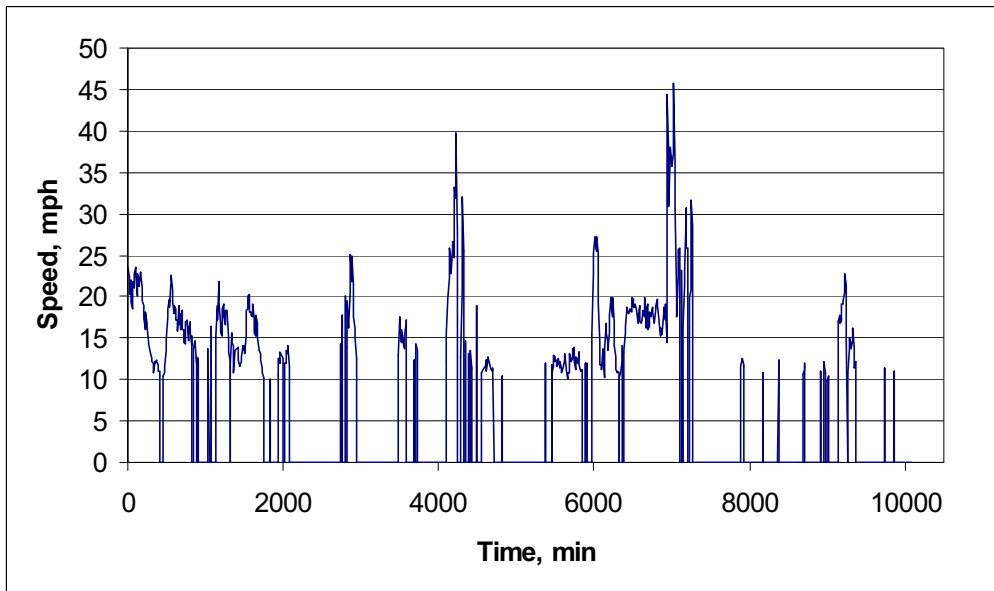


**Figure 84: Kilowatt hours generated/delivered to utility, June 8-14<sup>th</sup>**

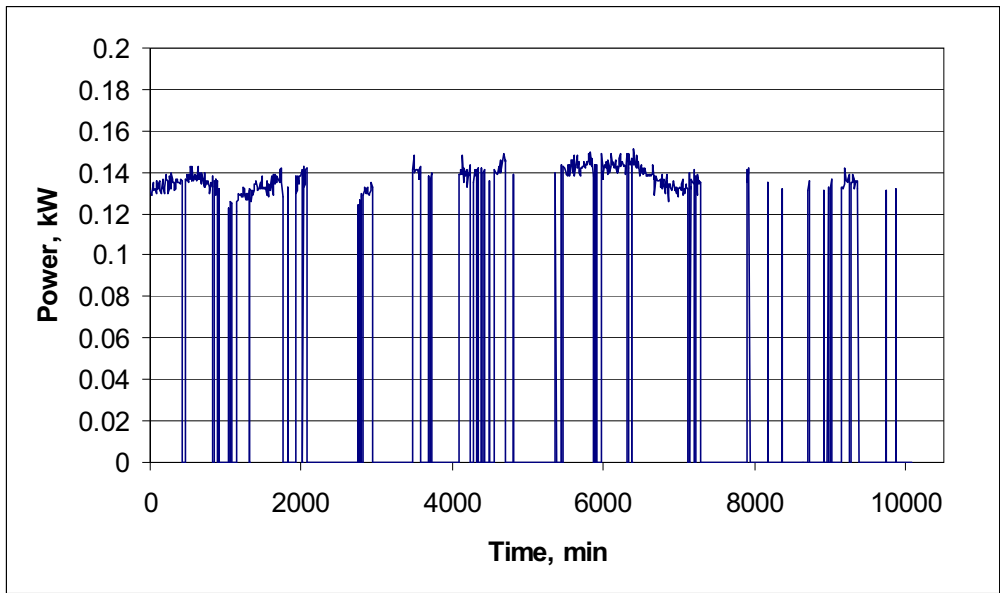


**Figure 85: Kilowatt hours used by RO, June 8-14<sup>th</sup>**

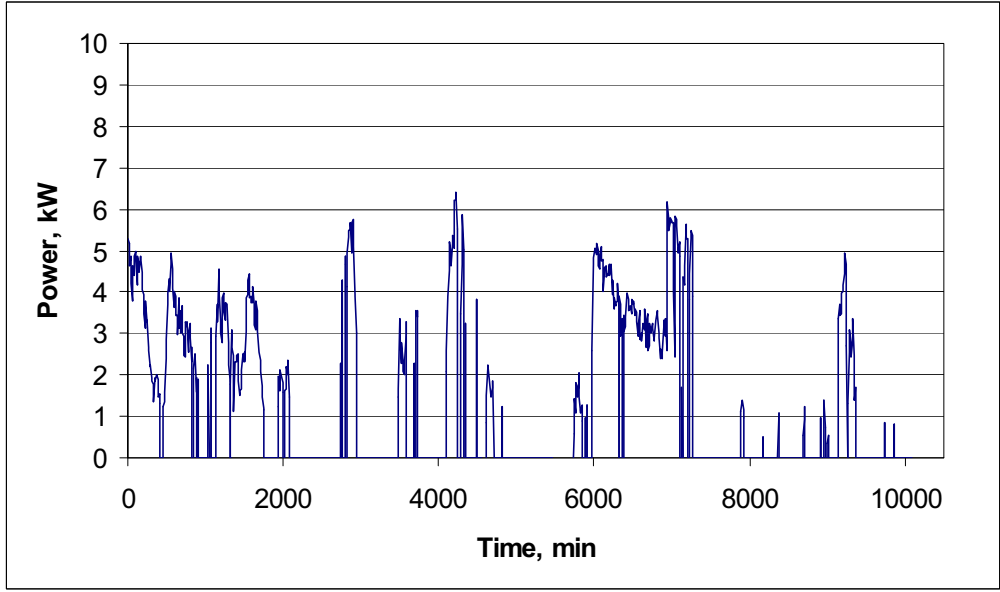
**Week #11 (June 15-21<sup>st</sup>)**



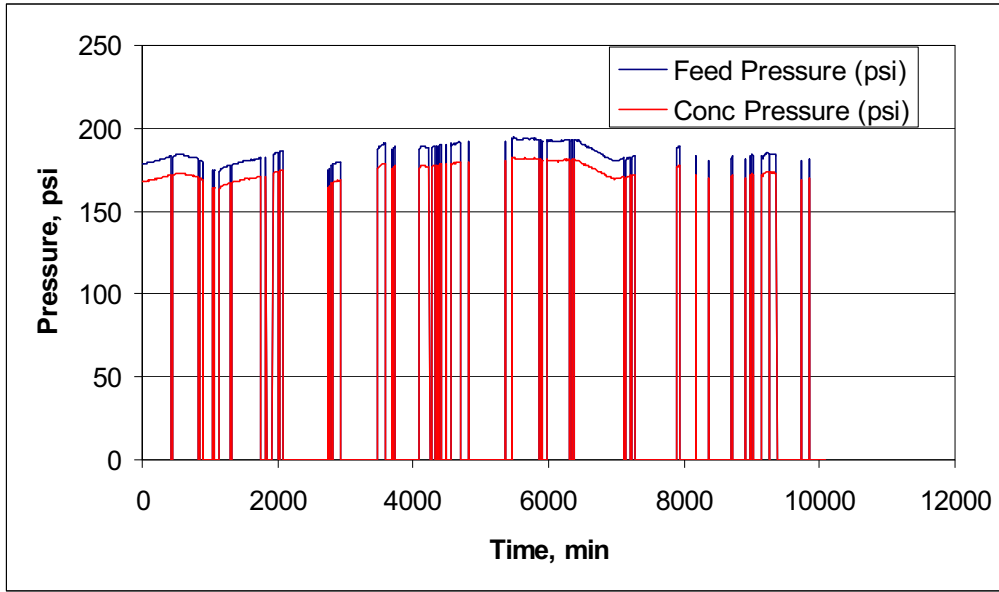
**Figure 86: Wind Speed, June 15-21<sup>st</sup>**



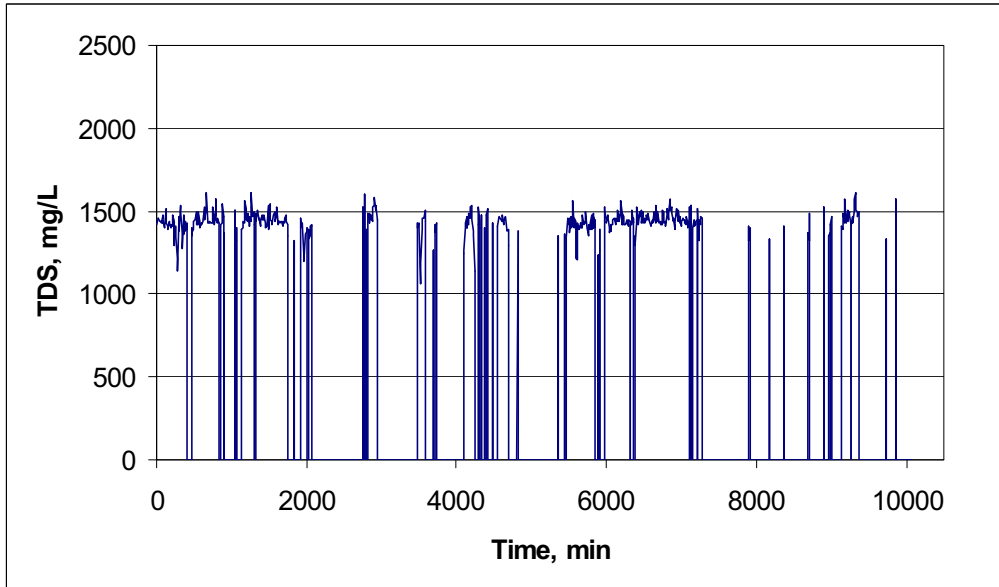
**Figure 87: RO Power, June 15-21<sup>st</sup>**



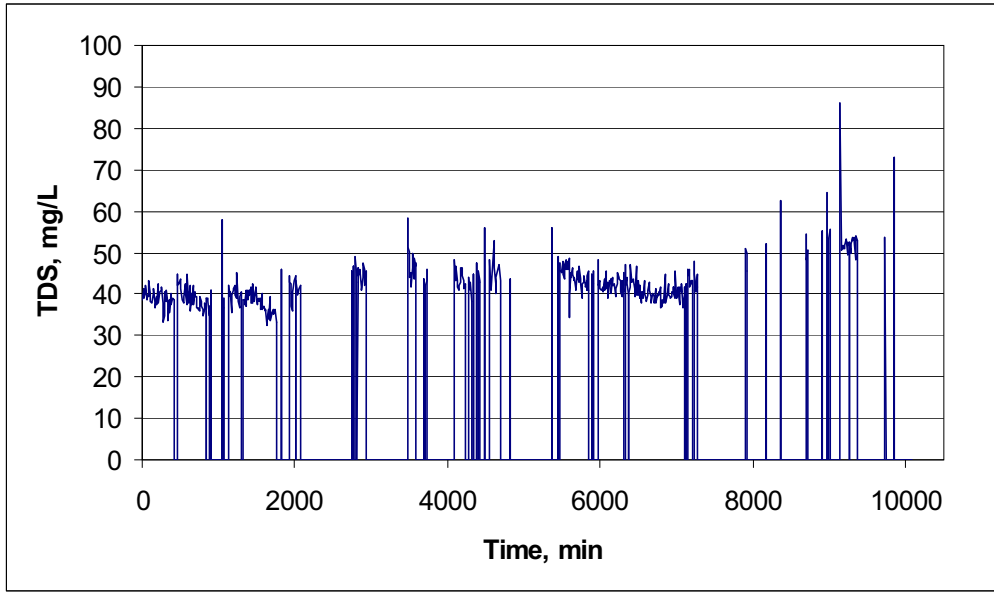
**Figure 88: Wind Power, June 15-21<sup>st</sup>**



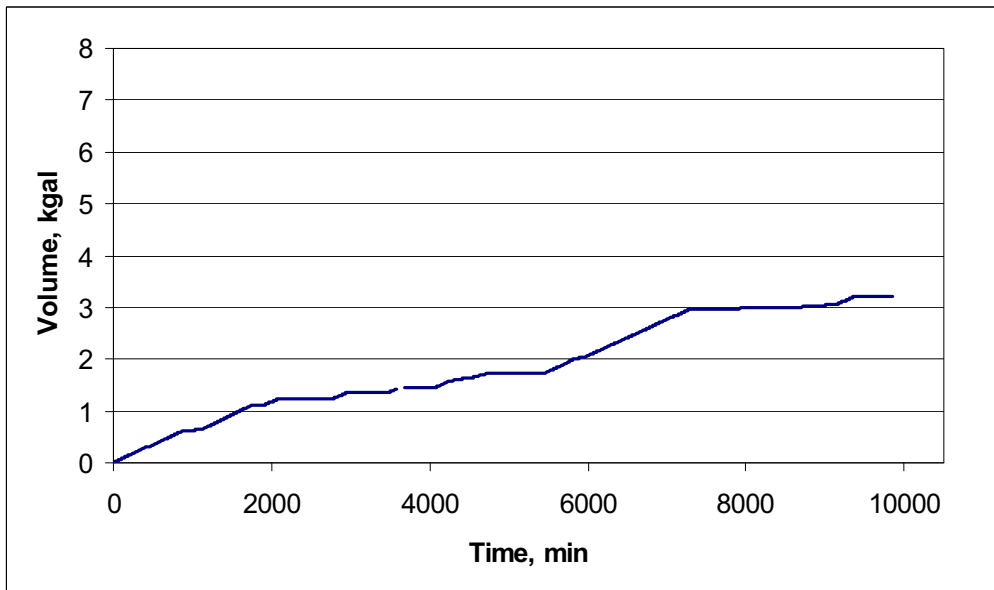
**Figure 89: Feed/Concentrate pressure, June 15<sup>th</sup> - 21<sup>st</sup>**



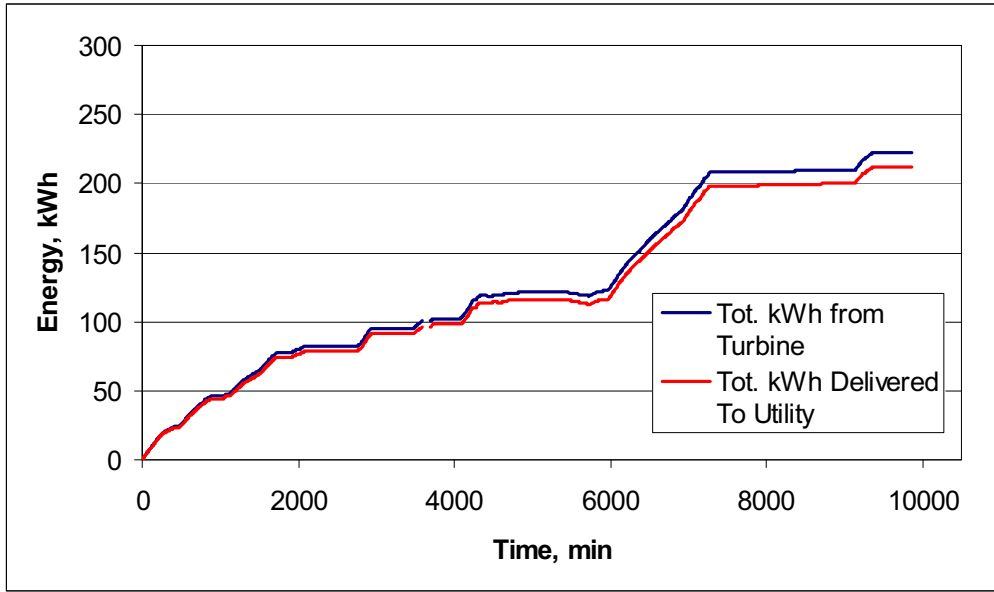
**Figure 90: Feed TDS, June 15-21<sup>st</sup>**



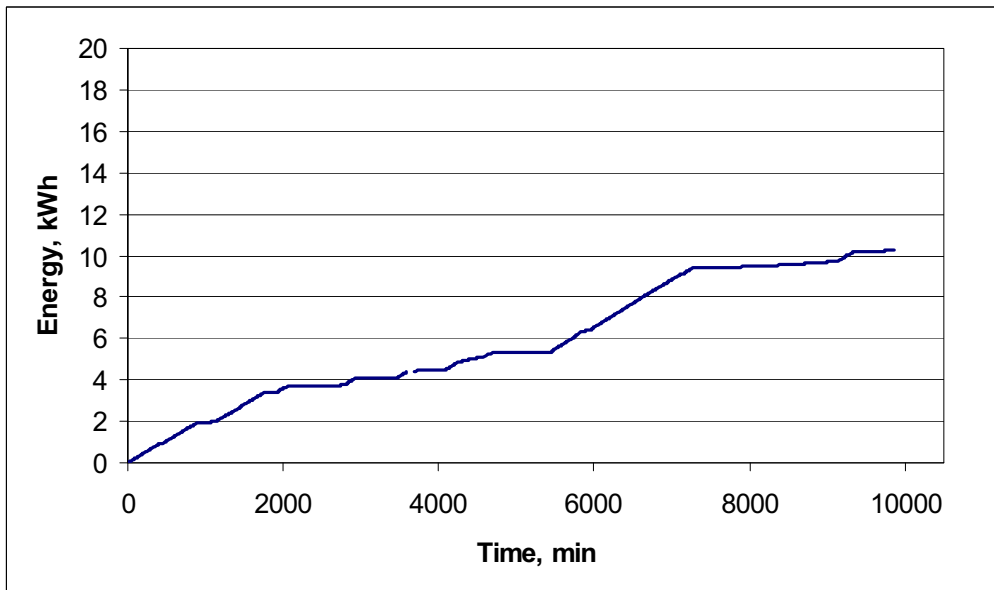
**Figure 91: Permeate TDS, June 15-21<sup>st</sup>**



**Figure 92: Permeate Produced, June 15-21<sup>st</sup>**



**Figure 93: Kilowatt hours generated/delivered to utility, June 15-21<sup>st</sup>**



**Figure 94: Kilowatt hours used by RO, June 15-21<sup>st</sup>**