

# RECLAMATION

*Managing Water in the West*

Desalination and Water Purification Research  
and Development Program Report No. 151

## Research and Development for Horizontal/Angle Well Technology



U.S. Department of the Interior  
Bureau of Reclamation

October 2008

# REPORT DOCUMENTATION PAGE

Form Approved  
OMB No. 0704-0188

Public reporting burden for this collection of information is estimated to average 1 hour per response, including the time for reviewing instructions, searching existing data sources, gathering and maintaining the data needed, and completing and reviewing this collection of information. Send comments regarding this burden estimate or any other aspect of this collection of information, including suggestions for reducing this burden to Department of Defense, Washington Headquarters Services, Directorate for Information Operations and Reports (0704-0188), 1215 Jefferson Davis Highway, Suite 1204, Arlington, VA 22202-4302. Respondents should be aware that notwithstanding any other provision of law, no person shall be subject to any penalty for failing to comply with a collection of information if it does not display a currently valid OMB control number. **PLEASE DO NOT RETURN YOUR FORM TO THE ABOVE ADDRESS.**

<b>1. REPORT DATE (DD-MM-YYYY)</b> May 2008		<b>2. REPORT TYPE</b> Final	<b>3. DATES COVERED (From - To)</b> April 2004 – April 2008	
<b>4. TITLE AND SUBTITLE</b> Research and Development for Horizontal/Angle Well Technology			<b>5a. CONTRACT NUMBER</b> Agreement No. 04-FC-81-1152	
			<b>5b. GRANT NUMBER</b>	
			<b>5c. PROGRAM ELEMENT NUMBER</b>	
<b>6. AUTHOR(S)</b> Dennis E. Williams, Ph.D. GEOSCIENCE Support Services, Inc.			<b>5d. PROJECT NUMBER</b>	
			<b>5e. TASK NUMBER</b> 1	
			<b>5f. WORK UNIT NUMBER</b>	
<b>7. PERFORMING ORGANIZATION NAME(S) AND ADDRESS(ES)</b> Municipal Water District of Orange County 10500 Ellis Ave. Fountain Valley, California 92728			<b>8. PERFORMING ORGANIZATION REPORT NUMBER</b> DWPR Report No. 151	
<b>9. SPONSORING / MONITORING AGENCY NAME(S) AND ADDRESS(ES)</b> U.S. Department of the Interior Bureau of Reclamation Denver Federal Center PO Box 25007 Denver, Colorado 80225-0007			<b>10. SPONSOR/MONITOR'S ACRONYM(S)</b> Reclamation	
			<b>11. SPONSOR/MONITOR'S REPORT NUMBER(S)</b> DWPR No. 151	
<b>12. DISTRIBUTION / AVAILABILITY STATEMENT</b> Available from the National Technical Information Service Operations Division, 5285 Port Royal Road, Springfield, Virginia 22161				
<b>13. SUPPLEMENTARY NOTES</b> Report can be downloaded from Reclamation Web site: <a href="http://www.usbr.gov/pmts/water/publications/reports.html">www.usbr.gov/pmts/water/publications/reports.html</a>				
<b>14. ABSTRACT (Maximum 200 words)</b> The report provides a review of angle well, HDD well, and other extraction technologies, their capabilities, challenges, and potential improvements, and determines the suitability of the technologies for constructing seawater desalination intakes. Key design/construction needs and technology improvements are assessed and key areas for specialized testing and development are identified. Recommended next steps of key construction design/construction improvements for angle and HDD construction methods are provided.				
<b>15. SUBJECT TERMS</b> angle well, HDD well				
<b>16. SECURITY CLASSIFICATION OF:</b> UL			<b>17. LIMITATION OF ABSTRACT</b> SAR	<b>18. NUMBER OF PAGES</b> 77
<b>a. REPORT</b> U	<b>b. ABSTRACT</b> U	<b>c. THIS PAGE</b> U		
			<b>19b. TELEPHONE NUMBER (include area code)</b> 303-445-2871	

**Desalination and Water Purification Research  
and Development Program Report No. 151**

# **Research and Development for Horizontal/Angle Well Technology**

**Agreement No. 05-FC-81-1152**

*by*

**Dennis E. Williams, Ph.D.  
GEOSCIENCE Support Services, Inc.  
For the Municipal Water District of Orange County**



**U.S. Department of the Interior  
Bureau of Reclamation  
Technical Service Center  
Water and Environmental Services Division  
Water Treatment Engineering Research Team  
Denver, Colorado**

**October 2008**

## **MISSION STATEMENTS**

The mission of the Department of the Interior is to protect and provide access to our Nation's natural and cultural heritage and honor our trust responsibilities to Indian tribes and our commitments to island communities.

---

The mission of the Bureau of Reclamation is to manage, develop, and protect water and related resources in an environmentally and economically sound manner in the interest of the American public.

### **Disclaimer**

The views, analysis, recommendations, and conclusions in this report are those of the authors and do not represent official or unofficial policies or opinions of the United States Government, and the United States takes no position with regard to any findings, conclusions, or recommendations made. As such, mention of trade names or commercial products does not constitute their endorsement by the United States Government.

# Acknowledgements

GEOSCIENCE Support Services, Inc., under the overall project management of the firm's principal, Dr. Dennis E. Williams, was responsible for conducting the research related to angle/horizontal well technology and preparation of this report. Angle/horizontal well experience and knowledgeable advice was provided by:

- WDC Exploration & Wells, Houston, Texas
- Halliburton (West Coast Directional Drilling Office), Bakersfield, California
- Lang Exploratory Drilling (Division of Boart Longyear Co.), Salt Lake City, Utah
- Cherrington Corporation, Sacramento, California
- Laney Directional Drilling Co., Humble, Texas
- Jehn Water Consultants, Inc., Denver, Colorado
- Layne-Christensen Co., Pewaukee, Wisconsin
- Foremost Industries, L.P., Calgary, Alberta, Canada
- Pierre Gagne Contracting Ltd., Ontario, Canada
- Beylik Drilling Co. (now Layne Christensen Co.), Fontana, California
- Geo-Tech Explorations, Inc. (Division of Boart Longyear Co.), Tualatin, Oregon
- Construction Drilling Inc., British Columbia, Canada
- Wright-Pierce, Inc., Portsmouth, New Hampshire
- Quad-State Services, Inc., Perry, Kansas
- Quality Drilling Fluids Engineering Inc., Fort Lupton, Colorado
- Collector Wells International (Acquired by Layne in 2006), Columbus, Ohio
- Baroid Industrial Drilling Products, Denver, Colorado
- Roscoe Moss Co., Los Angeles, California

Special appreciation goes to Project Manager Mr. Richard Bell, Mr. Kevin Hunt, Mr. Karl Seckel, and Ms. Michelle Tuchman, Municipal Water District of Orange County, and to the Board of Directors of the Municipal Water District of Orange County for their stewardship and leadership in supporting this investigation.



# Table of Contents

	<i>Page</i>
1. Introduction .....	1
1.1 Purpose and Scope .....	2
1.2 Sources of Data .....	3
1.2.1 Literature Review .....	3
1.2.2 Summary of Meetings and Interviews with Horizontal Drilling Contractors .....	4
1.3 Background of the Dana Point Ocean Desalination Project .....	12
2. Review of Angle Well Technology, Capabilities, Challenges and Further Research Needs .....	15
2.1 Overview of Angle Well Uses .....	15
2.2 Dual Rotary Slant Well Technology .....	16
2.3 Dual Rotary Slant Well Capabilities .....	19
2.4 Dual Rotary Slant Well Examples .....	22
2.5 Advantages of Using Dual Rotary Slant Well Technology .....	24
2.6 Emerging Dual Rotary Slant Well Technology Challenges .....	26
2.7 Further Research and Development Needs for Dual Rotary Slant Well Drilling Technology .....	28
3. Review of HDD Well Technology, Capabilities, Challenges, and Further Research Needs .....	31
3.1 HDD Well Capabilities .....	35
3.2 HDD Well Examples .....	36
3.3 Advantages of HDD Technology .....	38
3.4 Emerging HDD Well Technology Challenges .....	39
3.5 Further Research and Development Needs for HDD Well Drilling Technology .....	41
4. Review of Other Construction Methods for Subsurface Intakes for Desalination Supply .....	43
4.1 Nearshore Vertical Beach Wells .....	43
4.2 Ranney-Type Horizontal Collector Wells .....	43
4.2.1 Traditional Horizontal Collector Wells .....	43
4.2.2 Sonoma Method Horizontal Collector Wells .....	46
4.3 Infiltration Galleries .....	46
5. Recommended Next steps of Key Design/Construction Improvements for Angle and HDD Construction Methods .....	48
6. References .....	51
6.1 General References .....	51
6.2 Slant and Horizontal Well Hydraulics References .....	59

<i>Table</i>	<i>Page</i>
1 Summary of Horizontal Angle Wall Construction Methods .....	61
2 Comparison of Dual Rotary Rig Capabilities .....	20



# Acronyms and Abbreviations

<b>DR</b>	dual rotary
<b>DWR</b>	California Department of Water Resources
<b>EPA</b>	U.S. Environmental Protection Agency
<b>gpm</b>	gallons per minute
<b>HDD</b>	horizontal directionally-drilled wells
<b>HDPE</b>	high density polyethylene
<b>ID</b>	inside diameter
<b>MD</b>	measured depth
<b>mgd</b>	million gallons per day
<b>MWD</b>	measurement while drilling
<b>MWDOC</b>	Municipal Water District of Orange County
<b>NTU</b>	nephelometric turbidity units
<b>O&amp;M</b>	operations and maintenance
<b>OD</b>	outside diameter
<b>psi</b>	pounds per square inch
<b>RWD</b>	ream while drilling
<b>SDI</b>	silt density index
<b>SWRO</b>	seawater reverse osmosis
<b>TAP</b>	Technical Advisory Panel
<b>TVD</b>	true vertical depth



# 1. Introduction

Municipal Water District of Orange County (MWDOC) is conducting a phased investigation into the feasibility of using subsurface intakes for feed water supply to a proposed desalination plant located at the mouth of San Juan Creek at Doheny State Beach in Dana Point, California. The investigation has been partially funded by the California Department of Water Resources (DWR), by a Proposition 50 Desalination Grant (2005) under Agreement No. 4600004110, entitled Horizontal/Slant Well Technology Application in Alluvial Marine Aquifers for Feedwater Supply and Pretreatment. Under Task 3 of the phased investigation, the dual

rotary (DR) drilling and horizontal directional drilling (HDD) methods were evaluated to determine their suitability for constructing a subsurface seawater intake system at the mouth of San Juan

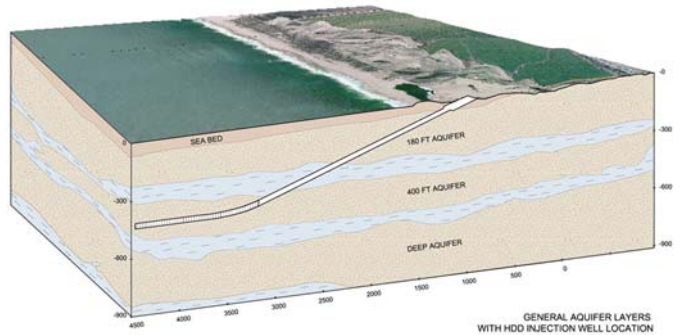

**HDD beach well schematic (GEOSCIENCE, 2005c).**

Creek prior to implementing the drilling and construction phase of the work. This report summarizes the research and investigation that occurred regarding these two main methods for drilling and constructing directionally drilled wells (i.e., dual rotary and HDD) and presents recommendations for key areas of future research and development to support the feasibility of slant well drilling and construction in similar geologic environments.



**Drilling in sensitive beach environments (photo by GEOSCIENCE).**

The use of subsurface intakes for desalination supply requires production of large quantities of high-quality saline ground water that minimizes impacts to onshore fresh ground water. This has resulted in the need to develop well construction technology to place the screen section as far as possible offshore. Slant

wells with screens located offshore have the potential to yield water of higher salinity than onshore vertical wells while generating lesser impacts to onshore ground water levels. Wells that penetrate subsea aquifers on an angle have the potential to be more productive than vertical onshore wells having well screens that are limited in length to the vertical thickness of the aquifer. Benefits of subsurface intakes over traditional open ocean intakes for desalination supply include elimination of entrainment and impingement of marine organisms, the potential to eliminate the costly pre-filtration step for the seawater reverse osmosis (SWRO) process, protection from shock-loading (caused by such events as storms, spills, and algal blooms), and the elimination of physical construction-related impacts to the beach and ocean.

The main technologies evaluated for the Dana Point Ocean Desalination Project for drilling wells at an angle included dual rotary drilling and HDD. These two methods proved the most promising for constructing wells with screens of sufficient length (greater than 200 feet) to obtain seawater from an offshore source under the seabed. Both of these methods have been previously used somewhat in the construction of water wells, although not specifically for seawater/desalination intake applications, and not necessarily requiring artificial filter packs.

Other types of wells, such as vertical beach wells and Ranney-type radial collector wells, have been used for seawater intake, but were not considered for use at Doheny State Beach because of construction and geohydrologic constraints. These constraints are discussed briefly in section 4 of this report. Other available drilling methods that may be modified to construct seawater intake wells at an angle but are not discussed in this report are sonic drilling or fluid reverse systems; however, preliminary discussions with drillers specializing in these methods did not reveal benefits superior to the dual rotary or HDD methods.

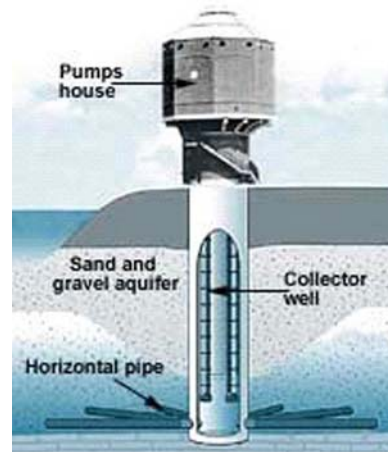

**Radial collector well (Reynolds, 2002).**

## 1.1 Purpose and Scope

The purpose of the Task 1 research and development evaluation was to review angle and HDD well technology and determine the suitability of the technology for constructing seawater desalination intakes. Specifically, the scope of work included:

- Reviewing angle well technology, capabilities, challenges, and potential improvements.
- Reviewing HDD well technology, capabilities, challenges, and potential improvements.
- Assessing key design/construction needs and technology improvements.
- Identifying key areas for specialized testing and development.
- Research development for HDD well technology improvements.
- Identifying next steps for technology implementation.
- Preparation of a report.

In support of Reclamation Task 1 (Task 3 of the DWPR grant), GEOSCIENCE personnel conducted research into the dual rotary and HDD drilling methods between 2004 and 2006 under the direction of MWDOC Principal Engineer Richard Bell. In addition, Technical Advisory Panel (TAP) meetings were convened by MWDOC on May 12, 2005, and November 29, 2005, to discuss the technical considerations of the drilling and construction procedure and obtain advice from others who are experienced in slant well drilling, collector well construction, and seawater desalination applications.

## **1.2 Sources of Data**

In addition to meeting with drilling contractors and other horizontal drilling industry experts to discuss state-of-the-art directional drilling, prior to constructing the MWDOC test slant well, GEOSCIENCE personnel conducted research for available data on the subject of HDD, slant and collector well drilling technology. The primary sources researched were trade journal and other publications for the oilfield and ground water industries, government publications, text books, and the internet.

### **1.2.1 Literature Review**

In the compilation and summary of information for this report, a number of references were relied upon (“References”). In addition, as the science of HDD and especially slant well hydraulics is relatively new (or not commonly used) compared to vertical well hydraulics, “Slant and Horizontal Well Hydraulics References” is a compilation of references that relate to that specific area of interest.

### **1.2.2 Summary of Meetings and Interviews with Horizontal Drilling Contractors**

Various drilling, drilling services, water well services, and construction companies as well as drilling consultants were contacted and/or visited to brainstorm the best approach for drilling and constructing a test slant well at Doheny State Beach. These companies included:

- WDC Exploration & Wells, Houston, Texas
- Halliburton (West Coast Directional Drilling Office), Bakersfield, California
- Lang Exploratory Drilling (Division of Boart Longyear Co.), Salt Lake City, Utah
- Cherrington Corporation, Sacramento, California
- Laney Directional Drilling Co., Humble, Texas
- Jehn Water Consultants, Inc., Denver, Colorado
- Layne-Christensen Co., Pewaukee, Wisconsin
- Foremost Industries, L.P., Calgary, Alberta, Canada
- Pierre Gagne Contracting Ltd., Ontario, Canada
- Beylik Drilling Co. (now Layne Christensen Co.), Fontana, California
- Geo-Tech Explorations, Inc. (Division of Boart Longyear Co.), Tualatin, Oregon
- Construction Drilling Inc., British Columbia, Canada
- Wright-Pierce, Inc., Portsmouth, New Hampshire
- Quad-State Services, Inc., Perry, Kansas
- Quality Drilling Fluids Engineering Inc., Fort Lupton, Colorado
- Collector Wells International (Acquired by Layne in 2006), Columbus, Ohio
- Baroid Industrial Drilling Products, Denver, Colorado
- Roscoe Moss Co., Los Angeles, California

The following chronology details meetings that GEOSCIENCE staff attended in support of research and selection of the appropriate technology for test slant well construction.

GEOSCIENCE began investigating the application of subsurface intakes for desalination supply in early 2004, while under contract to RBF Consulting.

Specifically, the feasibility of subsurface intakes was being investigated for a proposed desalination project at Moss Landing, in Monterey County, California.

In April 2004, GEOSCIENCE personnel met with Mr. Doug Watson of Beylik Drilling Company (now Layne Christensen Company) and Mr. Ted Caldwell of Roscoe Moss Company to discuss an ongoing project—a blind HDD well in the Denver Basin. Beylik was drilling the well for the Castle Pines North Metropolitan District in conjunction with its consultant, Jehn Water Consultants. The project involved connecting a vertical well at depth with a directionally drilled horizontal well, whose vertical entry point was located approximately 1,800 feet away, in order to maximize production and recharge from the Arapahoe Sandstone aquifer. Mud motor technology (using the direct mud rotary drilling method) was used in the directionally drilled borehole to guide the drilling bit through the turn from vertical to horizontal and to intersect the casing at the bottom of the vertical well (Jehn Water Consultants, 2004).

In June 2004, GEOSCIENCE personnel traveled to Denver, Colorado, to meet with Ms. Theresa Jehn-Dellaport of Jehn Water Consultants to discuss the design of two HDD well projects in the Denver Basin. Drilling and construction for the Castle Pines North Metropolitan District project had been completed and was in the process of developing and testing both the vertical and horizontal wells, while the Antelope Hills well, near Bennett, Colorado, was drilled and constructed during 2002-03. The purpose of the Antelope Hills well was to increase production from the Arapahoe Sandstone by drilling at an angle through the available aquifers, increasing the length of the screen. The Antelope Hills well was not yet in production as it had become “air locked” during development. Meanwhile, the project was on hold waiting for the air to dissipate.

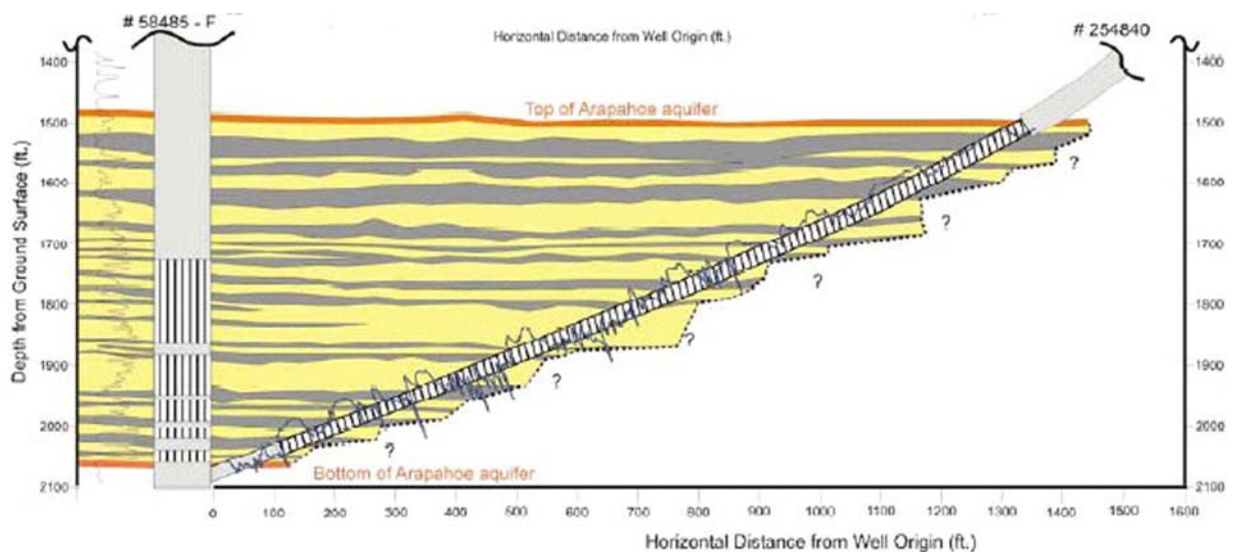

Castle Pines North directional well, Colorado (Jehn Water Consultants, Inc., 2004).

Beylik was the drilling contractor for the Castle Pines North project and provided a 280 Challenger drilling rig and support equipment that included mud pumps, shale shakers, and desanding cones. Baroid Industrial Drilling Products provided the polymer-based drilling mud and was onsite on a daily basis to monitor and adjust the drilling fluid parameters during the drilling process. Sperry Sun (now Sperry Drilling Services), a subsidiary of Halliburton, provided the mud motors and directional steering technology to maintain the correct path of the wellbore, while Halliburton provided pressurized cementing services to seal casings against leakage. Schlumberger provided service for geophysical borehole logging, which is a measurement of downhole formation properties to determine aquifer characteristics such as porosity and permeability. At the time of GEOSCIENCE's visit, Layne Christensen was in the initial stages of developing both the vertical and horizontal wells. According to Beylik, the cost of labor, mud program, materials, and geophysical borehole logging was \$2 to 2.5 million. A daily rate of \$14,400 was charged for the drilling rig.

In reviewing challenges associated with the project, Ms. Jehn acknowledged that the main problems encountered when drilling HDD wells are primarily issues involving borehole stability and development of the completed well. Both Denver Basin projects were drilled in a single full-diameter pass with the drilling bit (i.e., without reaming or enlarging the initial borehole) using a polymer-based drilling mud program. Threaded joints were used on both the casing and screen

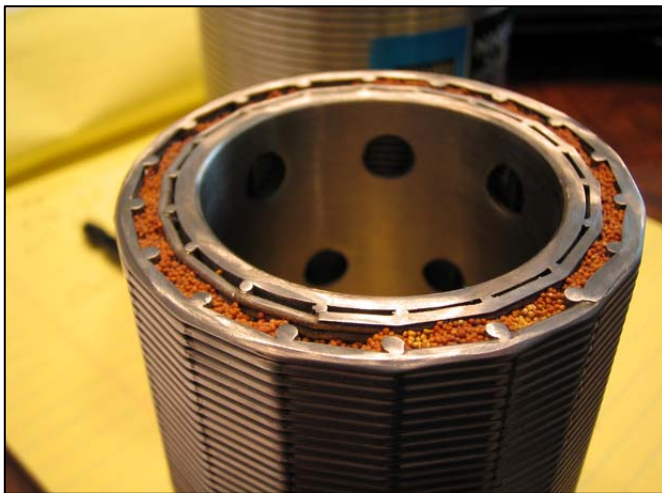

**Prepacked well screen used in Castle Pines North Metro HDD well, Colorado (photo by GEOSCIENCE).**

sections as it was felt that welded joints would not flex as much as was needed for the application. Prepacked well screens were used in order to avoid installation of a filter pack within the annular space. During drilling, penetration rates were monitored to ensure complete removal of all cuttings (i.e., formation materials broken by the drill bit), development of proper wall cake characteristics, and

thorough conditioning of the borehole wall. Details to be changed in the future would be to use a larger drilling rig with more pullback capacity of at least 200,000 pounds, rather than continuing on with the 110,000-pound drilling rig that was used. Additionally, it was felt that triplex mud pumps should be used in the future to provide additional fluid pressure and volume instead of the duplex



pumps that were used. Use of polymer-based drilling fluids was considered favorable in achieving adequate borehole stability during drilling and construction while facilitating the development process.



**Mud motors (photo by GEOSCIENCE).**

drilling fluids available and how they can assist in overcoming borehole stability problems in HDD wells, and to discuss other various oilfield tools available, such as MWD devices.

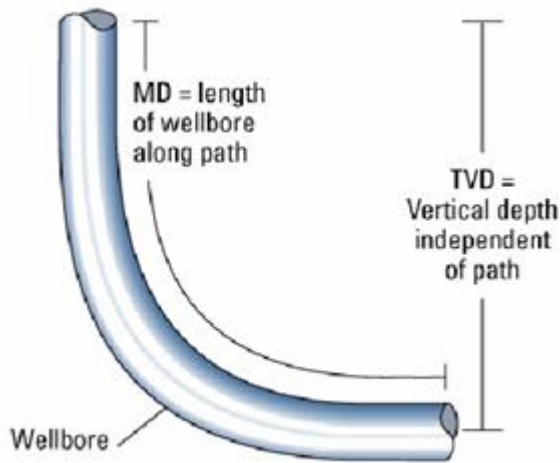

**True vertical depth and measured depth (Schlumberger, 2007).**

technology was first used in the late 1920s; however, it was not until the development of mud motor technology in the 1970s, with the development of MWD and other tools, that the widespread use of HDD technology became feasible in the oilfield. Since 1994, Halliburton's West Coast Directional Drilling

Following the meeting with Theresa Jehn, GEOSCIENCE personnel met with Mr. Fred Rothauge, owner of Quality Drilling Fluids in Fort Lupton, Colorado. Mr. Rothauge is a mud engineer with extensive drilling experience in both the water well and oil industries, including directional drilling. The purpose of the visit was to gain further information on the HDD drilling process, to learn further how mud motors work, to discuss types of

In August 2004, GEOSCIENCE personnel traveled to Bakersfield to meet with Halliburton's West Coast Directional Drilling Office to discuss directional drilling methodology. Preliminary conversations with Halliburton indicated that drilling a 10-inch-diameter HDD well with a true vertical depth (TVD) of approximately 800 feet was feasible using a 10-degree ( $^{\circ}$ ) dogleg<sup>1</sup> per section of drill pipe to rotate the 12 $\frac{1}{4}$ -inch borehole from vertical to horizontal. Horizontal drilling

<sup>1</sup> A dogleg is the total angular change between the tangent to the borehole at one point and the tangent to the borehole at another point (Schlumberger, 2007).

office in Bakersfield, California, has completed more than 900 horizontal oil wells. At first, laterals with a maximum length of 300 to 400 feet were drilled, while lateral lengths currently exceed 1,000 to 1,500 feet. In the experience of Halliburton personnel that attended the meeting, the largest diameter casing that has been pushed through a 90° bend was 9-7/8 inches outer diameter (OD) in a 12¼-inch diameter borehole. That particular well had a TVD of 477 feet and a measured depth (MD) of 750 feet and was drilled using 12° doglegs.

Halliburton personnel described mud motor technology as it is applied to directional drilling and described how mud motors are steerable in all directions (up, down, left, right). Changes in borehole direction are accomplished by rotating the mud motor and drill bit while pushing with the drill string without rotating the drill string. Once the desired borehole angle is reached, the drill bit and drill string are rotated to maintain the proper course. Once the directionally drilled portion of the borehole has been completed, the mud motor is removed and the starter pipe, or surface casing, is cemented into place through the entire turn, or bend, to stabilize the borehole before drilling the horizontal lateral. Underreaming bits are commonly used to “open up,” or enlarge the diameter of the lateral to a greater diameter than that of the starter pipe using the ream while drilling (RWD) process. Halliburton personnel advised that it was not feasible to drill a borehole from vertical to horizontal and then back up toward land surface as the casing and screen can only be pushed uphill a short distance due to torque and drag created while fighting gravity through the bend in the borehole.

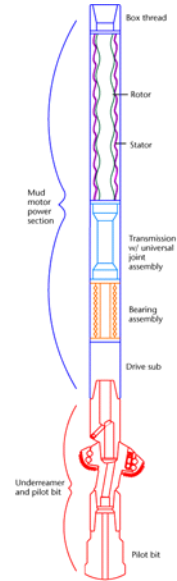

**Mud motor and underreaming bit (Graber et al., 2002).**

Following the face-to-face meeting, GEOSCIENCE personnel had further telephone discussions with Halliburton regarding geophysical borehole logging using their Tool Pusher™ High-Angle Logging Services and prepacked screen completion methods. Geophysical borehole logging is accomplished by using a side-door entry subassembly with the cable for the tools being run along the outside of the drill string. The drill string is removed from the borehole after the geophysical logging tools have been placed in the bottom of the borehole. Logging then proceeds from the bottom of the borehole to the top while pulling the cable that is attached to the tools. Each type of tool requires a separate run, making geophysical logging a time-intensive process. Preliminary costs obtained from Halliburton indicated that using oilfield technology was very expensive and that probably it would not be cost-effective means to obtain the borehole diameter

and depths needed to complete a horizontal well in the shallow aquifers encountered at Dana Point.



**Cherrington HDD drilling rig  
(photo by GEOSCIENCE).**



**Desanding and desilting equipment  
(photo by GEOSCIENCE).**

In January 2005, GEOSCIENCE personnel met with Mr. Randy Mayer of Lang Exploratory (a division of Boart Longyear Company) to discuss using HDD to construct a slant well along the California coast for the proposed desalination project in Monterey County. Mr. Mayer's primary concerns were regarding borehole stability (i.e., keeping the borehole open during drilling and construction), the ability to get casing and screen to the bottom of the borehole, and, if there were problems, getting the casing and screen back out of the borehole. If caving occurred while drilling the borehole, causing the downhole tools to become stuck in the hole, the mud motor may need to be sacrificed at the cost of approximately \$100,000. Lang provided a ballpark cost estimate of \$2,000,000 for construction of a 1,000 foot 12-inch diameter well constructed at an angle of 30° below horizontal.

In June 2005, MWDOC and GEOSCIENCE personnel traveled to Sacramento, California, to meet with Cherrington Corporation to discuss HDD technology and how it could be applied to the Dana Point project to construct a high-capacity seawater source well. Martin Cherrington had drilled the first HDD river crossing in 1971, and his company has drilled continuous boreholes up to 1,500 feet in

length with as little as 10 to 20 feet of soil cover (Cherrington, 2004). The company's experience with high-capacity municipal water wells is limited. However, in one such water well project, Cherrington completed a horizontal well for SAMDA Inc., in Cambria, California, that did not initially produce as expected. Halliburton hydro-fractured the well in order to further develop it; however, the initially high production rates quickly declined. Another such HDD ground water extraction project that Cherrington completed was an environmental well at the Sacramento Army Depot. This well did not have a filter pack, but was completed using a stand-alone screen that immediately became clogged, likely due to a lack of a filter pack, which allowed fine-grained formation materials to migrate into and lodge within the screen openings. Recently, Cherrington completed a 22-inch diameter blind borehole off the Oregon coast at Rockaway Beach, within which a 12-inch diameter high density polyethylene (HDPE) casing was installed. The type of screen and the production capacity of the well are not known.

Cherrington drills HDD boreholes using a bentonite-based drilling mud, as boreholes are often left open up to three weeks, but other types of drilling muds can be used such as salt-based bentonite or polymers. Although each drilling rig is equipped with desanding and desilting equipment, typically only 40 to 50% of the cuttings are removed. The result is the need to drill a borehole that is 35 to 50% greater in diameter than the casing and screens being installed. Annular velocities when drilling horizontal wells are much lower than in vertical wells (40 feet per minute versus 70 feet per minute) making borehole cleaning more difficult. It was discussed that the volume and number of mud pumps could be increased to assist in cleaning the borehole and maintaining borehole stability (i.e., keeping it open). Cherrington did not feel that it could achieve an adequately thin wall cake, as there is not enough hydrostatic head exerted in a shallow horizontal borehole. The large cobbles and boulders anticipated at Dana Point as a result of the vertical sonic boreholes that were drilled during February 2005 to characterize the site were a cause of concern to Cherrington. Loose and unconsolidated cobbles and boulders gives HDD drilling "fits" as the drill bit is steered using a bent subassembly and mud motor assembly.

In July 2005, GEOSCIENCE met with another HDD company, Laney Directional Drilling, based in Humble, Texas. Laney's recent experience has been with continuous utility borings near Brownsville, Texas, at various locations along the Gulf Coast, north of Sacramento, California, and at Fairchild Air Force Base near Spokane, Washington. Most recently, it drilled a 5,000 foot utility crossing under the Delaware River near Philadelphia, Pennsylvania. At the time of the meeting, Laney was running 11 HDD rigs with pullback capacities ranging from 300,000 to 1,700,000 pounds, with typical pullback capacity being 300,000 to 800,000 pounds. A preliminary design considered feasible by Laney involved drilling a 9-

to-10-inch diameter pilot borehole at 12° to 15° from horizontal using the mud rotary method, washing over the drill string with large-diameter pipe, removing the drill string, installing 18-inch OD casing and 10-inch inside diameter (ID) prepacked screens inside the large diameter was hover casing, and extracting the carrier casing during well installation.



**Sonic core samples showing coarse-grained formation materials (photos by GEOSCIENCE).**

Technical concerns for Laney also included the presence of large gravels and cobbles, as well as a potential for boulders, in the unconsolidated sediments at Dana Point. These coarse materials can cause the drilling bit to deviate from the desired course. The cobbles would also make it difficult to maintain an open borehole. Another concern was the potential for drilling mud to “frac out” to the sea floor (i.e., pressurized drilling mud escaping from the borehole to the subsurface). If downhole materials are fine-grained, they can be jetted to create the borehole; however, due to the presence of cobbles in the subsurface at Dana Point, mud motor technology with a full drilling fluid system would be required.



**Slant well construction (photo by GEOSCIENCE).**

Because the technical concerns associated with using HDD technology to construct a test slant well at Doheny Beach did not seem resolvable in the short timeframe leading up to the project start date, MWDOC and GEOSCIENCE shifted focus to using the dual rotary drilling method for slant well construction. As discussed in section 2,

the dual rotary drilling method had been recently used to successfully construct wells at a shallow angle near rivers in South Dakota and New York. In September 2005, GEOSCIENCE personnel contacted the manufacturer of the dual rotary rig, Foremost Industries, to obtain up-to-date equipment information and a list of recommended contractors. After consultation with several dual rotary drilling contractors, GEOSCIENCE recommended that the MWDOC test slant well be drilled by Geo-Tech Division of Boart Longyear.

The dual rotary drilling method answered the challenge of borehole instability without the use of a drilling mud, as well as allowing placement of filter pack material around the screen during construction. Additionally, the drilling contractor was able to modify a dual rotary drilling rig to perform slant drilling and was able to perform the work within the timeframe required.

### **1.3 Background of the Dana Point Ocean Desalination Project**

The first geohydrologic study for the Dana Point Ocean Desalination Project was undertaken in 2001, when GeoPentech preliminarily evaluated the feasibility of beach wells to supply ocean water for a desalination plant at San Juan Creek, under subcontract to Boyle Engineering. The study recommended a site-specific feasibility investigation, including a geophysical survey, geotechnical borings, a test well and monitoring wells, and an aquifer pumping test (GeoPentech, 2002). However, only a very preliminary mention of feasibility and costs for several different subsurface intake construction methods was discussed in the GeoPentech report.

In 2005, GEOSCIENCE was selected to conduct Task 1 for MWDOC in order to obtain the site-specific information needed to assess the feasibility of subsurface intakes at the mouth of San Juan Creek (GEOSCIENCE, 2005). The investigation included drilling four vertical exploratory boreholes using a sonic drilling rig, completing two boreholes as nested monitoring wells, and performing laboratory analyses of water quality and permeability. The Task 1 investigation found brackish ground water and favorable aquifer materials, consisting largely of sands and gravels with some cobble and clay layers. Based on the favorable geohydrologic results, and the need to further characterize the sediments offshore, GEOSCIENCE recommended that MWDOC pursue construction of a shallow angle test well and performance of an aquifer pumping test. Construction of the proposed slant well beneath the ocean was recommended in order to develop hydraulic continuity with an ocean water recharge source.

After extensive research and consultation (detailed in section 1.2), the dual rotary method of drilling and well construction was selected for construction of the

MWDOC test slant well. This method was chosen because it presented the least amount of risk during drilling and installation of a large-diameter, high-capacity, artificially filter-packed well within a cased borehole.

The drilling, construction, and testing work for the MWDOC test slant well at Doheny State Beach took place from February to May 2006. The well was drilled at an angle of 23° below horizontal, and was completed to a depth of 350 lineal feet using 12¾-inch OD 316L stainless steel casing and Ful-Flo louvered well screen. The well was pump tested for five continuous days at a constant discharge rate of 1,660 gallons per minute (gpm) in April 2006. The MWDOC test slant well represents the first time a high-capacity artificially filter-packed slant well has been successfully completed beneath the ocean floor.

The following sections discuss in detail the dual rotary angle well drilling and HDD well drilling technologies. Other technologies for subsurface intake systems are briefly reviewed, and recommendations are made regarding future research and development.



**Starting to drill dual rotary test slant well (photo by GEOSCIENCE).**



**Drill site on Doheny Beach, Dana Point, California (photo by GEOSCIENCE).**



**Discharging from SL-1 during pumping (photo by GEOSCIENCE).**



## 2. Review of Angle Well Technology, Capabilities, Challenges, and Further Research Needs

### 2.1 Overview of Angle Well Uses

Horizontal drilling technology was initially developed in the 1920s by Leo Ranney in Texas and Ohio as a method for improving oil recovery (Hunt, 2002). When falling oil prices made horizontal oil wells less cost effective, Ranney modified the technology for water supply. The first horizontal collector well for water supply was constructed in London in 1933. By 1936 the first Ranney-type horizontal collector well (section 4.2) was constructed in the United States in order to obtain water supply via riverbank filtration (Hunt, 2002). Today there are approximately 220 collector wells in the United States, each pumping an average of 5 million gallons per day (mgd).<sup>2</sup>

In 1971, the first river crossing using HDD technology was accomplished in California to install a gas utility line. During the 1970s, HDD technology began to be widely used for subsurface utility installations (e.g., electrical lines, fiber-optic cables, and pipelines) under roadways, buildings, and bodies of water. Technology advancement was assisted by the use of mud motors (section 3).

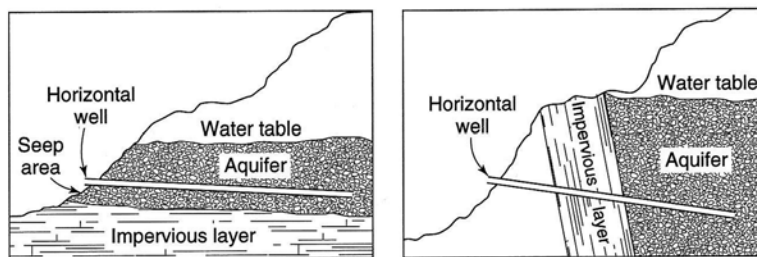

**Example of horizontal wells capturing artesian and spring water flows (Todd and Mays, 2005).**

By the late 1980s, HDD technology was being applied to environmental remediation projects in order to more effectively extract contaminated ground water and free product from the shallow subsurface, to extract vapors from the vadose zone, for chemical and air injection to volatilize and remove contaminants (air sparging), and for bioremediation. Currently there are more than 1,000 environmental horizontal wells in the United States (Kaback, 2002).

<sup>2</sup> Personal communication with Henry Hunt, 2007.

However, the diameter of wells used in environmental applications (generally 4 to 6 inches) is smaller than feasible for desalination intake supply.

Other common uses for small-diameter horizontal boreholes include core drilling (e.g., in mines), blast hole drilling, capturing spring water supply in bedrock, and draining water from sloped landmasses for improved stability (e.g., hydraugers).

## 2.2 Dual Rotary Slant Well Technology

A dual rotary drilling rig (formerly known as a Barber drilling rig)<sup>3</sup> has two drives comprising a lower hydraulic drive that clamps onto the exterior of the drive casing and an upper top-head drive to rotate the inner drill string. In the dual rotary drilling process, an outer drill casing is advanced using the lower drive that can be telescoped from larger to smaller casing diameters (e.g., 24-inch to 20-inch, etc.) while simultaneously removing formation materials from the inside the casing during advancement using a conventional dual-tube<sup>4</sup> reverse circulation system that is driven by the top-head drive. As formation materials are removed by reverse circulation through the rotating dual-tube drill string, the borehole is advanced by simultaneously rotating the outer drill casing with the lower drive. Construction of slant wells using the dual rotary drilling method requires the mast of drilling rig to be detached from the power unit and mounted on an angled cradle or platform at the required angle. A slant well can be constructed at any shallow angle dictated by the platform angle, theoretically even horizontal—as long as the rig is lowered into an excavated and shored pit or is otherwise positioned to target a horizontal zone.



**Dual rotary drilling method with dual-tube inner drill string (Foremost Industries, LP, 2003).**

The dual-tube reverse-circulation rotary method uses flush-jointed, double-walled drill pipe. Compressed air or air with a small amount of water is injected through an inlet on the side of the rotary head and forced downward under high pressure

---

<sup>3</sup> The first dual rotary drill was manufactured by Barber Industries in 1979. The technology was acquired by Foremost Industries, L.P., of Canada, in 1993 ([http://www.foremost.ca/index\\_dr.php](http://www.foremost.ca/index_dr.php), accessed 1/23/07).

<sup>4</sup> The dual-tube is used interchangeably with dual-wall in the drilling industry.

between the outer barrel (or wall) of the drill string and the inner barrel. At the leading end of the dual-tube drill string, a drill bit breaks up large-diameter formation materials (i.e., large gravel and cobbles) for removal during advancement of the borehole. During drilling, the bit can be either run just inside the leading edge of the casing, well inside the leading edge of the casing, or ahead of the casing, depending upon downhole conditions. After the outer drill casings are advanced to total depth, the drill string is removed and well casing and screen materials are then completed within the cased hole.



**Dual rotary drilling rig (DR-24HD) drilling MWDOC test slant well, Dana Point, California (photo by GEOSCIENCE).**

Placement of an artificial filter pack (i.e., gravel envelope) or sealing material around the well screen or casing involves extracting the temporary outer drill casing simultaneously with installation of the filter pack and sealing materials.

Experience with the MWDOC test slant well showed that a fenced-area of approximately 60 feet wide by 130 feet long (7,800 square feet) is the minimum area required in which to carry out all well drilling, construction, development and testing operations (shown below).

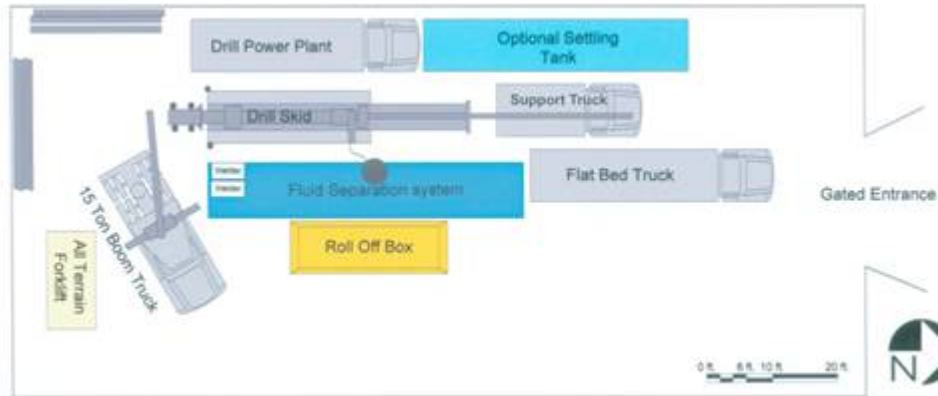

**Site layout for MWDOC test slant well, Dana Point, California (drawing by Boart Longyear Geo-Tech Division, 2006).**

Equipment required at the work site includes the dual rotary drilling rig mounted on its angled platform, a drilling rig power unit, a 23-ton truck-mounted crane, a 900 cubic foot per meter (cfm)/350 pounds per square inch (psi) air compressor, a water source, as well as a 21,000 gallon Baker tank for managing water generated by the drilling process and for circulation back to the borehole. Additional equipment required onsite includes a 20 cubic yard roll-off bin and cyclone for collection of drill cuttings, a forklift for moving materials onsite and from the staging area, and a small baffled (12,000 gallon) Baker tank for initial collection of discharge water during development and testing operations.



**Hollowstem auger rig setting anchors used to stabilize dual rotary drill rig (photo by GEOSCIENCE).**

In order to accommodate the forces exerted by the drilling rig when pulling down on the casing during drilling and when pulling back the casing during extraction, anchors need to be installed at both the front and the back of the mast. The anchors for the rig used to drill the MWDOC test slant well consisted of 8-5/8-inch OD casings (two in the front, four in the back) set into boreholes that were drilled to 18 feet below ground surface (bgs) using a hollow stem auger rig.

Table 1 at the end of this report summarizes slant or angle well construction methods along with HDD well construction methods.

## 2.3 Dual Rotary Slant Well Capabilities

The production potential of a slant well drilled using the dual rotary method depends upon geohydrologic conditions, well diameter, and length of well screen. Assuming favorable geohydrologic conditions (permeable sand and gravel aquifer materials and successful well development), the production potential of a dual rotary-drilled slant well is limited by the size of the submersible pump that can fit within the well's diameter. The maximum diameter of the slant well is constrained by the size of the drilling rig. Currently, the dual rotary drilling rig is manufactured in two sizes, the DR-24 and DR-40. A DR-40 dual rotary rig allows for drilling and placing temporary casing in boreholes up to 40 inches in diameter, while a DR-24 rig can drill and place temporary casing in boreholes up to 24 inches in diameter.<sup>5</sup> Within the outer drill casings, there must be sufficient room for installation of well casing and screens (usually assisted by centering guides along the outer surface of the casing and screen) and room for installation of an artificial filter pack ideally of at least 2-inch thickness between the outside of the well and the inside wall of the outer drill casing.

Currently, the 350-foot-long MWDOC test slant well at Doheny State Beach is the longest dual rotary-drilled artificially filter packed slant well. The test slant well has 220 feet of screen measured from the bottom of the well. This 12-inch well was drilled using a DR-24HD rig, included an approximately 2-inch thick artificial filter pack, and maintained a production rate of approximately 1,660 gpm during a 5-day constant rate pumping test. Wells with greater production potential are being designed for the full-scale 30 mgd desalination intake system using a telescoping well design. With a larger diameter upper casing (e.g., 16-inch) serving as a pump house chamber, a submersible pump capable of 3,000 gpm may be installed. Geo-Tech Explorations, the drilling contractor for the MWDOC test slant well, has said that the 20-inch outer drill casing could probably be taken to a depth of 500 feet using the DR-24HD rig, extending the maximum length of a 12-inch diameter well to 500 feet (Boart Longyear, 2007). Slant wells consisting of telescoping casings with diameters ranging from 16 inches to less than 12 inches could be drilled to lengths greater than 500 feet. The length of a dual rotary-drilled well is limited by the ability of the rig's lower drive to pull back the outer drill casing from around the well at total depth.

---

<sup>5</sup> The DR-24 rig is available as a heavy duty version (DR-24HD) that has additional pull back and pull down capabilities.

**Table 2. Comparison of Dual Rotary Rig Capabilities**

	<b>DR-24</b>	<b>DR-24HD</b>	<b>DR-40</b>
Top drive pullback	58,000 pounds	84,000 pounds	84,000 pounds
Top drive torque	12,500 foot pounds	12,500 foot pounds	22,000 foot pounds
Lower drive pullback	72,000 pounds	117,000 pounds	75,000 pounds
Lower drive pulldown	33,000 pounds	42,000 pounds	33,000 pounds
Lower drive torque	83,000 foot pounds	208,000 foot pounds	288,000 foot pounds
Drill power source	PTO or deck engine	PTO or deck engine	Deck engine
On-board air - PTO from carrier	900 cfm/350 psi	900 cfm/350 psi	N/A
On-board air -600 hp (447kW) deck engine	1,150 cfm/350 psi	1,150 cfm/350 psi	1,150 cfm/350 psi
Total gross vehicle weight	56,000-72,000 pounds	68,000-84,000 pounds	105,000 pounds

Source: Foremost Industries, LP, 2003.



**12<sup>3</sup>/<sub>4</sub>-inch OD 316L stainless steel ful-flo louvered screen**



**Filter packing the test slant well (photos by GEOSCIENCE).**

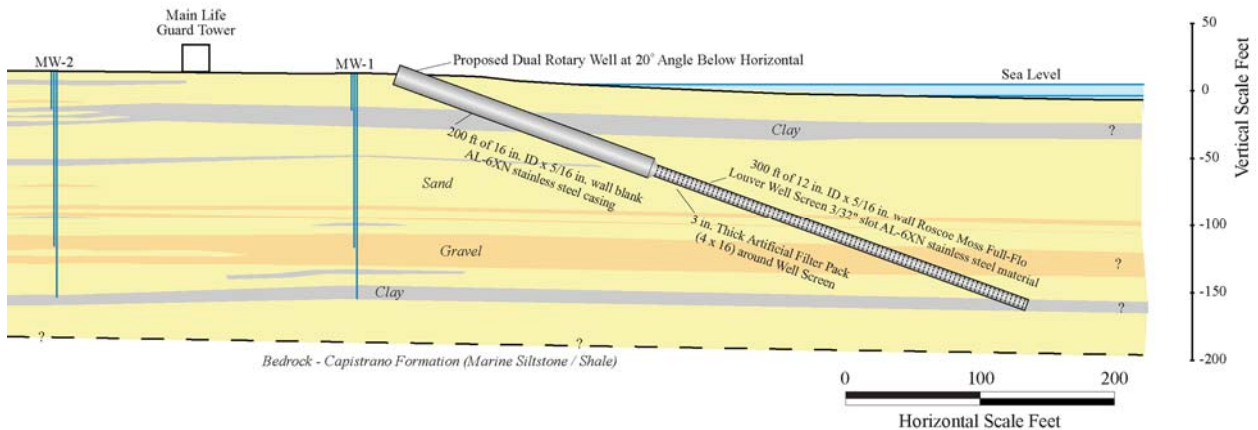

**Conceptual design of 500-foot slant well for 30-million-gallon-per-day ocean water intake system (GEOSCIENCE, 2007).**

When a configuration of multiple slant wells is required to meet system demands, slant wells can be constructed in clusters, with each cluster consisting of three (or more) arrays as shown in the inset on the following page. Impacts of specific configurations should be evaluated using a site specific three-dimensional variable density flow and solute transport model, such as the U.S. Geological Survey's SEAWAT-2000. Several alternatives are available for placement of pumps in slant wells. These include placing individual submersible pumps in each slant well, or constructing a centralized collection system.



Three slant well clusters with three slant wells per cluster. Dashed lines indicate backup wells (GEOSCIENCE, 2007).

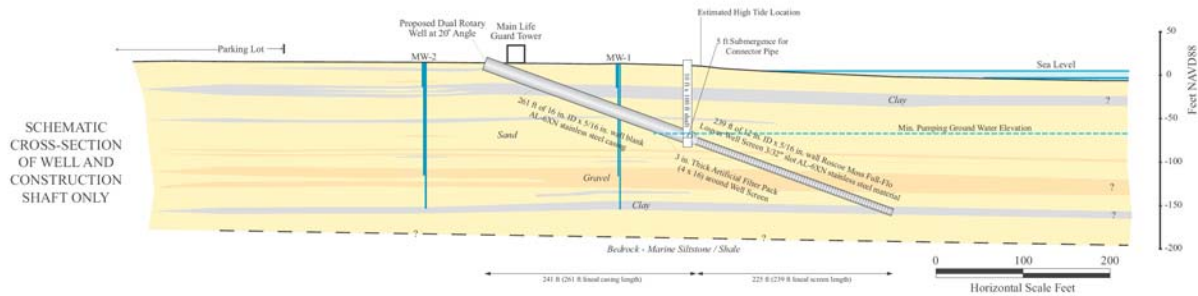
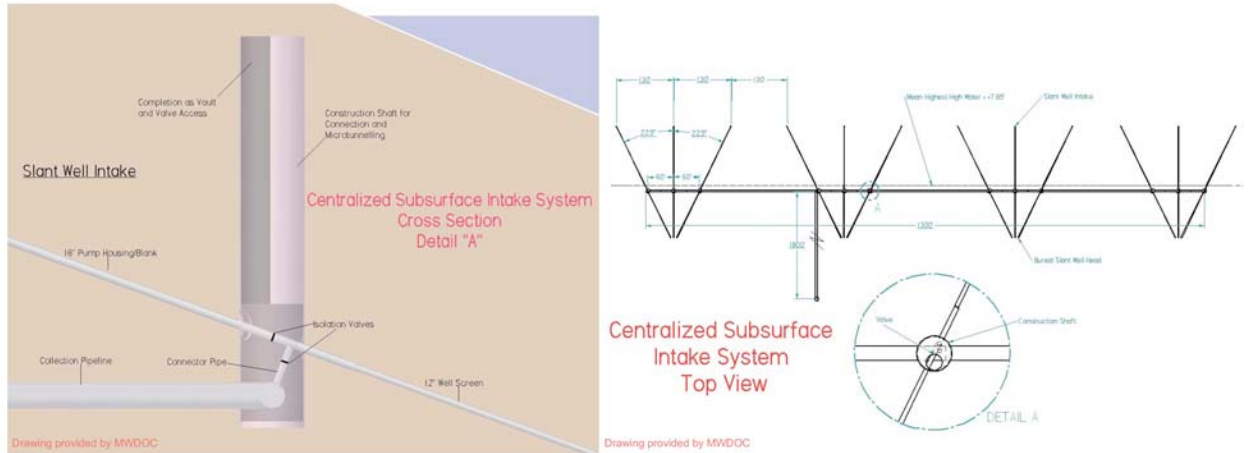

Example of centralized subsurface intake system at Dana Point, California (GEOSCIENCE, 2007).

## 2.4 Dual Rotary Slant Well Examples

The dual rotary drilling method for constructing slant wells was selected for construction of the MWDOC test slant well in 2006. The 12-inch diameter artificially filter-packed slant well was constructed at Doheny State Beach in order to evaluate the feasibility of subsurface intakes for the Dana Point Ocean Desalination Project. The well was constructed at an angle of 23° from horizontal with a total completed length of 350 feet. The artificially filter-packed well was constructed with 316L stainless steel materials, and completed with a 12¾-inch OD casing and screen<sup>6</sup>. Five-day constant rate pumping test results showed the well had a sustained discharge rate of 1,660 gpm and a specific capacity of approximately 80 gpm/foot. Silt density index (SDI) field measurements during pump testing were low, averaging 0.58.

<sup>6</sup> The inside diameter (ID) of the MWDOC test slant well is 12 1/8 inches.



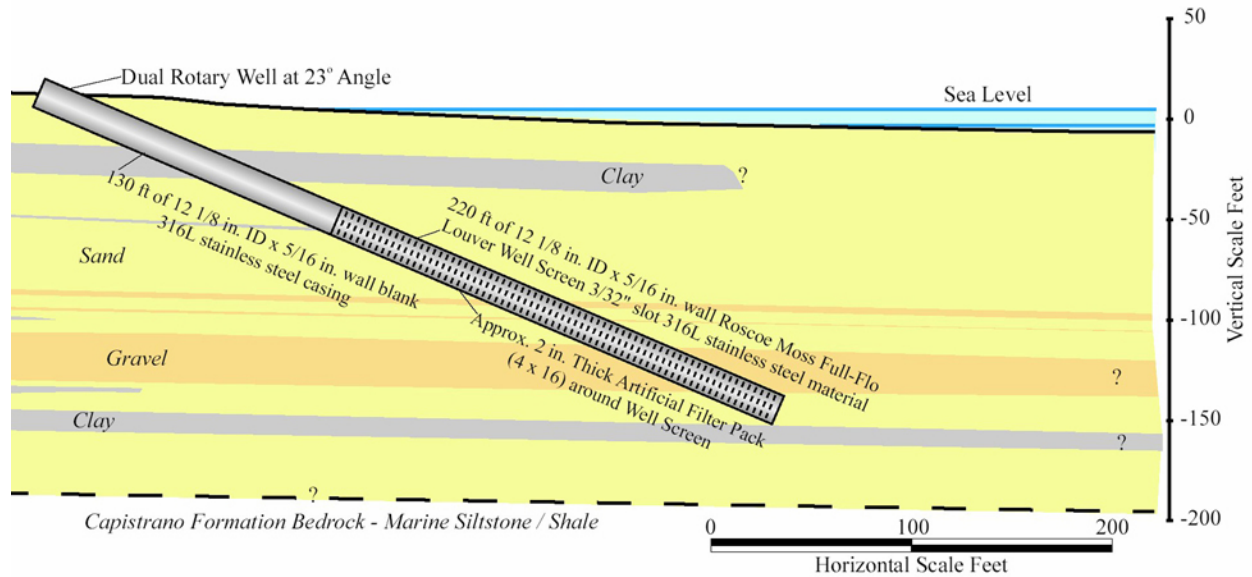

**MWDOC test slant well, Dana Point, California (drawing by GEOSCIENCE).**

Prior to the MWDOC Dana Point Ocean Desalination Project, slant wells had been constructed using the dual rotary drilling method in New York (2001) and South Dakota (2004). The New York project was designed by Earth Tech, and entailed construction of five slant wells under the Hudson River using a DR-24 rig drilling at an angle of 20° below horizontal. The wells were constructed using 16-inch-diameter 304L stainless steel materials and were gravel-packed. Each well was approximately 125 feet long with approximately 65 feet of wire-wrap screen measured from the bottom of the well. The Hudson River angle wells were each capable of producing approximately 600 gpm in an area where vertical wells produced only 250 gpm. The specific capacity of the angle wells was 46 gpm/foot of drawdown compared to 17 gpm/foot that is characteristic of vertical wells in the same area.

The South Dakota project was designed by Quad-State Services, Inc., and entailed drilling an angle well along the Missouri River at an angle of 23° below horizontal for the Lewis and Clark Rural Water System. The well was 18 inches in diameter, approximately 240 feet long, and had 50 feet of wire-wrap screen at the bottom of the well. The well was naturally-packed because of favorable aquifer materials, and was capable of producing 2,100 gpm. The calculated specific capacity was 73 gpm/foot during a constant rate pumping test (Quad State Services, Inc., 2005).

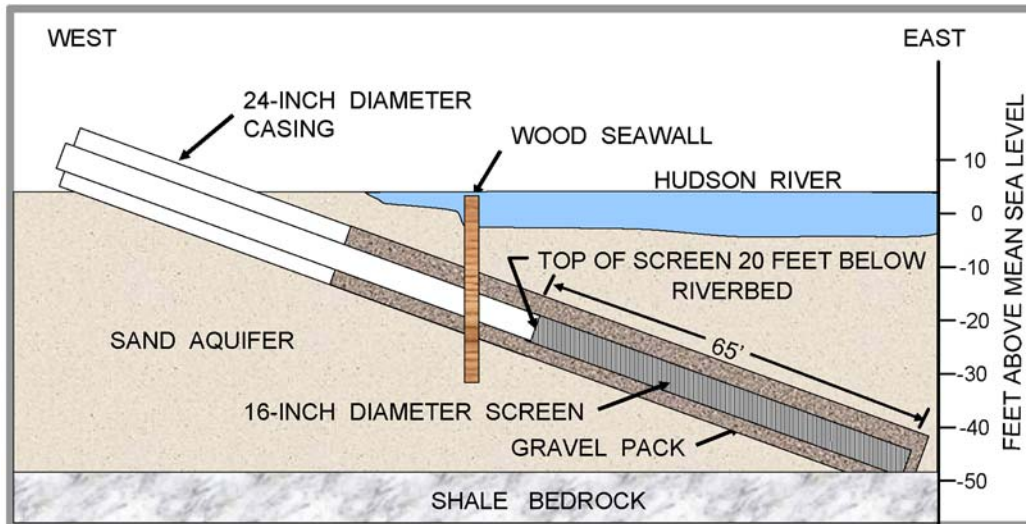

Hudson River slant well, Bethlehem, New York (provided by Gary Smith, 2005).

## 2.5 Advantages of Using Dual Rotary Slant Well Technology



Dual rotary outer casing stabilizes borehole during drilling (photo by GEOSCIENCE).

There are several advantages to the using the dual rotary drilling method for construction of slant wells. Dual rotary drilling solves perhaps the most important technical hurdle to overcome in slant drilling in a beach environment—to maintain an open borehole in unconsolidated aquifer materials during drilling and well construction. With the dual rotary method, the outer drill casing ensures a stable borehole. Not only does the cased borehole facilitate well construction, it is beneficial for well development. Other drilling methods use drilling fluids to stabilize the borehole, which may plug the surrounding aquifer and can be difficult to remove during the well development process if improperly controlled. Dual rotary drilling is also a relatively fast method of construction—a

slant well could be drilled, constructed, developed, and tested in approximately 3 months. It is important to note that the dual rotary-drilled and filter-packed test

slant well constructed at Dana Point has excellent filtering capacity, as evidenced by low field SDI measurements of 0.58.

Another benefit of the dual rotary drilling method is accurate and continuous sampling of the formation as it being drilled. When the casing is advanced simultaneously with the drill bit, the cuttings returning to a cyclone collection system are fully representative of the formation materials occurring at the bit face, and do not contain materials from the



**Welding carbide-studded guide shoe to casing (photo by GEOSCIENCE).**

borehole walls. The dual rotary drilling method is also able to successfully drill through cobbles and boulders with the help of a carbide-studded casing guide. The casing guide, or guide shoe, is embedded with carbide buttons and welded to the leading end of the drill casing to keep it from collapsing or from becoming dented.



**Drilling holes for anchor pipes (photo by GEOSCIENCE).**

The dual rotary drilling method is also advantageous because of its relatively small footprint (requiring a site that is approximately 60 feet by 130 feet), which minimizes environmental and visual impacts during construction. Because the dual rotary drilling method does not use drilling fluids, there is no need for large onsite mud circulation and cleaning systems that are typically required by other drilling

methods. Additionally, the risk of accidental release of drilling mud to the site and surrounding environment is removed. As with other drilling methods, the

completed wellhead of a dual rotary-drilled slant well can be located underground, leaving no signs of the well on the beach.



Below-ground completion of slant wells (photo by GEOSCIENCE).

## 2.6 Emerging Dual Rotary Slant Well Technology Challenges

Drawbacks to the dual rotary drilling method for constructing slant wells include limited well length and the difficulty of fully ensuring proper filter pack placement around the well screen. The length restriction may be a drawback in some locations if potential impacts to onshore ground water resources (e.g., lowering of ground water levels) call for a well



Tremie pipe held in guides attached to top of screen (photo by GEOSCIENCE).

screen located further offshore. Because dual rotary construction requires the outer drill casing to be extracted from around the installed well, the rig's pullback capacity limits the length of the well constructed by limiting the frictional drag on the outer casing. However, research is underway to manufacture larger and more powerful drilling rigs (Boart Longyear, 2007). Currently, and until further testing is completed, a 12-inch diameter dual rotary-drilled well is limited to a length of approximately 500 feet. This length estimate assumes construction within 20-

inch-diameter outer drill casing and includes installation of an artificial filter-pack. If naturally developed wells are feasible in a specific geohydrologic environment, a 12-inch-diameter well could be constructed within a borehole that exceeds 500 feet using a smaller diameter drill casing. Also, by telescoping the casing (i.e., using reduced diameters of casing as drilling the borehole progresses to reduce frictional drag on the drill casing), longer completion lengths may be achieved. Currently, the maximum slant well length achievable by the dual rotary drilling method is dependent on downhole conditions as well as the comfort level of the drilling contractor.



**Gravel packing phase of slant well construction (photo by GEOSCIENCE).**

An artificial filter pack, or gravel pack, is usually required in the highly laminated and non-uniform alluvial formations found in the western United States (Roscoe Moss, 1990) to control the migration of fine-grained sediments into the well during pumping. During construction of the MWDOC test slant well, an artificial filter pack was

installed within the annular space between the borehole wall and the screen and casing via a 1½-inch diameter steel tremie pipe. The complete filter packing procedure is discussed in the well completion report (GEOSCIENCE, 2006). The gravel packing procedure involved using a small centrifugal pump to pump water and filter pack material into the bottom of the borehole through the small-diameter tremie pipe while simultaneously extracting the outer drill casing from around the well. To ensure proper placement of the filter pack material, a fire hose was used to add water to the inside of the casing on a continual basis to keep the filter pack moving downward. The addition of large volumes of water into the annular space added hydrostatic pressure on the formation to keep formation sand from “heaving” or pushing into the bottom of the outer casing, which could potentially disrupt or “bridge” the filter pack. During installation, the top of the filter pack within the annular space was kept 5 to 10 feet above the bottom of the outer drill casing to ensure that no voids would occur within the filter pack. The development of voids in the filter pack would allow formation material to fall directly against the well screen and potentially allow the production of sand.

To ensure compaction of the filter pack within the annular space, each 20-foot section of screen was mechanically swabbed and airlifted immediately after placement, using a swabbing tool that had packers spaced 3 feet apart. Some reduction was seen between the theoretical annular volume (i.e., between the borehole and screen) and the volume of filter pack material actually placed. This



**Swabbing tool with UHMW packers (photo by GEOSCIENCE).**

difference was most likely due to reduction in annular volume during withdrawal of the temporary casing (i.e., the pressure of the filter pack as it was being placed was probably not great enough to keep the borehole from caving in somewhat).

Development is crucial for the successful completion of a slant well. Aggressive development measures may be required to thoroughly clean the screen, filter pack and near-well zone to remove all sediments. In the development of slant wells, the process is challenged by the inability to completely remove all debris left in the well following construction, as remaining debris will not collect by gravity in a sump as at the bottom of a vertical well, but will collect on the inclined bottom side of the well itself. Standard airlifting from between packers within the screened intervals will not completely remove this material; therefore, a vacuum truck or similar equipment is needed for thorough removal.

## **2.7 Further Research and Development Needs for Dual Rotary Slant Well Drilling Technology**

Based upon experience gained through construction and testing of the MWDOC test slant well, there is a need to improve the filter-packing technique in the dual rotary-drilling method of slant well construction. A properly developed filter pack will ensure against sand production and will maximize specific capacity in non-uniform alluvial aquifers. Section 5 details potential revisions to the filter packing procedure that should be implemented during construction of subsequent dual rotary-drilled slant wells to ensure that a higher proportion of the calculated annular volume is filled with gravel pack material. The use of prepacked well screens is another option that should be considered to ensure placement of

sufficient filtering material around the well intake. However, a chief concern in using prepacked well screens is the high potential for clogging to occur and the inability to completely rehabilitate them once they have become clogged. Additionally, because of the weight of large diameter prepacked screens, this may not be a practical alternative in some geohydrologic environments.

There is also need for further research and development on lowering the angle of entry for the slant well. The MWDOC test slant well contractor, Boart Longyear, stated that the dual rotary drilling rig could theoretically drill horizontally (i.e., 0° below horizontal) – however, the excavation necessary to house the drilling rig would likely be infeasible or non-permittable in a beach environment. The most desirable angle of entry and well length for slant wells varies among project sites, and depends on local geohydrology. Future slant wells at the Doheny Beach site could benefit from a lower angle of entry, which would allow for a greater length of screen within the productive aquifer zones between 40 and 200 feet below ground surface.



**Downhole metal coupon rack used for corrosion testing (photo by GEOSCIENCE).**

Further research and development is needed for investigating appropriate well materials for use in the beach environment.

Because of its ready availability and relative strength in a corrosive environment, 316L stainless steel material was used for the casing and screen of the MWDOC test slant well. However, there are other types of stainless steels that may perform better in the near-shore environment. A professor of metallurgy has recommended several types of stainless steel materials (316L, AL-6XN®, Alloy 625, Hastelloy® C276, and Outokumpu Stainless Grade 254 SMO®) for downhole coupon testing for crevice and stress corrosion (King, 2006).

Downhole coupon testing in the well should be conducted under

operating conditions and during periods of non-pumping, as crevice and pitting corrosion are mitigated by reduced oxygen and flowing conditions.

It is also recommended that a method for conducting flowmeter or spinner surveys in dual rotary-drilled slant wells is developed. Spinner survey tools that are used in vertical wells help quantify the contribution of flow from the various aquifer intervals within a well (i.e., provide data to develop a distribution profile for flow into the well). In order to conduct a spinner survey within a low angle slant well, it is necessary to install the tool prior to installation of the test pump. Additionally, the spinner tool would be modified to be mounted on a wheeled carrier or “skateboard” which will centralize the tool and facilitate its installation to the bottom of the well. It is critical that the intake section of the pump is covered with a screen so that the cable for the spinner tool is not pulled into the pump impellers. Once the tool and pump have been installed and the pump has operated long enough to draw down and stabilize water levels within the well, stationary readings (i.e., stop counts) would be performed at intervals of no more than 10 feet throughout the screened interval of the well. From this data, a spinner log can be constructed.



### 3. Review of HDD Well Technology, Capabilities, Challenges, and Further Research Needs

Horizontal directional drilling was investigated thoroughly for its suitability in constructing subsurface seawater desalination intakes, but there were too many unresolved technical issues (section 3.4) to use the technology for the Dana Point Ocean Desalination Project.

HDD utilizes “open hole” technology, meaning that drilling fluid is required to hold the borehole open during drilling and construction. Drill pipe and downhole tools are used to advance the borehole, while drilling fluid is used to cool and lubricate the bit, stabilize the borehole and carry cuttings (drill spoils) to the surface. Drilling of the borehole is generally achieved in two stages: drilling the small diameter pilot borehole, followed by enlarging the pilot borehole in one or more reaming passes to the diameter required to contain the casing, screen, and filter pack.

HDD wells are classified in two categories, blind wellbores<sup>7</sup> or continuous wellbores. Blind wellbores are generally used in deep subsurface oilfield applications to increase recovery of oil and gas, or in relatively shallow environmental remediation applications where the target formation is located under a building or some other obstacle. Blind wellbores drilled for oilfield applications may start either vertically or on an incline, while those drilled for environmental applications, due to their shallow TVD, generally start only on an incline. Once the targeted depth is reached, the drill string is rotated to horizontal for the required distance before being

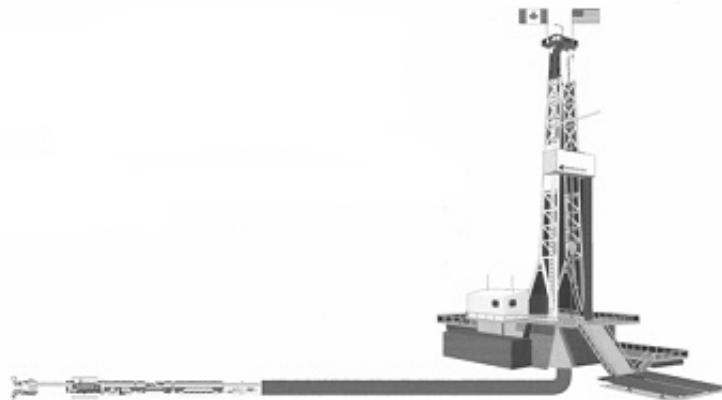

**Blind HDD with vertical entry point application for oil wells (Cathedral Energy Services, Inc.).**

---

<sup>7</sup> With respect to directional drilling, EPA distinguishes between wellbores and boreholes: the term wellbore is used when the permeability of the host material is preserved, while the term borehole is used when the formation is penetrated without regard to maintaining its permeability (EPA, 1994).

terminated in the subsurface at the targeted point. Reaming is accomplished by pushing and rotating the drill bit as it follows the pilot bore to its completion depth. In most cases with blind wellbores, the borehole is stabilized by casing and cementing through the curvature prior to drilling the horizontal portion of the wellbore. Once the wellbore has been reamed to the required diameter, well completion materials are pushed into place in the open borehole. The well intake structure may consist of either stand-alone screen; prepacked screen; or open-hole, gravel-packed screen. The configuration of the screen may include horizontal louvered openings, horizontal or vertical slotted openings or continuous wire-wrapped pipe-based material, among others. If stand-alone screens are used, they may be made with a resin and gravel pack coating or may be sintered material.

Continuous well bores are typically used in shallow applications such as installing utilities under water bodies, roadways, or buildings, and for environmental remediation wells. Continuous wellbores are inclined at both their entry point and exit point and are started at ground surface at a shallow entry angle. After reaching the targeted depth, the drill string is rotated to horizontal for the required length of bore, before being guided back to the ground surface where it is terminated at the specifically located exit point. Reaming (borehole enlargement) is accomplished by either attaching a reaming bit to the drill string at the exit point where it is pulled back to the entry point through the pilot bore with the drill string under tensional forces, or attaching the reaming bit at the entry side and pushing and rotating it to follow the pilot borehole under compressive forces.

Table 1 at the end of this report summarizes HDD construction methods, along with slant well and other construction methods.

In order to directionally drill these boreholes, the drill bit is guided by a downhole hydraulic mud motor and bent subassembly. The mud motor is powered by pressurized drilling fluid that is pumped down the center of the drill string, which causes the mud motor to rotate the cutting face of the bit. By rotating the mud motor and pushing on the drill string, the slightly offset bent subassembly causes the borehole to be drilled straight ahead. By pushing and rotating on the mud motor without rotation of the drill string, the bent subassembly causes the borehole to deviate in the direction that it is set. If the formation is fine-grained and does not contain cobbles, a jetting tool or a compaction tool may be used instead of a rotating drill bit to advance the wellbore.

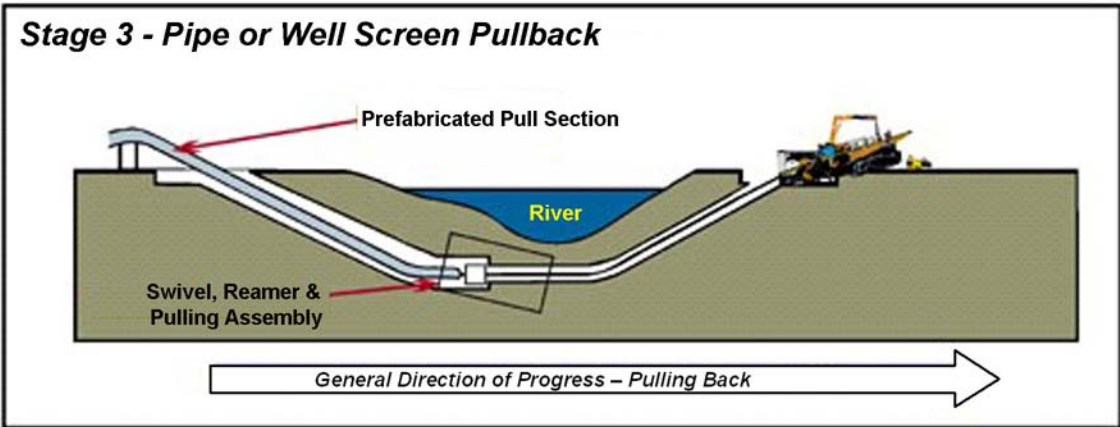
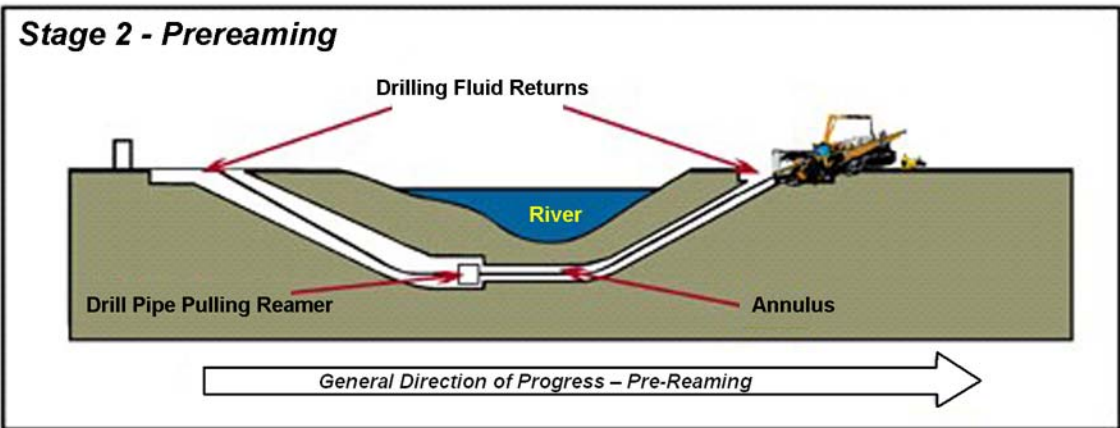
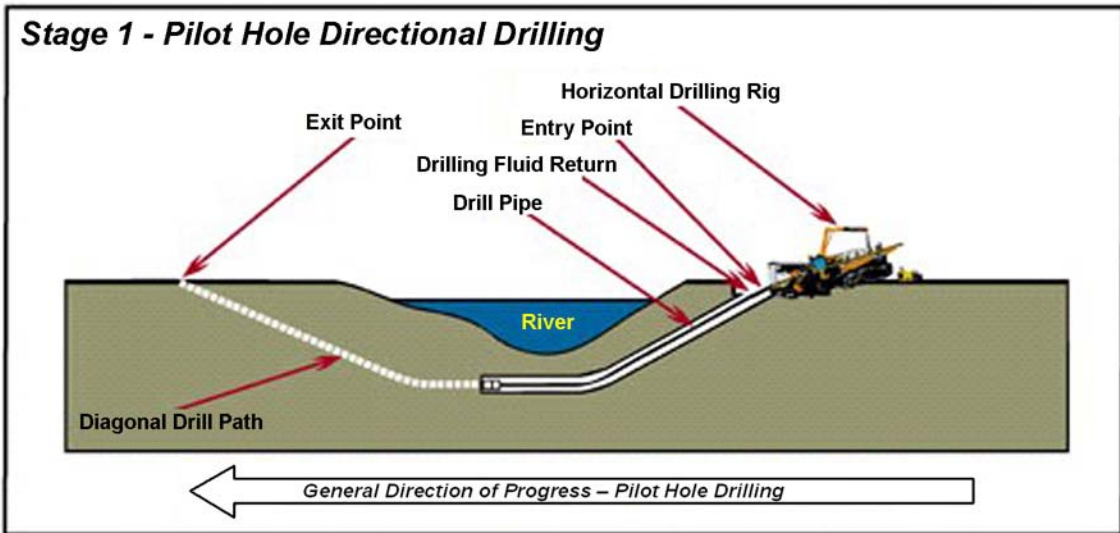

Sequence of drilling a continuous HDD well (A&L Underground, 2005).

In the construction of HDD wells in unstable formations, a “washover” pipe that is slightly smaller in diameter than the drill bit is carried behind the drill bit to maintain and support the open borehole (similar to the function of the outer casing in the dual rotary drilling method). Once the borehole has been completed, well completion materials are installed inside the carrier (i.e., washover)



**Portion of bottom hole assembly (drill bit, bent subassembly and mud motor) (Hill et al., 1996).**

pipe, which is then pulled back to expose the screen to the formation. In using a carrier pipe, the screen materials are much less likely to become smeared and clogged during installation with formation materials, drilling mud, and wall cake material as the force of gravity causes the string of casing and screen to drag along the bottom of the borehole during installation.

The trajectory of the HDD borehole must be closely monitored throughout the drilling process to ensure that the required path is maintained at all times. For deep oil and gas wells, an oilfield directional service company such as Sperry Directional Services is subcontracted at considerable expense to oversee the deviation or “steering” of the borehole. Additionally, MWD systems can be installed behind the drill bit to continually collect and transmit to the surface real-time directional (azimuth and inclination) and other downhole measurements to monitor the location of the bit as the wellbore is being advanced. In shallower environmental applications, more simplified “walk-over” tools (e.g., radio beacon-receiver, magnetometer-accelerometer, or gyroscopic systems) are used to guide the borehole trajectory (Denhan, 1993).

HDD drilling equipment is made by many manufacturers and is rated by torque, rotation, and push/pullback power. HDD rigs used in the utilities and environmental industries have inclined decks of 0 to 45°. Small HDD rigs are typically truck- or track-mounted units and are rated at less than 40,000 pounds pullback. They are limited to casings of less than 4 inches in diameter and continuous completions. Medium-sized rigs are trailer-mounted or may be self-

propelled (tire or track) and are rated at less than 80,000 pounds and can handle casing up to 8-inches in diameter in either continuous or blind applications. Large drilling rigs are either skid-mounted or are mounted on trailers and have a rating of up to 800,000 pounds. The large rigs can handle continuous or blind well installations up to 14 inches in diameter (Kaback, 2002).

The drilling contractor Cherrington has indicated that an HDD well construction site would require a minimum work area of approximately 150 feet by 150 feet (22,500 square feet). Typical support equipment onsite would be similar to that used for dual rotary drilling, with the addition of mud pumping units, drilling fluid circulation tanks, and related cleaning equipment. Because of the use of a drilling fluid program, an HDD well construction site would also require stringent containment and mud control measures. An anchor system would also need to be installed for the HDD rig in order to accommodate pull-down and pull-back forces. Burial of a dead-man weight may be required as an additional safety measure.

Recent advancement in oilfield technology has included the modification of oilfield drilling rigs to incline the mast to allow a well to be drilled at a 45° angle from horizontal. In doing this, the borehole can be turned from the starting angle to horizontal at depths as shallow as 400 feet below ground surface. The primary drawback to this is the large size of the drilling equipment for beach locations.

### **3.1 HDD Well Capabilities**

Very few wells specifically constructed for water supply have been constructed using horizontal directional drilling methods. Wells up to 6 inches in diameter have been constructed for environmental remediation purposes, capable of producing up to 80 gpm with well screens up to 840 feet long.<sup>8</sup> These wells constructed for environmental remediation purposes are usually shallow, at less than 26 feet deep and are constructed using utility installation contractors (Kaback, 2002).

Section 3.2 discusses two types of ground water production wells that have been constructed using the blind HDD method typical of the oil industry and the continuous HDD method characteristic of utility installation. The blind HDD method used near Bennett, Colorado, resulted in a relatively deep well (approximately 1,000 feet below ground surface) capable of producing 90 gpm from the Arapahoe Sandstone, while the continuous HDD well construction method used in Des Moines, Iowa, installed parallel to a river, resulted in a

---

<sup>8</sup> <http://www.longbore.com/us/CaseHistories1.htm>. Accessed January 23, 2007.

relatively shallow well (approximately 30 feet below ground surface) that was capable of producing 1,800 gpm.

Cherrington advised that, as a rule of thumb, an HDD borehole should be 1.35 to 1.5 times larger in diameter than the desired pipe size. Halliburton and Quality Drilling Fluids advised that another industry rule of thumb is to allow 100 feet of radius for every inch in diameter of casing in order to allow the casing to bend from vertical to horizontal. For example, for 12-inch-diameter casing, a curve with a radius of 1,200 feet would typically be required to make the turn from vertical to horizontal.

Wellbores are classified based on the radius of curvature. Short-radius wellbores have curvatures of less than 150 feet and have build rates (change in direction per unit of distance) as high as 3° per foot drilled. Medium-radius wells have curvatures of 150 to 800 feet and have build rates of 8° to 30° per 100 feet drilled. Long-radius wellbores have curvatures that are greater than 800 feet and have build rates of 6° per 100 feet drilled (Kaback, 2002 and USDOE, 1993). The smaller the radius the greater the stress on the drill pipe and well completion materials as it passes through the area of curvature.

### **3.2 HDD Well Examples**

In 1998, HDD technology was first used to install a high-capacity ground water production well specifically for municipal water supply by Des Moines Water Works, Des Moines, Iowa. The project entailed drilling a 1,950-foot continuous horizontal wellbore (intersecting the ground surface at both ends) parallel to the Raccoon River, to a maximum depth of 30 feet. The pilot borehole was reamed to 26 inches in diameter before constructing the well using 1,220 feet of 12-inch pipe-based, wire wrapped, stainless steel screen (0.050-inch slots) with 360 feet of 18-inch steel casing as the riser pipe and 370 feet of 12-inch steel casing as the tail pipe (Rash, 2001; A&L Underground, 2007). After developing the well to optimize production, the horizontal well was placed into service at a consistent production rate of 1,800 gpm in 2000.<sup>9</sup>

In 2003, a blind HDD well was drilled by Longbore Ltd. under the Thames River in London for the purpose of municipal water supply. The horizontal well was installed to a total vertical depth of 62 feet below the bed of the river and was completed using 810 feet of 16-inch casing that was cemented into place. The horizontal lateral was lined with 1,160 feet of 8-5/8-inch casing that included 892 feet of perforations. Following development, the well was tested at

---

<sup>9</sup> [http://www.hydro-klean.com/pdf/inf\\_horizontalwellcleaningtelevising.pdf](http://www.hydro-klean.com/pdf/inf_horizontalwellcleaningtelevising.pdf). Accessed January 24, 2007.

1,109 gpm with a reduction in turbidity from 200 nephelometric turbidity units (NTU) (river water) to 1 NTU from the well (National Ground Water Association, 2005). Although large gravel, cobbles, and boulders limit the depth and length of HDD wells, Longbore reports recently completing a 1,434-foot continuous HDD well in a cobble and gravel formation.<sup>10</sup>

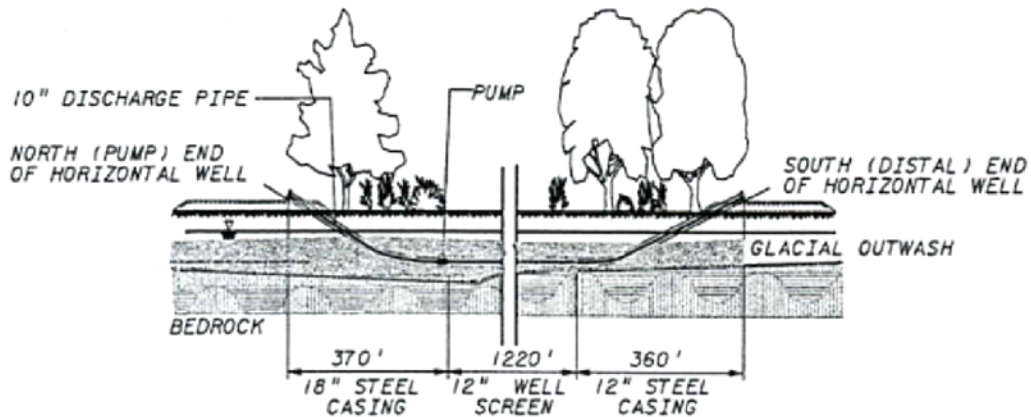

**Continuous HDD well, Des Moines, Iowa (Rash, 2001).**

Two blind HDD wells were designed by Jehn Water Consultants, Inc. for municipal water supply purposes. The Antelope Hills HDD well was drilled in 2003 for the town of Bennett, Colorado, and started with a vertical entry point. After a 9 5/8-inch surface casing was cemented to 800 feet, the lateral portion of the well was drilled to a vertical depth of over 1,000 feet, with a horizontal length of 2,100 feet. The intake portion of the well is 4½-inch ID casing and screen. The Antelope Hills HDD well produces 90 gpm, while vertical wells in the area are capable of producing 60 gpm. The Castle Pines North Metropolitan District blind HDD well was drilled in 2004 to intersect the bottom of an existing 14-inch diameter vertical well to increase recharge. The directionally drilled well has a vertical entry point that is located 1,800 feet away from the vertical well. The horizontal well begins to deviate from vertical at a depth of 674 feet below ground surface and continues on a shallow angle for a total horizontal length of approximately 1,800 feet. The upper 1,350 feet of the directionally drilled borehole measures 14 inches in diameter and is cased with 10¾-inch ID casing. At a depth of approximately 1,500 feet, the casing diameter is reduced to 9-5/8 inches in diameter and is screened using 1,350 feet of 7-inch OD pipe-based prepacked screen (5 inches ID) with 0.040-inch openings. The screens are made of 304 stainless steel manufactured by Nagaoka USA Corporation, with carbolite (ceramic) beads comprising the filter pack. Pipe-based screen was used to ensure

<sup>10</sup> <http://www.longbore.com/us/Faq.htm>. Accessed January 24, 2007.

it would bend (Theresa Jehn, 2004). At this time production data is not available for the Castle Pines North directional well as it is not in service (CDM, 2005).

On its Web site, Baker Oil Tools reports that Petrobras has economically constructed sand-free blind HDD wells for oil and gas production purposes in unconsolidated sandstone reservoirs in the Compos Basin, offshore of Brazil. The wells were drilled to 4,000 feet and have 2,572 feet horizontal laterals measuring 8½ inches in diameter. The laterals were completed using 5½-inch screens that were slurry-packed using a 20 x 40 filter pack material and using open borehole gravel packing methods.<sup>11</sup>

### 3.3 Advantages of HDD Technology

An advantage of the HDD method is the ability to construct relatively long boreholes, and relatively long wells (up to 2,000 feet). This capability is enabled by the large pullback capacity of the bigger HDD rigs, on the order of 800,000 pounds pullback compared to the 117,000 pounds pullback rating of the DR-24HD dual rotary rig. A major benefit of wells with longer screens is higher production potential. Additionally, the salinity of water from an HDD well screened offshore within the saltwater wedge would more closely approximate that of seawater. Also, by being able to locate a screen further offshore with the

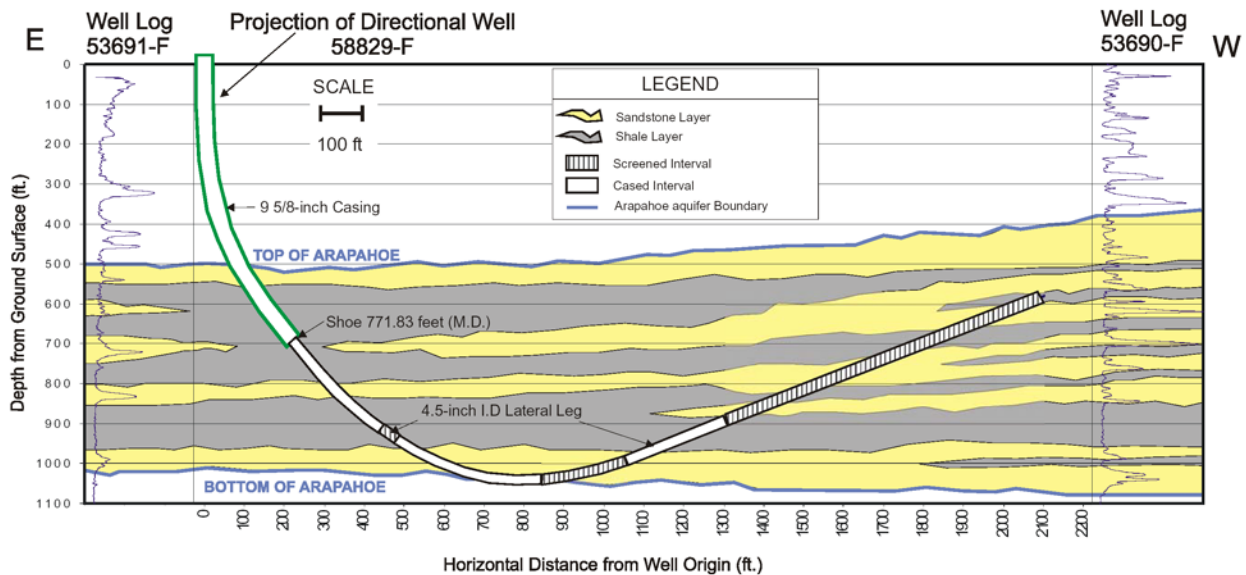

#### Blind HDD well, Bennett, Colorado (Jehn Water Consultants, 2003).

<sup>11</sup> <http://www.bhidirect.com/bakerhughes/casefile/301.htm>. Accessed January 24, 2007.



HDD method, the cone of depression would be less likely to impact onshore ground water levels. Another major benefit of the long boreholes drillable with the HDD method is the ability to avoid obstacles or sensitive areas (such as a public beach). The HDD method ensures accurate borehole trajectory using remote sensing and MWD technology.

The relatively short drilling and construction time frame for an HDD well is advantageous in terms of costs and public access. An HDD well could be drilled and constructed in approximately one month, although development could take several additional months. Additionally, the HDD well construction operations create minimal surface disturbance being similar to that of dual rotary drilling, but much less than trenching and radial collector well construction requiring a central caisson. As in most other well construction methods, the completed wellhead for the HDD well can be buried to minimize visual impact.

### **3.4 Emerging HDD Well Technology Challenges**

Maintaining borehole stability in unconsolidated alluvial aquifer materials remains the most significant challenge for applying HDD techniques for the construction of subsurface desalination intake wells, which require relatively large boreholes. Keeping the borehole open during placement of the well screen and/or artificial filter pack is a very real challenge, and alternative methods need to be researched. Careful mud control is necessary to protect the borehole and filter pack and maintain the permeability of the near-well zone. Using HDD for a water well application requires the drilling fluids and borehole cuttings to be fully removed from the well in order to enable effective well development. Contractors have indicated that a low percentage (less than 50%) of borehole materials is actually removed during drilling of HDD boreholes, which is a great concern for water well applications and its resulting effect on ability to fully develop the well.

The possibility of installing artificial filter packs (necessary to stabilize unconsolidated formations) in shallow HDD wells that are completed in unconsolidated aquifers is yet to be demonstrated successfully and on a consistent basis. Open borehole gravel packing is still considered a sizeable challenge in terms of both risk and expense. Once casing and screen have been placed, the walls of the wellbore may not remain stable during filter packing. If the well is to be naturally developed, the formation is allowed to collapse against the screen. However, if sand control is required, either an artificial filter pack must be placed in the annular space, or a prepacked screen must be installed. If downhole conditions are favorable, it is possible to install filter pack in the open borehole through a small diameter tremie pipe that has been placed alongside the casing and screen. Filter pack is pumped through the tremie pipe so that it exits the bottom end and fills the annular space between the screen and the wall of the

wellbore. Quality assurance for placement of the filter pack in a horizontal wellbore is tricky, as it is extremely difficult to inject the filter pack and ensure proper placement around the entire circumference of the casing. Oilfield technology includes practices for inducing turbulent flow along the well screen during placement of the filter pack to carry the material into place. However, because of the high pressures required with this method, frac-out of fluid to the surface is a danger in shallow unconsolidated formations, and should be considered very risky in a sensitive beach and ocean floor environment.

Prepacked screens can be used when there is a need for sand control, although they can be expensive depending upon materials of manufacture. Additionally, prepacked screens larger than 6 inches ID can be very stiff and heavy, and may not be able to handle the tensile or compressive stresses induced within the curved borehole. A larger radius of curvature is required when using a prepacked screen due to its stiffness. One author feels that prepacked screens are highly recommended, as installation of a filter pack in a horizontal well is virtually impossible (Kaback, 2002). However, other authors feel that prepacked screens tend to clog easily and many oilfield contractors are using open borehole gravel packing technology with increasing success. If prepacked well screens become clogged, well production will significantly decrease as a result of sand-sealing of the near well zone. The inability to rehabilitate the well and restore production is a very serious concern.

Drilling fluids are necessary in HDD drilling to stabilize the borehole, lubricate and cool the drill bit, and carry cuttings to the surface. Drilling fluids can be either bentonite-based, or synthetic or natural polymers, or a combination of both. Some polymer drilling fluids have the ability to biodegrade naturally once drilling has been completed. If not properly controlled, bentonite mud may invade the near-well zone, making removal and successful development of the well a very difficult task. The use of drilling fluids under pressure also creates the potential for the environmental hazard of “frac-out,” whereby drilling mud escapes vertically to the surface.

Because of the larger and more powerful equipment necessary, the footprint of the site may need to be much larger than with the dual rotary drilling method. During the June 2004 meeting with Cherrington, it was voiced that a 150-foot- by 150-foot site would be the minimum amount of space required to adequately perform the work. This may not be feasible on the beach; however, with longer drilling lengths available due to the technology, it may be more acceptable to move the entry point further back from the beach into the adjacent parking areas.

As with all water wells, development is crucial to the successful completion of an HDD well. Aggressive development measures may be required to thoroughly clean the screen, filter pack, and near-well zone to remove all fine-grained

sediments remaining from the drilling process. Mechanical and chemical means may be used; however, it should be recognized that development of horizontal wells will take much longer than development of vertical wells; therefore, it is important that development procedures immediately follow construction.

For both HDD wells and dual rotary slant wells, the development process is additionally challenged by the inability to completely remove all debris left in the well following construction. In angle wells, remaining debris will not collect by gravity as in the bottom of a vertical well, but will collect on the bottom side of the well (and particularly on the screen) itself. Standard airlifting from between packers within the screened intervals may not completely remove this material; therefore, a vacuum truck or similar equipment is needed.

In shallow HDD well completions, there is little gravity available to assist in adding weight on the bit to break up cobbles, or to assist in pushing casing, screen and filter pack into place. The lack of gravity to assist in pushing vertically and horizontally requires significant additional rig “pull down,” potentially necessitating large anchors and buried dead-man weights to push casing and screen a few thousand feet horizontally offshore at relatively shallow depths of 30 to 50 feet into the alluvial marine aquifer.

Additionally, because of the lack of hydraulic head (which translates into downhole pressure) additional challenges are met in controlling drilling fluid properties, particularly in creating an adequate filter cake on the wall of the borehole to reduce damage to the near-well zone.

Shallow HDD installations are generally constructed using continuous wellbores, which would be technically challenging in the nearshore environment. A shallow HDD well on the beach extending underneath the ocean would require an exit point within the ocean surf zone, which may be difficult to permit, if not technically infeasible.

Finally, horizontal directional drilling does not work well in the presence of loose unconsolidated cobbles or boulders. These types of materials tend to steer the drilling bit off course, and make it difficult to maintain an open borehole.

### **3.5 Further Research and Development Needs for HDD Well Drilling Technology**

Areas requiring further research and development for using HDD technology to construct filter-packed water wells include: methods and drilling fluids to maintain borehole stability, methods to install artificial filter packs, methods to more completely remove drill cuttings, and well development methods to

accommodate screens installed on an angle. Further research into appropriate well materials for use in sea water applications is also required, including coupon testing as well as strength and corrosion testing.

## **4. Review of Other Construction Methods for Subsurface Intakes for Desalination Supply**

### **4.1 Nearshore Vertical Beach Wells**

Vertical wells can be constructed on the beach by a variety of drilling methods to produce water from alluvial formations. However, because they do not extend beneath the ocean, vertical wells would pull in a greater amount of onshore ground water rather than sea water. The yield from a vertical well is expected to be less than the yield from a slant well, because in an aquifer of limited thickness, the slant well has the ability to produce from a greater saturated aquifer thickness. In comparison of construction duration, the time required for a vertical beach well would be approximately 2 months, while the footprint would be about the same as that of a slant well constructed using the dual rotary drilling method. However, because more vertical wells would be required to produce the same amount of water as a slant well, the resulting overall construction footprint would likely be prohibitively large for desalination plant intake application.

### **4.2 Ranney-Type Horizontal Collector Wells**

#### **4.2.1 Traditional Horizontal Collector Wells**

Horizontal radial collector wells were developed in the 1920s for the oil industry in Texas and Ohio by Leo Ranney as a method to drill horizontally for oil recovery. The technology was later modified in London in 1933 where large amounts of water were centrally pumped from a single large-diameter vertical shaft or caisson. In the United States, the first radial collector well for water supply was constructed in 1936; today, there are approximately 220 active collector wells in the country (Hunt, 2002).

Prior to construction of a radial collector well, it is necessary to drill a number of vertical exploratory borings throughout the area to determine the subsurface geohydrologic characteristics. These characteristics include the location, lateral extent, type, and thickness of permeable aquifers, the location of potential faults in the area, and ground water quality and quantity.

During construction of a radial collector well, the central caisson must be located very close to a surface water source and may range from 8 to 20 feet in diameter. The caisson can be 120 to 260 feet in depth with six to eight (or more) horizontal

laterals radiating outward from near the bottom of the vertical shaft (Hunt, 2002). The laterals contain sections of screen and are placed by either jacking outward from the vertical shaft under hydraulic pressure, or by jetting them into place. Compressive screen strength and type of formation material encountered are limiting factors that determine the maximum distance that the laterals can extend outward. Currently, the length of the laterals used for water supply is typically 127 to 240 feet (Hunt, 2002).

The central caisson consists of sections of large-diameter, steel-reinforced concrete pipe that are either prefabricated or are fabricated onsite with water-tight joints and are designed to withstand the forces under which they will be subjected. Soil is excavated or undermined from beneath the structure as it is being pulled downward with hydraulic rams causing the caisson to settle downward to the designed depth. At desired locations, specially designed “windows” or portholes are placed in the walls of the caisson through which the horizontal laterals are placed. It should be noted that laterals can be placed in more than one plane, if the aquifer thickness allows. As the laterals are placed, packers are used to control the inflow of water from each lateral until construction is completed. Additionally, the interior of the caisson must be continually dewatered so that work on the laterals can take place. Development is minimal as the laterals are naturally developed and are designed so that the velocity of fluid entering the screens remains very low. A gravel-packing procedure for collector wells has been developed by Preussag in Germany, and has been used in the United States via license agreement.<sup>12</sup> The use of filter-packed screens makes collector well technology more adaptable to all aquifer grain sizes, enabling sand-free production.

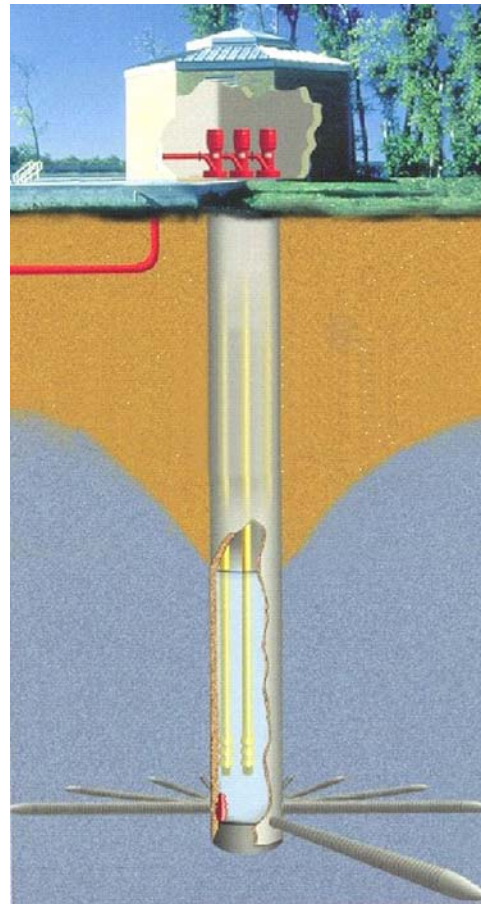

**Radial collector well schematic (Bennett&Williams, 2004).**

---

<sup>12</sup> <http://www.collectorwellsint.com/wells.asp>. Accessed March 13, 2007.

In permeable aquifers with a constant recharge source, collector wells are capable of very high production rates of 2 to 92 mgd and have been used for both fresh water and seawater intakes. Other uses include cooling water intake for power plants, industrial and municipal purposes, irrigation, and for climate control through the use of heat pumps.

Because of recent advances in gravel packed screens placed in the laterals, collector wells are successful in a wide range of geologic environments. However, most radial collector wells still utilize slotted well screens and development of a natural filter pack by removal of fine-grained sediments from the formation materials, and do not have the benefit of a gravel envelope to filter out sand and sediment. Radial collector wells rely on very low entrance velocities to keep sand production and turbidity to a minimum.

There are several advantages to using collector wells over vertical wells. The cost of a single collector well can be less than the equivalent of six or eight vertical wells. Operation and maintenance (O&M) costs for pumps, pipelines, roadways, buildings, electrical switching and control facilities are reduced, as only one pumping facility is needed per collector well. The required lot size for the well facility is also relatively small and only slightly larger than the completed well; however, the area needed during construction is much larger.

Limitations to the use of collector wells for desalination plant feed water supply include restricted lateral lengths and construction-related issues in the beach environment. The length of the laterals is currently limited to approximately 127 to 240 feet for the traditional Ranney-type collector well and 350 to 375 feet for collector wells using the Sonoma method of construction (discussed in section 4.2.2). The construction of a large caisson on the beach, even if ultimately buried, would



**Sonoma County collector well along the Russian River Valley (photo by C.D. Farrar).**

require a large construction footprint, including dewatering operations. The timeframe for constructing a collector well is approximately 6 to 9 months—two to three times the time needed to construct a slant well.

#### **4.2.2 Sonoma Method Horizontal Collector Wells**

The “Sonoma Method” refers to a traditional Ranney-type radial collector well that has been modified to include the addition of one or two larger diameter collector arms that are drilled using mud rotary technology rather than being hydraulically jacked into place. Sonoma County Water Authority’s newest collector well (well #6) is located at a greater distance from the Russian River than previous collector wells in order to minimize impacts on riparian habitat. In addition to the standard tier of laterals, the Sonoma collector well has an added tier that has two 18-inch diameter lateral arms that radiate outward (toward the river) from the bottom of a 110-foot-deep vertical caisson that is 30 feet in diameter. The laterals were constructed at distances of 350 and 375 feet from the vertical caisson, and each produce 18 mgd. They consist of laser-slotted well screen with a natural filter pack. The contractor’s personnel worked under pressure and were submerged inside the caisson using SCUBA gear. Two months of time were spent in developing the laterals due to the use of drilling mud and poorly-sorted aquifer material. The current capacity of the Sonoma method radial collector well is 40 to 45 mgd; older collector wells in the area produce 90 to 92 mgd (Jasperse, 2005). Friction caused by the flow of water within each lateral reduces its flow. To remedy this, future construction may be designed with larger diameter laterals (Wittman Hydro Planning Associates, Inc., 2006).

### **4.3 Infiltration Galleries**

An infiltration gallery intake system consists of horizontal collector screens placed in permeable aquifer materials, usually adjacent to a water body or beneath its bed. Infiltration galleries are used where aquifer thickness is insufficient to support ground water extraction. Screens are placed in open trenches and backfilled with appropriate filter materials. Water entering the infiltration gallery is often collected in a sump constructed beneath the end of the screens; in galleries with high infiltration rates, a centrifugal pump is manifolded to the screens. Because they are constructed via open excavation, they are generally limited to depths of approximately 25 feet (Driscoll, 1986).

Fukuoka District Waterworks Agency in Japan completed a seawater desalination plant in March 2005 that uses an infiltration-type of intake system, in which a network of perforated pipes is buried approximately eight feet under the seabed to collect clean seawater through the sand layer above at a slow infiltration speed. The seawater intake capacity of the system is 103,000 cubic meters per day



(m<sup>3</sup>/day) (27 mgd), and the intake screens cover an area of approximately 20,000 m<sup>3</sup> (5 acres).

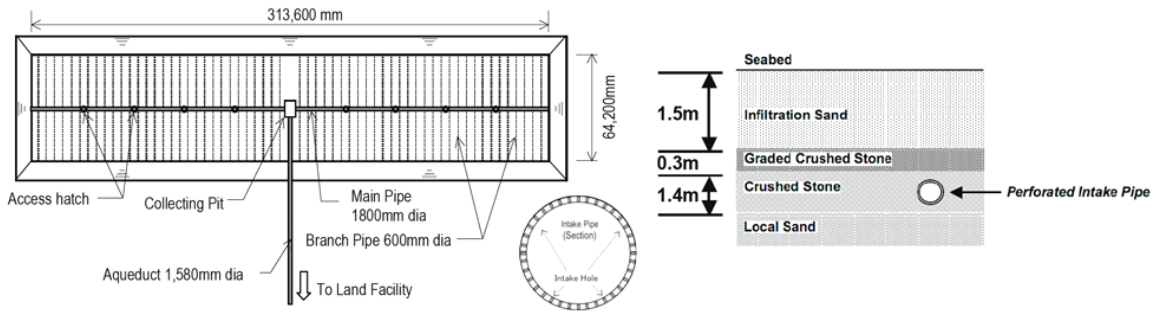

**Fukuoka District Waterworks Agency seabed infiltration system (Pankratz, 2006).**

Because of the large construction footprint that would be required on the beach, infiltration galleries were not considered a feasible intake alternative for the MWDOC Dana Point Ocean Desalination Project. Additionally, infiltration galleries can be very difficult to maintain due to incrustation caused by iron bacteria that thrive in an aerated environment, and their tendency to clog if overpumped or if left inactive (Driscoll, 1986).

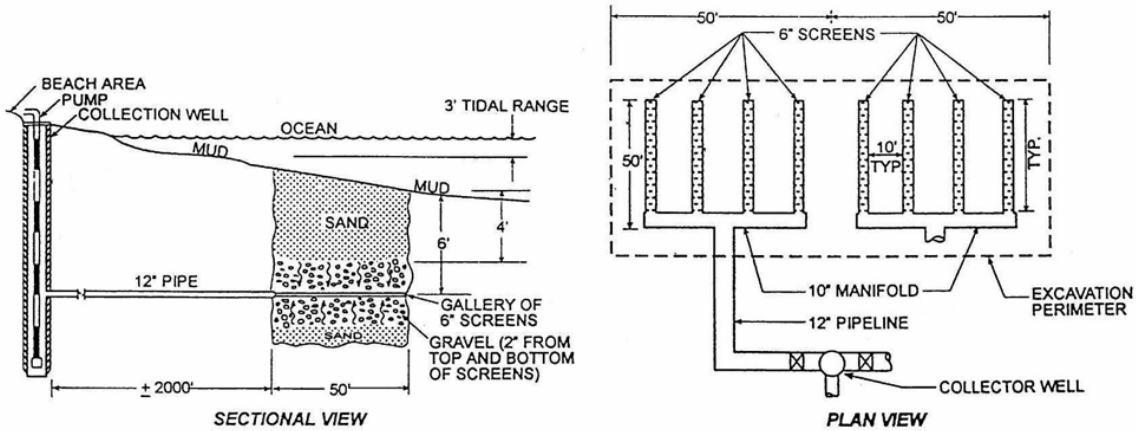

**Seabed infiltration gallery schematic (Schwarz, 2000).**

## **5. Recommended Next Steps of Key Design/Construction Improvements for Angle and HDD Construction Method**

### **Slant Wells**

1. Investigate development methods to combat sand production in a completed slant well should levels be unacceptable. Investigate methods to identify high sand production zones and, more importantly, methods to permanently block off (remove from production) these zones with high sand content or otherwise reduce sand production to acceptable levels.
2. Investigate methods that use chemicals or carbon dioxide gas to facilitate initial development.
3. Investigate the use of jetting the well screens to during initial development.
4. Investigate final development procedures using down hole pumping equipment.
5. Reach a better understanding of the available range of TVD for various commonly used water well casings and screens for completion diameters ranging from 6 to 16 inches.
6. Research the maximum lineal completion length capable with dual rotary drilling technology.
7. Research additional field testing regarding “telescoping” well completions that incorporate installation of artificial filter packs.
8. Research placement of filter pack materials (i.e., methods) to ensure that the material completely fills the annular space during placement and simultaneous removal of the outer temporary drill casing (e.g., vibratory methods or simultaneous “rocking” of the casing while airlifting or otherwise swabbing and agitating the screen and filter-packed annulus to ensure complete settlement).
9. Research minimum and maximum drilling angles (i.e., below horizontal angles) and any specialized equipment and techniques related to these angles (e.g., gravel pump pressures, specialized centering devices for

casing and screen strings, geophysical borehole logging devices, flow meter survey equipment etc.).

10. Research feasibility of extending an open borehole (using mud motors) horizontally from the bottom of slanted drill casing.

### **HDD Wells**

1. Investigate drilling mud properties to adequately keep the borehole open during drilling and until installation of the casing, screen, and filter pack has been completed.
2. Investigate procedures to physically place an artificial filter pack through a tremie pipe at deep depths and long lengths (>1,000 feet) in an open hole environment while ensuring that the annular space between the casing and screen is filled with filter pack material. Specifically, investigate how to place the filter pack and ensure both an adequate filter pack thickness, as well as settlement of the pack after placement and prior to initial development.
3. Investigate assurance of borehole integrity during placement of casing and screen and filter pack so that the open borehole is not compromised (i.e., prevent the borehole from caving and avoid complete collapse of the borehole).
4. Investigate “recovery” methods that can be used to stabilize the open borehole following a partial or complete collapse. Specifically, investigate techniques to use if collapse occurs during placement of the filter pack material.
5. Investigate development methods to combat sand production in a completed HDD well should levels be unacceptable. Investigate methods to identify high sand production zones and, more importantly, methods to permanently block off (remove from production) these zones with high sand content, or otherwise reduce sand production to acceptable levels.
6. Investigate methods that use chemicals to facilitate initial development.
7. Investigate the use of jetting the well screens to facilitate initial development.
8. Investigate initial development procedures using either conventional swabbing or procedures for simultaneously airlifting and swabbing between packers.

9. Investigate final development procedures using down hole pumping equipment.
10. Reach a better understanding of the available range of TVD for various commonly used water well casings and screens for completion diameters ranging from 6 to 16 inches.
11. Investigate methods to successfully run a flowmeter (i.e., “spinner”) survey in a slanted or horizontal hole while keeping the tool centered and installed in the well below the pump.
12. Investigate available geophysical borehole logs for horizontal boreholes that are not compromised by the presence of sand or other drilling debris found in the borehole or well.
13. Investigate methods to minimize the drilling footprint for sensitive beach environments.
14. Investigate minimizing potential for stress corrosion cracking and/or crevice corrosion in casing and screen materials that are forced to bend from a vertical to horizontal.
15. Investigate methods to free up and remove material if the pump becomes “sand locked” during production operations.

## 6.1 References

### 6.1 General References

- A&L Underground, 2007. <http://www.alunderground.com/english/hdd.htm>. Accessed January 24, 2007.
- Ali, S., R. Dickerson, C. Bennett, P. Bixenman, M. Parlar, C. Price-Smith, S. Cooper, J. Desroches, B. Foxenberg, K. Godwin, T. McPike, E. Pitoni, G. Ripa, B. Steven, D. Tiffin, J. Troncoso, 2007. "High-Productivity Horizontal Gravel Packs." *Oilfield Review*, <http://www.slb.com/media/services/resources/oilfieldreview/ors01/sum01/p5273.pdf>. Accessed March 9, 2007.
- Baker Hughes, 2007. Case File 301 Horizontal Gravel Packing – Offshore Brazil, <http://www.bhidirect.com/bakerhughes/casfile/301.htm>. Accessed March 9, 2007.
- Bakker, M., V. Kelson, and K. Luther, 2005. "Multilayer Analytic Element Modeling of Radial Collector Wells." *Ground Water*, Vol. 43, No. 6, November 2005, pp. 926-934(9).
- Bardsley, D., 2001. "Horizontal Wells Work." *Water Well Journal*, November 2001.
- Bardsley, D., 2001. "Horizontal Wells: What Are the Records?" *Drilling Marketplace*, April 15, 2001. <http://www.ngwa.org/pdf/hddaprildm.pdf>. Accessed March 9, 2007.
- Burton, R., and R. Hodge, 2003. "Key Drilling and Completion Concerns in Horizontal Wells." Paper presented at AADE 2003 National Technology Conference "Practical Solutions for Drilling Challenges." Houston, Texas, April 1-3, 2003. <http://www.aade.org/TechPapers/2003Papers/Productivity%20Optimization/AADE-03-NTCE-16-Burton.pdf>. Accessed March 9, 2007.
- California Department of Water Resources, Office of Water Use Efficiency (DWR OWUE), 2003. "Feedwater Intake Working Paper." Prepared by the California Water Desalination Task Force. Revised Draft Dated September 12, 2003. <http://www.owue.water.ca.gov/recycle/desal/Docs/FeedwaterIntake.doc>. Accessed July 29, 2004. Accessed March 9, 2007.

- California DWR OWUE, 2003. "Beach Wells." Prepared by the California Water Desalination Task Force. Draft Dated September 2, 2003. <http://www.owue.water.ca.gov/recycle/desal/Docs/BeachWells.doc>. Accessed March 9, 2007.
- Callnon, D. and J. Carr, 2004. "An HDD Challenge in San Diego Bay." *Trenchless Technology*, June 2004.
- Callnon D. and K. Weeks, 1996. "Directional Drill Keys Completion of South China Sea Pipeline." *Oil & Gas Journal*, April 8, 1996.
- CDM, 2006. Castle Pines North Metropolitan District Water Conservation Plan August 2006. <http://www.cpnmd.org/attachments/waterConservation/FinalConservationPlan.pdf>. Accessed January 24, 2007.
- CDM, 2003. "Technical Memorandum – Alternatives for Desalination Feedwater Supply and Disposal." March 19, 2003.
- CDM, 2003. Monterey Peninsula Water Supply EIR Phase 1 Technical Memorandum, Section 3, March 19, 2003.
- Cherrington, M., K. Weeks, and H. Anderson, 1993. "Directional Drilling for Gas Line Sets Two Records." *Oil & Gas Journal*, OGJ Special, September 6, 1993.
- Davis, R. and T. Oothoudt, 1997. "Drilling method may be gold at end of rainbow for difficult terrains." *Soil & Groundwater Cleanup*, May 1997.
- Denhan, M.E., 1993. "Industry Survey for Horizontal Wells Final Report. Westinghouse Savannah River Company." July 22, 1993.
- DHV Water BV and BRL Ingénierie, 2004. "Seawater and Brackish Water Desalination in the Middle East, North Africa and Central Asia, A Review of Key Issues and Experience in Six Countries." Prepared for the World Bank with funding from the Bank-Netherlands Water Partnership, December 2004.
- Directed Technologies Drilling, Inc., 2004. "Horizontal Environmental Well Design and Installation," December 2004. [http://www.horizontaldrill.com/assets/pdf/DTD\\_Horizontal\\_EnvWell\\_Handbook.pdf](http://www.horizontaldrill.com/assets/pdf/DTD_Horizontal_EnvWell_Handbook.pdf). Accessed March 9, 2007.
- Doesburg, J., 2005. "Operating and Maintaining Horizontal Wells." *Water Well Journal*, December 2005.

- Douglas, B., "Hybrid Horizontal Wells – Strength, Flexibility, and Cost Savings." *Water Well Journal*, February 2004.
- Driscoll, F.G., 1986. *Groundwater and Wells*, Second Edition. Johnson Division, St. Paul Minnesota.
- Edment, B., F. Elliot, J. Gilchrist, B. Powers, R. Jansen, T. McPike, H. Onwusiri, M. Parlar, A. Twynam, and A. van Kranenburg, 2005. "Improvements in Horizontal Gravel Packing." *Oilfield Review*, Spring 2005.  
[http://www.slb.com/media/services/resources/oilfieldreview/ors05/spr05/05\\_improvements\\_in\\_horizontal.pdf](http://www.slb.com/media/services/resources/oilfieldreview/ors05/spr05/05_improvements_in_horizontal.pdf). Accessed March 9, 2007.
- Ellins, M. and N. Nawfal, 1999. "A milestone in directional operations: Drilling 1,000 horizontal wells in Oman." *Drilling Contractor*, July/August 1999.
- Elson, T.D., Darlington, R.H. and Mantooh, M.A., 1984. "High-Angle Gravel-Pack Completion Studies." *Journal of Petroleum Technology*, January 1984.
- EPA, 1994. *Manual: Alternative Methods for Fluid Delivery and Recovery*, EPA/625/R-94/003, September 1994,  
<http://www.epa.gov/ORD/WebPubs/fluid.pdf>. Accessed January 23, 2007.
- Evans, R. and M. Parsons, 1997. "The Bandon Bay Project." *Outside Plant*, September 1997.
- Fjellstad, V., R. Bergkvam, and T. Little, 2006. "Sand control gains from new technology." *E&P*, October 2006.  
[http://www.halliburton.com/public/pe/contents/Papers\\_and\\_Articles/web/Q\\_through\\_Z/SandControl\\_HartsEP.pdf](http://www.halliburton.com/public/pe/contents/Papers_and_Articles/web/Q_through_Z/SandControl_HartsEP.pdf). Accessed March 9, 2007.
- Foremost Industries, L.P., 2003. *Benefits of Dual Rotary Drilling in Unstable Overburden Formations*.  
[http://www.foremost.ca/pdf/en/dr\\_benefits.pdf](http://www.foremost.ca/pdf/en/dr_benefits.pdf). Accessed 13-Mar-07.
- Fournier, L.B., 2005. "Horizontal Wells in Water Supply Applications." *Water Well Journal*, June 2005.
- Fournier, L.B., 2004. "Can a Horizontal Water Well Provide the Same Benefits as a Vertical Well?" *Water Well Journal*, August 2004.
- GEOSCIENCE, 2007. "Subsurface System Intake Feasibility Assessment – Task 4 Report." Prepared for Municipal Water District of Orange County, March 1, 2007.

- GEOSCIENCE, 2006. “Results of Drilling, Construction, Development and Testing of Dana Point Ocean Desalination Project Test Slant Well.” Prepared for the Municipal Water District of Orange County. July 2006 (Draft).
- GEOSCIENCE, 2005a. “Dana Point Ocean Desalination Project – Phase 2 Research and Development – Subsurface Intake System Feasibility Investigation – Test Slant Well Construction and Testing Plan.” Prepared for Municipal Water District of Orange County, October 14, 2005.
- GEOSCIENCE, 2005b. “Dana Point Ocean Desalination Project - Phase 1 Hydrogeology Investigation.” Prepared for Municipal Water District of Orange County, October 2005.
- GEOSCIENCE, 2005c. “Feasibility of Using HDD Wells for Water Supply and Brine Discharge for the Coastal Water Project Desalination Plant, North Marina Site.” Prepared for RBF Consulting/Cal American Water, May 9, 2005.
- GEOSCIENCE, 2004. “Feasibility of Using Horizontal Directionally-Drilled (HDD) Wells to Supply Water for the Coastal Water Project Desalination Plant at Moss Landing.” Prepared for RBF Consulting/Cal American Water, August 3, 2004, Draft.
- Halliburton (Bakersfield Office), 2004. Personal communication, August 2, 2004.
- Hamano, T., H. Tsuge, and T. Goto, 2006. “Innovations Perform Well in First Year of Operation.” *Desalination & Water Reuse*, Vol. 16, No. 1, May/June 2006.
- Henahan, M., 1999. “Dual Rotary Drilling in Unconsolidated Overburden.” *Water Well Journal*, July 1999.
- Hill, D., E. Neme, and C. Ehlig-Economides, 1996. “Reentry Drilling Gives New Life to Aging Fields.” *Oilfield Review*, Autumn 1996.  
<http://www.slb.com/media/services/resources/oilfieldreview/ors96/aut96/08960417.pdf>. Accessed March 9, 2007.
- Hix, G.L., 1996. “More on the Development of Horizontal Wells.” *Water Well Journal*, February 1996.
- Hunt, H., 2002. “American Experience in Installing Horizontal Collector Wells.” In *Riverbank Filtration, Improving Source-Water Quality*, published by Kluwer Academic Publishers, NWRI, 2002.



- Hunt, H., 1996. "Filtered Seawater Supplies – Naturally." *Desalination & Water Reuse*, Vol. 6, No. 2, August 1996.
- Hüper, G., 1993. *Horizontale Wasserfassungen Anwendung*, Stand der Technik.
- Jehn Water Consultants, 2004. Personal communication, June 25, 2004.
- Joshi, S.D., 2003. "Cost/Benefits of Horizontal Wells." Society of Petroleum Engineers, SPE Western Regional/AAPG Pacific Section Joint Meeting, Long Beach, California, May 19-24, 2003.
- Kaback, 2002. "Technology Status Report: A Catalogue of the Horizontal Environmental Wells in the United States." Prepared for Ground-Water Remediation Technologies Analysis Center (GWRTAC), January 2002. <http://www.gwrtac.org/pdf/hor-wells.pdf>. Accessed May 5, 2004.
- LaFontaine, J., M. Sanders, T. Hailey, I. Mickelburgh, and D. Lord, 1999. "New Concentric Annular Packing System Limits Bridging in Horizontal Gravel Packs." Society of Petroleum Engineers, 1999 SPE Annual Technical Conference and Exhibition, Houston, Texas, October 3-6, 1999.
- Longbore, 2007. <http://www.longbore.com/us/Faq.htm>. Accessed March 9, 2007.
- Losonsky, G., W. Brady, and M. Lodato, 2003. "Horizontal Wells: New Applications for Remedial System Design." *Water Well Journal*, June 2003.
- Lovo, R., 2001. "Initial Evaluation of the Subfloor Water Intake Structure System (SWISS) vs. Conventional Multimedia Pretreatment Techniques." Reclamation Desalination Research and Development Program Report No. 66, May 2001.
- Matthews, M., 2006. "Angled Wells are Tapping Big Muddy's Sweet Spot." *Engineering News Record*, January 16, 2006.
- Mehmert, M.H., 1983. "Vibro Hammer is Answer to Tough Casing Pullback." *Johnson Drillers Journal*, Second Quarter, 1983.
- Miller, R., 1996. "Horizontal Wells, Technology Overview Report TO-96-02." Prepared for Ground-Water Remediation Technologies Analysis Center, October 1996. [http://www.cluin.org/download/toolkit/horiz\\_o.pdf](http://www.cluin.org/download/toolkit/horiz_o.pdf). Accessed March 9, 2007.

- National Ground Water Association, 2005. "Horizontal Wells in Water Supply Applications." In *Horizontal News*, Vol. 8, No. 1, Fall 2005.  
<http://www.ngwa.org/pdf/hwig-fall05.pdf>. Accessed January 24, 2007.
- Nwoke, L., J. Arukhe, and C. Uchendu, 2003. "Intelligent-Thinking Restored Well Productivity in Horizontal Completions Plugged-off by Sand Deposits: Huge Reward." Society of Petroleum Engineers, SPE Production and Operations Symposium, Oklahoma City, Oklahoma, March 22-25, 2003.
- Ojo, K.P., S.O. Osisanya, and K.B. Ayeni, 2006. "Factors Affecting Horizontal Well Gravel-Pack Efficiency." Society of Petroleum Engineers, SPE Annual Technical Conference and Exhibition, San Antonio, Texas, September 24-27, 2006.
- Onwusiri, H., C. Onwuzurike, T. McPike, and R. Jansen, 2003. "Horizontal Openhole Gravel Packing in a Depleted and Heterogeneous Reservoir." Society of Petroleum Engineers, SPE Annual Technical Conference and Exhibition, Denver, Colorado, October 5-8, 2003.
- Pankratz, T., 2006. "Seawater Desalination Technology Overview." Presentation for Georgia Joint Comprehensive Desalination Study Committee, St. Simons Island, Georgia, August 22-23, 2006.
- Pizzarelli, S.G., O.E. Gonzalez, P. Justiniano, S.A. Olivares, and J.J. Potma, 2002. "Results of Thermal Horizontal Completions with Sand Control in Lake Maracaibo, Venezuela: Case Histories of Horizontal Gravel Packs in Bachaquero-01 Reservoir." Society of Petroleum Engineers, SPE/PS-CIM/CHOA International Thermal Operations and Heavy Oil Symposium and International Horizontal Well Technology Conference, Calgary, Alberta, Canada, November 4-7, 2002.
- Quality Drilling Fluids Engineering, Inc., 2004. Personal communication, June 25, 2004.
- Rash, V.D., 2001. "Predicting Yield and Operating Behavior of a Horizontal Well." Paper presented at AWWA Annual Conference, Washington, DC, June 2001.
- Reed, T., 2005. "2005 Large Directional Drilling Rig Census." *Underground Construction*, November 2005,  
[www.oildompublishing.com/uceditorialarchive/November05/novrig.pdf](http://www.oildompublishing.com/uceditorialarchive/November05/novrig.pdf). Accessed March 9, 2007.
- Riegert, D.S., 2006. "Reassessing Ranney Wells." *Public Works Magazine*, April 15, 2006.

- Roscoe M., 1990. *Handbook of Ground Water Development*. John Wiley & Sons, New York.
- Schwarz, J., 2000. Beach Well Intakes for Small Seawater Reverse Osmosis Plants. Project 97-BS-015 of the Middle East Desalination Research Center, August 2000. <http://www.medrc.org.om/dwnftp/97-BS-015.zip>. Accessed May 25, 2004.
- Schlumberger, 2007. Oilfield Glossary.” <http://www.glossary.oilfield.slb.com>. Accessed March 13, 2007.
- Segalen, A., P. Pavelic, and P. Dillon, 2005. “Review of Drilling, Completion and Remediation Methods for ASR Wells in Unconsolidated Aquifers.” CSIRO Land and Water Technical Report No. 04/05, March 2005. <http://www.clw.csiro.au/publications/technical2005/tr4-05.pdf>. Accessed March 9, 2007.
- Singh, K. and J. Ulloa, 2003. “Distribution Feeder Crosses the San Leandro Channel.” *Transmission and Distribution World*, August 2003.
- Sparlin, D., 2005. “Sand Control in Horizontal Wells.” *World Oil Magazine*, [http://worldoil.com/magazine/magazine\\_detail.asp?ART\\_ID=2659](http://worldoil.com/magazine/magazine_detail.asp?ART_ID=2659). Accessed March 9, 2007.
- Spiridonoff, S. V., 1964. “Design and Use of Radial Collector Wells.” *Journal American Water Works Association*. Vol. 56, June 1964.
- Strawn, J., 2006. “A New Direction: Water supply project uses angled wells to reach ground water under the Missouri River.” *Water Well Journal*, May 2006.
- Sun, D. and H. Zhan, 2006. “Flow to a horizontal well in an aquifer-aquitard system.” *Journal of Hydrology*, Vol. 321, Issues 1-4, pp. 364-376, April 30, 2006.
- Taylor, S.W. and L.C. Headland, 2005. “Analysis and Design of Infiltration Seawater Intakes.” In *Proceedings of the 2005 World Water and Environmental Resources Congress*, May 15-19, 2005, Anchorage, Alaska; sponsored by Environmental and Water Resources Institute (EWRI) of the American Society of Civil Engineers.
- Todd, D.K. and Mays, L.W., 2005. *Groundwater Hydrology*. John Wiley and Sons, 2005.

- Tubb, R., 2004. "Michels USA Completes 10 HDDs in Gulfstream Pipeline Expansion." *Pipeline & Gas Journal*, November 2004.
- U.S. Department of Energy, 1998. "Horizontal Wells, Innovative Technology Summary Report." <http://apps.em.doe.gov/ost/pubs/itsrs/itsr1927.pdf>. Accessed March 9, 2007.
- U.S. Department of Energy, 1993. "Drilling Sideways: A Review of Horizontal Well Technology and its Domestic Application." Prepared by the Energy Information Administration, Office of Oil and Gas, April 1993, <http://tonto.eia.doe.gov/FTP/ROOT/petroleum/tr0565.pdf>. Accessed March 9, 2007.
- Voutchkov, N., 2006. "Desalination Challenges and Considerations When Using Coastal Aquifers for Seawater Desalination." *Ultrapure Water*, September 2006.
- Voutchkov, N., 2004. "Thorough Study is Key to Large Beach-Well Intakes." *Desalination & Reuse Quarterly*, Vol. 14, No. 1, May/June 2004.
- Wilson, D., 1996. "Horizontal Well Development Made Easy." *Water Well Journal*, October 1996.
- Wilson, D., 1995. "Horizontal Well Development: A Plan is Needed." *Water Well Journal*, August 1995.
- Wittman Hydro Planning Associates, Inc., 2006. Statement of Qualifications, <http://www.wittmanhydro.com/>. Accessed January 23, 2007.
- Wong, S.K., P.S. Fair, K.F. Bland, and R.S. Sherwood, 2003. "Balancing Act: Gulf of Mexico Sand Control Completions, Peak Rate Versus Risk of Sand Control Failure." Society of Petroleum Engineers, 2003 SPE Annual Technical Conference and Exhibition, Denver, Colorado, October 5-8, 2003.
- Zhan, H. and Zlotnik, V.A., 2002. "Ground water flow to a horizontal or slanted well in an unconfined aquifer." *Water Resources Research*, Vol. 38, No. 7, July 20, 2002.

## 6.2 Slant and Horizontal Well Hydraulics References

- Barlow, P.M., and Moench, A.F., 1999. "WTAQ – A computer program for calculating drawdowns and estimating hydraulic properties for confined and water-table aquifers." USGS Water-Resources Investigations Report 99-4225.
- Chen, C., Wan, J., and Zhan, H., 2003. "Theoretical and experimental studies of coupled seepage-pipe flow to a horizontal well." *Journal of Hydrology*, 281, Issues 1-2, 159-171, September 2003.
- Daviau, F., Mouronval, G., Bourdarot, G. and Curutchet, P., 1988. "Pressure Analysis for Horizontal Wells." *SPE Formation Evaluation*, pp. 716-724, December 1988.
- Falta, R. W., 1995. "Analytical solutions for gas-flow due to gas injection and extraction from horizontal wells." *Ground Water*, Vol. 33, No. 2, pp. 235–246, March-April 1995.
- Goode, P. A. and R. K. M. Thambynayagam, 1987. "Pressure drawdown and buildup analysis of horizontal wells in anisotropic media." *SPE Formation Evaluation*, 2(4), 683–697.
- Hantush, M. S., 1964. "Hydraulics of Wells." In *Advances in Hydrosience*, edited by V. T. Chow, Academic, San Diego, California.
- Hantush, M. S., and I. S. Papadopoulos, 1962. "Flow of ground water to collector wells." *Journal of the Hydraulics Division*, ASCE 88, HY5, 221–244, 1962.
- Joshi, S.D., 1988. "Augmentation of Well Productivity Using Slant and Horizontal Wells." *Journal of Petroleum Technology*, pp. 729-739, June 1988.
- Joshi, S. D., 1987. "A review of horizontal well and drainhole technology." Society of Petroleum Engineers, SPE Annual Technical Conference and Exhibition, Dallas, Texas, September 27-30, 1987.
- Kawecki, M. W., 2000. "Transient flow to a horizontal water well." *Ground Water*, Vol. 38, No. 6, pp. 842–850.
- Kawecki, M. W. and Al-Subaikhy, H. N., 2005. "Unconfined Linear Flow to a Horizontal Well." *Ground Water*, Vol. 43, No. 4, pp. 606-610. July-August 2005.

- Kompani-Zare, M., Zhan, H., and Samani, N., 2005. "Analytical study of capture zone to a horizontal well in a confined aquifer." *Journal of Hydrology*, 307 Issues 1-4, 48-59, June 9, 2005.
- Kuchuk, F. J., P. A. Goode, D. J. Wilkinson, and R. K. M. Thambynayagam, 1991. "Pressure transient behavior of horizontal wells with and without gas cap or aquifer." *SPE Formation. Evaluation*, 6, 86– 94, 1991.
- Langseth, David E., Smyth, A.H., and May, J., 2004. "A Method for Evaluating Horizontal Well Pumping Tests." *Ground Water*, Vol. 42, No, 5, pp. 689-699. September-October 2004.
- Maurer, W. C., 1995. "Recent advances in horizontal drilling." *Journal of Canadian Petroleum Technology*, 34, 25– 33, 1995.
- Moench, A. F., 1995. "Combining the Neuman and Bolton models for flow to a well in an unconfined aquifer." *Ground Water*, Vol. 33, No. 3, pp. 378-384, 1995.
- Morgan, J. H., 1992. "Horizontal drilling applications of petroleum technologies for environmental purposes." *Ground Water Monitoring Review*, 12(2), 98–102.
- Murdoch, L. C., 1994. "Transient analyses of an interceptor trench." *Water Resources Research*, 30(11), 3023–3031.
- Papatzacos, P., 1992. "Gas-coning by a horizontal well." In *The Mathematics of Oil Recovery*, edited by P. R. King, pp. 805– 817, Clarendon, Oxford, United Kingdom.
- Park, E., and Zhan, H., 2002. "Hydraulics of a finite-diameter horizontal well with wellbore storage and skin effect in leaky aquifers." *Advances in Water Resources*, 25(4), 389-400, January 30, 2002.
- Penmatcha, V. R., S. Arbabi, and K. Aziz, 1997. "Effect of pressure drop in horizontal wells and optimum well length." Paper presented at 1997 SPE Production Operations Symposium, Society of Petroleum Engineers, Oklahoma City, Oklahoma, March 9-11, 1997.
- Sawyer, C. S., and K. K. Lieuallen-Dulam, 1998. "Productivity comparison of horizontal and vertical ground water remediation well scenarios." *Ground Water*, 36(1), 98–103.

- Seines, K., S. C. Lieu, and B. T. Haug, 1994. "Troll horizontal well tests demonstrate large production potential from thin oil zones." *SPE Reservoir Engineering*, 9(2), 133-139.
- Tarshish, M., 1992. "Combined mathematical model of flow in an aquifer–horizontal well system." *Ground Water*, 30(6), 931– 935.
- Zhan, H., 1999. "Analytical study of capture time to a horizontal well." *Journal of Hydrology*, Vol. 217, Issues 1-2, pp. 46-54.
- Zhan, H. and Cao, J., 2000. "Analytical and semi-analytical solutions of horizontal well capture times under no-flow and constant-head boundaries." *Advances in Water Resources*, 23(8), 835-848, July 2000.
- Zhan, H. and Park, E., 2003. "Horizontal Well Hydraulics in Leaky Aquifers." *Journal of Hydrology*, Vol. 281, Issues 1-2, pp 129-146, September 25, 2003.
- Zhan, H., Wang, L. V., and Park, E., 2001. "On the horizontal-well pumping tests in anisotropic confined aquifers." *Journal of Hydrology*, Vol. 252, Issues 1-4, pp. 37-50, October 2001.

**Table 1. Summary of Horizontal Angle Wall Construction Methods**

Horizontal/Angle Well Construction Method	Angle of Entry Point [degrees below horizontal]	Angle of Completion Section [degrees below horizontal]	Well Construction Method	Drilling Fluid System	Typical Depth [vertical feet]	Typical Length of Well [lineal feet]	Typical Screen Length [lineal feet]	Borehole Diameter [inches]	Casing or Lateral Diameter [inches]	Production Rate [gallons per minute, gpm]	Artificial Filter Pack	Example of Construction Location
Dual Rotary Slant Wells	0°-90° possible, 23° at Dana Point	23° (20° Planned)	Dual Rotary	Water	148	350 (500 Planned)	220 (300 Planned)	20 (24 and 20 Planned)	12 (16 and 12 Planned)	2,000 (3,000 Planned)	Yes	MWDOC Dana Point, California
Horizontal Directionally Drilled (HDD) Wells Blind Completion (Surface to Subsurface end) Slant Borehole at Entry Point (Environmental and Municipal Applications)	Typically 15°-23° (Kaback, 2002)	Horizontal (0°)	Direct Mud Rotary, High Pressure Jetting, or Driving (including ramming, compaction or percussion methods - i.e. advancing borehole without removal of formation materials)	Bentonite-Based, Water or Polymer (none with driving methods)	Typically Less than 25, but as Deep as 235	Typically 70-500, to over 1,00 ft in some cases	< 14	Typically 4-6, However 8 5/8 for Thames River Horizontal Well	Generally Less than 10, but as Much as 80 for Environmental Applications, ~1,200 gpm in Thames River Horizontal Well	Yes, typically only 40% of the calculated volume of filter pack is placed.	Yes, however pre-packed screens are used.	Environmental Applications, e.g. Savannah River Site, South Carolina; Thames River, London, England
Horizontal Directionally Drilled (HDD) Wells Blind Completion (Surface to Subsurface End) Vertical Borehole at Entry Point (Oilfield Applications)	45°-90° However, 45° Possible (Schlumberger, 2007)	Horizontal (0°)	Direct Mud Rotary	Bentonite-Based or Polymer	500-3,500	Typically < 4,000	1,000-2,500	12 1/4	4 1/2 - 9 7/8	Unknown	Yes, however pre-packed screens are used.	Oilfield applications; Castle Pines North Metropolitan District, Castle Pines North, Colorado; and Antelope Hills Water District, Bennett, Colorado
Horizontal Directional Drilled (HDD) Wells Continuous Completion (Surface to Surface) Slant Borehole at Entry Point (Utility Boring Method)	7°-25° (Kaback, 2002)	Horizontal (0°), Can Be Turned Back Up Toward Surface	Direct Mud Rotary, High Pressure Jetting, or Driving (including ramming, compaction or percussion methods - i.e. advancing borehole without removal of formation materials)	Bentonite-Based, Water or Polymer (none with driving methods)	< 50	Typically < 2,000	100-1,220	4 - 12, may be reamed to 26	12 with 16 in. surface pipe	1,800	Yes, however DMWW did not install an artificial filter pack	Des Moines Water Works, Des Moines, Iowa
Ramney-type Radial Collector Wells	Vertical (90°) Caisson	Horizontal (0°) Laterals	High Pressure Jetting, Hydraulic Jacking of Well Screen and Casing	Water	75-150 ft Caisson	127-240 ft Laterals	127-240	8-12	8-12 in. Laterals	6-11 MGD per Lateral	No	Numerous River Bank Filtration Sites Throughout United States
Ramney-type Radial Collector Wells (Sonoma Method)	Vertical (90°) Caisson	Horizontal (0°) Laterals	Direct Mud Rotary, High Pressure Jetting, Hydraulic Jacking of Well Screen and Casing (Drilling Personnel Worked Under Water and Under Pressure at ~100 ft Depth Using SCUBA Gear)	Bentonite-Based or Polymer	110 ft Caisson	350-375 ft Laterals	350-375	18	18 in. Laterals	18 MGD per Lateral	No	Sonoma County Water Agency, Sonoma, California