

ARM Pyrgometer Calibrations & Field Measurements

Information Regarding the Data Restriction Notice

Tom Stoffel
7 December 2005

DOE/SC-ARM/P-05-011

Outline

- Why the need for longwave data restriction?
 - Important Considerations and the 12 Wm⁻² longwave results problem
- What ARM data are effected?
 - List of station-dates
- Can the data be adjusted?
 - Using available 20-sec data samples
- How is ARM addressing pyrgeometer calibration?
 - In Search of a Measurement Reference
- References
- Acronyms
- Appendix
 - Fundamentals of pyrgeometer operation and calibration

Why a Data Access Restriction?

The ARM Program's data quality control measures discovered an unexpected shift in the time series of longwave irradiance data following a change in pyrgeometer calibration procedures for field instruments deployed at all SIRS, SKYRAD, and GNDRAD installations beginning in August 2002 and completed in March 2004.

The change is being studied and we will lift the restriction after we are satisfied that the data stream in its current or reprocessed form adequately portrays the effects of scientifically acceptable calibration procedures.

The following slides provide more specific information about the evidence suggesting a calibration shift in the longwave data. Before we begin, it is important to review some key points (see the Appendix for pyrgeometry basics).

Pyrgeometer Calibrations: Important Considerations

- There is currently no accepted international measurement reference for longwave irradiance.
- Temperature-controlled blackbodies are central to the calibration and operation of longwave radiation measuring instruments.
- Pyrgeometer measurements and blackbody calibration standards provide no information about uncertainty of the absolute value of atmospheric longwave radiation measurements (Philipona et al., 2001)
- Established by the World Meteorological Organization in September 2004, the World Infrared Radiation Calibration Center, Physikalisch-Meteorologisches Observatorium Davos (PMOD) in Switzerland now provides pyrgeometer calibrations consistent with the Second International Pyrgeometer and Absolute Sky-scanning Radiometer Comparisons (IPASRC-II) (Marty et al., 2003).
- IPASRC methodology uses blackbody calibration of pyrgeometers adjusted for agreement with outdoor comparisons under clear-sky conditions with the Absolute Sky-scanning Radiometer (ASR) maintained in Davos.
- The BSRN community has adopted IPASRC-II as an interim consensus reference (WCRP, 2004).
- In the absence of an ASR, outdoor measurement comparisons provide opportunities for *relative* performance characterizations of pyrgeometers.
- Pyrgeometer blackbody calibration differences are greatest during clear-sky conditions (high levels of net radiation) and least during cloudy sky periods (low levels of net radiation).
- The 4-coefficient method for computing irradiance from pyrgeometer outputs has been shown to improve the *precision* of the outdoor data compared to methods of Albrecht & Cox or Philipona (Reda, et al., 2002, Reda, et al., 2003). Measurement *biases* are attributed to the pyrgeometer blackbody calibration system.

Why the need for longwave data restriction?

The 12 Wm⁻² measurement bias

Recent analyses suggests a longwave irradiance bias has been introduced by the NREL pyrgeometer calibration method:

- *LW QME* analyses show AERI data from 1997 is on average ~2 Wm⁻² lower than pyrgeometer data based on EPLAB calibrations and ~10 Wm⁻² higher using the NREL calibrations for a total difference of ~12 Wm⁻² between the two calibration methods (see next slide).
- *4-Pyrgeometer round-robin* between NOAA/GMD* & NREL blackbodies, and *2-pyrgeometer round-robin* between NREL & PMOD blackbodies from July - Oct 2005 confirms a 12 Wm⁻² blackbody calibration bias between NREL and PMOD or NOAA.
- Both of the above analyses have also shown that on average, compared to the BSRN-recommended longwave reference (IPASRC-II), the PMOD, NOAA and EPLAB blackbody calibrations would result in 6 Wm⁻² higher irradiance and the NREL blackbody calibrations will result in 6 Wm⁻² lower irradiance.

* Global Monitoring Division, Earth System Research Laboratory, formerly CMDL

LW QME Findings

Search for temperature dependence of PIR - AERI measurements finds 12 Wm⁻² bias between calibration methods using data from AERI, SIRS, and SMOS instruments:

AERI and SIRS Data from 1997

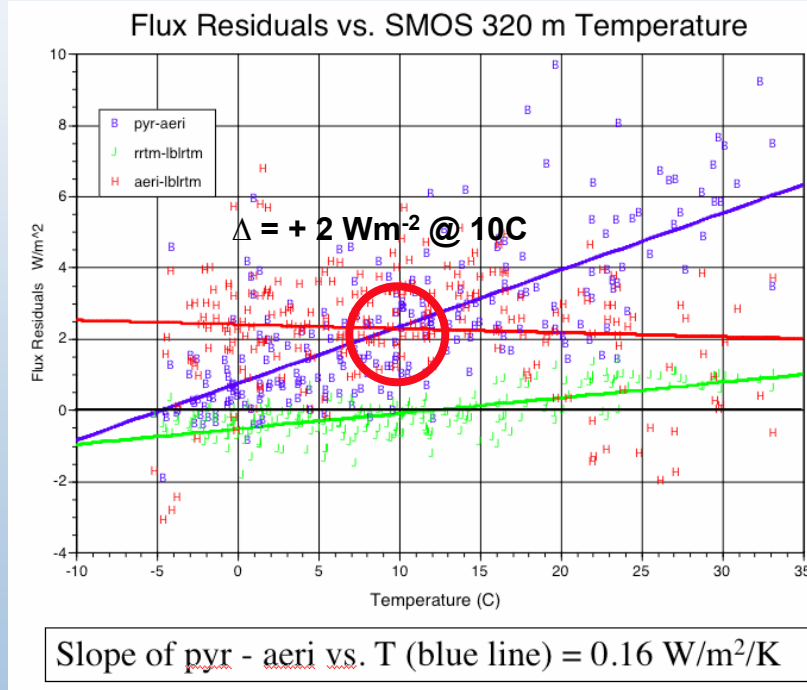

PIR data based on EPLAB blackbody calibrations and 2-coefficient analyses of field measurements

AERI and SIRS Data from 2004

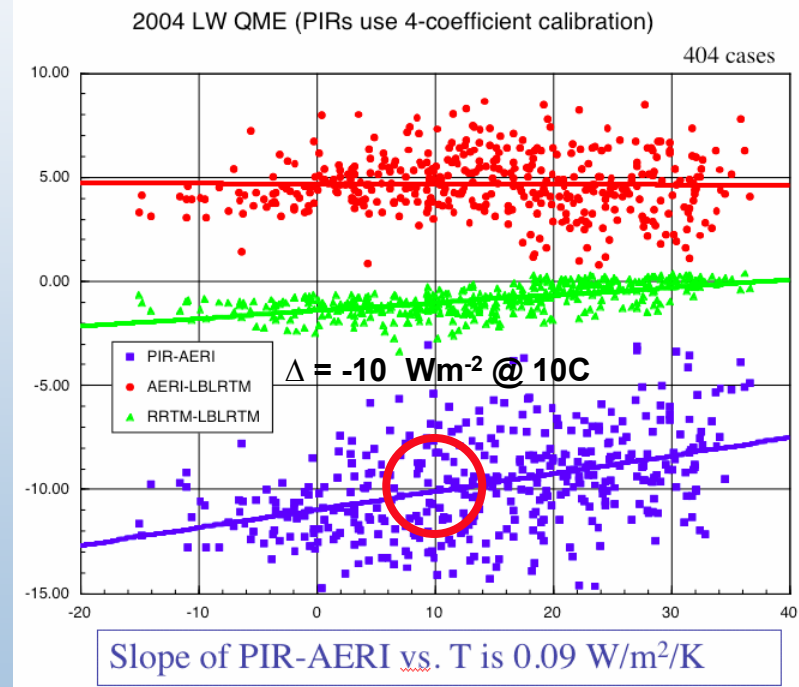

PIR data based on NREL blackbody calibrations and 4-coefficient analyses of field measurements

LW QME and the 12 Wm⁻² Longwave Problem

Based on analyses of the temperature dependence of the observed differences between the downwelling longwave irradiances from the pyrgeometers and AERI data at the SGP Central Facility, the 12 Wm⁻² differences are apparent between PIR data collected with the EPLAB factory calibration (1997 SIRS data) and the NREL blackbody calibrations (2004 SIRS data).

In the following slide, we have re-plotted the AERI-SIRS longwave temperature-dependence data. The results suggest that the four PIRs used in SIRS during these periods (pairs of SIRS PIRs were used in 1997 and in 2004 to compute the average 1-min data) are consistent with the previous blackbody comparisons based on PIR s/n 31195F3.

LW QME Results for (Pyrgeometer - AERI)

Another look at the temperature dependence of irradiance differences between AERI and PIR's with two pyrgeometer calibration methods based on measurements at the SGP Central Facility

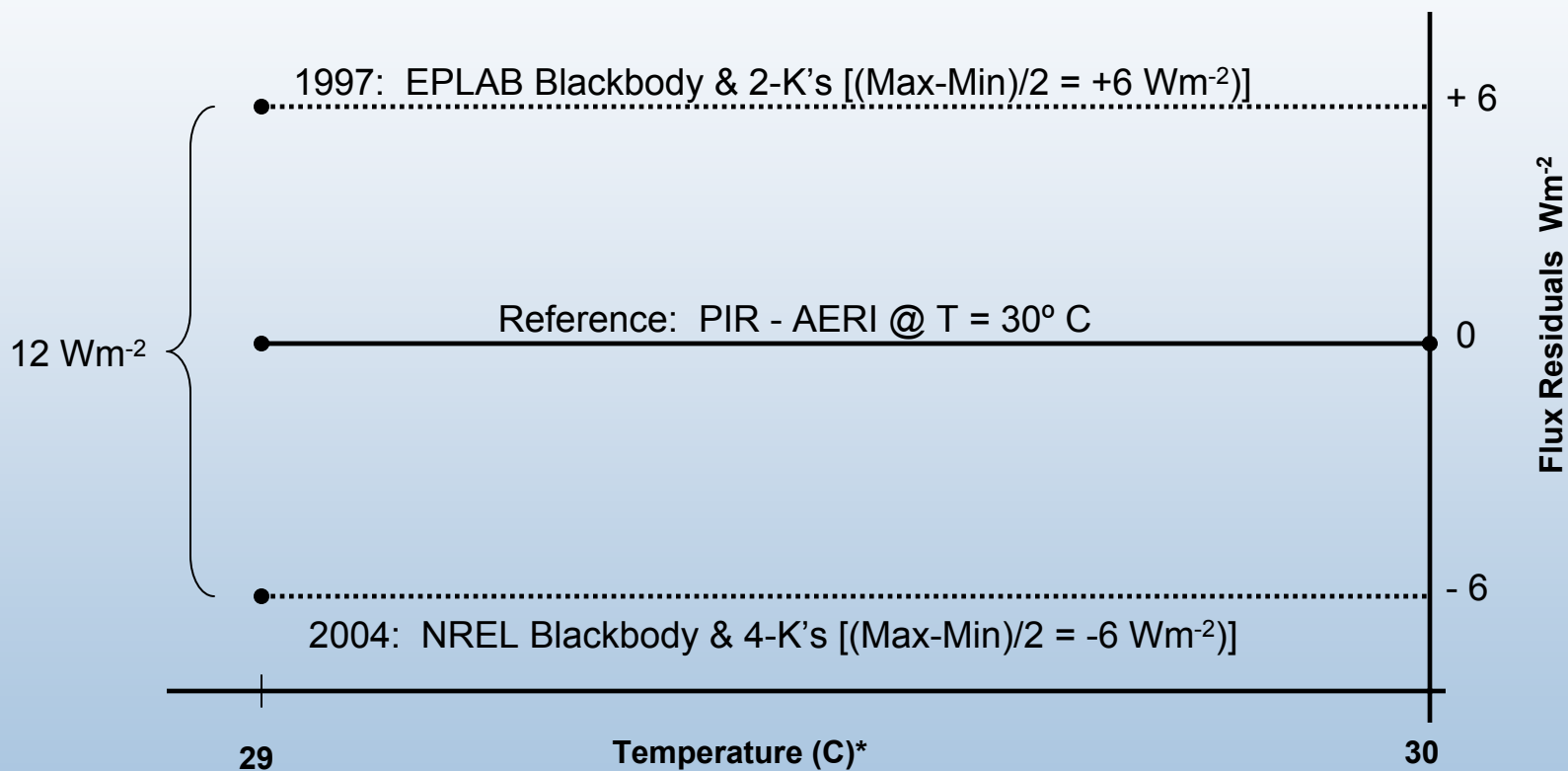

* At ambient temperature = 30°C, the PIR thermopile output would be minimum (larger negative value) under clear sky conditions. This would increase the flux residuals if there was an error in the pyrgeometer responsivity, which would resemble the conditions in the previous plots, supporting the 12 Wm⁻² difference between two pyrgeometer blackbody calibration systems.

Recent Comparisons of Pyrgeometers

Subsequent slides describe comparisons of from two to four pyrgeometers among NREL, NOAA, & PMOD during the period July - November 2005.

The comparisons are made from independent blackbody calibrations and outdoor measurements from the selected pyrgeometers.

The next slide summarizes the essential findings of the outdoor comparisons at NREL when applying the different blackbody calibration factors to the outdoor measurements collected at NREL for a few weeks.

Note: Data from PIR serial number 31195F3 is used to realize the IPASRC-II “measurement scale” because it is the only PIR we had access to for this study that also participated in both international comparisons.

Blackbody Comparisons - July 2005

Average outdoor measurements of 4 pyrgometers wrt IPASRC-II* calibration of PIR 31195F3, the only pyrgometer with NREL calibration participating in IPASRC-I & II.

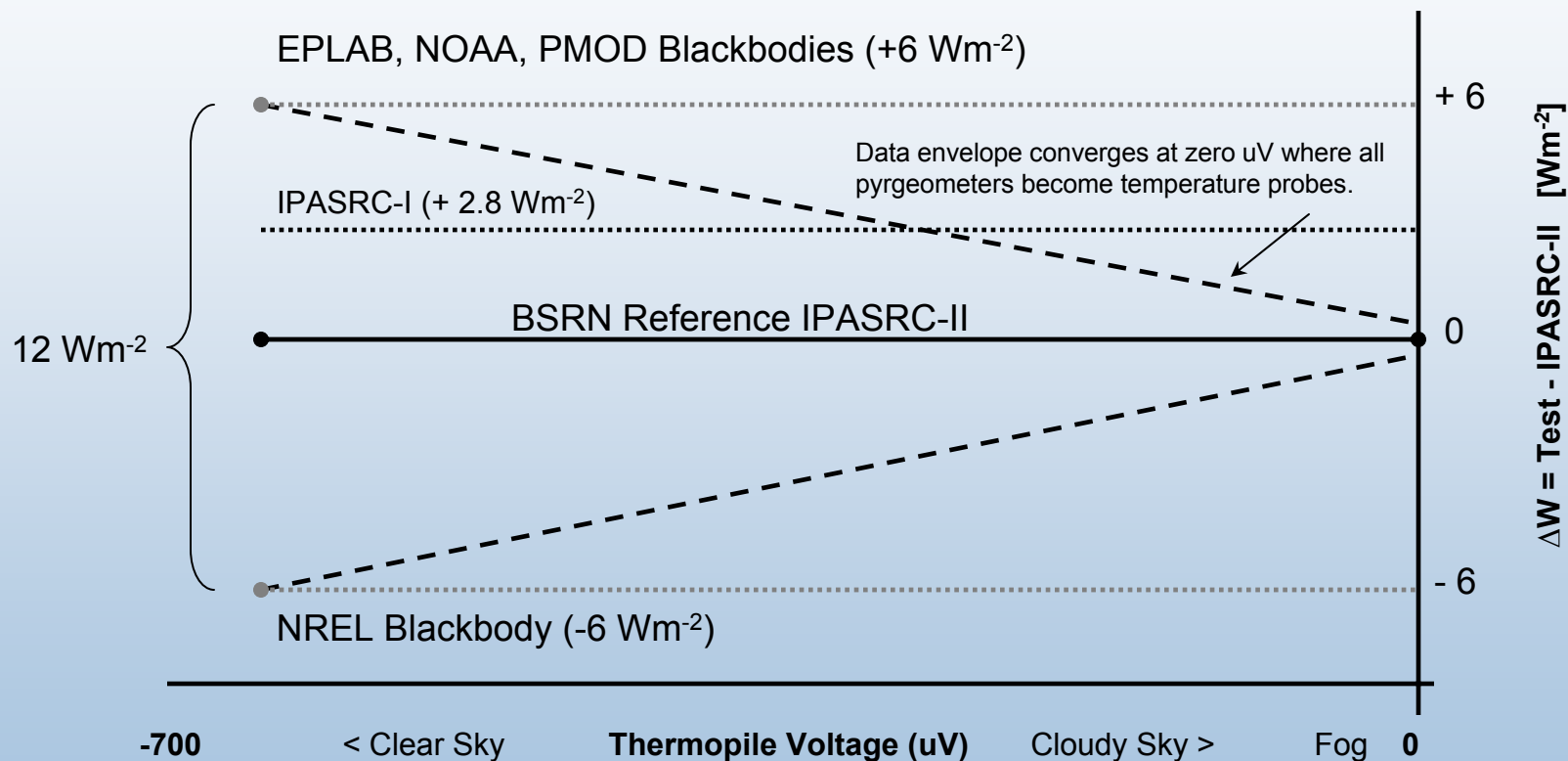

* International Pyrgometer and Absolute Sky-scanning Radiometer Comparisons (IPASRC) incorporate blackbody characterizations, outdoor comparisons with ASR under nighttime clear-sky conditions, and "Field" adjustments to thermopile sensitivities and case emissivities based on outdoor comparisons under clear and overcast sky conditions.

What We Know About Pyrgeometer Precision

IPASRC-I (conducted in 1999) comparison of hourly averaged range of longwave irradiance measured by **8 pyrgeometers** using CMDL blackbody calibrations with Albrecht & Cox analysis (Max-Min):

Nighttime = 8.4 Wm^{-2} (for data 260-390 Wm^{-2})

Daytime = 8.8 Wm^{-2} (for data 300-420 Wm^{-2})

IPASRC-II (conducted in 2001) as above for **8 pyrgeometers** (4 of which were also in IPASRC-I) using CMDL blackbody calibrations with Albrecht & Cox analysis (Max-Min):

Nighttime = 5.4 Wm^{-2} (for data 120-200 Wm^{-2})

Daytime = 6.1 Wm^{-2} (for data 120-200 Wm^{-2})

July 2005 round-robin outdoor measurement results for **4 pyrgeometers** using CMDL and NREL blackbody calibrations with Albrecht & Cox analysis (Max-Min):

CMDL_{BB} Day/Night range = $\pm 6 \text{ Wm}^{-2}$

NREL_{BB} range = $\pm 5 \text{ Wm}^{-2}$ (all data 180-350 Wm^{-2})

Precision and Accuracy based on July 2005 Round-Robin Outdoor Measurements

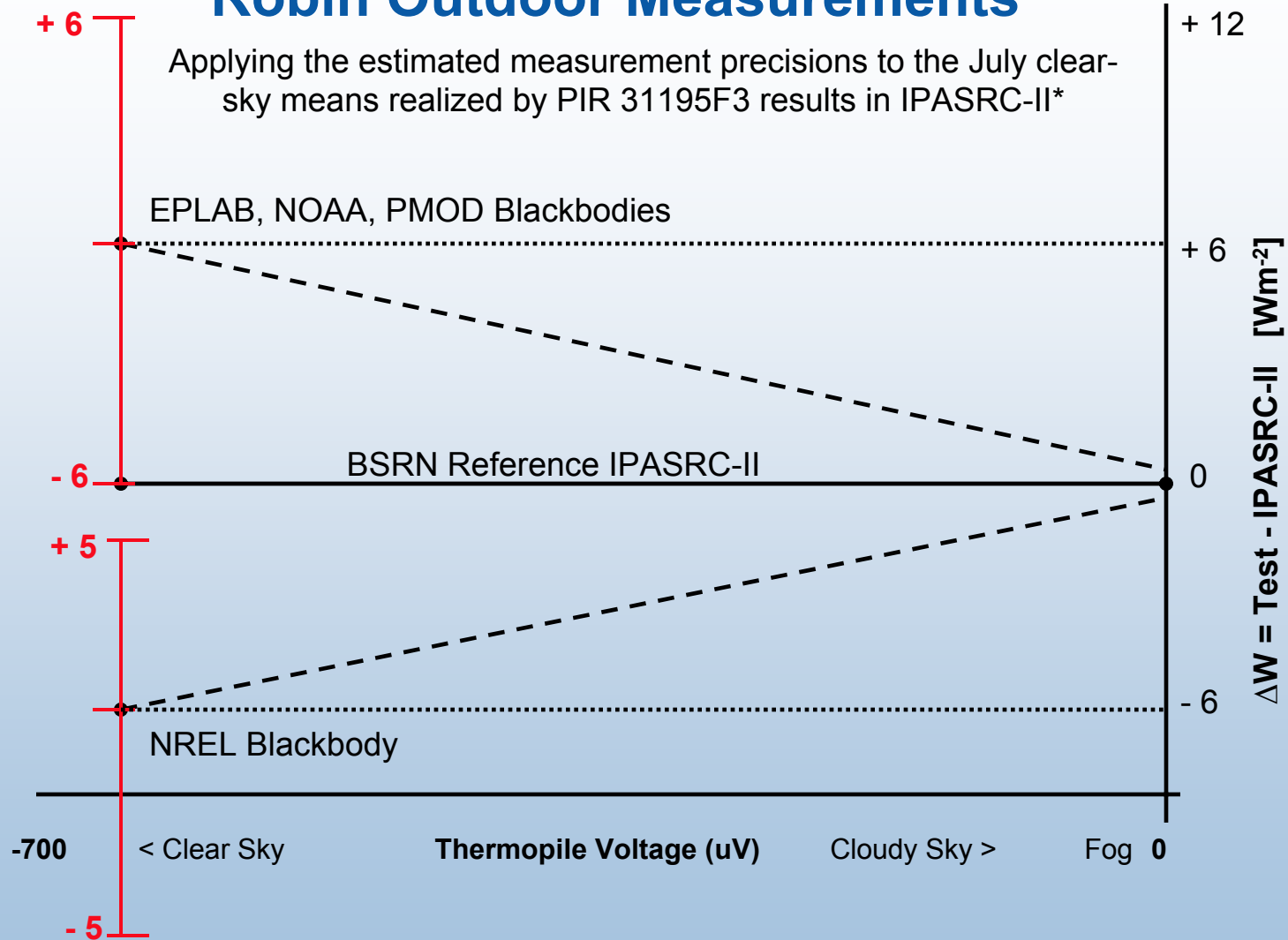

* PIR 31195F3 participated in IPASRC-I & II and the July 2005 Round Robin between NOAA and NREL

Pyrgometer Precision (Concluded)

Intermediate to the two IPASRC's and the July 2005 "mini-round-robin", we evaluated the NREL blackbody results by comparing the performance of 12 PIRs at the SGP/RCF (Reda, et al., 2003):

NREL Method:

$\pm 3 \text{ Wm}^{-2}$

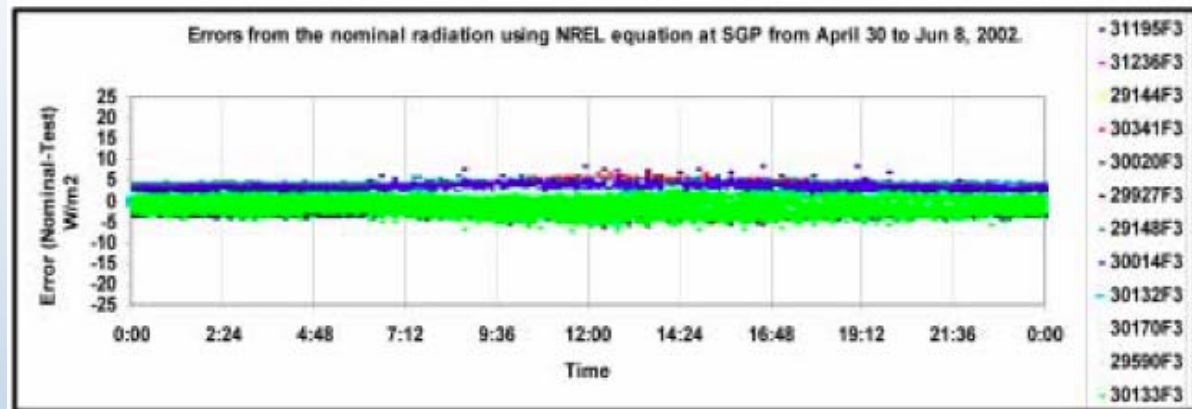

Traditional Method*:

$\pm 15 \text{ Wm}^{-2}$

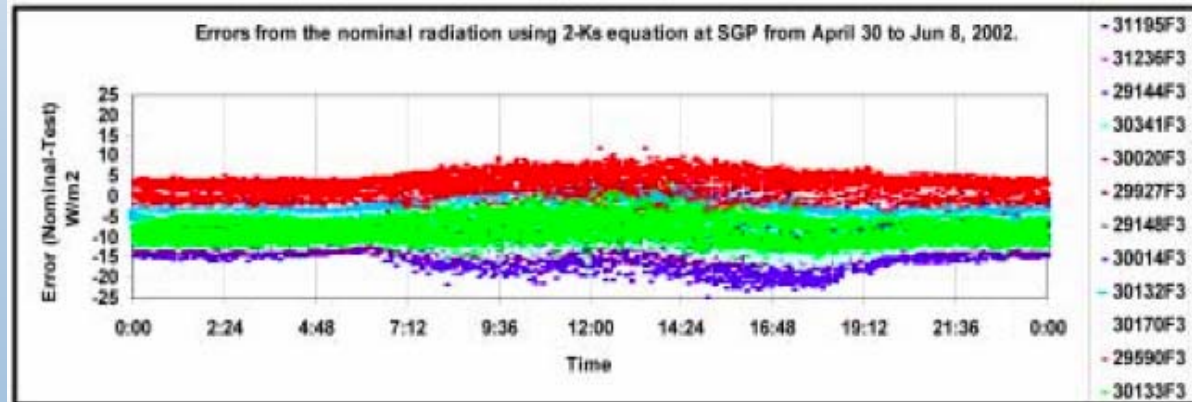

* Data from 2-coefficient calibration results determined with NREL Pyrgometer Blackbody Calibration System NOT from the original EPLAB calibrations.

What ARM Data Are Effected?

All longwave measurements collected from the SIRS, SKYRAD, and GNDRAD instrumentation since the dates shown for the installation of re-calibrated pyrometers using the NREL calibration are effected by this data restriction.

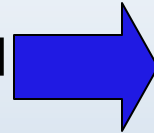

Access restrictions to current data will be removed once the data acquisition systems have been re-programmed with EPLAB PIR calibration factors (Dec 2005).

ARM Pyrometer Installations			4-Coeff Cal
Site	Date GMT	Time GMT	11/16/05
SGP:			
BRS	12/11/03	19:35	
C1	12/11/03	19:50	
E1	2/10/04	20:55	
E2	2/12/04	16:30	
E3	3/10/04	17:15	
E4	3/10/04	17:20	
E5	3/10/04	20:30	
E6	3/11/04	16:10	
E7	2/20/04	20:00	
E8	2/10/04	18:45	
E9	12/17/03	16:40	
E10	2/20/04	17:30	
E11	2/17/04	17:53	
E12	7/22/03	16:40	
E13	12/11/03	19:35	
E15	7/22/03	16:50	
E16	7/23/03	16:05	
E18	7/22/03	22:00	
E19	7/24/03	16:00	
E20	7/23/03	22:20	
E21	2/19/03	16:00	
E22	7/23/03	18:30	
E24	7/24/03	16:40	
E27	5/2/03	19:00	
TWP:			
C1	10/24/02	0:00	
C2	9/20/02	0:00	
C3	8/21/02	0:00	
NSA:			
C1	9/19/03	18:48	
C2	9/22/03	2:45	
AMF			
M1	Pt Reyes	0:00	

Can the Data be Adjusted?

Yes, through a parallel process addressing future measurements and historical data:

1. Build a new ARM/PIR Calibration Reference Group from the five pyrgeometers now at, or recently returned from, the PMOD with direct traceability to IPASRC-II field calibrations. Use the new reference group to establish transfer standard PIRs at SGP and NREL for routine calibrations of field pyrgeometers by outdoor comparisons and blackbody characterizations per IPASRC methods. (See the next slide for a concept of this estimated 9-month effort that started in September 2005.)
2. Pending a new calibration method, revert to original EPLAB calibration factor for thermopile responsivity and dome correction factor fixed at 4.0 for each PIR, based on latest information from EPLAB (compatible with existing data logger program at all ARM sites). This will decrease the precision of measured data (up to +/- 14 Wm⁻²) as shown by results of IPASRC=I & II, but this option provides measurements consistent with historical record, AERI data, and radiative transfer models. (See “Data Reconstruction” slide.)

New Approach to ARM Pyrgeometer Calibrations

New Traceable Method: Outdoor comparisons* with reference standards traceable to new World Infrared Standard Group

5 pyrgeometers calibrated at PMOD/WRC -->>>

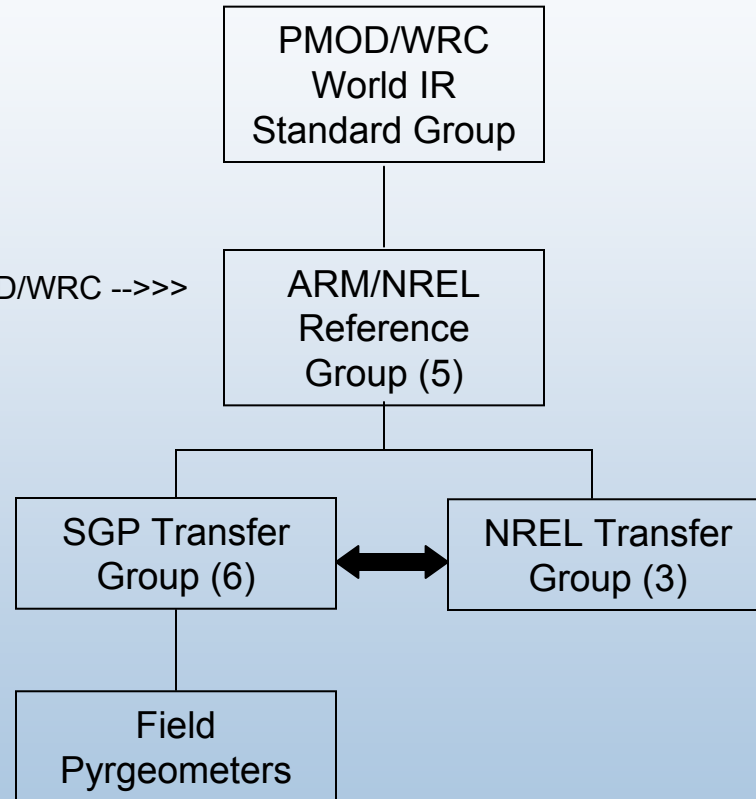

9 pyrgeometers calibrated at NREL & SGP/RCF -->>>

- 6 serve as Measurement Assurance Standards, rotating sets of 3 each annually between SGP & NREL.
- 3 serve as Transfer Standards to calibrate field pyrgeometers.

* Note: All new field pyrgeometers require blackbody characterization to determine thermal offset and dome correction factor. Thermopile responsivity and case emissivity factors adjusted as needed by outdoor comparisons with Transfer Group.

Data Reconstruction

Access to historical SIRS, SKYRAD, and GNDRAD data will resume once the 60-second averages are recomputed with new calibration information applied to the available 20-second samples of the pyrgeometer output signals.

NREL is analyzing the statistical effects of the reprocessing the longwave data in this manner.

Data Reconstruction (continued)

Until a more appropriate set of pyrgeometer calibration coefficients is determined late in 2006, the infrared flux can be computed:

$$IR = K_1 * V_{tp} + \sigma * T_c^4 + K_3 * \sigma * (T_d^4 - T_c^4)$$

where,

IR	= infrared flux	[Wm ⁻²]
K ₁	= thermopile calibration factor*	[Wm ⁻² /uV]
V _{tp}	= thermopile output voltage	[uV]
σ	= Stefan-Boltzmann Constant 5.67E-08	[Wm ⁻² K ⁴]
T _c	= pyrgeometer case temperature	[K]
K ₃	= pyrgeometer dome correction factor = 4.0	
T _d	= pyrgeometer dome temperature	[K]

* Based on original EPLAB value shown on the pyrgeometer label.

Data Reconstruction (continued)

To convert the recorded case and dome thermistor resistances to temperature:

$$T = 1 / [A + BX + CX^3]$$

where,

T = Temperature [K]

A = 1.0295E-03

B = 2.391E-04

C = 1.568E-07

X = 5 * Ln(10) + Ln(R/100)

R = Resistance [KOhm]

A, B, & C are Steinheart coefficients for fitting resistance-to-temperature data from YSI Precision Thermistor 44031 used in the PIR (10K Ohms at +25 C).

R is the thermistor resistance value determined by the data logger using a resistance bridge and excitation voltage duty cycle to minimize self-heating.

Summary & Recommendations

- Recent pyrgeometer round-robin comparisons and evaluations of pyrgeometer and AERI data from the SGP Central Facility has indicated the NREL pyrgeometer blackbody calibration system has introduced an average clear-sky bias of -12 Wm^{-2} to all SIRS, SKYRAD, and GNDRAD longwave measurements recorded since new calibration coefficients replaced the factory values during the period August 2002 - March 2004 (depending on the site). NREL will continue to explore potential cause(s) for this bias.
- As soon as practical, all SIRS, SKYRAD, and GNDRAD data loggers should be re-programmed with the following coefficients:
 - K0 = 0.0
 - K1 = original EPLAB (factory) calibration coefficient
 - K2 = 1.00 (case emissivity factor)
 - K3 = 4.0 (dome correction factor)
- Routine access to SIRS, SKYRAD, and GNDRAD data will resume shortly after the date of each data system re-programming event at each site.
- Available PIR field spares at SGP/RCF can be sent to EPLAB for re-calibration to determine stability of original EPLAB calibration factors. If statistically significant differences are found, then begin rotation of all ARM PIR's through similar re-calibrations, beginning with TWP sites in support of ICE.
- Continue development of a new Pyrgeometer Calibration Reference Group, traceable to the PMOD World Infrared Standard Group.
- Support development of the WISG with additional Absolute Sky-scanning Radiometers to maintain an internationally recognized measurement reference for longwave irradiance.

References

- Albrecht, B., and S.K. Cox, Procedures for improving pyrgeometer performance, *J. Apl. Meteorol.* 16, 188-197, 1977.
- Marty, C., R. Philipona, J. Delamere, E.G. Dutton, J. Michalsky, K. Stamnes, R. Storvold, T. Stoffel, S.A. Cough, and E.J. Mlawer, Downward longwave irradiance uncertainty under arctic atmospheres: Measurements and modeling. *J. Geophysical Research*, 108, D12, 4385, 2003
- Philipona, R., E.G. Dutton, T. Stoffel, J. Michalsky, I. Reda, A. Stifter, P. Wendling, N. Wood, S.A. Clough, E.J. Mlawer, G. Anderson, H.E. Rivercomb, and T.R. Shippert., Atmospheric longwave irradiance uncertainty: Pyrgeometers compared to an absolute sky-scanning radiometer, atmospheric emitted radiance interferometer, and radiative transfer model calculations, *J. Geophys. Res.*, 106, 28,129-28,141, 2001.
- Reda, I., J.R. Hickey, T. Stoffel, and D. Myers, Pyrgeometer calibration at the National Renewable Energy Laboratory (NREL), *J of Atmospheric and Solar-Terrestrial Physics*, 64, 1623-1629, 2002.
- Reda, I., P.A. Gotseff, T.L. Stoffel, and C. Webb, Evaluation of Improved Pyrgeometer Calibration Method, Thirteenth ARM Science Team Meeting Proceedings, Broomfield, Colorado, March 31-April 4, 2003.
- WCRP, World Climate Research Program, Baseline Surface Radiation Network (BSRN) Report of the Eighth BSRN Science and Review Workshop, Exeter, England, 26-30 July, 2004.

Acronyms

AERI - Atmospheric Emitted Radiance Interferometer measures the absolute infrared spectral radiance (watts per square meter per steradian per wavenumber) of the sky directly above the instrument. The spectral measurement range of the instrument is 3300 to 520 wavenumbers (cm⁻¹) or 3-19.2 microns for the normal-range instruments and 3300 to 400 cm⁻¹ or 3-25 microns for the extended-range polar instruments. Spectral resolution is 1.0 cm⁻¹. Instrument field-of-view is 1.3 degrees.
(<http://www.arm.gov/instruments/instrument.php?id=aeri>)

ASR - Absolute Sky-scanning Radiometer developed at the PMOD to provide absolute measurements of sky radiance in the infrared region using a pyroelectric detector and an integrated blackbody calibration source.
(<http://www.pmodwrc.ch/>)

EPLAB - The Eppley Laboratory, Inc. manufactures radiometers, including the Model PIR.
(<http://www.eppleylab.com>)

IPASRC - International Pyrgeometer and Absolute Sky-scanning Radiometer Comparisons were conducted to evaluate a new absolute reference for longwave irradiance measurements.

LW QME - Long Wave Quality Measurement Experiment is a value-added data product (<http://www.arm.gov/data/vaps.php?id=qmelwflux>)

NREL - National Renewable Energy Laboratory in Golden, Colorado serves as the broadband radiometer instrument mentor for the ARM Program. Contact: thomas_stoffel@nrel.gov.

PIR - EPLAB Model PIR (Precision Infrared Radiometer) measures the infrared irradiance from 3.5 to 50 microns with a 180 degree field of view using a thermopile-based detector under a hemispherical interference filter.
(See also <http://www.eppleylab.com/>)

Acronyms (continued)

PMOD - Physikalisch-Meteorologisches Observatorium Davos (PMOD) operates the World Radiation Center in Switzerland. In September 2004, the World Meteorological Organization established the World Infrared Radiation Calibration Center at the PMOD. (<http://www.pmodwrc.ch>)

RCF - Radiometer Calibration Facility located at the Southern Great Plains Central Facility.

SIRS - Solar and Infrared Radiation Station is a collection of broadband radiometers providing six elements of broadband shortwave (solar) and longwave (infrared) irradiances as 60-s averages of 2-s samples. The “raw” data files also contain 20-s samples of radiometer output signals.

WISG - World Infrared Standard Group of radiometers forming the basis of pyrgeometer calibrations for the World Meteorological Organization

Appendix

Pyrgometer Fundamentals

Tom Stoffel
November 2005

What's a Pyrheliometer?

Pyrheliometers measure longwave (infrared) irradiances using thermopile-based detectors mounted inside a protective and spectrally selective filter. By design, the thermopile responds to the radiative flux balance at the plane of the detector. Determining this flux balance requires knowledge of the thermopile output voltage and temperatures of the instrument case and protective filter.

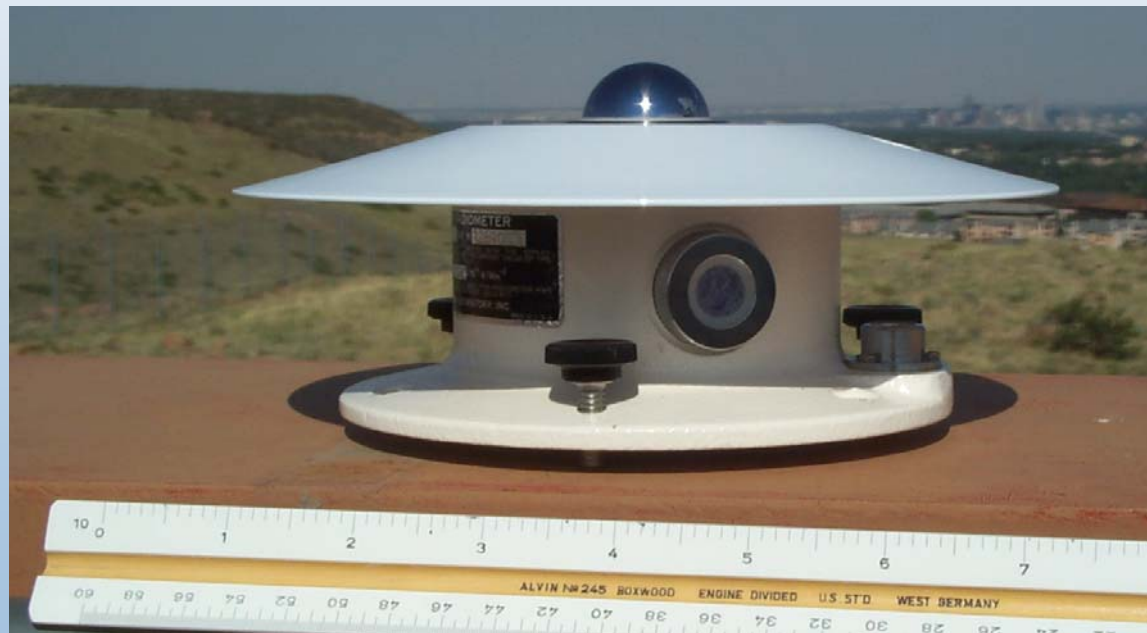

Pyrgeometer Calibration

Historically, low-temperature blackbody sources have been used to simulate sky/atmospheric radiation for calibrating pyrgeometers based on measurements traceable to temperature and electrical calibration standards. Data from these *blackbody calibrations* can be analyzed using a variety of methods to determine the individual pyrgeometer measurement characteristics (Reda, et al., 2002).

Recent measurement research indicates the need for including outdoor characterization of pyrgeometers to an absolute reference (Philipona, et al., 2001 and Marty, et al. 2003).

Let's review some fundamental concepts...

Pyrgeometer Fundamentals

Eppler Model Precision Infrared Radiometer (PIR) Output Signals:

Thermopile Voltage

$$V_{TP}$$

Dome Thermistor*

$$\Omega_{Dome}$$

Case Thermistor**

$$\Omega_{Case}$$

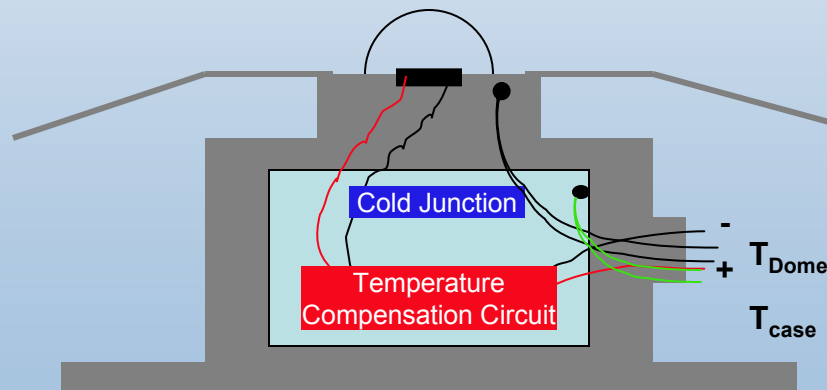

*Dome thermistor installed near base of hemispherical interference filter (transmits $\lambda > 3.5 \mu\text{m}$).

** Case thermistor installed inside pyrgeometer body
(both thermistors are YSI 44031).

Data logger lacking resistance measurement capabilities requires excitation of resistance bridge measurements to sense voltage drop across the dome or case thermistors.

4-wire measurements used for ARM PIRs to reduce signal cable lead-losses.

27

Pyrgeometer Fundamentals (continued)

A pyrgeometer responds to infrared flux balance at the receiver-detector:

$$W_{\text{net}} = W_{\text{in}} - W_{\text{out}} + \Delta W$$

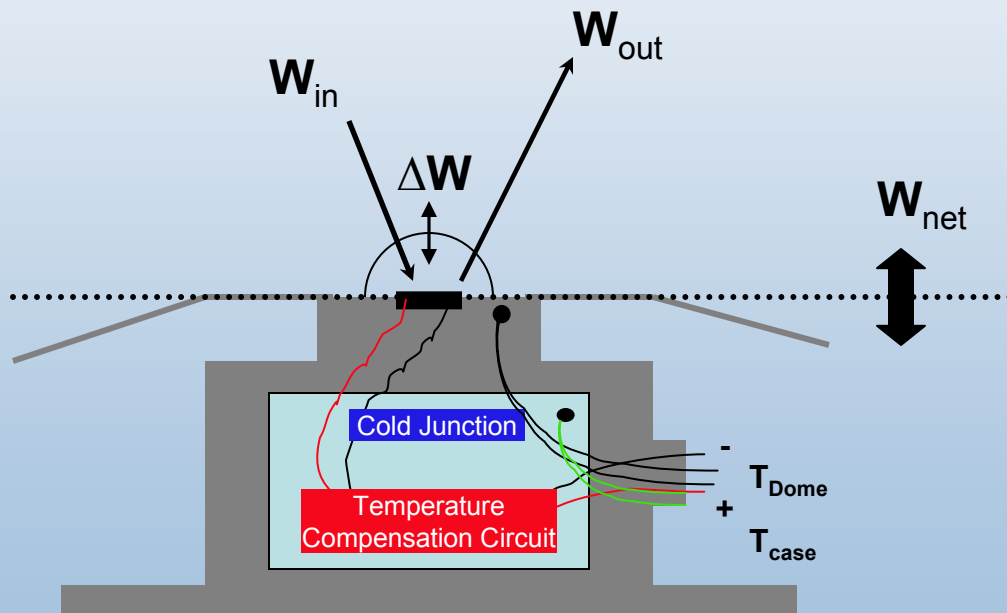

where,

W_{in} = Incoming infrared flux,
 $\varepsilon_{\text{sky}}\sigma T_{\text{sky}}^4$

W_{out} = Outgoing infrared flux,
 $\varepsilon_{\text{receiver}}\sigma T_{\text{receiver}}^4$

ΔW = Dome-case flux interaction
 as “seen” by the detector,
 $\varepsilon_{\text{case}}\sigma T_{\text{case}}^4 - \varepsilon_{\text{dome}}\sigma T_{\text{dome}}^4$

ε = effective emissivity

σ = Stefan-Boltzmann constant

Pyrgeometer Data Reduction Methods

1. Traditional, 2Ks:

$$W_{in} = K_1 * V + W_c + K_3 * (W_d - W_c)$$

2. Albrecht & Cox, 3Ks:

$$W_{in} = K_1 * V + K_2 * W_c + K_3 * (W_d - W_c)$$

3. Philipona et al.:

$$W_{in} = K_1 * V + K_2 * W_c + K_3 * (W_d - W_c) + K_4 * \sigma * V * T_c^3$$

$\sim \text{“}(U_{emf}/C) * (1 + K_1 * \sigma * T_c^3) + K_2 * W_c + K_3 * (W_d - W_c)\text{”}$

4. Reda et al.:

$$W_{in} = K_0 + K_1 * V + K_2 * W_r + K_3 * (W_d - W_r)$$

$\text{where } W_r = \sigma * T_r^4 = \sigma * (T_c + 0.0007044 * V)^4$

$$W_x = \sigma T_x^4$$

V = tp voltage
K_x = fit coefficient
d - dome
c - case
r - receiver surface

Pyrgeometer Fundamentals (continued)

Computing the Incoming Infrared from Pyrgeometer Signals using Albrecht & Cox method:

$$\begin{aligned} \mathbf{W}_{in} &= \mathbf{W}_{net} + \mathbf{W}_{out} - \Delta\mathbf{W} \\ &= K_1 V_{tp} + K_2 \sigma T_c^4 - K_3 \sigma (T_d^4 - T_c^4) \end{aligned}$$

where,

K_1	= pyrgeometer thermopile cal factor	[Wm ⁻² /uV]
V_{tp}	= pyrgeometer thermopile voltage	[uV]
K_2	= effective case (receiver) emissivity	[1.0]
σ	= Stefan-Boltzmann constant	[Wm ⁻² /K]
T_c	= case temperature	[K]
K_3	= dome correction factor	[3.5 - 4.0]
T_d	= dome temperature	[K]

Pyrgeometer Calibrations

Temperature-controlled blackbody surfaces provide reference sources of infrared radiance to compare with the pyrgeometer output signals.

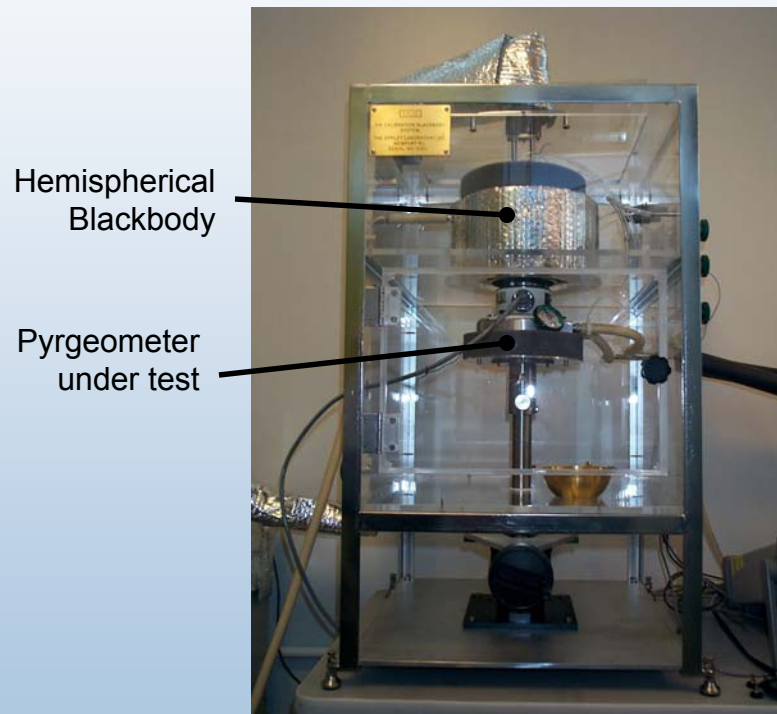

Enclosure purged with dry air
(Dry air generator not shown)



Temperature-controlled fluid circulation bath
(This is the smaller of two baths required for controlling the blackbody and the pyrgeometer case temperatures)

Unfortunately, the atmosphere is not a perfect blackbody limiting the use of laboratory blackbody calibrations of pyrgeometers to determining their measurement precision. Absolute measurements require comparisons with a unique *Absolute Sky-scanning Radiometer* developed by the World ³¹ Radiation Center in Davos, Switzerland.

NREL Blackbody Calibration



$$W_{bb} = K_0 + K_1 * V + K_2 * \sigma T_r^4 + K_3 * \sigma (T_d^4 - T_r^4)$$

where,

W_{bb} = Blackbody radiation, in Watt/m²

$K_{i=0-3}$ = PIR calibration coefficients

V = PIR thermopile output voltage, in μ V

σ = $5.6697 * 10^{-8}$ Watt/(m².Kelvin⁴)

T_d = PIR dome temperature, in Kelvin

T_r = PIR receiver temperature, in Kelvin,
= $T_c + \alpha * V$

where,

T_c = PIR case temperature, in Kelvin.

$1/\alpha = S * n * E.$

and,

S = Seebeck coefficient = 39, in μ V/K

n = number of junctions = 56

E = thermopile efficiency factor = 0.65

Then $T_r = T_c + 0.0007044 * V.$

The calibration is performed at 7 *pyrgeometer case* and *blackbody* temperature 32 combinations, then a linear regression is used to calculate the calibration coefficients.

Blackbody Calibrations and Outdoor Measurement Comparisons*

- Calibrate 4 PIRs using 4 different calibration transfer equations in two independent labs (NREL & CMDL-now GMD) each with its own blackbody (BB)
- Outdoors, compare observed instantaneous variability in IR irradiances from each of four PIRs relative to three arbitrary references**
- Outdoors, compare observed mean IR irradiances from each of four PIRs relative a single fixed reference***

* Excerpts from a presentation by Ellsworth Dutton (NOAA/GMD) at the Instantaneous Radiative Flux (IRF) Workshop, Nov 2-4, 2005, Annapolis, MD. Comparisons took place for 20 days in July 2005 at NREL/SRRL, Golden, CO

** To take into account variability in a particular reference

*** Fixed reference used is a single PIR using a single calibration equation.

33

The difference between the reference irradiance and the calculated irradiance using different equations from CMDL-BB Calibration

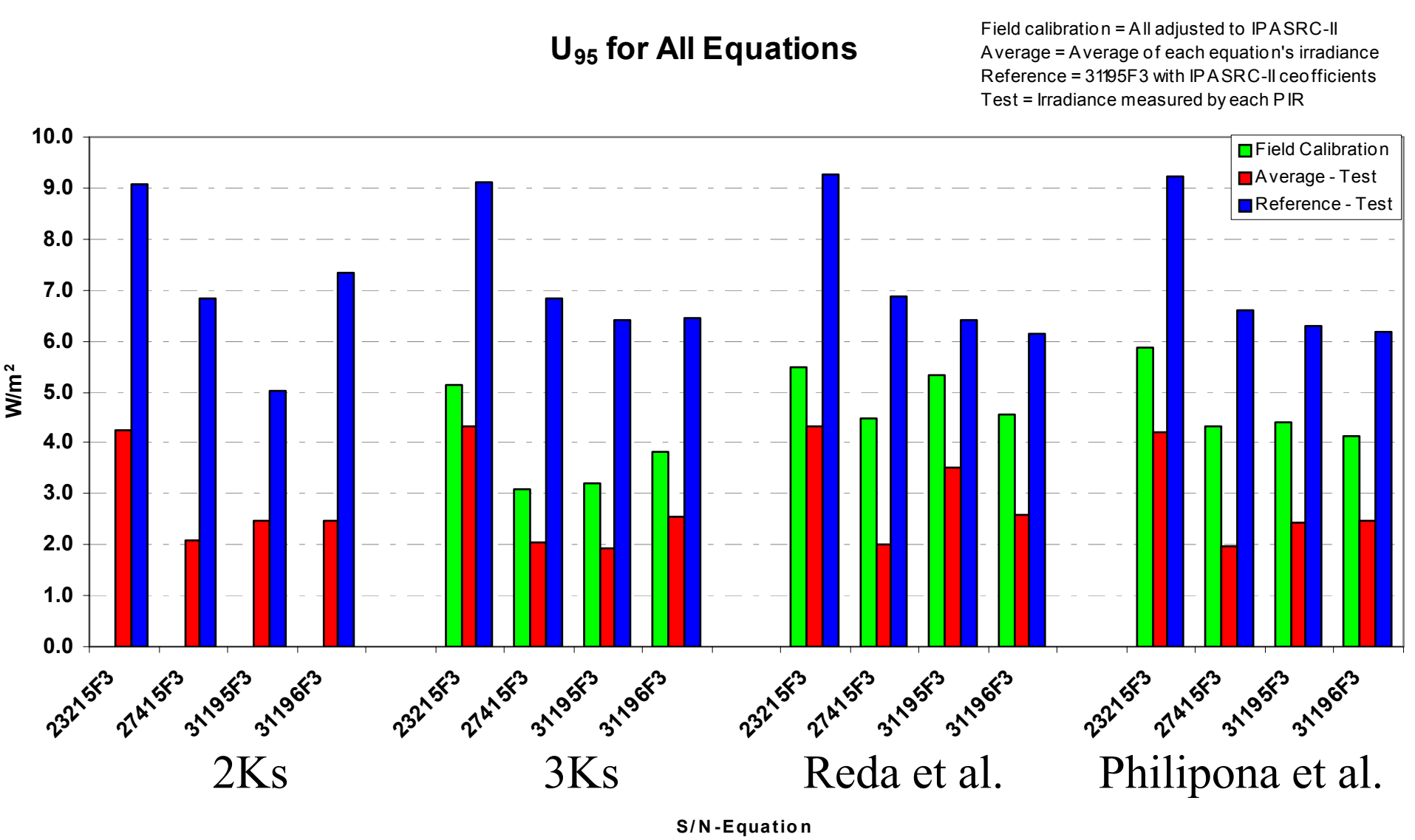

The difference between the reference irradiance and the calculated irradiance using different equations from NREL-BB Calibration

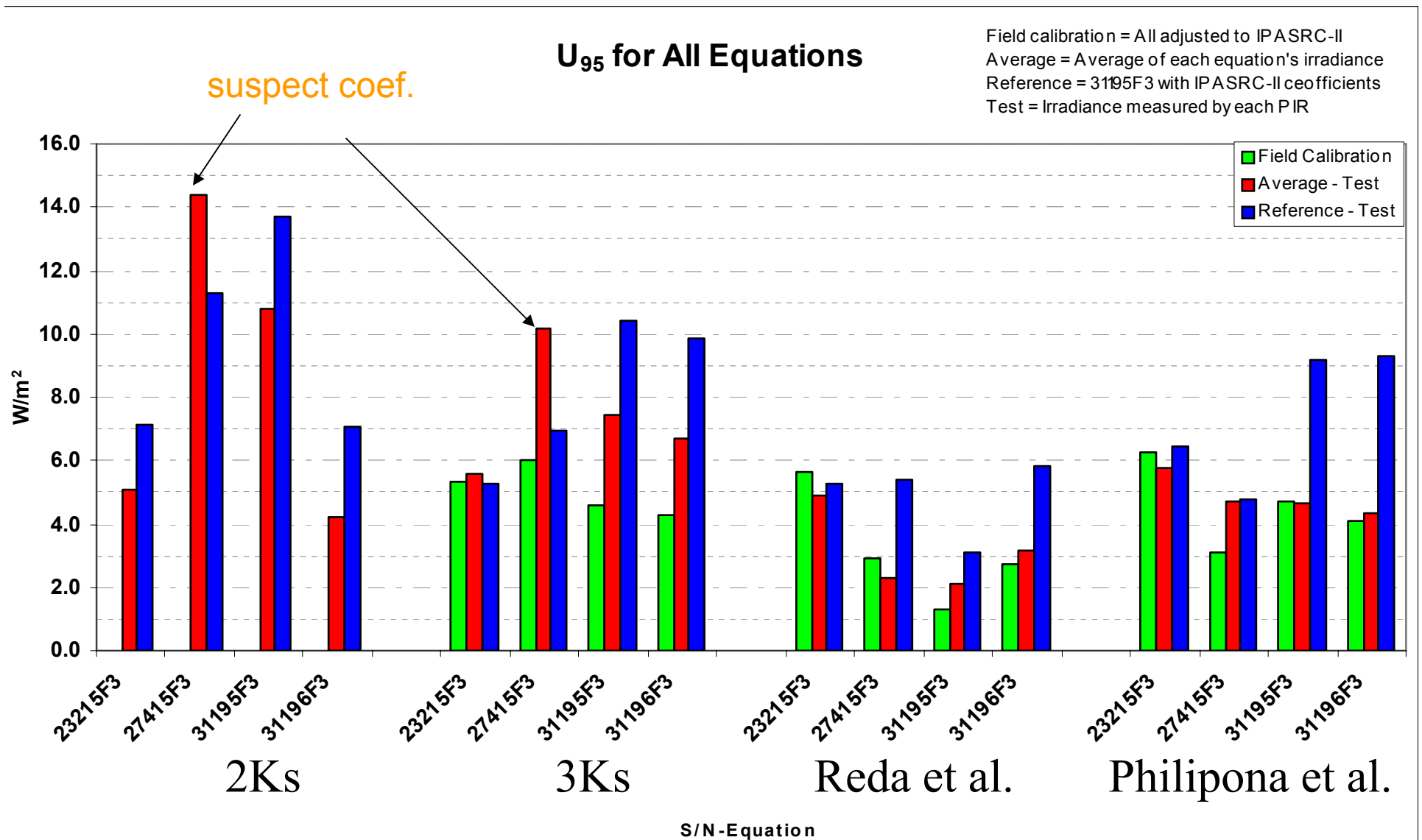

Reference-23215F3(2Ks,CMDL)

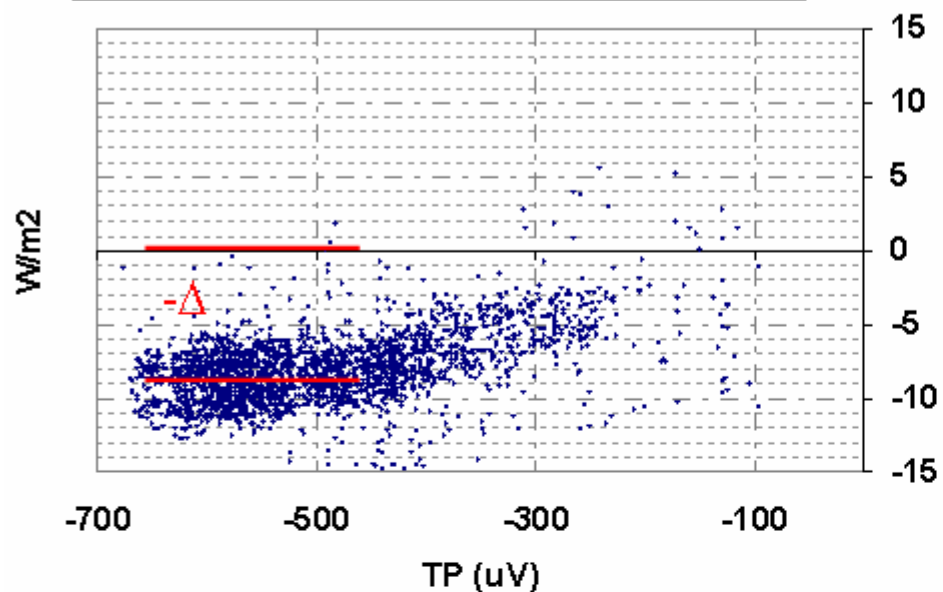

Reference-23215F3(3Ks,CMDL)

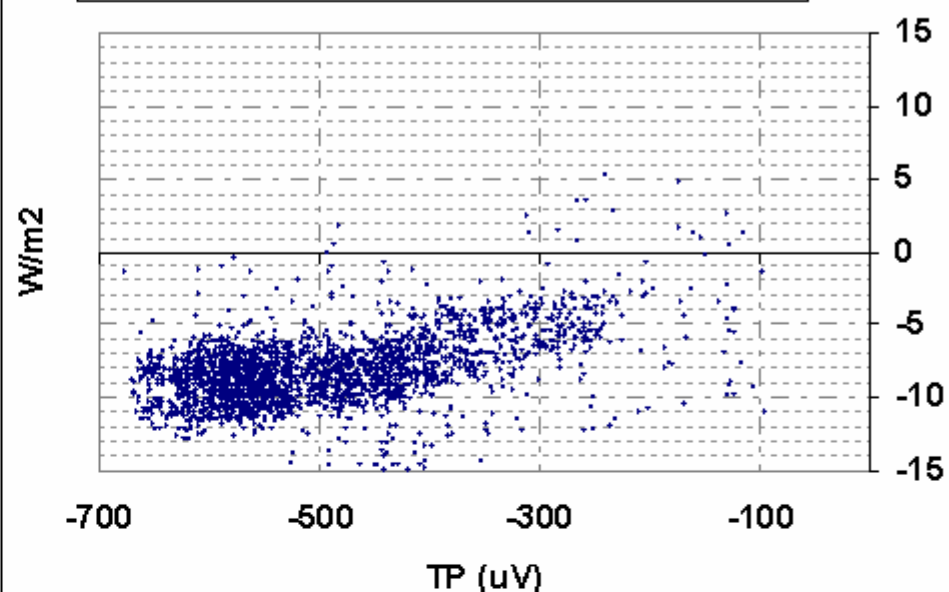

Reference-23215F3(Reda,CMDL)

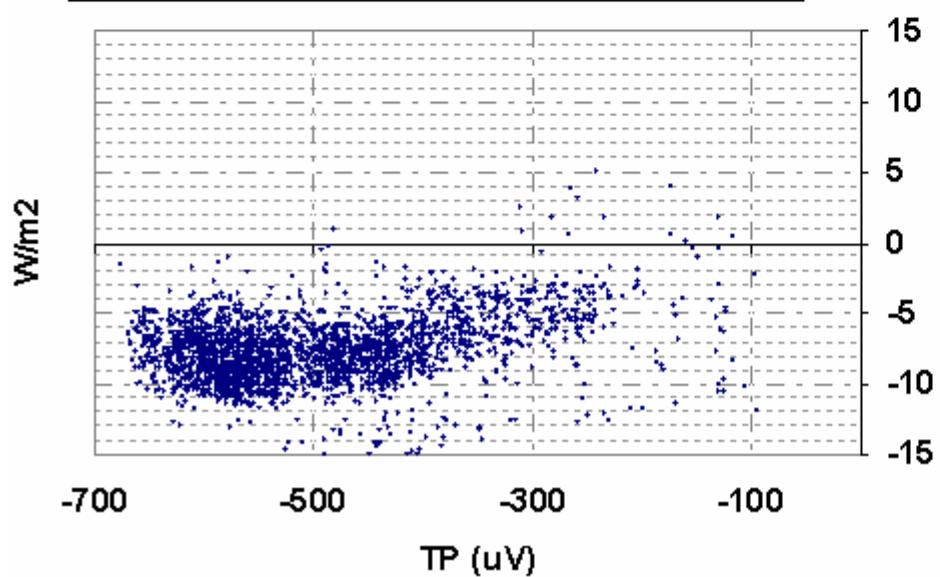

Reference-23215F3(Philipona,CMDL)

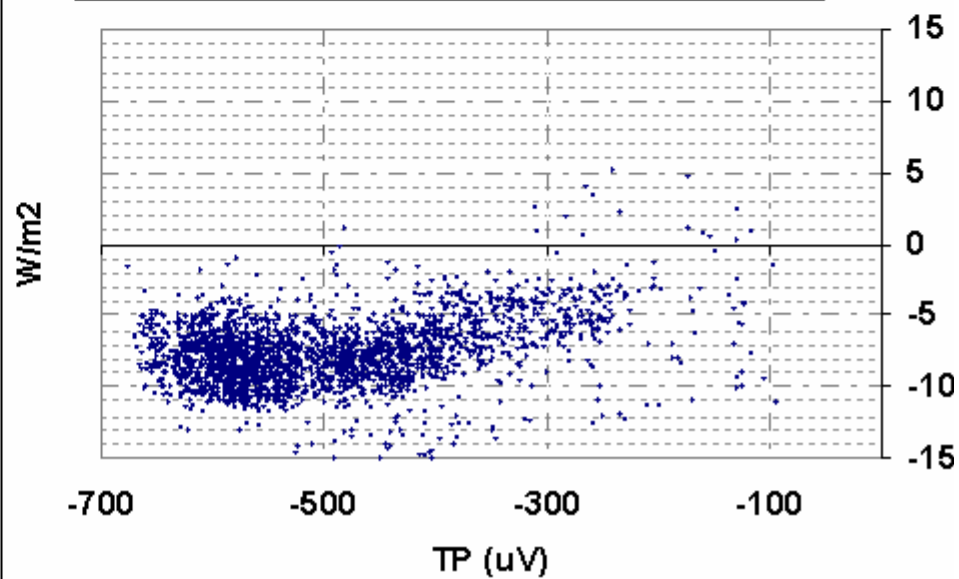

Summary

Pyrgeometers have been widely used for atmospheric longwave irradiance measurements.

Low-temperature blackbody systems are used to calibrate pyrgeometers.

Outdoor comparisons of multiple pyrgeometers calibrated with different blackbodies and different data analysis methods suggest various degrees of measurement precision are possible.

An absolute measurement standard is required to access the absolute accuracy of a pyranometer.