



practice guide

Stopwatch and Timer Calibrations (2009 edition)



Jeff C. Gust
Robert M. Graham
Michael A. Lombardi

NIST
National Institute of
Standards and Technology
U.S. Department of Commerce

Special
Publication
960-12

NIST recommended

960-12

NIST Recommended Practice Guide

NIST Special Publication 960-12

Stopwatch and Timer Calibrations (2009 edition)

Jeff C. Gust
Richard J. Bagan, Inc.

Robert M. Graham
Sandia National Laboratories

Michael A. Lombardi
National Institute of Standards and Technology

January 2009



U.S. Department of Commerce
Carlos M. Gutierrez, Secretary

National Institute of Standards and Technology
Patrick D. Gallagher, Deputy Director

Certain equipment, instruments or materials are identified in this paper in order to adequately specify the experimental details. Such identification does not imply recommendation by the National Institute of Standards and Technology nor does it imply the materials are necessarily the best available for the purpose.

Official contribution of the National Institute of Standards and Technology; not subject to copyright in the United States.

National Institute of Standards and Technology
Special Publication 960-12 Natl. Inst. Stand. Technol.
Spec. Publ. 960-12
80 pages (January 2009)
CODEN: NSPUE2

U.S. GOVERNMENT PRINTING OFFICE
WASHINGTON: 2009

**For sale by the Superintendent of Documents
U.S. Government Printing Office**

Internet: bookstore.gpo.gov Phone: (202) 512-1800 Fax: (202) 512-2250
Mail: Stop SSOP, Washington, DC 20402-0001

FOREWORD

Stopwatch and timer calibrations are perhaps the most common calibrations performed in the field of time and frequency metrology. Hundreds of United States laboratories calibrate many thousands of timing devices annually to meet legal and organizational metrology requirements. However, prior to the publication of the first edition of this guide in May 2004, no definitive text had existed on the subject. This *NIST Recommended Practice Guide* was created to fill a gap in the metrology literature. It assists the working metrologist or calibration technician by describing the types of stopwatches and timers that require calibration, the specifications and tolerances of these devices, the methods used to calibrate them, and the estimated measurement uncertainties for each calibration method. It also discusses the process of establishing measurement traceability back to national and international standards.

ACKNOWLEDGEMENTS

The authors thank the following individuals for their extremely useful suggestions regarding this new revision of the guide: Georgia Harris and Val Miller of the NIST Weights and Measures Division, Warren Lewis and Dick Pettit of Sandia National Laboratories, and Dilip Shah, the chair of the American Society for Quality (ASQ) Measurement Quality Division.

Contents

Section 1: Introduction to Stopwatch and Timer Calibrations.....	1
1.A. The Units of Time Interval and Frequency	1
1.B. A Brief Overview of Calibrations	3
1.C. Traceability and Coordinated Universal Time (UTC).....	5
Section 2: Description of Timing Devices that Require Calibration	9
2.A. Stopwatches	9
2.B. Timers.....	13
2.C. Commercial Timing Devices.....	14
Section 3: Specifications and Tolerances	15
3.A. Interpreting Manufacturer’s Specifications.....	15
3.B. Tolerances Required for Legal Metrology	19
Section 4: Introduction to Calibration Methods.....	23
Section 5: The Direct Comparison Method	25
5.A. References for the Direct Comparison Method	25
5.B. Calibration Procedure for the Direct Comparison Method	29
5.C. Uncertainties of the Direct Comparison Method	31
Section 6: The Totalize Method	39
6.A. Calibration Procedure for the Totalize Method.....	39
6.B. Uncertainties of the Totalize Method	41
6.C. Photo Totalize Method	45
Section 7: The Time Base Method.....	49
7.A. References for the Time Base Method	49
7.B. Calibration Procedure for the Time Base Method.....	49
7.C. Uncertainties of the Time Base Method	53

❖ Stopwatch and Timer Calibrations

Section 8: How to Determine if the Calibration Method Meets the Required Uncertainty	55
Section 9: Other Topics Related to Measurement Uncertainty	57
9.A. Uncertainty Analysis of Using a Calibrated Stopwatch to Calibrate another Device.....	57
9.B. The Effects of Stability and Aging on Calibrations of 32.768 Hz Crystals.....	58
9.C. Factors That Can Affect Stopwatch Performance	60
Appendix A: Calibration Certificates.....	63
Appendix B: References	65

List of Figures

Figure 1. The calibration and traceability hierarchy 6

Figure 2. Type I digital stopwatch 9

Figure 3. Type II mechanical stopwatch 9

Figure 4. Interior of digital (Type I) stopwatch 11

Figure 5. Inner workings of a mechanical (Type II) stopwatch or timer 12

Figure 6. A collection of timers..... 14

Figure 7. Sample manufacturer’s specifications for a digital stopwatch
(Example 1)..... 16

Figure 8. Sample specifications for a digital stopwatch (Example 2)..... 18

Figure 9. Typical performance of quartz wristwatches using 32 768 Hz
time base oscillators 19

Figure 10. Portable shortwave radio receiver for reception of audio
time signals 28

Figure 11. Reaction time measurements (four operators, 10 runs each)
for the direct comparison method 33

Figure 12. Averaging measurement results for four different operators 34

Figure 13. Block diagram of the totalize method 39

Figure 14. Using the start-stop button of the stopwatch to start the counter ... 40

Figure 15. Measured reaction times (four operators, 10 runs each) for
totalize method..... 42

Figure 16. Mean reaction times (four operators, 10 runs each) for the
totalize method..... 43

Figure 17. Photo totalize start reading 45

List of Figures, cont'd

Figure 18. Photo totalize stop reading 46

Figure 19. Ambiguous photo totalize reading..... 47

Figure 20. Time base measurement system for stopwatches and timers 50

Figure 21. A time base measurement system for stopwatches and timers
with an integrated graphics display..... 52

Figure 22. Graph of the frequency stability of two stopwatches 59

Figure 23. Factors that can change the quartz time base frequency 60

Figure 24. Stopwatch accuracy versus temperature..... 61

Figure A1. Sample calibration certificate. (page 1) 63

Figure A1. Sample calibration certificate. (page 2) 64

List of Tables

Table 1 - Metric prefixes (may be applied to all SI units).....	2
Table 2 - Unit values, dimensionless values, and percentages.....	4
Table 3 - Type I and Type II stopwatch characteristics.....	10
Table 4 - Legal metrology requirements for field standard stopwatches and commercial time devices.....	20
Table 5 - Comparison of calibration methods.....	23
Table 6 - Traceable audio time signals.....	25
Table 7 - The contribution of a 300 ms variation in reaction time to the measurement uncertainty	30
Table 8 - Uncertainty analysis for direct comparison method (digital DUT) using a land line	36
Table 9 - Uncertainty analysis for direct comparison method (digital DUT) using a cell phone.....	36
Table 10 - Uncertainty analysis for direct comparison method (analog DUT) using a land line	37
Table 11 - Uncertainty analysis for totalize method	44
Table 12 - The effect of the length of the measurement time on stability (based on 25 readings)	51
Table 13 - Uncertainty analysis of using a calibrated stopwatch to calibrate another device	58

1. INTRODUCTION TO STOPWATCH AND TIMER CALIBRATIONS

This document is a recommended practice guide for stopwatch and timer calibrations. It discusses the types of stopwatches and timers that require calibration, their specifications and tolerances, and the methods used to calibrate them. It also discusses measurement uncertainties and the process of establishing measurement traceability back to national and international standards.

This guide is intended to serve as a reference for the metrologist or calibration technician. It provides a complete technical discussion of stopwatch and timer calibrations by presenting practical, real world examples of how these calibrations are performed.

There are nine sections in this guide. Section 1 provides an overview, and serves as a good introduction if you are new to the field of metrology or to time and frequency measurements. Section 2 describes the types of timing devices that require calibration. Section 3 discusses specifications and tolerances. Sections 4 through 7 discuss calibration methods and their associated uncertainties. Section 8 provides additional information to help determine if the selected calibration method can meet the required level of uncertainty, and Section 9 discusses other topics related to measurement uncertainty. A sample calibration report and references are provided in the appendices.

1.A. The Units of Time Interval and Frequency

Stopwatches and timers are instruments used to measure *time interval*, which is defined as the elapsed time between two events. One common example of a time interval is a person's age, which is simply the elapsed time since the person's birth. Unlike a conventional clock that displays *time-of-day* as hours, minutes, and seconds from an absolute epoch or starting point (such as the beginning of the day or year), a stopwatch or timer simply measures and displays the time interval from an arbitrary starting point that begins at the instant when the stopwatch is started.

The standard unit of time interval is the *second* (s) [1]. Seconds can be accumulated to form longer time intervals, such as minutes, hours, and days; or they can be sliced into fractions of a second such as milliseconds (10^{-3} s, abbreviated as ms) or microseconds (10^{-6} s, abbreviated as μ s). Table 1 lists these and other prefixes that can be used with seconds, as well as the multiples/submultiples and symbols used to represent them. The second is one of the seven base units in the International System of Units (SI). Other units (most notably the meter and the volt) have definitions that depend upon the definition of the second.

❖ Stopwatch and Timer Calibrations

Table 1 - Metric prefixes (may be applied to all SI units).

Multiples and Submultiples	Prefix	Symbol
1 000 000 000 000 = 10^{12}	tera	T
1 000 000 000 = 10^9	giga	G
1 000 000 = 10^6	mega	M
1 000 = 10^3	kilo	k
1 = 10^0		
0.001 = 10^{-3}	milli	m
0.000 001 = 10^{-6}	micro	μ
0.000 000 001 = 10^{-9}	nano	n
0.000 000 000 001 = 10^{-12}	pico	p
0.000 000 000 000 001 = 10^{-15}	femto	f

The SI defines the second based on a property of the cesium atom, and for this reason *cesium oscillators* are regarded as primary standards for both time interval and frequency. A second is defined as the time interval required for 9 192 631 770 transitions between two energy states of the cesium atom to take place. The atomic definition of the second, together with current technology, allows it to be measured with much smaller uncertainties than any other SI unit. In fact, the National Institute of Standards and Technology (NIST) can currently measure a second with an uncertainty of less than 1 part in 10^{15} , or more than 1 billion (10^9) times smaller than the uncertainties required for the calibrations described in this guide!

The *resolution* of a stopwatch or timer represents the smallest time interval that the device can display. Resolution is related to the number of digits on the device's display for a digital stopwatch, or the smallest increment or graduation on the face of an analog stopwatch. For example, if a stopwatch display shows two digits to the right of the decimal point, it has a resolution of 0.01 s (10 ms, or 1/100 of a second). This means, for example, that it can display a value of 42.12 s or 42.13 s, but that it lacks the resolution to display 42.123 s. Resolution of 10 ms is common for digital stopwatches, but some devices have 1 ms resolution (0.001 s), or even smaller. For analog stopwatches, a common resolution is 1/5 of a second, or 0.2 s.

Although stopwatches and timers measure time interval, they do so by using a *frequency* source. Frequency is the rate of a repetitive event, defined as the number of events or cycles per second. The standard unit of frequency (f) is the hertz (Hz), which is not a base unit of the SI, but one of the 21 derived SI units. One hertz equals one event per second, one kilohertz (kHz) equals 10^3 events per second, one megahertz (MHz) equals 10^6 events per second, and so on. The *period* (T) is the reciprocal of the frequency, $T = 1/f$. For example, a 1 MHz sine wave would produce 10^6 cycles per second, or one cycle every microsecond.

A *time base* oscillator (sometimes called a clock or reference oscillator) produces the frequency signals used by the stopwatch or timer to measure time intervals. In today's devices, the time base oscillator is nearly always a quartz crystal oscillator. However, older devices used either a mechanical oscillator, the alternating current (AC) line frequency (60 Hz in the United States), or an oscillator based on a tuned electronic circuit as their frequency source. The time base oscillator serves as the reference for all of the time and frequency functions performed by the device. The most common frequency used by quartz time base oscillators is 32 768 ($= 2^{15}$) Hz. In this case, when the stopwatch or timer has counted 32 768 oscillations from its time base oscillator, it then records that 1 s has elapsed. If you want to think of this time base as a clock, it “ticks” 32 768 times per second, or once every 30.518 μ s.

Throughout this guide, time interval is always presented in units of seconds (or fractions of a second), and frequency is presented in units of hertz (or multiples of a hertz). However, measurement uncertainties are presented as dimensionless values that represent a fractional percentage error. Since these dimensionless values are usually very small percentages, they are often expressed in scientific notation. For example, if a stopwatch has a measurement uncertainty of 1 s over a time interval of 10 000 s, the uncertainty is expressed as either a percentage (0.01 %) or as a dimensionless value (1×10^{-4}). Table 2 provides more examples.

1.B. A Brief Overview of Calibrations

Like all calibrations, stopwatch and timer calibrations are simply comparisons between the device under test (DUT) and a measurement reference, or *standard*. When a stopwatch or timer is calibrated, either a time interval standard or a frequency standard is used as the measurement reference. If a time interval standard is used, it is compared to the DUT's display. If a frequency standard is used, it is compared to the DUT's time base oscillator. Both types of calibrations are described in detail later in this guide.

Table 2 - Unit values, dimensionless values, and percentages.

Time uncertainty	Length of test	Dimensionless uncertainty (literal)	Dimensionless uncertainty (scientific notation)	Percentage uncertainty (%)
1 s	1 minute	1 part per 60	1.67×10^{-2}	1.67
1 s	1 hour	1 part per 3600	2.78×10^{-4}	0.027 8
1 s	1 day	1 part per 86 400	1.16×10^{-5}	0.001 16
1 s	100 s	1 part per hundred	1×10^{-2}	1
1 s	1000 s	1 part per thousand	1×10^{-3}	0.1
1 s	10 000 s	1 part per 10 thousand	1×10^{-4}	0.01
1 s	100 000 s	1 part per 100 thousand	1×10^{-5}	0.001
1 ms	100 s	1 part per 100 thousand	1×10^{-5}	0.001
1 ms	1000 s	1 part per million	1×10^{-6}	0.000 1
1 ms	10 000 s	1 part per 10 million	1×10^{-7}	0.000 01
1 ms	100 000 s	1 part per 100 million	1×10^{-8}	0.000 001

Most of the calibrations described in this guide are *laboratory calibrations*, as opposed to *field calibrations*. To understand what this means, consider an example where a stopwatch is calibrated in the laboratory against a standard, and a calibration certificate and/or sticker are issued to the customer. That same stopwatch or timer can then be thought of as a *field standard*, a *working standard*, or a *transfer standard*, and used as the measurement reference during a *field calibration*. In other words, it can be brought outside the laboratory and used to calibrate another timing device, such as a parking meter. The same basic principles that apply to laboratory calibrations apply to field calibrations, although laboratory calibrations generally take longer and are made much more carefully because the required measurement uncertainties are smaller. Devices that are field calibrated are generally not used as a measurement reference for performing other calibrations. Instead, they are working instruments used for scientific, business, or legal purposes. Therefore, their calibration can be thought of as a periodic test or inspection that ensures that these devices are working properly and meeting their specifications.

Common sense dictates that the measurement reference for any calibration (either the laboratory reference or the field standard) must always outperform the devices it needs to test. A parking meter, for example, might have an acceptable uncertainty of 1 % when timing a 5 minute interval (± 3 s). A field standard stopwatch used to test a parking meter should be certified to an uncertainty small enough so that it contributes no significant uncertainty to the parking meter calibration. In other words, we need to be able to trust our reference so that we can trust our measurement of the DUT.

When a laboratory calibration is completed, the metrologist has determined the offset¹ of the DUT with respect to the reference. This offset can be stated as a percentage or in units of time interval or frequency (or both) on the calibration certificate, and should be quantified with a statement of measurement uncertainty. Field calibrations are generally “pass/fail” calibrations. This means that the device is tested to see whether it meets its intended or legal metrology requirements, and it either passes or fails. If it fails, it is removed from service until it can be adjusted, repaired, or replaced.

1.C. Traceability and Coordinated Universal Time (UTC)

As previously discussed, when a device is calibrated by comparing it to a measurement reference, the reference must be more accurate (have lower measurement uncertainties) than the DUT. Otherwise, the measurement results will be invalid. How do we know the accuracy of the measurement reference? The answer is: we only know its accuracy if it has been recently compared to a more accurate standard. That more accurate standard needs to be periodically compared to an *even more accurate* standard, and so on, until eventually a comparison is made against a national or international standard that represents the best physical realization of the SI unit that is being measured (in this case, the SI second). This measurement traceability hierarchy is sometimes illustrated with a pyramid as shown in Figure 1. The series of comparisons back to the SI unit is called the *traceability chain*. Metrological traceability is defined, by international agreement, as:

The property of a measurement result whereby the result can be related to a reference through a documented unbroken chain of calibrations, each contributing to the measurement uncertainty. ^[3]

¹ The term ‘offset’ is commonly used in the discipline of frequency and time measurement and will be used throughout this text. In terms of the *ISO Guide to the Expression of Uncertainty in Measurement* [2], the offset would be considered the measurement result.

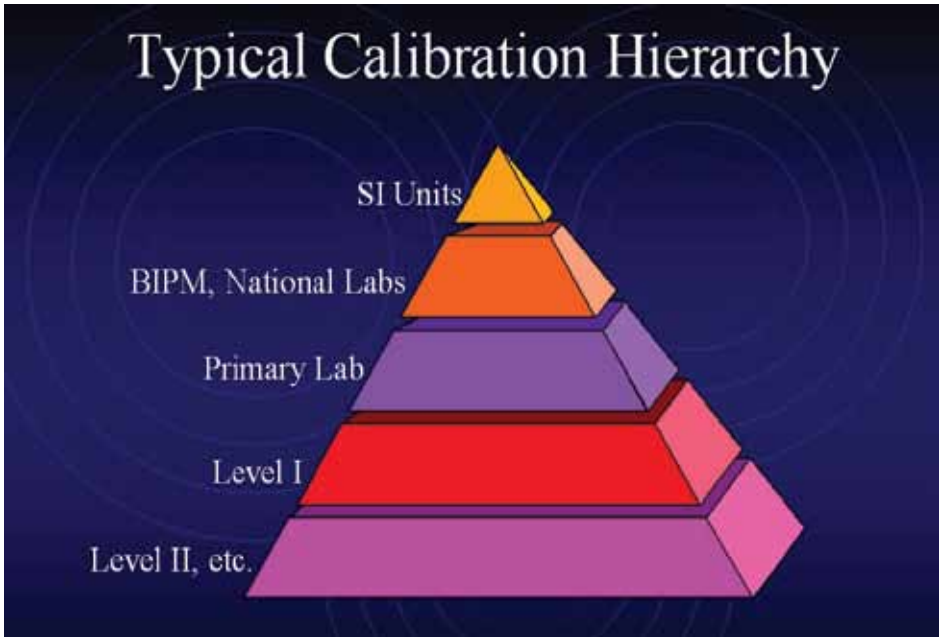

Figure 1. *The calibration and traceability hierarchy.*

The definition of metrological traceability implies that unless the measured value is accompanied by a stated measurement uncertainty, the traceability chain is broken. It is the responsibility of the calibration laboratory to determine and report the uncertainty of its measurements to its customers so that metrological traceability is maintained [4].

The International Bureau of Weights and Measures (BIPM) located near Paris, France, is responsible for ensuring the worldwide uniformity of measurements and their traceability to the SI. The BIPM collects and averages time interval and frequency data from more than 60 laboratories around the world and creates a time scale called Coordinated Universal Time (UTC) that realizes the SI second as closely as possible. Thus, UTC serves as the international standard for both time interval and frequency. However, the BIPM does not produce a physical representation of the second; it simply calculates a weighted average that is published weeks after the actual measurements were made. This document, known as the BIPM *Circular T*, shows the time offset of each contributing laboratory with associated uncertainties, and can be downloaded from the BIPM web site (www.bipm.org).

The laboratories that provide data to the BIPM maintain the oscillators and clocks that produce the actual signals that are used as measurement references. Most of these laboratories are national metrology institutes (NMIs) that serve as the caretakers of the national measurement references for their respective countries. Thus, to establish traceability to the SI for time interval and frequency calibrations, the traceability chain for a measurement must link back

to signals that originate from an NMI or a national timekeeping laboratory. The NMI that is chosen as a reference must contribute to the derivation of UTC by sending its measurement data (with associated uncertainties) to the BIPM.

NIST is the ultimate reference point for most measurements made in the United States, and as such, submits time and frequency data to the BIPM. NIST provides its own real-time representation of UTC, designated UTC(NIST), that is distributed to the public using a variety of radio, telephone, and Internet signals. These signals are described in more detail in Section 5, and can serve as references for measurements that are traceable back to the SI.

The traceability chain is easy to visualize if you think of it as a series of calibrations. Every link in the chain is a calibration; comparing a device to a higher standard, until eventually a comparison is made to the SI unit. Every calibration has some measurement uncertainty. At the top of the chain, the measurement uncertainties are so tiny they are insignificant to those of us who calibrate stopwatches and timers. For example, the difference between the best possible estimate of the SI second and UTC(NIST) is measured in parts in 10^{16} . This represents a time offset of less than 0.1 ns (10^{-10} s) over the course of a day. As we move down the traceability chain to the actual calibration of a stopwatch or timer, the uncertainties become larger and larger. For example, if the calibration laboratory uses an audio signal from NIST radio station WWV (Section 5) to calibrate its standard, the uncertainty of the received tones might be 1 ms. This uncertainty is still small enough for the WWV tones to be used as a stopwatch calibration reference, because the uncertainty introduced by an operator starting and stopping the watch (human reaction time) is much larger, typically tens or even hundreds of milliseconds. In summary, as long as each link of the chain and its uncertainty are known, traceability to the SI can be established.

Stopwatch and timer calibrations are among the least demanding of all time and frequency measurements. Relatively speaking, the instruments requiring calibration are low cost, and the acceptable measurement uncertainties can be quite large. Even so, for legal, technical, and practical reasons it is very important to establish traceability to the SI for these calibrations. If a valid traceability chain to the SI is established, it ensures that the working device was properly calibrated, and, if correctly used, will produce valid results.

Section 2

Description of Timing Devices that Require Calibration

This section describes the various types of stopwatches (Section 2.A. Stopwatches) and timers (Section 2.B. Timers) that are calibrated in the laboratory. These types of stopwatches and timers are often used as transfer standards to perform field calibrations of the commercial timing devices described in Section 2.C.

2.A. Stopwatches

Stopwatches can be classified into two categories, Type I and Type II [5]. Type I stopwatches have a digital design employing quartz oscillators and electronic circuitry to measure time intervals (Figure 2). Type II stopwatches have an analog design and use mechanical mechanisms to measure time intervals (Figure 3). The key elements of Type I and Type II stopwatches are summarized in Table 3.



Figure 2. Type I digital stopwatch.



Figure 3. Type II mechanical stopwatch.

❖ Stopwatch and Timer Calibrations

Table 3 - Type I and Type II stopwatch characteristics.

Description	Type I Stopwatch (digital)	Type II Stopwatch (analog)
Operating principle	Time measured by division of time base oscillator	Time measured by mechanical movement
Time base	<ul style="list-style-type: none"> Quartz oscillator 	<ul style="list-style-type: none"> Mechanical mainspring Synchronous motor, electrically driven
Case	<ul style="list-style-type: none"> Corrosion resistant metal Impact resistant plastic 	
Crystal	<ul style="list-style-type: none"> Protects display Allows for proper viewing May be tinted May employ magnification 	<ul style="list-style-type: none"> Protects dial/hands Allows for proper viewing Must be clear and untinted
Minimum time interval	<ul style="list-style-type: none"> 48 hours without replacement of battery 	<ul style="list-style-type: none"> 3 hours without rewinding
Start and Stop	<ul style="list-style-type: none"> Corrosion resistant metal Impact resistant plastic 	
Reset	<ul style="list-style-type: none"> Must reset stopwatch to zero 	
Split Time (if equipped)	<ul style="list-style-type: none"> Corrosion resistant metal Impact resistant plastic 	
Force to Operate Controls	<ul style="list-style-type: none"> Must not exceed 1.8 N (0.4046 lbf) 	
Dial and Hands		<ul style="list-style-type: none"> Face must be white Graduations must be black or red Hands must be black or red
Required Markings	<ul style="list-style-type: none"> Unique, nondetachable serial number Manufacturer's name or trademark Model number (type I only) 	
Digital Display	<ul style="list-style-type: none"> Providing delimiting character for hours, minutes, seconds (usually colon) 	
Minimum Increment	<ul style="list-style-type: none"> 0.2 s 	
Minimum Elapsed Time at Rollover	<ul style="list-style-type: none"> 1 h 	<ul style="list-style-type: none"> 30 min
Physical Orientation	<ul style="list-style-type: none"> Stopwatch meets tolerance regardless of physical orientation 	

2.A.1. Basic Theory of Operation

Every stopwatch is composed of four elements: a power source, a time base, a counter, and an indicator or display. The design and construction of each component depends upon the type of stopwatch.

2.A.1.a. Digital (Type I) Stopwatches

The power source of a Type I stopwatch is usually a silver-oxide or alkaline battery that powers the oscillator and the counting and display circuitry. The time base is a quartz crystal oscillator that usually has a nominal frequency of 32 768 Hz, the same frequency used by nearly all quartz wristwatches. The 32 768 Hz frequency was originally chosen because it can be converted to a 1 pulse per second signal using a simple 15 stage divide-by-two circuit. It also has the benefit of consuming less battery power than higher frequency crystals. Figure 4 shows the inside of a typical digital device, with the printed circuit board, quartz crystal oscillator, and battery visible. The counter circuit consists of digital dividers that count the time base oscillations for the period that is initiated by the start/stop buttons [6, 7]. The display typically has seven or eight digits.

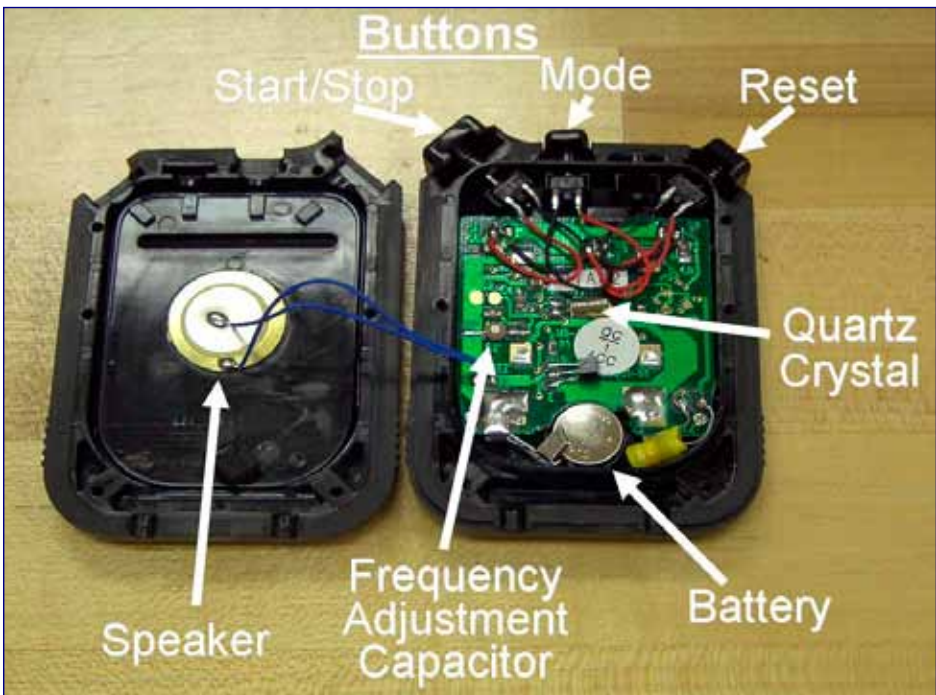

Figure 4. Interior of digital (Type I) stopwatch.

❖ Stopwatch and Timer Calibrations

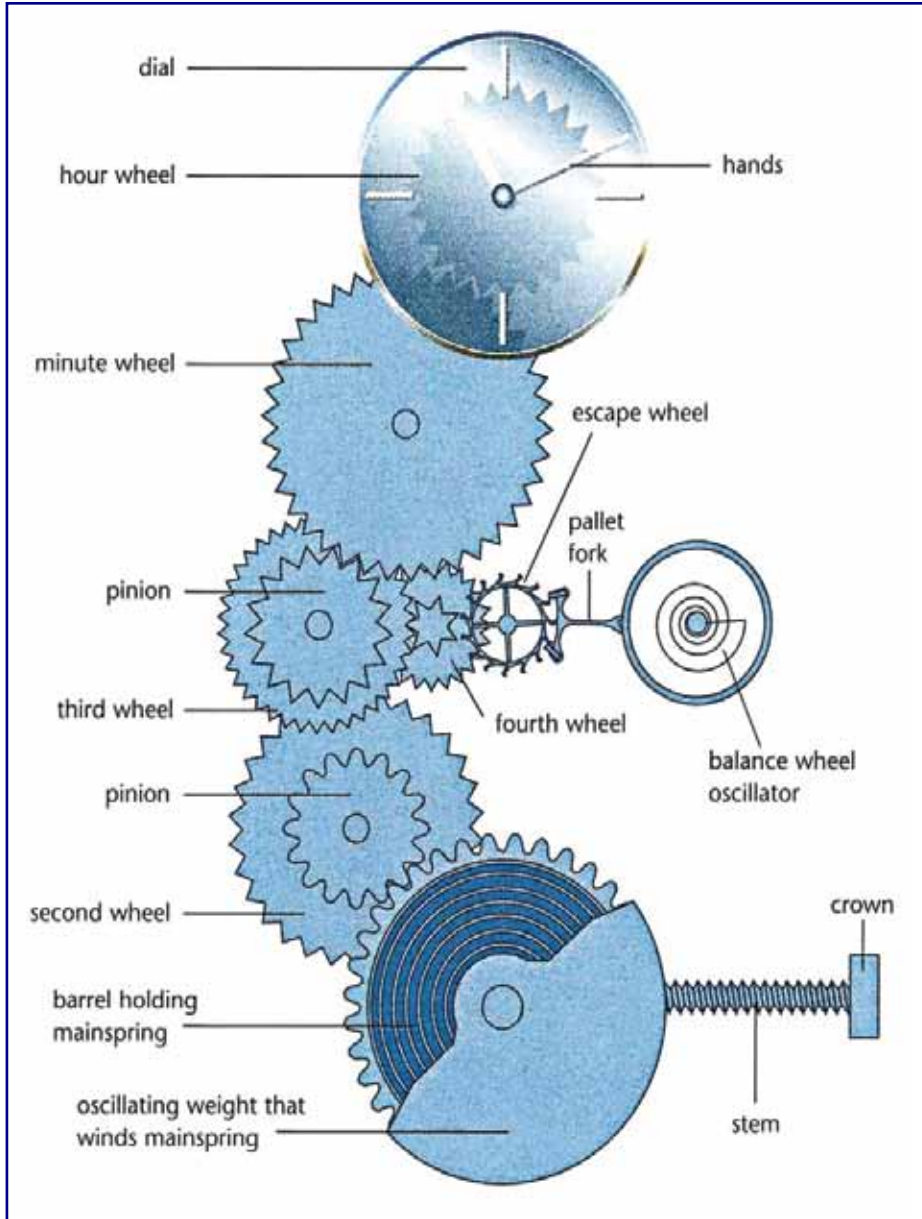

Figure 5. Inner workings of a mechanical (Type II) stopwatch or timer.

2.A.1.b. Mechanical (Type II) Stopwatches

In a traditional mechanical stopwatch, the power source is a helical coil spring, which stores energy from the winding of the spring. The time base is usually a balance wheel that functions as a torsion pendulum. The rate at which the spring unwinds is governed by the balance wheel, which is designed to provide a consistent period of oscillation relatively independent of factors such as friction, operating temperature, and orientation. In most mechanical stopwatches, the balance wheel is designed to oscillate at 2.5 periods per second, which produces 5 “ticks” or beats per second. The balance wheel is connected to an escapement that meters the unwinding of the coil spring and provides impulses that keep the balance wheel moving. It is this metered unwinding of the coil spring that drives the counter indicator. In this type of device, the counter is composed of a gear train that divides the speed of rotation of the escapement wheel to the appropriate revolution speed for the second, minute, and hour hands. The time interval from the counter is displayed either on a face across which the second and minutes hands sweep, or on a series of numbered drums or discs that indicate the elapsed time (Figure 5) [6].

Another form of the Type II stopwatch uses a timer driven by a synchronous motor that also drives the hands or numbered wheels. For this device, the power source is the 60 Hz AC line voltage. The power source drives an electric motor within the timing device. The time base is derived from the controlled regulation of the 60 Hz frequency of AC electric power as supplied by the power utility company. The frequency limits for distributed AC power in the United States are 59.98 Hz to 60.02 Hz, or $60 \text{ Hz} \pm 0.033 \%$ of the nominal value. However, the actual frequency is controlled much more accurately than this, in order to advance or retard the grid frequency and synchronize the power distribution system [8]. The counter and display circuitry are similar to those used in the mechanical stopwatches previously discussed.

2.B. Timers

Timers, unlike stopwatches, count down from a preset time period instead of counting up from zero. They can be small, battery-operated devices that are used to signal when a certain time period has elapsed, or they can be larger devices that plug into a wall outlet and control other items (Figure 6). A parking meter is an example of a countdown timer. Inserting a coin starts the internal timer counting down from an initial preset point. When the preset time has elapsed, the EXPIRED flag is raised.

One type of timer used extensively in industry is the process control timer. As their name implies, process control timers measure or control the duration of a specific process. For example, when a product is made, it may need to be heat treated for a specific length of time. In an automated manufacturing system, the process control timer determines the length of time that the item is heated. In

❖ Stopwatch and Timer Calibrations



Figure 6. A collection of timers.

some applications, such as integrated circuit manufacturing, the timing process can be critical for proper operation.

Process control timers are also used in many different types of laboratory environments. Calibration laboratories use timers to calibrate devices such as radiation detectors, by regulating the amount of time that the device is exposed to the radiation source. The uncertainty in the time of exposure directly influences the overall measurement uncertainty assigned to the detector calibration.

Timers are also used in the medical field. For example, medical laboratories use process control timers when specimen cultures are grown. Hospitals use timers to regulate the amount of medication given to patients intravenously.

2.C. Commercial Timing Devices

Many types of timing devices are used every day in commercial applications. Parking meters, automatic car wash facilities, taxicab meters, and commercial parking lots are examples of entities that either charge a certain amount for a specified period, or provide a certain period of service for a specified amount of money.

The calibration requirements and allowable tolerances for these devices are usually determined on a state-by-state basis by state law, or locally by city or municipality ordinances. The allowable uncertainties are often 1 % or larger. Generic guidance is provided in Section 3.

Section 3

Specifications and Tolerances

Whether we are developing a calibration procedure, or performing an uncertainty analysis for a given calibration process, we need to be able to understand and interpret the specifications and tolerances for both the DUT and the test equipment associated with the calibration. This section reviews both manufacturer's specifications and legal metrology requirements for stopwatches and timing devices.

3.A. Interpreting Manufacturer's Specifications

When reviewing manufacturer's specification sheets, it quickly becomes obvious that not all instrument manufacturers specify their products in the same way. This section defines and describes the most common types of specifications quoted for stopwatches and timing devices.

3.A.1. Absolute Accuracy Specifications

The absolute accuracy² of an instrument is the maximum allowable offset from nominal. Absolute accuracy is defined in either the same units, or a fractional unit quantity of the measurement function for an instrument. For example, the absolute accuracy of a ruler might be specified as ± 1 mm for a scale from 0 to 15 cm.

In the case of timing devices, it isn't useful to provide an absolute accuracy specification by itself. This is because a device's time offset from nominal will increase as a function of the time interval. If the timing device were able to measure an infinite time interval, the offset (or difference in time from nominal) of the device would also become infinitely large. Because of this, when timing devices are specified with an absolute accuracy number, it is also accompanied by a time interval for which this specification is valid. As an example, the absolute accuracy specification for the stopwatch shown in Figure 7 is 5 s per day.

If the stopwatch in Figure 7 were used to measure a time interval longer than one day, we could determine a new absolute accuracy figure by simply multiplying the original specification by the longer time interval. For example 5 s per day becomes 10 s per two days, 35 s per week, and so on.

While it is usually acceptable to multiply the absolute accuracy specification by longer time intervals than the period listed in the specifications, caution must be

² In this section, the term "accuracy" is used in order to allow the reader to correlate the concepts of this chapter directly with published manufacturer specifications. In terms of the *ISO Guide to the Expression of Uncertainty in Measurement* [2], the quantities associated with accuracy are understood to be uncertainties.

❖ Stopwatch and Timer Calibrations

- Handsome stopwatch with large display provides timing to 1/100th of a second over a range of 9 hours 59 minutes and 59.99 seconds.
- Accurate to ± 5 s/day
Built-in memory recalls up to ten laps.
- Clock function (12 or 24 hrs) features a programmable alarm with an hourly chime plus built-in calendar displays day, month and date.
- Countdown timer function features input ranges from one minute to 9 hours, 59 minutes.
- Dimensions/Weight: 2.5 x 3.2 x 0.8, (63 x 81 x 20 mm), 2.8 oz.
- Water resistant housing is complete with lithium battery



Figure 7. Sample manufacturer's specifications for a digital stopwatch (Example 1).

used when dividing the absolute accuracy specification for shorter time intervals than the period listed in the specifications. This is because for shorter measurements periods, a new source of uncertainty, the resolution uncertainty of the instrument, becomes an important consideration. For example, the absolute accuracy of the example stopwatch (Figure 7) during a time interval of 30 s is determined as

$$\frac{5 \text{ s}}{\text{day}} \times 30 \text{ s} = \frac{5 \text{ s}}{\text{day}} \times \frac{1}{2880} \text{ day} = 0.0017 \text{ s}$$

We can see from the specifications in Figure 7 that the stopwatch has a resolution of 1/100 of a second, or 0.01 s. In this case, computing the absolute accuracy specification for a 30 s interval results in a number (0.0017 s) that is about six times smaller than the smallest value the stopwatch can display. Most manufacturers of timing devices do not consider the resolution of the product in their specifications, but we will include resolution uncertainty in our examples.

3.A.2 Relative Accuracy Specifications

While absolute accuracy specifications are helpful, sometimes it is more desirable to specify accuracy relative to the measured time interval. This makes its significance easier to understand. For this purpose, we define a quantity called relative accuracy:

$$\text{Relative Accuracy} = \frac{\text{Absolute Accuracy}}{\text{Measured Time Interval}}$$

Using the previous example from Figure 7, the stopwatch has an absolute accuracy specification of 5 s per day, so the relative accuracy is:

$$\text{Relative Accuracy} = \frac{5 \text{ s}}{1 \text{ day}} = \frac{5 \text{ s}}{86\,400 \text{ s}} = 0.000\,058 = 0.0058\% = 5.8 \times 10^{-5}$$

Note that because the absolute accuracy specification and the measured time interval are both expressed in seconds, the unit cancels out; leaving a dimensionless number that can be expressed either as a percentage or in scientific notation. Relative accuracy specifications can also be converted back to absolute time units if necessary. For example, Figure 8 shows the manufacturer's specifications for a stopwatch that is accurate to 0.0003 % (although not stated, it is assumed that this percentage has been stated as a percent of reading or relative accuracy). To compute the time accuracy for a 24 h measurement, we simply multiply the relative accuracy by the measurement period:

$$0.0003\% \times 24 \text{ h} = 0.000\,072 \text{ h} = 0.2592 \text{ s}$$

This computation shows that this stopwatch is capable of measuring a 24-hour interval with an accuracy of about 0.26 s. However, it is again important to note that when measuring small time intervals, the resolution uncertainty of the stopwatch must be considered. For example, if the stopwatch in Figure 8 is used to measure a time interval of 5 s, the computed accuracy is much smaller than the resolution of the stopwatch:

$$0.0003\% \times 5 \text{ s} = 0.000\,015 \text{ s}$$

❖ Stopwatch and Timer Calibrations

Timer: 9 hours, 59 minutes, 59 seconds, 99 hundredths.

Stopwatch: Single-action timing: time-in/time-out; continuous timing; cumulative split, interval split and eight memories. Triple display shows cumulative splits, interval splits and running time simultaneously.

Features: Captures and stores up to eight separate times. After timed event is complete, stopwatch displays information in its memory. Counter box shows number of split times taken. Solid-state design with an accuracy of 0.0003 %. Durable, water-resistant construction makes stopwatch suitable for field use (operates in temperature from 1° to 59° C [33° to 138° F]). With triple line LDC: top two lines are each 1/8 in. high (3.2 mm); third line is 1/4 in. high (6 mm).



Figure 8. Sample specifications for a digital stopwatch (Example 2).

3.A.3. Typical Performance

During the NIST centennial celebration of 2001, an exhibit at the NIST laboratories in Boulder, Colorado, allowed visitors to measure the time base accuracy of their quartz wristwatches. Over 300 wristwatches were tested. These wristwatches contained a 32 768 Hz time base oscillator, the same technology employed by a Type I digital stopwatch. The results of these measurements, showing the loss or gain in seconds per day for the watches, are summarized in Figure 9, and give some idea of the typical performance of a quartz stopwatch or timer. Roughly 70 % of the watches were able to keep time to within 1 s per day or better, a relative accuracy of approximately 0.001 % (1×10^{-5}). About 12 % had a relative accuracy larger than 5 s per day, or larger than 0.005 %. It is interesting to note that nearly all of the watches in this study gained time, rather than lost time; and were presumably designed that way to help prevent people from being late. This characteristic will not necessarily apply to stopwatches and timers.

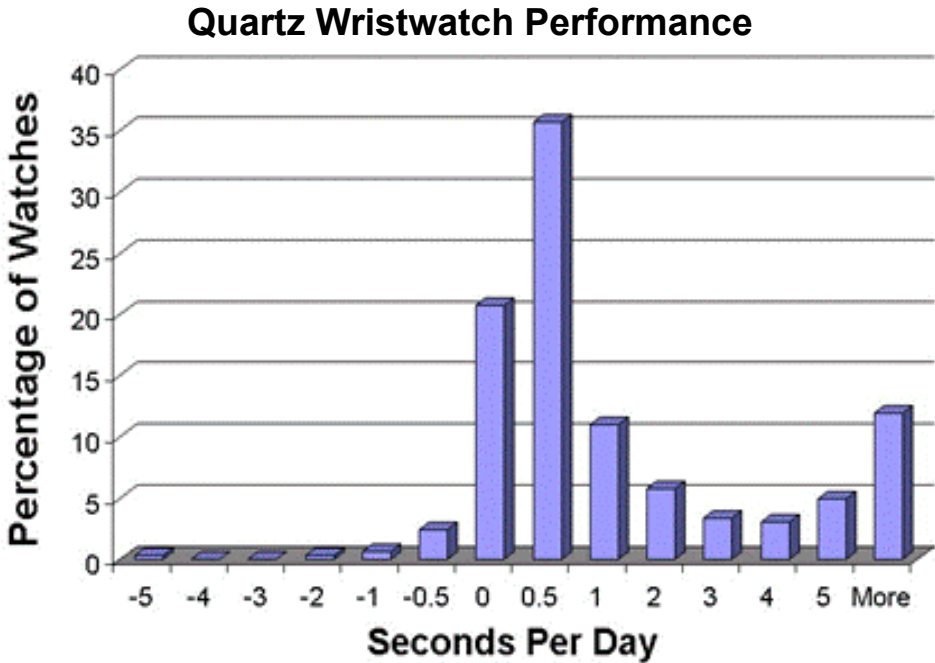

Figure 9. Typical performance of quartz wristwatches using 32 768 Hz time base oscillators.

3.B. Tolerances Required for Legal Metrology

General specifications for field standard stopwatches and commercial timing devices are provided in Section 5.55 of *NIST Handbook 44* [9], and are summarized in Table 4. *NIST Handbook 44* is recognized by nearly all 50 states as the legal basis for regulating commercial weighing and measuring devices. However, some state governments and some regulatory agencies have other specifications that need to be satisfied for a given calibration. Therefore, be sure to check and understand the required tolerances and regulations for the types of calibration that a calibration laboratory is asked to perform [10].

The terms *overregistration* and *underregistration* are used when specifying the accuracy of commercial timing devices. The terms are used to describe conditions where the measurement device does not display the actual quantity. In timing devices, underregistration is the greatest concern, because an underregistration error occurs when the timing device indicates that the selected time interval has elapsed before it actually has. An example of underregistration would be paying for 10 minutes on a parking meter, and then having the meter indicate that time had expired when only 9 minutes and 45 s had actually elapsed.

Table 4 - Legal metrology requirements for field standard stopwatches and commercial time devices.

Commercial timing device	Interval Measured	Overregistration		Underregistration	
		Requirement	Uncertainty	Requirement	Uncertainty
Parking meter	30 minutes or less	None	NA	10 s per minute, but not less than 2 minutes	11.7 % to 16.7 %
	Over 30 minutes up to and including 1 hour	None	NA	5 minutes plus 4 s per minute over 30 minutes	
	Over 1 hour	None	NA	7 minutes plus 2 minutes per hour over 1 hour	
Time clocks and time recorders		3 s per hour, not to exceed 1 minute per day	0.07 % to 0.08 %	3 s per hour, not to exceed 1 minute per day	0.07 % to 0.08 %
Taximeters		3 s per minute	5 %	9 s per minute on the initial interval, and 6 s per minute on subsequent intervals	10 % to 15 %
Other timing devices		5 s for any interval of 1 minute or more	NA	6 s per minute	10 %

NIST Handbook 44 [9] specifies that instruments that are required to calibrate timing devices must be accurate to within 15 s per 24 h period (approximately 0.017 %). If stopwatches are used as the calibration standard, this becomes the minimum allowable tolerance for the stopwatch. Another reference, *NIST Handbook 105-5* [5] states that the tolerance for instruments used to calibrate timing devices must be three times smaller than the smallest tolerance of the device being calibrated. *Handbook 105-5* also provides a nearly identical specification for stopwatches, stating that the tolerance for stopwatches is ± 0.02 % of the time interval tested (approximately 2 s in 3 hours), rounded to the nearest 0.1 s.

The uncertainties listed above were meant to be achievable with Type II (mechanical) devices, but Type I devices are normally capable of much lower uncertainties. As a result, organizations and jurisdictions that rely exclusively on digital stopwatches (Type I) might require that devices be calibrated to a tolerance of 0.01 %, or even 0.005 %. For example, the State of Pennsylvania code [11] uses the same specifications as *NIST Handbook 44* for mechanical stopwatches (15 s per 24 hours), but states that a quartz stopwatch shall comply with the following more rigorous standards:

(i) The common crystal frequency shall be 32 768 Hz with a measured frequency within plus or minus 3 Hz, or approximately 0.01 % of the standard frequency.

(ii) The stopwatch shall be accurate to the equivalent of plus or minus 9 seconds per 24-hour period.

3.B.1. Time Clocks and Time Recorders

The specification for both overregistration and underregistration is 3 s per hour, not to exceed 1 minute per day.

3.B.2. Parking Meters

The specifications for parking meters have no tolerance for overregistration. Parking meters with a time capacity of 30 minutes or less are specified to have a maximum underregistration error of 10 s per minute, but not to exceed 2 minutes over the 30 minute period. For parking meters with a capacity of greater than 30 minutes, but less than 1 hour, the tolerance for underregistration is 5 minutes, plus 4 s per minute for every minute between 30 minutes and 60 minutes. Parking meters that indicate over 1 hour have an underregistration tolerance of 7 minutes plus 2 minutes per hour for time intervals greater than 1 hour.

3.B.3. Other Timing Devices

All other timing devices have an overregistration tolerance of 5 s for any time interval of 1 minute or more and an underregistration tolerance of 6 s per indicated minute. If the instrument is a digital indicating device, the tolerance is expanded by one half of the least significant digit.

Section 4 Introduction to Calibration Methods

There are three generally accepted methods for calibrating a stopwatch or timer: the direct comparison method, the totalize method, and the time base method. The first two methods consist of time interval measurements that compare the time interval display of the DUT to a traceable time interval reference. In the case of the direct comparison method, the time interval reference is normally a signal broadcast by an NMI, usually in the form of audio tones. In the case of the totalize method, the time interval reference is generated in the laboratory using a synthesized signal generator, a universal counter, and a traceable frequency standard. The third method, the time base method, is a frequency measurement. It compares the frequency of the DUT’s time base oscillator to a traceable frequency standard [12]. The properties of the three methods are briefly summarized in Table 5, and the following three sections are devoted to the three methods. Each section explains how to perform a calibration using each method, and how to estimate the measurement uncertainties.

Table 5 - Comparison of calibration methods.

Method Properties	Direct comparison	Totalize	Time base measurement
Equipment Requirements	Best	Better	Better
Speed	Good	Better	Best
Uncertainty	Good	Good	Best
Applicability	Good	Best	Better

The methods used to estimate the uncertainty of measurement are described in the *ISO Guide to the Expression of Uncertainty in Measurement (GUM)* [2]. This guide does not attempt to summarize the GUM, but does strive to produce estimates of uncertainty that are consistent with the GUM. The resulting expanded uncertainty of measurement is presented with a coverage factor that represents an approximate 95 % level of confidence.

Section 5 The Direct Comparison Method

The direct comparison method is the most common method used to calibrate stopwatches and timers. It requires a minimal amount of equipment, but has larger measurement uncertainties than the other methods. This section describes the references used for this type of calibration and the calibration procedure.

5.A. References for the Direct Comparison Method

The direct comparison method requires a traceable time-interval reference. This reference is usually an audio time signal, but in some cases a traceable time display can be used. The audio time signals are usually obtained with a shortwave radio or a telephone. Since time interval (and not absolute time) is being measured, the fixed signal delay from the source to the user is not important as long as it remains relatively constant during the calibration process. A list of traceable audio time sources is provided in Table 6.

Table 6 - Traceable audio time signals.

National Metrology Institute (NMI)	Location	Telephone numbers	Radio call letters	Broadcast frequencies
National Institute of Standards and Technology (NIST)	Fort Collins, Colorado, United States	(303) 499-7111 *	WWV	2.5, 5, 10, 15, 20 MHz
National Institute of Standards and Technology (NIST)	Kauai, Hawaii, United States	(808) 335-4363 *	WWVH	2.5, 5, 10, 15 MHz
United States Naval Observatory (USNO)	Washington, DC, United States	(202) 762-1401 * (202) 762-1069 *	----	----

❖ Stopwatch and Timer Calibrations

United States Naval Observatory (USNO)	Colorado Springs, Colorado, United States	(719) 567-6742 *	----	----
National Research Council (NRC)	Ottawa, Ontario, Canada	(613) 745-1576 @ (English language) (613) 745-9426 @ (French language)	CHU	3.33, 7.850, 14.67 MHz
		(442) 215-39-02 * (442) 211-05-06 ! (442) 211-05-07 # (442) 211-05-08 ##		
Centro Nacional de Metrologia (CENAM)	Querétaro, México	Time announcements are in Spanish, a country code must be dialed to access these numbers from the United States, see www.cenam.mx for more information.	XEQK (Mexico City)	1.35 MHz
Korea Research Institute of Standards and Science (KRISS)	Taedok, Science Town, Republic of Korea	----	HLA	5 MHz
National Time Service Center (NTSC)	Lintong, Shaanxi, China	----	BPM	2.5, 5, 10, 15 MHz

* Coordinated Universal Time (UTC)

@ Eastern Time

! Central Time

Mountain Time

Pacific Time

Please note that local “time and temperature” telephone services are not traceable references and **should not be used**. For traceable calibrations, use only sources that originate from a national metrology institute, such as those listed in Table 6. The following sections briefly describe the various radio and telephone time signals, and provide information about the types of clock displays that can and cannot be used.

5.A.1. Audio Time Signals Obtained by Radio

The radio signals listed in Table 6 include a voice announcement of UTC and audio ticks that indicate individual seconds. WWV, the most widely used station, features a voice announcement of UTC occurring about 7.5 s before the start of each minute. The beginning of the minute is indicated by a 1500 Hz tone that lasts for 800 ms. Each second is indicated by a 1 kHz tone that lasts for 5 ms. The best way to use these broadcasts is to start and stop the stopwatch when the beginning of the minute tone is heard.

Most of the stations listed in Table 6 are in the high-frequency (HF) radio band (3 MHz to 30 MHz), and therefore require a shortwave radio receiver. A typical general-purpose shortwave receiver provides continuous coverage of the spectrum from about 150 kHz, which is below the commercial AM broadcast band, to 30 MHz. These receivers allow the reception of the HF time stations on all available frequencies. The best shortwave receivers are designed to work with large outdoor antennas, with quarter-wavelength or half-wavelength dipole antennas often providing the best results. However, in the United States, adequate reception of at least one station can usually be obtained with a portable receiver with a whip antenna, such as the one shown in Figure 10. This type of receiver typically costs a few hundred dollars or less.

HF radio time stations normally broadcast on multiple frequencies because some of the frequencies are not available at all times. In many cases, only one frequency can be received, so the receiver might have to be tuned to several different frequencies before finding a usable signal. In the case of WWV, 10 MHz and 15 MHz are probably the best choices for daytime reception, unless the laboratory is within 1000 km of the Fort Collins, Colorado station, in which case 2.5 MHz might also suffice. Unless the receiver is near the station, the 5 MHz signal will probably be the easiest to receive at night [13].



Figure 10. Portable shortwave radio receiver for reception of audio time signals.

5.A.2. Audio Time Signals Obtained by Telephone

The telephone time signals for NIST radio stations WWV and WWVH are simulcasts of the radio broadcasts, and the time (UTC) is announced once per minute. The length of the phone call is typically limited to 3 minutes. The formats of the other broadcasts vary. The USNO phone numbers broadcast UTC at 5 s or 10 s intervals. The NRC phone number broadcasts Eastern Time at 10 s intervals, and CENAM offers separate phone numbers for UTC and the local time zones of Mexico.

5.A.3. Time Displays

It might be tempting to use a time display from a radio controlled clock or from a web site synchronized to UTC as a reference for stopwatch or timer calibrations. As a general rule, however, these displays are not acceptable for establishing traceability. Nearly all clock displays are synchronized only periodically. In the period between synchronizations they rely on a free running local oscillator whose frequency uncertainty is usually unknown. And of course, an unknown uncertainty during any comparison breaks the traceability chain. For example, a low cost radio controlled clock that receives a 60 kHz signal from NIST radio station WWVB is usually synchronized only once per day. In between synchronizations, each “tick” of the clock originates from a local quartz oscillator whose uncertainty is unknown, and that probably is of similar or lesser quality than the oscillator inside the device under test. The NIST web clock (time.gov) presents similar problems. It synchronizes to UTC(NIST) every 10 minutes if the web browser is left open. However, between synchronizations it keeps time using the computer’s clock, which is usually of poorer quality than a typical stopwatch, and whose uncertainty is generally not known. In contrast, each “tick” of an audio broadcast from WWV originates from NIST and is synchronized to UTC. Therefore, WWV audio always keeps the traceability chain intact.

There are a few instances where a time display can be used to establish traceability. One example would be a display updated each second by pulses from a Global Positioning System (GPS) satellite receiver. In this case, if the traceable input signal were not available, the display would stop updating. Therefore, if the display is updating, then it is clear that each “tick” is originating from a traceable source. However, nearly all GPS receivers have the capability to “coast” and keep updating their display even when no satellite signals are being received. In order for a GPS display to be used as a reference, there must be an indicator on the unit that shows whether the display is currently locked to the GPS signal, or is in “coast” mode. If the receiver is in “coast” mode, it should not be used as a calibration reference.

Another example of a traceable time display would be a digital time signal obtained from a telephone line, such as signals from the NIST Automated Computer Time Service (ACTS), which is available by dialing (303) 494-4774 [13]. With an analog modem and simple terminal software (configured for 9600 baud, 8 data bits, 1 stop bit, and no parity), you can view time codes on a computer screen, and use these codes as a reference in the same way that you would use the audio time announcements from WWV. However, the length of a single telephone call is limited to 48 s. In theory, Internet time codes could be used in the same way, but the transmission delays through the network can vary by many milliseconds from second to second. For this reason, the currently available Internet signals should not be used as measurement references.

5.B. Calibration Procedure for the Direct Comparison Method

Near the top of the hour, dial the phone number (or listen to the radio broadcast) of a traceable source of precise time. Start the stopwatch at the signal denoting the hour, and write down the exact time. After a suitable time period (depending on the accuracy of the stopwatch), listen to the time signal again, and stop the stopwatch at the sound of the tone, and write down the exact stopping time. Subtract the start time from the stop time to get the time interval, and compare this time interval to the time interval displayed by the stopwatch. The two time intervals must agree to within the uncertainty specifications of the stopwatch for a successful calibration. Otherwise, the stopwatch needs to be adjusted or rejected.

5.B.1. Advantages of the Direct Comparison Method

This method is relatively easy to perform and, if a telephone is used, does not require any test equipment or standards. It can be used to calibrate all types of stopwatches and many types of timers, both electronic and mechanical.

5.B.2. Disadvantages of the Direct Comparison Method

The operator's start/stop reaction time is a significant part of the total uncertainty, especially for short time intervals. Table 7 shows the contribution of a 300 ms variation in human reaction time to the overall measurement uncertainty, for measurement periods ranging from 10 s to 1 day.

Table 7 - The contribution of a 300 ms variation in reaction time to the measurement uncertainty.

Hours	Minutes	Seconds	Uncertainty (%)
		10	3
	1	60	0.5
	10	600	0.05
	30	1800	0.01666
1	60	3600	0.00833
2	120	7200	0.00416
6	360	21 600	0.00138
12	720	43 200	0.00069
24	1440	86 400	0.00035

As Table 7 illustrates, the longer the time interval measured, the less impact the operator's start/stop uncertainty has on the total uncertainty of the measurement. Therefore, it is better to measure for as long as practical to reduce the uncertainty introduced by the operator, and to meet the overall measurement requirement.

To get a better understanding of the numbers in Table 7, consider a typical stopwatch calibration where the acceptable measurement uncertainty is 0.02 % (2×10^{-4}). If the variation in human reaction time is known to be 300 ms for the direct comparison method, a time interval of at least 1500 s is needed to reduce the uncertainty contributed by human reaction time to 0.02 %. However, if we use a 1500 s interval, we could possibly be measuring the variation in human reaction time, and nothing else. Therefore, we need to extend the time interval so that human reaction time becomes an insignificant part of the measurement. For example, *NIST Handbook 105-5* [4] states that a stopwatch is considered to be within tolerance if its time offset is 2 s or less during a three hour calibration. Three hours is a long enough time interval to exceed the 0.02

% requirement and to ensure that the uncertainty contribution of human reaction time is insignificant. There is no hard and fast rule; the length of the calibration can vary according to each laboratory's procedures, but it must be long enough to meet the uncertainty requirements for the device being tested. If your uncertainty requirement is 0.01 % or lower, the direct comparison method might not be practical.

5.C. Uncertainties of the Direct Comparison Method

The Direct Comparison Method has three potentially significant sources of uncertainty that must be considered: the uncertainty of the reference, the reaction time of the calibration technician, and the resolution of the DUT.

5.C.1. Uncertainty of the Traceable Time Interval Reference

If the reference signal is one of the telephone services listed in Table 6, two phone calls are usually made. The first call is made to obtain the signal to start the stopwatch, and the second call is made to obtain the signal to stop the stopwatch. If both calls are made to the same service and routed through the same phone circuit, the delay through the circuit should be nearly the same for both calls. Of course, the delays will not be exactly the same, and the difference between the two delays represents the uncertainty of the time interval reference. In most cases, this uncertainty will be insignificant for our purposes, a few milliseconds or less. For example, callers in the continental United States using ordinary land lines can expect signal delays of less than 30 ms when dialing NIST at (303) 499-7111, and these delays should be very repeatable from phone call to phone call. Even in a theoretical case where the initial call had no delay, and the final call had a 30 ms delay, the magnitude of the uncertainty would be limited to 30 ms.

However, if an ordinary land line is not used, the uncertainties associated with telephone time signals must be assumed to be larger. For example, wireless phone networks or voice over Internet protocol (VOIP) networks sometimes introduce larger delays that are subject to more variation from phone call to phone call than ordinary land lines. If wireless or VOIP networks are used, however, it is reasonable to assume that the transmission delay does not exceed 150 ms, since the International Telecommunication Union (ITU) recommends that delays be kept below this level to avoid the distortion of voice transmissions [14]. Calls made from outside the continental United States might occasionally be routed through a communications satellite, introducing delays of about 250 ms. Although the use of satellites is now rare, if the first call went through a satellite, and the second call didn't (or vice versa), a significant uncertainty would be introduced. Therefore, common sense tells us that a laboratory in Illinois (for example) shouldn't start a calibration by calling the NIST service in Colorado, and then stop the calibration by calling the NIST service in Hawaii. Based on this discussion, it is recommended that an uncertainty of 150 ms be



Stopwatch and Timer Calibrations

assigned if wireless or VOIP networks are used, or 250 ms if calls are routed through a satellite.

During a single phone call, the uncertainty of the time interval reference is essentially equal to the stability of a telephone line (the variations in the delay) during the call. Phone lines are surprisingly stable. The ITU recommendations for timing stability within the telephone system call for stabilities of much less than 0.1 ms for the North American T1 system [15]. A NIST study involving the Automated Computer Time Service (ACTS), a service that sends a digital time code over telephone lines, showed phone line stability at an averaging time of 1 s to be better than 0.1 ms over both a local phone network and a long distance network between Boulder, Colorado and WWVH in Kauai, Hawaii [16]. While it is not possible to guarantee this stability during all phone calls, it is reasonable to assume that the stability should be much less than 1 ms during typical calls, which are limited to about 3 minutes in length. Thus, the uncertainties contributed by phone line instabilities are so small that they can be ignored for our purposes.

If the radio signals listed in Table 6 are used as a reference instead of a telephone signal, the arrival time of the signal will vary slightly from second to second as the length of the radio signal path changes, but not enough to influence the results of a stopwatch or timer calibration. Shortwave signals that travel over a long distance rely on skywave propagation, which means that they bounce off the ionosphere and back to Earth. A trip from Earth to the ionosphere is often called a hop, and a hop might add a few tenths of a millisecond, or in an extreme case, even a full millisecond to the path delay. Normally, propagation conditions will remain the same during the course of a calibration, and the variation in the radio signal will be negligible, often less than 0.01 ms. Even if an extra hop is added into the radio path during the calibration; for example if a one hop path becomes a two hop path, the received uncertainty of the radio signal will still not exceed 1 ms [13].

If a traceable time display is used instead of a radio signal or telephone signal, it can generally be assumed that the uncertainty of the display is less than 1 ms. This is because instruments that continuously synchronize their displays to traceable signals will normally have repeatable and stable delays. However, in order for this uncertainty estimate to be valid, be sure to use only time displays that meet the traceability requirements discussed in Section 5.A.3.

5.C.2. Uncertainty Due to Human Reaction Time

To understand the effect of human reaction time on stopwatch and timer calibration uncertainties, a small study was conducted at Sandia National Laboratories. Four individuals were selected and asked to calibrate a standard stopwatch using the direct comparison method. Two separate experiments were conducted. In the first experiment, the operators were asked to use a traceable

audio time signal, and in the second experiment, the operators were asked to use a traceable time display. The time base of the stopwatch was measured before and after each test (using the Time Base Method), and its offset from nominal was found to be small enough that it would not influence the test. Therefore, differences in readings between the stopwatch being tested and the standard would be due only to the operator's reaction time. Each operator was asked to repeat the measurement process 10 times, and the resulting 10 differences between the standard and the stopwatch were recorded and plotted (Figure 11).

As shown in Figure 11, the average reaction time was usually less than ± 100 ms, with a worst-case reaction time exceeding 700 ms. The mean and standard deviation for each operator was computed and graphed in Figure 12. This graph indicates that the average (mean) reaction time of the operator can be either negative (anticipating the audible tone) or positive (reacting after the audible tone). Figure 12 also shows that in addition to the average reaction time having a bias, the data is somewhat dispersed, so both elements of uncertainty will need to be considered in a complete uncertainty budget. For this experiment, the worst case mean reaction time was 120 ms and the worst case standard deviation was 230 ms. It should be noted that in the measurements recorded in Figure 12, Operators 1 and 2 had no previous experience calibrating stopwatches. Based on these results, it is recommended that each calibration laboratory perform tests to determine the uncertainty of their operator's reaction time.

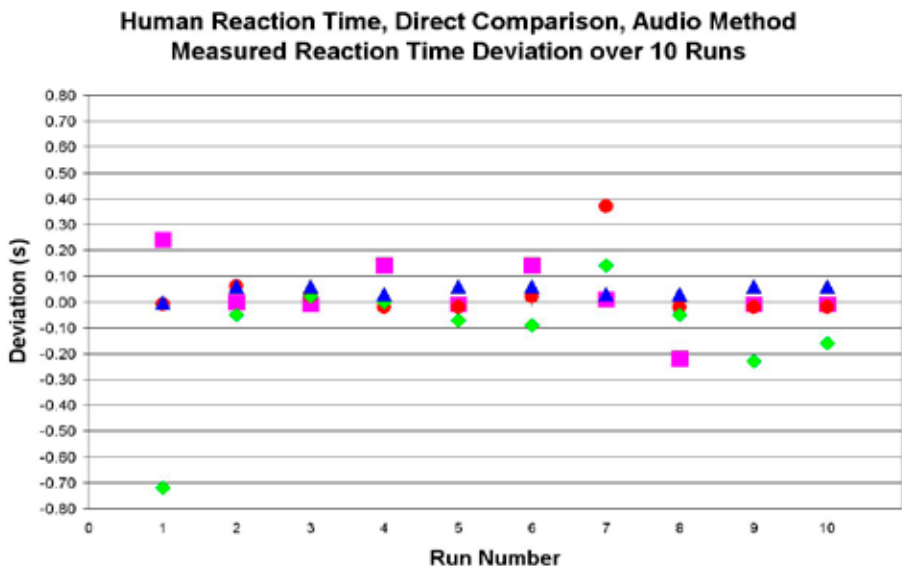

Figure 11. Reaction time measurements (four operators, 10 runs each) for the direct comparison method.

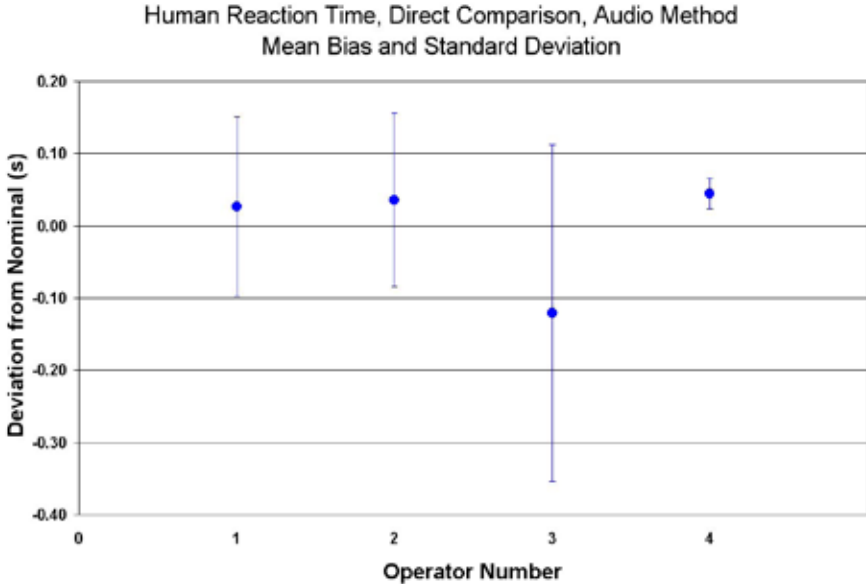

Figure 12. Averaging measurement results for four different operators.

When a traceable time display was used, the uncertainty due to human reaction time was found to be approximately the same as the human reaction time for an audible tone. Keep in mind that these results are presented to illustrate the nature of uncertainty due to human reaction time, and to provide a very rough estimate of its magnitude. We strongly encourage each person calibrating stopwatches and timers to perform repeatability and reproducibility experiments to help better determine the uncertainty of human reaction time.

5.C.3. Device Under Test (DUT) Resolution Uncertainty

Since the direct comparison method requires observing data from the DUT display, the resolution of the DUT must also be considered. For digital indicating devices, resolution uncertainty is understood to be half of the least significant digit, with an assumed rectangular probability distribution. For an analog watch, the same method of determining resolution uncertainty may be used because the watch moves in discrete steps from one fraction of a second to the next.

5.C.4. Uncertainty Analysis

This section provides an example of how data collected using the direct comparison method can be used to perform an uncertainty analysis. For this estimate of uncertainty we will include the mean bias as an estimate of

uncertainty, rather than correcting for it, because the mean bias can be either negative or positive, and may vary from time to time for the same user [17]. In this calibration process, the mean bias can be considered a measurement of reproducibility, and the standard deviation a measure of repeatability.

5.C.4.a. Uncertainty Distributions

Because of the lack of knowledge regarding distributions of the mean bias and delay deviation between telephone calls, both components of uncertainty are treated as rectangular distributions. Since the resolutions of digital and analog stopwatches have known, discrete quantities, their distribution is also rectangular [12]. All other data are considered to be normally distributed.

5.C.4.b. Method of Evaluation

Even though the data provided in previous sections were treated statistically, they were collected from previous measurements, and not during the actual stopwatch calibration. Because the metrologist does not have statistical data based on a series of observations to support these uncertainties, they are identified as Type B.

5.C.4.c. Combination of Uncertainties

In the following examples, the uncertainty budgets were developed for a calibration using traceable land lines (Table 8 and Table 9), and for a calibration using a cellular phone or satellite signal (Table 10) based upon the data previously provided. The human reaction time was based on the worst case data presented in Section 5.C.2. The uncertainties are rounded to the nearest millisecond. The uncertainty components are considered to be uncorrelated, so they are combined using the root sum of squares method.

❖ Stopwatch and Timer Calibrations

Table 8 - Uncertainty analysis for direct comparison method (digital DUT) using a land line.

Source of uncertainty	Magnitude, ms	Method of evaluation	Distribution	Standard uncertainty, ms
Human reaction time bias	120	Type B	Rectangular	69
Human reaction time standard deviation	230	Type B	Normal ($k = 1$)	230
Telephone delay deviation	30	Type B	Rectangular	17
$\frac{1}{2}$ DUT resolution	5	Type B	Rectangular	3
Combined uncertainty				241
Expanded uncertainty ($k = 2$, representing approximately a 95 % level of confidence)				482

Table 9 - Uncertainty analysis for direct comparison method (digital DUT) using a cell phone.

Source of uncertainty	Magnitude, ms	Method of evaluation	Distribution	Standard uncertainty, ms
Human reaction time bias	120	Type B	Rectangular	69
Human reaction time standard deviation	230	Type B	Normal ($k = 1$)	230
Telephone delay deviation	150	Type B	Rectangular	87
$\frac{1}{2}$ DUT resolution	5	Type B	Rectangular	3
Combined uncertainty				255
Expanded uncertainty ($k = 2$, representing approximately a 95 % level of confidence)				511

Table 10 - Uncertainty analysis for direct comparison method (analog DUT) using a land line.

Source of uncertainty	Magnitude, ms	Method of evaluation	Distribution	Standard uncertainty, ms
Human reaction time bias	120	Type B	Rectangular	69
Human reaction time standard deviation	230	Type B	Normal ($k = 1$)	230
Telephone delay deviation	30	Type B	Rectangular	17
½ DUT resolution	100	Type B	Rectangular	58
Combined uncertainty				248
Expanded uncertainty ($k = 2$, representing approximately a 95 % level of confidence)				495

Section 6

The Totalize Method

The totalize method partially eliminates the measurement uncertainty from human reaction time, but requires two test instruments: a calibrated signal generator, and a universal counter.

6.A. Calibration Procedure for the Totalize Method

The counter is set to TOTALIZE, with a manual gate. A signal from a calibrated synthesized signal generator is connected to the counter's input, and the laboratory's primary frequency standard is used as the external time base for the synthesizer and the counter (Figure 13). The frequency should have a period at least one order of magnitude smaller than the resolution of the stopwatch. For example, if the stopwatch has a resolution of 0.01 s (10 ms); use a 1 kHz frequency (1 ms period). This provides the counter with one more digit of resolution than the stopwatch.

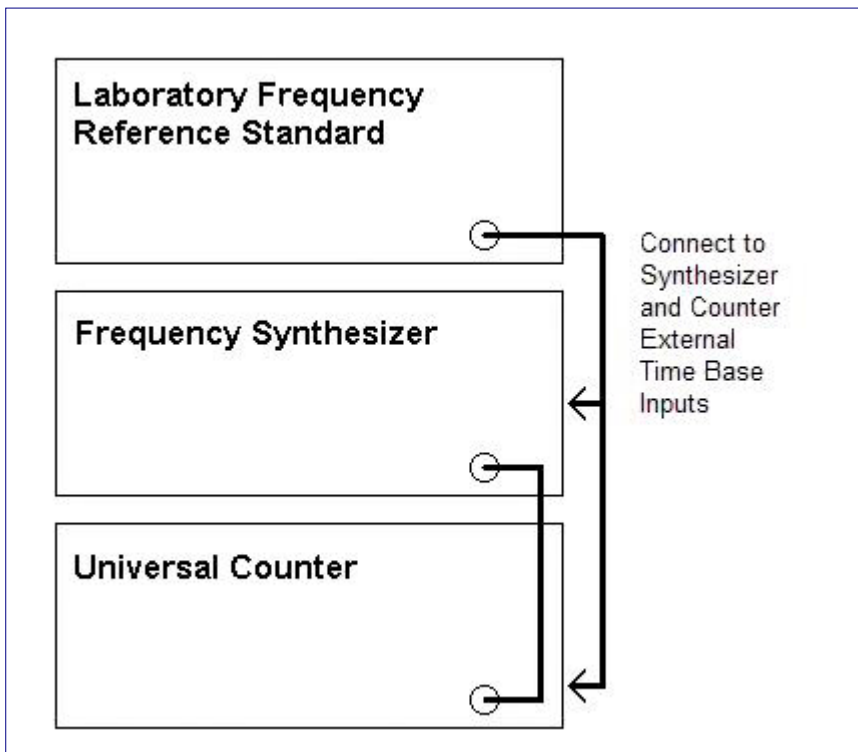

Figure 13. Block diagram of the totalize method.

❖ Stopwatch and Timer Calibrations

To begin the measurement, start the stopwatch and manually open the gate of the counter at the same time. One way to do this is by rapidly pressing the start-stop button of the stopwatch against the start button on the counter (Figure 14). Another method is to press the start/stop button of the stopwatch with one hand and simultaneously pressing the start/stop button of the counter. After a suitable period of time (determined by the calibration requirements of the stopwatch or timer being calibrated), use the same method to simultaneously stop the stopwatch and close the gate of the counter.



Figure 14. Using the start-stop button of the stopwatch to start the counter.

Once the counter and stopwatch are stopped, compare the two readings. Use the equation $\Delta t/T$ to get the results, where Δt is the difference between the counter and stopwatch displays, and T is the length of the measurement run. For example, if $\Delta t = 100 \text{ ms}$ and $T = 1 \text{ hour}$, the time uncertainty is $0.1 \text{ s} / 3600 \text{ s}$ or roughly 2.8×10^{-5} (0.0028 %).

6.A.1. Advantages of the Totalize Method

When using the stopwatch's start/stop button to open and close the counter's gate, this method partially eliminates human reaction time, and therefore has a lower measurement uncertainty than the direct comparison method.

6.A.2. Disadvantages of the Totalize Method

This method requires more equipment than the direct comparison method.

6.B. Uncertainties of the Totalize Method

The factors that contribute to the measurement uncertainty of this method are discussed below.

6.B.1. Uncertainty of the Frequency Reference

A synthesized signal generator that was recently calibrated typically has a frequency uncertainty ranging from 1×10^{-6} to 1×10^{-9} . If the signal generator time base is externally locked to a laboratory frequency standard such as a cesium oscillator or a GPS disciplined oscillator, the frequency uncertainty can be much smaller, typically parts in 10^{12} or less.

6.B.2. Uncertainty Due to Human Reaction Time

This source of uncertainty is due to any difference between the starting of both the stopwatch and counter, and the stopping of both the stopwatch and counter. In order to estimate this source of uncertainty, a study was conducted at Sandia National Laboratories. Four individuals were selected and asked to calibrate a standard stopwatch using the totalize method, using one hand to start and stop the stopwatch, and one hand to start and stop the frequency counter. The time base of the stopwatch was measured before and after each test (using the time base method), and its offset from nominal was found to be small enough so that it would not influence the test. Therefore differences in readings between the stopwatch being tested and the standard would be due only to the operator's reaction time.

Each operator was asked to repeat the measurement process 10 times, and the resulting difference between the standard and the stopwatch were recorded.

❖ Stopwatch and Timer Calibrations



Figure 15. Measured reaction times (four operators, 10 runs each) for totalize method.

As shown in Figure 15, the average reaction time was usually less than 40 ms. The largest deviation was about 90 ms. The mean and standard deviations for each operator were computed and graphed in Figure 16. The data demonstrates that the worst case mean reaction time was 27 ms, and the worst case standard deviation was 10 ms, which is a significant improvement over the direct comparison method. Subsequent measurements of human reaction time were made by placing the start/stop button of the stopwatch directly against the start/stop button of the frequency counter (as shown in Figure 12) so that both buttons were pushed at the same time. The experimental data showed that this method provided no significant advantage over using one hand to start the stopwatch and the other hand to start the frequency counter.

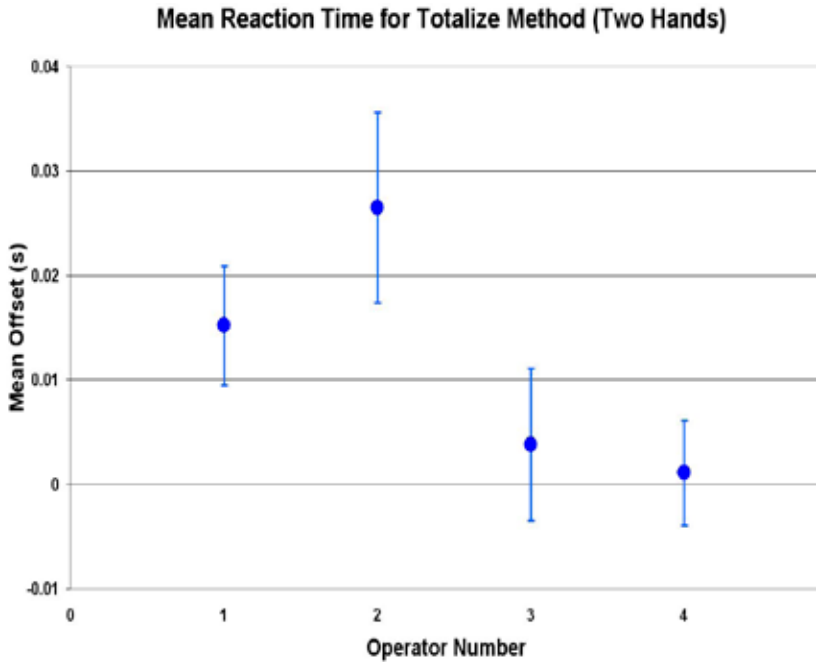

Figure 16. Mean reaction times (four operators, 10 runs each) for the totalize method.

6.B.3. Uncertainty Due to the Counter

For this method, the uncertainty of the counter is related to the counter resolution. The internal time base of the counter is not used, because the gate time is controlled by the manual start/stop function. This method does not use the counter gate or trigger, so the uncertainties associated with these functions are also eliminated. The counter is simply used as an event counting device, and the uncertainty is equivalent to ± 1 least significant digit on the display.

6.B.4 Device Under Test (DUT) Resolution Uncertainty

Since the totalize method involves observing data from the DUT, the resolution of the DUT must also be considered. For digital indicating devices, resolution uncertainty is understood to be half of the least significant digit, with a rectangular distribution. A rectangular distribution is also used for analog timers, since these devices move in discrete steps from one fraction of a second to the next.

6.B.5 Method of Evaluation

Since the sources of uncertainty in this calibration are different types, such as the absolute accuracy specification for reaction time, the relative accuracy specification for the frequency source, and an absolute specification of ± 1 count for the counter, it is necessary to define the calibration conditions and convert all specifications to a common format.

The uncertainty example in Table 11 assumes that the synthesized signal generator can produce a 1 kHz signal with an uncertainty of 1×10^{-8} or less. The stopwatch is compared to the counter for 3 hours (10 800 s). The stopwatch is started and stopped with one hand, and the counter is started and stopped with the other. The stopwatch is digital and the resolution is 0.01 s. As in the previous uncertainty example, all sources of uncertainty are combined by root sum of squares, and uncertainties are rounded to the nearest millisecond.

Table 11 - Uncertainty analysis for totalize method.

Source of uncertainty	Magnitude, ms	Method of evaluation	Distribution	Standard uncertainty, ms
Human reaction time bias	27	Type B	Rectangular	16
Human reaction time standard deviation	10	Type B	Normal ($k = 1$)	10
Synthesizer accuracy	0	Type B	Rectangular	0
Totalize counter resolution	1	Type B	Rectangular	1
$\frac{1}{2}$ DUT resolution	5	Type B	Rectangular	3
Combined uncertainty				19
Expanded uncertainty ($k = 2$, representing approximately a 95 % level of confidence)				38

6.C. Photo Totalize Method

An alternative measurement technique to the totalize method previously discussed involves using a high speed camera (digital or film type). The equipment is set up in the same manner as in Section 6.A. In this method, both the stopwatch being calibrated and the universal counter are started in no particular order. When both instruments are counting, a photo is taken of the two instruments. Under appropriate shutter and lighting conditions, the resulting photo will clearly show the time displayed on both the stopwatch and counter. Both readings are recorded as the initial measurements in the calibration. After an appropriate amount of time has elapsed, a second photo is taken and the displays are recorded as the closing measurements. The difference in elapsed time for the stopwatch is compared to the difference in elapsed time for the counter to determine the measured offset of the stopwatch.

Figure 17 shows that the initial counter reading is 53.980 s and the stopwatch is at 57.52 s. Figure 18 shows that the counter reading is 82.049 s and the stopwatch is at 1 minute 26.18 s (86.18 s). The elapsed time on the counter is $82.049 - 53.980 = 28.069$ s, and likewise the elapsed time on the stopwatch is $86.18 - 57.52 = 28.66$ s. This would indicate that over the 28 s interval, the stopwatch was in error by 0.59 s or approximately 1820 s per day.



Figure 17. Photo totalize start reading.

❖ Stopwatch and Timer Calibrations



Figure 18. Photo totalize stop reading.

WARNING NOTE - In order for this method to provide accurate results, the photo system must be set up in a manner that captures the stopwatch and counter display correctly. If the shutter speed is too slow, the images will not produce discernable information, as Figure 19 shows for the stopwatch. We could interpret this stopwatch reading with the 1/10 s digit as 9, 7, 3, or 4, and the 1/100 s digit as 3, 5, or 6.

Additionally, often when the photo yields a very clear display as in Figures 17 and 18, the resulting measurement is not valid. This stopwatch was previously calibrated using other methods described in this book and was found to have an offset of less than 1 second per day, which is significantly different from the photo totalize method results indicated above. For this example and photo equipment setup, the method produced false results. Anyone using the photo totalize method must validate the measurement results of their measurement process by comparing results obtained for a particular instrument to other measurement methods discussed in this book.



Figure 19. Ambiguous photo totalize reading.

Section 6.C.1. Advantages of the Photo Totalize Method

Using this measurement method, all uncertainty due to human reaction time is reduced to zero. This makes the estimate of measurement uncertainty smaller, and the amount of time needed to complete a calibration shorter than the direct comparison or totalize method. This method also makes it possible to calibrate multiple stopwatches at the same time, and then maintain the photos as archival data.

Section 6.C.2. Disadvantages of the Photo Totalize Method

This method can **VERY EASILY** produce erroneous results. As previously stated, the measurement results for the particular cameras used by the laboratory should always be compared to measurement results of the same unit under test using other methods described in this book.

Section 7

The Time Base Method

The time base measurement method is the preferred method for stopwatch and timer calibrations, since it introduces the least amount of measurement uncertainty. Because the DUT's time base is measured directly, the calibration technician's response time is not a factor.

The exact method of measuring the stopwatch's time base depends upon the type of stopwatch or timer being calibrated. If the unit has a quartz crystal time base, an inductive or acoustic pickup is used to monitor the stopwatch's 32 768 Hz time base frequency on a calibrated frequency counter (the pickup is fed into an amplifier to boost the signal strength). If the unit is an older LED-type stopwatch, the frequency is usually 4.19 MHz. An inductive pickup can even be used to sense the stepping motor frequency of analog mechanical stopwatches, or the "blink rate" of a digital stopwatch display. Or, an acoustic pickup can be used to measure the "tick" of a mechanical stopwatch.

7.A. References for the Time Base Method

The reference for a time base calibration is the time base oscillator of the measuring instrument. For example, if a frequency counter is used, the measurement reference is the time base oscillator of the frequency counter. In order to establish traceability, the frequency counter time base must have been recently calibrated and certified. However, a better solution is to have the laboratory maintain a traceable 5 MHz or 10 MHz signal that can be used as an external time base for the frequency counter and all other test equipment. If an external time base is used and its measurement uncertainty is known, it is unnecessary to calibrate the internal time base oscillator.

7.B. Calibration Procedure for the Time Base Method

Two methods of calibrating a stopwatch time base are described below. One uses a commercially available measurement system; the other uses a frequency counter with an acoustic pickup. Note that neither calibration method requires opening the case of the stopwatch or timer. Keep in mind that you should never disassemble a stopwatch or timer and attempt to measure the time base frequency by making a direct electrical connection. The crystal oscillators in these units are very small, low-power devices. Their frequency can dramatically change if they are disturbed or loaded down by the impedance of a frequency counter, and in some cases they can even be destroyed by incorrect electrical connections.

7.B.1. Using a Commercial Time Base Measurement System

Time base measurement systems are available from several vendors. One example of a commercially available time base measurement system (Figure 20) is described here for the purposes of illustration. This unit measures the frequency of the time base oscillator, and converts this information to a display of seconds per day, or seconds per month. This same function could be performed with a sensor (acoustic or inductive pickup), a frequency counter, and the conversion formula described in the next section.



Figure 20. Time base measurement system for stopwatches and timers.

The example unit uses a 4.32 MHz quartz time base oscillator as a measurement reference. In a 2 s measurement period (the shortest period used by the instrument), the oscillator produces 8 640 000 cycles, which equals the number of 0.01 s intervals in one day. Therefore, the instrument resolution is 0.01 s per day. Cycles from the DUT time base are counted by a sensor that is connected to the measurement system. The sensor uses the cycle count from the DUT to start and stop the cycle count from the reference time base. For a 2 s measurement interval, a 32 768 Hz DUT would stop the cycle count from the reference time base after counting to 65 536 ($32\,768 \times 2$). If the reference time base counted to 8 639 900 during this same interval, then the system would estimate that the DUT would gain about 1 s per day (100×0.01 s).

The time base measurement system shown in Figure 20 allows the measurement interval to be set from 2 s to 960 s. Selecting an interval longer than 2 s is effectively the same thing as increasing the gate time on a frequency counter. It is important to measure for a long enough period to get an accurate and stable reading. When testing a 32 768 Hz quartz stopwatch, a 10 s to 12 s measurement is normally sufficient to obtain a reading stable to ± 1 count. When testing an older mechanical (Type II) stopwatch, a longer measurement of 120 s or more may be required. Table 12 shows the effect that the length of the measurement time has on the stability of the stopwatch calibrator's readings.

Table 12 - The effect of the length of the measurement time on stability (based on 25 readings).

Measurement time	2 s	10 s	12 s	20 s
Mean	-0.03	-0.06	-0.06	-0.06
Standard deviation of the mean	0.0050	0.0012	0.0011	0.0006
Maximum	0.00	-0.05	-0.05	-0.06
Minimum	-0.09	-0.07	-0.07	-0.07
Range	0.09	0.02	0.02	0.01

To support 0.01 s resolution, the instrument’s 4.32 MHz time base oscillator must be calibrated to within 1.16×10^{-7} . If the instrument is calibrated to within specifications, the display uncertainty is ± 0.05 s per day (maximum time base frequency offset of about 6×10^{-7}). In all cases, the uncertainty of the time base oscillator relative to UTC must be known in order to establish traceability. The system can be calibrated by applying either a traceable 1 pulse per second (pps) signal to a pin connector on the back of the unit or a traceable 32 768 Hz reference signal to the sensor, or by extracting and measuring the 4.32 MHz signal directly with a traceable frequency measurement system.

The DUT can be a Type 1 stopwatch (both 32 768 Hz and 4.19 MHz devices can be measured), or a Type 2 mechanical stopwatch. The 32 768 Hz signal is picked up with an acoustic sensor, and then compared to the time base oscillator. A 1 Hz offset in the 32 768 Hz signal translates to a time offset of about 2.6 s per day. A capacitive sensor is used to detect the 4.19 MHz frequency of quartz time base oscillators, an acoustic or inductive pickup is used to sense the stepping motor frequency of analog mechanical stopwatches, and an inductive pickup is used to sense the “blink rate” of digital stopwatches.

Front panel switches allow the operator to select the type of device being tested, the measurement interval, and whether the time offset should be displayed as seconds per day or seconds per month. Once these parameters have been chosen, the device is measured by simply positioning it on top of the sensor until a usable signal is obtained, waiting for the measurement interval to be completed, and then recording the number from the display. It is always a good idea to allow the stopwatch calibrator to complete at least two complete measurement cycles before recording a reading.

Figure 21 shows a more elaborate time base measurement system with some additional features. This device has a small LCD display with graphics capability, built-in temperature measurement capability, an RS-232 interface that allows measurement results to be transferred to a computer, and an optional Global Positioning System (GPS) satellite receiver that corrects and calibrates the quartz time base oscillator. Like the system shown in Figure 20, this system can measure the 32 768 Hz quartz crystal frequency of Type 1 stopwatches, the

❖ Stopwatch and Timer Calibrations

stepping motor frequency of analog stopwatches, and the “blink rate” of digital stopwatches. As an additional benefit, this system can measure the quartz crystal frequency and the stepping motor frequency at the same time. This can be useful if the device under test compensates for the frequency offset of the quartz crystal by applying corrections to the stepping motor, thus making the analog display more accurate than the time base (a common practice in analog quartz wristwatches).



Figure 21. A time base measurement system for stopwatches and timers with an integrated graphics display.

7.B.2. Using a Frequency Counter and an Acoustic Pickup

If an acoustic pickup and amplifier are available, you can measure the frequency of a stopwatch time base directly with a frequency counter. The reading on the counter display can be used to calculate the frequency offset using this equation:

$$f(\text{offset}) = \frac{f_{\text{measured}} - f_{\text{nominal}}}{f_{\text{nominal}}},$$

where f_{measured} is the reading displayed by the frequency counter, and f_{nominal} is the frequency labeled on the oscillator (the nominal frequency it is supposed to produce).

If f_{nominal} is 32 768 Hz and f_{measured} is 32 767.5 Hz, then the frequency offset is $-0.5 / 32\,768$ or -1.5×10^{-5} or -0.0015% . To get time offset in seconds per day, multiply the number of seconds per day (86400) and the frequency offset:

$$86\,400 \times (-1.5 \times 10^{-5}) = -1.3 \text{ s per day,}$$

which means the stopwatch can be expected to lose 1.3 s per day. You might find it easier to note that a 1 Hz error in a 32 768 Hz device equates to a time offset of about 2.64 s, since $86\,400 / 32\,768 = 2.64$. Therefore, a 2 Hz offset is about 5.3 s / day, a 3 Hz offset is about 7.9 s / day, and so on. If the acceptable tolerance is 10 s / day, then you'll know that 3 Hz is well within tolerance.

These results show that even a low cost eight-digit frequency counter will provide more measurement resolution than necessary when measuring 32 768 Hz devices. The last digit on an eight-digit counter represents 0.001 Hz (1 mHz), and a 1 mHz frequency offset represents a time offset of just 2.6 ms per day. Very few stopwatches or timers can perform at this level.

7.B.3. Advantages of the Time Base Method

The time base method completely eliminates the uncertainty introduced by human reaction time. The measurement uncertainty can be reduced by at least two orders of magnitude when compared to the direct comparison method, often to 1×10^{-6} or less. This method is also much faster. The measurement can often be performed in a few seconds, as opposed to the several hours typically required for the direct comparison method.

7.B.4. Disadvantages of the Time Base Method

This method requires more equipment than the direct comparison method, and does not easily work on some electrical, mechanical, or electro-mechanical units. It also does not test the functionality of the stopwatch or timer, only the time base. Function tests need to be performed separately by starting the unit, letting it run for a while (a few minutes to a few hours, depending on how the unit is used), and stopping the unit. If the unit appears to be counting correctly, the displayed time interval will be accurate.

7.C. Uncertainties of the Time Base Method

This method utilizes either a time base measurement system or a frequency counter with an acoustic or inductive pickup to measure the frequency of the device's internal time base oscillator. If we use the time base measurement system shown in Figure 20 as an example, and take into account its specified accuracy of ± 0.05 s/day and its resolution of 0.01 s, then the measurement uncertainty equals 0.05 s/day (50 ms/day). There is no uncertainty contributed by human reaction time, and the resolution uncertainty of the stopwatch calibrator is insignificant compared to its accuracy specification. Resolution uncertainty does not need to be considered, since data are not observed from the DUT's display. Since there is only one uncertainty component, we did not include an uncertainty analysis table.

Section 8

How to Determine if the Calibration Method Meets the Required Uncertainty

The preceding sections have provided estimates of expanded measurement uncertainty associated with various types of stopwatch calibrations. It is important to ensure that the achievable measurement uncertainty is relatively small when compared to the stopwatch tolerance we are attempting to verify. For example, if we use the direct comparison method to calibrate a stopwatch with an accuracy of 5 s per day (0.01 s resolution), and we decide to use a calibration period of 5 minutes, the accuracy of the stopwatch over the 5 minute interval would be about 17 ms. The first problem arises in that the resolution of the stopwatch is 0.01 s, and cannot display 0.017 s, making the specification impossible to verify for this time period. Furthermore, the measurement uncertainty for the calibration process is 480 ms, approximately 28 times larger than the accuracy that we are trying to verify! Clearly a 5 minute calibration period for this stopwatch and calibration method is not adequate. Even a 1 hour calibration is inadequate, because the quantity required to be measured, now about 208 ms, is still less than half of the measurement uncertainty.

As stated in *ISO/IEC 17025* [4], when a statement of compliance to a metrological specification is made (for example, is the DUT “in tolerance” or “out of tolerance” based on the manufacturer’s specifications), the laboratory must take the measurement uncertainty into account. It is the responsibility of the calibration laboratory to decide whether the measurement uncertainty associated with the calibration method is small enough to comply with the metrological requirement. Calibration laboratories generally use some sort of decision rule for determining whether the uncertainty associated with the calibration method is adequate. Examples of such rules are the N:1 decision rule (where the tolerance of the instrument to be tested is N times larger than the calibration uncertainty and is mostly commonly stated as 4:1 or 3:1), or some form of guardbanding (where the calibration uncertainty or some fraction of it is subtracted from the DUT accuracy specification and the calibration results are acceptable only if the measured offset was within the guardband limit). Whatever the case, it is important to compare the calibration measurement uncertainty to the tolerance of the DUT, in order to ensure that the calibration process is valid.

To illustrate this, assume that a laboratory employs a 4:1 rule for acceptable uncertainty. This means that the expanded measurement uncertainty of the calibration must be four times smaller than the acceptable tolerance of the DUT in order to declare the unit in or out of tolerance. The laboratory is calibrating a digital stopwatch to a tolerance of 0.02 %, using the direct comparison calibration method via a telephone landline (Table 8). The estimated expanded measurement uncertainty for this method was 482 ms. In order for 482 ms to be one quarter of the tolerance of the DUT, the tolerance must be 1928 ms. The amount of time required to elapse on the stopwatch during the calibration would be at least:

❖ Stopwatch and Timer Calibrations

$$\frac{1.928 \text{ s}}{0.02 \%} = X \text{ s} = 9640 \text{ s} = 2 \text{ h } 41 \text{ minutes} .$$

For the same scenario, if we were trying to verify the stopwatch shown in Figure 8 to the manufacturer's specification of 0.0003 %, the stopwatch would have to run for more than 1 week (178 hours, 31 minutes, and 7 s). This is impractical, and the laboratory that is testing to 0.0003 % would clearly want to consider the time base method as a much faster, more appropriate method.

Section 9

Other Topics Related to Measurement Uncertainty

This section discusses other important topics related to measurement uncertainty. The first involves estimating the uncertainty of a field calibration, where a reference standard stopwatch is brought into the field and used to calibrate another device. Next, the stability and aging of 32 768 Hz quartz crystal oscillators used in stopwatches and timers is discussed, followed by discussions of how the performance of a stopwatch can change when a new battery is installed, and how extreme temperature conditions can affect stopwatch performance.

9.A. Uncertainty Analysis of Using a Calibrated Stopwatch to Calibrate another Device

A calibrated stopwatch is often used to perform field calibrations of other timing devices, such as an industrial timer or parking meter. In this example (Table 13), we are calibrating an industrial timer with 1 s resolution. The reference for the calibration is a stopwatch that has a specified accuracy of 5 s per day (about 208 ms per hour), 0.01 s resolution, and a calibration uncertainty of 0.2 s per day (roughly 8 ms per hour). As previously discussed in Section 5.C.2, the human reaction time bias is 120 ms, and the human reaction time standard deviation is 230 ms. The measurement time for the calibration is 1 hour (3600 s). Using these values and the analysis provided in Table 13, the uncertainty of the industrial timer when measuring a 1 hour interval is 789 ms, or 0.02 %. All values in Table 13 are rounded to the nearest millisecond.

When performing this analysis, it is important to include the specified accuracy of the reference stopwatch, which takes into account long-term sources of error during the calibration interval that may not have been noticeable during the time of calibration. It is also important to consider the uncertainty of the stopwatch calibration as part of the budget when using a stopwatch as a reference, because it may be relatively large when compared to the other sources of uncertainty in the measurement process.

❖ Stopwatch and Timer Calibrations

Table 13 - Uncertainty analysis of using a calibrated stopwatch to calibrate another device.

Source of uncertainty	Magnitude, ms	Method of evaluation	Distribution	Standard uncertainty, ms
Unit under test resolution ½ digit	500	Type B	Rectangular	289
Human reaction time bias	120	Type B	Rectangular	69
Human reaction time standard deviation	230	Type B	Normal ($k = 1$)	230
Stopwatch accuracy	208	Type B	Rectangular	120
Stopwatch resolution ½ digit	5	Type B	Rectangular	3
Stopwatch calibration uncertainty	8	Type B	Normal ($k = 2$)	4
Combined uncertainty				394
Expanded uncertainty ($k = 2$, representing approximately a 95 % level of confidence)				789

9.B. The Effects of Stability and Aging on Calibrations of 32 768 Hz Crystals

Aging is the systematic change in frequency over time due to internal changes in an oscillator. All quartz oscillators are subject to aging, and the rate at which they age is often a key factor in determining their calibration interval. The aging rate of a quartz crystal oscillator often depends upon its surface area to volume ratio, and small, low frequency crystals generally have low aging rates [18]. Thus, the 32 768 Hz crystals found in stopwatches and timers usually tend to age slowly and have very good long term stability, and their frequency changes by a surprisingly small amount over time.

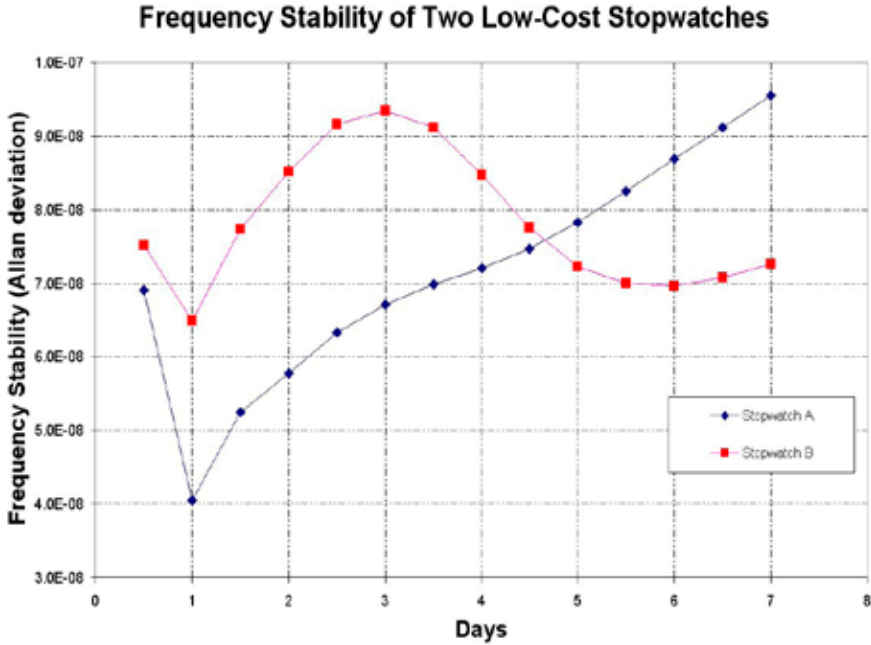

Figure 22. Graph of the frequency stability of two stopwatches.

To illustrate this, Figure 22 is a graph of the frequency stability of two stopwatches that were continuously measured over a period of more than one month using a previously described (Section 7.B.1) time base measurement system. Both stopwatches were low cost devices; stopwatch A had a suggested list price of about \$25 USD, and stopwatch B sells for about \$55 USD. The laboratory temperature during the measurement was about $23\text{ }^{\circ}\text{C} \pm 1\text{ }^{\circ}\text{C}$. The graph shows the Allan deviation (ADEV) of each stopwatch for averaging times ranging from 0.5 days to 7 days. ADEV is a commonly used statistic for estimating frequency stability [19]. It differs from the conventional standard deviation because it does not use the average frequency as a point of reference. Instead, it compares the frequency offset of the DUT during each measurement period with its frequency offset during the previous measurement period. By doing so, it reveals how the frequency of an oscillator changes over time due to effects such as aging.

Stopwatch A had an average frequency offset (accuracy) during the test of about 8×10^{-6} . As indicated in Figure 22, the stability (ADEV) was slightly better than 1×10^{-7} after one week, or about 80 times better than the accuracy. Stopwatch B had an average frequency offset (accuracy) during the test of about 5×10^{-7} . Its stability as estimated with ADEV was near 7×10^{-8} after one week, or about seven times better than its accuracy.

❖ Stopwatch and Timer Calibrations

Because of their slow aging rate, stopwatches tend to produce very repeatable results over long periods of time. When compared to the requirements for stopwatch calibrations discussed in Section 3, the small changes in frequency due to aging are usually insignificant. This makes it possible for a laboratory to allow long intervals (perhaps exceeding one year) between calibrations.

9.C. Factors That Can Affect Stopwatch Performance

Many factors can cause a quartz crystal oscillator to change frequency. Some of these are shown in Figure 23. Sharp temperature changes, vibration, and shock are some of the more common phenomena that can affect the time base on a day-to-day basis. Also, if power is removed from an oscillator and later restored, there can be a shift in the frequency. This is true of quartz crystal stopwatches when the battery is changed. This frequency change is usually small when compared to the stopwatch's time base specifications, usually less than 10 to 20 parts in 10^6 (~10 to 20 ms/day) and usually short-term, with the time base returning to its original frequency after a period ranging from a few hours to a few days.

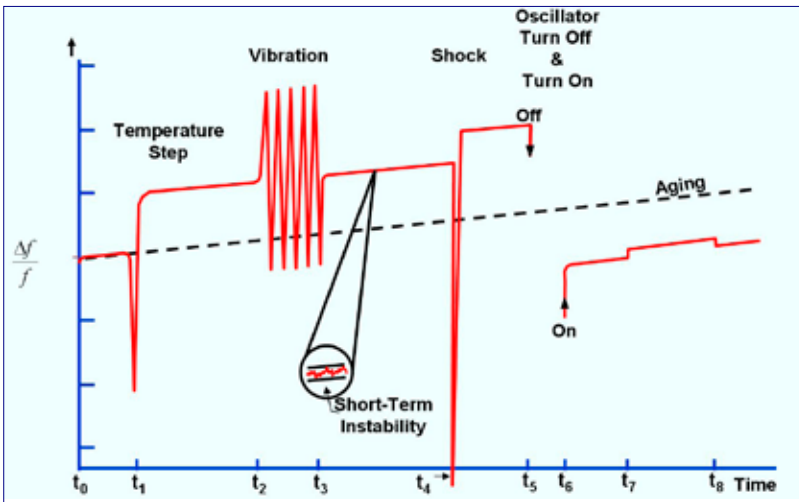

Figure 23. Factors that can change the quartz time base frequency.

Temperature is perhaps the most important factor that affects quartz crystal time base performance. The quartz crystals used in wrist watch time bases are cut in such a way as to make them most stable near body temperature. The time base acts as a thermally stable oscillator while it is on a person's wrist. Stopwatches, on the other hand, use quartz crystals that have been cut to be stable at or near room temperature. If they are used in very hot or very cold environments, the time base can vary by over 20 parts in 10^6 . Figure 24 shows the accuracy of a typical stopwatch over a temperature range of 0 °C to 50 °C (32 °F to 122 °F).

Other Topics Related to Measurement Uncertainty ❖

As can be seen in the figure, the flat portion of the performance curve is near room temperature (23 °C or 73 °F), and drops off as the temperature increases or decreases.

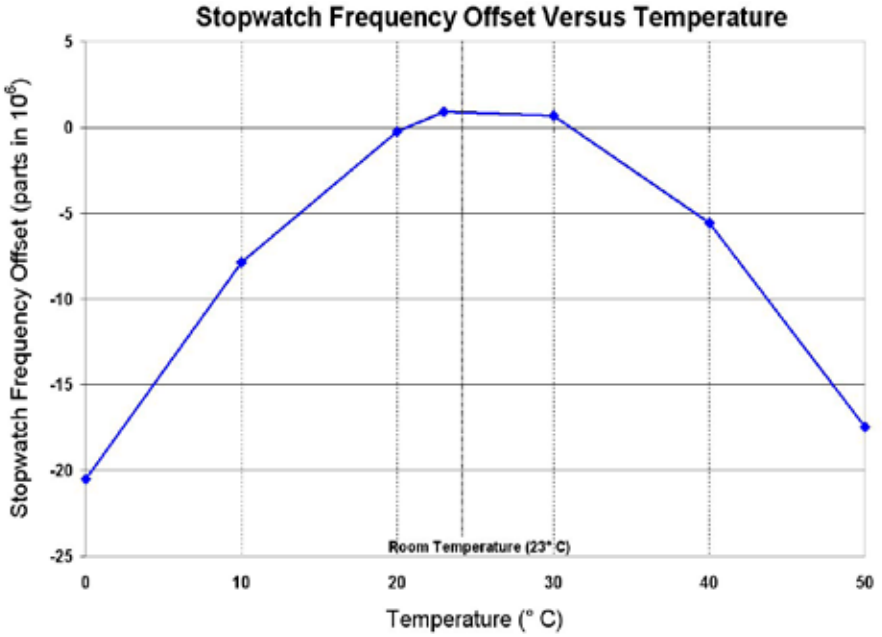

Figure 24. Stopwatch accuracy versus temperature.

Appendix A

Calibration Certificates

If a calibration certificate is issued for a stopwatch or timer, it should contain the information listed in Section 5.10 of *ISO/IEC 17025* [4]. Some of the necessary elements are the name and address of the laboratory, the name and address of the client, the identification of the method used, and a description of the item being calibrated. A sample calibration certificate that is compliant with *ISO/IEC 17025* is shown in Figure A1.

XXX CALIBRATION LABORATORY XXX Calibration Laboratory, City, State, Zip		CERTIFICATE
		CALIBRATION File: 47821
Instrument:	TIMER-CLOCK	
Manufacturer:	Fisher Scientific	
Model Number:	14-648-1	
Serial Number:	1234566	
Submitted by:	Timing Test Labs 123 Test Lab Lane Anytown, USA	
As Found Condition:	In Tolerance	
As left Condition:	Left As Found	
Certified:	November 18, 2002	
<p>This unit was tested using the Laboratory's Stopwatch/Timer Calibration Station, MMS #9410, utilizing procedure #LAB 9812. The calibration data indicates a deviation from the reference standard in seconds per day (+/-), tolerance of the Device Under Test, and Expanded Uncertainty of Measurement ($k=2$, representing approximately 95% confidence).</p>		
Calibration Data		
<u>Measured Value</u>	<u>Tolerance</u>	<u>Expanded Uncertainty</u>
+0.29 s/d	8.64 s/d	0.0864 s/d
Calibration Procedure:	Stopwatch/Timer Version 1,03/11/1999	
Laboratory Temperature:	23.0 °C ±2.0 °C	
Laboratory Humidity:	40.0 % ±5.0 %	
Certificate Number:	146316	
Metrologist: Calibration M. Technician	Approved by: I. M. Boss	
Example Cal Cert	Page 1 of 2	

Figure A1. Sample calibration certificate. (page 1)



Stopwatch and Timer Calibrations

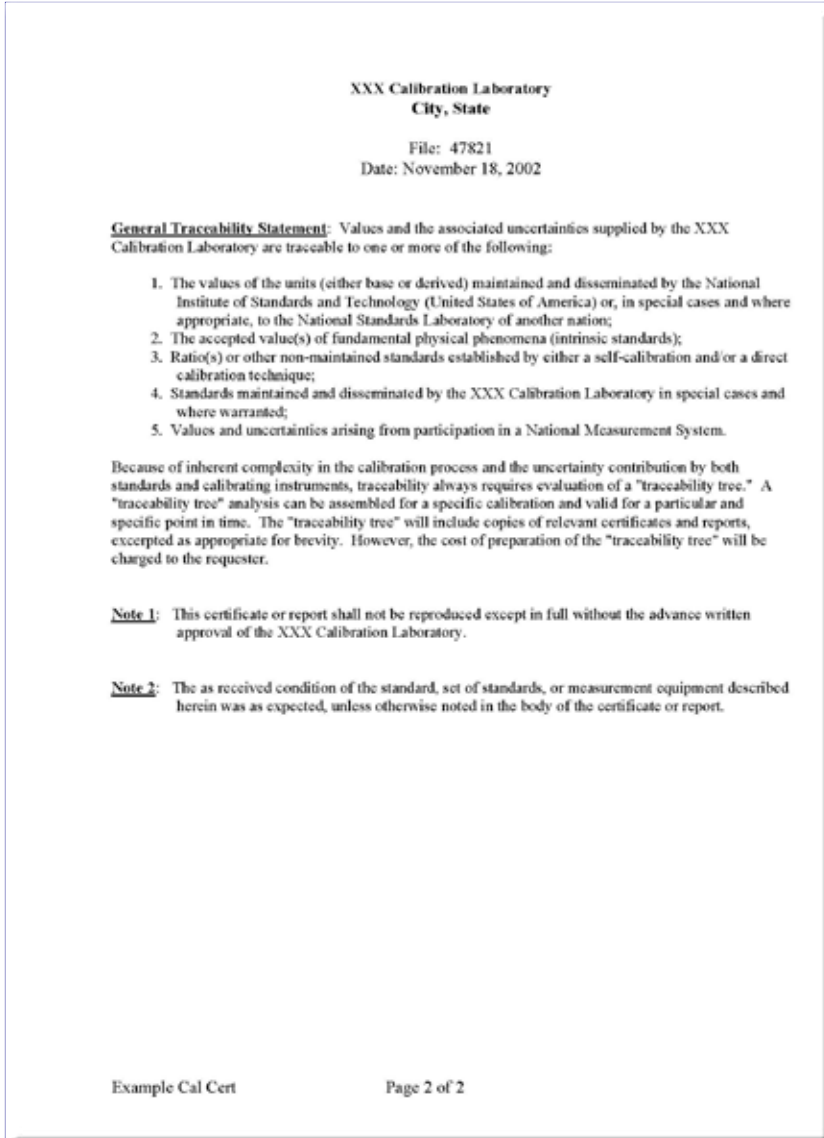

Figure A1. Sample calibration certificate. (page 2)

Appendix B

References

- [1] B. N. Taylor and A. Thompson, (Eds.), “The International System of Units (SI),” Natl. Inst. Stand. Technol. Special Publication 330, 2008 Edition, March 2008.
- [2] BIPM/IEC/IFCC/ISO/IUPAC/IUPAP/OIML, Guide to the Expression of Uncertainty in Measurement (GUM), 1995.
- [3] International Organization for Standardization (ISO), International Vocabulary of Metrology – Basic and General Concepts and Associated Terms (VIM), 2008.
- [4] International Organization for Standardization (ISO), General Requirements for the Competence of Testing and Calibration Laboratories, ISO/IEC Guide 17025, 2005.
- [5] R. J. Anderson and G. L. Harris, “Specifications and Tolerances for Field Standard Stopwatches,” Natl. Inst. Stand. Technol. Handbook 105-5, October 1997.
- [6] Robbins, Michael, “Electronic Clocks and Watches,” Howard W. Sams Co., Indianapolis, IN, 1975.
- [7] J. R. Vig, “Introduction to Quartz Frequency Standards,” Army Research and Development Technical Report, SLCET-TR-92-1, October 1992
- [8] North American Electric Reliability Council (NERC), “Time Error Correction,” Standard BAL-004-0, April 2005.
- [9] T. Butcher, L. Crown, L. Sebring, R. Suiter, J. Williams, editors, “Specifications, Tolerances, and other Technical Requirements for Weighing and Measuring Devices,” Natl. Inst. Stand. Technol. Handbook 44, 2007 edition (updated annually).
- [10] M. A. Lombardi, “Legal and Technical Measurement Requirements for Time and Frequency,” Measure: The Journal of Measurement Science, 1(3): 60-69, September 2006.
- [11] State of Pennsylvania code, 67 § 105.71(2), 2005.
- [12] R. M. Graham, “Calibration Techniques for Stopwatches and Timers,” Proc. 2003 National Conference of Standards Laboratories (NCSLI), 6 p., August 2003.
- [13] M. A. Lombardi, “NIST Time and Frequency Services,” Natl. Inst. Stand. Technol. Special Publication 432, 71 p., January 2002.
- [14] International Telecommunications Union (ITU), “One-way Transmission Time,” ITU Recommendation G.114, May 2003.

❖ Stopwatch and Timer Calibrations

[15] International Telecommunications Union (ITU), “The Control of Jitter and Wander within Digital Networks Which are Based on the 1544 kbit/s Hierarchy,” ITU Recommendation G.824, March 2000.

[16] D. W. Allan, D. D. Davis, J. Levine, M. A. Weiss, N. Hironaka, and D. Okayama, “New Inexpensive Frequency Calibration Service from NIST,” Proc. 1990 IEEE Freq. Cont. Symp., pp. 107-116, May 1990.

[17] S. D. Phillips, K. R. Eberhardt, “Guidelines for Expressing the Uncertainty of Measurement Results Containing Uncorrected Bias,” Natl. Inst. Stand. Technol. J. Res., 102(5): 577-585, September-October 1997.

[18] J. R. Vig and T. R. Meeker, “The Aging of Bulk Acoustic Wave Resonators, Filters, and Oscillators,” Proc. 1991 IEEE Freq. Cont. Symp., pp. 77-101, May 1991.

[19] IEEE, “IEEE Standard Definitions of Physical Quantities for Fundamental Frequency and Time Metrology - Random Instabilities,” IEEE Standard 1139-1999, March 1999.



January 2009