



NBS TECHNICAL NOTE 656

U.S. DEPARTMENT OF COMMERCE / National Bureau of Standards

Standard Time and Frequency: Its Generation, Control, and Dissemination by the National Bureau of Standards

NATIONAL BUREAU OF STANDARDS

The National Bureau of Standards¹ was established by an act of Congress March 3, 1901. The Bureau's overall goal is to strengthen and advance the Nation's science and technology and facilitate their effective application for public benefit. To this end, the Bureau conducts research and provides: (1) a basis for the Nation's physical measurement system, (2) scientific and technological services for industry and government, (3) a technical basis for equity in trade, and (4) technical services to promote public safety. The Bureau consists of the Institute for Basic Standards, the Institute for Materials Research, the Institute for Applied Technology, the Institute for Computer Sciences and Technology, and the Office for Information Programs.

THE INSTITUTE FOR BASIC STANDARDS provides the central basis within the United States of a complete and consistent system of physical measurement; coordinates that system with measurement systems of other nations; and furnishes essential services leading to accurate and uniform physical measurements throughout the Nation's scientific community, industry, and commerce. The Institute consists of a Center for Radiation Research, an Office of Measurement Services and the following divisions:

Applied Mathematics — Electricity — Mechanics — Heat — Optical Physics — Nuclear Sciences² — Applied Radiation² — Quantum Electronics³ — Electromagnetics³ — Time and Frequency³ — Laboratory Astrophysics³ — Cryogenics³.

THE INSTITUTE FOR MATERIALS RESEARCH conducts materials research leading to improved methods of measurement, standards, and data on the properties of well-characterized materials needed by industry, commerce, educational institutions, and Government; provides advisory and research services to other Government agencies; and develops, produces, and distributes standard reference materials. The Institute consists of the Office of Standard Reference Materials and the following divisions:

Analytical Chemistry — Polymers — Metallurgy — Inorganic Materials — Reactor Radiation — Physical Chemistry.

THE INSTITUTE FOR APPLIED TECHNOLOGY provides technical services to promote the use of available technology and to facilitate technological innovation in industry and Government; cooperates with public and private organizations leading to the development of technological standards (including mandatory safety standards), codes and methods of test; and provides technical advice and services to Government agencies upon request. The Institute consists of a Center for Building Technology and the following divisions and offices:

Engineering and Product Standards — Weights and Measures — Invention and Innovation — Product Evaluation Technology — Electronic Technology — Technical Analysis — Measurement Engineering — Structures, Materials, and Life Safety⁴ — Building Environment⁴ — Technical Evaluation and Application⁴ — Fire Technology.

THE INSTITUTE FOR COMPUTER SCIENCES AND TECHNOLOGY conducts research and provides technical services designed to aid Government agencies in improving cost effectiveness in the conduct of their programs through the selection, acquisition, and effective utilization of automatic data processing equipment; and serves as the principal focus within the executive branch for the development of Federal standards for automatic data processing equipment, techniques, and computer languages. The Institute consists of the following divisions:

Computer Services — Systems and Software — Computer Systems Engineering — Information Technology.

THE OFFICE FOR INFORMATION PROGRAMS promotes optimum dissemination and accessibility of scientific information generated within NBS and other agencies of the Federal Government; promotes the development of the National Standard Reference Data System and a system of information analysis centers dealing with the broader aspects of the National Measurement System; provides appropriate services to ensure that the NBS staff has optimum accessibility to the scientific information of the world. The Office consists of the following organizational units:

Office of Standard Reference Data — Office of Information Activities — Office of Technical Publications — Library — Office of International Relations.

¹ Headquarters and Laboratories at Gaithersburg, Maryland, unless otherwise noted; mailing address Washington, D.C. 20234.

² Part of the Center for Radiation Research.

³ Located at Boulder, Colorado 80302.

⁴ Part of the Center for Building Technology.

Standard Time and Frequency: Its Generation, Control, and Dissemination by the National Bureau of Standards

John B. Milton

**Time and Frequency Division
Institute for Basic Standards
National Bureau of Standards
Boulder, Colorado 80302**

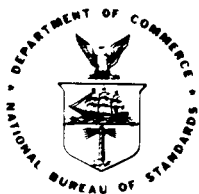

U.S. DEPARTMENT OF COMMERCE, Frederick B. Dent, Secretary

NATIONAL BUREAU OF STANDARDS Richard W. Roberts, Director

Issued June 1974

National Bureau of Standards Technical Note 656

Nat. Bur. Stand. (U.S.), Tech. Note 656, 21 pages (June 1974)

CODEN: NBTNAE

For sale by the Superintendent of Documents, U.S. Government Printing Office, Washington, D.C. 20402

(Order by SD Catalog No. C13.46:656) \$35

CONTENTS

	<u>Page</u>
1. INTRODUCTION	1
2. STANDARD FREQUENCY AND TIME GENERATION	3
2.1 Time and Frequency Division	3
2.1.1 The NBS frequency standard	3
2.1.2 Computed or "paper" time scales	4
2.1.3 Operational clock systems	4
2.2 Radio Station WWV, Fort Collins, Colorado	4
2.3 Radio Station WWVH, Kauai, Hawaii	7
2.4 Radio Station WWVB, Fort Collins, Colorado.	7
2.5 Radio Station WWVL, Fort Collins, Colorado.	7
3. TRANSMISSION OF TIME AND FREQUENCY	11
3.1 Transmission from WWV and WWVH	11
3.2 Transmission from WWVB	11
3.3 Transmission from WWVL (Experimental)	13
4. TIME AND FREQUENCY INTERCOMPARISONS	14
4.1 WWV Self-Comparisons	14
4.2 WWVH Self-Comparisons	14
4.3 WWV to WWVB and WWVL	14
4.4 Between the Fort Collins Standards and the WWVH Standard	16
4.5 Between the Fort Collins Standards and the NBS Standard	16
4.5.1 Portable clocks	16
4.5.2 TV synchronizing pulse method	16
5. SUMMARY	18
6. APPENDIX	18
6.1 Explanation of NBS Time Scales	18
6.1.1 AT(NBS)	18
6.1.2 UTC(NBS)	18

LIST OF FIGURES

	<u>Page</u>
Figure 1. System for Generation of Computed Time Scales AT(NBS) and UTC(NBS)	5
Figure 2. Standard Frequency and Time Interval Generating System	6
Figure 3. WWV Time and Frequency Generation-- One of Three Identical Systems Showing Intercomparisons	8
Figure 4. WWVH Time and Frequency Generation-- One of Three Identical Systems Showing Intercomparisons	9
Figure 5. WWVB Time and Frequency Generation and Control--One of Three Semi-independent systems	10
Figure 6. WWVL Frequency Generation and Control System	12
Figure 7. Clock Intercomparison WWV-WWVB-WWVL	15
Figure 8. Space-Time Diagram of TV Synchronization Method	17

STANDARD TIME AND FREQUENCY: ITS GENERATION, CONTROL,
AND DISSEMINATION BY THE NATIONAL BUREAU OF STANDARDS

John B. Milton

The Time and Frequency Division of the National Bureau of Standards maintains primary frequency standards, which provide a realization of the internationally-defined second, and two atomic time scales, AT(NBS) and UTC(NBS). AT(NBS) is dependent upon the primary frequency standards, an ensemble of commercial cesium clocks, and a computer algorithm to process the data. The UTC(NBS) scale is derived from AT(NBS) by the addition of small annual frequency adjustments and leap second adjustments to keep its time nominally synchronous with the international time scale UTC. The UTC(NBS) time scale is used to calibrate the clocks and secondary standards necessary for the operation of the NBS radio stations, WWV, WWVH, WWVB, and WWVL. These stations transmit various standard frequency and time signals throughout the world, and, in addition, provide certain official announcements such as geoalert warnings, marine weather advisories, and radio propagation forecasts.

Key Words: Clock synchronization; frequency and time dissemination; primary frequency standard; standard frequency broadcasts; time interval; time scales.

1. INTRODUCTION

Since its inception in 1901, the National Bureau of Standards has been involved in the design, construction, maintenance, and improvement of standards of frequency and time interval. During the first two decades of the 20th Century, the work on these standards was done by quite diverse groups.

The people maintaining the standard of time interval were concerned primarily with problems of navigation, while the standard of frequency was maintained by a group concerned chiefly with interference between adjacent channels in the radio spectrum.

Along with the maintenance and improvement of these standards came the need to disseminate these standards. In 1923 the National Bureau of Standards radio station WWV was established to disseminate the standard of frequency via experimental broadcasts. Time pulses were added to these broadcasts in 1935. Voice announcements of the time-of-day were added in 1945.

In 1948, NBS radio station WWVH was placed in operation on the island of Maui, Hawaii. In the 1950's, very good commercial standards were controlling both of these high-frequency radio stations. At that time, nothing was done at the stations beyond providing good crystal oscillators. Utilizing the ultra-high precision oscillators located at the NBS Boulder Laboratories, the time and frequency transmissions of these stations were checked daily. Any deviations from the NBS standard were noted and corrective instructions were relayed to the radio stations.

In 1956, the Boulder Laboratories of the NBS began experimental transmissions on 60 kHz from radio station WWVB. The 60 kHz driving frequency for this station was derived directly from the NBS standard of frequency located at the Boulder Laboratories. There was no control of the transmissions beyond providing this standard driving frequency.

In 1960, utilizing an antenna borrowed from the Central Radio Propagation Laboratory of NBS, radio station WWVL was placed in experimental operation on 20 kHz. This station was located some 10 miles west of the laboratories in a high mountain valley. Direct generation of the transmission frequency by the Boulder Laboratories was not feasible, but a method of phase control using servo systems was employed. Since January 1, 1960, when NBS began using a cesium beam device as its official standard, all broadcast frequencies have been referenced to the cesium resonance frequency.

WWVB and WWVL were moved to Fort Collins, Colorado, and began operation there in July 1963. The original time and frequency control for these stations was accomplished by continuously operating servo systems that compared the phase of these stations as received in Boulder against a phase reference derived from the NBS Frequency Standard. Phase corrective information was then sent to Fort Collins via a radio link.

Primarily in order for NBS to increase the precision and accuracy of the transmissions from station WWV, through more uniform U.S. coverage and the replacement of obsolete transmitting and control equipment, a new facility for that station was installed at Fort Collins, Colorado, in 1966. Station WWVH was moved to a new facility in 1971. The description of this new facility will be found in section 2.3.

Stations WWV, WWVB, and WWVL are, in essence, a composite facility with the ability to disseminate standards of time and frequency from 19.9 kHz to 25 MHz. These stations provide standard atomic frequency and a Universal Time scale, called UTC, which approximates the UT1 scale based on the rotation of the earth.

Even though the time and frequency control of these stations is provided by a highly precise ensemble of clocks and standards, the problem remained of finding a simple, reliable, and inexpensive method of providing a daily calibration of the Fort Collins standards with respect to the NBS reference standards in Boulder.

This paper describes some of the current activities of the Time and Frequency Division of the NBS. These include the generation of the computed NBS time scales, the control of working clocks, and the use of these clocks in coordination efforts with other standards laboratories. The coordination of the Fort Collins site clocks and frequency standards, the measurement and control of LF (and VLF) radiated phase, and the method of coordination of the Fort Collins master clock with that of NBS Boulder are also described. Additional information on the broadcasts is published annually in NBS Special Publication 236, available upon request from the Frequency-Time Broadcast Services Section 273.02, National Bureau of Standards, Boulder, CO 80302.

2. STANDARD FREQUENCY AND TIME GENERATION

2.1 Time and Frequency Division, Boulder, Colorado

With the advent of the first working atomic clock system in 1948, an ammonia device developed by Harold Lyons at NBS Washington, the era of the highly accurate atomic time standards was born. The construction of the original NBS cesium beam device, NBS-I, began in 1949. Much of the initial work at NBS Boulder was under the project direction of R. C. Mockler, and this early work included, among other things, refinement of the NBS-I frequency standard.

In late 1959, the Atomic Frequency Standards Project, including cesium beam and ammonia maser development work, was combined with the project concerned with theoretical and practical aspects of atomic time scales to form the Atomic Frequency and Time Standards Section. At that time, this section was part of the Radio Physics Division.

In 1967, the Atomic Frequency and Time Standards Section was combined with the Frequency-Time Broadcast Services Section and the Frequency-Time Dissemination Research Section to form the Time and Frequency Division.

2.1.1 The NBS Frequency Standard

From about 1959 to 1972 the NBS Frequency Standard (NBSFS) was based on a series of thoroughly-evaluated laboratory cesium beam standards, designated NBS-I, NBS-II, and NBS-III. During this period the specified one-sigma fractional accuracy of the NBSFS--i.e., a statistical estimate of how far the output frequency of the standard may deviate from the "ideal" frequency of the isolated cesium atom, improved from several parts in 10^{11} to 5×10^{-13} . The accuracy estimates are determined from an extensive set of evaluative measurements to assess the magnitude of possible frequency errors that might be introduced by various components, subsystems, and environmental conditions of the overall NBSFS system. Currently, the Quantum Electronic Frequency Standards Program Team is evaluating two new, refined cesium standards, designated NBS-4 and NBS-5. These devices currently produce a documented accuracy near 1×10^{-13} . Further improvements may be expected in the future. Present plans call for operation of this new NBSFS, consisting of the two devices NBS-4 and NBS-5, on an intermittent basis in order to periodically calibrate the frequencies of the working ensemble of clocks in the NBS time scale system. These data, as described next, are used in producing the AT(NBS) and UTC(NBS) time scales.

2.1.2 Computed or "paper" time scales

The Atomic Time Standards Program Team utilizes nine oscillator-clock combinations that produce the computed time scales. One might ask not only what is a "paper" time scale, but also how is it produced, and then how is it used.

The paper time scales, AT(NBS)¹ and UTC(NBS)¹, are in fact composite time scales given by computer printouts which relate the indicated time of each of the nine clocks in the ensemble to the computed scales that are produced by appropriately weighting the individual contributing oscillator-clocks. The computer utilizes the current measured or estimated frequency of each oscillator with respect to the NBSFS, along with the past history of each of the nine oscillators to apply a weighting factor to each oscillator based on its performance. The computed composite scales produced are more uniform than a scale produced by the best unit of the ensemble. The computer output is a set of numbers that are the time differences between each clock output and the computed scales. With this information one has a mechanism for comparing the timekeeping performance of individual clocks comprising the time scale system. This comparison is with respect to AT(NBS). Figure 1 is a simplified diagram of the system that produces the NBS time scales.

2.1.3 Operational Clock Systems

The Time and Frequency Division, through its Atomic Time Standards Program Team, maintains a number of operational clock systems. The outputs of these systems are electrical seconds pulses as well as visual displays of time of day. Two of these clocks' outputs closely approximate the UTC(NBS) time scale. Their deviations from the UTC(NBS) time scale seldom exceed ± 50 nanoseconds. A time comparator and alarm system are associated with these two clocks. The alarm is actuated if the clocks diverge by more than a small preset amount. An adjunct to the operational clock systems is the clock comparison link to Fort Collins that utilizes television synchronizing pulses. Figure 2 is a simplified diagram of these operational clock systems.

2.2 Radio Station WWV, Fort Collins, Colorado

The heart of the time and frequency generation system at WWV is a set of three commercial cesium beam frequency standards. These standards are the basis for three identical generating units which provide to the transmitters a composite RF signal containing the complete WWV format.

The cesium standards, through a series of dividers and distribution amplifiers, drive the three WWV clocks, or more specifically the three WWV time code generators. These time code generators provide the standard

¹ See Appendix

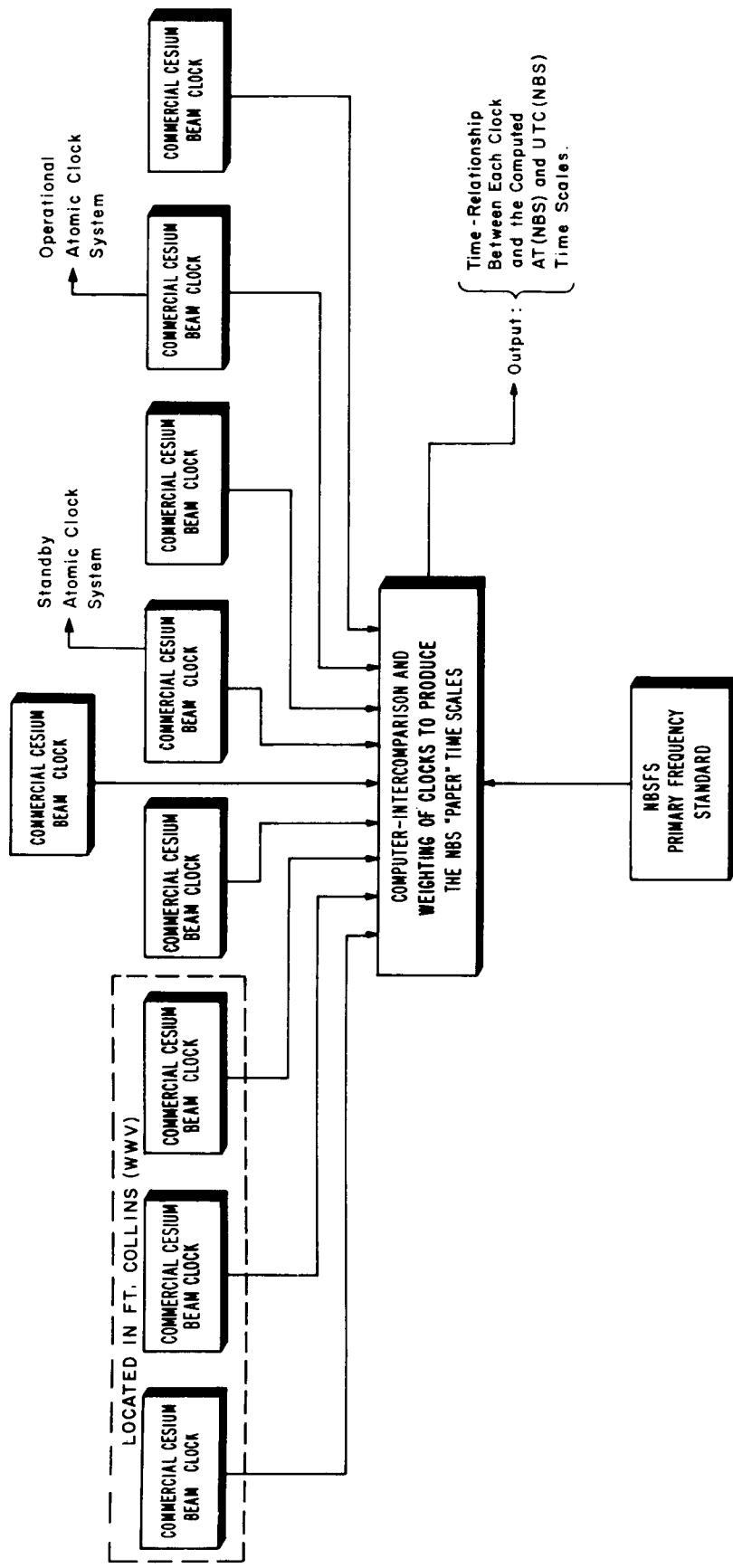

SYSTEM FOR GENERATION OF COMPUTED TIME SCALES
 AT(NBS) AND UTC(NBS)
 ATOMIC TIME STANDARDS PROGRAM AREA

Figure 1

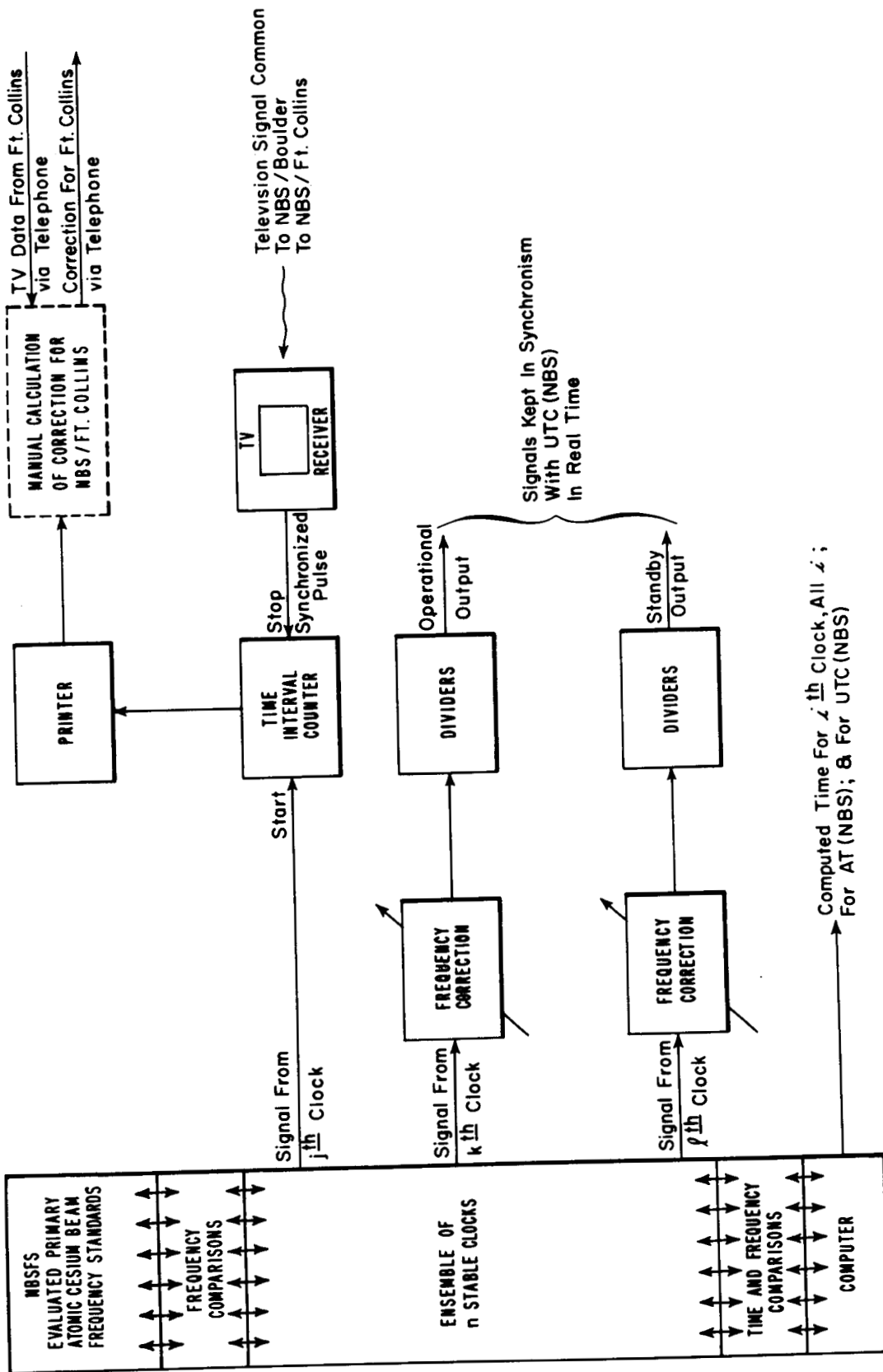

STANDARD FREQUENCY AND TIME INTERVAL GENERATING SYSTEM
ATOMIC TIME STANDARDS PROGRAM AREA

Figure 2

audio tones, time ticks, and all gates, codes, etc., necessary to produce this rather complex format. Figure 3 shows a simplified drawing of the WWV time and frequency generating system at Fort Collins.

2.3 Radio Station WWVH, Kauai, Hawaii

Station WWVH began operating at an old Navy site on the island of Maui in 1948. After long and distinguished service, this station was relocated near the town of Kekaha on the island of Kauai. The cesium standards at WWVH are referenced indirectly against NBSFS vis the NBS broadcasts, commercial and other government radio transmissions, and portable clocks.

The generation system for WWVH, Kauai, Hawaii, is essentially the same as the system at WWV. Figure 4 shows this system.

2.4 Radio Station WWVB, Fort Collins, Colorado

The WWVB time and frequency generating system is somewhat similar to that of WWV, although not as elaborate. WWVB uses a highly stable quartz crystal oscillator as the standard frequency generator. This crystal oscillator is referenced against NBSFS as noted later. Following this quartz crystal oscillator is a device known as a frequency drift corrector, which compensates for both frequency offset and frequency drift of the quartz crystal oscillator. The format for the time code and the 60 kHz driving frequency are produced by a special time code generator, while two other generators are driven by a second quartz oscillator. These generators, along with the oscillators and other equipment, provide three semi-independent generating systems. Figure 5 shows the arrangement of this equipment.

2.5 Radio Station WWVL, Fort Collins, Colorado

Although regularly-scheduled WWVL transmissions were suspended on July 1, 1972,² the essential equipment and antenna system remain available for experimental use by NBS or by other government agencies on a subscription basis. The following description applies to the WWVL system in its most recent configuration.

² Effective July 1, 1972, regularly scheduled transmissions from WWVL were discontinued. Contingent upon the need and the availability of funds, the station broadcasts experimental programs thereafter on an intermittent basis only.

Transmissions may be made available on a subscription basis to organizations or agencies of the Federal government. Arrangements for use of WWVL to broadcast experimental programs should be made through the Frequency-Time Broadcast Services Section 273.02, National Bureau of Standards, Boulder, CO 80302.

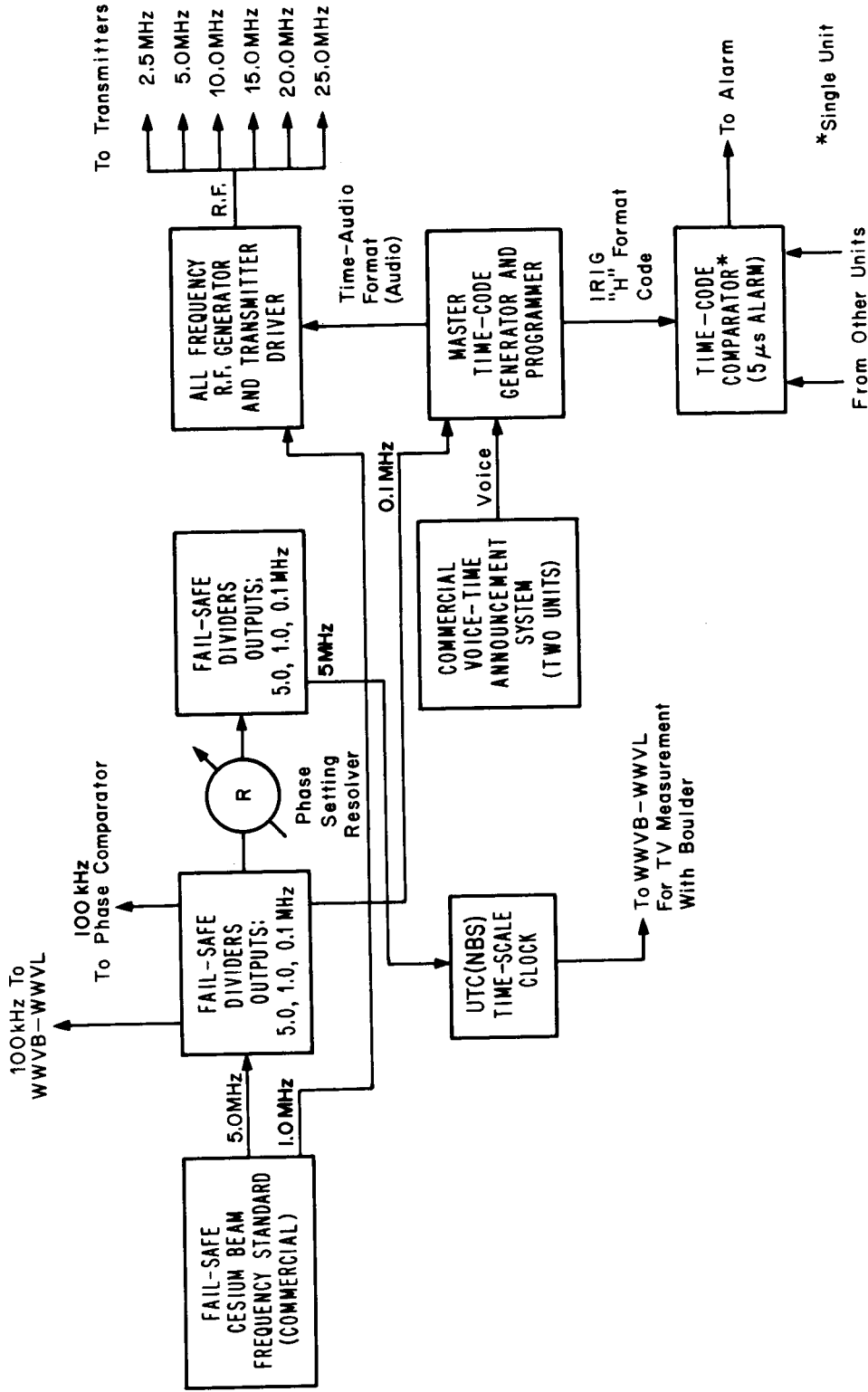

WWV TIME AND FREQUENCY GENERATION -
ONE OF THREE IDENTICAL SYSTEMS

Figure 3

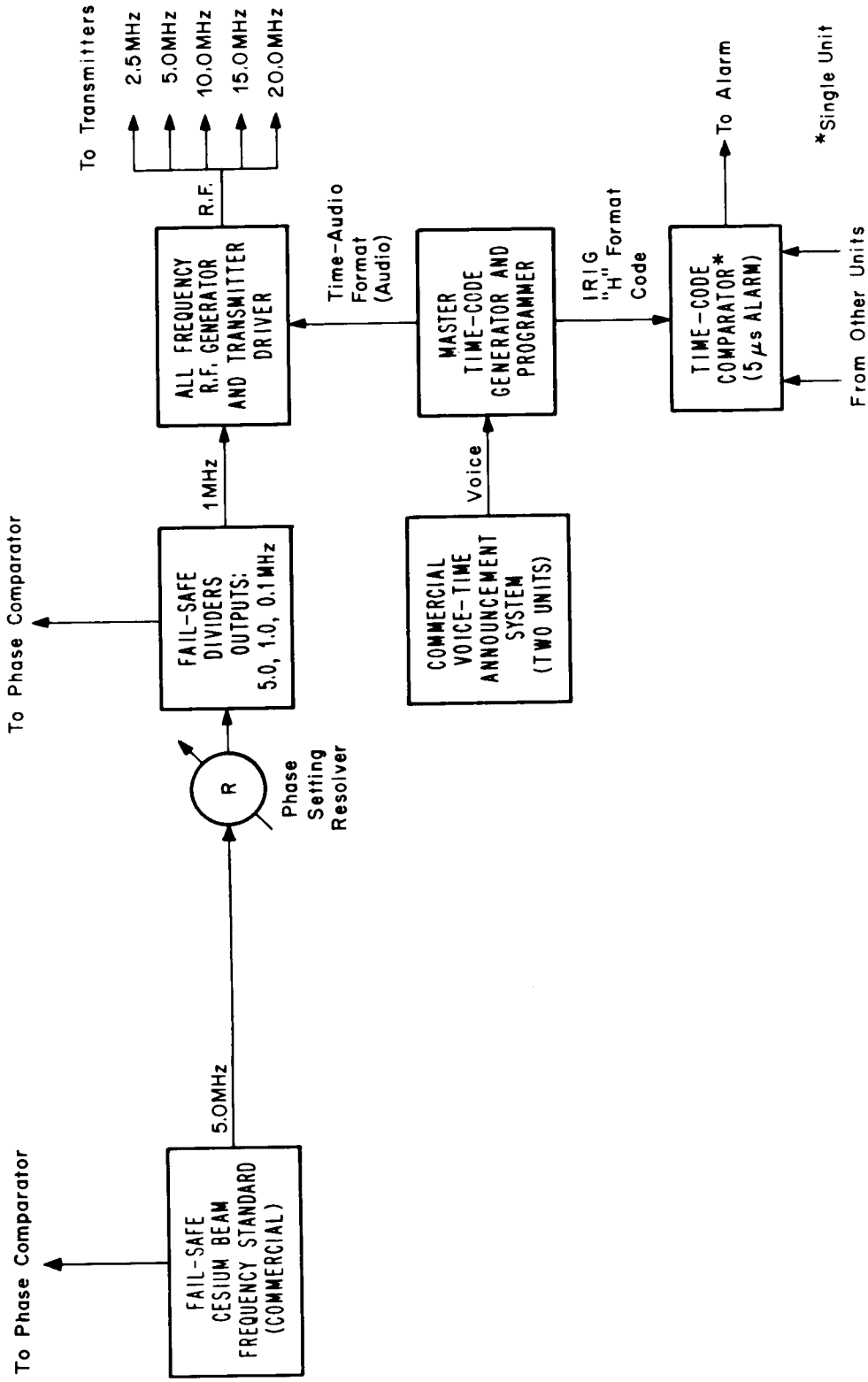

WWVH TIME AND FREQUENCY GENERATION -
ONE OF THREE IDENTICAL SYSTEMS

Figure 4

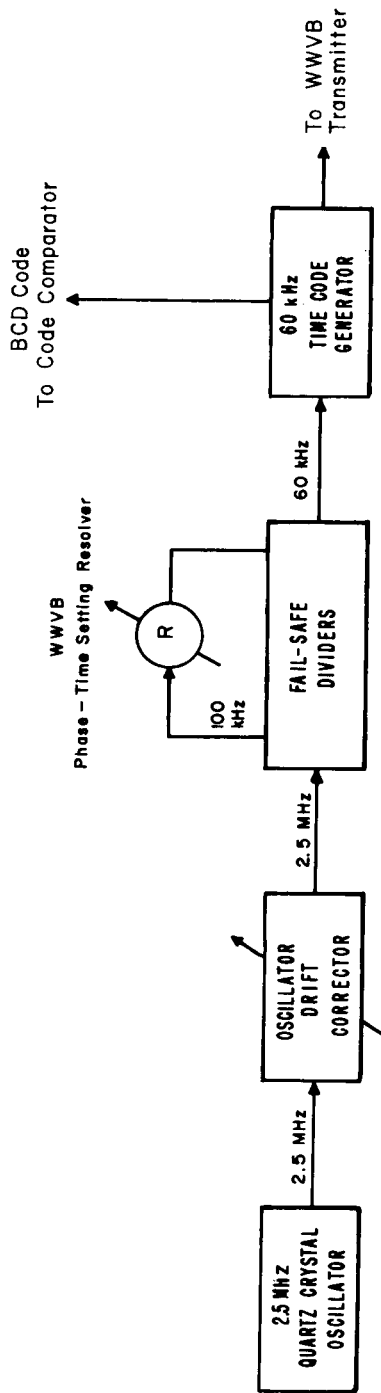

WWVB TIME AND FREQUENCY GENERATION AND CONTROL - ONE OF THREE SEMI - INDEPENDENT SYSTEMS

Figure 5

The frequency generation system for WWVL is like that of WWVB in that quartz crystal oscillators and drift correctors are used as the primary frequency generators. Since there is no complex time format in this case, the one, two, or three operating frequencies, usually selected from among 19.9, 20.0, and 20.9 kHz, are programmed to the transmitter by NBS-built equipment. The synthesizers are units from commercial VLF phase-tracking receivers. If multiple frequencies are being transmitted, the transmitter is shut off for about 0.1 second out of each period to allow the frequency changeover. The carrier shutoff is "on time" with respect to the UTC(NBS) time scale. The transmission period of each frequency is usually ten seconds.

The local servo system for the generation and control equipment is discussed in section 3. See figure 6 for a simplified diagram of the WWVL control system.

3. TRANSMISSION OF TIME AND FREQUENCY

3.1 Transmission from WWV and WWVH

The multiple outputs from the RF driver units in the shielded control room are supplied directly to the transmitters. The WWV and WWVH transmitters are simply high-power linear amplifiers and therefore do not contain audio circuits or modulators. The delay from the time code generator to the antenna is much less than the transmitted accuracy specified for either station and is therefore negligible.

The specifications for WWV and WWVH are: frequency within $\pm 1 \times 10^{-11}$ of the NBS Frequency Standard; time within ± 5 microseconds of the UTC(NBS) time scale.

3.2 Transmission from WWVB

WWVB's transmitter and radiating system have an overall "Q" factor of somewhat less than 100. This "Q" factor is sufficiently low to allow operation without any phase control on the antenna. Future plans call for a local servo system to continuously adjust the transmitted phase at the antenna to be in agreement with the local station reference. The local servo system compensates for the phase perturbations due to wind shifting the antenna. These excursions seldom exceed 0.5 microsecond peak to peak. To correct for discrete phase shifts that occur whenever the antenna is tuned, a manual phase compensation is made based on a continuously operating phase monitor.

The relationship between a time pulse or carrier cycle and the marker of a time scale becomes important when one operates a standard time and frequency station in the LF range. The time at which a particular positive-going carrier cycle crossover occurs for WWVB is published on a daily basis in the monthly issues of the Time and Frequency Services Bulletin. The first carrier crossover at the antenna occurs about six microseconds after the marker pulse of UTC(NBS).

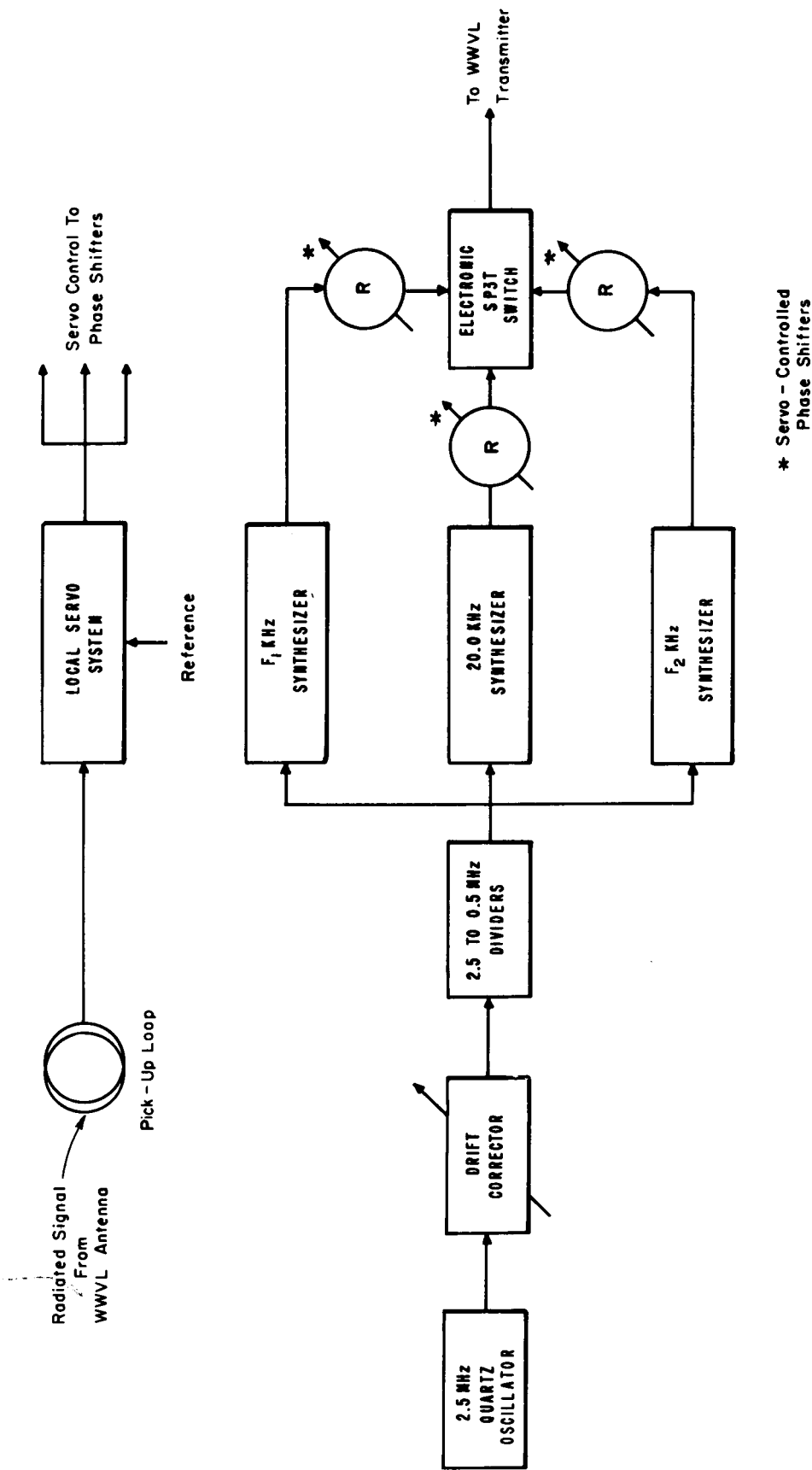

* Servo - Controlled Phase Shifters

WWVL FREQUENCY GENERATION AND CONTROL SYSTEM

Figure 6

The following points should be noted: (1) The radiated phase is late relative to the time marker of UTC(NBS) because of the delays through the WWVB transmission system. The master time code generator at WWVB is maintained in close agreement with UTC(NBS), and any time difference between UTC(NBS) and the WWVB time code generator is known to an adequate accuracy. (2) When a phase or time error between the marker of UTC(NBS) and the WWVB time code generator, and hence the WWVB radiated phase, occurs, the error is corrected by changing the frequency of the WWVB quartz crystal oscillator. The maximum rate of correction is limited to 0.1 microsecond per four-hour period. In other words, during times of phase correction, the frequency of WWVB can be in error with respect to the NBS reference frequency by as much as 6×10^{-12} .

3.3 Transmission from WWVL (Experimental)³

During periods when WWVL is operating, the transmitted phase is controlled more precisely than that of any other NBS transmission. There are two principal motivations for doing this: (1) The realizable stability of the transmission through the medium in the 20 kHz region is quite high; and (2) the susceptibility of the transmission system to phase perturbations is also quite high. The "Q" of the antenna system is of the order of 1000. With a tuning reactance of greater than 500 ohms, a change in this reactance of 0.2 percent causes a phase shift of 45° or more than 6 microseconds. Every effort is made to hold the transmitted phase to within ± 0.1 microsecond of its nominal value. This has been accomplished through the use of a highly sensitive local servo system.

This local servo begins with a pickup coil, located in the building containing the antenna loading coil. During a transmission, the voltage from this coil is supplied through a buried coaxial cable to the shielded control room in the transmitter building. In the control equipment, this signal is compared with the RF output of the WWVL synthesizer. Any phase shifts detected at the antenna loading coil building can be quickly compensated by the servo-driven phase shifter. Each transmitted frequency has its own phase shifter, but the system contains a single servo motor geared to all the phase shifters. Since each phase shifter is continuously driven, any phase error is precorrected for the phase shifter that will be controlling the transmitter during the upcoming transmitting period. This pre-correction reduces the phase noise of the transmission considerably. In addition, the input phase to the transmitter would be adjusted so that the zero voltage crossover of the radiated field as measured at the antenna occurs in coincidence with the time marker of the UTC(NBS) time scale.

³ See footnote².

4. TIME AND FREQUENCY INTERCOMPARISONS

4.1 WWV Self-Comparisons

As mentioned earlier, WWV has three independent time and frequency generating systems. These systems are intercompared at several points. First, the phases of the 0.1 MHz outputs from the dividers following the cesium standards are intercompared. The d-c outputs of the phase detectors used are applied to a multi-channel chart recorder that has a phase (time) full scale value of 1 microsecond. Second, the UTC(NBS) time scale clocks which are part of the time code generator-programmers and another set of UTC(NBS) clocks are intercompared several times daily.

The third comparison is accomplished at the time code generators. The IRIG-H time code from each generator is monitored by a code comparator. An alarm is sounded if the output from any unit diverges from any other by 5 microseconds, or if a clock jumps phase such that its code is misaligned with respect to that of any other unit. With these three comparison systems, any standard, divider chain, or time code generator that fails can be immediately detected. See figure 3 for a simplified block diagram showing the comparison systems.

4.2 WWVH Self-Comparisons

While the equipment complement at WWVH is essentially the same as that of WWV, the Hawaiian staff has arranged the components in a slightly different manner. Again as at WWV, there are three points of intercomparison of the triply-redundant systems. Initially the three cesium standards are directly intercompared. Then the outputs of the fail-safe dividers following the phase setting resolvers are compared. Finally the IRIG-H code from each unit is continuously compared in a code comparator that is identical to the WWV unit. Figure 4 shows the WWVH time and frequency generating system with the intercomparisons indicated. Other aspects of the system, such as chart scale widths and the use of phase error multipliers, are similar to those of WWV.

4.3 WWV-WWVB-WWVL Intercomparisons

The standard 100 kHz output from the WWV time and frequency generating system designated "Rack C" is sent by coaxial cable to the WWVB/WWVL control room. This standard frequency drives a digital clock at WWVB/WWVL. All measurements of the WWVL and WWVB local clocks, which are driven by the quartz crystal oscillators, are in terms of a high-stability clock in Rack C at WWV. Thus the Rack C clock is the master clock for the Fort Collins site.

This system of clock comparisons effectively prevents undetected clock or time code generator failures. In addition to the clock comparisons, the quartz crystal oscillators that form part of the LF and VLF generating systems are continuously compared with the standard 100 kHz signal from WWV. See figure 7.

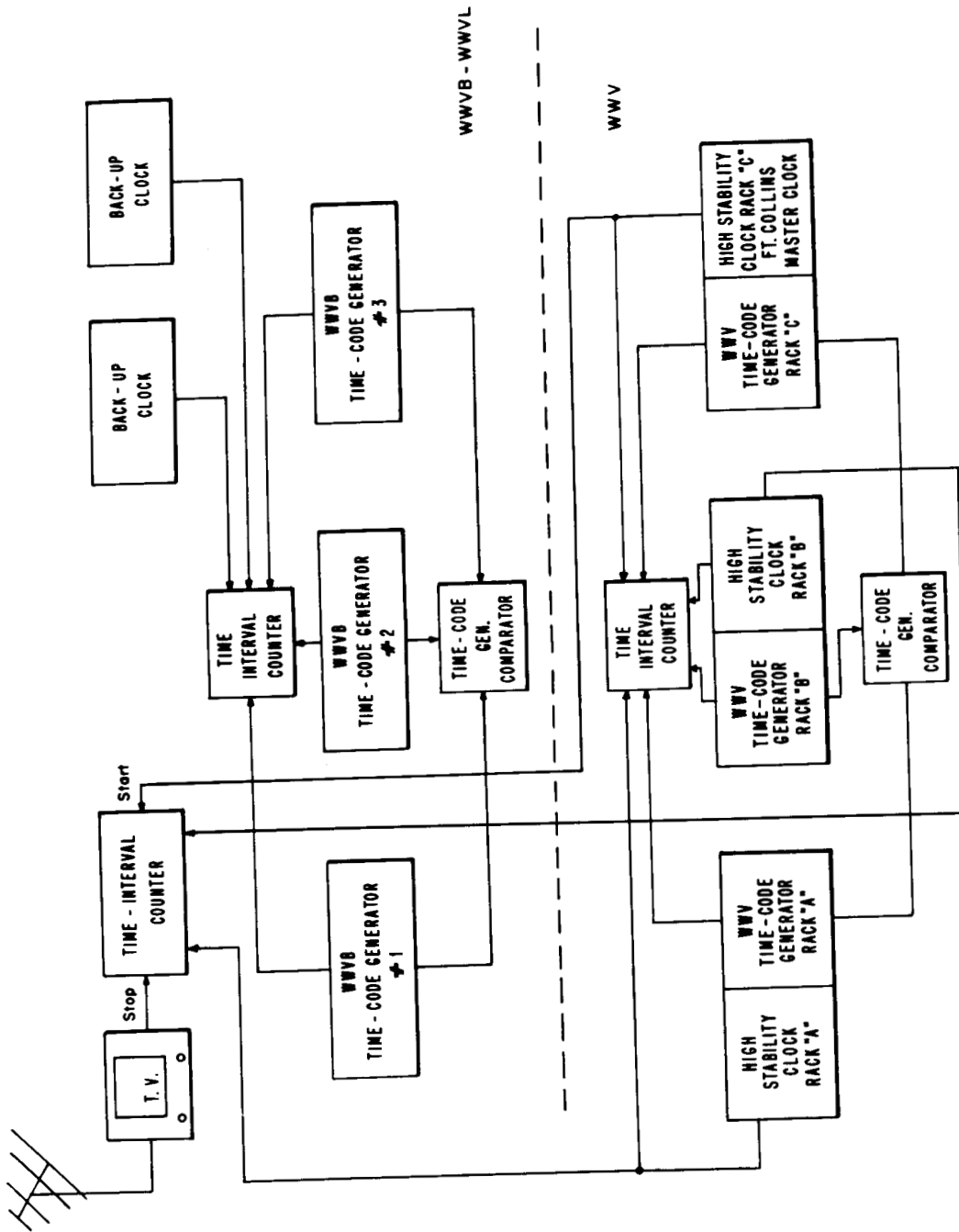

CLOCK INTERCOMPARISON WWV - WWVB - WWVL

Figure 7

4.4 Fort Collins-WWVH Comparisons

Station WWVH uses all available information to maintain close ties with the Fort Collins and NBS Boulder standards. This includes monitoring of a Hawaiian Loran-C station, monitoring of station WWVB, portable clock carries from NBS Boulder, and time comparisons via the NBS line-10 TV system with a phase-stabilized Naval communications station on the island of Oahu. From portable clock trips and satellite comparisons, the relationship between the master clocks at this Naval radio station and the clocks at the U. S. Naval Observatory, and ultimately at Fort Collins and Boulder, is known at all times to within about 1 microsecond.

4.5 Fort Collins-NBS Boulder Comparisons

4.5.1 Portable Clocks

A reliable high-precision method of comparing the Fort Collins Master Clock with the NBS Boulder Master Clock is to physically carry a cesium beam clock between the two locations. A highly accurate portable clock of this sort normally loses or gains less than 0.1 microsecond during the four-hour round trip. To perform this task on a daily basis is expensive and unnecessary. Nevertheless, a portable clock is occasionally carried to Fort Collins when circumstances dictate.

4.5.2 TV Synchronization Pulse Method

Because the portable clock method for clock synchronization is expensive and time consuming, a new method had to be found. In 1967, Tolman et al.⁴ described a method for comparing remote clocks using television synchronizing pulses for time transfer. Since May 1968, this method has been used to compare the Master Clock at Fort Collins with the NBS Master Clock at Boulder.

The system uses what are called line-10 synchronized pulse generators.⁵ These generators emit an electronic pulse each time line 10 (tenth line of the odd field) is received and processed by the TV sets. The repetition rate of line 10 is such that the generators emit almost 30 pulses per second. The master clocks at Boulder and Fort Collins are used to start a time interval measurement at each location at a particular second. The line-10 generator pulse is used to stop the time interval measurement. If the master clocks at the two sites are synchronized, the difference between the time interval measurements (using the same line-10 signal) would be the differential propagation delay time of the TV signal only. This differential delay value is known to be 257.9 microseconds for the particular TV channel employed.

⁴ Tolman et al., "Microsecond clock comparison by means of TV synchronizing pulses," IEEE Trans. on Instr. and Meas., IM-16, No. 3, September 1967.

⁵ D. D. Davis, B. E. Blair, and J. F. Barnaba, "Long-term continental U.S. timing system via television networks," IEEE Spectrum, 8, No. 8, August 1971.

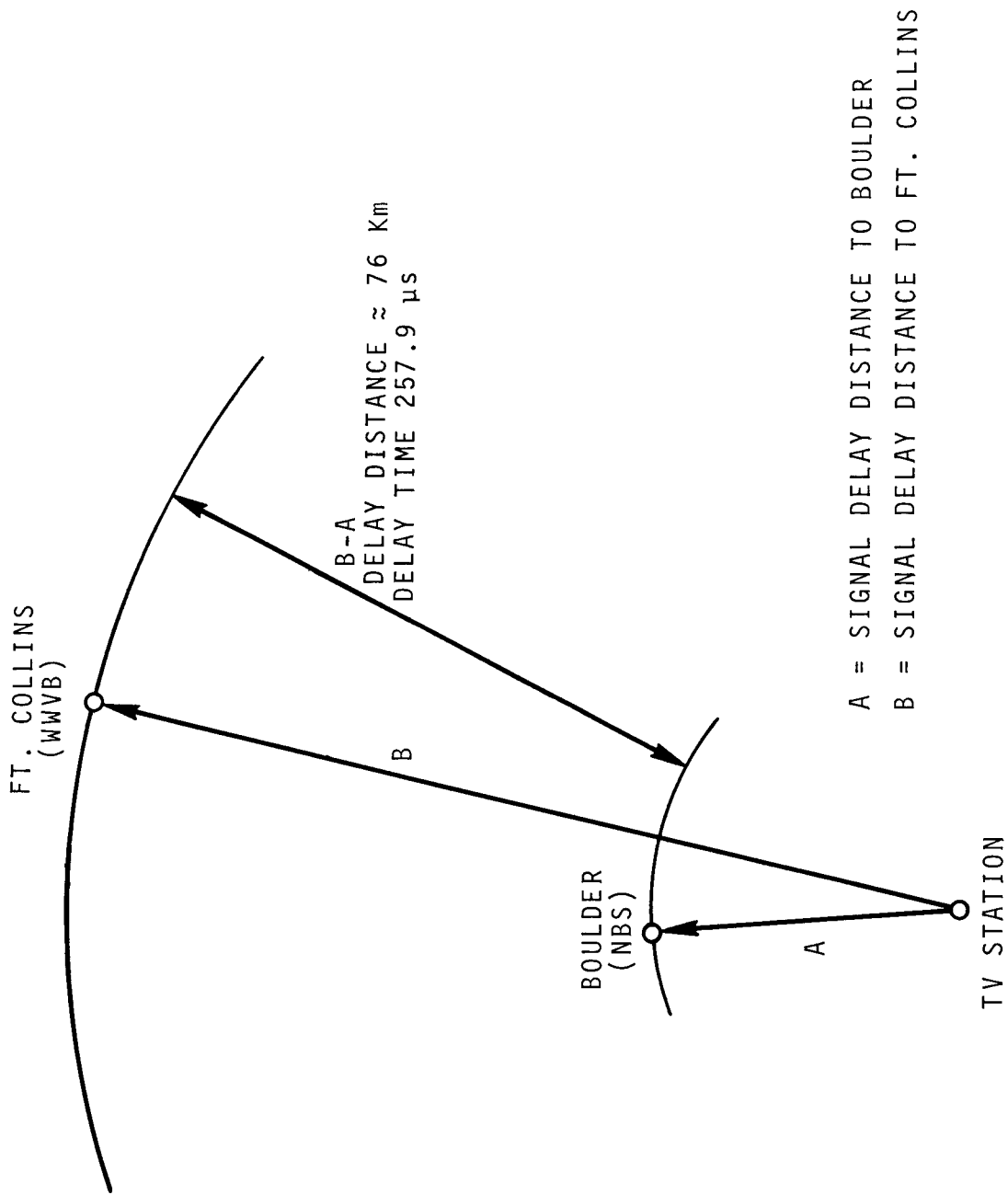

Figure 8. SPACE-TIME DIAGRAM OF TV SYNCHRONIZATION METHOD

This number was determined by carrying a portable cesium clock between the two sites, synchronizing the master clock at Fort Collins, and then measuring the delay time of the TV signal. If the time interval measurements indicate a delay time other than 257.9 microseconds, the difference is attributed to Fort Collins master clock error. Figure 8 shows the geography involved. As a result of these measurements, the difference between the UTC(NBS) time scale and the Fort Collins master clock is known with a precision of about 30 nanoseconds. The overall accuracy of the measurement is about ± 0.2 microsecond.

5. SUMMARY

The Time and Frequency Division of NBS maintains the NBS Frequency Standard, generates the NBS time scales, and disseminates standard time and frequency information via NBS radio broadcasts.

This report has presented some aspects of the work of the Time and Frequency Division. Methods of time scale generation were discussed. Technical aspects of radio stations WWV, WWVH, WWVB, and WWVL were presented. Methods of time scale comparisons between the various radio stations and the Boulder Laboratories were described. Simplified block diagrams of the radio stations' time and frequency generating systems as well as those at the NBS Boulder Laboratories were included. Details and more comprehensive diagrams are available to interested individuals upon request from the Frequency-Time Broadcast Services Section, 273.02, National Bureau of Standards, Boulder, CO 80302.

6. APPENDIX

6.1 Explanation of NBS Time Scales

6.1.1 AT(NBS)

AT(NBS) is an atomic time scale, previously called NBS-A, whose rate is determined by the primary frequency standards of the National Bureau of Standards (NBSFS). These standards provide the unit of time interval, the second, as defined in the International System of Units (SI). The origin marker of the scale was in agreement with UTC(NBS) at 0000 UT 1 January 1958.

6.1.2 UTC(NBS)

UTC(NBS) is a coordinated time scale; i.e., the Bureau International de l'Heure (BIH), Paris, France, determines when steps of 1.0 second should occur to keep this Universal Time Scale in approximate agreement with earth time UT1. The rate of UTC(NBS) is occasionally adjusted slightly to keep this scale in agreement with UTC(BIH). Because of these adjustments, and because laboratory standards around the world operate on slightly different frequencies, the rate of UTC(NBS) is usually not exactly the same as the rate of AT(NBS).

NBS TECHNICAL PUBLICATIONS

PERIODICALS

JOURNAL OF RESEARCH reports National Bureau of Standards research and development in physics, mathematics, and chemistry. Comprehensive scientific papers give complete details of the work, including laboratory data, experimental procedures, and theoretical and mathematical analyses. Illustrated with photographs, drawings, and charts. Includes listings of other NBS papers as issued.

Published in two sections, available separately:

- **Physics and Chemistry (Section A)**

Papers of interest primarily to scientists working in these fields. This section covers a broad range of physical and chemical research, with major emphasis on standards of physical measurement, fundamental constants, and properties of matter. Issued six times a year. Annual subscription: Domestic, \$17.00; Foreign, \$21.25.

- **Mathematical Sciences (Section B)**

Studies and compilations designed mainly for the mathematician and theoretical physicist. Topics in mathematical statistics, theory of experiment design, numerical analysis, theoretical physics and chemistry, logical design and programming of computers and computer systems. Short numerical tables. Issued quarterly. Annual subscription: Domestic, \$9.00; Foreign, \$11.25.

DIMENSIONS, NBS

The best single source of information concerning the Bureau's measurement, research, developmental, cooperative, and publication activities, this monthly publication is designed for the layman and also for the industry-oriented individual whose daily work involves intimate contact with science and technology —for engineers, chemists, physicists, research managers, product-development managers, and company executives. Annual subscription: Domestic, \$6.50; Foreign, \$8.25.

NONPERIODICALS

Applied Mathematics Series. Mathematical tables, manuals, and studies.

Building Science Series. Research results, test methods, and performance criteria of building materials, components, systems, and structures.

Handbooks. Recommended codes of engineering and industrial practice (including safety codes) developed in cooperation with interested industries, professional organizations, and regulatory bodies.

Special Publications. Proceedings of NBS conferences, bibliographies, annual reports, wall charts, pamphlets, etc.

Monographs. Major contributions to the technical literature on various subjects related to the Bureau's scientific and technical activities.

National Standard Reference Data Series. NSRDS provides quantitative data on the physical and chemical properties of materials, compiled from the world's literature and critically evaluated.

Product Standards. Provide requirements for sizes, types, quality, and methods for testing various industrial products. These standards are developed cooperatively with interested Government and industry groups and provide the basis for common understanding of product characteristics for both buyers and sellers. Their use is voluntary.

Technical Notes. This series consists of communications and reports (covering both other-agency and NBS-sponsored work) of limited or transitory interest.

Federal Information Processing Standards Publications. This series is the official publication within the Federal Government for information on standards adopted and promulgated under the Public Law 89-306, and Bureau of the Budget Circular A-86 entitled, Standardization of Data Elements and Codes in Data Systems.

Consumer Information Series. Practical information, based on NBS research and experience, covering areas of interest to the consumer. Easily understandable language and illustrations provide useful background knowledge for shopping in today's technological marketplace.

BIBLIOGRAPHIC SUBSCRIPTION SERVICES

The following current-awareness and literature-survey bibliographies are issued periodically by the Bureau:

Cryogenic Data Center Current Awareness Service (Publications and Reports of Interest in Cryogenics).
A literature survey issued weekly. Annual subscription: Domestic, \$20.00; foreign, \$25.00.

Liquefied Natural Gas. A literature survey issued quarterly. Annual subscription: \$20.00.

Superconducting Devices and Materials. A literature survey issued quarterly. Annual subscription: \$20.00.
Send subscription orders and remittances for the preceding bibliographic services to the U.S. Department of Commerce, National Technical Information Service, Springfield, Va. 22151.

Electromagnetic Metrology Current Awareness Service (Abstracts of Selected Articles on Measurement Techniques and Standards of Electromagnetic Quantities from D-C to Millimeter-Wave Frequencies). Issued monthly. Annual subscription: \$100.00 (Special rates for multi-subscriptions). Send subscription order and remittance to the Electromagnetic Metrology Information Center, Electromagnetics Division, National Bureau of Standards, Boulder, Colo. 80302.

Order NBS publications (except Bibliographic Subscription Services) from: Superintendent of Documents, Government Printing Office, Washington, D.C. 20402.