

CHAPTER 10

TIME AND FREQUENCY DISSEMINATION: AN OVERVIEW OF PRINCIPLES AND TECHNIQUES*●

Byron E. Blair†

Contents

	Page
10.1. Introduction.....	235
10.2. Dissemination Concepts.....	235
10.2.1. Basic Considerations Inherent in Transfer of Time and Frequency.....	235
10.2.2. Frequency from Time Measurements.....	237
10.2.3. Elements that Characterize the Dissemination System.....	237
10.2.4. Basic Techniques Common to a Clock Synchronization System.....	238
10.3. Radio Dissemination of Time and Frequency.....	239
10.3.1. Radio Propagation Factors.....	240
10.3.2. Radio Dissemination Techniques.....	240
a. Standard Frequency and Time Broadcasts.....	240
b. Very Low Frequency (VLF) Time and Frequency Systems.....	241
c. Low Frequency (LF) Time and Frequency Dissemination.....	245
d. High Frequency (HF) Time and Frequency Dissemination.....	247
e. Radio Navigation Systems for TFD.....	251
(1) Omega navigation system for TFD.....	251
(2) Loran-C navigation system for TFD.....	253
(3) Loran-A navigation system for TFD.....	257
f. Television TFD Techniques.....	259
g. TFD via Earth Satellites.....	269
h. Microwave Time and Frequency Transfer (SHF).....	281
i. Commercial Radio TFD Techniques.....	282
j. TFD from VHF Signals Reflected from Meteor Trails.....	283
10.3.3. Advanced T/F Systems Using Radio Techniques.....	284
a. Very Long Baseline Interferometry (VLBI) Time Synchronization.....	284
b. Moon Bounce Time Synchronization (MBTS).....	286
c. Aircraft Collision Avoidance System (ACAS).....	288
10.4. Dissemination of Time and Frequency via Portable Clock.....	290
10.4.1. On-Site Visits.....	292
10.4.2. Aircraft Flyover.....	293
10.5. TFD via Other Means.....	294
10.5.1. Time Transfer via Optical Pulsar Signals.....	294
10.5.2. TFD in Telephone Line and Coax Cable Transmission.....	296
10.5.3. Power Line (60-Hz) Signals as a Time Transfer Technique.....	298
10.6. T/F User and System Evaluation.....	299
10.6.1. Classification of T/F Users.....	299
10.6.2. Evaluation of T/F Systems.....	300

*Manuscript received April 1, 1973.

●Parts of this chapter have been modified from "Characterization and concepts of time-frequency dissemination" published in *Proc. IEEE*, May 1972 (see reference [16]). Publication herein is at concurrence of the IEEE.

†Time and Frequency Division, Institute for Basic Standards, National Bureau of Standards, Boulder, CO 80302. ●

	Page
10.7. Conclusions.....	302
10.8. References.....	303
Annex 10.A. Characteristics of Radio Frequency Bands 4 through 10.....	310a
Annex 10.B. Characteristics of Standard Frequency and Time Signals in Allocated Bands...	311
Annex 10.C. Characteristics of Stabilized Frequency and Time-Signal Emissions Outside Allocated Frequency Assignments.....	312
Annex 10.D. Characteristics of Frequency Stabilized Navigation Systems Useful for Time/Frequency Comparisons.....	313

"In any observation process there must be a signal coming from the observed system to the recording apparatus, and since the propagation of any signal requires a finite time interval, this gives the possibility of defining the arrival of the signal to be 'later' than the time of emission."

L. Rosenfeld, *Study of Time*, p. 479

This chapter reviews basic concepts and common elements that characterize time and frequency dissemination. The means by which time and frequency can be disseminated fall into four main categories: radio broadcasts, on-site comparisons, events in nature, and hardline wire systems. Interrelated elements include active and passive transfer methods and supplementary techniques available from systems with differing primary objectives (piggyback operations). Three categories of time and frequency users are classified according to accuracy needs, and means of providing these needs are shown. Various characteristics of time and frequency dissemination systems are charted and evaluated in terms of such factors as accuracy, ambiguity, geographical coverage, reliability, cost of user equipment, etc. Appraisal of these factors reveals many interrelationships and limitations to be functions of nature, economics, need, and availability. Annexes give descriptions of radio frequency propagation in various bands as well as characteristics of stabilized radio broadcasts useful for time and frequency dissemination.

The most accurate means of time and frequency dissemination today is through portable clocks, such as on-site visits and/or aircraft flyover; accuracy needs of the majority of time and frequency users can be met in a variety of ways; and existing or planned navigation and communication systems show excellent potential for time-frequency dissemination at little or no additional cost. We conclude that (1) no one system will satisfy all user needs, (2) any general purpose timing system should cost the user in proportion to his accuracy requirements, and (3) existing or proposed electronic systems with a time-frequency dissemination capability should be utilized to the fullest extent to realize frequency/spectrum conservation.

Key words: AC power lines; Aircraft Collision Avoidance System (ACAS); aircraft flyover; characteristics of stabilized broadcasts; commercial radio; HF radio; LF radio; line-10 TV; Loran-A; Loran-C; meteor trails; microwave systems; moonbounce; navigation systems; Omega; portable clocks; pulsars; radio propagation; satellite; standard frequency broadcast; telephone; television; TIMATION; time-frequency accuracy; time-frequency dissemination; time-frequency evaluation; time-frequency user needs; timekeeping; TRANSIT; very long base interferometry (VLBI); VLF radio.

10.1. INTRODUCTION

In recent years, advances in technologies of communication, transportation/navigation, time-keeping, and space tracking have placed stringent requirements on time and frequency information. In general, one might consider that optimum comparison of frequency standards or time scales to be through side by side measurements in a laboratory. Many needs of time and frequency, however, are at great distances from a standard time and frequency center. In this chapter we consider what means are available to bridge the distance gap between a standard-time and frequency source and a remotely located user. The concept of our presentation is graphically shown in figure 10.1, with a standard time and frequency source at the center of a circle and segments of larger concentric circles portraying various independent means of transferring this standard to a diverse group of users. The majority of dissemination methods employ some type of radio transmission, either in dedicated time and frequency emissions or established systems such as navigation and television. The most accurate means of time and frequency dissemination today is through portable clocks, such as on site visits and aircraft flyover. Looking into the future, one foresees that satellite systems and microwave communication networks will play a large part in providing time and frequency information to many users.

This chapter reviews some of the basic characteristics and limitations shared by most time and frequency dissemination (TFD) systems. Some systems, such as radio stations CHU and WWV, were built specifically for TFD while others, such as the Loran-C navigation system, can be adapted for TFD; in a few cases it even is possible to use a natural event such as a pulsar for time transfer. A user of a TFD system is generally trying to establish one or more of the following: time of day or date; frequency or time interval; and synchronism. The degree to which he can achieve these objectives will depend upon a number of elements which characterize the system, e.g., accuracy, ambiguity, repeatability, coverage, cost, etc. These various factors are interrelated; they are limited by nature, as well as the users' resources and skill. Such characteristics form a common base which permit evaluation of both new and old systems in similar terms of reference. Classification of timing needs into low, medium, and high-accuracy users gives one an overview of the general time and frequency community. From the discussion it is apparent that no one system will satisfy all user needs; that any general purpose timing system should cost the user proportionately to his accuracy requirement; and that actual or proposed electronic systems, having a potential for dissemination of time and frequency at additional modest cost, should be employed to stem a proliferation of limited-scope, special purpose timing systems. The dissemination techniques are

adaptable to a great variety of user needs and these should be properly weighed in any evaluation, consideration, or application of specific methods.

The intent of this chapter is to give a broad overview of various ways of disseminating time and frequency. Because of the scope and breadth of such an objective, one cannot give complete details for a given system; however, we have attempted to include adequate references for further study of specific dissemination techniques. Excellent publications exist which describe general aspects of time and frequency [1, 2, 3, 4].¹ (Our approach does not consider detailed system-receiving techniques; these will be detailed in later NBS publications.) Section 10.2 of the chapter defines and describes basic concepts inherent in time and frequency dissemination. This is followed by a section discussing aspects and techniques of radio dissemination of time and frequency. The final sections of the chapter discuss portable clock techniques, dissemination by other than radio means, and classification of users and evaluation of the various dissemination techniques. Annexes briefly describe radio propagation in various bands and give characteristics of stabilized broadcasts useful for TFD.

10.2. DISSEMINATION CONCEPTS

This section touches on basic considerations inherent in the transfer of time and frequency information; discusses elements that characterize the dissemination system; and describes utilization of a transfer standard. The section sets a foundation for comparative insight into the various techniques of time and frequency dissemination. It is taken for granted that the desirability of transferring time and/or frequency from a prime standard to a user as depicted in figure 10.1 is paramount. Frequency/time standards are not discussed in detail in this chapter; for such information the reader is referred to Chapters 2, 3, 4, 5, 6, and 9. We base our discussion on the following clock concepts. A clock is the fundamental component of timekeeping; it consists of a frequency standard, a means for counting and keeping track of oscillations, and a readout device for displaying the count. Often an interpolation device is added for use between counts. In essence, a clock is a device which accumulates the cycles of an oscillator (frequency standard) and presents the result in some convenient form.

10.2.1. Basic Considerations Inherent in Transfer of Time and Frequency

There are several basic concepts implicit in the transfer of time and frequency information, including date, frequency or time interval, and time/frequency (T/F) synchronization. By *date* we mean time of day

¹Figures in brackets refer to the references at end of this chapter.

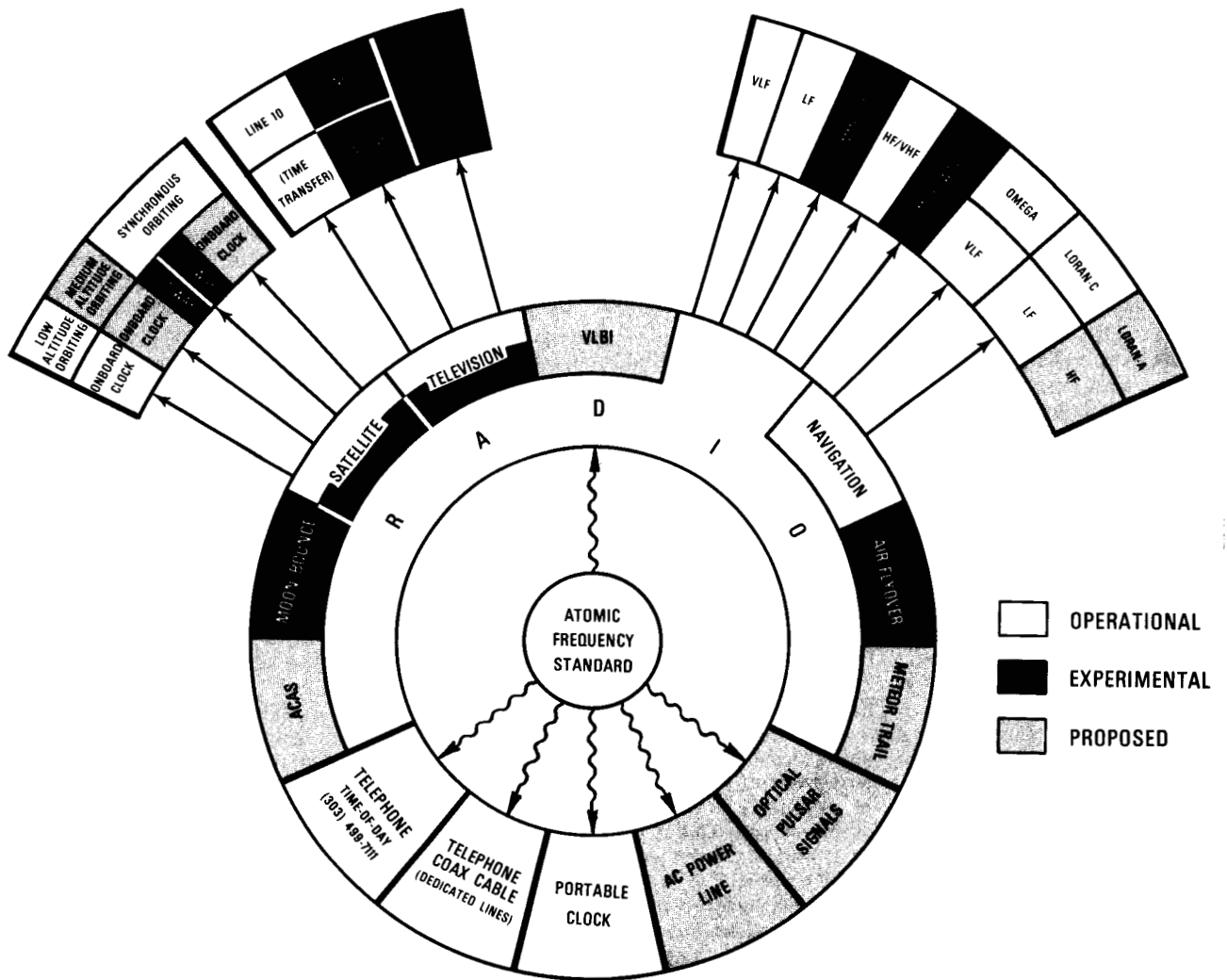

FIGURE 10.1. Concept and methods of time and frequency dissemination.

such as 1965, July 12th, 12h, 24m, 43.010 . . . s. In other words the time of an event reckoned from some consensual origin. *Time interval* refers to duration—the difference in time between two dates. Note that a time interval of 1h can be shown by a clock that is not on time, although running at the correct rate. Also, time interval and frequency are closely related concepts; the frequency of some phenomenon can be determined by the number of occurrences within a measured time interval. Synchronized clocks read the same time at a given point in time, although not necessarily on the basis of an absolute time scale. A coherent communications system is a good example of showing a requirement for synchronization. High rate messages, perhaps of 10 μ s duration, are transmitted, to an addressee who must be synchronized in time with the sender to obtain the message. For further discussions of these basic concepts the reader is referred to Chapter 1.

Time is a basic dimension that, apart from physical aspects, influences everyone. History has shown man attempting to keep time by various crude and sundry instruments such as water buckets, candles, sundials, and pendulum clocks [5]. In today's world, time indicators vary from wristwatches, chronometers, wall clocks, and radio signals to crystal oscillator and atomic clocks. Each of these timing devices shows varying degrees of accuracy and precision; a wristwatch meets a casual need, whereas exact time may require an atomic clock. For any particular event to occur, within some accuracy framework, it is important that all devices maintaining time indicate the same time of day; but since all time pieces are less than perfect, they gradually “drift” and must be continually set to a standard. The time standard has evolved through the years as pointed out by Humphrey Smith [6], and today the second is defined in terms of the resonance of cesium (see chap. 1). However, the cesium standard is much more stable than a time standard based on the earth movement, i.e., the lengths of atomic seconds are nearly identical. On the other hand, atomic time is essentially independent of that time required by navigators, geodesists, astronomers, and others requiring time based on earth rotation. Thus, a time scale called UT1 (universal time corrected for polar motion of earth) is also necessary; UT1 is referenced to the 0 meridian at Greenwich.

Many people today depend upon the electric wall clock whose rate is fixed by the power company's generator. In the United States the power utilities synchronize their generators to the National Bureau of Standards' low frequency broadcast, WWVB [7]. Thus, the U.S. clocks generally run at the same rate. The U.S. citizenry normally set such clocks through time announcements, either by radio or telephone.

Radio timing signals can be used either to perform a clock function or to set clocks. When one uses a radio wave instead of a clock, however, new considerations evolve. One is the delay time of approximately 3 μ s per km (propagation delay) it takes the

radio wave to propagate and arrive at the reception point. Thus, a user 1000 km from a transmitter receives the time signal 3 ms later than the on-time transmitted signal. If time is needed to better than 3 ms, correction must be made for the travel delay. An additional allowance must be made for the signal to pass through the antenna/receiver (receiver delay). Other problems related to radio wave propagation will be discussed later on.

In most cases the standard time and frequency emissions such as CHU, JJY, WWV, and WWVH are more than adequate for everyday needs. The launching of earth satellites during the late 1950's, however, required synchronization of worldwide tracking networks to better than 1 ms. In addition, the appearance of portable atomic frequency standards initiated planning of new navigational and communication systems requiring microsecond timing.

Today, many systems exist which are able to disseminate standard frequencies and time signals with sufficient convenience and accuracy for most users in metrology. These same systems may be used someday to disseminate other standard units of measurement, including those for electromagnetic force (volt), length (meter), and attenuation (decibel), among others. These dissemination systems, together with the inherently high precision of frequency standards and of frequency/time metrology, may help to establish a unified standard for measurement [8]. The progress and feasibility for a unified standard is discussed also in Chapter 7.

10.2.2. Frequency from Time Measurements

Dimensionally, frequency is the reciprocal of time interval. Frequency implies periodic motion or oscillation such as cycles per second (Hz). Its unit can be given as the period of one cycle, i.e., $1/60$ Hz \approx 17 ms. It is no surprise, then, that a frequency dissemination service can be useful for timekeeping and that frequency information can be obtained from a time broadcast. Any “time dissemination” service can be used as a frequency reference. If the time difference between a user's clock and the reference clock increases between measurements, the user knows that the oscillator in his clock is running at a different rate than that of the reference clock, and he can compute his frequency offsets.

10.2.3. Elements that Characterize the Dissemination System

A number of common elements characterize most time/frequency dissemination systems. Among the most important are: accuracy, ambiguity, repeatability, coverage, availability of time signal, reliability, ease of use, cost to the user, and the number of users served. There does not now appear to be any single system which incorporates all desired characteristics. The relative importance of these

characteristics will vary from one user to the next, and the kind of compromise solution for one user may not be satisfactory to another. We will introduce these common elements through detailed examination of a possible radio signal.

Consider a very simple system consisting of an unmodulated 10-kHz signal as shown in figure 10.2.

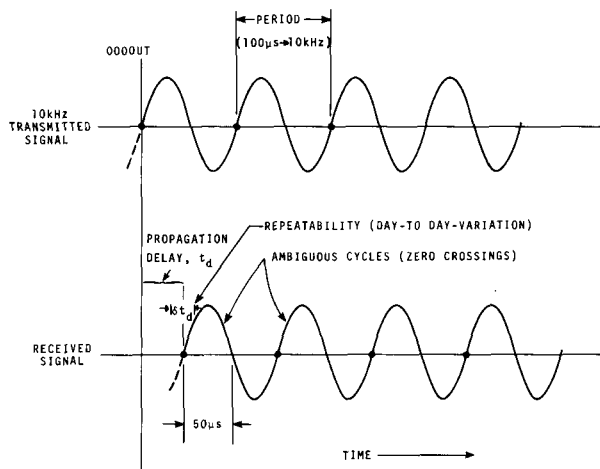

FIGURE 10.2. Single tone time dissemination.

A positive going zero-crossing of this signal, leaving the transmitter at 0000 UT, will reach the receiver at a later time equivalent to the propagation delay. The user must know this delay because the accuracy of his knowledge of time can be no better than the degree to which this delay is known. (By accuracy we mean the degree of conformity to some specified value or definition.) Since all cycles of the signal are identical, the signal is *ambiguous* and the user must somehow decide which cycle is the "on time" cycle. This means, in the case of our hypothetical 10-kHz signal, that the user must know the time to $\pm 50\mu\text{s}$ (half the period of the signal). Further, the user may desire to use this system, say once a day, for an extended period of time to check his clock or frequency standard. However, it may be that the delay will vary from one day to the next, and if the user is unaware of this variation, his accuracy will be limited by the lack of *repeatability* of the signal arrival time.

Many users, geophysicists and seismologists for example, are interested in making time coordinated measurements over large geographic areas. They would like all measurements to be referenced to one time system to eliminate corrections for different time systems used at scattered and/or remote locations. This is a very important practical consideration when measurements are undertaken in the field. In addition, a one reference system, such as a single time broadcast, increases confidence that all measurements can be related to each other in some known way. Thus, the *coverage* of a system is an important concept. Another

important characteristic of a timing system is the *percent of time available*. The man on the street who has to keep an appointment needs to know the time perhaps to a minute or so. Although he requires only coarse time information, he wants it on demand so he carries a wrist watch that gives the time to him 24 hours a day. On the other hand, a user who needs time to a few microseconds employs a very good clock which only needs an occasional update, perhaps only once or twice a day. An additional characteristic of time/frequency dissemination is *reliability*, i.e., the likelihood that a time signal will be available when scheduled. Propagation fadeout can sometimes prevent reception of HF signals. The characteristics discussed so far are for the most part related to the design of the signal and to the propagation characteristics of the medium. However, there are some important economic and human considerations.

Economic and human factors in a TFD system include (1) the cost of establishing and maintaining the service; (2) the number of users to be served by the system; (3) the cost of equipment investment to meet a given need; (4) the operator skill required for operation; and (5) data analysis required for timekeeping.

These factors are interrelated such that various combinations can determine accuracy levels, number of users served, and ultimate costs to both TFD sender as well as receiver. It appears to be an important corollary that the cost to the user for a particular time service should be proportional to the level of need. It is also true that as the accuracy needs become more stringent the number of potential users decrease.

10.2.4. Basic Techniques Common to a Clock Synchronization System

Identification, synchronization, and delay calibration are three operations that are common to all time dissemination schemes. In a standard time emission an event such as the transition from the zero to the one state in a binary system, or the beginning of a tone or a particular zero-crossing of a continuous tone in an analog system, is chosen to represent the time mark. This event must be identified unambiguously at the time reference transmitting station, and synchronized with the reference clock. The equipment delay is calibrated and the transmitted time adjusted accordingly. In order to recover the time from the received signal, a user must unambiguously identify the time mark in the signal format and synchronize his clock to it after accounting for the delay both in propagation and the receiving equipment. Thus identification, synchronization, and calibration operations must be performed at both the master and the user time stations. In the case of a standard time broadcast service these operations are being performed simultaneously by many users, while they are being performed only once at the reference station.

The dissemination "system" should be construed to include the equipment of all users as well as that of the reference station. The costs of the standard time broadcast service "system" are allocated such that the investment in user equipment at a single user station is vastly less than the investment in equipment at the reference station. Thus a standard time broadcast service is designed along the lines of a public utility, where a great many customers require the availability of similar services at all times. It is convenient, but not necessary in principle, for time or frequency information to be transferred from the reference station to the user station by a radio emission originating at the reference station.

Let us now consider the concepts of a time-transfer system as shown in figure 10.3. Assume that the reference station A and the user station B both have receivers tuned to monitor some electromagnetic event that is going to occur at a remote location TS. The coordinates of locations A, B, and TS are not known but are fixed. Both points A and B have monitoring devices that will record the time displayed by their clocks at the reception of the electromagnetic disturbance associated with the event. Finally, assume that clocks A and B are on time with each other. At t_A seconds after the event occurs, the time T_A displayed by clock A will be recorded, where t_A is the propagation delay from TS to point A. (This clock reading will depend on both the propagation delay and when the event occurred.) The time T_B , displayed in clock B, will be recorded t_B seconds after the event occurs. Since the time at which the event occurred is not known, and since the distances of points A and B from the source TS are not known, t_A and t_B are not predictable. But if the time readings T_A and T_B are compared (i.e., subtracted), one can learn the difference in τ_{d1} in the propagation delay time along the two fixed paths. If a second event is monitored at some later time the new readings, T'_A and T'_B , recorded at A and B will obviously be different from the first set. But the time difference τ_{d1} will be the same as before (provided that the clocks are still synchronized).

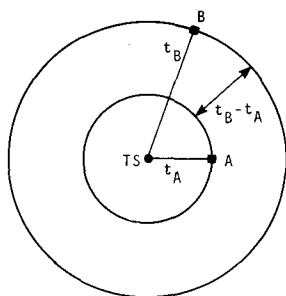

DIFFERENTIAL TIME BETWEEN STATIONS A AND B, $\tau_{d1} = t_B - t_A$

FIGURE 10.3. Time transfer system.

A change in this difference, τ_{d1} , could only be explained by a loss of coordination or change in path delay between clocks A and B. If clock B is adjusted by an amount equal to the change in τ_{d1} then it will once again be synchronized with clock A, since we had assumed initially that clocks A and B were synchronized. If no further loss of synchronization occurs, τ_{d1} computed for yet another event will be identical to its initial value. Thus the time difference between a reference clock and a user's clock can be determined by comparing each in turn to an independent "tick" available to both, and then differencing the comparisons. It resembles comparisons with a portable standard known to be operating at the correct rate but not necessarily on time. The time is "transferred" by a standard which is not, itself, on time; hence the term "time-transfer" technique.

The example used was chosen to emphasize the following aspects of the transfer standard technique:

- (1) The coordinates of the reference station, the user station, and the source of the transfer standard need not be known although they must not change.
- (2) The "event" monitored contains no time information, and the time of its occurrence need not be known; it must only be unambiguously identifiable.
- (3) If the "transfer standard" is a radio broadcast, as it normally is, the transmitting station plays no active part in the process and need not even be aware that it is being so used.

The requirement that the event must be unambiguously identifiable implies that the time separation between "events" must be greater than the uncertainty associated with the knowledge of both the user's clock time, and the propagation delays. If other means are employed to maintain gross clock coordination and the "transfer" technique is being used to keep track of short-term drifts, then the time separation of events need only be greater than the peak-to-peak drifts involved. Synchronization pulses from commercial television transmitters serve nicely for this purpose; Loran-C is also commonly used.

If a user wishes to initiate this technique to transfer time to a location having a clock not known to be on time, he may begin making comparisons and bring in a portable clock to "calibrate" the link at his convenience. He can then reconstruct the time history of his clock prior to the portable clock visit as well as maintain an "on time" clock.

10.3. RADIO DISSEMINATION OF TIME AND FREQUENCY

This chapter attempts to delineate distinguishing features of both present and future means of dis-

seminating time and frequency information to a distant user. Radio waves are essential to most dissemination techniques. Although different radio frequency bands show characteristic and relevant traits, and a multitude of techniques have emerged in these bands within the last 40 years, the words of NBS scientists in 1932 still hold true; "radio waves of which the frequency is carefully controlled and accurately known furnish a standard of frequency which is simultaneously available everywhere that the waves can be received." [9]. In 1932 the *transmitted* accuracy of WWV, based on the primary frequency standard was about 1×10^{-6} ; this accuracy could readily be obtained from received signals. Today the accuracy of the *transmitted* signal has been improved some five or six orders of magnitude, but the accuracy of the received signal has lagged considerably behind.

10.3.1. Radio Propagation Factors

Radio has offered attractive means of transferring standard time and frequency signals since the early 1900's [10]. As opposed to the physical transfer of time via portable clocks, the transfer of information by radio entails propagation of electromagnetic radiation through some transmission medium from a transmitter to a distant receiver. Let's consider a typical standard frequency and time emission.

In such broadcasts the signals are directly related to some master clock and are transmitted with little or no degradation in accuracy. In a vacuum, and noise free background, one should be able to receive such signals at a given point essentially as transmitted, except for a constant path delay with the wave propagating near the speed of light (i.e., 299,773 km/s). The propagation media, including the earth, atmosphere, and ionosphere, as well as physical and electrical characteristics of transmitters and receivers, influence the stability and accuracy of received radio signals, dependent upon the frequency of transmission and length of signal path. Variation and anomalies in propagation delays are affected in varying degrees by extraneous radiations in the propagation media, solar disturbances, diurnal effects and weather conditions, among others.

It is possible to classify radio dissemination systems in a number of different ways; one could divide those carrier frequencies low enough to be reflected by the ionosphere (below 30 MHz) from those sufficiently high to penetrate the ionosphere (above 30 MHz). The former may be observed at great distances from the transmitter but suffer from ionospheric propagation anomalies that limit accuracy; the latter are restricted to line-of-sight applications but show little or no signal deterioration caused by propagation anomalies. The most accurate systems tend to be those which use the higher, line-of-sight, frequencies, while broadcasts of the lower carrier frequencies show the greatest number of users.

A complete evaluation of propagation characteristics of the various bands used for time and frequency dissemination is beyond the scope of this chapter. (Frequency bands 4 through 10 are used and include VLF through SHF (3 kHz to 30 GHz)).² A summary description of propagation factors and general experience in these bands is given in the table of Annex A. Descriptions and mathematical models of the propagation medium useful for designing and understanding time/frequency dissemination systems are given by Wait, Budden, Crombie and others [11, 12], Johler [13], Davies [14], and Thompson et al. [15], among others. Various noise processes, such as additive and multiplicative, and considerations in signal design for TFD systems have been discussed by Jespersen et al. [16]. Basic understanding of radio propagation in the various frequency bands should permit one to optimize a choice for either dissemination or reception of time/frequency information.

10.3.2. Radio Dissemination Techniques

Referring to figure 10.1, one sees the variety of radio means for disseminating time and frequency information. This section gives pertinent characteristics of the various techniques, including advantages and limitations, and refers the reader to in-depth studies of various aspects. These techniques include dedicated systems as well as those outside the allocated bands; included are VLF, LF, and HF broadcasts; navigation systems; and methods using television, satellites, and microwave signals. Passing mention is made of techniques of limited potential such as meteor burst and commercial radio broadcasts. In this cursory survey lack of space prevents comprehensive analyses of various systems; some of the newer and more promising techniques are described at some length.

a. Standard Frequency and Time Broadcasts

The World Administrative Radio Council (WARC) has allocated certain frequencies in five bands for standard frequency and time signal emission as shown in table 10.1. For such dedicated standard frequency transmissions the CCIR recommends that carrier frequencies be maintained so that the average daily fractional frequency deviations from the internationally designated standard for measurement of time interval should not exceed $\pm 1 \times 10^{-10}$. Annex B gives characteristics of standard frequency and time signals that are assigned to allocated bands, as reported by the CCIR. Annex C gives characteristics of stabilized frequency and time signals that are broadcast outside the allocated frequencies which can, however, provide

²By international agreement, frequency band "N" is the frequency range between 0.3×10^6 Hz and 3.0×10^6 Hz. Thus, band 6 lies between 300 kHz and 3 MHz. See Annex 10.A.

TABLE 10.1. *International standard time and frequency radio assignments*

Band No.	Designation	Frequency Range
4	VLF (Very Low Frequency).	20.0 kHz \pm 50 Hz.
6	MF (Medium Frequency).	2.5 MHz \pm 5 kHz.
7	HF (High Frequency)	$\left\{ \begin{array}{l} 5.0 \text{ MHz} \pm 5 \text{ kHz.} \\ 10.0 \text{ MHz} \pm 5 \text{ kHz.} \\ 15.0 \text{ MHz} \pm 10 \text{ kHz.} \\ 20.0 \text{ MHz} \pm 10 \text{ kHz.} \\ 25.0 \text{ MHz} \pm 10 \text{ kHz.} \end{array} \right.$
9	UHF (Ultra High Frequency).	400.1 MHz \pm 25 kHz (satellite).
10	SHF (Super High Frequency).	$\left\{ \begin{array}{l} 4.202 \text{ GHz} \pm 2 \text{ MHz} \\ \text{(satellite-space to earth).} \\ 6.427 \text{ GHz} \pm 2 \text{ MHz} \\ \text{(satellite-earth to space).} \end{array} \right.$

useful time and frequency information. Information contained in Annexes B and C includes transmitter coordinates, frequency, radiated power, and accuracy of transmitted signals. The map in figure 10.4 shows the location of many radio stations used for TFD.

b. Very Low Frequency (VLF) Time and Frequency Systems

TFD systems in the VLF band nominally operate at frequencies from 10 to 30 kHz. The 10–13 kHz band is used by the Omega Navigation system and is described later in Section 10.3.2.e.(1). In this section we describe briefly the development and uses of VLF apart from the Omega system. VLF and the related LF transmissions are not new; they were used in the early 1900's for long range communications between colonial empires, by various navies, and for general transoceanic services [17, 18]. Even at that time VLF transmissions showed

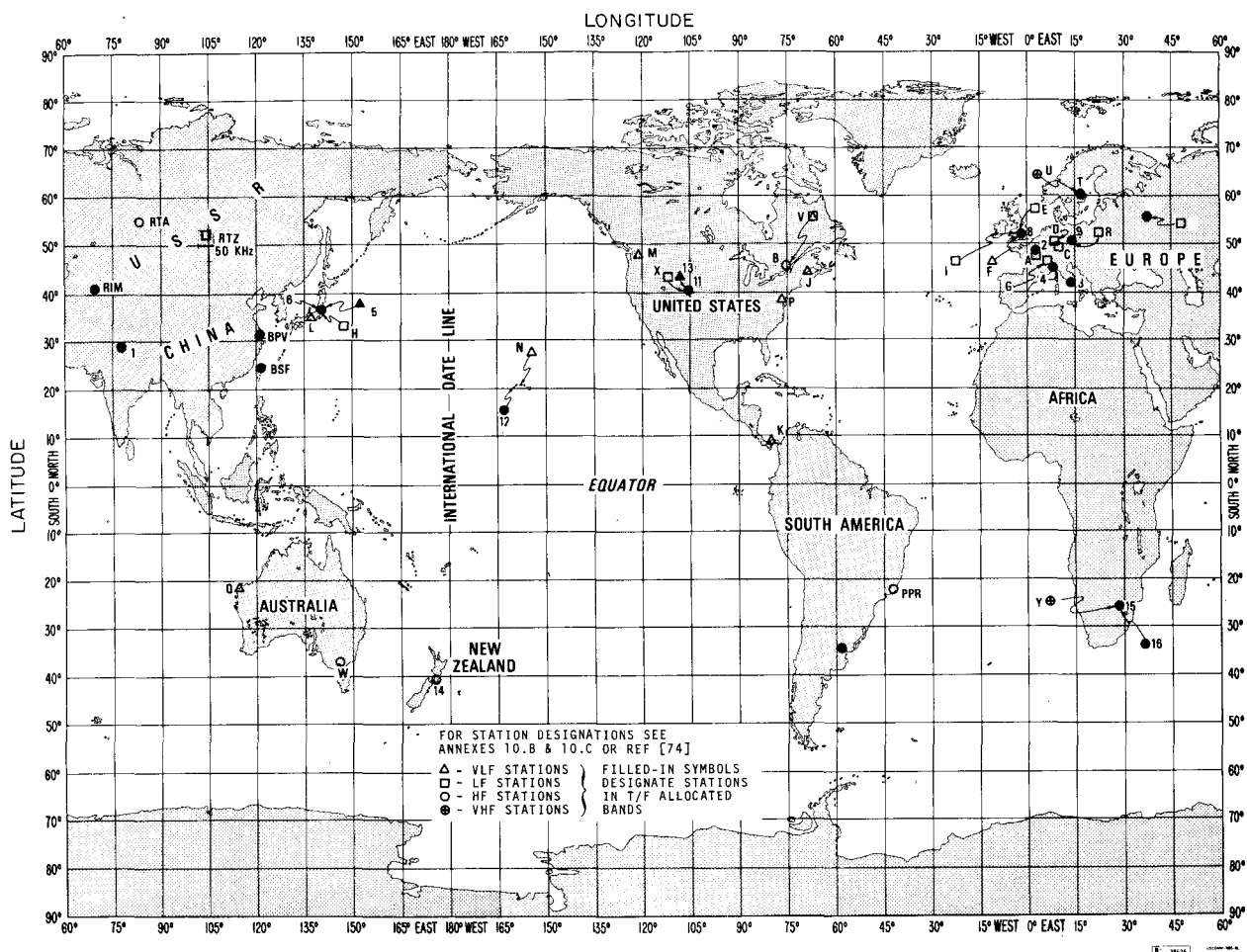

FIGURE 10.4. Worldwide location of broadcasting stations useful for TFD. (annexes 10.B and 10.C give additional information to keyed broadcast stations.)

good reliability with relatively low signal attenuation over large distances [19]. Many of these transmissions were replaced later by the lower-cost high frequency (HF) broadcasts which employed much smaller antennas, at increased efficiency over VLF antennas. Many different VLF antenna configurations have been built, e.g., long cables have been strung several km across volcano craters and valleys or from towers several hundred meters in height [18]. The present NAA antenna at Cutler, Maine (radiated power 1 Megawatt) is a top hat system supported by 26 masts ~ 300 m in height, covering an area ~ 2.2 km²; its radial ground system consists of $\sim 3.3 \times 10^6$ m of buried copper wire.

During World War II and shortly thereafter, attention was directed again to the low frequency band for navigation and communication. From such interest evolved the "Radux" navigation system [20, 21], where the low frequency carriers showed the excellent stability required for navigation systems. From the mid-1950's onward, there have been great strides in worldwide frequency and time comparisons via low frequency broadcasts. Methods used by Pierce, Mitchell, and Essen [22]; Pierce [23]; and Crombie et al. [24], among others showed improvement in frequency comparisons of two to three orders of magnitude better than those of HF techniques. It is particularly noteworthy that the more stable atomic frequency standards were replacing the crystal oscillator control of many of the VLF transmissions about this same time; thus in 1960, Pierce, Winkler and Corke showed that transatlantic phase comparisons of a 16-kHz carrier frequency could be made to about 2 μ s in a 24h period using atomic cesium standards [25]. Attention thus was directed towards VLF standard frequency broadcasts [23, 26, 27], and the VLF method has proven advantageous for comparing atomic frequency standards at global distances [28-32]. Today most VLF transmissions used for TFD are controlled by atomic frequency standards referenced to a coordinated international time base (UTC—see chap. 1). This has resulted in a reasonably economic and reliable means of disseminating frequency to several parts in 10^{11} or better in a 24h period.

The characteristics of various VLF broadcasts (outside the Omega band) useful for TFD are given in Annex 10.C. The propagation of VLF signals is described in Annex 10.A. Of particular significance are the diurnal phase shifts which are somewhat frequency dependent but quite distance related. Typically, these predictable shifts range from ~ 20 to 80 μ s for distances of 2000 to 10,000 km at frequencies of ~ 14 to 20 kHz [33, 34].

Within the last decade a variety of VLF techniques have been developed for time and frequency comparison. These methods have confirmed the

excellent stability shown in the 1950's and even today there is evidence that the limiting precision of VLF measurements has not been reached [35, 36]. We will briefly review several VLF time and frequency techniques.

(1) *VLF Single Frequency Comparison.* A common and economical VLF method utilizes single frequency phase comparison, such as shown in figure 10.5 [37]. In such an electromechanical system the servo-driven phase shifter continuously phase locks a synthesized signal from the local standard to the received VLF signal. A linear potentiometer output, connected to a constant direct voltage, generates a voltage signal and permits an analog recording of the phase shifter position. In other words, the recording shows the amount of phase shift the local synthesized signal experiences to agree with the phase of the received signal. A very narrow bandwidth (~ 0.01 to 0.001 Hz) is required for extraction of the coherent VLF signal level from characteristic higher noise levels > 20 to 40 dB. (Electronic-servo VLF comparators with internal calibrator-signal generators are now available; these units are more stable than the electromechanical type and provide improved control for clock synchronization.)

Measurements are made on the phase records generally at 24h intervals and at times when the propagation path is sunlit and phase fluctuations are minimal. The duration of such a quiet period varies with the seasons, reception path, and the path direction. (The standard deviation of phase fluctuations in NBA signals received and compared at NBS, Boulder—4300 km—were several tenths of a μ s for a series of 20 min measurements taken over a 7h period [38].) The single VLF comparison technique does not permit initial clock

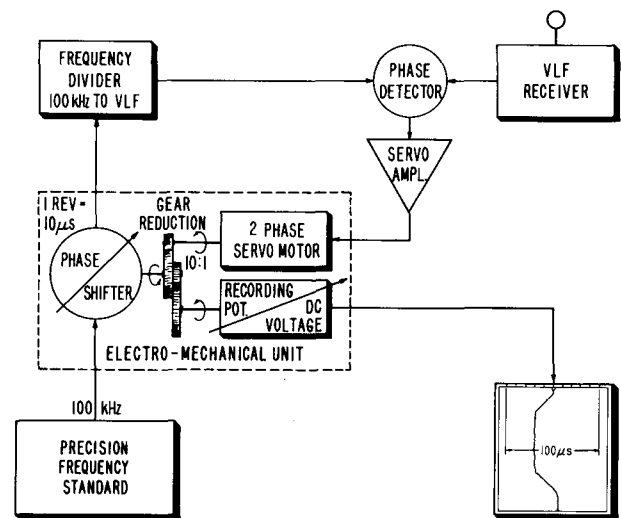

FIGURE 10.5. Typical VLF single-frequency comparator.

synchronization; it does, however, give day to day comparisons of a local clock to microseconds [2, 39–41]. Corrections to many VLF broadcasts can be made after the fact from periodic publications of various laboratories such as NBS [42], the USNO [43], and the Research Institute of the Swedish National Defense [44].

(2) *Multiple-Frequency VLF Techniques.* Another VLF approach is the so-called multiple-frequency technique which uses two or more coherently related, closely spaced signals which are transmitted sequentially [45, 46]. The method is based on similar principles as the Radux-Omega Navigation system [21]. It is the hope that this method might permit initial synchronization of clocks at remote sites and/or resynchronization of interrupted clocks. There is a distinction between such synchronization; i.e., initial synchronization, via a radio signal, requires accurate knowledge of the propagation delay. Initial synchronization along with direct measure of the propagation delay, however, can be performed by transportation of a portable clock to the site. On the other hand, clocks can be resynchronized through the multiple frequency technique by adjusting for the known propagation delay. There is evidence that theoretical predictions of propagation delay compare favorably with experimental results [47].

The multiple carrier VLF method extracts timing information in the difference frequencies, allowing individual *cycle identification* of one of the carrier frequencies. The method has been used with WWVL and is applicable to the Omega frequencies [48, 49]. The technique demands extreme stability in the signals as transmitted, the transmission medium, and the receiving/comparison equipment. In a typical synchronization, coarse time would be set initially via HF radio transmissions to several ms to resolve the difference frequency ambiguity ($< 1/2$ of the difference frequency period; i.e. ~ 2.5 ms for the dual Omega frequencies of 12.5 and 12.7 kHz). In using Omega frequencies of 12.5 and 12.7 kHz, it is necessary that the residual phase error (differential propagation delay corresponding to one cycle offset $= \pm 1.26 \mu\text{s}$) be less than $0.6 \mu\text{s}$ for resolving cycle ambiguity at 12.5 kHz [49]. That is, each cycle of 12.5 kHz (individual cycle period of $80 \mu\text{s}$) shows a differential phase offset of $1.26 \mu\text{s}$ at an appropriate comparison point of the 12.7 kHz signal. The number of error cycles within the difference frequency interval depends upon the so called *magnification factor*, $f_2/f_2 - f_1$, or 63.5 in the example of the 12.5 and 12.7-kHz signals (f_1 and f_2 respectively). Thus, the product of the magnification factor and the f_2 period gives the period of the difference frequency. A lower magnification factor places lesser demands on the measurement sensitivity.

The multiple carrier VLF method includes a local calibration signal for simulating the frequency

of the received signal to relate the local time scale to that of the transmitter. Agreement between the received and calibrated VLF phases is made systematically and the local clock phase-shifter adjusted until all simulated signal phases are identical to the actual received signal phases for a single setting of the phase shifter. This phase relationship remains essentially unchanged (except for clock interruption and phase loss), and the VLF receiver can be turned off and on without affecting the calibration.

A basic paradox in using 2 VLF signals for clock synchronization is that an increase in the spacing of the frequencies improves the cycle resolution problem but places more stringent requirements on the coarse timing. Reception of three or more VLF signals, such as provided by Omega, gives a combination of both narrow and wide separation of frequency pairs, thus insuring cycle identification of the prime carrier; the stability, after synchronization, should be equivalent to that of the single frequency system. Several laboratories have used the multifrequency VLF techniques in combination with other systems for resynchronization timing [40, 48].

(3) *VLF Time Transfer Techniques.* A time transfer VLF technique has been demonstrated by Becker [31]. This method also uses a simulated carrier calibration which obtains a daily time difference between the local time scale and the received signal. The USNO simultaneously each day makes identical measurements. The daily differences of these Δt 's gives a time difference of the time scales of the PTB and USNO via given VLF transmissions. These measurements, confirmed by Loran-C data, averaged over an 18 month period (NSS to PTB path ~ 6000 km) show an uncertainty of $\sim 1 \times 10^{-13}$. Becker also asserts that filtering and averaging techniques used at the PTB for analysis of VLF data could be employed profitably by the BIH in formation of the International Time Scale (TAI).

(4) *VLF Pulse Methods.* Several VLF transmitters periodically broadcast time signals (see ann. 10.C). Time pulses transmitted at VLF show a slow rise time (15 ms at NBA – 18 kHz in 1960) because of the high Q of the antennas and a resultant large time delay. Stone determined time from the NBA transmitted pulses at Summit, Canal Zone to a receiver at NRL in Washington, DC to a precision of $\sim 500 \mu\text{s}$ [50]. While such time determinations might be resolved to higher precision, limiting factors include the difficulty in fixing the start of the pulse and the uncertainty of the transmitter, propagation, and receiver delays.

(5) *Statistical Smoothing of VLF Data.* Allan and Barnes [51] and Guétrot et al. [52] have shown means for statistically reducing phase fluctuations on long term data. Guétrot applied optimum smoothing techniques to differential VLF data of NSS (21.4 kHz) and WWVL (20.0 kHz) over reciprocal paths in a study with the USNO. The results were compared

with portable clock measurements and showed day to day deviations of 70 ns over this 2400 km path.

(6) *Time Comparison via Frequency Shift Keying (FSK) of VLF Carriers.* Frequency Shift Keying (FSK) of VLF stabilized communication transmissions has been proposed for TFD [53]. This method shifts two carrier frequencies either plus or minus 50 Hz with bit lengths of 20 ms and a transition time between shifts of 2 ms. At such rates, phase coincidence of the two carrier frequencies occurs at a point within each transition time. The 20 ms time markers will occur nearly continuously and permit coarse timing to such a level. The transition points are "on time" within $\pm 1 \mu\text{s}$ of the station clocks. FSK transmissions are planned in 1973, and it is believed that the mid-point transition times can be resolved at a receiving site to $\pm 10 \mu\text{s}$ since the VLF signal periods range from ~ 30 to $60 \mu\text{s}$ a particular cycle can be identified and time extracted from the cycle zero crossing to $\sim 1 \mu\text{s}$. It is proposed also to transmit time-code pulses once an hour, possibly the last five minutes before the hour. Stone et al. [53] give results of two techniques for resolving FSK signals at a receiving station to about $\pm 10 \mu\text{s}$; e.g., through frequency discriminator techniques and/or those of a synchronous detector as used in many VLF tracking receivers. A signal averager is used for optimum resolution. The method shows promise for precise timing although receiving equipment is somewhat complex and costly.

(7) *Summary Statement of VLF Use in TFD.* The stability and reliability of VLF standard frequency transmissions during the last decade is attested to by their use for international comparisons of atomic frequency standards as previously mentioned; for control of HF standard frequency emissions [54]; for navigation [55]; for propagation studies [56–58]; and for adjustment of rubidium frequency standards which control the frequency of color TV broadcasts [59]. The Sperry report on methods for synchronizing remote clocks states in its conclusions: "Do not overlook the possibilities of obtaining both accuracy and low cost in the combination of a clock stabilized by reference to VLF signals and set once by a master clock" [2].

Advantages of VLF systems for TFD

- VLF phase comparisons can be made to several μs continuously at continental distances from a transmitter up to $\sim 10,000$ km and with low signal attenuation and stable propagation. This is an improvement of several orders of magnitude over HF techniques.
- Generally continuous transmission (24h per day) and many stations located at widely separated points.
- Single frequency comparisons can be made with relatively low-cost receiving equipment.
- Most VLF transmitters today are stabilized with atomic frequency standards, which, in part, accounts for VLF signal stability.

- Many VLF transmissions are monitored by national laboratories which publish corrections and permit reference to their time scales (after the fact).
- Although VLF signals are subject to diurnal phase variations, such changes are both predictable and repeatable.
- Once a propagation path is calibrated, multiple frequency VLF techniques can permit resynchronization of clocks at a remote site.

Limitations of VLF Systems Used for TFD

- Atmospheric noise at VLF is quite high and coherent signals often must be detected well below the noise. Noise from lightning strokes is a maximum at these frequencies, and the low attenuation rates of atmospheric noise at VLF allows worldwide propagation of such static.
- VLF propagation is subject to many phase anomalies such as diurnal variations, cycle slips, strong attenuation over ice fields, solar disturbances (Sudden Ionospheric Disturbances-SID's), long versus short path interference, nuclear blast effects, seasonal changes, and nighttime irregularities. In many cases, however, these are easily recognizable and can be accounted for. Some reduction in phase anomalies can be realized through composite wave analysis suggested by Pierce [60].
- For best results, phase measurements should be made when the transmitter-receiver path is sunlit. Some paths at high latitude can show limited sunlit conditions, however.
- Maximum success in VLF measurements requires atomic frequency standards at both the transmitter and receiver; good temperature control of equipment; back up battery supply for AC power; periodic phase and amplitude calibration for detection of phase drifts or jumps in the local equipment; and periodic checks of antenna connections, circuit board and chassis contacts [58].
- VLF transmissions received at distances of 1000 km or less from a transmitter are difficult to interpret because of the interference between ground and sky waves. There are also sensitive path distances at which modal interference critically destruct a received VLF signal, particularly during sunset and sunrise.
- VLF techniques alone are not now capable for initial clock setting at a remote site. Generally, propagation delay is determined and initial clock setting is performed by a portable clock visit.
- VLF signals experience dispersion (different phase velocities) and this can result in prohibitive variation in received signals for cycle identification in the multiple frequency technique.
- VLF techniques, although simple in concept and design, require experienced personnel to

properly interpret and analyze the signals as transmitted, propagated and received at a remote site.

c. Low Frequency (LF) Time and Frequency Dissemination

LF signals are transmitted in the band between 30 and 300 kHz. Today, at least 10 LF broadcasts (shown in annexes 10.B. and C.) are frequency stabilized in the accuracy range of ± 0.1 to 10 parts in 10^{10} and are useful for TFD. As the development of LF transmissions paralleled the VLF broadcasts, no attempt will be made to trace its history. Also, the Loran-C navigation system (100 kHz) is described separately in Section 10.3.2.e.(2).

Although the LF band also has long been known for its stability and reliable propagation to long distances, it was not until the late 1940's that Pierce showed the value of LF transmissions for navigation [20]. In 1950 the British commenced standard frequency broadcasts at 60-kHz (MSF) at daily short intervals of time [61]. In 1956 NBS also commenced low power 60-kHz broadcasts (KK2SEI later changed to WWVB) [62]. From limited broadcasts of these two stations, Pierce was able to predict daily measurement accuracies of 1 or 2 parts in 10^{11} for LF comparisons [63]. He was limited to a large extent by the variable crystal oscillator control of most transmissions at that time. As Pierce's predictions proved true, especially with the advent of atomic frequency control of transmitters, many frequency stabilized LF transmitters were constructed and are used for time/frequency dissemination today.

At this point we will discuss certain low frequency and time measurements in terms of the National Bureau of Standards WWVB broadcasts at 60 kHz. The NBS low-power LF station was moved to Ft. Collins, CO in mid-1963; today its radiated power is ~ 13 kw [64], and it generally can be received as a stable frequency source anywhere in the continental USA. Three types of LF time and frequency comparisons are considered:

(1) *Single-Frequency Phase Tracking at LF.* This method is quite similar to the VLF procedure [65].

LF signals usually propagate with greater attenuation than VLF, although perhaps at improved stability at distances up to ~ 2500 km. Ground wave LF signals provide a very stable reference at distances up to about 500 km. A typical WWVB phase record for the Ft. Collins, CO to Greenbelt, MD path (~ 2400 km) is shown in figure 10.6. This 50 μ s full scale record shows (a) the excellent phase stability during the sunlit portion of the path; (b) the repeatable diurnal phase shift at both sunset and sunrise when the effective ionosphere rises and lowers; (c) a typical cycle slip or fadeout at sunrise (Greenbelt); and (d) the somewhat irregular phase pattern when the path is in darkness. It is of particular note that WWVB transmitted with a radiated power of about 2 W at this time with frequency control via a rubidium atomic frequency standard. As previously pointed out, WWVB was used together with WWVL to remotely control the frequency of WWV in Maryland prior to its move to Ft. Collins, CO, to several parts in 10^{11} over a 21-month period [54]. The construction of a simple and economical receiver (cost \sim \$100) has been described for local WWVB comparisons [66].

(2) *WWVB Time Code.* Although the WWVB antenna shows a relatively high Q, its transmission characteristics are such as to support time code modulation. Since 1965 WWVB has broadcast time information continuously via a 10-dB level-shift carrier code. This binary coded decimal (BCD) code is synchronized with the 60-kHz carrier which, in turn, is referenced to the UTC(NBS) time scale [64]. Figure 10.7 shows the format of the WWVB pulse-width code which is repetitive and updated at one minute intervals. Basically, the code consists of one second markers, generated by reduction of the carrier power by 10 dB at the start of each corresponding second; power is restored 200 ms later for an uncoded marker or binary 0; 500 ms later for a binary 1, and 800 ms later for either a 10-s position marker or minute reference marker. Thus, the leading edge of each negative going pulse is on time; each minute frame contains coded information within 12 groups which includes complete UTC(NBS) time-of-year data in minutes, hours and day-of-year, the estimated difference of UT1 minus UTC (called DUT1), and the positive or negative relationship of the UT1 scale with respect to the UTC scale. The

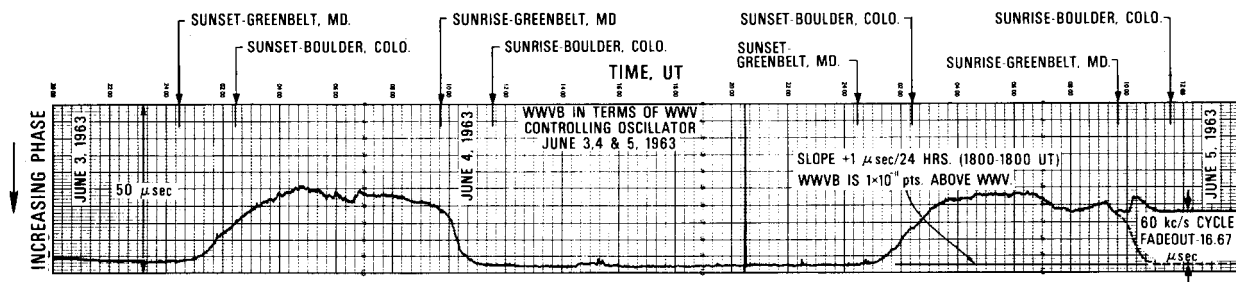

FIGURE 10.6. Typical LF phase record (WWVB transmission from NBS, Boulder, CO and received at Greenbelt, MD).

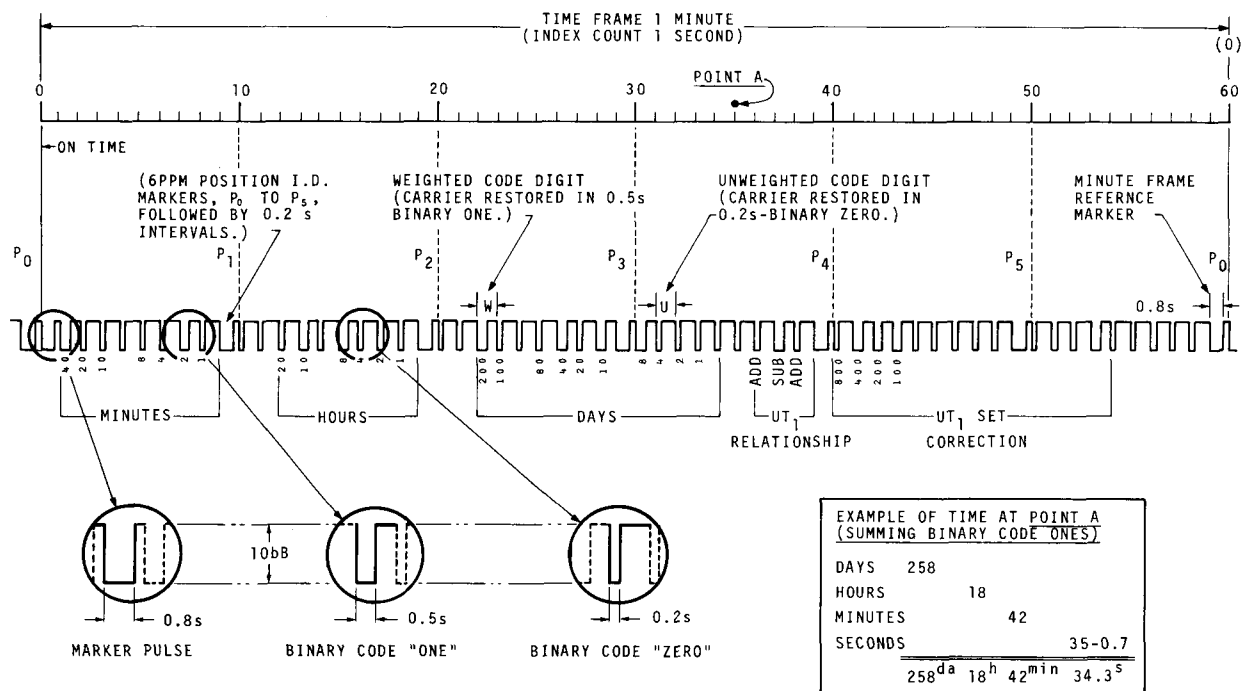

FIGURE 10.7. Format of WWVB one-minute time code.

individual pulses yields seconds information; the minute reference marker begins at zero seconds. Complete details of the WWVB time code are given in reference [64].

Equipment is available for automatically decoding the WWVB time code, and it has been stated that the time information is available to 50 μ s over a wide geographical area with the provision that propagation delay corrections are made from station WWVB [68]. The WWVB standard frequency and time code broadcasts are used to maintain synchronization of interconnected power grids in the continental U.S. [7]. Improved system control, using these low frequency broadcasts, has been proposed to attain frequency and time agreements between North American power areas of ± 0.001 Hz at 60 Hz and better than 50 ms respectively [69]. The code is used also for time reference of seismic recordings [70, 71]; and the WWVB 60-kHz signal is used as a standard for the telephone company [72].

(3) *LF Pulse Decay Time Measurements.* Andrews, Chaslain, and DePrins reported on time pulses emitted by HBG (75 kHz) and WWVB (60 kHz) at distances ~ 80 to 1000 km and obtained time to an accuracy of ± 40 μ s or better from measurements of the arrival time of an LF pulse [67]. Basically, they selected a point on the decay curve of the pulse (essentially transmitted as a square wave) and, through photographic integration, determined that

the minimum overall error occurs when the amplitude point selected for measurement on the decay envelope is between 75 and 90 percent. The timing error is directly related to the amplitude point chosen and depends also on (a) changes in pulse shape caused by variations in the transmitting antenna; (b) variations in propagation conditions and; (c) amplitude measurement errors of the received pulse envelope. During the measurements it is important that the phase between the received signal and the local reference remain unchanged during the integration time. In Brussels, Belgium the method has been used for time synchronization with ~ 40 μ s accuracy and for frequency measurements with an error less than 7 parts in 10^{12} over periods of a year [67].

The advantages and limitations of LF transmissions for TFD are quite similar to those shown for VLF. Some additional characteristics might include the following:

Advantages of LF Signals for TFD

- Stable results are obtained within groundwave distance of an LF transmitter because ground wave and skywave signal interference is not present at such ranges.
- Time pulse modulation, which is possible at LF, permits time synchronization to ~ 100 μ s or better, provided the propagation delay is known.

- The WWVB time code has proven of value in timing of seismic events, and coordinating North American power grids.
- Single LF phase comparisons can be made at accuracies of parts in 10^{11} per day with reasonably simple and economical receiving equipment.

Limitations of LF systems for TFD

- Automated decoding of LF time codes requires relatively expensive equipment.
- Because of attenuation factors LF signals are generally less useful than VLF at large distances from a transmitter (> 2500 km).
- Ionospheric anomalies degrade reception of WWVB in some geographic areas of the United States.
- LF propagation is subject to ionospheric variations; phase changes occur from diurnal effects, solar disturbances, and modal interference. (This latter factor can cause "cycle slippage" at critical propagation distances.)
- As for VLF comparisons, extreme care is required of LF receiving equipment for optimum results. Proper interpretation of data requires experienced personnel.
- It is not now possible to initially set remote clocks to high accuracy via LF radio techniques alone.

d. High Frequency (HF) Time and Frequency Dissemination

Today there are some 20 countries broadcasting stabilized HF standard time and frequency signals [73, 74]. Characteristics of many of the international stations, broadcasting in the frequency band between 3 and 30 MHz, are listed in Annex 10.B and 10.C. The ease of usage and worldwide reception capability of HF signals for TFD attests to their acceptance and value. In the U.S. the Navy first broadcast spot-time signals about 1904 [10]; in 1923 the NBS station WWV, commenced standard frequency broadcasts from the Washington, D.C. area. These transmissions were improved and later included standard time signals; in 1948 coverage of such T&F information was extended to the Pacific area with the WWVH emissions from Hawaii. The accuracy of the WWV signals as transmitted and received initially was about a part in 10^5 . Improvements in equipment and frequency control raised this to parts in 10^7 during the 1950's. Further progress, principally through use of atomic frequency standards as reference oscillators, improved the transmitted accuracy several orders of magnitude to today's value of a few parts in 10^{12} [64]. Unfortunately, ionospheric propagation of HF signals via skywaves generally restricts the accuracy of received standard frequencies to a few parts in 10^7 and received time signals to ~ 1

ms. (Long term refinements can improve these accuracies as described later).

Accuracy of signals received beyond groundwave range of an HF transmitter (~ 160 km) has not improved since World War II. This is shown graphically in figure 10.8 where the frequency accuracy of WWV transmissions is plotted for a 50-year period since 1923. Most of the restrictive ionospheric effects at HF are described in Annex 10.A. These uncontrollable ionospheric factors dictate the accuracy levels of HF time and frequency dissemination via skywaves and would preclude frequency accuracy improvements in the NBS high frequency transmitting equipment. At the receiving end, systems using diversity techniques for automatically and continuously locking on the optimum signal of several WWV or WWVH frequencies may provide some improvement in accuracy of received signals [75]. Also other diversity techniques such as separation of antennas in space, frequency separation and antenna polarization might be beneficial [76].

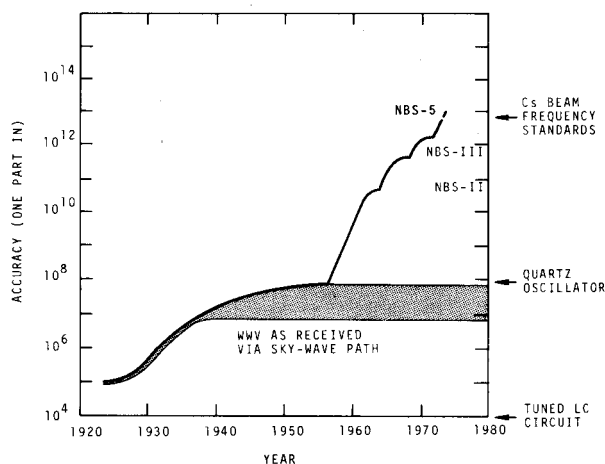

FIGURE 10.8. Accuracy of WWV transmissions from 1923 to 1973. Shaded area shows WWV as received via sky-wave path.

Many excellent HF broadcasts exist for TFD such as CHU, JJY, and MSF; various HF emission formats for TFD are illustrated in reference [73]. At this point we will describe briefly the WWV/WWVH formats to show the composition of a typical HF standard time and frequency transmission.

Station WWV now broadcasts from Ft. Collins, CO at the international allocated frequencies of 2.5, 5.0, 10.0, 15.0, 20.0, and 25.0 MHz [64, 77, 78]; station WWVH transmits from Kauai, Hawaii on the same frequencies with the exclusion of 25.0 MHz.



FIGURE 10.9. WWV transmitter building and antennas at Ft. Collins, CO.

The WWV transmitter building is shown in figure 10.9. The hourly broadcast formats of both WWV and WWVH are shown in figure 10.10; the broadcast signals include standard time and frequencies and various voice announcements. Complete details of these broadcasts are given in reference [64]. Both HF emissions are directly controlled by Cs beam frequency standards with periodic reference to the NBS atomic frequency and time standards [79]; corrections are published monthly [42].

Besides the standard carrier frequencies, an important part of the WWV and WWVH emissions includes audio tones and time ticks as shown in figure 10.10. The 1-second UTC markers are transmitted continuously by WWV and WWVH, except for omission of the 29th and 59th marker each minute. With the exception of the beginning tone at each minute (800 ms) all 1-second markers are of 5-ms duration; these WWV and WWVH pulses consist of 5 cycles of 1000 Hz and 6 cycles of 1200 Hz respec-

tively as shown in figure 10.11; this figure shows also the spectra of the WWV and WWVH pulses. Each pulse is preceded by a 10-ms period of silence and followed by 25 ms of silence; time voice announcements are given also at 1-minute intervals. All time announcements are Greenwich Mean Time and the actual reference time scale is the Universal Coordinated Time Scale UTC(NBS) (see chap. 1 for time zone changes from Greenwich).

WWV and WWVH also continuously emit a 100-Hz time code. This is an IRIG-H type of code with a 1-minute time frame; it uses the BCD system, includes 60 markers per second, and the leading edge of each pulse coincides with a positive zero-axis of the 100-Hz modulating frequency. The code contains similar information to the WWVB time code and 10-ms resolution should be obtainable. For details of the WWV/VH time code see reference [64].

There are various means of using the HF standard frequency and time emissions; they include the

WWV BROADCAST FORMAT

VIA TELEPHONE (303) 499-7111
(NOT A TOLL-FREE NUMBER)

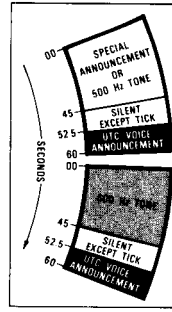
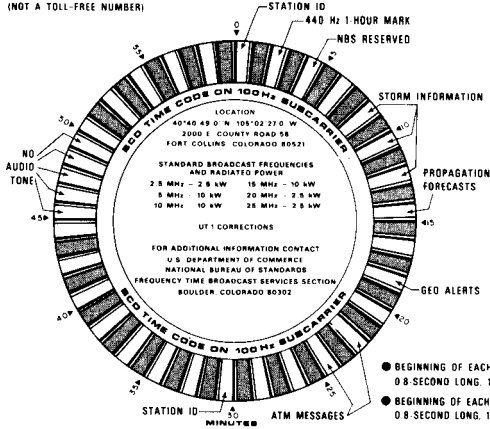

(a)

- BEGINNING OF EACH HOUR IS IDENTIFIED BY 0.8 SECOND LONG, 1500 Hz TONE
- BEGINNING OF EACH MINUTE IS IDENTIFIED BY 0.8 SECOND LONG, 1000 Hz TONE
- THE 29th & 59th SECOND PULSE OF EACH MINUTE IS OMITTED

WWVH BROADCAST FORMAT

VIA TELEPHONE (808) 335-4363 (NOT A TOLL-FREE NUMBER)

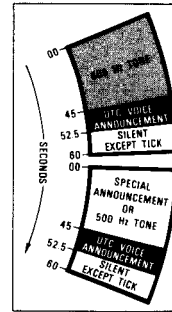
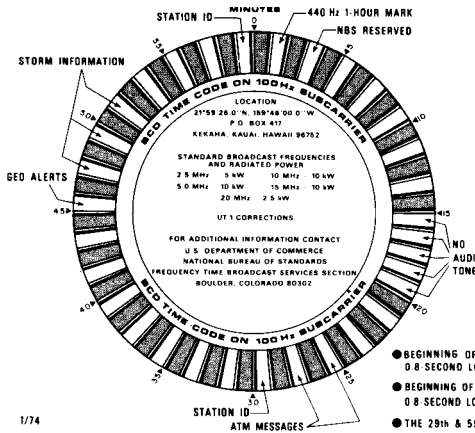

(b)

- BEGINNING OF EACH HOUR IS IDENTIFIED BY 0.8 SECOND LONG, 1500 Hz TONE
- BEGINNING OF EACH MINUTE IS IDENTIFIED BY 0.8 SECOND LONG, 1200 Hz TONE
- THE 29th & 59th SECOND PULSE OF EACH MINUTE IS OMITTED

FIGURE 10.10. Hourly broadcast format of WWV (a) and WWVH (b).

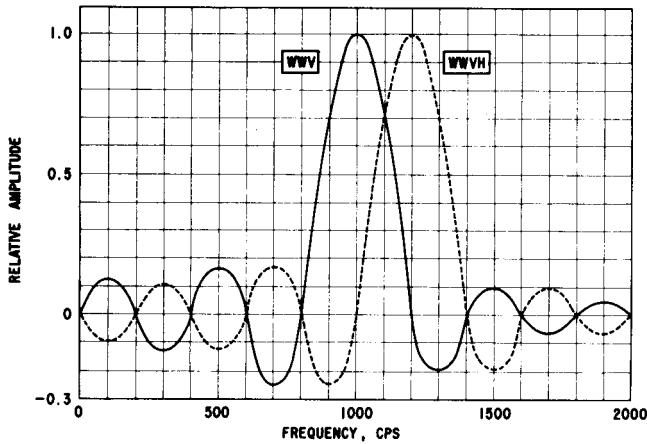

WWV AND WWVH SECONDS PULSES

THE SPECTRA ARE COMPOSED OF DISCRETE FREQUENCY COMPONENTS AT INTERVALS OF 1.0 CPS. THE COMPONENTS AT THE SPECTRAL MAXIMA HAVE AMPLITUDES OF 0.005 VOLT FOR A PULSE AMPLITUDE OF 1.0 VOLT. THE WWV PULSE CONSISTS OF FIVE CYCLES OF 1000 CPS. THE WWVH PULSE CONSISTS OF FIVE CYCLES OF 1200 CPS.

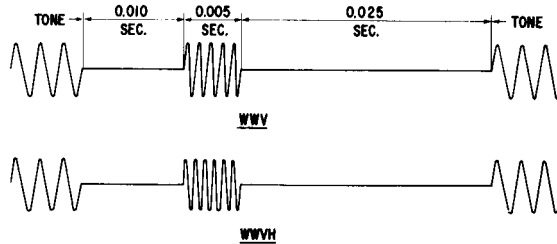

FIGURE 10.11. Characteristics of time-pulse emission from NBS radio stations WWV and WWVH.

zero-beat method of comparing frequencies (employing either multiplication or division to obtain a suitable frequency), time comparisons for either time or frequency information, and decoders for the IRIG-H time code [1, 4, 80, 81]. Although the previously stated accuracies for HF comparisons generally hold, Watt et al., have shown that improvements in precision can be obtained through averaging [27]. Their results are plotted in figure 10.12; frequency measurements are less precise than those by time pulse. They used a running 10-day average technique to obtain precisions of several parts in 10^{10} for a 30-day period. Angelotti and Leschiutta studied the MSF 10-MHz signals (path length 1040 km from Rugby, England to Torino, Italy) and for 3500 independent daily measurements over a 10-year period obtained a yearly mean average time difference of $200 \mu\text{s}$ between received signals and local clocks. Winkler also reports that WWV can be received at the USNO (15 MHz at the same time each day) to about $200 \mu\text{s}$ [83].

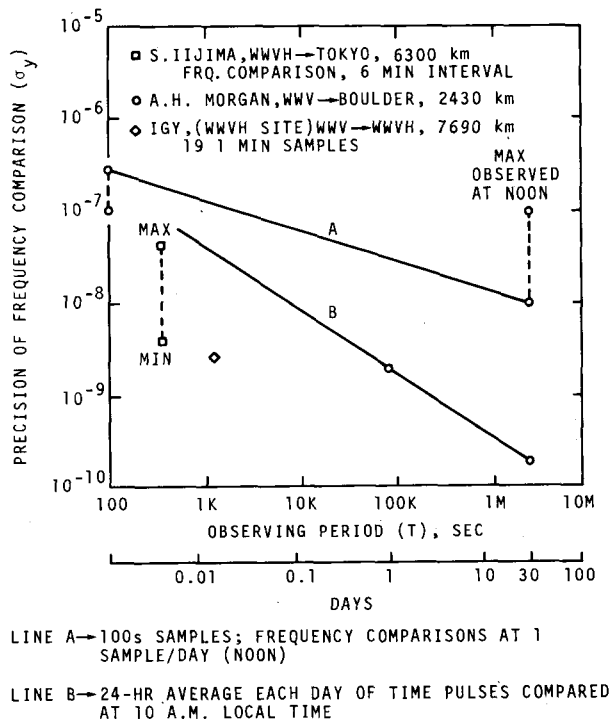

FIGURE 10.12. WWV/WWVH frequency comparison precision (10 MHz).

Optimum HF radio measurements can be obtained by following the below named procedures:

- (a) Make measurements at the same time each day when the radio path is in full daylight or darkness;

- (b) record no measurements when an ionospheric disturbance is in progress;
- (c) use the highest reception frequency which gives consistent results;
- (d) avoid radio paths that pass over or near either auroral zone;
- (e) use a good quality communications or special timing receiver with directional antenna oriented to provide shortest propagation path.

As with all radio systems, the determination of propagation delay limits the usefulness of HF signals for timing. An approximation for propagation delay for one hop skywaves, reflected from the E and F layers of the ionosphere, can be determined from a graph developed by Morgan and shown in figure 10.13 [84]. (E-layer exists during daytime only.) This graph shows an error of about $400 \mu\text{s}$ for a variation of 200 km in ionospheric height at a 3000 km single hop distance. HF methods are critical, especially at distances where transitions between dominant modes may occur; also in the determination of the existence of one-hop, two-hop, etc., conditions. With consideration of error sources, one can probably estimate HF propagation delay to about 1 ms. Barghausen et al., have

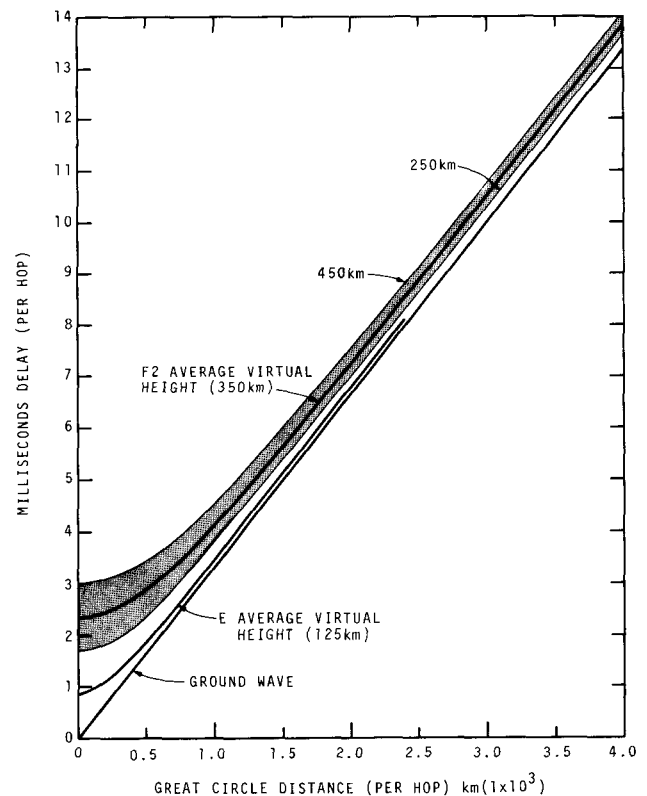

FIGURE 10.13. HF propagation delay versus distance for several ionospheric heights of reflection.

developed methods and techniques for predicting long-term performance of HF telecommunication systems [85]. Their computer programs can yield much useful information on given frequencies and propagation paths as described in Annex 10.A.

Advantages of High Frequency TFD

- Receiving equipment and antennas are simple and economical for time accuracies of ~ 1 ms.
- The widespread location of HF time and frequency transmitters, broadcasting UTC signals, enables reception of at least one of these transmissions almost anywhere in the world; they also serve an unlimited number of users simultaneously.
- HF transmitters and antennas are smaller, simpler, and of less cost than the low frequency broadcasting stations.
- Long-term averaging of HF data can remove some propagation anomalies, approaching precisions of parts in 10^{10} over 30-day periods.
- Groundwave signals (~ 160 km from transmitter) can be received with about the same accuracy as transmitted.
- Sufficient bandwidth is available at these frequencies to enable time pulse modulation.

Limitations of High Frequency TFD

- Received HF skywave signals suffer erratic excursions in time delay from ionospheric irregularities; this both degrades time and frequency comparisons and causes unreliability of reception.
- Propagation delays of HF skywaves are difficult to determine to better than 1 ms because of ionospheric variability from sunspot activity, time of day, seasons, distance, Doppler shifts, etc.
- The transmission modes (number of hops propagated) are difficult to predict for HF radio paths exceeding ~ 3500 km.
- Atomic frequency control of HF broadcasts give instantaneous frequency stabilities in the transmitted signal some four orders of magnitude greater than that realized at a receiver via skywave propagation; it appears that no equipment improvement can overcome this limitation of nature.

e. Radio Navigation Systems for TFD

Radio navigation systems have much in common with standard time and frequency radio emissions [86]. Both depend upon the constancy of the speed of light for their concept of operation and both employ some type of periodic format. Because of some nearly identical requirements in timing, communication, and navigation, various radio transmissions of precisely controlled frequency can serve multiple roles.

As one example of how standard time transmissions can be used for navigation consider the idea of range-range or rho-rho navigation. Refer to figure 10.14; assume that a time signal transmitted from T_1 is received at a ship located at A. If the coordinates of the transmitter are known, and the ship has an on-time clock, one could readily determine the propagation delay, t_d , of the received signal. This value would enable one to compute the distance, d_1 (since $t_d \cdot c = d_1$, where $c =$ velocity of light). It is thus determined that the ship is somewhere on a circle of radius d_1 . If one receives another time signal from T_2 , whose coordinates are also known, such information would also place the ship on another circle of radius d_2 , either at point A or B, the intersection points of the two circles. Such a position ambiguity could be resolved by other navigation means or by measuring a time signal from a third transmitter of known coordinates.

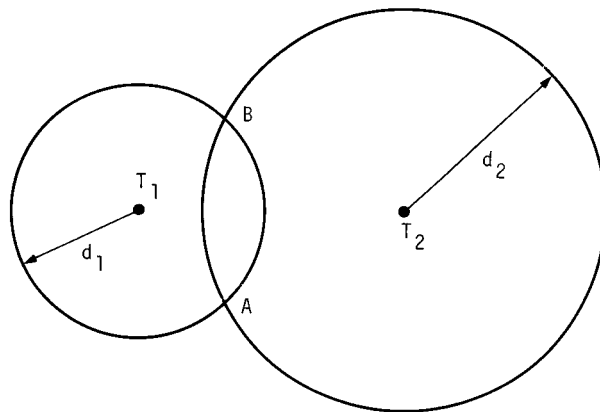

FIGURE 10.14. Concept of range-range navigation.

A corollary to this example is the use of navigation systems for time and frequency dissemination; it would be necessary that the signal format generator be frequency stabilized and that some recognizable character within the format be synchronized with the time tick. The accuracy of ranging and timing capability of some systems are graphed in figure 10.15.

Characteristics of some navigation systems useful for TFD are given in Annex 10.D. The following subsections give details of the radio navigation systems; Omega, Loran-C and Loran-A.

(1) Omega Navigation System for TFD

This system was originally conceived as a VLF radio navigation system for ships, submerged submarines, and aircraft [87, 88]. It is expected that both civilian and military craft of many nations eventually

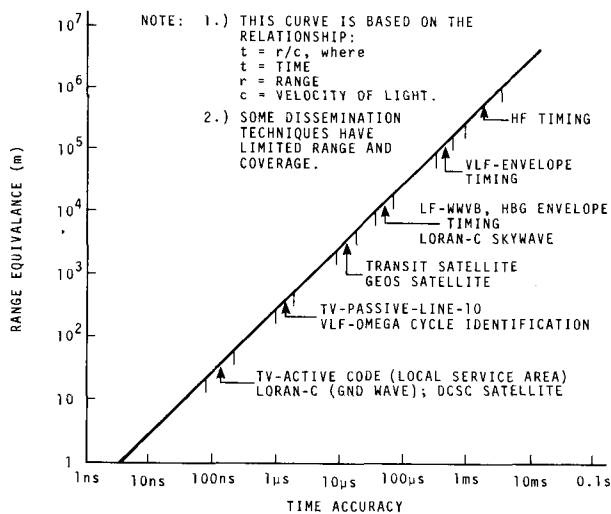

FIGURE 10.15. Relationships between ranging (navigation) and timing (clock) accuracy.

will navigate by Omega. For the past decade the system has been operating experimentally, using only four of the proposed eight transmitters broadcasting at low power and showing potential in both navigation and timekeeping [89, 90]. On October 1, 1968 the U.S. Defense Department approved an eight-station, 10-kW, Omega system with an operational target date in early 1970. (Now scheduled for the mid-1970's.) System implementation will involve capital expenditures of about \$100 million. Four cesium beam clocks will be installed at each of the eight transmitting stations. The eight-station system will provide reliable and near-global coverage. Figure 10.16 gives the proposed worldwide location of the eight-station network. (The Omega station at La Moure, North Dakota (USA) is now operational at full power.)

In the Omega system, each transmitter broadcasts several time-shared carrier frequencies between 10 and 14 kHz. The primary navigation frequency is 10.2 kHz. The basic Omega pattern consists of an eight-element 10-second format, within which the fundamental signals are of about 1-second duration [59] (see fig. 10.17 as an example of one proposed format). At a receiver, phase differences between 10.2-kHz signals from pairs of transmitters define hyperbolic lines of position. Since the observed phase differences of one frequency as received from two transmitters show multiple ambiguities (repeat at intervals of one-half wave length—about 29 km at 10.2 kHz) submultiple frequencies are employed in stages to permit observer location or so-called lane identification (equivalent to cycle identification in the timekeeping sense). Stated accuracies are about 1 km in the daytime and double that at night, and the VLF Omega frequencies can be received adequately at ranges up to about 13,000 km. After an initial fix (and barring unforeseen instrumental or transmitter difficulties), a ship's receiver system will automatically keep track of lane position while the ship is underway. Although the Omega signals are sensitive to propagation vagaries such as diurnal variations, solar activity, and polar cap attenuation [91], compensating factors such as the provision of multiple frequencies can overcome many of these degrading influences.

Conversely, in terms of TFD, frequency comparisons via Omega signals can be made now to a few parts in 10^{11} per day with commercially available equipment; extraction of timing information is similar to VLF techniques previously described. Daily phase values of currently-operating Omega transmissions are published weekly in terms of UTC (USNO) [43]. In this way corrections can be made after the fact. With the new Omega system, it is anticipated that one can continuously maintain phase to 3 μ s or less per day and/or make frequency comparisons to several parts in 10^{12} at global distances [59]. Lead-edge envelope timing measurements can be made with a precision of about 100 μ s

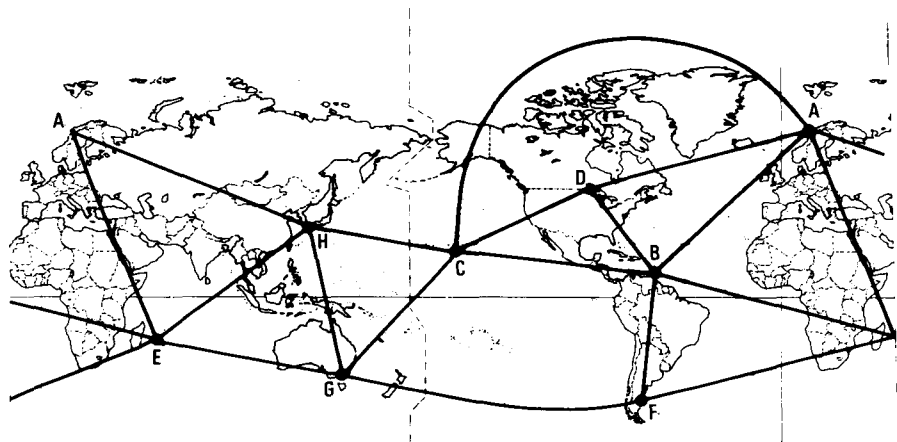

FIGURE 10.16. Proposed worldwide location of eight-station navigation Omega (VLF) network [59].

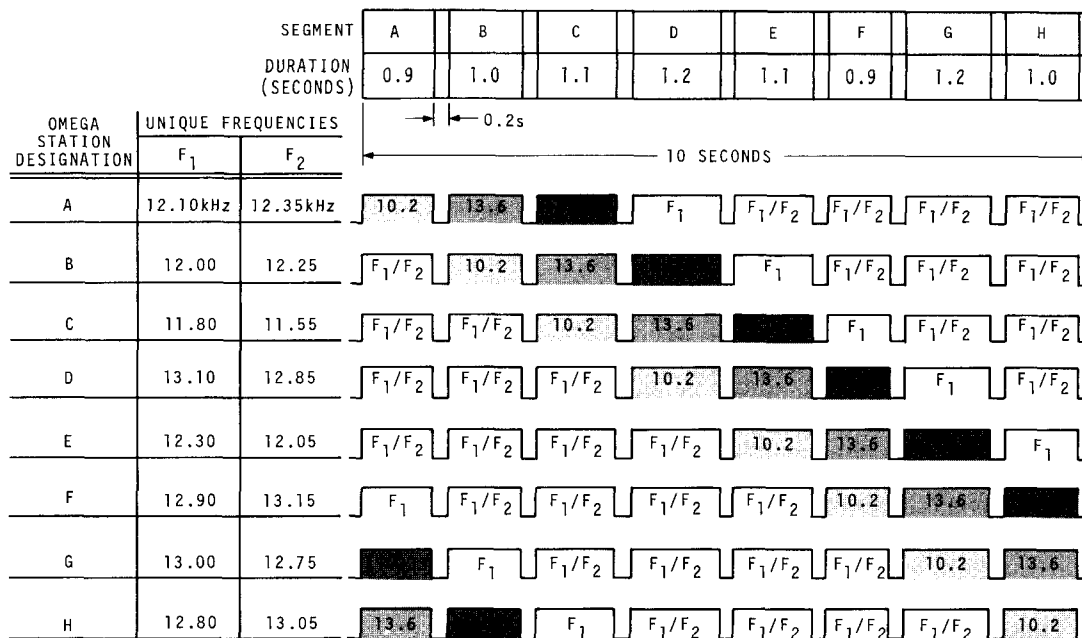

FIGURE 10.17. Proposed Omega eight-element 10-second format [92].

[59]. Since the phases of all the transmitted frequencies are closely synchronized, there is opportunity to employ the multiple VLF carrier technique such as NBS used with the WWVL broadcasts [46]. This method should resolve the basic timing ambiguities inherent in VLF techniques and permit identification of a specific cycle, thus allowing resynchronization of remote clocks. An experimental Omega precise timing receiver has been developed recently and is now being evaluated [92]. The Omega format also offers an excellent opportunity for disseminating time information such as day/hours/minutes in a low-bit-rate time code using two unique frequencies assigned to each station [93]. Such timing would not be required in the navigation function; it does, however, illustrate the significant potential of operational systems providing alternate functions to diverse user groups at negligible cost and inconvenience.

Civilian direction of the operational Omega system will be under the Department of Transportation (DOT) with control of non-U.S. stations provided by the foreign country furnishing the transmitter site. Such an arrangement, subject to international agreement, should insure some degree of permanency and reliability to both civilian and military users.

Advantages of the Omega system for TFD

- Transmitted frequencies of each station are based on consensus of four commercial cesium beam standards, and assure both reliability and stability of the Omega transmitted signals.
- The eight-station network will be synchronized to about 1 μ s and can provide VLF signals from 3 to 5 separate stations to global receiving sites.

- Day to day phase maintenance of several μ s appears feasible with corresponding frequency measurements to several parts in 10^{12} .
- System offers a strong potential for disseminating a time code at small additional costs.
- Nearly continuous operation of 24h/day.
- Some propagation factors are predictable, and time is traceable to UTC(USNO) through U.S. Naval Observatory monitoring and reporting.
- Omega system has potential for providing simultaneous timing and navigation information without interference to either.

Limitations of Omega TFD include the following:

- Repeated measurements at various frequencies or an external time source may be required to initially set the date or periodically verify coarse time.
- Modal or long-path/short-path interference can adversely affect reception, especially at critical ranges.
- Stable phase periods are generally restricted to certain times of the day, and the VLF signals are subject to degradation in accuracy from propagation factors, such as SID's, diurnal effects, SPA's, etc. (see VLF limitations—sec. 10.3.2.b.)
- The Q of the transmitter antenna limits the accuracy to which pulse transmission can be accomplished at VLF.

(2) Loran-C Navigation System for TFD

Loran-C (Long Range Navigation) is a navigation system which evolved from World War II

technology to provide precise position for ships, submarines, and aircraft. In the early 1960's NBS explored the timing potential of this navigation system and found encouraging results [94, 95]. Since then many studies have verified its usefulness for timekeeping [96-98].

Loran-C uses an LF 100-kHz carrier frequency (20 kHz bandwidth) and pulse transmission to form hyperbolic lines of position. The U.S. Coast Guard now operates and manages the system with close synchronization to the U.S. Naval Observatory time scale [UTC(USNO)]. The basic Loran-C unit is a chain, consisting of a master station and two or more slave stations located within ground-wave range of the master transmitter. There are now eight worldwide chains in operation, which, together with slave stations, comprise a total of about 34 stations. These stations are listed in table 10.2. Note that four chains, with details given in

Annex 10.D, are time synchronized and phase controlled within $\pm 15 \mu\text{s}$ of UTC(USNO). The other four chains employ Cs standards for frequency control but are not maintained within the limits of $\pm 15 \mu\text{s}$ of UTC. Synchronization of stations within a chain is held usually within $\pm 0.2 \mu\text{s}$. The coverage of the multicontinental Loran-C system is shown in figure 10.18.

Loran-C uses a pulse-coded format with rates assigned to (a) separate and identify chains and its members, (b) eliminate stray interference that is coherent, and (c) provide the optimum SNR for given geographic chain coverage. Pulse transmissions enable users to separate multipath (skywave) signals from the earlier arriving and more stable groundwave signals. Within a chain, a master station transmits exactly spaced groups of nine pulses and slave stations eight pulses, within the Group Repetition Period (GRP) assigned to the particular chains.

TABLE 10.2. Characteristics of Loran-C stations

Chain	Rate	Stations	Emission Delay (μs)	Power (kW)
U.S. East Coast	SS7	M Carolina Beach, NC.....		1,000
		W Jupiter, FL.....	13,695.48	400
		X Cape Race, NF.....	36,389.56	2,500
		Y Nantucket Is., MA.....	52,541.27	400
		Z Dana, IN.....	68,560.68	400
Mediterranean	SL1	M Simeri Crichi, Italy.....		300
		X Lampedusa, Italy.....	*12,757.12	400
		Y Targabarun, Turkey.....	32,273.28	300
		Z Estartit, Spain.....	50,999.68	300
Norwegian Sea	SL3	M Ejde, Faroe Is.....		400
		W Sylt, Germany.....	30,065.69	400
		X Bo, Norway.....	15,048.16	300
		Y Sandur, Iceland.....	48,944.47	1,500
Z Jan Mayen, Norway.....	63,216.20	300		
North Atlantic	SL7	M Angissoq, Greenland.....		500
		W Sandur, Iceland.....	15,068.10	1,500
		X Ejde, Faroe Is.....	27,803.80	400
		Z Cape Race, NF.....	48,212.80	2,500
North Pacific	SH7	M St. Paul, Pribiloff Is.....		400
		X Attu, AK.....	14,875.30	400
		Y Port Clarence, AK.....	31,069.07	1,800
		Z Sitkinak, AK.....	45,284.39	400
Central Pacific	S1	M Johnston Is.....		400
		X Upolo Pt., HI.....	15,972.44	400
		Y Kure, Midway Islands.....	34,253.02	400
Northwest Pacific	SS3	M Iwo Jima, Bonin Islands.....		3,000
		W Marcus Island.....	15,283.94	3,000
		X Hokkaido, Japan.....	36,684.70	400
		Y Gesashi, Okinawa.....	59,463.34	400
		Z Yap, Caroline Islands.....	80,746.78	3,000
Southeast Asia	SH3	M Sattahip, Thailand.....		400
		X Lampang, Thailand.....	13,182.87	400
		Y Con Son, South Vietnam.....	29,522.12	400
		Z Tan My, South Vietnam.....	43,807.30	400

*Approximate value, station operation scheduled to begin fall, 1972.

LORAN-C COVERAGE DIAGRAM

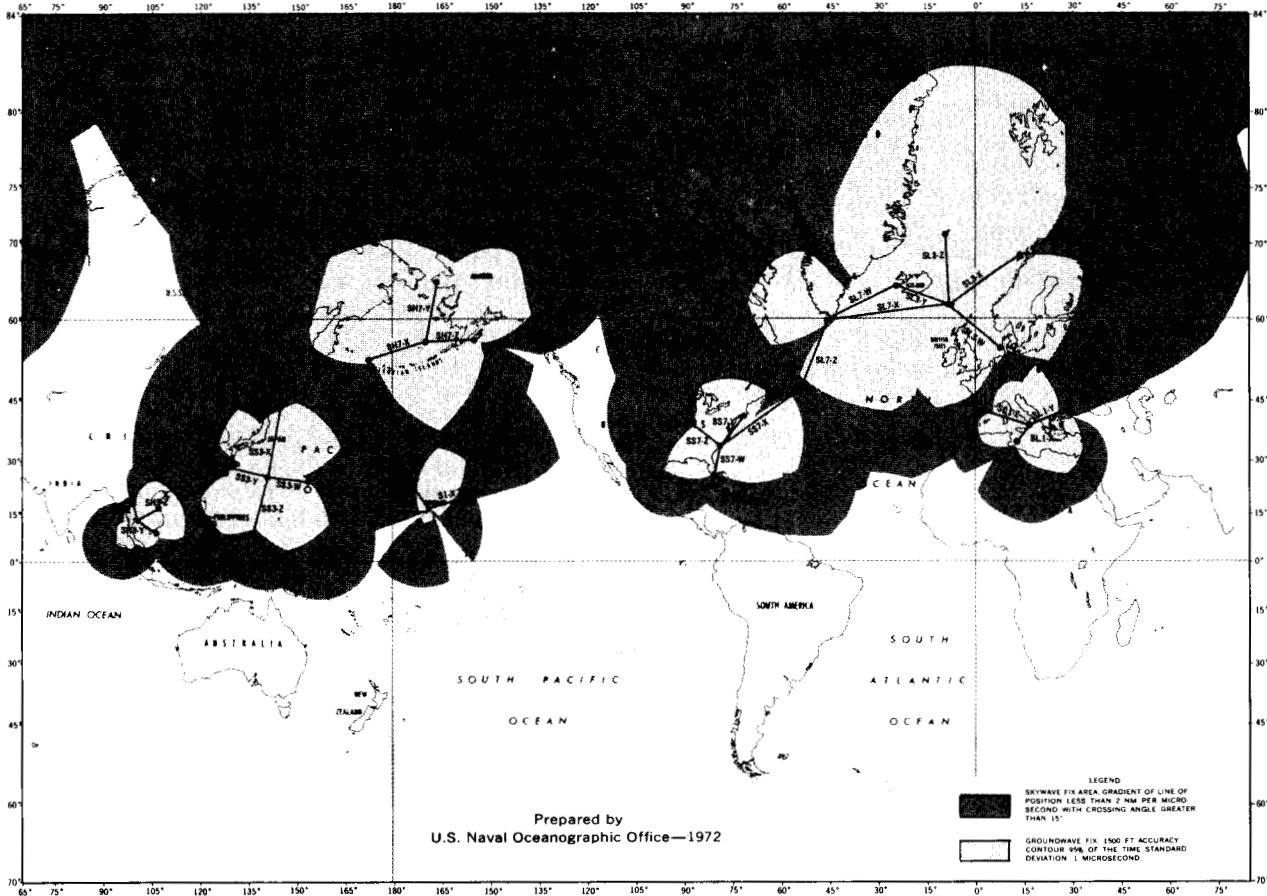

FIGURE 10.18. Coverage of Loran-C navigation system.

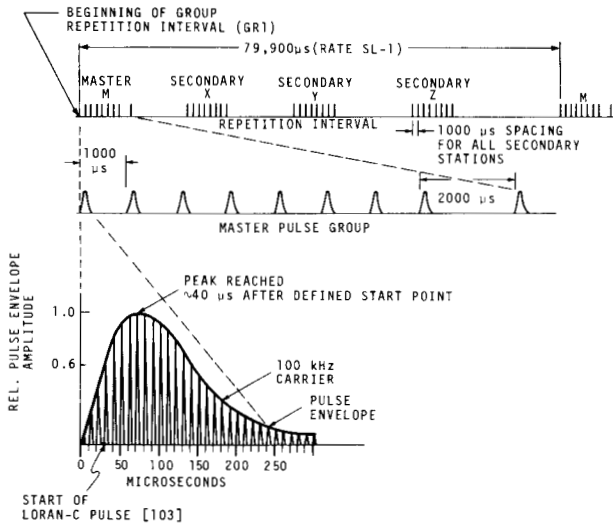

FIGURE 10.19. Loran-C pulse group format.

The Loran-C pulse group format is shown in figure 10.19. This figure also shows a typical pulse with a rise time near $30 \mu\text{s}$ (following first 3 cycles) for reaching about 60 percent of peak value; a feature permitted by the relatively wide bandwidth of $\pm 20 \text{ kHz}$.

For timing it is important to know the time of coincidence (TOC) of Loran-C signals relative to a universal time second on the UTC scale. Since these signals are transmitted by each station once during the GRP, only a particular pulse coincides with the UTC second, followed by periodic coincidence. Times of coincidence vary for the different rates; for example a repetition period of $59,600 \mu\text{s}$ gives a coincident interval of 149 whole seconds, whereas a rate of $49,600 \mu\text{s}$ repeats every 30 s. The basic rates and specific times of coincidence for Loran-C signals are shown in table 10.3. Generally, a Loran-C pulse coincides with a UTC second at least once after each 10,000 repetition periods [98]. The USNO devised a null ephemeris table which provides specific coincidences for the master Loran chains in operation. Coincidence measurements using slave

TABLE 10.3.a. *Loran-C basic and specific rates*¹

Specific	Basic→S	SH	SL	SS
0	50,000	60,000	80,000	100,000
1	49,900	59,900	79,900	99,900
2	49,800	59,800	79,800	99,800
3	49,700	59,700	79,700	99,700
4	49,600	59,600	79,600	99,600
5	49,500	59,500	79,500	99,500
6	49,400	59,400	79,400	99,400
7	49,300	59,300	79,300	99,300

¹ Pulse group repetition interval— μ s.

TABLE 10.3.b. *Period of time between UTS² and Loran rate coincidences (seconds)*

Specific	Basic→S	SH	SL	SS
0	1	3	2	1
1	499	599	799	999
2	249	299	399	499
3	497	597	797	997
4	31	149	199	249
5	99	119	159	199
6	247	297	397	497
7	493	593	793	993

² UTS=Universal Time Second or UTC second.

stations must account for corresponding emission delays. The initial date (epoch) for all Loran-C master stations has been set arbitrarily at 00^h00^m00^s, 1 January 1958. The USNO publishes the periodic coincidence from this origin in null ephemeris tables for each calendar year in the Series 9 of the Time Service Announcements [99].

The accuracy of timekeeping via Loran-C depends upon (a) the propagation delay and its variation between the transmitter and receiving antenna, (b) the delay through receiving equipment, and (c) operator skill in cycle selection. (The daily relative phase values are published by the USNO [43] and corrections can be made later.) In addition, synchronizations should be made at TOC seconds and time of the local clock must be known to better than one-half of the period of the appropriate chain repetition rate to eliminate GRP ambiguity (~ 25 to 50 ms).

The propagation delays depend upon such factors as all sea-water paths, mixed land and sea-water paths, groundwave or skywave propagation, and irregular terrain effects. Propagation delays can be computed using methods devised by Jöhler [100], Jöhler and Berry [101], and Wieder [102], with fair success. Potts and Wieder [103] point out that a single portable clock visit to a user site can calibrate propagation delay for skywave propagation and reduce the error to within an order of magnitude of that observed in groundwaves. If signals are embedded in noise, special procedures are required to enhance the Loran-C pulses. Stetina and Zufall give useful details for obtaining time synchronization of remote clocks from Loran-C signals [98]. Their report pre-

sents a description of Loran-C techniques for clock synchronization of the Manned Space Flight Network (MSFN) and illustrates use of the USNO Time of Coincidence (TOC) charts.

Pakos [97] has assessed the various errors involved in Loran-C timing and has devised some qualitative error budgets for different categories of synchronization; e.g., synchronizing to the same Loran-C station, two stations within a chain, stations in different chains, or "real" time or "after the fact" synchronization. Based on such estimates he obtains an rms error of about 0.35 μ s for two users within groundwave distance of the same station, wishing to synchronize with each other but not with the UTC time scale. Typically, much larger errors occur when synchronizing to stations in different chains. Shapiro [104] reports microsecond timing capability for Loran-C signals received at groundwave ranges of 1500 km landward and at twice this range over water. (The groundwave range is limited or effected by transmitter power, ground conductivity, noise, interference and signal averaging time.)

Users outside the normal groundwave range of the LF Loran-C signals can obtain useful timing information from skywave propagation but at reduced accuracy. Stone [105] has reported skywave synchronization accuracies at night of ± 50 μ s over mixed land and sea paths of 8000-km length. (This experiment was a visual technique requiring synchronous detection.) Doherty [106] has shown carrier phase stabilities of ± 1 and ± 4 μ s for daytime and nighttime, respectively, at ranges to 3200 km for single hop skywaves. Mazur recently reported time synchronization to better than 25 μ s using nighttime skyway reception of Loran-C at distances of $\sim 15,400$ km [107]. He points out that such results are demanding of both receiver performance and operator technique.

Advantages of Loran-C for TFD

- A fully operational system with firm implementation plans for equal status chains (i.e., UTC synchronization) will provide coverage to a large percentage of the world.
- Redundant cesium frequency standards are used for frequency and time control with monitoring and referencing to USNO(UTC) in most cases; phase corrections for six chains are published weekly by the USNO.
- Groundwave stability of Loran-C signals show microsecond precision capability with accuracies limited to about a μ s because of propagation effects. Skywave capabilities, depending upon hops, can give ± 10 –50- μ s synchronization accuracy. TOC for time coordinated chains are published in advance by USNO.
- Depending upon user requirements, equipment costs are reasonable but increase as timing needs become more stringent.
- The accuracy and stability of the Loran-C

system enable comparison of frequency standards and time scales of many nations and provide a highly rated input to the International Atomic Time (TAI) scale at the BIH in France.

- As with the Omega system, timing and navigational functions can coexist in one system with minimum interference, thus conserving electromagnetic spectrum.

Limitations of Loran-C for TFD

- The timing accuracies are limited to how well both propagation and equipment delays can be determined. Mixed ground and land paths, coupled with terrain effects, can limit accuracy.
- The local clock time must be known to better than half the chain repetition period to eliminate GRP ambiguity.
- Cycle selection is difficult and requires high operator skill.
- Coverage is not global and many areas in the southern Hemisphere are unable to receive Loran-C signals.

(3) Loran-A Navigation System for TFD

Loran-A is an MF radio navigation system, developed during World War II, to operate in the frequency range of 1.750 to 1.950 MHz [108, 109]. In this frequency range, coverage is limited to a typical station service area of radius 1800 km (groundwave range over land is reduced considerably); however, installations are worldwide (essentially in the northern Hemisphere) and are located at or near coastal areas. Some 60 pairs of Loran-A stations border the Atlantic and Pacific Oceans. Figure 10.20 gives a projected coverage map for the wide spread Loran-A stations. The U.S. Coast Guard maintains operation of the system, and it is used extensively for navigational purposes. Within certain restrictions, Loran-A is capable of microsecond relative timing or synchronization within moderate coverage areas of particular stations [2].

Loran-A stations operate in pairs using pulse transmissions on three frequency channels as follows:

Channel 1	1.950 MHz
Channel 2	1.850 MHz
Channel 3	1.900 MHz

Specific pulse repetition rates (PRR) are assigned a given Loran-A pair and each station transmits one pulse per Loran-A sequence [2]. The three basic repetition rate are 20, 25, and $33\frac{1}{3}$ pulses per second coded as S, L, and H respectively. Repetition periods for given PRR's are coded zero through seven; each integer represents 100 microseconds to be subtracted from the basic repetition period of $\sim 40,000\ \mu\text{s}$. Thus a Loran-A pair is designated by frequency channel, pulse repetition rate, and specific repetition period; e.g., 1S4 denotes a pair oper-

ating on the Channel 1 frequency (1.950 MHz), a PRR of 20 pulses per second and a specific repetition period of $39,500\ \mu\text{s}$. Pulses from two transmitters of a Loran-A pair are radiated with a fixed delay to ensure identification of the master and slave signals within the coverage areas. Baselines of Loran-A pairs range from about 300 to 1200 km and specific repetition rates are chosen to minimize interference from other pairs. Sometimes a third station is provided to form a Loran-triad. This station can operate on both specific repetition rates and perform mixed functions. The Loran-A pulse envelope has a cosine square shape; the pulse envelope rise time at the 50 percent amplitude point is about $20\ \mu\text{s}$ and the width at this point is about $40\ \mu\text{s}$. A typical Loran-A pulse is shown in figure 10.21.

Limited clock synchronization via Loran-A is feasible. Since each pair transmits independently, synchronization can be accomplished only within the coverage area of a particular pair. There is no UTC time base for Loran-A stations; each pair has its independent time base. Reception of these sky signals is limited by propagation effects [110]. Propagation of these MF signals over land paths is extremely limited. The groundwave signal strength of a 100-kW transmitter at 2 MHz received over an ~ 200 -km land path is about equivalent to that received over a 1200-km seawater path. On the other hand, the propagation of skywave signals is about equivalent for water and land paths. Skywave signals, via one-hop E-nighttime transmissions, are usable to about 2500 km, but with reduced accuracy. The ambient noise level experienced at MF also effects the usable range of Loran-A. A typical signal level of $5\ \mu\text{V/m}$ is required during the day in the middle latitudes to provide a maximum range of about 1200 km.

Advantages of Loran-A for TFD

- The system provides a means for synchronization to several μs within coverage range of pairs of stations (in the sense of a transfer standard) within groundwave proximity to the transmitters. Synchronization to $5\ \mu\text{s}$ is claimed for nighttime skywaves received in an area of over 3000-km radius about the transmitter [2].
- Ultimate system precision, through application of corrections for propagation effects, is predicted at $0.1\ \mu\text{s}$ over seawater [110].
- Receiving equipment and antenna requirements are minimal, however, commercial Loran-A receiving systems are not available solely for purposes of T/F comparison.
- System employs many worldwide stations in northern hemisphere with signals available to many coastal areas.
- All Loran-A transmitters are accurately located to within about 30 m (equivalent to less than $0.1\ \mu\text{s}$ error).

LORAN-A COVERAGE DIAGRAM

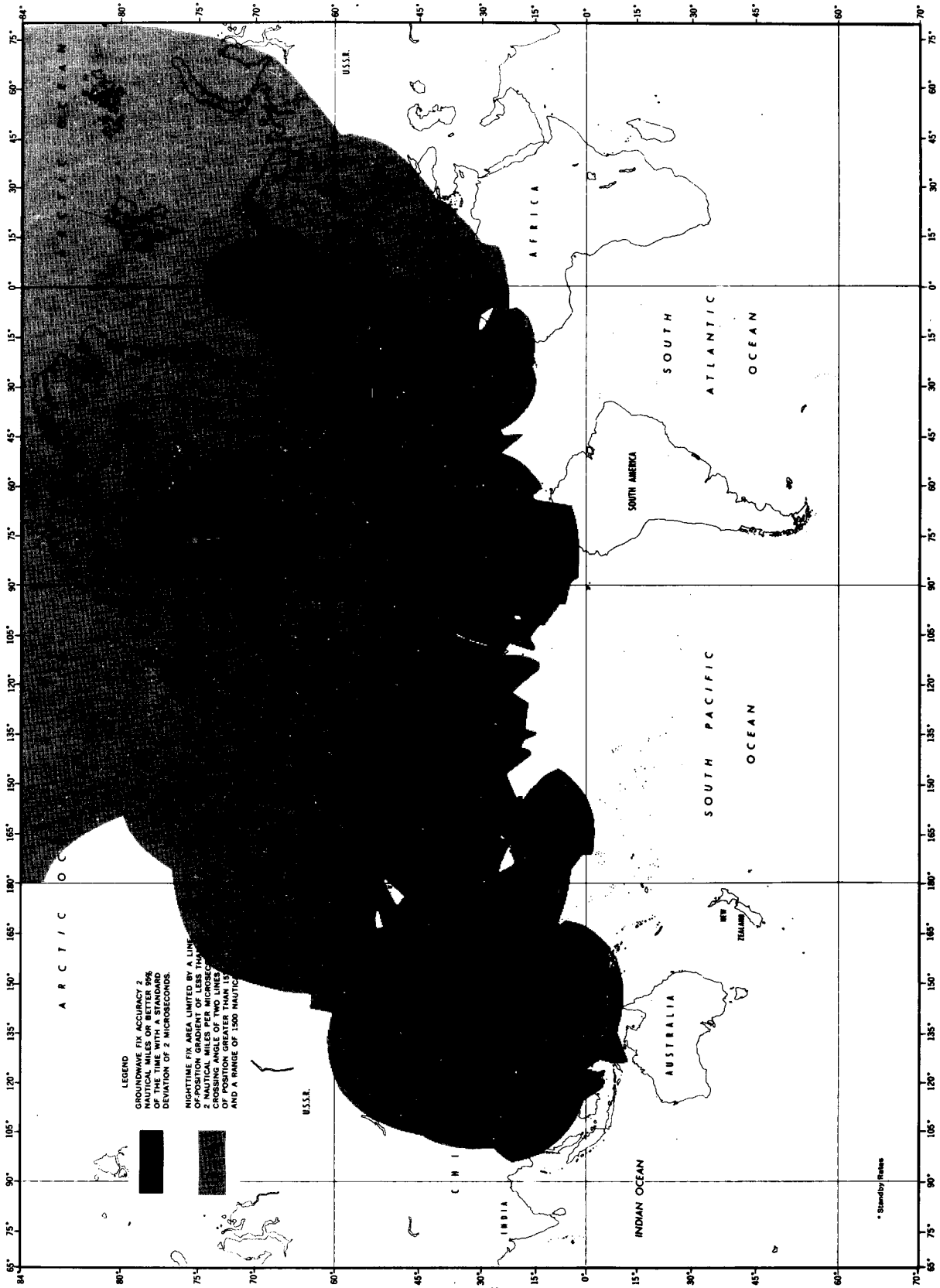

FIGURE 10.20. Coverage diagram of Loran-A navigation stations.

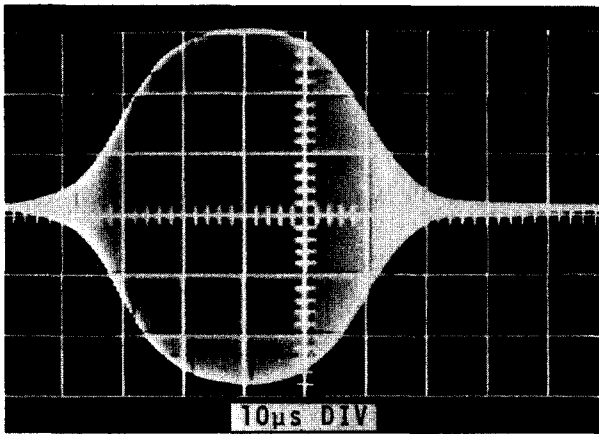

FIGURE 10.21. Typical Loran-A pulse envelope.

Disadvantages of Loran-A for TFD

- Pairs of stations in the Loran-A network are not linked together in time and repetition rates; they have no relation to the UTC time scale and are essentially 60 independent broadcasting systems.
- The area over which Loran-A time measurements could be made is limited to that in which signals from either of a pair of Loran-A transmitters can be received.
- Frequency generators are crystal oscillators which show aging effects relative to time; phase corrections are not published.
- Reception of Loran-A signals is limited to relatively short ranges and is subject to fluctuations inherent in MF propagation.
- The altitude of a receiving site above the surface is a factor that must be corrected for in precise time measurement; i.e. in an aircraft.
- Range of transmission coverage is affected by ambient noise level and is related to location on the earth, season, and day or night transmission.
- Land masses in the course of signal path adversely affect propagation.

f. Television TFD Techniques

Time and frequency comparisons via television signals have become a valuable and useful technique in many countries during the past 5 or 6 years [111-120]. Tolman et al., first demonstrated the utility of synchronizing remotely located clocks with television pulses transmitted over many microwave links; VHF television signals from one transmitter also provided clock synchronization to the same accuracy within the local TV broadcast service area [111]. A primary concern in long-term TV comparisons is the constancy of the propagation path delay between a multiplicity of microwave relays. Many studies have substantiated that such

path stability is in the range of 0.1 to 1.0 μs [112, 113, 116, 119]. For "on time" synchronization it is necessary to know the propagation path delay between the transmitter and receiver. This can be calibrated by a portable clock visit. Tolman et al., [111] reported that measured path delays agreed well with calculated values based on geographical distances and assumption of speed of light propagation. Leschiutta recently compared geographical delay computations for the Rome to Turin path in Italy (~ 745 km) with both round trip TV measurements and Loran-C data [120]. Geographical delay was determined by an ellipsoid computer program using established coordinates for transmitters, microwave relay stations, and receiving points. The calculated differential path delay agreed with the Loran-C data to less than 1 μs and with the round trip TV values to about 6 μs . Uncertainties in coordinates account for variation in these data. Such computed delays could prove useful to TV clock comparisons, dependent upon the accuracy required.

At this point we will consider the mechanism of various TV techniques for TFD. The following four categories have been investigated and will be discussed in terms of experience in the U.S.:

- (1) Time dissemination. TV transmissions can be utilized without auxiliary coding as a "transfer standard" (passive) for clock coordination [111, 112, 117].
- (2) Time and frequency dissemination. Sync pulse trains can be stabilized in frequency, then aligned in some fashion with a time scale [121].
- (3) Frequency dissemination. Frequencies contained in the TV transmission can be stabilized, providing accurate frequency information directly, or they can be used in a "transfer standard" application [116, 122].
- (4) Time and frequency dissemination. Time and frequency information can be injected into unused portions of the TV format for dissemination (active) [116, 119, 123, 124].

(1.a) *Sync Pulse "Transfer Standard" Clock Coordination.* The method was first demonstrated in 1965 when synchronization via TV microwave links was accomplished between Prague, Czechoslovakia and Potsdam, Germany [111]. The method has since gained wide acceptance. In 1968, NBS began using TV sync pulses from a common transmitter to synchronize the time broadcasts from Fort Collins, Colorado, to the UTC(NBS) Time Scale at NBS, Boulder [79]. The accuracy of such measurements is better than 1 μs with an rms day-to-day deviation of about 30 ns.

(1.b) *NBS Line-10 "Transfer Standard" Time Dissemination.* Following the work of Tolman and others, NBS developed the TV line-10 system as a passive means of comparing geographically-separated precision clocks [116, 125]. Figure 10.22 gives

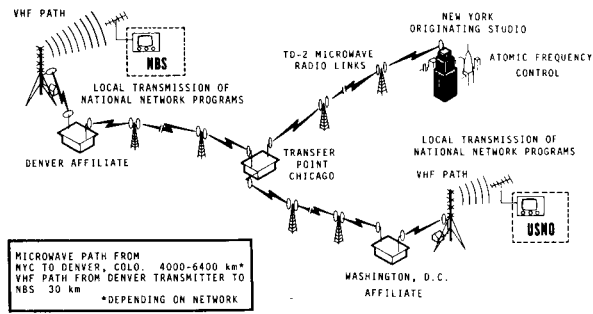

FIGURE 10.22. Overview showing routing of TV signals for time/frequency comparisons.

an overview of the system which permits periodic comparison of clocks throughout the U.S. via commonly received network broadcasts at a specified time. The broadcasts used by NBS originate from the New York City studios of three commercial TV networks (ABC, CBS, and NBC).³ These originating networks stabilize their transmissions with independent atomic frequency standards (rubidium gas cells). The New York signals, broadcast without auxiliary time coding, traverse varied and long paths using relays at microwave frequencies. This relay system is a chain of broadband radio links encom-

³ The results of this report are not to be used for advertising or promotional purposes, or to indicate endorsement or disapproval of the product(s) and/or services of any commercial institutions by the National Bureau of Standards.

passing the continental United States at line-of-sight distances of 40 to 60 km between repeaters. The routing of such networks in NBS experiments is shown in figure 10.23. The microwave relay system carrying over 95 percent of intercity television programs is known as the TD-2 system [126]. At a terminating station, such as an affiliate local transmitter, the microwave signal from the applicable repeater station is converted to a video signal and retransmitted by VHF or UHF (commercial TV) to a local service area. Reception points for typical line-10 experiments included the USNO at Washington, DC and NBS at Boulder, CO.

This version of TV timing uses the pulse identifying line-10 of the odd field in the 525-line system M (FCC standard for the U. S. and one of some 12 worldwide system [127]), as a passive transfer pulse. This pulse occurs during the blanking retrace interval between successive fields as shown in figure 10.24. The line-10 pulse, as the *transfer standard* element, is easy to identify with simple logic circuits. Figure 10.25 shows a typical equipment configuration for line-10 clock synchronization at a receiver site. Clock comparison occurs through differential measurements of TV line-10 data. Basic data are taken simultaneously from a common TV broadcast at given receiving sites; the differences between clock-counter output readings remain essentially unchanged within a few microseconds from day to day except for infrequent reroutes of microwave signals and/or instability or relative frequency offsets among the reference clocks [125].

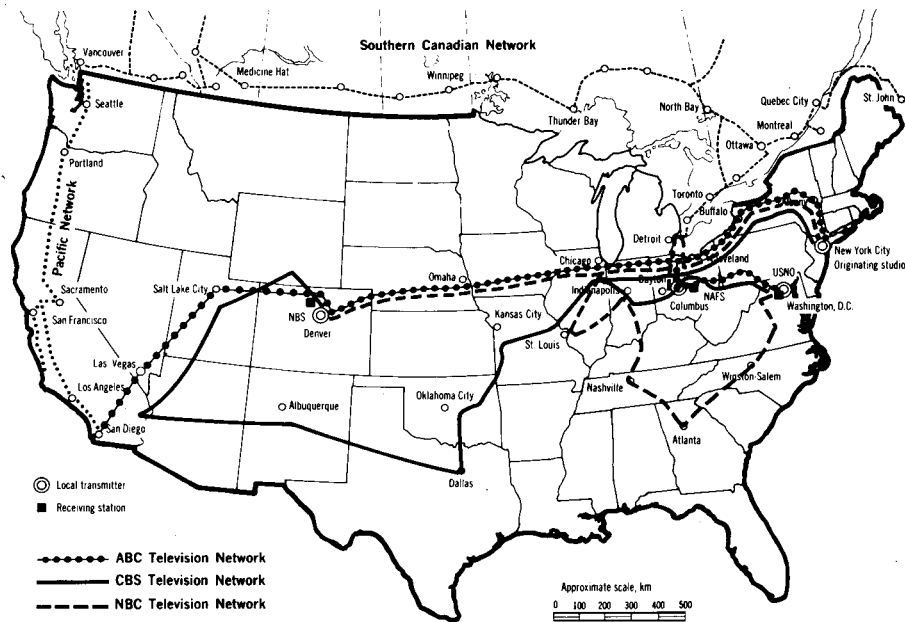

FIGURE 10.23. Microwave relay routing of different networks across continental U.S. used for NBS television experiments.

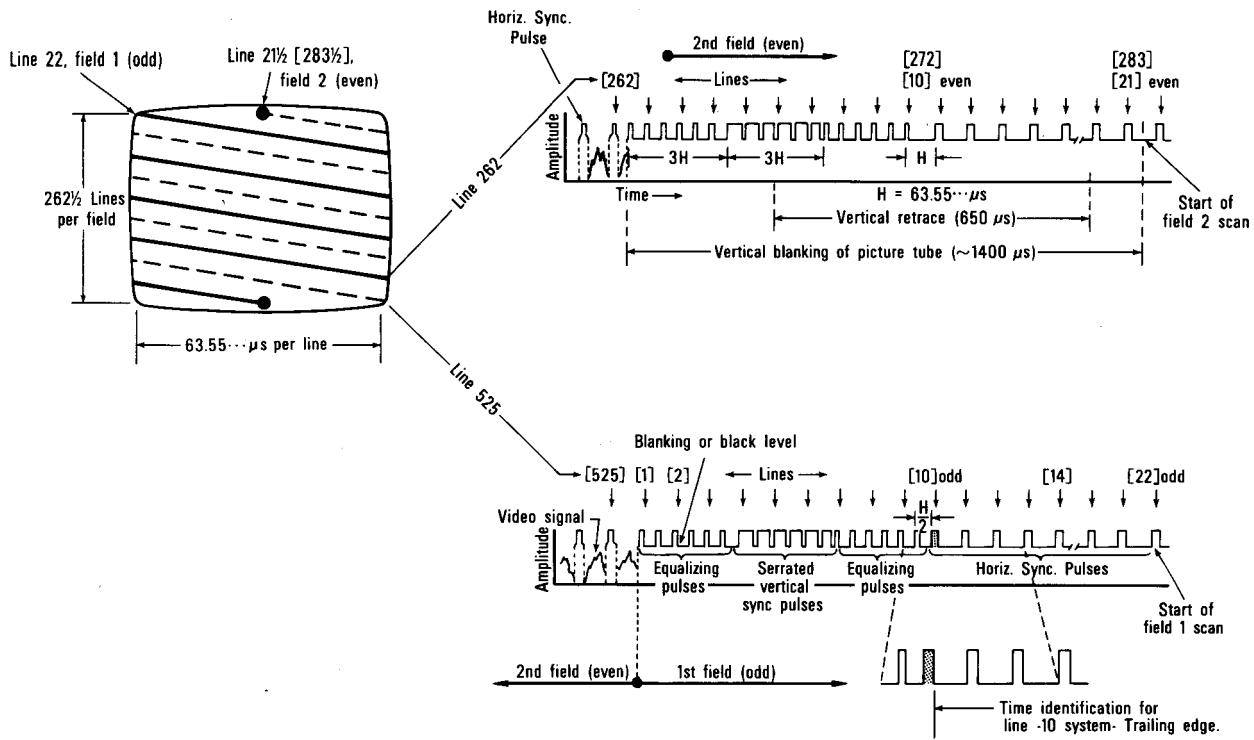

FIGURE 10.24. Pulses in vertical blanking interval of TV format.

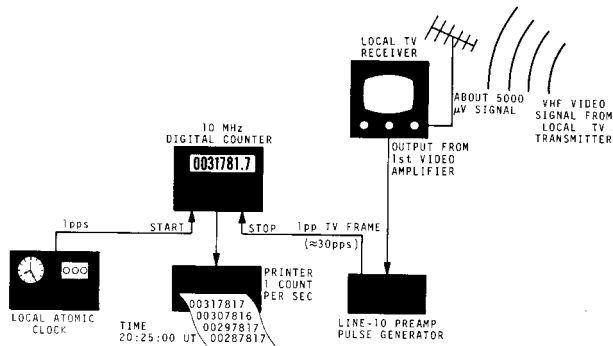

FIGURE 10.25. Typical equipment configuration for line-10 clock synchronization at a receiving site.

Likewise, other clocks in the U.S. can be related to the UTC(USNO) and UTC(NBS) scales through a similar reception and data processing technique. Comparisons can be made with daily line-10 measurements made at the USNO and NBS and published periodically [42, 43]. If the system is to be used to accurately set the clock's date, the delay of the propagation paths involved must be known; e.g., calibrated with a portable clock. Since the period of one TV frame is 33.3 . . . ms, it is also necessary to resolve this ambiguity at the receiving site to ~ 16 ms.

Typical TV signals in the U.S. may be routed over paths two to four thousand kilometers in length. The occasional network reroutes mentioned previously will produce an effective change in the propagation path delay. If the rerouting is not common to all clock comparison links it will adversely affect the results; consequently, it is highly advantageous to use all three networks to enable identification of any such changes in one link.

A detailed analysis was made of TV line-10 data for the period June 1969 to December 1970 [128]. Figure 10.26 gives a plot of fractional frequency stability $\Delta\sigma_y(\tau)$ ⁴ versus the sample time τ in days for the microwave paths between Washington, DC and Boulder, CO for each of the three networks; the instabilities of the reference time scales are assumed negligible. The time fluctuations were analyzed directly, and it was determined that the TV noise was reasonably modeled with an $\alpha = 1$ process, i.e., flicker noise phase modulation for this path [129, 130]. The dashed line in figure 10.26 corresponds to a noise process with $\alpha \geq 1$. The fractional frequency between AT(USNO)⁵ and

⁴The symbols used in Chapter 10 are defined in the glossary in Annex 8.A of Chapter 8.

⁵The designation AT(USNO) parallels our designation AT(NBS); it follows the New Delhi CCIR Recommendation 458 of Study Group 7 for Standard Frequency and Time Signals. USNO (Mean) or A.1 (Mean) in reference [131] is identical to AT(USNO) as used herein.

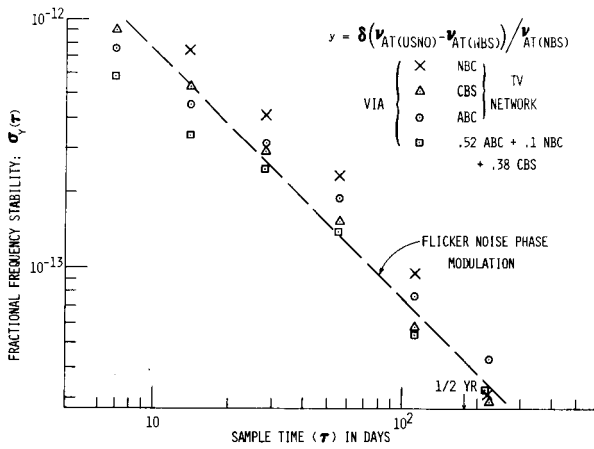

FIGURE 10.26. Fractional frequency stability $\sigma_y(\tau)$ versus sample time of AT(USNO)-AT(NBS) time scales compared by three-network TV line-10 technique.

AT(NBS) [131, 132] calculated over the period of analysis was:

$$\frac{\nu_{AT(USNO)} - \nu_{AT(NBS)}}{\nu_{AT(NBS)}} = \begin{cases} 4.48 \times 10^{-13} & \text{via ABC} \\ 4.43 \times 10^{-13} & \text{via CBS.} \\ 4.56 \times 10^{-13} & \text{via NBC} \end{cases} \quad (10.1)$$

The precision of these measurements is $\pm 3 \times 10^{-14}$ as indicated by the stability shown at $\tau = 224$ days.

The three essentially independent networks enables one to optimally combine the data by weighting each network set inversely proportional to its variance. The squares in figure 10.26 represent the combined network stability using such an optimum weighting procedure. Figure 10.27 gives a

plot of relative time differences (average rate removed) of the AT(NBS)-AT(USNO) time scales for the 1969-71 test period in terms of three-network TV line-10 (weighted), Loran-C, and cesium portable clocks. Good agreement is shown with portable clock measurements, and the maximum spread is well within $\pm 2 \mu\text{s}$. The results of the TV line-10 study indicated that this three-network TV system (properly filtered) could be used in major portions of the United States to maintain clock synchronization within an RMS precision of about:

$$\tau \sigma_y(\tau) = 5 \text{ ns } \tau^{1/3} \text{ s}^{-1/3}, \quad (10.2)$$

where τ ranges from 86400 s to about 2×10^7 s (1 to 224 days). Equation (10.2) is based on the assumption that the clocks were synchronized previously [128].

(2) *Real Time Synchronization from Stabilized TV Sync Pulses.* The USNO recently proposed a modification of the TV line-10 passive time synchronization technique [121]; in this method the TV color subcarrier frequency (3.57 . . . MHz) is stabilized with a cesium atomic standard [122] and phase shifted so that sync pulses in the vertical interval coincide with 1-pps signals referenced to the USNO master clock (MC). The method can be used to set remotely located clocks in a TV local service area within several nanoseconds of an absolute time scale. In a particular experiment the USNO stabilized the color subcarrier frequency of a local TV station in the Washington, DC area and maintained coincidence between the line-10 pulse marker (odd field) with a one-second pulse of the USNO-MC. Coincidence occurs at exactly 1001 seconds (16 min 41 s) intervals because of the unique TV frame repetition rate (33.366, 667 ms per frame—see refer-

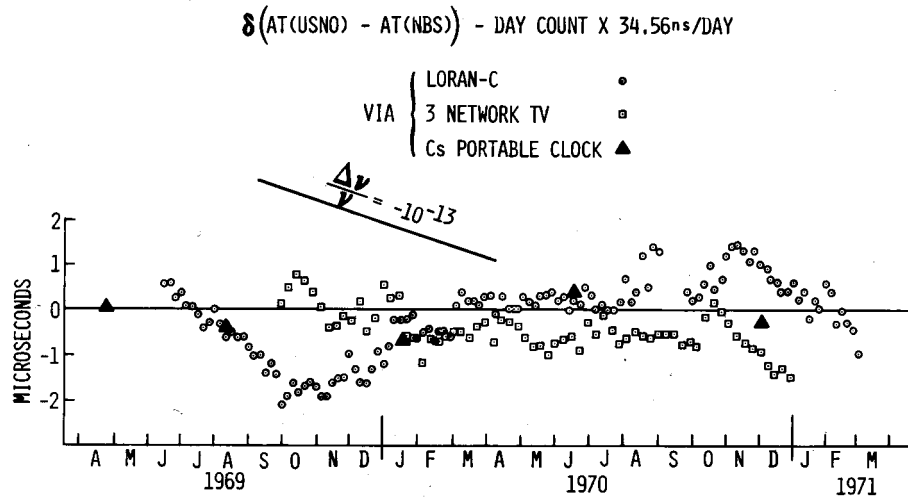

FIGURE 10.27. Relative time differences of the AT(NBS)-AT(USNO) time scales compared by the Loran-C, three-network TV line-10, and cesium portable clock techniques (plus arbitrary constants).

ence [125]). Such a relationship permits calculation of time of coincidence (TOC) dates or times, months in advance, referenced to some arbitrary initial TOC. The USNO has set an initial coincidence as 0000 UT January 1, 1958 and computed 3 time of coincidence Ephemeris Reference Tables similar to those used in Loran-C (see sec. 10.3.2.e(2)). An example of TOC table use for "on time" clock comparison is shown in table 10.4.

The USNO line-10 TV measurements at a receiving site are identical to those discussed previously in the NBS line-10 section. In the USNO experiment [121] the cesium oscillator controlling the local TV transmitter was not maintained in synchronism with the USNO Master Clock; however, over a 2-month period only a small drift of about 1 μ s was recorded between the two frequency standards. Absolute frequency stabilization of a TV transmission, together with TOC charts, offers an economical and accurate synchronization technique for referencing clocks in local TV service areas at any convenient time and completely independent of contact with the time referencing laboratory.

Certain advantages and limitations of passive television time synchronization techniques are outlined in table 10.5.

(3) *Stabilization of TV Color Subcarrier.* In the U.S. the major TV networks provide a means for precise frequency measurements in their color broadcasts. In such broadcasts a color subcarrier of 63/88 of 5 MHz (3.57 . . . MHz) is derived from a rubidium oscillator/synthesizer (stable to ~ 1 part in 10^{12} per day) at the originating station in New York City and transmitted on each horizontal sync pulse, together with the picture information. It is used as a reference to phase-lock the crystal oscillator in the home color TV receiver for demodulating the chrominance sidebands and maintaining color shades. Frequency stability measurements of the color subcarriers of the three major networks (originating in New York City) have been made at NBS, Boulder, Colorado [122]. The received subcarrier is compared in frequency to the NBS standard, and the networks are advised of their frequency offset so that they can adjust their oscillators. The rubidium oscillator frequencies are measured

TABLE 10.4. Example of using USNO Time of Coincidence (TOC) Ephemeris Reference Tables for frequency stability-TV, line-10 [121]

(a) Assume a clock synchronization was desired at about 1930 UT on September 19, 1971 in a local TV service area. Measurements between the local clock and the received line-10 signals gave the following printout:

h	min	s	
19	30	02	19 987.67 μ s
19	30	01	18 987.67
19	30	00	17 987.67
19	29	59	16 987.67
19	29	58	15 987.67

(b) TOC table values:

Table 1 First TOC each Day			Table 2 All TOC's per Day			TOC—Sept. 1971 Near 1930 UT (Addition Tables 1 and 2)			Table 3 Interpolation of Seconds Between TOC's				
h	min	s	h	min	s	h	min	s	h	min	s		
9/19/71	00	12	26			19	23	35	19 ^h	29 ^m	60 ^s		
				near	19	11	09	19	40	16	19	23	35
				1930 UT	19	27	50	19	56	57	6	25	
					19	44	31						

(c) \therefore The TV line-10 odd pulse following the 19^h30^m00^s UT 1-pps will be transmitted at 19^h30^m0.017966.67^s.

(d) Calculation of clock differences:

Local clock difference with received TV line-10 pulse (19 ^h 30 ^m 00 ^s —September 19, 1971)	17 987.67 μ s
Propagation time	— 18.00
	<hr/>
	17 969.67
TOC chart time of transmission	— 17 966.67
	<hr/>
Clock difference	3.00 μ s.

Thus UTC(local clock)—UTC(TV_{ref})=3.00 μ s (1930 UT September 19, 1971).

TABLE 10.5. *Advantages and limitations of passive television techniques for TFD*

Television Technique	Advantages	Limitations
(1. a) Transfer standard (differential) using a TV sync pulse received in a TV transmitter local service area.	<ol style="list-style-type: none"> 1. Precise clock comparisons can be made to better than 100 ns. 2. Comparisons can be made at any time during transmission without modification or influence on network programming. 3. Method is independent of microwave network routing. 4. Comparison equipment at a receiving station is relatively inexpensive. 5. Measurement methods are simple. 6. Simultaneous clock measurements can be made at an unlimited number of stations within a local service area. 	<ol style="list-style-type: none"> 1. Clock readings must be taken simultaneously by timing centers requiring synchronization. 2. Data must be exchanged between participating stations after the fact of measurement. 3. Technique gives only comparative clock differences. Calibrated path delays between stations is required for absolute time comparison. 4. Coverage is limited to line of sight VHF or UHF signals which may be subject to multipath interference within a local TV service area.
(1. b) Transfer standard (differential) using received TV line-10 throughout continental U.S.	<ol style="list-style-type: none"> 1. Precise clock comparisons can be made to about several microseconds nearly anywhere throughout continental U.S. 2. Three television networks with atomic clock references (Rb) provide redundancy and enable cross synchronization; system has no effect on network programming. 3. The required instrumentation is simple, easy to use, and reasonably inexpensive. (The line-10 pulse code generator costs less than \$200.) 4. One-a-day measurements are adequate for precise frequency standards. 5. Users can compare TV line-10 measurements with published NBS and USNO values and relate time scales if propagation path is calibrated. 6. Modular frame intervals can permit advance predicted TV delays. 	<ol style="list-style-type: none"> 1. Microwave paths can be interrupted or networks rerouted without notice. 2. Clock readings must be made simultaneously by all stations requiring synchronization. 3. Measurements require simultaneous viewing of "live" broadcasts originating from New York City studios for near-continental coverage; present network distribution system uses a delay tie-in with West Coast transmission lines which limits coverage of West Coast area; also there is limited availability of simultaneous viewing of nationwide network programs. 4. System will not work with tape delays. 5. NBS and USNO measurements are not made on weekends and reference data at these times are unavailable. 6. Line-10 TV system ambiguity is ~33 ms. 7. Propagation anomalies may limit system's usefulness in some areas of the continental U.S.
(2) Real time transfer from time-scale-related transmissions (line-10 in local TV service area).	<ol style="list-style-type: none"> 1. System can set or synchronize clocks within the local TV service area to a few nanoseconds of a reference clock. 2. The stabilized modular frame intervals permit prediction of TOC between 1 pps of an atomic time scale and emitted line-10 odd pulses, months in advance. This allows construction of TOC charts and independent clock synchronizations. 3. System will operate with existing line-10 TV receivers. 4. Operation is without interference or effect on regular programming. 5. Measurement methods are simple. 	<ol style="list-style-type: none"> 1. Requires installation of atomic cesium clock and phase shifting synthesizer at local TV transmitter. 2. Absolute clock calibrations require knowledge of delay between the transmitter atomic standard and local standard at TV receiving site. 3. Clock time must be known to half the system ambiguity or ~16 ms. 4. Same as item 4 for technique (1. a) previously given.

regularly at Boulder in terms of the rate of AT(NBS), and the average weekly data are published for the benefit of users throughout the country [42]; representative data are given in table 10.6. Note the agreement in offset frequency among the three networks during the week of January 22-26, 1973. Such agreement was intentional to permit interchange and split screen synchronization of the three network TV cameras during President Nixon's inauguration; the AT(NBS) scale was used as a common reference for such adjustment. (TV color

subcarrier frequencies are still offset from nominal by about -300 parts in 10^{10} .)

NBS designed instrumentation both to synthesize the output of a 1- or 5-MHz local frequency standard to 3.57 . . . MHz and to compare phases of the local synthesized signals to the received subcarrier frequency [122]. Figure 10.28 gives a block diagram of such a calibration system. Frequency stability measurements of the color subcarriers received at Boulder indicated resolution of the phase difference between the subcarrier and local 3.57 . . . -

TABLE 10.6. U.S. television network atomic standard frequencies in terms of AT(NBS)

Dates of Measurement Period 1973	Average Fractional Frequency Offset (parts in 10 ¹⁰)		
	NBC	CBS	ABC
2 Jan.- 5 Jan.	-302.85	-295.87	-305.18
8 Jan.-12 Jan.	-301.27	-295.85	-305.25
15 Jan.-18 Jan.	-301.21	-295.89	-299.23
22 Jan.-26 Jan.	-299.27	-299.04	-299.37
28 Jan.- 2 Feb.	-299.26	-295.84	-299.36

From NBS Time and Frequency Services Bulletin, February 1973. See reference [42].

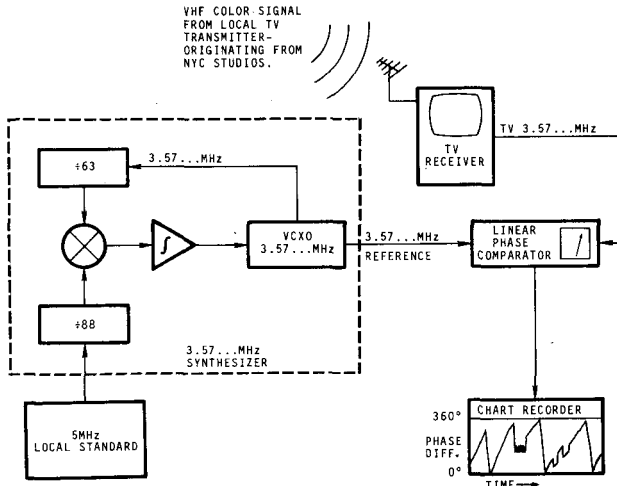

FIGURE 10.28. Equipment configuration for TV color subcarrier frequency comparisons.

MHz signal to less than 10 ns; this corresponds to a frequency resolution of about one part in 10¹¹ in ~ 17 minutes. A plot of relative fractional frequency stability versus sample time is given for the following data in figure 10.29: CBS TV color subcarrier; weighted three-network TV line-10; cesium portable clock and Loran-C [128]. An estimate of the time dispersion of the color subcarrier data plotted in figure 10.29 is as follows:

$$\tau\sigma_y(\tau) = 0.3\text{ns } \tau^{1/3}\text{s}^{-1/3}, \quad (10.3)$$

with τ in the range $125 \leq \tau \leq 384$ s. The measured frequency stability of the color subcarrier gave a $\tau\sigma_y(\tau)$ of 1 nanosecond in the range $1 \mu\text{s} \leq \tau \leq 1$ s. Figure 10.29 permits comparison of relative stabilities (precision) of the several techniques; e.g., at $\tau = 200$ s the values of $\sigma_y(\tau)$ for Loran-C, TV color subcarrier, and cesium portable clock are 1×10^{-10} , 1×10^{-11} , and 4×10^{-12} respectively [128].

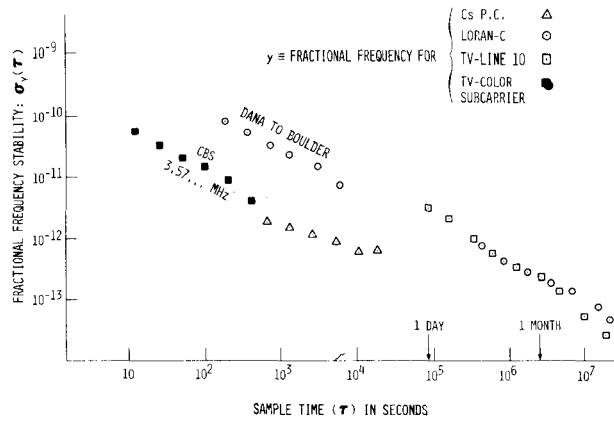

FIGURE 10.29. Relative fractional frequency stability, $\sigma_y(\tau)$ versus sample time for CBS TV color subcarrier; Loran-C; three-network TV line-10; and cesium portable clock.

Some advantages and limitations of the TV color subcarrier technique (3) of comparing frequency standards are as follows:

Advantages

- Provides resolution of frequency differences to about one part in 10¹¹ in less than 30 minutes; excellent short term stability is shown.
- TV color subcarrier comparisons can be made to the NBS(UTC) time scale through periodically published data [42].
- Comparison equipment is relatively inexpensive and simple to use (parts cost for the 5.0 to 3.57 . . . -MHz synthesizer and linear phase comparator is about \$100).
- The several independent networks allow both flexibility and redundancy of measurement.

Limitations

- Requires TV color transmission referenced to atomic frequency standard (originating network in New York City).
- Microwave relay links can fail or be rerouted causing disruption of signal.
- West coast tie-in to "live" programming from New York City is limited and the networks give minimal coverage to West coast areas of the U.S.
- Taped programs with local low grade oscillator control is unsatisfactory for color subcarrier comparisons.
- Propagation anomalies can limit usefulness of TV color subcarrier comparisons in some areas of the U.S.

(4) *Injection of Time and Frequency Information into TV Format (Active).* Techniques for transmitting time and frequency information within the broadcast TV format have been developed at NBS. Initial

tests were made at Denver, CO, using lines 15 to 17 [116]. In January 1971, Koide and Vignone tested the technique on a 45-km path in California and found the synchronization accuracy better than 100 ns [133]. The favorable results experienced in the early tests led to refined experiments across the continental U.S. from New York City to Boulder, CO and to Los Angeles, CA [123, 124]. This active line technique, called the "NBS TV Time System," used line one of the vertical blanking interval for transmission of time and frequency information. Such a proposed time and frequency dissemination system is undergoing evaluation. A section of the system, useful for local area distribution, is shown schematically in figure 10.30. The time and frequency information is injected into line one as shown in the wave form diagram of figure 10.31.

The user station is equipped with a TV receiver, a decoder, an alphanumeric character generator, and optional auxiliary equipment for automatically measuring the time difference between the received time signal and the user's clock. Several modes of operation are available to the user (see fig. 10.30).

(a) Coarse time (hours, minutes, and seconds) can be displayed on demand on the user's TV screen in alphanumeric characters.

(b) The time difference between the received time and the user's clock time can be displayed on the TV screen with nanosecond resolution.

(c) The received 1-MHz sine wave can be used for direct frequency comparison.

Digital time dissemination: A reference time standard and a time code generator are installed at the point of program origin (network or local studio). Both the code and its complement are sent for redundancy. The code, injected in the second half of line-1, carries hour-minute-second (HMS) information derived from the reference time standard (see fig. 10.31). The system does not measure propagation delay time; this delay is treated as clock error, which is insignificant for coarse timing. The user must make a calibration of the path delay between the clock at the code injection point and the clock at the receiver if accurate time is desired.

At the user's clock station a decoder is required. Optional comparison instrumentation is available if desired. The active line system provides an HMS readout on a modified commercial TV receiver, which includes a built-in digital clock regulated by the time code. In the event no code is received, the digital clock reverts to internal control.

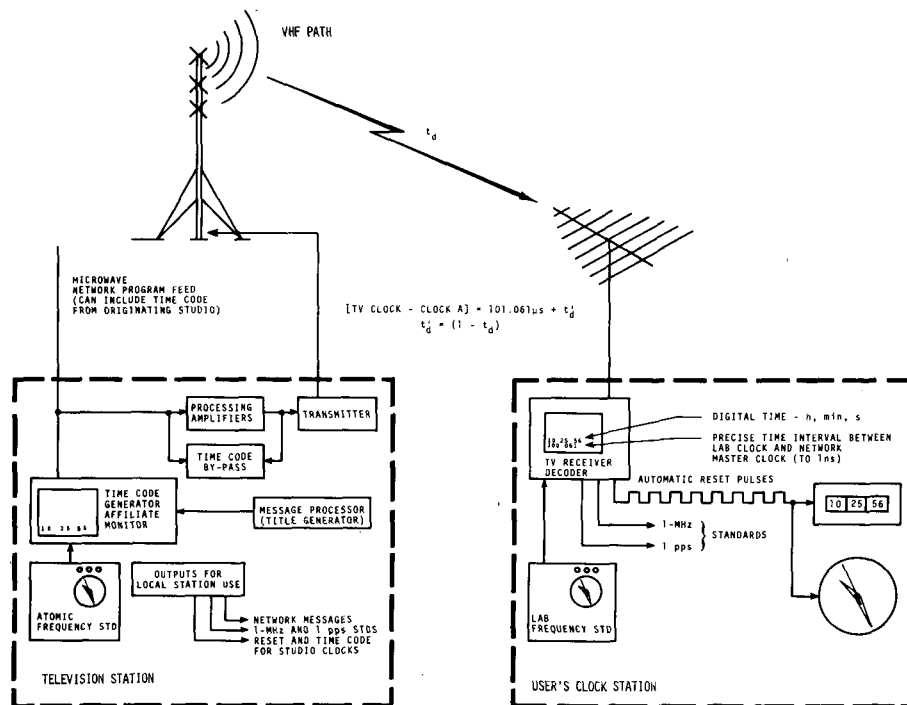

FIGURE 10.30. Active-line TV Time system at local television station.

1-MHz frequency dissemination: The active line system also provides a precise frequency standard. A stable 1-MHz carrier is transmitted during the interval between the first and second equalizing pulses of lines 1 and 262½ (see fig. 10.31). At the decoder, a phase-locked oscillator recovers this signal using an approach similar to the detection of the color subcarrier in a color TV receiver. Results at NBS indicate that such a received standard frequency permits calibration of a local standard to 1 part in 10^{11} in less than ½ h.

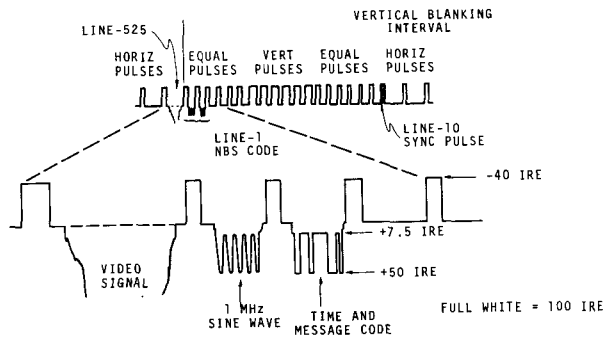

FIGURE 10.31. Method of injecting time-frequency information on active line in vertical blanking interval.

The reported active line-1 experiment compared a cesium reference 1-MHz signal at NBS Boulder to a TV line-1 received 1-MHz signal generated by a cesium standard at the ABC New York City studio [123, 124]; typical phase variations of about ± 10 ns were shown in one hour as indicated by a comparison record given in figure 10.32. The short term stability of a 1-MHz quartz oscillator, phase locked to the received 1-MHz TV signal originating at New York City, was determined; measurements indicated that this active line-1 data were only slightly less stable than the color subcarrier data except for measurement times $< \sim 20$ ms [124]. This is noteworthy, in that the line-1 system is sampled at about 1/100 the rate as that for the color subcarrier. Figure 10.33 is a block diagram which shows the capability of phase-locking a local crystal oscillator to a received 1-MHz signal from an active TV line. This TV system shows a long term (several days) stability of a few parts in 10^{12} . (It should be noted that the Department of Commerce petitioned the FCC in December 1972 for the use of line 21 in the vertical interval for time and frequency dissemination similar to the line-1 active system.)

Capabilities and limitations of the active line TV dissemination of time and frequency are listed in table 10.7.

TABLE 10.7. Capabilities and limitations of active line TV time/frequency dissemination (category 4)

Television Technique	Capability	Limitations
Time and frequency coding of active line in Blanking Interval.	<ol style="list-style-type: none"> 1. System permits calibration and phase-locking of remote oscillator to about 1 part in 10^{11} within ½ h. 2. System can transfer real time to submicrosecond accuracy in a local service area; provides hrs., min., and seconds in continuous digital update. 3. It is estimated that 70% of the U.S. population could be reached by installing synchronized coders at network centers in New York City and distributing the active code over existing microwave links. 4. Transmission of data has no effect on network programming and system transmission is cost free to user. 5. As the UTC scales of both NBS and USNO are mutually coordinated to $\sim \pm 5 \mu\text{s}$ of each other, users of TV active line system would have effective access to both scales. 6. User cost is proportional to required precision. 7. System is unambiguous to 24 h for date information, and reliability to $10 \mu\text{s}$. 8. Three or four major networks would provide redundancy and permit cross checking. 9. System supports other uses such as captioning for the hearing impaired. 	<ol style="list-style-type: none"> 1. Requires installation of cesium standard and encoders at TV transmitters. (A time and frequency decoder, capable of nanosecond resolution, would cost about \$1000.) 2. Clock decoder must be installed at clock comparison receiving station. 3. Microwave paths can be interrupted or networks rerouted without notice. 4. Equipment requires modification to allow time code compatibility with local time in case of taped shows. 5. The viewing time of nationwide network programs is limited; the active line must be "live" for measurements referred to the network cesium beam standard. 6. Real time comparisons require knowledge of propagation and equipment delay time between the transmitter atomic standard and the frequency standard at the receiver.

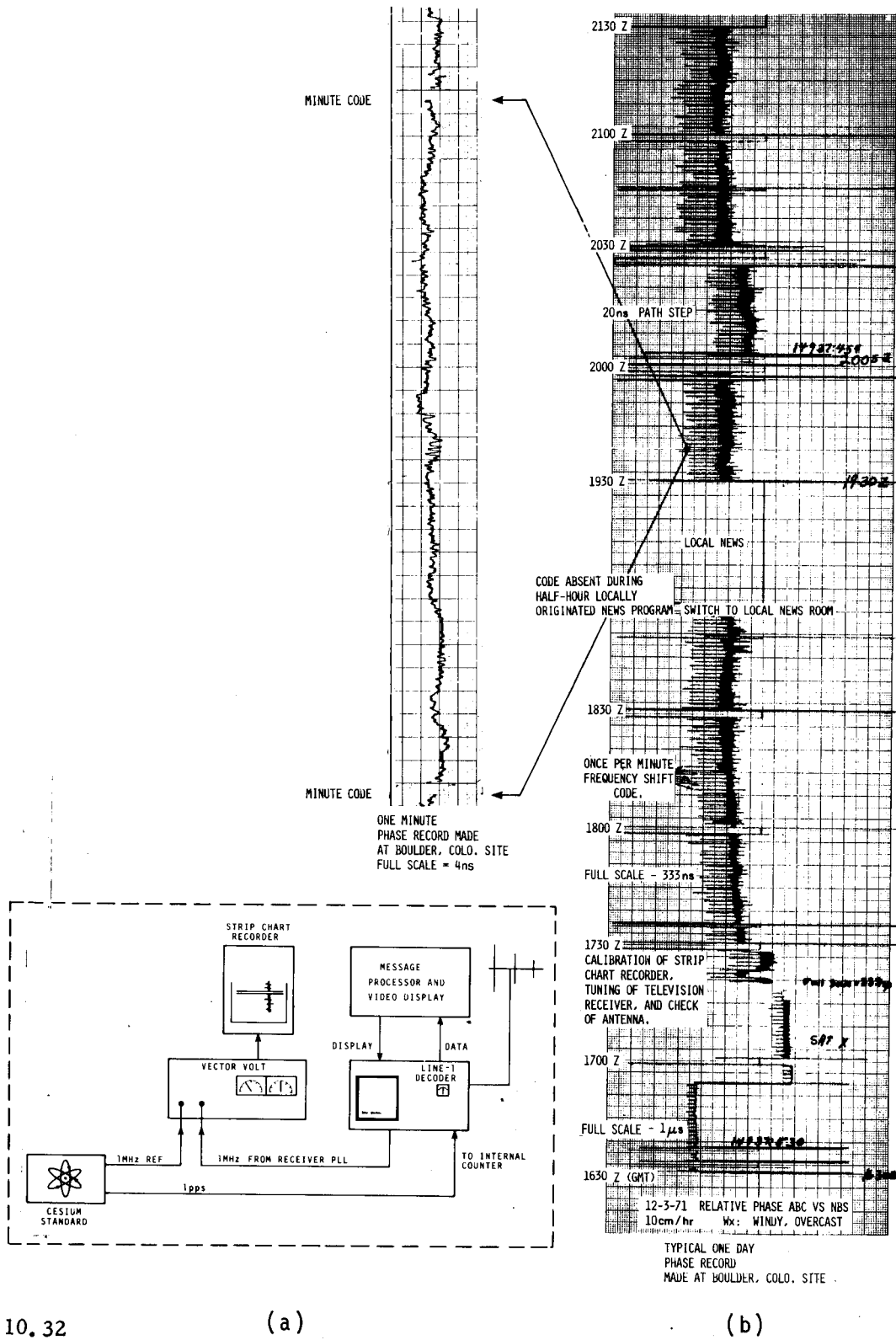

10.32 (a) Typical equipment configuration for phase versus time measurements (TV); (b) phase record comparing 1-MHz signal from cesium standard at Boulder, CO with 1-MHz signal derived from line-1 active code generated from cesium standard at New York City studio.

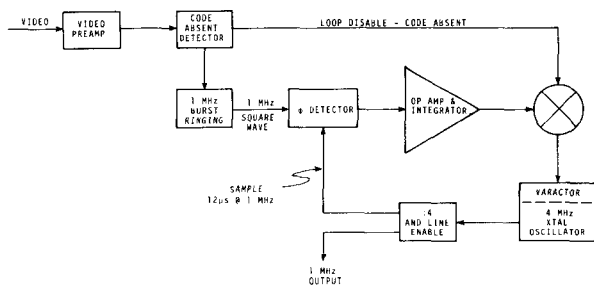

FIGURE 10.33. Phase locked crystal oscillator via TV line-1 (1-MHz reference signal).

g. TFD via Earth Satellites

The appearance of Sputnik satellites in 1957 signalled a new potential in terrestrial-space radio techniques. Since then, artificial earth satellites have been proposed and used for a variety of purposes including telecommunications, navigation, geodesy, traffic control, and safety [134-138]. It is significant that many of these applications require time/frequency techniques, yielding an ancillary capability for TFD. Satellites are more advantageous than many conventional TFD techniques in terms of global coverage, accuracy of time transfer and propagation degradation. This occurs through the unique height position of a satellite relative to earth, allowing satellite visibility to intercontinental areas using line of sight radio frequency propagation. During the past decade many TFD experiments have been made via satellite; the results have been very encouraging. In the future, satellites may broadcast time and frequency signals on an operational basis; such transmissions, however, will no doubt be supplementary in function, as the cost of construction, launch, and maintenance would seem to prohibit a dedicated satellite solely for purposes of TFD. It is beyond the scope of this study to examine in detail the many satellite transfers of time and frequency. In turn we will (1) discuss some basic concepts of satellites as related to TFD, (2) give comparative results of TFD via satellite over the last 10 years, (3) briefly describe several U.S. Navy navigation satellite systems useful for TFD, (4) show the NBS approach to distributing time and frequency signals via satellite, and (5) outline both advantages and limitations of satellite systems for TFD.

(1) *Some Basic Satellite Concepts.* The major problem confronting the user of TFD techniques by earth-bound radio signals is the difficulty of predicting the radio delay path which results from the complexities and reflections in the ionospheric-atmospheric propagation. Artificial satellites, however, are used both as relays and signal sources with onboard clocks and, in combination with

VHF (and higher) radio signals, can overcome the radio delay uncertainty problem to a large extent [139]. Propagation delays of satellite signals can be calculated to high accuracy ($\leq 10 \mu\text{s}$); the refractive index for most satellite-to-earth radio paths is near the free space value since the ionosphere and troposphere constitute a small fraction of the total path; and multipath effects are negligible for all but the highest accuracy users who might receive the signals at low elevation angles. On the other hand, satellite systems are expensive, launched for primary missions other than TFD, and the satellite is never exactly fixed in position relative to a user antenna. Consequently, there is a multiplicity of choices and tradeoffs to be made in designing a satellite system for a given situation.

TABLE 10.8. Classification of satellites by altitude

Altitude Classification	Altitude Range—km (Above earth's surface)	Satellite Period
Low	900- 2,700	~ 100 to 150 min.
Medium	13,000-20,000	7 to 12 h
High (Synchronous)	22,000-48,000	13 to 35 h
	36,000	24 h

Consider the matter of orbit. Should it be circular or elliptical? At what altitude above earth? Easton classifies satellites by altitude as shown in table 10.8 [140]. Very definite characteristics are implicit in these 3 classifications. Figure 10.34 shows one of these; namely, the farther out the satellite is the greater the earth coverage until near maximum coverage is reached at synchronous altitude. On the other hand, the signal strength decreases with altitude increase; also, if the satellite is equipped to maintain a precise orbit and fixed orientation to earth as well as possess the capability of transponding signals, additional integral components are required. Or, look at the factor of earth coverage—one synchronous equatorial satellite is constantly in view (24 h) to about $\frac{1}{3}$ of the earth's surface (3 satellites could provide near global coverage); a decrease in satellite altitude is characterized by a shortened period with nearly global coverage (in view for short periods of time at one station), and the Doppler effect, sometimes used in navigation, becomes more pronounced. Operation of a satellite with an on-board clock complicates clock maintenance and necessitates periodic adjustments, although no continuous RF transmission is required from the ground. Use of a satellite relay or transponder permits the clock to be maintained on the ground and allows use of a general purpose communication satellite on a time-shared basis. In a one-way satellite system the users receive signals from the satellite in a listen or receive-only mode. A two-way satellite system usually involves bilateral communications between separated reference and receiver

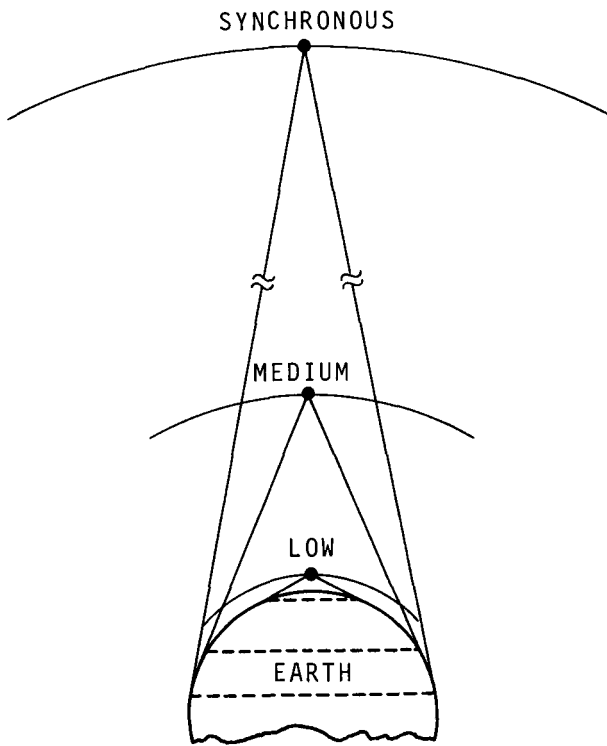

FIGURE 10.34. Relative earth coverage by satellites at various altitudes.

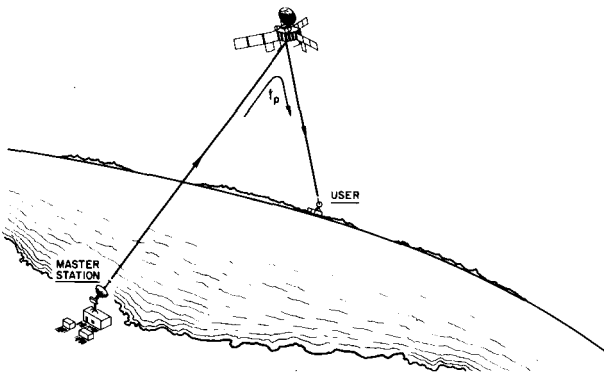

FIGURE 10.35. One-way satellite timing mode.

clocks on the ground through relay via the satellite transponder. In either one or two-way transponder mode the satellite must be visible to both the ground transmitter and all receiving stations at an angle of at least 5° above the horizon of each. An on-board clock mode provides timing information directly from a satellite in a one-way mode. The following discussions describe the 3 major means of satellite TFD:

One-way mode. The users operate in a listen or receive-only method. As shown in figure 10.35 the

transmitted terrestrial standard source is relayed by the satellite transponder to the earth receiver. The accuracy of time transfer in this mode is dependent upon the knowledge of the absolute propagation delay between the ground transmitter—satellite transponder— and ground receiver.

With VHF transponders (ATS 1 and 3) the available bandwidth is ~ 100 kHz which limits use of pulses at fast risetime. An alternative means for resolving time differences in the one-way mode employs the so-called side-tone ranging technique. (This technique also can be used in the two-way mode.) There are variations even in this technique; one method uses a 10-kHz tone, phase locked to a time standard with its zero crossing coincident with the clock's 1 pps [141]. Bursts of the 10-kHz tone are transmitted at different repetition rates to resolve ambiguities. The receiving station detects the satellite-transponded signal and decodes with sampling rates equivalent to the transmitted tone-burst rate in terms of the receiver clock. A typical decode by this technique is shown in figure 10.36, where burst repetition rates of 1, 10, 100, and 1000 times per second, as well as the continuous frequency of 10 Hz, were transmitted and received to determine the total relative time difference between two remote clocks. The beginning of each tone burst marks the time delay increment for each different pulse rate except that the continuous 10-Hz signal is read when the tone crosses the zero axis. The lowest tone used reduces the ambiguity of the timing information, while the highest tone provides the limit of resolution. The delay thus determined includes the clock differences, equipment delays, and propagation path delays.

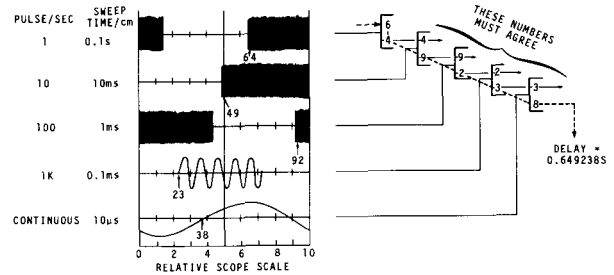

FIGURE 10.36. Example of arrival time via side-tone ranging of satellite signals [150].

If the path delays can be separated out, the other factors are resolvable to high accuracy. Path delays may be determined from orbital elements which sometimes are relayed by satellite. (Orbital elements describe the satellite's orbit and its position in that orbit at a given date; they include six constants of motion which in one form include period, eccentricity and inclination [142].) The orbital elements

are obtained from observations over a period of time and are issued periodically by agencies responsible for operation of a given satellite. A major difficulty in timing via the one-way mode satellite system is the variability in delay caused by the satellite motion. A Root-Sum-Square (RSS) error analysis for the one-way mode is reported as $0.9 \mu\text{s}$ when factors of equipment and VHF propagation delays, position uncertainties of the satellite and receiving stations, and clock instabilities are taken into account [2]; another analysis, without a clock instability factor, gives an RSS error of $0.35 \mu\text{s}$ [3].

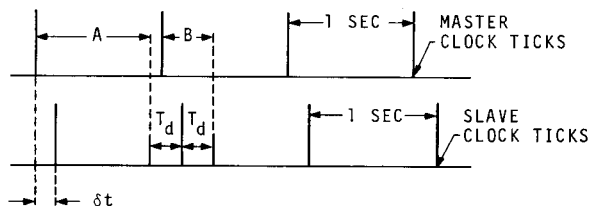

FIGURE 10.37. Typical two-way satellite time diagram.

Two-way mode. The users operate in both a listen (passive) and transmit (active) mode, although the satellite still relays the signals as in the one-way case. However, an exchange of information between the two ground sites permits a measure of the path delay, thus obviating the need for knowing the location of either the satellite or earth stations. A simplified timing diagram for a two-way satellite system is shown in figure 10.37. Specific techniques vary but the following is given as an example. Assuming that the master and slave clocks are synchronized to one second, one can adjust the transmitted time signals to arrive “on time” at the slave site via a voice communication link. The total delay in the transmitted time signal is designated A in figure 10.37. A is related to the time difference between the master and slave clocks, δt , and the one-way path delay between ground transmitter—satellite—slave ground station, T_d , as follows (using 1 pulse per second time ticks):

$$A = \delta t + (1 - T_d). \quad (10.4)$$

Following synchronization of the slave clock with the master clock, the slave station transmits uncorrected clock signals directly back to the master station where they arrive via the satellite relay at a time B later. B has the following relationship

$$B = \delta t + T_d. \quad (10.5)$$

Since one can measure both A and B at the master station, the difference between the two ground clocks, δt , can be determined by combining eqs (10.4) and (10.5) with the propagation delay, T_d ,

dropping out. Thus,

$$\delta t = (A + B - 1)/2. \quad (10.6)$$

In this case $0 \leq \delta t \leq T_d$; in most cases δt will be less than T_d which is ~ 0.25 s in the synchronous satellite case. (Different formulas hold for other clock-difference, propagation-delay relationships.)

Jespersen et al., used the above technique with alternate pulse rates of 1 and 100 pps to synchronize widely separated clocks to about $4 \mu\text{s}$ with a synchronous-satellite transponding VHF signals [143]. Degrading factors such as satellite movement during satellite signal exchange, nonreciprocity of path, carrier frequency dispersion, and variation in equipment delays can adversely affect the accuracy of the two-way mode. If one neglects clock instability, two reported error budgets give RSS values of $\sim 0.2 \mu\text{s}$ [2] and $\sim 0.14 \mu\text{s}$ [3], of which equipment delays are principal contributors.

On-board clock mode. This satellite technique can employ either a crystal or atomic clock within the satellite which transmits timing information directly to a terrestrial receiver. (It is conceivable that aircraft also could receive such timing information for use in collision avoidance or air traffic control.) The degree of accuracy realized in this timing mode is directly related to the certainty with which the propagation delay between the satellite and ground station is known, as in the one-way mode. This technique offers an excellent means of clock time transfer whereby two stations receive the same satellite transmission and difference their results over a period of time (time transfer technique). Although the position of a clock-carrying satellite in geostationary orbit could be fairly well established, time data from such synchronous satellites would be subject to relativistic gravitational shifts of $\sim 50 \mu\text{s/day}$ and second order Doppler shifts of about $4.4 \mu\text{s/day}$ [144]; these constant terms, however, are compensable and should not limit the accuracy.

On the other hand, TFD via low altitude orbiting satellites is complicated by the Doppler effect of the moving transmitter which can cause shifts as large as 25×10^{-6} in the received frequency at a ground station (minimum Doppler shift occurs at closest approach to an earth receiver). Thus, timing resolution requires accurate tracking information. An error budget for the satellite on-board clock has been given as $0.25 \mu\text{s}$ RSS [3] and $0.7 \mu\text{s}$ RSS [2]. The variations of these estimates result from differences in the assumptions for carrier-frequency propagation errors and uncertainties in both satellite position and equipment delays.

In summary, the one-way mode can satisfy a multiplicity of users at widely separated points with some sacrifice in accuracy principally because of path delay uncertainties caused by satellite position error. The two-way mode can service only a small

number of users, but, with elimination of the path delay problem and the addition of a communication link, it appears this method could realize submicrosecond capability. On-board clock techniques have similar advantages and limitations of the one-way mode.

(2) *Some results of TF comparisons via satellites.* The first time experiments via artificial satellites were conducted in August 1962, using the communication satellite Telstar [145]. These experiments related time at the USNO in Washington, DC to that at the Royal Greenwich Observatory (RGO) in England to about 1 μ s (with about $\pm 20 \mu$ s assigned to an LF ground link error). The two-way mode was employed

using 5- μ s pulses at a 10-pps rate and microwave carrier frequencies. Since that time many experiments have been made via the one-way mode and the low orbiting on-board clock technique. Laidet reports a relative accuracy of 20 μ s between the TRANSIT satellite on-board clock and Centre National d'Etudes Spatiales (CNES) network clocks [146]. Table 10.9 shows results of various time and frequency experiments via satellites during the past ten years, including applicable satellite characteristics. These results indicate the excellent potential for TFD via satellites between widely separated global points in the microsecond accuracy range.

TABLE 10.9. Selected Time/Frequency Comparisons via Satellites (1962-1973)

Date	Satellite	Orbit	Carrier frequency	Mode of measurement	Purpose of test	Stated accuracy	Reference
August 1962	TELSTAR	Elliptical Apogee ~ 4800 km Perigee ~ 800 km	(SHF) 6.4/4.1 GHz	Two-way relay	Clock comparison—RGO (England) and USNO (Washington, DC) via Andover, ME	~ 1 μ s	[145]
February 1965	RELAY II	Elliptical Apogee ~ 4800 km Perigee ~ 1400 km	(SHF) 1.7/4.1 GHz	Two-way relay	Clock comparison—RRL (Japan) and USNO via Mojave, CA	~ 0.1 μ s	[147, 148]
June-July 1967	ATS-1	Equatorial near synchronous	(VHF) 149.2/135.6 MHz	Two-way relay	Two-way time sync experiment	4 \pm 2 μ s	[143]
November-December 1967	ATS-1	Equatorial near synchronous	(VHF) 149.2/135.6 MHz	One-way relay	Worldwide time sync experiment	10 to 60 μ s*	[149]
January 1968-April 1972	GEOS-II	Elliptical near polar Apogee 1480 km Perigee 1110 km	(VHF) 136.3 MHz	One-way from on-board clock	Time sync of some 8 worldwide tracking stations	25 μ s	[150, 151]
March-October 1969	TRANSIT	Low altitude (~ 1100 km) circular/polar	(UHF/VHF) 400.0/150.0 MHz	One-way from on-board clock	Synchronization of 6 French satellite control networks	20 μ s	[146]
February 1970	DSCS	Near synchronous drifting ~ 25%/day	(SHF)	Two-way relay	Experimental program to determine feasibility of replacing military portable clock trips	0.1 μ s (σ ~ 0.2 μ s)	[152]
June-July 1970	ATS-3	Equatorial near synchronous	(SHF)(C-Band) 6.2; 6.3/4.1 GHz	Two-way relay	Time sync experiments at C-band carrier frequencies	0.05 μ s	[153]
February-August 1971	TACSAT	Equatorial near synchronous	(UHF/VHF) 303.4/249.6 MHz	One-way relay	Evaluation of one-way mode for clock sync at stations in North and South America	150 μ s†	[154, 155]
	LES-6	Equatorial near synchronous	(UHF/VHF) 302.7/249.1 MHz	One-way relay		25 μ s ‡	
Late 1971	TIMATION II	Low altitude (~ 925 km) circular 70° inclination	(UHF) 400 MHz	One-way from on-board clock	Satellite time sync experiment	~ 1 μ s ■ ~ 4 μ s ■■	[156]
August 1971-1973	ATS-3	Equatorial near synchronous	(VHF) 149.2/135.6 MHz	One-way relay-wide area broadcast	Experimental Time/Frequency Dissemination	~ 50 μ s	[157]

* Dependent upon age of orbital elements.

† Within 2 weeks of orbital element date.

‡ Within 12 h of orbital element date.

■ 4-day old orbital data.

■■ 6-day old orbital data.

TABLE 10.10. Characteristics of the Operational TRANSIT Satellites

Scientific Name	Designation	Launch Date	Period (min)	Perigee (km)	Apogee (km)	Inclination (deg)	Eccentricity	Right Ascension of Ascending Mode (deg)
1970 67A	30190	27 Aug 1970	106.98	949.7	1218.2	90.04	0.018	238.2
1968 12A	30180	2 Mar 1968	106.93	1024.7	1138.4	89.99	0.0076	279.0
1967 92A	30140	25 Sept 1967	106.75	1036.0	1110.6	89.23	0.0050	88.1
1967 48A	30130	18 May 1967	106.96	1066.8	1099.0	89.63	0.0022	12.4
1967 34A	30120	14 Apr 1967	106.48	1046.9	1074.3	90.20	0.0018	348.8

(3) *Timing via U.S. Navy navigation satellites.*
 (a) *Navy Navigation Satellite System (NNSS)—TRANSIT.* The NNSS is primarily a means for determining accurate navigation fixes through Doppler measurements of accurate radio signals transmitted from low-altitude moving satellites (velocity ≈ 7 m/ms) [142, 158, 159]. A secondary function, of interest to TFD, is the continuous transmission of timing marks at 2-minute intervals. These marks are referenced to the UTC time scale and are periodically updated through a ground support network. The TRANSIT system became operational in 1964; it presently consists of 5 satellites with on-board clocks and in nearly-circular polar orbit as shown in figure 10.38. The satellites were spaced initially so that their planes of orbit would be $\sim 45^\circ$ apart at the equator. Each are visible from all points on earth several times a day due to their orbital motion around the rotating earth. Characteristics of the 5 orbiting satellites are given in table 10.10.

A fairly elaborate correction network exists for the TRANSIT system. It consists of 4 tracking stations in Hawaii, California, Minnesota, and Maine,

a computing center, a time reference link to the USNO, and two ground to satellite communication sites or injection stations [160]. A pictorial diagram of the TRANSIT system is given in figure 10.39. The satellites are monitored continuously with information flow to the computing center; orbit predictions for the 16-hr intervals are determined and transmitted to the TRANSIT satellites, together with timing resets, from the injection stations. This information is rebroadcast from the satellites as explained below.

The heart of the on-board clocks consists of high quality 5-MHz crystal oscillators, requiring a frequency stability of at least a part in 10^9 for an observation period of ~ 15 minutes. An example of the TRANSIT crystal oscillator stability is shown in figure 10.40 where the effects of launch are shown as well as the stability recovery 12 to 16 hours after launch. About 2 weeks later the stability per day is better than a part in 10^{10} . Current in-orbit oscillators exhibit stabilities of several parts in 10^{11} per day over intervals of 100 days [160].

The TRANSIT satellite continuously transmits crystal stabilized signals at two phase modulated (PM) frequencies— ~ 150 and ~ 400 MHz. (Two frequencies are used to minimize the refraction error which is inversely proportional to the square of the carrier frequency.) The radiated power is ~ 0.1 watt, providing useful signals up to distances of about 3500 km [160]. Navigation information is given in 2-min segments which begin and end at the instant of each even minute. A digital encoded time marker is broadcast with time uniquely marked at the instant of the even minute by the appearance of a 400-Hz switching tone. A typical TRANSIT timing signal is shown in figure 10.41. Laidet used such TRANSIT signals in synchronizing worldwide French tracking stations to $20 \mu\text{s}$ [146].

In the timing application of TRANSIT signals one must know the orbit of the satellite and the location of receiving site. For a stationary receiving position one can fix the satellite's position from the transmitted orbital parameters, calculate the range and thus determine the signal propagation delay. Presently, the satellite time is set to UTC in $10\text{-}\mu\text{s}$ steps; thus, $10 \mu\text{s}$ is the upper bound of clock setting accuracy although averaging can reduce these time step effects [146]. The equipment for the complete navigation capability for NNSS, including

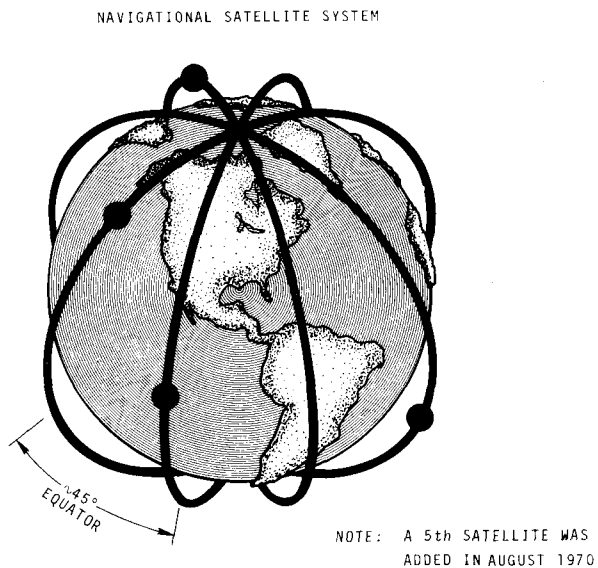

FIGURE 10.38. TRANSIT satellites showing 4 polar orbits. (Consecutive orbits do not repeat around rotating earth.)

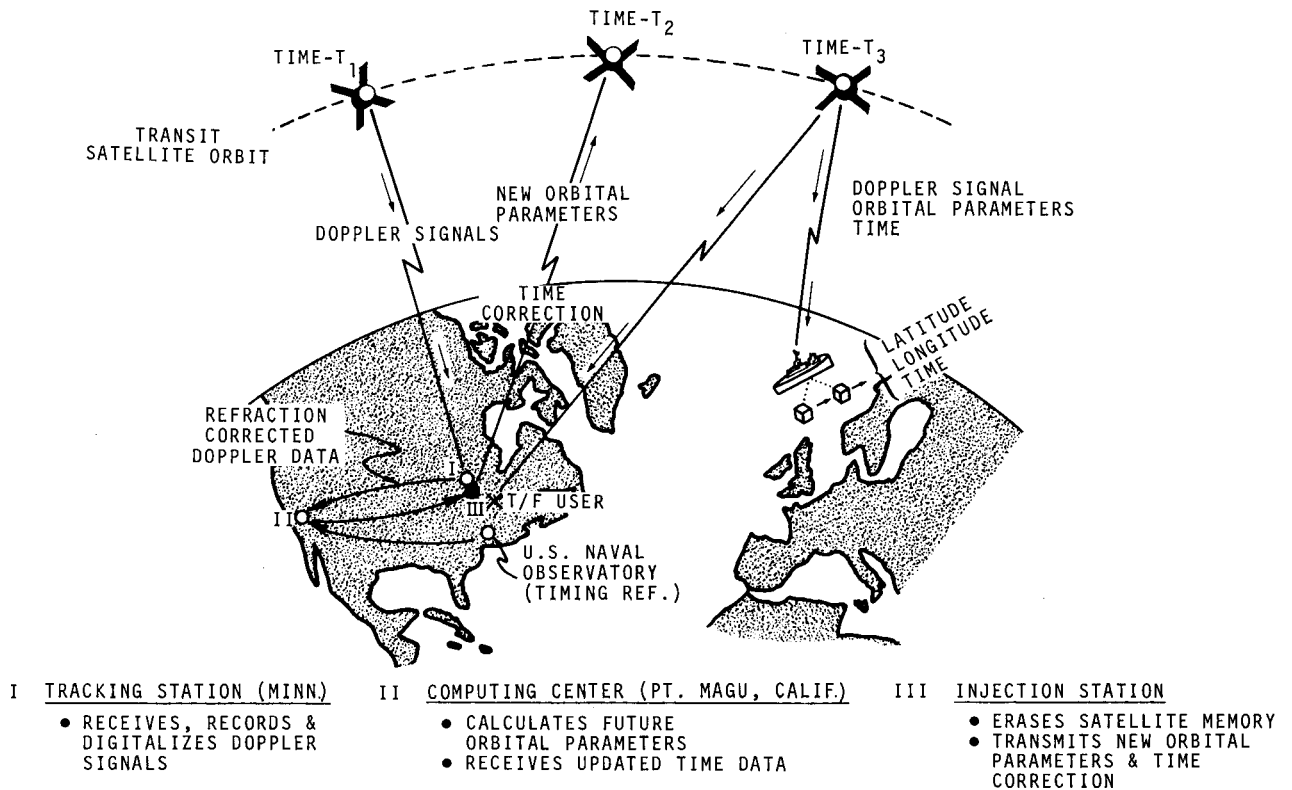

FIGURE 10.39. TRANSIT satellite system operation.

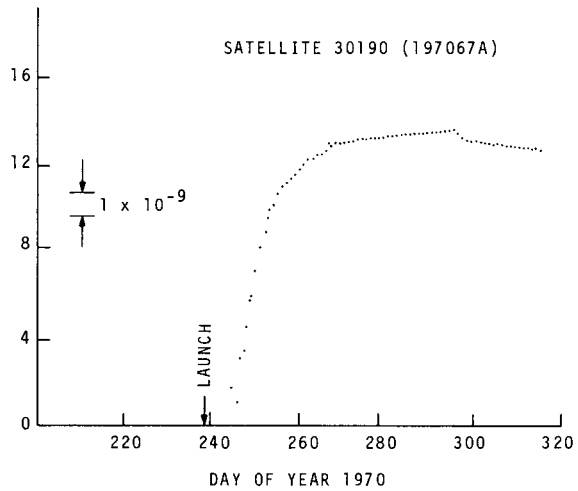

FIGURE 10.40. Typical TRANSIT on-board oscillator stability curve.

digital computer and data processor is quite expensive, however, a simple non-directional whip antenna can be used at a ground station with a commercially available "satellite time recovery receiver,"

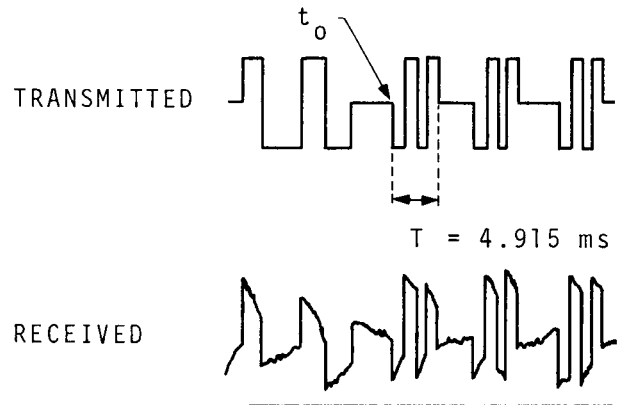

FIGURE 10.41. TRANSIT timing signal (transmitted every 2 min. [146]).

costing about \$2500 [160]. Future plans for TRANSIT type satellites include crystal oscillator drift correction, coarse time resolution to 200 ns, date adjustment precision ~ 1 ns, and pseudo random noise (PRN) time-code modulation [160, 161].

TABLE 10.11. Characteristics of TIMATION Satellites

Name	Launch Date	Period (min)	Orbit	Altitude (km)	Carrier Frequency	Oscillator Stability	Status
TIMATION I	31 May 1967	~ 103	Circular 70° inclination	925	400 MHz	3×10^{-11}	Inactive
TIMATION II	30 Sept 1969	103.4	Circular 70° inclination	925	{ 150 MHz 400 MHz	1×10^{-11}	Active
TIMATION III	FY 1974	~ 480	Circular 125° inclination	13,875	{ 335 MHz 1580 MHz	$\sim 2 \times 10^{-12}$	Scheduled Launch

(b) Navy TIMATION satellites for TFD. TIMATION is a proposed navigation system using a multiplicity of medium-altitude, circular-orbiting satellites with on-board clocks. Two experimental satellites have been launched to date in a low-altitude orbit; a third launch to medium altitude is planned for the near future [140, 163]. Characteristics of TIMATION satellites are given in table 10.11.

Easton has described a TIMATION timing technique for determining the travel times between a moving satellite and a receiving station through phase comparisons of a received radio signal [140]. His technique includes (1) transformation of the satellite position to that of a celestial navigation concept; (2) use of a Marcq St.-Hilaire type of precomputed intercept chart for plotting arrival times and determining a fix; (3) transmissions of low frequency modulations on a UHF carrier, sequenced in order similar to side-tone ranging; (4) comparison of the received signals at a remote site where a duplicate sequence of time-ordered frequencies is generated, thereby determining an arrival time measurement consisting of both propagation delay and satellite-receiver clock differences, and (5) plotting the arrival times on the Marcq St.-Hilaire intercept chart to determine the clock differences as well as the range and/or path delay to the satellite. TIMATION satellite positions, both prediction and post-diction, were obtained from Doppler measurements by the TRANET tracking network and processed to give a computed time delay between the satellite and selected receiving stations.

In 1968, TIMATION satellites were used in an experiment to compare widely separated clocks in Alaska; Colorado; Washington, DC; and Florida. The results of these time-transfer measurements are given in figure 10.42; the overall RMS error shown over a period of 10 to 15 days is stated to be $0.55 \mu\text{s}$ [140]. Experiments in late 1971, using TIMATION II passes in a southeasterly direction over the central USA and the Atlantic Ocean, gave differences between computed and measured delays of $\sim 1 \mu\text{s}$ for 4-day old orbit ephemeris data; 6-day old data gave results 3 to 4 μs in error [156]. In 1972 time transfer measurements between clocks at the Royal Greenwich Observatory (RGO) and the USNO were made via TIMATION II at nearly concurrent times.

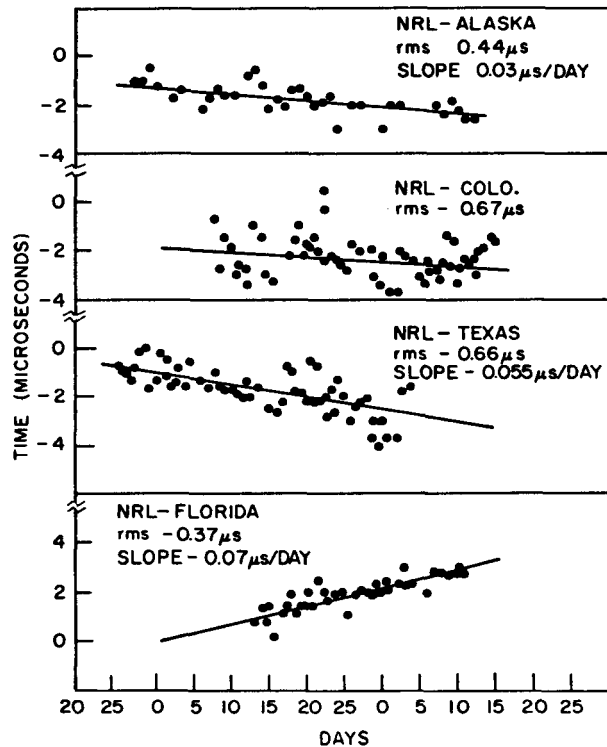

FIGURE 10.42. Time transfer results via Timation II satellite [140].

The results were comparable to Loran-C and portable clock measurements within $1.5 \mu\text{s}$ and indicated a time-transfer capability of $0.5 \mu\text{s}$ accuracy [162].

TIMATION III, scheduled for launch in Fiscal 1974, is a considerably improved version of TIMATION II [163]. It will be visible over intercontinental ranges for observation periods of ~ 2 hr; provide limited use of pseudo-noise modulation signals at 1.580 GHz, and possess a memory which can store orbital information. Considerable attention is given

the TIMATION crystal oscillators to compensate for temperature changes and radiation effects as well as lower the crystal aging rate. A TIMATION satellite receiver has been developed and built; its cost estimate is \$20,000, although quantity demand should reduce this considerably.

(c) *Defense Satellite Communication System (DSCS) for TFD.* The DSCS uses some 21 equatorial drifting satellites (Phase-1 type drifting $\sim 25^\circ/\text{day}$ at $> 32,000\text{-km}$ altitude [135, 152, 164]) for communication, and the system provides a precise time mechanism for comparison of clocks at inter-continental military installations. The DSCS method is being used to successfully compare distant clocks to less than $1 \mu\text{s}$, replacing many expensive portable clock trips.

With certain communications equipment the time transfer requires no signal insertion or disturbance of normal operation; the regular pseudo-random code stream is transmitted, received, and matched to give a measure of clock difference if the propagation delay is accounted for. Both two-way and one-way modes have been used to determine clock differences in the *time transfer method* (subtraction of clock data). DSCS timing tests between Brandywine, MD and the SATCOM facility at Heleman, HI gave about $0.1\text{-}\mu\text{s}$ clock difference and a standard deviation of $0.16\text{-}\mu\text{s}$ for a series of 34 clock measurements in 1970 [152]. DSCS time transfer systems have been developed for terminals not equipped with regular communication modems (mini-modems) [165]. Clock comparisons have been made between short earth distances to about $0.2 \mu\text{s}$ using the Mini-Modem equipment [152]. The DSCS operationally transfers USNO time, via a microwave link to the Brandywine, Maryland terminal, to points in Europe, USA, and the Pacific area to $\sim 0.1 \mu\text{s}$ as shown in figure 10.43 [166].

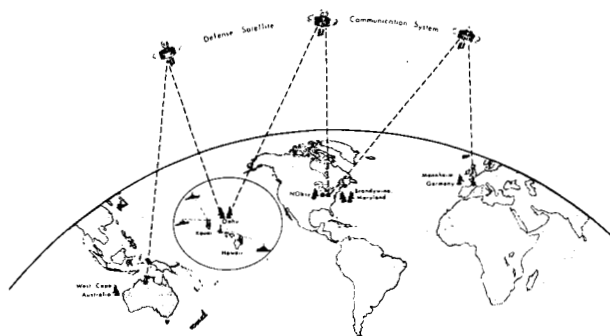

FIGURE 10.43. TFD via Defense Satellite Communication System (DSCS).

(4) *NBS satellite TFD experiments.* The high accuracy and wide bandwidth at microwave carrier frequencies of complex military satellite transmissions is at the expense of costly equipment which is beyond the range of many users. Such high cost

of equipment prompted NBS to take a somewhat different approach to still realize the potential of accurate time and frequency dissemination via artificial earth satellites. An experimental satellite timing program has been in progress at NBS since mid 1967 and is part of a continuing research effort to develop systems beneficial to a large number of users. NBS has worked only with geostationary satellites, and initially conducted two-way experiments using the NASA-Application Technology Satellites (ATS) containing VHF transponders at about 150 MHz. With inexpensive receivers and transmitters, accuracies of about $4 \mu\text{s}$ were reported for these studies [143]. Basic ionospheric effects did not appear to limit the results. One-way satellite experiments, using the ATS transponder at VHF, gave clock comparison accuracies of 10 and $60 \mu\text{s}$ for respective orbit positions a) at the time of measurement, and b) for a one week advanced prediction [149].

Recently, NBS has performed additional one-way transmission tests with communications satellites such as LES-6 (Lincoln Experimental Satellite) and TACSAT (Tactical Communications Satellite) [154, 155] as well as the Application Satellite ATS-3 [157]. These satellites operated in the VHF and UHF bands in the frequency range of 150 to 304 MHz. At these frequencies and with the power of transmission involved, one is able to use small, inexpensive antennas with a SNR more than adequate for the measurements. A pictorial view of the master station and five receiving stations used in typical one-way clock synchronizations is shown in figure 10.44. The results of such measurements have been given in table 10.9.

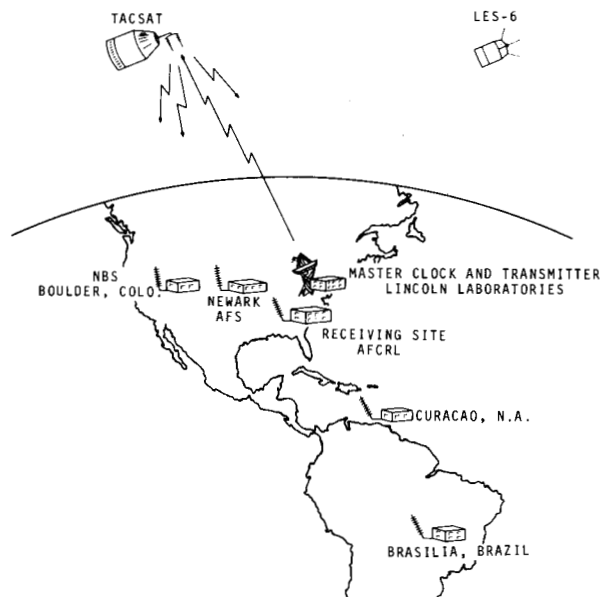

FIGURE 10.44. Experimental TACSAT and LES-6 satellite network

As noted earlier, the satellite positions used in the NBS experiments have been based on orbital information supplied by the agencies controlling the satellites. NBS investigated an alternative approach which could prove adequate for many users. Trilateration techniques were used to locate a satellite through relay range measurements by three widely separated stations during simultaneous transmission of timing signals. Concurrent with the trilateration measurements was the synchronization of clocks at other remote sites; the same timing signal was used for simultaneous ranging and clock synchronization. The accuracy of the range determination depends upon the accuracy of the clock synchronization at the remote sites as well as the range measurement resolution. (A rather low range resolution of 3000 meters was obtained for these experiments.) From the determined satellite position, propagation delays to earth points can be computed; using this approach, it was possible to synchronize clocks other than tracking site clocks to about $40\mu\text{s}$ over intercontinental distances using TACTAC and LES-6 at two different times [155]. It is estimated that the technique could provide accuracies near 1 to $10\mu\text{s}$ if one used precisely synchronized clocks and improved the range resolution; i.e., less uncertainty in the equipment delays.

A similar technique has been reported by Russian scientists; they used an ISZ type MOLNIYA-1 satellite (in an inclined elliptic orbit at low to high altitude [136, 167]) together with the "orbit" television system to synchronize remotely-located time scales [115]. The satellite coordinates were determined at the moment of time synchronization from three widely separated points; i.e., Moscow and Vladivostok in Russia and a reception point of the "orbit" television signals in France. The experimental results, after establishing earth coordinates and measuring delays, showed synchronization of time scales to about $10\mu\text{s}$ over earth distances of 8000 km. The technique is of value for synchronizing remote sites which are inaccessible to direct TV reception [115].

At this point we will describe some concepts and techniques which have evolved from recent experimental work at NBS with the ATS-3 satellite. A promising experiment, ending in late 1973, consisted of two 15-min broadcasts (5 days a week) with a WWV/WWVH type format from ATS-3 [157]. The broadcasts were "on time" with reference to UTC and originated at the NBS Laboratories at Boulder, CO. The signals were transmitted (uplink) to the ATS-3 satellite via a 149.245 MHz carrier; they were transponded (downlink) at a carrier frequency of 135.624 MHz to a wide earth coverage area including North and South America, large parts of the Atlantic and Pacific Ocean and parts of Western Europe and Africa.

The 1971-73 experiments show a potential for various accuracy levels of service; three have been demonstrated and will be described briefly. First,

a coarse time check is possible through simply listening to the time ticks or voice announcements broadcast from the satellite. These signals are accurate to about 0.25 second—the signals left Boulder on time but were delayed in traveling to the satellite at $\sim 36,000$ km altitude and back to earth. (The transponder delay is insignificant at this level.)

The second level of accuracy is attained by measuring the difference between the arrival time of the received "ticks" and those generated by a local clock. From oscilloscope measurements one can achieve 10-ms resolution between the received signal and his clock by visually averaging the position of a positive-going zero crossing of the first cycle of the tick. However, as in all one-way satellite measurements, allowance must be made for propagation delay. To overcome this problem NBS prepared path delay contours on ATS-3 coverage maps, based on orbital elements issued by NASA, as shown in figure 10.45. From such contours one can read the propagation delay from the Boulder transmitter to the satellite and from the satellite to an earth receiving point. Satellite movement obsoletes these contours; updated contours were published monthly, together with receiving antenna pointing charts which gave elevation and azimuth angles to the satellite anywhere within the coverage area [42]. Application of such chart corrections to the oscilloscope readings provides timing to a few milliseconds.

The third level of service provides timing to better than $50\mu\text{s}$. This technique is predicated upon the accuracy of NASA's orbital elements which permit predicted propagation delays from Boulder to any point in the satellite's view to within 10 to $20\mu\text{s}$. Voice broadcast gave the satellite's longitude, latitude and a radius correction. To take advantage of this capability for the benefit of the user, NBS designed a special purpose delay computer in the form of a circular slide rule [168]. Figure 10.46 shows a picture of the prototype delay computer. To use this computer one enters the satellite position information together with the latitude/longitude coordinates of the receiving point and determines the propagation delay to within 10 to $20\mu\text{s}$.

The differences between theoretical delay measurements and slide rule calculations at NBS Boulder from the transmitter—satellite—receiver are shown in figure 10.47. The slide rule calculated delays agree with the theoretical computer delays to several microseconds over a relatively large range of latitude and longitude. The results of these ATS-3 experiments are reported in detail by Hanson and Hamilton [157]. Figure 10.48 gives both a block diagram and photo of the receiving equipment that could be used in the ATS-3 timing experiments. The receiving equipment can be simple and inexpensive; for optimum results it included a 10-dB gain Yagi antenna, low-noise transistorized preamplifier and a modified FM receiver which costs $\sim \$150$.

The experimental ATS-3 satellite broadcasts have proven that concepts of simplicity, various

SAMPLE CALCULATION OF PROPAGATION DELAY FOR A RECEIVER IN WASHINGTON, D.C.	}	DELAY FROM BOULDER, CO. TO SATELLITE	128.9ms	
		DELAY FROM SATELLITE TO WASH. D.C.	126.1ms	
			TOTAL DELAY	255.0ms

(BOULDER, CO. COORDINATES 105°W 40°N WASH. D.C. COORDINATES 77°W 39°N)

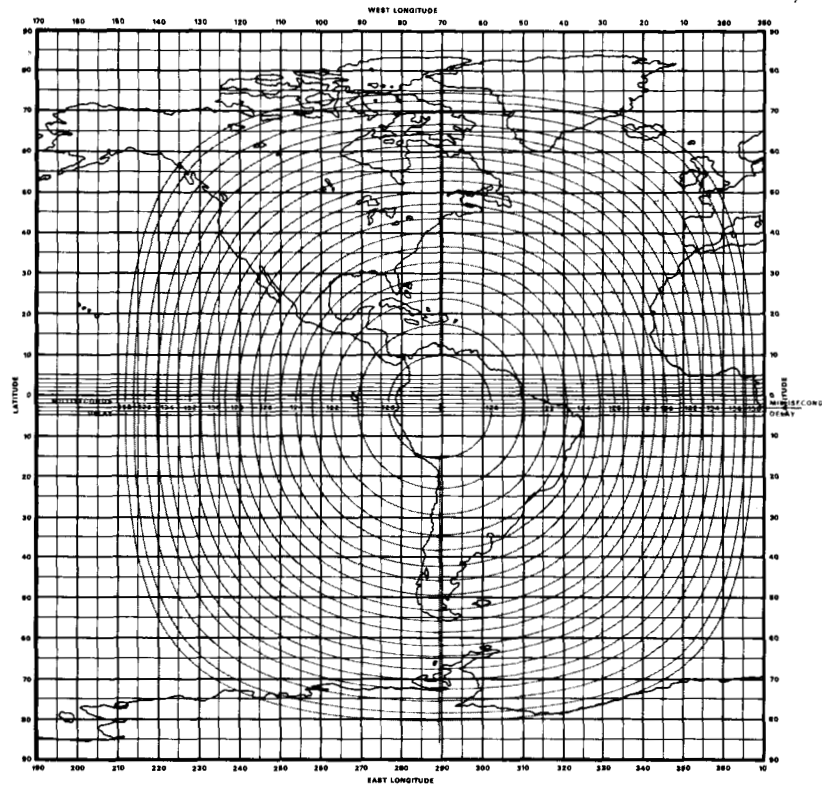

FIGURE 10.45. ATS-3 satellite coverage map with propagation delay contours (1700-1715 GMT, March 1973).

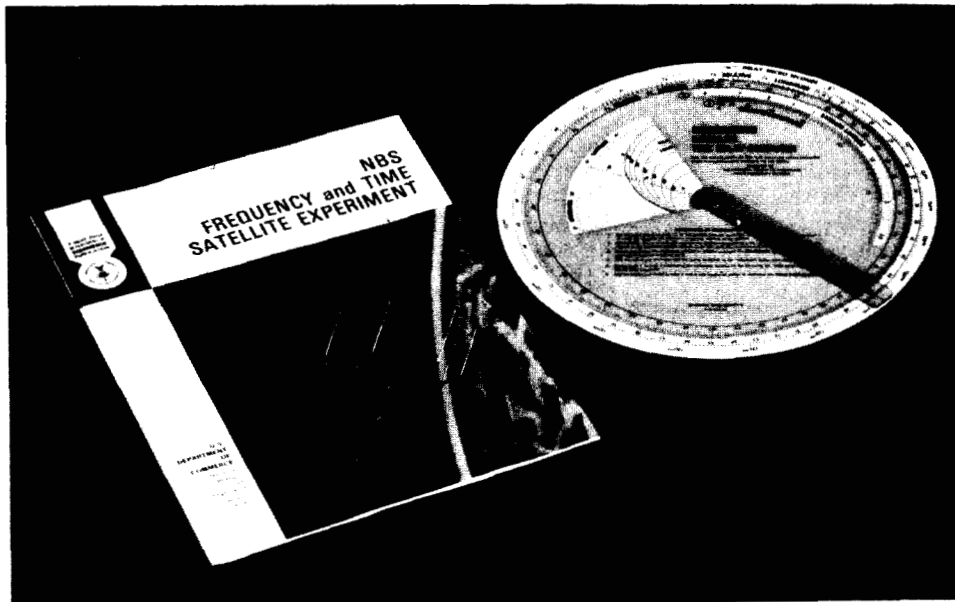

FIGURE 10.46. Slide rule calculator for determining ATS-3 satellite arrival times.

SUB SATELLITE POINT
 (SSP) = 0.518°N, 68.601°W

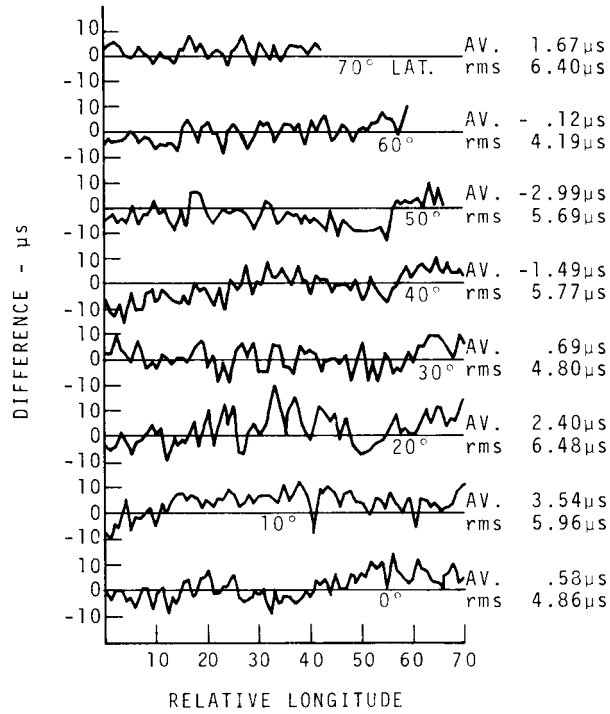

FIGURE 10.47. Theoretical propagation delay minus slide-rule calculated delay (systematic errors removed).

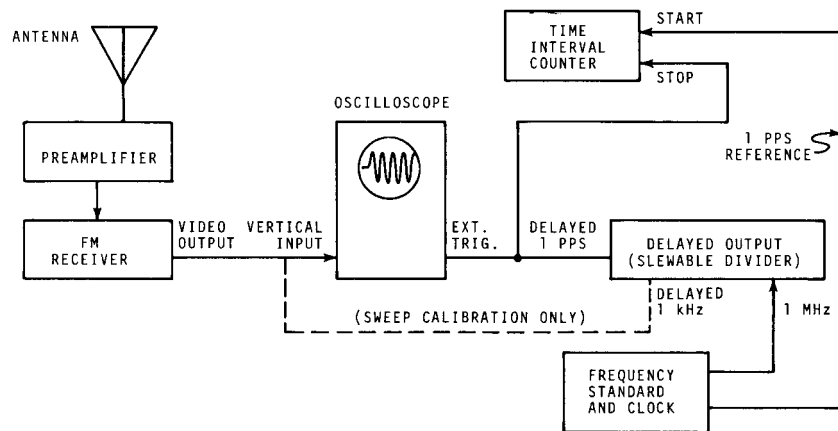

FIGURE 10.48. Block diagram and photo of equipment for ATS-3 satellite experiments.

levels of accuracy, and reliability are achievable with low-cost receiving equipment and are commensurate with the degree of the measurement complexity. NBS may provide 24-h experimental timing at some future time through a Department of Commerce satellite. Many of the concepts and techniques developed in these experimental programs would be applicable to an eventual TFD service via satellite.

(5) *Advantages and limitations of satellites for TFD.* The advantages and limitations are given in

table 10.12 for the two categories of the low-altitude orbiting clock and the synchronous radio-relay. In this evaluation one assumes that these satellites are not launched or justified solely for TFD. (Synchronous satellites with on-board clocks have been proposed but are not considered in this evaluation.) The net conclusion is that satellites offer an excellent potential of meeting the timing needs of many classes of users at various accuracy levels.

TABLE 10.12. *Advantages and Limitations of Satellites for TFD*

Satellite Type	Advantages	Limitations
Low-altitude orbiting satellite with on-board clock.	<ol style="list-style-type: none"> Worldwide (periodic) coverage is possible even with one satellite (polar orbit). Timing synchronization is available to an unlimited number of passive users within sight of the satellite at any one time. Users do not require transmitters as in a two-way mode. Short line-of-sight range between the satellite and the user gives a favorable SNR at high elevation angles. Clock differences can be determined between receiving stations in a short time period with auxiliary communication. This technique is capable of synchronizing world wide clocks to one primary time standard. 	<ol style="list-style-type: none"> The satellite dynamic motion causes variation in the signal propagation delay and requires correction for Doppler effects. Compensation for propagation delay is a major factor for use of these satellites in TFD; knowledge of orbit position is essential. The availability of timing signals is limited to ~ 10 to 15 min per pass several times a day. Accurate time comparison requires continual accounting for equipment delays. The on-board clock has limited life and cannot be repaired or modified. Clocks in orbit require monitoring and periodic adjustment. Operational military systems require expensive and complex receiving components which are impractical for many users. Satellite power can fail and/or the satellites can be destroyed. The system requires many satellites for redundant and frequent passes.
Radio-relay type satellites in synchronous orbit.	<ol style="list-style-type: none"> There is <i>continuous</i> availability of timing signals to a large area of the earth (~ 1/3 of the globe). Two-way modes using simultaneous radio transmissions over reciprocal paths need no correction for propagation delays. The system offers an attractive means for re-broadcast of standard frequency radio signals to simultaneous receivers at high accuracy and low cost, using VHF-UHF transponders. The master clock is accessible at a ground station and can be continuously referenced to UTC(NBS). Wide band microwave transponders are available which permit fast rise pulses and clock synchronization at a receiver to less than 1 μs. This is at the expense of costly equipment, however. The ionosphere-atmosphere portion of the radio path is small in relation to the total path and causes minor degradation in the line-of-sight VHF and higher frequencies. System can replace expensive portable clock trips. 	<ol style="list-style-type: none"> Near world-wide coverage requires at least three equatorial synchronous satellites. Even synchronous satellites show some movement, and accurate orbital elements are required at the time of measurement for microsecond time synchronization. The much longer radio path than that of the low-altitude satellites requires higher transmission power and/or the use of high gain directional antennas. Synchronous satellites can be moved, thus changing the earth coverage area, or they may be destroyed. Synchronous satellites are considerably more expensive to launch than low-altitude satellites. Accurate time comparison requires knowledge of equipment delays.

h. Microwave Time and Frequency Transfer (SHF)

The usefulness of this band for TFD has been demonstrated by the TD-2 microwave system in the USA and various systems abroad in long distance routing of television signals; such techniques were discussed earlier in Section 10.3.2.f. Two specific examples of microwave TFD are now described.

Phillips et al., have demonstrated that time and frequency can be transferred two-way at a frequency of ~ 7 GHz between the Naval Research Laboratory (NRL) and the USNO (line-of-sight path of 11.75 km in the Washington, DC area) [169]. In the NRL/USNO microwave experiment, NRL transmitted a 1-MHz signal, derived from a hydrogen maser, to the USNO as shown in figure 10.49. This signal was compared to the USNO master clock; also, the USNO transmitted time and frequency information simultaneously to NRL by the algebraic addition of a 1-MHz signal and 1-pulse per second, both in terms of the USNO master clock. Such a technique enables continuous comparison of both phase (frequency) and date (time) at NRL. Phase resolution was found to be better than 10 ns and date transfer $\leq 0.1 \mu\text{s}$. A second microwave link between the USNO and the Waldorf Satellite Research Communication Station (path length of 32.2 km) also provided phase resolution to better than 10 ns. Such a link to nearby Brandywine, MD will be used in connection with the DSCS network for disseminating T/F information to continental terminals [170] (see sec. 10.3.2.g).

The NRL/USNO link has been operating for more than 3 years and shows no diurnal dependence with little effect from seasonal or temperature changes. Wet snow accumulating on the antenna did adversely affect the results. The effects of high-density air traffic crossing the transmission path at a local airport were minimal and of small consequence. The propagation delay is determined by a portable atomic clock. The carrier frequency stability was not critical, and the narrow beam width minimized multipath error. The first information received was by direct path so that the pulse leading edge was used for timing when multipath reflection occurred.

The Jet Propulsion Laboratory (JPL) is also pursuing microwave TFD to link 3 remotely located precision timing systems to a master timing source over distances up to ~ 16 km at the Goldstone Deep Space Communications Complex (GDSC) [171]. They transmit a 1-pps of $50 \mu\text{s}$ duration at baseband frequencies generally above 2.5 MHz. The rise time of the return pulses is $\sim 0.4 \mu\text{s}$ between 10 and 90 percent of the initial slope as compared to half that time for the input pulse. Over a period of time some microwave system drift was noted, up to ± 200 ns. These changes were cyclic and believed to be related to weather anomalies such as relative humidity, temperature changes, and dust storms. In a typical 10-day period the total cyclic excursion did not exceed $\sim \pm 20$ ns. This microwave system presently links two stations in the Goldstone complex to a relative synchronization accuracy of better than $1 \mu\text{s}$.

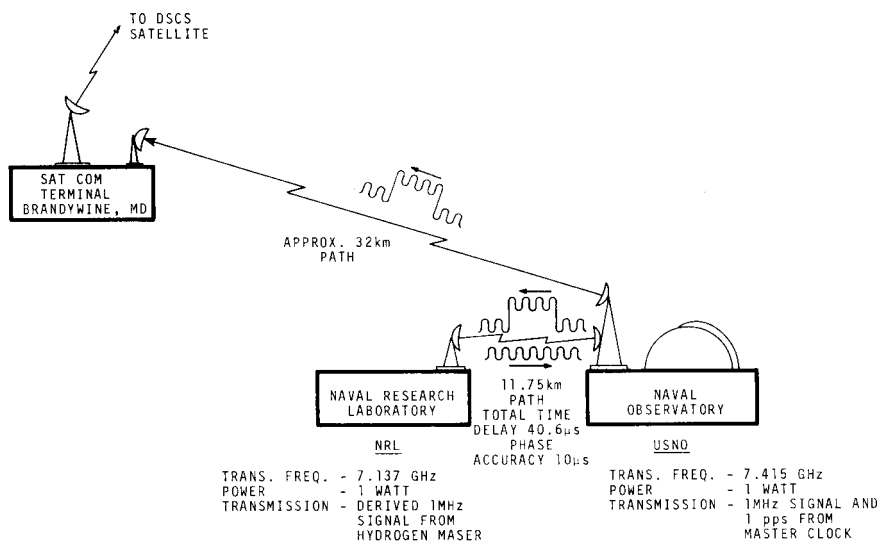

FIGURE 10.49. NRL/USNO microwave links.

Advantages of Microwave TFD

- The system provides extremely accurate transfer of frequency and time information, i.e., phase resolution to ~ 10 ns and time to $0.1 \mu\text{s}$.
- System is reliable generally showing small effects from diurnal changes, propagation anomalies, weather, or temperature.
- Once established, the measurement system is simple and straight-forward.
- Simultaneous time and frequency measurements are possible between remote sites of limited range (~ 40 km) with good reliability.
- System requires very low power of radiation (~ 1 watt).
- Multipath causes small interference and carrier frequency stability is not critical (precise modulation).

Limitations of Microwave Time and Frequency Transfer

- Initial cost of microwave equipment is high.
- The system is limited to line-of-sight distances of maximum range ~ 40 km.
- Accumulation of snow or ice on the dish antennas can seriously affect the microwave transmission.
- Only a very limited number of users can be served with a microwave T&F system because of geometric limitations of the transmission beams.

i. Commercial Radio TFD Techniques

The idea of providing standard frequency signals from commercial radio broadcasts is not new, having been employed in the United States in the middle 1920's [172]. In 1927 there were 13 so-called standard frequency stations broadcasting in the range of 17 to 1000 kHz and referenced to standards at the National Bureau of Standards at Washington, DC. The number of stations was limited to those which could be received regularly and reliably at NBS; the results of these measurements were published monthly. Additional "constant frequency stations" were designated when broadcast frequencies were maintained close to licensed values. Of course the accuracies of these signals were many orders of magnitude less than now obtainable; they do, nevertheless, foreshow a potential means of standard frequency dissemination possible today.

About 36 years ago a commercial station in Nashville, TN stabilized their broadcast carrier at 650 kHz to an accuracy of ~ 1 part in 10^6 . They used a multiple temperature-controlled oscillator which was periodically checked with WWV at Beltsville, MD [173]. Within the last several years a CCIR

member encouraged this clear channel station to improve the precision control of their broadcasts. They have demonstrated that, today, a commercial broadcast station can transmit precise time and frequency information traceable to NBS and at relatively low cost [174]. The carrier frequency is phase locked to the WWVB received signals at 60 kHz through division, multiplication, and long-term integration, and the resultant frequency stability is $\leq 1 \times 10^{-9}$. In addition, a 1-kHz time pulse signal of 400 ms duration is broadcast every 15 minutes. This time is referenced to WWV, with allowance made for propagation delay, and is considered accurate within the range of 1 to 10 ms [175]. A low-cost receiver frequency-marker-generator (\$100) has been designed and built; this unit will receive the 650-kHz signal, to which a 10-MHz crystal oscillator is locked, and produce marker pulses from 10 MHz down to audio frequencies. Initial tests have shown satisfactory results from Nashville to both Evansville, IN (~ 225 km) and to Boston, MA (~ 1500 km). Generally, the signal is stable during daytime, but multipath adversely affects it at night. The received accuracy of the broadcast carrier within groundwave distance should be equivalent to that as transmitted in the local Nashville area; received accuracies at skywave distances will be degraded in a similar manner as MF transmissions.

Advantages of Commercial Broadcast TFD

- Simple, cheap and readily available receivers can be used to obtain time and frequency information to relatively high accuracy within ground wave distance of a commercial broadcast station. The commercial station thus serves as a secondary standard which is directly traceable to NBS standards of time and frequency.
- The commercial broadcast station can perform an additional service to the public at small additional cost to itself through NBS low-frequency broadcast reference.
- The service would be of special value to a great number of users who do not require the full accuracy capability of the NBS standard time and frequency broadcasts.
- A network of frequency-stabilized commercial broadcast stations located throughout the larger populated areas of the U.S. could provide secondary time and frequency references to a large percentage of the population.

Limitations of TFD via Commercial Broadcast Stations

- The high accuracy signals generally are limited to ground wave range around the transmitting antenna.
- Special techniques are required for high accuracy comparisons through skywave reception of commercial broadcasts.

j. TFD from VHF Signals Reflected from Meteor Trails

Both in the United States and Russia, investigators have reported that meteor burst links will support precise time synchronization and frequency comparisons between remote sites via reflection of VHF signals [176–178]. Sporadic meteors, entering the upper atmosphere about 120 to 80 km above the earth's surface, evaporate and form a thin ionized trail, ~ 15 to 50 km long with a typical lifetime of fractions of a second (100% > 150 ms and 2% ≈ 1.5 s [179]); durations up to a minute, however, have been observed [180]. Meteor scatter forward reflection provides optimum support at the lower portions of the VHF band and the maximum great circle range, limited by the earth's curvature, is ~ 2100 km. Sporadic bursts occur randomly with some 40 to 150 usable meteor trails available per hour. Latorre indicates the minimum time between bursts as one second with only about 5 percent of the intervals between bursts exceeding 100 s [179]. The number of bursts predominate in July with a minimum in February. There are orientation restrictions in transmission and reception of the VHF signals, and directional antennas generally are used. Reflections are specular (angle of incidence equals the angle of reflection at the grazing point of the meteor trail), and the time and frequency measurements depend upon mutual reciprocity of the reflected VHF signals. Sanders et al., report an equivalent rate in change of the propagation path delay as 0.137 μs/s for operation at 46.55 MHz [177]. Such a change, even for a 1 ms time interval between alternate reflections from a common meteor trail, represents ~ 0.1 ns and would be insignificant in precise timing.

Most of the time synchronization studies via Meteor Burst in the U.S. were made between Seattle, WA and Bozeman, MT during the 1960's [176, 177, 181]. The great circle path distance was 880 km and a 46.55-MHz carrier frequency was used at a peak power of ~ 1 kW. In one mode of operation both stations transmitted 50 to 100 pps, derived from local clocks which were coarse synchronized to several ms through WWV broadcasts. At the occurrence of a usable meteor trail, each site simultaneously receives pulses transmitted from the opposite station since they traveled the nearly reciprocal path and experienced the same propagation delay. The time relationship of the received pulses to the local clock pulses provides a measure of the time difference, δ , between the clocks at the two remote sites. Consider the simplified timing diagram in figure 10.50. Transmitter No. 1 transmits a square wave pulse with positive-going leading edge at $t=0$; at the time $t=\delta$, transmitter 2 also transmits a pulse. While a meteor trail is reflecting, station 1 receives a pulse at time $T_0 + \delta$ and station 2 at a time $T_0 - \delta$ as measured at stations 1 and 2 respectively (where T_0 is the propagation delay between a transmitter, meteor and receiver). As different meteors with varying paths are used, T_0 will vary but δ will remain essentially unchanged

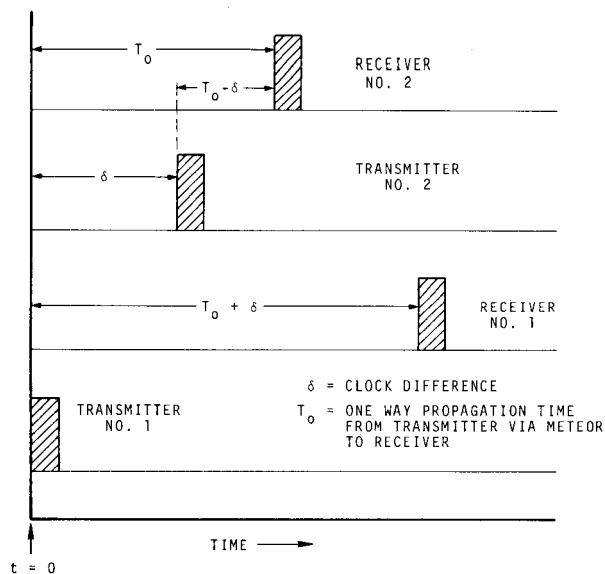

FIGURE 10.50. Simplified meteor-burst timing pulses.

for precise atomic clocks. The difference between the readings at the two stations cancels the propagation delays and yields twice the clock error; the sign of the difference shows the sense of one clock error in terms of the reference clock. A comprehensive analysis must include allowance for transmitter equipment and receiver delays as well as the degree of reciprocity in the propagation delays. It is felt that these delays can be determined ultimately to several hundred nanoseconds [182]; use of identical equipment at each end of the path would minimize the delay determination. The meteor burst method is unique in that the actual propagation delay is measured and can be known.

Different modes of operation have been tried, including both manual and automatic systems. Sanders et al., from timing measurements over a 30-day period, determined the frequency offset $\delta\nu/\nu_0$ between two remote frequency standards; these data agreed with VLF/LF phase measurements to several parts in 10^{10} [177]. March et al., has shown the inherent phase stability of the meteor-trail, reflected VHF signals and reports that time synchronization via this method has μ s capability [181].

In 1971 it was reported that the Khar'kov State Scientific Research Institute of Metrology (Kh GNIM) compared time scales with the State Standard Scale of the All-Union Scientific Research Institute of Physicotechnical and Radiotechnical Measurements (VNIIFTRI) via meteoric reflection of radio waves [178]. Their method is similar to that previously described except that they employ duplex transmission and retransmission of different pulse trains between two remote sites. This permits an independent readout of the clock difference, δ , at each station. The method also minimizes equipment delay errors provided that identical equipment is

used at each station. The system uses a 72.0-MHz carrier frequency with a pulse power of 30 kW and a directional antenna; pulses are of 4 μ s duration and grouped into code pulses—4 for interrogation and 7 for reception. The marker repetition rate is 10 ms. Measurements were made at 0100 to 0400 (Moscow time) to eliminate interference from AM and FM broadcasting stations, usually off the air at this time. A series of 12 timing measurements for one day over a 4-hour period showed deviations less than 0.8 μ s and standard deviations of 0.2 to 0.3 μ s.

Advantages of VHF Reflection from Meteor Trails for TFD

- The phase stability of the VHF propagation enables comparison of time scales to high accuracy ($< 1 \mu$ s) and frequency to parts in 10^{11} at remote sites up to several thousand km apart. This distance probably could be extended through intermediate repeater stations.
- The technique is based on the natural event of meteor bursts and from this standpoint is independent of man-made devices or systems.
- The system would be useful for time and frequency comparisons at remote sites such as the far north and/or inaccessible islands where other techniques are unsuitable or unavailable.
- The technique does not appear to be limited by the propagation, and lack of delay reciprocity seems to be minimal.
- Portable equipment could be used as accurate knowledge of path distance is not required.

Limitations of the Meteor Burst System for TFD

- The accuracy of the system is equipment-limited by bandwidth, S/N, and the ability to measure actual component delays.
- The number of potential users is severely restricted because of the directional nature of the propagation.
- The meteor bursts are sporadic, unpredictable as to time of occurrence, and of variable short life. (Some of these limitations can be overcome by statistical techniques and coherent detection.)
- Reception and pulse recognition is hampered by multipath effects, such as Sporadic E, aurora, multiple meteor trails, or changing trail patterns. These effects will vary with such factors as season, time of day, location on the earth, operating frequency, and the orientation of the meteor trail (reflections are specular).
- The meteor burst channel is noncontinuous, and it is indeterminate when time and frequency comparisons can be made.
- Curvature of the earth's surface limits the maximum great circle distance between sites to ~ 2100 km.
- Additive noise can adversely affect the leading edges of the received pulses causing uncertainty in the pulse position measurements.
- The necessary equipment is somewhat complex with relatively high initial cost.

10.3.3. Advanced T/F Systems Using Radio Techniques

Varied types of advanced systems with primary or related time synchronization capability, have been operated and/or proposed within the last several years. Several of these such as very long base interferometry (VLBI), the "moon bounce" (lunar radar) synchronization method, and aircraft collision avoidance systems (ACAS) are considered briefly to acquaint the reader with their capabilities and characteristics.

a. Very Long Baseline Interferometry (VLBI) Time Synchronization

Within the last several years, a new technique of radio interferometry has evolved whereby a point source of radio radiation can be received and coordinated at independent antennas, separated by thousands of kilometers, through precise timing available with atomic frequency standards [183–186]. Initially, long baseline interferometry was used for precise angular measurements of extraterrestrial radio sources. The increased sensitivity of VLBI, resulting from long, widely-separated baselines with independent coherent time references at each end, gives impetus to various scientific experiments and proposals; included are studies of global geodesy, radio astronomy, tidal oscillations, continental drift, polar motion, earth rotation, relativity measurements, and global time and frequency synchronization [187–190].

Let's look initially at the basic concepts of VLBI. Figure 10.51 gives the geometry of VLBI in simplified form. Two antennas, Nos. 1 and 2, are separated on earth by a distance D , and this baseline forms an angle, θ , within a line to the source of electromagnetic radiation. With extraterrestrial radio sources, the wave front is considered plane to the earth surface and traveling with the speed of light in a vacuum (disregarding at the moment atmospheric

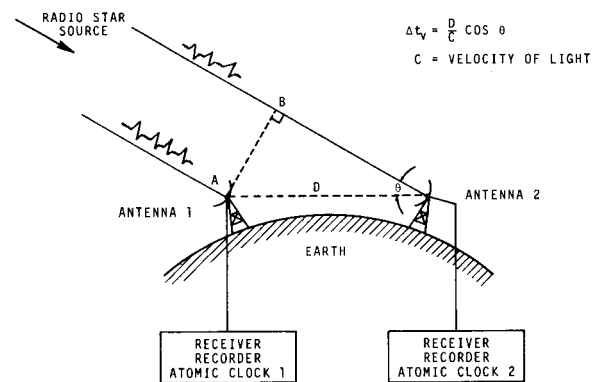

FIGURE 10.51. Geometry of VLBI receiving sites.

effects, etc.). At points A and B, the signals are identical; however, the phase of the received signals at antennas 1 and 2 will differ by the delay time, Δt_v . (Δt_v is a key factor in nearly all VLBI proposals and experiments, and its determination results from many measurements of various point sources at different observatories with a complicated statistical structure, involving many parameters.) Shapiro and Knight [188] point out, however, that the various geophysical effects proposed for study all have characteristic time variations in the observed Δt_v , and extraction of the estimated relevant geophysical quantities is feasible.

At a given antenna, the received signals are converted to video frequencies, tape recorded on magnetic tape, and time referenced to local atomic clocks. The recordings from two widely separated and independent receivers are then brought together and cross correlated through computer reduction and manipulation; maximum cross correlation occurs when the recordings are offset in time by Δt_v for the various frequencies of radiation (essentially microwave band), based on synchronous time sources at both antenna sites. Corrections are made for the earth's orbital motion and Doppler shifts from the earth rotation. In one series of measurements in January 1969, reported by Shapiro and Knight [188], an 845-km path separated the MIT 120 ft. (~37 m) diameter Haystack dish antenna in Tyngsboro, MA, and the National Radio Astronomy Observatory (NRAO) 140 ft (~43 m) diameter dish antenna in Green Bank, WV. The measurements were at L-band (1.6 GHz) of 24 hours duration, and included observations of sources 3C 273, 3C 279, 3C 345, and 3C 454.3. The experiment included 30 different measurements of Δt_v from these four distant objects to determine some 12 parameters. The error in determining each Δt_v was estimated as 1 ns, and the standard error in determining the baseline, d , as about 1.5 meter (5 ns). This is tempered with the statement that the "true error may be somewhat greater." Hydrogen masers were used at both receiving sites. The worldwide net of radio astronomy stations that have participated in VLBI experiments are shown in figure 10.52. More recently, VLBI experiments were performed at a baseline length of 8035 km between NRAO, Green Bank, WV and the Crimea Astrophysical Observatory on the Crimea peninsula, USSR [191].

With such promising results, it is not surprising that suggestions are made to use the VLBI technique in reverse to synchronize remotely located clocks; i.e., to provide precise *time transfer* via a common source [186, 188, 190]. Such a technique requires knowledge of the geometric delay, Δt_v . Thus, recordings of signals from a point source, received at two widely separated fixed points and referenced to precise frequency standards, could be time shifted to obtain maximum correlation. The



FIGURE 10.52. Worldwide net of radio astronomy stations participating in VLBI experiments.

difference between this time offset and Δt_v is essentially the clock difference. VLBI time synchronizations are limited by the precision in the Δt_v determinations; Rogers and Moran state that "without first using the interferometer as a survey instrument, the geometric delay can only be computed reliably to within 20 nanoseconds" [190]. Uncertainties in Δt_v occur from errors in estimating positions of both the source and receiving antenna as well as variable propagation delay of signals through the atmosphere [192]. It is predicted that intercontinental synchronizations of precise clocks can be made via VLBI techniques within the range of 1 to 50 ns [186, 190, 192]. Recently, frequency differences between two hydrogen frequency standards were determined as several parts in 10^{14} through VLBI measurements over a 16-km baseline; (10-min to 4 h measuring period [193]). Lunar and/or satellite beacons as well as moon based antenna have been proposed for increased sensitivity of VLBI [188].

Advantages of VLBI Clock Synchronization

- Clock synchronizations to nanoseconds or better at widely separated intercontinental distances appear possible.
- Although the present VLBI systems are fixed-base, portable installations with transportable antennas 3–5 meters in diameter, could be situated globally for time synchronization purposes [194].
- At the 50-ns region the results are relatively independent of ionospheric and atmospheric effects [190]. Ionospheric effects can be reduced through the use of frequencies above ~5 GHz [195].

- The actual sync measurements require short integration times (in order of minutes), although the data reduction, correlation and processing may take days. Rogers and Moran [190], however, suggest that suitable HF links could be tied into a computer to obtain nearly real-time synchronization.
- Radio astronomy sites are geographically well known and already the installations include much of the equipment required for VLBI.
- Radio astronomy sites could provide primary time synchronization referenced to a national or international time scale.
- Clocks can be compared independent of physical transfer, and the synchronization possibilities could be extended to aircraft or ships at sea through appropriate communication links and computer facilities.
- Apart from clock synchronization, VLBI methods offer promise of precisely determining many geodetic and radio astronomical factors as well as relativity effects.

Limitations of VLBI Time Synchronization

- The system is elaborate, cumbersome and requires expensive instrumentation, such as high-speed, digital tape recorders, low-noise microwave receivers, and auxiliary equipment. In addition, the data must be reduced and cross correlated by computer analysis. Equipment costs, apart from computer time but including atomic clocks and dividers at an observatory with a large dish antenna is estimated at about \$145,000.
- The method is limited to the extent to which the geometric delay, Δt_v , can be determined. This determination is based upon systematic errors in source positions, receiving site locations, baseline length, and sidereal time.
- VLBI is subject also to errors from atmospheric delay caused by variation in water vapor content, ionospheric and plasma phase delays, signal to noise ratio of the receiving system, instability of atomic frequency standards during measurement (timekeeping for maintaining minimum "clock offset errors" between interferometer sites may require 8h clock stability of 0.1 ns; many measurements now are integrated over 3-min periods), and changes in antenna orientation. Minimum atmospheric errors occur when the zenith angle is small at both terminals; however, separations at inter-continental distances at various latitudes give different elevation angles at the receiving antennas, and high accuracy measurements at such locations would require atmospheric correction.
- The system cannot determine time through single frequency recording of a given radio

source, but requires wide band measurements to resolve the Δt_v factor through sampling many widely-separated narrow band frequency channels [196].

- Clock synchronization via VLBI is now at the experimental and proposal stage. While the technique shows great promise, much work yet remains in making measurements at many sites, encompassing diverse global baselines at different latitudes, from various extraterrestrial sources to adequately define the geometric delay, Δt_v , and to simplify the reduction and correlation processes of the data analysis.
- Clock synchronizations would be delayed after the fact.

b. Moon Bounce Time Synchronization (MBTS)

This technique, also called a lunar radar time synchronization system, was devised and designed by the Jet Propulsion Lab, Pasadena, CA [197-199]. The system is in operational use for deep space tracking and synchronizes clocks within $20\mu\text{s}$ or better at 5 worldwide tracking stations with a master clock at Goldstone, California, through reflections of radar signals off the moon.

Basically, the MBTS method uses biphasic modulated, X-band radar (8.4501 GHz) signals which are transit-time and Doppler shift corrected, bounced from the moon, and received on time at tracking stations. A primary concept of the system stresses simplicity of the receiving antenna and the receiver operation at the tracking site; the moon must be simultaneously visible to both the transmitter and receiver for at least 10 minutes daily. This latter point coupled with the necessity of computer corrections for transit time and Doppler shifts at a given station, dictates that only one station can be synchronized at a given time period.

A simplified diagram of the MBTS system is shown in figure 10.53. Briefly, the essentials of operation are as follows:

- (1) The X-band transmitted signal is pseudo-noise (PN) modulated; it is both frequency-compensated for Doppler shifts at the receiver and time-advanced by 2-3 seconds for propagation time delay determined by a computer.
- (2) The PN code is transmitted at one minute intervals and scans $\pm 30\mu\text{s}$ in $1\mu\text{s}$ steps.
- (3) The transmitted signal is directed at and reflected from the moon at an effective sub-radar point and received and compared at the remote station with a PN code generated by the local clock and identical to the transmitted code.
- (4) The offset between the received and locally generated code is determined by cross correlation between the two as shown on a strip

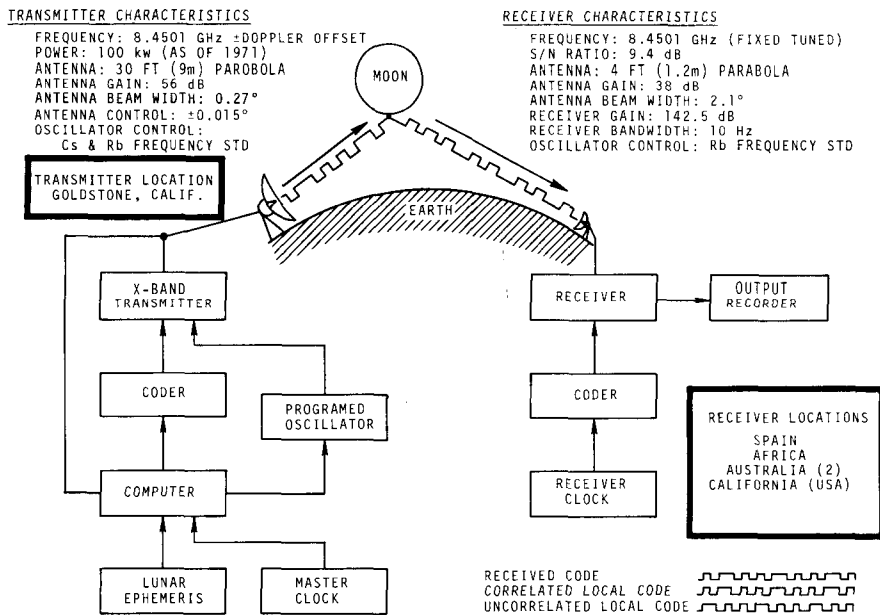

FIGURE 10.53. Simplified diagram of MBTS (Lunar Radio) system.

chart recorder at the receiver. Thus, maximum correlation occurs when the two codes are in coincidence; typically, this point occurs within the 60-second scan of $1 \mu\text{s}/\text{second}$ ($\pm 30 \mu\text{s}$ overall) and gives the time differences between the master and receiver, provided the propagation delays, Doppler shifts, etc., are correct. If the receiver clock has an error in excess of $\pm 30 \mu\text{s}$ or if there is a clock failure, one can resynchronize to 10 ms through radio standard-time transmissions such as WWV. The Goldstone control facility can change the transmission code rate scan to 10 or $90 \mu\text{s}/\text{s}$ thus giving a search range flexibility of up to $5400 \mu\text{s}$. This technique permits setting a clock within 10 ms of true time and synchronizing to the original accuracy of $\sim 20 \mu\text{s}$ by scanning through 3 transmission periods.

Some interesting work reported by Higa and Ward [200] gives evidence of lunar topography causing fluctuations in the MBTS method. Librations of the moon cause the subradar reflection point to move from hills to valleys within the lunar period of 28 days; this front cap can be considered as a complex surface about 180 km in diameter which moves from day to day. Higa and Ward, through meticulous calculation, determined the varying altitudes of the equivalent frontal cap for a three-month period in 1970 and converted these distances to equivalent propagation delay times. At the same time, MBTS measurements were made between the Goldstone transmitter and a receiver at the USNO. Figure

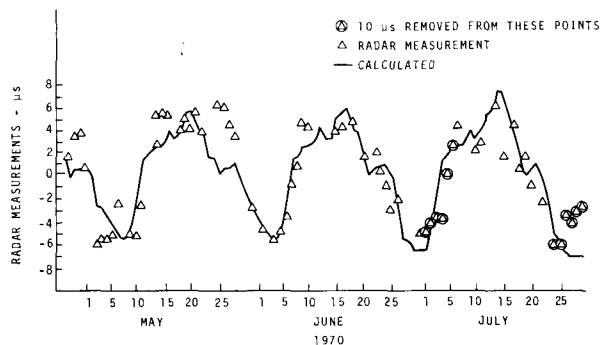

FIGURE 10.54. MBTS (Lunar Radar) results at Goldstone, CA (Courtesy Jet Propulsion Laboratory).

10.54 gives the results, and a very high correlation exists between the two sets of measurements. It is concluded that the MBTS accuracy can be improved from about $\pm 20 \mu\text{s}$ to $\pm 5 \mu\text{s}$ through corrections for lunar topography. Much work has been reported by JPL in the prototype work, implementation, and operational use of the MBTS method [201–203]. Higa lists advantages and limitations of the MBTS [198], some of which appear below:

Advantages of MBTS for TFD

- MBTS can provide $\pm 20 \mu\text{s}$ accuracy as proven by portable clock measurements. With further improvement and lunar topography corrections the technique shows an accuracy potential of $\pm 5 \mu\text{s}$; as such it could provide worldwide time synchronization to widely separated clocks.

- Varying ionospheric or earth atmosphere propagation effects have minimal influence on this TFD system.
- Receiving sites maintain atomic frequency standards and time scales which can provide μs timing related to NBS or USNO time to about $\pm 10\mu\text{s}$ and can serve as time reference stations for portable clock calibrations.
- The moon is likely to hold its orbit indefinitely, its position can be determined and predicted with precision, and it passively reflects radio signals in contrast to the limited and inherent electronics of artificial satellite transponders.
- Accurate μs measurements require a relatively short time period (about 10 min).
- The receiver operation is simple and requires a minimum of man-power and maintenance. The complicated computer programming for continuously updating the ephemeris and Doppler delays is performed at the transmitter, and these functions are independent of the receiving site.
- The system is capable of resetting clocks on time provided rough synchronization to about 10 ms can be obtained by other means such as HF radio time broadcasts.

Limitations of MBTS for TFD

- Receiver systems are expensive (about \$50,000 per unit); however, Baumgartner [197] states a simplified receiver could be built for about \$15,000.
- The moon must be in common view of both the transmitter and receiver sites for T/F measurements. The time period of common views for worldwide sites can vary from ~ 10 min to several hours per day; there are variations also at monthly intervals as well as every 19 years.
- Propagation delays must be known between the transmitter and a receiver site (ephemeris data) well in advance of measurements.
- Coordination with JPL and both the USNO and NBS would be required for time synchronizing a remote site via moon-bounce to UTC(USNO) and/or UTC(NBS).
- The system is subject to various systematic errors, such as ephemeris discrepancies (present accuracy can predict moon's center of gravity to 150 m which could cause a time error of about $1\mu\text{s}$), variation in reflection points on moon (roughness), errors in station location, unknown equipment delays, code jitter and noise sources. The variance of all these errors is felt to fall well within $\pm 10\mu\text{s}$ limits [204], however.
- Fixed station reception at known geographic sites is required for time synchronization; as such, system is unsuitable for synchronizing clocks at nonstationary or portable sites.

- Only one receiving station can be synchronized at a given time period.

c. Aircraft Collision Avoidance System (ACAS)

Disastrous collisions between flying aircraft over the past decades, coupled with ever-increasing aircraft congestion, have aroused much public concern and shown the need for better air traffic control. Culminating many years of research and development, the ATA (Air Transport Association—composed of airlines, manufacturers, and government representatives) has proposed a time and frequency collision avoidance system (TF-CAS) [205, 206]. In its present concept, the TF-CAS is complex, expensive and specialized. Because the system has varied and imminent potential for time and frequency dissemination for the non-aircraft user, it is included with a brief description. For in-depth detail, the reader is referred to publications in the open literature [207–211].

Basically, the proposed ATA CAS is cooperative (all aircraft are equipped and carry precision oscillators); will perform in aircraft densities > 1000 in number within 250 miles (~ 400 km) or line-of-sight; and will protect aircraft operating at speeds as high as Mach 3, up to altitudes of 80,000 ft. (24 km). The system is T/F referenced and predicated on each participating aircraft maintaining time synchronization $< 1\mu\text{s}$ [212, 213]. Prime synchronization is initiated by master ground stations; it can be maintained by ground stations and/or other aircraft through a hierarchy classification up to ~ 40 units, which, dependent upon their time degradation, can give or receive time information.

The ATA proposal provides for a time-ordered format of 2000 message slots, each of $1500\text{-}\mu\text{s}$ duration, repeated every 3 seconds. Each aircraft or ground station is assigned particular message slots (for transmission of their CAS data) which are switched sequentially at 5-MHz increments at L-band assigned frequencies in the range of 1.592–1.622 GHz. A simplified CAS fine time synchronization is diagrammed in figure 10.55. TF-CAS, relying on both precise time and frequency synchronization, automatically provides one way Doppler ranging, closing rate determination, and altitude difference measurements between aircraft. The basic criterion for determining collision potential is the “tau” (τ_a) parameter, the ratio of reported range to closing rate or time to nearest approach or collision projected under existing conditions. Its value is the key to no action, or positive instruction to either climb or descend with a warning period of 60 s or less. As presently conceived, τ_a is only as good as the time synchronization of the on-board clocks, considered as a common time reference between aircraft ($0.1\mu\text{s}$ insures ranging accuracy of about 100 ft. or 30.5 m). The system can use

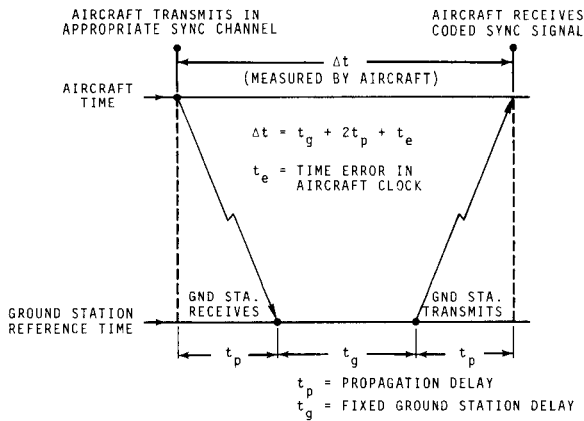
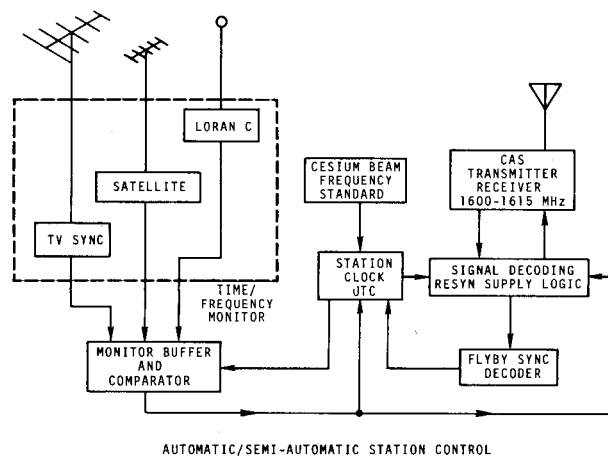

FIGURE 10.55. Simplified CAS fine time synchronization.

crystal clocks in aircraft (stability of 1×10^8 or better), provided sufficient repetitive resynchronizations are made at least every 3-min to insure overall synchronization to $\sim 2\mu s$ [214]. An atomic clock has recently been developed for airborne CAS which can extend resynchronization time to more than 28 hours [215]. Such clocks would be extremely valuable and almost necessary for long, oversea flights.

A commercial TF-CAS incorporating many of the ATA recommended features has been developed and shown successful operation since 1965 for some 17,000 flights, centered around one ground station [214]. As presently proposed, time synchronization is zoned around ground stations with other aircraft in the vicinity supplying backup synchronization. As a plane leaves a given zone, supposedly no time degradation would occur at resynchronization with a new ground station. It has been reported that a network of some 60 ground stations is planned by the FAA to adequately cover the continental U.S. [210]. Eventual worldwide networks are implied in the long range plans. A major problem will be the synchronization of such ground stations to within $0.1 \mu s$ of each other, and considerable study is now occurring in this area [216]. A typical ground station timing system has been suggested by Perkinson and Watson [214] and is shown in figure 10.56.

Besides the collision avoidance, traffic control, and navigation/communication aspects of T/F-CAS, Perkinson and Watson also point out its potential for TFD [214]. Three particular areas are mentioned: (1) walk-in service; (2) passive reception; and (3) active participation. Ground stations, considered as reservoirs of precise standards referenced to national standards, could provide T/F synchronization of portable standards on a walk-in basis. The passive reception of CAS radio signals within line-of-sight of a ground station would provide a submicrosecond



AUTOMATIC/SEMI-AUTOMATIC STATION CONTROL

FIGURE 10.56. ACAS ground timing station.

time source, with calibration of the RF propagation time between the ground station and the user. A receiver and decode equipment for such use is estimated as costing $\sim \$200$. The third mode of operation might satisfy needs of automatic vehicular monitoring (AVM) [217], marine position fixing [218], and others requiring position of moving vehicles within range of a T/F-CAS ground station or overflying aircraft. In this case modified equipment, estimated to cost $\sim \$1000$, can actively participate in the TF-CAS and obtain fix position through trilateration and difference in arrival time calculations. A further consideration of TF-CAS is the precise clock intrinsic to each aircraft equipment. This provides an excellent potential for aircraft flyover T/F synchronization similar to that discussed in Section 10.4.2. If the system becomes operational in 8 to 10 years with both flying aircraft and ground stations synchronized worldwide to $0.1 \mu s$, it will have tremendous impact on time and frequency technology.

Advantages of TF-CAS Time and Frequency Synchronization (partly from [214])

- Synchronizations to less than $1 \mu s$ appear feasible over large areas of the earth, either through line-of-sight μ wave signals from ground stations or flying aircraft. Fail safe operation is assured and the coherent signals are transmitted at low power with little or no interference.
- Portable equipment can be synchronized due to the worldwide coverage of the synchronization network.
- At line-of-sight distances, propagation effects are minimal, requiring little or no correction.
- Receiving and comparison instrumentation should be relatively inexpensive, although there must be provision for decoding time ordered slots for time synchronization.

- TF-CAS provides a network for coordination and maintenance of a worldwide primary time scale such as the TAI.
- The time period required for synchronization is only of the order of minutes at the most, and initial clock setting appears possible.
- In some modes no physical transport of clocks is required.
- System could provide multilateral functions with T/F aspects such as surveillance, navigation, vehicular location, etc.

Limitations of TF-CAS Time Synchronization

- The system in its present form is expensive and requires complex instrumentation techniques (the best aircraft system is estimated to cost about \$50,000 [207], although cheaper, less versatile systems would be available).
- The system will not be operational for at least 8 to 10 years.
- The TF-CAS will require exquisite synchronization techniques with backup facilities for maintaining and controlling worldwide timing to about $0.1\mu\text{s}$.
- Reception is limited essentially to line-of-sight distance from a transmitter (aircraft or ground station).
- Possibility exists for multipath interference causing degradation of time synchronization.
- Some time variation may occur as a synchronizee changes references from one master station to another.

10.4. DISSEMINATION OF TIME AND FREQUENCY VIA PORTABLE CLOCK

The general method of transporting and inter-comparing frequency standards is not new. W. G. Cady, in 1923, made international comparisons of frequency standards by carrying portable piezo resonators to seven laboratories in Italy, France, England, and the United States [219]. He showed agreement between primary standards to about 1 part in 10^3 . From 1925 to 1927, the U.S. National Bureau of Standards made similar tests using quartz crystal oscillators and determined average agreement between frequency standards of five national laboratories in 1927 as about 3 parts in 10^5 . This informative comparison and the relation of accurate frequency to reduction of interference in the new field of radio are ably described by Dellinger in 1928 [220]. At about this same time, Marrison described the first quartz crystal clock [221], a precise timekeeping device which integrated or summed up recurrent cycles of accurate frequency generated by the crystal oscillator. He indicated the rate of

these crystal clocks to be stable to a few parts in 10^7 or approximately 10 ms per day. During the interim between the 1930's and the present day, many refinements and improvements were incorporated into quartz crystal standards. A bibliography of pertinent references is beyond the scope of this paper; much of the work has been reviewed in the literature [222-226] (see also chap. 2). A fundamental problem in quartz oscillators, still existing today, is crystal aging with time. Aging can be compensated to some extent, however, by drift correction [227].

In the late 1950's, commercial cesium beam standards were developed in which a quartz crystal oscillator was controlled, through electronic servo systems, to the atomic resonance of cesium. This provided the impetus for side by side comparison of atomic frequency standards of different construction. In 1958, two U.S. commercial atomic frequency standards were transported to the National Physical Laboratory in England and compared with the NPL laboratory atomic standard [228]. Agreement of several parts in 10^{10} was shown with a measurement precision of several parts in 10^{11} . In 1958, Morgan proposed synchronizing widely separated clocks by transporting a master clock to correct remotely-located slave clocks [84]. During 1959, Reder and Winkler organized a worldwide synchronization of atomic clocks by air-transporting commercial atomic standards to slave sites in the continental U.S., Hawaii, Australia, and South America [229]. Synchronization at the various stations was maintained between clock visits via phase tracking of VLF signals. These test results indicated global time synchronization via flying atomic clocks then to be about $5\mu\text{s}$ [230]. The experiments also revealed areas for improvement such as reduction in the size and weight of the frequency standards, a decrease in power consumption, inclusion of standby battery supplies, modification of electronic divider circuitry, and a lessened sensitivity to rotational movements.

In 1962, a portable crystal clock was used to compare time scales between WWV at Greenbelt, Maryland, and NBS, Boulder, Colorado, with an overall time closure of $5\mu\text{s}$ [231]. Dependent upon the timing requirements, cost limitation, and accessibility, the crystal clock can be very useful in time and frequency synchronization.

In 1964, a new portable cesium beam clock was developed which was considerably improved in size and weight characteristics; it also showed accuracy and stability approaching a laboratory standard, required low power with a standby battery supply, included a quartz crystal oscillator which of itself aged at a rate less than $5\mu\text{s/day}$, and was coupled to an electronic clock which integrated the cesium resonance frequency to give a true atomic time output and display [232]. A series of "flying clock" measurements, using these standards, were made

from 1964 to 1967 [233–235]. Standard time and frequency were correlated and compared at some 50 laboratories, observatories, standard frequency broadcast stations, etc., in 18 countries in Europe, Asia, Africa, and North America through this portable clock carrying technique. The 1967 experiment continued over a period of 41 days and the clocks were transported over a distance range of some 100,000 km. The time closure between the reference standard and the two portable clocks was several μs , corresponding to frequency differences of parts in 10^{13} between the portable atomic standards. The time correlations on the 41-day trip were believed to be accurate to about $0.1 \mu\text{s}$. Time scale comparisons, made 16 months apart on two of these

experiments, between NBS and seven worldwide laboratories are given in table 10.13. An average time change of about $50 \mu\text{s}$ in 16 months indicates an agreement of time scales to about 2 parts in 10^{12} . Also, in 1967, Swiss portable atomic clocks (cesium) were flown to various time centers in the U.S., Canada, and the Far East for time comparisons. At the conclusion of these tests, one of the clocks showed a time closure of $26.7 \mu\text{s}$ over a 255-day period when compared with the laboratory standard at the Cantonal Observatory [236]. Smaller and lighter weight cesium beam standards are being developed [215]; also, small portable rubidium clocks are available, however, little has been written about their use.

TABLE 10.13. *Differences between 7 International Time Scales and the NBS UA Time Scale for two comparisons made 16 months apart via portable clocks (from ref. [235])*

Laboratory	1966		1967		Change μs
	Date	Time Diff. μs	Date	Time Diff. μs	
Radio Research Laboratory (Japan)	18 May	1,474	16 Oct.	1,400	-75
National Research Council (Canada)	19 May	200,489	18 Sept.	200,557	+68
USN Observatory (USA)	18 May	79	11 Sept.	165	+86
Neuchatel (TUA) Observatory (Switzerland)	22 May	2,405	23 Sept.	2,468	+63
Dominion Ob- servatory (Canada)	20 May	1	17 Sept.	54	+53
Physikalisch- Technische Bundesanstalt (Germany)	3 June	¹ 433	26 Sept.	489	+56
Royal Greenwich Observatory (England)	3 June	59	4 Oct.	154	+95

¹1966 time difference value corrected for known time scale frequency offset existing from 3 June to 30 December 1966.

10.4.1. On-site Visits

There have always been and presumably will be applications for time synchronization that exceed the capabilities of dedicated time dissemination services for coverage or accuracy. Portable clocks can be employed to meet requirements which are hard to satisfy by other techniques. Basically, a portable clock consists of a stable oscillator whose output is integrated or counted by a clock mechanism to indicate time. Typical outputs include standard frequencies such as 5 MHz, 1 MHz, and 100 kHz and time ticks such as 1 pps. The portable clock method consists of establishing the time of the portable unit (which may be a quartz crystal or atomic clock) in terms of the reference time scale prior to a clock synchronization trip. Usually, the clock is flown to a general area where the measurements are to be made, with intermediate transportation by auto. A typical scene in the transportation of a portable cesium beam clock is shown in figure 10.57. Self-contained batteries can maintain power for periods of hours. Time synchronization consists of bringing designated time pulses into coincidence or to fixed delay relationships. Frequency comparison can be made through phase intercomparison for a given time interval. At the conclusion of a trip the portable clock is again compared with the original time scale reference, and the time closure difference is distributed backwards as the deviation within which the portable clock measurements fall.



FIGURE 10.57. Example of portable clock carrying in Oslo, Norway during a 1966 clock synchronization experiment (photo courtesy of Hewlett-Packard).

The success of portable atomic clocks to bridge distance gaps between a master standard and user led the U.S. Naval Observatory (USNO) to establish in 1968 a master clock location and six worldwide time reference stations around the world [237].

(These station locations are shown in ann. 11.E.1 of chap. 11.) Reference atomic clocks at each of the time stations are available for precise time measurements which can be referred to the USNO master clock in Washington, D.C. Periodic portable clock measurements between the USNO master clock and the reference station clock show typical time closures of $\sim 1 \mu\text{s}$ [238]. As the USNO and NBS UTC time scales are mutually coordinated within $\sim 5 \mu\text{s}$ of each other [239] clock synchronizations at the USNO time reference stations can also be related to the NBS time scale within this tolerance (or even better post facto). The effectiveness of portable clock carrying has been demonstrated by the periodic synchronization of some 21 worldwide laboratories or remote sites as reported by the USNO over the last several years [43].

General methods of maintaining synchronization at remote stations between portable clock checks include VLF phase tracking, navigation system comparison, satellite comparisons, and TV measurements as discussed in detail in Section 10.3.2. In consideration of the portable clock method of time and frequency dissemination, we list below both advantages and limitations of the method:

Advantages:

- Provides a means of microsecond time synchronization of remote clocks without a dependent link to a master clock with attendant delays and propagation errors as in radio methods.
- A minimum of manpower is required, and the synchronization can be simply and quickly performed with the usual equipment found in a standards laboratory.
- The portable clocks are relatively lightweight, rugged, and have a power operation versatility from either internal standby batteries or ac/dc current; such flexibility maintains accuracy, stability, and reliability over long periods of time.
- The portable clocks are easily transported by commercial airlines and automobiles.
- Newer portable cesium beam standards are relatively insensitive to shock and vibration, smaller in size, and lighter in weight.

Limitations:

- The most accurate portable clocks are expensive, and the method requires physical transportation of the clocks, which of itself can be a monetary concern. The accuracy obtainable is directly related to the cost of the clock.
- The clocks are usually hand-carried and, although experience has indicated high reliability, there is possibility of clocks stopping or changing rate en route due to power outages, excessive vibration, or environmental changes of temperature, humidity, or air pressure.
- It is difficult or impossible to make portable clock side-by-side measurements at some loca-

tions such as inaccessible islands, mountain stations, beacons, ships, etc. (The aircraft flyover technique may be used in some of these instances, however, see following sec. 10.4.2.) Auxiliary equipment is required to maintain synchronization between clock settings.

In summary the best clock for a particular application is not necessarily the most expensive or accurate clock available. Specific need, environmental conditions, budgets, and other considerations may all interface to dictate the optimum choice and/or compromise for a given portable clock measurement. The cost of portable clock comparisons may decrease in the near future with the availability of a new and smaller cesium beam portable clock [215].

10.4.2. Aircraft Flyover

Another method of time synchronization is a refinement of the portable clock technique. In aircraft flyover, planes carry an atomic clock and transmit a coherent time signal to synchronize a time scale at a receiving site. The method dispenses with cross-country and local transportation, reduces the time required to synchronize many remote locations, and affords the opportunity to synchronize inaccessible sites such as mountain or island stations, ships, other aircraft, etc. Some aspects of

this method were considered in connection with early aircraft collision avoidance studies. The method was first reported by Markowitz [240] and was recently refined by Besson [241]. The basic technique of aircraft flyover synchronization is illustrated in figure 10.58. The S-band transmissions (2.2 to 2.3 GHz) are amplitude modulated at a peak power of about 50 W. The pass band is 10 MHz. The time scale is coded and sent at a 10-Hz rate permitting 10 time scale measurements per second. The receiving site uses a counter with 10- μ s resolution and a readout which prints the deviations between the radio-received time scale and the local time scale 5 to 10 times per second.

Aircraft flyover determines the clock difference between the ground station time, H_G , and aircraft time, H_A , which is shown to be

$$H_G - H_A = (H_G - H_{A'}) - (\tau_{TR} + \tau_p), \quad (10.7)$$

where $H_{A'}$ = received aircraft time at ground station;
 $= H_A - (\tau_{TR} - \tau_p)$;

τ_{TR} = time delay of transmitter-receiver equipment (nearly constant);

τ_p = time delay for aircraft signal to reach receiver, dependent upon aircraft location relative to receiver.

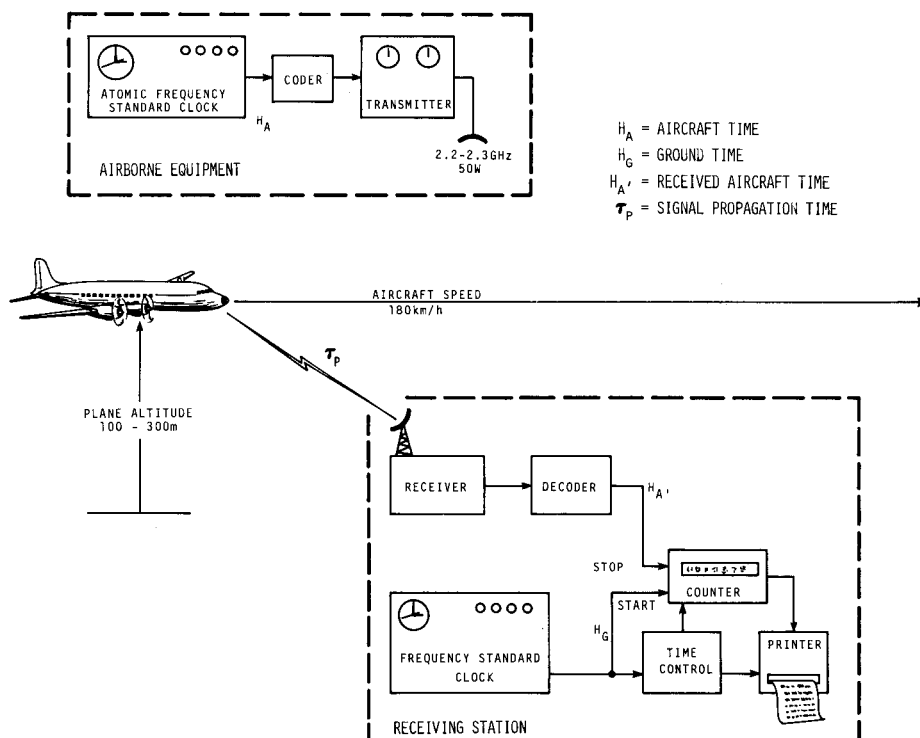

FIGURE 10.58. Aircraft flyover method of T/F comparisons.

The evaluation of τ_{TR} and τ_p should resolve the time scale deviations, ($H_G - H_A$). Two methods have been proposed.

Method 1. This is a one-way system in which the aircraft passes over the site to be synchronized at low altitude (100–300m) at a flight speed of about 50 m/s and transmits timing pulses. The observed time scale difference, $H_G - H_A$, approaches a minimum as the aircraft reaches the point directly over the receiver and then increases as flyover continues. The minimum reading corresponds to the vertical distance between the aircraft and receiver and is the true altitude recorded by the aircraft instruments. This critical distance point should not exceed 10° from perpendicularity. Besson indicates that with a transmission rate of 10 sync pulses per second and a 3-percent altitude error, the propagation time standard deviation, $\Delta\tau_p$, is 30 ns or less. The instrumentation delay standard deviation, $\Delta\tau_{TR}$, is reported as 10ns or less [241].

Method 2. This technique is a two-way system involving simultaneous transmission by both the user and the aircraft so the propagation time delay, τ_p , drops out of the equation for clock time difference. The aircraft does not have to fly directly over the receiver at a fixed altitude. Limitations in the two-way system include the degree of accuracy to which the time scale deviations between the aircraft and ground station clocks can be measured in the short time available and the difficulty of measuring the equipment delays at both time sources.

In September 1970 the French group (Office National d'Études et de Recherches) cooperated with several globally located time centers and made an international comparison of atomic clock scales through aircraft overflight. The experiment plan included both one- and two-way type of comparisons with three or four overflights of each time center. A nonstop one-way flight was expected to take about 18 hours. The experiment, named Synchran (North Atlantic Synchronization), was performed during the period September 9–15, 1970. Corrections included propagation delays, instrument factors, clock drifts, and relativity effects. The results show that aircraft flyover has many attractive features in rapidly intercomparing time scales at remote points with standard deviations typically 30 to 40 ns [242].

Advantages of aircraft flyover time dissemination include:

- Rapid precise synchronization of many intercontinental clocks without physically transferring clocks; provides a means of quickly evaluating the TAI.
- Enables clock synchronization at remote sites inaccessible to physical clock-carrying.

- The over-all short duration of worldwide comparisons lessens the possibility of clock failures and enhances the probability of successful clock comparisons.
- Insignificant propagation degradation with line-of-sight microwave frequencies.

Disadvantages include:

- Method is expensive; it requires the use of aircraft and auxiliary equipment such as transmitters, receivers, etc.
- Clock synchronization at a given site requires auxiliary techniques to maintain accurate time between clock comparisons.

10.5. TFD VIA OTHER MEANS

The following TFD methods are unique in that conventional radio waves are not involved in carrying the timing information. The methods include optical pulsar signals, telephone/coax cable transmission, and ac power lines. The techniques are characterized by some of the most complex as well as simplest noted in this dissemination overview.

10.5.1. Time Transfer via Optical Pulsar Signals

The precise periodicity of pulsar radiations can provide a means of time transfer to remote points on earth. Pulsars are believed to be rapidly rotating neutron stars which periodically emit a narrow beam, like a lighthouse, each time the beam intercepts an observer [243, 244]. Neutron stars consist of tightly packed neutrons with a mass approximately that of the sun but a radius of less than 30 km [245]. First discovered in 1967 [246], there are now about 60 such identified bodies [247]. A striking characteristic of today's known pulsars is the variability of their periods; these range from 33 ms to about 4 s with the average about 1 s [245]. After months of study it was found that the periods of pulsars are increasing; i.e., the apparent pulsations are slowing down and those rotating the fastest at the greatest rate. The slow-down rates vary from about 40 to 0.3 ms per day [243]. Initially, all pulsar received-signals were from radio sources; in 1968 and later it was discovered that the Crab Nebula Pulsar (NP 0532) exhibits similar pulsations and structure at radio, optical, and X-ray frequencies [248–251]. (As of 1972 the Crab Nebula pulsar is the only such body known to be radiating optical wavelengths.)

The Crab Nebula was found to contain the fastest rotating pulsar—namely the NP 0532—which flashed about 30 times a second. This body is ~ 6600 light years distant and believed to be the remnant of a supernova explosion observed by Chinese astronomers in 1054 AD [243]. NP 0532 shows a mean pulse

period of 33.105 ms (November 1969–April 1970) [252] with a slow down of ~ 36.5 ns per day (~ 4 parts in 10^4 per year in terms of the mean period) [243]; its emitted optical signal consists of both a major and minor pulse separated by ~ 14 ms. In terms of power emitted, the optical flux is roughly 10^2 greater than the radio flux; the X-ray flux exceeds the optical by $\sim 10^2$ [243].

The absolute times of arrival of optical pulsar signals has been determined to an accuracy of several μ s (UTC) by Papaliolios et al. [250], who also suggest that time-of-arrival measurements of pulsar signals would enable clock synchronizations to several μ s at any two observatories with at least 24-in (61-cm) telescopes observing the Crab Pulsar. Recently, Allan has shown this possibility of transferring time in the μ s range between two widely separated points on earth via near-synchronous reception of the NP 0532 pulsar optical signals [253]. He analyzed pulsar reception data from the Lawrence Radiation Laboratory (LRL), Berkeley, California, and Harvard University, Cambridge, Massachusetts, which were compared previously [254]. The basic data were obtained at one end of the link by a method similar to that diagrammed in figure 10.59. Several thousand pulsar optical emissions, received by a phototube at the focus of a telescope, are amplified, enhanced, and averaged by a signal averager to improve the SNR. The signal averager scans the phototube signals at the simulated pulsar rate via a synthesizer referenced to a precise reference clock. The output of the signal averager gives the time interval between the pulsar

arrival time and the local clock. To evaluate the pulsar time transfer system, differences were taken in pulsar arrival times at Harvard and LRL for two periods in 1970 (adjustments in the raw-data were required to provide a commonality in the reduced data). The data difference took the form:

$$T_H(t) - T_L(t') \approx \Delta T(t), \quad (10.8)$$

where t and t' represent the local clock times at Harvard and LRL, respectively, on nights of mutual observations. Both the Harvard and LRL local clocks were referenced to the same time scale via the Loran-C East Coast system and an atomic clock at Santa Clara, California, respectively. The stability of the differential data was determined as follows:

$$\frac{\Delta T(t + \tau_s) - \Delta T(t)}{\tau_s} = \frac{\delta\nu}{\nu}, \quad (10.9)$$

where τ_s is the time interval between nights of mutual observation of the pulsar signals. A data plot of such differential fractional frequency deviations between the Harvard and LRL clocks versus sample time is shown in figure 10.60. The dashed line approximates a fit for the data and indicates an rms time error of $\sim 13\mu$ s; the slope of the line, inversely proportional to the sample time, provides evidence that uncertainties of the pulsar reception times are influenced by white noise statistics.

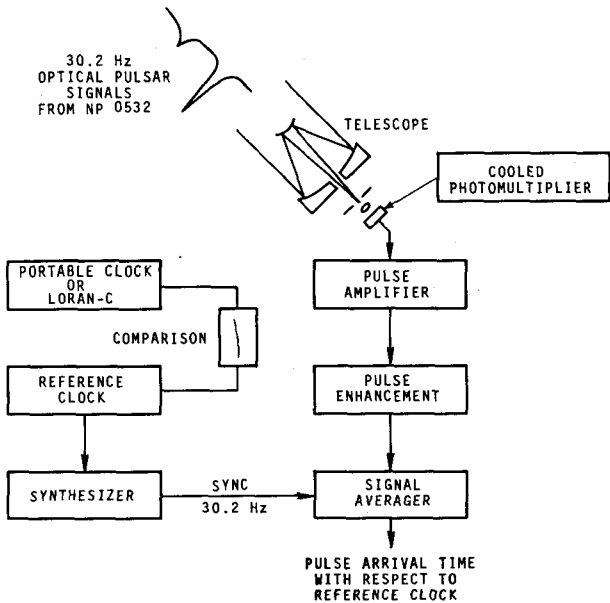

FIGURE 10.59. Method of time transfer via optical pulsar pulses.

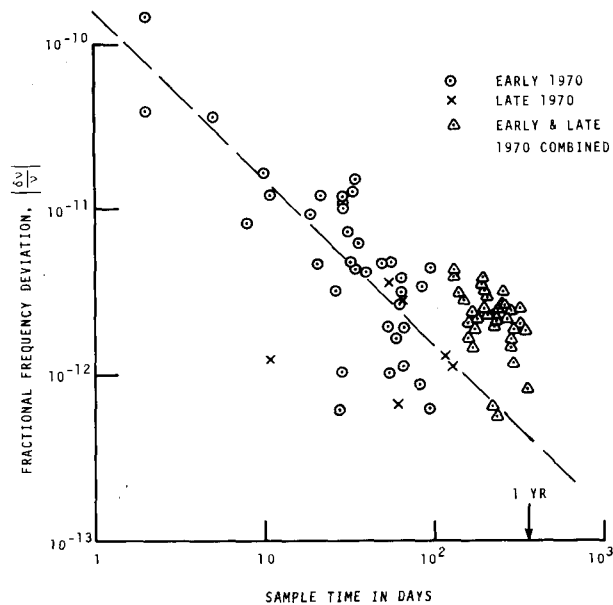

FIGURE 10.60. Differential fractional frequency deviations between Harvard and LRL clocks vs. sample time via optical pulsar signal NP 0532.

There are indications that nonuniformity of determining the arrival times at the observatory sites, as well as equipment differences, adversely affected the data analysis.

Advantages of Pulsar Optical Time Transfer TFD:

- The pulsar time transfer technique offers both accuracy and precision in the μs region on a global basis. (A resolution to $\sim 2\mu\text{s}$ is believed possible at a 2-h sampling time using a 24-in (61-cm) diameter telescope [253].)
- The propagation effects for pulsar optical emissions are minimal; the earth's atmosphere increases the delay by ~ 10 ns, and the spinning earth delay is < 8 ns if the earth position can be known to < 5 ms (1500 km).
- Pulsar photons are natural events which can provide a free source for time transfer without interference to or dependence on man-made systems.

Limitations of the Pulsar Optical Time Transfer Technique:

- Measurements can be made only at night; measurements are not possible during the latter part of May, all of June, and early July because at these times the source is within a few degrees of the sun.
- The signal strength of pulsar emissions at the earth is low, and relatively expensive equipment is required for detection and comparison ($\sim \$20,000$ without telescope and atomic clock).
- Comparisons are restricted to fixed locations housing telescopes and required instrumentation.
- The data analysis for time synchronization requires computer techniques as well as communications between comparing sites or observatories. Measurements should be made simultaneously or nearly so for optimum results.
- Cloud cover severely affects the effectiveness of pulsar time transfer.
- Pulsar period show jumps because of quakes or sudden disturbances [250], and this could cause errors in extrapolated sampling rates for the signal averager.

10.5.2. TFD in Telephone Line and Coax Cable Transmission

Telephone lines and/or coax cables often are used for time and frequency distribution between closely spaced points (~ 1 to 30 km). This section briefly reviews the properties and characteristics of such hardware systems for TFD.

a. *Telephone Line Distribution.* In 1965 the Naval Research Laboratory (NRL) in Washington, D.C., used underground balanced land lines (broadband—100 to 15,000 Hz) to carry a 10-kHz signal, derived from a hydrogen maser, for comparison with atomic frequency standards at the USNO [255]. This dedicated line was 16 km in length one-way and

passed through no switching centers. Narrow band amplifiers were used at each end of the line to improve the SNR and isolate the output. The 10-kHz signal was stable in frequency to better than 1 part in 10^{12} as transmitted. The same signal, returned from the USNO, was compared with the NRL transmitted signal to determine the effect of the telephone line on the transmission. The phase differences were found to be $< 1\mu\text{s}$, and averages over a 24-hour period gave frequency errors to < 1 -part in 10^{12} . Notice that these telephone lines were underground and thus at fairly constant temperature.

In 1966 Koide also described the use of multipair telephone lines for TFD [256]. He transmitted a 1-kHz standard frequency over leased multipair telephone lines, extending 37 km one-way. (Some tests were run two-way for a total path distance of 74 km.) This line, from Downey to Anaheim, California, was routed about halfway underground and the remainder by pole suspension in air; the voice grade line was without loading coils or repeater amplifiers. Each multiplier telephone cable consisted of four pairs (three different wire sizes) with each line showing a SNR > 50 dB at 1 kHz; at the terminals the crosstalk between adjacent lines was attenuated ≤ 40 dB. It was found that daily temperature changes caused diurnal phase shifts in the transmitted 1-kHz signal similar to diurnal ionospheric effects in VLF/LF propagation. From relationships of the 1-kHz phase change vs. temperature change, and changes in temperature versus dc resistance of the telephone line, it was possible to determine the resistance change versus the 1-kHz phase change. Illustrative simultaneous plots of dc resistance and phase change over the two-way, 74-km telephone path are shown in figure 10.61. These plots show that the dc phone line resistance correlates directly with the phase changes, and there is significant phase delay during the nighttime transmission.

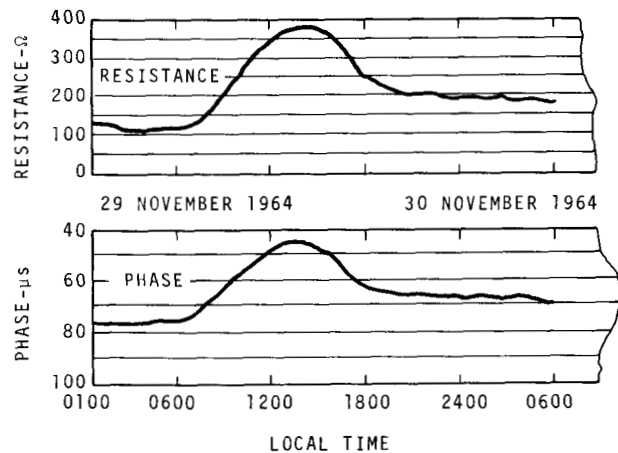

FIGURE 10.61. Diurnal changes in resistance of phone line and transmitted 1-kHz phase, caused by temperature change.

Figure 10.61 indicates an increase in dc resistance of $\sim 285 \Omega$ caused a phase retardation of $30 \mu\text{s}$ over a 6-hour period. Over a 4-month period the dc resistance-phase sensitivity averaged somewhat less; i.e., 8.3Ω per μs over this telephone path.

With such information it was possible to design an Automatic Phase Corrector (APC). This device, placed at the transmitting end of the line, sensed the dc resistance change in the telephone line and, through a Wheatstone bridge and servo potentiometers, maintained a null in the bridge; the servo simultaneously drove a phase shifter which corrected the transmittal signal an amount proportional to the resistance change. A round trip evaluation showed a corrected phase variation $< 0.5 \mu\text{s}$ for a 12-hour period in which the actual phase in an adjacent line varied from -24 to $+18 \mu\text{s}$. This correction is equivalent to a frequency offset of $\sim 1 \times 10^{-11}$. On short underground telephone lines (2–3 km in length) Koide has used various carrier frequencies from 1 kHz to 1 MHz; the higher frequencies showed stability and noise degradation coupled with much greater attenuation [257]. Typically, 22 gauge wire shows ~ 5 -dB attenuation per 1.61 km at 10 kHz [258].

In comparing frequency standards at the Mt. Stromlo Observatory in Australia, Grimsley and Miller report the transmission of a 10-kHz standard signal over a 12-km landline (~ 10.5 km underground and 1.5 km in air) [259]. During a 40-hour period with a temperature variation of -1° to $+16.5^\circ \text{C}$, no diurnal effect was noticeable in the received signal; a phase comparison between a rubidium standard and a crystal oscillator at nearly equal frequency indicated no frequency errors $> 1 \times 10^{-11}$ resulting from the telephone transmission.

The WWV standard time and frequency broadcasts are now available via telephone by dialing (303) 499-7111 (Boulder, Colorado). The telephone signals are the live broadcasts as transmitted by WWV. Propagation and equipment delays limit the accuracy of these telephone signals to ~ 30 ms or better as received anywhere in the continental USA [64]. A service call is automatically limited to 3 minutes.

b. *Coax Cable Distribution.* Information on the use and stability of coax cable is limited; we will review several examples in the literature. In 1945–46, phase comparisons were made in England between spaced aerial systems via coax cable from London to Birmingham, a one-way distance of 163 km [260]. The primary signal frequency was 1 kHz, and the standard deviation of the phase change over the entire loop (326 km) for periods of several weeks was 7° or $\sim 20 \mu\text{s}$. There were unspecified long and short period variations, and it is unknown whether the cable was underground. Tolman et al. [111] used a coax cable link ~ 340 km long in connection with microwave TV time comparisons in 1965 and determined agreement to $2 \mu\text{s}$ irrespective of the transmission medium used.

Koide mentions the use of coax cable in the distribution of standard 100 and 1000-kHz signals for slaving electronic counters (external time base signal) and timing clocks within a manufacturing/engineering laboratory [257]. He used coax lengths up to ~ 180 m for distribution within buildings and employed coax impedance transformers. Frequency checks over such lines, using an Rb atomic standard, indicate that the coax cable contribute errors \leq parts in 10^{10} [258].

At the Jet Propulsion Laboratory (JPL) in California, coax cable is used to distribute precise 1 pulse per second (pps) signals over short distances between distribution amplifiers and microwave transmitters at the Goldstone tracking facility [261]. About $100 \mu\text{s}$ in duration, and with a risetime near 200 ns, such pulses were degraded little by the coax distribution; a combination coax-microwave system (base bands ≥ 2.5 MHz) transfers such pulses with an uncertainty of $\pm 3 \mu\text{s}$. In a typical installation the coax cables were run underground via constant-temperature cable tunnels, avoiding diurnal degrading effects.

Leschiutta recently reported impressive test results for transmission of phase data over coax lines between Rome and Turin, Italy—a distance of ~ 740 km [120]. Phase changes from diurnal temperature variations were avoided since the cable and associated amplifiers were underground at a depth > 1 meter. A stabilizer carrier frequency of 300 kHz was transmitted from Rome; received at Turin it was continuously compared with a synthesized 300-kHz signal from a local frequency standard. Such a system is calibrated every third month and within the last several years has drifted < 100 ns. The received signal shows white phase noise for time intervals 10 ms to 10 s; for $\tau = 1$ s, a fractional frequency stability of $\sim 3 \times 10^{-9}$ was shown. The transmitted data were subject to random jumps of 30 and 50 ns, probably caused by line connections or amplifier changes. Such jumps are inconsequential on the stability measurements for long term. Comparisons of transmitted time and frequency data over the coax line and a nearly identical TV path (microwave link using eight relay stations) yielded a difference usually $< 3 \mu\text{s}$ over measurement periods of 100 days. Part of this difference is attributed to propagation delay variations in the radio links.

Advantages of Hardwire Distribution Systems for TFD

- Dedicated telephone lines offer a relatively inexpensive means for distributing standard frequencies (1 to 10 kHz) between points ~ 30 km apart at accuracies $\leq 1 \times 10^{-10}$. (Monthly lease charges approximate \$2 to \$3 per airline mile for a two pair-four line circuit.)
- Underground telephone lines require little maintenance and show minor temperature-caused phase variations in transmitted signals.

- Precise time pulses can be transmitted over coax cable for relatively short distances with little degradation with care, provided pulse shaping techniques are used. Underground coax cable shows excellent stability for transmission of standard frequencies (~ 300 kHz) over relatively long distances (~ 750 km).
- Reliability and percent-of-time available factors are excellent for hardwire systems.
- WWV telephone signals can provide time to ~ 30 ms anywhere in continental U.S.

Limitations of Hardwire Distribution TFD Systems

- Aerially mounted hardwire systems degrade the transmitted precision signal because of temperature-related variations of the line dc resistance. Precise TFD via hardwire requires undergrounding of all transmission cable.
- Auxiliary equipment such as automatic phase correctors (APC), amplifiers, and filters are required for transmission and recovery of signals over long telephone lines in the open air.
- The signal attenuation per kilometer increases with frequency and is a practical limitation to the use of frequencies higher than 100 kHz in many cases. The lines are distance-limited for a given frequency because of signal attenuation.
- Coax cables may be impracticable for T/F distribution for distances much greater than several hundred meters because of the high cost of either initial purchase or monthly lease.
- As opposed to radio coverage, hardwire systems are inflexible to the extent that coverage is limited to those users connected into the system.
- For T&F distribution, telephone lines must be dedicated to this sole transmission; they should be balanced, unloaded, without repeaters, and bypass switching centers. The telephone TFD cannot tolerate unknown and variable delays from these latter factors.
- It is impractical to transmit timing pulses with high precision over telephone lines because of band pass limitations.
- Underground hardwire systems require a constant ambient temperature environment for highest precision.

10.5.3. Power Line (60-Hz) Signals as a Time Transfer Technique

Large a-c power utilities in the continental U.S. are divided into a network of interconnected systems serving major portions of the country [262]. The American Electric Power (AEP) Company at Canton, Ohio, synchronizes and manually controls the electric time of these grids with a tolerance of ± 2 seconds; offsets of the 60-Hz frequency in steps of ± 0.02 Hz compensate for time errors [7]. The time and frequency reference for most of these networks is the NBS 60-kHz broadcast from Ft. Collins, Colorado. (Cohn proposes automatic and continuous

time error control through use of NBS standard frequency broadcasts in all power areas [263].) Time coordination enables efficient transfer of power from one area to another (load diversity) without inadvertent interchange time accumulation.

The U.S. coast-to-coast interconnected power grid is essentially a phase coherent system. Allan et al. have shown its potential as a time transfer system [264]. We will describe several of their examples. Initially, they studied the fractional frequency stability of the 60-Hz power signal at the NBS Laboratories, Boulder, Colorado. In using $\sigma_y(\tau)$ (square root of an Allan variance [129, 130]), it was determined that the data exhibited flicker noise frequency modulation (see chap. 8) over a τ range of 17 ms to 10^5 s and at a $\langle \sigma_y^2(N, T, \tau, f_h) \rangle^{1/2}$ range of $\sim 5 \times 10^{-5}$. Similar results were obtained for measurements on different dates.

Another study compared the 60-Hz power line phase in California and Colorado relative to atomic clocks at the Hewlett-Packard (HP) Laboratory, Santa Clara, California, and at the NBS, Boulder, Colorado. Part of these data are plotted in figure 10.62, and strong phase correlation exists for the

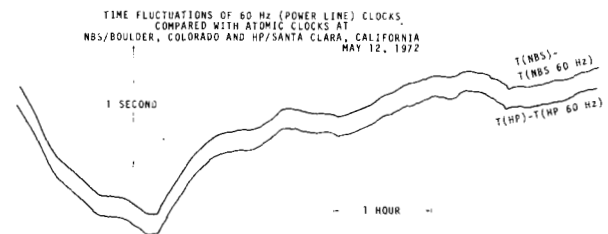

FIGURE 10.62. Comparison of 60-Hz (power line) clocks and local atomic clocks at Boulder, CO and Santa Clara, CA.

two distant sites in different interconnected systems [264]. A study of the differential delay, τ_D , between Santa Clara and Boulder (determined by differencing the first zero-crossing measurements of the 60-Hz signal following a given second tick at each site) gave a fractional frequency stability of 1 part in 10^8 for $\tau = 1$ day. Similar data for longer periods of time suggest that two remote clocks, located at distant points within different grid networks, could be kept within 1 ms, provided the particular path was calibrated.

Day-to-day synchronization requires that no cycle slips occur between measurement points. Tests were run, using dividers which generated precise 1 pps from the 60-Hz signal, and no cycle slippage occurred between three sites (Santa Clara, CA; Boulder, CO; and Ft. Collins, CO) over an interval of several days with continuous power. A plot of the fractional frequency stability versus averaging time

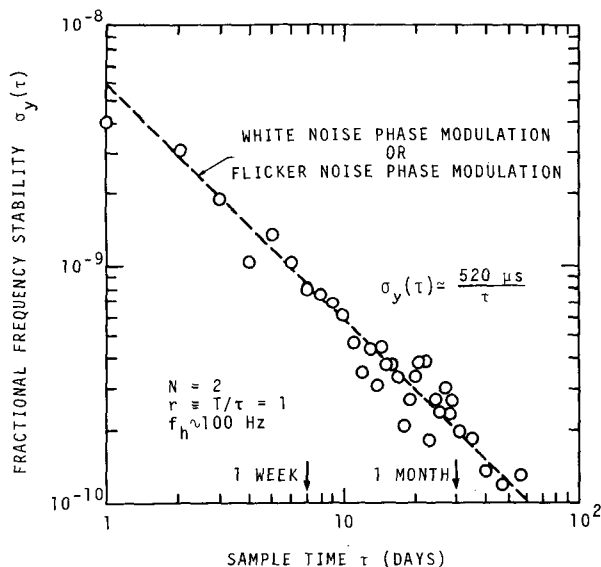

FIGURE 10.63. Fractional frequency stability vs. averaging time for 60-Hz power frequency between Santa Clara, CA and Boulder, CO.

of the Santa Clara-Boulder path is shown for 60-Hz power line data in figure 10.63. The 60-Hz stability data for the shorter WWV-Ft. Collins to Boulder path shows an improvement by a factor of 6 over the longer Santa Clara-Boulder path. Although the stability degrades with distance, stability of clock measurements of several ms may be possible across interconnected power systems throughout the continental U.S.

Advantages of a-c Power (60-Hz) for TFD

- Equivalent precision to WWV received sky-wave signals is possible from 60-Hz power line signals via the differential mode. (The WWV time signals are much more accurate than 60-Hz power line signals.)
- The 60-Hz time transfer system utilizes exceptionally cheap receivers (e.g., ~ \$20 for a low pass filter and transformer).
- The a-c power is continuously available to wide areas throughout the continental U.S.; the power grids of the U.S. are interconnected and synchronized to form a phase coherent system.
- The ambiguity of 16.67 ms could probably be resolved nearly everywhere in the USA via the WWV audio telephone signal, (303) 499-7111.

Limitations of the 60-Hz Power System for TFD

- The stability of the 60-Hz power system degrades with distance.
- Local area power outages or phase shifts occur, which can cause errors in the clock comparisons.

- The ambiguity of the 60-Hz power system is 16.67 ms.
- The system does not provide precise or accurate timing for the sophisticated user.

10.6. T/F USER AND SYSTEM EVALUATION

Having described the varied means of TFD, we would now subjectively classify real and potential T/F users as well as evaluate the various T/F dissemination systems and techniques. Three classes of users in terms of accuracy requirements are discussed below; the evaluation of systems provides direct comparison in some ten pertinent categories.

10.6.1. Classification of T/F Users

It is convenient to classify users of time into three categories: low accuracy (coarser than 1 ms); intermediate (1 ms to about 50 μ s); and high accuracy (more stringent than 50 μ s). Figure 10.64 illustrates the time accuracy requirements of some users below the time scale line and the normal capabilities of representative time dissemination techniques and services above the reference line. The accuracy obtainable by a given technique varies considerably with the location and skill of the user.

The low accuracy group contains the largest number of users; their needs are generally met by telephone time-of-day service, telephone access to WWV, commercial radio time announcements, and standard time emissions (WWV, CHU, JJY, etc.).

The intermediate group is fast growing. Organizations engaged in satellite geodesy, seismic monitoring, and satellite tracking require time in the intermediate accuracy range. The basic characteristics of reliability, geographical coverage, availability of signals, accuracy propagation predictions, and equipment costs relevant to needed accuracy have been explored largely in response to this group's needs.

High accuracy is required by coherent detection communication systems, long baseline interferometry facilities, and organizations engaged in precision ranging. Submicrosecond accuracy is generally sought by laboratories with clocks capable of maintaining time at that level. The proposed T/F aircraft collision avoidance system, for instance, requires widespread dissemination of time with submicrosecond accuracy [214]. Reliability, percentage of time available, coordination among facilities and systems, and worldwide coverage are of paramount importance to system designers in the high accuracy group. Although the number of time users who have present requirements for submicrosecond accuracy is relatively small, these are not negligible and can be met with sophisticated but expensive techniques.

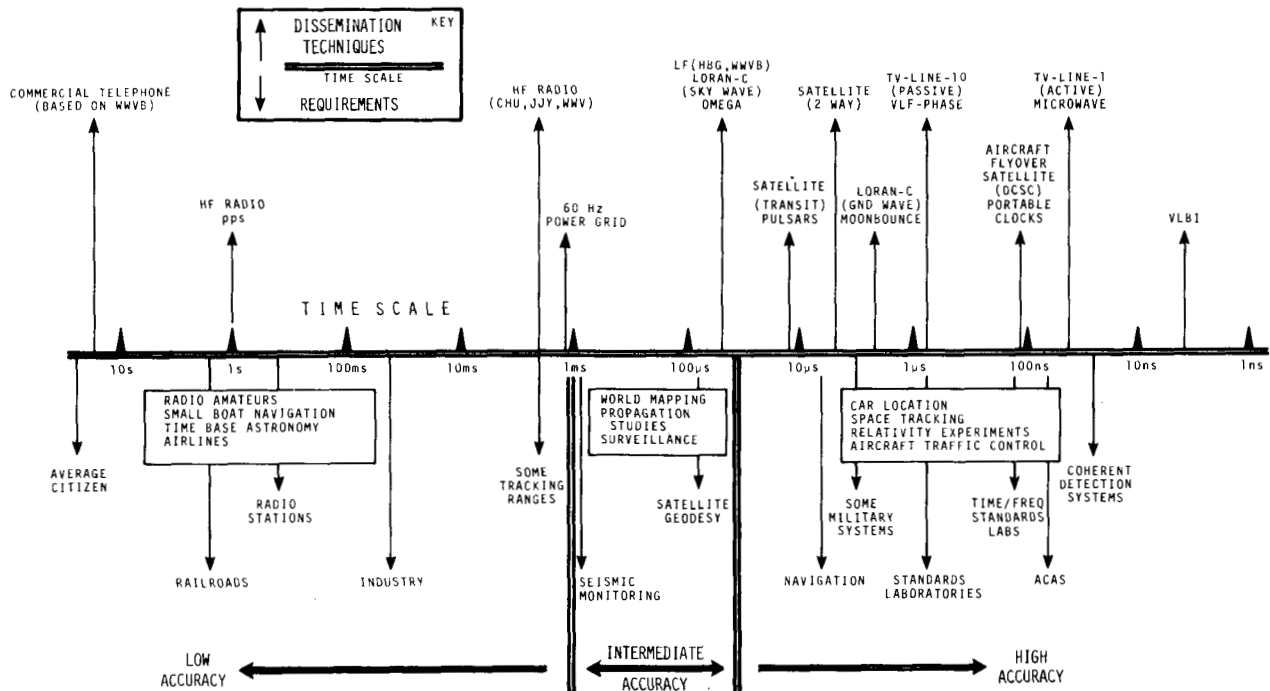

FIGURE 10.64. Time-accuracy requirements and capabilities of some time dissemination techniques and services.

10.6.2. Evaluation of T/F Systems

Figure 10.65 compares some TFD techniques. Such an evaluation is subjective, and some classifications are borderline. It is an attempt though, to show a realistic picture of present or proposed dissemination systems in terms of their capabilities and potentials. Accuracy figures are documented by applicable references. The ratings of good, fair, and poor are both arbitrary and broad. In the context of this presentation they are given for purposes of comparison and evaluation. Further explanatory comments concerning the scope and intent of the various characteristics identified in figure 10.65 follow:

(1) *Accuracy of date transfer.* Refers to that accuracy (degree of conformity with some specified value) to which time of day can be established at a given location. The numbers given are believed to be realistic for most users; it must be recognized that these numbers must be adjusted for either extremely favorable or unfavorable conditions, locations, etc. The ratings of good, fair, and poor are referenced to the needs of high, medium, and low accuracy users as shown in figure 10.64.

(2) *Accuracy of frequency synchronization.* Refers to that accuracy to which frequency standards can be synchronized within some frame of reference.

As with date transfer the three basic ratings are in terms of the classes of accuracy users shown in figure 10.64.

(3) *Ambiguity.* Applies to that interval of time which a given system or technique can provide with certainty. In some cases two values are shown, one is the basic period of a given carrier frequency, sequence, or audible tone; the other, by means of time code provides date information for periods up to a year. For instance, the period of a TV frame, 33 ms, is the ambiguity of the TV line-10 technique. The line-1 TV system, using the coded data displays, has 24-hour ambiguity.

(4) *Coverage.* Refers to the geographical region in which the dissemination technique can be used to obtain the stated accuracy. In many cases special considerations such as ground wave versus sky wave, propagation over land or water, availability of TV line networks, etc., may affect the coverage of a specific signal.

(5) *Percent of time available.* Describes the operating time of a service, i.e., continuous (good), a certain portion of a day (usually specified fair), or only occasionally, irregularly or by special arrangement (poor). Interruptions caused by propagation conditions such as sudden ionospheric disturbances, VLF diurnal phase shifts, or HF ionospheric disturbances are not considered.

DISSEMINATION TECHNIQUES		ACCURACY/FREQUENCY SYNCHRONIZATION STATUS (1)	ACCURACY FOR DATE TRANSFER	AMBIGUITY (4)	COVERAGE FOR STATED ACCURACY	% OF TIME AVAILABLE	RELIABILITY	RECEIVER COST FOR STATED ACCURACY	COST PER CALIBRATION	NUMBER OF USERS THAT CAN BE SERVED	OPERATOR SKILL REQUIRED FOR STATED ACCURACY	REFERENCES
VLF RADIO	COMMUNICATION/SFB GBR, NBA, WWVL	O	$1 \cdot 10^{11}$	ENVELOPE 500 μ s	PHASE $\sim 50 \mu$ s	GLOBAL						30,31,50
	NAVIGATION SYSTEM OMEGA	O/P	$< 1 \cdot 10^{11}$	$\leq 10 \mu$ s	PROPOSED CODE 1 YR PHASE $\sim 100 \mu$ s	GLOBAL		MODERATE				TIME CODE 59,93,265
LF RADIO	STANDARD FREQ. BROADCAST (WWVB)	O	$1 \cdot 10^{11}$ (PHASE 24h)	ENVELOPE $\sim 50 \mu$ s	1 YR	USA (WWVB) LIMITED		MODERATE			USA (WWVB) EUROPE OTHERS	65,67
	NAVIGATION SYSTEM LORAN-C	O	$1 \cdot 10^{12}$	$\sim 1 \mu$ s (GND) 50 μ s (SKY)	50ms	SPECIAL AREAS					SPECIAL AREAS	35,103
HF/MF RADIO	STANDARD FREQ. BROADCASTS (WWV)	O	$1 \cdot 10^{10}$	1000 μ s	1 DAY	HEMISPHERE		DEPENDS ON CONDITIONS				84,266
	NAVIGATION SYSTEM LORAN-A	O	$5 \cdot 10^{10}$	2.5 μ s NOT UTC	0.5 min	LIMITED AREAS		DEPENDS ON CONDITIONS			SPECIAL AREAS	2,100
TELEVISION (VHF/SHF RADIO)	PASSIVE LINE-10	O	$1 \cdot 10^{11}$ (24h)	$\sim 1 \mu$ s	1 DAY	NETWORK COVERAGE	"LIVE" PROGRAMS				USA FOR EXAMPLE	11,125,128
	ACTIVE LINE-1 (NBS TV TIME SYSTEM)	E	$1 \cdot 10^{11}$ (< 30 min)	< 100 ns	1 DAY	NETWORK COVERAGE					USA FOR EXAMPLE	124
SATELLITES (VHF/UHF/SHF RADIO)	STATIONARY SATELLITES (TRANSPONDER) ONE WAY	E/O	$1 \cdot 10^{10}$ (24h)	10-50 μ s	DEPENDS ON FORMAT	HEMISPHERE	STATIONARY					149,154,157
	STATIONARY SATELLITES (TRANSPONDER) TWO WAY	E/O	$1 \cdot 10^{12}$ (24h)	~ 100 ns	DEPENDS ON FORMAT	HEMISPHERE			MODERATE			143,170
	ON BOARD CLOCK (ACTIVE) ONE WAY LOW ALTITUDE	O	$\sim 1 \cdot 10^{10}$ (24h)	0.5-50 μ s	DEPENDS ON FORMAT	WORLD	10-15 min PER PASS 2-4 PER DAY	CLOCK NEEDS ADJUSTMENT				140,146,160
SHF RADIO	MICROWAVE	E/O	$\sim 1 \cdot 10^{13}$ (PER WEEK)	≤ 100 ns	PHASE COMPARISON	LOCAL LINKS						169
	VLF	P	$5 \cdot 10^{14}$	~ 1 ns	DEPENDS ON FORMAT	HEMISPHERE	AS NEEDED					186,192
PORTABLE CLOCKS	PHYSICAL TRANSFER	O	$1 \cdot 10^{12}$	100ns	1 DAY	LIMITED BY TRANSPORTATION	AS NEEDED	NONE				235,238
	AIRCRAFT FLYOVER 2 WAY	E	$1 \cdot 10^{12}$	≤ 100 ns	DEPENDS ON FORMAT	LIMITED BY TRANSPORTATION	AS NEEDED					240,241
PULSARS	OPTICAL SIGNAL \rightarrow NP 0532	P	$1 \cdot 10^{10}$	$\sim 10 \mu$ s	~ 33 ms	HEMISPHERE	NIGHTTIME					253
AC POWER LINE	POWER NETWORK SYSTEM	P	$1 \cdot 10^8$	~ 100 ns	16.7ms	CONTINENTAL USA		MINIMAL	MINIMAL	CONTINENTAL USA		264

GOOD FAIR POOR

NOTES: (1) Status of technique indicated as follows: O—Operational; P—Proposed; E/O—Experimental operational. (2) Estimates of day-to-day measurements within 2000 km (1250 mi) of Loran-A stations. These emissions not coordinated with UTC and manually operated crystal clocks drift. (3) From day-to-day phase measurements e.g., 1 μ s per day phase change approximates 1 pt. in 10^{11} in frequency difference. (4) Left-hand designation gives the shortest time interval that cannot be resolved; Right-hand number gives basic ambiguity. ♦, by ground wave 1600 km; by sky wave thousands of kilometers depending upon conditions. ■, with proposed time code. ●, closure after 1 day. ▲, within local service area of TV transmitter and path delay known.

FIGURE 10.65. Evaluation of selected time/frequency dissemination techniques.

(6) *Reliability.* Estimates the degree of confidence in the operation of a system; considers such factors as propagation conditions, system components in satellite environment, rerouting of TV network programs, etc.

(7) *Receiver cost for stated accuracy.* Refers to the relative cost of an appropriate receiver and antenna system for obtaining the stated accuracy of a given technique. Equipment such as oscilloscopes, digital counters, etc., is not included. A poor rating implies a cost greater than several thousand dollars; fair refers to a cost in the \$1,000 to \$2,000 range; and good indicates a cost less than \$1,000.

(8) *Cost per calibration.* Considers factors such as the cost of required instrumentation to make the calibration and the probable frequency of calibration.

(9) *Number of users that can be served.* Refers to the probable number of users for a given dissemination technique assuming regular availability of the service, and considering the equipment costs involved. For example, the TV technique is considered to have more potential users than the WWVB broadcasts, even though both cover the continental U.S. Relevant factors also include the low cost of TV receivers and random propagation disturbances associated with WWVB reception.

(10) *Operation skill required for stated accuracy.* Describes the degree of difficulty in making a time/frequency measurement to the stated accuracy. A good rating is shown if the time information can be obtained simply from an oscilloscope display or a counter reading. A fair category indicates that the user must process the data to obtain the required information, make multiple measurements or select particular cycles of a radio signal, and/or use specialized receiving techniques. A poor rating indicates that complex procedures and special skills are required for a given technique. The use of the Omega system for determining time, for example, requires envelope recognition followed by cycle identification.

The following connotations are used in figure 10.65 in connection with the satellite techniques: A transponder satellite relays time signals from a ground reference station to users in either a *one-way* or *two-way* mode. In this evaluation *active* describes a satellite with an onboard clock. A *stationary* satellite is earth-synchronous or geostationary while an *orbiting* satellite is one with a period of revolution other than 24 hours.

It must be emphasized that the ratings are relative and arbitrary. Indeed, a system with a poor rating may be the best choice for many users. A severe limitation on the usefulness of figure 10.65 is that it reflects judgments of all parameters of a given system assuming that a user desires the highest accuracy normally available from the system. In the case of Loran-C, for example, use of a sky wave is excluded, with the result that *coverage* is rated poor.

A system designer will probably be forced to make compromises in choosing a dissemination service. He may have to trade *receiver cost* for *reliability*, or accept a *low percent of time available* for high *accuracy* and good *coverage*. Note that most techniques that rate "good" in accuracy are shown as fair or poor in other important categories. No one technique shows all favorable ratings, but HF broadcasts, stationary satellite relays (passive), and the proposed NBS TV Time System stand out with only one poor rating each. At present there is no implemented time dissemination system that permits comparison of a user's clock to a primary standard anywhere in the world at will and to an accuracy level that fully exploits the capability of atomic standards. Satellites appear to be capable of meeting such a challenge but worldwide satellite time dissemination service has not yet been implemented.

10.7. CONCLUSIONS

We have attempted to present a snapshot of proposed, experimental and operational systems for bridging the dissemination gap between a fre-

quency standard and a remote user. Many options are available to a time frequency user; choices must be based on evaluations of overall objectives, economics, advantages, and limitations for a particular situation. The picture is one of contrasts and variations in techniques, user requirements and accuracies, coupled with a multiplicity of inherent characteristics. In detail we see the time and frequency technology touching many diverse and increasingly important areas of human life; e.g. public safety, national defense, electric power utilities, integrated computing networks, broadcasting/television activities, transportation including aircraft-collision avoidance, telecommunication systems, etc. Basic science is influenced also in terms of a unified standard, international time scales, time/frequency calibrations, and time bases for monitoring natural events of nature. In summary, many time and frequency needs are now being met at various accuracy levels and in a variety of ways; on the other hand, some needs are unfulfilled because of accuracy requirements, economic factors, location of receivers, etc. We would emphasize the capability of present day communication and navigation systems (which of themselves require high timing accuracy) for providing time and frequency dissemination at small additional cost and ultimately at great savings to the frequency spectrum. Operationally, it is apparent that the capability for keeping accurate time has outstripped the capabilities for widespread and economic dissemination for the last several decades. Nevertheless, proposed and experimental systems show great promise. If one integrates and optimizes the TFD possibilities in today's picture and projects these elements into the future, an achievable challenge is seen; one can foresee the dissemination gap effectively eliminated with user equivalence of on-site standards-comparison at high accuracy, nearly global coverage and with reasonable-cost equipment.

ACKNOWLEDGEMENTS

As an overview chapter, this presentation relies extensively upon published material as referenced; we are indebted, thus, to the research efforts of many individuals. We wish to thank R. Beehler, J. Barnes, J. Stanley, W. Hanson, A. Risley, and W. Hamilton of the National Bureau of Standards, Boulder, Colorado; and W. Klempner and D. Hilliard of the National Oceanic and Atmospheric Administration, Boulder, Colorado, for their contributions in reviewing and discussing portions of this paper. In addition, we thank G. Hufford, Anita Longley, G. Haydon, G. Gierhart, and B. Wieder of the Office of Telecommunications staff (ITS) at Boulder for detailed review and comments on Annex 10.A. The help of Sharon Erickson is greatly appreciated in the typing and preparation of this Chapter.

10.8. REFERENCES

- [1] Bagley, A., "Frequency and time measurements," *Handbuch der Physik* (Encyclopedia of Physics), A. E. Panenborg (Ed.), **23** (*Electrical Instruments*), pp. 289-372 (Springer-Verlag Publishing Co., Berlin, Germany, 1966).
- [2] Sperry Staff, "Study of methods for synchronizing remotely-located clocks," *Sperry Gyroscope Co. Rep. NASA CR-738*, 206 pages (NTIS, N67-19896, March 1967).
- [3] Begley, W. W., and Shapiro, A. H., "Aspects of precision timing systems," *Aerospace Corp. Rep. TOR-0066(5306)-2*, 115 pages (NTIS, AD 695458, October 1969).
- [4] Hewlett Packard Staff, "Frequency and time standards," *Appl. Note 52*, 91 pages (Hewlett-Packard, Palo Alto, CA 94304, November 1965); "Fundamentals of time and frequency standards," *Appl. Note 52-1* (Hewlett Packard, Palo Alto, CA 94304—in press).
- [5] Ward, F. A. B., *Time Measurement*, Pt. 1—Historical Review, 60 pages (H.M.S.O., William Clowes and Sons Ltd., London, England, 1961).
- [6] Smith, H. M., "International time and frequency coordination," *Proc. IEEE*, **60**, No. 5, pp. 479-487 (May 1972).
- [7] Willennar, A., Private communication (American Electric Power Co., Canton, OH 44720, January 18, 1973).
- [8] Halford, D., Hellwig, H., and Wells, J. S., "Progress and feasibility for a unified standard for frequency, time and length," *Proc. IEEE*, **60**, No. 6, pp. 623-625 (May 1972).
- [9] Dellinger, J. H., and Hall, E. L., "Radio dissemination of the national standard of frequency," *Radio Eng.*, **12**, No. 5, pp. 23-24 (May 1932).
- [10] Hellweg, J. F., "Time determination and time broadcast," *J. Franklin Inst.*, **223**, No. 5, pp. 549-563 (May 1937).
- [11] Selected references on theory of VLF propagation:
 - a. Wait, J. R., "Introduction to the theory of VLF propagation," *Proc. IRE*, **50**, No. 7, pp. 1624-1647 (July 1962).
 - b. Wait, J. R., "Recent theoretical advances in the terrestrial propagation of VLF electromagnetic waves," *Advan. Electron. and Electron. Physics*, L. Marton (Ed.), **25**, pp. 145-209 (Academic Press, Inc., New York, NY 10003, 1968).
 - c. Budden, K. G., *The Waveguide Mode Theory of Wave Propagation*, 325 pages (Prentice-Hall Publishing Co., Englewood Cliffs, NJ 07632, 1961).
- [12] Selected references on VLF propagation:
 - a. Crombie, D. D., "Further observations of sunrise and sunset fading of very-low frequency signals," *Radio Science*, **1**, (New Series), No. 1, pp. 47-51 (January 1966).
 - b. Crombie, D. D., "The waveguide mode propagation of VLF radio waves to great distances" (A Survey), *Proc. Conf. on MF, LF and VLF Radio Propagation*, W. T. Blackband, Chairman (London, England, November 8-10, 1967), *Inst. Elec. Eng. (London) Conf. Publ. No. 36*, pp. 138-158 (Savoy Place, London, England, 1967).
 - c. Wait, J. R., and Spies, K. P., "Characteristics of the earth-ionosphere waveguide for VLF radio waves," *Nat. Bur. Stand. (U.S.) Tech. Note 300*, 94 pages (USGPO, 1964); 1st Suppl., 24 pages (February 1965); 2nd Suppl., 14 pages (March 1965).
 - d. Reder, F. H., Abom, C. J., and Winkler, G. M. R., "Precise phase and amplitude measurements on VLF signals propagated through the arctic zone," *J. Res. Nat. Bur. Stand. (U.S.)*, **68D** (*Radio Sci.*), No. 3, pp. 275-281 (March 1968).
- [13] Jöhler, J. R., "Theory of propagation of low frequency terrestrial radio waves—mathematical interpretation of D-region propagation studies," *ESSA Tech. Rep. IER48-ITSA-47*, 47 pages (USGPO, August 1967).
- [14] Davies, K., *Ionospheric Radio Waves*, 460 pages (Blaisdell Publishing Co., Waltham, MA 02154, 1969).
- [15] Thompson, M. C., Jr., Vogler, L. E., Janes, H. B., and Wood, L. E., "A review of propagation factors in the telecommunications applications of the 10 to 100 GHz radio spectrum," *OT Eng. Rep. 34*, 76 pages (USGPO, August 1972).
- [16] Jespersen, J. L., Blair, B. E., and Gatterer, L. E., "Characterization and concepts of time-frequency dissemination," *Proc. IEEE*, **60**, No. 5, pp. 502-521 (May 1972).
- [17] Carter, P. S., and Beverage, H. H., "Early history of the antennas and propagation field until the end of World War I, Part 1—Antennas," *Proc. IRE*, **50**, No. 5, pp. 679-682 (May 1962).
- [18] Watt, A. D., *VLF Radio Engineering*, 701 pages (Pergamon Press, Inc., Oxford, England, 1967).
- [19] Austin, L. W., "Some quantitative experiments in long-distance radio telegraphy," *Nat. Bur. Stand. (U.S.) J. Res.*, **7**, No. 3, pp. 315-366 (October 1911).
- [20] Pierce, J. A., "Radux," *Cruft Lab Tech. Rep. No. 17* (Harvard Univ., Cambridge, MA 02138, July 1947).
- [21] Casselman, C. J., Heritage, D. P., and Tibbals, M. L., "VLF propagation measurements for the Radux-Omega navigation system," *Proc. IRE*, **47**, No. 5, pp. 829-839 (May 1959).
- [22] Pierce, J. A., Mitchell, H. T., and Essen, L., "World-wide frequency and time comparisons by means of radio transmissions," *Nature (Lett.)*, **174**, No. 4437, p. 922 (November 13, 1954).
- [23] Pierce, J. A., "Intercontinental frequency comparisons by very low frequency radio transmission," *Proc. IRE*, **45**, No. 6, pp. 794-803 (June 1957).
- [24] Crombie, D. D., Allan, A. H., and Newman, M., "Phase variations of 16 kc/s transmissions from Rugby as received in New Zealand," *Proc. Inst. Elec. Eng. (London)*, **105**, Part B, No. 21, pp. 301-304 (May 1958).
- [25] Pierce, J. A., Winkler, G. M. R., and Corke, R. L., "The 'GBR experiment': a transatlantic frequency comparison between cesium-controlled oscillators," *Nature*, **187**, No. 4741, pp. 914-916 (September 10, 1960).
- [26] Watt, A. D., and Plush, R. W., "Power requirements and choice of an optimum frequency for a worldwide standard frequency broadcasting station," *Nat. Bur. Stand. (U.S.) J. Res. (Radio Prop.)*, **63D**, No. 1, pp. 35-44 (July-August 1959).
- [27] Watt, A. D., Plush, R. W., Brown, W. W., and Morgan, A. H., "Worldwide VLF standard frequency and time signal broadcasting," *Nat. Bur. Stand. (U.S.) J. Res. (Radio Prop.)*, **65D**, No. 6, pp. 617-627 (December 1961).
- [28] Essen, L., and Steele, J. McA., "The international comparison of atomic standards of time and frequency," *Proc. Inst. Elec. Eng. (London)*, **109**, Part B, (Electron. and Commun. Eng.) Paper No. 3752M, pp. 41-47 (January 1962).
- [29] Mitchell, A. M. J., "Frequency comparison of atomic standards by radio signal," *Nature*, **198**, No. 4886, pp. 1155-1158 (June 1963).
- [30] Blair, B. E., Crow, E. L., and Morgan, A. H., "Five years of VLF worldwide comparison of atomic frequency standards," *Radio Science*, **2**, (New Series), No. 6, pp. 627-636 (June 1967).
- [31] Becker, G., Fischer, B., and Kramer, G., "Methoden und Ergebnisse im Internationalen Zeitvergleich mit Langswellen" (Methods and results of international VLF-time comparisons) *Proc. Colloque International de Chronometrie* (Intern. Horological symp., Paris, France, September 16-20, 1969). Paper A22, 24 pages (Nouvelle Faculte des Sciences, 11, Quai St., Paris (5), France, 1969).
- [32] Loutfy el Sayed, A., "Frequency standard work in Egypt," *Proc. IEEE (Lett.)*, **60**, No. 5, pp. 627-628 (May 1972).
- [33] Blackband, W. T., "Diurnal changes in the time of propagation of VLF waves over single mode paths," *Propagation of Radio Waves at Frequencies Below 300 kc/s* (Proc. 7th Meet. of the AGARD Ionos. Res. Comm., Munich, Germany, 1962), W. T. Blackband (Ed.), Chap. 16, pp. 219-229 (Pergamon Press, Ltd., Oxford, England, 1964).
- [34] Westfall, W. D., "Diurnal changes of phase and group velocity of VLF radio waves," *Radio Science*, **2** (New Series), No. 1, pp. 119-125 (January 1967).

- [35] Morgan, A. H., "Distribution of standard frequency and time signals," *Proc. IEEE*, **55**, No. 6, pp. 827-836 (June 1967).
- [36] Reder, F. H., "VLF phase tracking for PTTI application," *Proc. 3rd Ann. DOD Precise Time and Time Interval (PTTI) Strat. Plan. Meet.* (USNO, Washington, DC 20390; November 16-18, 1971), pp. 117-147 (USNO, Washington, DC 20390, 1972) (NTIS, AD 758739).
- [37] Looney, C. H., "A very-low frequency (VLF) synchronizing system," *Proc. IRE*, **49**, No. 2, pp. 448-452 (February 1961).
- [38] Morgan, A. H., Crow, E. L., and Blair, B. E., "International comparison of atomic frequency standards via VLF radio signals," *J. Res. Nat. Bur. Stand. (U.S.)*, **69D** (Radio Sci.) No. 7, pp. 905-914 (July 1965).
- [39] Echols, J. D., "Calibrating frequency standards with VLF transmissions," *Electronics*, **35**, No. 17, pp. 60-63 (April 1962).
- [40] Alpert, A., and Murphy, D., "Establishing, synchronizing, and maintaining a standard clock for the USAF calibration program," *Frequency*, **6**, No. 5, pp. 17-21 (May 1968).
- [41] Feistel, C. H., "Calibrating frequency standards with VLF/LF signals," *On Frequency*, **1**, No. 2, pp. 2-7 (Tracor, Austin, TX 78721, March 1969).
- [42] Viezbicke, P. P., (Ed.), "Time and frequency services bulletin," (Distributed upon request on basis of need) (National Bureau of Standards, Boulder, CO 80302, published monthly).
- [43] USNO, "Daily relative phase values," *Time Service Announcement Series 4* (issued weekly and distributed on basis of need); *Time Service Lett.* (Supplement No. 5 to daily phase values, Series 4): "Instructions to interpret the 'phase values' bulletin and teletype messages," 7 pages (USNO, Washington, DC 20390, September 30, 1968).
- [44] FOA, "Phase of standard frequency transmissions as received in Stockholm," (Research Institute of Swedish National Defense, Stockholm, Sweden—published monthly).
- [45] Fey, R. L., and Looney, C. H., Jr., "A dual frequency VLF timing system," *IEEE Trans. on Instrum. and Meas.*, **IM-15**, No. 4, pp. 190-195 (December 1966).
- [46] Baltzer, O. J., "Microsecond timekeeping by means of multiple frequency VLF reception," *Electron. Instrum. Digest (EID)*, (PMA Section) **6**, No. 12, pp. 75-79 (December 1970).
- [47] Hamilton, W. F., and Jespersen, J. L., "Application of VLF theory to time dissemination," *Nat. Bur. Stand. (U.S.) Tech. Note* **610**, 170 pages (USGPO, November 1971).
- [48] Fuzie, R. E., "DSIF network maintenance facility: reference standards frequency and timing laboratory," *Jet. Propulsion Lab. Space Programs Sum.* 37-63, **II**, pp. 101-107 (JPL, California Inst. of Technol., Pasadena, CA 91103, May 1970).
- [49] Wright, J. R., "Multiple frequency VLF timing," *On Frequency*, **1**, No. 3, pp. 2-6 (Tracor, Austin, TX 78721, May 1969).
- [50] Stone, R. R., Jr., Markowitz, W., and Hall, R. G., "Time and frequency synchronization of Navy VLF transmissions," *IRE Trans. on Instrum.*, **I-9**, No. 2, pp. 155-161 (September 1960).
- [51] Allan, D. W., and Barnes, J. A., "Some statistical properties of LF and VLF propagation," *Phase and Frequency Instability in Electromagnetic Propagation* (AGARD/EWP XIII Symp., Ankara, Turkey, October 9-12, 1967) *AGARD Conf. Proc. No. 33*, K. Davies (Ed.), Chap. 15, pp. 219-230 (Technivision Services, Slough, England, 1970).
- [52] Guétrot, A., Higbie, L. S., Lavanceau, J., and Allan, D. W., "An application of statistical smoothing techniques on VLF signals for comparison of time between USNO and NBS" (Summary), *Proc. 23rd Ann. Symp. on Frequency Control* (U.S. Army Electronics Command, Ft. Monmouth, NJ 07703, May 6-8, 1969), p. 248 (NTIS, AD 746209, 1969).
- [53] Stone, R. R., Jr., Gattis, T. H., Petit, R. C., and Liberman, T. N., "Time control of frequency shift keyed transmissions at VLF," *Proc. 25th Ann. Symp. on Frequency Control* (U.S. Army Electronics Command, Ft. Monmouth, NJ 07703, April 26-28, 1971), pp. 152-158 (NTIS, AD 746211, 1971).
- [54] Blair, B. E., and Morgan, A. H., "Control of WWV and WWVH standard frequency broadcasts by VLF and LF signals," *J. Res. Nat. Bur. Stand. (U.S.)*, **69D** (Radio Sci.), No. 7, pp. 915-928 (July 1965).
- [55] Stanbrough, J. H., Jr., "A VLF radio relative navigation system," *Navigation: J. Inst. Nav.*, **11**, No. 4, pp. 417-428 (January 1965).
- [56] Chilton, C. J., Crombie, D. D., and Jean, A. G., "Phase variations in VLF propagation," *Propagation of Radio Waves at Frequencies below 300 kc/s* (Proc. 7th Meet. of the AGARD Ionos. Res. Commun., Munich, Germany, 1962), W. T. Blackband (Ed.), Chap. 19, pp. 257-290 (Pergamon Press, Ltd., Oxford, England, 1964).
- [57] Iijima, S., Torao, M., and Fujiwara, K., "Phase variations of VLF waves, GBR, and GBZ as received," *Annals of Tokyo Astron. Observ.*, 2nd Series **11**, No. 1, 28 pages (1968).
- [58] Reder, F. H., "VLF propagation phenomena observed during low and high solar activity," *Progress in Radio Science-1966-1969* (Proc. XVth Gen. Assem. of URSI, Ottawa, Canada, August 18-28, 1969), J. A. Lane et al. (Eds.), **2**, pp. 113-140 (URSI, Brussels, Belgium, 1971).
- [59] Swanson, E. R., and Kugel, C. P., "VLF timing: conventional and modern techniques including Omega," *Proc. IEEE*, **60**, No. 5, pp. 540-551 (May 1972).
- [60] Pierce, J. A., "The use of composite signals at very low radio frequencies," *Harvard Tech. Rept. No. 522*, 31 pages (NTIS, AD 666567, February 1968).
- [61] Essen, L., "Standard frequency transmissions," *Proc. Inst. Elec. Eng. (London)*, **101**, No. 72, Pt. III (Paper No. 1677), pp. 249-255 (July 1954).
- [62] George, W. D., "Low frequency standard transmission," *Proc. 11th Ann. Symp. on Frequency Control* (Signal Corps Eng. Lab., Ft. Monmouth, NJ 07703, May 7-9, 1957), pp. 574-585 (NTIS, AD 298 323, 1957).
- [63] Pierce, J. A., "Recent long-distance frequency comparisons," *IRE Trans. on Instrum.*, **I-7**, Nos. 3 and 4, pp. 207-210 (December 1958).
- [64] Viezbicke, P. P. (Ed.), "NBS frequency and time broadcast services," *Nat. Bur. Stand. (U.S.) Spec. Publ. 236*, 1973 Edition, 19 pages (USGPO, May 1973).
- [65] Hartke, D., "Simplified local comparisons with USFS," *Frequency*, **2**, No. 2, pp. 32-33 (March-April 1964).
- [66] Manly, E. P., "WWVB 60 kHz frequency comparator receiver," *73 Magazine*, No. 144, pp. 16-18, 20, 22-24, 26 (September 1972).
- [67] Andrews, D., Chaslain, C., and DePrins, J., "Reception of low frequency time signals," *Frequency*, **6**, No. 9, pp. 13-21 (September 1968).
- [68] LaVeau, B. J., "A new time standard," *Leeds and Northrup Tech. J.*, Issue 7, pp. 10-15 (Fall 1969).
- [69] Cohn, N., "Power systems time and frequency," *Leeds and Northrup Tech. J.*, Issue 7, pp. 3-9 (Fall 1969).
- [70] Eaton, J. P., O'Neill, M. E., and Murdock, J. N., "After-shocks of the 1966 Parkfield-Cholame California earthquake: a detailed study," *Bull. Seismol. Soc. Amer.*, **60**, No. 4, pp. 1151-1197 (August 1970).
- [71] Mereu, R. F., and Kovach, R. J., "A portable inexpensive seismic system for crustal studies," *Bull. Seismol. Soc. Amer.*, **60**, No. 5, pp. 1607-1613 (October 1970).
- [72] Luichinger, M. J., "More about time and the telephone company," *Telephony*, **174**, No. 20, pp. 33, 36, 38, 40, 72, 74, and 76 (May 18, 1969).
- [73] CCIR, "Standard frequency and time signals," (Study Group 7), *XIIIth Plenary Assembly* (New Delhi, India, 1970), **III**, pp. 229-240 (ITU, Geneva, Switzerland, 1970).
- [74] USNO, "Worldwide primary VLF and HF transmissions," *Time Service Announcement, Ser. 1*, No. 2, 10 pages (USNO, Washington, DC 20390, June 15, 1972).
- [75] van Groos, J. C., "Time and frequency standards," *Measurements and Data*, **3**, No. 1, page 92 (January-February 1969).
- [76] Stanley, J., Private communication (January 26, 1973).

- [77] Beers, Y., "WWV moves to Colorado," Parts I and II, *QST*, **LI**, No. 1, pp. 11-14 (January 1967); **LI**, No. 2, pp. 30-36 (February 1967).
- [78] Viezbicke, P. P., "NBS frequency-time broadcast station WWV, Fort Collins, Colorado," *Nat. Bur. Stand. (U.S.) Tech. Note 611*, 29 pages (USGPO, October 1971).
- [79] Milton, J. B., "Standard time and frequency: its generation, control, and dissemination from the National Bureau of Standards Time and Frequency Division," *Nat. Bur. Stand. (U.S.) Tech. Note 379*, 27 pages (USGPO, August 1969) (or future updates).
- [80] Systron Donner Appl. Eng. Staff, *Handbook of Precision Timekeeping and Tape Search*, 138 pages (Systron Donner Corp., Concord, CA 84520, January 1970).
- [81] Stanley, J., "Use and limitation of standard broadcast for time and frequency comparison," *Proc. 4th Ann. NASA and DOD Precise Time and Time Interval (PTTI) Plan. Meet.* (NASA Goddard Space Flight Center, Greenbelt, MD 20771, November 14-16, 1972), pp. 249-258 (NASA, X-814-73-72, Greenbelt, MD 20771, 1973).
- [82] Angelotti, E., and Leschiutta, S., "A new determination of HF time measurements accuracy," IEN Report, 7 pages (Torino, Italy, 1968).
- [83] Winkler, G. M. R., "Concept and advantages for PTTI integration of time ordered systems," *Proc. 2nd Ann. Precise Time and Time Interval (PTTI) Strat. Plan. Meet.* (USNO, Washington, DC 20390, December 10-11, 1970), **I**, pp. 156-168 (NTIS, AD 881 014L, 1971).
- [84] Morgan, A. H., "Precise time synchronization of widely separated clocks," *Nat. Bur. Stand. (U.S.) Tech. Note 22*, 65 pages (NTIS, PB 151 381, July 1959).
- [85] Barghausen, A. F., Finney, J. W., Proctor, L. L., and Schultz, L. D., "Predicting long-term operational parameters and high-frequency sky-wave telecommunications systems," *ESSA Tech. Rep. ERL 110-ITS 78*, 290 pages (USGPO, May 1969).
- [86] Swanson E. R., "Time dissemination effects caused by instabilities of the medium," *Phase and Frequency Instabilities in Electromagnetic Wave Propagation* (Ankara, Turkey, October 9-12, 1967) *AGARD Conf. Proc. No. 33*, K. Davies (Ed.), Chap 13, pp. 180-197 (Technivision Services, Slough, England, July 1970).
- [87] Piece, J. A., "Omega," *IEEE Trans. on Aerospace Electron. Syst.*, **AES-1**, No. 3, pp. 206-215 (December 1965).
- [88] Pierce, J. A., Palmer, W., Watt, A. D., and Woodward, R. H., *Omega—a worldwide navigational system*, 2d Edition, 270 pages (NTIS, AD 630 900, May 1966).
- [89] Kirby, R. A., "Evaluation of Omega navigation system," *Geophysics*, **35**, No. 2, pp. 344-356 (April 1970).
- [90] Kugel, C. P., "Omega system synchronization," *NELC Rep. 1529*, 24 pages (Naval Electronics Laboratory Center, San Diego, CA 92152, January 1968).
- [91] Burgess, B., and Walker, D., "Effects in Omega from propagation variations," *J. Inst. Nav.* (London), **23**, No. 1, pp. 49-59 (January 1970).
- [92] Wilson, J. J., Britt, J. E., and Chi, A. R., "Omega timing receiver, design, and system test," *Proc. 4th Ann. NASA and DOD Precise Time and Time Interval (PTTI) Plan. Meet.* (NASA, Goddard Space Flight Center, Greenbelt, MD 20771, November 14-16, 1972), pp. 345-361 (NASA, X-814-73-72, Greenbelt, MD 20771, 1973).
- [93] Fey, L., "A time code for the Omega worldwide navigation system," *Proc. IEEE (Lett.)*, **60**, No. 5, p. 630 (May 1972).
- [94] Doherty, R. H., Hefley, G., and Linfield, R. F., "Timing potentials of Loran-C," *Proc. IRE*, **49**, No. 11, pp. 1659-1673 (November 1961).
- [95] Hefley, G., "The development of Loran-C navigation and timing," *Nat. Bur. Stand. (U.S.) Monogr. 129*, 157 pages (USGPO, October 1972).
- [96] Shapiro, L. D., "Time synchronization from Loran-C," *IEEE Spectrum*, **5**, No. 8, pp. 46-55 (August 1968).
- [97] Pakos, P. E., "Use of the Loran-C system for time and frequency dissemination," *Frequency Technology*, **7**, No. 7, pp. 13-18 (July 1969).
- [98] Stetina, F. L., and Zufall, S. Z., "Loran-C—A time synchronization technique," *Goddard Space Flight Center Tech. Rept. X-832-69-514*, 87 pages (NASA, Goddard Space Flight Center, Greenbelt, MD 20771, September 1969).
- [99] USNO, "Time of coincidence (null) ephemeris for Loran-C chains," *Time Service Announcement Ser. 9* (USNO, Washington, DC 20390) (Published in advance and available upon basis of need.).
- [100] Johler, J. R., "Propagation of the low frequency radio signal," *Proc. IRE*, **50**, No. 4, pp. 404-427 (April 1962).
- [101] Johler, J. R., and Berry, L. A., "Loran-D phase corrections over inhomogeneous irregular terrain," *ESSA Tech. Rept. IER 59-ITSA 56*, 70 pages (USGPO, November 1967).
- [102] Wieder, B., "Use of Loran-C over land," *Proc. 25th Ann. Symp. on Frequency Control* (U.S. Army Electronics Command, Ft. Monmouth, NJ 07703, April 26-28, 1971), pp. 171-178 (NTIS, AD 746211, 1971).
- [103] Potts, C. E., and Wieder, B., "Precise time and frequency dissemination via the Loran-C system," *Proc. IEEE*, **60**, No. 5 pp. 530-539 (May 1972).
- [104] Shapiro, L. D., "Loran-C timing," *Frequency*, **3**, No. 2, pp. 32-37 (March-April 1965).
- [105] Stone, C. S., "Loran-C skywave timing experiment," *Austron Tech. Note 168-1*, 9 pages (Austron, Inc., Austin, TX 78753, 1968).
- [106] Doherty, R. H., "Experimental observations and theoretical calculations leading to a model of the lower ionosphere," *Proc. Intern. Conf. on the Ionosp.*, (Imperial College, London, England, July 2-6, 1962), pp. 428-434 (Inst. of Phys. and Phys. Soc., London, England, July 1963).
- [107] Mazur, W. E., Jr., "Operational considerations for the use of Loran-C skywaves for time synchronization," *Goddard Space Flight Center Tech. Rep. X-573-71-148*, 52 pages (NTIS, N71-24880, April 1971).
- [108] Pierce, J. A., McKensie, A. A., and Woodward, R. H., (Eds.), *Loran-Long Range Navigation*, 476 pages (McGraw-Hill Book Co. Inc., New York, NY 10020, 1948).
- [109] Beck, G. E., (Ed.), *Navigation Systems—A Survey of Modern Electronic Aids*, pp. 89-99 (Van Nostrand Reinhold Co., London, England, 1971).
- [110] Johler, J. R., "Loran-A ground wave pulse propagation," *OT/ITS Rep. RR 10*, 71 pages (USGPO, March 1971).
- [111] Tolman, J., Ptáček, V., Souček, A., and Stecher, R., "Microsecond clock comparison by means of TV synchronizing pulses," *IEEE Trans. on Instrum. and Meas.*, **IM-16**, No. 3, pp. 247-254 (September 1967).
- [112] Souček, A., "Travel time stability on TV relay links," *Radio Television* (Oirt Publication), No. 5, pp. 29-31 (Prague, Czechoslovakia, September 1969).
- [113] Allan, D. W., Leschiutta, S., and Rovera, G., "TV frame pulses used for precision time synchronization and their noise distribution," *Alta Frequenza*, **34** (English issue No. 2), p. 180E (March 1970).
- [114] Miller, M. J., "Synchronization of distant clocks by television pulse comparisons," *Astron. Soc. Australia*, **1**, No. 7, p. 352 (April 1970).
- [115] Pali, G. N., "Experimental evaluation of the error of joining time scales over wide-band communication and television channels," *Izmeritel'naya Tekhnika*, No. 5, pp. 28-31, May 1970; English translation—*Meas. Techniques*, **13**, No. 5, pp. 670-674 (Plenum Publishing Co., New York, NY 10011, May 1970).
- [116] Davis, D. D., Jespersen, J. L., and Kamas, G., "The use of television signals for time and frequency dissemination," *Proc. IEEE (Lett.)*, **58**, No. 6, pp. 931-933 (June 1970).
- [117] Parcelier, P., "Time synchronization by television," *IEEE Trans. on Instrum. and Meas.*, **IM-19**, No. 4, pp. 233-238 (November 1970).
- [118] Becker, G., and Enslin, H., "Genauere Zeit- und Frequenzverleiche mittels Fernseh-Bildimpulsen," (Exact time and frequency comparison via television sync pulses), *Frequenz*, **26**, No. 12, pp. 332-337 (December 1972) (in German).
- [119] Pali, G. N., Luk'yanchenko, Ya. I., Fedorov, Yu. A., and Vnukov, E. M., "Experimental high precision system for transmitting time units and frequency over television

- channels," *Izmeritel'naya Tekhnika*, No. 1, pp. 34-37, January 1972; English translation—*Meas. Techniques*, **15**, No. 1, pp. 54-59 (Plenum Publishing Co., New York, NY 10011, January 1972).
- [120] Leschiutta, S., "Long-term accuracy of time comparisons via TV signal along radio relay links," *IEEE Trans. on Instrum. and Meas.*, **IM-22**, No. 1, pp. 84-87 (March 1973).
- [121] Lavanceau, J. D., and Carroll, D., "Real time synchronization via passive television transmission," *Proc. 3rd Ann. Precise Time and Time Interval (PTTI) Strat. Plan. Meet.* (USNO, Washington, DC 20390, November 16-18, 1971), **1**, pp. 331-366 (USNO, Washington, DC 20390, 1972) (NTIS, AD 758739).
- [122] Davis, D. D., "Frequency standard hides in every color set," *Electronics*, **44**, No. 10, pp. 96-98 (May 10, 1971).
- [123] Howe, D. A., "Results of active line-1 TV timing," *Proc. IEEE (Lett.)*, **60**, No. 5, pp. 634-637 (May 1972).
- [124] Howe, D. A., "Nationwide precise time and frequency distribution utilizing an active code within network television broadcasts," *IEEE Trans. on Instrum. and Meas.*, **IM-21**, No. 3, pp. 263-276 (August 1972).
- [125] Davis, D. D., Blair, B. E., and Barnaba, J. F., "Long-term continental U.S. timing system via television networks," *IEEE Spectrum*, **8**, No. 8, pp. 41-52 (August 1971).
- [126] Berger, U. S., "TD-2: eighteen years and still growing," *Bell Lab Record*, **46**, No. 7, pp. 210-216 (July/August 1968).
- [127] Westman, H. P., (Ed.), *Reference Data for Radio Engineers*, 5th Ed., Sec. 28, pp. 29-34 (Howard W. Sams & Co., Indianapolis, IN 46268, 1969).
- [128] Allan, D. W., Blair, B. E., Davis, D. D., and Machlan, H. E., "Precision and accuracy of remote synchronization via network television broadcasts, Loran-C and portable clocks," *Metrologia*, **8**, No. 2, pp. 64-72 (April 1972).
- [129] Allan, D. W., "Statistics of atomic frequency standards," *Proc. IEEE*, **54**, No. 2, pp. 221-230 (February 1966) (see chap. 8).
- [130] Barnes, J. A., Chi, A. R., Cutler, L. S., Healey, D. J., Leeson, D. B., McGunigal, T. E., Mullen, J. A. Jr., Smith, W. L., Sydnor, R., Vessot, R. F. C., and Winkler, G. M. R., "Characterization of frequency stability," *IEEE Trans. on Instrum. and Meas.*, **IM-20**, No. 2, pp. 105-120 (May 1971) (see chap. 8).
- [131] Winkler, G. M. R., Hall, R. G., and Percival, D. B., "The U.S. Naval Observatory clock time reference and the performance of a sample of atomic clocks," *Metrologia*, **6**, No. 4, pp. 126-134 (October 1970).
- [132] Allan, D. W., and Gray, J. E., "Comments on the October 1970 Metrologia paper 'the U.S. Naval Observatory clock time reference and the performance of a sample of atomic clocks,'" *Metrologia*, **7**, No. 2, pp. 79-82 (April 1971).
- [133] Koide, F. K., and Vignone, E. J., "TV time synchronization in the western U.S.," *Electron. Instrum. Dig. (EID) (PMA Section)* **7**, No. 10, pp. 26-31 (October 1971).
- [134] Jaffee, L., "Communication by satellite," *Intern. Science and Tech.*, No. 8, pp. 44-51 (August 1962).
- [135] McKenzie, A. A., "What's up in satellites," *IEEE Spectrum*, **9**, No. 5, pp. 16-27 (May 1972).
- [136] Chistyakov, N. I., "Broadcasting by means of satellites," English translation of *Radioveshchaniye Cherez Sputniki* (Zvanize Press Moscow, 1972), 49 pages (NTIS, N 71-17466, February 1971).
- [137] Freiesleben, H. C., "The use of satellites for maritime purposes," *Eurospace Memoranda*, No. 8, 88 pages (NTIS, N72-16514, July 1971).
- [138] Keane, L., Brandel, D. L., Engles, P. D., and Waetjen, R. M., "Global navigation and traffic control using satellites," *NASA Tech. Rep. TRR-342*, 26 pages (NTIS, N70-33324, July 1970).
- [139] Osborne, E. F., "Global timing systems of nanosecond accuracy using satellite references," *Tech. Memo. TF-1086*, Johns Hopkins Univ., Appl. Phys. Lab., 182 pages (NTIS, AD 700 661, October 1969).
- [140] Easton, R., "The role of time/frequency in Navy navigation satellites," *Proc. IEEE*, **60**, No. 5, pp. 557-563 (May 1972).
- [141] Mazur, W. E., and Laios, S. C., "A compendium of satellite time-synchronization techniques," *NASA-GSFC Rep. X-573-69-394*, 13 pages (NASA, Goddard Space Flight Center, Greenbelt, MD 20771, August 1969).
- [142] Guier, W. H., and Weiffenbach, G. C., "A satellite Doppler navigation system," *Proc. IRE*, **48**, No. 5, pp. 507-516 (April 1960).
- [143] Jespersen, J. L., Kamas, G., Gatterer, L. E., and MacDoran, P. F., "Satellite VHF transponder time synchronization," *Proc. IEEE*, **56**, No. 7, pp. 1202-1206 (July 1968).
- [144] Autonetics Staff, "Analysis of an advanced time-frequency national air space system concept," **2**, *North American Rockwell Rep. No. RD-69-32-11*, 407 pages (NTIS, AD 695 436, August 1969).
- [145] Steele, J. McA., Markowitz, W., and Lidback, C. A., "Telstar time synchronization," *IEEE Trans. on Instrum. and Meas.*, **IM-13**, No. 4, pp. 164-170 (December 1964).
- [146] Laidet, L. M., "Worldwide synchronization using the TRANSIT satellite system," *Proc. IEEE (Lett.)*, **60**, No. 5, pp. 630-632 (May 1972).
- [147] RRL Freq. Std. Sect. and Kashima Branch, "Report on clock pulse synchronization experiment via RELAY II satellite," *J. Radio Res. Lab.*, **12**, No. 63, pp. 311-316 (September 1965).
- [148] Markowitz, W., Lidback, C. A., Uyeda, H., and Muramatsu, K., "Clock synchronization via RELAY II satellite," *IEEE Trans. on Instrum. and Meas.*, **IM-15**, No. 4, pp. 177-184 (December 1966).
- [149] Gatterer, L. E., Bottone, P. W., and Morgan, A. H., "Worldwide clock synchronization using a synchronous satellite," *IEEE Trans. on Instrum. and Meas.*, **IM-17**, No. 4, pp. 372-378 (December 1968).
- [150] Laios, S. C., "STADAN clock synchronization via GEOS-II satellite," *NASA-GSFC Rep. No. X-570-69-159*, 43 pages (NASA, Goddard Space Flight Center, Greenbelt, MD 20771, March 1969).
- [151] Laios, S. C., "Satellite time synchronization of a NASA network," *Proc. IEEE (Lett.)*, **60**, No. 5, pp. 632-633 (May 1972).
- [152] Murray, J. A., Jr., "Satellite communications system," *Proc. 2nd Ann. Precise Time and Time Interval (PTTI) Strat. Plan. Meet.*, (USNO, Washington, DC 20390, December 10-11, 1970), **1**, pp. 55-78 (NTIS, AD 881014-L, 1971).
- [153] Mazur, W. E., Jr., "Dual transponder time synchronization at C band using ATS-3," *Proc. IEEE (Lett.)*, **60**, No. 5, pp. 633-634 (May 1972).
- [154] Hanson, D. W., and Hamilton, W. F., "One-way time synchronization via geostationary satellites at UHF," *IEEE Trans. on Instrum. and Meas.*, **IM-20**, No. 3, pp. 147-153 (August 1971).
- [155] Hanson, D. W., and Hamilton, W. F., "Clock synchronization for satellite tracking," *IEEE Trans. on Aerospace and Electron. Sys.*, **AES-7**, No. 5, pp. 895-899 (September 1971).
- [156] Easton, R., "Timing receiver for timation satellite," *Proc. 3rd Ann. DOD Precise Time and Time Interval (PTTI) Strat. Plan. Meet.* (USNO, Washington, DC 20390, November 16-18, 1971), pp. 45-66 (USNO, Washington, DC 20390, 1972) (NTIS, AD 758739).
- [157] Hanson, D. W., and Hamilton, W. F., "Time and frequency broadcast experiments from the ATS-3 Satellite," *Nat. Bur. Stand. (U.S.), Tech. Note 645*, 115 pages (November 1973).
- [158] Kershner, R. B., and Newton, R. R., "The TRANSIT system," *J. Inst. Nav. (England)*, **15**, No. 2, pp. 129-144 (April 1962).
- [159] Stansell, T. A., Jr., "TRANSIT, the Navy navigation satellite system," *Navigation: J. Inst. Nav.*, **18**, No. 1, pp. 93-109 (Spring 1971).
- [160] Rueger, L. J., "TRANSIT navigation system," *Proc. 2nd Ann. Precise Time and Time Interval (PTTI) Strat. Plan. Meet.* (USNO, Washington, DC 20390, December 10-11, 1970), **1**, pp. 84-107 (NTIS, AD 881014-L, 1971).

- [161] Kershner, R. B., "The incremental phase shifter and PRM time transfer," *Proc. 3rd Ann. DOD Precise Time and Time Interval (PTTI) Strat. Plan. Meet.* (USNO, Washington, DC 20390, November, 16-18, 1971), pp. 23-42, (USNO, Washington, DC 20390, 1972) (NTIS, AD 758739).
- [162] Easton, R., "British American satellite time transfer experiments," *Proc. 4th Ann. NASA and DOD Precise Time and Time Interval (PTTI) Plan. Meet.* (NASA, Goddard Space Flight Center, Greenbelt, MD 20771, November 14-16, 1972), pp. 14-28 (NASA, X-814-73-72, Greenbelt, MD 20771, 1973).
- [163] Bartholow, C. A., "TIMATION III satellites," *Proc. 4th Ann. NASA and DOD Precise Time and Time Interval (PTTI) Plan. Meet.* (NASA, Goddard Space Flight Center, Greenbelt, MD 20771, November 14-16, 1972), pp. 7-13 (NASA, X-814-73-72, Greenbelt, MD 20771, 1973).
- [164] Enright, R. E., "DSCS PTTI transfer," *Proc. 3rd Ann. DOD Precise Time and Time Interval (PTTI) Strat. Plan. Meet.*, (USNO, Washington, DC 20390, November 16-18, 1971), pp. 167-180 (USNO, Washington, DC 20390, 1972) (NTIS, AD 758739).
- [165] Murray, J. A., Jr., "Mini modem for PTTI dissemination," *Proc. 3rd Ann. DOD Precise Time and Time Interval (PTTI) Strat. Plan. Meet.* (USNO, Washington, DC 20390, November 16-18, 1971), pp. 103-115 (USNO, Washington, DC 20390, 1972) (NTIS, AD 758739).
- [166] Schneider, R. J., "Time and frequency standardization," *Proc. 3rd Ann. DOD Precise Time and Time Interval (PTTI) Strat. Plan. Meet.* (USNO, Washington, DC 20390, November 16-18, 1971), pp. 7-21 (USNO, Washington, DC 20390, 1972) (NTIS, AD 758739).
- [167] Sivers, A. P., *Osnovy Kosmicheskoy Radioelektroniki (Principles of Space Radioelectronics)* "Satellite communication line networks and systems,"—English translation, Sec. 8 of Chap. IV, pp. 174-182 (Moscow, Izd-vo Sovetskoye Radio, Russia) (NTIS, N-211157, 1972).
- [168] Hamilton, W. F., and Hanson, D. W., "A synchronous satellite time delay computer," *Nat. Bur. Stand. (U.S.) Tech. Note 638*, 39 pages (USGPO, July 1973).
- [169] Phillips, D. H., Phillips, R. E., and O'Neill, J. J., "Time and frequency transfer via microwave link," *IEEE Trans. on Instrum. and Meas.*, **IM-20**, No. 1, pp. 23-28 (February 1971).
- [170] Murray, J. A., Pritt, D. L., Blocker, L. W., Leavitt, W. E., Hooten, P. M., and Goring, W. D., "Time transfer by Defense communication satellite," *Proc. 25th Ann. Symp. on Frequency Control* (U.S. Army Electronics Command, Ft. Monmouth NJ 07703, April 26-28, 1971), pp. 186-193 (NTIS, AD 746211, 1971).
- [171] Curtwright, J. B., "Precision time distribution within a deep space communications complex," *Proc. 4th Ann. NASA and DOD Precise Time and Time Interval (PTTI) Plan. Meet.* (NASA, Goddard Space Flight Center, Greenbelt, MD 20771, November 14-16, 1972), pp. 203-212 (NASA, X-814-73-72, Greenbelt, MD 20771, 1973).
- [172] Strock, M. S., "Standard frequency dissemination," *Proc. IRE*, **15**, No. 8, pp. 727-731 (August 1927).
- [173] Montgomery, L. H., "Frequency standardization of broadcast carriers," *CPEM Digest 1970—Conference on Precision Electromagnetic Measurements* (NBS/IEEE/URSI, Boulder, CO 80302, June 2-5, 1970) *IEEE Cat. No. 70C 20 PREC.*, p. 79 (1970).
- [174] Montgomery, L. H., "Standard frequency and time service using radio broadcasting facilities," *Proc. 26th Ann. Symp. on Frequency Control* (U.S. Army Electronics Command, Ft. Monmouth, NJ 07703, June 6-8, 1972), pp. 317-318 (Electron. Ind. Assn., Washington, DC 20006, 1972).
- [175] Montgomery, L. H., Private communication (January 24, 1973).
- [176] Latorre, V. R., "The phase stability of VHF signals reflected from meteor trails," *IEEE Trans. on Ant. and Prop.*, **AP-13**, No. 4, pp. 546-550 (July 1965).
- [177] Sanders, W. R., Albright, D. L., Tashiro, S., and March, D. N., "A meteor burst clock synchronization experiment," *IEEE Trans. on Instrum. and Meas.*, **IM-15**, No. 4, pp. 184-189 (December 1966).
- [178] Dudnik, B. S., Kashcheev, B. L., Leikin, A. Ya., Smirnov, A. N., and Sopol'nikov, M. D., "Use of meteoric reflection of radio waves to compare the clocks of time and frequency service stations," *Izmeritel'naya Tekhnika*, No. 12, pp. 38-42, December 1971; English translation—*Meas. Techniques*, **14**, No. 12, pp. 1842-1847 (Plenum Publ. Co., New York, NY 10011, December 1971).
- [179] Latorre, V. R., "Messages by Meteor," *Electronics*, **38**, No. 21, pp. 102-106 (October 18, 1965).
- [180] Sugar, G. R., "Radio propagation by reflection from meteor trails," *Proc. IEEE*, **52**, No. 2, pp. 116-136 (February 1964).
- [181] March, D. N., Tashiro, S., and Sanders, W. R., "Meteor trail forward scatter time synchronization system," *Frequency*, **6**, No. 2, pp. 12-17 (February 1968).
- [182] Latorre, V. R., and Johnson, G. L., "Time synchronization techniques," *1964 IEEE Intern. Conv. Record*, Pt. 6, pp. 422-427 (March 1964).
- [183] Broten, N. W., Legg, T. H., Locke, J. L., McLeish, C. W., Richards, R. S., Chisholm, R. M., Gush, H. P., Yen, J. L., and Galt, J. A., "Long baseline interferometry, a new technique," *Science*, **156**, No. 3782, pp. 1592-1593 (June 23, 1967).
- [184] Bare, C., Clark, B. G., Kellerman, K. I., Cohen, M. H., and Jauncey, D. L., "Interferometer experiment with independent local oscillators," *Science*, **157**, No. 3785, pp. 189-191 (July 14, 1967).
- [185] Burke, B. F., "Long-baseline interferometry," *Physics Today*, **22**, No. 7, pp. 54-63 (July 1969).
- [186] Klemperer, W. K., "Long-baseline radio interferometry with independent frequency standards," *Proc. IEEE*, **60**, No. 5, pp. 602-609 (May 1972).
- [187] Hinteregger, H. F., Shapiro, I. I., Robertson, D. S., Knight, C. A., Ergas, R. A., Whitney, A. R., Rogers, A. E. E., Moran, J. M., Clark, T. A., and Burke, B. F., "Precision geodesy via radio interferometry," *Science*, **178**, No. 4059, pp. 396-398 (October 27, 1972).
- [188] Shapiro, I. I., and Knight, C. A., "Geophysical applications of long-baseline radio interferometry," *Earthquake Displacement Fields and the Rotation of the Earth*, L. Mansinha et al. (Eds.), pp. 284-301 (D. Reidel Publ. Co., Dordrecht, Holland, 1970).
- [189] Gold, T., "Radio method for the precise measurement of the rotation period of the earth," *Science*, **157**, No. 3786, pp. 302-304 (July 21, 1967).
- [190] Rogers, A. E. E., and Moran, J. M., Jr., "Very long baseline interferometry as a means of worldwide time synchronization," *Lincoln Lab. Tech. Rep. 478*, 9 pages (NTIS, AD 704134, February 1970).
- [191] Broderick, J. J., Clark, B. G., Cohen, M. H., Ephanov, V. A., Hansson, B., Jauncey, D. L., Kellerman, K. I., Kogan, L. R., Kostenko, V. I., Matveyenko, L. I., Moiseyev, I. G., Payne, J., and Vitkevitch, V. V., "Interferometric observations on the Green Bank—Crimea baseline summary," *Radio Science*, **5**, No. 10, p. 1281 (October 1970).
- [192] Hurd, W. J., "An analysis and demonstration of clock synchronization by VLBI," *Proc. 4th Ann. NASA and DOD Precise Time and Time Interval (PTTI) Plan. Meet.* (NASA, Goddard Space Flight Center, Greenbelt, MD 20771, November 14-16, 1972) pp. 100-122 (NASA, X-814-73-72, Greenbelt, MD 20771, 1973).
- [193] Fanselow, J. L., MacDoran, P. F., Thomas, J. B., Williams, J. G., Finnie, C. J., Sato, T., Skjerve, L., and Spitzmesser, D. J., "The Goldstone interferometer for earth physics," *Jet Propulsion Lab. Tech. Rep. 32-1526*, **V**, pp. 45-57 (JPL, Calif. Inst. of Technol., Pasadena, CA 91103, October 1971).
- [194] Klemperer, W. K., Private communication (June 1971).
- [195] Mather, N. C., Grossi, M. D., and Pearlman, M. R., "Atmospheric effects in very long baseline interferometry," *Radio Science*, **5**, No. 10, pp. 1253-1261 (October 1970).
- [196] Rogers, A. E. E., "Very long baseline interferometry with large effective bandwidth for phase-delay measure-

- ments," *Radio Science*, **5**, No. 10, pp. 1239-1247 (October 1970).
- [197] Baumgartner, W. S., and Easterling, M. F., "A worldwide lunar radar time synchronization system," *Advanced Navigational Tech.* (papers of 14th AGARD/AVIONICS Panel Meet., Milan, Italy, September 12-15, 1967), *AGARD Conf. Proc. No. 28*, pp. 143-162, W. T. Blackband, (Ed.) (Technivision Services, Slough, England, February 1970).
- [198] Higa, W. H., "Time synchronization via lunar radar," *Proc. IEEE*, **60**, No. 5, pp. 552-557 (May 1972).
- [199] Baumgartner, W. S., Smith, J. R., Easterling, M. F., Arnold, R. E., Sato, E. R., Kron, M., Coffin, R. C., Martin, W. L., and Emerson, R., "Time-synchronization system," *JPL Space Programs Summary 37-43*, **III**, pp. 92-107 (JPL, Calif. Inst. of Technol., Pasadena, CA 91103, January 1967).
- [200] Higa, W. H., and Ward, S. C., "Moon-bounce time synchronization," *Proc. 2nd Ann. Precise Time and Time Interval (PTTI) Strat. Plan. Meet.* (USNO, Washington, DC 20390, December 10-11, 1970) **I**, pp. 111-118 (NTIS, AD 881014-L, 1971).
- [201] Coffin, R. C., Emerson, R. F., and Smith, J. R., "Time-synchronization system," *JPL Space Programs Summary 37-45*, **III**, pp. 72-75 (JPL, Calif. Inst. of Technol., Pasadena, CA 91103, May 1967).
- [202] Baugh, H. W., "DSN time-synchronization subsystem," *JPL Space Program Summary 37-53*, **II**, pp. 97-99 (JPL, Calif. Inst. of Technol., Pasadena, CA 91103, September 1968).
- [203] Baugh, H. W., "Clock synchronization system performance," *JPL Space Programs Summary 37-62*, **II**, pp. 116-118 (JPL Calif. Inst. of Technol., Pasadena, CA 91103, March 1970).
- [204] Wells, R., (JPL), Private communication (June 17, 1971).
- [205] ATA, "Airborne collision avoidance system, statement of airline policy and requirements, and a technical description of the system," Airline Air Traffic Control Committee, *CAS Tech. Working Group*, Air Transport Assoc. of Amer., *ANTC Rep. 117*, Revision 10 (May 1971).
- [206] Borrok, M. J., and Rider, D. C., "Results of the ATC CAS flight test program," *Navigation: J. Inst. Nav.*, **17**, No. 3, pp. 278-289 (Fall 1970).
- [207] Holt, J. M., "Avoiding air collisions," *Science and Technol.*, No. 78, pp. 56-63 (June 1968).
- [208] Borrok, M. J., "EROS in operation," *Navigation: J. Inst. Nav.*, **14**, No. 3, pp. 315-320 (Fall, 1967).
- [209] White, F. C., (Ed.), Special Section on Aircraft Collision Avoidance, *IEEE Trans. on Aersp. and Electron. Syst.*, **AES-4**, No. 2, pp. 234-314 (March 1968).
- [210] Friedlander, G. D., "At the crossroads in air-traffic control," *IEEE Spectrum*, Pt. I, **7**, No. 6, pp. 26-40 (June 1970); Pt. II, **7**, No. 7, pp. 69-83 (July 1970); Pt. III, **7**, No. 8, pp. 76-89 (August 1970).
- [211] Jaycox, R. L., "Collision avoidance system synchronization," *IEEE Trans. on Aersp. and Electron. Syst.*, **AES-4**, No. 2, pp. 257-264 (March 1968).
- [212] McIntire, O. E., (Chairman), *Utilization of Time/Frequency in Collision Avoidance Systems (CAS)* (Minutes of CAS-FAA Meet., Washington, DC 20590, August 27-28, 1968) 125 pages (NTIS, AD 681 881, 1968).
- [213] Weihe, V. I., "Frequency and time in air traffic control and collision avoidance applications," *Proc. 25th Ann. Symp. on Frequency Control* (U.S. Army Electronics Command, Ft. Monmouth, NJ 07703, April 26-28, 1971., pp. 82-87 (NTIS, AD 746211, 1971).
- [214] Perkinson, R. E., and Watson, F. D., "Airborne collision avoidance and other applications of time/frequency," *Proc. IEEE*, **60**, No. 5, pp. 572-579 (May 1972).
- [215] Hyatt, R., Throne, D., Cutler, L. S., Holloway, J. H., and Mueller, L. F., "Performance of newly developed cesium beam tubes and standards," *Proc. 25th Ann. Symp. on Frequency Control* (U.S. Army Electronics Command, Ft. Monmouth, NJ 07703, April 26-28, 1971), pp. 313-324 (NTIS, AD 746211, 1971).
- [216] Brennan, J. L., "Time and frequency relating to collision avoidance systems," *Proc. 3rd Ann. DOD Precise Time and Time Interval (PTTI) Strat. Plan. Meet.* (USNO, Washington, DC 20390, November 16-18, 1971), pp. 305-316 (USNO, Washington, DC 20390, 1972) (NTIS, AD 758739).
- [217] Roth, S. H., "Time and frequency applications to automatic vehicle location," *Proc. IEEE (Let.)*, **60**, No. 5, pp. 637-638 (May 1972).
- [218] Claggett, B. D., "Study of precision fixing requirements in special purpose marine operations," *Geonautics, Inc., Contract Rep. DOT-CG-83291-A*, 153 pages (NTIS, AD 690 929, July 1969).
- [219] Cady, W. G., "An international comparison of radio wavelength standards by means of piezo-electric resonators," *Proc. IRE*, **12**, No. 6, pp. 805-816 (December 1924).
- [220] Dellinger, J. H., "The status of frequency standardization," *Proc. IRE*, **16**, No. 5, pp. 579-592 (May 1928).
- [221] Marrison, W. A., "The crystal clock," *Nat. Acad. Science*, **16**, pp. 496-507 (July 1930).
- [222] Mason, W. P., "Quartz crystal applications," *Bell Sys. Tech. J.*, **22**, No. 2, pp. 178-223 (July 1943).
- [223] Cady, W. G., *Piezoelectricity*, Chaps. XIII-XIX, General Bibliography, pp. 284-509, 755-787 (McGraw Hill Book Co., Inc., New York, NY 10020, 1946).
- [224] Marrison, W. A., "The evolution of the quartz crystal clock," *Bell Sys. Tech. J.*, **27**, No. 3, pp. 510-588 (July 1948).
- [225] Lewis, F. D., "Frequency and time standards," *Proc. IRE*, **43**, No. 9, pp. 1046-1068 (September 1955).
- [226] Gerber, E. A., and Sykes, R. A., "State of the art - quartz crystal units and oscillators," *Proc. IEEE*, **54**, No. 2, pp. 103-116 (February 1966) (see chap. 2).
- [227] Austron, "Austron model 2010B disciplined frequency standard," 7 pages (Austron, Austin, TX 78753, November 1971).
- [228] Essen, L., and Parry, J. V. L., "Comparison of caesium frequency standards of different construction," *Nature (Let.)*, **182**, No. 4627, pp. 41-42 (July 5, 1958).
- [229] Reder, F. H., and Winkler, G. M. R., "World-wide clock synchronization," *IRE Trans. on Military Electron.*, **MIL-4**, No. 2-3, pp. 366-376 (April-July 1960).
- [230] Reder, F. H., Winkler, G. M. R., and Bickart, C., "Results of a long-range clock synchronization experiment," *Proc. IRE*, **49**, No. 6, pp. 1028-1032 (June 1961).
- [231] Barnes, J. A., and Fey, R. L., "Synchronization of two remote atomic time scales," *Proc. IEEE* (Corresp.), **51**, No. 11, p. 1665 (November 1963).
- [232] Bagley, A. S., and Cutler, L. S., "A new performance of the 'flying clock' experiment," *Hewlett-Packard J.*, **15**, pp. 1-5 (HP, Palo Alto, CA 94304, July 1964).
- [233] Bodily, L., "Correlating time from Europe to Asia with flying clocks," *Hewlett-Packard J.*, **16**, pp. 1-8 (HP, Palo Alto, CA 94304, April 1965).
- [234] Bodily, L., Hartke, D., and Hyatt, R. C., "World-wide time synchronization," *Hewlett-Packard J.*, **17**, pp. 13-20 (HP, Palo Alto, CA 94304, August 1966).
- [235] Bodily, L. N., and Hyatt, R. C., "'Flying clock' comparisons extended to East Europe, Africa and Australia," *Hewlett-Packard J.*, **19**, No. 4, pp. 12-20 (HP, Palo Alto, CA 94304, December 1967).
- [236] Philibert, V., "The cesium-beam atomic clock," *Electron. World*, **83**, No. 6, pp. 40-41, 67 (June 1970).
- [237] USNO, "U.S. Naval Observatory time reference stations," Time Service Announcement, Series **14**, No. 1, 2 pages (USNO Washington, DC 20390, April 17, 1968) (see chap. 11 - ann. 11.E.1).
- [238] Hall, R. G., Private communication (January 1972).
- [239] NBS, "Nation gets unified time system," *Nat. Bur. Stand. (U.S.) Tech. News Bull.*, **53**, No. 2, p. 34 (USGPO, February 1969).

- [240] Markowitz, W., "Air/ground synchronization," *USNO Report* (August 1966).
- [241] Besson, J., "Comparison of national time standards by simple overflight," *IEEE Trans. on Instrum. and Meas.*, **IM-19**, No. 4, pp. 227-232 (November 1970).
- [242] CCIR, "International comparison of atomic time scales," *CCIR Study Group 7 Doc. 7/8-E*, Rep. 363-1, 4 pages (ITU, Geneva, Switzerland, December 1970).
- [243] Tilson, S., "Pulsars may be neutron stars," *IEEE Spectrum*, **7**, No. 2, pp. 42-55 (February 1970).
- [244] Pacini, F., and Rees, M. J., "Rotation in high energy astrophysics," *Scientific American*, **228**, No. 2, pp. 98-105 (February 1973).
- [245] Smith, S. G., "The pulsars," *Telecommunications J.*, **37**, No. 11, pp. 750-752 (November 1970).
- [246] Hewish, A., Bell, S. J., Pilkington, J. D. H., Scott, P. F., and Collins, R. A., "Observations of a rapidly pulsating radio source," *Nature*, **217**, No. 5130, pp. 709-713 (February 24, 1968).
- [247] Manchester, R. N., "Pulsars: Observations and current investigation," *1971 IEEE International Conv. Digest*, No. 71C8-IEEE, pp. 154-155 (March 1971).
- [248] Staelin, D. H., and Reifenstein, E. C., III, "Pulsating radio sources near the Crab Nebula," *Science*, **162**, No. 3861, pp. 1481-1482 (December 27, 1968).
- [249] Cocke, W. J., Disney, M. J., and Taylor, D. J., "Discovery of optical signals from Pulsar NP 0532," *Nature*, **221**, No. 5180, pp. 525-527 (February 9, 1969).
- [250] Papaliolios, C., Carleton, N. P. and Horowitz, P., "Absolute time-of-arrival measurements of optical pulses from the Crab pulsar," *Nature*, **228**, No. 5270, pp. 445-450 (October 31, 1970).
- [251] Fritz, G., Henry, R. C., Meekins, J. F., Chubb, T. A., and Friedman, H., "X-ray pulsar in the Crab Nebula," *Science*, **164**, No. 3880, pp. 709-712 (May 9, 1969).
- [252] Duthie, J. G., and Murdin, P., "Accurate timing of light flashes from the pulsar in the Crab Nebula during the 1969-1970 season," *Astrophys. J.*, **163**, No. 1, pp. 1-10 (January 1, 1971).
- [253] Allan, D. W., "Time transfer using near-synchronous reception of optical pulsar signals," *Proc. IEEE (Lett.)*, **60**, No. 5, pp. 625-627 (May 1972).
- [254] Horowitz, P., Papaliolios, C., Carleton, N. P., Nelson, J., Middleditch, J., Hills, R., Cudaback, D., Wampler, J., Boyton, P. E., Groth, E. J., Partridge, R. B., Wilkinson, D. T., Duthie, J. G., and Murdin, P., "Optical time-of-arrival measurements from the Crab pulsar: comparison of results from four observatories," *Astrophys. J.*, **166**, pp. L91-L93 (June 15, 1971).
- [255] Hastings, H. F., "Transmission to Naval Observatory of reference derived from hydrogen masers at NRL," *NRL Progress Rep.*, pp. 46-47 (March 1965).
- [256] Koide, F. K., "Standard frequency transmission over telephone line," *Instrum. and Control Syst.*, **39**, No. 4, pp. 123-128 (April 1966).
- [257] Koide, F. K., "Aerospace frequency and time distribution system," *Meas. and Data*, **1**, No. 3, pp. 98-108 (May/June 1967).
- [258] Koide, F. K., Private communication (Autonetics, California, January 1973).
- [259] Grimsley, S. W., and Miller, M. J., "Phase comparison of frequency standards," *Proc. IREE (Australia)*, **29**, No. 1, pp. 14-17 (January 1968).
- [260] Redgeman, P. G., and Watson, D. W., "Very-long-wave phase differences between spaced aerial systems," *Proc. Inst. Elec. Eng. (London)*, **94**, No. 6, Pt. III A, pp. 1016-1022 (1947).
- [261] Curtwright, J. B., "Intra-DSCC microsecond timing using a communication microwave link," *JPL Space Programs Summary* 37-59, **II**, pp. 154-157 (JPL, Calif. Inst. of Technol., Pasadena, CA 91103, September 20, 1969).
- [262] Cohn, N., *Control of generation and power flow on interconnected systems*, 132 pages (John Wiley and Sons, Inc., New York, NY 10016, 1966).
- [263] Cohn, N., "Techniques for improving the control of bulk power transfers on interconnected systems," *IEEE Trans. on Power Applicat. Syst.*, **PAS-90**, No. 6, pp. 2409-2419 (November/December 1971).
- [264] Allan, D. W., Machlan, H. E., and Marshall, J., "Time transfer using nearly simultaneous reception times of a common transmission," *Proc. 26th Ann. Symp. Frequency Control (U.S. Army Electronics Command, Ft. Monmouth, NJ 07703, June 6-8, 1972)*, pp. 309-316 (Electron. Ind. Assn., Washington, DC 20006, 1972).
- [265] Palmer, W., "The Omega navigation system as a source of frequency and time," *Proc. 24th Ann. Symp. on Frequency Control (U.S. Army Electronics Command, Ft. Monmouth, NJ 07703, April 27-29, 1970)*, pp. 345-360 (Electron. Ind. Assn., Washington, DC 20006, 1970).
- [266] Dejager, C., and Jappel, A., (Eds.), "Commission 31: Time (l'Heure), Report of Meetings 19, 21, 24 and 26, August 1970," *Trans. IAU*, **XIV-B**, page 196 (D. Reidel Publishing Co., Holland, 1971).
- [267] Kaiser, A. B., "An explanation of VLF diurnal phase change observations," *Radio Science*, **4**, No. 1, pp. 17-21 (January 1969).
- [268] Budden, K. G., *Radio Waves in the Ionosphere*, 542 pages (Cambridge University Press, London, England, 1961).
- [269] Jöhler, J. R., "Loran-C, D phase corrections over irregular, inhomogeneous terrain-simplified computer methods," *ESSA Tech. Report ERL 116-ITS 83*, 55 pages (USGPO, April 1969); also see ref. [13].
- [270] Berry, L. A., "Wave hop theory of long distance propagation of low frequency radio waves," *Radio Science (J. Research) NBS/USNC, URSI*, **68D**, No. 12, pp. 1275-1284 (December 1964).
- [271] Belrose, J. S., "The lower ionosphere—a review," *Proc. Conf. on MF, LF, and VLF Radio Propagation (London, England, November 8-10, 1967)*, *Inst. Elec. Eng. (London) Conf. Publ. No. 36*, pp. 331-339 (1967).
- [272] Kobayashi, S., Nakajima, M., and Sato, T., "Accuracy of the domestic time synchronization by the reception of JFY signals at long distances," *Radio Res. Lab. Rev.*, **14**, No. 72, pp. 373-377 (May 1968) (in Japanese).
- [273] Haydon, G. W., Lucas, D. L., and Hanson, R. L., "Technical considerations in the selection of optimum frequencies for high frequency skywave communication services," unpublished report (1962).
- [274] Bullington, K., "Radio propagation at frequencies above 30 megacycles," *Proc. IRE*, **35**, No. 10, pp. 1122-1136 (October 1947).
- [275] Lawrence, R. S., Little, C. G., and Chivers, H. J. A., "A survey of ionospheric effects upon earth-space radio propagation," *Proc. IEEE*, **52**, No. 1, pp. 4-27 (January 1964).
- [276] Aarons, J., Whitney, H. E., and Allen, R. S., "Global morphology of ionospheric scintillations," *Proc. IEEE*, **59**, No. 2, pp. 159-172 (February 1971).
- [277] Reed, H. R., and Russell, C. M., *Ultra High Frequency Propagation*, 562 pages (Boston Tech. Publ., Cambridge, MA 02139, 1964).
- [278] Bean, B. R., and Dutton, E. J., *Radio Meteorology, Nat. Bur. Stand. (U.S.) Monogr. 92*, 435 pages (USGPO, 1966).
- [279] Dougherty, H. T., "A survey of microwave fading mechanisms, remedies, and applications," *ESSA Tech. Rep. ERL 69-WPLA*, 82 pages (USGPO, April 1968).
- [280] Thompson, W. I., III, "Atmospheric transmission handbook: A survey of electromagnetic wave transmission in the earth's atmosphere over the frequency (wavelength) range 3 kHz (100 km)-3000 THz (0.1 micron m)," *Dept. of Trans. Tech. Rep. DOT-TSC-NASA-71-6*, 296 pages (NTIS, N71-20121, February 1971).
- [281] Guinot, B., Feissel, M., and Graveaud, M., *Bureau International de l'Heure Annual Report—1971* (BIH, Paris, France, 1972).

ANNEX 10.A. CHARACTERISTICS OF RADIO FREQUENCY BANDS 4 THROUGH 10

Frequency Band	Frequency Ranges	Wave Length Range	Typical Stability	Typical Uses	Factors Affecting Propagation	General Description of Frequency Band Transmission
VLF (Very Low Frequency) Band 4	3-30 kHz Omega (10.2 to 13.6 kHz) Communications (16 to ~26 kHz) Time/Frequency (20 kHz)	$10^5 - 10^4$ m	pts in 10^{11} per day or better (10-30 kHz)	Navigation; Time/Frequency Disseminations; Communications	Time of day; propagation over land or water; ground conductivity; direction of propagation; noise; solar activity; atmospheric disturbances; polar cap and varied latitude paths; daily variation in height of ionosphere causes diurnal shifts at sunrise and sunset. At long distances from a transmitter (>10,000 km), the long path signal can interfere with the short path signal. Nighttime propagation shows increased variation over daytime propagation. Dispersion effects (phase velocity of radio signal varies as a function of its frequency) cause phase and group velocities to differ and must be evaluated in timing systems using multi-frequency techniques. Mode interference at sunrise and sunset can cause cycle "slips", especially at high frequencies in band.	VLF signals propagate between the bounds of the ionospheric D layer and earth and are thus guided around the curvature of the earth to great distances with low attenuation and excellent stability. Diurnal changes are very abrupt when transmitter and receiver are near or at the same longitude; the amount of the diurnal change varies with the distance of the path travel and carrier frequency, and the diurnal phase shift is predictable to several microseconds [34, 267]. VLF propagation has been extensively studied and reported [11a, 12a, 268] and models have been developed for predicting phase delay and signal strength at varying distances and transmitter power. It has been found both experimentally and theoretically that the phase variation with distance tends to become more regular in the 10-20 kHz region as the distance from the transmitter increases. The high Q of VLF antennas precludes a rapid pulse rise which limits envelope timing to about 1 ms. VLF signals are broadcast from worldwide transmitters radiating about 1 kW to 1 MW power. Stable VLF signal reception, during daylight hours with totally sunlit path, permits day-to-day phase comparisons accurate to one or two μ s [30, 31, 46]. (Swanson and Kugel [59] describe both Omega and other VLF signals.)
LF (Low Frequency) Band 5	30-300 kHz Time/Frequency (40 to ~100 kHz) Loran-C (100 kHz) Stabilized Carrier Broadcast Stations (~90 to 200 kHz) mainly European stations	$10^4 - 10^3$ m	pts in 10^{11} per day (60-200 kHz) dependent on propagation path and distance) pts in 10^{13} per day for ground wave signals	Navigation; Time/Frequency Disseminations; Ionospheric Studies; Communications; Commercial Broadcasts	Propagation over water and land paths shows variation; time of day; ground conductivity; solar activity; atmospheric disturbances; interactions of modes during sunrise and sunset cause cycle "slips"; daily ionospheric height changes cause diurnal changes at sunrise and sunset. Appreciable dispersion occurs in ground wave propagation. LF, in contrast to VLF, allows pulsed systems because lower Q antennas can be used. Pulsed transmissions allow separation of ground wave from sky wave signals, so that only ground conductivity and irregular terrain effects need be considered.	LF continuous wave (CW) propagation is similar to that of VLF signals. The higher frequency broadcasts are most stable within ground wave distance of the transmitter (about 500 km). LF signals generally show greater attenuation with distance than VLF signals. A wider bandwidth permits pulsed signals at 100 kHz. This allows separation of the stable ground wave pulse from the variable sky wave pulse up to 1500 km and overseas ranges to more than 2000 km. LF signals are broadcast from North America, Europe, and Japan with transmitter radiated powers of 5 to 400 kW. Stable CW LF signal reception during daylight hours with a totally sunlit path can give phase comparisons to several μ s for paths greater than 5000 km [54]. LF envelope time measurements are good to about 40-50 μ s [67] while LF ground wave signals provide precisions of nanoseconds and accuracies of about a μ s. LF propagation characteristics have been described by Johler, Berry, and Belrose [269-271]. (Potts and Wieder [98] describe the Loran-C navigation system and its use for time dissemination.)
MF (Medium Frequency) Band 6	300 kHz-3 MHz Commercial Station Broadcasts (535-1605 kHz) Loran-A (1.85-1.95 MHz)	$10^3 - 10^2$ m	pts in 10^7 (Loran-A can provide better stability in some cases)	Commercial Broadcasts; Maritime Services; Navigation (Loran-A); Standard Frequency Broadcasts	During daytime, absorption in the D layer eliminates the sky wave. At night, reflections occur from E and F layers resulting in reception of sky waves at distant points. Moving layers and interaction of modes can cause severe distortion. Atmospheric noise varies greatly, being especially high during summer nights. In urban areas, man-made noise can dominate.	The MF band is most useful within ground wave distance (less than 150 km in the day, perhaps half of that at night). It will support signals with a sufficient bandwidth for time pulses, especially at the high end. Coarse time signals are accurate to about 500 μ s. Time comparison accuracies of $\pm 30 \mu$ s are expected from JYJ broadcasts at reception distances of 1000 km using 2.5 MHz signals [272]. A commercial broadcast station in Tennessee, U.S.A. (650 kHz) is phase stabilized to several μ s/day of the NBS WWVB broadcasts [173], providing a local relay standard frequency service. Standard frequency and time broadcasts are transmitted at radiated powers ranging from less than 1 kW to about 5 kW.
HF (High Frequency) Band 7	3,0-30 MHz Worldwide Short Wave Broadcasts	$10^2 - 10$ m	pts in 10^7	Standard Frequency Broadcasts; Communications; Short Wave Broadcasts	Ionospheric reflections from E, F1, or F2 layers, depending on distance, frequency, time of day, and conditions of the ionosphere (quiet or disturbed). Distant reception may be through multiple hops (ionosphere-ground reflections). Movement of reflection points in the ionosphere and interference between hop modes may cause severe distortion. Other factors include the 11-year sunspot cycle, seasonal and diurnal variations, global location, solar flares, ionospheric storms, magnetic storms, sporadic E, etc. Atmospheric noise varies widely, being highest during summer nights. Man-made noise may predominate.	This is the so-called short wave band. The ionosphere absorbs little energy, resulting in worldwide reception. Movement of reflection points can introduce Doppler shifts and fluctuations in amplitude and phase, degrading accuracy to pts in 10^7 . For more accurate reception, one is limited to the ground wave at distances less than 160 km during the day, perhaps half that at night. A 30 MHz frequency is the approximate upper limit for usual sky wave propagation. Sufficient bandwidth is available to enable time pulse transmission in this frequency band. Many studies of HF band have been made [14, 273]. Computer programs can predict maximum usable frequencies (MUF), optimum frequencies (FOT), and critical frequency with given circuit reliability and service [85] for different locations, directions of propagation, time of day, season, sunspot activity, etc. Winkler [83] notes that WWV signals received at the USNO, Washington, DC (2400 km land path) showed day-to-day variations of ~200 μ s if the measurement is duplicated at the same time every day on the same frequency. Receiving equipment and antennas are simple and inexpensive. Standard frequency and time are transmitted at radiated powers that range from 0.5 - 20 kW.
VHF (Very High Frequency) Band 8	30-300 MHz	10-1 m	pts in 10^{12} (Line-of-sight)	Television; FM Commercial Broadcasts; Satellite Experimental Time Broadcasts; Communication Satellites	Influenced principally by terrain, it is difficult to propagate signals over hills because of diffraction effects. Signals can also reflect from tall buildings, mountains, etc., causing multipath distortion and fading. Other influencing factors include atmospheric inhomogeneities; turbulence, ducts, sporadic E, in earth-satellite links, the ionosphere also introduces Faraday rotation, scintillation, and dispersion. Propagation path for satellite signals essentially reciprocal. Angle of signal transmission will determine, to some extent, accuracy obtainable from satellite signals because of the length of ionospheric path. Man-made and galactic noise are both fairly low.	Signals in this band are generally limited to line-of-sight and near line-of-sight (usually <150 km); however, ionospheric scatter (1000 km or more) and tropospheric scatter (<1000 km) systems exist. Signals penetrate the ionosphere with low loss of stability (at least at mid-latitudes). Satellite transmitter power is relatively low (40-100W), and can transfer signals to nearly a whole hemisphere [154]. TV transmissions show potential for precise time broadcasts in a local service area [116, 121, 133]. Propagation characteristics have been described by Bullington; Lawrence, et al.; Aarons, et al. [274-276]. For low power applications, the cost of antenna and receiving equipment is fairly low. Directional antennas, capable of responding to varied polarizations, give optimum response to VHF satellite signals.
UHF (Ultrahigh Frequency) Band 9	300 MHz-3.0 GHz	1-0.1 m	pts in 10^{12} (Line-of-sight)	Television; Communications; Time/Frequency Comparisons; Radar	Diffraction can cause serious attenuation. Otherwise, the major effects are due to atmospheric inhomogeneities. The index of refraction is a function of water vapor content, temperature, and pressure, and varies from point to point and instant to instant. Phase scintillations show RMS jitter directly proportional to frequency. In earth-satellite links, refraction through the atmosphere takes place primarily in the lower 20 km, and most effects on satellite timing are at low elevation angles. Ionospheric effects are almost negligible. The band is characterized by low noise density (man-made noise predominates); receiver thermal noise and galactic noise may also be important.	Most of the troposcatter systems are found in this band. These are high powered, point-to-point communication links from 100 to almost 1000 km long. Otherwise, signals are limited to line-of-sight (usually less than 100 km). Such signals are very stable, although multipath distortion and fading may be present. Propagation characteristics are described by Reed and Russell; Bean and Dutton [277, 278]. Many of the environmental satellites and most of the broadcast satellites are expected to operate in this band. UHF TV is available and can be used in ways similar to TV at VHF. Relatively low power of transmission is required for hemispheric coverage of satellite signals with excellent stability. Directional antennas are advisable; both antenna and equipment complexity tend to increase, especially at the higher frequencies.
SHF (Super High Frequency) Band 10	3,0-30 GHz	10-1 cm	pts in 10^{12} (Line-of-sight)	Telecommunications Networks; Time/Frequency Comparisons; Navigation Satellites; Communication Satellites; Radar	Diffraction causes serious attenuation. Multipath phenomena become factors of concern to users of this frequency band. Atmospheric variations give rise to subrefractive and super-refractive conditions, ground based and elevated ducts, all of which may lead to anomalous propagation. At the higher end of the band, rainfall attenuation and scatter may be limiting factors, and molecular absorption by oxygen and water vapor begins to be significant. Noise density is very low; man-made noise is comparable to receiver thermal noise; at 10 GHz, the sky brightness temperature begins to dominate, particularly at low elevation angles. Ionosphere appears transparent to these frequencies and effects are nearly non-existent.	This is the so-called microwave or centimeter wave band. Signals are limited to line-of-sight, and the microwave relay systems are composed of many short (40-60 km) hops or links. The long haul lines of the common carriers usually use such systems. They seem to show long range stabilities of several μ s [125, 128]. Microwave links are also used to relay time signals from a source to a remote broadcast terminal. A 32 km link at the USNO uses signals in the 7 GHz region (radiated power 7 W) and shows phase resolution less than 10 ns and a time setting capability better than 100 ns [169]. Antennas are usually highly directive; they and the system equipment tend to be both expensive and complex. At the higher end, where molecular absorption is present, there are nevertheless "windows" which enable stable signals to be transmitted between earth and space with little signal degradation. Propagation characteristics are described by Dougherty and Thompson [279, 280].

ANNEX 10.B. CHARACTERISTICS OF STANDARD FREQUENCY AND TIME SIGNALS IN ALLOCATED BANDS⁽¹⁾

MAP NO.	STATION			TRANSMITTER			CARRIER ⁽²⁾				TIME SIGNALS ⁽²⁾		PERIOD OF OPERATION	
	SEE FIGURE 10.4	CALL SIGN	APPROXIMATE LOCATION	LONGITUDE LATITUDE	ANTENNA TYPE	RADIATED CARRIER POWER kW	NUMBER OF SIMULTANEOUS TRANSMISSIONS	STANDARD FREQUENCIES MHz	MODULATION Hz	ACCURACY PTS IN 10 ¹⁰	TIME PULSES pps	DURATION MIN	TIME SIGNAL ADJUSTMENT	DAYS PER WEEK
1	ATA	New Delhi, INDIA	+28°34'N -77°19'E	HORIZONTAL DIPOLE	2	1	10	1,1000	±200	YES	CONTINUOUS	VLF STEERING PORTABLE CLOCK	5	5
2	FFH	Paris, FRANCE	+48°32'N -02°27'E	RADIATING MAST	5	1	2.5	1,1000	±2	YES	30/h	UTC	5(M-F)	8.5
3	IAM	Rome, ITALY	+41°52'N -12°27'E	VERTICAL 1/4	1	1	5	1,1000	±0.5	YES	10/15	UTC	6	2
4	IBF	Torino, ITALY	+45°02'N -07°46'E	VERTICAL 1/4	5	1	5	1,1000	±0.5	YES	CONTINUOUS	UTC	7	2.75
5	JG2AR	Tokyo, JAPAN	+35°42'N -139°31'E	OMNI-DIRECTIONAL	3	1	0.02	1	±1		CONTINUOUS	NON-OFFSET CARRIER	5(M-F)	2 (0530-0730 UT)
6	JJY	Tokyo, JAPAN	+35°42'N -139°31'E	VERTICAL 1/2 DIPOLES; (1/2 DIPOLE, TOP-LOADED FOR 2.5 MHz)	2		2.5; 5; 10; 15	1,600; 1000; 1600	±0.5	YES	CONTINUOUS	UTC	7	24 (9 MIN INTERRUPTION PER h)
7	L0L	Buenos Aires, ARGENTINA	-34°37'S -58°21'W	HORIZONTAL 3-WIRE FOLDED DIPOLE	2	3	5; 10; 15	1,440; 1000	±0.2	YES	CONTINUOUS	UTC	7	5
8	MSF	Rugby, UNITED KINGDOM	+52°22'N +01°11'W	HORIZONTAL QUADRANT DIPOLES; (VERTICAL MONOPOLE, 2.5 MHz)	0.5	3	2.5; 5; 10	1,1000	±1	YES	5/10	UTC	7	24
9	OMA	Praha, CZECHOSLOVAK S.R.	+50°07'N -14°35'E	T	1	1	2.5	1,1000	±10		15/30	UTC	7	24
10	RWM/RES	Moskva, U.S.S.R.	+55°45'N -37°18'E		20	1	5; 10; 15	1,1000	±50	YES	10/2 h	UTC (UT1-UTC TO 10 ms)	7	19
11	WWV (3)	Fort Collins, COLORADO U.S.A.	+40°41'N +105°02'W	VERTICAL 1/2 DIPOLES	2.5-10	6	2.5; 5; 10; 15; 20; 25	1,100; 440; 500; 600; 1000; 1500	±0.1	YES	CONTINUOUS	UTC	7	24
12	WWVH (3)	Kaui, HAWAII U.S.A.	+ 21°59'N +159°46'W	PHASED VERTICAL 1/2 DIPOLE ARRAYS (VERTICAL 1/2 FOR 2.5 MHz)	2.5-10	5	2.5; 5; 10; 15; 20	1,100; 440; 500; 600; 1200; 1500	±0.1	YES	CONTINUOUS	UTC	7	24
13	WWVL (4)	Fort Collins, COLORADO U.S.A.	+40°41'N +105°03'W	TOP-LOADED VERTICAL	1.8	1	0.02	NIL	±0.1	NIL	NIL	NON-OFFSET CARRIER	7	24
14	ZLFS	Lower Hutt, NEW ZEALAND	-41°14'S -174°55'E		0.3	1	2.5	NIL	±1	NIL	NIL		1	3
15	ZUD	Olifantsfontein, REPUBLIC OF SOUTH AFRICA	-25°58'S -28°14'E	VERTICAL MONOPOLE	4	1	5	1,1000	±0.5	YES	CONTINUOUS	UTC	7	24
16	ZUD	Johannesburg, REPUBLIC OF SOUTH AFRICA	-26°11'S -28°04'E	HORIZONTAL DIPOLE	0.25	1	10	1,1000	±0.5	YES	CONTINUOUS	UTC	7	24

- NOTES: (1) PRINCIPAL INFORMATION EXTRACTED FROM CCIR PROC. XIth PLENARY ASSEMBLY (NEW DELHI, INDIA, 1970). VOL. III [73] AND THE BIH ANNUAL REPORT FOR 1971 [281]. WE REFER THE READER TO THESE DOCUMENTS FOR ADDITIONAL NOTES ON VARIATIONS OF SOME BROADCASTS, AS WELL AS TRANSMISSION FORMATS.
- (2) UTC TIME ADJUSTMENT AND ZERO OFFSET OF CARRIER FREQUENCIES (ATOMIC FREQUENCY) COMMENCED JANUARY 1, 1972. STEP ADJUSTMENTS OF 1 s (LEAP SECONDS) WILL BE MADE AT DESIGNATED TIMES TO PREVENT UT1 DIFFERING FROM UTC BY MORE THAN ±0.7s. A SPECIAL CODE IS DISSEMINATED WITH TIME SIGNALS TO GIVE DIFFERENCE UT1 - UTC TO 100 ms. THE USSR BROADCASTS ALSO WILL GIVE DIFFERENCE TO 10 ms. TIME SIGNALS OF ALL STANDARD FREQUENCY BROADCASTS ARE TO BE MAINTAINED WITHIN ±1 ms. OF UTC.
- (3) AN IRIG-H (MODIFIED) BCD TIMING CODE IS TRANSMITTED CONTINUOUSLY. THIS CODE IS PRODUCED AT A 1 pps RATE AND CARRIED ON A 100 Hz SUBCARRIER, AT A COMPLETE TIME FRAME OF 1 min. THE CODE GIVES UTC IN s, min, h AND DAY OF YEAR AND CONTAINS 60/min CLOCKING RATE, 6/min POSITION IDENTIFICATION MARKERS, AND A 1/min REFERENCE MARKER. THE 100 Hz IS SYNCHRONOUS WITH THE CODE PULSES, PROVIDING 10 ms RESOLUTION.
- (4) WWVL CAN BE USED FOR SYNCHRONIZATION; IT IS AN EXPERIMENTAL BROADCAST ONLY AND IS ON AN INTERMITTENT TRANSMISSION SCHEDULE.

ANNEX 10.C. CHARACTERISTICS OF STABILIZED FREQUENCY AND TIME-SIGNAL EMISSIONS OUTSIDE ALLOCATED FREQUENCY ASSIGNMENTS (1)

MAP NO. SEE FIGURE 10.4	STATION			TRANSMITTER			CARRIER (2)				TIME SIGNALS (2)		PERIOD OF OPERATION	
	CALL SIGN	APPROXIMATE LOCATION	LONGITUDE LATITUDE	ANTENNA TYPE	RADIATED CARRIER POWER KW	# OF STIMULATED-TONEUS BROADCASTS	STABILIZED FREQUENCIES KHz	MODULATION Hz	ACCURACY PTS IN 10 ¹⁰	TIME PULSES pps	DURATION MIN	TIME SIGNAL ADJUSTMENT	DAYS PER WEEK	HOURS PER DAY
A		Alibon, FRANCE	+47°10'N -02°12'E	OMNI-DIRECTIONAL	500	1	163.84	NIL	±0.5	NIL	NIL	ZERO OFFSET CARRIER	7	24
B	Chu	Ottawa, CANADA	+45°18'N +75°45'W	FOLDED DIPOLES & RHOMBIC	3; 5	3	3330;7335; 14670	1;1000	±0.2	YES	CONTINUOUS FREQ/Voice ANNOUNCEMENT	UTC	7	24
C		Donebach, F.R. of GERMANY	+49°34'N -09°11'E	OMNI-DIRECTIONAL	70	1	151	NIL	±0.3	NIL	NIL	ZERO OFFSET CARRIER	7	24
D	DCF77	Mainflingen, F.R. of GERMANY	+50°01'N -09°00'E	OMNI-DIRECTIONAL	12	1	77.5	1;440	±0.2	YES	CONTINUOUS	ZERO OFFSET CARRIER	7	24
E		Droitwich, UNITED KINGDOM	+52°16'N +02°09'W	T	400	1	200	NIL	±0.2	NIL	NIL	ZERO OFFSET CARRIER	7	22
F	GBR	Rugby, UNITED KINGDOM	+52°22'N +01°11'W	OMNI-DIRECTIONAL	60(EST.)	1	15.95 16.00	1	±0.2	A1 TYPE	4 x 5 PER DAY	UTC	7	22 (OFF 1300-1430 UT DAILY)
G	HBG	Prangins, SWITZERLAND	+46°24'N -06°15'E	OMNI-DIRECTIONAL	20	1	75	1	±0.2	CARRIER INTERRUPTION	CONTINUOUS	UTC	7	24
H	JJF-2 JGZAS	Kemigawa, Chiba C JAPAN	+35°38'N -140°04'E	OMNI-DIRECTIONAL	10	1	40	NIL	±0.5	NIL	NIL	UTC	7	24
I	MSF	Rugby, U.K.	+52°22'N +01°11'W	OMNI-DIRECTIONAL	50	1	60	1	±0.2	CARRIER INTERRUPTION	CONTINUOUS	UTC	7	24
J	NAA (4)	Cutler, MAINE U. S. A.	+44°39'N +67°17'W	OMNI-DIRECTIONAL	1000 (EST.)	1	17.8	NIL	±0.5	NIL	NIL	UTC	7	24
K	NBA (4)	Balboa, Panama Canal Zone U. S. A.	+09°04'N +79°39'W	OMNI-DIRECTIONAL	150 (EST.)	1	24	1	±0.5	CW TIME PULSES	5 EVERY EVEN h EXCEPT 2400	UTC	7	24
L	NDT (4)	Yosami, JAPAN	34°58'N 137°01'E		50	1	17.4	NIL			NIL	UTC		
M	NPG/ NLK (4)	Jim Creek, WASHINGTON U. S. A.	+48°12'N +121°55'W	OMNI-DIRECTIONAL	250 (EST.)	1	18.6	NIL	±0.5	NIL	NIL	UTC	7	24
N	NPM (4)	Lualaba, HAWAII U. S. A.	+21°25'N +158°09'W	OMNI-DIRECTIONAL	140 (EST.)	1	23.4	NIL	±0.5	NIL	NIL	UTC	7	24
P	NSS (4)	Annapolis, MARYLAND U. S. A.	+38°59'N +76°27'W	OMNI-DIRECTIONAL	100 (EST.)	1	21.4	1	±0.5	CW TIME PULSES	5 EVERY h	UTC	7	24
Q	NWC (4)	North West Cape, AUSTRALIA	+21°49'S -114°10'E	OMNI-DIRECTIONAL	1000 (EST.)	1	22.3	1	±0.5	FSK PULSES	2 BEFORE 0430,1630 (EXPERIMENTAL)	UTC	7	24
R	OMA	Podebrazy, CZECHOSLOVAK S. R.	+50°08'N -15°08'E	T	5	1	50	1	±10	CARRIER INTERRUPTION A1 TYPE	23 h PER DAY	UTC	7	24
S	RWM-RES	Moskva, U. S. S. R.	+55°45'N -37°18'E		20	1	100	1	±50	A1 TYPE	5 EVERY h EXCEPT 2000	UTC	7	21
T	SAZ	Enköping, SWEDEN	+59°35'N -17°08'E	YAGI (12 db)	0.1 (EST.)	1	10 ⁵	NIL	±50	NIL	NIL	ZERO OFFSET CARRIER	7	24
U	SAJ	Stockholm, SWEDEN	+59°20'N -18°03'E	OMNI-DIRECTIONAL	0.1 (EST.)	1	1.5 x 10 ⁵	NIL	±1	NIL	NIL	ZERO OFFSET CARRIER	1 (FRIDAY)	2 (0930-1130 UT)
V	VE9BBS (3)	Ottawa, CANADA	+45°22'N +75°53'W	TOP-LOADED VERTICAL	0.006-1.4 (DEPENDENT ON FREQ.)	1	16.9, 23-200	NIL	±0.3	NIL	NIL	UTC	7	24
W	VNG	Lyndhurst, VICTORIA AUSTRALIA	-38°03'S -145°16'E	OMNI-DIRECTIONAL	10	2	4500;7500 12000	1;1000	±1	YES	CONTINUOUS EXCEPT FOR SILENT PERIODS	UTC	7	24 (VARIES BY FREQUENCY)
X	WWVB	Fort Collins, COLORADO U. S. A.	+40°40'N +105°03'W	TOP-LOADED VERTICAL	13	1	60	1	±0.1	TIME CODE	CONTINUOUS	UTC	7	24
Y	ZUO	Johannesburg, REPUBLIC OF SOUTH AFRICA	-26°11'S -28°04'E	OMNI-DIRECTIONAL	0.05	1	10 ⁵	1	±0.5		CONTINUOUS	UTC	7	24 (SILENT 15-25 MIN PAST h)

NOTES: (1) INFORMATION OBTAINED AS IN ANNEX B; IN ADDITION FROM REF. [74].

(2) AS NOTE (2) IN ANNEX B.

(3) EXPERIMENTAL LF STATION USED PRIMARILY FOR PROPAGATION STUDIES. FOR SCHEDULE OF FREQUENCIES BROADCAST, CONTACT DR. J. BELROSE, DEPARTMENT OF COMMUNICATIONS, SHIRLEY BAY, ONTARIO, CANADA.

(4) THESE STATIONS ARE USED PRIMARILY FOR COMMUNICATION. TRANSMISSIONS ARE REFERENCED TO C_s FREQUENCY STANDARDS AND ARE USEFUL FOR FREQUENCY SYNCHRONIZATION. STATION CHARACTERISTICS ARE SUBJECT TO CHANGE; HOWEVER, CHANGES ARE ANNOUNCED IN ADVANCE TO INTERESTED USERS BY USNO, WASHINGTON, D.C., U.S.A.

(5) FORMAT IN PLANNING STAGE.

ANNEX 10.D. CHARACTERISTICS OF FREQUENCY STABILIZED NAVIGATION SYSTEMS USEFUL FOR TIME/FREQUENCY COMPARISON⁽¹⁾

STATION ⁽²⁾				TRANSMITTER		CARRIER ⁽³⁾				TIME SIGNALS ⁽³⁾		PERIOD OF OPERATION	
CALL SIGN	CHAIN DESIGNATION ⁽⁴⁾	APPROXIMATE LOCATION	LONGITUDE LATITUDE	ANTENNA TYPE	CARRIER POWER KW ⁽⁵⁾	STABILIZED FREQUENCIES kHz	GROUP REPLICATION PERIODS (GRP) μ s	ACCURACY PTS IN 10 ¹⁰	TIME PULSES pps	DURATION	METHOD OF ADJUSTMENT	DAYS PER WEEK	HOURS PER DAY
LORAN-C SS7-M	EAST COAST U. S. A.	Caroline Beach, N. C. U. S. A.	+34°03'46"N +77°54'46"W	OMNI-DIRECTIONAL	800	100	99,300	±0.05	YES	CONTINUOUS	1 μ s STEPS	7	24
LORAN-C SS7-W		Jupiter, FLORIDA U. S. A.	+27°01'59"N +80°06'53"W	OMNI-DIRECTIONAL	400	100							
LORAN-C SS7-X		Cape Race, NEWFOUNDLAND	+46°46'32"N +53°10'29"W	OMNI-DIRECTIONAL	3000	100							
LORAN-C SS7-Y		Nantucket Island U. S. A.	+41°15'12"N +69°58'39"W	OMNI-DIRECTIONAL	400	100							
LORAN-C SS7-Z		Dana, INDIANA U. S. A.	+39°51'08"N +87°29'11"W	OMNI-DIRECTIONAL	400	100							
LORAN-C SL3-M	NORWEGIAN SEA	Ejde, Faroe Is.	+62°17'57"N + 7°04'15"W	OMNI-DIRECTIONAL	400	100	79,700	±0.05	YES	CONTINUOUS	1 μ s STEPS	7	24
LORAN-C SL3-W		Syllt, GERMANY	+54°48'29"N - 8°17'41"E	OMNI-DIRECTIONAL	300	100							
LORAN-C SL3-X		Bo, NORWAY	+68°38'05"N -14°27'54"E	OMNI-DIRECTIONAL	200	100							
LORAN-C SL3-Y		Sandur, ICELAND	+64°54'31"N +23°55'08"W	OMNI-DIRECTIONAL	3000	100							
LORAN-C SL3-Z		Jan Mayen, NORWAY	+70°54'56"N + 8°43'59"W	OMNI-DIRECTIONAL	200	100							
LORAN-C SH4-M	CENTRAL PACIFIC	Johnston Is.	+ 16°44'44"N +169°20'32"W	OMNI-DIRECTIONAL	300	100	59,600	±0.05	YES	CONTINUOUS	1 μ s STEPS	7	24
LORAN-C SH4-X		Upolo Pt., HAWAII	+ 20°14'50"N +155°53'09"W	OMNI-DIRECTIONAL	300	100							
LORAN-C SH4-Y		Kure, MIDWAY IS.	+ 28°23'41"N +178°17'30"W	OMNI-DIRECTIONAL	300	100							
LORAN-C SS3-M		Iwo Jima, JAPAN	+ 24°48'04"N -141°19'29"E	OMNI-DIRECTIONAL	4000	100							
LORAN-C SS3-W		Marcus Is.	+ 24°17'08"N -153°58'51"E	OMNI-DIRECTIONAL	4000	100							
LORAN-C SS3-X	NW PACIFIC	Hokkaido, JAPAN	+ 42°44'33"N -143°43'05"E	OMNI-DIRECTIONAL	400	100	99,700	±0.05	YES	CONTINUOUS	1 μ s STEPS	7	24
LORAN-C SS3-Y		Gesshoi, OKINAWA	+ 26°36'27"N -128°08'54"E	OMNI-DIRECTIONAL	400	100							
LORAN-C SS3-Z		Yap CAROLINE IS.	+ 9°32'46"N -138°09'55"E	OMNI-DIRECTIONAL	4000	100							
OMEGA O/N (5)	NIL	Alora, NORWAY	+66°25'N -13°09'E	TOP-LOADED FJORD SPAN	4(ERP) (6)	10.2-A 11-1/3-C 12.2(u) 13.6-(7)	NIL	±0.5	NIL(8)	CONTINUOUS (9)	(3)	7	24
OMEGA O/RD (REPLACES O/N)	NIL	La Moure, N.D., U.S.A.	+46°22'N +98°20'W	TOP-LOADED VERTICAL UMBRELLA	10(ERP)	10.2-D 11-1/3-F 13.6-E 12.85 (u) 13.1 (u)	NIL	±0.5	NIL(8)	CONTINUOUS (9)	(3)	7 (ABOUT APRIL 1972)	24
OMEGA O/T	NIL	Trinidad, WEST INDIES	+10°42'N +31°38'W	TOP-LOADED VALLEY-SPAN	1(ERP)	10.2-B 11-1/3-D 12.0(u) 13.6-C	NIL	±0.5	NIL(8)	CONTINUOUS (9)	(3)	7	24
OMEGA O/H	NIL	Haiku, HAWAII U. S. A.	+ 21°24'N +157°50'W	TOP-LOADED VALLEY-SPAN	2(ERP)	10.2-C 11-1/3-E 12.2(u) 13.6-D	NIL	±0.5	NIL(8)	CONTINUOUS (9)	(3)	7	24

- NOTES: (1) INFORMATION OBTAINED AS IN ANNEX B.
- (2) LOCATION OF LORAN-C STATIONS SHOWN IN FIGURE 10.18; OMEGA PROPOSED LOCATIONS ARE SHOWN IN FIGURE 10.16.
- (3) THESE BROADCASTS WILL BE TRANSMITTED WITH ZERO OFFSET AFTER JAN. 1, 1972; OMEGA SYSTEM WILL NOT MAKE LEAP SECOND ADJUSTMENTS.
- (4) THESE LORAN -C CHAINS ARE TIME SYNCHRONIZED AND PHASE CONTROLLED WITHIN ±15 μ s OF UTC(USNO). (M DESIGNATION INDICATES MASTER; W, X, Y, Z INDICATE SLAVE STATIONS.) FOUR ADDITIONAL CHAINS ARE USED FOR LORAN-C NAVIGATION AND EMPLOY Cs STANDARDS FOR FREQUENCY CONTROL, BUT ARE NOT MAINTAINED WITHIN ±15 μ s OF UTC. OF THESE, THE MEDITERRANEAN AND NORTH ATLANTIC ARE TIME-MONITORED AND CORRECTIONS IN TERMS OF UTC(USNO) ARE PUBLISHED WEEKLY; THE NORTH PACIFIC (ALASKA) AND SOUTHEAST ASIA ARE UNSYNCHRONIZED AND ARE NOT RELATED TO UTC. THESE LATTER FOUR CHAINS ARE SUBJECT TO TIME JUMPS AND EQUIPMENT FAILURES. SYNCHRONIZATION OF STATIONS WITHIN A CHAIN USUALLY HELD WITHIN ±0.2 μ s.
- (5) PEAK POWER EXCEPT AS NOTED ESTIMATED RADIATED POWER (ERP).
- (6) EIGHT WORLDWIDE OMEGA NAVIGATION STATIONS ARE PLANNED FOR FULL IMPLEMENTATION IN THE 1970'S. GLOBAL COVERAGE IS ANTICIPATED WITH EACH STATION RADIATING 15 kW OF POWER AT STABILIZED FREQUENCIES BETWEEN 10.2 and 13.6 kHz. FOUR INTERIM STATIONS ARE NOW IN OPERATION AND ARE IN PROCESS OF BEING UPGRADED. ADDITIONAL OMEGA STATIONS WILL BE CONSTRUCTED IN JAPAN, AUSTRALIA-NEW ZEALAND AREA, LA REUNION (INDIAN OCEAN), AND ARGENTINA.
- (7) LETTERS REFER TO SEGMENTS OF OMEGA FORMAT EXCEPT u WHICH INDICATES UNIQUE ASSIGNED FREQUENCY TO GIVEN STATION.
- (8) DAY, h, min, LOW-BIT RATE TIME CODE PROPOSED FOR FUTURE INCLUSION IN OMEGA FORMAT.
- (9) OMEGA FORMAT IS TIME MULTIPLEXED.