

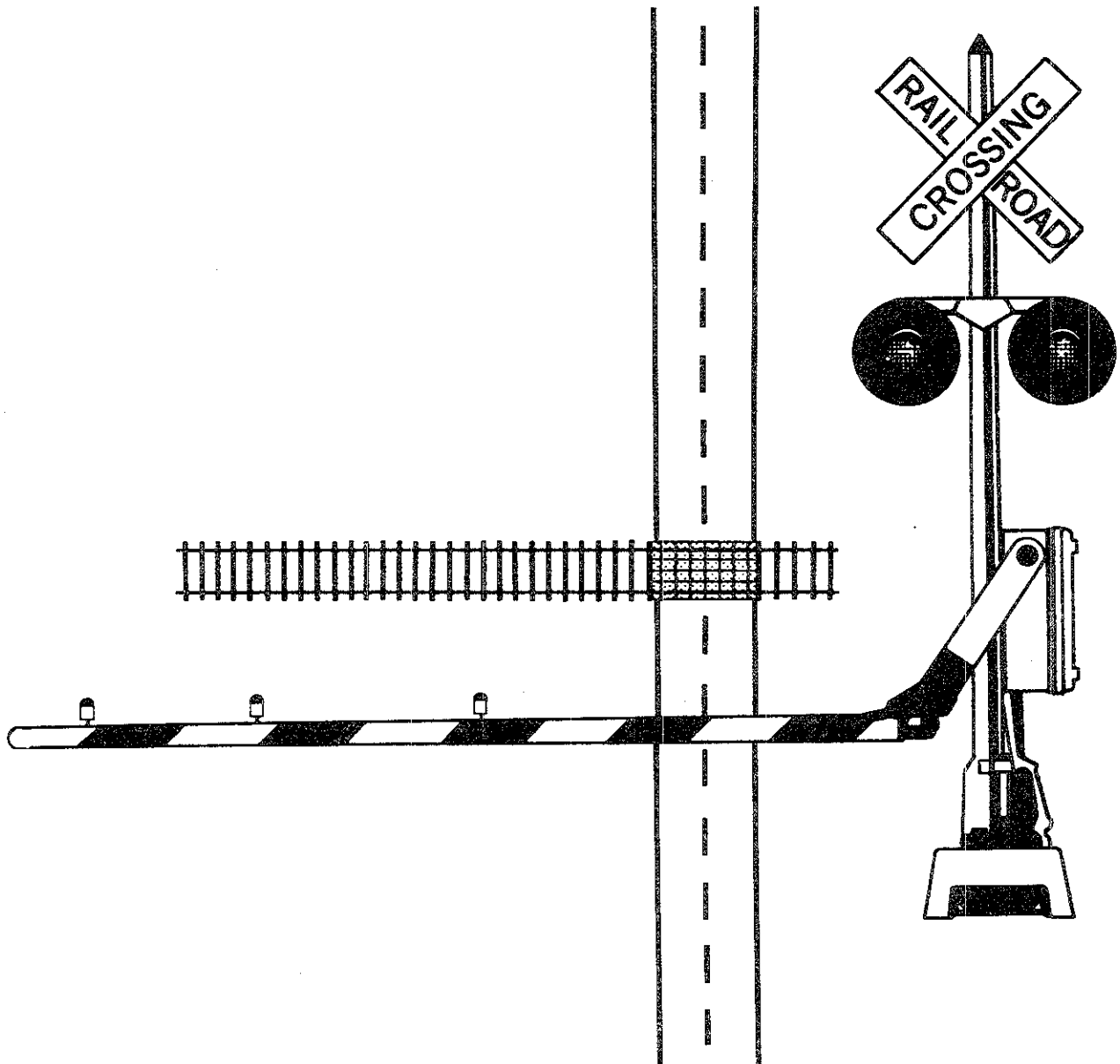

U.S. Department  
of Transportation  
**Federal Highway  
Administration**

# RAILROAD-HIGHWAY GRADE CROSSING HANDBOOK

—SECOND EDITION FHWA-TS-86-215  
SEPTEMBER 1986



## FOREWORD

This handbook provides general information on railroad-highway crossings, including characteristics of the crossing environment and users, and the physical and operational improvements for safe and efficient use by both highway and rail traffic. The handbook will be of interest to Federal, State and local highway agency personnel, railroad officials, consulting engineers and educators involved with railroad-highway grade crossing safety and operation.

The late William J. Hedley contributed generously of his background and experience toward the completion of this handbook.

This is the second printing of the second edition of the handbook. The only change from the first printing is a revision of Figure 24, page 103, to reflect the guidance for placement of the railroad crossing pavements marking symbol in relation to the location of the advance warning sign.

A standard distribution of the handbook was made to the FHWA Region and Division offices, the State highway agencies and the T<sup>2</sup> Centers in 1986. Copies of the handbook were also provided to the Federal Railroad Administration and the Association of American Railroads for their use. A limited number of copies are available from the Railroads, Utilities and Programs Branch, HNG-12, Federal Highway Administration, Washington, D.C. 20590 and the RD&T Report Center, HRD-11, Federal Highway Administration, 6300 Georgetown Pike, McLean, Virginia 22101-2396. Copies may be purchased from the National Technical Information Service, 5285 Port Royal Road, Springfield, Virginia 22161.



Stanley R. Byington  
Director, Office of Implementation  
Federal Highway Administration

## NOTICE

This document is disseminated under the sponsorship of the Department of Transportation in the interest of information exchange. The United States Government assumes no liability for its contents or use thereof. The contents of this report reflect the views of the author, who is responsible for the accuracy of the data presented herein. The contents do not necessarily reflect the official policy of the Department of Transportation. This report does not constitute a standard, specification, or regulation.

The United States Government does not endorse products or manufacturers. Trade or manufacturers' names appear herein only because they are considered essential to the object of this document.

1. Report No. FHWA TS-86-215		2. Government Accession No.		3. Recipient's Catalog No.	
4. Title and Subtitle Railroad-Highway Grade Crossing Handbook-2nd Edition				5. Report Date September 1986	
				6. Performing Organization Code	
7. Author(s) B.H. Tustin, H. Richards, H. McGee, and R. Patterson				8. Performing Organization Report No.	
9. Performing Organization Name and Address Tustin Enterprises 2903 Maple Lane Fairfax, Virginia 22031				10. Work Unit No. (TRAIS) FCP Category 1Z (A)	
				11. Contract or Grant No. DTFH61-83-C-00092	
				13. Type of Report and Period Covered Final Report Sept. 1983 to Sept. 1986	
12. Sponsoring Agency Name and Address Office of Implementation Federal Highway Administration 6300 Georgetown Pike McLean, Virginia 22101-2296				14. Sponsoring Agency Code	
15. Supplementary Notes FHWA Contract Manager (COTR): Eric Munley (HRT-20) FHWA Office of Engineering Contact: Jim Overton (HNG-12) FRA Office of Safety Analysis: Tom P. Woll (RRS-21)					
16. Abstract Rail-Highway grade crossing safety and operational problems involve two components-- the highway and the railroad. The highway component involves drivers, pedestrians, vehicles and roadway segments in the vicinity of the crossing. The railroad component involves the trains and the tracks at the crossing. The element of risk present at a given location is a function of the characteristics of the two components and their corresponding elements. Several formulas are described which seek to quantify the degree of risk, identify the locations most urgently in need of improvement, and prioritize the hazardous locations which have been isolated. Various types of at-grade crossing improvements described include active warning devices, passive warning devices, sight distance improvements, operational improvements, and crossing surface improvements. Grade separations, or crossing closures are suggested as improvement solutions where either extremely high or low demand for the crossing exists. The ultimate choice for a crossing improvement is determined by balancing the benefits in accident reduction and reduced user costs against costs for the improvement. Procedures, models and computer programs which will assist making these selections are described.					
17. Key Words Grade Crossing, Railroad, Traffic Control, Crossing Surfaces			18. Distribution Statement No restriction. This document is available to the public through the National Technical Information Service, Springfield, Virginia 22161.		
19. Security Classif. (of this report) Unclassified		20. Security Classif. (of this page) Unclassified		21. No. of Pages 273	22. Price

# METRIC (SI\*) CONVERSION FACTORS

## APPROXIMATE CONVERSIONS TO SI UNITS

Symbol	When You Know	Multiply By	To Find	Symbol
<b>LENGTH</b>				
in	inches	2.54	millimetres	mm
ft	feet	0.3048	metres	m
yd	yards	0.914	metres	m
mi	miles	1.61	kilometres	km

### AREA

in <sup>2</sup>	square inches	645.2	millimetres squared	mm <sup>2</sup>
ft <sup>2</sup>	square feet	0.0929	metres squared	m <sup>2</sup>
yd <sup>2</sup>	square yards	0.836	metres squared	m <sup>2</sup>
mi <sup>2</sup>	square miles	2.59	kilometres squared	km <sup>2</sup>
ac	acres	0.395	hectares	ha

### MASS (weight)

oz	ounces	28.35	grams	g
lb	pounds	0.454	kilograms	kg
T	short tons (2000 lb)	0.907	megagrams	Mg

### VOLUME

fl oz	fluid ounces	29.57	millilitres	mL
gal	gallons	3.785	litres	L
ft <sup>3</sup>	cubic feet	0.0328	metres cubed	m <sup>3</sup>
yd <sup>3</sup>	cubic yards	0.0765	metres cubed	m <sup>3</sup>

NOTE: Volumes greater than 1000 L shall be shown in m<sup>3</sup>.

### TEMPERATURE (exact)

°F	Fahrenheit temperature	5/9 (after subtracting 32)	Celsius temperature	°C
----	------------------------	----------------------------	---------------------	----

## APPROXIMATE CONVERSIONS TO SI UNITS

Symbol	When You Know	Multiply By	To Find	Symbol
<b>LENGTH</b>				
mm	millimetres	0.039	inches	in
m	metres	3.28	feet	ft
m	metres	1.09	yards	yd
km	kilometres	0.621	miles	mi

### AREA

mm <sup>2</sup>	millimetres squared	0.0016	square inches	in <sup>2</sup>
m <sup>2</sup>	metres squared	10.764	square feet	ft <sup>2</sup>
km <sup>2</sup>	kilometres squared	0.39	square miles	mi <sup>2</sup>
ha	hectares (10 000 m <sup>2</sup> )	2.53	acres	ac

### MASS (weight)

g	grams	0.0353	ounces	oz
kg	kilograms	2.205	pounds	lb
Mg	megagrams (1 000 kg)	1.103	short tons	T

### VOLUME

mL	millilitres	0.034	fluid ounces	fl oz
L	litres	0.264	gallons	gal
m <sup>3</sup>	metres cubed	35.315	cubic feet	ft <sup>3</sup>
m <sup>3</sup>	metres cubed	1.308	cubic yards	yd <sup>3</sup>

### TEMPERATURE (exact)

°C	Celsius temperature	9/5 (then add 32)	Fahrenheit temperature	°F
----	---------------------	-------------------	------------------------	----

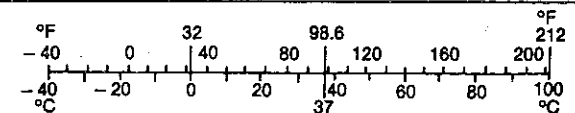

These factors conform to the requirement of FHWA Order 5190.1A.

\* SI is the symbol for the International System of Measurements



# RAILROAD-HIGHWAY GRADE CROSSING HANDBOOK

Chapter	Page
List of Figures .....	v
List of Tables .....	ix

## I. OVERVIEW

A. Background .....	1
1. Introduction to Railroad-Highway Grade Crossings .....	1
2. Safety and Operations at Railroad-Highway Grade Crossings .....	4
B. Railroad-Highway Grade Crossing Programs .....	8
C. Responsibilities at Railroad-Highway Grade Crossings .....	14
D. Some General Legal Considerations - Railroad-Highway Grade Crossings .....	23
E. References .....	27

## II. COMPONENTS OF A RAILROAD-HIGHWAY GRADE CROSSING

A. The Highway Component .....	29
1. Driver .....	29
2. Vehicle .....	33
3. Roadway .....	36
4. Pedestrian .....	40
B. Railroad Components .....	40
1. Train .....	41
2. Track .....	45
C. References .....	49

## III. ASSESSMENT OF CROSSING SAFETY AND OPERATION

A. Collection and Maintenance of Data .....	51
B. Identification of Crossings for Further Analysis .....	63
1. Peabody Dimmick Formula .....	63
2. New Hampshire Index .....	66
3. NCHRP 50 .....	66
4. U.S. DOT Accident Prediction Equations .....	70
5. Florida DOT Accident Prediction Model .....	76
C. Engineering Study .....	79
1. Diagnostic Study Team Method .....	79
2. Other Engineering Studies .....	84
D. The Systems Approach .....	85
E. References .....	87

## IV. IDENTIFICATION OF ALTERNATIVES

A. Elimination .....	89
1. Grade Separation .....	90
2. Highway and Railroad Relocation .....	91
3. Closure .....	92
4. Abandoned Crossings .....	94
B. Passive Traffic Control Devices .....	96
1. Signs .....	96
2. Pavement Markings .....	102
C. Active Traffic Control Devices .....	103
1. Flashing Light Signals .....	104
2. Automatic Gates .....	108
3. Warning Bell .....	110
4. Active Advance Warning Sign .....	114
5. Traffic Signals .....	115
6. Train Detection .....	125
D. Site and Operational Improvements .....	131
1. Sight Distance .....	131
2. Geometrics .....	135
3. Illumination .....	140
4. Shielding Supports for Traffic Control Devices .....	141
5. Flagging .....	142
6. Miscellaneous Improvements .....	142
E. Crossing Surfaces .....	143
1. Unconsolidated .....	150
2. Asphalt .....	150
3. Wood Plank .....	154
4. Sectional Treated Timber .....	155
5. Precast Concrete Slabs .....	156
6. Continuous Concrete Pavement .....	159
7. Steel Sections .....	159
8. Rubber Panels .....	161
9. High Density Polyethylene Modules .....	164
F. Removal of Grade Separation Structures .....	166
G. References .....	168

## V. SELECTION OF ALTERNATIVES

A. Warrant Procedures .....	171
B. Economic Analysis Procedures .....	171
1. Cost-Effectiveness Analysis .....	172
2. Benefit-Cost Ratio .....	173
3. Net Annual Benefit .....	175
C. Resource Allocation Procedure .....	177
D. Selection of Other Improvements .....	179
E. References .....	181

## VI. IMPLEMENTATION OF PROJECTS

A. Funding .....	183
1. Federal Sources .....	183
2. State Funding .....	185
3. Local Agency Funding .....	186
4. Railroad Funding .....	186
B. Agreements .....	186
C. Accounting .....	187
D. Design and Construction .....	189
E. Traffic Control During Construction .....	191
1. Traffic Control Zones .....	194
2. Traffic Control Devices .....	196
3. Application .....	200
F. References .....	203

## VII. MAINTENANCE PROGRAM

A. Maintenance Program .....	205
B. References .....	208

## VIII. EVALUATION OF PROJECTS AND PROGRAMS

A. Project Evaluation .....	210
B. Program Evaluation .....	211
C. Administrative Evaluation .....	212
D. References .....	212

## IX. SPECIAL ISSUES

A. Private Crossings .....	213
B. Short Line Railroads .....	215
C. High Speed Rail Corridors .....	217
D. Special Vehicles, Pedestrians, Motorcycles, and Bicycles .....	218
1. Trucks with Hazardous Material Cargo .....	218
2. Long and Heavily Laden Trucks .....	219
3. Buses .....	219
4. Motorcycles and Bicycles .....	219
5. Pedestrians .....	220
E. References .....	221

Chapter	Page
---------	------

X. SUPPORTING PROGRAMS

A. Driver Education and Enforcement .....	223
B. Research and Development .....	225
C. References .....	231

APPENDICES

A. Separate State Funding Programs Crossing Improvements .....	233
B. States Having Maintenance Funding Programs .....	235
C. Class I and II Railroads .....	237
D. Example of a Diagnostic Team Crossing Evaluation Report used by Nebraska .....	239
E. State Agencies Having Authority to Close Crossings .....	245
F. Crossing Surfaces used by States, Trial Basis or Adopted for General Use, 1984 .....	247
 GLOSSARY .....	 249
INDEX .....	257

## LIST OF FIGURES

Figure	Page
1. Crossing Exposure Index .....	4
2. Historical Phases of Crossing Safety Programs .....	6
3. Public Crossing Accident Rate by Type of Urban Road, 1983 .....	37
4. Public Crossing Accident Rate by Type of Rural Road, 1983 .....	38
5. Public Crossing Accident Rate by Annual Average Daily Traffic, 1983 .....	39
6. Public Crossing Accident Rate by Number of Trains per Day, 1983 .....	46
7. U.S. DOT/AAR National Rail-Highway Crossing Inventory Form .....	53
8. Crossing Identification Number Tag .....	52
9. Accident Report Form for Federal Railroad Administration .....	57
10. Accident Report Form for National Highway Traffic Safety Administration .....	58
11. Accident Report Form for Bureau of Motor Carrier Safety .....	61
12. Accident Report Form for Materials Transportation Bureau .....	64
13. Curves for Peabody Dimmick Formula .....	67
14. NCHRP 50 Priority Index .....	69
15. Sample Questionnaire for Diagnostic Team Evaluation .....	81
16. Study Positions for Diagnostic Team .....	82
17. Type III Barricade .....	94
18. Typical Crossing Signs .....	97
19. Crossing Sign (Crossbuck) .....	98
20. Typical Sign Placement Where Parallel Road is over 100 feet from Crossing .....	100
21. Typical Sign Placement Where Parallel Road is within 100 feet of Crossing and Intersecting Road Traffic must Stop .....	100
22. Typical Sign Placement Where Parallel Road is within 100 feet of Crossing and Parallel Road Traffic must Stop .....	100
23. Typical Application of a Stop Sign at a Crossing .....	101
24. Typical Placement of Warning Signs and Pavement Markings .....	103
25. Typical Alignment Pattern for Flashing Light Signals with 30-15 Degree Roundel, Two-Lane, Two-Way Roadway .....	105
26. Typical Alignment Pattern for Flashing Light Signals with 20-32 Degree Roundel, Multi-Lane Roadway .....	106
27. Typical Flashing Light Signal - Post Mounted .....	106
28. Typical Flashing Light Signal - Cantilevered .....	106
29. Use of Multiple Flashing Light Signals for Adequate Visibility Horizontal Curve to the Left .....	108
30. Use of Multiple Flashing Light Signals for Adequate Visibility Horizontal Curve to the Right .....	108
31. Typical Clearances for Flashing Light Signals with Automatic Gates .....	110
32. Typical Location of Signal Devices .....	110
33. Typical Location Plan, Right Angle Crossing, One-Way Two Lanes .....	111
34. Typical Location Plan, Right Angle Crossing, One-Way Three Lanes .....	111

Figure	Page
35. Typical Location Plan, Divided Highway with Signals in Median, Two Lanes Each Way .....	112
36. Typical Location Plan, Divided Highway with Signals in Median, Three Lanes Each Way .....	112
37. Typical Location Plan, Divided Highway with Insufficient Median for Signals, Two Lanes Each Way .....	113
38. Typical Location Plan, Acute Angle Crossing for Divided Highway with Signals in Median, Two or Three Lanes Each Way .....	113
39. Typical Location Plan, Obtuse Angle Crossing for Divided Highway with Signals in Median, Two or Three Lanes Each Way .....	114
40. Examples of Active Advance Warning Signs .....	114
41. Example of Cantilevered Active Advance Warning Sign .....	114
42. Key to be Used with Figures 43 through 53 .....	117
43. Typical Preemption Sequence, Signalized Intersection, Four Lane Undivided Roadways, Two Phase Operation .....	117
44. Typical Preemption Sequence, Signalized Intersection, Two Lane Roadways with Railroad Bisecting Intersection, Two Phase Operation .....	118
45. Typical Preemption Sequence, Signalized Intersection, Four Lane Undivided Roadways with Railroad Bisecting Intersection, Two Phase Operation .....	118
46. Typical Preemption Sequence, Signalized Intersection, Two Lane Roadways with Crossings on Two Approaches, Two Phase Operation .....	119
47. Typical Preemption Sequence, Signalized Intersection, Four Lane Undivided Roadways with Crossing on Two Approaches, Two Phase Operation .....	119
48. Typical Preemption Sequence, Signalized Intersection, Four Lane with Railroad Bisecting One Roadway, Two Phase Operation with Pedestrian Signals .....	120
49. Typical Preemption Sequence, Crossing Between Two Signalized Intersections, Two Phase Operation with Pedestrian Signals .....	120
50. Typical Preemption Sequence, Signalized Intersection, Four Lane Divided and Two Lane Roadways with Crossing on Major Approach, Three Phase Operation .....	121
51. Typical Preemption Sequence, Signalized Intersection, Four Lane Divided and Two Lane Roadways with Crossing on Minor Approach, Three Phase Operation .....	121
52. Typical Preemption Sequence, Intersection with Beacon Control, Crossing on Major Approach .....	122
53. Typical Preemption Sequence, Intersection with Beacon Control, Crossing on Minor Approach .....	122
54. Relocation of Intersection Stop Line to Reduce Possibility of Vehicles Stopping on Tracks .....	123
55. Relocation of Intersection Stop Line and Signal Faces to Reduce Possibility of Vehicles Stopping on Tracks .....	124
56. Use of Additional Traffic Control Signals at Crossings .....	124
57. Standby Power Arrangement .....	126
58. DC Track Circuit .....	127
59. Three Track Circuit System .....	128

Figure	Page
60. Track Circuits with Timing Sections .....	128
61. AC-DC Track Circuit .....	128
62. Audio Frequency Overlay Track Circuit .....	129
63. Motion Sensitive Track Circuit Bi-Directional Application .....	129
64. Motion Sensitive Track Circuit Uni-Directional Application .....	130
65. Constant Warning Time Track Circuit Uni-Directional Application .....	130
66. Constant Warning Time Track Circuit Bi-Directional Application .....	130
67. Crossing Sight Distances .....	131
68. Sight Distance for a Vehicle Stopped at Crossing .....	134
69. Elements of a Highway Cross Section .....	137
70. Elements of a Railroad Track Cross Section .....	138
71. Typical Pullout Lane at a Crossing .....	139
72. Connection of the Rail to the Crosstie .....	147
73. Typical Cross Section thru Plain Bituminous Crossing .....	150
74. Typical Cross Section thru Asphalt Crossing with Timber Headers .....	153
75. Typical Cross Section thru Asphalt Crossing with Flange Rails .....	153
76. Detail Section thru Flangeway of Asphalt Crossing .....	154
77. Typical Cross Section of Epflex Railseal .....	154
78. Typical Cross Section thru Wood Plank Crossing .....	155
79. Typical Cross Section thru Sectional Treated Timber Crossing .....	155
80. Typical Cross Section thru Concrete Slab Crossing .....	156
81. Typical Cross Section thru FAB-RA-CAST Crossing .....	158
82. Typical Cross Section thru Premier Crossing .....	158
83. Typical Cross Section thru Continuous Concrete Pavement .....	159
84. Typical Cross Section thru Steelpank Crossing .....	160
85. Typical Cross Section thru R.R. Crossings, Inc. Crossing .....	160
86. Typical Cross Section thru Goodyear Tire & Rubber Co. Crossing .....	161
87. Typical Cross Section thru OMNI Crossing .....	162
88. Typical Cross Section thru Parko Crossing .....	162
89. Typical Cross Section thru Red Hawk Crossing .....	163
90. Typical Cross Section thru Strail Hi-Rail Crossing .....	163
91. Typical Cross Section thru SAF & DRI Crossing .....	164
92. Typical Cross Section thru COBRA X Crossing .....	164
93. Sample Cost-Effectiveness Anaylsis Worksheet .....	174
94. Sample Benefit-to-Cost Analysis Worksheet .....	176
95. Crossing Resource Allocation Procedure .....	178
96. Resource Allocation Procedure Field Verification Worksheet .....	180
97. Areas in a Traffic Control Zone .....	195
98. Typical Signs for Traffic Control in Work Zones .....	197
99. Use of Hand Signaling Devices by Flagger .....	200
100. Crossing Work Activities, Two Lane Highway, One Lane Closed .....	201
101. Crossing Work Activities, Multi-lane Urban Divided Highway, One Roadway Closed, Two Way Traffic .....	201
102. Crossing Work Activities, Closure of Side Road Crossing .....	202

Figure	Page
103. Crossing Work Activities, One Lane of Side Road Crossing Closed .....	202
104. Typical Private Crossing Sign .....	215
105. Recommended Sign and Marking Treatment for Bicycle Crossing .....	220



## LIST OF TABLES

Table	Page
1. Railroad Line Miles and Track Miles .....	2
2. Freight and Passenger Train Miles .....	2
3. Public At-Grade Crossings by Functional Classification, 1983 .....	3
4. Public At-Grade Crossings by Highway System, 1983 .....	4
5. Fatalities at Public Crossings, 1920 - 1983 .....	5
6. Accidents, Fatalities, and Injuries at Public Crossings, 1975-1983 .....	5
7. State and Local Government Jurisdictional Authorities Concerned with Crossings .....	20
8. Public Crossings by Warning Device, 1983 .....	30
9. Needed Information and Desired Responses of Vehicle Operator .....	32
10. Motor Vehicle Accidents and Casualties at Public Crossings by Vehicle Type, 1983 .....	34
11. Design Lengths for Design Vehicles .....	35
12. Types of Freight Equipment .....	44
13. Public At-Grade Crossings by Number of Thru Trains and Switching Trains Per Day, 1983 .....	45
14. Accidents at Public Crossings Involving Motor Vehicles by Type of Train, 1983 .....	45
15. Maximum Train Speed as a Function of Track Class .....	46
16. Public At-Grade Crossings by Type of Track, 1983 .....	48
17. Accidents and Casualties at Public Crossings Involving Motor Vehicles by Track Type and Track Class, 1983 .....	49
18. Variations of New Hampshire Index .....	68
19. U.S. DOT Accident Prediction Equations for Crossing Characteristic Factors .....	71
20. U.S. DOT Accident Prediction Factor Values for Crossings with Passive Warning Devices .....	71
21. U.S. DOT Accident Prediction Factor Values for Crossings with Flashing Light Warning Devices .....	72
22. U.S. DOT Accident Prediction Factor Values for Crossings with Gate Warning Devices .....	72
23. U.S. DOT Final Accident Prediction from Initial Prediction and Accident History (1 year of accident data (T = 1)) .....	73
24. U.S. DOT Final Accident Prediction from Initial Prediction and Accident History (2 years of accident data (T = 2)) .....	74
25. U.S. DOT Final Accident Prediction from Initial Prediction and Accident History (3 years of accident data (T = 3)) .....	74
26. U.S. DOT Final Accident Prediction from Initial Prediction and Accident History (4 years of accident data (T = 4)) .....	75
27. U.S. DOT Final Accident Prediction from Initial Prediction and Accident History (5 years of accident data (T = 5)) .....	75
28. Equations for Crossing Characteristic Factors for U.S. DOT Fatal Accident Probability Formula .....	76
29. Equations for Crossing Characteristic Factors for U.S. DOT Injury Accident Probability Formula .....	76

Table	Page
30. Factor Values for U.S. DOT Fatal Accident Probability Formula .....	77
31. Factor Values for U.S. DOT Injury Accident Probability Formula .....	77
32. Distances to Establish Study Positions for Diagnostic Team Evaluation .....	82
33. Placement Distances for Advance Warning Signs .....	99
34. Effectiveness of Active Crossing Warning Devices .....	104
35. Coefficients of Friction .....	132
36. Sight Distances for Combinations of Highway Vehicle and Train Speeds .....	133
37. Rate of Change in Elevation of Pavement Edges .....	138
38. Approach Length of Pullout Lane .....	140
39. Downstream Length of Pullout Lane .....	140
40. Public Crossings by Surface Type, 1983 .....	144
41. Ground Stabilization Fabrics .....	146
42. Crossing Surface Data Sheet .....	151
43. Comparison of Cost-Effectiveness, Benefit/Cost, and Net Benefit Methods .....	177
44. Effectiveness/Cost Symbol Matrix .....	179
45. Channelizing Devices for Tapers .....	196
46. Sign Spacing for Urban Areas .....	200
47. Accidents at Private Crossings, 1979-1983 .....	214
48. Accidents at Private Crossings by Roadway User, 1983 .....	214
49. Motor Vehicle Accidents at Private Crossings by Traffic Control Device, 1983 .....	214

## I. OVERVIEW

This handbook provides general information on railroad - highway crossings, characteristics of the crossing environment and users, and the physical and operational improvements that can be made at railroad-highway grade crossings to enhance safety and operation of both highway and rail traffic over crossing intersections. The guidelines and alternative improvements presented in this handbook are primarily those that have proven to be effective and that are accepted nationwide. This handbook supersedes the Railroad-Highway Grade Crossing Handbook of August 1978.

### A. Background

#### 1. Introduction to Railroad-Highway Grade Crossings

The railroad-highway grade crossing is unique in that it constitutes the intersection of two transportation modes, which differ both in the physical characteristics of their traveled ways and in their operations.

Railroad transportation in the United States had its beginning during the 1830's and became a major factor in accelerating the great westward expansion of this country by providing a reliable, economical, and rapid method of transportation. Today, railroads are major movers of coal, ores and minerals, grains and other farm products, chemicals and allied products, food and kindred products, lumber and other forest products, motor vehicles and equipment, and other bulk materials and products.

As additional railroad lines were built and extended, they facilitated the establishment and growth of towns in the midwest and west by providing a relatively rapid means of transportation of goods and people. Towns depended on the railroads and therefore were developed along the railroad lines. The Federal government and certain States encouraged westward expansion of the railroads and financially supported them by land grants and loans. The Federal Government enjoyed reduced freight rates on its cargoes for many years as a result of these land grants. In the east, railroads were built to serve the existing towns and cities. Many communities wanted a railroad and certain concessions were made to obtain one. Railroads were allowed to build their tracks across existing streets and roads at-grade, primarily to avoid the high capital costs of grade separations. As people followed the railroads west, there was a need for new highways and streets most of which, primarily for economic reasons, crossed the railroads at-grade.

The number of railroad line miles grew until a peak was reached in 1920 when 252,845 miles of railroad line were in service. The number of railroad line miles and track miles have been decreasing since the 1930's as shown in Table 1. While the number of railroad line and track miles have been decreasing continuously at about 2 percent per year during the past few years, and the number of train miles operated has gone up and down with the fluctuations in industrial activity, there has been an overall decline in train miles. The heaviest decline has been in passenger train miles. Table 2

Table 2. Freight and Passenger Train Miles

Table 1. Railroad Line Miles\* and Track Miles\*\*

<u>Year</u>	<u>Line Miles</u>	<u>Track Miles</u>
1939	235,064	386,085
1944	227,335	374,710
1947	225,806	374,027
1951	223,427	371,782
1955	220,670	366,406
1967	209,826	341,499
1971	205,220	334,932
1975	199,126	324,156
1979	184,500	300,000
1980	179,000	290,000
1981	168,000	278,000
1982	159,123	263,330
1983	155,879	258,703

\*Except for years 1982 and 1983, railroad line miles are the aggregate length of roadway of all line-haul railroads. It excludes yard tracks, sidings, and parallel lines. Jointly used track is counted only once. Years 1982 and 1983 include Class I railroads only.

\*\*Except for years 1982 and 1983, railroad track miles are total miles of railroad track in the United States, including multiple main tracks, yard tracks and sidings, owned by both line-haul and switching and terminal companies. Years 1982 and 1983 include Class I railroads only. On average, the Class I railroads account for about 95 percent of total railroad mileage. For 1979 and subsequently, data include estimates for other than Class I.

Source: Ref. 12

<u>Year</u>	<u>Train Miles</u>
1974	534,039,763
1975	468,321,148
1976	491,057,525
1977	493,890,675
1978	497,134,000
1979	499,514,000
1980	488,948,812
1981	467,614,668
1982	401,374,432
1983	388,534,905
1984	411,070,321

Source: Ref. 16

shows the trend in freight and passenger train miles since 1974.

Initially, safety at railroad-highway grade crossings was not considered a problem. Trains were few in number and slow, as were highway travelers who were usually on foot, horseback, horse-drawn vehicles, or cycles. By the end of the century, crossing accidents were increasing and communities became concerned about safety and delays at crossings. Many States, cities, and towns adopted laws, ordinances, and regulations that required the railroads to eliminate some crossings and provide safety improvements at others.

Railroad-highway grade crossings became more of a concern with the advent of the automobile in the early 1900's. By 1920 vehicles traveled approximately 45 billion miles annually. Vehicle miles of travel have increased more than 36-fold during the intervening 63 years to 1.65 trillion vehicle miles in 1983. More recently, vehicle miles of travel have been increasing at a lower rate of 1.3% per year. Road mileage also

grew during the 63 years to approximately 3.88 million miles in 1983.

The number of railroad-highway grade crossings grew with the growth in highway miles. In cities and towns, the grid method of laying out streets was utilized, particularly in the midwest and west. A crossing over the railroad was often provided for every street, resulting in about ten crossings per mile. In 1983, there were 379,611 total intersections of vehicular and pedestrian traveled ways with railroads. This equates to approximately 2.4 crossings per railroad line mile.

Crossings are divided into categories. Public crossings are those on highways under the jurisdiction of, and maintained by, a public authority and open to the traveling public. In 1983, there were 242,980 public crossings, of which 205,339 were at-grade and 37,641 were grade separated. Private crossings are those on roadways privately owned and utilized only by the land owner or licensee. There were 133,011 private crossings in 1983. Pedestrian crossings are those that are used solely by pedestrians and there were 3,620 pedestrian crossings in 1983.

Sixty-three percent, 128,462, of public at-grade crossings were located in rural areas, compared to 76,877 in urban areas. For both urban and rural areas, the majority of crossings are located on local roads as depicted in Table 3. Twenty-three percent of public at-grade crossings are located on Federal-aid highways as shown in Table 4. Fifteen percent, 32,200, are located on State highways.

The most important single statistic affecting the occurrence of accidents at railroad-highway grade

Table 3. Public At-Grade Crossings by Functional Classification, 1983

Rural	
<u>Functional Classification</u>	<u>Number</u>
Interstate*	20
Other principal arterial	1,568
Minor arterial	4,633
Major collector	13,793
Minor collector	13,296
Local	95,108
Not reported	44
Total	128,462

Urban	
<u>Functional Classification</u>	<u>Number</u>
Interstate*	95
Other freeway/expressway	529
Other principal arterial	7,472
Minor arterial	12,837
Collector	11,475
Local	44,469
Total	76,877

\*Crossings classified as "Interstate" are typically located on ramps.

Source: Ref. 11

crossings is the exposure index, the product of annual train miles and vehicle miles, divided by 10 to the 18th power for convenience. The exposure index quantifies the interaction between railroad and highway traffic, and provides a suitable base for assessing trends in crossing safety. Figure 1 illustrates the trend in the exposure index.

Table 4. Public At-Grade Crossings by Highway System, 1983

<u>Highway System</u>	<u>Number</u>
Interstate	129
Federal-aid primary	10,182
Federal-aid urban	13,398
Federal-aid secondary	24,193
Non-federal-aid	157,394
Not reported	43
<b>Total</b>	<b>205,339</b>

Note: Crossings classified as "Interstate" are typically located on ramps.

Source: Ref. 11

## 2. Safety and Operations at Railroad-Highway Grade Crossings

National statistics on crossing accidents have been kept since the early 1900's as a result of the requirements of the Accident Reports Act of 1910. The Act required rail carriers to submit reports of accidents involving railroad personnel and railroad equipment, including those that occurred at crossings. Not all crossing accidents were reported because the railroads were required to report only those accidents that resulted in:

- o a fatality;
- o an injury to a person sufficient to incapacitate him or her for a period of 24 hours in the aggregate during the 10 days immediately following; or,
- o more than \$750 damage to railroad equipment, track or roadbed.

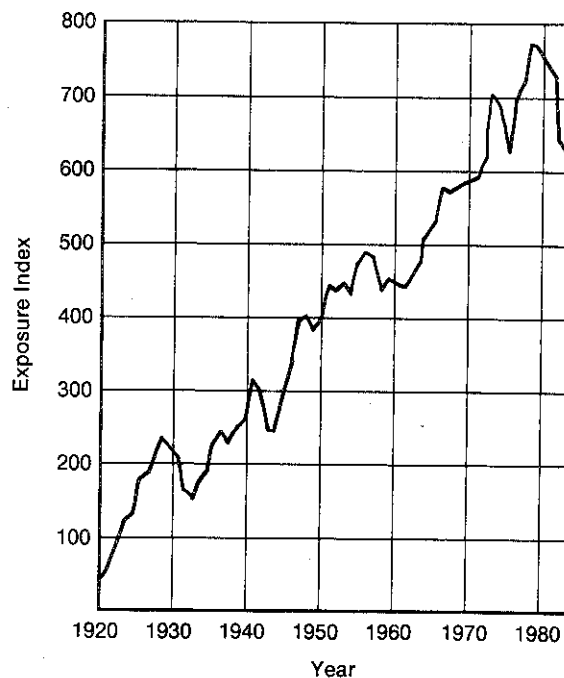

Figure 1. Crossing Exposure Index

These reporting requirements remained essentially the same until 1975 when the Federal Railroad Administration (FRA) redefined a reportable railroad-highway grade crossing accident. Under the new guidelines, any impact "between railroad on-track equipment and an automobile, bus, truck, motorcycle, bicycle, farm vehicle, pedestrian or other highway user at a rail-highway crossing"<sup>1</sup> must be reported.

Table 5 gives the number of fatalities occurring at public railroad-highway grade crossings from 1920 to 1983. Also shown separately

<sup>1</sup>Rail-Highway Crossing Accident/ Incident and Inventory Bulletin No. 6 Calendar Year 1983, Washington, DC: Federal Railroad Administration 1984.

Table 5. Fatalities at Public Crossings, 1920-1983

<u>Year</u>	<u>All Fatalities</u>	<u>Motor Vehicle Fatalities</u>	<u>Year</u>	<u>All Fatalities</u>	<u>Motor Vehicle Fatalities</u>	<u>Year</u>	<u>All Fatalities</u>	<u>Motor Vehicle Fatalities</u>
1920	1,791	1,273	1940	1,808	1,588	1960	1,364	1,261
1921	1,705	1,262	1941	1,931	1,691	1961	1,291	1,173
1922	1,810	1,359	1942	1,970	1,635	1962	1,241	1,132
1923	2,268	1,759	1943	1,732	1,396	1963	1,302	1,217
1924	2,149	1,688	1944	1,840	1,520	1964	1,543	1,432
1925	2,206	1,784	1945	1,903	1,591	1965	1,534	1,434
1926	2,491	2,062	1946	1,851	1,575	1966	1,780	1,657
1927	2,371	1,974	1947	1,790	1,536	1967	1,632	1,520
1928	2,568	2,165	1948	1,612	1,379	1968	1,546	1,448
1929	2,485	2,085	1949	1,507	1,323	1969	1,490	1,381
1930	2,020	1,695	1950	1,576	1,410	1970	1,440	1,362
1931	1,811	1,580	1951	1,578	1,407	1971	1,356	1,267
1932	1,525	1,310	1952	1,407	1,257	1972	1,260	1,190
1933	1,511	1,305	1953	1,494	1,328	1973	1,185	1,077
1934	1,554	1,320	1954	1,303	1,161	1974	1,220	1,128
1935	1,680	1,445	1955	1,446	1,322	1975	978	788
1936	1,786	1,526	1956	1,338	1,210	1976	1,114	978
1937	1,875	1,613	1957	1,371	1,222	1977	944	846
1938	1,517	1,311	1958	1,271	1,141	1978	1,021	929
1939	1,398	1,197	1959	1,203	1,073	1979	834	727
						1980	788	708
						1981	697	623
						1982	580	526
						1983	542	483

Source: Ref. 11 and 13

are fatalities resulting from collisions involving motor vehicles. Table 6 provides data on the number of accidents, injuries and fatalities at public railroad-highway grade crossings for the period from 1975 - 1983. Accidents and injuries from 1920 to 1974 are not provided because not all accidents and injuries were required to be reported during those years.

The motor vehicle fatality statistics are depicted graphically in Figure 2 which clearly demonstrates the overall improvement in safety at crossings. The exposure index provides a means by which crossing statistics can be compared throughout the years. The fatality ratio (number of fatalities divided by the exposure index) for the years 1920 through 1983 is also depicted in Figure 2.

Table 6. Accidents, Fatalities, and Injuries at Public Crossings, 1975-1983

<u>Year</u>	<u>Accidents</u>	<u>Fatalities</u>	<u>Injuries</u>
1975	11,354	978	4,168
1976	12,114	1,114	4,831
1977	12,299	944	4,649
1978	12,435	1,021	4,256
1979	11,552	834	4,172
1980	9,763	788	3,662
1981	8,546	697	3,121
1982	7,158	580	2,508
1983	6,562	542	2,467

\*Including motor vehicle and non-motor vehicle accidents.

Source: Ref. 11

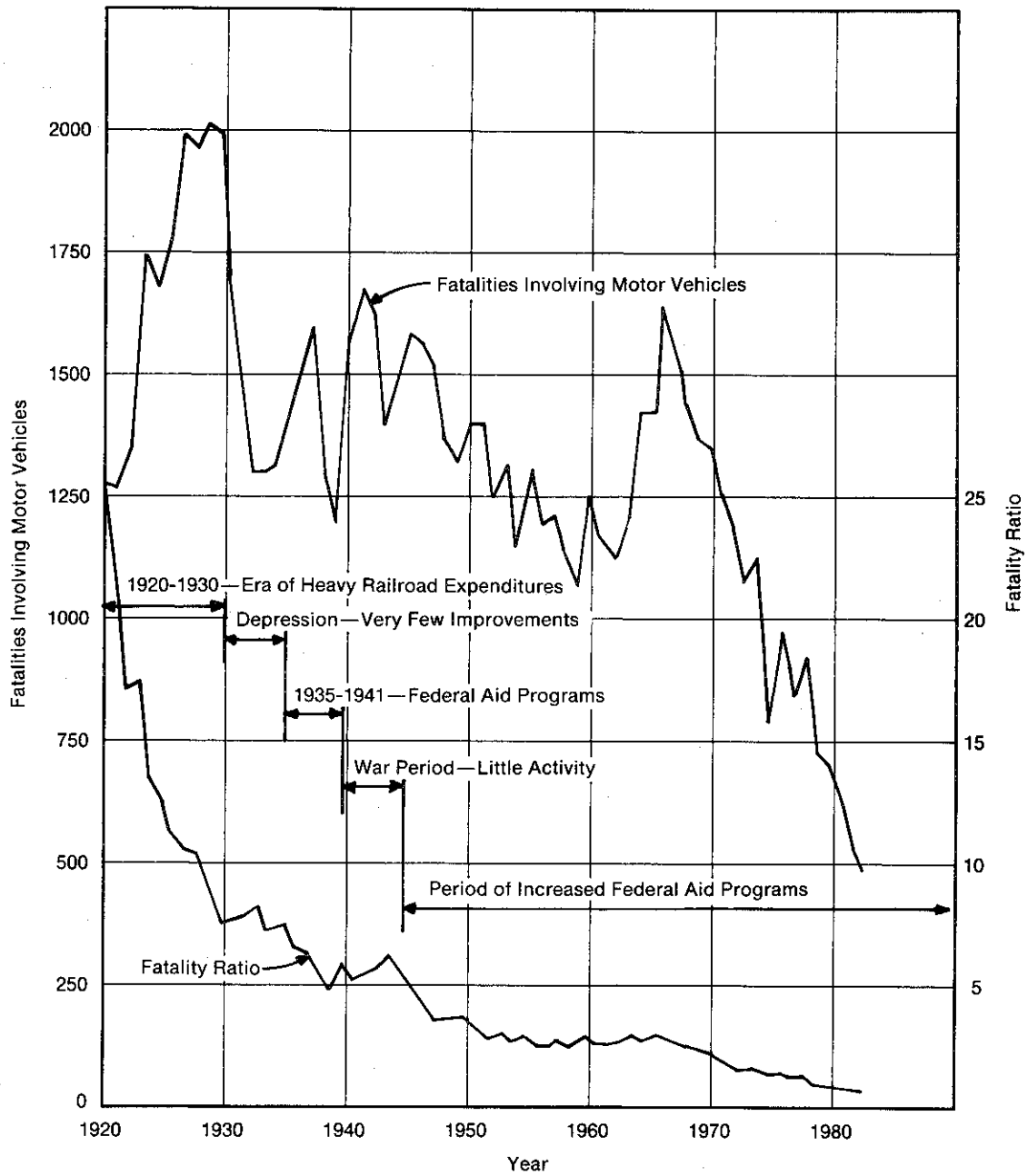

Figure 2. Historical Phases of Crossing Safety Programs



The variation in the fatality ratio appears to be related to various occurrences over the years. From 1920 to 1930, railroad expenditure for the construction of grade separations and crossing active traffic control devices was extensive. During the early four year period of the depression, railroad expenditures for crossing improvements lagged, and the fatality ratio remained about the same. Starting in 1935 some special Federal programs were initiated to improve crossing safety and the fatality ratio decreased. During the war period of the 1940's, crossing improvement work was greatly reduced and the fatality ratio increased slightly. Since 1946, Federal-aid has increased and the fatality ratio has correspondingly been decreasing.

During the period between 1960 and 1967, the fatality ratio remained almost constant; however, the number of fatalities increased as did the exposure index. This was in spite of continual Federal funding for grade separations and crossing traffic control device improvements. A national concern for crossing safety was developed as witnessed by the holding of national conferences to address the increase in casualties. The U.S. Congress responded by establishing a categorical funding program for crossing safety improvements in the 1973 Highway Act. This categorical safety program was extended in the 1976 Highway Act, and the 1978 and 1982 Surface Transportation Acts. The result of this safety program and other emphases on crossing safety is illustrated in Figure 2 which shows the dramatic reduction in the number of fatalities involving motor vehicles.

In 1983, approximately 18.3 million motor vehicle traffic accidents occurred. Crossing accidents ac-

counted for 0.03% of all motor vehicle accidents on public roads. However, the severity of crossing accidents demands special attention. In 1983, there were 483 motor vehicle fatalities at crossings and a total of 42,584 motor vehicle fatalities. Thus, crossing fatalities accounted for 1.1% of all motor vehicle fatalities. One out of every 430 vehicle accidents resulted in a fatality, but one out of every 12 crossing accidents resulted in a fatality.

While railroad - highway grade crossing accidents account for only a small portion of all highway accidents, they represent a large portion of all railroad accidents. In 1983, there were 1,073 fatalities resulting from all railroad accidents / incidents. Of these, 53.6%, 575, occurred at crossings, both public and private.

In addition to the possibility of a collision between a train and a highway user, a railroad - highway grade crossing presents the possibility of an accident that does not involve a train. Non-train accidents include: rear-end accidents in which a vehicle that has stopped at a crossing is hit from the rear; collisions with fixed objects such as signal equipment or signs; and, non-collision accidents in which a driver loses control of the vehicle.

These non-train accidents are also a concern particularly with regard to the transportation of hazardous materials by truck and the transportation of passengers, especially school buses. These "special vehicles" are, in many States, required by law to stop at all crossings and look for a train before proceeding across the tracks. The driver of a vehicle that is following a special vehicle may not expect to stop and

may rear-end the vehicle, perhaps resulting in a catastrophic accident.

While safety is a primary concern, railroad-highway grade crossings affect the public and railroads in other ways. In the 19th century most communities and cities welcomed and actively encouraged the construction of railroad lines to and within the community. As the benefits of this transportation service were realized, the communities and the railroad system within the communities grew. Today, highway-oriented transportation provides much of the service needed for commercial and other land uses in and near the central city. Newer industrial developments that need rail transportation are frequently located in outlying areas.

Historically, railroads came into the centers of communities because the railroads were first or because the community wanted the railroad to enter to provide transportation to the rest of the country. In today's environment, especially with high vehicular traffic, conflicts have arisen over the railroads' location in central cities. From the community viewpoint, the railroad is now a dividing force providing delays, congestion, and concerns over emergency vehicle response while trains are moving through, blocking many street crossings. Some communities impose speed restrictions on the trains, thereby exacerbating the situation of delays because trains take longer to clear crossings.

From the railroad viewpoint, speed restrictions are undesirable because of the delays incurred by trains slowing down to pass through the community. However, the central city location has an advantage for the railroad. Its right-of-way may be attractive to power companies who

wish to reach electric customers in the city, hence railroads may lease space for electric power transmission lines. Also, with the new development of fiber optic cables for high capacity communications services, communications common carriers are also finding railroad rights of way into center cities very attractive. Thus, on the positive side, communities and railroads are finding mutual advantages in communicating and cooperating with each other on this mutual situation.

#### **B. Railroad-Highway Grade Crossing Programs**

The first authorization of Federal funds for highway construction occurred in 1912 when the U.S. Congress allocated \$500,000 for an experimental rural post road program. The Federal-Aid Road Act of 1916 provided Federal funds to the States for the construction of "rural post roads". These funds could be expended for railroad-highway grade crossing safety improvements as well as other highway construction. The States had to match the funds on a 50-50 basis and they often required the railroads to pay the State's 50% share and sometimes more. The Federal Highway Act of 1921 provided funds with similar provisions except that the expenditure of Federal funds was restricted to a limited connected system of principal roads now called the Federal-aid primary highway system.

The Depression era of the 1930's brought about a change in railroad and highway traffic volumes and created a need for Federal assistance to promote safety as well as to provide employment throughout the nation. Congress passed the National Industrial Recovery Act in 1933 that,

among other things, authorized the President to provide grants totaling \$300 million to the States to be used in paying any or all of the costs for eliminating the hazards of railroad-highway grade crossings. The States did not have to provide matching funds and the improvements did not have to be made at crossings on the Federal-aid highway system.

The Hayden - Cartwright Act of 1934 authorized additional funds for the construction of railroad-highway grade separations and traffic control devices at crossings. Federal funds were available for initial construction costs but not for maintenance costs nor for right-of-way costs. Other Federal-aid highway funds were provided in the Emergency Relief Appropriation Act of 1935, the Authorization and Amendment Act of 1936, the Federal-Aid Highway Act of 1938, and the Federal Highway Act of 1940. In spite of these efforts to eliminate crossings, the number of crossings actually increased due to numerous highway construction projects being completed during the same period.

The Federal-Aid Highway Act of 1944 authorized the expenditure of Federal funds for Federal-aid highways in urban areas and provided for the designation of a Federal-aid secondary highway system and a national system of Interstate Highways. While the States had to provide 50% matching funds for expenditures on the primary, secondary, and urban highway systems, the entire cost for the elimination of railroad-highway grade crossing hazards on the Federal-aid system could be paid from Federal funds. However, no more than 50% of the right-of-way and property damage costs could be paid with Federal funds. In addition, no more than 10% of the total funds apportioned to each State in any year could be used

for crossing projects on a reimbursable basis up to 100%.

In the 1960's the Interstate Commerce Commission conducted an investigation of railroad-highway grade crossing safety. It concluded that the public was now responsible for crossing safety and recommended that Congress take appropriate action by stating:

Since the Congress has the authority to promulgate any necessary legislation along this line it is recommended that it give serious study and consideration to enactment of legislation with a view to having the public including the principal users, assume the entire cost of railroad-highway grade crossing improvements or allocating the costs equitably between those benefited by the improvements.<sup>2</sup>

In 1970, the U.S. Congress passed two acts, the Highway Safety Act and the Federal Railroad Safety Act, that contained specific provisions concerning railroad - highway grade crossings. The Highway Safety Act authorized two demonstration projects, one for the elimination of at-grade crossings along the Northeast Corridor high speed rail passenger route from Washington, D.C. to Boston, MA and the other for the elimination or installation of traffic control devices at public crossings in and near Greenwood, SC. The Act provided \$31 million for these demonstration projects.

-----  
<sup>2</sup>Prevention of Rail - Highway Grade Crossing Accidents Involving Railway Trains and Motor Vehicles, Washington, DC: Interstate Commerce Commission, November 1962.

## Chapter I Overview

The Railroad Safety Act of 1970 required the Secretary of Transportation to undertake "...a comprehensive study of the problem of eliminating and protecting railroad grade crossings" and to provide "recommendations for appropriate action including, if relevant, a recommendation for equitable allocation of the economic costs of any program proposed as a result of such study". Similarly, the Highway Safety Act of 1970 called for "...a full and complete investigation and study of the problem of providing increased highway safety at public and private ground-level rail-highway crossings ... including the estimate of the cost of such a program".<sup>3</sup>

The Federal Highway Administration (FHWA) and the Federal Railroad Administration (FRA) prepared a two-part report to satisfy the requirements of the legislation. Part I discussed the crossing safety problem and Part II provided crossing improvement recommendations, one of which was a Federal funding program exclusively for crossings. The Secretary also recommended that the Department of Transportation, in cooperation with the railroad industry and appropriate State agencies, develop a national inventory of crossings and a uniform national numbering system of crossings. In addition, the Secretary recommended that railroad-highway grade crossing safety research be emphasized and that efforts to educate drivers regarding the potential hazards of crossings be furthered.

-----  
<sup>3</sup>Railroad-Highway Safety, Part I: A Comprehensive Statement of the Problem, A Report to Congress, Washington, DC: U.S. Department of Transportation, November 1971.

Based on the recommendations of this study, the U.S. Congress, in the Highway Safety Act of 1973, established a categorical safety program for the elimination of hazards at railroad - highway grade crossings. Section 203 of the Act authorized, from the Highway Trust Fund, \$175 million for crossing improvements on the Federal-aid highway system. The Federal share of improvement costs was set at 90%. This Act also established funds for other categorical safety programs that could be used for crossing improvements at the States' discretion. Section 230 established the Safer Roads Demonstration Program that provided funding for safety improvements off the Federal-aid highway system. Funds under this program were available for three types of safety projects: to eliminate hazards at railroad-highway grade crossings; to improve highway marking and signing; and, to eliminate roadside obstacles. The Pavement Marking Demonstration Program, Section 205, provided funds for pavement markings on any road. The Federal-Aid Highway Amendments of 1974 added Section 219, which provided funds for the construction, reconstruction, and improvement of highways off the Federal-aid highway system.

In 1975, all public and private crossings had been surveyed in the U.S. DOT/AAR National Rail-Highway Crossing Inventory program. This inventory showed that the majority of crossings, 77%, were located off the Federal-aid highway system and thus were not eligible for improvement with Federal funds from the Section 203 program. Thus, in 1976 the U.S. Congress provided funding for all public crossings. The legislation authorized an additional \$250 million from the Highway Trust Fund for crossings on the Federal-aid highway system and \$168.75 million from the

general fund for crossings off the Federal-aid highway system.

The Surface Transportation Assistance Act of 1978 continued the Section 203 categorical funding program by providing \$760 million for safety improvements at any public crossing -- the distinction between on and off the Federal-aid highway system was eliminated.

In 1982, Congress again continued the railroad-highway grade crossing safety improvement program in the Surface Transportation Assistance Act. The Act provided \$760 million for crossing safety projects during the four fiscal years 1983 through 1986.

The Section 203 funds are apportioned to the States in the following manner: 50% of the money is apportioned according to the ratio of the number of public crossings in each State to the total number of public crossings in the entire country. The remainder is apportioned on the basis of area, population and road mileage. The Federal funds are eligible for 90% of the project costs and may be used for any public crossing, on or off the Federal-aid highway system. For more information on the requirements governing the expenditure of Federal funds on grade crossing improvements, see Chapter VI, Implementation of Projects.

Other regular Federal-aid highway funds, such as those from the primary, secondary, and urban programs, may also be used for crossing improvements on the Federal-aid highway system. These improvements can include the installation of standard signs and pavement markings, the installation or upgrading of active traffic control devices, crossing illumination, crossing surface improve-

ments, new grade separations and reconstruction of existing grade separations, crossing closures or removal of existing crossings, and crossing eliminations by relocation of highways and/or relocation of railroads. For projects to eliminate or reduce hazards at crossings, the State may utilize Federal funds for 100% of the preliminary engineering and construction costs. Right-of-way costs are funded at 75%. Most projects require no additional railroad share of costs.

The Federal-Aid Highway Act of 1973, Section 163, established a demonstration program to eliminate railroad-highway conflicts in specified urban areas. Additional funds were provided in the Federal-Aid Highway Amendments of 1974, the National Mass Transportation Assistance Act of 1974, the Federal-Aid Highway Act of 1976 and the Surface Transportation Assistance Acts of 1978 and 1982.

These demonstration projects are intended to determine the feasibility of increasing highway safety by the relocation, consolidation, or separation of rail lines in center-city areas. The funds are available for 95% of the project costs, with the State or local governments providing the matching 5%.

These demonstration projects were designated for Elko, NV; Lincoln, NE; Wheeling, WV; Blue Island, Carbondale, Dolton, East St. Louis and Springfield, IL; New Albany, Terre Haute, Lafayette, and Hammond, IN; Anoka, MN; Brownsville, TX-Matamoros, Mexico; Greenville, TX; Metairie, LA; Augusta, GA; and Pine Bluff, AR.

In the Surface Transportation Assistance Act of 1982, Title II, Section 202, Congress authorized the

## Chapter I Overview

expenditure of \$7.05 billion for the continuation of the on and off system highway bridge replacement and rehabilitation program. All bridges carrying highway traffic on public roads, regardless of ownership or maintenance responsibility, are eligible for improvement under this program. This includes highway bridges owned by railroads.

In addition to administering Federal funds for improvements at railroad-highway grade crossings, the FHWA is active in conducting research on crossings. The FRA is also active in conducting research pertaining to railroad - highway grade crossings. More detailed information on crossing research is contained in Chapter X, Supporting Programs.

Many States have been active in crossing improvement programs for decades. States have been responsible for initiating and implementing projects under the various Federal funding programs. In general, most States once required the railroad or the local government to provide the funds needed to match the Federal contribution. However, in the 1930's some States began to apportion financial responsibility for crossing improvements based on the benefits each, the public (highway agency) and the private (railroad) received, from the project.

California was the first State to establish a State crossing protection fund. In 1953, the Public Utilities Commission was authorized by legislation to expend or allocate funds from the State Highway User Fund, or any other fund, to assist the cities and counties in paying their allocated portion of the costs for the installation of active traffic control devices on non-Federal-aid highways and streets. In 1957

California established a grade separation fund with an initial appropriation of \$5 million per year. The purpose of the fund was to eliminate existing at-grade crossings by constructing new grade separations or by improving existing grade separations. Eighteen additional States have since established separate funding programs for crossing improvements. Appendix A contains a brief description of the State funding programs as of 1984.

States may also utilize other State funds for crossing improvements and to provide the required 10% match for projects funded under the Federal Section 203 program. In addition to financing costs directly associated with the improvement of railroad-highway grade crossings, all States contribute incidentally to the crossing components. In general, for crossings located on the State highway system, States provide for the construction and maintenance of the highway approaches and for traffic control devices not located on railroad right-of-way. Typically, these include advance warning signs and pavement markings. Presently, 17 States have programs to contribute towards the maintenance of flashing lights, gates, track circuitry, crossing surfaces, and crossbucks. These States are listed in Appendix B. More information on State maintenance programs is included in Chapter VII, Maintenance Program.

States are involved in other areas of crossing safety improvement besides the financial contributions towards improvement projects. Government agencies and the nation's railroads are participating in Operation Lifesaver programs which have been established in forty - four States. Operation Lifesaver Programs are designed to improve crossing safety through education of the pub-

lic regarding the hazards of crossings, promotion of engineering improvements, and enforcement of motorist traffic laws at crossings. These individual State programs are coordinated on the national level by the National Safety Council. More information on Operation Lifesaver is included in Chapter X, Supporting Programs.

Some States also conduct railroad-highway grade crossing research, utilizing Highway Planning Research (HPR) funds made available by the FHWA. Other studies are conducted in-house or on a contractual basis with consultant firms and universities and are financed from regular State highway funds.

Some local government agencies participate in railroad-highway grade crossing safety by providing the matching funds for improvement projects constructed under the Section 203 Federal program. Localities have been contributing for decades through the installation and maintenance of traffic control devices located in advance of crossings. Some cities and counties conduct safety studies at specific crossing locations.

The railroad industry has, historically, contributed greatly to the improvement of railroad-highway grade crossings. Until the advent of the automobile in the early 1900's the railroads were considered to be primarily responsible for safety at crossings. After that, the concept of joint responsibility between public agencies and private agencies, i.e. the railroads, began to emerge. As discussed previously, the Federal government and State governments began to contribute financially towards crossing improvement projects, thus accepting part of the responsibility that originally had been placed sole-

ly upon the railroads. The question of who is responsible for what aspects of the crossing program continues to be refined.

While public agencies have established funding programs for crossing improvements, railroads have continued to contribute financially as well. In some cases, the railroad may pay all or a portion of the required matching funds of a Federal Section 203 project in exchange for some other benefit such as the closure of an adjacent crossing. Many railroads have established right-of-way clearance programs that assist in improving quadrant sight distance at crossings.

At present, costs for maintenance of crossing traffic control devices and crossing surfaces are primarily funded by the railroads. Crossing devices and surfaces are usually maintained by railroad work forces because they are integrated into the signal system regulating train operations and into the physical railroad track structure. Also, labor agreements generally specify that union members are to perform this type of work. A survey by the Association of American Railroads determined that annual maintenance costs associated with active traffic control devices can range from \$1,200 to \$3,000 per crossing in 1982 dollars dependent upon the complexity of the system. With over 55,000 crossings with active traffic control devices, the annual expenditure by railroads for crossing maintenance is substantial, with minimal cost sharing by other involved parties, such as Federal, State, or local government agencies.

Railroads also work with local communities to alleviate operational concerns at railroad-highway grade

## Chapter I Overview

crossings. For example, locations for train crew changes can be made outside of city limits to avoid blocking crossings by non-moving trains. Railroads conduct some research for the purpose of identifying new technologies and furthering new concepts regarding crossing safety and operations.

The Association of American Railroads (AAR) has been active in crossing programs and has established a separate State-Rail Programs Division within its Operations and Maintenance Department. This Division provides information to the U.S. Congress and the U.S. Department of Transportation to assist in the establishment and administration of crossing programs. Railroad interests and concerns regarding crossings are typically coordinated through the AAR office. The State-Rail Programs Division has appointed a railroad employee in each State to serve as the AAR State Representative on crossing programs. A list of these representatives is available from the AAR.

Other railroad related companies also participate in crossing safety programs. The signal suppliers and the manufacturers of crossing surfaces provide guidance for the selection of a specific device or crossing surface. In addition, these companies are actively conducting research to improve their products.

Other groups and organizations are actively involved in railroad-highway grade crossing safety programs. These include the National Safety Council, the National Transportation Safety Board, the American Railway Engineering Association, the Railway Progress Institute, the Transportation Research Board, and various other highway safety organizations. The responsibilities of

these organizations are discussed in the next section.

### C. Responsibilities at Railroad - Highway Grade Crossings

An issue that is as old as the grade crossing safety problem itself is that of responsibility. Who should provide and pay for the traffic control devices at railroad-highway grade crossings?

During the years from 1850 to 1870, there was tremendous growth in population that followed the railroads west. Consequently there was need for new highways and streets, practically all of which crossed the railroads at grade. In most cases the responsibility for these crossings automatically fell upon the railroads. Occasionally, there were accidents at crossings, but they were usually not as serious as those occurring today.

One of these early accidents, involving the collision of a train and wagon at Lima, Indiana, resulted in a court suit that eventually reached the U.S. Supreme Court in 1877. In *Continental Improvement Co. v. Stead*, the Court had to determine who was liable for the damages incurred. In its decision the Court said that the duties, rights, and obligations of a railroad company as well as a traveler on the highway at the public crossing were "mutual and reciprocal". It also said that a train had the right - of - way over crossings because of its "character", "momentum", and "the requirements of public travel by means thereof". The railroad, however, was bound to give reasonable and timely warning of the train's approach. The Court further stated that "those who are crossing a railroad track are bound to exercise



ordinary care and diligence to ascertain whether a train is approaching". This Supreme Court decision clearly indicated that there was a responsibility upon the railroads to warn travelers on the highways of approaching trains and a responsibility of travelers to look, listen and stop for approaching trains.<sup>4</sup>

During the late 1890's, the number of crossings and the number of accidents increased. Many States, cities, and towns demanded that the railroads take immediate action to eliminate the hazardous crossings and to provide better traffic control devices at others to minimize the accidents. Numerous laws, ordinances, and regulations were enacted or adopted to enforce these demands. There was no uniformity among the laws, ordinances, and regulations. Neither was the division of responsibility nor the allocation of costs specified.

In 1893, the U.S. Supreme Court, in *New York & N.E. Ry. v. Town of Bristol*, upheld the constitutionality of a Connecticut statute that required the railroads to pay three-fourths of the costs to improve or eliminate crossings where the highway was in existence before the railroad. If the highway was constructed after the railroad, the State required the railroad to pay one-half of such costs. This so-called "Senior-Junior" principle was followed by the commissions and courts in several States to determine the railroads' division of responsibility or liability for the construction, improvement or elimination of crossings. From 1896 to 1935 the U.S. Supreme Court adhered to the position that a State could allocate to the railroads all, or a portion,

of the expense or cost for the construction, maintenance, improvement, or elimination of public railroad-highway grade crossings.

The crossing safety problem was changed greatly by the appearance of motor vehicles on the Nation's highways and streets in 1893. As the number of motor vehicles, highway mileage, and railroad trackage increased, so did the number of crossings and crossing accidents. The demands for elimination of crossings grew stronger nationwide. Because of the dominance and financial status of the railroad industry during this period, the public, State legislative and regulatory bodies, and most of the courts, did not hesitate to place the major, or entire, responsibility for crossing separations and improvements on the railroads. By 1915 the railroads were beginning to feel the impact of the crossing safety problem, and established a national committee to study the problem. During the period from 1915 to 1924, this committee, the National Safety Council, and the American Railway Association engaged in extensive public education programs to reduce the number of accidents at crossings.

The depression era of the 1930's brought about abrupt and varying changes in the volumes of rail and highway traffic, which contributed to changes in the responsibility for crossing improvements. A new idea of public responsibility was enhanced by Congress in its passage of the National Industrial Recovery Act of 1933 and The Hayden-Cartwright Act of 1934 that provided funds for the construction of railroad-highway grade separations and the installation of crossing traffic control devices.

This expanded Federal highway construction program had a great deal

---

<sup>4</sup>Ibid.

## Chapter I Overview

of influence on the U.S. Supreme Court's landmark decision in Nashville, C. & St. L. Ry. v. Walters in 1935. Justice Brandeis, writing for the majority of the Court, said:

The railroad has ceased to be the prime instrument of danger and the main cause of accidents. It is the railroad which now requires protection from dangers incident to motor transportation.<sup>5</sup>

In light of that decision, some State legislatures, commissions, and courts revised their division of responsibility criteria, and the resulting allocation of costs relating to crossing safety projects.

The Federal-Aid Highway Act of 1944 provided that any railroad involved in any crossing improvement project, paid for entirely or in part with Federal funds, would be liable to the United States for "a sum bearing the same ratio to the net benefits received by such railway from such project that the Federal funds expended on such project would bear to the total cost of such project". This subsection also provided that the net benefits received by a railway should not "be deemed to have a reasonable value in excess of ten percent of the cost of any such project". The Commissioner of Public Roads was authorized to determine the railroad benefits on the basis of recommendations made by the State highway departments and other information.<sup>6</sup>

During the period from 1944 to 1946, many crossing safety projects

-----  
<sup>5</sup>Ibid.

<sup>6</sup>Ibid.

were delayed, or never started, because of prolonged negotiations, arguments, and litigation on the issue of railroad benefits. A compromise was eventually reached whereby each of the crossing improvement projects would be classified as being in one of five general classes. Depending upon the classification assigned to an individual project, the railroads would be liable for up to 10% of the costs of crossing improvements financed with Federal - aid highway funds. The FHWA later modified this policy and presently the railroads are required only to share in 5 percent of the costs of certain types of crossing work on Federal-aid highway projects.

In the early 1960's, the Interstate Commerce Commission completed an investigation to determine what action should be taken to prevent crossing accidents. In its report and accompanying order, the Commission said that:

For practical reasons costs associated with crossing safety improvements should be borne by public funds as users of the crossing plus the fact that it is the increasing highway traffic that is the controlling element in accident exposure at these crossings.

The Commission also said that:

In the past it was the railroad's responsibility for protection of the public at grade crossings. This responsibility has now shifted. Now it is the highway, not the railroad, and the motor vehicle, not the train which creates the hazard and must be primarily responsible for its removal. Railroads were in operation before the problem

presented itself and if the increasing seriousness is a result of the increasing development of highways for public use, why should not the cost of grade crossing protection be assessed to the public?

The Commission found:

That highway users are the principal recipients of the benefits following from rail - highway grade separations and from special protection at rail-highway grade crossings. For this reason the cost of installing and maintaining such separations and protective devices is a public responsibility and should be financed with public funds the same as highway traffic devices.

During the 1970's the public assumed more of the responsibilities for financing crossing safety improvements. Federal highway legislation in 1973, 1976, 1978, 1980, and 1982 provided categorical funds for crossing safety improvements. Today, an understanding exists that, because railroad-highway grade crossings involve two transportation modes, one public and the other private, their safe and efficient operation require strict cooperation and coordination of the involved agencies and organizations. Public agencies having responsibilities at an intersection of the two modes include the following.

-----  
<sup>7</sup>Prevention of Rail - Highway Grade Crossing Accidents Involving Railway Trains and Motor Vehicles, Washington, DC: Interstate Commerce Commission, November 1962.

At the Federal Level

- o Federal Highway Administration (FHWA)
- o Federal Railroad Administration (FRA)
- o National Transportation Safety Board (NTSB)
- o National Highway Traffic Safety Administration (NHTSA)

At the State Level

- o State highway departments
- o State departments of transportation
- o State regulatory agencies
- o State highway safety agencies
- o State departments of public safety

At the Local Level

- o Highway department field maintenance offices
- o County road engineer offices
- o City public works agencies
- o Law enforcement agencies

The U.S. Department of Transportation (DOT) seeks to ensure that a viable and safe national transportation system is maintained to transport people and goods while making efficient use of our national resources. Three agencies within the U.S. DOT, FHWA, FRA, and NHTSA, actively participate in crossing programs.

## Chapter I Overview

The FHWA administers Federally funded programs, several of which are available for crossing improvements. In addition to funds from the Section 203 categorical crossing program, funds from the primary, secondary, and urban programs may be utilized at crossings. The FHWA apportions these funds to the States according to legislated formulae and in the amounts authorized by Congress for each program. It establishes procedures by which the States obligate the funds to specific projects. It oversees the overall implementation of the Federally funded programs.

The FHWA establishes standards for traffic control systems at crossings and publishes these in the Manual on Uniform Traffic Control Devices. The FHWA has also adopted, for use in Federal-aid highway projects, various design criteria and guidelines developed by AASHTO and other organizations. The FHWA provides technical assistance to the States through the distribution of state - of - the - art handbooks and through special training classes.

The FHWA conducts research to support the above activities. Typical research involves road-side traffic control devices, accident causation, program management tools, and accident countermeasures. All of FHWA's crossing research is coordinated with FRA and, in some cases FRA contributes financially to the projects. The FHWA promotes maintenance of individual State grade crossing inventories and maintenance of the national inventory by the individual States.

The FRA maintains the Railroad Accident/Incident Reporting System that contains information reported by the railroads on all crossing accidents. The FRA also serves as custo-

dian of the National Rail-Highway Crossing Inventory that contains physical and operating characteristics of each crossing. The information is submitted voluntarily by the railroads and States. The FRA works with other agencies and organizations in overseeing the submission of the inventory data to ensure accurate and timely information.

The FRA conducts field investigations of selected railroad accidents, including crossing accidents. The FRA investigates complaints by the public pertaining to crossings and makes recommendations to the industry, as appropriate.

The FRA conducts research to identify solutions to crossing problems, primarily from a railroad perspective. Typical research includes program management tools, train-borne warning devices, and track circuitry improvements. Research is coordinated with FHWA and in some cases, FHWA contributes financially.

Both the FHWA and FRA have field offices located throughout the country, which collaborate with the State highway agencies, and the individual railroads, respectively, on a day-to-day basis. They ensure that policies and regulations are effectively implemented and provide feedback to headquarters regarding needs realized at the field level. FHWA has a Division Administrator located in each State.

The NHTSA is involved in the crossing program on a limited basis. It maintains the Fatal Accident Reporting System (FARS), a data base containing information on all fatal highway accidents. NHTSA cooperates with FRA and FHWA in providing information contained in FARS that is pertinent to crossings.

The National Transportation Safety Board (NTSB) provides a comprehensive review of the safety aspects of all transportation modes. Through special analyses and accident investigations, it identifies specific safety problems and associated remedies that are presented as recommendations to specific agencies and organizations. Results of recommendations pertaining to crossings include: 1) the adoption of the Operation Lifesaver Program by the National Safety Council; and, 2) the development by FHWA of a specific program addressing the operation of trucks carrying hazardous materials over crossings.

Jurisdiction over railroad-highway grade crossings resides primarily with the States. Within some States, responsibility is divided among several public agencies and the railroad. In a number of States, jurisdiction over the crossing is assigned to a regulatory agency referred to as a Public Utilities Commission, Public Service Commission, or similar designation. In other States, the authority is divided among the public administrative agencies of the State, county, and city having jurisdiction and responsibility for their respective highway systems. State highway agencies are responsible for the implementation of a program that is broad enough to involve any public crossing within the State. Table 7 indicates the State agencies responsible for public and private crossings, and whether their jurisdiction is regulatory or administrative.

State and local law enforcement agencies are responsible for the enforcement of traffic laws at crossings. Local government bodies are responsible for ordinances governing operational matters related to crossings.

Private and non-profit agencies and organizations having some concerns for crossings include the following:

- o Railroad companies
- o Equipment suppliers
- o Rail labor organizations
- o Association of American Railroads (AAR)
- o American Railway Engineering Association (AREA)
- o American Short Line Railroad Association (ASLRA)
- o Railway Progress Institute (RPI)
- o American Association of State Highway and Transportation Officials (AASHTO)
- o Transportation Research Board (TRB)
- o National Safety Council (NSC)
- o American Road and Transportation Builders Association (ARTBA)
- o American Trucking Association (ATA)
- o Institute of Transportation Engineers (ITE)

The Association of American Railroads is a voluntary, unincorporated, non-profit organization composed of member railroad companies operating in the United States, Canada and Mexico. It is a joint representative and agent of these railroads in connection with Federal regulatory matters of common concern to the industry as a whole.

Table 7. State and Local Government Jurisdictional Authorities Concerned with Crossings

State	Has Authority Relating To						
	Agency		Public Crossings			Private Crossings	
	Regulatory	Admini- strative	Improvement	Cost Allocation	Closing	Improvement	Closing
Alabama	--	S-C-C	Yes	Yes	No	No	No
Alaska	--	Hwy.C	Yes	Yes	Yes	No	No
Arizona	Corp.C	--	Yes	Yes	Yes	No	No
Arkansas	--	S-C-C	Yes	No	Yes	No	No
California	PUC	--	Yes	Yes	Yes	Yes	Yes
Colorado	PUC	S-C-C	Yes	Yes	Yes	No	No
Connecticut	DOT	--	Yes	Yes	Yes	Yes	Yes
Delaware	DOT	DOT	Yes	Yes	Yes	No	No
Florida	DOT	DOT	Yes	Yes	Yes	No	No
Georgia	--	S-C-C	Yes	Yes	Yes	No	No
Hawaii	--	--	--	--	--	--	--
Idaho	PUC	S-C-C	Yes	Yes	Yes	No	No
Illinois	Com.C	--	Yes	Yes	Yes	No	No
Indiana	PSC	S-C-C	Yes	Yes	Yes	No	No
Iowa	DOT	DOT	Yes	Yes	Yes	No	No
Kansas	Corp.C	--	Yes	Yes	No	No	No
Kentucky	--	S-C-C	Yes	Yes	Yes	No	No
Louisiana	--	S-C-C	Yes	No	Yes	No	Yes
Maine	DOT	--	Yes	Yes	Yes	No	No
Maryland	DOT	S-C-C	Yes	Yes	Yes	Yes	Yes
Massachusetts	PUC	--	Yes	Yes	Yes	No	No
Michigan	DOT	--	Yes	Yes	Yes	--	No
Minnesota	DOT	DOT	Yes	Yes	Yes	No	No
Mississippi	PSC	S-C-C	Yes	Yes	Yes	No	No
Missouri	PSC	S-C-C	Yes	Yes	Yes	No	No
Montana	PSC	Hwy.C	Yes	Yes	Yes	No	No
Nebraska	--	S-C-C	Yes	Yes	Yes	No	No
Nevada	PSC	DOT	Yes	Yes	Yes	No	No
New Hampshire	PUC	Hwy.C	Yes	Yes	Yes	Yes	Yes
New Jersey	DOT	DOT	Yes	Yes	Yes	Yes	Yes
New Mexico	Corp.C	--	Yes	Yes	Yes	No	No
New York	DOT	DOT	Yes	Yes	Yes	No	No
North Carolina	--	Hwy-Cty	Yes	Yes	Yes	No	No
North Dakota	PSC	--	Yes	Yes	Yes	Yes	Yes
Ohio	PUC	S-C-C	Yes	Yes	Yes	No	No
Oklahoma	Corp.C	--	Yes	Yes	Yes	No	No
Oregon	PUC	--	Yes	Yes	Yes	No	No
Pennsylvania	PUC	--	Yes	Yes	Yes	No	No
Rhode Island	PUC	DOT	Yes	Yes	Yes	Yes	Yes
South Carolina	--	S-C-C	Yes	Yes	Yes	No	No
South Dakota	DOT	DOT	Yes	Yes	Yes	Yes	Yes
Tennessee	PSC	S-C-C	Yes	Yes	Yes	No	No
Texas	--	S-C-C	Yes	Yes	Yes	No	No
Utah	PSC	DOT	Yes	Yes	Yes	No	No
Vermont	PSC	--	Yes	Yes	Yes	No	No
Virginia	Corp.C	Hwy.C	Yes	Yes	Yes	No	No
Washington	U&TC	--	Yes	Yes	Yes	No	No
West Virginia	PSC	Hwy-Cty	Yes	Yes	Yes	No	No
Wisconsin	TC	--	Yes	Yes	Yes	No	No
Wyoming	PSC	--	Yes	Yes	Yes	No	No

## LEGEND

Com.C	Commerce Commission	PUC	Public Utilities Commission, Division of
Corp.C	Corporation Commission		Public Utilities, Public Utility Commissioner
DOT	Department of Transportation	S-C-C	State, County, City, divided authority
Hwy.C	Highway Commission, Department of Highways,	TC	Transportation Commission
Hwy-Cty	Highway Commission and City, divided authority	U&TC	Utilities and Transportation Commission
PSC	Public Service Commission, Public Service Board		

Source: Ref. 6

In the area of crossings, the AAR works closely with the U.S. DOT, the U.S. Congress, NTSB, the National Safety Council (NSC), the Railway Progress Institute (RPI) and others.

The AAR has crossing representatives in each State. These State representatives, who are railroad employees, provide liaison with groups and government agencies having interests in crossings within that State. They hold meetings when deemed necessary to ensure that a cooperative approach is established and maintained.

The AAR provides some of the financial support for the National Operation Lifesaver program and works closely with the NSC in promoting the continued development of this program.

The AAR conducts research pertaining to crossings. Some of this research is conducted jointly with other organizations, e.g. AASHTO and the U.S. DOT. Recent research has included a compilation of State laws and regulations pertaining to crossings and a review of the utilization of train-borne traffic warning devices. The AAR cooperates with other organizations conducting research by providing information on crossings from the railroad perspective.

The American Railway Engineering Association (AREA), an organization of railway engineers and officers, and having a close relationship with AAR, serves to advance knowledge pertaining to the scientific and economic location, construction, and maintenance of railways. It has 22 technical committees that develop facts and information pertaining to their scientific and technical interests and develop recommended practices for adoption in the Manual for Railway Engineering and Portfolio of Track-

work Plans. Committee 9, Highway Railway Programs, is charged with matters pertaining to railroad-highway grade crossings.

The American Short Line Railroad Association (ASLRA) is a non-profit organization representing the interests of its member railroads. It provides liaison between its members and other groups having interests in the railroad industry. The ASLRA works with the U.S. DOT and the U.S. Congress to ensure that the unique characteristics of small railroads are considered in national legislations and regulations.

The Railway Progress Institute (RPI) is an organization of railroad equipment suppliers. It serves as liaison on the national level between its members and those agencies and organizations having interests in the railroad industry.

The RPI monitors the development of national policies and programs and determines their impact on its members. It identifies the future demand for its members' products and identifies areas of needed product development and research.

Each of its members is continually conducting in-house research for the purpose of improving existing products and developing new products to meet railroad needs. Improvements in the crossing area involve constant warning time devices, crossing surfaces, and modifications to automatic traffic control devices. RPI is a financial supporter of Operation Lifesaver and a collaborator with the National Safety Council.

The American Association of State Highway and Transportation Officials (AASHTO) is an organization of officials from State highway agen-

## Chapter I Overview

cies. AASHTO seeks to foster the development of a national transportation system and serves as liaison between its members and other agencies and organizations having interests in highway transportation.

AASHTO develops and publishes recommended standards for the design, operation and maintenance of highways, including crossings. It conducts research as appropriate and participated with the AAR in the development of information pertaining to rail-highway related matters.

The Transportation Research Board (TRB) was established in 1920 and operates under the corporate authority of the National Research Council, which serves both the National Academy of Sciences and the National Academy of Engineering. The purpose of TRB is to advance knowledge of the nature and performance of transportation systems through the stimulation of research and dissemination of information. The TRB's objectives are accomplished through technical committee activities, annual meetings, seminars and workshops, computerized information services, publications, and special projects.

TRB Committee A3A05, Railroad-Highway Grade Crossings, promotes crossing research and sponsors technical papers for publication and presentation at the TRB Annual Meeting. It identifies areas of needed research and publishes a bibliography of past crossing research and other substantive documents in the general area of railroad-highway grade crossings.

The National Safety Council (NSC) was established in 1913 and chartered by Congress as a not-for-profit voluntary service organization

solely committed to preventing accidents and occupational illnesses. The NSC coordinates the National Operation Lifesaver Program. The NSC works with State agencies to encourage the development and promotion of Operation Lifesaver programs within each State. It sponsors national conferences for the purpose of sharing unique Operation Lifesaver programs and for identifying solutions to existing impediments. The NSC develops Operation Lifesaver materials and guides for use in individual State programs.

The American Road and Transportation Builders Association (ARTBA) is an organization whose members include representatives of the railroad industry, public officials at all levels of government, business firms in the traffic safety industry, and highway contractors. For many years, ARTBA has supported programs of Federal assistance for safety improvements at grade crossings.

American Trucking Associations, Inc. (ATA) is the national organization of trucking industry management. It represents all segments of the industry and deals with all phases of the industry's operations.

Safety has the highest priority. As a part of its overall safety effort, the ATA's Safety Department develops material to inform management and drivers of grade crossing hazards and the safe practices necessary to avoid accidents. The department has developed a grade crossing evaluation program for use by members of its safety arm, the ATA Council of Safety Supervisors, at the State and national level.

The Institute of Transportation Engineers (ITE) is a professional scientific society of transportation



professionals responsible for planning, design, operations, and maintenance of surface transportation facilities. The ITE has more than 7000 members in over 70 countries. The majority of its members are involved in highway and public transportation. Many Institute members, employed by government agencies, industry, and consulting firms, work directly with railroad - highway grade crossing issues and problems.

#### **D. Some General Legal Considerations- Railroad-Highway Grade Crossings**

Highway and railroad engineers are becoming increasingly involved in a field of litigation that was recently of concern only to attorneys. Today, it is incumbent upon staffs of State highway departments, local transportation agencies, and railroads to become aware and keep abreast of highway law in general and the legal elements of operational practices in particular. This discussion of legal considerations in the administration and management of railroad-highway grade crossings is a very basic discussion of a very complex subject. It is not meant to interpret the law or establish guidelines. It is intended only to alert transportation agencies and railroads of the need to recognize and respond to the possible consequences of failure to maintain and safeguard the railroad-highway grade crossing. The particular aspects of a specific potential legal problem should be discussed with an attorney.

Until recently, government entities were generally immune from lawsuits on the theory of "sovereign immunity" derived from English common law. Under the sovereign immunity doctrine, a government entity can be sued only if it consents to the suit

in advance. Over the past 25 years this situation has changed dramatically. Sovereign immunity has been eroded through the actions of courts and/or legislatures and now survives in less than a third of the States. Consequently, many State highway departments have become vulnerable to lawsuits for damages resulting from highway accidents.

Since many States now may be sued for negligence on the part of its officers or employees, new emphasis has been placed upon the legal responsibility of parties involved in the selection and implementation of crossing safety improvements. This is especially true when the State is responsible for determining which crossings are to be upgraded and the type of warning systems to be installed.

The State has a duty to correct a dangerous condition when its agency has actual or "constructive" notice of the hazards. The actual notice requirement does not apply when the dangerous condition is the result of the State's own negligence. For example, a State is not required to have actual notice of faulty construction, maintenance, or repair of its highways, because the State is expected to know of its own actions, i.e. "constructive" notice. "Constructive" notice is knowledge imputed by law, usually after an injury has occurred. However, if the danger did not arise as a consequence of active negligence (such as faulty construction), the agency has the duty to make repairs once it has actual notice of the defect.

Most courts hold that the State must have had notice of the defect or hazard for a sufficient or reasonable time "to afford them a reasonable opportunity to repair the condition or

take precautions against the danger." Statutes may require that States have notice of the condition for a specified period of time. If, for example, the notice period is five days, and an accident was caused by a defect that originated early in the day of the accident, the statutory notice period would not be satisfied and the agency would not have had a reasonable opportunity to effect repairs. On the other hand, the notice may be satisfied where the condition has existed for such a time and is of such a nature that the State should have discovered the condition by reasonable diligence, particularly where there is no statutory specified time. In such instances, the notice is said to be constructive, and the State's knowledge of the condition is said to be implied. In deciding whether the State had notice, the courts may consider whether the defect was latent and difficult to discover. That is, the court will consider the nature of the defect, its location and duration, the extent and use of the highway, and whether the defect could be readily and instantly perceived. Routine inspection and correction procedures are important in light of the trend by courts to permit less and less time before finding "constructive notice".

To understand the legal responsibilities of traffic agencies and railroads, it is necessary to understand the basic principles and terminology of tort law.

A tort in legal terminology is a civil wrong other than breach of contract, for which a court of law will provide a remedy in the form of an action for money damages. There are three basic elements involved in any tort action:

- o a legal duty exists between the parties;
- o a violation or breach of that duty by one of the parties; and,
- o damage to the other party as a proximate result of the breach of duty.

Torts can be either intentional (e.g., assault, and battery, false imprisonment, trespass, and theft) or unintentional (e.g., negligence). The primary concern for crossings are allegations of negligence.

Liability for a tort means the legal obligation to pay money damages to the person injured or damaged. More than one person or organization may be liable for damages arising out of the same incident. In the case of negligent conduct by an employee, both the employee and the employer may be liable.

Negligence can be defined as the failure to do something that a "reasonable person" would ordinarily do, or the doing of something that a reasonably prudent person would not do. Negligent conduct is that which creates an unreasonable risk for others to whom is owed a duty of exercising care.

The reasonable person is a criteria used to set the standard of care in judging conduct. In effect, this test of negligence represents the "failure to use ordinary care," and is most often used in determining liability. In the context of this Handbook, engineers may be found to be negligent if their conduct does not measure up to that of a hypothetical reasonable, prudent, and careful engineer under similar circumstances.

Contributory negligence refers to conduct that falls below the standard of care that a person (e.g. a driver) is legally required to exercise for his own safety, and this failure is a contributing cause to the injury or damage he has suffered. Until recently, in most States, a finding of contributory negligence by the court would bar a plaintiff from recovering damages even if the defendant's negligence had been established and was the primary cause of the accident. Contributory negligence as a bar to recovery is being gradually eroded in the U.S. by the doctrine of "comparative negligence".

Comparative negligence is a rule of law adopted by many States whereby the negligence of both parties is compared, and recovery is permitted despite the contributory negligence of the plaintiff. However, plaintiff's damages are usually decreased in proportion to his own contributory negligence.

Duty in tort law is an obligation requiring persons to conform to a certain standard of conduct for the protection of others against unreasonable risks. Negligence is a breach of duty to exercise reasonable care owed to those persons to whom the duty applies. In this context, a highway department owes a duty to all travelers on the highway to avoid creating unreasonable risks for those travelers, and to meet the standard of care imposed upon that department.

The standard of care may be established by a multitude of factors. As a minimum, all persons are required to avoid the creation of unreasonable risks, where feasible. In addition, statutes and regulations governing conduct are also components of the standard of care by which conduct is judged.

Finally, and perhaps most importantly, the accepted standards and practices of a profession, trade, or industry define the standard of care by which conduct is judged. Included in the definition of "accepted standards and practices" is the Manual on Uniform Traffic Control Devices and other similar standards. The American Railway Engineering Association promulgates technology pertaining to railroads in its Manual of Railway Engineering. This is not a standard, however, but a means of providing railroad engineers with guidelines for the construction of railroads.

To place the above concepts in perspective, it is necessary to recognize the following characteristics of tort liability.

- o Negligence is the failure to use reasonable care.
- o Court decisions in tort claims are based on the concept of the existence of a "reasonable person" exercising "ordinary care", i.e. "reasonable care" under the same or similar circumstances which would be exercised by a prudent person.
- o The three elements necessary in every tort claim are:
  - existence of legal duty owed by the defendant to the plaintiff;
  - a breach of that duty; and,
  - the occurrence of damage or injury which is the reasonably foreseeable result of that breach of duty.

In effect, this means that the plaintiff (the one bringing the suit), if he is to win a judgment in

## Chapter I Overview

a basic highway negligence case, must prove the following.

- o The defendant (agency) had a legal duty to use reasonable care towards the plaintiff (the injured party).
- o The defendant breached that duty, (fell below the standard of care thus committing an act of negligence).
- o The damages (injuries, property damage, pain and suffering, loss of income, etc.) suffered by the plaintiff were caused by the breach (defendant's negligence), and were the foreseeable result of that breach. That is, but for the defendant's negligence, the plaintiff would not have suffered damages.
- o Finally, depending on whether the State follows the "contributory" or "comparative" negligence doctrine, the plaintiff, in order to recover all of the damages suffered, must not have contributed to that negligence ("contributory" negligence), or must have been less at fault than the agency ("comparative" negligence).

To understand the concept of legal duty, it is necessary to recognize the distinctions between discretionary acts and ministerial (nondiscretionary) acts. Many States that no longer retain their sovereign immunity have enacted a Tort Claims Act. This Act prescribes the conditions under which the State, their agencies, and their employees may be held accountable. Most of these include a limited exemption from liability for negligence in the performance (or in the nonperformance) of so-called discretionary activities.

The term "discretionary" refers to the power and duty to make an informed choice among alternatives. It requires consideration of these alternatives and the exercise of independent and professional judgment in arriving at a decision or in choosing a course of action. On the other hand, ministerial duties involve clearly defined tasks performed with minimum leeway as to personal judgment and not requiring any evaluating or weighing of alternatives. Consequently, they are nondiscretionary.

In modern law, the distinctions between discretionary and ministerial functions are of great importance in judging tort claims against governmental entities. In general, a public organization or its employees are not liable for negligence in the performance of discretionary activities. However, the courts are constantly revising the law in these areas, and the classification of a particular governmental activity as either discretionary or ministerial is subject to shifting legal interpretations.

It should be recognized that the limited exemption from liability that has been afforded to discretionary activities in no way provides absolute protection from legal liability. If discretion is abused or exercised recklessly or unjustly, courts may move in and substitute their own discretion for that of the agency.

The courts are fairly uniform in holding that the design of highways is a discretionary function because it involves high-level planning activity and evaluation of policies, alternatives, and other factors. This is supported by court decisions which hold that design functions are quasi-legislative in character and must be protected from second-guessing by the courts who are inexpert at

making such decisions. Design immunity statutes represent a further effort by legislatures to immunize governmental bodies and employees from liability arising out of negligence or errors in a plan or design duly approved under current standards of reasonable safety.

The courts consider two factors in determining whether a State has taken reasonable care in giving the public adequate warning at a railroad-highway grade crossing. These factors can be stated in the following manner.

- o In light of the history of accidents and/or level of traffic at the particular crossing, was an accident reasonably foreseeable? If so,
- o Was the State reasonable in its choice of warning devices to alert the public of the foreseeable risk?

Liability for accidents occurring at grade crossings is governed by the law of negligence. The law imposes upon states and railroads the duty to exercise reasonable care to avoid injury to persons using the highway. States and railroads are under no duty to provide absolute safety.

Potential liability in crossing accidents may create a reluctance on the part of States, railroads, and suppliers, to initiate new technology or procedures that may lead to charges of negligence. Experimentation and in-service trials of new devices is restricted by both potential litigation and the contractual, insurance requirements and negotiation that are involved.

The scheduling of improvement projects has become a significant issue in recent court cases involving crossing accidents. The application of administrative rules and procedures to ensure the expeditious installation of safety improvements based upon the principal of the alleviation of the highest potential hazard is a major factor in these cases.

It should be obvious that it is more logical to expend public funds in sound management practices and in proper highway maintenance than in the settlement of claims or in payment of adverse judgments. Consequently, it would seem appropriate to review maintenance activities and reporting procedures to limit exposure to tort liability. It would also seem helpful to assure that all agency employees involved in such activities are well informed of the legal implications of their functions.

It has been suggested that agencies and railroads could significantly reduce tort liability suits involving traffic control devices by implementing four basic principles.

- o Know the laws relating to traffic control devices
- o Conduct and maintain an inventory of devices
- o Replace devices at the end of their effective lives
- o Apply approved traffic control device specifications and standards

**E. References**

1. Accident/Incident Bulletin, Washington, DC: Federal Railroad Administration, published annually.

Chapter I Overview

2. Alternative Solutions to Railroad Impacts on Communities, Final Report, Minnesota Department of Transportation and North Dakota State Highway Department, December 1981.
3. Amos, Charles L., "Railroad Crossings", Better Roads, Vol. 49, No. 9, September 1979, No. 10, October 1979.
4. Annual Report on Highway Safety Improvement Programs, Washington, DC: Federal Highway Administration, published annually.
5. Federal-Aid Highway Program Manual, Washington, DC: Federal Highway Administration, updated periodically.
6. Federal Highway Administration Survey of Region and Division Offices, unpublished, 1984.
7. Gertler, Judith B., A Study of State Programs for Rail-Highway Grade Crossing Improvements, Washington, DC: Federal Railroad Administration, Report FRA-OPPD-78-7, June 1978.
8. Highway Statistics, Washington, DC: Federal Highway Administration, published annually.
9. "Maintenance Cost Study of Railroad-Highway Grade Crossing Warning Systems", Association of American Railroads, October 1982.
10. Prevention of Rail-Highway Grade Crossing Accidents Involving Railway Trains and Motor Vehicles, Washington, DC: Interstate Commerce Commission, November 1962.
11. Rail-Highway Crossing Accident/Incident and Inventory Bulletin, Washington, DC: Federal Railroad Administration, published annually.
12. Railroad Facts, Washington, DC: Association of American Railroads, September 1983 and October 1984.
13. Railroad-Highway Safety, Part I: A Comprehensive Statement of the Problem, A Report to Congress, Washington, DC: U.S. Department of Transportation, November 1971.
14. Railroad-Highway Safety, Part II: Recommendations for Resolving the Problem, A Report to Congress, Washington, DC: U.S. Department of Transportation, August 1972.
15. Report on the Unit Coal Train Community Impact Conference, Washington, DC: U.S. Department of Transportation, August 1979.
16. Schercinger, John M., "1984 Grade Crossing Statistics Show Continued Safety Improvement", Washington, DC: Association of American Railroads, September 1984.
17. Schoppert, David W. and Dan W. Hoyt, Factors Influencing Safety at Highway-Rail Grade Crossings, Washington, DC: Highway Research Board, NCHRP Report 50, 1968.
18. Traffic Control Devices Handbook, Washington, DC: Federal Highway Administration, 1983.

## II. COMPONENTS OF A RAILROAD-HIGHWAY GRADE CROSSING

A railroad-highway grade crossing may be viewed as simply a special type of highway intersection, in that the three basic elements of highways are present: the driver, the vehicle, and the physical intersection. As with a highway intersection, drivers must appropriately yield the right - of - way to opposing traffic; but unlike highway intersections, the opposing traffic, trains, only rarely must yield the right-of-way to the motorist. Drivers of motor vehicles have the flexibility of altering their path of travel and can alter their speed within a short distance. Locomotive engineers, on the other hand, are restricted to moving their trains down a fixed path and changes in speed can only be accomplished much more slowly. Because of this, motorists bear most of the responsibility for avoiding collisions with trains. In effect, the "Railroad Crossing" crossbuck is a "Yield" sign and motorists have an obligation to so interpret it. Traffic and highway engineers can assist motorists in their task by providing them with proper highway design and traffic control devices.

The components of a railroad-highway grade crossing are divided into two categories: highway and railroad. The highway component is further classified into four elements: driver, vehicle, roadway, and pedestrians. The railroad component is classified into train and track elements. The location where these two components intersect must be designed to incorporate the basic needs of both highway vehicles and trains.

Traffic control devices are utilized to provide the motorist with information concerning the crossing.

Typically, an advance warning sign and pavement markings inform the motorist that a crossing lies ahead in the travel path. The crossing itself is identified through the use of the crossbuck. These traffic control devices, advance warning sign, pavement markings, and crossbuck, are termed "passive" because their message remains constant with time.

"Active" traffic control devices tell the motorist whether or not a train is approaching or occupying the crossing and thus give a variable message. Typical active traffic control devices are flashing lights and automatic gates.

The U.S. DOT/AAR National Railroad-Highway Crossing Inventory provides information on the number of public crossings having each type of traffic control device as shown in Table 8.

### A. The Highway Component

#### 1. Driver

The driver is a key component of the railroad-highway grade crossing scene and is responsible for obeying traffic control devices, traffic laws, and the rules of the road. Highway and railroad engineers, who plan and design initial installations and later improvements of railroad-highway grade crossings, should be aware of the several characteristics, capabilities, requirements, needs, and obligations of the driver. This information will help them, through the proper engineering design of crossing installations and improvements, to assist drivers in meeting their responsibilities.

Chapter II Components of a Railroad-Highway Grade Crossing

Table 8. Public Crossings  
by Warning Device, 1983

<u>Warning Device</u>	<u>Number</u>	<u>Percent</u>
Gates	19,473	9.48
Flashing lights	34,120	16.62
Highway signals, wigwags or bells	2,618	1.27
Special*	7,181	3.50
	-----	-----
Total Active	63,392	30.87
Crossbucks	126,963	61.83
Stop signs	1,374	0.67
Other signs	889	0.43
	-----	-----
Total Passive	129,226	62.93
No signs or signals	12,721	6.20
	-----	-----
Total	205,339	100.00

\*"Special" are traffic control systems that are not train activated, such as, a crossing being flagged by a member of the train crew.

Source: Ref. 8

The Uniform Vehicle Code (UVC), a model set of motor vehicle laws, describes the actions that a driver is required to take at crossings. The UVC defines the "appropriate actions" that vehicle operators are to take for three situations: vehicle speed approaching the crossing; vehicle speed traversing the crossing; and, stopping requirements at the crossing. Set out below are the provisions in the Uniform Vehicle Code for these actions.

o Approach Speed (Sec. 11-801)

No person shall drive a vehicle at

a speed greater than is reasonable and prudent under the conditions and having regard to the actual and potential hazards then existing. Consistent with the foregoing, every person shall drive at a safe and appropriate speed when approaching and crossing an intersection or railroad grade crossing...<sup>8</sup>

o Passing (Sec. 11-306)

No vehicle shall be driven on the left side of the roadway under the following conditions:

when approaching within 100 feet of or traversing any ... rail highway crossing unless otherwise indicated by official traffic control devices ...<sup>9</sup>

o Stopping (Sec. 11-701)

Obedience to signal indicating approach of train. Whenever any person driving a vehicle approaches a rail highway crossing under any of the circumstances stated in this section, the driver of such vehicle shall stop within 50 feet, but not less than 15 feet from the nearest rail of such railroad, and shall not proceed until he can do so safely. The foregoing requirements shall apply when:

- a clearly visible electric or mechanical signal device gives warning of the train;

-----  
<sup>8</sup>Uniform Vehicle Code and Model Traffic Ordinances, Evanston, IL: National Committee on Uniform Traffic Laws and Ordinances, 1961, and Supplement published in 1984.

<sup>9</sup>Ibid.



- a crossing gate is lowered or when a human flagman gives or continues to give a signal of the approach or passage of a railroad train;
- a railroad train approaching within approximately 1,500 feet of the highway crossing emits a signal audible from such distance and such railroad train, by reason of its speed or nearness to such crossing, is an immediate hazard; and,
- an approaching railroad train is plainly visible and is in hazardous proximity to such crossing.<sup>10</sup>

The UVC also prohibits any vehicle from driving around or under any gate or barrier while it is closed or while it is being opened or closed (Sec. 11-701b).

Each State has its own regulations that may vary from those above. More information on State laws and regulations affecting crossings are contained in a Compilation of State Laws and Regulations on Matters Affecting Rail-Highway Crossings.

The situations faced by a driver of any vehicle at a crossing occurs in three areas or zones. These zones are adapted from the information handling zones defined in A User's Guide to Positive Guidance. Information handling zones are particular areas of road that correspond to sections of highway on which drivers should ideally make certain decisions concerning the upcoming crossing. The three zones are described below and shown in Table 9.

-----  
<sup>10</sup>Ibid.

Approach Zone -- This zone is the area in which drivers begin to formulate actions needed to avoid colliding with trains. Drivers use this zone to search for a train or signal, to recognize any hazards, and to decide on the proper course of action. The approach zone precedes the nonrecovery zone.

Within the approach zone, the vehicle operator must become aware that a crossing is ahead. Information is usually provided by an advance warning sign and, in some cases, by pavement markings. In virtually all situations, the driver must take notice through visual observation of the crossing itself, its associated control devices, and sometimes through the sound of the train horn.

The advance warning should be placed at a distance in advance of the crossing such that the driver is provided sufficient time to alter vehicle speed and take the appropriate action. It is incumbent upon the driver to heed the advance warning and to operate the vehicle such that the driver can respond properly to the conditions ahead. Sign placement distances for advance warning signs are discussed in Chapter IV, Identification of Alternatives.

Nonrecovery Zone -- The nonrecovery zone begins at the point along the road where drivers must make a stop decision if a train is approaching or occupying a crossing. Theoretically, if the stop/go decision is delayed beyond the beginning of the nonrecovery zone, the amount of highway remaining will be insufficient to avoid a collision. The nonrecovery zone ends at the beginning of the hazard zone. It starts at the stopping sight distance point required by the vehicle speed. Stopping sight

Chapter II Components of a Railroad-Highway Grade Crossing

Table 9. Needed Information and Desired Responses of Vehicle Operator

Location	<u>Needed Information</u>	<u>Desired Response</u>
Approach Zone	<u>Approach Zone</u>	
	Crossing is ahead	Look ahead for more data on present conditions
	Train may be present	Look ahead
Non-recovery Zone	<u>Non-recovery Zone</u>	
	If: 1) Train is on crossing 2) Train is approaching crossing 3) Train not in vicinity	Begin stop maneuver Begin stop maneuver Be cautious and look left and right for information
	<u>Hazard Zone</u>	
Hazard Zone	If: 1) above 2) above and velocity and direction of train 3) Verification of no train	Stop Go/No-go across tracks Look and go across tracks

\*Information should be obtained from signs, markings, and signals provided at, and in advance of the crossing. Vehicle speed should be adjusted to correlate with the length of the Non-recovery Zone.

distances are discussed in Chapter IV, Identification of Alternatives.

The proper design and installation of traffic control devices will provide the majority of drivers with the information needed to make the decision to stop, if necessary. At crossings with passive traffic control devices, the motorist is provided with a view of the crossbuck that, by its design, informs the motorist of the location of the crossing and requires, as a regulatory device, that the motorist approach the crossing at a speed such that the vehicle can be stopped safely if a train is approaching or occupying the crossing. Having been provided this information, the motorist must operate the vehicle as required by the prevalent conditions, e.g. visibility of an approaching train. Thus, if a driver's view of an approaching train is restricted, e.g. due to sight obstructions, inclement weather, or darkness, the driver should reduce vehicle speed so that, if necessary, it can be stopped.

Active traffic control devices are designed to assist the driver in making the appropriate stop/go decision. Active traffic control devices are activated by an approaching train and thus provide this information to the motorist who is then required by law to stop in advance of the crossing. Ideally, all crossings would have active traffic control devices; however, the cost to install and maintain them at the 205,000 public at-grade crossings is prohibitive. Thus, active traffic control devices are placed at those crossings considered to be more hazardous than others.

Hazard Zone -- The hazard zone is the rectangle formed by the width of the highway and a distance meas-

ured along the highway on either side of the tracks. This zone is the area where stopped or approaching motor vehicles can collide with approaching or stopped trains. This zone can be considered as being 15 feet either side of the closest and farthest rail.

In this final zone, the objective is for the motorist to cross the tracks safely. At crossings with passive control devices, the prudent driver has heeded the advance warning and the crossbuck and has determined if a train is occupying or approaching the crossing. The driver then brings the vehicle to a stop short of the hazard zone. At crossings with active traffic control devices, the prudent driver has heeded the activated device and brings the vehicle to a stop short of the hazard zone.

Once stopped, a driver must not cross the tracks until a decision has been made that it is safe to do so. This action is dictated by law or regulation.

## 2. Vehicle

The design and operation of a railroad-highway grade crossing must take into consideration the variety of vehicles that are likely to traverse the crossing. In this regard, crossings are exposed to the full array of vehicle types found on the highway, from motorcycles to tractor-trailer trucks. These vehicles have widely different characteristics that will directly influence the design elements of the crossing. Equally important is the cargo these vehicles carry, especially children in school buses and hazardous materials in trucks.

Table 10 shows the number, type, and percentage of motor vehicle acci-

Chapter II Components of a Railroad-Highway Grade Crossing

Table 10. Motor Vehicle Accidents and Casualties  
at Public Crossings by Vehicle Type, 1983

	<u>Automobiles</u>	<u>Buses</u>	<u>Trucks</u>	<u>Motorcycles</u>	<u>Total</u>
<b>Total Accidents</b>					
Number	4,273	11	1,945	43	6,272
Rate*	3.50	1.63	4.76	3.58	---
Percent	68.13	0.17	31.01	0.69	100.0
<b>Total Fatalities</b>					
Number	315	0	151	17	483
Rate*	0.26	0.00	0.37	1.42	---
Percent	65.22	0.00	31.26	3.52	100.0
<b>Total Injuries</b>					
Number	1,603	35	717	17	2372
Rate*	1.31	5.18	1.76	1.40	---
Percent	67.58	1.47	30.23	0.72	100.0
Vehicle miles of travel (billions)	1,221.85	6.75	408.51	12.00	1,649.11
Registered vehicles	123,169,738	555,819	35,197,962	5,736,001	164,659,520
Accidents per million vehicles	34.69	19.79	55.26	7.50	---

\*Rate is the number of accidents, fatalities or injuries divided by billions of vehicle miles traveled.

Source: Ref. 8

dents by vehicle type involving trains at crossings during 1983. The data provides some indication of the relative hazard for each of the vehicles. Trucks have the highest overall accident rate, i.e. number of accidents per number of vehicle miles traveled on all highways.

Motorcycle accidents have a higher fatality rate, probably because of the lack of operator protection provided by the vehicle. Buses, trucks and motorcycles all have higher injury rates than automobiles. The relatively high injury rate for

buses can be attributed to the high number of passengers typically found in buses. Of the 11 bus accidents occurring in 1983, five involved school buses.

Several physical and performance characteristics of vehicles influence the safety of vehicles at crossings. These include vehicle dimensions, braking performance, and acceleration performance.

Vehicle Dimensions. The length of a vehicle has a direct bearing on the inherent safety of a vehicle at a

crossing and consequently is an explicit factor considered in the provision of sight distance. Long vehicles, and vehicles carrying heavy loads, have longer braking distances and slower acceleration capabilities; hence, long vehicles may be exposed to a crossing for an even greater period of time than that in proportion to their length.

Vehicle length is explicitly considered in determining the effect of sight distance and the corner sight triangle on the safe speed for vehicles approaching the crossing, and in determining the sight distance along the track for vehicles stopped at the crossing. Design lengths of various vehicles are specified by the American Association of State Highway and Transportation Officials (AASHTO) and are shown in Table 11. This data was, however, developed prior to the enactment of the Surface Transportation Assistance Act of 1982, which increased the allowable maximum dimensions for truck tractor-trailer combinations. In some cases, geometric and design vehicle criteria contained in the AASHTO design manual are thus not appropriate for those highways which must accommodate certain of the larger truck configurations. It is anticipated that AASHTO will publish updated criteria to accommodate these concerns.

Unless trucks are prohibited on the crossing, it is desirable that the design vehicle be at least a tractor semi-trailer truck (WB-50). Typically, the design vehicle should be a tractor semi-trailer full-trailer truck (WB-60) for those crossings on routes designated for larger trucks, although special consideration should be given to especially long vehicles that may be present.

Table 11. Design Lengths  
for Design Vehicles

<u>Type Vehicle</u>	<u>Designation</u>	<u>Length (ft)</u>
Passenger car	P	19
Single unit truck	SU	30
Single unit bus	BUS	40
Intermediate semi-trailer truck	WB-40	50
Large semi-trailer truck	WB-50	55
Semi-trailer, full-trailer truck	WB-60	65

Source: Ref. 6

The width of the vehicle may be a factor in considering the width of the highway surface and hence the length of the crossing surface measured along the track. With the passage of the Surface Transportation Assistance Act of 1982, trucks with widths of 102 inches will become more commonplace.

Another vehicle dimension that is important in the design of crossings is the combination of underclearance and wheelbase. This is particularly relevant for long truck trailers with low clearances such as low-bed trailers and furniture vans. These vehicles can become lodged on a crossing if the grades of the crossing and its approaches are not adequate.

Braking Performance. One component of stopping sight distance is a function of the vehicle's braking performance. If a crossing experiences a significant percentage of heavy trucks, any given sight distance will dictate a slower speed of operation to allow for the braking performance of these vehicles.

## Chapter II Components of a Railroad-Highway Grade Crossing

Acceleration Performance. Acceleration of vehicles is important to enable a stopped vehicle to accelerate and clear the crossing before a train that was just out-of-sight, or just beyond the train detection circuitry, reaches the crossing. Large trucks that have relatively poor acceleration capabilities, coupled with their long lengths, make them particularly hazardous in this type of situation.

There are three phases of operation for a truck that has stopped at a crossing:

- o start-up when the clutch is being engaged;
- o acceleration from the point of full clutch engagement; and,
- o continued travel until the crossing is cleared.

Another aspect of the acceleration performance of vehicles at crossings is the design of the crossing and the condition of the crossing surface. Crossings and approaches that are on a steep rise are difficult and time consuming to cross. Also, vehicles will move slower over crossings that have rough surfaces.

Special Vehicles. Three vehicle types are of particular concern for crossing safety: a) trucks carrying hazardous materials; b) vehicles carrying passengers for hire; and, c) school buses. Accidents involving these vehicles can result in numerous injuries and/or fatalities, perhaps in catastrophic proportions if certain hazardous cargoes are involved.

In a special study conducted by the National Transportation Safety Board (NTSB), it was determined that an average of 62 accidents involving

train collisions with trucks transporting hazardous materials occur annually. Their examination of the accident data revealed that these accidents tend to occur near truck terminals.

Provisions to enhance safety for these special vehicles are further discussed in Chapter IX, Special Issues.

### 3. Roadway

A major component of the crossing consists of the physical aspects of the highway on the approach and at the crossing itself. The following roadway characteristics are relevant to the design and control of railroad-highway grade crossings.

- o Location -- urban, rural
- o Type of road -- arterial, collector, local
- o Traffic volume
- o Geometric features -- number of lanes, horizontal and vertical alignment, sight distance, crossing angle, etc.
- o Crossing surface and elevation
- o Nearby intersecting highways
- o Illumination

These elements will be discussed briefly in this Chapter and in detail in subsequent Chapters.

Location and Type of Road. Figures 3 and 4 show the accidents per crossing per year for 1983 as a function of type of road for the urban and rural system. Roads are classified by function, from interstates to local roads. Crossings designated as

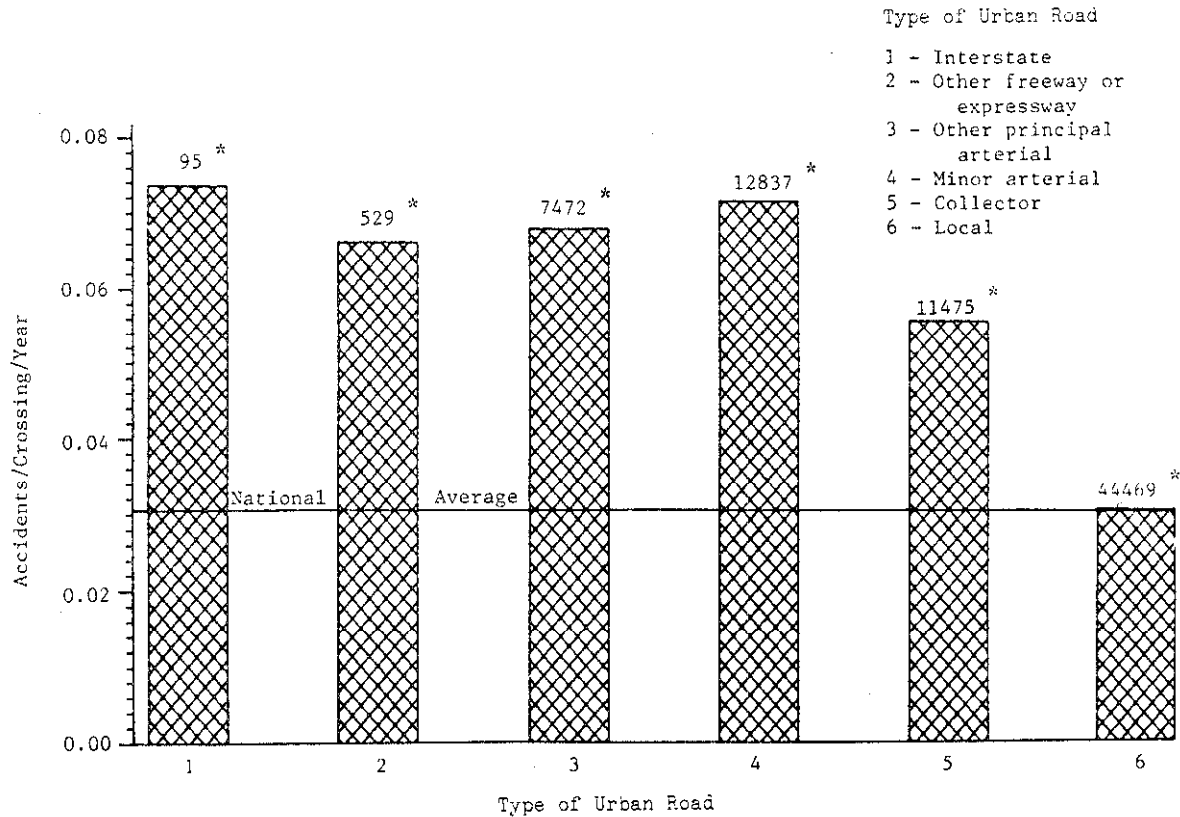

\*The number at the top of each bar represents the number of crossings for that type of road.

Figure 3. Public Crossing Accident Rate by Type of Urban Road, 1983

Source: Ref. 8

interstate are primarily on interstate ramps or frontage roads.

Accidents occurring at crossings on all types of urban roads exceeded the overall 1983 national average of 0.03 accidents per year as shown in Figure 3. Urban crossings often carry more vehicular traffic than rural crossings and have sight restrictions due to developed areas. Urban crossings also involve obstructions to continuous traffic flow such as controlled intersections, driveways, business establishments and distractive signs, significant lane interaction, and parking lanes.

For the rural system, the number of accidents per crossing per year by type of highway is shown in Figure 4. Accident rates for crossings on rural minor collectors and local roads are below the national average. The high number of crossings on the local rural system that have minimal accidents influences the national average, which was 0.03 accidents per crossing per year in 1983.

Traffic Volume. The effect of traffic volume on the number of accidents per crossing is evident from Figure 5. All other factors being the same, especially train volumes,

## Chapter II Components of a Railroad-Highway Grade Crossing

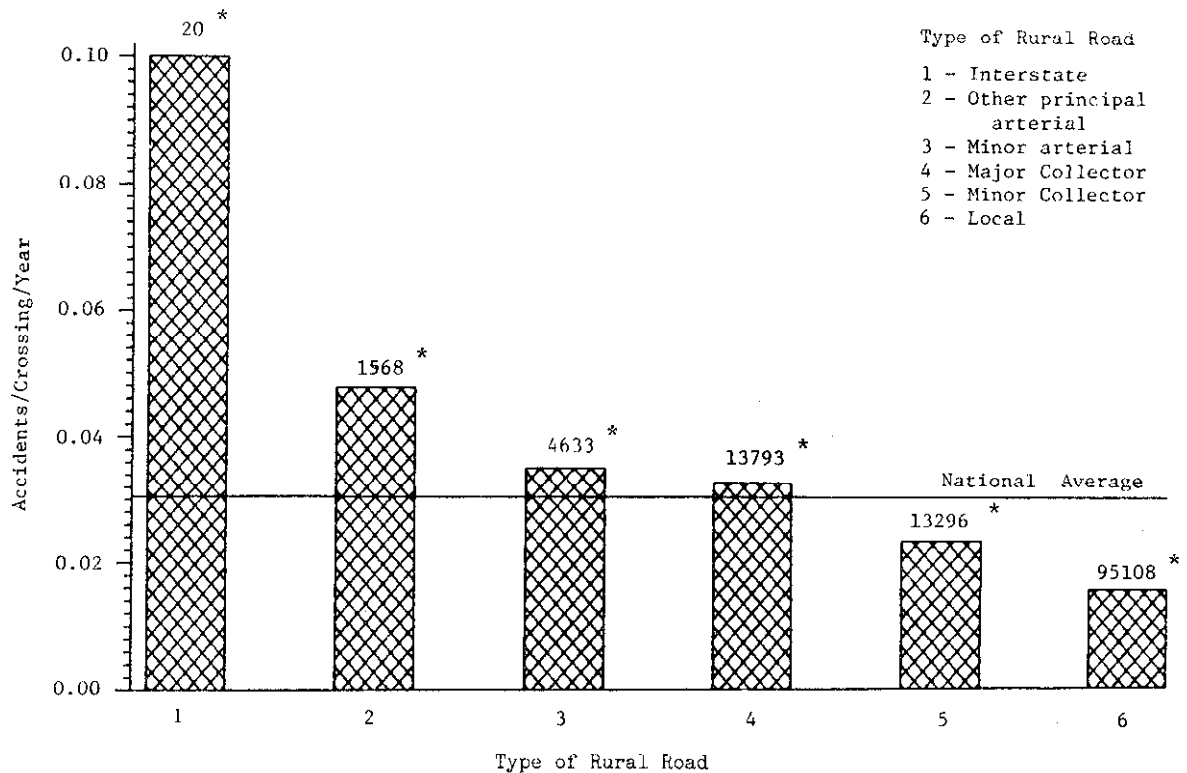

\* The number at the top of each bar represents the number of crossings for that type of road.

Figure 4. Public Crossing Accident Rate by Type of Rural Road, 1983

Source: Ref. 8

accident frequency increases with increasing traffic volume. However, traffic volume alone is not a sufficient forecaster of accidents at crossings, as demonstrated by accident prediction models, that are discussed in Chapter III, Assessment of Crossing Safety and Operation.

Geometric Features. The geometric design features that can affect safety at railroad - highway grade crossings include the following.

- o Number of lanes and pavement width
- o Horizontal and vertical alignment
- o Crossing angle
- o Crossing elevation

These features, in turn, affect sight distance to, and at crossings.

Number of Lanes. Only a small portion, 6%, of crossings are on highways with more than two lanes. It is not known how many crossings with two lanes have an approach width greater than two lanes. The reduction of lane width at a crossing can affect vehicle-vehicle accidents as well as accidents with trains.

At two lane crossings, a pullout lane may be provided for trucks or buses that are required to stop at the crossing. By providing a pullout



Chapter II Components of a Railroad-Highway Grade Crossing

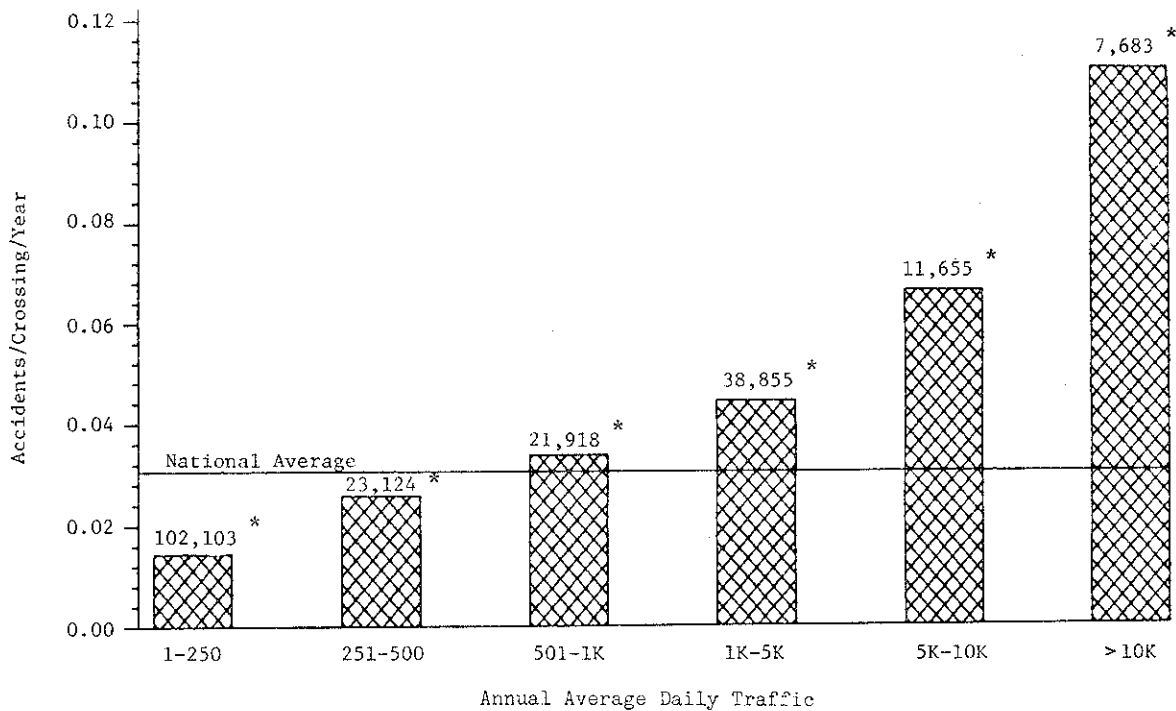

\* The number at the top of each bar represents the number of crossings with that level of traffic.

Figure 5. Public Crossing Accident Rate by Annual Average Daily Traffic, 1983

Source: Ref. 8

lane, the likelihood of a rear-end collision may be reduced.

Crossings with more than two lanes may be candidates for cantilevered flashing lights to improve visibility for the driver.

Alignment and Sight Distance. Sight distance to the crossing is affected by the horizontal and vertical alignment of the highway and the crossing angle. Crossings located around a curve or over the crest of a hill may require special attention from the motorist.

Crossing Surface. The roughness of a crossing surface and its approaches is often a major area of concern for the driver. A rough sur-

face may contribute to an accident by diverting the driver's attention from the continuing prime obligation of looking for a train. In order to maintain a smooth crossing, the fundamental difference between the two traveled ways must be recognized. The railroad track is a flexible platform and the highway subgrade supports a rigid pavement. There must be a complete separation between them and there should be adequate drainage.

Another aspect of the crossing is its elevation. Vehicles that must cross the tracks from a stop position cannot accelerate quickly on steep grades. In addition, trucks with low underclearances may become trapped on a severely humped crossing.

Intersecting Highways. Approximately 36% of public railroad-highway grade crossings have a highway intersection within 75 feet. Frequently, roads parallel tracks and intersecting roads also intersect the railroad resulting in a crossing near the highway intersection.

The higher occurrence of accidents at these crossings is in part due to a short storage area for vehicles waiting to move through the intersection after passing over the crossing. If the intersection is signalized, or if the approach from the crossing is controlled by a stop sign, then queues may develop to the crossing, leaving a vehicle "trapped" on the crossing. Also there are more distractions to the motorist and more vehicle-vehicle conflicts.

Crossings within a close distance to a signalized or stop-controlled intersection should be carefully evaluated for proper controls. The critical distance is a function of the number of vehicles expected to be stopped by the intersection control.

Illumination. Illumination of the crossing can definitely aid the motorist. In 1983, 2,582, of 6,272 total crossing accidents, occurred during darkness. Illumination may be effective in reducing accidents at night. The U.S. DOT / AAR National Rail-Highway Crossing Inventory reports that commercial power is available at over 90% of public crossings. Therefore, lighting is feasible at most crossings, depending, of course, on the reliability of the power source. Design details on illumination are discussed in Chapter IV, Identification of Alternatives.

#### 4. Pedestrian

In 1983, accidents involving pedestrians at crossings accounted for only 1%, 68, of all crossing accidents. As can be expected, these accidents almost always result in an injury or fatality. In fact, in 1983 there were 37 pedestrian fatalities, 6.8% of all crossing fatalities. These statistics do not include pedestrian accidents occurring elsewhere along railroad tracks. Excluding accidents and incidents at crossings, 400 trespasser fatalities occurred on railroad property during 1983. This represents 37% of all railroad related fatalities.

There are several types of preventive measures that might be employed. The list includes:

- o fencing or other devices for enclosing rights-of-way;
- o grade separations;
- o additional signing;
- o safety education; and,
- o surveillance and enforcement.

These measures are discussed in more detail in Chapter IX, Special Issues.

#### B. Railroad Components

Railroad companies are classified by the Interstate Commerce Commission (ICC) on the basis of gross revenue. Effective January 1, 1982, the ICC adopted a procedure to adjust the Class I threshold for inflation by restating current revenues in 1978 constant dollars. A Class I railroad company has an annual gross operating revenue in excess of \$50 million in 1978 dollars which equates to about

\$83.5 million in 1983 dollars. A Class II railroad has an annual gross operating revenue of between \$10 and \$50 million in 1978 dollars. Class III railroads include all switching and terminal companies and all railroads with annual gross operating revenues of less than \$10 million in 1978 dollars. In 1983, there were 27 Class I and 18 Class II railroads in operation as shown in Appendix C.

In 1983, there were about 270 Class III line-haul railroads and about 142 switching and terminal companies, also Class III. Many of these Class III railroads provide switching and terminal services for the larger Class I and II railroad companies. Some Class III railroads take over the operation of a single line that a larger railroad abandoned for economic reasons. Class III railroads often require assistance with regard to railroad-highway grade crossings because of their limited manpower and financial resources. These small railroads are often unable to seek out Federal and State funds for improving crossings, yet safety at their crossings is just as important as at any other crossing.

For the purposes of this handbook, the railroad components of railroad-highway grade crossings have been divided into two categories, train and track, as discussed below.

#### 1. Train

During every business day, approximately 100,000 freight cars are loaded in the United States, Canada, and Mexico. Statistics as to the average length, net lading, and overall speed of freight trains in a typical year do not begin to describe the variety of operations involved in railroad freight movements. Unit trains may cover over 1,500 miles without a

change of consist and gross from 6,500 to 13,500 tons, while a car in a local freight may move only a couple of miles and represent the entire train consist. Dedicated piggyback trains may be limited to 25 to 50 cars, and run over several railroads with few, if any, intermediate stops to set out and pick up blocks of cars at major terminals. This variation in rail movements occurs also on the microscale, i.e. at individual railroad-highway grade crossings. Thus, the design of traffic control systems at crossings must allow for a wide variation in train length, train speed, and train occurrence.

Long trains, e.g. unit trains, directly affect the operation of highway traffic over crossings and indirectly affect safety as well. Unit trains consist of as many as 100 freight cars with the same lading. Coal and grain are two major commodities that are transported in unit trains. Because of their lengths, unit trains will take longer to pass over a crossing and, in effect, close the crossing to highway traffic for a longer period of time. In addition, some communities have passed ordinances restricting train speed for the purpose of improving safety. However, this practice directly reduces the level of service for highway traffic and may also affect safety. Because of the longer period of time during which the crossing is closed to highway traffic, a motorist may take risks by passing over the crossing just ahead of a train. In many cases, risks such as these are not successful and collisions result.

Trains other than unit trains typically consist of a variety of cars and loadings. A few cars may be picked up along the way and may be dropped off from the same train or

## Chapter II Components of a Railroad-Highway Grade Crossing

may be taken to a railroad yard where a new train is made up of cars with similar destinations. It is obvious that trains must stop to pick up cars, but it is unfortunate that some of these pick-up points are located in the central portion of communities. This results in trains moving slowly over the crossing, or even standing on the crossing as the pick-up is made. With the lengths of freight trains today, an entire community can be physically divided by a freight train stopped on all of its crossings.

Railroads have operating procedures designed to prevent extensive blockage of crossings and many States have passed regulations prohibiting the blockage of crossings for various lengths of time. Twenty-nine States expressly prohibit trains from blocking crossings for a period that varies from 5 to 15 minutes. Of these, 16 States exempt moving trains. A freight train can be divided to allow highway traffic to pass through, but this practice requires the braking system to be filled with air, which can take considerable time. Changes in operating practices that may assist in the alleviation of these types of problems are discussed further in Chapter IV, Identification of Alternatives.

Railroads carry passengers in addition to freight although this mode of transportation has declined during recent decades due to construction of the interstate highway system, the convenience of the automobile, and the speed of the airplane. Amtrak, the National Railroad Passenger Corporation, provides passenger service nationwide. This railroad, created by Congress in 1971, operates over track owned by itself (primarily in the Northeast) and over track owned by other rail-

road companies. In accordance with labor agreements, employees of privately owned railroad companies operate Amtrak passenger trains over that railroad's trackage. Some private railroad companies continue to operate passenger trains particularly for commuter service in urban areas. Some municipal, regional, and State authorities have taken over railroad commuter services. Many light-rail transit companies are in operation and being constructed in this country with numerous crossings and longitudinal street use. (These are not normally considered as railroads in tabulating crossing accidents). On the heavy rail rapid transit systems, there are few crossings of public highways at-grade.

Locomotives and cars obviously form a train, but for crossing purposes any rail operation over a highway is of concern, whether it is one or more engines or a group of cars pushed over a crossing. Most locomotives today are diesel-electric or straight electric although some railroads operate steam locomotives as special passenger trains for historical purposes. In 1983, there were 25,838 locomotive units in service on Class I railroads, all but 63 of the units were diesel-electric.

All locomotives are equipped with headlights that are illuminated whenever the locomotive is in motion. One type of light is a 30 volt, 200 watt PAR-56 sealed beam lamp with an output of 200,000 to 300,000 candlepower. The lamp is usually used in pairs. Some railroads use oscillating headlights, comprised of one or more standard locomotive headlight lamps on a mounting plate that is moved by a small motor in a figure eight, circular, or oval pattern. The light beam thus "sweeps" across the tracks.

## Chapter II Components of a Railroad-Highway Grade Crossing

Several different types of roof lights are sometimes used on locomotives to serve as markers in yards so that the locomotive can be easily located among numerous freight cars. These types of roof lights include beacon lights, strobe lights, and sequentially flashing lights. In an effort to make the locomotive as visible as possible, some railroads utilize these types of lights at railroad-highway grade crossings, either illuminating them whenever the locomotive is in motion or illuminating them in advance of crossings. The Federal Railroad Administration (FRA) considered a regulation that would require the mandatory use of strobe lights or, in a later proposed rulemaking, the use of any of the four types of roof lights at crossings. However, based on information received in response to the proposed rulemakings and on an indepth analysis of costs and benefits, the FRA concluded that "...the information in the Docket does not support the proposition that alerting lights are effective in reducing the incidence of grade crossing accidents. Without that support a Federal regulatory requirement that railroads equip their locomotives with an alerting light is not justified".<sup>11</sup>

Locomotives are also equipped with air powered horns that are used to sound a warning of a train's approach to a crossing and are used for various other signals in railroad operations. The FRA requires the horn to produce a minimum sound level of 96db(A) at 100 feet forward of the

---

<sup>11</sup>"Display of Altering Lights by Locomotives at Public Rail-Highway Crossings: Termination of Rule Making," Docket No. RSGC-2, Notice 4, Federal Register, Vol. 48, No. 88, Washington, DC: May 5, 1983.

locomotive. The locomotive engineer sounds the horn in advance of a crossing in a sequence of two long blasts, followed by a short blast, then followed by one long blast. The point of initiation of the whistle is indicated by a whistle post located alongside of the tracks. Many States have laws pertaining to the location where the horn must be blown. Nineteen States specify 80 rods (1/4 mile), but 14 others specify varying distances ranging from 300 to 1,800 feet.

Some local agencies have passed ordinances prohibiting the sounding of the whistle in certain areas to lessen the environmental noise impact. This is not generally recommended because the train whistle provides warning to a motorist or pedestrian that a train is approaching the crossing. Even at crossings with active traffic control systems, the train whistle provides a redundant indication that affects the hearing of a highway user while the traffic control device affects sight.

In 1983, there were 1,542,278 freight cars in service. The majority of these were box cars, hoppers, and covered hoppers as shown in Table 12. In addition, there were 2,610 passenger-train cars in service in 1983, not including those owned by commuter authorities which do not report to the Interstate Commerce Commission. The majority of freight cars have a capacity of 70 or 100 tons; however, 125 ton cars are used on track rated to support them. Overall car size is standardized by AAR interchange regulations. A car 10.08 feet wide by 15.08 feet high can go anywhere. Some cars may be as high as 17.08 feet. Overall car body length is limited to 89 feet, or 95 feet including the couplers.

## Chapter II Components of a Railroad-Highway Grade Crossing

Table 12. Types of Freight Equipment

<u>Type</u>	<u>Number</u>
Box Cars:	
Plain box	178,465
Equipped box	157,291
Covered hoppers	303,172
Flat cars	142,291
Refrigerator cars	63,705
Gondolas	171,554
Hoppers	315,805
Tank	183,730
Other	26,265
Total	1,542,278

Source: Ref. 9

Railroad freight cars are not illuminated and the installation of reflectorized markers on freight cars has been studied for some time. The most recent study found that the rapid accumulation of dirt necessitates frequent cleaning of the reflectors, which represents more than half of the total cost of freight car reflectorization. In this study, tests were conducted on the Canadian railroad system, where reflectors have been installed on freight cars since 1959, and on the Boston and Maine Railroad that installed high intensity retroreflectors for the purposes of the study. Reflector reflective intensity was found to be reduced to 23% of its initial value after six months in service. After one and two years in service, reflective intensity degraded to 14 and 5%, respectively, of its initial value. This degradation of reflective intensity results in the reflector providing little to no improvement in visibility of freight cars at crossings.

Primarily because of their enormous weight, railroad trains are slow to accelerate and decelerate. Numer-

ous factors affect a train's acceleration capability such as the number of locomotive units, the horsepower rating of each unit and, of course, the number and weight of freight cars. At low speeds, a commuter train may accelerate at 1.5 mph per second while a fast freight may accelerate at 0.3 mph per second. As speed increases, the acceleration rate decreases, a freight with 4.0 hp per ton can accelerate at only about 0.1 mph per second at 70 mph.

The braking system used on trains is the air brake that provides adequate uninterrupted pressure from car to car. The single air hose at the end of each car is manually connected to its neighbor and then the brake system is charged. When braking is required, the pressure in the brake pipe leading back through the train is reduced. This causes the valve on each car to use air from the auxiliary reservoir to build up pressure in the brake cylinder, thus applying the brakes. For an emergency application, the brake valve opens the brake pipe to atmospheric pressure and the resulting rapid rate of brake pipe pressure reduction causes the car valves to dump the contents of both auxiliary and emergency reservoirs into the brake cylinder.

Braking distances are dependent on many factors that vary for each train, e.g. number and horsepower rating of locomotives, number and weight of cars, adhesion of wheels on rails, speed, and grade. Therefore, the braking distance of a train can not be stated exactly. An estimate is that a typical 100 car freight train traveling 60 mph would require over one mile to stop in emergency braking.

Table 13 shows that the majority of crossings have rail traffic con-

Chapter II Components of a Railroad-Highway Grade Crossing

Table 13. Public At-Grade Crossings by Number of Thru Trains and Switching Trains Per Day, 1983

Switching Trains	Through Trains								Total
	<1	1-2	3-5	6-10	11-15	16-20	21-25	>25	
<1	30,571	35,637	15,665	16,130	5,051	5,983	2,194	4,385	115,616
1-2	27,905	9,233	6,745	6,716	2,823	2,176	964	1,656	58,218
2-3	6,770	1,883	2,054	2,659	1,253	670	501	919	16,709
6-10	3,740	982	942	1,630	819	989	299	627	10,028
11-15	754	190	192	302	90	108	81	132	1,849
16-20	621	133	117	218	87	94	115	123	1,508
21-25	143	36	20	66	17	15	36	47	380
>25	346	84	81	144	105	105	27	139	1,031
Total	70,850	48,178	25,816	27,865	10,245	10,140	4,217	8,028	205,339

Source: Ref. 8

sisting of less than three through trains per day and less than three switching movements per day. The majority of crossing accidents involve freight trains as shown in Table 14.

Generally, crossings with higher numbers of trains per day would be expected to have more crossing accidents. Figure 6 demonstrates this by giving the crossing accident rate by

Table 14. Accidents at Public Crossings Involving Motor Vehicles by Type of Train, 1983

Type of Train	Accidents
Freight	4,540
Passenger	223
Yard switching	748
Other*	761
Total	6,272

\*"Other" includes mixed trains, work trains, light locomotives, single car or cut of cars.

Source: Ref. 8

number of trains per day. The crossing accident rate is the number of accidents occurring at crossings with the specified number of trains per day, divided by the number of crossings within the category having that same number of trains per day.

In summary, trains, and their operations, vary considerably from day to day. While averages can be developed for length, weight, number of engines, and number of cars, this average train would rarely be seen in reality. Likewise, the scheduling of trains varies such that a motorist can never depend on it when negotiating through a crossing. Speeds of trains also vary considerably, such that one crossing may be used by passenger trains traveling at 80 mph, freight trains traveling at 50 mph, and switching trains traveling at only five mph.

2. Track

In the United States, railroad trackage is classified into six categories based upon maximum permissible operating speed. The Federal Railroad Administration's (FRA) track safety standards set maximum train speeds

Chapter II Components of a Railroad-Highway Grade Crossing

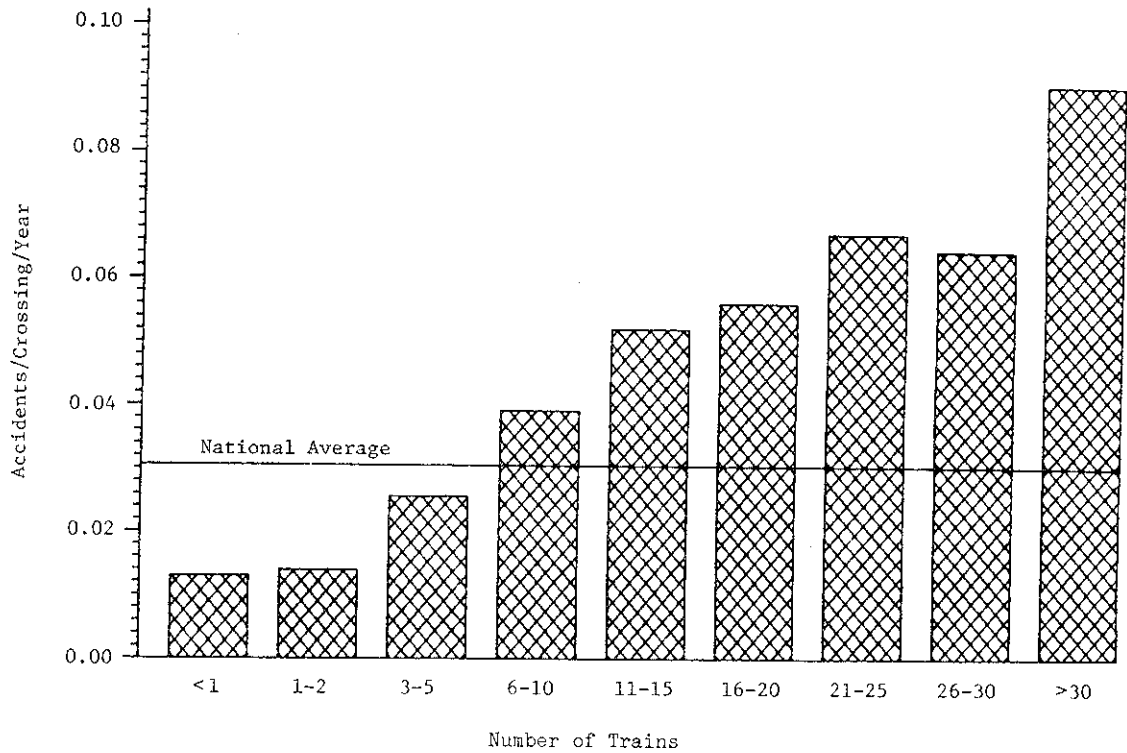

Figure 6. Public Crossing Accident Rate by Number of Trains per Day, 1983

Source: Ref. 8

for each class of track as shown in Table 15.

Initially, there were many different track gauges; however, in 1863, President Lincoln designated 4 feet 8.5 inches as the gauge for the railroad to be built to the Pacific coast. Other railroads then began changing to this gauge.

The rolling resistance that provides many of the technological advantages for railroads as a means of transportation is made possible by the steel wheel rolling on a steel rail. This steel wheel to steel rail contact involves pressures of over 50,000 lbs per square inch, that are then reduced to pressures acceptable

Table 15. Maximum Train Speed as a Function of Track Class

Track Class	Passenger	Freight
6	110 mph	110 mph
5	90	80
4	80	60
3	60	40
2	30	25
1	15	10
Excepted	None Allowed	10

Source: Ref. 12

to the underlying soil by a series of steps, going from the rail to a steel plate under the rail (tie plate), that spreads the load over a wooden



tie, that spreads the load over rock or slag ballast, that spreads the load to a sub-ballast (usually gravel, cinders, or sand), that spreads the load to the subgrade consisting of either the native soil below or some superior material obtained off site.

Rail is rolled from high quality steel and that being rolled today weighs from 115 to 140 lbs. per yard and is six to eight inches high. For the last 50 years the standard rail length has been 39 feet for transportation in 40 foot cars. In track, these rails are held together by bolted joint bars or are welded end to end in long strings. Bolted joints are, however, less rigid than the rest of the rail so that the rail ends wear more rapidly. Continuously welded rail is often used today, particularly on main line tracks. Rail is welded into lengths of about 1,500 feet and taken to the point of installation. The remaining joints can be eliminated by field welding in-place.

The steel rails are spiked to ties that are typically made of wood with preservative impregnated to prevent decay. The ties hold the rails to gauge, support the rail, distribute the load to the ballast, and provide flexibility to cushion impacts of the wheels on the rail. Prestressed concrete ties have come into greater use on American railroads in recent years, but still represent under 1% of the ties in use in the U.S.

Spikes or other rail fasteners are used to connect the rail to the ties for the primary purpose of preventing the rail from shifting sideways. Since rail has a tendency to move lengthwise, rail anchors are used, particularly on heavy-duty track.

Ballast is used to hold the ties in place, to prevent lateral deflections, and to spread out the load that averages about 100 psi just underneath the tie. Ballast must be able to resist degradation from the effects of tie motion that generate "fines" that may "cement" into an impervious mass. Ballast must also provide good drainage that is especially important for the strength of the subgrade, and also prevents mud from working its way up to contaminate the ballast.

Railway track is normally maintained by sophisticated high production mechanized equipment. Track surface is maintained by tamping machines that raise the track and compact the ballast under the ties. In this process it is often necessary to raise the track a few inches, and the best track stability will occur if this raise can continue through the crossing area instead of leaving a dip in the track. Lowering track is a very costly operation and can lead to subgrade instability problems.

Track components are generally replaced as needed. A typical heavy-duty freight line on tangent may be surfaced every two years, have about 25% of its ties renewed every eight years, and have its rail changed every 12 years.

Similar to highways, railroad track is classified into several categories dependent on its utilization in terms of traffic flow. Main tracks are used for through train movements between and through stations and terminals. Branch line trackage typically carries freight from its origin to the main line on which it moves to its destination or to another branch line to its destination. Passing tracks, sometimes called sidings, are used for meeting

## Chapter II Components of a Railroad-Highway Grade Crossing

and passing trains. Side tracks and industrial tracks are used to store cars and to load or unload them.

The U.S. DOT/AAR National Rail-Highway Crossing Inventory reports that, as of 1983, 120,538 public at-grade crossings consist of one main track only. "Main" track is one which carries through movement as opposed to switching movements or terminal movements. Therefore, branch lines have a main track as do main lines. Public at-grade crossings by number of main and other tracks are given in Table 16.

Accident statistics show that the majority of accidents occur on main tracks. This is, of course, due to the fact that there are more crossings with main tracks and generally more train traffic moves over main tracks. Accidents and casualties by track type and track class are given in Table 17.

During the early years of railroading, methods had to be devised to ensure that two trains did not meet at the same time on the same section of track. This was initially accomplished through the use of timetables and train orders. Block signal systems were developed that indicated to the locomotive engineer whether or not a train was ahead in the next block of track. These signals were set manually until the track circuit was developed that sensed the presence of a train in the block and set the signals automatically. The track circuit was designed to be fail-safe so that if the battery or any wire connections fail, or if a rail was broken, a clear signal would not be displayed. Insulated joints were used to define the limits of the block. Various types of track circuits are utilized in automatic traffic control device installations at railroad-highway grade crossings.

Table 16. Public At-Grade Crossings by Type of Track, 1983

Other Tracks	Number of Main Tracks							Total
	0	1	2	3	4	5	≥5	
0	0	120,538	10,132	322	87	5	3	131,087
1	23,213	25,269	2,845	96	21	1	--	51,445
2	5,331	8,627	1,259	40	12	2	--	15,271
3	1,626	2,572	423	25	8	--	--	4,654
4	448	898	197	12	7	--	--	1,562
5	178	342	106	8	3	--	1	638
≥5	167	335	102	1	4	2	--	611
Total	30,963	158,581	15,064	504	142	10	4	205,268

Note: The number and type of tracks were not provided for 71 crossings.

Source: Ref. 8

Chapter II Components of a Railroad-Highway Grade Crossing

Table 17. Accidents and Casualties at Public Crossings Involving Motor Vehicles by Track Type and Track Class, 1983

Track Type	Track Class*						Unknown	Total
	1	2	3	4	5	6		
<b>Main</b>								
Accidents	823	1,360	1,748	1,382	93	3	71	5,480
Killed	18	48	159	219	26	---	3	473
Injuries	236	529	758	590	33	1	35	2,182
<b>Yard</b>								
Accidents	278	69	20	5	---	---	44	416
Killed	2	---	---	---	---	---	---	2
Injuries	44	25	11	2	---	---	13	95
<b>Siding</b>								
Accidents	79	22	7	4	1	---	10	123
Killed	---	---	---	---	---	---	---	---
Injuries	15	8	1	---	---	---	---	24
<b>Industry</b>								
Accidents	174	29	11	10	---	---	20	244
Killed	5	---	---	---	---	---	3	8
Injuries	48	5	---	3	---	---	11	67
<b>Unknown</b>								
Accident	1	1	2	2	---	---	3	9
Killed	---	---	---	---	---	---	---	---
Injuries	---	---	2	1	---	---	1	4
<b>Total</b>								
Accidents	1,355	1,481	1,788	1,403	94	3	148	6,272
Killed	25	48	159	219	26	---	6	483
Injuries	343	567	772	596	33	1	60	2,372

\*See Table 15 for a definition of Track Class

Source: Ref. 8

**C. REFERENCES**

1. Accident/Incident Bulletin, Washington, DC: Federal Railroad Administration, published annually.

2. Armstrong, John H., The Railroad - What It Is, What It Does, Omaha, NE:

Simmons - Boardman Publishing Corp., 1982.

3. Code of Federal Regulations, Title 23, Washington, DC: General Services Administration, published annually.

Chapter II Components of a Railroad-Highway Grade Crossing

4. "Display of Alerting Lights by Locomotives at Public Rail-Highway Crossings", Termination of Rule making, Docket No. RSGC-2, Notice 4, Federal Register, Vol. 48, No. 88, Washington, DC: May 5, 1983.
5. Poage, J.L., J.C. Pomfret, and J.B. Hopkins, Freight Car ReflectORIZATION, Washington, DC: Federal Railroad Administration, Report FRA-RRS-83-1, December 1982.
6. A Policy on Geometric Design of Highway and Streets, Washington, DC: American Association of State Highway and Transportation Officials, 1984.
7. Post, T.J., G.J. Alexander, and H. Lunenfeld, A User's Guide to Positive Guidance, Second edition, Washington, DC: Federal Highway Administration, Report FHWA-TO-81-1, December, 1981.
8. Rail-Highway Crossing Accident/Incident and Inventory Bulletin, Washington, DC: Federal Railroad Administration, published annually.
9. Railroad Facts, Washington, DC: Association of American Railroads, October 1984.
10. Railroad/Highway Grade Crossing Accidents Involving Trucks Transporting Bulk Hazardous Materials, A Special Study, Washington, DC: National Transportation Safety Board, Report NTSB-HZM-81-2, September 1981.
11. Russell, Eugene, R., Beverly Narum, Charles L. Amos, and John M. Schercinger, Compilation of State Laws and Regulations on Matters Affecting Rail-Highway Crossings, Washington, DC: Federal Railroad Administration, Report FHWA-TS-83-203, April 1983.
12. Traffic Control Devices Handbook Washington, DC: Federal Highway Administration, 1983.
13. Uniform Vehicle Code and Model Traffic Ordinance, National Committee on Uniform Traffic Laws and Ordinances, 405 Church Street, P.O. Box 1409, Evanston, Illinois 60204, 1961 and Supplement published in 1984.

### III. ASSESSMENT OF CROSSING SAFETY AND OPERATION

The Federal Highway Administration (FHWA) requires each State to develop and implement a highway safety improvement program that consists of three components: planning, implementation, and evaluation. The process for improving safety and operations at railroad - highway grade crossings consists of the same three components and may be considered a part of a State's highway safety improvement program.

FHWA policy and procedures for a highway safety improvement program are contained in the Federal - Aid Highway Program Manual, Volume 8, Chapter 2, Section 3 (FHPM 8-2-3). The objective of a highway safety improvement program is to reduce "the number and severity of accidents" and decrease "the potential for accidents on all highways".

FHPM 8-2-3 requires the planning component to consist of:

- o a process for collecting and maintaining a record of accident, traffic, and highway data, including, for railroad - highway grade crossings, the characteristics of both highway and train traffic;
- o a process for analyzing available data to identify highway locations, sections, and elements determined to be hazardous on the basis of accident experience or accident potential;
- o a process for conducting engineering studies of hazardous locations, sections, and elements to develop highway safety improvement projects; and,

- o a process for establishing priorities for implementing highway safety improvement projects.

The implementation component consists of a process for programming and implementing safety improvements. The evaluation component consists of a process for determining the effect that safety improvements have in reducing the number and severity of accidents and potential accidents.

This section of the Railroad-Highway Grade Crossing Handbook provides guidance for the planning component consisting of the collection and maintenance of data, the analysis of data, and engineering studies. In addition, the "systems approach", a method by which several crossings are studied collectively, is discussed. Chapter IV identifies the various crossing improvements that are available. Chapter V presents guidelines for selecting improvements based on safety and operational effectiveness and costs. Chapter VI provides guidelines for the implementation component of the safety program and Chapter VIII addresses the evaluation component.

#### A. Collection and Maintenance of Data

A systematic method of identifying problem locations is most important. For railroad - highway grade crossings two types of information are needed: inventory and accident data. Inventory data includes the location of the crossing, volumes of highway and train traffic over the crossing, and physical elements of the crossing. Accident data for each crossing are also needed.

### Chapter III Assessment of Crossing Safety and Operation

The FHPM 8-2-3 specifies that each State maintain "a record of accidents, highway data, highway traffic and train traffic for railroad-highway grade crossings". State maintenance of the U.S. DOT/AAR National Rail-Highway Crossing Inventory will satisfy this survey requirement. State inventories containing data similar to that provided in the national inventory will also suffice.

The U.S. DOT/AAR National Rail-Highway Crossing Inventory was developed in the early 1970's through the cooperative efforts of the Federal Highway Administration (FHWA), Federal Railroad Administration (FRA), Association of American Railroads (AAR), individual States, and individual railroads. Each crossing was surveyed, both public and private, grade separated and at-grade, and data were recorded on the inventory form shown in Figure 7. The inventory contains data on the location of the crossing, amount and type of highway and train traffic, traffic control devices, and other physical elements of the crossing.

Each crossing was assigned a unique identification number consisting of six numeric characters and an alphabetic character. The alphabetic character provides an algorithmic check of the six numeric characters. To determine the correct alphabetic character, sum the products of each of the first six digits times the digit's position (position one is the left-most digit). Divide this total sum by 22 and then interpolate the remainder according to the following:

0 - A	6 - G	12 - N	17 - U
1 - B	7 - H	13 - P	18 - V
2 - C	8 - J	14 - R	19 - W
3 - D	9 - K	15 - S	20 - X
4 - E	10 - L	16 - T	21 - Y
5 - F	11 - M		

The crossing identification number, shown in Figure 8, was installed at each crossing by nailing or strapping a temporary tag to a crossbuck or flashing light post. These temporary tags were designed to last a maximum of five years and should be replaced with permanent tags. The two most common methods used to install permanent tags at the crossing are: 1) metal tag on which the crossing number is embossed by raised imprinting; and, 2) stenciling the number on the post.

The FRA voluntarily serves as custodian of the national inventory file. Data in the inventory are kept current through the voluntary submission of information by the States and railroads. Since the national inventory is updated by numerous States and railroads, systematic and uniform procedures are required to assist the FRA in processing the data. Three basic procedures have been developed.

Individual Update Forms. This is the procedure originally developed for updating the national inventory. Whenever a change occurs at a crossing, e.g. installation of traffic control devices, the railroad or State initiates an update form. This involves completing the following identification data elements on the form: crossing identification num-

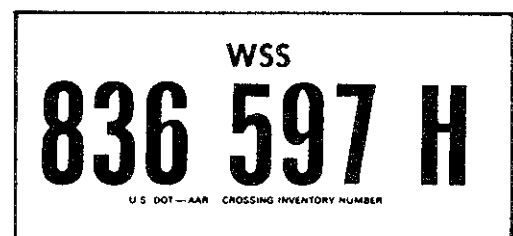

Figure 8. Crossing Identification Number Tag



ber, effective date of the change, State code, county code, railroad code, and type of update, i.e. a change at an existing crossing, a new crossing, or a closed crossing. Other data elements are completed only if they have changed or if they were not previously reported, such as for a new crossing.

To ensure that the State and railroad are in agreement on the elements contained in the inventory, a process was developed by which each would have the opportunity to review an update initiated by the other. If the railroad initiated the update, it would retain a copy of the four-part form (usually the last copy that is orange) and send the other three copies to the State agency. The State reviews the information and makes any appropriate changes. It then sends the pink copy back to the railroad for its files, retains the yellow copy for its files, and sends the original, or green copy, to the FRA for processing.

If a State initiates the update, it retains the orange copy and sends the other three to the railroad for its review. The railroad then retains the pink copy for its files and returns the other two (green and yellow) to the State. The State retains the yellow copy and submits the green copy to the FRA for processing.

This procedure allows both the State and railroad to concur on the crossing information prior to submittal to FRA and establishes the State as the agency that submits all data to FRA. Another advantage of this procedure is that both the State and railroad have a hard copy record of the update that can be placed in a file along with the original inventory record.

The primary disadvantage of the individual form method is that the form must be completed for every change. This may result in a time-consuming effort particularly for changes that affect a number of crossings. For example, if a railroad changes its operation over a route that results in an increase in the number of trains per day, an individual form would be completed for each crossing. To assist in these types of changes, the FRA has established procedures for the "mass" updating of one or two data elements.

Fill-in-the-Blanks List. One of the "mass" updating procedures is the fill-in-the-blanks list that consists of a printout of specified information currently contained in the inventory on a crossing and a series of blanks for those data elements that are to be changed. The list can be obtained from the FRA by request. For example, if a State wanted to change the annual average daily traffic (AADT) for all crossings in a county, the list would consist of the six identifying elements, the current AADT and a blank. The State can quickly review the crossing information on the list and enter the new AADT if it had changed.

The list is usually sorted by railroad (if it is a State request) or by State (if it is a railroad request) so that a copy of the list can be sent to the other party. The entire list is then sent to the FRA for processing.

Magnetic Tape. Another "mass" updating procedure involves the submission of data via computer magnetic tape. This method is advantageous for those States and railroads that maintain the inventory on a computer. A State or railroad may enter changes



onto its own computer file and then periodically send FRA a magnetic tape of the changes in a prescribed format. This method, once established, provides for the updating of the national file with relative ease. However, three cautions should be noted.

- o The information contained on the magnetic tape must be in the prescribed format. Since FRA receives information from 50 States and numerous railroads it must be able to process the magnetic tape without having to make any changes to its format. Details on the required format can be obtained from FRA.
- o The magnetic tape must contain only changed information and not the entire crossing record. FRA's procedures create a new crossing record whenever any data element is changed. Submission of a State or railroad's entire crossing file would result in a new record for each crossing regardless of whether any data element changed. The national inventory consists of 500,000 original crossing records most of which have been updated at least once. The unnecessary creation of a new record would result in an extremely large file to manipulate and maintain.
- o The other party must be provided with a printout of the changed information on the magnetic tape for its records.

One primary disadvantage of the two "mass" updating procedures is that a single form is not generated for each crossing which could be placed in a manual file. Many States and railroads do not have computer facilities for maintaining the inventory and rely upon a manual file on each crossing. To overcome this, the

FRA will provide "feedback" to any State or railroad upon request. The FRA can provide information from the national inventory in three primary ways.

- o One Page Per Crossing Printout -- This is simply a computer generated printout that contains all the information for a crossing on a single 8.5 inch by 11 inch sheet of paper. The information has been decoded and is easily read.
- o Continuous Feed Form -- This is a form identical to the individual update form that can be generated by computer.
- o Lists -- The FRA will also generate, upon request, a list of specified information for specified crossings. This might be useful for obtaining current data on the elements contained in a priority index formula.

The continuous feed form may also be used for updating by States and railroads that have computer facilities. Changes are made on the State or railroad's computer and an update form is automatically generated and processed as described under the "individual form" procedure.

Data contained in the national inventory or a State inventory must be used with care. The data should be verified in the field as discussed in a later section on engineering studies. The national inventory is used not only by States and railroads in conducting their crossing improvement programs but also by national and Federal agencies in assessing crossing improvement needs and in conducting research. Both States and railroads are urged to keep the information in this valuable data base up-to-date.

### Chapter III Assessment of Crossing Safety and Operation

Information on railroad-highway grade crossing accidents is also needed to assess safety and operations. Data on accidents involving trains are essential in identifying crossings with safety problems. In addition, data on accidents not involving trains, but occurring at or near a crossing, are useful. For example, non-train involved accidents may indicate a deficiency in sight distance such that a vehicle suddenly stops at a crossing causing the following vehicle to hit the leading vehicle in the rear.

Accident data are available from several sources including State and local police and the FRA. In addition, the National Highway Transportation Safety Administration (NHTSA) and the FHWA maintain some information on crossing accidents.

Most State and local police maintain a record of all highway traffic accidents, including those occurring at or near crossings. It is essential that the police record the crossing identification number on the accident report form. If the accident did not involve a train, but occurred at or near a crossing, the crossing identification number should also be recorded on the report form. Thus, accidents in which the presence of the crossing (regardless of the presence of a train) was a contributing factor to the accident can be identified. It is recommended that the accident report form give the crossing identification number for accidents that occur within 200 feet of a crossing.

The FRA requires each railroad to report any "impact between railroad on-track equipment and an automobile, bus, truck, motorcycle, bicycle, farm vehicle, or pedestrian at a

rail-highway grade crossing".<sup>12</sup> The form used for reporting crossing accidents is shown in Figure 9. An annual summary of the accident data (and the national inventory data) is prepared by FRA, titled Rail-Highway Crossing Accident/Incident and Inventory Bulletin. This document and other data contained in the accident data file can be obtained from FRA.

The NHTSA maintains a data base on all fatal highway traffic accidents including those occurring at railroad - highway grade crossings. The data base is called FARS for Fatal Accident Reporting System. The form utilized for these fatal accidents is shown in Figure 10.

The Bureau of Motor Carrier Safety (BMCS) maintains data on highway accidents involving motor carriers. A reportable accident is one that involves "a motor vehicle engaged in the interstate, foreign, or intrastate operations of a motor carrier who is subject to the Department of Transportation Act resulting in: 1) the death of a human being; or, 2) bodily injury to a person who, as a result, receives medical treatment away from the scene of the accident; or, 3) total damage to all property aggregating \$2,000 or more based on actual costs or reliable estimates".<sup>13</sup> These accidents are reported on the form shown in Figure 11.

Accidents involving the transport of hazardous materials are reported to the Materials Transporta-

---

<sup>12</sup>Code of Federal Regulations, Title 49, Washington, DC: Superintendent of Documents, Government Printing Office, published annually.

<sup>13</sup>Ibid.

# Chapter III Assessment of Crossing Safety and Operation

DEPARTMENT OF TRANSPORTATION  
FEDERAL RAILROAD ADMINISTRATION

## RAIL-HIGHWAY GRADE CROSSING ACCIDENT/INCIDENT REPORT

FORM APPROVED  
OMB NO. 0494033

1. NAME OF REPORTING RAILROAD <div style="text-align: right;">Amtrak Autotrain</div>		1a. Alphabetic Code	1b. Railroad Accident/Incident No.
2. NAME OF OTHER RAILROAD INVOLVED IN TRAIN ACCIDENT/INCIDENT		2a. Alphabetic Code	2b. Railroad Accident/Incident No.
3. NAME OF RAILROAD RESPONSIBLE FOR TRACK MAINTENANCE (single entry)		3a. Alphabetic Code	3b. Railroad Accident/Incident No.
4. U. S. DOT-HAR GRADE CROSSING IDENTIFICATION NUMBER		5. DATE OF ACCIDENT/INCIDENT month    day    year	6. TIME OF ACCIDENT/INCIDENT am <input type="checkbox"/> pm <input type="checkbox"/>
<b>LOCATION</b>			
7. NEAREST RAILROAD STATION		8. COUNTY	9. STATE (two letter code)    CODE
10. CITY (if in a city)		11. HIGHWAY NAME OR NUMBER (if private crossing, so state)	
<b>ACCIDENT/INCIDENT SITUATION</b>			
12. TYPE 1. Auto    3. Truck-Trailer    6. Motorcycle 4. Bus    5. School Bus    7. Pedestrian 8. Other (specify)		CODE	16. EQUIPMENT 1. Train (units pulling)    3. Train (standing)    6. Light locom(s) (moving) 2. Train (units pushing)    4. Car(s) (moving)    7. Light locom(s) (standing) 5. Car(s) (standing)    8. Other (specify)
13. SPEED (estimated mph at impact)	14. DIRECTION (geographical) 1. North    3. East 2. South    4. West	CODE	17. POSITION OF CAR/UNIT IN TRAIN    CODE
15. POSITION 1. Stalled on crossing    2. Stopped on crossing    3. Moving over crossing	CODE	18. CIRCUMSTANCE 1. Train struck highway user    2. Train struck by highway user	CODE
19. Was the highway user and/or rail equipment involved in the impact transporting hazardous materials?		1. Highway user    2. Rail equipment    3. Both    4. Neither    CODE	
<b>ENVIRONMENT</b>			
20. TEMPERATURE (specify, if minus) °F	21. VISIBILITY (single entry) 1. Dawn    3. Dusk 2. Day    4. Dark	CODE	22. WEATHER (single entry) 1. Clear    3. Rain    5. Sleet 2. Cloudy    4. Fog    6. Snow    CODE
<b>TRAIN AND TRACK</b>			
23. TYPE OF TRAIN 1. Freight    3. Mixed    5. Yard/Switching 2. Passenger    4. Work    6. Light Locomotive(s)	CODE	24. TRACK TYPE USED BY TRAIN INVOLVED    CODE 1. Main    3. Siding 2. Yard    4. Industry	
25. TRACK NUMBER OR NAME	26. FRA TRACK CLASSIFICATION	27. NUMBER OF LOCOMOTIVE UNITS	
28. NUMBER OF CARS	29. TRAIN SPEED (recorded speed, if available) MPH    Recorded    Est	30. TIME TABLE DIRECTION    CODE 1. North    3. East 2. South    4. West	
<b>CROSSING WARNING</b>			
31. TYPE (place X in appropriate box(es)) 1. <input type="checkbox"/> Gates    5. <input type="checkbox"/> Hwy. Traffic Signals    9. <input type="checkbox"/> Watchman 2. <input type="checkbox"/> Cantilever FLS    6. <input type="checkbox"/> Audible    10. <input type="checkbox"/> Flagged by crew 3. <input type="checkbox"/> Standard FLS    7. <input type="checkbox"/> Crossbucks    11. <input type="checkbox"/> Other (specify) 4. <input type="checkbox"/> Wig Wags    8. <input type="checkbox"/> Stop Signs    12. <input type="checkbox"/> None	32. SIGNALLED CROSSING WARNING Was the signaled crossing warning identified in item 31 operating? 1. Yes    2. No    CODE		
33. LOCATION OF WARNING 1. Both sides    2. Side of vehicle approach    3. Opposite side of vehicle approach    CODE	34. CROSSING WARNING INTERCONNECTED WITH HIGHWAY SIGNALS 1. Yes    2. No    3. Unknown    CODE	35. CROSSING ILLUMINATED BY STREET LIGHTS OR SPECIAL LIGHTS 1. Yes    2. No    3. Unknown    CODE	
<b>MOTORIST ACTION</b>			
36. MOTORIST PASSED STANDING HIGHWAY VEHICLE 1. Yes    2. No    3. Unknown    CODE		37. MOTORIST DROVE BEHIND OR IN FRONT OF TRAIN AND STRUCK OR WAS STRUCK BY SECOND TRAIN 1. Yes    2. No    3. Unknown    CODE	
38. MOTORIST 1. Drove around or thru the gate    2. Stopped and then proceeded    3. Did not stop    4. Other (specify)    5. Unknown    CODE		39. VIEW OF TRACK OBSCURED BY (primary obstruction) 1. Permanent structure    2. Standing railroad equipment    3. Passing train    5. Vegetation    7. Other (specify) 4. Topography    6. Highway vehicles    8. Not obstructed    CODE	
<b>HIGHWAY VEHICLE PROPERTY DAMAGE/CASUALTIES</b>			
40. HIGHWAY VEHICLE PROPERTY DAMAGE (est. dollar damage)	41. DRIVER WAS 1. Killed    2. Injured    3. Uninjured    CODE	42. WAS DRIVER IN THE VEHICLE? 1. Yes    2. No    CODE	
43. TOTAL NUMBER OF OCCUPANTS KILLED	44. TOTAL NUMBER OF OCCUPANTS INJURED	45. TOTAL NUMBER OF OCCUPANTS (include driver)    CODE	
46. IS A RAIL EQUIPMENT ACCIDENT/INCIDENT REPORT BEING FILED? 1. Yes    2. No    CODE			
47. TYPED NAME AND TITLE	48. SIGNATURE	49. DATE	

FORM FRA F 6180-57 (12-74) REPLACES FORM FRA F 6180-13 (10-67) WHICH IS OBSOLETE

Figure 9. Accident Report Form for Federal Railroad Administration

# Chapter III Assessment of Crossing Safety and Operation



U.S. Department of Transportation  
National Highway Traffic Safety Administration

## 1984 Fatal Accident Reporting System (FARS) ACCIDENT LEVEL

Form Approved thru  
G.M.B. No. 2127-0006  
CODED BY:  
DATE CODED:  
STATE CASL NO.

CASE NUMBER STATE (GSA CODES)		1	2	CONSECUTIVE NUMBER		3	4	5	TRANSACTION CODE		7	8	CARD NO.	9			
									11 - Original Submission 12 - Update or Change	13 - Delete 14 - List	1		1				
CITY		COUNTY		MONTH		DAY		YEAR		DATE		TIME		LAND USE			
										8 4		Military Time 9999 - Unknown		1 - Urban 2 - Rural 9 - Unknown			
ROADWAY FUNCTION CLASS		FEDERAL AID SYSTEM		CLASS TRAFFICWAY		TRAFFICWAY IDENTIFIER		MILEPOINT		SPECIAL JURISDICTION		FIRST HARMFUL EVENT		MANNER OF COLLISION			
1 - Principal Arterial Interstate 2 - Principal Arterial Other Urban 3 - Principal Arterial Other 4 - Minor Arterial 5 - Urban Collector 6 - Major Rural Collector 7 - Minor Rural Collector 8 - Local Road or Street 9 - Unknown		1 - Interstate 2 - Other Federal Aid Primary 3 - Federal Aid Secondary 4 - Federal Aid Urban Arterials 5 - Federal Aid Urban Collectors 6 - Non Federal Aid Arterials 7 - Non Federal Aid Collectors 8 - Non Federal Aid Local 9 - Unknown		1 - Interstate 2 - Other U.S. Route 3 - Other State Route 4 - County Road 5 - Local Street 8 - Other 9 - Unknown		Actual Posted Number, Assigned Number, or Common Name (if No Posted or Assigned Number) Except - Nine Fill if Unknown		Actual to Nearest 1 Mile (Assumed Decimal) Except: 00000 - None 99999 - Unknown		0 - No Special Jurisdiction 1 - National Park Service 2 - Military 3 - Indian Reservation 4 - College/University Campus 5 - Other Federal Properties 8 - Other 9 - Unknown		(See Instruction Manual)		0 - Not Collision with Vehicle in Transport 1 - Rear-End Direction 2 - Head-On Direction 3 - Rear to Rear 4 - Angle 5 - Sideswipe Same Direction 6 - Sideswipe Opposite Direction 9 - Unknown			
RELATION TO JUNCTION		RELATION TO ROADWAY		TRAFFICWAY FLOW		NUMBER OF TRAVEL LANES		SPEED LIMIT		ROADWAY ALIGNMENT		ROADWAY PROFILE		ROADWAY SURFACE TYPE			
1 - Non Junction 2 - Intersection 3 - Intersection Related 4 - Interchange Area 5 - Driveway, Alley Access, etc. 6 - Entrance/Exit Ramp 7 - Rail Grade Crossing 8 - In Crossover 9 - Unknown		1 - On Roadway 2 - Shoulder 3 - Median 4 - Roadside 5 - Outside Right-of-Way 6 - Off Roadway - Location Unknown 7 - In Parking Lane 8 - Gore 9 - Unknown		1 - Not Physically Divided (Two Way Trafficway) 2 - Divided Highway Median Strip (Without Traffic Barrier) 3 - Divided Highway Median Strip (With Traffic Barrier) 4 - One Way Trafficway 9 - Unknown		Actual Value Except: 7 - Seven or more lanes 9 - Unknown		Actual Miles Per Hour Except: 00 - No Statutory Limit 99 - Unknown		1 - Straight 2 - Curve 9 - Unknown		1 - Level 2 - Grade 3 - Hillcrest 4 - Sag 5 - Unknown		1 - Concrete 2 - Blacktop (Bituminous) 3 - Brick or Block 4 - Slag, Gravel or Stone 5 - Dirt 8 - Other 9 - Unknown		1 - Dry 2 - Wet 3 - Snow or Slush 4 - Ice 5 - Sand, Dirt, Oil 6 - Other 9 - Unknown	
TRAFFIC CONTROL DEVICE FUNCTIONING		HIT AND RUN		LIGHT CONDITION		ATMOSPHERIC CONDITIONS		CONSTRUCTION/MAINTENANCE ZONE		NOTIFICATION TIME EMS		ARRIVAL TIME EMS		SCHOOL BUS RELATED			
0 - No Controls 1 - Device Not Functioning 2 - Device Functioning - Functioning Improperly 3 - Device Functioning Properly 9 - Unknown		0 - No Hit and Run 1 - Hit Motor Vehicle in Transport 2 - Hit Pedestrian or Non Motorist 3 - Hit Parked Vehicle or Object		1 - Daylight 2 - Dark 3 - Dark but lighted 4 - Dawn 5 - Dusk 9 - Unknown		1 - No Adverse Atmospheric Conditions 2 - Rain 3 - Sleet 4 - Snow 5 - Fog 6 - Rain and Fog 7 - Sleet and Fog 8 - Other: Smog, Smoke, Blowing Sand or Dust 9 - Unknown		0 - None 1 - Construction 2 - Maintenance 3 - Utility 4 - Work Zone, Type Unknown		Military Time Except 0000 - Not Notified 9999 - Unknown		Military Time Except: 0000 - Not Notified 9999 - Unknown		0 - No 1 - Yes		83 - School Bus Related 84 - 85 - Related Factors 86 - 87 - 88 - 89 - 90 - RAIL GRADE CROSSING IDENTIFIER 96 -	
CARD NO.		ADDITIONAL STATE INFORMATION		RELATED FACTORS		RAIL GRADE CROSSING IDENTIFIER		CONSTRUCTION/MAINTENANCE ZONE		NOTIFICATION TIME EMS		ARRIVAL TIME EMS		SCHOOL BUS RELATED			
2		(See Instruction Manual)		(See Instruction Manual "Related Factors - ACCIDENT LEVEL")		(See Instruction Manual)		14		24		33					

HS Form 214 (Rev. 1/84)

Figure 10. Accident Report Form for National Highway Traffic Safety Administration

# Chapter III Assessment of Crossing Safety and Operation



US Department of Transportation  
National Highway Traffic Safety  
Administration

## 1984 Fatal Accident Reporting System (FARS) VEHICLE/DRIVER LEVEL

Form Approved thru  
O.M. No. 2127-0006  
CODED BY \_\_\_\_\_  
DATE LOGGED \_\_\_\_\_  
STATE CASE NO. \_\_\_\_\_

CASE NUMBER STATE (GSA CODES)		1	2	CONSECUTIVE NUMBER	3	4	5	6	TRANSACTION CODE		7	8	CARD NO	9	VEHICLE NUMBER (Assigned by Analyst)	10	11																						
									21 - Original Submission 22 - Update or Change				2																										
VEHICLE MAKE (See Instruction Manual)		14		15		VEHICLE MODEL (See Instruction Manual)		16		17		BODY TYPE (See Instruction Manual)		18		19		MODEL YEAR		20		21																	
																		Actual Value Except 99 - Unknown																					
VEHICLE IDENTIFICATION NO		22		23		24		25		26		27		28		29		30		31		32		33		34		35		36		37		38					
REGISTRATION STATE		39		40		HAZARDOUS CARGO		45		VEHICLE TRAILERING		46		SPECIAL USE		47		48		49		50		51		52		53		54		55							
GSA CODES Except 00 - Not Applicable 92 - No Registration 93 - Multiple State Reg. in State 94 - Multiple State Reg. Out of State						0 - No Rollover 1 - First Event 2 - Subsequent Event				0 - No 1 - Yes, One Trailing Unit 2 - Yes, Two Trailing Units 3 - Yes, Three or More Trailing Units 4 - Yes, Number of Trailing Units Unknown 9 - Unknown				0 - No Special Use 1 - Taxi 2 - Vehicle Used as School Bus 3 - Vehicle Used as other Bus				0 - Not an Articulated Vehicle 1 - No 2 - First Event 3 - Subsequent Event																					
TRAVEL SPEED		43		44		HAZARDOUS CARGO		45		VEHICLE TRAILERING		46		SPECIAL USE		47		48		49		50		51		52		53		54		55							
Actual Miles Per Hour Except: 00 - Stopped Vehicle 97 - Ninety seven MPH or Greater 99 - Unknown						0 - No 1 - Yes 9 - Unknown				0 - No 1 - Yes, One Trailing Unit 2 - Yes, Two Trailing Units 3 - Yes, Three or More Trailing Units 4 - Yes, Number of Trailing Units Unknown 9 - Unknown				0 - No Special Use 1 - Taxi 2 - Vehicle Used as School Bus 3 - Vehicle Used as other Bus				0 - Not an Articulated Vehicle 1 - No 2 - First Event 3 - Subsequent Event																					
EMERGENCY USE		48		49		IMPACT POINT - INITIAL		50		IMPACT POINT - PRINCIPAL		51		52		53		54		55		56		57		58		59		60		61		62					
0 - No 1 - Yes						00 - Non Collision 01 - 12 - Clock Points 13 - Top 14 - Undercarriage		15 - Underride 16 - Override 99 - Unknown				00 - Non Collision 01 - 12 - Clock Points 13 - Top 14 - Undercarriage																											
EXTENT OF DEFORMATION		63		64		VEHICLE ROLE		65		MANNER OF LEAVING SCENE		66		67		68		69		70		71		72		73		74		75		76		77					
0 - None 2 - Other (Minor) 4 - Functional (Moderate)						0 - Non Collision 1 - Striking 2 - Struck		3 - Both 9 - Unknown				1 - Driven 2 - Towed Away 3 - Abandoned 9 - Unknown																											
FIRE OCCURRENCE		56		57		NUMBER OF OCCUPANTS		58		RELATED FACTORS		59		60		61		62		63		64		65		66		67		68		69		70					
0 - No Fire 1 - Fire Occurred in Vehicle During Accident						Actual Value if Total Known 96 - 96 or more 97 - Unknown - Only Injured Reported 99 - Unknown				See Instruction Manual "Related Factors VEHICLE LEVEL"																													
VEHICLE MANEUVER (See Instruction Manual)		63		64		MOST HARMFUL EVENT (See Instruction Manual)		65		66		67		68		69		70		71		72		73		74		75		76		77		78					
Card No	DRIVER PRESENCE	14		LICENSE STATE (GSA CODES)		15		16		LICENSE/CLASS VEHICLE COMPLIANCE		17		LICENSE STATUS		18		19		20		21		22		23		24		25		26		27					
2	1 - Driver Operated Vehicle 2 - Driverless Vehicle 3 - Driver Left Vehicle 4 - Unknown			Except 94 - Military 95 - Canada 96 - Mexico 97 - Other Foreign Countries 99 - Unknown						0 - No License Required 1 - No License, License Required 2 - Valid License for This Class Vehicle Only 3 - One Valid License, but Not for This Class Vehicle 4 - Multiple Class Licenses, Valid License for This Class Vehicle 5 - Multiple Class Licenses, No Valid License for This Class Vehicle 9 - Unknown				0 - None Required 1 - None 2 - Valid 3 - Suspended 4 - Revoked 5 - Expired 6 - Cancelled or Denied 7 - Learner's Permit 8 - Temporary 9 - Unknown																									
COMPLIANCE WITH LICENSE RESTRICTIONS		19		DRIVER TRAINING		20		VIOLATIONS CHARGED		21		PREVIOUS RECORDED ACCIDENTS		22		23		24		25		26		27		28		29		30		31		32		33			
0 - No Restrictions 1 - Restrictions Complied With 2 - Restrictions Not Complied With 3 - Restrictions, Compliance Unknown 9 - Unknown				0 - None 1 - High School 2 - Commercial 3 - School Bus 4 - Traffic School 5 - Two or more Types 6 - Training, Type Unknown 9 - Unknown				0 - None 1 - Alcohol or Drugs 2 - Speeding 3 - Alcohol or Drugs and Speeding 4 - Reckless Driving 5 - Driving with a Suspended or Revoked License 6 - Other Moving Violation 7 - Non-Moving Violation 8 - Violation, Type Unknown or Other Violation 9 - Unknown				Actual Value Except: 00 - None 99 - Unknown																											
PREVIOUS RECORDED SUSPENSIONS AND REVOCATIONS		24		PREVIOUS DWI CONVICTIONS		26		27		PREVIOUS SPEEDING CONVICTIONS		28		29		30		31		32		33		34		35		36		37		38		39		40		41	
Actual Value Except: 00 - None 99 - Unknown				Actual Value Except: 00 - None 99 - Unknown						Actual Value Except: 00 - None 99 - Unknown																													
PREVIOUS OTHER HARMFUL MV CONVICTIONS		30		DATE OF LAST ACCIDENT, SUSPENSION, OR CONVICTION		32		33		DATE OF FIRST ACCIDENT SUSPENSION, OR CONVICTION		36		37		RELATED FACTORS		40		41		42		43		44		45		46		47		48					
Actual Value Except: 00 - None 99 - Unknown				Mo Yr 00 - No Record 99 - Unknown						Mo Yr 00 - No Record 99 - Unknown						See Instruction Manual. "Related Factors - DRIVER LEVEL"																							

HS Form 214A (Rev. 1/84)

Figure 10. Accident Report Form for National Highway Traffic Safety Administration (Continued)

# Chapter III Assessment of Crossing Safety and Operation



U.S. Department of Transportation  
National Highway Traffic Safety Administration

## 1984 Fatal Accident Reporting System (FARS) PERSON LEVEL

Form Approved  
D.M.B. No. 2127-004  
CLASSIFIED BY \_\_\_\_\_  
DATE CODED \_\_\_\_\_  
STATE CASE NO. \_\_\_\_\_

CASE NUMBER STATE (GSA CODES)		1	2	CONSECUTIVE NUMBER			3	4	5	TRANSACTION CODE		7	8	CARD NO.	9	VEHICLE NUMBER (Assigned by Analyst)		10	11	PERSON NUMBER (Assigned by Analyst)		12	13
											31 - Original Submission 32 - Update or Change	3		1		00 - Non Motorist							
NON MOTORIST STRIKING VEHICLE NUMBER				Assigned Vehicle Number Except 99 - Unknown		14	15	AGE			16	17	SEX			18							
								Actual Value 00 - Up to One Year 97 - Ninety Seven Years or Older 99 - Unknown					1 - Male 2 - Female 9 - Unknown										
PERSON TYPE										SEATING POSITION													
1 - Driver of a Motor Vehicle in Transport 2 - Passenger of a Motor Vehicle in Transport 3 - Occupant of a Motor Vehicle Not in Transport 4 - Occupant of a Non-Motor Vehicle Transport Device 5 - Non-Occupant - Pedestrian 6 - Non-Occupant - Bicyclist 7 - Non-Occupant - Other Cyclist 8 - Non-Occupant - Other or Unknown 9 - Unknown Occupant Type in a Motor Vehicle in Transport										00 - Non Motorist 11 - Front Seat - Left Side (Driver's Side) 12 - Middle 13 - Right Side 18 - Other 19 - Unknown 21 - Second Seat - Left Side 22 - Middle 23 - Right Side 28 - Other 29 - Unknown 31 - Third Seat - Left Side 32 - Middle 33 - Right Side 38 - Other 39 - Unknown 41 - Fourth Seat - Left Side													
MANUAL (ACTIVE) RESTRAINT SYSTEM - USE										AUTOMATIC (PASSIVE) RESTRAINT SYSTEM - FUNCTION													
0 - None Used - Vehicle Occupant - Not Applicable - Non-Motorist 1 - Shoulder Belt 2 - Lap Belt 3 - Lap and Shoulder Belt 4 - Child Safety Seat 5 - Motorcycle Helmet 8 - Restraint Used - Type Unknown or Other including Other Helmet 9 - Unknown										0 - Not Equipped or Non-Motorist 1 - Automatic Belt in Use 2 - Automatic Belt Not in Use 3 - Deployed Air Bag 4 - Non-deployed Air Bag 9 - Unknown													
NON-MOTORIST LOCATION										EJECTION					EXTRICATION								
00 - Not Applicable - Vehicle Occupant 01 - Intersection - In Crosswalk 02 - Intersection - On Roadway, Not in Crosswalk 03 - Intersection - On Roadway, Crosswalk Not Available 04 - Intersection - On Roadway, Crosswalk Availability Unknown 05 - Intersection - Not on Roadway 09 - Intersection - Unknown 10 - Non-Intersection - In Crosswalk 11 - Non-Intersection - On Roadway, Not in Crosswalk 12 - Non-Intersection - On Roadway, Crosswalk Not Available 13 - Non-Intersection - On Roadway, Crosswalk Availability Unknown 14 - Non-Intersection - In Parking Lane 15 - Non-Intersection - On Road Shoulder 16 - Non-Intersection - Bike Path 17 - Non-Intersection - Outside Trafficway 18 - Non-Intersection - Other, Not on Roadway 19 - Non-Intersection - Unknown 99 - Unknown										0 - Not Ejected 1 - Totally Ejected 2 - Partially Ejected 9 - Unknown					0 - Not Extricated 1 - Extricated 9 - Unknown								
POLICE REPORTED ALCOHOL INVOLVEMENT										ALCOHOL TEST RESULT													
0 - No (Alcohol Not Involved) 1 - Yes (Alcohol Involved) 8 - Not Reported 9 - Unknown (Police Reported)										Actual Value (Decimal Implied before First Digit) (0.xx) 95 - Test Refused 96 - None Given 97 - AC Test Performed, Results Unknown 99 - Unknown													
INJURY SEVERITY					TAKEN TO HOSPITAL OR TREATMENT FACILITY					DEATH DATE													
0 - No Injury (0) 1 - Possible Injury (C) 2 - Nonincapacitating Evident Injury (B) 3 - Incapacitating Injury (A) 4 - Fatal Injury (K) 5 - Injured, Severity Unknown 6 - Died Prior to Accident 9 - Unknown					0 - No 1 - Yes 9 - Unknown					000000 - Not Applicable 999999 - Unknown MONTH DAY YEAR													
DEATH TIME										RELATED FACTORS													
Military Time Except: 0000 - Not Applicable 9999 - Unknown										See Instruction Manual "Related Factors - PERSON LEVEL"													

HS Form 214B (Rev. 1/84)

Figure 10. Accident Report Form for National Highway Traffic Safety Administration (Continued)

Chapter III Assessment of Crossing Safety and Operation

Form Approved  
OMB No. 004-R2394

**U.S. DEPARTMENT OF TRANSPORTATION  
FEDERAL HIGHWAY ADMINISTRATION  
BUREAU OF MOTOR CARRIER SAFETY** **MOTOR CARRIER ACCIDENT REPORT**

Original and two copies of MCS 50-T shall be filed with the Director, Regional Motor Carrier Safety Office, FHWA, as required by 394.9. Copy shall be retained in carrier's file. Circle or (X) appropriate boxes below.

1. Name of carrier (Corporate business name) (7-21) 2. Principal Address (Street and no., City, State, ZIP Code.) (22-50)

3. Type of carrier (51-66)  Private, Employer ID No. (IRS)  ICC authorized, MC  Other (Specify) Employer ID No. (IRS)

4. Type of trip (67)  Over-the-road  Local pick-up and delivery operation

5. Place accident occurred (Nearest Town or City, State) (68-78) 5A. Type of district (79)  Residential  Rural  Primarily business

6. Street or highway (Route or Name) (7-16) 6A. Location if off highway (17-26)

7. Day of week (27)  M  T  W  TH  F  S  S 8. Date accident occurred (28-33) -----/-----/----- 9. Time accident occurred (Military time to nearest hour) (34-35)

**10. ACCIDENT TYPE (Primary Event)**

10A. Collision (Check appropriate box) (36)  Not applicable  Collision with moving object  Collision with fixed or parked object

10B. Collision (Check other object involved) (37-45)  Not applicable  Commercial truck  Fixed object  Automobile  Pedestrian  Bus  Train  Bicyclist  Animal  Motorcycle  Other (Specify)

10C. Collision with another vehicle—Accident Classification (Check appropriate box) (46-48) zzz  not applicable

(46-48) VEHICLES				(46-48) VEHICLES				
ACTION				ACTION				
	1	2	3		1	2	3	
A				Slowing—Stopping	L			Intersection
B				Stopped	M			Passing
C				Parked	N			Changing Lanes
D				Rear-end	O			Sideswipe—Opposite Direction
E				Backing	P			Head-On—Crossed into Opposing Lane
F				Making Right Turn	Q			Skidding
G				Making Left Turn	R			Vehicle Out-Of-Control
H				Making U-Turn	S			Roll-Away
I				Proceeding Straight	T			Controlled Railroad Crossing
J				Merging	U			Uncontrolled Railroad Crossing
K				Entering Traffic From Shoulder, Median, Parking Strip or Private Drive	V			Other (Specify)

10D. Non-collision (Check primary event) (49-57)  Not applicable  Ran off road  Jackknife  Overturn  Separation of units  Fire  Loss or spillage of cargo  Cargo shift  Other (Specify)

10E. If not primary event, did accident result in (58)  Not applicable  Spillage of hazardous cargo  Fire  Spillage of non-hazardous cargo  Explosion

**11. DRIVER INFORMATION**

11A. Name of your driver (59-72) 11B. Age (73-74) 11C. Social Security No. (7-15) -----/-----/-----

11D. How long employed as your driver (To nearest year) (16-17)

11E. Hours actually driving since last period of 8 consecutive hours off duty (13)  1 hr.  2 hrs.  3 hrs.  4 hrs.  5 hrs.  6 hrs.  7 hrs.  8 hrs.  9 hrs.  10 hrs.  11-12 hrs.  Not applicable

11F. Estimated hours of driving for entire trip or portion of trip, since last period of 8 consecutive hours off duty (19)  1 hr.  2 hrs.  3 hrs.  4 hrs.  5 hrs.  6 hrs.  7 hrs.  8 hrs.  9 hrs.  10 hrs.  11-12 hrs.  Not applicable

11G. Condition of driver (20-28)  Apparently normal  Sick  Had been drinking  Dozed at wheel  Medical waiver  Other (Specify)

11H. Date of last medical certificate (29-34) -----/-----/-----

Form MCS 50-T (Property-Carrying) (Rev. 8-72) Previous editions of this form are obsolete (over)

Figure 11. Accident Report Form for Bureau of Motor Carrier Safety

Chapter III Assessment of Crossing Safety and Operation

12. CARRIER'S VEHICLE(S)										
Type (35-39)	Year (40-41)	No. of Axles (42-43)	Make (44-53)	Model No. (54-63)	Company No. (64-69)	TYPE OF BODY (70-74)				
						Van	Flat	Tank	Auto Carrier	Other (Specify)
<input type="checkbox"/> A Truck										
<input type="checkbox"/> B Tractor										
<input type="checkbox"/> C Semi-trailer										
<input type="checkbox"/> D Full trailer										
<input type="checkbox"/> E Full trailer (2nd)										
<input type="checkbox"/> F Other (Specify) _____										
13. Total length of vehicle/comb. (7-9) Ft.		13A. Total width of vehicle or cargo (10-11) Ft.			13B. Weight (cargo) (12-17) Lbs.		13C. Weight (gross) (18-23) Lbs.			
14. Type of fuel <input type="checkbox"/> A Gasoline <input type="checkbox"/> B Diesel <input type="checkbox"/> C L.P.G. <input type="checkbox"/> D Other (Specify) _____ (24-29)										
15. Cargo at time of accident (Your vehicle) (30-35) <input type="checkbox"/> A Hazardous materials in cargo (Specify classification) _____ <input type="checkbox"/> B Non-hazardous materials in cargo _____										
16. Check one of the following as principal type of cargo (36-44)										
<input type="checkbox"/> A General freight			<input type="checkbox"/> E Motor vehicles			<input type="checkbox"/> I Liquids in bulk			<input type="checkbox"/> N Mobile home (39-44)	
<input type="checkbox"/> B Household goods or uncrated furniture/fixtures			<input type="checkbox"/> F Driveaway-towaway			<input type="checkbox"/> J Explosives			<input type="checkbox"/> O Farm products	
<input type="checkbox"/> C Metal: Coils, sheets, rods, plates, etc.			<input type="checkbox"/> G Gases in bulk			<input type="checkbox"/> K Logs, poles, lumber			<input type="checkbox"/> P Other (Specify)	
<input type="checkbox"/> D Heavy machinery or other large objects			<input type="checkbox"/> H Solids in bulk			<input type="checkbox"/> L Empty			<input type="checkbox"/> M Refrigerated foods	
17. Was your driver killed? (45) <input type="checkbox"/> A Yes <input type="checkbox"/> B No		17A. Was driver injured? (46) <input type="checkbox"/> A Yes <input type="checkbox"/> B No		17B. Was your relief driver killed? (47) <input type="checkbox"/> A Yes <input type="checkbox"/> B No <input type="checkbox"/> C N/A		17C. Was relief driver injured? (48) <input type="checkbox"/> A Yes <input type="checkbox"/> B No <input type="checkbox"/> C N/A				
18. Number of other authorized persons in your vehicle Killed _____ Injured _____ (49-50)				18A. Number of unauthorized persons in your vehicle Killed _____ Injured _____ (51-52)						
19. Total number of other persons killed _____ injured _____ (53-56)					19A. Amount of total property damage in dollars \$ _____ (57-61)					
20. Were mechanical defects or failures apparent on your vehicle at time of accident? <input type="checkbox"/> A Yes <input type="checkbox"/> B No (62)										
21. Check appropriate boxes (Mechanical defects or failures) (63-69)										
<input type="checkbox"/> A Not applicable			<input type="checkbox"/> D Steering system		<input type="checkbox"/> G Driveline		<input type="checkbox"/> J Lights			
<input type="checkbox"/> B Fuel system			<input type="checkbox"/> E Suspension		<input type="checkbox"/> H Engine		<input type="checkbox"/> K Coupling			
<input type="checkbox"/> C Wheels and tires			<input type="checkbox"/> F Transmission		<input type="checkbox"/> I Brakes		<input type="checkbox"/> L Other (Specify) _____			
22. Was your vehicle equipped with seat belts? <input type="checkbox"/> A Yes <input type="checkbox"/> B No (70)										
23. Were seat belts in use by your driver(s) at time of accident? <input type="checkbox"/> A Yes <input type="checkbox"/> B No (71)										
24. OTHER VEHICLES INVOLVED										
24A. Company name or operator (Vehicle #2)				24B. Address				24C. Type of vehicle		
24D. Company name or operator (Vehicle #3)				24E. Address				24F. Type of vehicle		
25. Weather (7-12)					25A. Light (13-18)					
<input type="checkbox"/> A Rain <input type="checkbox"/> C Snow <input type="checkbox"/> E Cloudy/overcast					<input type="checkbox"/> A Day <input type="checkbox"/> C Dawn <input type="checkbox"/> E Dusk <input type="checkbox"/> F Dark					
<input type="checkbox"/> B Clear <input type="checkbox"/> D Fog/Smog <input type="checkbox"/> F Sleet <input type="checkbox"/> G Other (Specify) _____					<input type="checkbox"/> B Artificial lights <input type="checkbox"/> D Other (Specify) _____					
26. Road surface (19-23)			26A. Total number of lanes (24)			26B. Type of highway (25)				
<input type="checkbox"/> A Dry <input type="checkbox"/> C Snowy <input type="checkbox"/> E Other			<input type="checkbox"/> A One lane <input type="checkbox"/> C Three lanes			<input type="checkbox"/> A Divided <input type="checkbox"/> B Undivided				
<input type="checkbox"/> B Wet <input type="checkbox"/> D Icy (Specify) _____			<input type="checkbox"/> B Two lanes <input type="checkbox"/> D Four or more lanes							
26C. Check appropriate box <input type="checkbox"/> A Entrance ramp (Expressway) <input type="checkbox"/> B Exit ramp (Expressway) <input type="checkbox"/> C Not applicable (26)										
27. Account of accident by carrier official										
28. Name and title of person signing report						29. Signature				
30. Telephone Number Area Code						31. Date report submitted (27-32)				

Form MCS 50-T (8-72)

For sale by the Superintendent of Documents, U.S. Government Printing Office  
Washington, D.C. 20402 - Price \$1.25 per pad STOCK NO. 5004-00007

GPO 448-10-83124-1 474-405

Figure 11. Accident Report Form for Bureau of Motor Carrier Safety (Continued)



tion Bureau (MTB) of the Research and Special Programs Administration (RSPA). An immediate telephone notice is required under certain conditions and a detailed written report is required whenever there is any unintentional release of a hazardous material during transportation or temporary storage related to transportation. Accidents are to be reported when, as a direct result of hazardous materials: 1) a person is killed; 2) a person receives injuries requiring hospitalization; 3) estimated carrier or other property damage exceeds \$50,000; or, 4) a situation exists such that a continuing danger to life exists at the scene of the incident. The form used for reporting these accidents to MTB is shown in Figure 12.

#### B. Identification of Crossings for Further Analysis

A systematic method for identifying crossings that have the most need for safety and/or operational improvements is essential in order to comply with requirements of the Federal Highway Program Manual (FHPM), which specifies that each State should maintain a priority schedule of crossing improvements. The priority schedule is to be based on:

- o the potential reduction in the number and/or severity of accidents;
- o the cost of the projects and the resources available;
- o the relative hazard of public railroad-highway grade crossings based on a hazard index formula;
- o onsite inspections of public crossings;
- o the potential danger to large numbers of people at public crossings used on a regular basis by passenger trains, school buses, transit buses, pedestrians, bicyclists, or by trains and/or motor vehicles carrying hazardous materials; and,
- o other criteria as appropriate in each State.

Various hazard indices and accident prediction formulae have been developed for ranking railroad-highway grade crossings. These are commonly used to identify those crossings that are to be investigated in the field. Procedures for conducting the onsite inspection are discussed in the next section. Some hazard indices incorporate accident history as a factor in the ranking formula; if not, this factor should be subjectively considered.

There are several advantages of using a hazard index to rank crossings. A mathematical hazard index enhances objectivity. It can be calculated by computer, thus facilitating the ranking process. As crossing conditions change, a computerized data base can be updated and the hazard index recalculated.

The hazard indices or accident prediction formulae commonly used are the Peabody Dimmick Formula, the New Hampshire Index, the National Cooperative Highway Research Program Report 50 Formula (NCHRP 50), and the U.S. DOT Accident Prediction Formulae. Several States have developed their own formulae.

##### 1. Peabody Dimmick Formula

The Peabody Dimmick Formula, published in 1941, was based on five years of accident data from 3,563 rural crossings in 29 States. It is

Chapter III Assessment of Crossing Safety and Operation

DEPARTMENT OF TRANSPORTATION Form Approved OMB No. 04-5613

**HAZARDOUS MATERIALS INCIDENT REPORT**

**INSTRUCTIONS:** Submit this report in duplicate to the Director, Office of Hazardous Materials Operations, Materials Transportation Bureau, Department of Transportation, Washington, D.C. 20590, (ATTN: Op. Div.). If space provided for any item is inadequate, complete that item under Section H, "Remarks", keying to the entry number being completed. Copies of this form, in limited quantities, may be obtained from the Director, Office of Hazardous Materials Operations. Additional copies in this prescribed format may be reproduced and used, if on the same size and kind of paper.

<b>A INCIDENT</b>		
1. TYPE OF OPERATION 1 <input type="checkbox"/> AIR 2 <input type="checkbox"/> HIGHWAY 3 <input type="checkbox"/> RAIL 4 <input type="checkbox"/> WATER 5 <input type="checkbox"/> FREIGHT FORWARDER 6 <input type="checkbox"/> OTHER (Identify) _____		
2. DATE AND TIME OF INCIDENT (Month - Day - Year) _____ a.m. _____ p.m.		3. LOCATION OF INCIDENT _____
<b>B REPORTING CARRIER, COMPANY OR INDIVIDUAL</b>		
4. FULL NAME _____		5. ADDRESS (Number, Street, City, State and Zip Code) _____
6. TYPE OF VEHICLE OR FACILITY _____		
<b>C SHIPMENT INFORMATION</b>		
7. NAME AND ADDRESS OF SHIPPER (Origin address) _____		8. NAME AND ADDRESS OF CONSIGNEE (Destination address) _____
9. SHIPPING PAPER IDENTIFICATION NO. _____		10. SHIPPING PAPERS ISSUED BY <input type="checkbox"/> CARRIER <input type="checkbox"/> SHIPPER <input type="checkbox"/> OTHER (Identify) _____
<b>D DEATHS, INJURIES, LOSS AND DAMAGE</b>		
DUE TO HAZARDOUS MATERIALS INVOLVED		
11. NUMBER PERSONS INJURED _____	12. NUMBER PERSONS KILLED _____	13. ESTIMATED AMOUNT OF LOSS AND OR PROPERTY DAMAGE INCLUDING COST OF DECONTAMINATION (Round off in dollars) \$ _____
14. ESTIMATED TOTAL QUANTITY OF HAZARDOUS MATERIALS RELEASED _____		
<b>E HAZARDOUS MATERIALS INVOLVED</b>		
15. HAZARD CLASS (*Sec. 172.101, Col. 3) _____	16. SHIPPING NAME (*Sec. 172.101, Col. 2) _____	17. TRADE NAME _____
<b>F NATURE OF PACKAGING FAILURE</b>		
18. (Check all applicable boxes)		
(1) DROPPED IN HANDLING	(2) EXTERNAL PUNCTURE	(3) DAMAGE BY OTHER FREIGHT
(4) WATER DAMAGE	(5) DAMAGE FROM OTHER LIQUID	(6) FREEZING
(7) EXTERNAL HEAT	(8) INTERNAL PRESSURE	(9) CORROSION OR RUST
(10) DEFECTIVE FITTINGS, VALVES, OR CLOSURES	(11) LOOSE FITTINGS, VALVES OR CLOSURES	(12) FAILURE OF INNER RECEPTACLES
(13) BOTTOM FAILURE	(14) BODY OR SIDE FAILURE	(15) WELD FAILURE
(16) CHIME FAILURE	(17) OTHER CONDITIONS (Identify) _____	19. SPACE FOR DOT USE ONLY

Form DOT F 5800.1 (10-70) (9/1/76)  
\*Editorial change to incorporate redesignation per HM-112.

Figure 12. Accident Report Form for Materials Transportation Bureau

Chapter III Assessment of Crossing Safety and Operation

G PACKAGING INFORMATION - <i>If more than one size or type packaging is involved in loss of material show packaging information separately for each. If more space is needed, use Section H "Remarks" below keying to the item number.</i>				
ITEM		#1	#2	#3
20	TYPE OF PACKAGING INCLUDING INNER RECEPTACLES (Steel drums, wooden box, cylinder, etc.)			
21	CAPACITY OR WEIGHT PER UNIT (55 gallons, 65 lbs., etc.)			
22	NUMBER OF PACKAGES FROM WHICH MATERIAL ESCAPED			
23	NUMBER OF PACKAGES OF SAME TYPE IN SHIPMENT			
24	DOT SPECIFICATION NUMBER(S) ON PACKAGES (21P, 17E, 3AA, etc., or none)			
25	SHOW ALL OTHER DOT PACKAGING MARKINGS (Part 178)			
26	NAME, SYMBOL, OR REGISTRATION NUMBER OF PACKAGING MANUFACTURER			
27	SHOW SERIAL NUMBER OF CYLINDERS, CARGO TANKS, TANK CARS, PORTABLE TANKS			
28	TYPE DOT LABEL(S) APPLIED			
29	IF RECONDITIONED OR REQUALIFIED, SHOW	A	REGISTRATION NO. OR SYMBOL	
		B	DATE OF LAST TEST OF INSPECTION	
30	IF SHIPMENT IS UNDER DOT OR USCG SPECIAL PERMIT OR EXEMPTION, ENTER PERMIT OR EXEMPTION NO.			
<p>H REMARKS - Describe essential facts of incident including but not limited to defects, damage, probable cause, stowage, action taken at the time discovered, and action taken to prevent future incidents. Include any recommendations to improve packaging, handling, or transportation of hazardous materials. Photographs and diagrams should be submitted when necessary for clarification.</p>				
31. NAME OF PERSON PREPARING REPORT (Type or print)			32. SIGNATURE	
33. TELEPHONE NO. (Include Area Code)			34. DATE REPORT PREPARED	

Reverse of Form DOT F 5800.1 (10-70)

Figure 12. Accident Report Form for Materials Transportation Bureau (Continued)

Chapter III Assessment of Crossing Safety and Operation

sometimes referred to as the Bureau of Public Roads formula. The formula used to determine the expected number of accidents in five years is:

$$A_5 = 1.28 \frac{(V^{0.170})(T^{0.151})}{p^{0.171}} + K$$

where:

- A<sub>5</sub> = Expected number of accidents in 5 years
- V = AADT, Annual average daily traffic
- T = Average daily train traffic
- P = Protection coefficient
- K = Additional parameter

A<sub>5</sub> can be determined from a set of curves as shown in Figure 13.

2. New Hampshire Index

The New Hampshire Index is as follows:

$$HI = (V)(T)(P_f)$$

where:

- HI = Hazard index
- V = AADT, Annual average daily traffic
- T = Average daily train traffic
- P<sub>f</sub> = Protection factor
  - = 0.1 for automatic gates
  - = 0.6 for flashing lights
  - = 1.0 for signs only

Several modifications of the New Hampshire Index are in use. Some States use various other values for P<sub>f</sub> as follows.

- Automatic gates 0.13 or 0.10
- Flashing lights 0.33, 0.20 or 0.60
- Wigwags 0.67
- Traffic signal
  - preemption 0.50
  - Crossbucks 1.00

One State adds 1 to T, the average daily train traffic. Several States use a hazard index that basically incorporates the New Hampshire Index but also includes other factors such as:

- |                        |                                     |
|------------------------|-------------------------------------|
| Train speed            | Number of tracks                    |
| Highway speed          | Surface condition                   |
| Sight distance         | Nearby intersection                 |
| Crossing angle         | Functional class of highway         |
| Crossing width         | Vertical alignment                  |
| Type of tracks         | Horizontal alignment                |
| Surface type           | Population                          |
| Population             | Number of hazardous material trucks |
| Number of buses        | Number of passengers                |
| Number of school buses | Number of accidents                 |

Some of these hazard indices are shown in Table 18.

3. NCHRP 50

The hazard index presented in NCHRP Report 50 can be expressed as a complex formula or reduced to a more simple equation of coefficients that are taken from a few tables and graphs. The simple formula for calculating the expected number of accidents per year is shown in Figure 14.

NCHRP 50 also provides formulae for estimating the number of non-train involved accidents per year as follows.

Automatic gates:

$$X = 0.00866 + 0.00036 (ADT), \text{ or}$$

$$EA = \frac{ADT}{100} [0.00866 + 0.00036 (ADT)]$$

All other traffic control devices:

$$X = 0.00499 + 0.00036 (ADT), \text{ or}$$

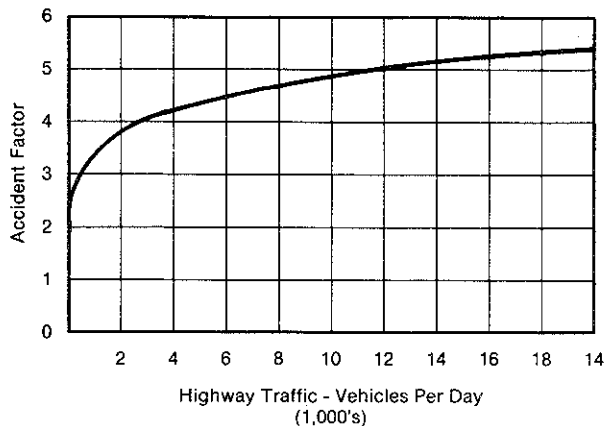

Figure 13a. Relation Between Highway Traffic and Accident Factor,  $V^a$

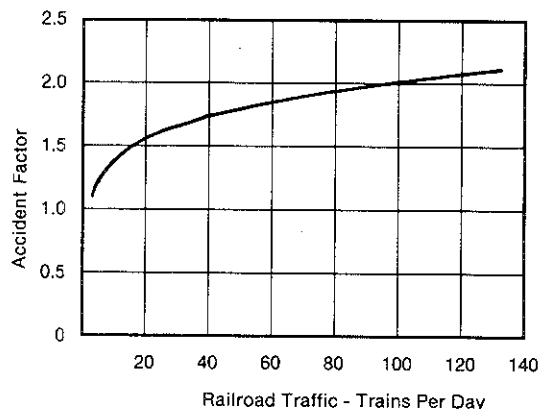

Figure 13b. Relation Between Railroad Traffic and Accident Factor,  $T^b$

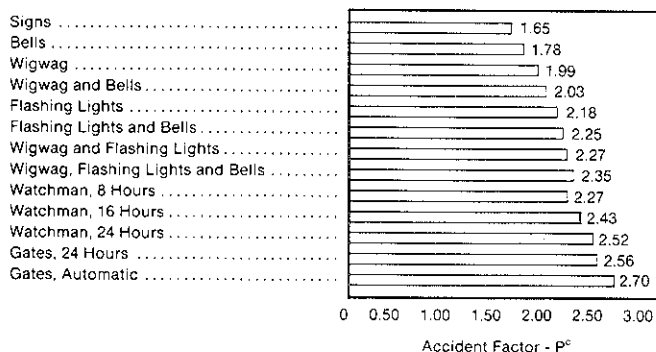

Figure 13c. Relation Between Warning Device and Accident Factor,  $P^c$

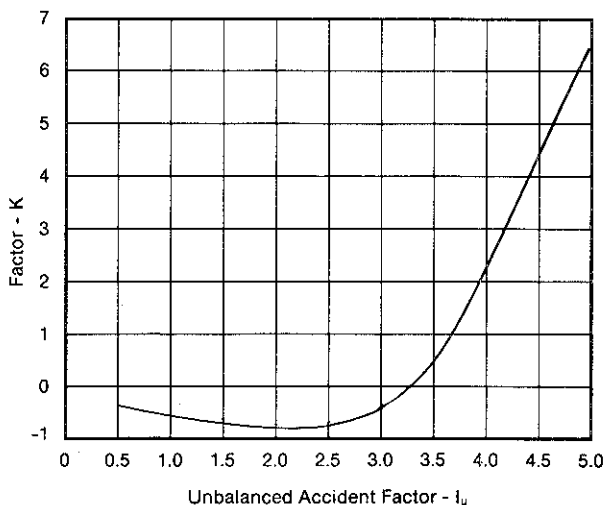

Figure 13d. Relation Between Unbalanced Accident Factor and Additional Parameter, K

The basic form of the equation for use with these curves is:

$$1.28 \frac{V^a \times T^b}{P^c} + K$$

EXAMPLE: Assume a crossing has an AADT of 3,442 vehicles, an average train traffic of 22 trains per day, and is equipped with wigwags. From Figure 13a, the factor due to highway traffic of 3,442 vehicles per day is found to be 3.99. From Figure 13b, the factor due to train traffic of 22 trains per day is found to be 1.59, and from Figure 13c, the factor for wigwags is found to be 1.99. Substituting these factors into the equation, it is found that the hazard index is equal to:

$$1.28 \frac{3.99 \times 1.59}{1.99} + K \quad \text{or,} \quad 4.08 + K.$$

From Figure 13d, K is determined to be + 2.58 for a value of  $I_u$  of 4.08 and, with this value for the parameter, the expected number of accidents in 5 years is 6.66.

Figure 13. Curves for Peabody Dimmick Formula

Chapter III Assessment of Crossing Safety and Operation

Table 18. Variations of New Hampshire Index

$$1: \quad HI = (V) (2T_f) (T_s) \frac{(SD + AN + NTR)}{4}$$

$$2: \quad HI = \frac{(V) (T) (A_5)}{P_f}$$

$$3: \quad HI = (V) (T) \frac{(TT + TTR + SD + AN + AL + L + G + VSD + W + LI)}{100}$$

$$4: \quad HI = \frac{(P_f) (V_f) (T) (TS) (NTR)}{160} + (70A_a)^2 + 1.2(SD); \quad A_a = (V + \frac{SBP}{1.2})(HM)$$

$$5: \quad HI = .1(P_f) (A_f) (T_1) + (AN)(NTR) (S) (.5L) + TS((FC \times P) + (\frac{V \times T}{10,000})) + SB$$

$$6: \quad HI = \frac{(V_f) (P_f) (T)}{TR + TN + T_f + HS + G + SD + AN}$$

$$7: \quad HI = (.01) (V) (T) + (.1) (HS) (TS) + (SD) (AN) (TR) (NTR) (AL) + (A_a^2 + 1) (RF) (LP)(P_f) + (SB) (SBP) + (10) (HM)$$

$$8: \quad HI = \frac{\sqrt{(V)} (T)}{P_f}$$

where:

- |  |   |
|--|---|
| $A_5$ = Number of accidents in five years      | $S$ = Factor for surface type                   |
| $A_a$ = Number of accidents per year           | $SB$ = Number of school buses                   |
| $A_f$ = Accident factor                        | $SBP$ = Number of school bus passengers         |
| $AL$ = Factor for highway alignment            | $SD$ = Factor for sight distance                |
| $AN$ = Factor for approach angle               | $T$ = Average number of trains per day          |
| $FC$ = Factor for functional class             | $T_f$ = Number of fast trains                   |
| $G$ = Factor for approach grades               | $T_s$ = Number of slow trains                   |
| $HI$ = Hazard Index                            | $T_1^S$ = Train factor                          |
| $HM$ = Factor for hazardous materials vehicles | $TN$ = Factor for number of night trains        |
| $HS$ = Factor for highway speed                | $TR$ = Factor for number and type of tracks     |
| $L$ = Factor for number of lanes               | $TS$ = Factor for train speeds                  |
| $LI$ = Factor for local interference           | $TT$ = Factor for type of train movements       |
| $LP$ = Factor for local priority               | $TTR$ = Factor for type of tracks               |
| $NTR$ = Factor for number of tracks            | $V$ = Annual average daily traffic              |
| $P$ = Factor for population                    | $V_f$ = Factor for annual average daily traffic |
| $P_f$ = Protection factor                      | $VSD$ = Factor for vertical sight distance      |
| $RF$ = Factor for rideability                  | $W$ = Factor for crossing width                 |

Source: Ref. 5

$$EA = \frac{ADT}{100} [0.00499 + 0.0036 (ADT)]$$

ADT = Average daily traffic  
EA = Expected number of accidents per year

where:

X = Probability of coincidental vehicle and train arrival scaled by  $10^{-3}$

Modifications of the NCHRP 50 hazard index exist. For example, one State's formula is:

## Chapter III Assessment of Crossing Safety and Operation

Expected Accident Frequency =

A x B x Current Trains per Day

EXAMPLE

ASSUME

Urban area  
Crossbucks  
5000 vehicles per day  
5 trains per day

Vehicles Per Day (10 yr. ADT)	'A' Factor
250	.000347
500	.000694
1000	.001377
2000	.002627
3000	.003981
4000	.005208
5000	.006516
6000	.007720
7000	.009005
8000	.010278
9000	.011435
10000	.012674
12000	.015012
14000	.017315
16000	.019549
18000	.021736
20000	.023877
25000	.029051
30000	.034757

EXPECTED ACCIDENT FREQUENCY

$EAf = .006516 \times 3.06 \times 5$   
 $EAf = 0.10$   
 $EAf = 1 \text{ accident every ten years}$

Accident frequency is greater than 0.02. This would indicate need for higher type device

Try flashing lights  
 $B = 0.23$

$EAf = .006516 \times .23 \times 5$   
 $EAf = 0.01$

**THEREFORE FLASHING LIGHTS ARE WARRANTED**

'B' FACTOR COMPONENTS ( 'B' FACTOR BASIC VALUE ADJUSTMENTS ) BASIC VALUES FOR EXISTING DEVICES		
A	Crossbucks, highway volume less than 500 per day	3.89
B	Crossbucks, urban	3.06
C	Crossbucks, rural	3.08
D	Stop signs, highways volume less than 500 per day	4.51
E	Stop signs	1.15
F	Wigwags	0.61
G	Flashing lights, urban	0.23
H	Flashing lights, rural	0.93
I	Gates, urban	0.08
J	Gates, rural	0.19

Figure 14. NCHRP 50 Hazard Index

Source: Ref. 12

NCHRP 50 Hazard Index  
 Site Evaluation + ACC/Yr

The Site Evaluation factor is based on the following:

- o most restrictive sight distance of all quadrants;

- o distance from crossing to business or crossroad;

- o crossing angle;

- o distraction from traffic control devices; and,

- o people factor.

### Chapter III Assessment of Crossing Safety and Operation

Each factor is rated from 1 (best) through 5 (worst) and the average of the 5 factors is used in the formula.

#### 4. U.S. DOT Accident Prediction Equations

The DOT accident prediction formula combines two independent calculations to produce an accident prediction value. The basic formula provides an initial prediction of accidents on the basis of a crossing's characteristics, similar to other formulae such as the Peabody-Dimmick formula and New Hampshire Index. The second calculation utilizes the actual accident history at a crossing over a determined number of years to produce an accident prediction value. This procedure assumes that future accidents per year at a crossing will be the same as the average historical accident rate over the time period used in the calculation.

The basic accident prediction formula can be expressed as a series of factors that, when multiplied together, yield an initial predicted number of accidents per year at a crossing. Each factor in the formula represents a characteristic of the crossing described in the national inventory. The general expression of the basic formula is shown below:

$$a = K \times EI \times MT \times DT \times HP \times MS \times HT \times HL$$

where:

- a = Initial accident prediction, accidents per year at the crossing
- K = Formula constant
- EI = Factor for exposure index based on product of highway and train traffic
- MT = Factor for number of main tracks

- DT = Factor for number of thru trains per day during daylight
- HP = Factor for highway paved (yes or no)
- MS = Factor for maximum timetable speed
- HT = Factor for highway type
- HL = Factor for number of highway lanes

Different sets of equations are used for each of the three categories of traffic control devices: passive, flashing lights, and automatic gates, as shown in Table 19.

The structure of the basic accident prediction formula makes it possible to construct tables of numerical values for each factor. To predict the accidents at a particular crossing whose characteristics are known, the values of the factors are found in the table and multiplied together. The factor values for the three traffic control device categories are found in Tables 20, 21, and 22, respectively.

The final accident prediction formula can be expressed as follows:

$$A = \frac{T_0}{T_0 + T} (a) + \frac{T}{T_0 + T} \left( \frac{N}{T} \right)$$

where:

- A = Final accident prediction, accidents per year at the crossing
- a = Initial accident prediction from basic formula, accidents per year at the crossing
- N = Accident history prediction, accidents per year, where N is the number of observed accidents in T years at the crossing
- T = accidents per year, where N is the number of observed accidents in T years at the crossing



Chapter III Assessment of Crossing Safety and Operation

Table 19. U.S. DOT Accident Prediction Equations for Crossing Characteristic Factors

General Form of Basic Accident Prediction Formula:  $a = K \times EI \times MT \times DT \times HP \times MS \times HT \times HL$

CROSSING CHARACTERISTIC FACTORS								
Crossing Category	Formula Constant K	Exposure Index Factor EI	Main Tracks Factor MT	Day Thru Trains Factor DT	Highway Paved Factor HP	Maximum Speed Factor MS	Highway Type Factor HT	Highway Lanes Factor HL
Passive	0.002268	$\frac{c \times t + 0.2}{0.2} \times 0.3334$	$e^{0.2094mt}$	$\frac{d + 0.2}{0.2} \times 0.1336$	$e^{-0.6160(hp-1)}$	$e^{0.0077ms}$	$e^{-0.1000(ht-1)}$	1.0
Flashing Lights	0.003646	$\frac{c \times t + 0.2}{0.2} \times 0.2953$	$e^{0.1088mt}$	$\frac{d + 0.2}{0.2} \times 0.0470$	1.0	1.0	1.0	$e^{0.1380(hl-1)}$
Gates	0.001088	$\frac{c \times t + 0.2}{0.2} \times 0.3116$	$e^{0.2912mt}$	1.0	1.0	1.0	1.0	$e^{0.1036(hl-1)}$

c = annual average number of highway vehicles per day (total both directions)	Highway Type	Inventory Code	ht Value
t = average total train movements per day	Rural		
mt = number of main tracks	Interstate	01	1
d = average number of thru trains per day during daylight	Other principal arterial	02	2
hp = highway paved, yes = 1.0, no = 2.0	Minor arterial	06	3
ms = maximum timetable speed, mph	Major collector	07	4
ht = highway type factor value	Minor collector	08	5
hl = number of highway lanes	Local	09	6
	Urban		
	Interstate	11	1
	Other freeway and expressway	12	2
	Other principal arterial	14	3
	Minor arterial	16	4
	Collector	17	5
	Local	19	6

Source: Ref. 7

Table 20. U.S. DOT Accident Prediction Factor Values for Crossings with Passive Warning Devices

K	"c" x "t"	EI	Main Tracks MT	Day Thru Trains DT	Highway Paved HP	Maximum Timetable Speed MS	Highway Typg* HT	Highway Lanes HL
0.002268	0*	1.00	0	1.00	0	1.00	01&11	1
	1 - 5	2.22	1	1.23	1	1.27	02&12	2
	6 - 10	3.30	2	1.52	2	1.38	06&14	3
	11 - 20	4.24	3	1.87	3	1.45	07&16	4
	21 - 30	5.01	4	2.31	4	1.50	08&17	5
	31 - 50	5.86	5	2.85	5	1.55	09&19	6
	51 - 80	6.89	6	3.51	6	1.58		7
	81 - 120	7.95			7	1.61		8
	121 - 200	9.29			8	1.64		9
	201 - 300	10.78			9	1.67		
	301 - 400	12.06			10	1.69		
	401 - 500	13.11		11-20	11-20	1.78		
	501 - 600	14.02		21-30	21-30	1.91		
	601 - 700	14.82		31-40	31-40	2.00		
	701 - 1000	16.21		41-60	41-60	2.09		
	1001 - 1300	17.93						
	1301 - 1600	19.37						
	1601 - 2000	20.81						
	2001 - 2500	22.42						
	2501 - 3000	23.97						
	3001 - 4000	25.98						
	4001 - 6000	29.26						
	6001 - 8000	32.73						
	8001 - 10000	35.59						
	10001 - 15000	39.71						
	15001 - 20000	44.43						
	20001 - 25000	48.31						
	25001 - 30000	51.65						
	30001 - 40000	55.98						
	40001 - 50000	60.87						
	50001 - 60000	65.08						
	60001 - 70000	68.81						
	70001 - 90000	73.74						
	90001 - 110000	79.44						
	110001 - 130000	84.42						
	130001 - 180000	91.94						
	180001 - 230000	100.92						
	230001 - 300000	109.94						
	300001 - 370000	118.87						

General Form of Basic Accident Prediction Formula:  $a = K \times EI \times MT \times DT \times HP \times HT \times HL$

"c" x "t" = Number of highway vehicles per day, "c", multiplied by total train movements per day, "t"

EI = Exposure index factor  
 MT = Main tracks factor  
 DT = Day thru trains factor  
 HP = Highway paved factor  
 MS = Maximum timetable speed factor  
 HT = Highway type factor  
 HL = Highway lanes factor

\*Less than one train per day  
 \*\*See Table 19 for definition of highway type codes

Source: Ref. 7

Chapter III Assessment of Crossing Safety and Operation

Table 21. U.S. DOT Accident Prediction Factor Values for Crossings with Flashing Light Warning Devices

K	"c" x "t"	EI	Main Tracks	MT	Day Thru Trains	DT	Highway Paved	HP	Maximum Timetable Speed	MS	Highway Type Code	HT	Highway Lanes	HL
0.003646	0*	1.00	0	1.00	0	1.00	1 (yes)	1.00	0	1.00	01811	1.00	1	1.00
	1 - 5	2.27	1	1.11	1	1.09	2 (no)	1.00	5	1.00	02812	1.00	2	1.15
	6 - 10	2.99	2	1.24	2	1.12			10	1.00	06814	1.00	3	1.32
	11 - 20	3.59	3	1.39	3	1.14			15	1.00	07816	1.00	4	1.51
	21 - 30	4.17	4	1.55	4	1.15			20	1.00	08817	1.00	5	1.74
	31 - 50	4.79	5	1.72	5	1.17			25	1.00	09819	1.00	6	1.99
	51 - 80	5.52	6	1.92	6	1.18			30	1.00			7	2.29
	81 - 120	6.27			7	1.18			35	1.00			8	2.63
	121 - 200	7.20			8	1.19			40	1.00			9	3.02
	201 - 300	8.22			9	1.20			45	1.00				
	301 - 400	9.07			10	1.20			50	1.00				
	401 - 500	9.77			11-20	1.23			55	1.00				
	501 - 600	10.37			21-30	1.26			60	1.00				
	601 - 700	10.89			31-40	1.28			65	1.00				
	701 - 1000	11.79			41-60	1.30			70	1.00				
	1001 - 1300	12.89							75	1.00				
	1301 - 1600	13.80							80	1.00				
	1601 - 2000	14.71							85	1.00				
	2001 - 2500	15.72							90	1.00				
	2501 - 3000	16.67												
	3001 - 4000	17.91												
	4001 - 6000	19.89												
	6001 - 8000	21.97												
	8001 - 10000	23.66												
	10001 - 15000	26.08												
	15001 - 20000	28.80												
	20001 - 25000	31.02												
	25001 - 30000	32.91												
	30001 - 40000	35.34												
	40001 - 50000	38.06												
	50001 - 60000	40.39												
	60001 - 70000	42.43												
	70001 - 90000	45.11												
	90001 - 110000	48.18												
	110001 - 130000	50.85												
	130001 - 180000	54.84												
	180001 - 230000	59.56												
	230001 - 300000	64.25												
	300001 - 370000	68.86												

General Form of Basic Accident Prediction Formula:  $a = K \times EI \times MT \times DT \times HP \times HT \times HL$

"c" x "t" = Number of highway vehicles per day, "c", multiplied by total train movements per day, "t"

EI = Exposure index factor  
 MT = Main tracks factor  
 DT = Day thru trains factor  
 HP = Highway paved factor  
 MS = Maximum timetable speed factor  
 HT = Highway type factor  
 HL = Highway lanes factor

\* Less than one train per day  
 \*\* See Table 19 for definition of highway type codes

Source: Ref. 7

Table 22. U.S. DOT Accident Prediction Factor Values for Crossings with Gate Warning Devices

K	"c" x "t"	EI	Main Tracks	MT	Day Thru Trains	DT	Highway Paved	HP	Maximum Timetable Speed	MS	Highway Type Code	HT	Highway Lanes	HL
0.001088	0*	1.00	0	1.00	0	1.00	1 (yes)	1.00	0	1.00	01811	1.00	1	1.00
	1 - 5	2.37	1	1.34	1	1.00	2 (no)	1.00	5	1.00	02812	1.00	2	1.11
	6 - 10	3.18	2	1.79	2	1.00			10	1.00	06814	1.00	3	1.23
	11 - 20	3.86	3	2.40	3	1.00			15	1.00	07816	1.00	4	1.36
	21 - 30	4.51	4	3.21	4	1.00			20	1.00	08817	1.00	5	1.51
	31 - 50	5.22	5	4.29	5	1.00			25	1.00	09819	1.00	6	1.68
	51 - 80	6.07	6	5.74	6	1.00			30	1.00			7	1.86
	81 - 120	6.94			7	1.00			35	1.00			8	2.07
	121 - 200	8.03			8	1.00			40	1.00			9	2.29
	201 - 300	9.23			9	1.00			45	1.00				
	301 - 400	10.25			10	1.00			50	1.00				
	401 - 500	11.08			11-20	1.00			55	1.00				
	501 - 600	11.80			21-30	1.00			60	1.00				
	601 - 700	12.43			31-40	1.00			65	1.00				
	701 - 1000	13.51			41-60	1.00			70	1.00				
	1001 - 1300	14.84							75	1.00				
	1301 - 1600	15.96							80	1.00				
	1601 - 2000	17.07							85	1.00				
	2001 - 2500	18.30							90	1.00				
	2501 - 3000	19.48												
	3001 - 4000	21.00												
	4001 - 6000	23.46												
	6001 - 8000	26.06												
	8001 - 10000	28.18												
	10001 - 15000	31.22												
	15001 - 20000	34.67												
	20001 - 25000	37.49												
	25001 - 30000	39.91												
	30001 - 40000	43.03												
	40001 - 50000	46.53												
	50001 - 60000	49.53												
	60001 - 70000	52.18												
	70001 - 90000	55.67												
	90001 - 110000	59.68												
	110001 - 130000	63.16												
	130001 - 180000	68.41												
	180001 - 230000	74.63												
	230001 - 300000	80.85												
	300001 - 370000	86.98												

General Form of Basic Accident Prediction Formula:  $a = K \times EI \times MT \times DT \times HP \times HT \times HL$

"c" x "t" = Number of highway vehicles per day, "c", multiplied by total train movements per day, "t"

EI = Exposure index factor  
 MT = Main tracks factor  
 DT = Day thru trains factor  
 HP = Highway paved factor  
 MS = Maximum timetable speed factor  
 HT = Highway type factor  
 HL = Highway lanes factor

\* Less than one train per day  
 \*\* See Table 19 for definition of highway type codes

Source: Ref. 7

Chapter III Assessment of Crossing Safety and Operation

$T_0$  = Formula weighting factor,

$$T_0 = \frac{1.0}{(0.05 + a)}$$

Values for the final accident prediction, A, for different values of the initial prediction, a, and different prior accident rates, N/T are tabularized in Tables 23 to 27. Each table represents results for a specific number of years for which accident history data are available. If the number of years of accident data, T, is a fraction, the final accident prediction, A, can be interpolated from the tables or determined directly from the formula. The formula provides the most accurate results if all the accident history available is used; however, the extent of improvement is minimal if data for more than five years are used. Accident history information older

than five years may be misleading because of changes that occur to crossing characteristics over time. If a significant change has occurred to a crossing during the most recent five years, such as the installation of signals, only the accident data since that change should be used.

The U.S. DOT has also developed a formula for predicting the severity of a crossing accident. The probability of a fatal accident given an accident, P(FA|A), is expressed as:

$$P(FA|A) = \frac{1}{1 + CF \times MS \times TT \times TS \times UR}$$

where:

- CF = Formula constant = 695
- MS = Factor for maximum timetable train speed

Table 23. U.S. DOT Final Accident Prediction from Initial Prediction and Accident History (1 year of accident data (T = 1))

Initial Prediction from Basic Model, a	Number of Accidents, N, in T Years					
	0	1	2	3	4	5
0.00	0.000	0.048	0.095	0.143	0.190	0.238
0.01	0.009	0.064	0.123	0.179	0.236	0.292
0.02	0.019	0.084	0.150	0.215	0.280	0.346
0.03	0.028	0.102	0.176	0.250	0.324	0.398
0.04	0.037	0.119	0.202	0.284	0.367	0.450
0.05	0.045	0.134	0.227	0.318	0.409	0.500
0.06	0.054	0.153	0.252	0.351	0.450	0.550
0.07	0.063	0.170	0.277	0.384	0.491	0.598
0.08	0.071	0.186	0.301	0.416	0.531	0.646
0.09	0.079	0.202	0.325	0.447	0.570	0.693
0.10	0.087	0.217	0.348	0.478	0.609	0.739
0.20	0.160	0.360	0.560	0.760	0.960	1.160
0.30	0.222	0.481	0.741	1.000	1.259	1.519
0.40	0.276	0.586	0.897	1.207	1.517	1.828
0.50	0.323	0.677	1.032	1.387	1.742	2.097
0.60	0.364	0.758	1.152	1.545	1.939	2.333
0.70	0.400	0.829	1.257	1.686	2.114	2.543
0.80	0.432	0.892	1.351	1.811	2.270	2.730
0.90	0.462	0.949	1.436	1.923	2.410	2.897
1.00	0.488	1.000	1.512	2.024	2.537	3.049
1.10	0.512	1.047	1.581	2.116	2.651	3.186
1.20	0.533	1.089	1.644	2.200	2.756	3.311
1.30	0.553	1.128	1.702	2.277	2.851	3.426
1.40	0.571	1.163	1.755	2.347	2.939	3.531
1.50	0.588	1.196	1.804	2.412	3.020	3.627
1.60	0.604	1.226	1.849	2.472	3.094	3.717
1.70	0.618	1.255	1.891	2.527	3.164	3.800
1.80	0.632	1.281	1.930	2.579	3.228	3.877
1.90	0.644	1.305	1.966	2.627	3.288	3.949
2.00	0.656	1.328	2.000	2.672	3.344	4.016
2.10	0.667	1.349	2.032	2.714	3.397	4.079
2.20	0.677	1.369	2.062	2.754	3.446	4.138
2.30	0.687	1.388	2.090	2.791	3.493	4.194
2.40	0.696	1.406	2.116	2.826	3.536	4.246
2.50	0.704	1.423	2.141	2.859	3.577	4.296

Source: Ref. 7

Chapter III Assessment of Crossing Safety and Operation

Table 24. U.S. DOT Final Accident Prediction from Initial Prediction and Accident History (2 years of accident data (T = 2))

Initial Prediction from Basic Model, a	Number of Accidents, N, in T Years								
	0	1	2	3	4	5	6	7	8
0.00	0.000	0.045	0.091	0.136	0.182	0.227	0.273	0.318	0.364
0.01	0.009	0.063	0.116	0.170	0.223	0.277	0.330	0.384	0.438
0.02	0.018	0.079	0.140	0.202	0.263	0.325	0.386	0.447	0.509
0.03	0.024	0.095	0.164	0.233	0.302	0.371	0.440	0.509	0.578
0.04	0.034	0.110	0.186	0.263	0.339	0.415	0.492	0.568	0.644
0.05	0.042	0.125	0.208	0.292	0.375	0.458	0.542	0.625	0.708
0.06	0.049	0.139	0.230	0.320	0.410	0.500	0.590	0.680	0.770
0.07	0.056	0.153	0.250	0.347	0.444	0.540	0.637	0.734	0.831
0.08	0.063	0.167	0.270	0.373	0.476	0.579	0.683	0.786	0.889
0.09	0.070	0.180	0.289	0.398	0.508	0.617	0.727	0.836	0.945
0.10	0.077	0.192	0.308	0.423	0.538	0.654	0.769	0.885	1.000
0.20	0.133	0.300	0.467	0.633	0.800	0.967	1.133	1.300	1.467
0.30	0.176	0.382	0.588	0.794	1.000	1.206	1.412	1.618	1.824
0.40	0.211	0.447	0.684	0.921	1.158	1.395	1.632	1.868	2.105
0.50	0.238	0.500	0.762	1.024	1.286	1.548	1.810	2.071	2.333
0.60	0.261	0.543	0.826	1.109	1.391	1.674	1.957	2.239	2.522
0.70	0.280	0.580	0.880	1.180	1.480	1.780	2.080	2.380	2.680
0.80	0.296	0.611	0.926	1.241	1.556	1.870	2.185	2.500	2.815
0.90	0.310	0.638	0.966	1.293	1.621	1.948	2.276	2.603	2.931
1.00	0.323	0.662	1.000	1.339	1.677	2.016	2.355	2.694	3.032
1.10	0.333	0.682	1.030	1.379	1.727	2.076	2.424	2.773	3.121
1.20	0.343	0.700	1.057	1.414	1.771	2.129	2.486	2.843	3.200
1.30	0.351	0.716	1.081	1.446	1.811	2.176	2.541	2.905	3.270
1.40	0.359	0.731	1.103	1.474	1.846	2.218	2.590	2.962	3.333
1.50	0.366	0.744	1.122	1.500	1.878	2.256	2.634	3.012	3.390
1.60	0.372	0.756	1.140	1.523	1.907	2.291	2.674	3.058	3.442
1.70	0.378	0.767	1.156	1.544	1.933	2.322	2.711	3.100	3.489
1.80	0.383	0.777	1.170	1.564	1.957	2.351	2.745	3.138	3.532
1.90	0.388	0.786	1.184	1.582	1.980	2.378	2.776	3.173	3.571
2.00	0.392	0.794	1.196	1.598	2.000	2.402	2.804	3.206	3.608
2.10	0.396	0.802	1.208	1.613	2.019	2.425	2.830	3.236	3.642
2.20	0.400	0.809	1.218	1.627	2.036	2.445	2.855	3.264	3.673
2.30	0.404	0.816	1.228	1.640	2.053	2.465	2.877	3.289	3.702
2.40	0.407	0.822	1.237	1.653	2.068	2.483	2.898	3.314	3.729
2.50	0.410	0.828	1.246	1.664	2.082	2.500	2.918	3.336	3.754

Source: Ref. 7

Table 25. U.S. DOT Final Accident Prediction from Initial Prediction and Accident History (3 years of accident data (T = 3))

Initial Prediction from Basic Model, a	Number of Accidents, N, in T Years												
	0	1	2	3	4	5	6	7	8	9	10	11	12
0.00	0.000	0.043	0.087	0.130	0.174	0.217	0.261	0.304	0.348	0.391	0.435	0.478	0.522
0.01	0.008	0.059	0.110	0.161	0.212	0.263	0.314	0.364	0.415	0.466	0.517	0.568	0.619
0.02	0.017	0.074	0.132	0.190	0.248	0.306	0.364	0.421	0.479	0.537	0.595	0.653	0.711
0.03	0.024	0.089	0.153	0.218	0.282	0.347	0.411	0.476	0.540	0.605	0.669	0.734	0.798
0.04	0.031	0.102	0.173	0.244	0.315	0.386	0.457	0.528	0.598	0.669	0.740	0.811	0.882
0.05	0.038	0.115	0.192	0.269	0.346	0.423	0.500	0.577	0.654	0.731	0.808	0.885	0.962
0.06	0.045	0.128	0.211	0.293	0.376	0.459	0.541	0.624	0.707	0.789	0.872	0.955	1.038
0.07	0.051	0.140	0.228	0.316	0.404	0.493	0.581	0.669	0.757	0.846	0.934	1.022	1.110
0.08	0.058	0.151	0.245	0.338	0.432	0.525	0.619	0.712	0.806	0.899	0.993	1.086	1.180
0.09	0.063	0.162	0.261	0.359	0.458	0.556	0.655	0.754	0.852	0.951	1.049	1.148	1.246
0.10	0.069	0.172	0.276	0.379	0.483	0.586	0.690	0.793	0.897	1.000	1.103	1.207	1.310
0.20	0.114	0.257	0.400	0.543	0.686	0.829	0.971	1.114	1.257	1.400	1.543	1.686	1.829
0.30	0.146	0.317	0.488	0.659	0.829	1.000	1.171	1.341	1.512	1.683	1.854	2.024	2.195
0.40	0.170	0.362	0.553	0.745	0.936	1.128	1.319	1.511	1.702	1.894	2.085	2.277	2.468
0.50	0.189	0.396	0.604	0.811	1.019	1.226	1.434	1.642	1.849	2.057	2.264	2.472	2.679
0.60	0.203	0.424	0.644	0.864	1.085	1.305	1.525	1.746	1.966	2.186	2.407	2.627	2.847
0.70	0.215	0.446	0.677	0.908	1.138	1.369	1.600	1.831	2.062	2.292	2.523	2.754	2.985
0.80	0.225	0.465	0.704	0.944	1.183	1.423	1.662	1.901	2.141	2.380	2.620	2.859	3.099
0.90	0.234	0.481	0.727	0.974	1.221	1.468	1.714	1.961	2.208	2.455	2.701	2.948	3.195
1.00	0.241	0.494	0.747	1.000	1.253	1.506	1.759	2.012	2.265	2.518	2.771	3.024	3.277
1.10	0.247	0.504	0.764	1.022	1.281	1.539	1.798	2.056	2.315	2.573	2.831	3.090	3.348
1.20	0.253	0.514	0.779	1.042	1.305	1.568	1.832	2.095	2.358	2.621	2.884	3.147	3.411
1.30	0.257	0.525	0.792	1.059	1.327	1.594	1.861	2.129	2.396	2.663	2.931	3.198	3.465
1.40	0.262	0.533	0.804	1.075	1.346	1.617	1.888	2.159	2.430	2.701	2.972	3.243	3.514
1.50	0.265	0.540	0.814	1.088	1.363	1.637	1.912	2.186	2.460	2.735	3.009	3.283	3.558
1.60	0.269	0.546	0.824	1.101	1.378	1.655	1.933	2.210	2.487	2.765	3.042	3.319	3.597
1.70	0.272	0.552	0.832	1.112	1.392	1.672	1.952	2.232	2.512	2.792	3.072	3.352	3.632
1.80	0.275	0.557	0.840	1.122	1.405	1.687	1.969	2.252	2.534	2.817	3.099	3.382	3.664
1.90	0.277	0.562	0.847	1.131	1.416	1.701	1.985	2.270	2.555	2.839	3.124	3.409	3.693
2.00	0.280	0.566	0.853	1.140	1.427	1.713	2.000	2.287	2.573	2.860	3.147	3.434	3.720
2.10	0.282	0.570	0.859	1.148	1.436	1.725	2.013	2.302	2.591	2.879	3.168	3.456	3.745
2.20	0.284	0.574	0.865	1.155	1.445	1.735	2.026	2.316	2.606	2.897	3.187	3.477	3.768
2.30	0.286	0.578	0.870	1.161	1.453	1.745	2.037	2.329	2.621	2.913	3.205	3.497	3.789
2.40	0.287	0.581	0.874	1.168	1.461	1.754	2.048	2.341	2.635	2.928	3.222	3.515	3.808
2.50	0.289	0.584	0.879	1.173	1.468	1.763	2.058	2.353	2.647	2.942	3.237	3.532	3.827

Source: Ref. 7

Chapter III Assessment of Crossing Safety and Operation

Table 26. U.S. DOT Final Accident Prediction from Initial Prediction and Accident History (4 years of accident data (T = 4))

Initial Prediction from Basic Model, a	Number of Accidents, N, in T Years														
	0	1	2	3	4	5	6	7	8	9	10	11	12	13	14
0.00	0.000	0.042	0.083	0.125	0.167	0.208	0.250	0.292	0.333	0.375	0.417	0.458	0.500	0.542	0.583
0.01	0.008	0.054	0.105	0.153	0.202	0.250	0.298	0.347	0.395	0.444	0.492	0.540	0.589	0.637	0.685
0.02	0.014	0.070	0.123	0.180	0.234	0.289	0.344	0.398	0.453	0.508	0.563	0.617	0.672	0.727	0.781
0.03	0.023	0.083	0.144	0.205	0.265	0.324	0.384	0.447	0.508	0.568	0.629	0.689	0.750	0.811	0.871
0.04	0.029	0.094	0.162	0.228	0.294	0.360	0.426	0.493	0.559	0.625	0.691	0.757	0.824	0.890	0.956
0.05	0.034	0.107	0.179	0.250	0.321	0.393	0.464	0.534	0.604	0.674	0.744	0.814	0.884	0.954	1.024
0.06	0.042	0.118	0.194	0.271	0.347	0.424	0.500	0.574	0.653	0.729	0.804	0.882	0.958	1.035	1.111
0.07	0.047	0.128	0.209	0.291	0.372	0.453	0.534	0.615	0.694	0.777	0.858	0.939	1.020	1.101	1.182
0.08	0.053	0.138	0.224	0.309	0.395	0.480	0.566	0.651	0.737	0.822	0.908	0.993	1.079	1.164	1.250
0.09	0.058	0.147	0.237	0.327	0.417	0.504	0.594	0.684	0.774	0.865	0.955	1.045	1.135	1.224	1.314
0.10	0.062	0.156	0.250	0.344	0.438	0.531	0.625	0.719	0.812	0.904	1.000	1.094	1.188	1.281	1.375
0.20	0.100	0.225	0.350	0.475	0.600	0.725	0.850	0.975	1.100	1.225	1.350	1.475	1.600	1.725	1.850
0.30	0.125	0.271	0.417	0.563	0.708	0.854	1.000	1.146	1.292	1.437	1.583	1.729	1.875	2.021	2.167
0.40	0.143	0.304	0.464	0.625	0.786	0.946	1.107	1.268	1.429	1.589	1.750	1.911	2.071	2.232	2.393
0.50	0.154	0.328	0.500	0.672	0.844	1.016	1.188	1.359	1.531	1.703	1.875	2.047	2.219	2.391	2.563
0.60	0.167	0.347	0.528	0.708	0.889	1.069	1.250	1.431	1.611	1.792	1.972	2.153	2.333	2.514	2.694
0.70	0.175	0.363	0.550	0.738	0.925	1.113	1.300	1.488	1.675	1.863	2.050	2.238	2.425	2.613	2.800
0.80	0.182	0.375	0.568	0.761	0.955	1.148	1.341	1.534	1.727	1.920	2.114	2.307	2.500	2.693	2.886
0.90	0.188	0.385	0.583	0.781	0.979	1.177	1.375	1.573	1.771	1.969	2.167	2.365	2.563	2.760	2.958
1.00	0.192	0.394	0.594	0.798	1.000	1.202	1.404	1.606	1.808	2.010	2.212	2.413	2.615	2.817	3.019
1.10	0.194	0.402	0.607	0.813	1.018	1.223	1.429	1.634	1.839	2.043	2.250	2.455	2.661	2.866	3.071
1.20	0.200	0.408	0.617	0.825	1.033	1.242	1.450	1.658	1.867	2.075	2.283	2.492	2.700	2.908	3.117
1.30	0.203	0.414	0.625	0.834	1.047	1.258	1.469	1.680	1.891	2.102	2.313	2.523	2.734	2.945	3.156
1.40	0.204	0.419	0.632	0.844	1.059	1.272	1.485	1.699	1.912	2.125	2.338	2.551	2.765	2.978	3.191
1.50	0.208	0.424	0.639	0.854	1.069	1.285	1.500	1.715	1.931	2.146	2.361	2.576	2.792	3.007	3.222
1.60	0.211	0.428	0.645	0.862	1.079	1.294	1.513	1.730	1.947	2.164	2.382	2.599	2.816	3.033	3.250
1.70	0.213	0.431	0.650	0.869	1.088	1.304	1.525	1.744	1.962	2.181	2.400	2.619	2.837	3.056	3.272
1.80	0.214	0.433	0.655	0.875	1.095	1.315	1.536	1.756	1.976	2.194	2.417	2.637	2.857	3.077	3.294
1.90	0.216	0.437	0.659	0.881	1.102	1.324	1.545	1.767	1.989	2.210	2.432	2.653	2.875	3.097	3.318
2.00	0.217	0.440	0.663	0.886	1.109	1.332	1.554	1.777	2.000	2.223	2.446	2.668	2.891	3.114	3.337
2.10	0.219	0.443	0.667	0.891	1.115	1.339	1.562	1.786	2.010	2.234	2.458	2.682	2.906	3.130	3.354
2.20	0.220	0.445	0.670	0.895	1.120	1.345	1.570	1.795	2.020	2.245	2.470	2.695	2.920	3.145	3.370
2.30	0.221	0.447	0.673	0.899	1.125	1.351	1.577	1.803	2.029	2.255	2.481	2.707	2.933	3.159	3.385
2.40	0.222	0.449	0.676	0.903	1.130	1.356	1.583	1.810	2.037	2.264	2.491	2.718	2.944	3.171	3.398
2.50	0.223	0.451	0.679	0.906	1.134	1.362	1.589	1.817	2.045	2.272	2.500	2.728	2.955	3.183	3.411

Source: Ref. 7

Table 27. U.S. DOT Final Accident Prediction from Initial Prediction and Accident History (5 years of accident data (T = 5))

Initial Prediction from Basic Model, a	Number of Accidents, N, in T Years														
	0	1	2	3	4	5	6	7	8	9	10	11	12	13	14
0.00	0.000	0.040	0.080	0.120	0.160	0.200	0.240	0.280	0.320	0.360	0.400	0.440	0.480	0.520	0.560
0.01	0.008	0.054	0.100	0.146	0.192	0.238	0.285	0.331	0.377	0.423	0.469	0.515	0.562	0.608	0.654
0.02	0.015	0.067	0.119	0.170	0.222	0.274	0.326	0.378	0.430	0.481	0.533	0.585	0.637	0.689	0.741
0.03	0.021	0.079	0.136	0.193	0.250	0.307	0.364	0.421	0.479	0.536	0.593	0.650	0.707	0.764	0.821
0.04	0.028	0.090	0.152	0.214	0.276	0.338	0.400	0.462	0.524	0.586	0.648	0.710	0.772	0.834	0.897
0.05	0.033	0.100	0.167	0.233	0.300	0.367	0.433	0.500	0.567	0.633	0.700	0.767	0.833	0.900	0.967
0.06	0.039	0.110	0.181	0.252	0.323	0.394	0.465	0.535	0.606	0.677	0.748	0.819	0.890	0.961	1.032
0.07	0.044	0.119	0.194	0.269	0.344	0.419	0.494	0.569	0.644	0.719	0.794	0.869	0.944	1.019	1.094
0.08	0.048	0.127	0.204	0.285	0.364	0.442	0.521	0.600	0.679	0.758	0.836	0.915	0.994	1.073	1.152
0.09	0.053	0.135	0.218	0.300	0.382	0.465	0.547	0.629	0.712	0.794	0.876	0.959	1.041	1.124	1.206
0.10	0.057	0.143	0.229	0.314	0.400	0.486	0.571	0.657	0.743	0.829	0.914	1.000	1.086	1.171	1.257
0.20	0.089	0.200	0.311	0.422	0.533	0.644	0.756	0.867	0.978	1.089	1.200	1.311	1.422	1.533	1.644
0.30	0.109	0.236	0.364	0.491	0.618	0.745	0.873	1.000	1.127	1.255	1.382	1.509	1.636	1.764	1.891
0.40	0.123	0.262	0.400	0.538	0.677	0.815	0.954	1.092	1.231	1.369	1.508	1.646	1.785	1.923	2.062
0.50	0.133	0.280	0.427	0.573	0.720	0.867	1.013	1.160	1.307	1.453	1.600	1.747	1.893	2.040	2.187
0.60	0.141	0.294	0.447	0.600	0.753	0.906	1.059	1.212	1.365	1.518	1.671	1.824	1.976	2.129	2.282
0.70	0.147	0.305	0.463	0.621	0.779	0.937	1.095	1.253	1.411	1.568	1.726	1.884	2.042	2.200	2.358
0.80	0.152	0.314	0.476	0.638	0.800	0.962	1.124	1.286	1.448	1.610	1.771	1.933	2.095	2.257	2.419
0.90	0.157	0.322	0.487	0.652	0.817	0.983	1.148	1.313	1.478	1.643	1.809	1.974	2.139	2.304	2.470
1.00	0.160	0.328	0.496	0.664	0.832	1.000	1.168	1.336	1.504	1.672	1.840	2.008	2.176	2.344	2.512
1.10	0.163	0.333	0.504	0.674	0.844	1.015	1.185	1.356	1.526	1.696	1.867	2.037	2.207	2.378	2.548
1.20	0.166	0.338	0.510	0.683	0.855	1.028	1.200	1.372	1.545	1.717	1.890	2.062	2.234	2.407	2.579
1.30	0.168	0.342	0.516	0.690	0.865	1.039	1.213	1.387	1.561	1.735	1.910	2.084	2.258	2.432	2.606
1.40	0.170	0.345	0.521	0.697	0.873	1.048	1.224	1.400	1.576	1.752	1.927	2.103	2.279	2.455	2.630
1.50	0.173	0.351	0.530	0.708	0.886	1.065	1.243	1.422	1.600	1.778	1.957	2.135	2.314	2.492	2.671
1.60	0.174	0.354	0.533	0.713	0.892	1.072	1.251	1.431	1.610	1.790	1.969	2.149	2.328	2.508	2.687
1.70	0.176	0.356	0.537	0.717	0.898	1.078	1.259	1.439	1.620	1.800	1.980	2.161	2.341	2.522	2.702
1.80	0.177	0.358	0.540	0.721	0.902	1.084	1.265	1.447	1.628	1.809	1.991	2.172	2.353	2.535	2.716
1.90	0.178	0.360	0.542	0.724	0.907	1.089	1.271	1.453	1.636	1.818	2.000	2.182	2.364	2.547	2.729
2.00	0.179	0.362	0.545	0.728	0.911	1.094	1.277	1.460	1.643	1.826	2.009	2.191	2.374	2.557	2.740
2.10	0.180	0.363	0.547	0.731	0.914	1.098	1.282	1.465	1.649	1.833	2.016	2.200	2.384	2.567	2.751
2.20	0.180	0.365	0.549	0.733	0.918	1.102	1.286	1.471	1.655	1.839	2.024	2.208	2.392	2.576	2.761
2.30	0.181	0.366	0.551	0.736	0.921	1.106	1.291	1.475	1.660	1.845	2.030	2.215	2.400	2.585	2.770
2.40	0.182	0.367	0.553	0.738	0.924	1.109	1.295	1.480	1.665	1.851	2.036	2.222	2.407	2.593	2.778

Source: Ref. 7

Chapter III Assessment of Crossing Safety and Operation

- TT = Factor for thru trains per day
- TS = Factor for switch trains per day
- UR = Factor for urban or rural crossing

The probability of an injury accident given an accident is:

$$P(IA|A) = \frac{1 - P(FA|A)}{(1 + CI \times MS \times TK \times UR)}$$

where:

- P(FA|A) = Probability of a fatal accident, given an accident
- CI = Formula constant = 4.280
- MS = Factor for maximum timetable train speed
- TK = Factor for number of tracks
- UR = Factor for urban or rural crossing

Table 28. Equations for Crossing Characteristic Factors for U.S. DOT Fatal Accident Probability Formula

Fatal Accident Probability Formula:

$$P(FA|A) = \frac{1}{(1 + CF \times MS \times TT \times TS \times UR)}$$

Crossing Characteristic Factor	Equation for Crossing Characteristic Factor
Formula constant	CF = 695
Maximum timetable train speed factor	MS = ms <sup>-1.074</sup>
Thru trains per day factor	TT = (tt + 1) <sup>-0.1025</sup>
Switch train per day factor	TS = (ts + 1) <sup>0.1025</sup>
Urban - Rural crossing factor	UR = e <sup>0.1880ur</sup>

where: ms = maximum timetable train speed, mph  
 tt = number of thru trains per day  
 ts = number of switch trains per day  
 ur = 1, urban crossing  
 = 0, rural crossing

Source: Ref. 3

The equations for calculating values of the factors are listed in Table 28 for the fatal accident probability formula and Table 29 for the injury accident probability formula. To simplify use of the formulae, the values of the factors have been tabulated for typical values of crossing characteristics and given in Tables 30 and 31 for the fatal accident and injury accident probability formulae, respectively.

5. Florida DOT Accident Prediction Model

The Florida State University developed an accident prediction model for the Florida Department of Transportation. The model was developed using stepwise regression analysis, transformation of data, dummy variables, and transformation of the accident prediction model to its original scale. The resulting model is as follows.

Table 29. Equations for Crossing Characteristic Factors for U.S. DOT Injury Accident Probability Formula

Injury Accident Probability Formula:

$$P(IA|A) = \frac{1 - P(FA|A)}{(1 + CI \times MS \times TK \times UR)}$$

Crossing Characteristic Factor	Equation for Crossing Characteristic Factor
Fatal accident probability	P(FA A) - See Table 28
Formula constant	CI = 4.280
Maximum timetable train speed factor	MS = ms <sup>-0.2334</sup>
Number of tracks factor	TK = e <sup>0.1176tk</sup>
Urban - Rural crossing factor	UR = e <sup>0.1844ur</sup>

where: ms = maximum timetable train speed, mph  
 tk = total number of tracks at crossing  
 ur = 1, urban crossing  
 = 0, rural crossing

Source: Ref. 3

Table 30. Factor Values for U.S. DOT Fatal Accident Probability Formula

Fatal Accident Probability Formula:

$$P(FA|A) = \frac{1}{(1 + CF \times MS \times TT \times TS \times UR)}$$

where: CF = 695.0, formula constant  
 UR = 1.207, urban crossing  
 = 1.000, rural crossing, and

Maximum Timetable Train Speed	MS	Thru Trains Per Day	TT	Switch Trains Per Day	TS
1	1.000	0	1.000	0	1.000
5	0.178	1	0.931	1	1.074
10	0.084	2	0.894	2	1.119
15	0.055	3	0.868	3	1.152
20	0.040	4	0.848	4	1.179
25	0.032	5	0.832	5	1.202
30	0.026	6	0.819	6	2.221
40	0.019	7	0.808	7	1.238
50	0.015	9	0.790	9	1.266
60	0.012	10	0.782	10	1.279
70	0.010	20	0.732	20	1.366
80	0.009	30	0.703	30	1.422
90	0.008	40	0.683	40	1.464
100	0.007	50	0.668	50	1.497

Source: Ref. 3

$$1. t_p = -8.075 + .318 \ln S_t + .484 \ln T + .437 \ln A + .387 \ln V_v + (.28 - .28 \frac{MASD}{RSSD})^{**} + (.33 - 1.23 \frac{MCS D}{RSSD})^* + .15 \text{ (no crossbucks)}$$

$$1a. y = \exp (.968t_p + 1.109) / 4$$

$$2. t_a = -8.075 + .318 \ln S_t + .166 \ln T + .293 \ln A + .387 \ln V_v + (.28 - .28 \frac{MASD}{RSSD}) + .225 (L - 2)^{***} - .233 \text{ (gates)}$$

$$2a. y = \exp (.938t_a + 1.109) / 4$$

where:

- A = Vehicles per day or annual average daily traffic
- L = Number of lanes
- ln = Logarithm to the base e

Table 31. Factor Values for U.S. DOT Injury Accident Probability Formula

Injury Accident Probability Formula:

$$P(IA|A) = \frac{1 - P(FA|A)}{(1 + CI \times MS \times TK \times UR)}$$

where: P(FA|A) = Fatal accident probability, See Tables 28 and 30  
 CI = 4.280, formula constant  
 UR = 1.202, urban crossing  
 = 1.000, rural crossing, and

Maximum Timetable Train Speed	MS	Total Number Of Tracks	TK
1	1.000	0	1.000
5	0.687	1	1.125
10	0.584	2	1.265
15	0.531	3	1.423
20	0.497	5	1.800
25	0.472	6	2.025
30	0.452	7	2.278
40	0.423	8	2.562
50	0.401	9	2.882
60	0.385	10	3.241
70	0.371	15	5.836
80	0.360	20	10.507
90	0.350		
100	0.341		

Source: Ref. 3

MASD = Actual minimum stopping sight distance along highway

MCS D = Clear sight distance (ability to see approaching train along the highway, recorded for the four quadrants established by the intersection of the railroad tracks and road)

RSSD = Required stopping sight distance on wet pavement

$S_t$  = Maximum speed of train  
 T = Yearly average of the number of trains per day

$t_a$  = ln of predicted number of accidents in four year period at crossings with active traffic control devices

$t_p$  = ln of predicted number of accidents in four year period at

### Chapter III Assessment of Crossing Safety and Operation

crossing with passive traffic control devices

$V_v$  = Posted vehicle speed limit unless geometrics dictate a lower speed

$y$  = Predicted number of accidents per year at crossing

Notes: \*This variable omitted if crossing is flagged or the calculation is less than zero.

\*\*This variable omitted if sight restriction is due to parallel road.

\*\*\*This variable omitted when gates are present.

The predicted number of accidents per year,  $y$ , is adjusted for accident history as follows:

$$Y = y \sqrt{H / (y) (P)}$$

where:

$Y$  = Accident prediction adjusted for accident history

$y$  = Accident prediction based on the regression model

$H$  = Number of accidents for six-year history or since year of last improvement

$P$  = Number of years of the accident history period

A simple method of rating each crossing from zero to 90 was derived based mathematically on the accident prediction. This method, entitled Safety (Hazard) Index, is used to rank each crossing. A Safety Index of 70 is considered safe (no further improvement necessary). A Safety Index of 60, or one accident every nine years, would be considered marginal. The Safety Index is calculated as follows:

$$R = X (1 - \sqrt{Y})$$

where:

$R$  = Safety Index

$Y$  = Adjusted accident prediction value

$X$  = 90 when less than ten school buses per day traverse the crossing

= 85 when ten or more school buses per day and active traffic control devices exist without gates

= 80 when ten or more school buses per day and passive traffic control devices exist

In general, those crossings that rank highest on the hazard index are selected to be investigated in the field by a diagnostic team as discussed in the next section. Other crossings may be selected for a field investigation because they are utilized by buses, passenger trains, and vehicles transporting hazardous materials. The FHPM requires that the potential danger to large numbers of people at crossings used on a regular basis by passenger trains, school buses, transit buses, pedestrians, bicyclists, or by trains and/or motor vehicles carrying hazardous materials be one of the considerations in establishing a priority schedule. Some States incorporate these considerations into a hazard index; thus providing an objective means of assessing the potential danger to large numbers of people.

Some States, however, consider these factors subjectively when selecting the improvement projects among the crossings ranked highest by the hazard index. Other States utilize a point system so that crossings high on the hazard index receive a specified number of points, as do crossings with a specified number of buses, passenger trains, and vehicles transporting hazardous materials.



Other States utilize the systems approach, considering all crossings within a specified system, e.g., all crossings along a passenger train corridor.

Crossings may also be selected for field investigation as a result of requests or complaints from the public. State district offices, local governmental agencies, other State agencies, and railroads may also request that a crossing be investigated for improvement. A change in highway or railroad operations over a crossing may justify the consideration of that crossing for improvement. For example, a new residential or commercial development may substantially increase the volume of highway traffic over a crossing such that its hazard index would greatly increase.

### C. Engineering Study

Engineering studies should be conducted of those railroad-highway grade crossings that have been selected from the priority schedule. The purpose of these studies is to:

- o review the crossing and its environment;
- o identify the nature of the problem; and,
- o recommend alternative improvements.

An engineering study consists of a review of the site characteristics, the existing traffic control system, and the highway and railroad operational characteristics. Based on a review of these conditions an assessment of existing and potential hazards can be made. If safety defi-

ciencies are identified, countermeasures can be recommended.

#### 1. Diagnostic Study Team Method

The procedure recommended in the original Handbook, adopted in FHWA's Highway Safety Engineering Studies Procedural Guide, and also adopted in concept by several States, is the diagnostic study team. This term is used to describe a simple survey procedure, utilizing experienced individuals from various agencies and disciplines. The procedure involves the diagnostic team's evaluation of the crossing as to its deficiencies and judgmental consensus as to the recommended improvements. The details of the procedure are discussed below.

The primary factors to be considered in the assignment of people to the diagnostic team are first, that the team is interdisciplinary in nature, and second, that it is representative of all groups having responsibility for the safe operation of crossings so that each of the vital factors relating to the operational and physical characteristics of the crossing may be properly identified. Individual team members are selected on the basis of their specific expertise and experience. The overall structure of the team is built upon three desired areas of responsibility: 1) local responsibility; 2) administrative responsibility; and, 3) advisory capability.

For the purpose of the diagnostic team, the operational and physical characteristics of crossings may be classified into three areas: 1) traffic operations; 2) traffic control devices; and, 3) administration. Each of these areas should be represented by one or more of the diagnostic team members as discussed below.

## Chapter III Assessment of Crossing Safety and Operation

Traffic Operations. This area includes both vehicular and train traffic operation. The responsibilities of highway traffic engineers and railroad operating personnel chosen for team membership include, among other criteria, specific knowledge of highway and railroad safety, types of vehicles and trains, and their volumes and speeds.

Control Devices. Highway maintenance engineers, signal control engineers, and railroad signal engineers provide the best source for expertise in this area. Responsibilities of these team members include knowledge of active traffic control systems, interconnection with adjacent signalized highway intersections, traffic control devices for vehicle operations in general and at crossings, and crossing signs and pavement markings.

Administration. It is necessary to recognize that many of the problems relating to crossing safety involve the apportionment of administrative and financial responsibility. This should be reflected in the membership of the diagnostic team. The primary responsibility of these representatives is to advise the team of specific policy and administrative rules applicable to modification of crossing traffic control devices.

To ensure appropriate representation on the diagnostic team, it is suggested that a team be comprised of at least a traffic engineer with safety experience and a railroad signal engineer. Following are other disciplines that might be represented on the diagnostic team.

- o Railroad administrative official
- o Highway administrative official
- o Human factors engineer
- o Law enforcement officer

- o Regulatory agency official
- o Railroad operating official

The diagnostic team should study all available data and inspect the crossing and its surrounding area with the objective of determining the conditions that affect safety and traffic operations. In conducting the study, a questionnaire is recommended to provide a structured account of the crossing characteristics and their effect on safety.

Figure 15 shows a sample questionnaire that could be altered to reflect individual agencies' needs. As an example, one State's questionnaire is shown in Appendix D. The questionnaire shown in Figure 15 is divided into four sections: 1) distant approach and advance warning; 2) immediate highway approach; 3) crossing proper; and, 4) summary and analysis.

Each of the sections that applies to the approaches is further divided into subsections. To conduct the study, traffic cones are placed on the approach as indicated in Figure 16.

Cone A is placed at the point where the driver first obtains information that a crossing is ahead, usually from the advance warning sign, pavement markings, or the crossing itself. The distance from the crossing is based on the decision sight distance, the distance required for a driver to detect a crossing and formulate actions needed to avoid colliding with trains. This distance is also the beginning of the approach zone as discussed in Chapter II.

Table 32 provides a range of distances from point A to the stop line, dependent upon design vehicle speed. The maximum distances are

### Chapter III Assessment of Crossing Safety and Operation

LOCATIONAL DATA: Street Name: \_\_\_\_\_ City: \_\_\_\_\_  
Railroad: \_\_\_\_\_ Crossing Number: \_\_\_\_\_

VEHICLE DATA: No. of Approach Lanes: \_\_\_\_\_ Approach Speed Limit: \_\_\_\_\_ AADT: \_\_\_\_\_  
Approach Curvature: \_\_\_\_\_ Approach Gradient: \_\_\_\_\_

TRAIN DATA: No. of Tracks: \_\_\_\_\_ Train Speed Limit: \_\_\_\_\_ Trains Per Day: \_\_\_\_\_  
Track Gradients: \_\_\_\_\_

#### SECTION I - Distance Approach and Advance Warning

1. Is advance warning of railroad crossing available? \_\_\_\_ If so, what devices are used? \_\_\_\_\_
2. Do advance warning devices alert drivers to the presence of the crossing and allow time to react to approaching train traffic? \_\_\_\_\_
3. Do approach grades, roadway curvature, or obstructions limit the view of advance warning devices? \_\_\_\_ If so, how? \_\_\_\_\_
4. Are advance warning devices readable under night, rainy, snowy, or foggy conditions? \_\_\_\_\_

#### SECTION II - Immediate Highway Approach

1. What maximum safe approach speed will existing sight distance support? \_\_\_\_\_
2. Is that speed equal to or above the speed limit on that part of the highway? \_\_\_\_\_
3. If not, what has been done, or reasonably could be done, to bring this to the driver's attention? \_\_\_\_\_
4. What restrictive obstructions to sight distance might be removed? \_\_\_\_\_
5. Do approach grades or roadway curvature restrict the driver's view of the crossing? \_\_\_\_\_
6. Are railroad crossing signals or other active warning devices operating properly and visible to adequately warn drivers of approaching trains? \_\_\_\_\_

#### SECTION III - Crossing Proper

1. From a vehicle stopped at the crossing, is the sight distance down the track to an approaching train adequate for the driver to cross the tracks safely? \_\_\_\_\_
2. Are nearby intersection traffic signals or other control device affecting the crossing operation? \_\_\_\_ If so, how? \_\_\_\_\_
3. Is the stopping area at the crossing adequately marked? \_\_\_\_\_
4. Do vehicles required by law to stop at all crossings present a hazard at the crossing? \_\_\_\_ Why? \_\_\_\_\_
5. Do conditions at the crossing contribute to, or are they conducive to, a vehicle stalling at or on the crossing? \_\_\_\_
6. Are nearby signs, crossing signals, etc. adequately protected to minimize hazards to approaching traffic? \_\_\_\_\_
7. Is the crossing surface satisfactory? \_\_\_\_ If not, how and why? \_\_\_\_\_
8. Is surface of highway approaches satisfactory? \_\_\_\_ If not, why? \_\_\_\_\_

#### SECTION IV - Summary and Analysis

1. List major attributes of the crossing which may contribute to safety. \_\_\_\_\_  
\_\_\_\_\_
2. List features which reduce crossing safety. \_\_\_\_\_  
\_\_\_\_\_
3. Possible methods for improving safety at the crossing: \_\_\_\_\_  
\_\_\_\_\_
4. Overall evaluation of crossing: \_\_\_\_\_  
\_\_\_\_\_
5. Other comments: \_\_\_\_\_  
\_\_\_\_\_

Figure 15. Sample Questionnaire for Diagnostic Team Evaluation

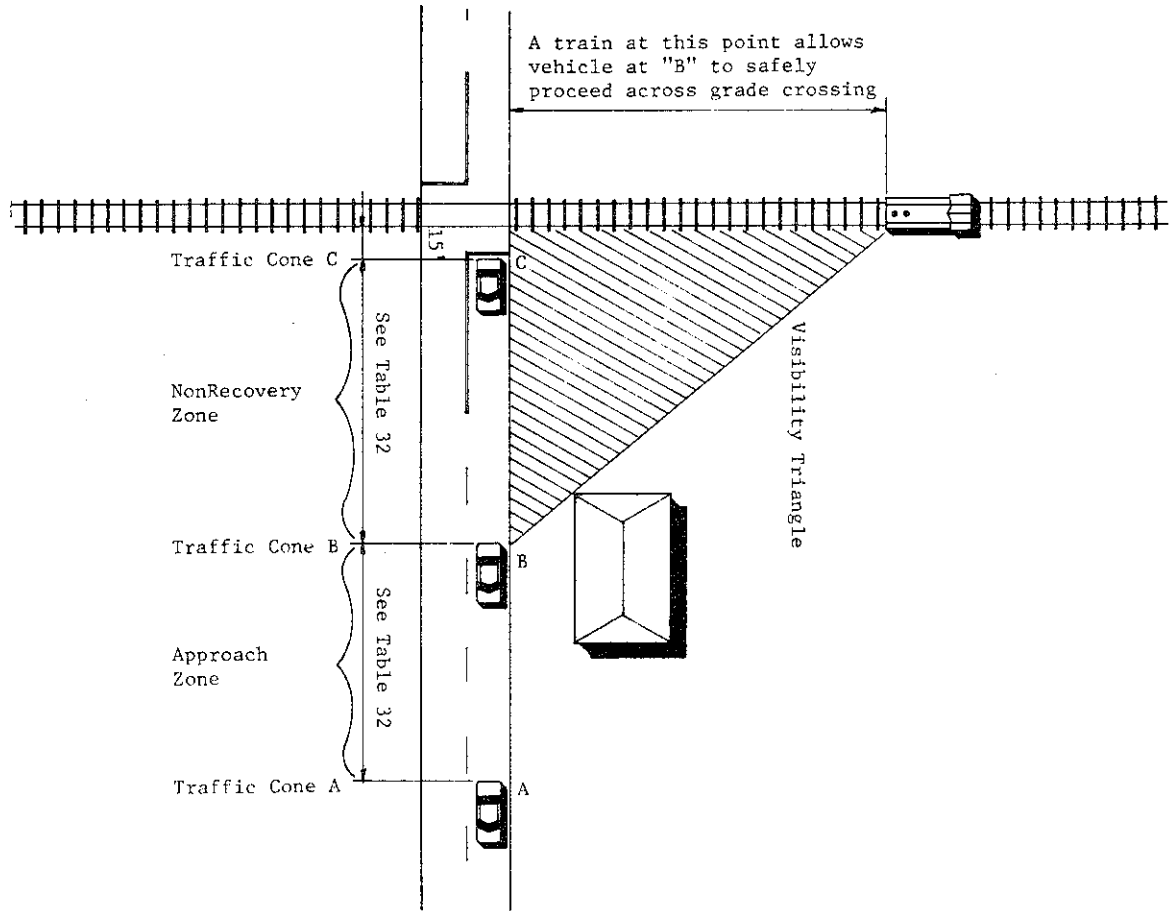

Figure 16. Study Positions for Diagnostic Team

Table 32. Distances to Establish Study Positions for Diagnostic Team Evaluation

Design Vehicle Speed (mph)	Distance from Stop Line*	
	to Cone A (ft)	to Cone B (ft)
30	450 - 625	210
40	600 - 825	325
50	750 - 1025	475
55	875 - 1150	555
60	1000 - 1275	645
70	1100 - 1450	850

\*The distance from the stop line is assumed to be 15 feet from nearest rail.

applicable to crossings with a high level of complexity.

Cone B is placed at the point where the driver must be able to see an approaching train so that a safe stop can be made if necessary. This point is located at the end of the approach zone and the beginning of the nonrecovery zone.

Distances to point B are based on the design vehicle speed and are shown in Table 32. These distances are stopping sight distances to the stop line (15 feet from the track) and are identical to the values in Table 36, Chapter IV (less the 15 feet). In calculating these dis-

tances, a level grade is assumed. If this is not the case, an allowance should be made for the positive or negative effects of grade.

Cone C is placed at the stop line, assumed to be 15 feet from the nearest rail.

The questions in Section I of the questionnaire (Figure 15) are concerned with the following.

- o Driver awareness of the crossing
- o Visibility of the crossing
- o Effectiveness of advance warning signs and signals
- o Geometric features of the highway

When responding to questions in this section, the crossing should be observed at the beginning of the approach zone, the location of traffic cone A.

The questions in Section II are concerned with whether or not the driver has sufficient information to detect an approaching train and make correct decisions about crossing safely. Observations for responding to questions in this section should be made from cone B. Factors considered by these questions include the following.

- o Driver awareness of approaching trains
- o Driver dependence on crossing signals
- o Obstruction of view of train approach
- o Roadway geometrics diverting driver attention

- o Potential location of standing railroad cars
- o Possibility of removal of sight obstructions
- o Availability of information for proper stop or go decisions by the driver

The questions in Section III apply to observations adjacent to the crossing, i.e. cone C. Of particular concern, especially when the driver must stop, is the ability to see down the tracks for approaching trains. Also, intersecting streets and driveways should be observed to determine whether intersecting traffic could affect the operation of highway vehicles over the crossing. Questions in this section relate to the following.

- o Sight distance down the tracks
- o Pavement markings
- o Conditions conducive to vehicle becoming stalled or stopped on the crossing
- o Operation of vehicles required by law to stop at crossing
- o Signs and signals as fixed object hazards
- o Opportunity for evasive action by the driver

In Section IV of the questionnaire the diagnostic team is given the opportunity to do the following.

- o List major features that contribute to safety
- o List features that reduce crossing safety

## Chapter III Assessment of Crossing Safety and Operation

- o Suggest methods for improving safety at the crossing
- o Give an overall evaluation of the crossing
- o Provide comments and suggestions relative to the questionnaire

In addition to completing the questionnaire, team members should take photographs of the crossing from both the highway and the railroad approaches.

Current and projected vehicle and train operation data should be obtained from the team members. Information on the use of the crossing by buses, school buses, trucks transporting hazardous material and passenger trains should be provided. The evaluation of the crossing should include a thorough examination of accident frequency, accident types, and accident circumstances. Both train-vehicle accidents and vehicle-vehicle accidents should be examined.

Team members should drive each approach several times to become familiar with all conditions that exist at, or near, the crossing. All traffic control devices (signs, signals, markings, and train detection circuits) should be examined as part of this evaluation. If the crossing is equipped with signals, the railroad signal engineer should activate them so that their alignment and light intensity may be observed.

Two principal references to be used for this evaluation are the Manual on Uniform Traffic Control Devices and the Traffic Control Devices Handbook. Also, A User's Guide to Positive Guidance provides information for conducting evaluations of traffic control devices.

After the questionnaire has been completed, the team is reassembled for a short critique and discussion period. Each member should summarize his observations pertaining to safety and operations at the crossing. Possible improvements to consider include the following.

- o Closing of crossing -- Available alternate routes for highway traffic.
- o Site Improvements -- Removal of obstructions in the sight triangle, highway realignment, improved cross section, drainage, or illumination.
- o Crossing Surfaces -- Rehabilitation of the highway structure, the track structure, or both. Installation of drainage and subgrade filter fabric.
- o Traffic Control Devices -- Installation of passive or active control devices and improvement of train detection equipment.

The results and recommendations of the diagnostic team should be documented. Recommendations should be presented promptly to programming and implementation authorities.

### 2. Other Engineering Studies

In addition to the factors mentioned above there are other considerations to complete a comprehensive examination of a crossing. These are briefly described below.

Traffic Flow Operations. Important considerations for traffic flow operations are the traffic volume (daily and peak hour), the mix of vehicle types, their operating speeds, the capacity of the road, delays, and

queue lengths. These should be reviewed in terms of their status and how they might be affected by improvements at the crossing. Two particular concerns are access across the railroad by emergency vehicles and the use of the crossing by special vehicles, i.e. trucks transporting hazardous material and buses. Standard data collection procedures for evaluating these factors are contained in FHWA's Highway Safety Engineering Studies, Procedural Guide or in the Institute of Transportation Engineer's Manual of Traffic Engineering Studies.

Community Separation. The engineering field survey should also consider the impacts of crossing operations on the community. Considerations include frequency and type of train operations, pedestrian and bicycle access, and number of crossings in the community needed to provide adequate vehicle access.

#### D. The Systems Approach

The procedures for evaluating railroad-highway grade crossings are generally based upon the physical and operational characteristics of individual crossings. A typical crossing safety program consists of a number of individual crossing projects. Funding for crossing safety is approved on the basis of the requirements of these individual projects. Therefore, crossing evaluation, programming, and construction follows traditional highway project implementation procedures.

The concept of using the systems approach to railroad - highway grade crossing improvements was enhanced when crossings off the Federal-aid system were made eligible for Federally funded programs. Since all pub-

lic crossings are now eligible for improvement with Federal funds, the systems approach provides a comprehensive method for addressing safety and operations at crossings.

The systems approach considers the railroad-highway grade crossing to be a part, or a component of, a larger transportation system. For this purpose, the transportation system is defined as a land surface system consisting of both highway and railroad facilities. The intersection of these two transportation modes affects both safety and operations of the entire system. The objective of the systems approach for crossings is to improve both safety and operations of the total system or segments of the system.

The systems approach may be applied to a segment of the rail component of the system. For example, to improve operating efficiency and safety over a specified segment of a rail line, all crossings would be considered in the evaluation. Thus, the systems approach is often called the corridor approach. Or, the systems approach may be applied to an urban area, city, or community. In this case, all public crossings within the jurisdiction of a public agency are evaluated and programmed for improvements. The desired outcome is a combination of engineering improvements and closures such that both safety and operations are highly improved.

Assume that a segment of rail line is to be upgraded for unit train operations or high speed passenger service. This type of change in rail operations would provide an ideal opportunity for the application of the systems approach. The rail line may be upgraded by track and signal improvements for train operations that

might cause a need for adjustments in train detection circuits of active traffic control devices. Also, modifications of train operations and speeds may require the installation of active traffic control devices at selected crossings.

A system approach developed for crossings in a specified community or political subdivision allows for a comprehensive analysis of highway traffic operations. Thus, unnecessary crossings can be closed and improvements made at other crossings. This approach enhances the acceptability of crossing closures by local officials and citizens.

Initially, all crossings in the system, both public and private, should be identified and classified by jurisdictional responsibility, e.g. city, county, and State for public crossings, and parties to the agreement for private crossings. Information should be gathered on highway traffic patterns, train operations, emergency access needs, land uses, and growth trends. The inventory records for the crossings should be updated to reflect current operational and physical characteristics. A diagnostic team, consisting of representatives from all of the public agencies having jurisdiction over the identified crossings and the railroads operating over the crossings, should make an on-site assessment of each crossing as described in the previous section. The diagnostic team's recommendations should consider, among other things, crossing closure, installation of active traffic control devices, upgrading existing active devices, elimination by grade separation, surface improvements, and improvements in the train detection circuits. In addition, modification of train operations near, and at,

each crossing, removal of sight obstructions, rerouting of special vehicles and emergency vehicles, and railroad relocation should be considered.

Federal, State, and local crossing funding programs should be reviewed to identify the eligibility of each crossing improvement for public funding. Other funding sources include railroads, urban renewal funds, land development funds, and other public or private funding sources.

There are several advantages of the systems approach. A group of crossings may be improved more efficiently through the procurement of materials and equipment in quantity, thus reducing product procurement and transportation costs. Usually, only one agreement between the State, local jurisdiction, and railroad is necessary for all of the improvements. Train detection circuits may be designed as a part of the total railroad signal system rather than custom designed for each individual crossing. Electronic components, relay houses, and signal transmission equipment may be more efficiently utilized. Labor costs may be significantly reduced. Travel time of construction crews may be reduced when projects are in close proximity of each other.

Railroads benefit from the application of the systems approach in several ways. Train speeds may be increased due to safety improvements at crossings. Maintenance costs may be reduced if a sufficient number of crossings are closed. Other improvements may enhance the efficiency of rail operations.

Safety improvements are an obvious benefit to the public. Other bene-



fits include reduced vehicular delays and better access for emergency vehicles.

One impediment to the systems approach is that most Federal and State crossing safety improvement programs provide funding for safety improvements only. Also, safety improvement projects may be limited to crossings that rank high on a priority schedule. Another impediment is the involvement of multiple jurisdictions.

The Federal Highway Administration (FHWA) has endorsed the systems approach and its resultant identification of low-cost improvements to crossing safety and operations. The FHWA has sponsored a demonstration project that utilized the systems approach to improve crossings along a rail corridor in Illinois.

In order to eliminate the need for project agreements with each local agency, the Illinois Commerce Commission issued a single order covering the work to be performed at nine locations. This accelerated the project and reduced labor intensive work. The FHWA and the Illinois Department of Transportation (DOT) agreed that minimal plan submittals would be required of the local agencies, and the local agencies agreed to perform the necessary work at mutually agreed upon lump sum prices under the supervision of Illinois DOT district representatives.

Improvements made as part of the demonstration project in Illinois included the following.

- o Removal of vegetation
- o Pavement widening
- o Reconstruction of approaches

- o Installation of 12-inch lenses in crossing signals
- o Relocation of train loading areas
- o Closure of crossings
- o Removal of switch track
- o Installation of traffic control signs pertinent to crossing geometrics

The Florida Department of Transportation (DOT) and other States have adopted policies incorporating the systems approach as a part of their crossing safety improvement programs. The Florida DOT selects track segments on the basis of the following conditions.

- o Abnormally high percentage of crossings with passive traffic control devices only
- o Freight trains carrying hazardous material in an environment that presents an unacceptable risk of a catastrophic event
- o Passenger train routes
- o Plans for increased rail traffic, especially commuter trains

#### E. References

1. Box, Paul C. and Oppenlander, J.C. Manual of Traffic Engineering Studies, Washington, DC: Institute of Transportation Engineers, 1976.
2. Code of Federal Regulations, Title 49, Washington, DC: Superintendent of Documents, Government Printing Office, published annually.
3. Farr, E.H. and J.S. Hitz, Accident Severity Prediction Formula for Rail-

Chapter III Assessment of Crossing Safety and Operation

Highway Crossings, Washington, DC: Federal Highway Administration, Federal Railroad Administration, Report FHWA-RD-83/092, July 1983.

4. Federal-Aid Highway Program Manual, Washington, DC: Federal Highway Administration, updated periodically.

5. Federal Highway Administration Survey of Region and Division Offices, unpublished 1984.

6. Goodell - Grivas, Inc., Highway Safety Engineering Studies, Procedural Guide, Washington, DC: Federal Highway Administration, FHWA-TS-81-220, June 1981.

7. Hitz, John and Mary Cross, Rail-Highway Crossing Resource Allocation Procedure User's Guide, Washington, DC: Federal Highway Administration and Federal Railroad Administration, Report FHWA-IP-82-7, December 1982.

8. Manual on Uniform Traffic Control Devices, Washington, DC: Federal Highway Administration, 1978, Revised 1979, 1983, and 1984.

9. A Policy on Geometric Design of Highway and Streets, Washington, DC: American Association of State Highway and Transportation Officials, 1984.

10. Post, T.J., G.J. Alexander, and H. Lunenfeld, A User's Guide to Positive Guidance, Second edition, Washington, DC: Federal Highway Administration, Report FHWA-TO-81-1, December 1981.

11. Railroad/Highway Grade Crossing Accidents Involving Trucks Transporting Bulk Hazardous Materials, A Special Study, Washington, DC: National Transportation Safety Board, Report NTSB-HZM-81-2, September 1981.

12. Schoppert, David W. and Dan W. Hoyt, Factors Influencing Safety at Highway-Rail Grade Crossings, Washington, DC: Highway Research Board, NCHRP Report 50, 1968.

13. Traffic Control Devices Handbook, Washington, DC: Federal Highway Administration, 1983.

14. Update Manual: National Railroad Highway Crossing Inventory, Washington, DC: U.S. Department of Transportation, 1976.

#### IV. IDENTIFICATION OF ALTERNATIVES

In the previous chapters, methodologies for selecting and analyzing potentially hazardous railroad-highway grade crossings were presented. In this chapter, alternative safety and operational improvements are discussed. These alternatives are presented by type: crossing elimination; installation of passive traffic control devices; installation of active traffic control devices; site improvements; crossing surface improvements; and, removal of grade separations. From information contained in this chapter, the highway engineer should select several alternative improvement proposals for any particular crossing being studied. The "do-nothing" alternative should also be considered a proposal. Procedures for selecting among the various alternatives are presented in Chapter V, Selection of Alternatives.

##### A. Elimination

The first alternative that should always be considered for a railroad-highway at-grade crossing is elimination. Elimination can be accomplished by grade separating the crossing, closing the crossing to highway traffic, or closure of the crossing to railroad traffic through the abandonment or relocation of the rail line. Elimination of a crossing provides the highest level of crossing safety because the point of intersection between highway and railroad is removed. However, the effects of elimination on highway and railroad operations may be beneficial or adverse. Thus, the benefits of the elimination alternative are primarily safety and perhaps operation-

al, offset by construction and operational costs.

Decisions regarding whether the crossing should be eliminated or otherwise improved through the installation of traffic control devices or site or surface improvements depends upon safety, operational, and cost considerations. However, the Federal Highway Program Manual (FHPM) does specify that "all crossings of railroads and highways at grade shall be eliminated where there is full control of access on the highway (a freeway) regardless of the volume of railroad or highway traffic".<sup>14</sup>

The major benefits of crossing elimination include reductions in accidents, reductions in highway vehicle delay, reductions in rail traffic delay, and reductions in maintenance costs of crossing surfaces and traffic control devices.

Safety considerations include both train - involved accidents and non-train involved accidents. Certain vehicles, e.g. school buses and trucks carrying hazardous materials, may be required to stop at all crossings. These vehicles, that may stop unexpectedly, may cause collisions with other vehicles. In addition, the presence of the crossing itself may cause non-train accidents. For example, when stopping suddenly to avoid a collision with an oncoming train, a driver may lose control of the vehicle and collide with a road-

-----  
<sup>14</sup>Federal - Aid Highway Program Manual, 6-6-2-1, Washington, DC: Federal Highway Administration.

side object. Thus, these types of accidents would be avoided if an at-grade crossing were eliminated.

Four types of delay are imposed on highway traffic by crossings.

- o Delay due to trains occupying crossings. Highway traffic should slow down to look for trains, particularly at crossings with passive traffic control devices. Vehicles must stop and wait for a train to clear a crossing. Furthermore, there may be some delay to vehicles which arrive at a crossing before those vehicles that were delayed by a train have cleared the crossing.
- o Delay to special vehicles. Certain vehicles may be required to stop at all crossings. These include school buses, buses carrying passengers for hire, and vehicles carrying hazardous materials. In addition to the delay incurred by these special vehicles, their stopping may also impose delay on following vehicles.
- o Delay due to crossing surface. Crossing surfaces should be maintained so that they provide a smooth surface.
- o Delay due to crossing. This delay occurs regardless of whether or not a train is approaching or occupying the crossing. Motorists usually slow down in advance of crossings so that they can stop safely if a train is approaching. In fact, this is a required safe driving practice in conformance with the Uniform Vehicle Code, which states "...vehicles must stop within 15 to 50 feet from the crossing when a train is in such proximity so as to constitute an

immediate hazard."<sup>15</sup> Therefore, the existence of a crossing may cause some delays to motorists who slow to look for a train.

Railroads also sometimes experience delays due to the presence of crossings, that may be alleviated should the crossings be eliminated. Some local jurisdictions restrict train speeds on the basis that crossing accidents would be less severe should they occur. Not only are delays caused by trains moving at slower speeds, but also because trains are slow to accelerate back to the higher speed. Eliminating crossings would also reduce train delay due to crossing accidents.

Another benefit of crossing elimination is the alleviation of maintenance costs of surfaces and traffic control devices. As discussed in a later chapter on maintenance, these costs can be quite substantial for both highway agencies and railroads.

Costs of eliminating crossings depend on whether the crossing is merely closed to highway traffic, a grade separation is constructed, or the highway or railroad is relocated. These costs are discussed along with other considerations for each type of elimination alternative.

#### 1. Grade Separation

The Traffic Control Devices Handbook suggests that grade separations be considered specifically in

-----  
<sup>15</sup>Uniform Vehicle Code and Model Traffic Ordinances, Evanston, IL: National Committee on Uniform Traffic Laws and Ordinances, 1961, and Supplement, 1984.

the design of new highway routes and improvements to railroad facilities. A grade separation is recommended for highways that must cross high speed railroad passenger routes.

While no Federal criteria for grade separations exist, many States have developed their own criteria or warrants. Specific criteria provide a means to justify the expenditure of funds for separating grades at some crossings while not separating grades at others. Obviously, costs and benefits should be considered in the decision-making process; however, as discussed in Chapter V, some costs and benefits are difficult to quantify. Thus, engineering judgment plays a major role in selecting the grade separation alternative.

A few States consider the grade separation alternative for a crossing if its priority index is above a specified value. A few other States utilize an exposure index such that if the product of train and highway traffic is above a specified value a separation of grade is considered.

It is recommended that grade separations be considered as an alternative for heavily traveled crossings. However, costs and benefits should be carefully weighed as grade separations are expensive to construct and maintain. In some cases, it may be feasible to separate grades at one crossing in a community or town and close most of the remaining crossings.

## 2. Highway and Railroad Relocation

Other alternatives to railroad-highway grade crossing problems are relocation of the highway or railroad or railroad consolidation. These alternatives provide a solution to other railroad impacts on communities;

however, the costs associated with relocation or consolidation can be quite high.

Railroads provide advantages and disadvantages to communities. They generate employment opportunities for local citizens, provide transportation services to local industries and businesses, and are a source of tax revenue to government agencies. But the presence of railroads in communities can impose some disadvantages, such as vehicular delay and safety concerns at railroad-highway grade crossings. In addition, the presence of railroads may impose noise and other environmental concerns upon the community. Railroad relocation to the outer limits of the community may be a viable alternative for alleviating these concerns while retaining the advantages of having railroad service. Relocation generally involves the complete rebuilding of railroad facilities. Not only does this require track construction, but also acquisition of right-of-way and construction of drainage structures, signals, communications, crossings and separations, station facilities, and utilities.

In some cases, consolidation of railroad lines into common corridors or joint operations over the same trackage may allow for the removal of some trackage through a community. Railroad consolidation may provide benefits similar to those of railroad relocation, and possibly at lower costs.

Benefits of railroad relocation, in addition to those associated with crossing safety and operations, include: improved environment resulting from decreased noise and air pollution; improved land use and appearance; and, improved railroad efficiency. Railroad relocation and con-

## Chapter IV Identification of Alternatives

solidation may also provide for the elimination of obstructions to emergency vehicles and the safer movement of hazardous materials. Collectively, the tangible and intangible benefits may justify the relocation or consolidation of railroad facilities, whereas, any one of the benefits alone might not provide sufficient justification for the expense.

Many factors must be considered in planning for railroad relocation. The new location should provide good alignment, minimum grades, and adequate drainage. Sufficient right-of-way should be available to provide the necessary horizontal clearances, additional rail facilities as service grows, and a buffer for abating noise and vibrations. The number of crossings should be minimized.

The railroad corridor can be further isolated from residential and commercial activity by zoning the property adjacent to the railroad as light and heavy industrial. Businesses and industry desiring rail service can locate in this area.

To accomplish a rail relocation or consolidation project, a partnership is required between the Federal government (if Federal funds are involved), State and local government agencies, the railroad, and the community. While the purpose of the project may be only to eliminate physical conflicts between the highway user and the railroad, the partnership developed for this project provides an atmosphere of cooperative working relationships that continues into the future.

Highway relocations are sometimes accomplished to provide improved highway traffic flow around communities and other developed ar-

reas. Planning for highway relocations should consider routes that would eliminate at-grade crossings by avoiding the need for access over railroad trackage or by providing grade separations.

### 3. Closure

Closure of a railroad-highway grade crossing to highway traffic should always be considered as an alternative. Numerous crossings were built when railroads first began operating. Then, safety was not a serious concern since horse drawn carriages could easily stop and train speeds were low.

Closure of at-grade crossings is normally accomplished by closing the highway. The number of crossings needed to carry highway traffic over a railroad in a community is influenced by many of the characteristics of the community itself. A study of highway traffic flow should be conducted to determine origin and destination points and needed highway capacity. Thus, optimum routes over railroads can be determined. Highway operation over several crossings may be consolidated to move over a nearby crossing with flashing lights and gates or over a nearby grade separation. Alternative routes should be within a reasonable travel time and distance from a closed crossing. The alternate routes should have sufficient capacity to accommodate the diverted traffic safely and efficiently.

There are several stumbling blocks to successful closure, such as negative community attitudes, funding problems, and lack of forceful State laws authorizing closure or reluctant utilization of State laws that permit closure.

Legislation that authorizes a State agency to close crossings facilitates the implementation of closures greatly. A list of State agencies that have the authority to close crossings is contained in Appendix E. These State agencies should utilize their authority to close crossings whenever possible. Often, a State agency can accomplish closure where local efforts fail due to citizen biases and fear of losing access across the railroad. Local opposition may sometimes be overcome through emphasis on the benefits resulting from closure such as improved traffic flow and safety as traffic is redirected to grade separations or crossings with active traffic control devices. Railroads often support closure, not only because of safety concerns, but also because maintenance costs associated with the crossing are eliminated.

To assist in the identification of crossings that may be closed, the systems approach might be utilized as discussed in Chapter III. With this method, several crossings in a community or rail corridor are improved by the installation of traffic control devices while other crossings are closed. This is accomplished following a study of traffic flows in the area to assure continuing access across the railroad. Traffic flows are sometimes improved by the installation of more sophisticated traffic control systems at the remaining crossings and perhaps the construction of a grade separation at one of the remaining crossings.

Another important matter to consider in connection with crossing closure is access over the railroad by emergency vehicles, ambulances, fire trucks, and police. Crossings that are frequently utilized by emergency vehicles should not be closed.

On the contrary, these crossings should be candidates for grade separations or the installation of active traffic control devices.

Specific criteria to identify those crossings that should be closed are difficult to establish because of the numerous and various factors that should be considered. The Traffic Control Devices Handbook suggests criteria that may be used for crossing closure. It is important that these criteria not be used without professional, objective, engineering, and economic assessment of the positive and negative impacts of crossing closures.

Criteria for crossings on branch lines:

- o less than 2,000 ADT;
- o more than two trains per day; and,
- o alternate crossing within 0.25 miles that has less than 5,000 ADT if two-lane, or less than 15,000 ADT if four-lane.

Criteria for crossings on spur tracks:

- o less than 2,000 ADT;
- o more than 15 trains per day; and,
- o alternate crossing within 0.25 miles with less than 5,000 ADT if two-lane, or less than 15,000 ADT if four-lane.

Criteria for crossing on main line:

- o any main line section with more than five crossings within a 1.0 mile segment.

When a crossing is permanently closed to highway traffic, the exist-

ing crossing should be obliterated by removing the crossing surface, pavement markings, and all traffic control devices both at the crossing and approaching the crossing.

Generally, the railroad is responsible for removing the crossing surface and traffic control devices located at the crossing, e.g. the crossbuck sign, flashing light signals, and gates.

The highway authority is responsible for removing traffic control devices in advance of and approaching the crossing, e.g. the advance warning signs and pavement markings. Nearby highway traffic signals which are interconnected with crossing signals located at the closed crossing should have their phasing and timing readjusted.

The highway authority is also responsible to alert motorists that the crossing roadway is now closed. A Type III barricade, shown in Figure 17, may be erected. If used, this barricade shall meet the design cri-

teria of Section 6C-8 of the Manual on Uniform Traffic Control Devices (MUTCD), except the colors of the stripes shall be reflectorized white and reflectorized red. Characteristics of a Type III barricade are provided in Figure 17.

Warning and regulatory signing should be installed to alert motorists that the crossing roadway is now closed. These signs include the "Road Closed Sign" (R11-2), "Local Traffic Only Sign" (R11-3, R11-4), and appropriate advance warning signs as applicable to the specific crossing.

Consideration should also be given to advising motorists of alternate routes across the railroad. If trucks use the crossing that is being closed they should be given advance information of the closure at points where they can conveniently alter their route.

#### 4. Abandoned Crossings

Railroad-highway grade crossings on abandoned railroad lines present a different kind of safety and operational problem. Motorists who consistently drive over crossings that are not maintained but have traffic control devices and at which they never see a train may develop a careless attitude and not take appropriate caution. A motorist may then maintain this attitude and behavior at crossings that have not been abandoned; perhaps resulting in a collision with a train. Thus, credibility of crossing traffic control devices may be reduced, not only for the abandoned crossing, but also for other crossings as well.

Operational problems exist for abandoned crossings. A careful motorist will slow down in advance of

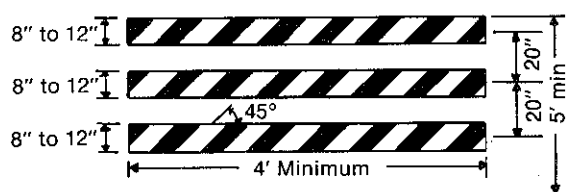

Type III Barricade

Width of Rail	8" min - 12" max
Length of Rail	4 ft. min
Width of Stripes	6 in.
Height	5 ft. min
Number of Reflectorized Rail Faces	3 if facing traffic in one direction

Note: For wooden barricades nominal lumber dimensions are satisfactory.

Figure 17. Type III Barricade

Source: Ref. 15



every crossing, especially those with passive traffic control devices. If the track has been abandoned, unnecessary delays result, particularly for special vehicles required by Federal and State laws to stop in advance of every crossing. These special vehicles include school buses, buses carrying passengers for hire, and vehicles transporting hazardous materials. In addition, these vehicles may be involved in vehicle-vehicle collisions that occur because of their unexpected stops.

The desirable action for abandoned crossings is to remove all traffic control devices related to the crossing and to remove or pave over the tracks. The difficulty is identifying abandoned railroad lines. For example, a railroad may discontinue service over a line or a track; with the possibility that another railroad, particularly a short line railroad, may later purchase or lease the line to resume that service. These railroad lines are called inactive lines and, obviously, removing or paving over the track will add substantial cost in reactivating the service.

Another type of inactive rail line is one whose service is seasonal. For example, rail lines that serve grain elevators may only have trains during harvest season. The lack of use during the rest of the year may cause the same safety and operational problems described earlier.

The first step in addressing the problem of crossings on abandoned rail lines is to obtain information from the Interstate Commerce Commission (ICC) or a State regulatory commission. Railroads are required to apply to the ICC for permission to abandon a rail line. In addition,

some State laws require the railroad to also apply for permission or notify a State agency of its intentions to abandon the line. The State highway engineer responsible for crossing safety and operations should be notified of these intentions. The State highway agency (SHA) might work out an agreement with the State regulatory commission that any information on railroad abandonments is automatically sent to the SHA. Additionally, the SHA should periodically call the State regulatory commission or the ICC to obtain the records on rail abandonments in the State. Railroad personnel responsible for crossing safety and operations should also seek the same information from their traffic and operating departments.

Once a rail line has been identified as abandoned or abandonment is planned, the crossings on that line should be identified. This can be determined from the State inventory of crossings or obtained from the Federal Railroad Administration, custodian of the U.S. DOT/AAR National Rail-Highway Crossing Inventory. A field inspection of these crossings should be made to determine if all crossings on that line, both public and private, are listed in the inventory and to verify the type of traffic control devices located at each crossing.

This field inspection provides an excellent opportunity to assess the safety and operations of each crossing on that line as discussed in Chapter III. If the rail line is not abandoned, the necessary information has been gathered to improve each crossing by one of the alternatives described in following sections.

If rail service has been discontinued, pending resolution of the abandonment application and thus for-

mal abandonment, immediate measures should be taken to inform the public. For example, "Exempt" signs, if authorized by State law or regulation, can be placed at the crossings to notify drivers of special vehicles that a stop at the crossing is not necessary. Gate arms should be removed and flashing light signal heads should be hooded, turned or removed. However, if these actions are taken, the traffic control devices must be restored to their original condition prior to operating any trains over the crossing. The railroad might flag the train over the crossing until such action can be taken.

If it appears that rail service has been permanently discontinued and resolution of official abandonment appears certain, the track might be paved over and all traffic control devices removed. This action should be taken immediately following official abandonment if no possibility exists for resumption of rail service. This can be determined by examining the potential for industry or business to require rail service. For example, if the rail line was abandoned because the industry that required the service has moved and other plans for the land area have been made, then it could be determined whether need for the rail service will continue. An agreement may be necessary between the public authority and railroad to accomplish the physical removal of the tracks.

#### **B. Passive Traffic Control Devices**

Passive traffic control devices provide static messages of warning, guidance, and in some instances, mandatory action for the driver. Their purpose is to identify and direct attention to the location of a crossing

in order to permit drivers and pedestrians to take appropriate action. Passive traffic control devices consist of regulatory, warning, and guide signs, and supplemental pavement markings. They are basic devices and are incorporated into the design of active traffic control devices.

Signs and pavement markings are to be in conformance with the Manual on Uniform Traffic Control Devices (MUTCD). The MUTCD is revised periodically as the need arises. If there are differences between this Handbook and the current edition of the MUTCD concerning both active and passive traffic control devices, the MUTCD should be followed.

Federal law requires that as a minimum each State shall provide signs at all crossings. The railroad crossbuck sign and other supplemental signs attached to the crossbuck mast are usually installed and maintained by the railroad company. The agency responsible for maintenance of the roadway is normally responsible for advance warning signs and pavement markings.

#### **1. Signs**

The typical signs used at railroad-highway grade crossings are shown in Figure 18. Individual characteristics and location requirements are discussed below.

In general, the MUTCD specifies that signs should be located on the right-hand side of the highway where the driver is looking for them. Signs should be located to optimize visibility. Signs should not be located in a highway dip nor beyond the crest of a hill. Care should be taken so that the sign is not obscured

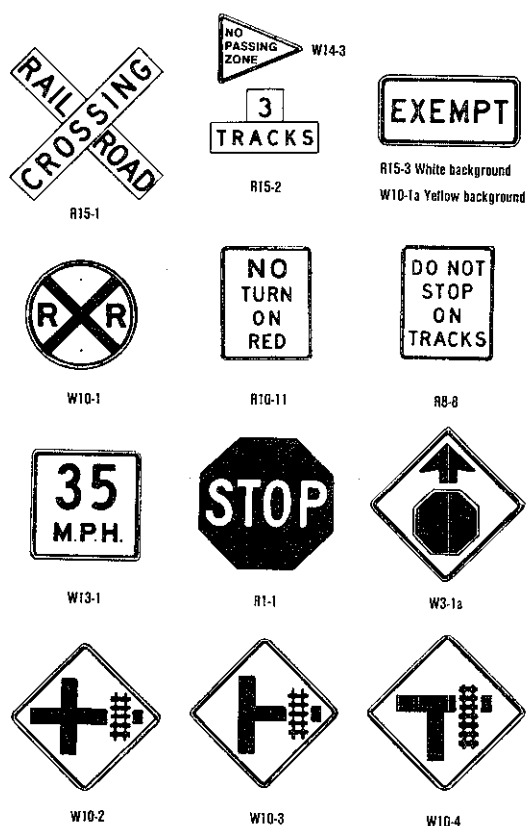

Figure 18. Typical Crossing Signs

Source: Ref. 29

by parked cars or foliage, or covered by roadside splatter or snow accumulation.

In rural areas, signs along the side of the road should be at least five feet high, measured from the bottom of the sign to the elevation of the near edge of the pavement. In business, commercial, and residential areas, where parking and/or pedestrian movement is likely to occur or where there are other sight obstructions, the clearance to the bottom of the sign should be at least seven feet. The height to the bottom of a secondary sign mounted below another sign may be one foot less than the height specified above.

Signs should have the maximum practical lateral clearance from the edge of the traveled way for the safety of motorists who may leave the highway and strike the sign supports. Advantage should be taken of existing guardrails, overcrossing structures, and other conditions to minimize the exposure of sign supports to traffic.

Normally, signs should not be closer than six feet from the edge of the shoulder, or if none, 12 feet from the edge of the traveled way. In urban areas, a lesser clearance may be used where necessary. Although two feet is recommended as a working urban minimum, a clearance of one foot from the curb face is permissible if sidewalk width is limited or where existing poles are close to the curb.

Signs should be mounted approximately at right angles to the direction of, and facing, the traffic that they are intended to serve. Post-mounted signs located close to the highway should be turned slightly away from the highway to avoid reflection of headlights off the sign directly back into the driver's eyes.

Sign posts and their foundations and sign mountings should be constructed to hold signs in a proper and permanent position, to resist swaying in the wind or displacement by vandalism. If ground mounted sign supports cannot be sufficiently offset from the pavement edge, sign supports should be of a suitable break-away or yielding design. Concrete bases for sign supports should be flush with the ground level.

Sign materials are usually aluminum, wood, or galvanized or non-galvanized steel. Signs are reflectorized or illuminated to provide visibility at night. The require-

## Chapter IV Identification of Alternatives

ments of sign illumination are not considered to be satisfied by street or highway lighting or by strobe lighting. Information on reflective materials is contained in the Traffic Control Devices Handbook.

Railroad Crossing (Crossbuck) Sign (R15-1) and Number of Tracks Sign (R15-2). The railroad crossing sign, commonly identified as the "crossbuck" sign, consists of a white reflectorized background with the words "Railroad Crossing" in black lettering as shown in Figures 18 and 19. A minimum of one crossbuck is to be used on each highway approach to every crossing, alone or in combination with other traffic control devices. If there are two or more tracks at the crossing, the number of tracks is to be indicated on an auxiliary sign mounted below the cross-

buck as shown in Figure 19. The use of this auxiliary sign is optional at crossings with automatic gates.

Where physically feasible and visible to approaching traffic the crossbuck sign should be installed on the right-hand side of the highway on each approach to the crossing. Where an engineering study finds restricted sight distance or unfavorable road geometry, crossbuck signs shall be placed back-to-back, or otherwise located, so that two faces are displayed to that approach. Some States and railroads use back-to-back crossbucks at every crossing, while other States and railroads place reflectorized white stripes on the back of every crossbuck.

Crossbuck signs should be located with respect to the highway pavement or shoulder as discussed above for all signs and should be located with respect to the nearest track in accordance with signal locations as discussed in the next section. Where unusual conditions exist, the placement of crossbucks should provide the best possible combination of view and safety clearances as determined by engineering judgment.

Advance Warning Signs (W10-1, W10-2, W10-3, W10-4). The round, black and yellow advance warning sign (W10-1) is located in advance of the crossing and serves to alert the motorist that a crossing is ahead. The advance warning sign has a minimum diameter of 36 inches. The sign is required in advance of all crossings except the following.

- o Low volume roadways (ADT below 500) with approach speeds below 40 mph which cross minor spurs or other tracks which are infrequently used and which are flagged by train crews

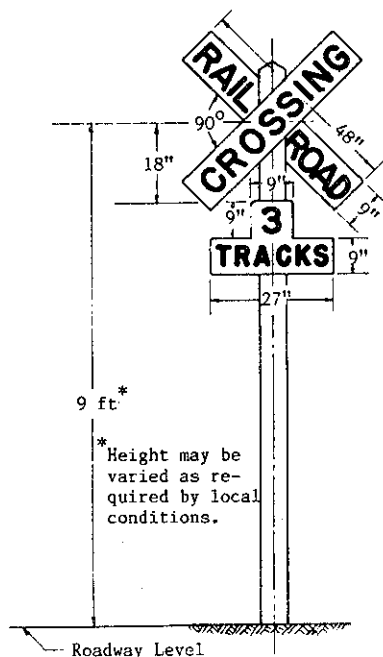

Figure 19. Crossing Sign (Crossbuck)

Source: Ref. 17

- o In business districts of large cities where active crossing traffic control devices are being used
- o In situations where physical conditions do not permit even a partially effective display of the sign

When the crossing is on a divided highway, it is desirable to place an additional advance warning sign on the left side of each approach. It may also be desirable to place an additional sign on the left side of a highway approach when the highway alignment limits the visibility of signs mounted on the right side.

The distance from the advance warning sign to the track is dependent upon the highway speed, but in no

case should it be less than 100 feet in advance of the nearest rail. This distance should allow the driver sufficient time to comprehend and react to the sign's message and to perform any necessary maneuver. The recommended distances are shown in Table 33.

Where a road runs parallel to a railroad and the perpendicular distance between the two is less than 100 feet, there is not enough distance to display the advance warning sign (W10-1). For traffic turning from the parallel road, one of three other warning signs (W10-2, W10-3, and W10-4) can be used when their need has been determined from an engineering study. Typical sign placements for crossings located near highway intersections are shown in Figures 20, 21, and 22.

Table 33. Placement Distances for Advance Warning Signs

Posted or 85 percentile speed (mph) (use higher speed)	Suggested Minimum Warning Sign Placement Distance (ft) <sup>1</sup> for						
	Condition A High judgment needed <sup>2</sup> (10 sec PIEV)	Condition B Stop condition <sup>3</sup>		Condition C Deceleration to advisory or desired speed (mph) <sup>3</sup>			
		0	10	20	30	40	50
20	175	(4)	(4)				
25	250	(4)	100				
30	325	100	150	100			
35	400	150	200	175			
40	475	225	275	250	175		
45	550	300	350	325	250		
50	625	375	425	400	325	225	
55	700	450	500	475	400	300	
60	775	550	575	550	500	400	300

<sup>1</sup>Distances shown are for level roadways, and corrections should be made for grades. Distances are based on 36-inch signs. If 48-inch signs are used, the legibility distance may be increased to 200 feet, thus reducing the placement distance by 75 feet.

<sup>2</sup>In urban areas, if there is an in-between intersection that might confuse the motorist, a supplementary plate underneath the warning sign should be used to specify the distance to the condition.

<sup>3</sup>Distance provides for 3-second PIEV, 125 feet sign legibility distance, braking distance for Condition B and comfortable breaking distance for Condition C.

<sup>4</sup>At these speeds, sign location depends on physical conditions at site and no suggested minimum distance is provided.

Source: Ref. 29

Chapter IV Identification of Alternatives

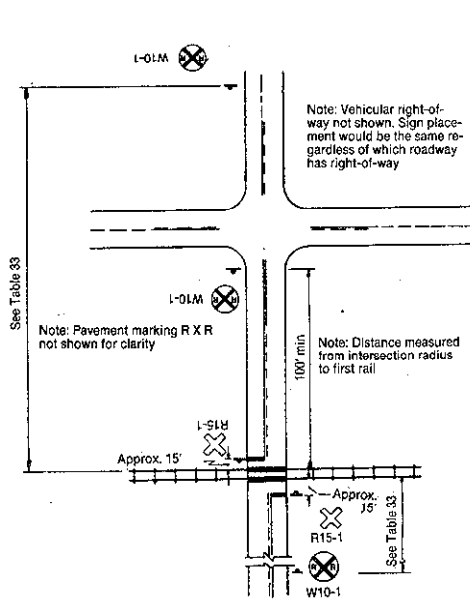

Figure 20. Typical Sign Placement Where Parallel Road is over 100 feet from Crossing

Source: Ref. 29

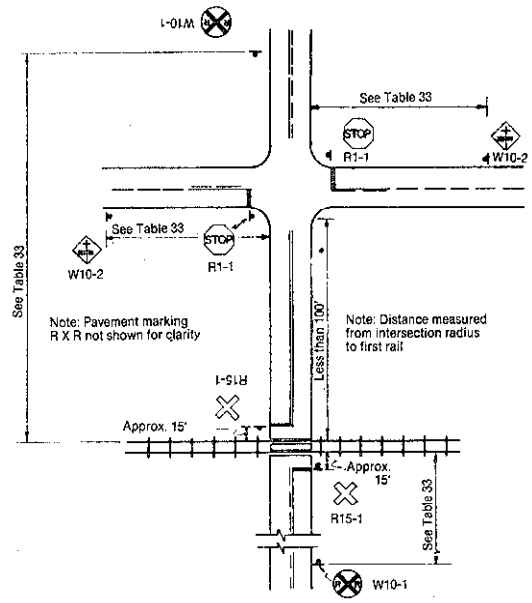

Figure 22. Typical Sign Placement Where Parallel Road is within 100 feet of Crossing and Parallel Road Traffic must Stop

Source: Ref. 29

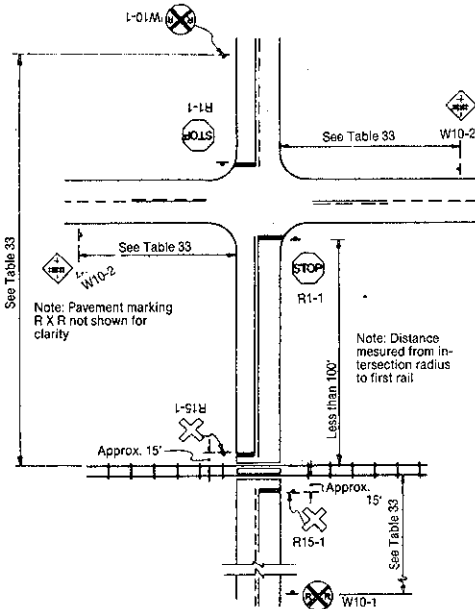

Figure 21. Typical Sign Placement Where Parallel Road is within 100 feet of Crossing and Intersecting Road Traffic must Stop

Source: Ref. 29

Advisory Speed Plate (W13-1).  
 The advisory speed plate should be used when sight or geometric conditions require a speed lower than the posted speed limit. The advisory speed plate should not be erected until the recommended speed has been determined by an engineering study of the specific crossing. If the plate is used, the recommended speed should be periodically reviewed and revised as necessary. Should it be determined that the advisory speed plate is not effective in reducing vehicular speeds, then it may be appropriate to use a regulatory speed limit sign (R2 - 1). The advisory speed plate must be mounted on the same assembly and is normally below the advance warning sign (W-10 series).

Stop Sign (R1-1) and Stop Ahead Sign (W3-1a). A stop sign consists of an octagon with a white message

and border on a red background. The standard size is 30" x 30"; however, a larger size is recommended where greater emphasis or visibility is required.

The use of the stop sign (R1-1) at railroad - highway grade crossings shall be limited to selected crossings where the need has been determined by a detailed traffic engineering study. Crossings considered for installation of stop signs should be limited to those having the following characteristics.

- o The highway should be secondary in character with low traffic counts (400 ADT in rural areas, and 1,500 ADT in urban areas).
- o Train traffic should be substantial (10 or more trains per day).
- o A restricted line of sight exists such that approaching traffic is required to reduce speed to 10 miles per hour or less in order to stop safely.

At the stop bar there must be sufficient sight distance down the track to afford ample time for a stopped vehicle to start and cross the track before the arrival of a train. An engineering study may determine other compelling reasons, such as accident history, to install a stop sign. In those latter cases, use of the stop sign should be considered an interim measure until active traffic control devices can be installed. A stop sign should never be used at a crossing with train activated signals.

Whenever a stop sign is installed at a crossing, a "stop ahead" sign (W3-1a) shall be installed in advance of the stop sign. Figure 23

shows a typical stop sign installation.

Do Not Stop On Tracks Sign (R8-8). Whenever an engineering study determines that the potential for vehicles stopping on the tracks is high, a "Do Not Stop On Tracks" sign should be used. The sign may be located on the near or far side of the crossing, whichever provides better visibility to the motorist to observe the sign and be able to comply with its message. On multilane and one-way roadways a second sign should be placed on the near or far left side of the crossing. Placement of the R8-8 sign(s) should be determined as part of an engineering study.

Exempt Sign (R15-3, W-10-1a)  
The exempt crossing sign is only used

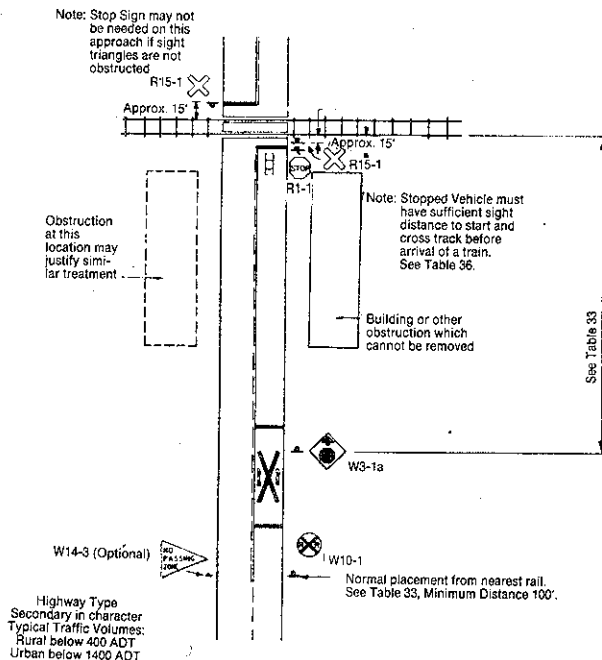

Figure 23. Typical Application of a Stop sign at a Crossing

Source: Ref. 29

when authorized by law or regulation. Its purpose is to inform drivers of vehicles, normally required to stop at all crossings, that a stop is not required at a specific crossing unless a train, locomotive, or other railroad equipment is approaching or occupying the crossing. When used, the exempt sign (R15-3) is placed under the crossbuck (R15-1) sign. A supplemental exempt sign (W10-1a) may be placed under the advance warning sign (W10-1).

Turn Prohibition Signs (R3-1a and R3-2a). At signalized highway intersections within 200 feet of a crossing, where traffic signal control is preempted by the approach of a train, all turning movements toward the crossing should be prohibited. Turn prohibition signs, "No Right Turn" (R3-1a) and "No Left Turn" (R3-2a), consist of a 24" x 30" rectangle with black letters and border on a white background. These signs are to be visible only when the turn prohibition is in effect; thus a blank-out or internally illuminated sign, or other type of changeable message sign may be used to accomplish this objective. These signs are activated by the approach of a train using the same train detection circuitry as flashing light signals. Therefore, these signs could be considered active traffic control devices.

No Passing Zone Sign (W14-3). The "No Passing Zone" sign may be installed at crossings to supplement no passing pavement markings. This sign consists of black letters and border on a yellow background and is in the shape of a pennant with dimensions of 36" x 48" x 48". The sign is to be placed on the left side of the highway at the beginning of the no passing zone.

## 2. Pavement Markings

Pavement markings are used to supplement the regulatory and warning messages presented by crossing signs and signals. Pavement markings have limitations in that they may be obliterated by snow, may not be clearly visible when wet, and may not be very durable when subjected to heavy traffic.

Pavement markings in advance of railroad-highway grade crossings consist of an X, the letters RR, a no passing marking for 2-lane roads, and certain transverse lines as shown in Figure 24. These pavement markings shall be placed on each approach lane on all paved approaches to crossings where crossing signals or automatic gates are located, and at all other crossings where the prevailing speed of highway traffic is 40 mph or greater. These markings are also to be placed at crossings where engineering studies indicate there is a significant potential conflict between vehicles and trains. These markings may be omitted at minor crossings or in urban areas if an engineering study indicates that other crossing devices provide suitable control.

The most common pavement marking material is paint; however, a wide variety of other materials is available. Pavement markings are to be reflectorized by mixing glass beads in wet paint or thermoplastic. Raised pavement markers can be used to supplement pavement markings in advance of crossings. The "X" lane lines and the stop line can be delineated by raised reflective markers to provide improved guidance at night and during periods of rain and fog. Disadvantages of the raised pavement markers



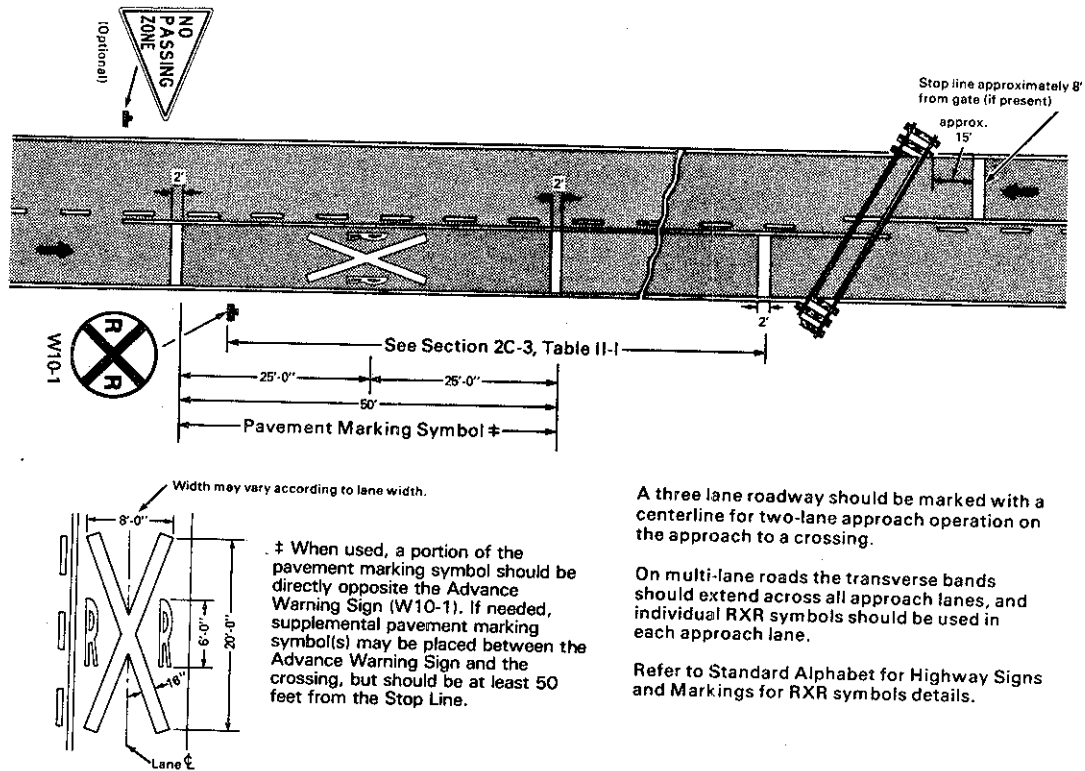

Figure 24. Typical Placement of Warning Signs and Pavement Markings

Source: Ref. 17

are the initial cost and the possibility of being damaged or removed by snow plows.

All pavement markings are to be reflectorized white except for the no passing markings that are to be reflectorized yellow. The stop line is to be 2 feet in width and extend across the approach lanes. The stop line should be located perpendicular to the highway centerline and approximately 15 feet from the nearest rail. Where automatic gates are installed, the stop line should be located approximately eight feet in advance of where the gate arm crosses the highway surface.

### C. Active Traffic Control Devices

Active crossing traffic control devices are those that give warning of the approach or presence of a train. They are activated by the passage of a train over a detection circuit in the track except in those few situations where manual control or manual operation is used. Active control devices are supplemented with the same signs and pavement markings that are used for passive control. Active traffic control devices include flashing light signals, both post-mounted and cantilevered, bells, automatic gates, active advance warning devices, and highway traffic signals. Also included in this section is a description of the various methods of train detection.

Chapter IV Identification of Alternatives

Driving tasks differ somewhat at crossings with active devices than at crossings with passive devices only. Passive devices indicate that a crossing is present and a highway user must look for an approaching train and take appropriate action. At crossings with active devices, a motorist is told when a train is approaching. The motorist must take appropriate action when the devices are activated. Crossing traffic control devices that are train activated normally incorporate some "fail-safe" design principles. As discussed in a following section on train detection, the warning system is designed to give the indication of an approaching train whenever the system has failed.

Active traffic control devices have proven to be an effective method of improving safety and operations at railroad - highway grade crossings. Effectiveness is the percentage reduction in accidents due to a crossing improvement. Utilizing data contained in the U.S. DOT/AAR National Rail-Highway Crossing Inventory and the Railroad Accident/Incident Reporting System data bases, effectiveness factors have been developed for active devices. The effectiveness factors are shown in Table 34 along with results obtained from a Califor-

nia study and from a study by William J. Hedley covering 23 years of experience on the Wabash Railroad.

The effectiveness factors presented in Table 34 were developed from "before and after" accident experience of groups of crossings actually improved. The same effectiveness would not necessarily be experienced at any other crossing where the same improvements (changes) were made. It should be remembered that in those studies the crossings were selected for improvement by competent authorities as a precondition to performance of the work. Similar effectiveness could be anticipated under similar conditions.

1. Flashing Light Signals

Flashing light signals consist of two light units that flash alternately at a rate of 45 to 65 times per minute. Thus, like its predecessor, the wigwag, it simulates a watchman swinging a red lantern. Wigwags consist of a single red light unit that sways back and forth.

The main components of a flashing light unit are the hood, background, roundel, lamp, lampholder, reflector, and housing. The back-

Table 34. Effectiveness of Active Crossing Warning Devices

<u>Category</u>	<u>Effectiveness Factors (Percent)</u>		
	<u>1980</u> <u>U.S. DOT</u>	<u>1974</u> <u>California</u>	<u>1952</u> <u>Hedley</u>
Passive to Flashing Lights	70	64	63
Passive to Automatic Gates	83	88	96
Flashing Lights to Automatic Gates	69	66	68

Source: Ref. 4, 12, and 20

ground is 20 or 24 inches in diameter and is painted a nonreflecting black to provide a contrast for the red light. The hood is also painted black.

Flashing light units are available in two roundel, or lens, sizes: 8-3/8 inch diameter and 12 inch diameter, the latter may provide somewhat better visibility.

The roundel is red and comes in a variety of designs that direct the light toward the motorist. The "spreadlight" roundel distributes light through the entire angle, one-half the angle being on each side of the beam axis. A deflecting roundel directs a portion of the light from the beam to one side of the axis in the direction indicated on the lens. A roundel having both spreadlight and deflecting features is designed so that the deflection is at a right angle to the spread. An example is the 30-degree horizontal deflection and 15-degree vertical spread. A roundel using a 20-degree spread and 32-de-

gree downward deflection can be used on cantilevers. Back light units may use a 70-degree horizontal spread.

The lamp consists of a low wattage bulb used to ensure operation on standby battery power should commercial power fail. The wattage most commonly used is 18 or 25 watt; however, some railroads use quartz-iodide bulbs of 16 or 36 watts. The reflector, or mirror, is mounted behind the lamp and directs the light back through the roundel.

Proper alignment of the light is essential. The lamp must be precisely aligned to direct the narrow intense beam toward the approaching motorist. The flashing light unit on the right hand side of the highway is usually aligned to cover a distance far from the crossing. The light units that are mounted on the back of the signals on the opposing approach, and thus on the left, are usually aligned to cover the near approach to the crossing. Figures 25 and 26 show typical alignment patterns for a two-

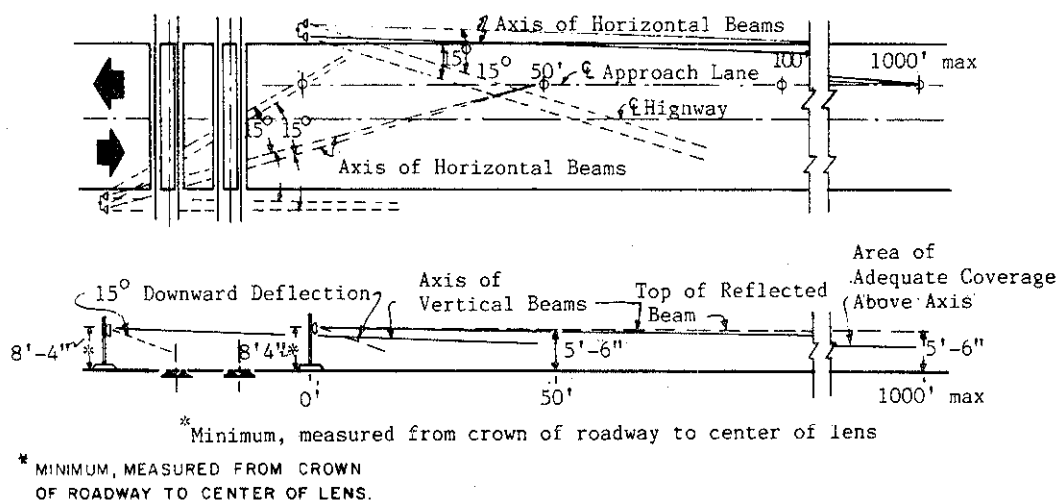

Figure 25. Typical Alignment Pattern for Flashing Light Signals with 30-15 Degree Roundel, Two Lane, Two-Way Roadway

Source: Ref. 29



- o Volume of vehicular traffic
- o Volume of railroad traffic
- o Speed of vehicular traffic
- o Speed of railroad traffic
- o Volume of pedestrian traffic
- o Accident record
- o Sight distance restrictions

Flashing light signals are generally post-mounted, but where improved visibility to approaching traffic is required, cantilevered flashing light signals are used. Cantilevered flashing lights may be appropriate when any of the following conditions exists.

- o Multilane highways (two or more lanes in one direction)
- o Highways with paved shoulders or a parking lane that would require a post-mounted light to be more than 10 feet from the edge of the travel lane
- o Roadside foliage obstructing the view of post - mounted flashing light signals
- o Line of roadside obstacles such as utility poles (when minor lateral adjustment of the poles would not solve the problem)
- o Distracting backgrounds such as excessive number of neon signs. (Conversely, cantilevered flashing lights should not distract from nearby highway traffic signals.)
- o Horizontal or vertical curves at locations where extension of flashing lights over the traffic lane will provide sufficient visibility for the required stopping sight distance.

A typical installation consists of one pair of cantilevered lights on each highway approach supplemented

with a pair of lights mounted on the supporting mast. However, two or more pairs of cantilevered flashing lights may be desirable for multi-lane approaches, as determined by an engineering study. The cantilevered lights can be placed over each lane so that the lights are mutually visible from adjacent driving lanes.

Cantilevers are available with fixed, rotatable or walkout supports. The primary disadvantage of the fixed support is that maintenance of the light unit is usually performed from equipment in the traffic lane, thereby blocking highway traffic. Rotatable cantilevers can be turned to the side of the highway for maintenance but not for aligning the flashing lights.

Walkout cantilevers allow for easier maintenance. Standard cantilevers for mounting flashing lights are made with arm lengths up to 40 feet. Where cantilever arm length in excess of 35 feet is required, a bridge structure is preferred.

Post-mounted flashing light signals are normally located on the right side of the highway on all highway approaches to the crossing. Horizontal clearances for flashing light signals are discussed in the next section along with clearances for automatic gates.

Additional pairs of light units may also be installed for side roads intersecting the approach highway near the crossing or for horizontal curves. Figure 29 shows the use of multiple pairs of lights to cover a horizontal curve to the left on the approach highway. A horizontal curve to the right may be covered by placing another roadside flashing light unit on the opposite side of the highway as shown in Figure 30.

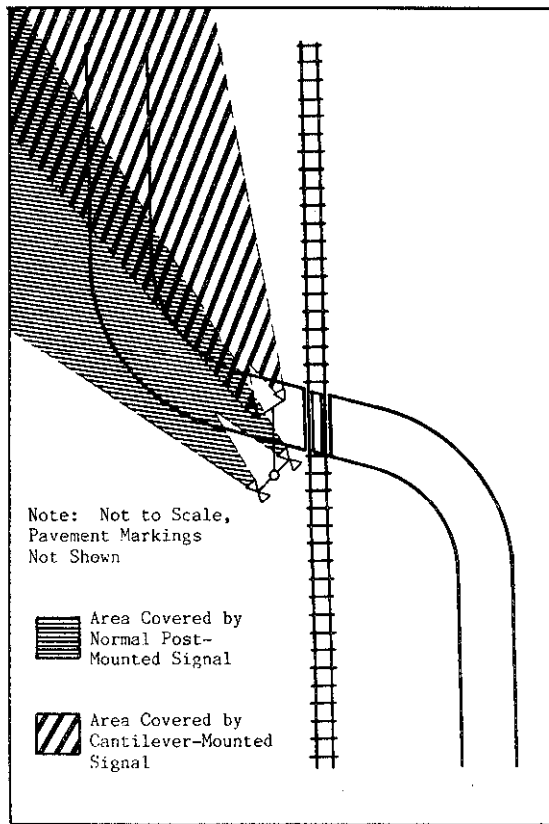

Figure 29. Use of Multiple Flashing Light Signals for Adequate Visibility Horizontal Curve to the Left

Source: Ref. 29

## 2. Automatic Gates

An automatic gate serves as a barrier across the highway when a train is approaching or occupying the crossing. The gate is reflectorized with 16 inch diagonal red and white stripes. To enhance visibility during darkness, three red lights are placed on the gate arm. The light nearest to the tip burns steadily while the other two flash alternately. The gate is combined with a standard flashing light signal that provides additional warning before the arm starts to descend, while the gate arm is across the highway, and

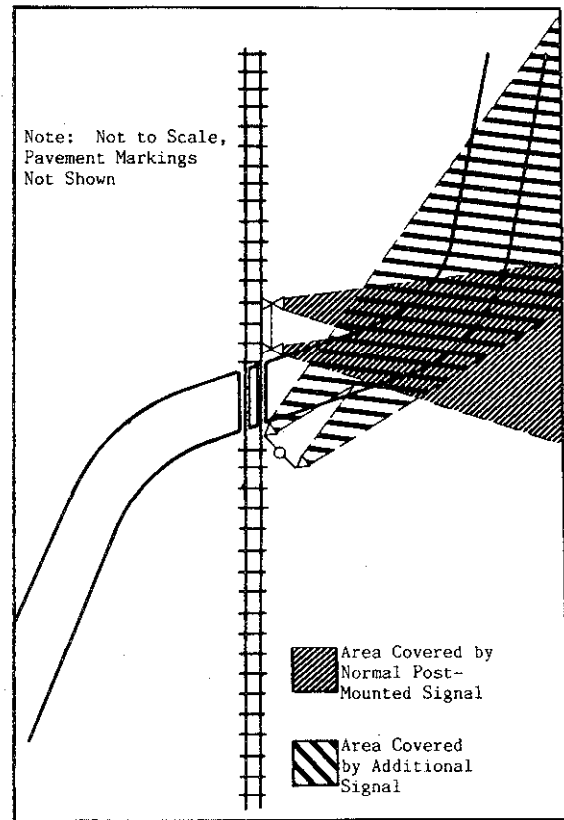

Figure 30. Use of Multiple Flashing Light Signals for Adequate Visibility Horizontal Curve to the Right

Source: Ref. 29

until the gate arm ascends to clearance. The gate mechanism is either supported on the same post with the flashing light signal or separately mounted on a pedestal adjacent to the flashing light signal post.

In a normal sequence of operation, the flashing light signals and the lights on the gate arm in its normal upright position are activated immediately upon the detection of the approach of a train. The gate arm, shall start its downward motion not less than three seconds after the signal lights start to operate, shall reach its horizontal position before

the arrival of the train, and shall remain in that position as long as the train occupies the crossing. When the train clears the crossing, and no other train is approaching, the gate arm shall ascend to its upright position normally in not more than 12 seconds, following which the flashing lights and the lights on the gate arm shall cease operation. In the design of individual installations, consideration should be given to timing the operation of the gate arm to accommodate slow moving trucks.

In determining the need for automatic gates the following factors may be considered.

- o Multiple main line railroad tracks
- o Multiple tracks where a train on or near the crossing can obscure the movement of another train approaching the crossing
- o High speed train operation combined with limited sight distance
- o A combination of high speed and moderately high volume highway and railroad traffic
- o Presence of school buses, transit buses, or farm vehicles in the traffic flow
- o Presence of trucks carrying hazardous materials, particularly when the view down the track from a stopped vehicle is obstructed (curve in track, etc.)
- o Continuance of accidents after installation of flashing lights
- o Presence of passenger trains

In addition to the above factors, some States utilize a specified

level of exposure or the priority index as a guideline for the selection of automatic gates.

On two-way streets, the gates should cover enough of the approach highway to physically block the motorist from driving around the gate without going into the opposing traffic lane. On multilane divided highways, an opening of approximately six feet may be provided for emergency vehicles.

Gates may be made of aluminum, fiberglass or wood. Fiberglass or aluminum gates may be designed with a breakaway feature so that the gate is disengaged from the mechanism when struck. The feasible gate length is 40 feet. When conditions indicate that a longer gate is required, it may be necessary to place gate assemblies in the median to cover the approach highway. In these cases, crash cushions or other safety barriers may be desirable. Under no circumstances should signals or gate assemblies be placed in an unprotected painted median.

A typical clearance plan for a flashing light signal with automatic gate is shown in Figure 31. When no train is approaching or occupying the crossing, the gate arm is held in a vertical position and the minimum clearance from the face of the vertical curb to the nearest part of the gate arm or signal is two feet for a distance of 17 feet above the highway. Where there is no curb, a minimum horizontal clearance of two feet from the edge of a paved or surfaced shoulder is required with a minimum clearance of six feet from the edge of the traveled highway. Where there is no curb or shoulder, the minimum horizontal clearance from the traveled way is six feet. Where flashing lights or gates are located in the

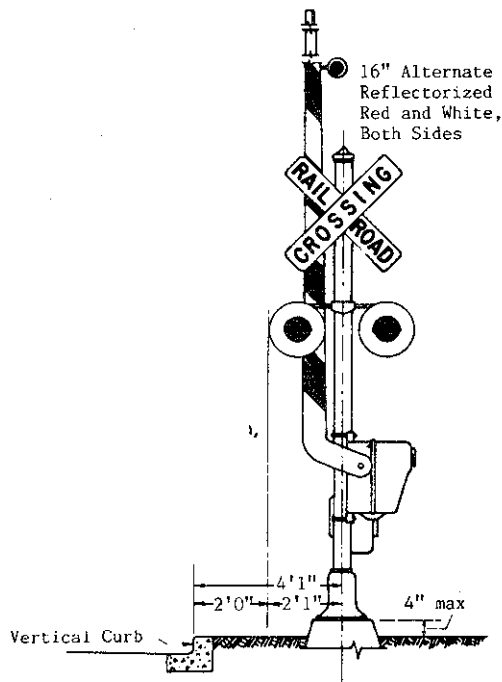
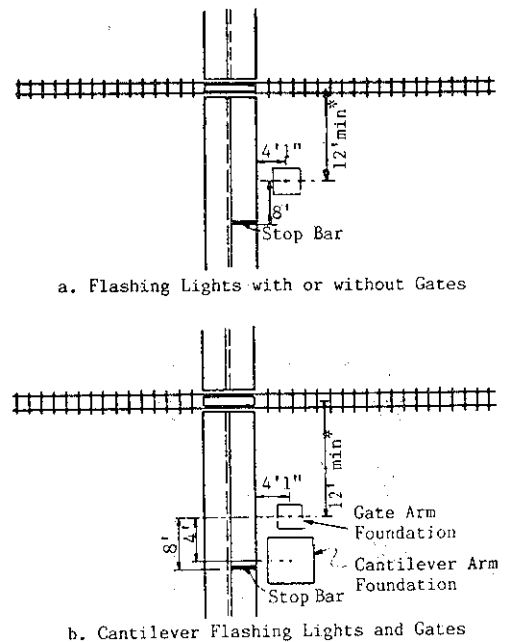

Figure 31. Typical Clearances for Flashing Light Signals with Automatic Gates

Source: Ref. 17

median, additional width may be required to provide the minimum clearances for the counterweight support.

The lateral location of flashing light and gate assemblies must also provide adequate clearances from the track as well as space for construction of the foundations. Figure 32 shows typical locational requirements for the foundations for flashing lights and cantilevered flashing lights with gates. The area for the foundation and excavation must be analyzed to determine the effect on sidewalks, utility facilities, and drainage. While these plans indicate a 12-foot minimum clearance between the center of the flashing light assembly and the center of the tracks, some railroads prefer a 15-foot minimum clearance.



\*Some railroads require minimum clearance of 15 feet.

Figure 32. Typical Location of Signal Devices

Source: Ref. 29

Figures 33 through 39 show typical location plans for flashing light signals with and without gates. If it is necessary to locate the supporting post in a potentially hazardous position to ensure adequate visibility, some type of safety barrier should be considered. These are discussed in a later section.

### 3. Warning Bell

A crossing bell is an audible warning device used to supplement other active traffic control devices. A bell is most effective as a warning to pedestrians and bicyclists.

When used, the bell is usually mounted on top of one of the signal support masts. The bell is usually activated whenever the flashing light



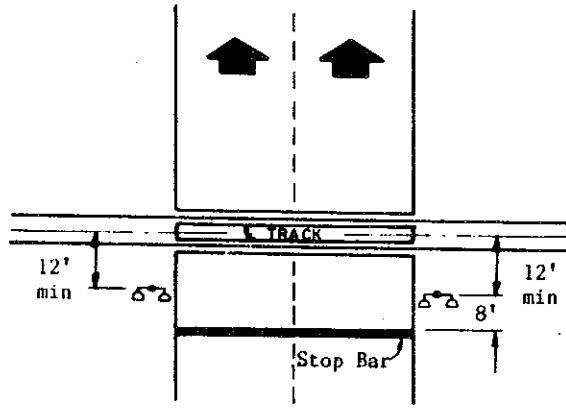

a. Flashing Lights

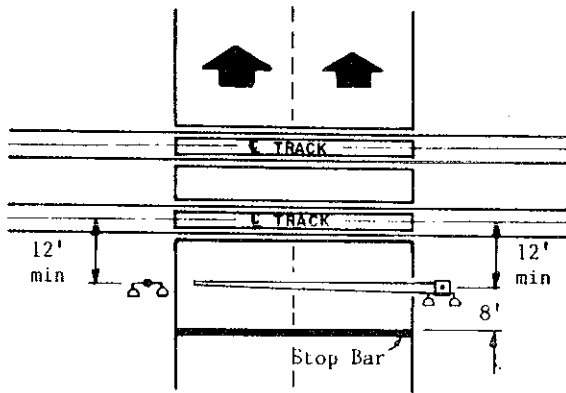

b. Flashing Lights and Gates

Note: Two gate arms may be used as an alternate.

Figure 33. Typical Location Plan Right Angle Crossing, One-Way Two Lanes

Source: Ref. 29

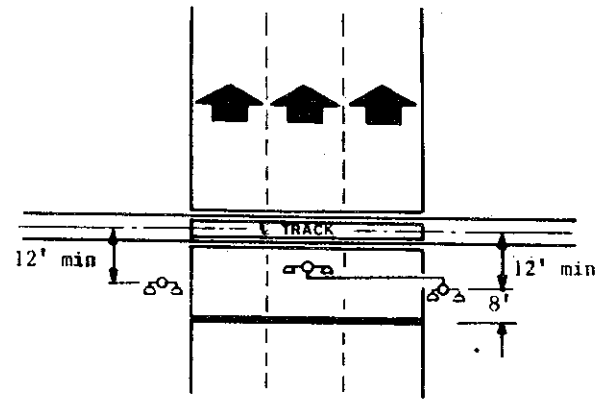

a. Flashing Lights

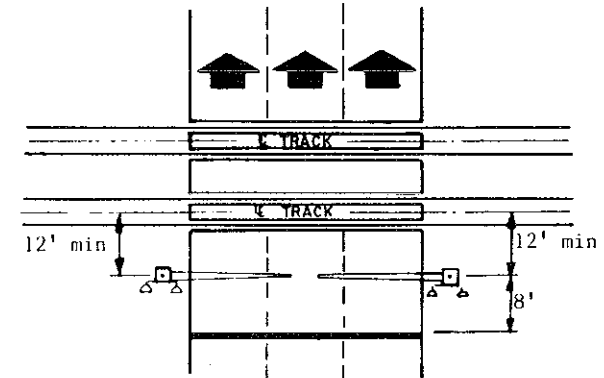

b. Flashing Lights and Gates

Figure 34. Typical Location Plan Right Angle Crossing, One-Way Three Lanes

Source: Ref. 29

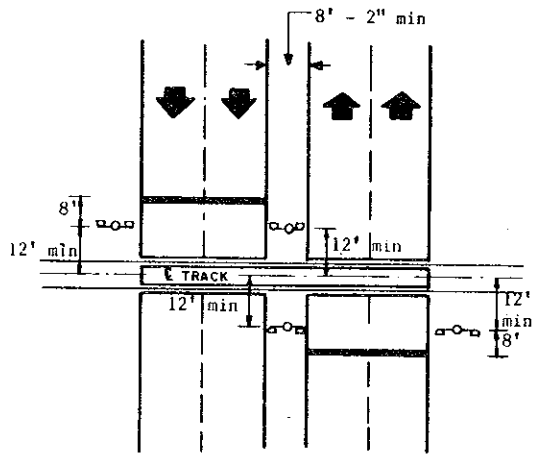

a. Flashing Lights

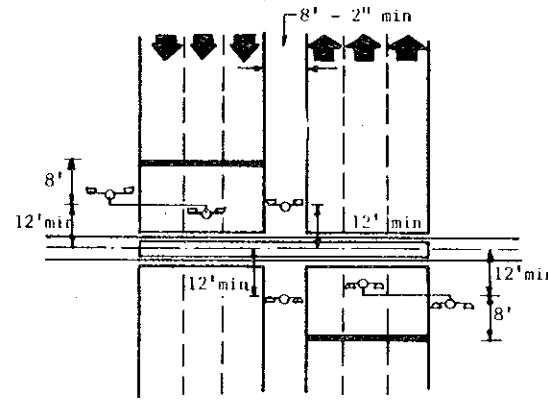

a. Flashing Lights

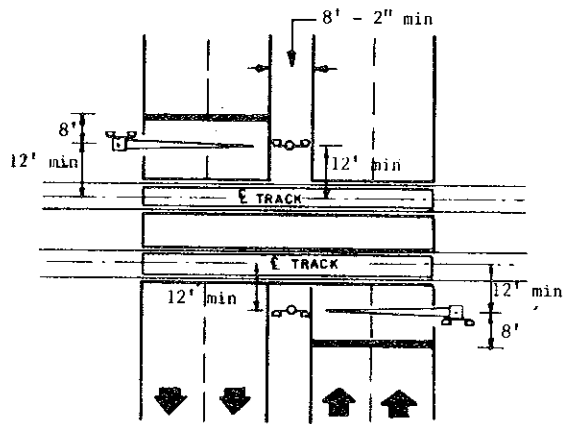

b. Flashing Lights and Gates

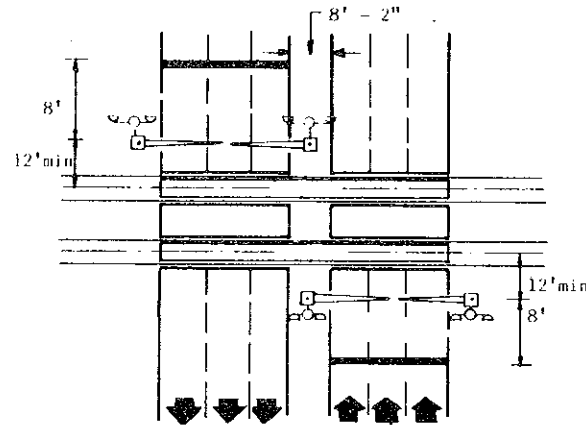

b. Flashing Lights and Gates

Note: The median width of 8'2" is an operation requirement and is not an AASHTO recommendation for median width.

Note: The median width of 8'2" is an operation requirement and is not an AASHTO recommendation for median width.

Figure 35. Typical Location Plan Divided Highway with Signals in Median, Two Lanes Each Way

Figure 36. Typical Location Plan Divided Highway with Signals in Median, Three Lanes Each Way

Source: Ref. 29

Source: Ref. 29

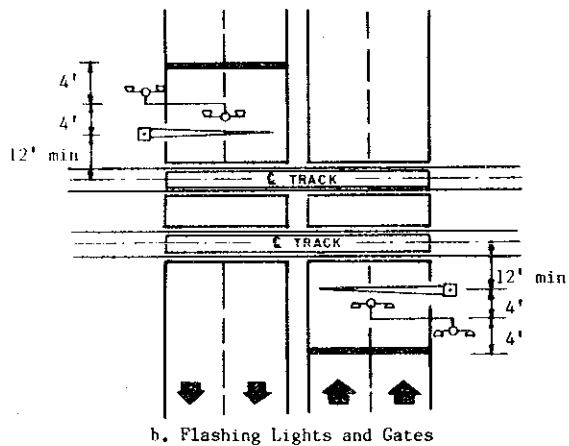
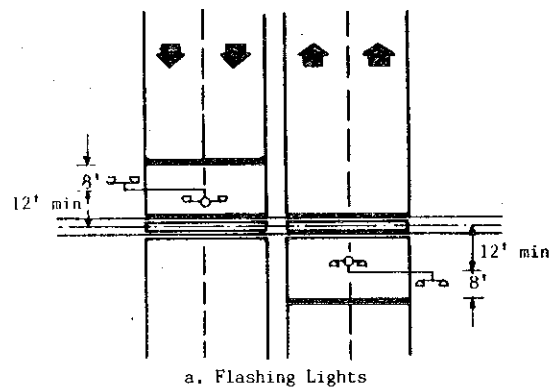
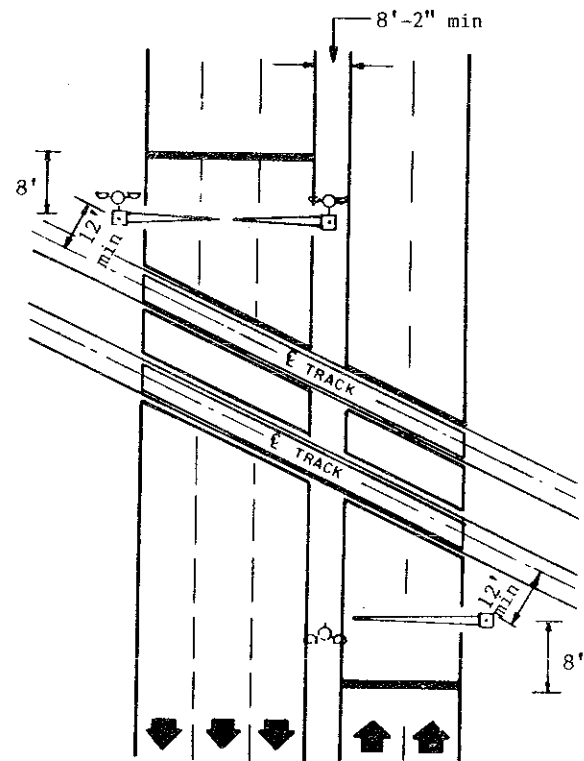

Figure 37. Typical Location Plan Divided Highway with Insufficient Median for Signals Two Lanes Each Way

Source: Ref. 29



Note: The median width of 8'2" is an operational requirement and is not an AASHTO recommendation for median width.

Figure 38. Typical Location Plan Acute Angle Crossing for Divided Highway with Signals in Median Two or Three Lanes Each Way

Source: Ref. 29

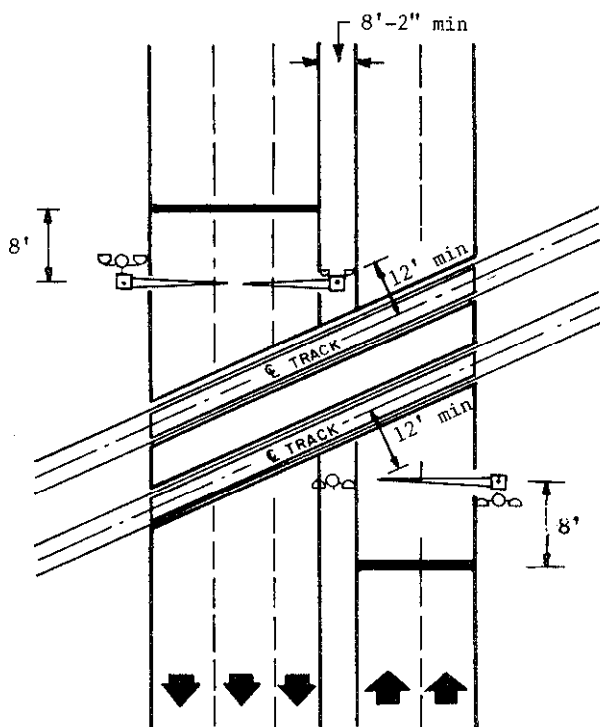

Note: The median width of 8'2" is an operational requirement and is not an AASHTO recommendation for median width.

Figure 39. Typical Location Plan Obtuse Angle Crossing for Divided Highway with Signals in Median Two or Three Lanes Each Way

Source: Ref. 29

signals are operating. Bell circuitry may be designed so that the bell stops ringing when the lead end of the train reaches the crossing. When gates are used, the bell may be silenced when the gate arms descend to within 10 degrees of the horizontal position. Silencing the bell when the train reaches the crossing or when the gates are down may be desired to accommodate residents of suburban areas.

#### 4. Active Advance Warning Sign

An active advance warning sign (AAWS) consists of one or two 8-inch

yellow hazard identification beacons mounted above the advance warning sign as shown in Figures 40 and 41. The AAWS provides a motorist with advance warning that a train is approaching the crossing. The beacons are connected to the railroad track circuitry and activated on the approach of a train. The AAWS should continue to be activated until the crossing signals have been deactivated.

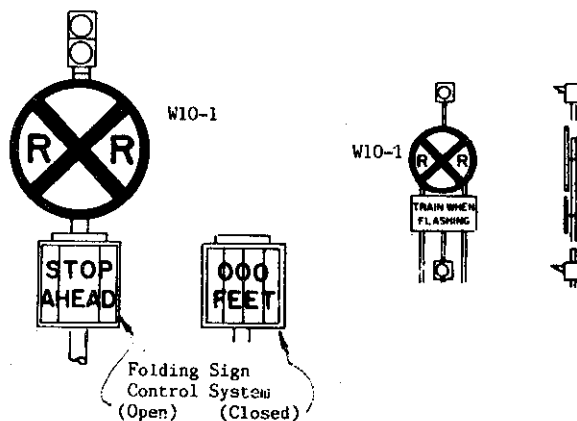

Figure 40. Examples of Active Advance Warning Signs

Source: Ref. 29

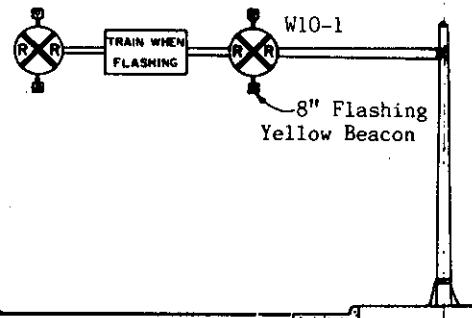

Figure 41. Example of Cantilevered Active Advance Warning Sign

Source: Ref. 29

A train-activated advance warning sign should be considered at locations where the crossing flashing light signals cannot be seen until an approaching motorist has passed the decision point (the distance from the track from which a safe stop can be made). Use of active advance warning signs may require some modification of the track circuitry. Consideration should be given to providing a backup source of power in the event of commercial power failure.

The AAWS is sometimes supplemented with a message, either active or passive, that indicates the meaning of the device, e.g. "Train When Flashing". A passive supplemental message remains constant while an active supplemental message changes when the device is activated by the approach of a train.

The AAWS should be placed at the location where the advance warning sign would normally be placed. To enhance visibility at crossings with unusual geometry or site conditions, the devices may be cantilevered or installed on both sides of the highway. An engineering study should determine the most appropriate location.

## 5. Traffic Signals

Highway traffic control signals located at intersections within 200 feet of a crossing should be preempted by the approach of a train. Signals at intersections further than 200 feet from a crossing should also be preempted if traffic flow is such that vehicles queue up on the crossing, or if an engineering study determines the need for preemption. Railroad-highway grade crossing signals are coordinated with adjacent highway traffic control signals so that the operation of these separate

control devices will at all times complement rather than negate each other. The Manual on Uniform Traffic Control Devices (MUTCD) stresses that "...design, installation, and operation should be based upon a total system approach in order that all relevant features may be considered."<sup>16</sup> A primary criterion is to avoid the entrapment of vehicles on the crossing by conflicting aspects of the highway signal and the crossing signal. The best way to do this is to prevent vehicle queues onto the tracks by the proper design and operation of the dual signal systems.

The preemption feature requires an electrical circuit between the control relay of the crossing warning system and the traffic signal controller. The circuit shall be on the closed circuit principle, that is, the traffic signal controller is normally energized and the circuit is wired through a closed contact of the energized control relay of the crossing warning system. This is to establish and maintain the preempted condition during the time the crossing signals are in operation. Where multiple or successive preemption may occur from differing modes, train actuation should receive first priority and emergency vehicles second priority.

Crossings without active traffic control devices but near signalized highway intersections also present a situation where vehicles may be entrapped on the crossing when a train is approaching. Thus, preemption of the highway traffic signal should be considered. If the neces-

-----  
<sup>16</sup>Manual on Uniform Traffic Control Devices, Washington, DC: Federal Highway Administration, 1978, Revised 1979, 1980, 1984.

sary circuitry is to be installed, consideration should be given to adding flashing light signals or automatic gates to the crossing at the same time.

In designing the preemption, the following elements should be considered: intersection geometrics, vehicular volume, queue lengths and dissipation rate, proximity of the crossing to the intersection, train movements, approach speeds for trains and motor vehicles, public transportation vehicles, school buses, and trucks carrying large or hazardous cargoes.

When preempted by train movements, the traffic control signal (after provision of the proper phase change intervals) will immediately provide a short green interval to the approach crossing the track. This is done to clear any vehicles that may be on, or so close to, the track as to be in danger, or where vehicles may interfere with the operation of crossing gates. The traffic signal will subsequently display indications to prevent vehicles from entering the track area, while at the same time traffic movements that do not conflict with the railroad movement may be permitted. If, at the time of preemption, the green interval is on an approach that does not cross the track, that green interval would be immediately terminated with a standard yellow phase change interval in order that green time may be given to the approach crossing the track. Conflicting indications must not be permitted and every green signal indication must be terminated with a yellow indication as specified in the MUTCD. Turning movements onto the highway with the crossing should be prohibited through the use of blank out signs that display "No Right Turn" or "No Left Turn" as appropriate.

Optically limiting devices may be employed for traffic signal indications to preclude driver observance of conflicting or misleading indications. The layout of the preemption sequences should specifically state what phase change interval is to occur no matter when the preemption begins in relation to the normal phasing sequence. There are an infinite number of railroad - highway grade crossing configurations. Figures 42 through 53 illustrate how the basic principles may be applied.

In some cases, geometric or operational characteristics may require a traffic signalization strategy other than the typical ones previously mentioned. This is especially true when the crossing is extremely close to the signalized intersection; is rather far from a signalized intersection but queues develop across the track; or, the crossing is located between two closely spaced signalized intersections.

When a crossing is located only a few car lengths from the signalized intersection's stop line, it is likely that vehicles will queue across the tracks during the red interval of each cycle. Although the track clearance interval of the preemption sequence may provide sufficient time to allow vehicles in the track area to proceed through the intersection, occasionally an anxious driver may stall the vehicle and not clear the crossing.

The potential for this situation can be reduced if the intersection stop line is removed from its normal location and the stop line in advance of the crossing is allowed to function as the intersection stop line. This configuration effectively incorporates the crossing area into the width of the intersection. The yel-

**FIGURE KEY**

- ∅ Signal Phase
- ▶ Overhead Mounted Signal Head
- ▶ Pedestal Mounted Signal Head
- R Circular Steady Red Indication
- FR Circular Flashing Red Indication
- Y Circular Steady Yellow Indication
- FY Circular Flashing Yellow Indication
- G Circular Steady Green Indication
- ▶ Steady Green Arrow Indication
- Y—▶ Steady Yellow Arrow Indication
- W Steady Lunar White Walk Indication
- FDW Flashing Portland Orange Don't Walk Indication
- DW Steady Portland Orange Don't Walk Indication
- R/W Green Interval
- CHANGE Yellow Change Interval
- T<sub>1</sub>, T<sub>1a</sub>, T<sub>1b</sub> Preemption Clearance Intervals Prior to Train Approach
- T<sub>2</sub> Yellow Change Interval Following T<sub>1</sub> Interval
- T<sub>3</sub> Yellow Change Interval Following T<sub>2</sub> Interval
- T<sub>4</sub> Yellow Change Interval Following T<sub>3</sub> Interval
- HOLD Signal Indications During Train Passage
- RELEASE Signal Indications Immediately After Train Passage
- BLANK Signal Indication Extinguished

**NOTES**

- 1 Turn prohibition signals are blank-out type and shall conform to the *Manual on Uniform Traffic Control Devices*
- 2 Turn prohibition messages shown herein may have to be modified to conform to applicable state or local law concerning right turn on red

Figure 42. Key to be Used with Figures 43 through 53

Source: Ref. 29

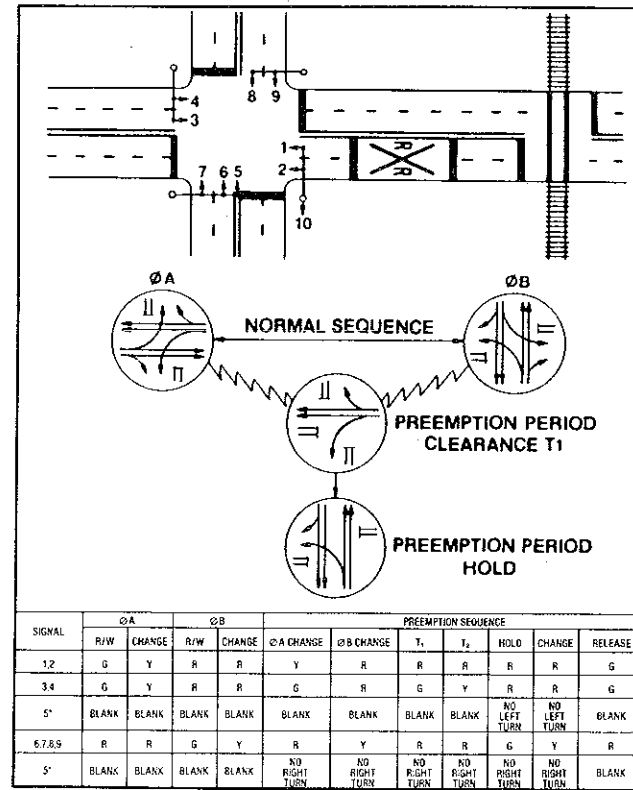

\*OPTIONAL

Figure 43. Typical Preemption Sequence Signalized Intersection Four Lane Undivided Roadways Two Phase Operation

Source: Ref. 29

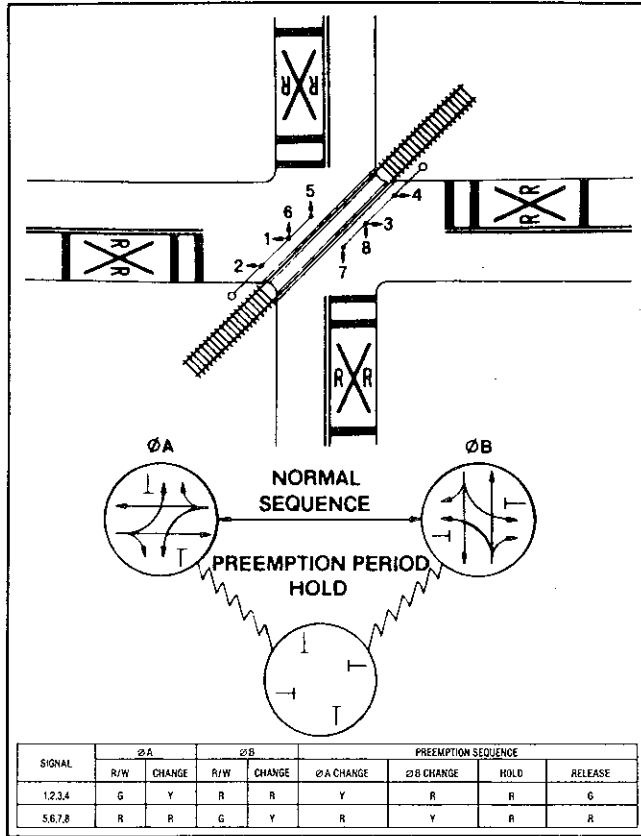

Figure 44. Typical Preemption Sequence Signalized Intersection, Two Lane Roadways with Railroad Bisecting Intersection Two Phase Operation

Source: Ref. 29

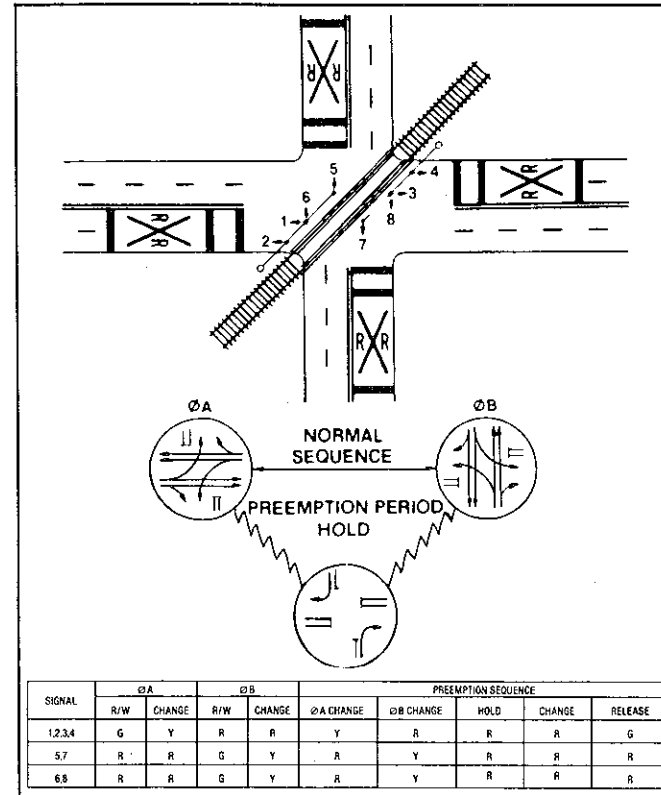

Figure 45. Typical Preemption Sequence Signalized Intersection, Four Lane Undivided Roadways with Railroad Bisecting Intersection Two Phase Operation

Source: Ref. 29



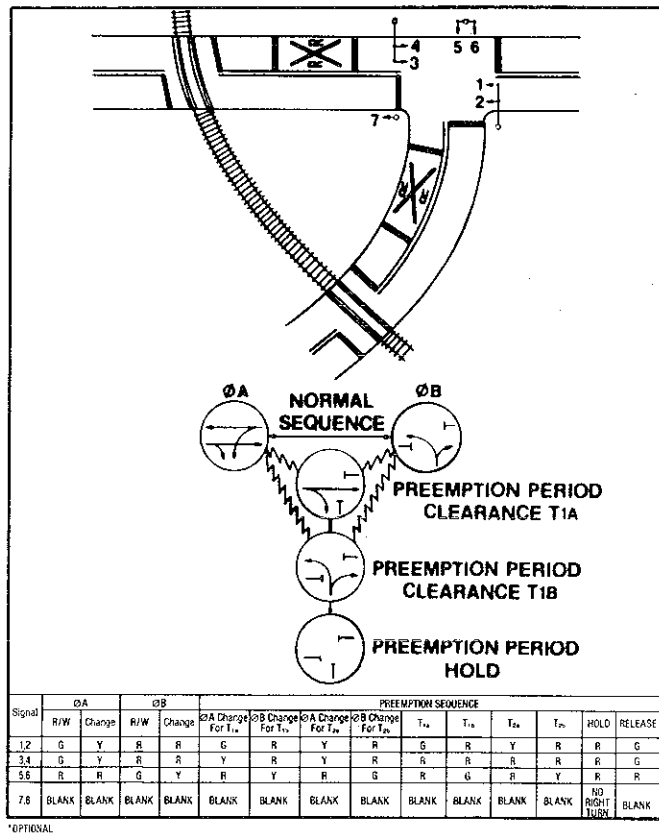

Figure 46. Typical Preemption Sequence Signalized Intersection, Two Lane Roadways with Crossings on Two Approaches, Two Phase Operation

Source: Ref. 29

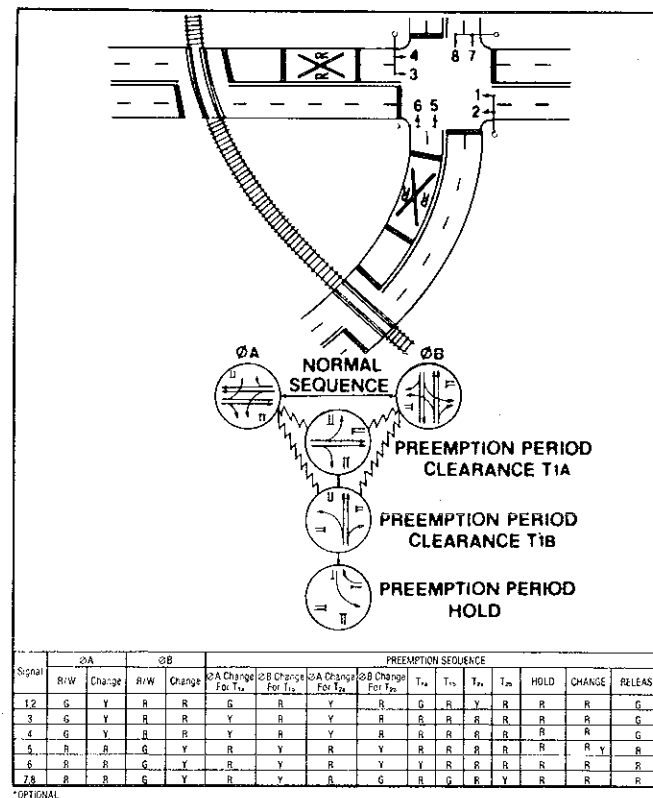

Figure 47. Typical Preemption Sequence Signalized Intersection, Four Lane Undivided Roadways with Crossing on Two Approaches, Two Phase Operation

Source: Ref. 29

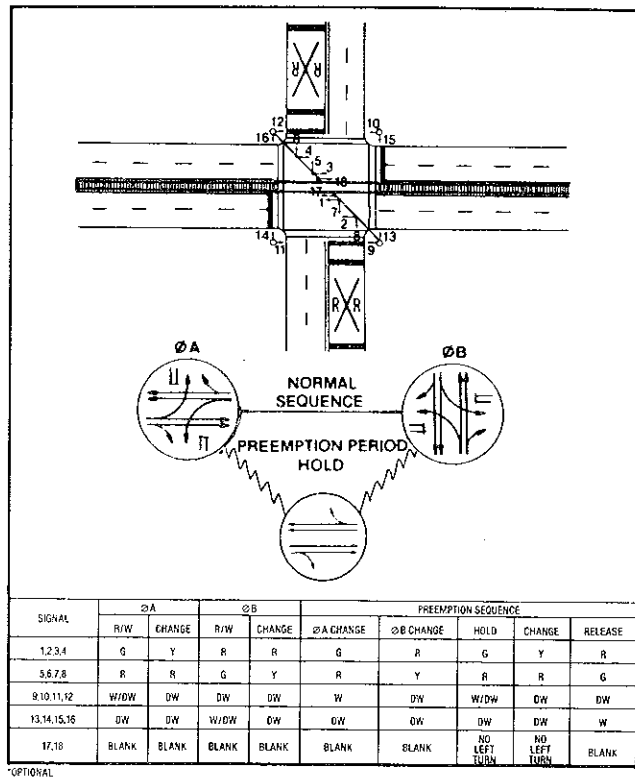

Figure 48. Typical Preemption Sequence Signalized Intersection, Four Lane with Railroad Bisecting One Roadway, Two Phase Operation with Pedestrian Signals

Source: Ref. 29

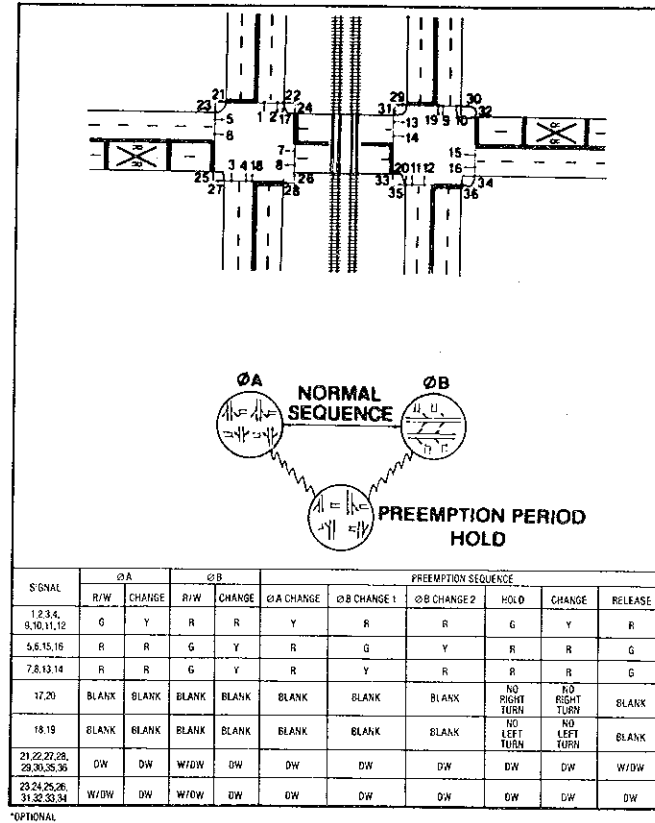

Figure 49. Typical Preemption Sequence Crossing Between Two Signalized Intersections, Two Phase Operation with Pedestrian Signals

Source: Ref. 29

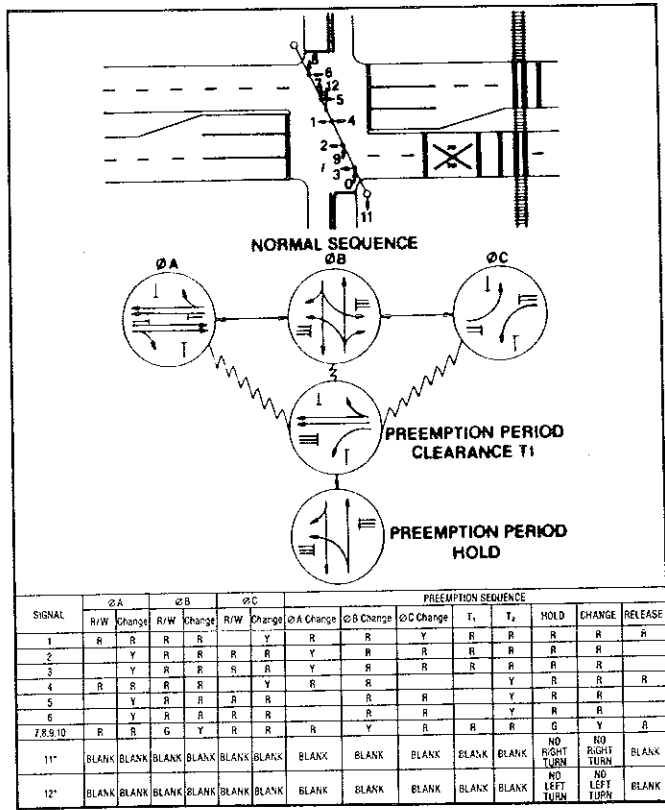

Figure 50. Typical Preemption Sequence Signalized Intersection, Four Lane Divided and Two Lane Roadways with Crossing on Major Approach Three Phase Operation

Source: Ref. 29

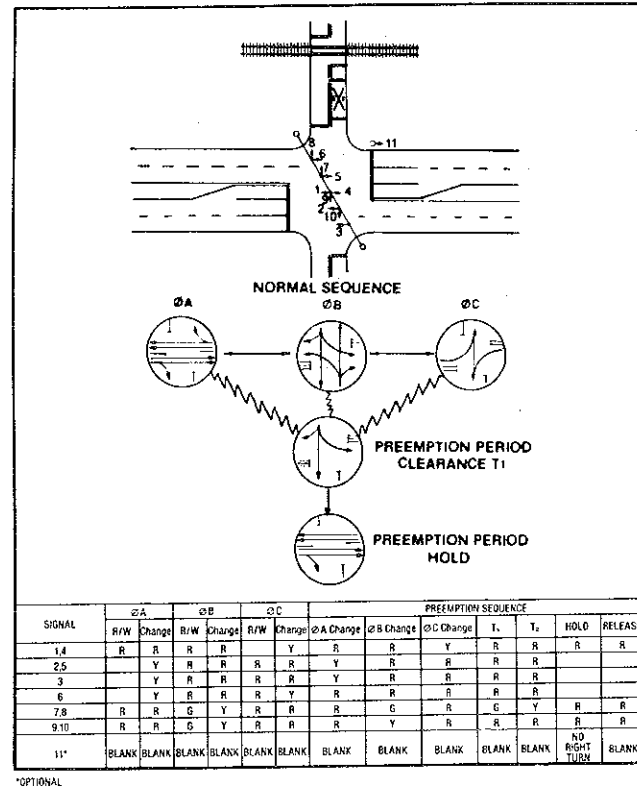
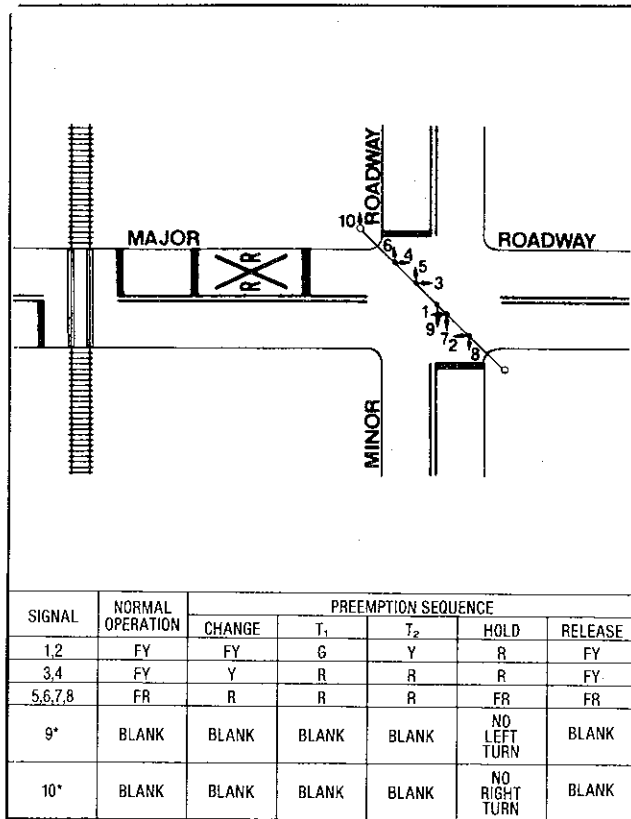

Figure 51. Typical Preemption Sequence Signalized Intersection, Four Lane Divided and Two Lane Roadways with Crossing on Minor Approach Three Phase Operation

Source: Ref. 29



\*OPTIONAL

Figure 52. Typical Preemption Sequence Intersection with Beacon Control Crossing on Major Approach

Source: Ref. 29

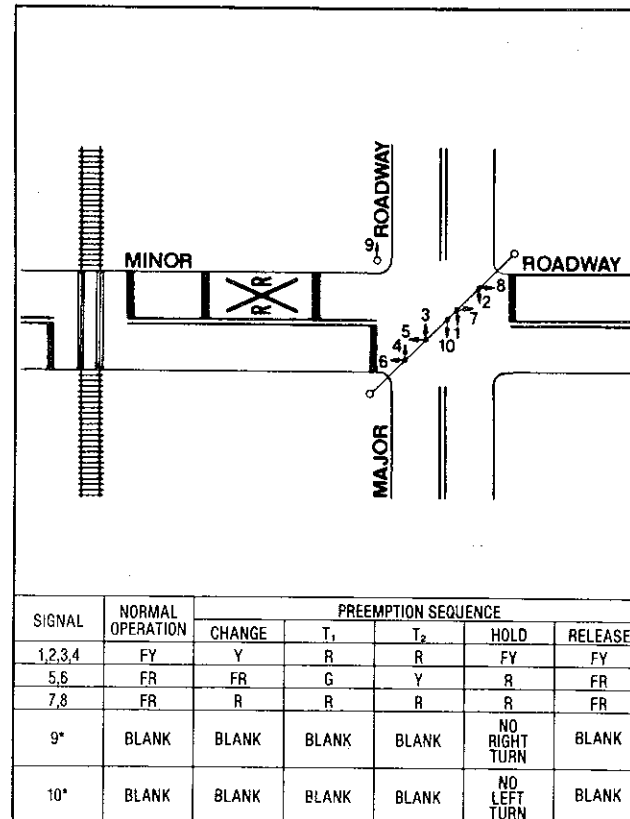

\*OPTIONAL

Figure 53. Typical Preemption Sequence Intersection with Beacon Control Crossing on Minor Approach

Source: Ref. 29

low clearance interval should be extended accordingly to compensate for the added travel distance. This situation is illustrated in Figure 54.

Sometimes the crossing stop line is greater than 120 feet from the farthest intersection signal face which governs that approach. When this occurs, the faces should either be relocated to the near side of the intersection or supplemental faces should be used. This is accomplished more economically if box span wire assemblies or mast arms are employed at the intersection. Then, a separate span wire assembly may be used on the near side of the intersection as shown in Figure 55. To enhance the effectiveness of these alternatives, permanent right-turn-on-red prohibitions would be appropriate for the track approach with a "Stop Here on Red" sign (R10-6) installed at the stop line.

Optically programmable signal faces should be considered for the far side of the intersection for the track approach. View of these signal faces should be limited to that portion of the approach from the tracks to the intersection. The supplemental heads should operate in unison with the primary signals during normal conditions. Upon detection of an approaching train and after appropriate phase change intervals, the programmable signal faces would display a green indication to clear the tracks while the primary signals would display a red indication in conjunction with the crossing flashing light signals to hold subsequent traffic at the crossing stop line.

When the distance between a crossing and a signalized intersection is approximately 150 feet or more and traffic volumes are such that vehicle queues routinely develop onto the tracks, the typical preemp-

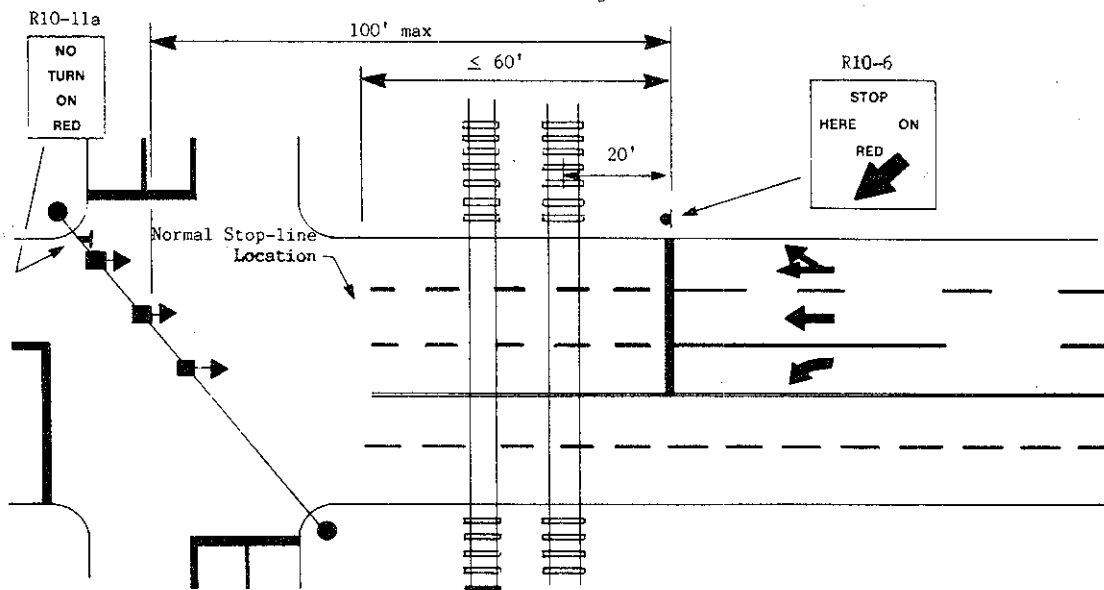

Figure 54. Relocation of Intersection Stop Line to Reduce Possibility of Vehicles Stopping on Tracks

Source: Ref. 29

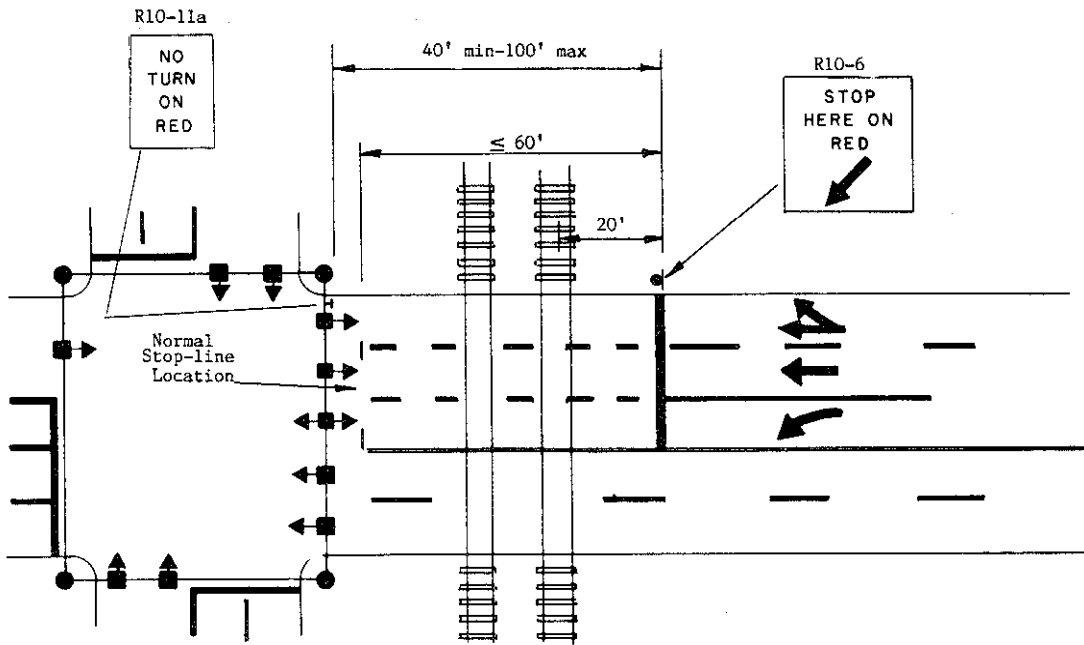

Figure 55. Relocation of Intersection Stop Line and Signal Faces to Reduce Possibility of Vehicles Stopping on Tracks

Source: Ref. 29

tion strategies may not be capable of clearing the tracks within the normal warning time provided by the train detection circuit. One solution, lengthening the warning time, may not be feasible. Another option is to employ traffic control signals at the crossing in addition to the ones at the intersection. The additional traffic control signals are located on the intersection side of the track approach as depicted in Figure 56.

A "Stop Here On Red" sign (R10-6) should be placed at the crossing stop line that also serves as the stop line for the traffic control signals. Using this option during normal signal operation, the additional signals would operate in coordination with the intersection signals. For the track approach movements, a double clearance interval is

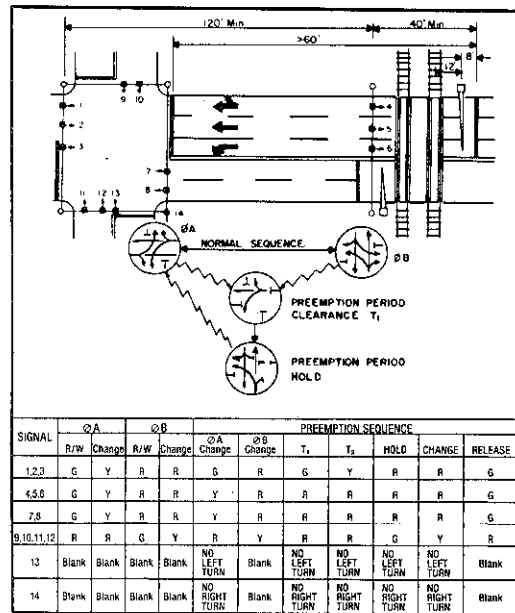

Figure 56. Use of Additional Traffic Control Signals at Crossings

Source: Ref. 29

provided to terminate green indications at the crossing signals prior to the termination of green at the intersection signals.

Highway traffic signals shall not be used in lieu of flashing light signals at crossings that are on mainline railroad tracks. However, highway traffic control signals may be used at industrial track crossings and other crossings where train movements are very slow as in switching operations. Operation of highway signals at crossings should provide approximately the same warning time as flashing light signals or automatic gates.

#### 6. Train Detection

To serve their purpose of advising motorists and pedestrians of the approach or presence of trains, active traffic control devices are activated by some form of train detection. Generally, the method is automatic, requiring no personnel to operate it, although a small number of such installations are operated under manual control. The automatic method uses the railroad circuit. This electrical circuit uses the rails as conductors in such a way that the presence of a solid electrical path, as provided by the wheels and axles of a locomotive or railroad car, shunts the circuit. The system is also designed to be "fail-safe"; that is, any shunt of the circuit, whether by railroad equipment, vandalism, or "open circuit", such as a broken rail or track connection, causes the crossing signals to be activated.

Standard highway traffic signals display a light, green, yellow, or red, at all times except when power has failed and the signals are dark. Crossing signals are normally dark

unless a train is approaching or occupying the crossing. There is no indication to the highway user when power has failed. Therefore, crossing control systems are designed to also operate on standby battery should commercial power be terminated for any reason. Solar energy may be used to charge storage batteries to power signals at crossings in remote locations.

Storage battery standby power is provided to span periods of commercial power failure. The standby assures normal operation of crossing signals during a commercial power outage.

When this practice was initiated, the crossing signals were normally supplied with AC power through a step-down transformer. The same AC source provided charging current through a rectifier for the standby battery to maintain the battery in a charged condition. When commercial AC power failed, crossing signal power connections were transferred from the AC source to the battery, as shown in Figure 57a. This arrangement was necessary because the "constant current" rectifiers used in this service were unable to respond to changes in battery voltage or load.

Present day "constant voltage" rectifiers can respond to changes in battery voltage and load, and can provide high DC current to the battery and load during periods when crossing signals are energized, tapering off quickly as soon as standby battery capacity has been replenished after the crossing signals are de-energized. This ability of the modern rectifiers permits DC operation of the signals whether AC supply voltage is present or not. The signals are connected directly to battery termi-

## Chapter IV Identification of Alternatives

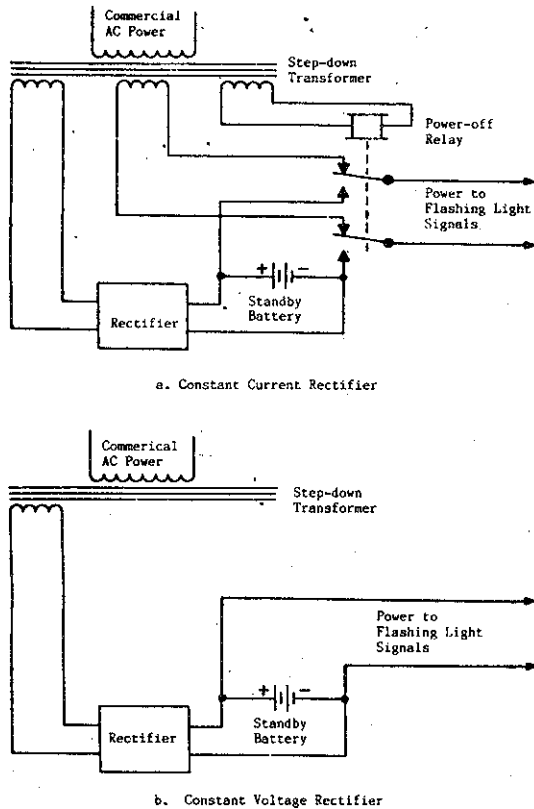

Figure 57. Standby Power Arrangement

Source: Ref. 25

nals and the power transfer is eliminated as shown in Figure 57b.

On tracks where trains operate at speeds of 20 mph or higher, the circuits controlling automatic flashing light signals shall provide for a minimum operation of 20 seconds before the arrival of any train. This 20 second warning time is a MINIMUM. The warning time should be of sufficient length to ensure clearance of a vehicle that might have stopped at the crossing and then proceeded to cross just before the flashing lights began operation. Some railroads use a warning time of 25 seconds at crossings with automatic gates. Factors that can affect this time include the width of the cross-

ing, length and acceleration capabilities of vehicles using the crossing, highway grades, and the condition of the crossing surface.

Care should be taken to ensure that the warning time is not excessive. If the motorist cannot see the train approaching (due to sight obstructions or track curvature), excessive warning time may cause a motorist to attempt to cross the tracks despite the operation of the flashing light signals.

Excessive warning time has been determined to be a contributing factor in some accidents. Motorists stopped at an activated flashing light signal and seeing no train approaching, or seeing a distant train moving very slowly, might ignore the warning of the signals and cross the tracks. An accident could result. For example, the signals may have been activated by a high speed passenger train just out of sight and not by the slower freight. However, if motorists are successful in clearing the tracks, they may assume that other crossings have excessive warning time. When they encounter a crossing with the minimum warning time, they may ignore the signals, move onto the crossing, and become involved in an accident. This credibility problem is strengthened if motorists continue to successfully pass through activated signals with excessive warning time.

Equipment housing should be located where it is least likely to be struck by a vehicle leaving the roadway. It should not unduly obstruct a motorist's view of an approaching train.

Factors that may be considered in the design and installation of a train detection system include:



- o existing rail and ballast conditions;
- o volume, speed, and type of highway and rail traffic;
- o other train detection circuits that may be used on the same pair of rails for the regulation of train movements;
- o train propulsion currents on electrified lines;
- o track switch locations within the approach warning distances for a crossing;
- o train detection circuits used for other crossings within the approaches (overlapping); and,
- o number of tracks.

Design and application of train detection circuits are accomplished by railroad signal engineers.

There are five basic types of train detection systems in use today:

- o direct current track circuit;
- o AC-DC track circuit;
- o audio frequency overlay track circuit;
- o motion sensitive track circuit; and,
- o constant warning time track circuit.

Direct Current (DC) Track Circuit. The DC track circuit, shown in Figure 58, was the first means used for automatic train detection. It is a relatively simple circuit and is still used in many crossing warning systems. The maximum length of these

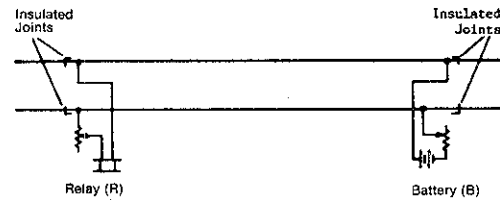

Figure 58. DC Track Circuit

Source: Ref. 25

circuits is more than adequate to provide the necessary warning time for crossing warning systems with today's train speeds.

The rails are used as conductors of energy supplied by a battery. This energy flows through a limiting resistor to one rail, then through another limiting resistor to the coil of a DC relay, back over the other rail to the battery, thereby completing a simple series circuit. The relay is energized as long as the rails are intact and no train is present on the circuit between the battery and the relay. The limits of the circuit are established by the use of insulated joints. Insulated joints are devices placed between adjoining rail sections to electrically isolate the two sections.

In order to provide a means for stopping the operation of the crossing warning system as soon as the train clears the crossing, three track circuits, as shown in Figure 59, and associated logic elements are required per track. The logic elements are arranged such that, as the train moves through the crossing, the crossing clears for highway traffic as soon as the rear end of the train leaves the island section.

All trains activate the crossing warning system as soon as the first set of wheels of the train enters the

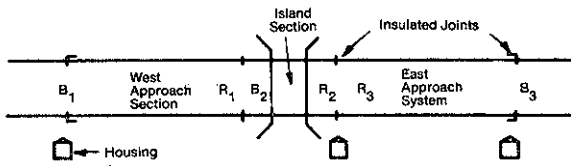

Figure 59. Three Track Circuit System

Source: Ref. 25

approach track circuit. This track circuit must be long enough to provide the minimum warning time for the fastest train. A slow train will operate the crossing warning system for a longer period of time. If a train stops before it reaches the crossing, the crossing warning system continues to operate which results in an additional delay to highway traffic.

In order to overcome this problem, approach sections may be divided into several short track circuits, as shown in Figure 60, and timers incorporated into the logic. This permits more consistent warning time. Also, if a train stops in the approach section, a "time-out" feature will deactivate the warning devices to allow highway traffic to move over the crossing.

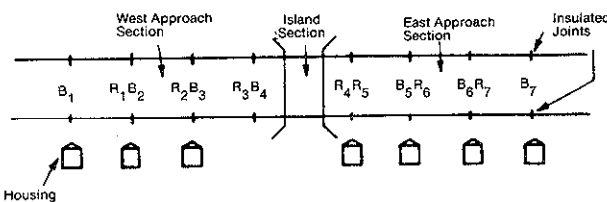

Figure 60. Track Circuits with Timing Sections

Source: Ref. 25

**AC-DC Track Circuit.** The AC-DC track circuit, shown in Figure 61, (sometimes referred to as Type C) is used quite extensively when approach distances are less than 3,000 feet and no other circuits are present on the rails. The AC-DC track circuit is a half-wave rectified AC circuit with all operating equipment located at the crossing. A rectifier is connected across the rails at the far end of the track circuit. As is the case with DC circuits, insulated joints define the limits. An advantage of this circuit is that all control equipment is located in a single housing at the crossing. Shunting is also improved due to the somewhat higher voltages used across the rails.

A simple explanation of the operation of the AC-DC (or Type C) track circuit is that the major portion of the transformer secondary current flows through the rectifier during one-half-cycle and through the relay during the other half-cycle thus providing a net DC component in the track relay. A shunt on the rails reduces the rail voltage causing the track relay to release, thereby activating the system. As is the case with DC track circuits, three circuits are normally used to establish train direction.

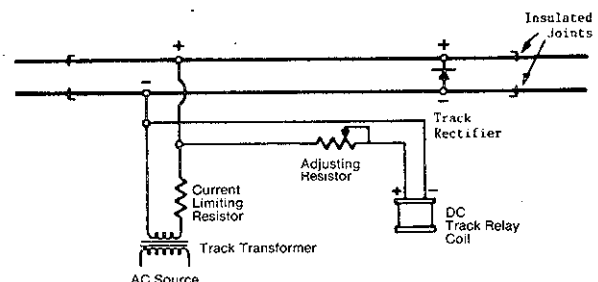

Figure 61. AC-DC Track Circuit

Source: Ref. 25

Audio Frequency Overlay Track Circuit (AFO). The AFO track circuit, shown in Figure 62, is similar in application to the DC track circuit, except that it can be superimposed over other circuits which may exist on the rails. Instead of the battery and relay used in the DC circuit, a transmitter and receiver of the same frequency are used for each AFO track circuit. No insulated joints are required with this type of circuit.

The AFO track circuit uses an AC signal applied to the rails through a transmitter. This signal is transmitted via the rails to a receiver at the opposite end of the track circuit, which converts the AC signal to DC to operate a relay, which in turn, performs the function of operating the warning devices via the control logic similar to the DC track circuit. Once again, three circuits are required to establish the direction in which the train is moving.



Figure 62. Audio Frequency Overlay Track Circuit

Source: Ref. 25

Motion Sensitive Track Circuit.

This type of circuit employs audio frequencies similar to the AFO equipment and is designed to detect the presence, as well as the direction of motion, of a train by continuously monitoring the track circuit impedance. As long as the track circuit is unoccupied or no train is moving within the approach, the impedance of

the track circuit is relatively constant. A decreasing track circuit impedance indicates that a train is moving toward the crossing. If a train should subsequently stop, the impedance will again remain at a constant value. If the train is moving away from a crossing, the impedance will increase. Thus, if the train stops on the approach, or moves away from the crossing, the crossing warning system is deactivated and the crossing is cleared for highway traffic.

This type of circuit is advantageous where trains stop or conduct switching operations within the normal approach limits of a particular crossing. All powered equipment is located at the crossing with the additional advantage that insulated joints are not required when applied in a bi-directional manner, as shown in Figure 63. Adjacent crossing circuits can be overlaid and overlapped with other train detection circuits. Tuned electrical shunts are required to define the end limits of motion sensitive circuits and coupling units are required to bridge any existing insulated joints used in conjunction with other types of track circuits such as might be required for wayside signaling purposes.

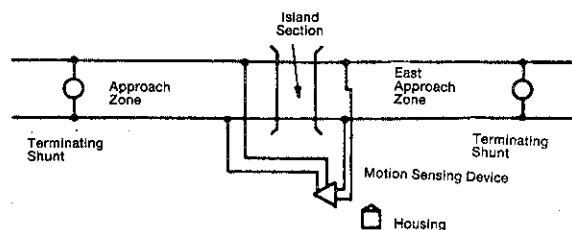

Figure 63. Motion Sensitive Track Circuit, Bi-Directional Application

Source: Ref. 25

Where longer approach zones are required, or where ballast or track conditions dictate, a uni-directional application may be desirable. In this type of application, one device is required for each approach zone, with insulated rail joints used to separate the two approach zones as shown in Figure 64.

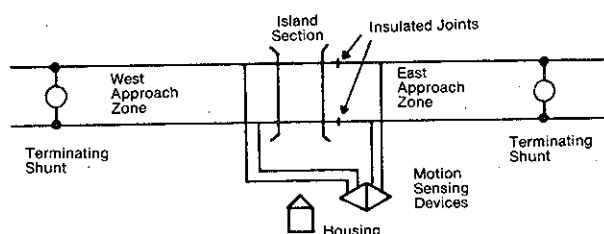

Figure 64. Motion Sensitive Track Circuit, Uni-Directional Application

Source: Ref. 25

Constant Warning Time Track Circuit. Constant warning time equipment has the capability of sensing a train in the approach section, measuring its speed and distance from the crossing and activating the warning equipment to provide the selected minimum warning time. Thus, regardless of train speed, a uniform warning time is provided. If a train stops prior to reaching the crossing, or is moving away from the crossing, the warning devices are deactivated to allow the highway traffic to move over the crossing. With constant warning time equipment, trains can move, or switch on the approaches without reaching the crossing, and, depending on their speed, never cause the crossing warning devices to be activated, thus eliminating unnecessary delays to highway traffic.

The latest constant warning time devices, like motion sensitive devices, may be applied either in a uni-directional or bi-directional mode as shown in Figures 65 and 66, respectively. A uni-directional application requires two devices, one monitoring each approach zone, with the approach zones being separated by insulated rail joints. A terminating shunt is placed at the outermost end of each approach zone. The location of the terminating shunt is determined by the fastest train using the crossing.

Uni-directional application is suggested in situations where there are closely following train moves or

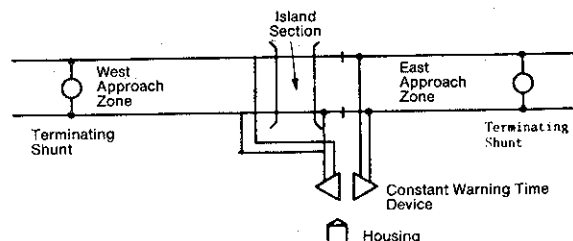

Figure 65. Constant Warning Time Track Circuit, Uni-Directional Application

Source: Ref. 25

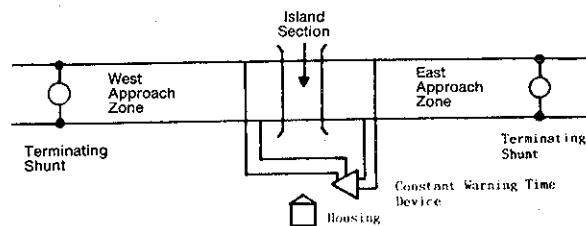

Figure 66. Constant Warning Time Track Circuit, Bi-Directional Application

Source: Ref. 25

to break up frequency pollution. Uni-directional installations are suggested to avoid bypassing insulated joint locations when bypassing these joints is not desirable.

A bi-directional application uses a single constant warning time device which monitors both approach zones. Insulated rail joints are not required in a bi-directional application. Again, terminating shunts are placed at the outermost end of each approach zone. The bi-directional application is normally used where moderate train speeds are employed, thus requiring shorter approach zones, and where track and ballast conditions permit.

Motion sensing and constant warning time track circuits should be considered for crossings on railroad mainlines, particularly at crossings with variations in train speeds and crossings with a number of switching movements on the approach sections.

**D. Site And Operational Improvements**

In addition to the installation of traffic control systems, site and operational improvements can contribute greatly to safety of railroad-highway grade crossings. Site improvements are discussed in six categories: sight distance, geometrics, illumination, safety barriers, flagging, and miscellaneous. Operational improvements are discussed under miscellaneous.

**1. Sight Distance**

Available sight distances help to determine the safe speed at which a vehicle may approach a crossing. There are three sight distances to consider: 1) the distance ahead to the crossing; 2) the distance to and

along the track(s) on which a train might be approaching the crossing in either direction; and, 3) the distance along the track(s) in either direction from a vehicle stopped at the crossing. These sight distances are illustrated in Figure 67.

In the first case, the distance ahead to the crossing, a driver must determine whether a train occupying the crossing or there is an active traffic control device indicating the approach or presence of a train. In such an event, the vehicle must be stopped short of the crossing and the available sight distance may be a determining factor limiting the speed of an approaching vehicle.

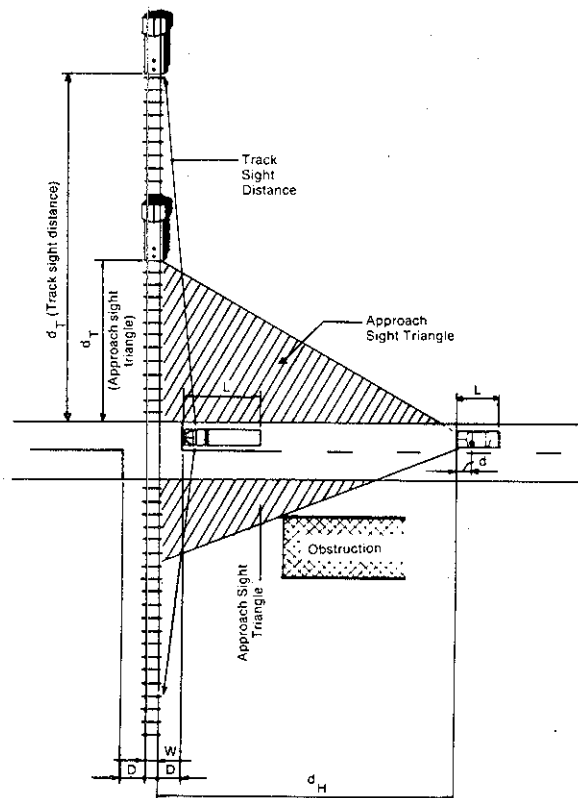

Figure 67. Crossing Sight Distances

The relationship between vehicle speed and this sight distance is set forth in the following formula:

$$d_H = 1.47 V_v t + \frac{V_v^2}{30f} + D + d_e$$

where:

$d_H$  = Sight distance measured along the highway from the nearest rail to the driver of a vehicle which allows the vehicle to be safely stopped without encroachment of the crossing area, feet

$V_v$  = Velocity of the vehicle, mph

$t$  = Perception reaction time, sec, assumed to be 2.5 sec

$f$  = Coefficient of friction, see Table 35

$D$  = Distance from the stop line or front of the vehicle to the nearest rail, feet, assumed to be 15 feet

$d_e$  = Distance from the driver to the front of the vehicle, feet, assumed to be 10 feet

The minimum safe sight distance ( $d_H$ ) along the highway for certain selected vehicle speeds are shown in the bottom line of Table 36. As noted, these distances were calculated for certain assumed conditions

Table 35. Coefficients of Friction

Speed (mph)	f
10	0.40
20	0.40
30	0.35
40	0.32
50	0.30
60	0.29
70	0.28

Source: Ref. 29

and should be increased for less favorable conditions.

The second sight distance situation utilizes a so called "sight triangle" in the quadrants on the vehicle approach side of the track. The triangle is formed by: 1) the distance ( $d_H$ ) of the vehicle driver from the track; 2) the distance ( $d_T$ ) of the train from the crossing; and, 3) the unobstructed sight line from the driver to the front of the train. The sight triangle is depicted in Figure 67. The relationships between vehicle speed, maximum timetable train speed, distance along the highway ( $d_H$ ), and distance along the railroad ( $d_T$ ) are set forth in the following formula:

$$d_T = \frac{V_T}{V_v} \left( 1.47 V_v t + \frac{V_v^2}{30f} + 2D + L + W \right)$$

where:

$d_T$  = Sight distance along the railroad tracks to permit the vehicle to cross and be clear of the crossing upon arrival of the train

$V_T$  = Velocity of the train, mph

$L$  = Length of vehicle, feet, assumed to be 65 feet

$W$  = Distance between outer rails, feet, assumed to be 5 feet for a single track

$V_v$ ,  $t$ ,  $f$ ,  $D$ , are as defined above.

Distances  $d_H$  and  $d_T$  are shown in Table 36 for several selected highway speeds and train speeds.

In the case of a vehicle stopped at a crossing, the driver needs to see both ways along the tracks to determine whether a train is approaching and estimate its speed. The driver needs to have a sight

Table 36. Sight Distances for Combinations of Highway Vehicle and Train Speeds

Train Speed (mph)	Vehicle Speed (mph)							
	0	10	20	30	40	50	60	70
	Distance ( $d_T$ ) Along Railroad From Crossing (ft)							
10	240	145	105	100	105	115	125	135
20	480	290	210	200	210	225	245	270
30	720	435	310	300	310	340	370	405
40	960	580	415	395	415	450	490	540
50	1200	725	520	495	520	565	615	675
60	1440	870	620	595	620	675	735	810
70	1680	1015	725	690	725	790	860	940
80	1920	1160	830	790	830	900	980	1075
90	2160	1305	930	890	930	1010	1105	1210
	Distance ( $d_H$ ) Along Highway From Crossing (ft)							
	n/a	70	135	225	340	490	660	865

Note: All calculated distances are rounded up to next higher 5-foot increment.

Assumptions: 65 foot truck crossing a single track at 90 degrees; flat terrain. Adjustments should be made for unusual vehicle lengths and acceleration capabilities, multiple tracks, skewed crossings, and grades.

Source: Ref. 29

distance along the tracks that will permit sufficient time to accelerate and clear the crossing prior to the arrival of a train, even though the train might come into view as the vehicle is beginning its departure process.

Figure 68 illustrates this maneuver. These sight distances, for a range of train speeds, are given in the column for vehicle speed equals zero in Table 36. These values are obtained from the following formula:

$$d_T = 1.47V_T \left( \frac{V_G}{a_1} + \frac{L + 2D + W - d}{V_G} + J \right)$$

where:

$V_G$  = maximum speed of vehicle in selected starting gear, assumed to be 8.8 ft/sec

$a_1$  = acceleration of vehicle in starting gear, assumed to be 1.47 ft/sec/sec

$J$  = sum of the perception time and the time required to activate the clutch or an automatic shift, assumed to be 2 sec

Chapter IV Identification of Alternatives

$d_a$  = distance the vehicle travels while accelerating to maximum speed in first gear, or

$$d_a = \frac{V_G^2}{2a_1} \quad \text{or,}$$

$$\frac{8.82}{(2)(1.47)} = 26.4 \text{ feet}$$

$d_T$ ,  $V_T$ ,  $L$ ,  $D$ , and  $W$  are as defined above.

Adjustments for longer vehicle lengths, slower acceleration capabilities, multiple tracks, skewed crossings, and other than flat highway grades are necessary. The formulas in this section may be used with proper adjustments to the appropriate dimensional value. It would be desir-

able that sight distances permit operation at the legal speed limit for approach highways. This is sometimes impractical.

In order to permit this, three areas of the crossing environment should be kept free from obstructions. The area on the approach from the driver ahead to the crossing should be evaluated to determine whether it is feasible to remove any obstructions which prevent the motorist from viewing the crossing ahead, a train occupying the crossing or active control devices at the crossing. Clutter is often a problem in this area, consisting of numerous and various traffic control devices, roadside commercial signing, utility and lighting poles, and vegetation. Horizontal and vertical alignment can also serve to obstruct motorist view of the crossing.

Clutter can often be removed with minimal expense, improving the visibility of the crossing and associated traffic control devices. Traffic control devices unnecessary for the safe movement of vehicles through the crossing area should be removed. Vegetation should be removed or cut back periodically. Billboards should be prohibited on the approaches.

Changes to horizontal and vertical alignment are usually more expensive. However, when constructing new highways or reconstructing existing highways, care should be taken to minimize the effects of horizontal and vertical curves at a crossing.

The approach sight triangle is the second area that should be kept free from obstructions. This area provides an approaching motorist with a view of an approaching train. It can encompass a rather large area that is usually privately owned. In

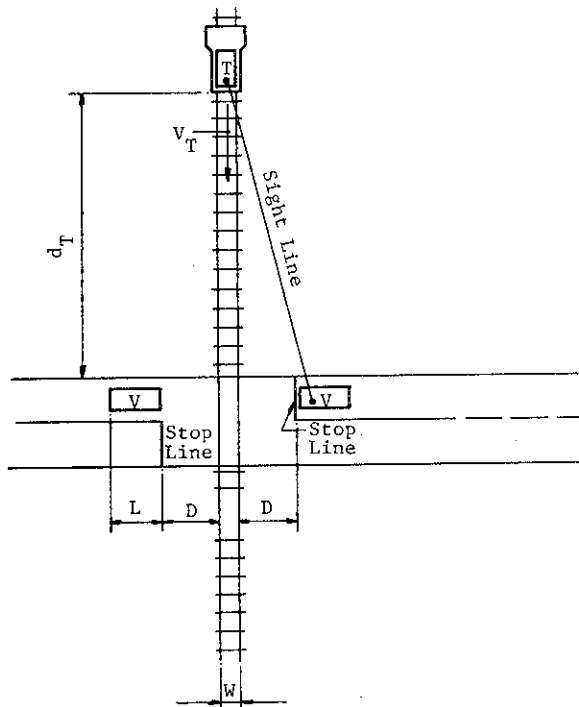

Figure 68. Sight Distance for a Vehicle Stopped at Crossing

Source: Ref. 29



rural areas, this sight triangle may contain crops or farm equipment that block the motorist's view. For this reason, clearing the sight triangle may be difficult to achieve. However, obstructions should be removed, if possible, to allow vehicles to travel at the legal speed limit for the approach highway. Vegetation can be removed or cut back periodically, billboards and parking should be prohibited, and small hills may be regraded.

The third area of concern is the track sight distance, or the area along the track. Usually, this area is located on railroad right-of-way. Vegetation is often desired along railroad right-of-way to serve as an environmental barrier to noise generated from train movements. However, the safety concern at crossings is of more importance and, if possible, vegetation should be removed or cut back periodically. Also, if practical, this sight distance area should be kept free of parked vehicles and standing railroad cars. Care should be taken to avoid the accumulation of snow in this area.

An engineering study, as described in Chapter III, should be conducted to determine if the three types of sight distance can be provided as desired. If not, other alternatives should be considered. The highway speed might be reduced, either through the installation of an advisory or regulatory speed sign, to a level which conforms with the available sight distance. It is important that a motorist understand why the speed reduction is necessary, otherwise, it may be ignored unless enforced. At crossings with passive control devices only, consideration might be given to the installation of active traffic control devices that warn of the approach of a train.

## 2. Geometrics

The ideal crossing geometry is a 90 degree intersection of track and highway with slight ascending grades on both highway approaches to reduce the flow of surface water toward the crossing. Few crossings have this ideal geometry because of topography or limitations of right-of-way for both the highway and the railroad. Every effort should be made to construct new crossings in this manner. Horizontal and vertical alignment and cross-sectional design are discussed below.

Horizontal Alignment. Desirably, the highway should intersect the tracks at a right angle with no nearby intersections or driveways. This layout enhances the driver's view of the crossing and tracks and reduces conflicting vehicular movements from crossroads and driveways. To the extent practical, crossings should not be located on either highway or railroad curves. Roadway curvature inhibits a driver's view of a crossing ahead and a driver's attention may be directed toward negotiating the curve rather than looking for a train. Railroad curvature inhibits a driver's view down the tracks from both a stopped position at the crossing and on the approach to the crossing. Those crossings that are located on both highway and railroad curves present maintenance problems and poor rideability for highway traffic due to conflicting superelevations. Similar difficulties arise when superelevation of the track is opposite to the grade of the highway.

If the intersection between track and highway cannot be made at right angles, the variation from 90 degrees should be minimized. One State limits the minimum skew to 70 degrees. At skewed crossings, motor-

## Chapter IV Identification of Alternatives

ists must look over their shoulder to view the tracks. Because of this more awkward movement, some motorists may only glance quickly and not take the necessary precaution.

Generally, improvements to horizontal alignment are expensive. Special consideration should be given to crossings that have complex horizontal geometrics as described above. These crossings may warrant the installation of active traffic control systems or, if possible, may be closed to highway traffic.

Vertical Alignment. It is desirable that the intersection of highway and railroad be made as level as possible from the standpoint of sight distance, rideability, and braking and acceleration distances. Drainage would be improved if the crossing were located at the peak of a long vertical curve on the highway. Vertical curves should be of sufficient length to insure an adequate view of the crossing.

Track maintenance can result in raising the track as new ballast is added to the track structure. Unless the highway profile is properly adjusted, this practice results in a "humped" crossing that may adversely affect safety and operation of highway traffic over the railroad. Humped crossings can be of particular concern for vehicles with low underclearances, e.g. "low-boy" trucks. It is possible for these trucks to become caught on the tracks, obviously causing a hazard.

Alternatives to this problem include a design standard that deals with maximum grades at the crossing, prohibiting truck trailers with a certain combination of underclearance and wheelbase to cross the crossing,

setting trailer design standards, or minimizing the rise in track due to maintenance operations.

Some States have addressed this issue by setting standards. The Illinois Commerce Commission specifies that from the outer rail of the outermost track, the road surface should be level for about 24 inches. From there to a distance of 25 feet, a maximum grade not to exceed one percent is specified. From that point to the railroad right-of-way line, the maximum grade is five percent.

The West Virginia Department of Highways recommends that when a track raise of one inch or more is necessary, the approach pavement should be tapered at a rate of not less than 10 feet per one inch of track raise. The pavement immediately adjacent to the outermost rail should be level for a minimum distance of three feet.

The Florida Department of Transportation (DOT) has initiated a survey of crossings on the State highway system to determine if a particular crossing profile will accommodate low bed vehicles that meet State road clearance requirements. The Florida DOT has identified seven different profile types and corresponding tables to be used in the determination of adequate profiles.

The American Railway Engineering Association (AREA) Manual for Railway Engineering recommends that the crossing surface be in the same plane as the top of rails for a distance of two feet outside of rails and that the surface of the highway be not more than three inches higher nor six inches lower than the top of nearest rail at a point 30 feet from the rail unless track superelevation dictates otherwise.

The Southern Pacific Railroad recommends that for a distance of 20 feet from a point two feet from the nearest rail, the maximum descent should be six inches. From that point for a distance of another 20 feet, the maximum descent should be two feet.

Drivers of low clearance vehicles can be warned regarding crossings that have a profile insufficient for a certain combination of wheelbase and underclearance. However, presently no nationally accepted criteria, procedures, or signing have been adopted to accomplish this.

New developments in track maintenance equipment minimize the raising of track during maintenance operations. The maintenance of track and highway should be coordinated between the railroad and the highway agency. In this manner, the crossing approach can be maintained to present a smooth transition to the crossing.

Improvements in vertical alignment are almost always expensive. Efforts should be made to build new crossings on as flat a grade as possible. Humped crossings are difficult to correct without regrading either the highway or railroad.

Cross Section. A physical railroad-highway grade crossing is a com-

posite of a railroad track structure supporting a vehicular roadway surface. At the crossing, the normal cross section of the track must be modified somewhat to provide support for the roadway surface. Several typical cross sections are shown in detail in a later section on crossing surfaces.

On the highway approaches to the crossing, the normal cross section of the highway must be modified gradually to accomplish transition from a crowned roadway surface to a basically level surface at the junction with the crossing. The highway surface and supporting components are discontinuous through the crossing area, ending on each side at the ends of the track crossties.

A typical railroad track structure permits open drainage through the ties into the ballast, out to the edge of shoulders, and into ditches in roadbed excavations. The highway has a nearly impermeable surface, and the base and subgrade remain at relatively constant moisture levels. These differences require special attention to drainage at crossings.

Elements of a highway cross section are shown in Figure 69. The roadway pavement should be crowned with a desirable cross slope of 1.5 to three percent; however, cross

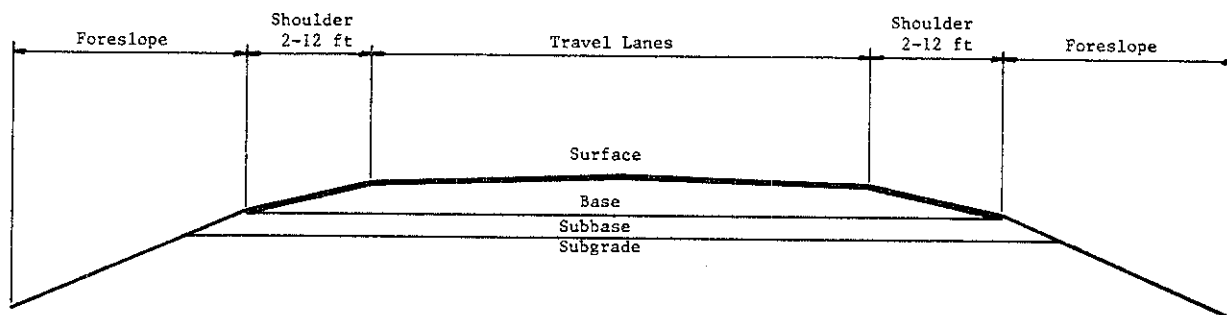

Figure 69. Elements of a Highway Cross Section

Chapter IV Identification of Alternatives

slopes of up to six percent are acceptable for low type surfaces. Shoulders should be sloped sufficiently to rapidly drain surface water but not to the extent that vehicular use would be hazardous. Typically, bituminous and concrete surfaced shoulders are sloped from two to six percent; gravel or crushed rock shoulders from four to six percent; and turf shoulders about eight percent. Foreslopes provide for drainage channels and desirably are no steeper than 4:1 (horizontal to vertical).

These guidelines are typical for tangent alignment in open areas. Variations for curves, urban areas, and other roadside environments are described in the American Association of State Highways and Transportation Officials' (AASHTO's) A Policy on Geometric Design of Highways and Streets.

Elements of a railroad cross section are shown in Figure 70. Shoulder to shoulder widths for single tracks typically vary from 20 to 26 feet. The top ballast is usually sloped at a ratio of 2:1. Variations in cross section occur for track on curves and where right-of-way is restricted.

The pavement surface adjacent to the track should be at the same ele-

vation as the track. This will require a change in the normal crowned highway. Crossings in curves may encounter superelevated track. The rate of change in elevation of the pavement edges should not exceed those shown in Table 37.

As with the usual design of highways and railroads, adequate drainage is essential to prevent saturation of the track subgrade and the pavement structural section and failure of the pavement adjacent to the crossing. Excessive moisture can lead to pumping and a consequent fouling of the ballast and settlement of the track. Where the grade of the highway approach descends toward the crossing, provisions should be made to intercept surface and subsurface drainage and discharge it laterally so that it will not be discharged on the track area.

Table 37. Rate of Change in Elevation of Pavement Edges

Design Speed (mph)	Distance Required for 1.0-foot Change in Elevation (ft)
40	175
50	200
60	225
70	250

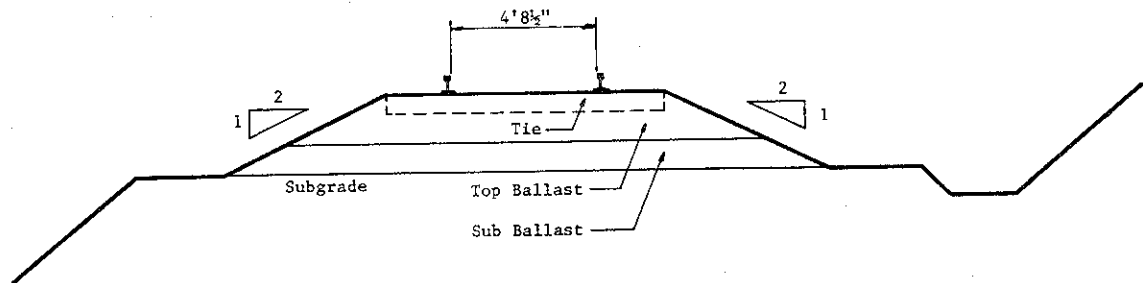

Figure 70. Elements of Railroad Track Cross Section

Surface ditches should be installed. If required, subdrainage with suitable inlets and the necessary provisions for clean-out should be made to drain the subgrade thoroughly and prevent the formation of water pockets. This drainage should be connected to a storm water sewer system, if available. If not, suitable piping, geotextile fabrics, or french drains should be installed to carry the water a sufficient distance from the roadbed. Where gravity drainage is not available, a nearby sump may provide an economical outlet, or the crossing may be sealed and the roadbed stabilized by using asphalt ballast or its equivalent.

The length of the crossing measured along the track should be sufficient to include all highway travel lanes and adjacent shoulders plus two feet, with the continuation of all traffic lanes across the tracks.

Intersections and driveways should be avoided near crossings. A driver's attention may be distracted toward another vehicle entering or exiting the highway and the driver

might not take appropriate cautionary action at the crossing. Parking should be avoided near crossings for the same reason and because parked vehicles may restrict a motorist's view of an oncoming train or a crossing warning device.

Certain vehicles (school buses, vehicles carrying passengers for hire, and vehicles transporting hazardous materials) are required to stop at all crossings before proceeding across the tracks. Pullout lanes are sometimes provided to remove these vehicles from the through lane such that they can stop without delaying following vehicles.

A typical pullout lane is shown in Figure 71. The length of the pullout lane on the approach is designed to provide for the deceleration of the special vehicle to a stop in advance of the crossing. Recent research establishes that the length,  $L_d$ , from the beginning of the taper to a point in advance of the crossing, is based on the appropriate speeds of the special vehicles as shown in Table 38. The length of the

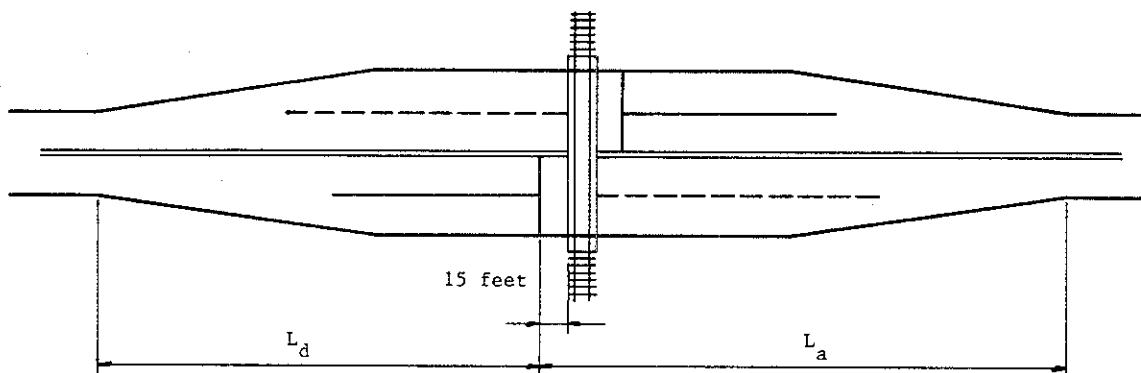

$L_d$  = Total length of pullout lane, approach  
 $L_a$  = Total length of pullout lane, exit

Figure 71. Typical Pullout Lane at a Crossing

Table 38. Approach Length of Pullout Lane

<u>Vehicle Speed (mph)</u>	<u>Length (ft)</u>
30	190
40	360
50	560
60	850

taper on the approach varies, depending on the type of highway facility and vehicle speed. Adequate storage length in advance of the crossing for stopped vehicles should be provided.

It would be desirable for the length of the pullout lane,  $L_a$ , from the stopped position in advance of the crossing to the end of the acceleration taper, downstream, to allow for acceleration up to the design speed of the roadway. However, it seldom would be practical to construct the extended lengths necessary for all vehicle types. The values in Table 39 are adequate to permit passenger cars to attain roadway speed prior to merging and will allow heavier vehicles to accelerate to a speed which will make merging with through traffic easier to accomplish. The length of the taper for acceleration varies depending on the type of highway facility and vehicle speeds.

Table 39. Downstream Length of Pullout Lane

<u>Vehicle Speed (mph)</u>	<u>Length (ft)</u>
30	190
40	380
50	760
60	1170

It is desirable that shoulders be provided for an escape route for errant vehicles. A driver trying to stop without sufficient distance may either lose control of the vehicle or need a space to direct the vehicle without colliding with a train on the crossing. Likewise, the area adjacent to the highway should be kept as level as possible and free from obstructions to provide a space for errant vehicles, subject to the space needed for traffic control devices.

In an engineering study, consideration should be given to low-cost improvements such as the removal of parking near the crossing and the closure of low volume intersecting highways and driveways.

### 3. Illumination

Illumination at a crossing may be effective in reducing nighttime accidents. Illuminating most crossings is technically feasible since commercial power is available at approximately 90% of all public crossings. Illumination may be effective under the following conditions.

- o Nighttime train operations
- o Low train speeds
- o Blockage of crossings for long periods at night
- o Accident history that indicates that motorists often fail to detect trains or traffic control devices at night
- o Horizontal and/or vertical alignment of highway approach such that vehicle headlight beam does not fall on the train until the vehicle has passed safe stopping distance

- o Long dark trains, e.g. unit coal trains
- o Restricted sight or stopping distance in rural areas
- o Humped crossings where oncoming vehicle headlights are visible under train
- o Low ambient light levels
- o A highly reliable source of power

Recommendations for the placement and type of luminaires are available in the FHWA's Roadway Lighting Handbook and the Illuminating Engineering Society's American National Standard Practice for Roadway Lighting. It is desirable that at least two luminaires be provided, one on each side of the tracks.

On uncurbed roadways, luminaire supports should be erected as far as practical from the traveled way, desirably outside the clear zone. When located within the clear zone, defined in the Guide for Selecting, Locating, and Designing Traffic Barriers, luminaire supports should have breakaway bases. If possible, luminaires should also be located to ensure damaged poles will not fall on the tracks. A distance of 25 to 50 feet from the nearest track is recommended.

Mounting height should be in the range of 30 feet to 40 feet. It is preferable that the illumination be distinctive in color, volume, or distribution so that it clearly distinguishes the crossing among other street lighting.

The Oregon Public Utility Commissioner recommends that there should be at least one foot-candle of average maintained illumination on a

vertical plane, five feet from the centerline of the track. The luminaires should be oriented toward the railroad. Maximum permissible level of illumination and exact orientation of the luminaires should be determined on a case-by-case basis and should consider site conditions and the level of ambient nighttime illumination. Ideally, luminaires should illuminate an area along the track that is 50% longer than the width of the road. Illumination should extend to approximately 15 feet above the top of rail.

The luminaires should be positioned to ensure that a motorist or railroad operator is not subjected to glare from the light source. If glare cannot be eliminated, cutoffs may be provided to shield the cone of vision of a motorist or locomotive engineer. In rural areas with high train speeds, some lighting should be directed down the tracks to illuminate the sides of an approaching train. Trains, traffic control devices, or signs should not be overpowered by background objects or lighting.

Train activated illumination circuitry can be designed, but should not be used as a substitute for active traffic control systems.

#### 4. Shielding Supports for Traffic Control Devices

The purpose of a traffic barrier, such as a guardrail or crash cushion, is to protect the motorist by redirecting or containing an errant vehicle. The purpose is not to protect a traffic control device against collision and possible damage. Their use should be limited to situations where hitting the object, i.e. a traffic control device, is more hazardous than hitting the traf-

## Chapter IV Identification of Alternatives

fic barrier and possibly redirecting the vehicle into a train.

A longitudinal guardrail should not be used for traffic control devices at crossings unless the guardrail is otherwise warranted, as for a steep embankment. The reason for not using a longitudinal guardrail is that it might redirect a vehicle into a train.

On some crossings, it may be possible to use crash cushions to protect the motorist from striking a traffic control device. Some crash cushions are designed to capture, rather than redirect a vehicle, and may be appropriate for use at crossings to reduce the redirection of a vehicle into the path of a train.

The ring type guardrail placed around a signal mast may create the same type of hazard as the signal mast itself, i.e. the guardrail may be a roadside obstacle. They do however serve to protect the signal mast. Since functioning devices are vital to safety, the ring type guardrail may be used at locations with heavy industrial traffic, such as trucks, and low highway speeds.

When a barrier is used, it should be installed according to the requirements in the Guide for Selecting, Locating and Designing Traffic Barriers.

### 5. Flagging

At certain crossings, railroad companies may have a policy to use a flagger to stop highway vehicles and pedestrians before allowing a train to move over the crossing. These crossings typically have only passive warning signs. Flaggers should be employed at crossings which do not

have active control devices when the railroad cars are not headed by an engine. Some railroad companies require flagging when the train has been split or when switching operations necessitate numerous movements across the roadway.

### 6. Miscellaneous Improvements

There are several other site improvements that can be made to enhance safety and operations at railroad-highway grade crossings. One of the alternatives is crossing closure, as discussed in an earlier section.

Prolonged blockage of crossings as a result of low train speeds or numerous switching movements can adversely affect crossing safety and operations. Increased vehicular delay not only affects operations but may also affect safety if emergency vehicles cannot respond to a life-threatening situation. Train speeds might be increased by upgrading the track class, removing local speed restrictions, and improving crossings to compensate for local concerns regarding the safety of higher speed trains. Crossings located on trackage that has numerous switching movements should be closed, if possible. If not, switches might be relocated or switching operations might be rescheduled at times other than peak highway traffic periods. Establishing "hotlines" between emergency services and the railroad can assist the railroad in opening blocked crossings to allow emergency vehicles access across the tracks. Sidings might be extended to allow space for storage of railroad equipment away from crossings. Rail operations, such as train crew changes and refueling points, might be relocated outside of communities.



Exposure between trains and school buses, commercial buses, and vehicles transporting hazardous materials should be minimized because of the potential catastrophic consequences. These types of vehicles might be rerouted to avoid crossing the railroad at-grade, if possible. If not, these vehicles may traverse the railroad at crossings with active traffic control devices.

Traffic divisional islands may be used at crossings on multi-lane roadways to prevent motorists from driving around a lowered gate. Traffic divisional islands are narrow elongated islands that follow the course of the highway to separate conflicting traffic movements.

An engineering study should be conducted to determine if traffic divisional islands are appropriate. The study should consider the accident history of the crossing, driver response to lowered gates, train and highway traffic volumes and conditions, need for upgraded train detection systems, and crossing approach geometry. Consideration should be given to the potential hazard of the island itself.

Islands must extend far enough back from the crossing to accommodate traffic queues and should not have cut-outs for access and egress of local traffic. The pavement may require widening to retain minimum lane widths. Vertical transitions on the raised island approaches should be treated similar to curbed gore areas. Delineators might be placed on the raised island to aid snow plowing operations.

The ends of the island should be protected as other traffic islands, to provide a maximum degree of warn-

ing of the presence of the island and a definite indication of the proper vehicle path or paths to be followed.

Comprehensive planning is essential to avoid future crossing problems. Community development should be planned to avoid crossings at-grade.

### E. Crossing Surfaces

This portion of the handbook provides general information of currently available types of crossing surfaces. The use of trade names and the identification of manufacturers and distributors are solely for the convenience of the reader. Such use and identification do not constitute an official endorsement by the U.S. Department of Transportation of any product to the exclusion of others that may be suitable.

As a vehicle moves across a railroad-highway grade crossing, the material on which its tires roll is commonly referred to as a crossing surface. It is supported by the railroad track structure, primarily the crossties, which in turn transfers the highway load, as well as the train load, through the ballast to the underlying subgrade.

For railroads, the crossing surface and the highway approach pavements leading up to the crossing confine the track structure and create drainage and maintenance problems.

For highway authorities, crossings create discontinuity in the normal highway surface, which at best results in somewhat poorer riding quality and may result in increased vehicle operating costs, hazard, and inconvenience to highway traffic.

## Chapter IV Identification of Alternatives

In negotiating a crossing, the degree of attention that the driver can be expected to devote to the crossing surface is related to the condition of that surface. If the surface is uneven, the driver's attention may be devoted primarily to choosing the smoothest path over the crossing, rather than to determining if a train is approaching the crossing. This type of behavior may be conditioned; that is, if a driver is consistently exposed to uneven crossing surfaces, he may assume that all crossing surfaces are uneven whether or not they actually are. Conversely, if a driver encounters an uneven surface unexpectedly, he may lose control of his vehicle resulting in an accident. Therefore, providing reasonably smooth crossing surfaces is viewed as one of the several elements toward improving crossing safety and operations.

Originally, crossing surfaces were made by filling the area between the rails with sand and gravel, probably from the railroad ballast. Later, crossing surfaces were made of planks or heavier timbers or of bituminous material, sometimes using planks to provide the flangeway openings. Treated timber panels and prefabricated metal sections followed, and in 1954 the first proprietary rubber panel crossing surface was put on the market. Presently available proprietary surfaces, usually patented, are fabricated from concrete, rubber, steel, synthetics, wood, and various combinations of these materials.

Crossing surfaces available today can be divided into two general categories: monolithic and sectional. Monolithic crossings are those that are formed at the crossing and cannot be removed without destroying them. Typical monolithic crossings

are asphalt, poured - in - place concrete, and cast - in - place rubber (elastomeric) compounds. Sectional crossings are those manufactured in sections (panels) that are placed at the crossing and can be removed and reinstalled. These crossing surfaces facilitate the maintenance of track through the crossing. Typical sectional crossings consist of treated timbers, reinforced concrete, steel, high density polyethylene, and rubber.

The U.S. DOT/AAR National Rail-Highway Crossing Inventory found that the majority of crossings are asphalt. Numbers and percent of crossings by surface type are given in Table 40.

Proper preparation of the track structure and good drainage of the subgrade are essential to good performance from any type of crossing surface. Excessive moisture in the soil can cause track settlement, accompanied by penetration of mud into the ballast section. Moisture

Table 40. Public Crossings by Surface Type, 1983

<u>Surface Type</u>	<u>Number</u>	<u>Percent</u>
Sectional timber	29,339	14.29
Full width plank	30,131	14.67
Bituminous asphalt	112,544	54.81
Concrete slab	849	0.41
Concrete pavement	896	0.44
Rubber	1,768	0.86
Metal sections	292	0.14
Other metal	294	0.14
Unconsolidated	28,797	14.03
Other	429	0.21
Total	205,339	100.00

Source: Ref. 7

can enter the subgrade and ballast section from above, below and/or adjacent subgrade areas. To the extent feasible, surface and subsurface drainage should be intercepted and discharged away from the crossing. Drainage can be facilitated by establishing an adequate difference in elevation between the crossing surfaces and ditches or embankment slopes. The highway profile at all crossings should be such that water drains away from the crossing.

In situations where the grade of the highway approach descends toward the crossing, provisions should be made to intercept surface and subsurface drainage and discharge it laterally so that it will not be discharged on the track area. Surface ditches should be installed. If required, subdrainage with suitable inlets and the necessary provisions for clean-out should be made to drain the subgrade and prevent the formation of water pockets. This drainage should be connected to a storm water drainage system, if available; if not, suitable piping, geotextile fabrics and/or french drains should be installed to carry the water a sufficient distance from the roadbed. Where gravity drainage is not available, a nearby sump may provide an economical outlet, or the crossing may be sealed and the roadbed stabilized by using asphalt ballast or its equivalent.

Since drainage is more of a problem in multitrack territory, the installation of catch basins between tracks at the ends of a crossing should be considered. Any lag bolt, drive spike or track spike holes in the ties should be filled and sealed to prevent entrance of moisture that causes early deterioration of the ties.

It is desirable that the subgrade be cleaned of all old contaminated ballast and bladed to a level surface. Selected subgrade material should be placed in layers no more than 12 inches thick, then thoroughly compacted by approved methods. Subgrade material may consist of select soils, soil cement, or asphaltic mixes, to be selected by the individual railroad.

Use of a suitable filter fabric over the entire subgrade area under the crossing and for a sufficient distance beyond can be a significant aid in separation, filtration, water transport, and tensile reinforcement. The fabric separates the ballast from the subgrade, and thus restricts ballast penetration down into the subgrade and prevents contamination of the ballast from the flow of soft subgrade material into the ballast layer through pumping action caused by heavy train loads. Fabrics also provide additional structural support at the ballast-subgrade interface such that loads are spread over a greater area.

Numerous stabilization fabrics are available from several manufacturers and are useful in a variety of civil engineering functions involving improvements in drainage and retention of fine soil particles. These fabrics are made of polymers; some are woven but many non-woven ones are produced by spunbonding or by felting. These fabrics are also called "engineering fabrics" or "plastic filter fabrics". However, the term stabilization fabrics better characterizes their function in highway and railroad applications where abrasion resistance and tensile strength under heavy loads are quite important. Some of the available products are listed in Table 41.

Chapter IV Identification of Alternatives

Table 41. Ground Stabilization Fabrics

<u>Manufacturer</u>	<u>Product</u>	<u>Description</u>
Amoco Fabrics Co.	ProPex 4557	Highly permeable nonwoven
Carthage Mills	Filter X	Woven fabric of polyvinylidene chloride Monofilament yarns
	Poly-Filter GB	Woven fabric of polypropylene monofilament yarns
	Poly-Filter X	Woven fabric of polypropylene monofilament yarns
Crown Zellerbach	Fibertex	Nonwoven polypropylene, spunbonded and needlepunched
E.I. Dupon de Numours & Co.	Typar	Continuous filaments of polypropylene, spunbonded
Hoechst Fibers Industries	Trevira Spunbond	Nonwoven polyester continuous filament fabric mechanically bonded by needling
Mirafi, Inc.	Mirafi 100 X	Woven polypropylene yarns
	Mirafi 500 X	Woven polypropylene yarns
	Mirafi 600 X	Woven polypropylene yarns
	Mirafi 700 X	Woven polypropylene monofilament yarns
Nicolon Corporation	Kontrol	Woven polypropylene
	Nicolon	Woven polypropylene
	Geolan	Woven polypropylene
Phillips Fiber Corporation	Supac N	Nonwoven polypropylene mechanically interlocked by needlepunching and heat bonding
	Supac W	Woven polypropylene
Quline Corporation	Q-Trac	Needledpunched and bonded, continuous filament
Texel, Inc.	Texel	Polyester or polypropylene mechanically bonded by needle-punch process. Texel is non-woven and Texpro is woven
	Texpro	
True Temper Railway Appliances, Inc.	True Tex	Nonwoven polyester with staple needlepunch bonding

Some of these fabrics allow the penetration of water but prevent movement of even the finest soil particles through them. In addition, these fabrics have various applications in below-grade drainage channels. Together with ballast or other granular material they are used to construct non-clogging French drains and may be combined with perforated pipe where greater flow capacity is needed.

When used, the fabric should be rolled beyond each end of the crossing for at least 20 feet. If a rail joint falls within this 20 foot distance, the fabric should extend at least five feet beyond the rail joint. If practical, the fabric should extend under the highway surface 15 feet each way from the center line of the track. One manufacturer suggests extending the fabric up the sides of the crossing to prevent soil fines from migrating horizontally into the clean ballast. This technique is called encapsulating or building a fabric envelope.

The ballast and subballast should be clean at least 10 inches below the bottoms of the ties. Clean ballast should be placed a minimum of one foot beyond the ends of the ties and 20 feet beyond the ends of the crossing. Ties should be either treated No. 4 or 5 hardwood ties or concrete ties through the crossing surface area and beyond for a minimum distance of 20 feet. Length and spacing of the ties should conform to the type of crossing surface materials being used.

All ties through the crossing area and at least 20 feet beyond each end of the crossing should be fully tie plated, with two or four spikes per tie plate, and fully box anchored. Optional placement of tie

pads is acceptable. Figure 72 illustrates the connection of the rail to the tie.

The rails through the crossing should be laid to eliminate joints within the crossing. Preferably, the nearest joint should be not less than 20 feet from the end of the crossing. Continuous welded rail may be used, or rails might be welded in the field. The use of heavier rail through the crossing area may be warranted at crossings with high traffic volumes.

Rails should be spiked to line and the track mechanically surfaced to appropriate grade and alignment such that the crossing surface will be in the same plane as, or slightly above, the top of the rails for a distance of two feet outside the rails. This will assist in avoiding any jarring and overturning effect on the rails from the movement of

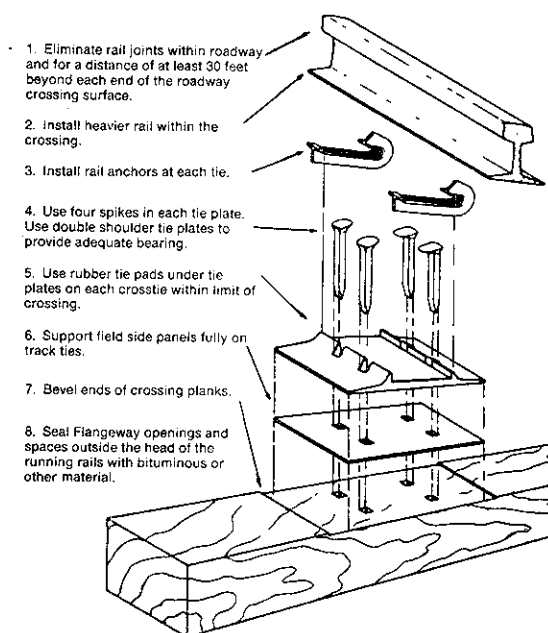

Figure 72. Connection of the Rail to the Crosstie

heavily loaded highway vehicles and will aid in providing a smooth riding surface. In turn, the first two or three inches of the top surface of any non-plastic crossing surface material immediately adjacent to the outside of the head of a running rail should be lowered by dapping approximately one quarter inch, so that it will not be damaged by contact with false flanges of railroad car wheels with worn treads.

Following completion of the original tamping, arrangements should be made for rail traffic to move over the track to induce any initial settlement, and the track should then be retamped to obtain optimum track stability. This retamping should include the area of the crossing and extend one rail length past the nearest joint. In its final position, the top of the crossing surface should be at the same elevation as the top of the adjacent highway surface.

Flangeway openings on the inside of the running rails are provided in various ways. Prefabricated sectional type surfaces make provision for flangeways in the design and fabrication of the individual sections. In the very simple monolithic bituminous crossing surfaces, flangeways may be formed by placing a removable wood strip adjacent to the head of the rail and removing it after the surface has been compacted by rolling. This procedure is not recommended, except for crossings with very light vehicular traffic. A more durable inner edge of the flangeway will be formed by using a line of permanently fastened timbers or scrap rails. Consideration must be given to the impact on track circuits and appropriate Federal Railroad Administration (FRA) rules. The flangeway opening should have a minimum width

of 2.5 inches and should extend at least two inches below the top of the running rails. Flangeway openings and spaces outside the head of the running rails should be sealed to reduce the flow of water into the ballast and subgrade in the crossing area.

The crossing length, measured along the track, should be sufficient to extend at least one foot beyond the edge of the highway pavement, including any paved shoulders on the highway approaches to the crossing. State laws may dictate that if hot-mix bituminous asphalt pavement is used on the highway approaches, consideration should be given to installing the pavement to at least the bottom of the tie elevation, placing it in several layers, and rolling it parallel to the track with the final layer rolled in both directions. The ends of the crossing surface should be beveled to avoid damage by dragging railroad equipment. Median strips, shoulder escape routes, and sidewalks normally should have the same surface material installed to provide one continuous crossing surface. In urban areas, separate sections of crossings may be provided for pedestrian use if sidewalks are somewhat removed from the highway. However, unless adequate drainage is provided, the unsurfaced pockets between the separate crossing areas may create undesirable soft subgrade conditions.

Proper preparation of subgrade cannot be overemphasized. Several States have experienced problems with crossing surfaces that can be directly related to inadequate subgrade preparation. Typical problems found at crossings include the following.

- o Replacement pavement failed (cracked and settled) in apron

area adjacent to crossing surface because of:

- inadequate compaction in apron area (from ends of ties to existing pavement) of subgrade, ballast, and pavement material;
  - failure to install header board when required;
  - failure to form pavement/crossing relief joint;
  - failure to seal pavement/crossing relief joint; or,
  - inadequate existing pavement removed for crossing installation, creating a space too narrow to properly compact replacement material. (Minimum of 36 inches is recommended.)
- o Frost heaving of pavement on highway approaches.
  - o Improper establishment of highway pavement and crossing surface elevations resulting in a non-uniform transition and causing a decrease in riding comfort.
  - o Track settlement causing poor transition, and loose outside panels due to:
    - Unstable subgrade (inadequate advance investigation) or,
    - Inadequate ballast depth and/or compaction.
  - o Improper placement of filter cloth and failure to place under track-bed.

Whenever either track resurfacing or highway resurfacing projects involve a crossing, appropriate measures should be taken to avoid detri-

mental effects to the serviceability of the crossing surface. In track surfacing projects, the general track raise should be tapered off in the area approaching the crossing so as not to disturb the elevation of the crossing. Or, the level of the entire crossing should be raised and gradual adjustments should be made in the grade line of the highway approaches consistent with the profile design criteria for the class of highway involved. If more than one track is involved, the adjusted surface of the entire crossing should lie in one plane and all tracks should be raised to correspond with the new elevation.

Caution must also be taken when constructing or maintaining crossing surfaces in signalized track territory. The rails must be kept insulated one from the other. Metal contact between the rails will shunt the track circuit and cause signal failures. Standing water in the crossing area may also shunt the circuit.

In highway resurfacing projects, the crossing surface should be raised, if necessary, to avoid creating a pocket that will increase the flow of surface drainage into the crossing area. Track raises should be made where necessary to accommodate the highway grade adjustment. Also, highway agencies should raise approaches where necessary to accommodate track grade adjustments.

Proper liaison should be established between railroad and highway authorities so that plans and scheduling of work can be coordinated to avoid the planning or execution of work on either the highway or railroad that might adversely affect the grade line of the other. This is especially true for removing snow from the crossing surface. Removal of

snow from only the crossing surface, and not the approaches, will result in a trough at the track and may cause a vehicle to stall on the track. The operation of snow plows must avoid damage to the rails. Windrows across the track or the highway should be avoided.

Following are descriptions of various types of crossing surfaces along with typical cross sections. These cross sections do not show a stabilization fabric because the best position for a fabric in each situation will depend on the combination of subgrade material, subballast, climatic conditions, drainage method, and other relevant characteristics of the site. Information on the use of several types of crossing surfaces by State is given in Appendix F. Table 42 provides a specification check list for several types of crossing surfaces.

1. Unconsolidated

Unconsolidated crossing surfaces are those that consist of sand, gravel or other material placed between and outside the rails. While they

may be appropriate for some very low density unpaved roads, particularly in combination with low-density rail operations, they are undesirable because without frequent replacement of the materials, vehicles may become caught between the rails. A surprisingly large number of public crossings have this type of surface. If they are used, they should be used only on highways that also are unconsolidated, i.e. gravel roads.

2. Asphalt

An asphalt crossing surface is monolithic, formed from a pavement type mixture of non-metallic aggregate and a bituminous binder (usually hot mix). It may include flangeway protectors of planks, flange rails, or other devices that form flangeway openings on the inside of the running rails. A line of timbers or flangeway rails is sometimes placed on the outside of the running rails. A cross section of a typical plain asphalt crossing is shown in Figure 73.

Asphalt crossings are relatively inexpensive to install. However, they must be torn out and completely re-

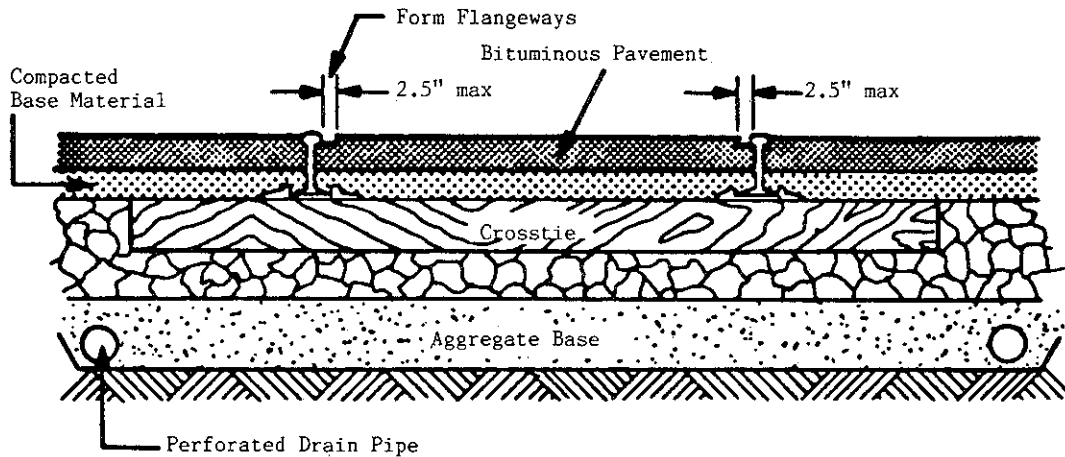

Figure 73. Typical Cross Section thru Plain Asphalt Crossing



Table 42. Crossing Surface Data Sheet

	Cobra X (R)	Fab-Ra-Cast (1984)	General Tire Genrac I	General Tire Genrac II	Goodyear Super Cushion	R.R. Crossings, Inc.* Steel-Epoxy Coat	Red Hawk Rubber Co.	Structural Rubber SafNDri Mod. C	Structural Rubber SafNDri Mod. S	Kralburg Strail "Hi-Rail"	Premier Conc. Precast Conc.	OMNI Rubber Products Inc.	Park Rubber Co. Parkco	Koppers Wear Guard
Length of Ties	8'-6"	8'-6" 9'-0"	9'-0"	8'-6"	8'-6" 9'-0"	8'-6" 9'-0"	8'-6" 9'-0"	8'-6" 9'-0"	8'-6" 9'-0"	8'-6" 9'-0"	N/A	8'-0" 9'-0"	8'-0", 8'-6" 9'-0"	8'-6" 9'-0"Y
Tie Spacing	18"	Any	18"	18"	18"	19½"	18"	18"	20"	18"	N/A	18"	18"	19-3/16"
Maximum Length of Tie Plates	18"	Any	14"	14"	16"	14"	16"	16"	14"	16"	N/A	18"	As Specified	As Specified
Size of Fasteners	3/4" x 12"	N/R	8"	11"	3/4" x 12"	7/8" x 7"	12"	12"	12"	N/R	N/A	10½"	8", 10", 12"	3/4" x 12" 5/8" x 5"
Type of Fasteners	Drive	N/R	TS/DR	TS/DR	Drive	LSW	TSW	LAG	LAG	N/R	Conc. Anchor	TS	Cable, Rod Lag	DR, LAG, TS
Fasteners Furnished	Y	N/R	Y	Y	Y	Y	Y	Y	Y	N/R	Y	Y	Y	Y
Additional Washers Necessary	Y	N/R	N	N	Y	Y	Y	N	N	N/R	N/R	N	Y	As Specified
Additional Washers Necessary	Y	N/R	N	N	Y	Y	Y	N	N	N/R	N/R	N	Y	Y
# Fasteners/Tie - Maximum	7	N/R	12	16	18	16	18	10	N/R	N/A	8	4	8	
# Fasteners/Tie - Average	7	N/R	12	7	12	12	11	6	5	N/R	N/A	5	N/A	8
X-ing Pads Predrilled	Y	N/R	Y	Y	Y	Y	Y	Y	Y	N/R	Y	If Required	If Required	Y
Spike Holes Countersunk	Y	N/R	Y	Y	Y	Y	Y	Y	Y	N/R	N/A	Y	N	Y
Spike Hole Plugs Furnished	N	N/R	Y	Y	Y	Optional	Y	N	N	N/R	N	Y	N/R	N/R
Length of Gage Pads	18"	96"	18"	72"	36"	58"	36"	35"	80"	36"	48"	72"	72"	96"
Length of Field Pads	18"	96"	18"	72"	36"	58"	36"	36"	80"	36"	48"	72"	72"	96"
Gage Pads - # of Pieces	1	1	1	2	1	2	1	1	2	1	2	2	2	2
Depth of Material	Full	Full	Full	2-3/8"	2½"	Full	3"	2-13/16"	5"	Full	Full	Full	3½"	1-1/8" Pad Full Timber
Steel Reinforced	N	Y	Y	Y	Y	N/A	Y	Y	Y	N	Y	N	Y	N
Tongue & Groove Design	Y	N	N	N	N	N	N	Y	Y	Y	N	N	Y	N
Weight of Gage Pads	90#	2,200#	240#	395#	310#	1,084#	320#	222#	680#	575#	700#	625#	325#	570#
Weight of Field Pads	34#	1,000#	105#	275#	116#	800#	125#	90#	460#	230#	3,800#	575#	175#	462#
Shims Necessary - Furnished	N/R	N/R	N/R	Y	Y	N/R	Y	Y	Y	N/R	N/R	N/R	Y	N/R
Shim Fasteners - Furnished	N/A	N/A	N/A	Y	Y	N/A	Y	Y	Y	N/R	N/A	N/A	Y	N/R

151

Table 42 (Continued). Crossing Surface Data Sheet

	Cobra X (R)	Fab-Ra-Cast (1984)	General Tire Genrac I	General Tire Genrac II	Goodyear Super Cushion	R.R. Crossings, Inc.* Steel - Epoxy Coat	Red Hawk Rubber Co.	Structural Rubber SafNDri Mod. C	Structural Rubber SafNDri Mod. S	Kralburg Strall "Hi-Roll"	Premier Conc. Precast Conc.	OMNI Rubber Products Inc.	Park Rubber Co. Parkco	Koppers Wear Guard
Abrasion Pads Recommended	Y	N	Y	Y	Y	N	Y	Y	Y	N	N	N	N	Y
Abrasion Pads Furnished	Y	N/R	Field Side Only	Y	Y	N	Y	Y	Y	N	N	N	If Specified	Y+
Header Board Required	N	N	N	Y	Y	N	Y	Y	Y	N	N	N	N	N
Type of Header Material	N/A	N/A	N/A	Rubber/Wood	Rubber/Wood	N/A	Rubber/Wood	Rubber/Wood	Rubber/Wood	N/A	N/A	N/A	Wood/Rubber/Polypropylene/Steel	N/A
Header Material Furnished	N	N	N	Y	Y	N	Y	Y	Y	-	N	N	As Specified	N/R
Maximum Curve Allowable	20°	22°	35°	0°	30°	20°	9°	30°	15°	9°	8°	Any	19°	Any
Can Materials be Ordered, Cut or Modified for Use in Switches?	Field Cut	Ordered To Fit	N	N	N	Ordered To Fit	Y	N	Ordered To Fit	Y	N	Y	Ordered To Fit	Y Factory Cut
End Plates Available	Y	Y	Y	Y	Y	Y	Y	Y	Y	Y	Y	Y	Y	N/R
End Plates Furnished	Y+	Y	Y	Y+	Y	Y	Y	Y	Y	Y	Y	Y+	Y	N/A
Gage Side Flangeway	Y	Y	Y	Y	Y	Optional	Y	Y	Y	Y	Y	Y	Y	Y
Gage Flangeway Type	Struct. Foam	Mastic	Rubber	Rubber	Rubber	Steel	Rubber	Rubber	Rubber	Rubber	Conc.	Rubber	Rubber	Timber
Can Pads in Center of X-ing be Removed Without Removing Balance of Crossing?	Y	Y	Y	Y	Y	Y	Y	Y	Y	N	Y	Y	Y	Y

- N/R = Not Required
- N/A = Not Applicable
- N = No
- Y = Yes
- DR or Drive = Washer Head Drive Spikes
- LAG = Lag Screws
- + = At additional cost
- LSW = Lag Screws with Attached Washer
- TS = Timber Screws
- TSW = Timber Screws with Attached Washers
- \* = Specifications are for R.R.C. Super Heavy Duty Model. Other lighter weight models available.

Note: The data on this table was collected by the Union Pacific Railroad

placed whenever track resurfacing is done. Good track conditions through the crossing area and good drainage of the subgrade will reduce maintenance costs. This type of crossing can be installed during paving of a street or road over light-density rail lines by allowing the asphalt paving machine to continue over the crossing, using the top of rails as a top of pavement reference.

The use of a plank or timber header, as shown in Figure 74, on each side of the running rail will

reduce deterioration of the crossing surface that might be caused by the effect of rail flexure on the bituminous surface material in direct contact with the rail. Planks or timbers must be wide enough to extend over the area of the tie plate and spikes, to provide support on the ties, and to be anchored to them.

A scrap railroad rail may be used to form a flangeway as shown in Figures 75 and 76. The rail is laid on its side with the head fitted against the web and under the head of

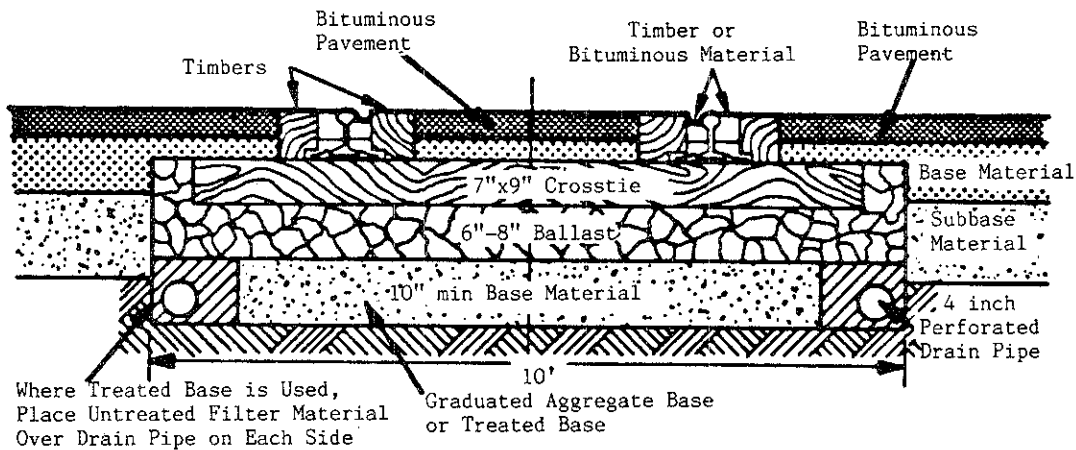

Figure 74. Typical Cross Section thru Asphalt Crossing with Timber Headers

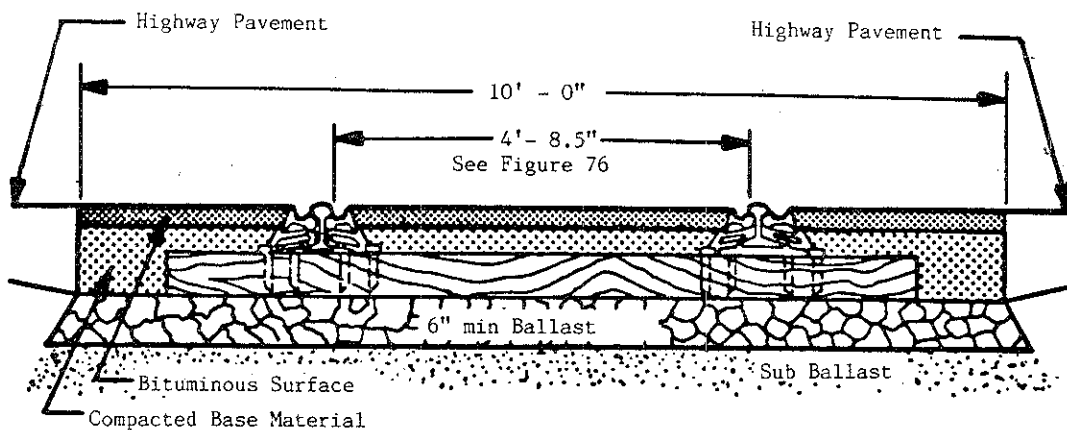

Figure 75. Typical Cross Section thru Asphalt Crossing with Flange Rails

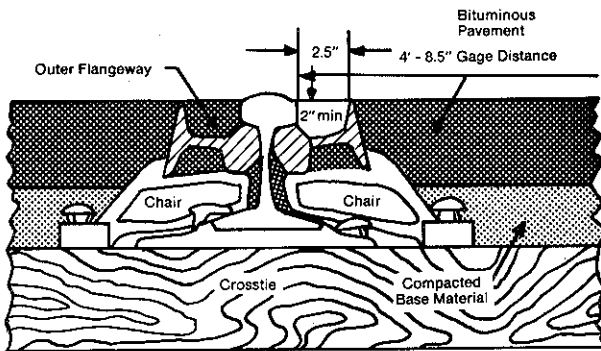

Figure 76. Detail Section Thru Flangeway of Asphalt Crossing

the running rail. The scrap rail is supported by steel chairs that are made and marketed by Nelson Iron Works, Inc. and also distributed by Virginia Suppliers. They are made to fit the desired combination of running rail and flangeway rail. With this flangeway construction, the bituminous material is placed against the vertically-positioned base of the flangeway rail and against the outside of the running rail. At crossings carrying heavier volumes of highway or railroad traffic, an additional scrap rail may be installed on rail chairs on the outside of the running rail to avoid the deteriorating effect of flexure of the running rail on the bituminous surface.

Another product that provides a formed flangeway and eliminates contact of the running rails with crossing surface materials is Epflex Railseal, produced and marketed by Epton Industries of Kitchener, Ontario, Canada. An extruded elastomeric product formed from an ethylene propylene copolymer, it can be used with asphalt, concrete and timber surfaces. Typical cross sections are shown in Figure 77. Epflex Railseal has been installed at more than 200 crossings on Canadian railroads, the first in 1970.

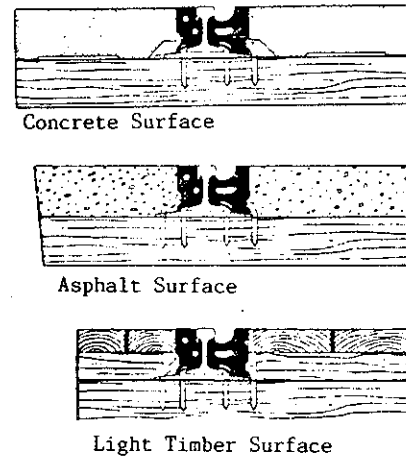

Figure 77. Typical Cross Section of Epflex Railseal

### 3. Wood Plank

A wood plank crossing surface is formed by installing planks or timbers as individual pieces over the entire crossing area as shown in Figure 78. An advantage of the wood plank crossing is that it can be continuously maintained by replacement of deteriorated or worn planks one at a time. A disadvantage is that it cannot be removed and replaced in sections for track maintenance purposes, making more difficult the continuing flow of highway traffic during maintenance operations.

Wood planks in a crossing may be full depth from top of rail to top of tie in order to eliminate the use of shims. Planks should not be less than four inches thick and where used, shims should not be less than 1.625 inches thick.

Flangeway openings on the gauge side of the running rail are provided in various ways, such as by dapping the underside of a plank to clear the tie plates and spike heads and spacing them to allow an appropriate flangeway width.

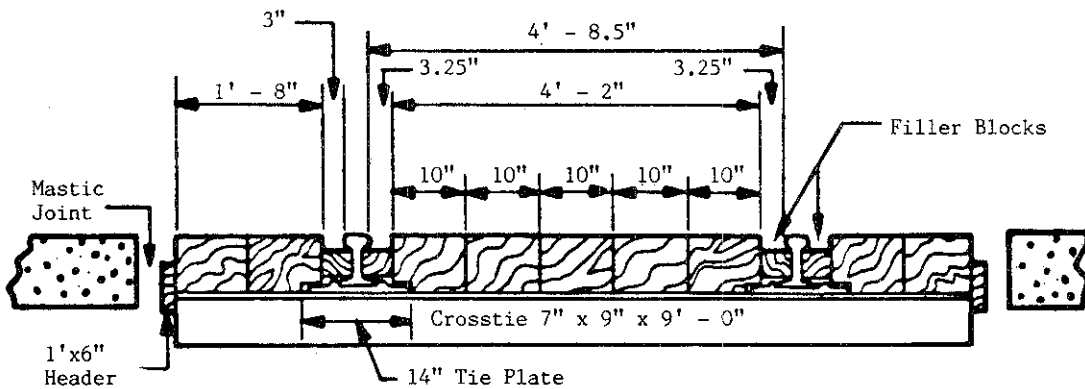

Figure 78. Typical Cross Section thru Wood Plank Crossing

4. Sectional Treated Timber

A sectional treated timber crossing consists of an assembly of pre-fabricated treated timber panels, installed between the rails and to the ends of the ties as shown in Figure 79. The panels can be removed and replaced for maintenance purposes.

The panels are fabricated from gum timbers or other suitable hardwood timbers. Usually, the timber is thick enough to extend from the top of the rail to the top of the tie and not require shims. Thinner timbers can be used with shims on top of the ties. The minimum thickness of timber should be 5.125 inches and the minimum thickness of shims should be 1.625 inches.

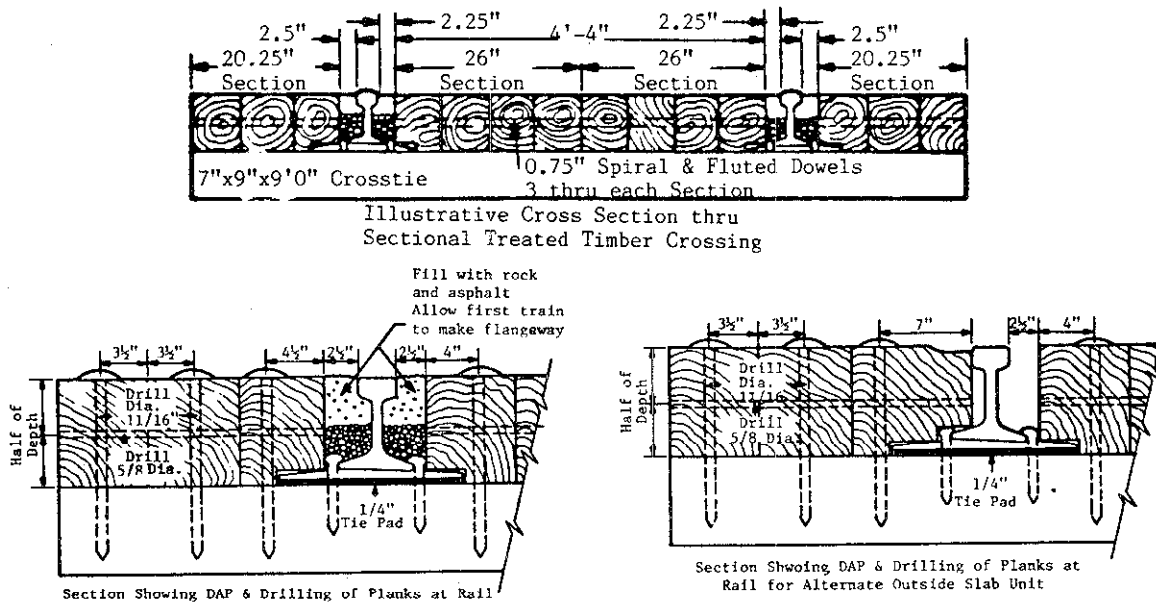

Figure 79. Typical Cross Section thru Sectional Treated Timber Crossing

The timbers are securely fastened together in panels to permit adequate dapping of the underside of the edge timbers to provide proper clearance over the tie plates and spike heads. A flangeway width of 2.5 inches on the gage side of the running rail is provided. The flangeway opening can be filled with rock and asphalt or a treated timber filler block.

The widths of the outside panels vary to accommodate various lengths of ties. Typically, the widths are 17 inches to accommodate eight foot ties, 20 inches for 8.5 foot ties, and 24 inches for nine foot ties. Inside panels are a standard 25.5 inches. Sections are usually furnished in eight foot or 6.4 foot lengths to accommodate 19.2 inch tie spacing. Other lengths are available. The end panels are beveled four inches at 45 degrees to minimize damage from dragging railroad equipment.

Dome-head drive spikes, washer-head drive spikes, or lag screws with steel washers are used to secure the timber panels to the ties. The heads of the washer-head drive spikes and the lag screws are countersunk to provide a smooth riding surface. One manufacturer has an optional double coil spring-loaded drive spike that absorbs shock from the traffic and is

designed to keep tension between the drive spike and timber.

Some manufacturers provide rubber cushions that are placed under the timber panels to reduce vibration. Others provide a non-skid safety plate on the top surface of the panels as an optional feature. For example, Koppers Company, Inc. recently introduced "Wear Guard" (patent pending) that is a replaceable 1.125 inch thick high-density polyethylene surface. These panels are secured to the timber panels with dome head lag screws or timber screws. This wear surface can be removed and replaced when needed without having to remove the entire crossing surface.

Manufacturers of treated timber panels are:

- o The Burke-Parsons-Bowlby Corp.;
- o International Track Systems, Inc.;
- o Kerr-McGee Chemical Corp.;
- o Koppers Company, Inc.; and,
- o W.J. Smith Wood Preserving Co.

### 5. Precast Concrete Slabs

This type of crossing surface consists of precast reinforced concrete panels, shown in Figure 80, that may be removed and reinstalled for maintenance and replacement purposes. However, due to their weight,

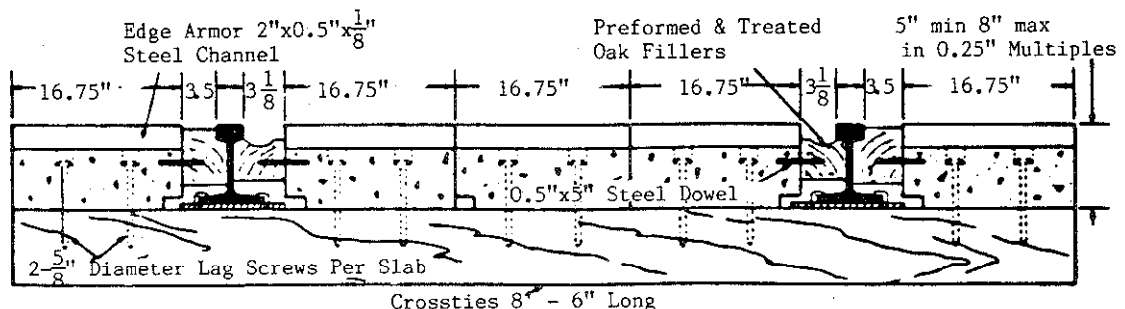

Figure 80. Typical Cross Section thru Concrete Slab Crossing

approximately 1,500 to 2,500 pounds, they must be removed by powered mechanical equipment.

The reinforcement typically consists of 10 longitudinal 0.375 inch deformed bars made into two mats of five bars each and spaced one inch from the top and bottom surfaces, and five 0.5 inch deformed bars laid transversely in the bottom of the slab. The concrete has a compressive strength of 5,000 to 6,000 lbs in 28 days and a one inch maximum slump.

The panels are manufactured in various lengths, usually six, eight, or nine feet. A crossing made by Permacrete Products Corporation has concrete slabs that fit 18 inch tie spacing and a crossing made by International Track Systems has a slab that fits 19.2 inch tie spacing. One or more center sections are placed between the running rails with flangeway openings ranging from 2.5 to 3.25 inches. Outside sections usually extend to the ends of the ties, although some are slightly narrower. Slabs are typically 16.75 inches wide.

International Track Systems, Inc. has a precast concrete slab that utilizes two slabs for the center section with treated guard timbers adjacent to the running rail, both on the inside and outside slabs. Permacrete's crossing also utilizes treated timbers adjacent to the running rail. The timbers are dapped to fit over the tie plates and spike heads and form the flangeway opening. Timbers are held to the concrete with tie rods.

The thickness of concrete slabs varies. Some are full depth from top of rail to top of tie while some use shims on the ties to bring the top surface of the slab up to the top of

rail. Typical slab thicknesses are five to eight inches. Some concrete slabs have edges that are protected with steel armor that require special provisions for electrical insulation when located in track circuit territory. End slabs are beveled to prevent possible damage from dragging railroad equipment. Rubber pads that are placed on the the ties are standard features of International Track Systems installations.

The design and installation of precast concrete slab crossings should be such that after a period of time they do not rock. Surface spalling of concrete slabs can be repaired using an epoxy product. Periodic surface treatments are sometimes used to reduce spalling.

One precast concrete slab crossing is designed so that the center slabs are not held in position by metal hardware but are restrained against lateral movement by rubber-resin filler between the edge of the slabs and the web of the running rail as shown in Figure 81. This filler is also used in the space between the outside slabs and the running rail. The slabs are supported vertically by grout bags resting on top of the ties. This surface is registered under the name FAB-RA-CAST and is distributed by Szarka Enterprises. The normal slab units are eight feet long and five inches thick. Clear openings of 2.5 inches are provided on both sides of each head of the running rails. This flangeway is filled with a cryogenically processed rubber and moisture cured polyurethane that is field mixed and poured in place. This filler is called FAB-RA-FILLER and is used to protect the integrity of signal and communications systems. Since the slabs are not connected to the ties, they can be installed in a track having con-

Chapter IV Identification of Alternatives

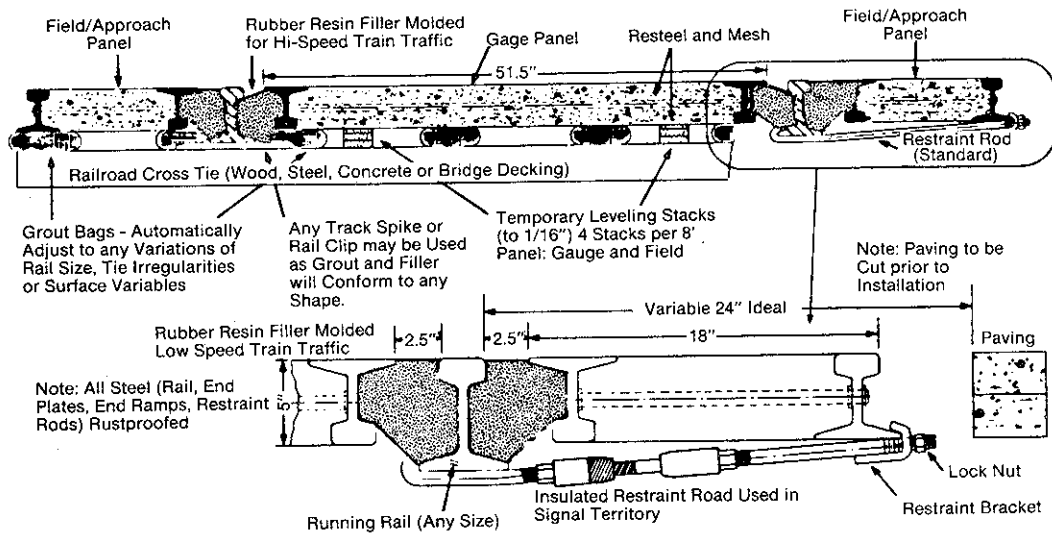

Figure 81. Typical Cross Section thru FAB-RA-CAST Crossing

crete ties as well as wood ties. The top surface is broom - finished to improve skid resistance and reduce hydroplaning.

The Premier crossing, shown in Figure 82, does not utilize cross-ties. It is a patented concrete slab crossing incorporating a precast reinforced concrete base placed on a compacted subgrade. The running rails are inserted in a custom formed recess and center panels bolted into place. The modules are reinforced with high tensile wire mesh. Rails

are placed on a 0.125 inch thick continuous polyurethane strip that prevents abrasion between steel and concrete and provides electrical insulation and less rail/wheel noise. No spikes, rail anchors or tie plates are utilized. The end concrete modules are sloped 45 degrees to prevent damage caused by dragging railroad equipment. A 2.5 inch flangeway width is provided. The top of the finished modules has a textured finish, cast against a non-skid floor plate surface. The Premier crossing surface is available from Pacific

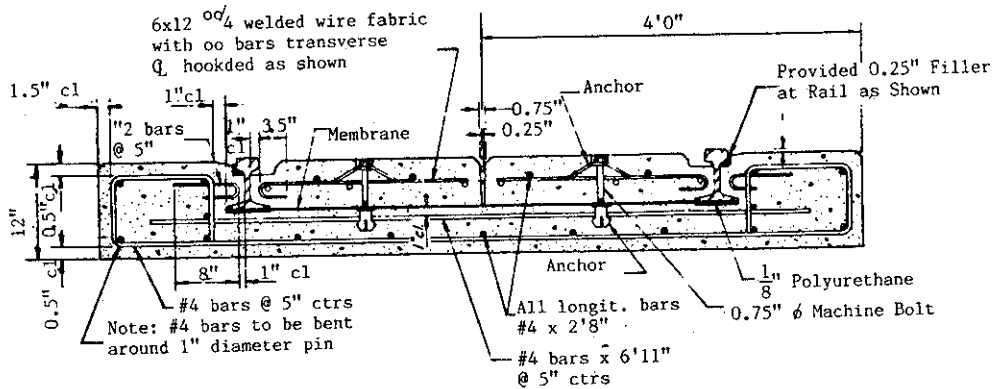

Figure 82. Typical Cross Section thru Premier Crossing



International Pipe and Engineering, Inc. and Railroad Crossings, Inc.

6. Continuous Concrete Pavement

The cross section of a cast-in-place continuous concrete surface that covers the entire crossing area encasing the crossties is shown in Figure 83. This type of surface does not allow for track maintenance without removing the surface. Therefore, a continuous concrete pavement should be used only on auxiliary tracks where track resurfacing will not be needed during the life of the crossing surface. Such a surface might be appropriate at locations where a track extends longitudinally in a paved street. While the encasement of a track in a concrete pavement is relatively expensive, it can provide excellent riding quality over the track area. It is totally unsuited for use on a main track.

7. Steel Sections

Several manufacturers have produced prefabricated steel sections of an open grating type, that may be installed and removed individually for maintenance and replacement purposes. An advantage of this crossing surface is the better aeration of

the ballast and roadbed section in the crossing area, providing the area under the crossing and on top of the ballast is kept clear of dirt and debris. Accumulation and retention of dirt on the steel crossing may lead to rapid corrosion. These surfaces generally have good riding quality but are sometimes difficult to hold in place. Shims are required on top of the ties. Insulation is required in track circuit territory.

Steelplank Corporation produces a solid surface sectional steel crossing that is shown in Figure 84. It is made of die formed 0.25 inch steel and consists of channel shaped planks for the running surface that are solidly welded to U-shaped supporting sections that rest directly on and are secured to the ties with six inch lag screws. These support risers run perpendicular to the ties and, while 19.5 inch tie spacing is preferred, minor variations in spacing are not critical. Center sections of the five-plank units are 6.5 feet long and 4.23 feet wide. Approach panels are 20 inches wide. Tapered end sections are available to prevent damage from dragging railroad equipment. To permit installation and removal of lag screws, access holes are provided in the center of

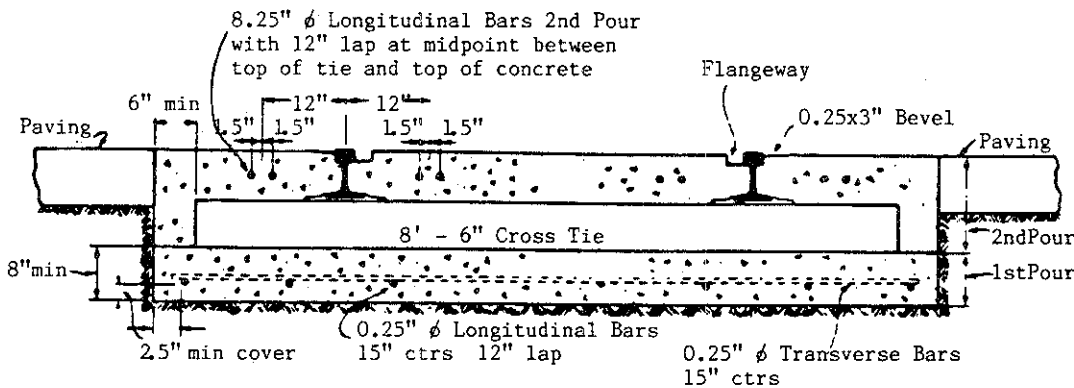

Figure 83. Typical Cross Section thru Continuous Concrete Pavement

Chapter IV Identification of Alternatives

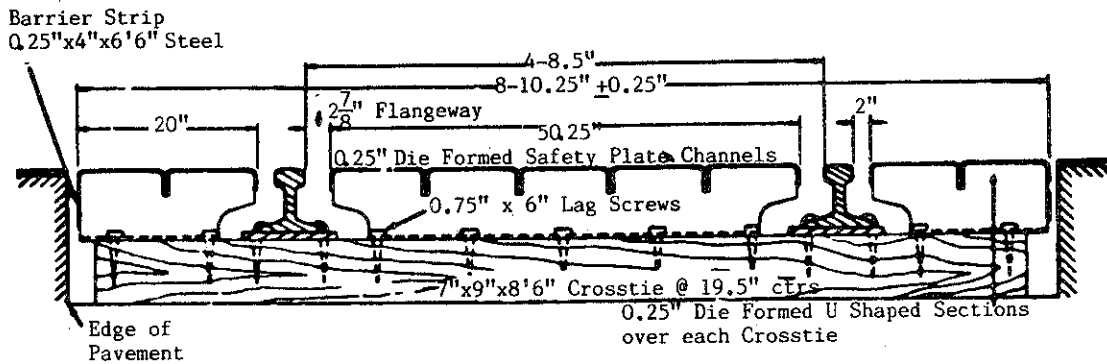

Figure 84. Typical Cross Section thru Steelplank Crossing

each plank at each end and the center of the panels. Steelplank crossings are made to fit the rail height and tie plate thickness and require no shims. The surface is made of steel safety plates with an abrasive epoxy finish for skid resistance. Complete epoxy encapsulation of crossing panels can be provided to meet unusual exposure problems. Steelplank panels can be built to accommodate curves, frogs, and turnouts.

R.R. Crossings, Inc. manufactures a steel crossing surface, Uni-Panel, shown in Figure 85, that is

designed for heavy wheel loadings for heavy industry. Most of their surfaces are used as custom applications for corporations that maintain their own sidings and crossing areas. Each standard steel Uni-Panel consists of a flat deck plate, formed box channel risers, a diagonal web, and end plates. Access holes through the deck plate permits fastening of the Uni-Panel to the tie, using either full-threaded lag screws or rotating drive spikes, along with rubber shock absorbers and metal washers. The Uni-Panel channel risers are custom made to match the combined height of

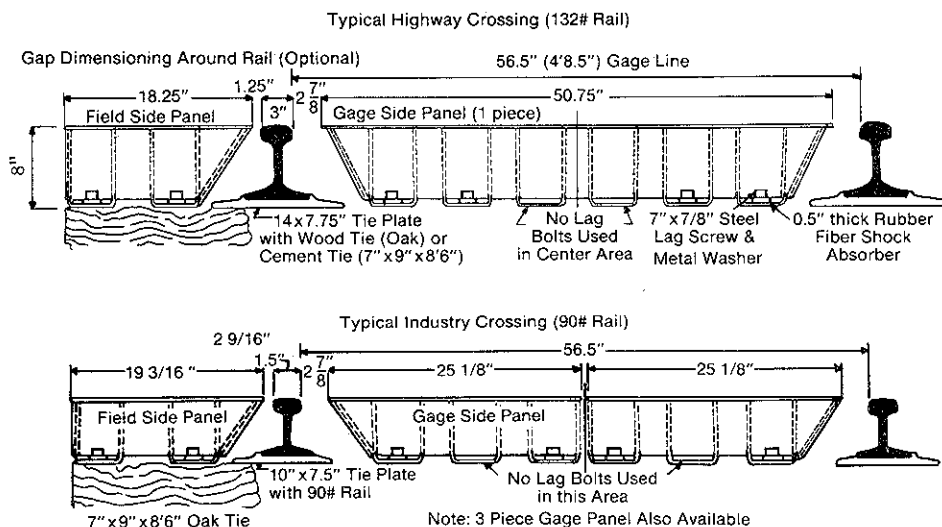

Figure 85. Typical Cross Section thru R.R. Crossings, Inc. Crossing

the rail and tie-plate. The standard tie spacing is 19.5 inches, but the surface can be customized for any crossing. Flangeways of 2.875 inches are provided. The steel surfaces are coated with a coal tar epoxy and the top surface given a non-skid treatment. End sections are tapered to prevent damage from dragging railroad equipment. A 0.25 inch rubber strip can be fastened between the center panels to provide signal insulation.

8. Rubber Panels

This type of crossing surface consists of molded rubber panels usually steel-reinforced and with a patterned surface. The panels can be removed and replaced for track maintenance. There are several manufacturers of rubber crossing panels as discussed below.

The Goodyear Tire and Rubber Company makes a rubber crossing surface, known as Supercushion and first produced in 1954, with panels that are three feet long, each spanning two tie spaces. The center pads extend from rail web to rail web, with 2.375 inch flangeway openings. Side panels are 21 inches wide at the top and fit against the head of the running rail as shown in Figure 86.

Thus the Goodyear crossing completely covers an 8 foot 6 inch tie and provides header strips at each end. For nine foot ties, extension pads are furnished as a part of the header strips. Panels require performed wood shims on top of the ties held in place by eight inch spikes driven into the ties. A 0.25 inch rubber abrasion pad is installed on top of the shims to reduce abrasion and wear. A diamond pattern antiskid surface is molded into the rubber. The transverse joints between the panels can be sealed against water penetration by applying pressure to compress a 0.125 inch by 0.25 inch protrusion at the top edge before the panels are fastened to the ties. Rubber header strips are now provided instead of wood header boards. Galvanized steel end plates are furnished to prevent damage by dragging railroad equipment.

OMNI Rubber Products, Inc, a subsidiary of Riedel International, has recently introduced a rubber crossing surface called OMNI. This crossing surface, is full-depth and requires no shims, as shown in Figure 87. It can be installed on concrete ties. The panels are custom molded to fit specific rail and tie plate dimensions and the six foot long pan-

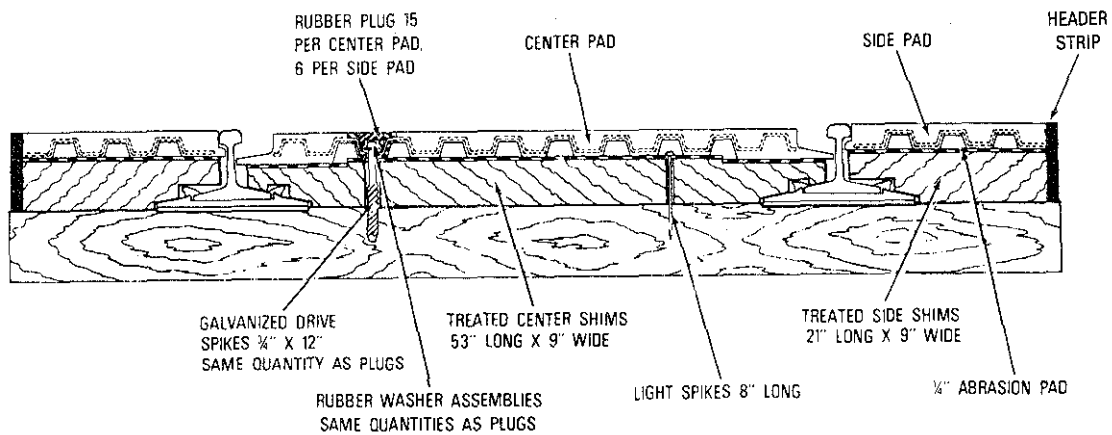

Figure 86. Typical Cross Section thru Goodyear Tire & Rubber Co. Crossing



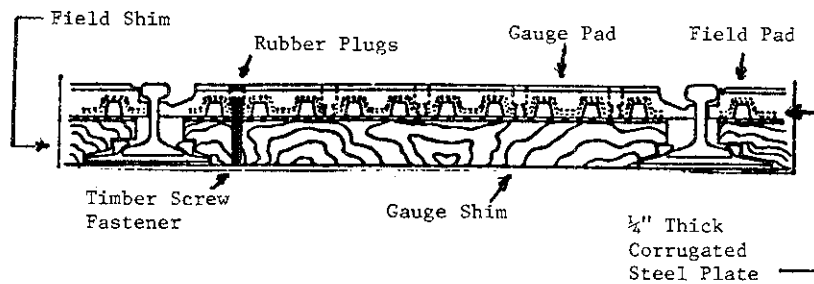

Figure 89. Typical Cross Section thru Red Hawk Crossing

shown in Figure 89, that contains a 0.25 inch thick corrugated steel plate that is completely encased in three inch thick rubber pads. Timber screws are used to fasten the panels and creosoted wood shims to the ties. The center pads are 3 feet long and 4.92 feet wide, providing a flangeway width of 2.5 inches. Side pads are 21 inches wide. Header material comes in 9 or 12 foot lengths, eight inches high and is made of timber, rubber, or polypropylene. Ties should be at least 8.5 feet long on 18 inch centers.

Strail Hi-Rail, a full depth ethylene propylene, rubber crossing is shown in Figure 90. This crossing was developed in Germany by the Kraiburg Rubber Company, the Huls Chemical Company, and the German Federal Railways. Being full depth, this crossing requires no shims. An anti-skid tread design is used for wear resistance, water shed, and weather proofing. The panels are fitted together using tongue and groove at the transverse joints to reduce noise and

to lock the system in place. No lag bolts, shims, or cables are required. The rubber panels accommodate 8.5 foot and 9.0 foot tie lengths, 85 lb to 140 lb rail heights and adapts to turn-outs and curves. The gauge and field pads are 36 inches in length. The gauge pad extends to and locks under the railhead and on top of the rail base on both sides.

Structural Rubber Products manufactures a rubber crossing surface called SAF & DRI, shown in Figure 91. The panels are formed of rubber encapsulated four by eight inch steel tubes. Two center panels are comprised of six tubes and the two side panels are comprised of two tubes each. The steel tubes are completely encased in rubber with a 0.3 inch top wearing surface and 0.5 inch pads on the bottom side of each tube at each tie location. Intermittent vibration dampeners bear against each side of the rail web. Special modeling configurations provide water tight flangeway openings on the gage side of the running rail along with addi-

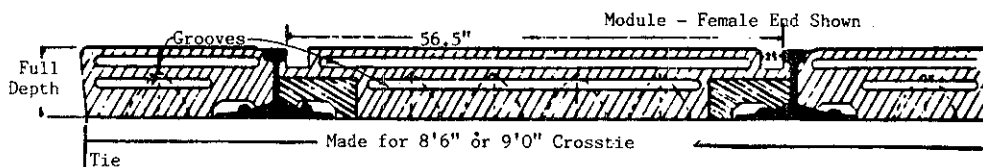

Figure 90. Typical Cross Section thru Strail Hi-Rail Crossing



inch flangeways. Field modules, are 20 inches wide, extending to the end of an 8.5 foot tie. These modules span one tie space of 18 inches. Preformed and countersunk holes, aligned with the ties, provide a drilling template for the anchoring drive spikes. The modules are available in various heights between six and eight inches to accommodate a variety of rail sizes and tie plate thicknesses. The modules are full depth and do not require shims.

No national guidelines exist for selecting the appropriate surface for a specified crossing. Thirty-seven States have guidelines for selecting the type of crossing surface. Ten States require the railroad to select, construct, and maintain crossing surfaces. Factors that should be considered in selecting an appropriate surface are as follows.

- o Highway traffic - The volume, type, and speed of highway traffic affects the loadings the surface must bear. Many States consider AADT and percent trucks when selecting a surface.
- o Highway functional classification - This factor is generally a measure of the volume and capacity of the highway.
- o Special vehicles - Crossings used regularly by special vehicles should be given very careful consideration.
- o Railroad traffic - The volume, type, and speed of railroad traffic affects the loading the supporting track and subgrade has to bear. Some States consider gross tonnage over the crossing.
- o Track classification - This factor generally is a measure of the

weight of rail and size as well as the volume and type of train traffic.

- o Accident history - Particularly, accidents related to the condition of the surface.
- o Engineering judgment
- o Costs - Initial construction cost, replacement cost, and maintenance cost.
- o Expected service life of surface

At least 23 States consider AADT as one factor in selecting a crossing surface. The AADT groups vary considerably. Rubber crossings are specified for crossings with AADT's greater than a certain value: the minimum value ranges from 1,000 to 10,000. Asphalt and timber crossings are specified for crossings with AADT's of certain values less than a value which ranges from 100 to 7,500.

Consideration should be given to using header boards or header strips made of materials other than wood, e.g. rubber, polymeric, or metal. Some States have found that wooden header boards deteriorate quickly. Whatever is used, careful steps should be taken to ensure a clean separation between crossing surface and approach pavement.

The Florida Department of Transportation (DOT), Office of Value Engineering, completed a Highway Planning Research study to develop criteria for the selection of crossing surfaces. The expected life of each surface type is reduced by factors for various characteristics of a crossing: AADT, percent trucks, track spacing, and gross train tonnage. These factors were determined from data on the actual condition of

## Chapter IV Identification of Alternatives

various surface types of various ages. The equivalent annual cost for each surface type is then determined based on costs per linear foot. The surface type with the lowest equivalent annual cost is selected.

The Florida DOT has also developed a procedure for the selection of crossing surfaces for improvement. Crossings are assigned points in four areas as follows.

- o Condition of surface - cracking and patching
- o Slowing and swerving by drivers
- o Dipping and bouncing of vehicles
- o Rail and pad movement

The final formula also considers AADT and percent trucks.

The condition of the crossing surface should be evaluated at least by physical inspection and by riding over it. Two States utilize the Mays Ride Meter to assess surface condition. One State performs skid tests. A few States assign a rating to the surface condition using a questionnaire or point system.

Other States have conducted evaluations of crossing surfaces in service. Because of the variety of test conditions, procedures, and documentations, the results of these evaluations are not reported here. Following is a list of States known to have completed a formal documented evaluation.

Connecticut	Mississippi	Ohio
Florida	Missouri	Pennsylvania
Illinois	Montana	South Dakota
Louisiana	Nebraska	Tennessee
Michigan	Nevada	Wisconsin

### F. Removal of Grade Separation Structures

There are nearly 38,000 public grade separated railroad - highway crossings in the United States. More than half of the grade separated crossings have a bridge or highway structure over the railroad tracks. As these structures age, become damaged, or are no longer needed because of changes in highway or railroad alignment or use, alternative engineering decisions must be made. The alternatives to be considered are: 1) upgrade the existing structure to new construction standards; 2) replace the existing structure; 3) remove the structure, leaving an at-grade crossing, and 4) close the crossing and remove the structure.

In general, crossing programs are based upon criteria established for the installation of traffic control devices or the elimination of a crossing. However, rehabilitation of structures is a significant part of the crossing improvement program at both the State and national level. Currently, there are no nationally recognized guidelines for evaluating the alternatives available for the improvement or the replacement of grade separation structures.

Some States have developed evaluation methods for the selection of projects to remove grade separation structures. The following is a summary of the State of Pennsylvania guidance.

The purpose of the Pennsylvania guidance is to assist highway department personnel in the selection of candidate bridge removal projects where the railroad line is abandoned. Both bridges carrying highways over railroad and bridges carrying aban-



## Chapter IV Identification of Alternatives

doned railroads over highways can be considered.

The factors to be considered in selecting candidate projects are as follows.

For bridges carrying highway over an abandoned railroad

- o Bridges that are closed or posted for a weight limit because of structural deficiencies (The length of the necessary detour is important.)
- o Bridges that are narrow and therefore hazardous
- o Bridges with hazardous vertical and/or horizontal alignment of the highway approaches (Accident records can be reviewed to verify such conditions.)

For bridges carrying abandoned railroad over a highway

- o Bridges that are structurally unsound and a hazard to traffic operating under the bridge
- o Bridges whose piers and/or abutments are in close proximity to the traveled highway and constitute a hazard
- o Bridges whose vertical clearance over the highway is substandard
- o Bridges where the vertical and/or horizontal alignment of the highway approaches are hazardous primarily because of the location of the bridge

It should be noted that this guidance is applicable to situations that involve abandoned rail lines.

In those instances where a railroad continues to operate, other decisions must be made. Some considerations for removing a grade separation over, or under a rail line that is still being operated are as follows.

- o Can the structure be removed and replaced with an at-grade crossing?
- o Who is liable if an accident occurs at the new at-grade crossing?
- o If the structure is to be rebuilt, who is to pay the cost or who is to share in the cost and to what extent?
- o To what standards is the structure to be rebuilt?
- o What is the future track use and potential for increase in train frequency?
- o If the structure is replaced with an at-grade crossing, what delays to motorists and emergency service will result? Are alternate routes available?
- o What impact will an at-grade crossing have on railroad operations?
- o What will be the impact on safety of an at-grade crossing vs. a structure?

To ensure a proper answer to these and other related questions, an engineering evaluation, including relative costs, should be conducted. This evaluation should follow procedures described in Chapter V.

**G. References**

1. American National Standard Practices for Roadway Lighting, New York, NY: Illuminating Engineering Society of America, July 1977.
2. Code of Federal Regulations, Title 23, Washington, DC: General Services Administration, published annually.
3. Collision of Amtrak Train No. 88 with Tractor Lowboy Semitrailer Combination Truck, Rowland, N.C., August 25, 1983, Washington, DC: National Transportation Safety Board, Report No. NTSB/RHR-84/01, 1984.
4. The Effectiveness of Automatic Protection in Reducing Accident Frequency and Severity at Public Grade Crossings in California, San Francisco, CA: California Public Utilities Commission, June 1974.
5. Federal-Aid Highway Program Manual, Washington, DC: Federal Highway Administration, updated periodically.
6. Federal Highway Administration Survey of Region and Division Offices, unpublished, 1984.
7. Federal Railroad Administration, Data from the U.S. DOT/AAR National Rail-Highway Crossing Inventory, 1984.
8. Field and Office Manual for Profile Surveys of Highway-Rail At-Grade Crossings on Existing Paved Roadways, Tallahassee, FL: Florida Department of Transportation, September 1984.
9. Fitzpatrick, Gary M., Standardization of Criteria for Rail/Highway Grade Crossing Construction, Tallahassee, FL: Florida Department of Transportation, Office of Value Engineering, August 1982.
10. Guide for Selecting, Locating, and Designing Traffic Barriers, Washington, DC: American Association of State Highways and Transportation Officials, 1977.
11. Heathington, K.W. and T. Urbanik, "Driver Information Systems for Highway-Railway Grade Crossings", Highway Research Record No. 414, Washington, DC: Highway Research Board, 1972.
12. Hedley, William J., Proceedings, American Railway Engineering Association, Volume 53, Chicago, IL: 1952.
13. Hedley, William J., Railroad-Highway Grade Crossing Surfaces, Washington, DC: Federal Highway Administration, August 1979.
14. Illinois Commerce Commission General Order No. 138 Revised, Springfield, IL: Illinois Commerce Commission, 1973.
15. Knoblauch, Karl, Wayne Hucke, and William Berg, Rail Highway Crossing Accident Causation Study. Volume II, Technical Report, Washington, DC: Federal Highway Administration, Report FHWA/RD-81/083, August 1982.
16. Manual for Railway Engineering, Washington, DC: American Railway Engineering Association, 1981.
17. Manual on Uniform Traffic Control Devices, Washington, DC: Federal Highway Administration, 1978, revised 1979, 1983, 1984.
18. Mather, Richard A., "Public Railroad-Highway Grade Crossing Illumination Project in Oregon", Washington, DC: Transportation Research Board, January 1983.
19. Monroe, Richard L., Debra K. Munsell, and T. James Rudd, Constant Warning Time Concept Development for

- Motorist Warning at Grade Crossings, Washington, DC: Federal Railroad Administration, Report FRA/ORD-81/07, May 1981.
20. Morrissey, J., The Effectiveness of Flashing Lights and Flashing Lights with Gates in Reducing Accident Frequency at Public Rail-Highway Crossings, 1975-1978, Washington, DC: Federal Railroad Administration and Federal Highway Administration, April 1980.
21. A Policy on Geometric Design of Highway and Streets, Washington, DC: American Association of State Highway and Transportation Officials, 1984.
22. Proceedings, National Conference on Railroad-Highway Crossing Safety, Colorado Springs, CO: U.S. Air Force Academy Interim Education Center, August 1974.
23. Proceedings, National Conference on Railroad-Highway Crossing Safety, Salt Lake City, UT: University of Utah, August 1977.
24. Proceedings, National Rail-Highway Crossing Safety Conference, Knoxville, TN: The University of Tennessee, June 1980.
25. Rail-Highway Grade Crossing Warning Systems and Surfaces, Alexandria, VA: The Railway Progress Institute, 1983.
26. Roadway Lighting Handbook, Washington, DC: Federal Highway Administration, Implementation Package 78-15, December 1978.
27. Ruden, Robert J., Albert Burg, and John P. McGuire, Activated Advance Warning for Railroad Grade Crossings, Washington, DC: Federal Highway Administration, Report FHWA/RD-80/003, July 1982.
28. Standard Alphabet for Highway Signs and Markings, Washington, DC: Federal Highway Administration.
29. Traffic Control Devices Handbook, Washington, DC: Federal Highway Administration, 1983.
30. Uniform Vehicle Code and Model Traffic Ordinance, National Committee of Uniform Traffic Laws and Ordinances, Charlottesville, VA: The Michie Company, 1961 and Supplement, 1979.
31. "Use of Traffic Divisional Islands at Railroad Grade Crossings," Technical Notes 84-1, Albany, NY: New York Department of Transportation, March 1984.
32. West Virginia's Highway-Railroad Manual, Charleston, WV: West Virginia Department of Highways, Railroad Section, Right of Way Division, preliminary, 1984.

## V. SELECTION OF ALTERNATIVES

In this Chapter, analyses are presented to assist in improvement alternative selection by examining the costs and benefits of each alternative and by making comparisons among alternatives. In addition, these analyses can be used to prioritize projects for implementations and funding.

Methods for selecting alternatives and economic analysis techniques which may be utilized are discussed. In addition, the Rail-Highway Crossing Resource Allocation Procedure is presented. Other low-cost solutions are also discussed.

### A. Warrant Procedures

As noted in Chapter IV, some Federal and/or State guidelines have been established for certain types of improvements. In some cases, these guidelines serve as a threshold for implementation action when certain conditions exist, thus dictating the appropriate improvement alternative. In most cases, however, the guidelines provide for several alternative improvements.

### B. Economic Analysis Procedures

An economic analysis may be performed to determine the possible alternative improvements which could be made at a railroad-highway grade crossing. These procedures involve estimates of expected project costs and safety and operational benefits for each alternative. Much of the following discussion is adapted from the methodology presented in the Highway Safety Improvement Program User's Manual (HSIP User's Manual).

Initially, information on the following elements must be established, using the best available facts and estimates.

- o Accident costs
- o Interest rates
- o Service life
- o Initial improvement costs
- o Maintenance costs
- o Salvage value
- o Traffic growth rates

Other considerations are the effectiveness of the improvement in reducing accidents and the effects on travel, such as reduction in delays.

The cost information is not always readily available, thus some States are reluctant to impute a dollar cost to human life or personal injury. Considerable care must be used in establishing values for these costs.

The selection of accident cost values is of major importance in the economic analyses. The two most common sources of accident costs are:

- o National Safety Council (NSC), and
- o National Highway Traffic Safety Administration (NHTSA).

NSC costs include wage losses, medical expenses, insurance administrative costs, and property damage. NHTSA includes the calculable costs associated with each fatality and injury plus the cost to society, i.e. consumption losses of individuals and society at large caused by losses in production and the inability to produce. Many states have developed their own values which reflect their situation and philosophy. Whichever

## Chapter V Selection of Alternatives

is selected the values ought to be consistent with those used for other safety improvement programs.

An appropriate interest rate is needed for most of the procedures considered. The selection of an inappropriate interest rate could result in unsuitable project costs and benefits and thus, in selection of an ineffective solution. Periods of rapid inflation and fluctuation of interest rates make the identification of an appropriate rate somewhat difficult. The standard rates used by the highway department should be selected.

The HSIP Users' Manual states that the service life of an improvement should be equal to the time period that the improvement can reasonably affect accident rates. Both costs and benefits should be calculated for this time period. Hence, the service life is not necessarily the physical life of the improvement. For railroad-highway grade crossings, however, it is a reasonable assumption that the improvement would be equally effective over its entire physical life. Thus, selecting the service life equal to the physical life would be appropriate.

The selected service life can have a profound effect on the economic evaluation of improvement alternatives; therefore, it should be selected using the best available information. The Depreciation Branch of the Interstate Commerce Commission (ICC) periodically studies individual Class I railroads to determine the economic life of railroad signal equipment. For example, their results indicate that the average ICC signal equipment depreciation period in 1977 for the 20 largest Class I railroads was 30 years.

Project costs should include initial capital costs and maintenance costs and be considered as life-cycle costs, i.e. all costs are distributed over the service life of the improvement.

The installation cost elements include the following.

- o Preliminary engineering
- o Labor
- o Material
- o Lease or rental of equipment
- o Miscellaneous costs

The maintenance costs are all those costs associated with keeping the system and components in operating condition. Maintenance costs are discussed in Chapter VII.

The salvage value is defined as the dollar value of a project at the end of its service life and is therefore dependent on the service life of the project. For crossing signal improvement projects, salvage values are generally very small.

There are several accepted economic analysis methods, all of which require different inputs, assumptions, calculations, and methods, and which may yield different results. Several appropriate methods are described here.

### 1. Cost-Effectiveness Analysis

The cost-effectiveness analysis method is an adaptation of a traditional safety analysis procedure based on the calculation of the cost to achieve a given unit of effect (reduction in accidents). The significant aspects of this procedure is that it need not require the assignment of a dollar value to human injuries or fatalities, and requires minimal manpower to apply.

The following steps should be performed for the cost-effectiveness technique.

1. Determine the initial capital cost of equipment, e.g. flashing lights or gates, and other costs associated with project implementation.
2. Determine the annual operating and maintenance costs for the project.
3. Select units of effectiveness to be used in the analysis. The desired units of effectiveness may be:
  - o number of total accidents prevented;
  - o number of accidents by type prevented;
  - o number of fatalities or fatal accidents prevented;
  - o number of personal injuries or personal injury accidents prevented; and/or,
  - o number of Equivalent Property Damage Only (EPDO) accidents prevented.
4. Determine the annual benefit for the project in the selected units of effectiveness, i.e. total number of accidents prevented.
5. Estimate the service life.
6. Estimate the net salvage value.
7. Assume an interest rate.
8. Calculate the equivalent uniform annual costs (EUAC) or present worth of costs (PWOC).

9. Calculate the average annual benefit, B, in the desired units of effectiveness.

10. Calculate the cost-effectiveness (C/E) value using one of the following equations:

$$C/E = EUAC / B , \text{ or}$$

$$C/E = PWOC (CRF \frac{i}{n}) / B$$

where:

$CRF \frac{i}{n}$  = Capital recovery factor for n years at interest rate i.

A sample worksheet, with fictitious values, is given in Figure 93 for illustration.

This is an iterative process for each alternative improvement. The results for all projects can then be arrayed and compared for selection. A computer program can be used for the analysis and ranking of projects.

## 2. Benefit-Cost Ratio

The benefit/cost ratio (B/C) is the accident savings in dollars divided by cost of the improvement. Using this method, costs and benefits may be expressed as either an equivalent annual or present worth value of the project.

The B/C technique requires the following steps.

1. Determine the initial cost of implementation of the crossing improvement being studied.
2. Determine the net annual operating and maintenance costs.

Chapter V Selection of Alternatives

COST-EFFECTIVENESS ANALYSIS WORKSHEET

Evaluation No.: \_\_\_\_\_ Project No.: \_\_\_\_\_ Date: \_\_\_\_\_  
 Evaluator: \_\_\_\_\_

- 1. Initial implementation cost, I: \$ 100,000
- 2. Annual operating and maintenance costs before project implementation: \$ 100
- 3. Annual operating and maintenance costs after project implementation: \$ 1,000
- 4. Net annual operating and maintenance costs,  $K = \#3 - \#2$ : \$ 900
- 5. Annual safety benefits in number of injury accidents prevented, B, from below: 2

Accident Type	Actual	-	Expected	=	Annual Benefit
Injury	4	-	2	=	2
Total					

- 6. Service life, n: 20 years
- 7. Salvage value, T: \$ 5,000
- 8. Interest rate: 10 % = 0.10  
(Annual compounding interest)

- 9. EUAC Calculation:  
 Capital recovery factor, CR = 0.1175  
 Sinking fund factor, SF = 0.0175

$$EUAC = I (CR) + K - T (SF)$$

$$= 100,000 (0.1175) + 900 - 5,000 (0.0175) = 12,562$$

- 10. Annual benefit: B (from #5) = 2 injury accidents

$$11. C/E = EUAC/B = 12,562 / 2 = \$6,281 / \text{injury accidents prevented}$$

- 12. PWOC Calculation:  
 Present worth factor, PW = 8.5136  
 Single payment present worth factor, SPW = 0.1486

$$PWOC = I + K (PW) - T (SPW)$$

$$= 100,000 + 900 (8.5136) - 5,000 (0.1486) = 106,919$$

- 13. Annual benefit  
 n (from #6) = 20 years  
 B (from #5) = 2 accidents prevented per year

$$14. C/E = PWOC (CR)/B$$

$$= (106,919)(0.1175) / 2 = \$ 6,281 / \text{injury accidents prevented}$$

Figure 93. Sample Cost-Effectiveness Analysis Worksheet

3. Determine the annual safety benefits derived from the project.
4. Assign a dollar value to each safety benefit unit (NSC, NHTSA or other).
5. Estimate the service life of the project based on patterns of historic depreciation of similar types of projects.
6. Estimate the salvage value of the project or improvement after its primary service life has ended.
7. Determine the interest rate by taking into account the time value of money.
8. Calculate the B/C ratio using equivalent uniform annual costs (EUAC) and equivalent uniform annual benefits (EUAB).
9. Calculate the B/C ratio using present worth of costs (PWOC) and present worth of benefits (PWOB).

A sample worksheet with fictitious values for the B/C analysis is given in Figure 94.

This method requires an estimate of accident severity in dollar terms, which can greatly affect the outcome. It is relatively easy to apply and is generally accepted in engineering and financial studies. As with the cost-effectiveness method, the process can be performed for alternative improvements at a single crossing, and arrayed for all projects to determine priorities for funding.

### 3. Net Annual Benefit

The net annual benefit method is based on the premise that the relative merit of an improvement is measured by its net annual benefit. This

method is used to select improvements that will ensure maximum total benefits at each location. The net annual benefit of an improvement is defined as follows.

$$\text{Net Annual Benefit} = (\text{EUAB}) - (\text{EUAC})$$

where:

$$\begin{aligned} \text{EUAB} &= \text{Equivalent Uniform Annual Benefit} \\ \text{EUAC} &= \text{Equivalent Uniform Annual Cost} \end{aligned}$$

A positive value for net annual benefit indicates a feasible improvement and the improvement, or set of improvements, with the largest positive net annual benefit is considered to be the best alternative.

The following steps should be used to compute the net annual benefit.

1. Estimate the initial cost, annual cost, terminal value, and service life of each improvement.
2. Estimate the benefits (in dollars) for each improvement.
3. Select an interest rate.
4. Compute the EUAB.
5. Compute the EUAC.
6. Calculate the Net Annual Benefit of each improvement.

For the data and calculations shown in Figure 94, the net annual benefit would be \$91,438, determined from an EUAB of \$104,000 less an EUAC of \$12,562.

While any of the three methods is an acceptable procedure to follow for economic analyses, they might



Chapter V Identification of Alternatives

BENEFIT-TO-COST ANALYSIS WORKSHEET

Evaluation No.: \_\_\_\_\_ Project No.: \_\_\_\_\_ Date: \_\_\_\_\_  
 Evaluator: \_\_\_\_\_

1. Initial implementation cost, I: \$ 100,000
2. Annual operating and maintenance costs before project implementation: \$ 100
3. Annual operating and maintenance costs after project implementation: \$ 1,000
4. Net annual operating and maintenance costs, K (#3 - #2): \$ 900
5. Annual safety benefits in number of accidents prevented:
 

Severity	Actual	-	Expected	=	Annual Benefit
a) Fatal accidents (fatalities)	0	-	0	=	0
b) Injury accidents (injuries)	4	-	2	=	2
c) PDO accidents (involvements)	5	-	3	=	2
6. Accident cost values (Source Department)
 

Severity	Cost
a) Fatal accident (fatality)	\$ <u>500,000</u>
b) Injury accident (injury)	\$ <u>50,000</u>
c) PDO accident (involvement)	\$ <u>2,000</u>
7. Annual safety benefits in dollars saved, B:
 

(5a) x (6a) =	<u>500,000 x 0 = 0</u>
(5b) x (6b) =	<u>50,000 x 2 = 100,000</u>
(5c) x (6c) =	<u>2,000 x 2 = 4,000</u>
Total =	<u>\$104,000</u>
8. Service life, n: 20 yrs
9. Salvage value, T: \$5,000
10. Interest rate, i: 10% = .10  
(Annual compounding interest)
11. EUAC Calculation:
 

Capital recovery factor, CR	= <u>0.1175</u>
Sinking fund factor, SF	= <u>0.0175</u>
EUAC = I (CR) + K - T (SF)	
=	<u>100,000 (0.1175) + 900 - 5,000 (0.0175) = 12,562</u>
12. EUAB Calculation: EUAB = B = 104,000
13. B/C = EUAB/EUAC = 104,000 / 12,562 = 8.3
14. PWOC Calculation:
 

Present worth factor, PW	= <u>8.5136</u>
Single payment present worth factor, SPW	= <u>0.1486</u>
PWOC = I + K (SPW) - T (PW)	
=	<u>100,000 + 900 (8.5136) - 5,000 (0.1486) = 106,919</u>
15. PWOB Calculation:
 

PWOB = B (SPW)	= <u>104,000 (8.5136) = 885,414</u>
----------------	-------------------------------------
16. B/C = PWOB/PWOC = 885,414 / 106,919 = 8.3

Figure 94. Sample Benefit-to-Cost Analysis Worksheet

produce different results depending on the values. Table 43 illustrates this point. In this table, the values shown for the second alternative are from the example provided above. Based on the cost - effectiveness method, the analyst would select the third alternative. The benefit/cost ratio method would lead to selecting the second alternative. The first alternative would be selected if the net benefit method was followed for this example.

Given that different results can occur, the agency should not follow just one procedure. At least two methods should be followed with the decision based on these results and other factors, constraints, and policies of the agency.

Table 43. Comparison of Cost-Effectiveness, Benefit/Cost, and Net Benefit Methods

Alternative	Initial Costs	Cost-Effectiveness (\$/acc.)	B/C	Net Benefit
A	1,000,000	106,000	2	200,000
B	100,000	6,281	8.3	91,438
C	20,000	5,100	5	70,000

### C. Resource Allocation Procedure

In lieu of the economic analysis procedures described above, the U.S. Department of Transportation (DOT) has developed a resource allocation procedure for railroad-highway grade crossing improvements. This procedure was developed to assist States and railroads in determining the effective allocation of Federal funds for crossing traffic control improvements.

The resource allocation model is designed to provide an initial list of crossing traffic control improvements that would result in the greatest accident reduction benefits on the basis of cost-effectiveness considerations for a given budget. As designed, the results are checked by a diagnostic team in the field and revised as necessary. It should be noted that the procedure considers only traffic control improvement alternatives as described below.

- o For passive crossings, single track, two upgrade options exist; flashing lights or gates.
- o For passive, multiple-track crossings, the model allows only the gate option to be considered in accordance with the FHPM 6-6-2-1.
- o For flashing light crossings, the only improvement option is gates.

Other improvement alternatives, such as removal of site obstructions, crossing surface improvements, illumination, and train detection circuitry improvements, are not considered in the resource allocation procedure.

The input data required for the procedure consists of the number of predicted accidents, safety effectiveness of flashing lights and automatic gates, improvement costs, and amount of available funding.

The number of annual predicted accidents can be derived from the U.S. DOT Accident Prediction Model or from any model that yields the number of annual accidents per crossing. (See discussion in Chapter III.)

Safety effectiveness studies for the equipment used in the resource allocation procedure have been com-

Chapter V Selection of Alternatives

pleted by the U.S. DOT, the California Public Utilities Commission, and William J. Hedley. The resulting effectiveness factors of these studies were given in Table 34 for the types of signal improvements applicable for the procedure. Effectiveness factors are the percent reduction in accidents occurring after the implementation of the improvement.

The model requires data on the costs of the improvement alternatives. Life cycle costs of the devices should be used, i.e. both installation and maintenance costs.

Costs used in the resource allocation procedure must be developed for each of the three alternatives:

- o passive devices to flashing lights;
- o passive devices to automatic gates; and,
- o flashing lights to gates.

Caution should be exercised in developing specific costs for a few selected projects while assigning average costs to all other projects. If this is done, decisions regarding the adjusted crossings may be unreasonably biased by the algorithm.

The amount of funds available for implementing crossing signal projects is the fourth input for the resource allocation procedure.

The resource allocation procedure is shown in Figure 95. It employs a step-by-step method, using the inputs described above.

For any proposed signal improvement, a pair of parameters,  $E_j$  and  $C_j$  must be provided for the resource allocation algorithm. As shown in Table 44,  $j = 1$  for flashing lights installed at a passive crossing,  $j = 2$  for gates installed at a passive crossing, and  $j = 3$  for gates installed at a crossing with flashing lights. The first parameter,  $E_j$  is

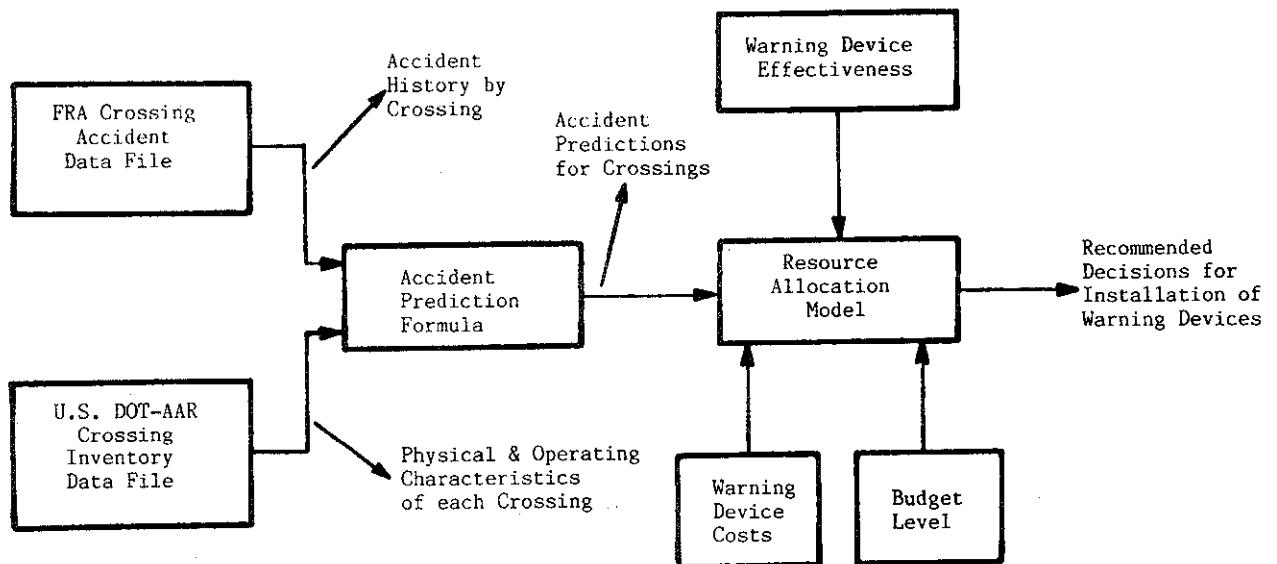

Figure 95. Crossing Resource Allocation Procedure

Source: Ref. 3

Table 44. Effectiveness/Cost  
Symbol Matrix

Proposed Warning Device	Existing Warning Device	
	Passive	Flashing Lights
Flashing Lights: Effectiveness	$E_1$	--
Cost	$C_1$	--
Automatic Gates: Effectiveness	$E_2$	$E_3$
Cost	$C_2$	$C_3$

Source: Ref. 3

the effectiveness of installing a proposed warning device at a crossing with a lower class warning device. The second parameter,  $C_i$  is the corresponding cost of the proposed warning device.

The resource allocation procedure considers all crossings with either passive or flashing light traffic control devices for signal improvements. If, for example, a single-track passive crossing,  $i$ , is considered, it could be upgraded with either flashing lights, with an effectiveness  $E_1$ , or gates, with an effectiveness of  $E_2$ . The number of predicted accidents at crossing  $i$  is  $A_i$ ; hence, the reduced accidents per year is  $A_i E_1$  for the flashing light option and  $A_i E_2$  for the gate option. The corresponding costs for these two improvements are  $C_1$  and  $C_2$ . The accident reduction/cost ratios for these improvements are  $A_i E_1 / C_1$  for flashing lights and  $A_i E_2 / C_2$  for gates. The rate of increase in accident reduction versus costs, that results from changing an initial decision to install flashing lights with a decision to install gates at crossing  $i$ , is referred to as the incremental accident reduction/cost ratio and is equal to:

$$A_i (E_2 - E_1) / (C_2 - C_1).$$

If a passive multiple-track crossing,  $i$ , is considered, the only improvement option allowable would be installation of gates, with an effectiveness of  $E_2$ , a cost of  $C_2$  and an accident reduction/cost ratio of  $A_i E_2 / C_2$ . If crossing  $i$  was originally a flashing light crossing, the only improvement option available would be installation of gates, with an effectiveness of  $E_3$ , a cost of  $C_3$  and an accident reduction/cost ratio of  $A_i E_3 / C_3$ .

The individual accident reduction/cost ratios which are associated with these improvements are selected by the algorithm in an efficient manner to produce the maximum accident reduction which can be obtained for a predetermined total cost. This total cost is the sum of an integral number of equipment costs ( $C_1$ ,  $C_2$  and  $C_3$ ). The total maximum accident reduction is the sum of the individual accident reductions of the form  $A_i E_j$ .

The resource allocation procedure is being updated to include the severity prediction equations discussed in Chapter III.

If this resource allocation procedure is used to identify high hazard crossings, a field diagnostic team should investigate each selected crossing for accuracy of the input data and reasonableness of the recommended solution. A worksheet for accomplishing this is included in Figure 96. This worksheet also includes a method for manually evaluating or revising the results of the computer model.

#### D. Selection of Other Improvements

The types of selection procedures described above require information on installation and mainte-

# Chapter V Selection of Alternatives

## RAIL-HIGHWAY CROSSING RESOURCE ALLOCATION PROCEDURE VERIFICATION WORKSHEET

This worksheet provides a format and instructions for use in field evaluation of crossing to determine if initial recommendations for warning device installations from the Resource Allocation Procedure should be revised. Steps 1 through 5, described below, should be followed in making the determination. In Steps 1 and 3, the initial information (left column) is obtained from office inventory data prior to the field inspection. In Step 4, the decision criteria values are obtained from the Resource Allocation Model printout.

### STEP 1: Validate Data used in Calculating Predicted Accidents:

<u>Crossing Characteristic</u>	<u>Initial Information</u>	<u>Revised Information</u>
Crossing Number	_____	_____
Location	_____	_____
Existing Warning Device	_____	_____
Total Trains per Day	_____	_____
Annual Average Daily Highway Traffic (c)	_____	_____
Day thru Trains (d)	_____	_____
Number of Main Tracks (mt)	_____	_____
Is Highway Paved? (hp)	_____	_____
Maximum Timetable Speed, mph (ms)	_____	_____
Highway Type (ht)	_____	_____
Number of Highway Lanes (hl)	_____	_____
Number of Years of Accident History (T)	_____	_____
Number of Accidents in T Years (N)	_____	_____
Predicted Accident Rate (A)	_____	_____

### STEP 2: Calculate Revised Accident Prediction from DOT Formula if any Data in Step 1 has been Revised.

Revised Predicted Accidents (A) = \_\_\_\_\_

### STEP 3: Validate Cost and Effectiveness Data for Recommended Warning Device

Assumed Effectiveness of Recommended Warning Device (E)	_____	_____
Assumed Cost of Recommended Warning Device (C)	_____	_____
Recommended Warning Device Installation	_____	_____

### STEP 4: Determine if Recommended Warning Device should be Revised if A, E, or C has Changed.

#### 1. Obtain Decision Criteria Values from Resource Allocation Model Output:

$$DC_1 = \text{_____} \quad DC_2 = \text{_____} \quad DC_3 = \text{_____} \quad DC_4 = \text{_____}$$

2. Calculate:  $R = \frac{\text{Revised A}}{\text{Previous A}} \times \frac{\text{Revised E}}{\text{Previous E}} \times \frac{\text{Previous C}}{\text{Revised C}}$

#### 3. Compare R with Appropriate Decision Criteria as shown Below:

Existing Passive Crossing (Classes 1, 2, 3, 4) Single Track		Existing Passive Crossing (Classes 1, 2, 3, 4) Multiple Tracks		Existing Flashing Light Crossing (Classes 5, 6, 7)	
<u>Comparison</u>	<u>Decision</u>	<u>Comparison</u>	<u>Decision</u>	<u>Comparison</u>	<u>Decision</u>
$DC_2 \leq R$	Gates	$DC_3 \leq R$	Gates	$DC_4 \leq R$	Gates
$DC_3 \leq R < DC_2$	Flashing Lights	$R < DC_3$	No Installation	$R < DC_4$	No Installation
$R < DC_1$	No Installation				

#### 4. Revised Recommended Warning Device Installation\* \_\_\_\_\_

### STEP 5: Determine other Characteristics that may Influence Warning Device Installation Decisions

Multiple tracks where one train/locomotive may obscure vision of another train? _____	Either, or any combination of, high vehicular traffic volumes, high numbers of train movements, substantial numbers of school buses or trucks carrying hazardous materials, unusually restricted sight distance or continuing accident occurrences** _____
Percent trucks _____	
Passenger train operations over crossing _____	
High speed trains with limited sight distance** _____	
Combination of high speeds & moderately high volumes of highway & railroad traffic** _____	

\*The cost and effectiveness values for the revised warning device are assumed to change by an amount proportional to the change in these values for the initial recommended warning device as determined in Step 3.

\*\*Gates with flashing lights are the only recommended warning device per 23CFR 646.214(b)(3)(i).

Figure 96. Resource Allocation Procedure Field Verification Worksheet

Source: Ref. 3

nance costs and safety effectiveness of each alternative improvement.

There is, however, a family of improvements for which there is no data on safety benefits. Such improvements include closure, removal of obstructions, surface improvements, train detection circuitry improvements, improved signing and pavement markings, preemption of highway signals at nearby intersections, innovative signals, and railroad operational improvements. Good engineering practice should be used to identify specific crossing problems and to reveal the most appropriate solutions for these situations. Extensive economic analysis may not be required to effect safety and operational improvements at crossings.

Some safety projects may be selected on the basis of other socio-economic considerations, such as State or local political constraints, availability of financial or manpower resources, etc. These situations must be decided on the basis of individual merit.

#### E. References

1. The Effectiveness of Automatic Protection in Reducing Accident Frequency and Severity at Public Grade Crossings in California, San Francisco, CA: California Public Utilities Commission, June 1974.

2. Highway Safety Improvement Program, User's Manual, Washington, DC: Federal Highway Administration.

3. Hitz, John and Mary Cross, Rail-Highway Crossing Resource Allocation Procedure User's Guide, Washington, DC: Federal Highway Administration and Federal Railroad Administration, Report FHWA-IP-82-7, December 1982.

4. Morrissey, J., The Effectiveness of Flashing Lights and Flashing Lights with Gates in Reducing Accident Frequency at Public Rail-Highway Crossings, Washington, DC: Federal Railroad Administration, Report FRA-RRS-80-005, April 1980.

## VI. IMPLEMENTATION OF PROJECTS

An organized approach to the implementation of a railroad-highway grade crossing improvement program is necessary so that its administrators will proceed effectively and expeditiously to obtain the benefits of the program. The implementation component consists of obtaining all required regulatory and funding approvals, preparing and executing agreements between participating parties (potentially Federal, State, railroad, and local highway authority), designing the selected alternative in detail, establishing appropriate accounting procedures (generally set forth in the agreements), and constructing the project.

### A. Funding

Sources of funds for railroad-highway grade crossing improvements include Federal, State, and local government agencies, railroad industry, and special funding. The following is a brief description of these funding sources.

#### 1. Federal Sources

The Surface Transportation Assistance Act of 1982 authorized the appropriation of Federal-aid highway funds through fiscal year 1986. This Act, a fourth in a series of highway safety acts, continues a railroad-highway grade crossing safety improvement program that began in 1973. This crossing program is commonly referred to as the Section 203 program. Fifty percent of the Section 203 funds are apportioned to the States according to the ratio of the number of public crossings in each State to the total number of public crossings in the nation. The remainder is ap-

portioned on the basis of population, area, and road mileage of each State compared to the total in the nation.

Federal Section 203 funds may be used for, but are not limited to, the following types of crossing improvement projects.

- o Crossing elimination by new grade separations, relocation of highways, relocation of railroads, and crossing closure without other construction
- o Reconstruction of existing grade separations
- o Crossing improvement by:
  - installation of standard signs and pavement markings;
  - installation or replacement of active warning devices, including track circuit improvements and interconnection with highway intersection traffic signals;
  - crossing illumination;
  - crossing surface improvements; and,
  - general site improvements

For projects completed with Section 203 funds, the Federal share of the improvement costs are 90%. States, local governments, railroads, and other involved parties may participate in the remaining 10% share of the costs.

States cannot require a railroad to participate in the cost of certain crossing improvement projects com-

## Chapter VI Implementation of Projects

pleted with Federal funds. These projects are specified by the Federal-aid Highway Program Manual (FHPM), 6-6-2-1, as follows.

- o Projects for crossing improvements are deemed to be of no ascertainable net benefit to the railroads and there shall be no required railroad share of the costs.
- o Projects for the reconstruction of existing separations are deemed to generally be of no ascertainable net benefit to the railroads and there shall be no required railroad share of the costs, unless the railroad has a specific contractual obligation with the State or its political subdivision to share in the costs.
- o On projects for the elimination of existing crossings at which active traffic control devices are not in place and have not been ordered or installed by a State regulatory agency, or on projects that do not eliminate an existing crossing, there shall be no required railroad share of the project cost.

The railroad share of Federal-aid projects that eliminate an existing crossing at which active traffic control devices are in place, or ordered to be installed by a State regulatory agency, is to be 5%. These costs are to include costs for preliminary engineering, right-of-way, and construction as described below.

- o Where a crossing is eliminated by grade separation, the structure and approaches required to transition to a theoretical highway profile that would have been constructed if there were no railroad present, for the number of lanes on the existing highway and in accordance with the current design

standards of the State highway agency

- o Where another facility, such as a highway or waterway, requiring a bridge structure is located within the limits of a grade separation project, the estimated cost of a theoretical structure and approaches as described above to eliminate the railroad - highway grade crossing without considering the presence of the waterway or other highway
- o Where a grade crossing is eliminated by railroad or highway relocation, the actual cost of the relocation project, or the estimated cost of a structure and approaches under specified conditions

Railroads may voluntarily contribute a greater share of project costs. Railroads may be willing to assume a greater share if certain concessions are made, e.g. closure of one or more crossings. Also, other parties may voluntarily assume the railroad's share.

At least one-half of the Section 203 Federal funds must be used for the installation of "protective" devices, which the Federal Highway Administration (FHWA) has defined to include crossbucks, warning signs, pavement markings, flashing light signals, automatic gates, crossing surfaces and illumination. The remaining funds may be used for any type of eligible improvement.

Another Federal program provides funds for railroad - highway grade crossings. The 1982 Surface Transportation Assistance Act authorized \$7.05 billion for the "on and off" system highway bridge replacement and rehabilitation program. All highway bridges on public roads, regardless



of existing ownership or maintenance responsibility, could be eligible under this program. The Federal share in this program is 80%. To be eligible for these funds, the highway bridge over the railroad must be included in the State's bridge inventory and be placed onto the State's prioritized implementation schedule.

In addition to the specific programs described above, other regular Federal-aid highway funds may be used for improvements at crossings. The Federal share is the normal pro-rata share for the Federal - aid highway funds involved, e.g. 75% for primary funds. However, under the provisions of the law, certain categories of funds may be increased up to 100% of the cost of preliminary engineering and construction. In this case right-of-way costs remain at 75%.

Other requirements pertaining to the use of Federal funds are as follows.

- o Federal funds are not eligible to participate in costs incurred solely for the benefit of the railroad.
  - o At grade separations Federal funds are eligible to participate in costs to provide space for more tracks than are in place when the railroad establishes, to the satisfaction of the State highway agency and FHWA, that it has a definite demand and plans for installation of the additional tracks within a reasonable time.
  - o The Federal share of the cost of a grade separation project shall be based on the cost to provide horizontal and/or vertical clearances used by the railroad in its normal practice, subject to limitations as agreed to periodically by FHWA
- and the joint American Association of State Highway and Transportation Officials (AASHTO) - Association of American Railroads (AAR) Committee, or as required by a State regulatory agency.
- There are a number of Federally funded railroad relocation and demonstration projects. These projects are site specific and are dependent upon annual authorization and appropriation by Congress.
- There are several other potential sources for Federal funding, particularly if the improvement project incorporates specific community benefits. These include the following.
- o Farmers Home Administration. Construction of community facilities such as fire and rescue services, transportation, social, health, cultural and recreational facilities
  - o Economic Development Administration. Construction of public facilities to initiate and encourage economic growth
  - o Health and Human Services. Assistance to develop regional emergency medical services including operations
  - o Department of Housing and Urban Development. Assistance for economic development, neighborhood revitalization and improved community services and facilities

## 2. State Funding

States also participate in the funding of railroad - highway grade crossing improvement projects. States often contribute the matching share for projects financed under the Fed-

## Chapter VI Implementation of Projects

eral-aid highway program. In addition, States sometimes finance entire crossing projects, particularly if the crossing is on a State highway.

As of 1984, 19 States had established State crossing funds. The monies in these funds are dedicated to crossing improvement projects, either financing them completely or providing the required match. These States, and a brief description of their State funding programs as of 1984, are contained in Appendix A.

In general, for crossings on the State highway system, States provide for the maintenance of the highway approach and for traffic control devices not located on the railroad right-of-way. Typically, these include advance warning signs and pavement markings. As of 1984, 17 States have legislation authorizing the State to contribute to the maintenance costs of traffic control devices and/or surfaces at the crossing proper. These States and a brief description of their maintenance programs as of 1984 are contained in Appendix B.

### 3. Local Agency Funding

There are a number of cities and counties that have established railroad-highway grade crossing improvement funds. Some of these programs provide funding for partial reimbursement of railroad maintenance costs at crossings, and some have been established to meet the matching requirements of State and Federal programs. Local agencies are often sources of funding for low-cost improvements such as removing vegetation and providing illumination. In addition, local agencies are responsible for maintaining the roadway approaches and the traffic control devices off the railroad right-of-way

on highways under their maintenance jurisdiction.

### 4. Railroad Funding

Except in certain instances, railroads cannot be required to contribute to the costs of most improvement projects that are financed with Federal funds. However, railroads often volunteer to participate if they receive some benefit from the project. For example, if a project includes the closure of one or more crossings, the railroad may benefit from reduced maintenance cost. Railroads also may assist in low-cost improvements such as changes in railroad operations, track improvements, right-of-way clearance, and others.

The maintenance costs incurred by railroads are increased significantly with the installation of additional active traffic control devices. These costs are discussed in Chapter VII.

### B. Agreements

An agreement between the railroad and the agency responsible for the highway should be executed for a crossing improvement project. For Federal-aid highway projects, the Federal-aid Highway Program Manual (FHPM), 6-6-2-1, specifies that the following be included in the written agreement between the State and the railroad.

- o The regulatory provisions of the FHPM 6-6-2-1 and 1-4-3 incorporated by reference
- o A detailed statement of the work to be performed by each party
- o Method of payment (either actual cost or lump sum)

- o For projects that are not for the elimination of hazards of railroad-highway crossings, the extent to which the railroad is obligated to move or adjust its facilities at its own expense
- o The railroad's share of the project cost
- o An itemized estimate of the cost of the work to be performed by the railroad
- o Method to be used for performing the work, either by railroad forces or by contract
- o Maintenance responsibility
- o Form, duration, and amounts of any needed insurance
- o Appropriate reference to or identification of plans and specifications
- o Statements defining the conditions under which the railroad will provide or require protective services during performance of the work, the type of protective services and the method of reimbursement to the railroad
- o Provisions regarding inspection of any recovered materials

Master agreements between a State and a railroad may be used to facilitate the progress of projects. A master agreement is intended to circumvent the necessity of processing and executing a separate agreement for each individual crossing project. The master agreement sets forth the purpose of an agency to engage in the construction or reconstruction of some part or parts of its highway system that calls for installation and adjustment of traf-

fic control devices at crossings. The master agreement requires a railroad to prepare detailed plans and specifications for the work to be performed and establishes responsibility for the procurement of materials for improvements. It contains other provisions pertaining to the general requirements contained in contractual agreements. Change orders in a specified format are then issued for individual projects.

For Federal-aid projects, a simplified procedure is provided in the FHPM 6-6-2-1. Eligible preliminary engineering costs include those incurred in selecting crossings to be improved, determining the type of improvement for each crossing, estimating costs, and preparing the required agreement. The agreement must contain the identification of each crossing location, a description of the improvements, an estimate of costs by crossing location, and an estimated schedule for the completion of work. Following programming, authorization, and approval of the agreement, FHWA may authorize construction, including the acquisition of materials, with the condition that work not be undertaken until the agreement is found satisfactory by FHWA and the final plans, specifications, and estimates are approved. Only material actually incorporated into the project will be eligible for Federal participation.

### C. Accounting

To be eligible for reimbursement, the costs incurred in work performed for railroad-highway grade crossing safety improvements must be in accordance with strict accounting practices and procedures. In that Federal-aid highway funds are the primary revenue source for crossing safety improvements, accounting prin-

## Chapter VI Implementation of Projects

principles adopted by the Federal Highway Administration (FHWA) have become the guide for most State and all Federal crossing programs. There are several reasons for the similarity between State and Federal accounting procedures. First, as mentioned previously, Federal-aid highway funds represent a major portion of total State expenditures for crossing improvements. Second, a large part of the State funds expended are in the form of matching funds. Third, since States reach agreement with railroad and local communities for the implementation of crossing projects, under both Federal and State funded programs, the accounting procedure for the two programs require compatibility.

The policies and procedures of the FHWA on reimbursement to the States for railroad - highway grade crossing work are contained in the Federal-Aid Highway Program Manual (FHPM), 1-4-3, for Federal-aid highway projects. To be eligible for reimbursement, the costs must be: 1) for work that is included in an approved program; 2) incurred subsequent to the date of authorization by FHWA; 3) incurred in accordance with FHPM 6-6-2; and, 4) properly attributable to the project.

The following is a brief description of railroad-highway grade crossing improvement costs that are generally considered eligible for reimbursement.

- o Labor costs: salaries and wages, including fringe benefits and employee expenses. Labor costs include labor associated with preliminary engineering, construction engineering, right-of-way, and force account construction. Fees paid to engineers, architects and

others for services are also reimbursable.

- o Material and supply costs: The actual costs of materials and supplies including testing, inspection and handling
- o Equipment costs: The actual expenses incurred in the operation of equipment. Costs incurred in equipment leasing and accrued equipment rental charges at established rates are also eligible for reimbursement.
- o Transportation costs: The cost of employee transportation and the transportation cost for the movement of material, supplies and equipment
- o Protective services costs: Expenses incurred in the provision of safety to railroad and highway operations during the construction process

An agreement providing for a lump sum payment in lieu of a later determination of actual costs may be used for the installation or improvement of crossing traffic control devices and/or crossing surfaces, regardless of costs. If the lump sum method of payment is used, periodic reviews and analyses of the railroad's methods and cost data used to develop lump sum estimates should be made.

Progress billings of incurred costs may be made according to the executed agreement between the State and the railroad. Costs for materials stockpiled at the project site or specifically purchased and delivered to the company for use on the project may also be reimbursed following approval of the agreement.

A major problem experienced in the accounting process is the timeliness of final billing. The railroad should provide one final and complete billing of all incurred costs, or of an agreed lump sum, at the earliest possible date. The final billing should include certification that the work is complete, acceptable, and in accordance with the terms of the agreement.

Salvage value of the existing traffic control devices is a concern at crossings to be closed or upgraded. If the equipment is relatively new and in good condition, it is desirable to reuse the equipment at another crossing. However, if the equipment is older, the cost to remove and refurbish it may be such that this is inefficient.

#### D. Design and Construction

The design of railroad-highway grade crossing improvement projects are usually completed by State or railroad engineering forces, or by an engineering consultant selected by the State or railroad with the same agency administering the contract. The designation of the designer is to be mutually agreed to by both the State and the railroad.

The railroad signal department usually prepares the design for the active traffic control system including the train detection circuits. In addition, the railroad signal department usually prepares a detailed cost estimate of the work.

Adequate provision for needed easements, rights-of-way, and temporary crossings for construction purposes, or other property interests

should be included in the project design and covered in the agreement.

For Federal - aid highway projects, it is expected that materials and supplies, if available, will be furnished from railroad company stock, except they may be obtained from other sources near the project site when available at less cost. If the necessary materials and supplies are not available from company stock, they may be purchased either under competitive bids or existing continuing contracts, under which the lowest available prices are developed. Minor quantities and proprietary products are excluded from these requirements. The company should not be required to change its existing standards for materials used in permanent changes to its facilities.

Some States allow railroads to stockpile crossing signal materials so that projects may be completed as rapidly as possible. Provided the design of the crossing signals is based on the most appropriate equipment for the individual project, this practice is acceptable.

Scheduling of crossing projects should be accomplished to maximize the efficiency of railroad, State, local, and contractor work forces. This requires coordination and cooperation between all parties. In addition, construction at crossings should be scheduled to minimize the effects on the traveling public. Notice of planned construction activities should be sent to local newspapers, and TV and radio stations one to three months in advance. Final notices should be given one week and one day in advance of commencement of construction work. Efforts should be made to avoid construction during

## Chapter VI Implementation of Projects

peak hours of highway and train traffic.

When scheduling construction activities, consideration should be given to accomplishing work at crossings in the same geographical area at the same time. In this manner, travel time of construction crews and transportation costs of materials are minimized. This is one advantage of the systems approach because all crossings in a specified rail corridor, community, or area are improved at the same time.

For Federal-aid highway projects construction may be accomplished by:

- o railroad force account;
- o contracting with the lowest qualified bidder based on appropriate solicitations;
- o existing continuing contracts at reasonable costs; or,
- o contract without competitive bidding, for minor work, at reasonable costs.

Reimbursement with Federal-aid highway funds will not be made for any increased costs due to changes in plans for the convenience of the contractor, nor for changes that have not been approved by the State and the Federal Highway Administration (FHWA).

Contractors may be subject to liability with respect to bodily injury to or death of persons and injury to or destruction of property, that may be suffered by persons other than their own employees as a result of their operations in connection with construction of highway projects located wholly or partly within railroad right-of-way and financed in

whole or in part with Federal funds. Under the Federal-Aid Highway Program Manual (FHPM), 6-6-2-2, protection to cover such liability of contractors is to be furnished under regular contractors' public liability and property insurance policies, issued in the names of the contractors. Such policies should be written to furnish protection to contractors respecting their operations in performing work covered by their contract.

If a contractor sublets a part of the work on any project to a subcontractor, the contractor should require insurance protection in his own behalf under the contractor's public liability and property damage insurance policies. This should cover any liability imposed on him by law for damages because of bodily injury to or death of persons, and injury to or destruction of property as a result of work undertaken by such subcontractors. In addition, the contractor should provide for and on behalf of any such subcontractors, protection to cover like liability imposed upon the latter as a result of their operations by means of separate and individual contractor's public liability and property damage policies. Alternatively, each subcontractor may provide satisfactory insurance on his own behalf to cover his individual operations.

The contractor should furnish to the State highway department evidence that the required insurance coverages have been provided. The contractor should also furnish a copy of this evidence to the railroad company(ies). The insurance specified should be kept in force until all work required to be performed has been satisfactorily completed and accepted in accordance with the contract.

In connection with crossing projects, railroad protective liability insurance should be purchased on behalf of the railroad by the contractor. Railroad protective insurance should be in conformance with appropriate State laws.

Railroad protective insurance coverage should be limited to liabilities and damages suffered by the railroad on account of occurrences arising out of the work of the contractor on or about the railroad right-of-way, regardless of the railroad's general supervision or control.

The maximum amount of coverage for which premiums are to be reimbursed from Federal funds with respect to bodily injury, death, and property damage normally is limited to a combined amount of \$2 million per occurrence with an aggregate of \$6 million applying separately to each annual period. In cases involving real and demonstrable danger of appreciably higher risks, higher dollar amounts of coverage for which premiums will be reimbursable from Federal funds will be allowed. These larger amounts will depend on circumstances and will be written for the individual project in accordance with standard underwriting practices upon approval of the FHWA Division Administrator.

In determining whether a larger dollar amount of coverage is necessary for a particular project, consideration should be given to the size of the project, the amount and type of railroad traffic passing through the project area, the volume of highway traffic in the project area, and the accident experience of the contractor involved in the project.

#### E. Traffic Control During Construction

Traffic control for railroad-highway grade crossing construction is very similar to traffic control for highway construction. The major difference is that the work area is in joint use right-of-way and the possibility of conflict exists between rail and highway traffic as well as in construction operations. Construction areas can present to the motorist unexpected or unusual situations as far as traffic operations are concerned. Because of this, special care should be taken in applying traffic control techniques in these areas.

Both railroad and highway personnel are well-trained in the safety and control of their respective traffic streams. However, construction practices, agency policy, labor work rules, and State and Federal regulations all contribute to the complexity of crossing work zone traffic control. When highway construction and maintenance activities at the intersection take place on the tracks or within 15 feet of an active running rail, railroad personnel should be present. Railroad maintenance and construction of crossing signals or surfaces will often require some measure of control of highway traffic.

An open communication channel between railroad and highway personnel is essential to the coordination of crossing construction and maintenance. For example, the railroad engineering department should notify all highway agencies several weeks in advance of track resurfacing or crossing reconstruction operations that require crossings to be closed to highway traffic. The exact sched-

## Chapter VI Implementation of Projects

ule of the track work activity should be confirmed by the railroad engineering department a few days before the actual work takes place. Proper coordination will ensure minimal crossing closure time and will reduce cost of work zone traffic control activities. Highway personnel should inform railroad engineering departments of any work scheduled within the railroad right-of-way weeks before the work begins. The schedule should be reconfirmed with the railroad a few days before the crews are to be on the site.

If the construction or maintenance activity requires the entire crossing to be removed, the crossing should be closed and traffic should be detoured over an alternate route or temporary bypass. Crossings on high volume rural and urban highways should not be closed during week days or peak hours. Traffic control for the construction or maintenance of crossings should be the same as that used for highway construction and maintenance and should comply with the applicable requirements of the Manual on Uniform Traffic Control Devices (MUTCD).

Traffic safety in construction zones should be an integral and high priority element of every project from planning through design and construction. Similarly, maintenance work should be planned and conducted with the safety of motorists, pedestrians, workers, and train crews in mind at all times. The basic safety principles governing the design of crossings should also govern the design of construction and maintenance sites. The goal should be to route traffic through such areas with geometrics and traffic control devices comparable, as nearly as possible, to those for normal crossing situations.

A traffic control plan, in detail appropriate to the complexity of the work project, should be prepared and understood by all responsible parties before the site is occupied. A traffic control plan is required to be included in the plans, specifications and estimates for all Federal-aid projects as indicated in the Federal Highway Program Manual (FHPM). Usually the highway agency develops the traffic control plans. Any changes in the traffic control plan should be approved by an individual trained in safe traffic control practices.

The method for accomplishing traffic control is to be worked out between the railroad and the State or local highway agency. There is a wide latitude as to which party does the work. Many States require that the agency responsible for the highway on which the crossing is located also be responsible for the preparation and implementation of the traffic control plan. This may be the State agency or a local county, city, or town. Some States require the railroad or contractor to implement the traffic control plan. It is emphasized that the individuals who prepare or implement the traffic control in work areas be trained in the requirements of the MUTCD. Reimbursement for traffic control costs for a Federal-aid project includes payment for force account costs and reimbursement for contractor services.

Traffic movement should be inhibited as little as practicable. Traffic control in work sites should be designed on the assumption that motorists will only reduce their speeds if they clearly perceive a need to do so. Reduced speed zoning should be avoided as much as practicable. Guidelines for determining



speed limits in detour, transitions, and median crossovers are as follows.

- o Detours and crossovers should be designed for speeds equal to the existing speed limit if at all possible. Speed reductions should not be more than 10 mph below the speed of the entering highway.
- o Where a speed reduction greater than 10 mph is unavoidable, the transition to the lower limit should be made in steps of not more than 10 mph.
- o Where severe speed reductions are necessary, police or flaggers may be used in addition to advance signing. The conditions requiring the reduced speed should be alleviated as soon as possible.

Frequent and abrupt changes in geometrics, such as lane narrowing, dropped lanes, or main highway transitions, that require rapid maneuvers should be avoided. Provisions should be made for the safe operation of work vehicles, particularly on high speed, high volume highways. Construction time should be minimized to reduce exposure to potential hazards.

Motorists should be guided in a clear and positive manner while approaching and traversing construction and maintenance work areas. Adequate warning, delineation, and channelization by means of proper pavement marking, signing, and use of other devices that are effective under varying conditions of light and weather should be provided to assure the motorist of positive guidance in advance of and through the work area.

Inappropriate markings should be removed to eliminate any misleading cues to drivers under all conditions of light and weather. On short term

maintenance projects, it may be determined that such removal is more hazardous than leaving the existing markings in place. If so, special attention must be paid to provide additional guidance by other traffic control measures. Flagging procedures can provide positive guidance to the motorist traversing the work area and should be employed when required to control traffic or when all other methods of traffic control are inadequate to warn and direct drivers.

Each person whose actions affect maintenance and construction zone safety, from the upper-level management personnel through construction and maintenance field personnel, should receive training appropriate to the job decisions each individual is required to make. Only those individuals who are qualified by means of adequate training in safe traffic control practices and have a basic understanding of the principles established by applicable standards and regulations, including those of the MUTCD, should supervise the selection, placement, and maintenance of traffic control devices in maintenance and construction areas.

To insure acceptable levels of operations, routine inspection of traffic control elements should be performed. This inspection should verify that all traffic control elements of the project are in conformity with the traffic control plan and are effective in providing safe conditions for motorists, pedestrians, and workers.

The maintenance of roadside safety requires constant attention during the life of the construction zone because of the potential increase in hazards. To accommodate run-off-the-road incidents, disabled

vehicles, or other emergency situations, it is desirable to provide an unencumbered roadside recovery area that is as wide as practical. Channelization of traffic should be accomplished by the use of pavement markings and signing, flexible posts, barricades, and other lightweight devices that will yield when hit by an errant vehicle. Whenever practical, construction equipment, materials, and debris should be stored in such a manner as not to be vulnerable to run-off-the-road vehicle impact.

As with highway traffic, control of train traffic through construction areas must provide for the safety of the labor forces and for safe train operations. Ideally, construction and maintenance at a railroad - highway grade crossing would occur under conditions of no highway or train traffic. However, this is rarely practical.

To minimize the impact on train operations careful planning is required. The railroad should be notified well in advance of planned construction or maintenance activities. Thus, necessary work can be coordinated and proper plans can be made for the operation of train traffic.

Rail traffic is not as easily detoured as highway traffic. Highway users may be directed over an adjacent crossing which may not be more than one mile away. Or, a temporary crossing surface may be inexpensively constructed adjacent to the work site.

Detours for rail traffic may greatly increase the costs of rail operations due to the increase travel time and distance. Temporary trackage (shoo-fly) may be expensive to construct. At multiple track crossings, work may sometimes be planned

to close only one track to train traffic at a time and provide for the continuation of all train traffic over the remaining track. At other times, the heavy cost of temporary railroad signaling and interlocking may preclude this solution.

Train crews are notified of construction or maintenance activities through train orders or railroad signal systems. Appropriate instructions for operating through the area are provided by the dispatcher. A railroad employee is established on the construction site as a flagman to advise of approaching trains so that the labor forces may move off the track while the train passes through the area.

When planning construction or maintenance work at railroad-highway grade crossings, proper coordination with the railroad is essential. Through the development of a work plan to meet the needs of rail and highway traffic, safety of highway users, highway and railroad work crews, and train crews can best be provided.

#### 1. Traffic Control Zones

When traffic is affected by construction, maintenance, utility, or similar operations, traffic control is needed to safely guide and protect highway users and workers in a traffic control zone. The traffic control zone is the distance between the first advance warning sign and the point beyond the work area where traffic is no longer affected.

Most traffic control zones can be divided into the following parts: advance warning area, transition area, buffer space, work area, and termination area. These are shown in Figure 97.

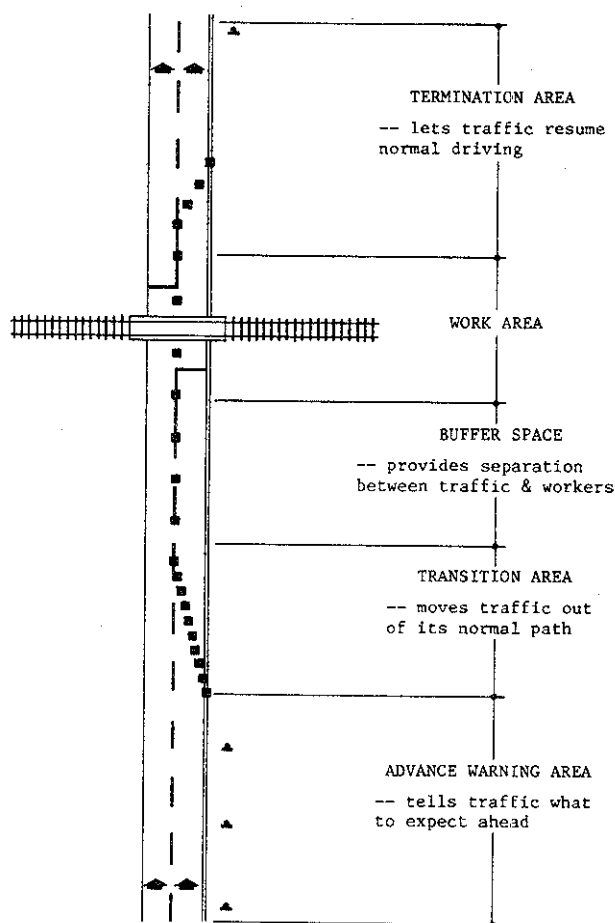

Figure 97. Areas in a Traffic Control Zone

Source: Ref. 4

The advance warning area should be long enough to give motorists adequate time to respond to the changed conditions. The length is at least 1500 feet in rural areas but may be a minimum of one block in urban areas.

If a lane or shoulder is closed, a transition area is needed to channelize traffic from the normal highway lanes to the path required to move traffic around the work area. The transition area contains the tapers that are used to close lanes. A taper is a series of channelizing

devices and pavement markings placed on an angle to move traffic out of its normal path. The length of taper is determined by the speed of traffic and the width of the lane to be closed. The formulae for determining the length of a taper are:

Posted speed 40 mph or less:

$$L = \frac{WS^2}{60}$$

Posted speed 45 mph or more:

$$L = WS$$

where:

L = taper length  
 W = width of lane or offset  
 S = posted speed or off peak 85 percentile speed

The recommended number and spacing of channelizing devices for various speeds and widths of closing are given in Table 45.

A two-way traffic taper is used in advance of a work area that occupies part of a two-way road in such a way that the remainder of the road is used alternately by traffic in either direction. A short taper is used to cause traffic to slow down by giving the appearance of restricted alignment. One or more flaggers are usually employed to assign the right-of-way. Two-way traffic tapers should be 50 to 100 feet long, with channelizing devices spaced a maximum of 10 to 20 feet.

The buffer space is the open or unoccupied space between the transition and work areas and provides a margin of safety for both traffic and workers. Channelizing devices should be placed along the edge of the buf-

Table 45. Channelizing Devices for Tapers

Speed Limit	Taper Length (L) Lane Width (feet)			Number of Channelizing Devices for Taper	Spacing of Devices Along Taper (feet)
	10	11	12		
20	70	75	80	5	20
25	105	115	125	6	25
30	150	165	180	7	30
35	205	225	245	8	35
40	270	295	320	9	40
45	450	495	540	13	45
50	500	550	600	13	50
55	550	605	660	13	55

Source: Ref. 4

fer space at a spacing in feet of two times the posted speed limit.

The work area is that portion of the highway that contains the work activity and is closed to traffic and set aside for exclusive use by workers, equipment, and construction materials. The work area is usually delineated by channelizing devices or shielded by barriers to exclude traffic and pedestrians.

The termination area provides a short distance for traffic to clear the work area and to return to the normal traffic lanes. A downstream taper may be placed in the termination area to shift traffic back to its normal path.

## 2. Traffic Control Devices

Signs. Regulatory and warning signs are used in construction work areas. Regulatory signs impose legal restrictions and may not be used without permission from the authority having jurisdiction over the highway. Warning signs are used to give notice of conditions that are potentially hazardous to traffic. Typical warn-

ing signs used in construction work areas are shown in Figure 98.

The high conspicuity of fluorescent orange colors provides an additional margin of safety by producing a high visual impact in hazardous areas. Therefore, where the color orange is specified for use in traffic control for construction and maintenance operations, it is acceptable to utilize materials having fluorescent red-orange or yellow-orange colors.

Signs may be attached to posts or portable supports that are lightweight, yielding, or breakaway. The minimum height requirements for signs attached to posts are shown in Figure 98. Signs on portable supports are required by the MUTCD to be at least one foot above the highway.

Pavement markings. Pavement markings and delineators outline the vehicular path, and thus guide the motorist through the construction area. Pavement markings include lane stripes, edge stripes, centerline stripes, pavement arrows, and word messages. Markings are made of paint

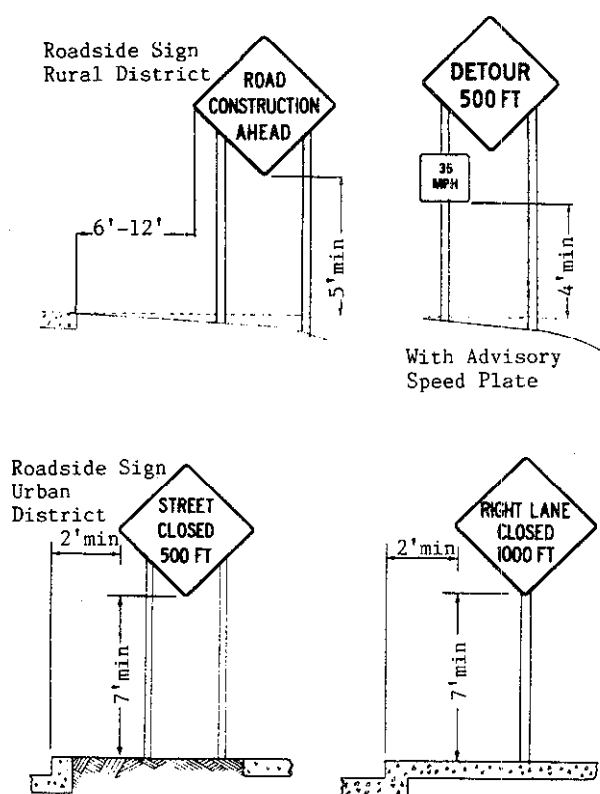

Figure 98. Typical Signs for Traffic Control in Work Zones

Source: Ref. 3

(with bead reflectorization), raised reflectorized markers, preformed adhesive - backed reflectorized tape, cold preformed reflectorized plastics, hot reflectorized plastics, epoxies, and other materials placed by heating and spraying.

The standard markings planned for the road should be in place before opening a new facility to traffic. Also, if revised lane patterns are planned for the work zone, temporary markings should be placed before the traffic is changed. Where this is not feasible, such as during the process of making a traffic shift or carrying traffic through surfacing operations, temporary delineation may

be accomplished with lines of traffic cones, other channelizing devices, or strips of adhesive - backed reflectorized tape.

When pavement placed during the day is to be opened to traffic at night and permanent striping cannot be placed before the end of work, a temporary stripe should be applied to provide an indication to the driver of the location of the lane or centerline. Standard marking patterns are most desirable for this use. On rock-screened seal coats, striping should be applied following removal of excess screenings.

For relatively long-term use or when the surface is to be covered later with another layer, reflectorized traffic paint, or preformed adhesive-backed tape, with or without raised pavement markers should be considered. For relatively short-term use, and when frequent shifts are to be made, adhesive - backed reflectorized tape is useful. Raised pavement markers may be used to form the pavement markings or may be used to supplement marked stripes. High speeds and volumes of traffic may justify raised markers for even comparatively short periods. They are particularly valuable at points of curvature and transition.

Pavement arrows are useful in guiding traffic when the traveled way does not coincide with the configuration of the exposed surface area, such as when the color of the transition pavement is different from the existing pavement. Pavement arrows are especially useful on a two-way, undivided roadway to remind the driver of opposing traffic. "Two-Way Traffic" signs should be used in conjunction with the arrows for the application. The arrows should be completely removed once the two-way

traffic condition is no longer needed.

Whenever traffic is shifted from its normal path, whether a lane is closed, lanes are narrowed, or traffic is shifted onto another roadway or a detour, conflicting pavement markings should be removed. Exceptions to this may be made for short-term operations, such as a work zone under flaggers' control or moving or mobile operations. Use of raised pavement markings or removable markings may be economical since they are usually easier to remove when no longer needed.

Delineators. Delineators are reflective units with a minimum dimension of approximately three inches. The reflector units can be seen up to 1,000 feet under normal conditions when reflecting the high beams of motor vehicle headlights. The delineator should be installed about four feet above the roadway on lightweight posts.

Delineators should not be used alone as channelizing devices in work zones but may be used to supplement these channelizing devices in outlining the correct vehicle path. They are not to be used as a warning device. To be effective, several delineators need to be seen at the same time. The color of the delineator should be the same as the pavement marking that it supplements.

Channelizing Devices. Channelizing devices consist of cones, tubular markers, vertical panels, drums, barricades, and barriers. Cones are lightweight devices that may be stacked for storage, are easy to place and remove, and are a minor impedance to traffic flow. They are at least 18 inches high. Cones that

are 28 inches high should be used on high speed roadways, on all facilities during hours of darkness, or whenever more conspicuous guidance is needed. Cones are reflectorized for use at night with a six inch wide reflectorized band placed no more than three inches from the top or with a lighting device.

Tubular markers are also lightweight, easy to install, and are a minor impedance to traffic flow. They must be set in weighted bases or fastened to the pavement. They should be at least 18 inches high with taller devices preferred for better visibility. Markers should be reflectorized for use at night with two reflectorized bands, three inches in width, placed no more than two inches from the top and no more than six inches between the bands.

Vertical panels are 8 to 12 inches in width and a minimum of 24 inches in height. They are advantageous in narrow areas where barricades and drums would be too wide. They are mounted on lightweight posts driven into the ground or placed on lightweight portable supports. The orange and white stripes on vertical panels slope down toward the side that traffic is to pass. They should be reflectorized as barricades and installed such that the top is a minimum of 36 inches above the highway.

Drums are highly visible and appear to be formidable objects thus commanding the respect of motorists. They should be marked with horizontal orange and white stripes that are reflectorized, four to eight inches wide. The drum must have at least two sets of orange and white stripes but can also have nonreflectorized spaces up to two inches wide between the stripes.

Barricades should be constructed of lightweight materials and are classified as Types I, II, and III. Types I and II are used for either channelizing or marking hazards. Type III barricades are used for road closures. The barricade rails have alternating orange and white reflectorized stripes that slope down toward the side traffic is to pass.

Barriers provide a physical limitation through which a vehicle would not normally pass. They are used to keep traffic from entering a work area or from hitting an exposed object or excavation. They provide protection for workers and construction and separate two-way traffic. They are usually made of concrete or metal and are designed to contain and redirect an errant vehicle. Exposed ends of barriers should have crash cushions to protect traffic or flared ends provided by extending the barrier beyond the clear roadside recovery area. Two types of crash cushions used in work zones are sand-filled plastic barriers and the portable "Guard Rail Energy Absorbing Terminal".

High level warning devices are tall, portable stands with flags and/or flashing lights. Three flags, 16 inch square or larger, are mounted at least eight feet above the highway.

Lighting Devices. Three types of warning lights may be used in construction areas. Flashing lights are appropriate for use on a channelizing device to warn of an isolated hazard at night or call attention to warning signs at night. High intensity lights are appropriate to use on advance warning lights day and night. Steady-burn lights are appropriate for use on a series of channelizing devices or on barriers that either

form the taper to close a lane or shoulder, or keep a section of lane or shoulder closed, and are also appropriate on the channelizing devices alongside the work area at night.

Work vehicles in or near the traffic areas are hazards and should be equipped with flashing lights such as emergency flashers, flashing lights, strobes, or rotating beacons. High intensity lights are effective both day and night. The laws of the agency having jurisdiction over the street or highway should be checked concerning requirements for flashing vehicle lights. These lights should be used in addition to other channelizing and warning devices. However, in some emergency situations, where the work will be in progress for a short time, these lights may be the only warning device.

Flashing arrow panels are signs with a matrix of lights capable of either flashing or sequential displays. They are effective day and night for moving traffic out of a lane to the left, to the right, and may be used for tapered lane closures. These arrow panels should not be used when no lanes are closed, when there is no interference in traffic flow, nor when a flagger is controlling traffic on a normal two-lane two-way road.

Flagging. Flagging should be used only when required to control traffic or when all other methods of traffic control are inadequate to warn and direct drivers. The procedures for flagging traffic are contained in Sections 6F-2 through 6F-7 of the MUTCD. The standard signals to be used by flaggers are illustrated in Figure 99. Flaggers should be in sight of each other or have direct communication at all times.

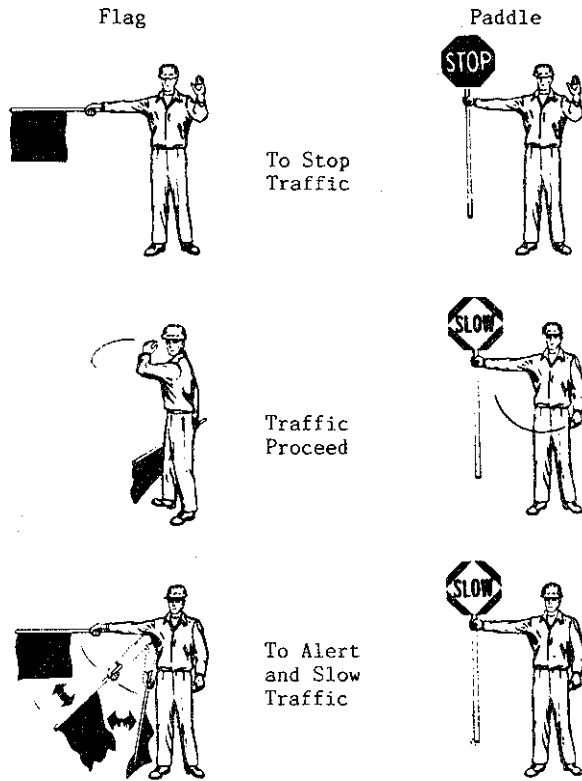

Figure 99. Use of Hand Signaling Devices by Flagger

Source: Ref. 3

A number of hand signaling devices such as STOP/SLOW paddles, lights, and red flags are used to control traffic through work zones. The sign paddle bearing the clear messages "Stop" or "Slow" provides motorists with more positive guidance than flags and should be the primary hand-signaling device. The use of flags should be limited to emergency situations and at spot locations that can best be controlled by a single flagger.

3. Application

Typical applications of traffic control devices in crossing work zones are shown in Figures 100 through 103. The dimensions shown in

these figures may be adjusted to fit field conditions in accordance with the guidelines presented in the MUTCD and the Traffic Control Devices Handbook. When numerical distances are shown for sign spacing, the distances are intended for rural areas and urban areas with a posted speed limit of 45 mph or more. For urban areas with a posted speed of 45 mph or less, the sign spacing should be in conformance with Table 46.

Signs with specific distances shown should not be used if the actual distance varies significantly from that shown. The word message "Ahead" should be used in urban areas and in other areas where a specific distance is not applicable. Standard crossing pavement markings are not shown in the figures for clarity and should be utilized where appropriate.

All applicable requirements for traffic control in work areas set forth in the MUTCD shall apply to construction and maintenance of crossings. Additional traffic control devices other than those shown in the figures should be provided when highway and traffic conditions warrant. These devices should conform to the requirements of the MUTCD. All traffic control devices that are not applicable at any specific time shall be covered, removed, or turned so as to not be visible to the motorist.

Table 46. Sign Spacing for Urban Areas

Speed Limit	Sign Spacing	
	X	Y
30 mph or less	300 ft	200 ft
35 mph or 40 mph	450 ft	300 ft

Source: Ref. 4



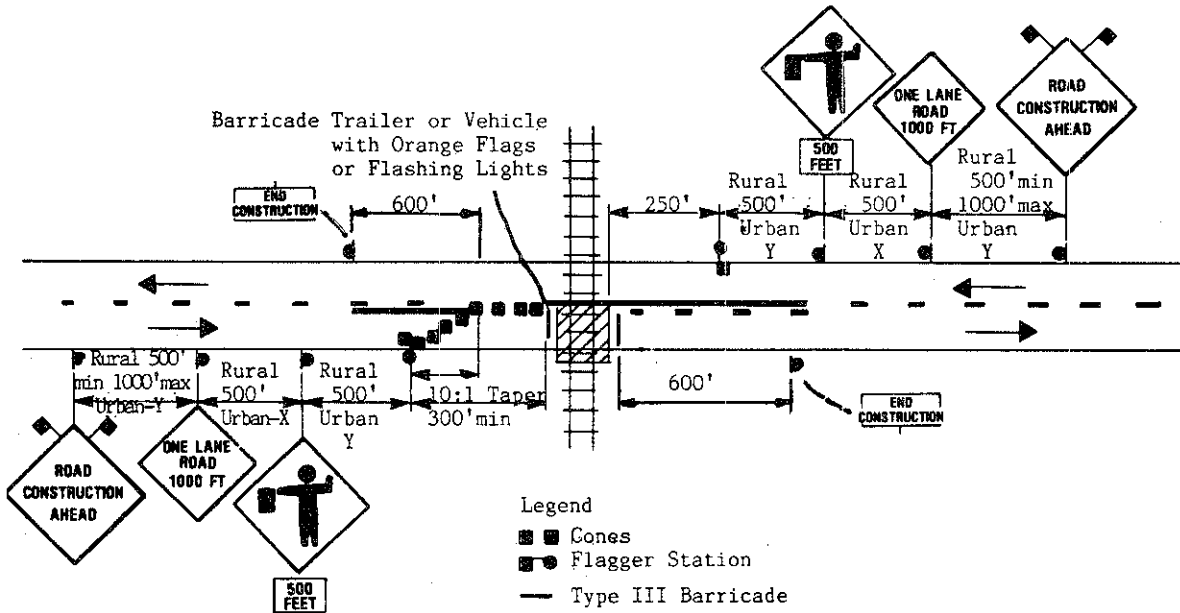

For X and Y dimensions, See Table 46

Figure 100. Crossing Work Activities, Two Lane Highway, One Lane Closed

Source: Ref. 4

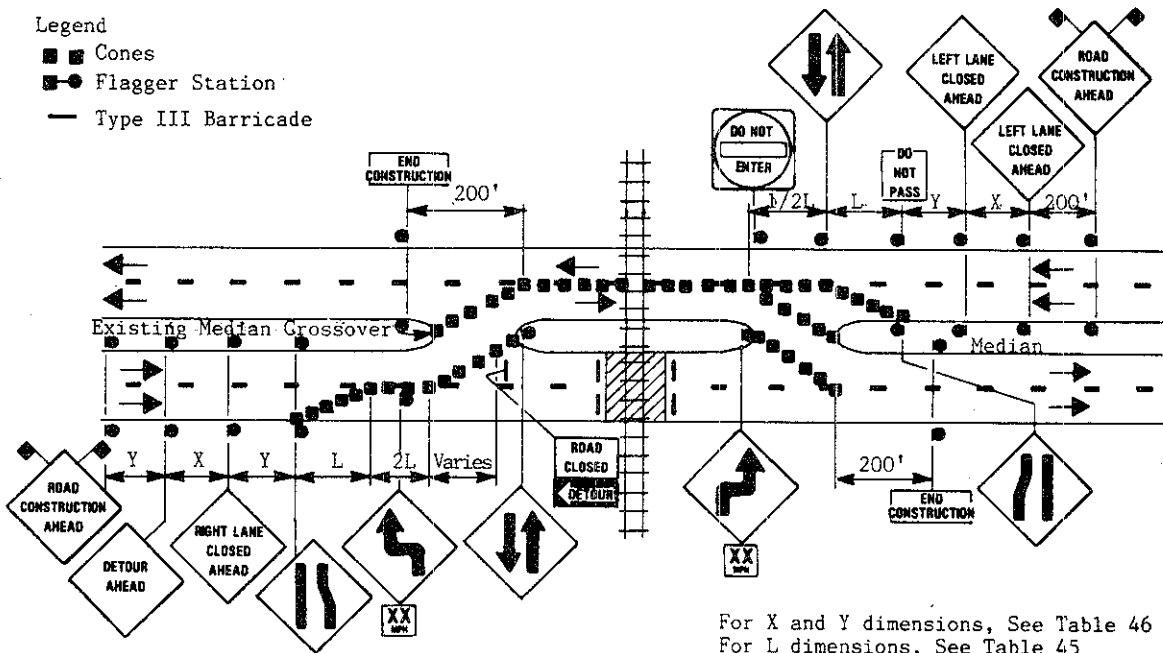

Figure 101. Crossing Work Activities, Multi-lane Urban Divided Highway One Roadway Closed, Two Way Traffic

Source: Ref. 4

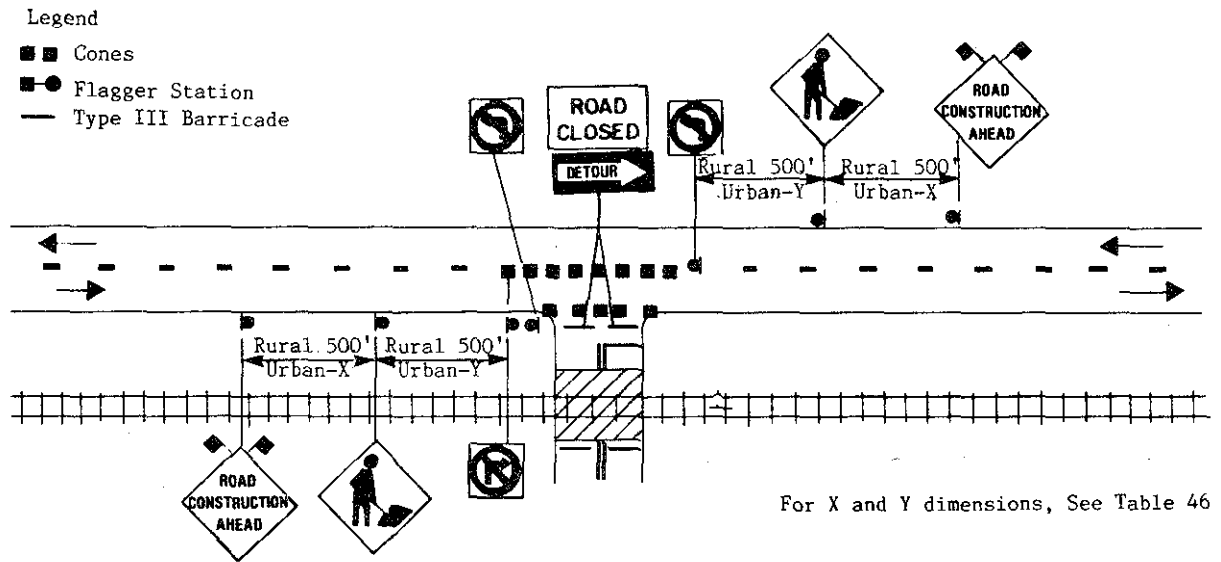

Figure 102. Crossing Work Activities, Closure of Side Road Crossing

Source: Ref. 4

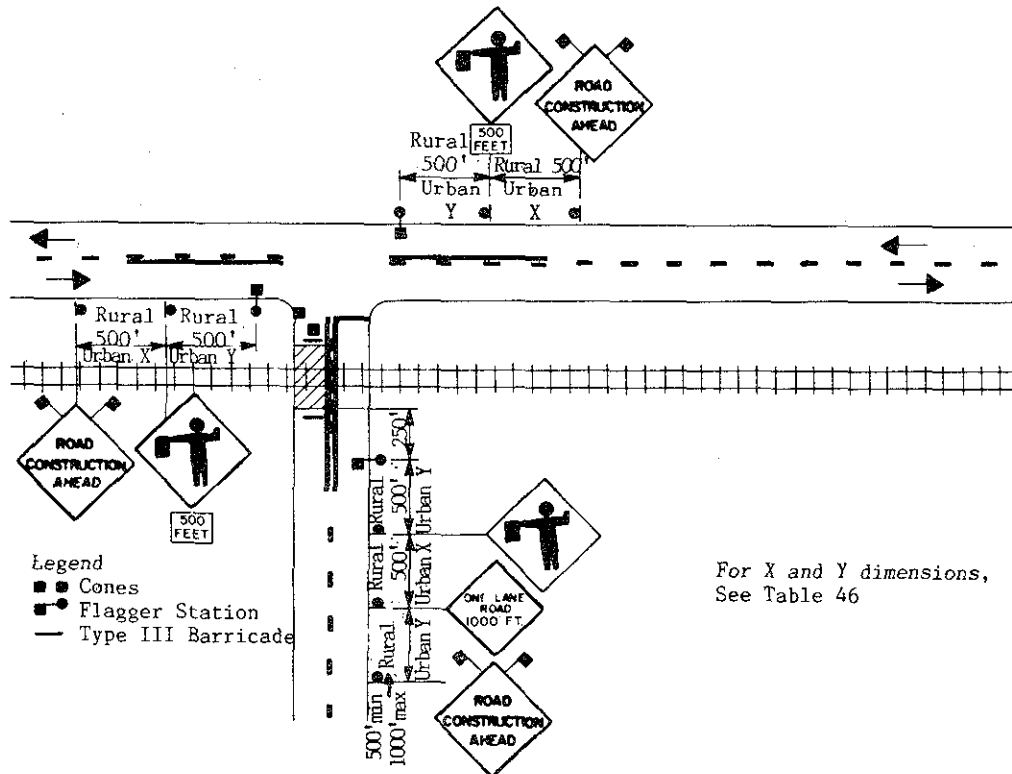

Figure 103. Crossing Work Activities, One Lane of Side Road Crossing Closed

Source: Ref. 4

**F. References**

1. Federal-Aid Highway Program Manual, Washington, DC: Federal Highway Administration, updated periodically.
2. Federal Highway Administration Survey of Region and Division Offices, unpublished, 1984.
3. Manual on Uniform Traffic Control Devices, Washington, DC: Federal Highway Administration, 1978, Revised 1979, 1983, 1984.
4. Traffic Control Devices Handbook, Washington, DC: Federal Highway Administration, 1983.

## VII. MAINTENANCE PROGRAM

### A. Maintenance Program

The railroad - highway grade crossing is unique to other highway facilities in that railroads design, install, operate, and maintain the traffic control devices located at the crossing. Even though a large portion of the cost of design and construction of crossings, including traffic control devices, is assumed by the public, current procedures place maintenance responsibility with the railroads. The public agency having responsibility for the maintenance of the roadway approaches generally terminates its maintenance responsibility for the roadway at the crossing surface. Traffic control devices on the approach, in most instances, is the full responsibility of the public agency.

Railroad personnel maintain the devices at the crossing and their control circuitry. Highway traffic signals located near the crossing may be preempted utilizing the same train detection circuitry as the signals at the crossing. Where this occurs, coordination of railroad and highway maintenance activities is essential to safe and efficient traffic operation.

Normally, railroad maintenance of traffic control devices is accomplished as a part of the regular maintenance program for signals controlling train operations. Railroad signal maintenance personnel are stationed at specific locations along the railroad line and are responsible for all signal maintenance within their assigned territories. Generally, the maintenance of crossing devices is only a portion of the railroad signal maintainer's daily

activity. Although there are currently no Federal safety regulations specifically addressing the maintenance of these devices, a few State regulatory agencies have established regulations for their maintenance. All railroad companies have instructions for the inspection and maintenance of the devices.

The maintenance of crossing surfaces is performed by another department of the railroad. The Maintenance of Way Department of the railroad company has responsibility for all track, roadbed and drainage maintenance. Maintenance of surfaces is usually a part of the railroad's periodic track maintenance program. Site specific maintenance is performed only in emergencies or upon special request.

The highway agency is usually responsible for maintaining the highway approaches, all traffic control devices on the approaches, except the crossbuck sign, illumination, and special signing at the crossing such as the "Exempt" sign, the "Do Not Stop On Tracks" sign, and the stop sign.

An open channel of communication between the local maintenance staff of the highway agency and the railroad company is essential. Each highway agency maintenance foreman should have a railroad company telephone number available on a 24 hour basis to report crossing device failure or malfunction. In addition, the railroad signal maintainer should establish and maintain contact with the highway agency maintenance supervisor(s) in the signal maintainer's assigned territory.

## Chapter VII Maintenance Program

The U.S. DOT/AAR inventory number assigned to the crossing should be used in any communication between railroad and highway maintenance personnel. This requires that the inventory number board be displayed at each crossing and properly maintained.

Highway maintenance personnel, during the course of their normal travel, should be encouraged to be on the lookout for damaged or malfunctioning crossing traffic control devices. To ensure the proper reporting of devices in disrepair, the railroad signal department should inform highway agency personnel as to how and why the devices operate and what constitutes failure. A procedure for reporting damaged or malfunctioning devices should be developed. In Texas the State highway agency has posted signs at all crossings on the State highway system. These signs request notification of devices in disrepair. A toll free number along with the crossing inventory number is included on the sign that is mounted on the flashing light signal post.

The highway agency maintenance program should follow normal highway inspection and maintenance procedures. For example, both signs and pavement markings should be inspected during both daylight and nighttime conditions every three to six months. This inspection should include the condition and adequacy of reflectivity of the signs and markings. Pavement marking experience at a particular locale may indicate an approximate interval between repainting operations. Such a determination will permit the programming of repainting into the overall striping program for the area. However, periodic inspection should not be eliminated in any case as spilled loads, resurfacing and other occurrences may obliterate

the markings. Sign deterioration is only one of several factors to be considered in sign maintenance. Of equal or greater importance are vandalism and inadvertent damage. Careful choice of material, mounting height and mounting technique can reduce damage from vandalism. Damage caused by accidents can be constrained through regular inspection and repair.

The maintenance of the sight triangle, beyond railroad right-of-way, presents a unique problem. Except for the portion of the sight triangle within the roadway right-of-way, most of the sight triangle involves private property. The removal of trees, vegetation, crops, buildings, signs, storage facilities, and other obstructions to the driver's view of an approaching train requires access to the property and an agreement with the property owner for the removal of the obstruction.

Some maintenance activities at or near crossings may require traffic control. The procedures specified in Chapter VI for traffic control in construction areas are applicable to maintenance activities as well.

In addition to their usual responsibility for the maintenance of the crossing surface and traffic control devices at the crossing, railroads also maintain sight clearance within railroad right-of-way. This includes vegetation control, removal of unused railroad buildings and placement of rail cars.

Since these maintenance activities are a part of routine railroad signal and maintenance-of-way activity, site specific maintenance costs are difficult, if not impossible, to calculate. As with most Federal highway funding programs, maintenance

expenditures associated with crossings are not reimbursable under the program. However, 17 States and a few local governmental agencies have passed legislation authorizing contribution, by the State, to the maintenance of crossing surfaces and/or traffic control devices located at the crossing. Funding for these programs is either by State legislature appropriations or by local ordinance. Appendix B contains information on State maintenance programs.

Such maintenance agreements between a railroad and a State must contain mutually agreed to definitions of eligible devices. In some cases, the devices are defined as flashing lights only or flashing lights and gates, with specification of the number of tracks. Or, traffic control devices may be defined in terms of AAR units. Railroad signal systems are comprised of component parts, each of which (individually or in combinations) have been assigned relative unit values by the Association of American Railroads (AAR). The relative unit values were developed for accounting and record purposes directed toward determining installation, replacement, maintenance and operating costs on an industry-wide uniform basis. Committees of the AAR have established recommended practices for the application of these units. A 1982 AAR technical report classifies the following types of crossing traffic control systems by AAR units.

- o Type I -- Standard flashing light signals at single track, average AAR units 13.85
- o Type II -- Standard flashing light signals with gates at single track, average AAR units 23.89
- o Type III -- Cantilever type signals at single track, average AAR units 18.23
- o Type IV -- Cantilever type signals with gates at single track, average AAR units 27.81
- o Type V -- Standard flashing light signals with gates at two main tracks, average AAR units 34.30
- o Type VI -- Cantilever type signals with gates at two main tracks, average AAR units 36.04
- o Type VII -- Special layout with multiple gates and tracks, average AAR units 48.25

The AAR unit method for defining crossing maintenance provides an opportunity for negotiating a specific dollar value for each unit and then applying this value to any combination of units. Dollar values are reported for AAR units in the 1982 publication. These values, if used, should be adjusted for current economic conditions.

Any method used for the reimbursement of maintenance costs should consider the components of maintenance. Maintenance costs are comprised of equipment, material, labor, transportation, administration, accounting, and training costs. Labor costs involve the hourly wage and benefits received by the railroad, State, local government, or contractor employee. Materials associated with maintenance include the spare and replacement parts as well as the tools needed for repair. Transportation must be provided for laborers and materials.

## Chapter VII Maintenance Program

### B. References

1. Federal Highway Administration Survey of Region and Division Offices, unpublished, 1984.
2. "Maintenance Cost Study of Railroad-Highway Grade Crossing Warning Systems," Washington, DC: Association of American Railroads, October 1982.

## VIII. EVALUATION OF PROJECTS AND PROGRAMS

An integral part of any railroad-highway grade crossing improvement program is the evaluation of individual projects and the overall program. The Federal - aid Highway Program Manual (FHPM), 8-2-3, specifies that each State's highway safety improvement program should include an evaluation of the program. This evaluation component is to include a determination of the effects the improvements have in reducing accidents, accident potential, and accident severity. This process should include:

- o the cost of, and the safety benefits derived from, the various means and methods used to mitigate or eliminate hazards;
- o a record of accident experience before and after the implementation of a highway safety improvement project; and,
- o a comparison of accident numbers, rates, and severity observed after the implementation of a highway safety improvement project with the accident numbers, rates, and severity expected if the improvement had not been made.

In addition, the evaluation program is to include an annual evaluation and report of the State's overall safety improvement program and the State's progress in implementing the individual Federal programs, such as the Section 203 crossing program.

Evaluation is an assessment of the value of an activity as measured by its success or failure in achieving a predetermined set of goals or objectives. The ultimate goal of

evaluation is to improve the agency's ability to make future decisions regarding the improvement program. These decisions can be aided by conducting formal effectiveness and administrative evaluations of ongoing and completed improvement projects and programs.

In the Highway Safety Evaluation, Procedural Guide, two types of evaluation are addressed: effectiveness evaluation and administrative evaluation. These two types of evaluation will be discussed in this chapter only in sufficient detail for the user to be aware of the need for it and the procedures. However, the reader should refer to the Procedural Guide for more details. Also, the following references provide more useful information on safety evaluation procedures.

- o Lunenfeld, H. Evaluation of Traffic Operations, Safety and Positive Guidance Projects, Washington, DC: Federal Highway Administration, Report No. FHWA-10-80-1, October 1980.
- o Tarrants, W.E. and Veigel, C.H., The Evaluation of Highway Traffic Safety Programs, Washington, DC: National Highway Traffic Safety Administration, Report DOT-HS-80-525, February 1978.
- o Council, F. M. et al., Accident Research Manual, Washington, DC: Federal Highway Administration, Report FHWA/RD-80/016, February 1980.
- o Berg, W. D., Experimental Design for Evaluating the Safety Benefits of Railroad Advance Warning Signs,



Washington, DC: Federal Highway Administration, Report FHWA-RD-79-78, April 1979.

### A. Project Evaluation

Improvements to railroad-highway grade crossings that have as their objective the enhancement of safety should be evaluated as to their effectiveness. This can be done for individual projects and should be done for the overall improvement program. An effectiveness evaluation for safety purposes is the statistical and economic assessment of the extent to which a project or program achieves its ultimate safety goal of reducing the number and/or severity of accidents. It also can be expanded to include an assessment of the intermediate effects related to safety enhancement. The latter type evaluation becomes particularly relevant for crossings because the low number of accidents occurring at a crossing may preclude any meaningful accident-based evaluation of individual crossings or a small number of them.

The Procedural Guide lists seven functions that should be followed in conducting an effectiveness evaluation.

- o Develop an evaluation plan
- o Collect and reduce data
- o Compare measures of effectiveness
- o Perform statistical tests
- o Perform economic analyses
- o Prepare evaluation documents
- o Develop and update a data base

The essential elements of the principal functions are described below.

The evaluation plan addresses such issues as the selection of: 1) projects for evaluation; 2) project

purposes; 3) evaluation objectives and measures of effectiveness; 4) experimental plans; and, 5) data requirements.

While it would be desirable to evaluate all improvement projects, manpower and fiscal capabilities do not always permit this. Consequently when selecting projects for evaluation, the following factors should be considered.

- o Improvement types that are questionable as to their effectiveness
- o Projects that have sufficient data necessary for statistical analysis
- o Projects that are directly related to accident reduction

If the number of accidents occurring before the improvement is too few to allow a significant reduction of accidents to occur, the project may be evaluated along with other similar projects. This is frequently the situation with crossings since they experience very few accidents. If projects are aggregated for evaluation, it is essential that the:

- o countermeasures for each be identical;
- o types of locations be similar; and,
- o project purposes be similar.

The experimental plan selected should be consistent with the nature of the project and the completeness and availability of data. The most common experimental plans for evaluating safety improvement projects are: 1) before and after study with control sites, and 2) before and after study.

The most desirable measure of effectiveness (MOE) for crossing safety improvements would be the reduction of accident frequency or severity. However, since a long period of time may be required to amass an adequate sample size, especially for individual projects, evaluations can be made based on other measures such as:

- o traffic performance - speed, stopping behavior, and conflicts, or
- o driver behavior - looking, compliance, and awareness.

The evaluation plan describes the types and amounts of data necessary for the evaluation. Data for the before situation could be obtained from the engineering study (see Chapter III) used to assist in determining the crossing problem and appropriate improvement. Additional data, if not available from historical records, will have to be collected before the improvement is made. If the measure of effectiveness involves accident data, several years of data would be required. Traffic and driver behavior data can be collected four to six weeks after project implementation.

The effect of the project(s) on the selected MOE must be determined. Computations are made to determine the expected value of the MOE if the project(s) had not been implemented and the difference between the expected MOE and the actual observed value of the MOE. This difference should then be tested to determine if it is statistically significant.

An important objective of an effectiveness evaluation is to obtain a complete picture of how well the completed project is performing from a safety standpoint. Economic analysis

provides another perspective. From such analysis, an assessment of cost and accident reduction effects, in combination, may be made. This aspect of an evaluation is very important as it is possible to have a very effective project that is cost-prohibitive in terms of future use under similar circumstances.

There are many economic analysis techniques. The two most commonly used for evaluating completed highway safety improvement projects are the benefit/cost (B/C) and cost/effectiveness (C/E) methods.

An effectiveness data base is an accumulation of project evaluation results that are directly usable as input to future project selection. The data base:

- o contains pertinent information on the accident reducing capabilities of countermeasures and/or projects;
- o must be continually updated with new effectiveness evaluation information; and,
- o should only contain evaluation results from reliable and properly conducted evaluations.

With such a data base, accident reduction factors can be established and refined over time. These factors in turn can be used in determining the most cost-effective improvements.

## B. Program Evaluation

The preceding section outlined the process for conducting evaluations of one or more improvement projects. This evaluation process can and should be applied to the entire crossing improvement program or com-

## Chapter VIII Evaluation of Projects and Programs

ponents of it. The entire program would consist of all those activities including physical improvements to the crossing, changes in railroad or highway traffic operations, and changes in law enforcement and in driver education.

Throughout the program it may be useful for the policy maker to identify whether certain specific program subsets are effective. These program subsets could include types of improvements such as:

- o installation of flashing lights;
- o relocation of crossing;
- o illumination;
- o sight distance improvements; or,
- o combinations of two or more types.

The steps and procedures in conducting the program, or subset of the program, effectiveness evaluation are essentially the same as for projects. FHWA's Procedural Guide should be referred to for details.

### C. Administrative Evaluation

This evaluation is the assessment of the scheduling, design, construction, and operational review activities undertaken during the implementation of the crossing improvement program. It evaluates these activities in terms of actual resource expenditures, planned versus actual resource expenditures, and productivity.

In the FHWA Procedural Guide, eight steps are recommended for administrative evaluation as listed below.

- o Select evaluation subjects
- o Review project (program) details

- o Identify administrative issues
- o Obtain available data sources
- o Prepare administrative data summary tables
- o Evaluate administrative issues
- o Prepare and distribute the evaluation report
- o Develop and update data base

### D. References

1. Berg, William D., Experimental Design for Evaluating the Safety Benefits of Railroad Advance Warning Signs, Washington, DC: Federal Highway Administration, Report FHWA-RD-79-78, April 1979.
2. Council, F.M. et al., Accident Research Manual, Washington, DC: Federal Highway Administration, Report FHWA/RD-80/016, February 1980.
3. Federal-Aid Highway Program Manual, Washington, DC: Federal Highway Administration, updated periodically.
4. Goodell - Grivas, Inc., Highway Safety Evaluation Procedural Guide, Washington, DC: Federal Highway Administration, FHWA-TS-81-219, October 1980.
5. Lunenfeld, H. Evaluation of Traffic Operations, Safety and Positive Guidance Projects, Washington, DC: Federal Highway Administration, Report No. FHWA-10-80-1, October 1980.
6. Tarrant, W.E. and Veigel, C. H., The Evaluation of Highway Traffic Safety Administration, Report DOT-HS-80-525, February 1978.

## IX. SPECIAL ISSUES

There are several issues that are important to railroad - highway grade crossing safety and operations that either were not specifically covered in previous chapters or that warrant special consideration. These include private crossings, short line railroads, high speed rail corridors, pedestrians, bicycles and motorcycles, and special vehicles.

### A. Private Crossings

Private railroad-highway grade crossings are those that are on roadways not open to use by the public nor are they maintained by a public authority. According to the U.S. DOT/AAR National Rail-Highway Crossing Inventory, in 1983 there were 133,011 private crossings in the United States. Usually, an agreement between the land owner and the railroad governs the use of the private crossing.

Typical types of private crossings are as follows.

- o Farm crossings that provide access between tracts of land lying on both sides of the railroad
- o Industrial plant crossings that provide access between plant facilities on both sides of the railroad
- o Residential access crossings over which the occupants and their invitees reach private residences from another road, frequently a public road paralleling and adjacent to the railroad right-of-way
- o Temporary crossings established for the duration of a private

construction project or other seasonal activity

In some instances, changes in land use have resulted in an expansion of a crossing's use to the extent that it has become a public crossing as evidenced by frequent use of the general public. This may occur whether or not any public agency has accepted responsibility for maintenance or control of the use of the traveled way over the crossing. The railroad and highway agency should continually review the use of private crossings so that mutual agreement is obtained on its appropriate classification. If the general public is making use of the crossing, appropriate traffic control devices should be installed for their warning and guidance. Usually, State and Federal funds are not available for use at private crossings.

The number of accidents at private crossings represent a small portion of all crossing accidents; however, safe design and operation at private crossings should not be overlooked. Very few private crossings have active traffic control devices and many do not have signs. Typically, they are on narrow gravel roads often with poor roadway approaches.

In 1983, there were 599 accidents, 33 fatalities, and 156 injuries at private crossings. These represent reductions, since 1979, of 37.4% in accidents, 32.7% in fatalities, and 24.3% in injuries as shown in Table 47.

As with accidents at public crossings, the majority of accidents at private crossings involved automobiles. Table 48 gives the number of

Chapter IX Special Issues

Table 47. Accidents at Private Crossings, 1979 - 1983

<u>Year</u>	<u>Accidents</u>	<u>Fatalities</u>	<u>Injuries</u>
1979	957	49	206
1980	848	45	228
1981	749	31	172
1982	590	27	129
1983	599	33	156

Source: Ref. 3

accidents and casualties by roadway user for 1983.

At private crossings, the majority of motor vehicle accidents, 345 or 61.4%, occurred during daylight, while 185, or 32.9%, occurred during darkness. The remaining 32 accidents occurred during either dusk or dawn. Most of the accidents involving motor vehicles, 244 or 43.4%, occurred at crossings without signs or signals as shown in Table 49. Accident rates (number of accidents at crossings

Table 49. Motor Vehicle Accidents at Private Crossings by Traffic Control Device, 1983

<u>Traffic Control Device</u>	<u>Accidents</u>	<u>Percent</u>
Automatic gates	7	1.24
Flashing lights	26	4.63
Highway signals, wigwags or bells	13	2.31
Special*	37	6.58
Crossbucks	162	28.83
Stop signs	52	9.25
Other signs	21	3.74
No signs or signals	244	43.42
Total	562	100.00

\*"Special" are traffic control systems that are not train activated, such as a crossing being flagged by a member of the train crew.

Source: Ref. 3

Table 48. Accidents at Private Crossings by Roadway User, 1983

<u>Type of Vehicle</u>	<u>Accidents</u>		<u>Fatalities</u>		<u>Injuries</u>	
	<u>No.</u>	<u>%</u>	<u>No.</u>	<u>%</u>	<u>No.</u>	<u>%</u>
Automobile	261	43.57	17	51.52	76	48.72
Truck	189	31.55	11	33.33	50	32.05
Tractor-trailer	111	18.53	1	3.03	20	12.82
Bus	---	-----	---	-----	---	-----
School bus	---	-----	---	-----	---	-----
Motorcycle	1	0.17	---	-----	---	-----
Pedestrian	2	0.34	2	6.06	---	-----
Other*	35	5.84	2	6.06	10	6.41
Total	599	100.00	33	100.00	156	100.00

\*"Other" usually refers to farm equipment.

Source: Ref. 3

with each type of traffic control device divided by number of crossings with that type of traffic control device) cannot be determined for private crossings since no national statistics are kept on the type of traffic control devices at private crossings.

Some States and railroads have established minimum signing requirements for private crossings. Typically, these signs consist of a crossbuck, stop sign, and/or a warning against trespassing. California and Oregon public utility commissioners use a standard highway stop sign together with a sign indicating that the crossing is a private crossing. A typical configuration is shown in Figure 104.

As with public crossings, the first consideration for improving private crossings is closure. Adjacent crossings should be evaluated to determine if they can be used instead

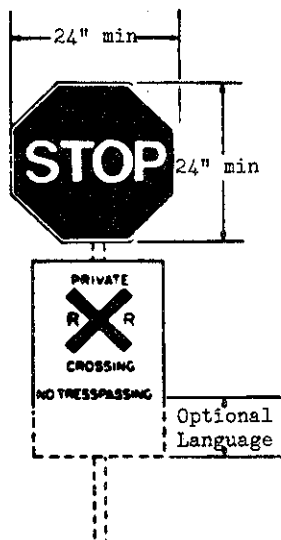

Figure 104. Typical Private Crossing Sign

Source: Ref. 1

of the private crossing. Every effort to close the crossing should be made.

If the private crossing is determined to be essential to the private landowner, then the crossing should be marked with some type of sign. Controversy exists over whether the marking should be identical to public crossings so that the motorist is presented with uniform traffic control devices, or whether the marking should be distinct to notify the motorist that the crossing is private and that use without permission is trespassing. No national guidelines exist; however, it seems reasonable that the crossing should be marked so that it is identified as a private crossing. Supplemental crossbucks or stop signs might also be installed.

Some private crossings have sufficient train and roadway traffic volume that they require active traffic control devices. Considerations for the installation of these devices are the same as for public crossings, as discussed in Chapter IV. Federal funds, and often State funds, cannot be used for the installation of traffic control improvements at private crossings. The railroad and the landowner usually come to an agreement regarding the financing of the devices. In some cases, if the landowner is required to pay for the installation of the crossing and its traffic control devices, the landowner might reevaluate the need for the crossing.

## B. Short Line Railroads

There are numerous short line railroads and the number is growing due to Federal deregulation. Short line railroads are typically Class III railroads, as defined by the Interstate Commerce Commission (ICC).

Class III railroads include all switching and terminal companies and all line-haul railroads that have an annual gross revenue of less than \$10 million, in 1978 constant dollars. Many of these short line railroads provide switching and terminal services for the larger Class I and II railroad companies. Many of the short line railroads belong to the American Short Line Railroad Association (ASLRA). Headquartered in Washington, DC, the ASLRA provides liaison with governmental agencies, serves as a source for information and assistance, and provides other benefits to short line railroads.

Some short line railroads took over the operation of a single line that a larger railroad abandoned for economic reasons. Short line railroads often require assistance with regard to railroad - highway grade crossings because of their limited manpower and financial resources. These small railroads are often unable to seek out Federal and State funds for improving crossings, yet safety at their crossings is just as important as at any other crossing.

Ownership of these smaller lines are from a variety of investment sources such as, State or local governments, port authorities, other short lines, private entrepreneurs, and shipper groups. Many new owners of short lines are keenly aware of costs of line acquisition, track and rolling stock rehabilitation, along with other operational expenditures. Yet, new operators may be unaware of the substantial expenditures needed for rebuilding crossing surfaces, renewing older traffic control systems, and maintaining them.

Costs associated with crossings may comprise a considerable portion of the limited annual maintenance-of-

way budgets of short line railroads. The general condition of the abandoned plant, as acquired by the new owner, is usually far from best. The track condition may be adequate, requiring relatively little annual expense in comparison to other plant needs. Therefore, as annual track maintenance costs are reduced, crossing expenditures may constitute as much as 50% of the annual maintenance-of-way budget over the next 10 years. This, of course, depends on factors such as the location of the line in relation to population centers, and intensities of heavy truck traffic.

On short line railroads, there is often a lack of specialized personnel for handling the many crossing responsibilities, such as the continuing maintenance of highly complex electronic crossing traffic control equipment.

While rail traffic on the smaller lines generally tends to be sparse, as well as slow, these crossings, in comparison to the larger railroads are not necessarily safer. National statistics indicate that the vast majority of crossing accidents occur at relatively low train speeds.

Adequate planning is essential to ensure the proper formation of new short line railroads and to improve their survival as a necessary part of the nation's transportation system. When dealing with short line railroads, State agencies should be aware of their limited experience, skills, and knowledge. State agencies can assist by informing short line railroads of the requirements for improving crossings on their system and direct them to other appropriate sources of information. State agencies should ensure that the short line railroads operating in their

State are included in the lines of communication regarding crossings. Short line railroads also should be encouraged to participate in other crossing safety programs such as Operation Lifesaver.

### C. High Speed Rail Corridors

Special considerations must be given to railroad - highway grade crossings on high speed passenger train routes. The potential for a catastrophic accident, injuring many passengers, demands special attention. Not only does this include dedicated routes with speeds over 100 mph, but also other passenger routes over which trains may operate at speeds higher than freight trains.

Variation in warning time at crossings equipped with active traffic control devices may occur with high speed passenger trains. Because of the wide variation in train speeds (passenger trains versus freight trains), train detection circuitry should be designed to provide the appropriate advance warning for all trains.

High speed passenger trains present additional problems at crossings with only passive traffic control devices. Safe sight distance along the track from a stopped position must be much greater for a faster train. The sight distance along the track from the highway approach must also be greater unless vehicle speed is reduced. In addition, it is difficult to judge the speed of an oncoming train.

Private crossings are a major concern for high speed passenger trains. These crossings usually have only passive traffic control devices and often consist of narrow, unim-

proved or gravel roads with limited visibility along the railroad tracks.

Special attention should be given to crossings on high speed rail passenger routes. Some States utilize priority indices that include a factor for train speed or potential dangers to large numbers of people. In this manner, crossings with high speed passenger trains are likely to rank higher than other crossings and thus be selected for crossing improvements.

Another method for improving crossings on high speed passenger routes is to utilize the systems approach. As discussed in Chapter III, the systems approach involves the inspection and evaluation of safety and operations at crossings within a specified system, such as along a high speed rail corridor.

It is desirable that all crossings located on high speed rail corridors either be closed, grade separated, or equipped with automatic gates. The train detection circuitry should provide constant warning time. Where feasible, other site improvements may be necessary at these crossings. Sight distance should be improved by clearing all unnecessary signs, parking, and buildings from each quadrant. Vegetation should be periodically cut back or removed. Improvements in the geometrics of the crossing should be made to provide the best braking and acceleration distances for vehicles.

Education of the public is an important element for the improvement of safety and operations at crossings on high speed rail corridors. This can be accomplished by publicity campaigns and public service announcements as described in the next chapter. Public education might also



alleviate some fears of high speed trains and provide for better railroad-community relations. State agencies and railroads should cooperatively undertake this important public education campaign.

Special signing might also be employed at these crossings to remind the public that it is used by high speed trains. No national standard exists for such signing; however, the signing should be in conformance with the guidelines provided in the Manual on Uniform Traffic Control Devices (MUTCD).

#### **D. Special Vehicles, Pedestrians, Motorcycles, and Bicycles**

Railroad-highway grade crossings are designed and controlled to accommodate the vehicles that use them. The vast majority of these vehicles consist of automobiles, buses, and all types of trucks. Generally speaking, improvements to the crossing with these users in mind will be adequate for any other special users such as trucks carrying hazardous materials, long-length trucks, school buses, motorcycles, bicycles, and pedestrians. However, these users have unique characteristics and special needs which should be considered. Chapter II discussed some of these characteristics. This chapter will present some design and control considerations.

##### **1. Trucks with Hazardous Material Cargo**

Accidents involving trucks with hazardous material cargo are potentially the most dangerous because they can have deleterious effects over a wide area. Consequently, all crossings which are used by these vehicles should be considered for

improvements and, in turn, these improvements should consider the special needs of these vehicles.

Drawing on the National Transportation Safety Board's study of train accidents involving these vehicles, and their subsequent recommendations, there are several suggested ways to address this concern.

- o Trucks carrying bulk hazardous materials should use routes that have grade separations or active control devices. Where routes that have crossings with only passive control devices are near terminals, the crossings should be considered for upgrading to active control.
- o Insure that active warning devices provide sufficient warning time so that trucks have available the distance required for stopping. Also, for vehicles that are stopped at the crossing when signals are not operating, adequate warning time should be provided for clearance of tracks by loaded trucks before the arrival of a train.
- o If feasible, where there is an intersection in close proximity to the crossing, increase the storage room between the tracks and the intersecting highway. If on a direct route to a truck terminal, also consider giving right-of-way to the critical movement through control measures.
- o Promote a program of education and enforcement to reduce the frequency of hazardous driving and alert the driver of potential danger. Operation Lifesaver programs should be expanded to include a specific program which addresses the problems.

At crossings where there is a significant volume of trucks that are required to stop, consideration should be given to providing a pull-out lane. These auxiliary lanes allow the trucks to come to a stop and then to cross and clear the tracks without conflicting with other traffic. Hence, they minimize the likelihood of rear-end collisions or other vehicle-vehicle accidents. They would be appropriate for two-lane highways or for high-speed multilane highways.

## 2. Long and Heavily Laden Trucks

As discussed in Chapter II, large trucks have particular problems at crossings because of their length and performance characteristics. Longer clearance times are required for longer vehicles and those slow to accelerate. Also, longer braking distances become necessary when trucks are heavily laden, thus reducing their effective braking capability.

With the passage of the Surface Transportation Assistance Act of 1982, there will likely be both longer and heavier trucks. Consequently, when considering improvements, the designer should be aware of, and design for, the amount and type of current and expected truck traffic.

Areas that should be focused upon include:

- o longer sight distances;
- o placement of advance warning signs;
- o warning time for signals;
- o approach and departure grades; and,
- o storage area between tracks and nearby highway intersection.

## 3. Buses

Since buses carry many passengers and have performance characteristics similar to large trucks, these vehicles also need special consideration.

Many of the measures suggested for trucks with hazardous materials apply to buses. Railroad - highway grade crossings should be taken into consideration when planning school bus routes. Potentially hazardous crossings should be avoided if possible. Crossings along school bus routes should be evaluated by the appropriate highway and railroad personnel to identify potentially dangerous crossings and the need for improvements. Drivers should be instructed on safe crossing procedures and be made aware of expected railroad operations, such as the speed and frequency of train movements.

## 4. Motorcycles and Bicycles

Although motorcycles and bicycles typically travel at different speeds, these two-wheeled vehicles can experience the same problem at crossings. Depending on the angle and type of crossing, a cyclist may lose control of the vehicle if the wheel becomes trapped in the flangeway. The surface materials and the flangeway width and depth must be evaluated. The more the crossing deviates from the ideal 90-degree crossing, the greater the potential for a cycle wheel to be trapped in the flangeway. If the crossing angle is less than 45 degrees, consideration should be given to widening the bikeway to allow sufficient width to cross the tracks at a safer angle.

Other than smooth surface treatments, there are no special controls for these special vehicles. However,

if a bicycle trail crosses tracks at-grade, the bicyclist should be warned of this with suitable markings and signs such as those shown in Figure 105.

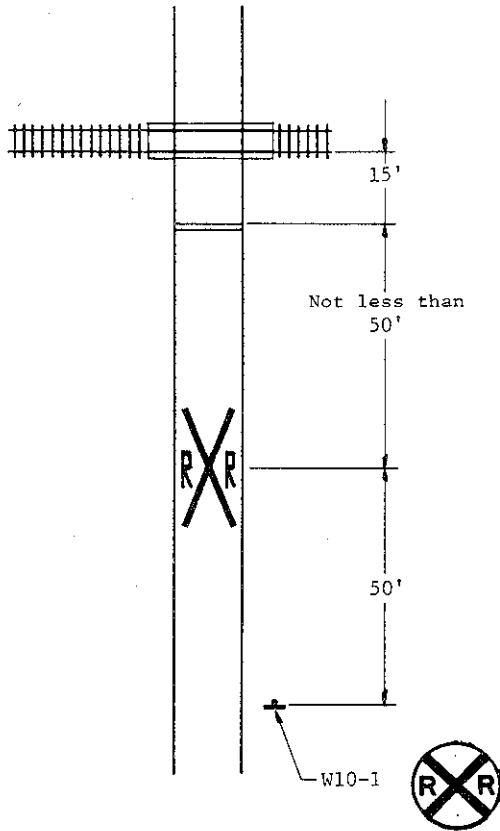

Figure 105. Recommended Sign and Marking Treatment for Bicycle Crossing

Source: Ref. 2

### 5. Pedestrians

The safety of pedestrians crossing railroads is the most difficult to control because of the relative ease with which pedestrians can go under or around lowered gates. Pedestrians typically seek the shortest path and, therefore, may not always cross the tracks at the highway or designated pedestrian crossing.

Nonetheless, there are several types of preventive measures which can be employed.

Fencing. Fencing that encloses the right-of-way may be used to restrict access. A six to eight foot high chain link fencing, sometimes topped with barbed wire, is commonly used. Fencing is usually placed on both sides of the right-of-way, but it can be an effective deterrent to indiscriminate crossing if placed on only one side. The main objection to fencing is its cost, which may be in excess of \$100,000 per mile for construction. Furthermore, it does not bar entrances at crossings. Alternatively, a single four foot fence, placed parallel to the track and across a pedestrian crossing route might be a lower-priced and somewhat effective deterrent. Fencing is commonly used between multiple tracks at commuter stations. Maintenance is an additional cost of fencing.

Separated Crossings. In order to prevent vandalism of continuous fencing, pedestrian crossings might be provided over or under the track(s) at reasonable intervals. Pedestrian grade separations are expensive and should be designed to maximize pedestrian use. If a structure is built, it should be accessible and pedestrians should be directed to it through the use of barriers, fencing, or signs.

Improved Signing. An example whereby pedestrian and trespasser safety near railroads can be enhanced through improved signing concerns electrified rail lines, in particular, their catenaries (the overhead wires used to carry energy to electric locomotives). The electrical current is so great that shocks can result without actual contact with the wire. Warning signs along elec-

trified railroads can reduce accidents. These signs should provide both symbolic representation (such as a lightning bolt) and the warning legend.

Safety Education. The education of actual and potential trespassers can reduce the incidence of right-of-way accidents. Individual railroads, as well as the Association of American Railroads, have for many years conducted active railroad safety programs through the schools.

Surveillance and Enforcement. No form of a pedestrian safety program can be effective without some level of surveillance and enforcement. At present, trespassing is generally considered a misdemeanor, and law enforcement officials are often indisposed to prosecute. A more effective procedure for some forms of railroad trespassing would be to treat it like jaywalking, and issue a citation with automatic imposition of a fine if a hearing were waived. Such a procedure would impose some burden on the trespasser who might otherwise only be reprimanded.

Because of the variety of factors that may contribute to pedestrian hazards, detailed studies are necessary to determine the most effective measures to provide for pedestrian safety at specific locations.

#### E. References

1. Federal Highway Administration Survey of Region and Division Offices, unpublished, 1984

2. Manual on Uniform Traffic Control Devices, Washington, DC: Federal Highway Administration, 1978, Revised 1979, 1983, 1984.

3. Rail-Highway Crossing Accident/Incident and Inventory Bulletin, Washington, DC: Federal Railroad Administration, published annually.

4. Railroad/Highway Grade Crossing Accidents Involving Trucks Transporting Bulk Hazardous Materials, A Special Study, Washington, DC: National Transportation Safety Board, Report NTSB-HZM-81-2, September 1981.

5. Railroad-Highway Safety, Part II: Recommendations for Resolving the Problem, A Report to Congress, Washington, DC: U.S. Department of Transportation, August 1972.

6. Sonefeld, Otto F., "Crossing Costs Can Endanger New Short Line Viability", Railway Track and Structures, May 1983.

## X. SUPPORTING PROGRAMS

Programs other than engineering support, and in fact are essential to, railroad-highway grade crossing safety and operations. These programs include public education of crossing components and driver responsibilities, enforcement of the traffic laws governing movement over crossings, and research of the various components of crossings.

### A. Driver Education and Enforcement

As discussed in Chapter II, motorists have major responsibilities for their safe movement over crossings. Since railroad trains cannot stop as quickly as motor vehicles, drivers must take precaution to avoid collisions with trains. However, many motorists are unaware of these responsibilities and do not know the meaning of crossing traffic control devices. Education of motorists on safe driving actions, train operations, and crossing traffic control devices can minimize crossing accidents.

Since the early part of this century, railroads have endeavored to educate the public about crossings. On their own initiative, many railroads developed materials and distributed them to the news media, law enforcement agencies, schools, and civic clubs. They made presentations at schools, civic club meetings, and other gatherings of people.

Today, these educational programs have evolved into a nationwide program called Operation Lifesaver. This program is coordinated by the National Safety Council and supported by the U.S. Department of Transportation, Association of American Rail-

roads, American Association of State Highway and Transportation Officials, American Short Line Railroad Association, National Transportation Safety Board, American Trucking Association, National Tank Truck Carriers Inc., National School Transportation Association, American Driver and Traffic Safety Education Association, National Association of Women Highway Leaders Inc., Railway Progress Institute, and other national organizations. Forty-four States have adopted Operation Lifesaver programs.

While many railroads had educational programs, Operation Lifesaver was formally initiated by the cooperative effort of the Union Pacific Railroad, the State of Idaho, and many communities in Idaho in 1972. Cooperation between the railroad and public agencies was what made this program different from previous railroad educational programs. Encouraged by the results of the Idaho program, the Union Pacific Railroad and the State of Nebraska started a statewide program. Programs were also initiated in Kansas and Georgia.

In 1977, it became evident that a national focal point was needed to facilitate effective exchange of information concerning these individual State programs. The National Transportation Safety Board recommended that the National Safety Council, a private, nonprofit, nongovernmental organization, serve as an Operation Lifesaver catalyst. In January 1978, the National Safety Council assumed the responsibility to serve as the national coordinator for the development, implementation, and evaluation of a nationwide Operation Lifesaver program. The Council has worked to develop programs in all States, has

## Chapter X Supporting Programs

developed materials to be used by State programs, and has held national and regional workshops and symposiums to train volunteers and disseminate information.

A State Operation Lifesaver program usually begins by the establishment of an advisory and a coordinating committee. The advisory committee is made up of highly visible individuals from government agencies, civic organizations, and the railroad industry who support the program by their endorsements and by seeking the support of other influential persons. The support of the Governor of the State is important and usually achieved. It is important that the advisory committee has representation from both the railroad industry as well as State highway agencies to demonstrate the cooperative aspects of the program. The coordinating committee is responsible for the development and implementation of the Operation Lifesaver program.

Educational activities of Operation Lifesaver programs are varied. The goal is to reach as many people as possible through whatever medium is available and appropriate. Typically, the Operation Lifesaver committee and volunteers make presentations at schools, civic association meetings, and other gatherings of people. They distribute materials at fairs, in shopping centers, through the mail, and wherever people are gathered. They work with the media, TV, radio, and newspapers to broadcast public service announcements, to appear on talk shows, and to print articles and editorials regarding crossings. They develop the materials, films, slide shows, and public service announcements that are distributed.

Many Operation Lifesaver programs work with drivers of special vehicles, i.e. school bus drivers and truck drivers, to educate them on their responsibilities and the potential danger at crossings. In some States, associations representing these groups are actively involved in the program. Many Operation Lifesaver programs work with driver training courses to ensure that safe driving practices at crossings are included in course material. Many State driving manuals have been revised to include or update the section on railroad-highway grade crossings.

While education may be considered the primary effort of Operation Lifesaver programs, many address enforcement, engineering, and evaluation as well. Enforcement of traffic laws is important to remind motorists of safe driving practices at crossings as well as to "punish" the reckless driver. Many State laws require motorists to stop at crossings at which the flashing light signals are activated and not to proceed until it is safe to do so. Many drivers, however, do not stop. Other State laws prohibit drivers from moving around lowered gates; however, many drivers do so. Through the enforcement of these traffic laws, and others, drivers will understand that these laws exist for their own safety.

In some States, local and/or State police have become active in Operation Lifesaver by making presentations and by writing citations when a motorist violates the law. This support is essential. It is also important to educate the police in the matter of traffic laws and safe driving practices at crossings. Many instances have occurred where a police officer unknowingly violated

the law or, when questioned, displayed lack of knowledge of crossing traffic laws.

Railroad police are also involved in Operation Lifesaver programs. They assist primarily in making presentations. While they do not have the authority to stop and arrest motorists at crossings, they can arrest or warn trespassers. They also can assist by notifying the State or local police of unsafe driving practices occurring at specific crossings.

Railroads also assist by having locomotive crews report near misses. Train crews who observe drivers who narrowly escape collision with the train, can record the license plate number or a commercial vehicle's owning company or identifying number, and provide the Operation Lifesaver committee, the State or local police, or the railroad safety department with this information. Action can be taken to station police officers at crossings where near misses most often occur, to conduct an educational campaign in the community, or to visit the company owning the trucks whose drivers are observed to have unsafe driving practices.

Operation Lifesaver programs sometimes assist in the engineering aspects of crossing safety and operations. A combined effort of conducting educational campaigns in a community, while making engineering improvements at crossings, has proven to be most effective in improving safety. The Operation Lifesaver committee can assist by making the appropriate State and railroad engineers aware of crossings that may need engineering improvements.

Another area of concern for Operation Lifesaver programs is eval-

uation to ensure that the quality of the program is maintained and that it is reaching its stated goals.

While Operation Lifesaver is designed to improve safety at railroad-highway grade crossings, the program has many positive side effects. First, the cooperative effort between the State, local communities, and railroads often enhances relationships. Many communities have been aggravated by rail operations that they may perceive to be too slow, too fast, too noisy, or unattractive. Through Operation Lifesaver, railroads and States work with their communities through established communication channels.

Another positive side effect of Operation Lifesaver is that, while the program's message is primarily directed toward motorists, it also pertains to pedestrians and trespassers as well. School children are a major safety concern around railroad tracks. Many children are inquisitive about the railroad and daring enough to play on the tracks. Educating children, as well as adults, about crossing safety assists them in obtaining a respect for railroad operations in general.

While Operation Lifesaver programs are usually directed toward motorist behavior at public crossings, the same behavior is needed and desired at private crossings as well. People reached through Operation Lifesaver may be the same people who use private crossings.

## B. Research and Development

The U.S. Department of Transportation has been active in conducting crossing research. Specifically, the Federal Highway Administration (FHWA)

## Chapter X Supporting Programs

and the Federal Railroad Administration (FRA) are sponsors of crossing research and development efforts.

A summary of the studies underway or completed during the past 10 years by the FHWA or by the States through the Highway Planning and Research (HPR) program is presented below. Some of the research reports are available from the National Technical Information Service (NTIS), as indicated by the listing of the order number identified by the letters "PB". To determine the availability of these reports, contact the NTIS at 5285 Port Royal Road, Springfield, VA 22161.

Analysis of Driver Reaction to Warning Devices at a High-Accident Rural Grade Crossing, by Dr. Eugene Russell, Purdue University, Lafayette, IN, Joint Highway Research Project, Report JHRP-74-16, August 1974. This Indiana HPR study included testing and evaluation of alternative active traffic control devices at a high-accident crossing. Strobe lights on gate arms were investigated with favorable results.

Development of Techniques to Evaluate New and Existing Railroad Passive Protection Devices, by I.N. Dommasch, R.L. Hollinger, and E.F. Reilly, New Jersey Department of Transportation, Division of Research and Development, Trenton, NJ, December, 1975. This HPR study was completed in New Jersey to evaluate existing and experimental passive signs. Driver looking behavior was found to be very variable and there were very few cases observed during field testing where drivers were looking down the tracks for an approaching train.

Structural and Geometric Design of Highway-Rail Grade Crossings, by

T. Newton, R.L. Lytton, and R.M. Olson; Texas Transportation Institute, Texas A&M University, College Station, TX, January 1976. This Texas HPR study investigated the structural and geometric design of crossings. The study findings indicated that many of the crossings studied warranted more permanent type surfaces. Although, initial costs are higher, longer life and smoother, safer rides are often offsetting factors. Several relatively inexpensive maintenance functions were identified that would extend crossing life and improve rideability.

Development of an Improved Rail-Highway Grade Crossing Risk Factor, by Donald Scheck, Ohio University, Athens, OH, November 1981. This HPR study updated the Armour Index factor used by Ohio to discriminate between high and low risk crossings. The study was performed by Ohio University and concluded that the New Hampshire formula would be simpler and less costly to update and would be as effective.

Prioritization of Rail-Highway Grade Crossing Surfaces, by Florida Department of Transportation, 1982. This HPR study developed criteria to assist the Florida DOT and railroads in selecting and evaluating crossing surface materials.

Railroad Grade Crossing Passive Signing Study, J. Koziol and P. Mengert, Transportation Systems Center, Cambridge, MA, August 1978, FHWA-RD-78-34, PB# 286-528/AS. A study funded by FHWA, FRA and 25 States investigated new at-crossing and advance warning signs. The use of the new signs resulted in an 8 to 10 % increase in driver looking behavior.



Railroad Passive Sign Experiment Design, Dr. William Berg, University of Wisconsin, 1978. Following the above mentioned study, FHWA funded a study to develop an experimental plan to evaluate the safety benefits due to the use of a red and yellow crossing advance warning sign. The study findings indicated that very large samples would be needed to detect a significant reduction in accidents. The costs of undertaking the field testing to determine the accident reduction would, under some conditions, equal the costs of replacing all existing advance warning signs with the new advance warning signs.

Grade Crossing Resource Allocation Procedure and Institutional Studies, Transportation Systems Center (TSC), Cambridge, MA. A crossing hazard index model and a resource allocation model were developed by TSC for use by States and railroads to assist them in identifying crossings for improvement.

The issue of liability was analyzed by TSC to determine if the use of innovative warning devices at crossings increased a railroad's liability in the event of a crossing accident. No evidence was found during this effort to support the premise that the use of innovative devices would increase a railroad's liability. Alternative methods to manage crossing liability were analyzed in a study performed by TSC.

Identification and Evaluation of Off-Track Train Detection Systems for Grade Crossing Applications, E.E. Nylund and P.C. Holtermann, Gard Inc., FRA/ORD-80-32, PB# 80-186430, April 1980. This study was funded by FHWA and FRA. The objectives were to investigate the feasibility of off-track train detection and to develop and field test prototype devices. Ap-

proximately 25 percent of all crossings have some form of active devices. The track circuit is used for train detection in all forms of active warning devices. Previous work by TSC indicated that off-track train detection may be feasible but further work was needed. Various concepts for off-track train detection were analyzed. The most promising concept was field tested. The results of the limited field testing were not promising and no follow-on work is planned in this area.

Activated Advance Warning for Railroad Crossings, R.J. Ruden, A. Berg, and J.P. McGuire, J.G.M. Associates, Palo Alto, CA, FHWA/RD-80/003, PB# 83-161869, March 1980. The objectives of this study were to identify crossing environments where active advance warning signals are needed, to evaluate the effectiveness of such devices, and to develop, test, and evaluate prototype active advance warning devices. This effort was funded by FHWA and FRA. This study analyzed drivers' understanding of active advance warning signals, studied driver behavior data and speed profile data, analyzed costs of providing active advance warning signals, and field tested and evaluated various active advance warning signals. No single active advance warning signal was shown to be significantly better than the others, but all signals tested proved effective in alerting drivers and preparing them for the at-crossing signal activation.

Rail-Highway Crossing Accident Causation Study, K. Knoblauch, W. Hucke, and W. Berg, Input-Output Computer Services, Washington, DC, FHWA/RD-81/083, PB# 83-158733, April 1981. This study analyzed the human factors causes of crossing accidents. State accident reports were reviewed and

## Chapter X Supporting Programs

crossing accident locations were visited. Based on the accidents investigated, the study findings indicate that the main cause of accidents at crossbuck crossings involved recognition errors by drivers. At crossings with flashing lights, the main cause of accidents involved driver decision errors.

Constant Warning Time Concept Development for Motorist Warning at Grade Crossings, R.L. Monroe, D.K. Munsell, and T.J. Rudd, Systems Technology Laboratory Inc., Arlington VA, FRA/ORD-81/07, PB# 81-205684, May 1981. This study was jointly funded by FHWA and FRA. The objectives were to improve crossing safety through the effective use of constant warning time devices, to improve the reliability of such devices, and to lower their costs. The constant warning time device provides a uniform warning time for all trains regardless of speeds. High costs and high power requirements currently limit the increased installation of these devices. Magnetic and acoustic detectors were identified as the more promising concepts to use in the constant warning time devices. Limited field testing was undertaken at Fort Eustis, Virginia.

Railroad-Highway Crossings and Route Selection for Transporting Hazardous Materials, Janet A. Coleman, Public Roads, Vol. 48, No. 2, September 1984. This study involved the development of a methodology to analyze alternative routes for transporting hazardous materials over railroad-highway grade crossings.

### Current Studies

Cost Effectiveness Analysis of Using Railroad Highway Crossing Active Advance Warning Devices. This

study involves a field demonstration of active advance warning devices. The contractor will analyze and evaluate the alternative devices, determine the most effective active advance warning device, and develop guidelines for its use.

Resource Allocation Procedure. The available crossing accident and inventory data are being analyzed to determine the feasibility of expanding the number of categories of warning devices in the resource allocation procedure. Accident severity prediction equations were developed and will be added to the resource allocation procedure.

Innovative Railroad - Highway Crossing Active Warning Devices. This study involves the development and testing of innovative devices at controlled test sites. The innovative concepts were identified and ranked by representatives of FHWA, FRA, the railroad industry, the railroad signal suppliers, and non-railroad signal suppliers. The candidate innovative devices to be evaluated during the controlled testing included four-quadrant gates with and without skirts, standard highway traffic signals with bar strobes in the red signal heads, and existing flashing light signals on both sides of the roadway supplemented by cantilevered strobes.

Alternative Ways to Improve the Visibility of Railroad-Highway Crossing Signals. The objective of this study is to develop prototype signal hardware components and assemblies of alternate approaches for improving crossing signal visibility as well as reliability and uniformity of the signal display.

Consequences of Mandatory Stops for Certain Classes of Vehicles at

Railroad-Highway Crossings. The objectives of this study are to investigate the safety, operational, environmental and economic consequences of: maintaining the current Federal regulation requiring certain classes of vehicles to stop at all crossings; modifying the requirement to require stopping only at passive crossings and at active crossings only when the devices are activated; and, eliminating special pullout lanes at crossings with active warning devices with and without the requirement that certain classes of vehicles are required to stop.

Effectiveness of Warning Devices at Rail - Highway Grade Crossings. This HPR study involves the modification of the DOT accident prediction formula by adding additional variables. Among the variables being investigated are train speed difference, train speed ratios, and crossing angles.

The FRA is also active in sponsoring research pertaining to crossings. It jointly sponsored many of the research projects mentioned above with the FHWA. Other research projects undertaken by FRA are listed below.

- o A Program Definition Study for Rail-Highway Grade Crossing Improvement. Prepared by Alan M. Voorhees and Associates, Inc., for FRA, Report FRA-RP-70-2, October 1969, PB # 190401.
- o The Visibility and Audibility of Trains Approaching Rail-Highway Grade Crossings. Prepared by Systems Consultants, Inc., for FRA, Report FRA-RP-71-1, May 1971, PB # 202668.
- o Technological Innovation in Grade Crossing Protective Systems. Pre-

pared by TSC for FRA, Report DOT-TSC-71-3, June 1971, PB # 201624.

- o Enhancement of Train Visibility. Prepared by TSC for FRA, Report FRA-ORD&D-74-15, September 1973, PB # 223899.
- o Grade Crossing Protection In High-Speed, High - Density, Passenger-Service Rail Corridors. Prepared by TSC for FRA, Report FRA-ORD&D-74-14, September 1973, PB # 223738.
- o State Grade Crossing Programs: A Case Study. Prepared for FRA/TSC by CONSAD Research Corp., Report FRA-ORD&D-75-8, September 1974, PB # 244175.
- o Field Evaluation of Locomotive Conspicuity Lights. Prepared by TSC for FRA, Report FRA-ORD&D-75-54, May 1975, PB # 244532.
- o Guidelines for Enhancement of Visual Conspicuity of Trains at Grade Crossings. Prepared by TSC for FRA, Report FRA-ORD&D-75-71, May 1975, PB # 244551.
- o A Communication-Link Approach to Actuation of Grade Crossing Motorist-Warning Systems. Prepared by TSC for FRA, Report FRA-ORD&D-75-80, July 1975, PB # 244584.
- o A Methodology for Determination of Grade Crossing Resource Allocation Guidelines. Prepared by TSC for FRA, Report FRA - ORD&D - 76-04, August 1975, PB # 259005.
- o Locomotive to Automobile Baseline Crash Tests. Prepared by Ultra Systems for FRA, Report FRA-ORD&D-76-03, August 1975, PB # 250564.
- o Lightning and Its Effects on Railroad Signal Circuits. Prepared by

## Chapter X Supporting Programs

- University of Lowell, Lowell, MA, for FRA/TSC, Report FRA-ORD&D-76-129, December 1975, PB # 250621.
- o Standby Power for Railroad-Highway Grade Crossing Warning Systems. Prepared by University of Lowell, Lowell, MA, for FRA/TSC, Report FRA-ORD&D-76-286, September 1976, PB # 263592.
  - o Improvement of the Effectiveness of Motorist Warnings at Railroad-Highway Grade Crossings. Prepared by TSC for FRA, Report FRA/ORD-77/07, February 1977, PB # 266784.
  - o Potential Means at Cost Reduction in Grade Crossing Automatic Gate Systems. Prepared by MB Assoc., et.al. for TSC/FRA, Reports FRA/ORD 77-06.I and 77-06.II, February 1977, PB # 265724 and 265725.
  - o Innovative Concepts and Technology for Railroad-Highway Grade Crossing Motorist Warning Systems. Prepared by Cincinnati Electronics et.al. for TSC/FRA, Reports FRA/ORD-77/37.I and 77/37.II, September 1977, PB # 273354 and 273355.
  - o Potential Means of Cost Reduction in Grade Crossing Motorist-Warning Control Equipment. Prepared by Storch Engineers et.al. for TSC/FRA Reports FRA/ORD-77/45.I and 77/45.II, December 1977, PB # 277946 and 277947.
  - o Analysis of NPRM Strobe Lights on Locomotives. Prepared by IOCS, Inc., for FRA, Report FRA-OPPD-79-4, May 1978, PB # 293483.
  - o A Study of State Programs for Rail-Highway Grade Crossing Improvements. Prepared by TSC for FRA, Report FRA-OPPD-78-7, June 1978, PB # 279774.
  - o Legal Effects of Use of Innovative Equipment at Railroad - Highway Grade Crossings on Railroad's Accident Liability. Prepared by TSC for FRA, Report FRA-RRS-80-01, October 1979, PB # 80-137888.
  - o Rail-Highway Crossing Hazard Prediction Research Results. Prepared by TSC for FRA, Report FRA-RRS-80-02, March 1980, PB # 80-170749.
  - o Operational Testing of Locomotive-Mounted Strobe Lights. Prepared by TSC for FRA, Report DOT-TSC-FRA/ORD-80-48, June 1980, PB # 80-224348.
  - o Grade Crossing Accident Injury Minimization Study. Prepared by HH Aerospace Design Company, Inc., for FRA, Report No. FRA/ORD-80-87, December 1980, PB # 81-155236.
  - o Freight Car Reflectorization. Prepared by TSC for FRA, Report No. FRA-RRS-83-1, December 1982, PB # 84-131283.

In addition to conducting research, the FRA annually publishes a document that contains statistical information on crossings and crossing accidents. These data are generated from the U.S. DOT/AAR National Rail-Highway Crossing Inventory, of which FRA serves as custodian, and from the Railroad Accident/Incident Reporting System.

The National Cooperative Highway Research Program (NCHRP) is administered by the Transportation Research Board (TRB). One NCHRP project pertaining to railroad - highway grade crossings is currently underway. The study is titled "Guidelines for Evaluating Alternatives for Replacing a Grade-Separated Rail/Highway Crossing." Its objective is to provide a

comprehensive framework for use in evaluating alternatives and developing recommendations regarding grade separation reconstruction, replacement, or removal. The framework is to be applicable for determining the best alternative for new crossings and for changes to existing at-grade crossings.

The TRB also assists in disseminating research results through presentations made at its annual meeting in January. The TRB committee responsible for crossings, Committee A3A05, sponsors one or two sessions on crossings. The committee is also active in identifying areas of needed research and in encouraging an appropriate agency and/or organization to undertake the research. Two versions of a bibliography, Railroad-Highway Grade Crossings, Bibliography 57 and 58, are available from TRB.

The Association of American Railroads (AAR) often conducts informal research and sometimes sponsors research by a contractor. For example, it participated in the funding of the compilation of State laws. The American Railway Engineering Association's Committee 9 on crossings is often active in informal research by its members' employers. This committee also identifies areas of needed research and encourages the most appropriate agency or organization to conduct the research.

The National Transportation Safety Board conducts special studies on the safety aspects of a particular area pertaining to crossings. For example, it conducted a study on trucks carrying hazardous materials at crossings. The report title is Railroad/Highway Grade Crossing Accidents Involving Trucks Transporting Bulk Hazardous Materials.

Individual railroads and crossing equipment suppliers often conduct special studies or research and development activities. For example, railroads often monitor the performance of a particular crossing surface or test the use of special lighting devices. Suppliers often conduct in-house research to identify improvements of existing products and to develop new products.

### C. References

1. National Safety Council, Operation Lifesaver Program Guide, Chicago, IL: National Safety Council.
2. Rogers, William Charles, The Effectiveness of Operation Lifesaver in Reducing Railroad - Highway Grade Crossing Accidents, College Station, TX: Texas A & M University, December 1980.

## APPENDIX A

### Separate State Funding Programs for Crossing Improvements

Following is a list of States which have established separate funding programs for railroad - highway grade crossing improvements. This list was developed from information obtained in a Federal Highway Administration survey through its region and division offices in 1984. The content of this list may change as the States enact new legislation pertaining to crossings.

- California - \$15 million per year for grade separations
- Colorado - \$240,000 per year for active traffic control devices
- Florida - \$800,000 per year for crossing improvements on Amtrak routes and \$810,000 per year for crossing surfaces
- Idaho - \$100,000 per year for traffic control devices and crossing closures
- Illinois - \$6 million per year for traffic control devices, crossing closures, grade separations and other types of improvements
- Iowa - \$900,000 per year for crossing surfaces
- Kansas - \$5.5 million per year for active traffic control devices and crossbucks
- Minnesota - \$600,000 per year for traffic control devices, crossing closures, grade separations, and sight distance improvements
- Missouri - \$600,000 per year for active traffic control devices
- Nebraska - \$360,000 per year for active traffic control devices and crossing closures and \$1.6 million from the train/mile tax for grade separations
- North Dakota - \$100,000 biennium for the 10 % match for Federal funds for active traffic control devices
- Ohio - \$1.2 million per year for active traffic control devices
- Oklahoma - Funds provided from the Railroad Revolving Fund for the 10% match for Federal funds
- Oregon - \$600,000 per year for active traffic control devices, grade separations, crossing closures, and some site improvements
- South Dakota - \$200,000 per year for traffic control devices, grade separations, crossing closures, and sight distance improvements
- Texas - \$5.5 million per year for traffic control devices and surfaces, and \$10.0 million per year for grade separations
- Washington - \$500,000 per year to provide the 10 % match for Federal funds for active traffic control devices and crossing closures
- Wisconsin - \$500,000 per year for traffic control devices and \$100,000 per year for crossing surfaces
- Wyoming - \$120,000 per year for active traffic control devices

## APPENDIX B

### States Having Maintenance Funding Programs

Seventeen States have passed legislation that authorizes the expenditure of funds for maintenance of railroad-highway grade crossing traffic control systems and/or crossing surfaces. Following is a list of these States and a brief description of their maintenance programs. This information was obtained in 1984 and is subject to change.

- Alaska - Contributes 100% to the maintenance of traffic control devices and surfaces.
- California - Contributes 100% for new street crossings requested by public agencies and 50% for existing crossings upgraded with either Federal or State funds.
- Delaware - Contributes 100 % to the maintenance of active traffic control devices and surfaces at new crossings and 50% to the maintenance of active traffic control devices at existing crossings. Costs are based on an agreement.
- Florida - Contributes 50 % to the maintenance of flashing lights and automatic gates. Costs are based on an agreement.
- Iowa - Contributes up to 75 % to the maintenance of active traffic control devices. Costs are based on AAR signal units.
- Kentucky - Contributes 100 % to the maintenance of flashing lights and gates at specified crossings. Costs are based on an agreement.
- Louisiana - Contributes up to 50 % to the maintenance of active traffic control devices and surfaces at specified crossings. Costs are based on an agreement.
- Massachusetts - Contributes 100 % to the maintenance of crossbucks and surfaces.
- Michigan - Contributes \$10.00 per month to the maintenance of flashing lights. Contributes 50 % to the maintenance of crossbucks.
- Montana - Contributes to the repair or replacement of damaged traffic control devices.
- North Carolina - Contributes 50 % to the maintenance of flashing lights and gates. Costs are based on an agreement.
- Nevada - Contributes 50% to the maintenance of active traffic control devices. No funds have been spent.
- South Dakota - Contributes variable amounts to the maintenance of surfaces.
- Tennessee - Contributes to the maintenance of crossbucks.
- Texas - Contributes 40% to the maintenance of active control devices on the State highway system.
- Virginia - Contributes 50 % to the maintenance of active traffic control devices. Costs are based on an agreement.
- Wisconsin - Contributes 50 % to the maintenance of active traffic control devices. Contributes 85 % to the maintenance of surfaces. Costs are based on AAR signal units and agreement.

## APPENDIX C

### Class I and II Railroads

Railroad companies are classified by the Interstate Commerce Commission (ICC) on the basis of gross revenue. Effective January 1, 1982, the ICC adopted a procedure to adjust the Class I threshold for inflation by restating current revenues in 1978 constant dollars. A Class I railroad company has an annual gross operating revenue in excess of \$50 million in 1978 dollars which equates to about \$83 million in 1983 dollars. A Class II railroad has an annual gross operating revenue of between \$10 and \$50 million in 1978 dollars. Class III railroads include all switching and terminal companies and all railroads with annual gross operating revenues of less than \$10 million in 1978 dollars.

Following is a list of Class I railroads as of 1984. Several of these Class I Railroads have merged their operations; however, they still report as individual railroad companies.

Atchison, Topeka and Santa Fe Railway Company	CSX Corporation
Bessemer and Lake Erie Railroad Company	Chessie System
Burlington Northern Railroad Company	Baltimore and Ohio Railroad
Chicago and North Western Transportation Company	Chesapeake and Ohio Railway
Chicago, Milwaukee, St. Paul, and Pacific Railroad	Seaboard System Railroad
Consolidated Rail Corporation (Conrail)	Denver and Rio Grande Western Railroad
	Duluth, Missabe and Iron Range Railway
	Elgin, Joliet and Eastern Railway
	Florida East Coast Railway
	Grand Trunk Corporation
	Grand Trunk Western Railroad
	Guilford Industries
	Boston and Maine Corporation
	Delaware and Hudson Railway
	Illinois Central Gulf Railroad
	Kansas City Southern Railway
	Missouri-Kansas-Texas Railroad
	National Railroad Passenger Corporation (Amtrak)
	Norfolk Southern Corporation
	Norfolk and Western Railway
	Southern Railway System
	Pittsburg and Lake Erie Railroad
	Soo Line Railroad
	Southern Pacific Transportation Company
	St. Louis Southwestern Railway
	Southern Pacific



Appendix C

Union Pacific System

Missouri Pacific Railroad Company  
Union Pacific Railroad Company

The following companies were  
classified as Class II railroads in  
1984.

Bangor and Aroostook Railroad Company

Canadian Pacific Lines in Maine

Carolina and Northwestern Railway

Central Vermont Railway Inc.

Chicago and Illinois Midland Railway  
Company

Chicago South Shore and South Bend  
Railroad

Duluth, Winnipeg and Pacific Railway  
Company

Georgia Southern and Florida Railway

Green Bay and Western Railroad

Maine Central Railroad Company

Michigan Interstate Railroad, Ann  
Arbor

Monogahela Railway

Northwestern Pacific Railroad

Providence and Worcester Railroad  
Company

Richmond, Fredericksburg and Potomac  
Railroad Company

Spokane International Railroad

Texas and Northern Railway Company

Texas Mexican Railway Company

**APPENDIX D**

Example of a Diagnostic Team Crossing Evaluation Report Used by Nebraska

# DIAGNOSTIC TEAM CROSSING EVALUATION REPORT

AAR/DOT NO.:

DATE OF DIAGNOSTIC REVIEW:

LOCATION DATA			
RAILROAD:		STATE:	COUNTY:
R.R. DIVISION:		CITY: (In or Near)	
STREET/ROAD NAME:		R.R. MILEPOST:	
NEAREST R.R. TIMETABLE STATION:		BRANCH/LINE NAME:	
DIAGNOSTIC REVIEW			
INITIATED BY	<input type="checkbox"/> RAILROAD	<input type="checkbox"/> STATE	<input type="checkbox"/> LOCAL <input type="checkbox"/> OTHER
NAME		DATE INITIATED	
DIAGNOSTIC TEAM	1	AFFILIATION	
	2		
	3		
	4		
	5		
	6		
	7		
RAILROAD DATA			
DAILY TRAIN MOVEMENT		CHECK IF LESS THAN ONE MOVEMENT PER DAY:	
TOTAL TRAINS:	AMTRAK MOVEMENTS PER DAY	TYPE AND NUMBER OF TRACKS	
DAY THRU		MAIN	IF 'OTHER', SPECIFY:
NIGHT THRU		OTHER	
DAY SWITCH	SPEED OF TRAIN		Can two trains occupy crossing at the same time? <input type="checkbox"/> YES <input type="checkbox"/> NO
NIGHT SWITCH	Max. .... m.p.h.	Can one train block the motorists' view of another train at the crossing? <input type="checkbox"/> YES <input type="checkbox"/> NO	IF 'YES', EXPLAIN:
	Typical ..... to ..... m.p.h.		
CROSSING SURFACE	TRACK	TYPE	WIDTH
CROSSING ANGLE:			
ROADWAY DATA			
AGENCY HAVING JURISDICTION:		ADT:	PERCENT TRUCKS %
SPEED OF VEHICLE		SCHOOL BUS OPERATION	ROADWAY SURFACE:
Max. .... m.p.h.	<input type="checkbox"/> YES <input type="checkbox"/> NO	<input type="checkbox"/> YES <input type="checkbox"/> NO	ROADWAY WIDTH:
Typical ..... to ..... m.p.h.	No./Day	No./Day	ROADWAY CONDITION:
			<input type="checkbox"/> YES <input type="checkbox"/> NO
SHOULDER	<input type="checkbox"/> YES <input type="checkbox"/> NO	IF YES, WIDTH:	IS THE SHOULDER SURFACED? <input type="checkbox"/> YES <input type="checkbox"/> NO
			IS SIDEWALK PRESENT? <input type="checkbox"/> YES <input type="checkbox"/> NO
SPECIAL CONDITIONS REQUIRED AS A RESULT OF NEARBY HIGHWAY INTERSECTIONS:			

Appendix D

AAR/DOT NO.:

EXISTING WARNING DEVICE											
YES	NO	QTY	TYPE OF WARNING DEVICE			YES	NO	QTY	LENSES	TYPE OF WARNING DEVICE	
			ADVANCE WARNING SIGNS	LOCATION:					8" 12"	MAST MOUNTED FLASHING LIGHTS	
			STOP SIGNS	LOCATION:						CANTILEVER FLASHING LIGHTS	
			STOP AHEAD SIGNS	LOCATION:						SIDE LIGHTS	
			PVMT. MARKINGS	LOCATION:						AUTOMATIC GATES	
			CROSSBUCKS								
			NUMBER OF TRACKS SIGNS							WIGWAGS	
			INVENTORY TAGS							BELLS	
			INTERCONNECTED HIGHWAY TRAFFIC SIGNALS							SIDEWALK GATE ARMS	
<b>FIVE YEAR ACCIDENT DATA</b>										"NO TURN" SIGNS	
<b>TOTAL ACCIDENTS</b>			PROPERTY DAMAGE ONLY								ILLUMINATION
			PERSONAL INJURY ACCIDENTS								OTHER <i>Specify:</i>
			FATAL ACCIDENTS								
Number of personal injuries			Number of fatalities			IS CROSSING FLAGGED BY TRAIN CREW?					
TYPE OF DEVELOPMENT											
<input type="checkbox"/> OPEN SPACE		<input type="checkbox"/> RESIDENTIAL		<input type="checkbox"/> INDUSTRIAL		<input type="checkbox"/> INSTITUTIONAL		<input type="checkbox"/> COMMERCIAL		NEW DEVELOPMENTS THAT COULD AFFECT ADT? <input type="checkbox"/> YES <input type="checkbox"/> NO	
LOCATION OF NEARBY SCHOOLS:										IF YES, DESCRIBE:	
ADJACENT CROSSINGS											
DOT NO.	STREET/ROAD NAME				WARNING DEVICE				ADT		
IS THERE ADEQUATE ACCESS FROM THIS CROSSING TO ADJACENT CROSSINGS?					<input type="checkbox"/> YES		SKETCH:				
IF YES, WHICH CROSSING(S):					<input type="checkbox"/> NO						
CAN ROADWAY REALIGNMENT BE ACCOMPLISHED TO ALLOW CONSOLIDATION OF CROSSINGS? IF YES, PROVIDE SKETCH.					<input type="checkbox"/> YES						
IMPACT OF CLOSURE:					<input type="checkbox"/> NO						

AAR/DOT NO.:

A TRAIN AT THIS POINT ALLOWS A VEHICLE TO BE SAFELY STOPPED AT A ROADWAY CROSSING.

WE TAKE INTO ACCOUNT THE DISTANCE BETWEEN THE RAILROAD CROSSING AND THE ROADWAY CROSSING.

TRAFFIC CONE B

TRAFFIC CONE A

VISIBILITY TRIANGLE

**REQUIRED DESIGN SIGHT DISTANCE FOR COMBINATIONS OF HIGHWAY AND TRAIN VEHICLE SPEEDS**

TRAIN SPEED	HIGHWAY SPEED IN MPH							
	0	10	20	30	40	50	60	70
	DISTANCE ALONG RAILROAD FROM CROSSING ("A")							
10	162	126	94	94	99	107	118	129
20	323	252	188	188	197	214	235	258
30	484	378	281	281	295	321	352	387
40	645	504	376	376	394	428	470	515
50	807	630	470	470	492	534	586	644
60	967	756	562	562	590	642	704	774
70	1129	882	656	656	684	750	822	904
80	1290	1008	752	752	788	856	940	1032
90	1450	1134	844	844	884	964	1056	1160
	DISTANCE ALONG HIGHWAY FROM CROSSING ("B")							
	20	65	125	215	330	470	640	840

NOTE: 1 mph = 1.61 kph  
1 foot = .304 meters.

SIGHT DISTANCE LOCATION SKETCH:

SIGHT DISTANCE				STOPPED VEHICLE SIGHT DISTANCE			
TYPICAL TRAIN SPEED	mph	TYPICAL HIGHWAY SPEED	mph	STOPPED SCHOOL BUS = (13.5) (TRAIN SPEED) =			
REQUIRED DISTANCE "A"	ft.	REQUIRED DISTANCE "B"	ft.	STOPPED SEMI-TRAILER = (17.5) (TRAIN SPEED) =			
<b>NORTHWEST QUADRANT</b>				<b>NORTHEAST QUADRANT</b>			
SIGHT OBSTRUCTION:				SIGHT OBSTRUCTION:			
ACTUAL DISTANCE:				ACTUAL DISTANCE:			
"A" = ..... ft.				"A" = ..... ft.			
<b>SOUTHWEST QUADRANT</b>				<b>SOUTHEAST QUADRANT</b>			
SIGHT OBSTRUCTION:				SIGHT OBSTRUCTION:			
ACTUAL DISTANCE:				ACTUAL DISTANCE:			
"A" = ..... ft.				"A" = ..... ft.			

Appendix D

AAR/DOT NO.:

RECOMMENDATIONS		
ARE IMPROVEMENTS TO THE CROSSING RECOMMENDED? <input type="checkbox"/> YES <input type="checkbox"/> NO		IF NO, EXPLAIN:
IF YES, WHAT IMPROVEMENTS		
YES	NO	DESCRIBE
	SIGHT IMPROVEMENT	
	CROSSING SURFACE	
	ROADWAY APPROACHES	
	HIGHWAY TRAFFIC SIGNS	
	CROSSING SIGNALS	
	CROSSING CLOSURE	
	ILLUMINATION	
	OTHER	



## Appendix E

### State Agencies Having Authority to Close Crossings

According to the Compilation of State Laws and Regulations on Matters Affecting Rail-Highway Crossings the following State agencies have authority to close crossings.

Alaska Public Service Commission	Missouri Public Service Commission
Arkansas Commerce Commission	Nevada Public Service Commission
Arizona Corporation Commission	New Hampshire Public Utilities Commission
California Public Utilities Commission	New Jersey Department of Transportation
Colorado Public Utilities Commission	New Mexico State Corporation Commission
Connecticut Department of Transportation	New York Department of Transportation
Delaware Department of Transportation	North Carolina Department of Transportation and North Carolina Utilities Commission
Florida Department of Transportation	North Dakota Public Service Commission
Idaho Public Utilities Commission	Oklahoma Corporation Commission
Illinois Commerce Commission	Oregon Public Utility Commissioner
Indiana Public Services Commission	Pennsylvania Public Utility Commission
Louisiana Department of Transportation and Development	Rhode Island Department of Transportation
Maryland Department of Transportation	South Dakota Public Utilities Commission
Massachusetts Department of Public Works	Tennessee Public Service Commission
Michigan Public Utilities Commission	Utah Department of Transportation
Minnesota Public Service Commission	Vermont Public Service Board
Mississippi Highway Department (only State maintained)	Virginia State Corporation Commission
	Washington State Utilities and Transportation Commission

West Virginia Department of Highways

Wisconsin Office of Commissioner of  
Transportation

Wyoming Public Service Commission



APPENDIX F

Crossing Surfaces Used By States  
Trial Basis or Adopted for General Use, 1984

State	Rubber						Concrete			Polyethylene		Steel
	Good-year	Parkco	SAF& DRI	Red Hawk	Omni	Strail	FAB-RA CAST	Perma crete	Other	Oneida	Cobra	Steel Plank
Alabama	Adopt	Adopt	Adopt				Adopt					
Alaska												
Arizona	Adopt	Adopt										
Arkansas	Adopt	Adopt									Trial	
California												
Colorado												
Connecticut	Adopt	Adopt								Trial	Adopt	
Delaware	Adopt	Trial		Trial		Trial					Trial	
D.C.	Adopt	Adopt										
Florida	Adopt	Adopt				Trial	Trial		Adopt		Trial	
Georgia	Trial	Trial	Trial				Trial				Trial	
Hawaii												
Idaho	Adopt	Adopt	Adopt							Trial	Trial	
Illinois	Adopt	Adopt	Adopt	Adopt	Trial	Trial	Adopt				Trial	
Indiana	Adopt	Adopt	Adopt			Trial					Trial	
Iowa	Trial	Adopt	Adopt	Trial							Trial	
Kansas	Trial	Trial	Trial									
Kentucky	Trial	Adopt	Adopt	Adopt	Adopt	Trial	Adopt				Trial	
Louisiana	Adopt	Adopt	Adopt	Trial	Trial	Trial	Trial				Trial	Trial
Maine	Trial	Trial	Trial									
Maryland	Adopt			Adopt			Trial				Trial	
Massachusetts	Adopt	Adopt					Trial				Adopt	
Michigan	Adopt	Trial	Trial				Trial			Trial	Trial	Trial
Minnesota	Adopt	Adopt	Adopt	Trial	Trial						Adopt	
Mississippi	Adopt	Adopt	Adopt	Trial		Trial						
Missouri	Trial	Trial	Trial								Trial	
Montana	Trial										Trial	
Nebraska	Adopt		Adopt			Trial					Adopt	
Nevada	Adopt	Trial		Trial	Trial				Trial	Trial	Adopt	
New Hampshire	Trial	Trial	Trial									
New Jersey	Trial	Trial									Trial	
New Mexico	Adopt	Trial	Trial									
New York	Adopt	Adopt		Trial			Trial			Trial	Adopt	Trial
North Carolina	Trial											
North Dakota												
Ohio	Adopt	Adopt									Trial	
Oklahoma	Adopt		Trial								Trial	
Oregon												
Pennsylvania	Adopt	Adopt	Trial	Trial	Trial						Trial	
Puerto Rico												
Rhode Island		Adopt									Adopt	
South Carolina												
South Dakota	Adopt	Adopt	Adopt	Adopt	Trial	Trial						
Tennessee												
Texas	Adopt	Trial	Trial				Trial		Adopt		Trial	Trial
Utah	Trial										Trial	
Vermont	Adopt	Adopt										
Virginia		Adopt				Adopt	Adopt				Trial	
Washington	Adopt	Adopt	Adopt			Adopt						
West Virginia	Adopt	Trial				Trial					Trial	Trial
Wisconsin	Adopt	Trial	Adopt	Adopt							Trial	
Wyoming	Trial	Trial									Trial	

## GLOSSARY

**Abandonment** - The relinquishment of interest (public or private) in right-of-way or activity thereon with no intention to reclaim or use again for highway or railroad purposes.

**Accident Rate** - 1) The number of accidents, fatalities, or injuries divided by a measure of vehicle activity to provide a means of comparing accident trends through time. 2) The number of accidents per crossing per year.

**Allotment** - An action by administrative authority making funds available for obligations and expenditures for specified purposes and for certain periods.

**Anchors** - Rail fastening devices used to resist the longitudinal movement of rail under traffic and to maintain proper expansion allowance at joint gaps for temperature changes.

**Apportionment** - An administrative assignment of funds based on a prescribed formula by a governmental unit to another governmental unit for specific purposes and for certain periods.

**Appropriation** - An act of a legislative body which makes funds available for expenditures with specific limitations as to amount, purpose, and period.

**At-Grade Intersection (Crossing)** - An intersection (crossing) where roadways (and railroads) join or cross at the same level.

**Ballast** - Material placed on a track roadbed to hold the track in align-

ment and elevation; it consists of hard particles that are stable, easily tamped, permeable and resistant to plant growth.

**Benefit-Cost Ratio** - The economic value of the reduction in fatalities, injuries, and property damage divided by the cost of the accident reducing measure.

**Branch Line** - A secondary line of railroad usually handling light volumes of traffic.

**Cab** - The space in a locomotive unit or "MU" car containing the operating controls and providing shelter and seats for the engine crew.

**Catenary System** - A system that consists of overhead supporting cables and a conductor (trolley wire) that supplies electricity to power rolling stock through contact with a pantograph or trolley current-collecting device (trolley pole).

**Centralized Traffic Control (CTC)** - A traffic control system whereby train movements are directed through the remote operation of switches and signals from a central control point.

**Comparative Negligence** - A legal doctrine applicable in negligence suits, according to which the negligence of the plaintiff as well as that of the defendant is taken into account. Damages are based upon the outcome of a comparison of the two and are thus proportioned.

**Consist** - 1) The makeup or composition (number and specific identity) of a train of vehicles. 2) Contents.

## Glossary

**Construction** - The actual physical accomplishment of building, improving, or changing a railroad-highway grade crossing or other finite facility.

**Contract** - The written agreement between the contracting agency and the contractor setting forth the obligations of the parties thereunder for the performance of the prescribed work. The contract includes the invitation for bids, proposal, contract form and contract bond, specifications, supplemental specifications, special provisions, general and detailed plans, and notice to proceed. The contract also includes any change orders and agreements that are required to complete the construction of the work in an acceptable manner, including authorized extensions thereof, all of which constitute one instrument.

**Contractor** - The individual, partnership, firm corporation, or any acceptable combination thereof, or joint venture, contracting with an agency for performance of prescribed work.

**Corridor** - A strip of land between two termini within which traffic, topography, environment and other characteristics are evaluated for transportation purposes.

**Cross Section** - A vertical section of the ground and facilities thereon at right angles to the center line.

**Crossing Angle** - The angle of 90 degrees or less at which a railroad and a highway intersect.

**Crosstie** - The wooden or concrete support upon which track rails rest and which holds them to gauge and transfers their load through the ballast to the subgrade.

**Culvert** - Any structure under the roadway with a clear opening of twenty feet or less measured along the center of the roadway.

**Diagnostic Team** - A group of knowledgeable representatives of the parties of interest in a railroad-highway crossing or a group of crossings.

**Do-Nothing Alternative** - An alternative which refers to the existing state of the system.

**Easement** - A right to use or control the property of another for designated purposes.

Drainage Easement - An easement for directing the flow of water.

Planting Easement - An easement for reshaping roadside areas and establishing, maintaining, and controlling plant growth thereon.

Sight Line Easement - An easement for maintaining or improving the sight distance.

Slope Easement - An easement for cuts or fills.

**Economic Analysis** - Determination of the cost-effectiveness of a project by comparing the benefits derived and the costs incurred in a project.

Cost/Benefit Analysis - A form of economic evaluation in which input is measured in terms of dollar costs and output is measured in terms of economic benefit of a project as compared to the incurred cost of the project.

Cost/Effectiveness Analysis - A comparison study between the cost of an improvement (initial plus maintenance) and the benefits it provides. The latter may be de-

rived from accidents reduced, travel time reduced, or increased volume of usage, and translated into equivalent dollars saved.

**Encroachment** - Unauthorized use of highway or railroad right-of-way or easements as for signs, fences, buildings, etc.

**Equipment Rental Rate** - Equipment usage charges usually established on a time or mileage use basis, including direct costs, indirect costs and depreciation.

**Expenditures** - A term applicable to accrual accounting, meaning total charges incurred, including expenses, provision for retirement of debt, and capital outlays. The making of a payment is a disbursement.

**Exposure Index** - A method of measuring the conflict of highway traffic with train traffic at railroad-highway grade crossings for the purpose of developing accident rates. The exposure index is the product of annual train miles and vehicle miles divided by 10 to the 18th power for convenience.

**Force Account Work** - Prescribed work paid for on the basis of actual costs and appropriate additives.

**Functional Classification** - Division of a transportation network into classes, or systems, according to the nature of the service they are to provide.

**Grade** - The rate of ascent or descent of a roadway, expressed as a percent; the change in roadway elevation per unit of horizontal length.

**Grade Separation** - A crossing of two highways, or a highway and a railroad, at different levels.

**Guardrails** - Traffic barriers used to shield hazardous areas from errant vehicles.

**Highway, Street, or Road** - A general term denoting a public way for purposes of vehicular travel, including the entire area within the right-of-way.

**Lading** - Freight or cargo making up a shipment.

**Lane** - A strip of roadway used for a single line of vehicles.

Auxiliary Lane - The portion of the roadway adjoining the through traveled way for parking, speed change, turning, storage for turning, weaving, truck climbing or for other purposes supplementary to through traffic movement.

Pullout Lane - An auxiliary lane provided for removal from the through traffic lane those vehicles required to stop at all railroad-highway grade crossings.

Speed-Change Lane - An auxiliary lane, including tapered areas, primarily for the acceleration or deceleration of vehicles entering or leaving the through traveled way.

Traffic Lane - The portion of the traveled way for the movement of a single line of vehicles.

**Line Haul** - The movement of freight over the tracks of a railroad from one town or city to another town or city.

**Local Freight Train** - A train with an assigned crew that works between predesignated points. These trains handle the switching outside the jurisdiction of a yard switcher.

## Glossary

**Locomotive** - A self-propelled unit of on-track equipment designed for moving other rail freight and passenger equipment on rail tracks.

**Main Line** - The principle line or lines of a railway.

**Main Track** - A track extending through yards and between stations, upon which trains are operated by timetable or train order or both, or the use of which is governed by block signals or by centralized traffic control.

**Materials** - Any substances specified for use in the construction of a project and its appurtenances.

**Measure of Effectiveness (MOE)** - A measurable unit or set of units assigned to each evaluation objective. The data collected in the units of the MOE will allow for a determination of the degree of achievement for that objective.

**Pavement Markings** - Markings set into the surface of, applied upon, or attached to the pavement for the purpose of regulating, warning, or guiding traffic.

**Pavement Structure** - The combination of subbase, base course, and surface course placed on a subgrade to support the traffic load and distribute it to the roadbed.

**Base Course** - The layer or layers of specified or selected material of designed thickness placed on a subbase or subgrade to support a surface course.

**Surface Course** - One or more layers of a pavement structure designed to accommodate the traffic load, the top layer of which resists skid-

ding, traffic abrasion, and the disintegrating effects of climate. The top layer sometimes called "Wearing Course".

**Subbase** - The layer or layers of specified or selected material of designed thickness placed on a subgrade to support a base course.

**Subgrade** - The top surface of a roadbed upon which the pavement structure and shoulders including curbs are constructed.

**Plaintiff** - The person who begins an action at law; the complaining party in an action.

**Plans** - The contract drawings which show the location, character, and dimensions of the prescribed work, including layouts, profiles, cross sections and other details.

**Precedent** - An adjudged case or judicial decision that furnishes a rule or model for deciding a subsequent case that presents the same or similar legal problems.

**Preliminary Engineering** - The work necessary to produce construction plans, specifications, and estimates to the degree of completeness required for undertaking construction thereunder, including locating, surveying, designing, and related work.

**Rail Joint** - A fastening designed to unite abutting ends of rail.

**Railroad Line Miles** - The aggregate length of road of linehaul railroads. It excludes yard tracks, sidings, and parallel lines. Jointly-used track is counted only once.

**Railroad Track Miles** - Total miles of railroad track including multiple

main tracks, yard tracks and sidings, owned by both line-haul and switching and terminal companies.

**Railroad-Highway Grade Crossing** - The general area where a highway and a railroad cross at the same level, within which are included the railroad, roadway, and roadside facilities for traffic traversing that area.

Pedestrian Crossing - A railroad-highway grade crossing that is used by pedestrians but not by vehicles.

Private Crossing - A railroad-highway grade crossing that is on a privately owned roadway utilized only by the owner's licensees and invitees.

Public Crossing - A railroad-highway grade crossing that is on a roadway under the jurisdiction of, and maintained by, a public authority and open to the traveling public.

**Right-of-Way** - A general term denoting land, property, or interest therein, usually in a strip, acquired for or devoted to transportation purposes.

**Roadway** - The portion of a highway, including shoulders, for vehicular use. A divided highway has two or more roadways.

**Salvage Value** - Estimated residual worth of program or project components at the end of their expected service lives.

**Service Life** - The period of time, in years, in which the components of a program or project can be expected to actively affect accident experience.

**Shoulder** - The portion of the roadway contiguous with the traveled way primarily for accommodation of stopped vehicles for emergency use, and for lateral support of base and surface courses.

**Sidewalk** - That portion of the roadway primarily constructed for the use of pedestrians.

**Sovereign Immunity** - The immunity of a government from being sued in its own courts except with its consent, or other exception.

**Statute of Limitations** - A statute that imposes time limits upon the right to sue in certain cases.

**Stopping Sight Distance** - The length of highway required to safely stop a vehicle traveling at a given speed.

**Superelevation Rate** - The rate of rise in cross section of the finished surface of a roadway on a curve, measured from the lowest or inside edge to the highest or outside edge.

**Tie Plate** - A flanged plate between a rail and a crosstie that distributes the rail load over a larger area and helps hold track gauge.

**Timetable** - 1) The authority for the movement of regular trains subject to the rules; it contains classified schedules with special instructions relating to the movement of trains and engines. 2) A listing of the times at which vehicles are due at specified time points (colloquial).

**Tort** - Any private or civil wrong by act or omission, but not including breach of contract. Some torts may also be crimes.

## Glossary

**Track** - 1) An assembly of rails, ties, and fastenings over which cars, locomotives and trains are moved. 2) the width of a wheeled vehicle from wheel to wheel and usually from the outside of the rims.

Double or Multiple - Two or more main tracks over which trains may travel in both directions.

Single - 1) The main track on a roadbed having one main track upon which trains are operated in both directions. 2) In multiple track territory, the process of running all trains, regardless of direction on one track while the other track(s) is (are) temporarily out of service.

**Track Gauge** - The distance between the inside face of the heads of the two rails of a track measured perpendicular to the center line. (Standard gauge in U.S. is 4'-8.5".)

**Traffic Control Device** - A sign, signal, marking or other device placed on or adjacent to a street or highway by authority of a public body or official having jurisdiction to regulate, warn, or guide traffic.

Active Traffic Control Device - Those traffic control devices activated by the approach or presence of a train, such as flashing light signals, automatic gates and similar devices, as well as manually operated devices and crossing watchmen, all of which display to motorists positive warning of the approach or presence of a train.

Passive Traffic Control Device - Those types of traffic control devices, including signs, markings and other devices, located at or in advance of grade crossings to indi-

cate the presence of a crossing but which do not change aspect upon the approach or presence of a train.

Traffic Control Signal - Any device whether manually, electrically, or mechanically operated by which traffic is alternately directed to stop or permitted to proceed.

Traffic Markings - All lines, patterns, words, colors, or other devices, except signs, set into the surface of, applied upon, or attached to the pavement or curbing or to the objects within or adjacent to the roadway, officially placed for the purpose of regulating, warning, or guiding traffic.

**Traffic Operation Plan** - A program of action designed to improve the utilization of a highway, a street, or highway and street network, through the application of the principles of traffic engineering.

**Traffic Sign** - A device mounted on a fixed or portable support whereby a specific message is conveyed by means of words or symbols, officially erected for the purpose of regulating, warning, or guiding traffic.

**Traffic Signal** - A power-operated traffic control device by which traffic is regulated, warned, or alternately directed to take specific actions.

Cycle Time - The time required for one complete sequence of signal indications.

Detectors - Mechanical or electronic devices that sense and signal the presence or passage of vehicular or railroad traffic at one or more points in the roadway or track.

Phase - Those right-of-way and clearance intervals in a cycle assigned to any independent movement(s) of vehicular traffic.

Train - 1) One or more locomotive units with or without connected cars.  
2) Two or more vehicles physically connected and operated as a unit.

Through - A freight train operating between major classification yards and serving non-local traffic.

Unit - A freight train moving great tonnage of single bulk products between two points coupled with a system of efficient, rapid loading and unloading facilities.

Train Orders - Authorization to move a train as given by a train dispatcher either in writing or verbally.

Traveled Way - The portion of the roadway for the movement of vehicles, exclusive of shoulders.

Vehicle - A means of carrying or transporting something.

Bicycle - A vehicle having two tandem wheels, propelled solely by human power, upon which any person or persons may ride.

Bus - A self-propelled rubber-tired vehicle designed to accommodate 15 or more passengers and to operate on streets and roads.

Design Vehicle - A selected motor vehicle, the weight, dimensions and operating characteristics of which are used in highway design.

Motorcycle - A two-wheeled motorized vehicle having one or two saddles and sometimes a sidecar with a third supporting wheel.

Passenger Car - A motor vehicle, except motorcycles, designed for carrying 10 passengers or less and used for the transportation of persons.

Semi-trailer - A vehicle with or without motive power, designed for carrying persons or property and for being drawn by a motor vehicle and so constructed that some part of its weight and that of its load rests upon or is carried by another vehicle.

Special Vehicle - A vehicle whose driver is required by law to stop in advance of all railroad-highway grade crossings. Typically, special vehicles include: vehicles transporting passengers for hire; trucks carrying hazardous materials; and school buses.

Truck Tractor - A motor vehicle designed for drawing other vehicles but not for a load other than a part of the weight of the vehicle and load drawn.

Volume - The number of vehicles passing a given point during a specified period of time.

Average Daily Traffic - The average 24-hour volume, being the total volume during a stated period divided by the number of days in that period. Unless otherwise stated, the period is a year. The term is commonly abbreviated as ADT.

Design Volume - A volume determined for use in design, representing traffic expected to use the highway. Unless otherwise stated, it is an hourly volume.

Warrants - The minimum conditions which would justify the establishment



## Glossary

of a particular traffic control regulation or device, usually including such items as traffic volumes, geometrics, traffic characteristics, accident experience, etc.

Yard - A system of tracks within defined limits that is provided for making up trains, storing cars, and other purposes.

## INDEX

- Abandonment: 41, 89, 94-96, 166-167, 216, 249
- Accident Prediction Formulae: 38, 63, 66-78, 87, 177-180, 228-230
- Accidents: 3-8, 14-16, 18-19, 27-28, 34, 36-40, 42-43, 45-46, 48-52, 56-62-78, 84, 87, 89-90, 101, 104, 107, 109, 126, 140, 143-144, 165, 167-169, 171-181, 206, 209-214, 217, 219, 221, 223, 226-228, 231, 249, 251, 253, 256
- Accident Costs: 171-176
- Active Advance Warning Signs: 81, 83, 103, 114-115, 169, 227-228
- Active Traffic Control Devices: 7, 11-13, 21, 29, 33, 43, 48, 66-72, 77-78, 80, 84-86, 89, 93, 96, 99, 101-125, 141-143, 168, 177-179, 183-186, 189, 191, 205, 213-215, 217-218, 226-230, 233, 235, 254
- Advance Warning Signs: 12, 29, 31, 80-81, 83, 94, 96-103, 114-115, 186, 194, 209, 212, 219-220, 226-227
- Advisory Speed Plates: 97, 100
- Agreements: 13, 42, 86-87, 95-96, 183, 186-189, 207, 213, 250
- American Association of State Highway and Transportation Officials: 19, 21, 35, 50, 88, 138, 168-169, 185, 223
- American Railway Engineering Association: 14, 19, 21, 25, 136, 168, 231
- American Road and Transportation Builders Association: 19, 22
- American Short Line Railroad Association: 19, 21, 216, 223
- American Trucking Association: 19, 22, 223
- Annual Average Daily Traffic: 36-39, 51-52, 54, 66-72, 77, 79, 84, 93, 98, 165-166, 180, 255
- Approach Zones: 31, 80, 82-83
- Association of American Railroads: 13-15, 19, 28, 50, 185, 207-208, 221, 223, 231, 235
- Audible Traffic Control Devices: 31, 43, 110
- Automatic Gates: 12, 29-31, 66-72, 78, 92, 94, 96, 98, 102-104, 107, 116, 125, 143, 169, 173, 177-179, 181, 184, 207, 214, 217, 224, 226, 228, 230, 235, 254
- Ballast: 47, 127, 130-131, 136-138, 143-145, 147-150, 159, 164, 249-250
- Barricades: 94, 194, 198-199, 201-202
- Benefit-Cost Analysis: 43, 91, 173, 175-177, 211, 249-250
- Bicycles: 4, 56, 63, 78, 85, 110, 213, 218-220, 255
- Blocked Crossings: 8, 14, 42, 140, 142
- Bridge Rehabilitation and Replacement: 12, 184-185
- Bureau of Motor Carrier Safety: 56, 61-62

## Index

- Buses: 4, 34-36, 38, 56, 63, 66, 78, 84-85, 90, 95, 109, 116, 139, 143, 214, 218-219, 255
- Cantilevered Flashing Lights: 39, 103, 105-107, 110, 113-115, 207
- Channelizing Devices: 193-199
- Closure: 11, 13, 54, 84-87, 89-94, 136, 140, 142, 166, 181, 183-184, 191-192, 194-196, 233, 245-246
- Community Relations: 1-2, 13, 41-42, 85-86, 91-93, 142, 225
- Cost-Effectiveness Analysis: 172-175, 177, 211, 228, 250
- Cross Sections: 84, 135, 137-140, 150, 153-164, 250, 252-253
- Crossbucks: 12, 29-30, 33, 52, 66, 69, 94, 96-102, 106, 184, 205, 214-215, 228, 233, 235
- Crossties: 47, 137, 143, 145, 147-151, 153-165, 250, 253-254
- Delineators: 143, 193, 196, 198
- Diagnostic Teams: 78-84, 86, 177, 179, 239-243, 250
- Do Not Stop on Tracks Signs: 97, 101, 106, 205
- Drainage: 39, 47, 84, 92-93, 110, 136-139, 143-145, 147-150, 153, 164, 205, 250
- Driver Characteristics: 29-33, 41, 80-83, 90, 126, 131-134, 168, 211, 223, 226-227
- Driver Education: 10, 12, 15, 40, 212, 217-218, 221, 223-225
- Driver Enforcement: 13, 19, 40, 135, 212, 218, 221, 223-225
- Economic Analysis: 43, 93, 171-181, 250
- Elimination: 2, 9-12, 15, 86, 89-96, 166, 183-184
- Engineering Studies: 51, 55, 79-85, 87-88, 93, 98-102, 107, 115, 135, 140, 143, 167, 175, 211, 221
- Evaluation: 26, 51, 79-85, 166-167, 171-181, 209-212, 215, 224-225, 227, 231, 239-243, 250, 252
- Exempt Crossing/Signs: 96-97, 101, 205
- Exposure Index: 3-5, 7, 70-72, 91, 106, 109, 251
- Federal Highway Administration: 10, 12-13, 16-19, 28, 50-52, 56, 79, 85, 87-89, 116, 141, 168-169, 181, 184-185, 187-188, 190-191, 203, 208-209, 212, 221, 225-229, 233
- Federal Railroad Administration: 4, 10, 12, 17-18, 27-28, 43, 45, 49-50, 52, 54-57, 87-88, 95, 148, 168-169, 181, 221, 226-230
- Flagging: 30-31, 78, 96, 98, 131, 142, 193-195, 198-203, 214, 254
- Flangeway: 144, 148, 150, 152-165, 219
- Flashing Lights: 12, 29-30, 52, 66-72, 92, 94, 96, 102-116, 123, 125-126, 169, 173, 177-179, 181, 184, 206-207, 214, 224, 228, 235, 254
- Freight Cars: 41-45, 47-48, 125, 254-256
- Freight Car Reflectors: 44, 50, 230
- Funding: 7-11, 13, 15-18, 27, 41, 85-87, 91, 92, 171, 175, 177-178, 183-187-188, 190-191, 206-207, 213, 215-216, 233, 235, 249

- Gate (see Automatic Gate)
- Geometrics: 35-36, 38, 78, 83, 87-88, 98, 100, 115-116, 131, 135-140, 143, 169, 192-193, 217, 226, 256
- Grade Separations: 1, 3, 7, 9, 11-12, 15, 17, 40, 52, 86, 89-93, 166-167, 183-185, 217, 220, 230-231, 233, 251
- Hazard Zones: 31-33
- Hazardous Materials: 7, 19, 33, 36, 56, 63, 66, 68, 78-79, 84-85, 87-90, 92, 95, 109, 116, 139, 143, 180, 218-219, 221, 228, 231, 255
- High Speed Railroads: 9, 85, 91, 109, 126, 141-142, 180, 213, 217-218, 229
- Highway Relocation: 11, 90-92, 183-184
- Highway Safety Improvement Program: 10, 17, 28, 51, 171-172, 181, 209
- Horizontal Alignment: 36, 38-39, 66, 68, 81, 84, 134-136, 138, 140, 167
- Illumination: 11, 36, 40, 84, 97-98, 131, 140-141, 168-169, 177, 183-184, 205, 212
- Improvement Costs: 9-12, 15-17, 33, 51, 56, 63, 87, 89-91, 140, 165-167, 171-180, 183-190, 205, 228, 250
- Information Handling Zones: 31-33
- Institute of Transportation Engineers: 19, 22-23
- Insurance: 27, 171, 187, 190-191
- Interstate Commerce Commission: 9, 16, 28, 40, 43, 95, 172, 215-216, 237
- Islands, Traffic: 143, 169
- Liability: 14-16, 23-27, 190-191, 227, 230
- Locomotives: 42-45, 50, 125, 229-230, 249, 252, 254-255
- Maintenance: 3, 9, 12-13, 15, 17-18, 21-23, 27-28, 33, 39, 47, 86, 90-91, 93, 96, 107, 135-137, 143-144, 149, 153-156, 159, 161, 165, 171-176, 178-181, 185-187, 191-194, 196, 200, 206-208, 213, 216, 220, 235, 250, 253
- Materials Transportation Bureau: 56, 63-65
- Motorcycles: 4, 33-34, 56, 213-214, 218-220, 255
- National Highway Traffic Safety Administration: 17-18, 56, 59-60, 171, 175, 209
- National Safety Council: 13-15, 19, 21-22, 171, 175, 223, 231
- National Transportation Safety Board: 14, 17, 19, 36, 88, 168, 218, 221, 223, 231
- Nearby Highway Intersections: 36-37, 40, 66, 80-81, 94, 99-100, 102, 107, 115-125, 135, 139, 181, 183, 205, 218
- Net Annual Benefit: 175-177
- Nonrecovery Zones: 31-32, 82
- Operation Lifesaver: 12-13, 19, 21-22, 217-218, 223-225, 231
- Passive Traffic Control Devices: 29, 33, 66-72, 78, 80, 84, 87, 89, 90, 94, 96-104, 134, 137, 141-142, 177, 181, 183-184, 186, 206, 213-214, 217-220, 226-229, 233, 235, 254

## Index

- Pavement Markings: 10-12, 29, 31, 80, 83-84, 94, 96, 101-103, 169, 186, 193-194, 196-198, 200, 206, 220, 252, 254
- Pedestrians: 3-4, 29, 40, 56, 63, 78, 85, 96-97, 107, 110, 125, 142, 148, 192-193, 196, 213-214, 218, 220-221, 225, 253
- Preemption of Highway Traffic Signals: 40, 66, 80-81, 94, 102, 115-125, 181, 183, 205
- Priority (Hazard) Index/Schedule: 55, 63-69, 78-79, 87, 91, 106, 109, 171, 185, 217, 226
- Private Crossings: 3, 7, 10, 19, 52, 86, 95, 213-215, 217, 225, 253
- Public Crossings: 3-5, 7, 9-11, 14-15, 19, 29-30, 33-34, 37-40, 43, 45-46, 48-49, 52, 63, 85-86, 95, 140, 144, 166, 181, 213, 215, 225, 253
- Pullout Lanes: 38-39, 139-140, 219, 229, 251
- Railroad Line Miles: 1-3, 252
- Railroad Relocation: 11, 86, 89, 90-92, 183-185
- Railroad Track Miles: 1-2, 15, 252
- Railroad Train Miles: 1-3, 41, 251
- Railway Progress Institute: 14, 19, 21, 169, 223
- Research: 10, 13-14, 18, 21-22, 55, 226-231
- Resource Allocation Procedure: 88, 177-181, 227-229
- Roadway Functional Classification: 3, 36, 66, 68, 71-72, 165, 251
- Roadway Miles: 2-3, 10, 15
- Safety Barriers: 109-110, 131, 141-142, 168, 196, 198-199, 220, 251
- School Buses: 7, 33-34, 36, 63, 66, 68, 78, 84, 89-90, 95, 109, 116, 139, 143, 180, 214, 218-219, 224, 255
- Short Line Railroads: 41, 95, 213, 215-217, 221
- Sight Distance: 13, 31, 33, 35-39, 56, 66, 68-69, 77-78, 80-84, 97-98, 100-101, 107, 109, 126, 131-136, 141, 180-181, 206, 212, 217, 219, 233, 250, 253
- Solar Energy: 125
- Special Vehicles: 7, 36, 85-86, 89-90, 95-96, 139, 165, 213, 218-221, 229, 255
- Stabilization Fabrics: 84, 139, 147, 150
- Stop Ahead Signs: 97
- Stop Signs: 30, 40, 97, 100-101, 214-215
- Stopping Distances: 31, 33, 35, 44, 77, 82, 107, 115, 131, 140-141, 211, 217, 219, 253
- Surfaces: 11-14, 36, 39, 66, 68, 81, 84, 86, 89-90, 94, 126, 136-137, 143-166, 168-169, 177, 181, 183-184, 186, 188, 191, 194, 205-207, 216, 219, 226, 231, 233, 235, 247
- Systems (Corridor) Approach: 51, 79, 85-87, 93, 115, 190, 217, 250
- Track Characteristics: 39, 41, 43, 45-49, 125-138, 147-165, 250, 252-254, 256

- Traffic Control Devices: 7, 9, 11-15, 17-18, 21, 23, 27-31, 33, 41, 43, 48, 50, 52, 66-72, 77-81, 84-85, 87-90, 93-94, 95-125, 134, 137, 139-143, 166, 168-169, 172, 177-180, 183-184, 186-189, 191-193, 196-203, 205-208, 213-221, 223-224, 226-230, 233, 235, 254, 256
- Train Characteristics: 41-45, 125-134, 223, 249, 251-255
- Train Detection Circuits: 12, 18, 21, 36, 48, 84-86, 102-104, 114-116, 124-131, 149, 157, 159, 177, 181, 183, 189, 205, 217, 227-229
- Train Horn/Whistle: 43
- Transportation Research Board: 14, 19, 22, 230-231
- Trespassers: 40, 215, 221, 225
- Trucks: 4, 7, 22, 33-36, 38-39, 56, 66, 84-85, 88-89, 93-94, 109, 116, 133, 136, 142, 168, 180, 214, 218-219, 221, 224, 231, 251, 255
- Turn Prohibition Signs: 102, 123
- Uniform Vehicle Code: 30-31, 50, 169
- U.S. DOT/AAR National Rail-Highway Crossing Inventory: 10, 18, 29, 40, 48, 50, 52-56, 70, 88, 95, 104, 144, 168, 206, 213
- Vehicle Characteristics: 29, 33-36, 39, 80, 82, 132-134, 137, 219, 255
- Vehicle Miles: 2-3, 34, 251
- Vertical Alignment: 36, 38-39, 66, 81, 84, 135-137, 140, 167, 219
- Warning Bells: 30, 67, 103, 110, 114, 214
- Warning Time: 14, 27, 31, 108-109, 116, 125-131, 133, 168, 217-219
- Wigwags: 30, 66, 104, 214
- Work Zones: 191-202