

THE MEASUREMENT OF DAMPING AND NATURAL FREQUENCIES
IN LINEAR SYSTEMS BY USING THE
RANDOM DECREMENT TECHNIQUE

by

Chih-Po Lin

Thesis submitted to the Faculty of the Graduate School
of the University of Maryland in partial fulfillment
of the requirements for the degree of
Master of Science
1981

ABSTRACT

Title of Thesis: The Measurement of Damping and Natural Frequencies in Linear Systems by using the Random Decrement Technique

Chih-Po Lin, Master of Science, 1981

Thesis co-directed by: Dr. Jackson C. S. Yang
Professor of Mechanical Engineering

Dr. Nicholas Dagalakis
Assistant Professor of Mechanical Engineering

The objective of this work is to investigate analytically the accuracy of the Random Decrement Technique in determining the natural frequencies and the damping ratios of dynamic systems. The dynamic systems used were a second order, a fourth order and a high order system. Lumped parameter models were used for the second and fourth order systems. A finite element model was used for the high order system.

The natural Frequencies and the Damping ratios were obtained directly from the Random Decrement Signature by the logarithmic decrement technique and with the use of a curve fitting algorithm. For the case where the modes are well separated the accuracy of the two techniques were compared.

The accuracy of the Random Decrement Technique was also investigated as a function of the number of Random Decrement Averages.

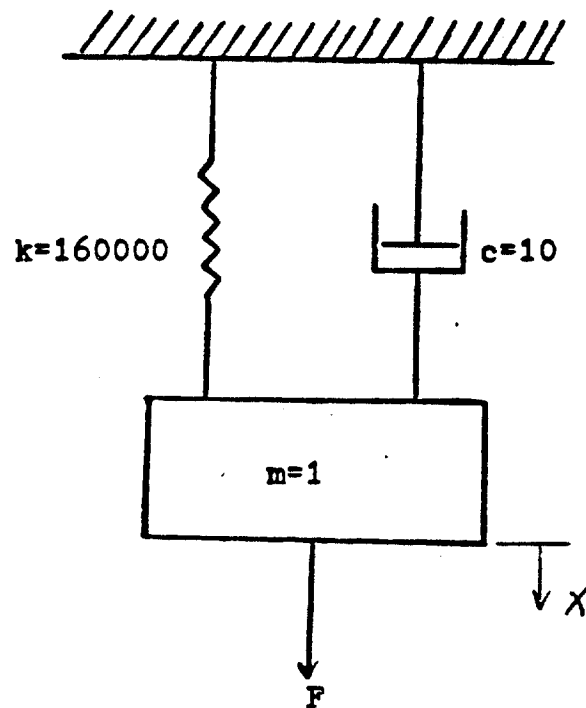

Figure 3. Single-Degree-of-Freedom System (Model A)

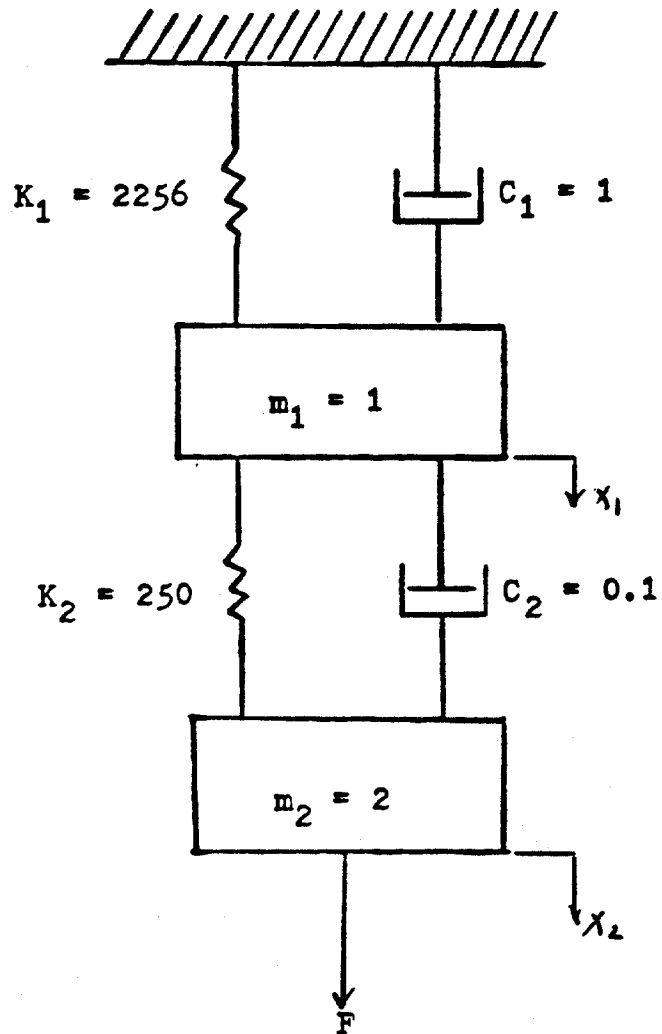

Figure 5. Two-Degree-of-Freedom System with Well-Separated Modes (Model B)

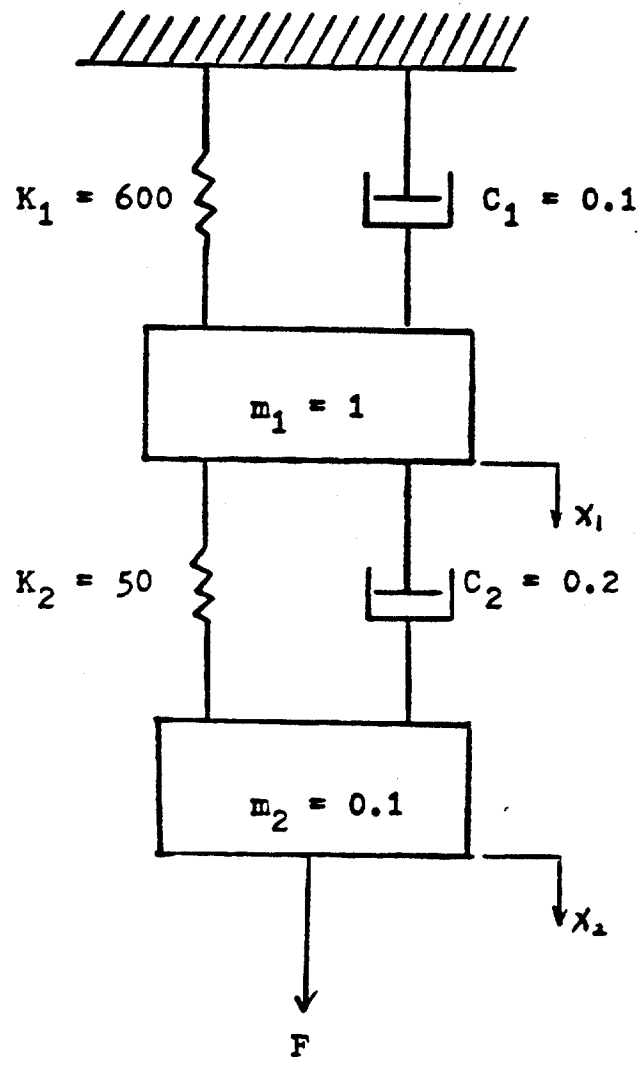

Figure 11. Two-Degree-of-Freedom System with Closely-Spaced Modes (Model C)

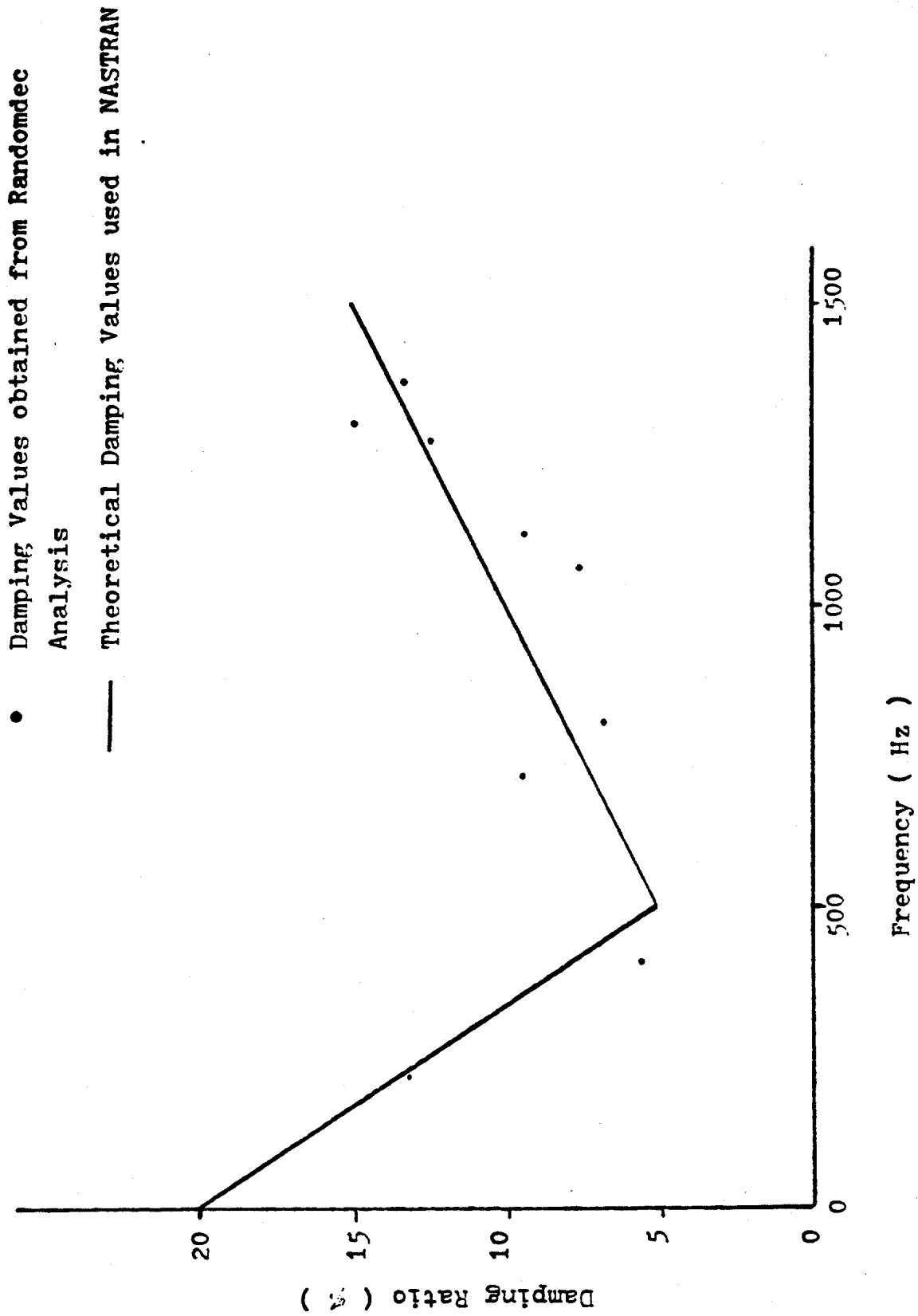

Figure 32. Comparison of the obtained Damping values with the theoretical damping values used in NASTRAN 64

THE MEASUREMENT OF DAMPING AND NATURAL FREQUENCIES
IN LINEAR SYSTEMS BY USING THE
RANDOM DECREMENT TECHNIQUE

by

Chih-Po Lin

Thesis submitted to the Faculty of the Graduate School
of the University of Maryland in partial fulfillment
of the requirements for the degree of
Master of Science
1981

APPROVAL SHEET

Title of Thesis: The Measurement of Damping and Natural Frequencies in Linear Systems by using the Random Decrement Technique

Name of Candidate: Chih-Po Lin
Master of Science, 1981

Thesis and Abstract Approved:

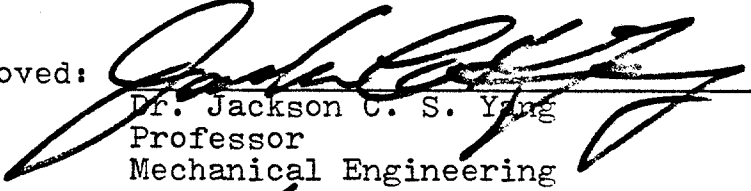
Dr. Jackson C. S. Yang
Professor
Mechanical Engineering

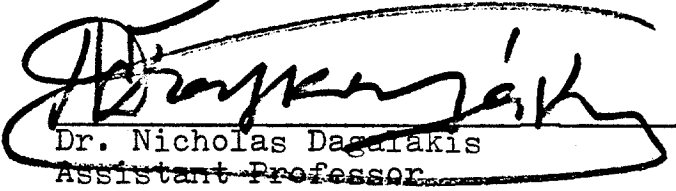
Dr. Nicholas Dagalakis
Assistant Professor
Mechanical Engineering

Date Approved: _____

CIRRICULUM VITAE

Name: Chih-Po Lin.

Permanent address: 88 Yeou Herng Street
Taichung, Taiwan
Republic of China.

Degree and date to be conferred: M.S., 1981.

Date of birth: March 8, 1954.

Place of birth: Taichung, Taiwan, Republic of China.

Secondary education: Provincial Taichung Senior High School,
June 1972.

Collegiate institutions attended	Dates	Degree	Date of Degree
National Taiwan University	1973-1977	B.S.	June 1977
University of Maryland	1979-1981	M.S.M.E.	May 1981

Major: Mechanical Engineering.

Minors: Mathematics, Automatic Controls.

THE MEASUREMENT OF DAMPING AND NATURAL FREQUENCIES
IN LINEAR SYSTEMS BY USING THE
RANDOM DECREMENT TECHNIQUE

by
Chih-Po Lin

Thesis submitted to the Faculty of the Graduate School
of the University of Maryland in partial fulfillment
of the requirements for the degree of
Master of Science
1981

@ Copyright Chih-Po Lin 1981

ACKNOWLEDGEMENTS

I would like to express my sincere thanks to Dr. Jackson C. S. Yang and Dr. Nicholas Dagalakis for their advice and encouragement in the preparation of this thesis; to Mr. Kam Chen, Dr. Chen and Dr. Tsai for their helpful discussions; to my wife for her patience and understanding. This research was supported in part by Research Grant N-00014-78-C-0675 from the Office of Naval Research and the United States Geological Survey and by the Naval Ship Research and Development Center.

TABLE OF CONTENTS

ACKNOWLEDGMENTS.	ii
LIST OF FIGURES.	iv
LIST OF TABLES.	vii
CHAPTER	
1. INTRODUCTION.	1
2. BACKGROUND.	4
3. NUMERICAL TEST OF THE SINGLE-DEGREE-OF-FREEDOM AND TWO-DEGREE-OF-FREEDOM SYSTEMS AND THE APPLICATION TO A COMPLEX NUMERICAL (FINITE ELEMENT) SIMULATED SYSTEM.	10
4. RESULTS AND DISCUSSIONS	23
APPENDIX A. FIGURES	32
APPENDIX B. TABLES.	73
APPENDIX C. RANDOM NUMBER GENERATOR	82
SELECTED BIBLIOGRAPHY.	85

LIST OF FIGURES

1.	Extraction of a Random Decrement Signature	33
2.	Geometrical Illustration of the Random Decrement Analysis	34
3.	Single-Degree-of-Freedom System (Model A)	35
4.	Random Decrement Signature of Model A	36
5.	Two-Degree-of-Freedom System with Well-Separated Modes (Model B)	37
6.	Power Spectral Density Curve of the Input Excitation and Output Response of Model B	38
7.	Random Decrement Signature of the lower frequency Mode of Model B	39
8.	Random Decrement Signature of the higher frequency Mode of Model B	40
9.	Power Spectral Density Curve of the Random Decrement Signature of Model B (lower frequency mode)	41
10.	Power Spectral Density Curve of the Random Decrement Signature of Model B (higher frequency mode)	42
11.	Two-Degree-of-Freedom System with closely-spaced Modes (Mode C).	43
12.	Power Spectral Density Curve of Input Excitation and Output Response of Model C	44
13.	Random Decrement Signature of Model C	45
14.	Power Spectral Density Curve of the Random Decrement Signature of Model C	46
15.	Power Spectral Density Curve of the Response Signal of Finite Element Model (Point 1)	47
16.	Random Decrement Signature of the Finite Element Model (Filter Range 210-250 Hz)	48

17.	Random Decrement Signature of the Finite Element Model (Filter Range 345-365 Hz)	49
18.	Random Decrement Signature of the Finite Element Model (Filter Range 365-385 Hz)	50
19.	Random Decrement Signature of the Finite Element Model (Filter Range 400-450 Hz)	51
20.	Random Decrement Signature of the Finite Element Model (Filter Range 650-720 Hz)	52
21.	Random Decrement Signature of the Finite Element Model (Filter Range 920-970 Hz)	53
22.	Random Decrement Signature of the Finite Element Model (Filter Range 1120-1155 Hz)	54
23.	Random Decrement Signature of the Finite Element Model (Filter Range 1155-1180 Hz)	55
24.	Power Spectral Density Curve of the Random Decrement Signature of the Finite Element Model (Filter Range 210-250 Hz)	56
25.	Power Spectral Density Curve of the Random Decrement Signature of the Finite Element Model (Filter Range 345-365 Hz)	57
26.	Power Spectral Density Curve of the Random Decrement Signature of the Finite Element Model (Filter Range 365-385 Hz)	58
27.	Power Spectral Density Curve of the Random Decrement Signature of the Finite Element Model (Filter Range 400-450 Hz)	59
28.	Power Spectral Density Curve of the Random Decrement Signature of the Finite Element Model (Filter Range 650-720 Hz)	60
29.	Power Spectral Density Curve of the Random Decrement Signature of the Finite Element Model (Filter Range 920-970 Hz)	61
30.	Power Spectral Density Curve of the Random Decrement Signature of the Finite Element Model (Filter Range 1120-1155 Hz)	62

31.	Power Spectral Density Curve of the Random Decrement Signature of the Finite Element Model (Filter Range 1155-1180 Hz)	63
32.	Comparison of the Obtained Damping Values with the Theoretical Damping Values used in NASTRAN	64
33.	Plot of the Error Functions between Successive Averages	65
34.	Power Spectral Density Curve of the Response Signal of the Finite Element Model (Point 2).	72

LIST OF TABLES

1.	Summary of the Results of Model A	74
2.	Summary of the Results of Model B	75
3.	Summary of the Results of Model C	76
4.	Summary of the Results of the Finite Element Model. .	78
5.	Comparison of the Random Decrement Signatures with Different number of Random Decrement Averages	79
6.	Comparison of the Sum of Squares of Errors between Successive Random Decrement Averages	80
7.	Summary of the Results for different Random Decrement Averages by the Curve Fitting Method	81

CHAPTER 1

INTRODUCTION

The analysis of dynamic systems through the use of experimental data is of considerable importance in many areas of engineering analysis. The modal damping and natural frequencies of a structure can be determined through the analysis of the experimental data. Once determined, the information can be used to study and modify the vibration characteristics and dynamic behavior of the structure. Several authors [1-3] have shown that the natural frequencies and modal damping of a structure can be measured through the application of frequency response method.

In many practical problems the structures are excited by random inputs, such as in the case of aircraft wings subjected to turbulent boundary layer flow, building subjected to earthquake, oil platform subjected to ocean wave loading, etc. In such cases, the use of the Random Decrement Technique to obtain the dynamic characteristics of structures is a powerful technique.

The Random Decrement Technique has been used successfully for crack detection [4,5] of structures and modal damping measurement in single-degree-of-freedom systems [6]. This technique analyzes the dynamic response of a system subjected

to random excitation. It is an average procedure to produce a Random Decrement Signature which represents the free vibration decay curve of the system.

The Random Decrement Technique is relatively independent of the input excitation; it only requires that the input is random. For single-degree-of-freedom systems, the frequency and damping ratio can be calculated directly from the Random Decrement Signature by the logarithmic decrement measurement. For multi-degree-of-freedom systems with well separated natural modes, the Random Decrement Signature of each mode can be obtained by filtering the response data first. If the system possesses closely spaced modes, it is difficult to separate them by the filter to obtain single-mode Random Decrement Signatures. There will be distortions and beating in the Random Decrement Signature. In such cases a curve fitting technique can be applied to extract the natural frequencies and modal dampings from this multi-mode Random Decrement Signature. These quantities are obtained by fitting the digitized time history data in a least-squares sense with complex exponential functions.

A power spectral density program is utilized to obtain the power spectral density curves of both the response signal and Random Decrement Signature. It is an ensemble average of the square of the magnitude of the Fourier Transform of a number of segments of the time history. From the power spectral of the response signal we can select the approximate filter ranges in applying the Random Decrement procedure.

From the power spectral of the Random Decrement Signature we can provide an estimate of the number of modes contained in the Random Decrement Signature to be used in the curve fitting method.

One single-degree-of-freedom system and two two-degree-of-freedom systems were investigated for the theoretical study of the Random Decrement analysis. One of the two-degree-of-freedom systems has well-separated modes, the other one possesses closely-spaced modes. Different approaches were introduced to handle each case. Finally these were applied to a complex piping numerical (Finite Element) simulated system to extract the natural frequencies and modal dampings of the system. These numerical investigations are presented in chapter 3.

The results obtained from Random Decrement analysis for theoretical simple models agree well with calculated theoretical values. In the application to the complex piping system there are discrepancies in the damping values used in the finite element computer program. There are many possible sources of error that may cause the discrepancies. A study on these possible sources of error is presented in chapter 4.

CHAPTER 2

BACKGROUND

2-1. INTRODUCTION

Since the development of the Random Decrement Technique by H. A. Cole, many reports about this technique have been presented (5-7, 10-12) . In this chapter only the highlights of this technique will be described. A detailed description on the curve fitting technique used in this investigation is also presented.

2-2. RANDOM DECREMENT TECHNIQUE

The Random Decrement Technique was developed by H. A. Cole for the measurement of modal damping and failure detection of a structure (10) . The basic concept of this technique is based on the fact that the random response of a system due to a random input can be divided into two parts: deterministic part and random part. By averaging enough segments of the response, the random part will average out. If the segments of the response are selected at a constant level and have alternatively positive and negative slope, the resulting signature is representative of the free vibration decay curve of the system with an initial displacement. The method of extracting a Random Decrement Signature is shown in figure 1* . A detailed description can be found in reference 6.

* Figures are found in Appendix A.

The Random Decrement Signature is dependent on system characteristics, such as natural frequency and modal damping, and relatively independent of the input excitation. For a single-degree-of-freedom system the natural frequency and damping ratio can be calculated directly from the Random Decrement Signature by the logarithmic decrement measurement since the signature is a free vibration decay curve of the system. For multi-degree-of-freedom systems where the modes are well separated these can be determined by bandpass filtering the response data about the natural frequency first to yield a single-mode Random Decrement Signature of interest. However, if the principle modes of a multi-degree-of-freedom system are closely spaced, they can not be separated by a filter without distorting the Random Decrement Signature. In such a case curve fitting is introduced to solve this problem. This curve fitting technique will be described in the next section.

2-3. LEAST SQUARES CURVE FITTING TECHNIQUE

As mentioned previously it is difficult to extract the natural frequencies and modal dampings by setting the filter ranges about the mode of interest in Random Decrement analysis if the system contains closely-spaced modes. Distorted Random Decrement Signature will result if too narrow bandwidth of filter cut-off frequency is chosen. On the other hand a multi-frequency Random Decrement Signature will result if the bandwidth of the filter is chosen wide enough to include the closely

spaced modes. For the latter case a least squares curve fitting technique can be used to extract the natural frequencies and modal dampings from this multi-frequency Random Decrement Signature.

The least squares curve fitting method is an approximating procedure by fitting the empirical data $f(x_i)$ to a theoretical function $f^*(x)$ which is a linear combination of given functions so that the given norm of the error function $f^* - f$ becomes as small as possible - that is

$$\|f^* - f\|^2 = \sum_{i=c}^m |f^*(x_i) - f(x_i)|^2 w_i$$

(w_i is weighted function)

becomes as small as possible.

The curve fitting technique adopted in this thesis was developed by R. M. Bennett and R. N. Desmarais (13) and was applied successfully for extracting the modal parameters from transient response data. This method may also be applied to Random Decrement Signature since it is representative of the free vibration curve of the system.

The transient response data $f(t_i)$ ($i=1,2,\dots,n$) can be approximated by a theoretical homogeneous solution with complex exponential functions in the form

$$y(t) = a_0 + \sum_{k=1}^m e^{-\zeta_k w_k t} (a_k \cos w_k \sqrt{1-\zeta_k^2} t + b_k \sin w_k \sqrt{1-\zeta_k^2} t) \quad (2.3.1)$$

The least squares curve fitting technique will minimize the

mean squared-error difference between input time history $f(t_i)$ and output fit $y(t_i)$. The squared-error difference is given by

$$E = \sum_{i=1}^{21} [y(t_i) - f(t_i)]^2 \quad (2.3.2)$$

If ω_k and ζ_k are preassigned, the coefficient a_0 , a_k and b_k can be computed by simply solving a linear least-squares problem. The nonlinear parameters ω_k and ζ_k are then determined by a direct search technique. Finally one set of ω_k and ζ_k which minimizes E in equation (2.3.2) will be obtained. Hence, the intent of the curve-fitting procedure is to determine the best approximations of a_0 , a_k , b_k , ω_k and ζ_k such that the obtained theoretical solution $y(t)$ will best describe the input transient response data $f(t)$ in the least squares sense.

The least-squares fit of the transient response data is performed by a combination of a stepping method and a linear improvement method. First of all the nonlinear parameters are computed by a stepping processes in the coordinate directions. Then the linear parameters are caculated by performing a least-squares fit using the nonlinear parameters previously obtained. As the least-squares solution is approached, the linear improvement for the nonlinear parameters is accomplished by approximating the nonlinear problem into an equivalent linear problem by using Taylor's series expansion about the previous solution.

The coordinate stepping and the linear improvement

processes that are embedded in the program are progressed as follows:

- (1) Starting with an initial set of coordinates w_k, b_k , the linear parameters a_0, a_k and b_k are calculated by performing a least-squares fit and the error E is computed.
- (2) The linear improvements for w_k, b_k are obtained by Taylor's series expansion of the approximating function $y(t)$ around the previously known coordinates w_k, b_k .
- (3) Using the improved estimates of w_k, b_k from step (2), the linear parameters a_0, a_k and b_k are recalculated and the error E is recomputed.
- (4) The iteration process consisting of the above three steps is continued until the condition that the error computed under step (3) is greater than or equal to the error computed under step (1) is satisfied.
- (5) A starting step size is now assigned and the lowest error under step (4) is termed the central error E for the coordinate space (w_k, b_k) . By adding and subtracting the step size to or from each value of w_k and b_k , $2k$ additional coordinate space are obtained for which the error E is calculated.
- (6) If the central error E under step (5) is less than any of the $2k$ peripheral values of E , then the step size is reduced by 75%, and the iteration process consisting of steps (2), (3), (4) and (5) is repeated.
- (7) If the central error E under step (5) is not less than

any of the $2k$ peripheral values of E , then the coordinate space corresponding to the lowest value of E is selected as the new central coordinate space, and the step size is increased by 10 %. The iteration process consisting of steps (5) and (6) is then repeated.

- (8) The procedure is terminated when a preassigned number of iterations or a preassigned number of stepping processes have been executed.

CHAPTER 3

NUMERICAL TEST OF THE SINGLE-DEGREE-OF-FREEDOM AND TWO-DEGREE-OF-FREEDOM SYSTEMS AND THE APPLICATION TO A COMPLEX NUMERICAL (FINITE ELEMENT) SIMULATED SYSTEM

3-1. INTRODUCTION

Before one can analyze a dynamic system one must be able to determine its performance. Both this ability and the precision of the results depend on how well the system equations can be expressed. The simplest vibration system is a single-degree-of-freedom system which consists of mass, spring and dashpot elements. Its system equation is easily obtained by Newton's second law. A continuous system has infinite degrees of freedom. However, it may be reduced to a lumped system or may be assumed to be composed of discrete parts which can be closely approximated by a single-degree-of-freedom system of approximate natural frequency and damping value in the region near each of the system's natural frequencies. The systems to be analyzed in this thesis are assumed to be time-invariant, lumped and linear.

The Random Decrement analysis can be performed either on an analog or digital computer. In this thesis it was done on a UNIVAC 1140 digital computer. A geometrical

illustration of the Random Decrement analysis to obtain the natural frequencies and the modal damping of a system is given in figure 2. The response data of a system due to a random input excitation are generated by a time integration routine and the data is stored on computer tape. This data is then analyzed to obtain the power spectral density curve of the response data and the locations of the modes. After selecting proper filter cut-off frequencies the same response data is used as input for the Random Decrement program to calculate the Random Decrement Signature. If the system to be analyzed is a single-degree-of-freedom system, the natural frequency and the damping ratio are directly calculated from the signature by the logarithmic decrement method. If the system contains more than one mode, a further check of the Random Decrement Signature is necessary to see whether the signature contains one or more system mode. This can be done by analyzing the Random Decrement Signature with the use of a power spectral density program. If the Random Decrement Signature contains more than one mode, a curve fitting program is then used to extract the natural frequencies and modal damping from the signature. One single-degree-of-freedom and two two-degree-of-freedom systems will be used for the theoretical study of the Random Decrement analysis. Finally this will be applied to a numerical (finite element) simulated piping system to extract the natural frequencies and the modal damping.

3-2. MATHEMATICAL MODEL OF A SINGLE-DEGREE-OF-FREEDOM SYSTEM (MODEL A).

The equation of motion of a single-degree-of-freedom system shown in figure 3 is given by

$$m\ddot{x} + c\dot{x} + kx = F \quad (3.2.1)$$

where m (mass) = 1

k (spring stiffness) = 160000

c (damping coefficient) = 10

F : random input excitation.

The theoretical values of the natural frequency and damping ratio of this system can be calculated by the following relationship:

$$\text{Natural frequency } \omega_n = \frac{k}{m} = \frac{160000}{1} = 400 \text{ rad/sec}$$

$$\text{Damping ratio } \zeta = \frac{c}{2m\omega_n} = \frac{10}{2 \times 1 \times 400} = 0.0125$$

The first step before doing the Random Decrement analysis is to generate the response data of the system subjected to random excitation by using a time simulation routine. Using the state-space approach, the n -th order differential equation of motion for the system can be expressed as n first-order differential equations. In the example of single-degree-of-freedom system this was accomplished by letting

$$w_1 = x, \quad w_2 = \dot{x}, \quad \dot{w}_2 = \ddot{x}$$

Then the equation (3.2.1) may be written as

$$\begin{bmatrix} w_1 \\ w_2 \end{bmatrix} = \begin{bmatrix} 0 & 1 \\ -160000 & -10 \end{bmatrix} \begin{bmatrix} w_1 \\ w_2 \end{bmatrix} + \begin{bmatrix} 0 \\ F \end{bmatrix} \quad (3.2.2)$$

There are various time simulation programs for solving the time response problems associated with n first-order differential equations. One of those is the 4th order Runge-Kutta method which was used for this thesis to generate the time response of the systems. The accuracy of the time simulation routine depends on the time step size. Reducing the time step size Δt is expected to improve the time simulation routine as long as the time step is not so small to create the significant round-off error.

In order to generate the random response, a digitized random input excitation must be supplied to the system. This is done by using a random number generating routine which was developed by Dr. G. C. Everstine. This routine generates a random function Y_j by summing N sets of equal-amplitude, random frequency and random phase sinusoids over a frequency range that is desired. This routine also call a UNIVAC random number generator RANDU which generates a set of uniformly distributed random numbers over the range (0,1) and then fed back to the routine. A more detailed description and the mathematical expression of this random function Y_j is given in Appendix C.

After the response data was generated, it was stored on computer tape. The response data was then used as the input to the Random Decrement program. No filter was used in this single-degree-of-freedom case. The mean and the standard deviation of the response data were computed. The mean value was used to change the data values to have a zero mean. A fraction of the standard deviation was used for the selection of the Random Decrement threshold level. Each time the signal crossed this level a segment of the signal was summed to previous segments to obtain the Random Decrement Signature. Once the Random Decrement Signature was obtained, the damping ratio was calculated by the logarithmic decrement method. The damped natural frequency was calculated from an average of periods of oscillation. A plotting routine within the Random Decrement program displayed the Random Decrement Signature.

The Random Decrement Signature obtained is shown in figure 4. A summary of the results is given in table 1*.

3-3. MATHEMATICAL MODEL OF A TWO-DEGREE-OF-FREEDOM SYSTEM WITH WELL-SEPARATED MODES (MODEL B).

The equation of motion for the two-degree-of-freedom system shown in figure 5 is given by

$$\begin{aligned} m_1 \ddot{x}_1 + (c_1 + c_2) \dot{x}_1 - c_2 \dot{x}_2 + (k_1 + k_2)x_1 - k_2 x_2 &= 0 \\ m_2 \ddot{x}_2 + c_2 \dot{x}_2 - c_2 \dot{x}_1 + k_2 x_2 - k_2 x_1 &= F \end{aligned} \quad (3.3.1)$$

*Tables are found in Appendix B.

where $m_1 = 1, k_1 = 2256, c_1 = 1$
 $m_2 = 2, k_2 = 250, c_2 = 0.1$

The state equations (n first-order differential equations) of this model can be obtained by letting

$$w_1 = x_1, w_2 = \dot{x}_1, w_3 = x_2, w_4 = \dot{x}_2$$

Then equations (3.3.1) may be written as

$$\begin{aligned} \dot{w}_1 &= w_2 \\ \dot{w}_2 &= -\frac{k_1 + k_2}{m_1} w_1 - \frac{c_1 + c_2}{m_1} w_2 + \frac{k_2}{m_1} w_3 + \frac{c_2}{m_1} w_4 \\ \dot{w}_3 &= w_4 \\ \dot{w}_4 &= \frac{k_2}{m_2} w_1 + \frac{c_2}{m_2} w_2 - \frac{k_2}{m_2} w_3 - \frac{c_2}{m_2} w_4 + \frac{F}{m_2} \end{aligned} \quad (3.3.2)$$

By substituting the values of the parameters into equation (3.3.2), we get the state equations of model B in the following

$$\begin{aligned} \dot{w}_1 &= w_2 \\ \dot{w}_2 &= -2506w_1 - 1.1w_2 + 250w_3 + 0.1 w_4 \\ \dot{w}_3 &= w_4 \\ \dot{w}_4 &= 125w_1 + 0.05w_2 - 125w_3 - 0.05w_4 + \frac{F}{2} \end{aligned} \quad (3.3.3)$$

The state equations represented by equations (3.3.3) can be expressed in matrix notations as

$$\dot{\underline{W}} = \underline{A} \underline{W} + \underline{B} \underline{F} \quad (3.3.4)$$

where

$$\dot{\underline{W}} = \begin{bmatrix} \dot{w}_1 \\ \dot{w}_2 \\ \dot{w}_3 \\ \dot{w}_4 \end{bmatrix}, \quad \underline{W} = \begin{bmatrix} w_1 \\ w_2 \\ w_3 \\ w_4 \end{bmatrix}, \quad \underline{A} = \begin{bmatrix} 0 & 1 & 0 & 0 \\ -2506 & -1.1 & 250 & 0.1 \\ 0 & 0 & 0 & 1 \\ 125 & 0.05 & -125 & -0.05 \end{bmatrix}$$

$$\underline{B} = \begin{bmatrix} 0 \\ 0 \\ 0 \\ 0.5 \end{bmatrix}$$

Matrix A is so called plant characteristic matrix. The eigenvalues S of the system can be obtained by solving the characteristic equation of A, namely,

$$\det (S \underline{I} - \underline{A}) = 0 \quad (3.3.5)$$

The characteristic equation is denoted by $Q(S)$, then equation (3.3.5) becomes

$$Q(S) = 2S^4 + 2.3 S^3 + 5262.1 S^2 + 475.6S + 564000 = 0 \quad (3.3.6)$$

A computer program was used to solve the polynomial equation (3.3.6). The roots S are the two complex conjugate pairs, -0.02265 ± 10.58407 and -0.55235 ± 50.18713 .

The relationships between a complex conjugate pair of

roots (s, s^*) and the damped natural frequency, the undamped natural frequency and the damping ratio are shown in the following.

If $s = a+bi$ and $s^* = a-bi$, then

$$\text{damped natural frequency } \omega_n = b \quad (3.3.7)$$

$$\text{undamped natural frequency } \omega_n = \sqrt{a^2 + b^2} \quad (3.3.8)$$

$$\text{and damping ratio } \zeta = \frac{a}{\sqrt{a^2 + b^2}} \quad (3.3.9)$$

The theoretical calculated natural frequencies and damping ratio are shown in table 2.

By following the same procedure mentioned in section 3-2 the response data of the displacement x_1 was generated and stored on computer tape for analyzing. Before doing the Random Decrement analysis the power spectral of the response signal was obtained to locate the filter cut-off frequencies. This was the result of the average of 15 Fast Fourier Transforms of the response data. 512 data points were used for each Fast Fourier Transform.

From the power spectral density curve shown in figure 6, we can see that the input excitation has a relatively uniform power spectral as we desired. The output has two well-separated resonant peaks which correspond to the principle modes of the system. Two sets of filter cut-off frequencies were selected. One was selected from 0 to 6 Hz. The other one was chosen from 6 to 10 Hz.

The selection of the filter cut-off frequencies is important. If the filter cut-off frequencies were chosen too

far apart, a multi-frequency Random Decrement Signature would result. On the other hand, if the filter cut-off frequency were selected too close together, the actual resonant peak would be distorted (11).

The next step was to calculate the Random Decrement Signature for each mode. The same procedure as the one mentioned in section 3-2 was preceded twice by filtering the response data with each filter cut-off frequencies. The Random Decrement Signatures obtained are shown in figures 7 and 8. In order to check if the Random Decrement Signatures were distorted or not, the power spectral density curves of the Random Decrement Signatures were obtained and are shown in figures 9 and 10. A single peak can be seen on each power spectral density curve. Each Random Decrement Signature represents a free vibration decay curve of the system for each mode. The natural frequencies and the damping ratio were then calculated from the Random Decrement Signatures by the logarithmic decrement method and with the use of the curve fitting technique. These two sets of results will be compared. A summary of the results in this investigation is given in table 2.

3-4. MATHEMATICAL MODEL OF A TWO-DEGREE-OF-FREEDOM SYSTEM WITH CLOSELY SPACED MODES (MODEL C).

The equation of motion for the two-degree-of-freedom system was given by equation (3.3.1). By substituting the

values of parameters of the model C shown in figure 11, we obtain

$$\begin{aligned} \ddot{x}_1 + 0.3 \dot{x}_1 - 0.2 \dot{x}_2 + 650 x_1 - 50 x_2 &= 0 \\ 0.1 \ddot{x}_2 + 0.2 \dot{x}_2 - 0.2 \dot{x}_1 + 50 x_2 - 50 x_1 &= F \end{aligned} \quad (3.4.1)$$

The state equation can be obtained the same way as mentioned previously as

$$\begin{bmatrix} w_1 \\ w_2 \\ w_3 \\ w_4 \end{bmatrix} = \begin{bmatrix} 0 & 1 & 0 & 0 \\ -650 & -0.3 & 50 & 0.2 \\ 0 & 0 & 0 & 1 \\ 500 & 2 & -500 & -2 \end{bmatrix} \begin{bmatrix} w_1 \\ w_2 \\ w_3 \\ w_4 \end{bmatrix} + \begin{bmatrix} 0 \\ 0 \\ 0 \\ 1 \end{bmatrix} F \quad (3.4.2)$$

The characteristic equation $Q(S)$ of this system is

$$Q(S) = 0.1S^4 + 0.23S^3 + 115.02S^2 + 125S + 30000 = 0 \quad (3.4.3)$$

The roots S of equation (3.4.3) were found to be two complex conjugate pairs, -0.678 ± 27.335 and -0.472 ± 20.025 . The damped natural frequencies, undamped natural frequencies and damping ratios were calculated by equations (3.3.7) to (3.3.9) and are shown in table 3.

The system was excited by Dr. Everstine's random input. The response data of displacement x_1 was generated and stored on computer tape for analyzing. First of all the power spectral density curve of the response data was obtained.

This power spectral density curve is shown in figure 12. From this power spectral density curve, we can see that the system contains two closely spaced modes. It is difficult to obtain the Random Decrement Signature for each mode by filtering the response data with a narrowband filter. Several efforts were made to separate these two modes by selecting proper filter cut-off frequencies, but did not succeed. The Random Decrement Signatures obtained were distorted and has beating.

A multi-frequency Random Decrement Signature was obtained without passing the response data through the filter. This signature is shown in figure 13. The power spectral density curve of this Random Decrement Signature was also obtained and is shown in figure 14. From the power spectral, we can see that it contains two closely spaced modes. Then a curve fitting technique was used to extract the natural frequencies and damping ratio From the Random Decrement Signature. The signature was fitted with a theoretical complex exponential function in least-square sense.

A summary of the results in this investigation is given in table 3.

3-5. APPLICATION TO A COMPLEX PIPING NUMERICAL (FINITE ELEMENT) SIMULATED SYSTEM.

A simple analytical test was performed to assess the ability of the Random Decrement Technique to determine the

natural frequencies and the damping ratios contained in the non-trivial higher order system. A NASTRAN finite element model with many degrees of freedom and preselected frequency-dependent damping values was used for analyzing. The response data of two points on the model subjected to a random input was computed and stored on computer tape. One set of the response data was analyzed to calculate the Random Decrement Signatures for different filter cut-off frequencies. The filter cut-off frequencies selected only covered individual modes of the system.

Again before doing the Random Decrement analysis, the power spectral density curve of the response data was obtained, in order to locate the filter cut-off frequencies. This was the result of the average of 23 Fast Fourier Transforms of the response data. 512 data points were used for each Fast Fourier Transform. This power spectral density curve is shown in figure 15.

Eight sets of the filter cut-off frequencies were selected. The next step was to generate the Random Decrement Signatures. The same data was then passed through the Random Decrement program for each of the proper selected filter cut-off frequencies. Eight signatures resulted and are shown from figure 16 to 23. Apparently some of the Random Decrement Signatures are not free decay response curves. In this case the natural frequencies and the damping ratio can not be calculated directly from the signatures by the logarithmic decrement method.

The power spectral density curves of the Random Decrement Signatures were obtained to identify the number of modes contained in the signatures. The power spectral density curves are shown from figure 24 to 31. For those Random Decrement Signatures which appeared to contain only one mode, the natural frequency and the damping ratio were calculated directly from the signature by the logarithmic decrement method. For those signatures which contain more than one mode, the least-square curve fitting technique was used to extract the natural frequencies and the damping ratio from each signature.

The procedure of curve fitting the multi-frequency Random Decrement Signatures was the same as mentioned previously. The estimate of the number of modes contained in the signature to be curve fitted should be supplied to the program. It was obtained from the power spectral density curves of the Random Decrement Signatures.

A summary of the results in this investigation is given in table 4.

CHAPTER 4

RESULTS AND DISCUSSIONS

4-1. RESULTS

Table 1 shows the results of the single-degree-of-freedom system case and the comparison with the theoretically calculated data. 570 Random Decrement averages were selected to obtain the Random Decrement Signature. The damped natural frequency and the damping ratio of $f_d = 63.816$ Hz, $\zeta = 0.0126$ were determined from the Random Decrement Signature. These values when compared to the theoretically calculated damped natural frequency and damping ratio, indicate that the relative errors are less than 3 %.

Table 2 shows the results of the two-degree-of-freedom system with well-separated modes. In order to minimize the truncation error during the time simulation, the proper time step size was selected for the higher frequency mode. This could limit the time history length of the lower frequency mode during the time simulation and reduce the number of the Random Decrement averages. This can be clearly seen from table 2. 915 averages were selected for the higher frequency mode. Only 190 averages were taken for the lower frequency mode.

There are two sets of results shown in table 2. In

the first case the natural frequencies and damping ratios were calculated directly from the Random Decrement Signature by the logarithmic decrement method. In the second case they were obtained by curve fitting the Random Decrement Signatures obtained with a theoretical exponential function. In both cases the results obtained for the higher frequency mode are better than that for the lower frequency mode. Insufficient number of Random Decrement averages selected to yield the Random Decrement Signature might be the main reason to obtain the coarse result for the lower frequency mode. This will be verified in section 4-2. Now comparing the results obtained by logarithmic decrement method and the curve fitting method, we found that the curve fitting method gave us a better result than the logarithmic decrement did.

Table 3 shows the results of the two-degree-of-freedom-system where the modes are closely spaced. From the power spectral density curve shown in figure 12 we can see that the system contains two closely spaced modes. These two modes can not be separated by the narrowband filter. Individual Random Decrement Signature could not be obtained for each mode. The Random Decrement Signature obtained without passing the response signal through the narrowband filter is shown in figure 13. The natural frequencies and damping ratios were then determined by the curve fitting method.

The selection of four hundred fourteen Random decrement averages were made in this investigation. The damped natural frequencies and damping ratios of $f_1 = 3.179$ Hz, $f_2 = 4.378$ Hz, $\zeta_1 = 0.0237$, $\zeta_2 = 0.0254$ were extracted from the Random

Decrement Signature. These values when compared to the theoretically calculated damped natural frequencies and damping ratios, indicate that the relative errors are less than 3 %.

Table 4 shows a summary of the overall results in the investigation of the finite element model case. A comparison of the obtained results with the preselected frequency-dependent damping values used in the finite element computer model is given in figure 32. The results obtained show fair agreement with the preselected data.

There are several possible sources of error that may cause this discrepancy. In this investigation a total of 12,000 response data points were computed from the NASTRAN finite element analysis. By selecting the standard deviation of the response data analyzed as the threshold level, we were only able to get about 300 Random Decrement averages to yield the Random Decrement Signatures below frequency 600 Hz. This number is probably not enough to average out the random part of the response signal to obtain a Random Decrement Signature which represents the free decay vibration curve of the system. This might be the main reason why we got the coarse results for the frequency below 600 Hz in this investigation.

An investigation on the effect of the number of the Random Decrement averages on the results will be given in section 4-2. Some other possible sources of error, such as the time simulation error and the location of the response measuring station, may probably cause the coarse results.

These will be investigated and discussed in sections 4-3 and 4-4. A check for the convergence of the Random Decrement Signature will also be investigated in section 4-5.

4-2. THE EFFECT OF THE NUMBER OF RANDOM DECREMENT AVERAGES

When insufficient number of Random Decrement averages are selected from the response signal, the resulting Random Decrement Signature is rather coarse. In (6) it was shown that the error function between the Random Decrement Signature obtained and the theoretical free response curve depends on the number of the Random Decrement averages. The more the Random Decrement averages, the smaller the error. Here a simple test was performed to investigate the effect of the number of Random Decrement averages on the determination of the natural frequencies and damping ratios from the Random Decrement Signatures.

Response signal of model C was investigated. Two different lengths of the response signal were analyzed to obtain the Random Decrement Signatures. The natural frequencies and the damping ratios were then extracted from the Random Decrement Signatures by the curve fitting method. In the first case 192 averages were selected. The damped natural frequencies and damping ratios of $f_1 = 3.18$ Hz, $f_2 = 4.363$ Hz, $\zeta_1 = 0.018$, $\zeta_2 = 0.02$ were determined from the Random Decrement Signature. In the second case the selection of 414 averages were made. The damped natural frequencies and damping ratios of $f_1 = 3.179$ Hz, $f_2 = 4.378$ Hz, $\zeta_1 = 0.0237$, $\zeta_2 = 0.0254$

were determined from the Random Decrement Signature. These values were compared to the theoretically calculated damped natural frequencies and damping ratios of $f_1 = 3.187$ Hz, $f_2 = 4.349$ Hz, $\zeta_1 = 0.0236$, $\zeta_2 = 0.0248$. The relative errors of the results for both cases were also calculated and indicated that the results obtained from 414 Random Decrement averages were much more accurate. A summary of the results in this investigation is given in table 5.

4-3. LOCATION OF THE RESPONSE MEASURING STATION

From the study of the two-degree-of-freedom system where the modes are well-separated, we found that the results obtained by analyzing the displacement response data x_1 had no much difference from those obtained by analyzing the displacement response data x_2 .

In practice all the real structures contain multiple vibrational modes. However, the effects of some modes may not manifest themselves at the point in consideration. For example the selection of the nodal point of a particular model would make it impossible to identify it. This may affect the determination of the damping ratio at that mode.

Two sets of response data of the finite element model measured from two different locations were investigated. Their power spectral density curves were obtained and are shown in figures 15 and 34. From the power spectral density curves we can see the presence of relatively few distinct modes. For instance the mode at frequency 220 Hz in figure

15 did not show up in figure 34. Also from NASTRAN finite elements eignvaule analysis we found that there were more modes than those obtained from Random Decrement analysis.

4-4. TIME SIMULATION ERRORS

As mentioned previously the accuracy of the time simulation routine for initial value problems depends on the time step size. The smaller the time step size, the smaller the truncation error.

In order to obtain enough Random Decrement averages, a long time history length need to be taken during the time simulation. Eventually it is uneconomical and the round-off error becomes significant if the time step size is chosen to small. On the other hand, when the time step size is chosen too large, the truncation error will become significant. A good rule of thumb is that during the numerical integration one should compute a variable at least 10 to 20 times per cycle of its highest frequency mode. The choice of twenty points per cycle was made in the investigations of the models A, B and C during the time simulation process. For the finite element model case the choice of twenty points per cycle was made at frequency about 600 Hz. Only nine points per cycle were computed for the mode of frequency about 1,400 Hz. The global truncation error might be significant in that case. This is probably one of the reasons why the coarse results were obtained for the higher frequency modes in the investigation of the finite element model case.

The accuracy of the time simulation may be improved either by the Richardson extrapolation method 15 or with the proper choice of the time step size.

4-5. CHECK FOR CONVERGENCE OF THE RANDOM DECREMENT SIGNATURE

In section 4-2 it was shown that the number of the Random Decrement averages would affect the accuracy of the natural frequency and damping ratio obtained by the use of the Random Decrement analysis. The question was raised as to how many Random Decrement averages should be taken to yield a Random Decrement Signature which was representative of the free vibration curve of the system analyzed. In stead of answering this question the check for convergence of the Random Decrement Signature was investigated.

Different lengths of the response signal of model B was analyzed to obtain the Random Decrement Signatures for the higher frequency mode. The number of the Random Decrement averages was varied from 4 to 952. In stead of caculating the error function between each Random Decrement Signature and the theoretical free decay curve (6), the check for convergence was performed by comparing the sum of the square of errors between the successive averages. The caculated sum of square of errors are given in table 6. The plot of the error function between successive Random Decrement Signatures was also obtained and is shown in figure 33.

Another investigation for checking the convergence of the Random Decrement Signature was made by using the curve

fitting method. The Random Decrement Signatures obtained in the first investigation were curve fitted with the theoretical exponential functions. The norms of the error functions between the Random Decrement Signature and the theoretically approximating exponential functions were obtained. The natural frequencies and damping ratios were also determined from the Random Decrement Signatures. The results of this analysis are given in table 7.

From the above investigations it is clear that the Random Decrement Signature will converge after approximately 800 to 900 Random Decrement averages are taken.

4-6. CONCLUSION

The Random Decrement Technique is found to be a powerful and accurate method in the determination of the natural frequency and damping ratio by only analyzing the response signal of a system subjected to the random excitations.

Through these studies a good understanding of this technique has been obtained. The conclusion from these studies are:

1. For single-degree-of-freedom systems the natural frequency and damping ratio can be determined directly from the Random Decrement Signature by the logarithmic decrement method.
2. For multi-degree-of-freedom systems where the modes are well-separated, the Random Decrement Signatures of the individual modes can be obtained by bandpass

filtering the response data first. The natural frequencies and damping ratios are determined from the Random Decrement Signatures by the logarithmic decrement method.

3. For multi-degree-of-freedom systems where the modes are closely spaced, the natural frequencies and damping ratios can be determined by curve fitting the Random Decrement Signature which contains the closely spaced modes with a theoretical exponential function.
4. The accuracy of the Random Decrement Technique is a function of the number of the Random Decrement averages. Insufficient Random Decrement averages may cause the coarse results for determining the natural frequency and damping ratio from the Random Decrement Signature.
5. The Random Decrement Signature will converge as the number of the Random Decrement averages increases. The investigations made in section 4-5 indicate that the Random Decrement Signature converges after approximately 800 to 900 Random Decrement averages were taken.

APPENDIX A

FIGURES

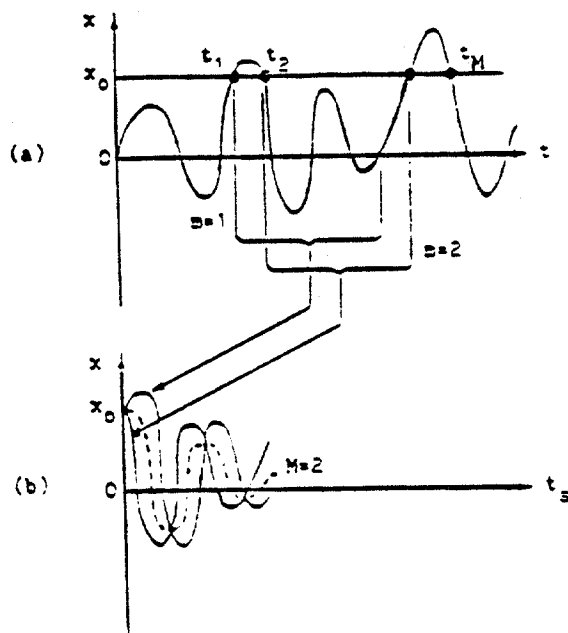

Figure 1. Extraction of a Random Decrement Signature

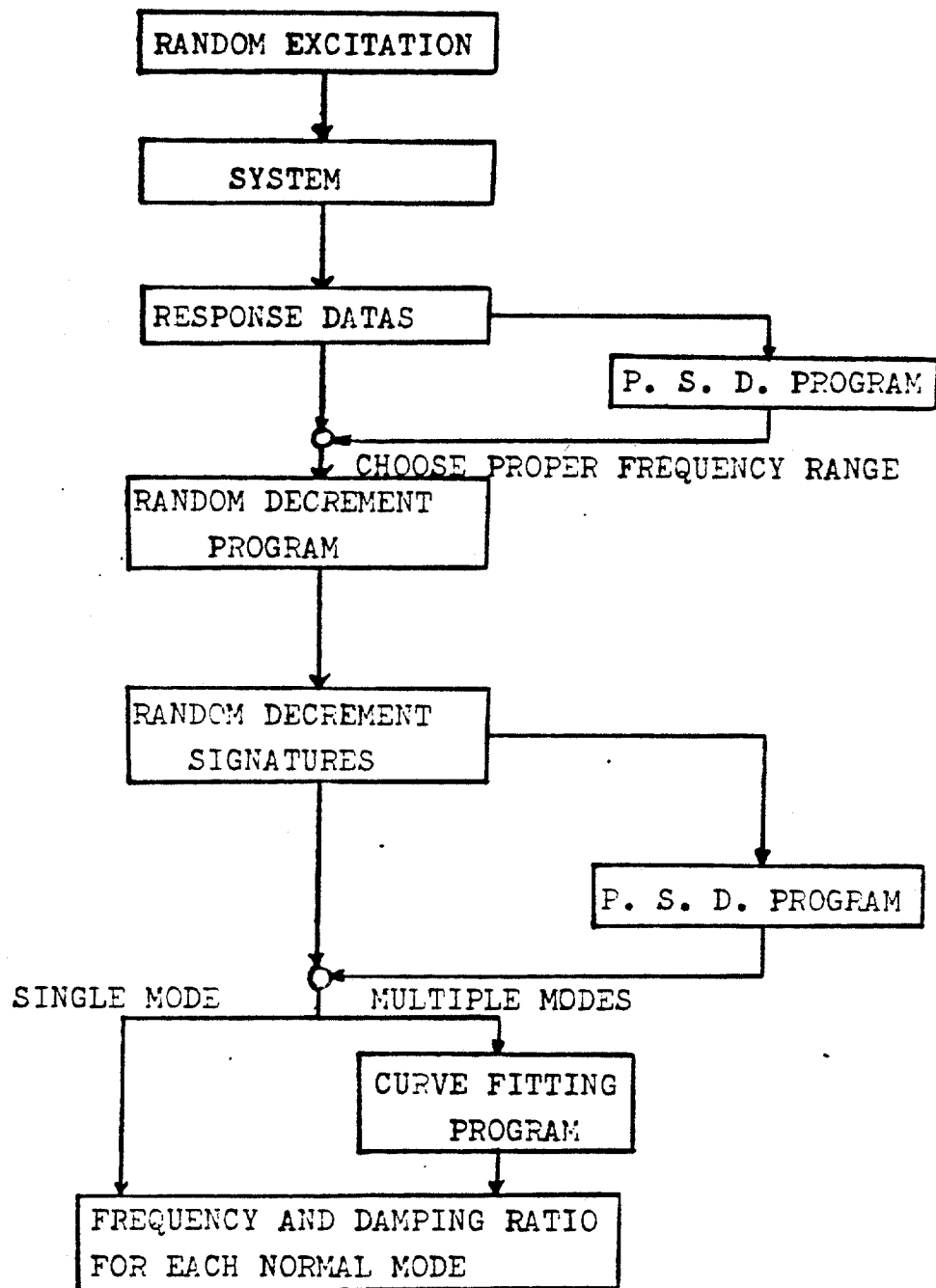

Figure 2. Geometrical Illustration of the Random Decrement Analysis

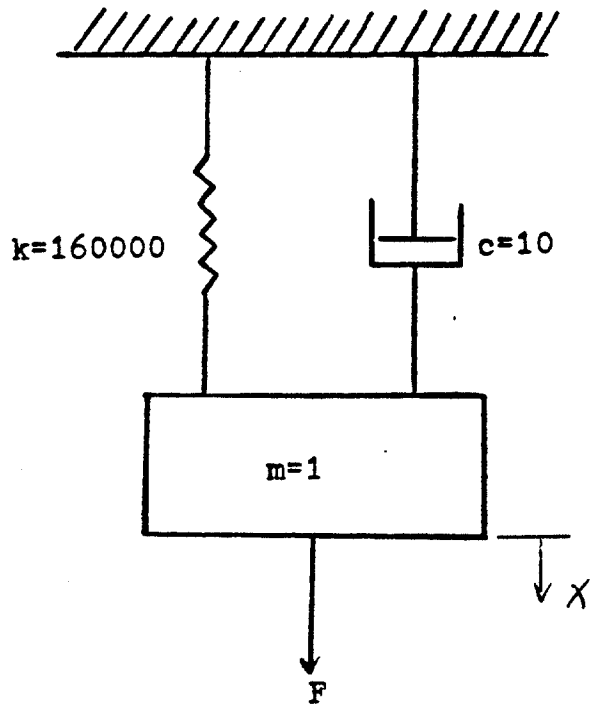

Figure 3. Single-Degree-of-Freedom System (Model A)

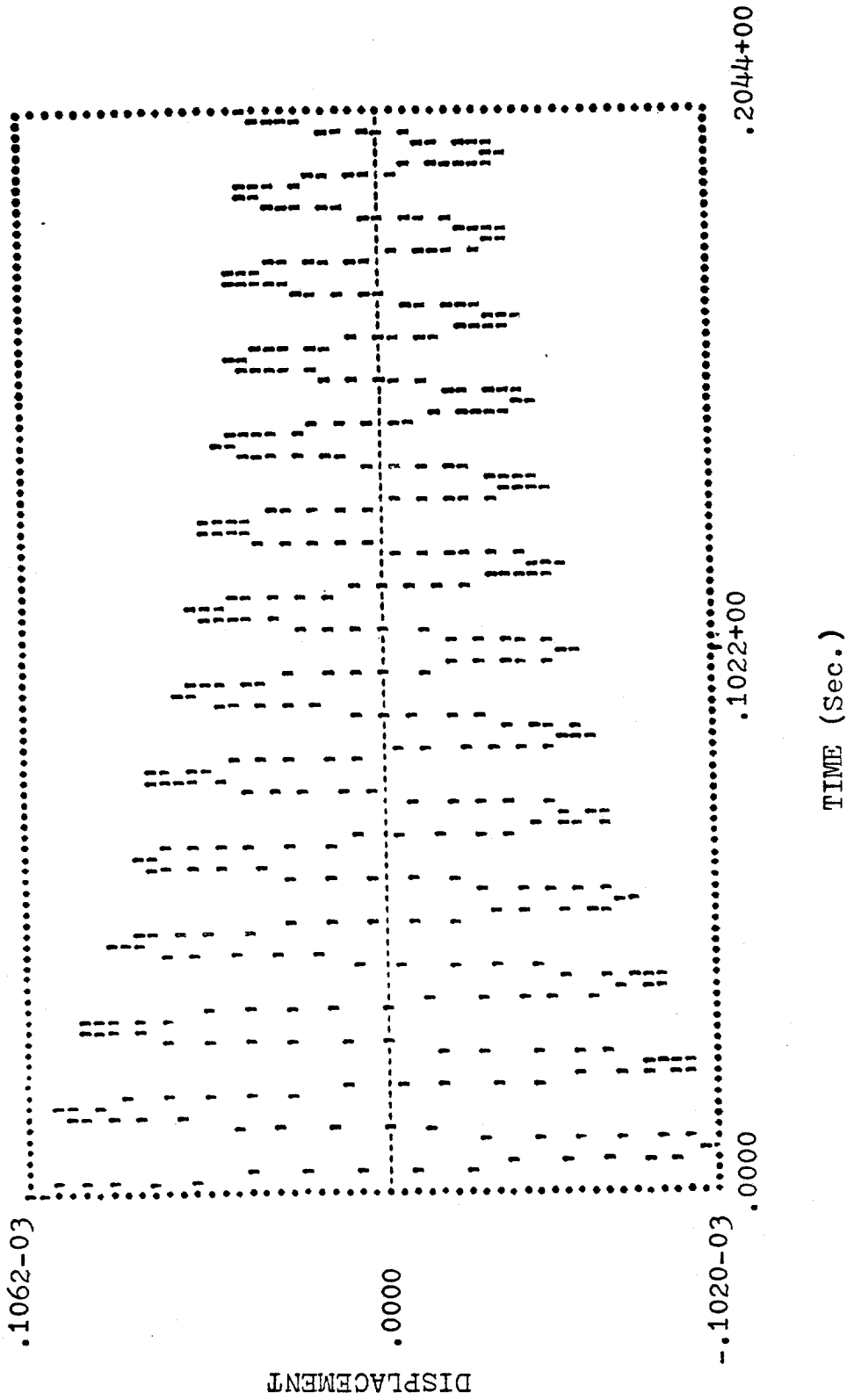

Figure 4. Random Decrement Signature of Model A

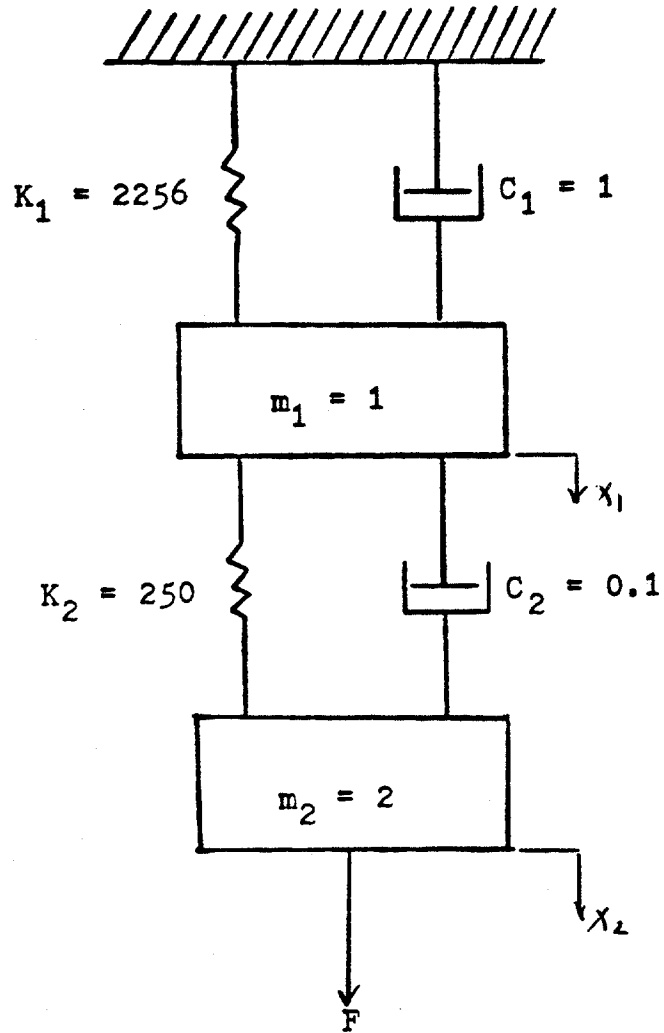

Figure 5. Two-Degree-of-Freedom System with Well-Separated Modes (Model B)

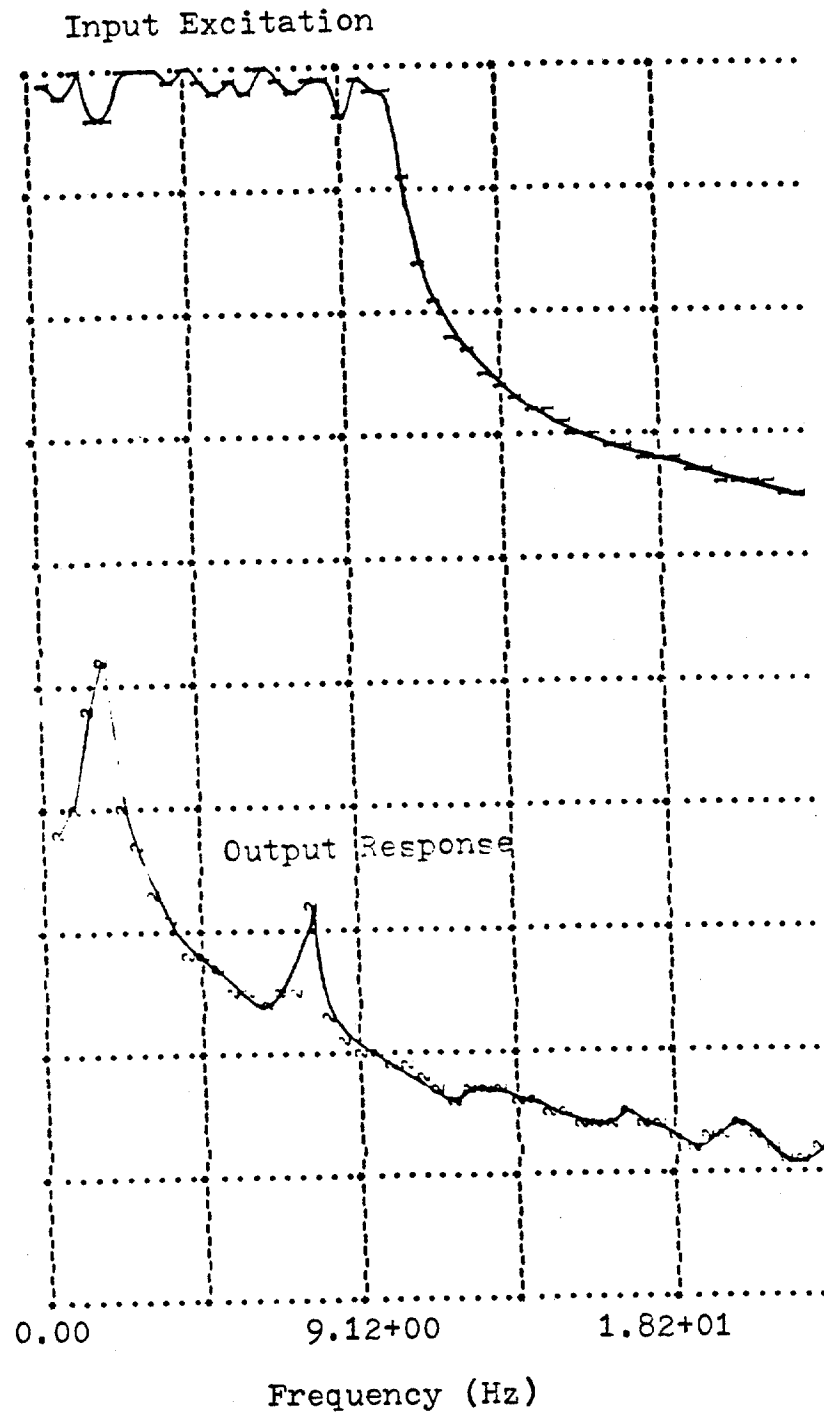

Figure 6. Power Spectral Density Curve of the Input Excitation and Output Response for Model B

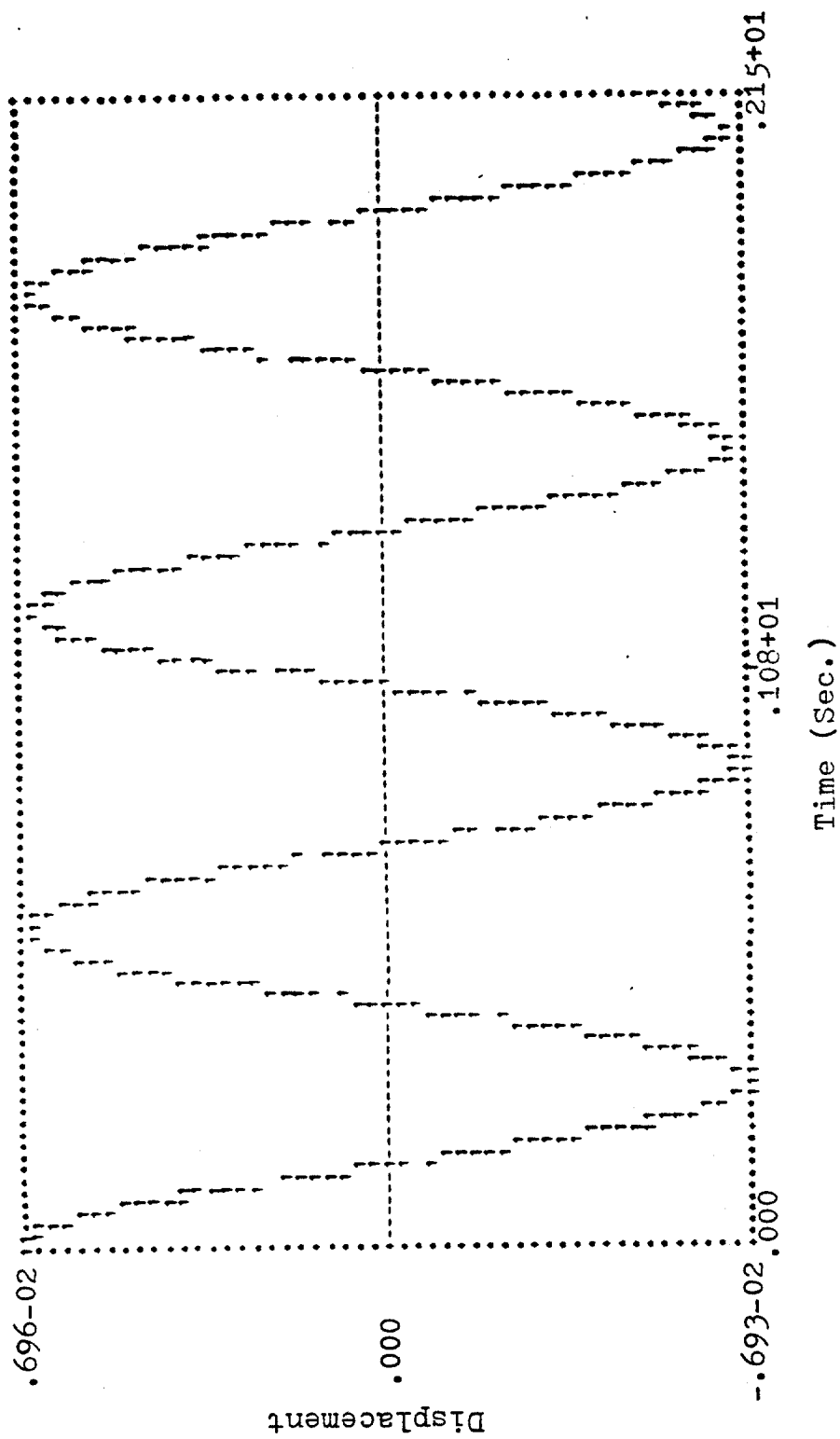

Figure 7. Random Decrement Signature of the Lower Frequency Mode of Model B

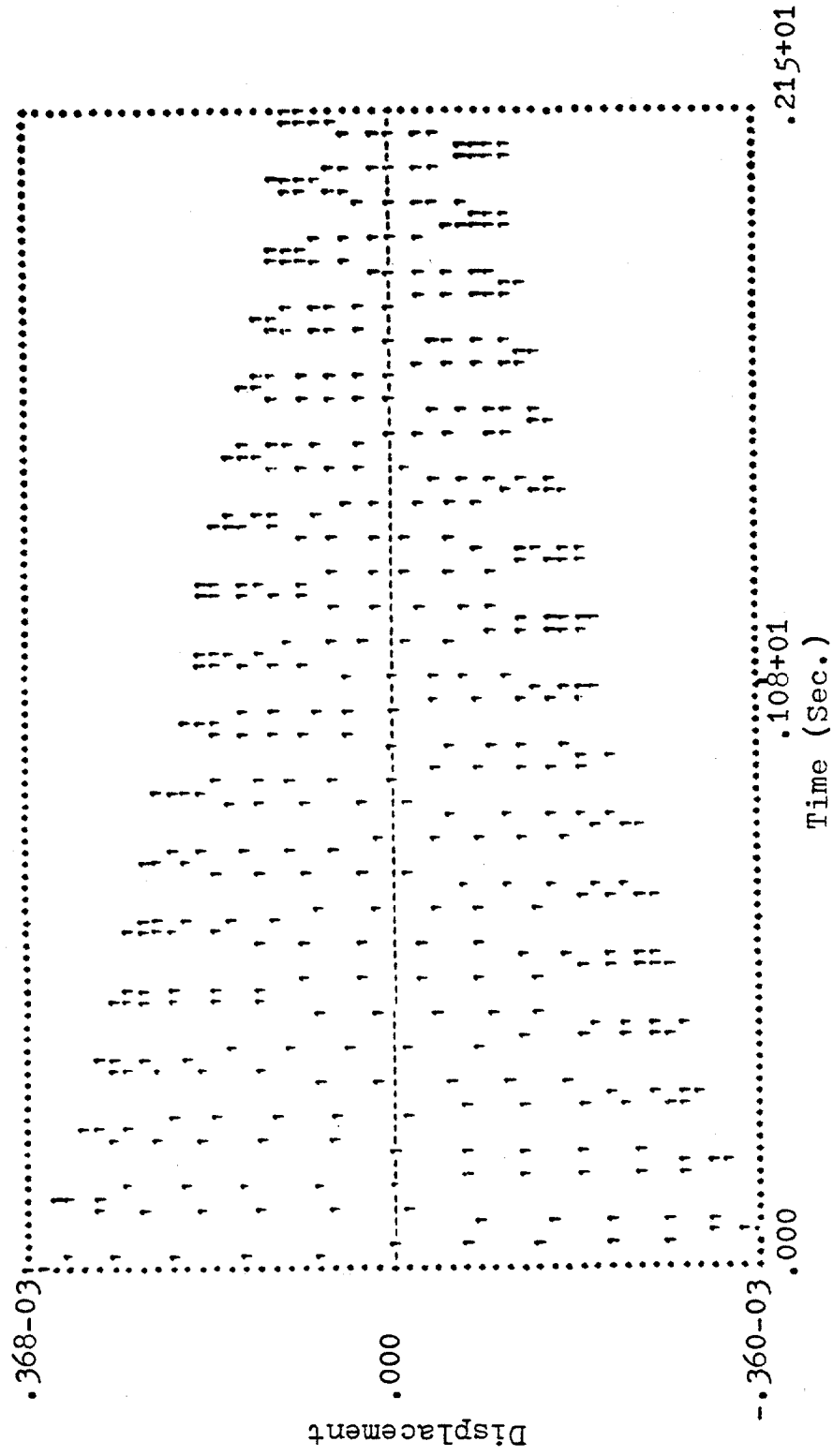

Figure 8. Random Decrement Signature of the Higher Frequency Mode of Model B

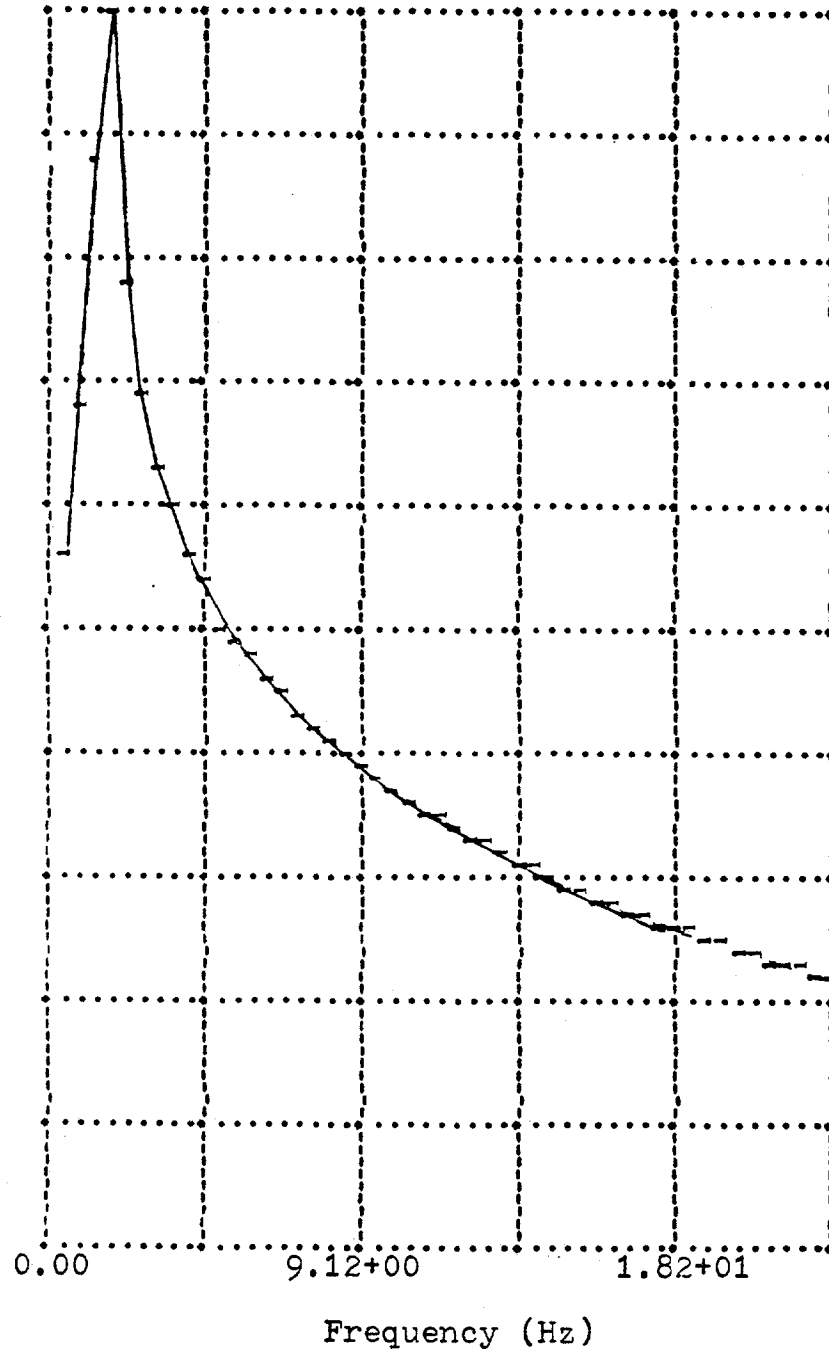

Figure 9. Power Spectral Density Curve of the Random Decrement Signature of Model B (Lower Frequency Mode)

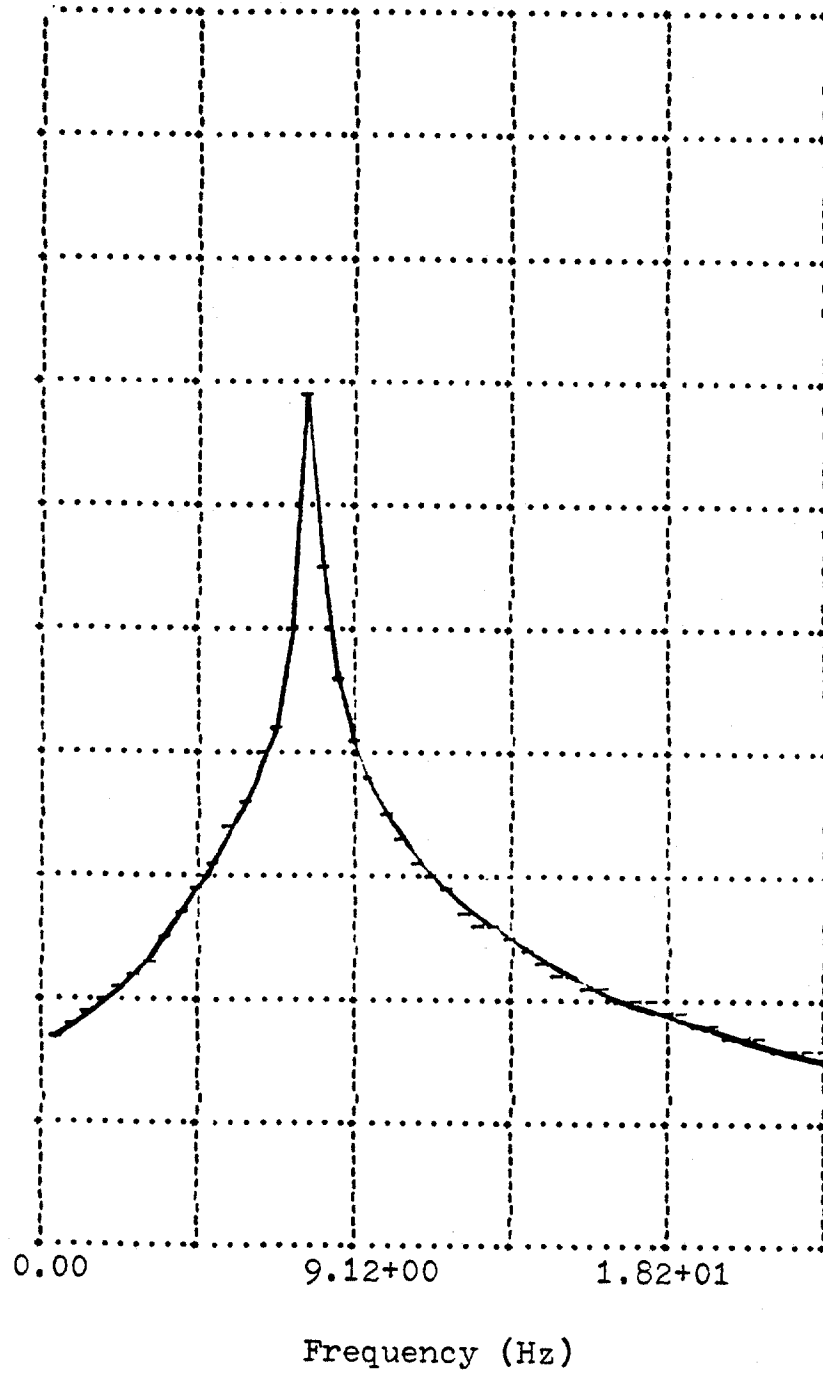

Figure 10. Power Spectral Density Curve of the Random Decrement Signature of Model B (Higher Frequency Mode)

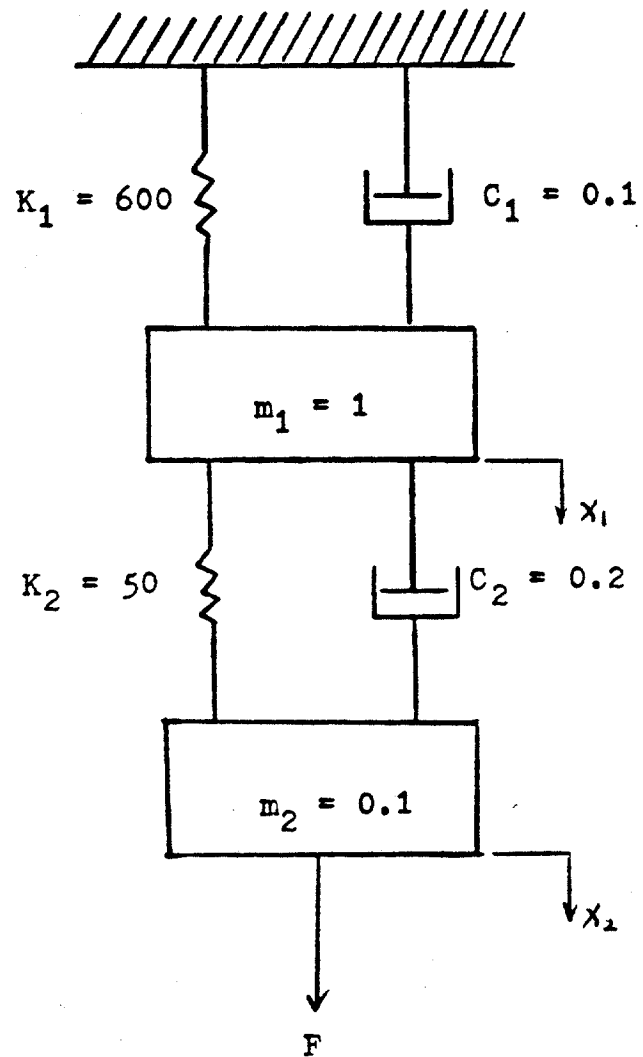

Figure 11. Two-Degree-of-Freedom System with Closely-Spaced Modes (Model C)

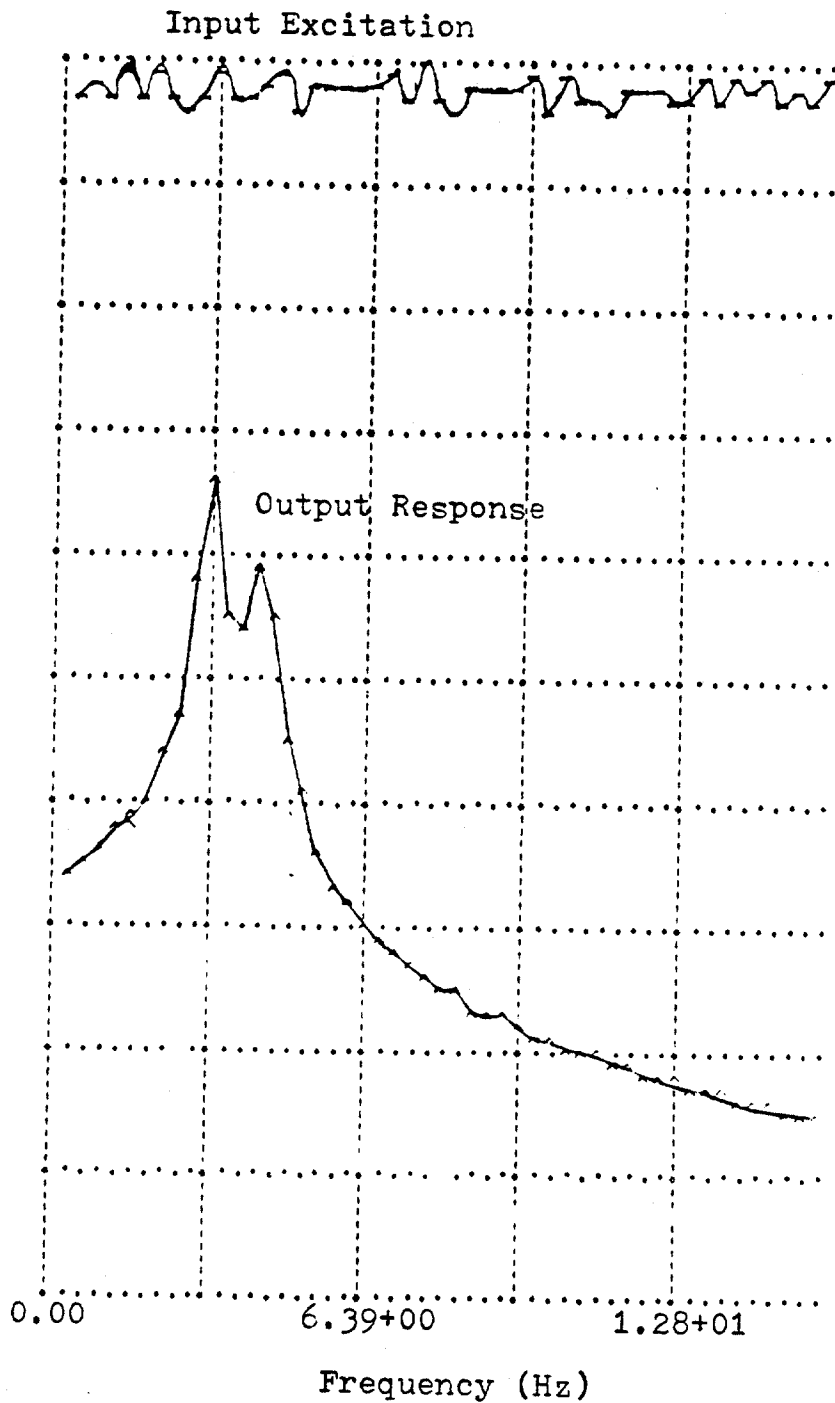

Figure 12. P. S. D. Curve of Input Excitation and Output Response of Model C

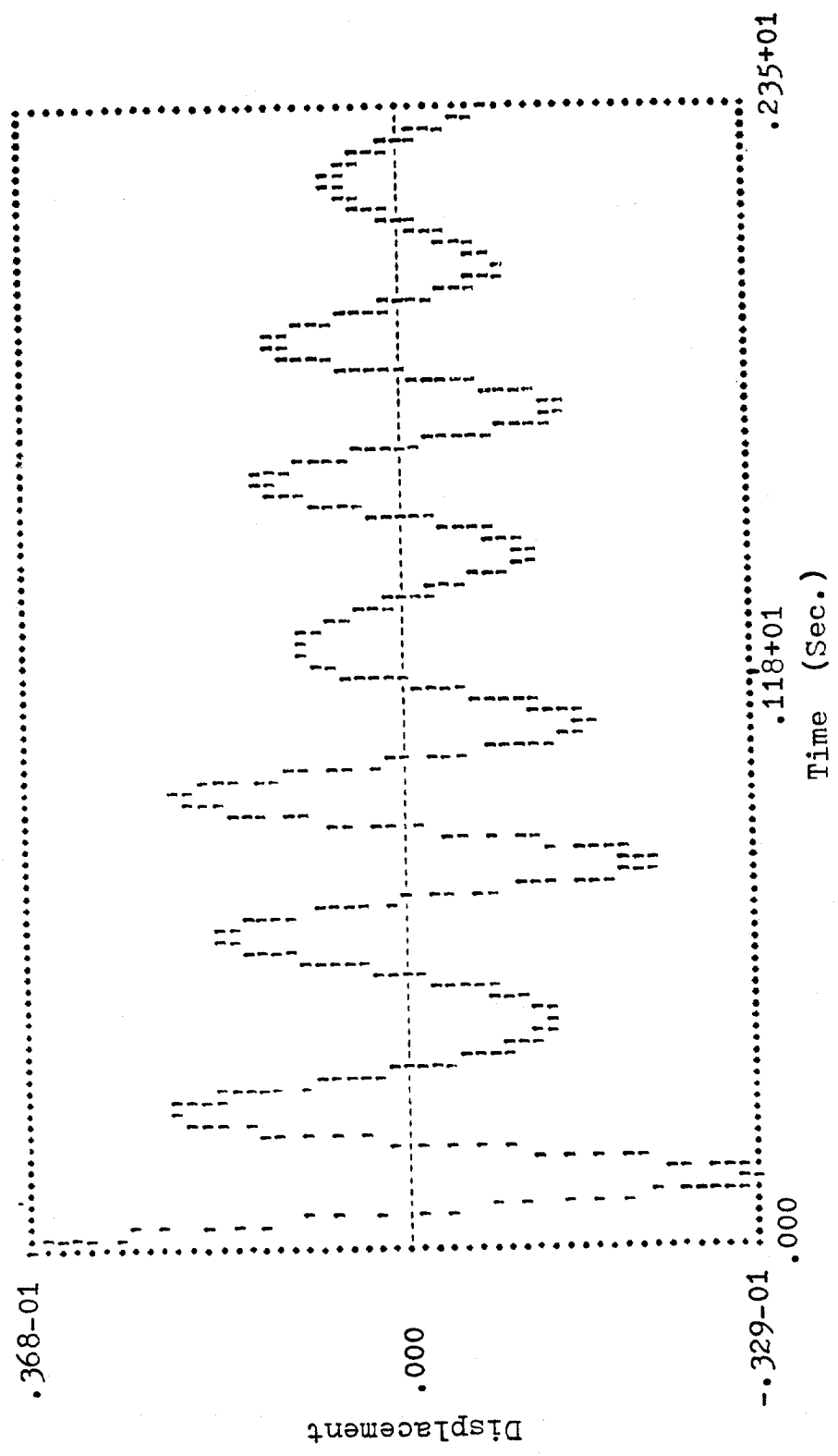

Figure 13. Random Decrement Signature of Model C



Figure 14. Power Spectral Density Curve of the Random Decrement Signature of Model C

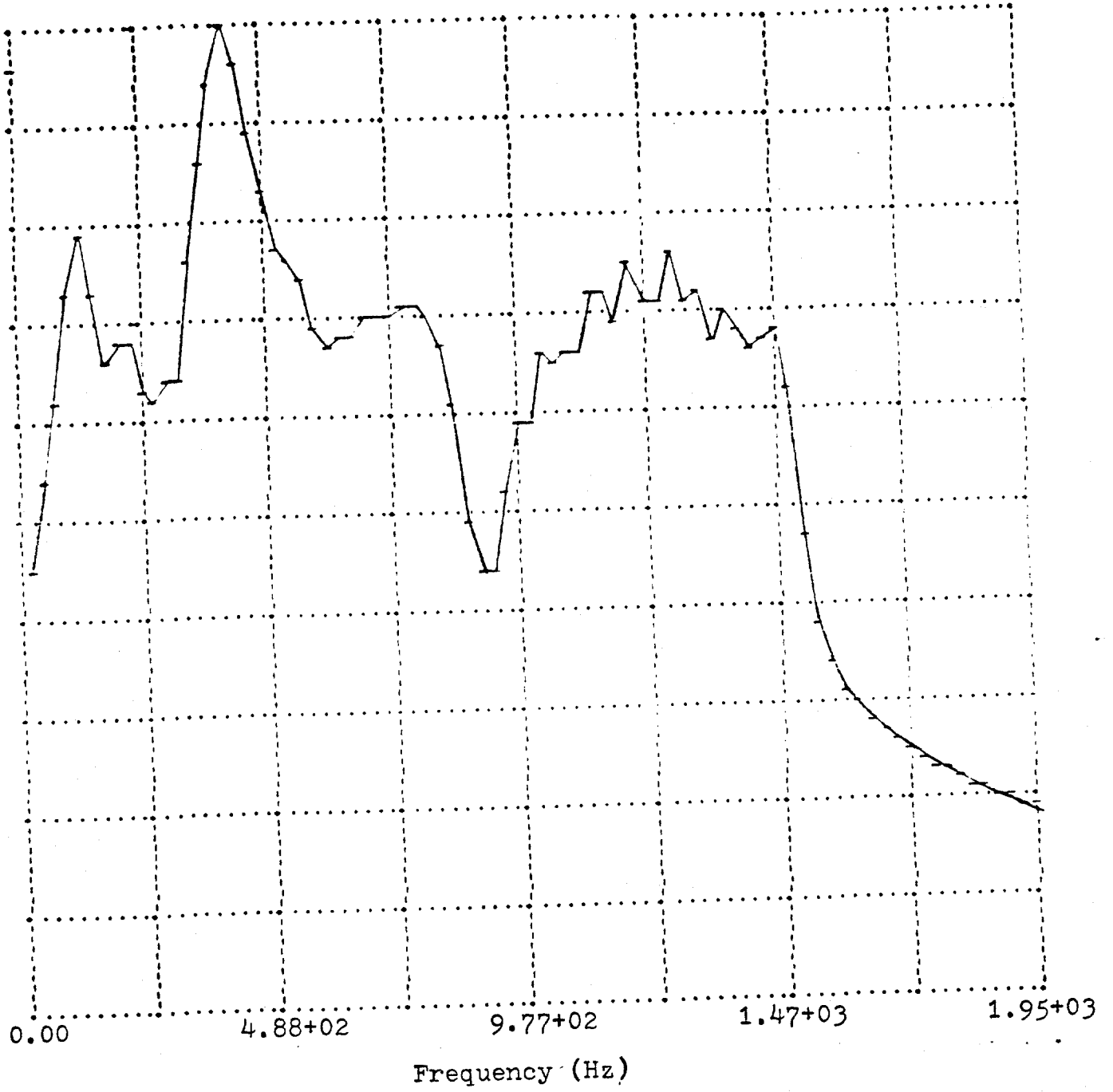

Figure 15. P. S. D. Curve of Response Signal of Finite Element Model (Point 1)

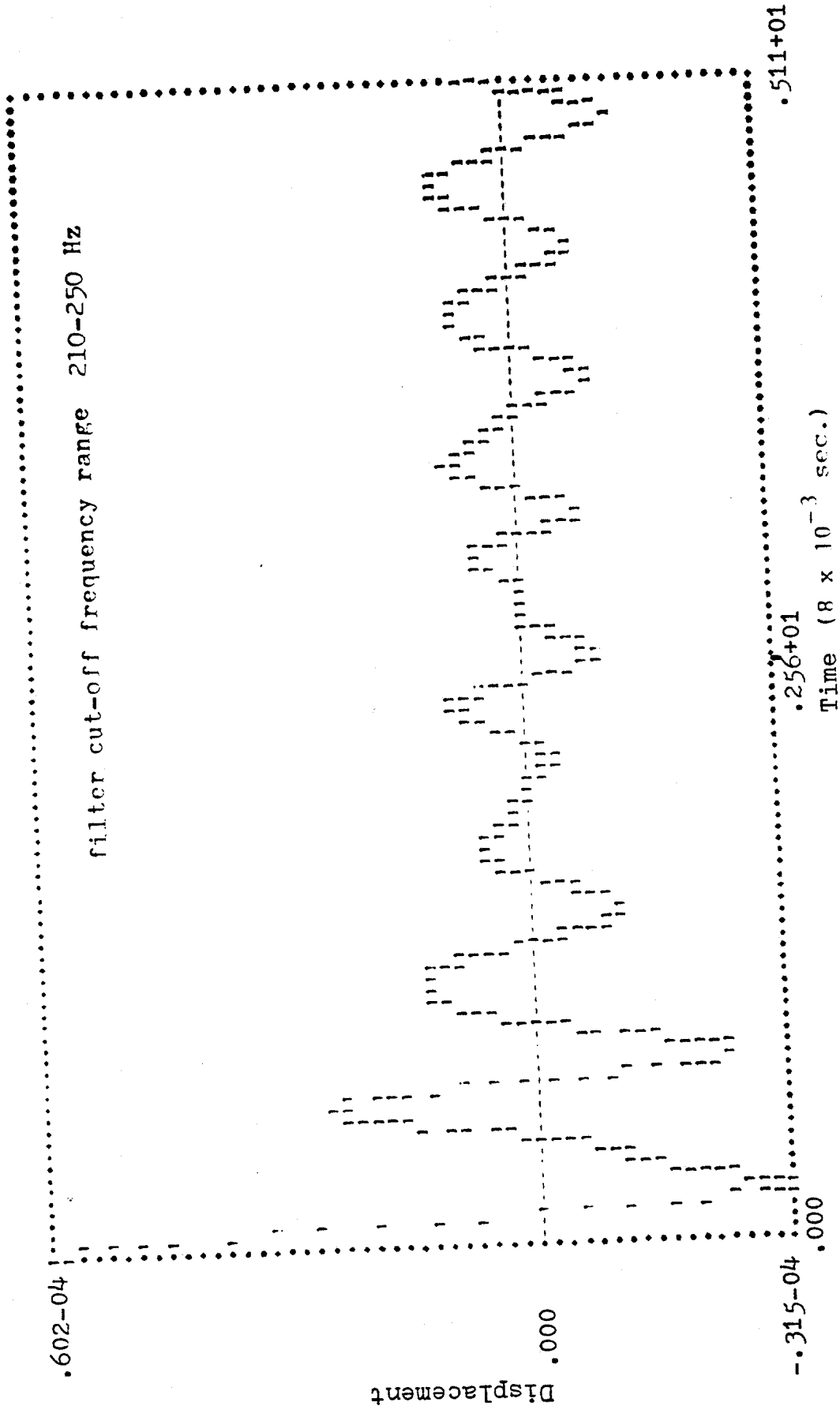

Figure 16. Random Decrement Signature of the Finite Element Model

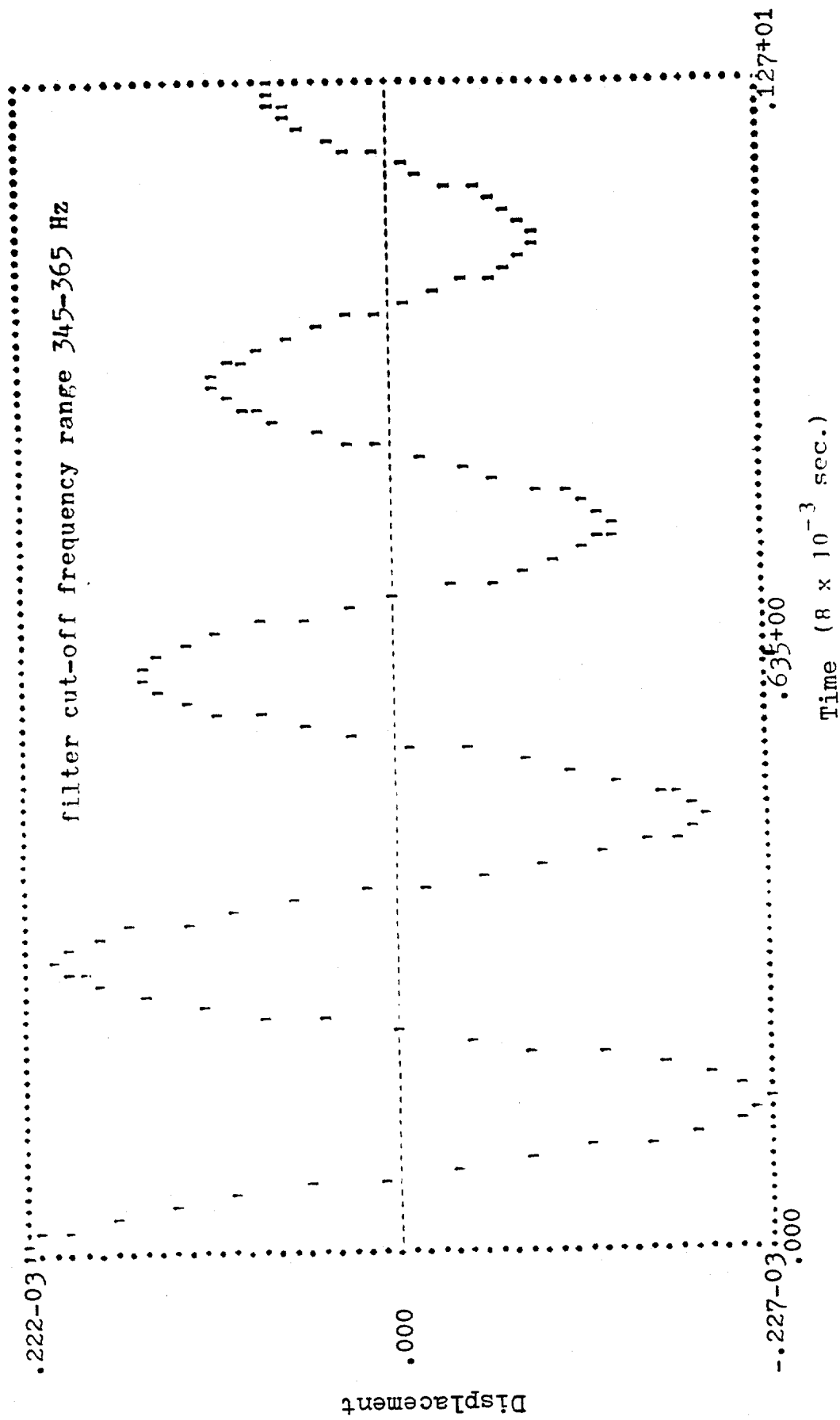

Figure 17. Random Decrement Signature of the Finite Element Model

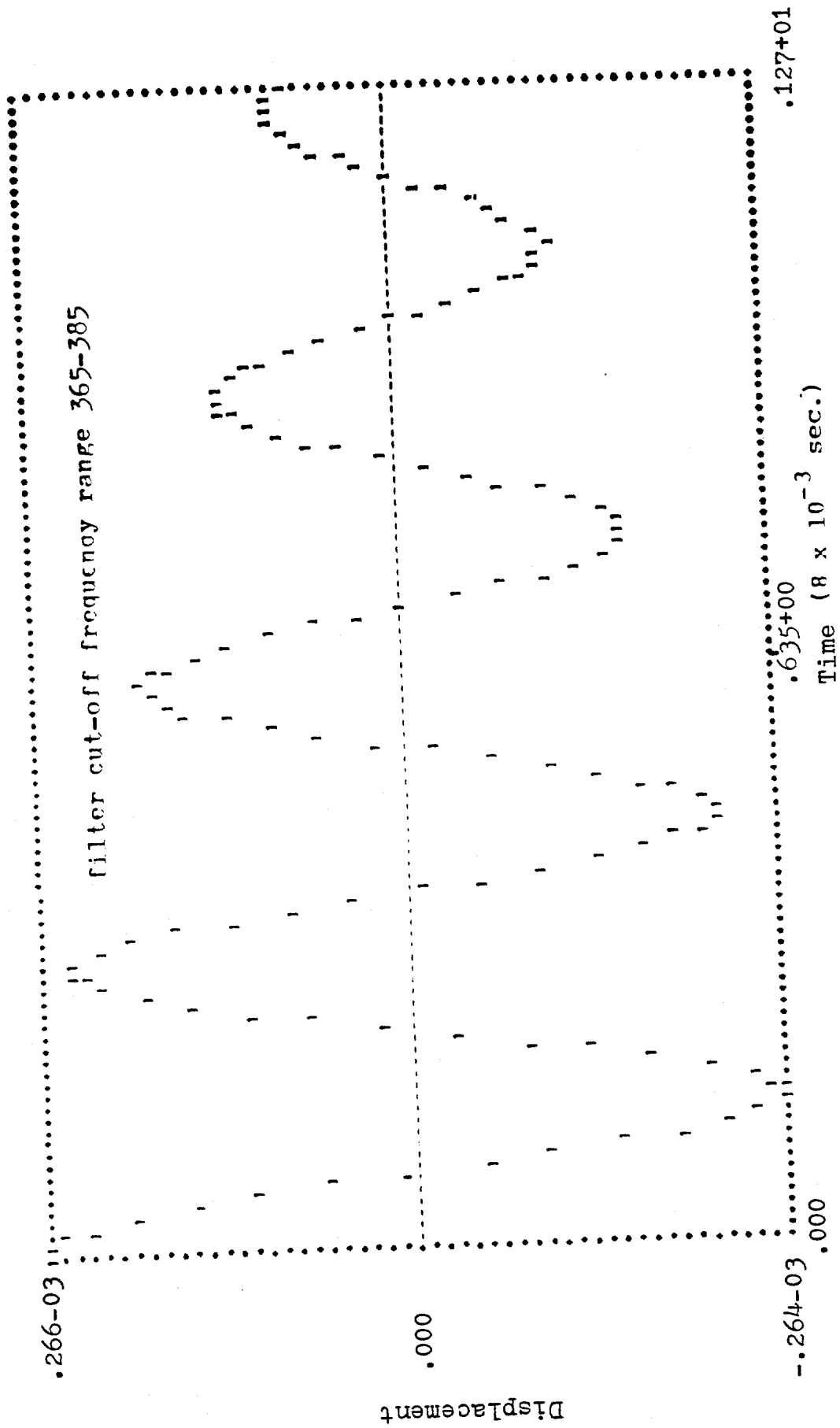

Figure 18. Random Decrement Signature of the Finite Element Model

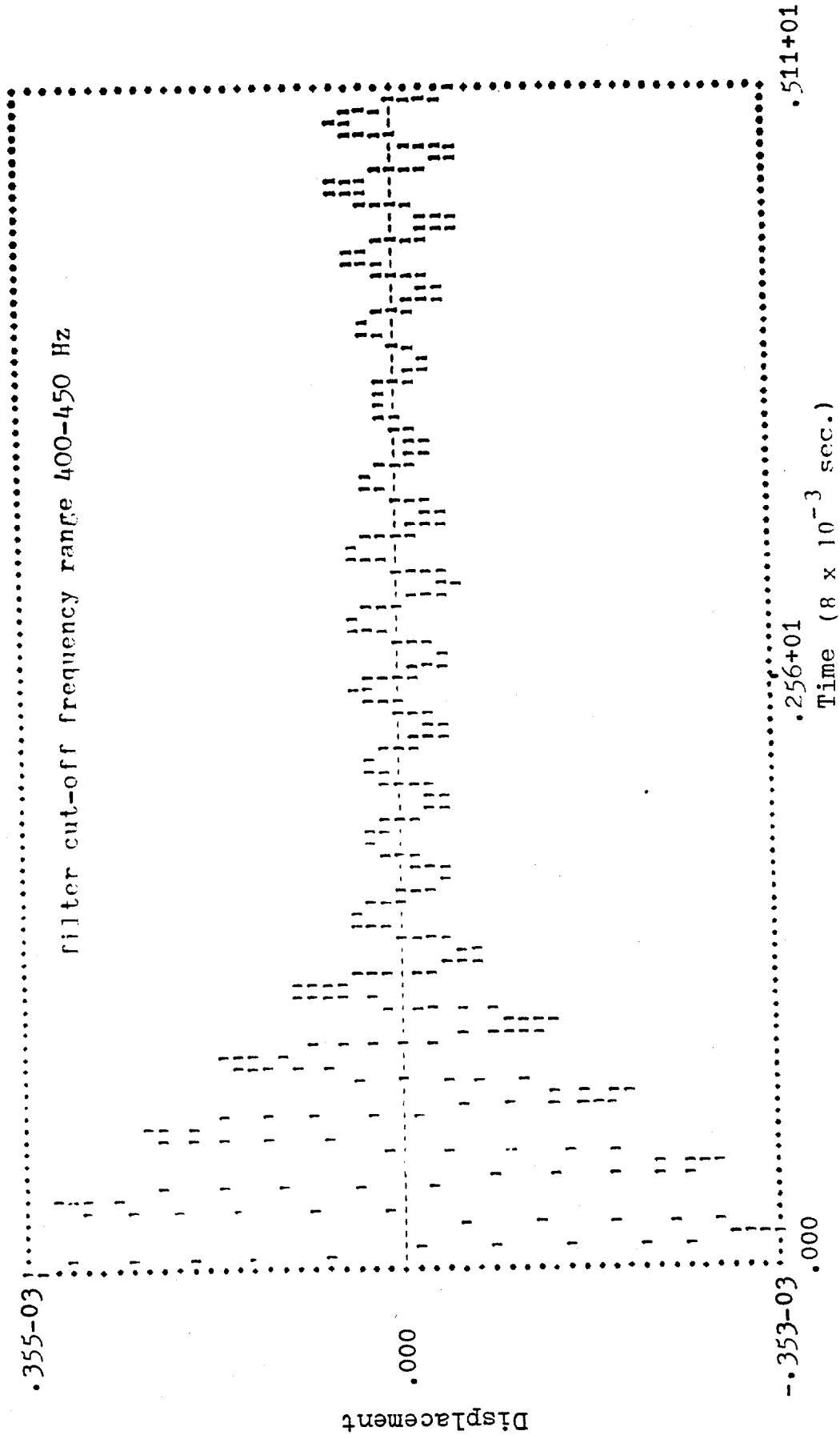

Figure 19. Random Decrement Signature of the Finite Element Model

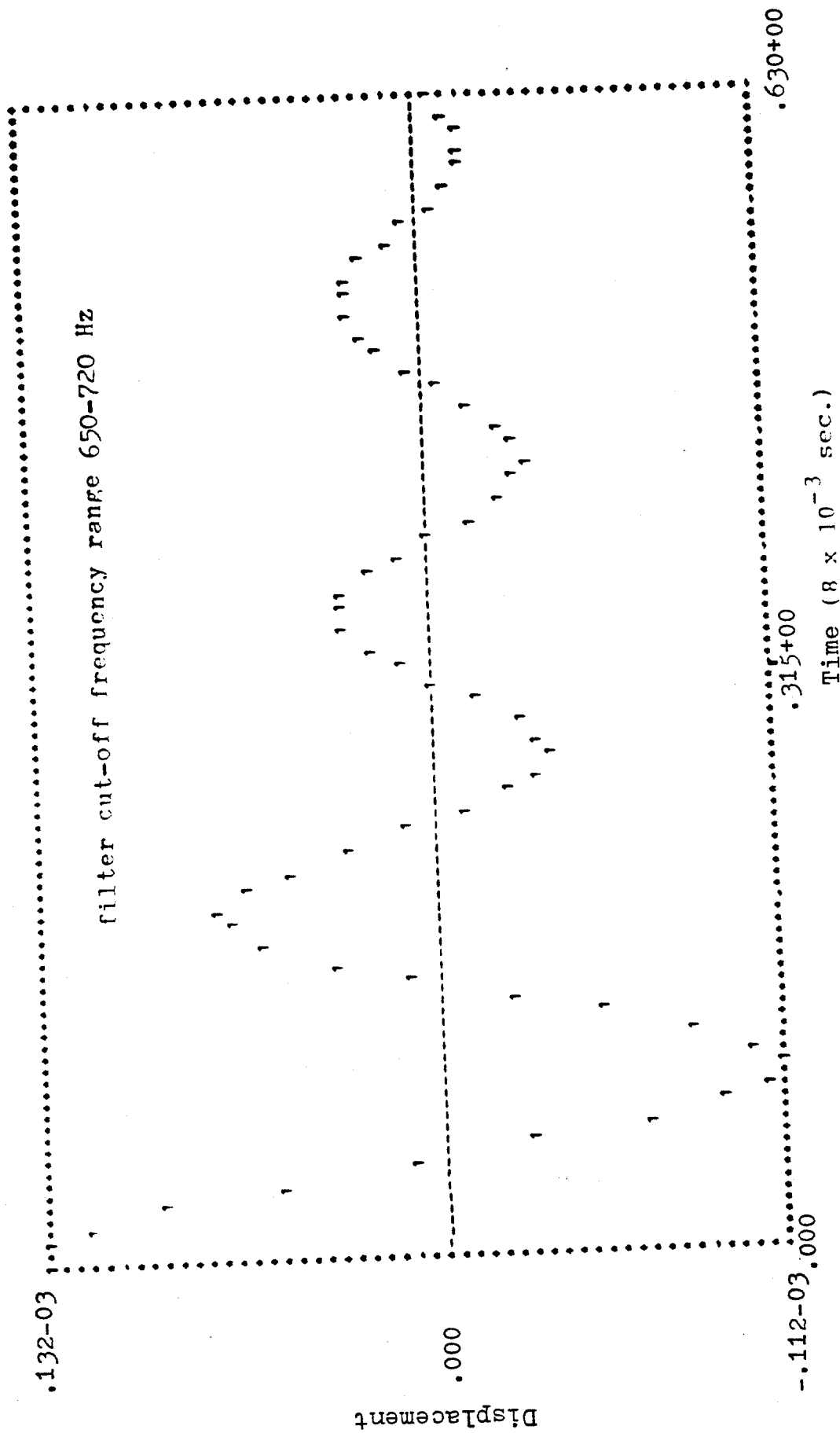

Figure 20. Random Decrement Signature of the Finite Element Model

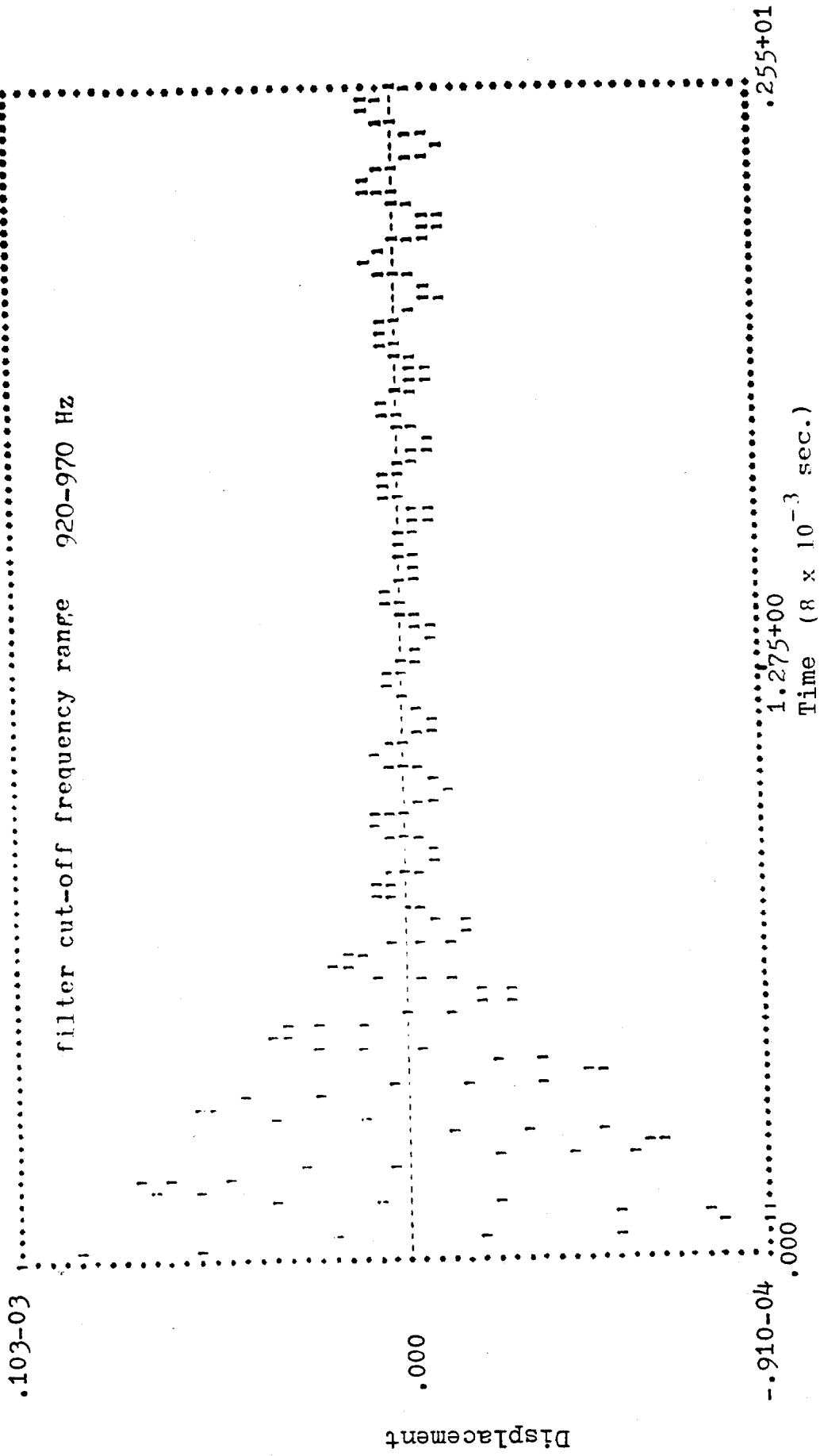

Figure 21. Random Decrement Signature of the Finite Element Model

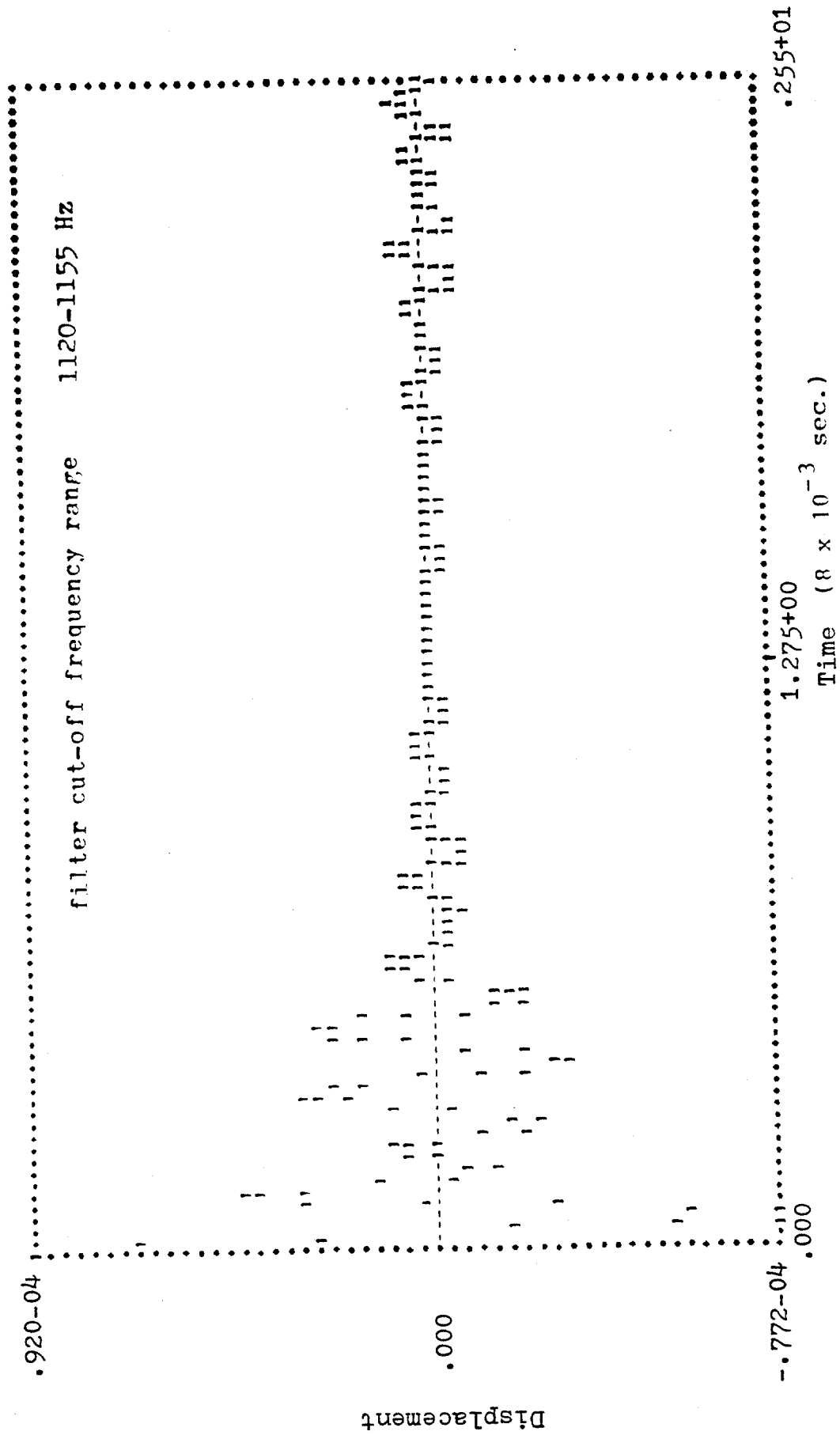

Figure 22. Random Decrement Signature of the Finite Element Model

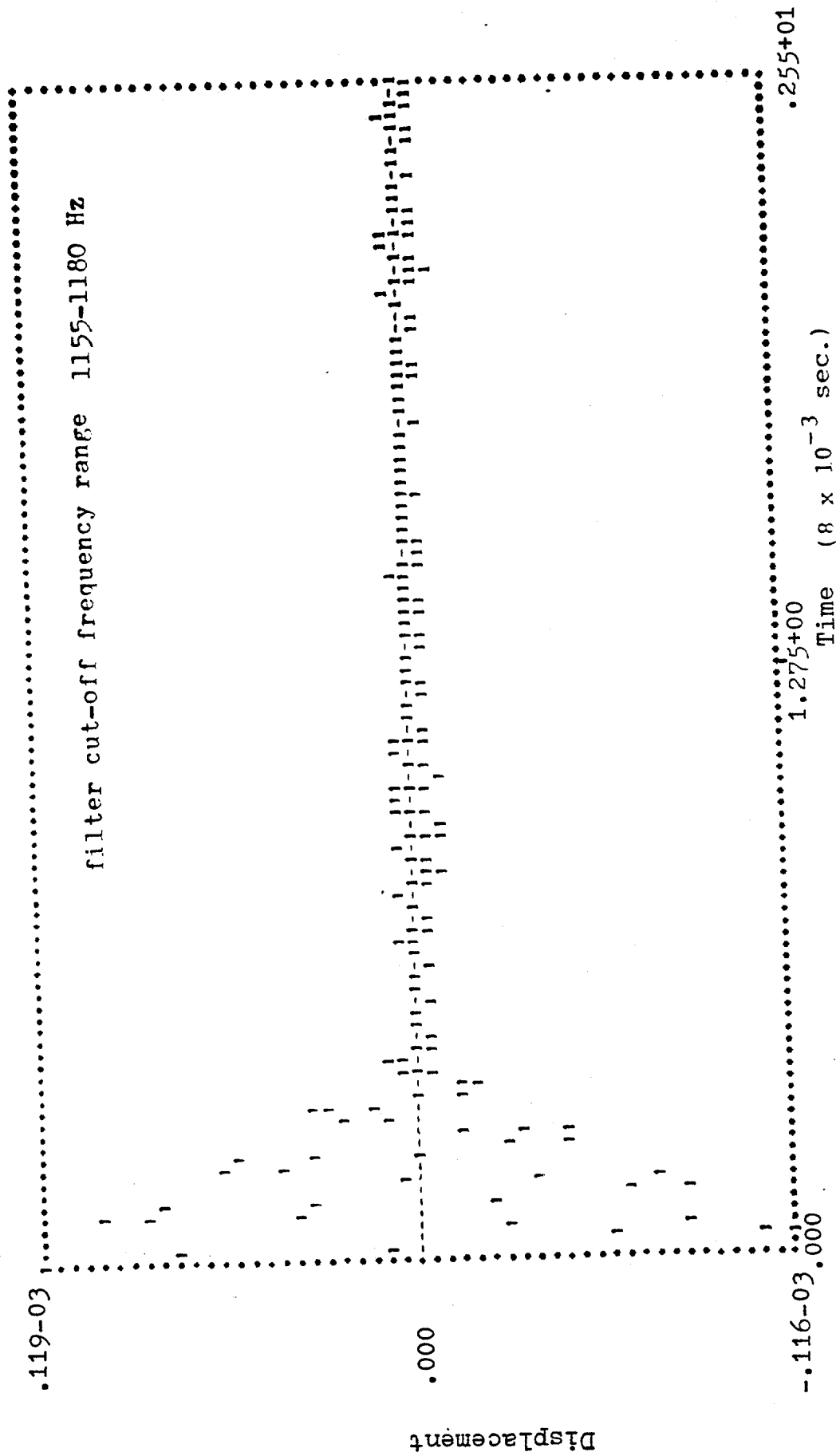

Figure 23. Random Decrement Signature of the Finite Element Model

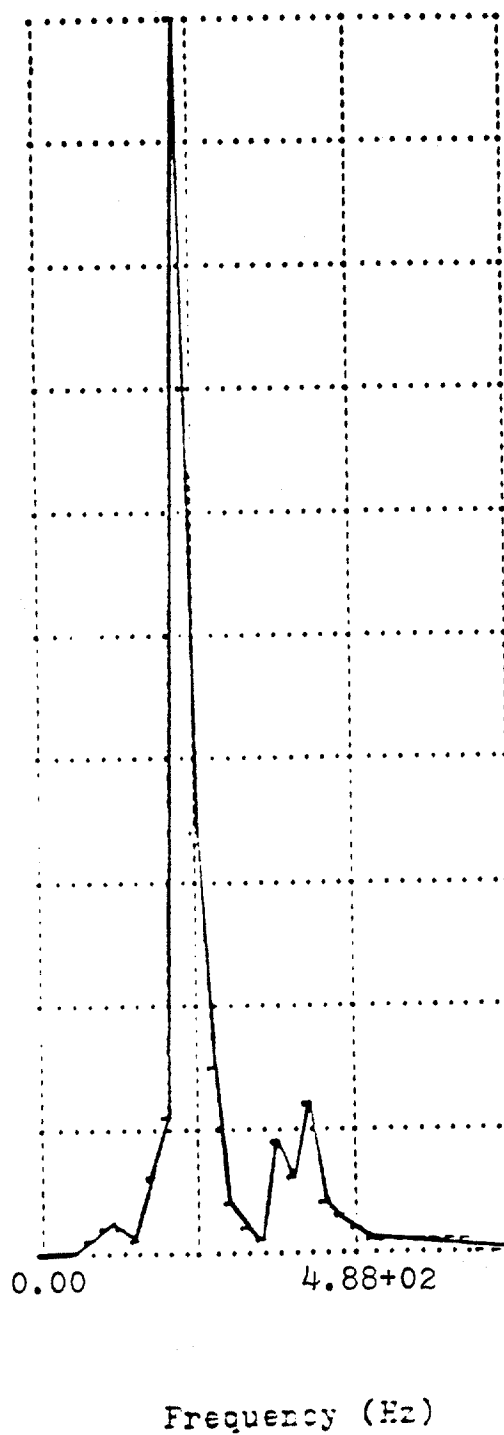

Figure 24. Power Spectral Density Curve of the Random Decrement Signature of the Finite Element Model (Filter Range 210-250 Hz)

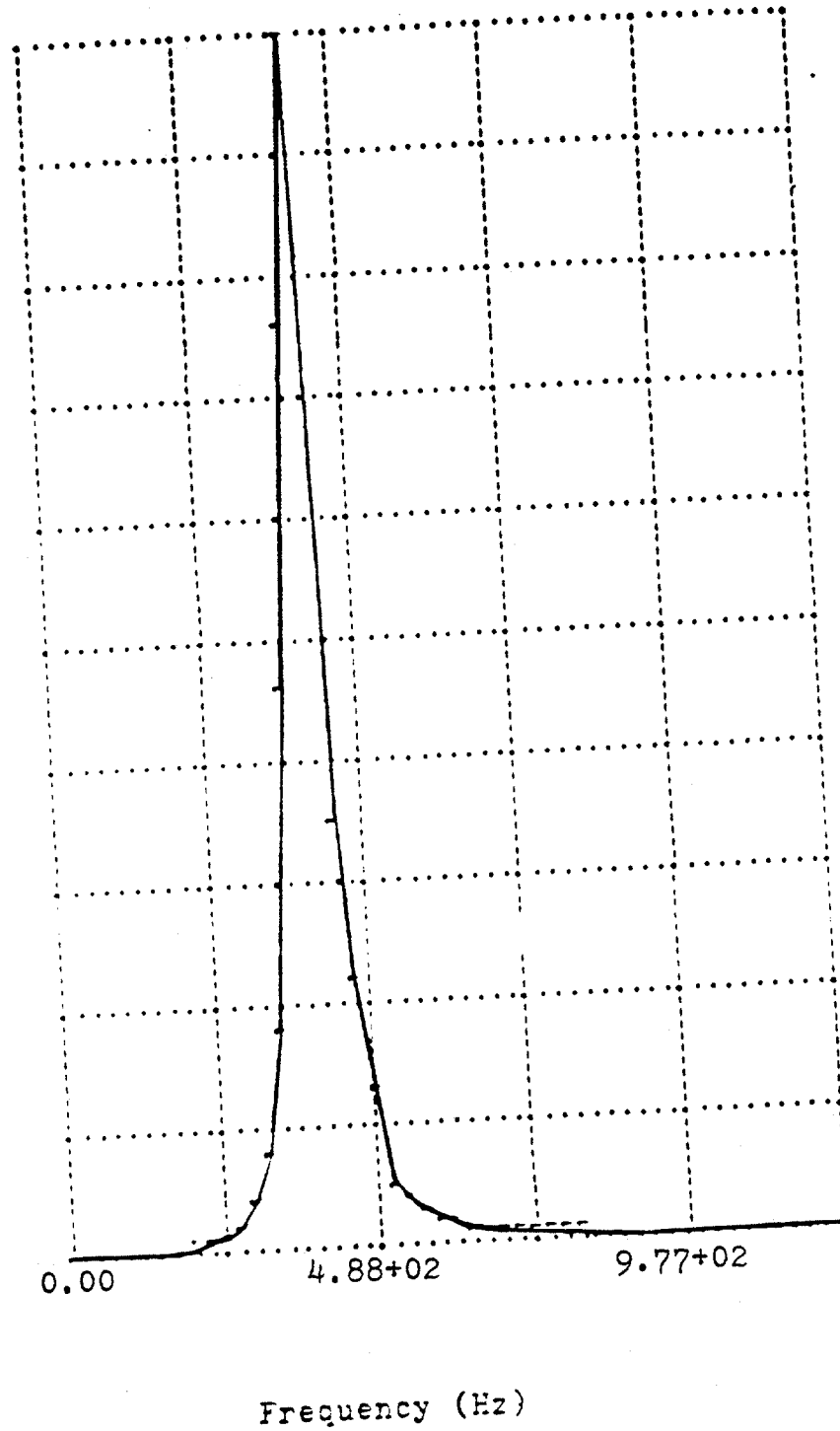

Figure 25. Power Spectral Density Curve of the Random Decrement Signature of the Finite Element Model (Filter Range 345-365 Hz)

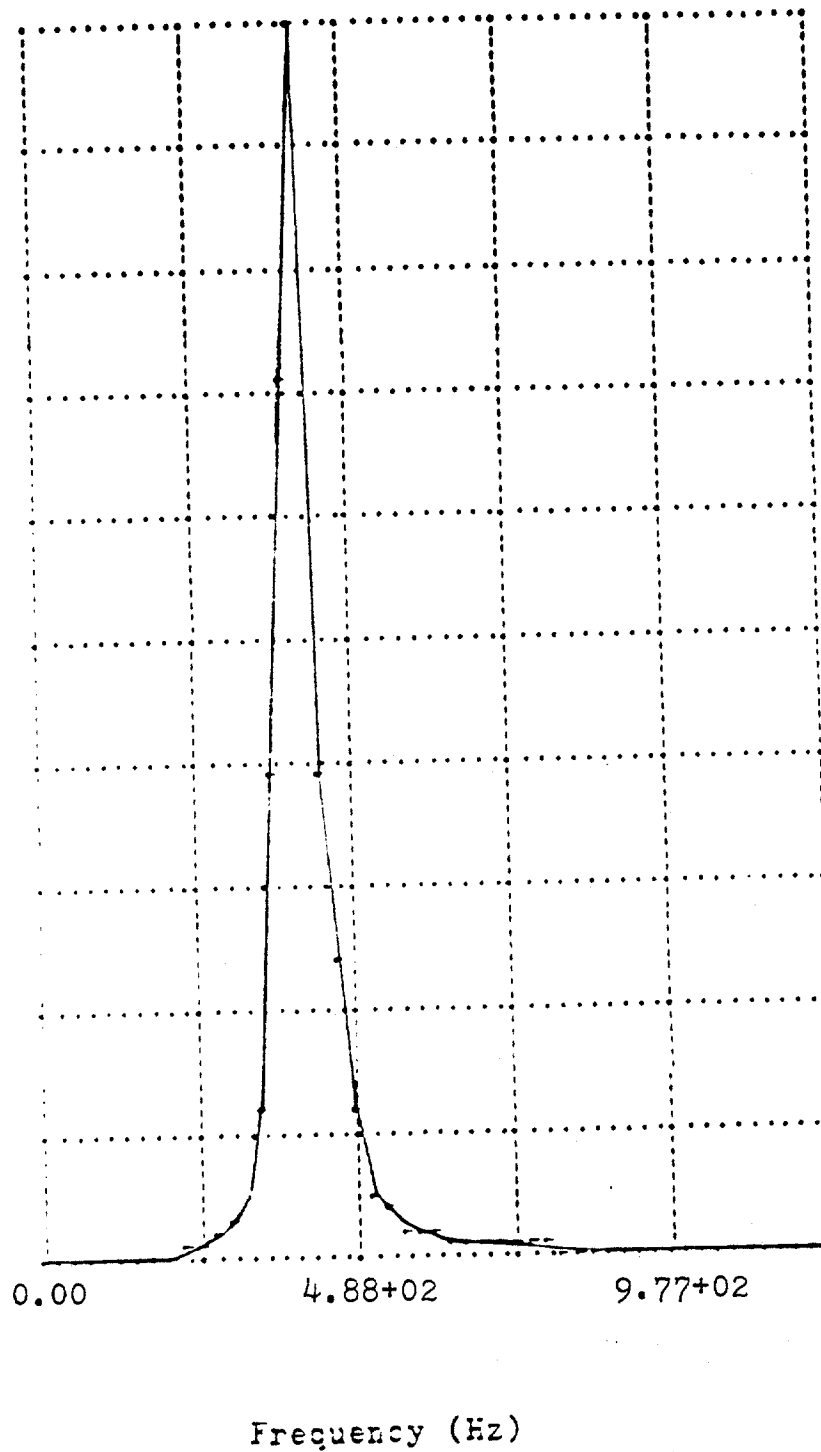

Figure 26. Power Spectral Density Curve of the Random Decrement Signature of the Finite Element Model (Filter Range 365-385 Hz)

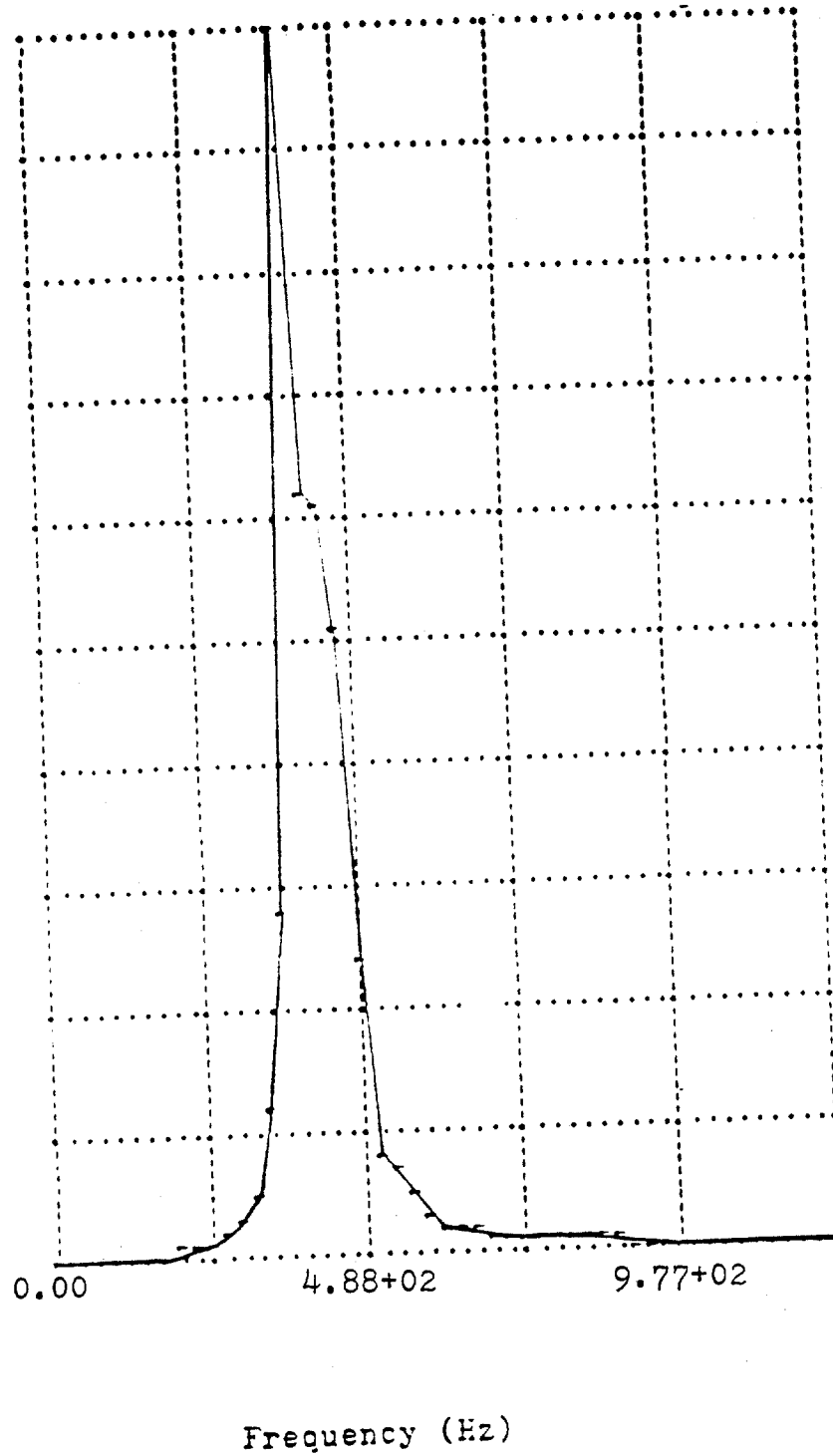

Figure 27. Power Spectral Density Curve of the Random Decrement Signature of the Finite Element Model (Filter Range 400-450 Hz)

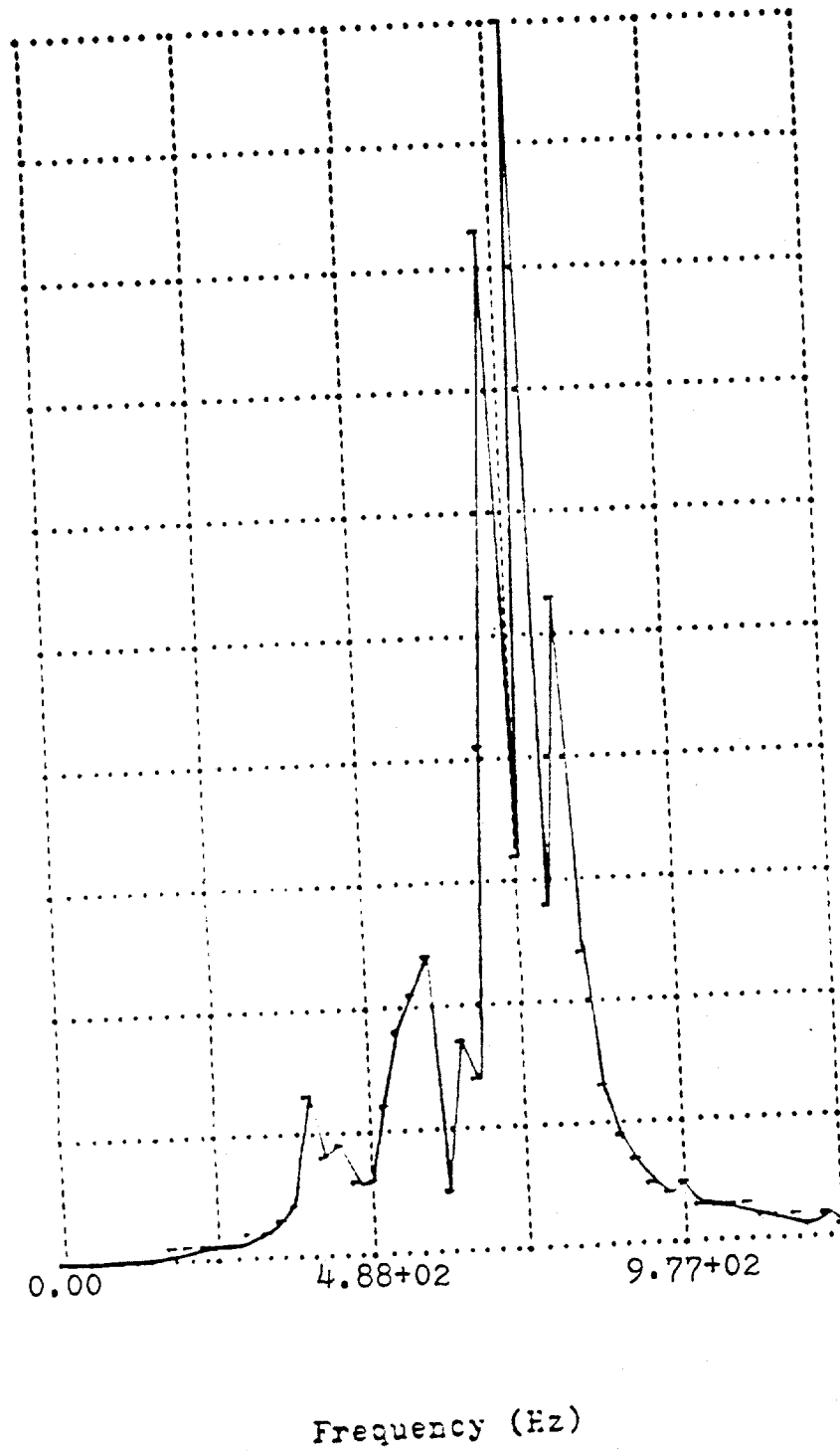

Figure 28. Power Spectral Density Curve of the Random Decrement Signature of the Finite Element Model (Filter Range 650-720 Hz)

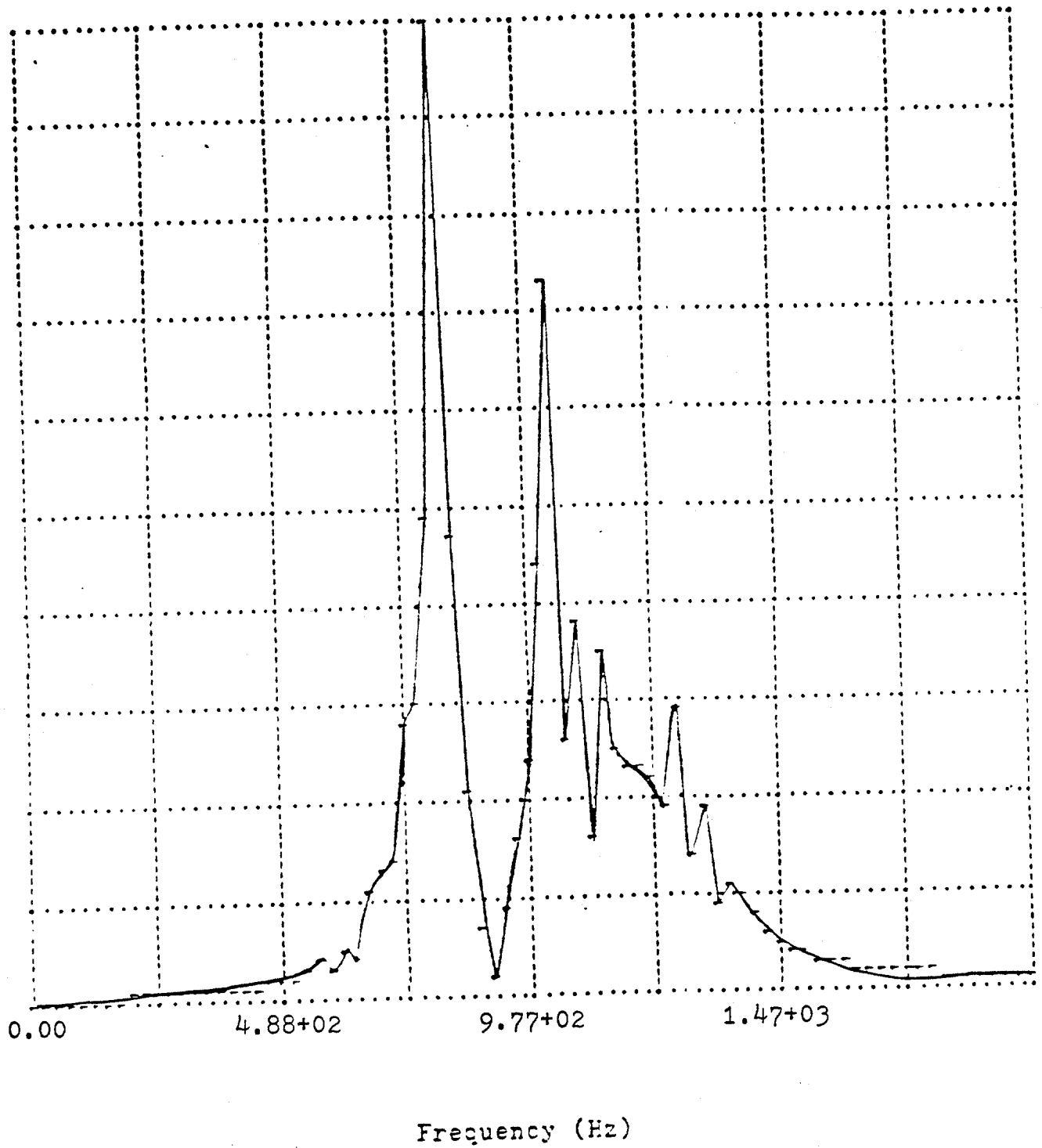

Figure 29. Power Spectral Density Curve of the Random Decrement Signature of the Finite Element Model (Filter Range 920-970 Hz)

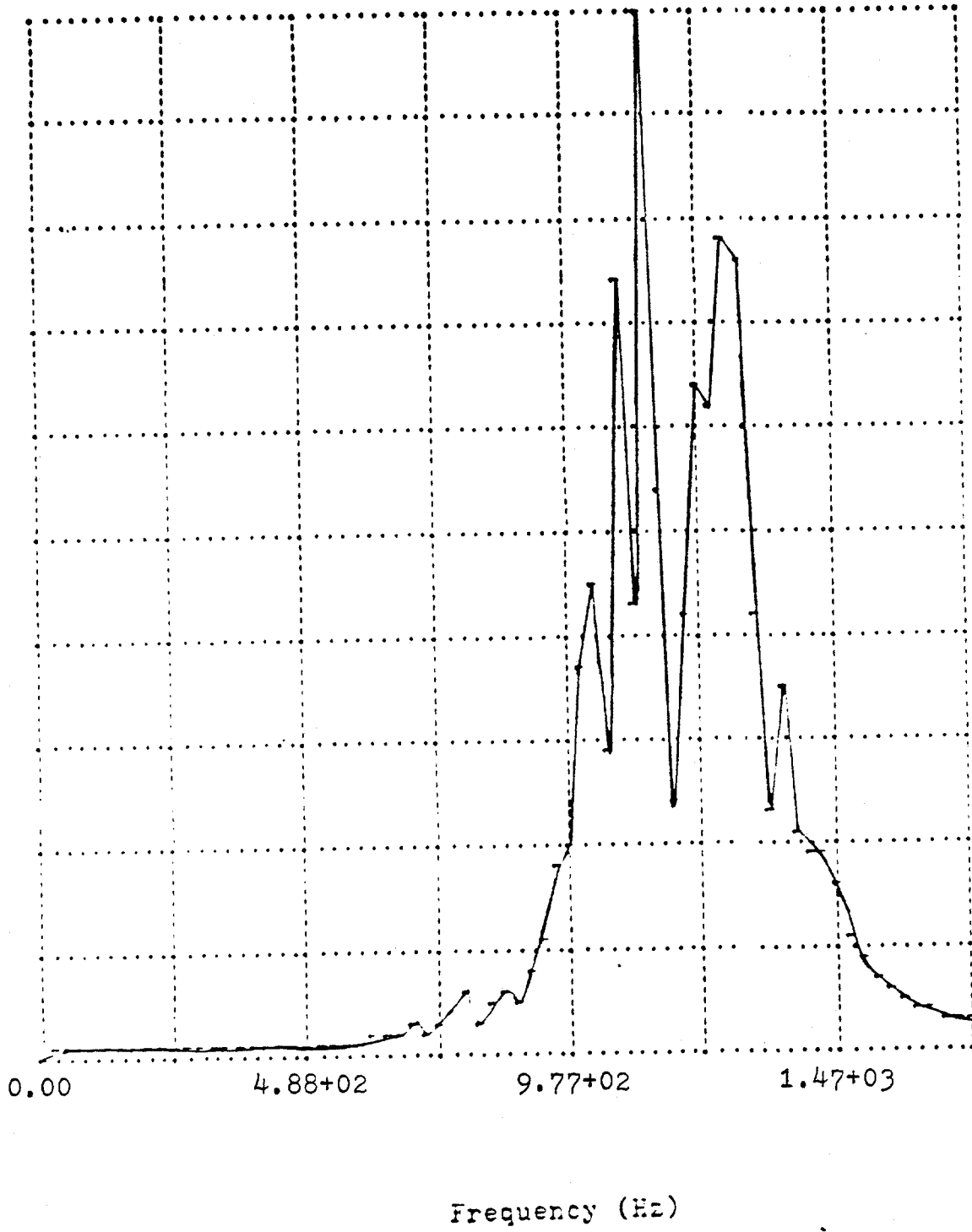

Figure 30. Power Spectral Density Curve of the Random Decrement Signature of the Finite Element Model (Filter Range 1120-1155 Hz)

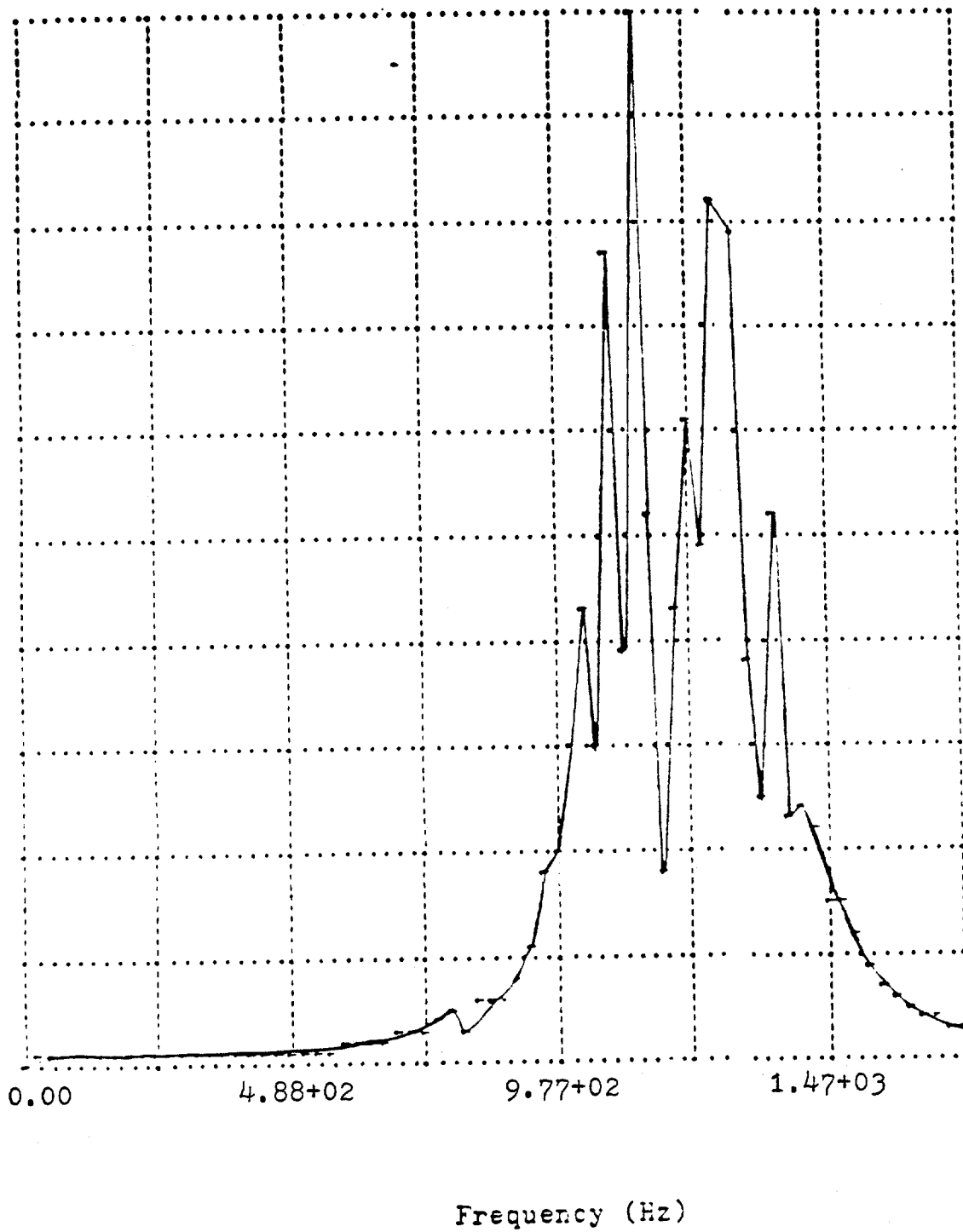

Figure 31. Power Spectral Density Curve of the Random Decrement Signature of the Finite Element Model (Filter Range 1155-1180 Hz)

• Damping Values obtained from Randomdec Analysis
 — Theoretical Damping Values used in NASTRAN

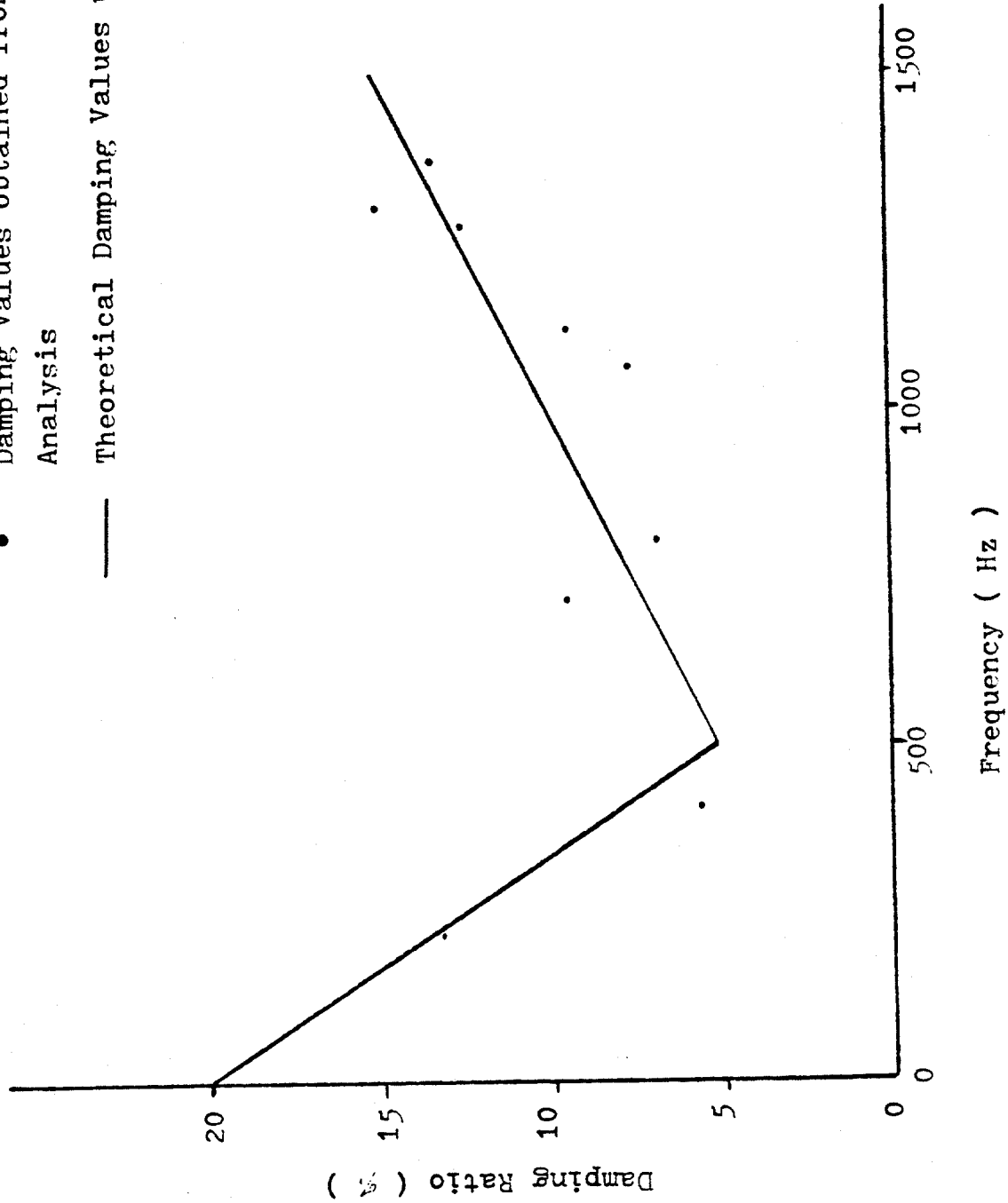

Figure 32. Comparison of the obtained Damping values with the theoretical damping values used in NASTRAN

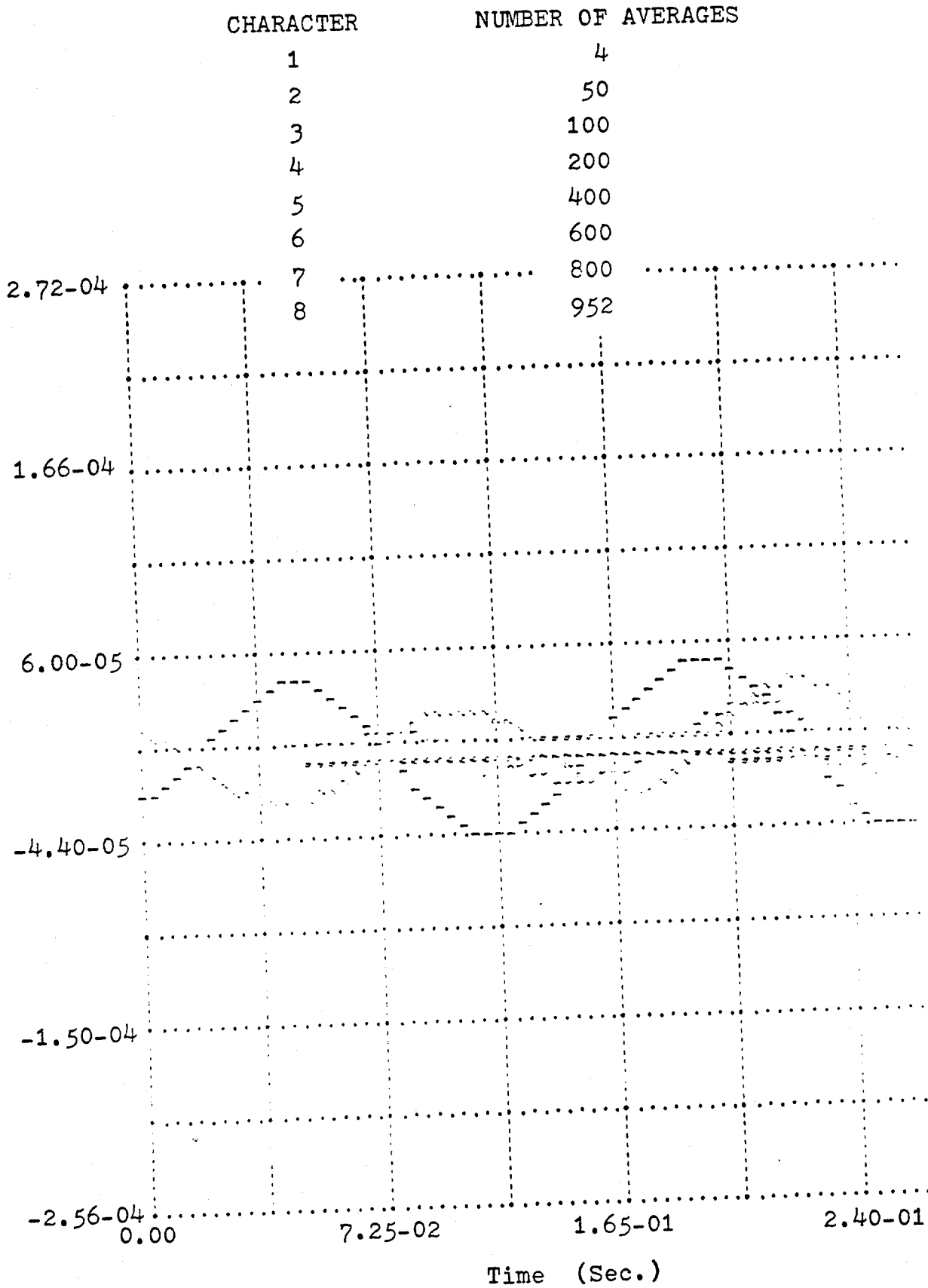

Figure 33. Plot of Error Function Between Successive Averages

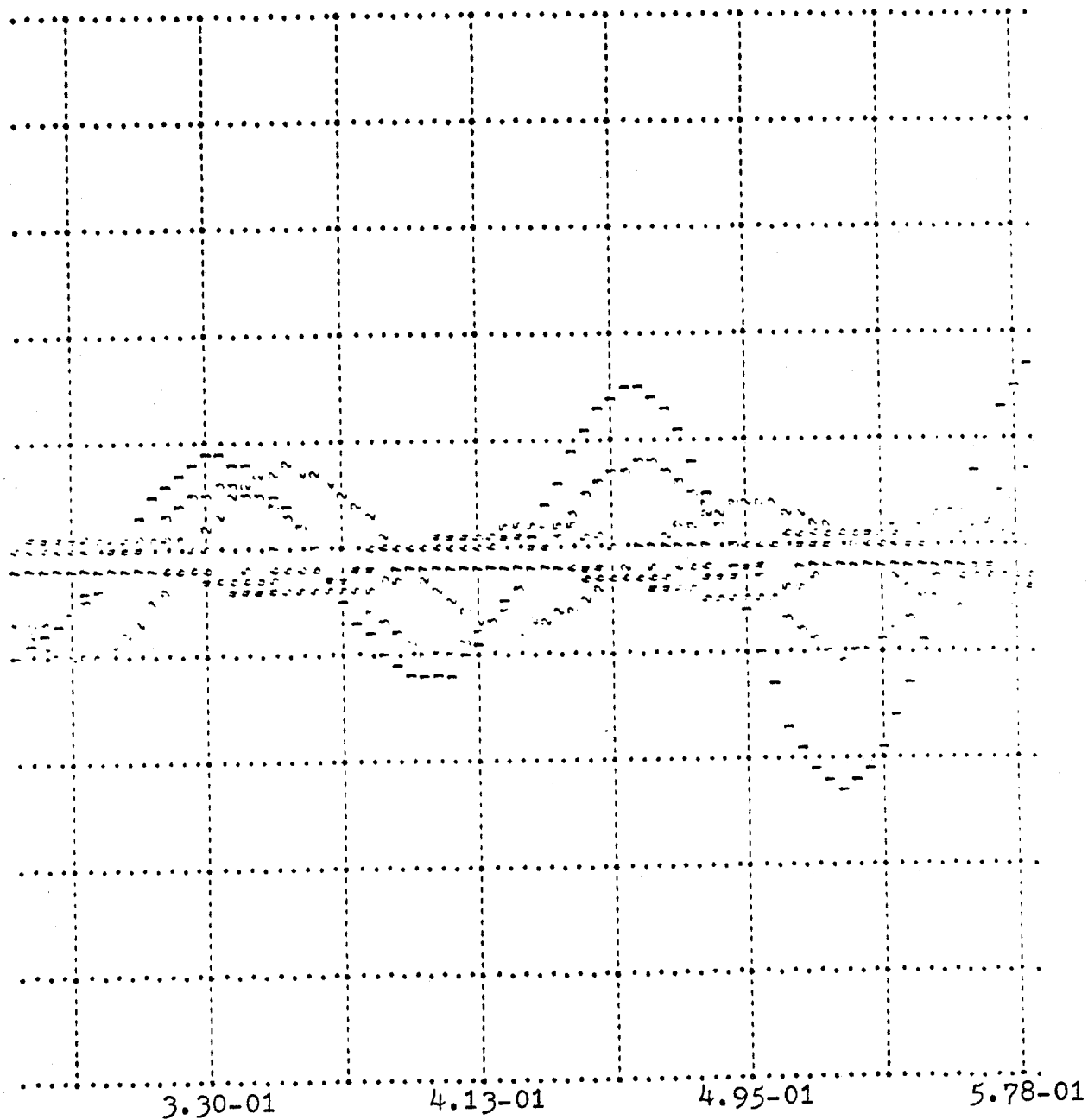

Figure 33. Plot of Error Function Between Successive Averages
(continued)

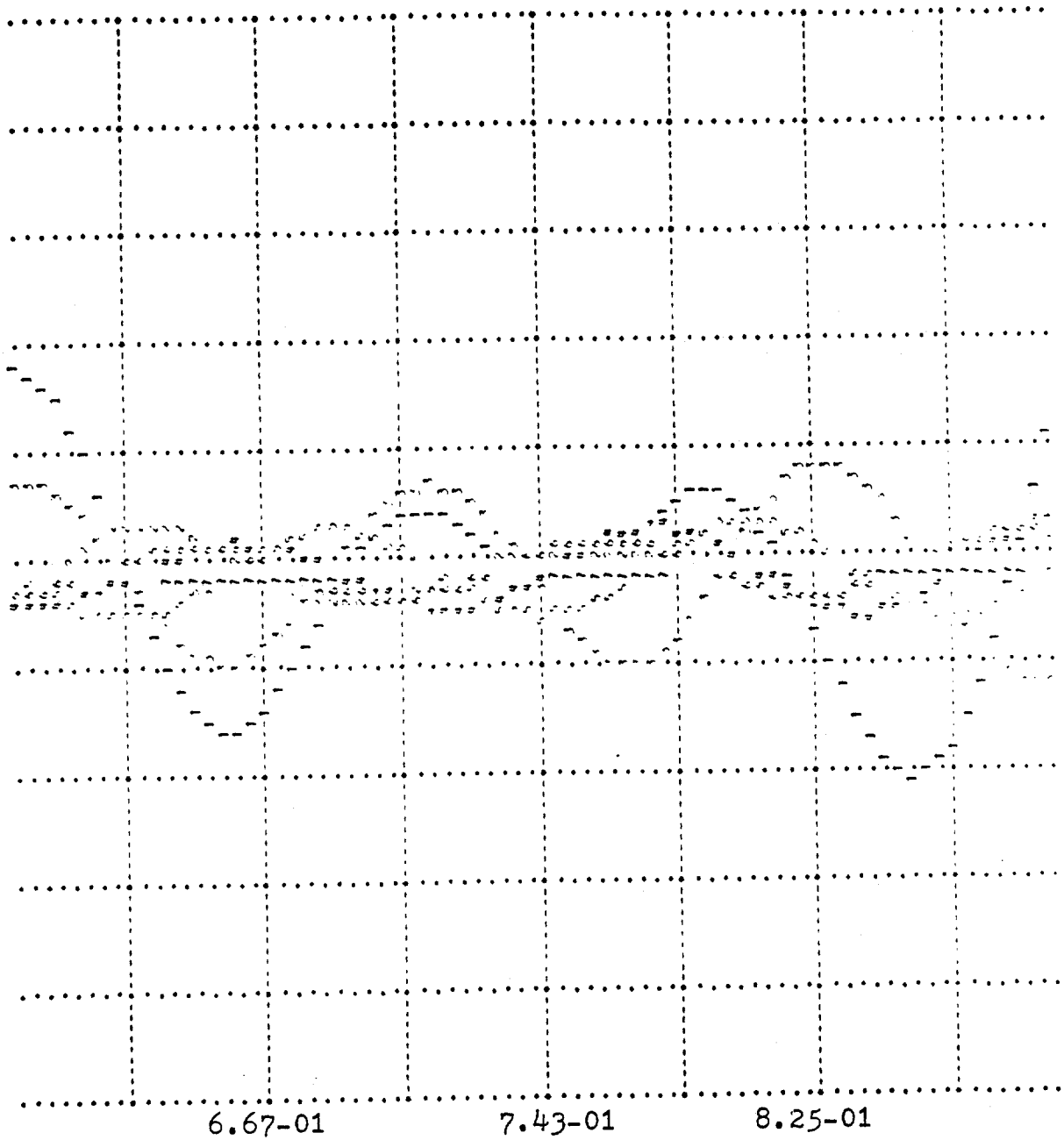

Figure 33. Plot of Error Function Between Successive Averages
(Continued)

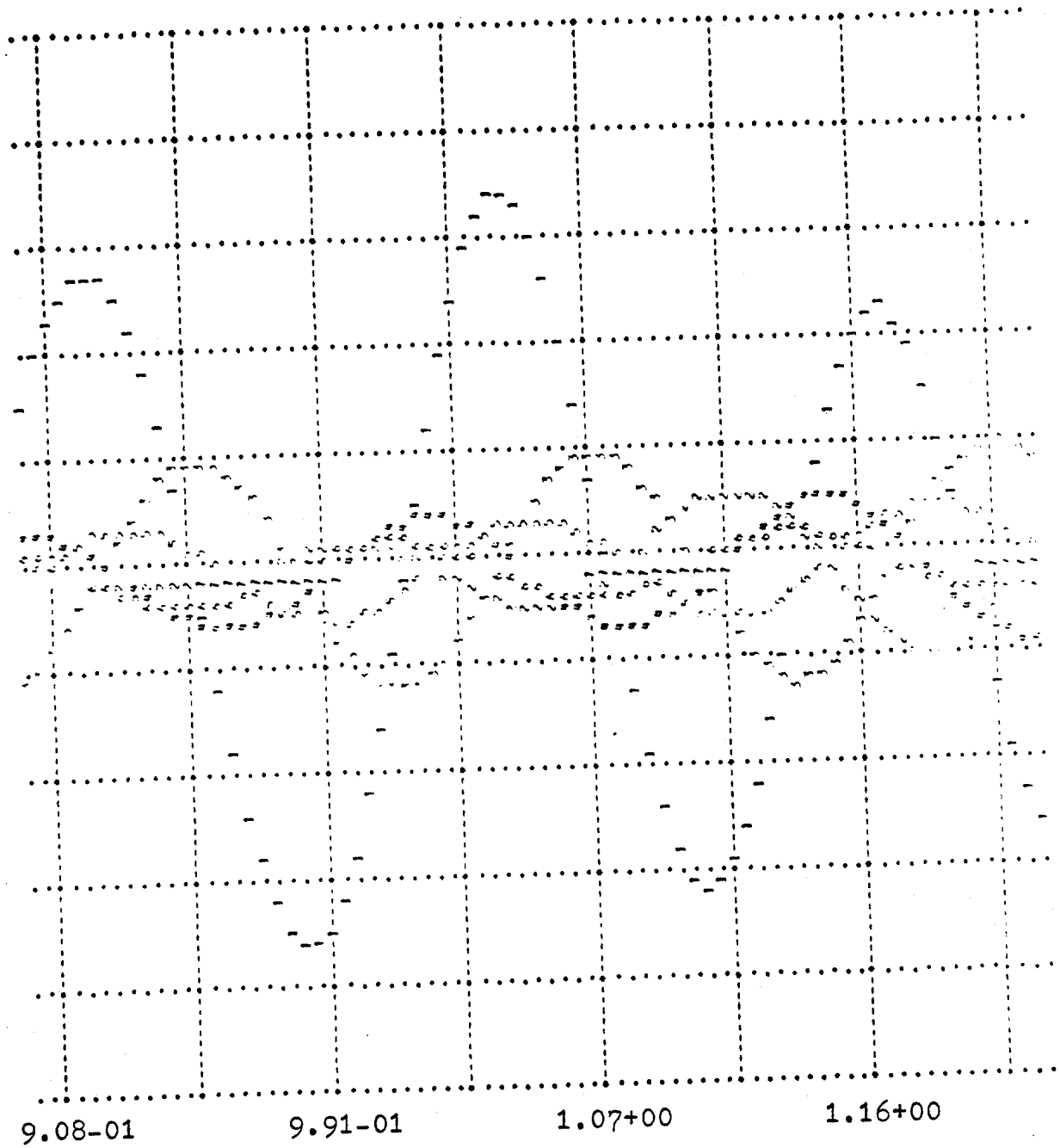

Figure 33. Plot of Error Function Between Successive Averages
(Continued)

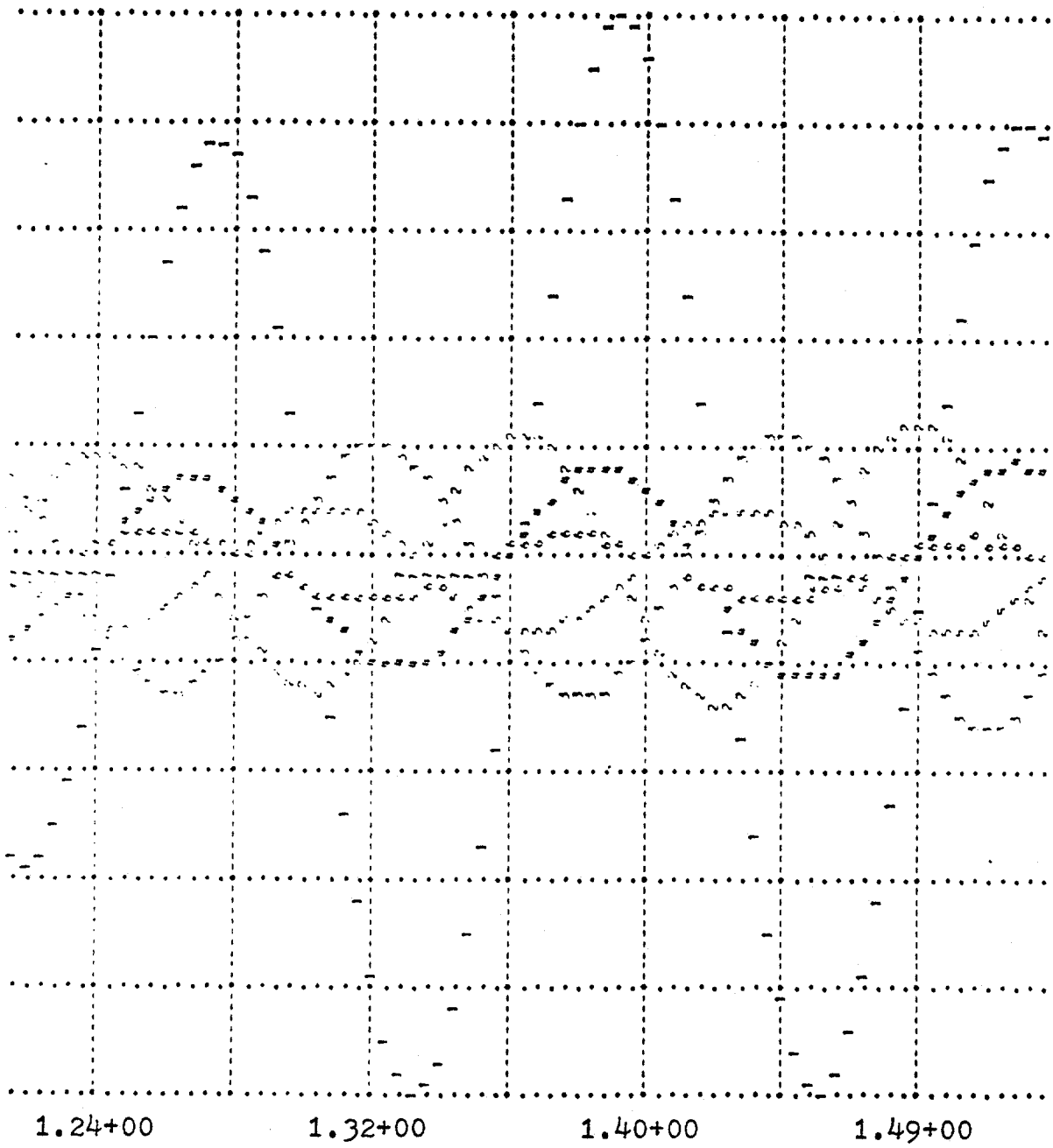

Figure 33. Plot of Error Function Between Successive Averages
(Continued)

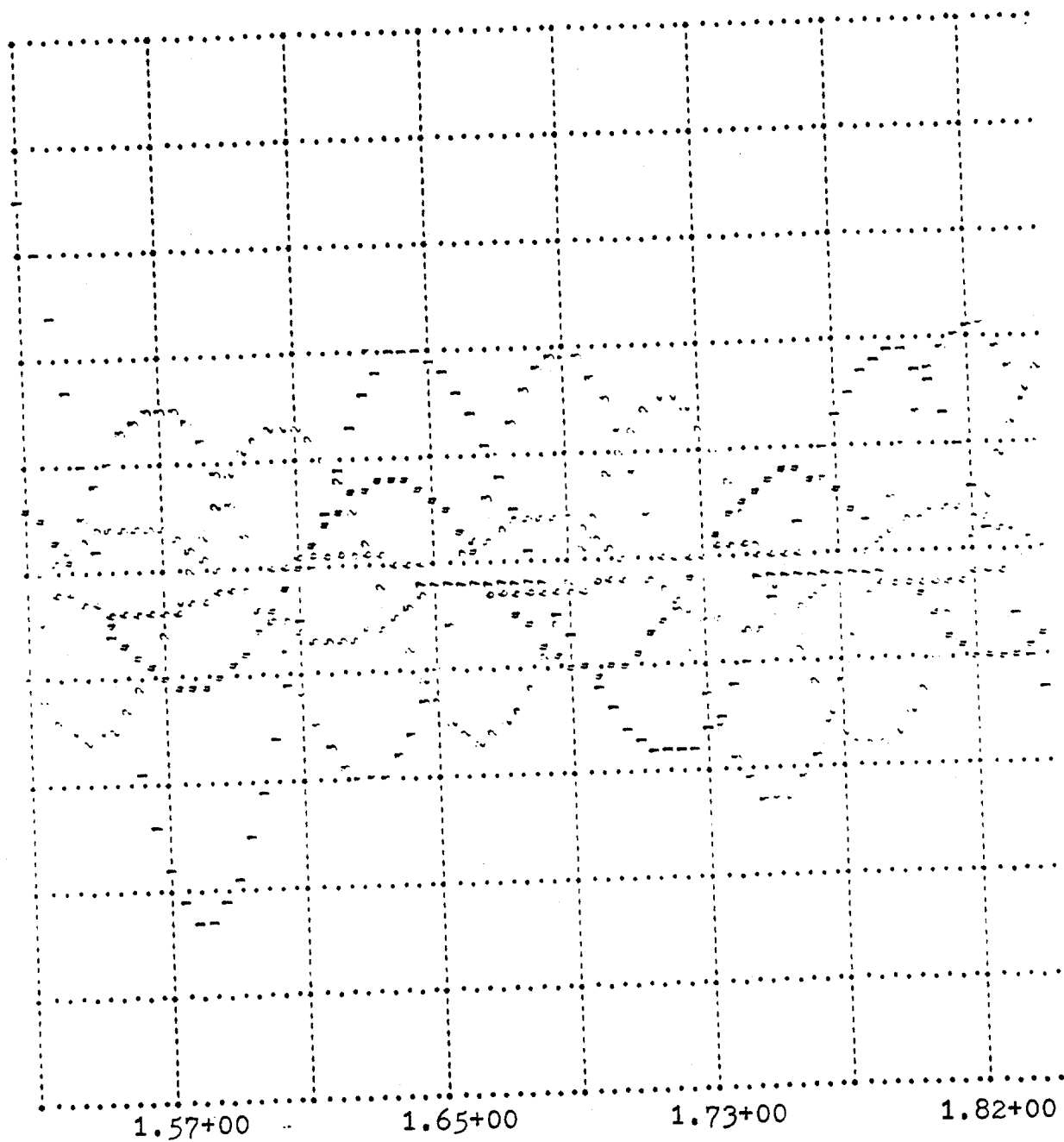

Figure 33. Plot of Error Function Between Successive Averages
(Continued)

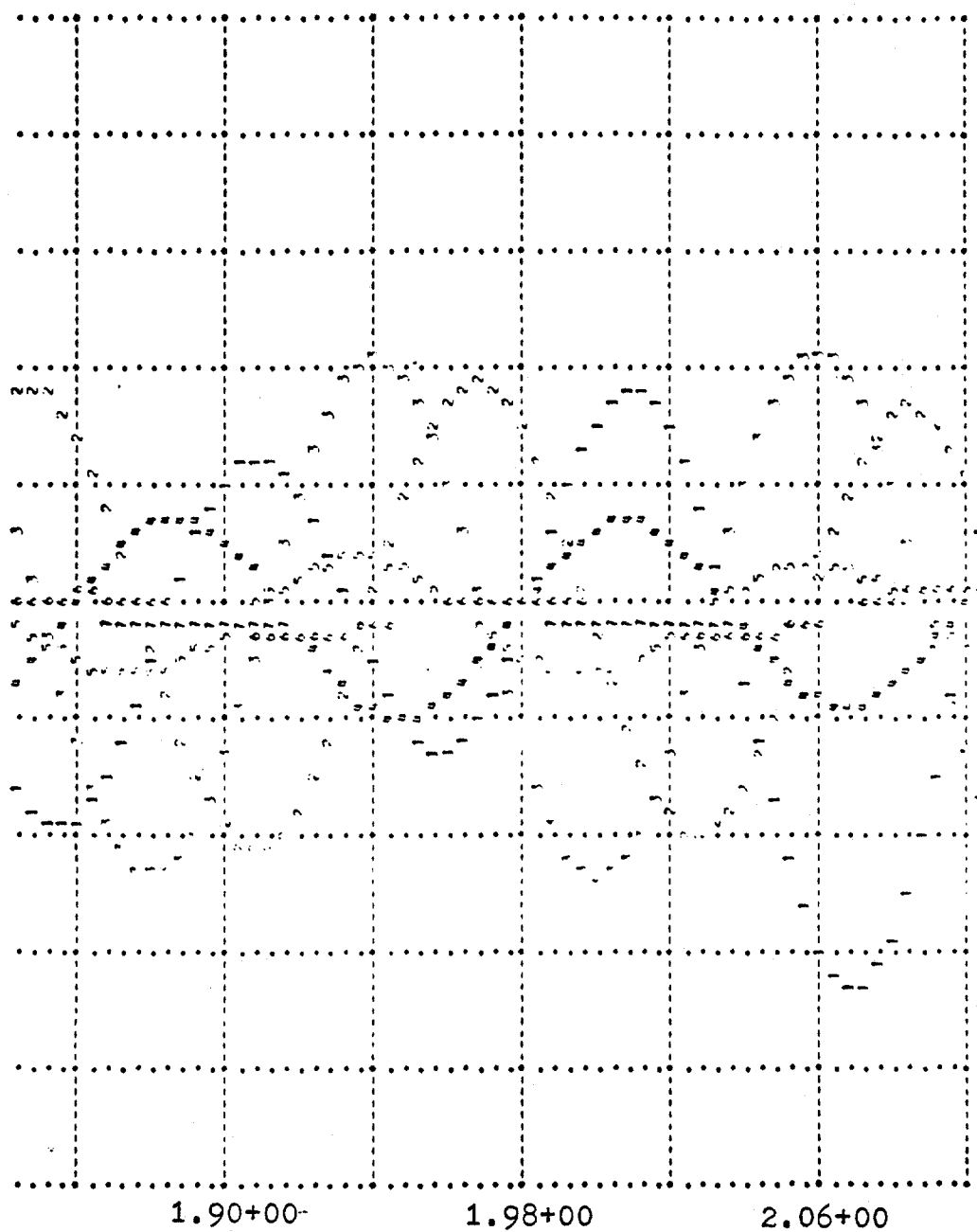

Figure 33. Plot of Error Function Between Successive Averages
(Continued)

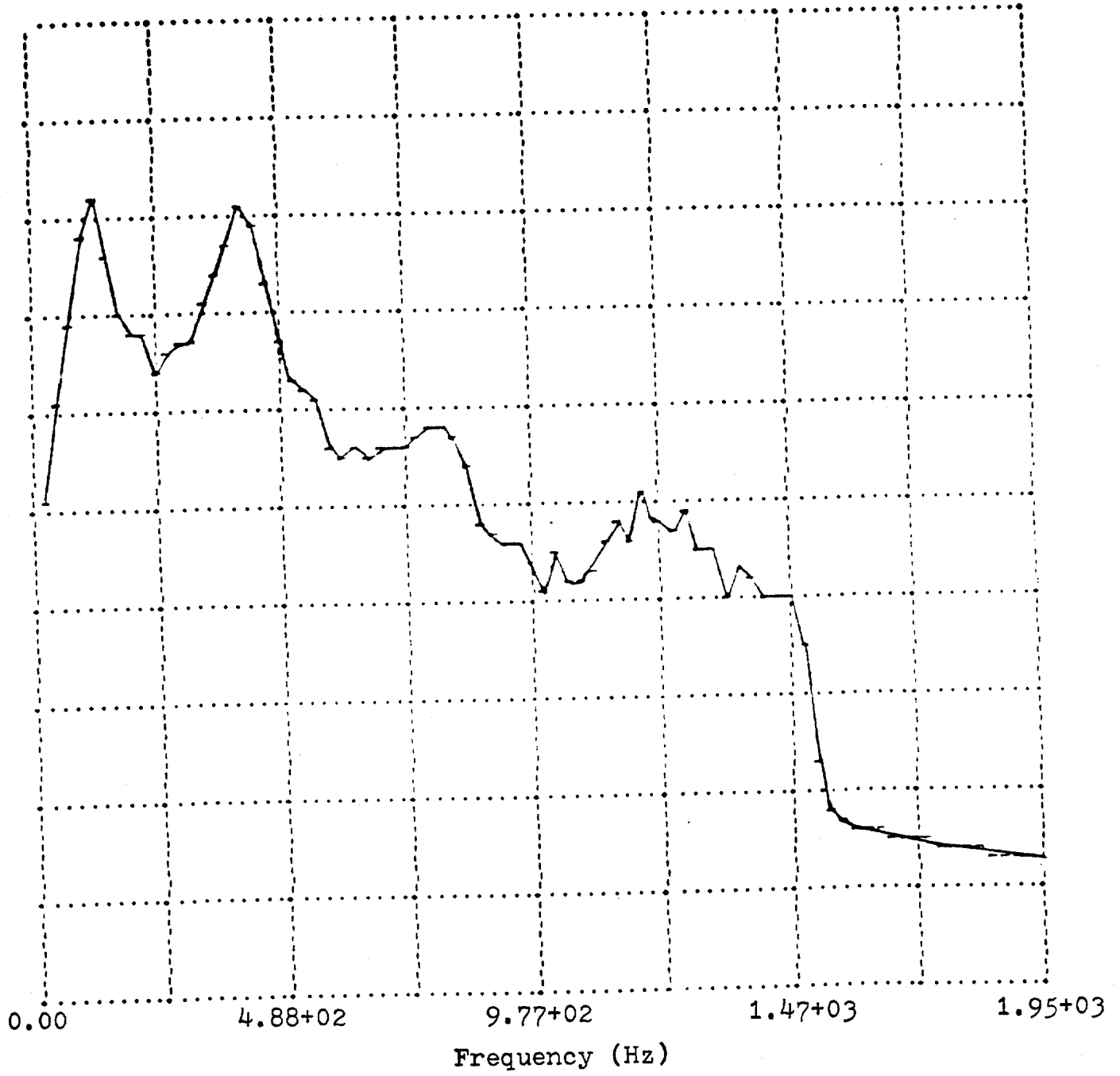

Figure 34. P. S. D. Curve of Response Signal of Finite Element Model (Point 2)

APPENDIX B

TABLES

Theoretically Calculated Values

Damped Natural Frequency = $f = 63.662$ Hz

Damping Ratio = $\zeta = 0.0125$

Random Decrement Signature Results

Number of Time Samples used to find the Signature = 19489

Number of Random Decrement Averages selected = 570

Damped Natural Frequency = $f_R = 63.816$ Hz

Damping Ratio by the Logarithmic Decrement Method = $\zeta_R = 0.0126$

Relative Errors of

Damped Natural Frequency = $\frac{f_R - f}{f} = 0.242$ %

Damping Ratio = $\frac{\zeta_R - \zeta}{\zeta} = 0.8$ %

Table 1. Summary of the Results of the Single-degree-of-freedom System (Model A)

Theoretically Calculated Values

	<u>First Mode</u>	<u>Second Mode</u>
Damped Natural Frequency	$f_1 = 1.684 \text{ Hz}$	$f_2 = 7.988 \text{ Hz}$
Damping Ratio	$b_1 = 0.00214$	$b_2 = 0.011$

Random Decrement Signature ResultsFirst Mode

Filter Range: 0-6 Hz

Number of Time Samples used to find the Signature = 24489

Number of Random Decrement Averages selected = 190

Second Mode

Filter Range: 6-10 Hz

Number of Time Samples used to find the Signature = 24489

Number of Random Decrement Averages selected = 952

Results obtained by the Logarithmic Decrement Method

	<u>First Mode</u>	<u>Second Mode</u>
Damped Natural Frequency	$f_{R1} = 1.685 \text{ Hz}$	$f_{R2} = 7.988 \text{ Hz}$
Damping Ratio	$b_{R1} = 0.00244$	$b_{R2} = 0.012$
<u>Relative Errors of</u>		
Damped Natural Frequency	$\frac{f_R - f_1}{f_1} = 0.06 \%$	$\frac{f_R - f_2}{f_2} = 0 \%$
Damping Ratio	$\frac{b_{R1} - b_1}{b_1} = 14.1 \%$	$\frac{b_{R2} - b_2}{b_2} = 9 \%$

Table 2. Summary of the Results of Model B

Results obtained by the Curve Fitting Method

	<u>First Mode</u>	<u>Second Mode</u>
Damped Natural Frequency	$f_{C_1} = 1.687 \text{ Hz}$	$f_{C_2} = 7.977 \text{ Hz}$
Damping Ratio	$b_{C_1} = 0.00243$	$b_{C_2} = 0.011$
<u>Relative Errors of</u>		
Damped Natural Frequency	$\frac{f_{C_1} - f_1}{f_1} = 0.178 \%$	$\frac{f_{C_2} - f_2}{f_2} = 0.137 \%$
Damping Ratio	$\frac{b_{C_1} - b_1}{b_1} = 13.5 \%$	$\frac{b_{C_2} - b_2}{b_2} = 0 \%$

Table 2. (Continued)

Theoretically Calculated Values

	<u>First Mode</u>	<u>Second Mode</u>
Damped Natural Frequency	$f_1 = 3.187 \text{ Hz}$	$f_2 = 4.349 \text{ Hz}$
Damping Ratio	$b_1 = 0.0236$	$b_2 = 0.0248$

Random Decrement Signature Results

Filter Range: None (No Filter used)

Number of Time Samples used to find the Signature = 24489

Number of Random Decrement Averages selected = 414

Results obtained by the Curve Fitting Method

	<u>First Mode</u>	<u>Second Mode</u>
Damped Natural Frequency	$f_{C1} = 3.179 \text{ Hz}$	$f_{C2} = 4.278 \text{ Hz}$
Damping Ratio	$b_{C1} = 0.0237$	$b_{C2} = 0.0254$
<u>Relative Errors of</u>		
Damped Natural Frequency	$\frac{f_{C1} - f_1}{f_1} = 0.251 \%$	$\frac{f_{C2} - f_2}{f_2} = 0.667 \%$
Damping Ratio	$\frac{b_{C1} - b_1}{b_1} = 0.424 \%$	$\frac{b_{C2} - b_2}{b_2} = 2.42 \%$

Table 3. Summary of the Results of Model C

<u>Filter Cut-Off Frequency, Hz</u>	<u>Damped Natural Frequency, Hz</u>	<u>Damping Ratio Average, %</u>	<u>Number of Random Decrement Averages</u>
210-250	217	13.2	204
400-450	407	5.58	304
650-720	707	9.5	498
780-820	806	6.7	598
920-970	1060	7.5	738
1120-1155	1114	9.3	914
	1274	12.4	
1155-1180	1300	14.9	912
1380-1420	1365	13.2	998

* Time Step: 8×10^{-5} sec.

* Number of Time Samples used: 7500

Table 4. Summary of the Results of the Finite Element Model

Theoretically Calculated Values

	<u>First Mode</u>	<u>Second Mode</u>
Damped Natural Frequency	3.187 Hz	4.349 Hz
Damping Ratio	0.0236	0.0248

Random Decrement Signature Results

Number of Random Decrement Averages	192	414
Damped Natural Frequency, Hz	$f_1 = 3.180$ $f_2 = 4.363$	$f_1 = 3.179$ $f_2 = 4.378$
Damping Ratio, %	$b_1 = 0.018$ $b_2 = 0.02$	$b_1 = 0.0237$ $b_2 = 0.0254$

Table 5. Comparison of the Random Decrement Signatures
with different number of the Random Decrement Averages

<u>Comparison between successive Averages</u>	<u>Sum of the Squares of Errors</u>
4 and 50	$.479 \times 10^{-5}$
50 and 100	$.897 \times 10^{-6}$
100 and 200	$.134 \times 10^{-5}$
200 and 400	$.303 \times 10^{-6}$
400 and 600	$.147 \times 10^{-6}$
600 and 800	$.387 \times 10^{-7}$
800 and 952	$.222 \times 10^{-8}$

Table 6. Comparison of the Sum of Squares of Errors between
Successive Random Decrement Averages

<u>Number of Random Decrement Averages</u>	<u>Damped Natural Frequency, Hz</u>	<u>Damping Ratio (%)</u>	<u>Error</u>
4	8.02	0.85	0.4×10^{-5}
50	7.93	1.22	0.77×10^{-6}
100	7.95	0.77	0.22×10^{-6}
200	8.0	0.96	0.59×10^{-7}
400	7.97	1.04	0.66×10^{-7}
600	7.98	1.17	0.26×10^{-7}
800	7.98	1.1	0.15×10^{-7}
952	7.98	1.1	0.95×10^{-8}
Theoretical Values	7.988	1.1	

* Errors = $\sum_{i=1}^n \left[y(t_i) - f_i \right]^2$ as mentioned in section 2-3.

Table 7. Summary of the Results for different Random Decrement Averages by the Curve Fitting Method

APPENDIX C

RANDOM NUMBER GENERATOR

RANDOM NUMBER GENERATOR

The random number generating routine used in this thesis to generate the random response during the time simulation was developed by Dr. G. C. Everstine*. This routine generates a random function Y_j by summing N sets of equal-amplitude, random frequency and random phase sinusoids over a frequency range that is desired. The mathematical derivation of the random function Y_j is shown in the following.

F_i s ($i=1,m$) are sinusoidal functions with randomly chosen phase angles and frequencies. Let f_i ($i = 1,m$) be the i th sinusoidal frequency and have $f_1 \quad f_2 \quad \dots \quad f_m$. x_0 and x_N are the initial and final time of the time history. The time history has N steps. Thus a random function y_j is determined in the following equation

$$y_j = \sum_{i=1}^m \cos 2\pi(x_0 + (j-1)\Delta x) f_{i+m}^* + \theta_i^* \quad (j = 1, N+1)$$

where $\theta_i^* = 2\pi R_i^*$ ($i = 1,m$)

$$f_{i+m}^* = f_1 + (i-1) \frac{f_m - f_1}{m} + \frac{f_m - f_1}{m} R_i^*$$

$$\Delta x = \frac{x_N - x_0}{N}$$

R_i^* = random numbers obtained from uniformly distributed random function over the range (0, 1).

The phase angles of this random function y_j are randomly determined between 0 and 2π . Frequencies are randomly determined between f_1 and f_m .

The mean of the random function y_j are computed and subtrated from the random function y_j . Then the desired random function Y_j which has zero mean is obtained. The number of the sinusoidals with randomly spaced frequencies is recommended to be at least 200 in order to get a reasonably random function.

* Dr. G. C. Everstine, DTNSRDC 1844, Phone: 202-227-1660

SELECTED BIBLIOGRAPHY

SELECTED BIBLIOGRAPHY

1. B. L. Clarkson and C. A. Mercer, "Use of Cross-Correlation in studying the Response of Lightly Damped Structure to Random Forces". AIAA Journal, Vol. 3, No. 12, Dec 1965.
2. R. C. Lewis and O. L. Wrisley, "A System for the Excitation of Pure Natural Modes of Complex Structure", J. of Aerospace Science, Vol. 17, No. 11, Nov. 1950.
3. R. W. Trail-Nash, "On the Excitation of Pure Natural Modes in Aircraft Resonance Testing", J. of Aerospace Science, Vol. 25, pp. 775, 1958.
4. Erwin Kummer, "The Detection of Fatigue Cracks in Structural Members by the Random Decrement Technique", M.S. Thesis, University of Maryland, 1980.
5. Caldwell, D. W., "The Measurement of Damping and Detection of Damage in Structures by the Random Decrement Technique", M.S. Thesis, University of Maryland, 1975.
6. Caldwell, D. W., "The Measurement of Damping and the Detection of Damage in Linear and Nonlinear Systems by the Random Decrement Technique", Ph.D. Dissertation, University of Maryland, 1978.
7. Thomson, W. T., "Theory of Vibration with Applications", Prentice-Hall, Inc., Englewood Cliffs, N.J., 1965.
8. Meirovitch, L., "Analytical Methods in Vibrations", The Macmillan Company, N.Y., 1967.
9. Beranek, Leo L., "Noise and Vibration Control", McGraw-Hill Book Co., Inc., N.Y., 1971.
10. Cole, H. A., "On-Line Failure Detection and Damping Measurement of Aerospace Structure by the Random Decrement Signatures", NASA CR-2205, 1973.
11. R. E. Reed and H. A. Cole, "Mathematical Background and Application to Detection of Structure Deterioration in Bridge", FHWA Report No. 181, Federal Highway Administration, Washington, DC., 1976.

12. Cheng, C. S., "Study of Dynamic Characteristics of Aeroelastic Systems utilizing Random Decrement Signatures", NASA CR-132563, 1975.
13. Bennett, R. M. and Desmarais, R. N., "Curve Fitting of Aeroelastic Transient Response Data with Exponential Functions", NASA SP-415, Oct. 1975.
14. Chikyarappa, "Determination of Modal Characteristics using Transient Response Data", M.S. Paper, University of Maryland, 1978.
15. Germund Dahlquist, "Numerical Methods", Prentice-Hall Inc., Englewood Cliffs, N.J., 1974.