



Department of Defense Legacy Resource Management Program

PROJECT 00-109

Investigation of the *CSS Alabama*

Institute for International Maritime Research, Inc.
Association *CSS Alabama*
CSS Alabama Association

November 7, 2000

THIS REPORT IS UNCLASSIFIED AND MAY BE RELEASED TO THE PUBLIC

Investigation of the *CSS Alabama* 2000

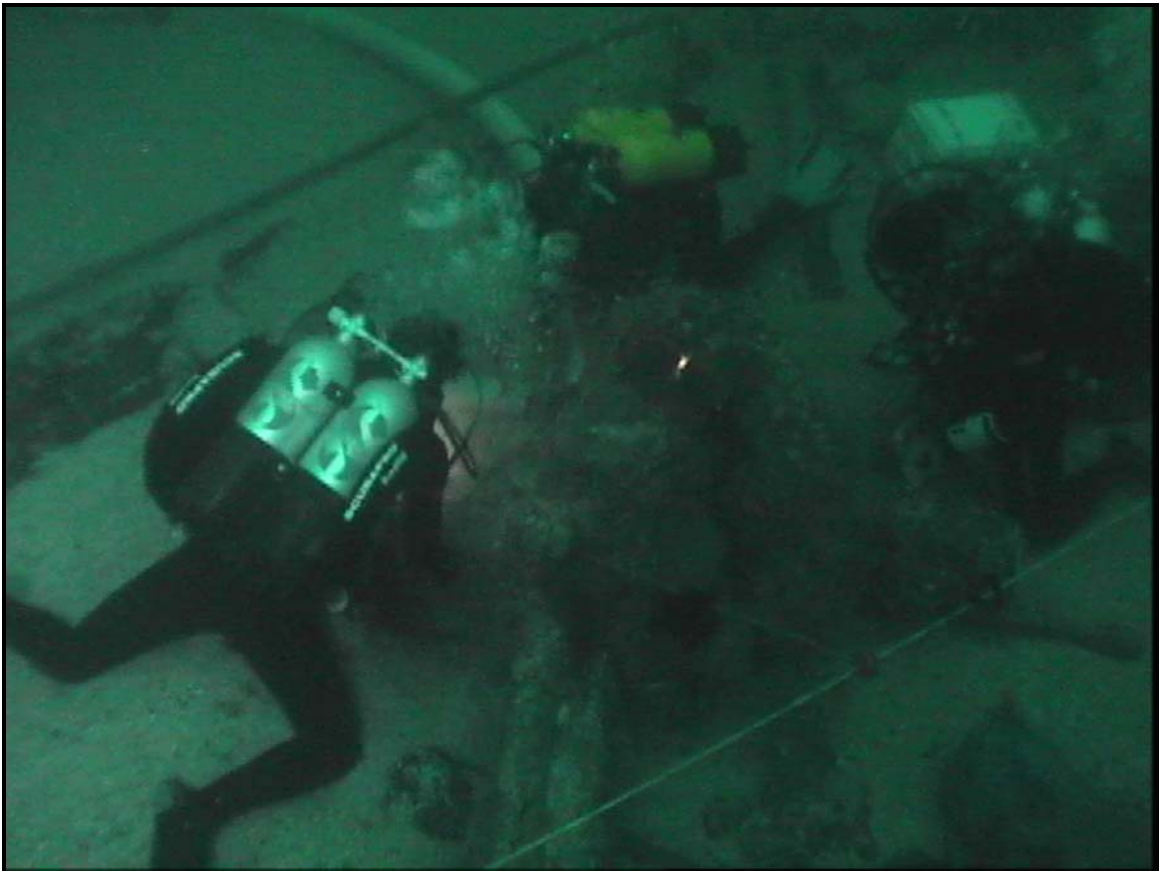

Association CSS Alabama
34 Avenue de New York
75116 - Paris

CSS Alabama Association
P. O. Box 2744
Mobile, Alabama 36652-2744

**Investigation of the CSS *Alabama*
2000**

Submitted to:

**Joint French American Scientific Committee
for the CSS *Alabama***

Submitted by:

**Gordon P. Watts, Jr., Ph.D.
Institute for International Maritime Research, Inc.
P. O. Box 2494
Washington, North Carolina 27889**

**Association CSS *Alabama*
34 Avenue de New York
75116 - Paris**

**CSS *Alabama* Association
P. O. Box 2744
Mobile, Alabama 36652-2744**

7 November 2000

Abstract

During June and July 2000, the French Association *CSS Alabama* and the American *CSS Alabama* Association carried out an archaeological investigation of the remains of the Confederate commerce raider *CSS Alabama*. Under the direction of Dr. Gordon P. Watts Jr., American and French archaeologists, French volunteer divers and French Navy personnel cooperated in an examination of the wreck that took place between 19 June and 16 July. Objectives for the investigation included documentation of the wreck, test excavations and recovery of selected artifacts. Although weather and equipment problems complicated on-site research activity, the investigation generated new information about the *CSS Alabama* and additional insight into conducting work at the wreck site.

Table of Contents

	Page
Abstract.....	i
Table of Contents	ii
List of Figures	iii
Introduction.....	1
Project Authorization.....	2
Project Organization and Administration	2
Synopsis of Previous Research.....	3
Location and Description of the Wreck Site.....	4
2000 Project Objectives	9
Description of the Research	11
Description of the Artifacts.....	23
Results of the Investigation.....	45
Conclusions.....	51
Appendix A - Ministry of Culture and Communication Permit	1

List of Figures

	Page
Figure 1. Location of the CSS <i>Alabama</i> off the Normandy Peninsula.....	5
Figure 2. Projection of the surviving hull remains (Guérout, 1994).	6
Figure 3. Projection of the degree of starboard list (Guérout 1994).....	7
Figure 4. CSS <i>Alabama</i> Site Plan (Guérout, 1992).....	8
Figure 5. Drawing of the aft fire pump (Guérout, 1995).	12
Figure 6. Design of the Fawcett, Preston & Company 32-pounder (A. Bowcock).	13
Figure 7. Historic photograph illustrating a Fawcett, Preston & Co. 32-pounder, an ordnance chest and the tangent sight on the breech of the stern pivot gun of the CSS <i>Alabama</i>	14
Figure 8. Recovery of the Fawcett, Preston & Co, 32-pounder.	14
Figure 9. Example of a Trotman anchor similar to those of the CSS <i>Alabama</i>	15
Figure 10. Excavation at the base of the aft fire pump.	16
Figure 11. Using a diver propulsion vehicle for excavation.	16
Figure 12. Base of the aft fire pump and an associated valve chest.....	17
Figure 13. Example of a mosaic illustrating the aft fire pump.	18
Figure 14. Initial examination and inventory of artifacts aboard <i>Little Pocket</i>	18
Figure 15. Processing artifacts in the CIN French Association laboratory facility.	19
Figure 16. Packaging material for shipment to Charleston, South Carolina.....	20
Figure 17. Unloading the <i>Alabama</i> artifacts in Charleston, South Carolina.....	21
Figure 18a. Documenting the <i>Alabama's</i> lifting frame.	22
Figure 18b. Documenting the <i>Alabama's</i> propeller.....	22
Figure 19. Ironstone jar (ALS-225) exposed on the bottom surface.....	23
ALS-215 Hull Fragment with Fasteners Figure 20	24
ALS-216 Scupper Figure 21	25
ALS-217 32-pounder Cannon Figure 22	26
ALS-217 Makers Mark on the 32-pounder Cannon Figure 23.....	27
ALS-218 Percussion Lock in Concretion Figure 24	28
ALS-219 Port Light Figure 25	29
ALS-220 Stoneware Base Shard Figure 26.....	30

ALS-221 Stoneware Base Shard Figure 27	31
ALS-222 Lever Lock Mechanism Figure 28.....	32
ALS-223 Hull Fragment Figure 29.....	33
ALS-224 Ironstone Plate Figure 30	34
ALS-225 Stoneware Jar Figure 31	35
ALS-226 Tack Figure 32.....	36
ALS-227 Antler Figure 33.....	37
ALS-228 Port Light Figure 34.....	38
ALS-229 Port Light Figure 35.....	39
ALS-230 Concretion Figure 36	40
ALS-231 Port Light Brass Rim Figure 37	41
ALS-232 Port Light Figure 38.....	42
ALS-233 Wood Shell Container Figure 39.....	43
ALS-234 Cannon Truck Tackle Block Figure 40	44
Figure 41. <i>Robo</i> sonar image of the CSS Alabama.	46
Figure 42a. Mosaic aft of Engineering Space.	48
Figure 42a. Mosaic forward of Engineering Space.....	49
Figure 43. Water pump used to power the induction dredge.....	50
Figure 44. Drawing of the Screw and Lifting Frame.	52

Introduction

The wreck of CSS *Alabama* was discovered by the French Navy mine hunter *La Circe* in 1984. Captain Max Guérout, then on active duty, undertook identification of the wreck at the request of the French Navy. His research confirmed that the vessel was indeed the Confederate commerce raider. Announcement of the location of the CSS *Alabama* led to diplomatic negotiation between France and United States that subsequently resulted in an executive agreement concerning ownership and management of the wreck. The Executive Agreement of 3 October 1989 also established the framework for authorization and supervision of scientific investigation of the Confederate vessel. Guérout's research and identification of the wreck as the CSS *Alabama* also led to the founding of the French non-profit Association CSS *Alabama*. As a consequence of requests to continue on-site research, France as the territorial power of the wreck site, and the United States of America as the owner of the wreck and its associated artifacts, jointly authorized the Association CSS *Alabama* to undertake additional investigations at the wreck site in 1988.

The 1988 investigation of the CSS *Alabama* was organized around a cadre of volunteer divers, archaeologists and historians working in conjunction with Captain Guérout. Location of *Alabama*'s wheel, with the ship's motto "Aide-toi et Dieu t'aidera" provided absolute identification of the wreck. Data from the 1988 expedition facilitated the development of plans for volunteer diver supported research projects conducted by the Association CSS *Alabama* in 1989, 1990, 1991, 1992, 1993, 1994 and 1995. Captain Guérout served as Principal Investigator and each investigation was authorized according to the terms of the 1989 Executive Agreement. Funding for the research carried out between 1988 and 1995 was raised almost entirely in France. Those investigations resulted in a complex plan of the wreck and the recovery of an important collection of some 200 objects, including: the wheel, several flushing toilets with transfer-printed ceramic bowls, and a variety of plates, glasses, salt cellars, and other galley and tableware, deck tracks for the vessel's ordnance trucks, a pivot carriage and a heavy Blakely rifled cannon.

In 1999, after a two year hiatus in field research, a reconnaissance investigation of the wreck was organized and carried out by the Association CSS *Alabama*, with the cooperation of the Association of the Friends of CSS *Alabama*, a newly formed American sister organization. Funding for the 1999 project was provided by a grant from the U. S. Department of Defense Legacy Resource Management Project, and was channeled through the American to the French association. Field research was designed to determine if significant changes had occurred at the wreck site and to collect data to support planning more complex and extensive on-site investigation. That reconnaissance was performed on 19 and 21 June 1999 under the direction of Principal Investigator Dr. Gordon. P. Watts, Jr.

Based on the 1999 reconnaissance, a more complex investigation of the CSS *Alabama* was organized for the summer of 2000. Under the direction of Dr. Watts, American and French archaeologists, French volunteer divers and French Navy personnel cooperated in an examination of the wreck that took place between 19 June and 16 July. Objectives for the investigation included documentation of the wreck, test excavations and recovery of selected

artifacts. Although weather and equipment problems complicated on-site research activity, the investigation generated new information about the wreck and additional insight into conducting work on the site.

Project Authorization

The remains of the CSS *Alabama* are the property of the United States of America and the management responsibility of the U. S. Naval Historical Center in Washington, D. C. The wreck lies in French territorial waters and, as an underwater archaeological resource, falls under the administration of the Ministry of Culture. By mutual agreement between the United States and France, all on-site research activity requires authorization from both the Naval Historical Center, representing the present owner, and the Ministry of Culture, representing the territorial authority. The 2000 investigation of the CSS *Alabama* was performed according to the terms of the authorizations of both the American and the French official entities.

Project Organization and Administration

The 2000 investigation of the CSS *Alabama* was organized and conducted by the French Association CSS *Alabama* and the United States CSS *Alabama* Association. Under the direction of its president, Dr. Ulane Bonnel, the French Association CSS *Alabama* obtained the necessary permits for on-site research from the Ministry of Culture, all required authorizations of naval and civilian authorities of Cherbourg, the dive boat, the divers and the surface assistance personnel and insured the boat and all operational personnel, including the American archaeologists. The French Association CSS *Alabama* also negotiated participation of the French Navy. That participation resulted in the authorization of Navy divers to assist with on-site research and approval for the use of navy equipment and vessels.

The CSS *Alabama* Association, under the direction of its president, Mr. Robert Edington of Mobile, Alabama, obtained Legacy Grant and privately donated funds to support the 2000 research project. The CSS *Alabama* Association also coordinated activities in the United States and supported the production of a newsletter to make project research activities public. That organization also entered into an agreement with the Naval Historical Center and the Institute for International Maritime Research, Inc., (I²MR) of Washington, N. C., to carry out the project.

Under that Memorandum of Agreement, I²MR worked in conjunction with the French and American Associations and the Naval Historical Center, to plan, organize and conduct on-site research activity. Under the direction of the president, Dr. Gordon P. Watts, Jr., Institute personnel developed plans for the 2000 investigation, identified and organized the American underwater archaeological team and directed and supervised the on-site research activity. I²MR personnel also prepared the report on 2000 project research activity.

Dr. Gordon Watts, an underwater archaeologist and member of both the American and French organizations, served as the project's principal investigator. Archaeologists John William Morris, Steve Brodie, Mark Padover and underwater photographer Paul Stone comprised the American research team. Brodie and Padover worked with Watts to analyze the data and prepare the project report. Joë Guesnon assisted with project organization and provided coordination with the French dive club, Cherbourg Natation Plongée. Michael Chapron was responsible for diving safety and provided technical direction and coordination with the Cherbourg Natation Plongée, whose dive boat, *The Little Pocket*, and other facilities were contracted for by the French Association.

French Navy participation in the 2000 campaign was authorized by Contre-Amiral Lagane, Prefect Maritime of the Channel and North Sea, and was coordinated by Dr. Ulane Bonnel. Use of the facilities at the Centre d'Instruction Naval de Querqueville were authorized by Captain C. V. Le Roux. Diving operations of the Groupe des Plongeurs-Demineurs de la Manche (GPD) were directed by Lieutenant L.V. Stephane Giudicelli. Lt. Joshua Price, USN on assignment to the GDP, served as coordinator for French Navy activities.

Synopsis of Previous Research

The wreck of the *Alabama* was discovered in November of 1984 by Lieutenant Commander Bruno Duclos of the French Navy minesweeper *Circe*. The French Navy had been searching for the wreck for a number of years as part of their training regimen for sonar operators. Duclos dispatched divers who returned to the surface with confirmation of a wooden hull, iron machinery, and English china. Commander Max Guérout was immediately called to verify the ship's identity. Guérout later concluded that this was almost certainly the wreck of the CSS *Alabama*.

The first archaeological investigation of the remains of the CSS *Alabama* was undertaken in 1988 under the direction of Commander Guérout. Data from the 1988 expedition facilitated the development of plans for diver supported research projects conducted by the Association CSS *Alabama* in 1989, 1990, 1991, 1992, 1993, 1994 and 1995, all duly authorized according to the terms of the Executive Agreement of 3 October 1989. That research has resulted in a complex plan of the wreck and the recovery of an important collection of some 200 objects, including; the wheel, several flushing toilets with transfer printed ceramic bowls, and a variety of plates, glasses, salt cellars, and other galley and tableware, deck tracks for the vessel's ordnance trucks, a pivot carriage and a large Blakely rifled cannon.

In 1999, after a two year hiatus in field research, a reconnaissance investigation of the wreck was organized and carried out by the Association CSS *Alabama*, with the cooperation of the Association of the Friends of CSS *Alabama*, an American sister organization. Field research was designed to determine if significant changes had occurred at the wreck site and to collect data to support planning more complex and extensive on-site investigation. That reconnaissance was performed on 19 and 21 June 1999.

Location and Description of the Wreck Site

Wreckage of the CSS *Alabama* lies in the channel off the Normandy Peninsula (Figure 1). The site is approximately 5.5 miles (8.9 km) offshore of Nacqueville and 6 miles (9.7 km) north-northeast of Cherbourg Fort de L'Ouest. [Location information is not provided in circulation copies of this report].

The remains of the *Alabama* lie in approximately 61 meters (190 feet) of water. That depth makes work at the site both complex and hazardous. While water temperatures increase above 40 degrees Fahrenheit (5°C) in the summer, the cold adds measurably to the risks associated with the conduct of on-site research. Visibility was observed as variable with ranges from virtually zero to approximately 65 feet (20 m). Currents at the site pose the most complex obstacle. During the tidal cycle, water flow over the wreck reaches four knots. In addition to restricting on-site research activity, currents have had an important effect on the wreck. The *Alabama* lies on a hard bottom consisting of rocks, pebbles, shell hash and sand. This has limited scour settling of the wreck and with the exception of sand and shell deposited within and around the wreck, most of the hull remained exposed to the elements. This highly dynamic bottom has contributed to the deterioration of exposed structural material. During the 1988 project, more than a meter of bottom surface sediments, mostly shell hash, were observed to migrate rapidly away from the wreck and return. In this highly abrasive environment, the *Alabama's* exposed hull remains, already weakened by biological activity, have deteriorated to the level of the bottom surface.

Only the unexposed lower hull and portions of the starboard side of the *Alabama* survive intact (Figure 2). The hull lists approximately 30 degrees to starboard and is oriented perpendicular to the prevailing current pattern (Figure 3). Depth measurements taken by the divers and submersible, precision depth recorder profiles, and observations at the site confirm that sediment consisting of shell hash, pebbles, and sand has accumulated within and around the *Alabama* to a depth of almost three meters. The major accumulation of material is amidships and is probably a result of the *Alabama's* machinery and boilers. Amidships, the port side of the hull is exposed to the approximate position of the turn of the bilge while the starboard side could survive to the approximate location of the weather deck clamp. Toward the stern, the depth of the deposit rapidly decreases to the approximate level of

(FIGURE WITH LOCATION INFORMATION REMOVED FROM PUBLIC RELEASE / CIRCULATION COPY)

Figure 1. Location of the CSS *Alabama* off the Normandy Peninsula.

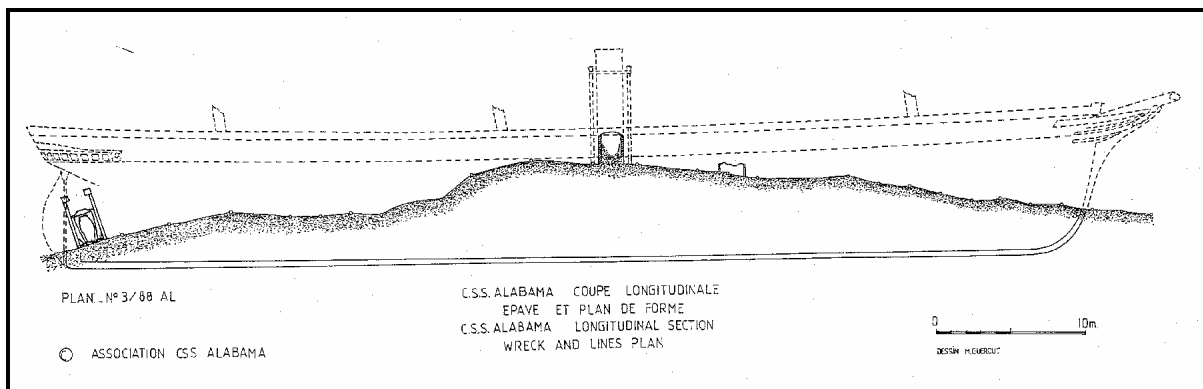

Figure 2. Projection of the surviving hull remains (Guérout, 1994).

the propeller shaft. At the stern, a little less than half of the propeller is exposed along with its brass lifting frame. No evidence of the stem was observed making it difficult to determine the amount of sediment accumulation forward. It is also possible that the hull may not lie on an even keel fore and aft and the amount of surviving structure is considerably less. Very little of the surviving hull structure is exposed at the site. The majority of exposed hull fabric is on the starboard side amidships and adjacent to the boilers.

A preliminary site map was prepared by Guérout and the ASAM divers in 1988 and has been improved by subsequent investigations (Figure 4). To control mapping, a baseline was deployed from the propeller in the stern to the approximate location of the stem. Using the baseline as a reference, exposed wreck structure and associated material was recorded. The most dominant structural features of the wreck were found to be the boilers and smoke pipe, sections of the hull amidships, and propeller and elevating frame. The partially exposed port boilers each measured approximately 20 feet (6 m) in length and 10 feet (3 m) in height. Their shape is rectangular and each is connected to the smoke pipe by a common flue system.

Although most of the hull of the *Alabama* has been destroyed by the elements, sediment accumulating in the vicinity of the steam machinery appears to have preserved a portion of the starboard side of the ship. Adjacent to the boilers the starboard hull could survive up to the level of the weather deck clamp. Although the 30° list documented by divers suggests that more of the starboard side of the ship may be preserved fore and aft of the machinery, it does not appear to be much beyond the turn of the bilge. In the stern the exposed propeller and elevating frame confirm that the hull has deteriorated to the level of the propeller shaft and hub. Forward of the machinery, perhaps even less hull fabric remains.

The stern of the *Alabama* was identified by the propeller. A single blade of the brass propeller and the top of its lifting frame are exposed above the bottom surface. While no evidence of the bow was identified, portions of two Trotman's Patent anchors confirm

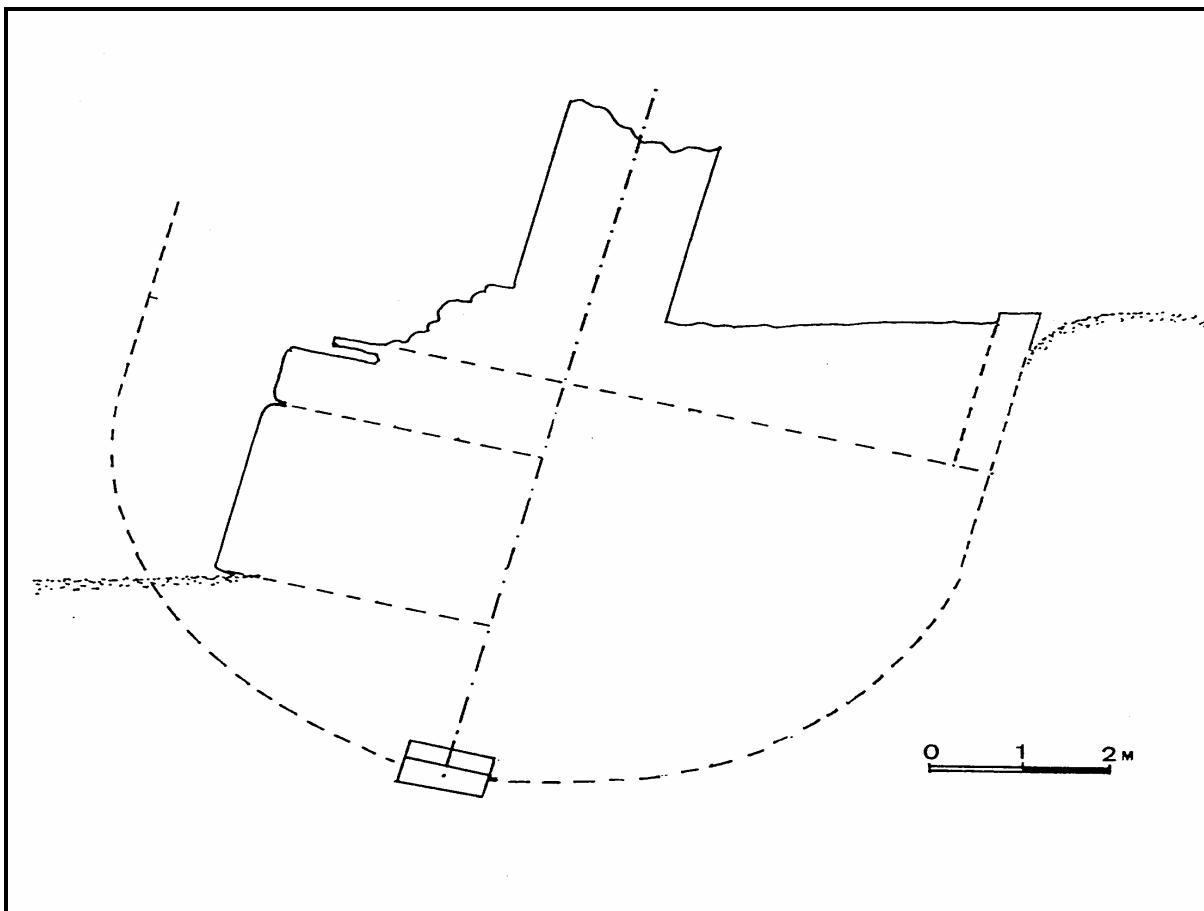

Figure 3. Projection of the degree of starboard list (Guérout 1994).

its proximity. One anchor lies along the starboard extremity of the hull structure and the second lies to port of the wreck. Development of the site plan also revealed the iron main mast step, a capstan, several sets of bits, a hawse hole throat, and anchor chain. Three unique toilets were also found in the vicinity of the ship's engineering space. Each contained an English porcelain bowl with a transfer-printed scene inside.

Six heavily concreted pieces of ordnance were identified during the investigation. The largest one immediately forward and starboard of the smoke pipe remained associated with its truck. A second cannon was identified immediately forward and to starboard of the propeller. Thirty feet (10 m) forward of the propeller and starboard of the two brass reinforcing rings from the ship's steering wheels, the muzzle of a third cannon was identified. Immediately aft and to port of the smoke pipe, a fourth gun tube rested on the after port boiler. The remaining two guns were found approximately ten meters forward of the smoke pipe. One was located on the approximate centerline of the vessel and the other adjacent to the ship's starboard side. In addition to cannon, the site contained shot, gun truck wheels, and brass tracks for the gun carriages.

(FIGURE WITH LOCATION INFORMATION REMOVED FROM PUBLIC
RELEASE / CIRCULATION COPY)

Figure 4. CSS *Alabama* Site Plan (Guérout, 1992).

2000 Project Objectives

Although reconnaissance dives in 1999 confirmed that changes in the wreck and wreck site environment have been nominal since 1996, additional project objectives could not be accomplished due to weather, equipment and restraints on diving personnel. Several of those objectives, documentation of vessel structure and associated material exposed at the wreck site, excavation in the stern of the vessel, recovery of several large artifacts and sufficient testing to support assessment of the problems associated with recovery of the aft pivot gun and lifting screw became the focus of research in 2000.

The first objective of on-site research during the 2000 field season was to deploy an anchor or clump at the wreck site. Deployment of an anchor or clump capable of mooring a 65 to 100 foot (20 to 30 m) vessel at the wreck site would be essential to supporting more extensive on-site research. The position of the clump was to be approximately amidships and off to one side of the surviving hull remains. The location of the anchor or clump was to be surveyed to prevent damage to structure or material associated with the wreck.

The second objective of on-site research during the 2000 field season was to be documentation of vessel structure and associated material exposed at the wreck site. Initial documentation of the wreck site would be accomplished using a high resolution digital side scan sonar. The sonar was to be interfaced with a differential global positioning system (DGPS) and a computer equipped with survey software to control vessel positioning and data collection. An electronic grid was to be developed to cover the remains of the CSS *Alabama* and the bottom surface surrounding the wreck site. Acoustic data would be systematically collected using DGPS positioning. The sonar images would provide a highly detailed image of the exposed wreck structure and any previously unidentified remains in the immediate vicinity of the hull. That imagery was to be used to enhance the site map and identify additional exposed wreckage for diver identification and assessment.

Documentation was also to include generation of a video and photographic record of the exposed wreck structure. Using a diver propulsion vehicle equipped to carry an underwater video, 35mm camera(s) and lights, a video and photographic record of material on the bottom surface was to be made by archaeologists and divers. A baseline web connecting major features of the exposed wreckage would be used to help control systematic data collection. That same baseline web was to be used to guide the development of a wreck site mosaic designed to enhance the previously developed site plan.

On-site operations proposed for 2000 also included continuation of the test excavation previously begun within the surviving hull in the stern. The excavation was to be accomplished using 4 and/or 6-inch (10/15 cm) induction dredges or airlifts. Power for the dredges was to be provided by high pressure water pumps on the research vessel, pumps on the bottom operated by hydraulic power from the research vessel or 24-volt electric powered from the surface of a submersible battery pack. Excavation was to be controlled by a grid constructed of ridged or non-ridged material such as aluminum or PVC. Documentation of the excavation and recording of material exposed by excavation was to be accomplished by

either electronic or mechanical triangulation. Material recovered from the test excavation would be documented *in situ*, placed in containers for transportation to the surface, cataloged, documented and packaged for shipment to the Naval Historical Center for conservation.

In addition to recovering artifacts and data designed to shed light on life on the CSS *Alabama*, the excavation was to be designed to generate information on the nature and scope of the archaeological record. Perhaps the most significant issues associated with investigation of the remains of the *Alabama* regard how much of the hull structure survives below the bottom surface and what is the nature and extent of the archaeological record preserved within that structure. Data from limited previous excavation suggests that preservation below the shell hash is excellent with intact features and associated artifacts with undisturbed provenience. Additional test excavation would also generate data concerning the difficulties of working in the dynamic environment of the CSS *Alabama*. Previous excavation has already illustrated some of the problems associated with diver time on site and the impact of currents on excavation stability. The proposed excavation would, for the first time, employ a much more powerful and effective means of sediment removal and utilize an aluminum or sand-filled fabric structure to isolate the excavation from the currents and migrating shell hash. The amount of excavation time would also be increased significantly by employing a mixed-gas rebreather system to support divers.

Using information from the video and photographic documentation and limited temporary removal of bottom surface shell hash, an effort would be made to identify a second area of test excavation in the bow of the wreck. In one or more areas identified in the site plan and documented by additional video and photography, shell hash was to be removed using induction dredges or diver propulsion vehicle adapted propwash systems. Evidence of the stem and hull remains that define the bow was to be located and identified using fiberglass rods. If possible, the area of the crew's quarters in the fo'c'sle would be identified and the site of a proposed test excavation isolated by one of the sand filled fabric structures. That structure was to be left in place to determine if it will be effective in long term efforts to isolate areas of the wreck from migrating shell hash.

During the 2000 campaign, limited excavations were also to be undertaken at the base of the propeller and at the location of the stern pivot gun. Those excavations were to be designed to determine if the propeller and lifting frame remain attached to the keel and deadwood and if the pivot gun is still associated with its carriage and truck. That information would be essential to formulating plans for recovery of both those items. Excavation was also to be undertaken at the site of the aft fire pump. That excavation was to be designed to clear the pump for documentation and recovery.

Recovery of several large artifacts was also planned in conjunction with fieldwork during the summer of 2000. Artifacts identified for recovery were the aft fire pump, one or more of the 32-pounder cannon and possibly their trucks, and possibly one of the two Trotman Patent anchors. After thorough documentation, recovery was to be accomplished using lift bags or a combination of lift bags and lifting equipment aboard the surface support platform. Like material recovered from the test excavation, large objects were to be documented *in situ*,

prepared for transportation to the surface, raised, cataloged, documented and packaged for shipment to conservation facilities in Charleston, South Carolina.

Description of the Research

Diving at the site was scheduled to take place during the most ideal tidal coefficients between 19 and 29 June and 8 and 16 July. On-site investigation was initiated by relocating the wreck and placing reference buoys on one of the 32-pounder cannon near the stern and one of the Trotman Patent anchors at the bow. That work was accomplished by divers from the GPD and French volunteers on 19 and 21 June. Those buoys provided references for currents over the wreck and down lines for divers. French volunteer divers and American archaeologists operated from the vessel *Little Pocket* and French Navy divers operated from the *Vulcain* and a 60' vedette.

Because of the limited availability of the French Navy vessel *Vulcain*, documentation and recovery of a 32-pounder, a Trotman anchor and the aft fire pump was scheduled as one of the first on-site priorities. In order to make all the heavy lifts while the *Vulcain* was available, the French Navy divers immediately began excavation to clear the starboard Trotman anchor. French volunteer divers and American archaeologists simultaneously began an excavation designed to expose the base of the fire pump (Figure 5). Excavation at the anchor was necessary to expose the stock and chain. The stock would have to be clear and the chain removed or cut to clear the way for recovery. Likewise, it was necessary to clear the base of the pump to establish if and how it remained attached to the surviving hull structure. Freeing the pump was a necessary prerequisite to recovery.

Other American archaeologists focused their attention on identifying one of the 32-pounders for recovery. It was well established that the CSS *Alabama* carried six 32-pounders. Two of those were a traditional Royal Navy pattern and the remaining four were specifically cast for the CSS *Alabama*. Research carried out by Andrew Bowcock revealed that those four cannon were produced by Fawcett, Preston & Company in Liverpool (Figure 6). Bowcock's research and historic photographs of the CSS *Alabama* identified design criteria that made it possible for archaeologists to identify the Fawcett, Preston & Co. guns at the site (Figure 7). One of those was selected for recovery by the *Vulcain*.

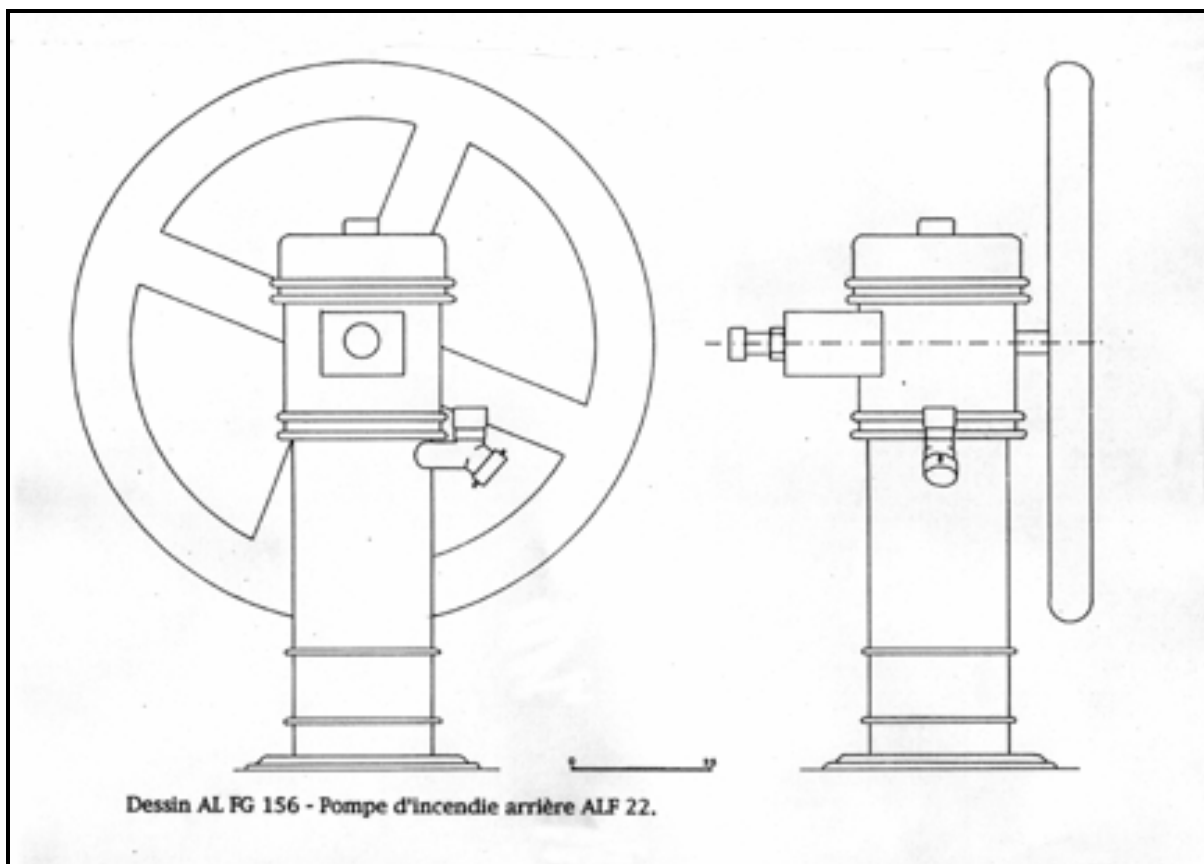

Figure 5. Drawing of the aft fire pump (Guérout, 1995).

Once the gun had been identified, French Navy divers rigged the 32-pounder with nylon straps. Air bags were used to make a succession of lifts that brought the gun from the bottom to approximately 60 feet (18 m). From that depth, a winch on the *Vulcain* was used to raise the gun to the surface. At the surface, a deck crane was used to lift the gun over the transom and place it on deck for the trip to Cherbourg (Figure 8). At Cherbourg, the crew of the *Vulcain* placed the 32-pounder on the bottom of the harbor adjacent to one of the commercial docks operated by the Cherbourg Port Authority. Following construction of a shipping container, the cannon was recovered and packed for shipping to the Warren Lasch Conservation Center in Charleston, South Carolina under the direction of Dr. Bonnel.

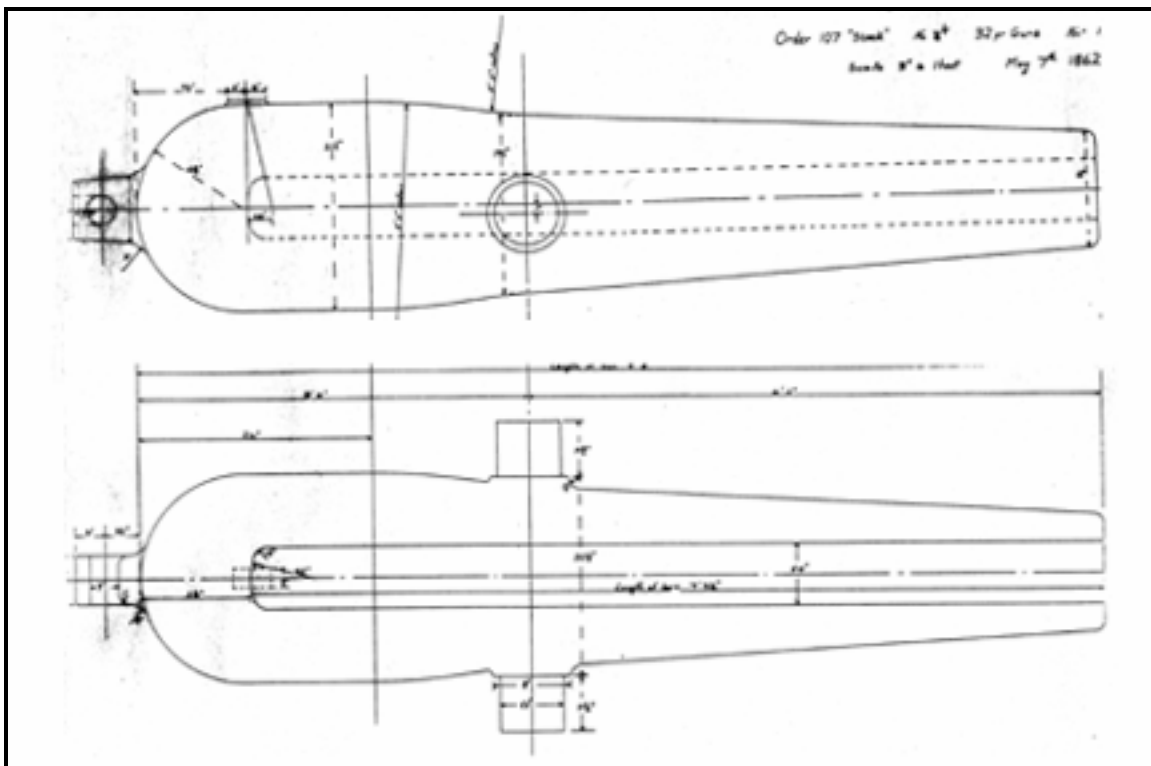

Figure 6. Design of the Fawcett, Preston & Company 32-pounder (A. Bowcock).

Before the end of the first dive period, considerable effort was focused on excavations at the base of the aft fire pump and around the starboard Trotman anchor (Figure 9). French Navy divers using an airlift excavated the anchor shank to a depth of almost two meters. At that point consolidated sediment frustrated excavation and the stock was not exposed. Efforts to move the anchor proved entirely unsuccessful by the time the first dive period came to an end on 29 June. Although excavation was to continue during the second dive period in July, recovery of the anchor was abandoned as French Navy assistance was unavailable. A subsequent examination of the anchor indicated that the stock and chain lay under the surviving remains of the starboard bow and extensive excavation would be required to clear it for lifting.

In addition to the 32-pounder and anchor, French volunteer divers and American archaeologists worked to clear the base of the aft fire pump (Figure 10). Excavation at the base of the pump was carried out using an induction dredge powered by a pump in one of the inflatable boats and the propwash from diver propulsion vehicles (Figure 11). Neither the scooter nor the induction dredge had sufficient power to excavate beneath the plate that attached the pump to the *Alabama*'s deck structure. Below that plate, a brass pipe extended into the sediment (Figure 12).



Figure 7. Historic photograph illustrating a Fawcett, Preston & Co. 32-pounder, an ordnance chest and the tangent sight on the breech of the stern pivot gun of the CSS *Alabama*.



Figure 8. Recovery of the Fawcett, Preston & Co, 32-pounder.



Figure 9. Example of a Trotman anchor similar to those of the CSS *Alabama*.

That pipe probably served as the pump intake and extended into the bilge. It became readily apparent that the pump either remained attached to the unexposed hull structure or the intake was buried in consolidated sediment and could not be cleared for lifting. Rather than risk damaging the pump, efforts to recover it were abandoned until the second period of diving.

During the first period of on-site activity, underwater television was used to record the exposed wreck structure and underwater activity. Documentation of the on-site activity was designed to provide illustrations for reports and publications. Documentation of the wreck structure was designed to provide images of the features being cleared for recovery and collect sufficient digital data to produce mosaics of the wreck site. Documentation of the underwater work provided a graphic record of excavation of the aft fire pump. However, producing images for the mosaic was frustrated by video equipment problems. Efforts to record the wreck structure in plan view produced a very limited amount of usable imagery (Figure 13).

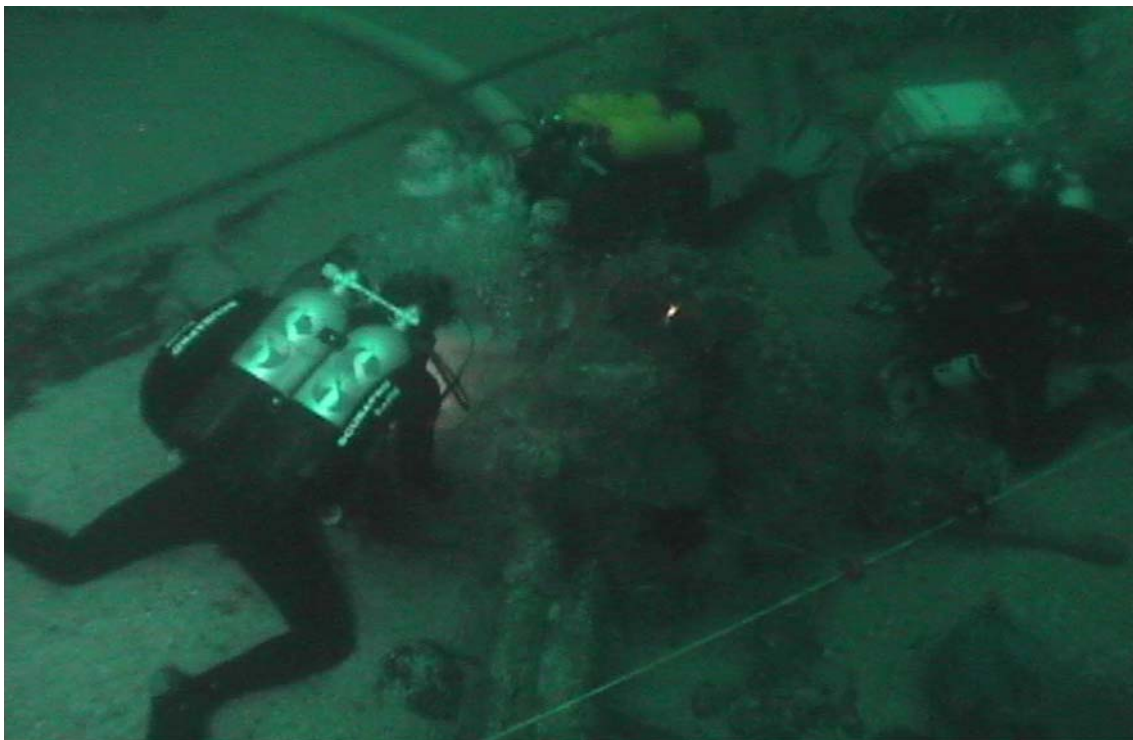

Figure 10. Excavation at the base of the aft fire pump.

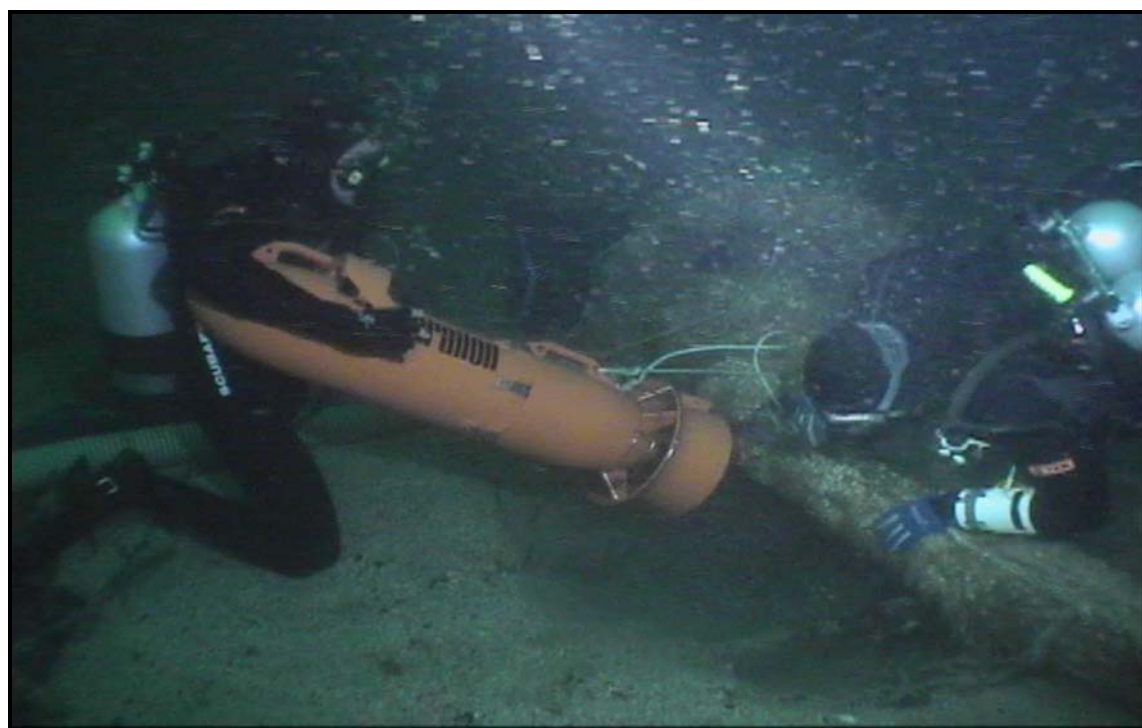

Figure 11. Using a diver propulsion vehicle for excavation.

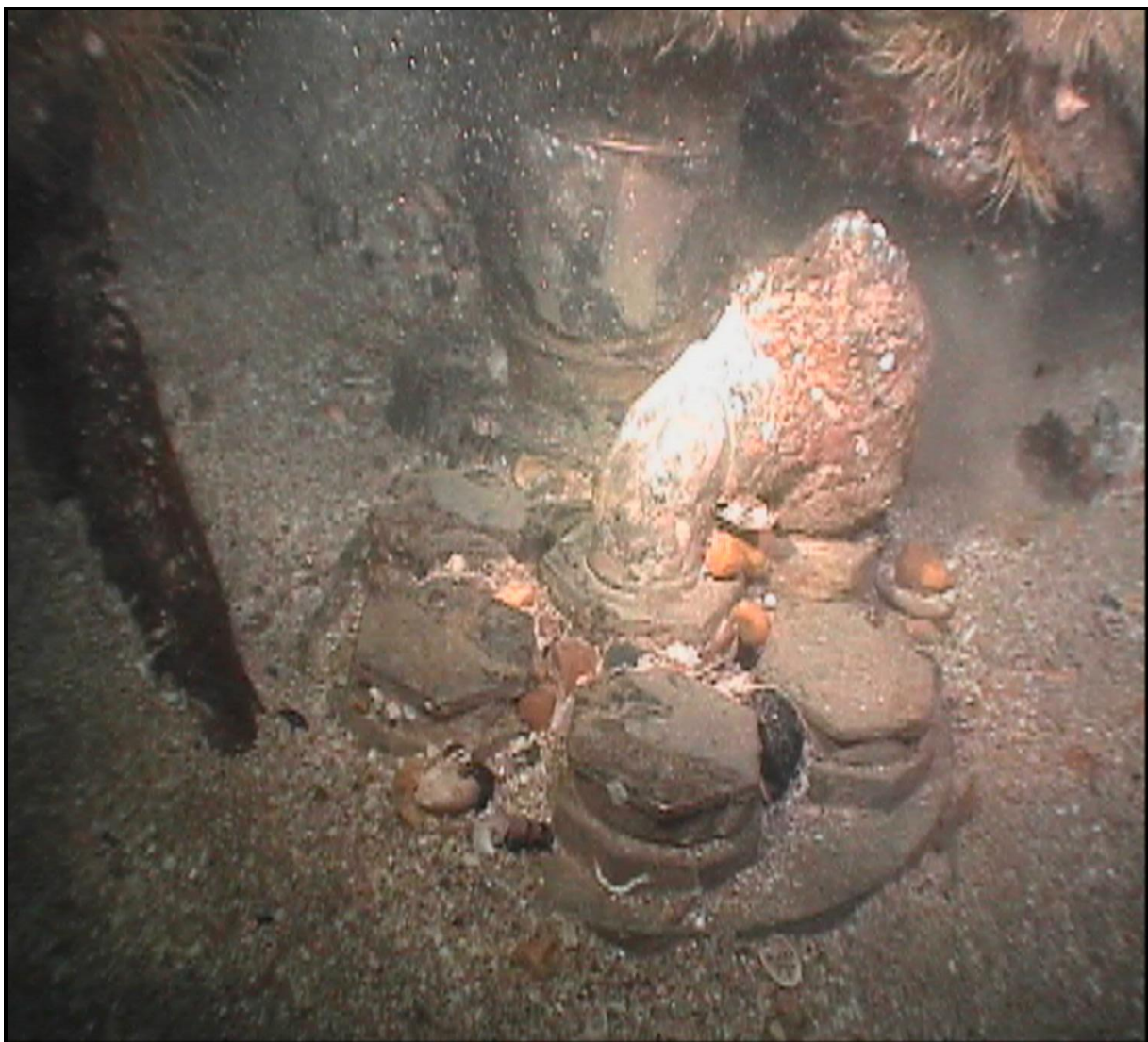

Figure 12. Base of the aft fire pump and an associated valve chest.

As work on the site progressed, a number of exposed artifacts were identified. After video documentation and triangulation those that were considered at risk were recovered. While large artifacts were recovered individually by divers, small material was brought to the surface using plastic crates with partitions that isolated and protected each artifact. Aboard the *Little Pocket* fragile material was transported in containers filled with seawater (Figure 14).

In the interim, between the first and second period of diving, operations in Cherbourg were focused on the recovered artifacts, equipment and planning for the second phase of diving. Artifacts recovered during the first phase of on-site activity had been placed

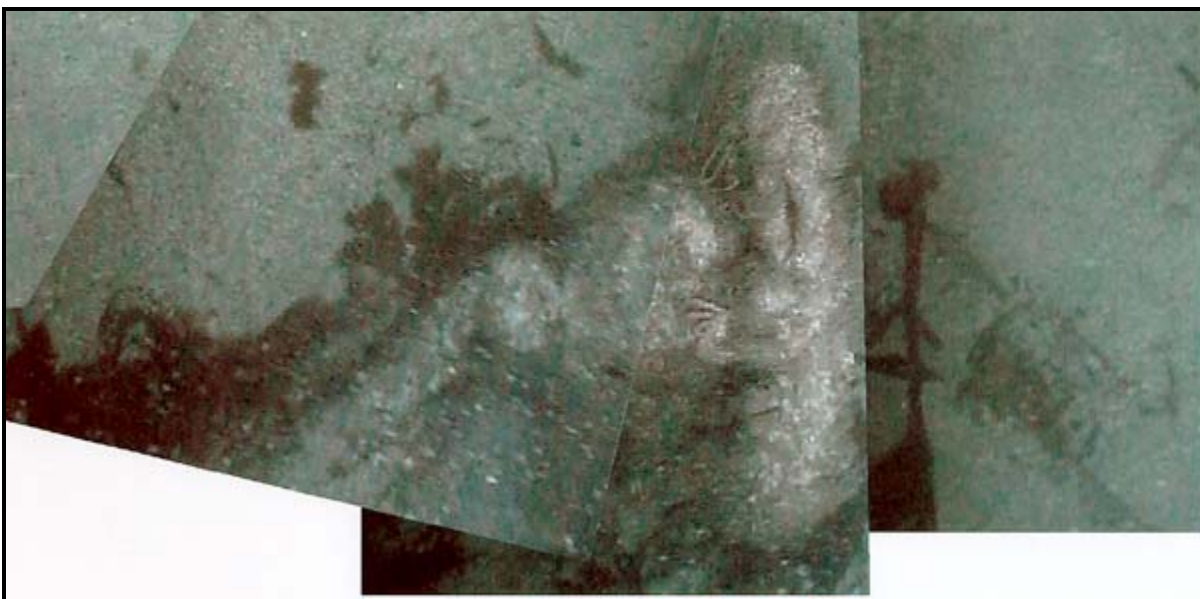

Figure 13. Example of a mosaic illustrating the aft fire pump.



Figure 14. Initial examination and inventory of artifacts aboard *Little Pocket*.

in temporary storage in French Association conservation facility at the Centre d'Instruction Navale de Querqueville by conservator Philippe de Vivies (Figure 15). There each artifact was inventoried, photographed, cleaned, documented and repacked for shipment to conservation facilities in Charleston, South Carolina (Figure 16). A special crate with a watertight iron liner was constructed for shipping the 32-pounder to Charleston. Construction of the crate was contracted by Dr. Bonnel with Mainco in Tournalville (Figure 17).



Figure 15. Processing artifacts in the CIN French Association laboratory facility.



Figure 16. Packaging material for shipment to Charleston, South Carolina.

The second phase of on-site research was carried out by French volunteer divers and American archaeologists. With a more powerful water pump, French divers resumed excavation at the base of the aft fire pump. The new pump failed to produce the desired results and bad weather made operating it from an inflatable dangerous. After testing the system produced discouraging results and rough seas made the operation hazardous, excavation was abandoned. To facilitate documentation, French divers used the DPV's to blow sediment away from the propeller and lifting mechanism.

While French divers recovered the excavation equipment, American archaeologists worked on collecting data for the video mosaic and recording the screw and lifting mechanism. A series of transects between the screw and machinery were recorded using the underwater

video. With the on-site baseline as a reference, a video record of the bottom surface was recorded from an elevation of approximately six feet. The camera was operated vertically so that a continuous record of exposed wreck structure was obtained. Video was also used to document the aft fire pump and the propeller and lifting mechanism. Before the end of the second phase of diving, a reconnaissance was made at the bow. A brief examination of the anchor was made and a transect between the anchor and the *Alabama*'s machinery was recorded using the underwater video. As in the stern, the camera was operated vertically so that a continuous record of exposed wreck structure was obtained.

Due to the number of days lost to bad weather, diving was extended until the 16th of July. On those final two days archaeologists focused on recording details of the propeller and lifting mechanism (Figure 18a and 18b). French divers recovered all remaining equipment and removed the buoys at the bow and stern. During the diving several additional exposed artifacts were recovered.



Figure 17. Unloading the *Alabama* artifacts in Charleston, South Carolina.



Figure 18a. Documenting the *Alabama's* lifting frame.



Figure 18b. Documenting the *Alabama's* propeller.

Description of the Artifacts

Artifacts recovered during the 2000 investigation of the *CSS Alabama* consisted of material exposed on the bottom surface and material exposed by excavation. Due to the dynamic environment at the wreck site, artifacts exposed on the bottom surface are considered to be at risk and their provenience is questionable (Figure 19). Recovery has been accepted as the most appropriate method of insuring their preservation. During the 2000 campaign, a total of 19 artifacts were recovered. They included ordnance, ceramics, ship fittings, gun carriage hardware and fragments of the vessel's hull. The largest artifact was one of the 32-pounders cast by Fawcett, Preston & Company in Liverpool in 1862.



Figure 19. Ironstone jar (ALS-225) exposed on the bottom surface.



ALS-215 Hull Fragment with Fasteners

Figure 20

Artifact ALS-215 is a large fragment from the hull of the CSS *Alabama*. Although it is impossible to determine its exact location in the vessel structure the wood and fasteners suggest that it consisted of a section of deck clamp, hull planking and futtock. The multi-component artifact is made up of three different wood species. The outer portion is teak that represents hull planking. The middle section appears to be white oak and represents remnants of a futtock. The inner portion is mahogany and represents the remains of a deck clamp. Copper fasteners run through each piece and are corroded away on the inner side. The pins are peened over roves outside the teak planking.

Artifact Dimensions:

Length:	87.5 inches	222.25 cm
Width of Oak:		
Width of Teak:	3.6 inches	9.1 cm
Width of Mahogany:		
Pin Diameter:	.75 inches	1.9 cm
Rove Diameter:	1.5 inches	3.8cm



ALS-216 Scupper

Figure 21

Artifact ALS-215 is a lead scupper. The configuration of the scupper suggests that it would have extended from the water course through the hull at an angle of approximately 15 degrees. The scupper pipe and flanges were fashioned from lead sheet and soldered together. The water course flange was secured around the perimeter with copper tacks on 1.50 inch centers. A small fragment of what appears to be oak remains attached to the back of the watercourse flange by one of several of the tacks that secured the flange to the water course timber. The lower round flange was also tacked around its perimeter on 1.00 inch centers though no tacks remain. The pipe throat is oblong in cross-section

Artifact Dimensions:

Length:	26 inches	66 cm
Throat Diameter	3.50 x 4.50 inches	8.9 x 11.4 cm
Tack Spacing:	1.50 inches (on center)	3.8 cm
Pipe Length:	22 inches	55.9 cm

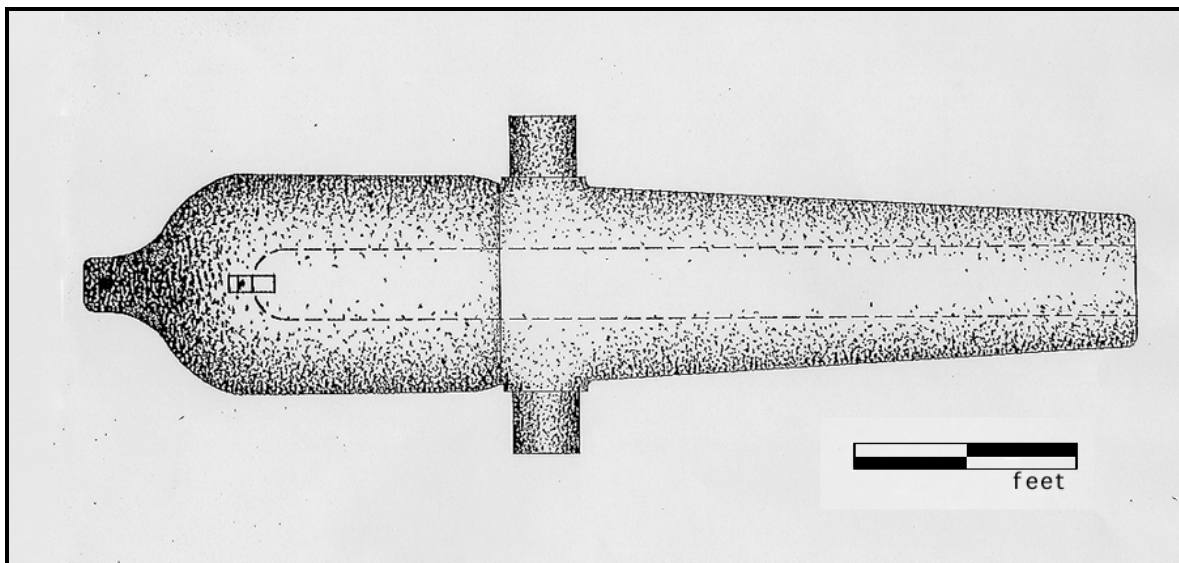

ALS-217 32-pounder Cannon

Figure 22

Artifact ALS-217 is a 32-pounder cast iron smooth bore cannon. The *Alabama* 32-pounder was cast for John Laird and Son by Fawcett, Preston, and Company of Liverpool, England specifically for the Confederate cruiser. Although preliminary drawings illustrate many of the design characteristics of the barrel, a critical section around the trunions and the barrel forward of the trunions remains obscured by a calcarious crust formed by deteriorating iron, seawater and sediment. The configuration of the tube is somewhat similar to the rifled ordnance designs of Captain T. A. Blakely. Although cleaning will have to be completed before a thorough assessment can be made, the barrel forward of the trunions resembles the 7-inch Blakely rifle removed illegally from the Confederate commerce raider *Florida*. That Blakely was also cast by Fawcett, Preston, and Company in 1861. Unlike the CSS *Florida* rifle which is banded, the breech of the *Alabama* 32-pounder appears to be cast and resembles a 4.5-inch Blakely rifle at Fort Pulaski, Georgia that was also produced by Fawcett, Preston, and Company in 1861. As Fawcett, Preston, and Company produced a variety of Blakely patent cannon, it is reasonable to assume that the 32-pounder might be one of his designs. However, the design of an Armstrong patent rifle in Whitby, Canada also bears a resemblance to the 32-pounder's design. According to historical data collected by Andrew Bowcock, this 32-pounder was one of four guns of this type aboard the *Alabama*. Unlike the two 32-pounder naval guns also onboard the *Alabama*, this gun has no reinforces along its length and no muzzle flare.



ALS-217 Makers Mark on the 32-pounder Cannon

Figure 23

A concretion (ALS-218) that came from the top breech contains the percussion lock mechanism. An adjustable brass tangent sight remains attached to the left side of the gun. Stamped lettering on the top of the gun reads:

Fawcett Preston & Co.
 Liverpool
 1862

Artifact Dimensions:

Length:	105.75 inches	2.69 m
Bore Diameter:	6.40 inches	16.26 cm
Breech Diameter:	21.50 inches	54.6 cm
Muzzle Diameter:	12.25 inches	31.1 cm
Trunion Diameter:	6.50 inches	16.5 cm
Bore Length:	89.75 inches	2.28 m

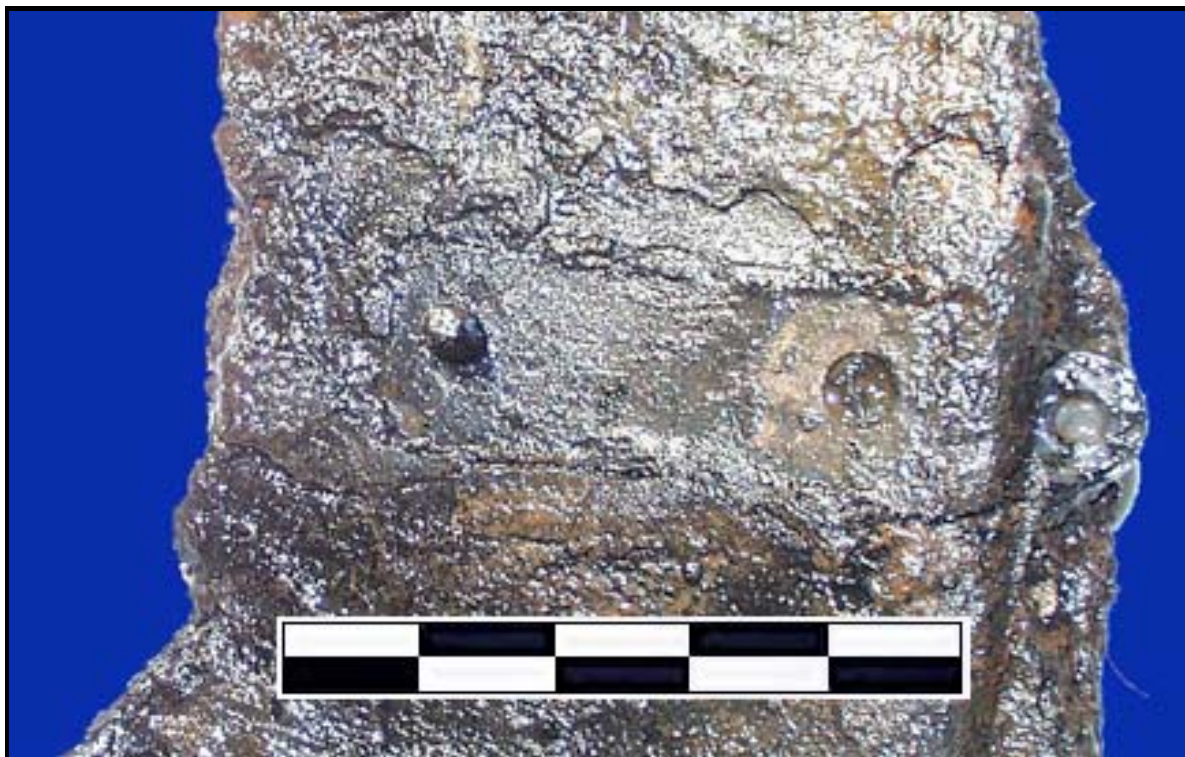

ALS-218 Percussion Lock in Concretion

Figure 24

Artifact ALS-218 is a percussion lock mechanism from the breech of the Fawcett, Preston, and Company 32-pounder recovered in 2000. As the lock mechanism has not been cleaned, virtually nothing can be said of its design at present. However, historical photographs and underwater photographs of the CSS Alabama's aft pivot gun do provide an indication of its characteristics.

Artifact Dimensions:

Length:	6.00 inches	15.24 cm
Width:	1.50 inches	3.8 cm



ALS-219 Port Light

Figure 25

Artifact ALS-219 is a port light. Port lights were used to direct light into the lower decks of the ship and to serve as view ports for crewmembers. The glass lens is set in a tapered brass rim. The brass rim has recessed rings at either end. The lead sleeve is formed around the brass rim. The long tapered sleeve served as a through-hull fitting. Remains of both interior and exterior flanges are apparent and would have been secured with tacks. Additional similar port lights were also recovered during the 2000 campaign though this one exhibits the best state of preservation.

Artifact Dimensions:

Lens Diameter:	5.50 inches	14 cm
Rim Diameter:	6-7 inches	15.24-17.78 cm
Lens Thickness:	.50 inches	1.27 cm
Sleeve Thickness:	.19 inches	.48 cm
Sleeve Length:	24 inches	61 cm
Sleeve Diameter:	7-16 inches	17.78-40.54 cm



ALS-220 Stoneware Base Shard

Figure 26

Artifact ALS-220 is a large stoneware pottery shard. The shard appears to represent more than half the base of a small bowl. The vessel was glazed on both the interior and exterior surfaces. A radius from the center of the base indicates that the base would have been approximately 5.25 inches in diameter. The base of the vessel is recessed inside a heavy foot ring. No makers markings are apparent on the piece.

Artifact Dimensions:

Base Diameter:	5.25 inches	13.33 cm
Base Thickness:	.35 inches	.89 cm
Wall Thickness:	.25 inches	.63 cm



ALS-221 Stoneware Base Shard

Figure 27

Artifact ALS-221 is a large stoneware pottery shard. . The shard represents more than half the base and a portion of the side of a small jug or jar. The vessel was glazed on both the interior and exterior surfaces. A radius from center of the base indicates that the vessel would have had a base diameter of about 7.38 inches. No markings are apparent on the piece.

Artifact Dimensions:

Height:	7.38 inches	18.75 cm
Width:	8.19 inches	20.8 cm
Base Radius:	3.88 inches	9.85 cm
Wall Thickness	.25 inch	.64 cm
Base Thickness:	.31 inches	.79 cm



ALS-222 Lever Lock Mechanism

Figure 28

ALS-222 is a two piece locking mechanism. Both components are cast brass. The lever or key has a cylindrical keyed shaft protruding from one end. The lock has a slotted round recess to accept the keyed shaft. A photograph of John McIntosh Kell on the deck of the Alabama (**Figure 7**) shows a chest in the foreground that appears to have a similar locking mechanism. The chest could possibly have served as storage for small arms that might have been kept on the deck.

Artifact Dimensions:

Lever Length:	4.19 inches	10.64 cm
Shaft Diameter:	.63 inches	1.6 cm
Shaft Length:	1.50 inches	3.81 cm
Receiver Diameter:	1.38 inches	3.5 cm



ALS-223 Hull Fragment

Figure 29

Artifact ALS-223 appears to be a fragment from the hull of the ship. The larger wood fragment appears to be teak and matches closely the historical dimensions for the *Alabama's* hull planking. The smaller wood fragment appears to be oak and perhaps represents a sample of one of the *Alabama's* futtocks. A copper pin runs through both pieces and is peened over a rove on the outer edge of the teak. The shadow of a second pin is evident 7.50 inches on center from the first.

Artifact Dimensions:

Length:	15.90 inches	40.4 cm
Teak width:	3.75 inches	9.52 cm
Oak width:	9.00 inches	22.9 cm
Pin Diameter:	.75 inches	1.9 cm
Rove Diameter:	1.50 inches	3.81 cm



ALS-224 Ironstone Plate

Figure 30

Artifact ALS-224 is a white ironstone plate with a cobalt blue transfer printed decoration. The interior of the plate is decorated with fouled anchor inside a garter that is located in the center and a cable decorates the perimeter. A figure 8 shaped makers stamp on the underside of the plate reads “Davenport Ironstone China”. Inside the stylized figure 8 are an anchor and the number 2. The word “Davenport” is also transfer printed on the bottom near the makers stamp. Numerous similar plates have been recovered from the stern area of the *Alabama*.

Artifact Dimensions:

Diameter:	10.38 inches	26.36 cm
Height:	1.25 inches	3.175 cm
Center Emblem Diameter:	1.94 inches	4.93 cm
Band Width:	.25 inch	.64 cm

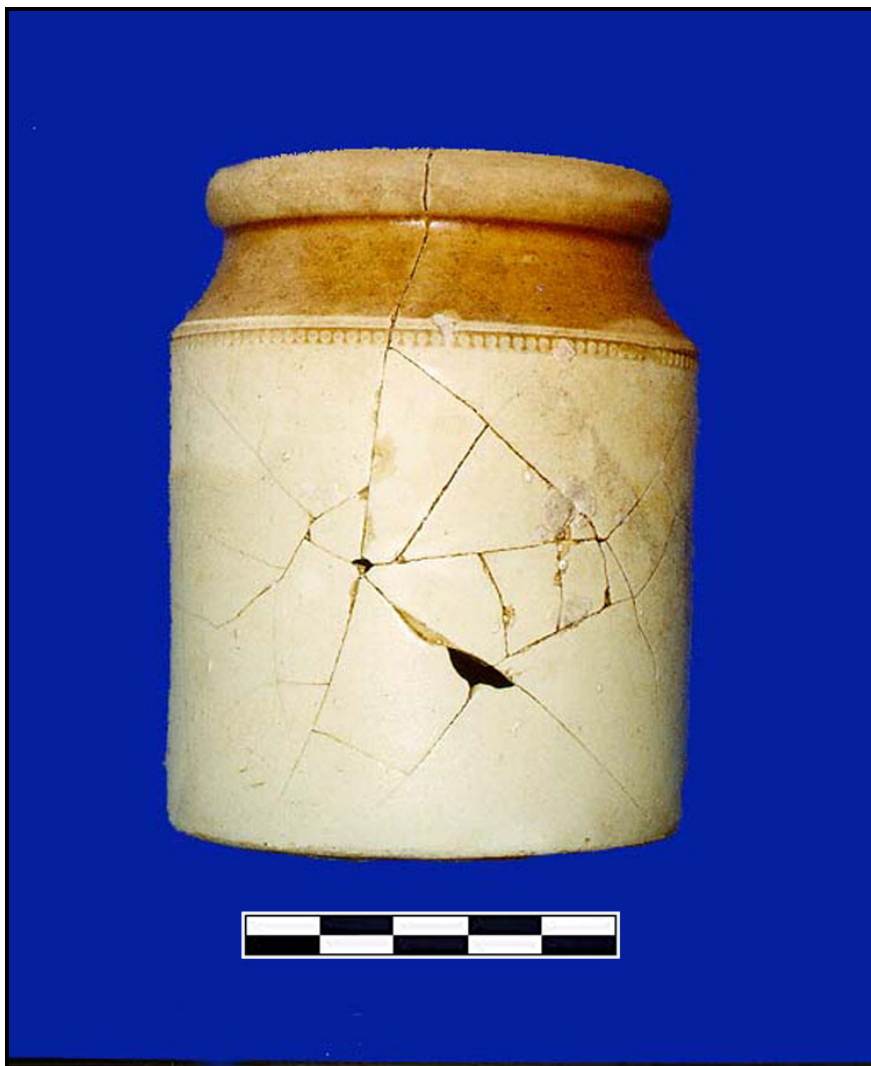

ALS-225 Stoneware Jar

Figure 31

Artifact ALS-225 is an stoneware jar. The lower body is cylindrical and cream colored. The top narrows in a concave style above the stamp decorated shoulder. A heavy lip forms the mouth of the vessel. Above the shoulder and inside the vessel light brown slip has been applied under a salt glaze. One side of the jar contains an impact break. Only a few of the fragments associated with the impact break are missing and it is possible that the break has been partially repaired.

Artifact Dimensions:

Body Diameter:	6.19inches	15.7 cm
Height:	7.63inches	19.4 cm
Rim Diameter:	5.50 inches	14 cm



ALS-226 Tack

Figure 32

Artifact ALS-226 is a square brass tack that was used to fasten the rectangular flange of the lead scupper to the deck. Little can be ascertained about the shape of the head as it is badly corroded. However, the tack appears to be a common sheathing tack of the type used to attach copper sheathing to the hull of ships.

Artifact Dimensions:

Length:

1.13 inches

2.87 cm



ALS-227 Antler

Figure 33

Artifact ALS-227 is an antler. Although presently unidentified, the antler could be associated with a food or game animal from one of the ports of call of the *Alabama*. For example, the officers of the *Alabama* were big game hunting in South Africa just a few months prior to the sinking off Cherbourg.

Artifact Dimensions:

Length:	16.50 inches	41.9 cm
Diameter:	1 - 1.25 inches	2.54-3.18 cm



ALS-228 Port Light

Figure 34

Artifact ALS-228 is a port light. Port lights were used to direct light into the lower decks of the ship and to serve as view ports for crewmembers. The glass lens is set in a tapered brass rim. The brass rim has recessed rings at either end. The lead sleeve is formed around the brass rim. The long tapered sleeve served as a through-hull fitting. Remains of both interior and exterior flanges are apparent and would have been secured with tacks. Additional similar port lights were also recovered during the 2000 campaign.

Artifact Dimensions:

Lens Diameter:	5.50 inches	14 cm
Rim Diameter:	6-7 inches	15.24-17.78 cm
Lens Thickness:	.50 inches	1.27 cm
Sleeve Thickness:	.19 inches	.48 cm
Sleeve Length:	24 inches	61 cm
Sleeve Diameter:	7-16 inches	17.78-40.64 cm



ALS-229 Port Light

Figure 35

Artifact ALS-229 is a port light. Port lights were used to direct light into the lower decks of the ship and to serve as view ports for crewmembers. The glass lens is set in a tapered brass rim. The brass rim has recessed rings at either end. The lead sleeve is formed around the brass rim. The long tapered sleeve served as a through-hull fitting. Remains of both interior and exterior flanges are apparent and would have been secured with tacks. Additional similar port lights were also recovered during the 2000 campaign.

Artifact Dimensions:

Lens Diameter:	5.50 inches	14 cm
Rim Diameter:	6-7 inches	15.24-17.78 cm
Lens Thickness:	.50 inches	1.27 cm
Sleeve Thickness:	.19 inches	.48 cm
Sleeve Length:	24 inches	61 cm
Sleeve Diameter:	7-16 inches	17.78-40.64 cm

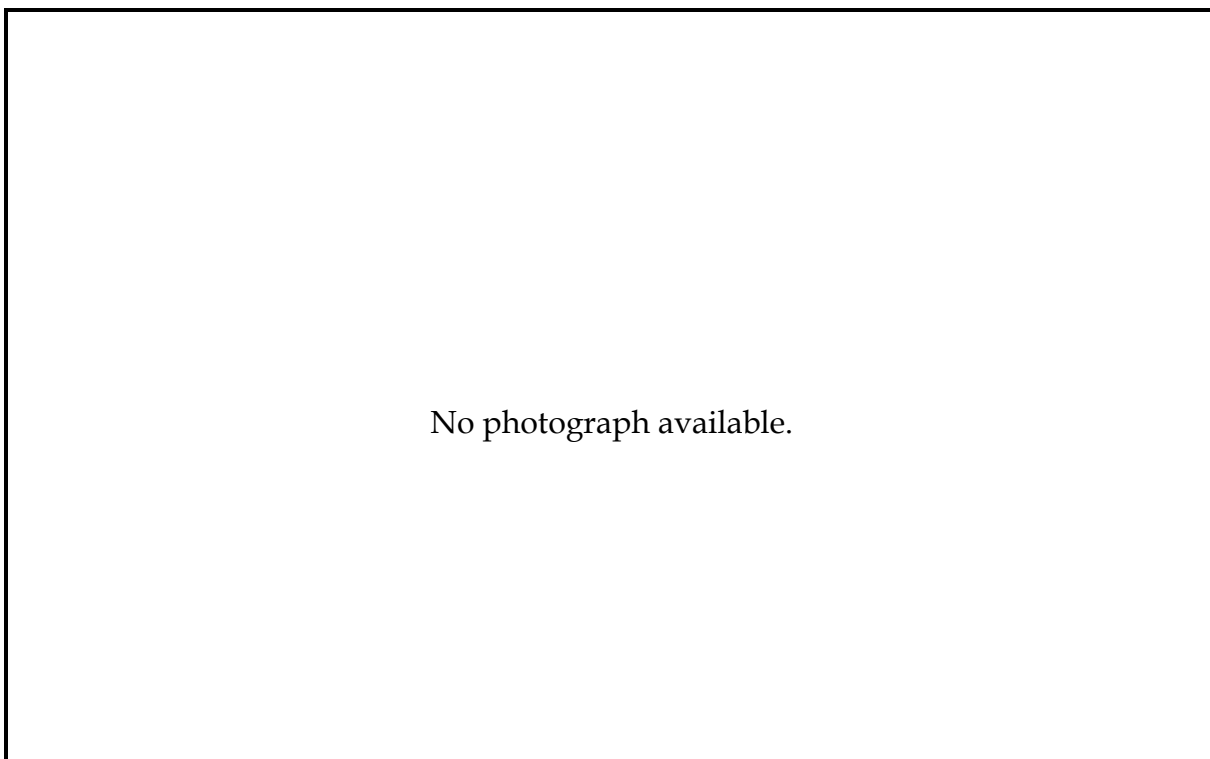

ALS-230 Concretion

Figure 36

Artifact ALS-230 is one of numerous concretions from the muzzle and breech of the 32 pound cannon(artifact ALS-217)

Artifact Dimensions: Not available.

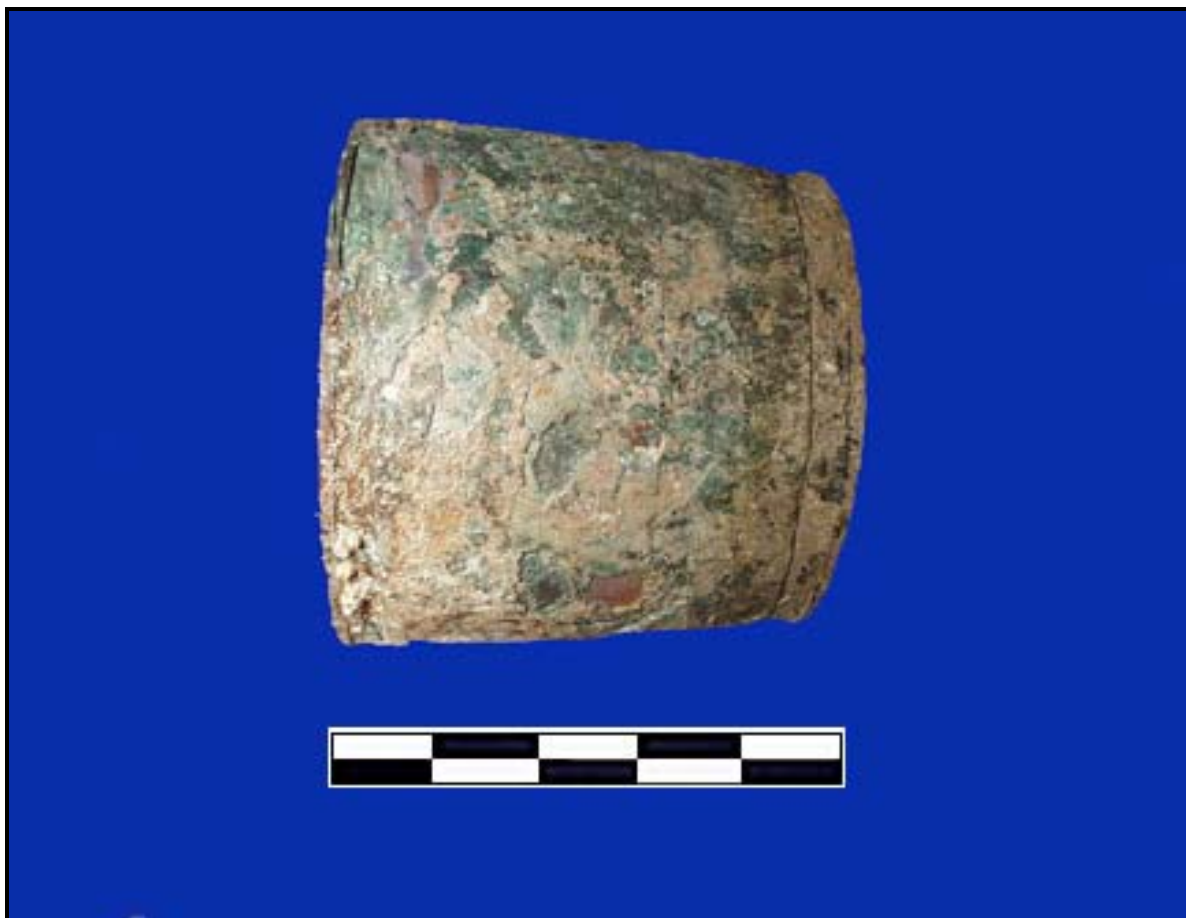

ALS-231 Port Light Brass Rim

Figure 37

Artifact ALS-231 is a port light rim. Port lights were used to direct light into the lower decks of the ship and to serve as view ports for crewmembers. The glass lens is set in this tapered brass rim. The brass rim has recessed rings at either end. The lead sleeve would be formed around the brass rim. The long tapered sleeve served as a through-hull fitting. Additional similar port lights were also recovered during the 2000 campaign.

Artifact Dimensions:

Lens Diameter:	5.50 inches	14 cm
Lens Thickness:	.50 inches	1.27 cm
Rim Diameter:	6-7 inches	15.24-17.78 cm
Rim Length:	5 inches	12.7 cm



ALS-232 Port Light

Figure 38

Artifact ALS-228 is a port light. Port lights were used to direct light into the lower decks of the ship and to serve as view ports for crewmembers. The glass lens is set in a tapered brass rim. The brass rim has recessed rings at either end. The lead sleeve is formed around the brass rim. The long tapered sleeve served as a through-hull fitting. Remains of both interior and exterior flanges are apparent and would have been secured with tacks. Additional similar port lights were also recovered during the 2000 campaign.

Artifact Dimensions:

Lens Diameter:	5.50 inches	14 cm
Rim Diameter:	6-7 inches	15.24-17.78 cm
Lens Thickness:	.50 inches	1.27 cm
Sleeve Thickness:	.19 inches	.48 cm
Sleeve Length:	24 inches	61 cm
Sleeve Diameter:	7-16 inches	17.78-40.64 cm

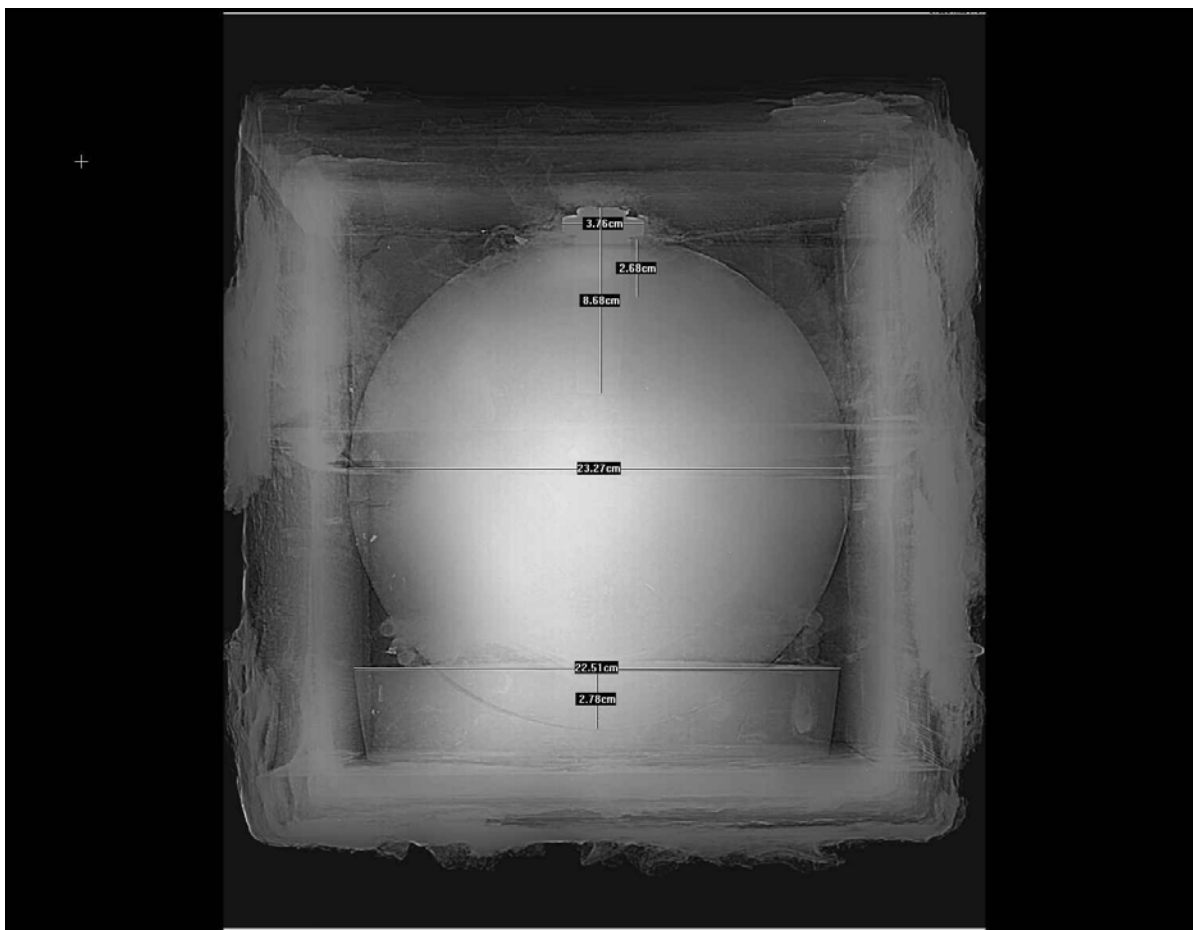

ALS-233 Wood Shell Container

Figure 39

Artifact ALS-233 is a simple six-sided wooden box. No hinges or openings are readily apparent. Box edges are joined with a simple nailed butt joint. Remnants of what appear to be a leather covering survive. The leather was attached to the box with copper tacks. The contents of the box have not been identified, however iron oxide residue leaking through the seams indicates that at least some of the content material could be iron.

Artifact Dimensions:

Length:	10.50 inches	26.7 cm
Width:	10.50 inches	26.7 cm
Depth:	10.00 inches	25.4 cm
Wall Thickness:	.88 inches	2.23 cm



ALS-234 Cannon Truck Tackle Block

Figure 40

Artifact ALS-234 is a cannon truck tackle block. It is likely that the block was used to move and secure one of *Alabama's* large pivot guns. One such block is visible in the photo of Raphael Semmes leaning against aft pivot gun. This particular single sheave block was hooked to a large eye bolt in the deck. This was coupled with a double sheave block hooked to the cannon truck to provide mechanical advantage when pivoting the cannon. One of the upper double-sheave blocks was recovered from the site in 1991. The tackle block is made entirely of brass.

Artifact Dimensions:

Length:	17.50 inches	44.45 cm
Wheel Diameter:	5.50 inches	13.97 cm
Wheel Thickness:	1.88 inches	4.78 cm

Results of the Investigation

Investigation of the CSS *Alabama* during June and July 2000 generated new information about the wreck and additional insight into conducting work at the site. Although weather, equipment and other problems complicated on-site research activity, some of the proposed objectives were accomplished. Failure to achieve some of the project objectives provides important insight into the planning and conduct of future operations.

The first on-site objective of research during the 2000 field season was to be deploying an anchor or clump at the wreck site. Placing an anchor or clump at the site was to facilitate mooring a 65 to 100 foot (20 to 30 m) research vessel in the immediate vicinity of the wreck. When plans to use the 65 foot (20 m) research vessel *Robo* were abandoned at the last minute as a consequence of unacceptable contract demands, the mooring issue was also abandoned. Although a more appropriate surface support platform was obtained from England, French regulations prevented working from the vessel and the mooring became a moot point. That was reinforced by the dive protocols of the French Navy and the French volunteers. As the two groups dove independently there would not have been sufficient operational space over the wreck site for three dive support vessels.

The second objective of on-site research during the 2000 field season was to be a remote sensing documentation of wreck site. A high resolution digital side scan sonar was to be used in conjunction with differential global positioning to survey the wreck and the adjacent seabed. The sonar images would provide a highly detailed image of the exposed wreck structure and any previously unidentified remains in the immediate vicinity of the hull. That imagery was to be used to enhance the site map and identify additional exposed wreckage for diver identification and assessment.

Although that objective was also compromised by the last minute cancellation of the support vessel *Robo*, that vessel did subsequently make several passes over the wreck with sonar. The images were produced by a 600kHz Marine Sonics sonar. Unfortunately, the range scale used, the direction of the survey transects, and the height of the transducer in the water column combined to produce images which revealed little of the exposed wreck structure of the wreck site environment (Figure 41). Thus, the imagery could not be used to enhance the site map or identify additional exposed wreckage for diver identification and assessment.

Documentation planned for the 2000 campaign was also to include generation of a video and photographic record of the exposed wreck structure. While that objective was undermined by weather, personnel and equipment problems, some usable digital data was

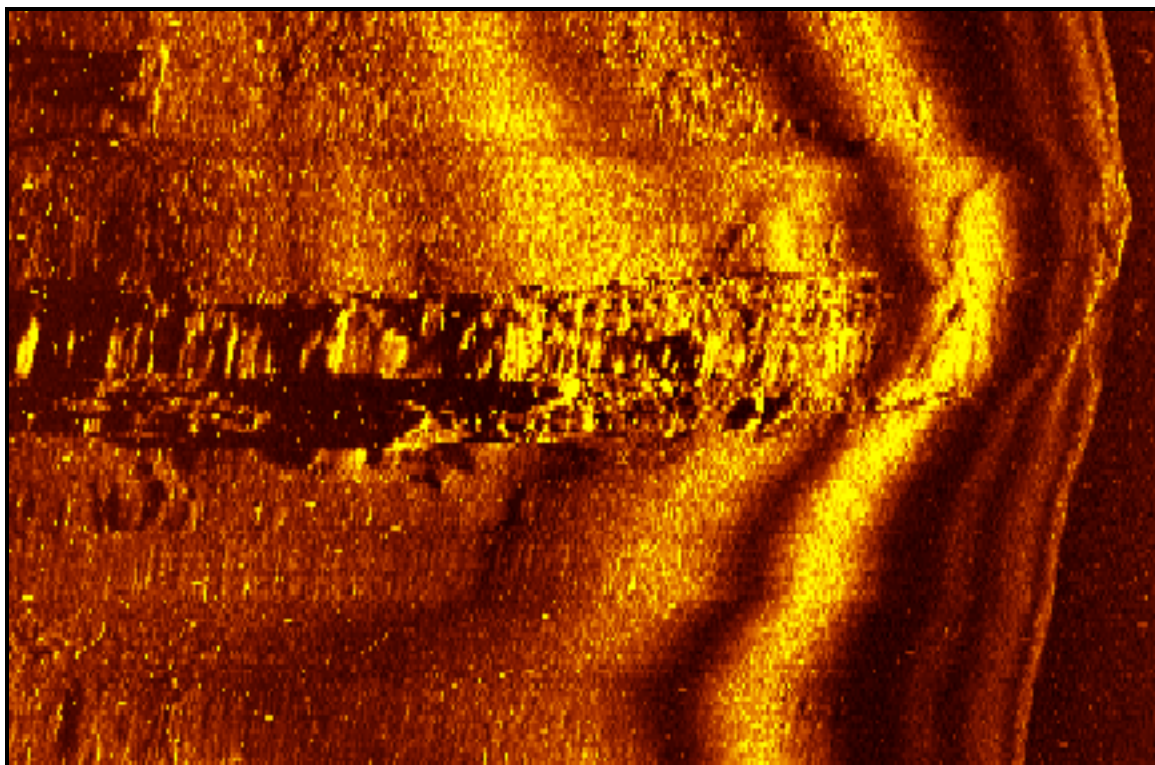

Figure 41. *Robo* sonar image of the CSS Alabama.

collected. One of the most adverse impacts on documentation was the fact that the project personnel responsible for conducting the underwater video and photographic operations were not permitted to dive. Because American personnel anticipated diving from the *Robo*, no French diving equivalency was obtained. When the *Robo* contract was cancelled at the last minute and the English vessel could not be used for dive support, two of the American divers could not participate in any of the underwater research.

Video and photographic data collection was further complicated by problems with the underwater video lens, lights and housing. The wide angle lens provided with the Light and Motion housing employed for the Sony PC100 proved not to be wide enough to provide coverage at the elevation required by visibility and one of two external battery packs used to power the video lights flooded on testing. The battery of buttons provided to enhance control over the video system proved almost impossible to operate with neoprene gloves. In addition, camera settings could not be effectively determined using the internal view port. Use of the external liquid crystal display did little to rectify the problem. All of these problems could have been identified by prior testing of the equipment, but that was not possible due to perpetual delays in delivering the housing. These problems consumed a great deal of bottom time available for data collection.

In spite of those problems, the underwater video was employed to document much of the underwater activity and collect data useful in assembling the first mosaics. Because the project photographer was unable to make a 35mm photographic record on-site activities, the underwater video was used for that purpose. Frames captured by computer provided a digital record of mapping and excavation activity. Using the on-site baseline that extended from the lifting frame in the stern to the starboard anchor at the bow as a reference, a series of transects were documented. Because of the lens supplied with the underwater housing the area documented in each individual frame was limited. The lights that accompanied the system were also highly sensitive to adjustment and could not be used in conjunction with the diver propulsion vehicle. Instead, the camera system was operated by a diver.

The data produced by the underwater video system was less than ideal. However when selected frames were mosaiced and placed over an AutoCAD version of the site plan developed by Max Guérout and the French divers, the result clearly demonstrated the potential of the concept (Figure 42a and 42b). It was readily apparent that a better lens and housing would be necessary. It was also apparent that a diver based system was not the most effective approach to collecting data for the mosaic.

Excavation at the CSS *Alabama* wreck site has been a perpetual problem. Without an adequate surface support vessel, the problem continued to plague operations during the 2000 campaign. In the bow, excavation around the starboard anchor was carried out using a 4-inch (10 cm) air lift. Air for the lift was provided by large capacity high pressure tanks taken to the bottom by each dive team. The tanks were attached to the air lift by a regulator that permitted the volume of air forced into the lift tube to be controlled. Although the system required bottom time on each dive to set up and disassemble, it worked reasonably well. A larger diameter lift would have increased excavation capacity and reduced clogging. Having the lift secured to the anchor eliminated the danger of an uncontrolled ascent associated with clogging.

In the stern French volunteers used water induction dredges and diver propulsion vehicles to excavate at the base of the pump. Neither the induction dredge nor the diver propulsion vehicle proved very satisfactory. The induction dredge was powered by a small pump located in an inflatable boat anchored to the buoy attached to the lifting screw. The first pump proved to have insufficient pressure and volume to operate the dredge with any degree of efficiency (Figure 43). A second pump improved efficiency somewhat, but was also not powerful enough to make the dredge operate as designed. Without adequate power the hose clogged constantly. Availability of an adequately powered pump would have made the system effective. Excavation with the diver propulsion vehicles worked well in the shell hash but failed to perform adequately in consolidated sand and when the depth of excavation reached below two feet (61 cm). The propeller wash was simply not powerful enough to push sediment away from the excavation.

(FIGURE REMOVED FROM PUBLIC RELEASE / CIRCULATION COPY)

Figure 42a. Mosaic aft of Engineering Space.

(FIGURE REMOVED FROM PUBLIC RELEASE / CIRCULATION COPY)

Figure 42a. Mosaic forward of Engineering Space.

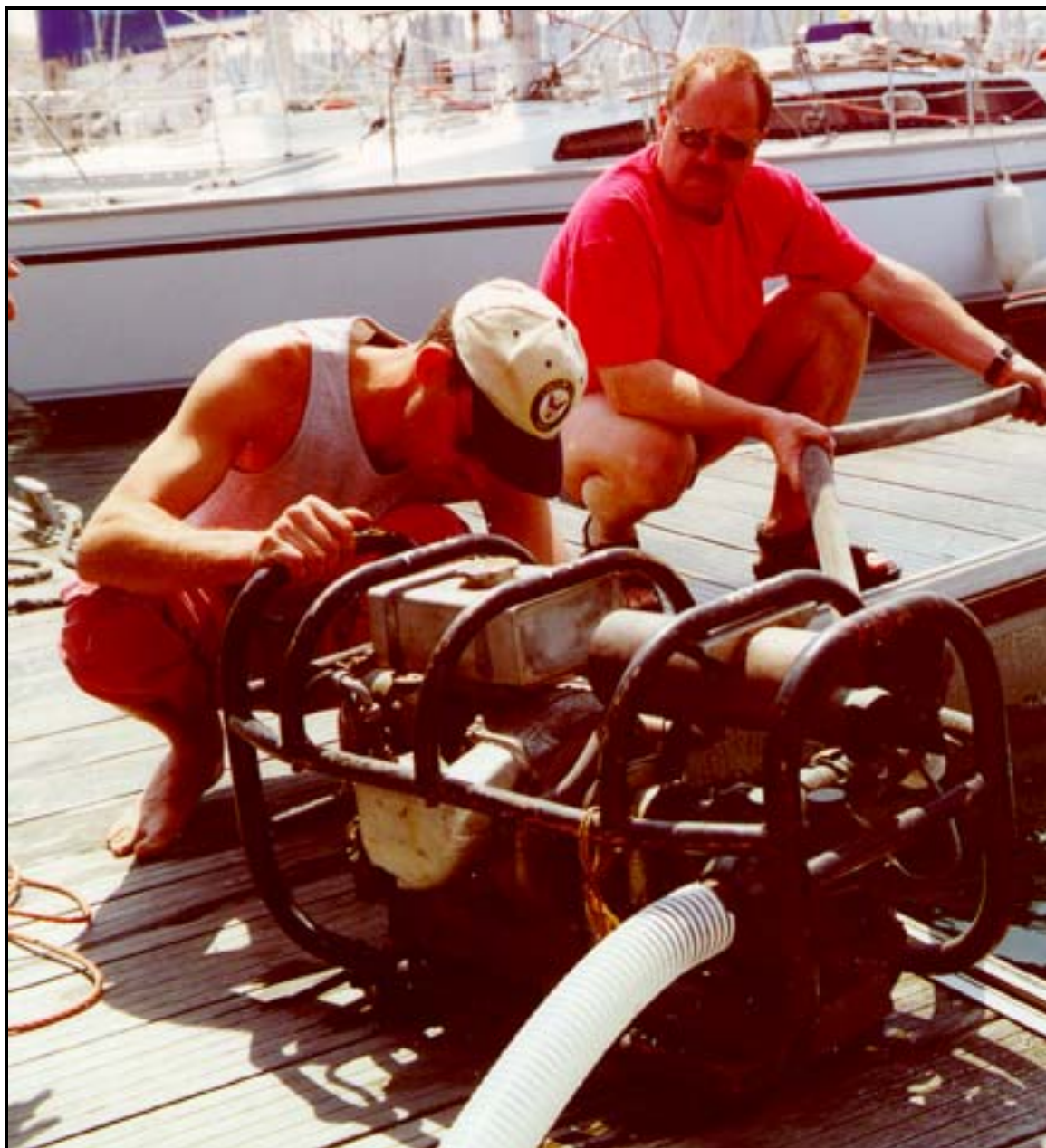

Figure 43. Water pump used to power the induction dredge.

Although test excavations were proposed for both the bow and stern of the wreck, a number of critical factors made it prudent to abandon those objectives. First, bad weather significantly reduced the number of days that diving was possible. The lack of an adequate surface support platform eliminated the option for employing more powerful pumps and compressors to power the dredges and air lifts. The lack of French certification for all of the

American divers reduced the archaeological staff from five to three and the necessity for diving conventional scuba eliminated diver communications and computer controlled decompression. Finally, the second phase of diving was limited to French volunteers and American archaeologists. Based on these constraints, the decision was made to focus on limited recovery, documentation and video.

Limited excavation was attempted at the base of the propeller and at the location of the stern pivot gun. Those excavations were to be designed to determine if the propeller and lifting banjo remain attached to the keel and deadwood and if the pivot gun is still associated with its carriage and truck. While attempts to expose the pivot gun failed to produce any new insight into any present association with its carriage, the diver propulsion vehicles were employed to remove shell hash and sediment obscuring the propeller hub and top of the shaft forward of the hub. Additional design details of the lifting mechanism were recorded using measured drawings and video (Figure 44).

Recovery of several large artifacts was also planned in conjunction with fieldwork during the summer of the year 2000. Artifacts identified for recovery were the aft fire pump, one or more of the 32-pounder cannon and possibly their trucks, and one of the two Trotman Patent anchors. While one of the Fawcett, Preston & Company 32-pounders was quickly identified by American archaeologists and recovered by French Navy divers, the anchor and aft fire pump proved to be impossible to remove from the wreck site.

Although, the air lift used by the French Navy worked, it was not powerful enough to uncover the stock of the starboard anchor. An inspection of the anchor during the second phase of diving indicated that it was buried underneath a section of the starboard bow. Excavation also failed to expose the association between the aft fire pump and the hull remains of the *Alabama*. Like the anchor it appears to be secured by parts of the hull. As neither the anchor nor the fire pump could be recovered without the possibility of damaging the artifact of the surviving hull structure, both were left *in situ*.

Conclusions

On-site research activity at the CSS *Alabama* site was complicated by a variety of factors. Perhaps the most significant and adverse impact was the weather. Out of the eighteen days originally scheduled for diving, six were completely lost due to heavy weather. On two additional days, diving activity had to be curtailed as it was too rough to dive the normal fifteen minute schedule and decompress on oxygen.

Additional on-site time was lost as a consequence of Air Canada canceling the original flight of the American team. Although their flight was rescheduled, the connecting flight to Paris was never ticketed and three days were lost in Washington, D.C. Instead of arriving in Paris on 16 June, the team arrived on the 19th of June. An additional two days were

(FIGURE REMOVED FROM PUBLIC RELEASE / CIRCULATION COPY)

Figure 44. Drawing of the Screw and Lifting Frame.

lost as equipment shipped from the United States to Cherbourg was not properly inventoried and no Customs declaration had been prepared. Clearly, in the future shipping must be closely supervised and travel arrangements should be designed around the ineptitude of potential air carriers.

Work on the site was additionally complicated by the fact that only three of the five man American team was permitted to dive. In anticipation of diving from the American flag vessel *Robo*, efforts to have the entire team certified by the French Institut National de Plongee Professionnelle (INPP) were suspended. As a replacement vessel was procured from Great Britain, there appeared to be no need to resurrect the certification issue. When it finally proved to be impossible to make effective use of that vessel, it was apparently too late for the INPP to act on certification of the remaining two American divers. Before the end of the project, new French regulations were apparently adopted requiring that all underwater archaeological investigation in French waters be carried out aboard a French flag vessel.

It is essential to have clear definition concerning the issues of foreign flag vessels and diver certification. As the site is United States property, it does not appear unreasonable to request special permission to employ American flag surface support vessels, including those of the United States Navy, in the conduct of on-site research. Neither does it appear unreasonable to request permission for divers, including those of the United States Navy, to be permitted to operate on-site using American dive protocols. Answers to these questions will have a significant impact on the future of research at the CSS *Alabama* site and could have made a significant difference in the level of success of the 2000 campaign. Without question, this will be a pivotal consideration in planning and conducting operations in 2001.

The procurement and testing of equipment for the 2000 CSS *Alabama* project was also a serious problem. Because funding was not available until March 2000, much of the necessary equipment could not be ordered in time for timely delivery. Almost all of the equipment arrived too late for testing and had to be shipped to France immediately in order to be available for on-site operations. That precluded time for testing and familiarization. Many problems that could have been identified and solved before field work was initiated became serious issues during the campaign. As rudimentary as the concept of testing of, and training on, equipment is in field research, every effort must be made to ensure that untested equipment does not become a problem in the future. As much of the equipment is associated with life support, it is also essential that the project staff be provided time to train before beginning field operations. As was the case in 2000, this will be a critical consideration in planning and conducting operations in 2001.

In spite of the problems encountered, the 2000 investigation of the CSS *Alabama* produced worthwhile results. Although problems with the underwater video system could not be resolved during on-site operations, efforts to collect usable data were partially successful. In spite of the wrong lens and difficulty with lights and camera controls, frames from the video record were used to document project activity. More importantly video data has been used to develop preliminary mosaics of small sections of the wreck site.

Strings of captured frame data have been used to support production of mosaics. Although complications prevented use of a reference web to control scale, the data was collected along the on-site baseline. That baseline permitted the mosaics to be properly oriented and integrated with an AutoCAD version of the site plan developed by Max Guérout. Those mosaics reveal the high level of detail that can be documented and demonstrate that a comprehensive image of the site can be developed. Given the limited amount of time required to collect video data serious consideration should be given to use of an ROV based system with electronic positioning.

The limited number of artifacts recovered from the *CSS Alabama* during the 2000 campaign provide additional indication of the rich and varied archaeological record associated with the wreck. The 32-pounder, largest and most dramatic of the small collection, confirms the historical record that identifies Fawcett, Preston & Company as the manufacturer of at least four pieces of the Confederate commerce raider's ordnance. Because Fawcett, Preston & Company manufactured a considerable number of Blakely patent artillery pieces that found their way into the Confederacy and on to Confederate warships, it is possible that they also produced the *Alabama's* unmarked Blakely forward pivot rifle. Recovery of the stern pivot gun and one of the Royal Navy pattern 32-pounders from the *Alabama* would strengthen the hypothesis that all of the vessel's ordnance was Blakely designed.

The remainder of the artifacts reflect the ship itself, the ship's fittings and hardware and life aboard the commerce raider. A section of the hull structure suggests the contract specifications for the *Alabama's* construction were followed. Although wood samples have not been positively identified, timber used in framing the ship appears to have been oak. The planking appears to be teak and the remains of a deck clamp appears to be mahogany. Fittings, as specified, were brass 7/8 inch (2.22 cm) in diameter and peened over roves. A bronze block associated with the forward pivot rifle and a lock mechanism, possibly associated with a small arms chest, also confirm the high quality of material used in constructing and fitting out the *Alabama*. While examples of tableware and storage jars testify to the temper of everyday life, an as yet unidentified antler suggests an association with shore leave entertainment or foraging in one of the ports visited by the Confederate vessel.

There can be little question of the value of the archaeological record in enhancing our understanding of life aboard the *CSS Alabama*. However, it is also apparent that diver based research has significant limitations and involves considerable risk. One of the most effective means of reducing that risk, and at the same time increasing the amount of data recovered, is the use of remote operated equipment. If excavation within the hull of the *CSS Alabama* is ever to recover the archaeological record that the wreck preserves, time on the bottom will have to be greatly extended.

While advanced diving techniques can increase the amount of time on-site, the physical environment remains a obstacle. Tidal currents place limits on the duration of diving activity regardless of the methodology employed. It appears that a combination of remote operated equipment (ROE) with limited diving support could be the most effective means of

conducting extended excavation within the hull structure. ROE has been developed to conduct complex operations at depths well below that of the CSS *Alabama* and in currents well in excess of those off the Normandy peninsula. ROE could be designed or adapted to remain on the bottom throughout the tidal cycle. It could be controlled from a vessel anchored above, in the vicinity or well inshore of the CSS *Alabama*. Operations could be managed from an onshore facility. Diving operations similar to those used to support previous investigation could be limited to periodic support of the ROE.

Recommendations

It is apparent that research at the CSS *Alabama* site has reached a critical juncture. While production of a comprehensive mosaic of the site should be completed regardless of decisions concerning future work on the wreck, a decision must be made about the feasibility of more detailed investigation. That decision must be based on management and research priorities, available resources and technology.

As a consequence of the complications and results of the 2000 campaign, a number of recommendations appear to be in order. Those recommendations concern the nature and scope of research in 2001 and planning for more extended investigations in 2002. They relate to the methodology, equipment and personnel to be employed and also the means of administering future projects. In order for on-site research to be successful, operations will have to be well planned, organized and funded. Because of the *Alabama's* unique physical and political environment, those activities will have to be set in motion early and be carefully coordinated. Equipment determined to be the most appropriate must be tested to ensure against the loss of valuable on-site time.

In light of research priorities and the time remaining to plan, organize and approve a campaign for 2001, a limited investigation must be recommended. The most important objective and highest priority would be the completion of the wreck site mosaic. Conduct of the remote sensing survey planned for the 2000 campaign would be a worthwhile second objective. A third secondary objective would be the recovery of artifacts that are exposed on the bottom surface and are considered to be "at risk." A final secondary objective could be the recovery of one of the Royal Navy pattern 32-pounders and the aft pivot gun. Completion of a site mosaic must be considered the most important research goal for future investigation. Recovery of "at risk" artifacts provides new insight into the vessel and recovery of one of the Royal Navy pattern 32-pounders and the aft pivot gun would preserve an example of the *Alabama's* entire battery and permit a more comprehensive study of that commerce raider's ordnance.

If excavation is to be scheduled in 2001, it will be essential to obtain and test the equipment prior to on-site operations. Attempts to excavate clearly demonstrated that both water and air can be used to power excavation equipment. What will now be necessary is to identify and obtain a compressor or pump capable of providing sufficient volume and pressure to support efficient operations. If recovery of additional ordnance is to be one of the 2001 objectives, excavation will be necessary.

To accomplish the primary objective, a remote operated vehicle [ROV] is recommended. Unlike diver based data collection, decompression is not a consideration and the ROV can operate for more than an hour during each tidal cycle. Thus, the ROV can carry out the work in less time and with a higher degree of accuracy. A modest size ROV can operate on-site as long as the current permits. That could be as much as five times the amount of bottom time available to divers. An ROV of modest size can also be readily fitted with appropriate cameras and lighting equipment. Highly accurate positioning can be accomplished using a system of transducers positioned on the wreck. Because the wreck site is small, data for the entire mosaic could be collected within three to four days.

With time an appropriate system can be found, equipped and tested. It is possible that both equipment and services can be donated to the project. However, it is frequently difficult to control and sometimes impossible depend on donated equipment and services. Because the on-site time is limited and the equipment is not inordinately expensive, serious consideration must be given to raising the funding necessary to contract for both the equipment and services. If other submerged cultural resource management agencies such as NOAA are interested in a similar survey, some cost sharing might be possible. It might also be possible to obtain the services of an ROV and operators from the United States Navy or one or more research institutions such as Woods Hole or the University of North Carolina at Wilmington. One of the first objectives will be to identify available equipment and personnel.

Prior to ROV operations, divers would be used to set up either an on-site reference baseline web or locate electronic transmitters on the wreck to control ROV positioning. After video and photographic data to support development of the mosaic has been collected, French and American divers would recover the transducers and any "at risk" artifacts that were documented by the ROV.

If time and resources permit, French and American divers could rig one of the Royal Navy pattern 32-pounders for recovery. With more powerful excavation equipment, the and the aft pivot gun could be exposed, documented and also rigged for recovery. Recovery of the ordnance could be handled by divers from either the French or perhaps the American Navy.

In the event that remote or more complex diving operations do not prove to be technologically or financially realistic, investigation of the remains of the *CSS Alabama* could be brought to a close. Operations in 2002 could be focused on completion of reports, development of exhibits and the production of publications and media productions that would convey the results of this important project to the international public.

If more complex investigation of the remains of the *CSS Alabama* is desirable in 2002 and beyond, serious consideration should be given to more sophisticated diving and/or remote controlled equipment based operations. Given the limitations placed on work at the wreck site by the natural environment, investigation of more sophisticated diving and remote means of conducting comprehensive on-site investigations appear to be inevitable

The only feasible way to extend investigation time on the bottom appears to be by employing remote operated or more sophisticated diving equipment. Today, remote operated equipment is capable of carrying out complex and sophisticated tasks miles below the surface. The degree of sophistication of the tasks remote operated equipment can perform has been very effectively demonstrated both in the depths of the sea and in outer space. Cable ships are equipped with large remote operated vehicles that can perform numerous functions in high current environments at considerable depth.

Highly sophisticated diving systems are also available. Those include mixed gas and saturation systems that can greatly extend bottom time at depths below the practical limits of scuba. In addition, diver delivery systems can transport personnel through the water column in currents that make scuba impractical. However, one of the biggest drawbacks is the amount of personnel required to support diver based operations and the degree of training required to effectively use the systems.

Regardless of the approach, the technology certainly exists to increase the scope of on-site activity at the site of the *CSS Alabama*. In addition to suggesting a project of limited scope for 2001, a survey of both remote operated equipment and more sophisticated diving systems is also recommended. That survey could be designed to identify diving systems and available remote operated equipment that could be used to conduct more protracted on-site excavations. The survey could also identify and compare costs involved in use of diving and remote systems. Perhaps as important as assessing the potential for use of diving and/or remote systems on the *CSS Alabama* site, the survey could identify systems that might be donated or procured at significantly reduced cost.

Because of the amount of time required to assess remote and diving systems, the survey should begin immediately. A report on the findings should be available for consideration by the fall of 2001. That will require personnel time in addition to communications and travel funds. The proposed survey could also identify other agencies with responsibility for deep water shipwrecks that would be interested in, and possibly support, developing and testing systems for underwater archaeological research.

The remains of the CSS *Alabama* contain a rich and varied archaeological record. That record preserves irreplaceable and highly specific insight into life aboard the most successful Confederate commerce raider. It also preserves more generalized insight into the South's most effective means of making the war felt in the United States. Although the wreck site lies in a very dynamic environment, that record can be recovered. If archaeological techniques are to be employed in recovering and reconstructing that record the means of conducting research at the site will have to be improved.

Appendix A - Ministry of Culture and Communication Permit

Monsieur Gordon P. WATTS, Jr
Box 2494
Washington
North Carolina
27889
USA

000499

27 MARS 2000

Direction
de l'architecture
et du patrimoine
Service de la connaissance,
de la conservation et de la création
Sous-Direction de l'Archéologie
4, rue d'Aboukir
75002 PARIS

☎ 01.40.15.77.00

Affaire suivie par
poste
Références

M. GRENIER DE MONNER
01.40.15.77.53
DAPA/PGM/NC
6 avril 2000

Monsieur,

Je vous prie de trouver ci-joint le texte de l'arrêté vous autorisant à procéder, cette année, à une opération de fouille archéologique sous-marine sur le site de l'épave du CSS Alabama à Cherbourg.

Il m'a paru expédient, pour la préparation de l'opération, d'établir dès maintenant ce document sous une forme encore imparfaite, sans avoir encore l'avis du préfet maritime. J'appelle cependant votre attention sur le fait que le plein effet de cette décision reste subordonné à l'avis de ce haut fonctionnaire.

Je ne manquerai pas de vous tenir informé dès réception de cet avis.

Je vous prie d'agréer, Monsieur, l'expression de ma considération distinguée.

Le Sous-Directeur
de l'Archéologie

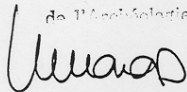

M. GRENIER de MONNER

MINISTÈRE DE LA CULTURE ET DE LA COMMUNICATION

**DIRECTION DE L'ARCHITECTURE
ET DU PATRIMOINE
SOUS-DIRECTION DE L'ARCHEOLOGIE
3, RUE DE VALOIS
75042 PARIS CEDEX 01**

N° :

La ministre de la culture
et de la communication,

VU l'arrangement du 3 octobre 1989 entre le gouvernement de la République française et le gouvernement des Etats-Unis d'Amérique au sujet de l'épave du CSS Alabama ;

VU la loi n° 89-874 du 1^{er} décembre 1989 relative aux biens culturels maritimes ;

VU le décret n° 91-1226 du 5 décembre 1991 pris pour l'application de la loi susvisée ;

VU le décret n° 94-423 du 27 mai 1994 portant création des organismes consultatifs des fouilles archéologiques et relatif à diverses dispositions concernant l'archéologie ;

après avis du conseil national de la recherche archéologique (commission des fouilles sous-marines) en date du 21 février 2000 ;

après avis de M. le préfet maritime de en date du

A R R E T E**Article 1er :**

Monsieur Gordon P. WATTS, Jr pourra procéder à une opération de fouille archéologique sous-marine,
à partir de la date du présent arrêté jusqu'au 31/12/2000.

Sur le site :
Département : Manche
Commune : Cherbourg
Lieu-dit : Epave CSS Alabama
Numéro de site :
Coordonnées géographiques :
■ latitude N 49° 45,17
■ longitude W 01° 41,65
Numéro de la carte marine : 71205
Profondeur : 60 m
Programme : 29 Archéologie navale.

Article 2 : prescriptions générales.

Les recherches sont effectuées sous la surveillance du chef du département des recherches archéologiques sous-marines, qui peut imposer toutes prescriptions qu'il juge utiles pour leur bonne exécution.

Le demandeur est seul responsable de tous les accidents et dégâts qui peuvent se produire lors des travaux.

A la fin de l'année, le titulaire de la présente autorisation adressera au chef du département des recherches archéologiques sous-marines, en double exemplaire, un rapport accompagné des plans et coupes précis des structures découvertes et des photographies nécessaires à la compréhension du texte. Il donnera un inventaire de l'ensemble du mobilier recueilli et signalera les objets d'importance notable. Il indiquera les études complémentaires envisagées et le délai prévu pour la publication.

L'ensemble des documents relatifs à l'opération (notes, photographies, relevés, correspondances, etc.) sera remis au chef du département des recherches archéologiques sous-marines, aussitôt que seront rédigés les rapports, notes ou publications scientifiques sur les recherches effectuées.

Le titulaire de la présente autorisation tiendra régulièrement informé le chef du département des recherches archéologiques sous-marines et ses travaux et découvertes. Il lui signalera immédiatement toute découverte importante de caractère mobilier ou immobilier et les mesures nécessaires à la conservation de ces vestiges devront être prises en accord avec lui.

Article 3

La mise en œuvre du présent arrêté est subordonnée à l'obtention par son titulaire des autorisations prévues par le décret n° 90-277 du 28 mars 1990 et de ses arrêtés d'application.

Article 4 : destination du matériel archéologique découvert.

Le statut juridique et le lieu de dépôt du matériel archéologique découvert au cours de l'opération seront réglés conformément aux dispositions de l'article 2 de la loi n° 89-874 du 1^{er} décembre 1989 susvisée, aux prescriptions du code des domaines et, le cas échéant, aux termes des conventions passées avec les propriétaires des biens culturels maritimes concernés.

Article 5 : prescriptions particulières à l'opération.

Article 6 : le chef du département des recherches archéologiques sous-marines est chargé de l'exécution du présent arrêté.

Fait à Paris, le 27 MARS 1990

Pour le ministre et par délégation,
le sous-directeur de l'archéologie,

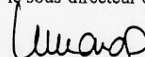
Patrick MONOD

Le plein effet de la présente décision est subordonné à l'avis de M. préfet maritime de la Manche et de la mer du Nord

COPIES A :

Intéressé(e) Préfet de région Mairie(s) Direction régionale des affaires culturelles
 Organisme de rattachement Préfet(s) du(des) département(s) concerné(s) Gendarmerie Sous-direction de l'archéologie
 Propriétaire(s) du(des) terrain(s)