



Department of Defense Legacy Resource Management Program

PROJECT 01-109

Investigation of the Confederate Commerce Raider *CSS Alabama* - 2001

Institute for International Maritime Research, Inc.
CSS Alabama Association
Association *CSS Alabama*

November 11, 2001

THIS REPORT IS UNCLASSIFIED AND MAY BE RELEASED TO THE PUBLIC

Investigation of the Confederate Commerce Raider *CSS Alabama* 2001



***CSS Alabama* Association
P. O. Box 2744
Mobile, Alabama 36652-2744**

**Association *CSS Alabama*
34 Avenue de New York
75116 Paris**

**Investigation of the Confederate Commerce Raider
CSS *Alabama*
2001**

Submitted to:

**Joint French American Scientific Committee
for the *CSS Alabama***

Submitted by:

**Gordon P. Watts, Jr., Ph.D.
Institute for International Maritime Research, Inc.
P. O. Box 2494
Washington, North Carolina 27889**

***CSS Alabama* Association
P. O. Box 2744
Mobile, Alabama 36652-2744**

**Association *CSS Alabama*
34 Avenue de New York
75116 Paris**

11 November 2001

Abstract

During June and July 2001, the American CSS *Alabama* Association and the French Association CSS *Alabama* carried out an archaeological investigation of the remains of the Confederate commerce raider CSS *Alabama*. Under the direction of Dr. Gordon P. Watts Jr., American and French archaeologists, French volunteer divers and French Navy personnel cooperated in an examination of the wreck that took place between 6 June and 4 July. Objectives for the investigation included video and 35mm photographic documentation of the wreck, limited test excavation in the officer's quarters and recovery of selected artifacts exposed on the bottom surface. Unfortunately the most important objective, video and 35mm documentation of the wreck site to generate data that would generate data for the production of a site mosaic and computer model was compromised by unsuccessful efforts to obtain French authorization for use of the U. S. Navy research submarine *NR-1* or a U. S. Navy remote operated vehicle. On site research was limited to test excavation in the officer's quarters and recovery of selected artifacts including one of the two Blakely patent British Royal Navy Pattern 32-pounders carried by the CSS *Alabama*. Test excavation reached a stratigraphic level within the hull that has been undisturbed since the CSS *Alabama* filled with silt in the years following her loss. Below that level of sediment both the wreck structure and associated cultural material appear to survive in an anoxic environment. A number of intact artifacts were recovered including glass storage bottles, ceramic tablewares and a decorated pipe bowl. This limited testing suggests an exceptional degree of preservation below the dynamic layer of shell hash and sand that covers most of the CSS *Alabama*'s remains.

Table of Contents

	Page
Abstract.....	ii
Table of Contents	iii
List of Figures	iv
Introduction	1
Project Authorization	4
Project Organization and Administration.....	4
Synopsis of Previous Research.....	5
Location and Description of the Wreck Site.....	7
2001 Project Objectives.....	14
Description of the Artifacts.....	38
Results of the 2001 Investigation.....	100
Conclusions and Recommendations	102
Appendix A – 1995 Agreement between France and the United States	
Appendix B - Downton Pump Patent	
Appendix C – Ministry of Culture and Communication Permit	

List of Figures

	Page
Figure 1. Remains of the ships wheel.....	2
Figure 2. Location of the CSS <i>Alabama</i> off the Normandy Peninsula.....	7
Figure 3. Example of the sediment covering the wreck.	8
Figure 4. Projection of the surviving hull remains (Guérout, 1994).....	9
Figure 5. Projection of the degree of starboard list (Guérout 1994).....	9
Figure 6. CSS <i>Alabama</i> Site Plan (Guérout, 1992).....	11
Figure 7. Propeller and lifting frame.....	12
Figure 8. Starboard Trotman patent anchor in-situ.	13
Figure 9. Example of mosaic from 2000.....	14
Figure 10. The U. S. Navy research submarine <i>NR-1</i>	15
Figure 11. Deep Ocean Engineering S2of ROV.....	16
Figure 12. Compressor aboard the American research vessel <i>Enrica</i>	17
Figure 13. Diver propulsion vehicle used for excavation.	18
Figure 14. Semmes stands next to the 8-inch smoothbore pivot gun.....	19
Figure 15. Midshipman E. M. Anderson with a British Royal Navy pattern 32-pounder.....	20
Figure 16. The French Navy lift vessel <i>Vulcain</i>	21
Figure 17. One of the GPD vedettes.	22
Figure 18. The American research vessel <i>Enrica</i>	23
Figure 19. Blakely designed British Royal Navy pattern 32-pounder (A. Bowcock).....	23
Figure 20. Design of the Fawcett, Preston & Company 32-pounder (A. Bowcock).....	24
Figure 21. Markers mark on 32-pounder recovered in 2000.....	24
Figure 22. Locations of cannon recovered from the CSS <i>Alabama</i>	25
Figure 23. Recovery of the 32-pounder by the <i>Vulcain</i>	26
Figure 24. Excavations at the base of the pump.	26
Figure 25. Artifacts exposed by excavation at the base of the pump.....	27
Figure 26. Divers load plates in a protective crate.	28
Figure 27. Artifact ALS-251 being transported to Cherbourg.	29
Figure 28. Conservator Catherine Augel documents ALS-257.	30

Figure 29. British Royal Navy pattern 32-pounder being loaded in the shipping crate.....	30
Figure 30. Schematic of the Downton pump (A. Bowcock).....	31
Figure 31. PVC grid in location prior to excavations.....	32
Figure 32. Location of test excavation for 2001.....	33
Figure 33. CNP Dive vessel <i>Little Pocket</i>	34
Figure 34. Sample of grid documentation from video.....	35
Figure 35. Diver excavates in grid using the 4-inch air lift.	35
Figure 36. Archaeologist documents artifacts before recovery.....	36
Figure 37. Container being unloaded in Charleston.....	37
Figure 38. Collection of artifacts exposed on the bottom surface.	38
Figure 39. ALS-235 Hull Fragment with Fastener.....	39
Figure 40. ALS-236 Drift pin with rove.....	40
Figure 41. ALS-237 Drift pin with rove.....	41
Figure 42. ALS-238 Scupper with fasteners.....	42
Figure 43. ALS-239 Small jar.....	43
Figure 44. ALS-240 Plate with blue design.....	44
Figure 45. ALS-241 Lock.	45
Figure 46. ALS-242 Square Bottle.....	46
Figure 47. ALS-243 Gravy Boat.	47
Figure 48. ALS-244 Ironstone Plate Fragment with Brown Design.....	48
Figure 49. ALS-245 Ironstone Plate Fragment with Brown Design.....	49
Figure 50. ALS-246-1 Ironstone Plate with Brown Design.....	50
Figure 51. ALS-246-2 Ironstone Plate with Brown Design.....	51
Figure 52. ALS-246-3 Ironstone Plate with Brown Design.....	52
Figure 53. ALS-246-4 Ironstone Plate with Brown Design.....	53
Figure 54. ALS-247-1 Ironstone Soup Bowl with Brown Design.	54
Figure 55. ALS-247-1 Ironstone Soup Bowl with Brown Design.	55
Figure 56. ALS-247-1 Ironstone Soup Bowl with Brown Design.	56
Figure 57. ALS-247-1 Ironstone Soup Bowl with Brown Design.	57
Figure 58. ALS-247-1 Ironstone Soup Bowl with Brown Design.	58
Figure 59. ALS-247-1 Ironstone Soup Bowl with Brown Design.	59
Figure 60. ALS-247-1 Ironstone Soup Bowl with Brown Design.	60

Figure 61. ALS-247-1 Ironstone Soup Bowl with Brown Design.	61
Figure 62. ALS-247-1 Ironstone Soup Bowl with Brown Design.	62
Figure 63. ALS-248 Fragment of plate glass.....	63
Figure 64. ALS-249 Undetermined material on wreck.....	64
Figure 65. ALS-250 White Plate.....	65
Figure 66. ALS-251 Fire Nozzle, Box, and artifacts in concretion.....	66
Figure 67. ALS-252 Wood fragment.	67
Figure 68. ALS-253 Wall Mount.....	68
Figure 69. ALS-254 a and ALS-254 b Fragments of Plate.....	69
Figure 70. ALS-255 Fragment of Plate.....	70
Figure 71. ALS-256 White plate.....	71
Figure 72. ALS-257 Pipe Bowl.....	72
Figure 73. ALS-258 Boiled Egg Cup.....	73
Figure 74. ALS-259 Wooden Disc.	74
Figure 75. ALS-260 Ironstone Soup Bowl with Cobalt Blue Design.....	75
Figure 76. ALS-261 Ironstone Plate with Cobalt Blue Design.	76
Figure 77. ALS-262 White Plate.....	77
Figure 78. ALS-263 Piece of glass.....	78
Figure 79. ALS-264 Davenport Mug.....	79
Figure 80. ALS-265 Drift Pin with Rove and Wood.....	80
Figure 81. ALS-266 Cannon Pivot with wood and fasteners.	81
Figure 82. ALS-267 Copper Spike.....	82
Figure 83. ALS-268 Handle.....	83
Figure 84. ALS-269 Broken Glass.....	84
Figure 85. ALS-270 Broken Glass.....	85
Figure 86. ALS-271 Broken Glass.....	86
Figure 87. ALS-272 Broken Glass.....	87
Figure 88. ALS-273 Plate Fragment.	88
Figure 89. ALS-274 Sheet Copper.	89
Figure 90. ALS-275 Ironstone Soup Bowl with Green Design.....	90
Figure 91. ALS-276 a and ALS-276 b Ironstone Soup Tureen with Lid.....	91
Figure 92. ALS-277 Ironstone Plate with Green Design.....	92
Figure 93. ALS-278 Broken Bottle.....	93

Figure 94. ALS-279 Decanter.	94
Figure 95. ALS-280 Bottle with cork inside.	95
Figure 96. ALS-281 Bottle.	96
Figure 97. ALS-282 White ceramic pitcher.	97
Figure 98. ALS-283 Wood and copper fragment.	98
Figure 99. ALS-284 British Royal Navy Pattern 32-Pounder Cannon.	99

Introduction

The French Navy mine hunter *La Circe* discovered the wreck of the Confederate commerce raider *CSS Alabama* in 1984. Captain Max Guérout, then on active duty, undertook identification of the wreck at the request of the French Navy. His research confirmed that the vessel was indeed the Confederate commerce raider. Announcement of the location of the *CSS Alabama* led to diplomatic negotiation between France and United States that subsequently resulted in an executive agreement concerning ownership and management of the wreck. The Executive Agreement of 3 October 1989 also established the framework for authorization and supervision of scientific investigation of the Confederate vessel. Guérout's research and identification of the wreck as the *CSS Alabama* also led to the founding of the French non-profit Association *CSS Alabama*. As a consequence of requests to continue on-site research, France as the territorial power of the wreck site, and the United States of America as the owner of the wreck and its associated artifacts, jointly authorized the Association *CSS Alabama* to undertake additional investigations at the wreck site in 1988.

The 1988 investigation of the *CSS Alabama* was organized around a cadre of volunteer divers, archaeologists and historians working in conjunction with Captain Guérout. Location of *Alabama's* wheel, with the ship's motto "Aide-toi et Dieu t'aidera" provided absolute identification of the wreck (Figure 1). Data from the 1988 expedition facilitated the development of plans for volunteer diver supported research projects conducted by the Association *CSS Alabama* in 1989, 1990, 1991, 1992, 1993, 1994, 1995 and 1996. Captain Guérout served as Principal Investigator and each investigation was authorized according to the terms of the 1989 Executive Agreement. Funding for the research carried out between 1988 and 1996 was raised almost entirely in France. Those investigations resulted in a complex plan of the wreck and the recovery of an important collection of approximately 200 objects, including: the wheel, several flushing toilets with transfer-printed ceramic bowls, and a variety of plates, glasses, salt cellars, and other galley and tableware, deck tracks for the vessel's ordnance trucks, a pivot carriage and a heavy Blakely rifled cannon.

In 1999, after a two-year hiatus in field research, investigation of the wreck resumed under the joint sponsorship of the French Association *CSS Alabama* and a newly formed American sister organization, the American Association of the Friends of *CSS Alabama*. Principal funding for projects in 1999 and 2000 was provided by



Figure 1. Remains of the ships wheel.

grants from the U. S. Department of Defense Legacy Resource Management Project. Those funds were channeled through the American Association of the Friends of *CSS Alabama*. The Alabama Power Foundation, the City and County of Mobile, Alabama, members of the Association of the Friends of *CSS Alabama* and the City of Cherbourg, France, provided additional funding. Dive equipment used by the American archaeologists was generously provided by Scubapro, Inc. In 2000, the American Association of the Friends of *CSS Alabama* and the Naval Historical Center entered into a Memorandum of Agreement with the Institute for International Maritime Research, Inc. (IIMR), a Washington, North Carolina based 501 (c) (3) corporation to plan, organize and conduct the field research. IIMR planned, organized and supervised research at the wreck site during the summers of 2000 and 2001.

The 1999 field research was designed to determine if significant changes had occurred at the wreck site and to collect data to support planning more complex and extensive on-site investigation. That reconnaissance was performed on 19 and 21 June 1999 under the direction of Principal Investigator Dr. Gordon. P. Watts, Jr. Based on the 1999 reconnaissance, a more complex investigation of the *CSS Alabama* was organized for the summer of 2000. Under the direction of Dr. Watts, American and French archaeologists, French volunteer divers and French Navy personnel cooperated in an examination of the wreck that took place between 19 June and 16 July.

Objectives for the 2000 investigation ultimately focused on documentation of the wreck site using underwater video, continuation of test excavation previously carried out within the surviving hull in the stern and recovery of selected artifacts. The video data generated was used to test new electronic methods of mosaic construction. Limited test excavations were also undertaken within the hull aft, at the base of the propeller and at the location of the stern pivot gun. Excavation was also to be undertaken at the site of the aft fire pump and the starboard Trotman patent anchor. In addition to recovering artifacts and data that would shed light on life aboard the CSS *Alabama*, the test excavation was to be designed to generate information on the nature and scope of the archaeological record within the surviving hull structure. Although weather and equipment problems complicated on-site research activity, the investigation generated new information about the wreck and additional insight into conducting work on the site.

Based on the work carried out in 2000, objectives for operations in 2001 were focused on documentation of the exposed wreck structure, test excavation and recovery of selected and “at risk” artifacts. Documentation of the wreck structure was to be based on use of the U. S. Navy research submarine *NR-1* and a U. S. Navy remote operated vehicle (ROV). Unfortunately, authorization for use of the *NR-1* and ROV could not be obtained from the French government and the primary research objective had to be abandoned. Without data from the proposed *NR-1* and ROV surveys, the focus of on site activity was shifted to excavation and artifact recovery. A test excavation in the stern produced a number of interesting artifacts and new information concerning the nature, scope and degree of preservation of the archaeological record within the CSS *Alabama*'s surviving hull structure. Efforts to recover the aft pump were again suspended until a better understanding of the methods of attachment could be determined. With assistance from the French Navy one of the *Alabama*'s two Blakely patent British Royal Navy pattern 32-pounders was recovered.

Research at the wreck site was carried out between 4 June and 4 July 2001. American archaeologists Gordon P. Watts, Jr., John W. Morris III, Steve Brodie and Mark Padover and French volunteers Jean Loup and Pasquale Rapilly worked from the American flag vessel *Enrica*. French volunteers under the direction of Joe Guesnon and Michael Chapron worked from the French vessel *Little Pocket*. French Navy divers operated from the one of several vedettes and the *Vulcain*. Diving operations were scheduled during periods of low tidal coefficients from 9 to 19 June and from 27 June to 2 July. Gordon P. Watts, Jr., Steve Brodie, Mark Padover, Robin Arnold and Raymond Tubby carried out preparation of this report.

Project Authorization

The remains of the CSS *Alabama* are the property of the United States of America and the management responsibility of the U. S. Naval Historical Center in Washington, D. C. The wreck lies in French territorial waters and, as an underwater archaeological resource, falls under the administration of the Ministry of Culture. By mutual agreement between the United States and France, all on-site research activity requires authorization from both the Naval Historical Center, representing the present owner, and the Ministry of Culture, representing the territorial authority. The 2001 investigation of the CSS *Alabama* was performed according to the terms of authorizations from both the Naval Historical Center and the French Ministry of Culture. The joint American-French Scientific Committee, formed to make management and research recommendations for the CSS *Alabama*, reviewed and approved the project research design.

Project Organization and Administration

The 2001 investigation of the CSS *Alabama* was organized and conducted by the United States CSS *Alabama* Association and the French Association CSS *Alabama*. Under the direction of its president, Dr. Ulane Bonnel, the French Association CSS *Alabama* was responsible for obtaining all of the necessary permits for on-site research from the Ministry of Culture and all of the required authorizations from naval and civilian authorities in Cherbourg. The Association CSS *Alabama* also negotiated use of the CNP dive boat and facilities, coordinated the activities of the French volunteer divers and the surface assistance personnel and arranged insurance for the boat and all operational personnel, including the American archaeologists. The French Association CSS *Alabama* also negotiated participation of the French Navy. That participation resulted in the authorization of Navy divers to assist with on-site research and approval for the use of navy equipment and vessels.

The CSS *Alabama* Association, under the direction of its president, Mr. Robert Edington of Mobile, Alabama, obtained Legacy Grant and privately donated funds to support the 2001 research project. The CSS *Alabama* Association also coordinated activities in the United States and supported the production of a newsletter to make project research activities public. That organization also entered into an agreement with the Naval Historical Center and the Institute for International Maritime Research, Inc., of Washington, N. C., to carry out the 2001 on-site investigations.

Under that Memorandum of Agreement, IIMR worked in conjunction with the French and American associations and the Naval Historical Center, to plan, organize and conduct on-site research activity. Under the direction of the president, Dr.

Gordon P. Watts, Jr., Institute personnel developed plans for the 2001 investigation, identified and organized the American underwater archaeological team and directed and supervised the on-site research activity. IIMR personnel also prepared this report on 2001 project research activity.

Dr. Gordon Watts, an underwater archaeologist and member of both the American and French organizations, served as the project's principal investigator. Archaeologists John William Morris, Steve Brodie, and Mark Padover comprised the American research team. Brodie and Padover worked with Watts to analyze the data and prepare the project report. Joë Guesnon assisted with project organization and provided coordination with the French dive club, Cherbourg Natation Plongée. Michael Chapron was responsible for diving safety and provided technical direction and coordination with the Cherbourg Natation Plongée, whose dive boat, *Little Pocket*, and other facilities were contracted for by the French Association.

Contre-Amiral Lagane and later Contre-Amiral Meier authorized French Navy participation in the 2001 campaign. Both Lagane and Meier served as Prefect Maritime of the Channel and North Sea during the planning and conduct of 2001 operations and coordination with their offices was carried out by Dr. Ulane Bonnel. Dr Bonnel was also responsible for coordinating all necessary French permit applications for the *NR-1* and ROV operations as well as providing proper field conservation facilities. Diving operations of the Groupe des Plongeurs-Demineurs de la Manche (GPD) were directed by Lieutenant de Vaisseau François Hurel. Lt. Michael Bruneau, USN on assignment to the GDP, served as coordinator for French Navy activities.

Synopsis of Previous Research

The wreck of the *Alabama* was discovered in November of 1984 by Lieutenant Commander Bruno Duclos of the French Navy minesweeper *Circe*. The French Navy had been searching for the wreck for a number of years as part of their training regimen for sonar operators. Duclos dispatched divers who returned to the surface with confirmation of a wooden hull, iron machinery, and English china. Commander Max Guérout was immediately called to verify the ship's identity. Based on comparison of the material observed and recovered from the wreck site with historical data, Guérout later concluded that this was almost certainly the wreck of the Confederate commerce raider CSS *Alabama*.

The first archaeological investigation of the remains of the CSS *Alabama* was undertaken in 1988 under the direction of Commander Guérout. Data from the 1988 expedition facilitated the development of plans for diver supported research projects conducted by

the Association CSS *Alabama* in 1989, 1990, 1991, 1992, 1993, 1994, 1995 and 1996, all duly authorized according to the terms of the Executive Agreement of 3 October 1989. That research has resulted in a complex plan of the wreck and the recovery of an important collection of approximately 200 artifacts, including; the wheel, several flushing toilets with transfer printed ceramic bowls, and a variety of plates, glasses, salt cellars, and other galley and tableware, deck tracks for the vessel's ordnance trucks, a pivot carriage and the large Blakely rifled pivot cannon. Reports documenting projects undertaken between 1988 and 1996 were prepared and submitted by Max Guérout.

In 1999, after a two-year hiatus in field research, a reconnaissance investigation of the wreck was organized and carried out by the Association CSS *Alabama*, with the cooperation of the Association of the Friends of CSS *Alabama*, an American sister organization. Field research was designed to determine if significant changes had occurred at the wreck site and to collect data to support planning more complex and extensive on-site investigation. That reconnaissance was performed on 19 and 21 June 1999.

Based on the 1999 reconnaissance, a more complex investigation of the CSS *Alabama* was organized for the summer of 2000. Under the direction of Dr. Watts, American and French archaeologists, French volunteer divers and French Navy personnel cooperated in an examination of the wreck that took place between 19 June and 16 July. On site operations during the summer of 2000 were ultimately focused on documentation of the wreck site using underwater video, continuation of test excavation previously carried out within the surviving hull in the stern and recovery of selected artifacts. In spite of a variety of problems, limited video documentation of the exposed wreck structure was accomplished. The video data generated was used to test new methods of mosaic construction. In addition to recovering artifacts and data that would shed light on life aboard the CSS *Alabama*, test excavation was to be designed to generate information on the nature and scope of the archaeological record within the surviving hull structure. Limited excavations were also undertaken at the base of the propeller and at the location of the stern pivot gun. Those excavations were designed to help determine if the propeller and lifting frame remain attached to the keel and deadwood and if the pivot gun is still associated with its carriage and truck. Excavation was also to be undertaken at the site of the aft fire pump to clear it for documentation and recovery. While recovery of the starboard Trotman Patent anchor and the aft fire pump were not possible, one of the 32-pounder Blakely patent cannon was raised.



(IMAGE SHOWING LOCATION INFORMATION REMOVED FROM PUBLIC VERSION / CIRCULATION COPY)

Figure 2. Location of the CSS *Alabama* off the Normandy Peninsula.

Location and Description of the Wreck Site

Wreckage of the CSS *Alabama* lies in the channel off the Normandy Peninsula (Figure 2). The site is approximately 5.5 miles (8.9 km) offshore of Nacqueville and 6 miles (9.7 km) north-northeast of Cherbourg Fort de L'Ouest. [Geographical coordinates for the wreck location are not provided in circulation copies of the report].



Figure 3. Example of the sediment covering the wreck.

The remains of the *Alabama* lie in approximately 61 meters (190 feet) of water. That depth makes work at the site both complex and hazardous. While water temperatures increase above 40 degrees Fahrenheit (5°C) in the summer, the cold adds measurably to the risks associated with the conduct of on-site research. Visibility was observed as variable with ranges from virtually zero to approximately 65 feet (20 m). Currents at the site pose the most complex obstacle. During the tidal cycle, water flow over the wreck reaches four knots. In addition to restricting on-site research activity, currents have had an important effect on the wreck. The *Alabama* lies on a hard bottom consisting of rocks, pebbles, shell hash and sand (Figure 3). This has limited scour settling of the wreck and with the exception of sand and shell deposited within and around the wreck, most of the hull remained exposed to the elements. This highly dynamic bottom has contributed to the deterioration of exposed structural material. During the 1988 project, more than a meter of bottom surface sediments, mostly shell hash, were observed to migrate rapidly away from the wreck and return. In this highly abrasive environment, the *Alabama's* exposed hull remains, already weakened by biological activity, have deteriorated to the level of the bottom surface.

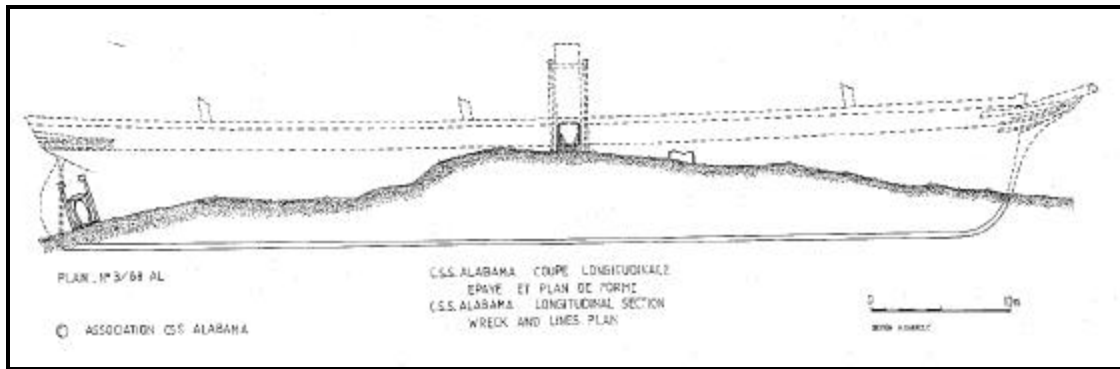

Figure 4. Projection of the surviving hull remains (Guérout, 1994).

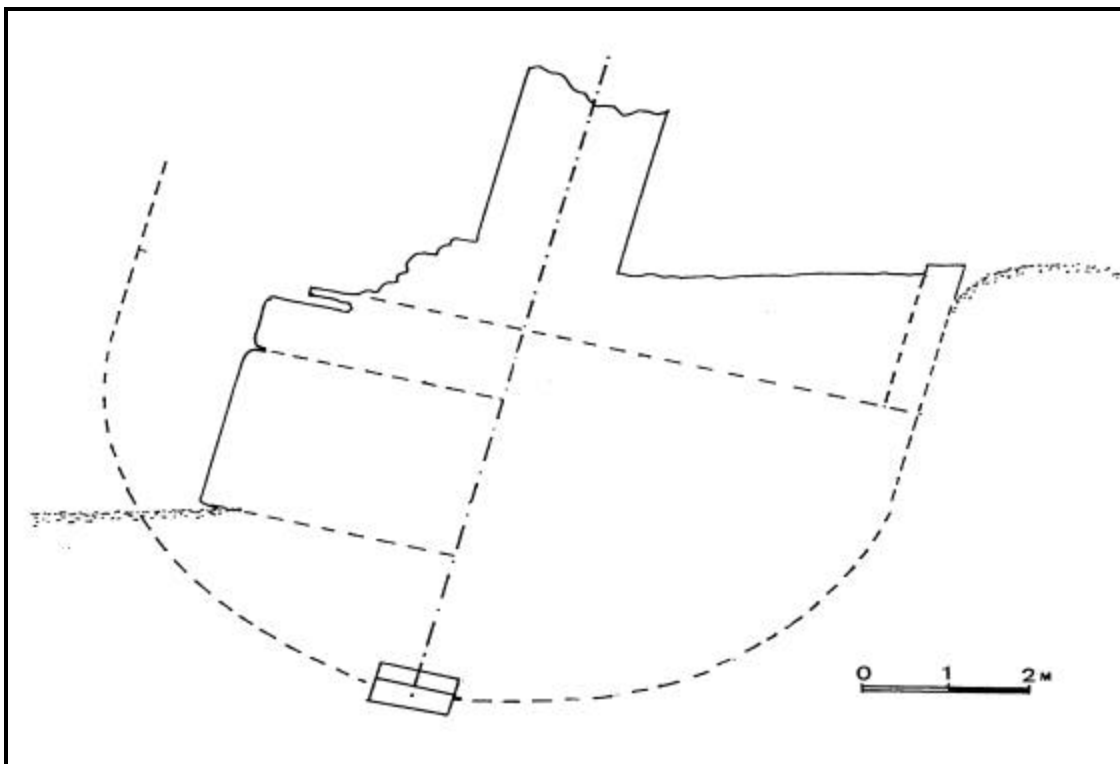

Figure 5. Projection of the degree of starboard list (Guérout 1994).

Only the unexposed lower hull and portions of the starboard side of the *Alabama* survive intact (Figure 4). The hull lists approximately 30 degrees to starboard and is oriented perpendicular to the prevailing current pattern (Figure 5). Depth measurements taken by the divers and submersible, precision depth recorder profiles, and observations at the site confirm that sediment consisting of shell hash,

pebbles, and sand has accumulated within and around the *Alabama* to a depth of almost three meters. The major accumulation of material is amidships and is probably a result of the *Alabama's* machinery and boilers. Amidships, the port side of the hull is exposed to the approximate position of the turn of the bilge while the starboard side could survive to the approximate location of the weather deck clamp. Toward the stern, the depth of the deposit rapidly decreases to the approximate level of the propeller shaft. At the stern, a little less than half of the propeller is exposed along with its brass lifting frame. No evidence of the stem was observed making it difficult to determine the amount of sediment accumulation forward. It is also possible that the hull may not lie on an even keel fore and aft and the amount of surviving structure is considerably less. Very little of the surviving hull structure is exposed at the site. The majority of exposed hull fabric is on the starboard side amidships and adjacent to the boilers.

A preliminary site map was prepared by Guérout and the ASAM divers in 1988 and has been improved by subsequent investigations (Figure 6). To control mapping, a baseline was deployed from the propeller in the stern to the approximate location of the stem. Using the baseline as a reference, exposed wreck structure and associated material was recorded. The most dominant structural features of the wreck were found to be the boilers and smoke pipe, sections of the hull amidships, and propeller and elevating frame. The partially exposed port boilers each measured approximately 20 feet (6 m) in length and 10 feet (3 m) in height. Their shape is rectangular and each is connected to the smoke pipe by a common flue system.

Although most of the hull of the *Alabama* has been destroyed by the elements, sediment accumulating in the vicinity of the steam machinery appears to have preserved a portion of the starboard side of the ship. Adjacent to the boilers the starboard hull could survive up to the level of the weather deck clamp. Although the 30° list documented by divers suggests that more of the starboard side of the ship may be preserved fore and aft of the machinery, it does not appear to be much beyond the turn of the bilge. In the stern the exposed propeller and elevating frame confirm that the hull has deteriorated to the level of the propeller shaft and hub. Forward of the machinery, perhaps even less hull fabric remains.

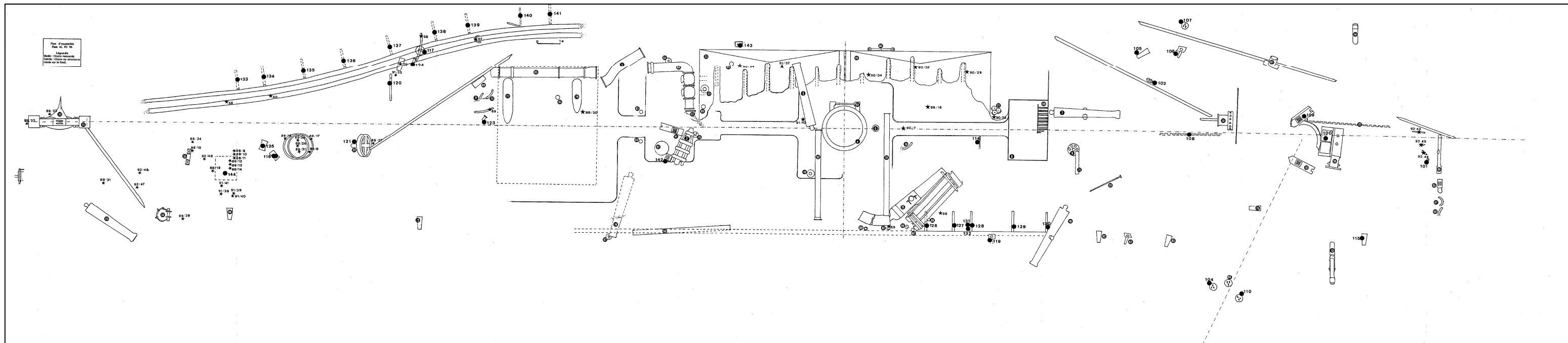

Figure 6. Site Plan of the CSS *Alabama* prepared by Max Guerot.



Figure 7. Propeller and lifting frame.

The propeller identified the stern of the Alabama. A single blade of the brass propeller and the top of its lifting frame are exposed above the bottom surface (Figure 7). While no evidence of the bow was identified, portions of two Trotman's patent anchors confirm its proximity. One anchor lies along the starboard extremity of the hull structure and the second lies to port of the wreck (Figure 8). Development of the site plan also revealed the iron main mast step, a capstan, several sets of bitts, a hawse hole throat, and anchor chain. Three unique toilets were also found in the vicinity of the ship's engineering space. Each contained an English porcelain bowl with a transfer-printed scene inside.

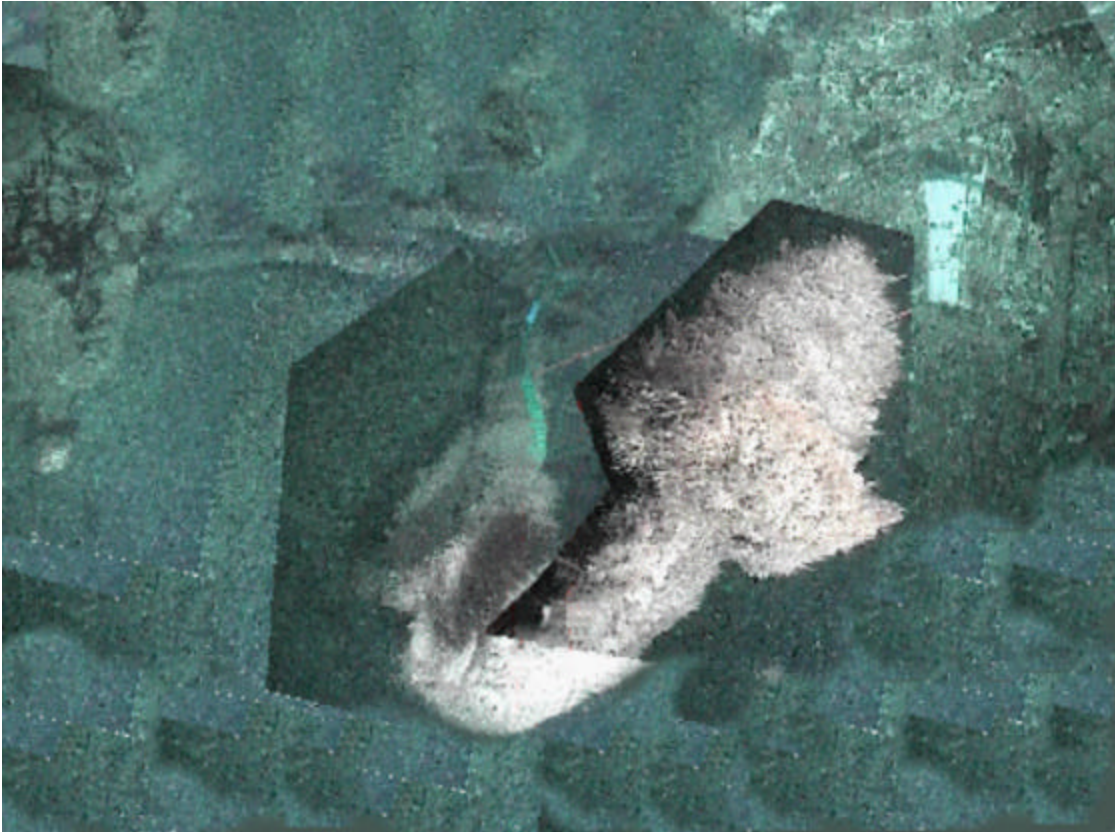

Figure 8. Starboard Trotman patent anchor in-situ.

Six heavily concreted pieces of ordnance were identified during the investigation. The largest one immediately forward and starboard of the smoke pipe remained associated with its truck. A second cannon was identified immediately forward and to starboard of the propeller. Thirty feet (10 m) forward of the propeller and starboard of the two brass reinforcing rings from the ship's steering wheels, the muzzle of a third cannon was identified. Immediately aft and to port of the smoke pipe, a fourth gun tube rested on the after port boiler. The remaining two guns were found approximately ten meters forward of the smoke pipe. One was located on the approximate centerline of the vessel and the other adjacent to the ship's starboard side. In addition to cannon, the site contained shot, gun truck wheels, and brass tracks for the gun carriages.

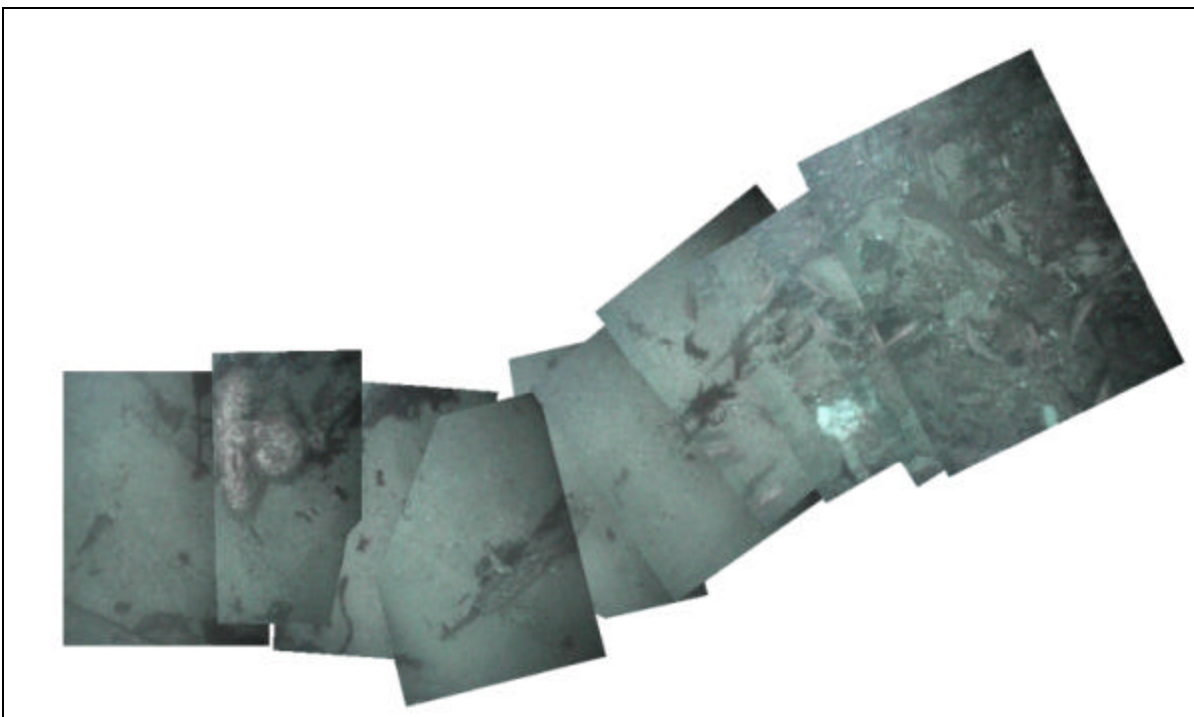

Figure 9. Example of mosaic from 2000.

2001 Project Objectives

Initial work on the photo mosaic site map following the 2000 investigation revealed the limitations of a diver based system for gathering this type of data. Without a more systematic geo-referenced method of documentation, the mosaic could not be properly scaled without an on-site reference web (Figure 9). Completion of the photo mosaic site map employing the U.S. Navy nuclear research submarine *NR-1* and U. S. Navy ROV became the primary focus for the 2001 field season. Secondary objectives included test excavation in the stern of the vessel, documentation and recovery of the 8 inch pivot gun, documentation and recovery of a British Royal Navy pattern 32-pounder gun, documentation and recovery of the aft fire pump, and documentation and recovery of all small “at risk” artifacts.

The first objective of on-site research during the 2001 field season was to be documentation of the vessel structure and associated cultural material exposed at the wreck site. Initial documentation of the wreck site was to be accomplished using a high-resolution digital side scan sonar aboard the *NR-1* research submarine (Figure 10). The sonar was to be interfaced with a differential global positioning system (DGPS) and a computer equipped with survey software to control vessel positioning and data collection. An electronic grid was to be developed to cover the remains of the *CSS Alabama* and the bottom surface surrounding the wreck site.



Figure 10. The U. S. Navy research submarine *NR-1*.

Acoustic data would be systematically collected using DGPS positioning. The sonar images would provide a highly detailed image of the exposed wreck structure and any previously unidentified remains in the immediate vicinity of the hull. That imagery was to be used to enhance the site map and identify additional exposed wreckage for diver identification and assessment.

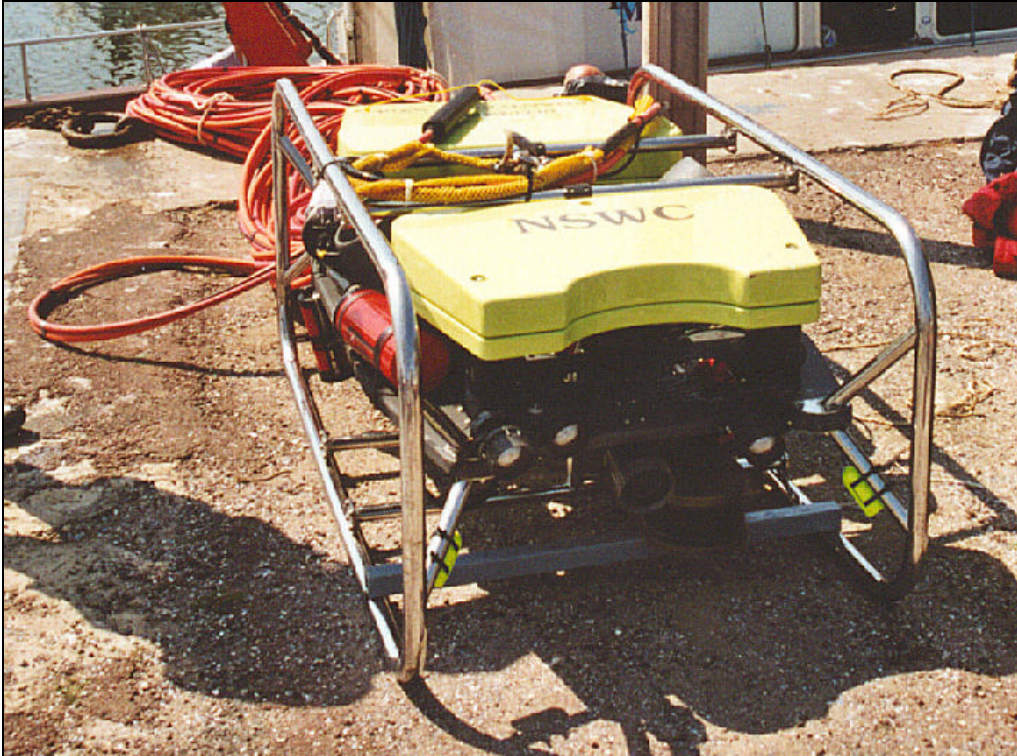

Figure 11. Deep Ocean Engineering S2of ROV.

NR-1 documentation of the wreck was also to include complete video and photographic recording of the exposed wreck structure. The video and photographic imaging was also to be interfaced with DGPS and a computer equipped with survey software to record vessel positioning and control image collection. The same electronic grid employed during the sonar survey was to be used for recording the wreck with video and photography. Images of the wreck would be electronically transformed into a seamless mosaic. That mosaic would provide the detailed data necessary to develop a three-dimensional computer model of the entire site.

In the event that the *NR-1* survey of the wreck site was compromised by weather or emergency rescheduling, arrangements were made to employ a U. S. Navy ROV to document the CSS *Alabama*'s remains. The Deep Ocean Engineering S2of ROV was to be in France to support the Naval Historical Center's survey of World War II shipwrecks and submerged cultural resources associated with the Normandy Invasion (Figure 11). The end of that survey was to correspond with the no-diving period at the CSS *Alabama* site. The ROV would be operated from the American research vessel *Enrica* and employ both video and photography to document the exposed wreck structure. A baseline web deployed at the wreck would control data collection.



Figure 12. Compressor aboard the American research vessel *Enrica*.

On-site operations proposed for 2001 also included continuation of the test excavation previously begun within the surviving hull in the stern. The excavation was to be accomplished using 4inch airlifts. Power for the airlifts was to be provided by a high-volume, low-pressure rotary compressor aboard the American research vessel (Figure 12). Excavation was to be controlled by a grid constructed of ridged or non-ridged material such as aluminum or PVC. Documentation of the excavation and recording of material exposed by excavation was to be accomplished by video, photography and either electronic or mechanical triangulation. Material recovered from the test excavation would be documented *in situ*, placed in containers for transportation to the surface, cataloged, documented and packaged for shipment to the Naval Historical Center for conservation.

In addition to recovering artifacts and data designed to shed light on life on the CSS *Alabama*, the excavation was to be designed to generate information on the nature and scope of the archaeological record within the hull structure. Perhaps the most significant issues associated with investigation of the remains of the *Alabama* regard how much of the hull structure survives below the bottom surface and what is the nature and extent of the archaeological record preserved within that structure. Data



Figure 13. Diver propulsion vehicle used for excavation.

from limited previous excavation suggests that preservation below the shell hash is excellent with intact features and associated artifacts with undisturbed provenience. Additional test excavation would also generate data concerning the difficulties of working in the dynamic environment of the *CSS Alabama*. Previous excavation has already illustrated some of the problems associated with diver time on site and the impact of currents on excavation stability. The proposed excavation would, for the first time, employ a much more powerful and effective means of sediment removal and, if possible, utilize an aluminum or sand-filled fabric structure to isolate the excavation from the currents and migrating shell hash.

Based on information from the *NR-1* video and photographic documentation and limited temporary removal of bottom surface shell hash, an effort would be made to identify a second area of test excavation in the bow of the wreck. In one or more areas identified in the site plan and documented by additional video and photography, shell hash was to be removed using airlifts or diver propulsion vehicle adapted prop wash systems (Figure 13). Evidence of the stem and hull remains that define the bow was to be located and identified using fiberglass rods. If possible,

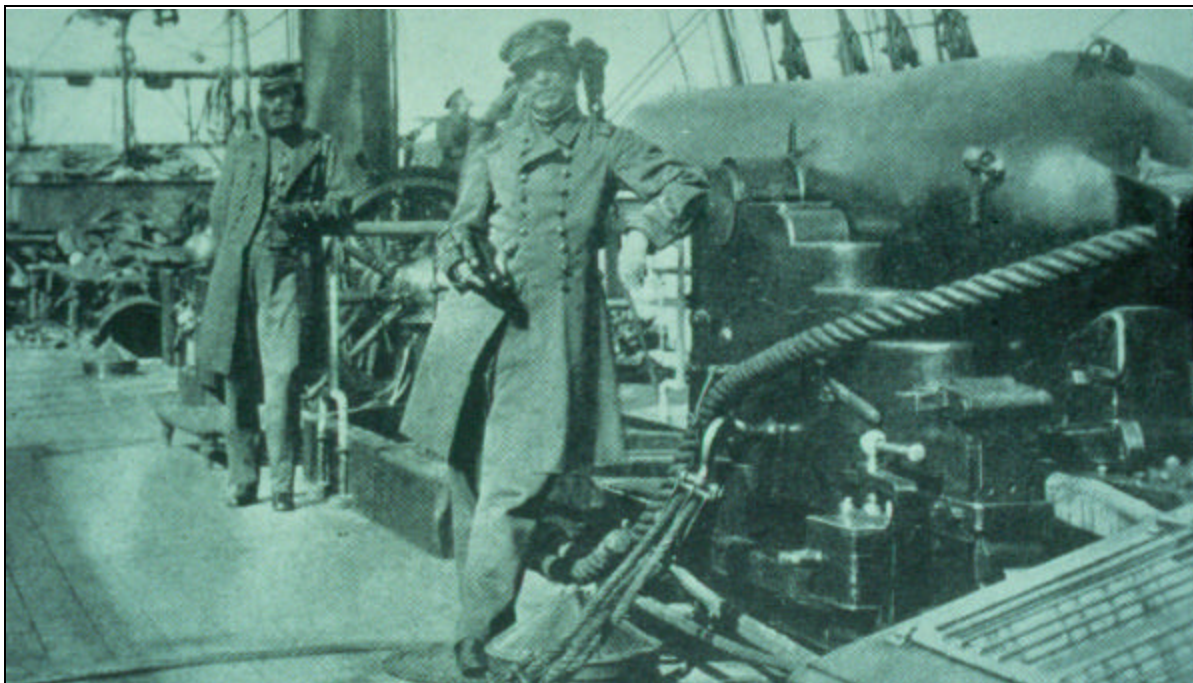

Figure 14. Semmes stands next to the 8-inch smoothbore pivot gun.

the area of the crew's quarters in the fo'c'sle would be identified and the site of a proposed test excavation isolated by one of the sand filled fabric structures. That structure was to be left in place to determine if it will be effective in long term efforts to isolate areas of the wreck from migrating shell hash.

During the 2001 campaign, limited excavations were also to be undertaken at the base of the propeller and at the location of the stem pivot gun. Those excavations were to be designed to determine if the propeller and lifting frame remain attached to the keel and deadwood and if the pivot gun is still associated with its carriage and truck. That information would be essential to formulating plans for recovery of both those items. Excavation was also to be continued at the site of the aft fire pump. That excavation was to be designed to clear the pump for further documentation and, if possible, recovery.

Recovery of several large artifacts was planned in conjunction with fieldwork during the summer of 2001. Artifacts identified for recovery were the aft fire pump, the aft 8-inch smoothbore pivot gun (Figure 14) and associated carriage, and one or more of the Blakely patent British Royal Navy pattern 32-pounders (Figure 15) and possibly their trucks. After thorough documentation, recovery was to be accomplished using lift bags or a combination of lift bags and lifting equipment aboard the surface support platform. Like material recovered from the test excavation, large objects were to be documented *in situ*, prepared for transportation to the surface, raised, cataloged, documented and packaged for shipment to conservation facilities in Charleston, South Carolina.

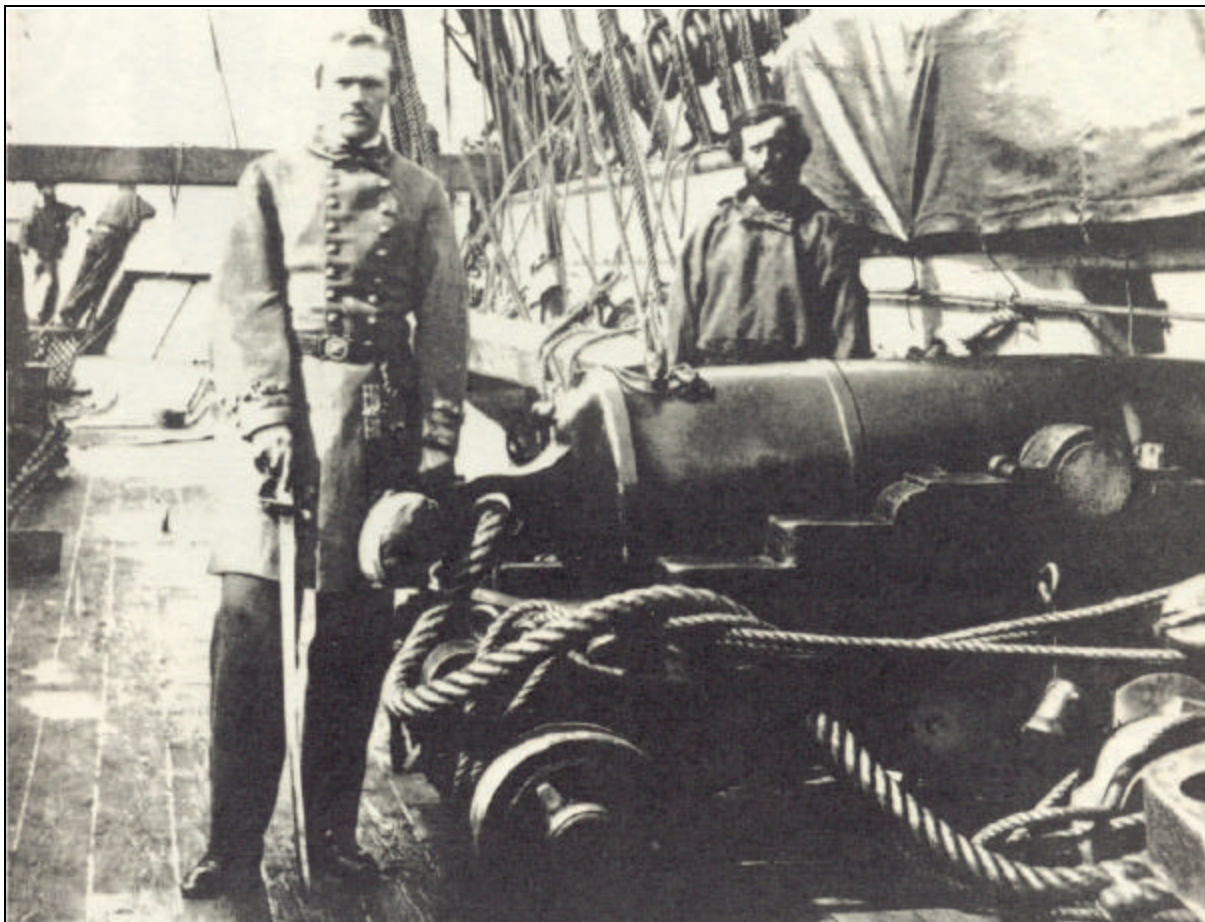

Figure 15. Midshipman E. M. Anderson with a British Royal Navy pattern 32-pounder.

Description of On-site Research Activity

The first on-site operations scheduled for the 2001 field season were those of the U. S. Navy research submarine *NR-1*. Unfortunately, French authorization for *NR-1* documentation of the *CSS Alabama* could not be obtained. While the submarine and her tender were enroute to Normandy, failure to obtain French permission for the proposed operations compelled rescheduling of the vessel. The *CSS Alabama* survey was cancelled and the *NR-1* proceeded to other missions in the Mediterranean. Failure to obtain approval for the *NR-1* survey effectively eliminated any possibility of accomplishing the most important objective of the 2001 investigation; conduct of the GPS controlled sonar, video and photographic documentation survey.



Figure 16. The French Navy lift vessel *Vulcain*.

However, the U. S. Navy ROV operation was still scheduled. Unfortunately as the time approached for conducting those operations, it became apparent that the American research vessel was only marginally capable of supporting the ROV. The decision was made to employ the British vessel *Genesis*, previously utilized by the Naval Historical Center for their ROV survey of submerged cultural resources off the D-day beaches. Last minute attempts to obtain authorization for use of a different support vessel brought the ROV operation to the attention of the French Navy and approval for use of the underwater vehicle and the alternate support vessel was denied.

Without data from the proposed video and photographic documentation, on-site research was refocused on the secondary objectives. Diving operations at the CSS *Alabama* site were scheduled to take place during the most ideal tidal coefficients from June 8 through June 16 and from June 24 through July 2. On-site investigation was initiated by relocating the wreck and placing reference buoys on one of the 32-pounder cannon near the stern and the telescoping stack forward. Divers from the GPD and French volunteers accomplished that work on 6 and 7 June. Those buoys provided references for currents over the wreck and down lines for divers. French Navy divers operated from the lift vessel *Vulcain* (Figure 16) and one of several 60-foot (18 m) vedettes (Figure 17).



Figure 17. One of the GPD vedettes.

Because of the limited availability of the French Navy divers and the vessel *Vulcain*, documentation and recovery of one of the Blakely patent British Royal Navy pattern 32-pounders, the aft fire pump and the stern pivot gun were scheduled as the first on-site activities. In order to make all the heavy lifts while the *Vulcain* was available, French divers and American archaeologists immediately began excavations to clear the 8 inch pivot gun and expose the base of the fire pump to clear the way for their recovery (Figure 5). Excavation was carried out using an airlift powered by a rotary compressor aboard the American research vessel *Enrica* (Figure 18). Other American archaeologists focused their attention on identifying one of the British Royal Navy pattern 32-pounders for recovery.

Historical research confirmed that the CSS *Alabama* carried six 32-pounders. Two of those were Blakely designed British Royal Navy pattern guns (Figure 19) and the remaining four were a more modern Blakely design (Figure 20) specifically cast for the CSS *Alabama* by Fawcett, Preston & Company. Historical photographs and research carried out by Andrew Bowcock helped archaeologists identify one of those for recovery in 2000. Subsequent examination of that 32-pounder confirmed it had indeed been produced by Fawcett, Preston & Company in Liverpool (Figure 21). Bowcock's research and historic photographs of the CSS *Alabama* provided design criteria that made it possible for archaeologists to identify the heavily concreted British Royal Navy pattern guns at the site (Figure 22). One of those was selected for recovery by the *Vulcain*.



Figure 18. The American research vessel *Enrica*.

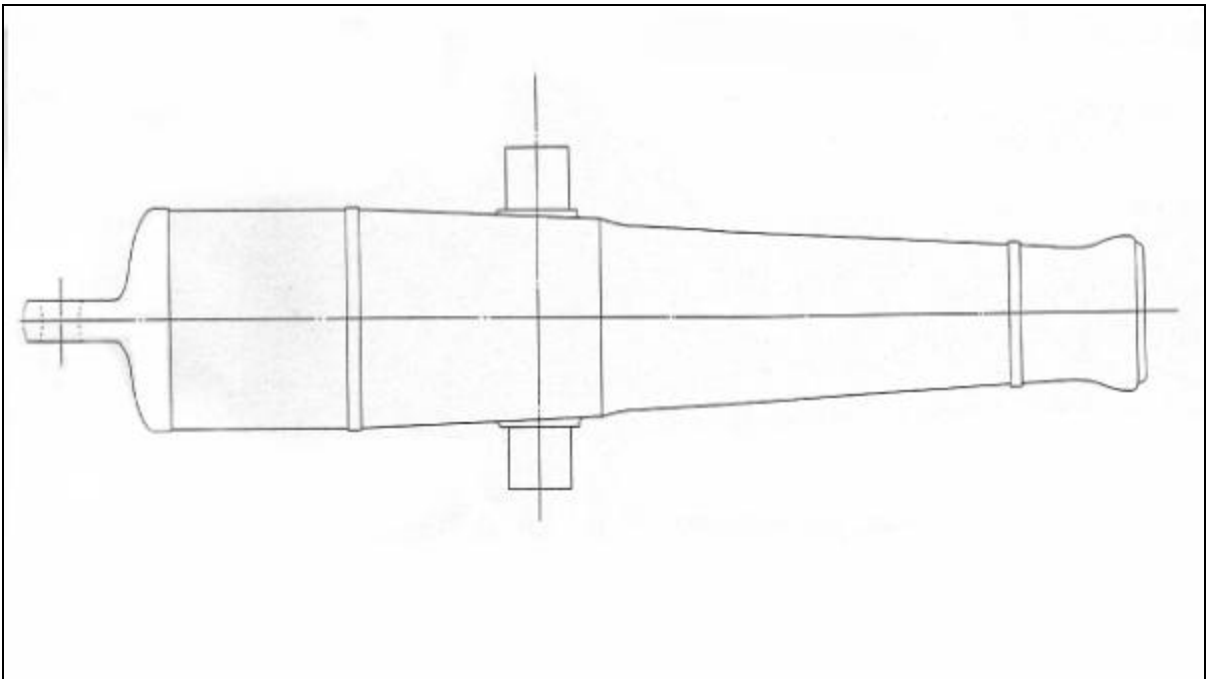

Figure 19. Blakely designed British Royal Navy pattern 32-pounder (A. Bowcock).

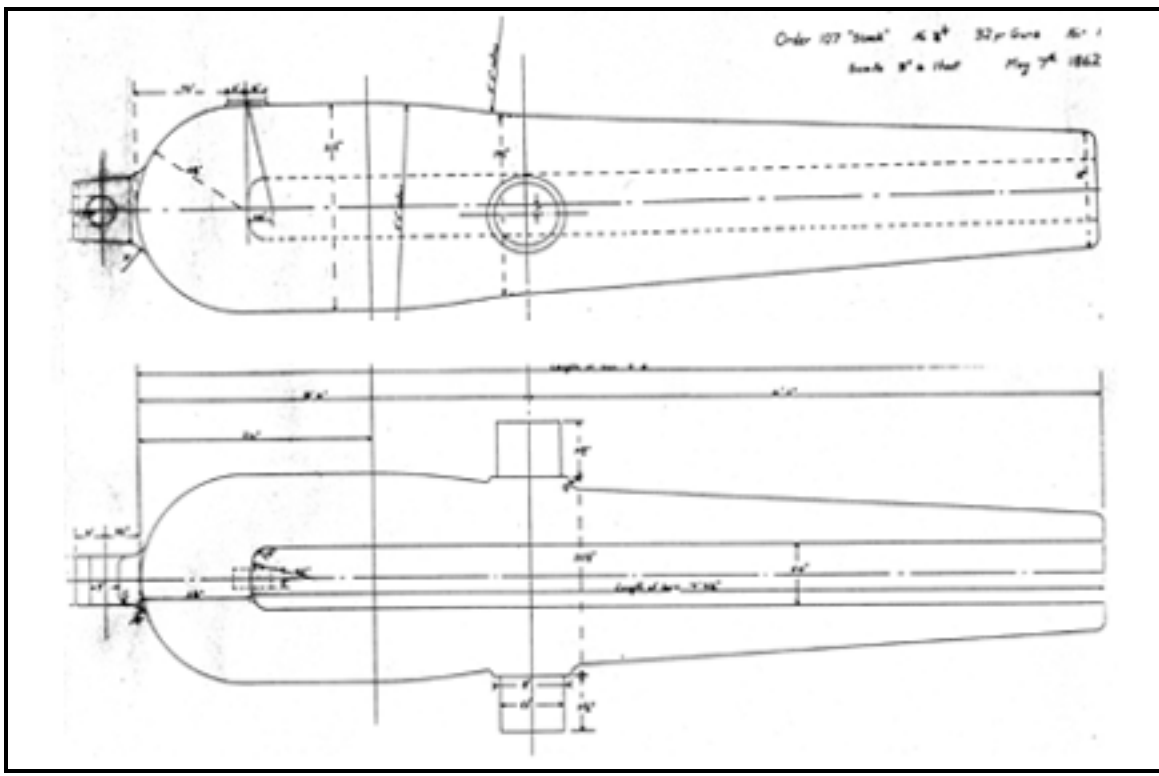

Figure 20. Design of the Fawcett, Preston & Company 32-pounder (A. Bowcock).



Figure 21. Markers mark on 32-pounder recovered in 2000.

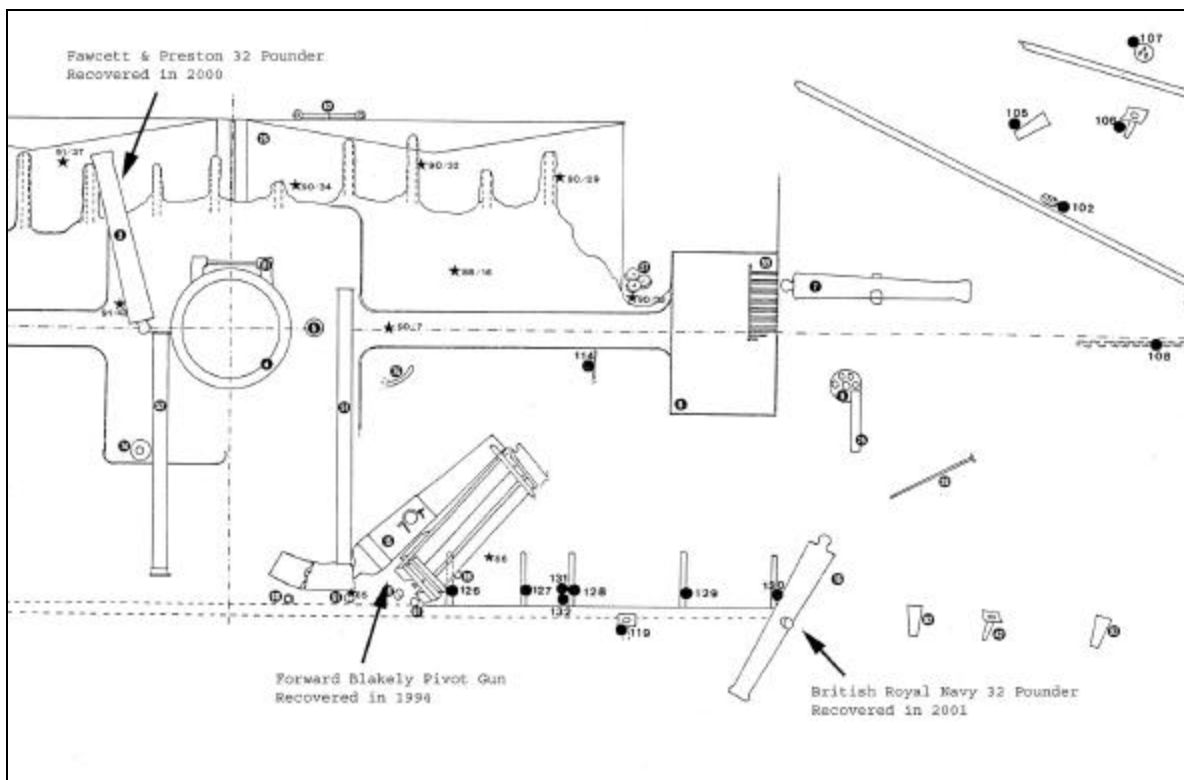

Figure 22. Locations of cannon recovered from the CSS *Alabama*.

Once the British Royal Navy pattern gun had been identified, French Navy divers rigged that 32-pounder with nylon straps. Air bags were used to make a succession of lifts that brought the gun from the bottom to a depth of approximately 60 feet (18 m). From that depth, a winch on the *Vulcain* was used to raise the gun to the surface. At the surface, a hydraulic crane was used to lift the gun over the transom and place it on deck for the trip to Cherbourg (Figure 23). At Cherbourg, the crew of the *Vulcain* placed the 32-pounder on the bottom of the harbor adjacent to one of the commercial docks operated by the Cherbourg Port Authority. Following adaptation of a shipping container, the cannon was raised and packed for transport to the Warren Lasch Conservation Center in Charleston, South Carolina under the direction of Dr. Bonnel.

Before the end of the first dive period, considerable effort was focused on excavations at the base of the aft fire pump and around the aft pivot gun (Figure 24). Excavation one the pivot gun confirmed that the weapon was not longer attached to its carriage. However, due to the calculated size and weight, it was apparent that the capacity of the lifting equipment on the *Vulcain* was not sufficient to hoist the cannon onto the aft deck. Rather than expose more of the barrel, excavation to clear the gun for recovery was halted.



Figure 23. Recovery of the 32-pounder by the *Vulcain*.



Figure 24. Excavations at the base of the pump.



Figure 25. Artifacts exposed by excavation at the base of the pump.

In addition to working on the 32-pounder and pivot gun, American archaeologists and French volunteer divers attempted to clear the base of the aft fire pump. Their excavation revealed new details about the pump's attachment and piping arrangement. Enough sediment was removed to confirm that the base of the pump and intake pipes associated with the valve chest were still intact. That array of intake pipes would require detachment in order to recover the pump and valve chest intact. Excavation proceeded slowly as numerous artifacts were clustered around the base of the pump (Figure 25). As work progressed, it became readily apparent that the pump either remained attached to unexposed hull structure or the intake pipe was buried in consolidated sediment that could not be cleared for lifting by the *Vulcain*. Rather than risk damaging the pump, efforts to recover it were abandoned until the second period of diving.

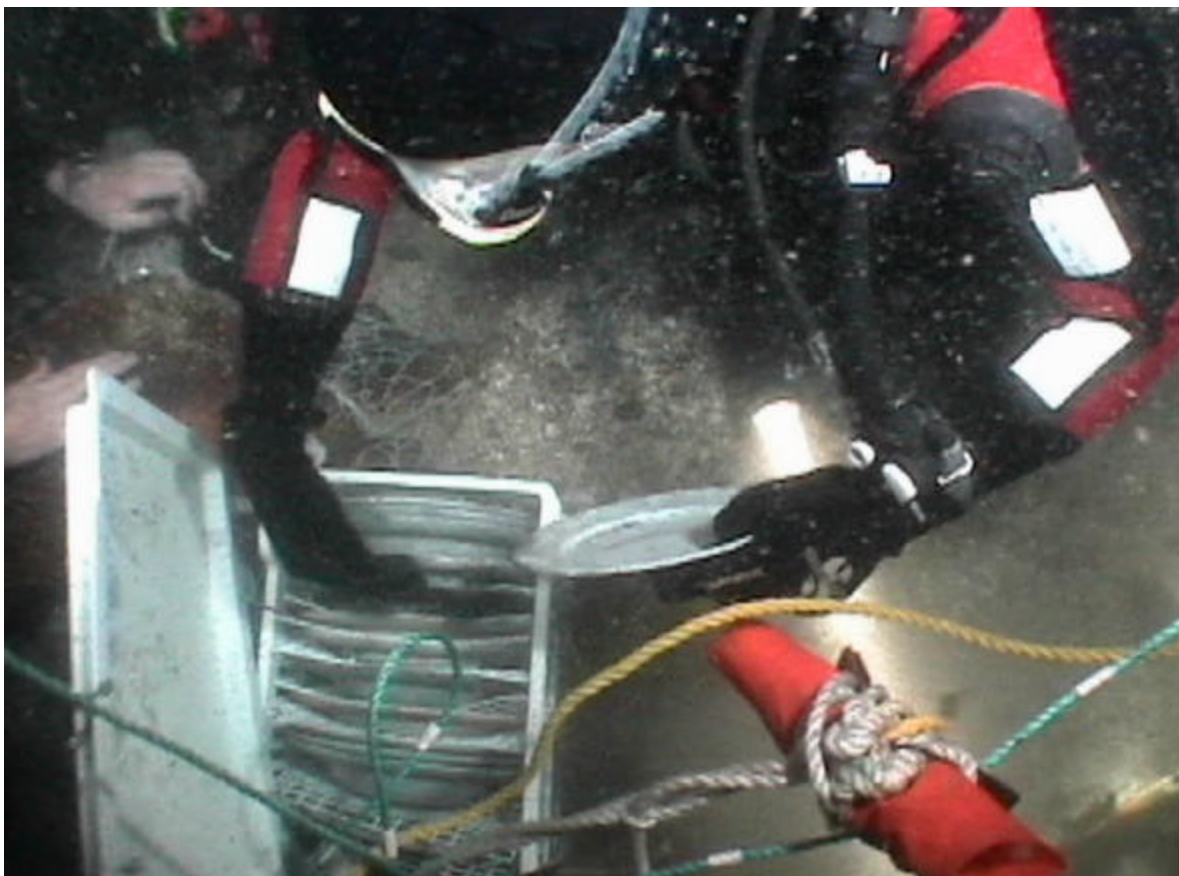

Figure 26. Divers load plates in a protective crate.

During the first period of on-site activity, a digital video camera in an underwater housing was used to record the exposed wreck structure and underwater activity. The video archive created was designed to document the on-site activity and to provide illustrations for reports and publications. Documentation of the wreck structure was designed to provide images of the features being cleared for recovery and collect sufficient digital data to produce mosaics of wreck site features. Documentation of the underwater work provided a graphic record of excavations and the locations of artifacts before recovery.

As work on the site progressed, a variety artifacts were identified. After video documentation and triangulation those that were exposed by excavation were recovered. While divers recovered large artifacts individually, small items were brought to the surface using plastic crates with partitions that isolated and protected each artifact (Figure 26). Aboard the *Little Pocket* fragile material was transported back to Cherbourg in containers filled with seawater (Figure 27).



Figure 27. Artifact ALS-251 being transported to Cherbourg.

During the first period of diving, and in the interim between the first and second period of on-site operations, artifacts were cataloged, cleaned and documented. Artifacts recovered during the first phase of on-site activity were placed in temporary storage at the CNP facility by conservator Catherine Augel (Figure 28). Ms. Augel developed a descriptive inventory of the collection assigning a sequential number for each artifact. Every item was photographed as it was recovered and then cleaned. Each of the cleaned artifacts was documented using photography and measured drawings. All of the CSS *Alabama* material was packed for shipment to conservation facilities in Charleston, South Carolina. Arrangements were also made for a waterproof liner and new lid to be fabricated for the iron lined shipping container that had been constructed in 2000 to transport the first 32-pounder to Charleston (Figure 29).

During the interim period plans were formulated for research during the second period of diving. British research historian Andrew Bowcock arrived with historical information that positively identified the CSS *Alabama*'s pumps as a design patented by Jonathan Downton in 1825 (Figure 30). Downton's unusual pumps were constructed with three pistons that operated inside a single cylinder. A common crankshaft moved the pistons in a sequence that provided continuous suction and discharge. Patent information discovered by Bowcock also confirmed the *Alabama*



Figure 28. Conservator Catherine Augel documents ALS-257.



Figure 29. British Royal Navy pattern 32-pounder being loaded in the shipping crate.

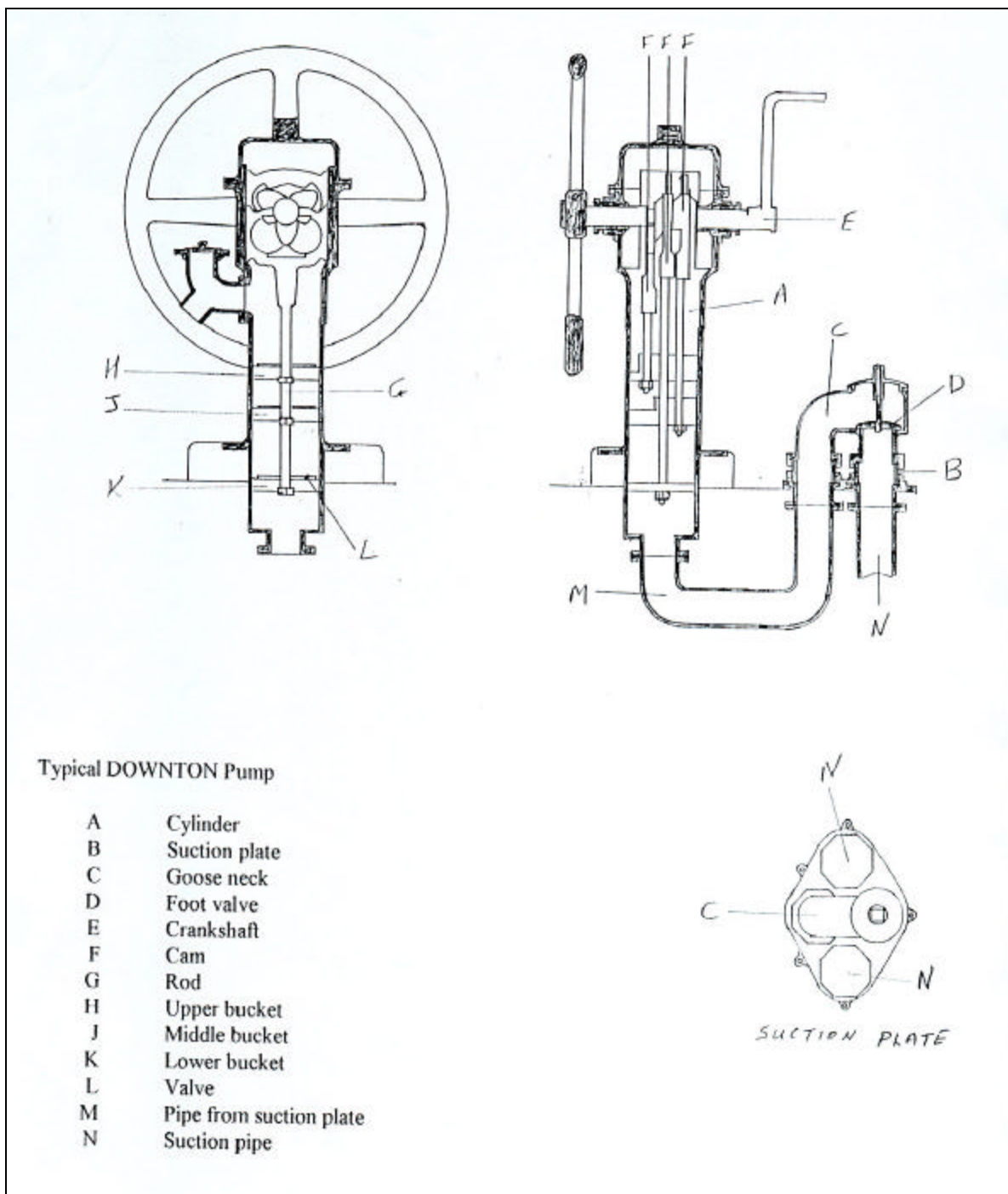

Figure 30. Schematic of the Downton pump (A. Bowcock).

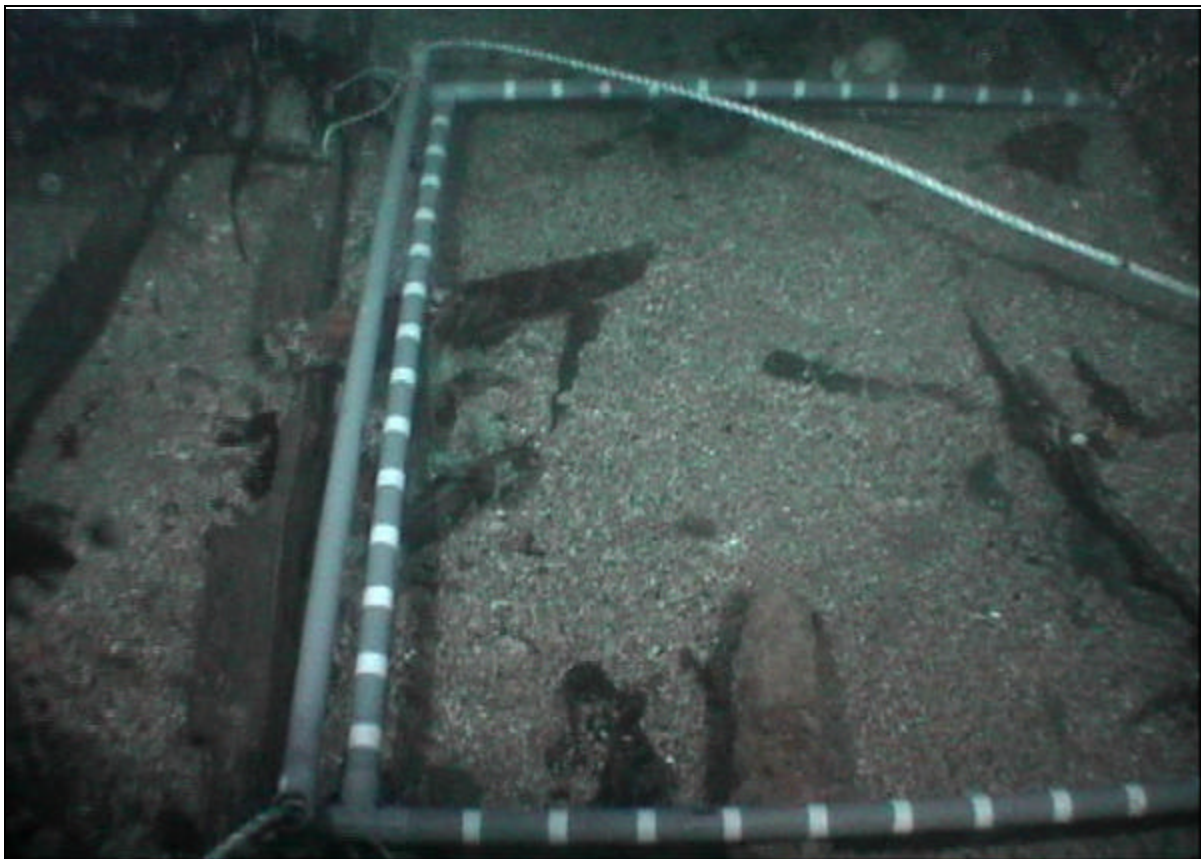

Figure 31. PVC grid in location prior to excavations.

pump's association with its valve chest and the means of attachment to the deck structure. The most important question answered by Bowcock's research was that the valve chest, not the pump, was connected to the *Alabama's* bilges. While excavation of the pump was possible during the second phase of diving, recovery would be complicated by the lack of a vessel with adequate lifting capacity. Rather than risk damaging the pump, recovery was put off until 2002.

As neither the *Vulcain* nor the French Navy divers would be available during the second period, on-site operations were refocused on a test excavation in the stern. A 2-meter by 2-meter grid structure was fabricated from PVC pipe (Figure 31). Line run through two parallel sides of the grid structure made it possible for the grid to be attached to the CSS *Alabama's* hull remains yet still be repositioned along an athwartship corridor identified for investigation (Figure 32). The grid structure was to be deployed over a pre-selected site in the stern that corresponded with previous test excavation. Video from the first period of diving was used to determine the best position for the grid structure.

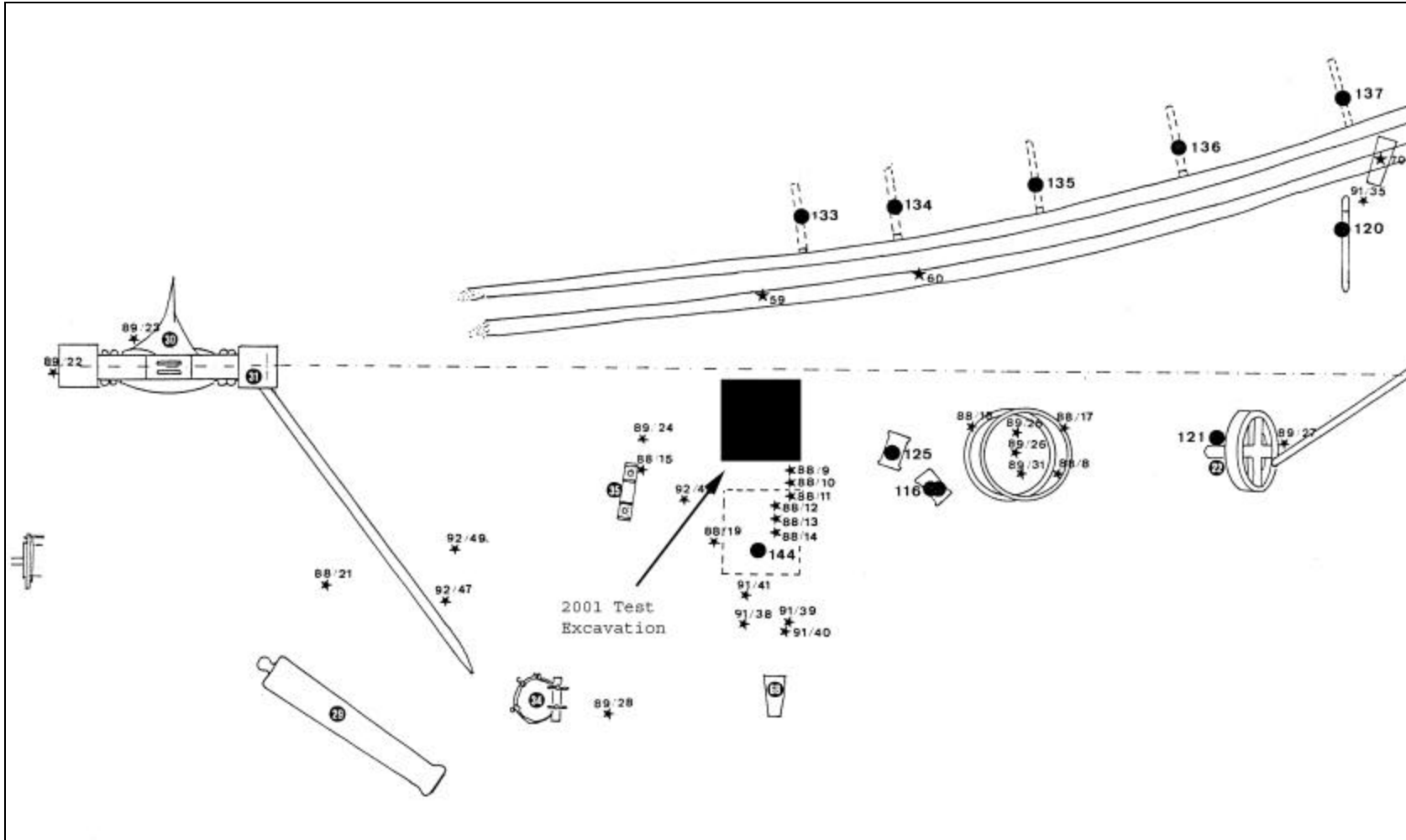

Figure 32. Location of test excavation for 2001.



Figure 33. CNP Dive vessel *Little Pocket*.

American archaeologists and French volunteer divers carried out the second phase of on-site research. Operating the vessels *Enrica* and *Little Pocket* (Figure 33), teams positioned the PVC grid in the aft section of the wreck. The position of the grid was recorded using both triangulation from documented features of the wreck and video recording (Figure 34). A series of transects between the screw and pump were recorded using the underwater video. With the on-site baseline as a reference, a video record of the bottom surface was recorded from an elevation of approximately six feet. The camera was operated vertically so that a continuous record of exposed wreck structure and grid location was obtained.

Using 4-inch air lifts (Figure 35) powered by the compressor aboard *Enrica*, dive teams cleared away the upper layer of shell hash and sand. Below the shell hash and sand, the nature of sediment within the hull changed to dark gray mud. Within the mud formed by the deposition of fine organic materials, artifacts and interior features of the CSS Alabama were exposed. The position of artifacts and features exposed by excavation was established using triangulation and video documentation. As material was exposed and mapped, it was removed and placed

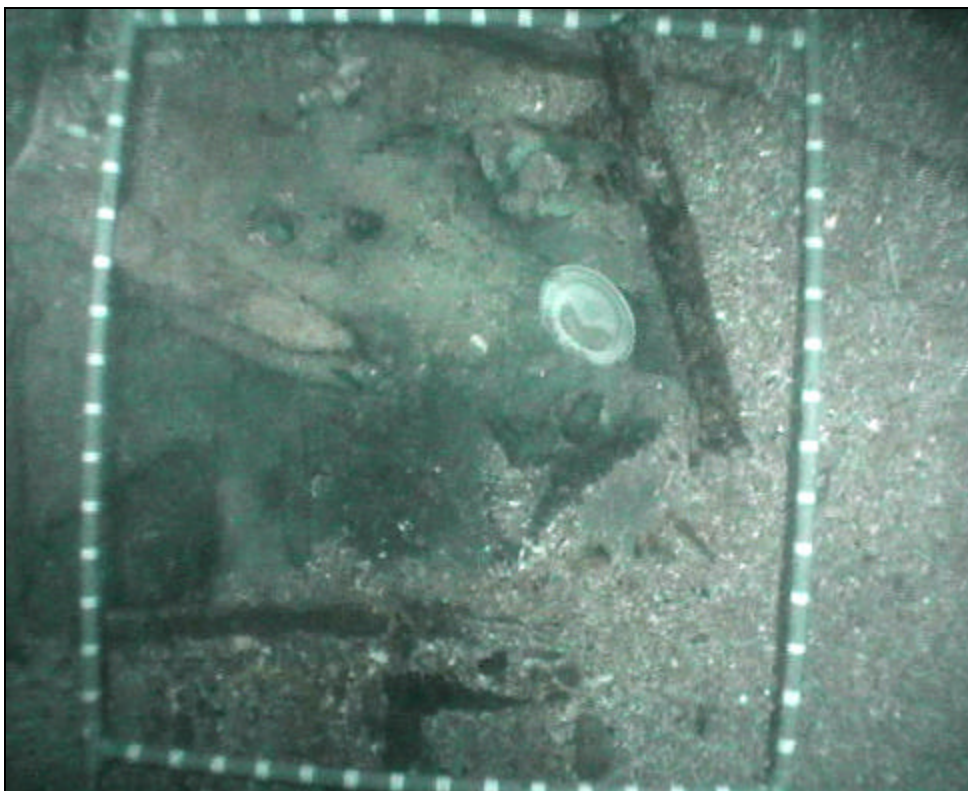

Figure 34. Sample of grid documentation from video.



Figure 35. Diver excavates in grid using the 4-inch air lift.

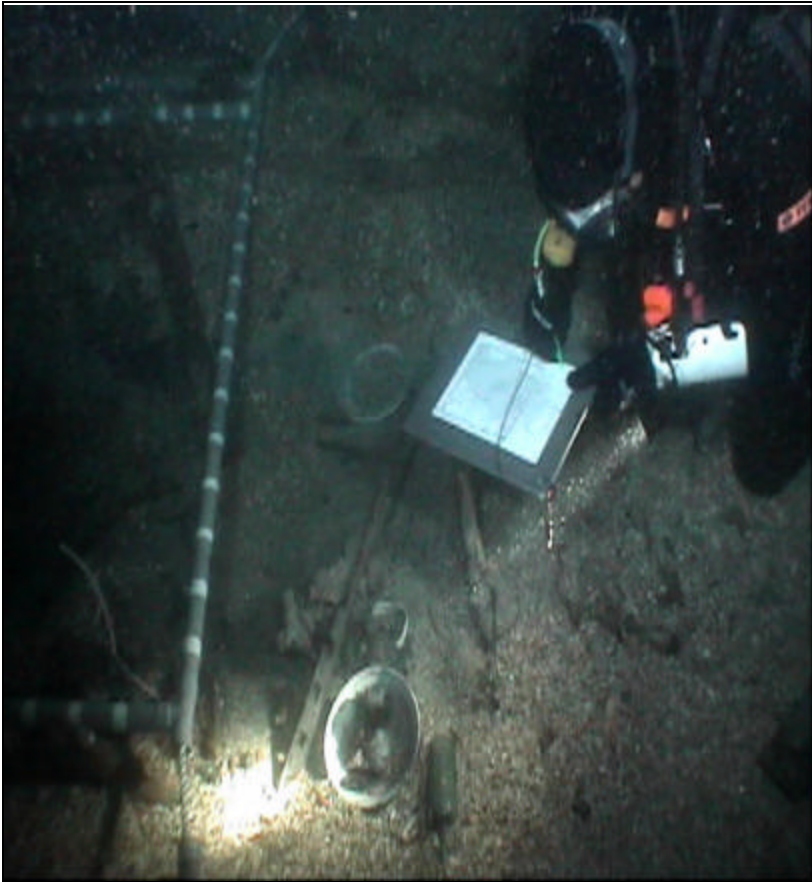

Figure 36. Archaeologist documents artifacts before recovery.

in plastic containers for recovery. On those final day of diving archaeologists focused on recording the excavation (Figure 36). French and American divers recovered all remaining equipment and removed the buoys at the bow and stern. During the diving several artifacts exposed on the bottom surface were also recovered.

During both periods of on-site activity, underwater television was used to record the exposed wreck structure and underwater activity. Documentation of the underwater work provided a graphic record of the recovered 32-pounder, exposed artifacts, the test excavation and investigation of the aft fire pump. Lack of sufficient personnel precluded producing additional images for the mosaic begun in 2000.



Figure 37. Container being unloaded in Charleston.

Following the completion of fieldwork, artifacts recovered during the 2001 campaign were packaged for shipment to conservation facilities in Charleston, South Carolina. A special iron crate with a watertight liner was constructed in 2000 for shipping one of the 32-pounders to Charleston, South Carolina. That shipping container was adapted for transporting the 32-pounder recovered in 2001. With assistance from the French Navy that cannon was lifted from Cherbourg harbor and placed in the shipping container in July. Conservator Catherine Augel packed the small artifacts inside the water filled cannon shipment crate and it was placed inside a 20-foot metal shipping container with diving and excavation equipment (Figure 37).

Description of the Artifacts

Material recovered during the 2001 investigation of the *CSS Alabama* consisted of artifacts exposed on the bottom surface and artifacts exposed by test excavation (Figure 38). Due to the dynamic environment at the wreck site, artifacts exposed on the bottom surface are considered to be at risk and their provenience is questionable. Recovery has been accepted as the most appropriate method of insuring their preservation. During the 2001 campaign, a total of 62 artifacts were recovered. They included ordnance, ceramics, glass, a pipe bowl, ship fittings, gun carriage hardware and fragments of the vessel's hull. The largest artifact was one of the *Alabama's* British Royal Navy pattern 32-pounders.



Figure 38. Collection of artifacts exposed on the bottom surface.



Figure 39. ALS-235 Hull Fragment with Fastener.

Artifact ALS-235 is a fragment from the hull of the CSS *Alabama*. Although it is impossible to determine its exact location in the vessel structure the wood and fasteners suggest that it consisted of a section of deck clamp, hull planking and futtock. The multi-component artifact is made up of three different wood species. The outer portion is teak that represents hull planking. The middle section appears to be white oak and represents remnants of a futtock. The inner portion is mahogany and represents the remains of a deck clamp. The pins are peened over roves outside the teak planking.

Artifact Dimensions:

Length max :	20.47 inches	520 mm
Diameter of the pin :	0.7 inches	18 mm
Large piece of wood :	6.69 x 3.54 inches	170 x 90 mm

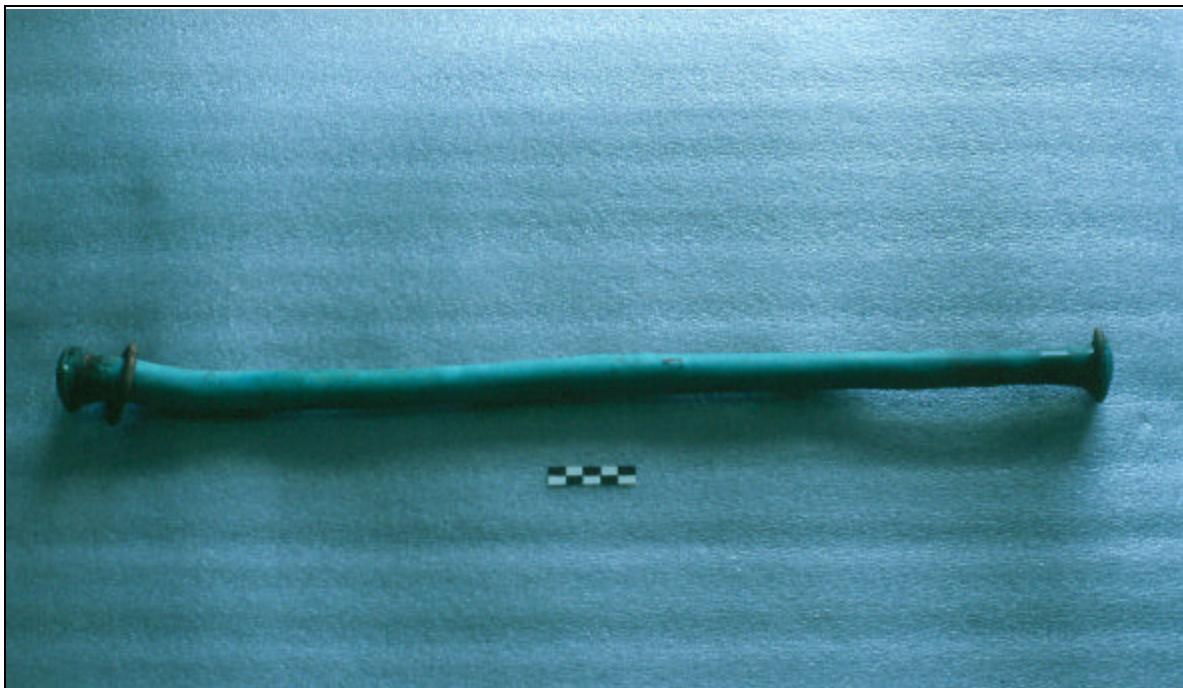

Figure 40. ALS-236 Drift pin with rove.

Artifact ALS-236 is a copper drift pin with rove. The ends of the drift pin have been peened over the roves. Both of the peened over ends are at nearly 90 degrees to the pin itself. This would indicate that the pin came from an area where the interior and exterior surfaces were parallel, such as the side of the hull or in joining interior futtocks. On this piece, one of the roves is loose.

Artifact Dimensions:

Length max :	24.21 inches	615 mm
Diameter of the pin :	0.82 to 0.98 inches	21 to 25 mm
Diameter of the head :	1.53 to 1.69 inches	39 mm and 43 mm
Diameter of the rove :	1.81 inches	46 mm

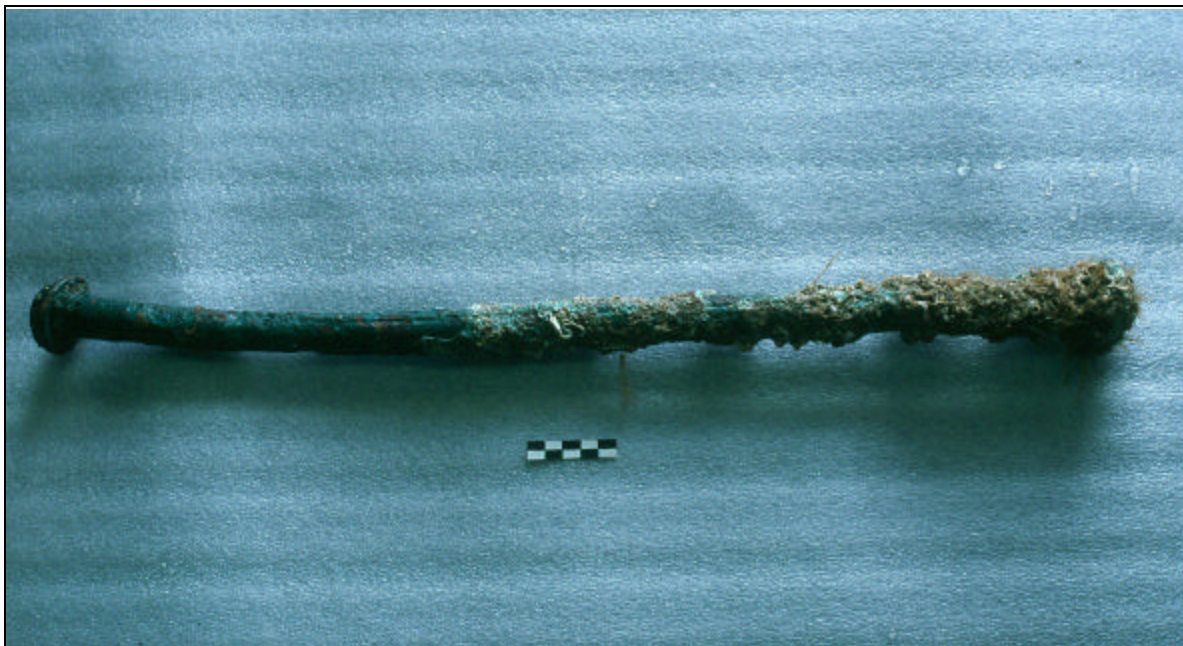

Figure 41. ALS-237 Drift pin with rove.

Artifact ALS-237 is a copper drift pin with rove. The ends of the drift pin have been peened over the roves. On the end of the pin not encrusted by marine organisms, there are fibers visible which probably served to help seal the hole.

Artifact Dimensions:

Length max :	24.8 inches	630 mm
Diameter of the pin :	0.98 inches	25 mm
Diameter of the head :	1.49 inches	38 mm
Diameter of the rove:	1.77 inches	45 mm



Figure 42. ALS-238 Scupper with fasteners.

Artifact ALS-238 is a deck scupper with 10 copper fasteners. The configuration of the scupper suggests that it would have extended from the water course through the hull at an angle of approximately 15 degrees. The scupper pipe and flange were fashioned from lead sheet and soldered together. The water course flange was secured around the perimeter with 20 copper tacks on 1.50-inch centers. The pipe throat is oblong in cross-section and was formed by rolling a sheet of lead and welding along the seam. Similar scuppers have been recovered during previous investigations.

Artifact Dimensions:

Length max :	26.77 inches	680 mm
Height max :	10.23 inches	260 mm
Length of the pipe :	22.83 inches	580 mm
Thickness of the pipe walls :	0.19 inches	5 mm
Flange Length :	10.23 inches	260 mm
Flange Width :	9.05 inches	230 mm
Flange Thickness :	0.27 to 0.31 inches	7 to 8 mm



Figure 43. ALS-239 Small jar.

Artifact ALS-239 is a small glazed jar. This jar has no makers mark. Though it was designed for and probably had a lid while it was in use, the lid was not found in the immediate vicinity. Jars of this type would have served utilitarian purposes, containing any number of things. A jar very similar in design, though slightly larger, was recovered in the 1995 operation (ALS 203).

Artifact Dimensions:

Height :	2.87 inches	73 mm
Diameter of the bottom :	2.79 inches	71 mm

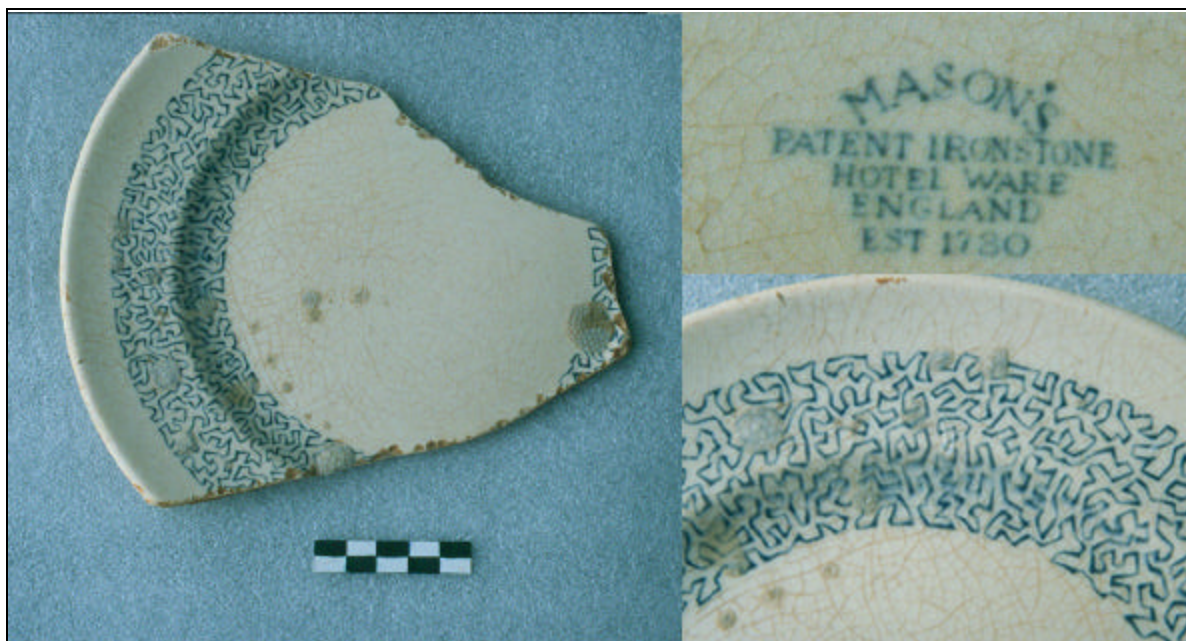

Figure 44. ALS-240 Plate with blue design.

Artifact ALS-240 is a fragment of a plate with a blue geometric design. The mark on the bottom reads “MASON’S, PATENT IRONSTONE, HOTEL WARE, ENGLAND, EST 1730.” This piece was most likely manufactured in one of the Broad Street works. Charles James Mason took out a patent in 1813 for the manufacturing process of his famous ironstone china. The patent passed to Francis Morley in 1851. In 1859 the patent was again sold to George and Taylor Ashworth. If ALS-240 is contemporary with the wreck, it was likely manufactured by F. Morley and Co. as this pottery had been in existence since the 1720’s or 1730’s. The Ashworth brothers used a different makers mark than was on the plate. As ALS-240 was found in the shell hash layer, it is possible that it migrated onto the wreck at a time after the sinking. Further research is necessary to determine whether this piece does date to the time of the wreck.

Artifact Dimensions:

Estimated Diameter :	8.97 inches	228 mm
Height :	0.51 inches	13 mm
Thickness :	0.19 to 0.23 inches	5 to 6 mm
Width of the decoration :	1.37 inches	35 mm

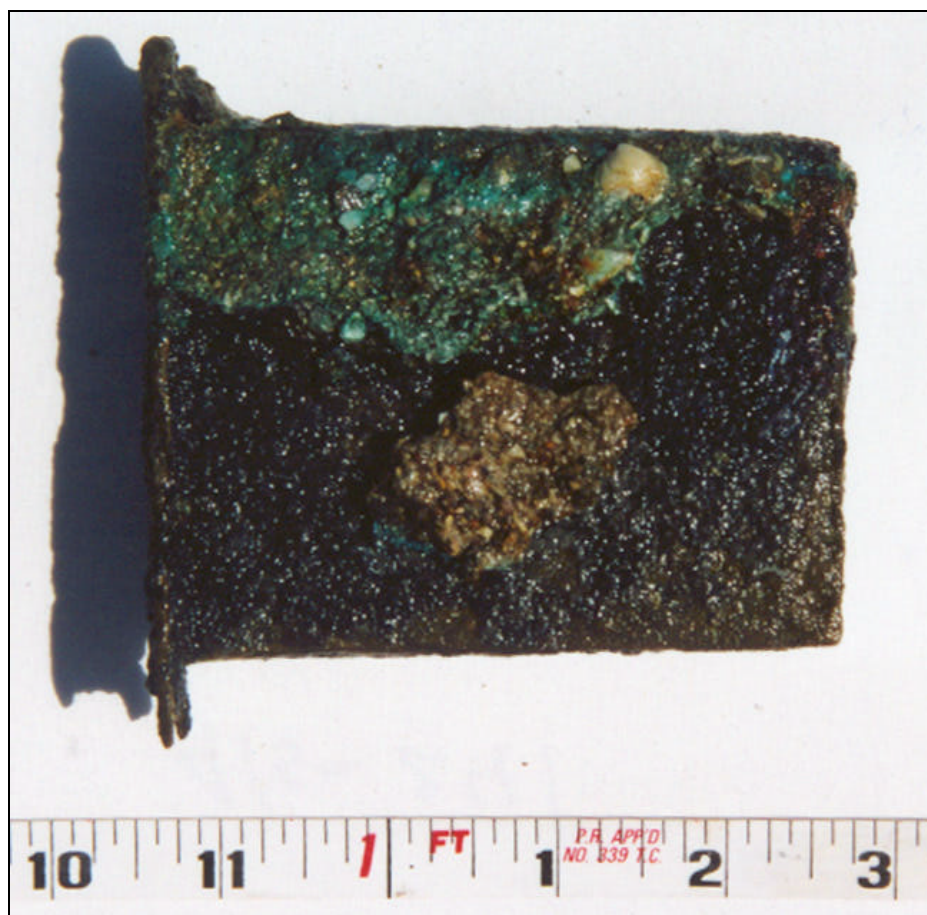

Figure 45. ALS-241 Lock.

Artifact ALS-241 is a quadrangular lock mechanism. The interior of the lock has corroded away, but from the design and dimensions, it was probably used for an interior door aboard the vessel. One of the sides has eroded away, so the interior mechanisms are visible. The presence of sulfides inside the lock indicates that a part of the internal mechanism was made of iron and has deteriorated to an irreversible extent. What remains indicate the bolt was moved via a hollow-stemmed key.

Artifact Dimensions:

Length :	3.93 inches	100 mm
Height :	2.95 inches	75 mm
Thickness :	0.47 inches	12 mm



Figure 46. ALS-242 Square Bottle.

ALS-242 is green glass bottle. The bottle was cast in two parts (traces of the mold are still visible). The glass of the bottle contains air pockets. The base and body is square with the shoulder changing to round and fluted. The base of the neck has 3 horizontal bands. Bottles of this type would have contained items such as water or condiments. Identical bottles were recovered in the 1994 operation (ALS-169, ALS-180, ALS-181, ALS-182, ALS-188)

Artifact Dimensions:

Height :	10.62 inches	270 mm
Width max :	2.83 inches	72 mm
Outside diameter of the neck :	1.73 inches	44 mm
Thickness of the neck :	0.07 to 0.11 inches	2 to 3 mm



Figure 47. ALS-243 Gravy Boat.

Artifact ALS-243 is an intact white ceramic gravy boat. The sides have convex ridges, while the base and upper portion have concave ridges. Around the widest part is a band with leaf decorations below. The handle is also decorated with a leaf. There is no makers mark present.

Artifact Dimensions:

Height max :	5.59 inches	142 mm
Width max :	3.54 inches	90 mm
Dimensions of the foot :	3.77 x 2.75 inches	96 x 70 mm

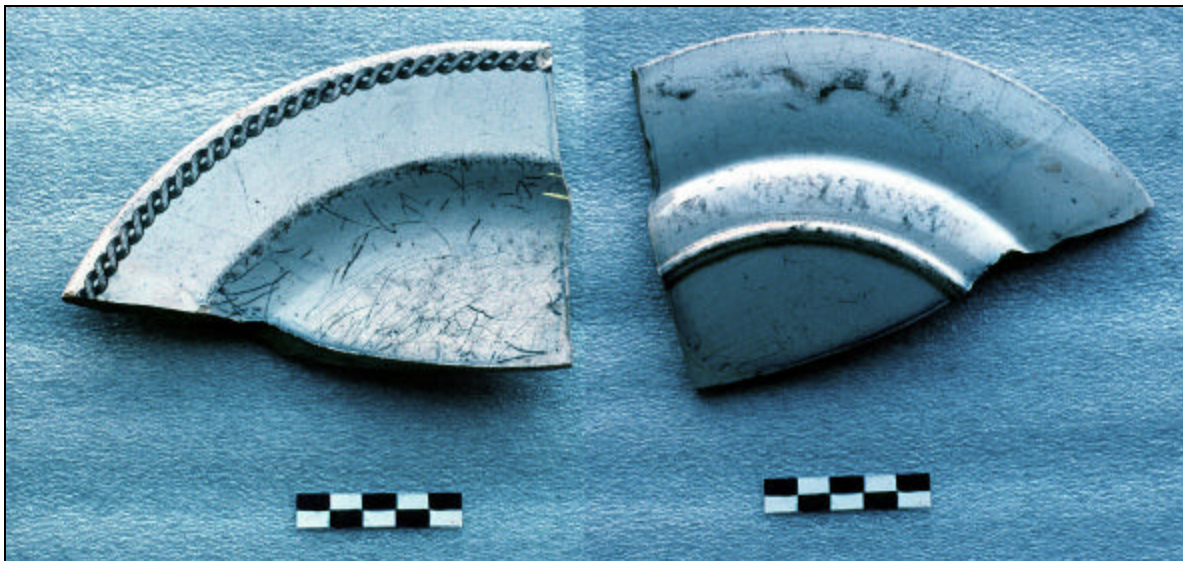

Figure 48. ALS-244 Ironstone Plate Fragment with Brown Design.

Artifact ALS-244 is a white ironstone plate fragment with a brown transfer printed decoration. Numerous similar completely intact plates have been recovered from the stern area of the *Alabama*. Though the makers mark is not present, it is identical to those manufactured by Davenport Ironstone China.

Artifact Dimensions:

Length max :	6.29 inches	160 mm
Width max :	4.29 inches	109 mm
Height :	0.82 inches	21 mm
Thickness max :	0.31 inches	8 mm

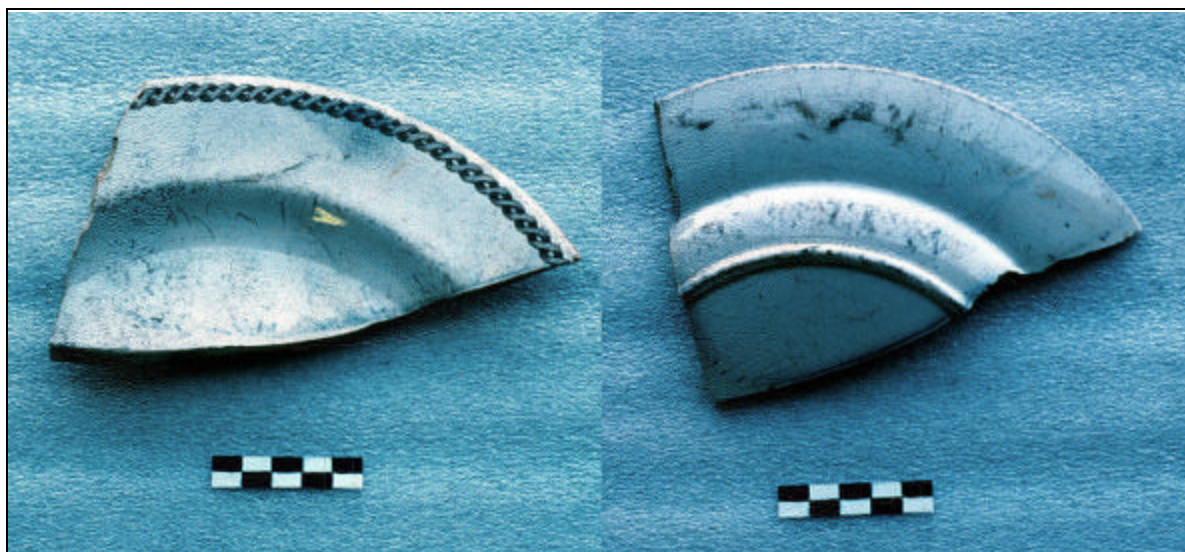

Figure 49. ALS-245 Ironstone Plate Fragment with Brown Design.

Artifact ALS-245 is a white ironstone plate fragment with a brown transfer printed decoration. Numerous similar plates have been recovered from the stern area of the *Alabama*. Though the makers mark is not present, it is identical to those manufactured by Davenport Ironstone China.

Artifact Dimensions:

Length max :	6.29 inches	160 mm
Width max :	4.33 inches	110 mm
Height :	1.49 inches	38 mm
Thickness max :	0.31 inches	8 mm



Figure 50. ALS-246-1 Ironstone Plate with Brown Design.

Artifact ALS-246-1 is a white ironstone plate with a brown transfer printed decoration. The interior of the plate is decorated with fouled anchor that is located in the center and a cable decorates the perimeter. A figure 8 shaped makers stamp on the underside of the plate reads “Davenport Ironstone China”. Inside the stylized figure 8 are an anchor and the number 2. To the left of the anchor is the number 6 and to the right of the anchor is the number 0. The word “Davenport” is also transfer printed on the bottom near the makers stamp. Numerous similar plates have been recovered from the stern area of the *Alabama*.

Artifact Dimensions:

Diameter:	10.38 inches	263 mm
Height:	1.25 inches	31 mm
Center Emblem Diameter:	1.94 inches	49 mm



Figure 51. ALS-246-2 Ironstone Plate with Brown Design.

Artifact ALS-246-2 is a white ironstone plate with a brown transfer printed decoration. The interior of the plate is decorated with fouled anchor that is located in the center and a cable decorates the perimeter. A figure 8 shaped makers stamp on the underside of the plate reads “Davenport Ironstone China”. Inside the stylized figure 8 are an anchor and the number 2. To the left of the anchor is the number 6 and to the right of the anchor is the number 0. The word “Davenport” is also transfer printed on the bottom near the makers stamp. Numerous similar plates have been recovered from the stern area of the *Alabama*.

Artifact Dimensions:

Diameter:	10.38 inches	263 mm
Height:	1.25 inches	31 mm
Center Emblem Diameter:	1.94 inches	49 mm



Figure 52. ALS-246-3 Ironstone Plate with Brown Design.

Artifact ALS-246-3 is a white ironstone plate with a brown transfer printed decoration. The interior of the plate is decorated with fouled anchor that is located in the center and a cable decorates the perimeter. A figure 8 shaped makers stamp on the underside of the plate reads “Davenport Ironstone China”. Inside the stylized figure 8 are an anchor and the number 2. To the left of the anchor is the number 6 and to the right of the anchor is the number 0. The word “Davenport” is also transfer printed on the bottom near the makers stamp. Numerous similar plates have been recovered from the stern area of the *Alabama*.

Artifact Dimensions:

Diameter:	10.38 inches	263 mm
Height:	1.25 inches	31 mm
Center Emblem Diameter:	1.94 inches	49 mm



Figure 53. ALS-246-4 Ironstone Plate with Brown Design.

Artifact ALS-246-4 is a white ironstone plate with a brown transfer printed decoration. The interior of the plate is decorated with fouled anchor that is located in the center and a cable decorates the perimeter. A figure 8 shaped makers stamp on the underside of the plate reads “Davenport Ironstone China”. Inside the stylized figure 8 are an anchor and the number 2. To the left of the anchor is the number 6 and to the right of the anchor is the number 0. The word “Davenport” is also transfer printed on the bottom near the makers stamp. Numerous similar plates have been recovered from the stern area of the *Alabama*.

Artifact Dimensions:

Diameter:	10.38 inches	263 mm
Height:	1.25 inches	31 mm
Center Emblem Diameter:	1.94 inches	49 mm

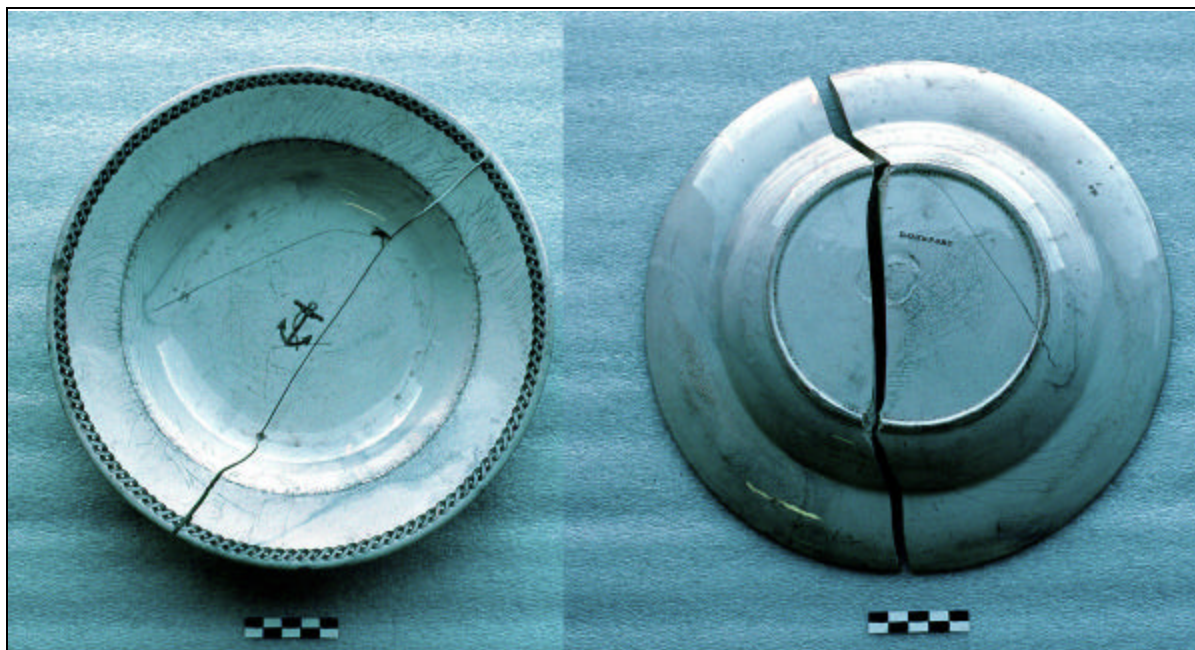

Figure 54. ALS-247-1 Ironstone Soup Bowl with Brown Design.

Artifact ALS-247-1 is a broken white ironstone soup bowl with a brown transfer printed decoration. The interior of the plate is decorated with fouled anchor that is located in the center and a cable decorates the perimeter. A figure 8 shaped makers stamp on the underside of the plate reads “Davenport Ironstone China”. Inside the stylized figure 8 are an anchor and the number 2. To the left of the anchor is the number 6 and to the right of the anchor is the number 0. The word “Davenport” is also transfer printed on the bottom near the makers stamp. Numerous similar plates have been recovered from the stern area of the *Alabama*.

Artifact Dimensions:

Diameter:	10.5 inches	263 mm
Height:	2 inches	49 mm

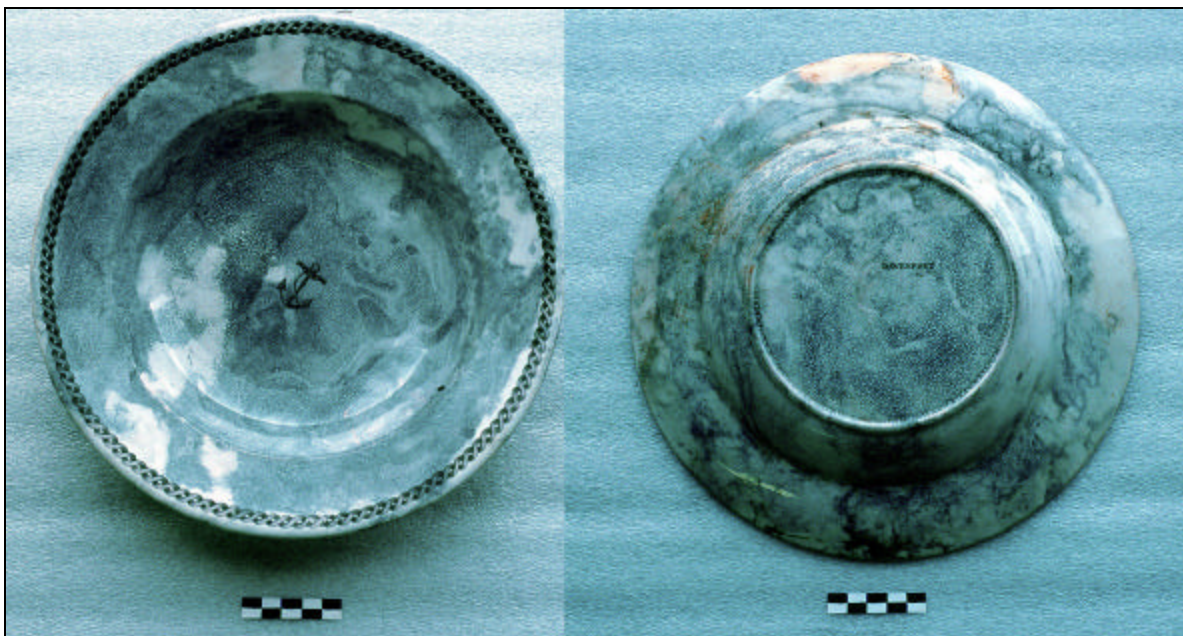

Figure 55. ALS-247-1 Ironstone Soup Bowl with Brown Design.

Artifact ALS-247-2 is a white ironstone soup bowl with a brown transfer printed decoration. The interior of the plate is decorated with fouled anchor that is located in the center and a cable decorates the perimeter. A figure 8 shaped makers stamp on the underside of the plate reads “Davenport Ironstone China”. Inside the stylized figure 8 are an anchor and the number 2. To the left of the anchor is the number 6 and to the right of the anchor is the number 0. The word “Davenport” is also transfer printed on the bottom near the makers stamp. Numerous similar plates have been recovered from the stern area of the *Alabama*.

Artifact Dimensions:

Diameter:	10.5 inches	263 mm
Height:	2 inches	49 mm



Figure 56. ALS-247-1 Ironstone Soup Bowl with Brown Design.

Artifact ALS-247-3 is a white ironstone soup bowl with a brown transfer printed decoration. The interior of the plate is decorated with fouled anchor that is located in the center and a cable decorates the perimeter. A figure 8 shaped makers stamp on the underside of the plate reads “Davenport Ironstone China”. Inside the stylized figure 8 are an anchor and the number 2. To the left of the anchor is the number 6 and to the right of the anchor is the number 0. The word “Davenport” is also transfer printed on the bottom near the makers stamp. Numerous similar plates have been recovered from the stern area of the *Alabama*.

Artifact Dimensions:

Diameter:	10.5 inches	263 mm
Height:	2 inches	49 mm

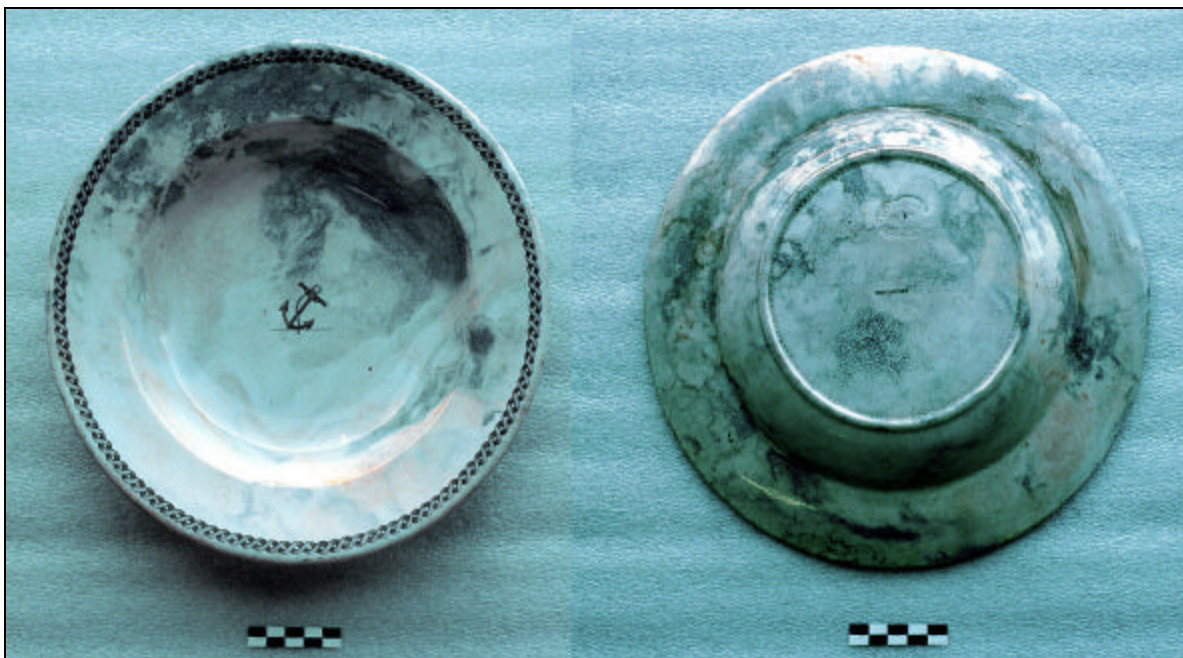

Figure 57. ALS-247-1 Ironstone Soup Bowl with Brown Design.

Artifact ALS-247-4 is a white ironstone soup bowl with a brown transfer printed decoration. The interior of the plate is decorated with fouled anchor that is located in the center and a cable decorates the perimeter. A figure 8 shaped makers stamp on the underside of the plate reads "Davenport Ironstone China". Inside the stylized figure 8 are an anchor and the number 2. To the left of the anchor is the number 6 and to the right of the anchor is the number 0. The word "Davenport" is also transfer printed on the bottom near the makers stamp. Numerous similar plates have been recovered from the stern area of the *Alabama*.

Artifact Dimensions:

Diameter:	10.5 inches	263 mm
Height:	2 inches	49 mm

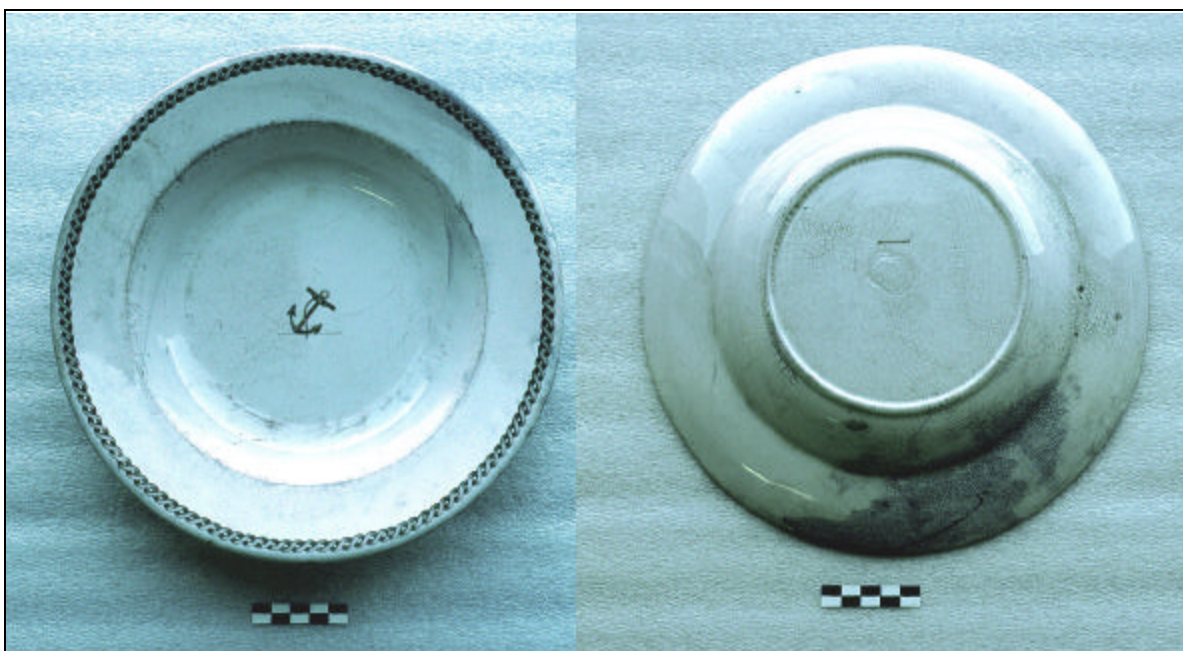

Figure 58. ALS-247-1 Ironstone Soup Bowl with Brown Design.

Artifact ALS-247-5 is a white ironstone soup bowl with a brown transfer printed decoration. The interior of the plate is decorated with fouled anchor that is located in the center and a cable decorates the perimeter. A figure 8 shaped makers stamp on the underside of the plate reads “Davenport Ironstone China”. Inside the stylized figure 8 are an anchor and the number 2. To the left of the anchor is the number 6 and to the right of the anchor is the number 0. The word “Davenport” is also transfer printed on the bottom near the makers stamp. Numerous similar plates have been recovered from the stern area of the *Alabama*.

Artifact Dimensions:

Diameter:	10.5 inches	263 mm
Height:	2 inches	49 mm



Figure 59. ALS-247-1 Ironstone Soup Bowl with Brown Design.

Artifact ALS-247-6 is a white ironstone soup bowl with a brown transfer printed decoration. The interior of the plate is decorated with fouled anchor that is located in the center and a cable decorates the perimeter. A figure 8 shaped makers stamp on the underside of the plate reads “Davenport Ironstone China”. Inside the stylized figure 8 are an anchor and the number 2. To the left of the anchor is the number 6 and to the right of the anchor is the number 0. The word “Davenport” is also transfer printed on the bottom near the makers stamp. Numerous similar plates have been recovered from the stern area of the *Alabama*.

Artifact Dimensions:

Diameter:	10.5 inches	263 mm
Height:	2 inches	49 mm

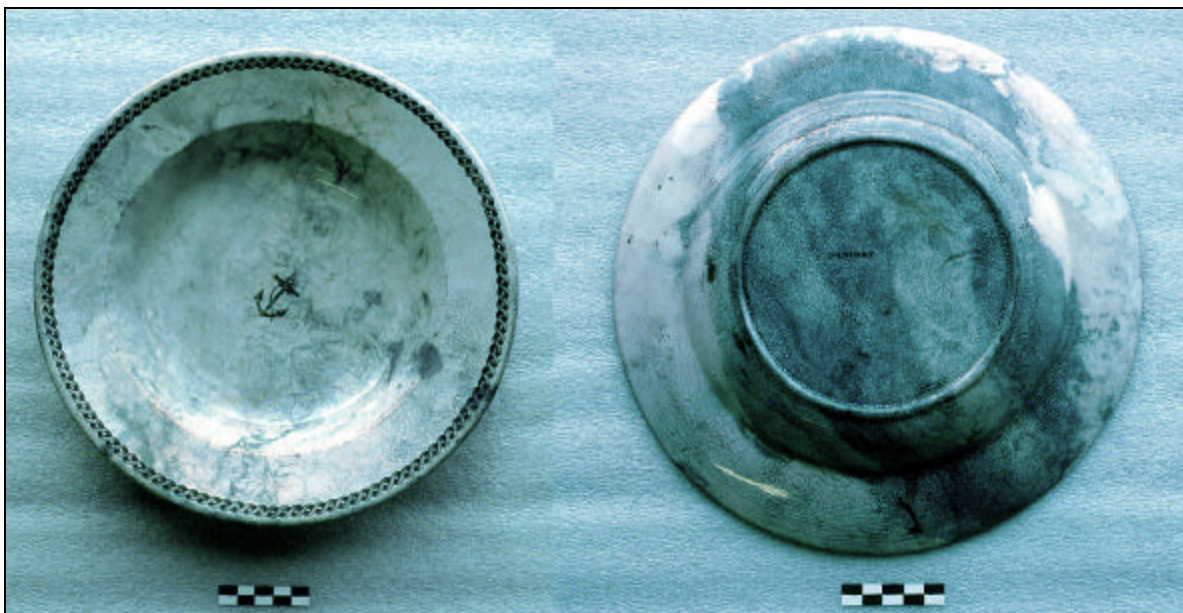

Figure 60. ALS-247-1 Ironstone Soup Bowl with Brown Design.

Artifact ALS-247-7 is a white ironstone soup bowl with a brown transfer printed decoration. The interior of the plate is decorated with fouled anchor that is located in the center and a cable decorates the perimeter. A figure 8 shaped makers stamp on the underside of the plate reads “Davenport Ironstone China”. Inside the stylized figure 8 are an anchor and the number 2. To the left of the anchor is the number 6 and to the right of the anchor is the number 0. The word “Davenport” is also transfer printed on the bottom near the makers stamp. Numerous similar plates have been recovered from the stern area of the *Alabama*.

Artifact Dimensions:

Diameter:	10.5 inches	263 mm
Height:	2 inches	49 mm

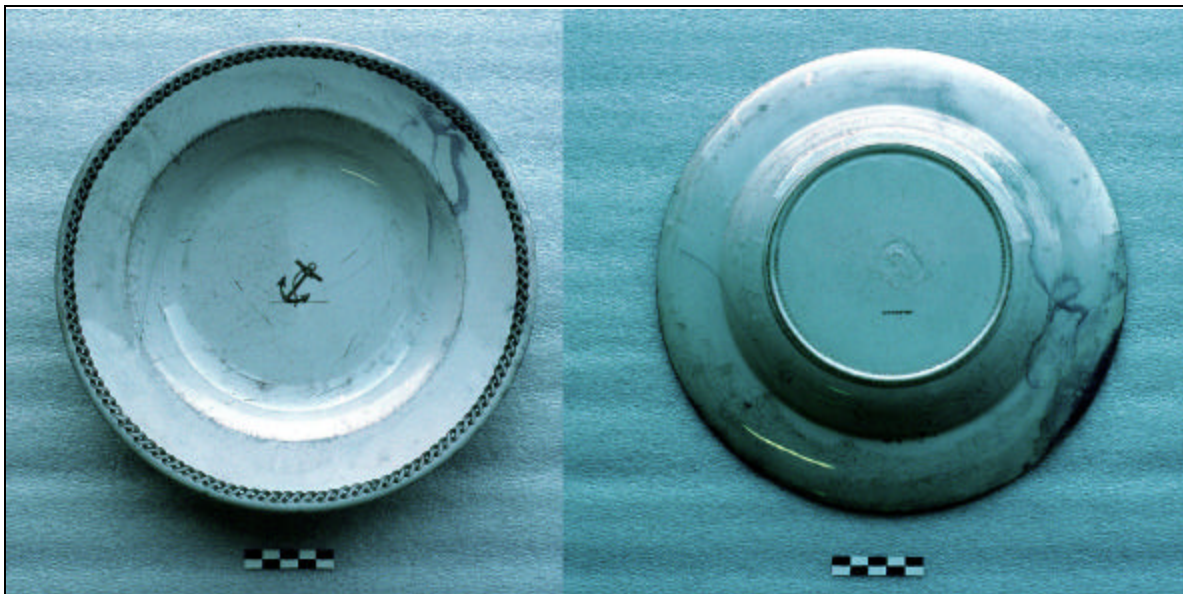

Figure 61. ALS-247-1 Ironstone Soup Bowl with Brown Design.

Artifact ALS-247-8 is a white ironstone soup bowl with a brown transfer printed decoration. The interior of the plate is decorated with fouled anchor that is located in the center and a cable decorates the perimeter. A figure 8 shaped makers stamp on the underside of the plate reads “Davenport Ironstone China”. Inside the stylized figure 8 are an anchor and the number 2. To the left of the anchor is the number 6 and to the right of the anchor is the number 0. The word “Davenport” is also transfer printed on the bottom near the makers stamp. Numerous similar plates have been recovered from the stern area of the *Alabama*.

Artifact Dimensions:

Diameter:	10.5 inches	263 mm
Height:	2 inches	49 mm

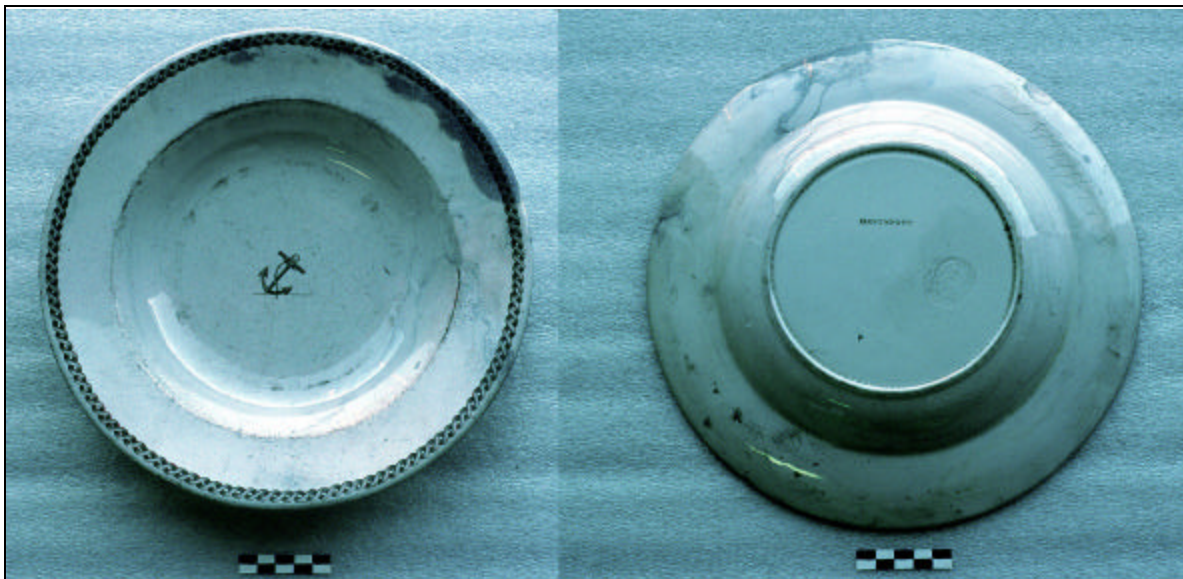

Figure 62. ALS-247-1 Ironstone Soup Bowl with Brown Design.

Artifact ALS-247-9 is a white ironstone soup bowl with a brown transfer printed decoration. The interior of the plate is decorated with fouled anchor that is located in the center and a cable decorates the perimeter. A figure 8 shaped makers stamp on the underside of the plate reads “Davenport Ironstone China”. Inside the stylized figure 8 are an anchor and the number 2. To the left of the anchor is the number 6 and to the right of the anchor is the number 0. The word “Davenport” is also transfer printed on the bottom near the makers stamp. Numerous similar plates have been recovered from the stern area of the *Alabama*.

Artifact Dimensions:

Diameter:	10.5 inches	263 mm
Height:	2 inches	49 mm



Figure 63. ALS-248 Fragment of plate glass.

Artifact ALS-248 is a fragment of plate glass. It is unlikely that it was part of an external window due to its thickness.

Artifact Dimensions:

Length max :	3.54 inches	90 mm
Width max :	2.55 inches	65 mm
Thickness :	0.07 inches	2 mm



Figure 64. ALS-249 Undetermined material on wreck.

Artifact ALS-249 is a sample of a large piece of material on the wreck site. It is believed to be tallow or something similar. The piece is white to gray. It has a waxy and soft consistency and has a strong smell. When heated the material turns to a viscous liquid.



Figure 65. ALS-250 White Plate.

Artifact ALS-250 is a plain white ironstone plate. The makers mark on the bottom reads “STONE CHINA, JAMES EDWARDS & SON, DALEHALL”. The symbol is a shield topped by a crown, straddled by a lion on one side and a unicorn on the other. Stamped into the plate is “EDWARDS, & SON, DALEHALL”. James Edwards was a renowned manufacturer of china in England. He started as a thrower, and rose through the ranks until he purchased the Rogers works in 1842. He won several awards and medals for his wares and apparatus. Mr. Edwards, who had taken his son Richard into partnership, retired in 1861 and died in 1867. The works continued to be manufactured by Richard Edwards under the style of “James Edwards and Son” until 1882. It is said that his white granite ware was the standard of perfection to which the aims of other houses were directed.

Artifact Dimensions:

Diameter :

9.64 inches

245 mm



Figure 66. ALS-251 Fire Nozzle, Box, and artifacts in concrete.

Artifact ALS-251 is a composite artifact consisting of a brass fire-fighting nozzle concreted to a wooden box. There is a collection of small artifacts in the concrete including pieces of glass, parts of bottles, parts of ceramics, a toothbrush handle, and a length of the copper riveted leather hose used to supply water to the nozzle from the pump. A scan with a metal detector indicates that the box contains at least one iron object centered inside. Further investigation will be necessary to determine the contents of the box and exactly what artifacts are included in the concrete.

Artifact Dimensions:

Length max :	44.09 inches	1120 mm
Height max :	15.74 inches	400 mm
Width max :	11.81 inches	300 mm
Box Length :	15.35 inches	390 mm
Box Width :	10.23 inches	260 mm
Box Height :	9.05 inches	230 mm



Figure 67. ALS-252 Wood fragment.

Artifact ALS-252 is a fragment of wood from the wreck. It appears to be pine, indicating that it came from the interior of the ship. It has a mortise fashioned into one end indicating it was attached to a tenon in another piece of wood. This is a strong joint commonly used in cabinetry and carpentry.

Artifact Dimensions:

Length :	5.51 inches	140 mm
Height :	3.34 inches	85 mm
Thickness max :	1.37 inches	35 mm



Figure 68. ALS-253 Wall Mount.

Artifact ALS-253 is a cast copper alloy wall mount. The base plate contains two holes for attaching it to the wall with screws or nails. The base plate and projecting piece were manufactured separately and soldered together. Though many of the fine details have eroded away, it can still be seen that it was originally a quite intricate floral motif. Pieces like this could have been used on board to hang lamps or other objects from.

Artifact Dimensions:

Length :	7.48 inches	190 mm
Height max :	4.13 inches	105 mm
Thickness :	3.74 inches	95 mm

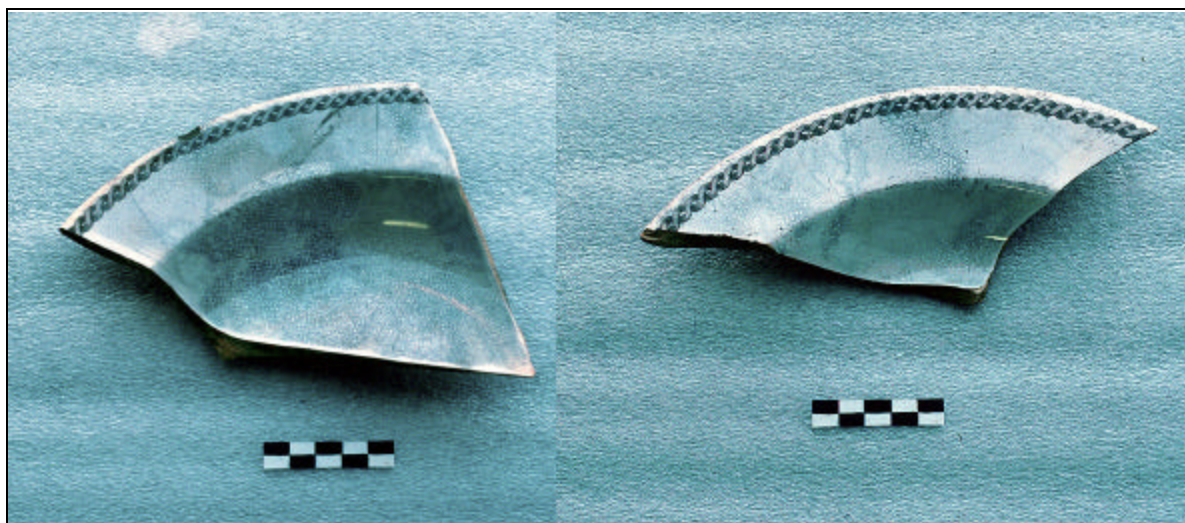

Figure 69. ALS-254 a and ALS-254 b Fragments of Plate.

Artifacts ALS-254 a and ALS-254 b are 2 fragments of the same broken ironstone plate with a brown cable design around the perimeter. Its characteristics appear to be identical to those of the Davenport plates recovered this year and during previous investigations.

Artifact Dimensions:

ALS-254 a

Length max :	6.10 inches	155 mm
Width max :	5.51 inches	140 mm
Thickness max :	0.31 inches	8 mm

ALS-245 b

Length max :	7.71 inches	196 mm
Width max :	3.38 inches	86 mm
Thickness max :	0.31 inches	8 mm



Figure 70. ALS-255 Fragment of Plate.

Artifact ALS-255 is a fragment of a broken plate found in the same location as ALS 254a and ALS 254b. Its characteristics appear to be identical to those of the Davenport plates recovered this year and during previous investigations.

Artifact Dimensions:

Length max :	2.48 inches	63 mm
Width max :	1.73 inches	44 mm
Thickness max :	0.23 inches	6 mm



Figure 71. ALS-256 White plate.

Artifact ALS-256 is an intact decorated white plate. There is a circular seal imprinted into the bottom, but it is illegible. A plate with the same pattern was recovered in the 1995 investigation (ALS-206). ALS-206 had the makers mark “E. Challinor & Co”.

Artifact Dimensions:

Diameter :	7.75 inches	197 mm
Thickness :	0.19 inches	5 mm



Figure 72. ALS-257 Pipe Bowl.

Artifact ALS-257 is the bowl from a meerschaum pipe. The bottom of the bowl is decorated in a shell motif. The face of the surface of the pipe where the stem is inserted has 9 V-shaped notches carved into it. When recovered, the smell of tobacco was still present. There are 3 screws for attaching the bowl to the stem, however only 2 penetrate to the interior bore of the pipe.

Artifact Dimensions:

Height :	2.36 inches	60 mm
Length :	3.34 inches	85 mm
Exterior Bowl Diameter :	1.37 to 1.61 inches	35 to 41 mm
Interior Bowl Diameter :	0.86 inches	22 mm
Diameter of stem hole :	0.51 inches	13 mm

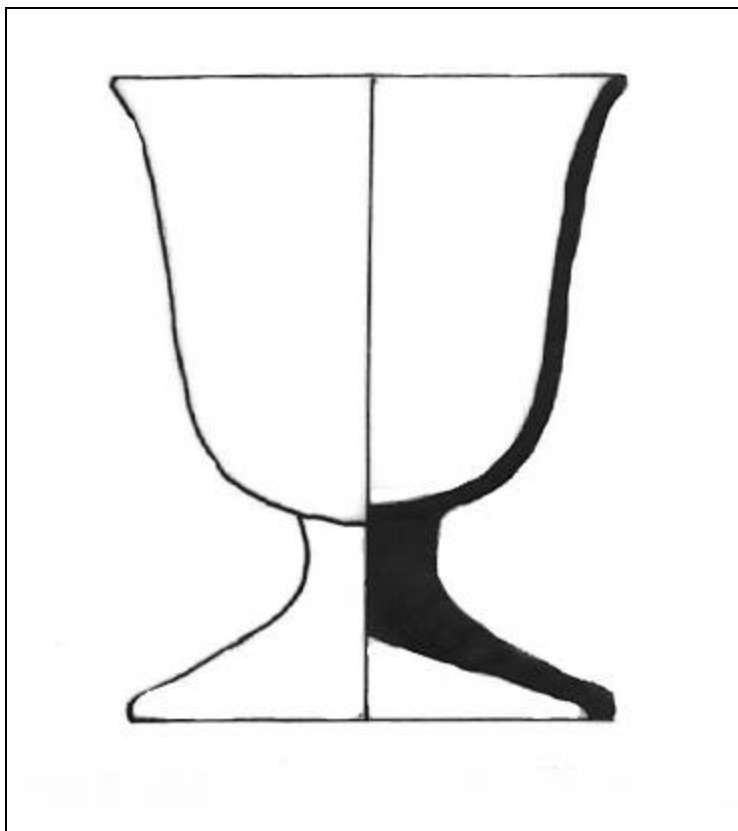

Figure 73. ALS-258 Boiled Egg Cup.

Artifact ALS-258 is what appears to be an egg cup. The cup has a small piece missing. The bottom has a blue transfer print of “Davenport” in an arc above an anchor.

Artifact Dimensions:

Height :	2.51 inches	64 mm
Diameter of the cup :	1.96 inches	50 mm
Diameter of the foot :	1.69 inches	43 mm
Thickness of the cup :	0.07 to 0.09 inches	2 to 2.5 mm

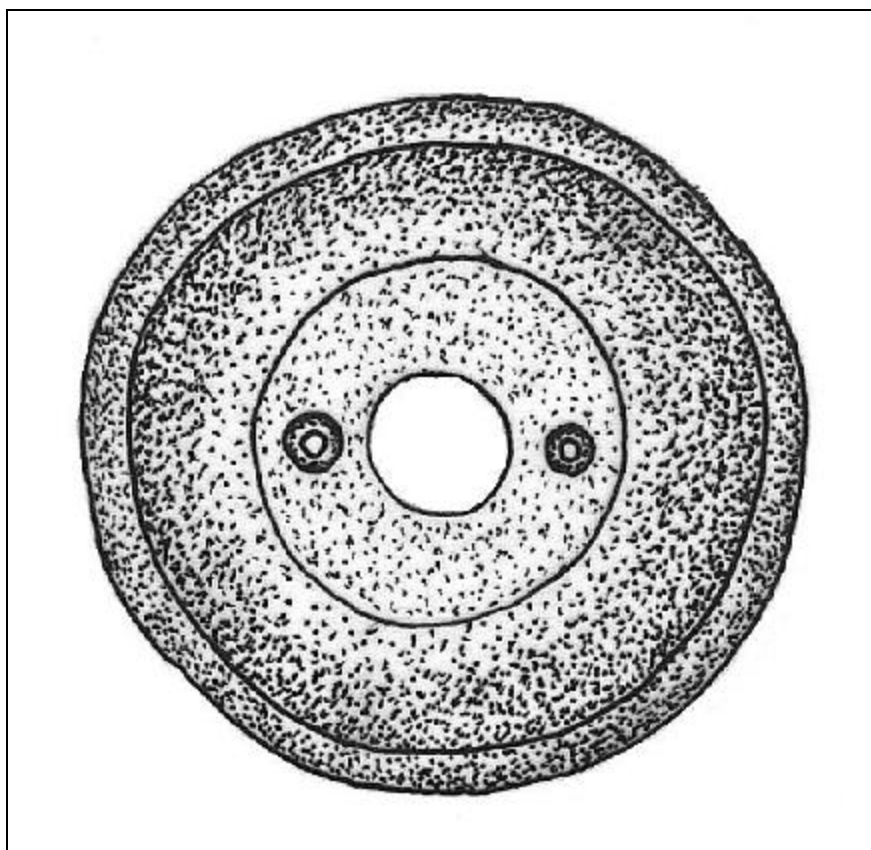

Figure 74. ALS-259 Wooden Disc.

Artifact ALS-259 is a small wooden disc. There is a 12 mm center hole, with one 5 mm hole above and one 5 mm hole below. It is likely this piece was used as a cover piece. The small holes would have been used to fasten the piece to the substrate with nails or more likely small screws. It is similar to the plate used around the base of a modern doorknob.

Artifact Dimensions:

Diameter :	2.24 inches	57 mm
Thickness :	0.33 inches	8.5 mm
Internal Diameter of the circle :	1.18 inches	30 mm
Diameter of the center circle :	0.47 inches	12 mm
Diameter of the perforations :	0.19 inches	5 mm

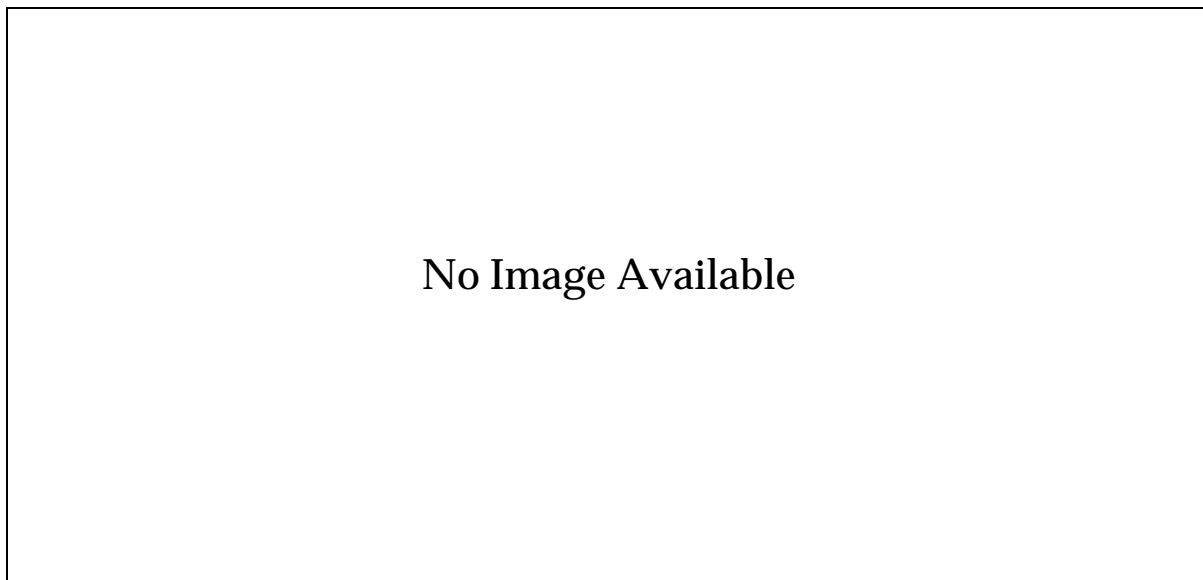

Figure 75. ALS-260 Ironstone Soup Bowl with Cobalt Blue Design.

Artifact ALS-260 is a white ironstone soup bowl with a cobalt blue transfer printed decoration. The interior of the bowl is decorated with fouled anchor that is located in the center with a garter surrounding it and a cable decorates the perimeter. A figure 8 shaped makers stamp on the underside of the plate reads "Davenport Ironstone China". Inside the stylized figure 8 are an anchor and the number 2. To the left of the anchor is the number 6 and to the right of the anchor is the number 0. The word "Davenport" is also transfer printed in blue on the bottom near the makers stamp. Numerous similar bowls in the brown pattern were recovered this year.

Artifact Dimensions:

Diameter:	10.5 inches	263 mm
Height:	2 inches	49 mm



Figure 76. ALS-261 Ironstone Plate with Cobalt Blue Design.

Artifact ALS-261 is a white ironstone plate with a cobalt blue transfer printed decoration. The interior of the plate is decorated with fouled anchor that is located in the center with a garter surrounding it and a cable decorates the perimeter. A figure 8 shaped makers stamp on the underside of the plate reads “Davenport Ironstone China”. Inside the stylized figure 8 are an anchor and the number 2. To the left of the anchor is the number 6 and to the right of the anchor is the number 0. The word “Davenport” is also transfer printed in blue on the bottom near the makers stamp. The photo above is of an identical plate recovered in 2000. Numerous similar plates have been recovered during previous investigations.

Artifact Dimensions:

Diameter:	10.38 inches	263 mm
Height:	1.25 inches	31 mm
Center Emblem Diameter:	1.94 inches	49 mm

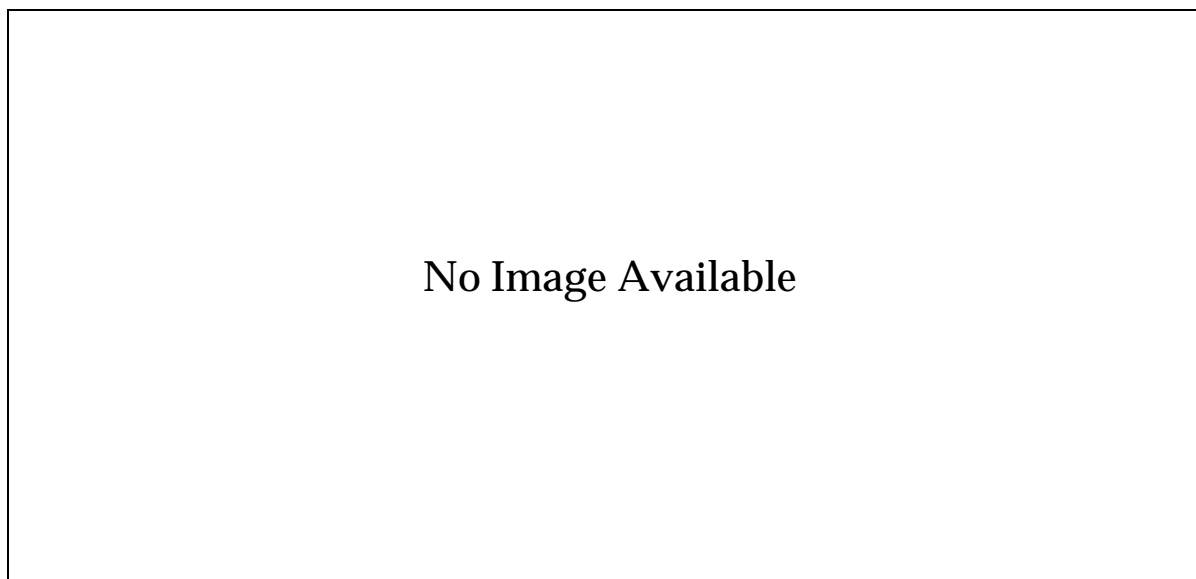

Figure 77. ALS-262 White Plate.

Artifact ALS-262 is a plain white plate. The top of the plate is decorated with a relief of pattern. The bottom has a makers mark of “Anthony Shaw, Burslem”. The makers mark has a lion and unicorn on either side of a crown. This plate was manufactured at the Mersey Pottery works which was established by Anthony Shaw in 1850. The works carried this mark until 1882, when it changed to “Anthony Shaw & Sons.” They specialized in white graniteware specifically adapted for the various North American and South American markets.

Artifact Dimensions:

Diameter :	7.71 inches	196 mm
Thickness :	0.21 inches	5.5 mm

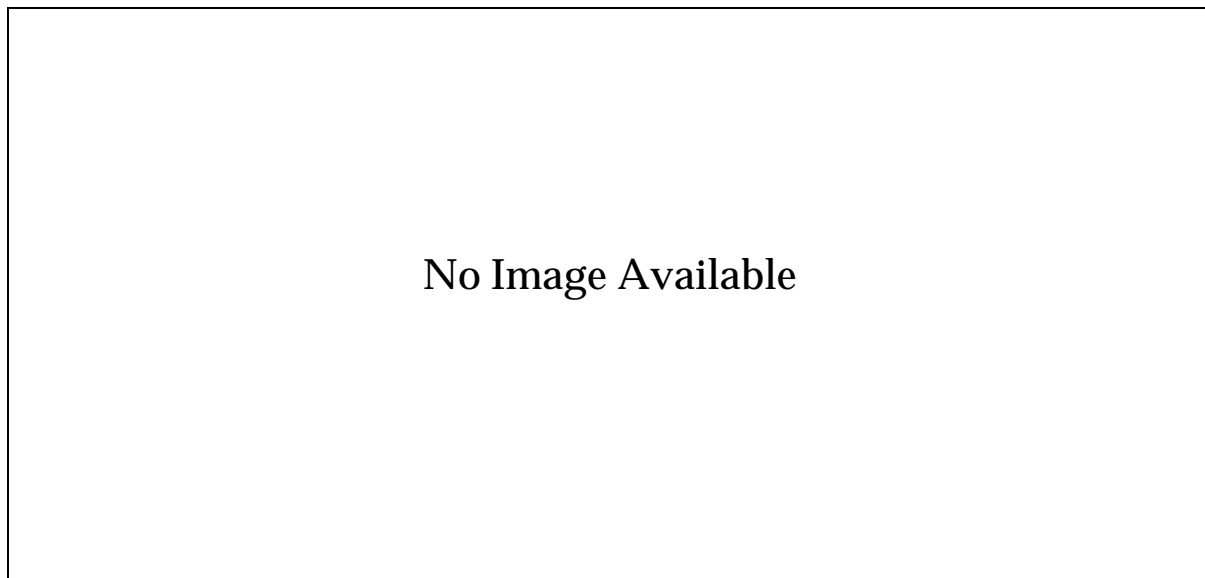

Figure 78. ALS-263 Piece of glass.

Artifact ALS-263 is a flat piece of glass. One face appears to be frosted. It is not clear whether this was the case when it was manufactured or whether it is the result of abrasion by sediment over time at the wreck site.

Artifact Dimensions:

Length :	13.97 inches	355 mm
Width :	10.23 inches	260 mm
Thickness :	0.27 inches	7 mm



Figure 79. ALS-264 Davenport Mug.

Artifact ALS-264 is a largely intact ironstone mug. It is free from decoration with the exception of a molding around the base. The bottom has a blue transfer print of “Davenport” in an arc above an anchor.

Artifact Dimensions:

Height :	2.95 inches	75 mm
Diameter of the lip :	2.87 inches	73 mm
Diameter of the base :	3.14 inches	80 mm
Thickness :	0.07 to 0.11 inches	2 to 3 mm

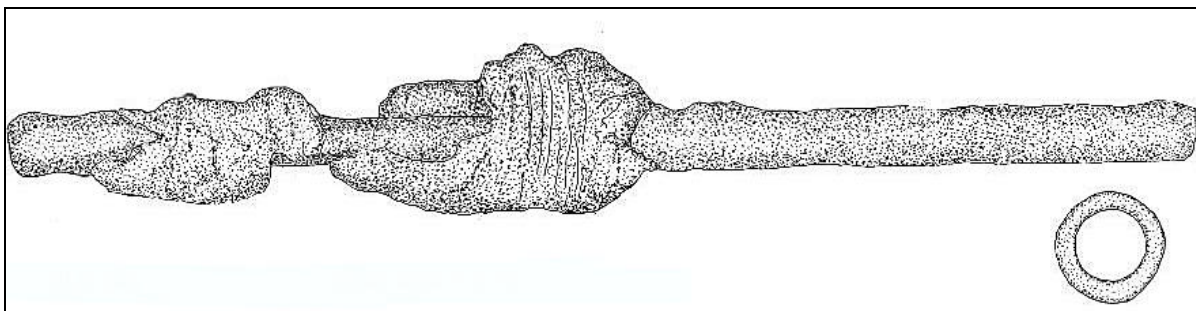

Figure 80. ALS-265 Drift Pin with Rove and Wood.

Artifact ALS-265 is a copper alloy drift pin and rove with mineralized wood. It is similar to many other drift pins recovered previously.

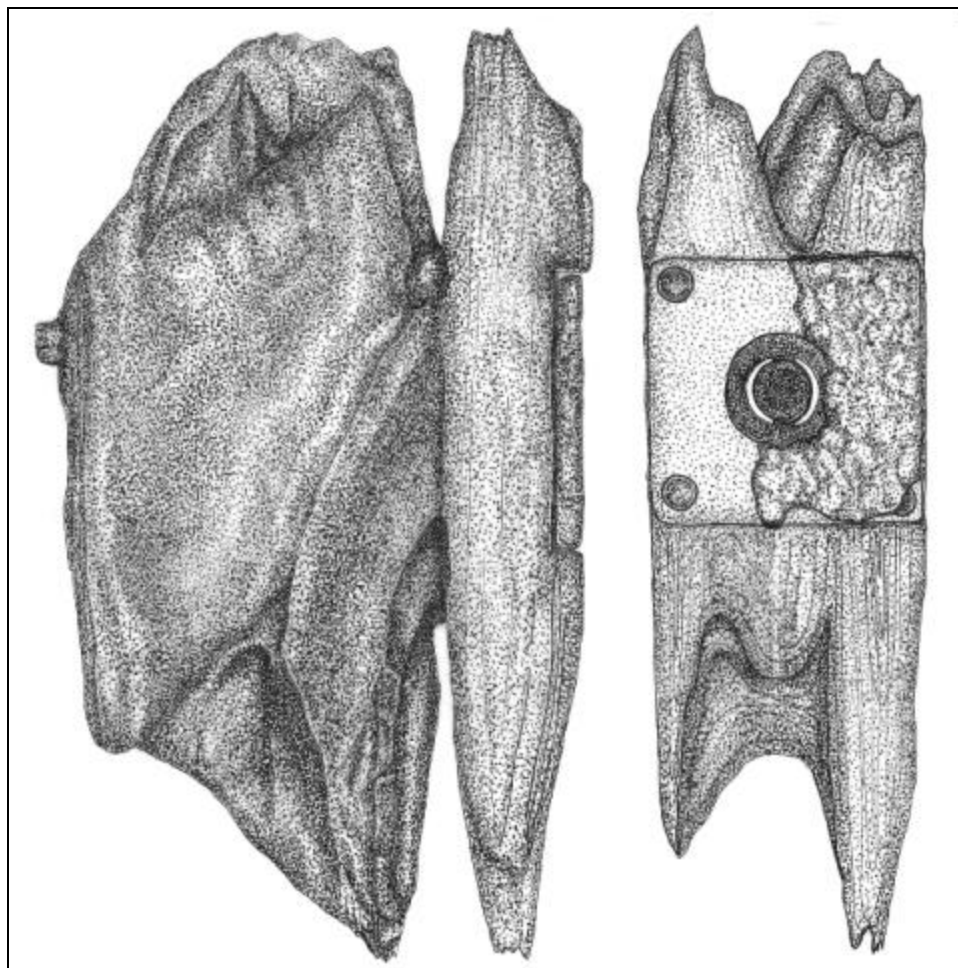

Figure 81. ALS-266 Cannon Pivot with wood and fasteners.

Artifact ALS-266 is composite artifact consisting of the pivot for one of the cannon with wood from the deck and a screw and a nail. The pivot was secured to the deck via screws in each of the four corners. There is an unknown white material between the mounting plate and the wood of the deck. Similar cannon pivots have been recovered during previous investigations (ALS-66, ALS-107, ALS-147, ALS-150, and ALS- 208).

Artifact Dimensions:

Length max :	21.85 inches	555 mm
Width max :	6.69 inches	170 mm
Height max :	12.59 inches	320 mm
Mounting Plate :	6.29 x 6.29 inches	160 x 160 mm
Plate Thickness :	0.43 inches	11 mm about
Diameter of the Screw Holes :	0.86 inches	22 mm
Depth of pivot hole :	7.08 inches	180 mm

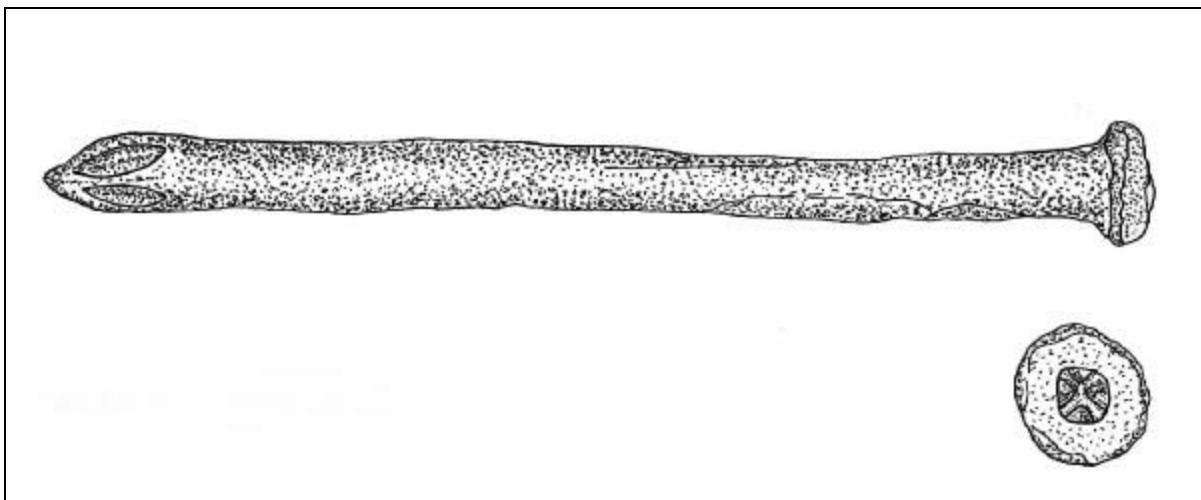

Figure 82. ALS-267 Copper Spike.

Artifact ALS-267 is a copper spike. This large copper or copper alloy spike could have served any number of purposes on the *Alabama*.

Artifact Dimensions:

Length :	6.14 inches	156 mm
Diameter of the head :	0.70 inches	18 mm
Diameter of the point :	0.39 inches	10 mm

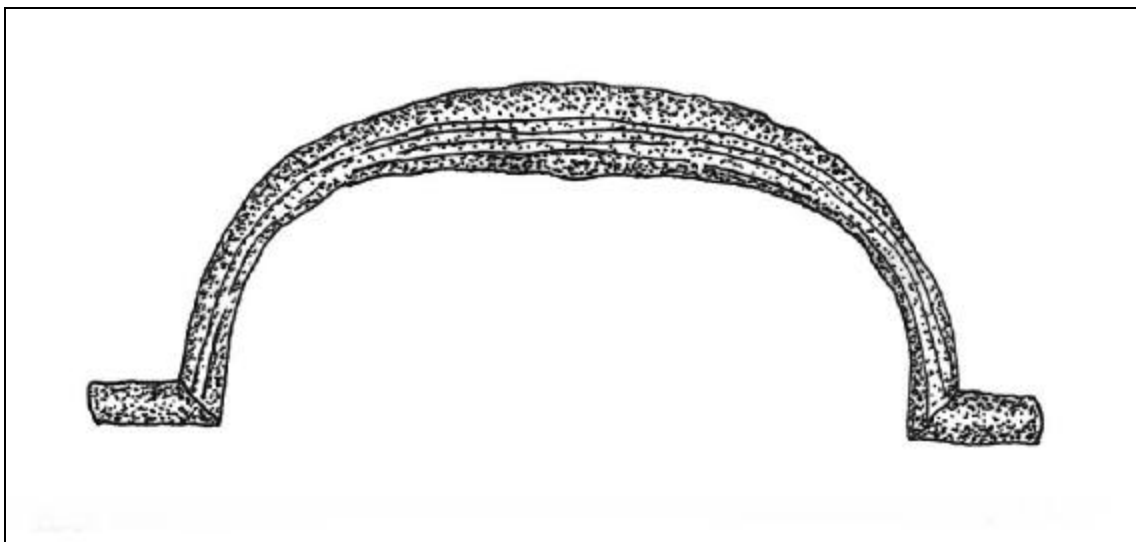

Figure 83. ALS-268 Handle.

Artifact ALS-268 is a handle made of copper. It was probably used as a drawer pull. Further investigation is necessary to determine its exact identity and use.

Artifact Dimensions:

Length max :	4.33 inches	110 mm
Height max :	1.77 inches	45 mm
Thickness max :	0.43 inches	11 mm



Figure 84. ALS-269 Broken Glass.

Artifact ALS-269 is a broken piece of crystal. The base, stem, and bottom of the cup are present. The part that is present is identical to ALS-270.

Artifact Dimensions:

Height :	3.74 inches	95 mm
Diameter of the cup :	3.34 inches	85 mm
Diameter of the foot :	2.75 inches	70 mm



Figure 85. ALS-270 Broken Glass.

Artifact ALS-270 is a broken piece of crystal. Though it is broken, it has a complete archaeological profile. The glass appears to be hand turned, with a geometric pattern of three parallel lines interrupted by diamonds on the cup. Between the geometric pattern and the stem is a row of oval impressions. The stem and base are plain.

Artifact Dimensions:

Height :	4.88 inches	124 mm
Diameter of the cup :	3.34 inches	85 mm
Diameter of the foot :	2.75 inches	70 mm

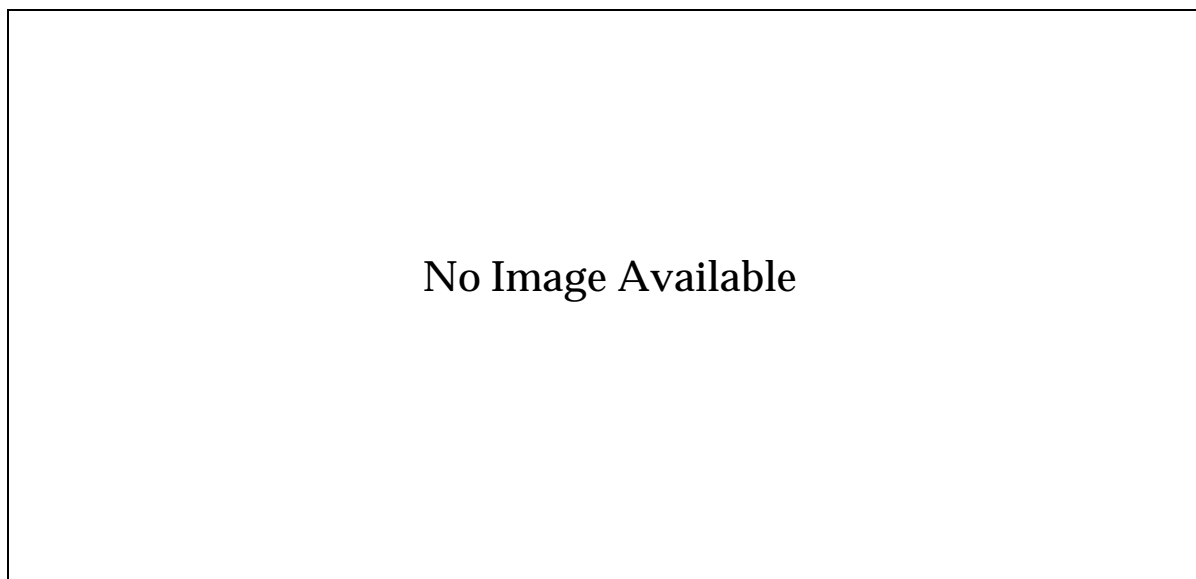

Figure 86. ALS-271 Broken Glass.

Artifact ALS-271 is a broken piece of crystal consisting of a portion of the cup. The stem and base are broken off. The cup is decorated like ALS-270.

Artifact Dimensions:

Height :	3.54 inches	90 mm
Diameter of the cup :	3.34 inches	85 mm

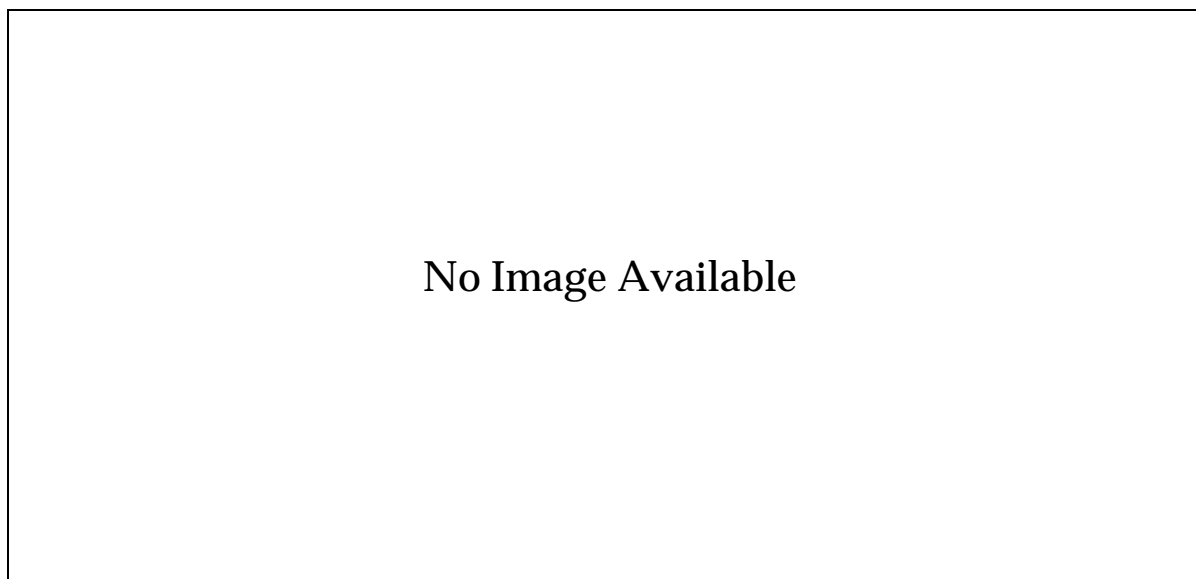

Figure 87. ALS-272 Broken Glass.

Artifact ALS-272 is a broken piece of crystal consisting of a portion of the cup. The stem and base are broken off. The cup is decorated like ALS-270.

Artifact Dimensions:

Height :	3.74 inches	95 mm
Diameter of the cup :	3.34 inches	85 mm

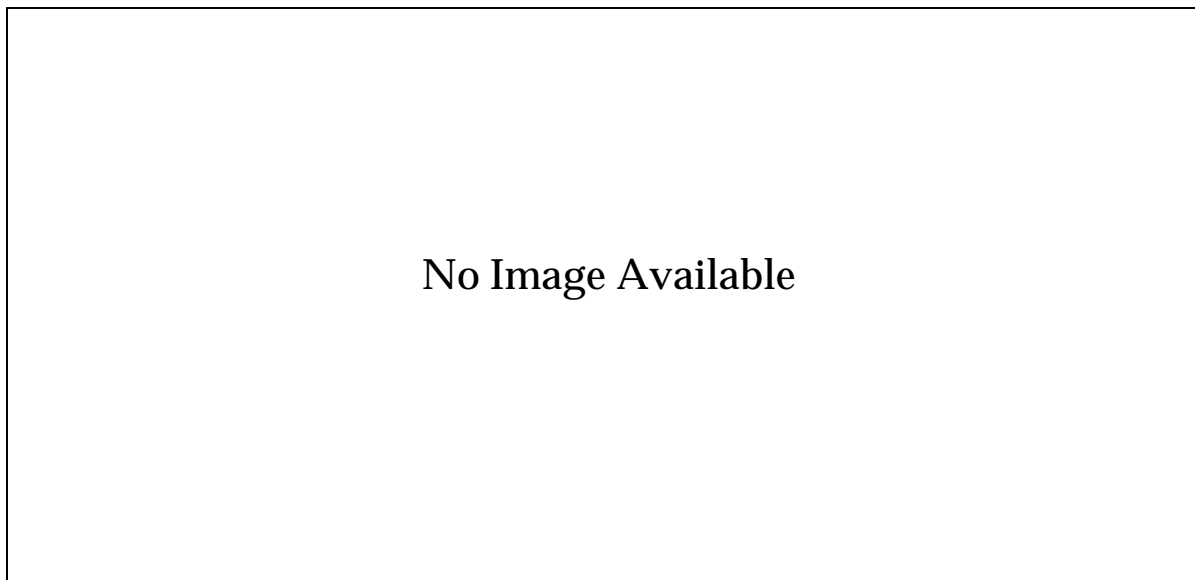

Figure 88. ALS-273 Plate Fragment.

Artifact ALS-273 is a fragment from a white plate.

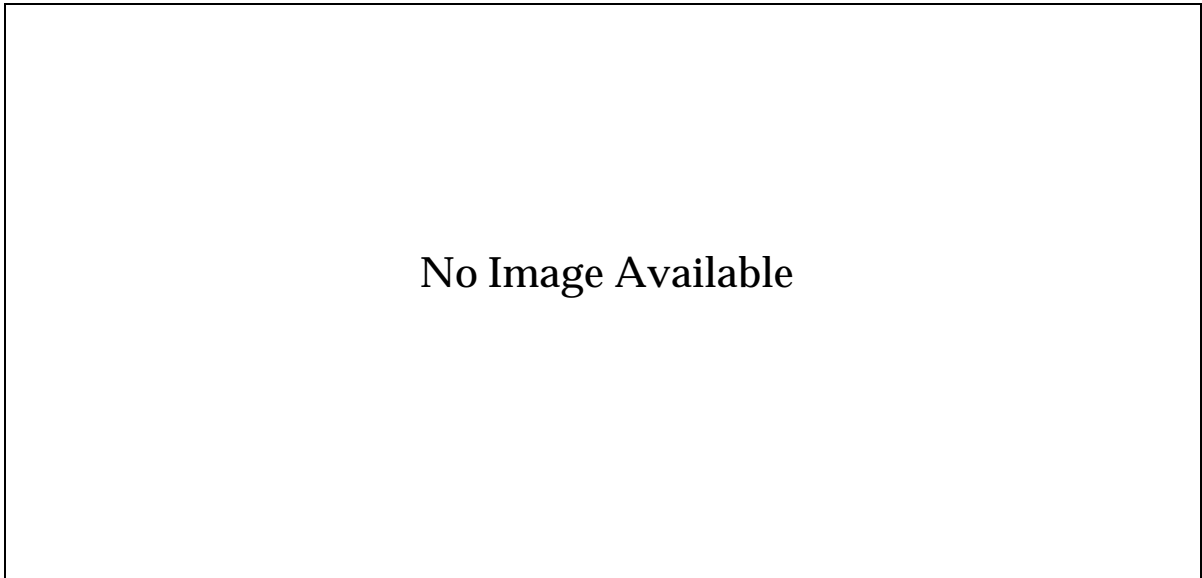

Figure 89. ALS-274 Sheet Copper.

Artifact ALS-274 is a long piece of sheet copper fashioned into a semi-circular shape. It was possible used to cover the wood of a handrail for a staircase. There are, however, no holes used for fasteners to attach the piece to the substrate. It is possible, therefore, that it was simple held on by it conformity to the shape of the base object.

Artifact Dimensions:

Length approximate:	59.0 inches	1500 mm
Width approximate:	4.13 inches	105 mm

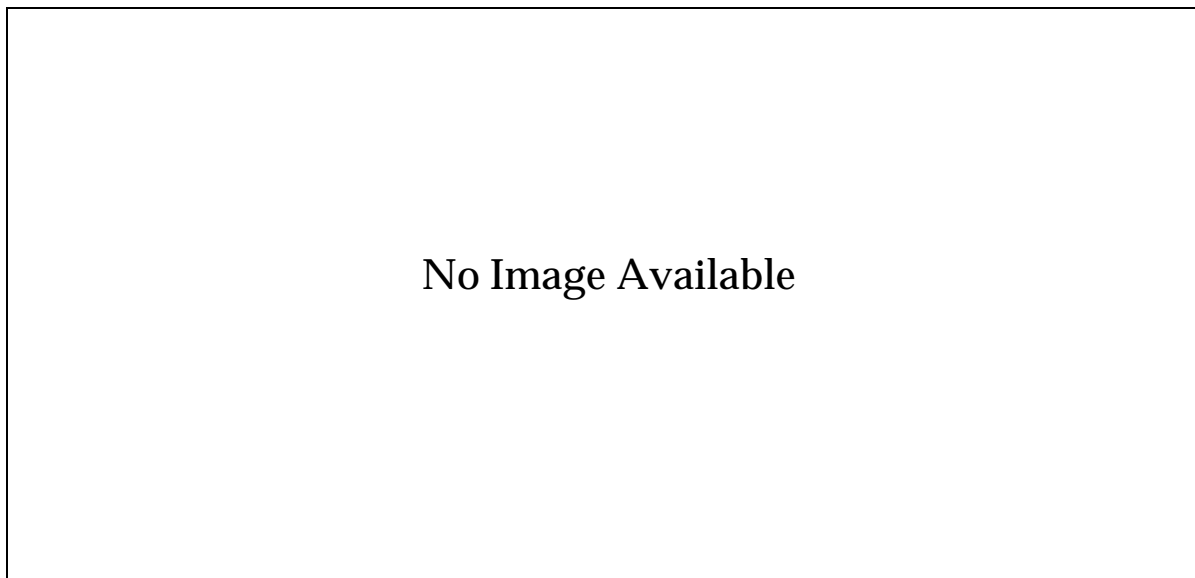

Figure 90. ALS-275 Ironstone Soup Bowl with Green Design.

Artifact ALS-275 is a white ironstone soup bowl with a green transfer printed decoration. The interior of the plate is decorated with fouled anchor that is located in the center and a cable decorates the perimeter. A figure 8 shaped makers stamp on the underside of the plate reads "Davenport Ironstone China". Inside the stylized figure 8 are an anchor and the number 2. To the left of the anchor is the number 6 and to the right of the anchor is the number 0. The word "Davenport" is also transfer printed on the bottom near the makers stamp. Numerous plates with a similar design have been recovered from the stern area of the *Alabama* during previous investigations.

Artifact Dimensions:

Diameter: 10.35 inches 263 mm



Figure 91. ALS-276 a and ALS-276 b Ironstone Soup Tureen with Lid

Artifacts ALS-276a and ALS-276b are a white ironstone soup tureen and matching lid with a green transfer printed decoration. The interior of the bowl is decorated with crossed anchors inside a garter in the center with a cable decorating the perimeter. The exterior of the bowl is decorated with the cable pattern around the base and around the body of the bowl. Though there are a few pieces missing from the rim, the bowl is largely intact. The lid is fully intact. It is decorated with crossed anchors inside a garter on opposite sides with a cable decorating the rim. A figure 8 shaped makers stamp on the underside of the bowl reads “Davenport Ironstone China”. Inside the stylized figure 8 are an anchor and the number 2. To the left of the anchor is the number 6 and to the right of the anchor is the number 0. The word “Davenport” is also transfer printed on the bottom near the makers stamp. A piece of an identical lid was recovered in the 1995 operation (ALS-200).

Artifact Dimensions:

Diameter max :	9.96 inches	253 mm
Base Diameter :	6.41 inches	163 mm
Lid Diameter :	8.89 inches	226 mm
Height of the Bowl :	3.14 inches	80 mm
Total Height :	5.11 inches	130 mm

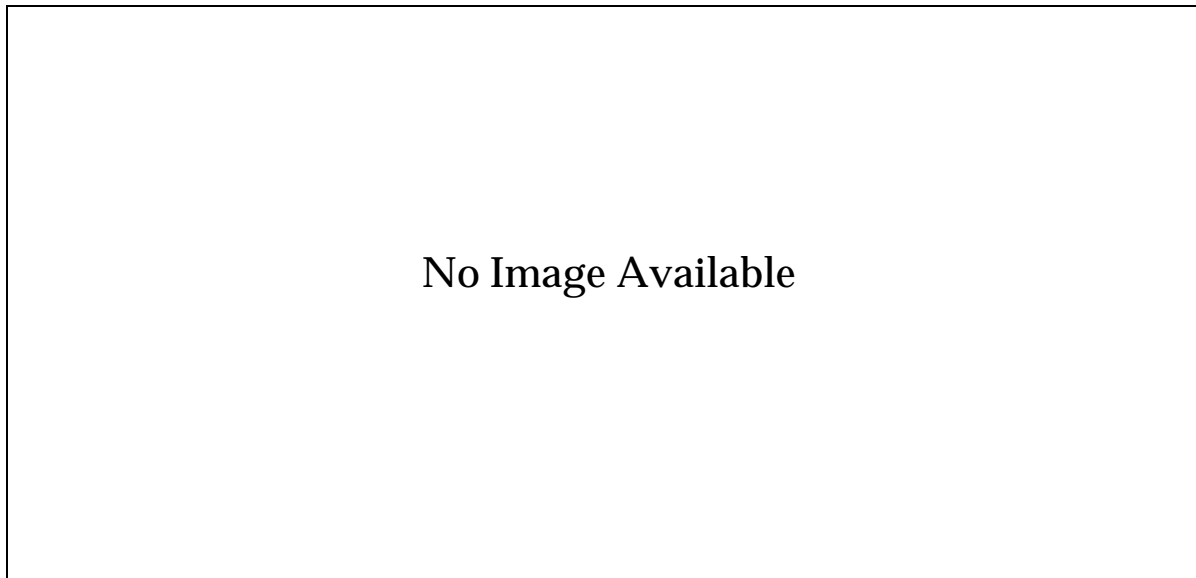

Figure 92. ALS-277 Ironstone Plate with Green Design.

Artifact ALS-277 is a white ironstone plate with a green transfer printed decoration. The interior of the plate is decorated with fouled anchor that is located in the center and a cable decorates the perimeter. A figure 8 shaped makers stamp on the underside of the plate reads “Davenport Ironstone China”. Inside the stylized figure 8 are an anchor and the number 2. To the left of the anchor is the number 6 and to the right of the anchor is the number 0. The word “Davenport” is also transfer printed on the bottom near the makers stamp. Numerous similar plates have been recovered from the stern area of the *Alabama*.

Artifact Dimensions:

Diameter:	10.27 inches	261 mm
-----------	--------------	--------

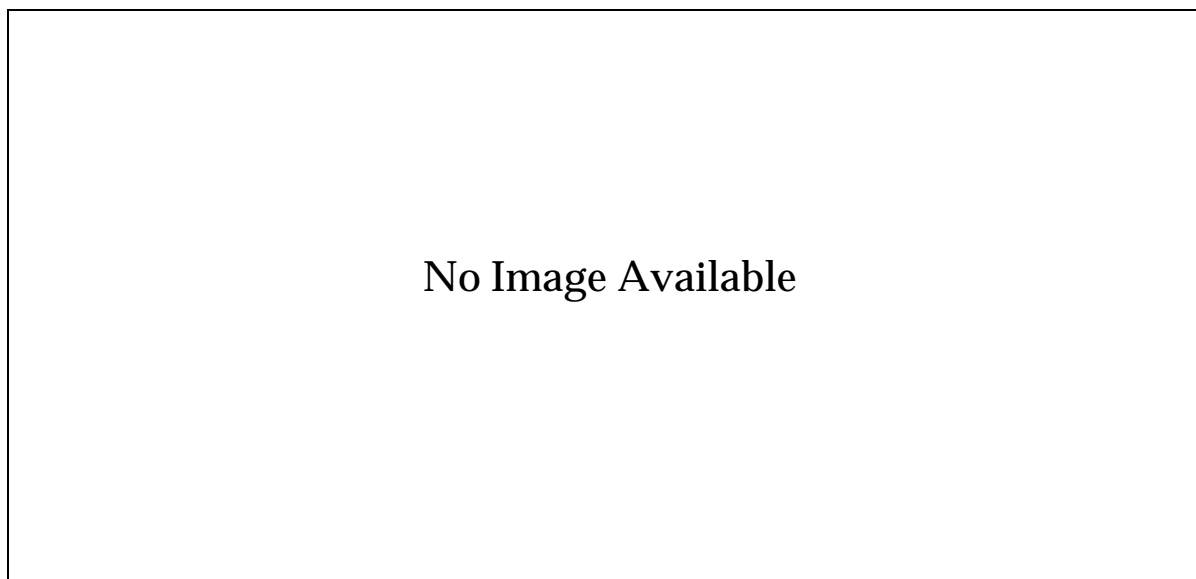

Figure 93. ALS-278 Broken Bottle.

Artifact ALS-278 is a broken piece of a square bottle. The base and part of the sides are present.

Artifact Dimensions:

Height max :	2.83 inches	72 mm
Width max :	1.85 inches	47 mm
Thickness :	0.11 to 0.19 inches	3 to 5 mm



Figure 94. ALS-279 Decanter.

Artifact ALS-278 is a glass decanter. It appears to be had blown as no mold marks are present. It may have been used for serving water or wine onboard the vessel.

Artifact Dimensions:

Height :	9.21 inches	234 mm
Diameter of the neck :	1.88 inches	48 mm
Diameter of the body max :	3.97 inches	101 mm



Figure 95. ALS-280 Bottle with cork inside.

Artifact ALS-280 is a green smoked blown-glass bottle. Though not apparent in the picture, once the sediment was removed, the cork was found inside the bottle. Bottles of this type were common throughout the period and could have held any one of a number of liquids.

Artifact Dimensions:

Height :	9.33 inches	237 mm
Diameter of the base :	2.55 inches	65 mm
Diameter of the neck :	1.02 inches	26 mm



Figure 96. ALS-281 Bottle.

Artifact ALS-281 is a large clear glass bottle. The base is square, tapering to round at the shoulder. The base of the neck has a single large band. The sides are not identical. One side has an oval impression with a wheat type pattern above and below the impression. The other 3 sides have an impression that is square on the bottom and rounded on the top with the wheat type pattern only above the impression.

Artifact Dimensions:

Height :	13.58 inches	345 mm
Base :	3.54 x 3.54 inches	90 x 90 mm



Figure 97. ALS-282 White ceramic pitcher.

Artifact ALS-282 is an intact white ceramic pitcher. It has a highly intricate relief pattern with a crosshatch design with interwoven wheat tassels in a band around the throat draping down over the top of the crosshatch pattern. The bottom bears an impressed makers mark consisting of a crown and letters which are illegible. It is identical to two pitchers that were recovered in 1994 (ALS-185 and ALS-186).

Artifact Dimensions:

Height max :	7.08 inches	180 mm
Diameter of the body :	5.11 inches	130 mm
Diameter of the base :	3.14 inches	80 mm

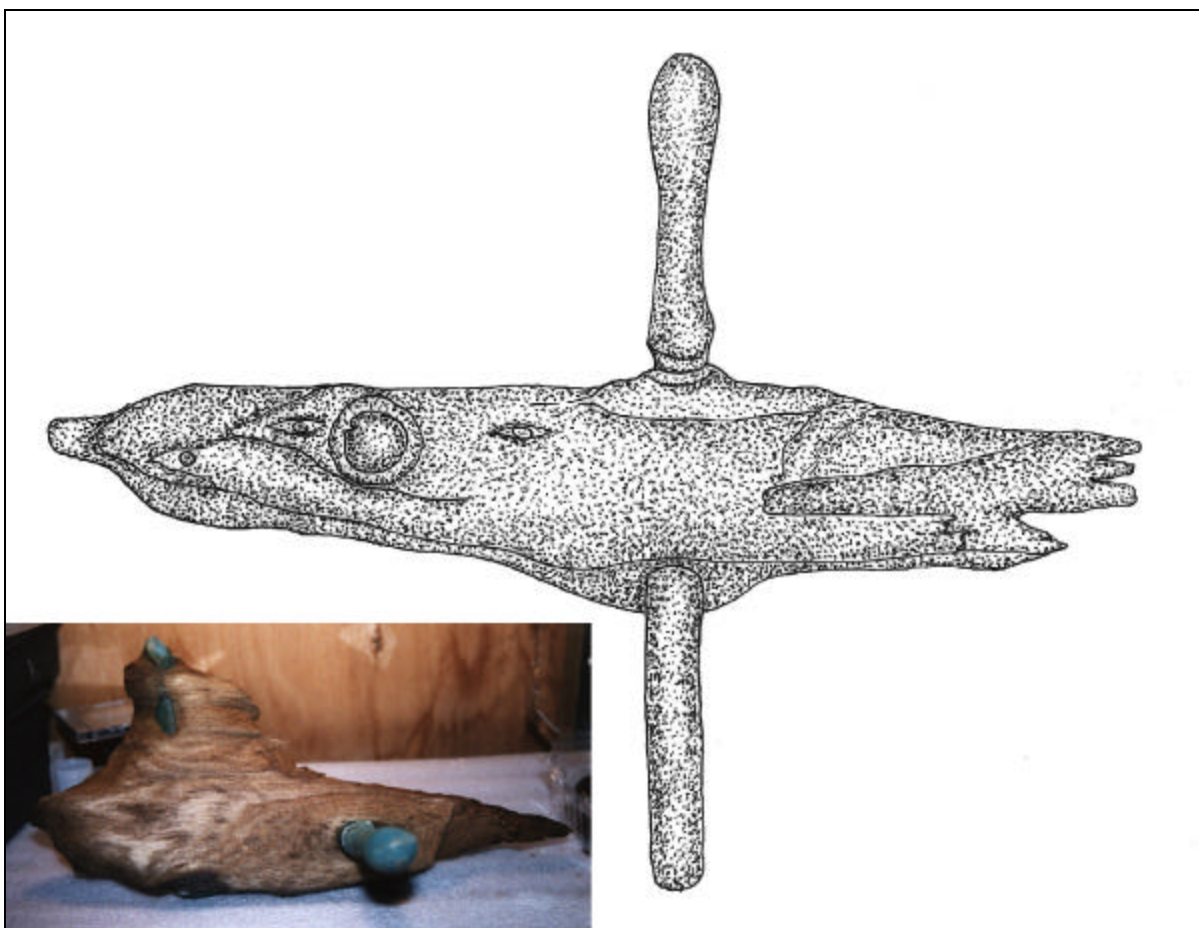

Figure 98. ALS-283 Wood and copper fragment.

Artifact ALS-283 is a fragment of wood with copper fasteners. The wood is in a very good state of preservation. There are 3 nails visible in the piece of wood.

Artifact Dimensions:

Length max :	14.96 inches	380 mm
Width max :	7.28 inches	185 mm
Height max :	11.41 inches	290 mm



Figure 99. ALS-284 British Royal Navy Pattern 32-Pounder Cannon.

Artifact ALS-284 is one of the broadside guns from the *Alabama*. It is a British Royal Navy pattern 32-pounder of unknown manufacture. The *Alabama* had 6 32-pounders and two large pivot guns. Of the 6 32-pounders, 4 were made by Fawcett and Preston specifically for the *Alabama*. The other 2 were British Royal Navy pattern 32-pounders commonly used on many other vessels of the time. The forward Blakely pivot gun was recovered in 1994. One of the Fawcett and Preston 32-pounders was recovered in 2000. Although preliminary drawings of the British Royal Navy pattern 32-pounder illustrate many of the design characteristics of the barrel, most of the tube remains obscured by a calcareous crust formed by deteriorating iron, seawater and sediment. Cleaning will have to be completed before a thorough assessment can be made.

Results of the 2001 Investigation

The most important objective of the 2001 CSS *Alabama* investigation was documentation of the wreck site. That objective was compromised by loss of the services of the U. S. Navy research submarine *NR-1* and the Deep Ocean Engineering ROV. Without the data that could have been generated by *NR-1* and ROV operations, the proposed mosaic and three-dimensional model of the wreck site could not be developed. Without the *NR-1* and ROV operations “at risk” artifacts exposed on the bottom surface could not be identified and recovered. In spite of the *NR-1* and ROV setbacks, on-site investigation generated some new information about the wreck, produced additional insight into working at the site and resulted in the recovery 62 artifacts.

Excavation at the CSS *Alabama* wreck site has been a perpetual problem. Without an adequate surface support vessel and power for excavation equipment, the problem continued to plague operations during the 2000 campaign. Both problems were resolved in 2001 by mounting a 100-psi, 100 cfm compressor on the American research vessel *Enrica*. The low-pressure screw compressor provided sufficient volume to adequately power a 4-inch airlift at the Alabama’s depth. Air hose for the airlift was mated to a mooring line attached to one of the 32-pounder cannon located in near the stern. At the bottom of the mooring line, the air hose was weighted with lead anchors and successively arranged to support excavation at the stern pivot gun, the bilge pump and finally the test excavation site. Securing the lift at the bottom and providing an air volume control handle for the diver, eliminated the potential danger of an uncontrolled ascent associated with clogging in the discharge hose.

Using the airlift, shell hash and sand that migrates around the bottom in the vicinity of the wreck could be quickly removed from the area of excavation defined by the grid frame. Although coordination complicated the process, teams of divers and archaeologists working in succession carried out excavation. 9 The first team excavated sediment from within the grid leaving artifacts exposed in-situ. A second team videotaped and mapped the exposed material, continued the excavation and removed documented artifacts. The third team continued removing exposed artifacts, packed them in a recovery basket and brought them to the surface. That arrangement worked reasonably well although conditions at the site, equipment problems and the nature of material exposed by excavation frequently dictated changes in the methodology. Excavation time was limited to less than 30 minutes a day by both personnel and tide time.

In spite of those limitations the test was carried to a depth of 18 inches below the bottom of the upper stratum of shell hash and sand. Cultural material exposed by excavation consisted almost entirely of ceramic tablewares, glass storage bottles, fixtures and a decorated pipe bowl. The tablewares included stoneware plates and bowls decorated with a cable around the rim and an anchor in the center. Glass included several storage bottles. At least one survived with the contents intact. The pipe bowl appears to be meerscham and was decorated with a stylized shell.

Excavation was also carried out at the base of the bilge pump. A wooden box with a fire nozzle, leather hose, fragments of glass bottles and other artifacts concreted to it was recovered from the bottom surface near the pump. The upper stratum of shell hash and sand was quickly cleared with the airlift, but the number of artifacts clustered around the base of the pump dictated a slower pace. A variety of white stoneware plates and saucers and a small earthenware jar were removed before excavation resumed. Underneath a brass mounting collar, remains of the deck were identified. Below that collar an intake tube extended into the sediment. Because excavation was halted due of the number of artifacts, it was not possible to determine if the intake pipe continued into the bilge. Under the valve chest, several additional pipes extended into the sediment in the direction of the bilge. Patent drawings located by Andrew Bowcock ultimately determined that the intake pipe on the pump was plumbed into the bottom of the valve chest and not the bilge.

Limited excavation associated with the aft pivot gun confirmed that the weapon is no longer mounted on its carriage. One of the trunions was exposed by excavation and the trunion strap was not in place. Although there was wood buried along one side of the cannon, it was not part of the carriage as originally believed. Efforts to expose the gun during the second phase of diving were frustrated by sediment that migrated in to obscure the weapon and a large fragment of the hull structure that was deposited on top of the gun by the current. Because of the calculated weight of the cannon it could not be lifted by the *Vulcain* and excavation was halted.

Recovery of one of the 32-pounder cannon was also planned in conjunction with fieldwork during the summer of the year 2001. One of the British Royal Navy pattern 32-pounders was quickly identified by American archaeologists and recovered by French Navy divers. . That cannon lay on the bottom surface forward of the Alabama's smoke pipe and was almost entirely exposed. In spite of heavy concretion it was identified as one of the ship's two British Royal Navy pattern 32-pounders. Unlike the four Fawcett and Preston cast 32-pounders, the two British Royal Navy pattern guns were designed with a flared muzzle, distinctive reinforces and a naval cascabel with tackle eye. That gun was recovered by the *Vulcain* and deposited in the harbor at Cherbourg until being loaded for shipment to the United States.

Test excavations were also proposed at the base of the propeller and in the bow. Those excavations were designed to determine if the propeller and lifting frame remain attached to the keel and deadwood and to assess the nature and scope of the archaeological record associated with the crew's quarters. However, a number of important factors made it prudent to abandon those objectives. First, the number of personnel available during the second dive period significantly reduced the diving activity that was possible. During the second phase of operations diving was limited to French volunteers and American archaeologists. In addition, resources only permitted the operation of one dredge. Based on these constraints, the decision was made to focus on the test excavation, video documentation and limited artifact recovery.

Conclusions and Recommendations

The hull remains of the *CSS Alabama* contain a rich and varied archaeological record. That record preserves irreplaceable and highly specific insight into life aboard the most successful Confederate commerce raider. It also preserves more generalized insight into the South's most effective means of making the war felt in the United States. Although the wreck site lies in a very dynamic environment, that record can be recovered. If archaeological techniques are to be employed in recovering and reconstructing that record the means of conducting research at the site must be improved.

Mosaic and Modeling of the *CSS Alabama*

To accomplish the primary objective identified for 2002, use of an ROV is recommended. Unlike diver based data collection, decompression is not a consideration and the ROV can operate for more than an hour during each tidal cycle. Thus, the ROV can carry out the work in less time and with a higher degree of accuracy. A modest size ROV can operate on-site as long as the current permits. That could be as much as five times the amount of bottom time available to divers. An ROV of modest size can also be readily fitted with appropriate cameras and lighting equipment. Highly accurate positioning can be accomplished using a system of transducers positioned on the wreck. Because the wreck site is small, data for the entire mosaic could be collected within three to four days. Prior to ROV operations, divers would be used to set up either an on-site reference baseline web or locate acoustic transmitters on the wreck to control ROV positioning. After video and photographic data to support development of the mosaic has been collected, French and American divers would recover the transducers and any "at risk" artifacts that were documented by the ROV.

In light of the loss of the services of the United States Navy research submarine *NR-1* and the Deep Ocean Engineering ROV, it is apparent that all of the necessary authorizations for the use of research equipment must be identified. It is also essential to identify the various government offices and personnel that are responsible for approving the use of research equipment. Channels of authority and responsibility must be clearly defined along with timetables for the decision making process. As nearly as possible, all options for research activity and the equipment required to conduct that work must be identified and approved in advance. However, all options for equipment and research activity cannot be defined for projects where available funding cannot be determined well in advance. Neither can unforeseen opportunities and vehicles of convenience be identified well in advance. In order for the CSS *Alabama* project to benefit from, often unpredictable, opportunities and the essential latitude to adapt, a means of obtaining approval for last minute authorizations is essential. Obtaining authorizations is the responsibility of the French Association CSS *Alabama*. It is essential the organization develop a document identifying all the necessary permits, all personnel responsible for approving research operations and a means for securing permission to take advantage of opportunities and adapt the research methodology when necessary to accomplish the approved objectives of the campaign.

Failure to obtain the necessary permits and authorizations for proposed *NR-1* and ROV operations eliminated any possibility of accomplishing the most important objective of on-site research. That primary objective was the systematic collection of geo-referenced video and photographic data. While the mosaics developed from the data collected by divers during the 2000 campaign confirmed the high level of detail that can be documented and demonstrated that a comprehensive image of the site can be electronically developed, it was apparent that a more sophisticated method of data collection was necessary. Loss of the opportunity to employ the *NR-1* or ROV to collect those data eliminated the possibility of developing a scaled mosaic of the CSS *Alabama* site and a computer model of the wreck.

Development of an accurate mosaic based plan of the CSS *Alabama* remains as the most important priority for continued on-site research. Although it does not appear that use of the *NR-1* will be possible in 2002, use of an ROV can probably be scheduled in conjunction with the Naval Historical Center's continuing efforts to locate and identify World War II submerged cultural resources off the DDay beaches of Normandy. ROV site documentation activities carried out by the Naval Historical Center in 2001 produced high quality images of WWII resources. By combining the ROV operations with a geo-referenced on-site acoustic positioning

system, sufficient data could be generated to support production of a comprehensive high quality mosaic and computer site model. That activity should be the primary objective in 2002 and every effort should be made to insure that the research would be authorized and permitted regardless of the ROV and surface support vessel to be used to conduct the work or the period of on-site operations.

Test Excavations

In spite of the problems encountered, the 2001 investigation of the CSS *Alabama* produced worthwhile results. Clearly one of the most important results involved identifying a successful method of excavation. The low-pressure, high-volume compressor produced sufficient air volume to power airlifts when the length of the discharge hose was increased to 40 feet. Suction was more than sufficient to quickly remove the surface layer of sand and shell hash. By hand fanning the more clastic sediment below the sand and shell hash into the airlift careful excavation of undisturbed areas was possible. Sufficient progress could be made to keep ahead of the filling that occurred during the change of the tide. With barriers to isolate the excavation from the migratory sand and shell hash significant progress can be made even in the limited time the site is accessible.

Development of an effective means of excavation in 2001 permitted test excavation to reach levels within the CSS *Alabama's* surviving structure that have remained undisturbed since sediment filled the hull in the years following her loss. Those levels preserve an undisturbed archaeological context. Cultural material recovered from the 2001 test excavation confirmed that artifacts and structural remains within the hull are extremely well preserved. To recover that irreplaceable record, additional investigation within the hull of the *Alabama* must be designed and carried out by archaeologically trained personnel. All excavation within that undisturbed context must be carried out employing a methodology designed to recover not only surviving cultural material but also the irreplaceable archaeological record associated with it.

Continued test excavation which would destroy the undisturbed archaeological context can only be recommended if both an experienced team and an acceptable methodology can be employed. Personnel of the team must be composed of archaeologists and archaeologically trained divers. An archaeologist must accompany each team. Based on previous experience at least three teams will be necessary to operate throughout the tidal window. Each team should be composed of at least three and ideally four members. Within a two-meter square investigation area, an archaeologist and an assistant could excavate, a second archaeologist could map exposed material and structural remains and the fourth member of the team could video and photograph the work and document the excavation.

A team of sufficient size to support continuous investigation through the tidal window would require from 9 to 12 diving personnel, a vessel and equipment operator and a diving safety officer. One if not all of the divers should be equipped with communications equipment to facilitate team and team to surface coordination of research activity. While the 29-foot vessel *Enrica* worked effectively during the 2001 investigation, there would not be sufficient space onboard to accommodate 9 to 12 divers, the necessary support personnel and equipment used in diving and conducting the excavation. For the level of on-site activity to be increased, additional experienced archaeological personnel must be obtained and a larger American flag vessel must be employed for surface support. The size of that vessel must be balanced between what is necessary to carry the required personnel and equipment and what can effectively be anchored at the site. Approximately 35 to 38 feet appears to be about the ideal compromise.

If sufficient resources are available for extended excavations in 2002, the focus of that activity should continue to be testing in the stern, excavation at the base of the lifting screw, and a test in the crew's quarters forward. Continued excavation at the test site in the stern should be designed to reach the bilge ceiling and expose both elements of the ship's structure preserved below the bottom surface and material within the hull. Additional excavation in the stern should be focused on the lifting screw and be carried to sufficient depth to determine if the lifting frame is still attached to the hull. A third objective would be testing the forward area of the ship where the crew would have stowed their personal effects. Testing forward would generate data concerning both the condition of the wreck forward and the nature and scope of the archaeological record associated with the crew. Limited excavation will also be necessary to expose the aft bilge pump and the aft pivot cannon so that they can be prepared for lifting.

Recovery of the aft pivot cannon was one of the objectives proposed for 2001. Due of the limited lift capacity of the *Vulcain*, recovery of the piece was not attempted. Excavation and recovery of that weapon is recommended as one of the secondary priorities for the 2002 campaign. With effective excavation equipment available, preparing the cannon for lifting should not be difficult. Obtaining the necessary lifting capacity can be accomplished by requesting the services of the French Navy vessel *Elan*. The *Elan* has an A-frame on the stern with a capacity of more than fifteen tons. The A-frame also provided sufficient clearance over the stern to safely swing the cannon over the aft deck and lower it onto a suitable cradle. Likewise the *Elan* can easily lift the *Alabama's* aft pump.

Diving, Training and Equipment Testing

The use of an American flag surface support vessel permitted American divers to operate on-site using American dive protocols. That will greatly facilitate integrating new personnel into the archaeological team if funding permits an extended operation in 2002. However work at the CSS *Alabama* is still carried out using traditional SCUBA equipment and compressed air. Much more sophisticated diving systems are available. Those include mixed gas and saturation systems that can greatly extend bottom time at depths below the practical limits of scuba. In addition, diver delivery systems can transport personnel through the water column in currents that make scuba impractical. However, one of the biggest drawbacks is the amount of personnel required to support diver based operations and the degree of training required to effectively use the systems.

The procurement and testing of equipment for the 2001 CSS *Alabama* project was also a problem. Because funding was not available until February 2001, much of the necessary equipment could not be ordered and shipped for timely delivery. Almost all of the equipment arrived too late for anything but superficial testing and had to be shipped to France in May in order to be available for on-site operations. That precluded time for testing and familiarization. Many problems that could have been identified and solved before fieldwork was initiated became serious issues during the campaign. As rudimentary as the concept of testing of, and training on, equipment is in field research, every effort must be made to ensure that untested equipment does not become a problem in the future. As much of the equipment is associated with life support, it is also essential that the project staff be provided time to train before beginning field operations. As has been the case in previous years, testing and training will be a critical consideration in planning and conducting extended operations in 2002.

Artifact Recovery

The collection of artifacts recovered from the CSS *Alabama* during the 2001 campaign provide additional confirmation of the rich and varied archaeological record associated with the wreck. The 32-pounder, largest and most dramatic artifact in the collection, contributes significantly to identification and analysis of the Confederate warship's battery. Recovery of the stern pivot gun in 2002 will provide an example of each of the four types of ordnance employed on the vessel and prove or disprove the hypothesis that all of the vessel's ordnance was Blakely designed.

The remainder of the artifacts reflect the ship itself, the ship's fittings and hardware and life aboard the commerce raider. Additional material from the hull structure provides additional confirmation that the contract specifications for the *Alabama's* construction were followed. Wood samples have not yet been positively identified,

however timber used in framing the ship appears to have been oak. Additional planking samples all appear to be teak. Additional fittings are, as was specified by Bulloch's contract with Lairds, brass 7/8 inch (2.22 cm) in diameter and peened over roves.

Additional examples of tableware, storage jars and glassware reflect the everyday life of the officers, crew and prisoners aboard the ship. The tablewares confirm historical data that identifies the china from the officer's mess as decorated with blue, that of the engineers and midshipmen as green and that of the crew as brown. Archaeological finds also show that not only were the colors different, but the center emblem is also different between the patterns. No example of the gold tableware from the captain's table has been recovered. Additional examples of plates, bowls and pitchers likely reflect china removed from the prize vessels of the *Alabama*. Storage jars of glass and ceramic material provide an indication of the types of victuals available to Semmes and his crew. At least one of the glass storage jars contains intact contents that may be identifiable. A shell decorated meerschaum pipe bowl represents one of the first personal possessions recovered from the CSS *Alabama*. Residue in the bowl remained fresh enough to retain the smell of tobacco and tar.

Remote Operated Equipment

While there can be little question as to the value of the archaeological record in enhancing our understanding of life aboard the CSS *Alabama*, it is also readily apparent that the current methods employed in conducting research at the site have significant limitations and involve considerable risk. One of the most effective means of reducing that risk, and at the same time increasing the amount of data recovered, is the use of remote operated equipment. If excavation within the hull of the CSS *Alabama* is ever to recover a significant portion of the archaeological record that the wreck preserves, investigation time on the bottom will have to be greatly extended.

While additional personnel, larger vessels and advanced excavation and diving techniques can increase the amount of time on-site, the physical environment will always remain an obstacle. Tidal currents place limits on the duration of diving activity regardless of the methodology employed. It appears that a combination of remote operated equipment (ROE) with limited diving support would be the most effective means of conducting extended excavation within the hull structure. ROE has been developed to conduct complex operations at depths well below that of the CSS *Alabama* and in currents well in excess of those off the Normandy peninsula. ROE could be designed or adapted to remain on the bottom throughout the tidal cycle. It could be controlled from a vessel anchored above, in the vicinity or well

inshore of the CSS *Alabama*. Operations could be managed from an onshore facility. Diving operations similar to those used to support previous investigation could be limited to periodic support of the ROE. Without a more sophisticated approach to investigation and increased on-site research time, work on the wreck will always be restricted to limited testing and recovery.

Options for Operations in 2002

Due to the fact that the level of resources available for a campaign in 2002 has not been determined, plans for additional work can only be identified as options. Increased funding would permit an expanded scope of research in 2002. Operations could include three phases of on-site activity. The primary objective would be ROV documentation of the wreck site. A second phase of investigation would focus on artifact recovery and additional test excavation, and a third phase would extend the test excavations. The test excavation previously begun in the stern would be resumed and a second site in the bow would be investigated. Artifact recovery would focus on at risk material exposed on the bottom surface and large objects including the aft pivot cannon, the aft bilge pump and possibly the *Alabama's* galley stove. That piece of the ship's equipment lies partially exposed forward of the engineering space. Few galley stoves from the period exist and it would provide useful information about food preparation on board the ship.

If the level of funding for 2002 is approximately the same as that available in 2001, on-site investigation would be designed around more limited objectives. The primary objective would be ROV documentation of the wreck site. A second objective would focus on limited excavation designed to focus on the untested area of the crew's quarters forward. That excavation would generate new insight into both the condition of the wreck forward and the nature and scope of the archaeological record associated with the crew. An additional consideration would be recovery of the CSS *Alabama's* galley stove. Limited excavation in the stern would also be required to expose the aft bilge pump and the pivot cannon so that they can be prepared for lifting.

As has been the case in the past underwater video cameras will be employed to document each phase of the proposed research. A professional photographer will be a part of the project staff so that archaeological personnel will not have to divide their attention between archaeology and documentation of the work activity. In addition, a staff position will be dedicated to on-board vessel operations so that archaeological personnel need not be employed for that purpose.

Proposed Scope of Expanded On-site Investigation 2002

Expanded on-site research proposed for the 2002 campaign would focus on documentation of the exposed wreck structure, continued excavation and recovery of material associated with the ship. Objectives would include:

1. Documentation of the exposed wreck structure using an ROV with electronic positioning.
2. Continued excavation with the hull structure aft of the engineering space.
3. Test excavation in the area of the crew's quarters forward.
4. Recovery of the aft pivot gun.
5. Recovery of the aft Downton pump.
6. Recovery of the galley stove.
7. Video and photographic documentation of the research.
8. Excavation and examination of the propeller and lifting frame to generate data essential to formulating plans for recovery.

Those objectives would be achieved during three phases of on-site activity. The first phase, possibly in May, would be dedicated to ROV documentation of the wreck. The second phase, scheduled for June, would involve French Navy and volunteer divers and American archaeologists in excavation and recovery of the artifacts from the wreck. The final phase, probably scheduled in July, would permit American archaeologists and French volunteers to undertake a new test in the bow.

Estimated Personnel Requirements for Expanded On-site Investigation 2002

Field personnel for an expanded campaign in 2002 will require both professional archaeologists, volunteer divers, French Navy divers, dive safety and equipment operators, conservators and a photographer to document project activities. A nucleus crew of professionals will have to be hired to conduct the archaeological investigation and to coordinate and supervise all volunteer diver activity. Personnel requirements for the proposed field work will include: Principal Investigator, Field Director, Dive Safety Officer, Archaeologists (9), Conservator, Underwater Photographer, a Vessel Tender and a Press Officer.

Proposed Scope of Limited On-site Investigation 2002

Limited on-site research proposed for the 2002 campaign would focus on documentation of the exposed wreck structure, limited excavation and limited recovery of material associated with the ship. Objectives would include:

1. Documentation of the exposed wreck structure using an ROV with electronic positioning.
2. Excavation in the area of the crew's quarters forward.
3. Recovery of the aft pivot gun.
4. Recovery of the Downton pump.
5. Recovery of the galley stove.
6. Video and photographic documentation of the research.
7. Excavation and examination of the propeller and lifting frame to generate data essential to formulating plans for recovery.

Limited objectives would be achieved during two phases of on-site activity. The first phase, possibly in May, would be dedicated to ROV documentation of the wreck. The second phase, scheduled for June, would involve French Navy and volunteer divers and American archaeologists in a new test excavation in the bow and recovery of the several large artifacts including the aft Downton pump and the stern pivot cannon.

Estimated Personnel Requirements for Limited On-site Investigation 2002

Field personnel for a limited campaign in 2002 will require both professional archaeologists, volunteer divers, French Navy divers, dive safety and equipment operators, conservators and a photographer to document project activities. A nucleus crew of professionals will have to be hired to conduct the archaeological investigation and to coordinate and supervise all volunteer diver activity. Personnel requirements for the proposed field work will include: Principal Investigator, Field Director, Dive Safety Officer, Archaeologists (2), Conservator, Underwater Photographer, a Vessel Tender and a Press Officer.

Appendix A – 1995 Agreement between France and the United States

AGREEMENT

This agreement is made by and between the United States Navy, represented by the Naval Historical Center, hereinafter referred to as the "Navy", acting for the Government of the United States of America, owner of the *ALABAMA* wreck and its associated artifacts,

on the one hand,

and the Association CSS Alabama, a non-profit private-law association registered under the French Law of 1901, hereinafter referred to as the "Association",

on the other hand,

and hereinafter together referred to as the "Parties" to this agreement.

Whereas the Government of the United States of America, as the successor State to the former Confederate States of America, is the owner of the wreck of the CSS *ALABAMA*, a Confederate warship sunk by the USS *KEARSARGE* in battle off Cherbourg, France, on 19 June 1864, including its contents, apparel and equipment; and

Whereas this ownership was recognized by the government of the Republic of France in the Verbal Note N° 2826 addressed to the Ambassador of the United States in France by the Ministry of Foreign Affairs, dated 18 October 1991; and

Whereas the Agreement signed by the United States of America and the Republic of France in Paris on 3 October 1989, a copy of which is attached as Exhibit A, hereinafter referred to as the "1989 Agreement", recognizes mutual national interests in this important heritage resource, and provides for the establishment of a Joint French-American Scientific Committee, hereinafter referred to as the "Committee", to make recommendations to the respective governments on the protection, the conditions of exploration and the scientific study of this wreck site in the historic and cultural interests of both nations; and

Whereas the above-mentioned 1989 Agreement recognizes that the wreck of the CSS *ALABAMA* resides within the territorial waters of the Republic of France and is therefore subject to French law, including regulations for the protection of historic shipwrecks and archaeological sites under laws administered by the French Ministry of Culture; and

Whereas a shipwreck was located by the French Navy's mine hunter *CIRCE* on 30 October 1984 and its identity later confirmed as that of CSS *ALABAMA* by Captain Max Guerout, French Navy; and

Whereas in 1988 the Association was founded as a non-profit organization and registered under the Law of 1901 for the purpose of conducting the scientific exploration and study of the CSS *ALABAMA* and its wreck site, in accordance with the laws of France governing underwater archaeology, and from 1988 to the present, has successfully financed, exclusively from French sources, and conducted seven annual investigations of the wreck and its immediate surroundings for the purpose of evaluating the archaeological potential of the site and undertaking excavation, thereby demonstrating its ability to carry out professional archaeological research on this difficult site; and

Whereas, as required by French law (Chapter IV of the Decree of 26 December 1961 and Article 9 of the Law 89-874 of 1 December 1989), the Association wishes to establish with the owner, represented by the U. S. Navy, an agreement on mutually acceptable operating principles by which the investigation of the wreck site can be continued and the development of its public and private funding pursued in the United States as well as in France and elsewhere; and

Whereas it is to the advantage of both the Association and the Navy to enter into an agreement recognizing their mutual interests in the wreck site, establishing an operating agreement by which the rights and responsibilities of the Navy and of the Association are recognized, and recognizing as well the particular rights afforded to the Association's principal archaeologist; and

Whereas the Association recognizes its responsibility for its own work and actions performed on the *ALABAMA* wreck by persons intervening on the site on its behalf, and for objects removed from the site while in its

custody, during field conservation treatment (Phases I and II of the conservation process; see Exhibit B) and until they have been transferred either to the owner or to the conservation laboratory designated by the owner. It may also help finance the cost of Phases III and IV of the conservation treatment performed in French laboratories when possible; and

Whereas the owner has recognized his responsibility for financing, to the extent that the necessary funds are available for this purpose, Phases III and IV of the conservation treatment of *ALABAMA* artifacts (see Exhibit B), in particular, but not exclusively, all such treatment performed in laboratories in the United States; and

Whereas the Navy, in addition to assuming its own administrative costs on behalf of the owner and the costs of conservation as indicated above, as well as ensuring the curation and security of the artifacts beginning with their transfer to the United States, may also agree to fund a share of the costs of the archaeological project, and may contribute cash, in-kind services, or provide other resources agreed upon by the Parties, to the extent those resources are available; and

Whereas, under French law and regulations, the Association as operator must present to the Ministry of Culture its financial plan for the operations for which it requests an official permit, and assumes thereby the responsibility for seeking the funds necessary to carry out the proposed archaeological operations in accordance with requirements pertaining to the excavation and conservation of retrieved objects;

Now, therefore, the two Parties do mutually agree, as follows:

1 . The study, management and protection of the CSS *ALABAMA* site is guided by the principle that the shipwreck is an important and unique part of both American and French naval history, of great mutual and international interest. Its exploration and study require the advice of the Committee. Considered to be a fragile, non-renewable heritage resource, the wreck is to continue to be studied in a manner consistent with its protection, insofar as its physical environment allows, for the present and for the future.

2. The government of the United States of America as owner of the wreck and the associated artifacts of the CSS *ALABAMA*, represented by the Navy, accredits the Association as operator of the *ALABAMA* archaeological project and recognizes its responsibility for the scientific study, research and management of this project, subject to official permits issued by the Ministry of Culture of France and to the Association's conformance with the terms of this agreement. In that capacity, the Association and its principal investigator are responsible for defining short and long term research goals and for incorporating them into a research "design" for their investigation of the wreck. This research plan shall be addressed to the Committee for review and for recommendations to the Minister of Culture, the cognizant French authority. A copy shall be sent to the representative of the owner unless he is also a member of the Committee.

3. a) The Association, as the authorized operator, assumes the responsibility for its actions on, to, and from the CSS *ALABAMA* wreck site defined to be the remains of the ship and its associated artifacts, including the consequences of accidents involving personnel intervening on the site on its behalf and under the authority of its principal investigator. For each campaign on the site, the Association shall subscribe, as in the past, an insurance policy covering civil responsibility claims resulting from actions of its personnel or of persons acting on its behalf and in accordance with instructions issued by its principal investigator. In the foregoing conditions, it hereby agrees not to hold the owner or his representative liable for damages incurred by personnel or equipment.

b) If U. S. Navy equipment and/or personnel are designated to perform a specific service for the Association on the *ALABAMA* site, a particular contract shall be signed specifying the duration of and the conditions attached to the service to be rendered. The Association shall then subscribe a special insurance policy to cover the risks assumed under the terms of that particular contract.

c) When, in accordance with the terms of the 1989 Agreement, United States observers are present on site (on the surface or underwater), the Navy assumes responsibility for their actions to the extent provided by applicable law.

4. The Navy has the responsibility, as representative of the owner, of funding its own administrative costs as well as those of Phases III and IV of the conservation treatment of *ALABAMA* artifacts, to the extent necessary

funds are available for this purpose, and of their curation while in its custody. It may also agree to contribute to the costs of the archaeological exploration itself, as well as to provide services and rights as set forth hereinafter.

5. The Association's prime responsibility is for the archaeological exploration of the site and the recovery of artifacts and material as approved by the Scientific Committee and the owner. It is also responsible for Phases I and II of the conservation process as defined above and consequently for the objects undergoing such treatment while in its custody. It may also attempt to fund or to obtain without cost to the owner Phases III and IV of the required conservation treatment, in particular when performed in French laboratories.

6. At its discretion, the Navy may support the efforts of the Association to investigate CSS *ALABAMA*, offering in-kind services to the extent they may be available and specific rights to the Association and its sponsors. They may include, but are not limited to, cooperative and supporting technical assistance in historical and archaeological research, field and laboratory investigations, diving, recovery, transportation, artifact conservation (cf. Para.4), data analysis, exhibition, publishing, communications. These services and/or rights must be mutually agreed to and desired by the Association and the Navy, except those provided in Paragraph 9 below.

7. Specific rights offered by the owner to the Association's sponsors may include, but are not limited to, short and long term loans of artifacts. In addition to those mentioned in Paragraph 6 above, specific rights offered by the owner to the Association may include, but are not limited to, the use in its own publications, subject to normal scholarly citation, of graphic images (films, photographs and video) and other documentation held in U. S. Navy collections.

. The Association holds all exclusive property rights over its own collection of photographic and other graphic images, including all such items as it may acquire by purchase or by gifts from individuals, groups or companies. Any photographs or other graphic images provided to the Navy shall be marked as "Proprietary data. Publication without the express permission of the Association CSS *ALABAMA* is prohibited."

9. The Association may decline specific rights offered by the Navy but accepts to fulfill the following requirements considered by the Navy to be necessary to follow onsite investigations and to protect the fundamental rights of the owner over its property:

A. The Association will observe and abide by the terms of the 1989 Agreement, including the possibility offered by Article 7 for both France and the United States to have at least one observer present at excavation operations. The observer(s) may operate either on the surface or underwater; in the latter case, his activities will be entirely separate from those of the Association under the conditions prescribed in 9 B below.

B. The surface observer(s) is free to witness and photograph from the Association's dive boat all objects as they arrive at the surface and are placed on the boat, and may at **will** collect graphic images and other data on the surface. He may also obtain from the Association's principal investigator information concerning past and present operations, including site conditions as they change, to be used solely for reporting to the representative (s) of the owner and to his own employer agency.

The underwater observer(s) may also dive on the wreck site and is free to witness and photograph during such dives, subject to the approval of the director of the archaeological project. Such approval shall normally be given, subject to prior notification by the owner (see paragraph 9 C) and to possible restrictions imposed by weather conditions, safety hazards or regulations, or due to the daily diving and work schedules that are the sole responsibility of the director of the archaeological project. The observer is responsible for obtaining in advance all authorizations required by the French Ministry of Labor for divers qualified to descend to 60 meters. He is also responsible for providing his own means of access to the site and shall not interfere in any way with the actual work underway on the bottom.

The Association and the observer(s) will provide assistance to each other in case of danger.

The owner and his representative are liable for any damage caused by the observer(s), to the extent provided by applicable law. The Association cannot be held liable for any damage caused by the observer(s).

C. The owner and its representative make the necessary agreements, contracts and arrangements for these and other services.

The owner or its representative shall provide the Association at least thirty days notice in the case of pending observer visits, and sixty days notice before transport or removal of artifacts in the custody of the Association which are not otherwise subject to existing loan agreements.

D. The conservators of either France or the United States that are funded or contracted by either the Association or the Navy to provide services to the *ALABAMA* project shall have the right to independently study, analyze, publish or otherwise disseminate technical information on artifact conservation performed on CSS *ALABAMA* artifacts under their supervision, subject to the terms of their contracts or agreements.

E. As in the past, the Association will continue to provide each French and U. S. representative to the Committee with one copy of its annual field report, including the registry of artifacts recovered, with photographs, sketches and any other pertinent information available. If additional copies are required for official purposes by any one of the representatives, they may be made by him at his expense. Annual field reports provided to the Navy shall include a statement that they contain proprietary information and their release is governed by paragraph 10.A. of this present agreement between the United States Navy and the Association CSS Alabama.

F. At the conclusion of the Association's study of the CSS *ALABAMA* and after publication of the archaeologist's findings, or at such point as the project may be otherwise terminated, the Association will, in accordance with French requirements, deposit its documentation in the Department des Recherché Archdologiques Sous-Marines at Marseille and **will** provide copies to the representative of the owner. The final study provided to the Navy shall include a statement that it contains proprietary information and its release is governed by paragraph 10.A of this present agreement between the United States Navy and the Association CSS Alabama.

10. The Navy hereby recognizes that the intellectual property rights of the Association and its principal archaeologist include the following:

A. The Association and its principal archaeologist have the right of first use and publication of their own findings, including methodology or techniques developed during the investigation, the analysis of the site and its contents, and other conclusions reached under their direction. This right of first use and publication shall not exceed ten years from termination of the last season of excavation. The rights of the Association and its principal investigator recognized in this paragraph shall not interfere with the Navy's ability to respond in general terms, preferably by using the Association's press releases, when these are made available to the Navy, to routine press or other inquiries regarding activities at the site and its agreement with the Association. The Navy shall provide copies of any such responses to the Association. All inquiries from archaeologists, historians or other writers, requiring substantial data or other information from any report of the archaeologist shall be referred to him for his response.

B. The Association owns and determines the use of its collection of photographic images of the wreck site, particularly of all underwater views. It reserves the right to release them to its sponsors, publishers, authors, or the media, to be used for public relations or for other purposes as it sees fit.

C. The Association and its principal archaeologist have the right of first use, study and publication concerning artifacts recovered by the Association from the CSS *ALABAMA* wreck site, as is compatible with the need for stabilization or conservation of recovered materials. This right shall not interfere with or delay publication or dissemination of technical information on artifact conservation by authorized conservators working with CSS *ALABAMA* artifacts in either France or the United States. This right shall not interfere with or delay timely stabilization and conservation of recovered materials, and, unless justified to the satisfaction of the Navy, this right shall not exceed twelve months from the date of recovery. Extensions may be granted for further study upon the documented request of the archaeologist, if without prejudice to the objects retained.

D. The Navy shall now and in the future prominently credit the Association CSS Alabama for funding and accomplishing the recovery of *ALABAMA* artifacts in all displays or publications concerning them, and shall likewise credit Electricitd de France for the conservation treatment of all such objects having been treated in its laboratories. The Association will likewise credit the Maryland Historical Trust for all such objects having been

treated in its laboratories, and the U. S. Navy for the conservation treatment that it finances. It will credit the Naval Historical Center for curation and documentation services provided. Both the Navy and the Association shall further require of all repositories receiving traveling exhibitions of *ALABAMA* objects to observe the same rules.

11. The Navy and the Association recognize that research questions pertaining to archaeological artifacts may arise long after an artifact has been released for transport, conservation or exhibition, or after this agreement has expired. Therefore, both Parties and their designated conservators and curators, shall make reasonable efforts to assist the Association's archaeologist with research inquiries that pertain to *ALABAMA* artifacts under their management. These efforts shall include artifact photography, visual inspection and communication of findings to the archaeologist. In addition, conservators and curators shall provide for access to the artifacts with reasonable advance notice so that the archaeologist may conduct his own research.

12. The Navy and the Association agree to inform each other of all developments, discoveries, changes of policy, or other factors that affect this agreement and the archaeological investigation of the CSS *ALABAMA* wreck site.

13. Unless otherwise agreed by both Parties in writing, each Party shall fund its own expenses for activities conducted pursuant to this agreement. All obligations of the Parties under this agreement are subject to national laws, regulations, and the availability of necessary resources or appropriated funds for such activities.

14. This agreement shall be in effect for five years from the date on which it is signed.

It may be amended by mutual agreement of the two Parties.

If circumstances outside the control of either or both Parties should constitute a case of force majeure, or if other imperative reasons should so require, this agreement may be terminated by either Party upon condition 1) that an opportunity for consultation has been offered to the other Party with a view to avoiding premature rupture, 2) that, in case it is decided to pursue premature termination, due notice be given to the other Party, and 3) that the date of termination not become effective until six months after due notice has been given.

The decision for premature termination shall be communicated to the Committee and to the Ministry of Culture of France by the Party responsible for the decision, or by both Parties if so desired.

We the undersigned, having read, understood and accepted the terms of this Agreement, so affix our signatures on duplicate copies, one of which shall be given to each of the signers:

ASSOCIATION CSS **ALABAMA**

UNITED STATES OF AMERICA

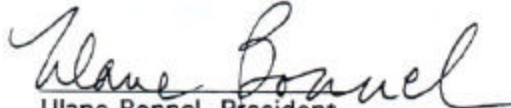
Ulane Bonnel, President
of the Association

Signed in ~~Paris~~ *Washington* on:
(date) *23 March 1995*

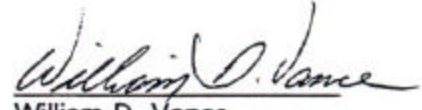
William D. Vance
Captain, U.S. Navy,
Director of Naval History,
acting for the United
States Navy

Signed in Washington on:
(date) *23 March 1995*

Attachments:

- Exhibit A: Agreement between the Government of the United States of America and the Government of the Republic of France concerning the Wreck of the CSS ALABAMA, signed in Paris on 3 October 1989
- Exhibit B: Compte rendu de la rdunion du Comit6 scientifique du CSS ALABAMA, 19-22 octobre 1992

EXHIBIT A

Agreement between
the Government of the United States of America and
the Government of the French Republic
concerning the Wreck of the CSS ALABAMA*

The Government of the United States of America and the Government of the French Republic,

Recognizing the historical and archeological importance of the CSS *ALABAMA*, sunk in battle with USS *KEARSARGE* on June 19, 1864, approximately 7 nautical miles off the coast of Cherbourg, France,

Wishing to co-operate to ensure the protection and study of the wreck, situated in French territorial waters,

Have agreed as follows:

Article 1. A Scientific Committee composed of two representatives of each of the two governments and of experts designated by each government is hereby established on a basis of equality.

Article 2. Any measure related to scientific activities or any project concerning the development of the wreck of the CSS *ALABAMA* shall be reviewed by the Scientific Committee, which shall make its decisions by agreement of the representatives of both governments.

Article 3. The provisions adopted by the French Government to establish a zone of protection around the wreck of the CSS *ALABAMA* shall remain in force for the term of this agreement, unless the Parties decide otherwise. The competent French authorities may amend these provisions, as necessary. Neither Party shall take measures adversely affecting the wreck or its associated artifacts without the agreement of the other Party.

If the conservation of the wreck is compromised, the competent French authorities may take, on their own authority or at the request of the United States authorities, the conservation measures necessitated by the situation. In the event such urgent action is taken by the French authorities, they will notify the United States authorities promptly of the full details regarding such action.

Article 4. Proposals adopted by the Scientific Committee will be submitted to the French Minister of Culture, who shall grant the necessary authorizations with due regard for the procedures provided for by French law.

Article 5. The Scientific Committee shall review the execution of the authorized scientific activities and shall follow the corresponding operations as they occur.

Article 6. Each Party will bear the costs of its representatives and its experts.

Article 7. Each Party will be entitled to have at least one observer present at each excavation operation.

Article 8. The Scientific Committee shall agree upon, as necessary, the procedures governing the participation of the Government of the United Kingdom of Great Britain and Northern Ireland in the operations that are undertaken.

Article 9. Such activities as the two Parties may undertake under this arrangement shall be contingent, for each, upon the availability of the necessary funds.

Article 10. This Agreement shall enter into force on the date of signature. It may be terminated by either Party by three months advance written notice to the other Party sent through the diplomatic channel.

Done at Paris, on October 3, 1989, in duplicate in the French and English languages, both texts being equally authentic.

For the Government of the
French Republic

For The Government of the
United States of America

JEAN-PIERRE PUISSOCHET

M. PETER BERNHARDT

* This is a copy of the text of the Agreement as communicated by the Department of State.

EXHIBIT B

ANNEX

Conservation Principles Regarding Objects Taken from the CSS ALABAMA Wreck

The committee examined the problems posed by the conservation of the artifacts resulting from the initial expeditions, paying special attention to the concerns expressed by the officials of the CSS Alabama Association, in order to assist in establishing a satisfactory procedure for the future from the dual perspective of safeguarding the artifacts and with regard to the duties of the different parties involved in the process.

The entire process of conserving and restoring the artifact discovered may be broken down into four major phases. At this point, the committee herewith proposes a description of these different phases and the scientific and financial responsibility of each of the different parties.

In general, the first and second phases discussed below can be described as field conservation. They are the responsibility of the organization (The CSS Alabama Association) that is undertaking the archeological project. The third and fourth phases shall be considered museum conservation and are the responsibility of the United States Government, which is the owner of the CSS Alabama and its associated artifacts

First phase: Collection and Registration.

This phase includes inventorying, registering, and documenting all objects excavated from the site. This stage can include the first simple cleaning, necessary for identifying the objects. These functions are the responsibility of the archeologist directing the excavation.

It should be understood that no objects will be excavated unless specific authorization is granted in advance by the owner. Before that authorization can be granted, the organization undertaking the excavation must submit a specific collection plan and a conservation plan for the artifacts involved. The basic principles to bear in mind are twofold: (1) that any excavation must be consistent with the collection plan of the United States Government (which receives advice on this matter from the CSS Alabama Scientific Committee); and (2) that no artifacts can be collected unless there is a conservation plan and assurance that the organization undertaking the excavation, as well as the owner, have

plans, facilities, and resources available to undertake their required conservation work.

Registration forms for the recovered artifacts shall be provided to the owner as soon as possible. Those forms shall be compatible with the accessioning procedures of the U. S. Naval Historical Center, which represents the U. S. Government on this matter. Among other elements of information, registration forms shall include data on the cleaning of the artifacts and their current location.

Second phase: Preservation

This involves the packaging and storage spaces to permit the safeguarding of the objects collected and to assure their active maintenance. A stable micro-environment suited to their conservation is recreated and maintained and the condition of the artifacts is monitored. This phase may include first aid measures when a major risk of deterioration is detected and the conservation of an object is endangered.

This phase ends with the evaluation, by the entity undertaking operations on the wreck site, of the conservation treatments necessary for the long-term safeguarding of the objects collected. This evaluation will include proposals for treatments, together with estimates of their respective costs and duration, and recommendations as to how soon these treatments ought to be undertaken and as to the laboratories able to perform the work.

The association responsible for excavation operations is responsible for this entire phase.

The proposed treatments and recommendations are transmitted to the legal owner of the objects, who makes decisions of his choices and ensures that these measures are implemented.

Third phase: Conservation treatments

Conservation treatments include all measures that will permit the lasting stabilization of the objects and their conservation, transportation, and display in the conditions to which museum objects normally are subjected. Treatments may include the processes of dechloridation or the elimination of salts, freeze drying, consolidation, and anti-corrosion treatments.

The United States Government, as the legal owner of the CSS Alabama artifacts, is responsible for assuring that conservation is undertaken in laboratories of its choice. Through mutual agreement,

the owner may assign this work to another organization, such as a museum that will receive the artifacts in question on long-term loan.

Fourth phase: Restoration

Activities related to restoration are aimed at improving the readability, visual appeal, and functional qualities of the objects and can be useful for understanding them and enhancing their cultural value. This work depends heavily on the purpose for which the objects will be used: that is, where they will be displayed. These processes may be proposed and undertaken by the legal owner; but also; the entity that is going to display these artifacts may recommend to the legal owner specific restoration measures and undertake that work at its own expense. But no restoration work may be performed without the previous agreement of the legal owner.

Appendix B - Downton Pump Patent



A.D. 1825 N° 5221.

Pumps.

DOWNTON'S SPECIFICATION.

TO ALL TO WHOM THESE PRESENTS SHALL COME, I, JONATHAN DOWNTON, of Blackwall, in the County of Middlesex, Shipwright, send greeting.

WHEREAS His present most Excellent Majesty King George the Fourth, by His Letters Patent under the Great Seal of Great Britain, bearing date at Westminster, the Nineteenth day of July, in the sixth year of His reign, did, for Himself, His heirs and successors, give and grant unto me, the said Jonathan Downton, His especial licence, that I, the said Jonathan Downton, my exors, admors, and assigns, or such others as I, the said Jonathan Downton, my exors, admors, or assigns, should at any time agree with, and no others, from time to time and at all times during the term of years therein expressed, should and lawfully might make, use, exercise, and vend, within England, Wales, and the Town of Berwick-upon-Tweed, and also in all His said Majesty's Colonies and Plantations abroad, my Invention of "CERTAIN IMPROVEMENTS ON MACHINES OR PUMPS;" in which said Letters Patent is contained a proviso, obliging me, the said Jonathan Downton, by an instrument in writing under my hand and seal, particularly to describe and ascertain the nature of my said Invention, and in what manner the same is to be performed, and to cause the same to be inrolled in His said Majesty's High Court of Chancery within six calendar months next and immediately after the date of the said recited Letters Patent, as in and by the same, reference being thereunto had, will more fully and at large appear.

Downton's Improvements in Pumps.

NOW KNOW YE, that in compliance with the said proviso, I, the said Jonathan Downton, do hereby declare the nature of my said Invention to consist in a new arrangement of valves, valve rods, and cranks for a pump, whereby a continued jet or stream is procured with the ordinary winch movement. And in further compliance with the said proviso, I, the said 5 Jonathan Downton, do hereby describe the manner in which I perform my said Invention by the following description thereof, reference being had to the Drawing annexed, and the Figures marked thereon, (that is to say:—

DESCRIPTION OF THE DRAWING.

Figure 1 represents a section of a pump case, and of my said improvements. 10
 A is the ordinary feed pipe; B is the fixed bottom box or valve; C is an ordinary pump case or cylinder; and D is the jet pipe. It will be seen that there are three moveable boxes or valves in the pump case here shewn, besides the bottom one before mentioned; of these three, F is the lower valve, G the middle valve, and H the upper valve, and the object of having three 15 valves is that one at the least may be always rising, and this is done by the following arrangement (that is to say):—By the valves rods working, one within the other, with a telescope movement; thus it will be seen by reference to the Figure, that the valve rods to G and H are hollow, and that the rod R of the lower valves F works within the rod J of the valve G, and this last- 20 mentioned rod works within the rods I of the valve H; this arrangement allows the up and down movements of each rod to be performed without the slightest impediment from or interference with the others; it only remains therefore to connect these rods to such a movement as will cause one or other of them to be constantly on the rise, and a continued stream of water flowing 25 from the jet must be the consequence; such a movement is shewn in this Figure, and is as follows (that is to say):—W is a fly wheel, a is the top of the rod J, and is furnished with a hoop or slot e, e, within which the friction wheel S revolves; P is an arm of the crank, of which the part marked C forms the axis of the wheel S; now it is evident that as this wheel S revolves by the 30 turning of the crank P, it will alternately raise and depress the rod J and its valve G. It is only necessary to observe in further explanation of this Figure that each rod head is furnished with one of these hoops or slots, and with a friction wheel within it, moved by and turning on a crank arm, and it is the position of these crank arms which determines the exact nature of the alternate 35 and relative up and down movement of the three rods and their respective valves; T, V, are parts better explained by the next Figure; and T is a mere collar or busking, or what would in a large pump be a stuffing box.

Downton's Improvements in Pumps.

Figure 2 is an elevation of a pump case, and of my said improvement; the letters on this Figure refer to the same parts as similar letters refer to in Figure 1, and such letters therefore as have been explained will not be referred to again in this Figure. T is a clamp or contrivance for attaching the solid rod *f*, I, to the hollow rod I, in order to connect it with the crank wheel and slot movement above it; and V is a similar contrivance for attaching the solid rod *g*, J, to the hollow rod J, for a similar purpose; X is a crank for giving a winch movement, and by which movement the pump is to be worked. Now it will be observed from the shading of the various cranks in this Figure to which the friction wheels are attached, that in the position here shewn the crank P, which governs the movement of the rod J, recedes, while the crank which governs the movement of the rod I advance, and the crank which governs the movement of the rod R is in its highest upward position; it follows therefore that if the winch X were turned so as to turn the fly wheel in the direction of the arrow, shewn at Figure 1, the rod J would be raised, while the rod I would be depressed, and the rod R, which in this view has attained its greatest elevation would begin to be depressed; also, if the motions which must necessarily follow a continuation of the revolution be traced, it will be found that at the moment the two rods J and I arrive at that point where they must remain for a moment nearly inactive, the rod R will be raising, and thus the continuity of the stream will be preserved.

Now, whereas I claim as my Invention, the arrangement of three or more working boxes or valves in a pump case or cylinder, caused to alternate in manner herein-before described, either by means of such an arrangement of cranks and sliding rods as is herein-before described, or any other means equally applicable to the purpose; and such Invention being to the best of my knowledge and belief entirely new, and never before used within that part of His said Majesty's United Kingdom of Great Britain and Ireland called England, His said Dominion of Wales, or Town of Berwick-upon-Tweed, nor in any of His said Majesty's Colonies or Plantations abroad, I do hereby declare this to be my Specification of the same, and that I do verily believe this my said Specification doth comply in all respects fully and without reserve or disguise with the proviso in the said herein-before in part recited Letters Patent contained; wherefore I hereby claim to maintain exclusive right and privilege to my said Invention.

In witness whereof, I, the said Jonathan Downton, have hereunto set my hand and seal, this Ninth day of January, in the year of our Lord One thousand eight hundred and twenty-six.

JONATHAN (i.s.) DOWNTON.

Downton's Improvements in Pumps.

HARVEY.
AND BE IT REMEMBERED, that on the Ninth day of January, in the year of our Lord 1826, the aforesaid Jonathan Downton came before our said Lord the King in His Chancery, and acknowledged the Specification aforesaid, and all and every thing therein contained and specified, in form above written. And also the Specification aforesaid was stamped according 5 to the tenor of the Statute made for that purpose.

Inrolled the Eleventh day of January, in the year of our Lord One thousand eight hundred and twenty-six.

LONDON:

Printed by GEORGE EDWARD EYRE and WILLIAM SPOTTISWOODE,
Printers to the Queen's most Excellent Majesty. 1857.

Appendix C - Ministry of Culture and Communication Permit

N°

001005

LA MINISTRE DE LA CULTURE ET DE LA COMMUNICATION

Vu la loi n° 89-874 du 1^{er} décembre 1989 relative aux biens culturels maritimes ;

Vu le décret n° 91-1226 du 5 décembre 1991 pris pour l'application de la loi n° 89-874 ;

Vu le décret n° 94-423 du 27 mai 1994 portant création des organismes consultatifs en matière d'archéologie nationale ;

Vu l'avis de l'autorité prévue à l'article 7 du décret du 5 décembre 1991 susvisé, en date du 14 mai 2001 (PREMAR Manche - Mer du Nord) ;

Vu l'avis du Conseil national de la recherche archéologique (commission des fouilles sous-marines) en date du 30 mars 2001 ;

Vu la demande présentée par M. Gordon P. WATTS

ARRETE

Article 1er :

M. Gordon P. WATTS est autorisé à procéder à une opération de fouille archéologique sous-marine pluriannuelle à partir de la date de notification du présent arrêté jusqu'au 31 décembre 2003

sur le(s) site(s) de :

Département : Manche

Commune : Cherbourg

Lieu-dit :

Coordonnées géographiques - latitude : 49° 45,17' N - longitude : 01° 41,65' W

Numéro de la carte marine : 71205

Profondeur : 60 mètres

Programme : 29

Article 2 :

Conformément à la loi du 1^{er} décembre 1989 susvisée, l'opération est exécutée sous la direction effective du titulaire de l'autorisation et placée sous sa responsabilité.

Article 3 :

L'opération est effectuée sous la surveillance du chef du DRASSM, qui prescrit toutes mesures qu'il juge utiles pour assurer le bon déroulement scientifique de l'opération.

Le titulaire de l'autorisation tient régulièrement informé le chef du DRASSM de ses travaux et découvertes. Il lui signale immédiatement toute découverte importante de caractère mobilier ou immobilier. Les mesures nécessaires à la conservation de ces vestiges doivent être prises en accord avec lui.

A la fin de l'opération, le titulaire de l'autorisation adresse au chef du DRASSM, en double exemplaire, un rapport accompagné des plans et coupes précis des structures découvertes et des photographies nécessaires à la compréhension du texte. Il donne un inventaire de l'ensemble du mobilier découvert et signale les objets d'importance notable. Il indique quelles sont les études complémentaires à envisager.

L'ensemble des documents relatifs à l'opération (notes, photographies, relevés, correspondances, etc..) est remis au chef du DRASSM aussitôt que sont rédigés les rapports, notes ou publications scientifiques sur les recherches effectuées.

Article 4 :

Dans le cas où la présente autorisation porte sur une opération pluriannuelle, le rapport visé à l'article 3 est remis à la fin de chaque année. Le titulaire adresse, en outre, à la fin de l'opération, au chef du DRASSM, un rapport de synthèse. Celui-ci comprend l'exposé détaillé des résultats scientifiques obtenus durant l'ensemble des campagnes, l'inventaire de l'ensemble du mobilier découvert avec, signalés, les objets d'importance notable et l'indication des études complémentaires envisagées.

Article 5 :

Le chef du DRASSM fixe, au vu de l'inventaire fourni par le titulaire, le lieu de dépôt du mobilier archéologique découvert au cours de l'opération ainsi que la durée de sa mise à disposition pour étude.

Article 6 :

Prescriptions particulières à l'opération : Les opérations devront respecter les recommandations du comité scientifique CSS Alabama telles que formulées dans la résolution du 9 novembre 2000.

Article 7 :

Le Chef du DRASSM est chargé de l'exécution du présent arrêté.

Fait à Paris le 11 JUIN 2001

 Pour la Ministre et par délégation,
Le sous-directeur de l'archéologie
Adjoint au Sous-directeur
de l'archéologie

Ph. GRENIER de MONNER

COPIES A :

DRASSM
 SCA

Préfet de département
 Préfet maritime

Affaires Maritimes
 DRAC - SRA

Maine(s)