

# **Vehicle to Electric Vehicle Supply Equipment Smart Grid Communications Interface Research and Testing Report**

## **Final Report**

*Kevin Morrow  
Dimitri Hochard  
Jeff Wishart  
James Francfort*

September 2011

The Idaho National Laboratory is a U.S. Department of Energy National Laboratory  
Operated by Battelle Energy Alliance

# **Vehicle to Electric Vehicle Supply Equipment Smart Grid Communications Interface Research and Testing Report**

**Kevin Morrow  
Dimitri Hochard  
Jeffrey Wishart  
James Francfort**

**September 2011**

**Idaho National Laboratory  
Idaho Falls, Idaho 83415**

**Prepared for the  
U.S. Department of Energy  
Assistant Secretary for Energy Efficiency and Renewable Energy  
Under DOE Idaho Operations Office  
Contract DE-AC07-05ID14517**

**DISCLAIMER**

This information was prepared as an account of work sponsored by an agency of the U.S. Government. Neither the U.S. Government nor any agency thereof, nor any of their employees, makes any warranty, expressed or implied, or assumes any legal liability or responsibility for the accuracy, completeness, or usefulness, of any information, apparatus, product, or process disclosed, or represents that its use would not infringe privately owned rights. References herein to any specific commercial product, process, or service by trade name, trade mark, manufacturer, or otherwise, does not necessarily constitute or imply its endorsement, recommendation, or favoring by the U.S. Government or any agency thereof. The views and opinions of authors expressed herein do not necessarily state or reflect those of the U.S. Government or any agency thereof.

## **ABSTRACT**

Plug-in electric vehicles (PEVs), including battery electric, plug-in hybrid electric, and extended range electric vehicles, are under evaluation by the U.S. Department of Energy's Advanced Vehicle Testing Activity (AVTA) and other various stakeholders to better understand their capability and potential petroleum reduction benefits. PEVs could allow users to significantly improve fuel economy over a standard hybrid electric vehicle, and, in some cases, depending on daily driving requirements and vehicle design, PEVs may have the ability to eliminate petroleum consumption entirely for daily vehicle trips. AVTA is working jointly with the Society of Automotive Engineers to assist in further development of standards necessary for advancement of PEVs.

This report analyzes different methods and available hardware for advanced communications between the electric vehicle supply equipment and the PEV; particularly, Power Line Devices and their physical layer. Results of this study are not conclusive, but add to the collective knowledge base in this area to help define further testing that will be necessary for development of the final recommended Society of Automotive Engineers communications standard.

The Idaho National Laboratory and the Electric Transportation Applications (dba ECOTality North America) conduct AVTA for the United States Department of Energy's Vehicle Technologies Program.

# CONTENTS

ABSTRACT.....	iv
1. INTRODUCTION.....	1
2. METHODOLOGY.....	1
2.1 System Evaluation.....	1
2.1.1 Evaluated Products.....	2
2.2 Functional Testing at the ECOTality North America Engineering Center.....	3
2.2.1 Validation of Setup.....	3
2.2.2 Data Collection.....	4
2.2.3 Reporting.....	4
2.3 Electromagnetic Compatibility Testing at the ECOTality North America Engineering Center.....	4
2.3.1 Conducted Emissions.....	4
2.4 Electromagnetic Compatibility Testing at Compliance Testing.....	4
3. RESULTS.....	4
3.1 Functional Tests.....	5
3.1.1 Yitran IT700.....	5
3.1.2 Maxim 2990/2991.....	5
3.1.3 Intellon/Netgear XAV101.....	6
3.2 Baseline Electromagnetic Compatibility Test Results.....	7
3.2.1 Yitran IT700.....	7
3.2.2 Maxim 2990/2991 (CPK Testing).....	8
3.2.3 Intellon XAV101.....	9
3.3 Formal Electromagnetic Compatibility Test Results.....	9
3.4 Integration Challenges.....	9
3.5 Test Laboratory Challenges.....	10
3.6 Performance Comparison.....	10
3.6.1 Radiated Performance.....	10
3.6.2 Data Throughput.....	11
3.7 Cost Analysis.....	12

4. CONCLUSIONS .....	13
Appendix A, Testing Descriptions.....	15
Appendix A-1, Setup Drawings for Validation .....	16
Appendix A-2, Setup Instructions for Validation.....	17
Appendix A-3, Microchip MRF24J40MA Data Sheets .....	18
Appendix A-4, Intellon INT6300 Technical Brief .....	45
Appendix A-5, Yitran IT700 Technical Brief .....	51
Appendix A-6, Maxim 2990/2991 Data Sheets.....	52
Appendix A-7, Functional Test Setup Drawings.....	55
Appendix A-8, Functional Test Setup Instructions .....	58
Appendix A-9, Durability Test Setup Drawings (Maxim 2990/2991) .....	69
Appendix A-10, Durability Test Setup Instructions (Maxim 2990/2991).....	70
Appendix B, Data Results.....	72
Appendix B-1, Functional Test Results (Yitran IT700).....	73
Appendix B-2, Signal Analysis Report (Yitran IT700).....	74
Appendix B-3, Functional Test Results (Maxim 2990/2991) .....	78
Appendix B-4, Functional Test Results (Intellon XAV101).....	80
Appendix B-5, Electromagnetic Capability Test Instructions at Electric Transportation Applications Engineering Center .....	82
Appendix B-6, Electromagnetic Capability Test Setup Drawings at Electric Transportation Applications Engineering Center .....	93
Appendix B-7, Electromagnetic Capability Test Report (CPK – Maxim 2990/2991).....	94
Appendix B-8, Electromagnetic Capability Test Report (Compliance Testing).....	97
Appendix B-9, Industrial Application Test Results (Maxim 2990/2991) .....	128
Appendix C, Cost Tables .....	132
Appendix C-1, Development Costs.....	133
Appendix C-2, Part Costs .....	134

Appendix C-3, Support Costs.....	135
----------------------------------	-----

## FIGURES

1. Illustration of the MRF24J40MA microchip from Zigbee .....	2
2. Illustration of the Intellon XAV101 from HomePlug AV .....	2
3. Illustration of the Yitran IT700 from HomePlug C&C.....	3
4. Illustration of the Maxim IC MAX2900/MAX2991.....	3
5. Data report screenshot for the Yitran IT700.....	5
6. Screen shot for the Maxim 2990/2991 console.....	6
7. Homeplug AV data throughput over the alternating current power line.....	6
8. Homeplug AV data throughput over the direct current power line during fast charge.....	7
9. Yitran IT700 conducted emissions test results .....	7
10. Yitran IT700 conducted emissions test results (no transmission).....	8
11. Radiated emissions test results for the Maxim 2990/2991 device .....	8
12. Intellon XAV101 conducted emissions test results .....	9
13. Wireless signal traffic results of the Intellon XAV101 product for a separation distance of 2 ft.....	11
14. Wireless signal traffic results for the Intellon XAV101 product for a separation distance of 5 ft.....	11

## TABLES

1. Data rate comparison for the three programmable logic controller products .....	11
--	----

# 1. INTRODUCTION

Plug-in vehicles are having a recent resurgence, with expectations of entering the marketplace as early as 2009. Major electric utilities are deploying or planning to deploy smart utility meters (commonly referred to as advanced metering infrastructure) that can have the ability to communicate and control local consumer and commercial electrical loads to better manage the electrical grid. Although advanced communication protocols were developed in the 1990s for direct current (DC) off-board charging, there were no provisions for advanced communication with the utility.

Advanced communication provisions are desired for all power levels, including alternating current (AC) Level 1 (120 VAC, single-phase, up to of 16 A), AC Level 2 (240 VAC, single-phase, up to 80 A) and off-board DC charging (240 VAC, single-phase through 480 VAC, three-phase). AC Levels 1 and 2 provide energy transfer to the vehicle through a common connector (SAE J1772) and DC charging is proposed to have a unique connector/coupler, meaning there will be a need for a unique location on the vehicle.

The objective of this project is to evaluate specific technologies in depth and to provide the Society of Automotive Engineers' (SAE's) working committees J1772 and J2293/J2836 with sufficient research, testing, and evaluation on the current known physical layers options available for advanced communication between the PEV and the electric vehicle supply equipment or utility advanced meter infrastructure. The objective also includes providing recommendations about what option or options should be adopted by these SAE standards.

The project was managed by the engineering and management team at ECOTALITY North America (ECONA). Project management activities were designed to lead the project using a variety of strategies (such as product selection, design of a functional test, selecting an appropriate test center, and supporting all technical aspects of the project) in consultation with the SAE J1772 and J2293/J2836 committees. Based on a consensus in support of the project scope, the following products were selected for evaluation: Yitran IT700, Maxim2990/2991, Intellon XAV101, and Microchip MRF24J40MA. These products were selected due to their novelty and their potential for meeting the interface requirements listed in the project scope of work. Other devices using legacy technology (e.g., modulated pilot wire, original SAE J1850 [2-wire], and CAN [2-wire]) were examined in another report and are only referenced in this report.

## 2. METHODOLOGY

All testing was scheduled and budgeted by ECONA engineering and management. Funding was structured in support of completing the system evaluation, functional testing of the candidate system, and electromagnetic compatibility (EMC) testing. Details covering each phase are provided in the following subsections.

### 2.1 System Evaluation

In order to validate a particular candidate solution, a system needed to be designed in a manner specific to the technology and interface requirements of both the electric vehicle charger and the vehicle. Additional criteria, unique to meeting future monitoring needs of the utility, also needed to be considered as stated in Section 2.1.2 of the SAE scope document. This scope required research involving specific attributes for the candidate technology and interface challenges with the charger and electric vehicle. Collaboration between ECONA engineering and SAE committee staff offered possible alternatives in evaluating each candidate system. Based on the collaboration effort, a series of setup drawings and setup instructions for each product under review were created. These items can be found in Appendixes A-1 and A-2, respectively. The evaluation process permitted the team to better examine all possible candidates in a manner that was fair and robust.



### 2.1.1 Evaluated Products

Based on the results of the system evaluation, a series of candidate devices were identified as possible solutions in meeting the needs of the project. With the candidate devices defined, a more rigorous analysis was enabled. Based on consultations with the SAE committee and ECONA, a series of detailed functional tests and EMC tests were conducted at the ECONA engineering center. Details about the testing are broken down by candidate device in the following subsections.

**2.1.1.1 MRF24J40MA – Microchip – (ZigBee).** This product is a printed circuit board solution that is Federal Communications Commission (FCC) certified. The product is already in use and requires no additional testing beyond the functional test. Figure 1 shows the bare device. The device must be placed 1 in. away from any conducting material (as specified in the datasheet located in Appendix A-3). Multiple tests of similar products have been performed by various utility companies. The weaknesses of this solution include having a short range and using a mesh networking device to perform point-to-point communication.

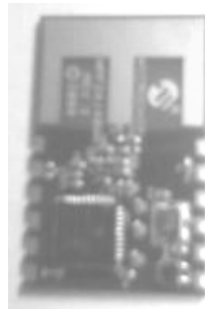


Figure 1. Illustration of the MRF24J40MA microchip from Zigbee.

**2.1.1.2 XAV101 – Netgear (Intellon 6300 chipset – HomePlug AV).** This product is a system currently in use for delivery of high-speed internet in consumer electronic products. The device of interest is the chipset, not the device as it is sold in its current form. However, testing the device will illustrate the suitability of the chipset as an integrated solution for high-speed programmable logic controller (PLC) applications in an electrical vehicle charging environment. The XAV101 uses a complex OFDM modulation (using up to 1,155 subcarriers) over the 2 to 28-MHz band. The tested Netgear XAV101 chip acts as a bridge between a network using cat5 cables and a network using a power line as its transport medium. The Netgear device is the only device evaluated that cannot be categorized as an evaluation board. It also is the only device that could not be powered externally, which is a limitation in the sense that it was not possible to isolate the power section from the data bus itself. Figure 2 shows the device in its current form as a Netgear Device. Datasheets detailing specific features of the device can be found in Appendix A-4.



Figure 2. Illustration of the Intellon XAV101 from HomePlug AV.

**2.1.1.3 IT700 – Yitran – (HomePlug C&C).** Yitran offers a low-cost, single chip solution. This device uses a patented differential code shift keying PLC operating at a low data rate (7.5 kbps) in the

Cenelec or FCC band. It consists of two modules: one acting as a base station (server) and one acting as a remote station. In its current form, the device pair interfaces with a personal computer hosting the user interface via a USB port. Because this is an evaluation board, additional testing beyond functional is required. Additional testing consists of an EMC validation under FCC and automotive standards. Figure 3 shows a typical Yitran IT700 module. Datasheets for the Yitran IT700 can be found in Appendix A-5.



Figure 3. Illustration of the Yitran IT700 from HomePlug C&C.

**2.1.1.4 MAX2990/MAX2991 – Maxim IC.** The Maxim modules are a two-chip set solution: one chip acts as the analog front end, while the other supports the orthogonal frequency demodulation process (MAX2990). The orthogonal frequency demodulation is in the Cenelec or FCC band, providing a data throughput of 80 kbps measured. This product was added to the evaluation lineup because Maxim IC had previously done work for smart meters deployed by Electricite Reseau Distribution France. Datasheets for the Maxim 2990/2991 devices can be found in Appendix A-6. Figure 4 shows 2990 and 2991 as a stacked pair.



Figure 4. Illustration of the Maxim IC MAX2990/MAX2991.

## 2.2 Functional Testing at the ECOtality North America Engineering Center

### 2.2.1 Validation of Setup

In consultation with SAE and ECONA engineering, a validation test plan was established. The goal of the test plan is to secure a method for validating the test setup. Based on summary discussions contained in the monthly progress reports, it was decided the functional test would be designed using a charger-to-electric-vehicle integration model. More specifically, the integration method used by ECONA engineering consisted of a Clipper Creek AC Level 2 charger and Mini-E electric vehicle. All four product candidates underwent this phase of initial validation for functional testing. Additionally, testing was done using ECONA industrial chargers and different sizes of battery packs with all three PLC devices validating communication over the DC power line when voltage was applied. The modules were tested with different chargers switching at different frequencies to test the effect of the power section on

the data throughput of the device signal. Appendix A-7 lists the functional test setup and operation instructions for three of the four modules under evaluation; the Microchip module was not evaluated due to known association issues with multiple electric vehicle supply equipment. Appendix A-8 lists all associated installation drawings for each module undergoing functional testing. Appendix A-9 lists all drawings associated with Maxim2990/2991 in support of the DC charger test. Appendix A-10 lists the setup instructions and drawings for the Maxim2990/2991 DC charger test. Similar tests were performed with the Intellon and Yitran products.

### **2.2.2 Data Collection**

Data capture involved using both automated and manual approaches. The automated method was secured by using the device control software provided by the candidate product manufacturer and included using test equipment at the ECONA engineering center. Manual data capture was collected in log format, using observation as it pertained to operation of the device.

### **2.2.3 Reporting**

This operation organized both manual data and automated data gathered during functional testing. This process also was done for preliminary EMC testing at the ECONA engineering center. EMC testing is discussed in Section 2.3.

## **2.3 Electromagnetic Compatibility Testing at the ECOtality North America Engineering Center**

Because of the novelty of PLC communication technology, a baseline average was needed to properly examine the performance features of the devices. Testing at the ECONA engineering center consisted only of the conducted emissions test. Specific details concerning this test are discussed in the following subsection. All of this was done in accordance with Section 2.1.4 of the SAE scope document.

### **2.3.1 Conducted Emissions**

The purpose for this test was to measure power line conductivity between all three devices: Intellon XAV101, Yitran IT700, and Maxim 2990/2991. This was done under stand-alone 120-Vac and 220-Vac voltages with a slave device acting as a load to the device under test.

The baseline is supposed to establish an average threshold between all three devices because it concerns the performance of isolation between the signal line and the power line for all three devices under test. Test setup instructions and drawings for the EMC tests conducted at the ECONA engineering center are listed in Appendix B-5.

## **2.4 Electromagnetic Compatibility Testing at Compliance Testing**

Compliance Testing is a local test center in Chandler, Arizona with experience in automotive and FCC EMC testing. The laboratory offered a test schedule that was favorable in adhering to the project timeline. The laboratory also demonstrated flexibility in setting up the needed tests and reporting the results. The staff at Compliance Testing demonstrated technical competence in operation of various test equipment and test procedures. The engineering team offered several suggestions in terms of procedure and the appropriate methods for obtaining correct results. The management team at Compliance Testing was forthcoming about the limitations of the laboratory's testing capability.

## **3. RESULTS**

This section includes performance results for both the functional test and the EMC tests, respectively. Functional test results are categorized by product and by mode of testing (e.g., DC or AC testing). Specific details for each product and test mode are listed in the following subsections.

## 3.1 Functional Tests

### 3.1.1 Yitran IT700

This product underwent two levels of functional AC testing. The primary level verified operability of the device, while the secondary level verified integration capability to a plug-in hybrid electric vehicle charger. The first test consisted of the product being tested using two laptops: one for the transmit module and the other for the receive module. The laptops had Yitran IT700 software to monitor and control the communication behavior of the devices. The modules were tested using the 120-Vac line and the Yitran power supply, as well as using an external 12-V battery to separate the communication line from the provided power line used by the module. Data were successfully transferred at 7.5 kbps over the power line. This was validated by an examination of the data report, as shown on the control interface in Figure 5. In preparation for EMC testing, Yitran engineering provided signal analysis reports. These are found in Appendix B-2. The display in Appendix B-1 shows device performance under 120 Vac with packet data being sent under the FCC configuration. Functional test results for Yitran IT700 undergoing the secondary test are located in Appendix B-1. Data traffic shows a 50% capacity at 7.5 kbps. The module showed virtually no performance difference between the first and second test, which involved a 120-V onboard charger.

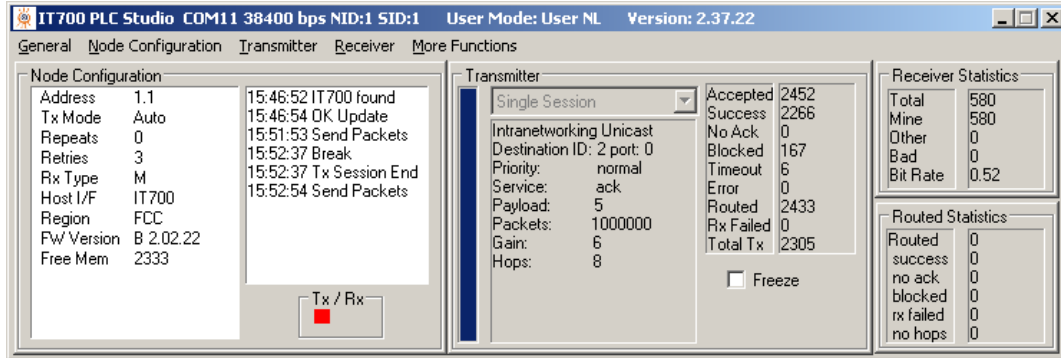


Figure 5. Data report screenshot for the Yitran IT700.

This product also underwent functional DC testing. Powered up with an external 12-V battery, the Yitran module was capable of communicating over the DC power line up to 250 V in its current configuration. However, as the current started to rise in those lines to charge the vehicle battery, communication became completely blocked (see Appendix B-5 for details).

### 3.1.2 Maxim 2990/2991

For the functional AC testing, the Maxim 2990/2991, like the Yitran IT700, was tested using two laptops with vendor-supplied software to monitor communication. The modules were configured to be tested in either Cenelec A with Robo mode ON or Cenelec A with Robo mode OFF. Robo mode is a robust mode designed for configuration in harsh environments. The modules also can be configured in FCC mode with the option of having Robo mode ON or OFF. The Maxim 2990/2991 EV kit was tested under 120 Vac, 220 Vac, with and without load, and using a 12-Vdc car battery to power up the modules. Data communication over the power line was validated using a console vendor-supplied application and an oscilloscope. A sample screen shot illustrating the console application is displayed in Figure 6. The screenshot illustrates, among others things, transmit data in bits per second and the success rate as indicated by ACK and ReTx indicators. A series of graphs illustrating data rates for both 120-Vac and 220-Vac load/no load conditions are displayed in Appendix B-3 (Maxim 2990/2991). All graphs represent FCC configuration with Robo mode ON. Robo mode illustrates the best case for device communication performance.

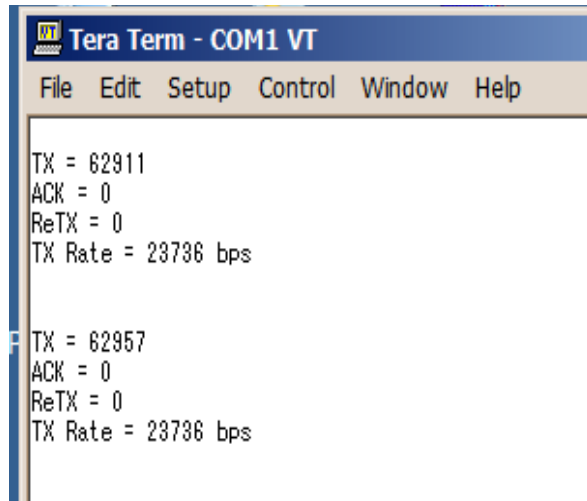


Figure 6. Screen shot for the Maxim 2990/2991 console.

For DC line testing, the Maxim EV kit was powered with an external 12-V power supply and the product was able to communicate over the DC power line up to 250 V in its current configuration. As the current to charge the vehicle battery started to rise in those lines, the communication was completely blocked (see Appendix A-9 for details). With the intervention of the Maxim engineer, it became possible to communicate on the high band of the FCC spectrum of 300 to 450 kHz (see Appendix B-9 for details).

### 3.1.3 Intellon/Netgear XAV101

The Intellon/Netgear XAV101 product differs from the Yitran and Maxim 2990/2991 in that it is sold as an active, approved consumer electronic device by meeting FCC Section 15, Part B. It is packaged as a Netgear product using TCP/IP communication over power line protocol. Testing the device requires two laptops with one module connected per laptop. The Netgear XAV101 runs under 135 to 400-Vdc bus or 100 to 240 Vac. The robustness of this capability was tested using a large file measuring 942 MB between two laptops and using a 180-Vdc bus, as well as a regular 110 Vac and a 220 Vac bus.

For the test over the AC line, the Homeplug AV device experienced no difficulty in communicating with a data rate of up to 50 Mbps. Typical data throughput was more around 35 Mbps (Figure 7).

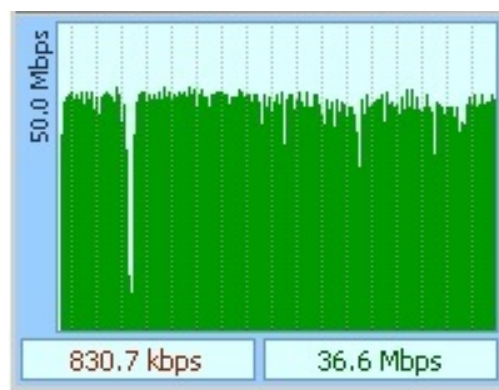


Figure 7. Homeplug AV data throughput over the alternating current power line.

For the test over the DC line, because of the design of the module, it was not possible to test the XAV101 module with the same setup as the other two products. The device was communicating the majority of the time, while simultaneously charging at up to 40 A. The throughput was highly reduced (from tens of Mbps down to 80 kbps). Communication occasionally would be impossible during a full

10-second period. Figure 8 shows the communication data throughput when the modules were installed on the output of the 25 analog front end Minit-Charger and the 200-V battery being charged at 25 A.

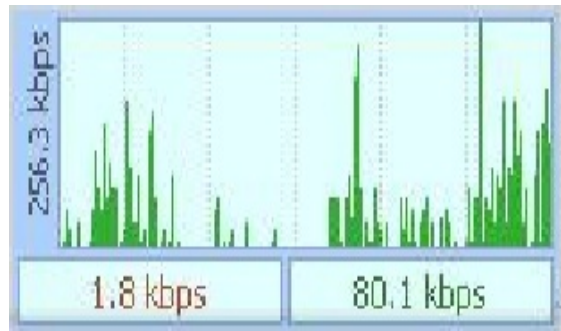


Figure 8. Homeplug AV data throughput over the direct current power line during fast charge.

### 3.2 Baseline Electromagnetic Compatibility Test Results

The EMC test results are separated by product family and test type. The different tests (such as AC or DC testing) were conducted separately. Before any testing of the modules could begin, a verification of the test setup needed to be carried out. Once this step was complete, the first module, Yitran IT700, was tested, followed by Maxim 2990/2991, and finally the Intellon XAV101. The main series of tests performed were the conducted emissions tests, which were reported in graphical form for each product. Radiated emissions measurements also were performed, but without an anechoic chamber, the results are of little value.

#### 3.2.1 Yitran IT700

Testing began with a simple calibration of the test equipment in accordance with standard industry practices. Once the system was operational, testing began in the 120-Vac mode followed by the 220-Vac mode. The performance of the Yitran IT700 under the conducted emissions baseline test with the device transmitting data is shown in Figure 9.

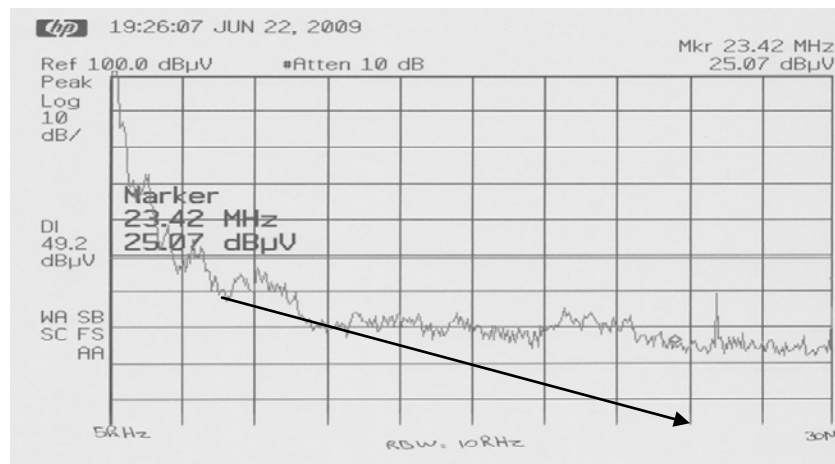


Figure 9. Yitran IT700 conducted emissions test results.

Figure 10 shows the conducted emissions measured when the device is not transmitting. Additionally, EMC testing results were performed in another laboratory under Yitran supervision to meet the current J551-5 EMC limits.

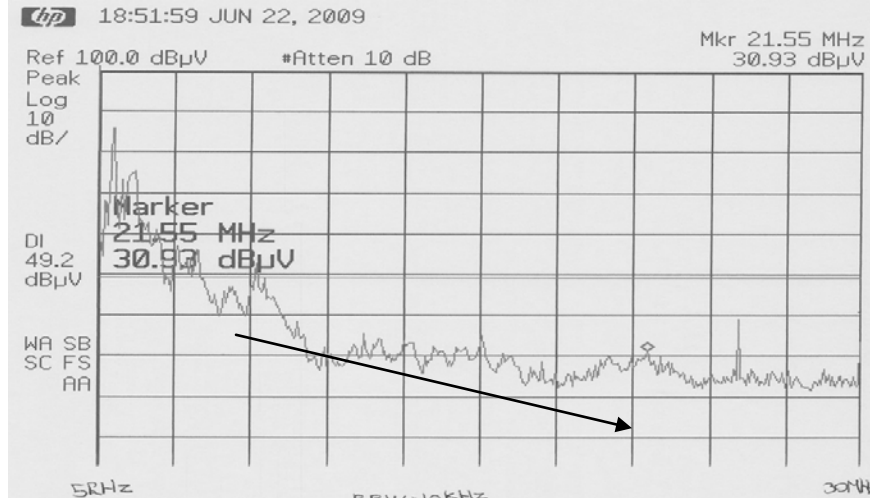


Figure 10. Yitran IT700 conducted emissions test results (no transmission).

### 3.2.2 Maxim 2990/2991 (CPK Testing)

Because the Maxim product entered the study later, ECONA did not have the opportunity to test the conducted and radiated emission on the evaluation kit for this product. A supporting preparation for EMC testing was furnished by the engineering team at CPK testing. This was conducted under the direction of Maxim management, with feedback from ECONA engineering. The results of the test cover radiated emissions in a graphical form and are listed in Appendix B-7. For the purposes of this report, the mode of operation under consideration is the FCC frequency (10 to 490 kHz) with Robo mode on. Figure 11 illustrates the radiated emissions test under the following frequency band from 30 to 242.4 MHz.

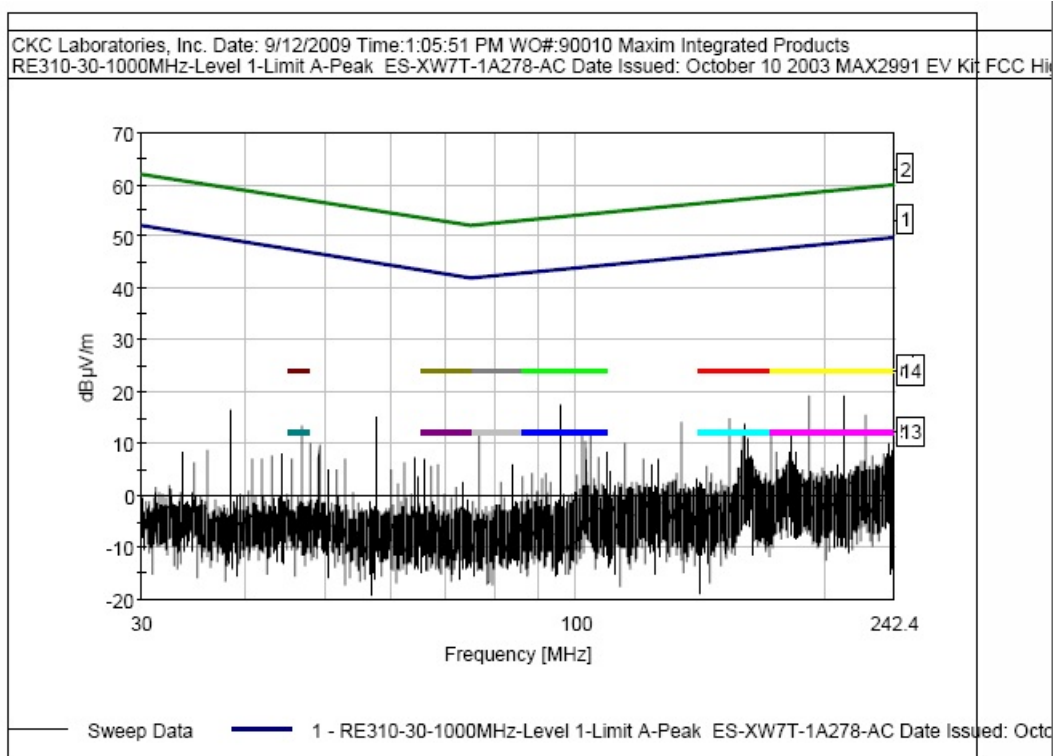


Figure 11. Radiated emissions test results for the Maxim 2990/2991 device.

The results provided by Maxim IC show that the device does not meet some of the Level 2 radiated emission requirements. However, it did not show any issue in meeting the Level 1 requirements, which is the level tested in this study.

### 3.2.3 Intellon XAV101

In a similar fashion to the Yitran IT700, the XAV101 was tested as a baseline for formal EMC testing. Because of the need for examining the similarities and differences with the Yitran IT700 product, conducted emission tests were performed at the ECONA engineering center. Because the Intellon XAV101 operates over a higher and much wider band (2 to 28 MHz), graphical results will be different than those for the other products in the study. Figure 12 shows performance of the Intellon XAV101.

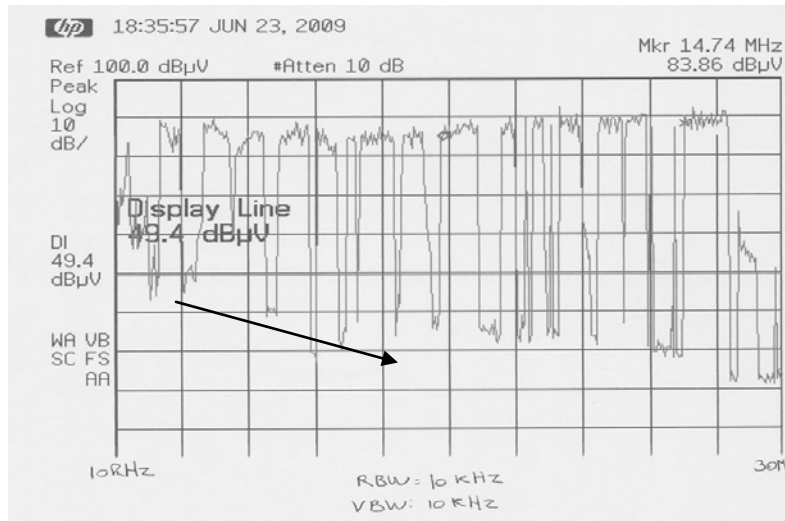


Figure 12. Intellon XAV101 conducted emissions test results.

A close examination of Figure 12 shows a higher rate of peaks covering the range of 10 to 30 MHz compared to the narrowband devices from Yitran and Maxim. The signal characteristic represents a large file transferred between the two devices, with a transmission control protocol/internet protocol. Conducted emissions of a Homeplug device are much higher than those recorded for the Yitran device on the 1.7 to 30-MHz band. Note that this band is not being measured by the Ford CE420 test that was selected to test conducted emissions; therefore, it might not be an issue for the Intellon device to meet the Ford EMC specifications.

## 3.3 Formal Electromagnetic Compatibility Test Results

All three devices underwent formal EMC testing at Compliance Testing. Compliance Testing is a licensed test facility specializing in FCC testing services. Four tests were conducted at Compliance Testing, starting with radiated emissions tests and followed by conducted emissions, bulk current injection, and radiated immunity tests.

The test center furnished a report covering specific results on all four test items. The test report is located in Appendix B-8. For the purposes of this study, the following sections will be directed at identifying the limitations of existing resources at the test laboratory and design challenges from the existing selection of products.

## 3.4 Integration Challenges

All three devices pose unique challenges because they apply to integration with the electric vehicle charger application. The EMC tests at Compliance Testing showed particular challenges with communication over the power line under a moderate frequency range of 150 kHz to 30 MHz. All three



devices exhibited a conducted signal gain in this region no matter the data rate or communication protocol. Of particular concern was the Intellon XAV101, which failed to meet FCC Part 15.107 Class B (a) in the 150-kHz to 30-MHz range, transmitting transmission control protocol/internet protocol packets at 1,500 bytes MTU, and also failed FCC Part 15.109, Table 1. Because the Intellon XAV101 product is already licensed under FCC Part 15 B, its EMC performance was expected to show characteristics of a passing unit under typical operating conditions. However, given the general performance of all three devices, a general pattern of signal activity at various ranges on the frequency scale can be observed. The Maxim 2990/2991 and Yitran IT700 exhibited a signal gain below the accepted range as specified by the testing standard. The formal EMC report is located in Appendix B-8.

### 3.5 Test Laboratory Challenges

The test laboratory was able to perform all four tests fairly well. Reporting of results was conducted in a professional manner under guidance of an experienced team of engineering professionals. Of particular concern was the limitation of not having a fully operational anechoic chamber. The FCC and Ford standards do not require it; they merely suggest it as a best practice. The alternative method is to use what is called an outside air testing chamber instead. The devices are placed in a tent structure while a high-gain antenna is placed outside. In order to capture accurate measurements, references are made to an average noise floor, which results in a test consisting of five points in place of a graphical display of results at various frequencies. The consequences of this result include the following:

- **Repeatability** – because the reporting of results is based on a noise floor, a repeat of the same test will produce different results due to the noise floor constantly changing.
- **No graphical representation** – because only five data points get captured, graphical representation becomes impractical. Using only five data points creates a false impression of the test performance over the entire test range. This omits important information regarding noise emissions under specific frequency bands within the test range.

### 3.6 Performance Comparison

All three products were tested under the same conditions and using the same methodology. Exceptions to this occurred regarding EMC testing at the ECONA engineering center. The exception concerns the Maxim 2990/2991 product and is due to a late arrival and acceptance of prior EMC tests performed by the vendor's test center. The following items were observed in meeting comparative criteria as defined by Sections 2.1.2 and 2.1.5 of the SAE scope document.

#### 3.6.1 Radiated Performance

The Intellon XAV101 has the highest data rate (up to 50 Mbps) compared to the Yitran IT700 (3 to 7.5 kbps, depending on what band is used) and Maxim 2990/2991 (30 to 80 kbps, depending on what band is used). The wireless behavior of the former at short range also was non-negligible. By connecting one Intellon device to a battery and the other to outlet power, the expectation would be that there would be no communication between the devices because no physical connection is made between the two devices. However, the results of this test showed that the two devices communicate at various lengths of separation. Figure 13 illustrates signal traffic between the Intellon devices at a separation distance of 2 ft. This was repeated on three occasions at this distance, with the devices facing each other, away from each other, and with one located at a height.

In order to better characterize the performance of the radiating behavior, a repeat of the test was performed at 5-ft separation. The results are illustrated in Figure 14; the graph shows less traffic than what is shown in Figure 13, but still enough to warrant an observation. File transfer between the two test laptops was not successful, even though they were able to see each other. Perhaps, lack of communication between the two devices is due to the signal noise attributes of the apparent over-the-air communication. Details on functional test results for Intellon XAV101 can be found in Appendix B-4. Similar radio tests



Table 1. Data rate comparison for the three programmable logic controller products.

	AC (no load)	AC (32-A load)	DC (no load)	DC (250-A load)*
<b>IT700 (FCC)</b>	7.5 kbps	7.5 kbps	7.5 kbps	0
<b>Maxim (ARIB)</b>	80 kbps	80 kbps	80 kbps	11 kbps**
<b>Intellon</b>	50 Mbps	50 Mbps	45 Mbps	***
<p>* The PLC modules were connected over the DC lines of a 24-V industrial traction battery and an ECONA industrial charger.  ** The Maxim evaluation kit was capable of communicating by tweaking the software and communicating on the high portion of the ARIB band only (see Appendix B-9 for details).  *** Because of the Netgear design, it was not possible to test the Intellon product with the ECONA industrial charger. The Intellon product was tested with a smaller battery having a voltage of 180-V nominal. It was clearly demonstrated that the data throughput was proportional to the current flowing in the line. Different tests with power sections led to very different data results, sometimes completely blocking the communication.</p>				

- **60-ft AC line test** – All three pairs of modules were individually set up on an isolated 60-ft line at 220-V, 60-Hz AC generated from a 110 to 220-V step-up transformer. One unit was used as the transmitter while its opposite was used as the receiver. All three devices demonstrated good communication with no loss of signal.
- **PLC communication while providing AC to an onboard charger** – The Maxim 2990/2991 product was tested with a 30-A, 220-V draw that was charging an electric Mini Cooper. The engineering team from Maxim USA provided a report covering the performance of this test. The document can be found in Appendix B-9. The Yitran IT 700 and the Intellon XAV101 were tested earlier with a 12-A, 110-V draw charging a converted plug-in hybrid Toyota Prius from Hymotion. All three technologies showed good signal transmission during charge events.
- **PLC communication on an industrial charger and off-board DC charger** – Every solution had difficulty communicating over DC lines when high current was sent to the battery. Maxim was able to modify their product to enable it to run under one charger; however, this is charger-specific and, in the real world, with multiple charger vendors and changing technology, it might be undesirable. One alternative is to use the earth ground line as one of the communication lines. ECONA has had good results using the battery positive line and earth ground wire to communicate with the Yitran and Maxim modules. The test could not be performed with the Intellon device because the communication and input power of the module cannot be separated.

### 3.7 Cost Analysis

A comparative cost analysis was done in support of Section 2.0 in the SAE scope document. The cost analyses consist of examining the integration capability of the technology under evaluation to the charger. Readiness of the product under evaluation to be integrated into a charger control system is examined in terms of hardware fit. The hardware fit must accommodate the basic function of the charger control system. However, there is no requirement that all features of the target product integrate if these features can be disabled without compromising the charger control system. Specific hardware criteria for each product under evaluation are discussed as follows:

- **Development costs** – Development costs consist of activities such as selecting a chip set, creating an engineering model, signal analysis studies, and PCB board layout. Items under this category include fabrication of prototypes, test validation plans, and manufacturability. For the purposes of this study, development costs will be limited to selection of a chipset and engineering model. The development costs for all four products under evaluation are listed in Appendix C-1.

- **Part costs** – The components needed for product manufacturing will be listed as the minimum required for integrating into the charger control system. All of this was done according to the chipset associated with each product. The Maxim and Yitran products operate exclusively under intended design criteria. The Intellon XAV101 operates as a Netgear product using a transmission control protocol/internet protocol. This will not be the protocol feature used in integrating this device to the charger control system. Instead, the part count will refer to the chipset features that better meet the needs of the current charger control systems most likely to be available on the market. The Zigbee product is a drop-in-place module requiring no component integration or redesign. It is for this reason there is no list of part costs involving this option. The part lists for the products are located in Appendix C-2.
- **Support costs** – In selecting a protocol technology, associated features will require additional support. This may consist of high-level software development for data capture, transmission, and storage. Support of point-of-sale service bundling, licensing, and other elements in support of media access also may be required. Given the wide array of features between all products under evaluation, a table is provided that lists rough costs for each product in Appendix C-3.

For the purposes of this study, the cost analysis excludes time-to-market because this requires knowing details such as lead times on all components, scheduling, and manufacturing contracts. The cost analysis does offer a solid examination of feasibility in selecting one technology over another. The benefits of selecting a technology must include a readiness for deployment into an existing charger design. To select a technology without this consideration will result in added costs in designing a charger to accommodate the limits of the candidate technology.

Deployment costs will be lower if the most advantageous technology is selected. This is due to software integration, which was not part of the study, but is a contributing factor in development and deployment of the charging system. Deployment costs are assumed to encompass operability of the charger. Operability entails functional items such as frequency of charging, current draw, temperature, electrolyte levels, and state of charge for all available batteries. Optimization of operability will depend on market conditions, needs of the end user, and utility participation.

## 4. CONCLUSIONS

This study demonstrated some good results with PLC solutions in an AC-charging application where only one vehicle is being charged. No tests have been performed when multiple vehicles are being charged simultaneously. With multiple devices sharing the communication line (i.e., the same power line), the data throughput is expected to be divided by at least the number of additional devices added on the line. For example, the data rate of the Yitran solution would be reduced from 7.5 to 3.75 kbps if two vehicles are being charged nearby and the traffic on the line is close to 100%.

However, when DC charging, it was apparent that there was some difficulty in using a PLC; it is recommended that an earth ground be used as one of the signal lines for DC PLC communication in the specific context of battery charging.

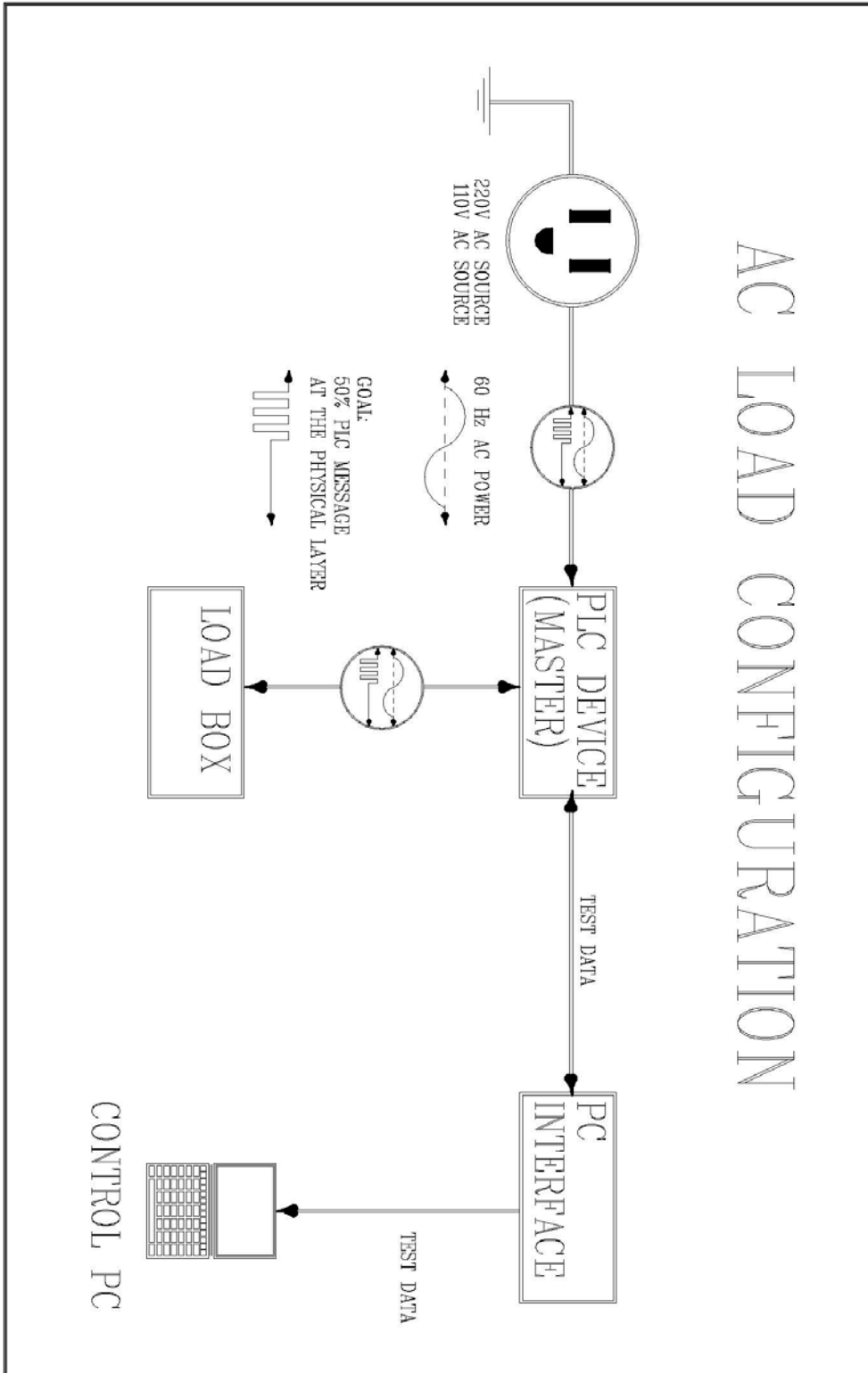
The EMC testing showed no real problem in using any of the tested products in the United States; however, the SAE recently agreed on reaching a similar communication solution with the International Standards Organization and International Electrotechnical Commission. Requirements for Europe and Japan also need to be met; they were not part of this investigation. In fact, for example, current regulations in Japan forbid the use of a Homeplug AV device outside the home.

Cost implications in selecting candidate devices were measured by examining the manufacturability, communication front end support, and operability of the charger system. Manufacturability consists of what would be needed for full integration of the system. This includes an estimated bill of material, requirements of software design, and the potential impact of accommodating a smart meter. Front end support entails communication using front-end software development in accommodating the candidate

protocol. Operability of the charger system consists of battery charging and monitoring while using a candidate device and its associated communication platform. The cost measure per candidate device for this category varied considerably, principally based on bandwidth features and communication speed. Currently, the chargers used by ECONA do not require high-speed communication. If this were added on as an ancillary feature, it would impact the cost of the charger because additional hardware and software support would be required. The degree of front end support costs depend on the interface technology and chip set configuration.

**Appendix A**  
**Testing Descriptions**

# Appendix A-1 Setup Drawings for Validation



## **Appendix A-2**

### **Setup Instructions for Validation**

**Preliminary:** The purpose of this procedure is to define a process for measuring integration applicability of select communication devices, namely PLC solutions. The process must be unbiased in nature and yet show flexibility in meeting select requirements for a variety of charger applications.

#### **Mode of Operation**

- Suitable 110-V, 220-V, AC power
- 12-V battery to power up the PLC device if possible
- Use paired device as load for the device under test
- Monitoring equipment appropriate for measuring the device under test
- Data collection procedures for transmitting and receiving data
- Record keeping procedures.

#### **Test Operation and Validation of Results**

- Develop procedures and methods for conducting various tests for repeatability.
- Examine and modify test procedures based on results and desired application.
- Validate and record for official record keeping purposes only those results that are repeatable under several test evolutions covering a wide time span.
- Be ready to terminate any test evolution if safety issues arise. Collect all data in preparation of a report.



**Appendix A-3**  
**Microchip MRF24J40MA Data Sheets**



**MRF24J40MA**  
**Data Sheet**

2.4 GHz IEEE Std. 802.15.4™  
RF Transceiver Module

---

---

**Note the following details of the code protection feature on Microchip devices:**

- Microchip products meet the specification contained in their particular Microchip Data Sheet.
- Microchip believes that its family of products is one of the most secure families of its kind on the market today, when used in the intended manner and under normal conditions.
- There are dishonest and possibly illegal methods used to breach the code protection feature. All of these methods, to our knowledge, require using the Microchip products in a manner outside the operating specifications contained in Microchip's Data Sheets. Most likely, the person doing so is engaged in theft of intellectual property.
- Microchip is willing to work with the customer who is concerned about the integrity of their code.
- Neither Microchip nor any other semiconductor manufacturer can guarantee the security of their code. Code protection does not mean that we are guaranteeing the product as "unbreakable."

Code protection is constantly evolving. We at Microchip are committed to continuously improving the code protection features of our products. Attempts to break Microchip's code protection feature may be a violation of the Digital Millennium Copyright Act. If such acts allow unauthorized access to your software or other copyrighted work, you may have a right to sue for relief under that Act.

---

Information contained in this publication regarding device applications and the like is provided only for your convenience and may be superseded by updates. It is your responsibility to ensure that your application meets with your specifications. MICROCHIP MAKES NO REPRESENTATIONS OR WARRANTIES OF ANY KIND WHETHER EXPRESS OR IMPLIED, WRITTEN OR ORAL, STATUTORY OR OTHERWISE, RELATED TO THE INFORMATION, INCLUDING BUT NOT LIMITED TO ITS CONDITION, QUALITY, PERFORMANCE, MERCHANTABILITY OR FITNESS FOR PURPOSE. Microchip disclaims all liability arising from this information and its use. Use of Microchip devices in life support and/or safety applications is entirely at the buyer's risk, and the buyer agrees to defend, indemnify and hold harmless Microchip from any and all damages, claims, suits, or expenses resulting from such use. No licenses are conveyed, implicitly or otherwise, under any Microchip intellectual property rights.

**Trademarks**

The Microchip name and logo, the Microchip logo, Accuron, dsPIC, KEELoQ, KEELoQ logo, MPLAB, PIC, PICmicro, PICSTART, rfPIC, SmartShunt and UNI/O are registered trademarks of Microchip Technology Incorporated in the U.S.A. and other countries.


FilterLab, Linear Active Thermistor, MXDEV, MXLAB, SEEVAL, SmartSensor and The Embedded Control Solutions Company are registered trademarks of Microchip Technology Incorporated in the U.S.A.

Analog-for-the-Digital Age, Application Maestro, CodeGuard, dsPICDEM, dsPICDEM.net, dsPICworks, dsSPEAK, ECAN, ECONOMONITOR, FanSense, In-Circuit Serial Programming, ICSP, ICEPIC, Mindi, MiWi, MPASM, MPLAB Certified logo, MPLIB, MPLINK, mTouch, PICkit, PICDEM, PICDEM.net, PICtail, PIC<sup>32</sup> logo, PowerCal, PowerInfo, PowerMate, PowerTool, REAL ICE, rfLAB, Select Mode, Total Endurance, WiperLock and ZENA are trademarks of Microchip Technology Incorporated in the U.S.A. and other countries.

SQTP is a service mark of Microchip Technology Incorporated in the U.S.A.

All other trademarks mentioned herein are property of their respective companies.

© 2008, Microchip Technology Incorporated, Printed in the U.S.A., All Rights Reserved.

 Printed on recycled paper.

**QUALITY MANAGEMENT SYSTEM**  
**CERTIFIED BY DNV**  
**== ISO/TS 16949:2002 ==**

*Microchip received ISO/TS-16949:2002 certification for its worldwide headquarters, design and wafer fabrication facilities in Chandler and Tempe, Arizona, Gresham, Oregon and design centers in California and India. The Company's quality system processes and procedures are for its PIC<sup>®</sup> MCUs and dsPIC<sup>®</sup> DSCs, KEELoQ<sup>®</sup> code hopping devices, Serial EEPROMs, microperipherals, nonvolatile memory and analog products. In addition, Microchip's quality system for the design and manufacture of development systems is ISO 9001:2000 certified.*



# MRF24J40MA

## 2.4 GHz IEEE Std. 802.15.4™ RF Transceiver Module

### Features:

- IEEE Std. 802.15.4™ Compliant RF Transceiver
- Supports ZigBee®, MiWi™, MiWi™ P2P and Proprietary Wireless Networking Protocols
- Small Size: 0.7" x 1.1" (17.8 mm x 27.9 mm), Surface Mountable
- Integrated Crystal, Internal Voltage Regulator, Matching Circuitry and PCB Antenna
- Easy Integration into Final Product – Minimize Product Development, Quicker Time to Market
- Radio Regulation Certification for United States (FCC), Canada (IC) and Europe (ETSI)
- Compatible with Microchip Microcontroller Families (PIC16F, PIC18F, PIC24F/H, dsPIC33 and PIC32)
- Up to 400 ft. Range

### Operational:

- Operating Voltage: 2.4-3.6V (3.3V typical)
- Temperature Range: -40°C to +85°C Industrial
- Simple, Four-Wire SPI Interface
- Low-Current Consumption:
  - RX mode: 19 mA (typical)
  - TX mode: 23 mA (typical)
  - Sleep: 2 µA (typical)

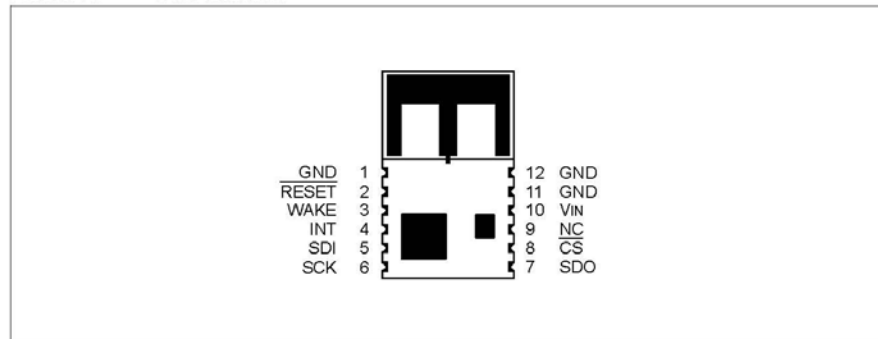
### RF/Analog Features:

- ISM Band 2.405-2.48 GHz Operation
- Data Rate: 250 kbps
- -94 dBm Typical Sensitivity with +5 dBm Maximum Input Level
- +0 dBm Typical Output Power with 36 dB TX Power Control Range
- Integrated Low Phase Noise VCO, Frequency Synthesizer and PLL Loop Filter
- Digital VCO and Filter Calibration
- Integrated RSSI ADC and I/Q DACs
- Integrated LDO
- High Receiver and RSSI Dynamic Range

### MAC/Baseband Features:

- Hardware CSMA-CA Mechanism, Automatic ACK Response and FCS Check
- Independent Beacon, Transmit and GTS FIFO
- Supports all CCA modes and RSSI/LQI
- Automatic Packet Retransmit Capable
- Hardware Security Engine (AES-128) with CTR, CCM and CBC-MAC modes
- Supports Encryption and Decryption for MAC Sublayer and Upper Layer

FIGURE 1: PIN DIAGRAM



# MRF24J40MA

---

## Table of Contents

1.0 Device Overview .....	3
2.0 Circuit Description .....	7
3.0 Regulatory Approval .....	15
4.0 Electrical Characteristics .....	19
Appendix A: Revision History .....	21
Index .....	23
The Microchip Web Site .....	25
Customer Change Notification Service .....	25
Customer Support .....	25
Reader Response .....	26
Product Identification System .....	27

### TO OUR VALUED CUSTOMERS

It is our intention to provide our valued customers with the best documentation possible to ensure successful use of your Microchip products. To this end, we will continue to improve our publications to better suit your needs. Our publications will be refined and enhanced as new volumes and updates are introduced.

If you have any questions or comments regarding this publication, please contact the Marketing Communications Department via E-mail at [docerrors@microchip.com](mailto:docerrors@microchip.com) or fax the **Reader Response Form** in the back of this data sheet to (480) 792-4150. We welcome your feedback.

#### Most Current Data Sheet

To obtain the most up-to-date version of this data sheet, please register at our Worldwide Web site at:

<http://www.microchip.com>

You can determine the version of a data sheet by examining its literature number found on the bottom outside corner of any page. The last character of the literature number is the version number. (e.g., DS3000A is version A of document DS30000).

#### Errata

An errata sheet, describing minor operational differences from the data sheet and recommended workarounds, may exist for current devices. As device/documentation issues become known to us, we will publish an errata sheet. The errata will specify the revision of silicon and revision of document to which it applies.

To determine if an errata sheet exists for a particular device, please check with one of the following:

- Microchip's Worldwide Web site: <http://www.microchip.com>
- Your local Microchip sales office (see last page)

When contacting a sales office, please specify which device, revision of silicon and data sheet (include literature number) you are using.

#### Customer Notification System

Register on our web site at [www.microchip.com](http://www.microchip.com) to receive the most current information on all of our products.

# MRF24J40MA

## 1.0 DEVICE OVERVIEW

The MRF24J40MA is a 2.4 GHz IEEE Std. 802.15.4™ compliant, surface mount module with integrated crystal, internal voltage regulator, matching circuitry and PCB antenna. The MRF24J40MA module operates in the non-licensed 2.4 GHz frequency band and is FCC, IC and ETSI compliant. The integrated module design frees the integrator from extensive RF and antenna design, and regulatory compliance testing, allowing quicker time to market.

The MRF24J40MA module is compatible with Microchip's ZigBee®, MiWi™ and MiWi P2P software stacks. Each software stack is available as a free download, including source code, from the Microchip web site <http://www.microchip.com/wireless>.

The MRF24J40MA module has received regulatory approvals for modular devices in the United States (FCC), Canada (IC) and Europe (ETSI). Modular approval removes the need for expensive RF and antenna design and allows the end user to place the

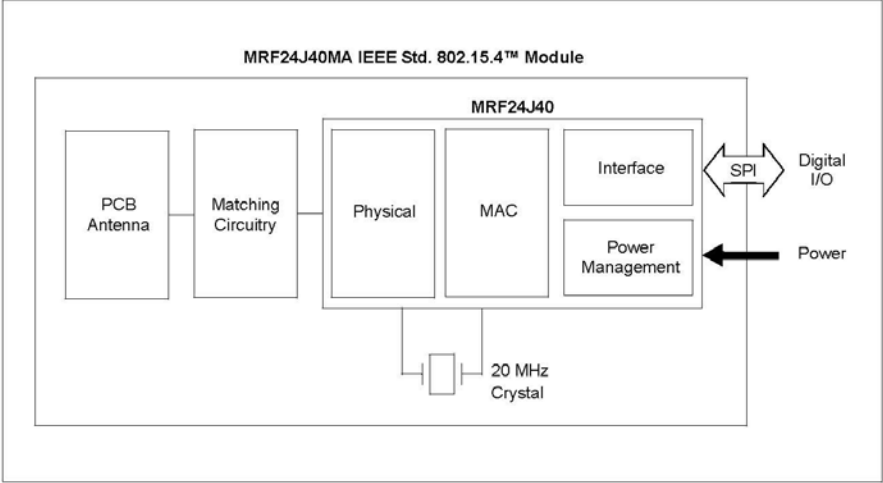
MRF24J40MA module inside a finished product and not require regulatory testing for an intentional radiator (RF transmitter). See Section 3.0 "Regulatory Approval" for specific requirements to be followed by the integrator.

### 1.1 Interface Description

Figure 1-1 shows a simplified block diagram of the MRF24J40MA module. The module is based on the Microchip Technology MRF24J40 IEEE 802.15.4™ 2.4 GHz RF Transceiver IC. The module interfaces to many popular Microchip PIC® microcontrollers via a 4-wire serial SPI interface, interrupt, wake, Reset, power and ground, as shown in Figure 1-2. Table 1-1 provides the pin descriptions.

Data communications with the MRF24J40MA module are documented in the "MRF24J40 IEEE 802.15.4™ 2.4 GHz RF Transceiver Data Sheet" (DS39776). Refer to the MRF24J40 Data Sheet for specific serial interface protocol and register definitions.

FIGURE 1-1: MRF24J40MA BLOCK DIAGRAM



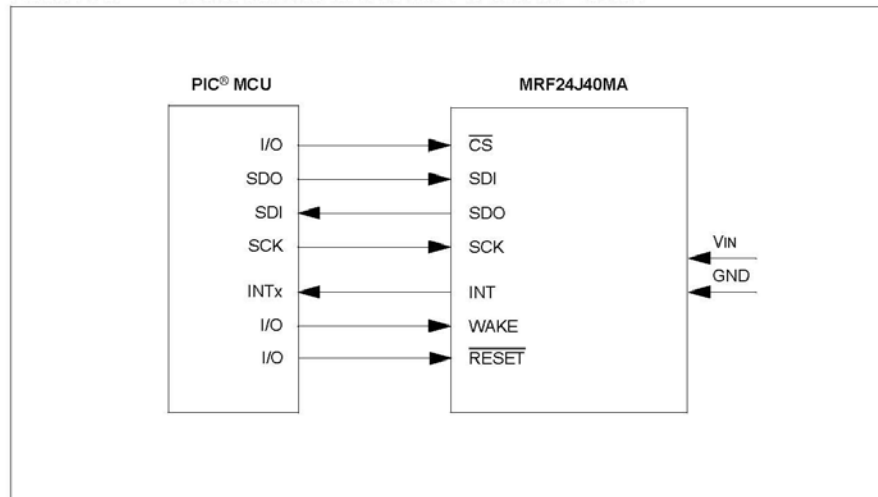
# MRF24J40MA

**TABLE 1-1: PIN DESCRIPTION**

Pin	Symbol	Type	Description
1	GND	Power	Ground
2	RESET	DI	Global hardware Reset pin
3	WAKE	DI	External wake-up trigger
4	INT	DO	Interrupt pin to microcontroller
5	SDI	DI	Serial interface data input
6	SCK	DI	Serial interface clock
7	SDO	DO	Serial interface data output from MRF24J40
8	CS	DI	Serial interface enable
9	NC	—	No connection (allow pin to float; do not connect signal)
10	VIN	Power	Power supply
11	GND	Ground	Ground
12	GND	Ground	Ground

**Legend:** Pin type abbreviation: D = Digital, I = Input, O = Output

**FIGURE 1-2: MICROCONTROLLER TO MRF24J40MA INTERFACE**



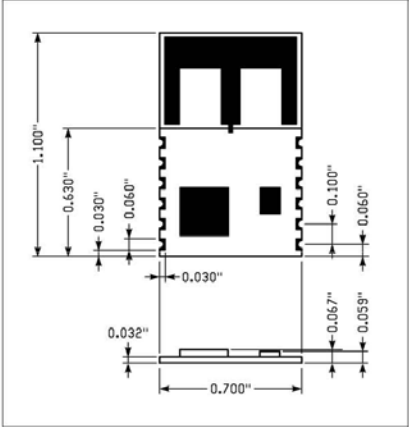
# MRF24J40MA

## 1.2 Mounting Details

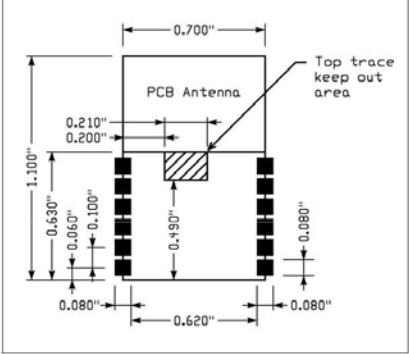
The MRF24J40MA is a surface mountable module. Module dimensions are shown in Figure 1-3. The module Printed Circuit Board (PCB) is 0.032" thick with castellated mounting points on the edge. Figure 1-4 is a recommended host PCB footprint for the MRF24J40MA.

The MRF24J40MA has an integrated PCB antenna. For the best performance, follow the mounting details shown in Figure 1-5. It is recommended that the module be mounted on the edge of the host PCB, and an area around the antenna, approximately 1.2", be kept clear of metal objects. A host PCB ground plane around the MRF24J40MA acts as a counterpoise to the PCB antenna. It is recommended to extend the ground plane at least 0.4" around the module.

**FIGURE 1-3: MODULE DETAILS**

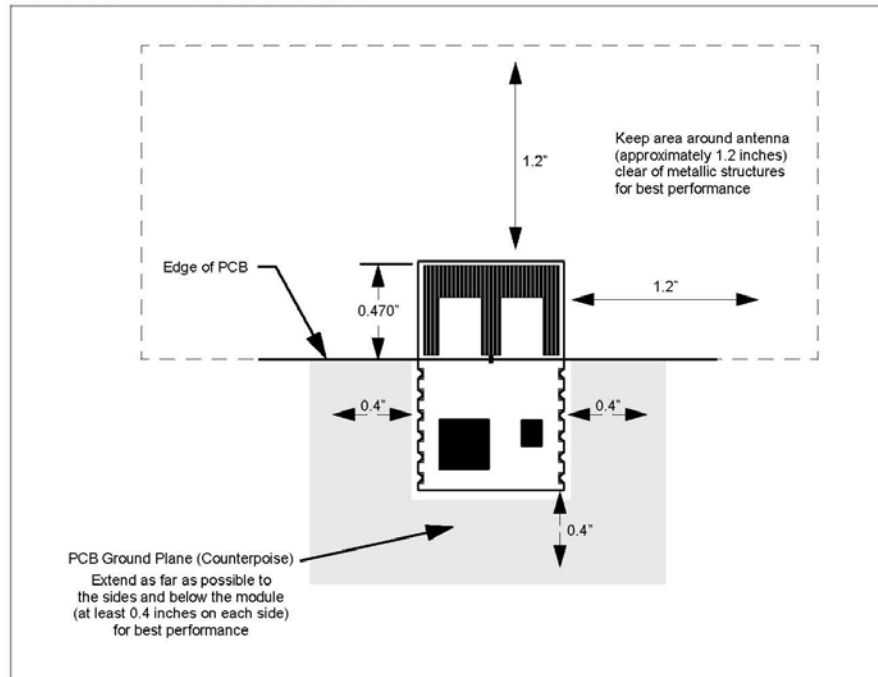


**FIGURE 1-4: RECOMMENDED PCB FOOTPRINT**



# MRF24J40MA

FIGURE 1-5: MOUNTING DETAILS





# MRF24J40MA

## 2.0 CIRCUIT DESCRIPTION

The MRF24J40MA is a complete 2.4 GHz IEEE Std. 802.15.4™ compliant surface mount module with integrated crystal, internal voltage regulator, matching circuitry and PCB antenna. The MRF24J40MA module interfaces to many popular Microchip PIC micro-controllers via a 4-wire serial SPI interface, interrupt, wake, Reset, power and ground. Data communications with the MRF24J40MA module are documented in the "MRF24J40 IEEE 802.15.4™ 2.4 GHz RF Transceiver Data Sheet" (DS39776). Refer to the MRF24J40 Data Sheet for specific serial interface protocol and register definitions.

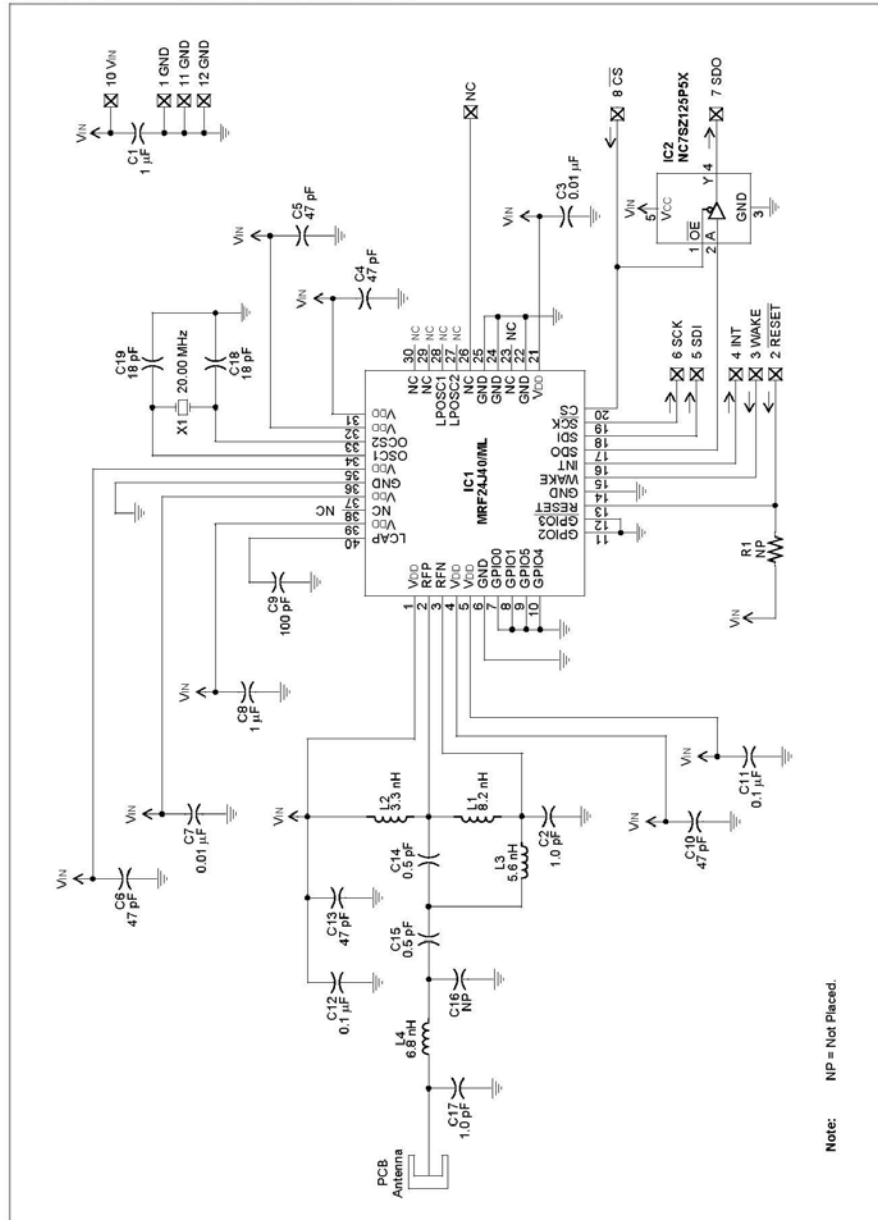
## 2.1 Schematic

A schematic diagram of the module is shown in Figure 2-1 and the Bill of Materials (BOM) is shown in Table 2-1.

The MRF24J40MA module is based on the Microchip Technology MRF24J40 IEEE 802.15.4™ 2.4 GHz RF Transceiver IC. The serial I/O (SCK, SDI, SDO and CS), RESET, WAKE and INT pins are brought out to the module pins. The SDO signal is tri-state buffered by IC2 to solve a silicon errata, where the SDO signal does not release to a high-impedance state, after the CS pin returns to its inactive state. Crystal, X1, is a 20 MHz crystal with a frequency tolerance of  $\pm 10$  ppm @ 25°C to meet the IEEE Std. 802.15.4 symbol rate tolerance of  $\pm 40$  ppm. A balun is formed by components: L1, L3, C2 and C14. L2 is an RF choke and pull-up for the RFP and RFN pins on the MRF24J40. C15 is a DC block capacitor. A low-pass filter is formed by components: L4, C16 and C17. The remaining capacitors provide RF and digital bypass.

# MRF24J40MA

FIGURE 2-1: MRF24J40MA SCHEMATIC



# MRF24J40MA

**TABLE 2-1: MRJ24J40MA BILL OF MATERIALS**

Designator	Description	Manufacturer	Part Number
C1	Chip Capacitor 0402 X5R 1U	Murata	GRM155R60J105ME19D
C2	Chip Capacitor 0402 COG 1.0P	Murata	GRM1555C1H1R0CZ01D
C3	Chip Capacitor 0402 X7R 10N	Murata	GRM155R71E103KA01D
C4	Chip Capacitor 0402 COG 47P	Murata	GRM1555C1H470JZ01D
C5	Chip Capacitor 0402 COG 47P	Murata	GRM1555C1H470JZ01D
C6	Chip Capacitor 0402 COG 47P	Murata	GRM1555C1H470JZ01D
C7	Chip Capacitor 0402 X7R 10N	Murata	GRM155R71E103KA01D
C8	Chip Capacitor 0402 X5R 1U	Murata	GRM155R60J105ME19D
C9	Chip Capacitor 0402 COG 100P	Murata	GRM1555C1H101JZ01D
C10	Chip Capacitor 0402 COG 47P	Murata	GRM1555C1H470JZ01D
C11	Chip Capacitor 0402 X5R 100N	Murata	GRM155R61A104KA01D
C12	Chip Capacitor 0402 X5R 100N	Murata	GRM155R61A104KA01D
C13	Chip Capacitor 0402 COG 47P	Murata	GRM1555C1H470JZ01D
C14	Chip Capacitor 0402 COG 0.5P	Murata	GRM1555C1HR50CZ01D
C15	Chip Capacitor 0402 COG 0.5P	Murata	GRM1555C1HR50CZ01D
C16	Not Placed		
C17	Chip Capacitor 0402 COG 1.0P	Murata	GRM1555C1H1R0CZ01D
C18	Chip Capacitor 0402 COG 18P	Murata	GRM1555C1H180JZ01D
C19	Chip Capacitor 0402 COG 18P	Murata	GRM1555C1H180JZ01D
IC1	IEEE 802.15.4™ RF Transceiver	Microchip	MRF24J40-I/ML
IC2	Buffer, SC70 Package	Fairchild	NC7SZ125P5X
L1	Chip Inductor 0402 8.2N	Panasonic	ELJ-RF8N2JFB
L2	Chip Inductor 0402 3.3N	Panasonic	ELJ-RF3N3DFB
L3	Chip Inductor 0402 5.6N	Panasonic	ELJ-RF5N6DFB
L4	Chip Inductor 0402 6.8N	Panasonic	ELJ-RF6N8JFB
R1	Not Placed		
X1	20 MHz Crystal	Abracon	ABM8-156-20.0000MHZ-T

# MRF24J40MA

## 2.2 Printed Circuit Board

The MRF24J40MA module printed circuit board is constructed with FR4 material, four layers and 0.032 inches thick. The layers are shown in Figure 2-2 through Figure 2-6. The stack up of the PCB is shown in Figure 2-7.

FIGURE 2-2: TOP SILK SCREEN

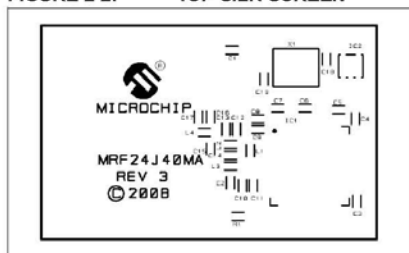


FIGURE 2-3: TOP COPPER

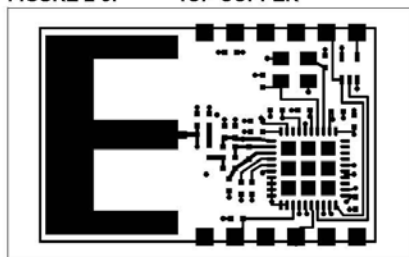


FIGURE 2-4: LAYER 2 – GROUND PLANE

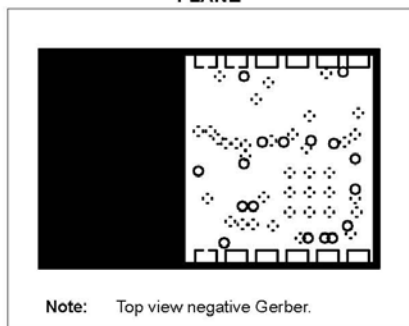
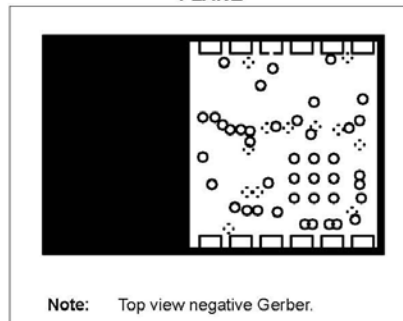
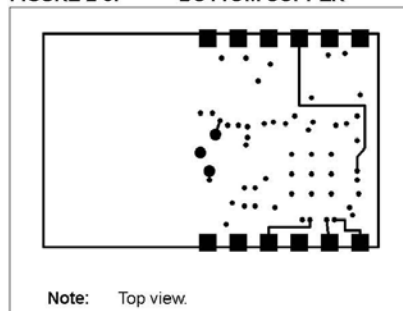


FIGURE 2-5: LAYER 3 – POWER PLANE



Note: Top view negative Gerber.

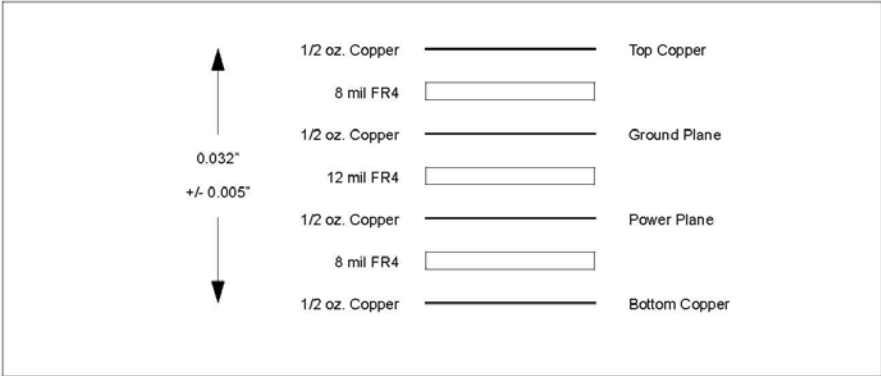
FIGURE 2-6: BOTTOM COPPER



Note: Top view.

# MRF24J40MA

**FIGURE 2-7: PCB LAYER STACK UP**



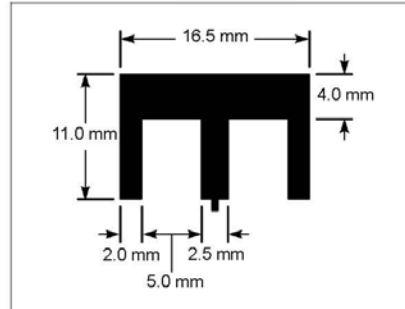
# MRF24J40MA

## 2.3 PCB Antenna

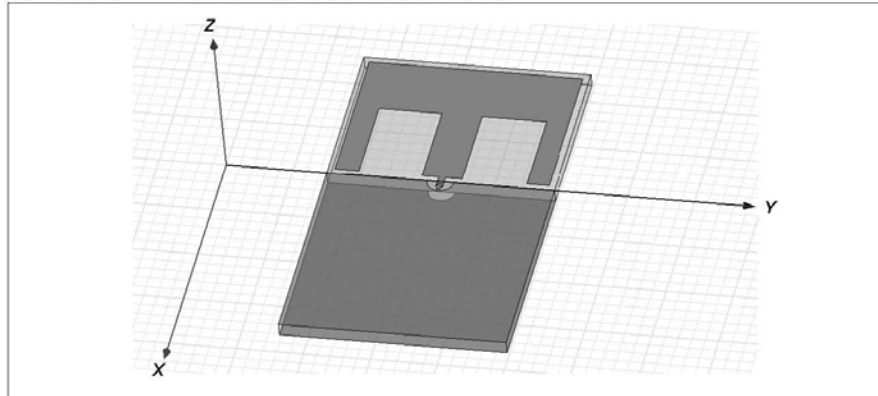
The PCB antenna is fabricated on the top copper trace. Figure 2-8 shows the trace dimensions. The layers below the antenna have no copper traces. The ground and power planes under the components serve as a counterpoise to the PCB antenna. Additional ground plane on the host PCB will substantially enhance the performance of the module. For best performance, place the module on the host PCB following the recommendations in **Section 1.2 "Mounting Details"**.

The Printed Circuit Board (PCB) antenna was designed and simulated using Ansoft Designer<sup>®</sup> and HFSS<sup>™</sup> 3D full-wave solver software by Ansoft Corporation ([www.ansoft.com](http://www.ansoft.com)). The design goal was to create a compact, low-cost antenna with the best radiation pattern. Figure 2-9 shows the simulation drawing and Figure 2-10 and Figure 2-11 show the 2D and 3D radiation patterns, respectively. As shown by the radiation patterns, the performance of the antenna is dependant upon the orientation of the module. Figure 2-12 shows the impedance simulation and Figure 2-13 shows the actual impedance measurement. The discrete matching circuitry matches the impedance of the antenna with the MRF24J40 transceiver IC.

**FIGURE 2-8: PCB ANTENNA DIMENSIONS**

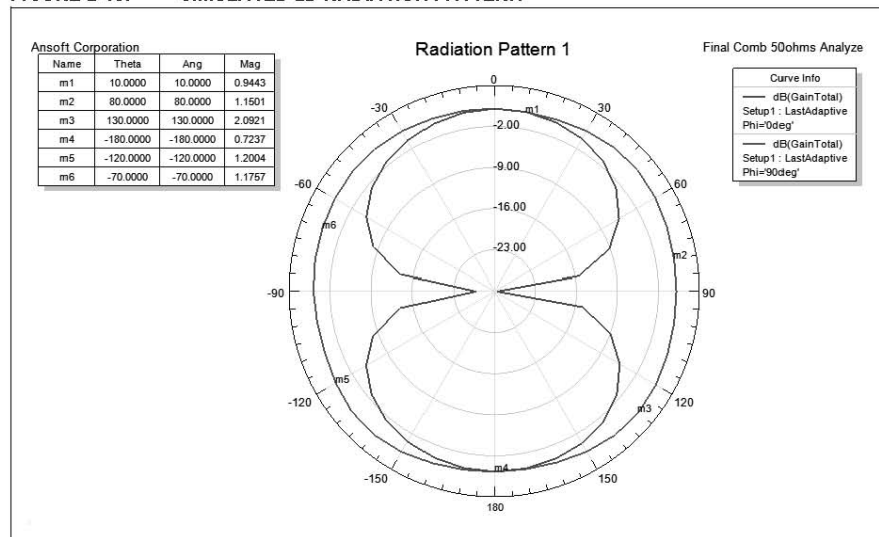


**FIGURE 2-9: PCB ANTENNA SIMULATION DRAWING**

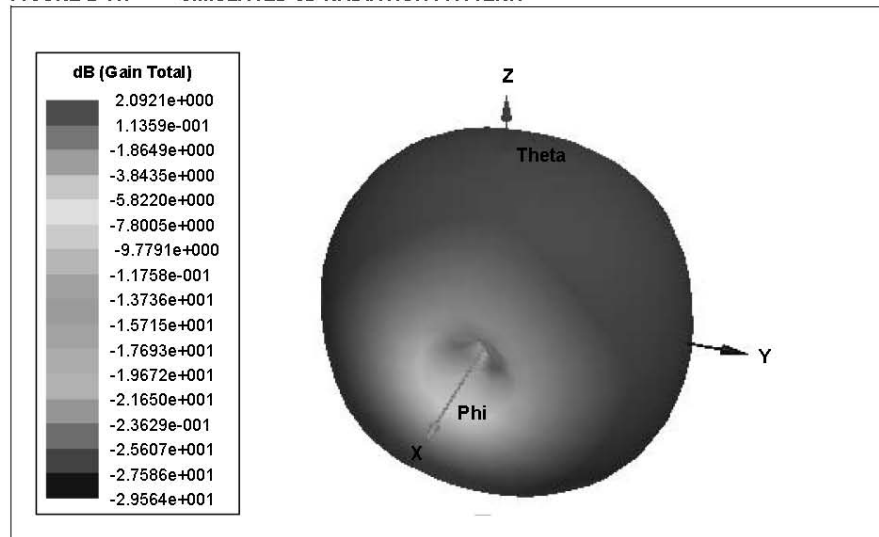


# MRF24J40MA

**FIGURE 2-10: SIMULATED 2D RADIATION PATTERN**

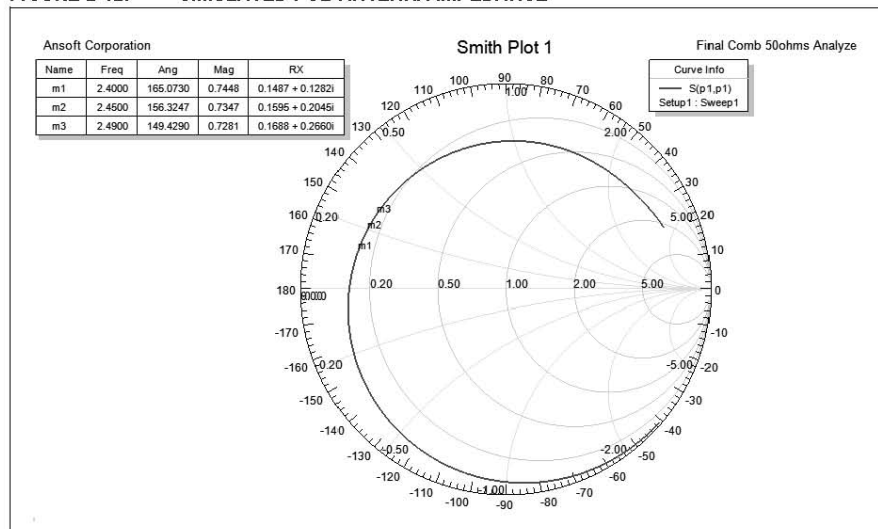


**FIGURE 2-11: SIMULATED 3D RADIATION PATTERN**

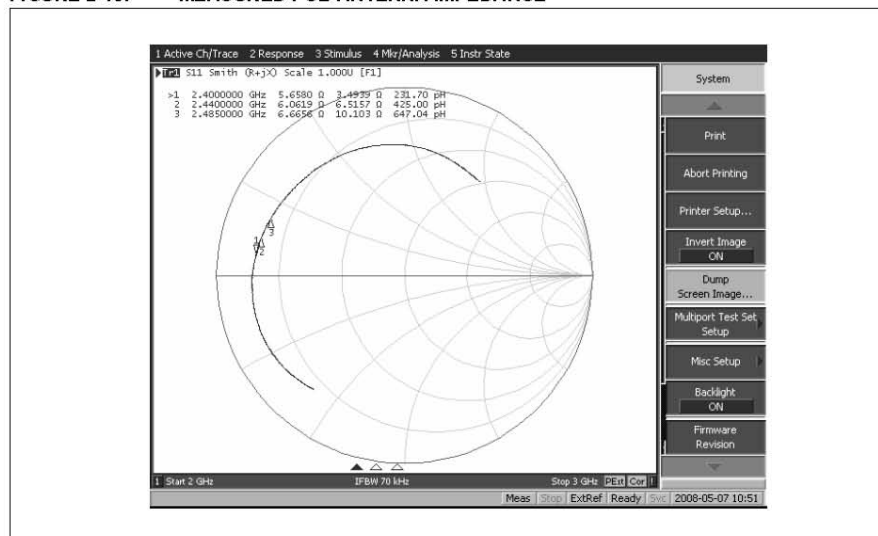


# MRF24J40MA

**FIGURE 2-12: SIMULATED PCB ANTENNA IMPEDANCE**



**FIGURE 2-13: MEASURED PCB ANTENNA IMPEDANCE**





# MRF24J40MA

## 3.0 REGULATORY APPROVAL

The MRF24J40MA module has received regulatory approvals for modular devices in the United States, Canada and European countries. Modular approval allows the end user to place the MRF24J40MA module inside a finished product and not require regulatory testing for an intentional radiator (RF transmitter), provided no changes or modifications are made to the module circuitry. Changes or modifications could void the user's authority to operate the equipment. The end user must comply with all of the instructions provided by the Grantee, which indicate installation and/or operating conditions necessary for compliance.

The integrator may still be responsible for testing the end product for any additional compliance requirements required with this module installed (for example: digital device emission, PC peripheral requirements, etc.) in the specific country that the end device will be marketed.

Annex F of the IEEE Std. 802.15.4 document has a good summary of regulatory requirements in various countries concerning IEEE Std. 802.15.4 devices. The standard can be downloaded from the IEEE Standards web page: <http://standards.ieee.org/getieee802/802.15.html>.

Refer to the specific country radio regulations for details on regulatory compliance.

### 3.1 United States

The MRF24J40MA has received Federal Communications Commission (FCC) CFR47 Telecommunications, Part 15 Subpart C "Intentional Radiators" 15.247 and modular approval in accordance with FCC Public Notice DA 00-1407 Released: June 26, 2000, Part 15 Unlicensed Modular Transmitter Approval. The MRF24J40MA module can be integrated into a finished product without obtaining subsequent and separate FCC approvals.

The MRF24J40MA module has been labeled with its own FCC ID number, and if the FCC ID is not visible when the module is installed inside another device, then the outside of the finished product into which the module is installed must also display a label referring to the enclosed module. This exterior label can use wording such as the following:

Contains Transmitter Module FCC ID:  
OA3MRF24J40MA  
-or-  
Contains FCC ID: OA3MRF24J40MA  
This device complies with Part 15 of the FCC Rules. Operation is subject to the following two conditions: (1) this device may not cause harmful interference, and (2) this device must accept any interference received, including interference that may cause undesired operation.

The user's manual should include the following statement:

This equipment has been tested and found to comply with the limits for a Class B digital device, pursuant to part 15 of the FCC Rules. These limits are designed to provide reasonable protection against harmful interference in a residential installation. This equipment generates, uses and can radiate radio frequency energy, and if not installed and used in accordance with the instructions, may cause harmful interference to radio communications. However, there is no guarantee that interference will not occur in a particular installation. If this equipment does cause harmful interference to radio or television reception, which can be determined by turning the equipment off and on, the user is encouraged to try to correct the interference by one or more of the following measures:

- Reorient or relocate the receiving antenna.
- Increase the separation between the equipment and receiver.
- Connect the equipment into an outlet on a circuit different from that to which the receiver is connected.
- Consult the dealer or an experienced radio/TV technician for help.

### 3.1.1 RF EXPOSURE

All transmitters regulated by FCC must comply with RF exposure requirements. OET Bulletin 65 "Evaluating Compliance with FCC Guidelines for Human Exposure to Radio Frequency Electromagnetic Fields" provides assistance in determining whether proposed or existing transmitting facilities, operations or devices comply with limits for human exposure to Radio Frequency (RF) fields adopted by the Federal Communications Commission (FCC). The bulletin offers guidelines and suggestions for evaluating compliance.

If appropriate, compliance with exposure guidelines for mobile and unlicensed devices can be accomplished by the use of warning labels and by providing users with information concerning minimum separation distances from transmitting structures and proper installation of antennas.

# MRF24J40MA

---

The following statement must be included as a CAUTION statement in manuals and OEM products to alert users of FCC RF Exposure compliance:

To satisfy FCC RF Exposure requirements for mobile and base station transmission devices, a separation distance of 20 cm or more should be maintained between the antenna of this device and persons during operation. To ensure compliance, operation at closer than this distance is not recommended.

The antenna(s) used for this transmitter must not be co-located or operating in conjunction with any other antenna or transmitter.

If the MRF24J40MA module is used in a portable application (antenna is less than 20 cm from persons during operation), the integrator is responsible for performing Specific Absorption Rate (SAR) testing in accordance with FCC rules 2.1091.

### 3.1.2 HELPFUL WEB SITES

Federal Communications Commission (FCC):  
<http://www.fcc.gov>

## 3.2 Canada

The MRF24J40MA module has been certified for use in Canada under Industry Canada (IC) Radio Standards Specification (RSS) RSS-210 and RSS-Gen.

From Section 7.1.1, RSS-Gen, Issue 2, June 2007, Modular Transmitter Approval:

Host devices which contain separately certified modules do not need to be recertified, provided that they meet the following conditions:

- a) The host device, as a stand-alone unit without any separately certified modules, complies with all applicable Radio Standards Specifications.
- b) The host device and all the separately certified modules it contains jointly meet the RF exposure compliance requirements of RSS-102, if applicable.
- c) The host device complies with the certification labeling requirements of each of the modules it contains.

**Note:** Compliance of a module in its final configuration is the responsibility of the applicant. A host device will not be considered certified if the instructions regarding antenna configuration provided in the original description, of one or more separately certified modules it contains, were not followed

From Section 5.2, RSS-Gen, Issue 2, June 2007, Equipment Labels:

All Category I radio equipment intended for use in Canada shall permanently display on each transmitter, receiver or inseparable combination thereof, the applicant's name (i.e., manufacturer's name, trade name or brand name), model number and certification number. This information shall be affixed in such a manner as to not be removable except by destruction or defacement. The size of the lettering shall be legible without the aid of magnification, but is not required to be larger than 8-point font size. If the device is too small to meet this condition, the information can be included in the user manual upon agreement with Industry Canada.

Label:

Contains IC: 7693A-24J40MA

From Section 7.1.6, RSS-Gen, Issue 2, June 2007, Digital Circuits:

If the device contains digital circuitry that is not directly associated with the radio transmitter, the device shall also have to comply with ICES-003, Class A or B as appropriate, except for ICES-003 labeling requirements. The test data obtained (for the ICES-003 tests) shall be kept by the manufacturer or importer whose name appears on the equipment label, and made available to Industry Canada on request, for as long as the model is being marketed in Canada.

### 3.2.1 HELPFUL WEB SITES

Industry Canada: <http://www.ic.gc.ca/>

# MRF24J40MA

---

## 3.3 Europe

The MRF24J40MA module has been certified for use in European countries. The following testing has been completed:

Test standard ETSI EN 300 328 V1.7.1 (2006-10):

- Maximum Transmit Power
- Maximum EIRP Spectral Density
- Frequency Range
- Radiated Emissions

Test standards ETSI EN 301 489-1:2008 and ETSI EN 301 489-17:2008:

- Radiated Emissions
- Electro-Static Discharge
- Radiated RF Susceptibility

A helpful document that can be used as a starting point in understanding the use of Short Range Devices (SRD) in Europe is the European Radio Communications Committee (ERC) Recommendation 70-03 E, downloadable from the European Radio Communications Office (ERO): <http://www.ero.dk>.

The end user is responsible for ensuring compliance with harmonized frequencies and labeling requirements for each country the end device is marketed and sold.

### 3.3.1 HELPFUL WEB SITES:

Radio and Telecommunications Terminal Equipment (R&TTE):  
[http://ec.europa.eu/enterprise/rtte/index\\_en.htm](http://ec.europa.eu/enterprise/rtte/index_en.htm)

European Conference of Postal and Telecommunications Administrations (CEPT): <http://www.cept.org/>

European Telecommunications Standards Institute (ETSI): <http://www.etsi.org/>

European Radio Communications Office (ERO):  
<http://www.ero.dk/>

# MRF24J40MA

---

NOTES:

# MRF24J40MA

## 4.0 ELECTRICAL CHARACTERISTICS

**TABLE 4-1: RECOMMENDED OPERATING CONDITIONS**

Parameters	Min	Typ	Max	Units
Ambient Operating Temperature	-40	—	+85	°C
Supply Voltage for RF, Analog and Digital Circuits	2.4	—	3.6	V
Supply Voltage for Digital I/O	2.4	3.3	3.6	V
Input High Voltage (VIH)	0.5 x VDD	—	VDD + 0.3	V
Input Low Voltage (VIL)	-0.3	—	0.2 x VDD	V

**TABLE 4-2: CURRENT CONSUMPTION**

(TA = 25°C, VDD = 3.3V)

Chip Mode	Condition	Min	Typ	Max	Units
Sleep	Sleep Clock Disabled	—	2	—	µA
TX	At Maximum Output Power	—	23	—	mA
RX		—	19	—	mA

**TABLE 4-3: RECEIVER AC CHARACTERISTICS**

Typical values are at TA = 25°C, VDD = 3.3V, LO Frequency = 2.445 GHz

Parameters	Condition	Min	Typ	Max	Units
RF Input Frequency	Compatible to IEEE Std. 802.15.4™, 2003	2.405	—	2.480	GHz
RF Sensitivity		—	-94	—	dBm
Maximum RF Input		+5	—	—	dBm
LO Leakage	Measured at Balun Matching Network Input at Frequency, 2.405-2.48 GHz	—	-60	—	dBm
Input Return Loss	Externally Matched to 50 ohm Source by a Balun Matching Network	-8	-12	—	dB
Noise Figure (including matching)		—	8	—	dB
Adjacent Channel Rejection	@ +/-5 MHz	30	—	—	dB
Alternate Channel Rejection	@ +/-10 MHz	40	—	—	dB
RSSI Range		—	50	—	dB
RSSI Error		-5	—	5	dB

# MRF24J40MA

---

**TABLE 4-4: TRANSMITTER AC CHARACTERISTICS**

Typical values are at TA = 25°C, VDD = 3.3V, LO Frequency = 2.445 GHz

Parameters	Condition	Min	Typ	Max	Units
RF Carrier Frequency		2.405	—	2.480	GHz
Maximum RF Output Power		—	0	—	dBm
RF Output Power Control Range		—	36	—	dB
TX Gain Control Resolution	Programmed by Register	—	1.25	—	dB
Carrier Suppression		—	-30	—	dBc
TX Spectrum Mask for O-QPSK Signal	Offset Frequency > 3.5 MHz, at 0 dBm Output Power	-33	—	—	dBm
TX EVM		—	15	—	%

# MRF24J40MA

---

## APPENDIX A: REVISION HISTORY

### Revision A (June 2008)

Original data sheet for the MRF24J40MA device.

### Revision B (November 2008)

Changed C17 to 1.0 pF and removed CLKOUT signal.

# MRF24J40MA

---

NOTES:



# MRF24J40MA

## INDEX

### A

AC Characteristics	
Receiver	19
Transmitter	20
Antenna Impedance	
Measured PCB	14
Simulated PCB	14

### B

Block Diagrams	
Microcontroller to MRF24J40MA Interface	4
MRF24J40MA	3

### C

Circuit Description	7
Customer Change Notification Service	24
Customer Notification Service	24
Customer Notification System	2
Customer Support	24

### E

Electrical Characteristics	19
Current Consumption	19
Recommended Operating Conditions	19
Errata	2
European Radio Communications (ERC)	17

### F

FCC ID Number	15
FCC RF Exposure Compliance	16

### H

Helpful Web Sites	16, 17
-------------------	--------

### I

Interface Description	3
Internet Address	24

### M

MAC/Baseband Features	1
Microchip Internet Web Site	24
MIWI P2P	3
MIWI Protocol	3
More Information	2
Customer Notification System	2
Errata	2
Mounting Details	5
MRF24J40 Data Sheet	3, 7
MRF24J40MA Bill of Materials (BOM)	9
MRF24J40MA Schematic	8

### O

Overview	3
----------	---

### P

PCB Antenna	12
Dimensions	12
Simulation Drawing	12
PCB Layers	
Bottom Copper	10
Layer 2 – Ground Plane	10
Layer 3 – Power Plane	10
Stack Up	11
Top Copper	10
Top Silk Screen	10
Pin Description	4
Pin Diagram	1
Printed Circuit Board (PCB)	10

### R

Radiation Pattern	
2D	13
3D	13
Reader Response	25
Regulatory Approval	15
Canada	16
Europe	17
United States	15
Revision History	21
RF Exposure	15
RF/Analog Features	1

### S

Serial I/O	
SCK, SDI, SDO, $\overline{CS}$	7
Short Range Devices (SRD)	17
Specific Absorption Rate (SAR)	16
SPI	7

### W

WWW Address	24
WWW, On-Line Support	2

### Z

ZigBee Protocol	3
-----------------	---

# MRF24J40MA

---

NOTES:

# MRF24J40MA

---

## THE MICROCHIP WEB SITE

Microchip provides online support via our WWW site at [www.microchip.com](http://www.microchip.com). This web site is used as a means to make files and information easily available to customers. Accessible by using your favorite Internet browser, the web site contains the following information:

- **Product Support** – Data sheets and errata, application notes and sample programs, design resources, user's guides and hardware support documents, latest software releases and archived software
- **General Technical Support** – Frequently Asked Questions (FAQ), technical support requests, online discussion groups, Microchip consultant program member listing
- **Business of Microchip** – Product selector and ordering guides, latest Microchip press releases, listing of seminars and events, listings of Microchip sales offices, distributors and factory representatives

## CUSTOMER CHANGE NOTIFICATION SERVICE

Microchip's customer notification service helps keep customers current on Microchip products. Subscribers will receive e-mail notification whenever there are changes, updates, revisions or errata related to a specified product family or development tool of interest.

To register, access the Microchip web site at [www.microchip.com](http://www.microchip.com), click on Customer Change Notification and follow the registration instructions.

## CUSTOMER SUPPORT

Users of Microchip products can receive assistance through several channels:

- Distributor or Representative
- Local Sales Office
- Field Application Engineer (FAE)
- Technical Support
- Development Systems Information Line

Customers should contact their distributor, representative or field application engineer (FAE) for support. Local sales offices are also available to help customers. A listing of sales offices and locations is included in the back of this document.

**Technical support is available through the web site at: <http://support.microchip.com>**

# Appendix A-4

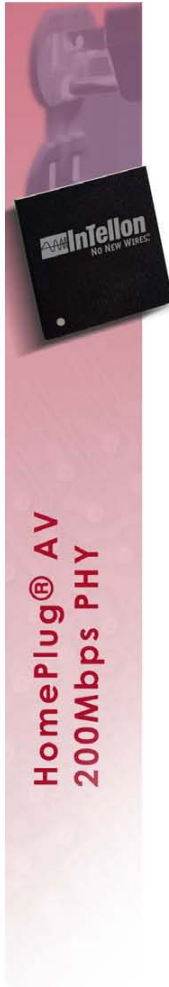
## Intellon INT6300 Technical Brief

TECHNICAL PRODUCT BRIEF

### INT6300



HomePlug® AV MAC/PHY/AFE Transceiver



#### Features

- Single-IC HomePlug® AV MAC, PHY and AFE
- MII (Host & PHY) MBI and PCI interfaces
- Co-existence with HomePlug® 1.0 Nodes
- HomePlug® AV PHY: 200 Mbps OFDM@1024-QAM
- Supports 1024/256/64/16/8-QAM, QPSK, BPSK and ROBO Modulation Schemes
- 128-bit AES Link Encryption with key management for secure powerline communications
- Windowed OFDM with noise mitigation based on patented line synchronization techniques improves data integrity in noisy conditions
- Dynamic channel adaptation and channel estimation maximizes throughput in harsh channel conditions
- Advanced Turbo Code Forward Error Correction (*France Telecom – TDF – Groupe des écoles des télécommunications Turbo codes patents license*)
- HomePlug® AV MAC: TDMA and priority-based CSMA/CA channel access schemes maximize efficiency and throughput
- Integrated Quality of Service (QoS) Enhancements: contention-free access, four-level priority based contention access, and multi segment bursting
- ToS, CoS and IP Port Number Packet Classifiers
- Supports IGMP managed multicast sessions
- 256-contact LFBGA, Pb-Free package
- Green Standard (ROHS) Compliant
- Low Power Design



#### Overview

The INT6300 is Intellon's 2<sup>nd</sup> generation HomePlug AV IC, offering higher performance and lower costs. Along with the AV MAC and PHY, the INT6300 includes the AFE. The integration of these blocks into one IC reduces total costs by reducing parts count, board space and assembly costs. Other internal improvements to the processing sections speed data flow and reduce latency.

The INT6300 IC is HomePlug AV standard-compliant delivering a 200 Mbps physical layer bit rate, which supports multi-channel SD and HD digital video distribution, along with other data traffic, throughout the home.

The INT6300 provides Ethernet 802.3 network connectivity with extensions to support audio, video and data streams. The HPAV MAC manages segmentation and reassembly, network admission, and Quality of Service (QoS). The HPAV PHY transmits and receives Orthogonal Frequency Division Multiplexing (OFDM) symbols on the power line.

## INT6300 Characteristics

### Physical

Parameter	Value	Description
Package Type	LFPGA-256, Pb-Free	256 contact Low Profile and Fine Pitch Ball Grid Array, 16 X 16 array, 1mm ball pitch, MCM
Dimensions	17 mm X 17 mm	Chip package dimensions
Height	1.61 mm	Maximum height above seating plane
Operating Temp. Range	0°C to 70°C	Safe package operating temperature range

### Electrical

Parameter	Value	Description
Core Voltage (V <sub>Core</sub> ) and PLL	1.0 VDC, -5% to +10%	DC Core and PLL Voltage
I/O Voltage (VDD <sub>I/O</sub> )	3.3 VDC, +/-10%	DC I/O Voltage
Analog Voltage (VDD <sub>A</sub> )	3.3 VDC, +/-10%	DC Analog Voltage
ESD	1000 V (HBM) 100 V (MM) 250 V (CDM)	ESD Immunity

### Interfaces

Type	Description
MI (Ethernet)	Host or PHY, IEEE 802.3u Media Independent Interface
PCI 2.2 Local Bus	Industry standard PCI 2.2 controller for video, voice, data and control
Memory Bus Interface (MBI)	16-bit Memory Peripheral, compatible with Motorola MC68000 Slave Memory/Peripheral Bus, ST Microelectronics Flash Memory/Peripheral Interface Bus (FMI) and Broadcom External Bus Interface (EBI)
SPI	Serial Peripheral Interface to read/write INT6300 configuration and firmware image stored in external flash memory and to configure the Analog Front End (AFE) analog transceiver
SDRAM	SDRAM memory controller operates at 75 MHz, 100 MHz, 112.5 MHz or 150 MHz with 16-bit or 32-bit data bus

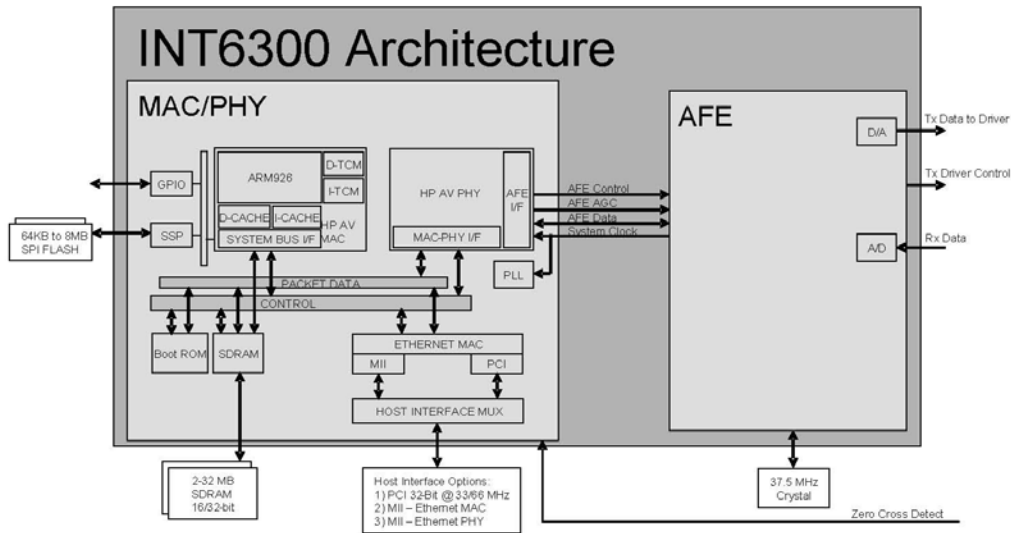
### Technologies

Type	Description
Windowed OFDM	Windowed Orthogonal Frequency Division Multiplexing – provides over 1,000 narrow-band carriers each of which can be independently turned off (30-dB notch) or modulated up to 1024-QAM for optimal performance
TDMA Channel Access	Time Division Multiple Access – a means of accommodating more than one service on the channel by assigning time slots – useful for ensuring parameterized Quality of Service (QoS) for video streams
CSMA/CA Channel Access	Carrier-Sense Multiple Access/Collision Avoidance – a means of sensing the presence of a carrier before transmission is attempted to avoid network collisions or contention

### Performance

Parameter	Value	Description
Maximum PHY Rate	200 Mbps	Maximum PHY rate including payload and overhead
Modulation	1024/256/64/16/8 QAM, QPSK, BPSK, ROBO	Each OFDM sub carrier can be independently modulated to optimize throughput for operating conditions
Encryption	128 bit AES	Industry standard Advanced Encryption System

## INT6300 Architecture



The INT6300 includes the HomePlug AV AFE – only a power amplifier and some external passive components are required to complete the analog interface. The AFE performs the required D/A, A/D, analog buffering and gain control functions. An external powerline coupler passes HomePlug AV OFDM signals to and from the powerline network while providing isolation from hazardous AC power voltages.

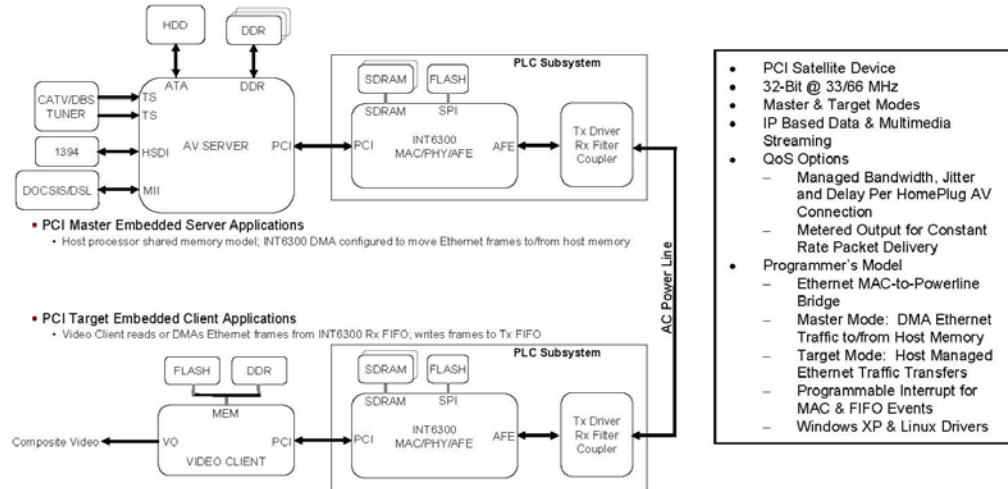
Within the INT6300, the HomePlug-AV MAC function is carried out by firmware running on an embedded ARM926EJ-S CPU, supported by DMA hardware, two dedicated CRC engines, and a large off-chip SDRAM data-store. The HomePlug-AV MAC firmware, running on the CPU, oversees operation of the integrated HomePlug AV PHY through an interface that carries control and status information in addition to transmit and receive data packets. General-purpose I/O pins are able to drive LEDs directly to indicate link status. An on-board PLL and built-in crystal oscillator driver permit generation of system clocks from a single external 37.5-MHz crystal.

### Host Interface Applications

The following sections describe various application scenarios in which the INT6300 is used, illustrating the use of the different interfaces.

**PCI**

The INT6300 PCI local bus controller, in the application shown in Figure 1, is used for video, voice and data streaming and for control and status exchange locally and over the power line. The PCI controller is a bridge between the INT6300 and an external PCI host.



**Figure 1 – PCI Local Bus Application**

The PCI controller supports satellite operation only and may be configured as either a master or target single-function device. As a master device, it includes DMA channels for transmit and receive bus transactions. The PCI controller supports external bus master arbitration and bus parking.

**MBI**

The Memory Bus Interface (MBI), illustrated in Figure 2, is used for video, voice and data streaming and for control and status exchange locally and over the power line. The MBI is designed to operate with three types of host devices:

- 1) Motorola M68000 Peripheral and Memory Bus compliant host devices configured for either asynchronous or synchronous operation
- 2) ST Microelectronics Flash Memory and Peripheral Bus (FMI) compliant host devices configured for either asynchronous or synchronous operation
- 3) Broadcom Corporation Enhanced Bus Interface (EBI) compliant host devices configured for M68000 compatible mode and either asynchronous or synchronous operation

The INT6300 MBI is a memory mapped slave controller and, therefore, does not require any bus control arbitration logic. The MBI slave controller operates as a networking peripheral with an embedded Ethernet MAC (EMAC) to emulate NIC functionality and to provide a common interface to application stacks designed for IP connectivity.

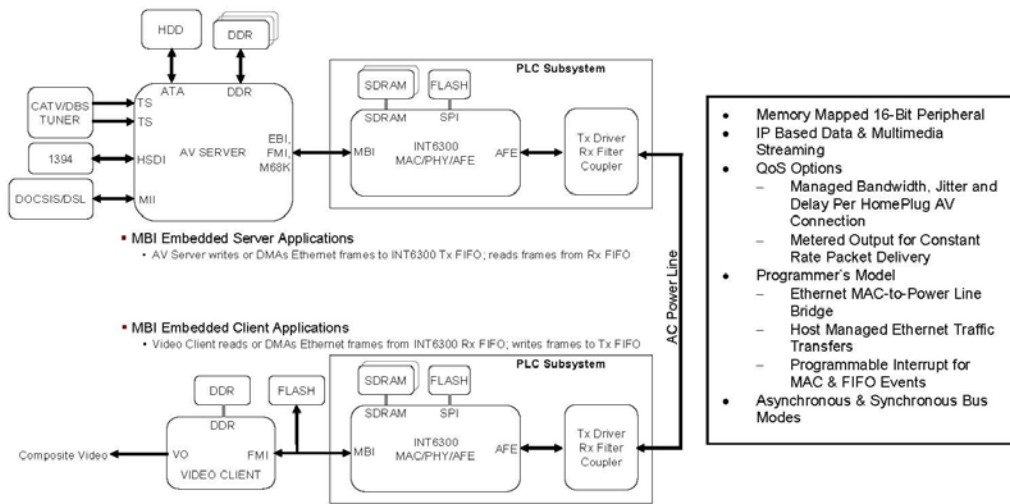


Figure 2 –Memory Bus Interface Application

**MII (Ethernet)**

The MII interface, illustrated in Figure 3, can be configured as either an Ethernet Host/DTE Controller or a Physical Medium Dependent (PMD or PHY) controller. MII is an industry standard, multi-vendor, interoperable interface between the Ethernet MAC and PHY sub-layers. It provides a simple connection between Ethernet PHY controllers and IEEE802.3 Ethernet MACs from a variety of sources.

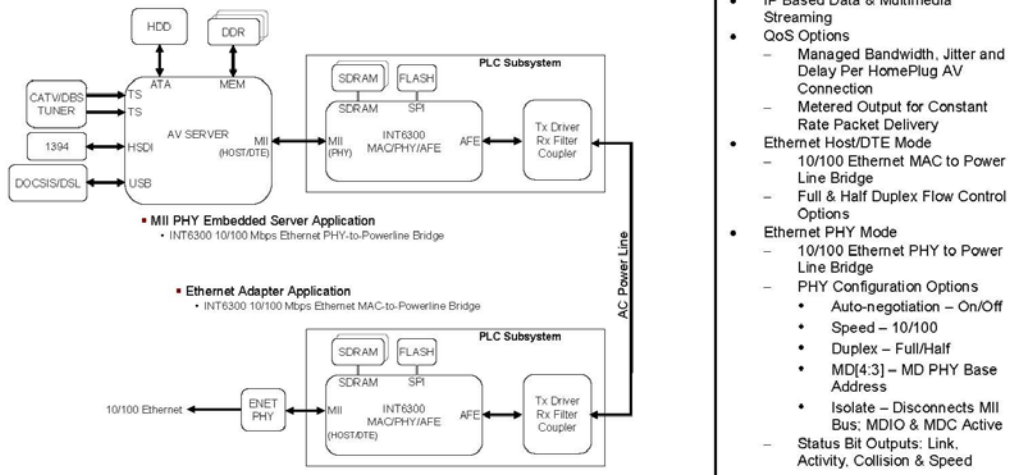


Figure 3 – MII Ethernet Application

- Memory Mapped 16-Bit Peripheral
- IP Based Data & Multimedia Streaming
- QoS Options
  - Managed Bandwidth, Jitter and Delay Per HomePlug AV Connection
  - Metered Output for Constant Rate Packet Delivery
- Programmer's Model
  - Ethernet MAC-to-Power Line Bridge
  - Host Managed Ethernet Traffic Transfers
  - Programmable Interrupt for MAC & FIFO Events
- Asynchronous & Synchronous Bus Modes

- IP Based Data & Multimedia Streaming
- QoS Options
  - Managed Bandwidth, Jitter and Delay Per HomePlug AV Connection
  - Metered Output for Constant Rate Packet Delivery
- Ethernet Host/DTE Mode
  - 10/100 Ethernet MAC to Power Line Bridge
  - Full & Half Duplex Flow Control Options
- Ethernet PHY Mode
  - 10/100 Ethernet PHY to Power Line Bridge
  - PHY Configuration Options
    - Auto-negotiation – On/Off
    - Speed – 10/100
    - Duplex – Full/Half
    - MD[4:3] – MD PHY Base Address
  - Isolate – Disconnects MII Bus: MDIO & MDC Active
  - Status Bit Outputs: Link, Activity, Collision & Speed



## INT6300 TECHNICAL PRODUCT BRIEF

Note that the AV Server, in Figure 3, utilizes the MII Host/DTE mode interface and is connected to the MII PHY mode interface of the INT6300. For the Ethernet adapter shown in Figure 3, the INT6300 uses MII Host/DTE to interface with the MII PHY (ENET PHY) on the Ethernet adapter. MII consists of separate 4-bit data paths for transmit and receive data along with carrier sense and collision detection. The MII interface also provides a two-wire bi-directional serial Management Data Interface (MDI). This interface provides access to the status and control registers in the Ethernet PHY logic. The MII and MDI pins are shared between the INT6300 MII Host/DTE and MII PHY interfaces.

**Ordering Information:** Part Number INT6300TR (lead-free on tape and reel) Lead-free is the only package option.



**Corporate Headquarters**  
5955 T.G. Lee Blvd.  
Suite 600  
Orlando, FL 32822  
(407) 428-2800  
(407) 428-2850 (Fax)

**Ocala Office**  
5100 West Silver Springs  
Blvd.  
Ocala, FL 34482  
(352) 237-7416  
(352) 237-7616 (Fax)

**San Jose Office**  
1731 Technology Drive  
Suite 580  
San Jose, CA 95110  
(408) 501-0320  
(408) 501-0323 (Fax)

**Toronto Office**  
144 Front Street West,  
Suite 385  
Toronto, Ontario M5J 2L7  
(416) 217-0451  
(416) 217-0459 (Fax)

© 2008 Intellon Corporation. The information contained in this document is provided "AS IS". Intellon reserves the right to make changes to this document and to any products without notice. INTELLON MAKES NO WARRANTY, REPRESENTATION OR GUARANTEE OF ANY KIND, EXPRESS OR IMPLIED, INCLUDING REGARDING THE CAPABILITY, PERFORMANCE OR SUITABILITY OF ITS PRODUCTS FOR ANY PARTICULAR PURPOSE. INTELLON ASSUMES NO RESPONSIBILITY OR LIABILITY ARISING OUT OF THE APPLICATION, THE USE OF ANY PRODUCT, THE USE OF ANY INFORMATION CONTAINED IN THIS DOCUMENT, OR FOR ANY INFRINGEMENT OF PATENTS OR OTHER INTELLECTUAL PROPERTY RIGHTS OWNED BY THIRD PARTIES. INTELLON SPECIFICALLY DISCLAIMS ANY AND ALL LIABILITY, INCLUDING WITHOUT LIMITATION, CONSEQUENTIAL OR INCIDENTAL DAMAGES. CERTAIN APPLICATIONS OR EQUIPMENT MAY BE SUBJECT TO REGULATORY REQUIREMENTS. INTELLON DISCLAIMS AND MAKES NO GUARANTEE OR WARRANTY, EXPRESS OR IMPLIED, THAT A PRODUCT WILL COMPLY WITH ANY SUCH REGULATORY REQUIREMENTS. All products are sold and services provided subject to Intellon's standard terms and conditions of sale, which are available on request.

Intellon and No New Wires are registered trademarks of Intellon Corporation. HomePlug is a registered trademark of the HomePlug Power line Alliance. All other trademarks are the property of their respective owners.

# Appendix A-5

## Yitran IT700 Technical Brief

### IT700 IC - FEATURES and BENEFITS

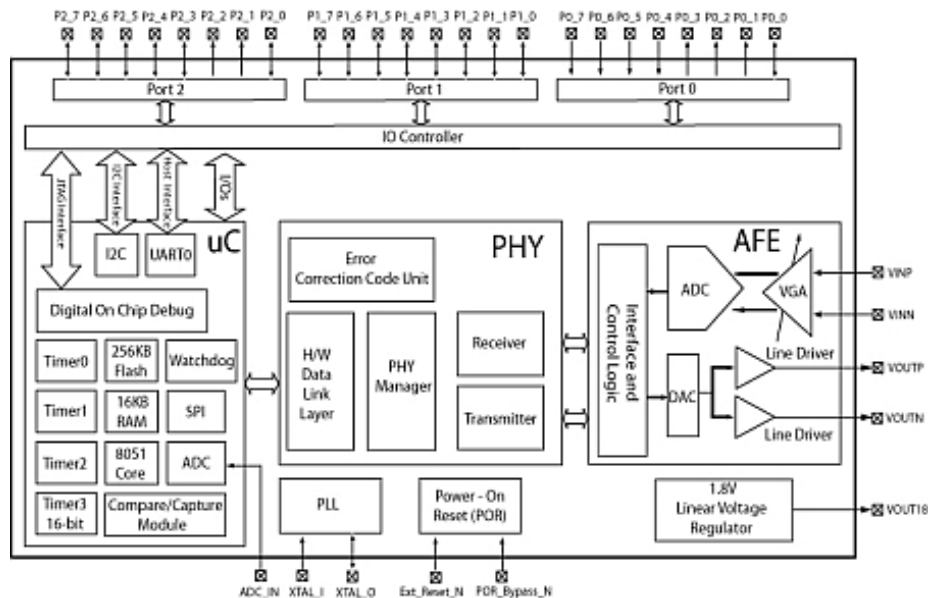
The IT700 is a highly integrated System-on-a-Chip (SoC) Powerline Communication (PLC) IC that incorporates Yitran's extremely robust Physical Layer (PHY), high-performance Data Link Layer (DLL) and Network (Y-Net) protocol. IT700 also features a 8051 Micro with 256 KB Flash for protocol stack and application implementation as well as 24 general purpose I/Os.

The IT700 PLC modem core uses Yitran's patented Differential Code Shift Keying (DCSK) advanced spread spectrum modulation technique for extremely robust communication with data rates up to 7.5Kbps. The device also utilizes several other mechanisms for enhanced communication robustness, such as a patented forward short-block soft-decoding error-correction algorithm and special synchronization algorithms.

The IT700 IC complies with worldwide regulations (FCC part 15, ARIB and CENELEC bands), is designed for [HomePlug Command & Control](#). IT700 is an ideal solution for a variety of command and control PLC applications.

The IT700 is available in two versions:

- The Protocol Controller Architecture version includes Yitran's Y-Net network protocol stack. A UART interface and simple command language provide seamless connection to an external Host controller and simplify application development. In this version, no access to the microcontroller's resources is provided.
- The Open Solution Architecture version allows utilization of the IT700 microcontroller's peripheral functions such as timers, interrupts, communication interfaces, A/D, spare memory resources and general-purpose I/Os to implement the application code, thereby eliminating the requirement for an external host controller. An Application Programming Interface (API) will enable easy integration of the application code with Yitran's code.



# Appendix A-6

## Maxim 2990/2991 Data Sheets

### ABRIDGED DATA SHEET

19-4116; Rev 0; 4/08



## 10kHz to 490kHz OFDM-Based Power Line Communication Modem

MAX2990

### General Description

The MAX2990 power line communication (PLC) base-band modem delivers a cost-effective, reliable, half-duplex asynchronous data communication over AC power lines at speeds up to 100kbps. The MAX2990 is a highly integrated system-on-chip (SoC) that combines the physical (PHY) and media access control (MAC) layers using Maxim's 16-bit MAXQ microcontroller core. The MAX2990 utilizes OFDM modulation techniques to enable robust data communication using the same electrical network that supplies power to all other devices on the network.

The MAX2990 includes the MAXQ microcontroller core. The MAXQ is a 16-bit RISC microcontroller with 32kB flash memory, 5.12kB of ROM, and 8kB SRAM, of which 4kB that can be simultaneously accessed by the MCU and the PHY. The MAX2990 is integrated with modules for serial communication (SPI™, I²C, UART) and a real-time clock (RTC) for time stamping, in addition to standard blocks such as timers, GPIO, and external interrupts.

The MAX2990 transceiver is based on an orthogonal frequency division multiplexing (OFDM) technique that allows robust data transmission over poor channel conditions specifically for environments with impulsive noise. OFDM with binary phase shift key (BPSK) and forward error correcting (FEC) blocks are used because of their inherent adaptability in the presence of frequency selective channels without the use of equalizers, resilience to jammer signals, robust communications in the presence of group delay spread, and robustness to impulsive noise. The MAX2990 features jammer cancellation that removes constant sinusoidal interference signals for FCC and ARIB bands. Privacy is provided by DES encryption.

The MAX2990 is available in a 64-pin LQFP package and is specified over the -40°C to +85°C extended temperature range.

### Applications

Automatic Meter Reading	Sensor Control and Data Acquisition
Home Automation	Remote Monitoring and Control
Heating Ventilation and Air Conditioning (HVAC)	Voice-Over-Powerline
Building Automation	Security Systems/Keyless Entry
Industrial Automation	
Lighting Control	

SPI is a trademark of Motorola, Inc.



Maxim Integrated Products 1

**For pricing, delivery, and ordering information, please contact Maxim Direct at 1-888-629-4642, or visit Maxim's website at [www.maxim-ic.com](http://www.maxim-ic.com).**

### Features

- ◆ Combines the Physical Layer (PHY) and Media Access Controller (MAC)
- ◆ Integrated Microcontroller with 32kB Password-Protected Flash Memory and 8kB SRAM
- ◆ Maximum Effective Data Rate in Normal Mode  
32kbps at 10kHz to 95kHz and 100kbps at 10kHz to 490kHz
- ◆ Complies with  
CENELEC A (10kHz to 95kHz)  
CENELEC B (95kHz to 120kHz)  
CENELEC C (120kHz to 140kHz)  
FCC (10kHz to 490kHz)  
ARIB (10kHz to 450kHz)
- ◆ Includes Forward Error Correction (FEC) Mechanism and CRC16
- ◆ Includes Fast DES Engine as the Encryption/Decryption Coprocessor and CRC32
- ◆ Jammer Cancellation for FCC and ARIB
- ◆ User-Configured Start and End Operating Frequency
- ◆ Carrier Sense Multiple Access/Collision Avoidance (CSMA/CA) Channel Access Arbitration
- ◆ Automatic Repeat Request (ARQ) to Enhance Error Detection and Improve Data Reliability
- ◆ Supports SPI, I²C, and UART Interfaces
- ◆ Real-Time Clock (RTC)
- ◆ PWM Counters
- ◆ Built-In Test Mode Engine for Identifying Channel Conditions

### Ordering Information

PART	TEMP RANGE	PIN-PACKAGE
MAX2990ECB+	-40°C to +85°C	64 LQFP

+Denotes a lead-free package.

Pin Configuration appears at end of data sheet.

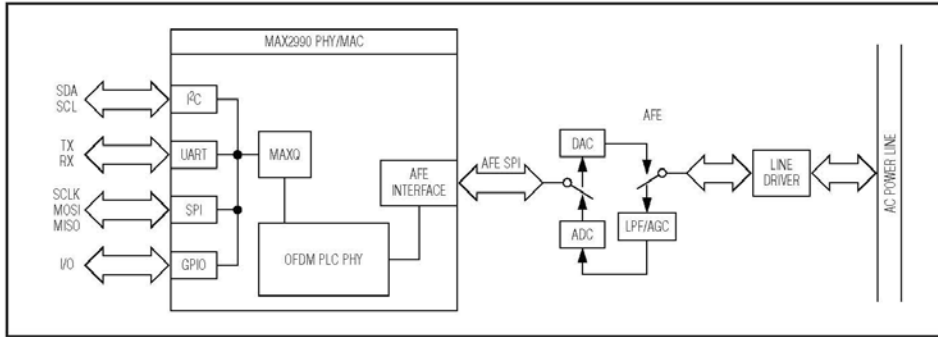
Typical Application Circuit appears at end of data sheet.

# ABRIDGED DATA SHEET

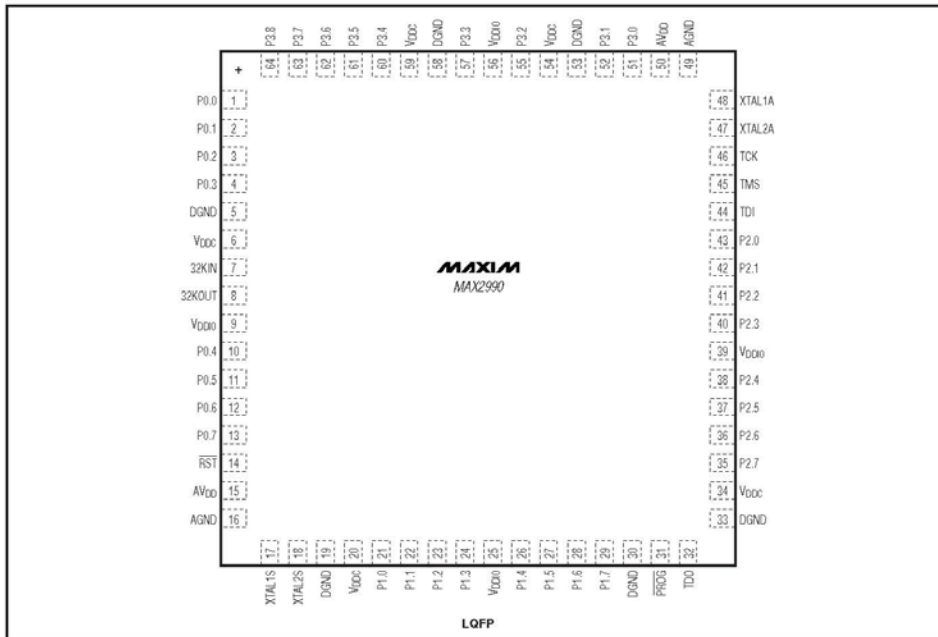
## 10kHz to 490kHz OFDM-Based Power Line Communication Modem

**MAX2990**

### Typical Application Circuit



### Pin Configuration



Maxim cannot assume responsibility for use of any circuitry other than circuitry entirely embodied in a Maxim product. No circuit patent licenses are implied. Maxim reserves the right to change the circuitry and specifications without notice at any time.

24 Maxim Integrated Products, 120 San Gabriel Drive, Sunnyvale, CA 94086 408-737-7600

© 2008 Maxim Integrated Products

MAXIM is a registered trademark of Maxim Integrated Products, Inc.



## Powerline Communications (PLC) Integrated Analog Front-End Transceiver

**MAX2991**

### General Description

The MAX2991 powerline communication analog front-end (AFE) is a state-of-the-art integrated circuit that delivers high integration and superb performance, while reducing the total system cost. The MAX2991 is the first AFE specifically designed for OFDM (orthogonal frequency division multiplexing) modulated signal transmission over power lines. Operating in the 10kHz to 490kHz band, the programmable filters allow compliance with CENELEC, FCC, and ARIB standards using the same device.

The MAX2991 transceiver provides two main paths: transmit (Tx) path and receive (Rx) path. The transmit path injects an OFDM modulated signal into the AC or DC line. The transmit path is composed of a digital IIR filter, DAC (digital-to-analog converter), followed by a lowpass filter, and a pre-line driver. The receiver path is for the signal enhancement, filtering, and digitization of the received signal. The receiver is composed of a lowpass and a highpass filter, a two-stage automatic gain control (AGC), and an ADC (analog-to-digital converter). The integrated AGC maximizes the dynamic range of the signal up to 60dB, while the lowpass filter removes any out-of-band noise, and selects the desired frequency band. The ADC converts the enhanced and amplified input signal to a digital format. An integrated offset cancellation loop minimizes the DC offset.

The MAX2991, along with the MAX2990 PLC baseband modem, delivers the most cost-effective data communication solution over power line networks in the market. The MAX2991 is specified over the -40°C to +85°C temperature range and is available in a 48-pin LQFP package.

### Features

- ◆ Optimized to Operate with the MAX2990 PLC Baseband
- ◆ Integrated Band Select Filter, AGC, and a 10-Bit ADC for Rx Path
- ◆ Integrated Wave-Shaping Filter, Programmable Pre-Driver Gain, and a 10-Bit DAC for Tx Path
- ◆ Variable Sampling Rate Up to 1.2Mps
- ◆ Built in 60dB Dynamic Range AGC and DC Offset Cancellation
- ◆ Programmable Filters Operate in the CENELEC, FCC, and ARIB Frequency Bands
- ◆ Single 3.3V Power Supply
- ◆ 70mA Typical Supply Current (Half-Duplex Mode)
- ◆ Extended Operating Temperature Range

### Applications

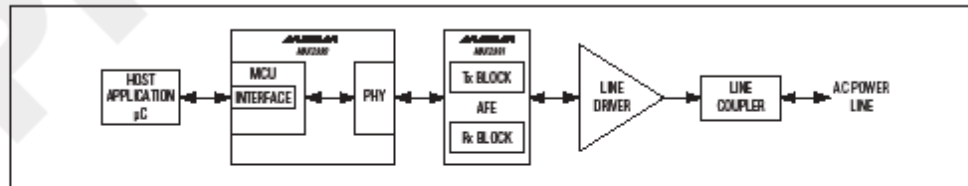
Automatic Meter Reading  
 Home Automation  
 Heating Ventilation and Air Conditioning (HVAC)  
 Building Automation  
 Industrial Automation  
 Lighting Control  
 Sensor Control and Data Acquisition (SCADA)  
 Remote Monitoring and Control  
 Security Systems/Keyless Entry  
 Smart Grid

### Ordering Information

PART	TEMP RANGE	PIN-PACKAGE
MAX2991ECM+	-40°C to +85°C	48 LQFP

+Denotes a lead(Pb)-free/RoHS-compliant package.

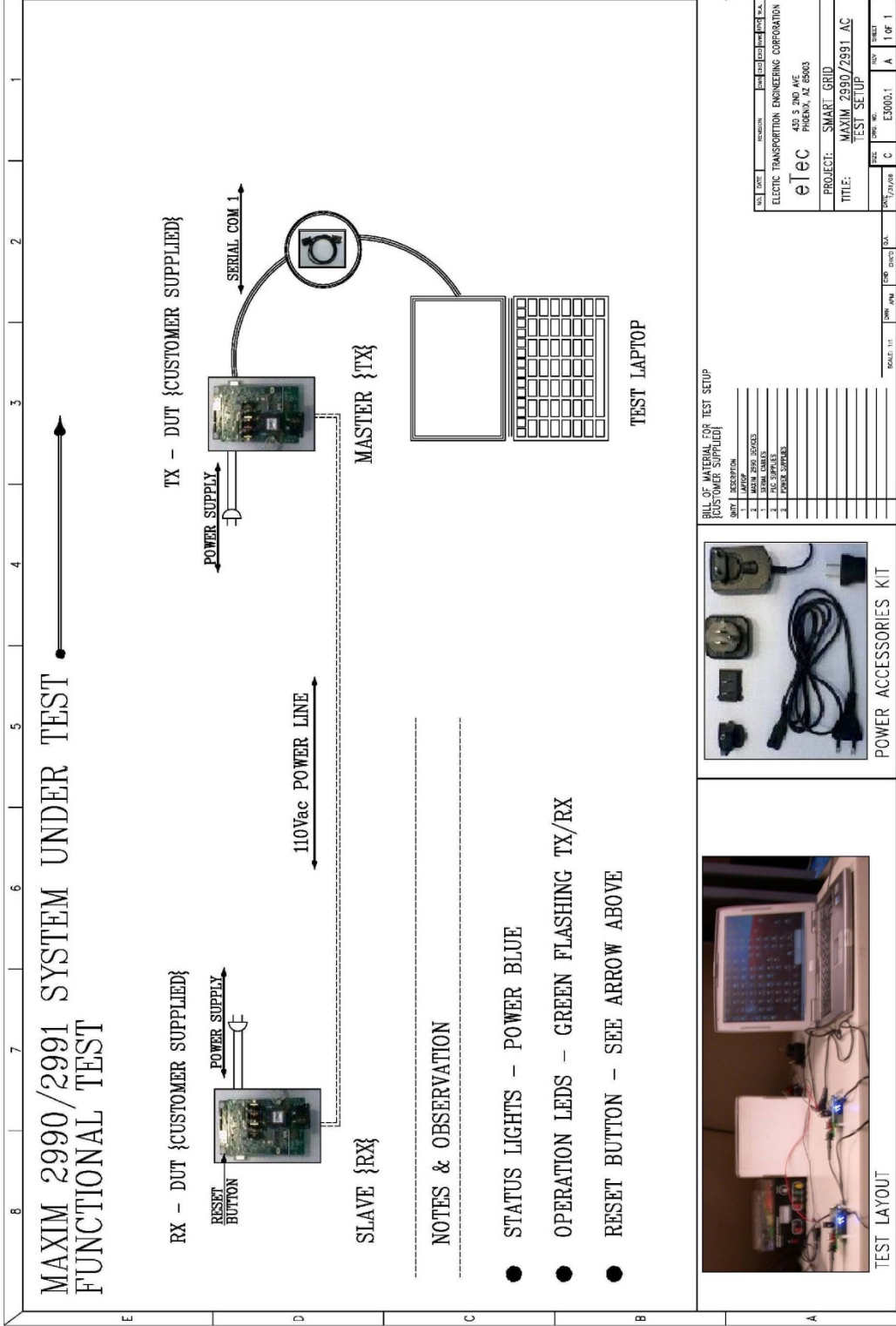
### Typical Application Circuit



Maxim Integrated Products 1

For pricing, delivery, and ordering information, please contact Maxim Direct at 1-888-629-4642, or visit Maxim's website at [www.maxim-ic.com](http://www.maxim-ic.com).





**MAXIM 2990/2991 SYSTEM UNDER TEST  
FUNCTIONAL TEST**

RX - DUT {CUSTOMER SUPPLIED}



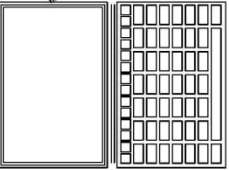
SLAVE {RX}

110Vac POWER LINE

TX - DUT {CUSTOMER SUPPLIED}



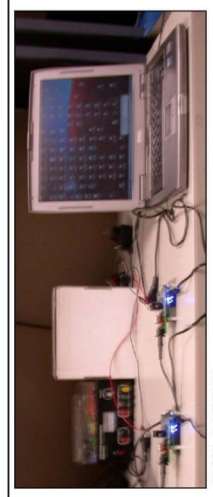
MASTER {TX}



TEST LAPTOP

**NOTES & OBSERVATION**

- STATUS LIGHTS - POWER BLUE
- OPERATION LEDS - GREEN FLASHING TX/RX
- RESET BUTTON - SEE ARROW ABOVE



TEST LAYOUT



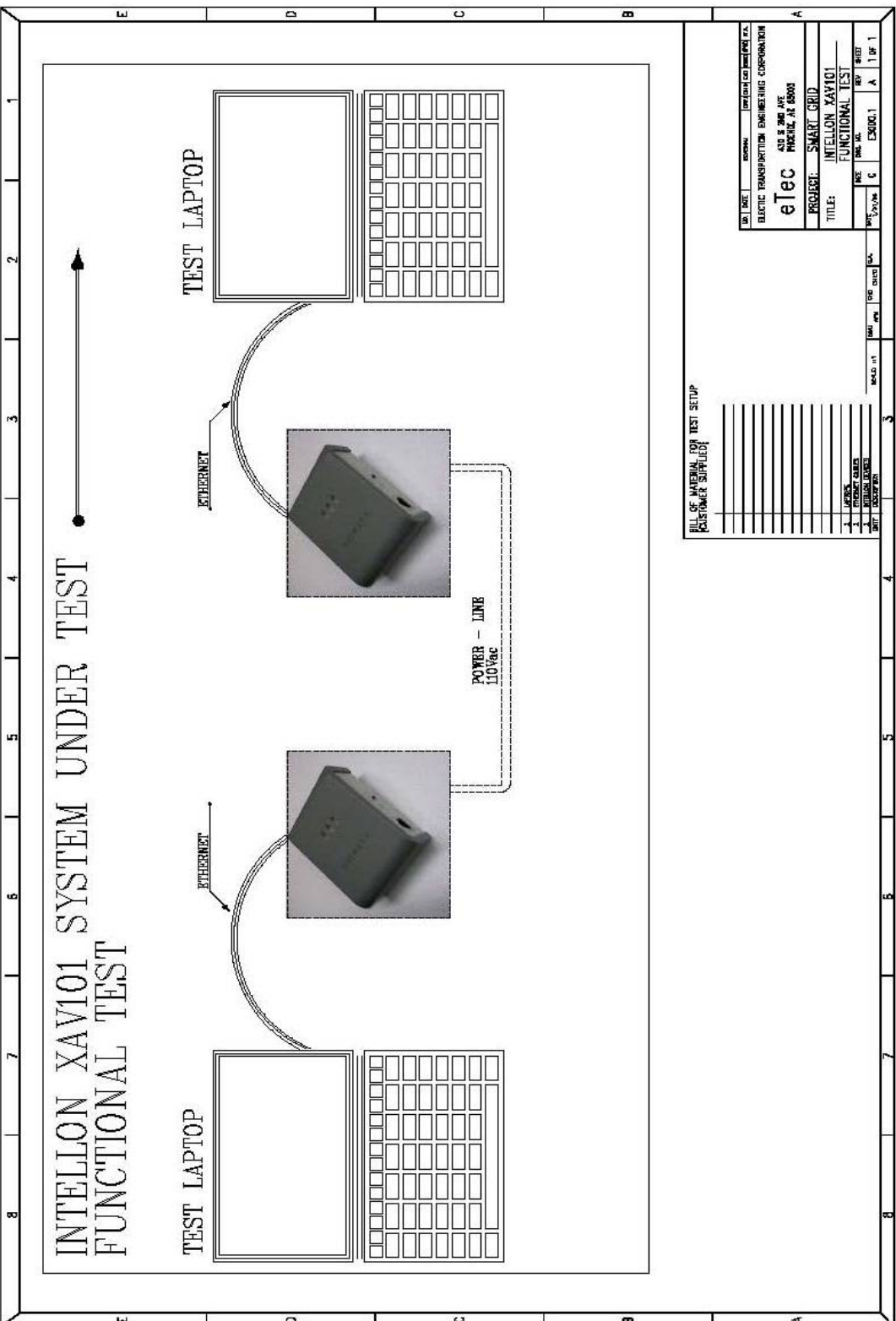
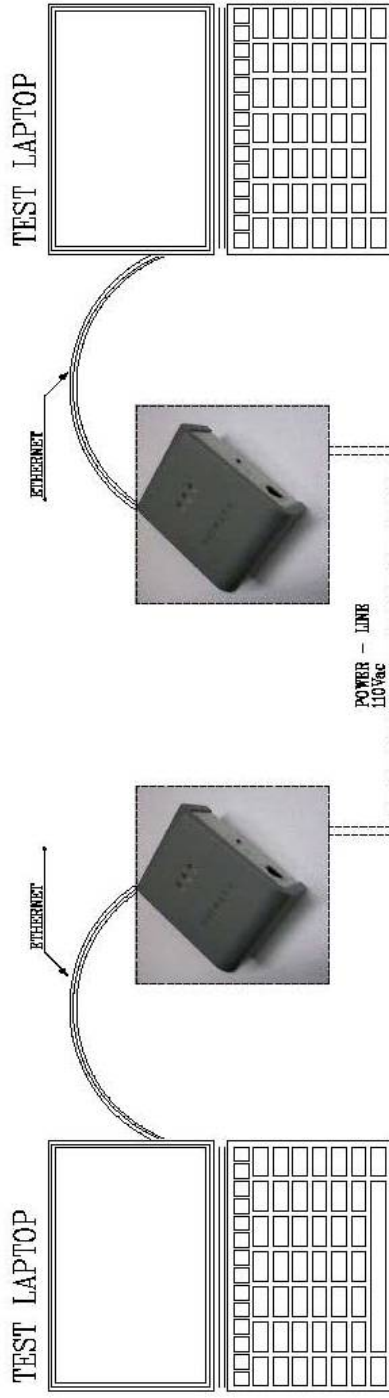
POWER ACCESSORIES KIT

**BILL OF MATERIAL FOR TEST SETUP  
{CUSTOMER SUPPLIED}**

QTY	DESCRIPTION
1	POWER SUPPLY
1	POWER SUPPLY
1	SERIAL CABLES
1	PC SUPPLIES
1	POWER CABLES

REV	DATE	BY	CHKD	APP'D	DATE
<b>eTec</b> ELECTRIC TRANSPORTATION ENGINEERING CORPORATION 450 S 7TH AVE PHOENIX, AZ 85003					
PROJECT: SMART GRID TITLE: MAXIM 2990/2991 AC TEST SETUP					
DATE	DATE	DATE	DATE	DATE	DATE
REV	BY	CHKD	APP'D	DATE	DATE
1					
2					
3					
4					
5					
6					
7					
8					
9					
10					
11					
12					
13					
14					
15					
16					
17					
18					
19					
20					
21					
22					
23					
24					
25					
26					
27					
28					
29					
30					
31					
32					
33					
34					
35					
36					
37					
38					
39					
40					
41					
42					
43					
44					
45					
46					
47					
48					
49					
50					
51					
52					
53					
54					
55					
56					
57					
58					
59					
60					
61					
62					
63					
64					
65					
66					
67					
68					
69					
70					
71					
72					
73					
74					
75					
76					
77					
78					
79					
80					
81					
82					
83					
84					
85					
86					
87					
88					
89					
90					
91					
92					
93					
94					
95					
96					
97					
98					
99					
100					

# INTELLON XAVI01 SYSTEM UNDER TEST FUNCTIONAL TEST



BILL OF MATERIAL FOR TEST SETUP  
CUSTOMER SUPPLIED

DATE	ISSUED	BY	DATE	BY	DATE	BY	DATE	BY
<b>eTec</b>								
ELECTRIC TRANSPORTATION ENGINEERING CORPORATION								
431 S. 2ND AVE. PASCAGO, AL 36800								
PROJECT: SMART GRID								
TITLE: INTELLON XAVI01								
FUNCTIONAL TEST								
NO.	REV.	DATE	BY	CHKD.	DATE	BY	CHKD.	DATE
1								
2								
3								
4								
5								
6								
7								
8								
9								
10								
11								
12								
13								
14								
15								
16								
17								
18								
19								
20								
21								
22								
23								
24								
25								
26								
27								
28								
29								
30								
31								
32								
33								
34								
35								
36								
37								
38								
39								
40								
41								
42								
43								
44								
45								
46								
47								
48								
49								
50								
51								
52								
53								
54								
55								
56								
57								
58								
59								
60								
61								
62								
63								
64								
65								
66								
67								
68								
69								
70								
71								
72								
73								
74								
75								
76								
77								
78								
79								
80								
81								
82								
83								
84								
85								
86								
87								
88								
89								
90								
91								
92								
93								
94								
95								
96								
97								
98								
99								
100								



# Appendix A-8

## Functional Test Setup Instructions

EMC Test Setup & Operation for PLC Communication  
Released 7 – 28 - 2009 Document Rev 1.0

**Preliminary:** The EMC Test setup and operation consists of four test configurations, and a test operation for each one. Test configurations are broken down as follows:

- Vitron AC Setup & Operation Phase I:
- Vitron DC Setup & Operation Phase II:
- Interlon: Ethernet over Powerline Phase III:
- MAXIM PLC 2990 AC 110 & 240 Hot Line:
- MAXIM PLC 2990 12V DC Setup & Operation Phase V:

**Instruction:** Each phase consists of instructions and references to drawings, manuals and screen shots as they apply to the test operation and setup.

**Phase I:** Vitron AC Setup and Test:

**Required Material:** The following materials will be needed for setting up Phase I

- Two Vitron Units labeled 1,2
- One USB Cable
- Two AC Power Supplies for the Vitron Units.
- One Laptop Computer with Vitron Software

**Procedure:** Apply the following steps in setting up and operating the Vitron units in AC mode using the following steps and accompanying diagrams and drawings.

### Hardware Setup

**Step 1:** Using Figure 1.0 located on page 1 of 2 on the drawing titled, "EMC\_Test Layout" as a reference connect Vitron 1 to the test laptop using a USB cable.

**Step 2:** Connect Vitron 1 to its power adapter and plug the power adapter into a receptacle.

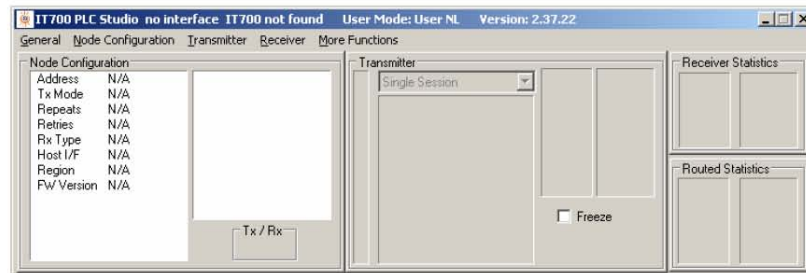
**Step 3:** Connect Vitron 2 to its power adapter and plug it into a separate receptacle away from where Vitron 1 is connected. Do not plug both Vitron 1 and Vitron 2 into the same receptacle.

Observes Vitron 2 does not have a USB cable connected to the laptop. This is a deliberate action given the interest in measuring PLC communication exclusively.

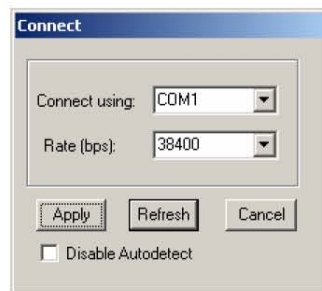
This completes setting up the hardware for this Phase.

**Phase I: Vitron AC Setup and Test Continued:**

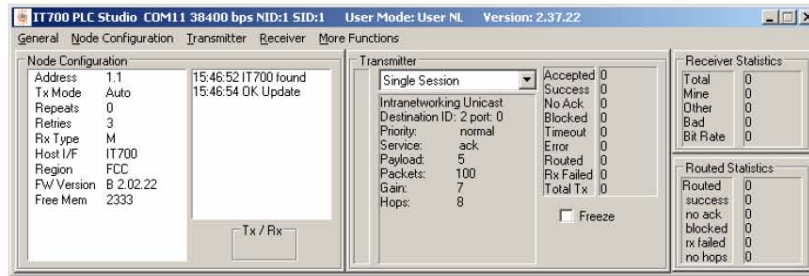
**Step 4:** Turn on the test laptop and turn on Vitron 1. Select Vitron Icon on the desktop. This starts the Test software specially made to communicate with Vitron. The following screen shot should display.



**Step 5:** Under the Title Transmitter select the option Connect. The following screen shot displays.

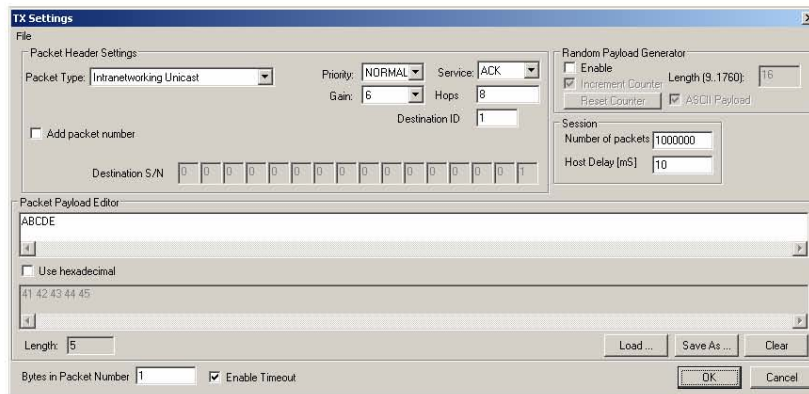


**Step 6:** Change the COM1 setting to COM11 keep the baud rate at 38400. The following screen shot should display with all appropriate fields enabled.

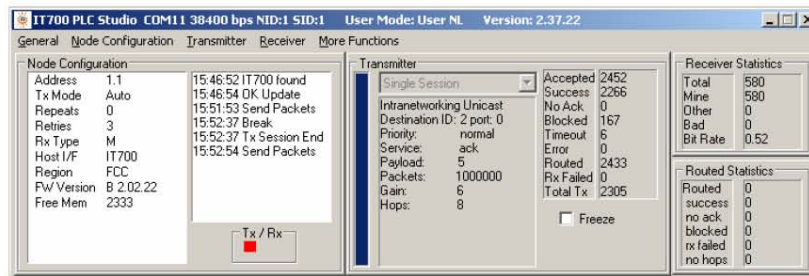


Phase I: Vitron AC Setup and Test Continued:

Step 7: Select The Transmitter option again the following screen shot displays.



Step 8: Under the field Number of packets enter 100000 and under Host Delay enter 10. Fill in ABCDE under the Packet payload Editor. Click OK and the following screen shot should display. Observe the Light flashing RED under the Tx/Rx box.



**Phase I: Vitron AC Setup and Test Continued:**

**Step 9 Observation:** Observe activity occurs on both Vitron Unit 1 & 2. See photos below for an illustration of transmit and receive activity.

Vitron #1



Vitron #2



**Summary:** From this point on the devices are operating, EMC test measurements can now take place as called for on the test specification in the PO. When measurements are done, tear down the test setup by clicking exit under the General menu heading. Turn off the laptop, Vitron devices and then remove and place in a box ready for shipment back to eTec.

**This Concludes Phase I**

**Phase II:** Vitron DC Setup and Test Continued:

**Required Material:** The following materials will be needed for setting up Phase II

- Two Vitron Units labeled 1,2
- One USB Cable
- Two DC Power Supplies for the Vitron Units.
- One Laptop Computer with Vitron Software

**Procedure:** Apply the following steps in setting up and operating the Vitron units in DC mode using the following steps and accompanying diagrams and drawings.

**Hardware Setup**

**Step 1:** Using Figure 2.0 located on page 1 of 2 on the drawing titled, "EMC\_Test Layout" as a reference connect Vitron 1 to the test laptop using a USB cable.

**Step 2:** Connect Vitron 1 to its power adapter and plug the power adapter into a DC Power Supply check the LED light illuminates before proceeding further, if it fails to light up, the battery needs to be recharged and testing will need to take place the following day.

**Step 3:** Connect Vitron 2 to its power adapter and plug it into another DC power supply. Again if the LED fails to illuminate, the DC power supply needs to recharge.

Observes Vitron 2 does not have a USB cable connected to the laptop. This is a deliberate action given the interest in measuring PLC communication exclusively.

This completes setting up the hardware for this Phase.

**Test Operation Section:** Continue with steps 4 – 9 as described in Phase I.

**This Concludes Phase II**

**Phase III: Ethernet Intellon Device**

**Required Material:** The following materials will be needed for setting up Phase III

- Two Intellon AV Ethernet devices
- Two Ethernet Cables
- Two Laptops.

**Procedure:** Apply the following steps in setting up and operating the Homeplug AV Ethernet devices.

**Hardware Setup**

**Step 1:** Using Figure 3.0 located on page 2 of 2 on the drawing titled, "EMC\_Test Layout". Plug in each device into two separate receptacles.

**Step 2:** Connect an Ethernet cable from laptop 1 to Intellon Ethernet device #1.

**Step 3:** Repeat Step 2 for Laptop 2 and Intellon AV Ethernet device #2.

This Completes setting up the hardware for this phase.

**Software Setup**

**Step 4:** Turn on test laptop 1 & 2 and assign the following

Laptop #1 IP Address(static) = 192.168.0.100

Default Gateway = 192.168.0.100

Subnet Mask = 255.255.255.0

Laptop #2 IP Address(static) = 192.168.0.101

Default Gateway =192.168.0.101

Subnet Mask = 255.255.255.0

{Keep the workgroup.}

**Step 5:** Transfer a large file from Laptop 1 to Laptop 2. Conduct EMC measurements during the file transfer. Use the CAD Video File.

**This Concludes Phase III**

**Phase IV:** Maxim 2990 Test setup & Operation:

**Required Material:** The following materials will be needed for setting up Phase IV

- Two Maxim 2990 devices
- Two Serial Cables
- Two Laptops.
- Power Accessories Kit
- Serial to Fiber converters

**Procedure:** Apply the following steps in setting up and operating the Maxim 2990 devices for 110 Vac test operation.

**Hardware Setup**

**Step 1:** Examine Figure 6.0 located on page 1 of 2 on the drawing titled, "EMC Maxim 2990". Using modules contained the power accessories kit, create two 110Vac plugs.

**Step 2:** Connect the cold wires to DUT#1 and DUT#2 on as illustrated in Figure 6.0. Use the overall layout snapshot located below figure 6.0 as a guide.

**Step 3:** Connect the cold wires by matching the correct polarity with jumper wires colored as red = + and Black = -.

**Step 4:** Examine the LED flash rate between DUT#1 and DUT#2. There should be two flashing lights operating in an alternating sequence. This indicates there is packet data being transferred between DUT#1 and DUT#2.

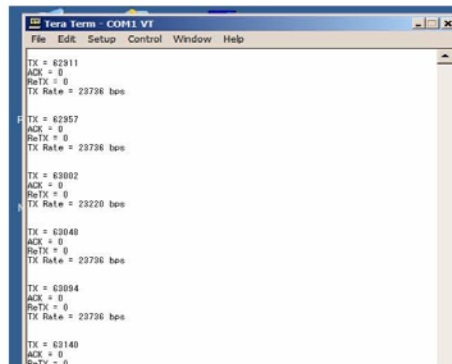
**Step 5:** Connect both laptops#1&2 to DUT#1&2 respectively, using a serial cable as See figure 6.0 on the "EMC Maxim 2990" drawing.

### Software Setup

**Step 6:** Turn on laptop 1 & 2 and select the program icon “t34mpro” on both laptops see illustration below:



**Step 7:** After selecting the icon, the following dialogue box appears illustrating packet data transfer between DUT #1 and DUT#2



**Step 8:** Verify traffic data is real by disconnecting one of the cold wires and observing all traffic activity STOPS between both laptops.



**This Concludes Phase IV**

**Phase V:** Maxim 2990 Test setup & Operation 12V dc:

**Required Material:** The following materials will be needed for setting up Phase V

- Two Maxim 2990 devices
- Two Serial Cables
- Two Laptops.
- Power Accessories Kit
- Serial to Fiber converters
- 12V dc Power Supply

**Procedure:** Apply the following steps in setting up and operating the Maxim 2990 devices for 12 Vdc test operation.

**Hardware Setup**

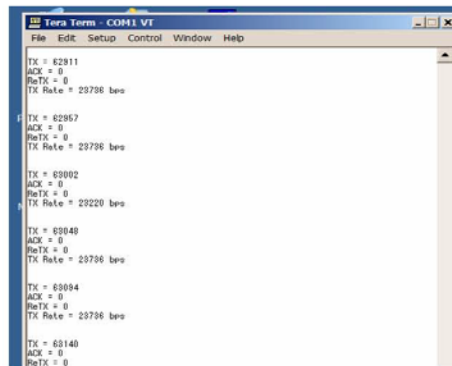
- Step 1:** Examine Figure 6.0 located on page 1 of 2 on the drawing titled, "EMC Maxim 2990". Using modules contained the power accessories kit, select the 100 to 200Vac input to 12Vdc output power adapter, create the plug for either 110Vac or a 220Vac receptacle.
- Step 2:** Connect the other end into the 12Vdc receptacle on each DUT.
- Step 3:** Connect the cold wires to DUT#1 and DUT#2 on as illustrated in Figure 6.0. Use the overall layout snapshot located below figure 6.0 as a guide.
- Step 4:** Connect the cold wires by matching the correct polarity with jumper wires colored as red = + and Black = -.
- Step 5:** Examine the LED flash rate between DUT#1 and Dut#2. There should be two flashing lights operating in an alternating sequence. This indicates there is packet data being transferred between DUT#1 and DUT#2.
- Step 6:** Connect both laptops#1&2 to DUT#1&2 respectively, using a serial cable as See figure 6.0 on the "EMC Maxim 2990" drawing.

### Software Setup

Step 6: Turn on laptop 1 & 2 and select the program icon “t34mpro” on both laptops see illustration below:



Step 7: After selecting the icon, the following dialogue box appears illustrating packet data transfer between DUT #1 and DUT#2

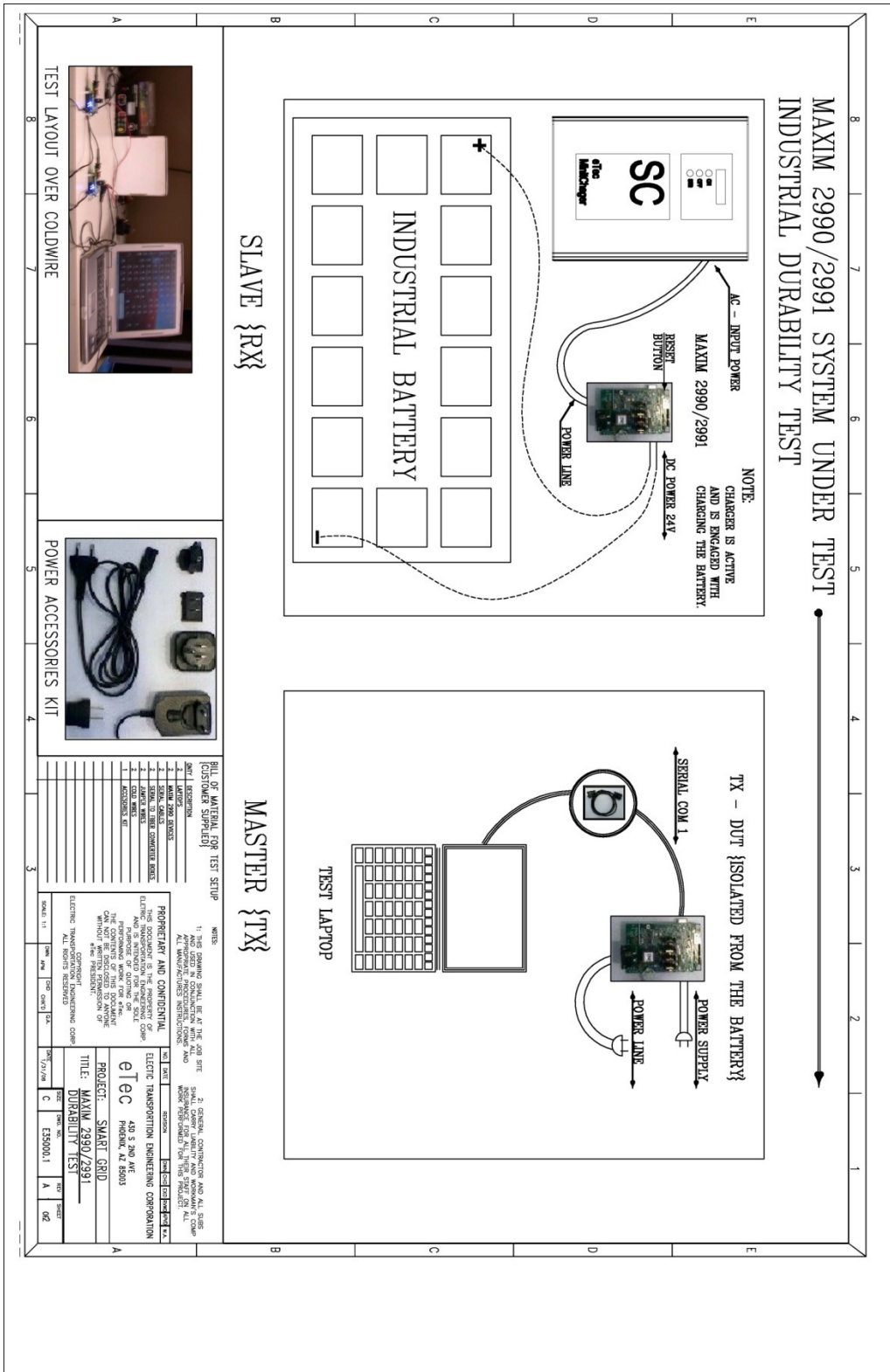


Step 8: Verify traffic data is real by disconnecting one of the cold wires and observing all traffic activity STOPS between both laptops.

**This Concludes Phase V**

**This Concludes Test Setup and Operation Procedure for PLC Communications.**

# Appendix A-9 Durability Test Setup Drawings (Maxim 2990/2991)



# Appendix A-10

## Durability Test Setup Instructions (Maxim 2990/2991)

\*\*\*Durability Functional Test Instructions for Maxim 2990/2991 EV kit\*\*\*  
Released 8 – 1 – 2009 Document Rev 1.0

**Preliminary:** The purpose of this test is to measure Maxim 2990/2991 perform under typical off road charging conditions. The setup shall comprise of Minit Charger Fast Charging Systems and associated battery hardware. Equipment list used for testing is as follows:

- eTec Minit Fast SC Charger
- 24V DC Hawker battery
- Associated charging cables
- Battery Device Controller BDC
- Maxim 2990/2991 EV kit
- Two test laptops

**Physical Setup:** Consists of two hardware setups once for the EV kit validation and the other for Charger setup validation. Verify safety by examining the area for potential safety hazards, such as broken wires, damaged equipment, excess debris, battery condition, and other related items. If all safety items are met proceed to the next series steps observing each in great detail.

### Maxim 2990/2991 EV Kit (Slave)

- Charger Setup Validation: With the power off, remove the SC charger case and locate the AC input lines.
- Using a prefabricated AC power line with ring terminals, connect each ring to the correct node on the input terminal.
- Since the SC charger was used on a 24V battery, an adaptor cable was required between the battery cable and the charger cables. Mate the cables by match their respective EBC connectors.
- Connect the Maxim EV modified power line with ring terminal to the respective +/- terminals. (This is the DC power used in supporting rail to rail voltage not the AC power line.)
- Connect AC Power from the charger AC input line to the slave (RX) of the Maxim 2990/2991 EV kit.

### Physical Setup Continued

#### Maxim 2990/2991 EV Kit (Master)

- Connect the Maxim 2990/2991 EV kit (Master) by first selecting an AC power line that draws the same power as the eTec Minit Fast charger.
- Connect rail to rail power using a 9V – 12V battery source, in like wise fashion to the Maxim 2990/2991 EV kit (Slave).
- Connect a Test laptop to the Maxim 2990/2991 EV (Master) kit using a serial cable connection.

#### Observation of Physical Connectivity

- Observe both modules illuminate with blue LED's flashing in an alternating sequence.
- After five minutes observe an alternating illumination of green LED's with no RED color in the sequence.
- On the Test laptop, open the Termpro console application and observe the data traffic.
- Connect an Oscilloscope to the Transmit pin on the Slave device and observe signal packet data. Adjust the frequency and time division accordingly until a clear visual is displayed on the screen.

#### Operational Execution of Durability Test.

- With the physical test validated and the charger ready turn on the charger by pressing the start button. The screen on the charger should illuminate with no errors, or messages saying "need service".
- Using a current probe, monitor the current draw on the charger display matches what is being measured by the current probe. The current probe should be measuring the DC charge cable connected to the battery.
- Observe the behavior on the Test laptop paying close attention to the error rate. Also, examine the LED behavior of the status LED's on the master and slave devices. Finally, as a backup observe the signal behavior on the oscilloscope for noise, especially as the charger begins to execute switching power in ramping up current to the battery.
- **Be ready to terminate the test if any safety issues should arise. Collect the data in preparation of a report.**

**Appendix B**  
**Data Results**

# Appendix B-1

## Functional Test Results (Yitran IT700)

The screenshot shows the IT700 PLC Studio interface with the following data:

Node Configuration	
Address	1.1
Tx Mode	Auto
Repeats	0
Retries	3
Rx Type	M
Host I/F	IT700
Region	FCC
FW Version	B 2.02.22
Free Mem	2333

Transmitter	
Session	Single Session
Mode	Intranetworking Unicast
Destination ID	2 port: 0
Priority	normal
Service	ack
Payload	6
Packets	5000000
Gain	6
Hops	8

Receiver Statistics	
Total	0
Mine	0
Other	0
Bad	0
Bit Rate	0

Routed Statistics	
Routed success	0
no ack	0
blocked	0
rx failed	0
no hops	0

Transmitter Statistics	
Accepted	55698
Success	51655
No Ack	0
Blocked	3810
Timeout	194
Error	11
Routed	55469
Rx Failed	4
Total Tx	52006

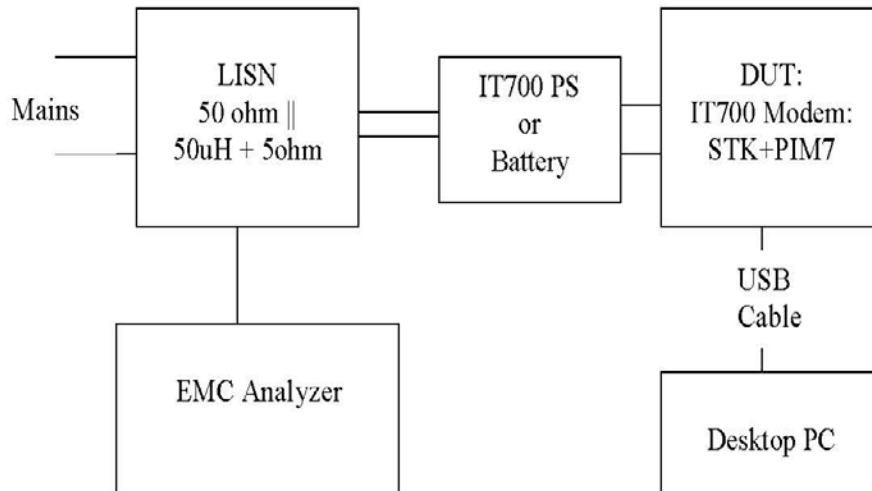
**Yitran IT700 Functional Test Data Report connected to PHEV Hymotion Prius.**



# Appendix B-2

## Signal Analysis Report (Yitran IT700)

### 1. Test Setup

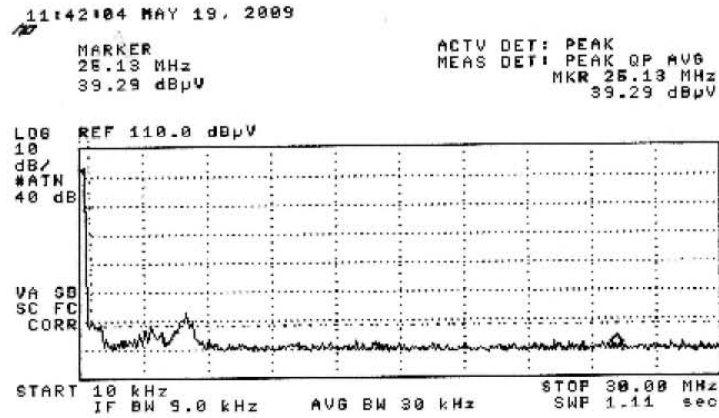


#### Notes:

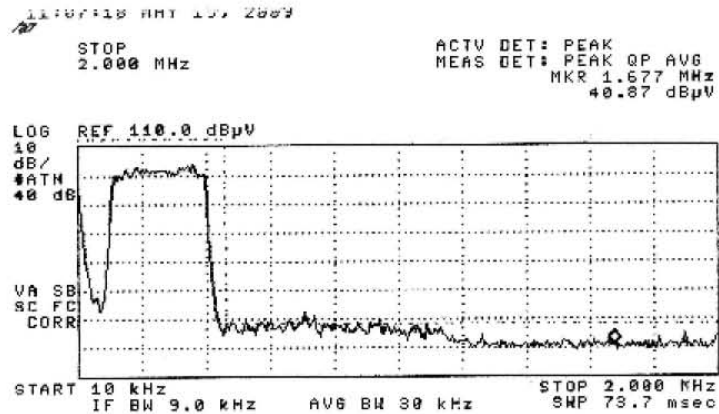
- Modem was tested with both Yitran standard universal power supply and a special set that included a battery for powering modem and IT700 power line coupler for PLC signal transmission.
- Modem transmission mode (set with Host application):
  - ARA disabled
  - Internetworking Broadcast
  - Power Level = 6
- Transmission duty cycle was set to max possible value:
  - Payload = 100
  - Host Delay = 0
  - TTL = 15000ms
- All equipment was properly earthed through wall sockets
- Two units (STK + Modem) were tested

### 3. TX Spectrum Measurements

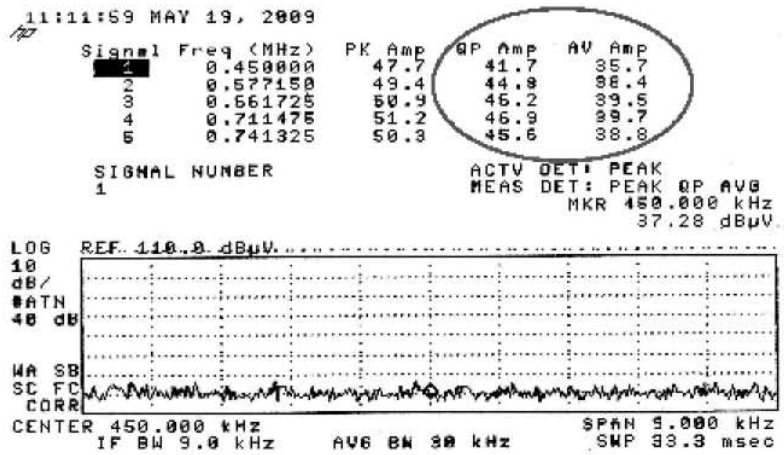
#### Typical TX Spectrums with Switching Mode Power Supply



The picture above shows typical spectrum recorded through SMPS unit with frequency sweep from 10 kHz to 30MHz. Limit (250uV = 48dBuV) is set by the dashed line. One can easily see a noise “hump” at 5MHz neighborhood that violates 48dBuV limit. This “violation” is caused by USB connection as we saw earlier. Therefore it was excluded from further consideration.

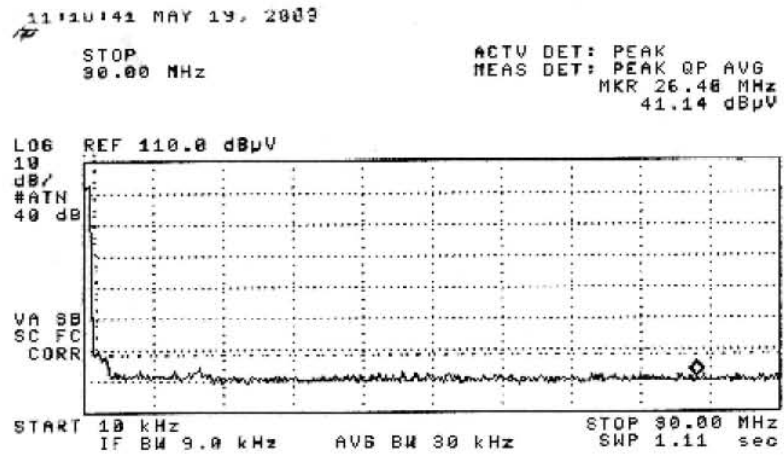


The picture above shows typical spectrum recorded through SMPS with frequency sweep from 10 kHz to 2MHz. Limit (250uV = 48dBuV) is set by the dashed line. One can see that some parts of the spectrum at frequencies between 500 kHz and 1 MHz cross the limit line. Those frequencies are considered as “suspicious” and measured precisely with quasi peak and average detectors. The measurements results are shown in the picture below:

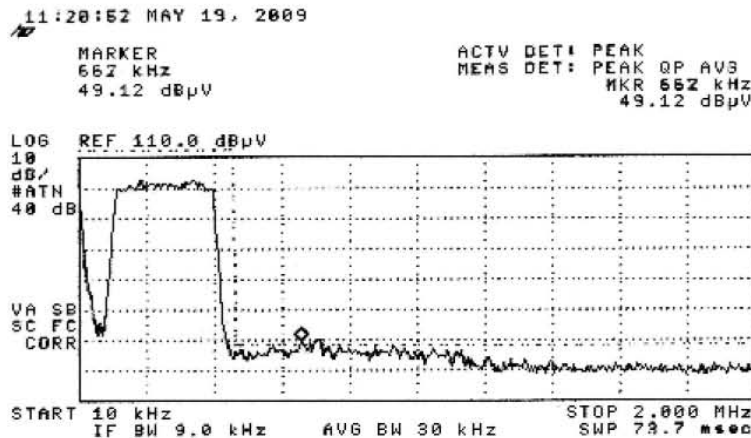


Quasi peak measurements do not show 48 dBuV limit violation.

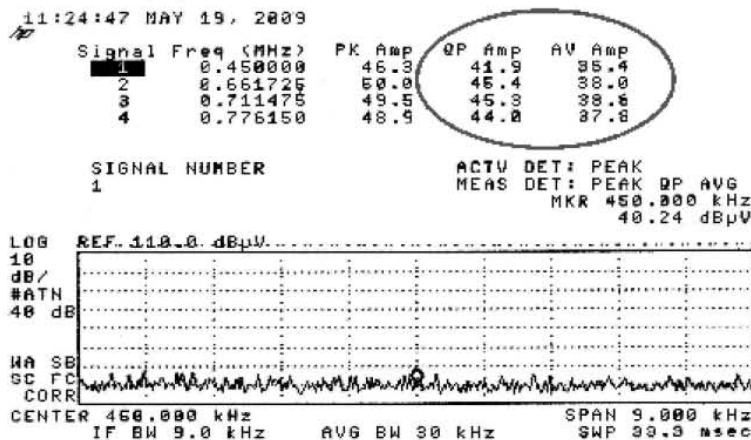
### Typical TX Spectrums with Battery Unit



The picture above shows typical spectrum recorded through battery unit with freq sweep from 10 kHz to 30MHz. Limit (250uV = 48dBuV) is shown by the dashed. One can see that no part of spectrum crosses limit at frequencies above 1-2 MHz. Moreover this part of spectrum has good spare of 5-8 dBuV.



The picture above shows typical spectrum recorded through battery unit with frequency sweep from 10 kHz to 2MHz. Limit (250uV = 48dBuV) is shown by the dashed line. One can see in general TX spectrum looks “cleaner” than in previous case with SMPS but some parts of the spectrum still cross the limit line. Those frequencies are considered as “suspicious” and measured precisely with quasi peak and average detectors. The measurements results are shown in the picture below:



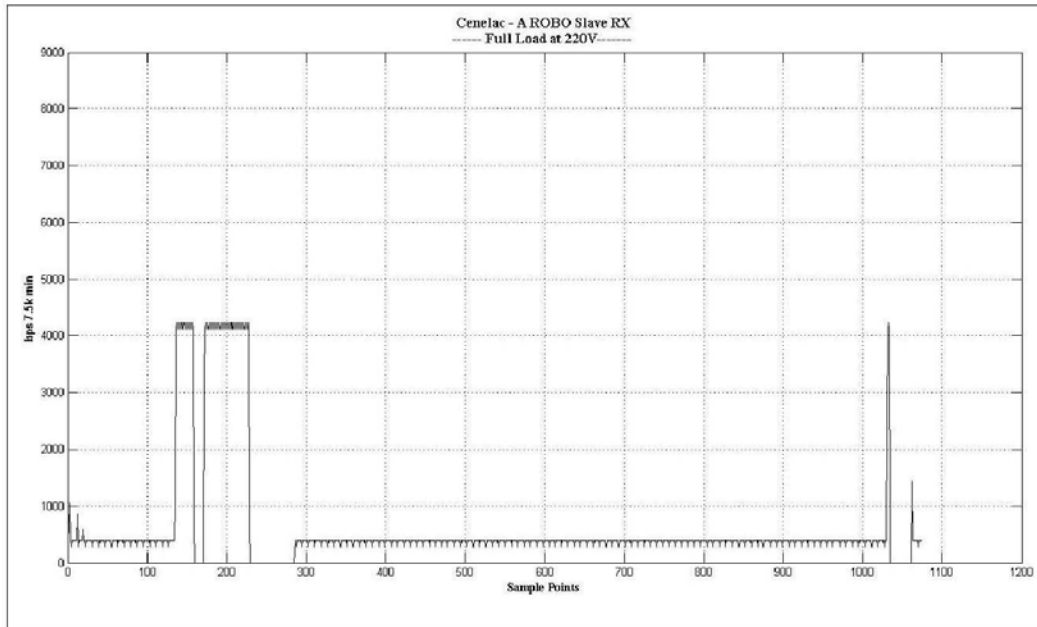
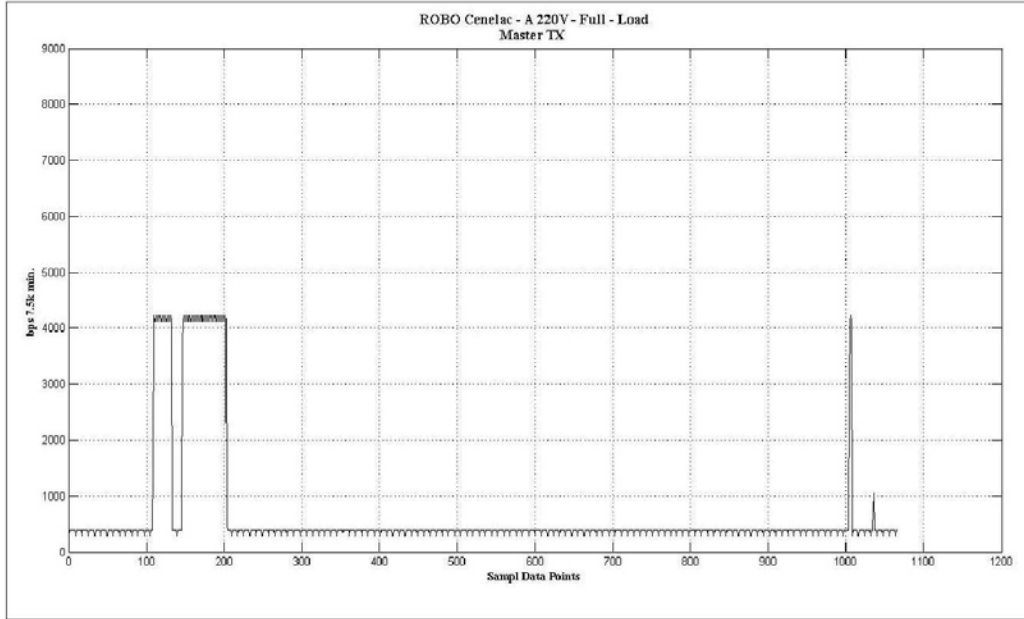
Quasi peak measurements do not violate limit of 48 dBuV and have better spares.

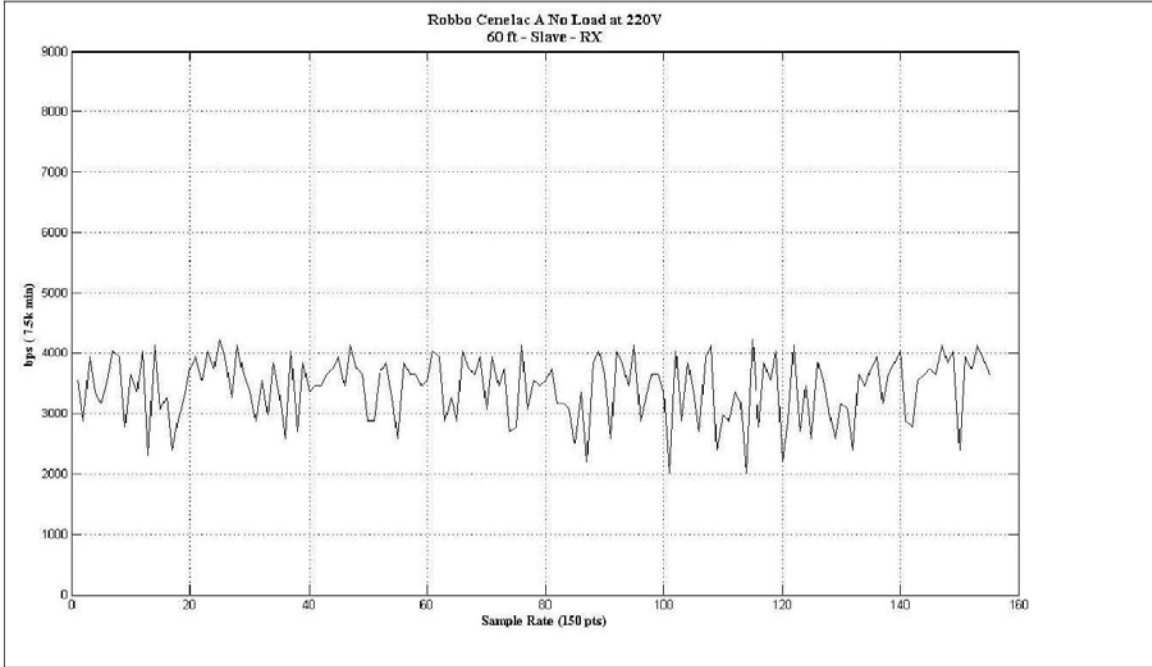
#### 4. Conclusion

- IT700 modem is able to pass SAE551-5 requirements at TX Power Level = 6 with spare of 2.5-3dB in the worst case.
- Yitran SMPS when used together with USB connection to PC (or opposite, USB connection paired with Yitran SMPS) causes very specific noise in 5MHz neighborhood.
- Battery unit has much lower background noise and almost does not create specific “USB-related” one.

# Appendix B-3

## Functional Test Results (Maxim 2990/2991)



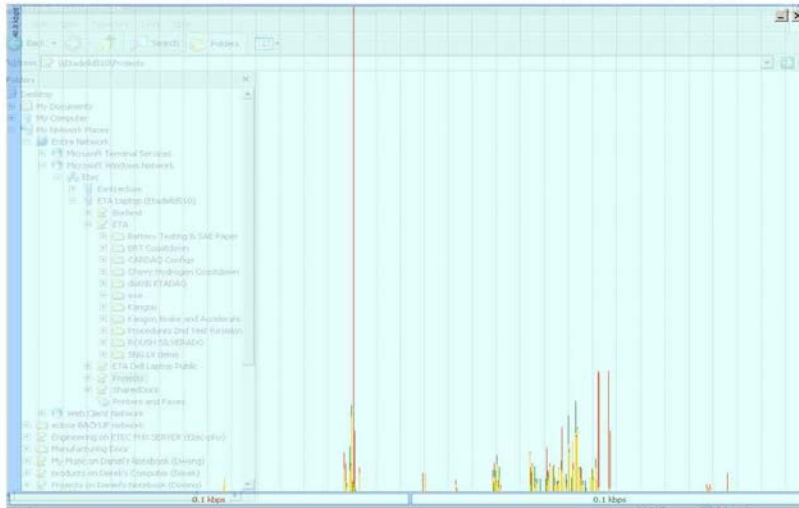


# Appendix B-4 Functional Test Results (Intellon XAV101)

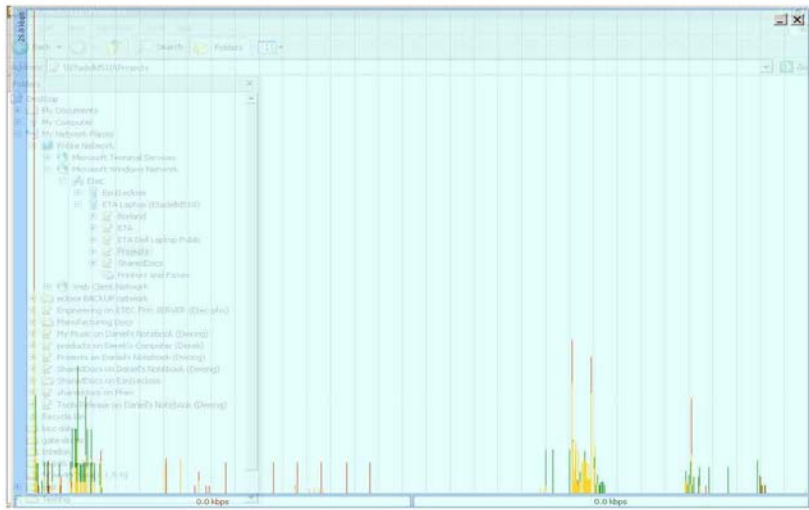
## Wireless Communication Validation at 2 FT



## Wireless Communication Validation at 4 FT



# Wireless Communication Validation at 6 FT





# Appendix B-5

## Electromagnetic Capability Test Instructions at Electric Transportation Applications Engineering Center

EMC Test Setup & Operation for PLC Communication  
Released 7 - 28 - 2009 Document Rev 1.0

**Preliminary:** The EMC Test setup and operation consists of four test configurations, and a test operation for each one. Test configurations are broken down as follows:

- Vitron AC Setup & Operation Phase I:
- Vitron DC Setup & Operation Phase II:
- Interlon: Ethernet over Powerline Phase III:
- MAXIM PLC 2990 AC 110 & 240 Hot Line:
- MAXIM PLC 2990 12V DC Setup & Operation Phase V:

**Instruction:** Each phase consists of instructions and references to drawings, manuals and screen shots as they apply to the test operation and setup.

**Phase I:** Vitron AC Setup and Test:

**Required Material:** The following materials will be needed for setting up Phase I

- Two Vitron Units labeled 1,2
- One USB Cable
- Two AC Power Supplies for the Vitron Units.
- One Laptop Computer with Vitron Software

**Procedure:** Apply the following steps in setting up and operating the Vitron units in AC mode using the following steps and accompanying diagrams and drawings.

### Hardware Setup

**Step 1:** Using Figure 1.0 located on page 1 of 2 on the drawing titled, "EMC\_Test Layout" as a reference connect Vitron 1 to the test laptop using a USB cable.

**Step 2:** Connect Vitron 1 to its power adapter and plug the power adapter into a receptacle.

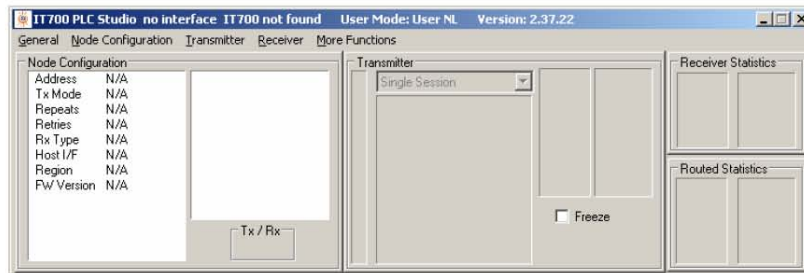
**Step 3:** Connect Vitron 2 to its power adapter and plug it into a separate receptacle away from where Vitron 1 is connected. Do not plug both Vitron 1 and Vitron 2 into the same receptacle.

Observes Vitron 2 does not have a USB cable connected to the laptop. This is a deliberate action given the interest in measuring PLC communication exclusively.

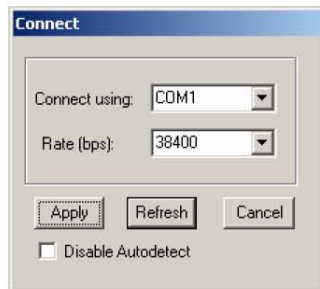
This completes setting up the hardware for this Phase.

**Phase I: Vitron AC Setup and Test Continued:**

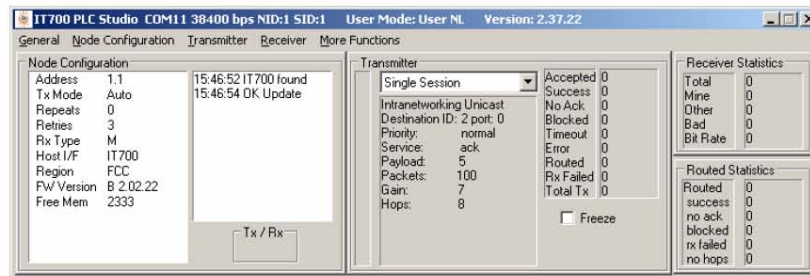
**Step 4:** Turn on the test laptop and turn on Vitron 1. Select Vitron Icon on the desktop. This starts the Test software specially made to communicate with Vitron. The following screen shot should display.



**Step 5:** Under the Title Transmitter select the option Connect. The following screen shot displays.

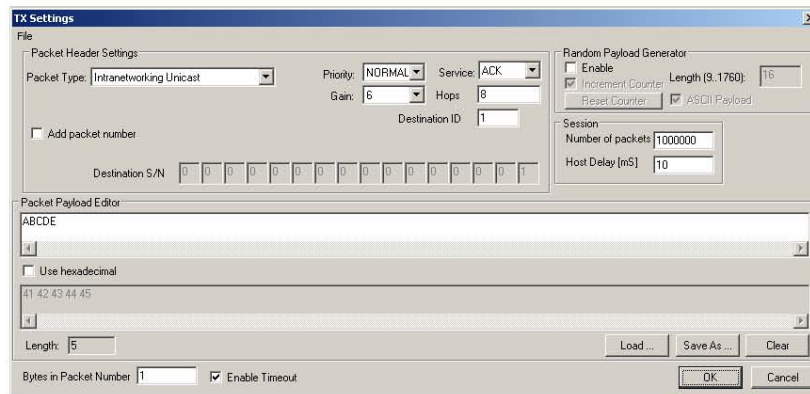


**Step 6:** Change the COM1 setting to COM11 keep the baud rate at 38400. The following screen shot should display with all appropriate fields enabled.

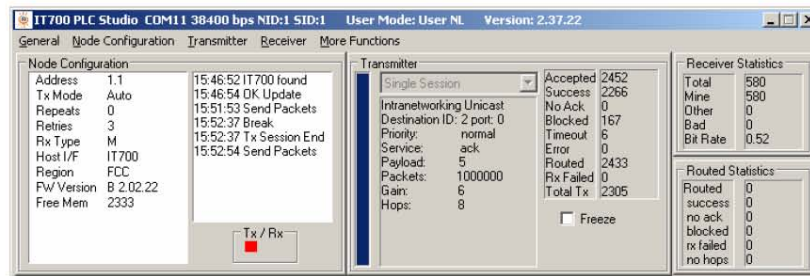


Phase I: Vitron AC Setup and Test Continued:

Step 7: Select The Transmitter option again the following screen shot displays.



Step 8: Under the field Number of packets enter 100000 and under Host Delay enter 10. Fill in ABCDE under the Packet payload Editor. Click OK and the following screen shot should display. Observe the Light flashing RED under the Tx/Rx box.



**Phase I: Vitron AC Setup and Test Continued:**

**Step 9 Observation:** Observe activity occurs on both Vitron Unit 1 & 2. See photos below for an illustration of transmit and receive activity.

Vitron #1



Vitron #2



**Summary:** From this point on the devices are operating, EMC test measurements can now take place as called for on the test specification in the PO. When measurements are done, tear down the test setup by clicking exit under the General menu heading. Turn off the laptop, Vitron devices and then remove and place in a box ready for shipment back to eTec.

**This Concludes Phase I**

**Phase II:** Vitron DC Setup and Test Continued:

**Required Material:** The following materials will be needed for setting up Phase II

- Two Vitron Units labeled 1,2
- One USB Cable
- Two DC Power Supplies for the Vitron Units.
- One Laptop Computer with Vitron Software

**Procedure:** Apply the following steps in setting up and operating the Vitron units in DC mode using the following steps and accompanying diagrams and drawings.

**Hardware Setup**

**Step 1:** Using Figure 2.0 located on page 1 of 2 on the drawing titled, "EMC\_Test Layout" as a reference connect Vitron 1 to the test laptop using a USB cable.

**Step 2:** Connect Vitron 1 to its power adapter and plug the power adapter into a DC Power Supply check the LED light illuminates before proceeding further, if it fails to light up, the battery needs to be recharged and testing will need to take place the following day.

**Step 3:** Connect Vitron 2 to its power adapter and plug it into another DC power supply. Again if the LED fails to illuminate, the DC power supply needs to recharge.

Observes Vitron 2 does not have a USB cable connected to the laptop. This is a deliberate action given the interest in measuring PLC communication exclusively.

This completes setting up the hardware for this Phase.

**Test Operation Section:** Continue with steps 4 – 9 as described in Phase I.

**This Concludes Phase II**

**Phase III: Ethernet Intellon Device**

**Required Material:** The following materials will be needed for setting up Phase III

- Two Intellon AV Ethernet devices
- Two Ethernet Cables
- Two Laptops.

**Procedure:** Apply the following steps in setting up and operating the Homeplug AV Ethernet devices.

**Hardware Setup**

**Step 1:** Using Figure 3.0 located on page 2 of 2 on the drawing titled, "EMC\_Test Layout". Plug in each device into two separate receptacles.

**Step 2:** Connect an Ethernet cable from laptop 1 to Intellon Ethernet device #1.

**Step 3:** Repeat Step 2 for Laptop 2 and Intellon AV Ethernet device #2.

This Completes setting up the hardware for this phase.

**Software Setup**

**Step 4:** Turn on test laptop 1 & 2 and assign the following

Laptop #1 IP Address(static) = 192.168.0.100

Default Gateway = 192.168.0.100

Subnet Mask = 255.255.255.0

Laptop #2 IP Address(static) = 192.168.0.101

Default Gateway =192.168.0.101

Subnet Mask = 255.255.255.0

{Keep the workgroup.}

**Step 5:** Transfer a large file from Laptop 1 to Laptop 2. Conduct EMC measurements during the file transfer. Use the CAD Video File.

**This Concludes Phase III**

**Phase IV:** Maxim 2990 Test setup & Operation:

**Required Material:** The following materials will be needed for setting up Phase IV

- Two Maxim 2990 devices
- Two Serial Cables
- Two Laptops.
- Power Accessories Kit
- Serial to Fiber converters

**Procedure:** Apply the following steps in setting up and operating the Maxim 2990 devices for 110 Vac test operation.

**Hardware Setup**

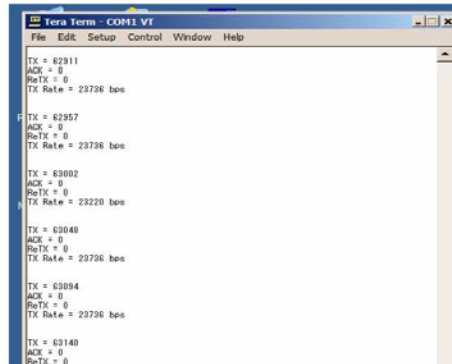
- Step 1:** Examine Figure 6.0 located on page 1 of 2 on the drawing titled, "EMC Maxim 2990". Using modules contained the power accessories kit, create two 110Vac plugs.
- Step 2:** Connect the cold wires to DUT#1 and DUT#2 on as illustrated in Figure 6.0. Use the overall layout snapshot located below figure 6.0 as a guide.
- Step 3:** Connect the cold wires by matching the correct polarity with jumper wires colored as red = + and Black = -.
- Step 4:** Examine the LED flash rate between DUT#1 and Dut#2. There should be two flashing lights operating in an alternating sequence. This indicates there is packet data being transferred between DUT#1 and DUT#2.
- Step 5:** Connect both laptops#1&2 to DUT#1&2 respectively, using a serial cable as See figure 6.0 on the "EMC Maxim 2990" drawing.

### Software Setup

Step 6: Turn on laptop 1 & 2 and select the program icon “t34mpro” on both laptops see illustration below:



Step 7: After selecting the icon, the following dialogue box appears illustrating packet data transfer between DUT #1 and DUT#2



Step 8: Verify traffic data is real by disconnecting one of the cold wires and observing all traffic activity STOPS between both laptops.



**This Concludes Phase IV**

**Phase V:** Maxim 2990 Test setup & Operation 12V dc:

**Required Material:** The following materials will be needed for setting up Phase V

- Two Maxim 2990 devices
- Two Serial Cables
- Two Laptops.
- Power Accessories Kit
- Serial to Fiber converters
- 12V dc Power Supply

**Procedure:** Apply the following steps in setting up and operating the Maxim 2990 devices for 12 Vdc test operation.

**Hardware Setup**

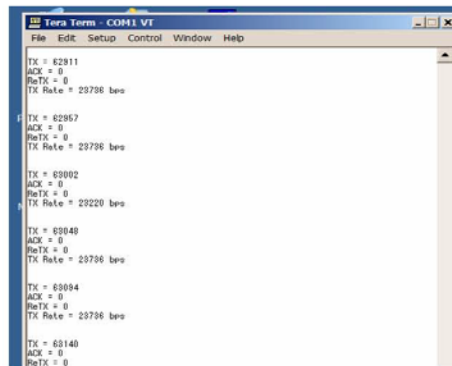
- Step 1:** Examine Figure 6.0 located on page 1 of 2 on the drawing titled, "EMC Maxim 2990". Using modules contained the power accessories kit, select the 100 to 200Vac input to 12Vdc output power adapter, create the plug for either 110Vac or a 220Vac receptacle.
- Step 2:** Connect the other end into the 12Vdc receptacle on each DUT.
- Step 3:** Connect the cold wires to DUT#1 and DUT#2 on as illustrated in Figure 6.0. Use the overall layout snapshot located below figure 6.0 as a guide.
- Step 4:** Connect the cold wires by matching the correct polarity with jumper wires colored as red = + and Black = -.
- Step 5:** Examine the LED flash rate between DUT#1 and Dut#2. There should be two flashing lights operating in an alternating sequence. This indicates there is packet data being transferred between DUT#1 and DUT#2.
- Step 6:** Connect both laptops#1&2 to DUT#1&2 respectively, using a serial cable as See figure 6.0 on the "EMC Maxim 2990" drawing.

### Software Setup

Step 6: Turn on laptop 1 & 2 and select the program icon “t34mpro” on both laptops see illustration below:



Step 7: After selecting the icon, the following dialogue box appears illustrating packet data transfer between DUT #1 and DUT#2



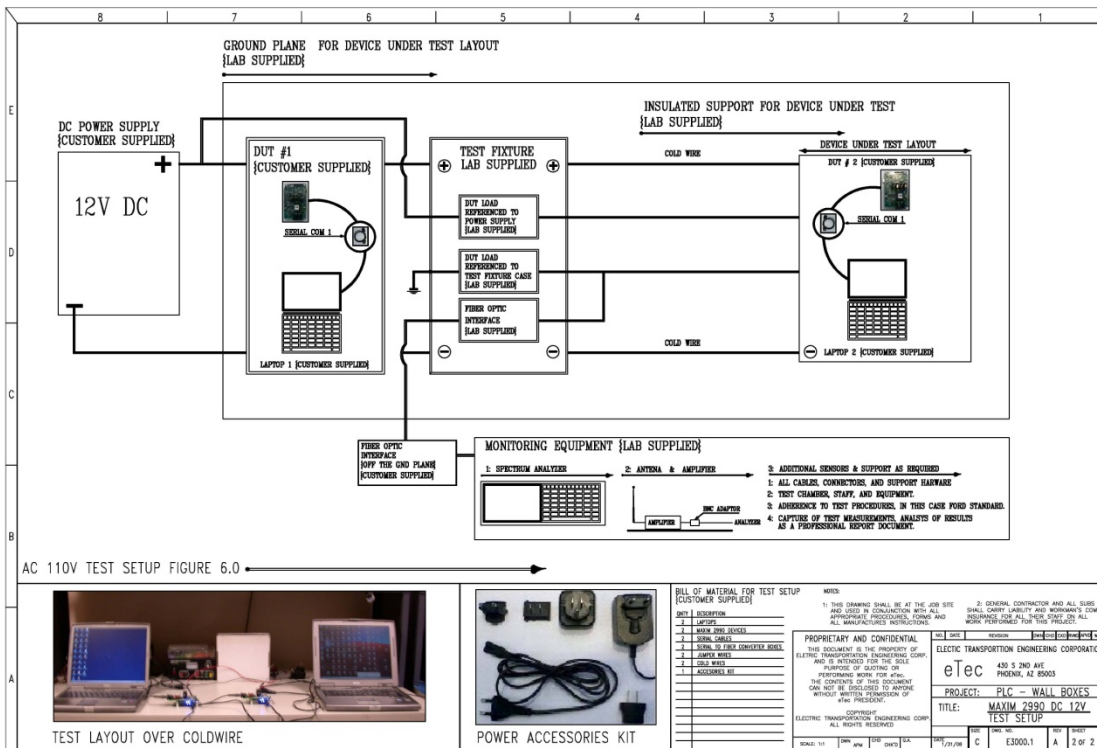
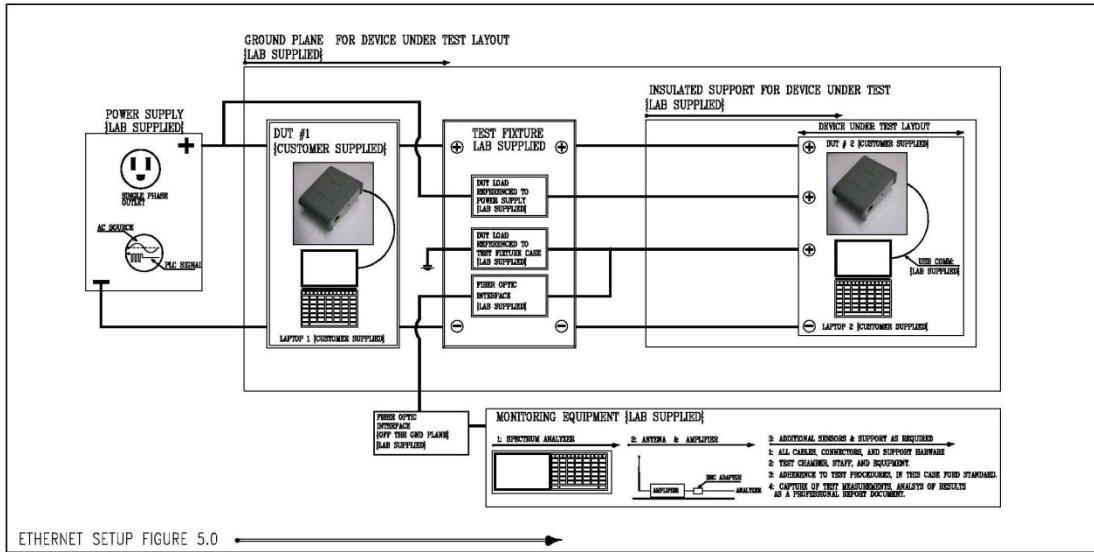
Step 8: Verify traffic data is real by disconnecting one of the cold wires and observing all traffic activity STOPS between both laptops.

**This Concludes Phase V**

**This Concludes Test Setup and Operation Procedure for PLC Communications.**

# Appendix B-6

## Electromagnetic Capability Test Setup Drawings at Electric Transportation Applications Engineering Center



# Appendix B-7

## Electromagnetic Capability Test Report (CPK – Maxim 2990/2991)



CKC Laboratories, Inc.  
1120 Fulton Place.  
Fremont, CA 94539  
(510) 249-1170

Customer: Maxim Integrated Products  
Specification: RE310-30-1000MHz-Level 1-Limit A-Peak ES-XW7T-1A278-AC Date Issued: October 10 2003

Work Order #:	90010	Date:	Sat Sep-12-2009
Test Type:	Radiated Scan	Time:	1:05:51 PM
Equipment:	Power Line Communications Devices With G3 AFE	Sequence:	9
Manufacturer:	Maxim Integrated Products	Tested By:	A. Brar
Model:	MAX2991 EV Kit FCC High Power Rev 1		
S/N:	None	File Name:	RE_SEQ9 30-242.4MHZ-HORIZ-FCC HP.DAT

**Test Equipment:**

Equipment	S/N	Calibrated Date	Cal Due Date	Asset#
Cable-12' Pasternack	None	12/11/2007	12/11/2009	P05438
LISN 5uH - 9117-5-TS-50-N	46583	03/31/2009	03/31/2011	2644
5uH LISN 9117-5-TS-50-N	46584	10/02/2008	10/02/2010	2645
LISN 5uH - 9117-5-TS-50-N	68844	11/07/2007	11/07/2009	2860
LISN 5uH - 9117-5-TS-50-N	089466	07/07/2009	07/07/2011	03153
10uF Cap 6512-106R	963816	11/01/2007	11/01/2009	P01656
10uF Cap 6512-106R	583	11/01/2007	11/01/2009	583
10uF Cap 6512-106R	X05	11/07/2007	11/07/2009	142
10uF Cap 6512-106R	87115	11/01/2007	11/01/2009	1729
50uH LISN	17512	01/27/2009	01/27/2010	2527
50uH LISN	17510	01/27/2009	01/27/2010	2532
SA - E4446A	US44300408	03/09/2009	03/09/2011	2668
Cable - RG 214/U	None	03/06/2009	03/06/2011	P05297
Andrew Cable- CNT-195	none	12/11/2008	12/11/2010	P01184
Bi-Con Antenna SAS-200/540	359	11/03/2008	11/03/2010	46
HP 8447D Preamp	2944A03850	01/06/2009	01/06/2011	501

**Equipment Under Test (\* = EUT):**

Function	Manufacturer	Model#	S/N
*Power Line Communications Devices With G3 AFE	Maxim Integrated Products	MAX2991 EV Kit FCC High Power Rev 1	None

**Support Devices:**

Function	Manufacturer	Model#	S/N
None			

**Test Conditions / Notes:**

The EUT under test is setup on 5cm non conductive surface. The AC power and DC power leads are routed 10cm in from the edge of the test table to the LISNs. The two sets of DC powers are routed to the four 5uH LISNs located at the edge of the test table, the power input of these LISNs is connected to two 10uF Feed-Thru capacitors mounted on the wall between the ante-room and test chamber. On the other side in the ante-room these two capacitors are connected to a DC power supply's output. The two AC powers over which the EUT communicates are connected to two 50uH LISNs due to impedance issue and the EUT not communicating. The input of these two 50uH LISNs is connected to two 10uF Feed-Thru capacitors mounted on the wall between the test chamber and Ante-Room, the other side of the capacitors is plugged into 110V/60Hz power. EUT's are communicating over the AC power connected to the two 50uH LISNs.

**Transducer Legend:**

T1=Cable ANP05438	T2=CAB-ANP05297-030609
T3=CAB-ANP01184-121108	T4=AMP-ANP00501-010609 Top Portion .01-1000
T5=ANT AN00046 20-330MHz	

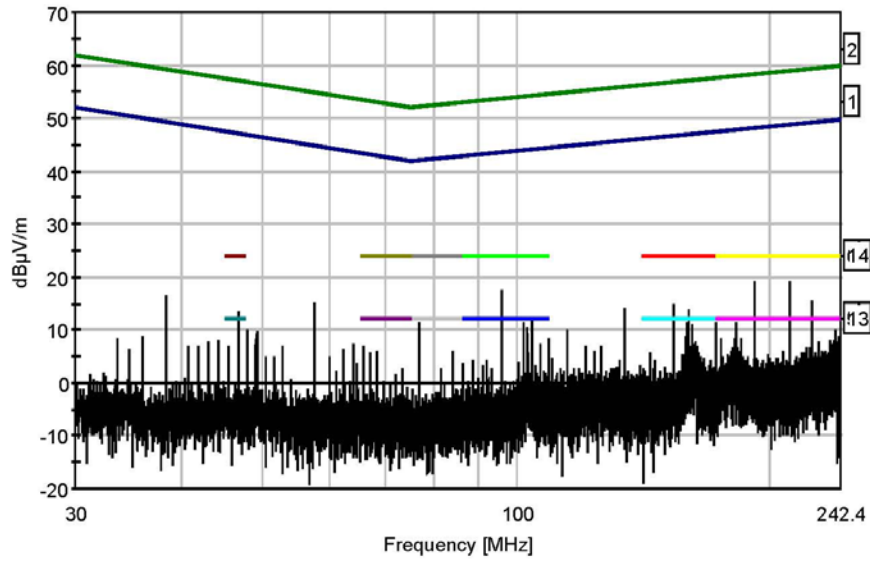
**Measurement Data:**

#	Freq MHz	Rdng dBuV	Readings listed by margin						Dist	Corr dBuV/m	Spec dBuV/m	Test Distance: 1 Meter		
			T1 T5	T2	T3	T4	Polar	Type				Margin		
1	96.006	32.1	+0.4 +10.9	+0.7	+0.1	-26.5	+0.0	17.7	43.6		Horiz	Peak	-25.9	
2	192.012	27.4	+0.5 +16.2	+0.9	+0.3	-26.2	+0.0	19.1	48.2		Horiz	Peak	-29.1	

CKC Laboratories, Inc.  
 1120 Fulton Place.  
 Fremont, CA 94539  
 (510) 249-1170

#	Freq MHz	Rdng dBµV	T1 T5	T2	T3	T4	Dist	Corr dBµV/m	Spec dBµV/m			Polar	Type	Margin
3	211.211	28.2	+0.6 +15.1	+0.9	+0.4	-26.0	+0.0	19.2	48.8			Horiz	Peak	-29.6
4	57.608	29.5	+0.4 +11.1	+0.5	+0.2	-26.6	+0.0	15.1	44.9			Horiz	Peak	-29.8
5	76.807	26.1	+0.4 +10.8	+0.6	+0.1	-26.6	+0.0	11.4	42.2			Horiz	Peak	-30.8
6	134.404	25.0	+0.5 +14.2	+0.8	+0.2	-26.4	+0.0	14.3	45.8			Horiz	Peak	-31.5
7	153.614	26.1	+0.4 +13.7	+0.8	+0.2	-26.3	+0.0	14.9	46.7			Horiz	Peak	-31.8
8	104.404	25.5	+0.4 +11.7	+0.7	+0.2	-26.5	+0.0	12.0	44.2			Horiz	Peak	-32.2
9	102.002	25.2	+0.4 +11.4	+0.7	+0.2	-26.5	+0.0	11.4	44.0			Horiz	Peak	-32.6
10	38.398	29.9	+0.4 +12.1	+0.5	+0.2	-26.7	+0.0	16.4	49.3			Horiz	Peak	-32.9

CKC Laboratories, Inc. Date: 9/12/2009 Time: 1:05:51 PM WO#: 90010 Maxim Integrated Products  
RE310-30-1000MHz-Level 1-Limit A-Peak ES-XW7T-1A278-AC Date Issued: October 10 2003 MAX2991 EV Kit FCC Hi



— Sweep Data — 1 - RE310-30-1000MHz-Level 1-Limit A-Peak ES-XW7T-1A278-AC Date Issued: Oct

# Appendix B-8

## Electromagnetic Capability Test Report (Compliance Testing)



### Compliance Testing

Previously Flom Test Lab  
RF, EMC & Safety Testing Experts Since 1963

toll-free: (866) 311-3268

fax: (480) 926-3598

<http://www.ComplianceTesting.com>

[info@ComplianceTesting.com](mailto:info@ComplianceTesting.com)

#### Engineering Development EMC/EMI Test Report

for

**Models:** Netgear XAV101, Yitran IT700, and Maxim 2990 EV Kit

to

**FCC Part 15, B Unintentional Radiator Class B**

and

**Ford ES-XW7T-1A278-AC:2003** (ED- Engineering Development)

RE310- Radiated Emissions

CE420- Conducted Emissions

RI112- Bulk Current Injection (BCI)

RI114- Radiated RF Immunity

**Date of Report:** October 16, 2009

**At the Request of:**

eTec  
430 S 2nd Ave  
Phoenix, Az 85003

**Attention of:**

Andre Masters  
Ph: (602) 716-9576 Ext 23  
E-mail: [amasters@etecevs.com](mailto:amasters@etecevs.com)

Reviewed By:

John Erhard, Engineering Manager

Compliance Testing  
3356 N. San Marcos Place, Suite 107  
Chandler, Arizona 85225-7176  
(866) 311-3268 phone, (480) 926-3598 fax

p09a0005, d09a0009 Rev 6.0



### Test Report Revision History

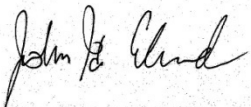
Revision	Date	Revised By	Reason for revision
1.0	October 16, 2009	S Nickels	Original Document
2.0	October 23, 2009	S. Nickels	Model #'s added
3.0	October 26, 2009	S. Nickels	Added CE correction
4.0	October 26, 2009	S. Nickels	Added CE "Line" correction
5.0	October 26, 2009	S. Nickels	Add Broadband over Power-line comment.
6.0	October 26, 2009	S. Nickels	Add Ford-AC CE Limit. Statement.

Compliance Testing  
3356 N. San Marcos Place, Suite 107  
Chandler, Arizona 85225-7176  
(866) 311-3268 phone, (480) 926-3598 fax

p09a0005, d09a0009 Rev 6.0

## Table Of Contents

Rule	Description	Page
	Test Report	1
	Standard Test Conditions and Engineering Practices	2
	Test Results Summary	3
15.109	Radiated Emissions	4
RE310	Radiated Emissions	11
15.107	Powerline Conducted Emissions	14
RI112	Radiated Immunity Bulk Current Injection	22
RI114	Radiated Immunity- ALSE Method	26
	Test Equip Utilized	28

- a) **Test Report**
- b) Laboratory: Compliance Testing  
(FCC: 31040/SIT) 3356 N. San Marcos Place, Suite 107  
(Canada: IC 2044A-1) Chandler, AZ 85225
- c) Report Number: d09a0009
- d) Client: eTec
- e) Identification: Netgear XAV101, Yitran IT700, and Maxim 2990 EV Kit  
Description: PLC Power Line Com System
- f) EUT Condition: Not required unless specified in individual tests.
- g) Report Date: October 16, 2009
- h, j, k): As indicated in individual tests.
- i) Sampling method: No sampling procedure used.
- l) Uncertainty: In accordance with Compliance Testing internal quality manual.
- m) Supervised by:  
  
John Erhard, Engineering Manager
- n) Results: The results presented in this report relate only to the item tested.
- o) Reproduction: This report must not be reproduced, except in full, without written permission from this laboratory.

### Test And Measurement Data

All tests and measurement data shown were performed in accordance with FCC Rules and Regulations, Volume II; Part 2 and the following individual Parts: 15.107, 15.109; Unintentional Radiators. Ford-AC testing was within the guidelines of the ES-XW7T-1A278-AC (October 2003) specification and the testing requests of the client. All Conducted Emissions testing was done to FCC Limits, due to the Ford-AC limits being significantly higher.

### Standard Test Conditions and Engineering Practices

Except as noted herein, the following conditions and procedures were observed during the testing:

In accordance with ANSI C63.4-2003, and unless otherwise indicated in the specific measurement results, the ambient temperature of the actual EUT was maintained within the range of 10° to 40°C (50° to 104 °F) unless the particular equipment requirements specify testing over a different temperature range. Also, unless otherwise indicated, the humidity levels were in the range of 10% to 90% relative humidity.

Prior to testing, the EUT was tuned up in accordance with the manufacturer's alignment procedures. All external gain controls were maintained at the position of maximum and/or optimum gain throughout the testing.

Measurement results, unless otherwise noted, are worst-case measurements.

**FCC OATS Reg. #933597**

**IC O.A.T.S. Number: 2044A-1**



**TESTING CERT# 2152.01**

This device is subject to Broadband over Power Line testing as defined in FCC Part 15 Rules, subpart G. This report does not reflect this testing because it was not evaluated at this time.

**Test Results Summary:**
**Netgear XAV101**

Specification	Test Name	Pass, Fail, N/A	Comments
FCC 15.109	Radiated Emissions	Fail	Netgear XAV101 was over limit at 500MHz (see data)
Ford-AC	RE310 Radiated Emissions	Pass	
FCC 15.107	Power line Conducted Emissions	Fail	Netgear XAV101 over limit 150kHz-30MHz
Ford-AC*	CE420 Conducted Emissions	Pass	
Ford-AC	RI112 Bulk Current Injection (BCI)	Pass	
Ford-AC	RI114 Radiated Immunity (ALSE)	Pass	

**Yitran IT700**

Specification	Test Name	Pass, Fail, N/A	Comments
FCC 15.109	Radiated Emissions	Pass	
Ford-AC	RE310 Radiated Emissions	Pass	
FCC 15.107	Power line Conducted Emissions	Pass	
Ford-AC*	CE420 Conducted Emissions	Pass	
Ford-AC	RI112 Bulk Current Injection (BCI)	Pass	
Ford-AC	RI114 Radiated Immunity (ALSE)	Pass	

**Maxim 2990 EV Kit**

Specification	Test Name	Pass, Fail, N/A	Comments
FCC 15.109	Radiated Emissions	Pass	
Ford-AC	RE310 Radiated Emissions	Pass	
FCC 15.107	Power line Conducted Emissions	Pass	
Ford-AC*	CE420 Conducted Emissions	Pass	
Ford-AC	RI112 Bulk Current Injection (BCI)	Pass	
Ford-AC	RI114 Radiated Immunity (ALSE)	Pass	

\* Ford-AC Conducted Emissions was only tested to EU1 and G1 limits due to the very high limit line as compared to the FCC Conducted Emissions testing. All 3 test samples passes the Ford-AC Conducted Emission requirement for ranges EU1 and G1.

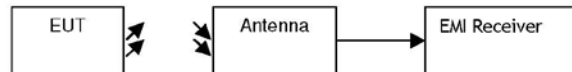
**Name of Test:** Radiated Emissions  
**Specification:** 15.109  
**Test Equipment Utilized** i00033, i00267

**Engineer:** Sam Nickels, NCT  
**Test Date:** October 16, 2009

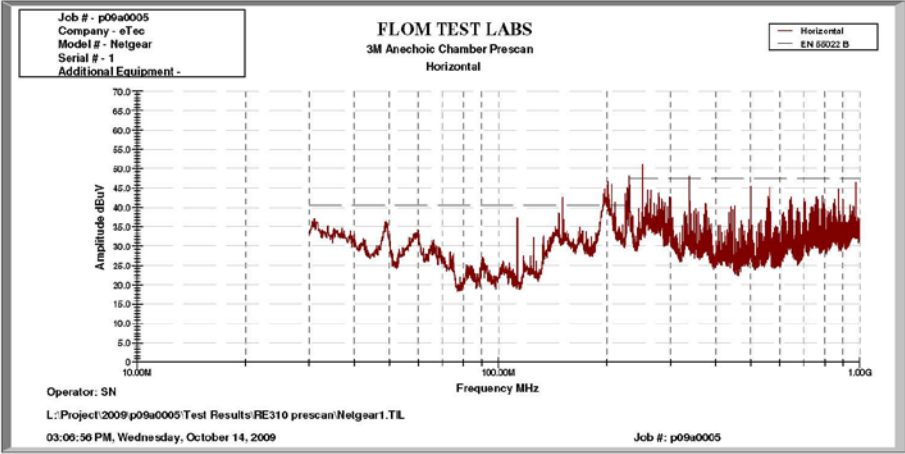
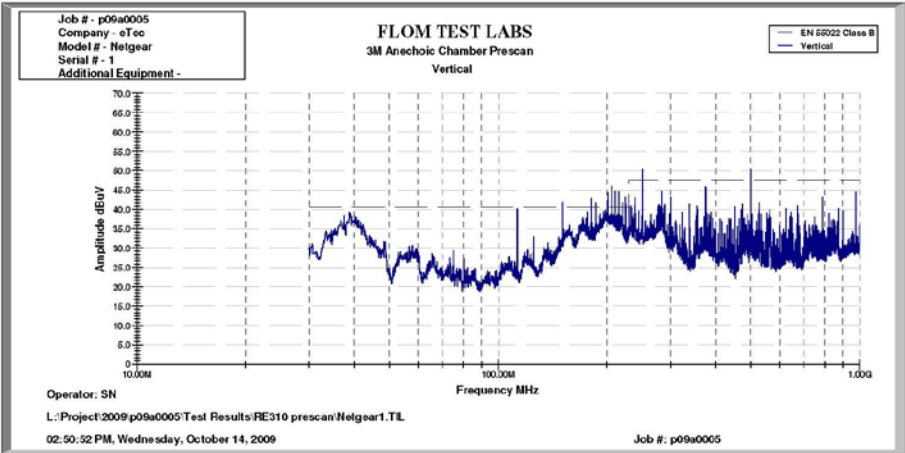
**Test Procedure**

The EUT was tested in an Open Area Test Site (OATS) set 3m from the receiving antenna. An EMI Receiver was used to verify that the EUT met the requirements for Radiated Emissions. The EUT was tested by rotating it 360° with the antennas in both the vertical and horizontal orientation and raised from 1 to 4 meters to ensure the TX signal levels were maximized. All emissions from 30 MHz to 1 GHz were examined.

**Test Setup**



Netgear XAV101 Peak Pre-Scans

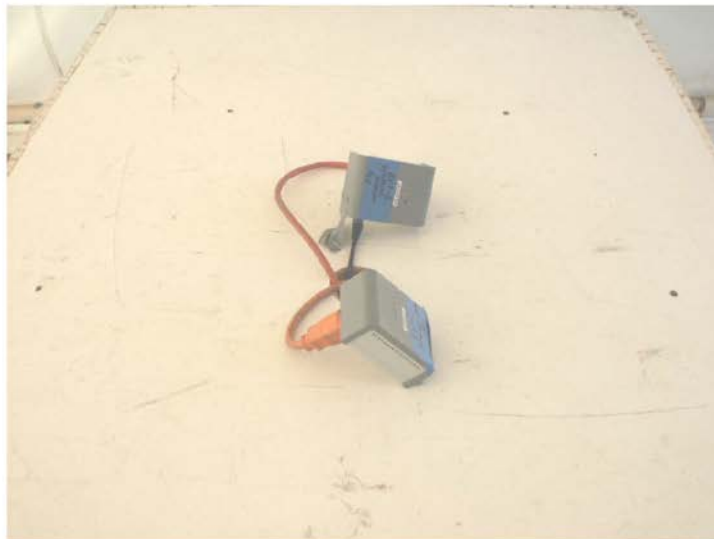


Quasi-peak Radiated Emissions-

Emission Freq (MHz)	Measured Value (dBuV/m)	Correction Factor (dB)	Corrected Value (dBuV/m)	Limit (dBuV/m)	Margin dB
40.27 (V)	15.7	13.6	29.2	40.0	-10.8
40.27 (H)	1.4	15.1	16.5	40.0	-23.5
112.51 (V)	16.1	12.9	29.0	43.0	-14.0
375.00 (V)	27.4	18.0	45.4	46.0	-0.6
375.00 (H)	27.1	18.0	45.1	46.0	-0.9
500.00 (V)	27.9	20.6	48.5	46.0	+2.5

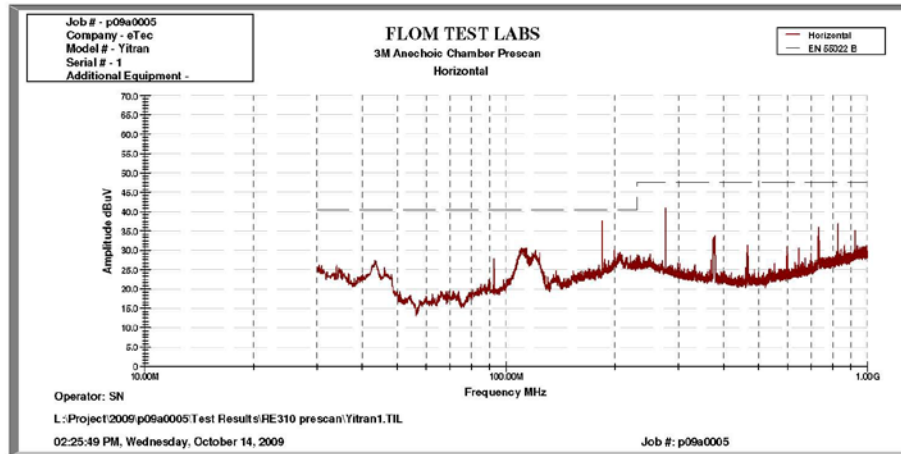
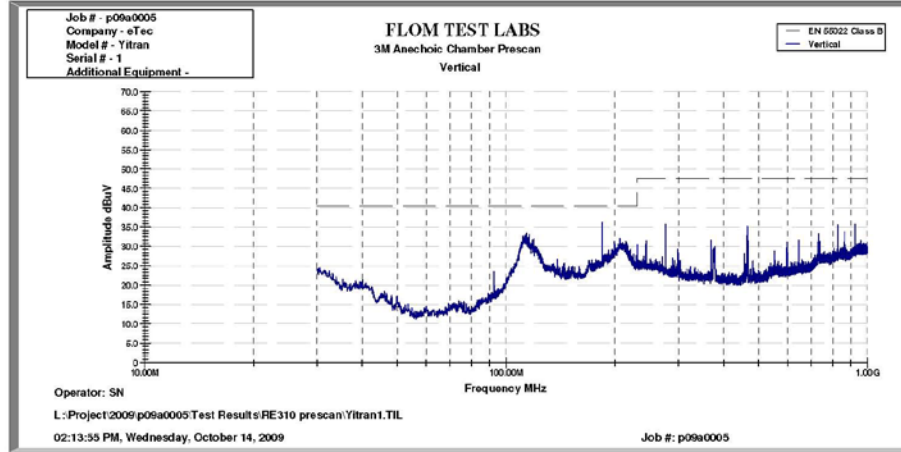
Compliance Testing  
 3356 N. San Marcos Place, Suite 107  
 Chandler, Arizona 85225-7176  
 (866) 311-3268 phone, (480) 926-3598 fax

**Netgear XAV101 Radiated Emissions Test Setup Photos:**





Yitran IT700 Peak Pre-Scans



Quasi-peak Radiated Emissions

Emission Freq (MHz)	Measured Value (dBuV/m)	Correction Factor (dB)	Corrected Value (dBuV/m)	Limit (dBuV/m)	Margin dB
38.57	18.9	14.5	33.3	40.0	-6.7
221.30	23.0	12.4	35.3	46.0	-10.7
368.65	22.1	17.6	39.7	46.0	-6.3
453.76	17.1	19.8	36.9	46.0	-9.1
664.47	8.5	23.5	32.0	46.0	-14.0
762.50	3.1	25.3	28.4	46.0	-17.6

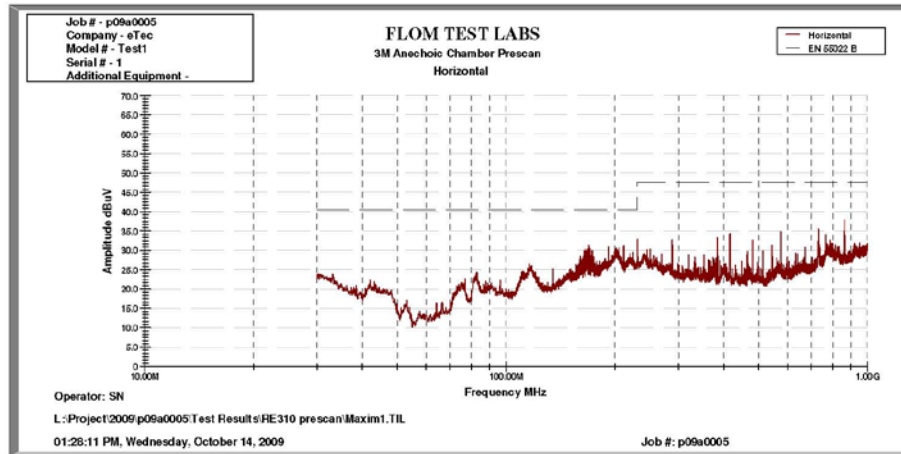
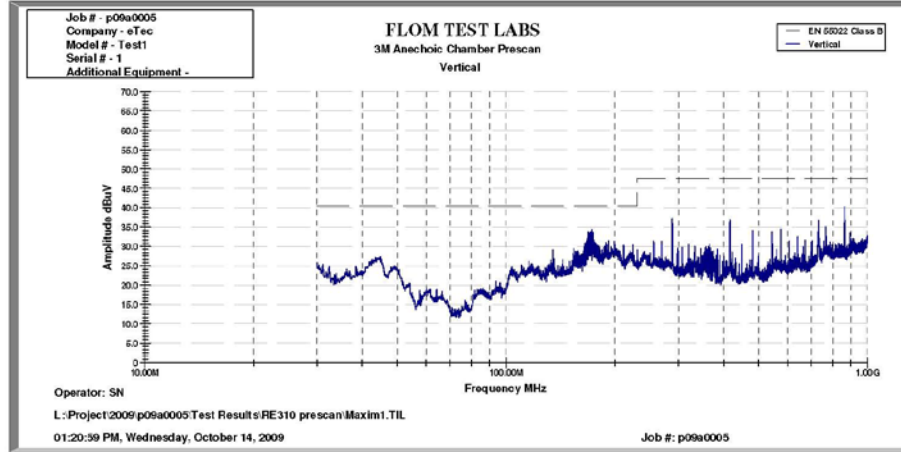
Compliance Testing  
3356 N. San Marcos Place, Suite 107  
Chandler, Arizona 85225-7176  
(866) 311-3268 phone, (480) 926-3598 fax

Page 7 of 28  
p09a0005, d09a0009 Rev 6.0

Yitran IT700 Radiated Emissions Test Setup Photos



Maxim 2990 EV Kit Peak Pre-Scans

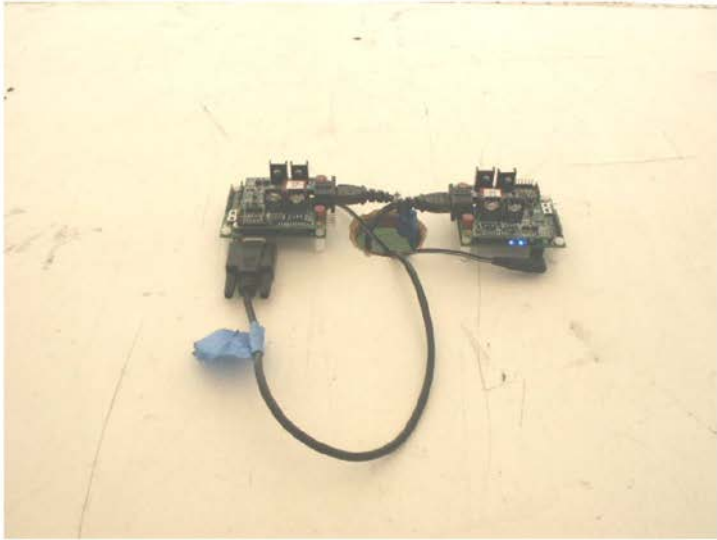


Quasi-peak Radiated Emissions-

Emission Freq (MHz)	Measured Value (dBuV/m)	Correction Factor (dB)	Corrected Value (dBuV/m)	Limit (dBuV/m)	Margin dB
38.26	4.3	16.2	20.5	40.0	-19.5
61.18	19.9	6.7	26.6	40.0	-13.4
221.40	9.2	12.2	21.4	46.0	-24.6
328.60	18.6	16.3	34.9	46.0	-11.1
528.67	17.9	20.9	38.7	46.0	-7.3
896.60	8.0	27.0	35.0	46.0	-11.0

Compliance Testing  
3356 N. San Marcos Place, Suite 107  
Chandler, Arizona 85225-7176  
(866) 311-3268 phone, (480) 926-3598 fax

Maxim 2990 EV Kit Test Setup Photos



Compliance Testing  
3356 N. San Marcos Place, Suite 107  
Chandler, Arizona 85225-7176  
(866) 311-3268 phone, (480) 926-3598 fax

Page 10 of 28  
p09a0005, d09a0009 Rev 6.0

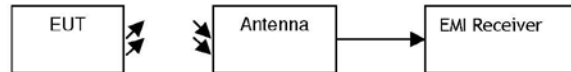
Name of Test: Radiated Emissions  
 Specification: RE310  
 Test Equipment Utilized: i00033, i00267

Engineer: Sam Nickels, NCT  
 Test Date: October 16, 2009

**Test Procedure**

The EUT was tested in an Open Area Test Site (OATS) on a ground plane, set 1m from the receiving antenna. An EMI Receiver was used to verify that the EUT met the requirements for Radiated Emissions. The EUT was tested by at 1m height in both Vertical and Horizontal orientations. All emissions from 30 MHz to 1 GHz were examined.

**Test Setup**



**Netgear XAV101 Radiated Emissions**

Emission Freq (MHz)	Measured Value (dBuV/m)	Correction Factor (dB)	Corrected Value (dBuV/m)	Limit (dBuV/m)	Margin dB
40.17	18.7	13.6	32.3	48.8	-16.5
300.00	28.6	15.4	44.0	51.1	-7.1
337.50	26.4	17.0	43.4	51.9	-8.5
375.00	27.9	17.7	45.6	52.6	-7.0
500.025	26.9	20.6	47.5	53	-5.5
562.43	11.6	22.3	33.8	53	-19.2

**Yitran IT700 Radiated Emissions**

Emission Freq (MHz)	Measured Value (dBuV/m)	Correction Factor (dB)	Corrected Value (dBuV/m)	Limit A (dBuV/m)	Margin dB
35.24	16.0	17.9	33.9	50.2	-16.3
276.50	22.0	15.3	37.3	50.6	-13.3
354.00	21.2	17.6	38.9	52.2	-13.3
375.00	19.8	18.0	37.8	52.6	-14.8
842.60	13.1	26.5	39.6	53	-13.4
925.68	6.8	27.9	34.7	53	-18.3

**Maxim 2990 EV Kit Radiated Emissions**

Emission Freq (MHz)	Measured Value (dBuV/m)	Correction Factor (dB)	Corrected Value (dBuV/m)	Limit A (dBuV/m)	Margin dB
38.26	14.6	14.6	29.2	49.3	-20.1
64.18	21.8	6.7	28.6	43.7	-15.1
328.60	23.4	16.3	39.7	51.7	-12.0
528.67	19.0	20.9	39.8	53	-13.2
869.60	5.3	27.0	32.3	53	-20.7
968.00	9.3	28.6	37.9	53	-15.1

**Netgear XAV101 RE310 Radiated Emissions Test Setup Photos**



**Yitran IT700 RE310 Radiated Emissions Photos Test Setup Continued**



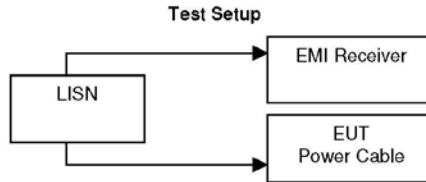
**Maxim 2990 EV Kit RE310 Radiated Emissions Test Setup Photos**



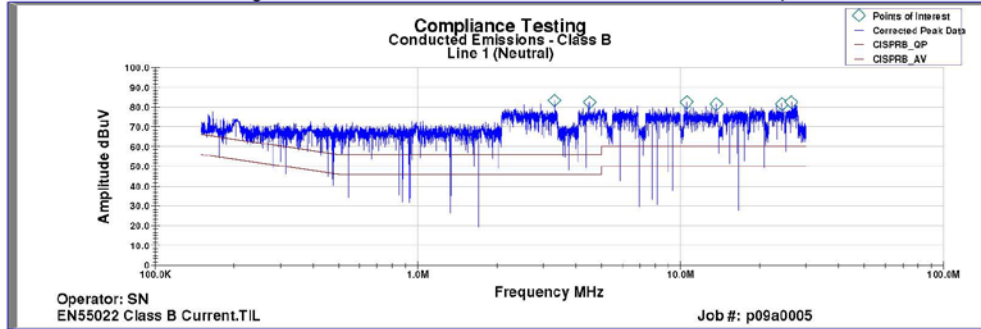
**Name of Test:** FCC Power line Conducted Emissions, Ford-AC Conducted Emissions  
**FCC Specification:** 15.107 **Engineer:** Sam Nickels, NCT  
**Ford-AC:** CE420; EU1 & G1 ranges passed  
**Test Equipment Utilized:** i00033, i00270 **Test Date:** October 19, 2009

**Test Procedure**

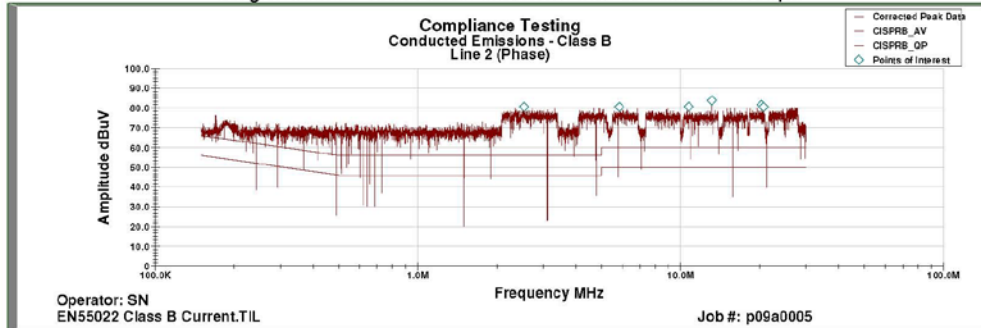
The EUT power cable connected to a LISN and the monitored output of the LISN was connected directly to an EMI Receiver. The conducted emissions from 150 kHz to 30 MHz were monitored and compared to the specification limits.



**Netgear XAV101 Conducted Emissions Line 1 Neutral Peak Graph**



**Netgear XAV101 Conducted Emissions Line 2 Neutral Peak Graph**





**Netgear XAV101 Line 1 Neutral AVG Detector**

Frequency (MHz)	Uncorrected Data (dBuV)	LISN Corr Fact (dB)	Cable Loss (dB)	Attenuator (dB)	Final L1 (dBuV)	Limit (dBuV)	AVG Margin (dB)
26.36 MHz	62.72	0.20	1.03	10.00	73.95	50.00	23.95
24.21 MHz	61.64	0.20	0.99	10.00	72.83	50.00	22.83
13.67 MHz	60.49	0.00	0.70	10.00	71.19	50.00	21.19
10.55 MHz	60.97	0.00	0.58	10.00	71.55	50.00	21.55
4.49 MHz	62.05	0.00	0.41	10.00	72.45	46.00	26.45
3.32 MHz	61.28	0.00	0.33	10.00	71.62	46.00	25.62

**Netgear XAV101 Line 2 Phase AVG Detector**

Frequency (MHz)	Uncorrected Data (dBuV)	LISN Corr Fact (dB)	Cable Loss (dB)	Attenuator (dB)	Final L1 (dBuV)	Limit (dBuV)	AVG Margin (dB)
20.70 MHz	63.03	0.10	0.92	10.00	74.05	50.00	24.05
20.31 MHz	63.55	0.10	0.91	10.00	74.56	50.00	24.56
13.08 MHz	62.91	0.00	0.67	10.00	73.59	50.00	23.59
10.74 MHz	63.20	0.00	0.59	10.00	73.79	50.00	23.79
5.85 MHz	62.81	0.00	0.47	10.00	73.28	50.00	23.28
2.53 MHz	62.21	0.00	0.29	10.00	72.50	46.00	26.50

**Netgear XAV101 Line 1 Neutral QP Detector**

Frequency (MHz)	Uncorrected Data (dBuV)	LISN Corr Fact (dB)	Cable Loss (dB)	Attenuator (dB)	Final L1 (dBuV)	Limit (dBuV)	QP Margin (dB)
26.36 MHz	75.11	0.20	1.03	10.00	86.34	60.00	26.34
24.21 MHz	73.77	0.20	0.99	10.00	84.96	60.00	24.96
13.67 MHz	73.23	0.00	0.70	10.00	83.93	60.00	23.93
10.55 MHz	74.19	0.00	0.58	10.00	84.77	60.00	24.77
4.49 MHz	73.97	0.00	0.41	10.00	84.38	56.00	28.38
3.32 MHz	73.38	0.00	0.33	10.00	83.71	56.00	27.71

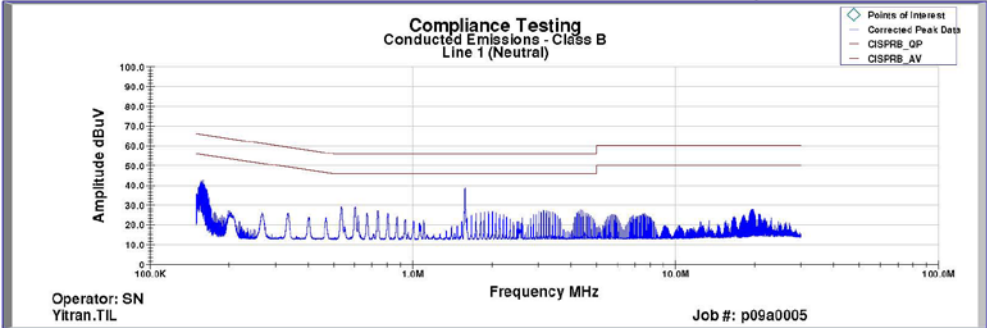
**Netgear XAV101 Line 2 Phase QP Detector**

Frequency (MHz)	Uncorrected Data (dBuV)	LISN Corr Fact (dB)	Cable Loss (dB)	Attenuator (dB)	Final L1 (dBuV)	Limit (dBuV)	QP Margin (dB)
20.70 MHz	73.75	0.10	0.92	10.00	84.77	60.00	24.77
20.31 MHz	75.48	0.10	0.91	10.00	86.49	60.00	26.49
13.08 MHz	74.18	0.00	0.67	10.00	84.85	60.00	24.85
10.74 MHz	74.28	0.00	0.59	10.00	84.87	60.00	24.87
5.85 MHz	73.59	0.00	0.47	10.00	84.06	60.00	24.06
2.53 MHz	72.68	0.00	0.29	10.00	82.97	56.00	26.97

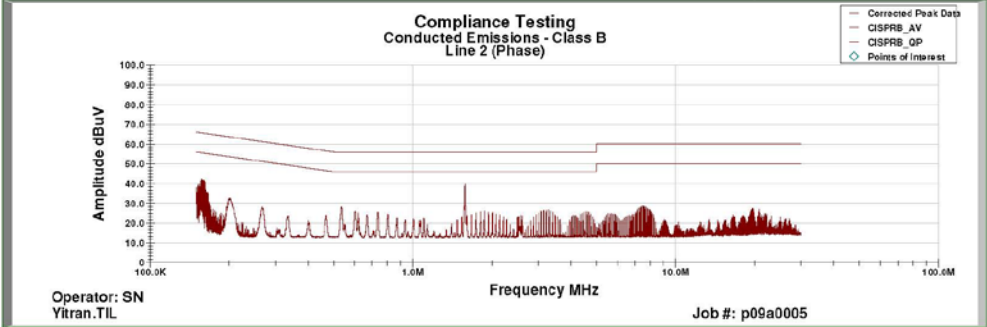
**Netgear XAV101 Conducted Emissions Test Setup Photos:**



Yitran IT700 Conducted Emissions Line 1 Neutral Peak Graph

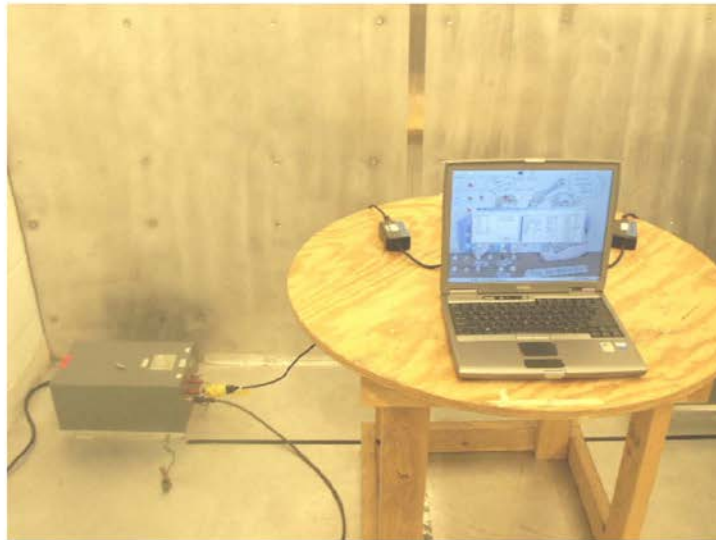


Yitran IT700 Conducted Emissions Line 2 Neutral Peak Graph

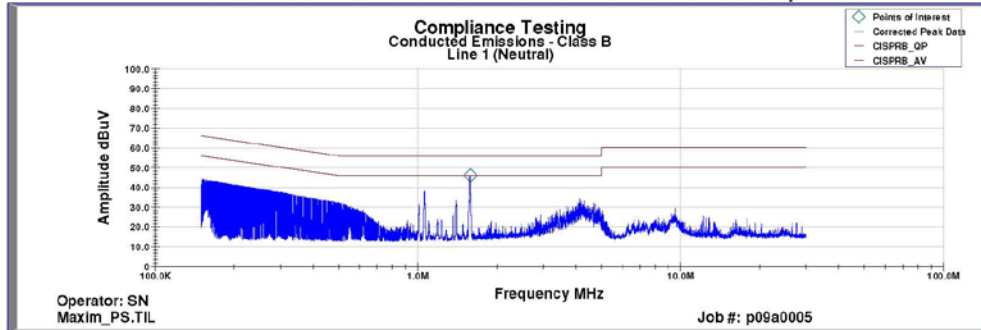


All peak emissions were below the quasi-peak and average limits.

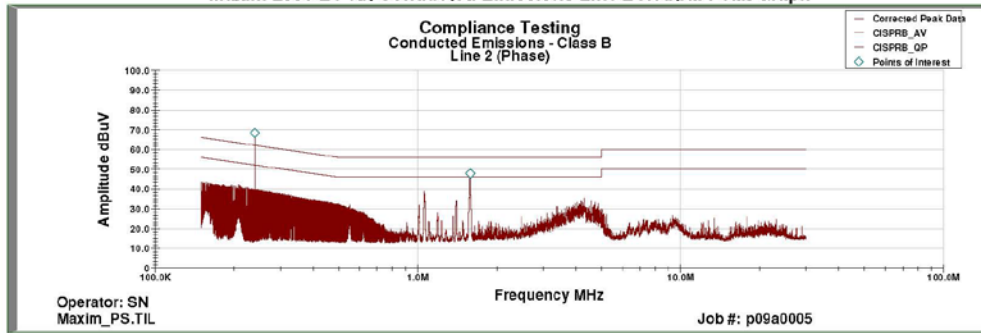
Yitran IT700 Conducted Emissions Photos Continued:



Maxim 2990 EV Kit Conducted Emissions Line 1 Neutral Peak Graph



Maxim 2990 EV Kit Conducted Emissions Line 2 Neutral Peak Graph



**Maxim 2990 EV Kit Line 1 Neutral AVG Detector**

Frequency (MHz)	Uncorrected Data (dBuV)	LISN Corr Fact (dB)	Cable Loss (dB)	Attenuator (dB)	Final L1 (dBuV)	Limit (dBuV)	AVG Margin (dB)
1.58 MHz	32.01	0.00	0.23	10.00	42.24	46.00	-3.76

**Maxim 2990 EV Kit Line 2 Phase AVG Detector**

Frequency (MHz)	Uncorrected Data (dBuV)	LISN Corr Fact (dB)	Cable Loss (dB)	Attenuator (dB)	Final L1 (dBuV)	Limit (dBuV)	AVG Margin (dB)
1.58 MHz	33.98	0.00	0.23	10.00	44.21	46.00	-1.79
227.34 KHz	-3.31	0.19	0.07	10.00	6.94	53.79	-46.85

**Maxim 2990 EV Kit TX Line 1 Neutral QP Detector**

Frequency (MHz)	Uncorrected Data (dBuV)	LISN Corr Fact (dB)	Cable Loss (dB)	Attenuator (dB)	Final L1 (dBuV)	Limit (dBuV)	QP Margin (dB)
1.58 MHz	35.15	0.00	0.23	10.00	45.38	56.00	-10.62

**Maxim 2990 EV Kit Line 2 Phase QP Detector**

Frequency (MHz)	Uncorrected Data (dBuV)	LISN Corr Fact (dB)	Cable Loss (dB)	Attenuator (dB)	Final L1 (dBuV)	Limit (dBuV)	QP Margin (dB)
1.5807 MHz	37.47	0.00	0.23	10.00	47.70	56.00	-8.30
227.34 KHz	24.31	0.19	0.07	10.00	34.56	63.79	-29.23

All other emissions were greater than 30 dB below the quasi peak or average limit.

Maxim 2990 EV Kit Conducted Emissions Photos Continued:



**Name of Test:** Radiated Immunity- Bulk Current Injection (BCI)  
**Specification:** RI112 **Engineer:** Sam Nickels, NCT  
**Test Equipment Utilized** i00031, i00262, i00263, i00275, **Test Date:** October 20, 2009  
i00358, i00315, i00041

#### Test Procedure

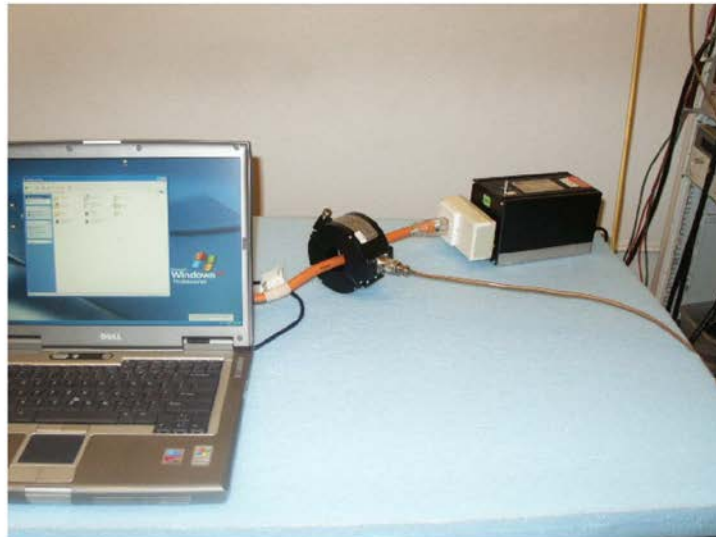
The EUT was tested using a signal generator and amplifier to inject an RF signal into the BCI Injection probe- this was placed at strategic locations on the EUT wiring/power lines. This was tested to 'Level 1' as required by the customer in accordance with Ford-AC BCI (engineering development testing). The BCI probe was placed on the USB or Serial connector to the laptop, the power lines, and both ends of the power supply/transformers.

#### Results:

- The only anomalous behavior observed was 90MHz-100MHz on the Yitran IT700 test units *only*. There was a "hardware reset" indicated in the software, but communications did not stop. The error went away after passing 100MHz (CW & AM). According to the Ford-AC Specification, this was *Function Performance Status II* behavior (being that the anomaly/test unit recovered without intervention after the RF was removed).
- The Netgear XAV101 and Maxim 2990 EV Kit exhibited no anomalous behavior (*Function Performance Status I*).



Netgear XAV101 RI112 Radiated Immunity Test Setup Photos



Yitran IT700 RI112 Radiated Immunity Test Setup Photos



Maxim 2990 EV Kit RI112 Radiated Immunity Test Setup Photos Continued:



**Name of Test:** Radiated Immunity- ALSE Method  
**Specification:** RI114  
**Test Equipment Utilized** i00266, i00280, i00281, i00310

**Engineer:** Sam Nickels, NCT  
**Test Date:** October 13, 2009

**Test Procedure**

The EUT was tested using a signal generator and RF amplifier to inject an RF signal into an antenna located in an anechoic chamber. This was tested to 'Level 1' as required by the customer in accordance with the Ford-AC ALSE (Absorber Lined Shielded Enclosure) method.

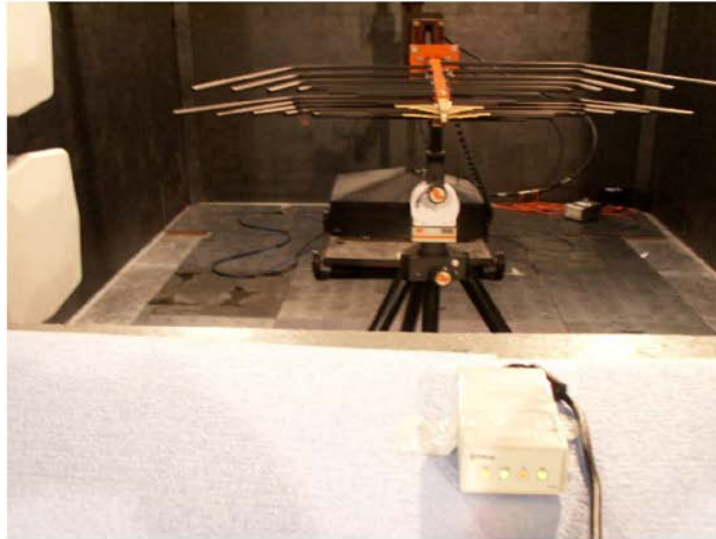
**Results:**

- None of the test samples exhibited anomalous behavior (*Function Performance Status I*).

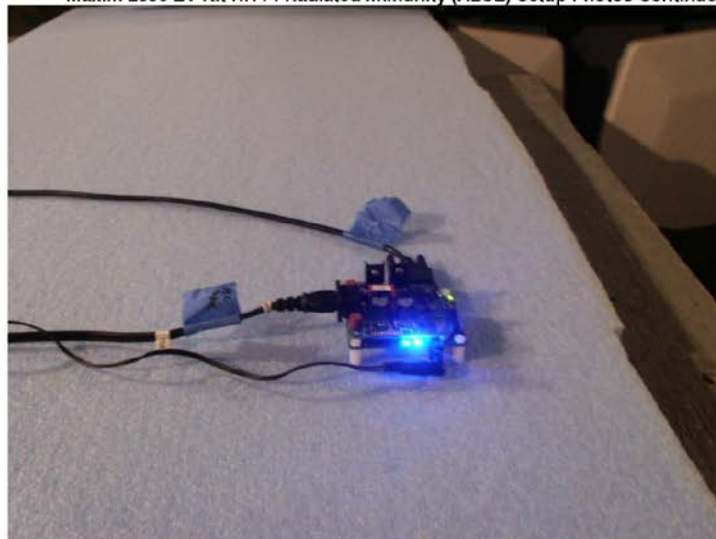
**Netgear XAV101 RI114 Radiated Immunity (ALSE) Setup Photos:**



Yitran IT700 RI114 Radiated Immunity (ALSE) Setup Photos Continued:



Maxim 2990 EV Kit RI114 Radiated Immunity (ALSE) Setup Photos Continued:



**Test Equipment Utilized**

Asset #	Manufacturer	Model	Serial Number	Cal Cycle	Calibration Due
i00031	HP	8656A	2402A06180	When used	Verified
i00033	HP	8546A	3325A00122	12 mo.	10/14/2009*
I00041	Amplifier Research	50W1000A	17772	When use	Verified
i00262	200 W 3dB Attenuator	50FH-003-200	160851	When used	Verified
i00263	200 W 3dB Attenuator	50FH-003-200	146304	When used	Verified
i00266	Rohde&Schwarz	SMT03	82611/005	When used	Verified
i00267	Schaffner	CBL611C	2910	24 mo.	11/6/2009
i00270	FCC	FCC-LISN-50-50-2-01	2050	24 mo.	9/17/2010
i00275	EIN	440LA	231	When used	Verified
i00280	Amplifier Research	AT5080	312715	When used	Verified
i00281	Amplifier Research	60S1G3	300262	When used	Verified
i00310	EMPower	2024 BBS1C4ALP	1009 D/C0609	When used	Verified
I00315	Solar Electric Co.	Type 9142-1N	063802	12 mo.	9/17/2010
i00358	Fischer Custom Comm.	F-120-9A	09104	12 mo.	1/23/2010

In addition to the above listed equipment standard RF connectors and cables were utilized in the testing of the described equipment. Prior to testing these components were tested to verify proper operation.

\* This item was granted a 30-day calibration extension per our calibration program under ISO17025.

END OF TEST REPORT

# Appendix B-9 Industrial Application Test Results (Maxim 2990/2991)

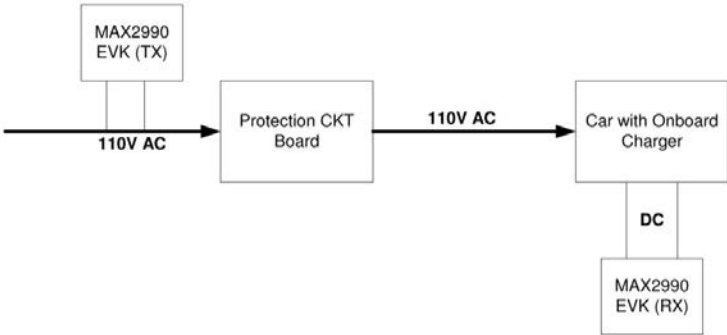


## eTec Test Results

Kedar Ponkshe  
08/31/2009-09/01/2009

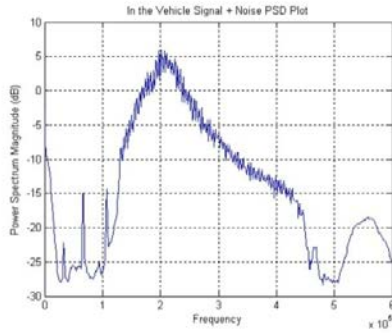


## Car with onboard Charger



Test Setup

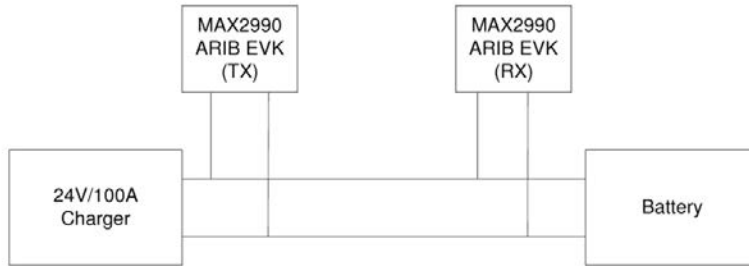
# Car with onboard Charger Signal Capture



ARIB Received Signal

- The communication frequency band is 130KHz-450KHz
- There is about 15dB more attenuation on high frequencies due to the Protection CKT.
- The frequency band of 250K-450K might give better performance.
- Data rate = 21Kbps in ARIB ROBO mode and ~85Kbps in Normal Mode
- Genelec = 4.5Kbps in ROBO mode and 19Kbps in Normal mode.

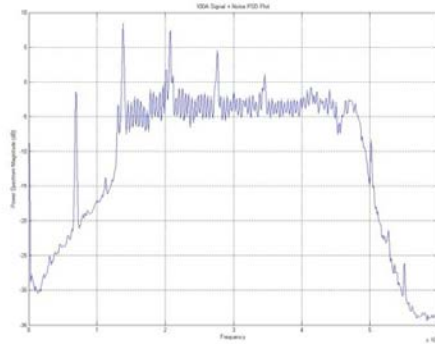
# 100A Charger



Test Setup



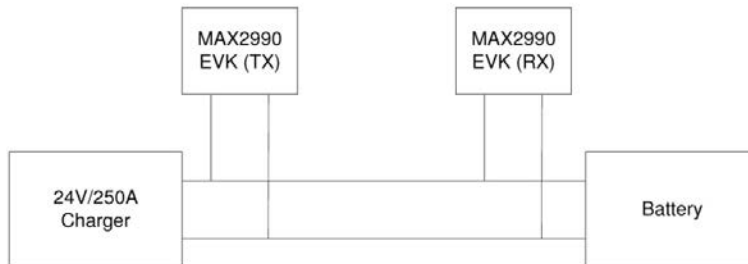
# 100A Charger Signal Capture



Received Signal

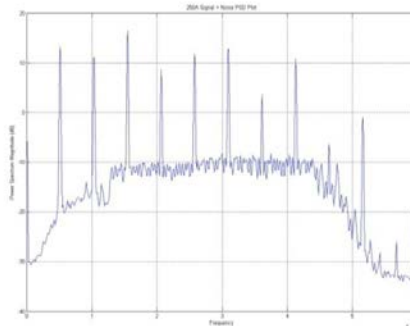
- Switching frequency harmonics @ 140KHz, 210KHz, 280KHz...
- It will be better to use high frequency band between 250KHz-450KHz to get better performance.
- ARIB Data rate = 21Kbps in ROBO mode and 85Kbps in Normal Mode

# 250A Charger



Test Setup

## 250A Charger Signal Capture



Received Signal

- 69KHz Switching frequency harmonics in the communication band.
- The harmonics are 20dB stronger than the OFDM signal.
- Cenelec or ARIB not functional in ROBO mode
- 300KHz-450KHz special frequency band to reduce the no. of harmonics in communication band.
- Data rate = 11Kbps in ROBO mode with 5% retransmission.

## Conclusion/Comments

- ARIB band gives the best performance for tests with onboard car charger and 100A DC charger. The data rate ~85Kbps in Normal mode and ~21Kbps in ROBO mode. However from the signal captures it might be better to use a frequency band between 250KHz-450KHz.
- 250A DC charger has harmonics ~20dB stronger than OFDM signal.
- The communication on 250A DC charger test is possible when the frequency band is modified to 300KHz-450KHz. The data rate is 11Kbps in ROBO mode.
- The PLC communication data rate is dependent on the amount of switching harmonics created by the charger unit as seen in the 250A DC charger test. But the ROBO mode on MAX2990 was able to recover the data in this noisy condition.
- The start and end frequencies for communication frequency band are programmable in MAX2990. So for different powerline conditions, the same chip can be programmed to communicate in user defined communication frequency band.

## **Appendix C**

### **Cost Tables**

## Appendix C-1 Development Costs

DEVELOPMENT COSTS FOR INTEGRATION	
<b>Chipset Evaluation Chip manufacturer</b>	
<p>The cost of implementing an engineering model using a select chip set under high part counts using the range of 10K piece orders assume chip manufacturer support for the following items</p> <p>1: Boot Sector Code, free emulator, and program kit</p> <p>2: Power Supply Design Support</p> <p>3: Free Support for configuration of the Chip Set</p>	
<b>Chipset Evaluation Design and Development Costs</b>	
<p>Note: Assume the Design Engineer is familiar with PLC technology and with the writing software for the chipset.</p> <p>1: Identification of Signal and Power features of the chipset</p> <p>2: Determine Power and Signal support for the chipset based on what is available from existing eTec chargers</p> <p>3: Assume a close match exists between items1 &amp; 2 Design an engineering model in support of the chipset. The engineering model is a high level signal and power flow graph.</p> <p>4: Develop Source Code using the development tools Offered by the manufacturer. {THIS ASSUMES THE CHIP MANUFACTURER PROVIDES ALL THE NEEDED LIBRARIES}</p> <p>5: Design the Power Supply section</p> <p>6: Layout and design the PCB board</p> <p>7: Test &amp; Debug the system</p> <p>8: FCC Testing</p> <p>Total Cost Estimate for Development</p>	<p>\$1,000.00</p> <p>\$2,000.00</p> <p>\$4,000.00</p> <p>\$3,000.00</p> <p>\$2000,00</p> <p>\$2,500.00</p> <p>\$4,000.00</p> <p>\$30,000</p> <p><b>\$46,500.00</b></p>

## Appendix C-2 Part Costs

MAXIM 2990 BILL OF MATERIAL ESTIMATE FOR INTEGRATION					
<u>Per unit cost at 10000 order level</u>					
QNTY	Item Description	Digikey Part Number	Part Cost	Total Cost	
1	MAXIM 2990	IN PRODUCTION	8.50	8.50	
2	MAXIM 2991	IN DEVELOPMENT	4.5	9	
1	MAX 1589	N/A		0	
1	MAX 3232	N/A		0	
1	ZENER DIODE SMT	S3M-FDITR-ND	0.116	0.116	
1	CRYSTAL 8.0 MHZ	887-1077-2-ND	0.225	0.225	
1	CRYSTAL 960 THOUGH HOLE	ECS-761.21-S-130T-ND	0.54	0.54	
2	POLARIZED CAPS	08052C102J4T2A-PD	0.056	0.112	
17	SMT CAPS 805	08052C102J4T2A-ND	0.056	0.952	
18	SMT CAPS 402	399-1023-2-ND	0.067	1.206	
14	SMT RESITORS 402	RHM2.0KJTR-ND	0.00373	0.05222	
16	SMT RESITORS 805	RHM.004AJTR-ND	0.419	6.704	
1	POWER TRANSORMER	14A-20-512-ND	12.5876	12.5876	
6	JUNCTION FIELD EFFECT TRANSISTOR	568-1965-2-ND	0.21663	1.29978	
4	ZENER DIODES 805	MAZ8360GMLTR-ND	0.08072	0.32288	
4	TVS DIODES	3.0SMCJ20ADITR-ND	0.3528	1.4112	
<b>90</b>	<b>TOTAL NUMBER OF PARTS</b>	<b>✗ TOTAL COST OF MATERIAL</b>		<b>43.03</b>	
NOTE:					
1	PRICES COVERING PASSIVE COMPONENTS SUCH AS CAPACITORS, RESISTORS, INDUCTORS, WERE SELECTED FROM THE MOST COMMONLY ORDERED.				
2	PRICES INVOLVING ALL OTHER MATERIALS ARE BASED ON WHAT IS AVAILABLE AS IT AFFECTS THE DESIGN				
3	PART ATTRIBUTES AS THEY APPLY TO PASSIVE COMPOENETS ASSUME 5% ACCURACY WITH 1/4 WATT POWER DISSIPATION AT 200 PPM/DEG.C (RESISTOR FAMILY)				
4	THRESHOLD QUANTITIES ASSUME A BUYER/BROKER NEGOTIATION TOWARD A BREAK AT THE NEXT PRICE LEVEL AS ACCOUNTED FOR IN THE RESULTS ABOVE.				

## Appendix C-3 Support Costs

SUPPORT COSTS	
<b>Chipset Evaluation Chip manufacturer REV Support</b>	
The degree of success in chip manufacturer support will depend on the sales volume of the product and the direction of charger technology.	
<b>Built Product Support</b>	
<p>Note: Assume the Design Engineer is familiar with PLC technology and with the writing software for the chipset.</p> <p>1: Startup Manufacturing Cost (PCB Board)</p> <p>2: Box Build Assembly (Includes Tooling and Sourcing)</p> <p>3: Field Installation and Support</p> <p>4: Field Integration with the Utility Smart Meter</p> <p>5: Post Instalation Support</p> <p>Note Costs associated with construction permits, outside structures, bracing, and additional engineering are not included This is due to the focus of this study being placed on the physical integration og the charger communication.</p>	<p>\$1,500.00</p> <p>\$3,000.00</p> <p>\$2,000.00</p> <p>\$2,000.00</p> <p>\$2,000.00</p>
<b>Total Cost Estimate for Development</b>	
	<b>\$10,500.00</b>