

Exploring Post 631

Computer Technology

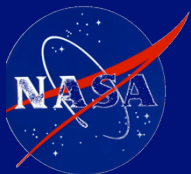
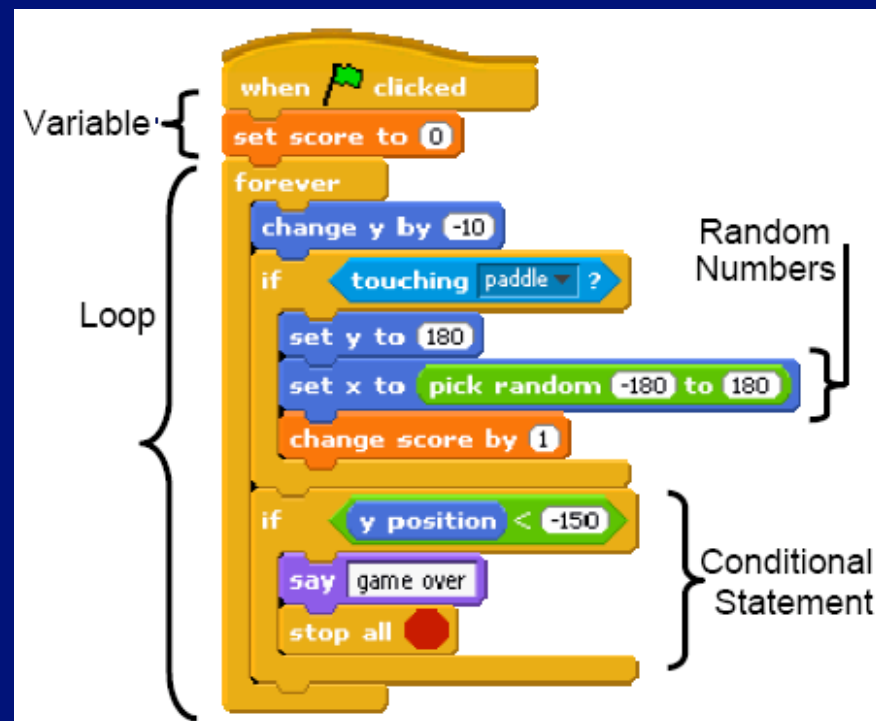

Exploring Post 631 Computer Technology

Who?

What?

When?

Where?

Why?



Why Join?

- Awareness of what computers can do
- Career exploration
- Learn how to create with a computer
- Leadership development
- Make friends

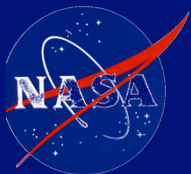

Post Advisors

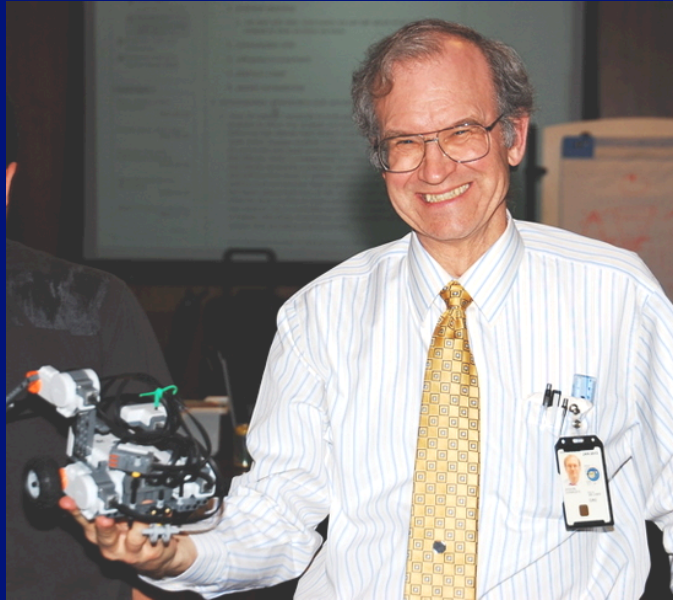

Don Braun

Josh Glemza

Matt Kunkel

Tim Palinski

Herb Schilling

Mary Vickerman

Lindsey Wilford

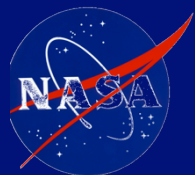

New Explorers and Parents

- Requirements:
 - Basic computer skills
 - Desire to learn
 - Willingness to share and participate in the Post



- Parents
 - Help with transportation on field trips
 - Feedback

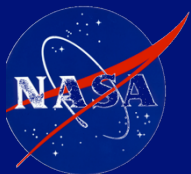

Types of Activities



Learning



Guest Speakers

Post 631



Volunteering

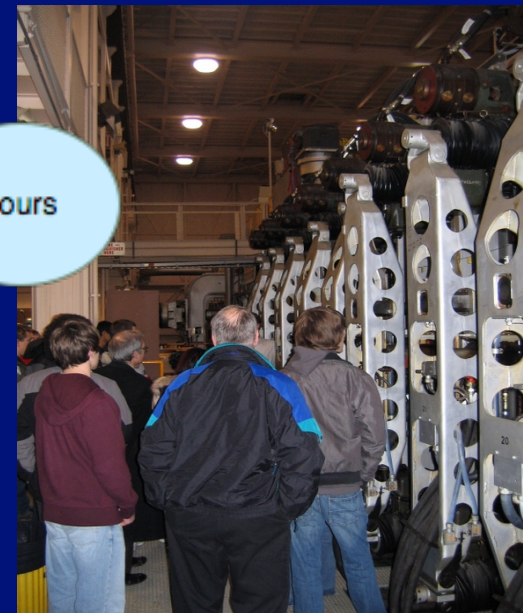

Tours

Fun

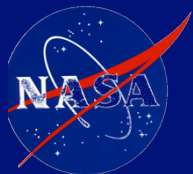

NASA Glenn Research Center

Exploring Post 631
October 11, 2011

Main Lessons

- Computer fundamentals
- Computer programming
- Interfacing computers with real world
- Using computers to solve problems
- Explore career options



Using Computers to Create!

```
File Edit Language Mode  
1 z_1 = 5  
2 z_2 = "Happy"  
3 z_3 = [z_1, z_2]  
4 z_4 = {z_1:z_2}  
5 z_4[7] = "Birthday"  
6 def z_func(an_arg):  
7     print an_arg + 2  
Language mode: Python
```

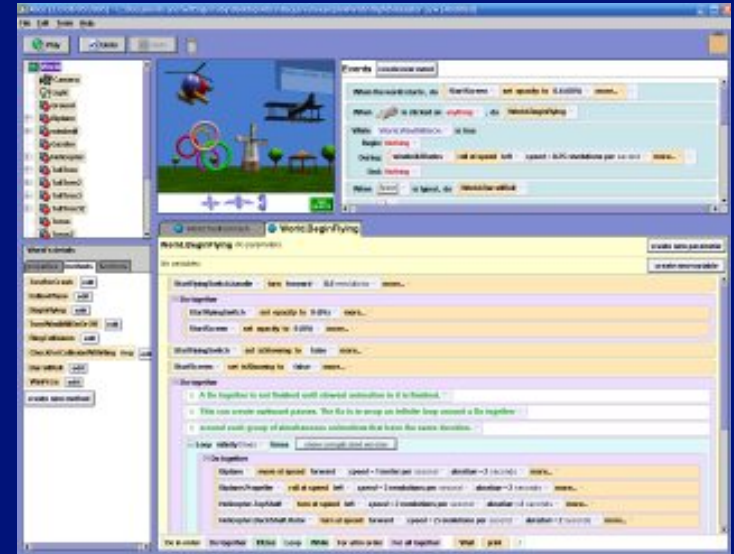

Backgrounds & Rules

Label:	<input type="text"/>
Longer Label:	Select Value
Even Longer Label:	<input type="text"/>
One More Label:	<input checked="" type="radio"/> Value 1 <input type="radio"/> Value 2

Additional Visual Elements

1 Label:	<input type="text"/>	9
2 Longer Label:	Select Value	10
3 Even Longer Label:	<input type="text"/>	12
4 One More Label:	<input checked="" type="radio"/> Value 1	13
5	<input type="radio"/> Value 2	14
6		15
7		

8

Impaired Scanning

Label:	<input type="text"/>
Longer Label:	Select Value
Even Longer Label:	<input type="text"/>
One More Label:	<input checked="" type="radio"/> Value 1 <input type="radio"/> Value 2

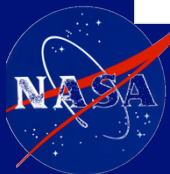
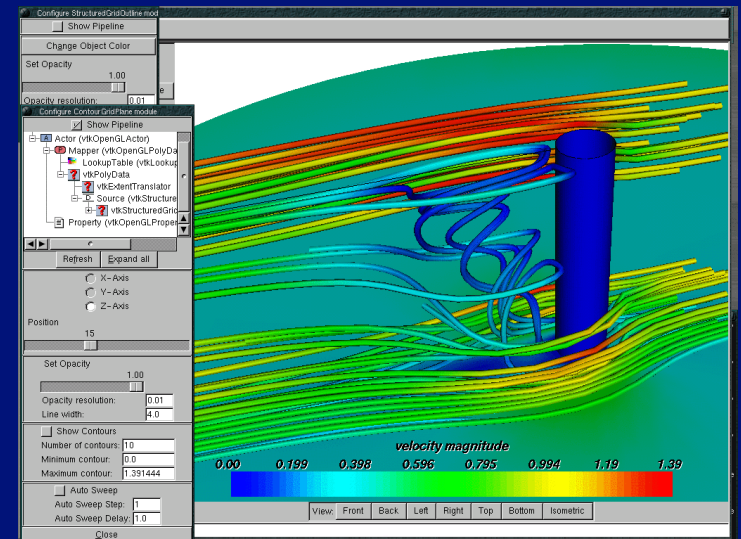

Programming - Scratch

The image shows the Scratch programming environment. The stage displays a coordinate plane with a purple line representing the equation $Y=mx+b$. The line passes through the origin (0,0), which is marked with a green dot. A speech bubble next to the Scratch character says "Y=mx+b". The script area on the left contains the following code:

```
when green flag clicked
  say Y=mx+b for 2 secs
  go to x: -235 y: m * -235 / 4 + b
  change pen color by 10
  pen down
  repeat until x position > 233
    if y position < -180 or y position > 180
      say Out of Range for 2 secs
      pen up
      stop script
    change x by 2
    set y to m * x position / 4 + b
  pen up
  broadcast place YI
```

The top toolbar includes navigation and editing tools. The bottom toolbar shows the Scratch character and a "clear" button. The bottom right corner displays mouse coordinates: mouse x: -570, mouse y: -437.

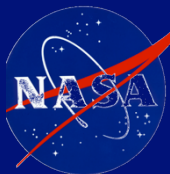

Computers and Electronics

Arduino Kits

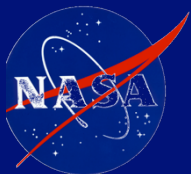
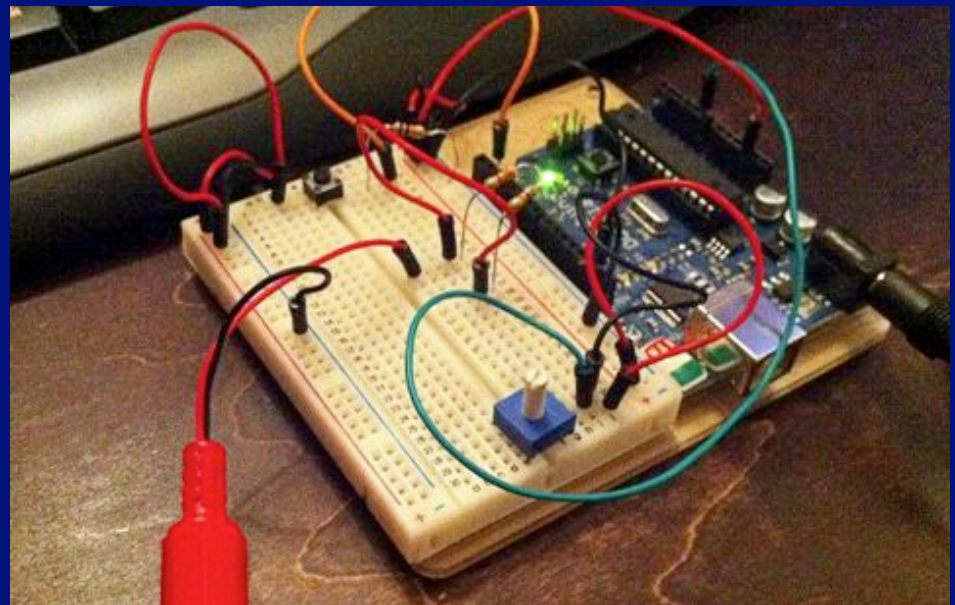
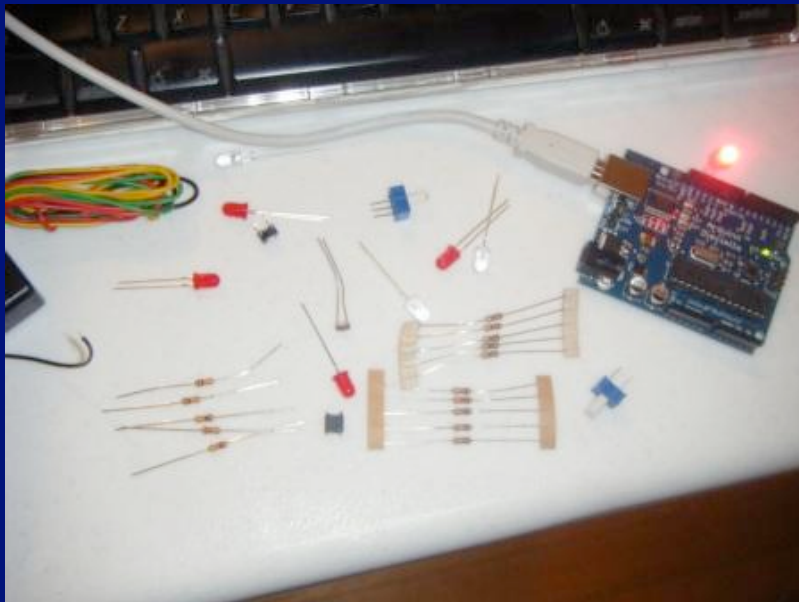

NASA Glenn Research Center

Exploring Post 631
October 11, 2011

Robotics

LEGO Mindstorms NXT

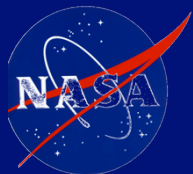
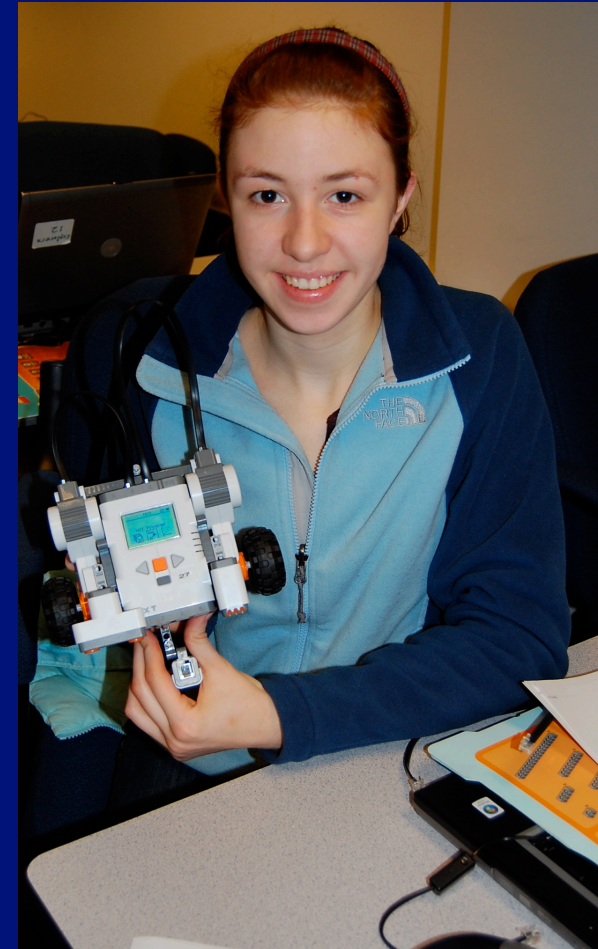
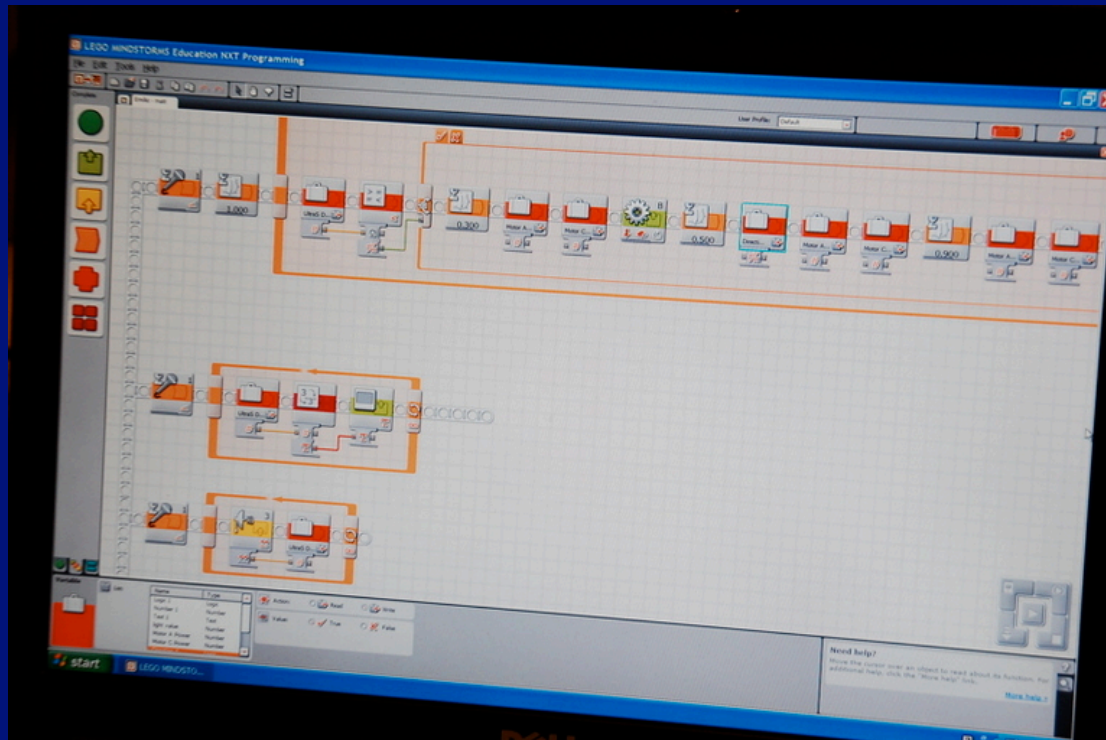

NASA Glenn Research Center

Exploring Post 631
October 11, 2011

Computer Fundamentals

Binary:	0	1	1	0	0	1	0	1
Decimal:	128	64	32	16	8	4	2	1
	No	Yes	Yes	No	No	Yes	No	Yes
		64	+ 32		+	4		+ 1
↓								
Decimal Equivalent: 101								

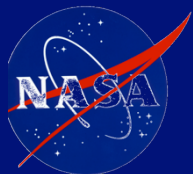
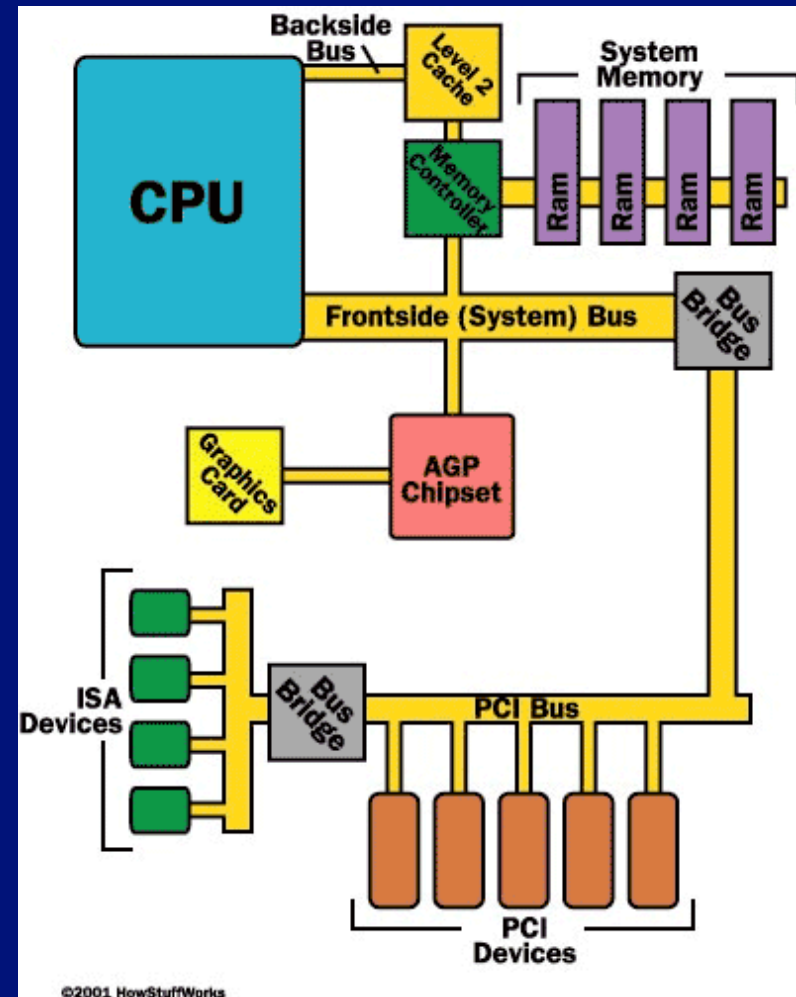

Data Visualization

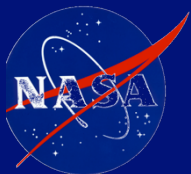
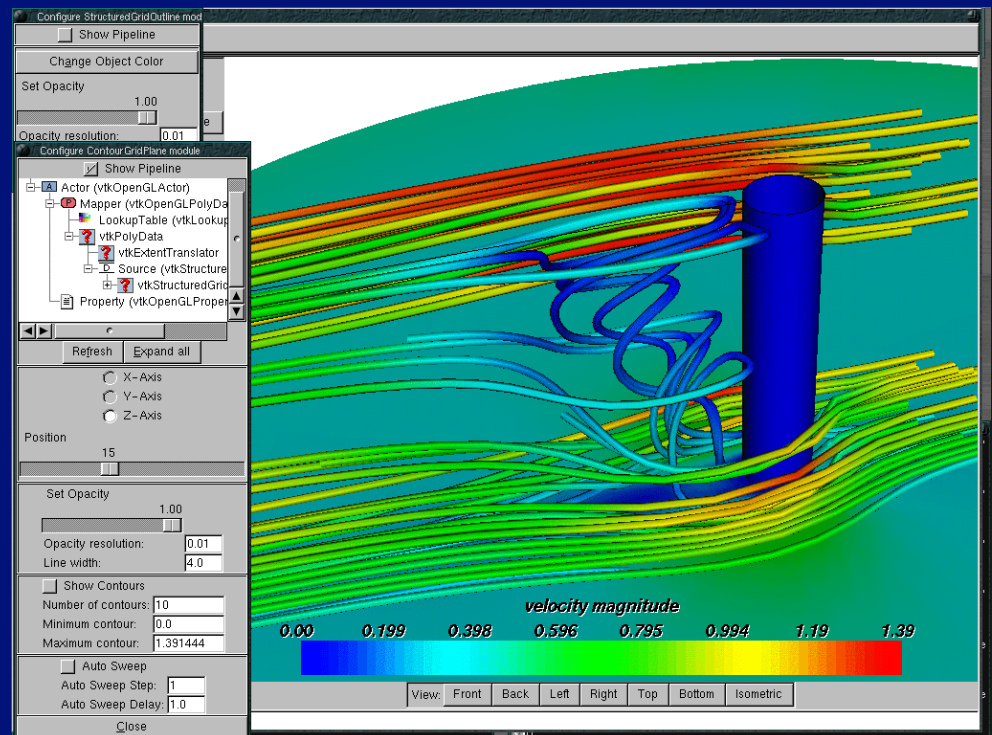
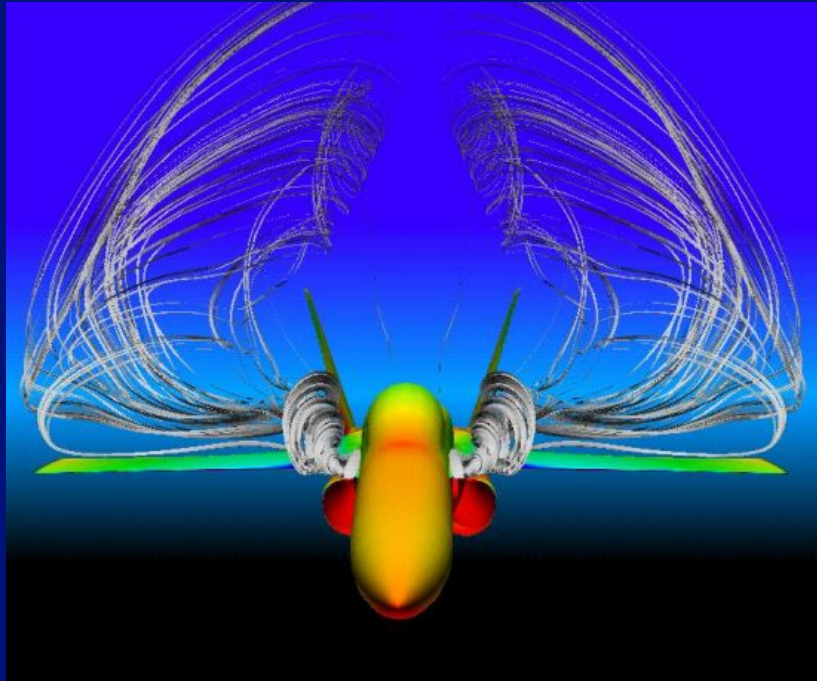

GameMaker

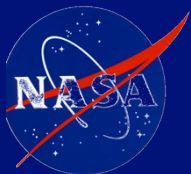

Virtual Reality

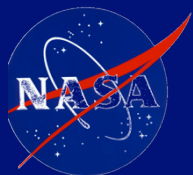
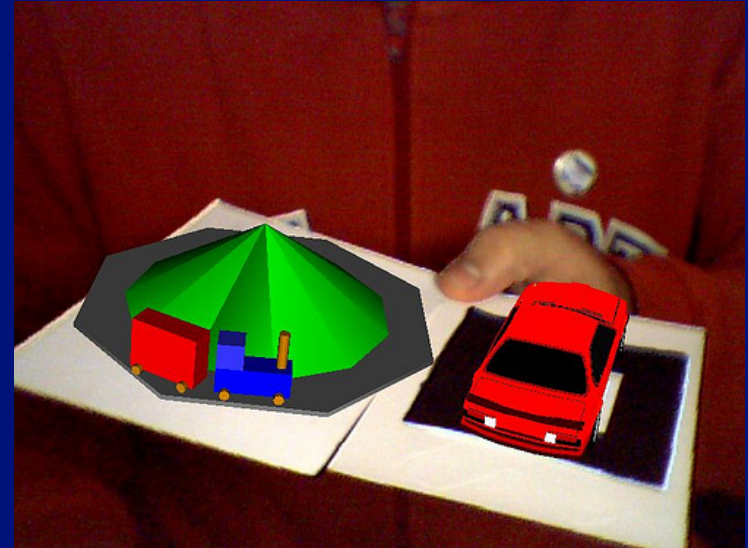
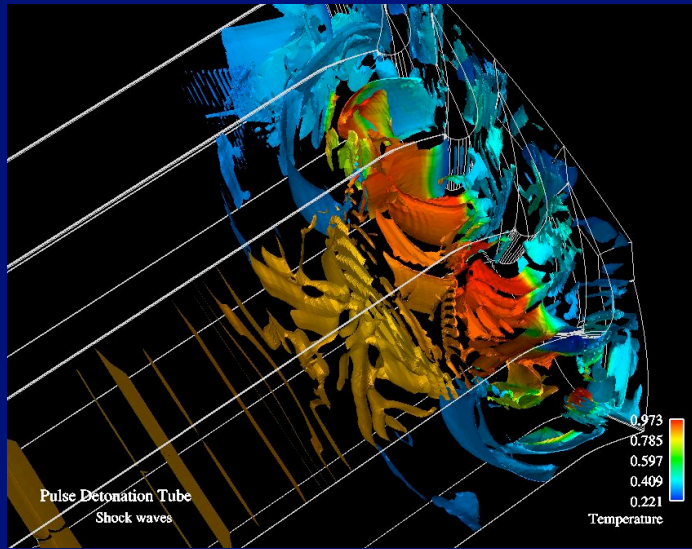

NASA Glenn Research Center

Exploring Post 631
October 11, 2011

Signal Processing

How do computers record and play back sound?

Sound source (e.g., music or speech)

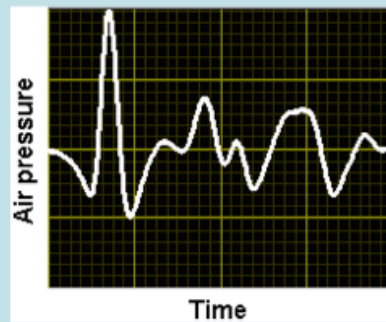

Microphone

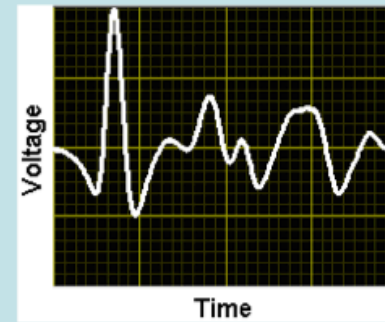

Analog to Digital Converter (ADC)

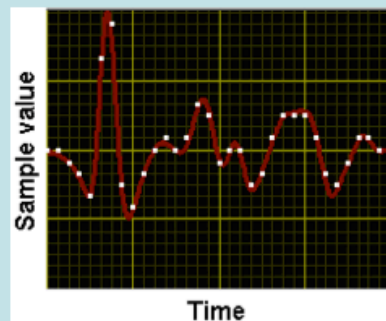

Store digitized numbers on a computer disk

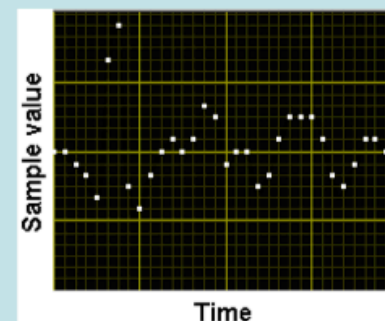

Digital to Analog Converter (DAC)

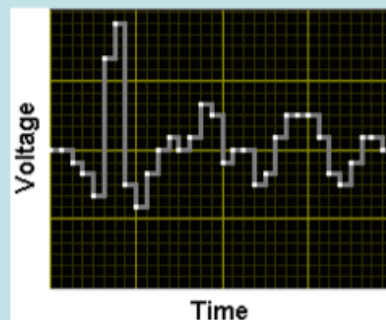

Speaker or earphone

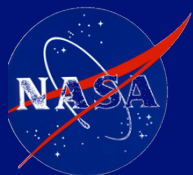
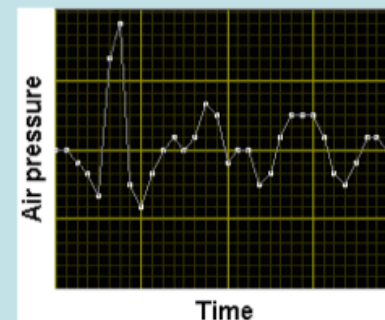

Web Page Design

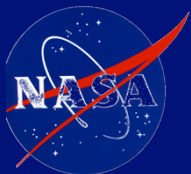
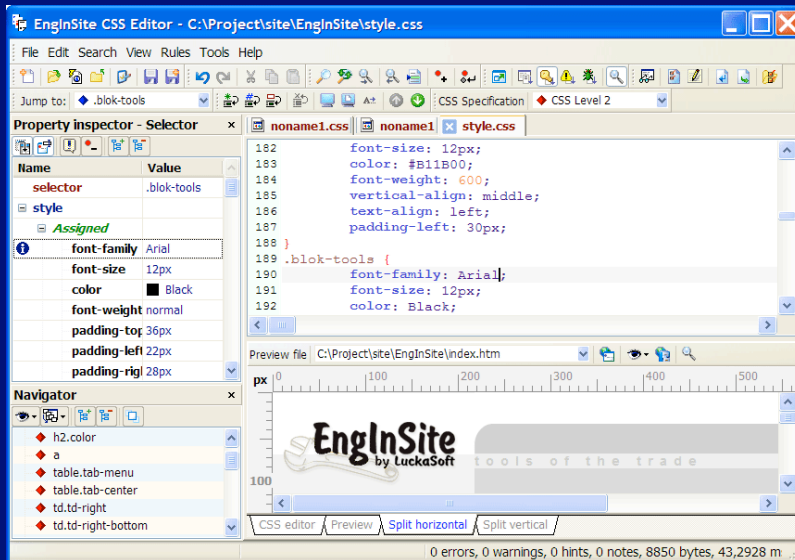

Mini-Lessons

- What the Advisors do at work
- Computer security
- Web 2.0
- Careers
- Intro to NASA
- Searching the Web
- Space exploration
- Algorithms
- Talks by former Explorers
- Computers and math
- Explorers share computer-related outside projects



Guest Speakers

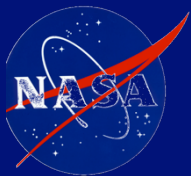

Tour of Case Western Reserve University Labs

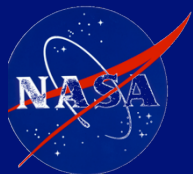
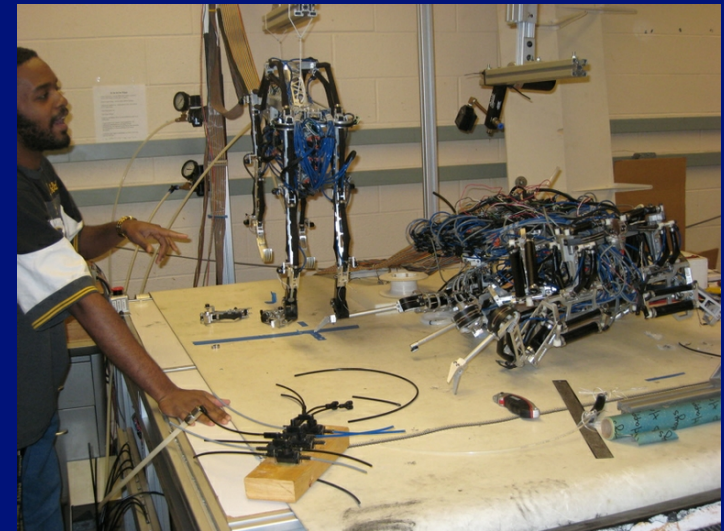
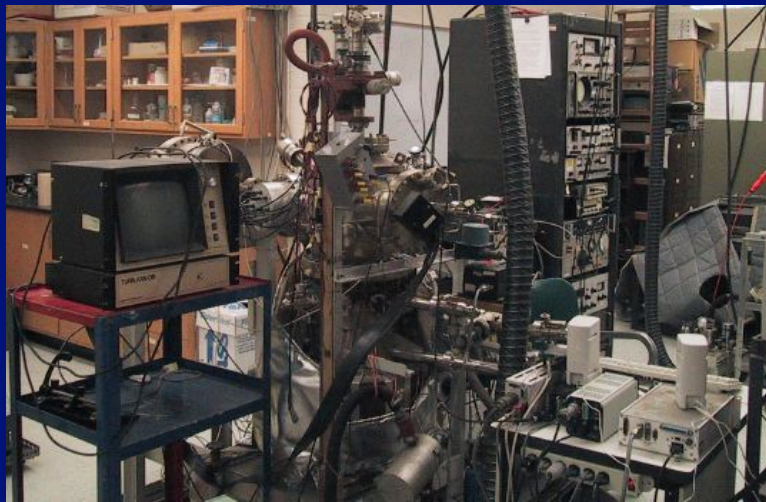

NASA Glenn Research Center

Exploring Post 631
October 11, 2011

Tours of NASA

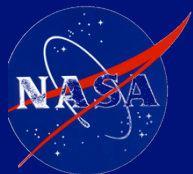

NASA Glenn Research Center

Exploring Post 631
October 11, 2011

Social Events

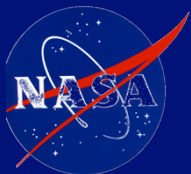

NASA Glenn Research Center

Exploring Post 631
October 11, 2011

Community Activities

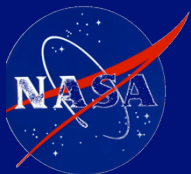

NASA Glenn Research Center

Exploring Post 631
October 11, 2011

When

Every Thursday, except holidays

5:15 to 7:15 PM

Oct 20 through April

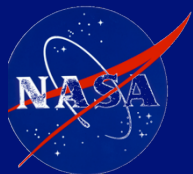

NASA Glenn Research Center

Exploring Post 631
October 11, 2011

Where

Building 142 on main NASA campus

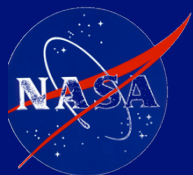

NASA Glenn Research Center

Exploring Post 631
October 11, 2011

What Explorers Say About Post 631

- This program was well put together and well organized. I wish more people could get into a program like this.
- It was fantastic...I enjoyed everything.
- This program was fun and enjoyable and I learned a lot.
- I learned new things, how to interact better with other people...This program made me feel more confident.
- I learned a lot about how technology is used in all kinds of different careers.

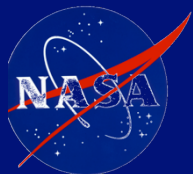

Computer Technology Post 631



Questions?

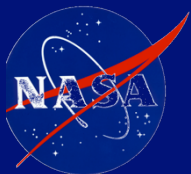

NASA Glenn Research Center

Exploring Post 631
October 11, 2011