

Light-Duty Vehicle Technology Cost Analysis, Mild Hybrid and Valvetrain Technology

Light-Duty Vehicle Technology Cost Analysis, Mild Hybrid and Valvetrain Technology

Assessment and Standards Division
Office of Transportation and Air Quality
U.S. Environmental Protection Agency

Prepared for EPA by
FEV, Inc.
EPA Contract No. EP-C-07-069
Work Assignment No. 3-3

NOTICE

This technical report does not necessarily represent final EPA decisions or positions. It is intended to present technical analysis of issues using data that are currently available. The purpose in the release of such reports is to facilitate the exchange of technical information and to inform the public of technical developments.

CONTENTS

<u>Section</u>	<u>Page</u>
Executive Summary	1
1 Introduction	1-1
1.1 Objectives	1-1
1.2 Study Methodology.....	1-1
1.3 Manufacturing Assumptions.....	1-4
1.4 Subsystem Categorization.....	1-7
1.5 Case Study Hardware Evaluated.....	1-8
1.6 Case Study Discussion and Result Layout.....	1-9
2 2007 Saturn Vue Green Line BAS Hybrid Cost Analysis, Case Study #0402.....	2-10
2.1 Vehicle & Cost Summary Overview	2-10
2.1.1 BAS Vehicle Hardware Overview	2-10
2.1.2 Direct Manufacturing Cost Differences between a 2007 Saturn Vue Green BAS Hybrid and a 2007 Conventional Baseline Saturn Vue Vehicle	2-11
2.2 Engine System & Cost Summary Overview.....	2-13
2.2.1 Engine Hardware Overview	2-13
2.2.2 Engine System Cost Impact.....	2-15
2.3 Transmission System	2-17
2.3.1 Transmission System Hardware Overview	2-17
2.3.2 Transmission System Cost Impact	2-21
2.4 Body System	2-23
2.4.1 Body System Hardware Overview	2-23
2.4.2 Body System Cost Impact	2-23
2.5 Brake Systems.....	2-25
2.5.1 Brake System Hardware Overview	2-25
2.5.2 Brake System Cost Impact	2-27
2.6 Electric Power Supply System.....	2-28
2.6.1 Start Motor/Generator Hardware Overview	2-28

2.6.2	BAS Battery Pack Hardware Overview	2-36
2.6.3	Electrical Power Supply System Cost Impact	2-43
2.7	Electrical Distribution and Electronic Control System.....	2-46
2.7.1	Electrical Wiring and Circuit Protection Subsystem Hardware Overview.....	2-46
2.7.2	Traction and High Voltage Power Distribution Subsystem Hardware Overview.....	2-47
2.7.3	Power Electronics Center (PEC) Subsystem Hardware Overview.....	2-48
2.7.4	Electrical Distribution and Electronic Control (EDEC) System Cost Impact.....	2-57
3	2010 Fiat MultiAir Cost Analysis, Case Study #0200	3-61
3.1	MultiAir Hardware Overview.....	3-61
3.1.1	MultiAir Versus Baseline ICE Hardware Differences	3-61
3.1.2	MultiAir System Hardware	3-62
3.2	Incremental Direct Manufacturing Cost Impact of Adding MultiAir Technology	3-75
3.2.1	Direct Manufacturing Cost of MultiAir Hardware.....	3-75
3.2.2	Direct Manufacturing Cost of Baseline Engine Modifications Required for MultiAir Hardware Integration.....	3-76
4	Glossary of Terms	4-78

LIST OF FIGURES

<u>Number</u>	<u>Page</u>
Figure 1-1: Cost Analysis Process Flow Steps and Document Interaction.....	1-3
Figure 1-2 : Illustration of Bill of Material Structure Used in Cost Analysis.....	1-7
Figure 2-1: Saturn Vue Green Line Primary BAS Technology Configuration.....	2-11
Figure 2-2 : Belt Alternator Starter Hardware	2-13
Figure 2-3 : Motor Generator Drive Belt	2-14
Figure 2-4 : Heater Core Coolant Electric Circulation Pump.....	2-14
Figure 2-5 : Transmission Electric Oil Pump	2-17
Figure 2-6 : Transmission Oil Lines	2-17
Figure 2-7 : Transmission Oil Pump.....	2-18
Figure 2-8 : Pump Housing and Cover	2-18
Figure 2-9 : Gerotor Gears Shaft and Seal	2-19
Figure 2-10 : Oil Pump Electric Drive Motor.....	2-19
Figure 2-11 : Base Plate and Motor Brushes	2-20
Figure 2-12 : Motor Can and Magnets.....	2-20
Figure 2-13 : Rotor Assembly and Bearings.....	2-20
Figure 2-14 : Rotor, Windings and Commutator	2-21
Figure 2-15 : Battery Pack Mount Bracket	2-23
Figure 2-16 : Brake Booster Vacuum Sensor	2-25
Figure 2-17 : Hill Hold Solenoid and Brake Pressure Sensor.....	2-25
Figure 2-18 : Hill Hold Solenoid & Bracket Assembly.....	2-26
Figure 2-19 : Hill Hold Solenoid Assembly Components	2-26
Figure 2-20 : Motor Generator Removed	2-28
Figure 2-21 : Motor Generator Assembly Assorted Views.....	2-28
Figure 2-22 : Motor Generator Pulley.....	2-28
Figure 2-23: Start Motor/Generator Die-Cast Housings.....	2-29
Figure 2-24 : Resolver, Cover, Vent and Target Wheel	2-29
Figure 2-25 : Cable Interface Block.....	2-30
Figure 2-26 : Cable Motor/Generator to PEB.....	2-30
Figure 2-27 : Brush Housing Assembly and Seals.....	2-31
Figure 2-28 : Contact Brushes	2-32
Figure 2-29 : Rotor Assembly.....	2-32
Figure 2-30 : Rotor Shaft	2-32
Figure 2-31 : Core Halves and Windings.....	2-33
Figure 2-32 : Rotor Magnets.....	2-33
Figure 2-33 : Cooling Fans	2-34
Figure 2-34 : Brush Slip Ring and Winding Connector.....	2-34
Figure 2-35 : Shaft Bearings	2-34
Figure 2-36 : Stator Assembly	2-35
Figure 2-37 : Temperature Sensor	2-35
Figure 2-38 : Saturn Vue Green Line 36V Battery Pack Installed in Vehicle (LHS) and Removed from Vehicle (RHS).....	2-36

LIST OF FIGURES

<u>Number</u>	<u>Page</u>
Figure 2-39 : Battery Tray/Housing	2-36
Figure 2-40 : Fan Housing	2-37
Figure 2-41 : Fan Assembly	2-38
Figure 2-42 : Battery Pack with Cover Removed	2-39
Figure 2-43 : Battery Modules and Sub-Modules	2-39
Figure 2-44 : Battery Case	2-40
Figure 2-45 : Positive Anode, Negative Anode and Separator paper	2-40
Figure 2-46 : Battery Pack Harness	2-41
Figure 2-47 : Encapsulated Battery Pack Control Module	2-41
Figure 2-48 : Battery Cables	2-42
Figure 2-49 : (clockwise from top left) Disconnect Box, Disconnect Relay, Switch, Bus bar, Current Sensor, and Fuse	2-43
Figure 2-50 : High Voltage Cable	2-47
Figure 2-65 : Cable Protective Covers	2-47
Figure 2-51 : Power Electronics Box (PEB)	2-49
Figure 2-52 : PEB Cable Interfaces	2-49
Figure 2-53 : PEB Installation	2-50
Figure 2-54 : 8-Pin Module	2-50
Figure 2-55 : 8-Pin Module Electrical Components	2-51
Figure 2-56 : PEB Cooling	2-52
Figure 2-57 : Base PEB Module Wrap	2-52
Figure 2-58 : Base PEB	2-53
Figure 2-59 : PEB Stacked Assembly	2-53
Figure 2-60 : PEB Main Circuit Board	2-54
Figure 2-61 : PEB Power Distribution	2-55
Figure 2-62 : PEB Aluminum Housing	2-56
Figure 2-63 : PEB Cooling	2-56
Figure 3-1 : MultiAir Hardware Illustration	3-61
Figure 3-2 : MultiAir Manifold Assembly Installed on the Fiat 1.4L, I4, ICE	3-63
Figure 3-3 : MultiAir System Forged Aluminum Manifold	3-63
Figure 3-4 : Oil Port Feeding Solenoid Reservoir Cavities for Valve Actuation Circuits	3-64
Figure 3-5 : Oil Port for Lash Adjuster and Rocker Contact Lubrication	3-64
Figure 3-6 : SOHC, RFF, and Hydraulic Piston	3-65
Figure 3-7 : Hydraulic Piston, RFF, and Lash Adjust Pivot Pin	3-65
Figure 3-8 : Piston Housing, Coil Spring, and Piston Assembly	3-66
Figure 3-9 : Piston, Spring Seat, and C-Clip	3-66
Figure 3-10 : Hydraulic Brake and Lash Adjusters (HBLA) in Hydraulic Manifold	3-67
Figure 3-11 : Hydraulic Brake and Lash Adjusters (HBLA)	3-67
Figure 3-12 : Lash Adjuster Components	3-68
Figure 3-13 : Hydraulic Solenoid Valve	3-68
Figure 3-14 : Solenoid pressed into manifold bore	3-69
Figure 3-15 : Bobbin Assembly Components	3-69

LIST OF FIGURES

<u>Number</u>	<u>Page</u>
Figure 3-16 : Over-Molded Steel Retainer Plate	3-70
Figure 3-17 : Solenoid Mechanical Valve	3-70
Figure 3-18 : Mechanical Valve Components	3-70
Figure 3-19 : Solenoid Oil Outlet Port (Pressed into the Valve Housing Oil Dump Outlet).....	3-71
Figure 3-20 : (Left) Magnetic Reaction Mass and Rod, (Right) Cylinder and Reaction Mass Assembly.....	3-71
Figure 3-21 : Oil Control Valve.....	3-71
Figure 3-22 : Oil Reservoir Cavity Cover System	3-72
Figure 3-23 : Oil Reservoir Cavity Lower Cover	3-72
Figure 3-24 : Oil Reservoir Cavity Lower Steel Cover	3-73
Figure 3-25 : Oil Reservoir Pressure Relief Valve	3-73
Figure 3-26 : Oil Reservoir Check Valve	3-73
Figure 3-27 : Manifold.....	3-74
Figure 3-28 : Valve Cover	3-74
Figure 3-29 : Oil Temperature Sensor	3-74

LIST OF TABLES

<u>Number</u>	<u>Page</u>
Table ES-1: New Technology Configurations Incremental Unit Cost Impact	2
Table 1-1: Summary of Universal Cost Analysis Assumptions Applied to All Case Studies	1-5
Table 2-1: Net Incremental Direct Manufacturing Cost of the Saturn Vue Green Line BAS Hybrid over a Conventional Saturn Vue.....	2-12
Table 2-2: Net Incremental Direct Manufacturing Cost of a Saturn Vue HEV Engine System in Comparison to a Saturn Vue Conventional Engine System	2-16
Table 2-3: Net Incremental Direct Manufacturing Cost of a Saturn Vue HEV Transmission System in Comparison to a Saturn Vue Conventional Transmission System	2-22
Table 2-4: Net Incremental Direct Manufacturing Cost of a Saturn Vue HEV Body System in Comparison to a Saturn Vue Conventional Body System	2-24
Table 2-5: Net Incremental Direct Manufacturing Cost of a Saturn Vue HEV Brake System in Comparison to a Saturn Vue Conventional Brake System	2-27
Table 2-6: Net Incremental Direct Manufacturing Cost of a Saturn Vue HEV Power Supply System in Comparison to a Saturn Vue Conventional Power Supply System.....	2-44
Table 2-7: Net Incremental Direct Manufacturing Cost of a Saturn Vue HEV EDEC System in Comparison to a Saturn Vue Conventional EDEC System	2-58
Table 3-1: Direct Manufacturing Cost of Fiat MultiAir Hardware.....	3-75
Table 3-2: Direct Manufacturing Cost Impact Associated with Changing Baseline Engine Components for MultiAir System.....	3-77

Light-Duty Vehicle Technology Cost Analysis, Mild Hybrid, and Valvetrain Technology

Executive Summary

The United States Environmental Protection Agency (EPA) contracted with FEV, Inc. to determine the incremental direct manufacturing costs for a set of advanced, light-duty vehicle technologies. The technologies selected are on the leading edge for reducing emissions of greenhouse gases in the future, primarily in the form of tailpipe carbon dioxide (CO₂).

This report, the fifth in a series of reports, addresses the direct incremental manufacturing cost associated with adding a belt alternator starter (BAS) hybrid system to a conventional vehicle's powertrain system and the incremental manufacturing costs of replacing an internal combustion engine (ICE) variable valve timing (VVT) subsystem with a variable valve timing and lift (VVTL) subsystem. These technologies are grouped under this report for the sake of convenience, not because they are functionally related.

The 2007 Saturn Vue Green Line was selected for the BAS incremental cost analysis. The technology provides a means of turning the internal combustion engine off while the vehicle is stopped in traffic without losing any customer-noticeable functionality. The addition of start-stop technology applied to a motor vehicle drives a number of changes to the existing vehicle design. Areas affected by the technology include engine, transmission, accessory drive, wiring, brakes, auxiliary heater core pump, and body. Additional components are also required in the adaptation of the technology. The major additional components are the battery pack and supporting hardware, power electronic control modules, and the alternator starter assembly. Each of these component systems are discussed in greater detail in Section 2.0.

It should be noted that the 2007 Saturn Vue Green Line was considered a logical selection for costing of mild hybrid technology at the time the decision was made, but, as with all rapidly evolving technology, is no longer considered state-of-the-art. It should also be noted that, consistent with the EPA team's priorities for the cost analysis work, FEV did not analyze the extent to which the 2007 Saturn Vue BAS technology could be cost-optimized through material cost reductions, high volume manufacturing techniques, part count reduction through component consolidation and integration, and new technology advancements. However, given that this vehicle design is representative of relatively early, low-volume BAS hybrid design, it is expected that such cost reductions could be quite sizeable. For this reason, the cost results for this technology should not be projected

onto newer-generation mild hybrid technology, such as GM's eAssist technology. Such comparison analysis did not fall within the scope of the work assignment.

The 2010 Fiat MultiAir system was selected for the VVTL incremental cost analysis. The MultiAir technology uses a hydraulic system to alter the interaction between the intake valves and the intake lobes on a single overhead camshaft (SOHC). Electronically controlled solenoid valves control the hydraulic pressure in the MultiAir system. When the solenoids are closed, the hydraulic fluid supports a rigid connection between the intake valves and SOHC intake lobes. In this scenario, valve timing and lift follow the intake cam profile similar to that of a traditional ICE. With the solenoid valves open, hydraulic pressure is minimized in the system, decoupling the intake valves from the camshaft. Through precisely timed solenoid valve opening and closing events, the intake valve lift and timing can be altered to provide improved engine performance and fuel economy. The components which make-up the MultiAir system are discussed in greater detail in Section 3.0

The calculated incremental direct manufacturing costs for adding the BAS hybrid system to a conventional Saturn Vue vehicle, and the Fiat MultiAir VVTL system to a conventional I4 1.4L ICE, dual-VVT are captured below in Table ES-1.

Table ES- 1: New Technology Configurations Incremental Unit Cost Impact

Case Study Reference Number	Technology Definition	Vehicle Class	Base Technology	New Technology	Incremental Unit Cost
0402	Belt Alternator Starter (BAS) hybrid system	Mid- to Large-Size Car, Passenger 4-6	CS# B0402 Saturn Vue Base Vehicle 2.5L I4 ICE	CS# N0402 Saturn Vue Green Line 2.4L I4 ICE	+ \$1,652.20
0200	Internal Combustion Engine Variable Valve Lift and Timing Subsystem	Subcompact-Size Car, Passenger 2-4	CS# B0200 1.4L I4 ICE Dual-VVT	CS# N0200 1.4L I4 ICE Fiat MultiAir	+ \$143.07

1 Introduction

1.1 Objectives

The objective of this work assignment is to determine the incremental direct manufacturing costs for two (2) new advanced light-duty vehicle transmission technology configurations using the costing methodology, databases, and supporting worksheets developed in the previously concluded pilot study (Light-Duty Technology Cost Analysis Pilot Study [EPA-420-R-09-020]).

1.2 Study Methodology

The first report published, “Light-Duty Technology Cost Analysis Pilot Study (EPA-420-R-09-020),” covers in great detail the overall costing methodology used to calculate an incremental cost delta between various technology configurations. In summary, the costing methodology is heavily based on teardowns of both new and baseline technology configurations having similar driver performance metrics. Only components identified as being different within the selected new and baseline technology configurations as a result of the new technology adaptation are evaluated for cost. Component costs are calculated using a ground-up costing methodology analogous to that employed in the automotive industry. All incremental costs for the new technology are calculated and presented using transparent cost models consisting of eight (8) core cost elements: material, labor, manufacturing overhead/burden, end item scrap, SG&A (selling general and administrative), profit, ED&T (engineering, design, and testing), and packaging. Information on how additional associated manufacturing fixed and variable cost elements (e.g., shipping, tooling, OEM indirect costs) are accounted for within the cost analysis is also discussed in the initial report (EPA-420-R-09-020).

Listed below, with the aid of **Figure 1-1**, is a high level summary of the ten (10) major steps taken during the cost analysis process. For additional information concerning the terminology used within the ten (10) steps, please reference the glossary of terms found at the end of this report.

Step 1: Using the *Powertrain-Vehicle Class Summary Matrix (P-VCSM)*, a technology is selected for cost analysis.

Step 2: Existing vehicle models are identified for teardown to provide the basis for detailed incremental cost calculations.

Step 3: Pre-teardown *Comparison Bills of Materials (CBOMs)* are developed, covering hardware that exists in the new and base technology configurations. These high level

CBOMs are informed by the team's understanding of the new and base technologies and serve to identify the major systems and components targeted for teardown.

Step 4: Phase 1 (high level) teardown is conducted for all subsystems identified in Step 3 and the assemblies that comprise them. Using *Design Profit® software*, all high level processes (e.g., assembly process of the high-pressure fuel pump onto the cylinder head assembly) are mapped during the disassembly.

Step 5: A *cross functional team (CFT)* reviews all the data generated from the high level teardown and identifies which components and assumptions should be carried forward into the cost analysis. The CBOMs are updated to reflect the CFT input.

Step 6: Phase 2 (component/assembly level) teardowns are initiated, based on the updated CBOMs. Components and assemblies are disassembled, and processes and operations are mapped in full detail. The process mapping generates key process information for the quote worksheets. Several *databases* containing critical costing information provide support to the mapping process.

Step 7: *Manufacturing Assumption and Quote Summary (MAQS) worksheets* are generated for all parts undergoing the cost analysis. The MAQS detail all cost elements making up the final unit costs: material, labor, burden, end item scrap, SG&A, profit, ED&T, and packaging.

Step 8: Parts with high or unexpected cost results are subjected to a *marketplace cross-check*, such as comparison with supplier price quotes or wider consultation with company and industry resources (i.e., subject matter experts) beyond the CFT.

Step 9: All costs calculated in the MAQS worksheets are automatically inputted into the *Subsystem Cost Model Analysis Templates (CMAT)*. The Subsystem CMAT is used to display and roll up all the differential costs associated with a subsystem. All parts in a subsystem that are identified for costing in the CBOM are entered into the Subsystem CMAT. Both the base and new technology configurations are included in the same CMAT to facilitate differential cost analysis.

Step 10: The final step in the process is creating the *System CMAT*, which rolls up all the subsystem differential costs to establish a final system unit cost. The System CMAT, similar in function to the Subsystem CMAT, is the document used to display and roll-up all the subsystem costs associated within a system as defined by the CBOM. Within the scope of this cost analysis, the System CMAT provides the bottom line incremental unit cost between the base and new technology configurations under evaluation.

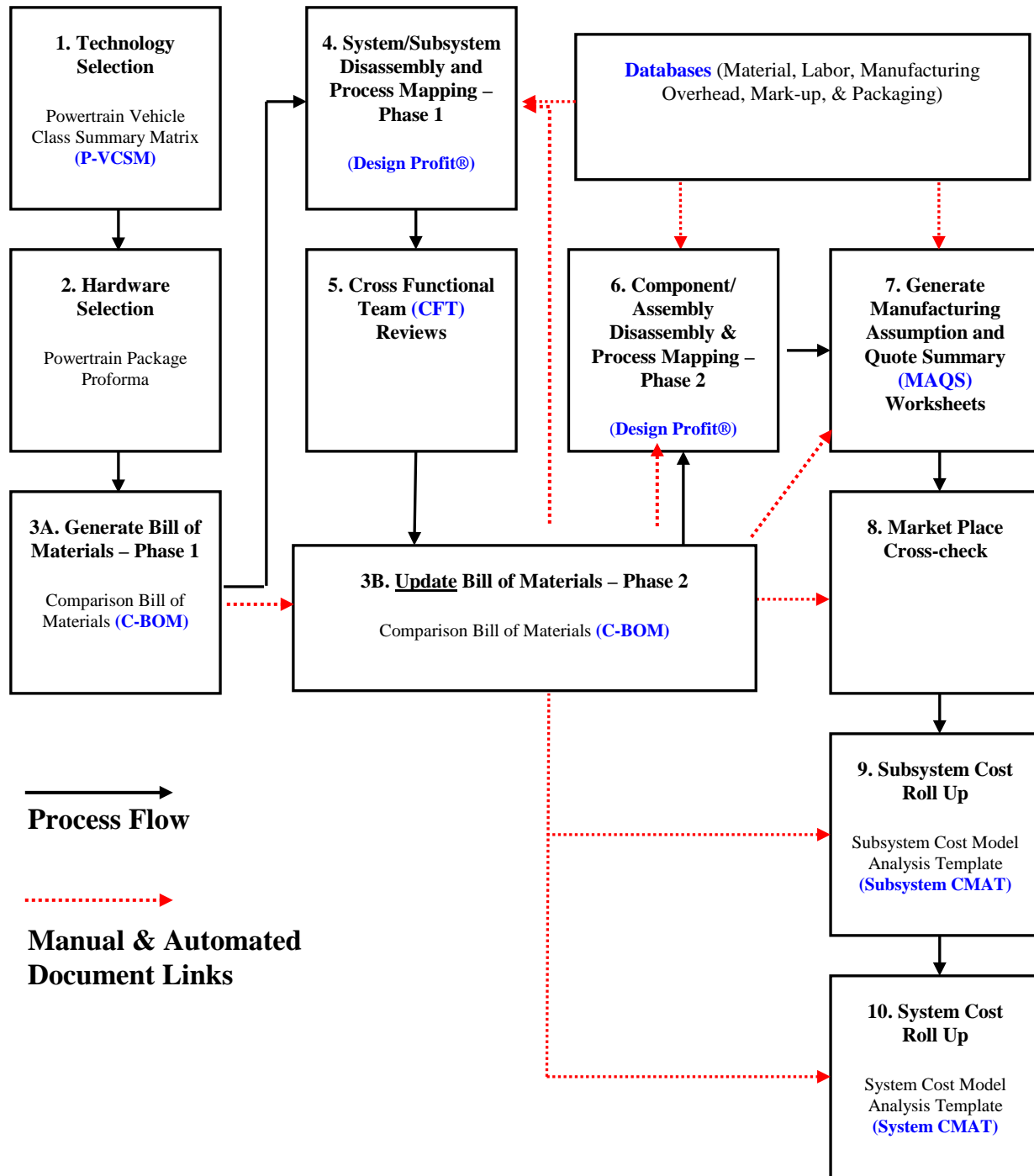

Figure 1-1: Cost Analysis Process Flow Steps and Document Interaction

1.3 Manufacturing Assumptions

When conducting the cost analysis for the various technology configurations, a number of assumptions are made in order to establish a consistent framework for all costing. The assumptions can be broken into universal and specific case study assumptions.

The universal assumptions apply to all technology configurations under analysis. Listed in **Table 1-1** are the fundamental assumptions.

The specific case study assumptions are those unique to a given technology configuration. These include volume assumptions, weekly operation assumptions (days, shifts, hours, etc.), packaging assumptions, and Tier 1 in-house manufacturing versus Tier 2/3 purchase part assumptions. Details on the case study specific assumptions can be found in the individual MAQS worksheets.

Table 1-1: Summary of Universal Cost Analysis Assumptions Applied to All Case Studies

Item	Description	Universal Case Study Assumptions
1	Incremental Direct Manufacturing Costs	<p>A. Incremental Direct manufacturing cost is the incremental difference in cost of components and assembly, to the OEM, between the new technology configuration and the baseline technology configuration.</p> <p>B. This value does not include Indirect OEM costs associated with adopting the new technology configuration (e.g., tooling, corporate overhead, corporate R&D, etc).</p>
2	Incremental Indirect OEM Costs are not handled within the scope of this cost analysis	<p>A. Indirect Costs are handled through the application of "Indirect Cost Multipliers" (ICMs) which are not included as part of this analysis. The ICM covers items such as:</p> <ul style="list-style-type: none"> a. OEM corporate overhead (sales, marketing, warranty, etc) b. OEM engineering, design, and testing costs (internal and external) c. OEM owned tooling <p>B. Reference EPA report EPA-420-R-09-003, February 2009, "Automobile Industry Retail Price Equivalent and Indirect Cost Multiplier" for additional details on the development and application of ICM factors.</p>
3	Product/Technology Maturity Level	<p>A. Mature technology assumption, as defined within this analysis, includes the following:</p> <ul style="list-style-type: none"> a. Well-developed product design b. High production volume c. Products in service for several years at high volumes c. Significant marketplace competition <p>B. Mature Technology assumption establishes a consistent framework for costing. For example, a defined range of acceptable mark-up rates:</p> <ul style="list-style-type: none"> a. End-item-scrap 0.3-0.7% b. SG&A/Corporate Overhead 6-7% c. Profit 4-8% d. ED&T (Engineering, Design, and Testing) 0-6% <p>C. The technology maturity assumption does not include allowances for product learning. Application of a learning curve to the calculated incremental direct manufacturing cost is handled outside the scope of this analysis.</p>

Item	Description	Universal Case Study Assumptions
4	Selected Manufacturing Processes and Operations	<p>A. All operations and processes are based on existing standard/mainstream industrial practices.</p> <p>B. No additional allowance is included in the incremental direct manufacturing cost for manufacturing learning. Application of a learning curve to the developed incremental direct manufacturing cost is handled outside the scope of this analysis.</p>
5	Annual Capacity Planning Volume	450,000 units
6	Supplier Manufacturing Location	North America (USA or Canada)
7	OEM Manufacturing Location	North America (USA or Canada)
8	Manufacturing Cost Structure Timeframe (e.g. Material Costs, Labor Rates, Manufacturing Overhead Rates)	2009/2010 production year rates
9	Packaging Costs	<p>A. Calculated on all Tier One (T1) supplier level components.</p> <p>B. For Tier 2/3 (T2/T3) supplier level components, packaging costs are included in T1 mark-up of incoming T2/T3 incoming goods.</p>
10	Shipping and Handling	<p>A. T1 supplier shipping costs covered through application of the Indirect Cost Multiplier (ICM) discussed above.</p> <p>B. T2/T3 to T1 supplier shipping costs are accounted for via T1 mark-up on incoming T2/T3 goods.</p>
11	Intellectual Property (IP) Cost Considerations	Where applicable, IP costs are included in the analysis. Based on the assumption that the technology has reached maturity, sufficient competition would exist suggesting alternative design paths to achieve similar function and performance metrics would be available minimizing any IP cost penalty.
12	Material Cost Reductions (MCRs) on analyzed hardware	Only incorporated on those components where it was evident that the component design and/or selected manufacturing process was chosen due to actual low production volumes (e.g., design choice made to accept high piece price to minimize tooling expense). Under this scenario, assumptions were made and cost analyzed assuming high production volumes.
13	Operating and End-of-Life Costs	No new, or modified, maintenance or end-of-life costs, were identified in the analysis.
14	Stranded Capital or ED&T expenses	No stranded capital or non-recovered ED&T expenses were considered within the scope of this analysis. It was assumed the integration of new technology would be planned and phased in minimizing non-recoverable expenses.

1.4 Subsystem Categorization

As with the first case study analysis, a design-based classification system was used to group the various components and assemblies making up the technology configurations. In general, every vehicle system (e.g., engine system, transmission system, etc.) is made up of several subsystems levels (e.g., the engine system includes a crank drive subsystem, cylinder block subsystem, cylinder head subsystem, valvetrain subsystem, etc.), which, in turn, is made up of several sub-subsystem levels (e.g., the crank drive subsystem includes the following sub-subsystems: connecting rod, piston, crankshaft, flywheel). The sub-subsystem is the smallest classification level in which all components and assemblies are binned.

Figure 1-2 illustrates the classification hierarchy as discussed above. In Sections 2.0 and 3.0, costs are presented for both technologies using this standard classification system.

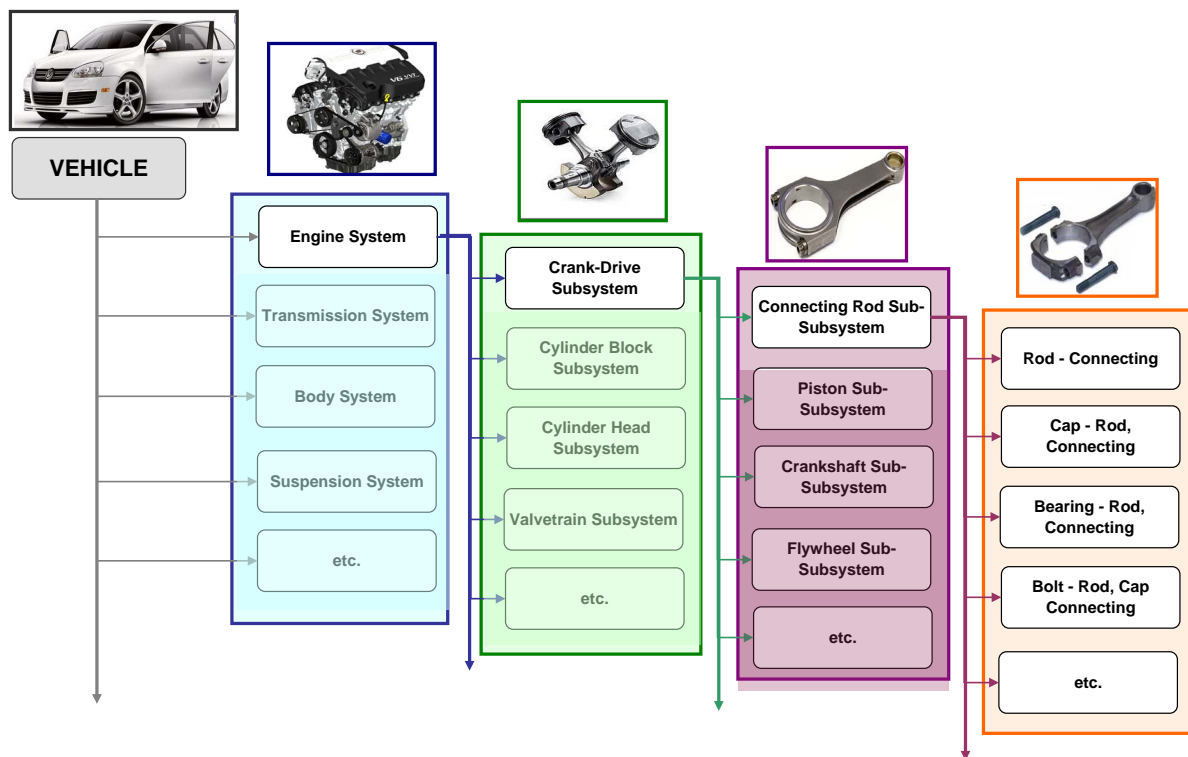

Figure 1-2 : Illustration of Bill of Material Structure Used in Cost Analysis

1.5 Case Study Hardware Evaluated

For the BAS cost analysis, the 2007 Saturn Vue Green Line vehicle was selected. At the time of the analysis it was one of the few production-available start/stop hybrids in the market place. Based on the team's initial assessment of the BAS technology, in particular the adaptation/integration of the BAS components into baseline vehicle configuration, a decision was made to only teardown the Saturn Vue Green Line vehicle. The team felt any changes made to baseline conventional vehicle could readily be identified in the advance vehicle hardware (i.e., Green Line Vehicle) without having the baseline vehicle hardware present for reference. In questionable cases, published service documentation was used to support the team's assumptions on the differences between the two technology configurations. In general, the design team for the Saturn Vue did a good job adding the BAS hardware with minimal disruption to the existing baseline vehicle. A great approach for a low annual volume production build vehicle sharing a common platform. Although one could argue that this low level integration of the new BAS components with the existing conventional components favors a conservative cost estimate for BAS systems at high volume.

For the variable valvetrain timing and lift (VVTL) technology configuration cost analysis, the Alfa Romeo MiTo 1.4L, I4, Turbo, Port Fuel Injected (PFI), MultiAir ICE (135 hp) was procured. Although the purchased engine came with a turbocharger air induction subsystem, it was excluded from the evaluation. Only components added or modified for the adaptation of the VVTL system were considered in the analysis. Previously completed case studies, such as V6 to I4 downsized, turbocharged gasoline direct injection engine and V8 to V6 downsized, turbocharged gasoline direct injection engine, were used to support the component modification costs to the baseline technology configuration (1.4L I4, NA, PFI, ICE, with dual variable valve timing). Examples of components referenced from these prior case studies include cam phasers and associated hardware, intake and exhaust cam shafts, and conventional valvetrain hardware.

1.6 Case Study Discussion and Result Layout

In the following two (2) report sections, the results for the BAS system (Section 2) and MultiAir system (Section 3) are provided. For each case study, a brief description of the technology under comparison is discussed. In addition, a high level overview of key hardware content is included for each technology evaluated.

Following the technology and hardware overviews for each case study, the increment direct manufacturing cost impact is generally summarized at a subsystem and/or system level Cost Model Analysis Template (CMAT). For subsystems and systems in which there were both new and baseline technology costs, the baseline technology costs are subtracted from the new technology costs developing the incremental direct manufacturing cost.

In subsystem and systems where there are no baseline costs (i.e., credits to offset new technology costs), the new technology direct manufacturing costs are the incremental direct manufacturing costs.

Because each case study consists of a large quantity of component and assembly Manufacturing and Assumption Quote Summary (MAQS) worksheets, hard copies were not included as part of this report. However, electronic copies of the MAQS worksheets, as well as all other supporting case study documents (e.g., Subsystem CMATs, System CMATs), can be accessed at <http://www.epa.gov/otaq/climate/publications.htm>.

2 2007 Saturn Vue Green Line BAS Hybrid Cost Analysis, Case Study #0402

2.1 Vehicle & Cost Summary Overview

2.1.1 BAS Vehicle Hardware Overview

In the BAS HEV cost analysis, both the Saturn Vue baseline (i.e., conventional vehicle) and new technology configuration (i.e., Green Line/BAS vehicle) utilized the same family engine and transmission. The internal combustion engine is GM's 2.4L Ecotec 170hp engine. The transmission is a small, mid-size car front-wheel-drive 4-speed automatic transmission. Modifications were required to both the engine and transmission in order to adopt the BAS system technology to the baseline Saturn Vue. The main engine hardware changes include the replacement of the standard alternator with a 14.5 kW starter motor/generator, which provides engine restart, launch assist and regenerative braking added functionality. To support the advanced starter motor/generator, a dual tensioner assembly replaced the standard baseline tensioner. The major modification on the transmission consisted of an externally mounted transmission pump required to maintain system pressure on ICE shut down.

A 36V, 18.4Ah, prismatic nickel metal hydride battery provides the necessary power to the starter motor/generator. The battery is package behind the rear passenger seat as shown in **Figure 2-1** below. Packaged under the hood, toward the front of the vehicle on the passenger side, is the starter generator control module (SGCM)/power electronic controls center. The SGCM is connected to the vehicle's 12V (conventional service battery) and 36V DC circuits. A high-voltage wire harness extends from the 36V battery pack to the SGCM via a high-voltage wire hardness packaged and protected on the underside of the vehicle. Three (3)-phase high-voltage AC cables also run between the SGCM and the starter motor/generator. In addition to the high voltage connections mentioned, the SGCM also controls items such as the transmission auxiliary pump, brake hill hold solenoids, auxiliary heater core pump, and SGCM auxiliary cooling pump.

Smaller design changes, with much less impact on the direct manufacturing costs were also made in the brake system and body-in-white system. Theses changes, as well as the ones previously discussed, will be covered in more detail in the subsections that follow.

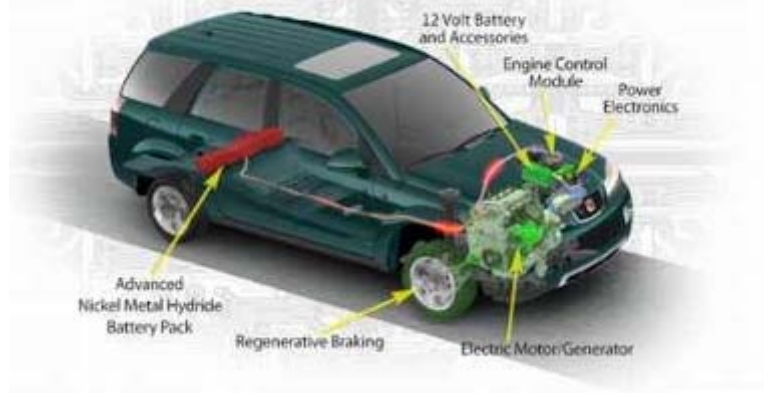

(Source: <http://revocars.com/190/2007-saturn-vue-green-line-hybrid-suv>)

Figure 2-1: Saturn Vue Green Line Primary BAS Technology Configuration

2.1.2 Direct Manufacturing Cost Differences between a 2007 Saturn Vue Green BAS Hybrid and a 2007 Conventional Baseline Saturn Vue Vehicle

A summary of the calculated, net incremental, direct manufacturing costs for producing a 2007 Saturn Vue Green Line BAS hybrid vehicle over the conventional Saturn Vue is presented in Table 2-1. The costs, captured only for vehicle differences having an overall positive or negative cost impact, are broken out for each of the major systems in both the Saturn Vue Green Line (New Technology Configuration) and Saturn Vue (Baseline Technology Configuration). At the bottom of the table, the baseline configuration costs are subtracted from the new technology configuration costs resulting in a net incremental cost.

From the cost element breakdown within the table, approximately 62% of the incremental direct manufacturing costs (i.e., \$1,388.77) are material costs, 13% labor costs, and 25% overhead costs. Relative to the net incremental direct manufacturing cost of \$1,652.20, approximately 84% are total manufacturing costs (i.e., material, labor, overhead) and the remaining 16% is applicable mark-up.

More than 90% of the costs for adding the BAS technology to the baseline configuration originate from the Electrical Power Supply (52%), Electrical Distribution and Control (34%), and Engine (7%) systems.

Additional details on the components evaluated within each vehicle system and their associated costs are discussed in the following sections.

Table 2-1: Net Incremental Direct Manufacturing Cost of the Saturn Vue Green Line BAS Hybrid over a Conventional Saturn Vue

SYSTEM & SUBSYSTEM DESCRIPTION		NEW TECHNOLOGY GENERAL PART INFORMATION: 2007 Saturn Vue, 2.4L, I4, 170 hp, Mild HEV (Electric Motor 14.5kW, Battery 36V, Nominal Pack Capacity 18.4Ah)										
Item	System Description	Manufacturing			Total Manufacturing Cost (Component/Assembly)	Markup			Total Markup Cost (Component/Assembly)	Total Packaging Cost (Component/Assembly)	Net Component/Assembly Cost Impact to OEM	
		Material	Labor	Burden		End Item Scrap	SG&A	Profit				ED&T-R&D
000000 Vehicle												
1	01 Engine System	\$ 71.84	\$ 33.14	\$ 23.08	\$ 128.06	\$ 0.69	\$ 8.14	\$ 8.16	\$ 3.65	\$ 20.65	\$ 0.46	\$ 149.17
2	02 Transmission System	\$ 16.64	\$ 15.04	\$ 15.95	\$ 47.63	\$ 0.20	\$ 2.58	\$ 2.38	\$ 0.99	\$ 6.16	\$ 0.07	\$ 53.86
3	03 Body System	\$ 3.41	\$ 2.50	\$ 7.98	\$ 13.89	\$ 0.03	\$ 0.44	\$ 0.35	\$ 0.09	\$ 0.91	\$ 0.03	\$ 14.83
6	06 Brake System	\$ 9.56	\$ 10.88	\$ 16.45	\$ 36.89	\$ 0.17	\$ 2.30	\$ 2.08	\$ 0.83	\$ 5.38	\$ 0.03	\$ 42.30
14	14 Electrical Power Supply System	\$ 503.67	\$ 76.19	\$ 244.84	\$ 824.70	\$ 5.58	\$ 58.65	\$ 64.35	\$ 30.85	\$ 159.43	\$ 2.42	\$ 986.55
18	18 Electrical Distribution and Control System	\$ 315.89	\$ 61.27	\$ 96.67	\$ 473.82	\$ 3.04	\$ 32.32	\$ 35.09	\$ 16.72	\$ 87.17	\$ 0.92	\$ 561.91
VEHICLE ROLL-UP		\$921.00	\$ 199.03	\$ 404.97	\$ 1,524.99	\$ 9.72	\$ 104.43	\$ 112.42	\$ 53.13	\$ 279.69	\$ 3.94	\$ 1,808.62

SYSTEM & SUBSYSTEM DESCRIPTION		BASE TECHNOLOGY GENERAL PART INFORMATION: 2007 Saturn Vue, 2.4L I4, 170hp, 162 ft-lb										
Item	System Description	Manufacturing			Total Manufacturing Cost (Component/Assembly)	Markup			Total Markup Cost (Component/Assembly)	Total Packaging Cost (Component/Assembly)	Net Component/Assembly Cost Impact to OEM	
		Material	Labor	Burden		End Item Scrap	SG&A	Profit				ED&T-R&D
000000 Vehicle												
1	01 Engine System	\$ 12.39	\$ 5.62	\$ 7.91	\$ 25.92	\$ 0.12	\$ 1.55	\$ 1.43	\$ 0.60	\$ 3.70	\$ 0.10	\$ 29.72
2	02 Transmission System	\$ -	\$ -	\$ -	\$ -	\$ -	\$ -	\$ -	\$ -	\$ -	\$ -	\$ -
3	03 Body System	\$ -	\$ -	\$ -	\$ -	\$ -	\$ -	\$ -	\$ -	\$ -	\$ -	\$ -
6	06 Brake System	\$ -	\$ -	\$ -	\$ -	\$ -	\$ -	\$ -	\$ -	\$ -	\$ -	\$ -
14	14 Electrical Power Supply System	\$ 42.06	\$ 17.88	\$ 45.21	\$ 105.15	\$ 0.47	\$ 6.60	\$ 6.13	\$ 2.51	\$ 15.71	\$ 0.09	\$ 120.95
18	18 Electrical Distribution and Control System	\$ 2.77	\$ 1.75	\$ 0.63	\$ 5.15	\$ 0.02	\$ 0.28	\$ 0.21	\$ 0.07	\$ 0.58	\$ 0.03	\$ 5.76
VEHICLE ROLL-UP		\$ 57.22	\$ 25.24	\$ 53.75	\$ 136.22	\$ 0.61	\$ 8.43	\$ 7.77	\$ 3.18	\$ 19.99	\$ 0.22	\$ 156.43

SYSTEM & SUBSYSTEM DESCRIPTION		INCREMENTAL COST TO UPGRADE TO NEW TECHNOLOGY PACKAGE										
Item	System Description	Manufacturing			Total Manufacturing Cost (Component/Assembly)	Markup			Total Markup Cost (Component/Assembly)	Total Packaging Cost (Component/Assembly)	Net Component/Assembly Cost Impact to OEM	
		Material	Labor	Burden		End Item Scrap	SG&A	Profit				ED&T-R&D
000000 Vehicle												
1	01 Engine System	\$ 59.45	\$ 27.52	\$ 15.17	\$ 102.14	\$ 0.57	\$ 6.59	\$ 6.73	\$ 3.06	\$ 16.95	\$ 0.37	\$ 119.46
2	02 Transmission System	\$ 16.64	\$ 15.04	\$ 15.95	\$ 47.63	\$ 0.20	\$ 2.58	\$ 2.38	\$ 0.99	\$ 6.16	\$ 0.07	\$ 53.86
3	03 Body System	\$ 3.41	\$ 2.50	\$ 7.98	\$ 13.89	\$ 0.03	\$ 0.44	\$ 0.35	\$ 0.09	\$ 0.91	\$ 0.03	\$ 14.83
6	06 Brake System	\$ 9.56	\$ 10.88	\$ 16.45	\$ 36.89	\$ 0.17	\$ 2.30	\$ 2.08	\$ 0.83	\$ 5.38	\$ 0.03	\$ 42.30
14	14 Electrical Power Supply System	\$ 461.61	\$ 58.32	\$ 199.62	\$ 719.55	\$ 5.11	\$ 52.05	\$ 58.22	\$ 28.33	\$ 143.72	\$ 2.33	\$ 865.60
18	18 Electrical Distribution and Control System	\$ 313.12	\$ 59.52	\$ 96.04	\$ 468.67	\$ 3.02	\$ 32.04	\$ 34.88	\$ 16.66	\$ 86.59	\$ 0.89	\$ 556.15
VEHICLE ROLL-UP		\$863.78	\$ 173.78	\$ 351.21	\$ 1,388.77	\$ 9.11	\$ 95.99	\$ 104.64	\$ 49.96	\$ 259.70	\$ 3.72	\$ 1,652.20

2.2 Engine System & Cost Summary Overview

2.2.1 Engine Hardware Overview

The internal combustion engine in the Saturn Vue Green Line is similar to the conventional vehicle engine (i.e., no ICE foundation changes are associated with the adaptation of the BAS technology). However, there are modifications regarding the ancillary components assembled to the engine. The greatest change is the replacement of the 12-volt alternator with a three (3)-phase starter motor/generator. **Figure 2-2** shows the starter motor/generator position on the engine. The addition of the starter motor also drives additional changes in the serpentine belt tensioner, as it needs to react in two directions as opposed to the current single direction. When the vehicle engine is off, the electric motor is used to drive the engine/AC compressor belt. This ensures adequate cooling in the event of the operator having the AC turned on. Additional details on the starter motor/generator are cover in Section 2.5, “Electric Power Supply Subsystem.”



Figure 2-2: Belt Alternator Starter Hardware

The belt tensioner (**Figure 2-3**) for the motor/generator is a spring-hydraulic design. The shock is fixed at the top and attaches to a dual pulley pivot plate. Note: the front pulley mount ear was damaged on the vehicle as received. Commodity-based pricing was used for the pulley bearings, shaft seal, spring, and fasteners. All other parts were analyzed in detail to calculate their associated costs. The pivot plate and both ends of the shock ears are die-cast machined aluminum. Both pulleys are a steel design assumed to be machined and painted from steel 1008 bar stock. The shock internal parts were machined from bar stock with the exception of the stamped star-shaped retainer clip.

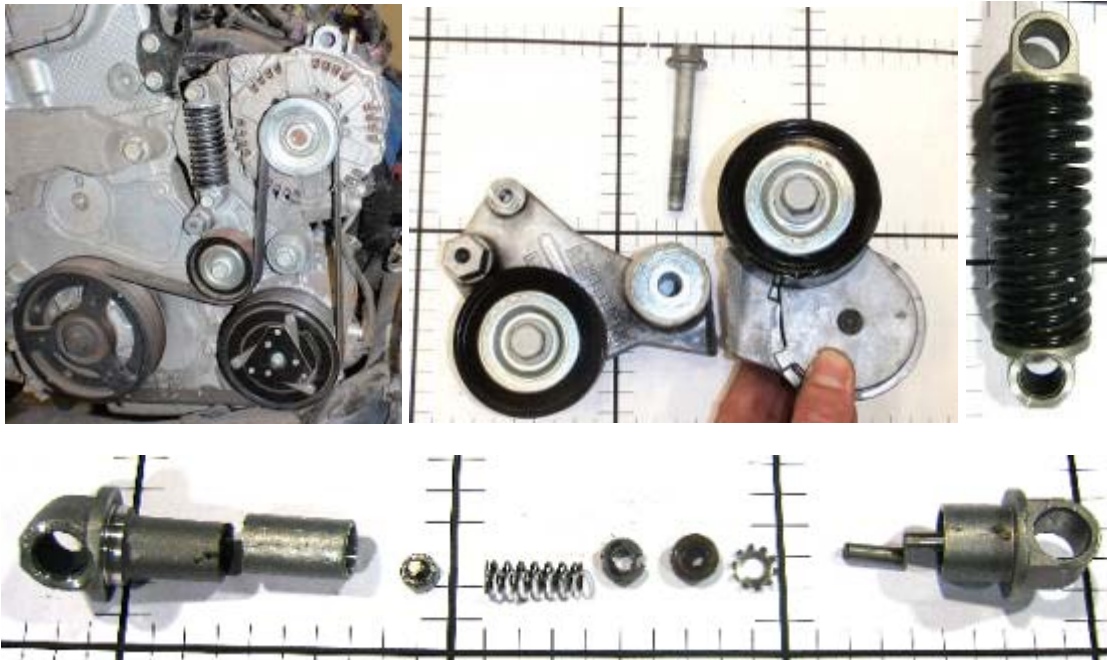

Figure 2-3: Motor Generator Drive Belt

During cold weather operation, an electric coolant pump is used to provide fluid flow for the heater core to maintain a desired temperature within the passenger compartment. The coolant pump is an additional component to the system and is tied into the existing heater core plumbing in the engine compartment (**Figure 2-4**).



Figure 2-4: Heater Core Coolant Electric Circulation Pump

The engine retains the typical 12-volt starter motor for use in cold start conditions. The attachment configurations of the BAS components to the engine, compared to the conventional 12-volt alternator system, were considered equal in the majority of cases. For example, the belt tensioner for the BAS system has a single mounting point to the engine similar to base vehicle design. Further, the starter motor/generator mounting bracket is considered to be comparable to what is typically used to support a 12-volt conventional alternator.

2.2.2 Engine System Cost Impact

The system overview discussion highlights the two (2) engine subsystems that saw the greatest magnitude of change required for Mild HEV adaptation. These components are captured within their respective subsystems. The two (2) subsystems that contributed to the net incremental, direct manufacturing engine system cost of \$119.46 are listed below and in **Table 2-2**.

- Accessory Drive Subsystem (\$30.75) (belt, tensioner, and bracket assembly). The additional cost is driven by the replacement of the 12-volt alternator with a three (3)-phase motor/generator and in turn causes modification to the serpentine belt.
- Cooling Subsystem (\$88.71) (auxiliary coolant pump, tubes and hoses). An auxiliary electric coolant pump is used to provide fluid flow for the heater core to maintain a desired temperature within the passenger compartment.

Table 2-2 : Net Incremental Direct Manufacturing Cost of a Saturn Vue HEV Engine System in Comparison to a Saturn Vue Conventional Engine System

SYSTEM & SUBSYSTEM DESCRIPTION			NEW TECHNOLOGY GENERAL PART INFORMATION: 2007 Saturn Vue, 2.4L, I4, 170 hp, Mild HEV (Electric Motor 14.5kW, Battery 36V, Nominal Pack Capacity 18.4Ah)										
Item	Subsystem	Subsystem Description	Manufacturing			Total Manufacturing Cost (Component/Assembly)	Markup			Total Markup Cost (Component/Assembly)	Total Packaging Cost (Component/Assembly)	Net Component/Assembly Cost Impact to OEM	
			Material	Labor	Burden		End Item Scrap	SG&A	Profit				ED&T-R&D
01 Engine System													
1	02	Engine Frames, Mounting and Brackets Subsystem	\$ -	\$ -	\$ -	\$ -	\$ -	\$ -	\$ -	\$ -	\$ -	\$ -	
8	09	Accessory Drive Subsystem	\$ 26.66	\$ 11.20	\$ 14.70	\$ 52.56	\$ 0.25	\$ 3.26	\$ 2.99	\$ 1.22	\$ 7.73	\$ 0.17	\$ 60.46
13	14	Cooling Subsystem	\$ 45.18	\$ 21.94	\$ 8.38	\$ 75.50	\$ 0.44	\$ 4.88	\$ 5.17	\$ 2.43	\$ 12.92	\$ 0.29	\$ 88.71
▲ SYSTEM ROLL-UP			\$ 71.84	\$ 33.14	\$ 23.08	\$ 128.06	\$ 0.69	\$ 8.14	\$ 8.16	\$ 3.65	\$ 20.65	\$ 0.46	\$ 149.17

SYSTEM & SUBSYSTEM DESCRIPTION			BASE TECHNOLOGY GENERAL PART INFORMATION: 2007 Saturn Vue, 2.4L I4, 170hp, 162 ft-lb										
Item	Subsystem	Subsystem Description	Manufacturing			Total Manufacturing Cost (Component/Assembly)	Markup			Total Markup Cost (Component/Assembly)	Total Packaging Cost (Component/Assembly)	Net Component/Assembly Cost Impact to OEM	
			Material	Labor	Burden		End Item Scrap	SG&A	Profit				ED&T-R&D
01 Engine System													
1	02	Engine Frames, Mounting and Brackets Subsystem	\$ -	\$ -	\$ -	\$ -	\$ -	\$ -	\$ -	\$ -	\$ -	\$ -	
8	09	Accessory Drive Subsystem	\$ 12.39	\$ 5.62	\$ 7.91	\$ 25.92	\$ 0.12	\$ 1.55	\$ 1.43	\$ 0.60	\$ 3.70	\$ 0.10	\$ 29.72
13	14	Cooling Subsystem	\$ -	\$ -	\$ -	\$ -	\$ -	\$ -	\$ -	\$ -	\$ -	\$ -	
▲ SYSTEM ROLL-UP			\$ 12.39	\$ 5.62	\$ 7.91	\$ 25.92	\$ 0.12	\$ 1.55	\$ 1.43	\$ 0.60	\$ 3.70	\$ 0.10	\$ 29.72

SYSTEM & SUBSYSTEM DESCRIPTION			INCREMENTAL COST TO UPGRADE TO NEW TECHNOLOGY PACKAGE										
Item	Subsystem	Subsystem Description	Manufacturing			Total Manufacturing Cost (Component/Assembly)	Markup			Total Markup Cost (Component/Assembly)	Total Packaging Cost (Component/Assembly)	Net Component/Assembly Cost Impact to OEM	
			Material	Labor	Burden		End Item Scrap	SG&A	Profit				ED&T-R&D
01 Engine System													
1	02	Engine Frames, Mounting and Brackets Subsystem	\$ -	\$ -	\$ -	\$ -	\$ -	\$ -	\$ -	\$ -	\$ -	\$ -	
8	09	Accessory Drive Subsystem	\$ 14.27	\$ 5.58	\$ 6.80	\$ 26.64	\$ 0.13	\$ 1.71	\$ 1.56	\$ 0.63	\$ 4.03	\$ 0.08	\$ 30.75
13	14	Cooling Subsystem	\$ 45.18	\$ 21.94	\$ 8.38	\$ 75.50	\$ 0.44	\$ 4.88	\$ 5.17	\$ 2.43	\$ 12.92	\$ 0.29	\$ 88.71
▲ SYSTEM ROLL-UP			\$ 59.45	\$ 27.52	\$ 15.17	\$ 102.14	\$ 0.57	\$ 6.59	\$ 6.73	\$ 3.06	\$ 16.95	\$ 0.37	\$ 119.46

2.3 Transmission System

2.3.1 Transmission System Hardware Overview

The transmission is a typical automatic design with minor modifications to support the BAS technology. An electric oil pump (**Figure 2-5**) is added to the transmission to ensure smooth launch characteristics following engine re-start. The oil pump is a separate external component attach to the outside of the transmission housing. Two (2) lines are attached to the pump: one pulling in oil from the sump and the second providing pressurized oil back into the transmission (assumed into pump pressure circuit offsetting the loss of normal pump pressure from the engine being off). There were no apparent changes to the transmission other than tying the electric pump lines into the existing oil supply circuits and mounting points for the pump. Machining operations costs were captured for all the additional required features.



Figure 2-5: Transmission Electric Oil Pump

The transmission oil pump is mounted on the side of the transmission (external) and secured with four (4) threaded fasteners. An inlet and outlet tube connects the pump to the internal transmission oil passages. The additional machining required for attaching the pump and the tubes to the case is captured as part of the analysis.



Figure 2-6: Transmission Oil Lines

Both transmission oil pump lines (**Figure 2-6**) are aluminum tube design. All fabrication processes were captured in detail. The tube is assumed to be tube stock that is bent to the required shape. The addition of machined aluminum fittings are slid in place on the long tube. The ends are then flared, capturing them in place. The same process is used on one end of the short tube; the opposite end of the short tube has a fitting that is brazed in place. O-rings are used at each end of the tube for sealing. The fasteners for attaching the tube ends are costed based on commodity pricing.



Figure 2-7: Transmission Oil Pump

The transmission oil pump depicted in **Figure 2-7** is an electric-driven gerotor design. The gears are captured between two (2) aluminum machined housings with the electric motor attached on one end. The motor is secured to the pump housing with four (4) threaded fasteners.



Figure 2-8: Pump Housing and Cover

The oil pump housing and cover in **Figure 2-8** are both die-cast machined aluminum A380 designs. The cover provides the interface to the external tubing, while the housing provides the gerotor pocket and interface to the electric motor.



Figure 2-9: Gerotor Gears, Shaft, and Seal

The gears shown in **Figure 2-9** are powdered metal design with ground surfaces on the front and back sides. The inner gear is pressed on to a machined shaft, which is driven by the electric motor. A shaft seal is used to prevent oil from exiting the pump into the electric motor.



Figure 2-10: Oil Pump Electric Drive Motor

The electric motor (**Figure 2-10**) is contained in a steel can with a base plate for the brushes and attachment to the gear housing. The rotor is installed into the can, followed by a gasket and then the base plate. The assembly is secured together once it is attached to the gear housing. The gasket is a stamped coated steel design.



Figure 2-11: Base Plate and Motor Brushes

The base plate (**Figure 2-11**) is die-cast machined aluminum A380. The brush mounting plate is injection-molded PBT with 30% glass fill and includes two (2) over-molded terminal plates.



Figure 2-12: Motor Can and Magnets

The motor can (**Figure 2-12**) is a deep-drawn galvanized design. Two magnets are contained inside the can held in place by magnetism only. A wire-formed locator is used to keep the magnets separated from each other once installed.



Figure 2-13: Rotor Assembly and Bearings

The rotor (**Figure 2-13**) is held on each end by a pair of bearings. Both bearings are pressed on to the ends of the shafts. The unsealed bearing sits in the bottom of the can while the sealed bearing is in a pocket inside the base plate.



Figure 2-14: Rotor, Windings, and Commutator

The rotor components are highlighted in **Figure 2-14**. The rotor shaft is assumed to be machined from bar stock 1060 steel. The rotor stack consists of twenty-six (26) stamped EM steel laminated plates locked together. The wire windings is made up of six (6) poles, 24 winds per pole, two phases (12 poles total), and 64 inches of 19.5 gauge (0.031") varnished copper wire. A segmented commutator is pressed onto one end of the shaft for connecting to the individual pole leads. The commutator is an injection-molded PPS with the brass segments insert-molded.

2.3.2 Transmission System Cost Impact

The system overview discussion describes the transmission subsystems requiring changes for the BAS system adaptation. Although the changes to the transmission crossed over several subsystems within the transmission, to simplify the analysis all cost impact was captured within the Oil pump and Filter Subsystem. The net incremental direct manufacturing cost for the transmission (\$53.86) is captured in **Table 2-3**, including cost element contributions (i.e., material, labor, manufacturing overhead, and mark-up).

In the transmission system analysis, only part and process additions and modifications, increasing the costs to the baseline transmission system, were identified. Because there are no baseline transmission system credits to offset the BAS system additions, there is no baseline or incremental direct manufacturing cost sub-tables included in **Table 2-3**. The new technology configuration direct manufacturing cost is the incremental direct manufacturing cost.

Table 2-3: Net Incremental Direct Manufacturing Cost of a Saturn Vue HEV Transmission System in Comparison to a Saturn Vue Conventional Transmission System



Technology Level: Mild Hybrid, Start-Stop Technology
 Vehicle Class: Mid to Large Size Passenger Vehicle, 4-6 Passengers
 Study Case#: 0402 (N=New, B=Base, 04=Technology Package, 02=Vehicle Class)

SYSTEM & SUBSYSTEM DESCRIPTION			NEW TECHNOLOGY GENERAL PART INFORMATION: 2007 Saturn Vue, 2.4L, I4, 170 hp, Mild HEV (Electric Motor 14.5kW, Battery 36V, Nominal Pack Capacity 18.4Ah)											
Item	Subsystem	Sub-Subsystem Description	Manufacturing			Total Manufacturing Cost (Component/Assembly)	Markup				Total Markup Cost (Component/Assembly)	Total Packaging Cost (Component/Assembly)	Net Component/Assembly Cost Impact to OEM	
			Material	Labor	Burden		End Item Scrap	SG&A	Profit	ED&T-R&D				
0		0206 Oil Pump and Filter Subsystem												
1		00 Assembly of Oil Pump and Filter Subsystem	\$ 0.32	\$ 3.07	\$ 0.47	\$ 3.87	\$ -	\$ -	\$ -	\$ -	\$ -	\$ -	\$ -	\$ 3.87
2		01 Oil Pump Assembly	\$ 14.29	\$ 7.26	\$ 8.75	\$ 30.30	\$ 0.15	\$ 1.97	\$ 1.82	\$ 0.76	\$ 4.70	\$ 0.03	\$ 35.03	
3		02 Covers	\$ -	\$ -	\$ -	\$ -	\$ -	\$ -	\$ -	\$ -	\$ -	\$ -	\$ -	
4		03 Filters	\$ -	\$ -	\$ -	\$ -	\$ -	\$ -	\$ -	\$ -	\$ -	\$ -	\$ -	
5		04 Oil Cooler	\$ -	\$ -	\$ -	\$ -	\$ -	\$ -	\$ -	\$ -	\$ -	\$ -	\$ -	
6		05 Oil Squirter	\$ -	\$ -	\$ -	\$ -	\$ -	\$ -	\$ -	\$ -	\$ -	\$ -	\$ -	
7		10 Plugs	\$ -	\$ -	\$ -	\$ -	\$ -	\$ -	\$ -	\$ -	\$ -	\$ -	\$ -	
8		70 Pipes, Hoses, Ducting	\$ 1.41	\$ 4.06	\$ 3.96	\$ 9.43	\$ 0.05	\$ 0.61	\$ 0.57	\$ 0.24	\$ 1.46	\$ 0.04	\$ 10.92	
9		75 Brackets	\$ -	\$ -	\$ -	\$ -	\$ -	\$ -	\$ -	\$ -	\$ -	\$ -	\$ -	
10		80 Boltings	\$ -	\$ -	\$ -	\$ -	\$ -	\$ -	\$ -	\$ -	\$ -	\$ -	\$ -	
11		85 Sealing Elements	\$ -	\$ -	\$ -	\$ -	\$ -	\$ -	\$ -	\$ -	\$ -	\$ -	\$ -	
12		90 Bearings Elements Misc	\$ -	\$ -	\$ -	\$ -	\$ -	\$ -	\$ -	\$ -	\$ -	\$ -	\$ -	
13		99 Miscellaneous	\$ 0.62	\$ 0.65	\$ 2.77	\$ 4.04	\$ -	\$ -	\$ -	\$ -	\$ -	\$ -	\$ 4.04	
		▲ SUBSYSTEM ROLL-UP	\$ 16.64	\$ 15.04	\$ 15.95	\$ 47.63	\$ 0.20	\$ 2.58	\$ 2.38	\$ 0.99	\$ 6.16	\$ 0.07	\$ 53.86	

2.4 Body System

2.4.1 Body System Hardware Overview

The addition of the various BAS components drove minor changes in the body-in-white. Two mounting brackets are added on the inboard side of each rear shock tower for attaching the battery pack.



Figure 2-15: Battery Pack Mount Bracket

The battery mount bracket (**Figure 2-15**) is a stamped steel design that is spot welded to the body on either side inboard of the rear shock tower. The stamping cost is estimated along with installation to the vehicle. The cost of painting the bracket is excluded as it is part of the body-in-white and requires no additional steps or operations; it has minimal to no impact on the total cost.

2.4.2 Body System Cost Impact

In **Table 2-4**, the incremental cost for adding the battery mounting brackets to the baseline body-in-white (BIW) are shown. The brackets are additional components required for the BAS system. With the addition of the BAS system, no baseline body credits are recognized. Therefore, the incremental direct manufacturing cost for BIW is equal to the new technology direct manufacturing costs (\$14.83).

Table 2-4: Net Incremental Direct Manufacturing Cost of a Saturn Vue HEV Body System in Comparison to a Saturn Vue Conventional Body System

NEW TECHNOLOGY GENERAL PART INFORMATION: 2007 Saturn Vue, 2.4L, I4, 170 hp, Mild HEV (Electric Motor 14.5kW, Battery 36V, Nominal Pack Capacity 18.4Ah)										NEW TECHNOLOGY PACKAGE QUOTE PARAMETERS			NEW TECHNOLOGY PACKAGE COST INFORMATION													
Item	Subsystem	Sub-Subsystem	Assembly	Subassembly	Component	Name/Description	Part Number	Subsystem	CI/VI	Full, Modification, Differential, or Not Applicable Quote Level	Notes	Manufacturing			Total Manufacturing Cost (Component/Assembly)	Markup				Total Markup Cost (Component/Assembly)	Total Packaging Cost (Component/Assembly)	Net Component/Assembly Cost Impact to OEM				
												Material	Labor	Burden		End Item Scrap	SG&A	Profit	ED&T-R&D							
0	0301 Body Structure Subsystem											\$ -	\$ -	\$ -	\$ -	\$ -	\$ -	\$ -	\$ -	\$ -	\$ -	\$ -	\$ -	\$ -	\$ -	
1	00 Assembly of Body Structure Subsystem											\$ 1.55	\$ 2.04	\$ 6.97	\$ 10.57	\$ -	\$ -	\$ -	\$ -	\$ -	\$ -	\$ -	\$ -	\$ -	\$ -	\$ 10.57
	A Assembly of Body Structure Subsystem Components											\$ 1.55	\$ 2.04	\$ 6.97	\$ 10.57	\$ -	\$ -	\$ -	\$ -	\$ -	\$ -	\$ -	\$ -	\$ -	\$ -	\$ 10.57
13	75 Brackets											\$ 1.86	\$ 0.46	\$ 1.01	\$ 3.32	\$ 0.03	\$ 0.44	\$ 0.35	\$ 0.09	\$ 0.91	\$ 0.03	\$ 4.27				
	A V - Brace Rear Battery Left											\$ 0.93	\$ 0.23	\$ 0.50	\$ 1.66	\$ 0.01	\$ 0.22	\$ 0.18	\$ 0.05	\$ 0.46	\$ 0.02	\$ 2.13				
	B V - Brace Rear Battery Right											\$ 0.93	\$ 0.23	\$ 0.50	\$ 1.66	\$ 0.01	\$ 0.22	\$ 0.18	\$ 0.05	\$ 0.46	\$ 0.02	\$ 2.13				
14	80 Boltings											\$ -	\$ -	\$ -	\$ -	\$ -	\$ -	\$ -	\$ -	\$ -	\$ -	\$ -				
	A Stud - V Ground Strap, Rear Battery to Body											\$ -	\$ -	\$ -	\$ -	\$ -	\$ -	\$ -	\$ -	\$ -	\$ -	\$ -				
	B Grommet - V High Voltage Wire Harness Assembly, Rear Floor Pan											\$ -	\$ -	\$ -	\$ -	\$ -	\$ -	\$ -	\$ -	\$ -	\$ -	\$ -				
	C V Weld Nut - Small, 36V Harness Asm											\$ -	\$ -	\$ -	\$ -	\$ -	\$ -	\$ -	\$ -	\$ -	\$ -	\$ -				
	D V Weld Nut - Large 36V Harness Asm											\$ -	\$ -	\$ -	\$ -	\$ -	\$ -	\$ -	\$ -	\$ -	\$ -	\$ -				
	E V Weld Nut - PEB Bracket Mount											\$ -	\$ -	\$ -	\$ -	\$ -	\$ -	\$ -	\$ -	\$ -	\$ -	\$ -				
	F V Weld Stud - PEB Bracket Mount											\$ -	\$ -	\$ -	\$ -	\$ -	\$ -	\$ -	\$ -	\$ -	\$ -	\$ -				
	G V Weld Stud, Ground Stud BIW, PEB											\$ -	\$ -	\$ -	\$ -	\$ -	\$ -	\$ -	\$ -	\$ -	\$ -	\$ -				
15	85 Sealing Elements											\$ -	\$ -	\$ -	\$ -	\$ -	\$ -	\$ -	\$ -	\$ -	\$ -	\$ -				
	A Body Sheet Metal Silicone Sealer											\$ -	\$ -	\$ -	\$ -	\$ -	\$ -	\$ -	\$ -	\$ -	\$ -	\$ -				
	Complete Subsystem Quote (Yes/No)											No	\$ 3.41	\$ 2.50	\$ 7.98	\$ 13.89	\$ 0.03	\$ 0.44	\$ 0.35	\$ 0.09	\$ 0.91	\$ 0.03	\$ 14.83			

2.5 Brake Systems

2.5.1 Brake System Hardware Overview

The Saturn Vue's brake system is also modified to support the start-stop technology. When the vehicle is at a stop and the engine is off, there is no means of providing additional vacuum to the brake booster. A hill hold feature is added to the existing brake system to compensate for the vacuum loss. The hill hold feature consists of a solenoid pack for holding brake pressure to both rear wheels of the vehicle. Two (2) sensors are added for system control: a pressure sensor in the brake line and a vacuum sensor in the brake booster.



Figure 2-16: Brake Booster Vacuum Sensor

The vacuum sensor in **Figure 2-16** is integrated with the brake booster vacuum check valve.

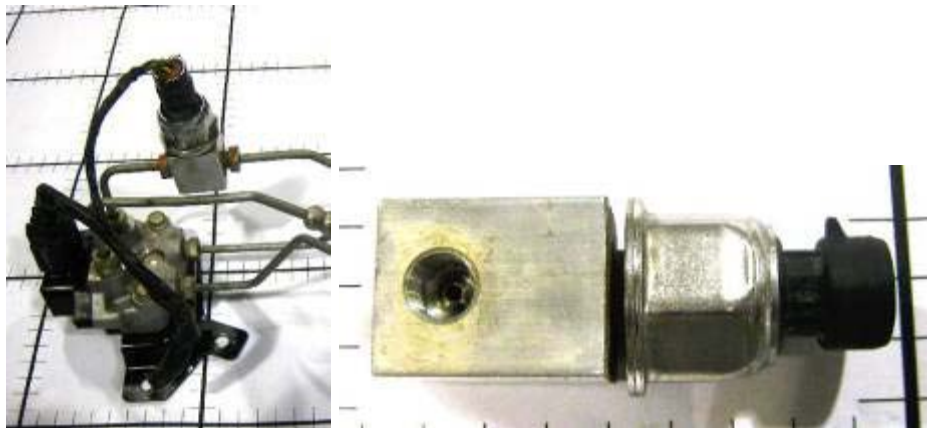

Figure 2-17: Hill Hold Solenoid and Brake Pressure Sensor

The brake pressure sensor in **Figure 2-17** requires extra components which are connected in line with the existing brake lines. The sensor are screwed into an extruded machined aluminum 7000 series block. Machined features provide a T-connection between the existing brake fluid circuit and the sensor. A break in the line also requires the addition of

two (2) tube nuts and additional fabrication to the lines for flaring operations. The addition of the solenoid results in four (4) more tube nuts and flaring operations.



Figure 2-18: Hill Hold Solenoid & Bracket Assembly

The hill hold solenoid in **Figure 2-18** is attached by two (2) threaded fasteners to the front of dash pannel just below the brake master cylinder. A painted, stamped steel plate is attached with two (2) threaded fasteners to the base of the valve housing.



Figure 2-19: Hill Hold Solenoid Assembly Components

The hill hold solenoid valve in **Figure 2-19** consists of a machined aluminum cast manifold with two (2) control valves and a pair of electric solenoids for control.

2.5.2 Brake System Cost Impact

The brake system overview discussion highlights three (3) additional primary brake components (i.e., hill hold solenoid, booster vacuum sensor, and brake line pressure sensor) required for the BAS brake system. The costs of these components are captured within their respective subsystems in **Table 2-5** below.

In the brake system analysis only part and process additions and modifications, increasing the costs to the baseline brake system, were identified. Because there are no baseline brake system credits to offset the BAS system additions, there is no baseline or incremental direct manufacturing cost sub-tables included in **Table 2-5**.

Table 2-5: Net Incremental Direct Manufacturing Cost of a Saturn Vue HEV Brake System in Comparison to a Saturn Vue Conventional Brake System



Technology Level: Mild Hybrid, Start-Stop Technology
 Vehicle Class: Mid to Large Size Passenger Vehicle, 4-6 Passengers
 Study Case#: 0402 (N=New, B=Base, 04=Technology Package, 02=Vehicle Class)

SYSTEM & SUBSYSTEM DESCRIPTION		NEW TECHNOLOGY GENERAL PART INFORMATION: 2007 Saturn Vue, 2.4L, I4, 170 hp, Mild HEV (Electric Motor 14.5kW, Battery 36V, Nominal Pack Capacity 18.4Ah)												
Item	Subsystem	Sub-Subsystem Description	Manufacturing			Total Manufacturing Cost (Component/Assembly)	Markup				Total Markup Cost (Component/Assembly)	Total Packaging Cost (Component/Assembly)	Net Component/Assembly Cost Impact to OEM	
			Material	Labor	Burden		End Item Scrap	SG&A	Profit	ED&T-R&D				
0906 Brake Controls Subsystem														
1		00 Assembly of Brake Controls Subsystem	\$ 0.08	\$ 3.52	\$ 0.54	\$ 4.14	\$ -	\$ -	\$ -	\$ -	\$ -	\$ -	\$ -	\$ 4.14
2		01 Brake Control Hardware	\$ -	\$ -	\$ -	\$ -	\$ -	\$ -	\$ -	\$ -	\$ -	\$ -	\$ -	\$ -
3		02 Brake Control Valves	\$ 3.21	\$ 3.05	\$ 6.42	\$ 12.67	\$ 0.07	\$ 0.87	\$ 0.79	\$ 0.32	\$ 2.05	\$ 0.01	\$ 14.74	
4		03 Sensors	\$ 6.27	\$ 4.31	\$ 9.49	\$ 20.08	\$ 0.11	\$ 1.42	\$ 1.29	\$ 0.51	\$ 3.32	\$ 0.02	\$ 23.42	
5		04 Brake Lines & Fittings	\$ -	\$ -	\$ -	\$ -	\$ -	\$ -	\$ -	\$ -	\$ -	\$ -	\$ -	
6		70 Pipes, Hoses, Ducting	\$ -	\$ -	\$ -	\$ -	\$ -	\$ -	\$ -	\$ -	\$ -	\$ -	\$ -	
7		75 Brackets	\$ -	\$ -	\$ -	\$ -	\$ -	\$ -	\$ -	\$ -	\$ -	\$ -	\$ -	
8		80 Boltings	\$ -	\$ -	\$ -	\$ -	\$ -	\$ -	\$ -	\$ -	\$ -	\$ -	\$ -	
9		85 Sealing Elements	\$ -	\$ -	\$ -	\$ -	\$ -	\$ -	\$ -	\$ -	\$ -	\$ -	\$ -	
10		90 Bearings Elements Misc	\$ -	\$ -	\$ -	\$ -	\$ -	\$ -	\$ -	\$ -	\$ -	\$ -	\$ -	
11		99 Miscellaneous	\$ -	\$ -	\$ -	\$ -	\$ -	\$ -	\$ -	\$ -	\$ -	\$ -	\$ -	
		▲ SUBSYSTEM ROLL-UP	\$ 9.56	\$ 10.88	\$ 16.45	\$ 36.89	\$ 0.17	\$ 2.30	\$ 2.08	\$ 0.83	\$ 5.38	\$ 0.03	\$ 42.30	

2.6 Electric Power Supply System

2.6.1 Starter Motor/Generator Hardware Overview

The starter motor/generator (**Figure 2-20** and **Figure 2-21**) was completely disassembled and analyzed to capture the cost impact to the BAS system. In the analysis, it is assumed that the motor/generator assembly was received at the OEM with the cables already attached for installation to the engine. Major pre-assembled components for the starter motor/generator assembly, discussed in more detail below, include the rotor, stator, resolver, power cables, and brush housing.



Figure 2-20: Motor Generator Removed



Figure 2-21: Motor Generator Assembly Assorted Views



Figure 2-22: Motor Generator Pulley

The starter motor/generator drive pulley (**Figure 2-22**) for the motor generator is assumed to be a manufactured form steel bar stock on a CNC turning machine. It also utilizes a pressed-in conical spacer/bushing design for assembly to the shaft. The conical bushing is also assumed to be manufactured from steel bar stock.



Figure 2-23: Starter Motor/Generator Die-Cast Housings

The motor generator is captured between two (2) die-cast machined aluminum housings, as shown in **Figure 2-23**. An additional die-cast aluminum housing (far left photo above) is attached on the back and provides a sealed environment for the resolver. All three housings are assumed to be manufactured from aluminum A380. The rear housing contains machined features to accommodate the cable block attachment. All three have as-cast cooling vent holes. Note the outside of the stator is not covered by the aluminum castings and is completely exposed to the elements.



Figure 2-24: Resolver, Cover, Vent and Target Wheel

A resolver is utilized to monitor the starter motor/generator speed. It is located at the back of the assembly inside a pocket in the end cover. It is secured to the housing with a stamped steel retainer plate and three (3) threaded fasteners. A separate stamped steel cover plate encloses the resolver and provides sealing against the elements. A duckbill vent is used to allow for one-way airflow in the resolver pocket, which is vented to the atmosphere. The sensor target consists of sixteen (16) stamped EM steel laminated plates pressed over the rotor shaft. Each of these components is illustrated in **Figure 2-24**. The

resolver was completely disassembled and analyzed to capture its total cost. It consisted of the following: 10" - 8 conductor shielded cable; wire grommet; 10-pin connector (w/CPA, TPA, and Rosebud), 7 - 0.10" male blade terminals; 5.5"x0.5" diameter braided sheath; 2 - 1-3/8" heat shrink tubing; 184 feet - 38 gauge (0.004") wire (12 poles, 174 winds per pole - 4 groups); 14 EM steel plates (0.020" thick); and a PPS injection molded housing.



Figure 2-25: Cable Interface Block

As shown in **Figure 2-25**, a cable block is installed on the back of the motor/generator assembly to the cast housing. It is an injection-molded PPS and contains several over/insert molded brass inserts. Three (3) molded rubber gromets are used to isolate/seal the stator leads coming through the housing.



Figure 2-26: Cable Motor/Generator to PEB

The cable connection for the motor/generator and power electronics bar (PEB) is through three separate cables. Each one has a different length because the connection point to the PEB is staggered. Red, white, and black primary cables are used to ensure each is properly connected (black shortest, red longest, etc.). Common o-ring sealed terminals are used on each end. All three utilize a blue convolute cover for additional protection. The cable assemblies are tied together in the middle with an insulated clamp and bracket, as seen in **Figure 2-26**.



Figure 2-27: Brush Housing Assembly and Seals

Power is applied to the rotors slip ring through a pair of spring-loaded contact brushes. The brushes are contained in an injection-molded PPS part. A split housing design is utilized to provide ease of installation. The smaller end piece is also injection-molded PPS with two (2) grooves for a slip-fit design to the main brush housing. Both ends of the shaft opening are sealed (face seal to case radial on top). **Figure 2-27** highlights the brush housing assembly and seals.

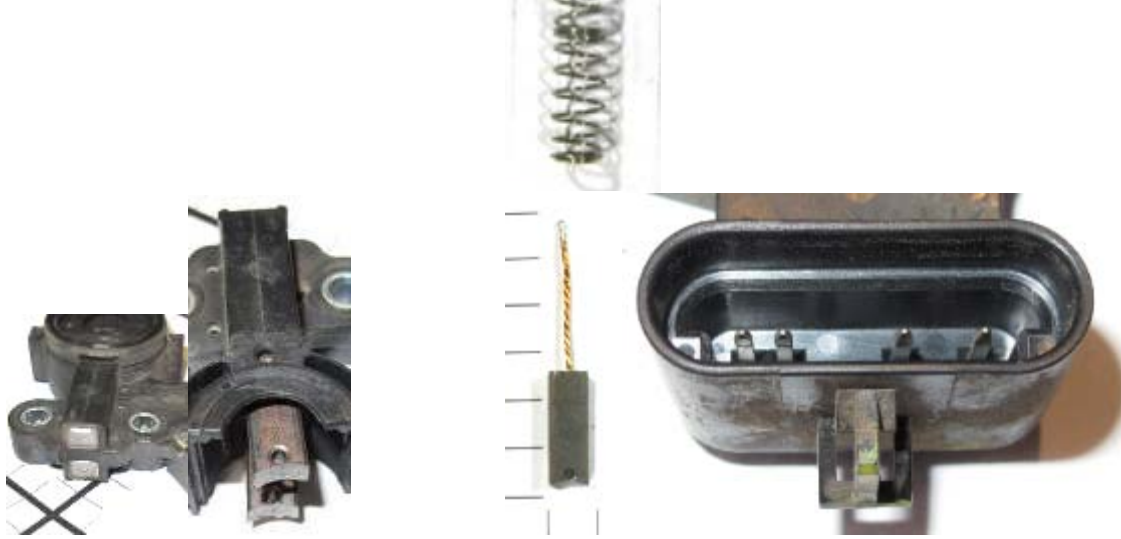

Figure 2-28: Contact Brushes

Four (4) stamped terminals are overmolded in the housing, providing electrical conductivity to the rotor. The brushes, as seen in **Figure 2-28**, are retained by their wire tails soldered in place at the back of the housing. The brushes are under constant spring tension and are self-contained for ease of installation over the shaft.



Figure 2-29: Rotor Assembly

The rotor assembly in **Figure 2-29** was disassembled down to its individual components. The rotor is assumed to go through a balancing operation (after the cores are pressed onto the shaft), coating operation and testing, in addition to the general assembly of the individual parts.



Figure 2-30: Rotor Shaft

The rotor shaft, **Figure 2-30**, is assumed to be machined from steel 4140 bar stock. Machining operations include numerous turned ODs, rolled splines, threading, and cut slots.



Figure 2-31: Core Halves and Windings

The rotor core halves as seen in **Figure 2-31** are common from end to end. The core is assumed to be a machined nodular cast iron. The external OD machining was captured after assembly to the shafts. Both cores and coil are assumed to be pressed in place all at the same time for assembly. The coil consisted of an injection-molded bobbin with 475 feet - 20 gauge (0.030") varnished copper wire wrapped around it. After the coil is wound and in place on the bobbin, it is wrapped with an insulating protective tape.

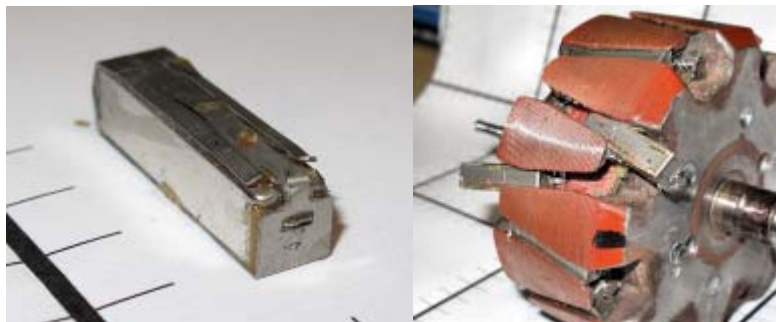

Figure 2-32: Rotor Magnets

Sixteen (16) magnets are pressed between each of the pole halves around the entire perimeter of the rotor (**Figure 2-32**). The magnets are contained inside a stamped steel case.

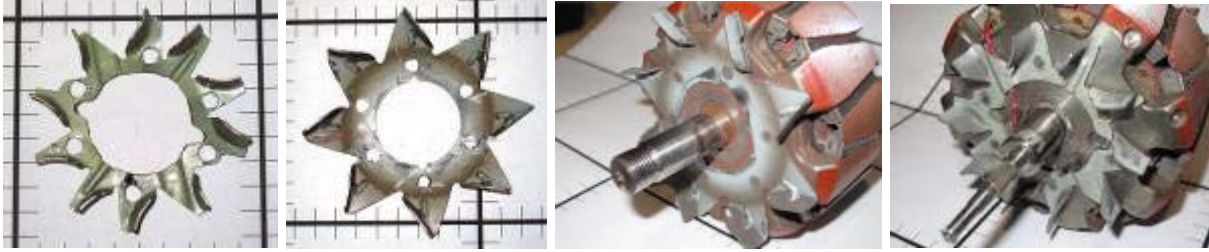

Figure 2-33: Cooling Fans

Both ends of the rotor contain fan blades for cooling as depicted in **Figure 2-33**. Both are a stamped steel design and are spot welded to the rotor core.



Figure 2-34: Brush Slip Ring and Winding Connector

The brushes transfer current through a pair of copper slip rings with leads connecting to the winding connector interface (**Figure 2-34**). The rings are assumed to be machined from copper tube stock pressed over a PPS injection-molded base. The terminal connector is a PPS injection-molded part with the terminal to winding stamped terminal leads overmolded into the connector.



Figure 2-35: Shaft Bearings

Both ends of the rotor shaft are supported by sealed bearings, as seen in **Figure 2-35**. One end is secured with a plate and three (3) threaded fasteners. The other end is pressed in place and has a stamped retainer plate.



Figure 2-36: Stator Assembly

The stator (**Figure 2-36**) consists of one hundred five (105) stamped laminated and locked EM steel plates. The windings are typical of motor alternator designs and use an 8 pole (9 winds per pole), three-phase (24 poles) design. Insulators are placed in each pole area before the wire is wound to the stator. The stator windings use 129 feet - 14 gauge (0.066") varnished copper wire. Final assembly of terminals and termination of wires along with final insulation and wrapping is assumed to have been done in a manual labor environment.

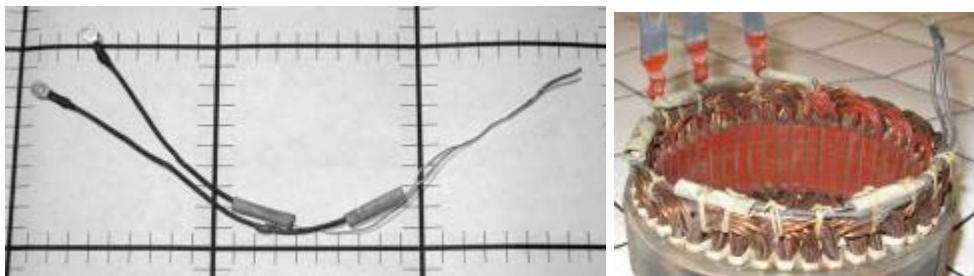

Figure 2-37: Temperature Sensor

A temperature sensor (**Figure 2-37**) is installed during the final wrap and tie off of the windings. The sensor sits along the top of the windings.

2.6.2 BAS Battery Pack Hardware Overview

The BAS technology requires an additional high capacity battery pack. The battery pack, as seen in **Figure 2-38**, is located directly behind the rear seat. It is assembled to the vehicle as a completed battery module. The battery module contains the battery cells, control board, battery disconnect module, internal low and high voltage wire harnesses, cooling hardware, and internal and external mounting brackets and covers.



Figure 2-38: Saturn Vue Green Line 36V Battery Pack Installed in Vehicle (LHS) and Removed from Vehicle (RHS)

The battery type and construction is a prismatic nickle metal hydride comprising of six (6) modules. The nominal system voltage provided by the battery is 36V; nominal pack capacity is 18.4 Ah. More detail on the pack construction is dicussed below.



Figure 2-39: Battery Tray/Housing

The battery is enclosed in a stamped steel housing. The bottom housing in **Figure 2-39** consists of the primary tray and six (6) brackets spot welded in place; one bracket a multi-piece hinged design. The top cover is a single-piece stamping with weld nuts attached by twelve (12) threaded fasteners to the tray.



Figure 2-40: Fan Housing

A cooling fan, as seen in **Figure 2-40**, is assembled to the side of the battery pack. It is covered by a stamped steel part with vent slots for air flow. The steel part provides protection of the motor as it is mounted on the outside of the battery pack. The fan assembly is mounted to the cover, then to the battery pack. The fan and fan housing are assumed to be injection-molded PBT components. The housing is assumed to be stamped 1008 steel folded and spot welded to form the box, then painted.



Figure 2-41: Fan Assembly

The cooling fan in **Figure 2-41** is pre-assembled to the circuit board before installation into the plastic housing. A stamped steel can is used to hold the magnet. The winding assembly consists of twenty (20) EM steel plates over-molded and then wound. The components of the circuit board were all identified and costed individually. The board top side mounted components included: FR4 bare board; 4-pin connector; SP8M8TBCT-ND MOSFETs - surface mount 2ea; PIC16F684 IC 1ea; F2933CT-ND fuse - surface mount 1ea; B340A-FDITR-ND diode - Schottky - surface mount 3ea; BC848C-TPMSCT-ND transistor - surface mount 1ea; DL5244B-TPMSCT-ND Zener diode - surface mount 1ea; SS3P3-E3/84AGICT-ND diode - Schottky - surface mount 1ea; P930-ND capacitor - surface mount 1ea; capacitors 5ea; and resistors 7ea.

The board bottom side mounted components included: SP8M8TBCT-ND MOSFETs - surface mount 2ea; PIC16F684 IC 1ea; F2933CT-ND fuse - surface mount 1ea; B340A-FDITR-ND diode - Schottky - surface mount 3ea; BC848C-TPMSCT-ND transistor - surface mount 1ea; DL5244B-TPMSCT-ND Zener diode - surface mount 1ea; SS3P3-E3/84AGICT-ND diode - Schottky - surface mount 1ea; P930-ND capacitor - surface mount 1ea; capacitors 5ea; and resistors 7ea.

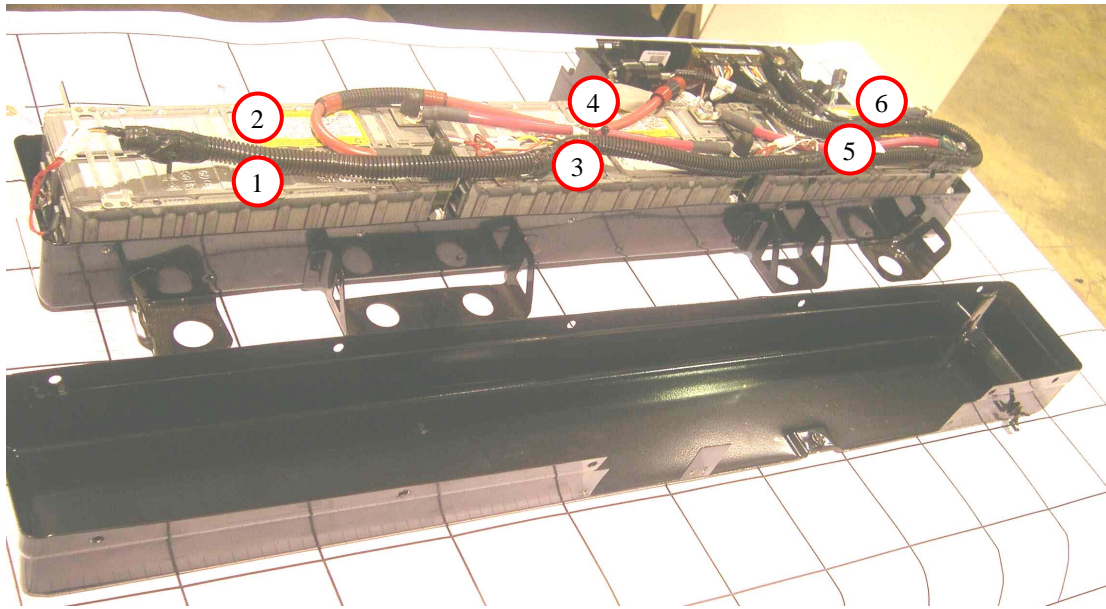

Figure 2-42: Battery Pack with Cover Removed

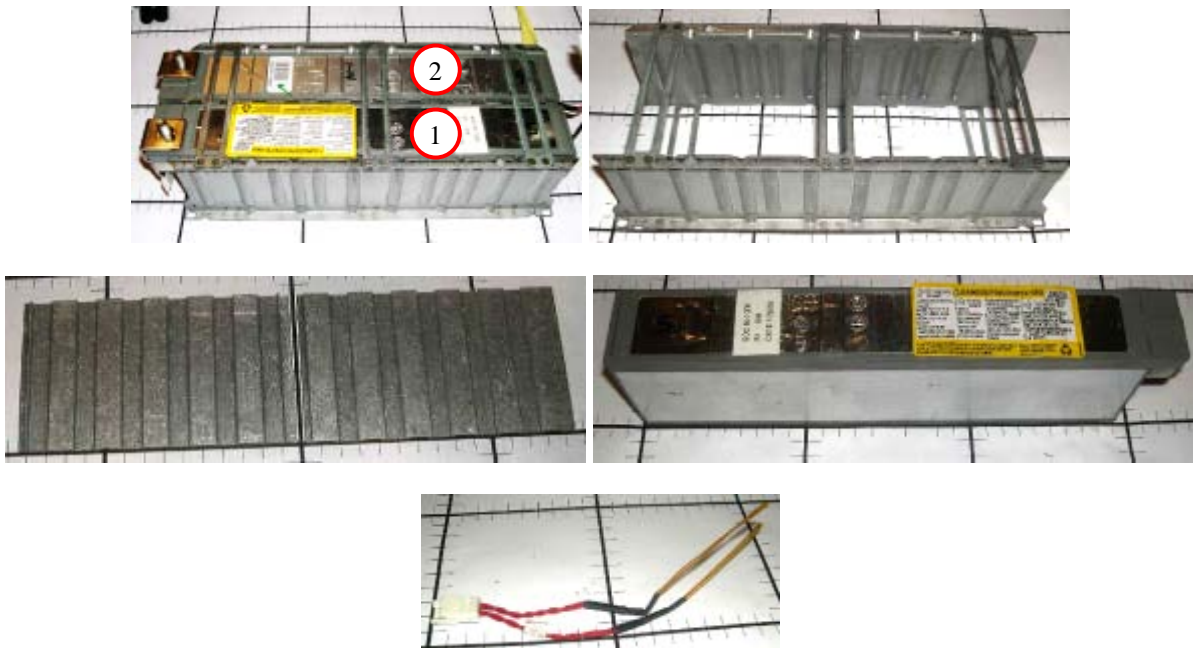

Figure 2-43: Battery Modules and Sub-Modules

As seen in **Figure 2-42**, a total of six (6) battery modules are used in the battery pack. The modules are grouped together in pairs (**Figure 2-43**), producing three (3) sets total. The modules in each pair are connected in parallel, the three (3) pairs are connected in series, producing a 36V nominal battery pack. Each battery module is made up of ten (10) cells (1.2V/cell), for a total battery pack quantity of sixty (60) cells.

Each pair is contained in a stamped welded galvanized steel frame separated by a pair of 2000 series aluminum extrusions. As each pair is assembled, a temperature sensor is inserted into the end of each battery.

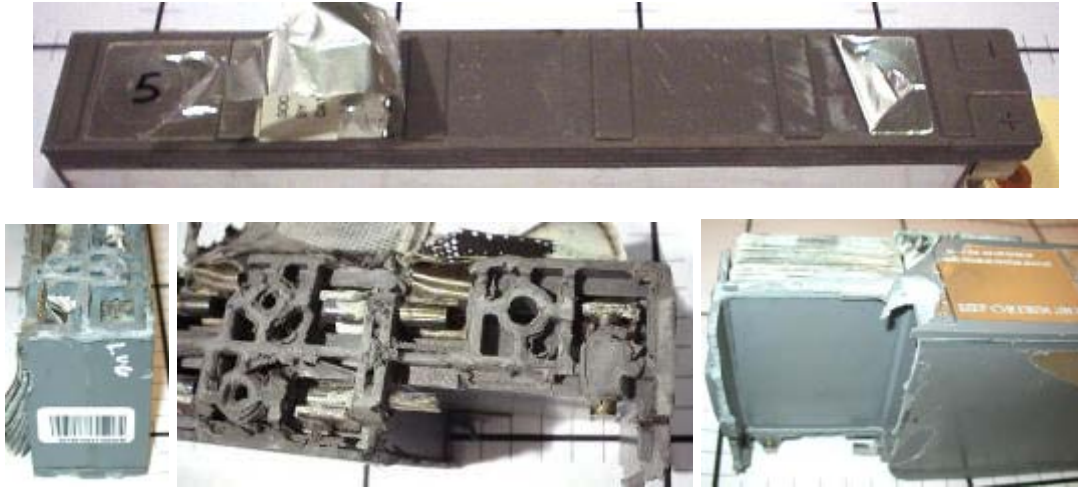

Figure 2-44: Battery Case

The battery module case (**Figure 2-44**) consists of five (5) injection-molded nylon 6 15% glass-filled parts. Once all the electrodes for each cell are in place and the tabs are welded together, each cell is filled with an electrolyte. The entire assembly is then sealed cover to the base by vibration welding. The battery module then goes through a charging and discharging cycle referred to as formation. It is allowed to age before final testing and capacitance grading of battery modules. This allows for sorting of the modules into equally balanced battery packs.



Figure 2-45: Positive Anode, Negative Anode and Separator paper

Figure 2-45 illustrates that both positive and negative electrode plates were analyzed in detail to establish their respective costs. The positive cathode uses a Ni foam substrate. The positive substrate is coated with a slurry mix consisting of Ni(OH)_2 , nickel hydroxide

powder, cobalt powder, cobalt sub-oxide and polyacrylamide crystals (binder). The negative anode uses a nickle plated steel substrate. The negative substrate is coated with a slurry mix consisting of La rich, AB5 metal alloy powder, carbon black 99.95% pure, PTFE injection grade (binder), and carboxyl methyl cellulose (thickener). The cell separator is constructed of a non-woven microporus polyolefin film.



Figure 2-46: Battery Pack Harness

The battery pack harness (**Figure 2-46**) consists of a control module and two (2) separate harnesses. One harness has eight (8) circuits (interface to body) and the other ten (10) (battery monitoring circuits).

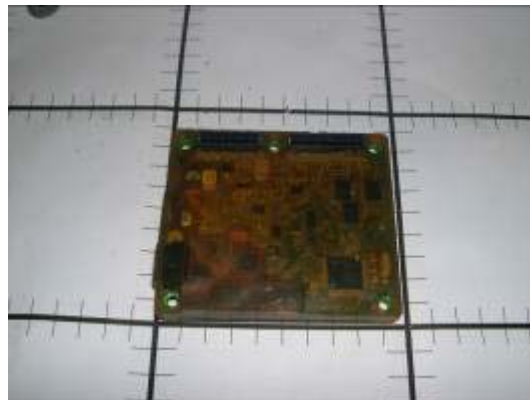

Figure 2-47: Encapsulated Battery Pack Control Module

The control module, removed from the wire harness assembly, is shown in **Figure 2-47**. The circuit board consists of the following bottom-side components: FR4 board 1ea; MC9S12DG128MPV-ND IC - surface mount 1ea; 255-2130-2-ND PhotoMOS - surface mount 3ea; 495-1868-2-ND IC - surface mount 1ea; TLE42754D-ND IC - surface mount 1ea; 497-1548-1-ND, IC - surface mount 1ea; IPS041L-ND MOSFET - surface mount 1ea; 160-1305-5-ND optoisolators - surface mount 1ea; 516-1731-1-ND optoisolators - surface mount 1ea; PCE3155TR-ND-1 aluminum capacitor - surface mount 3ea; 296-17563-2-ND IC - surface mount 1ea; 497-1170-2-ND IC - surface mount 1ea; 631-1011-6-ND CRYSTAL - surface mount 1ea; OPA343UA/2K5-ND IC - surface mount 2ea; MM74HC14SJX-ND IC - hex inverting trigger 2ea; capacitors 21ea; resistors 26ea; and 811-1556-5-ND DC DC converter - thru hole 1ea.

The top side of the board contains the following components: 296-17563-2-ND IC - surface mount 4ea; 516-1731-1-ND optoisolator - surface mount 4ea; 255-2130-2-ND PhotoMOS - surface mount 3ea; IPS041L-ND MOSFET - surface mount 1ea; MM74HC14SJX-ND IC - hex inverting trigger 1ea; capacitors 47ea; resistors 43ea; and WM3809-ND power connector - thru hole 1ea.

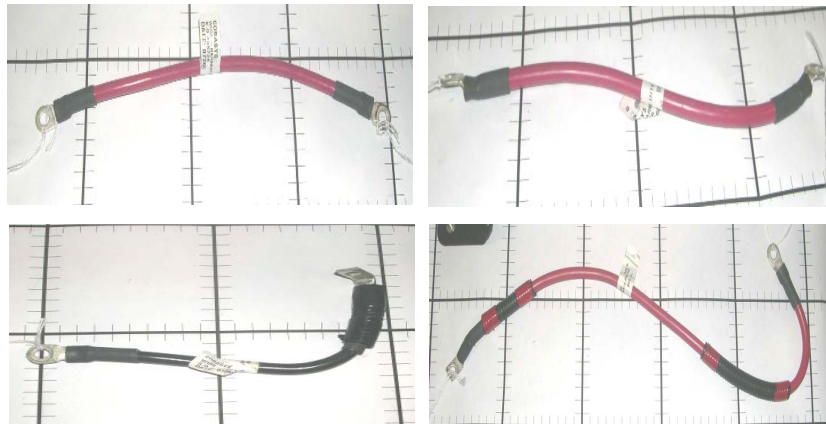

Figure 2-48: Battery Cables

A total of four (4) cables, as seen in **Figure 2-48**, are used to connect the three (3) battery packs in series.



Figure 2-49: (clockwise from top left) Disconnect Box, Disconnect Relay, Switch, Bus bar, Current Sensor, and Fuse

Figure 2-49 highlights a large, injection-molded ABS housing which is used for the battery disconnect box. It is mounted on the side of the battery pack and has a hinged door. When opened, it turns off the power from the battery pack (service disconnect). The box also contains the battery control module that was discussed in the battery pack wiring section. Other components located in the box include a disconnect relay, door open switch, bus bar, current sensor, and a 200-amp fuse.

2.6.3 Electrical Power Supply System Cost Impact

In the Electrical Power Supply system, the Generator/Alternator and Regulator Subsystem and High Voltage Traction Battery Subsystem had a combined net incremental direct manufacturing cost of \$865.60 as shown in **Table 2-6**.

Because the baseline vehicle does not have a 36V battery, the incremental direct manufacturing cost associated with the added battery equals \$813.66. Figure 2-50 provides additional details on the cost breakdown of the sub-subsystems with the battery.

Replacing the conventional alternator system hardware with the BAS system starter motor/generator results in an incremental direct manufacturing cost increase of \$51.94.

Table 2-6: Net Incremental Direct Manufacturing Cost of a Saturn Vue HEV Power Supply System in Comparison to a Saturn Vue Conventional Power Supply System

SYSTEM & SUBSYSTEM DESCRIPTION				NEW TECHNOLOGY GENERAL PART INFORMATION: 2007 Saturn Vue, 2.4L, I4, 170 hp, Mild HEV (Electric Motor 14.5kW, Battery 36V, Nominal Pack Capacity 18.4Ah)										
Item	Subsystem	Subsystem Description	Manufacturing			Total Manufacturing Cost (Component/ Assembly)	Markup			Total Markup Cost (Component/ Assembly)	Total Packaging Cost (Component/ Assembly)	Net Component/ Assembly Cost Impact to OEM		
			Material	Labor	Burden		End Item Scrap	SG&A	Profit				ED&T-R&D	
14 Electrical Power Supply System														
1	01	Service Battery Subsystem	\$ -	\$ -	\$ -	\$ -	\$ -	\$ -	\$ -	\$ -	\$ -	\$ -	\$ -	
2	02	Generator/Alternator and Regulator Subsystem	\$ 59.83	\$ 27.12	\$ 63.12	\$ 150.07	\$ 0.73	\$ 9.54	\$ 8.79	\$ 3.66	\$ 22.72	\$ 0.09	\$ 172.89	
3	03	High Voltage Traction Battery Subsystem	\$ 443.84	\$ 49.07	\$ 181.72	\$ 674.62	\$ 4.85	\$ 49.11	\$ 55.56	\$ 27.19	\$ 136.71	\$ 2.33	\$ 813.66	
4	05	Voltage Converter / Inverter Subsystem	\$ -	\$ -	\$ -	\$ -	\$ -	\$ -	\$ -	\$ -	\$ -	\$ -	\$ -	
5	08	Energy Management Module Subsystem	\$ -	\$ -	\$ -	\$ -	\$ -	\$ -	\$ -	\$ -	\$ -	\$ -	\$ -	
▲ SYSTEM ROLL-UP			\$ 503.67	\$ 76.19	\$ 244.84	\$ 824.70	\$ 5.58	\$ 58.65	\$ 64.35	\$ 30.85	\$ 159.43	\$ 2.42	\$ 986.55	

SYSTEM & SUBSYSTEM DESCRIPTION				BASE TECHNOLOGY GENERAL PART INFORMATION: 2007 Saturn Vue, 2.4L I4, 170hp, 162 ft-lb										
Item	Subsystem	Subsystem Description	Manufacturing			Total Manufacturing Cost (Component/ Assembly)	Markup			Total Markup Cost (Component/ Assembly)	Total Packaging Cost (Component/ Assembly)	Net Component/ Assembly Cost Impact to OEM		
			Material	Labor	Burden		End Item Scrap	SG&A	Profit				ED&T-R&D	
14 Electrical Power Supply System														
1	01	Service Battery Subsystem	\$ -	\$ -	\$ -	\$ -	\$ -	\$ -	\$ -	\$ -	\$ -	\$ -	\$ -	
2	02	Generator/Alternator and Regulator Subsystem	\$ 42.06	\$ 17.88	\$ 45.21	\$ 105.15	\$ 0.47	\$ 6.60	\$ 6.13	\$ 2.51	\$ 15.71	\$ 0.09	\$ 120.95	
3	03	High Voltage Traction Battery Subsystem	\$ -	\$ -	\$ -	\$ -	\$ -	\$ -	\$ -	\$ -	\$ -	\$ -	\$ -	
4	05	Voltage Converter / Inverter Subsystem	\$ -	\$ -	\$ -	\$ -	\$ -	\$ -	\$ -	\$ -	\$ -	\$ -	\$ -	
5	08	Energy Management Module Subsystem	\$ -	\$ -	\$ -	\$ -	\$ -	\$ -	\$ -	\$ -	\$ -	\$ -	\$ -	
▲ SYSTEM ROLL-UP			\$ 42.06	\$ 17.88	\$ 45.21	\$ 105.15	\$ 0.47	\$ 6.60	\$ 6.13	\$ 2.51	\$ 15.71	\$ 0.09	\$ 120.95	

SYSTEM & SUBSYSTEM DESCRIPTION				INCREMENTAL COST TO UPGRADE TO NEW TECHNOLOGY PACKAGE										
Item	Subsystem	Subsystem Description	Manufacturing			Total Manufacturing Cost (Component/ Assembly)	Markup			Total Markup Cost (Component/ Assembly)	Total Packaging Cost (Component/ Assembly)	Net Component/ Assembly Cost Impact to OEM		
			Material	Labor	Burden		End Item Scrap	SG&A	Profit				ED&T-R&D	
14 Electrical Power Supply System														
1	01	Service Battery Subsystem	\$ -	\$ -	\$ -	\$ -	\$ -	\$ -	\$ -	\$ -	\$ -	\$ -	\$ -	
2	02	Generator/Alternator and Regulator Subsystem	\$ 17.77	\$ 9.24	\$ 17.91	\$ 44.92	\$ 0.26	\$ 2.94	\$ 2.67	\$ 1.15	\$ 7.01	\$ 0.00	\$ 51.94	
3	03	High Voltage Traction Battery Subsystem	\$ 443.84	\$ 49.07	\$ 181.72	\$ 674.62	\$ 4.85	\$ 49.11	\$ 55.56	\$ 27.19	\$ 136.71	\$ 2.33	\$ 813.66	
4	05	Voltage Converter / Inverter Subsystem	\$ -	\$ -	\$ -	\$ -	\$ -	\$ -	\$ -	\$ -	\$ -	\$ -	\$ -	
5	08	Energy Management Module Subsystem	\$ -	\$ -	\$ -	\$ -	\$ -	\$ -	\$ -	\$ -	\$ -	\$ -	\$ -	
▲ SYSTEM ROLL-UP			\$ 461.61	\$ 58.32	\$ 199.62	\$ 719.55	\$ 5.11	\$ 52.05	\$ 58.22	\$ 28.33	\$ 143.72	\$ 2.33	\$ 865.60	

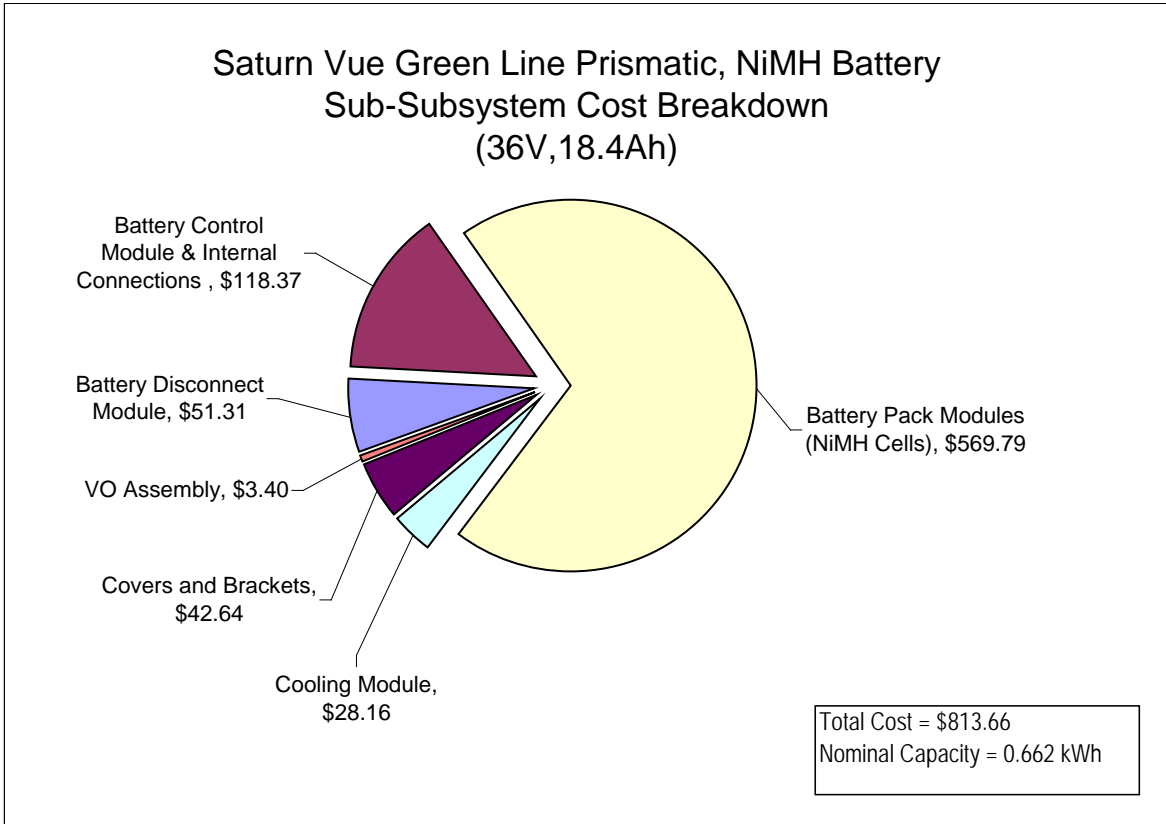

Figure 2-50: Saturn Vue Green Line Battery Cost Breakdown by Subsystem

2.7 Electrical Distribution and Electronic Control System

The majority of the controls for components added to the BAS system reside in the Starter Generator Control Module (SGCM). As introduced in Section 2.1.1, the SGCM interfaces and controls components such as the 36V NiMH battery, starter motor/generator, auxiliary transmission pump, brake hill-hold solenoid, and auxiliary coolant pumps. In Section 2.7.3 more details on the function and components within the SGCM will be discussed. Note that within the analysis, the terms Power Electronic Center and (PEC) Power Electronics Box (PEB) are alternative naming conventions used to describe the starter generator control module (SGCM).

Supporting the electrical connections between the components and controls are several new and updated wiring connections: On the high-voltage side a cable was added to connect the 36V battery to the SGCM (in the context of this report $\geq 36V$ will be considered high voltage). High-voltage cabling was also required in the connection between the starter motor/generator and the SGMC. More details on the high-voltage cabling are discussed in Section 2.7.2. In addition to high-voltage wiring additions, several low-voltage wiring additions/updates were required as well including engine, transmission, and body harness updates. These updates are discussed in section 2.7.1.

2.7.1 Electrical Wiring and Circuit Protection Subsystem Hardware Overview

The integration of the BAS system into the conventional Saturn Vue vehicle resulted in the addition of several new components requiring additional wiring and updates to existing wiring harnesses. The majority of the updates are listed in **Table 2-7**. In addition to the wiring, updates to the auxiliary fuse box are also accounted for in the cost analysis.

Table 2-7: Low-Voltage Wiring Additions/Updates

01 Engine and Transmission Wiring	
A	Wire Harness - Aux. Heater Coolant Pump (2 Pin.)
B	Wire Harness - Aux. SGCM/PEB Aux. Coolant Pump (2 Pin)
C	Wire Harness - Aux. Tran Pump (2 Pin)
D	Wire Harness - Fuse Block Aux, Hybrid Pump Drive, SGCM/PEB (5 :
E	Wire Harness Assembly - SGM Resolver (7 Pin)
F	Wire Harness Assembly - (x2 Temp & x2 Rotor)
G	Wire Harness Assembly, Brake Hill Hold Solenoids (4 Pins)
H	Wire Harness Assembly, Brake Hill Hold Pressure Sensor (3 Pin)
J	High Speed GMLAN Serial Data Bus (4 Pin)
K	Wire Harness Assembly, Brake Booter Vacuum Sensor

2.7.2 Traction and High Voltage Power Distribution Subsystem Hardware Overview

As discussed, additional high-voltage cabling is required to support the addition of the BAS technology components. Because the battery pack is located in the rear of the vehicle, a high-voltage, DC shielded cable (**Figure 2-51**) is required to connect the battery to the starter generator control module (SGCM) in the engine compartment. The cable is just over ten (10) feet in length.

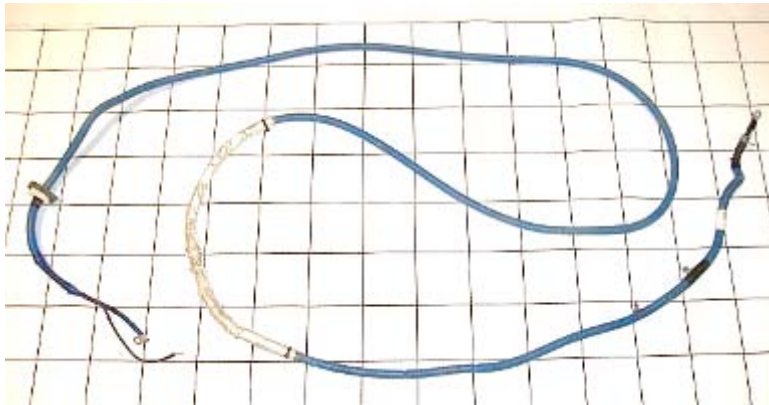

Figure 2-51: High-Voltage Cable

The cable was broken down into the following areas: 124" shielded cable, 11" ground lead, three (3) cable lugs, ground ferrule, cable gland w/bracket, two (2) wrap ties, label, edge biter clip, two (2) rosebud clips, 25" heat shield sheathing, 0.75" heat shrink tubing, cable end sleeve, 109.5" blue convolute (split), 1.25" adhesive heat shrink, 52" blue tape, 95" black tape, bulkhead grommet SBR, bulkhead grommet support two (2) nylon parts.



Figure 2-52: Cable Protective Covers

Two (2) stamped steel painted covers, as seen in **Figure 2-52**, are used to protect the high-voltage cable routed under the vehicle floor pan. The long cover is a multi-piece stamping with two (2) long cover sections spot welded together and three (3) attachment brackets spot welded in place. Note: the cable is attached to the cover with press-in plastic clips prior to installation to the vehicle. A second smaller cover is used in the engine compartment for routing and protection. This cover is also a stamped steel painted design.

Figure 2-53 below shows the high-voltage cable connection between the starter motor/generator and SGCM /PEB at each of the component interfaces. The three (3) cables range in length between 27 and 33 inches. Cable construction includes a shielded cable, cable lugs, cable sleeves, heat shrink isolators, protective convolute, and cable gland and end bracket.

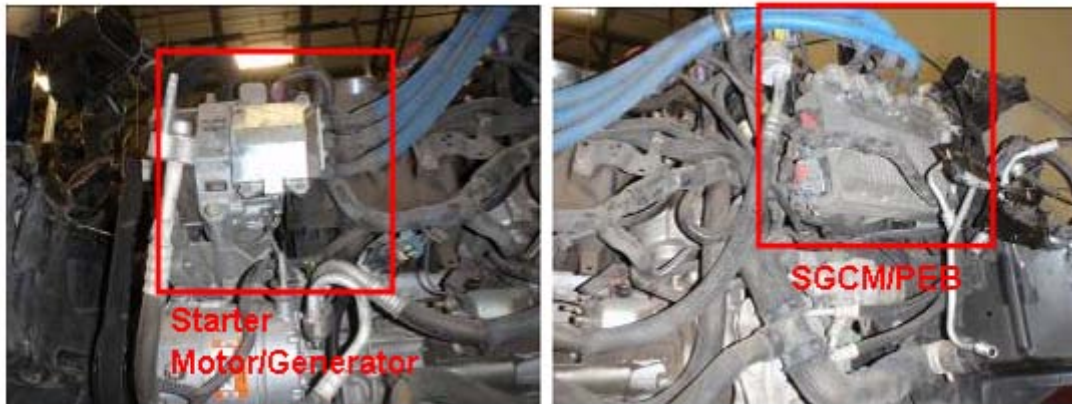

Figure 2-53: High-Voltage Cabling between Starter Motor/Generator and SGCM/PEB

2.7.3 Power Electronics Center (PEC) Subsystem Hardware Overview

The addition of the starter motor/generator requires a starter generator control module (SGMC)/power electronics box (PEB), as shown in **Figure 2-54**. The SGMC provides all of the electrical interfaces between AC/DC high-voltage and DC low-voltage (12-volt) systems. The module is located above the transmission and has a self-contained liquid cooling system driven by a separate electric coolant pump. Two multi-pin connectors provide an interface to the engine compartment harnesses for control interfaces. Separate pass-through holes are used for the high-voltage and 12-volt battery cables.



Figure 2-54: Starter Generator Control Module (SGCM)



Figure 2-55: SGCM Cable Interfaces

As seen in **Figure 2-55**, two (2) cable termination cavities/pockets are located on top of the SGCM housing, sealed with a stamped galvanized steel cover. Both use a separate die-cast and machined aluminum housing, which is attached to the SGCM main housing with threaded fasteners. The left side is for the three cables to the starter/generator (upper-left picture, left cavity with black, white and red terminal ends). The other is for the battery pack cable (blue sheathing) and the 12-volt supply to the lead acid battery (black convolute).



Figure 2-56: SGCM Installation

The main control module (**Figure 2-56**) for the start-stop technology consists of a large subassembly, which includes a number of features and functions. A smaller control module referred to as the 8-pin module (**Figure 2-57**) is attached to the outside of the main housing, directly on top of the cold plate. Inside the main housing are a large circuit board, capacitor bank, IGBT plates, inductor coils, and numerous bus bars for component connections. The module was attached to a large, stamped 1018 steel painted bracket, which was secured to the top of the transmission. A short ground strap was connected between the case and the transmission. The bracket was cost estimated using the detailed estimating method, while the fasteners and ground strap were considered commodity items.

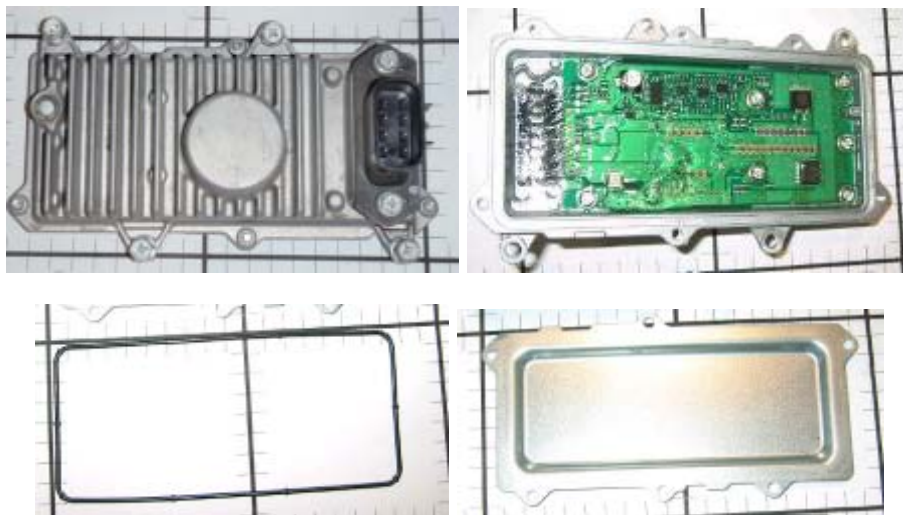

Figure 2-57: 8-Pin Module

The 8-pin module consisted of an aluminum die-cast machined housing with a sealed cover. Inside the module are one circuit board, an 8-pin sealed connector, and a coil. The entire module was filled with potting compound, covered, and sealed. The module

housing is a die-cast aluminum A380 design using a pre-formed elastomeric seal and a stamped galvanized steel cover retained by six (6) threaded fasteners.



Figure 2-58 : 8-Pin Module Electrical Components

The 8-pin module used a separate header for connection to the vehicle harness, which is secured to the housing with a pair of threaded fasteners and sealed with a pre-formed gasket (**Figure 2-58**). A wire stitch bonding process was used to connect the header to the circuit board after both were installed in the housing. A coil sits in a pocket of the housing and was assumed to be installed to the board prior to installation to the housing. The circuit board was analyzed completely to identify discrete components. Circuit board components consisted of the following: FR4 1ea; inductor coil 1ea; resistors - caps 87ea; transistors 3ea; capacitor - odd form 1ea; capacitor 5PW 33 50V 1ea; IC1 335H 1ea; IC2 5611T65K 1ea; IC3 1431Q1 1ea; IC4 277 21 543 1ea; IC5 842 21 528 1ea; IC6 NEC K3811 5XM 1ea; and IC7 0150 30SC4M 1ea. All discrete electrical component costs were commodity-based. Board processing and assembly were estimated using detailed calculation method.



Figure 2-59: SGCM Cooling

A cold plate cooling design (**Figure 2-59**) was used on the SGCM module with its own electric coolant circulation pump. The purpose of the cold plate is to pull heat from the high-power IGBTs residing on the inside housing. The cover is a die-cast machined aluminum A380 design with two (2) formed coated steel coolant fittings swaged in place. A pre-formed elastomeric seal is pressed into the main housing, providing a sealing surface for the cover. The cover is retained with ten (10) threaded fasteners. The cover also contained machined features for mounting the 8-pin module.



Figure 2-60: Base SGCM Module Wrap

The power distribution housing section of the SGCM (**Figure 2-60**) is a plastic molded design. A stamped, galvanized steel surround wrapped the entire plastic molded part. The wrap assumed to provide EMI shielding. The open side of the distribution housing is closed out with a die-cast aluminum machined cover.



Figure 2-61: Base SGCM

The SGCM, as shown in **Figure 2-61**, consists of two primary assemblies: an aluminum base and a plastic molded housing. The aluminum base contained the capacitor and coil banks along with a cold plate for IGBT mounting. The plastic housing provided power distribution and bus bar isolation, as well as mounting features for the main circuit board and interface connections for IGBT to circuit board.

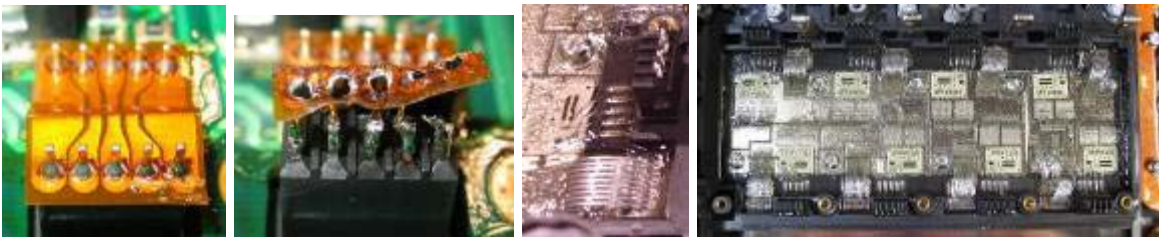

Figure 2-62: SGCM Stacked Assembly

As seen in **Figure 2-62**, the stacked assembly of the housing-mounted IGBTs, power distribution, and circuit board connections were accomplished with wire-stitch bonding and flexible ribbon. The connections of the IGBTs are all done by wire-stitch bonding to the terminals and bus bars which are contained in the injection molded housing. A total of five hundred twenty-five (525) wire connections are made during the operation. The IGBT low-current circuits are then connected by terminal strips in the housing to the circuit board. After the circuit board is installed, the terminal strips are connected to the board by eight (8) flex ribbons soldered in place.



Figure 2-63: SGCM Main Circuit Board

The SGCM main circuit board (**Figure 2-63**) is heavily populated on both sides and contains a mixture of standard components, odd form (unique), as well as a combination of through-hole and surface-mounted parts. Each step of the process was analyzed based on each part's attributes to establish total manufacturing costs. The individual components on the board were each identified and estimated based on commodity pricing of exact or similar-type parts in function. The board contained the following components: main circuit board FR4 1ea; 93C66B-I/ST-ND IC - memory - surface mount 1ea; LT1461DHS8-3#PBF-ND IC - surface mount 1ea; IR2101STR-ND MOSFET - surface mount 1ea; 641-1099-6-ND Schottky diode - surface mount 1ea; resistors 220ea; capacitors 114ea; HC6F800-S LEM current sensor 4ea; NTD20P06LT4GOSCT-ND MOSFET - surface mount 2ea; R5F61668RN50FPV-ND IC - surface mount 1ea; AD2S1200WSTZ-ND IC - analog to digital converter - surface mount 1ea, 445-2221-2-ND IC - choke - surface mount 2ea; APIC-S03 IC 1ea; 24LC16BH-I/SN-ND IC - memory - surface mount 1ea; IR21094SPBF-ND IC - surface mount 1ea; 296-11431-5-ND IC - voltage regulator - surface mount 1ea; 296-7354-2-ND IC - amplifier - surface mount 3ea; DSS6-0025BS-ND Schottky diode - surface mount 2ea; NTD70N03RT4GOSCT-ND MOSFET - surface mount 1ea; CMS04QMTR-ND Schottky diode - surface mount 4ea; FFD06UP20SCT-ND diode - surface mount 3ea; 296-14516-6-ND IC - surface mount 1ea; BAT 63-02V E6327-ND Schottky diode - surface mount 4ea; PC844 IC - surface mount 1ea; 641-1099-6-ND-1 Schottky diode - surface mount 3ea; 497-2529-2-ND Schottky diode - surface mount 22ea; capacitors 88ea; resistors 106ea; 513-1489-1-ND inductor 2ea; SRR1208-471KLTR-ND inductor 2ea; 493-2289-1-ND aluminum capacitor 4ea; AFK686M2AH32T-F-ND aluminum capacitor 4ea; AFK477M35H32T-F-ND aluminum capacitor 2ea; PCE4439TR-ND aluminum capacitor 1ea; PCE4442TR-ND aluminum capacitor 1ea; AFK336M50X16T-F-ND aluminum capacitor 1ea; LM1085ISX-3.3-ND LM1085 - voltage regulator 1ea; 631-1011-6-ND-1 IC - CRYSTAL 1ea; SMBJ5345B-TPMSTR-ND Zener diode 1ea; M8723-ND inductor 1ea; power transformer 1ea; flexible connector 8ea; and 12092320 connector 2ea.



Figure 2-64: SGCM Power Distribution

SGCM power distribution (**Figure 2-64**) is accomplished through a mix of individual buss bars and over-molded buss bars. Most of the connections were accomplished with threaded fasteners, with the exception of the IGBT wire-stitch bonding. Four (4) stamped copper buss bars connected over-molded cable attachment studs to internal posts. Five (5) additional stamped copper bus bars were used for circuit connections of the inductor coils and a capacitor. The three (3) round capacitor banks, with a fourth capacitor in-line, were all connected by the over-molded buss bars in the plastic housing. The injection-molded PPS housing contained the following components (all insert molded): 5-pin terminal set SGCM mid-base module housing 8ea; terminal plate capacitor anode 1ea; terminal SGCM main to heat sink plate 4ea; terminal block SGCM - mtr/alt pass-through 3ea; terminal block SGCM coil cavity 2ea; terminal plate capacitor cathode 1ea; and terminal block SGCM - fuse connect - coil cavity 1ea.



Figure 2-65: SGCM Aluminum Housing

The die-cast machined aluminum A380 housing base shown in **Figure 2-65** contained numerous cavities for various component mountings. Components located in the base pockets included the following: TDK inductor coil HSL-50PQ001 1ea; TDK inductor coil HSL-40PQ002 1ea; cap 80V 3000uf 3ea; cap 63V 3600uf 1ea; cap 75 VDC 50uf 1ea; and cap Nippon 2A106 6P07. All four larger capacitors had silicon pads underneath. An injection-molded PPS cover was used over the three round caps inline to help keep them oriented for assembly. A thermally conductive paste was applied to the cold plate surface prior to attaching the IGBTs with threaded fasteners. It was assumed the paste applied to the coils was also a thermal conductive type.



Figure 2-66: SGCM Cooling

The cold plate in the SGCM receives coolant from an electric coolant circulation pump. The cooling circuit is tied into the base vehicle's plumbing. Connection of the components requires two (2) T-joints, three (3) hoses, and associated hardware as seen in **Figure 2-66**.

2.7.4 Electrical Distribution and Electronic Control (EDEC) System Cost Impact

The system hardware overview discussion above highlights the subsystems which saw the greatest magnitude of change for adding the BAS technology to the conventional Saturn Vue vehicle. In **Table 2-8** below, the direct manufacturing cost impact for each EDEC subsystem is listed along with the net incremental direct manufacturing cost for the entire system. The EDEC system incremental direct manufacturing impact of \$556.16 represents approximately 34% of the net vehicle direct manufacturing cost impact.

The Traction and High Voltage Power Distribution subsystem account for approximately 17% of the EDEC system costs. Additional cost details for this subsystem can be found in **Table 2-9**.

The Power Electronic Center subsystem accounts for approximately 79% of the EDEC costs. Additional cost details for this subsystem can be found in **Table 2-10**. The remaining 4% cost impact is made-up from components within the electrical wiring and circuit protection subsystem.

Table 2-8: Net Incremental Direct Manufacturing Cost of a Saturn Vue HEV EDEC System in Comparison to a Saturn Vue Conventional EDEC System

SYSTEM & SUBSYSTEM DESCRIPTION			NEW TECHNOLOGY GENERAL PART INFORMATION: 2007 Saturn Vue, 2.4L, I4, 170 hp, Mild HEV (Electric Motor 14.5kW, Battery 36V, Nominal Pack Capacity 18.4Ah)										
Item	Subsystem	Subsystem Description	Manufacturing			Total Manufacturing Cost (Component/Assembly)	Markup				Total Markup Cost (Component/Assembly)	Total Packaging Cost (Component/Assembly)	Net Component/Assembly Cost Impact to OEM
			Material	Labor	Burden		End Item Scrap	SG&A	Profit	ED&T-R&D			
18 Electrical Distribution and Electronic Control System													
1	01	Electrical Wiring and Circuit Protection Subsystem	\$ 12.42	\$ 8.28	\$ 3.87	\$ 24.57	\$ 0.11	\$ 1.55	\$ 1.38	\$ 0.55	\$ 3.59	\$ 0.23	\$ 28.39
2	03	Electrical Distribution Switches Subsystem	\$ -	\$ -	\$ -	\$ -	\$ -	\$ -	\$ -	\$ -	\$ -	\$ -	\$ -
3	04	Miscellaneous Electrical Devices Subsystem	\$ -	\$ -	\$ -	\$ -	\$ -	\$ -	\$ -	\$ -	\$ -	\$ -	\$ -
4	06	Traction And High Voltage Power Distribution Subsystem	\$ 58.27	\$ 13.80	\$ 9.50	\$ 81.57	\$ 0.38	\$ 5.27	\$ 4.63	\$ 1.70	\$ 11.98	\$ 0.57	\$ 94.11
5	07	Power Electronics Center (PEC) Subsystem	\$ 245.20	\$ 39.18	\$ 83.29	\$ 367.68	\$ 2.54	\$ 25.50	\$ 29.08	\$ 14.47	\$ 71.60	\$ 0.12	\$ 439.40
6	08	EV, Hybrid, Fuel Cell Subsystem	\$ -	\$ -	\$ -	\$ -	\$ -	\$ -	\$ -	\$ -	\$ -	\$ -	\$ -
▲ SYSTEM ROLL-UP			\$ 315.89	\$ 61.27	\$ 96.67	\$ 473.82	\$ 3.04	\$ 32.32	\$ 35.09	\$ 16.72	\$ 87.17	\$ 0.92	\$ 561.91

SYSTEM & SUBSYSTEM DESCRIPTION			BASE TECHNOLOGY GENERAL PART INFORMATION: 2007 Saturn Vue, 2.4L I4, 170hp, 162 ft-lb										
Item	Subsystem	Subsystem Description	Manufacturing			Total Manufacturing Cost (Component/Assembly)	Markup				Total Markup Cost (Component/Assembly)	Total Packaging Cost (Component/Assembly)	Net Component/Assembly Cost Impact to OEM
			Material	Labor	Burden		End Item Scrap	SG&A	Profit	ED&T-R&D			
18 Electrical Distribution and Electronic Control System													
1	01	Electrical Wiring and Circuit Protection Subsystem	\$ 2.77	\$ 1.75	\$ 0.63	\$ 5.15	\$ 0.02	\$ 0.28	\$ 0.21	\$ 0.07	\$ 0.58	\$ 0.03	\$ 5.76
2	03	Electrical Distribution Switches Subsystem	\$ -	\$ -	\$ -	\$ -	\$ -	\$ -	\$ -	\$ -	\$ -	\$ -	\$ -
3	04	Miscellaneous Electrical Devices Subsystem	\$ -	\$ -	\$ -	\$ -	\$ -	\$ -	\$ -	\$ -	\$ -	\$ -	\$ -
4	06	Traction And High Voltage Power Distribution Subsystem	\$ -	\$ -	\$ -	\$ -	\$ -	\$ -	\$ -	\$ -	\$ -	\$ -	\$ -
5	07	Power Electronics Center (PEC) Subsystem	\$ -	\$ -	\$ -	\$ -	\$ -	\$ -	\$ -	\$ -	\$ -	\$ -	\$ -
6	08	EV, Hybrid, Fuel Cell Subsystem	\$ -	\$ -	\$ -	\$ -	\$ -	\$ -	\$ -	\$ -	\$ -	\$ -	\$ -
▲ SYSTEM ROLL-UP			\$ 2.77	\$ 1.75	\$ 0.63	\$ 5.15	\$ 0.02	\$ 0.28	\$ 0.21	\$ 0.07	\$ 0.58	\$ 0.03	\$ 5.76

SYSTEM & SUBSYSTEM DESCRIPTION			INCREMENTAL COST TO UPGRADE TO NEW TECHNOLOGY PACKAGE										
Item	Subsystem	Subsystem Description	Manufacturing			Total Manufacturing Cost (Component/Assembly)	Markup				Total Markup Cost (Component/Assembly)	Total Packaging Cost (Component/Assembly)	Net Component/Assembly Cost Impact to OEM
			Material	Labor	Burden		End Item Scrap	SG&A	Profit	ED&T-R&D			
18 Electrical Distribution and Electronic Control System													
1	01	Electrical Wiring and Circuit Protection Subsystem	\$ 9.65	\$ 6.53	\$ 3.24	\$ 19.42	\$ 0.10	\$ 1.27	\$ 1.17	\$ 0.49	\$ 3.01	\$ 0.20	\$ 22.63
2	03	Electrical Distribution Switches Subsystem	\$ -	\$ -	\$ -	\$ -	\$ -	\$ -	\$ -	\$ -	\$ -	\$ -	\$ -
3	04	Miscellaneous Electrical Devices Subsystem	\$ -	\$ -	\$ -	\$ -	\$ -	\$ -	\$ -	\$ -	\$ -	\$ -	\$ -
4	06	Traction And High Voltage Power Distribution Subsystem	\$ 58.27	\$ 13.80	\$ 9.50	\$ 81.57	\$ 0.38	\$ 5.27	\$ 4.63	\$ 1.70	\$ 11.98	\$ 0.57	\$ 94.11
5	07	Power Electronics Center (PEC) Subsystem	\$ 245.20	\$ 39.18	\$ 83.29	\$ 367.68	\$ 2.54	\$ 25.50	\$ 29.08	\$ 14.47	\$ 71.60	\$ 0.12	\$ 439.40
6	08	EV, Hybrid, Fuel Cell Subsystem	\$ -	\$ -	\$ -	\$ -	\$ -	\$ -	\$ -	\$ -	\$ -	\$ -	\$ -
▲ SYSTEM ROLL-UP			\$ 313.12	\$ 59.52	\$ 96.04	\$ 468.67	\$ 3.02	\$ 32.04	\$ 34.88	\$ 16.66	\$ 86.59	\$ 0.89	\$ 556.15

Table 2-9 : Incremental Direct Manufacturing Cost of Traction and High Voltage Power Distribution Subsystem, Saturn Vue Green Line

NEW TECHNOLOGY GENERAL PART INFORMATION: 2007 Saturn Vue, 2.4L, I4, 170 hp, Mild HEV (Electric Motor 14.5kW, Battery 36V, Nominal Pack Capacity 18.4Ah)					NEW TECHNOLOGY PACKAGE QUOTE PARAMETERS		NEW TECHNOLOGY PACKAGE COST INFORMATION												
Item	Sub-System	Sub-System	Assembly	Component	Name/Description	Part Number	QTY	Notes	Manufacturing			Total Manufacturing Cost (Component Assembly)	Markup			Total Markup Cost (Component Assembly)	Total Packaging Cost	Net Component Assembly Cost Impact to OEM	
									Material	Labor	Burden		End Item Scrap	SG&A	Profit				ED&T-R&D
0	n/a	n/a							\$ -	\$ -	\$ -	\$ -	\$ -	\$ -	\$ -	\$ -	\$ -	\$ -	
1806 Traction And High Voltage Power Distribution Subsystem																			
1	00 Assembly of Traction And High Voltage Power Distribution Subsystem								\$ 0.41	\$ 5.04	\$ 1.38	\$ 6.84	\$ 0.02	\$ 0.23	\$ 0.22	\$ 0.04	\$ 0.50	\$ -	\$ 7.34
	A	Assembly of Traction And High Voltage Power Distribution Subsystem			18 06 00	N0402-01	1		\$ 0.41	\$ 5.04	\$ 1.38	\$ 6.84	\$ 0.02	\$ 0.23	\$ 0.22	\$ 0.04	\$ 0.50	\$ -	\$ 7.34
									\$ -	\$ -	\$ -	\$ -	\$ -	\$ -	\$ -	\$ -	\$ -	\$ -	\$ -
2	01 High Voltage Wiring								\$ 50.05	\$ 5.97	\$ 3.83	\$ 69.85	\$ 0.29	\$ 3.88	\$ 3.54	\$ 1.46	\$ 9.16	\$ 0.20	\$ 69.23
	A	V High Voltage Harness Assembly			18 06 01	N0402-01	1		\$ 30.20	\$ 1.73	\$ 1.20	\$ 33.14	\$ 0.17	\$ 2.15	\$ 1.99	\$ 0.83	\$ 5.14	\$ 0.10	\$ 38.37
	B	V HV Wire, Red (Alternator to PEB)			18 06 01	N0402-02	1	Includes cost for assembling Red, White and Black cables together with V Bracket & Clamp plus packaging cost.	\$ 6.70	\$ 1.35	\$ 0.83	\$ 8.87	\$ 0.04	\$ 0.58	\$ 0.53	\$ 0.22	\$ 1.38	\$ 0.09	\$ 10.34
	C	V HV Wire, White (Alternator to PEB)			18 06 01	N0402-03	1		\$ 6.26	\$ 0.96	\$ 0.75	\$ 7.97	\$ 0.04	\$ 0.52	\$ 0.48	\$ 0.20	\$ 1.24	\$ -	\$ 9.20
	D	V HV Wire, Black (Alternator to PEB)			18 06 01	N0402-04	1		\$ 5.77	\$ 0.96	\$ 0.75	\$ 7.49	\$ 0.04	\$ 0.49	\$ 0.45	\$ 0.19	\$ 1.16	\$ -	\$ 8.65
	E	V Ground Strap, Rear Battery			18 06 01	N0402-05	1		\$ 1.12	\$ 0.96	\$ 0.30	\$ 2.39	\$ 0.01	\$ 0.14	\$ 0.10	\$ 0.02	\$ 0.27	\$ 0.01	\$ 2.67
3	75 Bracket								\$ 7.80	\$ 2.78	\$ 4.30	\$ 14.88	\$ 0.07	\$ 1.16	\$ 0.87	\$ 0.20	\$ 2.30	\$ 0.37	\$ 17.55
	A	V Bracket, For 3 Wire HV Wire Clamp (Secures Alt. Wires)			18 06 75	N0402-01	1		\$ 0.52	\$ 0.11	\$ 0.23	\$ 0.86	\$ 0.00	\$ 0.07	\$ 0.05	\$ 0.00	\$ 0.14	\$ -	\$ 0.99
	B	V Clamp, 3 HV Wire Clamp			18 06 75	N0402-02	1	Cost included in V Bracket, For 3 Wire HV Wire Clamp (Part Above)	\$ -	\$ -	\$ -	\$ -	\$ -	\$ -	\$ -	\$ -	\$ -	\$ -	\$ -
	C	V Steel Bracket - Long Harness Protect			18 06 75	N0402-03	1		\$ 5.84	\$ 2.49	\$ 3.35	\$ 11.68	\$ 0.05	\$ 0.90	\$ 0.68	\$ 0.17	\$ 1.81	\$ 0.36	\$ 13.85
	D	V Steel Stamped Harness Protect Bracket			18 06 75	N0402-04	1		\$ 1.44	\$ 0.18	\$ 0.71	\$ 2.34	\$ 0.01	\$ 0.18	\$ 0.13	\$ 0.03	\$ 0.35	\$ 0.01	\$ 2.70
4	80 Boltings								\$ -	\$ -	\$ -	\$ -	\$ -	\$ -	\$ -	\$ -	\$ -	\$ -	\$ -
	A	V Nut Ground Strap, Rear Battery, Bat.			18 06 80	N0402-01	1	PIA to Assembly of Traction And High Voltage Power Distribution Subsystem	\$ -	\$ -	\$ -	\$ -	\$ -	\$ -	\$ -	\$ -	\$ -	\$ -	\$ -
	B	V Bolt, Clamp, 3 HV Wires			18 06 80	N0402-02	1	PIA to V HV Wire, Red (Alternator to PEB)											
	C	V Bolt, V Bracket, For 3 HV Wire Clamp			18 06 80	N0402-03	1	PIA to Assembly of Traction And High Voltage Power Distribution Subsystem											
	D	V Nut, Harness Assembly (Long Harness Bracket)			18 06 80	N0402-04	2	PIA to Assembly of Traction And High Voltage Power Distribution Subsystem											
	E	V Bolt, Small, 36 Volt Harness Asm.			18 06 80	N0402-05	3	PIA to Assembly of Traction And High Voltage Power Distribution Subsystem											
	F	V Bolt, Harness Asm. Large			18 06 80	N0402-06	4	PIA to Assembly of Traction And High Voltage Power Distribution Subsystem											
	G	V Nut, Upper Bracket, 36 V Harness			18 06 80	N0402-07	2	PIA to Assembly of Traction And High Voltage Power Distribution Subsystem											
5	85 Sealing Elements																		
6	99 Miscellaneous								\$ -	\$ -	\$ -	\$ -	\$ -	\$ -	\$ -	\$ -	\$ -	\$ -	\$ -
	A	V Tie-strap, Standard			18 06 99	N0402-01	3	PIA to Assembly of Traction And High Voltage Power Distribution Subsystem	\$ -	\$ -	\$ -	\$ -	\$ -	\$ -	\$ -	\$ -	\$ -	\$ -	\$ -
	B	V Tie-strap, Metal			18 06 99	N0402-02	3	PIA to Assembly of Traction And High Voltage Power Distribution Subsystem	\$ -	\$ -	\$ -	\$ -	\$ -	\$ -	\$ -	\$ -	\$ -	\$ -	\$ -
	C	V Tie-strap, Xmas Tree			18 06 99	N0402-03	2	PIA to Assembly of Traction And High Voltage Power Distribution Subsystem	\$ -	\$ -	\$ -	\$ -	\$ -	\$ -	\$ -	\$ -	\$ -	\$ -	\$ -
									\$ 58.27	\$ 13.80	\$ 9.50	\$ 81.57	\$ 0.38	\$ 5.27	\$ 4.63	\$ 1.70	\$ 11.98	\$ 0.57	\$ 94.11

Table 2-10: Incremental Direct Manufacturing Cost of Power Electronic Center (PEC) Subsystem, Saturn Vue Green Line

NEW TECHNOLOGY GENERAL PART INFORMATION: 2007 Saturn Vue, 2.4L, I4, 170 hp, Mild HEV (Electric Motor 14.5kW, Battery 36V, Nominal Pack Capacity 18.4Ah)										NEW TECHNOLOGY PACKAGE QUOTE PARAMETERS		NEW TECHNOLOGY PACKAGE COST INFORMATION											
Item	Subsystem	Sub-Subsystem	Assembly	Subassembly	Component	Name/Description	Part Number	QTY/ Subsystem	Notes	Manufacturing			Total Manufacturing Cost (Component/ Assembly)	Markup				Total Markup Cost (Component/ Assembly)	Total Packaging Cost (Component/ Assembly)	Net Component/ Assembly Cost Impact to OEM			
										Material	Labor	Burden		End Item Scrap	SG&A	Profit	ED&T- R&D						
0	1807 Power Electric Center (PEC) Subsystem										\$ -	\$ -	\$ -	\$ -	\$ -	\$ -	\$ -	\$ -	\$ -	\$ -	\$ -	\$ -	\$ -
1	00 Assembly of Power Electric Center (PEC) Subsystem										\$ 0.91	\$ 5.36	\$ 0.83	\$ 7.10	\$ -	\$ -	\$ -	\$ -	\$ -	\$ -	\$ -	\$ 7.10	
	A					Assembly of SGCM subsystem/PEB	18 07 00 - N0402 - 01	1		\$ 0.91	\$ 5.36	\$ 0.83	\$ 7.10	\$ -	\$ -	\$ -	\$ -	\$ -	\$ -	\$ 7.10			
2	01 Power Electronics Control Center										\$241.82	\$ 33.15	\$ 81.42	\$ 356.39	\$ 2.49	\$ 24.95	\$ 28.51	\$ 14.26	\$ 70.21	\$ 0.12	\$ 426.72		
						V PEB Assembly	18 07 01 - N0402 - 01	1		\$21.14	\$ 15.12	\$ 23.70	\$ 59.95	\$ 0.42	\$ 4.20	\$ 4.80	\$ 2.40	\$ 11.81	\$ 0.12	\$ 71.89			
						V PEB Lower Base Module	18 07 01 - N0402 - 30	1		\$92.72	\$ 12.72	\$ 42.62	\$ 148.07	\$ 1.04	\$ 10.36	\$ 11.85	\$ 5.92	\$ 29.17	\$ -	\$ 177.24			
						V Main Circuit Board	18 07 01 - N0402 - 63	1		\$ 115.01	\$ 1.05	\$ 5.16	\$ 121.22	\$ 0.85	\$ 8.49	\$ 9.70	\$ 4.85	\$ 23.88	\$ -	\$ 145.10			
						Conn Module 8-pin	18 07 01 - N0402 - 110	1		\$ 12.95	\$ 4.27	\$ 9.93	\$ 27.14	\$ 0.19	\$ 1.90	\$ 2.17	\$ 1.09	\$ 5.35	\$ -	\$ 32.49			
3	75 Bracket										\$ 2.47	\$ 0.67	\$ 1.05	\$ 4.20	\$ 0.05	\$ 0.55	\$ 0.57	\$ 0.21	\$ 1.39	\$ -	\$ 5.59		
	A					V Bracket, PEB (SGCM)	18 07 75 - N0402 - 01	1	Includes assembly labor and fastener cost to mount bracket to PEB	\$ 2.47	\$ 0.67	\$ 1.05	\$ 4.20	\$ 0.05	\$ 0.55	\$ 0.57	\$ 0.21	\$ 1.39	\$ -	\$ 5.59			
4	80 Boltings										\$ -	\$ -	\$ -	\$ -	\$ -	\$ -	\$ -	\$ -	\$ -	\$ -	\$ -		
	A					V Nut, PEB to BIW	18 07 80 - N0402 - 01	2	PIA to Assembly of SGCM	\$ -	\$ -	\$ -	\$ -	\$ -	\$ -	\$ -	\$ -	\$ -	\$ -	\$ -			
	B					V Bolt, PEB to BIW	18 07 80 - N0402 - 02	2	PIA to Assembly of SGCM	\$ -	\$ -	\$ -	\$ -	\$ -	\$ -	\$ -	\$ -	\$ -	\$ -				
	C					V Bolt, PEB Bracket (PEB to Mount Bracket)	18 07 80 - N0402 - 03	7	PIA to V Bracket, PEB														
	D					V Bolt 12-V Cable PEB (Same for 36V Cable)	18 07 80 - N0402 - 04	2	PIA to Assembly of SGCM														
	E					V Bolt 36-V PEB to Alternator	18 07 80 - N0402 - 05	3	PIA to Assembly of SGCM														
	F					V Nut, Cables to PEB	18 07 80 - N0402 - 06	5	PIA to Assembly of SGCM														
	G					V Bolt PEB Cover (Bolt Assembly, washer, tinnerman)	18 07 80 - N0402 - 07	3	PIA to Assembly of SGCM														
	H					V lock, PEB conneters	18 07 80 - N0402 - 08	2	PIA to Assembly of SGCM														
	I					Nut -Ground to PEB (BIW)	18 07 80 - N0402 - 09	1	PIA to Assembly of SGCM														
5	85 Sealing Elements										\$ -	\$ -	\$ -	\$ -	\$ -	\$ -	\$ -	\$ -	\$ -	\$ -	\$ -		
	A					V Cover SGCM	18 07 85 - N0402 - 01	1	PIA to SGCM/PEB	\$ -	\$ -	\$ -	\$ -	\$ -	\$ -	\$ -	\$ -	\$ -	\$ -				
6	99 Miscellaneous										\$ -	\$ -	\$ -	\$ -	\$ -	\$ -	\$ -	\$ -	\$ -	\$ -	\$ -		
										\$ 245.20	\$ 39.18	\$ 83.29	\$ 367.68	\$ 2.54	\$ 25.50	\$ 29.08	\$ 14.47	\$ 71.60	\$ 0.12	\$ 439.40			

3 2010 Fiat MultiAir Cost Analysis, Case Study #0200

3.1 MultiAir Hardware Overview

3.1.1 MultiAir Versus Baseline ICE Hardware Differences

Figure 3-1 below illustrates the primary hardware associated with the MultiAir system. In the MultiAir I4 ICE application there are two (2) intake and exhaust valves per cylinder, the same as the conventional baseline I4 ICE. The MultiAir system has a single overhead cam (SOHC) that drives both the intake and exhaust valves. The exhaust valves in the MultiAir system are driven by direct contact between the exhaust cam lobes and mechanical buckets. The intake valves are actuated by the MultiAir hydraulic system. The intake cam lobe actuates a hydraulic piston via the finger follower assembly. A solenoid valve controls the hydraulic fluid flow from the hydraulic piston into the hydraulic brake and lash adjuster. When the solenoid is closed, the hydraulic fluid creates a rigid connection between the intake valve and SOHC intake lobe. In this scenario, valve timing and lift follow the intake cam profile, similar to that of a traditional ICE. With the solenoid valves open, hydraulic pressure is minimized in the system, decoupling the intake valves from the camshaft. Through precisely timed solenoid valve opening and closing events, the intake valve lift and timing can be altered.

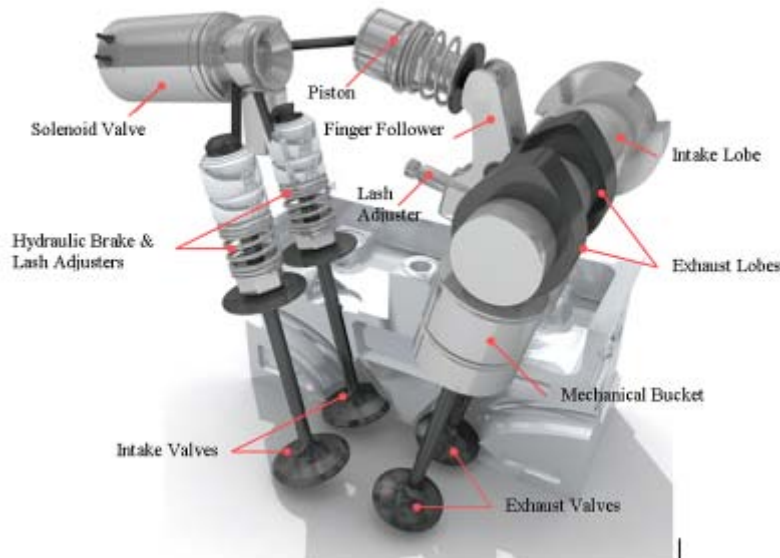

Figure 3-1: MultiAir Hardware Illustration

The baseline ICE configuration includes two overhead camshafts, an intake camshaft, and exhaust camshaft. In the baseline configuration, the intake and exhaust camshafts actuate the respective valves through the mechanical bucket valvetrain hardware – similar to the exhaust valvetrain system shown in Figure 3-1. With the baseline configuration, variable valve timing is accounted for using a cam phaser system. Outside of the changes to the valvetrain, cylinder head, air intake, and electrical/electronic engine subsystems, no other significant engine subsystem changes (e.g., cylinder block, crank drive, cooling, exhaust, fuel, etc.) were required to the baseline engine to add the MultiAir hardware.

3.1.2 MultiAir System Hardware

At the heart of the MultiAir system is a large forged aluminum manifold, which is utilized to control the volume of oil available for intake valve actuation (reference **Figure 3-2** and **Figure 3-3**). The manifold contains all components required to actuate the valves. It is secured directly to the cylinder head over the intake valves. Individual pistons are utilized in the manifold to supply oil pressure straight to both lash adjusters, which are mounted over each set of cylinder intake valves. Each of the four (4) manifold pistons is actuated by individual roller followers, which are driven by separate lobes on the exhaust camshaft. The MultiAir exhaust camshaft had a total of twelve (12) lobes, unlike the baseline engine which only had eight (8). Four (4) solenoids were pressed into the manifold, each controlling a pair of valves relative to their respective cylinders. The default solenoids “off position” allowed full intake valve lift and duration. Each solenoid could be individually actuated to bleed oil from the oil feed circuit to reduce lift and/or duration of each pair of intake valves, depending on the engine running conditions.



Figure 3-2: MultiAir Manifold Assembly Installed on the Fiat 1.4L, I4, ICE



Figure 3-3: MultiAir System Forged Aluminum Manifold

Two (2) oil feed ports were machined into the hydraulic manifold. One port is utilized for lash adjustment and rocker arm lubrication. A second filtered port feeds oil to the solenoid reservoir cavities for each of the valve actuation circuits. Both oil feed circuits received a continuous supply of oil from the engine oil pump (Reference **Figures 3-4** and **3-5**).

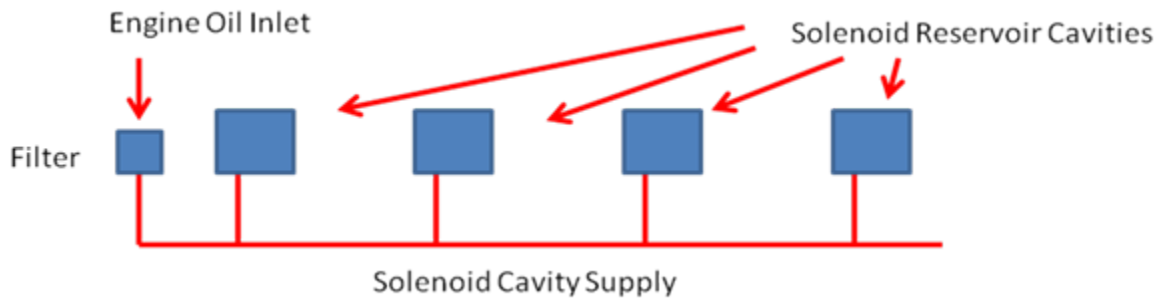

Figure 3-4: Oil Port Feeding Solenoid Reservoir Cavities for Valve Actuation Circuits

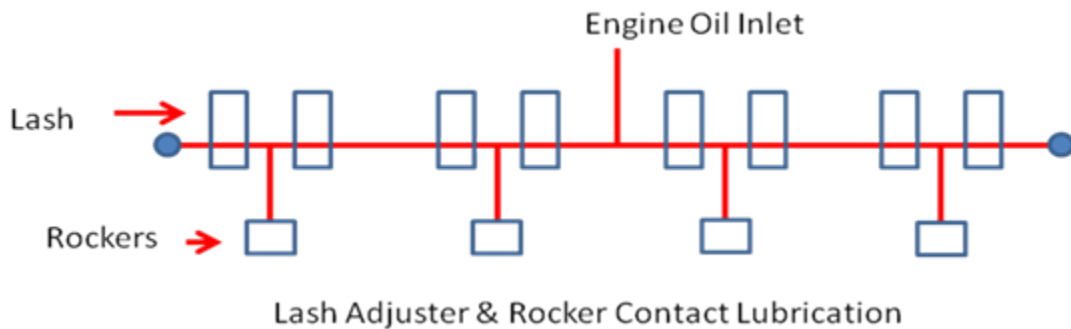

Figure 3-5: Oil Port for Lash Adjuster and Rocker Contact Lubrication

The primary function of each solenoid is to reduce the amount of valve lift and/or duration. This is accomplished through actuating the solenoid, which diverts pressurized oil into the reservoir cavity on top of the manifold. When the solenoid valve is held in the closed position, high-pressure oil is diverted into the hydraulic brake and lash adjuster and there is full intake valve duration and lift. When the solenoid valve is open, high-pressure is diverted from the hydraulic brake and lash adjuster. Additionally, each reservoir cavity is constantly fed oil from the engine to replenish the pressurized oil circuit. This is done by opening the solenoid while the piston roller finger follower (RFF) is riding along the base circle of the cam lobe.

Intake valve displacement is initiated by the intake lobe on the single overhead camshaft (SOHC). This intake lobe actuates the RFF, which then drives the manifold piston to pressurize the internal oil circuit (**Figure 3-6**). The assembly rests on a lash adjust pivot pin which is pressed into the manifold. The RFF assembly is a typical stamped/formed conventional ICE design (**Figure 3-7**). The machined rollers utilize needle bearings and are secured by pressed-in pins.

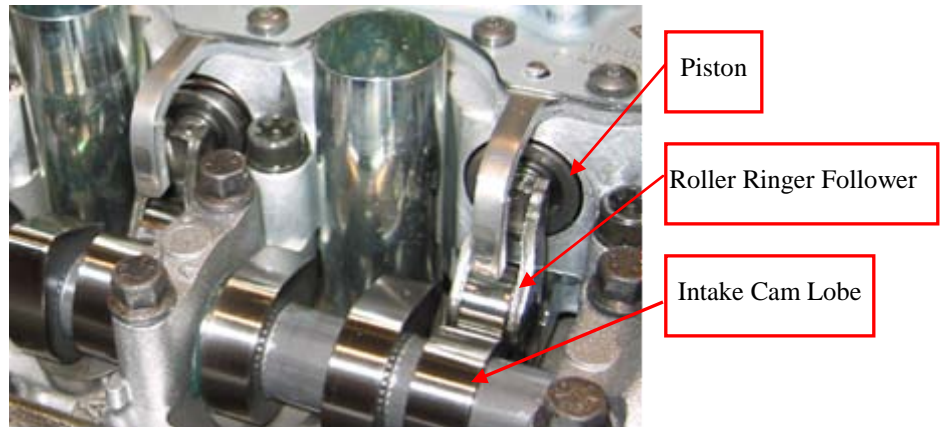

Figure 3-6: SOHC, RFF, and Hydraulic Piston

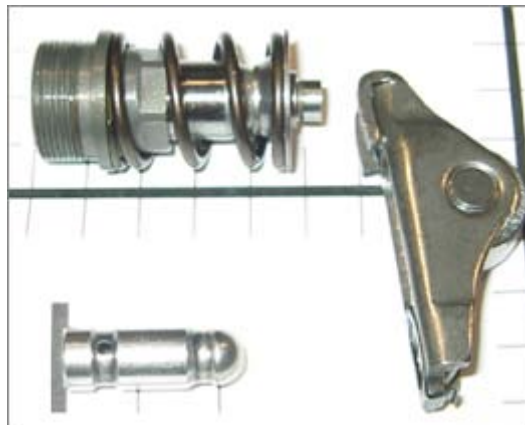

Figure 3-7: Hydraulic Piston, RFF, and Lash Adjust Pivot Pin

Each manifold piston consists of multiple parts (**Figure 3-8**). The piston housing is ground smooth along the internal bore and threaded on the outer diameter (OD). Additionally, the OD has a hex feature to facilitate assembly into the manifold. A coil spring is utilized to ensure constant contact between the piston and rocker arm. The piston assembly (**Figure 3-9**) consists of three (3) separate components: a piston, spring seat, and a C-clip, which retained the seat to the piston. The piston housings are assumed to be

manufactured from bar stock on a turning machine followed by induction hardening and coating applications. The spring seats are assumed to be stamped parts that are induction hardened. The springs, pistons and C-clips were treated as purchased commodities within the analysis.



Figure 3-8: Piston Housing, Coil Spring, and Piston Assembly

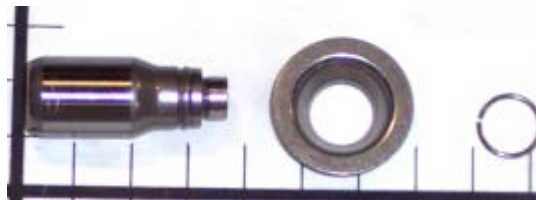

Figure 3-9: Piston, Spring Seat, and C-Clip

Oil is forced into the solenoid cavity as the piston is depressed. The pressurized oil branches off to both intake hydraulic brake and lash adjusters (HBLA) for their respective cylinders. Similar to the pistons, the HBLA are threaded into a machined cavity in the hydraulic manifold (**Figure 3-10** and **3-11**). The HBLA are preassembled prior to being installed in the manifold. Intake valve lash adjustment is accomplished by engine oil pressure fed through holes in the side of the assembly. The manifold piston pressure is applied to one end of the HBLA assembly, similar to a hydraulic lifter design. The opposite end is seated directly over the top of the intake valve stem.



Figure 3-10: Hydraulic Brake and Lash Adjusters (HBLA) in Hydraulic Manifold



Figure 3-11: Hydraulic Brake and Lash Adjusters (HBLA)

The lash adjusters consist of multiple components. The main housing assembly is assumed to be machined from bar stock. It has a number of internal and external machined features, including cross-drilling for oil flow and a threaded OD for installation. The inside of the housing has additional machining to achieve tight tolerances which allow the three separate parts to oscillate within the bore. In **Figure 3-12**, the cylinder on the far right is the reaction piston which receives pressure from the manifold piston. The reaction piston makes direct metal to metal contact with the inner sleeve. The inner sleeve is hollow with a check ball at the intake valve end. Lash adjustment is controlled by oil that travels through a port in the OD of the housing. The oil travels through a cross-drilled hole in the OD of the inner sleeve and down its inner

diameter (ID) to the end cap, which rests on the intake valve stem. A check valve holds the oil in the end cap, which prevents the lifter from collapsing. A C-clip is utilized to retain the end cap inside the housing. All three oscillating components are assumed to be machined from bar stock; the C-clip and two sealing O-rings are considered commodity items.

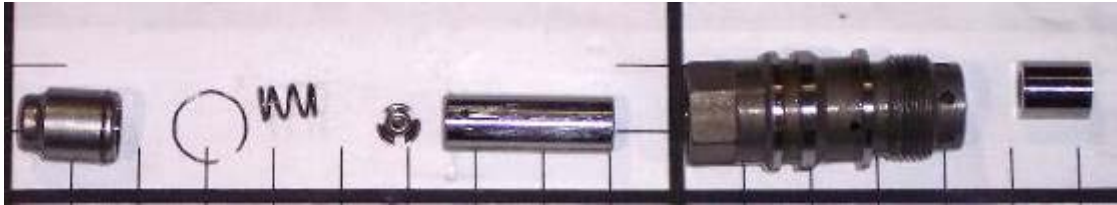

Figure 3-12: Lash Adjuster Components

The solenoid (**Figure 3-13**), although typically considered a commodity item, was disassembled and analyzed to establish its projected cost. The design and construction of the solenoid assembly is similar to those employed in anti-lock brake control module applications. Each solenoid is pressed/swaged into the manifold. Material displaced from the manifold bore is forced into two grooves on the solenoid OD as each is pressed in place (**Figure 3-14**). The displaced material collected inside the grooves permanently secures the solenoid in the manifold.



Figure 3-13: Hydraulic Solenoid Valve



Figure 3-14: Solenoid pressed into manifold bore

The solenoid assembly consists of numerous machined components, electrical (solenoid) components, and a few commodity parts. The commodity parts include three springs and a bobbin for the wire windings. Wire is wrapped around the plastic bobbin and terminal ends are attached. The wound bobbin assembly and a steel retainer plate are inserted into an injection molding machine. The assemblies are over-molded to form the housing and harness connector shell to achieve a one-piece design. The bobbin and steel retainer plate assembly (**Figure 3-16**) are press fit into the machined outer steel tube housing (**Figure 3-15**). The steel retainer plate is used as a back-up support during assembly. The completed solenoid is installed over the mechanical valve housing and captured by a formed (rolled) lower edge.



Figure 3-15: Bobbin Assembly Components



Figure 3-16: Over-Molded Steel Retainer Plate

The mechanical valve portion (**Figure 3-17**) of the solenoid consists of multiple parts. Part construction includes intricate machining, deep drawn stampings, powdered metals, injection moldings, and commodity-based components such as coil springs.



Figure 3-17: Solenoid Mechanical Valve

With the exception of the oil port outlet, all components pictured below (**Figure 3-18**) are inserted into the main mechanical valve housing from one direction.

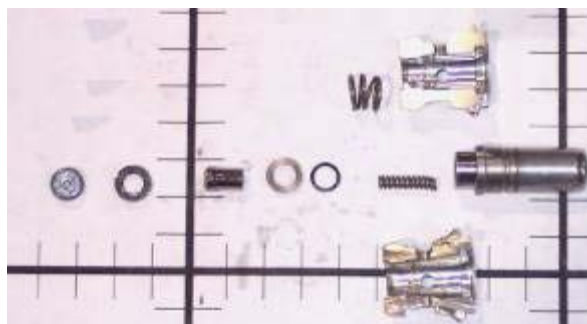

Figure 3-18: Mechanical Valve Components

The oil outlet port is a stamped part (**Figure 3-19**) which is pressed into the valve housing oil dump outlet.



Figure 3-19: Solenoid Oil Outlet Port (Pressed into the Valve Housing Oil Dump Outlet)

The magnetic reaction mass and rod are a press fit assembly. The reaction mass and rod assembly are placed in a deep drawn steel cylinder on top of a circular plastic insert. A spring is placed over the rod to keep the mass against the top. The cylinder and reaction mass assembly are laser-welded to the shaft bushing retainer (**Figure 3-20**).



Figure 3-20: (Left) Magnetic Reaction Mass and Rod, (Right) Cylinder, and Reaction Mass Assembly

Inside the valve housing is the oil control valve (**Figure 3-21**). The design of the oil control valve requires all the components to be installed sequentially and in the proper orientation. The valve components consist of two coil springs, the valve, and a pair of spring seats. One of the spring seats has a composite spacer.



Figure 3-21: Oil Control Valve

All interfaces between moving parts inside the valve are precision machined. Some of the parts appear to be treated with secondary coating applications. The bushing sleeve housing and reaction mass assembly are pressed into the valve housing and then staked, capturing the valve assembly.

On top of the hydraulic manifold (**Figure 3-22**) is an oil reservoir cavity associated with each of the four (4) solenoid valves. The cavities receive a constant oil flow from the engine oil pump. A check valve protects the oil circuit from back pressure spikes during solenoid pressure dumps. The cavity also has a pressure relief port which provides a path for the additional oil volume released by the solenoid during valve operation. The oil reservoir cavity cover system consists of two plates.



Figure 3-22: Oil Reservoir Cavity Cover System

The lower cover, located over the oil reservoir cavities, is a stamped, machined, aluminum plate with a molded-in-place gasket (**Figure 3-23**). Each chamber is individually sealed via a silicone sealing bead. Not visible in **Figure 3-23** are a pair of precision-machined orifices at each cavity for oil flow control.

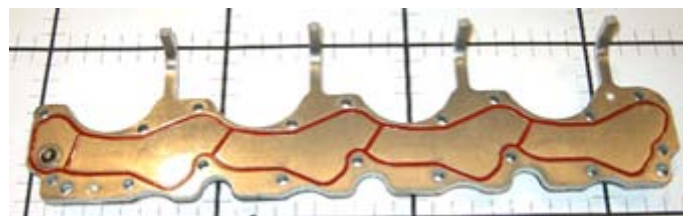

Figure 3-23: Oil Reservoir Cavity Lower Cover

A stamped steel cover (**Figure 3-24**) was installed over the first aluminum plate and provides a chamber for oil flow from the orifices in the first plate. A single small hole pierces the cover over each chamber to allow oil to return to the cylinder head.



Figure 3-24: Oil Reservoir Cavity Lower Steel Cover

The pressure relief valve (**Figure 3-25**) in each oil reservoir consists of opposing pistons, a coil spring, retainer clip, and an O-ring seal. The cavity piston has a solid top face and is sealed with an O-ring around the OD. The opposing piston has a center hole for oil flow and serves as the spring seat. The pistons are retained in their respective bores with a C-clip.



Figure 3-25: Oil Reservoir Pressure Relief Valve

Each oil reservoir cavity has a one-way check valve/ball (**Figure 3-26**) designed to allow engine oil to constantly feed into all four (4) reservoir chambers. The check valve prevents the pressurized solenoid dump oil from back-feeding into the circuit. The check valve consists of a steel ball, spring, and two stamped metal parts. Each check valve assembly is pressed into the oil inlet port of its respective reservoir.

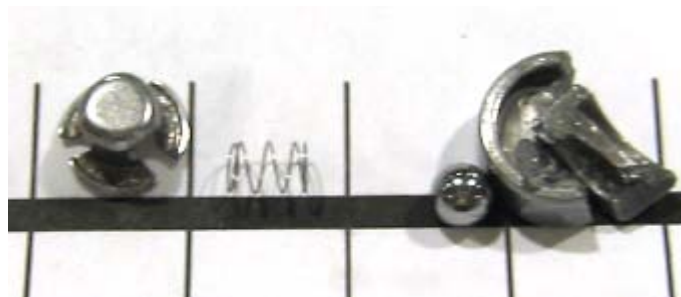

Figure 3-26: Oil Reservoir Check Valve

An additional sealing requirement for the hydraulic manifold housing includes a coated stamped steel gasket (**Figure 3-27**). This seals the manifold to the cylinder head. The shape and design of the interface between the valve cover (**Figure 3-28**) and cylinder

head resulted in a T-joint seal condition at each end of the manifold. A T-joint seal encompasses the three (3) separate sealing surfaces intersecting at a common point.



Figure 3-27 : Manifold



Figure 3-28: Valve Cover

To monitor oil temperature, a sensor (**Figure 3-29**) is added in a strategic location in the manifold. The oil temperature sensor is located in the oil circuit at the back of the manifold (**Figure 3-27**), the furthest point traveled by the oil in the entire circuit.



Figure 3-29: Oil Temperature Sensor

3.2.2 Direct Manufacturing Cost of Baseline Engine Modifications Required for MultiAir Hardware Integration

Adding the MultiAir hardware to a baseline 1.4L I4, NA, PFI, d-VVT ICE results in the addition, deletion, and modification of baseline engine components and processes. The largest cost impact is linked with changes to the baseline valvetrain, including deletion of cam phasers, intake camshaft and associated intake valvetrain hardware. In addition, a less complex machined cylinder head, as intake valvetrain features are transferred from the cylinder head into the MultiAir manifold, and a smaller intake manifold assembly result in savings on the baseline engine components.

Table 3-2 summarizes the cost impact associated with the baseline engine component changes required for the addition of the MultiAir system. The components and assemblies that are no longer required in the baseline engine are indicated in red. The parts/processes highlighted in green are additions that would be added along with the previously costed MultiAir system. The component costs (e.g., intake camshaft, exhaust camshaft, VVT mechanism) provided in **Table 3-2** are based on calculations completed in prior EPA case studies.

The net incremental direct manufacturing cost differential is calculated by adding the direct manufacturing cost of the MultiAir system (\$234.14) with the direct manufacturing cost of the changes to the baseline engine (-\$91.07). The resulting increase in the direct manufacturing cost to add the MultiAir VVTL system is \$143.07 (\$234.14-91.07).

Table 3-2: Direct Manufacturing Cost Impact Associated with Changing Baseline Engine Components for MultiAir System

<u>Component / Process Description</u>	<u>Std VVT</u>
RED =Parts/Processes Saved	(14 ICE)
GREEN =Additional Parts/Process Required	
Exhaust Camshaft (<i>additional lobes 4-1ea cylinder</i>)	\$ 25.63
Intake Camshaft (<i>+sensor & associated H/W</i>)	\$ (26.70)
Sprocket, Camshaft	\$ 2.25
Bolt, Sprocket	\$ 0.26
Bearing Caps, Camshaft	\$ (4.20)
Bolts, Bearing Cap (<i>10pcs-2ea cap</i>)	\$ (0.80)
VVT Mechanism / Module	\$ (61.23)
VVT ECM Drivers	\$ (15.00)
VVT Wiring Circuits (<i>Delta 4 Versus 2 Solenoids</i>)	\$ (2.00)
Intake Lifter Buckets (<i>8pcs-2ea bank</i>)	\$ (13.36)
Timing Belt (<i>Length & Width</i>) / Chain (<i>Length & Gauge</i>)	\$ (2.00)
Cylinder Head Processing:	\$ (15.42)
Bore Lifter Buckets	
Camshaft Line Bore	
Valve Cover/Intake Manifold Complexity/Size Reduction	\$ (10.00)
Valve Cover Size Reduction	
ECU Upgrades for Additional High and Low Side Drivers	\$ 31.50
Part / Technology Differential Costs:	\$ (91.07)
FM Multi-Air Hardware Cost	\$ 234.14
Net Incremental Direct Manufacturing Cost	\$ 143.07

4 Glossary of Terms

Assembly: generally refers to a group of interdependent components joined together to perform a defined function (e.g., turbocharger assembly, high pressure fuel pump assembly, high pressure fuel injector assembly).

BAS (Belt Alternator Starter): is a system design to start/re-start an engine using a non-traditional internal combustion engine (ICE) starter motor. In a standard internal ICE the crankshaft drives an alternator, through a belt pulley arrangement, producing electrical power for the vehicle. In the BAS system, the alternator is replaced with a starter motor/generator assembly so that it can perform opposing duties. When the ICE is running, the starter motor/generator functions as a generator producing electricity for the vehicle. When the ICE is off, the starter motor/generator can function as a starter motor, turning the crankshaft to start the engine. In addition to starting the ICE, the starter motor can also provide vehicle launch assist and regenerative braking capabilities.

Buy: is the terminology used to identify those components or assemblies as ones in which a manufacturer would purchase versus manufacture. All parts designated as a “buy” part, within the analysis, only have a net component cost presented. Typically these types of parts are considered commodity purchase parts having industry established pricing.

Cam Phaser: are additional components, added to an internal combustion engine’s valvetrain, enabling the opening and closing times between engine valves and the crankshaft to be changed during engine operation. The changing of time/phasing of valve events relative to crankshaft position optimizes engine performance for different operating conditions. Cam phasers can be mounted to the end of intake and exhaust camshafts.

CBOM (Comparison Bill of Materials): is a system bill of materials, identifying all the subsystems, assemblies and components associated with the technology configurations under evaluation. The CBOM records all the high level details of the technology configurations under study, identifies those items which have cost implications as a result of the new versus base technology differences, documents the study assumptions, and is the primary document for capturing input from the cross-functional team.

Component: is the lowest level part within the cost analysis. An assembly is typically made up of several components acting together to perform a function (e.g., the turbine wheel in a turbocharger assembly). However, in some cases a component can act independently performing a function within a sub-subsystem or subsystem (e.g., exhaust manifold within the exhaust subsystem).

Cost Estimating Models: are cost estimating tools, external to the Design Profit® software, used to calculate operation and process parameters for primary manufacturing

processes (e.g., injection molding, die casting, metal stamping, forging). Key information calculated from the costing estimating tools (e.g., cycle times, raw material usage, equipment size) is inputted into the Lean Design® process maps supporting the cost analysis. The Excel base cost estimating models are developed and validated by Munro & Associates.

Costing Databases: refer to the five (5) core databases which contain all the cost rates for the analysis. The material database lists all the materials used throughout the analysis along with the estimated price/pound for each. The labor database captures various automotive, direct labor, manufacturing jobs (supplier and OEM), along with the associated mean hourly labor rates. The manufacturing overhead rate database contains the cost/hour for the various pieces of manufacturing equipment assumed in the analysis. A mark-up database assigns a percentage of mark-up for each of the four (4) main mark-up categories (i.e., end-item scrap, SG&A, profit, and ED&T), based on the industry, supplier size, and complexity classification. The fifth database, the packaging database, contains packaging options and costs for each case.

Lean Design® (a module within the *Design Profit® software*): is used to create detailed process flow charts/process maps. Lean Design® uses a series of standardized symbols, each base symbol representing a group of similar manufacturing procedures (e.g., fastening, material modifications, inspection). For each group, a Lean Design® library/database exists containing standardized operations along with the associated manufacturing information and specifications for each operation. The information and specifications are used to generate a net operation cycle time. Each operation on a process flow chart is represented by a base symbol, operation description, and operation time, all linked to a Lean Design® library/database.

Make: is the terminology used to identify those components or assemblies as ones in which a manufacturer would produce internally versus purchase. All parts designated as a “make” part, within the analysis, are costed in full detail.

MAQS (Manufacturing Assumption and Quote Summary) Worksheet: is the standardized template used in the analysis to calculate the mass production manufacturing cost, including supplier mark-up, for each system, subsystem and assembly quoted in the analysis. Every component and assembly costed in the analysis will have a MAQS worksheet. The worksheet is based on a standard OEM (original equipment manufacturer) quote sheet modified for improved costing transparency and flexibility in sensitivity studies. The main feeder documents to the MAQS worksheets are process maps and the costing databases.

MCRs (Material Cost Reductions): is a process employed to identify and capture potential design and/or manufacturing optimization ideas with the hardware under evaluation. These savings could potentially reduce or increase the differential costs

between the new and base technology configurations, depending on whether an MCR idea is for the new or the base technology.

MultiAir: is an electro-hydraulic valvetrain system which can dynamically alter intake valve lift and timing for an internal combustion engine. Valve lift and timing adjustments can be made real-time within the profile of the baseline intake cam lobe profile. The technology has been developed by Fiat Powertrain Technologies.

Net Component/Assembly Cost Impact to OEM: is defined as the net manufacturing cost impact per unit, to the OEM, for a defined component, assembly, subsystem or system. For components produced by the supplier base, the net manufacturing cost impact to the OEM includes total manufacturing costs (material, labor, and manufacturing overhead), mark-up (end-item scrap costs, selling, general and administrative costs, profit, and engineering design and testing costs) and packaging costs. For OEM internally manufactured components, the net manufacturing cost impact to the OEM includes total manufacturing costs and packaging costs; mark-up costs are addressed through the application of an indirect cost multiplier.

NTAs (New Technology Advances): is a process employed to identify and capture alternative advance technology ideas which could be substituted for some of the existing hardware under evaluation. These advanced technologies, through improved function and performance, and/or cost reductions, could help increase the overall value of the technology configuration.

Process Maps: are detailed process flow charts used to capture the operations and processes, and associated key manufacturing variables, involved in manufacturing products at any level (e.g., vehicle, system, subsystem, assembly, component).

P-VCSM (Powertrain–Vehicle Class Summary Matrix): records the technologies being evaluated, the applicable vehicle classes for each technology, and key parameters for vehicles or vehicle systems that have been selected to represent the new technology and baseline configurations in each vehicle class to be costed.

Quote: refers to the analytical process of establishing a cost for a component or assembly.

Sub-subsystem: refers to a group of interdependent assemblies and/or components, required to create a functioning sub-subsystem. For example, the air induction subsystem contains several sub-subsystems including the following: turbocharging, heat exchangers, and pipes, hoses, and ducting.

Subsystem: refers to a group of interdependent sub-subsystems, assemblies and/or components, required to create a functioning subsystem. For example, the engine system contains several subsystems including the following: crank drive subsystem, cylinder

block subsystem, cylinder head subsystem, fuel induction subsystem, and air induction subsystem.

Subsystem CMAT (Cost Model Analysis Templates): is the document used to display and roll up all the sub-subsystem, assembly and component incremental costs associated with a subsystem (e.g., fuel induction, air induction, exhaust), as defined by the Comparison Bill of Material (CBOM).

Surrogate part: refers to a part similar in fit, form and function as the part required for the cost analysis. Surrogate parts are sometimes used in the cost analysis when actual parts are unavailable. The cost of a surrogate part is considered equivalent to the cost of the actual part.

System: refers to a group of interdependent subsystems, sub-subsystems, assemblies and/or components, working together to create a vehicle primary function (e.g., engine system, transmission system, brake system, fuel system, suspension system).

System CMAT (Cost Model Analysis Template): is the document used to display and roll up all the subsystem incremental costs associated with a system (e.g., engine, transmission, steering), as defined by the CBOMs.

Valvetrain: is the group of internal combustion engine (ICE) components responsible for controlling air flow (or a flow of mixed air and fuel) into the combustion chamber and after combustion, the combustion by-products out of the combustion chamber. The valvetrain subsystem is typically made up of the valves (e.g., intake, exhaust) and valve operating mechanisms (e.g., valve springs, rockers, finger followers, camshafts, cam sprockets).