

PB82-168949

Evaluation of the Greer Fuel Pre-Heater under  
Section 511 of the Motor Vehicle Information and  
Cost Savings Act

(U.S.) Environmental Protection Agency  
Ann Arbor, MI

May 81

U.S. Department of Commerce  
National Technical Information Service  
**NTIS**

**Evaluation of the Greer Fuel Pre-Heater Under Section 311  
of the Motor Vehicle Information and Cost Savings Act**

This document contains several pages which may not reproduce well. Any questions concerning the legibility of these pages should be directed to: Merrill W. Korth, Emission Control Technology Division, Office of Mobile Source Air Pollution Control, Environmental Protection Agency, 2565 Plymouth Road, Ann Arbor, MI 48105 (313) 668-4299 or FTS 374-8299.

by

Edward Anthony Barth

May, 1981

Test and Evaluation Branch  
Emission Control Technology Division  
Office of Air, Noise, and Radiation  
U.S. Environmental Protection Agency



UNITED STATES DEPARTMENT OF COMMERCE  
National Technical Information Service  
5285 Port Royal Road  
Springfield, Virginia 22181

Darcy Cahill  
U S EPA Library  
2565 Plymouth Road  
Ann Arbor, MI. 48105

Re your report: EPA-AA-TEB-511-81-2, Evaluation of the Greer Fuel Pre-Heater Under  
Section 511 of the Motor Vehicle Information & Cost Savings Act.

We are not able to process your report for the following reasons. Please make the corrections necessary and return the document and this letter to us. Report format is to conform with the ANSI standard, ANSI Z39.18, entitled "Format and Production for Scientific and Technical Reports" available @ \$4.00 from the American National Standards Institute, Inc., 1430 Broadway, New York, New York 10018.

- 1. Pages are missing. Attachment G incomplete
- 2. All pages are not numbered and some could therefore be missing. We suggest author or editor number the pages consecutively throughout the document, or within chapters if prefixed by the chapter designation.
- 3. Some pages are not reproducible. Pages 28 & 45 thru 54.
- 4. A Report Documentation Page (RDP) must accompany each title. Blank forms are enclosed.
- 5. This document has copyright or other restrictions. Please furnish written authorization for NTIS to reproduce and sell to the public.
- 6. An Accession Notice Card must accompany each title. Blank forms are enclosed.
- 7. We cannot microfiche pages larger than the standard 8½ x 11 in one frame (see ANSI standard). Please reduce pages exceeding 8½ x 11 in this document before returning and limit the page size of future documents to standard size.
- 8.

Sincerely,

*Charles H. Kane*  
for Asta Kane, Chief  
Information Services Branch  
Phone: 703-487-4690

Form NTIS-63 (Rev 3-78)

*MJF*

**TECHNICAL REPORT DATA**  
(Please read instructions on the reverse before completing)

1. REPORT NO. <b>EPA-AA-TEB-511-81-2</b>		2.	3. RECIPIENT'S ACCESSION NO. <b>PBB2 068949</b>	
4. TITLE AND SUBTITLE <b>Evaluation of the Greer Fuel Pre-Heater Under Section 511 of the Motor Vehicle Information and Cost Savings Act</b>			5. REPORT DATE <b>May 1981</b>	
7. AUTHOR(S) <b>Edward Anthony Barth</b>			6. PERFORMING ORGANIZATION CODE <b>055022</b>	
9. PERFORMING ORGANIZATION NAME AND ADDRESS <b>U.S. Environmental Protection Agency Office of Mobile Source Air Pollution Control Test and Evaluation Branch Ann Arbor, MI 48105</b>			8. PERFORMING ORGANIZATION REPORT NO.	
12. SPONSORING AGENCY NAME AND ADDRESS			10. PROGRAM ELEMENT NO.	
			11. CONTRACT/GRANT NO.	
			13. TYPE OF REPORT AND PERIOD COVERED <b>Technical</b>	
			14. SPONSORING AGENCY CODE	
15. SUPPLEMENTARY NOTES				
16. ABSTRACT <p>This document announces the conclusions of the EPA evaluation of the "Greer Fuel Pre-Heater" device under provisions of section 511 of the Motor Vehicle Information and Cost Savings Act.</p> <p>On January 20, 1981, the EPA received a request from Michael M. Greer for evaluation of a fuel saving device termed the "Greer Pre-Heater". This device is claimed ". . .to make an automobile use a greater percentage of the energy injected into the carburetor and increase the miles per gallon without affecting pollution factors" by preheating the gasoline before it reaches the carburetor. The device operates as a tube and shell heat exchanger. It uses the engine coolant as the heat source and transfers this heat to the gasoline by conducti</p>				
17. KEY WORDS AND DOCUMENT ANALYSIS				
a. DESCRIPTORS		b. IDENTIFIERS/OPEN ENDED TERMS		c. COSATI Field/Group
Fuel Consumption Automobiles Heating Gasoline Automotive Fuels Carburetors		Gas Saving Devices Fuel Economy		
18. DISTRIBUTION STATEMENT  Release Unlimited		19. SECURITY CLASS (This Report) Unclassified		21. NO. OF PAGES 54
		20. SECURITY CLASS (This page) Unclassified		22. PRICE

6560-26

ENVIRONMENTAL PROTECTION AGENCY

[40 CFR Part 610]

[FRL \_\_\_\_\_]

FUEL ECONOMY RETROFIT DEVICES

Announcement of Fuel Economy Retrofit Device Evaluation  
for "Greer Fuel Pre-Heater"

**AGENCY:** Environmental Protection Agency (EPA).

**ACTION:** Notice of Fuel Economy Retrofit Device Evaluation.

**SUMMARY:** This document announces the conclusions of the EPA evaluation of the "Greer Fuel Pre-Heater" device under provisions of Section 511 of the Motor Vehicle Information and Cost Savings Act.

BACKGROUND INFORMATION: Section 511(b)(1) and Section 511(c) of the Motor Vehicle Information and Cost Savings Act (15 U.S.C. 2011(b)) requires that:

(b)(1) "Upon application of any manufacturer of a retrofit device (or prototype thereof), upon the request of the Federal Trade Commission pursuant to subsection (a), or upon his own motion, the EPA Administrator shall evaluate, in accordance with rules prescribed under subsection (d), any retrofit device to determine whether the retrofit device increases fuel economy and to determine whether the representations (if any) made with respect to such retrofit devices are accurate."

(c) "The EPA Administrator shall publish in the Federal Register a summary of the results of all tests conducted under this section, together with the EPA Administrator's conclusions as to -

- (1) the effect of any retrofit device on fuel economy;
- (2) the effect of any such device on emission of air pollutants; and
- (3) any other information which the Administrator determines to be relevant in evaluating such device."

EPA published final regulations establishing procedures for conducting fuel economy retrofit device evaluations on March 23, 1979 [44 FR 17946].

ORIGIN OF REQUEST FOR EVALUATION: On January 20, 1981, the EPA received a request from Michael M. Greer for evaluation of a fuel saving device termed the "Greer Pre-Heater". This Device is claimed to "... to make an automobile use a greater percentage of the energy injected into the carburetor and increase the miles per gallon without affecting pollution factors" by preheating the gasoline before it reaches the carburetor. The Device operates as a tube and shell heat exchanger. It uses the engine coolant as the heat source and transfers this heat to the gasoline by conduction.

Availability of Evaluation Report: An evaluation has been made and the results are described completely in a report entitled: "EPA Evaluation of Greer Fuel Pre-Heater Under Section 511 of the Motor Vehicle Information and Cost Savings Act," report number EPA-AA-TEB-511-81-2 consisting of 54 pages including all attachments.

Copies of these reports may be obtained from the National Technical Information Service by using the above report numbers. Address requests to:

National Technical Information Service

U.S. Department of Commerce

Springfield, VA 22161

Phone: Federal Telecommunications System (FTS) 737-4650

Commercial 703-487-4650





EPA Evaluation of the Greer Fuel Pre-Heater Device under Section 511 of the Motor Vehicle Information and Cost Savings Act

The following is a summary of the information on the device as supplied by the Applicant and the resulting EPA analysis and conclusions.

1. Marketing Identification of the Device:

Greer Fuel Pre-Heater

2. Inventor of the Device and Patents:

A. Inventor

Michael M. Greer  
515 North East Eighth Street  
Grants Pass, Oregon 97526

B. Patent

Patent Pending - Number 217315 (See Attachment A)

3. Manufacturer of the Device:

Michael M. Greer, Inc.  
515 North East Eighth Street  
Grants Pass, Oregon 97526

4. Manufacturing Organization Principals:

Owner: Michael M. Greer

Manufacturer Michael M. Greer

5. Marketing Organization in U.S. making Application:

Michael M. Greer, Inc.  
515 North East Eighth Street  
Grants Pass, Oregon 97526

6. Applying Organization Principals:

Michael M. Greer - Owner

Charles T. Townsend

will represent the organization in communications with EPA.

400 Schoolhouse Creek Road  
Grants Pass, Oregon 97525

7. Description of Device:

A. Purpose of the Device (as supplied by Applicant):

"A fuel extender (gasoline)."

**B. Theory of Operation (as supplied by Applicant):**

"Pre-heated fuel vaporizes faster and burns more efficiently; to make an automobile use a greater percentage of the energy injected into the carburetor and increase the miles per gallon without affecting pollution factors."

**C. Detailed Description of Construction (as supplied by Applicant):**

"A relatively large diameter tube bears internally a small diameter tube with the larger diameter tube supplied with water from the radiator which normally is circulated through the automobile heater adjacent the passenger compartment. End caps telescopingly mounted to the larger diameter water tube bear slots which are alignable with slots within the ends of the water tube, the slots being of a width slightly larger than the diameter of the fuel line small diameter tube which projects through a hole defined by the aligned slots during telescoping of the end cap to the water tube. A high integrity water seal bond is effected between the end caps and the large diameter water tube and the fuel line at the point where it projects through the opening. The fuel preheater assembly is employable in a fuel pre-heating system which incorporates a bypass hose leading from the end of the water tube remote from its connection to the radiator to a second heater hose connected to the radiator and normally returning water from the heater. A manually operated heat control valve within the bypass hose permits circulation of water through the fuel pre-heater assembly during the summer when the heater is cut off to the radiator. (Blueprint attached)"

**8. Applicability of the Device (as supplied by Applicant):**

**A. "Make:**

"All American manufactured automobiles and some foreign made, with the exception of: diesel, fuel injection gas or air-cooled engines.

**B. "Model:**

"All American manufactured automobiles and some foreign made, with the exception of: diesel, fuel injection gas or air-cooled engines.

**C. "Engine size and carburetion:**

"All American manufactured automobiles and some foreign made, with the exception of: diesel, fuel injection gas or air-cooled engines.

**D. "Model Year:**

"All American manufactured automobiles and some foreign made, with the exception of: diesel, fuel injection gas or air-cooled engines.

E. "Transmission Type:

"All American manufactured automobiles and some foreign made, with the exception of: diesel, fuel injection gas or air-cooled engines.

F. "Ignition Type:

"All American manufactured automobiles and some foreign made, with the exception of: diesel, fuel injection gas or air-cooled engines."

9. Costs (as supplied by Applicant):

\$19.95 unassembled kit

\$29.95 assembled

cost does not include necessary hose and clamps to complete installation.

10. Device Installation - Tools and Expertise Required (as supplied by Applicant):

A. "General Instructions:

"Use good quality hoses and clamps. Do the installation with the engine cool. Make the fuel hoses as short as you can without kinking them. Keep hoses away from fan and exhaust manifolds. Put all vacuum hoses back on after preheater installation. (Instruction sheet attached)

B. "Vehicle make/model/year/engine/etc:

"This unit can be installed on all makes, models, year, engine and 4, 6, and 8 cylinder automobiles. (See instruction sheet)

C. "Tools required for installation:

"Flaring tool, tubing cutter, water hose cutter, pliers, hose clamps, screwdriver or adjustable wrench for tightening hose clamp screws.

D. "Equipment required to check the accuracy of the installation:

"No equipment necessary; visual checks for fuel or water leaks after the hose clamps are securely tightened."

E. "Adjustments to the vehicle or vehicle system as well as the device following installation:

"None required, however, automobiles must meet with factory specifications. (see attached installation sheet)" (See Attachment B)

F. "Skills associated with the installation of the device:

"Limited mechanical knowledge of cooling system. (see instruction sheet)" (See attachment B)

11. Device Operation (as supplied by Applicant):

"Complete information on instruction sheet and booklet, 'Guide to Greater Gas Mileage', enclosed with each and every unit." (See Attachments B and C)

12. Maintenance (claimed):

"Maintenance free and is also re-useable."

13. Effects on Vehicle Emissions (non-regulated) (claimed):

"None"

14. Effects on Vehicle Safety (claimed):

"Hose clamps should be maintained securely, normal safety precautions should be adhered to. (see attached instruction sheet and booklet)" (See Attachments B and C)

15. Test Results (Regulated Emissions and Fuel Economy) (claimed):

"Olson Engineering, Inc., Huntington Beach, California.

Department of Environmental Quality, Meford, Oregon.

Road test by individuals and their written testimonials.

Note: The Greer Pre-Heater will prove NOTHING when tested with a dynamometer, this unit should be tested in an automobile in a road test to be able to produce positive results. Please refer to booklet, 'Guide to Greater Gas Mileage.'

16. Analysis

A. Description of the Device:

The Device consists of a tube and shell heat exchanger. It uses the engine coolant as the heat source and transfers this heat to the gasoline by conduction. The Device is judged to be able to heat the fuel to some limited degree.

The Device is judged to be adequately described by the description provided in the patent application (Attachment A), description in Section 7 C, the Installation Instructions (Attachment C), and the "Guide to Greater Gas Mileage" (Attachment C).

**B. Applicability of the Device:**

The applicability of the Device, as stated in Section 8 of the application, to all makes, models, engines, carburetion, model year, transmissions, and ignition systems for "All American manufactured automobiles and some foreign made, with the exception of: diesel, fuel injected, gas or air cooled engines" is judged to be correct.

**C. Device Installation - Tools and Expertise Required: were identified in Section 10**

- (1) The general instructions provided are judged to be adequate for the physical installation of the device.
- (2) Although the Applicant does not provide the necessary hoses and clamps to complete installation with the kit, these parts should be readily available.
- (3) The Applicant's claims about applicability of the instructions, tools and specific equipment required, vehicle or device adjustment, and level of expertise required for installation are judged to be correct.

**D. Device Operation:**

The information referenced in Section 11 does not contain any information related to usage of the Device other than suggestions on how to properly test for fuel economy. However, this is judged to be adequate as long as no vapor lock or lean surging problems are encountered. The Applicant does not address these specific potential problems of a fuel preheater.

**E. Device Maintenance:**

The Applicant claims the Device is "Maintenance Free and is also re-useable" in Section 12. This is true in the general usage of the term maintenance, however, the added Device fuel fittings and fuel line installed in the vehicle, would require the normal periodic inspection accorded similar components in the vehicle.

**F. Effects on Vehicle Emissions (non-regulated):**

The Applicant submitted no test data, Section 13. However, since the Device does not appreciably modify the vehicle's emission control system or powertrain, it appears reasonable to assume that the Device would not significantly affect a vehicle's non-regulated emissions.

**G. Effects on Vehicle Safety:**

The device is judged to not adversely affect vehicle safety.

#### H. Test Results Supplied by Applicant:

Applicant did not submit any test data per the Federal Test Procedure or Highway Fuel Economy Test. These are the EPA recognized test procedures(1). The requirement for test data following these procedures is stated in the application test policy documents and two subsequent letters (Attachments D, E, F, and G) that EPA sent to the Applicant. Therefore, there was no technical basis to support the Applicant's claim of increased fuel economy.

The test data submitted by the Applicant are listed below and evaluated.

- (1) In Section 15 the Applicant referenced planned testing at Olson Engineering. This was identified as a single baseline (FTP and HFET) and single Device test (FTP and HFET) on one vehicle rather than the minimum specified by EPA of two duplicate baseline and two duplicate device tests on each of the two vehicles.

The Applicant did not provide the test results of the single vehicle testing at Olson Engineering.

- (2) In Section 15, the Applicant referenced testing by the Department of Environmental Quality, Medford, Oregon. However, the Applicant did not provide test results or a description of this testing.
- (3) In Section 15 the Applicant referenced road tests by individuals. The Applicant submitted copies of several of these testimonials and a summary of the benefits claimed by

- 
- (1) From EPA 511 Application test policy documents:

Test Results (Regulated Emissions and Fuel Economy):

Provide all test information which is available on the effects of the device on vehicle emissions and fuel economy.

The Federal Test Procedure (40 CFR Part 86) is the only test which is recognized by the U.S. Environmental Protection Agency for the evaluation of vehicle emissions. The Federal Test Procedure and the Highway Fuel Economy Test (40 CFR Part 600) are the only tests which are normally recognized by the U.S. EPA for evaluating vehicle fuel economy. Data which have been collected in accordance with other standardized fuel economy measuring procedures (e.g. Society of Automotive Engineers) are acceptable as supplemental data to the Federal Test Procedure and Highway Fuel Economy Data will be used, if provided, in the preliminary evaluation of the device. Data are required from the test vehicle(s) in both baseline (all parameters set to manufacturer's specifications) and modified forms (with device installed).

45 individuals. The Applicant claims that for all but a very few of thousands of units sold, the passenger vehicle owners reported improved fuel economy. The Device users undoubtedly felt they had achieved significant fuel economy benefits with the "Greer Fuel Pre-Heater". However, these were uncontrolled test of the Device and therefore cannot be used to evaluate the "Greer Fuel Pre-Heater". The Applicant also recognized the difficulties in verifying these claims.

"It is difficult to estimate the mileage gains on thousands of units installed by owners, of which very few reported no mileage gain on their cars. Domestic and import passenger cars have the greatest gains. About sixty per cent of light truck owners claimed some mileage gain.

"We cannot vouch for the accuracy of the actual mileage gains, since we obviously were not present for the very important before and after mileage testing. We strongly recommend you tune your car and carefully test it for mileage before and after you install the Greer preheater, then carefully retest for mileage after you install it."

- (4) In Section 15 the Applicant claimed that "The Greer Pre-Heater will prove NOTHING when tested with a dynamometer, this unit should be tested in an automobile in a road test to be able to produce positive results. Please refer to booklet, 'Guide to Greater Gas Mileage'."

The Applicant submitted no data or information that justified this claim.

J. EPA Testing of a Fuel Preheater:

EPA tested a fuel preheater<sup>(2)</sup> which used water from the engine block to heat the fuel in a copper tube and shell heat exchanger similar to the "Greer Fuel Pre-Heater". This fuel preheater did not improve vehicle fuel economy. Since the "Greer Fuel Pre-Heater" could be expected to operate in a similar fashion, in the absence of valid test data, there is no reason to expect the "Greer Fuel Pre-Heater" to improve the vehicle fuel economy nor justification for EPA to test the Device to further investigate the claim for fuel economy.

17. Conclusions:

EPA fully considered all of the information submitted by the device manufacturer in the application. The evaluation of the "Greer Fuel Pre-Heater" device was based on that information and the results of the EPA testing of a similar device.

---

(2) Evaluation of the Fuel Xpander, EPA-AA-TAEB-80-2

The Applicant submitted no valid test data that proved the "Greer Fuel Pre-Heater" would improve vehicle fuel economy.

EPA previously tested a similar device which failed to show a fuel economy benefit. Therefore, it is unlikely that testing of the device would have shown a fuel economy benefit.



## List of Attachments

Attachment A	Patent Application (provided with 511 Application)
Attachment B	Instruction Sheet (provided with 511 Application)
Attachment C	Guide to Greater Gas Mileage (provided with 511 Application)
Attachemnt D	EPA letter dated December 1, 1980 to Applicant
Attachment E	EPA letter dated January 8, 1981 to Applicant
Attachment F	EPA letter dated February 26, 1981 to Applicant
Attachment G	EPA letter dated February 26, 1981 to Applicant

LAW OFFICES

## SUGHRUE, ROTHWELL, MION, ZINN &amp; MACPEAK

1770 K STREET, N.W.

WASHINGTON, D. C. 20000

RICHARD C. SUGHRUE  
 G. FRANKLIN ROTHWELL  
 JOHN H. MION  
 DONALD E. ZINN  
 THOMAS J. MACPEAK  
 ROBERT J. SEAS, JR.  
 DARRYL MEXIC  
 ROBERT V. SLOAN\*  
 PETER D. OLEXY  
 J. FRANK OSHA  
 WADDELL A. BIGGART  
 ROBERT G. MEMORROW  
 LOUIS GUDINSKY  
 NEIL E. SIEGEL  
 ASPAHAN BOGORAD  
 MARK P. LEVY  
 DAVID J. CUSHING  
 CYNTHIA E. O. CLARKE  
 JOHN R. INGE\*  
 JOHN K. DONAGHY\*  
 ALAN S. LOVELESS  
 JOSEPH J. RUCH, JR.\*  
 LAWRENCE R. GOODWIN  
 DENNIS E. KOVACH\*

November 21, 1980

TELEPHONE  
 (202) 293-7060

CABLE ADDRESS  
 LEXPAT WASHINGTON

TELEX 248503

FACSIMILE  
 (202) 293-7860

\*NOT ADMITTED IN D.C.

Mr. Michael M. Greer  
 MMG Services  
 P. O. Box 415  
 Merlin, Oregon 97532

Re: U. S. Application of Michael M. Greer  
 SIMPLIFIED FUEL PREHEATER ASSEMBLY FOR  
 AUTOMOTIVE USE AND FUEL PREHEATING SYSTEM  
 EMPLOYING THE SAME  
 Our ref. A4036

Dear Mike:

Regarding our telephone conversations, we now enclose an application in clean draft form, hopefully ready for execution.

We have provided the appropriate formal papers. Please read the application carefully and execute the formal papers and return them to this office in the manner of past applications. We will file the original and have the drawings inked in the form shown, so the filed application will conform exactly to what is being forwarded.

As you can see, we have illustrated two typical embodiments noting that the end caps either take the form as shown in Figure 2 or that shown in Figures 4 and 5, that is, unitary in construction or formed of two portions, one a smaller diameter portion.

We believe these showings conform to the commercial product being sold and illustrated in your publication. Claims are directed both to the tubular assembly and to the improved preheater system.

Thank you for again allowing us to be of service to you.

Very truly yours,



Donald E. Zinn

DEZ/jc  
 Enc.

SIMPLIFIED FUEL PREHEATER ASSEMBLY  
FOR AUTOMOTIVE USE AND FUEL PRE-  
HEATING SYSTEM EMPLOYING THE SAME

ABSTRACT OF THE DISCLOSURE

A relatively large diameter tube bears internally a small diameter tube with the larger diameter tube supplied with water from the radiator which normally is circulated through the automobile heater adjacent the passenger compartment. End caps telescopically mounted to the larger diameter water tube bear slots which are alignable with slots within the ends of the water tube, the slots being of a width slightly larger than the diameter of the fuel line small diameter tube which projects through a hole defined by the aligned slots during telescoping of the end cap to the water tube. A high integrity water seal bond is effected between the end caps and the large diameter water tube and the fuel line at the point where it projects through the opening. The fuel preheater assembly is employable in a fuel preheating system which incorporates a bypass hose leading from the end of the water tube remote from its connection to the radiator to a second water hose connected to the radiator and normally returning water from the heater. A manually operated heat control valve in the bypass hose permits circulation of water through the preheater assembly during the summer when the heater is not used to the radiator.

### FIELD OF THE INVENTION

This invention relates to a fuel preheater assembly and more particularly to a simplified assembly involving only a water tube, the fuel line tube and one or more end caps which interfit to securely lock the fuel line tube to the water tube, and additionally to a fuel preheater system employable within a conventional automobile.

### BACKGROUND OF THE INVENTION

Many devices and gadgets have been employed in an attempt to effect gasoline mileage improvement on existing vehicles as well as new automotive vehicles. Some systems are complex. Others are relatively simple. However, most devices do not provide substantial improvement in gasoline mileage.

Attempts have been made to preheat the hydrocarbon fuel either prior to or subsequent to mixture with the air within the engine carburetor. Theoretically, preheated fuel vaporizes faster and burns more completely and efficiently, thus giving better mileage. The known fuel preheater techniques have been complicated and relatively expensive.

It is, therefore, an object of the present invention to provide an improved simplified and low cost fuel preheater assembly for automotive use and which may be incorporated within an automotive heater system under an arrangement permitting preheating of the fuel irrespective of heater operation.

### SUMMARY OF THE INVENTION

The present invention is directed to an improved, simplified fuel preheater assembly in one aspect consisting of a relatively large diameter water tube through which water

is passed which emanates from the vehicle radiator. A relatively small diameter fuel line tube is carried by the water tube, internally of the same, and is connected between the fuel pump and the engine carburetor. At least one end cap is provided to the end of the water tube, the cap and the water tube at that end bearing alignable slots within the ends thereof. The slots are of a width slightly larger than the outside diameter of the fuel line tube, such that upon telescoping the end cap to the water tube with the slots aligned, and with the fuel line tube inserted therebetween, a close fit connection can be made between the fuel line tube and the water tube where it enters the same. The end cap is sealably bonded to the water tube and the fuel line tube to the telescoping assembly of the water tube and the end cap at the point where the fuel line penetrates the water tube interior. The fuel line tube may enter the water tube at respective ends thereof through respective caps.

Alternatively, the relatively small diameter fuel line tube may be bent back upon itself with ends projecting exteriorly of the water tube from one end only through openings defined by diametrically opposite paired slots within the ends of the water tube and an end cap at one end only of the assembly.

The fuel preheater system employing the simplified fuel preheater assembly involves placement of the relatively large diameter water tube within the heater water supply hose intermediate of its connections at respective ends to the radiator and the automotive heater. Additionally, a first tee within a heater return hose returning water from the heater back to the radiator, is coupled to a bypass hose, the other end

of the bypass hose being coupled by a second tee to the heater supply hose at a point downstream from the fuel preheater assembly. A manually operated valve within the bypass hose selectively permits water circulation through the fuel preheater assembly from the radiator and back to the radiator, bypassing the heater during the summer months when the heater is not operating and there is a failure of circulation of water from the vehicle engine radiator to the heater. The bypass hose valve is separate from a heater control valve within the heater water return line controlling the rate of circulation of hot water from the radiator to the heater. The relatively small diameter fuel line tube connects at one end to the fuel pump and at its other end to the fuel inlet connection to the engine carburetor.

#### BRIEF DESCRIPTION OF THE DRAWINGS

Figure 1 is a perspective view of a fuel preheat system forming one aspect of the present invention and supplying the simplified fuel preheater assembly in one form as an illustrative embodiment of the present invention.

Figure 2 is a sectional view of the fuel preheater assembly illustrated in Figure 1.

Figure 3 is an exploded view of a portion of the fuel preheater assembly of Figure 2, showing the telescoping fit of the end cap to the water tube and the alignment of slots therein forming the opening through which the fuel line tube projects.

Figure 4 is a longitudinal sectional view of a second embodiment of the fuel preheater assembly of the present invention.

Figure 5 is an exploded view of a portion of the water tube and the end cap of the embodiment of the fuel preheater assembly illustrated in Figure 4.

DESCRIPTION OF THE PREFERRED EMBODIMENTS

The principal aspect of the present invention resides in the fuel preheater assembly forming the major component within the improved fuel preheat system illustrated in Figure 1, the fuel preheater assembly may take several forms, a first embodiment of which is illustrated in Figures 1, 2 and 3, and a second embodiment being illustrated in Figures 4 and 5.

In that regard, reference to Figure 2 shows the make up of one fuel preheater assembly, indicated generally at 10, which is constituted principally by three major components: a relatively large diameter water tube or pipe indicated generally at 12, formed of copper or other highly conductive metal; a much smaller diameter fuel line tube or pipe indicated generally at 14, which may also be formed of copper; and a pair of end caps indicated generally at 16. The water tube 12 has an inside diameter which is considerably larger than the outside diameter of the fuel line tube 14 which runs internal of and generally the complete length of the water tube 12. The fuel line tube 14 includes end portions 14a which curve generally at right angles to the longitudinal axis of a central portion 14b of tube 14 and which project outwardly of water tube 12 in the same direction, although they could project in opposite directions or at any given angle as desired, it being the purpose of the turns as at 14c to permit the ends to project outwardly of the water tube 12. Ends 14a of the tube 14 are swaged as at 18 in order that these ends may connect to either flexible hoses or to a further tubular metal fuel line. One end of tube 14 connects to the fuel pump, while the other connects to a fuel inlet hose 42 carried by the carburetor 46 and connected thereto.

As may be best appreciated by further reference to Figure 3, the water tube 12 at both ends 12a is provided with an elongated slot 20 which extends for a slight distance inwardly from end face 12b of the water tube 12 for a pre-determined distance. The slot 20 is provided with a curved end portion 20a which is generally circular. Further, end cap 16 is provided with a relatively large diameter portion or end 16a facing end 12a of the water tube 12, that relatively large diameter end portion 16a bearing an elongated slot 22 which projects axially inwardly from the end face 16b and which terminates in a circular end portion 22a. The slots 20 and 22 are of equal width and thus end portions 20a and 22a are of the same radius. The portion 16a of the end cap 16 is of a diameter which is just slightly larger than the diameter of the water tube 12, such that the water tube 12 telescopingly fits within the enlarged diameter section 16a of the end cap. The particular construction of the end cap 16 as shown includes a reduced diameter portion 16c joined by an integral tapered portion 16a, the smaller diameter portion 16c sealably receiving and partially carrying an end cap extension tube portion 24 which is swaged at 26 so as to assist in its being coupled to heater water supply hose 32, which heater water supply hose is severed intermediate its ends to permit the connection of the fuel preheater assembly 10 interposed between the engine radiator or engine block 34 and the automotive heater 38 servicing the passenger compartment of the vehicle. Alternatively, the end cap may be of one piece construction (Figure 4), such that tube 24 is simply an extension of the smaller diameter portion of the end cap. As shown a weld 28 insures a high integrity seal between the elements making up end cap 16.



The assembly is simplified but promotes a high integrity, high strength connection between end cap 16, water tube 12 and the fuel line tube 14. The curved portion 14c of the fuel line 14 projects through a hole defined by slots 20 and 22 when the end cap 16 is telescopingly joined such that the larger diameter portion 16a receives the end 12a of the water tube 12. Appropriately, solder or other water tight bonding material 30 is employed to mechanically bond and seal the tubes 12 and 14 and the end caps 16 together and to prevent the escape of water about the periphery of the fuel line tube 14 where it projects through the opening defined by slots 20 and 22 of the water tube 12 and end cap 16 at both ends of the fuel preheater assembly 10.

Reference to Figures 4 and 5 illustrates a second embodiment of the fuel preheater assembly forming a principal aspect of the present invention. Like elements are provided with like numerical designations. In this case, the fuel preheater assembly, indicated generally at 10', comprises a modified water tube as indicated generally at 12', which bears a fuel line tube or pipe as at 14' and employs, in this case, a single end cap as at 17', all of the elements being modified slightly from similarly employed elements in the embodiment of Figures 1, 2 and 3. The water tube 12', although being of the same diameter as tube 12 in the embodiment of Figure 2, has at the end opposite that bearing end cap 16', a reduced diameter portion 12'c which is integral with the main portion or body of the water tube by way of a flared or tapered portion 12'b, portion 12'c including a swaging at 26' in similar manner to the swaged portion 26 of the end cap 16 in the previously described embodiment. This permits the assembly to be

connected to a water hose of the same diameter as that employed in this embodiment.

As may be seen in Figure 5, the principal difference is the formation of two diametrically opposite slots 20 within end 12a' of the water tube 12, that is, the slots are 180° circumferentially from each other, as best seen in Figure 4. Similarly, end cap 16' is unitary in form and is simply cold molded or otherwise into a larger diameter portion 16'a, a smaller diameter portion 16'c joined by an integral tapered portion 16'b, and in similar fashion, the portion 16'c is swaged as at 26 identical to that of the reduced diameter portion of the water pipe and corresponding to swage 26 of the end cap 16 in the embodiment of Figures 1, 2 and 3. Additionally, the large diameter portion 16'c of end cap 16' bears a pair of diametrically opposite slots 22 in alignment with slots 20 of the water tube 12'a.

The third variation lies in the configuration given to the fuel line tube 14'. This tube 14' is bent into a modified Y configuration, that is, at its center 14'b it is bent back upon itself, forming 180° turn and providing two elongated portions 14'd which extend the major length of the water tube 12' with ends 14'a projecting outwardly through an opening defined by the aligned slots 20 and 22 on opposite sides of the assembly, the projection of the fuel line tube ends through the opening provided thereby being facilitated by an S-bend given to the tube within the area 14'e as shown, Figure 4. The fuel line tube 14' is swaged at its ends 18 in the same manner as the prior described embodiment.

Appropriately, a sealable bond is effected between end cap 16', water tube 12', and fuel line tube 14', by solder or other appropriate material, as at 30, in the same manner as the previously described embodiment. In this case, for a slightly shorter length water tube, there is an extended heat transfer surface area and path between the water traversing the interior of the water tube and the fuel line tube 14'. Connections are made in essentially the same manner as the embodiment of Figures 1, 2 and 3.

In that regard, reference to Figure 1 shows a preferred fuel preheater system employing the fuel of preheater assembly of the present invention in the form illustrated in Figures 2 and 3, the preheater assembly 10 being incorporated within a supply heater hose indicated generally at 32. The fuel preheater 10 is employed by incorporating it within a supply heater hose 32 which connects at one end 32a to a vehicle engine radiator or engine block, as at 34, by way of a conventional fitting 36, while the opposite end 32b of the supply heater hose connects to the passenger compartment heater, indicated generally at 38, via a connection or fitting 40. A fuel line 42 leading from the fuel pump connects via fitting or connection 44 to one end 14a of the fuel line tube 14, the projecting fuel line tube end 14a at the opposite end of that assembly 10 connects via fitting 46 to the carburetor fuel inlet hose 43. Hose 43 connects to carburetor 46 borne by an engine (not shown) beneath an air intake 48.

Conventionally, the heater 38 bears a second hose, this being a heater water return hose 50, one end of which connects to the heater 38 via fitting 52. Ordinarily, that hose 50

connects directly to the radiator or engine block 34 via fitting 53. However, in this case, hose 50 is severed, bears a tee 54, one portion of which at 54a is connected to a bypass hose 56, while a second portion 54b connects the two portions of the heater water return hose 50 to each other. The bypass hose 56 connects at its opposite end through a second tee, indicated generally at 58, to the heater water supply hose 32 intermediate of its connection to the fuel preheater assembly 10 and heater 38. The heater water return hose 50 carries a conventional manually or thermostatically operated valve indicated generally at 60 for regulating the flow of hot water from radiator or engine block 34 to heater 38. The present invention involves the utilization of a second manually operated valve indicated generally at 62 which may be similarly constructed to valve 60 within the bypass hose 56, the valve 62 including an actuating arm 62a and connecting via an operator wire 64 to a pull knob (not shown) or the like within the vehicle passenger compartment and which may be mounted to a dashboard, for instance. The bypass valve 62 may be opened in the summer time when the heater control valve 60 is closed to permit hot water circulation through water tube 12 of the fuel preheater assembly 10 via heater water supply hose 32, bypass hose 56 and the portion of the heater water return hose 50 from tee 54 back to the radiator or engine block 34.

While heater control valve 60 is part of the original equipment, the presence of the bypass valve 62 within the bypass hose 56 allows the fuel preheater to work with the heater "off". If percolation occurs on a superhot day, an

in-line electric shut off valve may be inserted in the fuel line if necessary which would function to shut off fuel when ignition is "off".

5 While the invention has been particularly shown and described with reference to preferred embodiments thereof, it will be understood by those skilled in the art that the foregoing and other changes in form and details may be made therein without departing from the spirit and scope of the invention.

## WHAT IS CLAIMED IS:

1. An improved, simplified preheater assembly for preheating fuel for an internal combustion engine driven automobile, said automobile including a vehicle passenger compartment heated by engine coolant water circulated there-  
5 through via a heater hose, said assembly comprising:

a relatively large diameter preheater water tube connected at its ends between portions of said heater hose,  
a relatively small diameter fuel line tube,  
at least one end cap, said end cap being  
10 telescopingly joined to an end of said relatively large diameter water tube,

alignable slots within the telescoping ends of said water tube and said end cap, said slots being of a width slightly larger than the diameter of said fuel line tube,

15 said fuel line tube being carried within said large diameter water tube and having an end projecting through an opening defined by said alignable slots, and

means for sealingly bonding said end cap, said water tube and said fuel line tube together where said fuel  
20 line tube passes through said aligned slot opening.

2. The assembly as claimed in claim 1, wherein said fuel line tube is bent back upon itself and into an essentially Y-shaped configuration including elongated portion running generally the length of said large diameter water tube, and wherein aligned  
5 slots within said water tube and end cap are formed at diametrically opposite locations therein such that both ends of said fuel line tube project through respective slots on opposite sides of the assembly at a given end of said water tube.

3. A fuel preheater system for an automotive vehicle or the like, said vehicle including:

an internal combustion engine radiator,

a coolant water borne by said engine radiator

for cooling said engine and being warmed during engine operation,

a carburetor for said engine,

a fuel line leading to said carburetor,

a vehicle passenger compartment heater,

a heater water supply hose leading from said vehicle engine to said heater for supplying hot water to said heater,

a heater water return hose connected to said heater and to said radiator for returning hot water from said heater,

a fuel preheater assembly operatively connected within said heater water supply hose and including a relatively large diameter water tube connected at respective ends to portions of said heater water supply hose intermediate of said heater and said engine, said relatively large diameter water tube bearing a smaller diameter fuel line tube, said fuel line tube being operatively connected within said fuel line leading to said carburetor for preheating fuel carried thereby,

a bypass hose connected to said water heater supply hose between said fuel preheater assembly and said heater and connected at its opposite end to said heater water return hose,

a heater control valve within said heater water return hose upstream of the connection to said bypass hose, and

a bypass hose control valve within said bypass hose,

such that during warm weather when said heater is shut off, opening of said bypass valve permits continuous hot water circulation through said fuel preheater assembly to insure preheating of said fuel leading to said carburetor.

FIG-1

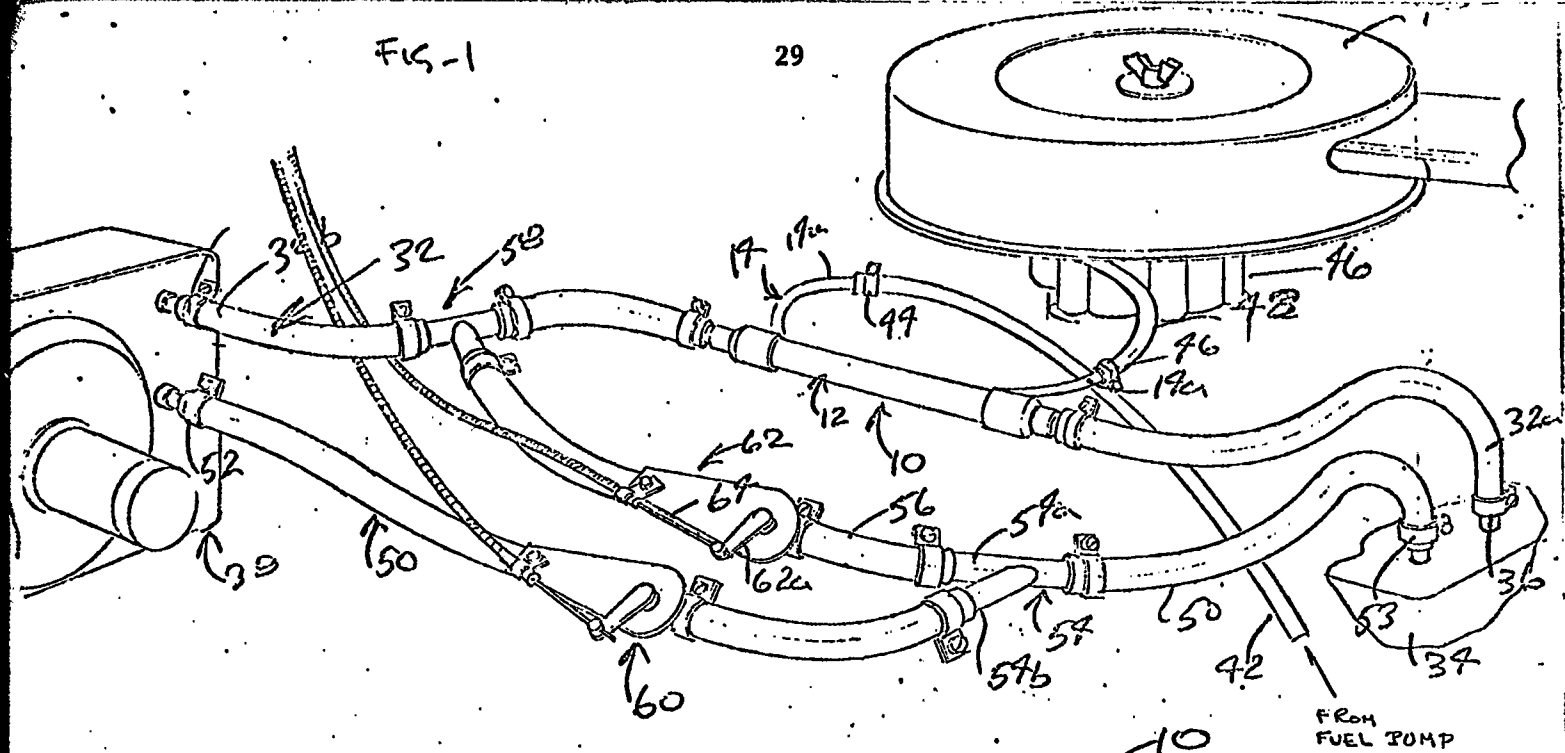

FIG. 2

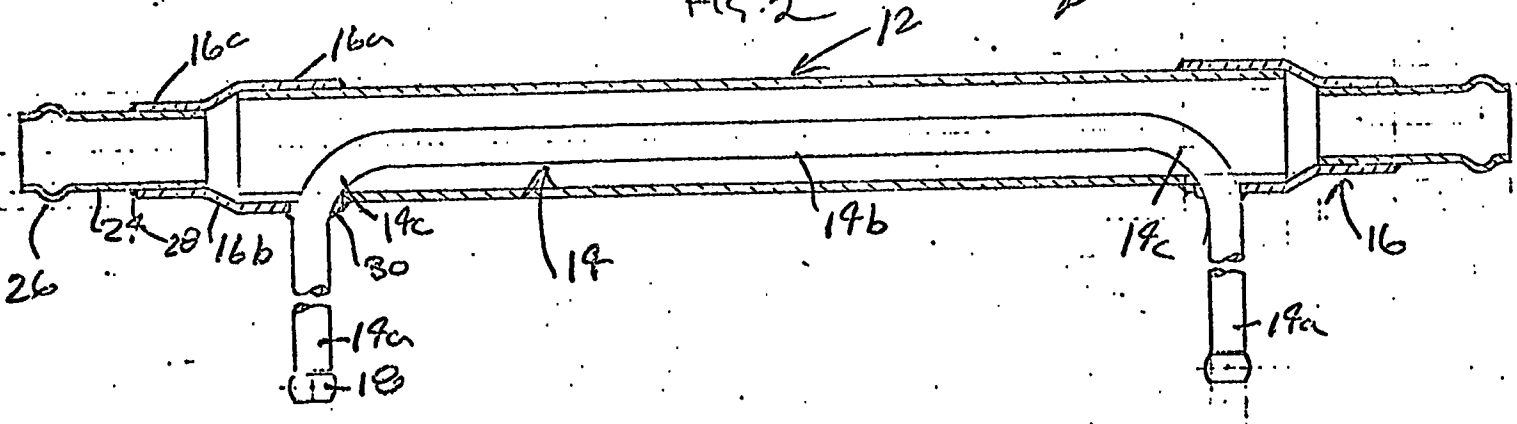

FIG-3

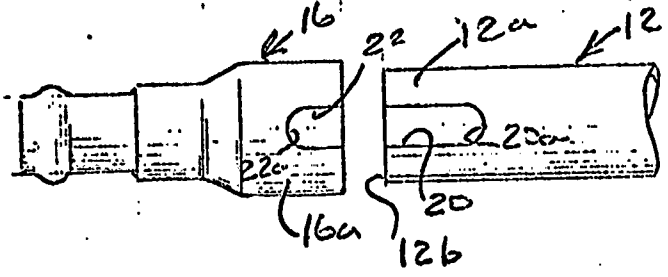

FIG-5

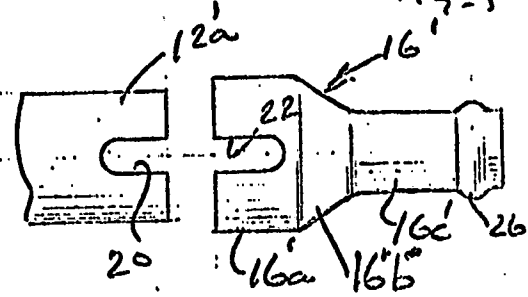
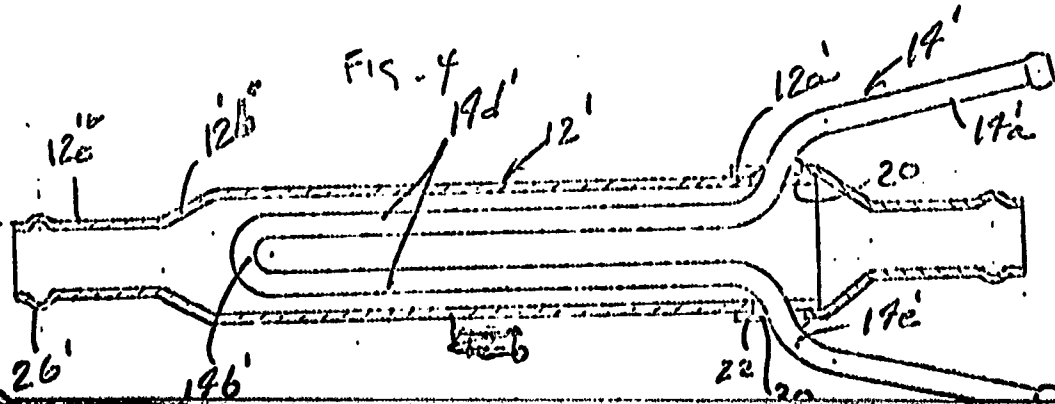

FIG-4





As a below named inventor, I hereby declare that my residence, post office address and citizenship are as stated below next to my name; that I verily believe I am the original, first and sole inventor (if only one name is listed below) or a joint inventor (if plural inventors are named below) of the invention entitled:

**SIMPLIFIED FUEL PREHEATER ASSEMBLY FOR AUTOMOTIVE USE AND FUEL PREHEATING SYSTEM EMPLOYING THE SAME**

which is described and claimed in:

- the attached application (for original application)       application Serial No. \_\_\_\_\_, filed \_\_\_\_\_ (for declaration not accompanying application);

that I do not know and do not believe the same was ever known or used in the United States of America before my or our invention thereof, or patented or described in any printed publication in any country before my or our invention thereof or more than one year prior to this application, that the same was not in public use or on sale in the United States of America more than one year prior to this application, that the invention has not been patented or made the subject of an inventor's certificate issued before the date of this application in any country foreign to the United States of America on an application filed by me or my legal representatives or assigns more than twelve months prior to this application, that I acknowledge my duty to disclose information of which I am aware which is material to the examination of this application, and that no application for patent or inventor's certificate on this invention has been filed in any country foreign to the United States of America prior to this application by me or my legal representatives or assigns, except as follows:

None

I hereby appoint Richard C. Sughrue, Reg. No. 16,866, G. Franklin Rothwell, Reg. No. 18,125, John H. Mion, Reg. No. 18,879, Donald E. Zinn, Reg. No. 19,046, Thomas J. Macpeak, Reg. No. 19,292, Robert J. Seas, Jr., Reg. No. 21,092, Darryl Mexic, Reg. No. 23,063, Robert V. Sloan, Reg. No. 22,775, Peter D. Olexy, Reg. No. 24,513, J. Frank Osha, Reg. No. 24,625, Waddell A. Biggart, Reg. No. 24,861, Robert G. McMorrow, Reg. No. 19,093, Louis Gubinsky, Reg. No. 24,835, and Neil B. Siegel, Reg. No. 25,200, my attorneys to prosecute this application and to transact all business in the Patent and Trademark Office connected therewith, and request that all correspondence about the application be addressed to SUGHRUE, ROTHWELL, MION, ZINN AND MACPEAK, 1776 K Street, N.W., Washington, D.C. 20006.

I hereby declare that all statements made herein of my own knowledge are true and that all statements made on information and belief are believed to be true; and further that these statements were made with the knowledge that willful false statements and the like so made are punishable by fine or imprisonment, or both, under Section 1001 of Title 18 of the United States Code and that such willful false statements may jeopardize the validity of the application or any patent issued thereon.

Date Nov. 26, 1980 First Inventor Michael M. Greer  
 Residence Merlin, Oregon Signature Michael M. Greer  
 Post Office Address P. O. Box 415  
 Citizenship United States Merlin, Oregon 97532

~~Date \_\_\_\_\_ Second Inventor \_\_\_\_\_  
 Residence \_\_\_\_\_ Signature \_\_\_\_\_  
 Post Office Address \_\_\_\_\_  
 Citizenship NONE~~

As a below named inventor, I hereby declare that my residence, post office address and citizenship are as stated below next to my name; that I verily believe I am the original, first and sole inventor (if only one name is listed below) or a joint inventor (if plural inventors are named below) of the invention entitled:

**SIMPLIFIED FUEL PREHEATER ASSEMBLY FOR AUTOMOTIVE USE AND FUEL PREHEATING SYSTEM EMPLOYING THE SAME**

which is described and claimed in:

- the attached application (for original application)       application Serial No. \_\_\_\_\_, filed \_\_\_\_\_ (for declaration not accompanying application);

that I do not know and do not believe the same was ever known or used in the United States of America before my or our invention thereof, or patented or described in any printed publication in any country before my or our invention thereof or more than one year prior to this application, that the same was not in public use or on sale in the United States of America more than one year prior to this application, that the invention has not been patented or made the subject of an inventor's certificate issued before the date of this application in any country foreign to the United States of America on an application filed by me or my legal representatives or assigns more than twelve months prior to this application, that I acknowledge my duty to disclose information of which I am aware which is material to the examination of this application, and that no application for patent or inventor's certificate on this invention has been filed in any country foreign to the United States of America prior to this application by me or my legal representatives or assigns, except as follows:

None

I hereby appoint Richard C. Sughrue, Reg. No. 16,866, G. Franklin Rothwell, Reg. No. 18,125, John H. Mion, Reg. No. 18,879, Donald E. Zinn, Reg. No. 19,046, Thomas J. Macpeak, Reg. No. 19,292, Robert J. Seas, Jr., Reg. No. 21,092, Darryl Mexic, Reg. No. 23,063, Robert V. Sloan, Reg. No. 22,775, Peter D. Olexy, Reg. No. 24,513, J. Frank Osha, Reg. No. 24,625, Waddell A. Biggart, Reg. No. 24,861, Robert G. McMorrow, Reg. No. 19,093, Louis Gubinsky, Reg. No. 24,835, and Neil B. Siegel, Reg. No. 25,200, my attorneys to prosecute this application and to transact all business in the Patent and Trademark Office connected therewith, and request that all correspondence about the application be addressed to SUGHRUE, ROTHWELL, MION, ZINN AND MACPEAK, 1776 K Street, N.W., Washington, D.C. 20006.

I hereby declare that all statements made herein of my own knowledge are true and that all statements made on information and belief are believed to be true; and further that these statements were made with the knowledge that willful false statements and the like so made are punishable by fine or imprisonment, or both, under Section 1001 of Title 18 of the United States Code and that such willful false statements may jeopardize the validity of the application or any patent issued thereon.

Date Nov. 26, 1980 First Inventor Michael M. Greer  
 Residence Merlin, Oregon Signature Michael M. Greer  
 Post Office Address P. O. Box 415  
 Citizenship United States Merlin, Oregon 97532

~~Date \_\_\_\_\_ Second Inventor \_\_\_\_\_  
 Residence \_\_\_\_\_ Signature \_\_\_\_\_  
 Post Office Address \_\_\_\_\_  
 Citizenship NONE~~

is passed which emanates from the vehicle radiator. A relatively small diameter fuel line tube is carried by the water tube, internally of the same, and is connected between the fuel pump and the engine carburetor. At least one end cap is provided to the end of the water tube, the cap and the water tube at that end bearing alignable slots within the ends thereof. The slots are of a width slightly larger than the outside diameter of the fuel line tube, such that upon telescoping the end cap to the water tube with the slots aligned, and with the fuel line tube inserted therebetween, a close fit connection can be made between the fuel line tube and the water tube where it enters the same. The end cap is sealably bonded to the water tube and the fuel line tube to the telescoping assembly of the water tube and the end cap at the point where the fuel line penetrates the water tube interior. The fuel line tube may enter the water tube at respective ends thereof through respective caps.

Alternatively, the relatively small diameter fuel line tube may be bent back upon itself with ends projecting exteriorly of the water tube from one end only through openings defined by diametrically opposite paired slots within the ends of the water tube and an end cap at one end only of the assembly.

The fuel preheater system employing the simplified fuel preheater assembly involves placement of the relatively large diameter water tube within the heater water supply hose intermediate of its connections at respective ends to the radiator and the automotive heater. Additionally, a first tee within a heater return hose returning water from the heater back to the radiator, is coupled to a bypass hose, the other end

connected to a water hose of the same diameter as that employed in this embodiment.

As may be seen in Figure 5, the principal difference is the formation of two diametrically opposite slots 20 within end 12a' of the water tube 12, that is, the slots are 180° circumferentially from each other, as best seen in Figure 4. Similarly, end cap 16' is unitary in form and is simply cold molded or otherwise into a larger diameter portion 16'a, a smaller diameter portion 16'c joined by an integral tapered portion 16'b, and in similar fashion, the portion 16'c is swaged as at 26 identical to that of the reduced diameter portion of the water pipe and corresponding to swage 26 of the end cap 16 in the embodiment of Figures 1, 2 and 3. Additionally, the large diameter portion 16'c of end cap 16' bears a pair of diametrically opposite slots 22 in alignment with slots 20 of the water tube 12'a.

The third variation lies in the configuration given to the fuel line tube 14'. This tube 14' is bent into a modified Y configuration, that is, at its center 14'b it is bent back upon itself, forming 180° turn and providing two elongated portions 14'd which extend the major length of the water tube 12' with ends 14'a projecting outwardly through an opening defined by the aligned slots 20 and 22 on opposite sides of the assembly, the projection of the fuel line tube ends through the opening provided thereby being facilitated by an S-bend given to the tube within the area 14'e as shown, Figure 4. The fuel line tube 14' is swaged at its ends 18 in the same manner as the prior described embodiment.

## ALIGNMENT-FRONT

GET THE FRONT END ALIGNED ABOUT EVERY 6 MONTHS, OR MORE OFTEN IF YOUR TIRES ARE WEARING UNEVENLY. AN OUT-OF-WHACK FRONT END EATS UP TIRES, TAKES MORE GAS, AND CAN BE DANGEROUS.

## ALIGNMENT-REAR

IF YOUR CAR HAS INDEPENDENT REAR SUSPENSION, IT NEEDS CHECKING FOR THE SAME REASONS THE FRONT NEEDS IT. IF YOU DON'T KNOW WHAT'S BACK THERE ON YOUR CAR, ASK AN EXPERIENCED MECHANIC, AND NOT THE GAS PUMP JOCKEY!

## TIRE BALANCE & SHOCK ABSORBERS

CHECK TIRE BALANCE ANY TIME YOU FEEL A VIBRATION IN THE STEERING, OR IF YOU SEE "CLIPPING" AT THE TIRE TREAD EDGES.

PUSH DOWN ON THE FENDER SEVERAL TIMES TO CHECK THE SHOCKS. WHEN YOU STOP PUSHING ON THE FENDER, IT SHOULD GO DOWN, THEN BOUNCE UP, THEN STOP. MORE BOUNCE THAN THAT, AND THE SHOCKS ARE BAD.

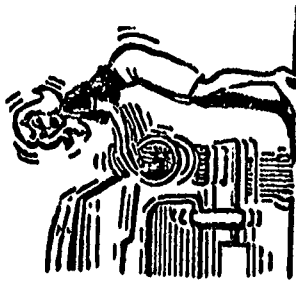

## LEAVE YOUR JUNK AT HOME

LIGHTER WEIGHT = LESS ENERGY USED TO RUN YOUR CAR. TAKE EVERYTHING OUT, AND JUST PUT BACK THE SPARE TIRE, JACK, AND SOME TOOLS.

GIVE THE REST TO GOODWILL.

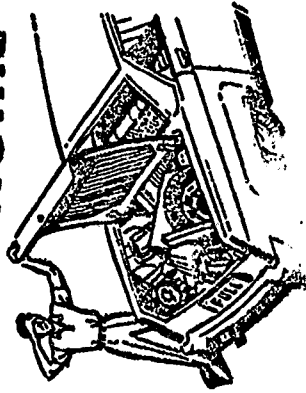

## REMOVE THE RACK

BESIDES BEING NOISY AND UGLY, YOUR ROOF (OR SKI) RACK CAN COST YOU UP TO FIVE M.P.G.! LEAVE THAT FUEL SUCKER IN THE GARAGE, EXCEPT WHEN YOU NEED IT!

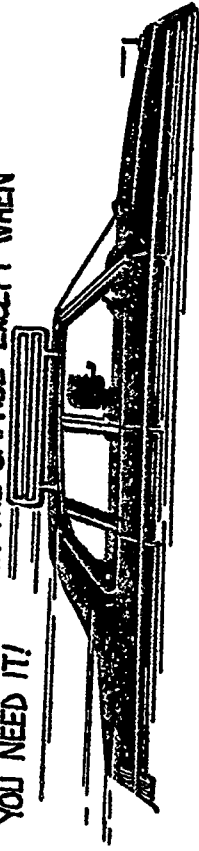

## SMOOTH DRIVING

YOUR OWN POOR DRIVING HABITS CAN COST YOU 5 OR 6 M.P.G.! JACKRABBIT STARTS EAT GAS AT AN ALARMING RATE. WATCH TRAFFIC SIGNALS AHEAD AND ADJUST YOUR SPEED TO HIT THEM ON GREEN. ON THE HIGHWAY, DRIVE AT AN EVEN SPEED. ON LONG HILLS, GO EASY ON THE THROTTLE, EVEN IF YOUR SPEED DROPS OFF A LITTLE. USE YOUR CRUISE CONTROL IF YOU HAVE ONE-IT SAVES GAS.

## MORNING WARM-UPS



WARMUP TIME = ZERO M.P.G. KEEP THE WARMUP TO 30-60 SECONDS (EXCEPT IN SUB-ZERO COLD) TO CIRCULATE ENGINE OIL THOROUGHLY, THEN DRIVE AWAY. JUST TAKE IT EASY UNTIL THE CAR WARMS UP, AVOIDING HARSH ACCELERATION DURING THIS PERIOD.

## GASOHOL

CHECK WITH YOUR MECHANIC ON THIS ONE. USUALLY GASOHOL IS OK, BUT THE ALCOHOL IN IT DISSOLVES SOME PLASTICS, PLASTIC FUEL FILTERS, CARBURETOR FLOATS, AND FUEL VALVES, COULD BE AFFECTED. THESE COULD BE CHANGED TO METAL BUT MIGHT LEAVE YOU STRAINED IF THEY FALL OUT ON THE ROAD.

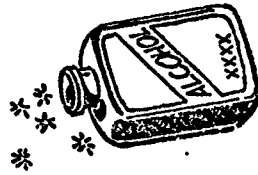

BACKGROUND INFORMATION: Section 511(b)(1) and Section 511(c) of the Motor Vehicle Information and Cost Savings Act (15 U.S.C. 2011(b)) requires that:

(b)(1) "Upon application of any manufacturer of a retrofit device (or prototype thereof), upon the request of the Federal Trade Commission pursuant to subsection (a), or upon his own motion, the EPA Administrator shall evaluate, in accordance with rules prescribed under subsection (d), any retrofit device to determine whether the retrofit device increases fuel economy and to determine whether the representations (if any) made with respect to such retrofit devices are accurate."

(c) "The EPA Administrator shall publish in the Federal Register a summary of the results of all tests conducted under this section, together with the EPA Administrator's conclusions as to -

- (1) the effect of any retrofit device on fuel economy;
- (2) the effect of any such device on emission of air pollutants; and
- (3) any other information which the Administrator determines to be relevant in evaluating such device."

EPA published final regulations establishing procedures for conducting fuel economy retrofit device evaluations on March 23, 1979 [44 FR 17946].

## ALIGNMENT-FRONT

GET THE FRONT END ALIGNED ABOUT EVERY 6 MONTHS, OR MORE OFTEN IF YOUR TIRES ARE WEARING UNEVENLY. AN OUT-OF-WHACK FRONT END EATS UP TIRES, TAKES MORE GAS, AND CAN BE DANGEROUS.

## ALIGNMENT-REAR

IF YOUR CAR HAS INDEPENDENT REAR SUSPENSION, IT NEEDS CHECKING FOR THE SAME REASONS THE FRONT NEEDS IT. IF YOU DON'T KNOW WHAT'S BACK THERE ON YOUR CAR, ASK AN EXPERIENCED MECHANIC, AND NOT THE GAS PUMP JOCKEY!

## TIRE BALANCE & SHOCK ABSORBERS

CHECK TIRE BALANCE ANY TIME YOU FEEL A VIBRATION IN THE STEERING, OR IF YOU SEE "CLIPPING" AT THE TIRE TREAD EDGES.

PUSH DOWN ON THE FENDER SEVERAL TIMES TO CHECK THE SHOCKS. WHEN YOU STOP PUSHING ON THE FENDER, IT SHOULD GO DOWN, THEN BOUNCE UP, THEN STOP. MORE BOUNCE THAN THAT, AND THE SHOCKS ARE BAD.

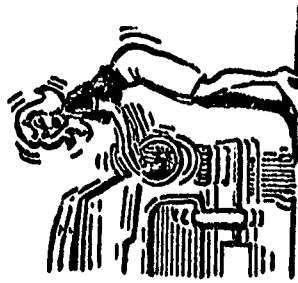

## LEAVE YOUR JUNK AT HOME

LIGHTER WEIGHT = LESS ENERGY USED TO RUN YOUR CAR. TAKE EVERYTHING OUT, AND JUST PUT BACK THE SPARE TIRE, JACK, AND SOME TOOLS.

GIVE THE REST TO GOODWILL.

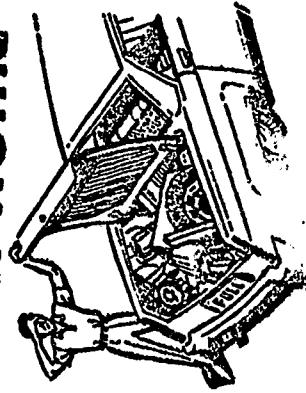

## REMOVE THE RACK

BESIDES BEING NOISY AND UGLY, YOUR ROOF (OR SKI) RACK CAN COST YOU UP TO FIVE M.P.G.! LEAVE THAT FUEL SUCKER IN THE GARAGE, EXCEPT WHEN YOU NEED IT!

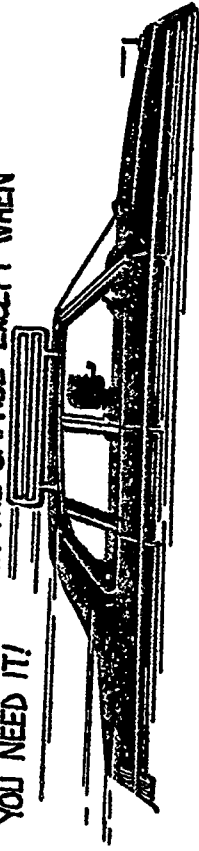

## SMOOTH DRIVING

YOUR OWN POOR DRIVING HABITS CAN COST YOU 5 OR 6 M.P.G.! JACKRABBIT STARTS EAT GAS AT AN ALARMING RATE. WATCH TRAFFIC SIGNALS AHEAD AND ADJUST YOUR SPEED TO HIT THEM ON GREEN. ON THE HIGHWAY, DRIVE AT AN EVEN SPEED. ON LONG HILLS, GO EASY ON THE THROTTLE, EVEN IF YOUR SPEED DROPS OFF A LITTLE. USE YOUR CRUISE CONTROL IF YOU HAVE ONE-IT SAVES GAS.

## MORNING WARM-UPS



WARMUP TIME = ZERO M.P.G. KEEP THE WARMUP TO 30-60 SECONDS (EXCEPT IN SUB-ZERO COLD) TO CIRCULATE ENGINE OIL THOROUGHLY, THEN DRIVE AWAY. JUST TAKE IT EASY UNTIL THE CAR WARMS UP, AVOIDING HARSH ACCELERATION DURING THIS PERIOD.

## GASOHOL

CHECK WITH YOUR MECHANIC ON THIS ONE. USUALLY GASOHOL IS OK, BUT THE ALCOHOL IN IT DISSOLVES SOME PLASTICS, PLASTIC FUEL FILTERS, CARBUJETOR FLOATS, AND FUEL VALVES, COULD BE AFFECTED. THESE COULD BE CHANGED TO METAL BUT MIGHT LEAVE YOU STRAINED IF THEY FALL OUT ON THE ROAD.

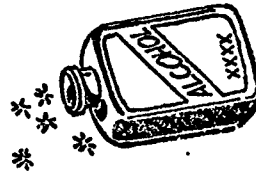

## GASOLINE

CHECK YOUR OWNER'S MANUAL FOR THE TYPE YOUR CAR NEEDS.

REGULAR-

GENERALLY, FOR ENGINES WITH COMPRESSION RATIOS UP TO 8 TO 1 AND NO CATALYTIC CONVERTER.

PREMIUM-

USUALLY, FOR ENGINES WITH OVER 8 TO 1 COMPRESSION AND NO CATALYTIC CONVERTER.

NO-LEAD-

FOR CARS WITH CATALYTIC CONVERTERS. USE OF LEADED FUELS WILL RUIN THE CONVERTER IN THESE CARS!

## PROPANE

THIS FUEL COSTS LESS PER GALLON THAN GASOLINE BUT MILEAGE IS USUALLY LESS. THE REAL KILLER IS THE COST OF THE PROPANE KIT - AT \$1000 - \$1500.

## TURBOCHARGING

THIS IS A PERFORMANCE PRODUCER AND NOT A MILEAGE IMPROVER. IN MOST ALL CASES, EXPENSIVE (\$1500-\$2000) AFTER MARKET KITS ARE AVAILABLE FOR A VARIETY OF CARS BUT EVEN IF YOUR ENGINE IS IN A-1 SHAPE, YOU COULD DESTROY IT IN A MATTER OF SECONDS IF FUEL MIXTURE OR A KNOCK SENSOR GOT OUT OF WHACK!

## FUEL ADDITIVES

THESE ARE NEARLY WORTHLESS EXCEPT TO DO A SPECIAL JOB, LIKE ABSORB MOISTURE FROM A BAD TANK OF GAS. AS FAR AS PRODUCING MORE GAS MILEAGE - FORGET IT!



## SPECIAL OILS, OIL ADDITIVES

SYNTHETIC OILS CAN IMPROVE MILEAGE BY REDUCING FRICTION BUT MANY CARS START USING OIL WHEN YOU SWITCH TO SYNTHETICS SO THERE GOES YOUR SAVINGS. OIL ADDITIVES ONLY DO SPECIAL JOBS-LIKE RAISING OIL VISCOSITY FROM SAE 30 TO SAE 40. IN THAT CASE YOU COULD HAVE USED SAE 40 OIL! FORGET OIL ADDITIVES - A WASTE OF MONEY!

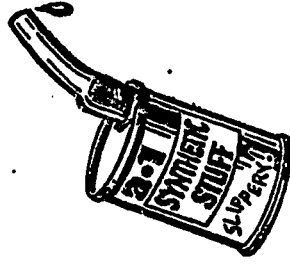

## A WORD ABOUT TESTING...

YOU PUT ON A FUEL SAVER. YOUR CAR RUNS GREAT. MUST BE MAKING MORE GAS MILEAGE, TOO - RIGHT? MAYBE, BUT HOW DO YOU KNOW? YOU'VE GOT TO TEST IT! HERE'S HOW: FILL THE TANK TO THE VERY TOP. DRIVE AT LEGAL SPEEDS ON A PREDETERMINED LOOP - 75 TO 100 MILES - THEN FILL UP AGAIN AT THE SAME STATION. DIVIDE GALLONS USED INTO MILES DRIVEN TO GET THE M.P.G. FIGURE. WRITE IT DOWN! NOW, EACH TIME YOU ADD A GADGET, REPEAT THIS PROCESS. WAS MILEAGE BETTER? WORSE? HOW DID THE CAR RUN? WHAT COLOR WAS THE EXHAUST PIPE (SEE BELOW)?

THIS IS THE METHOD I USED IN OVER 24,000 MILES OF TESTING BEFORE THIS BOOK WAS WRITTEN. THE DRILL IS NO FUN, BUT IT SURE TELLS YOU WHICH DEVICE WORKS AND WHICH IS JUNK!

## CAUTION!

CHECK YOUR CAR'S EXHAUST PIPE(S) FOR COLOR DURING TESTING. LIGHT GREY OR TAN IS GREAT. WHITE IS TOO LEAN - YOU COULD BURN SOME VALVES. DARK TAN OR GREY IS TOO RICH - YOU'RE WASTING GAS!

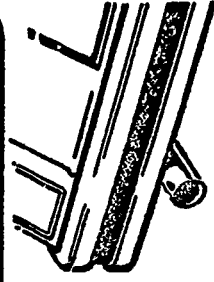

CHECK IT OFTEN!



# FEARLESS FREDDY'S FANTASTIC FUEL SAVING FRUMPMOBILE FOUR!

A FRIEND OF MINE IS A GAS SAVER GADGET FREAK. HE'S TRIED EVERY DEVICE EVER OFFERED TO CUT CONSUMPTION, MOST OF WHICH DIDN'T WORK. SOME TOOK MORE GAS AND A COUPLE WERE PLAIN DISASTERS FOR FREDDY'S ENGINE! THE WATCHWORD FOR YOU SHOULD BE CLEAR, EVEN WRITTEN IN LATIN: CAVEAT EMPITOR - "LET THE BUYER BEWARE!"

- OTHER MILEAGE MAKERS, CUT OF SIGHT IN THE CAR:
- FIVE SPEED GEARBOX.
  - TWO SPEED REAR END.
  - SPACE SAVER SPARE.
  - MAGNESIUM WHEELS.
  - FIBERGLASS FENDERS.
  - FIBERGLASS BUMPERS.
  - AIR HYDRAULIC SUSPENSION.
  - COV MAGNETS ON GAS HOSE.
  - PCV "REGULATOR" VALVE.

SILK WARNING FLAG IN GO-FAST ORANGE.

REAR SPOILER DAM-CORRECTS AIR FLOW AT REAR OF CAR TO REDUCE DRAG.

LOCKING GAS CAP.

DUAL EXHAUST

SUPER TURBULATOR HUB CAPS WITH AUTOMATIC WHEEL BALANCES.

RADIAL PLY TIRES - CUT ROLLING RESISTANCE, AID MILEAGE (ONE SIZE LARGER THAN STOCK).

PROTON COLLECTORS - FEED IONIZER CHAMBER ON FRONT FENDER THAT MAKES FUEL MOLECULES MORE LINEARLY LIQUID.

TONNEAU COVER - REDUCES TURBULENCE IN COCKPIT, THUS CUTTING WIND DRAG.

AUXILIARY SPEEDO DRIVE - GIVES ABSOLUTELY ACCURATE ODOMETER READINGS FOR MILEAGE CHECKS.

STREAMLINED HEADREST - REDUCES DRAG.

STREAMLINED HELMET - REDUCES DRAG.

STREAMLINED, CROSS-POLARIZED, LOW DRAG SUNGLASSES.

STREAMLINED MIRRORS CUT WIND DRAG AND DON'T VIBRATE.

VACUUM GAUGE - TO TELL BEST THROTTLE SETTING.

AIR COOLED COIL FOR ALCOHOL INJECTOR

FUEL FLOW METER TELLS RATE OF USE AT ANY TIME.

'RAMMER' AIR INDUCTION HORN - FOR COLD AIR & BUG INTAKE.

HIGH RISE BLOCK UNDER CAR.

WATER INJECTOR.

AIR DEFLECTOR - KEEPS BUGS OFF THE WINDSHIELD AND FREDDY'S GLASSES.

LINEAR IONIZER MOLECULIFER - LOOKS TERRIFIC!

FRONT SPOILER DAM - REDUCES AIR DRAG.

FREDDY'S CAR IS PRETTY CRAZY. BUT HE FOUND THAT SOME OF THE DEVICES DO WORK. I'LL SHOW YOU A FEW ON THE FOLLOWING PAGES...

## DO-IT-YOURSELF FUEL SAVING DEVICES THAT WORKED FOR ME!

I TRIED MANY DEVICES AND GADGETS IN OVER 24,000 MILES OF TEDIOUS, EXPENSIVE TESTING, AND ONLY A FEW SHOWED ANY MILEAGE IMPROVEMENT AT ALL. SOME DECREASED MILEAGE. MOST SIMPLY DID NOTHING. HERE ARE SOME THAT WORKED, AND YOU CAN BUILD THEM INEXPENSIVELY YOURSELF.

I DO URGE YOU TO USE CAUTION. CAREFULLY CHECK YOUR MILEAGE (SEE PAGE 9) BEFORE AND AFTER YOU INSTALL A DEVICE. MOST LEAN DOWN THE MIXTURE. SO CHECK YOUR EXHAUST PIPE CAREFULLY (SEE PAGE 9) TO SEE THAT YOU HAVEN'T GOT IT TOO LEAN. THE PISTONS YOU SAVE COULD BE YOUR OWN!

## FUEL PREHEATER

THEORETICALLY, PREHEATED FUEL VAPORIZES FASTER AND BURNS MORE COMPLETELY AND EFFICIENTLY, GIVING BETTER MILEAGE. THIS DEVICE IS PARTICULARLY EFFECTIVE IN WINTER MONTHS, UP TO 6 OR MORE M.P.G. MILEAGE IMPROVEMENT, COSTS UNDER \$10.

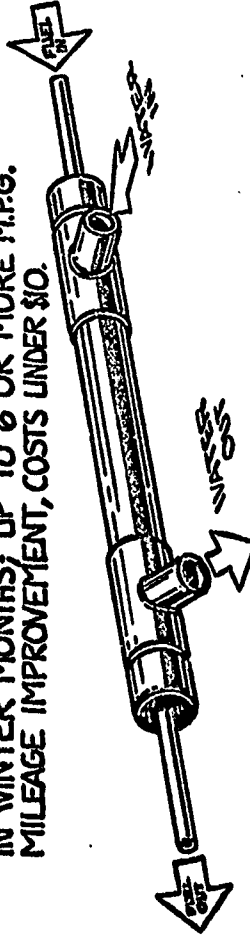

IT LOOKS SIMPLE AND IT IS, BUT IT WORKS. YOU CAN GET THE PARTS—COPPER PIECES—AT A PLUMBING SUPPLY STORE AND SOLDER THEM TOGETHER WITH A PROPANE TORCH (THEN TEST FOR LEAKS). ONCE INSTALLED, THE FUEL COMING OUT SHOULD BE HOT AS HOT TAP WATER, WITH A WARMED-UP ENGINE RUNNING AT 2500 R.P.M.

## NOTES ON THE PREHEATER:

DO NOT ATTEMPT TO INSTALL A PREHEATER ON DIESEL, FUEL INJECTION GAS, OR AIR-COOLED ENGINES! CONSULT A QUALIFIED MECHANIC IF YOU ARE IN DOUBT ABOUT INSTALLATION.

### BASIC NECESSARY PARTS:

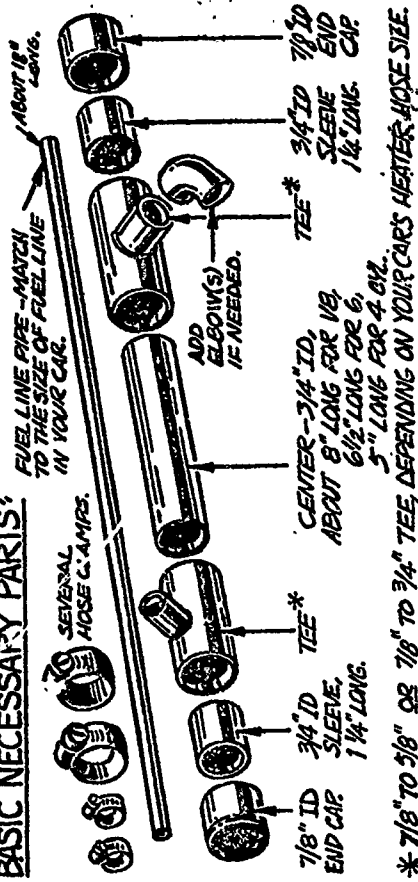

\* 7/8" TO 5/8" OR 7/8" TO 3/4" TEE, DEPENDING ON YOUR CAR'S HEATER HOSE SIZE.

## OTHER FORMS OF PREHEATERS:

YOU MAY WISH TO BUILD YOUR PREHEATER WITH A DIFFERENT SHAPE. HERE ARE SOME IDEAS. PREHEATERS USE HEATER WATER TO PREHEAT THE FUEL, IN ALL CASES.

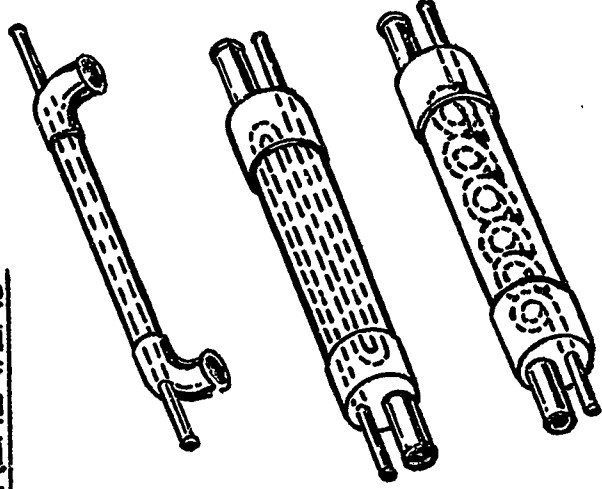

USE ONLY GOOD QUALITY TUBING, SOLDER, HOSES, CLAMPS, ETC., TO INSTALL YOUR PREHEATER! IT PAYS IN THE LONG RUN!

BE SURE TO FLARE THE ENDS OF THE TUBES SLIGHTLY SO HOSES STAY ON.

# FEARLESS FREDDY'S FANTASTIC FUEL SAVING FRUMPMOBILE FOUR!

A FRIEND OF MINE IS A GAS SAVER GADGET FREAK. HE'S TRIED EVERY DEVICE EVER OFFERED TO CUT CONSUMPTION, MOST OF WHICH DIDN'T WORK. SOME TOOK MORE GAS AND A COUPLE WERE PLAIN DISASTERS FOR FREDDY'S ENGINE! THE WATCHWORD FOR YOU SHOULD BE CLEAR, EVEN WRITTEN IN LATIN: CAVEAT EMPITOR - "LET THE BUYER BEWARE!"

- OTHER MILEAGE MAKERS, CUT OF SIGHT IN THE CAR:
- FIVE SPEED GEARBOX.
  - TWO SPEED REAR END.
  - SPACE SAVER SPARE.
  - MAGNESIUM WHEELS.
  - FIBERGLASS FENDERS.
  - FIBERGLASS BUMPERS.
  - AIR HYDRAULIC SUSPENSION.
  - COV MAGNETS ON GAS HOSE.
  - PCV "REGULATOR" VALVE.

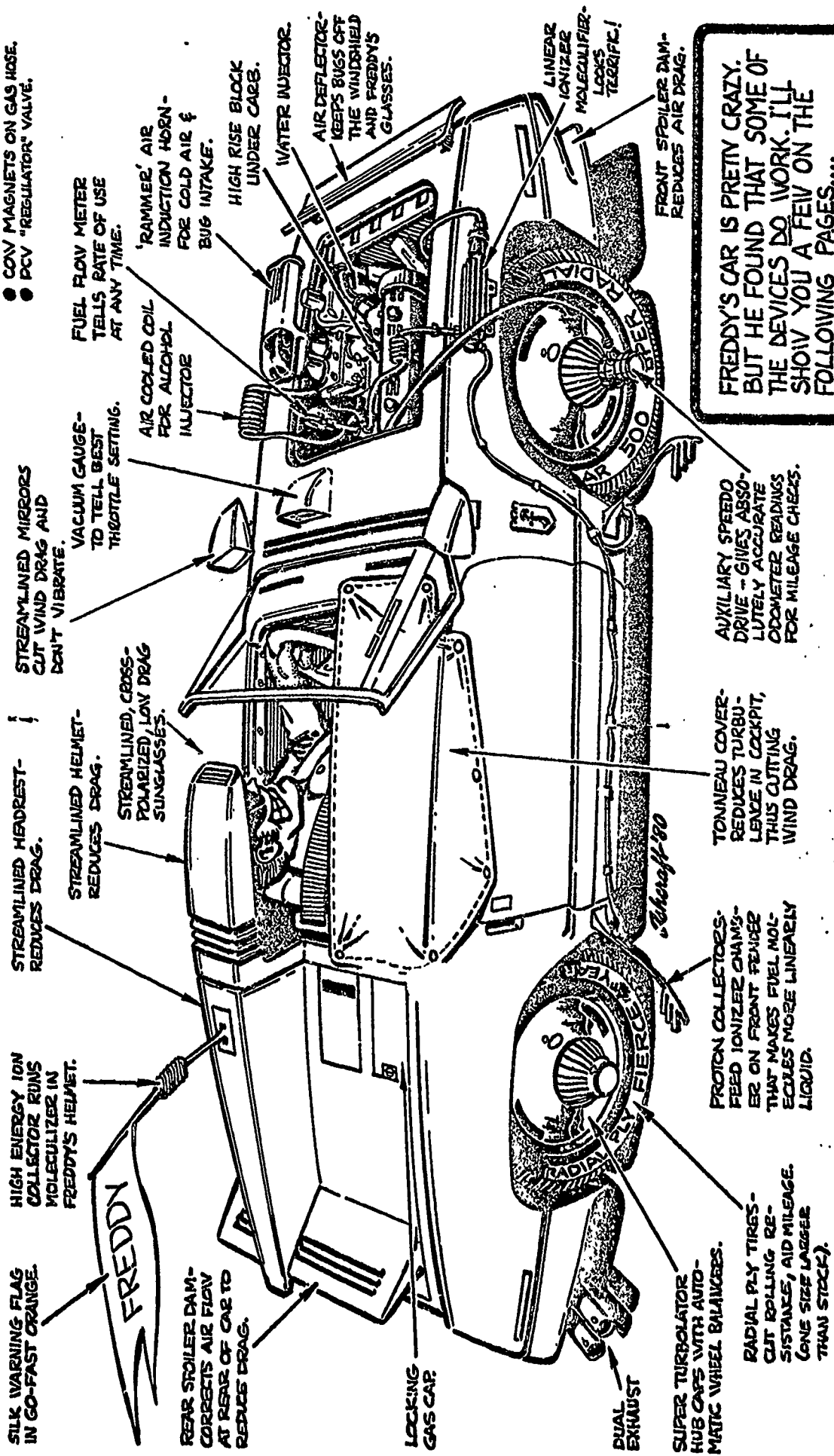

FREDDY'S CAR IS PRETTY CRAZY, BUT HE FOUND THAT SOME OF THE DEVICES DO WORK. I'LL SHOW YOU A FEW ON THE FOLLOWING PAGES...

# BIG GUN FOR BETTER MILEAGE

MOST PICKUPS AND 4VDS ARE OVER CARBURETED SO THEY WILL HAVE ADEQUATE POWER TO HANDLE THE OCCASIONAL HEAVY LOAD. A LARGE PORTION OF THE TIME THEY ARE DRIVEN LIKE A CAR, LIGHTLY LOADED, AND CAN BENEFIT FROM A SMALLER CARB. FOR V8 ENGINES UP TO 460 CUBIC INCHES, I HAD THE BEST RESULTS WITH A CARTER AFB, 400 CFM UNIT, THOUGH I TRIED OTHER BRANDS, TOO. THIS OFF-THE-SHELF CARB GAVE ALMOST 50% IMPROVEMENT ON MY 350 CID 4VD (FROM 10 M.P.G. TO 15 M.P.G.)! RE-JETTING THE ORIGINAL CARB. GAVE LITTLE OR NO IMPROVEMENT.

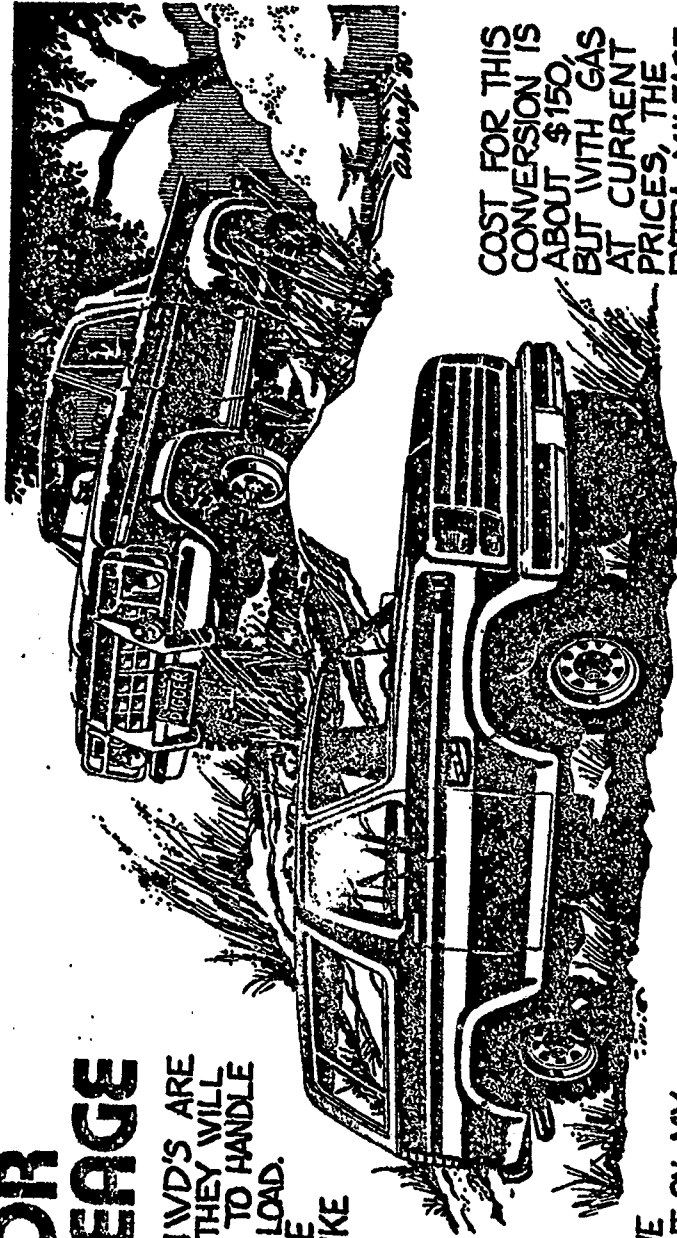

COST FOR THIS CONVERSION IS ABOUT \$150, BUT WITH GAS AT CURRENT PRICES, THE EXTRA MILEAGE WILL PAY FOR IT IN ABOUT 3000 MILES! AND YOU CAN GET FURTHER IMPROVEMENT IN MILEAGE BY USING THE DEVICES SHOWN IN THIS BOOK!

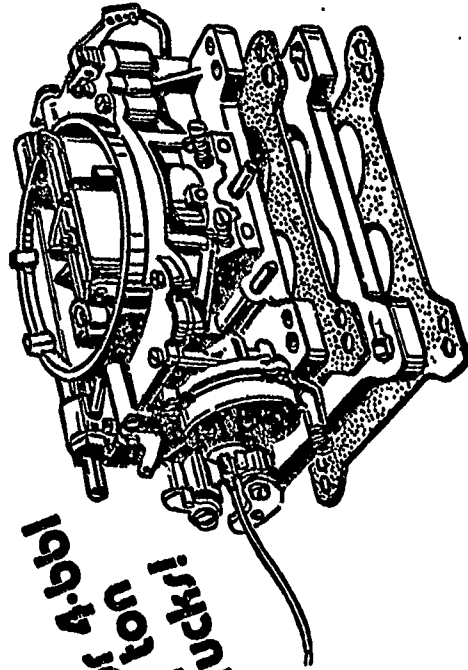

For you  
1/2 trucks!

CARTER AFB 400 CFM CARB WITH ADAPTOR.

CARTER PROVIDES APPROPRIATE FITTINGS AND CONNECTIONS SO THIS AFB 400 CFM MODEL WILL FIT YOUR ENGINE WITH VERY LITTLE WORK. IT ALSO HAS AN ELECTRIC CHOKE SO THERE IS NO HOOK-UP PROBLEM THERE.

YOUR ENGINE MAY REQUIRE AN ADAPTOR PLATE AND ANOTHER GASKET AS SHOWN ON THE LEFT.

PERFORMANCE IS STILL VERY GOOD WITH THIS CARBURETOR AND OVERALL DRIVEABILITY IS AS GOOD OR BETTER THAN STOCK.

over →

## NOTES

### the water-alcohol injector

THIS UNIT (SEE PAGE 14) CAN BE USED WITH JUST CLEAN TAP WATER DURING THE TIME OF YEAR WHEN YOU DON'T EXPERIENCE FREEZING TEMPERATURES.

### cow magnets

THESE PLASTIC COATED BAR MAGNETS HAVE RECEIVED A LOT OF PRESS COVERAGE RECENTLY. ATTACHED TO YOUR CAR'S FUEL LINE, THEY SUPPOSEDLY MAKE THE GAS MOLECULES POLARIZE THEMSELVES SO THEY BURN MORE EFFICIENTLY. SNAKE OIL! I TRIED 'EM IN A VARIETY OF CONFIGURATIONS WITH THE SAME RESULTS; NO IMPROVEMENT IN MILEAGE!

### some driving tips

YOU CAN AVOID COSTLY TOWING BILLS & INCONVENIENCE BY MAKING UP A SMALL SURVIVAL PARTS KIT TO CARRY IN YOUR VEHICLE. THE KIT SHOULD INCLUDE FUSES, FAN BELT(S), SPARK PLUGS, POINTS, RADIATOR CAP, THERMOSTAT (& GASKET), AND A SPARE FUEL FILTER.

TAKE ALONG A FEW HAND TOOLS, A FIRST AID KIT, JUMPER CABLES, FLARES, A FIRE EXTINGUISHER, AND A LARGE FLASHLIGHT. IN WINTERTIME, A TOW CABLE, TIRE CHAINS AND A BLANKET SHOULD BE ADDED.

THESE FEW ITEMS SHOULD LET YOU FIX 95% OF YOUR ROAD TROUBLES ON THE SPOT!

# SPECIAL BONUS ADDITION!

## FOR OWNERS OF PICKUPS & 4WD VEHICLES

SINCE THIS BOOK WENT TO PRESS, AN ADDITIONAL 5000 MILES OF TESTING — IN PICKUPS & 4WD VEHICLES — HAVE BEEN COMPLETED. LET'S FACE IT—THESE MACHINES GET TERRIBLE GAS MILEAGE—ABOUT 10 M.P.G.—AND NEED ALL THE HELP THEY CAN GET!

MANY OF THE DEVICES SHOWN IN THE BOOK (PAGES 12-18) AND THE TIPS (PAGES 4-7) APPLY TO PICKUPS & 4WD'S AS WELL AS TO CARS, BUT I DID SOME FURTHER EXPERIMENTATION AND MADE SOME FURTHER IMPROVEMENTS IN FUEL MILEAGE.

I'D LIKE TO SHARE THESE RESULTS WITH YOU BECAUSE THEY CAN MEAN A LOT LESS FUEL FILL UPS AT THE 'BIG BUCKS' GAS STATIONS!

## 2. Typical Installation-V8:

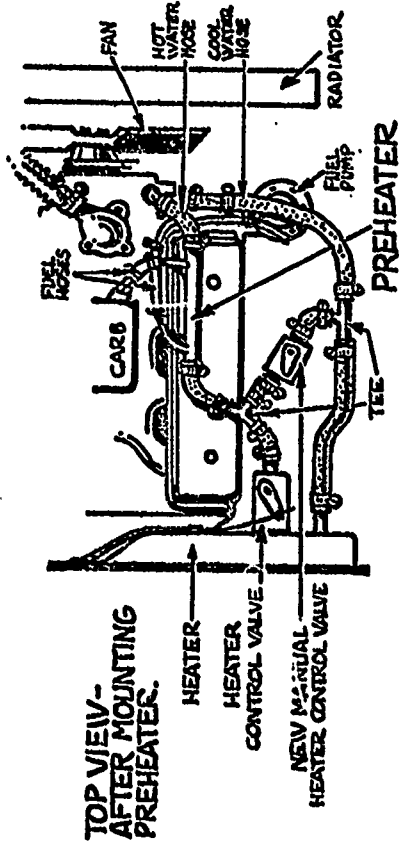
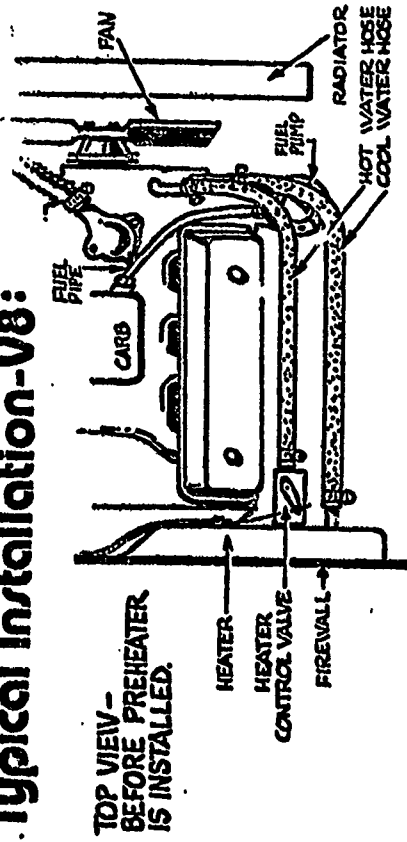

**NOTE:** AS YOU CAN SEE, IT'S JUST A MATTER OF TAPPING INTO THE HEATER HOSES AND THE FUEL HOSE OR PIPE, AND INSERTING THE COPPER PRE-HEATER. AN INEXPENSIVE IN-LINE HEAT CONTROL VALVE (AVAILABLE AT YOUR LOCAL AUTO PARTS STORE) IS NEEDED TO ALLOW THE DEVICE TO FUNCTION WHEN THE HEATER IS TURNED "OFF."

HERE'S A TIP: YOU CAN CUT A SECTION OF OLD HOSE & SLIP IT OVER HOSE OR PIPE TO PREVENT CHAFING ON SHARP EDGES.

5/16" FUEL PIPE FITS 5/16" OR 3/8" U.S. CAR FUEL HOSE.  
SAME 5/16" FUEL PIPE FITS IMPORT CAR 1/4" FUEL HOSE.

## 3. Typical Installation-6 Cylinder:

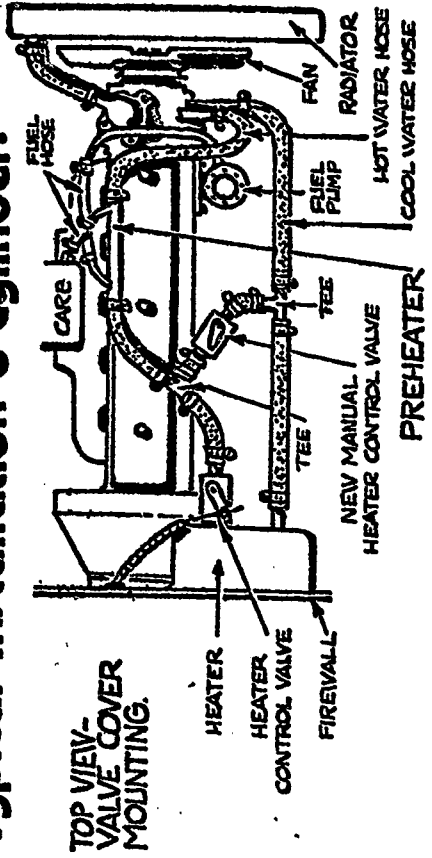

**NOTE:** SOME CARS HAVE HEAT CONTROL VALVES WITH THERMOSTATIC ENHANCEMENT. THAT TYPE IS MUCH MORE COMPLEX THAN THOSE SHOWN IN THESE SKETCHES AND ACTUALLY OPENS OR CLOSES THE VALVE MORE OR LESS THAN THE SELECTED SETTING IN ORDER TO COMPENSATE FOR THE WATER TEMPERATURE CHANGES THAT OCCUR WHEN THE ENGINE THERMOSTAT OPENS AND CLOSES. THIS COMPLEX TYPE IS EXPENSIVE AND IS NOT NEEDED FOR INSTALLING THE PREHEATER.

IF YOU CUT INTO ANY STEEL FUEL PIPES, DE-BURR THE OPENINGS AND PUT A SLIGHT FLARE ON THE ENDS OF THE PIPE SO THE FUEL HOSES WON'T SLIP OFF.

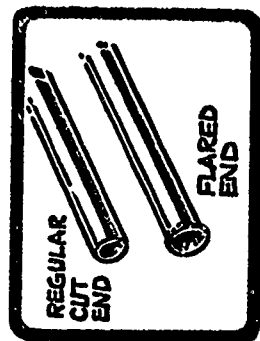

IT'S A GOOD IDEA TO HAVE THE COOLING-SYSTEM PRESSURE TESTED FOR LEAKS AFTER YOU INSTALL THE PREHEATER. ANY REPAIR SHOP OR RADIATOR REPAIR FACILITY CAN DO THE JOB FOR YOU, QUICKLY AND INEXPENSIVELY.

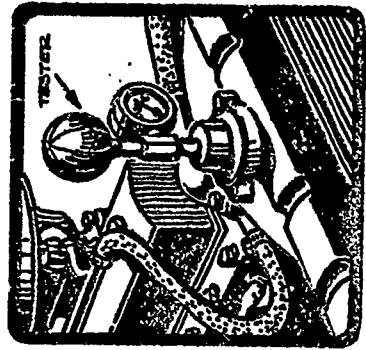

#### 4. Typical Installation - 4 Cylinder:

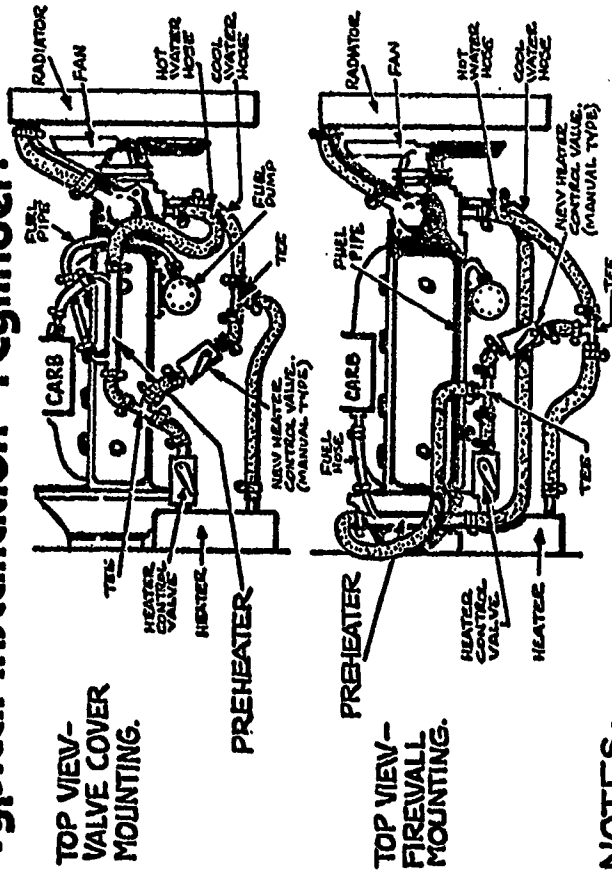

#### NOTES:

TEST YOUR VEHICLE FOR MILEAGE (SEE P9 OF BOOK) BEFORE AND AFTER YOU INSTALL THE DEVICE. PLAN YOUR WORK AND KEEP THE INSTALLATION AS SIMPLE AS POSSIBLE. CHECK YOUR VEHICLE'S IGNITION POINTS, TIMING, THERMOSTAT, AND ALL HOSES BEFORE INSTALLATION, AND ADJUST OR REPLACE AS NECESSARY. IN ANY CASE, REPLACE THE FUEL HOSES YEARLY.

YOUR FUEL PREHEATER CAN, IN MOST CASES, BE MOVED FROM ONE VEHICLE TO ANOTHER. CONSULT A QUALIFIED MECHANIC IF IN DOUBT.

REMEMBER - THIS PREHEATER IS NOT FOR VANS, TRUCKS, OR MOTORHOMES, AND CANNOT BE USED ON FUEL INJECTION GAS, DIESEL, OR AIR-COOLED ENGINES.

#### LIMITED WARRANTY

MIKE GREER, INC. WARRANTS THE FUEL PREHEATER AND TWO COPPER TEES FOR WORKMANSHIP AND MATERIALS ONLY, FOR A PERIOD OF SIX MONTHS FROM TIME OF PURCHASE. THIS WARRANTY DOES NOT COVER LOSS OF FUEL OR COOLANT OR DAMAGE TO YOUR VEHICLE IN ANY WAY, FOR ANY REASON.

# FUEL PREHEATER

## Do-It-Yourself INSTALLATION INSTRUCTIONS

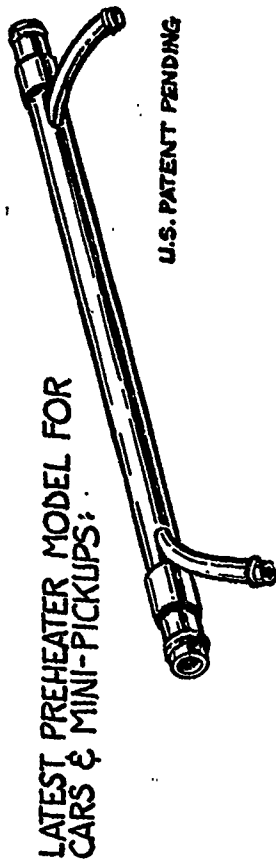

U.S. PATENT PENDING

LATEST PREHEATER MODEL FOR CARS & MINI-PICKUPS:

THIS IS A VERY SIMPLE, YET EFFECTIVE DEVICE; HOWEVER, THE MODERN AUTOMOBILE IS NOT! THERE ARE A NUMBER OF WAYS TO CONNECT THE PREHEATER INTO THE SYSTEM AND THESE PAGES ARE OFFERED AS A GUIDE FOR THE DO-IT-YOURSELFER.

IF, AFTER READING THESE INSTRUCTIONS AND LOOKING SERIOUSLY UNDER THE HOOD OF YOUR CAR OR MINI-PICKUP, YOU STILL CAN'T FIGURE IT OUT, DON'T START CUTTING HOSES AND HOPING THEY'RE THE RIGHT ONES - CONSULT A QUALIFIED MECHANIC!

#### INSTALLATION NOTES:

- USE GOOD QUALITY HOSES AND CLAMPS.
- DO THE INSTALLATION WITH THE ENGINE COOL!
- MAKE THE FUEL HOSES AS SHORT AS YOU CAN WITHOUT KINKING THEM.
- KEEP HOSES AWAY FROM FAN AND EXHAUST MANIFOLDS.
- PUT ALL VACUUM HOSES BACK ON AFTER PREHEATER INSTALLATION.

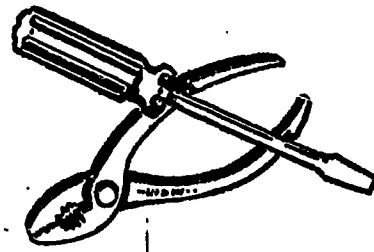

Attachment C

#### 4. Typical Installation - 4 Cylinder:

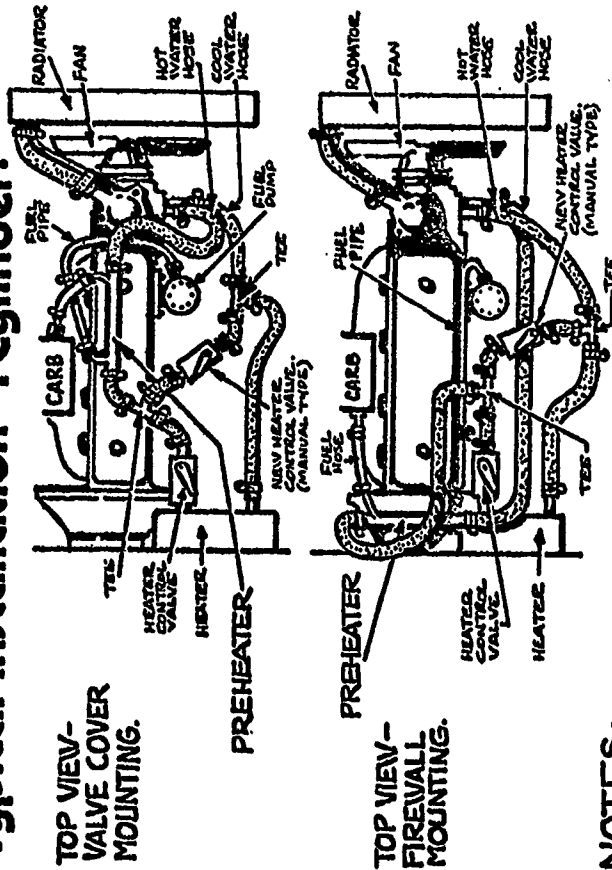

#### NOTES:

TEST YOUR VEHICLE FOR MILEAGE (SEE P9 OF BOOK) BEFORE AND AFTER YOU INSTALL THE DEVICE. PLAN YOUR WORK AND KEEP THE INSTALLATION AS SIMPLE AS POSSIBLE. CHECK YOUR VEHICLE'S IGNITION POINTS, TIMING, THERMOSTAT, AND ALL HOSES BEFORE INSTALLATION, AND ADJUST OR REPLACE AS NECESSARY. IN ANY CASE, REPLACE THE FUEL HOSES YEARLY.

YOUR FUEL PREHEATER CAN, IN MOST CASES, BE MOVED FROM ONE VEHICLE TO ANOTHER. CONSULT A QUALIFIED MECHANIC IF IN DOUBT.

REMEMBER - THIS PREHEATER IS NOT FOR VANS, TRUCKS, OR MOTORHOMES, AND CANNOT BE USED ON FUEL INJECTION GAS, DIESEL, OR AIR-COOLED ENGINES.

#### LIMITED WARRANTY

MIKE GREER, INC. WARRANTS THE FUEL PREHEATER AND TWO COPPER TEES FOR WORKMANSHIP AND MATERIALS ONLY, FOR A PERIOD OF SIX MONTHS FROM TIME OF PURCHASE. THIS WARRANTY DOES NOT COVER LOSS OF FUEL OR COOLANT OR DAMAGE TO YOUR VEHICLE IN ANY WAY, FOR ANY REASON.

# FUEL PREHEATER

## Do-It-Yourself INSTALLATION INSTRUCTIONS

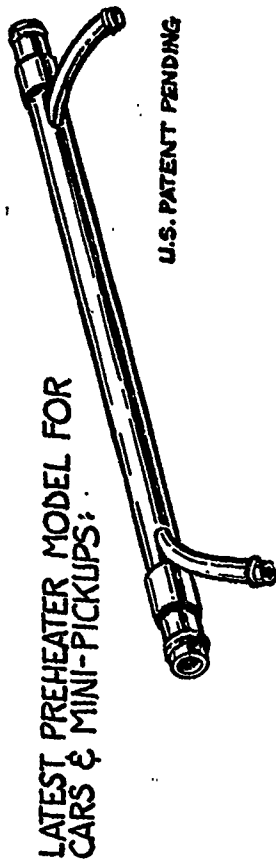

THIS IS A VERY SIMPLE, YET EFFECTIVE DEVICE; HOWEVER, THE MODERN AUTOMOBILE IS NOT! THERE ARE A NUMBER OF WAYS TO CONNECT THE PREHEATER INTO THE SYSTEM AND THESE PAGES ARE OFFERED AS A GUIDE FOR THE DO-IT-YOURSELFER.

IF, AFTER READING THESE INSTRUCTIONS AND LOOKING SERIOUSLY UNDER THE HOOD OF YOUR CAR OR MINI-PICKUP, YOU STILL CAN'T FIGURE IT OUT, DON'T START CUTTING HOSES AND HOPING THEY'RE THE RIGHT ONES - CONSULT A QUALIFIED MECHANIC!

#### INSTALLATION NOTES:

- USE GOOD QUALITY HOSES AND CLAMPS.
- DO THE INSTALLATION WITH THE ENGINE COOL!
- MAKE THE FUEL HOSES AS SHORT AS YOU CAN WITHOUT KINKING THEM.
- KEEP HOSES AWAY FROM FAN AND EXHAUST MANIFOLDS.
- PUT ALL VACUUM HOSES BACK ON AFTER PREHEATER INSTALLATION.

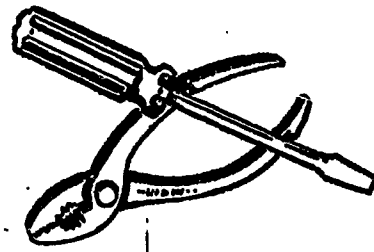

Attachment C



December 1, 1980

Mr. Charles T. Townsend  
400 Schoolhouse Creek road  
Grants Pass, Oregon 97526

Dear Mr. Townsend:

This letter is in response to your inquiry of November 20, 1980 regarding an EPA evaluation of a fuel pre-heater unit. The Environmental Protection Agency is charged by Congressional mandate to evaluate fuel economy and emission control devices. While the EPA does not actually "approve" such devices, it does conduct evaluations for the purpose of increasing the common knowledge in the area. For this reason, the outcome of any testing by EPA becomes public information. It is this information which may be cited although no claims can be made that any EPA findings constitute "approval" of the device or system.

Enclosed with this letter is a packet of materials which you will need to apply for an EPA evaluation of your device. This packet consists of 1) an application format, 2) a document entitled "EPA Retrofit and Emission Control Device Evaluation Test Policy" and 3) a copy of the applicable Federal Regulations.

In order for the EPA to conduct an evaluation of your device, we must have an application. Once you have reviewed all the documents in the packet, you should prepare an application in accordance with the guidelines of the application format. If you have not yet conducted the tests we require, we can assist in the development of a satisfactory test plan.

Once we receive your application, it will be reviewed to determine if it meets the requirements listed in the format. If so, you will be advised of our decision whether or not EPA will perform any confirmatory testing. Any EPA testing will be performed at no cost to you and you will be given the opportunity to concur with our test plan. Once this testing is complete, an evaluation report will be written. If no further testing is required, the report will be written solely on the basis of the test data submitted and our engineering analysis.

There are, however, several aspects concerning testing at an outside laboratory which I would like to bring to your attention at this time:

**Minimum Test Requirements** - Although different types of devices may require a more complex test plan, the minimum we require involves two vehicles and two test sequences run in duplicate. The vehicles should be selected from those listed in Table 1; if possible. Each vehicle is to be set to manufacturer's tune-up specifications for the baseline tests.

The tests are conducted in a "back-to-back" manner, once with the vehicle in baseline condition and again with the device installed with no vehicle adjustments between tests. If installation of the device also involves some adjustments, e.g. timing, fuel-air mixture, choke or idle speed, another test sequence with only these adjustments should be inserted between the first and last. Also as a minimum, the test sequence shall consist of a hot-start LA-4 portion (bags 1 and 2) of the Federal Test Procedure (FTP) and a Highway Fuel Economy Test (HFET). The details of these tests are contained in the enclosed packet. Although only a hot-start FTP is required to minimize the costs to you, you are encouraged to have the entire cold-start test performed since any testing and evaluation performed by EPA will be based on the complete FTP and you may wish to know how a vehicle with your device performs over this official test. As a final requirement, the personnel of the outside laboratory you select should perform every element of your test plan. This includes preparation of the test vehicle, adjustment of parameters and installation of the device.

**Submission of Data** - We require that all test data obtained from the outside laboratories in support of your application be submitted to us. This includes any results you have which were declared void or invalid by the laboratory. We also ask that you notify us of the laboratory you have chosen, when testing is scheduled to begin, what tests you have decided to conduct, allow us to maintain contact with the laboratory during the course of the testing, and allow the test laboratory to directly answer any questions at any time about the test program.

**Cost of the Testing** - The cost of the minimum test plan (two vehicles, two test sequences in duplicate) described above should be less than \$2000 per vehicle and less than \$4000 for the total test at any of the laboratories on the list. You will have to contact them individually to obtain their latest prices.

**Outcome of the Tests** - Although it is impossible to accurately predict the overall worth of a device from a small amount of testing, we have established some guidelines which will help you determine whether the test results with your device should be considered encouraging. These values have been chosen to assure both of us that a real difference in fuel economy exists and that we are not seeing only the variability in the results. The table below presents the minimum number of cars that need to be tested for varying degrees of fuel economy improvement assuming a typical amount of variability in fuel economy measurement. For a minimum test plan which was conducted on a fleet of two cars, the

average improvement should be at least 8%. If at least an 8% difference in average fuel economy can be shown, then we would be able to say statically at the 80% confidence level that there is a real improvement. Similarly, we would expect a minimum of 5% improvement for a fleet of 5 vehicles. Test results which display a significant increase in emission levels should be reason for concern.

Minimum Fuel Economy Improvements versus Size of Test Fleet

<u>Fleet Size</u>	<u>Average Improvement Required</u>
2	8%
3	7%
4	6%
5	5%
10	4%
25	2%

Once we receive your application, it will be reviewed to determine if it meets the requirements listed in the format. If your application is not complete, we will ask you to submit further information or data. After any missing information has been submitted, your application will be reconsidered and once it meets our requirements, you will be advised of our decision whether or not EPA will perform any confirmatory testing. Any EPA testing will be performed at no cost to you and you will be given the opportunity to concur with our test plan. Once this testing is complete, an evaluation report will be written. If no further testing is required, the report will be written solely on the basis of the test data submitted and our engineering analysis.

Despite the current backlog and increasing number of inquiries regarding fuel economy device evaluations, the EPA intends to process your application in as expeditious a manner as possible. We have established a goal of twelve weeks from the receipt of a complete application to the announcement of our report. The attainment of this objective requires very precise scheduling and we are depending on the applicant to respond promptly to any questions or to submit any requested data. Failure to respond in a timely manner will unduly delay the process. In the extreme case, we may consider lack of response as a withdrawal of the application.

I hope the information above and that contained in the enclosed documents will aid you in the preparation of an acceptable application for an EPA evaluation of your device. I will be your contact with EPA during this process and any subsequent EPA evaluation. My address is EPA, Motor Vehicle Emission Laboratory, 2565 Plymouth Road, Ann Arbor, Michigan, 48105. The telephone number is (313) 663-4200. Please contact me if you have any questions or require any further information.

Sincerely,

Merrill W. Korth, Device Evaluation Coordinator  
Emission Control Technology Division

Enclosures

*MWK*

For a minimum test plan which was conducted on a fleet of two cars, the average improvement should be at least 3%. If at least an 8% difference in average fuel economy can be shown, then we would be able to say stastically at the 80% confidence level that there is a real improvement.

Similarly, we would expect a minimum of 5% improvement for a fleet of 5 vehicles. Test results which display a significant increase in emission levels should be reason for concern.

Minimum Fuel Economy Improvements versus Size of Test Fleet

<u>Fleet Size</u>	<u>Average Improvement Required</u>
2	8%
3	7%
4	6%
5	5%
10	4%
25	2%

Once we receive your application, it will be reviewed to determine if it meets the requirements listed in the format. If your application is not complete, we will ask you to submit further information or data. After any missing information has been submitted, your application will be reconsidered and once it meets our requirements, you will be advised of our decision whether or not EPA will perform any confirmatory testing. Any EPA testing will be performed at no cost to you and you will be given the opportunity to concur with our test plan. Once this testing is complete, an evaluation report will be written. If no further testing is required, the report will be written solely on the basis of the test data submitted and our engineering analysis.

Despite the current backlog and increasing number of inquiries regarding fuel economy device evaluations, the EPA intends to process your application in as expeditious a manner as possible. We have established a goal of twelve weeks from the receipt of a complete application to the announcement of our report. The attainment of this objective requires very precise scheduling and we are depending on the applicant to respond promptly to any questions or to submit any requested data. Failure to respond in a timely manner will unduly delay the process. In the extreme case, we may consider lack of response as a withdrawal of the application.

I hope the information above and that contained in the enclosed documents will aid you in the preparation of an acceptable application for an EPA evaluation of your device. I will be your contact with EPA during this process and any subsequent EPA evaluation. My address is EPA, Motor Vehicle Emission Laboratory, 2565 Plymouth Road, Ann Arbor, Michigan, 48105. The telephone number is (313) 668-4200. Please contact me if you have any questions or require any further information.

Sincerely,

Merrill W. Korth  
Device Evaluation Coordinator  
Test and Evaluation Branch

Enclosures

*MWK*

# FEARLESS FREDDY'S FANTASTIC FUEL SAVING FRUMPMOBILE FOUR!

A FRIEND OF MINE IS A GAS SAVER GADGET FREAK. HE'S TRIED EVERY DEVICE EVER OFFERED TO CUT CONSUMPTION, MOST OF WHICH DIDN'T WORK. SOME TOOK MORE GAS AND A COUPLE WERE PLAIN DISASTERS FOR FREDDY'S ENGINE! THE WATCHWORD FOR YOU SHOULD BE CLEAR, EVEN WRITTEN IN LATIN: CAVEAT EMPITOR - "LET THE BUYER BEWARE!"

- OTHER MILEAGE MAKERS, CUT OF SIGHT IN THE CAR:
- FIVE SPEED GEARBOX.
  - TWO SPEED REAR END.
  - SPACE SAVER SPARE.
  - MAGNESIUM WHEELS.
  - FIBERGLASS FENDERS.
  - FIBERGLASS BUMPERS.
  - AIR HYDRAULIC SUSPENSION.
  - COV MAGNETS ON GAS HOSE.
  - PCV "REGULATOR" VALVE.

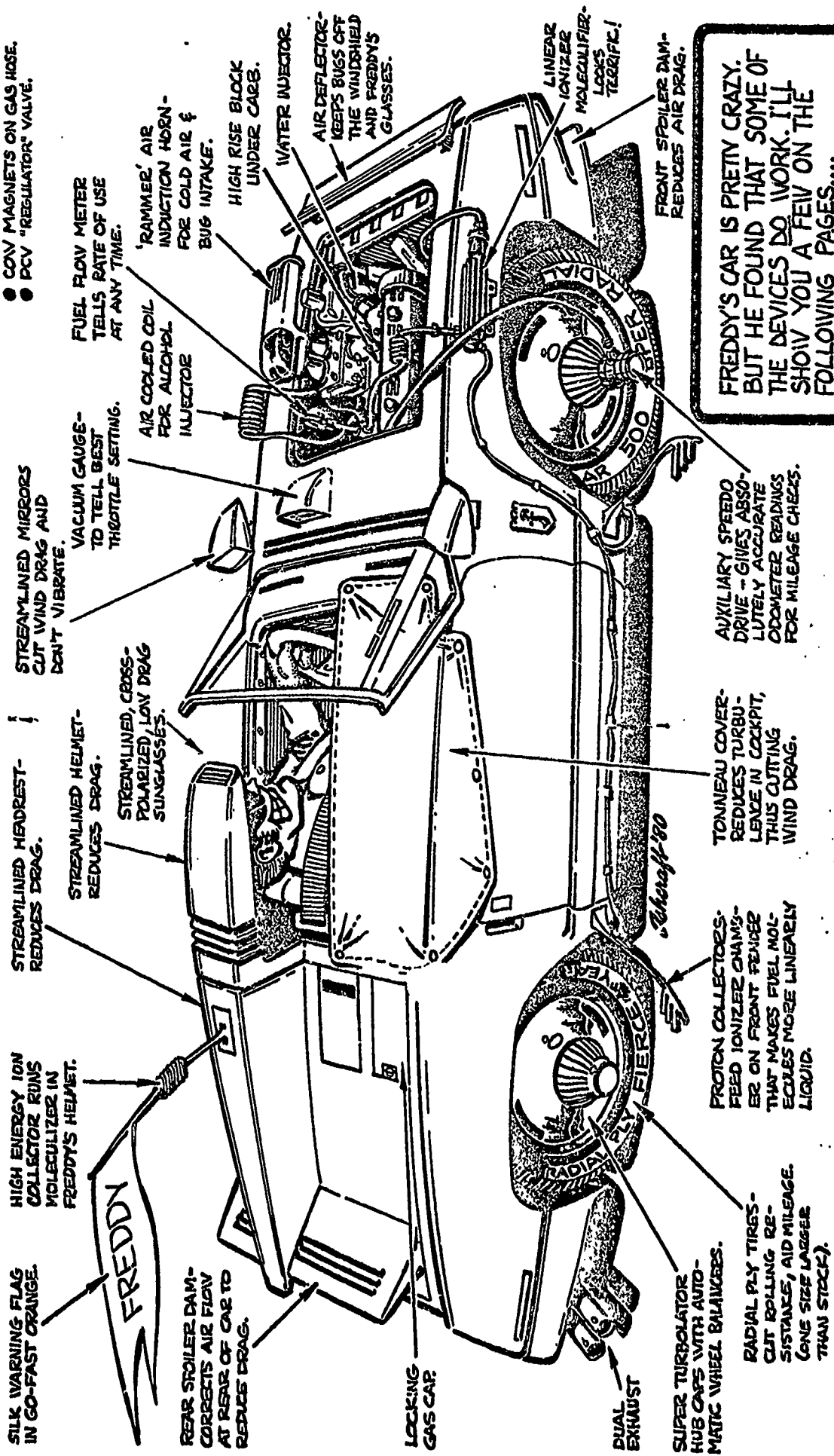

FREDDY'S CAR IS PRETTY CRAZY. BUT HE FOUND THAT SOME OF THE DEVICES DO WORK. I'LL SHOW YOU A FEW ON THE FOLLOWING PAGES...

**Minimum Test Requirements** - Although different types of devices may require a more complex test plan, the minimum we require involves two vehicles and two test sequences run in duplicate. The vehicles should be selected from those listed in Table 1; if possible. Each vehicle is to be set to manufacturer's tune-up specifications for the baseline tests.

The tests are conducted in a "back-to-back" manner, once with the vehicle in baseline condition and again with the device installed with no vehicle adjustments between tests. If installation of the device also involves some adjustments, e.g. timing, fuel-air mixture, choke or idle speed, another test sequence with only these adjustments should be inserted between the first and last. Also as a minimum, the test sequence shall consist of a hot-start LA-4 portion (bags 1 and 2) of the Federal Test Procedure (FTP) and a Highway Fuel Economy Test (HFET). The details of these tests are contained in the enclosed packet. Although only a hot-start FTP is required to minimize the costs to you, you are encouraged to have the entire cold-start test performed since any testing and evaluation performed by EPA will be based on the complete FTP and you may wish to know how a vehicle with your device performs over this official test. As a final requirement, the personnel of the outside laboratory you select should perform every element of your test plan. This includes preparation of the test vehicle, adjustment of parameters and installation of the device.

**Submission of Data** - We require that all test data obtained from the outside laboratories in support of your application be submitted to us. This includes any results you have which were declared void or invalid by the laboratory. We also ask that you notify us of the laboratory you have chosen, when testing is scheduled to begin, what tests you have decided to conduct, allow us to maintain contact with the laboratory during the course of the testing, and allow the test laboratory to directly answer any questions at any time about the test program.

**Cost of the Testing** - The cost of the minimum test plan (two vehicles, two test sequences in duplicate) described above should be less than \$2000 per vehicle and less than \$4000 for the total test at any of the laboratories on the list. You will have to contact them individually to obtain their latest prices.

**Outcome of the Tests** - Although it is impossible to accurately predict the overall worth of a device from a small amount of testing, we have established some guidelines which will help you determine whether the test results with your device should be considered encouraging. These values have been chosen to assure both of us that a real difference in fuel economy exists and that we are not seeing only the variability in the results. The table below presents the minimum number of cars that need to be tested for varying degrees of fuel economy improvement assuming a typical amount of variability in fuel economy measurement.

January 3, 1981

Mr. Charles T. Townsend  
400 Schoolhouse Creek Road  
Grants Pass, OR 97526

Dear Mr. Townsend:

On December 1, 1980, I received a package from you containing your fuel "Pre-heater" device. I immediately forwarded to you an application format to be used in applying for an EPA evaluation of your device, and also enclosed other documents explaining the EPA test policy for retrofit devices. Since we have not received an application from you, I am returning your device and sending you another application format along with associated policy documents. If you are still interested in an EPA evaluation, please send us an application prepared according to the application format along with any test data you have demonstrating the effectiveness of your device. The Environmental Protection Agency is charged by Congressional mandate to evaluate fuel economy and emission control devices. While the EPA does not actually "approve" such devices, it does conduct evaluations for the purpose of increasing the common knowledge in the area. For this reason, the outcome of any testing by EPA becomes public information. It is this information which may be cited although no claims can be made that any EPA findings constitute "approval" of the device or system.

Enclosed with this letter is a packet of materials which you will need to apply for an EPA evaluation of your device. This packet consists of 1) an application format, 2) a document entitled "EPA Retrofit and Emission Control Device Evaluation Test Policy" and 3) a copy of the applicable Federal Regulations.

In order for the EPA to conduct an evaluation of your device, we must have an application. Once you have reviewed all the documents in the packet, you should prepare an application in accordance with the guidelines of the application format. A critical part of the application is the substantiating test data. The required test results will have to be obtained at a laboratory of your choice. Such testing would be conducted at your expense. A list of laboratories which are known to have the equipment and personnel to perform acceptable tests has been included in the enclosed packet. If you desire, we can assist in the development of a satisfactory test plan.

FGTD:TES:KORTH:dkz:K259:2569PlymouthRd:1/3/81



## UNITED STATES ENVIRONMENTAL PROTECTION AGENCY

ANN ARBOR, MICHIGAN 48105

OFFICE OF  
AIR, NOISE AND RADIATION

February 26, 1981

Mr. Charles T. Townsend  
400 Schoolhouse Creek Road  
Grants Pass, OR 97526

Dear Mr. Townsend:

This is to inform you that we have completed our initial review of your application for an EPA evaluation of the Greer Fuel Pre-Heater.

The device description as provided, shows great similarity to a fuel heater which the EPA has tested; i.e. FuelXpander. The test program showed no significant effects attributable to that device (copy of report enclosed).

Because the application did not contain any data which shows a significant impact on fuel economy and because of the lack of a beneficial effect attributable to FuelXpander, the EPA can not schedule confirmatory testing of the Greer Fuel Pre Heater at this time.

The enclosed documents define the testing you must have performed at one of the laboratories on the EPA recognized list in order for the EPA to proceed with the evaluation based on data for the device. Lacking this data, the EPA will either have to conclude that the application was abandoned or extrapolate from the FuelXpander to the Greer Fuel Pre Heater to complete the application. In either case, the EPA is required to publish its finding in the Federal Register.

Please let us know by March 20, 1981 whether or not you will be securing the appropriate data. We will be happy to comment on your test plan for tests at the private lab.

Sincerely,

*Merrill W. Korth*  
Merrill W. Korth, Senior Project Manager  
Test and Evaluation Branch

Enclosure

cc. P. Hutchins



February 26, 1981

Mr. Charles T. Townsend  
400 Schoolhouse Creek Road  
Grants Pass, OR 97526

Dear Mr. Townsend:

The Environmental Protection Agency is charged by Congressional mandate to evaluate fuel economy and emission control devices. While the EPA does not actually "approve" such devices, it does conduct evaluations for the purpose of increasing the common knowledge in the area. For this reason, the outcome of any testing by EPA becomes public information. It is this information which may be cited although no claims can be made that any EPA findings constitute "approval" of the device or system.

Enclosed with this letter is a packet of materials which you will need to apply for an EPA evaluation of your device. This packet consists of 1) an application format, 2) a document entitled "EPA Retrofit and Emission Control Device Evaluation Test Policy" and 3) a copy of the applicable Federal Regulations.

In order for the EPA to conduct an evaluation of your device, we must have an application. Once you have reviewed all the documents in the packet, you should prepare an application in accordance with the guidelines of the application format. A critical part of the application is the substantiating test data. The required test results will have to be obtained at a laboratory of your choice. Such testing would be conducted at your expense. A list of laboratories which are known to have the equipment and personnel to perform acceptable tests has been included in the enclosed packet. If you desire, we can assist in the development of a satisfactory test plan.

Once we receive your application, it will be reviewed to determine if it meets the requirements listed in the format. If so, you will be advised of our decision whether or not EPA will perform any confirmatory testing. Any EPA testing will be performed at no cost to you, and you will be given the opportunity to concur with our test plan. Once this testing is complete, an evaluation report will be written solely on the basis of the test data submitted and our engineering analysis.

There are, however, several aspects concerning testing at an outside laboratory which I would like to bring to your attention at this time:

NOTE: TEL: 302-271-8242; FAX: 302-271-8242; 2/26/81; HALEX1:JobG