



Improving Motor and Drive System Performance:

A Sourcebook for Industry



U.S. Department of Energy
**Energy Efficiency
and Renewable Energy**

Bringing you a prosperous future where energy
is clean, abundant, reliable, and affordable

Acknowledgements

Improving Motor and Drive System Performance: A Sourcebook for Industry was developed for the U.S. Department of Energy's (DOE) Industrial Technologies Program (ITP). This project is one in a series of sourcebooks on industrial systems. Other publications in this series cover fan, compressed air, process heating, pumping, and steam systems. For more information about DOE and ITP, please see Section 4, "Where to Find Help."

This sourcebook was prepared for ITP by technical staff at Lawrence Berkeley National Laboratory and Resource Dynamics Corporation. They wish to thank the many organizations that so generously assisted in data collection and to acknowledge the helpful reviews and other contributions provided by the following individuals:

Dale Basso, Rockwell Automation
Thomas Bishop, Electrical Apparatus Service Association
Austin Bonnett, Electrical Apparatus Service Association
Rob Boteler, U.S. Electrical Motors
Dennis Bowns, Bowns & Co.
Don Casada, Diagnostic Solutions
Jasper Fischer, Industrial Motor Repair
John Kueck, Oak Ridge National Laboratory
John Machelor, Motor-Vations, LLC
John Malinowski, Baldor Electric Co.
Ilene Mason, Consortium for Energy Efficiency
Gil McCoy, Washington State Energy Office
Sally McInerney, University of Alabama
Cynthia Nyberg, Electrical Apparatus Service Association
Howard W. Penrose, Ph.D., SUCCESS by Design Reliability Services
Charles Straub, P.E., Marathon Electric
Edward J. Swann, Rockwell Automation
John Tolbert, Bristol Compressor
Chuck Yung, Electrical Apparatus Service Association

September 2008

Prepared for the U.S. Department of Energy
Office of Energy Efficiency and Renewable Energy
Industrial Technologies Program

By
Lawrence Berkeley National Laboratory
Berkeley, California

Resource Dynamics Corporation
McLean, Virginia

Produced by the National Renewable Energy Laboratory
Golden, Colorado

Table of Contents

Acknowledgements	i
Quick Start Guide	1
Section 1: Motor and Drive System Basics	3
Overview	3
A System Approach	3
Indications of Poor System Design	4
Types of Electric Motors	4
Motor Operating Characteristics	8
Load Characteristics	10
Matching Motors and Drives to Their Applications	11
Load Duty Cycles	14
Common Motor Selection Problems	15
Summary	16
Section 2: Performance Opportunity Roadmap	17
Overview	17
Efficiency Opportunities	17
Section 3: Motor System Economics	39
Overview	39
Understanding Corporate Policies	39
Measuring the Dollar Impact of Efficiency	39
Presenting the Finances of Efficiency	40
Relating Efficiency to Corporate Priorities	40
Summary	44
Section 4: Where to Find Help	45
Directory of Contacts	49
Resources and Tools	50
Training Courses	60
Appendices	61
Appendix A: Glossary of Basic Motor System Terms	63
Appendix B: Motor Tip Sheets	67
Appendix C: EPC Act Efficiency Levels and Premium Efficiency Levels	99
Appendix D: Motor Repair Service Center Checklist	105
Appendix E: Guidelines for Comments	111

List of Figures

Figure 1.	4
Figure 2.	6
Figure 3.	6
Figure 4.	8
Figure 5.	10
Figure 6.	11
Figure 7.	11
Figure 8.	12
Figure 9.	13
Figure 10.	15
Figure 11.	15
Figure 12.	18
Figure 13.	26
Figure 14.	27
Figure 15.	27
Figure 16.	34
Figure 17.	45
Figure 18.	46

List of Tables

Table 1.	23
Table 2.	27
Table 3.	29
Table 4.	43

Quick Start Guide

This sourcebook is designed to provide those who use motor and drive systems with a reference that outlines opportunities to improve system performance. It is not meant to be a comprehensive technical text on motor and drive systems; rather, it provides practical guidelines and information to make readers aware of potential performance improvements. Guidance on how to find more information and assistance is also included.

Plant engineers, facility managers, operations personnel, and others whose work involves motor and drive systems will find this sourcebook helpful in assessing the efficiency of their motor and drive applications. Discussions of improvement opportunities in this sourcebook emphasize the connection between operating efficiency and system reliability. For example, a plant project that increases the overall efficiency of a motor and drive system often reduces plant downtime, as well. This is one of several important benefits of efficiency improvements.

This sourcebook is divided into four main sections, as outlined below.

■ Section 1: Motor and Drive System Basics

For readers who are unfamiliar with the basics of motor and drive systems or would like a refresher, this section briefly describes important terms, relationships, and system design considerations. It also describes key factors involved in motor and drive selection and system design, and provides an overview of the different types of motors and drives and their applications. Readers who are already familiar with key terms and parameters used in selecting motors and drives, designing systems, and controlling their operation might want to skip this section and go on to the next one.

■ Section 2: Performance Opportunity Roadmap

This section describes the key components of a motor and drive system as well as opportunities for performance improvements. A systems approach is emphasized, rather than a focus on individual components. Guidance is provided in a set of efficiency opportunities, which cover the following topics in separate subsections for easy reference:

- Assessing Motor and Drive System Operating Conditions
- Establishing a Motor Management Program
- Providing Basic Maintenance
- Selecting the Right Motor
- Using Variable Frequency Drives
- Addressing In-Plant Electrical Distribution and Power Quality Issues
- Using the Service Center Evaluation Guide

■ Section 3: Motor System Economics

This section provides recommendations on how to propose projects like those described in Section 2 by highlighting for management the favorable economics of motor and drive system improvements. Topics include understanding and identifying corporate priorities, relating those priorities to efficiency, and clarifying the financial aspects of efficiency improvements, including life-cycle costs and payback periods.

■ Section 4: Where to Find Help

Section 4 provides a directory of associations and other organizations associated with motors and drives and their markets. This section also lists helpful resources for more information, tools, software, videos, and training opportunities.

■ Appendices

This sourcebook contains five appendices:

- Appendix A is a glossary of terms used in discussing motor and drive systems; these terms appear in bold type when they are first mentioned in the text.
- Appendix B contains a series of motor and drive system tip sheets. Developed by the U.S. Department of Energy (DOE), these tip sheets discuss opportunities for improving the efficiency and performance of motor systems, but in less detail than the efficiency opportunities described in Section 2.
- Appendix C provides Energy Policy Act (EPAct) efficiency levels for motors up to 200 horsepower (hp) in size, along with National Electrical Manufacturers Association (NEMA) Premium[®] motor efficiency levels.
- Appendix D includes a checklist for motor repair facilities.
- Appendix E provides guidelines for submitting suggested changes and improvements to the sourcebook.

Section 1: Motor and Drive System Basics

Overview

Electric motors, taken together, make up the single largest end use of electricity in the United States. In industrial applications, electric motors account for roughly 60% of electricity consumption; in the process industries, electric motors account for more than 70% of electricity use. Electric motors provide efficient, reliable, long-lasting service, and most require comparatively little maintenance. Despite these advantages, however, they can be inefficient and costly to operate if they are not properly selected and maintained. Industrial plants can avoid unnecessary increases in energy consumption, maintenance, and costs, by selecting motors that are well suited to their applications and making sure that they are well maintained.

A System Approach

Cost-effective operation and maintenance of a motor and drive system requires attention not just to individual pieces of equipment but to the system as a whole. A systems approach analyzes both the supply and demand sides of the system and how they interact, essentially shifting the focus from individual components to total system performance. Operators can sometimes be so focused on the immediate demands of their equipment that they overlook the ways in which the system's parameters are affecting that equipment.

A common engineering approach is to break a system down into its basic components or modules, optimize the selection or design of those components, and then assemble the system. An advantage of this approach is that it simplifies problems. A disadvantage is that this approach ignores the interaction of the components. For example, sizing a motor so that it is larger than necessary—essentially giving it a safety factor—ensures that the motor is strong enough to meet the needs of the application. However, an oversized motor can create performance problems with the driven equipment, especially in turbomachinery such as fans or pumps. In certain circumstances, an oversized motor can compromise the reliability of both the components and the entire system.

In a component approach, the engineer employs a particular design condition to specify a component. In a systems approach, the engineer evaluates the entire system to determine how end-use requirements can be provided most effectively and efficiently. Focusing on systems means expanding possibilities, from looking for one piece of

equipment that can meet worst-case needs to evaluating whether components can be configured to maintain high performance over the entire range of operating conditions.

A basic premise of a systems approach is that industrial systems usually do not operate under one condition all the time. Motor and drive system loads often vary according to cyclical production demands, environmental conditions, changes in customer requirements, and so on. To optimize system performance, the engineer must configure the system to avoid inefficiencies and energy losses. For example, motors that typically run at more than one-half to full load usually operate much more efficiently than they do at less than one-half load or into their service factor. The service factor is a multiplier that indicates the percentage of horsepower (or other nameplate rating, such as torque) above full load at which a motor can operate without causing a failure under certain conditions. Common service factor values are 1.10 and 1.15. Other avoidable losses include waste heat and flow energy that dissipates without performing useful work.

For example, suppose that a motor-driven pump supplies water to several heat exchangers and has a flow requirement that the system piping and heat exchangers were designed to handle. The pump was specified according to the requirements of this flow condition. However, actual operating conditions can vary according to the season, the time of day, and the production rate. To handle the need for variable flow rates, the system is equipped with valves and bypass lines. This equipment can be useful if it is properly applied, but wasteful if it is not.

Similarly, many fan systems have variable air delivery requirements. A common practice is to size the fan so that it meets the highest expected load and use dampers to restrict airflow during periods of low demand. However, one of the least efficient methods of controlling flow is to use dampers. Consequently, although the system provides adequate airflow, the lack of a drive to control the motor's speed (and thus airflow) can cause system operating costs to be significantly higher than necessary.

In addition to increasing energy costs, an inefficient motor and drive system often increases maintenance costs. When systems do not operate efficiently, the stress on the system caused by energy losses must be dissipated by piping, structures, dampers, and valves. Additional system stresses can accelerate wear and create loads for which the system was not originally designed. For example, in a pumping system, excess flow energy must be dissipated across throttle valves or through bypass valves, or it must be absorbed

by the piping and support structure. As a result, all of this equipment can degrade more easily. Throttle and bypass valves can require seat repair, and piping and support structures can develop cracks and leak as a result of fatigue loads. Repairing or replacing this equipment can be costly.

In addition, inefficient system operation in an industrial plant can create poor working conditions, such as high levels of noise and excessive heat. High noise levels can be the result of flow noise, structural vibrations, or simply operating the equipment. Excessive noise can fatigue workers more quickly and thus reduce productivity. In addition, inefficient systems often add heat to the workplace. This added heat usually must be removed by the facility's heating, ventilating, and air-conditioning (HVAC) system, further increasing total operating costs.

Indications of Poor System Design

Taking a component-based approach to industrial system design and operation tends to increase facility costs and maintenance requirements and reduce reliability. However, the problems associated with a poorly designed system—high energy costs, the need for frequent maintenance, and poor system performance—can be corrected, as indicated below.

■ High Energy Costs

High energy costs can be the result of inefficient system design as well as inefficient motor operation. Not selecting or designing a proper motor and drive system for the application can also lead to power quality problems, such as voltage sags, harmonics, and low power factor.

■ Frequent Maintenance

Equipment that is not properly matched to the requirements of the application tends to need more maintenance. The primary causes of increased maintenance requirements are the added stresses on the system and the increased heat that accompanies inefficient operation. Ironically, system designers often specify oversized motor and drive and end-use equipment in order to improve reliability. An oversized motor might be more reliable, but it might also make other parts of the system less reliable. A more effective way of ensuring high reliability is to design a system and specify system components so that the system's operating efficiency is high over the full range of operating conditions.

■ Poor System Performance

Operating a motor and drive system that was not properly selected for its application can result in poor overall system performance. Poor system performance is a major cause of increases in maintenance and decreases in reliability. Common indications include abrupt or frequent system starts and stops, high noise levels, and hot work environments. In many material handling systems, the work-in-process moves roughly from one work station to the next. The banging that often accompanies sudden accelerations and decelerations is symptomatic of stress on the motor and drive system. The consequences of this stress can be more frequent maintenance and poor operating efficiency.

High noise levels are common in inefficient fluid systems. Since energy losses in fluid flow often dissipate as noise, systems with large flow losses tend to be loud. In addition, inefficient equipment operation often greatly increases the temperature of the workspace, especially if the added heat load was not included in the design specifications for the HVAC system.

Types of Electric Motors

To ensure that motors are applied properly, it is essential to understand the various types of motors and their operating characteristics. Electric motors fall into two classes, based on the power supply: **alternating current (ac)** or **direct current (dc)**. The most common types of industrial motors are shown in Figure 1.

Alternating current (ac) motors can be single-phase or polyphase. In terms of quantity, single-phase motors are the most common type, mainly because many small motors are used for residential and commercial applications in which single-phase power is readily available. However, several operating constraints on these motors limit their widespread use in industrial applications. Integral single-phase

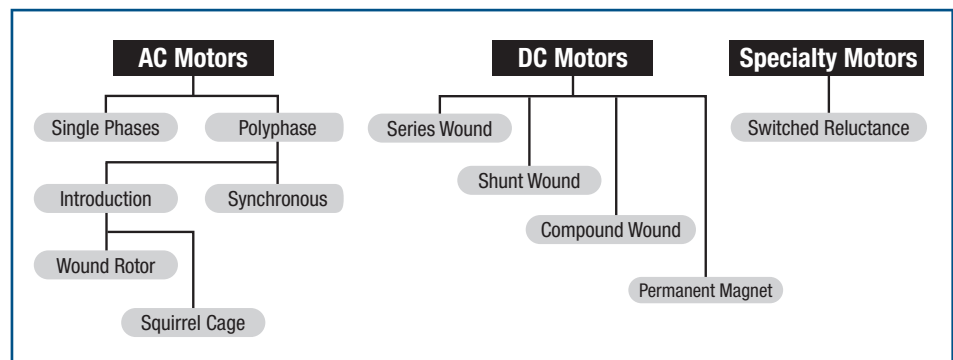

Figure 1. Types of motors

induction motors tend to pull large starting currents relative to the motor's size. In general, they operate less efficiently than three-phase motors of comparable size, and are not available in larger sizes.

In contrast, polyphase motors are used widely in industrial applications. They consume more than half of all the electricity used in industry. Polyphase motors can be found in almost every industrial process, and they often operate continuously to support production processes. These motors can achieve high efficiencies with favorable torque and current characteristics. The effectiveness and low cost of three-phase motors are major reasons why three-phase power is used so widely in industry. In terms of energy consumption and efficiency improvement opportunities, three-phase motor systems predominate. Therefore, they are the main focus of this sourcebook.

■ Direct Current Motors

Direct current (dc) power was central to Thomas Edison's vision of how electricity should be supplied. Because of their competitive advantages, however, ac power and ac motors soon became the industry favorite. Despite the predominance of three-phase ac motors, dc power has advantages in certain industrial applications and is still widely used.

The advantages of dc motors include excellent speed control and the ability to provide high torque at low speeds. However, a majority of dc motors use brushes to transfer electrical power to the motor **armature**. Brush assemblies not only require a larger motor, they can also increase maintenance requirements. As brushes wear, they create a housekeeping problem by generating carbon dust. Brushes are also sensitive to contamination, especially in machines that contain silicone materials, and they must be replaced periodically.

Since electric power is supplied as alternating current, additional equipment that generates dc power, such as motor generator sets or rectifier systems, is needed to run dc machines. Because batteries supply dc current, dc motors have an advantage in applications in which the motor is supplied by a dc bus as part of an uninterruptible power system. Although these applications are somewhat specialized, they could increase as industry becomes more sensitive to power quality problems and more aware of the high cost of interruptions in production.

There are four principal classes of dc motors: series wound, shunt wound, compound wound, and permanent magnet. Series wound, shunt wound, and compound wound motors all require brushes to supply current to the stator. The differences between these motors are based on how the stator (field frame) and the rotor (armature) are connected.

Series Motor. In a series motor, as the name implies, the stator and the rotor are connected in series and the same current passes through both. In this configuration, torque increases in proportion to the square of the increase in current. This relationship is true until the magnetic strength of the motor is reached, a condition known as *saturation*. Beyond saturation, any load increase is directly proportional to an increase in current.

Shunt Motor. In a shunt motor, the rotor and the stator circuits are connected in parallel. The torque and speed of these motors is relatively independent of the load. Consequently, adjusting the stator circuit resistance controls the strength of the magnetic field, and this permits relatively accurate control of the motor speed.

Compound Motor. A compound motor is a combination of a series and a shunt wound motor. It has two basic circuit branches; one circuit wraps around the stator, and the other is a series circuit that includes both the stator and the rotor. A key operating characteristic of this type of motor is that it can handle sudden increases in loads without a great change in speed.

Permanent Magnet. Permanent magnet (PM) motors rely on inherently magnetic materials—such as alloys of cobalt, nickel, iron, and titanium—to create a magnetic field. PM motors can be up to 600 hp in size. They can be constructed in several different ways, and some versions operate with ac power. However, most industrial PM motors are brushless dc types. An electronically commutated motor (ECM) is a type of brushless dc motor having speed and torque control. ECMs can use single-phase ac input power and convert it into three-phase operation. And they use electromagnetic force (EMF) sensing to determine rotor position and perform the commutation function. Because of their design, ECMs do not exhibit the brush wear and noise associated with typical dc motors.

PM motors have certain performance advantages over ac induction motors, especially in applications with wide variations in load and speed. PM motors can maintain relatively high efficiencies at low motor loads and, like other dc motors, they can provide high torque at low motor speeds. Since they do not require brushes, using PM motors

Section 1: Motor and Drive System Basics

avoids many of the operating and maintenance problems normally associated with dc motors. Advances in PM motor technology have made this type competitive with the more commonly used induction motor/**variable frequency drive** combination, in many applications. A drawback of PM motors is their tendency to accumulate magnetic contaminants, even when the motor is idle.

■ Alternating Current Motors

Alternating current (ac) motors are the most widely used in industry. Industry's preference for ac motors springs from their simplicity, low cost, and efficiency. There are two primary types of ac motors: induction (also referred to as asynchronous) and synchronous. With the exception of wound rotor motors that have slip rings, the rotors of induction motors are not physically connected to any external circuits; instead, the excitation current is induced by a magnetic field. In synchronous rotors, the excitation current is fed directly to the rotor by means of brushes or slip rings. Induction motors are used widely because of their simple design, rugged construction, relatively low cost, and characteristically long operating life. Synchronous motors, on the other hand, have some useful advantages and are used in more specialized applications.

In both types of motors, the stator circuit creates a magnetic field that rotates at a **synchronous speed**. This speed depends on the number of **poles** and the **frequency** of the electricity supply, and it is determined by the following equation:

$$\text{Synchronous speed} = \frac{120 \times \text{frequency (Hz)}}{\text{number of poles}}$$

For example, in a 60 Hz system, the stator field in a two-pole motor rotates at 3600 rpm, the field in a four-pole motor rotates at 1800 rpm, and the field in a six-pole motor rotates at 1200 rpm.

An important operating difference between induction motors and synchronous motors is that induction motors operate at somewhat less than synchronous speed. The difference between the actual speed and synchronous speed is known as slip. Synchronous motors operate without slip at synchronous speed.

Induction Motors. Induction motors include squirrel cage and wound rotor types. Induction motors rely on a magnetic field to transfer electromagnetic energy to the rotor. The induced currents in the rotor create a magnetic field that

interacts with the stator field. The speed of the rotor's magnetic field is slightly less than that of the stator (this difference is the slip). As the load on the motor increases, the slip also increases. A typical induction motor is shown in Figure 2.

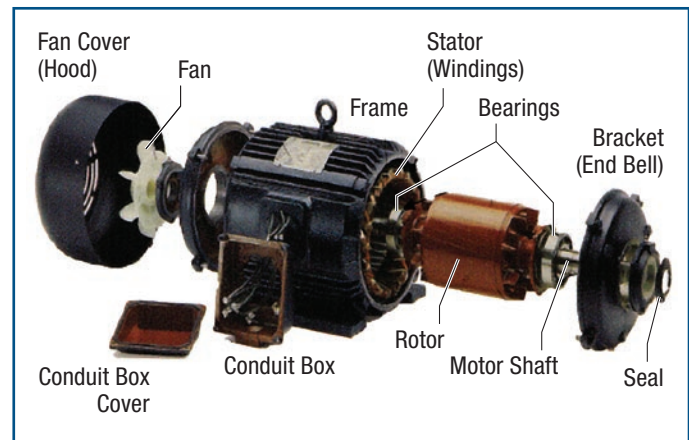

Figure 2. Induction motor

Courtesy of Leeson Electric Corporation

Squirrel Cage Motors. The most common type of industrial motor is the squirrel cage induction motor. The name derives from the similarity between the rotor and the type of wire wheel commonly found in pet cages at the time this motor was first developed (see Figure 3). Rotor **bars** are either welded or cast to two circular end rings, forming a circuit with very little resistance.

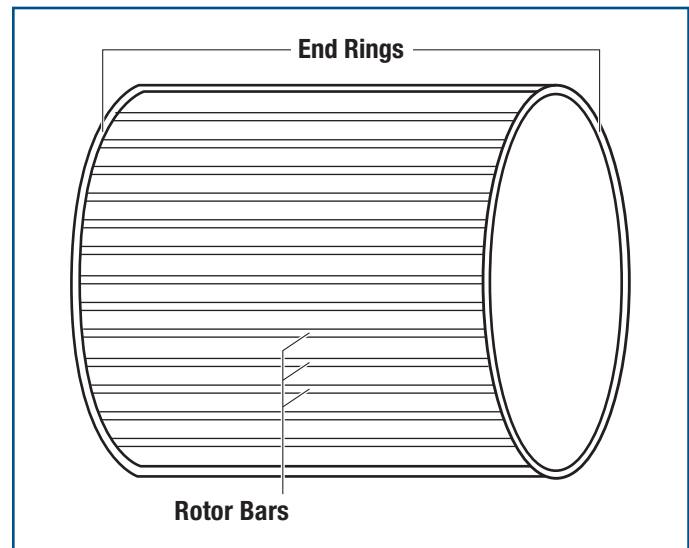

Figure 3. Squirrel cage rotor

Advantages of this type of motor include the following:

- Low cost
- Low maintenance
- High reliability
- A fairly wide range of torque and slip characteristics.

Since squirrel cage induction motors can be designed and built to have a relatively wide range of torque and slip characteristics, NEMA has developed a set of classifications for these motors. These classifications help engineers and designers select the right motors for applications that require certain starting torques, operating torques, and slip rates. For more on these motor classifications, see *Efficiency Opportunity No. 4, Selecting the Right Motor*, in Section 2 of this sourcebook.

Wound Rotor Motors. Another type of induction motor is the wound rotor. In this type, either bars are inserted into the rotor or wires are wound into slots in the rotor. In wound rotors, current is induced in the rotor and the resistance of the rotor circuit is varied by adding or removing external resistance to control torque and speed. An important operating characteristic of these motors is the ability to adjust speed and torque characteristics by controlling the amount of resistance in the rotor circuit.

Characteristics of this type of motor include the following:

- Excellent speed control
- High starting torque
- Low starting current
- Ability to handle high-**inertia** loads (induction motor slip losses would be too large and could overheat rotors)
- Ability to handle frequent starts and stops
- Ability to operate at reduced speeds for long periods.

Synchronous Motors. These motors, as their name implies, operate at the same speed as the rotating magnetic field. Although they are more expensive to purchase and maintain, they can be 1% to 2% more efficient—depending on motor size—than induction motors. They can also add a leading power factor component to a distribution system, which makes them attractive to many industrial facilities. In fact, synchronous motors are occasionally operated without a load, as synchronous condensers, just to increase a facility's power factor.

In industrial synchronous motors, an external supply of dc power is usually supplied to the rotor by a set of slip rings or brushes. In newer models, brushless excitation systems and permanent magnet generators are built into the rotor. Since the dc current does not change the polarity, the rotor needs a separate squirrel cage winding during starts. But

once the rotor approaches operating speed, the squirrel cage winding becomes inoperative; as the dc current is applied, the rotor speed is pulled into synchronicity with the rotating magnetic field created by the stator.

Switched Reluctance Motors. Switched reluctance (SR) motors have several performance, efficiency, and cost advantages that should encourage their use in an increasing number of applications. SR motors do not have magnets or rotor **windings**. Their simple, rugged design also provides higher reliability. Important advantages of SR motors include exceptional feedback and flexibility in speed and torque control.

SR motors operate much like an electromagnetic **coil**. The stator contains poles that, when energized, create a magnetic field that pulls the nearest pole on the rotor toward it. Consequently, the performance of SR motors is largely a function of the power electronics that control the sequencing of pole energizations. SR motors have characteristically high power-to-weight ratios and are well suited for vehicle applications. Their torque and speed control characteristics also make them suitable for pump and fan applications in which power is highly sensitive to operating speed. In the past, the disadvantages of SR motors included torque ripple (pole-to-pole variations in torque) and higher operating noise; however, improvements have been made in these areas.

SR motor technology was initially developed in the 19th century, but limitations in power electronics technology made this type of motor impractical. Later developments in power electronics improved their performance and lowered their costs, increasing their applicability. However, the cost of the power modules often offsets the lower cost of the SR motor itself. The modules are relatively specialized, often generating four-phase power.

Improvements in power electronics have made both PM and SR motors and similar systems much more suitable for many applications. Despite the many advantages of these motor systems, the most common type of industrial motor is still the squirrel cage induction type. Since motors are indispensable to plant operations, facilities tend to resist using a new motor technology if the current system is performing adequately. Adopting better operating practices or incorporating better controls into existing induction motor systems incurs less risk and can result in the same levels of efficiency and performance that new motor technologies exhibit.

Motor Operating Characteristics

The most important motor operating characteristics are horsepower, operating speed (measured in revolutions per minute [rpm]), and torque. These are related by the following equation:

$$\text{Hp} = \frac{\text{torque (ft-lb)} \times \text{rpm}}{5,252}$$

Motor performance depends on how well these operating characteristics match the load. The load on a motor is not always constant, and the response of the motor to changes in load is a fundamental factor in selecting the right motor for an application. For more on this, see *Efficiency Opportunity No. 4, Selecting the Right Motor*, in Section 2 of this sourcebook.

■ Voltages

The motor voltage must match the rated system supply voltage. A mismatch between the motor voltage and the system voltage can result in severe operating problems and, in some cases, immediate failure. However, this type of problem is not common. Operating a motor when the system voltage varies significantly from its rated level is a more critical concern. And, problems like these are often the result of a distribution system problem, such as **three-phase** voltage unbalance, voltage outages, sags, **surges**, and over or undervoltage.

Motor performance is significantly affected when a motor operates at voltages $\pm 10\%$ or more from its rated voltage. See *Efficiency Opportunity No. 6, Addressing In-Plant Electrical Distribution and Power Quality Issues*, in Section 2 of this sourcebook. A facility that experiences wide swings in voltage will probably have an abundance of power quality problems, including poor motor operation. If that is the case, the facility's distribution system should be reviewed.

■ Horsepower

The horsepower rating of the motor should be able to support the power requirements of the load without being oversized. In other words, the motor's horsepower should ensure that the motor not operate below 40% of full load for long periods (see Figure 4). Motor torque and speed are important additional considerations in determining a motor's ability to operate effectively and efficiently. The responsiveness of the motor in starting and operating is critical and should be considered concurrently with its horsepower.

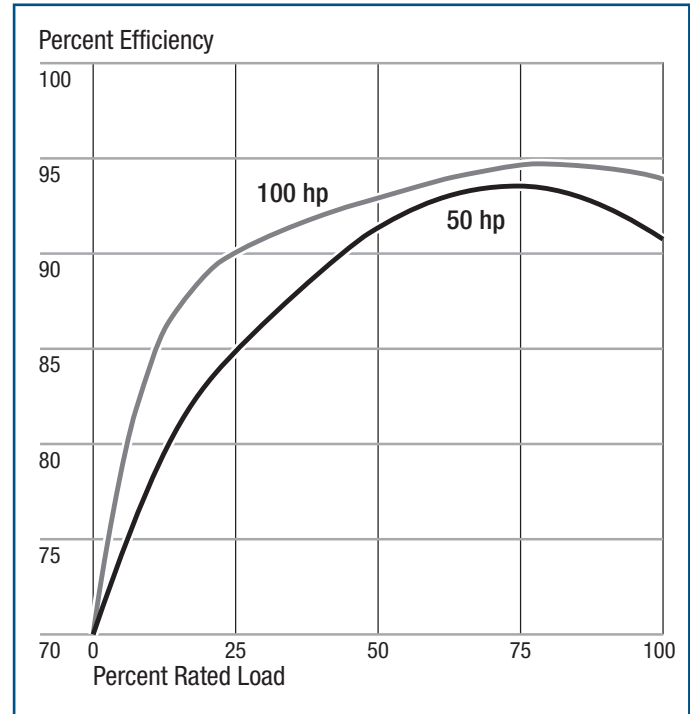

Figure 4. Typical motor part load efficiency curve
(Adapted from A. Bonnet, *IEEE Trans.* 36:1, Fig. 26, Jan. 2000)

Engineers should be careful not to oversize a motor just to satisfy a speed or torque requirement. Oversized motors tend to incur higher purchase, maintenance, and operating costs (including costs for power factor correction). A systems approach to motor selection is an effective way of ensuring adequate, cost-effective operation.

■ Speed

The speed of an electric motor is an important element that depends on many factors. The operating speed of a dc motor depends on the type of motor, the strength of the magnetic field, and the load. The operating speed of an ac motor depends on the rotor type, the number of poles, the frequency of the power supply, and slip characteristics. Synchronous ac motors operate at the speed of the rotating magnetic field; most induction motors operate within 1% to 3% of this speed, depending on the motor's slip characteristics.

Common synchronous speeds are 3600, 1800, 1200, 900, and 600 rpm. Many applications require speeds different from these, however, so motors are usually combined with various types of speed adjustment devices. These devices include gears, belts, eddy-current couplings, hydraulic couplings, variable frequency drives (VFDs), etc. Motors can also operate at multiple speeds by using separate

windings within the same motor or by using a single winding with an external switch that changes the number of poles.

An important consideration is whether the speed must be constant or variable. In constant speed applications, gears or belts can provide fixed speed ratios between the motor and the driven equipment. Variable speed applications can be served by multiple-speed motors or drive systems with adjustable speed ratios.

Adjustable Speed Motors. Many applications that are currently served by constant speed motors are well suited for variable speed motors. For example, in many pumping system and fan system applications, flow is controlled by using restrictive devices, such as throttle valves or dampers, or bypass methods. Although these flow control methods have advantages, speed control is often a more efficient and cost-effective option for many systems.

Similarly, in many material handling systems, adjustable speed drives can increase system efficiency and improve system reliability. For example, in many conveyor systems, lines are controlled by energizing and de-energizing a series of motors. These frequent starts and shutdowns are tough on motors and line components because of repeated stresses from starting currents and acceleration and deceleration of mechanical components. Using variable speed drives can smooth out line motion for more efficient and effective operation.

Some motors have inherent speed control capabilities. For example, dc motors have excellent speed and torque control characteristics and are often used when high torque at low speeds is required. The speed adjustments of dc motors can be as much as 20:1, and they can operate at 5% to 7% of the motor's base speed (some can even operate at 0 rpm). Some ac motors can also be used in speed adjustment situations. Wound rotor motors can have speed ratios of as much as 20:1 by changing the resistance in the rotor circuit.

Another common method of controlling speed is to use induction motors combined with VFDs. Induction motors are widely used in industrial applications because of their inherent advantages in terms of cost, reliability, availability, and low maintenance requirements. Mechanics and operators are usually familiar with these motors, which facilitate repair and maintenance tasks.

Combining an in-service motor with a VFD provides facilities with an effective speed control technology that does not require the use of a different type of motor. However, not all in-service induction motors can be combined with a VFD; engineers should evaluate motors case-by-case to see if such combinations are feasible. Misapplying VFDs to in-service motors can quickly cause motor failures. Moreover,

some motor-driven machines have speed-dependent lubrication systems, and these must be considered in any assessment associated with changes in speed.

Induction motors with VFDs are increasingly being used in applications that once featured dc motors. Although dc motors still have some operating advantages in low-speed, high-torque applications, the added complexity associated with operating and maintaining a dc motor system is an important factor behind the increasing numbers of induction motor/VFD systems. See *Efficiency Opportunity No. 5, Using Variable Frequency Drives*, in Section 2 of the sourcebook.

Another speed control option is to use an ac motor with an intermediate drive device that allows adjustable speed ratios. Eddy current and hydraulic couplings allow varying degrees of slip between the driver and the driven equipment to achieve the desired output speed. In eddy current couplings, the slip is controlled by adjusting the strength of the magnetic field in the coupling. In hydraulic couplings, a pump similar to the one used in automobile transmissions allows fluid to recirculate rather than perform mechanical work. Drawbacks to these devices include relatively low efficiency compared to that of other speed control devices, and high maintenance costs.

Multiple-Speed Motors. Multiple-speed motors are another speed control option. Ac motors can be built to operate at different, discrete speeds using two principal approaches. First, they can be constructed with multiple windings, one for each speed. These motors are usually two-speed, but they can be built to run at three or four speeds. Motors with different sets of windings are used in many cooling system applications so they can operate at different speeds. In general, these motors are less efficient because of the effects of the additional windings. Second, in many multiple-speed motors, a single winding can be controlled with a starter that allows the winding to be reconfigured into different speeds (with a ratio of only 2:1).

A principal advantage of multiple-speed motors is their ability to operate at different speeds using a compact motor/drive assembly. Floor space is valuable, and multiple-speed motors are space savers. Alternative speed control options often take up space savers, and require additional maintenance.

■ Torque

Torque is the rotational force that a motor applies to its driven equipment, and a fundamental factor in motor performance. The torque capacity of a motor depends on many design characteristics.

Figure 5 shows a torque curve for a typical induction motor. Starting torque is the instantaneous torque developed by the motor when it is first energized, and it is the same torque generated during locked rotor and stall conditions. This torque value is important because, even if a motor has sufficient horsepower, it could overheat before reaching operating speed if it cannot accelerate the load from rest.

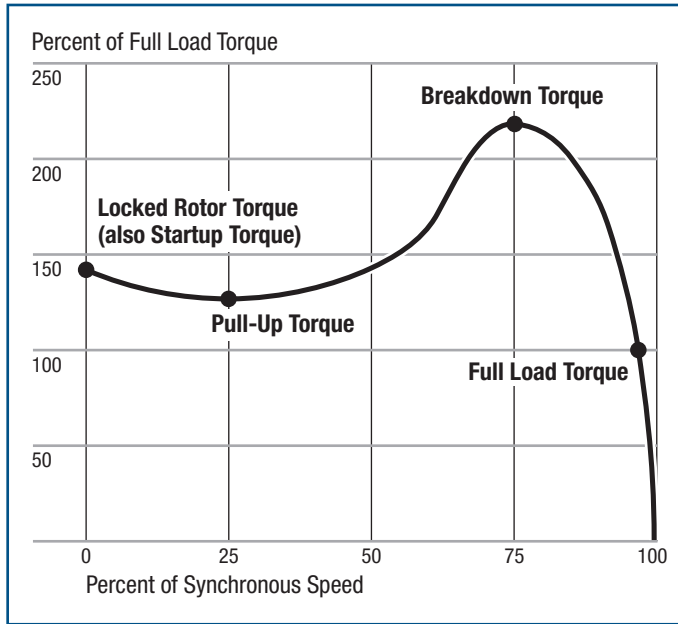

Figure 5. Typical motor speed torque curve

Pull-up torque is the minimum torque that the electric motor develops when it runs from zero to full-load speed (before it reaches the breakdown torque point). Full-load torque is the torque produced by the motor at rated horsepower. Motors sometimes exceed full-load torque during changes in the load; however, sustained operation above full load can reduce the operating life of a motor. Breakdown torque is the maximum torque that the motor can generate without an abrupt drop in speed. If the load exceeds this torque, the motor will stall, causing it to rapidly overheat and risking insulation failure if it is not properly protected.

Load Characteristics

There are four basic types of loads:

- Variable torque
- Constant torque
- Constant horsepower
- Cyclic loads.

The most common type of load has variable torque characteristics, in which horsepower and torque are proportional to speed. For example, in centrifugal pumps and fans, torque varies according to the square of speed.

In a constant torque load, the torque is independent of speed. Common applications include conveyor systems, hoists, and cranes. For example, conveying a 500-pound load along an assembly line requires the same amount of torque whether it is moving at a constant speed of 5 feet per minute or 10 feet per minute. Although horsepower varies according to speed, torque is constant.

In a constant horsepower load, the torque increases with decreasing speed and vice versa. A good example of this type of load is a winding machine in which the torque increases as the roll thickness builds up but the rotational speed slows down. Machine tools such as lathes and cutting machines display these operating characteristics.

A cyclic load is one in which the torque changes significantly within a cycle or over a series of cycles. An example is an oil well pump; in this application, the downstroke of the pump piston requires much less force than the upstroke. Also, some air compressors and refrigeration system compressors have cyclic load characteristics; they tend to shut down and start up in response to system pressures.

Load inertia refers to the resistance of the load to changes in speed. Applications that have high load inertia tend to require high starting torques. Load inertia is commonly referred to by the term Wk^2 . Examples of loads with high inertia are large fans and machines with flywheels, such as punch presses. The ratio of load inertia to motor torque has a strong effect on the responsiveness of the motor system to changes in the load.

Affinity Laws

$$\text{Flow}_{\text{final}} = \text{flow}_{\text{initial}} \left(\frac{\text{rpm}_{\text{final}}}{\text{rpm}_{\text{initial}}} \right)$$

$$\text{Pressure}_{\text{final}} = \text{pressure}_{\text{initial}} \left(\frac{\text{rpm}_{\text{final}}}{\text{rpm}_{\text{initial}}} \right)^2$$

$$\text{Power}_{\text{final}} = \text{power}_{\text{initial}} \left(\frac{\text{rpm}_{\text{final}}}{\text{rpm}_{\text{initial}}} \right)^3$$

Matching Motor and Drives to Their Applications

To select the proper motor for a particular application, the engineer needs to consider the basic requirements of the service. These include the load profile, environmental conditions, the importance of operating flexibility, and reliability requirements. About 60% of the energy consumed by industrial motor-driven applications is used to drive pumps, fans, and compressors. Within these applications, centrifugal pumps and fans share some common relationships between speed (commonly measured in rpm), flow, pressure, and power; these are known as affinity laws (see sidebar on page 10).

One important implication of these laws is that power consumption is highly sensitive to operating speed. Increasing the speed of a fan or a pump requires a relatively large increase in the power required to drive it. For example, doubling the speed of the machine requires eight times more power. Similarly, decreasing the speed of a fan or pump removes a significant load from the motor.

The pump performance curve shown in Figure 6 illustrates the relationship between power and speed. The operating point is the intersection between the system curve and the pump's performance curve. To achieve the desired operating flow with a fixed-speed pump, a throttle valve is used to control flow. The throttle valve increases the pressure in the pipe and takes pump performance to point A on the original performance curve. Opening the throttle valve drops the pressure.

Note how the amount of power that the pump uses is dramatically reduced by slowing its rotational speed. Reducing the pump's speed with an **adjustable speed**

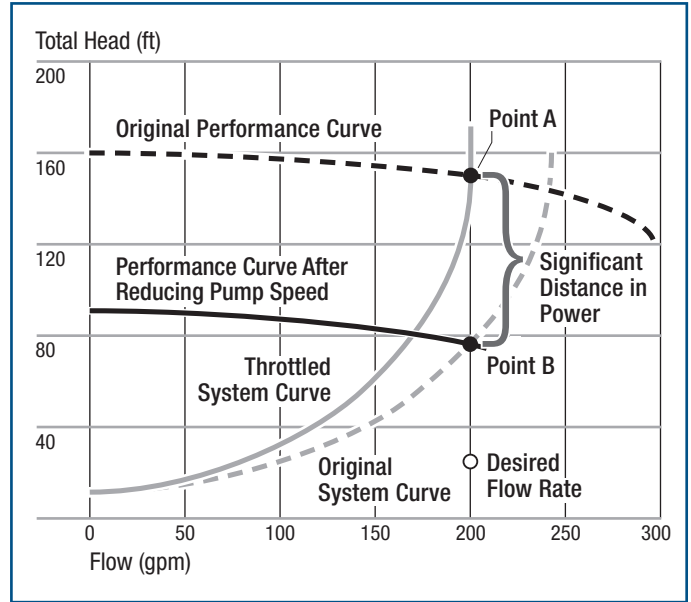

Figure 6. Effect of speed reduction on the power used by a pump

drive (ASD) takes the pump to operating point B. Although operating point B provides the same desired flow rate, it does so with much less horsepower. At point B, the pump operates much more efficiently, thus saving energy. There is no longer a large pressure drop across the throttle valve, so maintenance requirements, system noise, and system vibration are reduced. Additional examples of this relationship are shown in Figures 7 and 8.

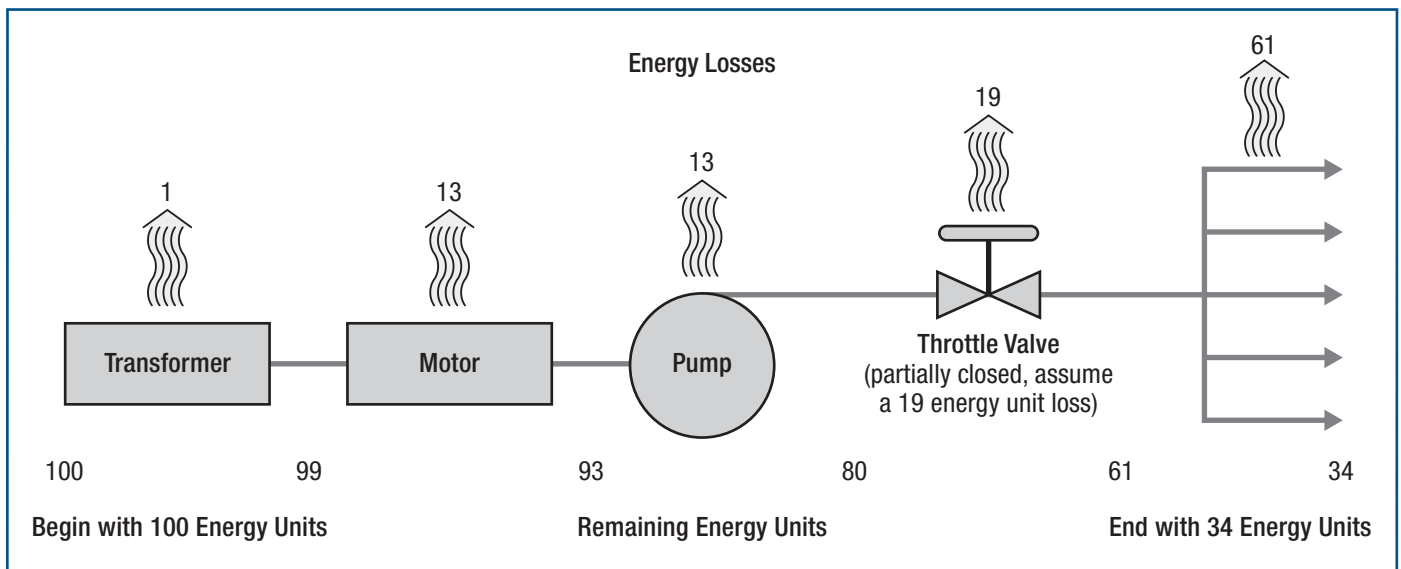

Figure 7. Energy losses in a pump system when a throttle valve controls flow

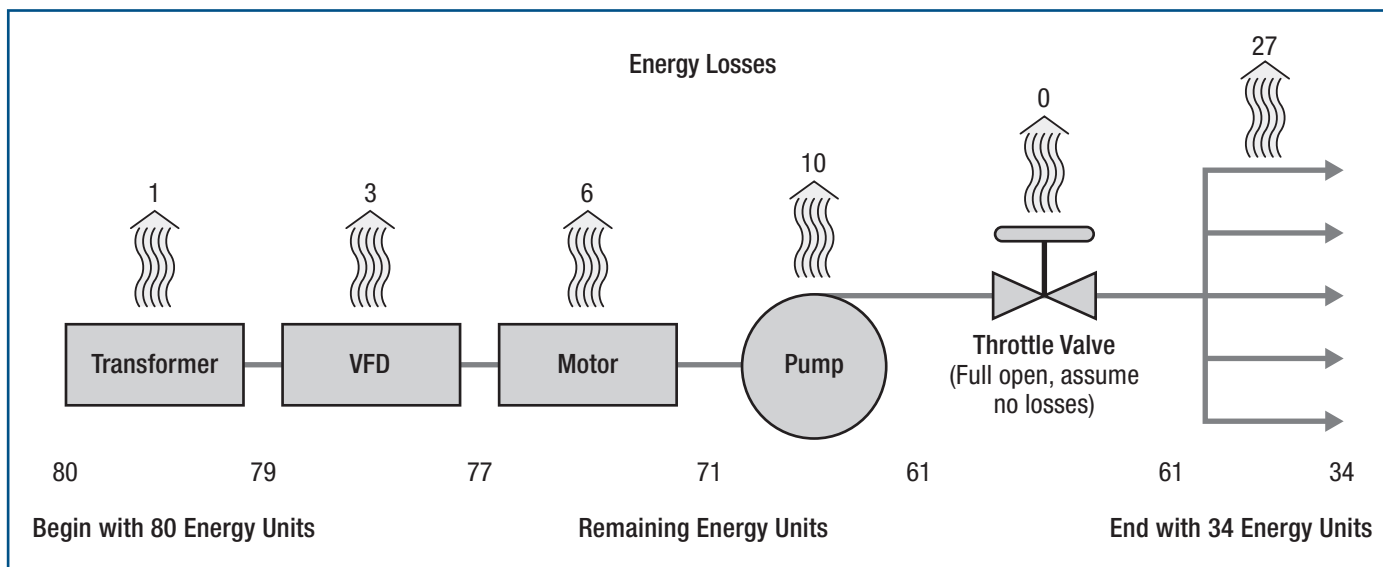

Figure 8. Energy losses in a pump system when an adjustable speed drive controls flow

Replacing a control valve with an ASD can increase system efficiency and provide significant energy savings. Note that in Figure 7, 100 energy units are supplied to the system; however, in Figure 8, the system does the same work with only 80 energy units. With the ASD, much less energy is lost across the throttle valve because the pump generates less flow.

■ Pumps

Centrifugal pumps are the type most commonly used, primarily because they are low in cost, simple to operate, reliable, and easy to maintain. In addition, they have relatively long operating lives.

System designers and engineers need to understand specific system operating conditions to size a centrifugal pump correctly. Many engineers tend to be conservative in estimating system requirements, and they often increase the size of the centrifugal pump and motor to accommodate design uncertainties, potential capacity expansions, and system fouling. However, this approach often leads to oversized pump/motor assemblies. Oversizing can increase operating costs as a result of increased energy and maintenance requirements and reduce system reliability because of added stresses on the system.

Pumping systems also frequently operate inefficiently because of poor flow control practices. Flow control options include throttle valves, bypass valves, multiple-speed pumps, multiple pump configurations, and pumps coupled to ASDs. Each flow control method has advantages and

drawbacks, depending on the particular application. When they are incorporated properly into a system, these methods provide adequate and efficient flow control. However, improper design or use can increase system costs significantly.

ASDs help to match the flow energy delivered to the system to the system's actual need. In pumping systems, VFDs are by far the most commonly used adjustable speed option. Reducing the pump speed proportionally reduces the flow while exponentially reducing the power requirement. Although installing VFDs can result in substantial energy savings, they are not suitable for all applications, particularly those in which pumps operate against high static (or elevation) head.

A useful tool for evaluating potential pumping system improvements is the Pumping System Assessment Tool (PSAT). Developed with the support of the U.S. Department of Energy Industrial Technologies Program (ITP) and available at no charge to users, the PSAT software helps the user evaluate pumping systems in order to determine the best improvement opportunities. A screening process identifies pump applications that are worth investigating further, and PSAT prompts the user to acquire data for further analysis. For more information on the PSAT and on properly matching pumps to system requirements, see *Improving Pumping System Performance: A Sourcebook for Industry*, which is available on the ITP Web site at www.eere.energy.gov/industry/bestpractices.

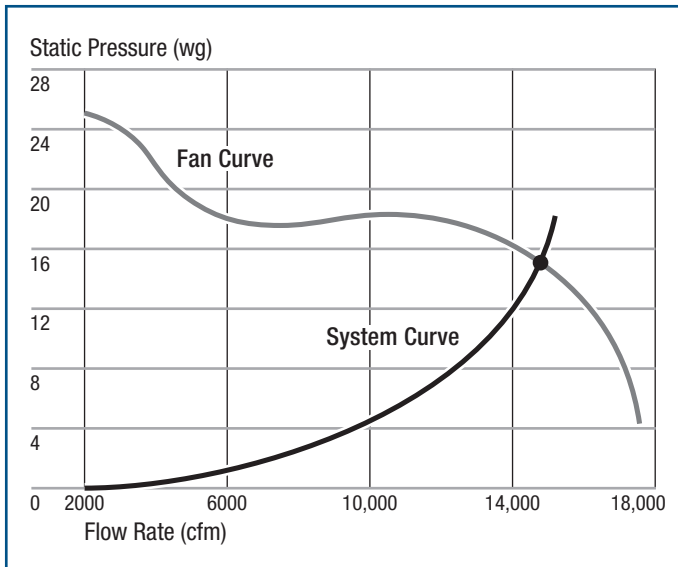

Figure 9. Typical fan and system curves

■ Fans

Fan performance curves (Figure 9) show that flow varies with pressure. Fans can be grouped into two fundamental classifications, based on the way that they impart flow energy to the airstream: axial fans and centrifugal fans.

Axial fans move air along the axis of a fan, much like a propeller. Centrifugal fans use a rotating impeller to accelerate air outward. This acceleration increases the kinetic energy of the airstream, which translates into an increase in pressure. These differences have several implications with respect to motors. Axial fans usually operate at higher speeds and, in some cases, they are directly coupled to the motor. Centrifugal fans tend to be heavier, and they often have high load inertia. This high load inertia can affect a plant's electrical distribution system, especially when the fans are started. However, many large fans can be equipped with suitable soft-start devices that avoid the stresses of across-the-line starts.

Most fans are driven by induction motors that operate at 3600, 1800, and 1200 rpm. Since these motor speeds are usually too high for direct drives, belt drives are usually used to establish the desired fan speed. An important exception to this guideline is vaneaxial fans. These fans are compact, efficient, and usually equipped with small fan blades to minimize the stresses caused by high rotating speeds.

Fan system designers also tend to be conservative, often specifying a larger fan than the system requires. However, oversized fans increase operating costs and can cause problems that are similar to those caused by oversized pumps. Oversized fans are often noisier than they should be, and they also require more maintenance.

Because required airflow rates often change according to the temperature, production level, occupancy, and boiler load, fans frequently experience varying **demand**. Although alternative flow control measures, such as dampers and inlet vanes, can be effective, often the most efficient option is to use a speed-control mechanism, such as a VFD, to adjust the fan's output. VFDs often have inherent soft-start capabilities that can limit starting currents. More information on fan systems can be found in *Improving Fan System Performance: A Sourcebook for Industry*, which is available on the ITP Web site at www.eere.energy.gov/industry/bestpractices.

A useful tool for evaluating potential fan system improvements is the Fan System Assessment Tool (FSAT). Developed with the support of ITP and available for download on the ITP Web site, FSAT software helps the user evaluate fan systems in order to determine the best improvement opportunities. A screening process identifies fan applications that are worth investigating further, and then prompts the user to acquire data for additional analysis. More information on FSAT and fan systems can be found in *Improving Fan System Performance: A Sourcebook for Industry*.

In other types of equipment—such as air compressors, positive displacement pumps, and positive displacement blowers—the relationship between flow and power is different from that of pumps and fans. Some energy-saving measures that are useful with certain centrifugal pump and fan systems, such as ASDs, can also save energy with these other systems. However, this is true only in certain applications, such as rotary screw compressors with variable loads. In addition, many common design and operating practices tend to reduce system efficiencies, particularly with respect to compressed air systems.

■ Air Compressors

Compressed air is important to most industrial facilities. It is used for such applications as driving hand tools, supplying pneumatic control systems, applying paints and coatings, and cleaning and drying parts. There are two principal types of air compressors: positive displacement and dynamic. Positive displacement compressors are more commonly used than dynamic ones.

Electric motors are widely available, and they provide power to compressors economically, reliably, and efficiently. Most compressors make use of standard polyphase induction motors; however, in some cases, motors with a higher service factor are used. In certain cases, the engineer can specify an energy-efficient or premium efficiency motor when a plant is purchasing a

compressor or replacement motor. The incremental cost of a premium efficiency motor is usually recovered in a very short time because of the resulting energy savings.

When replacing a standard motor with a premium efficiency one, it is important to pay careful attention to performance parameters such as full-load speed and torque. The replacement motor's performance should be as close as possible to that of the original motor. When replacing a drive motor in a compressor that uses a VFD as part of the control system, make sure the motor is designed to be used with **inverters**.

For most compressed air systems, demand varies widely from day to day. Changes in shifts and production levels, as well as downtime on nights and weekends, can create highly variable load duty cycles. Accommodating these wide fluctuations in demand is a principal challenge of compressed air system design.

The rotary screw air compressor is the type most widely used. Using VFD options to control output is becoming more common; however, most control systems still change flow demand by either starting and stopping the air compressor, using a load/unload mechanism, throttling the input, employing a variable displacement device, or using some other means of operating the compressor at part-load. A load/unload control strategy uses a valve or some other pressure-relieving device to reduce the load on the compressor so that it continues to operate.

These output control options for motor and drive systems can result in frequent starts and shutdowns and motors operating at low loads. Frequently starting and stopping large ac motors can result in power quality problems for the electrical distribution system and can cause motors to run at high temperatures. In addition, part-load operation of a motor usually results in a low power factor, which, if not corrected, can lead to power factor penalties. A variable displacement control strategy changes the output of the compressor by controlling the displacement volume. For more information on compressed air applications, see *Improving Compressed Air System Performance: A Sourcebook for Industry*, which is available on the ITP Web site at www.eere.energy.gov/industry/bestpractices.

A useful tool for assessing improvement opportunities in compressed air systems is AIRMaster+. This software tool was developed to help users simulate existing system operation and test potential modifications. AirMaster+

provides comprehensive information on assessing compressed air systems, including modeling existing and future system upgrades, and evaluating the savings and effectiveness of energy efficiency measures. By evaluating different operating schedules and control strategies, AIRMaster+ can help you determine how best to improve a compressed air system. AIRMaster+ is available for download on the ITP Web site.

■ Other Applications

Motors and drives are also used in a wide range of material handling and material processing services. These applications often have unique load characteristics, so they are somewhat difficult to describe in general terms. For example, material processing loads largely depend on the nature of the material being moved, mixed, chopped, or sifted. Also, these applications may be either batch-type or continuous, and operating priorities vary widely in each of those two categories.

Despite all of these differences, using a systems approach in designing, operating, and modifying motor and drive systems tends to reduce operating costs and increase system reliability. This approach stresses the importance of evaluating how different system components interact and how different control or sizing options can keep the components operating efficiently. One place to start is to evaluate the load duty cycle of system components.

Load Duty Cycles

The term *load duty* cycle refers to the amount of time that equipment operates at various loads relative to its rated capacity. An example of a load duty cycle is shown in Figure 10. Since motors are often specified according to worst-case operating conditions, applications in which normal operating loads are much smaller than the worst-case load often force the motor to operate at part-load much of the time. The load duty cycles for such motors would show a peak number of operating hours at low load levels.

This problem is actually relatively common. *The United States Industrial Electric Motor Systems Market Opportunities Assessment*, sponsored by ITP, found that more than 40% of the motors in industrial applications operate at or below 40% of their load rating. The consequences of operating a motor at these load levels include poor power factor and low efficiency.

When motors operate frequently at low loads and over a wide range of conditions, there are often many excellent opportunities to optimize the entire system, save energy, and improve reliability by making various improvements. Improvement opportunities can include replacing the motor with one of a more appropriate size or type, or installing a speed-adjusting device (or both).

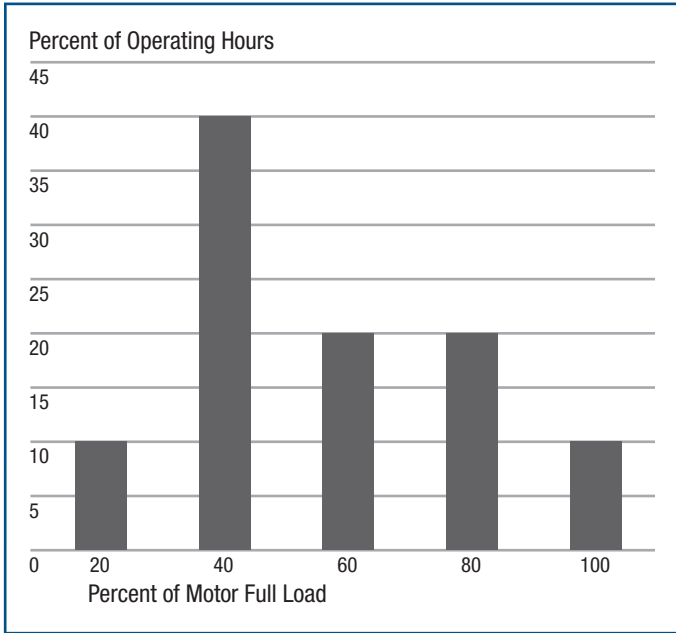

Figure 10. Load duty cycle – Example 1

In considering whether to downsize a motor, it is important to check the load duty cycle to avoid overloading the motor during peak-load conditions. This is especially applicable in seasonal industries that experience peak loads only a few times each year. For example, the motor described in Figure 10 operates near full load about 15% of the time. In that case, downsizing the motor could cause overheating, so speed control could be a better solution.

Common Motor Selection Problems

Electric motors are relatively inefficient when they are operated at very light loads, that is, below 40% of the rated load. They are usually most efficient at about 70% to 80% load. A good rule of thumb is to size motors to operate at about 75% load. This will also take into account occasional operational changes that require a higher load; problems such as voltage unbalance that require motor derating; and any errors in the calculation of the motor load.

■ Oversized Motors

Engineers frequently specify motors that are larger than needed to meet system requirements in order to ensure that the existing motor/drive assembly can support anticipated increases in capacity. However, the consequences of oversizing motors include the following:

- Lower efficiency
- Higher motor/controller costs
- Higher installation costs
- Lower power factor
- Increased operating costs.

Motor operation at low **load factor** can result when the driven load is smaller than anticipated. In many applications, original equipment manufacturers will overstate the horsepower needs of their equipment to avoid liability in specifying a motor that cannot meet service requirements. This practice and the tendency of engineers who assemble the system to be conservative can lead to the selection of a motor that operates far below its rated capacity.

■ Poor Power Factor

Another consequence of improper motor selection is low power factor. Power factor is the ratio of real power—the power used to perform mechanical work—to apparent power. In many motors, some of the electrical energy is stored in the magnetic field, creating a time difference between the motor’s peak voltage and its peak current. When current and voltage are out of phase, the amount of real power is less than the amount of electric power available (the scalar product of volts and **amps**) in the line. The vector difference between real power and the product of volts and amps is known as *reactive power*. This relationship is shown in Figure 11.

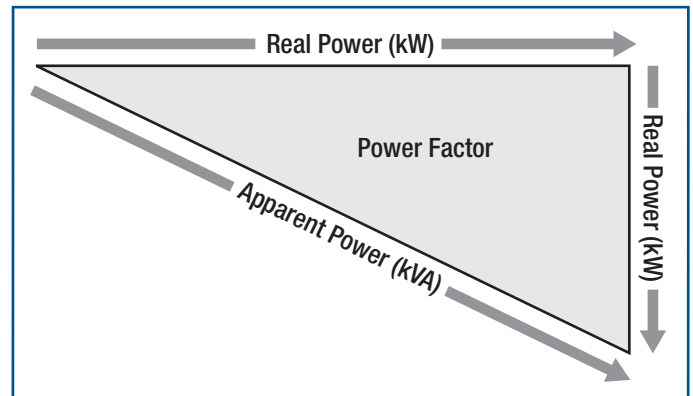

Figure 11. Vector representation of power factor

Reactive power creates additional I^2R losses in the distribution system and creates additional stress on transformers. (I refers to current and R refers to resistance; power lost because of current flow is the product of voltage drop and current; voltage drop in a resistive circuit is the product of current and resistance.) Consequently, utilities often assess fees for reactive power to recover the costs associated with stress on the distribution equipment. Plants that have large motor systems often face substantial power factor penalties; therefore, many facilities invest in **capacitors** to increase their overall power factor and thus minimize these costs.

■ Undersized Motors

Another type of motor selection problem is undersizing the motor for the intended application. Motors should be sized to operate from 75% to 100% of rated load. The principal consequence of operating a motor above its rated load is a higher winding temperature, which shortens the operating life of the motor. If the motor has a service factor of 1.0, the motor lifetime may be only a few months if it is operated above rated load or if it is operated at rated load when there is a power quality problem.

As a rule of thumb, every 10°C rise in winding temperature reduces insulation life by half. Although motor efficiency drops off slightly at higher-than-rated loads, the increase in energy cost is usually not as severe as the cost associated with shorter intervals between repairs or replacements.

Summary

Motor and drive systems can be highly efficient and reliable if they are specified, configured, and maintained properly. However, significant performance improvement opportunities can often be found in systems with poorly sized, ill-configured, or inadequately maintained motors. Often, most of the energy used by the motor systems in an industrial facility is concentrated in a few systems. These systems tend to feature large motors that run much of the time.

Energy-intensive motor and drive systems tend to be critically important to production. So, they might not often be evaluated for efficiency improvements, because then they would have to be shut down for a time for repairs or replacement. However, because of the close relationship between motor efficiency, performance, and reliability, it can be beneficial to implement energy efficiency projects that involve these systems.

Often, the most important benefit of an energy efficiency project is the increased level of motor reliability (i.e., uninterrupted service) that can result. Consequently, engineers, managers, and operators can provide their plants with an important competitive advantage by using a systems approach—one that includes all the benefits of greater system efficiency—to assess their motor and drive applications.

Section 2: Performance Opportunity Roadmap

Overview

For cost-effective operation and maintenance of a motor and drive system, operators must pay attention to the entire system as well as to its individual components. Often, operators are so focused on the immediate demands of this equipment that they overlook the bigger picture, which includes the ways in which system parameters affect all the equipment.

This big-picture view is embodied in the *systems approach*. In this approach, the engineer analyzes the system itself and how its components interact, essentially shifting the focus from individual components to total system performance. A systems approach usually involves the following types of interrelated actions:

- Establish current conditions and operating parameters
- Determine present process production needs and estimate future ones
- Gather and analyze operating data and develop load duty cycles
- Assess alternative system designs and improvements
- Determine the most technically and economically sound options, taking all subsystems into consideration
- Implement the best option
- Assess energy consumption with respect to performance
- Continue to monitor and optimize the system
- Continue to operate and maintain the system for peak performance.

Efficiency Opportunities

The rest of this section describes seven efficiency opportunities that address both component and system issues. Each one details a specific opportunity for improving motor system performance:

1. Assessing Motor and Drive System Operating Conditions
2. Establishing a Motor Management Program
3. Providing Basic Maintenance
4. Selecting the Right Motor
5. Using Variable Frequency Drives
6. Addressing In-Plant Electrical Distribution and Power Quality Issues
7. Using the Service Center Evaluation Guide

Effective motor and drive system management can reduce operating costs, improve performance, and increase reliability. An important first step is to determine current operating conditions. In this task, operators evaluate how effectively and efficiently the motors and the driven equipment are meeting the needs of the system. This has several benefits, which include helping to prioritize performance improvement opportunities and providing a useful baseline for determining whether system efficiency is declining and remedial actions need to be taken.

Efficiency Opportunity No. 1

Assessing Motor and Drive System Operating Conditions

A large industrial facility can contain thousands of motors, so it is usually not practical to evaluate every motor system in a plant individually. In many facilities, however, most of the energy used by motors is consumed by just a few systems, and these few systems are often essential to production. In addition, energy projects involving essential motor systems typically provide the shortest paybacks. Therefore, plant engineers and managers can usually determine the most cost-effective motor improvement projects by first screening all their motors to identify those that are essential and that consume the most energy.

The following sequence of steps can help plants identify the best opportunities for motor system improvements.

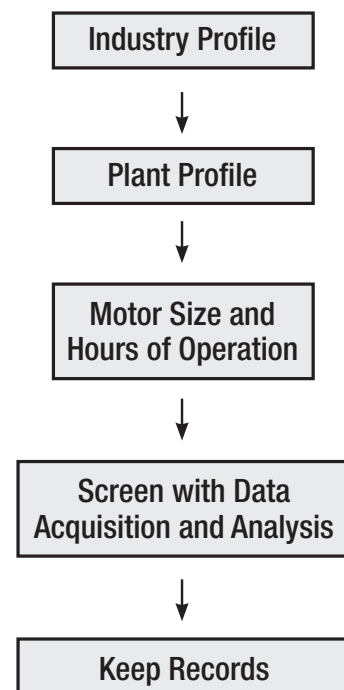

■ Industry Profile

Different industries have different motor system requirements. But in general, the largest motor system energy consumers can be found in industries that make frequent use of pumps, fans, material handling systems, and air compressors. The *United States Industrial Electric Motor Systems Market Opportunities Assessment*, a helpful resource developed by ITP, provides motor use profiles for many manufacturing industries. This publication can help users identify the systems in their plants that use the most energy, and can be found on the ITP Web site at www.eere.energy.gov/industry/bestpractices.

A series of documents development by ITP, *Energy Footprints*, map the flow of energy supply and demand in U.S. manufacturing industries. These publications identify the sources and end uses of energy to help pinpoint areas of energy intensity and characterize the unique energy needs of individual industries. Find *Energy Footprints* on the ITP Website at www.eere.energy.gov/industry/bestpractices.

■ Plant Profile

Even within a particular industry, motor requirements can vary widely and depend on each plant's level of integration. Consequently, staff in each facility should review plant processes to identify the most energy-intensive motor systems. A walk-through inspection of the larger motor systems, paying particular attention to how their operation is controlled, can help staff get started. The MotorMaster+ software tool, which was developed by ITP and is available on the ITP Web site, can be helpful in creating a profile of a plant's motor use.

■ Motor Size and Hours of Operation

Screening a plant's motors by motor size and annual operating hours can make it easier to identify the best opportunities for improvements. Large motors that operate for long periods of time are usually the best candidates for improvements. However, it can be difficult to justify making efficiency and performance improvements to small motors or motors that run infrequently.

■ Data Acquisition and Analysis

After identifying the most energy-intensive motor systems, the user can start collecting operating data on the motors and the systems slated for improvements. The data can be acquired by measuring the electrical power supplied to the motor and, in some fluid systems, by measuring the fluid power generated by a pump or fan.

When pressure and flow rate data are available, motor loads can often be estimated by measuring the pressure developed by the fan or pump. If performance curves for the fan or pump are available, then the motor load corresponding to these pressure data can be determined.

Material handling, compressed air, and some other systems do not usually have the instrumentation needed to estimate motor loads. In these cases, loads must be measured electrically. This can be done in any of several ways, depending on how the motor and the motor controller are configured. In many applications, an electrician can access the motor control center and, by using a power meter, can directly measure voltage, current, and power factor. Often, these measurements can be helpful in evaluating other aspects of motor systems, including tuning the in-plant distribution system.

For more information on some of the electrical problems that impair the performance of motor systems, see *Efficiency Opportunity No. 6, Addressing In-Plant Electrical Distribution and Power Quality Issues*. Electrical measurements are also useful in determining system economics, as discussed in Section 3 in this sourcebook on motor and drive system economics. In fact, the methods used to calculate annual motor energy use are the same.

A load duty cycle is helpful in evaluating motor system improvement opportunities. In many systems, loads vary significantly, depending on the weather, production demand, seasons, and product mix. Similarly, some motors normally operate near their full-load rating, while others normally

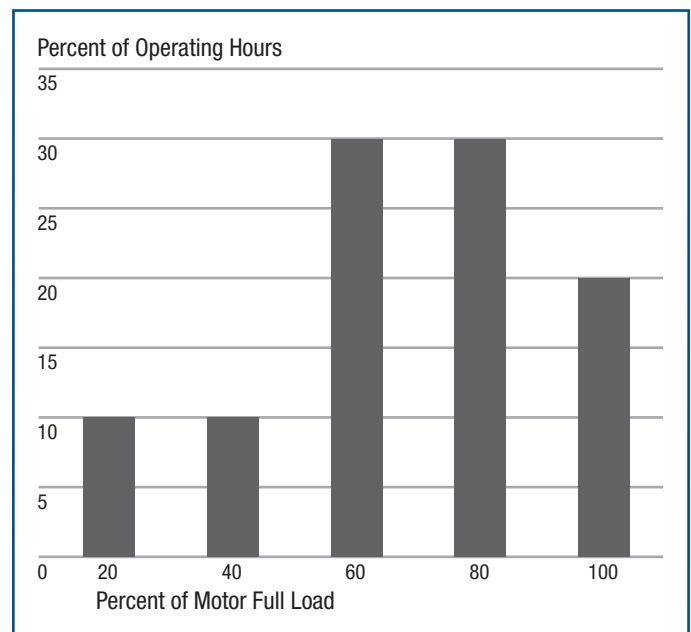

Figure 12. Load duty cycle – Example 2

operate at small portions of their full-load rating. Load duty cycles plot the load on a motor over time, as shown in Figure 12, and they should be developed for large motor systems. Depending on the factors that drive the system load, it may be feasible to develop separate load duty cycles for different seasons and product types.

System energy demand is an important data component that should be acquired, if possible. Correlating the system demand to a motor's power use provides a helpful indication of motor system efficiency. Examples of system demand are fluid power (especially in pumping and fan systems) and the combination of torque and speed (in material handling systems).

For more information on how different load duty cycles can impact motor selection, see *Efficiency Opportunity No. 4, Selecting the Right Motor*.

■ Recordkeeping

Creating an inventory record of energy-intensive (more than 50 hp) or production-critical motors can be valuable in developing maintenance schedules and in tracking motor life and performance. Maintaining a history of motors and their load duty cycles facilitates the identification of improvement opportunities and performance trends. These records can also be used to determine whether maintenance schedule adjustments are required. The MotorMaster+ program is a useful tool for developing and maintaining these records.

For more information on motor management, see *Efficiency Opportunity No. 2, Establishing a Motor Management Program*, or the 1-2-3 Approach to Motor Management tool offered by the Motor Decisions MatterSM national awareness campaign (www.motorsmatter.org).

■ Summary

Determining motor system operating conditions is a good place to start in order to identify opportunities that reduce motor-related costs, improve performance, and increase reliability. Although motor systems account for a large portion of the energy used at many industrial facilities, motor system management is often reactive, in that improvements are made only in response to obvious problems or motor failures. Adopting a proactive, systems-based approach is a good first step toward realizing the many benefits of an effective motor management program.

Efficiency Opportunity No. 2

Establishing a Motor Management Program

Although most industrial facilities rely heavily on motor systems to maintain or support production, these systems are often overlooked as manageable assets. A formal motor management program expands on the assessment activities described in *Efficiency Opportunity No. 1, Assessing Motor and Drive System Operating Conditions*, by defining strategies that support proactive, cost-effective planning. These strategies include instituting repair/replace and purchasing policies, establishing a motor inventory, tracking motor life, creating a spares inventory, and establishing a schedule for required maintenance. One or more of these strategies can be used, as appropriate, in a motor management program.

The benefits of implementing a motor management program include greater motor reliability, improved overall system performance, and lower energy costs. Additional information on establishing a motor management plan, such as a guidebook titled *Energy Management for Motor-Driven Systems*, can be found on the ITP Web site at www.eere.energy.gov/industry/bestpractices.

■ Instituting a Repair/Replace Policy

When a motor fails, getting it back in service is often a priority, especially if the motor is essential or critical to a production process. However, although a formal repair/replace policy can reduce inconsistencies in motor replace/repair decisions, many facilities do not have one.

An industrial user has two options when dealing with an electric motor failure: (1) replace the existing motor with a new motor, or (2) repair the motor at a qualified service shop. Several factors need to be taken into consideration when deciding between these two options. One factor is whether a motor is meeting the plant's current needs. For example, in production facilities, systems often change as a result of capacity expansions, product redesigns, advances in technology, and so on. Consequently, motor requirements also change. Thus, in some cases, a motor failure can be an opportunity to purchase a replacement motor of a more appropriate type or size.

General guidelines on motor replacement and repair options can be found in several resources. For example, *HorsePower Bulletin*, developed by the Industrial Electrotechnology Laboratory (now Advanced Energy) with support from ITP, is a motor management policy guide covering general motor repair and specific information for NEMA Designs A and B up to 200 hp. Another useful

resource is an Electrical Apparatus Service Association (EASA) booklet, *A Guide To AC Motor Repair And Replacement*. The Motor Decisions Matter campaign is also a good resource. See Section 4, “Where to Find Help,” for more information on these publications

When the initial costs of motor repair versus replacement are compared, the repair option is usually the less expensive one. However, instead of making a decision based solely on the initial cost, users can examine both options more thoroughly by means of a life-cycle cost analysis. This analysis takes into consideration two important factors—hours of operation and electricity costs—as well as purchase and repair costs. For example, suppose a hypothetical 100-hp, 94.5% efficient motor operates 6,300 hours per year for 18 years at a cost of \$0.075 per kilowatt-hour (kWh). In that case, electricity costs represent approximately 95% of the motor’s lifetime operating costs.

■ Instituting a Purchasing Policy

A motor purchasing policy accomplishes several key objectives:

- Ensures consistency in procurement
- Helps to ensure that the most appropriate, cost-effective motor is chosen for each application
- Streamlines the approval process for purchasing NEMA Premium motors, when appropriate
- Demonstrates management support for decisions based on life-cycle costs.

To be effective, the policy must be supported by management and disseminated to all those who regularly make motor-related decisions. Several sample policies are available. NEMA’s *General Specification for Consultants, Industrial and Municipal: NEMA Premium Efficiency Electric Motors (600 Volts or Less)* covers many design criteria as well as material and mechanical considerations. The condensed version is available free of charge at www.nema.org under “Standards.”

■ Evaluating Motor Repair Facilities

The cost benefits of repairing an existing motor usually can be realized only if the repair results in a slight deviation, or none at all, from the motor’s original specifications. Assurance of this result can be obtained by researching prospective motor service centers.

Evaluating repair facilities (service centers) provides quality control advantages similar to those gained when facilities evaluate vendors and suppliers of their parts and materials. However, evaluating a facility *after* a motor failure can

result in a costly loss of production time. The recommended practice is to evaluate repair facilities in advance. This can benefit both the motor user and the motor service center. The motor user can ensure the quality of the motor repairs and the motor service center can benefit from knowing what its customers expect.

The tip sheet in Appendix B titled “Model Repair Specifications for Low-Voltage Induction Motors,” was developed by Washington State University to provide detailed repair specifications. Several other resources also discuss motor repair specifications. See, for example, *Guidelines for Maintaining Motor Efficiency during Rebuilding*, which was developed by the Electrical Apparatus Service Association (EASA), and *Electric Motor Repair Specifications*, which was developed by the Bonneville Power Administration. Section 4, “Where to Find Help,” provides more information about these publications.

Along with analyzing cost issues in order to make a motor replacement/repair decision, motor repair quality is an important consideration. The *Service Center Evaluation Guide* provides useful information on service center quality; see *Efficiency Opportunity No. 7, Using the Service Center Evaluation Guide*. This guide discusses the attributes that a motor user should look for in a motor repair service center, and it provides a checklist to help the user perform the evaluation. The guide can be accessed from the ITP Web site at www.eere.energy.gov/industry/bestpractices.

Other sources of motor repair information include the EASA’s *Recommended Practice for the Repair of Electrical Apparatus* and EASA-Q. EASA standards contain guidelines for motor repair service shops, and the recommended practice discusses in some detail the minimum practices that motor service shops should follow. EASA-Q is a service shop evaluation program that parallels ISO 9000 standards for management practices with respect to motor repair quality assurance. See Section 4, “Where to Find Help,” for more information.

■ Using MotorMaster+ for Motor System Management

ITP helped to develop the MotorMaster+ motor system management software to assist industry in managing electric motor systems. MotorMaster+ can access performance data from nearly 30,000 industrial electric motors and perform several tasks to help motor users with system management. These tasks include performing a comparative benefits analysis of existing motors with possible alternatives, maintaining a plant’s electric motor inventory, keeping a historical record of motor maintenance, and calculating the life-cycle costs of a motor project.

MotorMaster+ helps users to find the most energy-efficient motors that meet the requirements of the application and to compare the life-cycle costs of potential replacements with the cost of a typical repair. Although motor repair costs vary considerably, MotorMaster+ minimizes some uncertainties by incorporating the expected operating life of the motor and other operational variables.

The electric motor database includes all NEMA and some International Electrotechnical Commission (IEC) metric motor types from 1 to 4,000 hp that operate at speeds of 900, 1200, 1800, and 3600 rpm at ratings up to 6600 volts (V). To ensure consistency among various manufacturers, electric motor efficiency data are based on an industry standard for measuring full- and part-load efficiencies.

MotorMaster+ was developed to achieve four basic objectives:

- Increase awareness of electric motor system efficiencies
- Emphasize a life-cycle cost approach to motor replacement decisions
- Assist motor users in selecting the proper motor for an application
- Assist users in establishing an effective motor system management program.

Increase Awareness of Motor Efficiency. Purchasing electric motors is a common and recurring procurement activity in most large industrial plants. The need to replace one or several motors is also an opportunity to improve the efficiency of a plant's motor systems. MotorMaster+ can help motor users understand how motor efficiency affects the life-cycle cost of an electric motor.

Using MotorMaster+, users can create a list of motors that includes performance and cost specifications to match specific operating requirements. This allows the user to view all possible motors, sorted by motor efficiency, for an application. MotorMaster+ can also compare an existing motor economically with other motors available in the market, as well as compare the cost of a new motor with that of a repaired motor to find the most cost-effective option.

Two methods can be used to perform a comparative analysis. The first method is a simple payback analysis to compare two motors at a time. MotorMaster+ calculates annual energy and demand costs and determines the simple payback period. If the user wants to perform a more in-depth analysis, MotorMaster+ will perform a life-cycle analysis on all motor and rewind options.

Track Motor Lifetimes and Life-Cycle Costs. Although many economic decisions are based on initial capital costs, hurdle rates, and/or payback periods, a life-cycle analysis presents a more realistic view of the investment value. The life-cycle module in MotorMaster+ enables users to evaluate comprehensive costs and benefits, considering capital depreciation, associated costs, financing details, electricity use, and the expected lifetime of the project. The program calculates life-cycle costs using various user-established scenarios.

For example, the life-cycle module depreciates capital equipment using several methods to incorporate these benefits into the final analysis. End-users can choose between the straight line, sum-of-year-digits, and double-declining balance methods to account for depreciating assets.

Like a typical life-cycle analysis, MotorMaster+ accounts for associated costs and financing details such as capital, installation, operation and maintenance, and fuel costs, along with different interest and tax rates. In addition, MotorMaster+ allows the user to input different fuel cost escalation scenarios for the predicted lifetime of the project.

MotorMaster+ also allows the user to input details about the plant's electricity service. Users have the flexibility to define the operating conditions related to electrical power to reflect realistic rate schedules, including electricity and demand charges, and specific load profiles.

All of these parameters are integrated into the life-cycle cost analysis according to the lifetimes of the proposed projects, along with the equipment life expectancy, the depreciation life, the salvage value, and the scrap value.

■ MotorMaster+ International

Some users might want to use the MotorMaster+ International software rather than MotorMaster+. This program includes many of the capabilities and features of MotorMaster+ but allows users to evaluate repair/replacement options on a broader range of motors. The user can conduct analyses in different currencies, calculate efficiency benefits for utility rate schedules with demand charges, edit and modify motor rewind efficiency loss defaults, and determine "best available" motors. This tool can be operated in English, Spanish, and French.

Improve Motor Selection Methods. Although low life-cycle costs are an important factor in selecting a motor replacement option, several other factors should be considered before making a final choice. These factors include frequent cycling or starting, required start-up

torques, insulation class, use of variable speed drives, a motors service factor, etc. In some cases, these factors may diminish a motor's reliability, negating the benefits of low life-cycle costs.

See Section 4, "Where to Find Help," for more on how to obtain MotorMaster+ and MotorMaster+ International.

■ Establishing a Spares Inventory

Once replacement requirements are understood, maintaining a spares inventory will guarantee that the proper motor is available when needed. This inventory helps to ensure that decisions are based on evaluation and planning rather than availability and first cost. It may also help to minimize downtime associated with unexpected motor failure. Motor sales and service providers are stepping up efforts to work with customers in this area. Customized programs might include stocking, storage, maintenance, and/or tracking agreements.

Efficiency Opportunity No. 3

Providing Basic Maintenance

Proper maintenance of motor and drive systems provides several economic benefits. The most obvious benefit is the extended operating life of the equipment. Others include increased reliability, lower life-cycle costs, and better use of assets.

Motor systems are often essential to industrial facility operations, so a motor failure can cause costly production delays. By minimizing the risk of unplanned downtime, effective maintenance programs can help plants avoid costly disruptions in production.

■ Preventative Maintenance

Inspections. Inspections of motor and drive system components should be based on such factors as run time, environmental conditions, consequences of failure, and so on. Often, these inspections can and should be combined with cleaning to remove contaminants from the motor.

Moisture or contaminated oil on motor windings, or both, accelerates motor wear by reducing the life of the insulation. Moisture directly reduces the dielectric strength of insulation, increasing the risk of sudden failure. Contaminated oil also degrades the dielectric strength and encourages the accumulation of contaminants. Since windings shift around in reaction to thermal and magnetic forces, contaminants on the winding insulation create abrasive wear that can lead to early insulation failure.

Because of potential problems with the brush assemblies, dc motors tend to require more frequent inspection and maintenance. Brush problems include poor contact, misalignment, and sparking. These problems can lead to quick deterioration of the brushes and damage to the slip ring surface on the motor shaft, an even greater consequence. Although the brushes themselves are relatively inexpensive, if the slip ring surface becomes pitted or out-of-round because the brushes are operating poorly, repairs can be costly and time intensive.

The causes of these problems include poor installation and maintenance practices as well as contamination. Contamination is particularly problematic in brush assemblies in which silicone-based insulation is used. The off-gassing that occurs from the insulation as it is heated during operation can cause the brushes to deteriorate quickly. Therefore, relatively frequent brush problems should be investigated to see whether the cause is exposure to silicone materials.

Table 1 contains a list of basic inspection and maintenance tasks and the recommended intervals for performing them.

Insulation Resistance Checks. Measuring the motor winding insulation resistance can indicate cleanliness and moisture levels and help to determine the potential for insulation failure. This test is performed by applying a voltage (typically 500 or 1000 V) to the motor windings and measuring the resistance from the insulation to ground. Expected resistances should be on the order of megohms as outlined in Institute of Electrical and Electronics Engineers (IEEE) Standard 43-2000 available on the IEEE Web site at www.ieee.org. A megohmmeter is used to measure the insulating resistance of electrical materials. Megohmmeter checks are commonly done on in-service motors, motors that have been idle for awhile, and motors that might be wet. Wet insulation is a common cause of low insulation resistance. Energizing motors with weak or wet insulation can lead to catastrophic failure of the motor. Therefore, a low resistance reading should be investigated further. Then, the insulation resistance should be remeasured to see if moisture was the problem or if the insulation itself is weak.

The insulation should be checked before more extreme measurement methods are used, such as a "hi-pot" (high-potential) test. Since hi-pot tests expose the insulation to much higher voltages, an insulation resistance check can indicate whether such a measurement will cause insulation damage. See IEEE Standard 43-2000, *IEEE Recommended Practice for Testing Insulation Resistance of Rotating Machinery*, on the IEEE Web site at www.ieee.org. When the insulation has been exposed to moisture, an insulation resistance check can indicate the need to dry the equipment before conducting additional tests.

Table 1. Common Inspection Tasks

Interval	Action	Remarks
Weekly	Inspect commutator and brushes	Look for sparking, seating contact, evidence of contamination*
	Check oil level in bearings	
	Check oil rings	
	Inspect the shaft for signs of oil leakage	
	Inspect starter, switches, and fuses	
	Check the start-up time for the motor	
Every 6 months	Clean the motor thoroughly	Blow out dirt (25-30 psig air); wipe down commutator and brushes
	Check brushes	Inspect for wear; verify proper position and pressure
	Inspect brush holders	
	Check oil quality in sleeve bearings	
	Check grease in antifriction bearings	
	Check operating speed	
	Verify end-play	
	Check electrical connections	
	Check enclosure	
	Check foundation connections	Look for signs of grout degradation or loosening of shims
	Check insulation resistance	
Annually	Regrease antifriction bearings	
	Check air gap	
	Check bearing clearances	
	Clean undercut slots in the commutator	

* Never use silicone-based insulation or leads in a motor with brushes.

A hi-pot test measures the dielectric strength of winding insulation and can determine whether the insulation has a weakness that may cause failure when the motor is operating. A high-pot test typically applies more than 1000 V to the windings for new motors, and 60% of this calculated value for used motors. Generally, this test is used on new motors, but it may be recommended for motors that have been idle for long periods. Since the test itself can damage the insulation, the manufacturer's guidelines should be carefully followed.

Balance and Alignment Checks. Like most rotating machinery, motors can be seriously affected by dynamic unbalances. The causes of balance problems include overhung loads, poor alignment between the motor and the driven equipment, shaft deflection, an imbalance in the driven equipment that transfers to the motor, and a weight imbalance on the motor fan or the motor shaft. Large, overhung loads create significant radial load conditions on motor bearings,

so it is important to design the motor/driven-load assembly properly in overhung load applications in order to prevent the development of balance and alignment problems.

Alignment problems can result from a poorly done installation, foundation movement, or bearing system wear. For example, many initial alignment problems can be attributed to the installation sequence. A motor might be correctly aligned to a pump before the system piping is connected to the pump flange. However, when the piping does not line up exactly with the pump flanges, installing mechanics often "force-fit" the connection. The pull exerted by severe force-fits can cause severe misalignment with the motor/pump shaft system. Similarly, welding tends to distort foundations. Unless the welding process is sequenced to limit this distortion, any machinery alignments should be checked after all the welding is completed.

Shaft deflection is an operating problem usually associated with pumps. It can influence the performance of the motor as a result of the added bearing loads. In pumps, severe shaft deflection usually occurs when the pump operates below its minimum flow requirement .

In addition, rotating imbalances can be caused by the driven equipment. For example, a ventilation fan that operates in a corrosive environment can become unbalanced as the materials in the fan blade degrade. In some applications, the motor fan itself can degrade, causing a damaging imbalance condition.

Motor/foundation interfaces that develop soft-foot problems can also have balance and alignment problems. *Soft foot* refers to the gaps that develop between a motor's mounting foot and the foundation. It is often the result of material loss around the mounting hardware that allows movement of the motor or drive assembly under load. As the motor or drive "flexes" on its soft foot, the resulting misalignment can produce bearing problems. To avoid this problem, the condition of the mounting feet should be periodically inspected. If the grout is damaged or if the shims or mounting bolts have come loose, the problem should be corrected and the motor/drive alignment rechecked.

Further information on electric motor maintenance can be found in the EASA publication, *How To Get The Most From Your Electric Motors*, which can be ordered from the EASA online catalog at www.easa.com.

■ Predictive Maintenance

Predictive maintenance programs are designed to increase the reliability of motor and drive systems. These methods are intended to identify problems that are developing but have not yet created a failure. Early identification of a developing problem improves the engineer's ability to plan the repair effectively. The most effective predictive maintenance tools for motors include vibration analysis, lubricant analysis, insulation resistance measurement (see also the section on insulation resistance in this efficiency opportunity), infrared (IR) scanning, and electrical motor diagnostics.

Vibration Analysis. Commercial vibration analyzers read and evaluate the vibration signature of a motor or other rotating machinery. Recording the vibration characteristics at different points in a motor's operating life can reveal trends that indicate developing problems. These devices are particularly useful in determining emerging bearing problems. Vibration analyzers can also detect unbalances and misalignments in the shaft system due to loose

couplings, motor fan problems, etc. Vibration analyzers are also useful in evaluating the condition of rotor bars in squirrel cage induction motors. Rotor bars that become loose will display vibration characteristics of a certain frequency.

Lubricant Analysis. A lubricant analysis can indicate the existence or the development of a bearing problem as well as determine whether the lubricant should be replaced. Lubricant analysis can also indicate the presence of high-temperature bearing problems. Lubricants are usually changed permanently by heat. This property is useful in detecting problems, especially intermittent ones. For example, a bearing problem that develops under specific but infrequent operating conditions may not be detected by conventional methods unless that load condition happens to occur during the measurement.

Infrared Scanning. Infrared (IR) scanning (thermography) is an effective method of determining the condition of insulation and the integrity of a connection. IR scanning evaluates the thermal image of a body to determine its temperature characteristics. Bearings that begin to run hot or connections that become weak and create more resistance will show up as hot spots on an IR scan. In motors, weakened insulation may show up as a high-temperature area on the motor stator. Like vibration analysis, measuring the temperature of a motor at successive intervals helps to identify trends. Misaligned or unbalanced couplings will also show up as hot during an IR scan. To avoid false positives, IR scanning should be performed by someone trained in thermography.

Electrical Motor Diagnostics. Electrical motor diagnostics (EMD) is effective in evaluating the condition of the electric motor circuit. There are several EMD methods. Motor circuit analysis, or MCA, provides information about the winding and ground insulation system and the motor rotor when equipment is de-energized. Motor current signature analysis, or MCSA, provides a fast Fourier transform (FFT) spectra and demodulated spectra of current in order to detect rotor, air-gap, and load-related faults while equipment is energized. FFT is a mathematical technique for efficiently calculating the frequency response of sampled time signals. An electrical signature analysis, or ESA, provides an FFT spectra of both the voltage and current of the motor circuit in order to detect current-related faults and supply faults while equipment is energized.

■ Maintenance of Stored or Idle Motors

Motors that operate infrequently, such as those in backup applications, should be activated periodically to keep the bearing surfaces lubricated and to prevent problems such as false brinelling. *False brinelling* refers to the indentation of the races or rotating elements (or both) of an antifriction bearing (e.g., ball bearings, roller bearings). This often occurs in motor bearings that remain idle for long periods but that are still subjected to external vibrations.

Keeping a bearing in a static position for a long time results in a loss of the lubrication film that separates the bearing surfaces. The vibrations common to machinery areas promote a brinelling effect at these points of contact. The indentations are usually small. However, when a motor is operating and the bearings are placed under a load, these surface imperfections can lead to poor bearing performance and shorten the motor's operating life.

To prevent brinelling during shipment, the motor shaft should be securely locked. To prevent brinelling during storage, the shaft should be rotated periodically as part of a preventive maintenance program. To prevent brinelling after installation, the motor should be operated periodically.

Efficiency Opportunity No. 4 **Selecting the Right Motor**

An essential component of cost-effective system performance is properly matching a motor type to its application. This requires an understanding of a motor's operating characteristics and the basic components of a motor system. Motors are fairly simple devices that rely on some basic principles of electricity and magnetism. Among the more important principles are that an electric current passing through a conductor generates a magnetic field, and the strength of the magnetic field depends on the strength of the current and the magnetic properties of the material in the field. These magnetic fields create torque that turns the motor shaft.

■ Motor Characteristics and Considerations

Several basic operating characteristics are important in properly specifying and operating a motor and drive system. The principal operating characteristics are horsepower, speed, and torque. Other important considerations include efficiency, power supply, motor enclosure, design letter, slip, power factor, and operating temperature.

Horsepower. The horsepower of a motor is the product of its torque and speed. A properly specified motor will match the power requirements of the load over the expected range

of operating conditions. However, to correctly specify a motor/drive system, it is usually not sufficient just to match the motor horsepower to the load horsepower. The speed and torque requirements of the driven equipment and the ability of the motor to respond to load changes are important factors in determining how well a motor performs.

The service factor is a multiplier that indicates the percentage of horsepower (or other nameplate rating like torque) at which a motor can operate above full load without causing failure under certain conditions; common service factor values are 1.1 and 1.15. Relying on the service factor rating of the motor under continuous-duty conditions is usually not recommended. In general, the service factor rating applies to short-term or occasional overloads.

Operating a motor above its rated horsepower can shorten the life of its insulation. As a guideline, motor life is reduced by one-half if the motor is operated continuously at the service factor level. Operating a motor at 1.15 rated load increases the winding temperature by about 20°C (depending on factors such as the enclosure type, speed, and elevation), and a motor's insulation life is halved for every 10°C increase in the heat at which the motor runs. The additional heat in the windings also translates to higher bearing temperatures and can impact lubricant life as well. More information on the service factor is available from EASA; see Section 4, "Where to Find Help."

Motor life is also reduced by power quality problems such as voltage imbalance, overvoltage, and undervoltage. Because of potential problems with power quality and the uncertainties associated with determining an actual service load, a good rule of thumb is to size motors so that they operate at about 75% of rated load. This also usually provides optimum efficiency.

Speed. There are several different ways to configure motor systems to provide effective speed control. Direct current motors are frequently selected for applications that require high torque at low speeds; the speed range adjustments of dc motors can be up to 20:1. They can operate as low as 5%-7% of the base speed of the motor, and some can operate even at 0 rpm.

Some ac motors, such as wound rotor motors, also offer effective speed control by controlling the resistance of the rotor circuits. The speed ratios of these motors can also be up to 20:1. To adjust the resistance of the rotor circuits, these motors are usually equipped with slip rings that connect to external resistance banks.

Large wound rotor applications can require the use of relatively large resistance banks, such as salt water rheostats that rely on plates immersed in salt water to provide electric resistance and heat dissipation. More advanced system designs allow wound rotor motors to regenerate power extracted from the rotor circuit. This regenerated power can be used to drive another motor or can be sent back into the power line. These options increase the efficiency of the speed adjustment process; however, they also increase the complexity, cost, and maintenance requirements of the system. Unless the energy pulled from the rotor circuit is recaptured, the losses associated with operation at slow speeds can increase a plant's energy costs.

Alternating current induction motors can be used in many applications with adjustable speed drives. The most commonly used ASD is the variable frequency drive (VFD), and the most common VFD is the pulse width modulation (PWM) type. These drives are commercially available at from 0 to 120 Hz and can be used to operate motors over a wide range of characteristics.

Torque. Torque is the rotational force exerted by the motor shaft. Motors have four principal torque characteristics: starting or locked-rotor, full-load, pull-up (usually the lowest point on the curve), and breakdown. Locked-rotor torque is that developed by the motor at zero speed. Full-load torque is that developed by a motor at its rated horsepower. Breakdown torque is the highest torque a motor can generate before stalling. Often, this is several times greater than the full-load torque.

Load Duty Cycle. A system load duty cycle (LDC) is helpful in choosing the right motor and motor control system (if required). In many systems, loads vary significantly according to the weather, production demand, seasons, and product mix. Therefore, some motors operate normally near their full-load rating, while others operate normally at small portions of their full-load rating. LDCs plot the load on a motor over time, as shown in Figure 13. A system with a constant load can probably use a standard motor without a control system. A varying load may be served best by a motor designed to be used with a VFD, a standard motor with another speed control device (such as an eddy current clutch), or a multiple-speed motor.

■ Efficiency and Losses

The efficiency of general purpose motors has significantly improved in the last 20 years, largely as a result of the

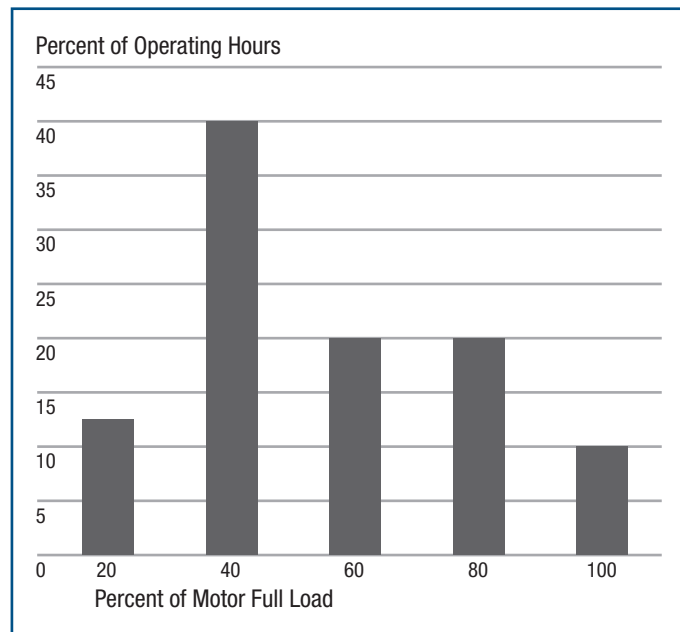

Figure 13. Load duty cycle – Example 3

efforts of motor manufacturers, with assistance from DOE. (See, for example, *Energy-Efficient Electric Motor Selection Handbook*, U.S. Department of Energy, 1993 at www.wbdg.org/ccb/DOE/TECH/ce0384.pdf). More recent motor efficiency improvements have been spurred by the Energy Policy Act (EPAAct), which went into effect in October 1997 and pertains to the most common types and sizes of motors. To improve efficiency, motor manufacturers have had to modify the design of motors and use better materials; this has resulted in slight changes in motor operating characteristics. EPAAct efficiency levels for a range of motor types are included in Appendix D of this sourcebook. Although the initial costs of motors have increased 10% to 20%, improvements in the efficiency of motors for high-run-time applications have resulted in very favorable payback periods.

The enactment of EPAAct has had several effects on the design and performance of motors. To achieve the required efficiency levels, motor manufacturers have had to change the designs of many of their Design A and B models. These changes have at times included reducing the resistance of the rotor and stator circuits, using electrical grade steel with improved magnetic characteristics for the stator and rotor laminations to reduce core losses, and redesigning the cooling fan to decrease fan windage losses. Other changes have included designing motors with a smaller slip (higher

speed) and using lower loss core iron. Losses vary among motors of different sizes and designs; Table 2 shows some typical ranges.

Table 2. Sources of Motor Losses	
Friction and Windage	5% – 15%
Core (Iron) Losses	15% – 25%
Stator (I ² R)	25% – 40%
Rotor (I ² R)	15% – 25%
Stray Load	10% – 20%

Motor efficiencies vary according to several factors, but generally range from 85% to 97% at full load. The primary factors affecting efficiency are speed (high-speed motors tend to be more efficient) and the size of the motor (larger motors tend to be more efficient). Additional factors include type of enclosure (open enclosures tend to be more efficient) and design classification (lower slip motors tend to be more efficient). Figure 14 shows some of these differences.

As a rough rule of thumb, motor efficiency for many EPA Design A and B motors is often relatively constant between 70% and 80% of rated load and drops slightly at full load. Motor efficiency may also drop slightly between 50% and 70% of rated full load. At loads below 40% of full load, motor efficiency begins to decline dramatically. Slightly oversizing a motor (up to 25%) can actually increase efficiency, but grossly oversizing a motor can lead

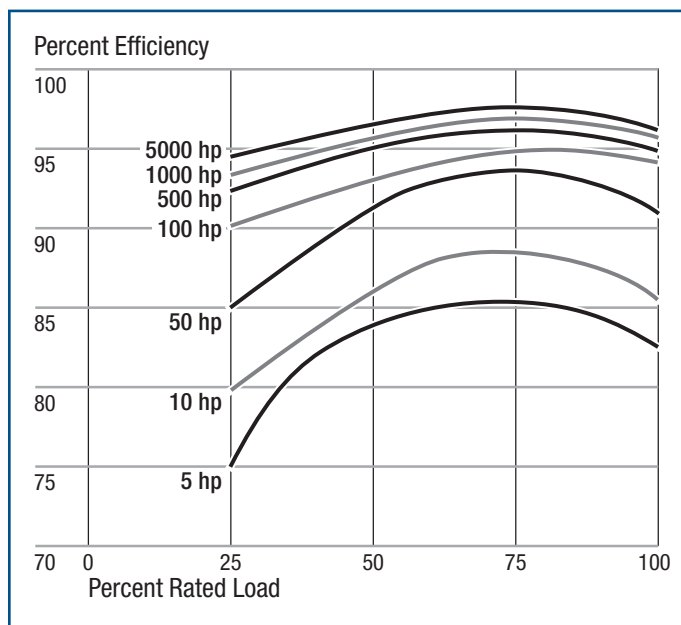

Figure 14. Typical motor efficiency vs. load (1800 rpm)

to substantial efficiency losses. These include not only the energy losses associated with inefficient operation but also the reduced power factor.

NEMA Premium® Efficiency Motors. The NEMA Premium® efficiency motors program of the National Electrical Manufacturers Association defines “premium efficiency” motors as those with higher levels of efficiency than the ones established by EPA. The NEMA Premium efficiency electric motors program covers continuous rated, single-speed, polyphase, 1 to 500 hp, 2-, 4-, and 6-pole NEMA Design A or B squirrel cage induction motors. Appendix C in this sourcebook shows efficiency levels for each motor type, size, and speed.

■ Design Classifications

NEMA has established several different motor classifications that reflect the speed and torque characteristics of induction motors. These characteristics are shown in Figure 15.

Design A. This type of motor is used primarily in special applications for which a comparable Design B motor would not have a high enough breakdown torque. In addition to higher breakdown torques, Design A motors usually have higher starting currents and less slip than Design B motors. This motor is usually selected for applications requiring high, transient increases in load. It can be a manufacturer’s most efficient motor solution and is often selected because of its efficiency advantages. Typical applications are injection molding machines, crushers, and air compressors.

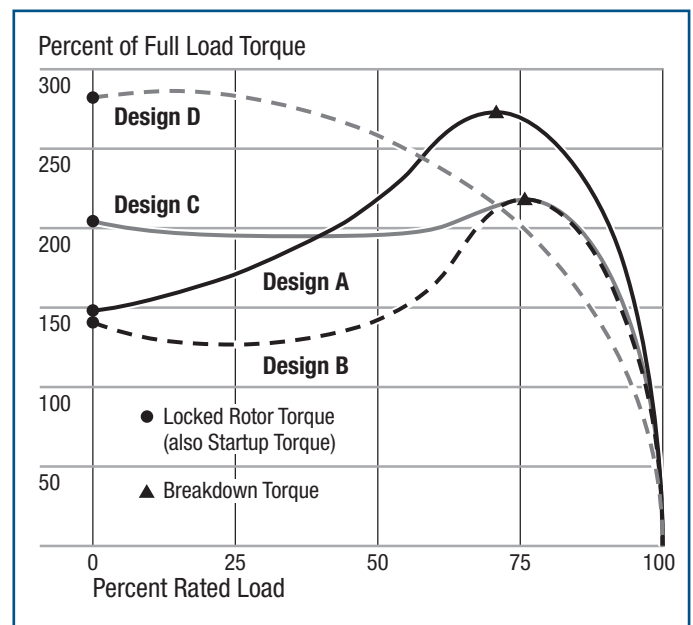

Figure 15. Torque and speed characteristics of various types of motors

Design B. This type of motor is similar to a Design A motor and is the most common type—a true industry workhorse. In fact, the operating characteristics of Design B motors are often compared with those of other motor designs in order to provide a practical perspective. Consequently, Design B motors have normal starting torques, normal breakdown torques, and moderate slip characteristics. Typical applications are pumps, fans, and air compressors.

Design C. This type is characterized by high torques and is often used in high-inertia applications. These motors are slightly less efficient than comparable Design B motors. Design C motors are often selected for applications requiring high starting torques. For example, positive displacement pumps and refrigeration compressors often start against high backpressures and therefore require high starting torques. To meet this starting torque, a relatively large Design B motor would be required, but a more properly sized Design C motor would be more cost-effective. Typical applications are material handling systems such as conveyors.

Design D. This type has very high starting torques and high slip characteristics, ranging from 5% to 13%. These motors are generally used in high transient, cyclical load applications such as punch presses. Because of their high slip characteristics, they are somewhat less efficient than the other classes. Oil well pumps are often powered by Design D motors because the load is cyclic, and there is a relatively large difference between the highest and the lowest torques in the cycle. A high-slip motor operates evenly within this load cycle; consequently, efficiency losses are balanced by the reduced electrical stress on the system resulting from lower current surges. Applications include systems with sudden load changes, such as hoists and punch presses.

■ Major Specification Characteristics

It is important to determine the voltage and enclosure needed when specifying an industrial motor. The voltage is usually determined by the power available in the plant's distribution system. The enclosure type is usually determined by environmental conditions such as air quality, exposure to moisture, any harmful vapors present, and so on.

Voltage. The voltage rating of a motor should match the power supply. Common motor voltages are 115, 200, 230, 460, 575, 2300, and 4000 V. Motors are relatively sensitive to the power supply voltage, but the motor voltage often does not precisely match the voltage rating of the power supply because of unanticipated voltage drops in the distribution system. Line voltages can vary according to the

utility supply, plant loads, power factor effects, and the performance of the transformer. It is important to understand the effects of these variables on the operation of a motor.

Decreasing the line voltage usually increases the current required by a motor to meet a particular load, except in cases of light loads. This higher current level generates more heat and losses in the motor windings and decreases a motor's operating efficiency. Prolonged operation at low voltages will shorten a motor's operating life. To protect against potential damage caused by operating a motor at low voltages, some motors are equipped with an undervoltage relay that de-energizes the motor in response to low voltage conditions. In fact, plants that experience frequent voltage sags often experience problems caused by the activation of these undervoltage relays. Motors are also subject to transient voltage events, such as surges and sags. These events can be triggered by utility switching or in-plant activities such as the energization of large loads.

Line voltage that is higher than a motor's rating can also affect the motor's life and performance. Depending on the design of the motor, overvoltage conditions can cause magnetic saturation of the iron core that can lead to overheating of the motor. However, for voltages up to 110% of the motor's rating, the full-load efficiency of the motor might actually increase up to 1% as a result of the lower current required. Also, at 110% of a motor's rated voltage, start-up and maximum running torques can increase more than 20%. Operation at high voltage can also decrease the power factor and increase the operating speed. For centrifugal loads such as pumps and fans, the result can be an increase in energy use.

Enclosure Type. The enclosure refers to the motor's level of protection from its environment. Table 3 contains a list of enclosure types. Because motors are sensitive to temperature, moisture, and contaminants, the proper enclosure must be selected in order for the motor to operate properly.

Bearings. Bearings are essential to the operation of a motor. When selecting a motor, it is important to ensure that the bearings are compatible with the load, temperature, and environmental conditions. In industrial motor applications, the most common bearing types are journal (sleeve) bearings and antifriction bearings. Antifriction bearings rely on the action of rolling elements such as balls or rollers to minimize friction while supporting the load. Journal bearings usually use a lubricant film to separate the metal surfaces and thus reduce friction. Since different bearing designs have different lubrication requirements,

Enclosure Type		Characteristics
Open	Drip-proof	Can withstand dripping liquids up to 15° off vertical
	Splash-proof	Can withstand splashing liquids up to 100° off vertical
	Guarded	Ventilation openings are less than 3/4 in. wide
	Externally ventilated	Ventilation is provided by a separate motor-driven fan
Totally Enclosed	Unventilated	Does not contain a means of external cooling
	Fan-cooled	Contains an integral fan
	Explosion-proof	Will not ignite an external gas
	Waterproof	Excludes leakage

it is important to follow the manufacturer's guidelines on lubrication procedures. Insulated bearings may be required for VFD applications to protect against bearing damage from the shaft voltage.

Compatibility with Inverter Drives. In VFD applications, especially those that use PWM controls, motor windings are exposed to short-duration, high-voltage spikes that can shorten their life. These pulses are caused by switching in the power electronics. Inverter-duty motors are specifically designed to handle the stresses of service with PWM inverters, and most motor manufacturers offer them. Insulation and winding placement are also improved. Many manufacturers also offer inverter-friendly insulation in their premium efficiency motors.

■ Common Problems

Motors can experience both mechanical and electrical damage. Mechanical damage includes bearing failure, and more than half of all motor failures involve bearings. In severe cases, bearings can seize as a result of a loss of lubrication or entrainment of solid contaminants. Because bearing failure usually results from the breakdown of lubrication, users should carefully consider the service and lubrication requirements of bearings when selecting a motor. Selecting the proper bearings depends on the load, temperature, environmental conditions, speed, coupling method, lubricant method, and the frequency of motor starts and stops.

Electrical damage has many causes and is evident in an insulation failure. An insulation failure usually results in a fault, such as a ground or a short. Grounding problems occur when a winding directly contacts a ground path. Faults can occur between windings of different phases or between different winding turns on the same phase or coil.

The causes of insulation failure include the high temperatures caused by a current overload and voltages that exceed the dielectric strength of the insulation. Even under normal conditions, winding insulation ages over time; however, heat accelerates this breakdown rate. Under normal operating conditions, most insulation classes are rated for a certain operating temperature (which varies according to the insulation class) and a certain operating life (typically 20,000 hours). Several conditions can cause high winding temperatures, including low voltage conditions and high motor loads. Conditions that impair the dissipation of heat—such as the contaminants that can build up on windings, motor surfaces, and fan blades—can also increase winding temperatures by reducing the amount of heat transferred away from the motor.

The induced bearing currents associated with PWM drives can also degrade bearings. This issue is discussed further in the *Efficiency Opportunity No. 5, Using Variable Frequency Drives*.

Efficiency Opportunity No. 5 Using Variable Frequency Drives

The advantages and benefits of motor speed control include lower system energy costs, improved system reliability, fewer maintenance requirements, and more effective process control. Many applications require accurate control of a motor's operating speed. Historically, dc motors have been used in these applications because of their effective speed control characteristics. However, as a result of improvements in power semiconductor technology, a recent trend in industry is to use VFDs with ac motors.

Some competing ASD technologies, such as hydraulic couplings and eddy current drives, offer similar advantages in terms of speed control. However, VFDs have substantial advantages in comparison to other speed control options. They are highly efficient, reliable, and flexible, and motor users can bypass them for maintenance or repairs without having to take the motor out of service. But they are not recommended for all motor/drive applications, so understanding their performance and application is essential in deciding whether to use them.

■ Common Applications

VFDs are used in a wide range of applications, including fluid (gas and liquid) systems, material handling systems, and machining and fabrication processes. VFDs can be incorporated into closed-loop control systems, and their speed adjustment ratios are similar to those of other speed control systems. The principal advantage of VFDs is improved operating efficiency, which means substantial cost savings in many motor systems. If they are used in place of mechanical drive options, VFDs can also improve system reliability by removing potential failure modes and requiring less maintenance because they have fewer components.

Fluid Systems. Because they can save a significant amount of energy, VFDs are well suited for fluid systems. In fan systems and systems served by centrifugal pumps, there is a cube power relationship between flow and power (see the discussion of affinity laws in Section 1). Since many fluid systems have varying flow requirements, a VFD can adjust the output of a pump or a fan to meet these requirements automatically.

VFDs can often be retrofitted to existing pump and fan motors; however, all existing motors should be evaluated for compatibility with this modification. But, even if the motor must be changed, other system components can be left intact, which makes this upgrade relatively nondisruptive.

VFDs can provide substantial flow control improvements and reduce the stress on the entire system. Unlike other flow control measures, such as throttle and bypass valves, that dissipate energy after it is added to the system fluid, VFDs reduce the amount of energy imparted to the system. This also reduces stress on the piping system and support structures.

Material Handling Systems. In material handling applications, VFDs allow better control of transport, mixing, and packaging processes. Conventional control processes use bypass or on-off controls to modulate the movement of work-in-process. However, bypass methods similar to those used in fluid systems tend to be wasteful. And, on-off methods tend to impose stresses on the system as material is abruptly stopped, then started. In contrast, VFDs allow the speed of a process or a feedstream to be slowed or accelerated according to an automated feedback signal. This can improve the quality of the finished product.

For example, VFDs are often used to control the speed of the winding machines in aluminum mills and paper plants. Using a signal that directly measures line speed, a VFD controls the rotation of the winder to maintain a constant process speed. In contrast, using a brake to control the

winding speed results in a loss of energy. Using a brake also requires the use of a motor with large slip characteristics and increases system maintenance requirements.

Machining and Fabrication. Most machining and fabrication applications use constant speed ac motors. The operating life of tools and cutting bits is highly sensitive to how well and constantly the cutting speed and pressure are maintained during machining operations. In this regard, VFDs offer several advantages. Conventional speed control options use gears or pulleys to maintain the cutting speed within a certain range; however, these devices have limited flexibility. Usually, speeds must be selected when the machine is being set up for the task. In contrast, VFDs can control the cutting speed continuously during the machine operation and can shift to different speeds without requiring the machine to be reconfigured. In many machining operations, VFDs can improve the process control and the speed of production, demonstrating that energy savings are not the only benefit of this technology.

■ Alternatives

There are two principal ways to adjust the speed of a motor/drive system:

- Adjust the speed of the motor directly
- Use a constant speed motor with an intermediate device between the motor and the driven equipment that can change the speed ratio.

Historically, when direct control of the motor speed was required, designers had to use dc motors or wound rotor ac motors. Although each type has advantages, they also have drawbacks in terms of maintenance and efficiency. For example, dc motors are relatively expensive, need more maintenance, and require a means of generating dc power. Wound rotor motors add resistance to the rotor circuit for speed control, which is inefficient unless a comparatively complex recovery system is used.

Using an intermediate speed adjustment device, such as a gearing system or an adjustable pitch pulley system, adds another component to the motor/drive system. These components increase the risk of failure and other problems.

Mechanical. Gear systems allow different speed ratios between the motor and the driven equipment; however, the speed ratio is usually fixed. Although clutch devices can allow shifting between different gears to achieve different speed ratios, these systems are limited to discrete speed changes that often interrupt a machine's operation. Thus, the key drawback of gear systems is their lack of flexibility.

Belt systems are similar to gear systems in that various combinations of pulleys can be used to achieve different speed ratios. Most belt systems use fixed pulleys that can be changed, although doing so requires securing the system and replacing one or more pulleys. This tends to be highly disruptive to the operation of the equipment. Some belt systems allow speed ratios to be continuously adjusted. The pulleys in these systems have a varying pitch angle that changes the speed ratio when the pulley is moved in or out. However, because of sidewear on the belts, these systems tend to require a lot of maintenance and are subject to reliability problems.

Hydraulic couplings work like a centrifugal pump, allowing speed to be adjusted continuously by controlling the amount of slippage. Although these systems adjust speeds during system operation, they are inherently inefficient. The energy lost because of increases in the amount of hydraulic slip is essentially unrecoverable.

Magnetic ASDs use rare-earth magnets to transmit torque from a motor to a load. Making use of the principle of magnetic induction, they consist of two components that do not come in physical contact with one another. A rotor assembly containing permanent magnets is mounted on the load shaft, and a conductor assembly with copper rings is connected to the motor shaft. The relative motion between the magnets and the copper rings creates a magnetic field that transmits torque through the air gap. Varying the width of the gap changes the coupling force, producing an infinitely variable output speed.

Electrical. Eddy current couplings allow speed to be adjusted continuously by controlling the strength of the magnetic field between the driver and driven component. Strengthening the field transfers more torque from the driver to the driven element while decreasing the field strength; this allows greater slip between the two. Eddy current couplings provide effective speed control; however, they result in comparatively high heat loss and are typically less efficient than VFDs. Eddy current clutches can also be maintenance intensive; for the most part, they have been replaced by VFDs.

■ Competitive Advantages

Depending on the application, VFDs have many benefits and provide numerous advantages over other control methods. For example, using VFDs in pumping and fan systems provides far greater energy savings than other flow control options, such as throttling and bypass. These advantages are discussed in more detail in *Improving Pumping System*

Performance: A Sourcebook for Industry and Improving Fan System Performance: A Sourcebook for Industry. Both are available on the ITP Web site at www.eere.energy.gov/industry/bestpractices.

■ Misapplications

VFDs are not recommended for applications in which slowing down the machine speed causes operating problems, such as insufficient torque or poor cooling. In pumping systems that have high static head characteristics, slowing down the pump speed too much can force the pump to operate in a virtual shutoff head condition. Under these conditions, the pump can experience damaging vibrations and could fail to provide adequate flow to the system.

Similarly, in applications in which the torque increases at low speeds, such as certain mixing processes, the power requirements of the motor will not drop significantly at lower speeds. In such cases, the integral motor fan may not provide sufficient cooling at lower speeds. In applications in which torque decreases with speed, this concern is not as important because the windings generate less heat. However, in some constant horsepower applications, additional cooling may be required to prevent the motor from overheating. In these cases, a cooling fan powered by its own motor is used.

Air compressors using VFDs are becoming more common. These systems work well in plants in which air demand varies.

The load characteristics of other machinery, such as positive displacement pumps, often do not favor the use of VFDs. In these applications, the linear relationship between output, power, and equipment speed tends to favor other control technologies.

Bearing Currents. In some VFD applications, motors experience bearing problems caused by current that travels through the bearing. The cause of these problems is the induction of a slight voltage in the shaft of a motor or its driven equipment. Since VFDs tend to generate harmonics in the power supply to the motor, the harmonics could contribute to the induced shaft voltage. In applications in which the shaft is connected to a ground source (for example, a pumping system) that provides a better discharge path for the voltage, bearing currents are generally not a problem. In other applications, the induced voltage discharges through the bearings, creating degradation problems. Although this current is relatively small, it can cause pitting on the bearing races and rolling elements, and this can result in increased wear rates under load.

One of the most common ways to avoid bearing current problems is to select or retrofit motors with insulated bearings. Insulated bearings on the motor could move bearing current issues downstream to the driven equipment. Another option involves equipping the shaft with a grounding brush to provide an alternate path for the shaft voltage discharge. While effective at reducing bearing currents, the grounding brush must be maintained, which often means replacing the element every three months.

Newer technologies are always being evaluated. One of the latest in the motor industry is the microfiber brush, which has been used on copying machines for years. Although this is not yet a proven technology for industrial motors, it could eventually be used to eliminate drag and require minimal maintenance. Finally, the use of electrochemical grease is recommended for some applications. This grease provides a ground path that can remove enough current to protect the bearing.

Power Quality Effects. Some VFDs, especially pulse width modulation (PWM) types, create rapid-rise-time pulses (spikes) in the voltage waveform. The pulses have a very steep leading edge, or rapid change of voltage with time. A voltage with a high rate of change is unevenly distributed along the motor's windings. The most harmful effect occurs when the motor feeder cable is relatively long. The inductance of a long motor feeder cable may create a resonance in the drive-cable-motor circuit. A reflected voltage wave may appear at motor terminals. When the voltage changes from zero to its full value, there can be an overshoot at the motor terminals of more than twice the normal value.

Almost half of that overshoot can be dropped across the first turn of the first coil of the motor stator winding. The turn-to-turn insulation is designed for only a few volts, and the overshoot voltage causes a discharge between the turns of the winding. Over time, this discharge can cause winding damage and premature failure of the motor.

There are several solutions to this problem. A choke, or inductor, can be placed on the output of the drive, a capacitor can be placed in parallel with the motor, or an L-C filter can be placed at the drive output. An L-C filter is a low pass filter that consists of an inductance (L) and a capacitance (C).

It is important to note that motor manufacturers have developed an insulation classification known as inverter-

duty, which is much more resistant to voltage pulses. Normally, inverter-duty motors should be used in PWM applications, although many manufacturers offer “inverter-friendly” insulation in their premium efficiency motors. Motor users should always consult the drive manual when using longer motor feeder cables to ensure that the cables do not exceed the maximum recommended length.

Efficiency Opportunity No. 6

Addressing In-Plant Electrical Distribution and Power Quality Issues

Motor system performance can be adversely affected by poorly designed and maintained in-plant electrical distribution systems as well as power quality issues. Power quality issues are usually expressed in deviations in voltage, current, or frequency, and they can cause equipment operation problems or even failure. Today's sophisticated motor systems employ newer technologies such as soft-starters, drives, and stepper motors along with programmable logic controllers (PLCs); these motor systems and others nearby are often sensitive to and affected by poor power quality.

Power quality is a growing concern in industry as more processes are being automated and more computers are being used to control and monitor equipment. Since digital equipment often must be reset or resynchronized after a power disturbance, the issue of power quality merits attention.

For some processes, power problems can be quite costly. For example, in plastics extrusion processes there is a risk that plastics or resins might solidify in production equipment during a process interruption. Clearing the equipment of solidified plastics can be costly and time-consuming. In pharmaceutical and other mixing or time-sensitive processes, expensive batches can be lost if a power quality problem strikes at the wrong time.

In addition, a common trend in many energy efficiency programs is to upgrade interior lights to high-intensity discharge lighting (HID). It can take several minutes for a ballast to bring these lights up to normal intensity. Consequently, a momentary loss of power can result in a lengthy delay in restoring adequate light. In fact, in emergency lighting applications, HID lighting systems must be supplemented by other lights to ensure safety.

These are the primary problems associated with in-plant electric distribution systems and power quality:

- Voltage problems, including outages, sags, transients and surges, harmonics, and other signal distortions
- Poor power factor
- Electromagnetic interference.

Finding solutions to these problems and correcting them can lower a plant's energy bills, reduce fire hazards, increase equipment life, and reduce downtime. Motor and drive systems that are intelligently configured and well-maintained are less likely to cause distribution system problems. Understanding the impact that motors have on the performance of a facility's electrical distribution system (and vice-versa) can help improve an industrial plant's overall operation.

■ Voltage Problems

Voltage problems—which include outages, sags, surges, and unbalances—are basically any deviations in a normal waveform. The consequences of voltage problems range from reduced performance characteristics to motor damage to complete motor failure. Since motor failure may interrupt a process, requiring replacement of the motor and restarting and perhaps resynchronizing the entire system, understanding common causes of outages and sags can prevent costly production problems. Sizing motors to operate at 80% voltage is a major cause of oversizing.

Outages. Outages, the most noticeable problem, can be momentary power losses caused by faults from either internal or external events. Faults that cause momentary power losses are usually cleared quickly. For example, wind might cause a power line to contact a ground source, causing an overcurrent condition that activates protective switchgear. However, once the fault is cleared, the switchgear can realign to provide power. Long-term outages are usually the result of a line problem, such as a damaged power line or the catastrophic failure of a transformer or switchgear component.

Outages can also be part of a utility's strategy to manage loads during high demand periods. To prevent one area from losing power for an extended period, some utilities use rolling brownouts to manage their capacity.

Sags. A voltage sag is a decrease in the magnitude of voltage from 10% to 90% that lasts anywhere from half a cycle up to five minutes. Voltage sags can be caused by utility system events such as faults created by equipment failure, lightning, and equipment contact with trees or vehicles. Voltage sags are most often caused by in-plant events or activities at a neighboring facility that pull large currents.

Motors with large starting currents can create voltage sags, especially if the motor is large relative to the capacity of the distribution system. Voltage sags can cause protective devices such as relays to de-energize, and they can also create problems with process control equipment. Facilities with low power factors often experience voltage sags caused by the high current levels in the distribution system.

Voltage sags often cause problems with PWM types of VFDs. However, drives can be specified to have an adequate ride-through capability if the duration and magnitude of the expected sag are known. Power quality monitors can be installed to record troublesome sags and to identify their source and duration.

Overvoltage and Undervoltage. Motors are designed to operate with $\pm 10\%$ of their rated voltage. However, even within this range, changes in the voltage supplied can affect a motor's performance, efficiency, and power factor. Ideally, deviations in the voltage supplied to a motor system should be less than $\pm 2\%$.

Changes in the voltage supplied to induction motors can affect their performance significantly. For example, a 10% decrease in the voltage supplied to a Design B induction motor decreases its torque by almost 20% while increasing its rated slip by more than 20%. Another consequence of low voltages is the increased current draw that the motor requires to meet the power requirement. In fact, many motors are equipped with an undervoltage relay that de-energizes the motor under low voltage conditions to prevent damage from the high current draw.

Conversely, increasing the motor's voltage by 10% improves some operating characteristics of the motor, such as its torque. However, the effect of overvoltage on motor efficiency depends on the motor's load. The motor's efficiency can increase when the line voltage is up to 10% higher than the rated voltage, but at part load the efficiency could decrease.

Voltage deviations can be caused by any of the following factors:

- Changes in loads associated with daytime, nighttime, and seasonal operation
- Improperly sized transformers
- Undersized conductors
- Poor connections
- Sources of low power factor in the distribution system.

These problems can be caused by sources within the plant or by the power supplier. Most utilities have standards for the power supplied to a customer's facility; a typical voltage standard is $\pm 5\%$. When a customer questions whether these standards are being met, a utility will often monitor the power supplied to the plant. Although facilities can sometimes be affected by power disturbances caused by neighboring customers, plants that experience voltage problems should first perform an internal review to determine if an internal source is responsible. System voltages can sometimes be corrected by adjusting transformer tap settings, installing automatic tap changing equipment, or installing power factor correction capacitors.

Seasonal changes also affect the power supply. In hot weather, utilities usually increase voltage levels to handle anticipated increases in cooling loads from air-conditioners, chillers, and so on. However, these increases should remain within the tolerances specified by the utility in its power supply agreement.

Unbalances. Three-phase electrical systems should have three vectors, each one of equal magnitude and out of phase by 120° . A nonsymmetrical—or unbalanced—system is so called because of differences between any two of the three phases. A voltage unbalance results in a current unbalance, which can significantly reduce the efficiency of a motor. An unbalance will also reduce the life of the motor because of the excess heat generated in the stator and rotor assembly.

Voltage unbalance can be caused by factors like these:

- The power supplier
- A nonsymmetrical distribution of single-phase loads, in which a disproportionate share of single-phase loads is placed on one of the three phases
- An open circuit on one phase
- Different-sized cables carrying the three phases
- Selection of the wrong taps on the distribution transformer
- Single phase loads that create low power factors.

When a voltage unbalance reaches 5%, the phase currents can differ by as much as 40%. This type of power supply unbalance can quickly lead to motor damage or failure. Therefore, phase voltages in a plant should be monitored, and if the unbalance exceeds 1%, corrective action should be taken.

Methods for correcting unbalanced voltages include redistributing single-phase loads or having the utility correct the supply voltage unbalance. NEMA Standard MG1 provides specific guidance on the motor derating factors used for various levels of voltage unbalance. The derating factors require the motors to be operated at greatly reduced loads. The overall effects of voltage unbalance on the performance, efficiency, and life of a motor due are negative.

Transients and Surges. Transients and surges are often the result of a large switching activity, such as energizing capacitor banks. In areas with large inductive loads, utilities will energize capacitor banks to increase the power factor, improve voltage, and reduce the system stresses that accompany large reactive loads. Unfortunately, energizing these capacitor banks can create transient voltage surges that affect sensitive equipment.

Lightning is another common cause of transients. The enormous amount of energy in a lightning strike can destroy controllers and equipment. Proper system grounding is essential to minimize the risk of equipment damage; however, sensitive equipment such as computers and automated control systems usually require additional protection. Dedicated transient voltage surge suppression (TVSS) devices are recommended for highly sensitive equipment.

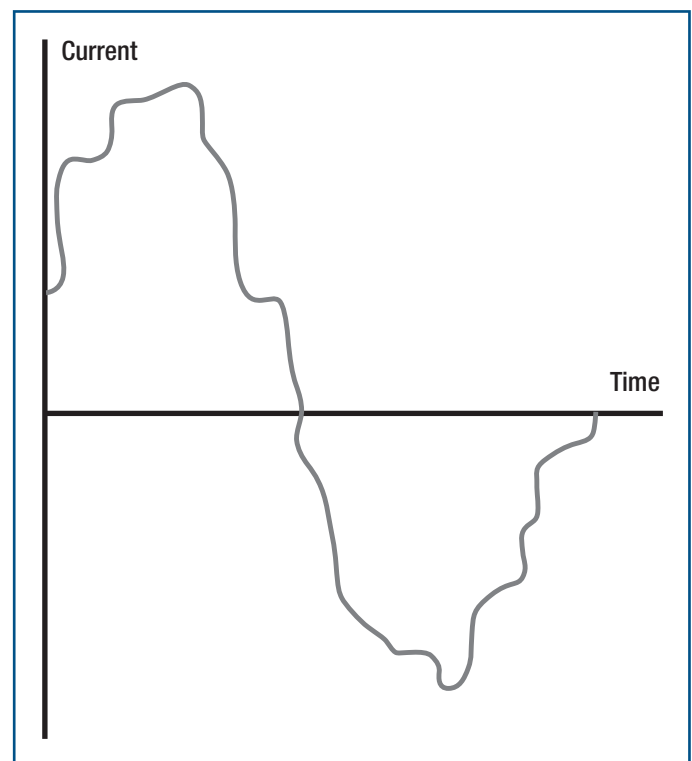

Figure 16. Waveform distorted by harmonic effects

Harmonics. Harmonics are a form of signal distortion in which whole-number multiples of the main frequency are superimposed on the 60 Hz waveform. When multiples of the fundamental are added in, they create a jagged appearance to the sine wave. A common multiple is the fifth harmonic, or 300 Hz. A sine wave with a fifth harmonic has a stair-step pattern. Figure 16 shows a wave with about 8% fifth harmonic. Harmonics negatively affect the performance of inductive machines, such as transformers and induction motors. Harmonics can also interfere with the accuracy of sensitive control equipment.

The harmonic content in a power signal is usually measured in terms of total harmonic distortion (THD), as defined by IEEE Standard 519. Electrical equipment is often rated to handle a certain amount of THD (a common value is 5%). Harmonics are created by large nonlinear loads such as welders and variable frequency drives. VFDs generate harmonic signals that affect both the incoming power supply and the power signal sent to the motors. To minimize the effect of harmonics, many facilities install filtering devices and isolation transformers with VFDs.

Harmonics increase the amount of heat generated in motor windings for a particular load. However, motors are typically much less sensitive to harmonics than computers or communication systems. NEMA has developed a special measure of harmonic distortion for motors called the *harmonic voltage factor*, which is defined in NEMA MG1.

The reactance of the line between the drive and the motor can contribute to a resonance that increases harmonic distortion. Consequently, as a rule of thumb, the line length between a VFD and a motor should be as short as possible.

■ Power Factor

Power factor is the ratio of real (working) power to apparent (total) power. Many electric utility companies charge additional fees (power factor penalties) if the power factor of the plant falls below 0.90. Since a typical induction motor operates at around 85% power factor, many facilities with large motor systems and low power factors face stiff penalties as to power factor if it is not corrected.

Low power factor problems result mainly from the high line currents required to meet the real power demand. The increased current flow causes resistive losses, which waste energy. Reactive power loads also reduce the in-plant electric distribution system's capacity by creating an additional voltage drop that can cause equipment to perform poorly.

Low power factor can also be caused by idling or lightly loaded motors and by operating equipment at above the

rated voltage. A low power factor can be corrected by installing capacitors at a particular motor, at a motor control center for a series of motors, or at the utility point of delivery, whichever is more appropriate. However, capacitors should never be installed directly at the motor terminals, where the capacitors are switched on and off with the motor contactor; this practice can lead to surges that damage the motor windings. In some facilities, large synchronous motors are used to add a leading power factor component to the distribution system.

■ Electromagnetic Interference

PWM types of VFDs can generate significant levels of electromagnetic interference (EMI), or *noise*, that is both radiated from the drive and conducted in conduit, cable tray, and ground wires. This noise is generated by high-frequency switching of the voltage. Because the switching is so rapid, the noise can be in the megahertz range. At these high frequencies, noise couples easily into grounding conductors. The noise can cause failures in electronic circuits such as computers, control circuits, and communications.

There are several ways to mitigate this noise; one is to use a common choke mode or filter on the output of the drive. Another is to enclose the entire motor feeder in metal conduit, from the drive to the motor.

■ Solutions

Facilities that have problems with equipment overheating, controllers that operate poorly, frequent sags, and so on should perform a power quality review. This can help plants locate the causes of problems and find cost-effective resolutions. As plants become increasingly automated, there is also an increase in the amount of equipment subject to power quality problems. Therefore, methods that help prevent such problems are worth considering. Hand-held power quality monitoring devices are becoming quite inexpensive. Many hand-held devices can record voltage and current waveforms that can be played back later on a personal computer for further analysis.

Soft-Starting Devices. Energizing large motors with “across-the-line” starting usually creates a large in-rush current, often six to eight times that of the normal operating current. Start-up currents like those can cause voltage sags and other power quality problems. In fact, premium efficiency motors have actually increased the frequency of starting current problems. The efficiency gains obtained with newer motors derive largely from a reduction in the rotor circuit resistance, compared to that of older, conventional motors. Thus, the starting torques of the new motors are lower and the starting currents are higher.

The electrical system stresses caused by starting large motors have prompted a demand for equipment that “softens” motor start-ups. The purpose of soft-starting equipment is to limit the starting current. Types of soft-starters include special motor controllers and most VFDs, which can usually limit starting currents to one and one-half to two times the motor’s rated operating current.

Although a properly designed system should not create power quality problems, several factors can degrade a system’s ability to maintain proper voltage and current during internal or external events. For example, adding single-phase loads to one phase of the distribution system can create a voltage unbalance among the phases that leads to poor motor performance. Degradation of the grounding system can also interfere with equipment operation or prevent fault-clearing devices from working properly. Capable electrical contractors or an electric utility can perform a site survey to determine whether the grounding system is adequate. A fundamental way to avoid many power quality problems is to review the capacity of the system before adding new loads.

Transient Voltage Surge Suppressors. Transient voltage surge suppressors (TVSSs) are designed to prevent sudden voltage surges from damaging sensitive equipment such as computers, numerically controlled equipment, controllers, and instrumentation. These devices usually contain metal oxide varistors (MOVs) configured to provide a path for current to flow away from the equipment during a transient event. TVSSs afford protection from both highly damaging voltage surges and the less noticeable transients that, while they do not cause an immediate equipment failure, increase the cumulative wear on the equipment, shortening its operating life. TVSSs should indicate visually that all elements are still working. And, like any piece of electrical equipment, they have a finite life.

Isolation Transformers. Typically, isolation transformers are used to filter damaging signal surges, noise, and harmonics to prevent them from reaching sensitive equipment. These devices are almost always used with VFDs of more than 1,000 hp, but they are also often used with smaller VFD applications. The drawbacks of these devices include slight efficiency losses, the introduction of another possible failure mode, and the additional maintenance required for the transformer.

Filters. Sophisticated filtering devices are often used with VFDs to prevent high-frequency harmonics from entering the power supply and disturbing other sensitive equipment in the distribution system. These filters are also used with many electrotechnology applications, such as

microwave heating and radio frequency drying equipment. In some cases, the filters are used to comply with Federal Communication Commission (FCC) regulations regarding the transmission of signals that interfere with communication channels.

Strategies for VFDs. The following actions can improve power quality in facilities using VFDs:

- Install input line reactors (typically, 3% impedance) to reduce impacts from transients and mitigate harmonic currents
- Keep the distance from the drive to the motor to within 50 feet; if a longer distance is required, consider using output filters to reduce potential overvoltage transients
- Separate input power, output power, and communication cables by at least 12 inches to minimize the EMI to control circuits. Install input, output power, and controls in separate metal conduit or use metal shielding between them if they are in adjacent cable trays
- If there are trips due to momentary high or low voltage, check with the manufacturer to determine if the trip settings bandwidth can be increased
- Consider automatic restart (flying restart) to mitigate trips caused by overvoltage or undervoltage, if an automatic restart is appropriate for the end-use and can be done safely.

Uninterruptible Power Supply Systems. Uninterruptible power supply (UPS) systems should be considered for plants in which voltage sags or power interruptions can be particularly costly. Although UPS systems can be configured in many ways, they can be grouped into two principal types: static and dynamic.

Static systems rely on batteries to provide power when the incoming power either sags or stops completely. Dynamic systems rely on the inertia of a rotating mass—usually a flywheel—to supply rotating force to a generator long enough for an engine to start and take over as the prime mover.

On-Site Power Generation. On-site power generation is used for cogeneration and to provide backup, standby, and emergency power. On-site power systems consist of generators that are powered by engines or turbines; these are in turn fueled by natural gas or stored fuels such as propane, diesel fuel, or oil. Fuels cells are a promising alternative technology. Key considerations in selecting on-site generation systems are maximum load, number of times the system is expected to operate, time required for the system to operate, and speed of start-up.

Current and frequency problems are not common in large utility systems, but they can occur in plants that self-generate. With on-site generation, the electric power generator is sized to reflect individual end-use loads. As large loads are added or dropped, the effect on the generator can be significant. In such cases, variations in frequency and current can be the result.

System Monitoring Software. Numerous computer-based monitoring systems are available to evaluate power quality. These software systems allow the power quality of a facility to be evaluated continuously. If problems are encountered, the systems note the particular problem (e.g., voltage sag, interruption). This information allows the engineer or operator to make better decisions regarding the type of equipment required to correct the power quality problem.

Efficiency Opportunity No. 7

Using the Service Center Evaluation Guide

Most users want to be sure that they are paying for a high-quality repair, but what does that mean? It certainly means more than ending up with a neat, clean motor. Errors and careless workmanship can reduce the efficiency and shorten the life of the repaired motor. This evaluation guide can assist industrial plants in evaluating a motor service center's capabilities, practices, and quality in regard to repairing low-voltage induction motors.

Customers of motor repair service centers need to be knowledgeable about the service they are purchasing. It is important to specify the expected scope and quality of work. However, this alone cannot ensure quality work if the service center is not capable of it.

There are several ways to evaluate a service center. Having a repaired motor tested at a lab certified by the National Volunteer Laboratory Accreditation Program can help to determine the motor's efficiency per IEEE 112-1996 method B and detect certain types of repair errors or shortcuts. However, this is usually impractical because of the time and expense involved, and it may not reveal whether a lower-than-nameplate efficiency resulted from the recent repair or predated it. This also cannot reveal whether one repaired motor is typical of all those from the same service center.

A variety of predictive maintenance tests can be done to rule out certain flaws or rewinding errors that could reduce a rebuilt motor's service life rather than lower its efficiency. It can also be helpful to inspect the service center and interview its staff.

■ Obtaining Information

The following elements can indicate a service center's ability to perform high-quality motor repair work.

Primary Market Niche. An important first step is to assess whether the service center does a significant amount of repair work on motors of the type and size that your plant is likely to submit. For example, a plant that uses small induction motors for the most part will want to avoid a service center whose "bread and butter" is locomotive motor-generator sets. Work done outside a service center's primary market niche may be unacceptable in terms of quality and price. Plants that use a wide range of motor types can benefit from selecting two or more appropriate, qualified repair service centers, as needed.

Tools and Facilities. Next, an informal inventory of the facility and its capabilities and tools can be very helpful. It is difficult to conduct thorough diagnostics and verify repairs without having equipment like surge testers and a well-regulated power supply. The service center must be able to handle the largest motors you expect to submit. For example, the winding heads must be able to duplicate the original winding patterns. Form-wound coils are often subcontracted, but these are not normally used in low-voltage motors.

Repair Materials. Then, it is helpful to check on whether the center houses a variety of materials needed for motor repairs, such as electrical insulation materials. These include slot liners, wire sleeves, special paper separators for coil groups, and material for tying and restraining end turns. Most service centers stock only class F or class H insulating materials, which often exceed original insulation heat ratings. This makes things simpler for the shop, and it adds a slight thermal margin for motors that were originally insulated at a lower thermal class.

The repair should duplicate the original coils—the same dimensions, wire size(s), number of effective turns, and cross-sectional area—unless proven better alternatives are agreed upon. To do this, service centers should either carry a broad inventory of wires in various sizes or describe how they obtain the sizes needed quickly in order to meet your turnaround requirements.

Staff. Next, it can be helpful to inquire about the repair service center's staff. The center's staff should be stable, knowledgeable, experienced, and well-trained. A low turnover rate can indicate a high degree of employee satisfaction and a willingness on the part of management to invest in training and education.

Recordkeeping. Motor management is like health care, in that a record of past problems and remedies can be invaluable for diagnosing or preventing new problems and resolving warranty issues. An elaborate computer system may be impressive, but many service centers keep good records on job cards. These can be thorough and retained for many years. So it is important to inquire about the repair center's recordkeeping system.

Cleanliness. Almost intuitively, we associate cleanliness with good quality management. This is more than a matter of aesthetics, because most of the materials and supplies used in a motor service center need to be protected from contamination. So, the next step is to observe the cleanliness of the center. Tools and test equipment should be organized so they can be retrieved and used easily. To maintain their calibration, gauges and testing equipment should be put away or protected from damage when they are not in use. Places where bearings and lubricants are stored or installed must be clean, because even a small particle can cause premature bearing failure.

Standard Operating Procedures. Finally, it is important for the center to maintain high levels of quality. Ideally, this includes a formal quality management system involving third-party inspections and certification. These are still rare, but they may become more commonplace as a result of EASA's promotion of the EASA-Q quality management system, Advanced Energy's *Proven Excellence* certification program, and increasing awareness of ISO 9000 quality management standards. Service center managers should be able to point to documents that provide standards, operating procedures, and important records. Examples are bearing fit standards, testing procedures, forms for recordkeeping, and calibration records.

Determining satisfactory adherence to high-quality workmanship standards can be time-consuming. Two methods are available for evaluation: interviews and inspections. Both should be used to an appropriate degree. To ensure a comprehensive evaluation, a Motor Repair Service Center Checklist is provided in Appendix D. It can be completed during the interview and annotated as necessary during a walk-through inspection. The checklist may not be necessary for infrequent customers of rewind services, but it does indicate the equipment and practices that are important for high-quality repairs.

■ Conducting the Evaluation

The first step is to make an appointment with the service center; plan to reserve at least half a day. Advise the service center manager that this is part of a structured evaluation and that the manager might be asked to produce evidence of such things as employee training or equipment calibration practices.

In spite of the rigorousness of the evaluation, try to make the service center manager feel comfortable. Allow the manager to explain answers. Do not hesitate to diverge from the written checklist to better understand the service center's practices, staff, and commitment to quality. Avoid giving the impression of making judgments on the spot.

Finally, be sure you are well informed. It is important to be familiar with motor construction, repair methods, and related issues. Read the *Motor Repair Tech Brief* and if possible, more detailed sources such as *Quality Electric Motor Repair: A Guidebook for Electric Utilities*. See Section 4, "Where to Find Help," for more details about these publications, including how to obtain them.

Section 3: Motor System Economics

Overview

Industrial facility managers often have to convince corporate management that energy efficiency improvements are worth the investment—which can be more of a challenge than the engineering behind the improvement. An effective way to begin the project proposal process is to analyze the economic (“dollars-and-cents”) impacts of the efficiency improvement. Experience shows that corporate officials usually respond more readily to this approach than to a proposal that emphasizes the kilowatt-hours saved or efficiency ratios.

An economic approach also enables facility managers to relate energy efficiency improvements to broad corporate goals. And it allows financing department staff members to help prepare the kind of proposal that will persuade corporate officers of the monetary benefits of system upgrades.

This section contains some recommendations for proposing energy efficiency improvement projects to management. The first step is to better understand the point of view and the priorities of corporate officers.

Understanding Corporate Priorities

Corporate officers are held accountable to a chief executive, a board of directors, and an owner or shareholders if the company is publicly held. The job of these officers is to create and grow the equity value of the firm. The corporation’s industrial facilities do so by generating revenue that exceeds the cost of owning and operating the facility. Plant equipment—including system components—are assets that must generate an economic return.

The *rate of return on assets* is the annual earnings attributable to the sale of goods produced by those assets, divided by the value of the assets. This rate of return is a key measure by which corporate decision-makers are held accountable. Financial officers look for investments that will generate a favorable return on assets. When faced with multiple investment opportunities, these officers favor the options that lead to both the largest and the quickest returns.

This approach to making business decisions can impose several priorities on the facility manager. These include assuring reliability in production, avoiding unwanted surprises by sticking with familiar technologies and practices, and contributing to cost control *today*, sometimes

by cutting corners in equipment maintenance and upkeep. As a result, efficiency is often viewed as a luxury rather than a necessity.

Fortunately, the story does not end here. The following sections describe the ways that industrial efficiency can save money and contribute to corporate goals while effectively reducing energy consumption and cutting noxious combustion emissions. This is information that the facility manager can use to make a more compelling case for an industrial efficiency project.

Measuring the Dollar Impact of Efficiency

Motor system improvement projects can move to the top of the list of corporate priorities if the proposals reflect distinct corporate needs. There are usually many opportunities to improve the motor systems of an industrial plant. Once the facility manager identifies one or more much-needed projects, the next task is to prepare a proposal that reflects corporate priorities in dollars-and-cents language.

The first step is to determine the total dollar impact of an energy efficiency measure. A life-cycle cost (LCC) analysis provides an effective framework for this. LCC analyses capture and total the expenses and benefits associated with an investment. The result—expressed as a net gain or loss—can be compared with other investment options or with the expected outcome of not making the investment. As a comprehensive accounting of an investment option, the LCC analysis for an efficiency measure includes projections of the following:

- Search and selection costs for an engineering implementation firm
- Initial capital costs, including the purchase and installation of the equipment and the cost of borrowing money to finance the project
- Maintenance costs
- Supply and consumable costs
- Energy costs over the economic life of the equipment
- Depreciation and tax impacts
- Scrap value or cost of disposal at the end of the equipment’s economic life
- Impacts on production, such as product quality and downtime.

This kind of analysis often shows that electricity costs represent as much as 96% of the total LCC, the initial capital outlay only makes up 3% of the total, and maintenance accounts for a mere 1%. Clearly, any measure

that reduces electricity consumption without reducing reliability and productivity will have a positive financial impact on the company.

LCC analyses should also include the “time value of money.” A helpful tool in determining the LCC of motor improvement projects is the DOE MotorMaster+ software program. For more information on this software tool, see *Efficiency Opportunity No. 2, Establishing a Motor Management Program*.

Presenting the Finances of Efficiency

There are many ways to measure the financial impact of investments in efficiency. Some analysis methods are more complex than others, and a proposal may be based on several of them. The choice is up to the presenter and should take the audience into account.

A simple (and widely used) measure of project economics is the *payback period*. This is the period of time required for a project to “break even,” or for the net benefits of an investment to accrue to the point where they equal the cost of the initial outlay. For a project that returns benefits in consistent, annual increments, the simple payback equals the initial investment divided by the annual benefit. It does not take into account the time value of money; in other words, it makes no distinction between a dollar earned today and one earned in the uncertain future. Still, the simple payback period is easy to use and understand and many companies use it as the basis for a quick “go/no-go” decision.

There are five important factors to remember when calculating a simple payback:

- It is an approximation, not an exact economic analysis
- All benefits are measured without considering their timing
- All economic consequences beyond the payback are ignored
- Because of the two previous factors, payback calculations do not always indicate the best choice among several project options
- The payback calculation does not take into account the time value of money or tax consequences.

More sophisticated analyses take into account factors such as discount rates, tax impacts, and the cost of capital. One approach involves calculating the *net present value* of a project, which is defined as follows:

Net present value = present worth of benefits – present worth of costs

Another commonly used calculation for determining economic feasibility of a project is the *internal rate of return*, which is the discount rate that equates future net benefits (cash) to an initial investment outlay. This discount rate can be compared to the interest rate at which a corporation borrows capital.

Many companies set a threshold (or hurdle) rate for projects, which is the minimum required internal rate of return for a project to be considered viable. Future benefits are discounted at the threshold rate, and the net present worth of the project must be positive in order for the project to be a “go.”

Relating Efficiency to Corporate Priorities

Future cost savings should be a strong incentive to improve the efficiency of a plant’s motor systems. But it might not be enough. The facility manager can strengthen the case for making improvements by relating a favorable LCC to determine corporate needs. Staff in finance departments can determine which of the following suggestions for interpreting the benefits of electricity cost savings would work best in a specific company:

■ A New Source of Permanent Capital

Lower electricity costs—a direct benefit of efficiency—can be regarded as a new source of capital for the company. The investment that makes greater efficiency possible will yield annual savings each year over the economic life of the improved system. Regardless of how the efficiency investment is financed—through borrowing, retained earnings, or third-party financing—the net annual cost savings will be a permanent source of funds as long as the efficiency savings continue.

■ Added Shareholder Value

Publicly held corporations usually take advantage of opportunities to enhance shareholder value, and motor system efficiency can be an effective way to capture this value. Shareholder value is the product of two variables: annual earnings and the price-to-earnings (P/E) ratio. The P/E ratio describes the corporation’s stock value as the current stock price divided by the most recent annual earnings per share. To take advantage of this measure, the efficiency project proposal should first identify the annual savings (or rather, addition to earnings) that the proposal will generate. Multiplying that earnings increment by the P/E ratio yields the total new shareholder value attributable to the efficiency project.

■ Greater Comfort and Safety

Optimizing motor systems requires continual monitoring and maintenance, and these benefit workers in terms of enhanced safety and comfort. Routine system monitoring usually uncovers operational abnormalities before they present a danger to plant personnel. Eliminating or controlling these dangers reduces the threats to life, health, and property in the workplace.

■ Improved Reliability and Capacity Utilization

Another benefit of greater efficiency is the more productive use of assets. Efforts to achieve and maintain energy efficiency will also contribute to operating efficiency. By ensuring the integrity of system assets, the facility manager can promise more reliable plant operations. From a corporate perspective, this also means a greater rate of return on a plant's assets.

■ A Better Bottom Line

Each dollar saved on electricity goes directly to the bottom line. For a corporation with a 10% profit margin, each dollar of electricity savings generates 10 times its equivalent in sales revenue.

■ A Call to Action

A proposal for implementing an efficiency improvement can be attractive to corporate decision makers if it contains the following:

- Specific opportunities for improving efficiency
- The LCC associated with each proposed efficiency project
- Identified project(s) that have the greatest net benefits
- Connections to current corporate financial priorities—added shareholder value, reduction of environmental compliance costs, and improved capacity utilization
- Ways in which the benefits of each project respond to current corporate needs.

■ Life-Cycle Costs

Motor systems are critical to the operation of almost every plant and account for about 60%-70% of all the electricity used in an average plant. In spite of this, many facilities have no idea how much motor system operation costs on an annual basis, or how much money they could save by improving the performance of their motor systems.

Life-cycle cost analysis is important when managing electric motor systems. Performing a life-cycle cost analysis

on a system refers to an economic analysis that takes into account all of a project's costs, including:

- Initial capital cost, including installation and the cost of borrowing money
- Maintenance costs
- Supply and consumable costs
- Energy cost
- Depreciation and tax impacts
- Other annual or periodic costs
- Scrap value or cost of disposal at the end of the project's or equipment's life
- Effects on production, such as product quality and downtime.

Life-cycle cost analyses should include the "time value of money." These analyses are typically performed to compare one alternative with another, or to see if a project should be undertaken, based on a company's minimum threshold for return on the investment. A helpful tool in determining motor life-cycle costs is the U.S. Department of Energy's MotorMaster+ software program. Further information on this tool is available in the *Efficiency Opportunity No. 2*, Establishing a Motor Management Program.

■ Calculating Electricity Costs

Electricity costs can be determined by using motor nameplate data or directly measuring current or power usage. With any of these methods, the data must represent actual system operating conditions in order to be useful. In systems with widely varying operating conditions, collecting data only once will not provide a true indication of the amount of energy that a motor system consumes.

Nameplate Data Method. A quick way to determine energy costs is to use the motor nameplate data. Additional data needed include annual hours of operation (hours per year), unit cost of electricity (\$/kWh), and average *load factor*, which refers to the average percentage of full load electric power at which the motor operates.

Motor system economic analyses are driven largely by the amount of time and the percentage of its full capacity at which the motor system operates. To account for the fact that a motor usually does not operate at its rated full load all the time, its average load factor can be estimated. Annual electricity costs can be calculated by inserting this information into the simple calculation equation shown in the box on page 42 titled "Simple Calculation."

Simple Calculation

Annual energy costs =
 (motor full-load brake horsepower) x (0.746 kW/hp) x
 (1/motor efficiency) x (annual hours of operation) x
 (electricity cost in \$/kWh) x load factor

Assumptions:

Cost of electricity = \$0.05/kWh
 Load factor = 65%
 Motor efficiency = 95%

Example:

Motor full-load hp = 100 hp
 Annual hours of operation = 8,760 hours (3-shift, continuous operation)

Annual electricity costs =

(100 hp) x (0.746 kW/hp) x (1/0.95) x (8,760 hours) x
 (\$0.05/kWh) x .65 = \$22,356

Most industrial motors have a service factor of 1.15. This means that a motor with a nominal nameplate rating of 100 hp could in fact be operated intermittently up to 115 hp. However, motor efficiency can drop slightly when the motor is operated above the rated load, which can significantly reduce insulation life. An important implication of the service factor is that the load factor could be greater than one if the motor is operated continuously.

Direct Measurement Method. A more accurate way to determine electricity consumption is to take electrical measurements. The direct measurement method requires reading power (kW) with a wattmeter or reading amps and volts and calculating kW using the nameplate power factor.

Wattmeters require two simultaneous inputs—voltage and current; many motor installations do not provide convenient access to both. To calculate electricity consumption, the measured kW value is multiplied by hours of operation and electricity costs, as shown in the calculation in Case I in the box titled “Direct Measurement” on this page. This calculation is for a motor with a constant load, that is, one that does not vary over time.

If a wattmeter is not available or if it is not practical to use one, then amps and volts can be measured separately. If there is a possibility the motor load is below 65% of the motor’s rated capacity, then calculations using direct measurement of amps and volts will not provide useful results.

A clamp-on type ammeter is used to measure current on each of the three power cables running to the motor; most industrial motors are three-phase. It can be convenient to take these readings at the motor controller; however, the connection box on the motor itself is sometimes more accessible. Line voltage is usually measured at the motor controller, preferably at the same time that the current reading is taken. In some facilities, line voltage drops with increases in power usage. See the calculation for a motor with a constant load shown in Case II in the box titled “Direct Measurement.”

Direct measurements of motor current are not always practical, however. Taking hot measurements (at high power levels) of motor current pose safety risks for workers; these measurements might not be feasible in an industrial environment where power connections are exposed to moisture or contaminants.

Direct Measurement

Assumptions:

3-phase motor
 0.85 power factor (nameplate)
 0.05 \$/kWh unit electricity cost
 Annual hours of operation = 8,760 hours (3-shift, continuous operation)

Case I. Using a Wattmeter

Annual electricity costs =
 Wattmeter reading (using a 3-phase setting) x (annual hours of operation) x (electricity cost in \$/kWh)

Example:

Wattmeter reading = 77.88 kWh

Case II. Using a Voltmeter and an Ammeter Separately

Annual electricity costs =
 [(load amps) x (volts) x (1.732) x (power factor)]/1000 x
 (annual hours of operation) x (electricity cost in \$/kWh)

Annual electricity costs =

(77.88 kWh) x (8,750 hours) x (\$0.05/kWh) = \$34,111

Example:

Average load amp measurement across all phases = 115 A
 Measured voltage = 460 V

Annual electricity costs =

[(115 A) x (460 V) x (1.732) x (0.85)]/1000 x (8,760 hours) x
 (\$0.05/kWh) = \$34,111

■ Energy and Demand Charges—Understanding Your Utility Bill

The calculations shown earlier use electricity rates stated in terms of dollars per kilowatt-hour (\$/kWh). However, electric utilities use more complicated rate structures to bill their industrial customers. These typically include both energy (\$/kWh) and demand charges (\$/kW). Different rates depend on the level of consumption and the time of year. Demand charges are based on the peak demand for a given month or season and can have significant impacts on the electricity costs of some customers. Other components of industrial electricity bills, such as power factor penalties, can be affected by electric motor systems. For example, the use of lightly loaded induction motors can adversely affect the power factor of a plant and lead to higher bills. For more information, see the *Efficiency Opportunity No. 6, Addressing In-Plant Electrical Distribution and Power Quality Issues*.

When the economic impacts of efficiency measures are calculated, the marginal cost of the electricity must be considered. This takes into account energy and demand charges, seasonal rates, power factor penalties, and different rates for different levels of consumption. Electric utilities can answer questions about electrical tariffs.

■ Maintenance Considerations and Life Cycle Costs

There are two principal types of maintenance: preventive or predictive maintenance (PPM) and repair. A PPM schedule can improve system reliability, reduce the risk of unplanned downtime, and help plants to avoid expensive failures. Repair involves both the parts and labor required to troubleshoot and fix equipment that is not performing

properly or has broken. In general, PPM is less costly than repair. A well-designed PPM schedule minimizes the need for repairs by detecting and resolving problems before they develop into more serious issues.

Similarly, effective design and equipment specification practices can help to minimize operating costs. Taking life-cycle costs into account during the initial system design phase or when planning system upgrades and modifications can both reduce operating costs and improve system reliability.

■ Motor Systems Market Study Life

A study commissioned by the U.S. Department of Energy has estimated that optimizing industrial motor systems through the implementation of mature, proven, cost-effective energy-saving techniques can reduce industrial energy consumption by 75 to 122 billion kWh per year, or up to \$5.8 billion per year. These estimates include only the energy savings, and do not factor in other benefits likely to result from optimization, such as improved control over production processes, reduced maintenance, and improved environmental compliance. This study is based upon on-site surveys of 265 industrial facilities in the United States, in a probability-based sampling of the U.S. manufacturing sector. The study, *United States Industrial Motor Systems Market Opportunities Assessment*, can be downloaded from the ITP Web site at www.eere.energy.gov/industry/bestpractices, or obtained through the EERE Information Center.

Table 4 displays motor systems energy use and potential savings per establishment in the 10 four-digit SIC groups with the highest annual motor energy consumption. In these

Table 4. Financial Impact of Motor Consumption and Savings for Selected Industries

Industry Groups	Motor Sys. Costs/ Estab.	Motor Energy Costs / Total Operating Costs	Savings per Estab. Per Year	Savings as % of Operating Margin
Paper Mills	4.6 million	6.5%	\$659,000	5%
Petroleum Refining	5.6 million	1.4%	\$946,000	1%
Industrial Inorganic Chemicals, nec.	1.6 million	10.4%	\$283,000	6%
Paperboard Mills	3.0 million	6.4%	\$492,000	5%
Blast Furnaces and Steel Mills	6.0 million	2.1%	\$358,000	2%
Industrial Organic Chemicals, nec.	1.3 million	1.0%	\$91,000	1%
Industrial Gases	1.1 million	21.7%	\$116,000	13%
Plastics Materials and Resins	1.5 million	1.5%	\$121,000	1%
Cement, Hydraulic	2.2 million	9.6%	\$219,000	4%
Pulp Mills	1.7 million	6.7%	\$483,000	5%

Sources: Manufacturers Energy Consumption Survey 1994, Bureau of Economic Analysis 1997, Census of Manufacturers 1993, and *United States Industrial Electric Motor Systems Market Opportunities Assessment*

industries, the annual cost of motor system energy in a typical plant exceeds \$1 million; in steel mills, the energy cost is \$6 million. Potential savings at the typical plant are also very large, ranging from \$90,000 per year in the industrial organic chemicals sector to nearly \$1 million per year in petroleum refineries.

The right-hand column of Table 4 shows potential energy savings as a percentage of operating margin. These figures suggest the potential impact of motor energy savings on the bottom line. The process industries listed in Table 4 operate on very thin margins, that is, the difference between revenues from sales and variable costs, including labor, materials, and selling costs. In 1996, operating margins for the 10 groups listed below ranged from 10% to 24%, and clustered around 16%. Thus, even relatively small increases in operating margin can have a significant impact on profitability.

Summary

A highly efficient motor system is not just one with an energy efficient motor. Rather, overall system efficiency is the key to maximum cost savings. Many motor system users tend to be more concerned with initial costs and obtaining the lowest bids for components than with system efficiency. For optimum motor system economics, motor system users should use a life-cycle cost analysis to select the best equipment and then carefully operate and maintain the equipment for peak performance.

Section 4: Where to Find Help

This portion of the sourcebook lists resources that can help end users increase the cost-effectiveness and performance of their motor and drive systems. These resources are organized in three main subsections: DOE's Industrial Technologies Program (ITP) and Technology Delivery, Directory of Contacts, and Resources and Tools.

- Through its Technology Delivery strategy, ITP is dedicated to improving the efficiency and performance of electric motor and other industrial systems nationwide. Resources include publications, software assessment tools, training sessions, and other resources that help industries improve the performance of industrial energy use.
- The Directory of Contacts section contains a list of associations and other organizations that can provide additional information on improving the performance of motor and drive systems.
- Resources and Tools provides information on books and reports, other publications, government and commercial statistics and market forecasts, software, training courses, and other sources of information

These resources can help motor system users make informed decisions when designing and purchasing motor and drive systems.

ITP and Technology Delivery

U.S. Department of Energy

Industrial Technologies Program (ITP)

Room 5F-065, MS EE-2F

1000 Independence Ave., SW

Washington, DC 20585

Phone: 1-877-EERE-INF (1-877-337-3463)

www.eere.energy.gov/industry

■ Overview

Industrial manufacturing facilities consume 36% of all the energy used in the United States. Therefore, ITP was established to assist industry in achieving significant energy process efficiency improvements. ITP develops and delivers advanced energy efficiency, renewable energy, and pollution prevention technologies and practices for many industrial applications. ITP works with the nation's most energy- and resource-intensive industries to develop a vision of their future and roadmaps on how to achieve these visions over a 20-year timeframe.

This collaborative process aligns industry goals with federal resources to accelerate research and development of advanced technologies identified as priorities by industry. The advancement of energy- and process-efficient technologies is complemented by ITP energy management best practices for immediate savings results. ITP helps industries identify and realize the best energy efficiency and pollution prevention options from a system and life-cycle cost perspective.

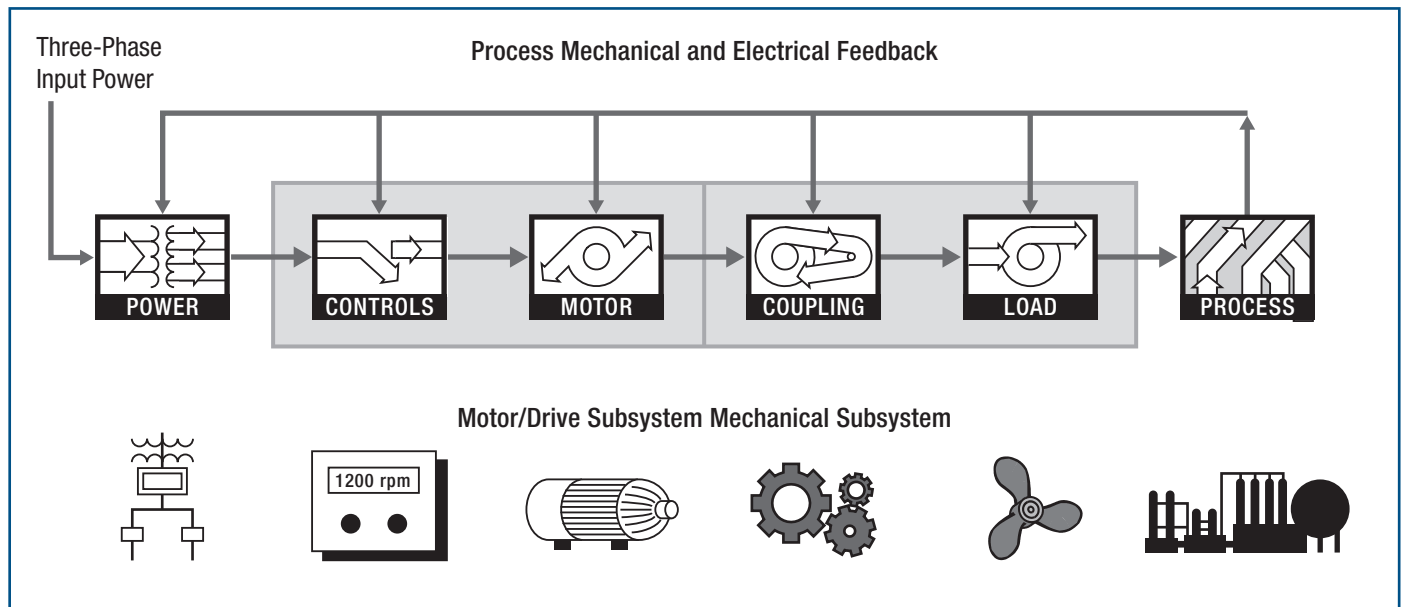

Figure 17. Electric Motor System

Section 4: Where to Find Help

In particular, through its Technology Delivery strategy, ITP offers several resources to assist in motor and drive system energy management. These include software tools, technical resources, and training; energy assessments through ITP's Save Energy Now strategy; and assessments for small- to mid-sized plants through university-based Industrial Assessment Centers (IAC). Collectively, these efforts assist industry in adopting near- and long-term energy-efficient practices and technologies.

Through activities such as energy assessments, implementation of emerging technologies, and technical resources for industrial systems energy management, ITP delivers energy solutions to help industry save energy and costs, reduce waste and pollution, and enhance environmental performance.

ITP encourages the use of a systems approach to motor system design and analysis. This approach seeks to increase the efficiency of electric motor systems by shifting the focus from individual components and functions to total system performance (see Figure 17 on page 45).

In a systems approach, process system design and manufacturing best practices are used to optimize the performance of the entire process system. Then, components and control strategies are selected that best match the new, reduced process load. The steps involved in accomplishing a system optimization involve characterizing the process load requirements; minimizing distribution losses; matching the driven equipment to load requirements; controlling the process load in the most optimal manner; considering all cycles of the process load; and properly matching the motor and drive to each other as well as to the load.

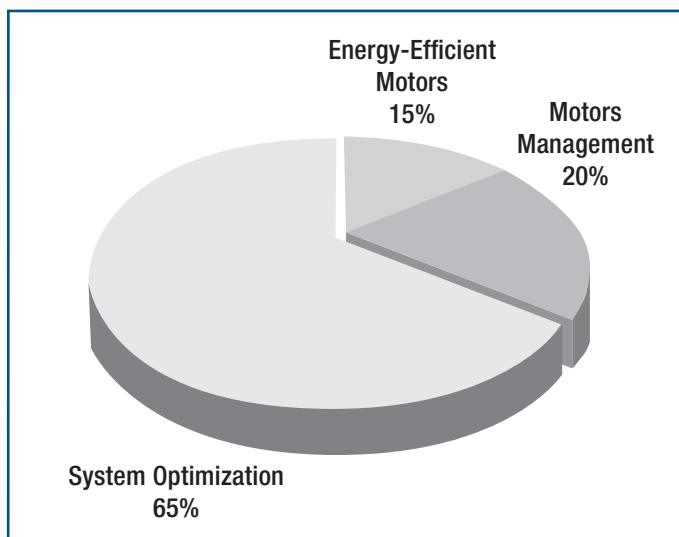

Figure 18. Potential energy savings

Figure 18 shows that two-thirds of the potential savings in manufacturing plants' motor systems are systems-related. This demonstrates that management decisions and technical actions reflecting a systems approach at the corporate and plant level are key to achieving large-scale energy efficiency improvements in industrial motor systems.

■ Energy Assessments

Depending on the industry, energy expenditures can be 10% or more of total operating costs. Save Energy Now energy assessments identify opportunities for implementing new technologies and system improvements to increase efficiency, reduce emissions, and boost productivity. Many of the recommendations made in these assessments have payback periods of less than 18 months and can still yield significant energy savings.

Through its Save Energy Now strategy, ITP offers ongoing, targeted industrial system assessments. ITP encourages the nation's largest energy-consuming plants to apply for energy assessments as an important first step in identifying energy efficiency opportunities. Visit ITP's Save Energy Now Web site at www.eere.energy.gov/industry/saveenergynow for more information.

In addition, small to medium-sized manufacturers can qualify for free assessments from IACs. Teams composed of engineering faculty and students from the centers, located at 26 universities around the country, conduct energy audits or industrial assessments and provide recommendations to manufacturers to help them improve productivity, reduce waste, and save energy. Learn more about IACs at www.eere.energy.gov/industry/bestpractices.

■ Emerging Technologies

Emerging technologies are those that result from R&D and are ready for full-scale demonstration in actual applications. ITP recognizes that companies may be reluctant to invest capital in new technologies even though they can provide significant energy and process improvements. However, through technology implementation solicitations, ITP helps mitigate the risk associated with using new technologies that are supported by industry partnerships. Shared implementation; third-party validation and verification of performance data; and expert assessments of energy, economic, and environmental benefits enable new technologies to be accepted more rapidly.

■ Energy Management

ITP encourages manufacturers to adopt a comprehensive approach to energy use that includes assessing industrial systems and evaluating potential improvement opportunities. Efficiency gains in compressed air, fan, motor, process heating, pumping, and steam systems can be significant, and usually result in immediate energy and cost savings. ITP offers software tools and training in a variety of system areas to help industry become more energy and process efficient, reduce waste, and improve environmental performance.

■ Qualified Specialists

A Qualified Specialist is an individual who has an extensive background in optimizing industrial systems. Individuals become qualified by taking DOE-sponsored training on BestPractices assessment and analysis software tools, and passing a rigorous exam. For more information on how to become a Qualified Specialist, or to locate Qualified Specialists in your area, go to www.eere.energy.gov/industry/bestpractices.

■ Technical Resources

ITP offers a variety of resources to help industry achieve increased energy and process efficiency, improved productivity, and greater competitiveness.

ITP and BestPractices Web Sites. The ITP and BestPractices Web sites offer a large array of information, products, and resources to assist manufacturers who are interested in increasing the efficiency of their industrial operations. You can learn about upcoming events, solicitations, and much more through the ITP site at www.eere.energy.gov/industry.

The BestPractices site offers case studies of companies that have successfully implemented energy-efficient technologies and practices, as well as software tools, tip sheets, training events, and solicitations for plant assessments. You can see these and other resources at www.eere.energy.gov/industry/bestpractices.

■ Software Tools

In addition to MotorMaster+ and MotorMaster+ International, ITP offers other software tools to help plant personnel identify and implement energy efficient practices in their manufacturing facilities.

- AIRMaster+ is a software tool developed by ITP and jointly sponsored by the Compressed Air Challenge™. AIRMaster+ helps end users assess the potential for

efficiency and productivity improvements in compressed air systems. The software features a number of what-if scenarios to determine which energy efficiency measures have the greatest savings potential for their facility.

- The Fan System and Assessment Tool (FSAT) helps determine the efficiency of fan system operations by identifying savings opportunities, rating system efficiency, and calculating energy savings.
- The Process Heating Assessment and Survey Tool (PHAST) provides an introduction to process heating methods and tools to improve thermal efficiency of heating equipment. Use the tool to survey process heating equipment that uses fuel, steam, or electricity, and identify the most energy-intensive equipment. Users can also perform an energy (heat) balance on selected equipment (furnaces) to identify and reduce non-productive energy use. Compare performance of the furnace under various operating conditions and test “what-if” scenarios.
- The Pumping System and Assessment Tool (PSAT) assesses pumping system efficiency by using achievable pump performance data from Hydraulic Institute standards and motor performance data from the MotorMaster+ database to calculate potential energy and associated cost savings.
- The Steam System Tool Suite helps users identify and implement the most effective solutions for a facility’s steam systems. This includes:
 - The Steam System Scoping Tool (SSST) helps steam system energy managers and operations personnel for large industrial plants profile and grade steam system operations and management, and evaluate steam system operations against identified best practices.
 - The Steam System Assessment Tool (SSAT) estimates the impact of key steam system improvements. The tool details the energy, cost, and emission savings of different improvements.
 - 3E-Plus® Insulation Appraisal Software was developed by the North American Insulation Manufacturers Association to increase awareness of the benefits of insulation and to assist plant personnel in assessing insulation opportunities.

■ Training

ITP offers training sessions in industrial systems improvements using DOE software tools, including MotorMaster+. See the discussion on the MotorMaster+ tool in *Efficiency Opportunity No. 2: Establishing a Motor Management Program* in Section 2 of this sourcebook. More information on motor systems training and other training offerings can be found on the BestPractices Web site at www.eere.energy.gov/industry/bestpractices.

■ EERE Information Center

The EERE Information Center fields questions on EERE products and services, including those focused on industrial energy efficiency. They can also answer questions about industrial systems such as compressed air, fans, motors, pumping, process heating, and steam. Contact the EERE Information Center at (877) 337-3463 or www.eere.energy.gov/informationcenter.

■ News

E-Bulletin is a monthly online newsletter that spotlights technologies, significant project developments, and program activities; new ITP and BestPractices products; training and events; Web updates; and solicitations. To subscribe online, go to www.eere.energy.gov/industry/resources/ebulletin.

Energy Matters is ITP's quarterly information source that informs the industrial audience of energy efficiency opportunities, technical issues, new products and services, and events related to motor systems and other industrial systems such as steam, process heating, and compressed air. Subscribe online at www.eere.energy.gov/industry/bestpractices/energymatters.

Educational and informative materials, including additional copies of this sourcebook, and further information on all aspects of the BestPractices Program are available by calling the EERE Information Center at (877) 337-3463. Software, publications, and information on training is also available at the BestPractices Web site at www.eere.energy.gov/industry/bestpractices.

Motor and Drive System Specific Resources

Software: MotorMaster+ and MotorMaster+ International

MotorMaster+ is an energy-efficient motor selection and management software tool, which includes a catalog of more than 20,000 ac motors. The software also features motor inventory management tools, maintenance log tracking, efficiency analysis, savings evaluation, energy accounting, and environmental reporting capabilities.

MotorMaster+ International includes many of the capabilities and features of MotorMaster+; however, users can evaluate repair/replacement options on a broader range of motors, including those tested under the Institute of Electrical and Electronic Engineers (IEEE) standard, and those tested using International Electrical Commission (IEC) methodology. With this tool, users can conduct analyses in different currencies, calculate efficiency benefits for utility rate schedules with demand charges, edit and modify motor rewind efficiency loss defaults, and determine "best available" motors. The tool can be modified to operate in English, Spanish, and French.

Technical Publications

- To increase industry awareness of several fundamental improvement opportunities, ITP has developed several motor tip sheets through its BestPractices program. These tip sheets provide concise descriptions of common improvement opportunities. Since BestPractices continues to develop and identify energy improvement programs, additional tip sheets are expected. Tip sheets can be found on the BestPractices Web site at www.eere.energy.gov/industry/bestpractices, and in Appendix B of this sourcebook.
- ITP has also developed technical publications that provide an increased level of detail and guidance in identifying and implementing performance improvement opportunities. These fact sheets, market assessments, and repair documents can be found on the BestPractices Web site at www.eere.energy.gov/industry/bestpractices/techpubs_motors.html.

Case Studies and Performance Spotlights

Motor system case studies and performance spotlights describe successful energy and process improvement projects that are boosting productivity and saving energy at U.S. industrial plants. Many case studies examine the bottom-line benefits that successful applications of energy-efficient practices and technologies can yield. These projects and the accompanying savings can be replicated at similar plants owned by the same company and by other industrial plants. See motor system-specific case studies and performance spotlights on the BestPractices Web site at www.eere.energy.gov/industry/bestpractices/case_studies.html.

Directory of Contacts

The following organizations can provide more information on improving the performance of motor and drive systems.

American National Standards Institute (ANSI)

25 West 43rd Street, 4th Floor
New York, New York 10036
(212) 642-4900; Fax: (212) 398-0023
www.ansi.org

To download standards: www.webstore.ansi.org

ANSI is a private, non-profit organization that administers and coordinates the U.S. voluntary standardization and conformity assessment system. The Institute's mission is to enhance both the global competitiveness of U.S. business and the U.S. quality of life by promoting and facilitating voluntary consensus standards and conformity assessment systems, and safeguarding their integrity.

The Consortium for Energy Efficiency, Inc. (CEE)

98 North Washington Street, Suite 101
Boston, MA 02114
(617) 589-3949; Fax: (617) 589-3948
www.cee1.org

CEE, a nonprofit public benefits corporation, develops national initiatives to promote the manufacturing and purchase of energy-efficient products and services. Efficiency programs across the U.S. and Canada use CEE national initiatives to increase the effectiveness of their local efforts. Founded in 1992, CEE is the only national organization for all ratepayer-funded efficiency program administrators.

CEE members include administrators of energy-efficiency programs and their key public stakeholders. This includes utilities, statewide and regional energy-efficiency administrators, environmental groups, research organizations and state energy offices.

Electric Power Research Institute (EPRI)

3420 Hillview Avenue
Palo Alto, CA 94304
(800) 313-3774
www.epri.com

EPRI is composed mainly of electric utility companies. EPRI's charter is to discover, develop, and deliver high value technological advances through networking and partnership with the electricity industry.

Electrical Apparatus Service Association, Inc. (EASA)

1331 Baur Boulevard
St. Louis, Missouri 63132
(314) 993-2220; Fax: (314) 993-1269
www.easa.com

EASA is an international trade organization of more than 2,100 electromechanical sales and service firms in 50 countries. Through its engineering and educational programs, EASA provides members with a means of keeping up-to-date on materials, equipment, and state-of-the-art technology. EASA publishes a software product, Motor Rewind Data, that contains specifications for rewinding electric motors from numerous manufacturers.

Institute of Electrical and Electronics Engineers (IEEE)

3 Park Avenue, 17th Floor
New York, New York 10016
(212) 419-7900; Fax: (212) 752-4929
www.ieee.org

The IEEE is a not-for-profit association and has more than 375,000 individual members in 160 countries. Through its technical publishing, conferences, and consensus-based standards activities, the IEEE produces 30% of the world's published literature in electrical engineering and computers, and control technology, and has more than 800 active standards, with 700 under development.

Motor Decisions MatterSM Campaign The Consortium for Energy Efficiency, Inc. (CEE)

98 North Washington Street, Suite 101
Boston, MA 02114
(617) 589-3949; Fax: (617) 589-3948
www.motorsmatter.org

Motor Decisions Matter is a national public awareness campaign that strives to educate corporate and plant decision-makers about the financial and productivity benefits of sound motor management policies. Managed as a special project by CEE, public and private sector sponsors include motor manufacturers, utility and state efficiency program administrators, regional efficiency organizations, and trade associations (including NEMA and EASA).

National Electrical Manufacturers Association (NEMA)

1300 North 17th Street, Suite 1752
Roslyn, VA 22209
(703) 841-3200; Fax: (703) 841-5900
www.nema.org

NEMA is the largest trade association for manufacturers of products used in the generation, transmission, distribution, and end-use of electricity. NEMA is a leading developer of voluntary standards for the electric component industry.

U.S. Department of Energy Office of Energy Efficiency and Renewable Energy EERE Information Center

(877) 337-3463.
www.eere.energy.gov/informationcenter

The Information Center is a one-stop-shop for resources and information on improving electric motor systems.

Resources and Tools

A wide range of information is available on the application and use of drives and motors. This section focuses on the following resources and tools:

- Books
- Other Publications (reports, guides, manuals, standards)
- Software
- Periodicals
- Training Courses
- Materials available from the EERE Information Center.

Note that the descriptions of these resources were taken from material developed by the publisher, software designer, or author. Inclusion here does not constitute a recommendation or endorsement by the U.S. Department of Energy.

Books

American Council for an Energy Efficient Economy

1001 Connecticut Avenue NW, Suite 801
Washington, DC 20036
(202) 429-0063
www.aceee.org

Energy Efficient Motor Systems: A Handbook on Technology, Program, and Policy Opportunities, 2nd Edition

Authors: Steven Nadel, R. Neal Elliott, Michael Shepard, Steve Greenberg, Gail Katz, and Anibal T. de Almeida
Description: Updates and revises the best-selling first edition; addresses how motors and motor systems can achieve greater efficiency through motor management, optimized controls, improved component sizing and repair, better transmission hardware, and comprehensive monitoring and maintenance. In understandable language to nonengineers, provides an overview of existing motor stock, chronicles experience with drivepower programs and policies, and offers recommendations for future efforts to increase motor system efficiency.

Barks Publications, Inc.

400 N. Michigan Avenue, Suite 900
Chicago, IL 60611-4104
(312) 321-9440
www.barks.com

Managing Motors

Author: Richard L. Nailen

Description: Covers standards and specifications, efficiency, power factor, and starting conditions. The middle portion considers motor application, explaining how motors are best matched to their power systems and operating environments. Also looks at components, such as insulation, windings, and bearings, and describes optional accessories and proper installation practices. Currently out of print; availability may be limited.

Bonneville Power Administration

Public Information Office
P.O. Box 3621
Portland, OR 97208
(503) 230-7334
www.bpa.gov/corporate/contact/publicinfo.cfm

Energy Efficient Electric Motor Selection Handbook, Rev. 4

Author: Washington State Energy Office

Description: Compiled to help industry identify opportunities for cost-effective application of energy efficient motors. It covers the economic and operational factors to be considered when motor purchase decisions are being made. Its audience includes plant managers, plant engineers, and others interested in energy management or preventive maintenance programs. Contains a discussion on the characteristics, economics, and benefits of standard versus high-efficiency motors in the 1 to 500 hp range. Includes descriptions of how operating factors such as speed and design voltage effect performance.

Cambridge University Press

100 Brook Hill Drive
West Nyack, NY 10994
(845) 353-7500
www.cambridge.org

Power Electronics and Motor Control, 2nd Edition

Authors: W. Shepherd, L. N. Hulley, and D. T. W. Liang
Description: Includes a new chapter on the application of PWM techniques in induction motor speed control in this second edition of a comprehensive introduction to power electronics. Chapters on electronic switching devices and adjustable speed drives are completely rewritten.

CRC Press - USA

6000 Broken Sound Parkway NW, Suite 300
Boca Raton FL 33487
(800) 272-7737
www.crcpress.co.uk

Energy-Efficient Electric Motors, 3rd Edition, Revised and Expanded

Author: Ali Emadi

Description: This detailed reference provides guidelines for the selection and utilization of electric motors for improved reliability, performance, energy efficiency, and life-cycle cost. Completely revised and expanded, the book reflects the recent state of the field, as well as recent developments in control electronics, the economics of energy-efficient motors and systems, and advanced power electronic drivers. It includes five new chapters covering key topics such as the fundamentals of power electronics applicable to electric motor drives, adjustable speed drives and their applications, advanced switched reluctance motor drives, and permanent magnet and brushless DC motor drives.

Permanent Magnet Motor Technology Revised

Authors: Jacek Gieras and Mitchell Wing

Description: Demonstrates the construction of permanent magnet (PM) motor drives and supplies ready-to-implement solutions for common roadblocks. The author presents fundamental equations and calculations to determine and evaluate system performance, efficiency, and reliability; explores modern computer-aided design of PM motors, including the finite element approach; and covers how to select PM motors to meet the specific requirements of electrical drives.

Delmar Cengage Learning

Executive Woods
5 Maxwell Drive
Clifton Park, NY 12065
(800) 648-7450
www.delmarlearning.com

Electric Motor Control, 7th Edition

Authors: Walter N. Alerich and Stephen L. Herman
Description: Provides explanations of motor control circuits, the hardware that makes up these circuits, applications of motor control circuits in industry, and troubleshooting motor controls. It also includes coverage of relay controls.

Electric Motors and Motor Controls

Author: Jeffrey J. Keljik
Description: Provides extensive coverage of electric motors and motor controls, from basic principles of electrical motors and controls to more complex “real-world” applications.

Electrician’s Technical Reference: Variable Frequency Drives

Author: Robert Carrow
Description: Presents practical information on ac variable frequency drives, how they work, how to apply them, and how to troubleshoot them. Both industrial and commercial variable frequency drive applications are addressed, with discussion of installation issues, troubleshooting, metering, sizing and selection, and energy savings with variable frequency drives. Basic theory is explained when necessary.

Electronic Variable Speed Drives, 3rd Edition

Author: Michael Brumbach
Description: Focuses on troubleshooting and maintenance. Different types of drive circuits are explained and practical instruction is emphasized, with little reliance on formulas.

Industrial Motor Control, 4th Edition

Authors: Stephen L. Herman and Walter N. Alerich
Description: Newly revised, provides easy-to-follow instructions and essential information for controlling industrial motors. Covers most commonly used devices in contemporary industrial settings. Many circuits explained with step-by-step sequences that help students learn the concepts and applications of control logic.

Elsevier

30 Corporate Drive, Fourth Floor
Burlington MA 01803
(781) 313-4700
www.elsevier.com

Electric Motors and Drives: Fundamentals, Types and Applications, 2nd Edition

Author: Austin Hughes
Description: For nonspecialist users of electric motors and drives, explaining and comparing most of the types currently in use with many examples and applications.

Power Electronics and Motor Drives: Advances and Trends

Author: Bimal K. Bose
Description: Power electronics is an area of extremely important and rapidly changing technology. Technological advancements in the area contribute to performance improvement and cost reduction, with applications proliferating in industrial, commercial, residential, military and aerospace environments. This book is meant to help engineers operating in all these areas stay up-to-date on the most recent advances in the field, as well as to be a vehicle for clarifying increasingly complex theories and mathematics.

Practical Electric Motor Handbook

Author: Irving Gottlieb
Description: Shows engineers and designers how to incorporate electric motors into their products, taking their expertise into account. The book offers a practical approach with minimum theory, and shows how motors can be utilized in various types of electric circuits and products.

Practical Machinery Management for Process Plants, Volumes 1-4

Authors: H.P. Bloch and F.K. Geitner
Description: A four-volume series of books for machinery management at process plants. Each provides a thorough analysis of its respective title subject with field-proven techniques, graphs, and illustrations. Covers electric motors and drives in each volume.

Volume 1: ***Improving Machinery Reliability*** (3rd Edition); Volume 2: ***Machinery Failure Analysis and Troubleshooting*** (3rd Edition); Volume 3: ***Machinery Component Maintenance and Repair*** (2nd Edition); Volume 4: ***Major Process Equipment Maintenance and Repair*** (2nd Edition)

Practical Variable Speed Drives and Power Electronics

Author: Malcom Barnes

Description: Provides a fundamental understanding of the installation, operation, and troubleshooting of variable speed drives, including coverage of control wiring, operating modes, braking types, automatic restart, harmonics, electrostatic discharge, and EMC/EMI issues.

The Fairmont Press, Inc.

700 Indian Trail
Lilburn, GA 30047
(770) 925-9388

www.fairmontpress.com

Efficient Electric Motor Systems Handbook

Author: Todd Litman

Description: For engineers, designers, equipment specifiers, and equipment operators who want to optimize the efficiency and reliability of their electric motor systems. Included is a comprehensive overview of electric motor systems currently available, strategies for avoiding typical problems that cause inefficiency and failure, design considerations, selection criteria, and operation and maintenance factors.

Variable Speed Drive Fundamentals, 3rd Edition

Author: Clarence A. Phipps

Description: Does not go into complex mathematical equations, but establishes basic relationships and rules of thumb helpful in applying relatively simple drive systems. Intended for technicians without a mathematical background.

Institute of Electrical & Electronics Engineers

3 Park Avenue, 17th Floor
New York, NY 10016
(212) 419-7900

www.ieee.org

Variable Frequency AC Motor Drive Systems

Author: David Finney

Description: Covers various types of ac motors, along with their power switching devices, inverters, converters and slip energy recovery systems.

ISA

67 Alexander Drive
Research Triangle Park, NC 27709
(919) 549-8411

www.isa.org

Variable Speed Drives: Principles and Applications for Energy Cost Savings

Author: David W. Spitzer

Description: Many applications of variable speed drive technology fall in the cracks between traditional engineering disciplines. This new edition of a venerable classic incorporates the additional insights of the author over the past decade and helps practicing engineers learn about the technical and economic potential of this technology. It presents the electrical, hydraulic, chemical, and instrumentation information necessary to technically evaluate and economically justify variable speed drive applications.

Jarsco Publishing

18901 State Street
Corona, CA 92881
(909) 735-5239

www.jarscopublishing.com/guide.html

Adjustable Speed Drives Applications Guide, 2nd Edition

Authors: Arthur Wallace, Ralph Ferraro, and John Benz

Description: The primary purpose of the EPRI *ASD Applications Guide* is to provide application and facility engineers with the basic information needed to use ASDs. But, the Guide is useful to anyone on the user side involved in evaluation, selection, specification and purchase of ASDs and motors. On the supplier side, engineers, sales and marketing professionals engaged in ASDs and motors would equally benefit from the publication. This electronic book is available on CD-ROM.

McGraw-Hill

1221 Avenue of the Americas
New York, NY 10020
(212) 904-2000

www.mcgraw-hill.com

Electric Drives: Concepts and Applications

Author: Vedam Subrahmanyam

Description: Comprehensively covers the subject of electric drives and their industrial applications. The characteristics

and dynamics of electric drives are discussed, as well as aspects of control, rating, and heating. Special discussions feature working examples of converters, and microprocessors.

Electric Motor Handbook

Authors: H. Wayne Beaty and James L. Kirtley, Jr.

Description: Provides a full range of information on electric motors used in a variety of consumer, industrial, and commercial applications. It covers data on sizes, shapes, performance, electrical and mechanical parameters, protection, and other factors involved in motor selection and application.

Electric Motor Maintenance and Troubleshooting

Author: Augie Hand

Description: Gives an overview of each motor type's components and operation, supplies troubleshooting procedures, which make concepts crystal-clear, and review questions at the end of each chapter to drive the concepts home. Covers essential safety issues.

Motor Control Electronics Handbook

Author: Richard Valentine

Description: Describes reliable electronic controls for any motor application. This resource assists in the design of motor controls with microcontrollers and IGBT power devices and provides an introduction to digital motor speed controls. It also describes step-by-step practical methods for reducing EMI problems and provides information about control's reliability and insights into motor control diagnostics. Other topics include dc and ac motor control designs; automotive and appliance motor controls; digital controls; power semiconductors; microcontrollers; communication networks; and motor control test procedures.

Oxford University Press

198 Madison Ave
New York, NY 10016
(212) 726-6000
www.oup.com/us/

Electric Motors and Their Controls: An Introduction

Author: Takashi Kenjo

Description: A translation of the Japanese book *ABC of Motors*; describes the principles, construction, and use of different motor types and controllers in simple, nontechnical terms.

Pearson Education POD

One Lake Street
Upper Saddle River, NJ 07458
(201) 236-7000
www.pearsoned.com

Modern Electric/Electronic Motors

Author: Martin Clifford

Description: Describes the history and growth of motors. The opening chapter describes the development of the electric motor and the fundamental principals of magnetism. The second chapter details the physical and electrical characteristics of motors in general. The remaining chapters look at the following technologies in detail: dc motors, ac motors, electronics for motors, brushless dc motors, stepping motors, and mechanical drives. This text is intended for the reader with a technical background who wants an understanding of the way motors work. The book is somewhat geared towards the reader who wishes to become involved in motor repair, as it contains sections on troubleshooting for each motor type. However, it is also a good general reference text on motors, although energy efficiency issues are not emphasized. This book can be purchased as an electronic facsimile at www.amazon.com.

Modern Industrial Electrical Motor Controls: Operation, Installation, and Troubleshooting

Authors: Thomas E. Kissell and Chris Hicks

Description: Covers the theory of operation, installation, and troubleshooting of motor controls and motors. Includes hundreds of pictures and diagrams pertaining to the operation and interfacing of motor controls. This book can be purchased as an electronic facsimile at www.amazon.com.

Prentice-Hall

One Lake Street
Upper Saddle River, NJ 07458
(201) 236-7000
www.prenticehall.com

Complete Handbook of Electric Motor Controls

Author: John E. Traister

Description: Provides information on theory, design, and practical applications to help all concerned with electric and electronic motor controls. The complete spectrum of motor control applications is examined.

Electric Motor Drives: Modeling, Analysis, and Control

Author: R. Krishnan

Description: Emphasizes a systematic approach to motor drives based on physical insight and practical implementation aspects. System equations are derived and each of the motor drives is illustrated with an industrial application in detail at the end of chapters so readers can relate theory to practice.

Springer

233 Spring Street
New York, NY 10013
(212) 460-1500
www.springer.com

Energy Efficiency Improvements in Electric Motors and Drives

Authors: Anibal de Almeida, Paolo Bertoldi, and Werner Leonhard

Description: This book covers the basics and the state of the art of energy-efficient motor technologies, which can be used now and in the near future to achieve significant and cost-effective energy savings. It describes recent developments in advanced motor technologies such as permanent magnet and reluctance motors. Energy-efficient motor technologies, though enabling a huge amount of electricity to be saved, still have not been widely adopted. The book presents barriers to the adoption of those technologies and features policies to promote the large scale penetration of energy-efficient technologies, describing the experiences carried out so far in different parts of the world.

Energy Efficiency in Motor Driven Systems

Authors: Francesco Parasiliti and Paolo Bertoldi

Description: This book reports the state of the art of energy-efficient electrical motor driven system technologies, which can be used now and in the near future to achieve significant and cost-effective energy savings. It includes the recent developments in advanced electrical motor end-use devices (pumps, fans and compressors) by some of the largest manufacturers. Policies and programs to promote the large scale penetration of energy-efficient technologies and the market transformation are featured in the book, describing the experiences carried out in different parts of the world.

Energy Efficient Electric Motors and Their Applications, 2nd Edition

Author: Howard E. Jordan

Description: Evaluates the energy savings potential of different energy efficient motors. It examines all aspects of motor and ASD technology and provides a step-by-step description of the process of selecting and applying motors. Also included are chapters on efficiency verification, power factor, and ac motor control.

TAB Books, a Division of McGraw-Hill, Inc.

1221 Avenue of the Americas
New York, NY 10020
(212) 904-2000
www.mcgraw-hill.com

Electric Motors and Control Techniques, 2nd Edition

Author: Irving M. Gottlieb

Description: Examines present and theoretical interfaces between motors and their control systems. The book's primary focus is on maximizing the efficiency of motors by carefully matching them with well-designed, state-of-the-art controls. Problems with electric vehicles are also discussed.

Wiley-IEEE Press

10475 Crosspoint Boulevard
Indianapolis, IN 46256
(317) 572-3000
www.wiley.com

Power Electronics and Variable Frequency Drives: Technology and Applications

Editor: Bimal K. Bose

Description: A compendium of papers from eleven well-known professionals to provide comprehensive coverage of power electronics and ac drive technology. Topics covered include power semiconductor devices, electrical machines, converter circuits, pulse-width modification techniques, ac machine drives, simulation techniques, estimation and identification, microprocessors, and artificial intelligence techniques.

Other Publications

(Reports, Guides, Manuals, and Standards)

Advanced Energy

909 Capability Drive, Suite 2100
Raleigh, NC 27606
(919) 857-9000
www.advancedenergy.org

HorsePower Bulletin

Author: Advanced Energy
Description: Outlines a policy for cost-effective management of motor purchase and repair and is based on comments from industrial customers, electric utilities, motor suppliers and repair shops.

American Public Power Association

1875 Connecticut Avenue NW, Suite 1200
Washington, DC 20009
(202) 467-2900
www.appanet.org

Adjustable Speed Drive Reference Guide, U.S. Edition

Authors: Maura C. Ryan and Richard Okrasa
Description: One of a series of product knowledge reference guides originally published by Ontario Hydro. A small format (7" x 5") guide contains chapters on how ASDs are classified, physical appearance, principals of operation, comparisons of ASDs, features of ASDs, economics, and harmonic distortion. Uses nontechnical language and is intended for utility representatives or customers who want a short primer on ASDs.

Motors Reference Guide, U.S. Edition

Author: Ontario Hydro
Description: One of a series of product knowledge reference guides published by Ontario Hydro. The U.S. Edition is available from the American Public Power Association (APPA). Small format (7" x 5") and contains chapters on how motors are classified, principals of operation, selection of motors, motor controls, and maintenance of motors. Uses nontechnical language and is intended for utility representatives or customers who want a short primer on motors.

Bonneville Power Administration

Public Information Office
P.O. Box 3621
Portland, OR 97208
(503) 230-7334 or (800) 622-4520
www.bpa.gov

Industrial Motor Repair in the United States

Authors: V. Schueler, P. Leistner, and J. Douglass
Description: Characterizes the motor repair industry in the United States and summarizes current motor repair and testing practice. It also identifies barriers to energy efficient motor repair practice and recommends strategies for overcoming those barriers.

The Consortium for Energy Efficiency

98 North Washington Street, Suite 101
Boston MA 02114
(617) 589-3949
www.cee1.org

National Summary of Energy-Efficiency Programs for Motors and Drives

Author: Ilene Mason
Description: Provides information about the incentive programs available to commercial and industrial customers for efficiency improvements through the installation of premium-efficiency motors, adjustable speed drives and motor system optimization projects from utilities and other administrators of publicly-funded benefit programs. Programs offer both financial and technical incentives. The summary includes a general description of terms as well as specific details and contact information for many local programs. An interactive map is included to help locate programs throughout the U.S. and Canada.

Electric Power Research Institute

3420 Hillview Avenue
Palo Alto, CA 94304
(800) 313-3774
www.epri.com

Electric Motor Predictive and Preventive Maintenance Guide

Author: J.A. Oliver
Description: A realistic maintenance schedule for the four types of electric motors commonly found in nuclear and fossil-fuel power plants, based on reviews of manufacturer, operator, and repair data. Failures typical in ac squirrel cage

induction motors, ac wound-rotor motors, ac synchronous-type motors, and dc motors are examined and described, as are tests that will reliably predict these failures. The preventive maintenance schedule outlined is less onerous than those prescribed by manufacturers, but, according to the authors, should be sufficient to prevent breakdowns.

Electrical Apparatus Service Association

1331 Baur Boulevard
St. Louis, MO 63132
(314) 993-2220
www.easa.org

EASA-Q: 2000 Quality Manual

Author: Electrical Apparatus Service Association
Description: EASA-Q was created to provide EASA members a practical means of developing a quality management system. Based on the international ISO 9002-1994 quality standard, EASA-Q is designed so that electrical apparatus service organizations can use it with minimal assistance.

The Effect of Repair/Rewinding on Motor Efficiency

Author: Electrical Apparatus Service Association
Description: Based on a joint study by EASA and the Association of Electrical and Mechanical Trades (AEMT) of the United Kingdom, this publication concludes that using best repair/rewind practices maintains motor efficiency. The report provides complete test data, extensive background information about test procedures and methodology, information about best practice repair/rewind procedures, resources for further reading, and an entire chapter on repair/replace considerations.

Guide to AC Motor Repair and Replacement

Author: Electrical Apparatus Service Association
Description: This booklet provides help in making the best decision when deciding whether to repair or replace ac motors, and highlights the importance of having an implementation plan ready before failures occur. Information about how to figure energy costs and why this is important when making repair/replacement decisions is also included.

Guidelines for Maintaining Motor Efficiency during Rebuilding

Author: Electrical Apparatus Service Association
Description: This pamphlet provides recommendations which contain safe values and correct procedures for repairing equipment properly and demonstrating that rewound motors retain their operating efficiency.

Global Engineering Documents

15 Inverness Way East
Englewood, CO 80112
(800) 624-3974, ext. 1950
www.global.ihs.com

NEMA Standard MG 1-2003, Motors and Generators

Description: Provides practical information concerning ratings, construction, testing, performance, and manufacture of ac and dc motors and generators.

NEMA Standard MG 10-1994, Energy Management Guide for Selection and Use of Polyphase Motors

Description: Provides practical information concerning the proper selection and application of polyphase induction and synchronous motors including installation, operation, and maintenance.

IEEE

3 Park Avenue
17th Floor
New York, NY 10016
(212) 419-7900
www.ieee.org

A Comparison of Two Energy Efficient Motors

Author: John D. Kueck et al.
Description: Evaluates considerations that affect the selection of premium and EPAct motors. Available in *IEEE Transactions on Energy Conversion*, Volume 13, No.2, June 1998.

Motor Decisions MatterSM

www.motorsmatter.org

Motor Planning Kit, Version 2.0

Author: Sponsors of Motor Decisions Matter
Description: A resource for those interested in developing a motor management plan, brochure provides step-by-step guidelines, tools and resources for developing and implementing a customized plan that suits individual organizational needs.

Penton Media, Inc., and *Machine Design Magazine*

1300 East 9th Street
Cleveland OH 44114
(216) 931-9458
www.penton.com
www.electricmotors.machinedesign.com

Electric Motors Reference Center

Author: Machine Design Magazine
Description: Online reference center for information on electric motors – includes descriptions of different ac/dc motor types, information on suppliers, and recent articles on electric motors.

Rocky Mountain Institute

2317 Snowmass Creek Road
Snowmass, CO 81654
(970) 927-3851
www.rmi.org/

The State of the Art: Drivpower

Author: Amory B. Lovins et al
Description: Published by Competitek, an information service of the Rocky Mountain Institute. Critically reviews diverse data on drivpower usage, the documented cost and performance of the best equipment available, and practices for providing unchanged or improved motor torque with less input energy. Compares empirical savings for more than 30 energy saving options and explores their numerous interactions.

U.S. Department of Energy

Industrial Technologies Program
www.eere.energy.gov/industry

EERE Information Center

877-337-3463
www.eere.energy.gov/informationcenter

Energy Management for Motor-Driven Systems

Authors: Gilbert McCoy and John Douglass
Description: Provides comprehensive information on electrical motor management, including electrical supply, selection, inventory management, maintenance, and repair. Assists engineers in identifying and evaluating energy conservation opportunities to reduce energy costs, improve the reliability and efficiency of motor-driven systems, and increase productivity.

University of Wyoming

Electrical Engineering Department
1000 East University Avenue, Department 3295
Laramie, WY 82071
(307) 766-6268
www.uwyo.edu

Energy Efficient Drivpower: An Overview

Author: Sadrul Ula et al.
Description: This document was prepared in a three-way cooperative effort between the Bonneville Power Administration, the DOE Denver Support Office, and the Western Area Power Administration. The report examines energy efficiency in systems that are driven by electric motors. It includes sections on motors, controls, electrical tune-ups, mechanical efficiency, maintenance, cooling, cleaning, and management, as well as estimates of the combined effects of using a system approach in improving the efficiency of motor-driven equipment. This report is largely a condensation of a report titled “The State of the Art: Drivpower” which is described elsewhere in this section.

Software

em2solutions

PO Box 190921
Boise, ID 83719-0921
(208) 322-6999
www.em2solutions.com

em2006

Developer: em2solutions with support from the Northwest Energy Efficiency Alliance
Description: An introductory motor system survey and analysis software; includes average efficiency, full load and no load amperage, new and rewind prices for motors 7½ thru 300 hp, 1100 thru 3600 RPM, TEFC and ODP. Features intuitive motor management direction, historical data, picture/data file containers, operation cost analysis and comparison, imbalance calculation, motor systems totals, and service center reporting capabilities.

Motor Decisions MatterSM

www.motorsmatter.org

The 1-2-3 Approach to Motor Management

Developers: Sponsors of Motor Decisions Matter
Description: This Microsoft Excel™ spreadsheet is a quick demonstration tool to showcase the benefits of proactive

motor management. By entering nameplate data from a few representative motors, the *1-2-3 Approach* helps identify motor opportunities within a facility. The 1-2-3 Approach is an introductory tool designed as a gateway to more comprehensive motor management tools and strategies.

U. S. Department of Energy

Industrial Technologies Program
www.eere.energy.gov/industry

MotorMaster+ 4.0

Developer: U.S. Department of Energy Industrial Technologies Program

Description: An energy-efficient motor selection and management software tool which includes a catalog of more than 20,000 ac motors. Features motor inventory management tools, maintenance log tracking, efficiency analysis, savings evaluation, energy accounting, and environmental reporting capabilities.

MotorMaster+ International

Description: Includes many of the capabilities and features of MotorMaster+ 4.0, but allows users to evaluate repair/replacement options on a broader range of motors. The user can conduct analyses in different currencies, calculate efficiency benefits for utility rate schedules with demand charges, edit and modify motor rewind efficiency loss defaults, and determine “best available” motors. The tool can be modified to operate in English, Spanish, and French.

Periodicals

ASHRAE Journal

American Society of Heating, Refrigerating, and Air-Conditioning Engineers
 Atlanta, GA
www.ashrae.org

Consulting-Specifying Engineer

Cahners Publishing Company
 A Division of Reed Elsevier Properties, Inc.
 Des Plaines, IL
www.csomag.com

IEEE Control Systems Magazine

Institute of Electrical and Electronics Engineers
 Control Systems Society (CSS)
 Indianapolis, IN
www.ieee.org

IEEE Industry Applications Magazine

Institute of Electrical and Electronics Engineers
 Industry Applications Society, (IAS)
 Indianapolis, IN
www.ieee.org

IEEE Power Engineering Magazine

Institute of Electrical and Electronics Engineers
 Power Engineering Society (PES)
 Los Angeles, CA
www.ieee.org

Industrial Maintenance & Plant Operation (IMPO)

Cahners Publishing Company
 A Division of Reed Elsevier Properties, Inc.
 Des Plaines, IL
www.impomag.com

Machine Design Magazine

Penton Media Inc.
 Cleveland, Ohio
www.machinedesign.com

Mechanical Engineering

American Society of Mechanical Engineers (ASME)
 New York, NY
www.memagazine.org

Plant Engineering

Cahners Publishing Company
 A Division of Reed Elsevier Properties, Inc.
 Des Plaines, IL
www.plantengineering.com

Training Courses

Association of Energy Engineers

4025 Pleasantdale Road, Suite 420
Atlanta, GA 30340
(770) 447-5083
www.aeecenter.org

Area(s) covered: Seminars offered for various topics of interest, including motor systems, energy management, conservation, and economics.

Electric Power Research Institute

3420 Hillview Avenue
Palo Alto, CA 94304
(800) 313-3774
www.epri.com

Area(s) covered: EPRI conducts hundreds of events throughout the year, including symposiums, workshops, conferences, and training courses.

Electrical Apparatus Service Association, Inc.

1331 Baur Blvd.
St. Louis, MO 63132
(314) 993-2220
www.easa.com

Area(s) covered: EASA offers its members and others with a means of keeping up to date on materials, equipment, and state-of-the-art technology for motors, drives, and other electromechanical equipments and offers courses in topics such as motors, pumps, and industrial maintenance issues.

Institute of Electrical and Electronics Engineering

3 Park Avenue, 17th Floor
New York, NY 10016
(212) 419-7900
www.ieee.org

Area(s) covered: The IEEE provides learning opportunities within the engineering sciences, research and technology.

U.S. Department of Energy

Industrial Technologies Program
www.eere.energy.gov/industry/bestpractices/training

Area(s) covered: DOE offers a one-day workshop covering key elements of motor system management, such as applications, inventory tracking, maintenance, repair, replacement decisions, and the impact and maintenance of power quality. A rigorous overview shows attendees how the MotorMaster+ software can help form the structure of a motor management program, reduce the work involved, and facilitate decision-making.

Appendices

This sourcebook contains the following five appendices:

- **Appendix A: A Glossary of Basic Motor System Terms**

This appendix contains a glossary of the main terms associated with motor and drive systems.

- **Appendix B: Motor Tip Sheets**

This appendix contains a series of tip sheets developed to increase users' awareness of potential performance benefits and energy savings that can be obtained by improving the efficiency of motor and drive systems. These brief tip sheets are less detailed than the efficiency opportunities in Section 2 of the sourcebook.

- **Appendix C: EPart Efficiency Levels and Premium Efficiency Levels**

This appendix provides EPart efficiency ratings and NEMA premium efficiency motor ratings for a range of motor sizes and types.

- **Appendix D: Motor Repair Service Center Checklist**

This contains a checklist for motor repair facilities.

- **Appendix E: Guidelines for Comments**

This appendix provides a place for readers to suggest changes and improvements to this sourcebook.

Appendix A: Glossary of Basic Motor System Terms

Here are some of the principal terms associated with motor and drive systems. For more, please see the IEEE Standard Dictionary of Electrical and Electronics Terms, The Institute of Electrical and Electronics Engineers, Inc., New York, 1984.

adjustable speed drive (ASD) – An electric drive designed to provide easily operable means for speed adjustment of the motor, within a specified speed range.

air gap – A separating space between two parts of magnetic material, the combination serving as a path for magnetic flux. Note: This space is normally filled with air or hydrogen and represents clearance between rotor and stator of an electric machine.

alternating current – A periodic current the average value of which over a period is zero. (Unless distinctly specified otherwise, the term refers to a current which reverses at regular recurring intervals of time and which has alternately positive and negative values.)

ambient – Immediate surroundings or vicinity.

amps – A unit of electric current flow equivalent to the motion of 1 coulomb of charge or 6.24×10^{18} electrons past any cross section in 1 second.

ANSI – American National Standards Institute.

armature – The member of an electric machine in which an alternating voltage is generated by virtue of relative motion with respect to a magnetic flux field. In direct-current universal, alternating current series, and repulsion-type machines, the term is commonly applied to the entire rotor.

ASHRAE – American Society of Heating, Refrigerating, and Air-Conditioning Engineers

ASME – American Society of Mechanical Engineers

ASTM – American Society for Testing and Materials

balancing – The process of adding (or removing) weight on a rotating part in order to move the center of gravity toward the axis of rotation.

bars – Axial conductors in a rotor cage.

bearing losses – The power losses resulting from friction in the bearings.

best efficiency point (BEP) – The operating condition at which a device operates most efficiently.

brake horsepower (BHP) – Mechanical energy consumed at a rate of 33,000-ft. lbs. per minute; a consumption rating.

breakaway torque – The torque that a motor is required to develop to break away its load from rest to rotation.

breakdown torque – The maximum shaft-output torque that an induction motor (or a synchronous motor operating as an induction motor) develops when the primary winding is connected for running operation, at normal operating temperature, with rated voltage applied at rated frequency. Note: A motor with a continually increasing torque as the speed decreases to standstill, is not considered to have a breakdown torque.

brushes – A conductor, usually composed in part of some form of the element carbon, serving to maintain an electric connection between stationary and moving parts of a machine or apparatus. Note: Brushes are classified according to the types of material used, as follows: carbon, carbon-graphite, electrographite, graphite, and metal-graphite.

Btu – British Thermal Unit; heat required to raise the temperature of 1 pound of water by 1°F. The Btu/hr. required to raise the temperature of a volume of standard air a specific number of degrees is calculated by the formula: $\text{Btu/hr} = (\text{Temperature Rise}) \times (\text{CFM}) \times 1.085$.

burnout oven – Heat cleaning oven used for stripping windings from a core. These are sometimes called roasting ovens. They operate at temperatures up to 750°F and may have water spray systems to control temperature transients and secondary combustion to control emissions. They are distinguished from lower temperature baking ovens, which are used to cure varnish.

cage – See “squirrel cage”.

capacitor – A device, the primary purpose of which is to introduce capacitance into an electric circuit. Capacitors are usually classified, according to their dielectrics, as air capacitors, mica capacitors, paper capacitors, etc.

coil – One or more turns of wire that insert into a single pair of core slots.

coil supports – Ring-like structures or individual blocking between coils to which a motor's end turns are tied to add rigidity. Sometimes called "surge rings".

commutator – An assembly of conducting members insulated from one another, in the radial-axial plane, against which brushes bear, used to enable current to flow from one part of the circuit to another by sliding contact.

compressor – A device that increases the pressure of a gas through mechanical action. Compressors are used to provide compressed air system to facilities and in mechanical vapor compression systems to provide cooling and refrigeration.

consumption – The amount of energy used by a motor system, measured in kilowatt-hours (kWh)

core – The magnetic iron structure of a motor's rotor or stator. It is comprised of stacked sheet iron.

core losses – The power dissipated in a magnetic core subjected to a time-varying magnetizing force. Note: Core loss includes hysteresis and eddy-current losses of the core.

corrosion – The deterioration of a substance (usually a metal) because of a reaction with its environment.

curve, performance – A graphic representation of pressure and flow for a pump or a fan.

curve, system – A graphic representation of the pressure versus flow characteristics of a given system.

demand – The load integrated over a specific interval of time.

demand charge – That portion of the charge for electric service based upon a customer's demand.

direct current – A unidirectional current in which the changes in value are either zero or so small that they may be neglected. (As ordinarily used, the term designates a practically non-pulsing current)

EASA – Electrical Apparatus Service Association, a trade association that serves many areas of the electrical repair market, including motor rewind facilities.

eddy current coupling – A type of adjustable speed drive that changes the strength of a magnetic field in a coupling to determine the amount of slip between the motor and the driven equipment.

efficiency – The ratio of the useful output to the input (energy, power, quantity of electricity, etc.). Note: Unless specifically stated otherwise, the term efficiency means efficiency with respect to power.

exciting current – Component of electric current used to induce a magnetic field.

fan – The part that provides an air stream for ventilating the machine.

frame size – A set of physical dimensions of motors as established by National Electrical Manufacturers Association (NEMA) for interchangeability between manufacturers. Dimensions include; shaft diameter, shaft height, and motor mounting footprint.

frequency – The number of periods per unit time.

friction/windage losses – The power required to drive the unexcited machine at rated speed with the brushes in contact, deducting that portion of the loss that results from:
(1) Forcing the gas through any part of the ventilating system that is external to the machine and cooler (if used).
(2) The driving of direct-connected flywheels or other direct-connected apparatus.

full load speed – The speed that the output shaft of the drive attains with rated load connected and with the drive adjusted to deliver rated output at rated speed. Note: In referring to the speed with full load connected and with the drive adjusted for a specified condition other than for rated output at rated speed, it is customary to speak of the full-load speed under the (stated) conditions.

full load torque – The torque required to produce the rated horsepower at full load speed.

harmonics – A sinusoidal component of a periodic wave or quantity having a frequency that is an integral multiple of the fundamental frequency. Note: For example, a component the frequency of which is twice the fundamental frequency is called the second harmonic.

hertz (Hz) – Unit of frequency, one cycle per second.

high potential test – Test of insulation integrity by application of a higher than nameplate rated ac or dc voltage between electrical winding or circuit elements and ground. Also called “hi pot test”

horsepower (hp) – A measure of the amount of the work a motor can perform in a period of time, 33,000 foot-lbs. per minute or 0.746 kW.

induction motor – The simplest and, by far, most commonplace ac motor design. The induction motor rotor is simple, having neither permanent magnets, externally excited electro-magnets, nor salient (projecting) poles. The rotor contains a conducting structure, which is excited by magnetic induction from the stator without necessity of brushes or other direct contact.

inertia – Tendency of an object to remain in the state it is in. For motors, inertia generally refers to the resistance of the rotor, coupling and load to acceleration.

insulation – Material or a combination of suitable non-conducting materials that provide isolation of two parts at different voltages.

inverter duty – Intended for being powered by a dc to ac inverter. An inverter comprises the output stage of all electronic adjustable speed drives, which are also known as variable speed drives or variable frequency drives. Part 31 of NEMA MG-1 provides recommended standards for Inverter Duty motors.

inverter – A machine, device, or system that changes direct-current power to alternating current power.

journal – Region on a shaft where a bearing is located. The journal must be precisely machined for a correct fit to the bearing bore. With sleeve bearings, the journal is the actual bearing surface on the shaft.

kilowatt – A measure of power equal to 1.34 hp; 1,000 watts.

load factor – The ratio of the average load over a designated period of time to the peak load occurring in that period.

locked rotor torque – The minimum torque of a motor which it will develop at rest for all angular positions of the rotor, with rated voltage applied at rated frequency.

losses – Motor input power that is lost rather than being converted to shaft power. The lost power manifests as heat in various parts of the motor structure.

low voltage – Voltage ratings not exceeding 600 VAC.

NEC – National Electrical Code.

NEMA – The National Electrical Manufacturers Association; the trade association establishing standards of dimensions, ratings, enclosures, insulation, and other design criteria for electric equipment.

poles – Poles are the total number of magnetic north/south poles produced in the rotating magnetic field of a motor. The number of poles is determined by the winding design and the motor speed is inversely related to the number of poles.

pound-foot (lb ft) – Torque rating or requirement; equivalent to the force required to move a one pound weight one foot in distance, equal to 12 lb in.

resistance, insulation – Resistance between points that are supposed to be electrically isolated.

resistance, winding – Resistance of the winding measured between each pair of line connections. Rewinding should replicate original resistance. Changed resistance after rewinding may indicate altered winding pattern, incorrect wire gauge, or a turn miscount.

rotor – The rotating part of an ac induction motor that includes the shaft, the laminated iron, and the squirrel cage.

rotor losses – The losses due to current flow in the rotor circuit (equal to I^2R where I is the current in the rotor and R is the resistance of the rotor circuit).

rpm – Revolutions per minute.

service factor – A multiplier that, when applied to the rated power, indicates a permissible power loading that may be carried under the conditions specified for the service multiplier.

slip – The quotient of (A) the difference between the synchronous speed and the actual speed of a rotor, to (B) the synchronous speed, expressed as a ratio, or as a percentage.

squirrel cage – This is the current conducting assembly used in most induction motor rotors. Sometimes called a rotor cage. It is typically cast aluminum in smaller motors and fabricated of copper alloy in larger motors.

separators – Insulating spacers used to separate coils of separate phases within a slot. Also called “slot sticks”.

stator – The stationary part of a motor’s magnetic circuit. In induction motors it is the outer annular iron structure containing the power windings.

stator losses – Losses due to the flow of current through the stator windings, (equal to I^2R , where I is the stator current and R is the resistance of the stator circuit).

stray load losses – The losses due to eddy currents in copper and additional core losses in the iron, produced by distortion of the magnetic flux by the load current, not including that portion of the core loss associated with the resistance drop.

surge – A transient wave of current, potential, or power in an electrical circuit.

synchronous speed – The speed of the rotation of the magnetic flux, produced by or linking the primary winding.

temperature rise – Temperature increase above ambient. National Electrical Manufacturers Association provides standards for temperature rise of fully loaded motors based upon insulation class and other motor parameters. Ensuring that temperature rise remains within these limits during no-load running is a worthwhile safeguard though it does not prove that temperature rise will remain within limits at rated load.

three-phase – Commonplace ac electrical service involving three conductors offset in phase from each other. The concept eliminates torque pulsation and accommodates creation of rotating magnetic fields within motors to facilitate starting and running torque.

torque – A force that produces rotation, commonly measured in lb.-ft. or lb.-in.

transients – A change in the steady-state condition of voltage or current, or both. As used in this guide, transients occurring in control circuits are a result of rapid changes in the power circuits to which they are coupled. The frequency, damping factor, and magnitude of the transients are determined by resistance, inductance, and capacitance of the power and control circuits and the degree of coupling. Voltages as high as 10 kV in the frequency range of 0.3 to 3.0 MHz have been observed where little or no protection was provided. Transients may be caused by lightning stroke, a fault, or by switching operation, such as the opening of a disconnect, and may readily be transferred from one conductor to another by means of electrostatic or electromagnetic coupling.

variable frequency drive – A type of adjustable speed drive that changes the frequency of the electric power supplied to a motor. Since motor speed is linearly related to electrical frequency, these devices directly control motor rotation, avoiding the need for an intermediate coupling between the motor and the driven equipment.

watt – The unit of power in the International System of Units (SI). The watt is the power required to do work at the rate of 1 joule per second.

windings – An assembly of coils designed to act in consort to produce a magnetic flux field or to link a flux field.

Appendix B: Motor Tip Sheets

The Industrial Technologies Program has developed the following tip sheets through its BestPractices activities.

Currently Available:

1. When to Purchase NEMA Premium Efficiency Motors
2. Estimating Motor Efficiency in the Field
3. Extend the Operating Life of Your Motor
4. The Importance of Motor Shaft Alignment
5. Replace V-Belts with Cogged or Synchronous Belts
6. Avoid Nuisance Tripping with Premium Efficiency Motors
7. Eliminate Voltage Unbalance
8. Eliminate Excessive In-plant Distribution System Voltage Drops
9. Improve Motor Operation at Off-design Voltages
10. Turn Motors Off When Not in Use
11. Adjustable Speed Drive Part-Load Efficiency
12. Is it Cost-Effective to Replace Old Eddy-Current Drives?
13. Magnetically Coupled Adjustable Speed Motor Drives
14. When Should Inverter-Duty Motors be Specified?
15. Minimize Adverse Motor and Adjustable Speed Drive Interactions

These tip sheets discuss opportunities for improving the efficiency and performance of motor systems and can be downloaded from the ITP Web site at www.eere.energy.gov/industry/bestpractices.

When to Purchase NEMA Premium™ Efficiency Motors

NEMA Premium™ efficiency motors should be considered for new motor procurements and when specifying motor-driven equipment. NEMA Premium motors should also be considered when repairing or rewinding failed standard-efficiency motors or as replacements for older, operable lower-efficiency motors—particularly when the existing motor has been rewound or is oversized and underloaded.

In August of 2001, the National Electrical Manufacturers Association (NEMA) implemented a new NEMA Premium Energy Efficiency Motor Standard. Under this voluntary program, a motor may be marketed as a NEMA Premium motor if it meets or exceeds a set of NEMA minimum full-load efficiency levels. These levels are higher than the minimum full-load efficiency standards for energy-efficient motors under the Energy Policy Act of 1992 (EPAAct).

NEMA Premium motor standards apply to NEMA Design A and B, three-phase low- and medium-voltage induction motors rated from 1-500 horsepower (hp) and designed for service at 5,000 volts or less. Motors with speeds of 1200, 1800, and 3600 revolutions per minute (rpm) with open drip-proof (ODP), explosion-proof, and totally enclosed fan-cooled (TEFC) enclosures are included.

NEMA Premium motors are particularly cost-effective when annual operation exceeds 2,000 hours, where utility rates are high, when motor repair costs are a significant fraction of the price of a replacement motor, or where electric utility motor rebates or other conservation incentives are available.

NEMA Premium motors typically cost 10% to 15% more than their energy-efficient counterparts. Annual energy savings are dependent upon operating profile, duty cycle, and efficiency gain. Examples of annual savings due to using NEMA Premium motors instead of motors that just meet the EPAAct energy-efficient motor standard are given in Table 1.

Horsepower	Full-load Motor Efficiency (%)		Annual Savings from Use of a NEMA Premium Motor	
	Energy Efficient Motor	NEMA Premium Efficiency Motor	Annual Energy Savings, kWh	Dollar Savings \$/year
10	89.5	91.7	1,200	\$60
25	92.4	93.6	1,553	78
50	93.0	94.5	3,820	191
100	94.5	95.4	4,470	223
200	95.0	96.2	11,755	588

Note: Based on purchase of a 1,800 rpm totally enclosed fan-cooled motor with 8,000 hours per year of operation, 75% load, and an electrical rate of \$0.05/kWh.

Suggested Actions

- Survey all critical motors in your plant. Focus on general purpose, 25 to 500 hp standard efficiency motors used more than 2,000 hours per year. Collect nameplate and application data and then measure the supply voltage and amperage for these in-service motors.
- Establish a motor repair/replace policy to achieve cost-effective and energy efficiency results, and tag motors for appropriate action. For example, replace immediately or upon failure with a NEMA Premium or Energy Efficient motor; rewind at failure with repair specifications and recommended guidelines.
- Adopt model motor repair specifications for low-voltage motors.

Resources

U.S. Department of Energy—Contact the EERE Information Center at 877-337-3463 to obtain cited publications or to request additional information on motor and driven-equipment energy efficiency opportunities. Additional resources and information on training is also available at the BestPractices Web site at www.eere.energy.gov/industry/bestpractices.

Example

An old, 75-hp standard efficiency boiler forced-draft fan motor is to be replaced with a NEMA Premium efficiency motor. The existing motor operates at a 75% load for 8,000 hours per year with an efficiency (η_{std}) of 91.0%. Determine the annual energy savings if the replacement motor has an efficiency (η_{PE}) of 95.4% and electricity is priced at \$0.05/kWh.

$$\begin{aligned} \text{Energy Savings} &= \text{hp} \times \text{load} \times 0.746 \times \text{hours} \times (100/\eta_{std} - 100/\eta_{PE}) \\ &= 75 \times 0.75 \times 0.746 \times 8,000 \times (100/91 - 100/95.4) = \mathbf{17,014 \text{ kWh/year}} \end{aligned}$$

$$\text{Energy Cost Savings} = 17,014 \times \$0.05 = \mathbf{\$851/\text{year}}$$

Over a 10-year operating period for a 75-hp motor, the purchase price might represent just 2% of the total motor installation and operating costs. Energy and maintenance costs account for the remaining 98%. Even a small improvement in motor operating efficiency can produce significant energy and dollar savings and provide a rapid return on investment.

Estimating Motor Efficiency in the Field

Some utility companies and public agencies have rebate programs in place to encourage customers to upgrade their existing standard-efficiency motors to NEMA Premium™ efficiency motors. Yet, to accurately estimate energy savings and determine annual dollar savings requires knowing the efficiency of the existing motor.

Efficiency is output power divided by input power, yet most of the methods and devices attempt to assess losses to circumvent the difficult task of measuring shaft output power. Efficiency needs to be measured accurately because, as shown in Table 1, a single percentage point of improved efficiency is worth significant dollar savings—even for motors as small as 25 horsepower (hp). A good electric power meter can provide an accuracy of 1%, but an inexpensive, portable way to measure shaft output power of a coupled motor does not exist. A further complication is that motor efficiency is dependent upon loading, power quality, and ambient temperature.

Horsepower	Full-load Motor Efficiency (%)		Annual Savings	
	Original Efficiency	Final Efficiency	Annual Energy Savings, kWh	Dollar Savings \$/year
10	89.5	90.5	605	30
25	92.4	93.4	1,420	71
50	93.0	94.0	2,803	140
100	94.5	95.5	5,431	272
200	95.0	96.0	10,748	537

Note: Based on purchase of a 1,800 rpm totally enclosed fan-cooled motor with 8,760 hours per year of operation, 75% load, and an electrical rate of \$0.05/kWh.

Credible efficiency ratings are normally obtained in a laboratory, following carefully controlled dynamometer testing procedures as described in IEEE Standard 112(b). Field measurements for determining motor efficiency pose challenges that require developing various methods and devices.

Motor losses fall into several categories that can be measured in various ways.

- Stator electric power (I^2R) losses
- Rotor electric power (I^2R) losses
- Friction and windage losses (including bearing losses, wind resistance, and cooling fan load)
- Stator and rotor core losses
- Stray load losses (miscellaneous other losses).

The most direct and credible methods of measuring these losses involve considerable labor, equipment, and the availability of electrical power. Power readings must be taken with the motor running under load, then uncoupled and running unloaded. Winding resistance must be measured. Temperature corrections must be performed.

Suggested Actions

- Conduct predictive maintenance tests to reveal whether efficiency is below the original or nameplate level. Decreased efficiency may be due to:
 - Higher winding resistance compared to manufacturer specifications or an earlier measurement. This may be caused by winding being at a higher temperature than that of the manufacturer's resistance specifications or by rewinding with smaller diameter wire. A low resistance ohmmeter is often required for winding resistance tests.
- Increase in no-load power or core losses. Core loss testing requires motor disassembly and is performed in a motor service center.
- Significant current unbalance when voltage is balanced.
- Evidence of cage damage.

Resources

U.S. Department of Energy—For additional information on motor and motor-driven system efficiency measures, to obtain the DOE's *MotorMaster+* software, or learn more about training, visit the BestPractices Web site at www.eere.energy.gov/industry/bestpractices.

Some of the available field motor-efficiency estimation methods include:

- **Loss accounting methods.** These measure most of the above losses using either special dedicated “lab-in-a-box” devices or very accurate conventional instruments, for example, power meters, thermometers, and micro-ohmmeters. These methods have the potential of being accurate within 1% to 3% if carefully applied. The necessary instruments are costly and the process is very time and labor consumptive. Power meters must be accurate at very low power factors that occur when motors operate unloaded.
- **Slip method.** The slip method has largely been discredited as a viable technique for estimating motor efficiency. This method computes shaft output power as the rated horsepower multiplied by the ratio of measured slip to the slip implied by the nameplate. Slip is the difference between synchronous and shaft speed.
- **Current signature predictive maintenance devices.** A number of sophisticated devices are marketed for analyzing motor condition, particularly current harmonics, based upon electrical measurements of an operating motor. While the accuracy of these devices has not been verified, the marginal cost and labor of using these devices is small if they are already deployed for predictive maintenance uses.
- **MotorMaster+ 4.0.** The *MotorMaster+ 4.0* software incorporates several methods for determining motor load. These involve the use of motor nameplate data in conjunction with selected combinations of input power, voltage, current, and/or operating speed. With the percent load known, the software determines as-loaded efficiency from default tables based on the motor type, condition, and horsepower. *MotorMaster+* automatically chooses the best available method based upon the data it is given.

Extend the Operating Life of Your Motor

Why do motors fail?

Certain components of motors degrade with time and operating stress. Electrical insulation weakens over time with exposure to voltage unbalance, over and under-voltage, voltage disturbances, and temperature. Contact between moving surfaces causes wear. Wear is affected by dirt, moisture, and corrosive fumes and is greatly accelerated when lubricant is misapplied, becomes overheated or contaminated, or is not replaced at regular intervals. When any components are degraded beyond the point of economical repair, the motor's economic life is ended.

For the smallest and least expensive motors, the motor is put out of service when a component such as a bearing fails. Depending upon type and replacement cost, larger motors—up to 20 or 50 horsepower (hp)—may be refurbished and get new bearings, but are usually scrapped after a winding burnout. Still larger and more expensive motors may be refurbished and rewound to extend life indefinitely. An economic analysis should always be completed prior to a motor's failure to ensure that the appropriate repair/replace decision is made.

How long do motors last?

Answers vary, with some manufacturers stating 30,000 hours, others 40,000 hours, and still others saying "It depends." The *useful* answer is "probably a lot longer with a conscientious motor systems maintenance plan than without one."

Motor life can range from less than two years to several decades under varying circumstances. In the best circumstances, degradation still proceeds, and a failure can occur if it is not detected. Much of this progressive deterioration can be detected by modern predictive maintenance techniques in time for life extending intervention.

Even with excellent selection and care, motors can still suffer short lifetimes in unavoidably severe environments. In some industries motors are exposed to contaminants that are severely corrosive, abrasive, and/or electrically conductive. In such cases, motor life can be extended by purchasing special motors, such as those conforming to the Institute of Electrical and Electronic Engineers (IEEE) 841 specifications, or other severe-duty or corrosion-resistant models.

The operating environment, conditions of use (or misuse), and quality of preventive maintenance determine how quickly motor parts degrade. Higher temperatures shorten motor life. For every 10°C rise in operating temperature, the insulation life is cut in half. This can mislead one to think that purchasing new motors with higher insulation temperature ratings will significantly increase motor life. This is not always true, because new motors designed with higher insulation thermal ratings may actually operate at higher internal temperatures (as permitted by the higher thermal rating). Increasing the thermal rating during rewinding for example, from Class B (130°C) to Class H (180°C), does increase the winding life.

The best safeguard against thermal damage is avoiding conditions that contribute to overheating. These include dirt, under and over-voltage, voltage unbalance, harmonics, high ambient temperature, poor ventilation, and overload operation (even within the service factor).

Suggested Actions

- Evaluate and select a motor repair service center. Refer to the Service Center Evaluation Guide (DOE/GO-10099-937), downloadable from the EERE BestPractices Web site at www.eere.energy.gov/industry/bestpractices. Ask for causes of failure and confirm proper repair. A competent motor service center can often pinpoint failure modes and indicate optional features or rebuild methods to strengthen new and rewound motors against critical stresses.
- Follow motor manufacturers' recommendations and user guides to protect out-of-service motors from humidity, vibration, and corrosion exposure.
- Establish and follow a good predictive and preventive maintenance program.

Resources

National Electrical Manufacturers Association (NEMA)—For information on NEMA Premium standards, visit www.nema.org.

Electrical Apparatus Service Association (EASA)—Provides guidelines on motor repair/rewind practices (www.easa.org).

Motor Decisions Matter—Download a motor management planning kit (www.motorsmatter.org) that contains advice on building your in-plant motor inventory, decision rules, critical planning tips, and motor replacement.

U.S. Department of Energy—Visit the BestPractices Web site at www.eere.energy.gov/industry/bestpractices to access many industrial energy efficiency resources and training.

Bearing failures account for *nearly one-half of all motor failures*. If not detected in time, the failing bearing can cause overheating and damage insulation, or can fail drastically and do irreparable mechanical damage to the motor. Vibration trending is a good way to detect bearing problems in time to intervene.

With bearings often implicated in motor failures, the L10h rating of a bearing may be cause for concern. The L10 rating is the number of shaft revolutions until 10% of a large batch of bearings fails under a very specific test regimen. It does not follow that simply having a large L10 rating will significantly extend motor bearing life. Wrong replacement bearings, incorrect lubricant, excessive lubricant, incorrect lubrication interval, contaminated lubricant, excessive vibration, misaligned couplings, excessive belt tension, and even power quality problems can all destroy a bearing. Always follow the manufacturer's lubrication instructions and intervals.

Make sure motors are not exposed to loading or operating conditions in excess of limitations defined in manufacturer specifications and National Electrical Manufacturers Association (NEMA) standard MG1. This NEMA standard defines limits for ambient temperature, voltage variation, voltage unbalance, and frequency of starts.

The Importance of Motor Shaft Alignment

The objective of optimized shaft alignment is to increase the operating life span of rotating machinery. To achieve this goal, components that are the most likely to fail must be made to operate within their acceptable design limits.

While misalignment has no measurable effect on motor efficiency, correct shaft alignment ensures the smooth, efficient transmission of power from the motor to the driven equipment. Incorrect alignment occurs when the centerlines of the motor and the driven equipment shafts are not in line with each other. Misalignment produces excessive vibration, noise, coupling and bearing temperature increases, and premature bearing or coupling failure.

Types of Misalignment

There are three types of motor misalignment:

Angular misalignment occurs when the motor is set at an angle to the driven equipment. The angle or mismatch can be to the left or the right, or above or below. If the centerlines of the motor and the driven equipment shafts were to be extended, they would cross each other, rather than superimpose or run along a common centerline. Angular misalignment can cause severe damage to the driven equipment and the motor.

Parallel misalignment occurs when the two shaft centerlines are parallel, but not in the same line. They are offset horizontally or vertically (or both), displaced to the left or right, or positioned at different elevations.

Combination misalignment occurs when the motor shaft suffers from angular misalignment in addition to parallel misalignment.

Couplings

Larger motors are usually directly coupled to their loads with rigid or flexible couplings. Rigid couplings do not compensate for any motor-to-driven-equipment misalignment while flexible couplings tolerate small amounts of misalignment. Flexible couplings can also reduce vibration transmitted from one piece of equipment to another, and some can insulate the driven equipment shaft against stray electrical currents. Even flexible couplings require a minimal alignment, defined in the instruction sheet for the coupling.

It is a mistake, however, to take advantage of coupling flexibility for excessive misalignment, as flexing of the coupling and of the shaft will impose forces on the motor and driven-equipment bearings. Effects of these forces include premature bearing, seal, or coupling failures, shaft breaking or cracking, and excessive radial and axial vibrations. Secondary effects include loosening of foundation bolts, and loose or broken coupling bolts. Operating life is shortened whenever shafts are misaligned.

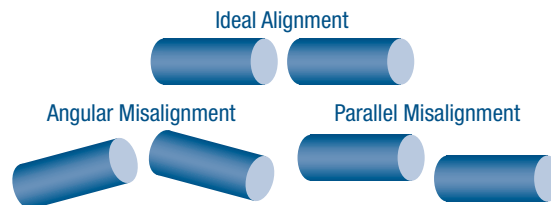

Suggested Actions

- Check shaft alignment of all production critical equipment annually.
- Monitor vibration as an indication of misalignment. Misalignment might be caused by foundation settling, insufficient bolt tightening, or coupling faults.
- After 3-6 months of operation, recheck newly installed equipment for alignment changes due to foundation settling.
- Predictive maintenance techniques, including vibration tests and frequency spectrum analysis, can be used to distinguish between bearing wear, shaft misalignment, or electrically caused vibrations.

Resources

Institute of Electrical Motor Diagnostics (IEMD)—For information on electrical motor diagnostic technologies and motor-system health, visit www.iemd.org.

Electrical Apparatus Service Association (EASA)—Provides information on motor maintenance topics (www.easa.org).

U.S. Department of Energy—For additional information on industrial energy efficiency measures and training, visit the BestPractices Web site at www.eere.energy.gov/industry/bestpractices.

Alignment Tolerances

Proper shaft alignment is especially critical when the motor is operated at high speeds. Typical alignment tolerances are summarized in Table 1.

Motor Speed, RPM	Parallel Offset (mils)		Angular Misalignment (mils)	
	Excellent	Acceptable	Excellent	Acceptable
1200	+/- 1.25	+/- 2.0	0.5	0.8
1800	+/- 1.0	+/- 1.5	0.3	0.5
3600	+/- 0.5	+/- 0.75	0.2	0.3

In practice, proper alignment is difficult to achieve without using alignment equipment such as dial indicators or laser alignment tools to check and correct for misalignment. The proper shaft alignment procedure is to secure the driven equipment first, and then install the coupling to the equipment. Moving a pump, for instance, would impose stress upon the connecting piping. Then the motor should be moved into proper alignment and joined to the coupling.

After the equipment has operated long enough to become temperature stabilized, shut it down and immediately recheck alignment. Due to thermal growth, machines that are aligned in the “cold” pre-operating condition are almost always out of alignment when operating temperatures are attained. Many equipment manufacturers publish thermal offset values so the alignment professional can correct for thermal growth during the initial alignment process.

Replace V-Belts with Cogged or Synchronous Belt Drives

About one-third of the electric motors in the industrial and commercial sectors use belt drives. Belt drives provide flexibility in the positioning of the motor relative to the load. Pulleys (sheaves) of varying diameters allow the speed of the driven equipment to be increased or decreased. A properly designed belt transmission system provides high efficiency, decreases noise, requires no lubrication, and presents low maintenance requirements. However, certain types of belts are more efficient than others, offering potential energy cost savings.

The majority of belt drives use *V-belts*. V-belts use a trapezoidal cross section to create a wedging action on the pulleys to increase friction and improve the belt's power transfer capability. Joined or multiple belts are specified for heavy loads. V-belt drives can have a peak efficiency of 95% to 98% at the time of installation. Efficiency is also dependent on pulley size, driven torque, under or over-belting, and V-belt design and construction. Efficiency deteriorates by as much as 5% (to a nominal efficiency of 93%) over time if slippage occurs because the belt is not periodically re-tensioned.

Cogged belts have slots that run perpendicular to the belt's length. The slots reduce the bending resistance of the belt. Cogged belts can be used with the same pulleys as equivalently rated V-belts. They run cooler, last longer, and have an efficiency that is about 2% higher than that of standard V-belts.

Synchronous belts (also called timing, positive-drive, or high-torque drive belts) are toothed and require the installation of mating toothed-drive sprockets. Synchronous belts offer an efficiency of about 98% and maintain that efficiency over a wide load range. In contrast, V-belts have a sharp reduction in efficiency at high torque due to increasing slippage. Synchronous belts require less maintenance and retensioning, operate in wet and oily environments, and run slip-free. But, synchronous belts are noisy, unsuitable for shock loads, and transfer vibrations.

Suggested Actions

- Conduct a survey of belt-driven equipment in your plant. Gather application and operating hour data. Then, determine the cost effectiveness of replacing existing V-belts with synchronous belts and sprockets.
- Consider synchronous belts for all new installations as the price premium is small due to the avoidance of conventional pulley costs.
- Install cogged belts where the retrofit of a synchronous belt is not cost effective.

Resources

U.S. Department of Energy—DOE's *MotorMaster+* and *MotorMaster+ International* software tools help you make motor comparisons and selection on a broad range of motors.

Visit the BestPractices Web site at www.eere.energy.gov/industry/bestpractices to access these and many other industrial energy efficiency resources and training.



Photo Courtesy of Gates Rubber Company

Example

A continuously operating, 100-hp, supply-air fan motor (93% efficient) operates at an average load of 75% while consuming 527,000 kWh annually. What are the annual energy and dollar savings if a 93% efficient (η_1) V-belt is replaced with a 98% efficient (η_2) synchronous belt? Electricity is priced at \$0.05/kWh.

$$\begin{aligned}\text{Energy Savings} &= \text{Annual Energy Use} \times (1 - \eta_1/\eta_2) \\ &= 527,000 \text{ kWh/year} \times (1 - 93/98) = \mathbf{26,888 \text{ kWh/year}}\end{aligned}$$

$$\text{Annual Cost Savings} = 26,888 \text{ kWh} \times \$0.05/\text{kWh} = \mathbf{\$1,345}$$

Further Considerations

For centrifugal fans and pumps, which exhibit a strong relationship between operating speed and power, synchronous belt sprockets must be selected that take into account the absence of slippage. Operating costs could actually increase if slippage is reduced and a centrifugal load is driven at a slightly higher speed.

Synchronous belts are the most efficient choice. However, cogged belts may be a better choice when vibration damping is needed or shock loads cause abrupt torque changes that could shear a synchronous belt's teeth. Synchronous belts also make a whirring noise that might be objectionable in some applications.

Avoid Nuisance Tripping with Premium Efficiency Motors

In most cases, upgrading to NEMA Premium™ efficiency motors has no noticeable impact on the electrical system. However, in rare cases nuisance trips can occur during startup. Addressing this topic requires an understanding of starting current.

The National Electrical Manufacturers Association (NEMA) recognizes and describes two components of starting current, instantaneous peak inrush and locked rotor current. Nuisance tripping has been primarily associated with the instantaneous peak inrush, which is a momentary current transient that occurs immediately (within half an AC cycle) after contact closure. Locked-rotor current is the root-mean-square or RMS current that establishes following the peak inrush; the current remains near the locked-rotor value during acceleration until the motor approaches its operating speed. (Note: The terms inrush or starting current are often used to mean locked-rotor current.)

NEMA Premium motors have slightly higher locked-rotor currents and locked-rotor code letters than lower-efficiency motors of the same rating. However, most NEMA Premium motors are NEMA Design B and are subject to the same maximum allowable locked-rotor current as their standard-efficiency counterparts. Locked-rotor current for specific new motor models can be looked up in the *MotorMaster+ 4.0* software or deciphered from the locked-rotor code letter on the motor nameplate. This letter, usually just designated as “Code,” is not the same as the motor design letter code. Locked-rotor code expresses current in kilovolt amperes (kVA) per horsepower (hp). The code letters are defined as follows:

Locked-Rotor Code, kVA/hp	
A 0-3.15	G 5.6-6.3
B 3.15-3.55	H 6.3-7.1
C 3.55-4.0	J 7.1-8.0
D 4.0-4.5	K 8.0-9.0
E 4.5-5.0	L 9.0-10.0
F 5.0-5.6	M 10.0-11.2

Example

The maximum locked-rotor current for a Code C, 460-volt, 100-hp motor is determined as follows.

$$\begin{aligned}
 \text{LR Current} &= \text{Motor horsepower} \times (\text{Maximum kVA/hp} / \text{Supply voltage in kV}) / \sqrt{3} \\
 &= 100 \text{ hp} \times \{(4.0 \text{ kVA} / \text{hp} / 0.46 \text{ kV}) / \sqrt{3}\} \\
 &= 502 \text{ Amps}
 \end{aligned}$$

The NEMA table actually continues all the way to letter V with current increasing about 12.3% for each letter increment. Only small and non-NEMA Design B motors have Codes beyond L.

The ratio of peak inrush to locked-rotor current tends to increase with higher-efficiency motors due to their lower power factor under locked rotor conditions.

Suggested Actions

If nuisance tripping occurs:

- Make sure power factor correction capacitors are installed ahead of the starter.
- Refer to Section 430 of the latest National Electric Code for guidance on increasing the instantaneous trip level of your circuit protector. The Code has been modified to allow adjustments to a greater allowable trip setting when nuisance trips occur. Note that the Code can be quite complicated and exceptions do exist. Don't hesitate to contact a licensed professional electrical engineer to resolve motor protection problems.
- If adjusting the trip setting is not sufficient, the circuit protector can be replaced with a circuit protector with a mechanical delay that lets it ride through half a cycle of current above the nominal setting.

Resources

National Electrical Manufacturers Association (NEMA)—For additional information on NEMA Premium standards, see the Motor Tip Sheet #1 (DOE/GO-102005-2019) on this topic or visit www.nema.org.

U.S. Department of Energy—For assistance in diagnosing nuisance motor trips and related information on industrial energy efficiency measures contact the EERE Information Center at (877) 337-3463. Visit the BestPractices Web site at www.eere.energy.gov/industry/bestpractices to access additional resources and information on training.

While NEMA Design B standards limit locked-rotor current, no standard limits the peak-inrush current. Fortunately, peak-inrush current is usually not a problem because it lasts only a few milliseconds. However, it can be a problem when the motor controller uses instantaneous magnetic-only circuit protectors that react in less than a single AC cycle. That is because peak inrush can be as high as 2.8 times the RMS locked-rotor current and may exceed the circuit protector current setting.

A motor may trip on peak-inrush current and start successfully on the next attempt. The exact peak-inrush current depends on the moment when contacts close in the AC voltage cycle, and how close to simultaneously the three-phase contacts close.

Nuisance trips are unlikely to occur in situations without instantaneous magnetic-only circuit protectors when the replacement motor is a NEMA Premium Design B motor of the same speed and horsepower. Even if instantaneous magnetic-only circuit protectors are present, you may not have a problem with nuisance trips. Many motor manufacturers offer NEMA Premium Design A motors that meet Design B torque requirements but exceed Design B locked-rotor current limits. Some of the most efficient motors are Design A, so do not limit choices to Design B unless you have locked-rotor current concerns.

Eliminate Voltage Unbalance

Voltage unbalance degrades the performance and shortens the life of a three-phase motor. Voltage unbalance at the motor stator terminals causes phase current unbalance far out of proportion to the voltage unbalance. Unbalanced currents lead to torque pulsations, increased vibrations and mechanical stresses, increased losses, and motor overheating, which results in a shorter winding insulation life.

Voltage unbalance is defined by the National Electrical Manufacturers Association (NEMA) as 100 times the absolute value of the maximum deviation of the line voltage from the average voltage on a three-phase system, divided by the average voltage. For example, if the measured line voltages are 462, 463, and 455 volts, the average is 460 volts. The voltage unbalance is:

$$\frac{(460 - 455)}{460} \times 100 = 1.1\%$$

It is recommended that the voltage unbalances at the motor terminals not exceed 1%. Unbalances over 1% require derating of the motor per Figure 20-2 of NEMA MG-1-2003, Revision 1-2004, and will void most manufacturers' warranties. Common causes of voltage unbalance include:

- Faulty operation of power factor correction equipment.
- Unbalanced or unstable utility supply.
- Unbalanced transformer bank supplying a three-phase load that is too large for the bank.
- Unevenly distributed single-phase loads on the same power system.
- Unidentified single-phase to ground faults.
- An open circuit on the distribution system primary.

The efficiency of a rewind, 1800-RPM, 100-hp motor is given as a function of voltage unbalance and motor load in the table. The general trend of efficiency reduction with increased voltage unbalance is observed for all motors at all load conditions.

Motor Efficiency* Under Conditions of Voltage Unbalance			
Motor Load % of Full	Motor Efficiency, %		
	Voltage Unbalance		
	Nominal	1%	2.5%
100	94.4	94.4	93.0
75	95.2	95.1	93.9
50	96.1	95.5	94.1

* Results vary depending upon motor design, speed, full-load efficiency, and horsepower rating. Typically, electric motors have peak efficiency near 75% load, but the above motor tested in the lab showed otherwise.

Voltage unbalance is probably the leading power quality problem that results in motor overheating and premature motor failure. If unbalanced voltages are detected, a thorough investigation should be undertaken to determine the cause. Energy and dollar savings occur when corrective actions are taken.

Suggested Actions

- Regularly monitor voltages at the motor terminals to verify that voltage unbalance is maintained below 1%.
- Check your electrical system single-line diagrams to verify that single-phase loads are uniformly distributed.
- Install ground fault indicators as required and perform annual thermographic inspections. Another indicator that voltage unbalance may be a problem is 120 Hz vibration. A finding of 120 Hz vibration should prompt an immediate check of voltage balance.

Resources

National Electrical Manufacturers Association (NEMA)—Visit www.nema.org for additional information on voltage imbalance.

U.S. Department of Energy—DOE's *MotorMaster+* and *MotorMaster+ International* software tools help you make motor comparisons and selection on a broad range of motors.

Visit the BestPractices Web site at www.eere.energy.gov/industry/bestpractices to access these and many other industrial energy efficiency resources and training.

Example

Assume that the motor tested as shown in the above table was fully loaded and operated for 8,000 hours per year, with an unbalanced voltage of 2.5%. With energy priced at \$0.05/kWh, the annual energy and dollar savings, after corrective actions are taken, are:

$$\text{Annual Energy Savings} = 100 \text{ hp} \times 0.746 \text{ kW/hp} \times 8,000 \text{ hrs/yr} \times (100/93 - 100/94.4) = \mathbf{9,517 \text{ kWh}}$$

$$\text{Annual Dollar Savings} = 9,517 \text{ kWh} \times \$0.05/\text{kWh} = \mathbf{\$476}$$

Overall savings may be much larger because an unbalanced supply voltage may power numerous motors.

Further Considerations

Voltage unbalance causes extremely high current unbalance. The magnitude of current unbalance may be 6 to 10 times as large as the voltage unbalance. For the 100-hp motor in this example, line currents (at full-load with 2.5% voltage unbalance) were unbalanced by 27.7%.

A motor will run hotter when operating on a power supply with voltage unbalance. The additional temperature rise is estimated with the following equation: Percent additional temperature rise = $2 \times (\% \text{ voltage unbalance})^2$. For example, a motor with a 100°C temperature rise would experience a temperature increase of 8°C when operated under conditions of 2% voltage unbalance. Winding insulation life is reduced by one-half for each 10°C increase in operating temperature.

References

Information in this tip sheet is extracted from *NEMA Standards Publication MG-1-2003, Motors and Generators, 2003*.

Eliminate Excessive In-Plant Distribution System Voltage Drops

Studies indicate that in-plant electrical distribution system losses—due to voltage unbalance, over- and under-voltage, low power factor, undersized conductors, leakage to ground, and poor connections—can account for less than 1% to over 4% of total plant electrical energy consumption. In a study at three industrial facilities, average electrical distribution system losses accounted for 2% of plant annual energy use. Losses due to poor connections represented one-third of these losses and accounted for 40% of the savings after corrective actions were taken.

Poor connections or inadequate conductor sizes result in excessive energy losses. The increased resistance converts electrical energy into heat and imposes additional loads on the distribution system. Maintenance of connections is generally referred to as termination maintenance. Termination maintenance is generally a cost-effective electrical distribution system energy savings measure.

Causes of poor connections include:

- Loose cable terminals and bus bar connections
- Corroded terminals and connections
- Poor crimps
- Loose, worn or poorly adjusted contacts in motor controllers or circuit breakers
- Loose, dirty, or corroded fuse clips on manual disconnect switches

Distribution system losses due to poor electrical contacts appear as hot spots caused by increased resistance or electric power (I^2R) losses. These hot spots may be detected by infrared thermography or a voltage drop survey. Inexpensive hand-held infrared thermometers can quickly and safely reveal hot spots.

Terminations should be regularly inspected. Replacing fuse clips or cleaning breaker fingers can be very cost-effective. The cost of cleaning or replacement is low compared to the significant energy savings and secondary benefits, including reduced downtime due to unscheduled equipment outages and improved safety due to reduced fire hazards.

Conducting a Voltage-Drop Survey

A voltage-drop survey can usually be done in-house with existing equipment such as a hand-held voltmeter. Voltage drop measurements should be taken from the input of each panel to the panel output for each load. For a typical motor circuit, measure the voltage drop from the bus bar to the load side of the motor starter. Compare the magnitude of the voltage drop for each phase with the voltage drop for the other phases supplying the load. A voltage drop difference of over 15% indicates that testing should be initiated to identify poor circuit connections. Even with good balance, an excessive voltage drop indicates that component voltage drop testing should be initiated.

Suggested Actions

- Conduct a voltage drop survey. The voltage drop is simply the voltage difference across the connection. Voltage drop information can be used to determine energy losses and excess energy consumption due to loose and dirty connections. Voltage-drop measurements should be taken at each phase. The total energy loss in a three-phase component is determined by summing the losses for each phase. Limit the load on each circuit or install larger-than-code-minimum conductors if the voltage drop exceeds 3%.

Resources

U.S. Department of Energy—Contact the EERE Information Center at 877-337-3463 to obtain cited publications or to request additional information on motor and driven-equipment energy efficiency opportunities. Additional resources and information on training is also available at the BestPractices Web site at www.eere.energy.gov/industry/bestpractices.

Energy Savings Example

Measurements at a motor control center (MCC) breaker indicate voltage drops of 8.1, 5.9, and 10.6 volts on L₁, L₂, and L₃, respectively. The driven equipment is continuously operated. Measured line currents are 199.7, 205.7, and 201.8 amps for L₁, L₂, and L₃. Voltage drop measurements for circuits serving similar loads indicate that a voltage drop of 2.5 volts should be obtainable. The potential annual energy and electrical demand savings due to correcting the problem are:

Circuit	Measured Voltage Drop, Volts	Excess Voltage Drop, Volts	Current, Amps	Excess Power, kW	Excess Energy Use, kWh
L ₁	8.1	5.6	199.7	1.12	9,796
L ₂	5.9	3.4	205.7	0.7	6,126
L ₃	10.6	8.1	201.8	1.63	14,318
Totals:				3.45	30,240

Assuming a utility energy charge of \$0.05/kWh with a demand charge of \$8.00/kW per month, potential savings are valued at:

$$\begin{aligned} \text{Savings} &= 3.45 \text{ kW} \times \$8.00/\text{kW}/\text{month} \times 12 \text{ months}/\text{year} + 30,240 \text{ kWh}/\text{year} \times \$0.05/\text{kWh} \\ &= \$331 + \$1,512 = \$1,843 \text{ per year (for a single breaker)} \end{aligned}$$

References

This tip sheet is extracted from two publications prepared for the Bonneville Power Administration: *Industrial Electrical Distribution Systems Study Report* and *Keeping the Spark in Your Electrical System: An Industrial Electrical Distribution Maintenance Guidebook*.

Improve Motor Operation at Off-Design Voltages

Motors are designed to operate within +/- 10% of their nameplate rated voltages. When motors operate at conditions of over- or under-voltage, motor efficiency and other performance parameters are degraded.

There are certain standard utilization voltages for motors. These correspond to (but are about 4% lower than) standard service voltages. The 4% difference was established to allow for a reasonable line voltage drop between the transformer secondary and the point of use (see Table 1).

Service Voltage	208	240	480	600	2400	4160
Utilization Voltage	200	230	460	575	2300	4000

Motors sometimes come in multivoltage ratings. The different voltages are accommodated by making different connections in the motor terminal box. For 1:2 ratios like 230/460, the connections change coil groups from parallel to series. For 1:1.73 like 2300/4000, the connections change coil groups from delta (for the lower voltage) to wye (for the higher voltage). There is no difference in performance at the different voltage ratings because the different connection compensates to put exactly the same total current through each winding turn. Tri-voltage motors (208-230/460 V) are designed to produce rated torque at each voltage, but will slip more and operate hotter at 208 volts than at 230 or 460 volts.

What Happens to Motor Performance when Voltage Varies?

With reduced voltage, torque capability is reduced over the whole accelerating range from initial start to stabilization at running speed. This reduces a motor's ability to break loose a stuck load and increases acceleration times. Running speed stabilizes at only a fraction of a percent lower than normal but the breakdown torque is reduced, meaning the motor has less ability to drive through a brief torque overload without stalling. Low voltage caused by high system impedance is exacerbated during starting and acceleration when the current is four to eight times nameplate full-load levels.

Power factor improves with under-voltage. This might be seen as a benefit except the reduction in reactive current is more than nullified by the increase in the total current necessary to deliver the real power at reduced voltage. Higher currents lead to increased resistance and power losses (I^2R), reduced motor efficiency, and possible overheating.

Slip and starting torque vary as the square of the voltage deviation. Slip is the difference between a motor's actual speed and synchronous speed. Synchronous speed is always 7200 RPM divided by the pole count, e.g. 3600 (2-poles), 1800 (4-poles), 1200 (6-poles), 900 RPM (8-poles), etc. The actual synchronous speed is always the lowest possible synchronous speed above the nameplate full-load speed. For example, the synchronous speed for a 1750 RPM motor is 1800 and the slip is 50 RPM. Running this motor at 10% over-voltage would increase the power draw for centrifugal fans and circulating pumps by around 1.5% because their power requirement is sensitive to speed.

Suggested Actions

The best motor performance occurs when power supplied to the motor terminals is close to the nominal utilization voltage. To ensure efficient motor performance, use the following tips to correct for over- or under-voltage and voltage unbalance.

- If voltage does not vary much, but is constantly too high or too low, change to a different main service transformer tap setting. Adjust branch or secondary transformer tap settings as necessary.
- If daily voltage variation occurs at the service entrance, an "auto-tap-changer" transformer is recommended. This can be provided by the customer or the utility.
- If voltage is constant at the service entrance, but varies within the facility due to load variations and distance from the transformer, conductor and/or in-plant transformer losses are excessive. Replace existing conductors with larger ones or add parallel conductors. Replace old, inefficient, or undersized transformers if they are the cause.
- For a single motor attached to a conventional motor starter, low power factor is usually corrected by installing capacitors attached to the load-side terminals of the motor starter. Correcting power factor at the points of use will reduce system current and associated voltage drop.
- When using a motor with an adjustable speed drive (ASD), the drive can compensate for voltage discrepancies as long as the input voltage is within the operating range of the drive. The drive's capacitors correct for low power factor.
- Have your service center rewind motors for the actual utilization voltage. At the same time, they can evaluate the design for other possible ways to improve reliability and efficiency.

Full load efficiency is at maximum between nominal voltage and about 10% over-voltage. However, at reduced load the best efficiency point shifts considerably toward lower voltages.

Sometimes low voltage only occurs at remote areas of a facility where high loads are concentrated. In new construction, or where correction of severe voltage drop is necessary, it may be practical to run medium voltage (>600 to 6600 volts) distribution lines to the remote areas. At medium voltage, even with dramatically reduced conductor cross section, the voltage drop and power losses are usually held to well under 1%. The medium voltage can be transformed down near the points of use, or the equipment can be driven by medium voltage motors. Standard medium voltage motors are available as small as 100 hp.

Resources

U.S. Department of Energy—For additional information on ways to improve motor efficiency by improving the voltage supplied to the motor terminals, refer to the DOE Motor Tip Sheet # 7: *Eliminate Voltage Unbalance*. Find this tip sheet and additional information or resources on motor and motor-driven system efficiency improvement measures on the BestPractices Web site at www.eere.energy.gov/industry/bestpractices, or contact the EERE Information Center at (877) 337-3463.

Turn Motors Off When Not in Use

Motors use no energy when turned off. Reducing motor operating time by just 10% usually saves more energy than replacing a standard efficiency motor with a NEMA Premium® efficiency motor. In fact, given that 97% of the life cycle cost of purchasing and operating a motor is energy-related, turning a motor off 10% of the time could reduce energy costs enough to purchase three new motors.

However, the belief that stopping and starting motors is harmful persists. Many users believe that repeated motor starts will use more energy than constant operation, increase utility demand charges, and shorten motor life. While these opinions are not totally without basis, they do need to be put into proper perspective.

When started, a motor accelerates and draws more power than when it is operating steadily at full load. While a typical NEMA Design B motor may draw from four to eight times the full-load *current* during starting, the power factor is low so the input power is not four to eight times rated load *power*. Starting usually takes under 2 seconds and is rarely over 10 seconds, even for large high inertia loads. Just 1 minute of additional running time consumes far more energy than a motor starting event.

Another motor starting concern involves increased utility demand charges. Again, the *excess starting demand* is small due to the short duration of the motor starting interval. Peak demand charges are generally based upon a facility's average energy use over a fixed or rolling average window of 15 to 60 minutes in duration. Check with your utility to determine how they assess peak demand charges.

Starting Stresses

Starting stresses a motor by:

- Applying higher than rated full load torque to the shaft during acceleration
- Applying high magnetic forces to the rotor cage and winding end turns
- Heating the stator winding and the rotor cage.

Frequent torque shocks to the shaft from starting could shorten shaft life through metal fatigue. However, most shaft failures are attributed to bearing failures, shock, excessive belt tension, misapplication, or creep during storage (large motors). Overheating the stator winding and the rotor cage occurs if frequency of starts and duration of rest time between starts exceeds the NEMA design range. Heat from exceeding these limits can degrade winding insulation and cause thermal stressing of the rotor cage, leading to cracks and failed end-ring connections.

Repeated Motor Starts and Stops

While it is true that starting stresses a motor, motors are designed to be started. For example, motors in applications like lift pumps or irrigation wells start and stop quite frequently, while lasting for 15 years or more. As long as the frequency of starts is not excessive, lifetime is not significantly affected.

Suggested Actions

- Keep track of your motors through a motor system management plan. Consider times when motors can be shut down, including shift changes, lunch breaks, or during process interruptions.
- Energy saving opportunities often exist when motors drive loads in parallel, such as compressors or pumps. Evaluate sequencing of these motors.
- Install automatic shutdown timers so motors will be turned off when they would otherwise be running idle or unloaded for intervals longer than the rest intervals identified in NEMA MG 10-2001.
- Shut down equipment that is energized but not in use for significant periods of time.
- Consider adjustable speed drives (ASDs), soft starters, wye-delta starting or autotransformers to reduce starting stresses on equipment that requires frequent starting and stopping.

Resources

National Electrical Manufacturers Association (NEMA)—Visit www.nema.org for more information. When making the decision to stop a motor, refer to NEMA MG 10-2001 “Energy Management Guide for Selection and Use of Fixed Frequency Medium AC Squirrel-Cage Polyphase Induction Motors.” For large induction motors, refer to NEMA MG 1-2006 “Motors and Generators” Part 20.12.

U.S. Department of Energy—For additional information or resources on motor and motor-driven system efficiency improvement measures, visit the BestPractices Web site at www.eere.energy.gov/industry/bestpractices, or contact the EERE Information Center at (877) 337-3463.

NEMA provides standards for starting duty which consider inertia of the load—an important factor in starting stress. NEMA also provides guidance relating to start-run-stop-rest cycles that are often employed in energy management programs.

Frequent stopping and starting, even within NEMA limits, does stress a motor due to mechanical flexing of the coils and rotor overheating during acceleration, but there is no known relationship between number of motor starts and *normal* motor life expectancy. Each start is one factor in the life expectancy and reliability of the motor and some reduction in life expectancy and reliability must be accepted when a motor is continuously applied at the upper range of its starting duty.

The greatest stress of pushing the limits on starting frequency is thermal. Multiple other factors also contribute to temperature rise. When operating in the upper range of starting duty, take these steps to ensure that you are well within tolerances on other sources of thermal stress:

- Keep the motor clean so air flow and heat transfer are not impeded
- Keep supply voltage nominal, avoiding voltage unbalance, under-voltage, and harmonic voltages
- Do not overload the motor
- Derate any motor used in severe ambient environments, such as over 3,000 feet altitude or above 40°C.

You may find that you can substantially increase the time your motors are shut down without approaching the NEMA MG 10-2001 starting duty limits.

Additional Information

- NEMA MG 1-2006 provides a table on the maximum inertia load for starting induction motors of various ratings. Motors driving loads that do not exceed these inertia limits can be started twice in immediate succession when the motor is initially at ambient temperature.
- NEMA MG 10-2001 (Table 7) gives the maximum number of allowable starts per hour for motors of various horsepower and synchronous speed ratings. The table indicates how frequently motors can be started with a *rest period* between starts and provides a minimum length for that rest period.

Adjustable Speed Drive Part-Load Efficiency

An adjustable speed drive (ASD) is a device that controls the rotational speed of motor-driven equipment. Variable frequency drives (VFDs), the most common type of ASDs, efficiently meet varying process requirements by adjusting the frequency and voltage of the power supplied to an AC motor to enable it to operate over a wide speed range. External sensors monitor flow, liquid levels, or pressure and then transmit a signal to a controller that adjusts the frequency and speed to match process requirements.

Pulse-width modulated (PWM) VFDs are most often used in variable torque applications in the 1 to 1,000 hp motor size range. For centrifugal fans or pumps with no static lift, the fluid or air flow provided varies directly with the pump or fan rotational speed. The input power requirement varies as the cube or third power of the speed ratio (see Figure 1). Small decreases in equipment rotating speed or fluid flow yield significant reductions in energy use. For example, reducing speed (flow) by 20% can reduce power requirements by approximately 50%.

$$hp_2 = hp_1 \times (RPM_2 / RPM_1)^3 = hp_1 \times (Flow_2 / Flow_1)^3$$

Where:

hp_1 = driven-equipment shaft horsepower requirement at original operating speed

hp_2 = driven-equipment shaft horsepower requirement at reduced speed

RPM_1 = original speed of driven equipment, in revolutions per minute (RPM)

RPM_2 = reduced speed of driven equipment, in RPM

$Flow_1$ = original flow provided by centrifugal fan or pump

$Flow_2$ = final flow provided by centrifugal fan or pump

Figure 1. Power requirement for centrifugal loads

Determining Energy Savings

To establish the energy savings that are possible when an ASD is applied to a variable torque load, you must determine the load duty cycle, or percentage of time that the fan or pump operates at each system operating point. You must also know the efficiency of the variable speed drive and the drive motor when the motor is operating partially loaded and at a reduced speed to satisfy variable flow requirements.

Variable and constant torque loads are expressed in terms of the shaft horsepower supplied by the motor. A motor “load factor” is the load imposed upon the motor by the driven equipment divided by the motor’s full output rating. The load on the ASD is the actual power supplied by the device (shaft horsepower divided by the motor efficiency at its load point) divided by the rated output power. Manufacturers can provide efficiency values for ASDs as a function of operating speed or load for both variable torque loads (centrifugal fans and pumps) and constant torque loads (cranes, hoists, and conveyors).

Suggested Actions

- Contact your supplier to obtain drive efficiency as a function of motor operating speed or drive power output.
- Use this information to accurately determine the energy savings due to the use of ASD versus throttle or damper flow control. When ASD part-load performance values are not readily available, use the values given in Table 1.

Resources

U.S. Department of Energy—For additional information on motor and motor-driven system efficiency, and to download the MotorMaster+ software tool, visit the BestPractices Web site at www.eere.energy.gov/industry/bestpractices, or contact the EERE Information Center at (877) 337-3463.

National Electrical Manufacturers Association (NEMA)—Visit the NEMA Web site at www.nema.org for information on motor standards, application guides, and technical papers.

When considering electronic PWM ASDs, you may use Table 1 to obtain efficiency values for drives of various ratings that supply power to motors connected to either variable or constant torque loads.

Variable Speed Drive hp Rating	Efficiency,%						
	Load, Percent of Drive Rated Power Output						
	1.6	12.5	25	42	50	75	100
3	31	77	86	90	91	93	94
5	35	80	88	91	92	94	95
10	41	83	90	93	94	95	96
20	47	86	93	94	95	96	97
30	50	88	93	95	95	96	97
50	46	86	92	95	95	96	97
60	51	87	92	95	95	96	97
75	47	86	93	95	96	97	97
100	55	89	94	95	96	97	97
200	61	91	95	96	96	97	97
400	61	91	95	96	96	97	97

1. These efficiency values may be considered representative of “typical” PWM ASD performance. There is no widely accepted test protocol that allows for efficiency comparisons between different drive models or brands. In addition, there are many ways to set up an ASD that can affect the operating efficiency.

Source: Safronics, Inc.

ASD efficiency decreases with decreasing motor load. The decline in efficiency is more pronounced with drives of smaller horsepower ratings. As shown in the following example, this reduction in efficiency is not as detrimental as it first seems.

Example

Consider an adjustable speed drive coupled to a motor that delivers 20 hp to an exhaust fan when operated at its full rated speed. At 1/4 of its rated operating speed, the fan delivers 25% of its rated airflow, but requires only 1/64 of full-load power. Even with the low drive efficiency of 47%, with adjustable speed operation the power required by the fan and the VFD is only 0.66 hp.

$$\text{hp}_{25\%} = (20 \text{ hp} \times (1/4)^3 / (47/100)) = 0.66 \text{ hp.}$$

Note: This example does not account for the efficiency at each load point for the fan drive motor.

Remember that the system efficiency is the product of the ASD efficiency, the motor efficiency at its load point, and the driven equipment efficiency ($E_{\text{system}} = E_{\text{ASD}} \times E_{\text{motor}} \times E_{\text{Equipment}}$). Efficiencies for integral horsepower NEMA Design A and B motors at full and part-load can readily be obtained from the U.S. Department of Energy’s MotorMaster+ 4.0 software tool. Efficiencies for driven equipment must be extracted from the appropriate pump or fan performance curves.

Is it Cost-Effective to Replace Old Eddy-Current Drives?

Overview

New pulse-width-modulated (PWM) adjustable speed drives (ASDs) may be cost-effective replacements for aging or maintenance-intensive eddy-current drives.

The eddy-current drive or clutch is a slip device consisting of two rotating elements that are coupled by a magnetic field with the slip and rotor speed based upon the magnetic field strength. An alternating current motor drives a constant-speed rotating drum that surrounds a cylinder (rotor), which is coupled to an output shaft. Torque is transmitted from the outer rotating drum to the rotor with an adjustable magnetic field. The maximum efficiency of a slip-based adjustable speed controller is approximately equal to the amount of slip, or difference between full-load speed and the operating speed. Table 1 indicates the efficiency of a magnetically coupled eddy-current drive when matched to a centrifugal load.

Drive Speed, % of Full-Load Speed	Load %	Eddy-Current Drive Efficiency, %
100	100	94.3 to 99.3
90	72.9	85.9 to 90.4
80	51.2	76.1 to 80.1
70	34.3	66.9 to 70.5
60	21.6	56.9 to 59.8
50	12.5	47.7 to 50.2
40	6.4	39.7 to 41.7
30	2.7	28.6 to 29.9

1. Source: Coyote Electronics, Inc. "Payback[®]" Magnetic-Coupled Variable Speed Drive Literature.

Energy Savings Example

An eddy-current drive on a 50 hp boiler forced-draft fan has reached the end of its useful operating life; the proposed replacement is a PWM ASD. The fan operates for 8,000 hours per year while delivering 90% of rated flow for 20% of the time, 80% flow for 50% of the time, and 70% of rated flow for the remaining operating hours. Energy savings are obtained due to the improved efficiency of the PWM drive over the eddy-current drive. In Table 2, the existing system or baseline annual energy consumption is determined as follows:

% of Rated Fan Speed/Flow	Load Duty Cycle, %	Load, Shaft hp	Motor Efficiency, %	Eddy-Current Drive Efficiency, %	Weighted Input Power (kW)
90	20	36.45	91.6	90.0	6.59
80	50	25.6	90.9	80.0	13.13
70	30	17.2	86.6	70.0	6.33
Total:					26.05

Suggested Actions

- Contact your drive supplier to obtain drive efficiency information as a function of motor operating speed or drive power output. Use this information to determine the energy savings due to the use of a PWM ASD versus an eddy-current drive.
- When ASD part-load performance values are not readily available, use the values given in the Motor Tip Sheet #11: *Adjustable Speed Drive Part-Load Efficiency*.
- Efficiencies for integral horsepower NEMA Design A and B motors at full and part-load can readily be obtained from the U.S. Department of Energy's Motor-Master+ 4.0 software tool.

Resources

U.S. Department of Energy—For additional information on motor and motor-driven system efficiency, and to download the MotorMaster+ software tool, visit the BestPractices Web site at www.eere.energy.gov/industry/bestpractices, or contact the EERE Information Center at (877) 337-3463.

National Electrical Manufacturers Association (NEMA)—Visit the NEMA Web site at www.nema.org for information on motor standards, application guides, and technical papers.

Note that the input power is equal to 0.746 times the shaft horsepower divided by the product of the motor and drive efficiency values. The weighted input power value is the input power times the load duty cycle percentage divided by 100. In Table 3 when the ASD is installed, the fan power requirements decrease.

Table 3. Average Power Requirements for a Centrifugal Fan with ASD Speed Control

% of Rated Fan Speed/Flow	Load Duty Cycle, %	Load Shaft hp	Motor Efficiency, %	ASD Efficiency, %	Weighted Input Power (kW)
90	20	36.45	91.6	96	6.18
80	50	25.6	90.9	95	11.05
70	30	17.2	86.6	93	4.76
Total:					21.99

As the eddy-current drive efficiency drops rapidly at loads below 70%, energy savings are very sensitive to the load profile and duty cycle. The annual energy savings for this application is:

$$(26.05 - 21.99) \text{ kW} \times 8,000 \text{ hours/year} = 32,480 \text{ kWh/year}$$

At an electrical rate of \$0.05/kWh, the value of these savings is:

$$32,480 \text{ kWh} \times \$0.05/\text{kWh} = \$1,624/\text{year}$$

The above example illustrates that although early replacement of an older eddy-current drive with an electronic ASD may not meet the two-year simple payback typically required by industry, the cost effectiveness can be significantly improved if a utility efficiency incentive is available. Other factors that may favor replacement include predictive maintenance tests indicating an impending failure or when equipment fails and requires repair.

Load Considerations

An ASD may not be a suitable replacement for high-torque repetitive-slip applications such as a punch press or a crusher. Eddy-current drives can produce more torque at low speed than an induction motor and ASD. When switching to an ASD for a constant torque load, the motor and the drive may require oversizing by a factor of 150% to 200%. Eddy-current drives can be used with standard efficiency motors, do not produce harmonic distortion, are not subject to nuisance trips due to power disturbances, and operate independently of the motor power supply voltage. As eddy-current drives are not directly coupled to the load shaft, they do not transmit vibrations to the motor and provide inherent protection against load seizures. Installers must ensure that operational problems are not created through installation of an electronic ASD.

Magnetically Coupled Adjustable Speed Motor Drives

Adjustable Speed Drive Overview

Alternating current electric motors rotate at a nearly constant speed that is determined by motor design and line frequency. Energy savings of 50% or more may be available when fixed speed systems are modified to allow the motor speed to match variable load requirements of a centrifugal fan or pump.¹

Loads that vary over time by 30% of full load offer good opportunities for cost effective adjustable speed drive (ASD) retrofits. Market assessment studies indicate that in light and medium industry 26% of motors exhibit fluctuating loads; 22% of these are in process industries and 35% are in other heavy industries.² However, ASD installations remain low (7%–13%). The majority of ASD-equipped industrial motor systems are of 20 hp or less—with the ASD often installed for improved control over the production process rather than energy savings.

Electronic ASDs

The current state-of-the-art speed control is the electronic ASD. Because of their energy efficiency and control capabilities, electronic ASD and motor combinations have replaced constant speed motors in virtually every type of industrial plant. Although electronic ASDs have been available for more than 20 years, they are not suited for all applications. For example, an estimated 15% to 20% of industrial plants use medium voltage (>600 to 6600 volts) to supply power to motors rated as low as 250 hp. Semiconductors for medium voltage motor applications are particularly expensive. Depending on the situation, other factors that can discourage electronic ASD use include:

- Creation of harmonics (requiring installation of line reactors or harmonic filters)
- Voltage spikes (leading to early motor failure)
- Motor bearing failures due to currents induced in the motor's rotor that flow to ground through the bearing
- Nuisance tripping
- Limitations on the distance that ASDs may be installed from the motor.

Magnetically Coupled ASDs

In contrast to an electronic ASD, a magnetically coupled ASD does not alter the power supplied to the motor. With a magnetically coupled ASD, the motor is generally brought up to operating speed while unloaded. The motor continues to operate at its rated design speed while the magnetic coupling controls the torque transferred and the speed of the driven equipment by varying the strength of the magnetic field between the motor shaft and the load shaft. The strength of the magnetic field is controlled by varying the width of an adjustable air gap or by varying the amount of current applied to an electromagnet.

Because the load and motor shafts are not directly coupled in magnetically coupled ASDs, vibrations that occur on the load side are isolated and not transmitted to the motor. For instance, a newsprint products plant recently installed a magnetically coupled ASD for a 250 hp/2300 V motor running a centrifugal pump with a by-

Suggested Actions

- Complete a survey to identify constant speed motors in your plant that are used to drive centrifugal pumps with throttling valves or recirculation (bypass) lines or centrifugal fans equipped with inlet and/or discharge dampers.
- Determine the load profile for systems that are in use for more than 2,000 hours per year.
- Determine the energy savings and cost effectiveness of installing an electronic ASD or magnetically coupled ASD motor controller.
- Consider magnetically coupled ASDs for intermediate voltage motors, when sensitive equipment cannot tolerate harmonic currents, or where maintenance requirements are high due to load vibrations being transferred to the motor bearings.

Resources

U.S. Department of Energy—For additional information or resources on motor and motor-driven system efficiency improvement measures, visit the BestPractices Web site at www.eere.energy.gov/industry/bestpractices, or contact the EERE Information Center at (877) 337-3463.

National Electrical Manufacturers Association (NEMA)—Visit the NEMA Web site at www.nema.org for information on motor standards, application guides, and technical papers.

pass flow control valve. This project resulted in annual energy savings of 633,000 kWh. Long-term maintenance costs decreased as pump cavitation was eliminated and vibration was dramatically reduced.³

Magnetically coupled ASDs do not have to be housed in a controlled environment. They allow for multiple motor starts with no “cool-off period” and are desirable where harmonic distortion cannot be tolerated or where poor power quality would result in excessive nuisance trips. Load seizure protection is also inherent with this design. Because magnetic coupled ASDs operate independent of motor power supply voltage, they are often cost-effective in applications with medium voltage power supplies. Other advantages include: compatibility with existing standard efficiency motors; avoidance of additional motor heating and the need for motor de-rating; and accommodation of shaft thermal expansion.

Disadvantages of magnetically coupled ASDs include space and weight constraints. Some are not compatible with vertical shaft motors or belt-driven loads. They are also maintenance-intensive and require repair by technicians with specialized training.

Magnetically coupled ASDs offer some operating advantages that are desirable for niche applications by providing speed control that can be up to 30% more efficient than damper fan control and 44% more efficient than throttled pump control. However, they capture only about 60% of the energy savings obtainable with conventional electronic ASDs. Savings decrease as the turndown increases.⁴

References

1. ADM Associates, Inc., “Adjustable-Speed Drive Case Studies,” prepared for the Wisconsin Center for Demand-Side Management, 1994.
 2. Xenergy, Inc., *United States Industrial Motor Systems Market Opportunities Assessment*, prepared for the U.S. Department of Energy’s Office of Industrial Technologies, December, 1998.
 3. Northwest Energy Efficiency Alliance, *Field Testing the MagnaDrive Coupling Speed Control Technology on Northwest Industrial Applications*, “Case Study: Ponderay Newsprint, Usk, Washington” 2000, www.nwalliance.org/research/documents/MagnaDriveCS_Pnderay2.6.pdf
 4. Motor Systems Resource Facility, Oregon State University, “Product Testing: MagnaDrive, Report No. 1,” Prepared for the Northwest Energy Efficiency Alliance, March, 2000, www.nwalliance.org/resources/reports/00-048.pdf
- Dan Greenberg, *Platts Research and Consulting*, “Magnetically Coupled Adjustable-Speed Drives: Going Where No VFD Has Gone Before,” ER-03-18, November, 2003.
- Quantec, “Market Progress Evaluation Report: MagnaDrive, No. 2,” prepared for the Northwest Energy Efficiency Alliance, Report E02-099, May, 2002.

When Should Inverter-Duty Motors Be Specified?

Electronic adjustable speed drives (ASDs) used to be marketed as “usable with any standard motor.” However, premature failures of motor insulation systems began to occur with the introduction of fast-switching pulse-width modulated (PWM) drives. The switching rates of modern power semiconductors can lead to voltage overshoots. These voltage spikes can rapidly damage a motor’s insulation system, resulting in premature failure of the motor.

Effects of ASDs on Induction Motors

The non-sinusoidal variable frequency output of PWM drives results in increased motor losses, inadequate ventilation at lower speeds, increased dielectric stresses on motor windings, magnetic noise, and the creation of shaft currents. These effects can combine to damage a motor’s insulation and severely shorten a motor’s useful operating life.

High switching rates of modern power semiconductors lead to rapid changes in voltage in relatively short periods of time (dv/dt, quantified in units of volts per microsecond). Steep-fronted waves with large dv/dt or very fast rise times lead to voltage overshoots and other power supply problems.

When the motor impedance is larger than the conductor cable impedance, the voltage wave form will reflect at the motor terminals, creating a standing wave (see Figure 1). Longer motor cables favor the formation of higher amplitude standing waves. Voltage spikes have been reported with peak values as high as 2150 volts in a 460 V system operating at 10% over-voltage. High voltage spikes can lead to insulation breakdown, resulting in phase-to-phase or turn-to-turn short circuits, with subsequent over-current trips by the drive sensor.

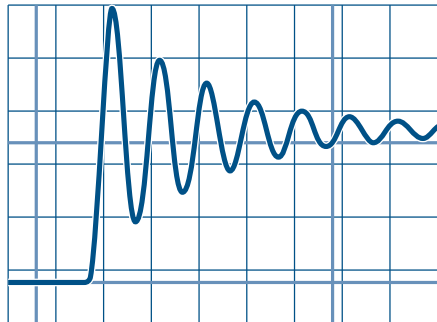

Figure 1. PWM pulse with reflected voltage or ringing

Inverter-Duty Motor Designs

Solutions used to prevent motor failures due to voltage spikes include the use of power conditioning equipment (filters, load reactors, and isolation transformers) and placing restrictions on the distance or lead length between the drive and the motor. Some drive installers also specify oversized motors or high-temperature-resistant Class H insulation.

Inverter-duty motors are wound with voltage spike-resistant, inverter-grade magnet wire to minimize adverse effects of ASD-produced waveforms. Improved insulation systems do not degrade as readily when subjected to transient voltage spikes. A greater thickness or build-up of premium varnish (through multiple dips and bakes) minimizes the potential for internal voids, and a lower heat rise design results in improved resistance to voltage stresses. Quality manufacturing also

Suggested Actions

- Obtain information from drive and motor manufacturers about inverter rise times and cable length effects, and use this information to evaluate the ability of existing motors to withstand drive-induced voltage stresses.
- Damaging reflected waves are generally not a problem when the distance between the motor and the drive is less than 15 feet.
- Voltage overshoots are more likely to occur with smaller motors and drives with faster rise times.
- The potential for damaging reflected waves is especially high when multiple motors are run from a single ASD.

Resources

U.S. Department of Energy—For additional information or resources on motor and motor-driven system efficiency improvement measures, visit the BestPractices Web site at www.eere.energy.gov/industry/bestpractices, or contact the EERE Information Center at (877) 337-3463.

National Electrical Manufacturers Association (NEMA)—Visit the NEMA Web site at www.nema.org for information on motor standards, application guides, and technical papers.

affects the corona inception voltage (CIV) of a motor. The CIV is a measure of the ability of the motor's windings to withstand voltage stresses and is the voltage at which partial discharges begin to occur.

Many manufacturers offer “inverter-friendly” insulation in their NEMA Premium® motors. These inverter-ready motors are suitable for variable torque loads over a wide speed range. The National Electrical Manufacturers Association (NEMA) specifies that insulation systems for low voltage (≤ 600 V) inverter-duty motors be designed to withstand an upper limit of 3.1 times the motor's rated line-to-line voltage. This is equivalent to an upper limit of 1,426 peak volts at the motor terminals for a 460 V rated motor. Rise times must equal or exceed 0.1 microsecond.

The insulation system on a 208/230 volt motor is identical to that of a 460 V motor. Thus, voltage spikes produced by inverters on 208 V or 230 V systems are unlikely to cause insulation damage at any cable length or drive carrier frequency.

Larger inverter-duty motors often have a constant speed auxiliary blower to provide adequate cooling at low motor operating speeds. Above the 500 frame size, inverter-duty motors should have both bearings insulated, and be equipped with a shaft grounding brush with a ground strap from the motor to the drive case.

Motor Selection Guidelines

- NEMA MG 1-2006 Part 30 provides performance standards for general-purpose motors used with ASDs. When operated under usual service conditions, no significant reduction in service life should occur if the peak voltage at the motor terminals is limited to 1000 V and rise times equal or exceed 2 microseconds. Contact the motor manufacturer for guidance relating to motor/drive compatibility when peak voltages or rise times are expected to exceed these limits. A definite-purpose inverter-duty motor and/or filters, chokes, or other voltage conditioning equipment may be required.
- Specify inverter-duty motors when operating at extremely low speeds or when operation over base speed is required.
- When an inverter-duty motor is required, ensure that it is designed and manufactured to meet the most current specifications defined by NEMA MG 1 Section IV, “Performance Standards Applying to All Machines,” Part 31 “Definite-Purpose Inverter-Fed Polyphase Motors.”

Minimize Adverse Motor and Adjustable Speed Drive Interactions

Electronic adjustable speed drives (ASDs) are an extremely efficient and valuable asset to motor systems. They allow precise process control and provide energy savings within systems that do not need to continuously operate at full output.

The most common ASD design sold today is the pulse-width modulated (PWM) ASD with a fast rise-time insulated gate bipolar transistor (IGBT) to reduce switching losses and noise levels. However, higher carrier frequencies and faster rise time transistors on PWM ASDs can produce voltage spikes or overshoots that can stress motor windings and bearings. These problems can be eliminated through proper design and equipment selection.

Electronic Adjustable Speed Drive Characteristics

All electronic adjustable speed drives rectify the 60 Hz fixed voltage alternating current (AC) to direct current (DC), and use an inverter to simulate an adjustable frequency and variable voltage AC output. Transistors, or electronic “switches,” create the AC voltage output, but have very high losses when they create wave shapes other than square waves.

To minimize switching losses and approximate sine waves, ASDs operate these switches full-on or full-off, creating square waves of much higher frequency than the fundamental, usually between 2 kHz and 20 kHz. This is called a carrier wave (see Figure 1). Each on-portion of the carrier wave is called a pulse and the duration of on-time of each pulse is called the pulse width. The pulses do not turn on instantaneously; there is a brief rise time.

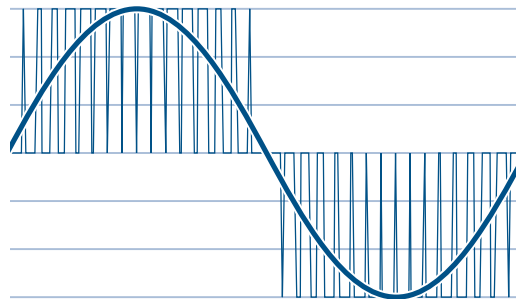

Figure 1. Sine wave overlaid on square carrier waves

Different types of transistors used in drives have different rise times. Voltage spikes originate with fast rise time, and carrier frequencies above 5 kHz are likely to cause bearing damage unless protective measures are taken.

Design Considerations

Several design considerations should be taken into account when purchasing an ASD or fixing problems with an existing one. On new installations, ensure that no harm comes to motors by minimizing the cable length from the ASD to the motor. As shown in Figure 2, ASDs can produce voltage overshoots or spikes with the increase over the normal peak voltage dependent upon both cable length and carrier frequency.

In Figure 2, the voltage increase is plotted against rise time in microseconds. Rise time is the time required for the voltage to increase from 10% to 90% of its steady state value. The rise time is a characteristic of the power transistor switches and can be provided by the drive supplier. Modern IGBT switches operate well down toward the left side of the graph so cable lengths of 50 feet or more almost always need mitigation.

Suggested Actions

To best avoid or mitigate voltage overshoots, consider locating the drive close to the motor. Where this is not possible, consider installing filtering devices such as:

- line inductors at the drive end of the cable
- harmonic suppression filters at the motor end of the cable.

Eliminate problems of current flow across the rolling elements of the motor’s bearings by isolating both bearings or using a shaft-grounding brush.

Resources

U.S. Department of Energy—For additional information or resources on motor and motor-driven system efficiency improvement measures, visit the BestPractices Web site at www.eere.energy.gov/industry/bestpractices, or contact the EERE Information Center at (877) 337-3463.

National Electrical Manufacturers Association (NEMA)—Visit the NEMA Web site at www.nema.org for information on motor standards, application guides, and technical papers.

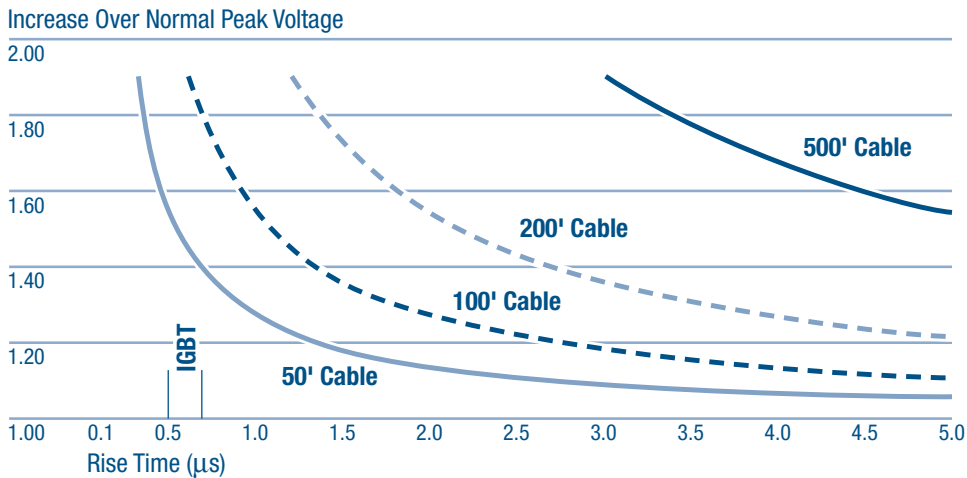

Figure 2. Effect of cable length on voltage increase

Longer cables reflect the voltage rise so that the reflections reinforce the original pulse rise. This produces electrical resonance or “ringing” characterized by an oscillating voltage overshoot. With short cables, rapid rise time is not a problem.

Existing general purpose low-voltage motors may work fine with PWM ASDs if peak voltages due to ringing are held below 1000 volts. If high frequency voltage overshoots exceed 1000 volts, electrical stresses can cause a turn-to-turn short within a motor coil group, usually within the first couple of turns.

Voltage overshoot is best avoided by locating the drive close to the motor. If a short cable run is not possible, a filtering device must be used. Sometimes ASD manufacturers provide a filter device along with the drive or even in the drive cabinet. There are two commonly used filter arrangements—*line inductors* (sometimes called load reactors), which should be placed at the drive end of the cable, and *harmonic suppression filters*, which are placed at the motor end of the cable. There are some losses associated with the filters, so keeping cables short is still the best alternative.

The fast rise time pulses from a PWM ASD can also create a potentially harmful current flow in bearings even when over-voltage is not significant. Causes include common mode voltage problems and/or line voltage unbalance on the ASD input. Capacitive coupling, resulting from irregular current waveforms and ground-mode currents, can cause bearing failure due to rapid voltage changes and a high frequency voltage potential on the shaft causing current flow across the rolling elements of the motor’s bearings. Problems can also occur in driven-load bearings if insulated couplings are not used. Eliminate these problems by isolating both bearings or using a shaft grounding brush.

Appendix C: EAct Efficiency Levels and Premium Efficiency Levels

Starting in October 1997, the Energy Policy Act (EAct) of 1992 required most general-purpose polyphase squirrel-cage induction motors manufactured for sale in the United States rated 1 through 200 horsepower to meet minimum efficiency standards.

In addition to the standards below, the American Council for an Energy-Efficient Economy (ACEEE) and the National Electrical Manufacturers Association (NEMA) have agreed to a new set of proposed energy efficiency standards for industrial electric motors. ACEEE and NEMA have submitted letters containing these recommendations to the House Energy and Commerce Committee and the Senate Energy and Natural Resources Committee for their consideration in energy legislation now under development.

The agreement recommends that minimum energy efficiency standards be established or increased for three broad categories of electric motors by a date that is 36 months from the date of enactment. Specifically:

1. The minimum efficiency standards of general purpose, integral-horsepower induction motors currently covered by federal efficiency standards should be increased to the “NEMA Premium” efficiency level specified in NEMA Standards Publication MG-1 (2006), Table 12-12, with the exception of “fire pumps” that will remain at the current Table 12-11 level as specified in EAct 1992. This level of efficiency is already required for new motors acquired for federal facilities by the purchasing guidelines of the Federal Energy Management Program.
2. Efficiency standards should be enacted for seven types of low voltage polyphase, integral-horsepower induction motors not currently covered under federal law. Specifically, seven motor modifications excluded from EAct 1992 standards of electric motors sized from 1 to 200 horsepower should meet the efficiency standards currently applicable to general purpose motors of the same size (i.e., efficiency levels specified in NEMA Standards Publication MG-1 [2006], Table 12-11).
3. In addition, general purpose motors of NEMA design “B” 201 to 500 horsepower should meet energy-efficient levels specified in NEMA Standards Publication MG-1 (2006), Table 12-11.

The Act applies to general purpose, T-Frame, single-speed, foot-mounted, continuous rated, polyphase squirrel-cage induction motors of National Electrical Manufacturers Association (NEMA) Designs A and B. The subject motors are designed to operate on 230/460 volts and 60 Hertz and have open and closed enclosures. The Act applies to 6 pole (1200 RPM), 4 pole (1800 RPM), and 2 pole (3600 RPM) open and enclosed motors rated 1 through 200 horsepower. The Act does not apply to definite-purpose motors (i.e., those designed for use under unusual conditions or for use on a particular type of application which cannot be used in most general applications) or special purpose motors (i.e., those designed for a particular application with special operating characteristics or mechanical construction).

Electric Motor Efficiency Levels Prescribed in the Energy Policy Act of 1992						
Motor Horsepower	Nominal Full-Load Efficiency					
	Open Motors			Enclosed Motors		
	Speed (RPM)					
	1200	1800	3600	1200	1800	3600
1	80.0	82.5	--	80.0	82.5	75.5
1.5	84.0	84.0	82.5	85.5	84.0	82.5
2	85.5	84.0	84.0	86.5	84.0	84.0
3	86.5	86.5	84.0	87.5	87.5	85.5
5	87.5	87.5	85.5	87.5	87.5	87.5
7.5	88.5	88.5	87.5	89.5	89.5	88.5
10	90.2	89.5	88.5	89.5	89.5	89.5
15	90.2	91.0	89.5	90.2	91.0	90.2
20	91.0	91.0	90.2	90.2	91.0	90.2
25	91.7	91.7	91.0	91.7	92.4	91.0
30	92.4	92.4	91.0	91.7	92.4	91.0
40	93.0	93.0	91.7	93.0	93.0	91.7
50	93.0	93.0	92.4	93.0	93.0	92.4
60	93.6	93.6	93.3	93.6	93.6	93.0
75	93.6	94.1	93.0	93.6	94.1	93.0
100	94.1	93.0	93.6	94.1	94.5	93.6
125	94.1	94.5	93.6	94.1	94.5	94.5
150	94.5	95.0	93.6	95.0	95.0	94.5
200	94.5	95.0	94.5	95.0	95.0	95.0

The NEMA Motor and Generator Section established a NEMA Premium® energy efficiency motors program to provide highly energy efficient products that meet the needs and applications of users and original equipment manufacturers based on a consensus definition of “premium efficiency” and use of the NEMA Premium logo for premium products. NEMA Premium energy efficiency motors are more efficient than equivalent rated motors that meet the EPA efficiency levels.

The NEMA Premium efficiency electric motor program scope is single-speed, polyphase, 1-500 horsepower, 2, 4, and 6 pole, squirrel cage induction motors, NEMA Design A or B, continuous rated. Products must meet or exceed the nominal energy efficiency levels presented below. The NEMA Premium efficiency levels are contained in NEMA Standards Publication MG 1- 2003, in Tables 12-12 and 12-13, respectively.

Nominal Efficiencies for NEMA Premium® Induction Motors Rated 600 Volts or Less (Random Wound)						
hp	Open Drip-Proof					
	1200 RPM (6-pole)		1800 RPM (4-pole)		3600 RPM (2-pole)	
	EAct*	NEMA Premium	EAct*	NEMA Premium	EAct*	NEMA Premium
1	80.0	82.5	82.5	85.5	N/A	77.0
1.5	84.0	86.5	84.0	86.5	82.5	84.0
2	85.5	87.5	84.0	86.5	84.0	85.5
3	86.5	88.5	86.5	89.5	84.0	85.5
5	87.5	89.5	87.5	89.5	85.5	86.5
7.5	88.5	90.2	88.5	91.0	87.5	88.5
10	90.2	91.7	89.5	91.7	88.5	89.5
15	90.2	91.7	91.0	93.0	89.5	90.2
20	91.0	92.4	91.0	93.0	90.2	91.0
25	91.7	93.0	91.7	93.6	91.0	91.7
30	92.4	93.6	92.4	94.1	91.0	91.7
40	93.0	94.1	93.0	94.1	91.7	92.4
50	93.0	94.1	93.0	94.5	92.4	93.0
60	93.6	94.5	93.6	95.0	93.0	93.6
75	93.6	94.5	94.1	95.0	93.0	93.6
100	94.1	95.0	94.1	95.4	93.0	93.6
125	94.1	95.0	94.5	95.4	93.6	94.1
150	94.5	95.4	95.0	95.8	93.6	94.1
200	94.5	95.4	95.0	95.8	94.5	95.0
250		95.4		95.8		95.0
300		95.4		95.8		95.4
350		95.4		95.8		95.4
400		95.8		95.8		95.8
450		96.2		96.2		95.8
500		96.2		96.2		95.8

Efficiencies for NEMA Premium® Induction Motors Rated 600 Volts or Less (Random Wound)						
hp	Totally Enclosed Fan-Cooled					
	1200 RPM (6-pole)		1800 RPM (4-pole)		3600 RPM (2-pole)	
	EAct*	NEMA Premium	EAct*	NEMA Premium	EAct*	NEMA Premium
1	80.0	82.5	82.5	85.5	75.5	77.0
1.5	85.5	87.5	84.0	86.5	82.5	84.0
2	86.5	88.5	84.0	86.5	84.0	85.5
3	87.5	89.5	87.5	89.5	85.5	86.5
5	87.5	89.5	87.5	89.5	87.5	88.5
7.5	89.5	91.0	89.5	91.7	88.5	89.5
10	89.5	91.0	89.5	91.7	89.5	90.2
15	90.2	91.7	91.0	92.4	90.2	91.0
20	90.2	91.7	91.0	93.0	90.2	91.0
25	91.7	93.0	92.4	93.6	91.0	91.7
30	91.7	93.0	92.4	93.6	91.0	91.7
40	93.0	94.1	93.0	94.1	91.7	92.4
50	93.0	94.1	93.0	94.5	92.4	93.0
60	93.6	94.5	93.6	95.0	93.0	93.6
75	93.6	94.5	94.1	95.4	93.0	93.6
100	94.1	95.0	94.5	95.4	93.6	94.1
125	94.1	95.0	94.5	95.4	94.5	95.0
150	95.0	95.8	95.0	95.8	94.5	95.0
200	95.0	95.8	95.0	96.2	95.0	95.4
250		95.8		96.2		95.8
300		95.8		96.2		95.8
350		95.8		96.2		95.8
400		95.8		96.2		95.8
450		95.8		96.2		95.8
500		95.8		96.2		95.8

**Nominal Efficiencies for NEMA Premium® Induction Motors Rated Medium Volts
— 5kV or Less (Form Wound)**

Open Drip-Proof			
hp	6-pole	4-pole	2-pole
250-500	95.0	95.0	94.5

**Nominal Efficiencies for NEMA Premium® Induction Motors Rated Medium Volts
— 5kV or Less (Form Wound)**

Totally Enclosed Fan-Cooled			
hp	6-pole	4-pole	2-pole
250-500	95.0	95.0	95.0

Appendix D: Motor Repair Service Center Checklist

The first two parts of the checklist assess service center capability. These respectively assess capacity capability and specific capability. Capacity pertains mainly to the size of motors that can be accommodated. Specific capability pertains mainly to the ability to do certain repairs that may not routinely be part of all motor rebuilds. Limitations of these capabilities do not necessarily indicate efficiency or quality problems for repair jobs not requiring those capabilities.

Motor Repair Service Center Checklist

Capacity Capability (for multiple devices, list maximum capability of each)

What is the largest motor for which the service center is fully equipped to rewind and test in-house?

	Rewind Capability	Testing
Weight	_____	_____
Length	_____	_____
Diameter	_____	_____
Horsepower	_____	_____
Voltage	_____	_____

Record Keeping

How long does service center keep records on each repaired motor? _____
 (Obtain sample copy of filled-in job card or computer printout.)

Specific Repair Capability

Check services offered:
Random wound polyphase ac motor repair
Form wound polyphase ac motor repair
dc motor repair
Single-phase motor repair
Machine shop capability

Appendix D: Motor Repair Service Center Checklist

<p>What primary methods of winding removal are used?</p> <p><input type="checkbox"/> Controlled Burn-out; typical temperature ____F (If sometimes higher, explain circumstances.)</p> <p><input type="checkbox"/> Chemical Stripping</p> <p><input type="checkbox"/> Mechanical Pulling at temperature under 400°F</p> <p><input type="checkbox"/> Other</p>	<p>Burnout most common. Best if core kept under 680°F.</p> <p>Mechanical pulling at reduced temperature can flare laminations and increase stray loads. It is rare in United States.</p>
<p>How does the service center ensure that the correct wire sizes and types are available for rewinding?</p> <p>What does the service center do if exact wire size is not in inventory?</p>	<p>Evidence of quick availability of all round wire sizes is important. Availability from in-house stock, quick pipeline to supplier, or explanation of stranding to replicate original circular mills can all be acceptable. Wire should be inverter grade if inverter powered motors will be rewound.</p>
<p>On random wound motors, is winding pattern ever revised for reasons other than customer ordered redesign?</p> <p><input type="checkbox"/> Yes <input type="checkbox"/> No</p> <p>If yes, what changes?</p> <p><input type="checkbox"/> Lap to concentric</p> <p><input type="checkbox"/> Concentric to lap</p> <p><input type="checkbox"/> Other (explain)</p>	<p>It is best to replicate the original winding pattern. However, it can be difficult to replicate some stator windings. Service center should have policies and technical guides to ensure original or better motor performance.</p>
<p>How many employees have the following years of experience?</p> <p>_____ More than 8 years</p> <p>_____ 4 - 8 years</p> <p>_____ Less than 4 years</p>	<p>Desirable to have 20% or more with more than 4 years experience.</p>
<p>What sort of supplemental training or professional development activity is offered to service center employees? (Obtain evidence if possible.)</p> <p><input type="checkbox"/> In-house training or structured mentoring (Describe)</p> <p><input type="checkbox"/> Off-site short courses, workshops or seminars one or more days in length</p> <p><input type="checkbox"/> Subsidized evening or part-time classes at college or trade school</p> <p><input type="checkbox"/> Attendance at trade conferences or conventions</p> <p><input type="checkbox"/> Other</p>	<p>Participation in job-related trainings is commendable. EASA offers many training courses and holds an annual convention.</p>
<p>How much training or professional development do service center employees receive?</p> <p>_____ Percentage of employees receiving offsite training annually</p> <p>_____ Average days off-site per year per employee receiving offsite training</p> <p>_____ Annual training expenditure per employee receiving off-site training</p>	<p>A training program culture involving formal internal or off-site training is desirable. Monitoring for continuous improvement such as tracking scrap rate and completed motor test results contributes to a more competent and careful staff.</p> <p>At least 10% should receive annual off-site training.</p> <p>One or more days off-site desirable. \$300 or more per employee desirable.</p>

In what trade or professional associations does service center have membership? _____

EASA membership is a definite plus, although very large service centers may have in-house capability to provide similar benefits.

What temperature classes of insulation are stocked and used? _____

F or H desirable.

What (if any) kind of core loss testing does service center use?

Loop or ring test; max kVA _____

Commercial tester; max kVA _____

Using a tester on all motors is evidence that service center is conscientious about core losses.

How often do they use it? _____

Are test records kept on permanent file? Yes No

How are results used? Check all that apply:

Check for hot spots to be repaired

Note watts per pound and compare to a standard

Document impact of burnout/rewind to customer

Certainly check for hot spots. Noting watts per pound and comparison to standard or before and after testing is commendable.

Is no-load testing done on all motors? Yes No

This should be mandatory for operational motors. If not, determine why not. Test should verify rotation at nameplate speed in the correct direction and check for abnormal sounds. It should also ensure that vibration and bearing temperature are not abnormally high.

Equipment Calibration

Item	Normal interval	Date last calibrated or certified
Ammeters	_____	_____
Wattmeters	_____	_____
Core Loss Tester	_____	_____
Burnout oven temp.	_____	_____
Micrometers & Calipers	_____	_____
Megohmmeter	_____	_____
Voltmeter	_____	_____

Annual

Annual

Annual

Annual

Annual OK; 6 months better. May be done in-house to certified clean dry standard blocks.

Annual

Annual

Appendix D: Motor Repair Service Center Checklist

<p>Surge Comparison Tester Brand _____ Model _____</p>	<p>Annual</p>
<p>ac Power Supply Voltage Range _____ kVA _____ Continuously variable voltage? _____</p>	<p>Annual on volts, amps, and power factor or watts unless these are monitored by the portable instruments above.</p>
<p>dc Power Supply Voltage Range _____ kW _____ Continuously variable voltage? _____</p>	<p>Annual on volts, amps, or watts unless these are monitored by the portable instruments above.</p>
<p><i>What % of motor rewind jobs get core loss testing both before and after rewinding? _____%</i></p>	<p>Ideally 100%. Explain lower percentages.</p>
<p>Varnish and resins spec. _____ spec. _____ spec. _____ spec. _____ spec. _____</p>	<p>Sample should have been taken and analyzed every 2-3 months, to ensure no degradation from aging.</p> <p>Manufacturer's material specs should be on file.</p>
<p>Vibration Analysis Equipment Brand _____ Model _____</p>	<p>Annual</p> <p>Annual to a certified standard resistance.</p>
<p><i>High Potential Tester (HiPot)</i> Brand _____ Model _____ ac rating _____ dc rating _____</p>	

Documents and Record Keeping

Check whether current copies of all the following documents are present. The dates shown below are current as of this printing:

- NEMA MG1-2003 Motors and Generators
- ABMA Std 7 Shaft & Housing Fits for Metric Radial Ball & Roller Bearings. 1995
- ABMA Std 20 Radial Bearings of Ball, Cylindrical Roller and Spherical Roller Types Metric Design. 1996
- ISO 1940-1 Mechanical Vibration – Balance Quality Requirements of Rigid Rotors Part 1. 2003
- ISO 10816-1 Mechanical vibration – Evaluation of machine vibration by measurements on non-rotating parts – Part 1: General guidelines. 1995
- ISO 9001, Quality Management and Quality Assurance. 2000
- IEEE Std 43 Testing Insulation Resistance of Rotating Machines. 2000
- IEEE Std 112 Test Procedures for Polyphase Induction Motors and Generators. 2004
- IEEE Std 432 Insulation Maintenance for Rotating Electric Machinery (5 HP to Less Than 10,000 HP). 1992
- IEEE Std 1068 Recommended Practice for the Repair and Rewinding of Motors for the Petroleum & Chemical Industry. 1996 (2)
- UL 674 Electric Motors and Generators for Use in Division 1 Hazardous (Classified) Locations. 2003 (1)
- EASA Technical Manual. 2002 (2)
- EASA Winding DATA on CD. 2001 (2)
- EASA Warranty. October 1999 (2)
- ANSI/EASA AR100-2001 Recommended Practice for the Repair of Rotating Electrical Apparatus

(1) Not applicable for service centers which do not serve this market

(2) Non-EASA members should produce equivalent documents or file material.

Reference:

Quality Electric Motor Repair: A Guidebook for Electric Utilities. This document, prepared by Washington State Energy Office, was originally co-sponsored and printed by Bonneville Power Administration as DOE/BP-2747, Nov. 1995 and Electric Power Research Institute as EPRI TR-105730s, June 1996. The Bonneville Power printing is available for download at www.osti.gov.

Original text authored by Johnny Douglass, Washington State University Energy Program

WSUEEP99004

Appendix E: Guidelines for Comments

Comments that can correct and improve this sourcebook are appreciated. Please copy this page and provide suggestions to the address listed below.

Improving Motor and Drive Performance: A Sourcebook for Industry Comment Form

Page Number(s)

Comments

From:

Contact: EERE Information Center
P.O. Box 43165
Olympia, WA 98504-3165
Phone: 877-EERE-INF (887-337-3463)
Fax: 360-236-2023



**About the Office of
Energy Efficiency and Renewable Energy**

A Strong Energy Portfolio for a Strong America
Energy efficiency and clean, renewable energy will mean a stronger economy, a cleaner environment, and greater energy independence for America. Working with a wide array of state, community, industry, and university partners, the U.S. Department of Energy's Office of Energy Efficiency and Renewable Energy invests in a diverse portfolio of energy technologies.

Industrial Technologies Program

**U.S. Department of Energy
Energy Efficiency and Renewable Energy
Washington, DC 20585-0121**

**Improving Motor and Drive System Performance:
A Sourcebook for Industry**

One in a series of industrial energy efficiency sourcebooks

To order additional copies of this sourcebook,
please contact:

EERE Information Center
1-877-EERE-INF
(1-877-337-3463)
www.eere.energy.gov

September 2008
DOE/GO-102008-2317