

Design and Evaluation of Effective Crosswalk Illumination

FINAL REPORT

Submitted by

John D. Bullough
Senior Research Scientist
Lighting Research Center
Rensselaer Polytechnic Institute

Xin Zhang
Graduate Research Assistant
Lighting Research Center
Rensselaer Polytechnic Institute

Nicholas P. Skinner
Senior Research Specialist
Lighting Research Center
Rensselaer Polytechnic Institute

Mark S. Rea
Director and Professor
Lighting Research Center
Rensselaer Polytechnic Institute



NJDOT Project Manager
Nazhat Aboobaker

In cooperation with

New Jersey
Department of Transportation
Bureau of Research
And
U.S. Department of Transportation
Federal Highway Administration

DISCLAIMER STATEMENT

The contents of this report reflect the views of the authors who are responsible for the facts and the accuracy of the data presented herein. The contents do not necessarily reflect the official views or policies of the New Jersey Department of Transportation or the Federal Highway Administration. This report does not constitute a standard, specification, or regulation.

TECHNICAL REPORT STANDARD
TITLE PAGE

1. Report No. FHWA-NJDOT-2009-003		2. Government Accession No.		3. Recipient's Catalog No.	
4. Title and Subtitle FINAL REPORT Design and Evaluation of Effective Crosswalk Illumination				5. Report Date March 2009	
				6. Performing Organization Code	
7. Author(s) Bullough, John D., Xin Zhang, Nicholas P. Skinner and Mark S. Rea				8. Performing Organization Report No. FHWA-NJDOT-2009-003	
9. Performing Organization Name and Address Lighting Research Center, Rensselaer Polytechnic Institute 21 Union Street Troy, NY 12180 USA				10. Work Unit No.	
				11. Contract or Grant No. 2008-03	
12. Sponsoring Agency Name and Address New Jersey Department of Transportation Federal Highway Administration P.O. Box 600 U.S. Department of Transportation Trenton, NJ 08625 Washington, DC				13. Type of Report and Period Covered FINAL REPORT 2008-2009	
				14. Sponsoring Agency Code	
15. Supplementary Notes Nazhat Aboobaker was the NJDOT Project Manager. John D. Bullough, Ph.D. and Mark S. Rea, Ph.D. were Co-Principal Investigators.					
16. Abstract Pedestrian-related crashes are a common cause of roadway fatalities, and reduced visibility at night is a probable contributor to pedestrian injuries and death. The purpose of the present study was to systematically evaluate different approaches to lighting at pedestrian crosswalks to improve pedestrian visibility and detection. The project team conducted a series of photometrically accurate lighting simulations in order to assess the visual conditions resulting from different lighting configurations, and assessed the economics (initial cost, and electricity and maintenance costs) of each system evaluated. Finally, the most promising lighting configuration was field tested during a one-night demonstration at an intersection in New Jersey. The results of visual performance and economic evaluations converged in that they suggested that a bollard-based fluorescent lighting system mounted at the ends of a crosswalk and oriented to provide vertical illumination on pedestrians in the crosswalk could be a feasible approach with reduced costs to improving pedestrian visibility. The results of the field demonstration also confirmed that the bollard-based solution was practical. Improvements of the approach such as use of louvers for glare control and coordinating light output level with the timing of pedestrian signals to provide an alerting signal are also provided.					
17. Key Words Crosswalk Lighting, Vertical Illuminance, Pedestrian Safety, Field Demonstration			18. Distribution Statement		
19. Security Classif. (of this report) Unclassified		20. Security Classif. (of this page) Unclassified		21. No of Pages 60	22. Price

ACKNOWLEDGMENTS

The authors gratefully acknowledge support from the New Jersey Department of Transportation (NJDOT) and the Federal Highway Administration, through the University Transportation Research Consortium (UTRC) of the City University of New York, for conducting the study described in this report. Nazhat Aboobaker, NJDOT Project Manager, assisted in the development of the questionnaire used in the field demonstration and provided helpful advice and guidance throughout the project. Former Project Manager W. Lad Szalaj was very helpful in the initial phases of the project. Joseph Powell and Debbie Kingsland from NJDOT's Office of Bicycle and Pedestrian Programs also provided very useful comments throughout the project. Camille Kamga from UTRC assisted in project management and administration. Howard Ohlhous from the Lighting Research Center (LRC) at Rensselaer Polytechnic Institute helped construct the luminaires used in the field demonstration. The authors also gratefully acknowledge the assistance of James Cleary, Old Bridge Township Engineer; Kenneth Preteroti, Middlesex County Engineering Department; Shari Blinn, Toubin Properties; Robert Oliver, Levin Management; Captain Robert Bonfante, Old Bridge Police Traffic and Safety Bureau; Dale Sulpy, New Jersey Transit Director of Bus Safety Operations; and Eric Anderson and Christopher Hammelef, Hadco Lighting; for their assistance and advice in setting up the field demonstration. Joseph Powell from NJDOT, Fredric Rubenstein, Chief Regional Supervisor, New Jersey Transit; Richard Gierolewicz, Supervisor of Terminal Operations, New Jersey Transit; and Officer Ronald Atlak, Old Bridge Police Department are also thanked for their participation during the nighttime crosswalk lighting field demonstration in Old Bridge, NJ.

TABLE OF CONTENTS

	Page
EXECUTIVE SUMMARY	1
BACKGROUND.....	2
OBJECTIVES	3
INTRODUCTION	4
LITERATURE REVIEW	6
Current Regulations and Recommendations.....	6
Previous Research Studies on Illuminance Requirements.....	8
Characterizing Visual Performance	9
Glare	13
Driving Behavior at Crosswalks.....	15
ANALYSES AND RESULTS.....	16
Visual Performance Analysis Approach.....	16
Economic Analysis Approach	36
Short-Term Field Demonstration.....	42
CONCLUSIONS AND RECOMMENDATIONS	48
IMPLEMENTATION AND TRAINING.....	50
REFERENCES	51

LIST OF FIGURES

Figure 1. Illustration of the Swiss crosswalk lighting method^(11,12)

Figure 2. RVP values⁽⁴⁾ as a function of luminance (left abscissa) and contrast (right abscissa)

Figure 3. Age-related reduction in retinal illuminance caused by lens thickening and yellowing and by pupil size reductions⁽⁴⁾

Figure 4. Comparison of predicted visual performance⁽⁴⁾ and measured performance for an office data entry task⁽⁷⁾

Figure 5. Measured visual response times for simulated highway sign stimuli⁽⁸⁾ and predictions based on RVP⁽⁴⁾

Figure 6. Schematic plan view layout of crosswalk scenarios.

Figure 7. a) Schematic diagram of conventional crosswalk lighting; b) computer simulation view; c) visual performance and glare summary

Figure 8. a) Schematic diagram of crosswalk lighting with luminaires located 15 ft ahead of crosswalk; b) computer simulation view; c) visual performance and glare summary

Figure 9. a) Schematic diagram of bollard-based crosswalk lighting and luminaire distribution; b) computer simulation view; c) visual performance and glare summary

Figure 10. a) Schematic diagram of pole-mounted spotlight crosswalk lighting and luminaire distribution; b) computer simulation view; c) visual performance and glare summary

Figure 11. a) Schematic diagram of overhead "S" shaped crosswalk lighting and luminaire distribution; b) computer simulation view; c) visual performance and glare summary

Figure 12. a) Schematic diagram of overhead point source array crosswalk lighting; b) computer simulation view; c) visual performance summary

Figure 13. a) Schematic diagram of batwing array crosswalk lighting and luminaire distribution; b) computer simulation view; c) visual performance and glare summary

Figure 14. a) Schematic diagram of indirect overhead crosswalk lighting and luminaire distribution; b) computer simulation view; c) visual performance summary

Figure 15. a) Schematic diagram of overhead "sparkle" mesh lighting and luminaire distribution; b) computer simulation view; c) visual performance summary

Figure 16. a) Schematic diagram of overhead batwing "sparkle" mesh lighting and luminaire distribution; b) computer simulation view; c) visual performance summary

Figure 17. a) Schematic diagram of overhead "S" shaped LED crosswalk lighting and luminaire; b) computer simulation view; c) visual performance summary

Figure 18. a) Schematic diagram of revised fluorescent bollard-based crosswalk lighting and luminaire; b) computer simulation view; c) visual performance and glare summary

Figure 19. a) Schematic diagram of revised LED overhead crosswalk lighting; b) computer simulation view; c) visual performance summary

Figure 20. a) Four-corner fluorescent pole-based crosswalk lighting system luminaire appearance and distribution; b) computer simulation view; c) visual performance summary

Figure 21. a) Refined fluorescent bollard-based crosswalk lighting system luminaire appearance and distribution; b) computer simulation view; c) visual performance summary

Figure 22. a) Schematic diagram of refined LED overhead crosswalk lighting; b) computer simulation view; c) visual performance summary

Figure 23. a) View of crosswalk lighting while looking south; b) view of crosswalk lighting while looking north

Figure 24. a) View toward crosswalk from Texas Road, showing the light pattern along the crosswalk; b) view of pedestrian crossing the road, showing the relatively high vertical illuminances

Figure 25. Illuminated area along sidewalk provided by the prototype lighting system

Figure 26. Glare responses

Figure 27. Visibility responses

Figure 28. Shadow responses

Figure 29. Brightness responses

Figure 30. Pedestrian comfort responses

Figure 31. Driver comfort responses

LIST OF TABLES

Table 1 - Recommended illuminances for high pedestrian conflict areas⁽²⁾

Table 2 - Recommended illuminances for medium pedestrian conflict areas⁽²⁾

Table 3 - Recommended illuminances for low pedestrian conflict areas⁽²⁾

Table 4 - Recommended illuminances for different road types in pedestrian areas⁽⁹⁾

Table 5 - Economic analysis for overhead "S" shaped LED crosswalk lighting

Table 6 - Economic analysis for fluorescent bollard crosswalk lighting

Table 7 - Economic analysis for overhead LED crosswalk lighting

Table 8 - Economic analysis for fluorescent pole-based crosswalk lighting

Table 9 - Economic analysis for revised fluorescent bollard-based crosswalk lighting

Table 10 - Economic analysis for revised overhead LED array crosswalk lighting

EXECUTIVE SUMMARY

Background

Pedestrian-related crashes are a common cause of roadway fatalities, and reduced visibility at night is a probable contributor to pedestrian injuries and death.

Objectives

The purpose of the present study was to systematically evaluate different approaches to lighting at pedestrian crosswalks to improve pedestrian visibility and detection.

Research Approach

The project team conducted a series of photometrically accurate lighting simulations in order to assess the visual conditions resulting from different lighting configurations, and assessed the economics (initial cost, and electricity and maintenance costs) of each system evaluated. Finally, the most promising lighting configuration was field tested during a one-night demonstration at an intersection in New Jersey.

Analyses and Results

The results of visual performance and economic evaluations converged in that they suggested that a bollard-based fluorescent lighting system mounted at the ends of a crosswalk and oriented to provide vertical illumination on pedestrians in the crosswalk could be a feasible approach with reduced costs to improving pedestrian visibility.

Conclusions and Recommendations

The results of the field demonstration also confirmed that the bollard-based solution was practical. Improvements of the approach such as use of louvers for glare control and coordinating light output level with the timing of pedestrian signals to provide an alerting signal are also provided.

BACKGROUND

Accidents involving pedestrians on crosswalks are a common cause of road fatalities. According to the National Highway Traffic Safety Administration (NHTSA), in 2006, more than 1000 pedestrians died when they were crossing the road or intersections, which accounted for more than 20% of the total number of pedestrians killed in traffic accidents. In New Jersey, the percentage of pedestrians killed in traffic accidents when they were crossing the road or intersections was higher.⁽¹⁾

Although the reasons for pedestrian accidents are multiple (speeding, alcohol, etc.), inadequate lighting at or adjacent to crosswalks might increase the risk to pedestrians crossing the road. The nighttime fatal accident rate in unlighted areas is around three times higher than the daytime rate.⁽²⁾ Normally, drivers detect the pedestrian and might respond with braking or other corrective action. The light level is directly related to visibility, and thus affects the responding time. Pedestrians often assume that drivers can see them clearly at night, based on their own ability to see the oncoming vehicles' headlamps.⁽³⁾ However, drivers often do not see pedestrians at night until they are within the safe stopping sight distance.⁽³⁾

Through an understanding of the way in which crosswalk lighting affects the visibility of pedestrians, there is a potential to reduce risk of pedestrians crossing the road by improving the lighting conditions. The objective of this study is to explore different ways to illuminate the crosswalk in order to improve pedestrian visibility and hopefully, safety.

OBJECTIVES

The request for proposals (RFP) issued by the New Jersey Department of Transportation (NJDOT) for the present study states:

"A frequent problem contributing to pedestrian accidents is inadequate lighting at or adjacent to crosswalks. Drivers often don't see a pedestrian in the crosswalk at night until it is too late. There are three types of lighting to be analyzed. The first is overhead lighting; this system would be a pedestrian activated overhead flashing light with a streetlight attached to the mast arm specifically configured to illuminate the rectangular crosswalk. The second is a system of lighting mounted 10 feet in advance of the crosswalk and angled to illuminate the entire crosswalk. The third option is lighting mounted to the curb face that would illuminate the crosswalk from street level. Crosswalk lighting will help alert drivers to see non-signalized crosswalks on multilane roadways. Markings could be words or symbols or a combination. The detection of the presence or absence of pedestrians leads to improved traffic flow. The curbside pedestrian detection system gives the option to cancel unnecessary or prank calls. It gives a better defined pedestrian waiting area."

The objectives of the present study are to investigate several alternatives for lighting along pedestrian crosswalks, including those described in NJDOT's RFP above, to improve the visibility of pedestrians. The criteria for evaluation include:

- Determination of the lighting distribution for the purpose of estimating the relative visual performance⁽⁴⁾ for drivers when approaching the crosswalk and for estimating the degree of glare experienced by drivers and pedestrians
- Estimation of the initial, energy and maintenance costs of alternative lighting systems to take into account equipment, electricity and labor costs

Based on these analyses of visual performance, glare and economic impacts, one of the promising candidate systems was developed for a short-term field demonstration, which provided the opportunity to obtain feedback from several individuals working in the areas of transportation, transit operations, and public safety, based on their in-person observations of the lighting.

INTRODUCTION

As described above, an important purpose of lighting at pedestrian crosswalks is to provide illumination that increases the visibility of pedestrians who may be crossing the street, or about to cross the street. For the purpose of the present project, focus is given on *illumination* systems, that is, lighting systems that provide illuminance on the pedestrians in and around the crosswalk, rather than on *indication* systems that provide a signal to drivers about the presence of pedestrians. Such latter systems were studied by NJDOT previously.⁽⁵⁾ For example, a system using in-ground, flashing lights embedded along the crosswalk edges was found to decrease approaching speeds and reduce the number of vehicle incursions into the crosswalk area, but such systems can be prone to maintenance issues, particularly in northern parts of the United States (U.S.) where regular snow plowing can lift objects from the paved surface of the roadway during wintertime.

Nonetheless, even lighting systems that are primarily designed for illumination can provide indication information, if their control is synchronized with traffic and pedestrian signals that might be found along many pedestrian crosswalks. The conclusions and recommendations section of the present report describes some approaches that could be integrated into recommendations for illumination systems that would provide such indication to drivers about the location of crosswalks and the likelihood that a pedestrian has entered or will be entering the crosswalk.

As will be described in more detail later in the present report, approaches to specifying lighting conditions necessary for sufficient pedestrian visibility have been primarily geared toward required illuminance levels (in units of lux or footcandles), either on the horizontal roadway surface or on a vertical plane corresponding to the expected locations of pedestrians. In general, specification of *vertical* rather than *horizontal* illuminance is more predictive of visibility, but visual performance is dependent upon not only the light level on an object to be seen, but also its contrast against its background (which in turn is partially dependent upon the reflectance [lightness] of the object), and its size. Different combinations of light level, object reflectance and size can result in levels of visual performance that are not always correlated with the light level alone.

In the present study, in order to more completely assess visibility, a model known as the relative visual performance (RVP) model⁽⁴⁾ is used as an initial screening tool for evaluating pedestrian visibility for different lighting geometries, locations and viewing conditions. The RVP model⁽⁴⁾ is cited in the Illuminating Engineering Society of North America (IESNA) *Lighting Handbook*⁽⁶⁾ as a basis for illuminance selection, and this model has been validated in a number of lighting application contexts including office work⁽⁷⁾ and traffic sign visibility.⁽⁸⁾ In addition, models for evaluating glare from outdoor lighting systems have been developed⁽⁶⁾ and a

lighting system that provides excellent visibility but also produces unacceptable levels of glare is not likely to be successful.

An additional criterion that is important for the evaluation of lighting systems in the context of pedestrian crosswalks is the cost, both the initial cost and the operating cost (e.g., accounting for electricity use and maintenance). Promising systems from the visual performance analyses that have very high costs relative to existing practices will not be practical.

Finally, based on the visual performance and economic analyses comparing different alternative approaches to lighting along pedestrian crosswalks, a real-world field installation is a valuable method for assessing practical and possibly unforeseen issues regarding the feasibility of a lighting system, and for validating the findings from analytical approaches. For this reason, the project team proposed to conduct a short-term field evaluation of the most promising lighting system based on the visibility and economic analyses, using input from public safety and transportation professionals to identify potential improvements and issues for consideration in a possible future implementation of the lighting system.

The subsequent sections of this report outline the findings from the literature review conducted for this study, describe the methods and results of the evaluations, and present conclusions and recommendations based on those findings.

LITERATURE REVIEW

The literature review focuses on two distinct categories of information:

- On the current regulations and recommendations by authorities such as the Illuminating Engineering Society North of America (IESNA) and the International Commission on Illumination (CIE)
- On previous research studies in this field

Current Regulations and Recommendations

As mentioned previously, darkness can increase the potential hazard to all the users of the roadway, which has been consistent with the ratio of the nighttime fatal accident rate to the daytime rate.⁽²⁾ Street lighting can reveal the environment beyond the range of vehicle headlamps and also can reduce the glare from oncoming vehicles by increasing the eye's adaptation level.⁽⁶⁾

The recommendations from the IESNA⁽²⁾ for roadway lighting have specified the required illuminance level for pedestrian conflict areas including the crosswalk. Considering that the pedestrian nighttime activity level varies with different districts (e.g., near a sports arena versus a commercial office district), the IESNA has classified the pedestrian conflict area into three levels by the magnitude of pedestrian flow: high, medium and low. A high area is defined as the one with significant number of pedestrians on the sidewalks or crossing the street during darkness, such as downtown retail areas, near cinemas, concert halls and transit terminals. Medium refers to an area with fewer numbers of pedestrians using the street at nighttime. The typical medium areas are downtown office areas, blocks with apartments and neighborhood shopping areas. Low refers to locations with low volumes of nighttime pedestrians, such as suburban residential streets and other low-density residential developments.

IESNA recommendations for light levels in pedestrian locations are based solely on illuminance, unlike many IESNA recommendations for roadway lighting, which can be based on illuminance or luminance values.

These include horizontal illuminances on the pavement and vertical illuminances at a height of 1.5 m (5 ft) in all directions of pedestrian travel. The detailed recommended illuminances for high, medium and low pedestrian conflict areas are shown in Tables 1, 2 and 3.

Table 1 - Recommended illuminances for high pedestrian conflict areas⁽²⁾

Recommended Illuminances for Walkways/Bikeways			
	E_H (lux)*	E_{Vmin} (lux)	E_{avg}/E_{min} **
Mixed Vehicle and Pedestrian***	20	10	4
Pedestrian Only	10	5	4

*10 lux is approximately equal to 1 footcandle.

**Horizontal only.

***Mixed Vehicle and Pedestrian refers to those areas where pedestrians are immediately adjacent to vehicular traffic without barriers or separation.

E_H = horizontal illuminance.

E_{Vmin} = minimum vertical illuminance at 1.5 m above walkway measured in both directions parallel to the main pedestrian flow.

Table 2 - Recommended illuminances for medium pedestrian conflict areas⁽²⁾

Recommended Illuminances for Walkways/Bikeways			
	E_H (lux)*	E_{Vmin} (lux)	E_{avg}/E_{min} **
Pedestrian Areas	5	2	4

*10 lux is approximately equal to 1 footcandle.

**Horizontal only.

E_H = horizontal illuminance.

E_{Vmin} = minimum vertical illuminance at 1.5 m above walkway measured in both directions parallel to the main pedestrian flow.

Table 3 - Recommended illuminances for low pedestrian conflict areas⁽²⁾

Recommended Illuminances for Walkways/Bikeways			
	E_H (lux)*	E_{Vmin} (lux)	E_{avg}/E_{min} **
Rural/Semi-Rural Areas	2	0.6	10
Low Density Residential	3	0.8	6
Medium Density Residential	4	1	4

*10 lux is approximately equal to 1 footcandle.

**Horizontal only.

E_H = horizontal illuminance.

E_{Vmin} = minimum vertical illuminance at 1.5 m above walkway measured in both directions parallel to the main pedestrian flow.

The CIE⁽⁹⁾ has not given a recommended light level value for crosswalk lighting, but it has specified light levels for pedestrian areas, which can be investigated for comparison purposes (Table 4). Similar to the IESNA, the CIE divides the road into several classes by the magnitude of pedestrian flow and specifies a recommended light level for each case.

Table 4 - Recommended illuminances for different road types in pedestrian areas⁽⁹⁾

Description of Road	Horizontal Illuminance	
	Average (lux)*	Minimum (lux)
High prestige road	20	7.5
Heavy nighttime use by pedestrians or bicyclists	10	3
Moderate nighttime use by bicyclists	7.5	1.5
Minor nighttime use by bicyclists or pedestrians solely associated with adjacent properties	5	1
Minor nighttime use by bicyclists or pedestrians solely associated with adjacent properties; important to preserve village or architectural character of environment	3	0.6
Very minor nighttime use by bicyclists or pedestrians solely associated with adjacent properties; important to preserve village or architectural character of environment	1.5	0.2

Previous Research Studies of Illuminance Requirements

Previous studies of crosswalk lighting trace back to the mid-1970s. The Federal Highway Administration (FHWA) commissioned a series of studies on fixed illumination for pedestrian safety to determine that the average recommended illuminance value for crosswalks should be 75 lux.⁽¹⁰⁾ The conclusion from these studies, although clear and straightforward, was not widely accepted by the American Association of State Highway and Transportation Officials (AASHTO) nor by the IESNA.

This study, by Freedman et al.,⁽¹⁰⁾ determined the *horizontal* illuminance needed for crosswalks. However, several studies further identified *vertical* illuminance as an important characteristic of crosswalk lighting. A recent field study to verify the benefit of crosswalk lighting technology originating in Switzerland⁽¹¹⁾ to pedestrian facilities in United States was performed by Hasson et al.⁽¹²⁾ According to the Swiss method, for roadways with pavement luminances less than 2 cd/m², poles should be placed on the approach side of the crosswalk and produce vertical illuminances of 40 lux (Figure 1).

Two sites with vertical illuminances between 8 and 11 lux were chosen by Hasson et al. for their field study. The comparison between the vertical illuminances resulting from current typical lighting designs (8 to 11 lux) and from the Swiss method (40 lux) indicated improvements both for the percentage of pedestrian "surrogate" targets seen and in the recognition of the number of surrogates. These results demonstrated that higher vertical illuminances resulted in better visibility in the crosswalk area. However, this experiment did not address

the issue of glare, which could also influence the visibility of pedestrians along crosswalks.

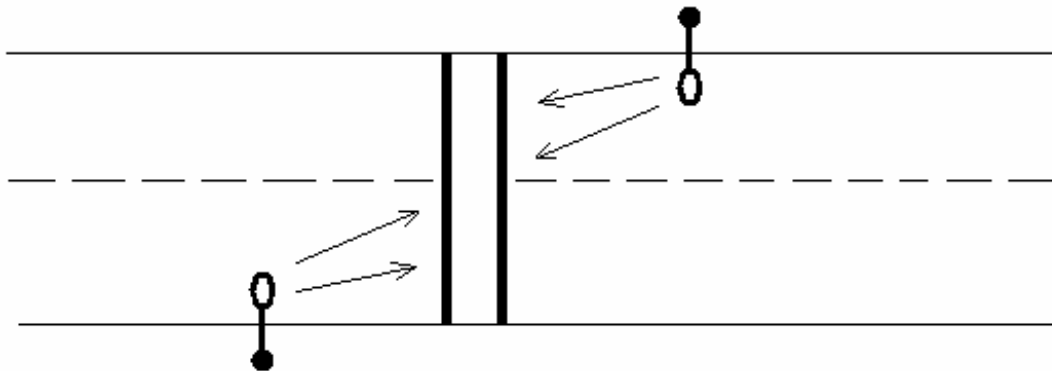

Figure 1. Illustration of the Swiss crosswalk lighting method^(11,12)

Since the influence of vertical illuminance on pedestrian visibility in the crosswalk area had been observed, a reasonable next step might be to determine the optimum value of vertical illuminance. In 2006, a study was conducted by Gibbons and Hankey.⁽¹³⁾ During their experiment, black-, denim- and white-clothed objects were located in randomly-assigned positions within a crosswalk illuminated to different levels using different lamp types, and participants were asked to detect the presence of the objects by pressing a button to record the response time. The experiment was repeated under different light levels of 5, 20, 40, or 60 vertical lux and under high pressure sodium (HPS) and metal halide (MH) lamps. Through the analysis of correct identifications and response times, vertical illuminances of 20 lux were found to be sufficient for pedestrian visibility, and there was no significant distinction between HPS and MH lamps.

Edwards and Gibbons⁽¹⁴⁾ conducted a similar study with different vertical illuminances (6, 10, 20 or 30 lux) and using two lamp types (HPS and MH). Twenty-six participants were asked to detect objects varying in color within a crosswalk area while driving a sport utility vehicle (SUV) equipped with low-beam halogen headlamps. Detection distance was used as the dependent variable in this study. The results revealed that object detection distance varied according to the light level, light source type and object type. The detection distance reached its highest, asymptotic, values at 30 lux for HPS and 20 lux for MH. Furthermore, the pedestrians dressed in white clothing showed better performance (in terms of visibility) than those dressed in other, darker, colors.

Characterizing Visual Performance

Illuminance on an object alone, as stated above, is not the only indicator of its visibility. The basis for visibility analyses summarized in this report is the RVP model developed by Rea and Ouellette.⁽⁴⁾ The RVP model provides a method for

determining the speed and accuracy with which visual information can be processed, given several relevant parameters:

- The size of the target
- The luminance of the background surrounding the target
- The luminance contrast between the target and its background
- The age of the observer

The RVP model⁽⁴⁾ was developed from the results of two experiments - one which measured response times to flashed targets varying in size and luminance contrast against surrounding backgrounds varying in luminance, and one which measured the speed and accuracy with which people could perform a numerical verification task. This task consisted of reading pages printed with two columns, each containing twenty five-digit numbers. All of the five-digit numbers on each page matched, except there was a single mismatched digit in zero to six of the five-digit numbers. Subjects in the experiment were asked to locate these mismatch errors on each page. The numerical verification task was performed under a range of lighting and luminance contrast conditions. Importantly, the results of each experiment were nearly identical, despite the very different methods they used, when the results were converted to the speed and accuracy of visual processing.

The RVP value is compared to the speed and accuracy of a reference condition corresponding to high light levels (such as those found in offices), high luminance contrast (such as that found on white laser-printed paper using black ink) and large size (such as 10- or 12-point type). This reference condition is defined to have an RVP value of one. RVP values close to one are expected to result in similar speeds and accuracy rates as the reference visual task would produce. RVP values of zero correspond to the legibility threshold (in other words, the point at which an object can be identified), and negative RVP values correspond to visual targets that can be detected but not identified (such as a shape in the road that could be an animal or a blowing item of trash but is not visible enough for someone to make the distinction).

Figure 2 shows a three-dimensional surface plot of RVP values for 10-point type varying in luminance contrast (i.e., having different ink lightnesses) and against a background varying in luminance (i.e., under different light levels). When both luminance and luminance contrast are low (i.e., reading light gray print on white paper under low light levels), visual performance drops precipitously. Once both luminance and luminance contrast have reached nearly asymptotic values (resulting in RVP values close to one), further increases in either luminance or luminance contrast will not substantially increase visual performance. This "plateau and escarpment" characteristic of visual performance has been illustrated in many other experiments as well. An RVP value of 0.9 is one that would result in excellent visibility, along the "plateau" of visual performance.

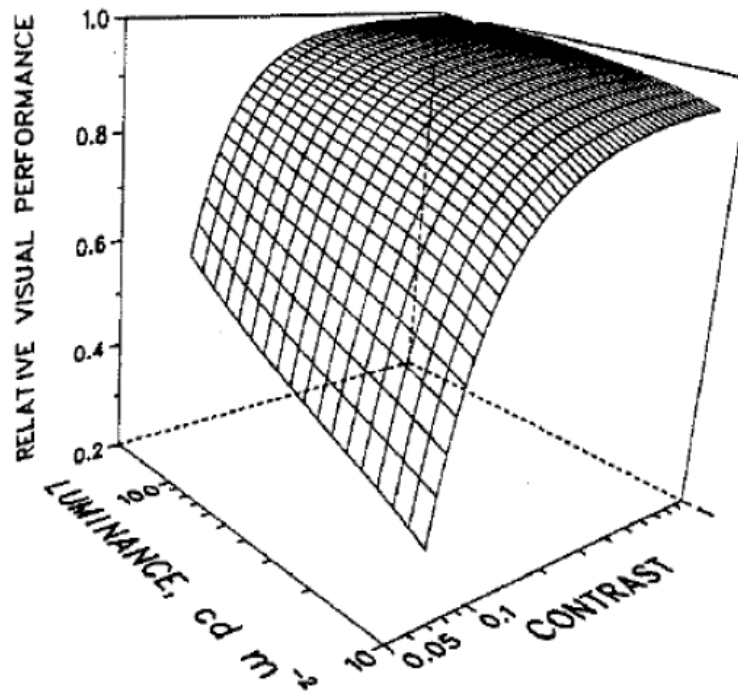

Figure 2. RVP values⁽⁴⁾ as a function of luminance (left abscissa) and contrast (right abscissa)

As described above, the size, background luminance, and luminance contrast of an object determine its visibility, but so does the age of the person viewing the object. Until a person reaches about 70 years in age, the eye undergoes gradual changes, mainly with respect to the transmission of light through the eye's lens, and with respect to the pupil size of the iris (this the aperture through which light travels when entering the eye). As one gets older, the lens increases in thickness and becomes more yellow in color, and the pupil size of the iris tends to get smaller. These effects taken together, result in an approximately linear reduction in the amount of light reaching the retina as one gets older. Figure 3⁽⁴⁾ illustrates this reduction in light as a function of age for individuals aged 20 years through 60 years. Until the age of about 70 years, these optical changes almost exclusively explain reductions in visibility exhibited by older adults, compared to younger adults. (After this age, effects such neurological and physiological deterioration contribute to reductions in visibility also.)

The RVP model is referenced by the IESNA *Lighting Handbook*⁽⁶⁾ as one of the methods used for assessing the impact of light levels for different lighting applications. An important consideration in the use of any model of visibility is the degree to which the model has been validated using independent data. Eklund et al.⁽⁷⁾ performed an experiment in which subjects were requested to identify alphanumeric codes of varying sizes (printed in 6 through 16 point text, and viewed from about 40 cm) printed in varying luminance contrasts (between 0.10

and 0.93) and background luminances (between 8 cd/m² and 2400 cd/m²). The performance obtained from subjects in this experiment (Figure 4) was highly correlated with the calculated values of RVP.⁽⁴⁾

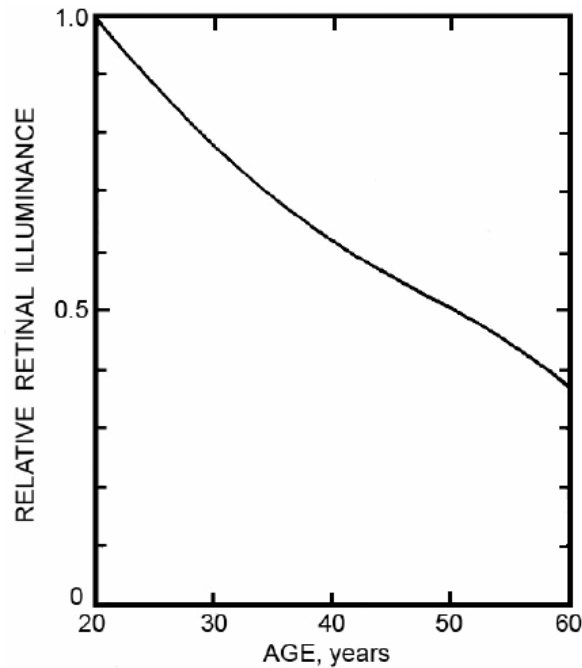

Figure 3. Age-related reduction in retinal illuminance caused by lens thickening and yellowing and by pupil size reductions⁽⁴⁾

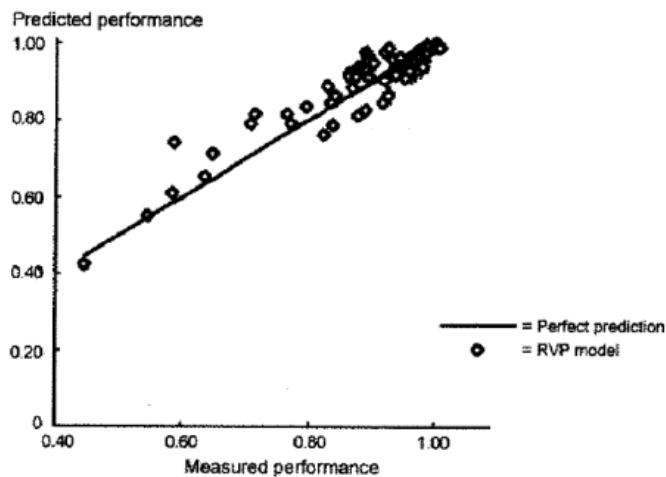

Figure 4. Comparison of predicted visual performance⁽⁴⁾ and measured performance for an office data entry task⁽⁷⁾

In a study related to highway sign visibility, Goodspeed and Rea⁽⁸⁾ evaluated the effects of luminance contrast and background luminance on the ability of individuals to accurately identify the orientation of Landolt "C" ring symbols. For

simulated highway sign displays, subjects were asked to identify the direction of the gap in the symbol (for a properly oriented "C" the gap is to the right). Subjects viewed conditions under several different levels of surround complexity in addition to different background luminance and luminance contrast conditions. Goodspeed and Rea compared their data to predictions of response time generated using the RVP model, and the RVP model closely predicted the measured response times (Figure 5) measured by Goodspeed and Rea,⁽⁸⁾ except at the lowest luminance contrast level. This close correspondence reinforced the ability of the RVP model to develop meaningful predictions of visual responses in a variety of contexts.

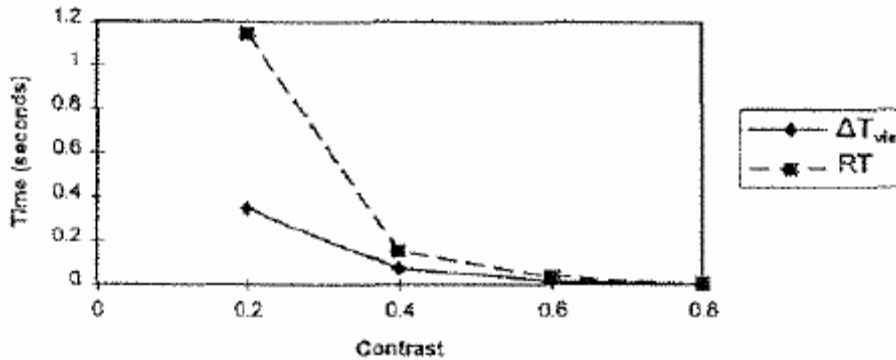

Figure 5. Measured visual response times for simulated highway sign stimuli⁽⁸⁾ and predictions based on RVP⁽⁴⁾

As stated above, the RVP model⁽⁴⁾ provides estimates of the visual processing times required for specific visual objects. Lower values of RVP are associated with longer visual response times.

Glare

In addition to visual performance, glare is another issue that can be important when considering appropriate lighting approaches for crosswalks. There are two types of glare:⁽⁶⁾ disability glare and discomfort glare. The former can reduce visual performance by scattering light within the eye, thereby reducing the luminance contrast on the retina of the eye, where the photoreceptors are found. The magnitude of disability glare can be estimated by an equivalent veiling (i.e., contrast-reducing) luminance (Equation 1):

$$L_v = 9.2 \sum_{i=1}^n \frac{E_i}{\theta_i(\theta_i + 1.5)} \quad (1)$$

where

L_v is the equivalent veiling luminance, in candelas per square meter (cd/m^2),
 E_i is the illuminance from the i th glare source at the eye in lux, and

θ_i is the angle between the target and i th glare source in degrees.

The luminance contrast of an object refers to the difference between the luminance of that object and its background. For example, dark print on white paper will have a large contrast, but a white thread seen against white fabric will have a low contrast, which can in turn result in poor visual performance. Equation 2 is one that is commonly used to characterize the contrast of a target:

$$C = \frac{(L_t - L_b)}{L_b} \quad (2)$$

where

L_t is the luminance of the target, in cd/m^2 , and
 L_b is the luminance of the background, in cd/m^2 .

The effect of disability glare on the luminance contrast of the object can be obtained by adding the equivalent veiling luminance to both the target luminance and the background luminance in the luminance contrast formula (Equation 3):

$$C = \frac{(L_t + L_v) - (L_b + L_v)}{(L_b + L_v)} = \frac{(L_t - L_b)}{(L_b + L_v)} \quad (3)$$

where

L_v is the equivalent veiling luminance in cd/m^2 from Equation 1,
 L_t is the target luminance in cd/m^2 , and
 L_b is the background luminance in cd/m^2 .

Because the denominator of Equation 3 is larger than in Equation 2, the resulting contrast will have an absolute value that is always lower than the luminance contrast without glare present.

The latter kind of glare, discomfort glare, does not necessarily cause any reduction in the visibility of objects, but does result in an annoying or even painful visual sensation.⁽⁶⁾ Although both types of glare are commonly present, some glare conditions can reduce visibility without causing much discomfort, and some conditions can cause discomfort without substantially reducing visibility. Since disability glare is directly related to visibility of pedestrians, and discomfort glare is related to the acceptability of outdoor lighting, both of these types of glare need to be avoided in a successful lighting design.

Driving Behavior at Crosswalks

The safety of pedestrians not only depends on their visibility but can also be related to drivers' behavior. An in-pavement flashing warning light system for pedestrian crosswalks has been proposed and then demonstrated to be a likely contributor to pedestrian safety by affecting drivers' yielding behavior as they approach a crosswalk occupied by a pedestrian. Comparison studies of the same crosswalk before and after striping, and after installation of an in-pavement flashing light system⁽⁵⁾ have determined some of the potential benefits of these actions. It was concluded that new crosswalk marking improved the visibility of the crosswalk and reduced the possibility of conflicts between pedestrians and vehicles, but showed little effect on decelerating the vehicles approaching the crosswalk, or on the mean number of vehicles passing over the crosswalk while pedestrians were waiting to cross the roadway.

However, the in-pavement flashing warning light system, when installed on the newly-striped crosswalk, was observed to further enhance the noticeability of the crosswalk, as suggested by the reduced average speed of vehicles approaching the crosswalk that was observed, and by a reduction in the number of vehicles driving over the crosswalk while pedestrians were waiting to cross.⁽⁵⁾ Nonetheless, one disadvantage of this solution is that the in-pavement flashing light system could be damaged by snow plowing operations during the wintertime.

In summary, both pedestrian visibility and driver behavior likely contribute to the safety of pedestrians at crosswalks. Past studies^(See references 10, 12, 13, and 14.) have shown the influence of both horizontal and vertical illuminance on pedestrian visibility in crosswalks, and resulted in preliminary recommendation values for light levels corresponding to about 20 vertical lux in the crosswalk. Of course, visual performance is not necessarily predicted solely by the vertical illuminance on an object, but also by the background luminance, the size of the target, and its reflectance. The RVP model⁽⁴⁾ for characterizing visual performance is a method for assessing the interactions among these factors as they relate to the speed and accuracy of processing visual information. Another technology, an in-pavement flashing light system embedded into the crosswalk,⁽⁵⁾ working as a signal light, was also demonstrated to influence drivers' yielding behavior in such a way that probably contributes to the safety of pedestrians crossing the road.

ANALYSES AND RESULTS

Several alternative configurations for lighting based on suggestions from NJDOT and from the literature review have been evaluated in terms of visual performance (the ability of approaching drivers to see and respond to pedestrians in the crosswalk) and economics (initial and operating costs). Based on the results of these analyses, one prototype lighting configuration was developed for field testing and installed for a short-term demonstration.

Visual Performance Analysis Approach

Using a photometrically accurate lighting calculation software package (AGI32, Lighting Analysts), the project team created a virtual scenario involving a crosswalk and an approaching vehicle. The assumed driving speed of the vehicle in the scenario was 30 mph. Assuming a required sight distance time of 2.5 s⁽¹⁵⁾ recommended by the American Association of State Highway and Transportation Officials (AASHTO), this time corresponds to a viewing distance of approximately 100 ft. The roadway containing the crosswalk was illuminated to an average horizontal illuminance of 0.7 footcandles with a minimum illuminance of 0.2 footcandles, corresponding to Section 11 of the NJDOT *Highway Design Manual*, with pole-mounted luminaires spaced about 150 ft apart. The approaching vehicle used halogen low-beam headlamps. The crosswalk was assumed to span four lanes in width. Five pedestrian locations were evaluated in the crosswalk, equally spaced along the width of the roadway.

The roadway reflectance was assumed to be asphalt at 7%;⁽⁶⁾ the sidewalk, 30% based on concrete, and the area beyond the sidewalk was assumed to be grass with a reflectance of 15%.⁽¹⁶⁾ The reflectance of the pedestrians was assumed to be 10% corresponding to dark colored clothing. A driver age of 40 years was assumed.

Figure 6 shows the plan view layout for the crosswalk scenarios. Initially, a series of lighting configurations was evaluated, using luminaire distributions from commercially available luminaires and lighting systems (in some cases, the luminaires were not specifically designed for use in exterior or roadway applications; the subsequent field demonstration would require use of luminaires that were rated for use in exterior environments):

- Pole-based luminaires located at the crosswalk position (traditional lighting technique)
- Pole-based luminaires located 15 feet ahead of the crosswalk
- Bollard-based luminaires located 15 feet ahead of the crosswalk
- Pole-mounted spotlight luminaires located 15 feet ahead of the crosswalk
- Overhead lighting in an "S" configuration to provide directional illumination
- An array of many "point" sources over the crosswalk
- A smaller (in number) array of "batwing" sources over the crosswalk

- An indirect illumination system over the crosswalk
- A mesh of very small, closely spaced "sparkle" over the crosswalk using point sources
- A mesh of very small, closely spaced "sparkle" over the crosswalk using batwing sources

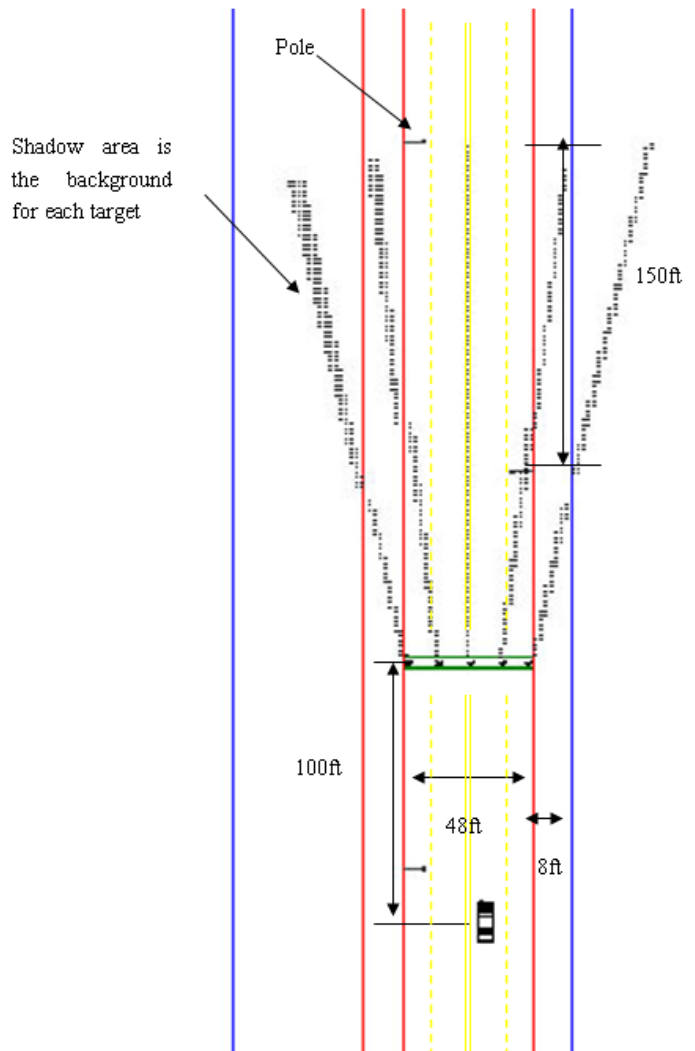

Figure 6. Schematic plan view layout of crosswalk scenarios.

As described above, one of the potential lighting configurations identified in NJDOT's request for proposals involved the use of curb face-mounted lighting. Initial review of the configurations suggested by NJDOT led to the tentative conclusion that curb-mounted lighting might be less than ideal, because mounting and maintaining equipment within the curb or roadway surface could be problematic. This is because dirt and debris buildup would be more common, and activities such as snowplowing could result in damaging lighting equipment mounted at ground level.⁽⁵⁾ Additionally, significant effort would be required to

install wiring in the curb face. For this reason, the lighting approaches listed above were included in the initial evaluations of visibility.

The other options suggested by NJDOT consisted of overhead lighting ahead of the crosswalk, which is a suggested technique for providing vertical illuminances on the crosswalk area,^(See references 11, 12, 13 and 14.) and a flashing beacon above the crosswalk to act as a signal to oncoming drivers. The project team proposes combining these two separate functionalities into a single system specification, based on previous research findings regarding the efficacy of vertical illumination and of providing a flashing signal light.

This section of the present report summarizes several simulation evaluations to assess the effectiveness of overhead illumination strategies from a visibility perspective.

The evaluations included relative visual performance⁽⁴⁾ for drivers and, when appropriate, unified glare rating⁽⁶⁾ for both drivers and pedestrians. Figures 7 through 16 summarize the light level, visual performance and glare characteristics of each configuration.

In general, the traditional lighting configuration (Figure 7) tended to result in pedestrians being seen in both positive (where the pedestrian is brighter than the background) and negative (where the pedestrian is less bright than the background) contrast. When both positive and negative contrast occurs, this means there is a location where the contrast approaches zero and objects could be more difficult to see (and, for example, where the walking direction of a pedestrian would be more difficult to discern). A criterion for subsequent analysis was to avoid negative contrast so that the pedestrians should always be seen in positive contrast.

Moving the pole locations 15 ft ahead of the crosswalk (this distance seemed to be optimal based on a sensitivity analysis and on the literature review) resulted in most, but not the leftmost (from the driver's perspective), of the pedestrians being seen in positive contrast (Figure 8). This is because the illumination for a particular direction is provided primarily by a single luminaire. Subsequent configurations explored placement of luminaires on both sides of the road (Figures 9 and 10), or overhead (Figures 11 through 16) to maximize positive contrast.

Regarding glare, a bollard-based solution using a luminaire containing fluorescent lamps (Figure 9) resulted in relatively little glare compared to the other solutions using high intensity discharge lamp-based luminaires. This is because the fluorescent lamp, being a linear source rather than a point source, has a lower luminance while still being able to provide light in the crosswalk.

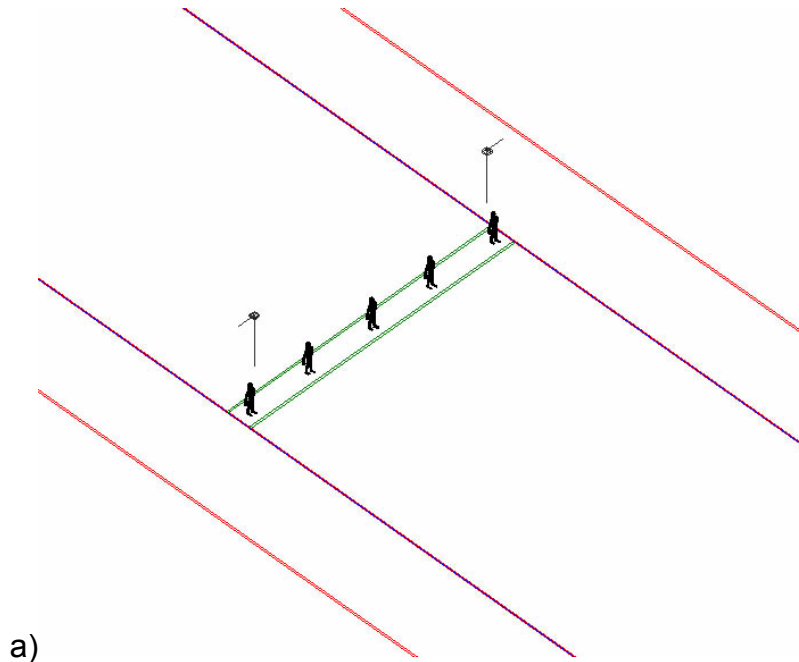

a)



b)

Pedestrian location no.	Object luminance (cd/m ²)	Background luminance (cd/m ²)	Contrast	RVP	Vertical illuminance (fc)
1	0.1	0.344	-0.709	0.946	0.2
2	0.15	0.135	0.114	0.635	0.3
3	0.25	0.198	0.261	0.878	0.6
4	0.25	0.374	-0.332	0.921	0.6
5	0.15	0.322	-0.535	0.937	0.3

Unified Glare Rating (UGR)

UGR from driver's view: 32

c) UGR from the pedestrian: 31

Figure 7. a) Schematic diagram of conventional crosswalk lighting; b) computer simulation view; c) visual performance and glare summary

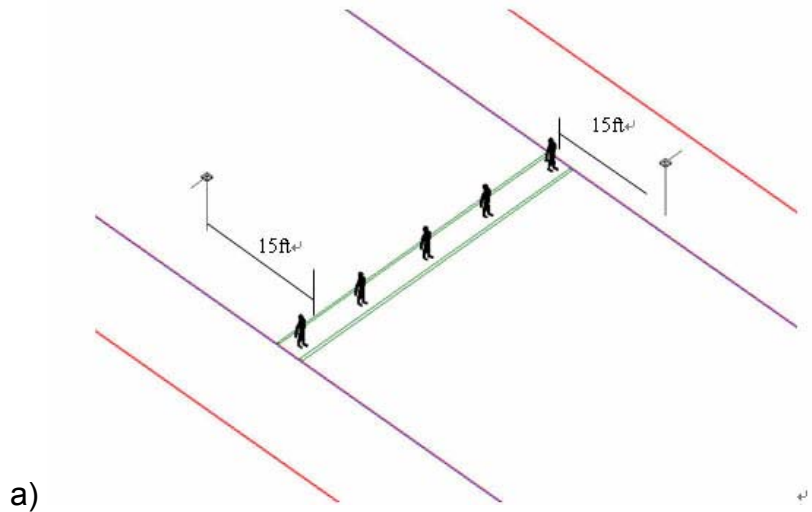

a)



b)

Pedestrian location no.	Object luminance (cd/m ²)	Background luminance (cd/m ²)	Contrast	RVP	Vertical illuminance (fc)
1	0.1	0.420	-0.762	0.952	0.2
2	0.2	0.149	0.341	0.913	0.7
3	0.5	0.196	1.550	0.953	1.5
4	0.5	0.358	0.395	0.931	1.6
5	0.4	0.241	0.659	0.942	1.3

c) **UGR**
 UGR from driver's view: 33
 UGR from the pedestrian: 31

Figure 8. a) Schematic diagram of crosswalk lighting with luminaires located 15 ft ahead of crosswalk; b) computer simulation view; c) visual performance and glare summary

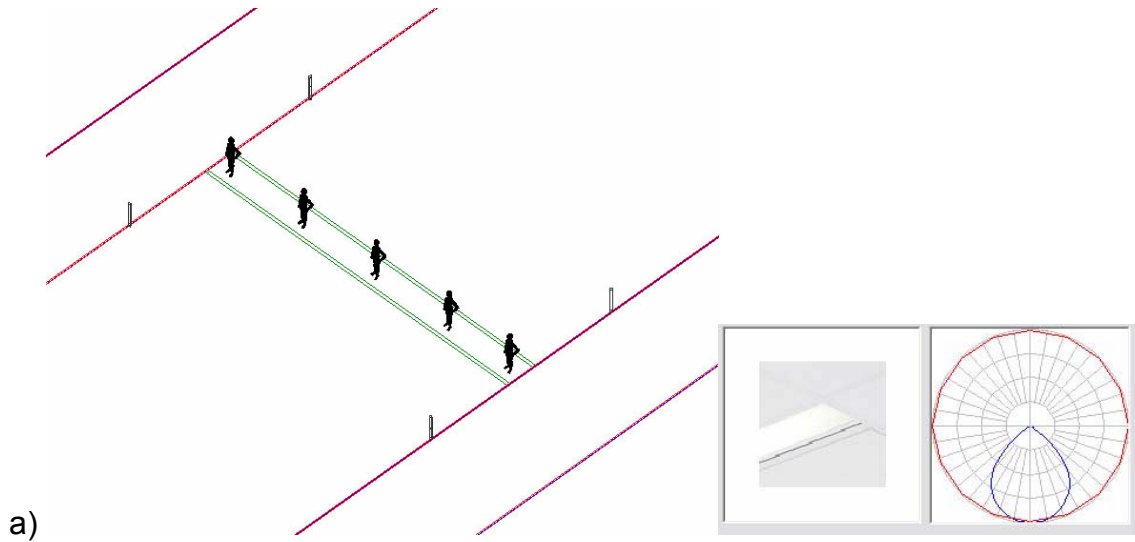

Pedestrian location no.	Object luminance (cd/m ²)	Background luminance (cd/m ²)	Contrast	RVP	Vertical illuminance (fc)
1	0.6	0.210	1.855	0.953	2.3
2	0.9	0.190	3.734	0.956	3.3
3	0.6	0.172	2.495	0.952	2.2
4	0.9	0.245	2.680	0.958	2.7
5	0.6	0.354	0.697	0.947	2.2

UGR
 UGR from driver's view: 18
 c) UGR from the pedestrian: 23

Figure 9. a) Schematic diagram of bollard-based crosswalk lighting and luminaire distribution; b) computer simulation view; c) visual performance and glare summary

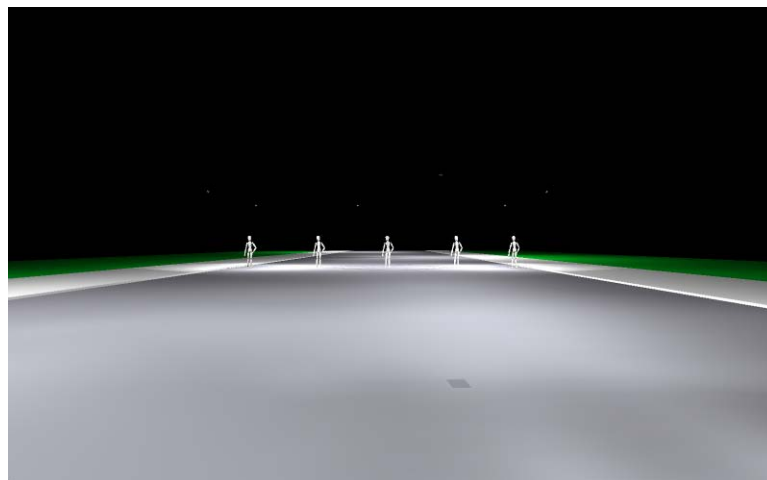
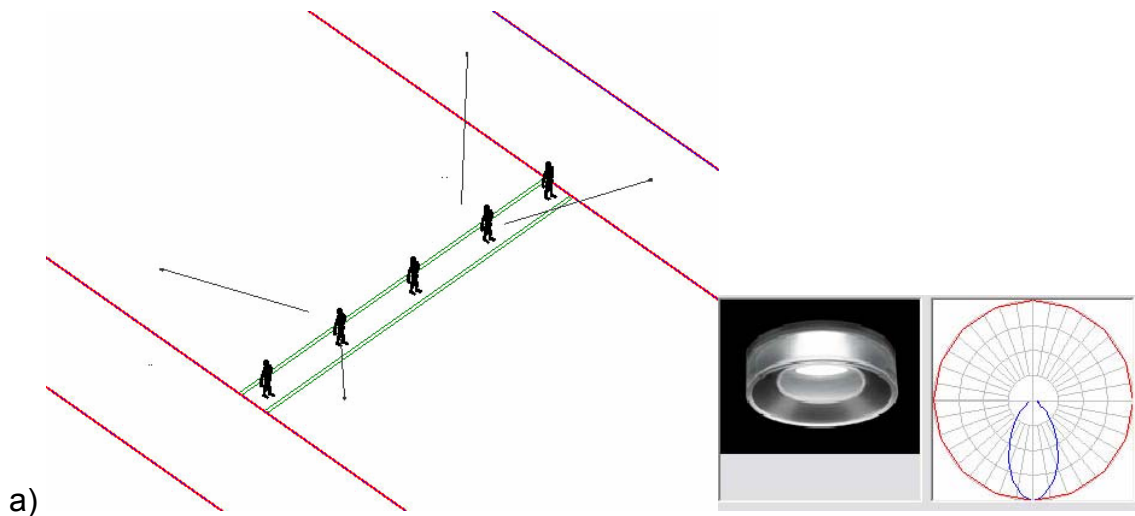

Pedestrian location no.	Object luminance (cd/m ²)	Background luminance (cd/m ²)	Contrast	RVP	Vertical illuminance (fc)
1	0.6	0.210	1.855	0.953	2.4
2	1	0.190	4.260	0.957	3.7
3	0.7	0.172	3.078	0.954	2.2
4	1	0.245	3.089	0.959	3.0
5	0.6	0.354	0.697	0.947	2.1

UGR:
 UGR from driver's view: 25
 c) UGR from the pedestrian: 32

Figure 10. a) Schematic diagram of pole-mounted spotlight crosswalk lighting and luminaire distribution; b) computer simulation view; c) visual performance and glare summary

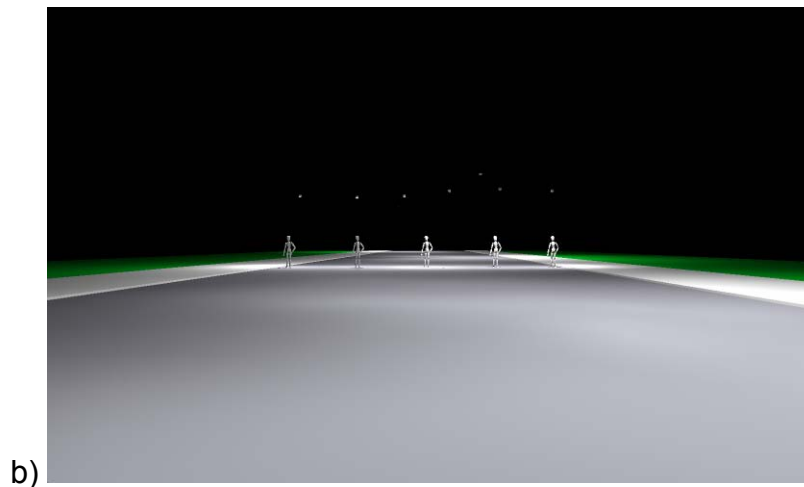
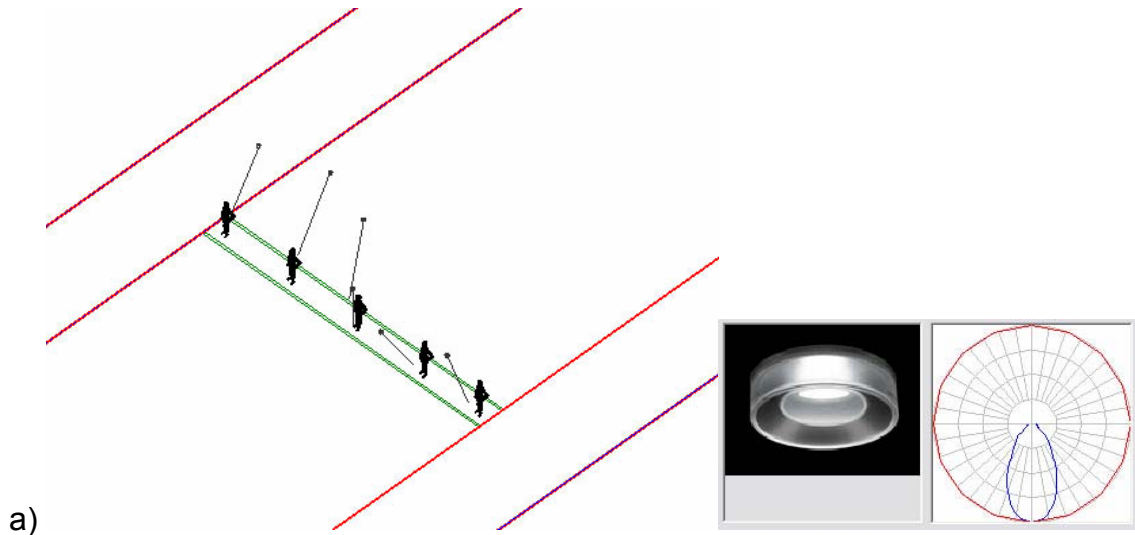

Pedestrian location no.	Object luminance (cd/m ²)	Background luminance (cd/m ²)	Contrast	RVP	Vertical illuminance (fc)
1	0.06	0.258	-0.767	0.942	0.2
2	0.1	0.228	-0.561	0.930	0.3
3	0.6	0.154	2.903	0.952	1.8
4	0.6	0.136	3.399	0.951	1.9
5	0.6	0.162	2.696	0.952	1.6

UGR ratings

Location no.	1	2	3	4	5	6
Pedestrian	27	27	25	24	21	18
Driver	20	20	20	n/a	n/a	n/a

c)

Figure 11. a) Schematic diagram of overhead "S" shaped crosswalk lighting and luminaire distribution; b) computer simulation view; c) visual performance and glare summary

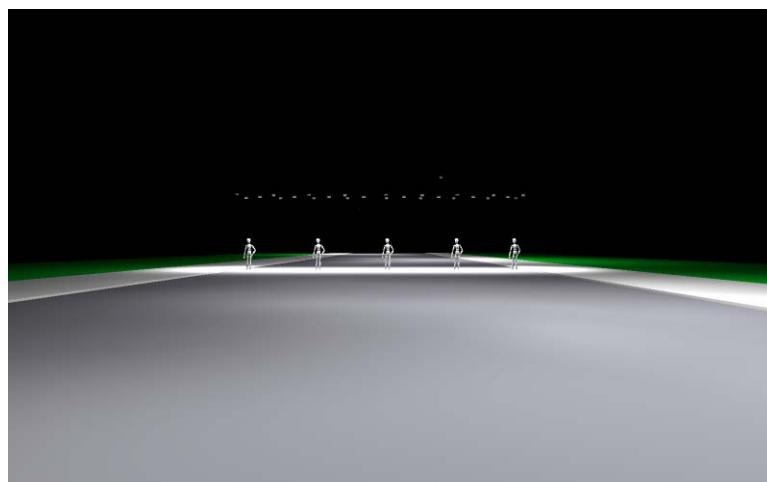
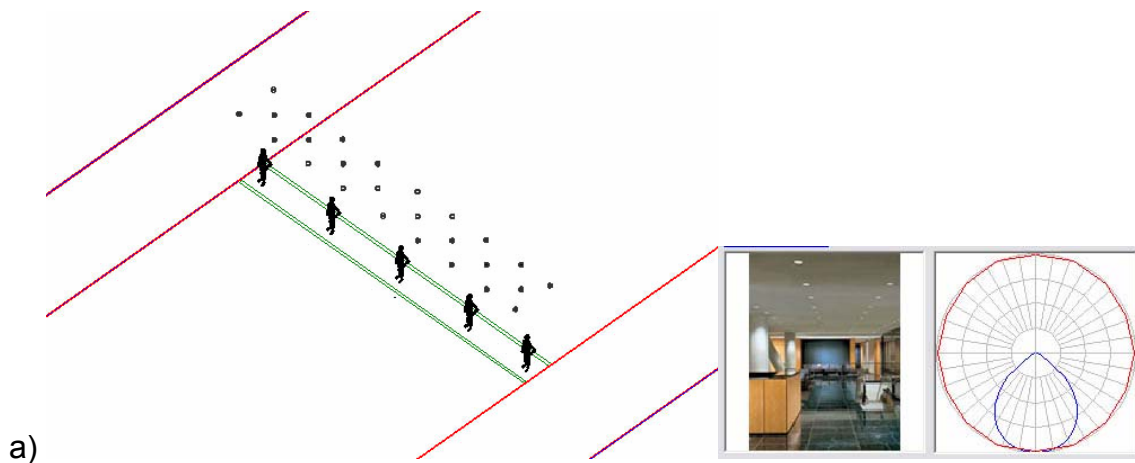

b)

Pedestrian location no.	Object luminance (cd/m ²)	Background luminance (cd/m ²)	Contrast	RVP	Vertical illuminance (fc)
1	0.6	0.434	0.381	0.932	1.4
2	0.6	0.139	3.328	0.951	1.6
3	0.6	0.165	2.639	0.952	1.6
4	0.6	0.264	1.271	0.952	1.6
5	0.6	0.384	0.561	0.943	1.4

c)

Figure 12. a) Schematic diagram of overhead point source array crosswalk lighting; b) computer simulation view; c) visual performance summary

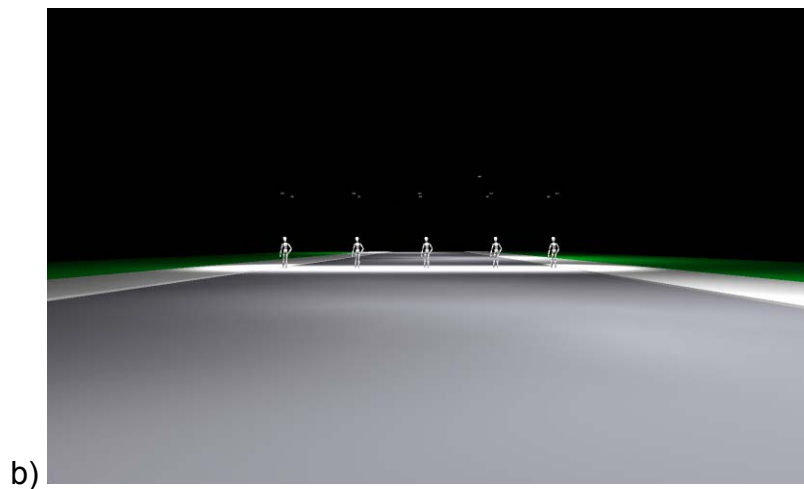
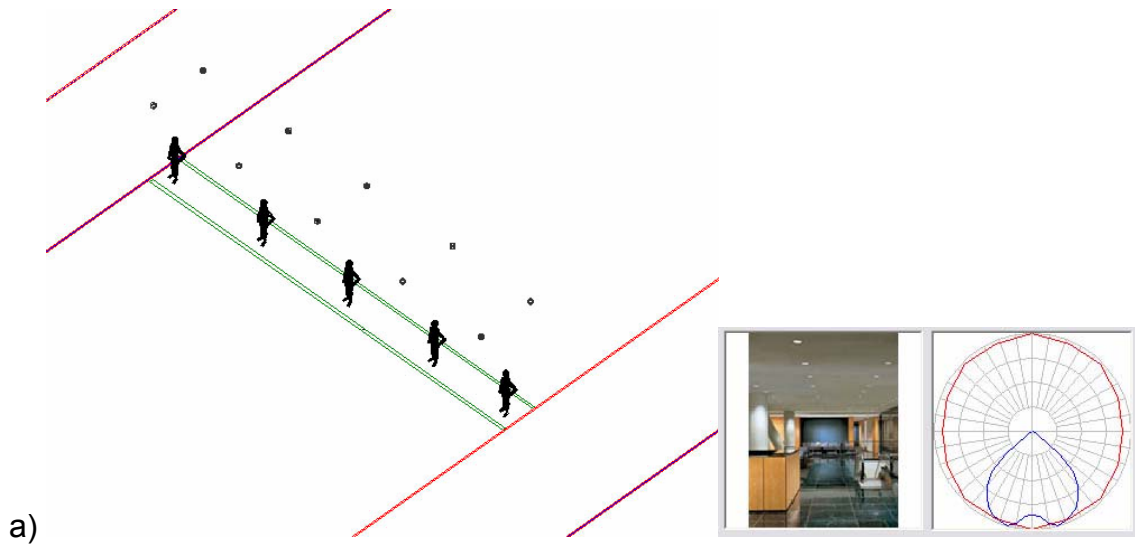

Pedestrian location no.	Object luminance (cd/m ²)	Background luminance (cd/m ²)	Contrast	RVP	Vertical illuminance (fc)
1	0.7	0.473	0.481	0.943	1.8
2	0.7	0.190	2.687	0.954	2
3	0.7	0.189	2.696	0.954	2
4	0.7	0.284	1.463	0.955	1.9
5	0.7	0.375	0.868	0.952	1.8

UGR ratings

Location no.	1	2	3	4	5
Pedestrian	25	25	21	18	15
Driver	n/a	n/a	11	n/a	n/a

c)

Figure 13. a) Schematic diagram of batwing array crosswalk lighting and luminaire distribution; b) computer simulation view; c) visual performance and glare summary

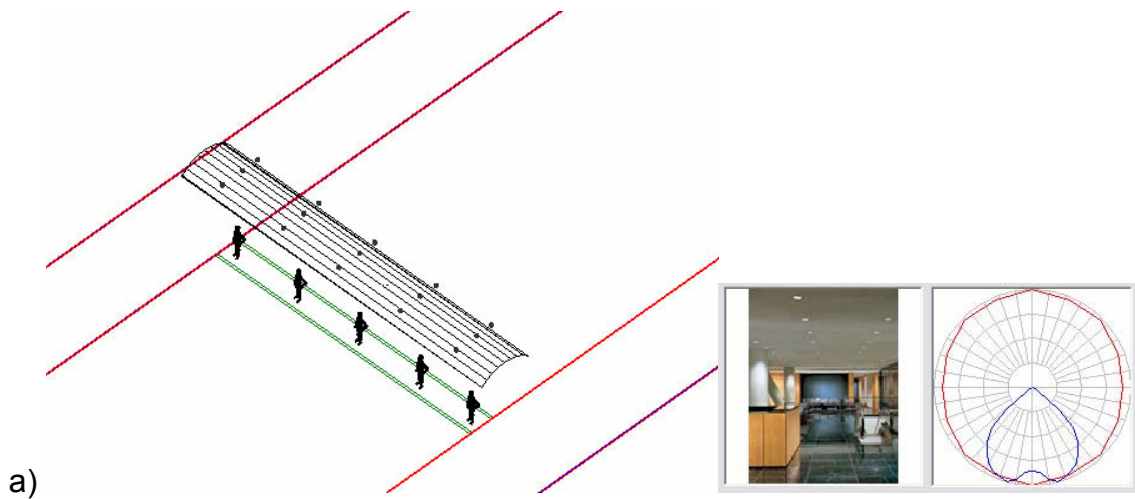

c)

Pedestrian location no.	Object luminance (cd/m ²)	Background luminance (cd/m ²)	Contrast	RVP	Vertical illuminance (fc)
1	0.6	0.778	-0.229	0.922	1
2	0.6	0.266	1.259	0.952	1.2
3	0.6	0.274	1.189	0.952	1.2
4	0.6	0.341	0.760	0.948	1.1
5	0.6	0.707	-0.151	0.883	1

Figure 14. a) Schematic diagram of indirect overhead crosswalk lighting and luminaire distribution; b) computer simulation view; c) visual performance summary

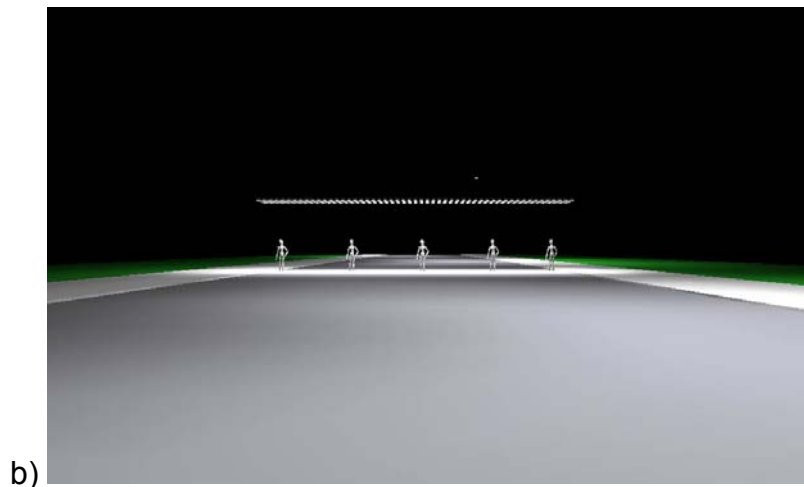
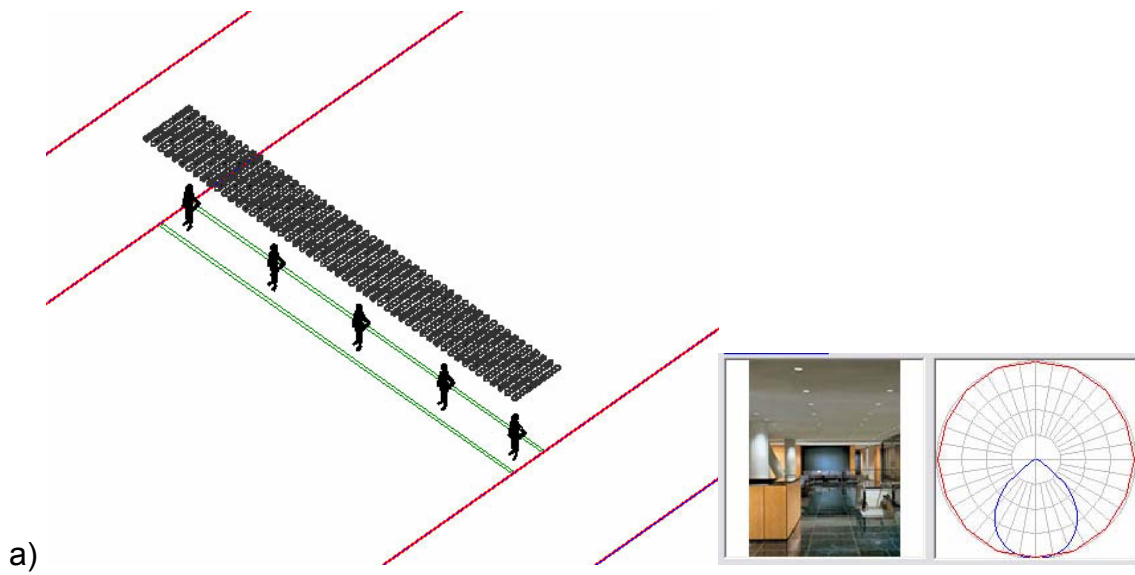

c)

Pedestrian location no.	Object luminance (cd/m ²)	Background luminance (cd/m ²)	Contrast	RVP	Vertical illuminance (fc)
1	0.3	0.279	0.074	0.542	0.8
2	0.4	0.184	1.168	0.944	1
3	0.4	0.176	1.272	0.944	1
4	0.4	0.259	0.547	0.932	0.9
5	0.3	0.275	0.093	0.681	0.7

Figure 15. a) Schematic diagram of overhead "sparkle" mesh lighting and luminaire distribution; b) computer simulation view; c) visual performance summary

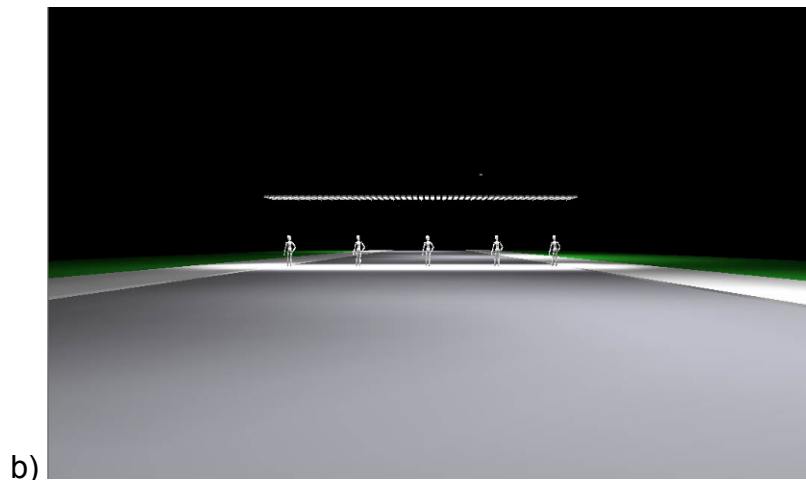
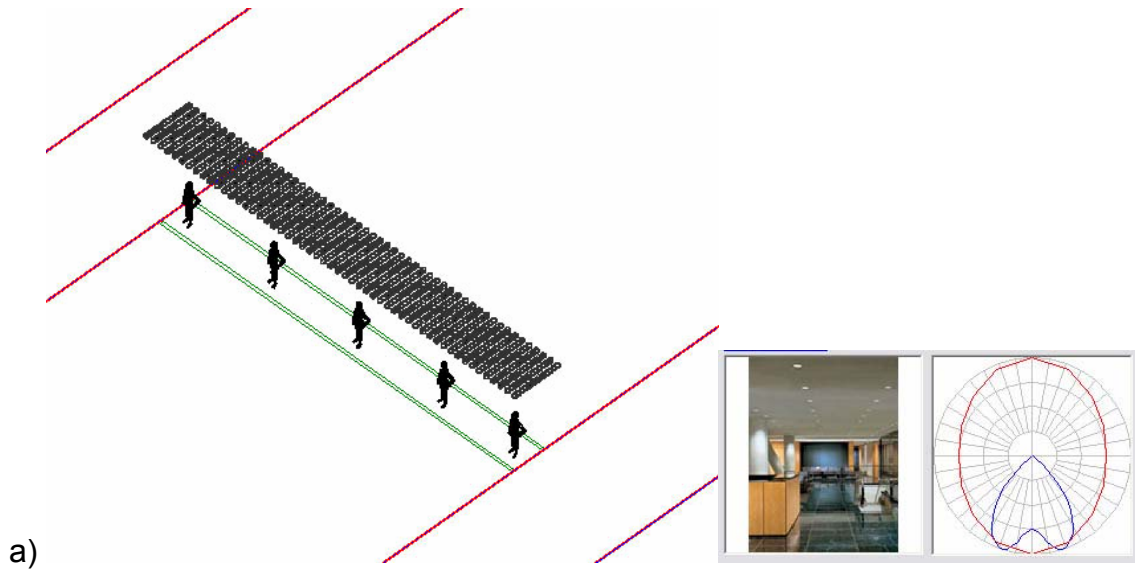

c)

Pedestrian location no.	Object luminance (cd/m ²)	Background luminance (cd/m ²)	Contrast	RVP	Vertical illuminance (fc)
1	0.5	0.380	0.317	0.919	1.1
2	0.6	0.200	2.004	0.953	1.4
3	0.6	0.189	2.168	0.952	1.4
4	0.6	0.278	1.162	0.952	1.3
5	0.5	0.313	0.599	0.940	1

Figure 16. a) Schematic diagram of overhead batwing "sparkle" mesh lighting and luminaire distribution; b) computer simulation view; c) visual performance summary

Based on these preliminary analyses, several configurations were refined and further evaluated:

- An "S" shaped overhead lighting using light emitting diode (LED) sources
- A bollard-based fluorescent system
- An array of overhead LEDs to provide illumination in the crosswalk

Except for the left-most pedestrian, the "S" shaped system (Figure 17) provided positive contrast, whereas the other two systems (Figures 18 and 19) resulted in positive contrast throughout the crosswalk. As discussed below, the overhead LED-based configurations were generally quite expensive in terms of initial cost, while the fluorescent-based bollard configuration was relatively inexpensive.

Because the bollard configuration worked well in terms of visual performance, this concept was further evolved so that it could be located closer to the crosswalk (5 ft rather than 15 ft) and incorporate a flashing source upon the press of a button, or through occupancy sensing (Figure 20). An LED bollard system (Figure 21) was evaluated as well to determine whether this source could become feasible in the future for crosswalk lighting. An overhead cable-mounted LED configuration (Figure 22) was also evaluated to determine if the initial high cost of LED systems could be reduced practically. All of these systems provided positive contrast throughout the crosswalk location.

An advantage of the bollard-based system is that it serves as an architectural element that can be used by drivers and pedestrians to locate and identify crosswalks and to distinguish them from other locations, both during the daytime and nighttime.

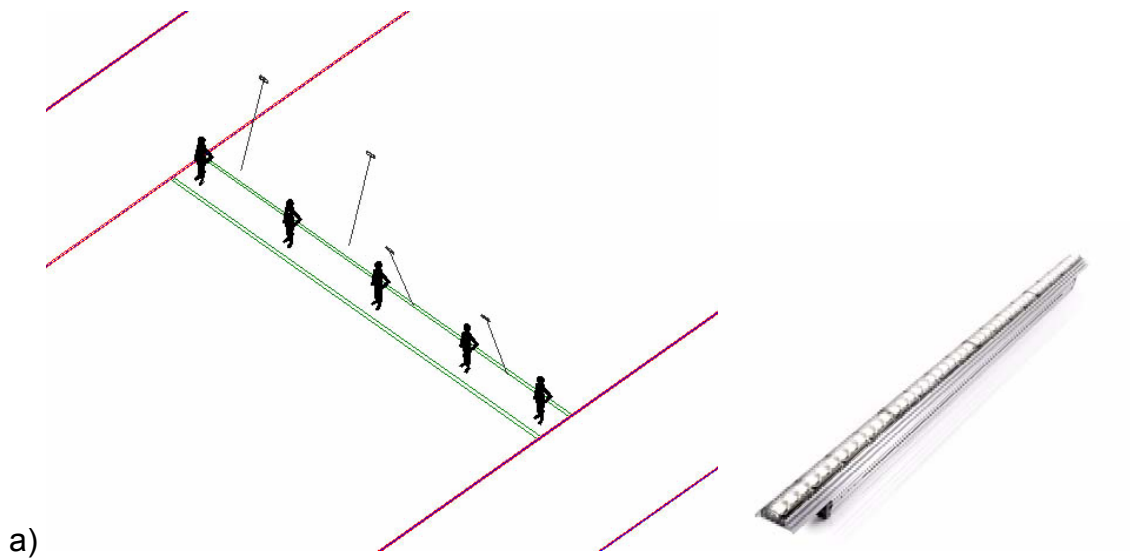

c)

Pedestrian location no.	Object luminance (cd/m ²)	Background luminance (cd/m ²)	Contrast	RVP	Vertical illuminance (fc)
1	0.1	0.124	-0.194	0.800	0.3
2	0.15	0.138	0.091	0.476	0.4
3	0.9	0.140	5.411	0.954	0.4
4	1.2	0.232	4.171	0.960	2.1
5	1	0.201	3.987	0.958	1.9

Figure 17. a) Schematic diagram of overhead "S" shaped LED crosswalk lighting and luminaire; b) computer simulation view; c) visual performance summary

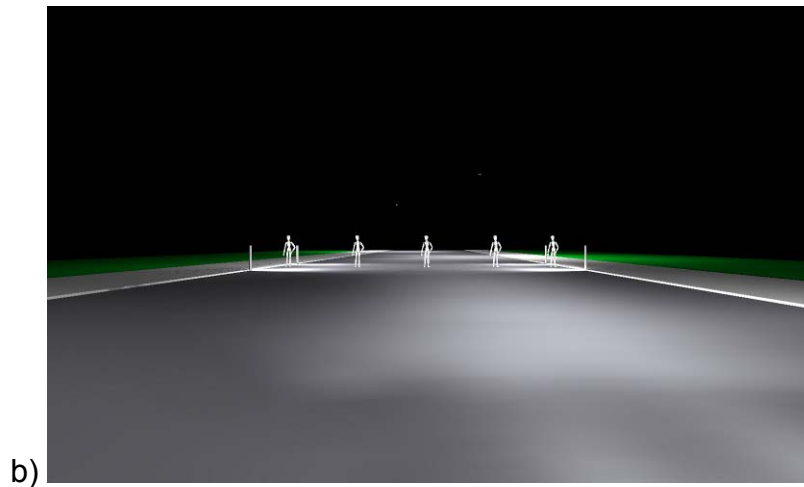
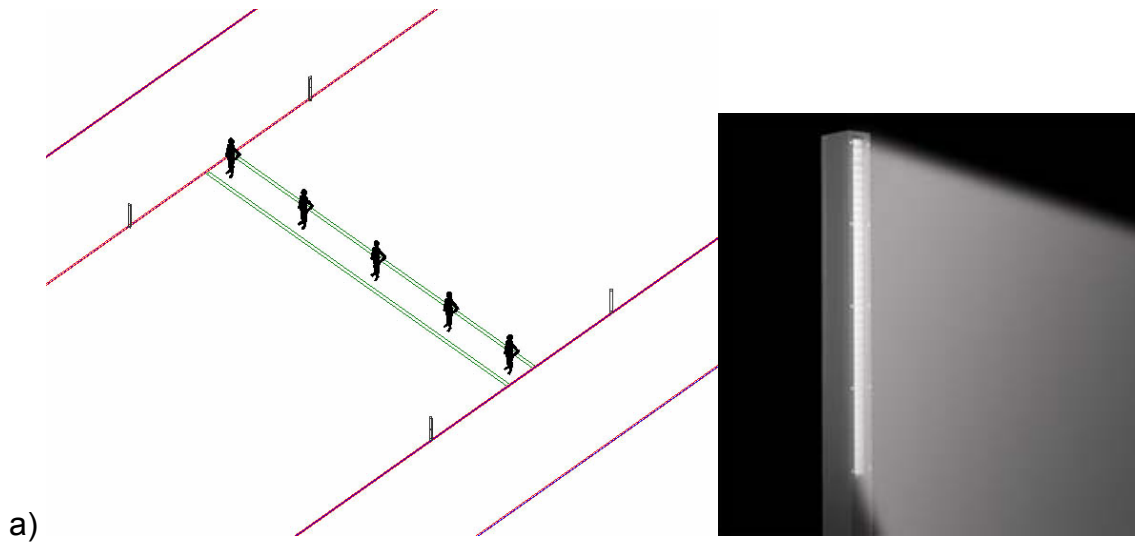

Pedestrian location no.	Object luminance (cd/m ²)	Background luminance (cd/m ²)	Contrast	RVP	Vertical illuminance (fc)
1	0.7	0.210	2.330	0.955	2.3
2	1	0.190	4.260	0.957	3.3
3	0.8	0.172	3.660	0.955	2.2
4	1	0.245	3.089	0.959	2.7
5	0.7	0.354	0.980	0.953	2.2

c) **UGR**
 UGR from driver's view: 18
 UGR from the pedestrian: 23

Figure 18. a) Schematic diagram of revised fluorescent bollard-based crosswalk lighting and luminaire; b) computer simulation view; c) visual performance and glare summary

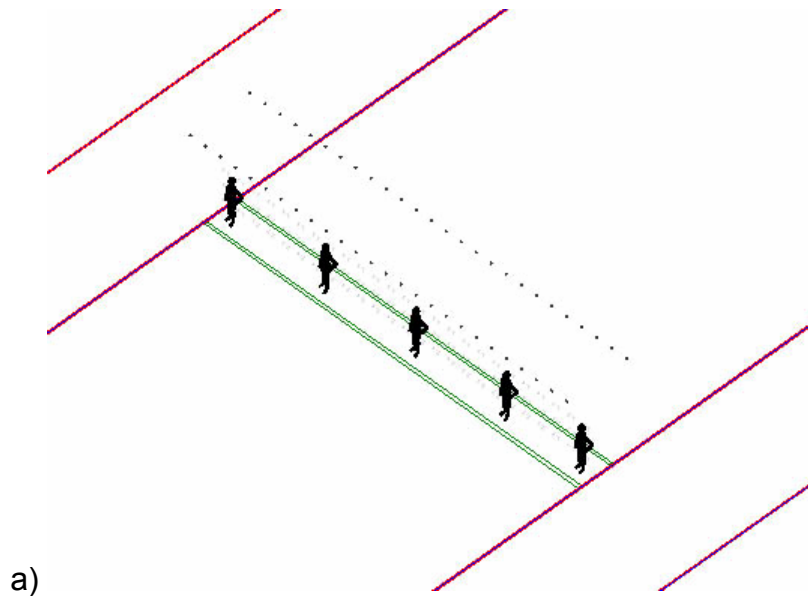

a)



b)

Pedestrian location no.	Object luminance (cd/m ²)	Background luminance (cd/m ²)	Contrast	RVP	Vertical illuminance (fc)
1	0.8	0.143	4.585	0.953	2.7
2	0.8	0.144	4.548	0.953	2.9
3	0.8	0.138	4.791	0.953	2.9
4	0.8	0.243	2.292	0.957	2.8
5	0.8	0.179	3.468	0.955	2.3

c)

Figure 19. a) Schematic diagram of revised LED overhead crosswalk lighting; b) computer simulation view; c) visual performance summary

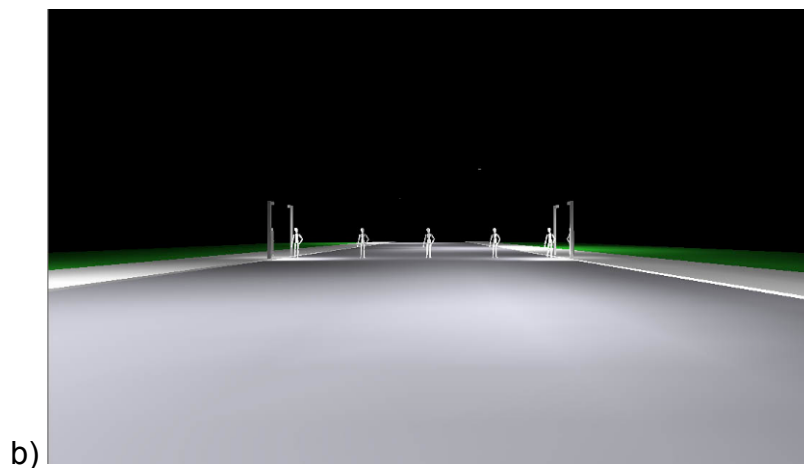
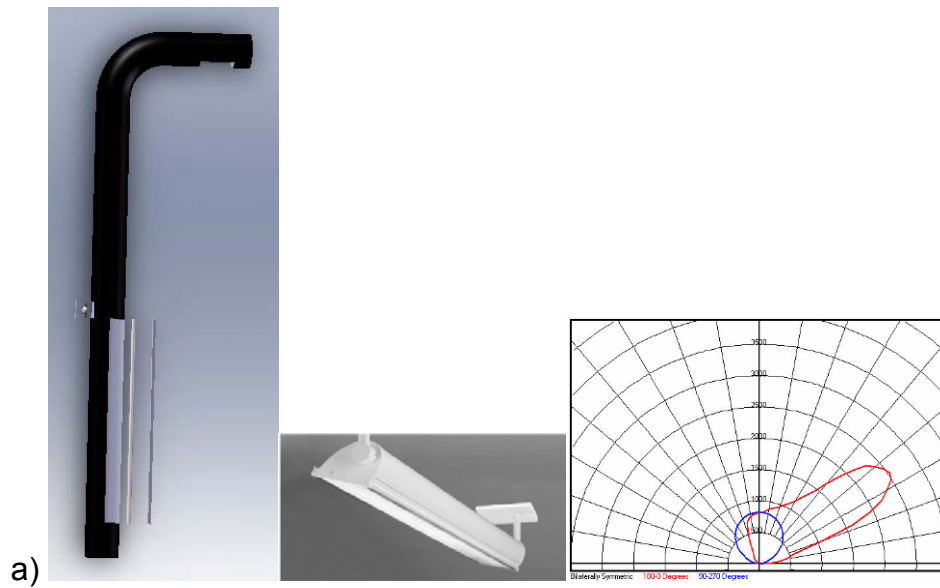

c)

Pedestrian location no.	Object luminance (cd/m ²)	Background luminance (cd/m ²)	Contrast	RVP
1	1.3	0.095	12.614	0.951
2	0.6	0.172	2.484	0.952
3	0.4	0.154	1.602	0.945
4	0.6	0.224	1.674	0.953
5	1.3	0.184	6.072	0.958

Figure 20. a) Four-corner fluorescent pole-based crosswalk lighting system luminaire appearance and distribution; b) computer simulation view; c) visual performance summary

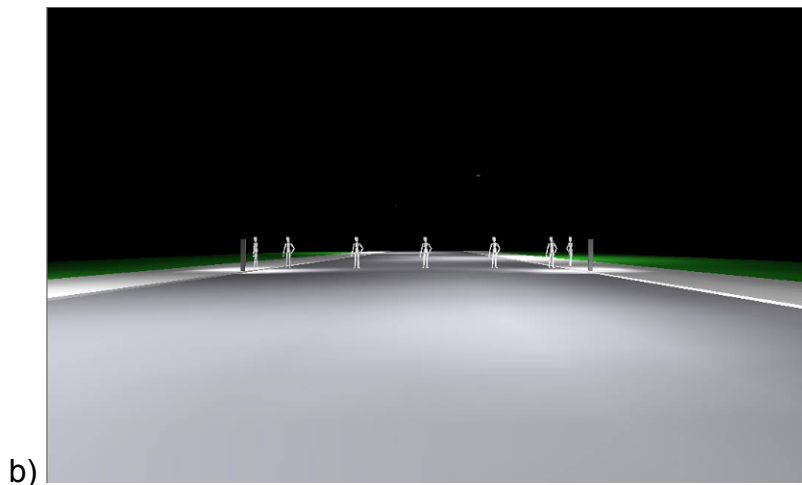
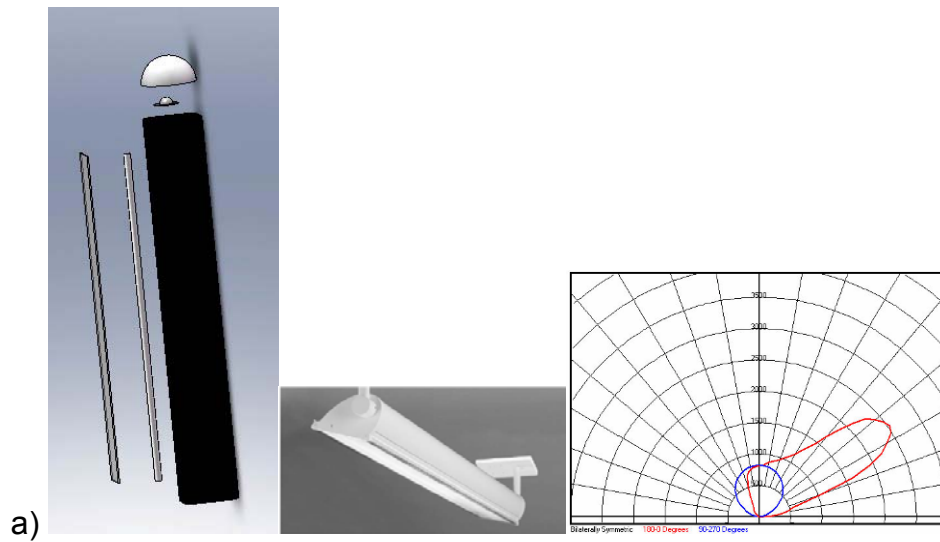

c)

Pedestrian location no.	Object luminance (cd/m ²)	Background luminance (cd/m ²)	Contrast	RVP
1	1.3	0.095	12.614	0.951
2	0.6	0.172	2.484	0.952
3	0.4	0.154	1.602	0.945
4	0.6	0.224	1.674	0.953
5	1.3	0.184	6.072	0.958

Figure 21. a) Refined fluorescent bollard-based crosswalk lighting system luminaire appearance and distribution; b) computer simulation view; c) visual performance summary

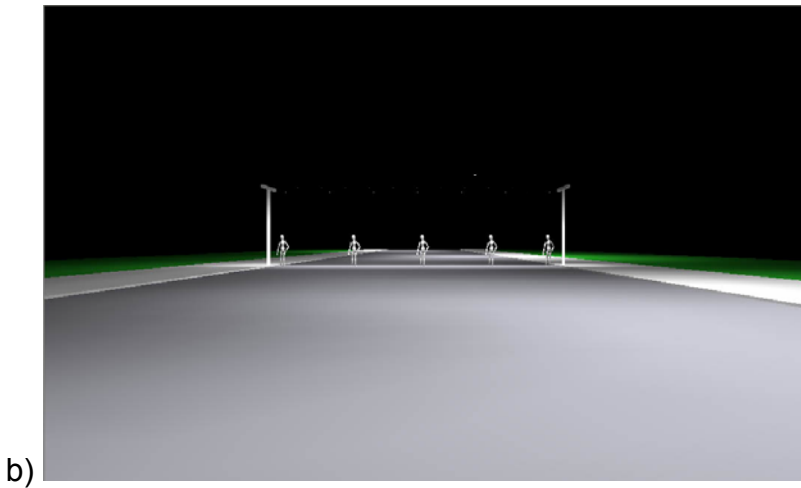
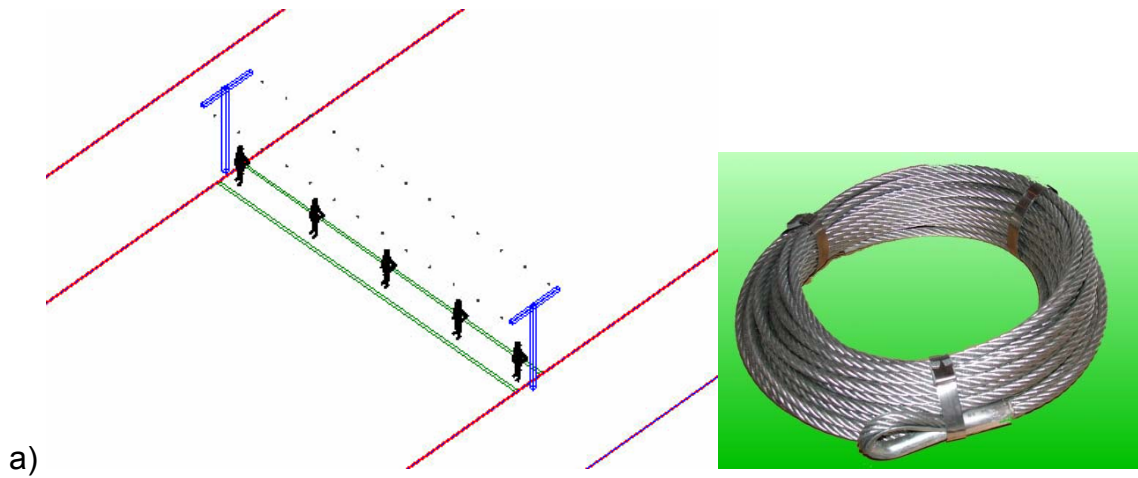

c)

Pedestrian location no.	Object luminance (cd/m ²)	Background luminance (cd/m ²)	Contrast	RVP
1	0.4	0.105	2.808	0.945
2	0.4	0.130	2.084	0.945
3	0.4	0.136	1.943	0.945
4	0.4	0.229	0.750	0.939
5	0.4	0.174	1.295	0.944

Figure 22. a) Schematic diagram of refined LED overhead crosswalk lighting; b) computer simulation view; c) visual performance summary

Economic Analysis Approach

Until several promising approaches for pedestrian visibility were identified, economic analyses were not performed for the initial configurations. Economic analyses were carried out for the following configurations:

- "S" shaped overhead lighting using light emitting diode (LED) sources (Table 5)
- A bollard-based fluorescent system (Table 6)
- An array of overhead LEDs to provide illumination in the crosswalk (Table 7)
- A refined, four-corner-pole-based fluorescent system (Table 8)
- A refined fluorescent bollard-based system (Table 9)
- A refined overhead LED array system (Table 10)

It is apparent from Tables 5 through 10 that at present, LED-based systems can be expensive. This is likely to be the case until sufficient quantities of LED systems are produced and specified in order to allow manufacturers to take advantage of the economies of scale associated with higher production and lower costs. The bollard based system would require trenching in order to provide power to the luminaires rather than overhead power lines, but the incremental cost of this compared to the work required to install new poles (since existing pole locations are almost always sub-optimal for crosswalk lighting) would not necessarily be large. Costs to install two conventional light poles with cutoff-type luminaires would be greater than \$5000,⁽¹⁷⁾ not dramatically different from the bollard and pole-based solutions evaluated here.

Table 5 - Economic analysis for overhead "S" shaped LED crosswalk lighting

Description	Quantity	Unit	Material		Labor	
			Unit price	total	Unit price	total
LED graze wall wash	4	EA	1200	4800	116	464
Aluminum poles	2	EA	665	1330	489	978
S-shape beam	1	EA	3800	3800	900	900
Initial Cost				12272.00		\$

Operating time	4662 hrs
Average Rated lamp life	50000 hrs
Lamp used	0.37
Relamping Labor	150.24 \$
Lamp replacement cost	1350.24 \$
Maintenance cost	503.59 \$
Input power	15 W
Energy use	279.72 KWh
Electricity cost	0.093 \$/KWh
Annual energy cost (X x Y)	25.92 \$
Annual operating cost	529.51 \$

Table 6 - Economic analysis for fluorescent bollard crosswalk lighting

Description	Quantity	Unit	Material		Labor	
			Unit price	total	Unit price	total
Bollard fixture T-5 54W	4	EA	645	2580	450	1800
T-5 54W tube	4	EA	6	24	17.24	68.96
Ballast cost	4	EA	50	200	30.3	121.2
Initial cost				4794.16		\$

Operating time per year (in NJ)	4662 hrs
Average Rated lamp life	20000 hrs
Lamp used	0.9324
Relamping Labor	22.54 \$
Lamp replacement cost	26.54 \$
Average Rated ballst life	20000 \$
ballast used	0.93
labor cost of replacing the ballast	77.74 \$
Replace the ballast	127.74 \$
Maintenance cost	143.85 \$
Input power	60 W
Energy use	1118.88 KWh
Electricity cost	0.093 \$/KWh
Annual energy cost	103.69 \$
Annual operating cost	247.55 \$

Table 7 - Economic analysis for overhead LED crosswalk lighting

Description	Quantity	Unit	Material		Labor	
			Unit price	total	Unit price	total
LED module	52	EA	300	15600	116	6032
Poles cost	2	EA	665	1330	489	978
Beam	2	EA	1825	3650	900	1800
Initial cost				29390.00		\$

Operating time	4662 hrs
Average Rated lamp life	10000 hrs
Lamp used	24.24
Relamping Labor	150.24 \$
Lamp replacement cost	450.24 \$
Maintenance cost	10914.90 \$
Input power	1 W
Energy use	242.42 KWh
Electricity cost	0.093 \$/KWh
Annual energy cost	22.47 \$
Annual operating cost	10937.37 \$

Table 8 - Economic analysis for fluorescent pole-based crosswalk lighting

Description	Quantity	Unit	Material		Labor	
			Unit price	total	Unit price	total
pole fixture	4	EA	1665	6660	489	1956
T-8 32W tube	4	EA	13	52	17.24	68.96
Ballast cost	4	EA	14	56	30.3	121.2
Initial cost				8914.16		\$

Operating time per year (in NJ)	4662 hrs
Average Rated lamp life	18000 hrs
T-8 32w Lamp used	1.036
Relamping Labor	22.54 \$
Lamp replacement cost	35.54 \$
Average Rated ballst life	20000 \$
ballast used	0.93
labor cost of replacing the ballast	77.74 \$
Replace the ballast	91.74 \$
Maintenance cost	122.36 \$
Input power	35.56 W
Energy use	663.04 KWh
Electricity cost	0.093 \$/KWh
Annual energy cost	61.45 \$
Annual operating cost	183.81 \$

Table 9 - Economic analysis for revised fluorescent bollard-based crosswalk lighting

Description	Quantity	Unit	Material		Labor	
			Unit price	total	Unit price	total
Bollard fixture T-8 44W	4	EA	1000	4000	450	1800
T-8 32W tube	4	EA	13	52	17.24	68.96
T-8 17W tube	4	EA	4.5	18	17.24	68.96
Ballast cost	4	EA	14	56	30.3	121.2
Initial cost				6185.12		\$

Operating time per year (in NJ)	4662 hrs
Average Rated lamp life	18000 hrs
T-8 44w Lamp used	1.036
Relamping Labor	22.54 \$
Lamp replacement cost	35.54 \$
Average Rated ballst life	20000 \$
ballast used	0.93
labor cost of replacing the ball:	77.74 \$
Replace the ballast	91.74 \$
Maintenance cost	122.36 \$
Input power	35.56 W
Energy use	663.04 KWh
Electricity cost	0.093 \$/KWh
Annual energy cost	61.45 \$
Annual operating cost	183.81 \$

Table 10 - Economic analysis for revised overhead LED array crosswalk lighting

Description	Quantity	Unit	Material		Labor	
			Unit price	total	Unit price	total
LED module	26	EA	300	7800	116	3016
Poles cost	2	EA	665	1330	489	978
steel cable	2	EA	25	50	50	100
arms	4	EA	100	400	16	64
Initial cost				13738.00		\$

Operating time	4662 hrs
Average Rated lamp life	50000 hrs
Lamp used	2.42
Relamping Labor	112 \$
Lamp replacement cost	412 \$
Maintenance cost	998.79 \$
Input power	1.5 W
Energy use	181.82 KWh
Electricity cost	0.093 \$/KWh
Annual energy cost	16.85 \$
Annual operating cost	1015.64 \$

Interim Conclusions from Visibility and Economic Analyses

Both the visual performance analyses based on photometric simulation of the lighting conditions evaluated in this study, and the economic analyses of initial and operating (electricity and maintenance) costs, the fluorescent bollard-based lighting solution was determined to be a worthwhile candidate for field demonstration. Following a discussion of the findings with NJDOT engineering staff at the time these analyses were completed, it was decided to proceed with a field demonstration at a crosswalk location in New Jersey.

Short-Term Field Demonstration

Following the results of the analyses of visibility and economics, the project team carried out a short-term field demonstration of a prototype bollard-based lighting system. Individuals from transportation agencies and the local municipality were invited to view the lighting, provide comments and feedback and complete a short questionnaire about the prototype lighting system.

Participating on-site during the field demonstration were Joseph Powell of NJDOT; Fredric Rubenstein, Chief Regional Supervisor, New Jersey Transit; Richard Gierolewicz, Supervisor of Terminal Operations, New Jersey Transit; Officer Ronald Atlak, Old Bridge Police Department; and John Bullough, Nicholas Skinner and Xin Zhang, from the LRC.

Overview of Lighting Installation

The demonstration was conducted on the evening of March 18, 2009 at the intersection of U.S. Route 9 and Texas Road in Old Bridge, NJ. Route 9 is a north-south highway and Texas Road travels east to west across it. The prototype lighting system was installed at the crosswalk across the western leg of Texas Road, running parallel to southbound traffic on Route 9. Some existing lighting was present at this location, consisting of high pressure sodium floodlights oriented toward the center of the intersection. The prototype lighting system consisted of four bollard-type fluorescent floodlight luminaires oriented vertically, with the objective of providing higher levels of vertical illumination on pedestrians in the crosswalk than provided by current typical lighting practices. This intersection is signalized with painted crosswalks and pedestrian signals, adjacent to a bus stop and some retail stores.

The bollard luminaires were mounted to metal stands and operated from 12 V (direct current) batteries and inverters to convert power to 120 V (alternating current). Each luminaire contained two 40 W fluorescent, biax lamps. Luminaires were floodlights rated for outdoor use.

The photographs in Figures 23, 24 and 25 illustrate the appearance of the prototype lighting system.



Figure 23. a) View of crosswalk lighting while looking south; b) view of crosswalk lighting while looking north



Figure 24. a) View toward crosswalk from Texas Road, showing the light pattern along the crosswalk; b) view of pedestrian crossing the road, showing the relatively high vertical illuminances

Horizontal and vertical light levels in the crosswalk were measured (when oncoming traffic on the western leg of Texas Road was not present, in order to isolate the lighting from vehicle headlamps) with the prototype lighting system switched off (to identify the baseline conditions) and with it switched on. Horizontal illuminances at a height of 3 ft above the pavement from the existing lighting ranged between 20 and 28 lux in the crosswalk. Vertical illuminances (in the direction that would be facing oncoming traffic on Texas Road) from the existing and surrounding lighting were 10 to 12 lux near the edges of the road, and reduced to 5 lx in the center of the crosswalk. When the prototype lighting system was switched on, vertical illuminances increased to about 40 to 50 lux near the edges of the road, and 10 lux in the center of the crosswalk. Visual observations of Figure 24 and of project team members using the crosswalk for set-up confirmed that pedestrians appeared brightest at the ends of the crosswalk but that they also appeared brighter in the center of the crosswalk.



Figure 25. Illuminated area along sidewalk provided by the prototype lighting system

Evaluation of Lighting System

After installation of the prototype lighting system, the participants in the field demonstration were invited to look at the crosswalk location from several different perspectives including that of a pedestrian crossing the roadway, and that of a driver approaching the crosswalk. Participants observed the location with the prototype lighting switched both on and off so that they could make judgments of the effects created by the lighting system. Each participant completed a brief questionnaire developed ahead of time in cooperation with NJDOT project manager Nazhat Aboobaker, for both lighting conditions. Each question was given in terms of a statement to which observers rated their agreement or disagreement using a five-point rating scale.

Figures 26 through 31 show the average (mean) responses on the questionnaires for each question and for each lighting condition (with or without the prototype switched on). Since each participant observed each lighting condition, the responses to each question were analyzed using a within-subjects analysis of variance (ANOVA). The following statistically significant ($p < 0.05$) differences were found between the prototype and baseline lighting conditions:

- The prototype system was seen as more glaring than the baseline lighting condition (Figure 26)
- Visibility of pedestrians was easier under the prototype lighting system (Figure 27)
- The prototype lighting system resulted in fewer shadows that might obscure pedestrians (Figure 28)
- The prototype lighting system was brighter (Figure 29)

- Crossing the street with the prototype lighting system was more comfortable (Figure 30)

Driving toward the crosswalk was seen as about equally comfortable with the prototype lighting system as without it (Figure 31).

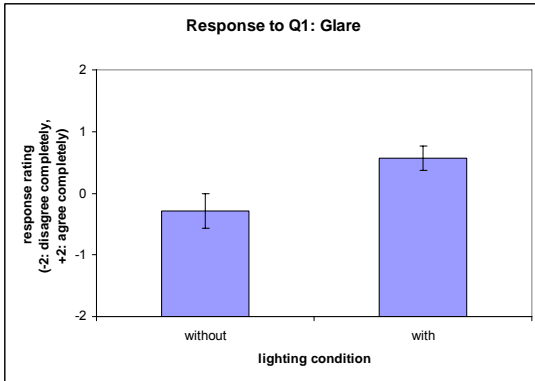

Figure 26. Glare responses

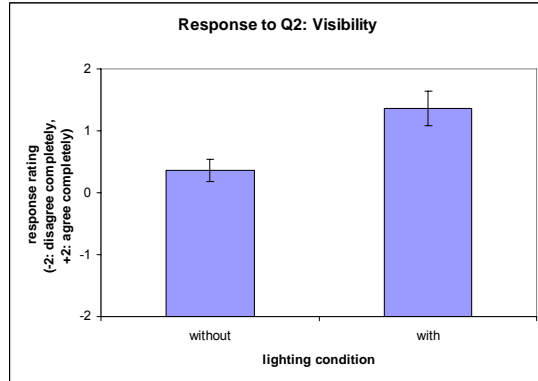

Figure 27. Visibility responses

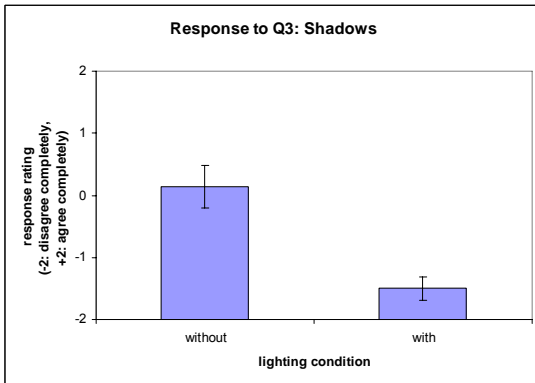

Figure 28. Shadow responses

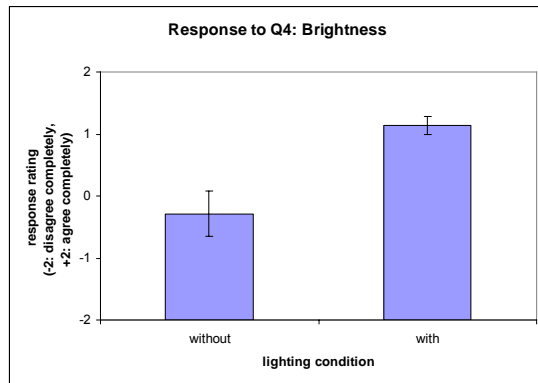

Figure 29. Brightness responses

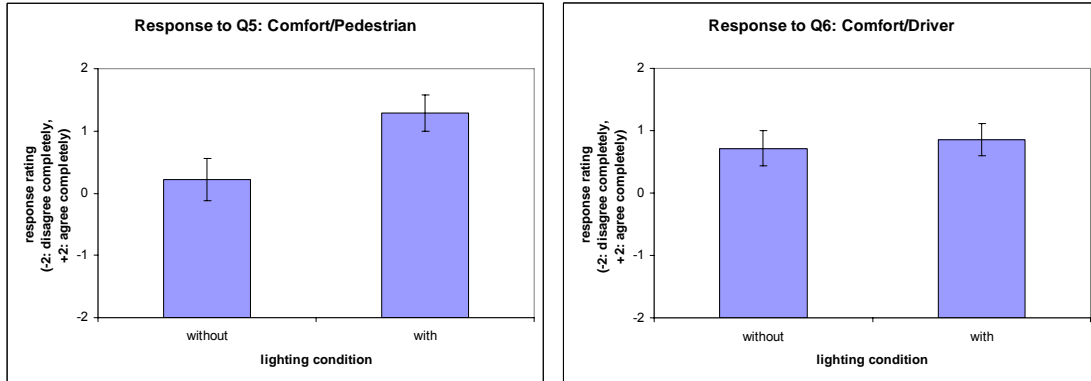

Figure 30. Pedestrian comfort responses Figure 31. Driver comfort responses

Although participants observed that the lighting system did not produce excessive or harsh levels of glare and that the lighting system could be viewed directly without visual discomfort, some concerns were expressed about the possibility of glare reducing visibility for drivers approaching the lighted crosswalk who might be turning onto the crossroad. The locations of the luminaires in the present field demonstration were quite close to the edge of the roadway (e.g., see Figure 23b), and this location could certainly result in some degree of disability glare for drivers trying to see around them. In a permanent installation, the bollard luminaires should be set further back from the roadway edge; this would result in the luminaires being seen further off-axis (where they would produce less glare).

Glare control might also be improved with larger baffles than are currently provided along the luminaire edges. Since direct view of the luminaires is neither needed nor desirable, extending the baffles to allow direct view of the luminaires only within the crosswalk area, and not to approaching traffic, would also reduce glare from its present level.

The type of control of lighting was also discussed by participants. A possibility of synchronizing the operation of the luminaires to the timing of the pedestrian signals (or to a pushbutton control whereby pedestrians press a button when they want to cross the street) was suggested, where the luminaires could be switched on only during times when pedestrians are authorized to cross. Another approach could be to reduce the output of the luminaires (but not switch them off completely) during such non-use periods. This latter approach would still provide some benefit of lighting for those pedestrians who might enter the roadway against a pedestrian signal.

In general, the comments and responses to the brief questionnaires supported the findings from previous analytical evaluations of visual performance and suggest that bollard-level pedestrian lighting could be an effective form of illumination for pedestrian crosswalks.

CONCLUSIONS AND RECOMMENDATIONS

The bollard-based lighting solution evaluated and demonstrated in the present study proved to be a feasible solution toward improving pedestrian visibility, and also for reducing operating and electricity costs. Luminaires rated for outdoor use and with light distributions appropriate for the application exist. Undoubtedly, the optimization of luminaire light distributions could be furthered in order to provide higher uniformity of vertical illuminance along the crosswalk and, as described in the field demonstration section of this report, glare control can be improved through use of louvers or baffles to limit light directed toward oncoming drivers, while maintaining light toward the crosswalk itself.

Although there is a benefit to the use of bollards as architectural elements to help direct pedestrian traffic to crosswalks, especially for mid-block applications, and for delineating the location of crosswalks to drivers during both daytime and nighttime, the use of bollard luminaires is not always going to be practical in certain locations. The results of the visibility and economic evaluations of the overhead lighting configurations conducted for the present study show that overhead lighting, offset ahead of the crosswalk location by about 15 ft, will result in improved visibility of pedestrians, at least in the lane of traffic occupied by oncoming traffic. Unless a luminaire is similarly located across the roadway, however, pedestrians can undergo a transition from positive to negative contrast (or vice versa) when crossing the roadway under such systems. The bollard configuration can be adapted to pole-mounted applications, as well, as illustrated in Figure 20.

As mentioned above, the distribution of the specific luminaires used in the field demonstration was not optimized for illuminating crosswalks across four-lane roadways, resulting in reduced vertical illuminances lower than the 20 lux value that has been recommended in previous studies. Lower vertical illuminances on pedestrians may not be a problem because the bollard luminaires, unlike the overhead lighting used by Gibbons and Hankey⁽¹³⁾ and by Edwards and Gibbons⁽¹⁴⁾ do not provide substantial levels of horizontal illumination on the roadway outside the crosswalk, and therefore there is less vertical illuminance on pedestrians required to ensure that they will be seen in positive contrast.

The use of fluorescent lighting technology for roadway applications is not common, although roadway lighting systems using this technology have been commercially available for many years. Equipment for starting and operating lamps at the proper current is operable for cold-weather conditions, and enclosed luminaires will achieve reasonably high internal temperatures even when exterior temperatures are low. Luminaires using high intensity discharge lamps tend to be much brighter than fluorescent luminaires; when used in pole-mounted systems at mounting heights greater than 20 ft, glare is less of an issue, but for a bollard luminaire, the use of fluorescent lamps has a strong utility when glare reduction is considered. Presently, the cost of LED components and systems do not make

them feasible candidates for roadway lighting at pedestrian crosswalks, although both the technology and its price points are evolving rapidly.

The use of a "signal" function to help draw attention to pedestrians waiting to use the crosswalk can be incorporated into the bollard-based system relatively easily. For example, light output of the system could be dimmed by operating only one lamp in a multiple-lamp ballast, or by operating them at reduced current using electronic ballasts, and either synchronized to the pedestrian signal timing, or timed to reach full light output if the pedestrian signal button is pressed. Operating the luminaires in such a way that they are off when no pedestrians are present (or when nobody has pressed the signal button) is not recommended because a reduced light level will still provide improved visibility over no lighting at all.

Finally, the analyses in the present report suggest a more general method that can be used by NJDOT in evaluating the visibility produced by pedestrian and roadway lighting systems. The RVP model⁽⁴⁾ is a validated system for quantifying the impact of lighting conditions on visual responses and can be used as a procedure for assessing novel approaches to lighting. Such a procedure can be especially useful in justifying the use of new approaches not considered in standardized documentation for lighting.

IMPLEMENTATION AND TRAINING

The findings of the present study are encouraging in that they suggest a new approach to crosswalk lighting can improve visibility and ultimately, to improve pedestrian safety by resulting in fewer pedestrian-related crashes at crosswalks. Nonetheless the limited, short-term demonstration, although a valuable validation of the promise and practicality of this approach, does not by itself provide sufficient evidence for the benefit of such lighting. NJDOT is encouraged to consider a longer-term demonstration at one or more locations in order to assess driver behavior for an extended period of time both before and after the installation of a lighting system corresponding to the present findings.

In addition, members of the project team plan to present the project findings to NJDOT design and safety personnel in order to help disseminate the results throughout the agency, and will submit the results to venues such as the Transportation Research Board and other related organizations.

REFERENCES

1. National Highway Traffic Safety Administration. 2006. Fatal Accident Reporting System. Washington, DC: U.S. Department of Transportation.
2. Illuminating Engineering Society of North America. 2000. American National Standard Practice for Roadway Lighting, IESNA-RP-8-00. New York: Illuminating Engineering Society of North America.
3. Federal Highway Administration. 2002. Pedestrian Facilities User's Guide: Providing Safety and Mobility, FHWA-RD-01-102. Washington, DC: Federal Highway Administration.
4. Rea MS, Ouellette MJ. 1991. Relative visual performance: A basis for application. *Lighting Research and Technology* 23(3).
5. Boyce PR, Van Derlofske J. 2002. Pedestrian Crosswalk Safety: Evaluating In-Pavement, Flashing Warning Lights, FHWA-NJ-2002-15. Trenton, NJ: New Jersey Department of Transportation.
6. Rea MS (ed.). 2000. IESNA Lighting Handbook: Reference and Application, 9th ed. New York: Illuminating Engineering Society of North America.
7. Eklund NH, Boyce PR, Simpson SN. 2001. Lighting and sustained performance: Modeling data-entry task performance. *Journal of the Illuminating Engineering Society* 30: 126.
8. Goodspeed CH, Rea MS. 1999. The significance of surround conditions for roadway signs. *Journal of the Illuminating Engineering Society* 28(1): 164.
9. International Commission on Illumination. 1995. Recommendations for the Lighting of Roads for Motor and Pedestrian Traffic, CIE 115. Vienna: International Commission on Illumination.
10. Freedman M, Janoff MS, Koth BW, McCunney W. 1975. Fixed Illumination for Pedestrian Protection: User's Manual, FHWA-RD-76-9. Washington, DC: Federal Highway Administration.
11. Wilken D, Ananthanarayanan B, Hasson P, Lutkevich PJ, Watson CP, Burkett K, Arens J, Havard J, Unick J. 2001. European Road Lighting Technologies, FHWA-PL-01-034. Washington, DC: Federal Highway Administration.
12. Hasson P, Lutkevich P, Ananthanarayanan B, Watson P, Knoblauch R. 2002. Field test for lighting to improve safety at pedestrian crosswalks. TRB Visibility Symposium, Iowa City, IA.

13. Gibbons R, Hankey J. 2006. Influence of vertical illuminance on pedestrian visibility in crosswalks. *Transportation Research Record* (1973): 105.
14. Edwards C, Gibbons R. 2008. The relationship of vertical illuminance to pedestrian visibility in crosswalks. *Transportation Research Record* (2056): 9.
15. Olson PL et al. 1984. Parameters Affecting Safe Stopping Distance, National Cooperative Highway Research Program Report No. 270. Washington, DC: Transportation Research Board.
16. Wyszecki G, Stiles WS. 1982. *Color Science*, 2nd ed. New York, NY: Wiley.
17. Leslie RP. 1998. A simple cost estimation technique for improving the appearance and safety of outdoor lighting installations. *Building and Environment* 33: 79.