

37

NOTICE
This report was prepared as an account of work sponsored by the United States Government. Neither the United States nor the United States Energy Research and Development Administration, nor any of their employees, nor any of their contractors, subcontractors, or their employees, makes any warranty, express or implied, or assumes any legal liability or responsibility for the accuracy, completeness or usefulness of any information, apparatus, product or process disclosed, or represents that its use would not infringe privately owned rights.

~~RESTRICTED DATA~~

JPL-CO0458
JPL-CO0458

14
DIN: VOY- CI- TRI
COPY 13
THIS DOCUMENT CONTAINS 42
NUMBERED PAGES
SEPTEMBER 29, 1966

Classification Cancelled

C.R.D. 9/29/66 *W. J. ...*
CLASS DATE AUTHORIZED CLASSIFIER

Or Changed To _____
By Authority Of *J. L. Marshall*
By *J. Hartshorn* Data 6/24/72

MASTER

RTG PARAMETRIC STUDY REPORT FOR THE RTG STUDY VOYAGER TASK C (U)

LOG-C04644

~~GROUP 1
EXCLUDED FROM AUTOMATIC
DOWNGRADING AND DECLASSIFICATION~~

~~RESTRICTED DATA
THIS DOCUMENT CONTAINS RESTRICTED DATA WITHIN
THE MEANING OF THE ATOMIC ENERGY ACT OF 1954.
ITS TRANSMISSION OR THE REVELATION OF ITS CON-
TENTS, IN ANY MANNER NOT AUTHORIZED BY THAT
ACT, IS PROHIBITED BY LAW.~~

BY: S. FREEDMAN,
J. FRIEDMAN,
J. SCHMIEDER.
ADVANCED NUCLEAR
SYSTEMS ENGINEERING

APPROVED: *A. Kirpich*
A. KIRPICH, COGNIZANT ENGINEER
VOYAGER TASK C, RTG STUDY
VOYAGER SYSTEM PROJECT

PREPARED FOR
JET PROPULSION LABORATORY
CALIFORNIA INSTITUTE OF TECHNOLOGY
4800 OAK GROVE DRIVE
PASADENA, CALIFORNIA

DISTRIBUTION OF THIS DOCUMENT IS UNLIMITED

UNDER JPL CONTRACT NO. 951112
MODIFICATION NO. 3

LAN: 7348-44-4
~~6648-15-5~~
6729-01-1

GENERAL  ELECTRIC

MISSILE AND SPACE DIVISION
Valley Forge Space Technology Center
P.O. Box 8555 • Philadelphia 1, Penna.

This document is
PUBLICLY RELEASABLE
Larry E. Williams
Authorizing Official
Date: 02/09/2006

~~CONFIDENTIAL
RESTRICTED DATA
ATOMIC ENERGY ACT 1954~~

UNCLASSIFIED

DISTRIBUTION OF THIS DOCUMENT UNLIMITED

DISCLAIMER

This report was prepared as an account of work sponsored by an agency of the United States Government. Neither the United States Government nor any agency Thereof, nor any of their employees, makes any warranty, express or implied, or assumes any legal liability or responsibility for the accuracy, completeness, or usefulness of any information, apparatus, product, or process disclosed, or represents that its use would not infringe privately owned rights. Reference herein to any specific commercial product, process, or service by trade name, trademark, manufacturer, or otherwise does not necessarily constitute or imply its endorsement, recommendation, or favoring by the United States Government or any agency thereof. The views and opinions of authors expressed herein do not necessarily state or reflect those of the United States Government or any agency thereof.

DISCLAIMER

Portions of this document may be illegible in electronic image products. Images are produced from the best available original document.

[Redacted]

[Redacted]

[Redacted]

[Redacted]

~~CONFIDENTIAL~~
~~RESTRICTED DATA~~

TABLE OF CONTENTS

	Page
RTG PARAMETRIC STUDY REPORT	
1.0 INTRODUCTION AND SUMMARY	1
2.0 ASSUMPTIONS	2
3.0 THE PARAMETRIC MODEL	4
4.0 GENERATOR WEIGHT OPTIMIZATION	6
5.0 RESULTS	6
5.1 Unit Weight and Size	7
5.2 Effects of Voltage Variation on Weight	7
5.3 System Fuel Loading	8
5.4 Cycle Temperature Effects on Fuel Loading	9
6.0 CONCLUSIONS	9

THIS DOCUMENT CONTAINS UNCLASSIFIED INFORMATION EXCEPT WHERE SHOWN OTHERWISE
IN THE A.E.C. ARE DISCLOSED THEREIN.

~~CONFIDENTIAL~~
~~RESTRICTED DATA~~

[Redacted]

[Redacted]

[Redacted]

[Redacted]

[Redacted]

~~CONFIDENTIAL~~
~~RESTRICTED DATA~~

LIST OF TABLES

Table	Title	Page
1	Weights and Dimensions of PbTe Units, 12 Beryllium Fins	11
2	Weights and Dimensions of SiGe Units, 12 Beryllium Fins	12
3	Minimum Weights of 600w RTG Systems for Various Length Limits.	13
4	Total Fuel Inventory, Kw for 600w Systems	14

~~SECRET~~



~~SECRET~~

~~CONFIDENTIAL~~
~~RESTRICTED DATA~~

LIST OF ILLUSTRATIONS

Figure	Title	Page
1	PbTe Thermopile Model	15
2	SiGe Thermopile Model	15
3	RTG Parametric Model	16
4	Voyager RTG System Weight	17
5	Voyager RTG Weight Versus T_{COLD} , PbTe Units	18
6	Voyager RTG Weight Versus T_{COLD} , SiGe Units	19
7	Voyager RTG Weight Versus Unit Size, PbTe Units	20
8	Voyager RTG Weight Versus Unit Size, SiGe Units	21
9	Voyager RTG Weight Versus Length, PbTe Units	22
10	Voyager RTG Weight Versus Length, SiGe Units	23
11	Voyager RTG Weight Versus Length, Power = 125w, PbTe Units	24
12	Voyager RTG Weight Versus Length, SiGe Units	25
13	Voyager RTG Weight Versus Length, Power = 200w, PbTe Units	26
14	Voyager RTG Weight Versus Length, SiGe Units	27
15	Voyager System Total Fuel Inventory, Kw Versus T_{COLD} , °F; T_{HOT} as a Parameter	28
16	Fuel for 600w RTG System Versus Carnot Efficiency $\frac{\Delta T}{T_H}$	29
17	Voyager RTG Weight Versus Number of Fins; Minimum Weight Temperature for PbTe Units	30
18	Voyager RTG Weight Versus Number of Fins, Minimum Weight Temperature SiGe $T_{HOT} = 1400^{\circ}F$, $T_{COLD} = 500^{\circ}F$	
19	Voyager RTG Outside Diameter Versus Length for a Series of PbTe Designs: $T_{HOT} = 1100^{\circ}F$, $T_{COLD} = 400^{\circ}F$	
20	Voyager RTG Outside Diameter Versus Length for a Series of SiGe Designs: $T_{HOT} = 1400^{\circ}F$, $T_{COLD} = 600^{\circ}F$	

[Redacted]

[Redacted]

[Redacted]

[Redacted]

1.0 INTRODUCTION AND SUMMARY

This report represents parametric sizing results for finned cylinder radioisotope generators (RTG's) for use with the Voyager spacecraft bus. A later revision to this report will cover considerations for 'flat-plate' RTG's, an analysis of performance margins, an analysis of additional weight allocations required for re-entry shielding, and a preliminary specification delineating physical and performance characteristics. 2

The range of finned cylinder RTG designs considered in this report have in some cases required operation in temperature regimes in excess of extensively proven levels. This has been done to include potentially lighter designs to the extent where higher temperature operation is considered feasible on the basis of limited data. No attempt is made to justify or condemn such designs, this being considered within the province of a detailed design effort.

The RTG weight and performance results were obtained by performing a parametric study of an RTG model. The model includes significant detail but does not in any sense provide a complete RTG design. Therefore the study results are considered semi-quantitative, in that they indicate the trends of weight and performance characteristics, rather than precise numerical results. Particularly for the long units, additional fuel capsule supports and strengthened fin mounting structure will be required, and the unit weight as obtained from a detailed design would be somewhat greater.

To allow estimation of total system weights, a spacecraft load of 600 watts was assumed. This assumed load is preliminary and may be revised.

The parametric study indicates that the lowest total weights for an assumed load of 600 watts will be between 200 and 300 lb. This result is based on the following factors:

- a. The best arrangement for the spacecraft appears to occur with four 150 watt or six 100 watt units.
- b. The spacecraft arrangement is most amenable to RTG overall lengths of less than 60 inches.
- c. Although the very lightest unit weights are obtained with a 1600° F hot junction temperature in a SiGe system, a detailed design for this type of unit would be required to identify the problems associated with the high temperature operation. The design of systems operating at these temperatures is beyond the present ←

~~CONFIDENTIAL~~
~~RESTRICTED DATA~~

state of the art, and consequently material and design problems not now identified may exist. Therefore the systems would require additional development work to guarantee reliability, and it is likely that additional weight would be added as a result.

The minimum weight systems are tabulated below.

Type, No., and Size of Unit	Hot Junction Temperature, °F	Approximate Total Weight for 600 Watt System, lbs
PbTe: 6-100w	<u>1100</u>	<u>300</u>
SiGe: 4-150w	1400	200
SiGe: 4-150w	1600	170*

*No allowance has been included for increased weight which may be necessary to accommodate the high-temperature capsule and thermopile operating conditions.

Typical dimensions for these units are given in the curves and tables which are included under "Results."

The optimum system weights are obtained with the higher T_H systems. However, the 1600°F SiGe system is not considered as a first choice because of the uncertainties regarding the high temperature regime.

The minimum fuel loads are obtained with the lowest cold junction temperatures, and consequently do not coincide with the minimum total weights.

The weights are not so strongly affected by variations in cold junction temperature.

The total generator weight is insensitive to the number of fins between the limits of 8 and 16 fins.

2.0 ASSUMPTIONS

Assumptions used in this study are as follows:

- Fuel - PU-238 microspheres
- Thermoelectric materials - PbTe and SiGe
- Configuration - Finned right circular cylinder
- Fin materials - Beryllium

~~CONFIDENTIAL~~

~~RESTRICTED DATA~~

Temperature Range:

<u>PbTe</u>		<u>SiGe</u>	
<u>Hot Junction Temperature, °F</u>	<u>Cold Junction Temperature, °F</u>	<u>Hot Junction Temperature, °F</u>	<u>Cold Junction Temperature, °F</u>
1000	300	1200	400
1100	350	1400	500
	400	1600	600
	450		
	500		

Sink Temperature: Minus 50°F. This temperature corresponds to that which would exist at approximate earth distance from the sun without the earth albedo.

Length Limits: 48 and 55 inch limits are shown in the parametric results. These lengths are typical of the radial clearance available for mounting the RTG's on the Voyager spacecraft bus.

Spacecraft Load: 600 watts (preliminary)

End-of-Life Thermopile Condition Specifications:

PbTe Thermopile 20% Extraneous resistance

SiGe Thermopile 10% Extraneous resistance

Minimum Length of Thermocouple Legs:

PbTe: 0.4 inch

SiGe: 0.5 inch

Minimum cross-sectional characteristic dimension of thermocouple legs:

PbTe: 0.125 inch diameter (circular cross-section)

SiGe: 0.125 inch side (square cross-section)

Density of thermocouple legs:

PbTe: N-leg -0.2945 lb/in.³

P-leg -0.2421 lb/in.³

SiGe: both legs -0.1156 lb/in.³

~~CONFIDENTIAL~~

~~RESTRICTED DATA~~

Generator heat loss (bypassing thermopile):

→ SEEMS HIGH
MAYBE 10-12%

PbTe: 30%, including insulation losses and end losses
SiGe: 20%, excluding insulation losses, including end losses
(insulation losses are calculated for the SiGe cases)

Hot frame hot junction temperature drop:

PbTe: 30°F
SiGe: 20°F

Cold junction - fin base temperature drop:

PbTe: 20°F
SiGe: 50°F

Voltage: 5, 15, and 28v

Capsule Parameters:

Fuel - Thermal conductivity = 1.3 Btu/hr-ft-°F
Density - .279 lb/in.³
Heat generation - 51.0 watts/in.³
Clad - Thickness - 0.06 in.
Density - 0.330 lb/in.³
Liner - Thickness - 0.02 in.
Density - 0.330 lb/in.³

Number of Fins:

8 to 16, with 12 being used for reference cases

? ⇒ Re-entry protection weight is not included in this report.

3.0 THE PARAMETRIC MODEL

The RTG parametric model comprises a fuel capsule assembly, a thermopile assembly, and a fin assembly. The total weight of the RTG is calculated by adding the weights of these components.

The independent parameters determining the generator size and weight are the hot and cold junction temperatures, sink temperature, number of fins, electrical power, voltage, extraneous resistance, generator aspect ratio, and type of thermoelements (PbTe or SiGe). Thermoelectric data is based upon material properties which were obtained from a thermoelectric materials performance program.

The SNAP-27 generator being developed under AEC Contract No. AT-30-1-3535 served as the basis for developing the parametric model. The PbTe couple design was modeled after the present SNAP-27 design and is shown in Figure 1. All dimensions and weights used to calculate thermopile weight are scaled from this reference design. Thermopile weight was taken to be a function only of the number of couples required to produce a given power level at a given voltage and hot and cold junction temperatures and the weight of each thermocouple and associated thermopile structure. Thermocouple size was limited to dimensions which are state-of-the-art.

The SiGe model was generated from a design prepared with thermoelement construction methods, similar to those used on the 250 watt generator study under AEC Contract No. AT-20-2-2048 which was prepared in conjunction with RCA/Harrison, manufacturers of SiGe models. Figure 2 is representative of this design. The RTG conceptual design is illustrated in Figure 3.

The logic of the optimization procedure is as follows: An initial thermocouple axial length is selected. A capsule is selected which has a cylindrical length equal to that of the thermo-
pile. The fuel is located in an annular region with a void volume of at least 45%.

Ellipsoidal dome ends are used on the capsule, the length of each of these ends being three-eighths of the cylinder diameter. Capsule weight includes fuel, clad, fuel liner, an allowance for miscellaneous capsule hardware, plus the weight of the spacers. The spacers are required since the fuel capsule is divided into individually sealed compartments. Fuel capsule compartmenting is necessary to avoid release of fuel on impact when high aspect ratio capsules are used. The spacers were used to keep the aspect ratio (L/D) of each compartment below 6.0. A check was included on the maximum temperature reached by the fuel. For the present study, a maximum allowable temperature for the inner fuel liner of 2000^oF was used. If this temperature were exceeded then the fuel distribution was changed in such a way that the temperature rise through the fuel and fuel capsule would be reduced.

Having set the thermopile and fuel capsule configurations the fin geometry was selected which had the minimum weight for the given heat rejection capability. This was done by

determining the fin weight required for the heat rejection for a given fin base thickness, and varying this base thickness until a minimum weight set of fins resulted. The fin heat rejection analysis accounted for fin efficiency, fin view factor to space, fin end blockage by the spacecraft body, heat rejection by the cylindrical outer case, fin base temperature, sink temperature, and number of fins.

An additional weight to account for possible stacking of generator sections is included since differential thermal expansion limits the thermopile length. The weight is composed of the weight of end regions on each generator. The maximum thermopile length used was 16.0 inches. The weight of the complete generator is obtained by adding the previously described components and including the weight of the generator ends.

4.0 GENERATOR WEIGHT OPTIMIZATION

The thermopile length is incremented by one thermocouple pitch and a new weight of thermopile, capsule, fins, and ends is calculated by a repetition of the entire procedure. A comparison of the total weights is made and the process is continued until the weight calculated in one iteration exceeds the previous value; the previous weight is then selected as the minimum weight.

The minimum in the total weight occurs because as length is increased, capsule weights tend to increase while the fin weight decreases. It was found, however, that the minimum weight configurations tend to be very long and small in diameter. Weights of generators shorter than those of the minimum weight configuration were obtained. These weights are also presented since support structure, shroud tip-off clearance and other power system integration factors can be expected to influence the RTG selection towards a shorter generator.

5.0 RESULTS

The results of the study are presented in Tables 1 through 4 and Figures 4 through 20.

Tables 1 and 2 provide the following data for PbTe systems and SiGe systems, respectively:

Weight of the RTG unit (W), lb

Overall axial length (L), inches

Envelope diameter over the fins (D), inches

Table 3 provides the total weight for a 600w assembly of RTG's for PbTe and SiGe systems.

Figure 4 presents the most significant results of the study, namely, the variation in total system weight as a function of unit size. The limits of 48 and 55 inches on the length of the generators affect the total weights, and these effects are shown on the plot. This figure shows that the total weight is strongly affected by the number and size of the units.

5.1. UNIT WEIGHT AND SIZE

The minimum weight for 50w, 125w, and 200w units as a function of cold junction temperature are shown in Figures 5 and 6. These weights are minimum where the optimization point has fallen within the length limitation. If the optimization point is not inside the length limit, the weights are the lowest attainable within the limit.

The optimum or minimum attainable unit weight as a function of unit size is given in Figures 7 and 8. These weights are a relatively uniform function of the power rating, but imposition of length limits causes a significant upward inflection of the curves.

Figures 9 through 14 show the variation in RTG weight with unit length.

To relate overall RTG envelope dimensions to unit power, a plot was made of the variation of envelope diameter with axial length for a specific set of hot and cold junction temperatures. The longest length for each power is either the optimum point or the maximum calculated length. The curves may then be interpreted as the variation of envelope dimensions for a given power with the optimum cold side operating temperature for a given hot side temperature. Figures 19 and 20 present these curves for PbTe and SiGe, respectively.

5.2 EFFECTS OF VOLTAGE VARIATION ON WEIGHT

The RTG system weight was based on an output voltage of 28v since this voltage can be used in the spacecraft with a minimum of voltage conversion. However, voltages of 5v and 15v were used in calculating three cases to determine the effects of voltage on RTG system characteristics.

~~CONFIDENTIAL~~

~~RESTRICTED DATA~~

The optimum weight cases for the PbTe and SiGe units were used as a base point. The results of the voltage changes are given below:

Type	Size, w	$T_H^{\circ F}$	$T_C^{\circ F}$	Generator weight, 28v	15v	5v
PbTe	200	1100	400	102	87	80
SiGe	200	1600	600	52	46	--

The weight reduction occurs because the number of thermocouples for the lower voltages is less than the number required for 28v. If it were possible to reduce the length and area of the individual thermocouples without limits, this reduction in weight would not occur. However, minimum lengths and areas are fixed by manufacturing considerations. In sizing the thermopile, the parameter $I(L/A)$ is selected to yield the best efficiency. However, as the voltage for a given power output is increased, the current decreases: hence the (L/A) ratio must increase to hold the $I(L/A)$ parameter constant. The (L/A) ratio can be increased to a certain extent by reducing the area, but when the minimum area is reached, further increases can only be attained by increasing the thermocouple length. The thermopile weight is consequently increased, as well as the outside diameter of the generator. If it is necessary to use parallel strings for reliability, the thermocouple current is reduced by an additional factor, which makes lower voltage even more beneficial in achieving a minimum-weight design.

The weight reduction given above must be traded off against the additional weight of the DC to DC conversion equipment. It appears that the weight savings resulting from low thermopile voltages is about equal to the additional weight required for the voltage step-up device. The actual RTG voltage can only be determined when a complete power system study is made.

5.3 SYSTEM FUEL LOADING

Table 4 gives the fuel requirements for the PbTe and SiGe systems. There is essentially no difference in the total fuel requirements, regardless of the unit size of the RTG. Figure 15 shows the fuel requirements versus cold junction temperature for the total system.

~~CONFIDENTIAL~~

~~RESTRICTED DATA~~

5.4 CYCLE TEMPERATURE EFFECTS ON FUEL LOADING

Figure 16 shows the variation in fuel loading for the PbTe and SiGe systems as a function of the maximum theoretical efficiency for the temperatures under consideration. The maximum efficiency is expressed as the Carnot efficiency $\Delta T/T_H$.

The plot shows that similar efficiencies (and consequently, similar fuel loadings) can be attained for the PbTe and SiGe systems, by proper selection of the hot and cold junction temperatures. For example, a SiGe system operating with $T_H = 1400^\circ\text{F}$ and $T_C = 500^\circ\text{F}$ has about the same fuel loading as a PbTe system with $T_H = 1000^\circ\text{F}$ and $T_C = 400^\circ\text{F}$.

The effects of the temperature range on the weight at equal efficiency are important:

- a. If efficiencies are equal for the two systems, the fuel inventories (and hence fuel weights) will be equal.
- b. The heat rejection area will be smaller for the system which operates at the higher temperature. Assuming that the fin efficiency, view factors, and the emissivities are equal for the two systems mentioned above, the area of the fins for the PbTe system is 1.5 times that of the SiGe system. Consequently the weight of the PbTe fin system will be greater. The fin system weight is typically 5% to 15% of the generator weight, while the fuel capsule weight is typically one-half the generator weight.

6.0 CONCLUSIONS

The optimum total weight of the Voyager system decreases as the unit size of the RTG increases. However, if a length limit of 48 or 55 inches is imposed, a minimum weight occurs with a unit size of around 100w for PbTe units. The SiGe units indicate a minimum weight at about 150w for a 1200°F or 1400°F hot junction temperature.

The total fuel inventory for all systems increases with increasing cold junction temperature. Therefore the minimum weight system will not have a minimum fuel inventory. This may indicate a tradeoff between weight and cost or radiation dose.

The unit weights of the RTG's are only slightly affected by varying the number of fins, as illustrated in Figures 17 and 18 for specific examples. The change is a maximum of 3% over the range of 10 to 16 fins, with the 200w units being most affected. For the PbTe

~~CONFIDENTIAL~~
~~RESTRICTED DATA~~

system, the weight increases as the number of fins is increased, while for the SiGe system a shallow minimum occurs with 14 fins for the 200w unit.

The PbTe units tend to be generally longer and of smaller diameter than the SiGe units. Also the length spread of the PbTe units is smaller. Hence the 125w and 200w PbTe units have their lowest attainable weight at the length limits while in some cases the SiGe lowest weight units are shorter than the maximum length.

~~CONFIDENTIAL~~
~~RESTRICTED DATA~~

~~CONFIDENTIAL~~
~~RESTRICTED DATA~~

TABLE 1. WEIGHTS AND DIMENSIONS OF PbTe UNITS, 12 BERYLLIUM FINs

W - lbs L&D - inches	$T_C = 300^\circ\text{F}$			$T_C = 350^\circ\text{F}$			$T_C = 400^\circ\text{F}$			W	L	D	
	W	L	D	W	L	D	W	L	D				
Power = 50w $T_H = 1000^\circ\text{F}$	33.3	37.6	16.9	30.9	37.2	13.0	37.8	22.5	17.3				
	37.1	26.5	23.8	33.3	26.9	19.1	38.5	19.7	19.6				
	61.4	17.0	29.5	41.0	17.5	29.4	40.3	17.5	23.3				
	$T_C = 450^\circ\text{F}$			$T_C = 500^\circ\text{F}$									
Power = 50w $T_H = 1100^\circ\text{F}$	39.7	23.5	12.5	44.0	22.1	10.5							
	40.3	20.0	15.1	44.6	19.4	13.0							
	41.5	17.9	17.8	45.2	18.4	13.5							
	$T_C = 450^\circ\text{F}$			$T_C = 500^\circ\text{F}$									
Power = 50w $T_H = 1100^\circ\text{F}$	$T_C = 300^\circ\text{F}$			$T_C = 350^\circ\text{F}$			$T_C = 400^\circ\text{F}$						
	29.0	35.7	15.9	28.0	37.5	10.9	29.3	32.1	10.0				
	32.4	26.0	22.2	29.2	27.4	16.1	29.8	25.0	14.3				
	50.6	16.5	27.0	35.9	16.6	27.1	33.5	16.9	21.5				
Power = 125w $T_H = 1000^\circ\text{F}$	$T_C = 300^\circ\text{F}$			$T_C = 350^\circ\text{F}$			$T_C = 400^\circ\text{F}$						
	Excessive Fin Wgt						67.5	66.6	14.7				
							76.4	46.4	23.0				
							170.0	24.8	31.0				
Power = 125w $T_H = 1000^\circ\text{F}$	$T_C = 450^\circ\text{F}$			$T_C = 500^\circ\text{F}$									
	70.8	67.8	10.9	80.7	55.0	12.3							
	77.8	45.4	18.3	83.4	42.9	15.9							
	73.2	54.9	15.1	99.5	25.8	27.5							
Power = 125w $T_H = 1100^\circ\text{F}$	$T_C = 300^\circ\text{F}$			$T_C = 350^\circ\text{F}$			$T_C = 400^\circ\text{F}$						
	60.2	76.3	20.1	58.0	71.6	16.2	56.8	65.3	13.6				
	76.6	54.2	28.4	63.2	54.6	21.5	60.7	53.0	17.8				
	90.2	48.5	28.5	68.5	48.1	24.6	63.1	48.1	19.9				
Power = 125w $T_H = 1100^\circ\text{F}$	$T_C = 450^\circ\text{F}$			$T_C = 500^\circ\text{F}$									
	62.5	54.7	12.9	65.4	52.1	11.1							
	65.6	41.3	18.2	66.9	41.0	15.2							
	86.2	24.5	30.6	80.1	24.9	21.1							
Power = 200w $T_H = 1000^\circ\text{F}$	$T_C = 300^\circ\text{F}$			$T_C = 350^\circ\text{F}$			$T_C = 400^\circ\text{F}$			$T_C = 450^\circ\text{F}$			
	Excessive Fin Wgt			120	76.4	27.0	109.3	76.2	22.1	109	76.3	17.5	
				231	55.0	29.3	144.0	53.3	29.5	130	53.6	26.8	
				603	48.4	29.5	166.5	48.6	29.7	140	47.9	30.2	
Power = 200w $T_H = 1000^\circ\text{F}$	$T_C = 500^\circ\text{F}$												
	115	76.8	13.7										
	129	53.7	22.3										
	136	47.8	24.8										
Power = 200w $T_H = 1100^\circ\text{F}$	$T_C = 300^\circ\text{F}$			$T_C = 350^\circ\text{F}$			$T_C = 400^\circ\text{F}$			$T_C = 450^\circ\text{F}$			
	Excessive Fin Wgt			103	76.5	24.9	102	76.2	20.0	90.7	76.5	15.3	
				156	54.8	29.3	112	55.0	29.5	106	53.7	23.7	
				252	48.4	29.5	131	47.8	29.7	113	48.1	26.9	
Power = 200w $T_H = 1100^\circ\text{F}$	$T_C = 500^\circ\text{F}$												
	92.8	76.2	12.5										
	102	53.6	18.9										
	107	47.9	21.2										

~~CONFIDENTIAL~~
~~RESTRICTED DATA~~

TABLE 2. WEIGHTS AND DIMENSIONS OF SiGe UNITS, 12 BERYLLIUM FINES

W - lbs L&D - inches	$T_C = 400^\circ\text{F}$			$T_C = 500^\circ\text{F}$			$T_C = 600^\circ\text{F}$		
	W	L	D	W	L	D	W	L	D
Power = 50w $T_H = 1200^\circ\text{F}$	_____			29.8	16.6	21.5	28.8	16.9	14.0
	_____			28.1	20.8	16.4	28.1	19.2	12.6
	_____			27.3	27.1	12.1	28.1	21.0	10.5
$T_H = 1400^\circ\text{F}$	27.6	16.4	25.6	21.4	16.3	16.3	20.5	15.6	10.4
	23.4	24.0	17.1	21.1	18.6	13.2	20.6	16.4	9.4
	22.7	31.5	12.9	21.0	21.1	11.2	20.7	15.7	10.5
$T_H = 1600^\circ\text{F}$	20.7	16.2	20.5	17.5	15.4	13.2	17.5	16.3	8.2
	20.0	18.4	17.3	17.6	16.2	12.2	17.3	15.5	8.3
	19.6	20.9	15.3	17.6	15.5	13.3	17.2	14.8	8.3
P = 125w $T_H = 1200^\circ\text{F}$	72.4	50.5	26.2	_____			71.0	25.5	16.4
	62.3	63.9	20.0	_____			64.6	36.7	16.8
	58.1	76.4	16.8	_____			60.6	48.0	12.5
$T_H = 1400^\circ\text{F}$	_____			45.1	55.0	11.0	44.3	38.3	10.4
	_____			45.4	40.3	16.3	44.8	30.6	14.7
	_____			59.3	23.9	28.8	47.9	24.0	18.9
$T_H = 1600^\circ\text{F}$	39.7	54.3	14.8	36.7	37.9	13.1	35.9	31.8	10.4
	43.6	38.9	22.0	37.8	30.7	17.4	35.9	27.4	12.6
	75.8	23.6	28.6	40.8	23.6	23.5	36.6	23.8	14.7
P = 200w $T_H = 1200^\circ\text{F}$	121	76.2	28.2	96.8	76.2	18.3	94.3	76.2	12.5
	287	53.7	28.6	116	54.9	26.7	104	55.1	18.9
	_____			129	48.3	28.9	109	48.2	21.1
$T_H = 1400^\circ\text{F}$	91.4	76.1	23.0	63.5	76.3	13.1	67.8	60.3	11.4
	124	53.5	28.4	76.8	54.7	19.4	70.0	45.3	15.7
	151	49.6	28.5	90.6	47.5	23.6	83.7	30.3	26.1
$T_H = 1600^\circ\text{F}$	60.6	76.2	16.8	54.6	69.6	10.9	54.6	46.2	11.4
	71.7	55.3	24.1	56.6	50.7	16.3	55.4	38.1	14.7
	79.4	48.7	28.3	75.4	29.9	28.7	59.6	30.0	19.7

~~CONFIDENTIAL~~
~~RESTRICTED DATA~~

TABLE 3. MINIMUM WEIGHTS OF 600w RTG SYSTEMS FOR VARIOUS LENGTH LIMITS

		75 In. Limit						55 In. Limit					
Unit No. & Size		T _H ^o F	T _C ^o F	W lbs	T _H ^o F	T _C ^o F	W lbs	T _H ^o F	T _C ^o F	W lbs	T _H ^o F	T _C ^o F	W lbs
PbTe Units	12 50	1000	300	435	1100	400	350	1000	300	435	1100	400	350
	6 100		400	340		400	284		400	362		400	292
	4 150		400	316		400	271		400	381		400	302
	3 200		400	330		500	306		500	435		500	336
48 In. Limit													
	12 50	1000	300	435	1100	400	350						
	6 100		400	362		400	292						
	4 150		400	400		400	328						
	3 200		500	500		500	390						
75 In. Limit													
SiGe Units	12 50	1200	500	318	1400	600	246	1600	600	204			
	6 100		500	292		600	220		600	187			
	4 150		500	278		500	194		500	170			
	3 200		600	282		500	180		500	156			
55 In. Limit													
	12 50	1200	500	318	1400	600	246	1600	600	204			
	6 100		500	292		600	220		600	187			
	4 150		500	278		600	202		600	171			
	3 200		600	312		600	198		500	162			
48 In. Limit													
	12 50	1200	500	318	1400	600	246	1600	600	204			
	6 100		500	292		600	220		600	187			
	4 150		600	292		600	202		600	171			
	3 200		600	336		600	200		600	164			

~~CONFIDENTIAL~~
~~RESTRICTED DATA~~

TABLE 4. TOTAL FUEL INVENTORY, Kw FOR 600w SYSTEM

T_C °F	PbTe Units		SiGe Units		
	$T_H = 1000$ °F	$T_H = 1100$ °F	$T_H = 1200$ °F	$T_H = 1400$ °F	$T_H = 1600$ °F
300	13.0	12.1	—	—	—
350	13.7	12.6	—	—	—
400	14.4	13.2	16.4	13.7	10.8
450	15.6	13.9	—	—	—
500	17.0	15.0	18.5	14.3	11.5
600	—	—	21.1	15.4	12.4

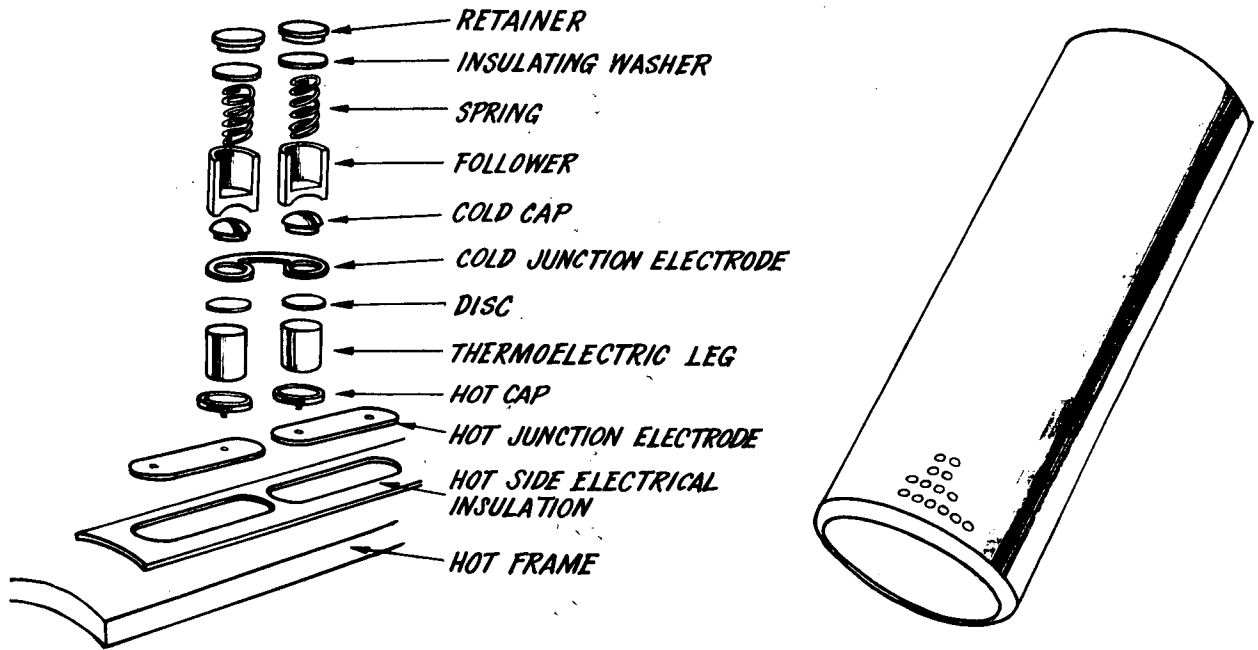

Figure 1. PbTe Thermopile Model

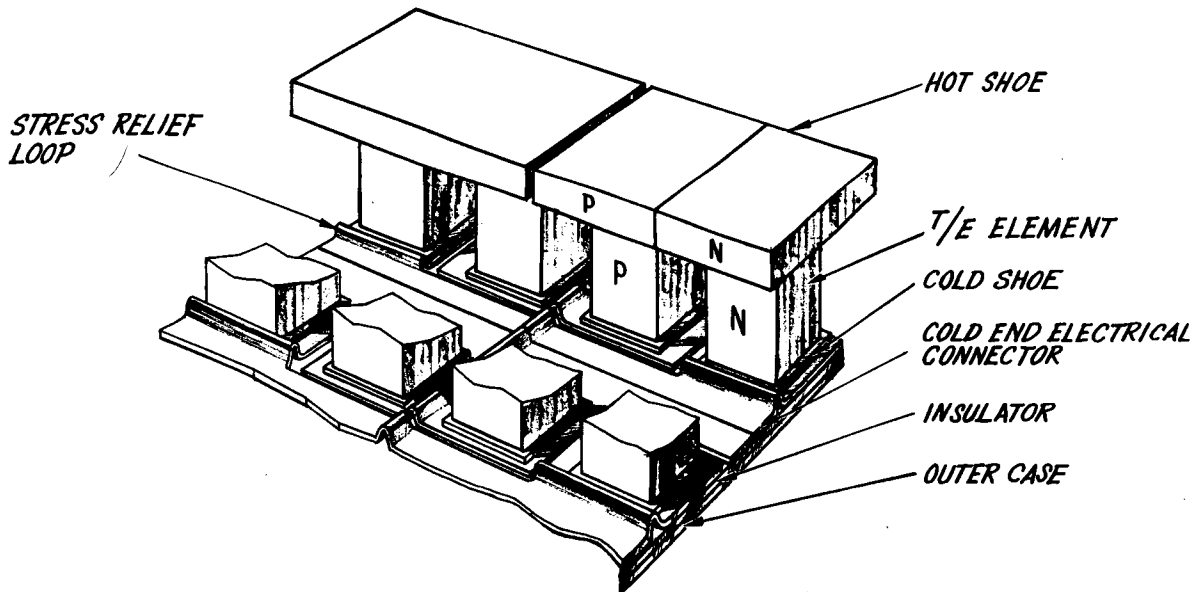

Figure 2. SiGe Thermopile Model

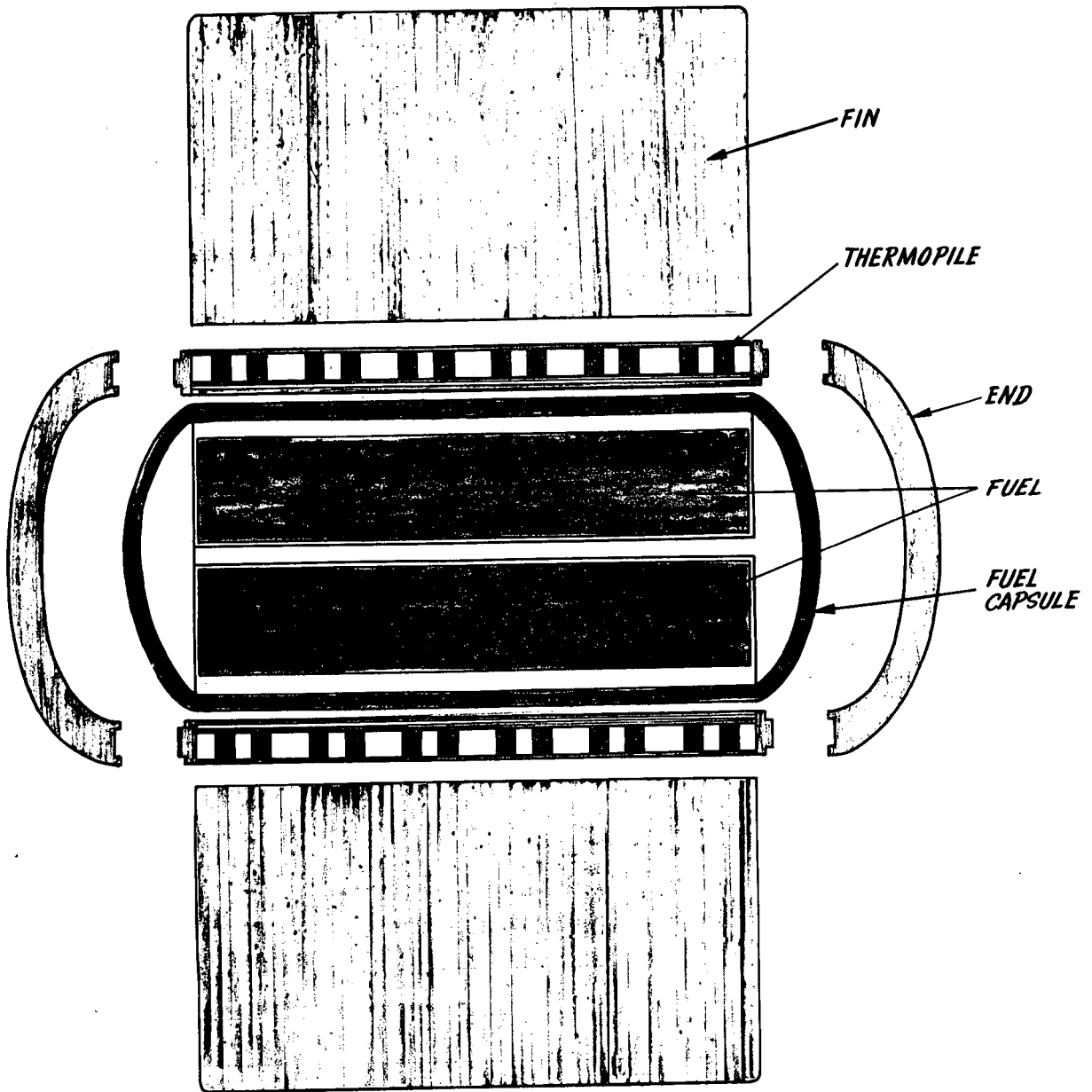

Figure 3. RTG Parametric Model

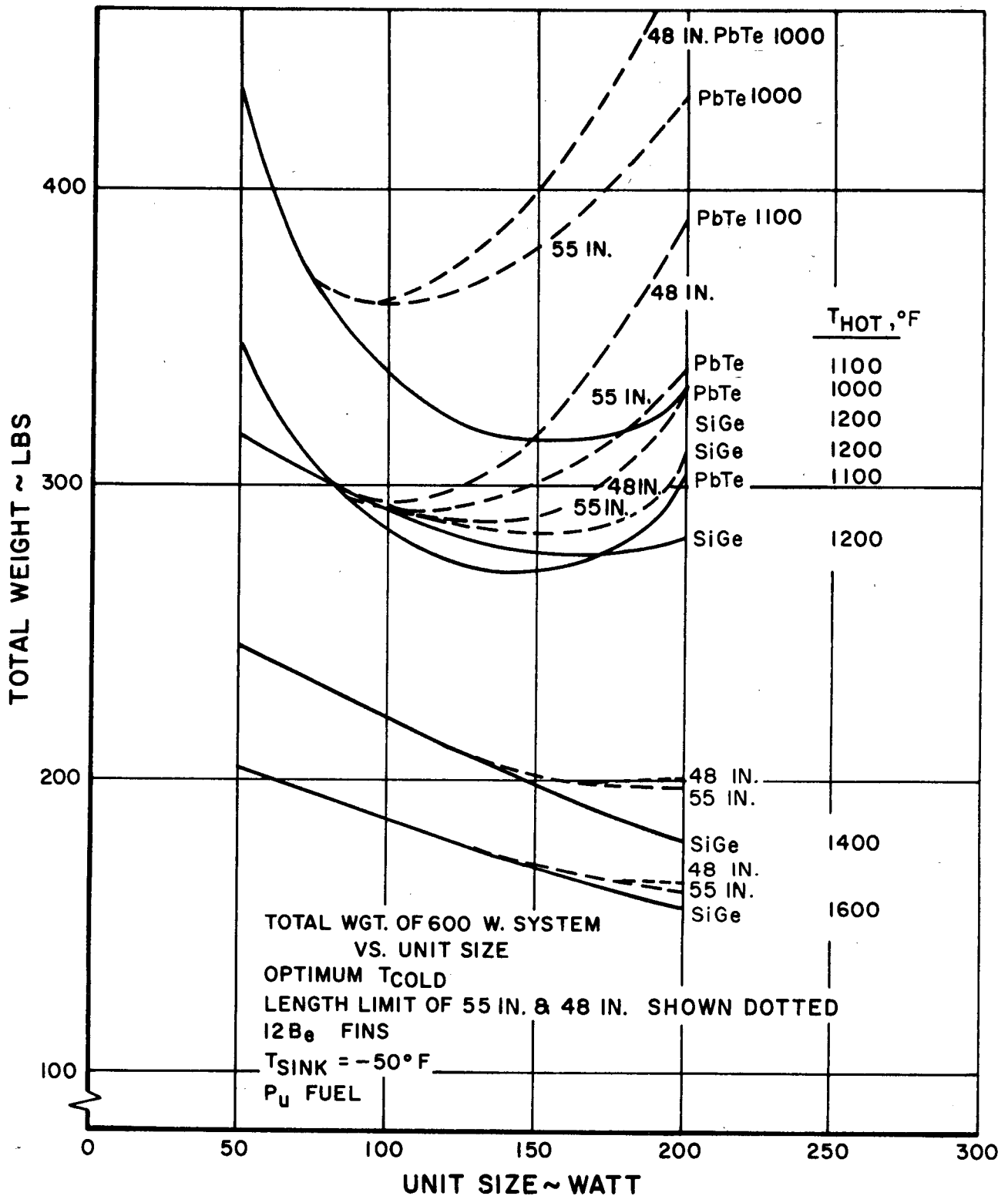

Figure 4. Voyager RTG System Weight

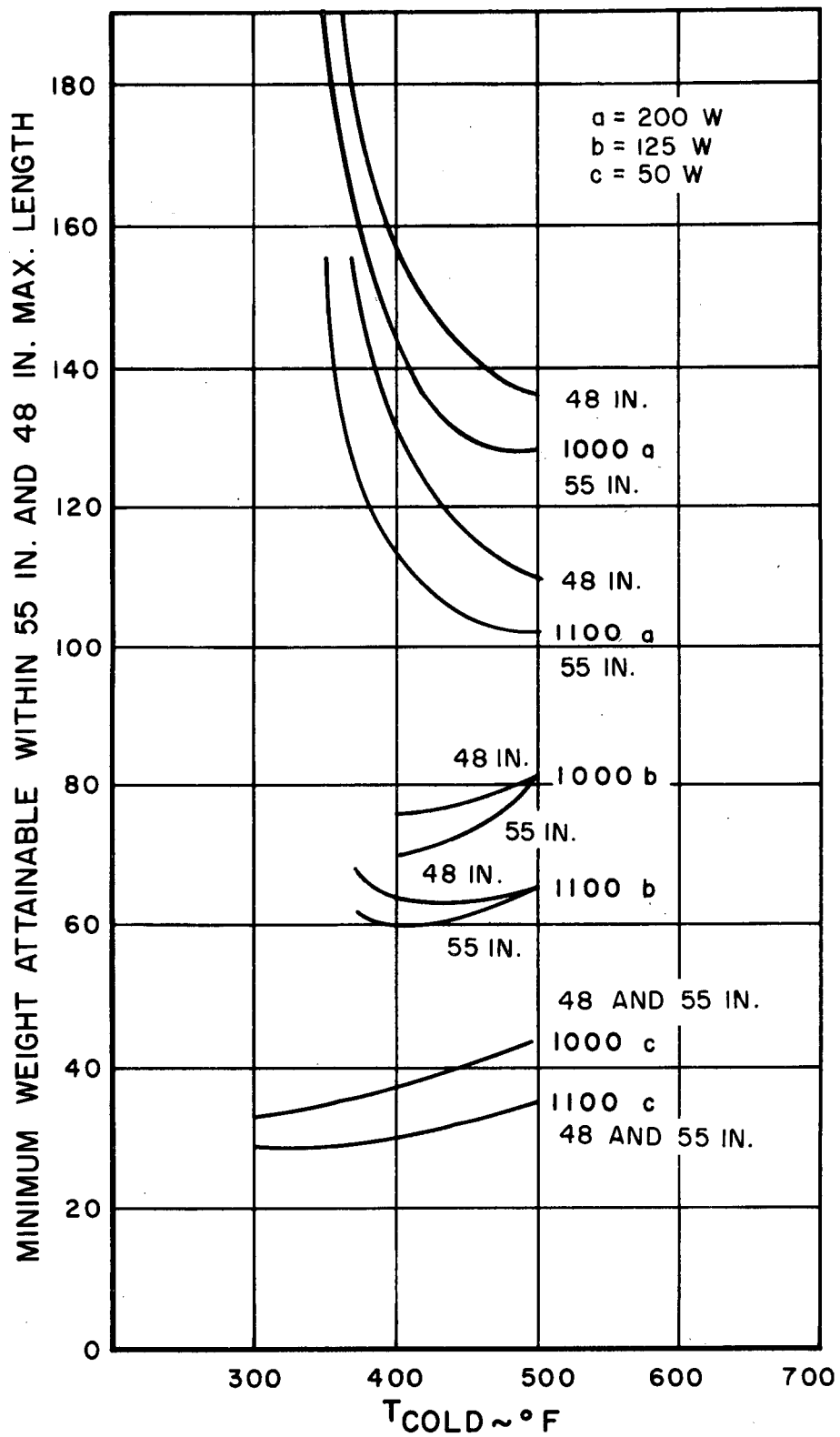

Figure 5. Voyager RTG Weight Versus T_{COLD} , PbTe Units

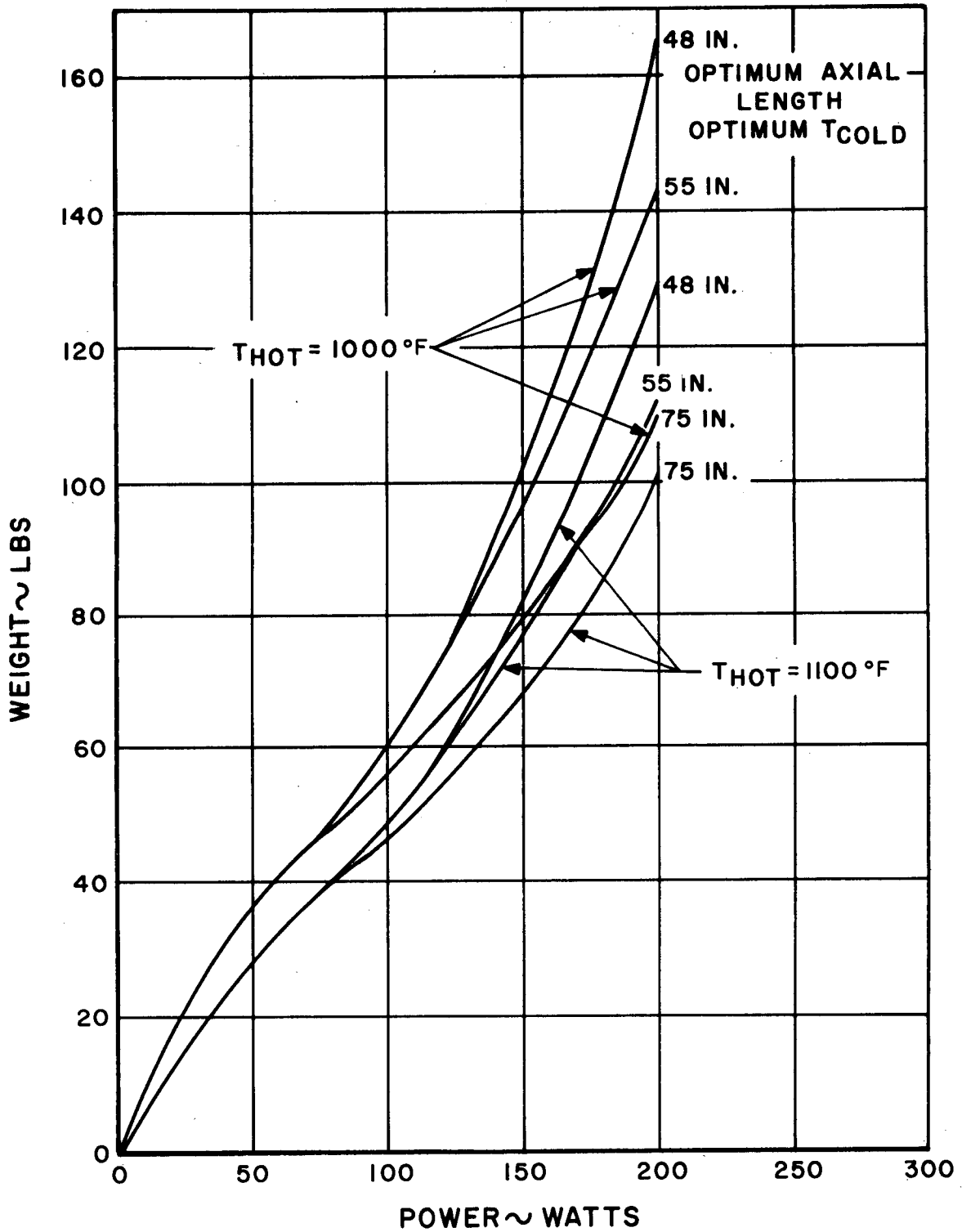

Figure 7. Voyager RTG Weight Versus Unit Size, PbTe Units

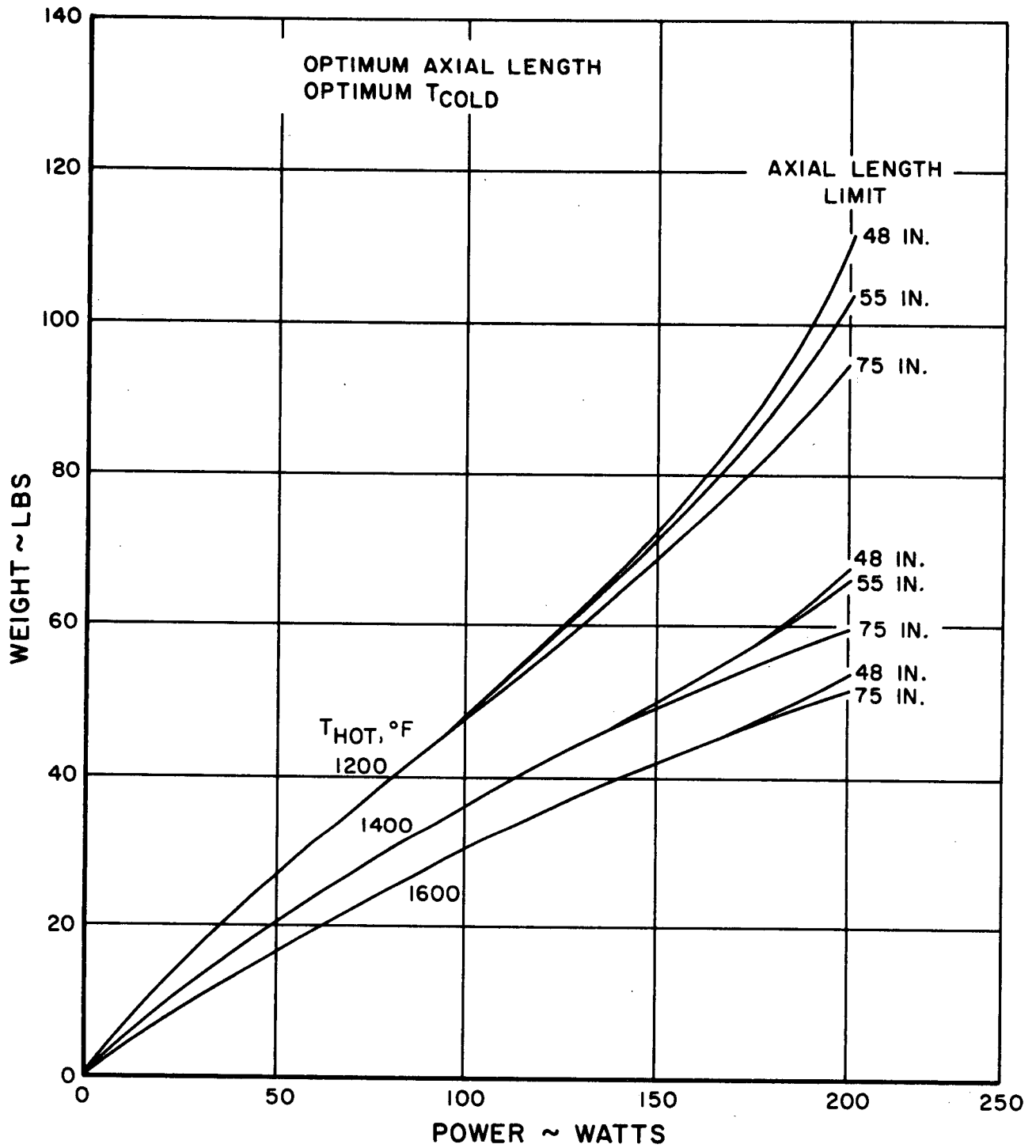

Figure 8. Voyager RTG Weight Versus Unit Size, SiGe Units

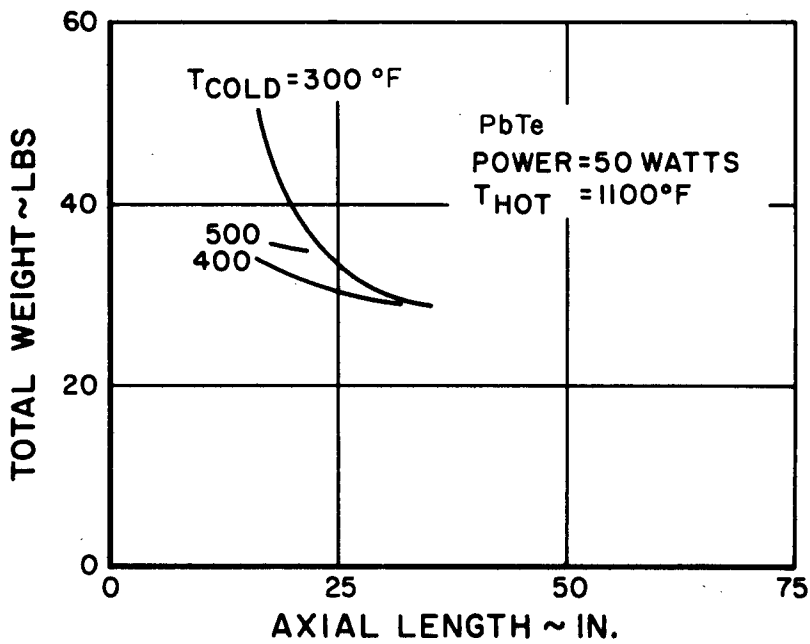
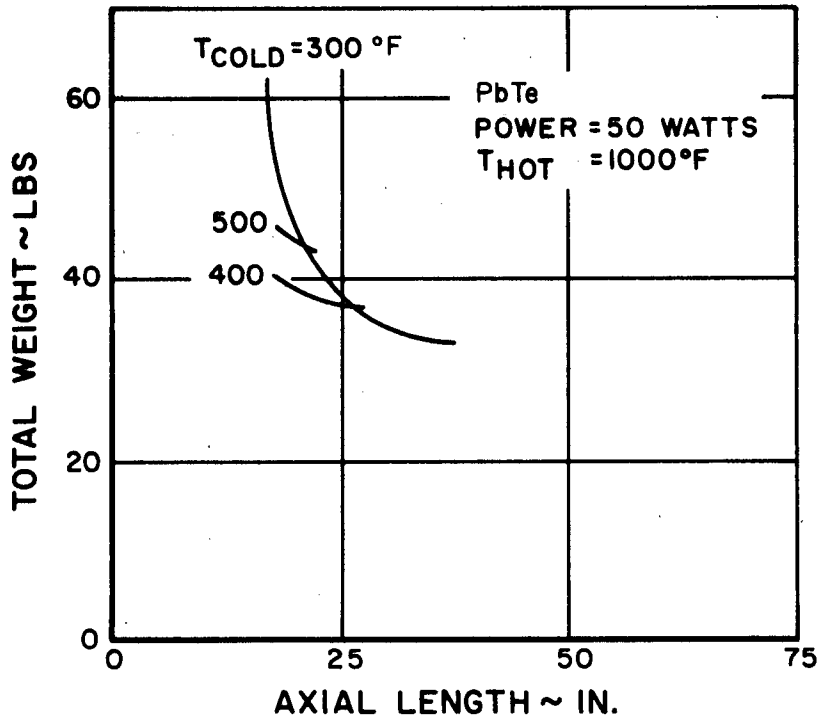

Figure 9. Voyager RTG Weight Versus Length, PbTe Units

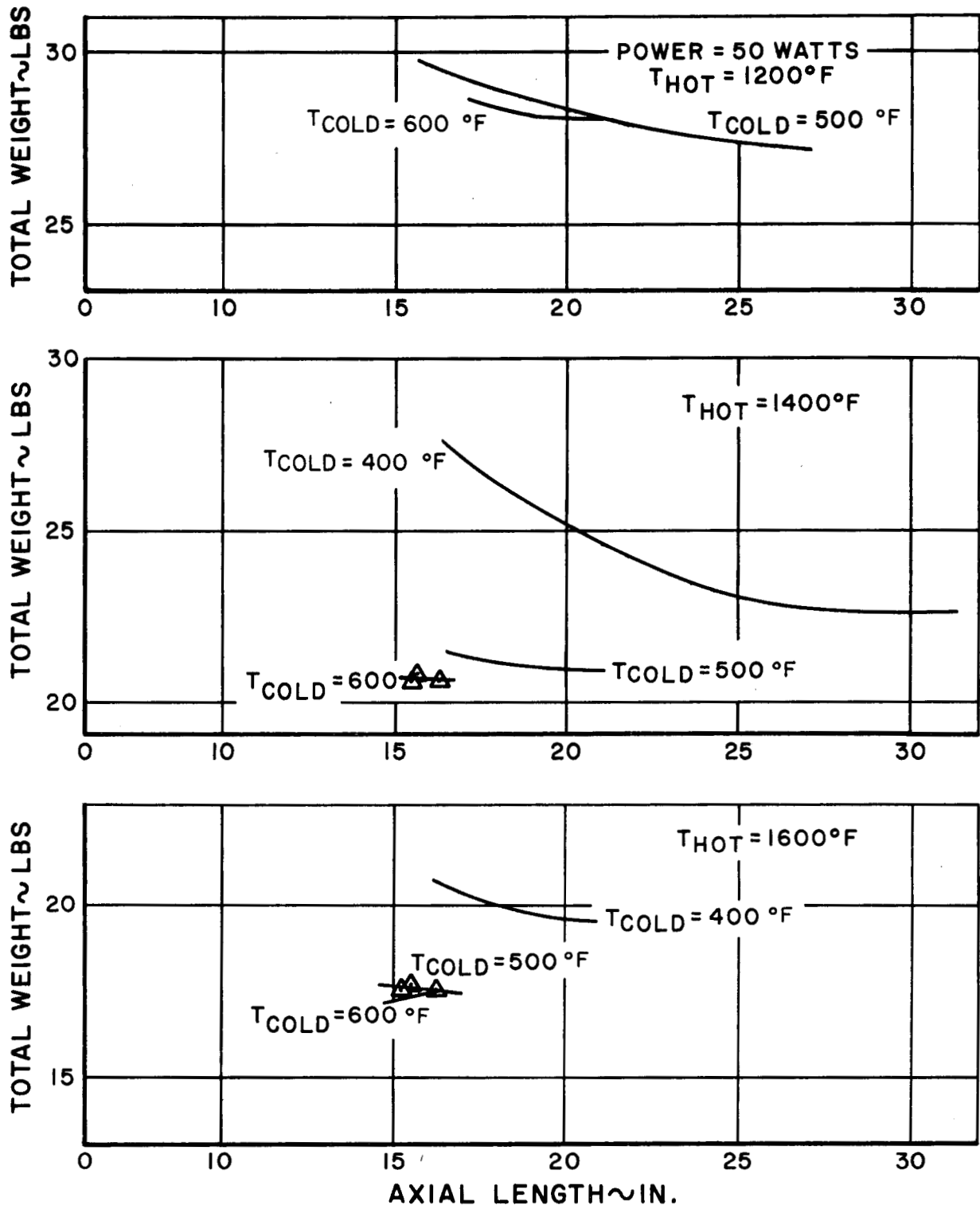

Figure 10. Voyager RTG Weight Versus Length, SiGe Units

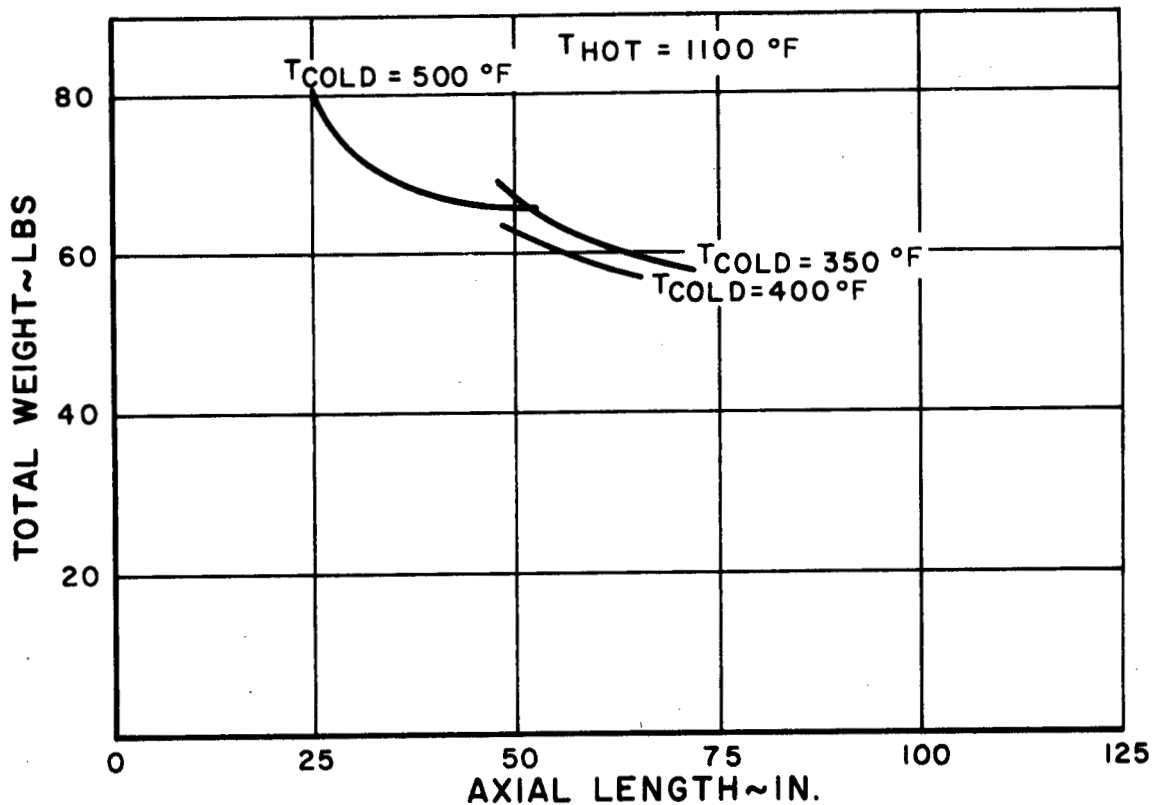
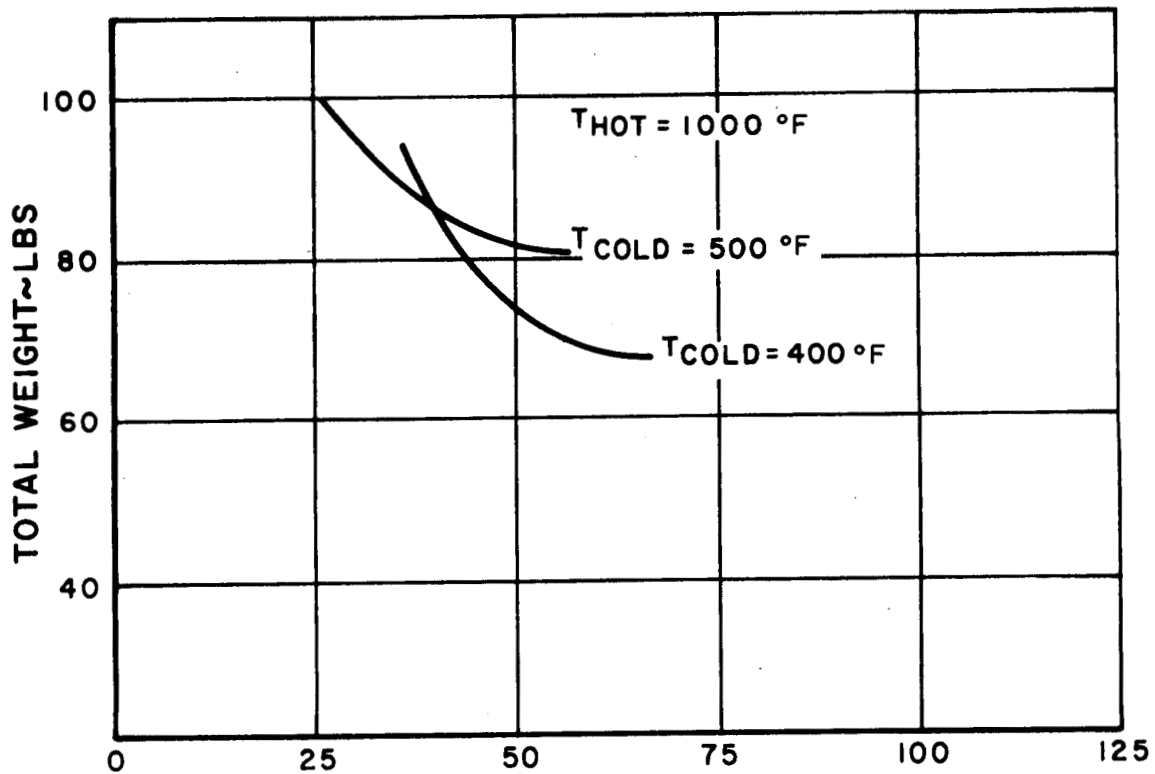

Figure 11. Voyager RTG Weight Versus Length, Power = 125w, PbTe Units

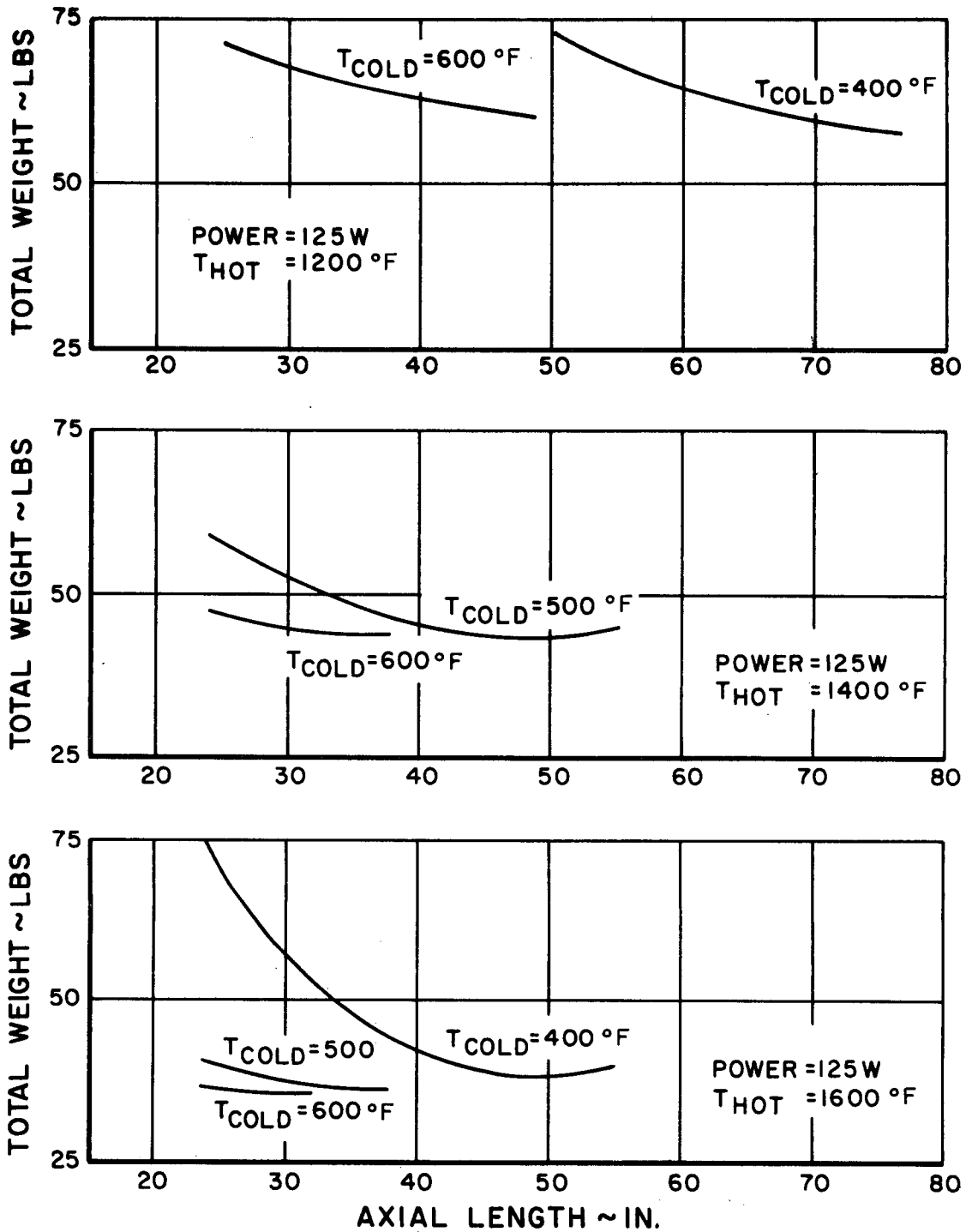

Figure 12. Voyager RTG Weight Versus Length, SiGe Units

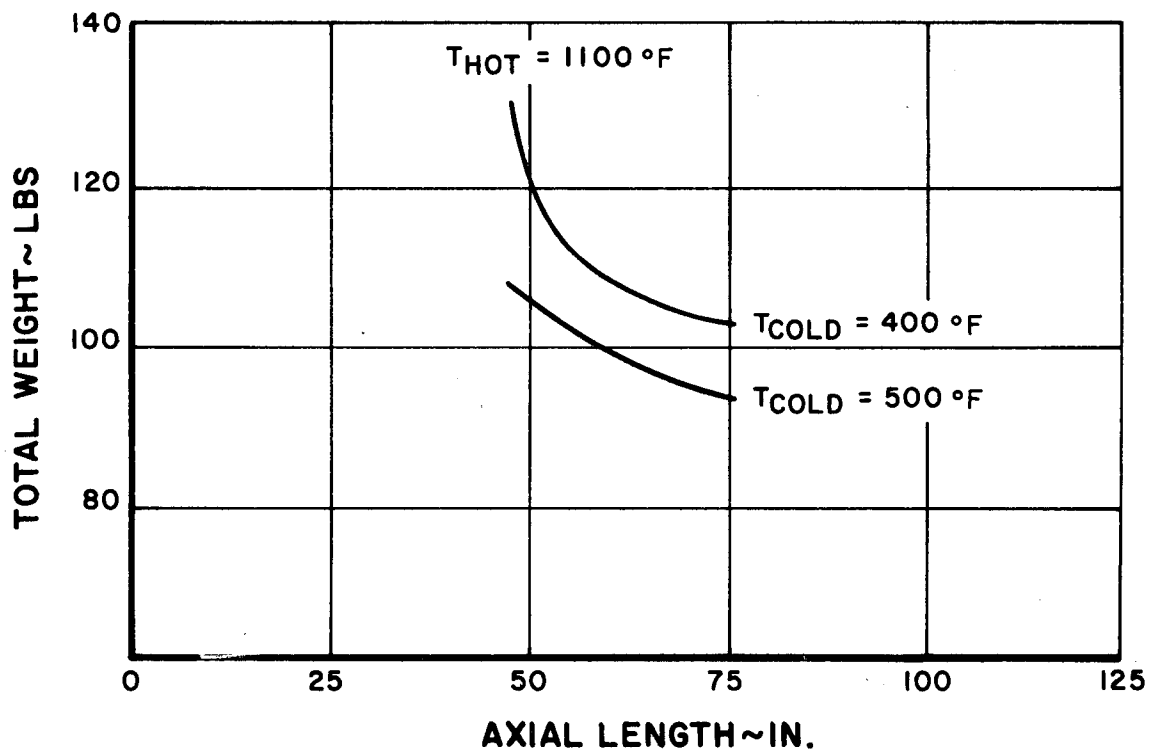
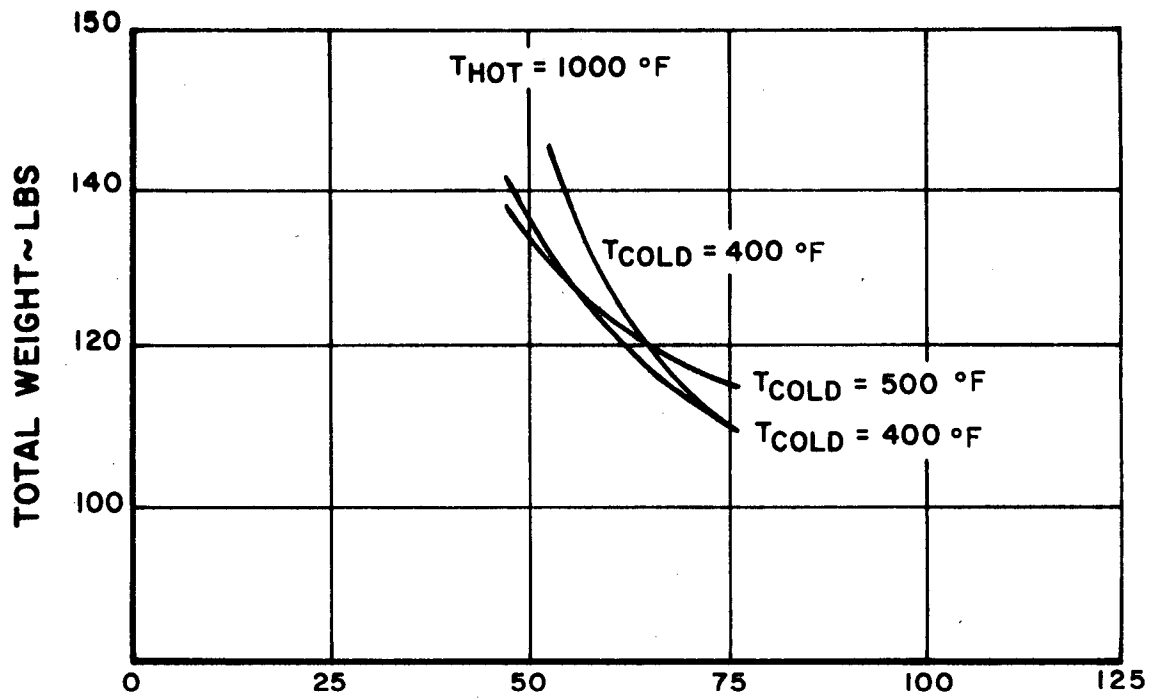

Figure 13. Voyager RTG Weight Versus Length, Power = 200w, PbTe Units

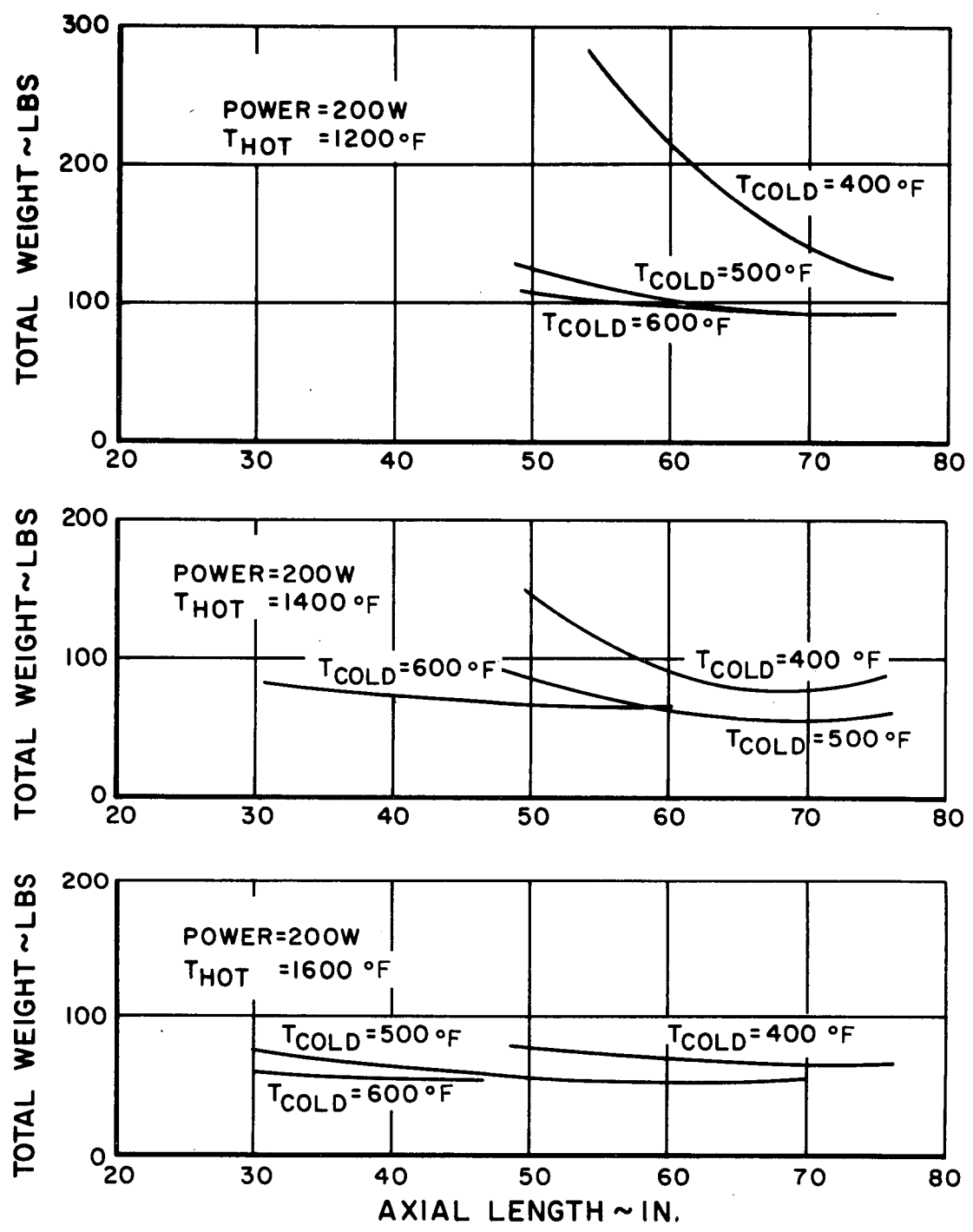

Figure 14. Voyager RTG Weight Versus Length, SiGe Units

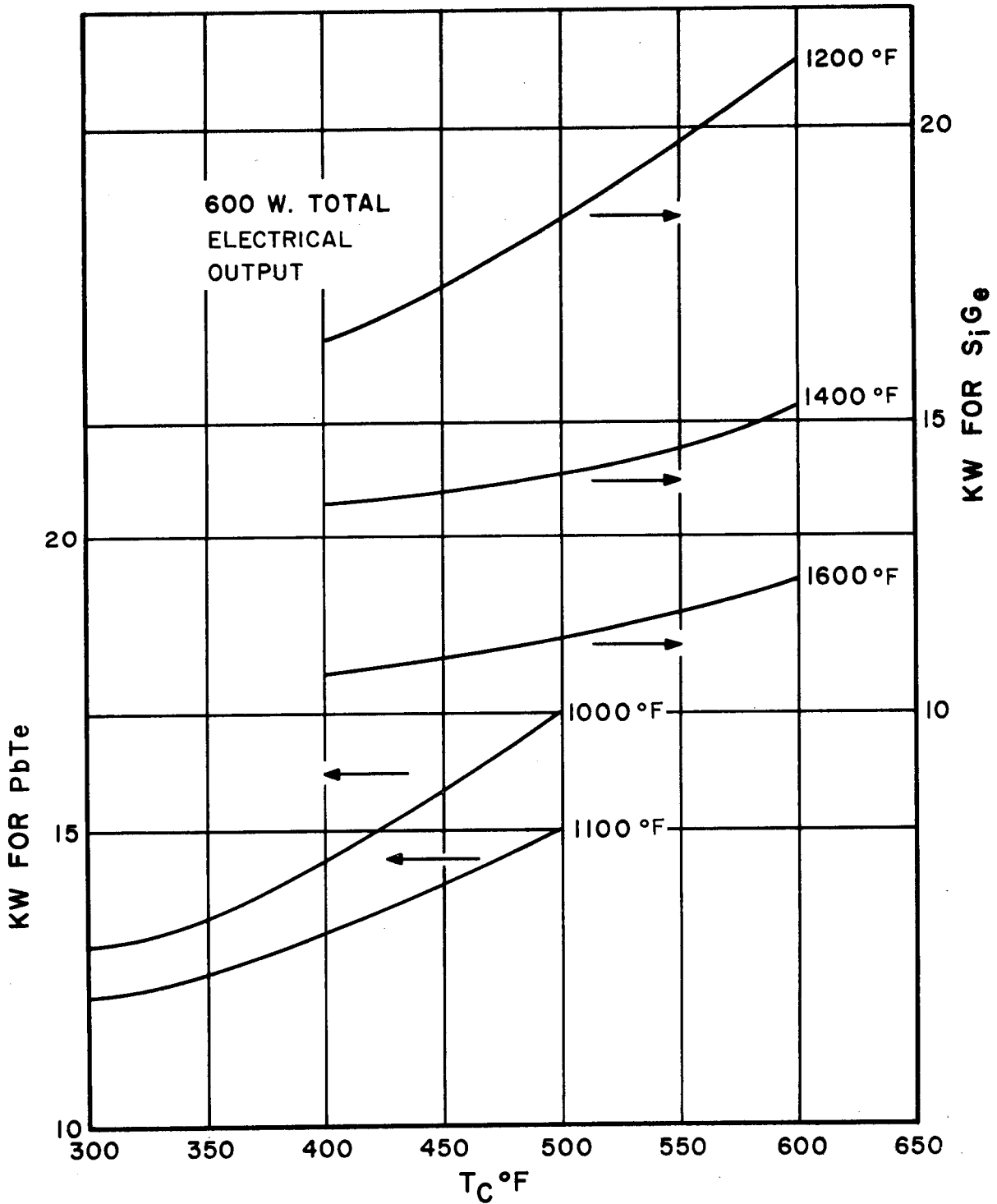

Figure 15. Voyager System Total Fuel Inventory, Kw Versus T_{COLD} , °F; T_{HOT} as a Parameter

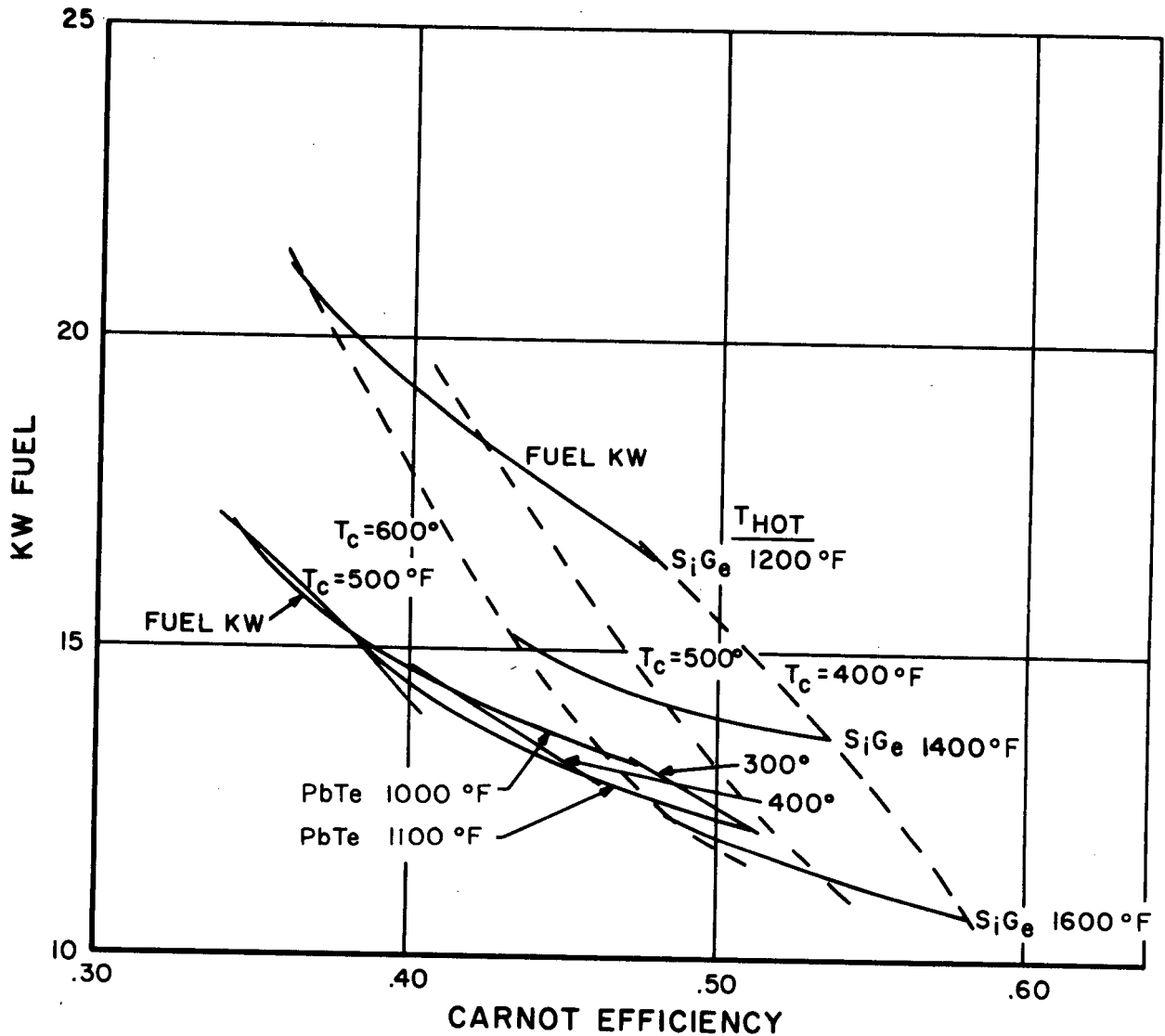

Figure 16. Fuel for 600w RTG System Versus Carnot Efficiency ($\frac{\Delta T}{T_H}$)

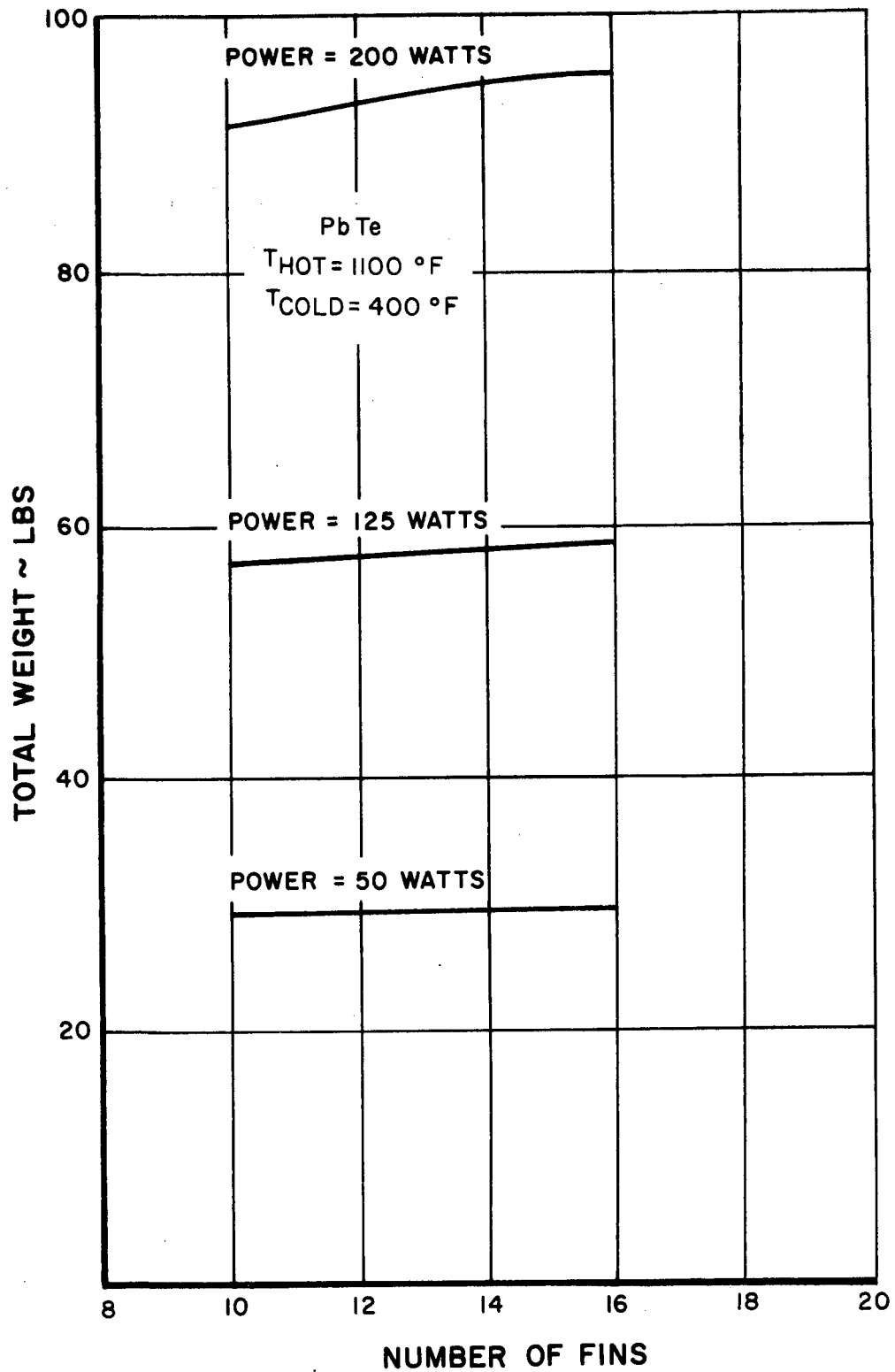

Figure 17. Voyager RTG Weight Versus Number of Fins; Minimum Weight Temperature for PbTe Units

~~CONFIDENTIAL~~

~~RESTRICTED DATA~~

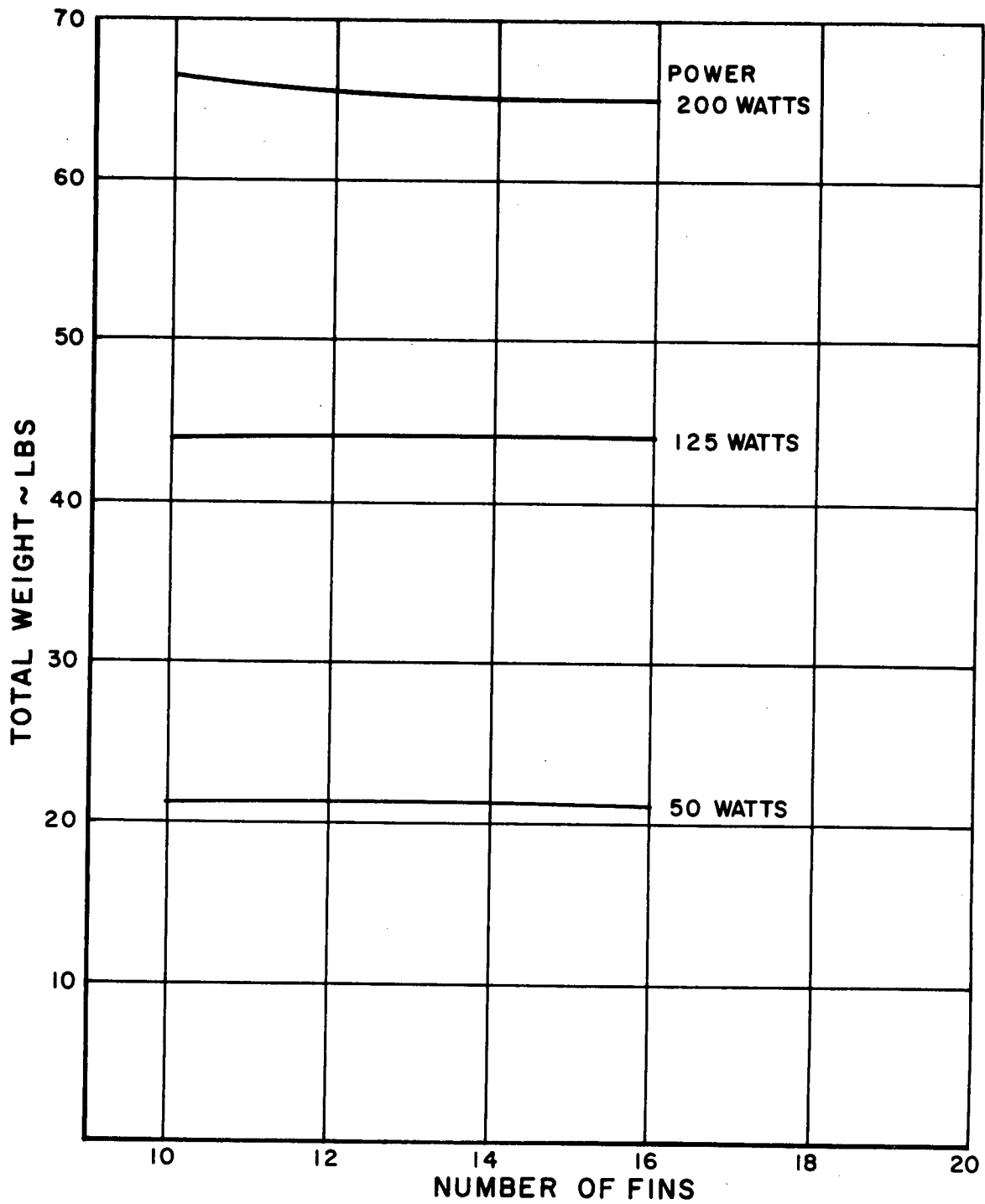

Figure 18. Voyager RTG Weight Versus Number of Fins, Minimum Weight Temperature
SiGe $T_{HOT} = 1400^{\circ}F$, $T_{COLD} = 500^{\circ}F$

~~CONFIDENTIAL~~

~~RESTRICTED DATA~~

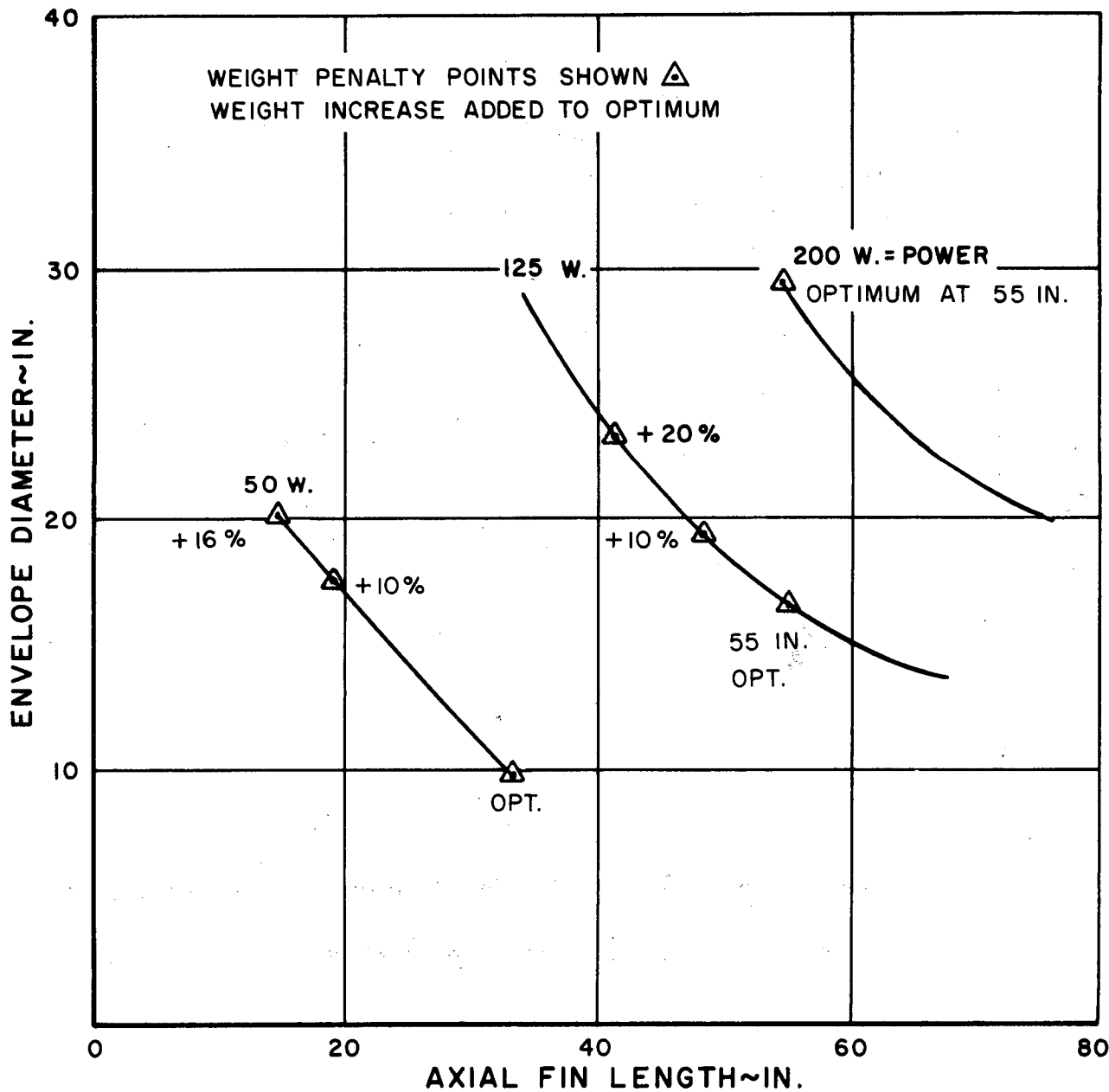

Figure 19. Voyager RTG Outside Diameter Versus Length for a Series of PbTe Designs:
 $T_{HOT} = 1100^{\circ}F$, $T_{COLD} = 400^{\circ}F$

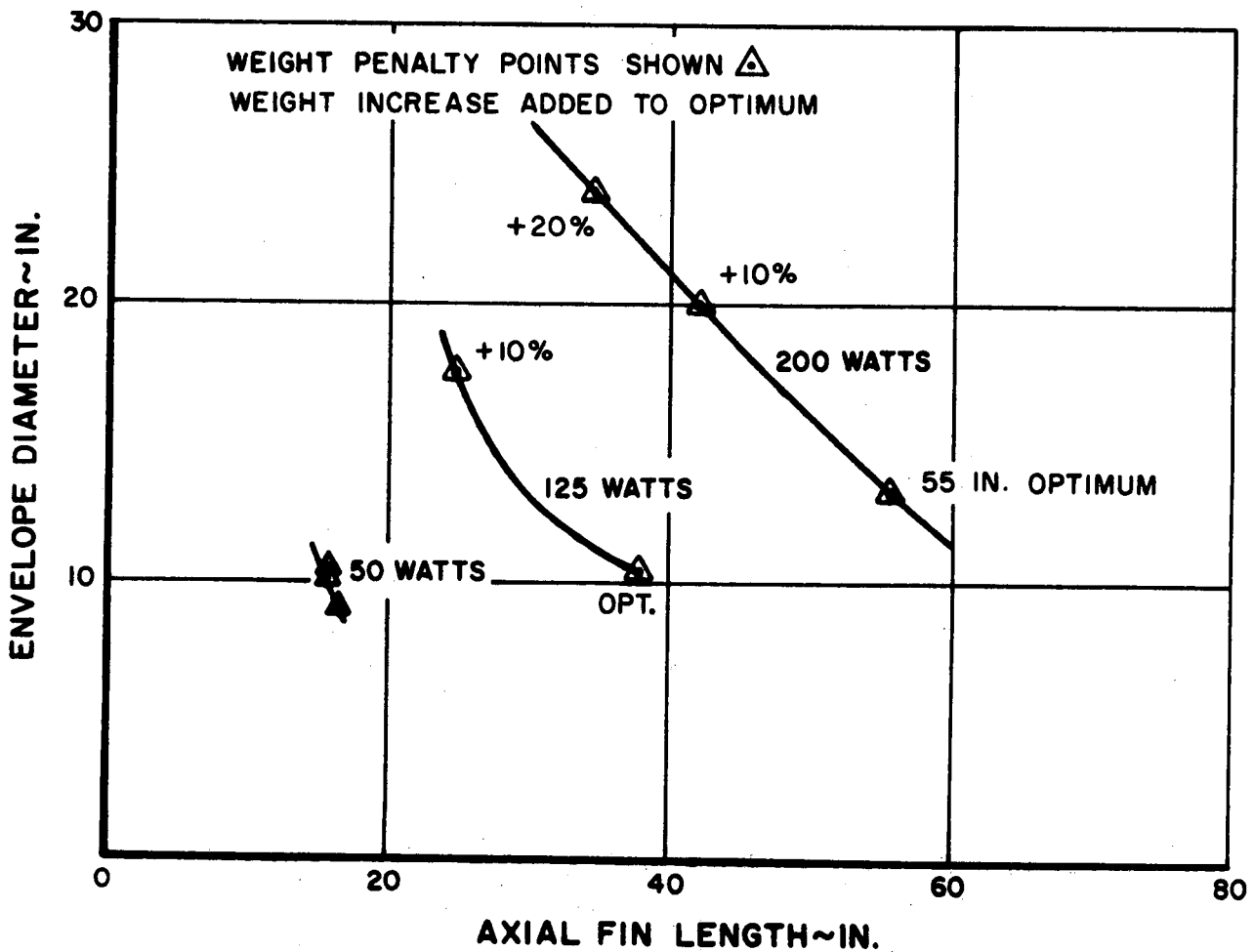

Figure 20. Voyager RTG Outside Diameter Versus Length for a Series of SiGe Designs:
 $T_{HOT} = 1400^{\circ}F$, $T_{COLD} = 600^{\circ}F$