



Prediction of Multi-physics Behaviors of Large Lithium-ion Batteries During Internal and External Short Circuit



Battery Safety 2010
In conjunction with
6th Lithium Mobile Power
Boston, MA, Nov 3rd, 2010

Gi-Heon Kim^{1,*}, Kyu-Jin Lee¹, Lawrence Chaney¹, Kandler Smith¹,
Eric Darcy^{1,2}, Ahmad Pesaran¹

¹National Renewable Energy Laboratory, Golden, CO, USA

²NASA Johnson Space Center, Houston, TX, USA

*: gi-heon.kim@nrel.gov

Performance, Durability and Safety

Physics of Li-Ion Battery Systems in Different Length Scales

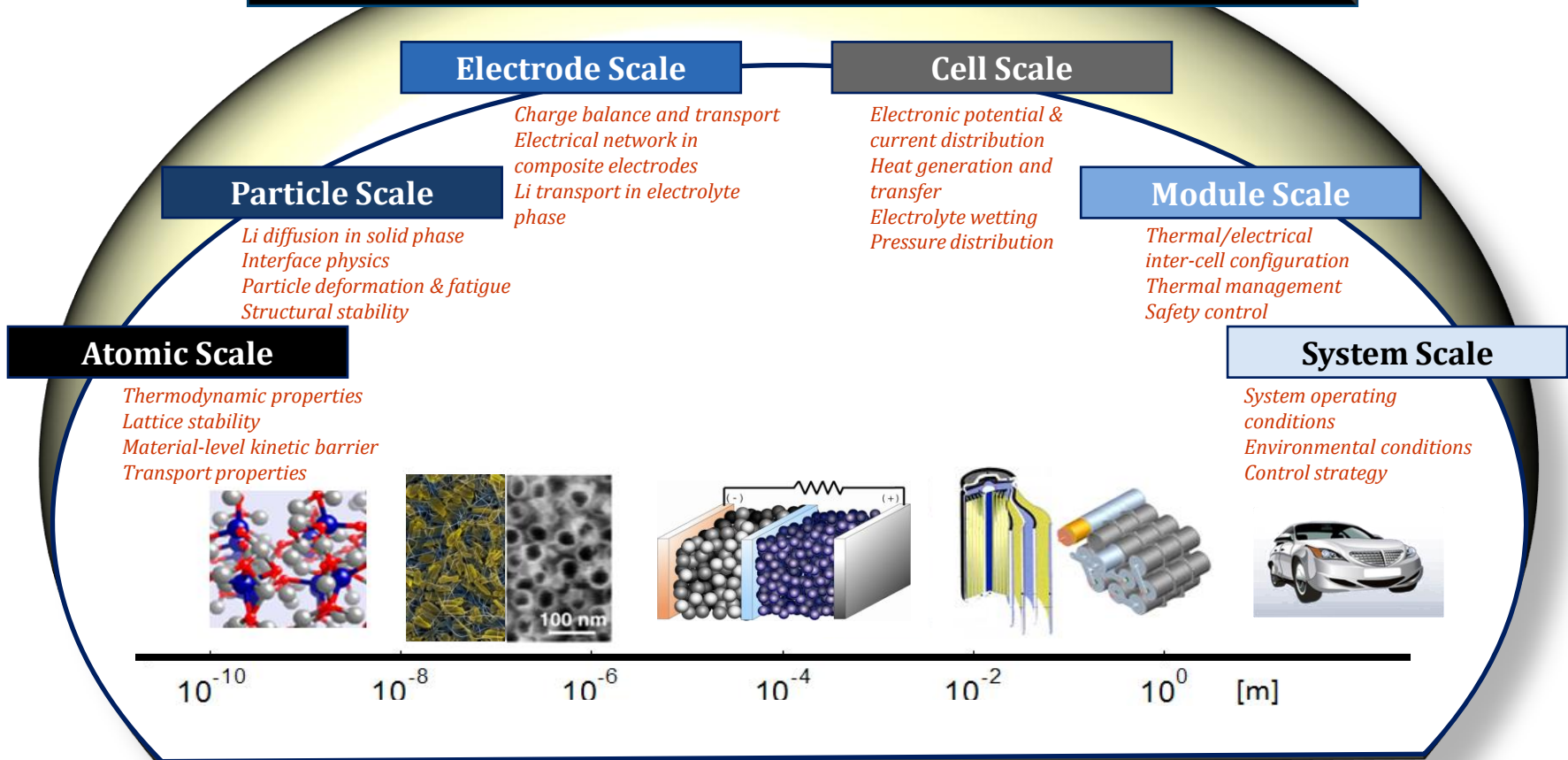

Thermal Runaway

Temperature



Exothermic Reactions

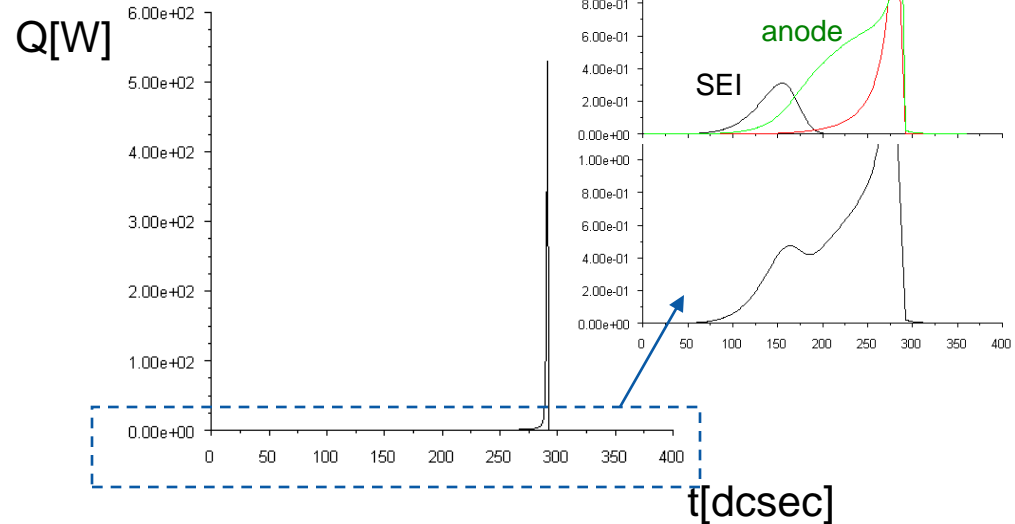
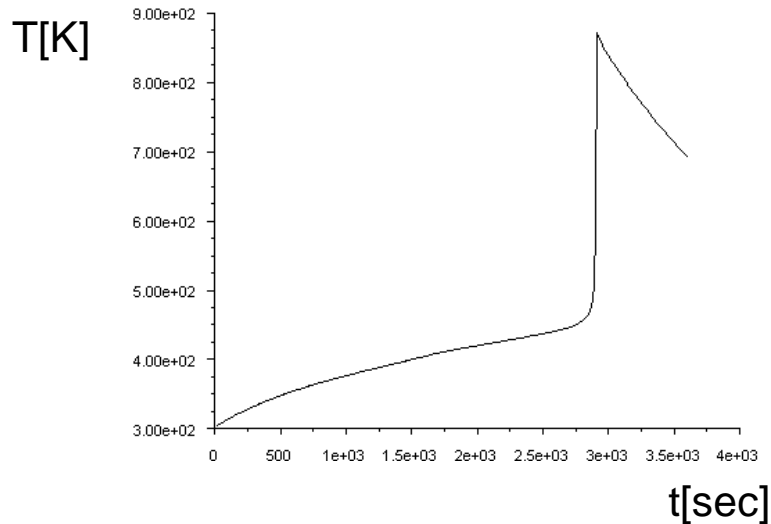

Modeling Thermal Runaway

- ✓ Constructed empirical reaction models using calorimetry data for component decompositions; Approach practiced by J. Dahn's group
- ✓ Enhanced understanding of the **interaction between heat transfer** and **exothermic abuse reaction propagation** for a particular cell/module design, and
- ✓ provided insight on how thermal characteristics and conditions can impact safety events of lithium-ion batteries.

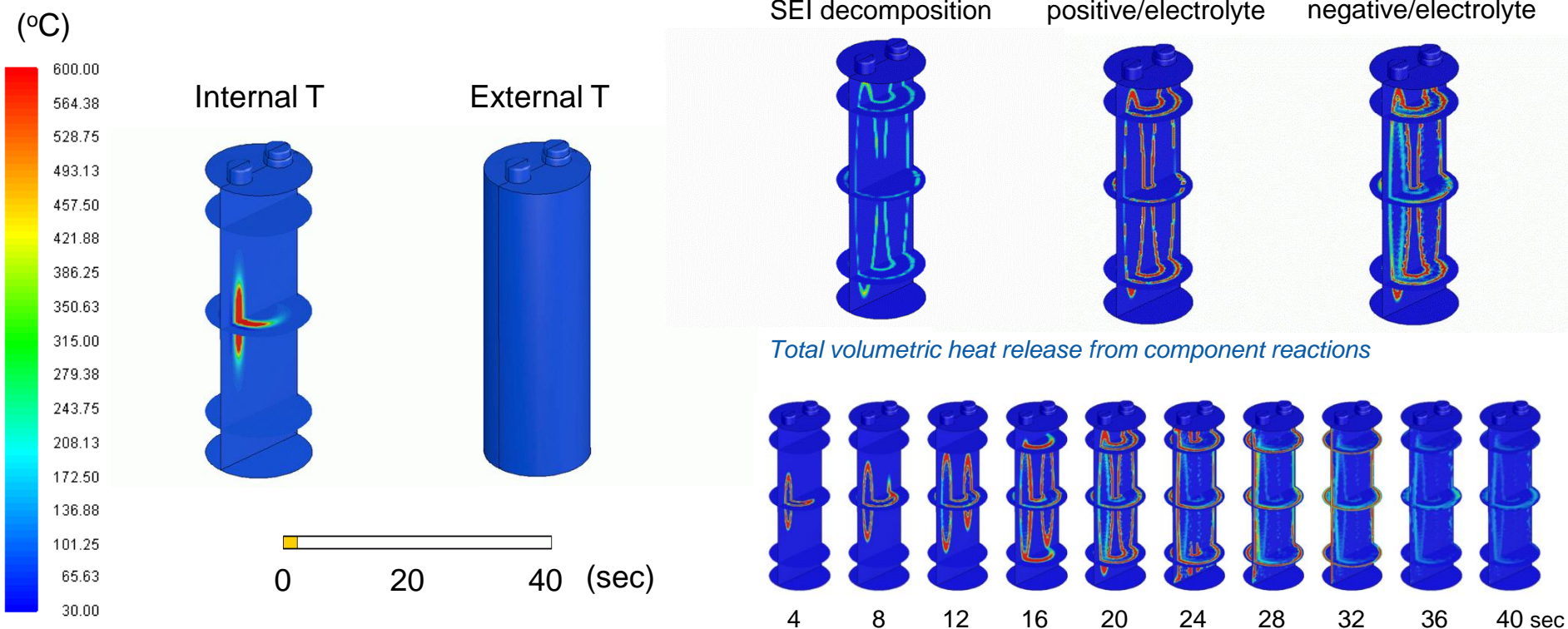

Reaction Propagation

- Propagates Initially in azimuthal direction
- Forms hollow cylinder shape reaction zone
- Center axis zone starts to react
- Finally reaction goes further in outer radius cylinder zone

SEI decomposition reaction front

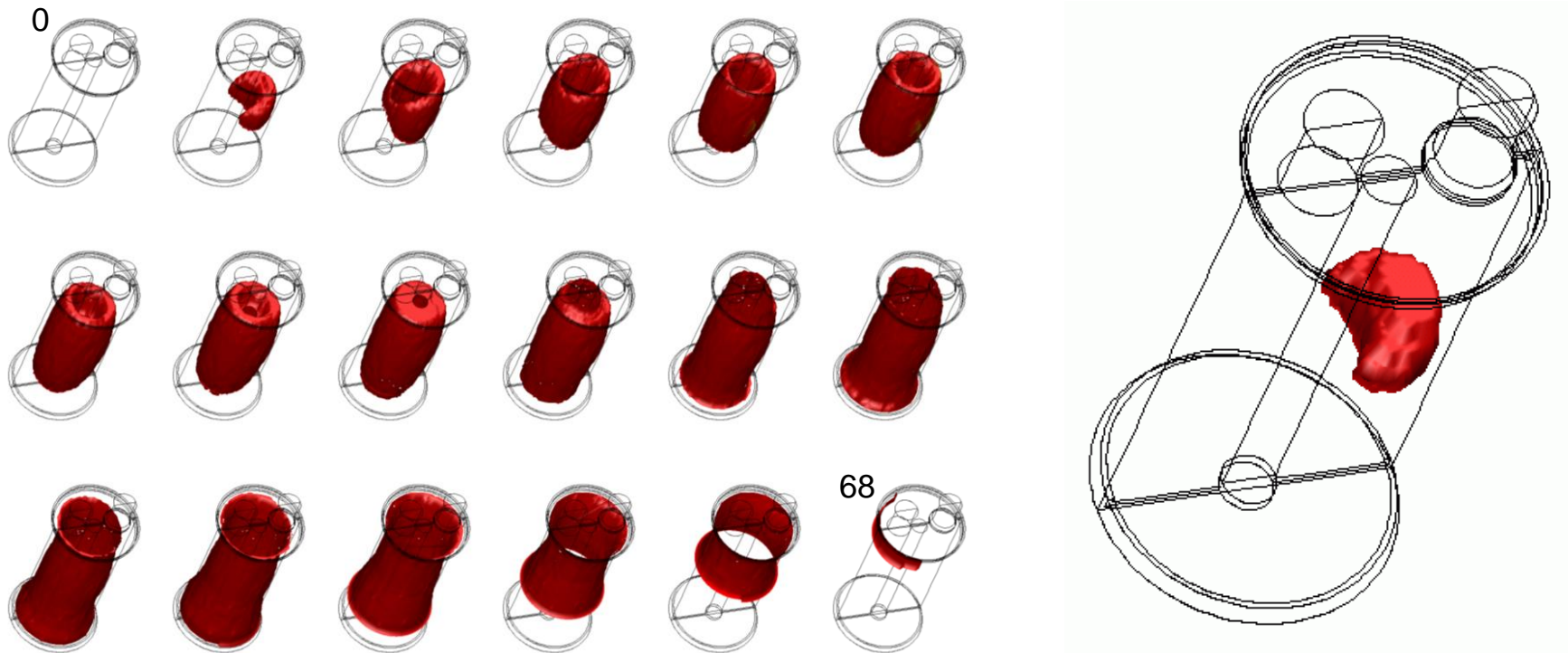

Runaway Propagation

In a multi-cell module

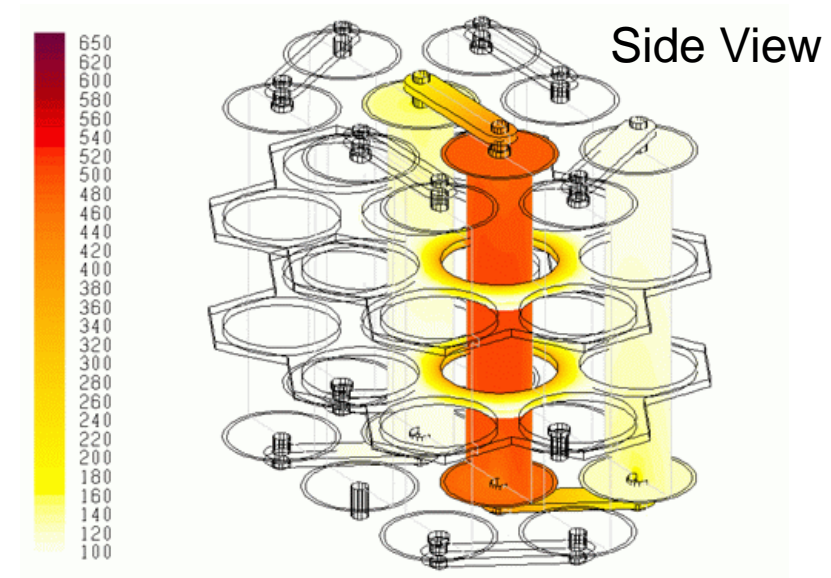
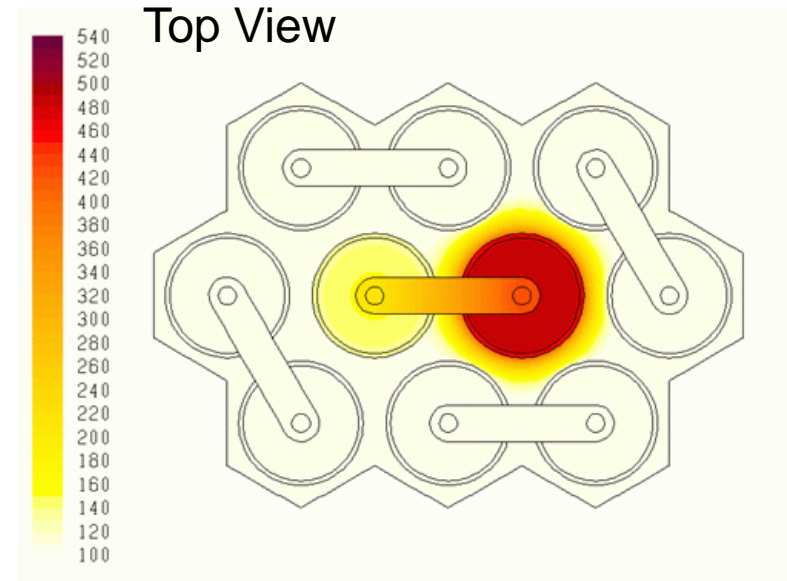
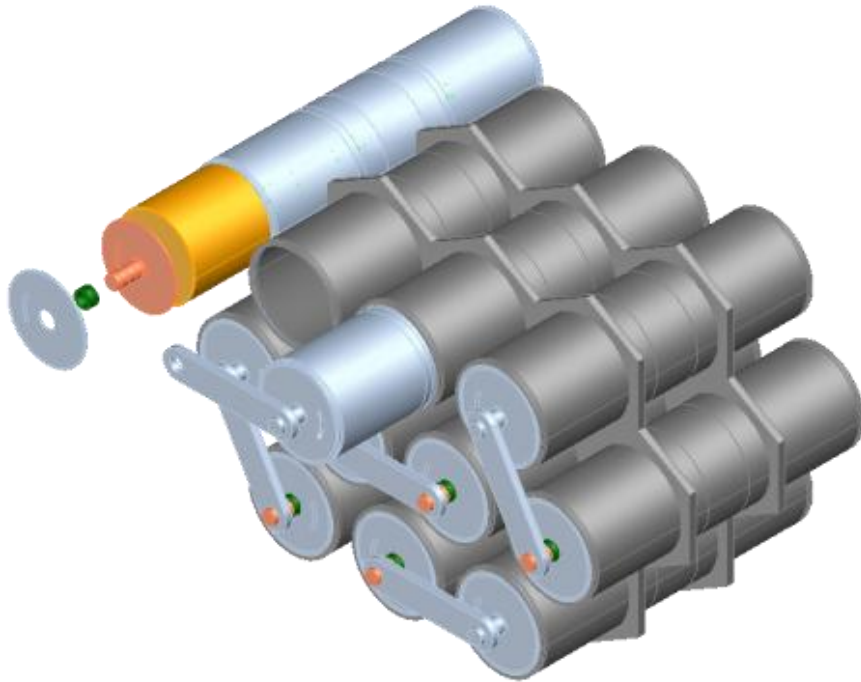

5 minutes apart between each frame

Closer Look at Reaction in an Individual Cell

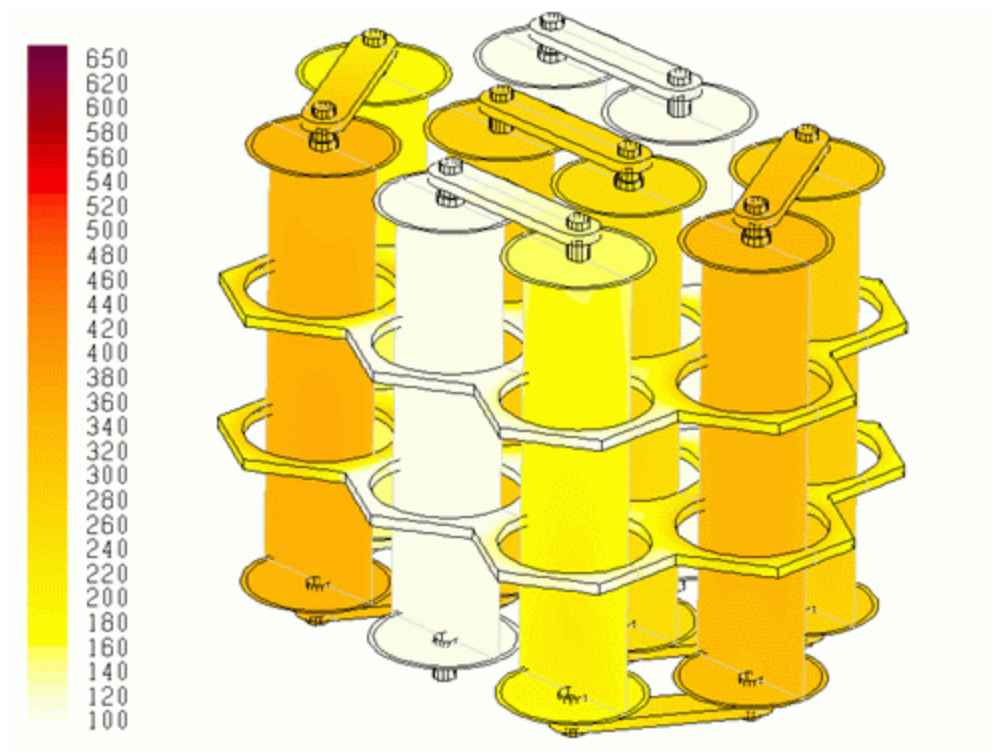

2 seconds apart between each frame

Fast Heat Dissipation

- ✓ Small cell module: 20 x 18650
- ✓ Highly conductive carbon matrix wetted with phase change materials

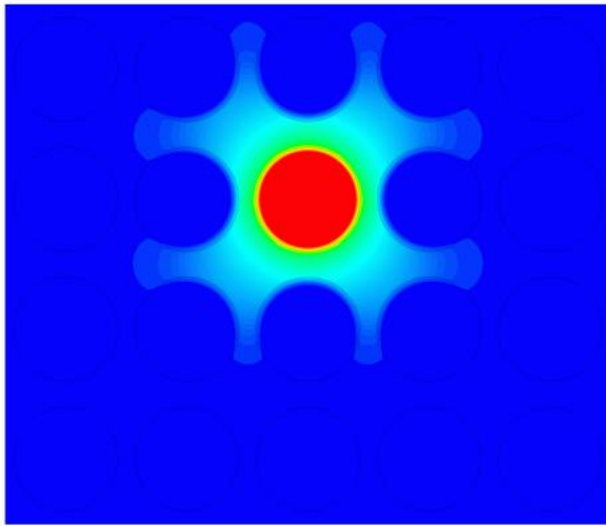

Temperature

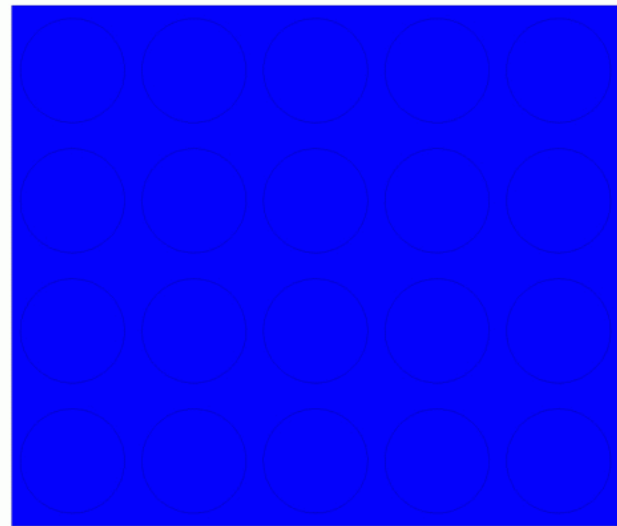

Heat of SEI decomposition

Multi-Physics Internal Short Circuit Model

- Developed an **integrated model** for multi-physics internal short circuit of lithium-ion cells by linking and integrating NREL's unique [electrochemical](#), [electro-thermal](#), and [abuse reaction kinetics](#) models
- Performed 3D multi-physics internal short simulation study to characterize an internal short and its **evolution over time**

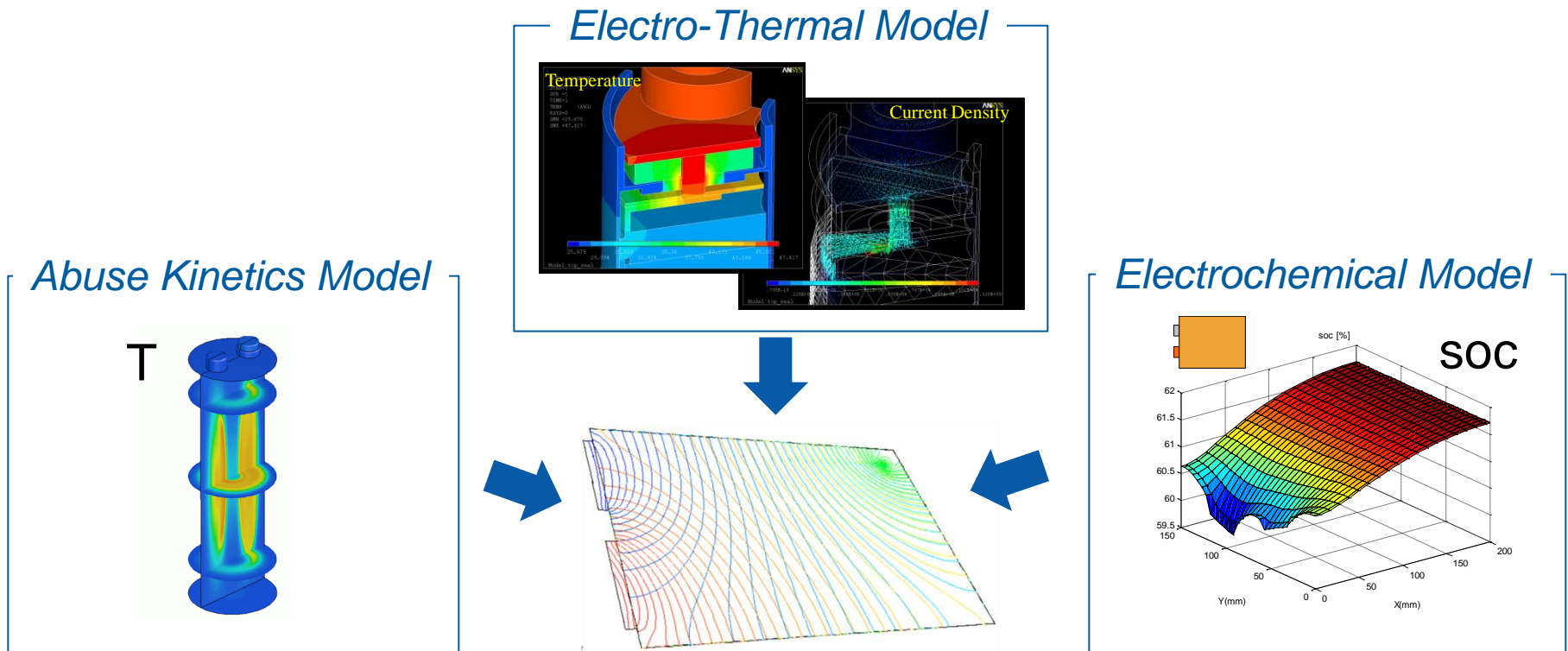

Internal Short Circuit Model Study

Performed Case Study with A 20Ah Prismatic Cell

To investigate impacts of various short natures and cell characteristics

- Case Studies – 20Ah Stacked Prismatic Cell
 - ISC between metal (Al & Cu) current collector foils
 - ISC between electrode (cathode & anode) layers
 - Impact of short area – separator hole propagation
 - ISC between Al to anode – short bypassing cathode
 - Impact of Cell Size
 - Comments on Shutdown Separator
 - Impact of ISC location

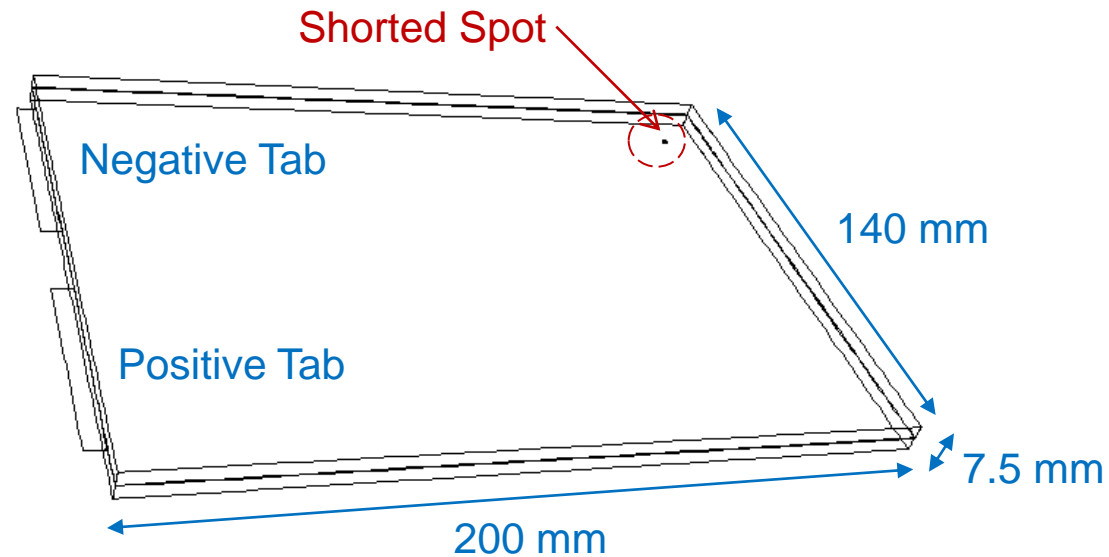
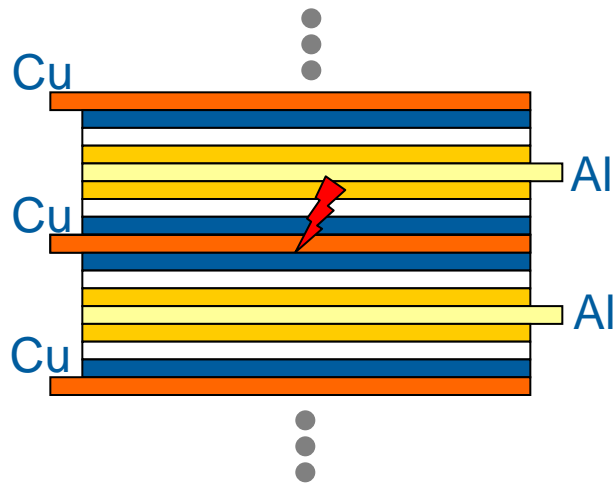

Results Agree Well with Laboratory Observations

The simulation results have reasonably reproduced the experimental observations from other research groups/companies including SNL, Exponent, Celgard, LGchem, and Sony

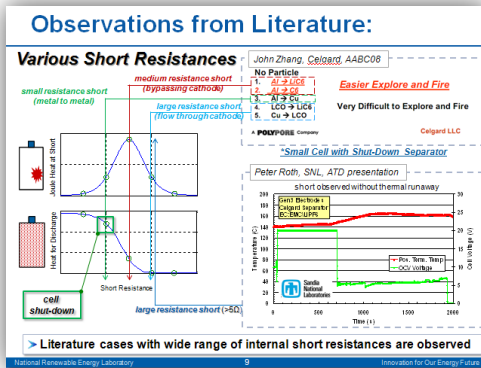

Exponent

Short Between Electrodes

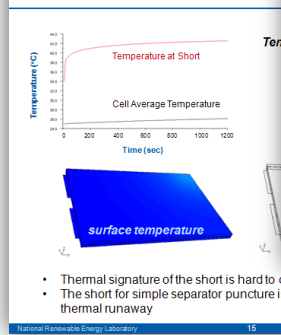

Observations: Simple Separator Puncture

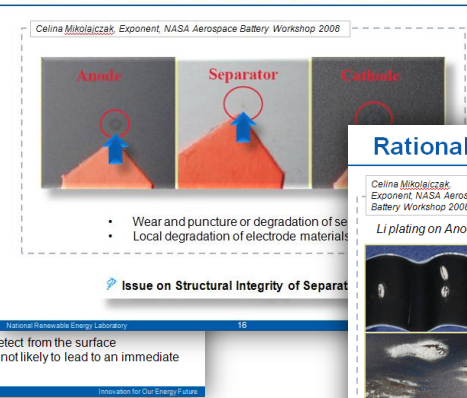

Rationale: metal plating – lowering R_s

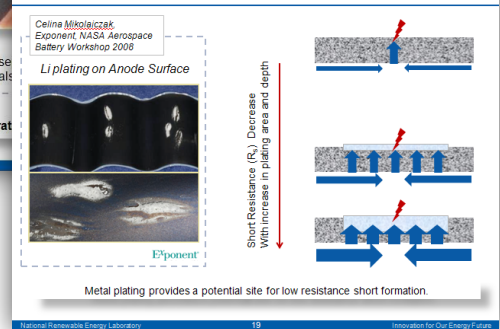

Sandia National Lab, Celgard

Short Between Electrodes: Impact of Short Area

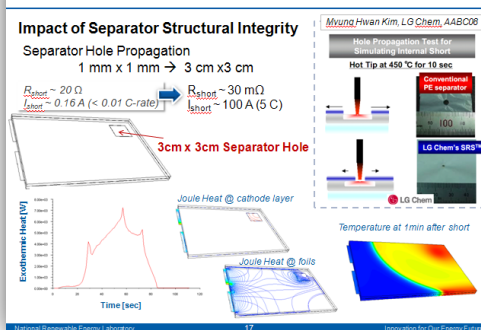

LG Chem

Short Between Anode and Al Foil

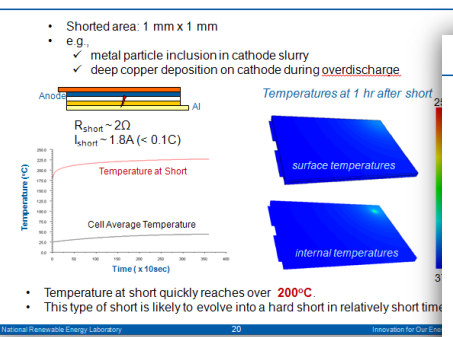

SONY

Observations: Cathode Layer Bypassing

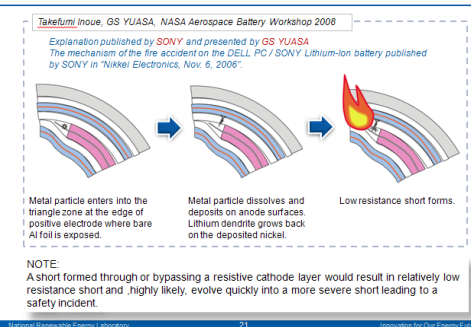

Shutdown Separator for Large Cells?

Short Between Al & Cu Metal Foils

- Cell Capacity: 20 Ah

$$R_{\text{short}} \sim 10 \text{ m}\Omega$$

$$I_{\text{short}} \sim 300 \text{ A (15 C-rate)}$$

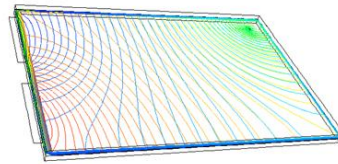

0.4 Ah

$$R_{\text{short}} \sim 7 \text{ m}\Omega$$

$$I_{\text{short}} \sim 34 \text{ A (85 C-rate)}$$

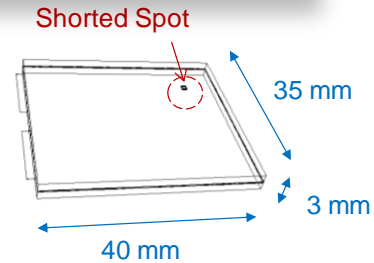

Joule heat for short

Temperature @10 sec after short

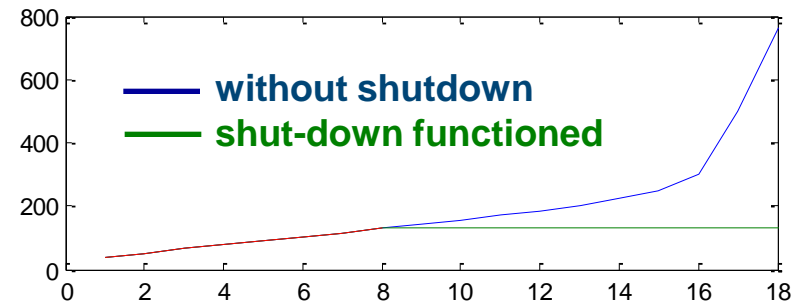
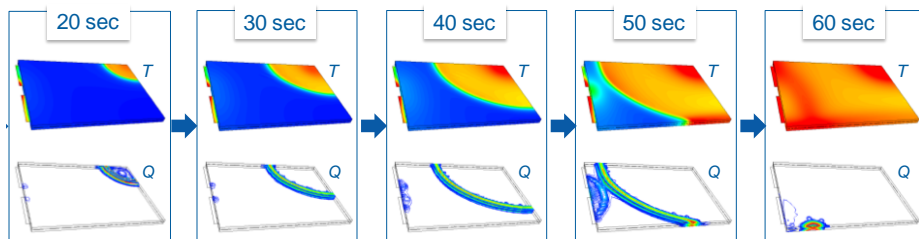
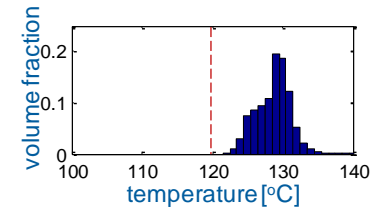
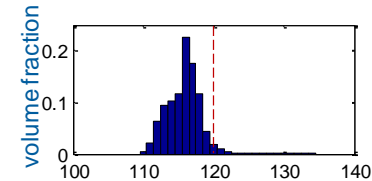
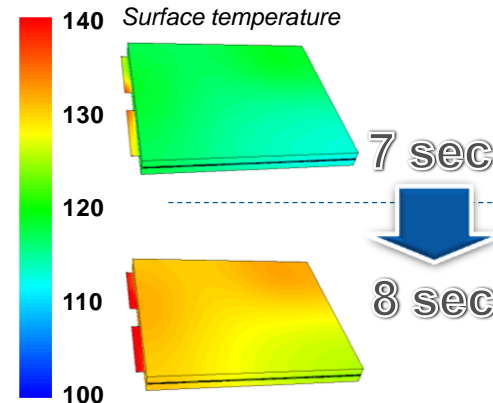
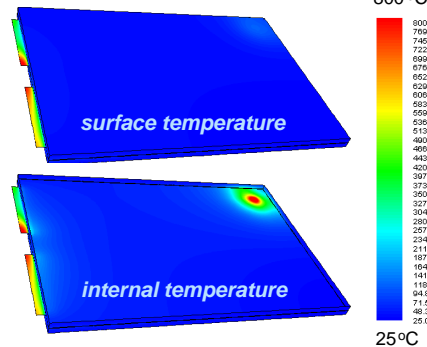
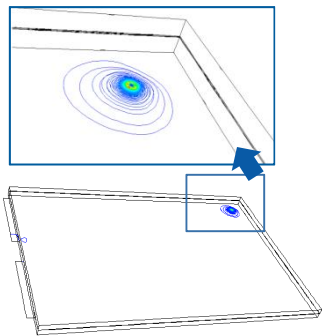

Shutdown Separator Limitation

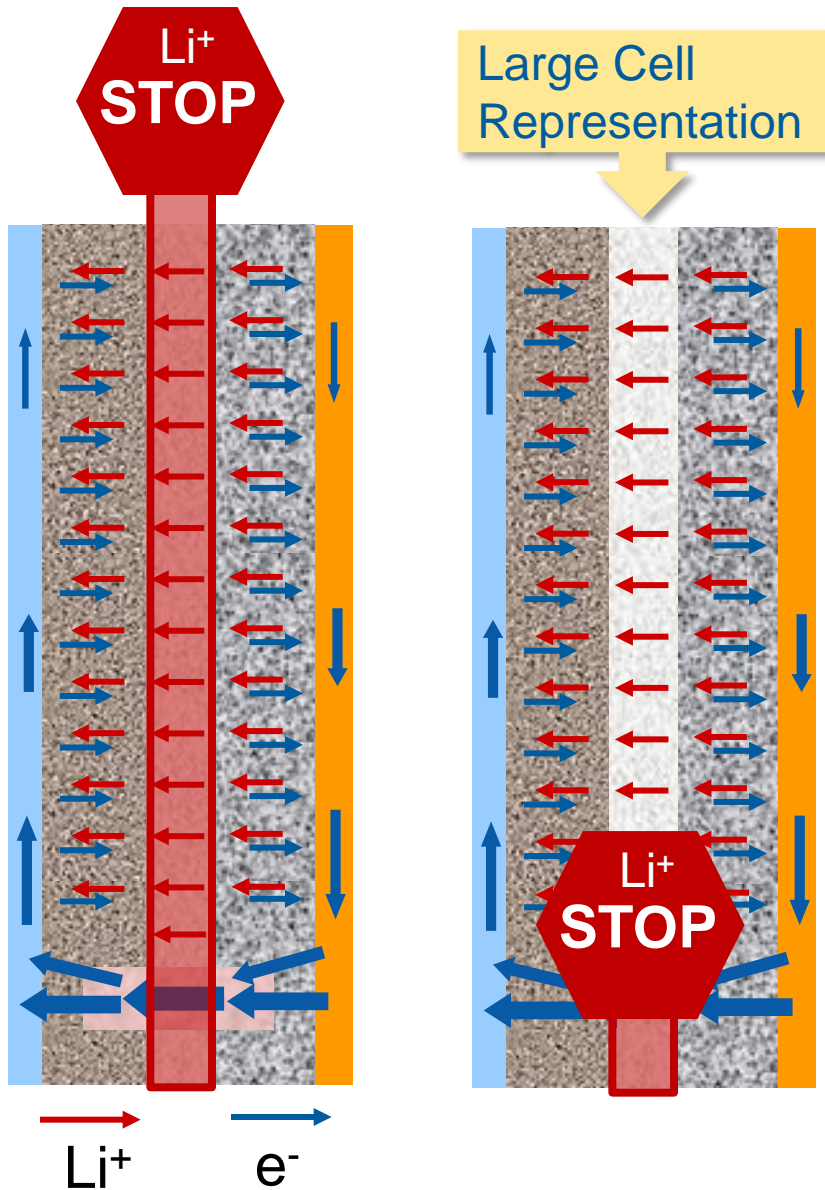

- Thermally triggered
- Block the ion current in circuit

Difficult to apply in

- Large capacity system
- High voltage system

Ceramic Reinforced Separator

Short Between Cathode and Anode Electrodes

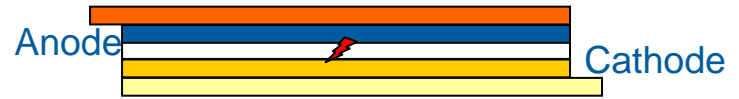

- Shorted area: 1 mm x 1 mm

$$R_{\text{short}} \sim 20 \Omega$$

$$I_{\text{short}} \sim 0.16 \text{ A} (< 0.01 \text{ C-rate})$$

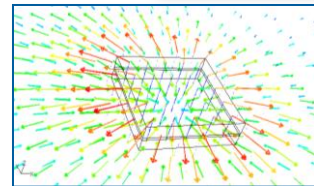

current density field near short

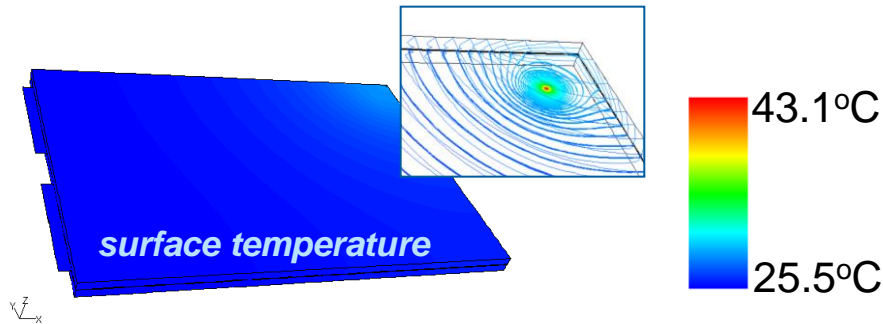

surface temperature

- Thermal signature of the short is hard to detect from the surface
- The short for simple separator puncture is not likely to lead to an immediate thermal runaway

separator hole propagation

3 cm x 3 cm

$$R_{\text{short}} \sim 30 \text{ m}\Omega$$

$$I_{\text{short}} \sim 100 \text{ A} (5 \text{ C})$$

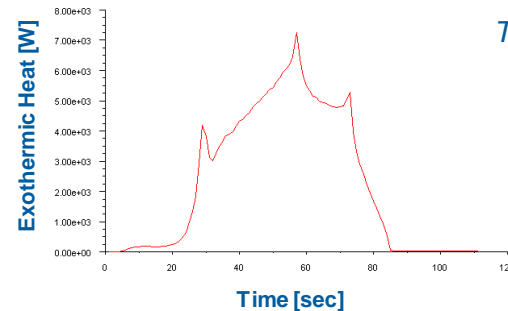
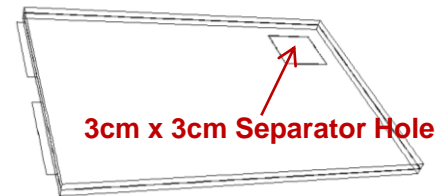

Temperature at 1min after short

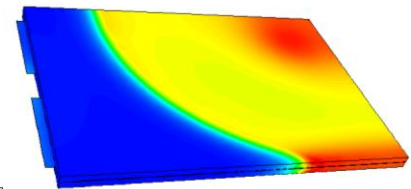

Myung Hwan Kim, LG Chem, AABC08

Hole Propagation Test for Simulating Internal Short
Hot Tip at 450 °C for 10 sec

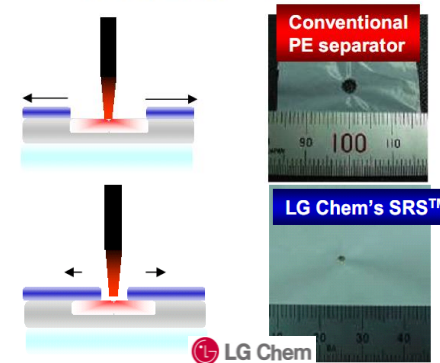

LG Chem

- Maintaining structural integrity of separator seems critical to delay short evolution

External Short of Multi-Cell Battery

Background

- Cell **PTC** device proven effective control for over-current hazards at Li-Ion cell and small battery level
- Known as ineffective in high-voltage or large capacity battery designs
- Need to verify if NASA's spacesuit battery design (16P-5S) array could depend on cell PTC devices to tolerate an external short

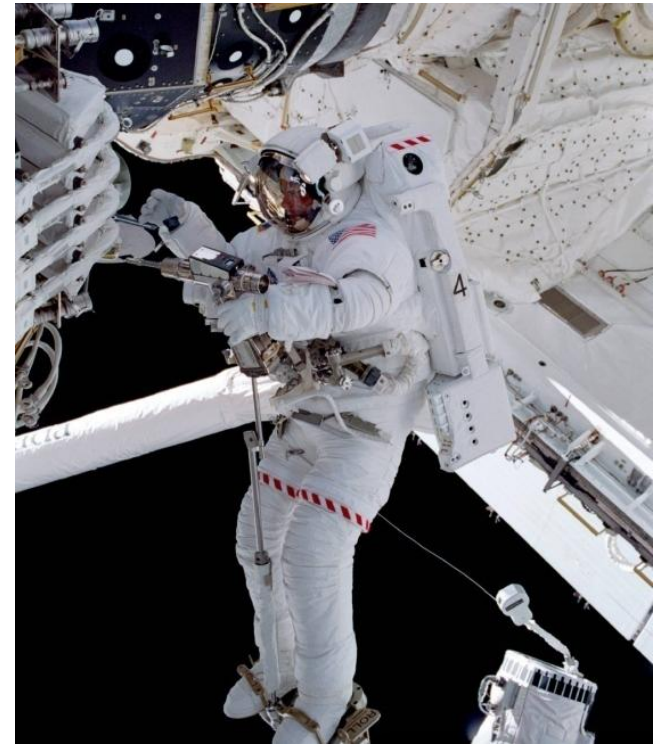
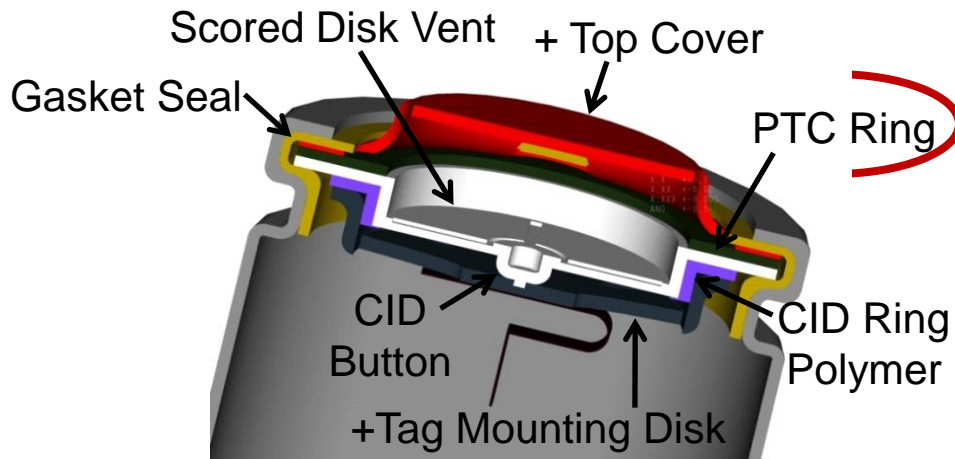
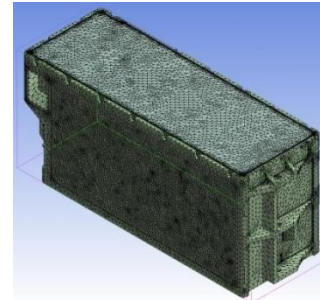
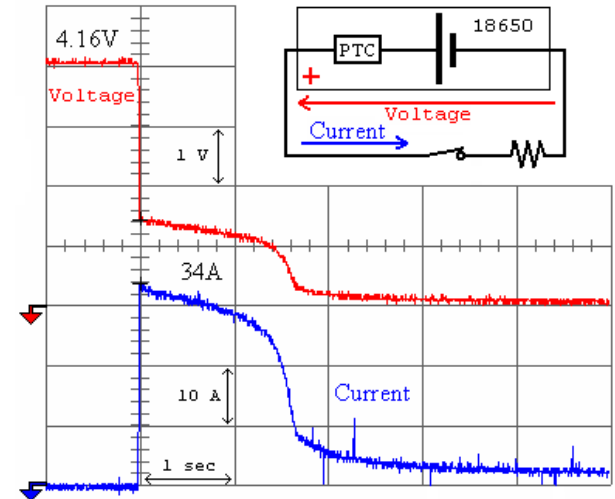

Photo: NASA



PTC Device

- Commercial lithium ion 18650 cells typically have a current-limiting PTC (positive temperature coefficient) device installed in the cell cap to limit external currents in the event of an external short to the cell.
- The PTC device consists of a matrix of crystalline polyethylene containing dispersed conductive particles, usually carbon black. The resistance of the PTC device increases sharply with temperature.
- Once triggered, PTC behaves as a thermal regulator
- PTC device **often fails to function in high voltage / high capacity systems**



PTC Resistance vs. Temp

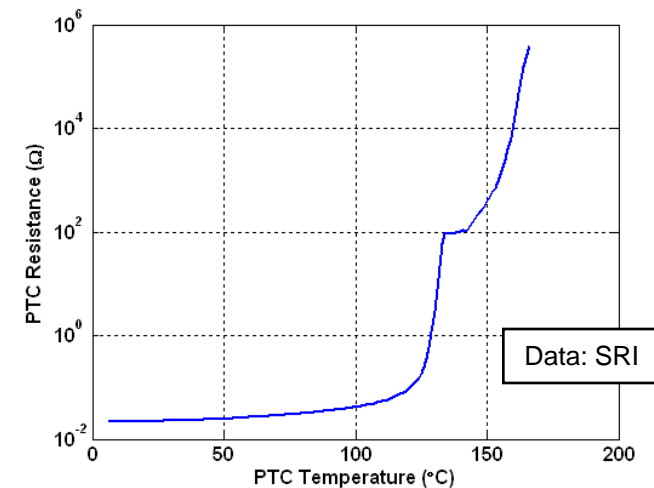

Model Development Approach

Integrated Thermal and Electrical Network Model of a Multicell Battery for Safety Evaluation of Module Design with PTC Devices during External Short

Unit Cell Model

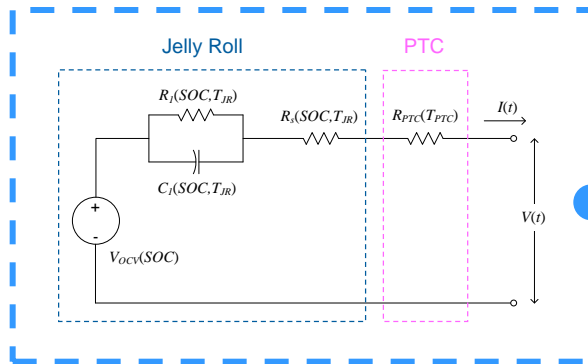

Electrical Model

Multicell T&E Network Model

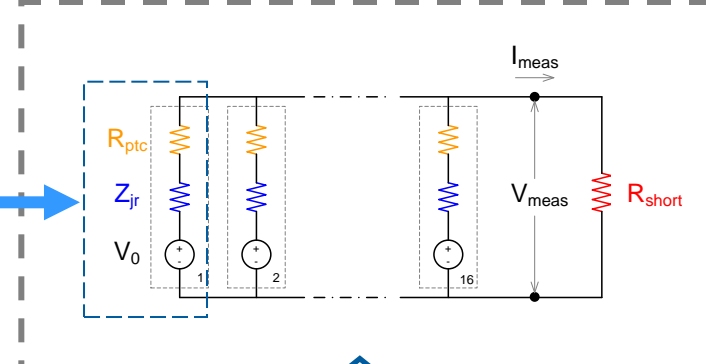

Electrical Network Model

electrical/thermal interaction

electrical/thermal interaction

5-Node Thermal Model

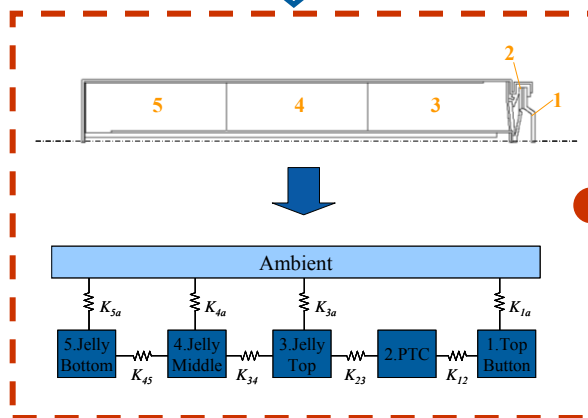

Thermal Network Model

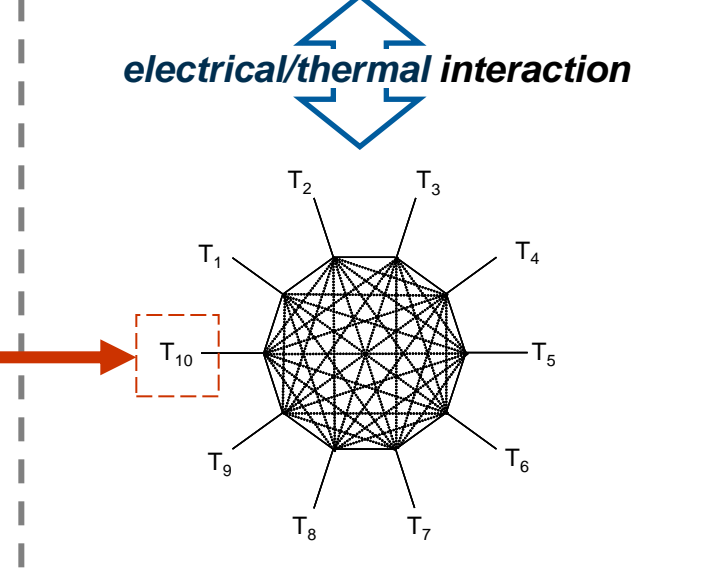

Unit Cell Model – Electrical

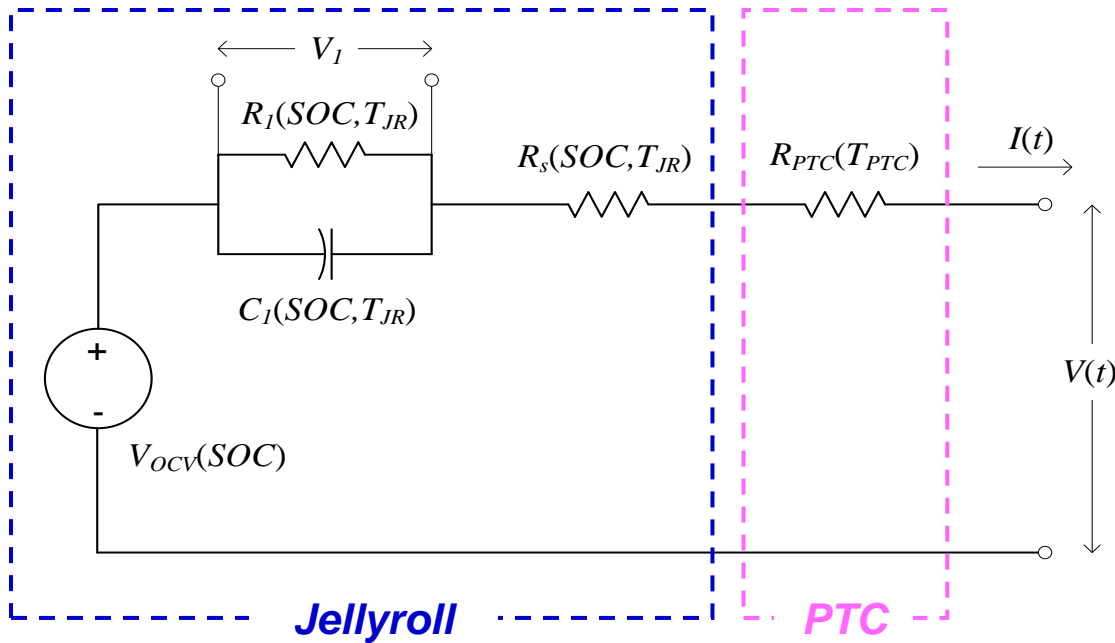

ECM including PTC device

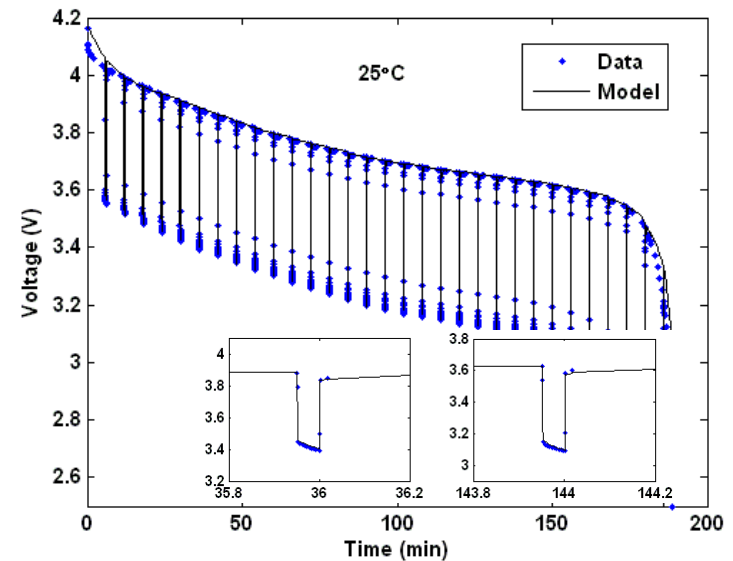
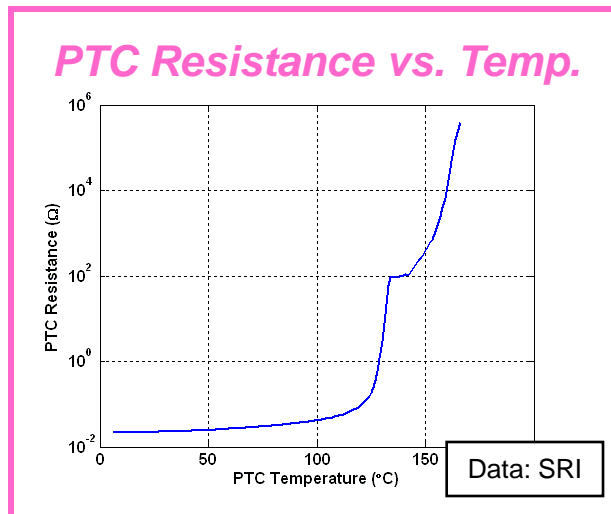
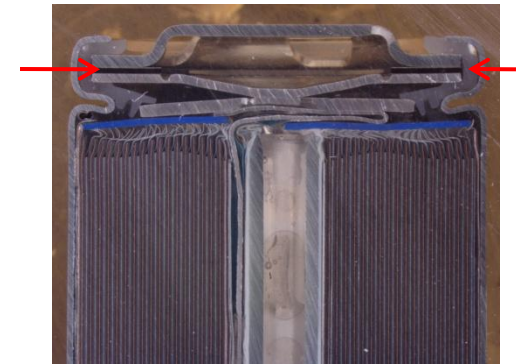

Unit Cell Model – 5-node Thermal

Detailed Cell Thermal Model

- Large computational requirement
- Not suitable for multicell modeling

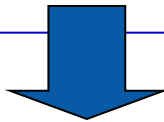
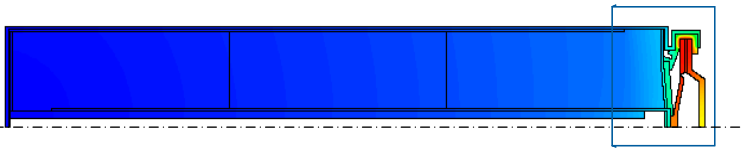

5-Node Cell Thermal Model

- Low order dynamic model
- Suitable for multicell modeling

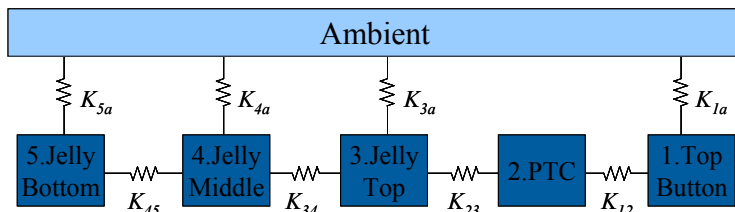
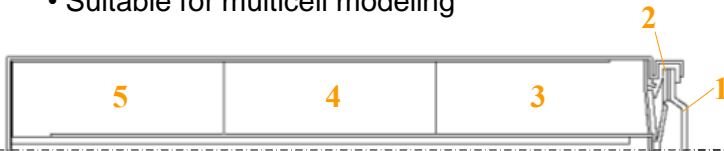

Comparison of Detailed and 5-Node Models for different heat generation conditions

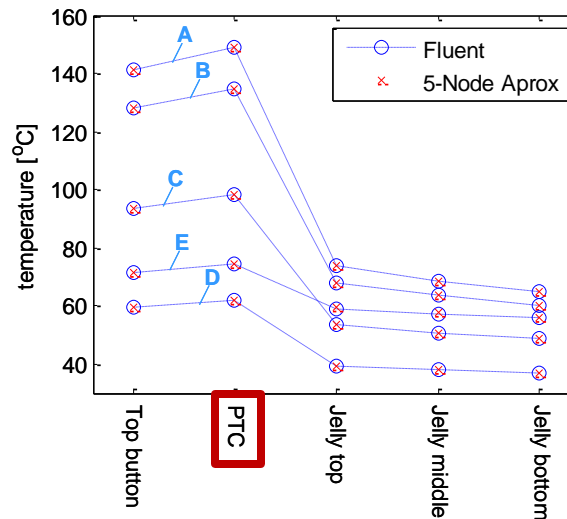

- A PTC:3.38W, Jelly:0.0093W
- B PTC:3.0W, Jelly:0.0093W
- C PTC:2.0W, Jelly:0.0093W
- D PTC:1.0W, Jelly:0.0093W
- E PTC:1.0W, Jelly:1.0W

Steady Form

$$Q_i = \sum_j K_{ij} (T_i - T_j)$$

Unsteady Form

$$Q_i = \sum_j K_{ij} (T_i - T_j) + MCp_i \frac{dT_i}{dt}$$

Multicell Network Model – Thermal

Thermal Network Model

Thermal Mass: Identifying thermal mass at each node

Heat Generation: PTC heat, discharge/charge heat (, abuse reaction heat)

Heat Transfer: Quantifying heat exchange among the nodes

➔
$$Q_{transport\ i} = \sum_{j=1, j \neq i} -Q_{ij}, \quad Q_{ij} = Q_{ij, radiation} + Q_{ij, connector_conduction} + Q_{ij, convection} \dots$$

Cell-to-Cell Irradiative Heat Transfer

Transverse Heat Transfer Through Plates

Heat Conduction Through Air Gap

Heat Rejection Through Wires

Heat Transfer to Ambient

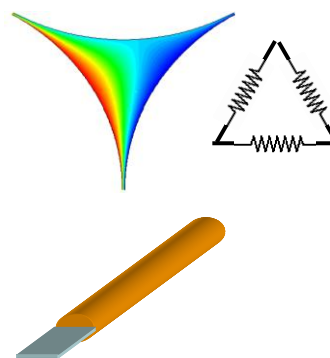
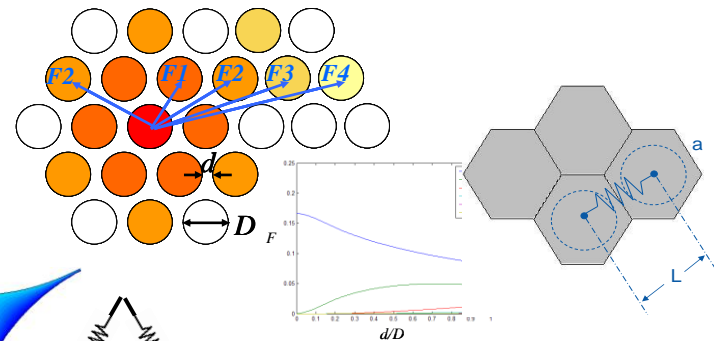

Photo: NASA ISS01E5361

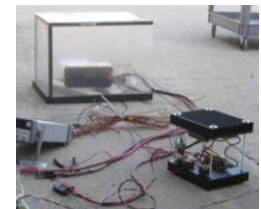

Photo: ABSL

Experimental Model Validation: 16P Bank

Test Data & Photo: SRI

16P model validated against a bank short test

- 10 m Ω external short
- Peak inrush current
- PTC device trip time
- Steady-state behavior
- Temperature rise profiles for all 16 cells

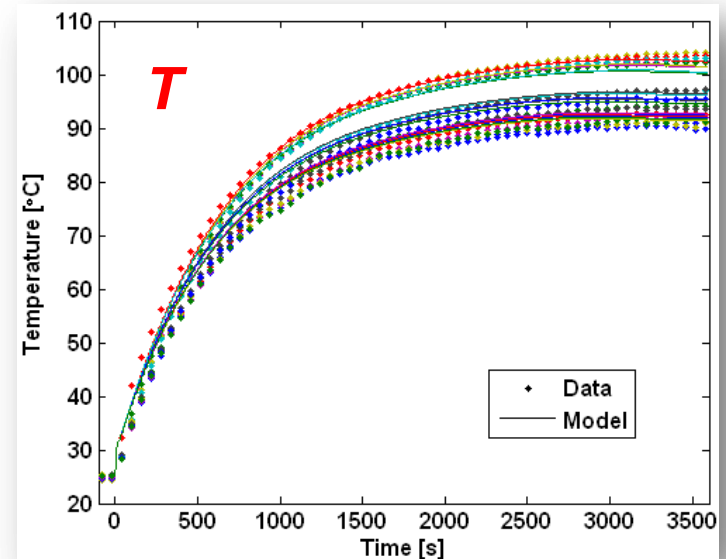
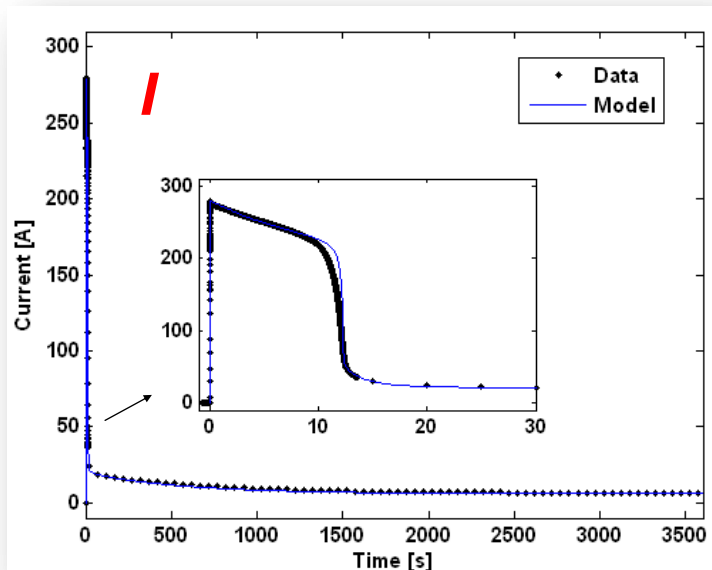

Simulation Results at Various Values of R_{short}

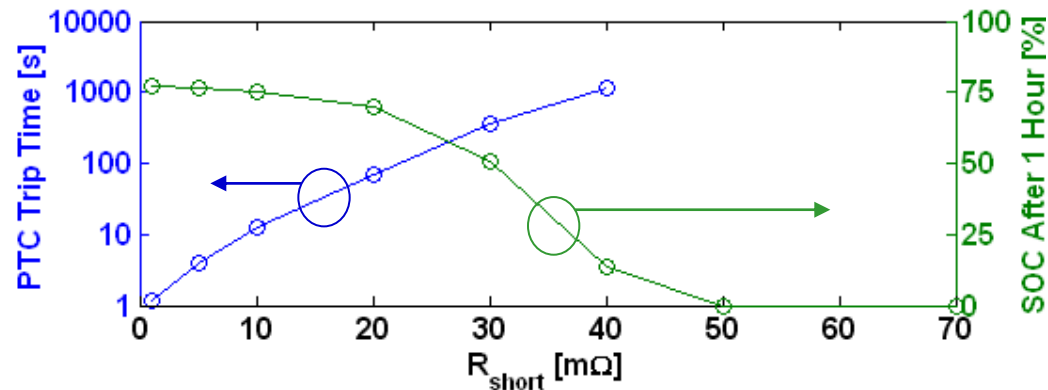

- $R_{short} \leq 40 \text{ m}\Omega$: PTC-limited
- $R_{short} \geq 50 \text{ m}\Omega$: SOC-limited

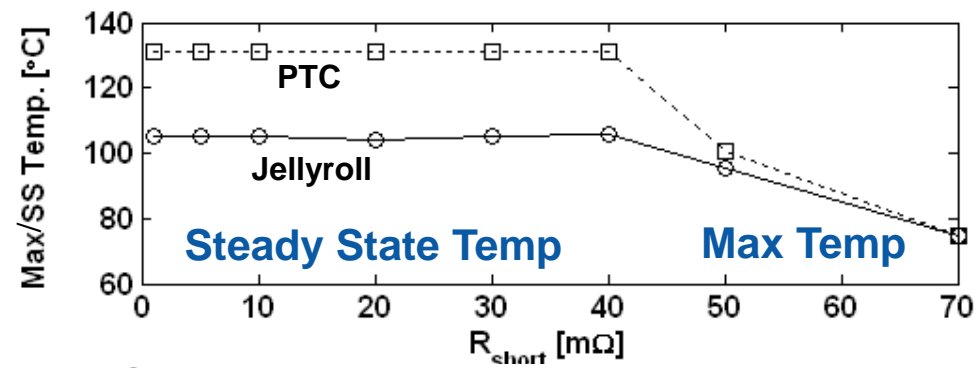

- Tripped PTC device serves as thermal regulator
- $[dR_{PTC}/dT]_{130^\circ\text{C}} = 3 \text{ } \Omega / ^\circ\text{C}$
 (5 orders of magnitude > than at 25°C)

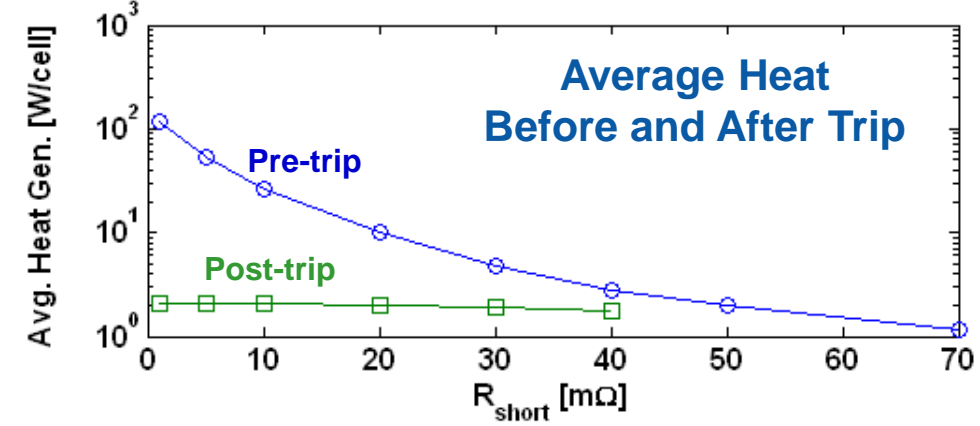

- Large pre-trip heat rates are safe provided that they have
 - Short duration
 - Sufficient thermal mass
 - Sufficient heat dissipation

Extend Validated 16P Model for 16P-5S Pack

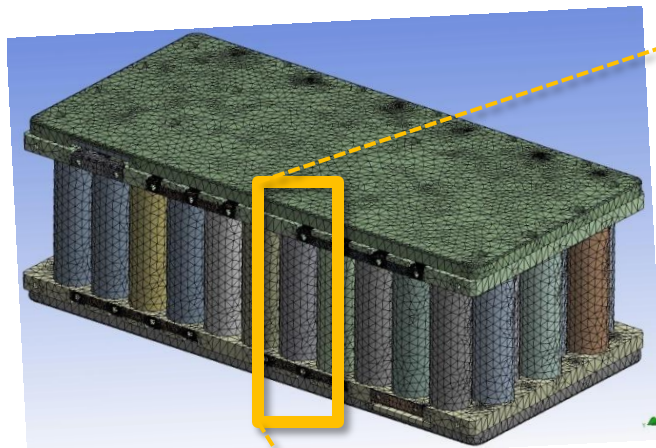

- 11 nodes are vertically placed at 80 cell locations
- Node thermal connections are defined considering various heat transfer modes
- Aluminum enclosure box is considered thermally lumped
- $11 \times 80 + 1 = 881$ node system

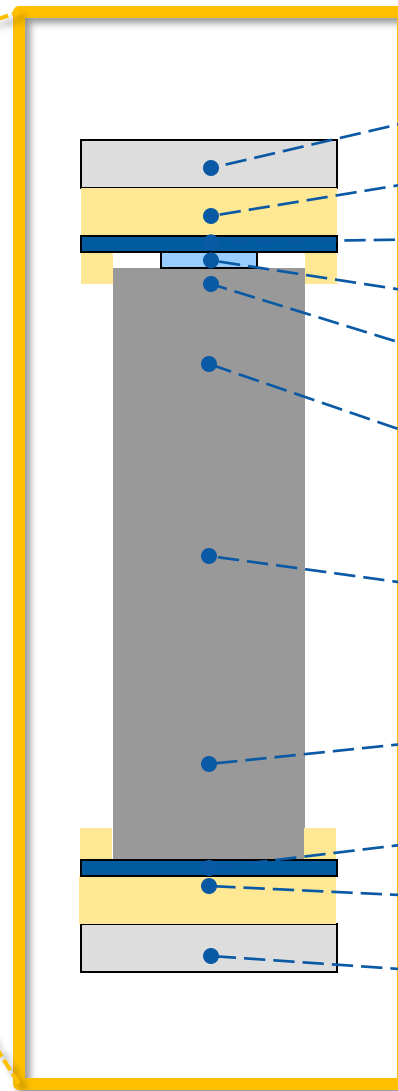
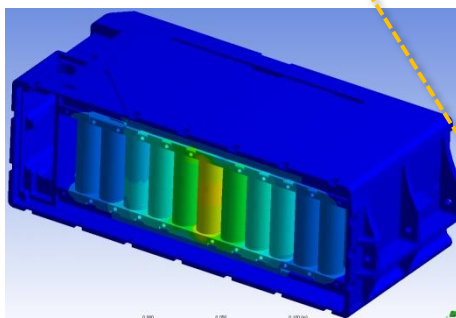
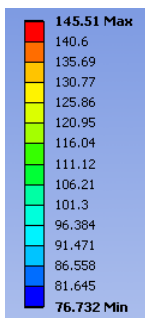

- Aluminum Plate
- Glass Reinforced Plastic Plate
- Nickel Bus Plate
- Top Button
- PTC
- Jelly Roll Node 1
- Jelly Roll Node 2
- Jelly Roll Node 3
- Nickel Bus Plate
- Glass Reinforced Plastic Plate
- Aluminum Plate

Model Validation for Pack External Short

ABSL experiment: Bank 3 short through external resistor

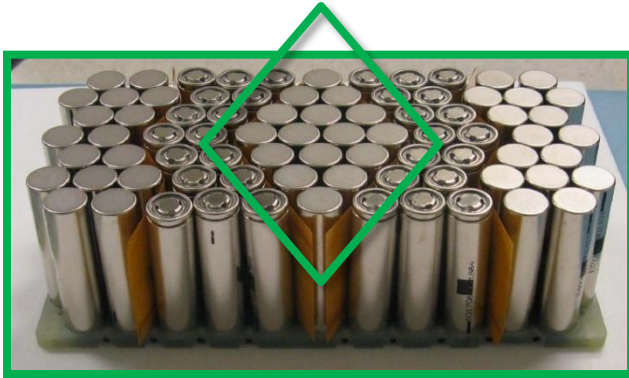
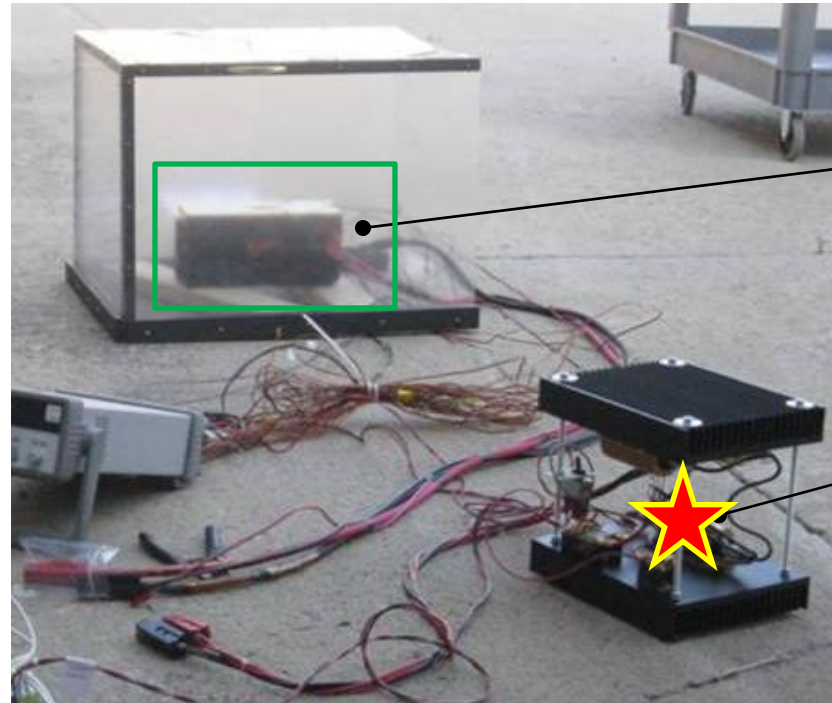

Photo: ABSL



80 cell battery in test enclosure

10 mΩ resistor

Photo: ABSL



Photo: NASA

ABSL Instrumentation

Cell Temperature Sensor Locations

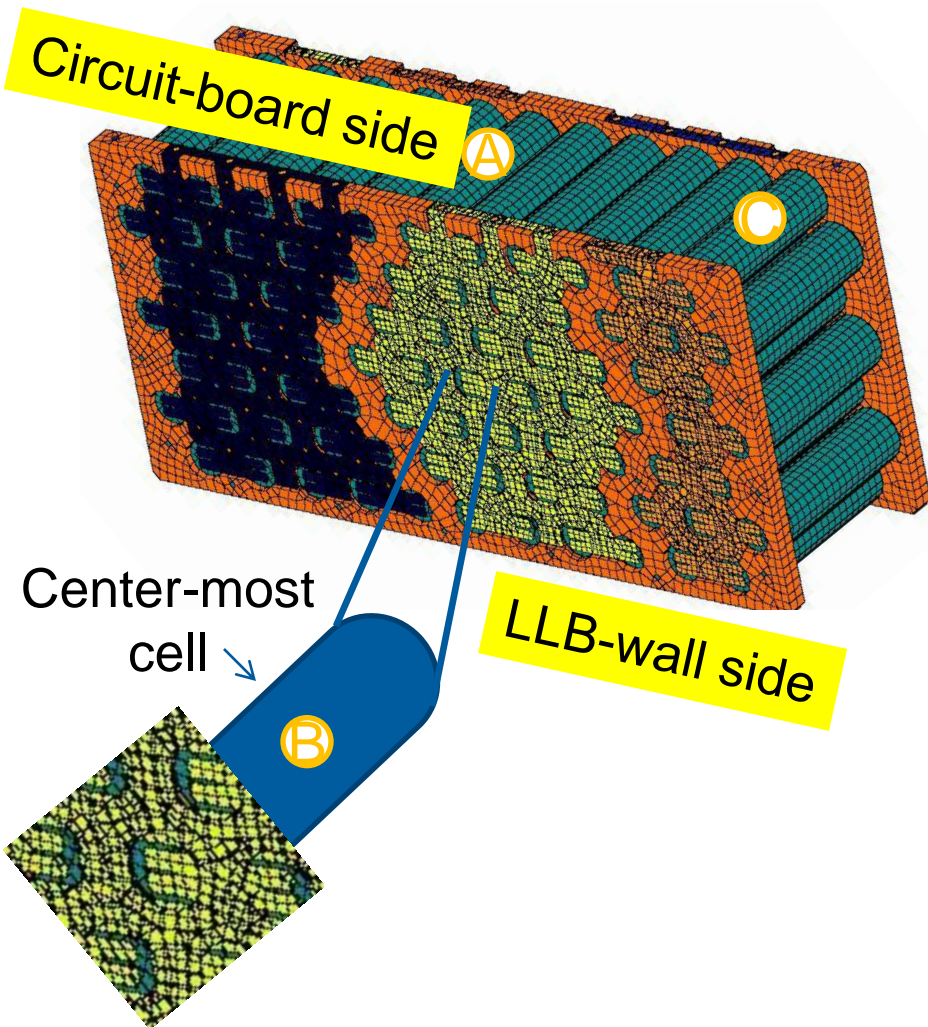

Brick Temperature Sensor Locations

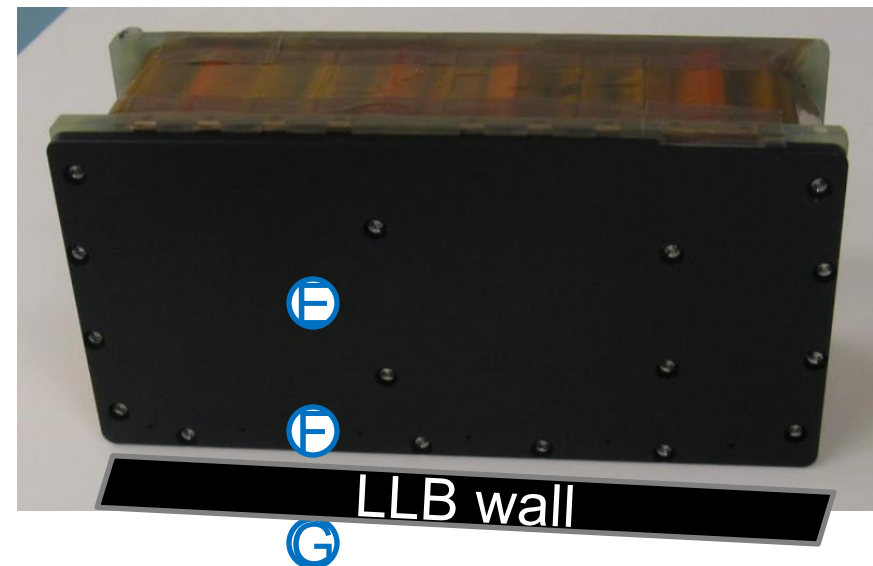
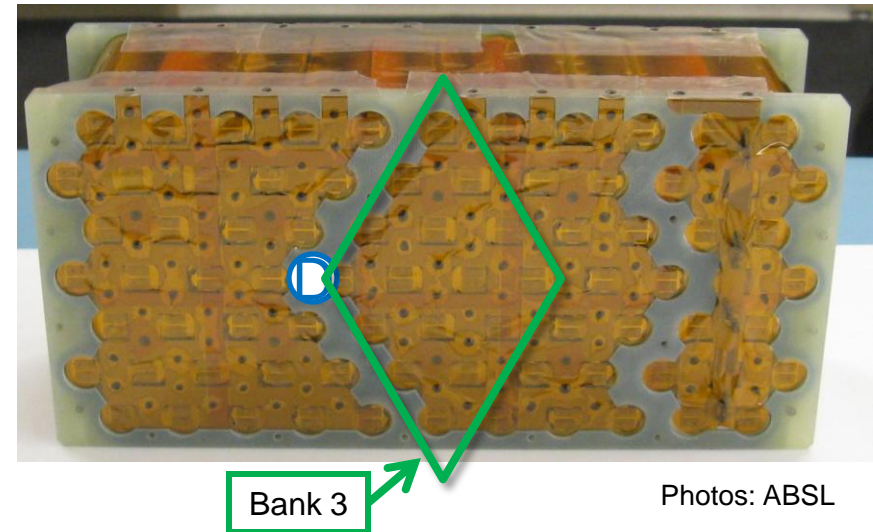

Model Validation – First 6000 seconds

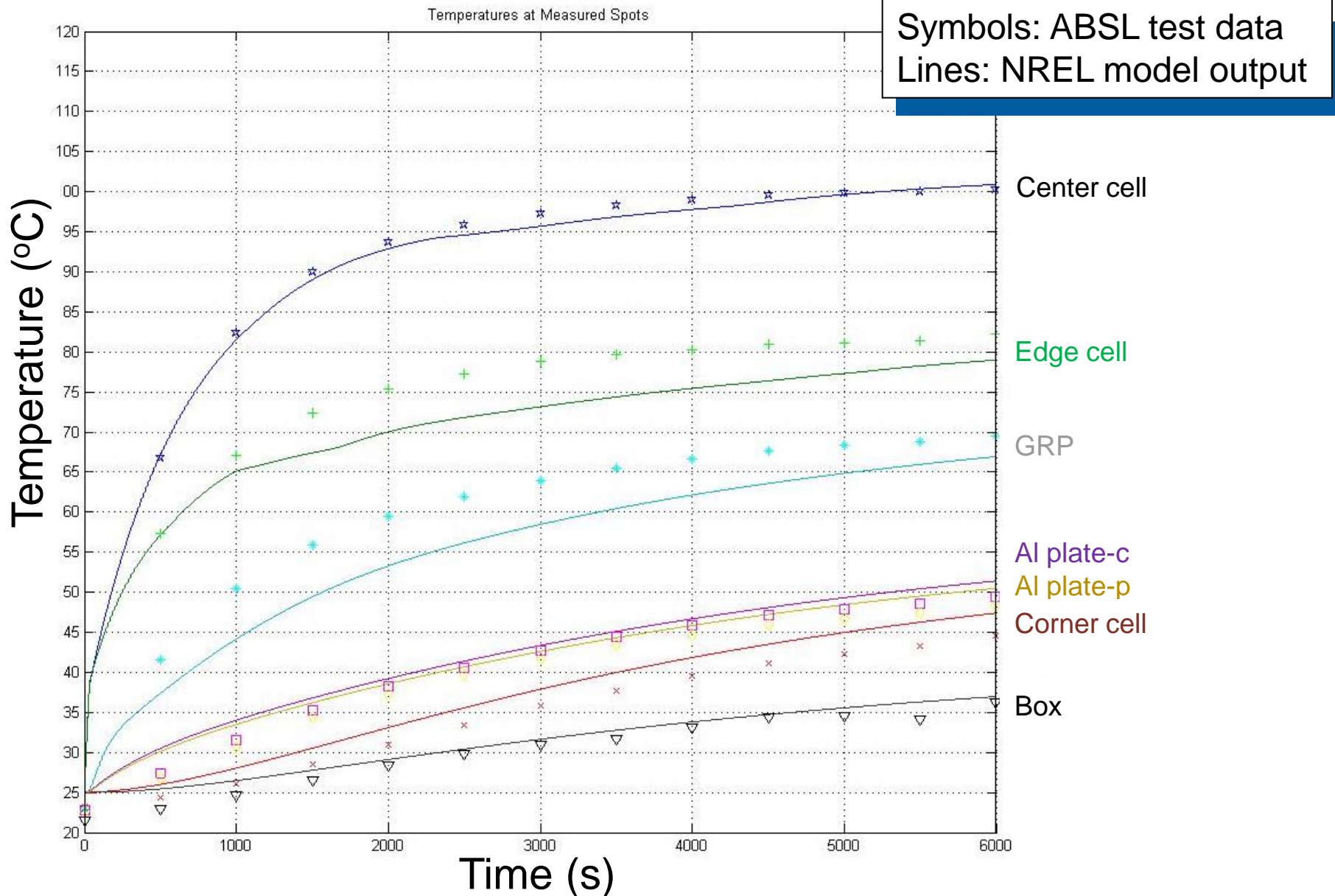

Cell Temperature Distribution at 6000 seconds

Height of cylinder depicts peak jellyroll temperature ($^{\circ}\text{C}$) of each cell as predicted by model.

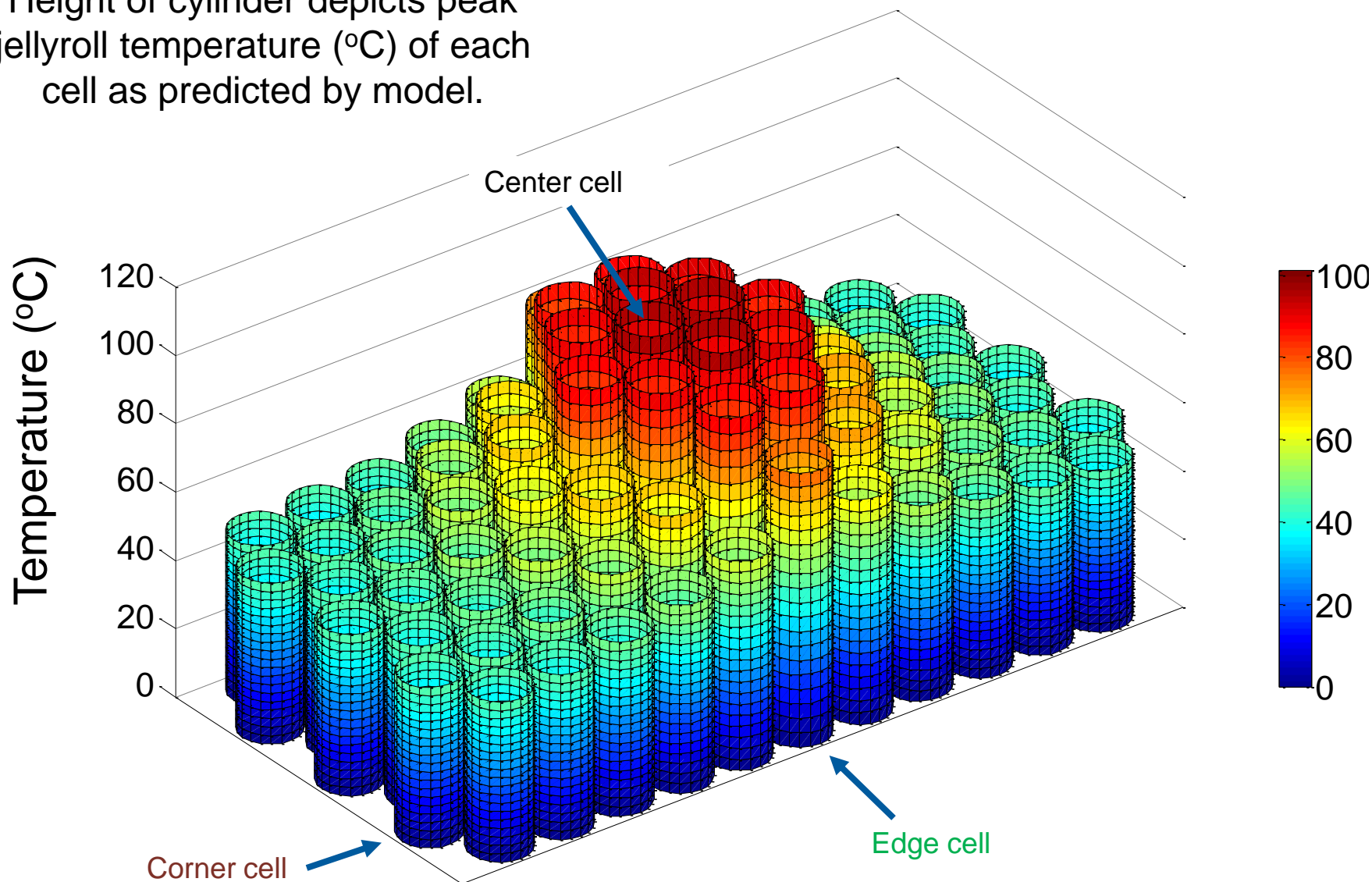

Model Analysis for Pack-Internal Shorts

E.g., bank 3 short is caused by foreign object between banks 3 and 4*

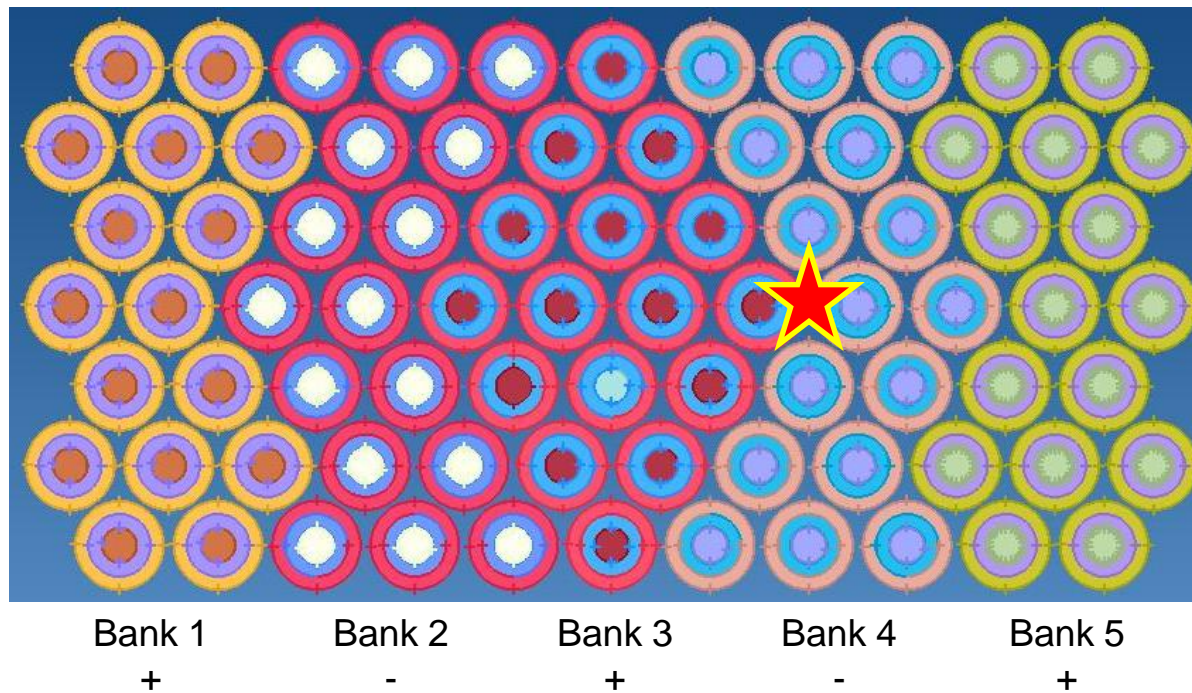

* Requires more than two faults: Introduction of foreign object debris & penetration of Kapton/Nomex/Kapton divider between banks

Schematic of Shorted Middle Cell Bank

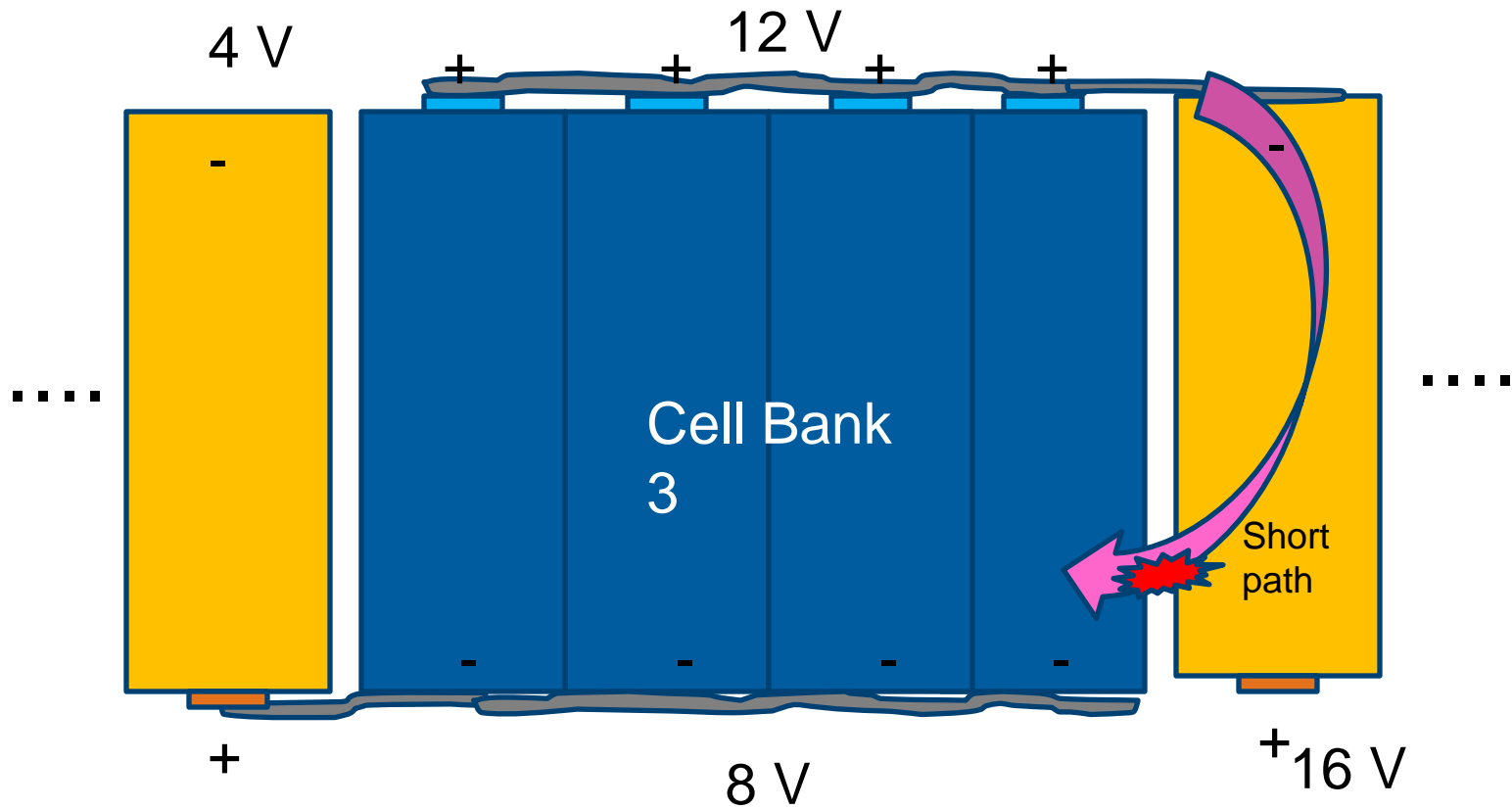

- Short runs through can of cell from adjacent bank 4
- Bare walls of cells are negatively biased
- Note that 3-layer (Kapton-Nomex-Kapton) bank-to-bank insulator is omitted for clarity

Bank 3 Short from 100% SOC

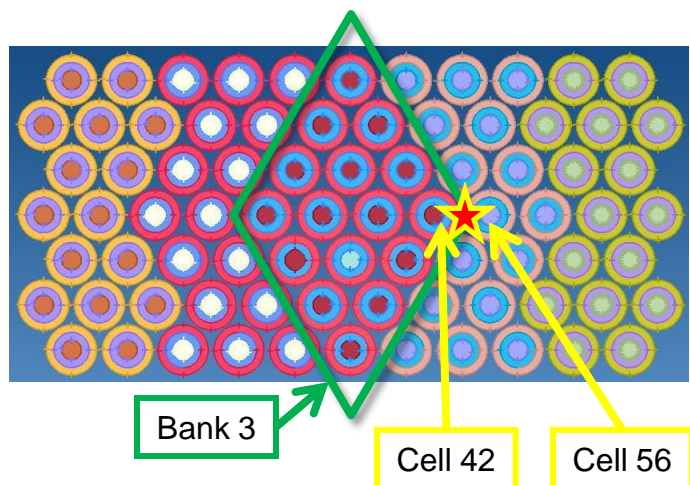

- Cell 42 (bank 3) participates in electrical discharge
 - Cell 56 (bank 4) does not electrically discharge; its external can wall serves as a path for short current
 - Model assumes ohmic heat of short shared equally by cells 42 and 56
-
- Internal-to-pack short more thermally severe than external-to-pack
 - Thermal mass dominates – negligible dependence on Earth vs. space boundary conditions
 - Runaway possibly prevented at 10 mΩ
 - Runaway predicted at 20,30 mΩ with collateral damage

R_{short}	Short Condition (SOC ₀ = 100%)	Cell 42 T _{max} (Bank 3)	Cell 56 T _{max} (Bank 4)
10 mΩ	External-to-pack, earth	97°C @ 6000-s	75°C @ 6000-s
	Internal-to-pack, earth	150°C @ 16-s	146°C @ 16-s
	Internal-to-pack, space	153°C @ 16-s	147°C @ 16-s
20 mΩ	Internal-to-pack, space	525°C @ 110-s	522°C @ 110-s
30 mΩ	Internal-to-pack, space	595°C @ 240-s	591°C @ 240-s

Bank 3 Short from 100% SOC: 10 mΩ vs. 20 mΩ

10 mΩ:

Bank 3 PTC devices trip **quickly** and uniformly because high inrush current causes PTC self-heating

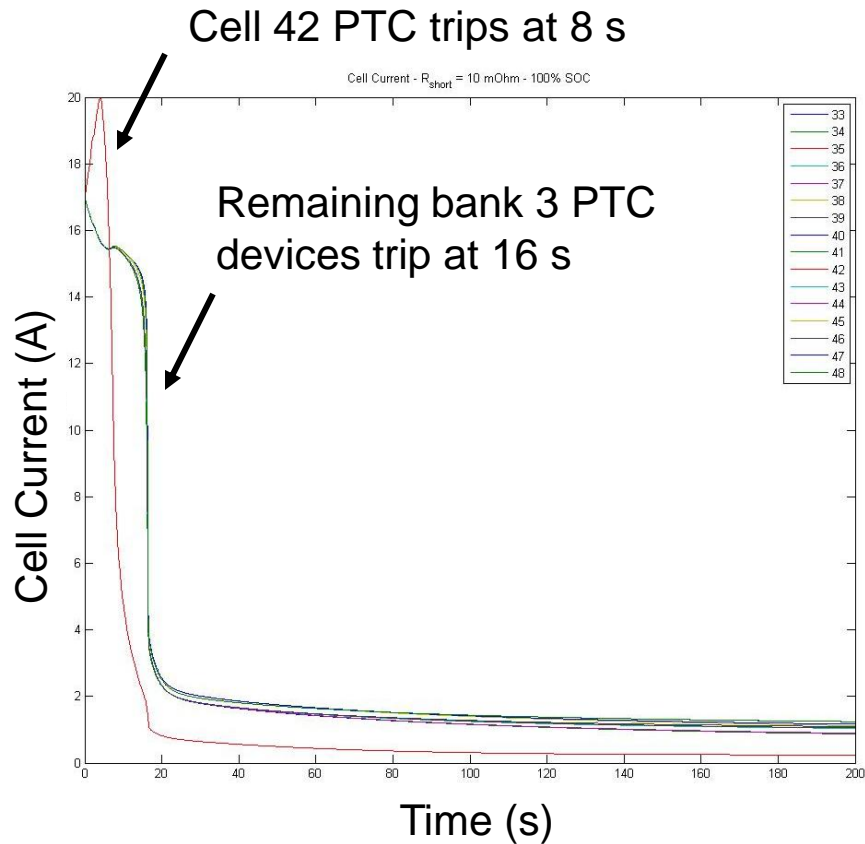

20 mΩ:

Bank 3 PTC devices trip **slowly** at different times, depending upon bank 3 temperature distribution

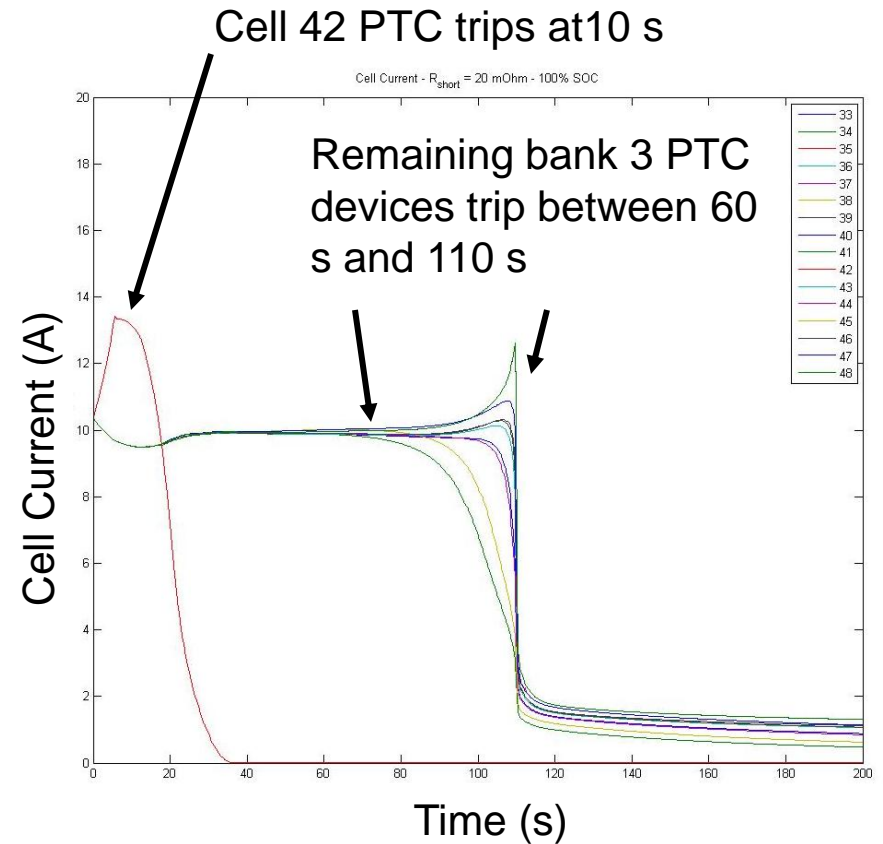

Bank 3 short from 100% SOC: 10 mΩ vs. 20 mΩ

10 mΩ:

Bank 3 PTC devices trip **quickly** and uniformly due to high in-rush current causing PTC self-heating

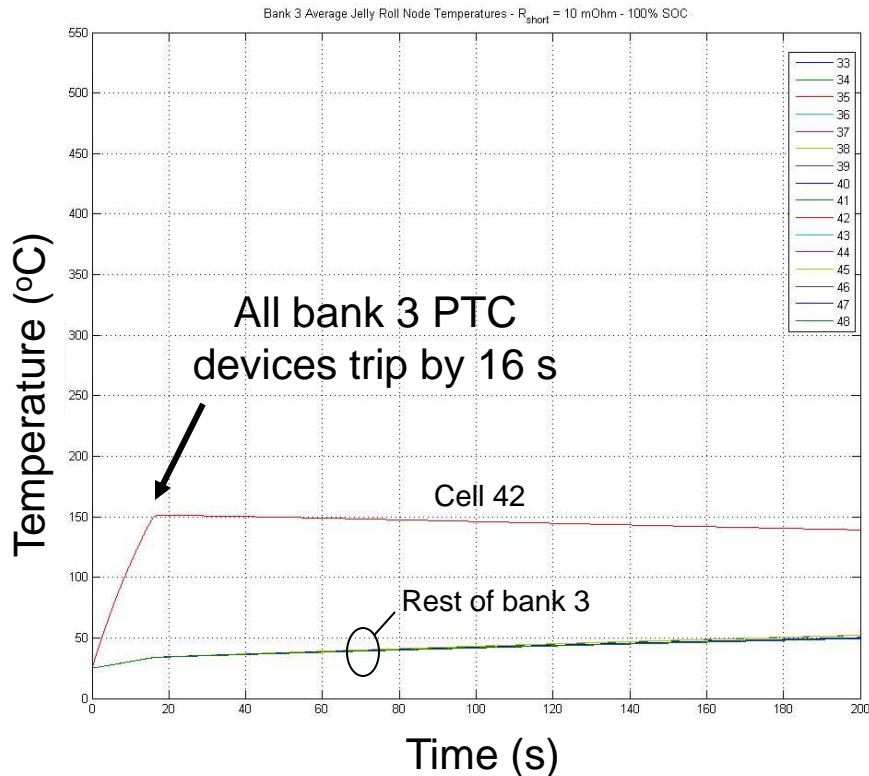

20 mΩ:

Bank 3 PTC devices trip **slowly**, at different times dependent upon bank 3 temperature distribution

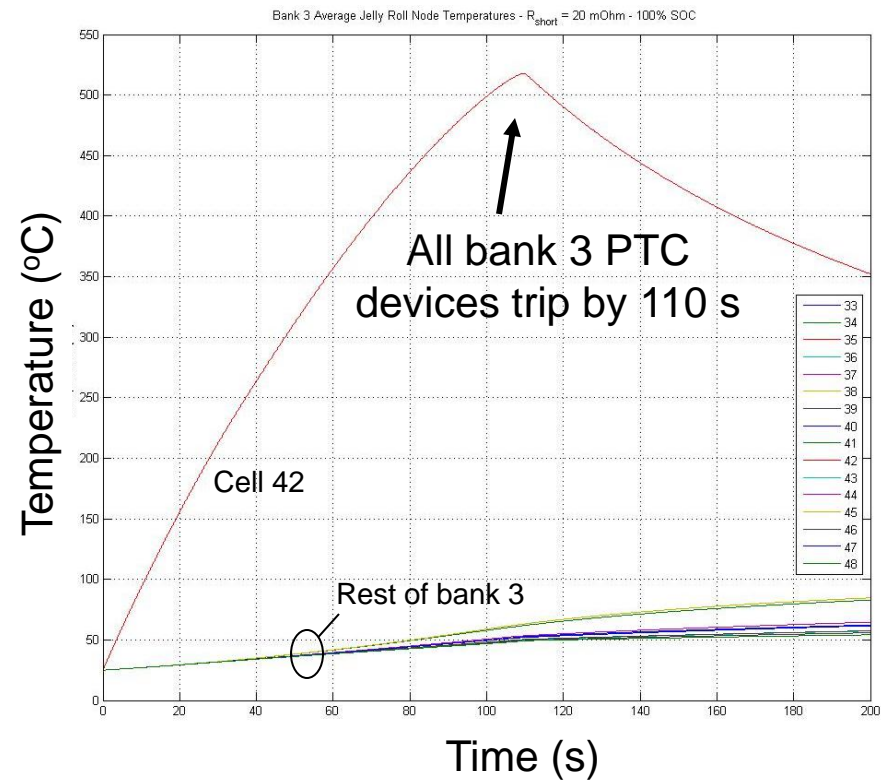

Bank 3 Short from 100% SOC: Cell-to-Cell Radiation

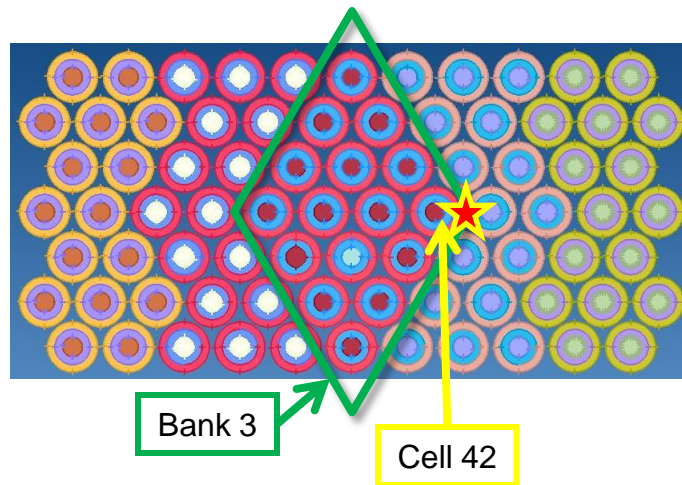

Design question:

Would a high-emissivity coating applied to bare cell walls help limit thermal excursion?

R_{short}	Short Condition (SOC ₀ = 100%)	Cell wall emissivity	Cell 42 T _{max} (Bank 3)
20 mΩ	Internal-to-pack, earth	$\epsilon = 0.3$ (Nominal)	525°C @ 110 s
		$\epsilon = 0.9$ (Coating)	410°C @ 102 s

(Insufficient impact)

Bank 3 Short: SOC Dependence

Is battery design tolerant to pack-internal shorts when stored at low SOC?

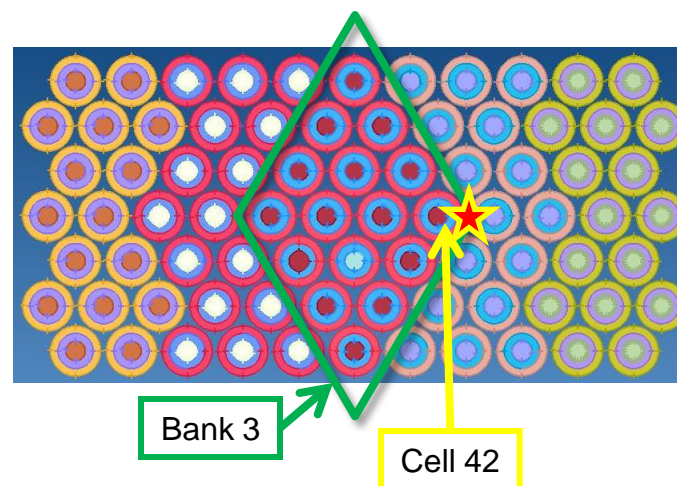

R_{short}	Short Condition	Initial SOC	Initial OCV	Cell 42 T_{max} (Bank 3)
20 m Ω	Internal-to-pack, earth	1.5%	3.428 V	117°C @ 85 s
		0.5%	3.346 V	83°C @ 80 s

No thermal runaway when stored at 0% SOC (3.25 OCV).

Summary

- NREL performed an internal short model simulation study to characterize an internal short and its evolution over time by linking and integrating NREL's electrochemical cell, electro-thermal, and abuse reaction kinetics models.
- Initial heating pattern at short events depends on nature of short, cell characteristics, and system configuration.
- Temperature rise for short is localized in large capacity cells.
- Short current is carried mostly by metal collectors.
- A simple puncture in the separator is not likely to lead to an immediate thermal runaway of a cell.
- Maintaining the integrity of the separator seems critical to delay short evolution.
- PTC device is an effective thermal regulator. Maximum cell temperature (final state) is very similar for a variety of initial and boundary conditions.

Summary

- 80-cell spacesuit battery electrical/thermal model
 - Captures relevant physics for cell-external shorting events, including PTC behavior
 - Agrees well with pack-external bank 3 short experiment run by ABSL
 - Predicts that design will tolerate all pack-external short resistance conditions
- Relocating short from pack-external (experimental validation) to pack-internal (modeling study) causes substantial additional heating of cells that can lead to cell thermal runaway
 - Negligible sensitivity to earth/space boundary conditions (thermal mass dominates)
 - Large sensitivity to R_{short}
 - $R_{\text{short}} < 10 \text{ m}\Omega$: 16P bank PTC devices trip quickly, most likely preventing runaway
 - $10 \text{ m}\Omega < R_{\text{short}} < 60 \text{ m}\Omega$: Thermal runaway appears likely
 - Nevertheless, this finding re-emphasizes the general imperative of battery pack assembly cleanliness
- Design is tolerant to pack-internal short when stored at 0% SOC

Acknowledgments

Vehicle Technology Program at DOE

- Dave Howell



NASA Johnson Space Center

- NASA JSC under Interagency Agreement NNJ08HC04I
- Technical discussion: Sam Russell, Frank Davies



Symmetry Resources Inc.

- Brad Strangways

ABSL

- Craig Flora

Thank you for your attention!

Digital Battery Innovation

Multi-physics design and analysis paving the road for future automotive batteries

Designing Li-Ion cells and modules using computer aided design and engineering tools to

- Reduce the process of product design, build, and test cycle.
- Accelerate product development cycle to reduce battery cost.

The goal is to use state of the art battery modeling tools and codes developed by NREL, universities, National Labs, battery companies and others in an integrated system for universal use.

The requirements for lithium-ion batteries for next generation electrified vehicles must be addressed over various length and time scales in which physical and chemical processes are occurring—from atomic variations to vehicle interface controls.

Integrated multi-scale models need to provide a pathway toward expanding knowledge on the interplay of different scales and times in battery physics and chemistry to expedite the process of advanced battery system development enabling green mobility technologies.

Design of Materials

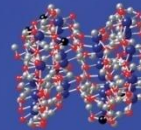

Design of Electrode Architecture



Design of Transport at Electrode/Electrolyte



Design of Electron Current & Heat Transport

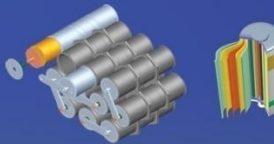

Design of Interface with Vehicles



Authors:
Ahmad Pesaran,
Gi-Heon Kim,
Kandler Smith

Negative Electrode Reaction

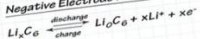

Positive Electrode Reaction

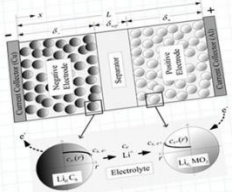
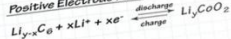

Negative Current Collector

Anode

Separator

Cathode

Positive Current Collector

Species Conservation

$$\frac{\partial(\epsilon_e c_e)}{\partial t} = \nabla \cdot (D_e^{eff} \nabla c_e) + \frac{1-t_e^0}{F} j^0 - i_e \cdot \nabla t_e^0$$

Charge Conservation

$$\nabla \cdot (K^{eff} \nabla \phi_e) + \nabla \cdot (K^{eff} \nabla c_e) + j^{Li} = 0$$

Energy Conservation

$$\rho C_p \frac{\partial T}{\partial t} = \nabla \cdot (k \nabla T) + q^m$$

Reaction Kinetics

$$j^{Li} = a_s i_0 \left\{ \exp \left[\frac{\alpha_a F}{RT} \eta \right] - \exp \left[-\frac{\alpha_c F}{RT} \eta \right] \right\}$$

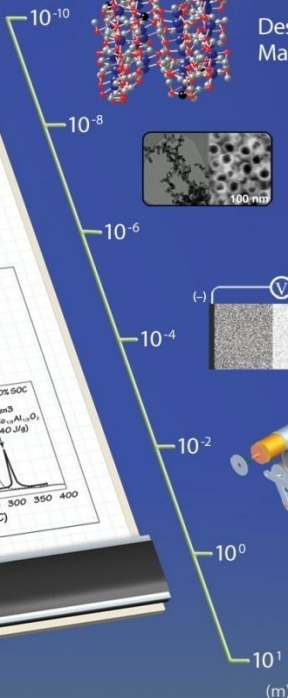
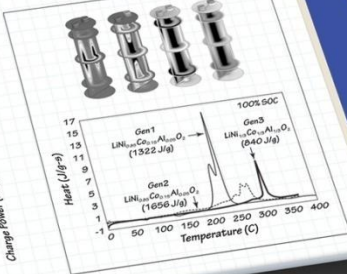
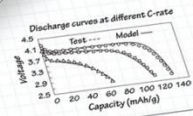
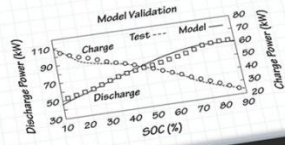

DOE's New CAEBAT Program

- Will integrate the accomplishments of battery modeling activities in national lab programs and make them accessible as design tools for industry
- Will shorten time and cost for design and development of EDV battery systems

