

Recent Analysis of UCAPs in Mild Hybrids

Ahmad Pesaran

Jeff Gonder

National Renewable Energy Laboratory
Golden, Colorado



6th Advanced Automotive Battery Conference

Baltimore, Maryland

May 17-19, 2006



Disclaimer and Government License

This work has been authored by Midwest Research Institute (MRI) under Contract No. DE-AC36-99GO10337 with the U.S. Department of Energy (the “DOE”). The United States Government (the “Government”) retains and the publisher, by accepting the work for publication, acknowledges that the Government retains a non-exclusive, paid-up, irrevocable, worldwide license to publish or reproduce the published form of this work, or allow others to do so, for Government purposes.

Neither MRI, the DOE, the Government, nor any other agency thereof, nor any of their employees, makes any warranty, express or implied, or assumes any liability or responsibility for the accuracy, completeness, or usefulness of any information, apparatus, product, or process disclosed, or represents that its use would not infringe any privately owned rights. Reference herein to any specific commercial product, process, or service by trade name, trademark, manufacturer, or otherwise does not constitute or imply its endorsement, recommendation, or favoring by the Government or any agency thereof. The views and opinions of the authors and/or presenters expressed herein do not necessarily state or reflect those of MRI, the DOE, the Government, or any agency thereof.

Outline

- Background and objectives
- Review of ucap-mild HEV analysis
- NREL's results with mild HEV with simple strategy
- Ucap roles in hybrid vehicles
- Energy requirements for various functions
- What applications could make ucaps attractive?
- Summary
- Proposed future analysis and testing

Background

- Last year's analysis by Burke (AABC-05) suggested that using a relatively small high-voltage, ultracapacitor pack in a midsize car, without any engine downsizing, could increase the city fuel economy improvement by:
 - 60% over conventional vehicle, and
 - 20% over the same hybrid using NiMH batteries.
- This created interest in evaluating high-voltage ultracapacitors for mild/moderate hybrid applications.
- Analysis and discussions were initiated among interested stakeholders.
 - We performed analysis using the assumptions in the previous study.
 - A recently proposed “sawtooth” control strategy with ucaps indicates up to 72% (city) and up to 24% (highway) fuel economy improvement over the conventional vehicle the same engine size (UCAP-06).
- The potential roles of ultracapacitors in meeting different requirements of hybrid vehicles were revisited.

Objectives

- Review the fuel economy improvement trends of today's HEVs with respect to degree of hybridization.
- Perform analysis to see the extent of fuel economy improvement possible with various strategies in mild/moderate HEVs, with no engine downsizing, using either batteries or ultracapacitors.
- Identify energy requirements of various driving events/functions – what matches a limited ucap's energy?
- Discuss potential roles for high-voltage ultracapacitors in HEVs, if any.

Background

Today's Commercial or Concept Hybrid Vehicles

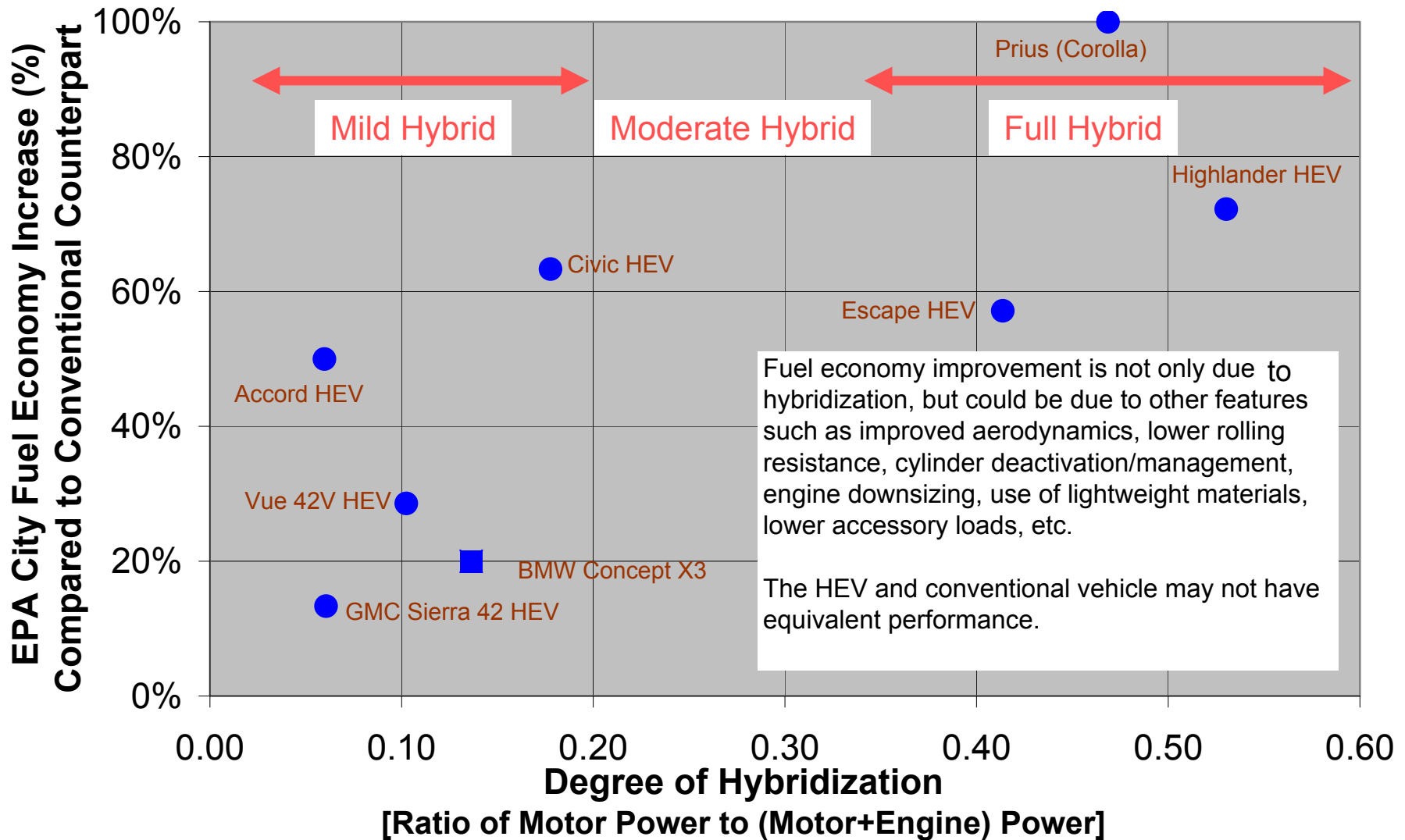

Background

One Example of Ucap Use in a Mild Fuel Cell Hybrid

Honda Fuel Cell Vehicle (FCX-V4)



Vehicle Mass = 1680 kg

Fuel Cell Power = 78 kW

Ucap Power = 28 kW

Deg. of Hybr. = 0.26

Utility of Ucaps:

- Improve fuel cell/ vehicle's response
- Recapturing regenerative braking for better fuel economy
- Energy for startup of the fuel cell

Item	Specification	Note
Volume (L)	36.8	
Weight (kg)	34.3	
Max. voltage (V)	216	
Max. power (kW)	28	
Energy (Wh)	80	216-→ 108V
Number	80	

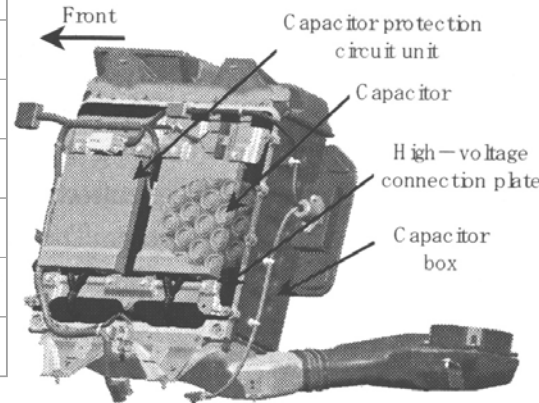

carbon-carbon with propylene carbonate electrolyte



EPA city/highway FE 62/51 miles per kg of hydrogen

Sources: AABC-03 and 2004 SAE Congress

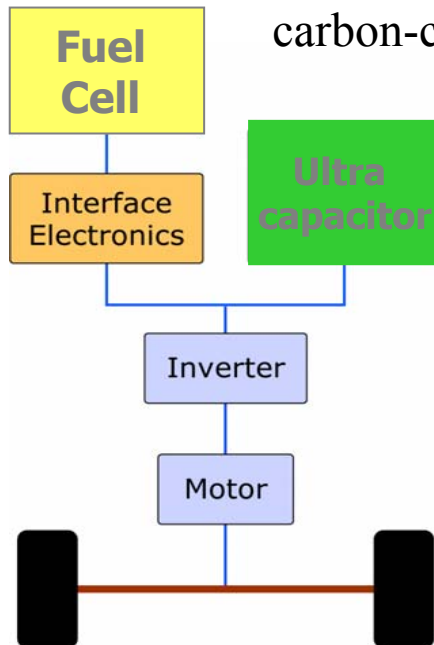

BMW X3 Efficient Dynamics Mild Hybrid Concept

- 6-cyl engine 190kW
- Motor 30kW (peak power 60kW) Deg. of Hybr. = 0.16
- Max. 600 Nm torque, 400 Nm from electric motor
- Start/Stop and regen functionality
- Ucap capacity 53 Wh
- Estimated acceleration 0-60 mph in 6.7 S
- Estimated 20% fuel economy increase



Maximale Leistung
Maximum performance

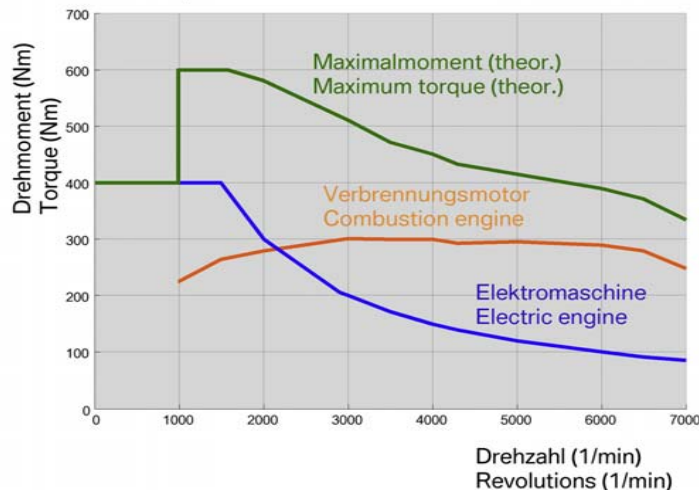

Supercaps (EPCOS?)

Ucap-Mild HEV Analysis

Results of Analysis by Burke (AABC-05)*

Conventional and Hybrid Vehicle Assumptions:

Mass = ~1500 kg; Engine = 120 kW peak; Motor = 15 kW continuous/27 kW peak

Ultracapacitor = 7 kg, ~35 Wh “available”; previous gen. NiMH Battery = 20 kg, ~200 Wh “available”

Control Strategy: Typical control parameters for full assist hybrids

<u>Configuration</u>	<u>ESS Technology</u>	<u>ESS kg</u>	<u>Unadjusted mpg*</u> (% mpg improvement)	
			<u>UDDS</u>	<u>US06</u>
Conv. CVT 120 kW	N/A	N/A	21.7	23.8
HEV CVT (120 + 15/27) kW	NiMH (previous generation)	20	32.9 (52%)	24.9 (5%)
HEV CVT (120 + 15/27) kW	Ultracap (advanced generation)	7	36.1 (66%)	26.3 (11%)

* Andrew Burke – “The Present and Projected Performance and Cost of Double-Layer and Pseudo-Capacitive Ultracapacitors for Hybrid Vehicle Applications,” AABC, Honolulu, Hawaii, June 2005, and other papers.

Engine Efficiency and Engine/Motor Power Distribution Based on our simulations similar to Burke's 2005 analysis

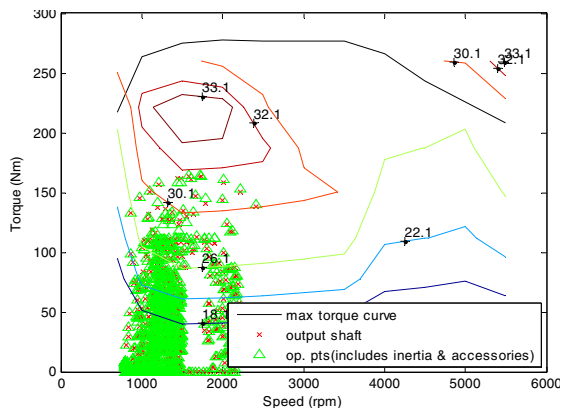

Conventional Vehicle - 21.7 mpg (city)

Avg Eff = 16%

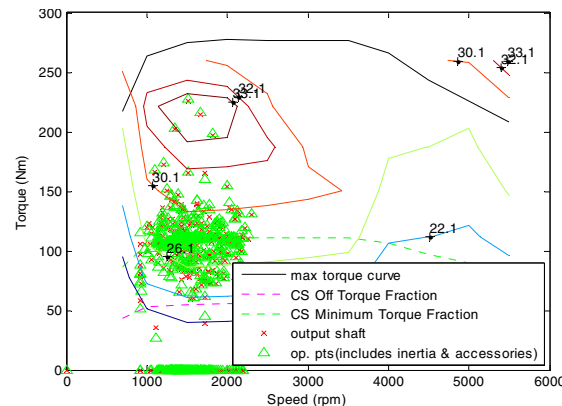
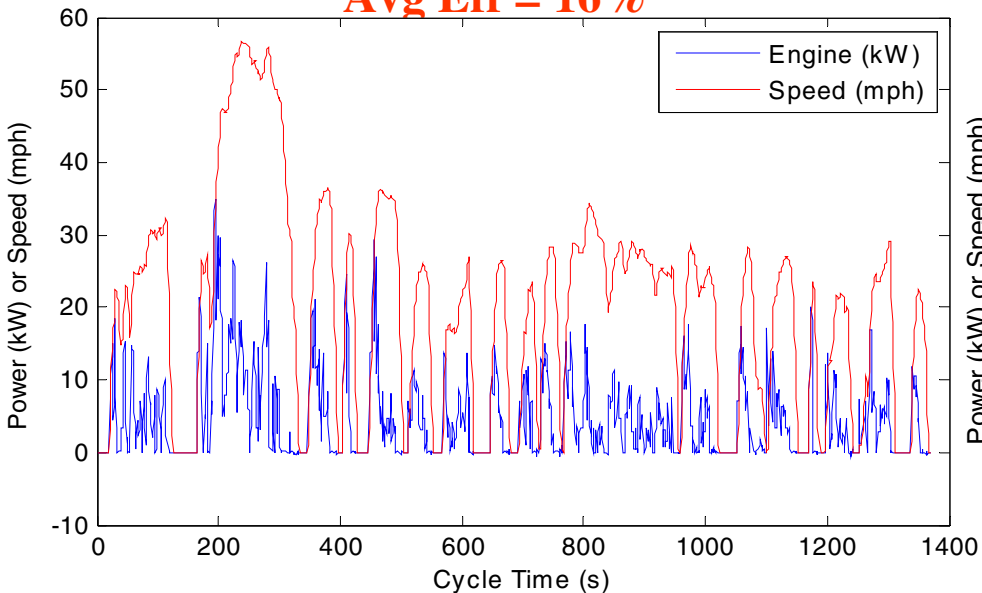

Ultracapacitor Mild Hybrid Vehicle - 36.1 mpg (city)

Avg Eff = 28%

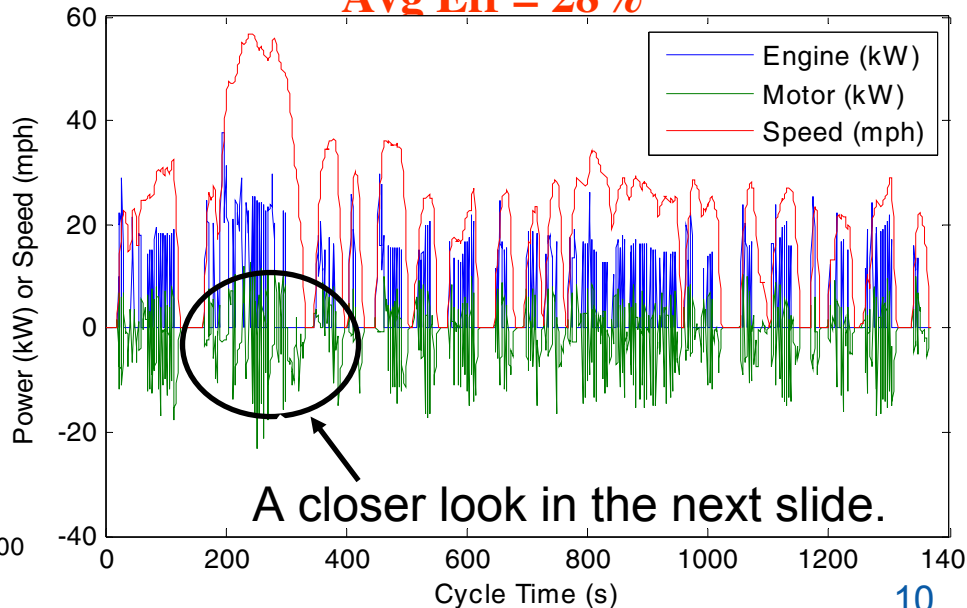

Closer Look at 2005 Analysis Showed Rapid Engine On/Off Oscillation for Ucap Hybrid

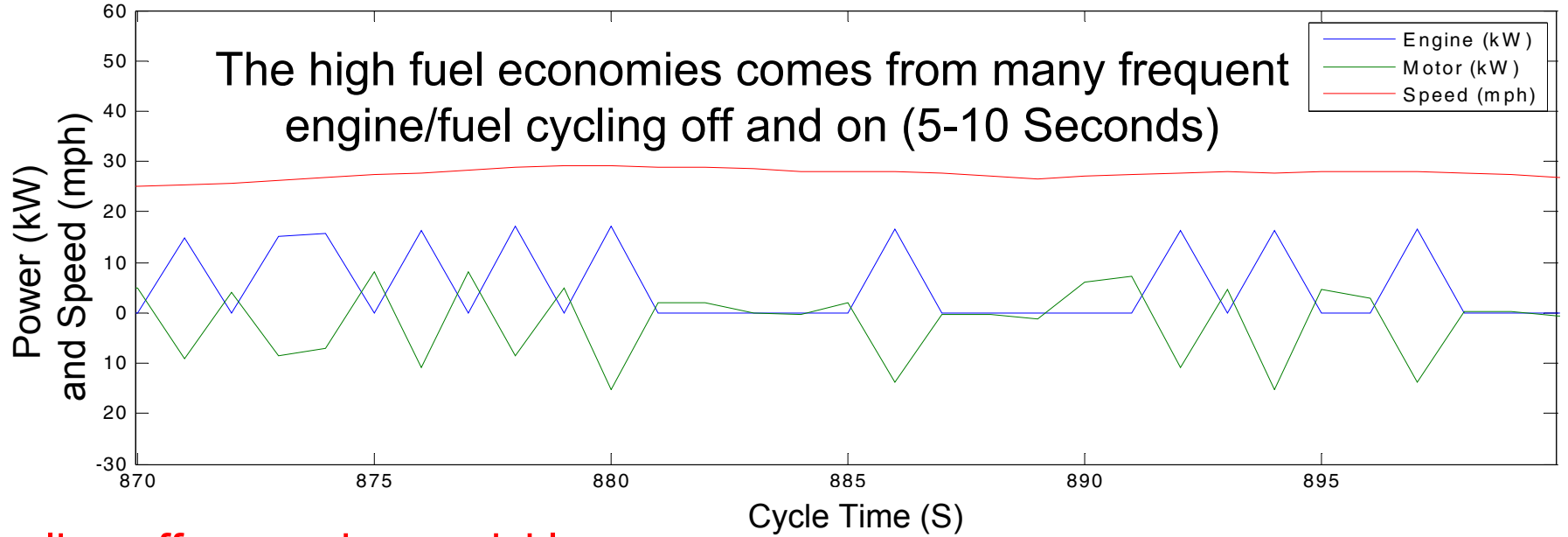

Cycling off-on engines quickly may not be practical from operating, noise, durability, and drivability perspectives so stated high fuel economy predictions would not be achievable.

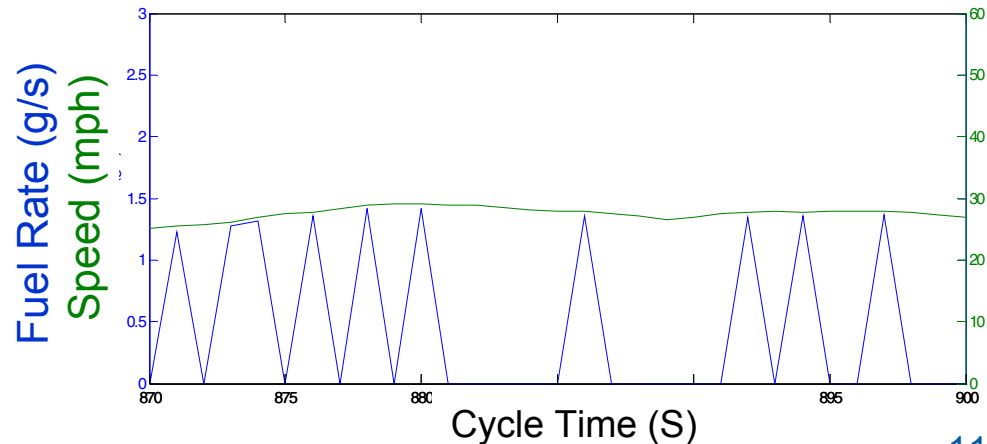

How Much Fuel Economy Is Possible with Ucaps? Relatively Aggressive *Mild Hybrid* Strategy Assumptions

Engine is OFF when vehicle has stopped, ON above electric launch speed, and OFF during decel below electric decel speed. Regen energy is captured. No extensive fuel cycling during higher speed driving.

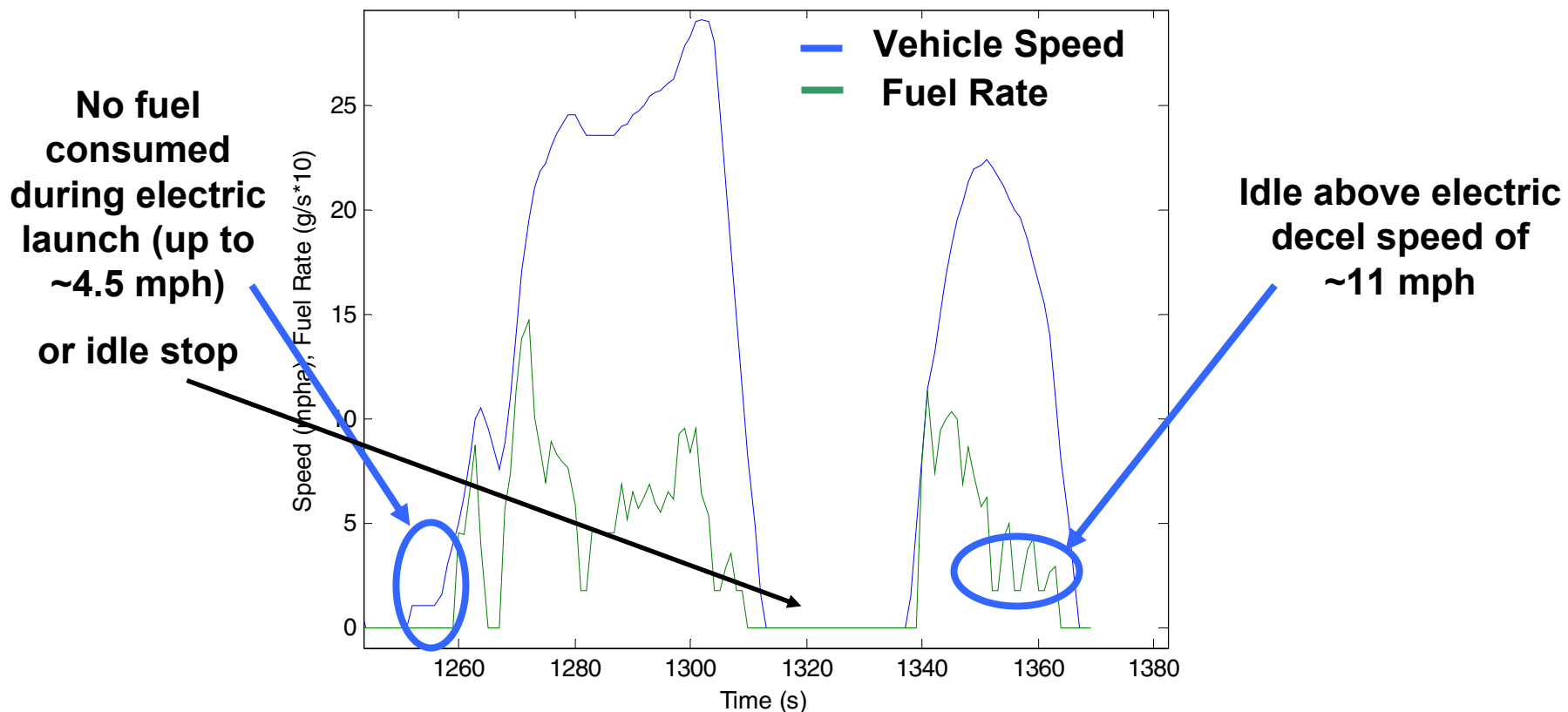

Idealized Low-Speed Engine Off Assumption: no added driveline friction when fuel off.

NREL Simulation Results – Mild Hybrid Strategy

Strategy: Practical engine OFF/ON and Regen Capture. Component sizing similar to Burke’s study except using 5 speed manual transmission: no downsizing of engine for a midsize car. Assumed that all runs are with hot engine, ignoring cold start losses.

<u>Configuration</u>	<u>ESS</u>	<u>ESS kg</u>	<u>Unadjusted mpg</u>		
			<u>UDDS</u>	<u>US06</u>	<u>HWFET</u>
Conv. 5-spd 120 kW	N/A	N/A	26.0	27.8	38.4
HEV 5-spd (120 + 15/27) kW	Advanced NiMH	20	31.8	31.3	39.6
HEV 5-spd (120 + 15/27) kW	Current Li-Ion	20	32.1	31.7	39.8
HEV 5-spd (120 + 15/27) kW	Ultracap	7	32.2	31.3	39.7

Fuel economy comparison with conventional

- Gains: 23% on UDDS, 13% on US06, 3% on HWFET
- More in line with hybridization benefits from commercial mild hybrids

Fuel economy comparison between hybrids

- No appreciable difference between ucap and battery hybrids in this configuration.

Categorization of Mild Hybrid Fuel Savings

(no significant mpg difference between Li-Ion and Ucap hybrids)

Driving Condition Category	UDDS		HWFET		US06	
	Ucap	Li-ion	Ucap	Li-ion	Ucap	Li-ion
Stationary - Stop	47%	48%	8%	7%	14%	13%
Decelerating	42%	44%	77%	82%	53%	52%
Accelerating	10%	9%	15%	10%	33%	36%

(Cycle mpg gain) (~23% over conv.) (~13% over conv.) (~3% over conv.)

Ucap Hybrid Fuel Rate Comparison -- US06

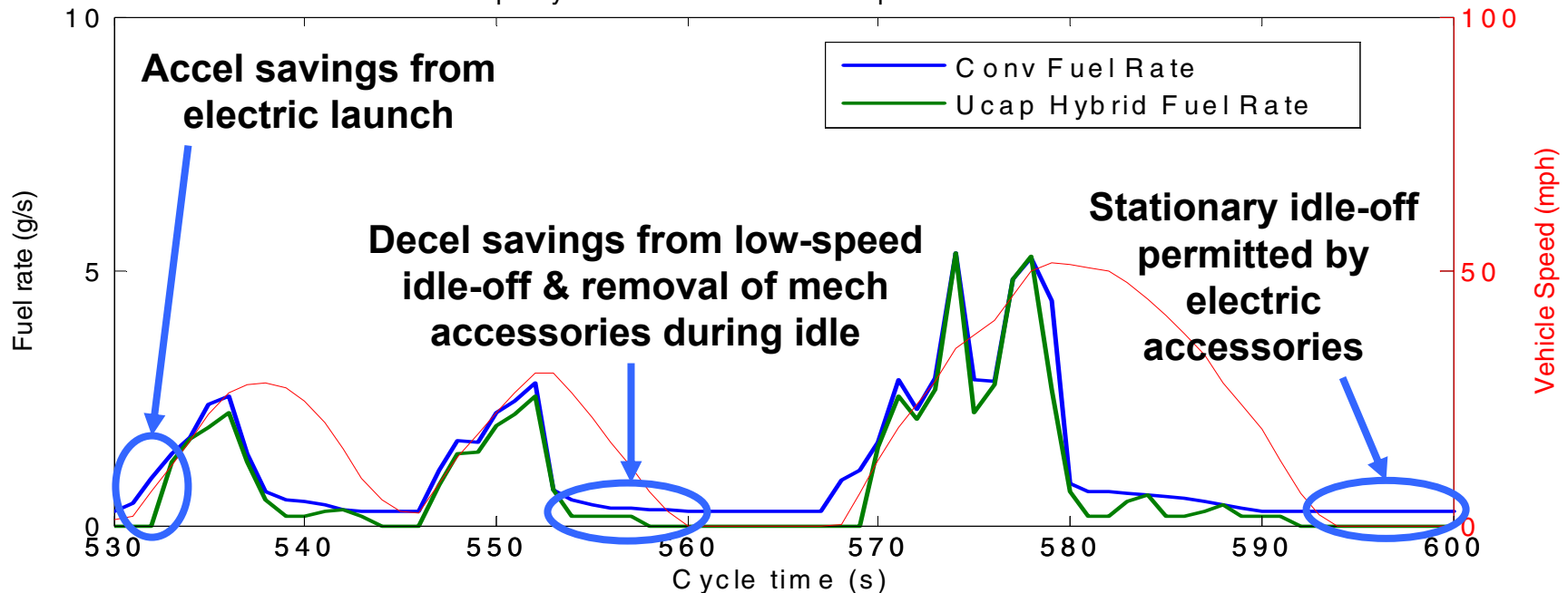

Ucap & Battery Energy Use Comparison

(Drive-cycle characteristics dictate the amount of energy needed.)

ESS Energy Use Comparison -- UDDS

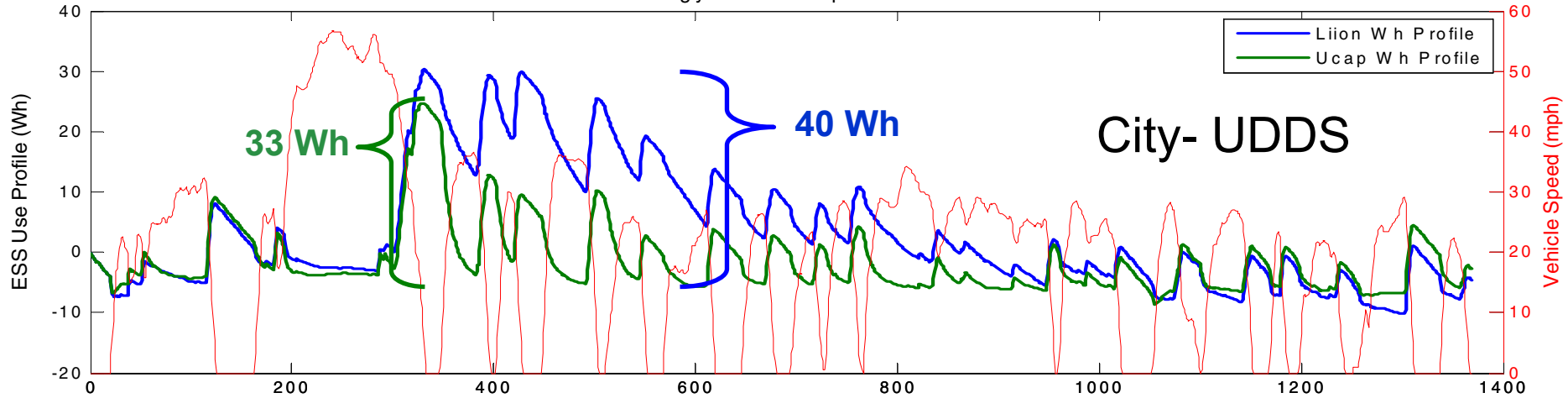

ESS Energy Use Comparison -- US06

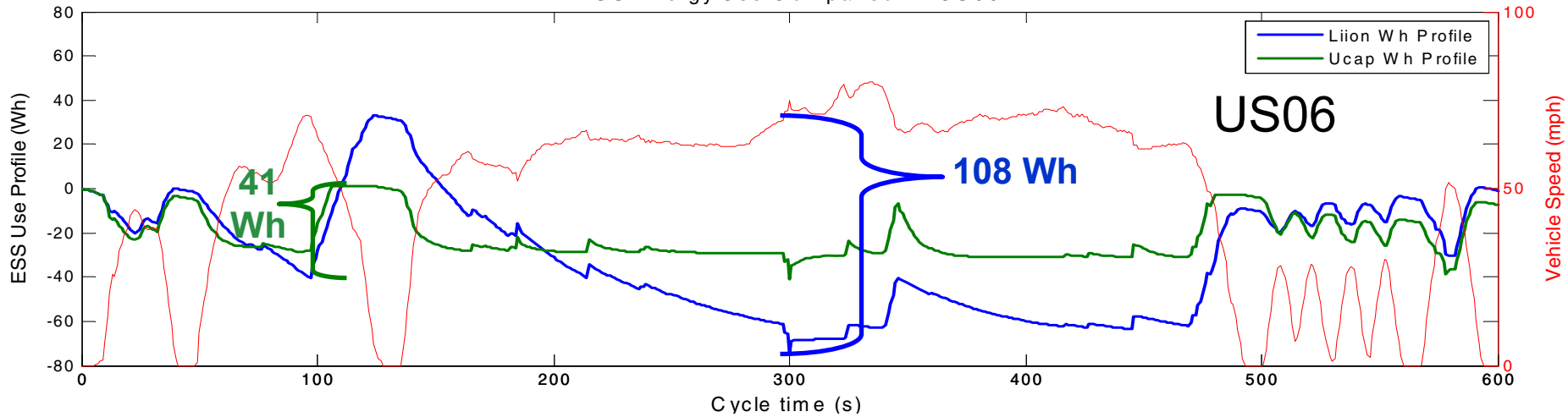

Comments on Results with Simple Mild-Hybrid Strategy and No Engine Downsizing

- Differences Between the Drive Cycles
 - Larger number and duration of stops on UDDS → larger mpg improvement from idle-off
- Comparing Hybrids' Performance
 - Efficiency gains of Ucap hybrid is offset by restricted regen capture from 100% SOC ceiling (limited energy)
 - Mild hybrid control strategy with no engine downsizing
 - → Small power flow through ESS relative to engine
 - → Diluted fuel economy impacts of ESS changes
 - Modeled batteries larger than needed – used <50% of available energy window for given control strategy and drive cycles.
 - Can this energy be used better if engine is downsized ?
 - Fuel economy improvements (23% for city and 13% for US06) may be on the high end due to idealized low-speed engine off assumption (neglecting any fuel penalty or added driveline friction)
 - No significant difference in fuel economy between Ucap and Li-ion hybrids

Comments on Recent Sawtooth Control Strategy for Mild HEVs*

- Fuel economy of baseline conventional vehicle seems too low – may contribute to high mpg improvement (74% in city with no engine losses).
- Many engine/fuel on/off cycles (e.g. – engine alternately ON for 30 seconds then OFF for 30 seconds over ~1/2 hour of highway driving).
 - Critical to properly model how this engine operation could be implemented.
 - Drivability and emissions must be considered.
- If not de-clutching the engine, repeatedly blending torque ON and OFF the driveline requires either idling the engine or accounting for a resistive torque/friction on the driveline when powering the wheels electrically.
 - Underestimating the engine idle or restart fuel requirement or driveline impact will result in over prediction of the fuel savings.
- Such outside-the-box HEV control strategies (pairing novel engine management with frequent but shallow cycling of the ESS) could create a natural application for Ucaps to provide significant FE improvements.
 - Requires practical treatment of drivability, noise, engine wear, emissions, etc.
 - Will compete with advanced engine strategies not as reliant upon energy storage (e.g. – cylinder deactivation/variable displacement) that provide high efficiency at the power requested, rather than alternately providing excess power at high efficiency and then switching the engine off.

Potential of Mild Hybrids with Ucaps for Fuel Economy

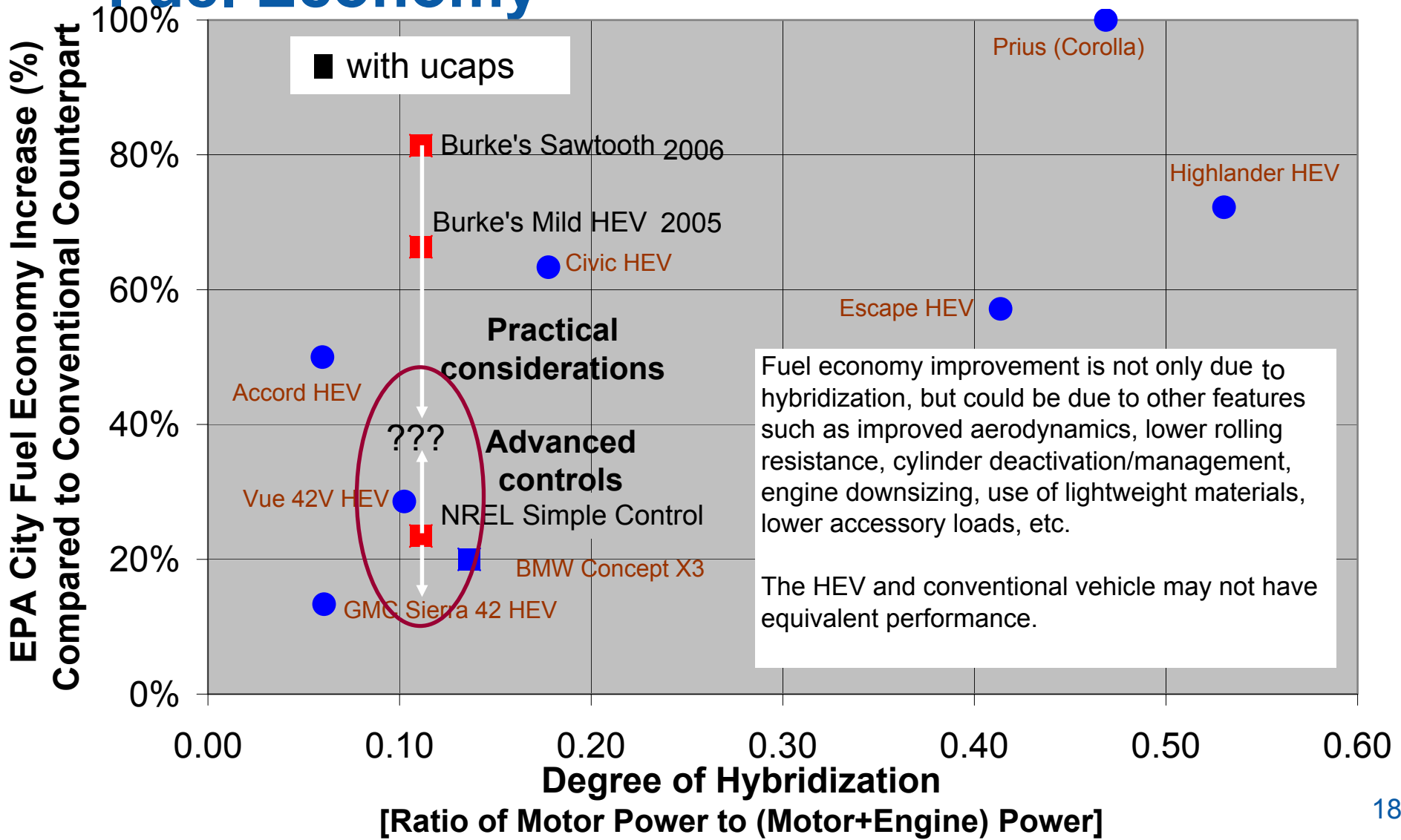

Rationale for Using Ultracapacitors with Electric Drive

Taking advantage of ultracapacitor's strengths (+) while minimizing impact of its weaknesses (-) if the COST was comparable to batteries

+ High specific power



Engine assist

+ Efficient charge acceptance



Regen capture

+ Low resistance



Low cooling needs

+ Quick response (short time constant)



Supporting engine transients

+ Long anticipated calendar and cycle lives

+ High specific power at low temperatures (cold starts)



Small energy storage

- Low specific energy



Limited power draw durations for

- Acceleration
- Engine assist, specifically for grade
- Running auxiliaries at idle

The best use for ucaps are strategies that make engine to operate more efficiently (idle off, load leveling), and recapturing regen energy.

Ucap is Energy Limited. How Much Energy Needed for Various Events?

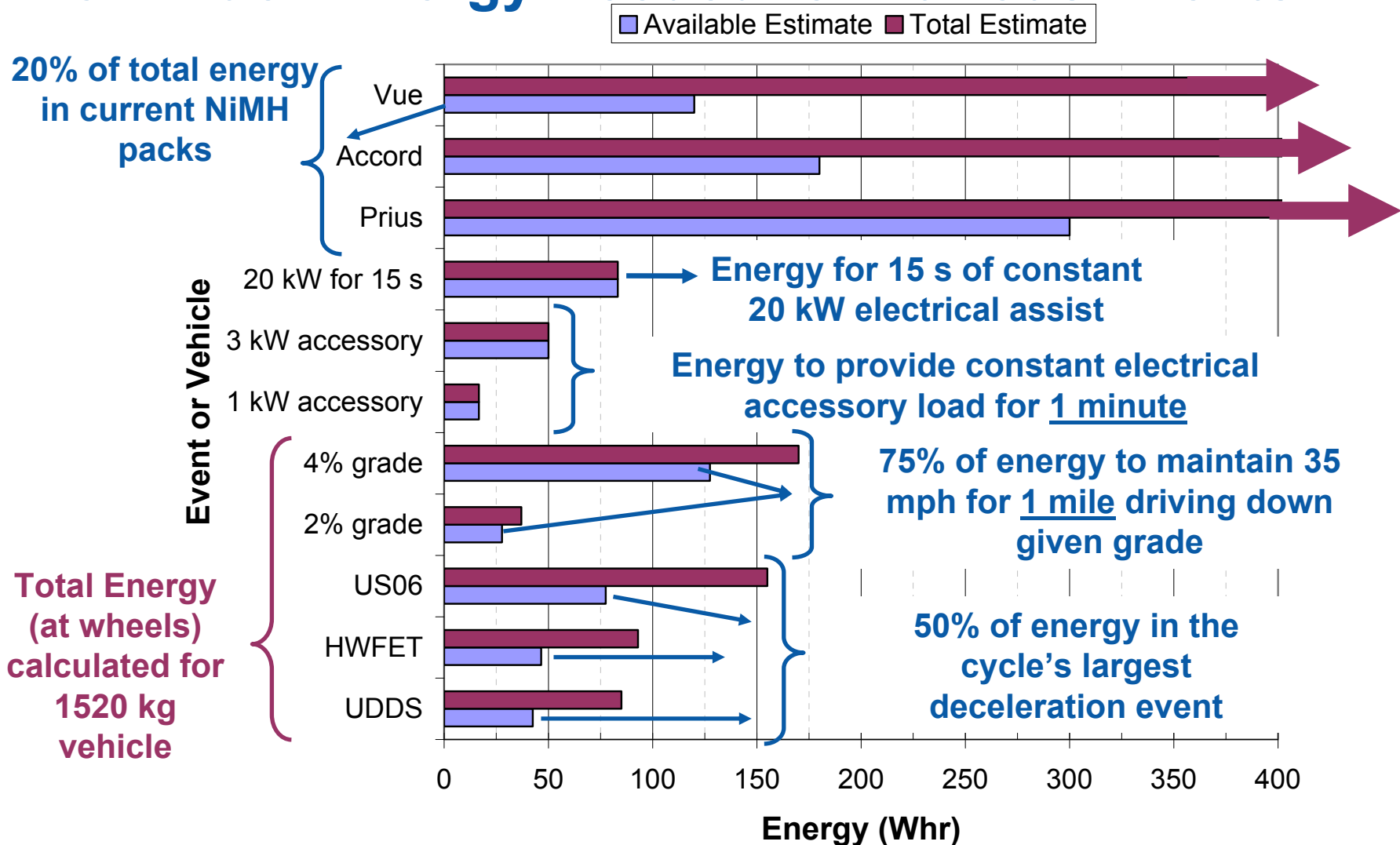

Summary - 1

- The high fuel economies reported last year (AABC-05) with use of relatively small, high-voltage ultracapacitor pack in mild hybrids are high and could not be achieved in practice.
- For Ucaps used with a simple mild hybrid control strategy utilizing idle-off and regen capture (and no engine downsizing) in a midsize vehicle, we found:
 - The fuel economy improvement could be at best ~20% for city driving.
 - There is little fuel economy difference with a hybrid using Li-Ion batteries.
 - If cost is the same, and without taking advantage of extra energy from Li-Ion, the superior life and low-temperature performance of Ucaps make them more attractive.

Summary - 2

- Ucaps provide opportunity for applications with low energy and quick response needs.
- Many of the functions required from an energy storage device in mild hybrids could be met with less than 100 Wh for a midsize car.
- Practical engine management and control strategies are “key” in enabling Ucaps (or batteries) to achieve fuel economy improvements much higher than 20% with novel mild hybrid approaches.
- Some advanced engine and control strategy development may match especially well with particular Ucap attributes such as quick response, high power, and high efficiency.

Future Work for High-Voltage Ucap HEVs

- Need to go beyond “no downsized” engine mild hybrid applications.
- Evaluate different component sizes (engine, motor, and ESS) and control parameter values over a realistic range to find the optimum vehicle design for a set of drive cycles.
- Apply constraints to define what is “optimum” (e.g., hold performance constant and maximize fuel economy; find best mpg/\$-increment vehicle; maximize combined equation for performance, cost and fuel economy; consider cold start, life, etc.).
- Study could also output relationship between ESS usable energy and fuel economy improvement (given by optimized control parameters at each Wh size increment).
- Evaluate concepts by perform experiments using advanced, but practical control and engine management strategies.

Acknowledgments

DOE and FreedomCAR Program Support

- Tien Duong
- Dave Howell



USABC Technical Guidance

- Franco Leonardi
- Cyrus Ashtiani
- Harshad Tataria

