

Rates Calculators

USPS Web Tools™

Application Programming Interface

Reference

Document Version 1.5 (01/22/2012)



To Our Customers

In registering for use of the USPS Web Tools™ (Web Tools), you received a user ID that will allow you to begin sending calls to the server when you are ready. Any additional information or contact with you will occur as indicated on the registration form, please return to the Web Tools [eCommerce API Technical Guides site](#) for the most recent documentation from any of the Web Tools.

If you require technical support, contact the USPS Internet Customer Care Center (ICCC). This office is staffed from 7:00 AM to 11:00 PM EST daily.

E-mail address: uspstechsupport@esecurecare.net

Telephone: 1-800-344-7779 (7:00 AM to 11:00 PM EST daily)

USPS Customer Commitment

The United States Postal Service fully understands the importance of providing information and service anytime day or night to your Internet and e-commerce customers. For that reason, the USPS is committed to providing 24 x 7 service from our Web Tools servers, 365 days a year.

Trademarks

Express Mail, First-Class Mail, Global Express Mail, GXG, Global Priority Mail, Parcel Post, Parcel Select, Priority Mail, **Express Mail International, First Class Mail International, Priority Mail International**, USPS, and ZIP + 4 are registered trademarks of the U.S. Postal Service.

Delivery Confirmation, Global Express Guaranteed, International Parcel Post, Priority Mail Global Guaranteed, Signature Confirmation, USPS Web Tools, and ZIP Code are trademarks of the U.S. Postal Service.

Microsoft and Visual Basic are registered trademarks of Microsoft Corporation.

Adobe Acrobat is a trademark of Adobe Systems Incorporated.

DUNS is a registered trademark of Dun & Bradstreet.

Table of Contents

1	Introduction.....	4
1.1	Error Responses.....	4
2	Domestic Rates API (V4).....	5
2.1	RateV4 Request	5
2.1.1	API Signature	5
2.1.2	Request Diagram	6
2.1.3	Request Parameters	9
2.1.4	RateV4 Service Request Matrix.....	18
2.1.5	Request Examples.....	23
2.2	RateV4 Response	25
2.2.1	Response Diagram	25
2.2.2	Response Parameters.....	28
2.2.3	Response Example – No Revision Tag	37
2.2.4	Response Example – Revision =”2”	40
3	International Rates API (V2)	46
3.1	IntlRateV2 Request.....	46
3.1.1	API Signature	46
3.1.2	Request Diagram.....	47
3.1.3	Request Parameters.....	49
3.1.4	Request Examples.....	54
3.2	IntlRateV2 Response	56
3.2.1	Response Diagram	56
3.2.2	Response Parameters.....	60
3.2.3	Response Example – No Revision Tag	66
3.2.4	Response Example – Revision =”2”	78

1 Introduction

This document contains a Reference Guide to the Rates Calculator APIs. See the Developer's Guide to Web Tools APIs to learn the administrative process for gaining access to the Web Tools APIs as well as the basic mechanism for calling the APIs and processing the results. The Developer's Guide also contains information on testing and trouble-shooting.

Note: The Request Parameter sections present the XML input tags for generating Live requests along with the restrictions on the values allowed. An error message will be returned if an incorrect value is entered. Also, be aware of the maximum character amounts allowed for some tags. If the user enters more than those amounts, an error will not be generated. **The Web Tool will simply pass in the characters up to the maximum amount allowed and disregard the rest.** This is important since the resulting value could prevent a correct response.

When building the XML request, pay particular attention to the **order and case** for tags. An error message will be returned if an incorrect value is entered. Remember that all data and attribute values in this document are for illustration purposes and are to be replaced by your actual values. For instance, a line of sample code may be:

```
<ZipDestination>12345</ZipDestination>
```

In this instance, you will replace "12345" with the destination ZIP Code for the domestic-bound package.

1.1 Error Responses

Error conditions are handled at the main XML document level. When parsing, it is best to check for an error document first before checking for good data. Error documents have the following format:

```
<Error>  
  <Number></Number>  
  <Source></Source>  
  <Description></Description>  
  <HelpFile></HelpFile>  
  <HelpContext></HelpContext>  
</Error>
```

Where:

- Number = the error number generated by the Web Tools server.
- Source = the component and interface that generated the error on the Web Tools server.
- Description = the error description.
- HelpFile = [reserved for future use].
- HelpContext = [reserved for future use].

Errors that are further down in the hierarchy also follow the above format.

2 Domestic Rates API (V4)

2.1 RateV4 Request

2.1.1 API Signature

<i>Scheme</i>	<i>Host</i>	<i>Path</i>	<i>API</i>	<i>XML</i>
http://	production.shippingapis.com	/ShippingAPI.dll	?API=RateV4	&XML=(see below)

2.1.2 Request Diagram

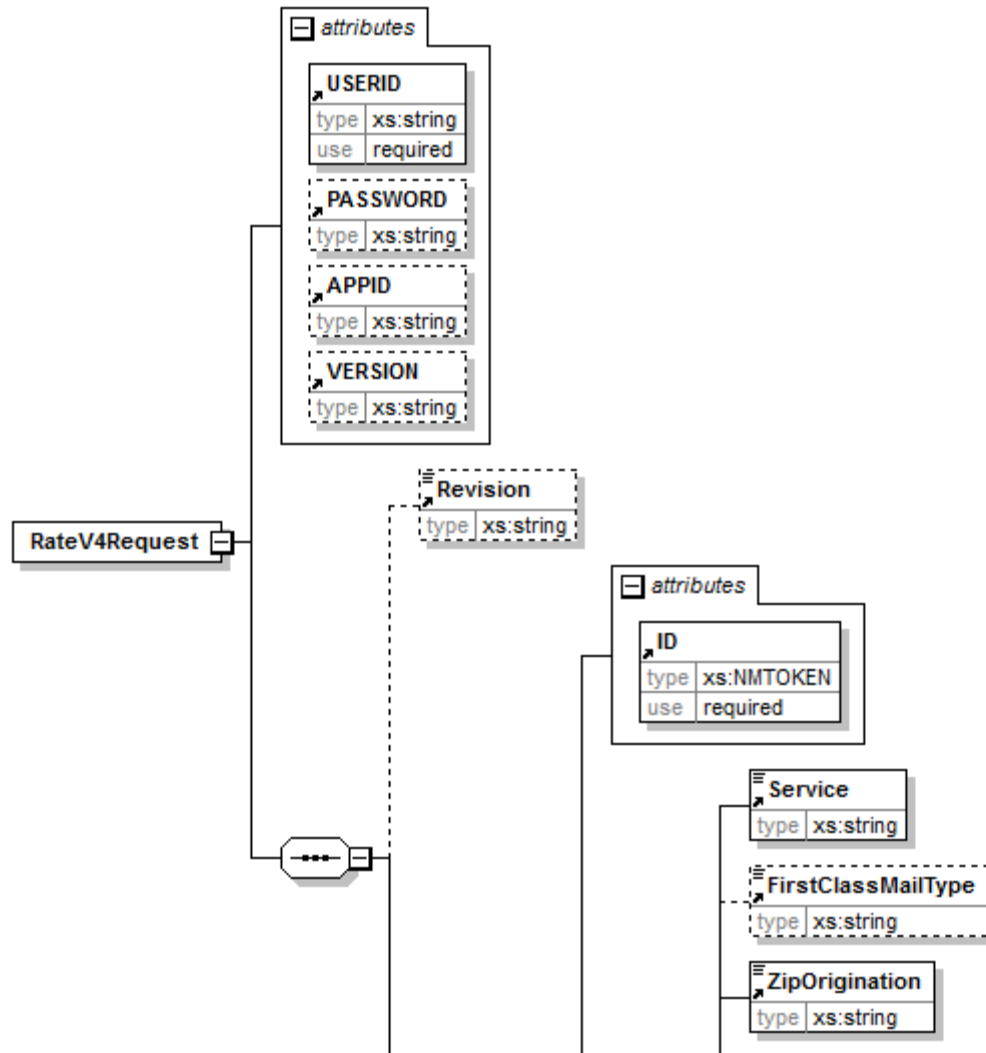

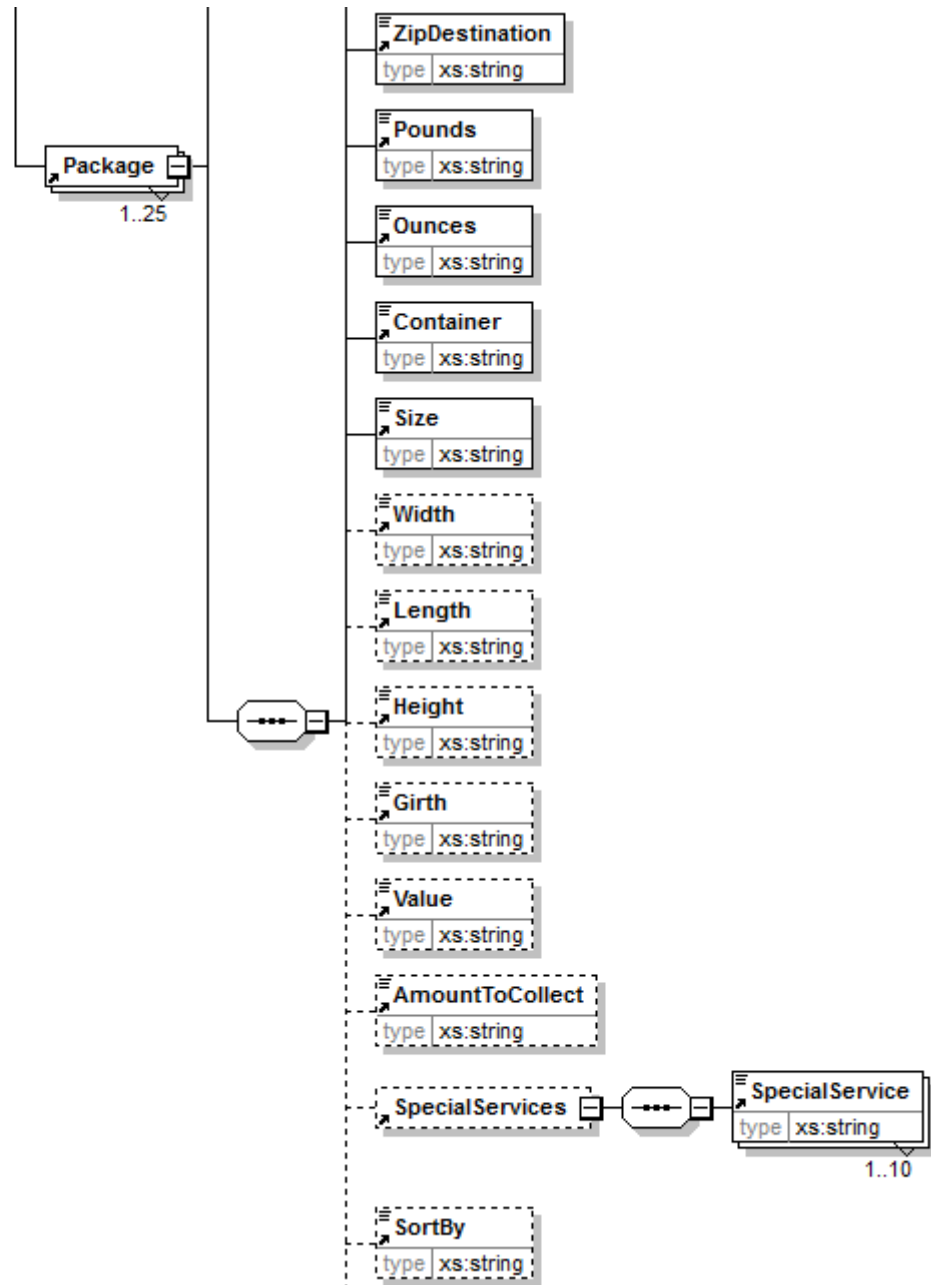

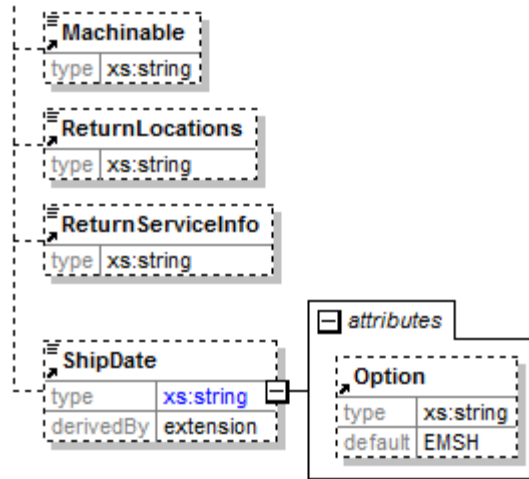

2.1.3 Request Parameters

Tag Name	Occurs	Description	Type	Validation
RateV4Request	required once	API=RateV4 This API returns the current USPS postage corresponding to the parameters given such as destination, weight of package, class of mail service, and so on.	(group)	
RateV4Request / @USERID	required	This attribute specifies your Web Tools ID. See the Developer's Guide for information on obtaining your USERID.	NMTOKEN	
RateV4Request / @PASSWORD	optional	For backward compatibility; not validated.	NMTOKEN	
RateV4Request / Revision	optional	Optional for "Base" RateV4 functionality. For full RateV4 functionality use Revision="2"	string	
RateV4Request / Package	required once repeating up to 25 times	See the RateV4 Service Request chart for valid combinations of the following tags.	(group)	
RateV4Request / Package / @ID	required	No restrictions on number or type of characters provided valid XML syntax and unique to request. For example: <Package ID="0"/>	NMTOKEN	

Tag Name	Occurs	Description	Type	Validation
RateV4Request / Package / Service	required once	<p>Web Tool validates the entry to one of the service types.</p> <p>For example: <Service>EXPRESS</Service></p>	string	whiteSpace=collapse enumeration=FIRST CLASS enumeration=FIRST CLASS COMMERCIAL enumeration=FIRST CLASS HFP COMMERCIAL enumeration=PRIORITY enumeration=PRIORITY COMMERCIAL enumeration=PRIORITY HFP COMMERCIAL enumeration=EXPRESS enumeration=EXPRESS COMMERCIAL enumeration=EXPRESS SH enumeration=EXPRESS SH COMMERCIAL enumeration=EXPRESS HFP enumeration=EXPRESS HFP COMMERCIAL enumeration=PARCEL enumeration=MEDIA enumeration=LIBRARY enumeration=ALL enumeration=ONLINE
RateV4Request / Package / FirstClassMailType	optional	<p>Required when:</p> <p>RateV4Request[Service='FIRST CLASS'] or RateV4Request[Service='FIRST CLASS COMMERCIAL'], or RateV4Request[Service='FIRST CLASS HFP COMMERCIAL']</p> <p>For example: <FirstClassMailType>LETTER</FirstClassMailType></p>	string	whiteSpace=collapse enumeration=LETTER enumeration=FLAT enumeration=PARCEL enumeration=POSTCARD enumeration=PACKAGE SERVICE

Tag Name	Occurs	Description	Type	Validation
RateV4Request / Package / ZipOrigination	required once	ZIP code must be valid. For example: <ZipOrigination>20770</ZipOrigination>	string	whiteSpace=collapse length=5 pattern=\d{5}
RateV4Request / Package / ZipDestination	required once	ZIP code must be valid. For example: <ZipDestination>54324</ZipDestination>	string	length=5 whiteSpace=collapse pattern=\d{5}
RateV4Request / Package / Pounds	required once	Value must be numeric. Package weight in ounces is computed by $16 * \text{RateV4Request/Package/Pounds} + \text{RateV4Request/Package/Ounces}$. Package weight cannot exceed 70 pounds. For example: <Pounds>2</Pounds>	string	maxInclusive=70 minInclusive=0
RateV4Request / Package / Ounces	required once	Value must be numeric. Package weight in ounces is computed by $16 * \text{RateV4Request/Package/Pounds} + \text{RateV4Request/Package/Ounces}$. Package weight cannot exceed 70 pounds (1120 ounces). For example: <Ounces>0</Ounces>	string	maxInclusive=1120.0 minInclusive=0.0 totalDigits=10

Tag Name	Occurs	Description	Type	Validation
RateV4Request / Package / Container	required once	<p>Use to specify special containers or container attributes that may affect postage; otherwise, leave blank.</p> <p>Note: RECTANGULAR or NONRECTANGULAR must be indicated when <Size>LARGE</Size>.</p> <p>For example: <Container>LEGAL FLAT RATE ENVELOPE</Container></p>	string	default=VARIABLE whiteSpace=collapse enumeration=VARIABLE enumeration=FLAT RATE ENVELOPE enumeration=PADDED FLAT RATE ENVELOPE enumeration=LEGAL FLAT RATE ENVELOPE enumeration=SM FLAT RATE ENVELOPE enumeration=WINDOW FLAT RATE ENVELOPE enumeration=GIFT CARD FLAT RATE ENVELOPE enumeration=FLAT RATE BOX enumeration=SM FLAT RATE BOX enumeration=MD FLAT RATE BOX enumeration=LG FLAT RATE BOX enumeration=REGIONALRATEBOXA enumeration=REGIONALRATEBOXB enumeration=REGIONALRATEBOXC enumeration=RECTANGULAR enumeration=NONRECTANGULAR
RateV4Request / Package / Size	required once	<p>Defined as follows:</p> <p>REGULAR: Package dimensions are 12" or less; LARGE: Any package dimension is larger than 12".</p> <p>For example: <Size>REGULAR</Size></p>	string	whiteSpace=collapse enumeration=LARGE enumeration=REGULAR
RateV4Request / Package / Width	optional	<p>Value must be numeric. Units are inches. Required when RateV4Request/Size is LARGE.</p> <p>For example: <Width>5.5</Width></p>	string	minExclusive=0.0 totalDigits=10

Tag Name	Occurs	Description	Type	Validation
RateV4Request / Package / Length	optional	Value must be numeric. Units are inches. Required when RateV4Request/Size is LARGE. For example: <Length>11</Length>	string	minExclusive=0.0 totalDigits=10
RateV4Request / Package / Height	optional	Value must be numeric. Units are inches. Required when RateV4Request/Size is LARGE. For example: <Height>11</Height>	string	minExclusive=0.0 totalDigits=10
RateV4Request / Package / Girth	optional	Value must be numeric. Units are inches. Required when RateV4Request/Size is LARGE, and RateV4Request/Container is NONRECTANGULAR or VARIABLE/NULL. For example: <Girth>11</Girth>	string	minExclusive=0.0 totalDigits=10
RateV4Request / Package / Value	optional	Available when RateV4Request[Revision='2']. Package value. Used to determine availability and cost of extra services. For example: <Value>150.00</Value>	string	minExclusive=0.0 totalDigits=10
RateV4Request / Package / AmountToCollect	optional	Available when RateV4Request[Revision='2']. Collect on delivery amount. Used to determine availability and cost of extra services. For example: <AmountToCollect>150.00</AmountToCollect>	string	minExclusive=0.0 totalDigits=10

Tag Name	Occurs	Description	Type	Validation
RateV4Request / Package / SpecialServices	optional	<p>Available when RateV4Request[Revision='2'].</p> <p>Groups the SpecialServices elements.</p> <p>Special Services prices and availability will not be returned when Service = "ALL" or "ONLINE"</p>	(group)	

Tag Name	Occurs	Description	Type	Validation																																		
RateV4Request / Package / SpecialServices / SpecialService	optional, repeating up to 10 times	<p>Available when RateV4Request[Revision='2'].</p> <p>Defines extra services desired in order to determine cost of desired services and availability of other, additional services.</p> <p>An initial rate call <u>without</u> the SpecialService tag specified is recommended to determine base availability of special services for each mail service.</p> <p>The extra service definitions are as follows:</p> <table border="1" data-bbox="527 638 1234 1235"> <thead> <tr> <th>Special Service Name</th> <th>ServiceID</th> </tr> </thead> <tbody> <tr><td>Certified</td><td>0</td></tr> <tr><td>Insurance</td><td>1</td></tr> <tr><td>Restricted Delivery</td><td>3</td></tr> <tr><td>Registered without Insurance</td><td>4</td></tr> <tr><td>Registered with Insurance</td><td>5</td></tr> <tr><td>Collect on Delivery</td><td>6</td></tr> <tr><td>Return Receipt for Merchandise</td><td>7</td></tr> <tr><td>Return Receipt</td><td>8</td></tr> <tr><td>Certificate of Mailing (per individual article)</td><td>9</td></tr> <tr><td>Certificate of Mailing (for firm mailing books)</td><td>10</td></tr> <tr><td>Express Mail Insurance</td><td>11</td></tr> <tr><td>Delivery Confirmation</td><td>13</td></tr> <tr><td>Signature Confirmation</td><td>15</td></tr> <tr><td>Return Receipt Electronic</td><td>16</td></tr> <tr><td>Adult Signature Required</td><td>19</td></tr> <tr><td>Adult Signature Restricted Delivery</td><td>20</td></tr> </tbody> </table> <p>For example: <SpecialServices> <SpecialService>1<SpecialService> <SpecialService>13<SpecialService> </SpecialServices></p>	Special Service Name	ServiceID	Certified	0	Insurance	1	Restricted Delivery	3	Registered without Insurance	4	Registered with Insurance	5	Collect on Delivery	6	Return Receipt for Merchandise	7	Return Receipt	8	Certificate of Mailing (per individual article)	9	Certificate of Mailing (for firm mailing books)	10	Express Mail Insurance	11	Delivery Confirmation	13	Signature Confirmation	15	Return Receipt Electronic	16	Adult Signature Required	19	Adult Signature Restricted Delivery	20	string	
Special Service Name	ServiceID																																					
Certified	0																																					
Insurance	1																																					
Restricted Delivery	3																																					
Registered without Insurance	4																																					
Registered with Insurance	5																																					
Collect on Delivery	6																																					
Return Receipt for Merchandise	7																																					
Return Receipt	8																																					
Certificate of Mailing (per individual article)	9																																					
Certificate of Mailing (for firm mailing books)	10																																					
Express Mail Insurance	11																																					
Delivery Confirmation	13																																					
Signature Confirmation	15																																					
Return Receipt Electronic	16																																					
Adult Signature Required	19																																					
Adult Signature Restricted Delivery	20																																					

Tag Name	Occurs	Description	Type	Validation
RateV4Request / Package / SortBy	optional	<p>Available when RateV4Request[Revision='2'].</p> <p>Returns all mailing services available based on item shape. When specified, value in <Container> is ignored.</p> <p>Available when: RateV4Request[Service='ALL'] RateV4Request[Service='ONLINE']</p> <p>For example: <SortBy>PACKAGE</SortBy></p>		<p>default=CONTAINER enumeration=LETTER enumeration=LARGEENVELOPE enumeration=PACKAGE enumeration=FLATRATE</p>
RateV4Request / Package / Machinable	optional	<p>RateV4Request/Machinable is required when:</p> <p>RateV4Request[Service='FIRST CLASS' and (FirstClassMailType='LETTER' or FirstClassMailType='FLAT')] RateV4Request[Service='PARCEL POST'] RateV4Request[Service='ALL'] RateV4Request[Service='ONLINE']</p> <p>For example: <Machinable>>true</Machinable></p>	string	<p>whiteSpace=collapse enumeration=true enumeration=false</p>
RateV4Request / Package / ReturnLocations	optional	<p>Include Dropoff Locations in Response if available. Requires "ShipDate" tag.</p>	string	<p>default=true enumeration=true enumeration=false</p>
RateV4Request / Package / ReturnServiceInfo	optional	<p>Include mail service specific information in Response if available.</p>	string	<p>enumeration=false enumeration=true</p>
RateV4Request / Package / ShipDate	optional	<p>Date Package Will Be Mailed. Ship date may be today plus 0 to 3 days in advance. Enter the date in format: dd-mmm-yyyy, such as 14-Feb-2011.</p> <p>Example: <ShipDate Option="HFP">01-Feb-2011</ShipDate></p>	string	<p>pattern=\d{2}-[a-zA-z]{3}-\d{4}</p>

Tag Name	Occurs	Description	Type	Validation
RateV4Request / Package / ShipDate / @Option	optional	The value of this attribute specifies how the RateV4Response will structure the Express Mail Commitment data elements.	string	default=EMSH enumeration=EMSH enumeration=HFP

2.1.4 RateV4 Service Request Matrix

<Service/>	<FirstCl.../>	<Size/>	<Container/>	<Machinable/>	Dimensions	<Girth/>	<ShipDate/>	Max. Weight
All & Online	Ignored	Regular	Variable/Null	Required	Ignored	Ignored	Optional	70 lbs.
All & Online	Ignored	Large	Rectangular	Required	Required	Ignored	Optional	70 lbs.
All & Online	Ignored	Large	Nonrectangular	Required	Required	Required	Optional	70 lbs.
All & Online	Ignored	Large	Variable/Null	Required	Required	Ignored	Optional	70 lbs.
First Class	Letter	Ignored	Ignored	Required	Ignored	Ignored	Ignored	3.5 oz.
First Class	Flat	Ignored	Ignored	Required	Ignored	Ignored	Ignored	13 oz.
First Class	Parcel	Regular	Variable/Null	Ignored	Ignored	Ignored	Ignored	13 oz.
First Class	Parcel	Large	Rectangular	Ignored	Required	Ignored	Ignored	13 oz.
First Class	Parcel	Large	Nonrectangular	Ignored	Required	Required	Ignored	13 oz.
First Class	Parcel	Large	Variable/Null	Ignored	Required	Ignored	Ignored	13 oz.
First Class	Postcard	Regular	Ignored	Ignored	Ignored	Ignored	Ignored	3.5 oz.
First Class	Postcard	Large	Ignored	Ignored	Ignored	Ignored	Ignored	3.5 oz.
First Class Commercial	Package Service	Regular	Variable/Null	Ignored	Ignored	Ignored	Ignored	13 oz.
First Class Commercial	Package Service	Large	Rectangular	Ignored	Required	Ignored	Ignored	13 oz.
First Class Commercial	Package Service	Large	Nonrectangular	Ignored	Required	Required	Ignored	13 oz.
First Class Commercial	Package Service	Large	Variable/Null	Ignored	Required	Required	Ignored	13 oz.
First Class HFP Commercial	Package Service	Regular	Variable/Null	Ignored	Ignored	Ignored	Ignored	13 oz.
First Class HFP Commercial	Package Service	Large	Rectangular	Ignored	Required	Ignored	Ignored	13 oz.
First Class HFP Commercial	Package Service	Large	Nonrectangular	Ignored	Required	Required	Ignored	13 oz.
First Class HFP Commercial	Package Service	Large	Variable/Null	Ignored	Required	Required	Ignored	13 oz.
Priority	Ignored	Regular	Lg Flat Rate Box	Ignored	Ignored	Ignored	Ignored	70 lbs.
Priority	Ignored	Regular	Md Flat Rate Box	Ignored	Ignored	Ignored	Ignored	70 lbs.
Priority	Ignored	Regular	Sm Flat Rate Box	Ignored	Ignored	Ignored	Ignored	70 lbs.

<Service/>	<FirstCl.../>	<Size/>	<Container/>	<Machinable/>	Dimensions	<Girth/>	<ShipDate/>	Max. Weight
Priority	Ignored	Regular	Regular Flat Rate Box	Ignored	Ignored	Ignored	Ignored	70 lbs.
Priority	Ignored	Regular	Flat Rate Env.	Ignored	Ignored	Ignored	Ignored	70 lbs.
Priority	Ignored	Regular	Legal Flat Rate Env.	Ignored	Ignored	Ignored	Ignored	70 lbs.
Priority	Ignored	Regular	Padded Flat Rate Env.	Ignored	Ignored	Ignored	Ignored	70 lbs.
Priority	Ignored	Regular	Gift Card Flat Rate Env.	Ignored	Ignored	Ignored	Ignored	70 lbs.
Priority	Ignored	Regular	Window Flat Rate Env.	Ignored	Ignored	Ignored	Ignored	70 lbs.
Priority	Ignored	Regular	Sm Flat Rate Env.	Ignored	Ignored	Ignored	Ignored	70 lbs.
Priority	Ignored	Regular	Variable/Null	Ignored	Ignored	Ignored	Ignored	70 lbs.
Priority	Ignored	Large	Rectangular	Ignored	Required	Ignored	Ignored	70 lbs.
Priority	Ignored	Large	Nonrectangular	Ignored	Required	Required	Ignored	70 lbs.
Priority	Ignored	Large	Variable/Null	Ignored	Required	Required	Ignored	70 lbs.
Priority Commercial	Ignored	Regular	Lg Flat Rate Box	Ignored	Ignored	Ignored	Ignored	70 lbs.
Priority Commercial	Ignored	Regular	Sm Flat Rate Box	Ignored	Ignored	Ignored	Ignored	70 lbs.
Priority Commercial	Ignored	Regular	Regular Flat Rate Box	Ignored	Ignored	Ignored	Ignored	70 lbs.
Priority Commercial	Ignored	Regular	Md Flat Rate Box	Ignored	Ignored	Ignored	Ignored	70 lbs.
Priority Commercial	Ignored	Regular	Flat Rate Env.	Ignored	Ignored	Ignored	Ignored	70 lbs.
Priority Commercial	Ignored	Regular	Legal Flat Rate Env.	Ignored	Ignored	Ignored	Ignored	70 lbs.
Priority Commercial	Ignored	Regular	Padded Flat Rate Env.	Ignored	Ignored	Ignored	Ignored	70 lbs.
Priority Commercial	Ignored	Regular	Gift Card Flat Rate Env.	Ignored	Ignored	Ignored	Ignored	70 lbs.
Priority Commercial	Ignored	Regular	Window Flat Rate Env.	Ignored	Ignored	Ignored	Ignored	70 lbs.
Priority Commercial	Ignored	Regular	Sm Flat Rate Env.	Ignored	Ignored	Ignored	Ignored	70 lbs.
Priority Commercial	Ignored	Regular	Regional Rate Box A	Ignored	Ignored	Ignored	Ignored	15 lbs.
Priority Commercial	Ignored	Regular	Regional Rate Box B	Ignored	Ignored	Ignored	Ignored	20 lbs.
Priority Commercial	Ignored	Regular	Regional Rate Box C	Ignored	Ignored	Ignored	Ignored	25 lbs.
Priority Commercial	Ignored	Regular	Variable/Null	Ignored	Ignored	Ignored	Ignored	70 lbs.
Priority Commercial	Ignored	Large	Rectangular	Ignored	Required	Ignored	Ignored	70 lbs.
Priority Commercial	Ignored	Large	Nonrectangular	Ignored	Required	Required	Ignored	70 lbs.
Priority Commercial	Ignored	Large	Variable/Null	Ignored	Required	Required	Ignored	70 lbs.
Priority HFP Commercial	Ignored	Regular	Lg Flat Rate Box	Ignored	Ignored	Ignored	Optional	70 lbs.
Priority HFP Commercial	Ignored	Regular	Sm Flat Rate Box	Ignored	Ignored	Ignored	Optional	70 lbs.

<Service/>	<FirstCl.../>	<Size/>	<Container/>	<Machinable/>	Dimensions	<Girth/>	<ShipDate/>	Max. Weight
Priority HFP Commercial	Ignored	Regular	Regular Flat Rate Box	Ignored	Ignored	Ignored	Optional	70 lbs.
Priority HFP Commercial	Ignored	Regular	Md Flat Rate Box	Ignored	Ignored	Ignored	Optional	70 lbs.
Priority HFP Commercial	Ignored	Regular	Flat Rate Env.	Ignored	Ignored	Ignored	Optional	70 lbs.
Priority HFP Commercial	Ignored	Regular	Legal Flat Rate Env.	Ignored	Ignored	Ignored	Optional	70 lbs.
Priority HFP Commercial	Ignored	Regular	Padded Flat Rate Env.	Ignored	Ignored	Ignored	Optional	70 lbs.
Priority HFP Commercial	Ignored	Regular	Gift Card Flat Rate Env.	Ignored	Ignored	Ignored	Optional	70 lbs.
Priority HFP Commercial	Ignored	Regular	Window Flat Rate Env.	Ignored	Ignored	Ignored	Optional	70 lbs.
Priority HFP Commercial	Ignored	Regular	Sm Flat Rate Env.	Ignored	Ignored	Ignored	Optional	70 lbs.
Priority HFP Commercial	Ignored	Regular	Regional Rate Box A	Ignored	Ignored	Ignored	Optional	15 lbs.
Priority HFP Commercial	Ignored	Regular	Regional Rate Box B	Ignored	Ignored	Ignored	Optional	20 lbs.
Priority HFP Commercial	Ignored	Regular	Regional Rate Box C	Ignored	Ignored	Ignored	Optional	25 lbs.
Priority HFP Commercial	Ignored	Regular	Variable/Null	Ignored	Ignored	Ignored	Optional	70 lbs.
Priority HFP Commercial	Ignored	Large	Rectangular	Ignored	Required	Ignored	Optional	70 lbs.
Priority HFP Commercial	Ignored	Large	Nonrectangular	Ignored	Required	Required	Optional	70 lbs.
Priority HFP Commercial	Ignored	Large	Variable/Null	Ignored	Required	Required	Optional	70 lbs.
Express	Ignored	Regular	Flat Rate Box	Ignored	Ignored	Ignored	Optional	70 lbs.
Express	Ignored	Regular	Flat Rate Env.	Ignored	Ignored	Ignored	Optional	70 lbs.
Express	Ignored	Regular	Legal Flat Rate Env.	Ignored	Ignored	Ignored	Optional	70 lbs.
Express	Ignored	Regular	Variable/Null	Ignored	Ignored	Ignored	Optional	70 lbs.

<Service/>	<FirstCl.../>	<Size/>	<Container/>	<Machinable/>	Dimensions	<Girth/>	<ShipDate/>	Max. Weight
Express	Ignored	Large	Rectangular	Ignored	Required	Ignored	Optional	70 lbs.
Express	Ignored	Large	Nonrectangular	Ignored	Required	Required	Optional	70 lbs.
Express	Ignored	Large	Variable/Null	Ignored	Required	Required	Optional	70 lbs.
Express SH	Ignored	Regular	Flat Rate Box	Ignored	Ignored	Ignored	Optional	70 lbs.
Express SH	Ignored	Regular	Flat Rate Env.	Ignored	Ignored	Ignored	Optional	70 lbs.
Express SH	Ignored	Regular	Legal Flat Rate Env.	Ignored	Ignored	Ignored	Optional	70 lbs.
Express SH	Ignored	Regular	Variable/Null	Ignored	Ignored	Ignored	Optional	70 lbs.
Express SH	Ignored	Large	Rectangular	Ignored	Required	Ignored	Optional	70 lbs.
Express SH	Ignored	Large	Nonrectangular	Ignored	Required	Required	Optional	70 lbs.
Express SH	Ignored	Large	Variable/Null	Ignored	Required	Required	Optional	70 lbs.
Express HFP	Ignored	Regular	Flat Rate Box	Ignored	Ignored	Ignored	Optional	70 lbs.
Express HFP	Ignored	Regular	Flat Rate Env.	Ignored	Ignored	Ignored	Optional	70 lbs.
Express HFP	Ignored	Regular	Legal Flat Rate Env.	Ignored	Ignored	Ignored	Optional	70 lbs.
Express HFP	Ignored	Regular	Variable/Null	Ignored	Ignored	Ignored	Optional	70 lbs.
Express HFP	Ignored	Large	Rectangular	Ignored	Required	Ignored	Optional	70 lbs.
Express HFP	Ignored	Large	Nonrectangular	Ignored	Required	Required	Optional	70 lbs.
Express HFP	Ignored	Large	Variable/Null	Ignored	Required	Required	Optional	70 lbs.
Express Commercial	Ignored	Regular	Flat Rate Box	Ignored	Ignored	Ignored	Optional	70 lbs.
Express Commercial	Ignored	Regular	Flat Rate Env.	Ignored	Ignored	Ignored	Optional	70 lbs.
Express Commercial	Ignored	Regular	Legal Flat Rate Env.	Ignored	Ignored	Ignored	Optional	70 lbs.
Express Commercial	Ignored	Regular	Variable/Null	Ignored	Ignored	Ignored	Optional	70 lbs.
Express Commercial	Ignored	Large	Rectangular	Ignored	Required	Ignored	Optional	70 lbs.
Express Commercial	Ignored	Large	Nonrectangular	Ignored	Required	Required	Optional	70 lbs.
Express Commercial	Ignored	Large	Variable/Null	Ignored	Required	Required	Optional	70 lbs.
Express SH Commercial	Ignored	Regular	Flat Rate Box	Ignored	Ignored	Ignored	Optional	70 lbs.
Express SH Commercial	Ignored	Regular	Flat Rate Env.	Ignored	Ignored	Ignored	Optional	70 lbs.
Express SH Commercial	Ignored	Regular	Legal Flat Rate Env.	Ignored	Ignored	Ignored	Optional	70 lbs.
Express SH Commercial	Ignored	Regular	Variable/Null	Ignored	Ignored	Ignored	Optional	70 lbs.

<Service/>	<FirstCl.../>	<Size/>	<Container/>	<Machinable/>	Dimensions	<Girth/>	<ShipDate/>	Max. Weight
Express SH Commercial	Ignored	Large	Rectangular	Ignored	Required	Ignored	Optional	70 lbs.
Express SH Commercial	Ignored	Large	Nonrectangular	Ignored	Required	Required	Optional	70 lbs.
Express SH Commercial	Ignored	Large	Variable/Null	Ignored	Required	Required	Optional	70 lbs.
Express HFP Commercial	Ignored	Regular	Flat Rate Env.	Ignored	Ignored	Ignored	Optional	70 lbs.
Express HFP Commercial	Ignored	Regular	Legal Flat Rate Env.	Ignored	Ignored	Ignored	Optional	70 lbs.
Express HFP Commercial	Ignored	Regular	Variable/Null	Ignored	Ignored	Ignored	Optional	70 lbs.
Express HFP Commercial	Ignored	Large	Rectangular	Ignored	Required	Ignored	Optional	70 lbs.
Express HFP Commercial	Ignored	Large	Nonrectangular	Ignored	Required	Required	Optional	70 lbs.
Express HFP Commercial	Ignored	Large	Variable/Null	Ignored	Required	Required	Optional	70 lbs.
Parcel Post	Ignored	Regular	Variable/Null	Required	Ignored	Ignored	Ignored	70 lbs.
Parcel Post	Ignored	Large	Rectangular	Required	Required	Ignored	Ignored	70 lbs.
Parcel Post	Ignored	Large	Nonrectangular	Required	Required	Required	Ignored	70 lbs.
Parcel Post	Ignored	Large	Variable/Null	Required	Required	Required	Ignored	70 lbs.
Media Mail	Ignored	Regular	Variable/Null	Ignored	Ignored	Ignored	Ignored	70 lbs.
Media Mail	Ignored	Large	Rectangular	Ignored	Required	Ignored	Ignored	70 lbs.
Media Mail	Ignored	Large	Nonrectangular	Ignored	Required	Required	Ignored	70 lbs.
Media Mail	Ignored	Large	Variable/Null	Ignored	Required	Required	Ignored	70 lbs.
Library Mail	Ignored	Regular	Variable/Null	Ignored	Ignored	Ignored	Ignored	70 lbs.
Library Mail	Ignored	Large	Rectangular	Ignored	Required	Ignored	Ignored	70 lbs.
Library Mail	Ignored	Large	Nonrectangular	Ignored	Required	Required	Ignored	70 lbs.
Library Mail	Ignored	Large	Variable/Null	Ignored	Required	Required	Ignored	70 lbs.

2.1.5 Request Examples

Request with no Revision Tag:

```
<RateV4Request USERID="xxx">
  <Revision/>
  <Package ID="1ST">
    <Service>FIRST CLASS</Service>
    <FirstClassMailType>LETTER</FirstClassMailType>
    <ZipOrigination>44106</ZipOrigination>
    <ZipDestination>20770</ZipDestination>
    <Pounds>0</Pounds>
    <Ounces>3.5</Ounces>
    <Container/>
    <Size>REGULAR</Size>
    <Machinable>>true</Machinable>
  </Package>
  <Package ID="2ND">
    <Service>PRIORITY</Service>
    <ZipOrigination>44106</ZipOrigination>
    <ZipDestination>20770</ZipDestination>
    <Pounds>1</Pounds>
    <Ounces>8</Ounces>
    <Container>NONRECTANGULAR</Container>
    <Size>LARGE</Size>
    <Width>15</Width>
    <Length>30</Length>
```

Request with Revision Tag:

```
<RateV4Request USERID="xxx">
  <Revision>2</Revision>
  <Package ID="1ST">
    <Service>FIRST CLASS</Service>
    <FirstClassMailType>LETTER</FirstClassMailType>
    <ZipOrigination>44106</ZipOrigination>
    <ZipDestination>20770</ZipDestination>
    <Pounds>0</Pounds>
    <Ounces>3.5</Ounces>
    <Container/>
    <Size>REGULAR</Size>
    <Machinable>>true</Machinable>
  </Package>
  <Package ID="2ND">
    <Service>PRIORITY</Service>
    <ZipOrigination>44106</ZipOrigination>
    <ZipDestination>20770</ZipDestination>
    <Pounds>1</Pounds>
    <Ounces>8</Ounces>
    <Container>NONRECTANGULAR</Container>
    <Size>LARGE</Size>
    <Width>15</Width>
    <Length>30</Length>
```

```
<Height>15</Height>
<Girth>55</Girth>
</Package>
<Package ID="3RD">
  <Service>ALL</Service>
  <ZipOrigination>90210</ZipOrigination>
  <ZipDestination>96698</ZipDestination>
  <Pounds>8</Pounds>
  <Ounces>32</Ounces>
  <Container/>
  <Size>REGULAR</Size>
  <Machinable>true</Machinable>
  <ShipDate>13-Dec-2010</ShipDate>
</Package>
</RateV4Request>
```

```
<Height>15</Height>
<Girth>55</Girth>
<Value>1000</Value>
<SpecialServices>
  <SpecialService>1</SpecialService>
</SpecialServices>
</Package>
<Package ID="3RD">
  <Service>ALL</Service>
  <ZipOrigination>90210</ZipOrigination>
  <ZipDestination>96698</ZipDestination>
  <Pounds>8</Pounds>
  <Ounces>32</Ounces>
  <Container/>
  <Size>REGULAR</Size>
  <Machinable>true</Machinable>
  <ShipDate>13-Dec-2010</ShipDate>
</Package>
</RateV4Request>
```

2.2 RateV4 Response

2.2.1 Response Diagram

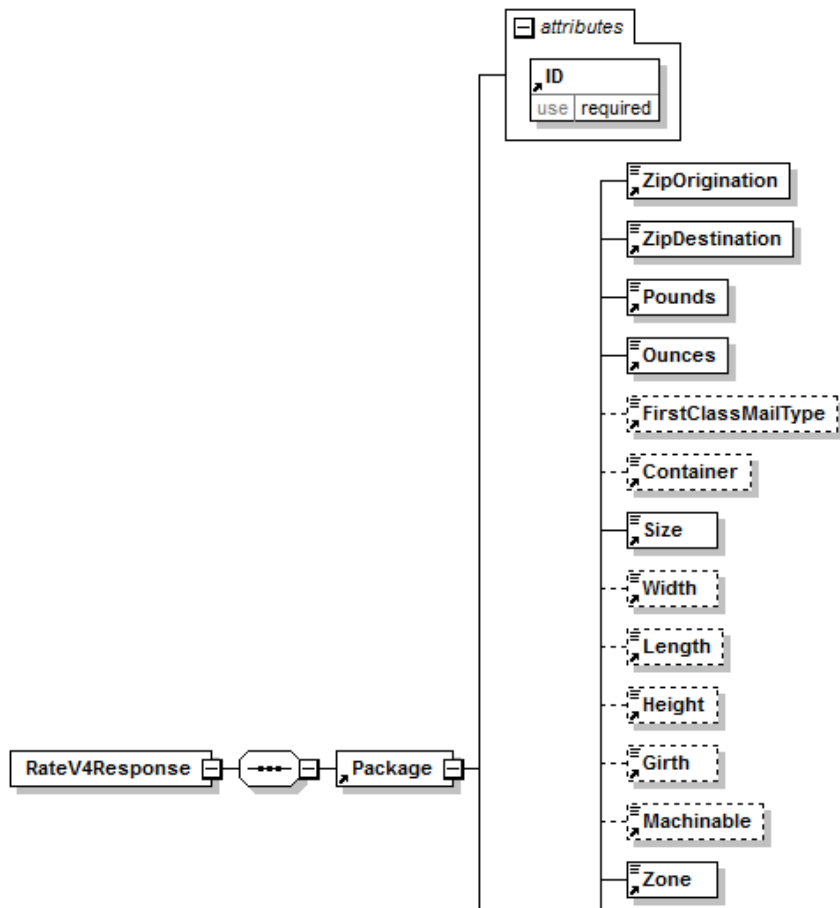

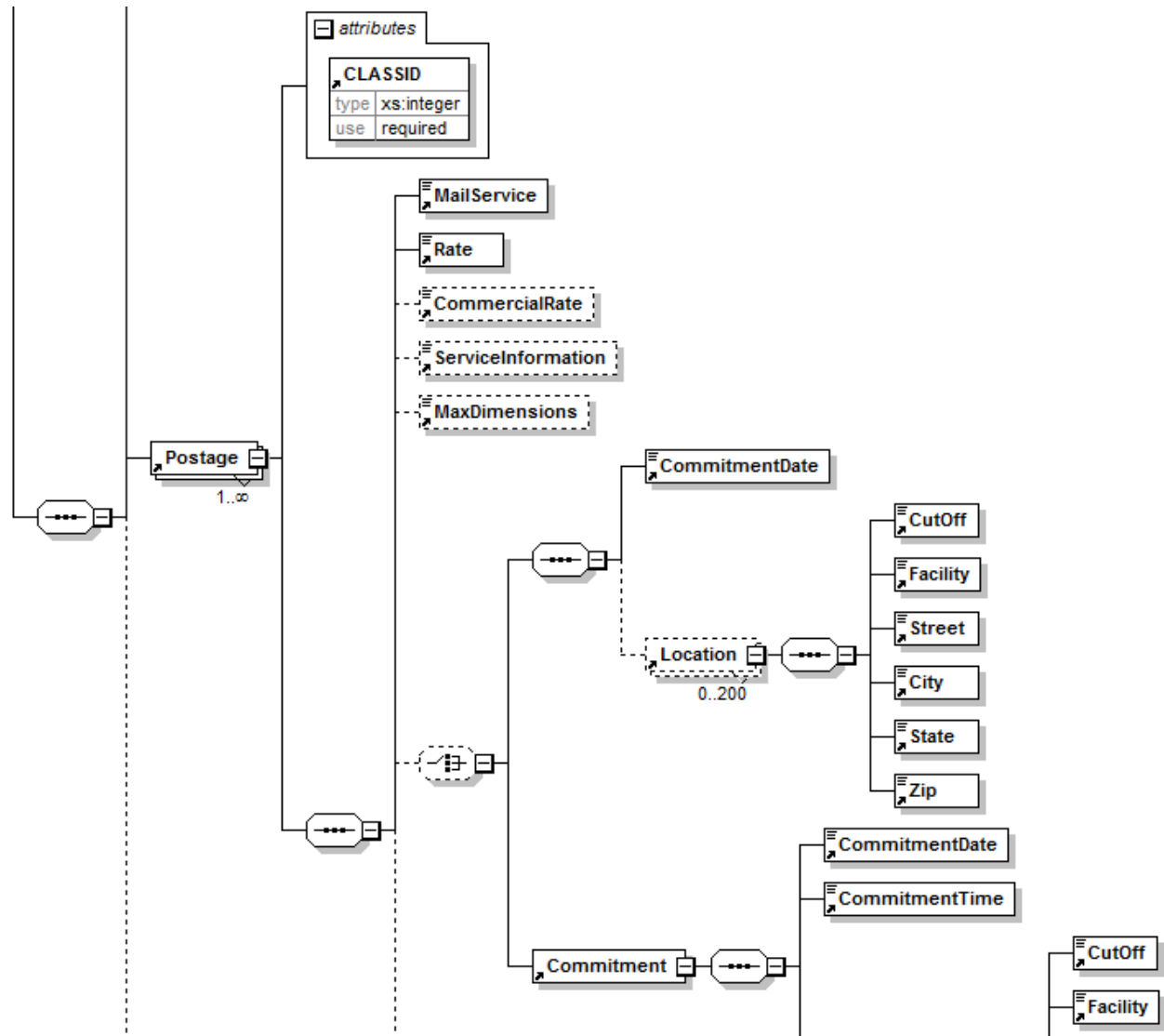

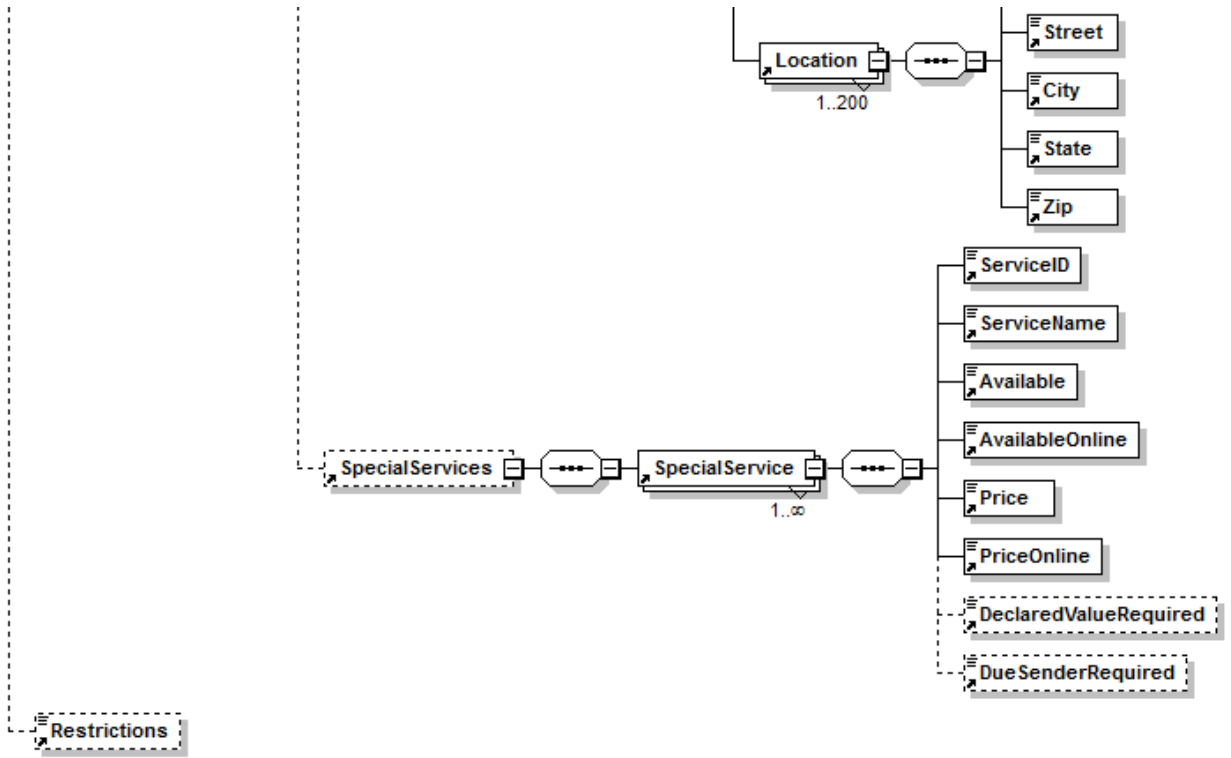

2.2.2 Response Parameters

Tag Name	Occurs	Description	Type	Validation
RateV4Response	required once		(group)	
RateV4Response / Package	required once repeating up to 25 times		(group)	
RateV4Response / Package / @ID	required	Corresponds to ID attribute in request. For example: <Package ID="0"/>	NMTOKEN	
RateV4Response / Package / ZipOrigination	required once	Origination ZIP Code from request	string	whiteSpace=collapse length=5 pattern=\d{5}
RateV4Response / Package / ZipDestination	required once	Destination ZIP Code from request	string	whiteSpace=collapse length=5 pattern=\d{5}
RateV4Response / Package / Pounds	required once	Package Weight (Pounds) from request	integer	maxInclusive=70 minInclusive=0
RateV4Response / Package / Ounces	required once	Package Weight (Ounces) from request	decimal	maxInclusive=1120.0 minInclusive=0.0 totalDigits=10
RateV4Response / Package / FirstClassMailType	optional	Appears when RateV4Request[Service='FIRST CLASS']. For example: <FirstClassMailType>LETTER</FirstClassMailType>	string	whiteSpace=collapse enumeration=LETTER enumeration=FLAT enumeration=PARCEL enumeration=POSTCARD enumeration=PACKAGE SERVICE

Tag Name	Occurs	Description	Type	Validation
RateV4Response / Package / Container	optional	Shipping Container (appears where applicable: RateV4Request[Service='ALL' or Service='EXPRESS*' or Service='PRIORITY*'])	string	whiteSpace=collapse enumeration=VARIABLE enumeration=FLAT RATE ENVELOPE enumeration=PADDED FLAT RATE ENVELOPE enumeration=LEGAL FLAT RATE ENVELOPE enumeration=SM FLAT RATE ENVELOPE enumeration=WINDOW FLAT RATE ENVELOPE enumeration=GIFT CARD FLAT RATE ENVELOPE enumeration=FLAT RATE BOX enumeration=SM FLAT RATE BOX enumeration=MD FLAT RATE BOX enumeration=LG FLAT RATE BOX enumeration=REGIONALRATEBOXA enumeration=REGIONALRATEBOXB enumeration=REGIONALRATEBOXC enumeration=RECTANGULAR enumeration=NONRECTANGULAR
RateV4Response / Package / Size	required once	Package Size from request	string	whiteSpace=collapse enumeration=LARGE enumeration=REGULAR
RateV4Response / Package / Width	optional	Package Width from request	decimal	minExclusive=0.0 totalDigits=10
RateV4Response / Package / Length	optional	Package Length from request	decimal	minExclusive=0.0 totalDigits=10
RateV4Response / Package / Height	optional	Package Height from request	decimal	minExclusive=0.0 totalDigits=10
RateV4Response / Package / Girth	optional	Package Girth from request	decimal	minExclusive=0.0 totalDigits=10

Tag Name	Occurs	Description	Type	Validation
RateV4Response / Package / Machinable	optional	Machinable (appears where applicable: RateV4Request[Service='ALL' or Service='FIRST CLASS' or Service='PARCEL POST'])	string	enumeration=TRUE enumeration=FALSE
RateV4Response / Package / Zone	required once	Postal Zone. Indicates the number of postal rate zones between the origin and destination ZIP codes.	string	
RateV4Response / Package / Postage	required once repeating up to unbounded times	Postage tag contains a nested postal rate and service description.	(group)	
RateV4Response / Package / Postage / @CLASSID	required	A mail class identifier for the postage returned. Not necessarily unique within a <Package/>.	integer	
RateV4Response / Package / Postage / MailService	required once	Service Type name	string	
RateV4Response / Package / Postage / Rate	required once	Retail Rate	decimal	
RateV4Response / Package / Postage / CommercialRate	optional	Commercial Rate. Appears only where applicable and only when requested via RateV4Request[Service='ONLINE' or Service='FIRST CLASS COMMERCIAL' or Service='FIRST CLASS HFP COMMERCIAL' or Service='PRIORITY COMMERCIAL' or Service='PRIORITY HFP COMMERCIAL' or Service='EXPRESS COMMERCIAL' or Service='EXPRESS SH COMMERCIAL' or Service='EXPRESS HFP COMMERCIAL'].	decimal	
RateV4Response / Package / Postage / ServiceInformation	optional	Mail Service Information. Appears where applicable: RateV4Request[ReturnServiceInfo='true']	string	

Tag Name	Occurs	Description	Type	Validation
RateV4Response / Package / Postage / MaxDimensions	optional	Maximum dimensions for a USPS produced product. Appears where applicable: RateV4Request[SortBy<>'CONTAINER']	string	
RateV4Response / Package / Postage / (choice)	optional	This choice depends on the RateV4Request / ShipDate / @Option attribute. If the attribute is missing or has the enumeration value of EMSH then the original Express Mail Sunday/Holiday structure is used. Otherwise, if the attribute has the enumeration value of HFP, then the Hold For Pickup structure is used. If RateV4Request / ShipDate is not present, then neither choice is returned.	(choice)	
RateV4Response / Package / Postage / (choice) / (sequence)	if used: required once	This sequence consisting of CommitmentDate and Location nodes is mutually exclusive with RateV4Response / Package / Postage / Commitment.	(group)	
RateV4Response / Package / Postage / (choice) / (sequence) / CommitmentDate	required once	Calculated Date Package Will Be Delivered: dd-mmm-yyyy, such as 14-Feb-2011. Only returned for Express Mail variants when "ShipDate" tag is present in the request.	string	
RateV4Response / Package / Postage / (choice) / (sequence) / Location	optional repeating up to 200 times	Collection of Dropoff Locations with Cutoff times. Only returned with Express Mail variants, when "ShipDate" tag is present in the request, and the "ReturnLocations" tag is not false. Example: <Location> <CutOff>8:00 PM</CutOff> <Facility>EXPRESS MAIL COLLECTION BOX</Facility> <Street>9201 EDGEWORTH DR</Street> <City>CAPITOL HEIGHTS</City> <State>MD</State> <Zip>20790</Zip> </Location>	(group)	

Tag Name	Occurs	Description	Type	Validation
RateV4Response / Package / Postage / (choice) / (sequence) / Location / CutOff	required once	Local cutoff time for drop-off	string	
RateV4Response / Package / Postage / (choice) / (sequence) / Location / Facility	required once	Facility Name	string	
RateV4Response / Package / Postage / (choice) / (sequence) / Location / Street	required once	Facility Address	string	
RateV4Response / Package / Postage / (choice) / (sequence) / Location / City	required once	Facility City	string	
RateV4Response / Package / Postage / (choice) / (sequence) / Location / State	required once	Facility State	string	
RateV4Response / Package / Postage / (choice) / (sequence) / Location / Zip	required once	Facility Zip	string	

Tag Name	Occurs	Description	Type	Validation
RateV4Response / Package / Postage / (choice) / Commitment	if used: required once repeating up to 5 times	This node is mutually exclusive with RateV4Response / Package / Postage / CommitmentDate and RateV4Response / Package / Postage / Location.	(group)	
RateV4Response / Package / Postage / (choice) / Commitment / CommitmentDate	required once	Calculated Date Package Will Be Delivered: dd-mmm-yyyy, such as 14-Feb-2010. Only returned for Express Mail variants when "ShipDate" tag is present in the request.	string	
RateV4Response / Package / Postage / (choice) / Commitment / CommitmentTime	required once	Commitment time of day. Only returned for Express Mail variants when "ShipDate" tag is present in the request.	string	enumeration=10:00 AM enumeration=12:00 PM enumeration=3:00 PM enumeration=
RateV4Response / Package / Postage / (choice) / Commitment / Location	optional repeating up to 200 times	Collection of Dropoff Locations with Cutoff times. Only returned with Express Mail variants, when "ShipDate" tag is present in the request, and the "ReturnLocations" tag is not false. Example: <Location> <CutOff>8:00 PM</CutOff> <Facility>EXPRESS MAIL COLLECTION BOX</Facility> <Street>9201 EDGEWORTH DR</Street> <City>CAPITOL HEIGHTS</City> <State>MD</State> <Zip>20790</Zip> </Location>	(group)	
RateV4Response / Package / Postage / (choice) / Commitment / Location / CutOff	required once	Local cutoff time for drop-off	string	

Tag Name	Occurs	Description	Type	Validation
RateV4Response / Package / Postage / (choice) / Commitment / Location / Facility	required once	Facility Name	string	
RateV4Response / Package / Postage / (choice) / Commitment / Location / Street	required once	Facility Address	string	
RateV4Response / Package / Postage / (choice) / Commitment / Location / City	required once	Facility City	string	
RateV4Response / Package / Postage / (choice) / Commitment / Location / State	required once	Facility State	string	
RateV4Response / Package / Postage / (choice) / Commitment / Location / Zip	required once	Facility Zip	string	
RateV4Response / Package / Postage / SpecialServices	optional	Returned when RateV4Request[Revision='2']. Groups the Special Service elements.	(group)	

Tag Name	Occurs	Description	Type	Validation
RateV4Response / Package / Postage / SpecialServices / SpecialService	required once, repeating up to unbounded times	Returned when RateV4Request[Revision='2']. "SpecialService" contains nested service name, availability, and pricing.	(group)	
RateV4Response / Package / Postage / SpecialServices / SpecialService / ServiceID	required once	Returned when RateV4Request[Revision='2']. Special service ID	Integer	
RateV4Response / Package / Postage / SpecialServices / SpecialService / ServiceName	required once	Returned when RateV4Request[Revision='2']. Special service name	string	
RateV4Response / Package / Postage / SpecialServices / SpecialService / Available	required once	Returned when RateV4Request[Revision='2']. Availability of special service. Availability may change depending on special services passed (selected) in request.	boolean	
RateV4Response / Package / Postage / SpecialServices / SpecialService / AvailableOnline	required once	Returned when RateV4Request[Revision='2']. Availability of special service for online only rates. Not all special services have online rates.	boolean	
RateV4Response / Package / Postage / SpecialServices / SpecialService / Price	required once	Returned when RateV4Request[Revision='2']. Special service pricing. Pricing may change depending on special services passed (selected) in request.	decimal	

Tag Name	Occurs	Description	Type	Validation
RateV4Response / Package / Postage / SpecialServices / SpecialService / PriceOnline	required once	Returned when RateV4Request[Revision='2']. Special service pricing. Pricing may change depending on special services passed (selected) in request. Not all special services have online rates.	decimal	
RateV4Response / Package / Postage / SpecialServices / SpecialService / DeclaredValueRequired	optional	Returned if applicable when RateV4Request[Revision='2']. Indicates if special service requires a declared package value (specified in RateV4Request[Value])to determine correct pricing.	boolean	
RateV4Response / Package / Postage / SpecialServices / SpecialService / DueSenderRequired	optional	Returned if applicable when RateV4Request[Revision='2']. Indicates if special service requires a due sender amount (specified in RateV4Request[AmountToCollect]) to determine correct pricing.	boolean	
RateV4Response / Package / Restrictions	optional	APO/FPO Restrictions provided if the Destination ZIP Code is an APO/FPO ZIP Code.	string	
RateV4Response / Package / Error	if used: required once	Error document (indicates request could not be completed).	See "Error" Schema	

2.2.3 Response Example – No Revision Tag

No Revision Response:

```
<RateV4Response>
  <Package ID="1ST">
    <ZipOrigination>44106</ZipOrigination>
    <ZipDestination>20770</ZipDestination>
    <Pounds>0</Pounds>
    <Ounces>3.5</Ounces>
    <FirstClassMailType>LETTER</FirstClassMailType>
    <Size>REGULAR</Size>
    <Machinable>TRUE</Machinable>
    <Zone>3</Zone>
    <Postage CLASSID="0">
      <MailService>First-Class Mail</MailService>
      <Rate>1.04</Rate>
    </Postage>
    <Restrictions />
  </Package>
  <Package ID="2ND">
    <ZipOrigination>44106</ZipOrigination>
    <ZipDestination>20770</ZipDestination>
    <Pounds>1</Pounds>
    <Ounces>8</Ounces>
    <Container>NONRECTANGULAR</Container>
    <Size>LARGE</Size>
    <Width>15</Width>
    <Length>30</Length>
    <Height>15</Height>
    <Girth>55</Girth>
    <Zone>3</Zone>
    <Postage CLASSID="1">
      <MailService>Priority Mail<sup>&reg;&reg;</sup></MailService>
      <Rate>22.25</Rate>
    </Postage>
    <Restrictions />
  </Package>
  <Package ID="3RD">
    <ZipOrigination>90210</ZipOrigination>
    <ZipDestination>96698</ZipDestination>
```

```
<Pounds>8</Pounds>
<Ounces>32</Ounces>
<Container>VARIABLE</Container>
<Size>REGULAR</Size>
<Machinable>TRUE</Machinable>
<Zone>4</Zone>
<Postage CLASSID="1">
  <MailService>Priority Mail<sup>&reg;&reg;</sup></MailService>
  <Rate>16.35</Rate>
</Postage>
<Postage CLASSID="22">
  <MailService>Priority Mail<sup>&reg;&reg;</sup> Large Flat Rate Box</MailService>
  <Rate>12.95</Rate>
</Postage>
<Postage CLASSID="17">
  <MailService>Priority Mail<sup>&reg;&reg;</sup> Medium Flat Rate Box</MailService>
  <Rate>10.95</Rate>
</Postage>
<Postage CLASSID="28">
  <MailService>Priority Mail<sup>&reg;&reg;</sup> Small Flat Rate Box</MailService>
  <Rate>5.20</Rate>
</Postage>
<Postage CLASSID="16">
  <MailService>Priority Mail<sup>&reg;&reg;</sup> Flat Rate Envelope</MailService>
  <Rate>4.95</Rate>
</Postage>
<Postage CLASSID="44">
  <MailService>Priority Mail<sup>&reg;&reg;</sup> Legal Flat Rate Envelope</MailService>
  <Rate>4.95</Rate>
</Postage>
<Postage CLASSID="29">
  <MailService>Priority Mail<sup>&reg;&reg;</sup> Padded Flat Rate Envelope</MailService>
  <Rate>4.95</Rate>
</Postage>
<Postage CLASSID="38">
  <MailService>Priority Mail<sup>&reg;&reg;</sup> Gift Card Flat Rate Envelope</MailService>
  <Rate>4.95</Rate>
</Postage>
<Postage CLASSID="42">
  <MailService>Priority Mail<sup>&reg;&reg;</sup> Small Flat Rate Envelope</MailService>
  <Rate>4.95</Rate>
```

```
</Postage>
<Postage CLASSID="40">
  <MailService>Priority Mail<sup>&reg;&lt;/sup>&lt;/sup>&lt;/sup> Window Flat Rate Envelope</MailService>
  <Rate>4.95</Rate>
</Postage>
<Postage CLASSID="4">
  <MailService>Parcel Post<sup>&reg;&lt;/sup>&lt;/sup>&lt;/sup></MailService>
  <Rate>11.61</Rate>
</Postage>
<Postage CLASSID="6">
  <MailService>Media Mail<sup>&reg;&lt;/sup>&lt;/sup>&lt;/sup></MailService>
  <Rate>6.04</Rate>
</Postage>
<Postage CLASSID="7">
  <MailService>Library Mail</MailService>
  <Rate>5.74</Rate>
</Postage>
<Restrictions>A1. Mail addressed to "Any Servicemember" or similar <!--1772 skipped-->.</Restrictions>
</Package>
</RateV4Response>
```

2.2.4 Response Example – Revision = "2"

Revision '2' Response:

```
<RateV4Response>
  <Package ID="1ST">
    <ZipOrigination>44106</ZipOrigination>
    <ZipDestination>20770</ZipDestination>
    <Pounds>0</Pounds>
    <Ounces>3.5</Ounces>
    <FirstClassMailType>LETTER</FirstClassMailType>
    <Size>REGULAR</Size>
    <Machinable>TRUE</Machinable>
    <Zone>3</Zone>
    <Postage CLASSID="0">
      <MailService>First-Class Mail</MailService>
      <Rate>0.95</Rate>
      <SpecialServices>
        <SpecialService>
          <ServiceID>9</ServiceID>
          <ServiceName>Certificate of Mailing</ServiceName>
          <Available>true</Available>
          <AvailableOnline>>false</AvailableOnline>
          <Price>1.15</Price>
          <PriceOnline>0</PriceOnline>
        </SpecialService>
        <SpecialService>
          <ServiceID>1</ServiceID>
          <ServiceName>Insurance</ServiceName>
          <Available>true</Available>
          <AvailableOnline>>false</AvailableOnline>
          <Price>1.80</Price>
          <PriceOnline>0</PriceOnline>
          <DeclaredValueRequired>>true</DeclaredValueRequired>
          <DueSenderRequired>>false</DueSenderRequired>
        </SpecialService>
        <SpecialService>
          <ServiceID>5</ServiceID>
          <ServiceName>Registered Mail<sup>&trade;&sup>&lt;/ServiceName>
          <Available>true</Available>
          <AvailableOnline>>false</AvailableOnline>
        </SpecialService>
      </SpecialServices>
    </Postage CLASSID="0">
  </Package ID="1ST">
</RateV4Response>
```



```
<Price>10.75</Price>
<PriceOnline>0</PriceOnline>
<DeclaredValueRequired>>true</DeclaredValueRequired>
<DueSenderRequired>>false</DueSenderRequired>
</SpecialService>
<SpecialService>
  <ServiceID>4</ServiceID>
  <ServiceName>Registered without Insurance</ServiceName>
  <Available>>true</Available>
  <AvailableOnline>>false</AvailableOnline>
  <Price>10.75</Price>
  <PriceOnline>0</PriceOnline>
</SpecialService>
<SpecialService>
  <ServiceID>0</ServiceID>
  <ServiceName>Certified Mail<sup>&reg;&lt;/sup>&lt;/sup>&reg;&lt;/sup>&lt;/sup></ServiceName>
  <Available>>true</Available>
  <AvailableOnline>>false</AvailableOnline>
  <Price>2.85</Price>
  <PriceOnline>0</PriceOnline>
</SpecialService>
<SpecialService>
  <ServiceID>6</ServiceID>
  <ServiceName>Collect on Delivery</ServiceName>
  <Available>>true</Available>
  <AvailableOnline>>false</AvailableOnline>
  <Price>5.75</Price>
  <PriceOnline>0</PriceOnline>
  <DeclaredValueRequired>>true</DeclaredValueRequired>
  <DueSenderRequired>>true</DueSenderRequired>
</SpecialService>
</SpecialServices>
</Postage>
<Restrictions />
</Package>
<Package ID="2ND">
  <ZipOrigination>44106</ZipOrigination>
  <ZipDestination>20770</ZipDestination>
  <Pounds>1</Pounds>
  <Ounces>8</Ounces>
  <Container>NONRECTANGULAR</Container>
```

```
<Size>LARGE</Size>
<Width>15</Width>
<Length>30</Length>
<Height>15</Height>
<Girth>55</Girth>
<Zone>3</Zone>
<Postage CLASSID="1">
  <MailService>Priority Mail<sup>&reg;&lt;/sup>&lt;/MailService>
  <Rate>22.25</Rate>
  <SpecialServices>
    <SpecialService>
      <ServiceID>1</ServiceID>
      <ServiceName>Insurance</ServiceName>
      <Available>true</Available>
      <AvailableOnline>true</AvailableOnline>
      <Price>12.10</Price>
      <PriceOnline>12.10</PriceOnline>
      <DeclaredValueRequired>true</DeclaredValueRequired>
      <DueSenderRequired>false</DueSenderRequired>
    </SpecialService>
    <SpecialService>
      <ServiceID>13</ServiceID>
      <ServiceName>Delivery Confirmation<sup>&trade;&lt;/sup></ServiceName>
      <Available>true</Available>
      <AvailableOnline>true</AvailableOnline>
      <Price>0.70</Price>
      <PriceOnline>0.00</PriceOnline>
    </SpecialService>
    <SpecialService>
      <ServiceID>4</ServiceID>
      <ServiceName>Restricted Delivery</ServiceName>
      <Available>true</Available>
      <AvailableOnline>false</AvailableOnline>
      <Price>4.50</Price>
      <PriceOnline>0</PriceOnline>
    </SpecialService>
    <SpecialService>
      <ServiceID>8</ServiceID>
      <ServiceName>Return Receipt</ServiceName>
      <Available>true</Available>
      <AvailableOnline>false</AvailableOnline>
    </SpecialService>
  </SpecialServices>
</Postage CLASSID="1">
```

```
<Price>2.30</Price>
  <PriceOnline>0</PriceOnline>
</SpecialService>
<SpecialService>
  <ServiceID>16</ServiceID>
  <ServiceName>Return Receipt Electronic</ServiceName>
  <Available>true</Available>
  <AvailableOnline>>false</AvailableOnline>
  <Price>1.15</Price>
  <PriceOnline>0</PriceOnline>
</SpecialService>
<SpecialService>
  <ServiceID>15</ServiceID>
  <ServiceName>Signature Confirmation<sup>&trade;&lt;/sup>&lt;/ServiceName>
  <Available>true</Available>
  <AvailableOnline>true</AvailableOnline>
  <Price>2.45</Price>
  <PriceOnline>2.05</PriceOnline>
</SpecialService>
</SpecialServices>
</Postage>
<Restrictions />
</Package>
<Package ID="3RD">
  <ZipOrigination>90210</ZipOrigination>
  <ZipDestination>96698</ZipDestination>
  <Pounds>8</Pounds>
  <Ounces>32</Ounces>
  <Container>VARIABLE</Container>
  <Size>REGULAR</Size>
  <Machinable>TRUE</Machinable>
  <Zone>4</Zone>
  <Postage CLASSID="1">
    <MailService>Priority Mail<sup>&reg;&lt;/sup>&lt;/MailService>
    <Rate>16.35</Rate>
  </Postage>
  <Postage CLASSID="22">
    <MailService>Priority Mail<sup>&reg;&lt;/sup> Large Flat Rate Box</MailService>
    <Rate>12.95</Rate>
  </Postage>
  <Postage CLASSID="17">
```

<MailService>Priority Mail^{®®}; Medium Flat Rate Box</MailService>
<Rate>10.95</Rate>
</Postage>
<Postage CLASSID="28">
<MailService>Priority Mail^{®®}; Small Flat Rate Box</MailService>
<Rate>5.20</Rate>
</Postage>
<Postage CLASSID="16">
<MailService>Priority Mail^{®®}; Flat Rate Envelope</MailService>
<Rate>4.95</Rate>
</Postage>
<Postage CLASSID="44">
<MailService>Priority Mail^{®®}; Legal Flat Rate Envelope</MailService>
<Rate>4.95</Rate>
</Postage>
<Postage CLASSID="29">
<MailService>Priority Mail^{®®}; Padded Flat Rate Envelope</MailService>
<Rate>4.95</Rate>
</Postage>
<Postage CLASSID="38">
<MailService>Priority Mail^{®®}; Gift Card Flat Rate Envelope</MailService>
<Rate>4.95</Rate>
</Postage>
<Postage CLASSID="42">
<MailService>Priority Mail^{®®}; Small Flat Rate Envelope</MailService>
<Rate>4.95</Rate>
</Postage>
<Postage CLASSID="40">
<MailService>Priority Mail^{®®}; Window Flat Rate Envelope</MailService>
<Rate>4.95</Rate>
</Postage>
<Postage CLASSID="4">
<MailService>Parcel Post^{®®};</MailService>
<Rate>11.61</Rate>
</Postage>
<Postage CLASSID="6">
<MailService>Media Mail^{®®};</MailService>
<Rate>6.04</Rate>
</Postage>
<Postage CLASSID="7">
<MailService>Library Mail</MailService>

```
<Rate>5.74</Rate>
</Postage>
<Restrictions>A1. Mail addressed to "Any Servicemember" or similar <!--1772 skipped-->.</Restrictions>
</Package>
</RateV4Response>
```

3 International Rates API (V2)

For specifications such as package dimensions, delivery information, etc., please refer to the International Mail Manual (IMM) at <http://pe.usps.com/>.

3.1 IntlRateV2 Request

3.1.1 API Signature

<i>Scheme</i>	<i>Host</i>	<i>Path</i>	<i>API</i>	<i>XML</i>
http://	production.shippingapis.com	/ShippingAPI.dll	?API=IntlRateV2	&XML=(see below)

3.1.2 Request Diagram

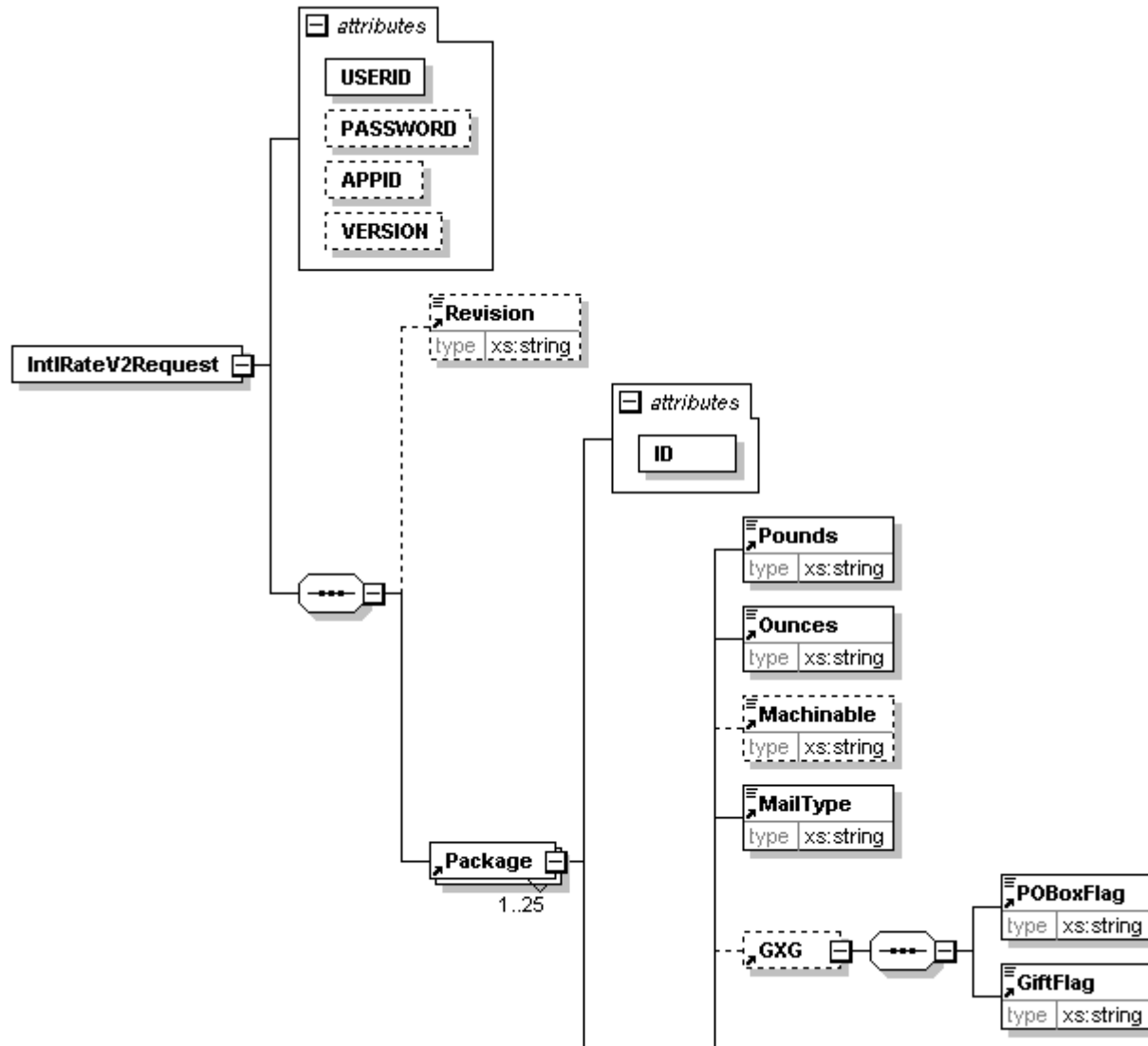

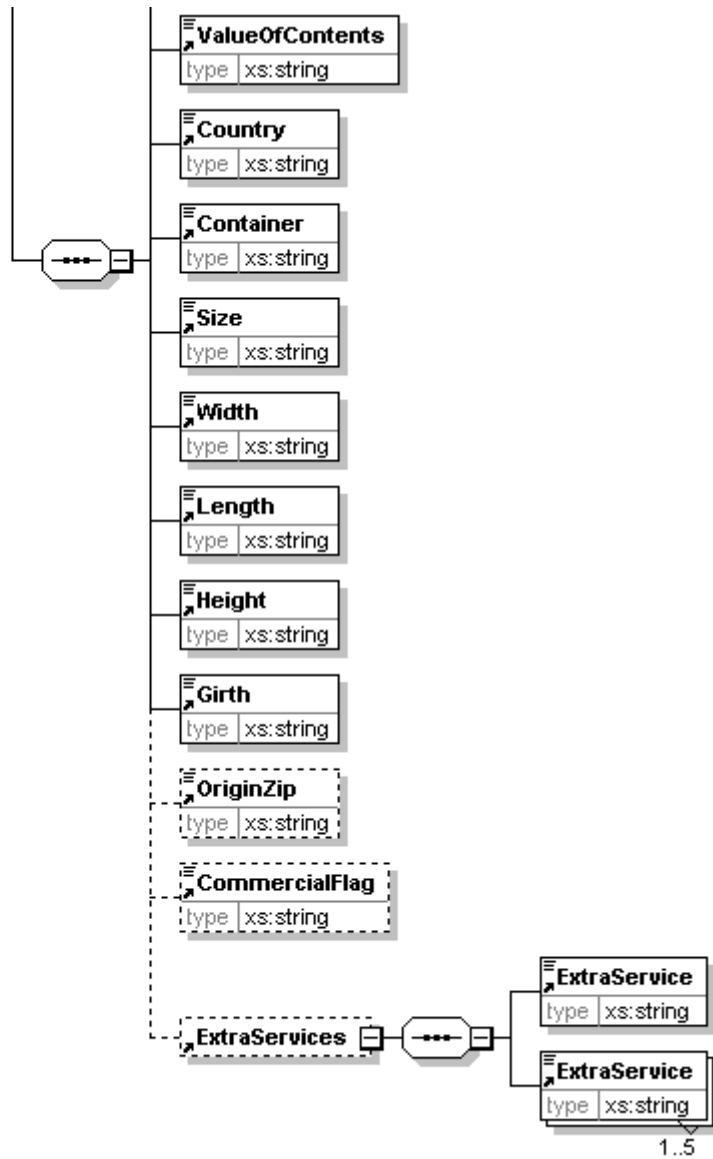

3.1.3 Request Parameters

Tag Name	Occurs	Description	Type	Validation
IntlRateV2Request	required once	Opening document tag.	(group)	
IntlRateV2Request / @USERID	required	This attribute specifies your Web Tools ID. See the Developer's Guide for information on obtaining your USERID.	NMTOKEN	
IntlRateV2Request / @PASSWORD	optional	For backward compatibility; not validated.	NMTOKEN	
IntlRateV2Request / Revision	optional	Optional for base IntlRateV2 functionality. For full IntlRateV2 functionality use Revision="2"	string	
IntlRateV2Request / Package	required once repeating up to 25 times	Opening Package tag.	(group)	
IntlRateV2Request / Package / @ID	required	No restriction on number or type of characters provided valid XML syntax and unique to request. For example: <Package ID="0">...</Package>	NMTOKEN	
IntlRateV2Request / Package / Pounds	required once	Value must be numeric. Package weight generally cannot exceed 70 pounds. Refer to the International Mail Manual (IMM) for weight requirements per country and mail service. The IMM can be found at the Postal Explorer web site . For example: <Pounds>2</Pounds>	integer	minInclusive=0

Tag Name	Occurs	Description	Type	Validation
IntlRateV2Request / Package / Ounces	required once	Value must be numeric. Package weight generally cannot exceed 70 pounds. Refer to the International Mail Manual (IMM) for weight requirements per country and mail service. The IMM can be found at the Postal Explorer web site . For example: <Ounces>4</Ounces>	decimal	minInclusive=0.0
IntlRateV2Request / Package / Machinable	optional	Indicates whether or not the item is machinable. A surcharge is applied to a First-Class Mail International item if it has one or more non-machinable characteristics. See International Mail Manual (IMM) Section 241.217 for more information. For example: <Machinable>True</Machinable>	boolean	default=true
IntlRateV2Request / Package / MailType	required once	Package type being shipped. One of: Package Postcards or aerogrammes Envelope LargeEnvelope FlatRate For example: <MailType>Package</MailType>	string	enumeration=All enumeration=Package enumeration=Postcards or aerogrammes enumeration=Envelope enumeration=LargeEnvelope enumeration=FlatRate
IntlRateV2Request / Package / GXG	optional	If GXG rate is desired, then this group must be specified. Note that if this data precludes delivery, due to size or availability of service at the destination, then GXG rates simply will not be returned (not an error condition.)	(group)	
IntlRateV2Request / Package / GXG / POBoxFlag	required once	Specify as "Y" if the destination is a post office box. For example <POBoxFlag>Y</POBoxFlag>	string	enumeration=Y enumeration=N
IntlRateV2Request / Package / GXG / GiftFlag	required once	Specify as "Y" if the package contains a gift. For example <GiftFlag>Y</GiftFlag>	string	enumeration=Y enumeration=N

Tag Name	Occurs	Description	Type	Validation
IntlRateV2Request / Package / ValueOfContents	required once	If specified, used to compute Insurance fee (if insurance is available for service and destination) and indemnity coverage. For example: <ValueOfContents>103.00</ValueOfContents>	decimal	minExclusive=0.0
IntlRateV2Request / Package / Country	required once	Entries must be from the USPS list of valid countries from the International Country Listings. To access the International Country Listings, go to the Index of Countries and Localities . For example: <Country>Albania</Country>	string	
IntlRateV2Request / Package / Container	required once	Use to specify special containers or container attributes that may affect postage. Required when Size="LARGE". For example: <Container>RECTANGULAR</Container>	string	enumeration=RECTANGULAR enumeration=NONRECTANGULAR
IntlRateV2Request / Package / Size	required once	Defined as follows: REGULAR: Package dimensions are 12" or less; LARGE: Any package dimension is larger than 12". For example: <Size>REGULAR</Size>	string	enumeration=REGULAR enumeration=LARGE
IntlRateV2Request / Package / Width	required once	Typically, the "thickness" of the package as measured in inches rounded to the nearest whole inch. Required to obtain GXG pricing and when Size="LARGE". For example: <Width>15</Width>	integer	minExclusive=0
IntlRateV2Request / Package / Length	required once	The longest side of the package as measured in inches rounded to the nearest whole inch. Required to obtain GXG pricing and when Size="LARGE". For example: <Length>15</Length>	integer	minExclusive=0

Tag Name	Occurs	Description	Type	Validation
IntlRateV2Request / Package / Height	required once	The "height" of the package as measured in inches rounded to the nearest whole inch. Required to obtain GXG pricing and when Size="LARGE". For example: <Height>15</ Height >	integer	minExclusive=0
IntlRateV2Request / Package / Girth	required once	The "girth" of the package as measured in inches rounded to the nearest whole inch. Required to obtain GXG pricing when pricing and when Size="LARGE" and Container="NONRECTANGULAR". For example: <Girth>15</Girth>	Integer	minExclusive=0
IntlRateV2Request / Package / OriginZip	optional	Available when IntlRateV2Request[Revision='2']. Origin Zip is used to determine mailability for GXG packages. It will also return a list of Post Office locations for GXG package acceptance. ZIP code must be valid. For example: <OriginZip>20770</OriginZip>	string	length=5 pattern=\d{5}
IntlRateV2Request / Package / CommercialFlag	optional	Returns commercial base postage. For example: <CommercialFlag>Y<CommercialFlag>	string	enumeration=Y enumeration=N
IntlRateV2Request / Package / ExtraServices	optional	Available when IntlRateV2Request[Revision='2']. Groups the ExtraService elements.	(group)	

Tag Name	Occurs	Description	Type	Validation														
IntlRateV2Request / Package / ExtraServices / ExtraService	required once, repeating up to 6 times	<p>Available when IntlRateV2Request[Revision='2'].</p> <p>Defines extra services desired by user in order to determine cost of desired services and availability of other, additional services.</p> <p>An initial rate call <u>without</u> the ExtraService tag specified is recommended to determine base availability of extra services for each mail service.</p> <p>The extra service definitions are as follows:</p> <table border="1" data-bbox="558 652 1266 901"> <thead> <tr> <th data-bbox="558 652 1115 690">Extra Service Name</th> <th data-bbox="1115 652 1266 690">ServiceID</th> </tr> </thead> <tbody> <tr> <td data-bbox="558 690 1115 727">Registered Mail</td> <td data-bbox="1115 690 1266 727">0</td> </tr> <tr> <td data-bbox="558 727 1115 764">Insurance</td> <td data-bbox="1115 727 1266 764">1</td> </tr> <tr> <td data-bbox="558 764 1115 802">Return Receipt</td> <td data-bbox="1115 764 1266 802">2</td> </tr> <tr> <td data-bbox="558 802 1115 839">Restricted Delivery</td> <td data-bbox="1115 802 1266 839">3</td> </tr> <tr> <td data-bbox="558 839 1115 876">Pick Up on Demand</td> <td data-bbox="1115 839 1266 876">5</td> </tr> <tr> <td data-bbox="558 876 1115 901">Certificate of Mailing</td> <td data-bbox="1115 876 1266 901">6</td> </tr> </tbody> </table> <p>For example: <ExtraServices> <ExtraService>1<ExtraService> <ExtraService>5<ExtraService> </ExtraServices></p>	Extra Service Name	ServiceID	Registered Mail	0	Insurance	1	Return Receipt	2	Restricted Delivery	3	Pick Up on Demand	5	Certificate of Mailing	6	integer	
Extra Service Name	ServiceID																	
Registered Mail	0																	
Insurance	1																	
Return Receipt	2																	
Restricted Delivery	3																	
Pick Up on Demand	5																	
Certificate of Mailing	6																	

3.1.4 Request Examples

Request with no Revision Tag:

```
<IntlRateV2Request USERID="xxx">
  <Package ID="1ST">
    <Pounds>15</Pounds>
    <Ounces>0</Ounces>
    <Machinable>True</Machinable>
    <MailType>Package</MailType>
    <GXG>
      <POBoxFlag>Y</POBoxFlag>
      <GiftFlag>Y</GiftFlag>
    </GXG>
    <ValueOfContents>200</ValueOfContents>
    <Country>Canada</Country>
    <Container>RECTANGULAR</Container>
    <Size>LARGE</Size>
    <Width>10</Width>
    <Length>15</Length>
    <Height>10</Height>
    <Girth>0</Girth>
    <CommercialFlag>N</CommercialFlag>
  </Package>
  <Package ID="2ND">
    <Pounds>0</Pounds>
    <Ounces>3</Ounces>
    <MailType>Envelope</MailType>
```

Request with Revision Tag:

```
<IntlRateV2Request USERID="xxx">
  <Revision>2</Revision>
  <Package ID="1ST">
    <Pounds>15</Pounds>
    <Ounces>0</Ounces>
    <Machinable>True</Machinable>
    <MailType>Package</MailType>
    <GXG>
      <POBoxFlag>Y</POBoxFlag>
      <GiftFlag>Y</GiftFlag>
    </GXG>
    <ValueOfContents>200</ValueOfContents>
    <Country>Canada</Country>
    <Container>RECTANGULAR</Container>
    <Size>LARGE</Size>
    <Width>10</Width>
    <Length>15</Length>
    <Height>10</Height>
    <Girth>0</Girth>
    <OriginZip>18701</OriginZip>
    <CommercialFlag>N</CommercialFlag>
  </Package>
  <Package ID="2ND">
    <Pounds>0</Pounds>
```

```
<ValueOfContents>750</ValueOfContents>
<Country>Algeria</Country>
<Container></Container>
<Size>REGULAR</Size>
<Width></Width>
<Length></Length>
<Height></Height>
<Girth></Girth>
<CommercialFlag>N</CommercialFlag>
</Package>
</IntlRateV2Request>
```

```
<Ounces>3</Ounces>
<MailType>Envelope</MailType>
<ValueOfContents>750</ValueOfContents>
<Country>Algeria</Country>
<Container> </Container>
<Size>REGULAR</Size>
<Width></Width>
<Length></Length>
<Height></Height>
<Girth></Girth>
<OriginZip/>
<CommercialFlag>N</CommercialFlag>
<ExtraServices>
  <ExtraService>6</ExtraService>
</ExtraServices>
</Package>
</IntlRateV2Request>
```

3.2 IntIRateV2 Response

3.2.1 Response Diagram

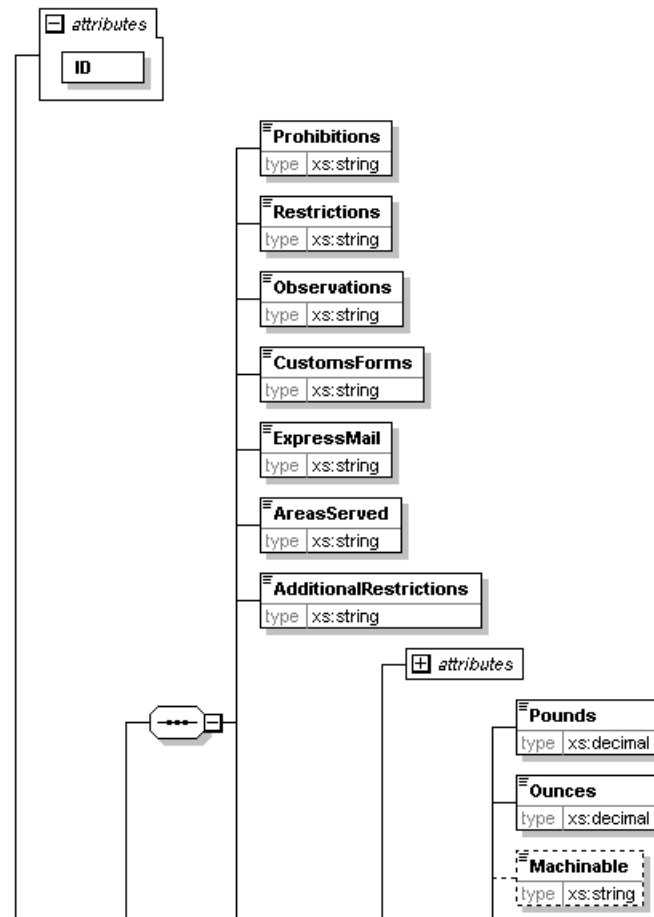

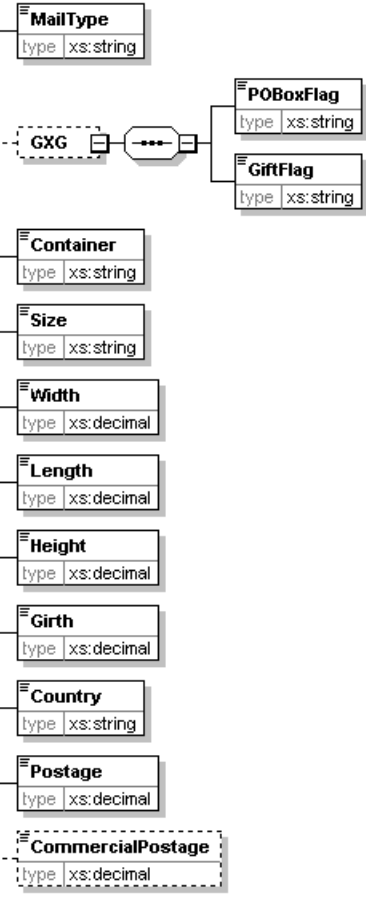
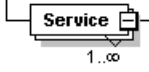
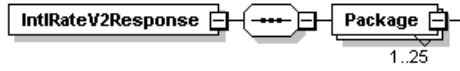

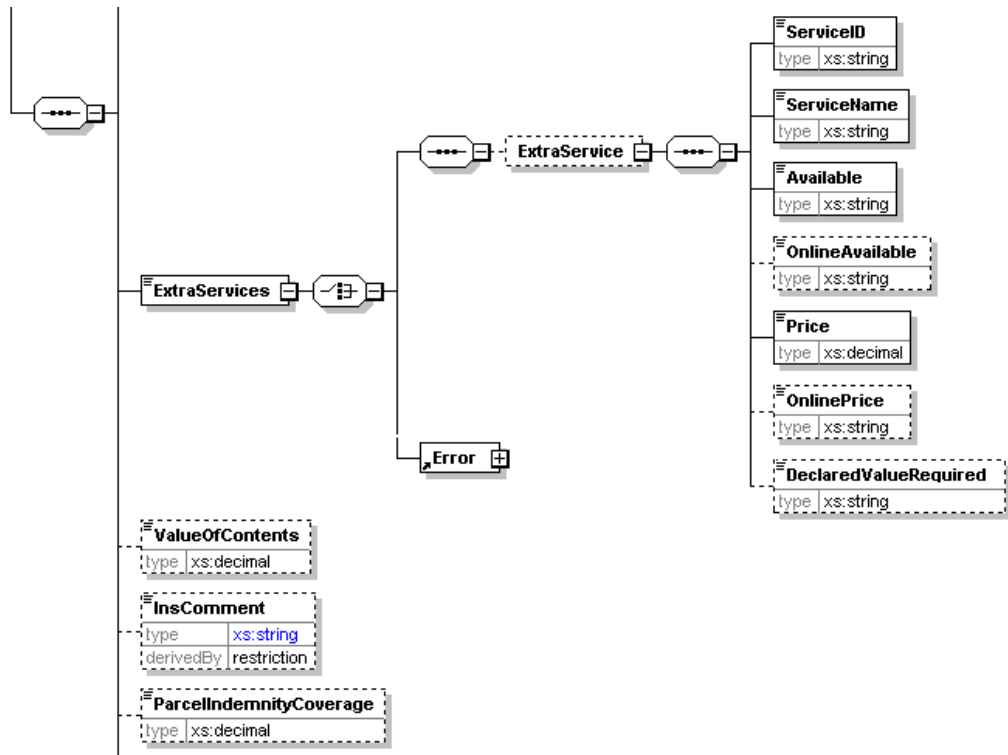

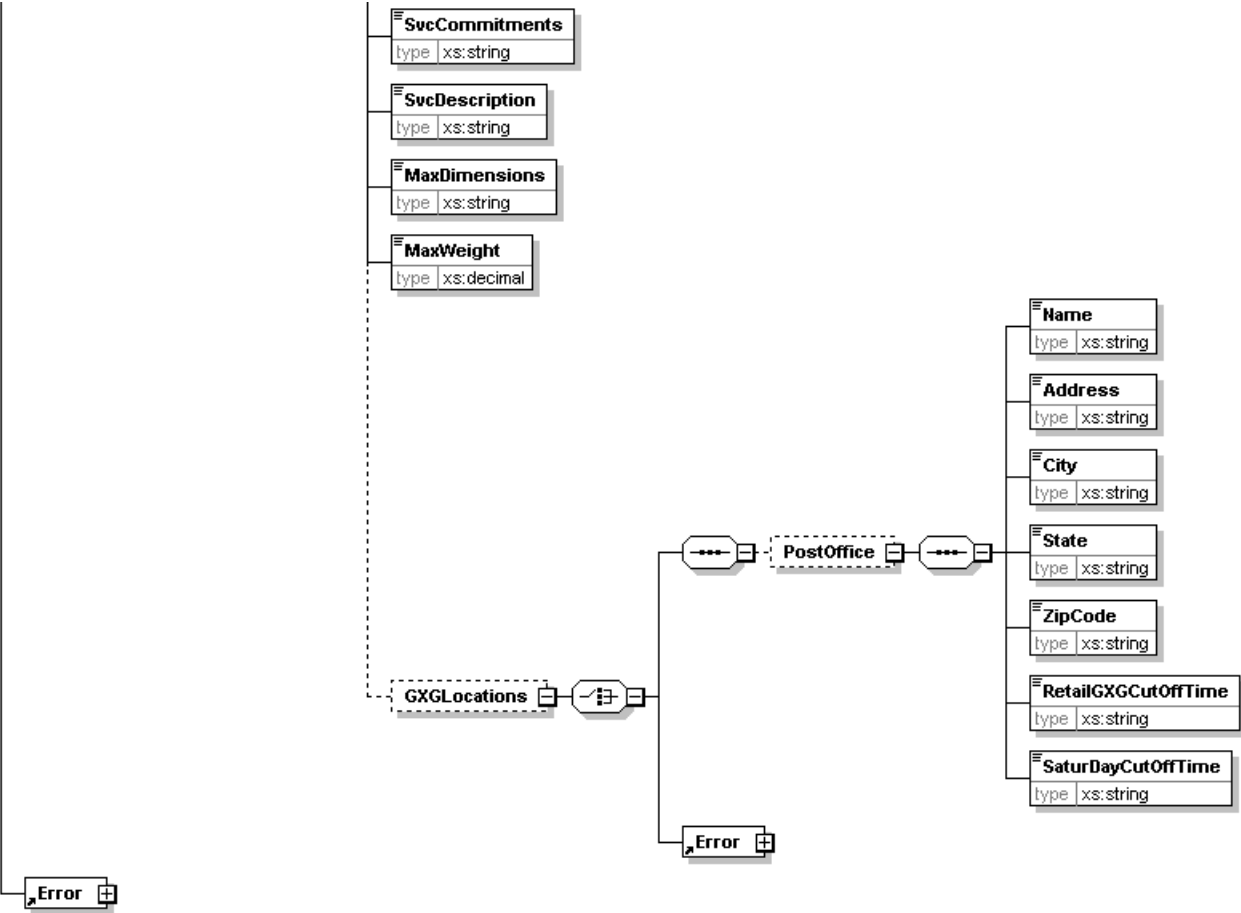

3.2.2 Response Parameters

Tag Name	Occurs	Description	Type	Validation
IntlRateV2Response	required once	Opening document tag.	(group)	
IntlRateV2Response / Package	required once repeating up to 25 times	Corresponds to each "Package" node in the request. Each "Package" node will contain either an "Error" node or the rate results.	(group)	
IntlRateV2Response / Package / @ID	required	Package Identification Number (matches IntlRateV2Request/Package/@ID)	NMTOKEN	
IntlRateV2Response / Package / Prohibitions	required once	Prohibitions	string	
IntlRateV2Response / Package / Restrictions	required once	Restrictions	string	
IntlRateV2Response / Package / Observations	required once	Observations	string	
IntlRateV2Response / Package / CustomsForms	required once	Customs Forms	string	
IntlRateV2Response / Package / ExpressMail	required once	Express Mail	string	
IntlRateV2Response / Package / AreasServed	required once	Areas Served	string	
IntlRateV2Response / Package / AdditionalRestrictions	required once	Additional restrictions on items being shipped to destination country	string	

Tag Name	Occurs	Description	Type	Validation
IntlRateV2Response / Package / Service	required once repeating up to unbounded times	"Service" tag contains a nested rate and service name.	(group)	
IntlRateV2Response / Package / Service / @ID	required	An integer reflective of the <SvcDescription/>.	integer	minInclusive=0
IntlRateV2Response / Package / Service / Pounds	required once	Weight of package (pounds)	integer	
IntlRateV2Response / Package / Service / Ounces	required once	Weight of package (ounces)	decimal	
IntlRateV2Response / Package / Service / Machinable	optional	If specified in request this is echoed back if relevant to computed postage.	string	
IntlRateV2Response / Package / Service / MailType	required once	If specified in request this is echoed back if relevant to computed postage.	string	
IntlRateV2Response / Package / Service / GXG	optional	If specified in request this is echoed back if relevant to computed postage.	(group)	
IntlRateV2Response / Package / Service / GXG / POBoxFlag	required once	If specified in request this is echoed back if relevant to computed postage.	string	
IntlRateV2Response / Package / Service / GXG / GiftFlag	required once	If specified in request this is echoed back if relevant to computed postage.	string	
IntlRateV2Response / Package / Service / Container	required once	If specified in request this is echoed back if relevant to computed postage.	string	
IntlRateV2Response / Package / Service / Size	required once	If specified in request this is echoed back if relevant to computed postage.	string	
IntlRateV2Response / Package / Service / Width	required once	If specified in request this is echoed back if relevant to computed postage.	string	

Tag Name	Occurs	Description	Type	Validation
IntlRateV2Response / Package / Service / Length	required once	If specified in request this is echoed back if relevant to computed postage.	string	
IntlRateV2Response / Package / Service / Height	required once	If specified in request this is echoed back if relevant to computed postage.	string	
IntlRateV2Response / Package / Service / Girth	required once	If specified in request this is echoed back if relevant to computed postage.	string	
IntlRateV2Response / Package / Service / Country	required once	Destination Country	string	
IntlRateV2Response / Package / Service / Postage	required once	Postage Rate Charged	decimal	
IntlRateV2Response / Package / Service / CommercialPostage	optional	Commercial Rate. Returned If specified in request.	decimal	
IntlRateV2Response / Package / Service / ExtraServices	required once	Groups the Extra Service elements.	(group)	
IntlRateV2Response / Package / Service / ExtraServices / ExtraService	optional, repeating up to unbounded times	<p>“ExtraService” contains nested service name, availability, and pricing.</p> <p>When IntlRateV2Request[Revision<'2'], the only service returned is Insurance.</p>	(group)	
IntlRateV2Response / Package / Service / ExtraServices / ExtraService / ServiceID	required once	Extra service ID	integer	
IntlRateV2Response / Package / Service / ExtraServices / ExtraService / ServiceName	required once	Extra service name	string	

Tag Name	Occurs	Description	Type	Validation
IntlRateV2Response / Package / Service / ExtraServices / ExtraService / Available	required once	Availability of extra service. Availability may change depending on extra services passed (selected) in request.	boolean	
IntlRateV2Response / Package / Service / ExtraServices / ExtraService / OnlineAvailable	optional	Availability of online pricing for extra service. Availability may change depending on extra services passed (selected) in request. Returns when IntlRateV2Request[Revision='2'] and IntlRateV2Request[CommercialPrice='Y'].	boolean	
IntlRateV2Response / Package / Service / ExtraServices / ExtraService / Price	required once	Extra service pricing. Pricing may change depending on extra services passed in request. When IntlRateV2Request[Revision<'2'], the insurance fee is fully calculated.	decimal	
IntlRateV2Response / Package / Service / ExtraServices / ExtraService / OnlinePrice	optional	Online extra service pricing. Pricing may change depending on extra services passed in request. Returns when IntlRateV2Request[Revision='2'] and IntlRateV2Request[CommercialPrice='Y'].	decimal	
IntlRateV2Response / Package / Service / ExtraServices / ExtraService / DeclaredValueRequired	optional	Indicates if package value is required to calculate extra service rate. Returns when IntlRateV2Request[Revision='2'].	boolean	
IntlRateV2Response / Package / Service / ValueOfContents	optional	This echoes back the value provided in the request. This value is used to calculate the insurance fee (ServiceID=1 under Extra Services) or the Insurance Comment explaining why Insurance Fee is not given.	decimal	pattern=\d+\.\d\d

Tag Name	Occurs	Description	Type	Validation
IntlRateV2Response / Package / Service / InsComment	optional	Returned when IntlRateV2Request[Revision<'2'] only. Explains why no insurance fee is returned, one of three reasons: SERVICE means insurance is not available for this service; DESTINATION means that insurance is not available to the given country via this service; INSURED VALUE means insurance is available for the country and service, but not for the given value.	string	enumeration=SERVICE enumeration=DESTINATION enumeration=INSURED VALUE
IntlRateV2Response / Package / Service / ParcelIndemnityCoverage	optional	Contains lesser of Maximum Parcel Indemnity Coverage per given weight and ValueOfContents, if applicable; otherwise, it is omitted.	decimal	pattern=\d+\.\d\d
IntlRateV2Response / Package / Service / SvcCommitments	required once	Service Commitments	string	
IntlRateV2Response / Package / Service / SvcDescription	required once	Service Description	string	
IntlRateV2Response / Package / Service / MaxDimensions	required once	Maximum Dimensions of Package Allowed	string	
IntlRateV2Response / Package / Service / MaxWeight	required once	Maximum Weight of Package Allowed	integer	
IntlRateV2Response / Package / Service / GXGLocations	optional	Mailing locations for GXG packages. Based on OriginZip sent in request.	(group)	
IntlRateV2Response / Package / Service / GXGLocations / PostOffice	optional	Individual Post Office information for mailing GXG packages.	(group)	

Tag Name	Occurs	Description	Type	Validation
IntlRateV2Response / Package / Service / GXGLocations / PostOffice / Name	required once	Name of Post Office.	string	
IntlRateV2Response / Package / Service / GXGLocations / PostOffice / Address	required once	Street Address of Post Office.	string	
IntlRateV2Response / Package / Service / GXGLocations / PostOffice / City	required once	City in which Post Office is located.	string	
IntlRateV2Response / Package / Service / GXGLocations / PostOffice / State	required once	State in which Post Office is located.	string	
IntlRateV2Response / Package / Service / GXGLocations / PostOffice / ZipCode	required once	Zip Code of Post Office.	string	
IntlRateV2Response / Package / Service / GXGLocations / PostOffice / RetailGXGCutOffTime	required once	Retail/GXG cut off time at location.	string	
IntlRateV2Response / Package / Service / GXGLocations / PostOffice / SaturdayCutOffTime	required once	Saturday cut off time at location.	string	
IntlRateV2Response / Package / Error	if used: required once		See "Error" Schema	

3.2.3 Response Example – No Revision Tag

Response with NO Revision Tag:

```
<?xml version="1.0" ?>
<IntlRateV2Response>
  <Package ID="1ST">
    <Prohibitions>An issue of a publication <!--2143 suppressed-->.</Prohibitions>
    <Restrictions>Coins; banknotes; curren<!--1558 suppressed--> </Restrictions>
    <Observations>1. Banknotes valued at <!--3059 suppressed-->.</Observations>
    <CustomsForms>First-Class Mail Intern <!--358 suppressed--></CustomsForms>
    <ExpressMail>Country Code: CA Recipro<!--2036 suppressed--> </ExpressMail>
    <AreasServed>Please reference Express Mail for Areas Served.</AreasServed>
    <AdditionalRestrictions>No Additional Restrictions Data found.</AdditionalRestrictions>
  <Service ID="4">
    <Pounds>15</Pounds>
    <Ounces>0</Ounces>
    <Machinable>True</Machinable>
    <MailType>Package</MailType>
    <GXG>
      <POBoxFlag>Y</POBoxFlag>
      <GiftFlag>Y</GiftFlag>
    </GXG>
    <Container>RECTANGULAR</Container>
    <Size>LARGE</Size>
    <Width>10</Width>
    <Length>15</Length>
    <Height>10</Height>
    <Girth>0</Girth>
    <Country>CANADA</Country>
    <Postage>112.50</Postage>
    <ExtraServices>
      <ExtraService>
        <ServiceID>1</ServiceID>
        <ServiceName>Insurance</ServiceName>
        <Available>True</Available>
        <Price>1.00</Price>
```

```
</ExtraService>
</ExtraServices>
<ValueOfContents>200.00</ValueOfContents>
<SvcCommitments>1 - 3 business days</SvcCommitments>
<SvcDescription>Global Express Guaranteed<sup>&reg;</sup> (GXG)** </SvcDescription>
<MaxDimensions>Max. length 46", width 35", height 46" and max. length plus girth combined 108" </MaxDimensions>
<MaxWeight>70</MaxWeight>
</Service>
<Service ID="12">
  <Pounds>15</Pounds>
  <Ounces>0</Ounces>
  <Machinable>True</Machinable>
  <MailType>Package</MailType>
  <Container>RECTANGULAR</Container>
  <Size>LARGE</Size>
  <Width>10</Width>
  <Length>15</Length>
  <Height>10</Height>
  <Girth>0</Girth>
  <Country>CANADA</Country>
  <Postage>112.50</Postage>
  <ExtraServices>
    <ExtraService>
      <ServiceID>1</ServiceID>
      <ServiceName>Insurance</ServiceName>
      <Available>True</Available>
      <Price>1.00</Price>
    </ExtraService>
  </ExtraServices>
  <ValueOfContents>200.00</ValueOfContents>
  <SvcCommitments>1 - 3 business days</SvcCommitments>
  <SvcDescription>USPS GXG<sup>&reg;</sup> Envelopes** </SvcDescription>
  <MaxDimensions>Cardboard envelope has a dimension of 12-1/2" x 9-1/2" and GXG tyvek envelope has a dimension of 15-1/2"
  x 12-1/2" </MaxDimensions>
  <MaxWeight>70</MaxWeight>
</Service>
<Service ID="1">
```

```
<Pounds>15</Pounds>
<Ounces>0</Ounces>
<Machinable>True</Machinable>
<MailType>Package</MailType>
<Container>RECTANGULAR</Container>
<Size>LARGE</Size>
<Width>10</Width>
<Length>15</Length>
<Height>10</Height>
<Girth>0</Girth>
<Country>CANADA</Country>
<Postage>83.60</Postage>
<ExtraServices>
  <ExtraService>
    <ServiceID>1</ServiceID>
    <ServiceName>Insurance</ServiceName>
    <Available>True</Available>
    <Price>0.80</Price>
  </ExtraService>
</ExtraServices>
<ValueOfContents>200.00</ValueOfContents>
<SvcCommitments>3 - 5 business days</SvcCommitments>
<SvcDescription>Express Mail<sup>&reg;&reg;</sup> International</SvcDescription>
<MaxDimensions>Max. length 42", max. length plus girth combined 79"</MaxDimensions>
<MaxWeight>66</MaxWeight>
</Service>
<Service ID="2">
  <Pounds>15</Pounds>
  <Ounces>0</Ounces>
  <Machinable>True</Machinable>
  <MailType>Package</MailType>
  <Container>RECTANGULAR</Container>
  <Size>LARGE</Size>
  <Width>10</Width>
  <Length>15</Length>
  <Height>10</Height>
  <Girth>0</Girth>
```



```
<Postage>97.75</Postage>
<ExtraServices>
  <ExtraService>
    <ServiceID>1</ServiceID>
    <ServiceName>Insurance</ServiceName>
    <Available>True</Available>
    <Price>7.00</Price>
  </ExtraService>
</ExtraServices>
<ValueOfContents>750.00</ValueOfContents>
<SvcCommitments>1 - 3 business days</SvcCommitments>
<SvcDescription>USPS GXG&lt;sup&gt; &trade; &lt;/sup&gt; Envelopes**</SvcDescription>
<MaxDimensions>Cardboard envelope has a dimension of 12-1/2" x 9-1/2" and GXG tyvek envelope has a dimension of 15-
1/2" x 12-1/2"</MaxDimensions>
<MaxWeight>70</MaxWeight>
</Service>
<Service ID="1">
  <Pounds>0</Pounds>
  <Ounces>3</Ounces>
  <MailType>Envelope</MailType>
  <Container />
  <Size>REGULAR</Size>
  <Width>0</Width>
  <Length>0</Length>
  <Height>0</Height>
  <Girth>0</Girth>
  <Country>ALGERIA</Country>
  <Postage>29.95</Postage>
  <ExtraServices>
    <ExtraService>
      <ServiceID>1</ServiceID>
      <ServiceName>Insurance</ServiceName>
      <Available>True</Available>
      <Price>3.70</Price>
    </ExtraService>
  </ExtraServices>
  <ValueOfContents>750.00</ValueOfContents>
```

```
<SvcCommitments>3 - 5 business days</SvcCommitments>
<SvcDescription>Express Mail<sup>&reg;&reg;</sup> International</SvcDescription>
<MaxDimensions>Max. length 36", max. length plus girth 79"</MaxDimensions>
<MaxWeight>44</MaxWeight>
</Service>
<Service ID="10">
  <Pounds>0</Pounds>
  <Ounces>3</Ounces>
  <MailType>Envelope</MailType>
  <Container />
  <Size>REGULAR</Size>
  <Width>0</Width>
  <Length>0</Length>
  <Height>0</Height>
  <Girth>0</Girth>
  <Country>ALGERIA</Country>
  <Postage>29.95</Postage>
  <ExtraServices>
    <ExtraService>
      <ServiceID>1</ServiceID>
      <ServiceName>Insurance</ServiceName>
      <Available>True</Available>
      <Price>3.70</Price>
    </ExtraService>
  </ExtraServices>
  <ValueOfContents>750.00</ValueOfContents>
  <SvcCommitments>3 - 5 business days</SvcCommitments>
  <SvcDescription>Express Mail<sup>&reg;&reg;</sup> International Flat Rate Envelope</SvcDescription>
  <MaxDimensions>USPS-Produced Envelope: 12-1/2" x 9-1/2"</MaxDimensions>
  <MaxWeight>44</MaxWeight>
</Service>
<Service ID="17">
  <Pounds>0</Pounds>
  <Ounces>3</Ounces>
  <MailType>Envelope</MailType>
  <Container />
  <Size>REGULAR</Size>
```

```
<Width>0</Width>
<Length>0</Length>
<Height>0</Height>
<Girth>0</Girth>
<Country>ALGERIA</Country>
<Postage>29.95</Postage>
<ExtraServices>
  <ExtraService>
    <ServiceID>1</ServiceID>
    <ServiceName>Insurance</ServiceName>
    <Available>True</Available>
    <Price>3.70</Price>
  </ExtraService>
</ExtraServices>
<ValueOfContents>750.00</ValueOfContents>
<SvcCommitments>3 - 5 business days</SvcCommitments>
<SvcDescription>Express Mail<sup>&reg;&reg;</sup> International Legal Flat Rate Envelope</SvcDescription>
<MaxDimensions>USPS-Produced Envelope: 15" x 9-1/2"</MaxDimensions>
<MaxWeight>44</MaxWeight>
</Service>
<Service ID="2">
  <Pounds>0</Pounds>
  <Ounces>3</Ounces>
  <MailType>Envelope</MailType>
  <Container />
  <Size>REGULAR</Size>
  <Width>0</Width>
  <Length>0</Length>
  <Height>0</Height>
  <Girth>0</Girth>
  <Country>ALGERIA</Country>
  <Postage>26.00</Postage>
  <ExtraServices />
  <ValueOfContents>750.00</ValueOfContents>
  <InsComment>SERVICE</InsComment>
  <ParcelIndemnityCoverage>64.52</ParcelIndemnityCoverage>
  <SvcCommitments>6 - 10 business days</SvcCommitments>
```



```
<SvcDescription>Priority Mail<sup>&reg;&reg;</sup> International</SvcDescription>
<MaxDimensions>Max. length 42", max. length plus girth combined 79"</MaxDimensions>
<MaxWeight>44</MaxWeight>
</Service>
<Service ID="8">
  <Pounds>0</Pounds>
  <Ounces>3</Ounces>
  <MailType>Envelope</MailType>
  <Container />
  <Size>REGULAR</Size>
  <Width>0</Width>
  <Length>0</Length>
  <Height>0</Height>
  <Girth>0</Girth>
  <Country>ALGERIA</Country>
  <Postage>13.95</Postage>
  <ExtraServices />
  <ValueOfContents>750.00</ValueOfContents>
  <InsComment>SERVICE</InsComment>
  <SvcCommitments>6 - 10 business days</SvcCommitments>
  <SvcDescription>Priority Mail<sup>&reg;&reg;</sup> International Flat Rate Envelope**</SvcDescription>
  <MaxDimensions> USPS-Produced Envelope: 12-1/2" x 9-1/2".<br>Maximum weight 4 pounds.</MaxDimensions>
  <MaxWeight>4</MaxWeight>
</Service>
<Service ID="22">
  <Pounds>0</Pounds>
  <Ounces>3</Ounces>
  <MailType>Envelope</MailType>
  <Container />
  <Size>REGULAR</Size>
  <Width>0</Width>
  <Length>0</Length>
  <Height>0</Height>
  <Girth>0</Girth>
  <Country>ALGERIA</Country>
  <Postage>13.95</Postage>
```

```
<ExtraServices />
<ValueOfContents>750.00</ValueOfContents>
<InsComment>SERVICE</InsComment>
<SvcCommitments>6 - 10 business days</SvcCommitments>
<SvcDescription> Priority Mail<sup>&reg;</sup> &reg; International Legal Flat Rate Envelope** </SvcDescription>
<MaxDimensions> USPS-Produced Envelope: 12-1/2" x 9-1/2".<br>Maximum weight 4 pounds.</MaxDimensions>
<MaxWeight>4</MaxWeight>
</Service>
<Service ID="23">
  <Pounds>0</Pounds>
  <Ounces>3</Ounces>
  <MailType>Envelope</MailType>
  <Container />
  <Size>REGULAR</Size>
  <Width>0</Width>
  <Length>0</Length>
  <Height>0</Height>
  <Girth>0</Girth>
  <Country>ALGERIA</Country>
  <Postage>13.95</Postage>
  <ExtraServices />
  <ValueOfContents>750.00</ValueOfContents>
  <InsComment>SERVICE</InsComment>
  <SvcCommitments>6 - 10 business days</SvcCommitments>
  <SvcDescription>Priority Mail<sup>&reg;</sup> &reg; International Padded Flat Rate Envelope** </SvcDescription>
  <MaxDimensions> USPS-Produced Envelope: 12-1/2" x 9-1/2".<br>Maximum weight 4 pounds.</MaxDimensions>
  <MaxWeight>4</MaxWeight>
</Service>
<Service ID="18">
  <Pounds>0</Pounds>
  <Ounces>3</Ounces>
  <MailType>Envelope</MailType>
  <Container />
  <Size>REGULAR</Size>
  <Width>0</Width>
  <Length>0</Length>
```

```
<Height>0</Height>
<Girth>0</Girth>
<Country>ALGERIA</Country>
<Postage>13.95</Postage>
<ExtraServices />
<ValueOfContents>750.00</ValueOfContents>
<InsComment>SERVICE</InsComment>
<SvcCommitments>6 - 10 business days</SvcCommitments>
<SvcDescription>Priority Mail<sup>&reg;&reg;</sup> International Gift Card Flat Rate Envelope**</SvcDescription>
<MaxDimensions> USPS-Produced Envelope: 10" x 7".<br>Maximum weight 4 pounds.</MaxDimensions>
<MaxWeight>4</MaxWeight>
</Service>
<Service ID="20">
  <Pounds>0</Pounds>
  <Ounces>3</Ounces>
  <MailType>Envelope</MailType>
  <Container />
  <Size>REGULAR</Size>
  <Width>0</Width>
  <Length>0</Length>
  <Height>0</Height>
  <Girth>0</Girth>
  <Country>ALGERIA</Country>
  <Postage>13.95</Postage>
  <ExtraServices />
  <ValueOfContents>750.00</ValueOfContents>
  <InsComment>SERVICE</InsComment>
  <SvcCommitments>6 - 10 business days</SvcCommitments>
  <SvcDescription>Priority Mail<sup>&reg;&reg;</sup> International Small Flat Rate Envelope**</SvcDescription>
  <MaxDimensions> USPS-Produced Envelope: 10" x 6".<br>Maximum weight 4 pounds.</MaxDimensions>
  <MaxWeight>4</MaxWeight>
</Service>
<Service ID="19">
  <Pounds>0</Pounds>
  <Ounces>3</Ounces>
  <MailType>Envelope</MailType>
```

```
<Container />
<Size>REGULAR</Size>
<Width>0</Width>
<Length>0</Length>
<Height>0</Height>
<Girth>0</Girth>
<Country>ALGERIA</Country>
<Postage>13.95</Postage>
<ExtraServices />
<ValueOfContents>750.00</ValueOfContents>
<InsComment>SERVICE</InsComment>
<SvcCommitments>6 - 10 business days</SvcCommitments>
<SvcDescription>Priority Mail<sup>&reg;&reg;</sup> International Window Flat Rate Envelope**</SvcDescription>
<MaxDimensions> USPS-Produced Envelope: 10" x 5".<br>Maximum weight 4 pounds.</MaxDimensions>
<MaxWeight>4</MaxWeight>
</Service>
<Service ID="13">
  <Pounds>0</Pounds>
  <Ounces>3</Ounces>
  <MailType>Envelope</MailType>
  <Container />
  <Size>REGULAR</Size>
  <Width>0</Width>
  <Length>0</Length>
  <Height>0</Height>
  <Girth>0</Girth>
  <Country>ALGERIA</Country>
  <Postage>2.54</Postage>
  <ExtraServices />
  <ValueOfContents>750.00</ValueOfContents>
  <InsComment>SERVICE</InsComment>
  <SvcCommitments>Varies by country</SvcCommitments>
  <SvcDescription> First-Class Mail<sup>&reg;&reg;</sup> International Letter**</SvcDescription>
  <MaxDimensions>Max. length 11-1/2", height 6-1/8" or thickness 1/4".</MaxDimensions>
  <MaxWeight>0.21875</MaxWeight>
</Service>
```

```
</Package>  
</IntIRateV2Response>
```

3.2.4 Response Example – Revision = "2"

Response with Revision Tag:

```
<?xml version="1.0" ?>
<IntlRateV2Response>
  <Package ID="1ST">
    <Prohibitions>An issue of a publication <!--2143 suppressed-->.</Prohibitions>
    <Restrictions>Coins; banknotes; curren<!--1558 suppressed--> </Restrictions>
    <Observations>1. Banknotes valued at <!--3059 suppressed-->.</Observations>
    <CustomsForms>First-Class Mail Intern <!--358 suppressed--></CustomsForms>
    <ExpressMail>Country Code: CA Recipro<!--2036 suppressed--> </ExpressMail>
    <AreasServed>Please reference Express Mail for Areas Served.</AreasServed>
    <AdditionalRestrictions>No Additional Restrictions Data found.</AdditionalRestrictions>
  <Service ID="4">
    <Pounds>15</Pounds>
    <Ounces>0</Ounces>
    <Machinable>True</Machinable>
    <MailType>Package</MailType>
    <GXG>
      <POBoxFlag>Y</POBoxFlag>
      <GiftFlag>Y</GiftFlag>
    </GXG>
    <Container>RECTANGULAR</Container>
    <Size>LARGE</Size>
    <Width>10</Width>
    <Length>15</Length>
    <Height>10</Height>
    <Girth>0</Girth>
    <Country>CANADA</Country>
    <Postage>112.50</Postage>
    <ExtraServices>
      <ExtraService>
        <ServiceID>1</ServiceID>
        <ServiceName>Insurance</ServiceName>
        <Available>True</Available>
        <Price>1.00</Price>
```



```
<Ounces>0</Ounces>
<Machinable>True</Machinable>
<MailType>Package</MailType>
<GXG>
  <POBoxFlag>Y</POBoxFlag>
  <GiftFlag>Y</GiftFlag>
</GXG>
<Container>RECTANGULAR</Container>
<Size>LARGE</Size>
<Width>10</Width>
<Length>15</Length>
<Height>10</Height>
<Girth>0</Girth>
<Country>CANADA</Country>
<Postage>112.50</Postage>
<ExtraServices>
  <ExtraService>
    <ServiceID>1</ServiceID>
    <ServiceName>Insurance</ServiceName>
    <Available>True</Available>
    <Price>1.00</Price>
    <DeclaredValueRequired>True</DeclaredValueRequired>
  </ExtraService>
  <ExtraService>
    <ServiceID>5</ServiceID>
    <ServiceName>Pick-up</ServiceName>
    <Available>True</Available>
    <Price>15.30</Price>
  </ExtraService>
</ExtraServices>
<ValueOfContents>200.00</ValueOfContents>
<SvcCommitments>1 - 3 business days</SvcCommitments>
<SvcDescription>USPS GXG<sup>&lt;&gt;&trade;&lt;/sup> Envelopes**</SvcDescription>
<MaxDimensions>Cardboard envelope has a dimension of 12-1/2" x 9-1/2" and GXG tyvek envelope has a dimension of 15-1/2"
x 12-1/2"</MaxDimensions>
<MaxWeight>70</MaxWeight>
<GXGLocations>
```



```
<PostOffice>
  <Name>STA A WILKES BARRE</Name>
  <Address>34 W MARKET ST</Address>
  <City>WILKES BARRE</City>
  <State>PA</State>
  <ZipCode />
  <RetailGXGCutOffTime>5:00 PM</RetailGXGCutOffTime>
  <SaturdayCutOffTime>12:00 PM</SaturdayCutOffTime>
</PostOffice>
<PostOffice>
  <Name>STA A WILKES BARRE</Name>
  <Address>300 S MAIN ST</Address>
  <City>WILKES BARRE</City>
  <State>PA</State>
  <ZipCode />
  <RetailGXGCutOffTime>5:00 PM</RetailGXGCutOffTime>
  <SaturdayCutOffTime>2:00 PM</SaturdayCutOffTime>
</PostOffice>
</GXGLocations>
</Service>
<Service ID="1">
  <Pounds>15</Pounds>
  <Ounces>0</Ounces>
  <Machinable>True</Machinable>
  <MailType>Package</MailType>
  <Container>RECTANGULAR</Container>
  <Size>LARGE</Size>
  <Width>10</Width>
  <Length>15</Length>
  <Height>10</Height>
  <Girth>0</Girth>
  <Country>CANADA</Country>
  <Postage>83.60</Postage>
  <ExtraServices>
    <ExtraService>
      <ServiceID>1</ServiceID>
      <ServiceName>Insurance</ServiceName>
```

```
<Available>True</Available>
<Price>0.80</Price>
<DeclaredValueRequired>True</DeclaredValueRequired>
</ExtraService>
<ExtraService>
  <ServiceID>5</ServiceID>
  <ServiceName>Pick-up</ServiceName>
  <Available>True</Available>
  <Price>15.30</Price>
</ExtraService>
</ExtraServices>
<ValueOfContents>200.00</ValueOfContents>
<SvcCommitments>3 - 5 business days</SvcCommitments>
<SvcDescription>Express Mail<sup>&reg;&reg;</sup> International</SvcDescription>
<MaxDimensions>Max. length 42", max. length plus girth combined 79"</MaxDimensions>
<MaxWeight>66</MaxWeight>
</Service>
<Service ID="2">
  <Pounds>15</Pounds>
  <Ounces>0</Ounces>
  <Machinable>True</Machinable>
  <MailType>Package</MailType>
  <Container>RECTANGULAR</Container>
  <Size>LARGE</Size>
  <Width>10</Width>
  <Length>15</Length>
  <Height>10</Height>
  <Girth>0</Girth>
  <Country>CANADA</Country>
  <Postage>47.65</Postage>
  <ExtraServices>
    <ExtraService>
      <ServiceID>1</ServiceID>
      <ServiceName>Insurance</ServiceName>
      <Available>True</Available>
      <Price>2.30</Price>
      <DeclaredValueRequired>True</DeclaredValueRequired>
```

```
</ExtraService>
<ExtraService>
  <ServiceID>6</ServiceID>
  <ServiceName>Certificate of Mailing</ServiceName>
  <Available>True</Available>
  <Price>1.15</Price>
</ExtraService>
<ExtraService>
  <ServiceID>5</ServiceID>
  <ServiceName>Pick-up</ServiceName>
  <Available>True</Available>
  <Price>15.30</Price>
</ExtraService>
</ExtraServices>
<ValueOfContents>200.00</ValueOfContents>
<ParcelIndemnityCoverage>108.34</ParcelIndemnityCoverage>
<SvcCommitments>6 - 10 business days</SvcCommitments>
<SvcDescription>Priority Mail<sup>&reg;&reg;</sup> International</SvcDescription>
<MaxDimensions>Max. length 79", max. length plus girth 108"</MaxDimensions>
<MaxWeight>66</MaxWeight>
</Service>
</Package>
<Package ID="2ND">
  <Prohibitions>Articles made of tortoise-!--607 suppressed--></Prohibitions>
  <Restrictions>Articles of gold or platin !--565 suppressed-->. </Restrictions>
  <Observations>Import permits or licen !--183 suppressed-->. </Observations>
  <CustomsForms>First-Class Mail Interna!--127 suppressed-->) </CustomsForms>
  <ExpressMail>Country Code: DZ Reciproc!--2320 suppressed--></ExpressMail>
  <AreasServed>Please reference Express Mail for Areas Served.</AreasServed>
  <AdditionalRestrictions>No Additional Restrictions Data found.</AdditionalRestrictions>
  <Service ID="12">
    <Pounds>0</Pounds>
    <Ounces>3</Ounces>
    <MailType>Envelope</MailType>
    <Container />
    <Size>REGULAR</Size>
    <Width>0</Width>
```

```
<Length>0</Length>
<Height>0</Height>
<Girth>0</Girth>
<Country>ALGERIA</Country>
<Postage>97.75</Postage>
<ExtraServices>
  <ExtraService>
    <ServiceID>1</ServiceID>
    <ServiceName>Insurance</ServiceName>
    <Available>True</Available>
    <Price>1.00</Price>
    <DeclaredValueRequired>True</DeclaredValueRequired>
  </ExtraService>
  <ExtraService>
    <ServiceID>5</ServiceID>
    <ServiceName>Pick-up</ServiceName>
    <Available>True</Available>
    <Price>15.30</Price>
  </ExtraService>
</ExtraServices>
<ValueOfContents>750.00</ValueOfContents>
<SvcCommitments>1 - 3 business days</SvcCommitments>
<SvcDescription>USPS GXG<sup>&trade;&lt;/sup> Envelopes**</SvcDescription>
<MaxDimensions>Cardboard envelope has a dimension of 12-1/2" x 9-1/2" and GXG tyvek envelope has a dimension of 15-
1/2" x 12-1/2"</MaxDimensions>
<MaxWeight>70</MaxWeight>
</Service>
<Service ID="1">
  <Pounds>0</Pounds>
  <Ounces>3</Ounces>
  <MailType>Envelope</MailType>
  <Container />
  <Size>REGULAR</Size>
  <Width>0</Width>
  <Length>0</Length>
  <Height>0</Height>
  <Girth>0</Girth>
```

```
<Country>ALGERIA</Country>
<Postage>29.95</Postage>
<ExtraServices>
  <ExtraService>
    <ServiceID>1</ServiceID>
    <ServiceName>Insurance</ServiceName>
    <Available>True</Available>
    <Price>0.80</Price>
    <DeclaredValueRequired>True</DeclaredValueRequired>
  </ExtraService>
  <ExtraService>
    <ServiceID>5</ServiceID>
    <ServiceName>Pick-up</ServiceName>
    <Available>True</Available>
    <Price>15.30</Price>
  </ExtraService>
</ExtraServices>
<ValueOfContents>750.00</ValueOfContents>
<SvcCommitments>3 - 5 business days</SvcCommitments>
<SvcDescription>Express Mail<sup>&reg;&reg;&reg;</sup> International</SvcDescription>
<MaxDimensions>Max. length 36", max. length plus girth 79"</MaxDimensions>
<MaxWeight>44</MaxWeight>
</Service>
<Service ID="10">
  <Pounds>0</Pounds>
  <Ounces>3</Ounces>
  <MailType>Envelope</MailType>
  <Container />
  <Size>REGULAR</Size>
  <Width>0</Width>
  <Length>0</Length>
  <Height>0</Height>
  <Girth>0</Girth>
  <Country>ALGERIA</Country>
  <Postage>29.95</Postage>
  <ExtraServices>
    <ExtraService>
```

```
<ServiceID>1</ServiceID>
<ServiceName>Insurance</ServiceName>
<Available>True</Available>
<Price>0.80</Price>
<DeclaredValueRequired>True</DeclaredValueRequired>
</ExtraService>
<ExtraService>
  <ServiceID>5</ServiceID>
  <ServiceName>Pick-up</ServiceName>
  <Available>True</Available>
  <Price>15.30</Price>
</ExtraService>
</ExtraServices>
<ValueOfContents>750.00</ValueOfContents>
<SvcCommitments>3 - 5 business days</SvcCommitments>
<SvcDescription>Express Mail<sup>&reg;&reg;&reg;</sup> International Flat Rate Envelope</SvcDescription>
<MaxDimensions>USPS-Produced Envelope: 12-1/2" x 9-1/2"</MaxDimensions>
<MaxWeight>44</MaxWeight>
</Service>
<Service ID="17">
  <Pounds>0</Pounds>
  <Ounces>3</Ounces>
  <MailType>Envelope</MailType>
  <Container />
  <Size>REGULAR</Size>
  <Width>0</Width>
  <Length>0</Length>
  <Height>0</Height>
  <Girth>0</Girth>
  <Country>ALGERIA</Country>
  <Postage>29.95</Postage>
  <ExtraServices>
    <ExtraService>
      <ServiceID>1</ServiceID>
      <ServiceName>Insurance</ServiceName>
      <Available>True</Available>
      <Price>0.80</Price>
```

```
<DeclaredValueRequired>True</DeclaredValueRequired>
</ExtraService>
<ExtraService>
  <ServiceID>5</ServiceID>
  <ServiceName>Pick-up</ServiceName>
  <Available>True</Available>
  <Price>15.30</Price>
</ExtraService>
</ExtraServices>
<ValueOfContents>750.00</ValueOfContents>
<SvcCommitments>3 - 5 business days</SvcCommitments>
<SvcDescription>Express Mail<sup>&#x26Amp;reg;</sup> International Legal Flat Rate Envelope</SvcDescription>
<MaxDimensions>USPS-Produced Envelope: 15" x 9-1/2"</MaxDimensions>
<MaxWeight>44</MaxWeight>
</Service>
<Service ID="2">
  <Pounds>0</Pounds>
  <Ounces>3</Ounces>
  <MailType>Envelope</MailType>
  <Container />
  <Size>REGULAR</Size>
  <Width>0</Width>
  <Length>0</Length>
  <Height>0</Height>
  <Girth>0</Girth>
  <Country>ALGERIA</Country>
  <Postage>26.00</Postage>
  <ExtraServices>
    <ExtraService>
      <ServiceID>6</ServiceID>
      <ServiceName>Certificate of Mailing</ServiceName>
      <Available>True</Available>
      <Price>1.15</Price>
    </ExtraService>
    <ExtraService>
      <ServiceID>5</ServiceID>
      <ServiceName>Pick-up</ServiceName>
```



```
</ExtraServices>
<ValueOfContents>750.00</ValueOfContents>
<InsComment>SERVICE</InsComment>
<SvcCommitments>6 - 10 business days</SvcCommitments>
<SvcDescription>Priority Mail<sup>&lt;&gt;&reg;&lt;/sup>; International Flat Rate Envelope**</SvcDescription>
<MaxDimensions> USPS-Produced Envelope: 12-1/2" x 9-1/2".<br>Maximum weight 4 pounds.</MaxDimensions>
<MaxWeight>4</MaxWeight>
</Service>
<Service ID="22">
  <Pounds>0</Pounds>
  <Ounces>3</Ounces>
  <MailType>Envelope</MailType>
  <Container />
  <Size>REGULAR</Size>
  <Width>0</Width>
  <Length>0</Length>
  <Height>0</Height>
  <Girth>0</Girth>
  <Country>ALGERIA</Country>
  <Postage>13.95</Postage>
  <ExtraServices>
    <ExtraService>
      <ServiceID>6</ServiceID>
      <ServiceName>Certificate of Mailing</ServiceName>
      <Available>True</Available>
      <Price>1.15</Price>
    </ExtraService>
    <ExtraService>
      <ServiceID>5</ServiceID>
      <ServiceName>Pick-up</ServiceName>
      <Available>True</Available>
      <Price>15.30</Price>
    </ExtraService>
  </ExtraServices>
  <ValueOfContents>750.00</ValueOfContents>
  <InsComment>SERVICE</InsComment>
  <SvcCommitments>6 - 10 business days</SvcCommitments>
```

```
<SvcDescription>Priority Mail<sup>&reg;</sup> International Legal Flat Rate Envelope**</SvcDescription>
<MaxDimensions> USPS-Produced Envelope: 15-1/2" x 9-1/2".<br>Maximum weight 4 pounds.</MaxDimensions>
<MaxWeight>4</MaxWeight>
</Service>
<Service ID="23">
  <Pounds>0</Pounds>
  <Ounces>3</Ounces>
  <MailType>Envelope</MailType>
  <Container />
  <Size>REGULAR</Size>
  <Width>0</Width>
  <Length>0</Length>
  <Height>0</Height>
  <Girth>0</Girth>
  <Country>ALGERIA</Country>
  <Postage>13.95</Postage>
  <ExtraServices>
    <ExtraService>
      <ServiceID>6</ServiceID>
      <ServiceName>Certificate of Mailing</ServiceName>
      <Available>True</Available>
      <Price>1.15</Price>
    </ExtraService>
    <ExtraService>
      <ServiceID>5</ServiceID>
      <ServiceName>Pick-up</ServiceName>
      <Available>True</Available>
      <Price>15.30</Price>
    </ExtraService>
  </ExtraServices>
  <ValueOfContents>750.00</ValueOfContents>
  <InsComment>SERVICE</InsComment>
  <SvcCommitments>6 - 10 business days</SvcCommitments>
  <SvcDescription>Priority Mail<sup>&reg;</sup> International Padded Flat Rate Envelope**</SvcDescription>
  <MaxDimensions> USPS-Produced Envelope: 12-1/2" x 9-1/2".<br>Maximum weight 4 pounds.</MaxDimensions>
  <MaxWeight>4</MaxWeight>
</Service>
```



```
<Container />
<Size>REGULAR</Size>
<Width>0</Width>
<Length>0</Length>
<Height>0</Height>
<Girth>0</Girth>
<Country>ALGERIA</Country>
<Postage>13.95</Postage>
<ExtraServices>
  <ExtraService>
    <ServiceID>6</ServiceID>
    <ServiceName>Certificate of Mailing</ServiceName>
    <Available>True</Available>
    <Price>1.15</Price>
  </ExtraService>
  <ExtraService>
    <ServiceID>5</ServiceID>
    <ServiceName>Pick-up</ServiceName>
    <Available>True</Available>
    <Price>15.30</Price>
  </ExtraService>
</ExtraServices>
<ValueOfContents>750.00</ValueOfContents>
<InsComment>SERVICE</InsComment>
<SvcCommitments>6 - 10 business days</SvcCommitments>
<SvcDescription>Priority Mail<sup>&reg;&reg;</sup> International Small Flat Rate Envelope**</SvcDescription>
<MaxDimensions> USPS-Produced Envelope: 10" x 6".<br>Maximum weight 4 pounds.</MaxDimensions>
<MaxWeight>4</MaxWeight>
</Service>
<Service ID="19">
  <Pounds>0</Pounds>
  <Ounces>3</Ounces>
  <MailType>Envelope</MailType>
  <Container />
  <Size>REGULAR</Size>
  <Width>0</Width>
  <Length>0</Length>
```

```
<Height>0</Height>
<Girth>0</Girth>
<Country>ALGERIA</Country>
<Postage>13.95</Postage>
<ExtraServices>
  <ExtraService>
    <ServiceID>6</ServiceID>
    <ServiceName>Certificate of Mailing</ServiceName>
    <Available>True</Available>
    <Price>1.15</Price>
  </ExtraService>
  <ExtraService>
    <ServiceID>5</ServiceID>
    <ServiceName>Pick-up</ServiceName>
    <Available>True</Available>
    <Price>15.30</Price>
  </ExtraService>
</ExtraServices>
<ValueOfContents>750.00</ValueOfContents>
<InsComment>SERVICE</InsComment>
<SvcCommitments>6 - 10 business days</SvcCommitments>
<SvcDescription>Priority Mail<sup>&reg;&reg;</sup> International Window Flat Rate Envelope**</SvcDescription>
<MaxDimensions> USPS-Produced Envelope: 10" x 5".<br>Maximum weight 4 pounds.</MaxDimensions>
<MaxWeight>4</MaxWeight>
</Service>
<Service ID="13">
  <Pounds>0</Pounds>
  <Ounces>3</Ounces>
  <MailType>Envelope</MailType>
  <Container />
  <Size>REGULAR</Size>
  <Width>0</Width>
  <Length>0</Length>
  <Height>0</Height>
  <Girth>0</Girth>
  <Country>ALGERIA</Country>
  <Postage>2.54</Postage>
```

```
<ExtraServices>
  <ExtraService>
    <ServiceID>6</ServiceID>
    <ServiceName>Certificate of Mailing</ServiceName>
    <Available>True</Available>
    <Price>1.15</Price>
  </ExtraService>
</ExtraServices>
<ValueOfContents>750.00</ValueOfContents>
<InsComment>SERVICE</InsComment>
<SvcCommitments>Varies by country</SvcCommitments>
<SvcDescription> First-Class Mail<sup>&reg;</sup> &reg; </sup> International Letter** </SvcDescription>
<MaxDimensions>Max. length 11-1/2", height 6-1/8" or thickness 1/4".</MaxDimensions>
<MaxWeight>0.21875</MaxWeight>
</Service>
</Package>
</IntIRateV2Response>
```