



International Agreement Report

Post-Test Calculation of the ROSA/LSTF Test 3-1 Using RELAP5/Mod3.3

Prepared by:

V. Martinez, F. Reventós, C. Pretel

Institute of Energy Technologies
Technical University of Catalonia
ETSEIB, Av. Diagonal 647, Pav. C
08028 Barcelona, SPAIN

A. Calvo, NRC Project Manager

**Office of Nuclear Regulatory Research
U.S. Nuclear Regulatory Commission
Washington, DC 20555-0001**

Manuscript Completed: January 2012

Date Published: March 2012

Prepared as part of
The Agreement on Research Participation and Technical Exchange
Under the Thermal-Hydraulic Code Applications and Maintenance Program (CAMP)

**Published by
U.S. Nuclear Regulatory Commission**

**AVAILABILITY OF REFERENCE MATERIALS
IN NRC PUBLICATIONS**

NRC Reference Material

As of November 1999, you may electronically access NUREG-series publications and other NRC records at NRC's Public Electronic Reading Room at <http://www.nrc.gov/reading-rm.html>. Publicly released records include, to name a few, NUREG-series publications; *Federal Register* notices; applicant, licensee, and vendor documents and correspondence; NRC correspondence and internal memoranda; bulletins and information notices; inspection and investigative reports; licensee event reports; and Commission papers and their attachments.

NRC publications in the NUREG series, NRC regulations, and *Title 10, Energy*, in the Code of *Federal Regulations* may also be purchased from one of these two sources.

1. The Superintendent of Documents
U.S. Government Printing Office
Mail Stop SSOP
Washington, DC 20402-0001
Internet: bookstore.gpo.gov
Telephone: 202-512-1800
Fax: 202-512-2250
2. The National Technical Information Service
Springfield, VA 22161-0002
www.ntis.gov
1-800-553-6847 or, locally, 703-605-6000

A single copy of each NRC draft report for comment is available free, to the extent of supply, upon written request as follows:

Address: U.S. Nuclear Regulatory Commission
Office of Administration
Publications Branch
Washington, DC 20555-0001
E-mail: DISTRIBUTION.RESOURCE@NRC.GOV
Facsimile: 301-415-2289

Some publications in the NUREG series that are posted at NRC's Web site address <http://www.nrc.gov/reading-rm/doc-collections/nuregs> are updated periodically and may differ from the last printed version. Although references to material found on a Web site bear the date the material was accessed, the material available on the date cited may subsequently be removed from the site.

Non-NRC Reference Material

Documents available from public and special technical libraries include all open literature items, such as books, journal articles, and transactions, *Federal Register* notices, Federal and State legislation, and congressional reports. Such documents as theses, dissertations, foreign reports and translations, and non-NRC conference proceedings may be purchased from their sponsoring organization.

Copies of industry codes and standards used in a substantive manner in the NRC regulatory process are maintained at—

The NRC Technical Library
Two White Flint North
11545 Rockville Pike
Rockville, MD 20852-2738

These standards are available in the library for reference use by the public. Codes and standards are usually copyrighted and may be purchased from the originating organization or, if they are American National Standards, from—

American National Standards Institute
11 West 42nd Street
New York, NY 10036-8002
www.ansi.org
212-642-4900

Legally binding regulatory requirements are stated only in laws; NRC regulations; licenses, including technical specifications; or orders, not in NUREG-series publications. The views expressed in contractor-prepared publications in this series are not necessarily those of the NRC.

The NUREG series comprises (1) technical and administrative reports and books prepared by the staff (NUREG-XXXX) or agency contractors (NUREG/CR-XXXX), (2) proceedings of conferences (NUREG/CP-XXXX), (3) reports resulting from international agreements (NUREG/IA-XXXX), (4) brochures (NUREG/BR-XXXX), and (5) compilations of legal decisions and orders of the Commission and Atomic and Safety Licensing Boards and of Directors' decisions under Section 2.206 of NRC's regulations (NUREG-0750).

DISCLAIMER: This report was prepared under an international cooperative agreement for the exchange of technical information. Neither the U.S. Government nor any agency thereof, nor any employee, makes any warranty, expressed or implied, or assumes any legal liability or responsibility for any third party's use, or the results of such use, of any information, apparatus, product or process disclosed in this publication, or represents that its use by such third party would not infringe privately owned rights.



International Agreement Report

Post-Test Calculation of the ROSA/LSTF Test 3-1 Using RELAP5/Mod3.3

Prepared by:

V. Martinez, F. Reventós, C. Pretel

Institute of Energy Technologies
Technical University of Catalonia
ETSEIB, Av. Diagonal 647, Pav. C
08028 Barcelona, SPAIN

A. Calvo, NRC Project Manager

**Office of Nuclear Regulatory Research
U.S. Nuclear Regulatory Commission
Washington, DC 20555-0001**

Manuscript Completed: January 2012

Date Published: March 2012

Prepared as part of
The Agreement on Research Participation and Technical Exchange
Under the Thermal-Hydraulic Code Applications and Maintenance Program (CAMP)

**Published by
U.S. Nuclear Regulatory Commission**

ABSTRACT

The Thermalhydraulic Studies Group of Technical University of Catalonia (UPC) holds a large background in nuclear safety studies in the field of Nuclear Power Plant (NPP) code simulators. RELAP5mod3.3 has been used in this study in order to analyze the LSTF Test 3-1, which simulates an anticipated transient without scram (ATWS) as a result of a small break LOCA without rods insertion (but with scram signal) and loss of off-site power. Two local phenomena have been object of study: U-tube liquid accumulation due to CCFL at the inlet of the SG U-tubes, and loop seal behavior during the transient.

FOREWORD

Extensive knowledge and techniques have been produced and made available in the field of thermal-hydraulic responses during reactor transients and accidents, and major system computer codes have achieved a high degree of maturity through extensive qualification, assessment and validation processes. Best-estimate analysis methods are increasingly used in licensing, replacing the traditional conservative approaches. Such methods include an assessment of the uncertainty of their results that must be taken into account when the safety acceptance criteria for the licensing analysis are verified.

Traditional agreements between the Nuclear Regulatory Commission of the United States of America (USNRC) and the Consejo de Seguridad Nuclear of Spain (CSN) in the area of nuclear safety research have given access to CSN to the NRC-developed best estimate thermalhydraulic codes RELAP5, TRAC-P, TRAC-B, and currently TRACE. These complex tools, suitable state-of-the-art application of current two-phase flow fluid mechanics techniques to light water nuclear power plants, allow a realistic representation and simulation of thermalhydraulic phenomena at normal and incidental operation of NPP. Owing to the huge required resources, qualification of these codes have been performed through international cooperation programs. USNRC CAMP program (Code Applications and Maintenance Program) represents the international framework for verification and validation of NRC TH codes, allowing to:

- Share experience on code errors and inadequacies, cooperating in resolution of deficiencies and maintaining a single, internationally recognized code version.
- Share user experience on code scaling, applicability, and uncertainty studies.
- Share a well documented code assessment data base.
- Share experience on full scale power plant safety-related analyses performed with codes (analyses of operating reactors, advanced light water reactors, transients, risk-dominant sequences, and accident management and operator procedures-related studies).
- Maintain and improve user expertise and guidelines for code applications.

Since 1984, when the first LOFT agreement was settled down, CSN has been promoting coordinated joint efforts with Spanish organizations, such as UNESA (the association of Spanish electric energy industry) as well as universities and engineering companies, in the aim of assimilating, applying, improving and helping the international community in the validation of these TH simulation codes¹, within different periods of the associated national programs (e.g., CAMP-España). As a result of these actions, there is currently in Spain a good collection of productive plant models as well as a good selection of national experts in the application of TH simulation tools, with adequate TH knowledge and suitable experience on their use.

Many experimental facilities have contributed to the today's availability of a large thermal-hydraulic database (both separated and integral effect tests). However there is continued need for additional experimental work and code development and verification, in areas where no emphasis have been made along the past. On the basis of the SESAR/FAP² reports "*Nuclear Safety Research in OECD Countries: Major Facilities and Programmes at Risk*" (SESAR/FAP, 2001) and its 2007 updated version "*Support Facilities for Existing and Advanced Reactors (SFEAR) NEA/CSNI/R(2007)6*", CSNI is promoting since 2001 several collaborative international actions in the area of experimental TH research. These reports presented some findings and recommendations to the CSNI, to sustain an adequate level of research, identifying a number of experimental facilities and programmes of potential interest for present or future international collaboration within the safety community during the coming decade.

CSN, as Spanish representative in CSNI, is involved in some of these research activities, helping in this international support of facilities and in the establishment of a large network of international collaborations. In the TH framework, most of these actions are either covering not enough investigated safety issues and phenomena (e.g., boron dilution, low power and shutdown conditions), or enlarging code validation and qualification data bases incorporating new information (e.g., multi-dimensional aspects, non-condensable gas effects). In particular, CSN is currently participating in the PKL and ROSA programmes.

¹ It's worth to note the emphasis made in the application to actual NPP incidents.

² SESAR/FAP is the *Senior Group of Experts on Nuclear Safety Research Facilities and Programmes* of NEA Committee on the Safety of Nuclear Installations (CSNI).

The PKL is an important integral test facility operated by of AREVA-NP in Erlangen (Germany), and designed to investigate thermal-hydraulic response of a four-loop Siemens designed PWR. Experiments performed during the PKL/OECD program have been focused on the issues:

- Boron dilution events after small-break loss of coolant accidents.
- Loss of residual heat removal during mid-loop operation (both with closed and open reactor coolant system).

ROSA/LSTF of Japan Atomic Energy Research Institute (JAERI) is an integral test facility designed to simulate a 1100 MWe four-loop Westinghouse-type PWR, by two loops at full-height and 1/48 volumetric scaling to better simulate thermal-hydraulic responses in large-scale components. The ROSA/OECD project has investigated issues in thermal-hydraulics analyses relevant to water reactor safety, focusing on the verification of models and simulation methods for complex phenomena that can occur during reactor transients and accidents such as:

- Temperature stratification and coolant mixing during ECCS coolant injection
- Water hammer-like phenomena
- ATWS
- Natural circulation with super-heated steam
- Primary cooling through SG depressurization
- Pressure vessel upper-head and bottom break LOCA

This overall CSN involvement in different international TH programmes has outlined the scope of the new period of CAMP-España activities focused on:

- Analysis, simulation and investigation of specific safety aspects of PKL/OECD and ROSA/OECD experiments.
- Analysis of applicability and/or extension of the results and knowledge acquired in these projects to the safety, operation or availability of the Spanish nuclear power plants.

Both objectives are carried out by simulating experiments and plant application with the last available versions of NRC TH codes (RELAP5 and TRACE). A CAMP in-kind contribution is aimed as end result of both types of studies. Development of these activities, technically and financially supported by CSN, is being carried out by 5 different national research groups (Technical Universities of Madrid, Valencia and Cataluña). On the whole, CSN is seeking to assure and to maintain the capability of the national groups with experience in the thermal hydraulics analysis of accidents of the Spanish nuclear power plants.

Francisco Fernández Moreno, Commissioner
Consejo de Seguridad Nuclear (CSN)

CONTENTS

	<u>Page</u>
ABSTRACT	iii
FOREWORD	v
CONTENTS	vii
FIGURES.....	viii
TABLES.....	viii
EXECUTIVE SUMMARY	ix
ACKNOWLEDGMENTS.....	x
ABBREVIATIONS	xi
1. INTRODUCTION	1-1
1.1 High-Power Natural Circulation Events.....	1-1
1.2 The OECD/NEA ROSA Project.....	1-2
2. FACILITY AND TEST DESCRIPTION	2-1
2.1 LSTF Test Facility.....	2-1
2.2 Boundary Conditions	2-2
2.3 Initial Conditions	2-2
2.4 Test Phase	2-2
3. CODE INPUT MODEL DESCRIPTION	3-1
3.1 Nodalization	3-1
3.2 Preliminary Calculations	3-4
4. RESULTS.....	4-1
4.1 Test Phase	4-1
4.2 Local Phenomena.....	4-6
4.2.1 Liquid Accumulation Due To CCFL	4-6
4.2.2 Loop Seal Behavior	4-10
5. RUN STATISTICS.....	5-1
6. CONCLUSIONS	6-1
7. REFERENCES	7-1

FIGURES

		<u>Page</u>
Figure 1	Thermal-hydraulic phenomena during SBLOCA without scram (Courtesy of the OECD/NEA ROSA group)	1-1
Figure 2	OECD/NEA ROSA project experiments (Courtesy of the OECD/NEA ROSA group)	1-2
Figure 3	LSTF Test Facility (Courtesy of the OECD/NEA ROSA group).....	2-1
Figure 4	Original supplied input nodalization.....	3-1
Figure 5	Break unit nodalization	3-2
Figure 6	Normalized pressure vs. distance on broken loop.....	3-3
Figure 7	Normalized pressure vs. distance on intact loop.....	3-3
Figure 8	Core collapsed liquid level.....	3-5
Figure 9	Upper plenum collapsed liquid level.....	3-5
Figure 10	Primary and secondary pressure.....	4-2
Figure 11	Break mass flow	4-2
Figure 12	Cold leg flow rate.....	4-3
Figure 13	Core level	4-3
Figure 14	Steam generators level	4-4
Figure 15	Maximum peak clad surface temperature	4-4
Figure 16	LSTF core power.....	4-5
Figure 17	Core void fraction	4-5
Figure 18	Froude Number	4-6
Figure 19	Flow regime number. Horizontal stratification associated to 12 value.....	4-7
Figure 20	Hot leg collapsed liquid level	4-7
Figure 21	Loop B liquid velocity.....	4-8
Figure 22	Loop B gas velocity	4-8
Figure 23	U-tube liquid level on broken loop	4-9
Figure 24	U-tube liquid level on intact loop.....	4-9
Figure 25	Core collapsed liquid level.....	4-10
Figure 26	Time-integrated accumulator mass flow rate.....	4-10
Figure 27	Loop seal collapsed liquid level on broken loop	4-11
Figure 28	Loop seal collapsed liquid level on intact loop.....	4-11

TABLES

		<u>Page</u>
Table 1	Chronology of the main events in Test 3-1.....	2-3
Table 2	Differential pressures into the vessel.	3-4
Table 3	Steady state conditions	3-4
Table 4	Comparison between experimental and simulated main events.	4-1

EXECUTIVE SUMMARY

Experimental research activities are being performed in Japan by the OECD/NEA ROSA project with the aim of obtaining thermal-hydraulic data for the validation of computer codes and models for system integral analyses coupled with detailed analyses of local phenomena. These experiments are carried out at the LSTF test facility.

This report analyses Test 3.1, which simulates an anticipated transient without scram (ATWS) as a result of a small break LOCA without rods insertion (but with scram signal) and loss of off-site power. One of the main aspects of this test is the supercritical natural circulation during initial high-core power.

Two local phenomena have been object of study: U-tube liquid accumulation due to counter current flow limitation at the inlet of the steam generator U-tubes, and loop seal behavior during the transient.

A nodalization has been created to simulate this test and the following ones. Calculations have been performed using RELAP5mod3.3 code.

In order to improve the base case, differential pressures around loops and vessel have been adjusted using initial condition experimental data, and downcomer-to-hot-leg bypass has been corrected to reproduce its theoretical value of 1% of core flow.

Many other aspects related to the nodalization have been adjusted and verified in order to improve results.

The general agreement between model predictions and experimental data qualifies the model as an appropriate tool to simulate this kind of LSTF tests. This level of qualification will certainly improve after testing the same model in other post-test calculations

ACKNOWLEDGMENTS

This paper contains findings that were produced within the OECD-NEA ROSA Project. The authors are grateful to the Management Board of the ROSA Project for their consent to this publication

ABBREVIATIONS

AFW	auxiliary feed water
ANAV	Asociación Nuclear Ascó-Vandellòs
ATWS	anticipated transient without scram
CCFL	counter current flow limitation
CNV II	Vandellòs II NPP
ECCS	emergency core cooling system
HPIS	high pressure injection system
INTE	Institut de Tècniques Energètiques
LOFW	loss of feed water
LPIS	low pressure injection system
LSTF	large scale test facility
MFW	main feed water
MSIV	main steam isolation valve
NEA	Nuclear Energy Agency
NPP	nuclear power plant
OECD	Organization for Economic Cooperation and Development
PORV	power operated relief valve
PZR	pressurizer
PWR	pressurized water reactor
RCP	reactor coolant pumps
RELAP	reactor excursion and leak analysis program
ROSA	rig of safety assessment
SBLOCA	small break loss of coolant accident
SG	steam generator
UPC	Universitat Politècnica de Catalunya (Technical University of Catalonia)

1. INTRODUCTION

Several safety activities have been performed during the last decades originated by the OECD to develop and improve computer codes. They include experiments performed at the LSTF test facility for the OECD/NEA ROSA project like Test 3-1 which is object of study in this report.

1.1 High-Power Natural Circulation Events

High-power events are transients with failure of scram in which core power decrease is due to negative reactivity feedback. Depending on the transient characteristics, this situation can lead to a relatively high core power during a long time.

Natural circulation occurs in transients with gradual loss of mass inventory (SBLOCA or LOFW –losses across the pressurizer relief valve due to overpressure on the primary system-). While there is high core power and water in the loops, vapor and liquid with high velocity exit from the vessel to the hot legs inducing supercritical flow during natural circulation. This phenomenon affects the coolant distribution due to counter-current flow limitation (CCFL) during condensing reflux at the inlet of the steam generators and U-tubes which causes liquid accumulation in them –see figure one-.

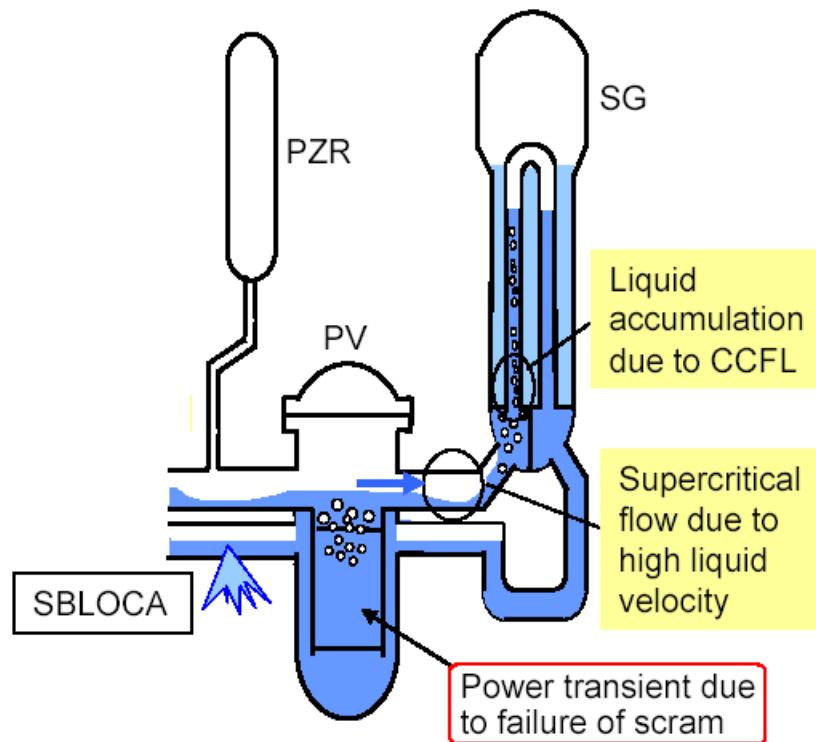

Figure 1 Thermal-hydraulic phenomena during SBLOCA without scram (Courtesy of the OECD/NEA ROSA group).

Break flow rate and liquid carryover into the pressurizer are affected by this phenomenon too.

1.2 The OECD/NEA ROSA Project

The OECD/NEA ROSA project includes several types of experiments (see figure two) on ROSA/LSTF test facility with the aim of providing a wide database for the validation of computer codes and models for system integral analyses coupled with detailed analyses of local phenomena. The main phenomena to study in these experiments are multi-dimensional mixing, stratification, parallel flows, unstable flows, convection and influences of non-condensable gas. Test 3-1 is included in the group of “High power natural circulation experiments.”

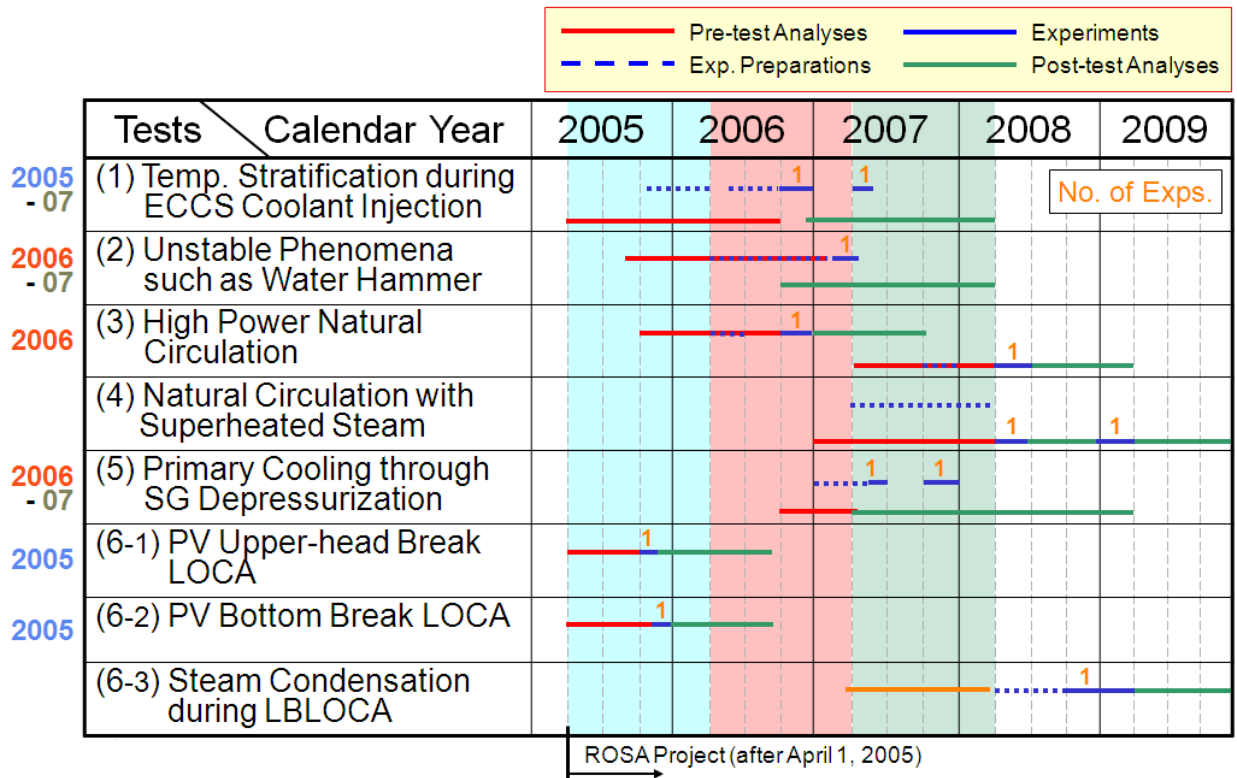

Figure 2 OECD/NEA ROSA project experiments (Courtesy of the OECD/NEA ROSA group)

2. FACILITY AND TEST DESCRIPTION

2.1 LSTF Test Facility

LSTF (see figure three) is an experimental facility designed to simulate a Westinghouse-type 4-loop 3,420 MWth PWR under accidental conditions. It is a full-height and 1/48 volumetrically-scaled two-loop system with a maximum core power of 10 MW (14 % of the scaled PWR nominal core power) and pressures scaled 1:1. Loops are sized to conserve volumetric factor (2/48) and to simulate the same flow regime transitions in the horizontal legs (respecting L/\sqrt{D} factor).

There is one SG for each loop respecting the same scaling factors. They have 141 full-size U-tubes, inlet and outlet plena, steam separator, steam dome, steam dryer, main steam line, four downcomers and other internals.

All emergency systems are represented and have a big versatility referred to their functions and positions. Many break locations (20) are available too.

LSTF test facility has about 1,760 measurement points that allow an exhaustive analysis of the tests. There are two types of data or measurements of interest: directly measured quantities (temperature, pressure, differential pressure), and derived quantities (from the combination of two or more direct measured quantities –coolant density, mass flow rate...-).

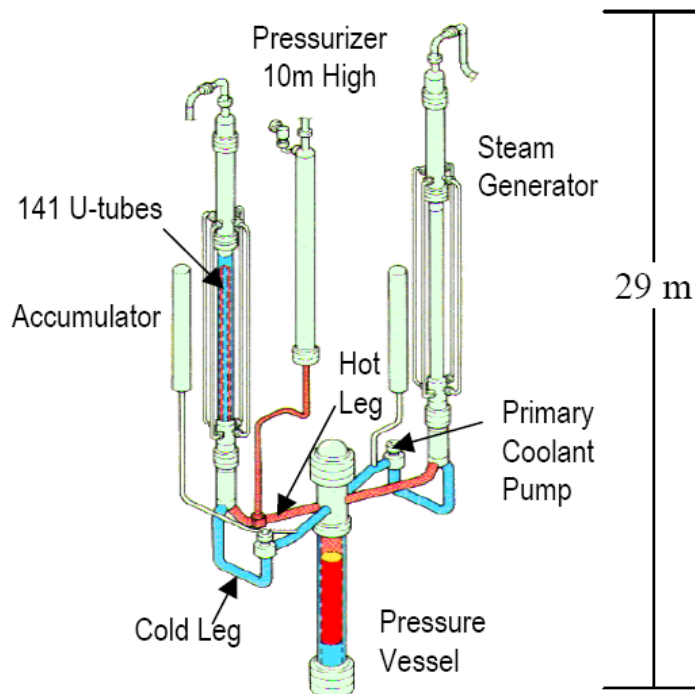

Figure 3 LSTF Test Facility (Courtesy of the OECD/NEA ROSA group)

Test 3-1 simulates a SBLOCA (break size of 1%) with scram failure and loss-of-offsite-power (HPI and LPI are unavailable). Due to the high-core power, supercritical natural circulation exists in the hot legs until the loops become empty. CCFL at the inlet of the steam generators and U-tubes during the two-phase natural circulation are objective of study in this test.

2.2 Boundary Conditions

The hardware configuration of LSTF is described in references [2] and [3]. Some important points are the following:

- *Break assembly*: small break in the cold leg of the loop without pressurizer (1 % of the scaled cross-sectional area of the reference PWR cold leg).
- *ECCs*: HPI and LPI are unavailable simulating loss of off-site power.
- *Core power curve*: pre-determined from a previous volumetrically scaled analysis performed with SKETCH-INS/TRAC-PF, which reproduces the transient in a commercial PWR (see Appendix A of reference [3] for more detailed information). As LSTF core power is limited to the 14% of the scaled reference plant nominal power, the portion higher than 10 MW is cut-off (see first 200 s of figure 16).
- *LSTF core protection system*: Core power is modified according to the maximum fuel rod surface temperature

2.3 Initial Conditions

Initial steady-state conditions were fixed according to the reference PWR conditions. Because of the LSTF initial core power (14 % of the scaled PWR nominal core power) core flow rate was set to 14 % of the scaled nominal flow rate to obtain the same PWR temperatures, and secondary pressure was raised to limit the primary-to-secondary heat transfer rate to 10 MW.

2.4 Test Phase

The transient is started opening the break at $t = 0$ s. After 20 seconds the scram signal is generated causing the closure of the MSIV and the stop valve (turbine trip); pressurizer heater is off, main feed water is closed and auxiliary feed water is started. Three seconds later, coast-down of the primary coolant pumps is initiated. Until 300 seconds while there is high core power, secondary pressure rises over the specified set-point causing the continuous opening of the SG relief valves and generating two-phase natural circulation in the primary loops. Between 300 and 1,600 seconds of the transient, the primary system is coupled with the isolated secondary system, which is depressurized with the cool auxiliary feed water that condenses vapor of the steam generators.

About 1,100 seconds, core liquid level starts to decrease rising the average temperature of the system. Then, the LSTF core protection system actuates decreasing the core power until the maximum fuel rod surface temperature is achieved. As a result of the low power, the primary pressure falls down below the secondary. About 2,100 seconds after the start of the transient, the accumulator injection system initiates causing a loop seal clearing in the loop without pressurizer 100 seconds later. At 5,547 seconds the break is closed and the transient finished. The main events are described in table one:

Table 1 Chronology of the main events in Test 3-1

Event	Time [s]
Break	0
SCRAM signal: · Turbine trip and closure MSIV · PZR heater off · End of main feedwater and begin of auxiliary feedwater	20
Start of coast-down of primary coolant pumps	23
Primary coolant pumps stop	272
End of continuous opening of SG RVs. End of two-phase natural circulation. Break flow from single-phase liquid to two-phase flow	About 300
Core liquid level starts to decrease (core uncover)	About 1100
Core power decrease by LSTF core protection system	1630
Max. fuel rod surface temperature	1825
Primary pressure lower than SG secondary-side pressure	About 1900
Initiation of accumulator injection system	About 2100
Loop seal clearing only in loop without PZR	About 2200
End of the transient	5547

3. CODE INPUT MODEL DESCRIPTION

3.1 Nodalization

The version of RELAP5 used to perform the post-test calculations is RELAP5/MOD3.3. Consequently, it has been necessary to adjust the original supplied input (see figure four) from RELAP5mod3.2 to this the newest version.

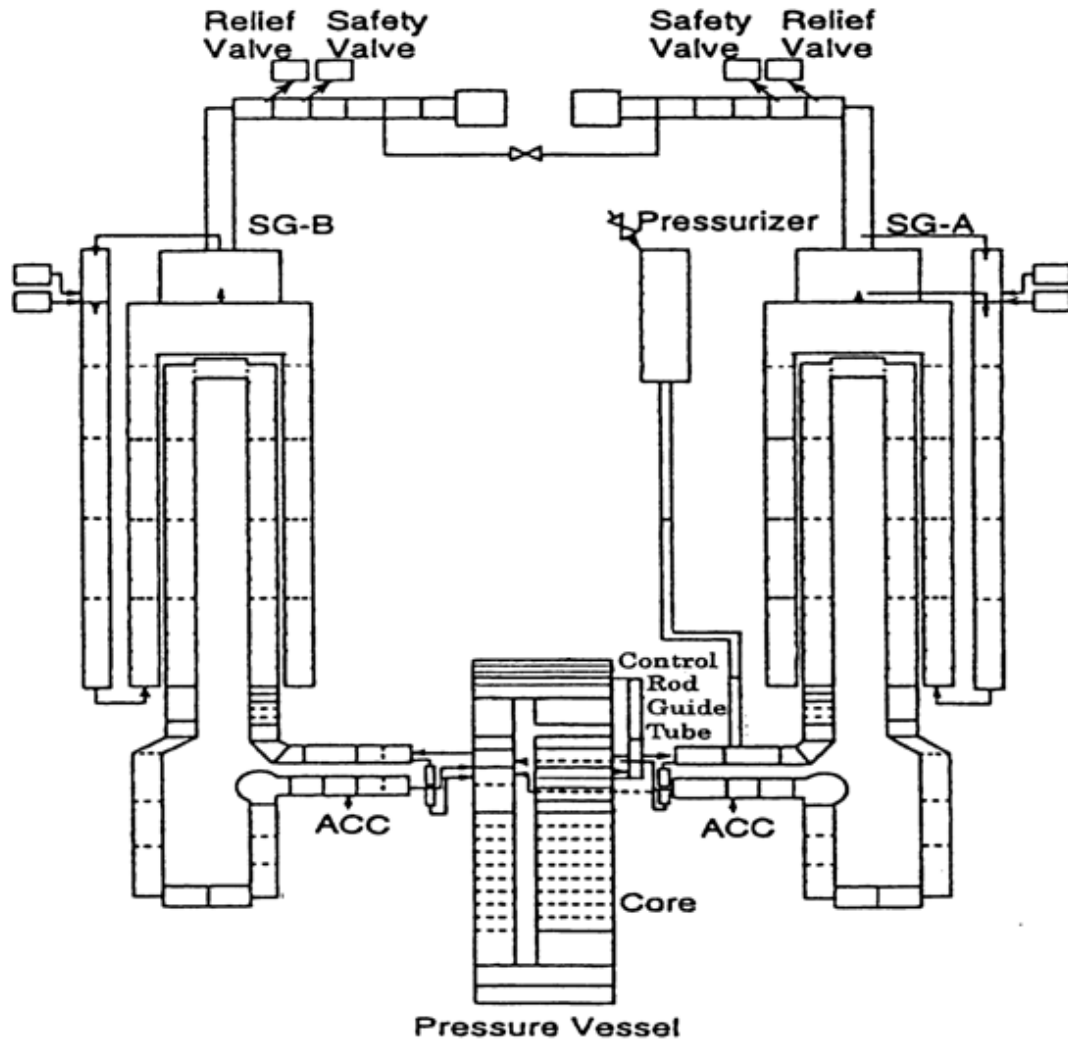

Figure 4 Original supplied input nodalization

Other improvements have been performed with the aim of obtaining a more realistic nodalization:

- Re-nodalization of the cold leg in the broken loop respecting the distance between pump, accumulator nozzle, break orifice and core inlet.
- Simulation of the bypass between the UH and the UP with an annulus around the upper core support plate and a multiple junction reproducing the orifices at the upperhead bottom.

- New break unit that reproduces pipes and junctions between the orifice assembly and the storage tank (see figure five).

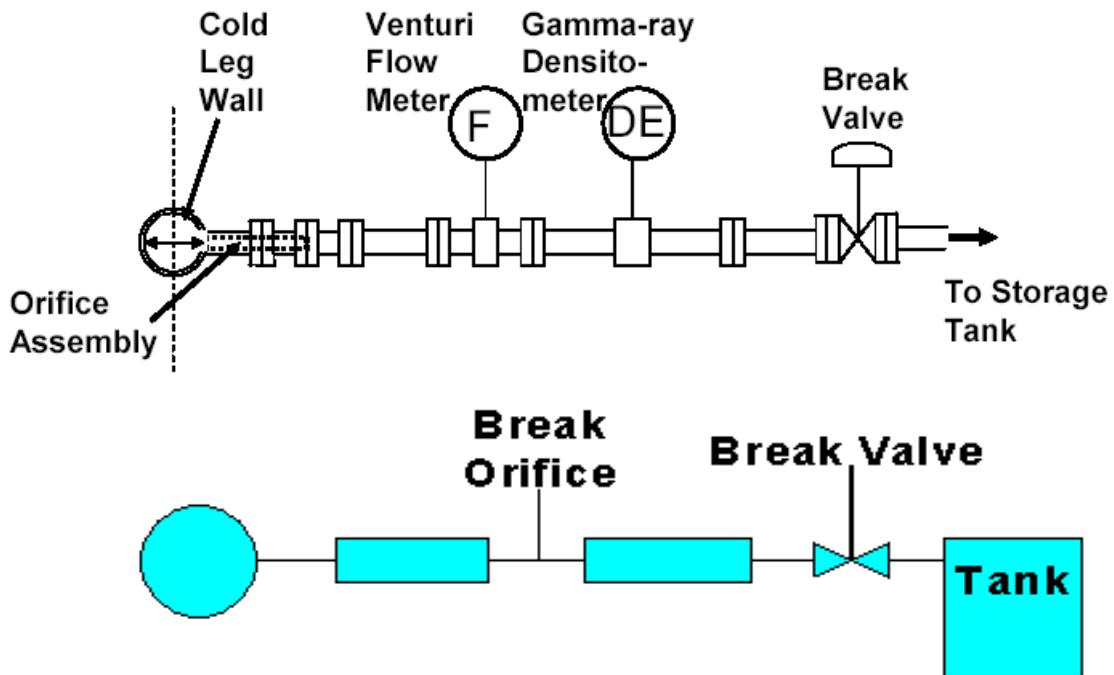

Figure 5 Break unit nodalization

Finally, differential pressures around the loops (figures six and seven) and into the vessel (Table two) have been adjusted to improve the steady-state conditions. Figures six and seven show an important divergence in the pump inlet. Table two shows the deviation in kPa between predicted and experimental data. As RELAP code computes pressure in the middle of the volumes, differential pressures have been corrected to level the heights

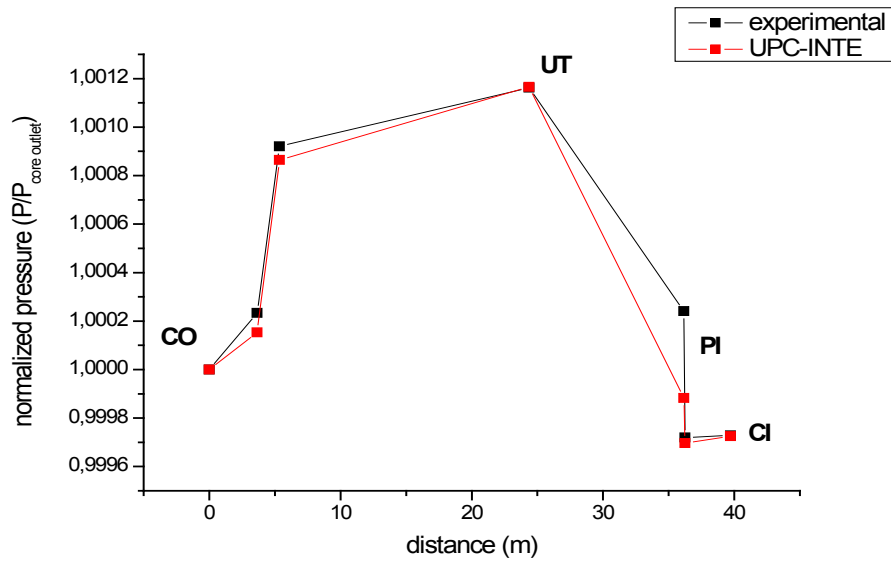

Figure 6 Normalized pressure vs. distance on broken loop

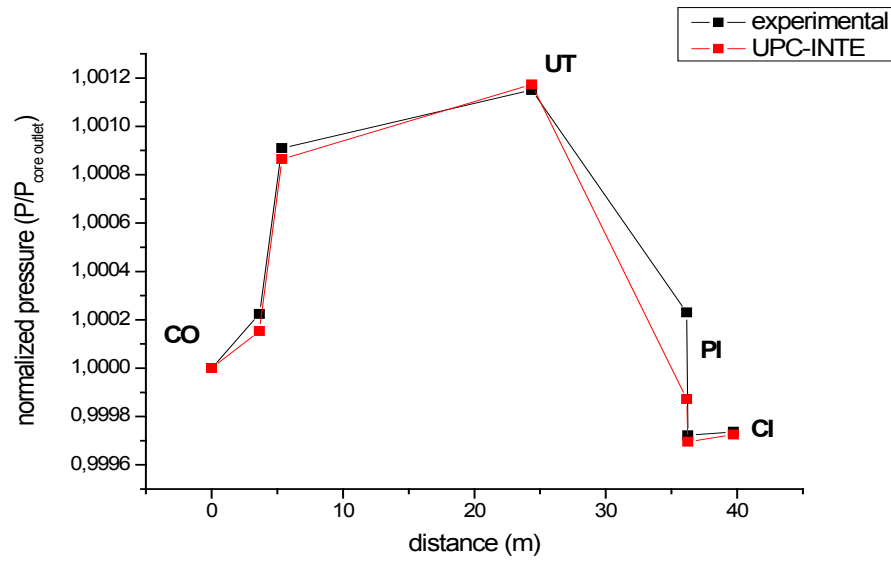

Figure 7 Normalized pressure vs. distance on intact loop.

Table 2 Differential pressures into the vessel.

Vessel	Elevation (m)	Differential pressures (kPa)	Differential pressures -correcting elevation- (kPa)
Upper head	-2.19	-9.58	-1.00
Upper plenum	-2.13	-0.63	-0.30
Core	-3.64	-1.39	0.54
Lower plenum total	-1.42	-3.96	0.60
Downcomer	-8.82	1.53	0.00
TOTAL	-8.21	28.63	0.40

3.2 Preliminary Calculations

Preliminary calculations show an important divergence in the downcomer-to-hot leg bypass mass flow rate (see table three; values are normalized to the measured steady state conditions).

Table 3 Steady state conditions

	Preliminary RELAP simulation (loops w / wo PZR)	UPC-INTE RELAP model (loops w / wo PZR)
Core power	0.990	0.990
Hot leg temperatura	1.0 / 0.9997	1.0 / 0.9997
Cold leg temperatura	1.001 / 1.0	1.001 / 1.0
Mass flow rate (x loop)	1.04 / 1.021	1.04 / 1.021
Downcomer-to-hot-leg bypass	7.042 / 7.021	1.001 / 1.001
Pressurizer pressure	1.003	1.003
Pressurizer liquid level	0.971	0.971
Secondary-side pressure	0.998 / 0.998	0.998 / 0.998
Secondary-side liquid level	1.003 / 0.998	1.003 / 0.998
Main feedwater temperatura	1.001 / 0.999	1.001 / 0.999
Auxiliar feedwater temperatura	1.0	1.0
Main feedwater flow rate	1.008 / 1.031	1.008 / 1.031
Accumulators pressure	1.0	1.0
Accumulators temperatura	1.0 / 1.0	1.0 / 1.0
Steam flow rate	1.002 / 1.029	1.002 / 1.029

Correcting the bypass mass flow rate, both modifying the section ($0.58 \cdot 10^{-4} \text{ m}^2$) and modifying the flow energy loss coefficients (345.0), the drop delay in the core collapsed liquid level of the preliminary simulation disappears (see figure eight).

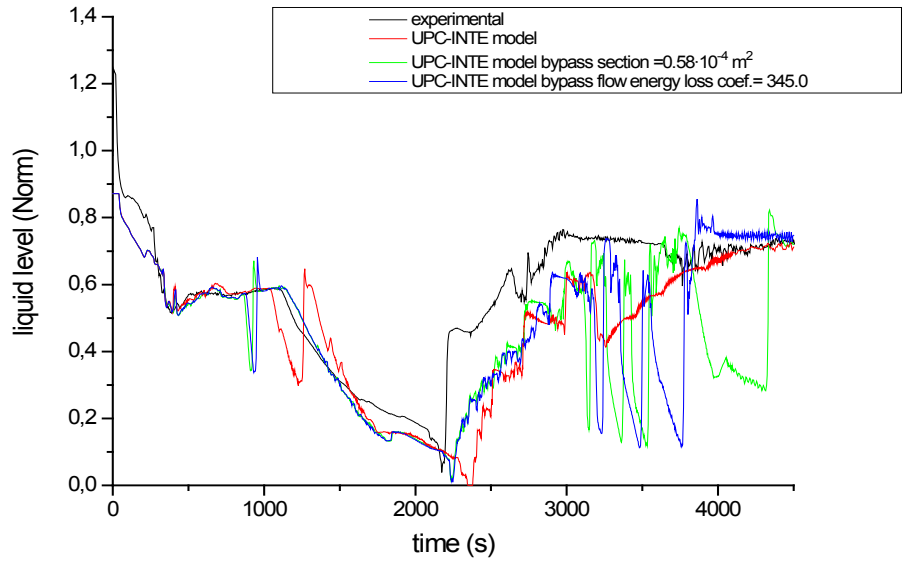

Figure 8 Core collapsed liquid level

Although both cases improve it, only the second partly reproduces the upper plenum refilling (see figure nine). So the final nodalization incorporates the new flow energy loss coefficients. The other main parameters of the transient are not meaningfully affected by the downcomer-to-hot leg bypass mass flow.

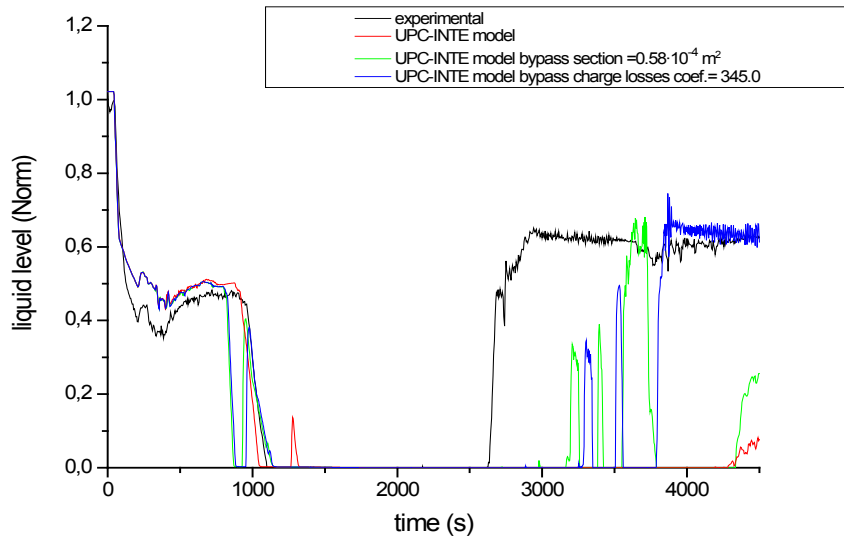

Figure 9 Upper plenum collapsed liquid level

4. RESULTS

4.1 Test Phase

Table four shows the chronology of the main events occurred in Test 3-1, comparing the experimental values with the calculated ones.

Table 4 Comparison between experimental and simulated main events

Event	Experimental [s]	UPC-INTE model [s]
Break	0	0
SCRAM signal: · Turbine trip and closure MSIV · PZR heater off · End of main feedwater and begin of auxiliary feedwater	20	20
Start of coastdown of primary coolant pumps	23	23
Primary coolant pumps stop	272	272
End of continuous opening of SG RVs, End of two-phase natural circulation, break flow from single-phase liquid to two-phase flow	About 300	300-400
Core liquid level starts to decrease (core uncover)	About 1100	About 1100
Core power decrease by LSTF core protection system	1630	1707
Max. fuel rod surface temperature	1825	1875
Primary pressure lower than SG secondary-side pressure	About 1900	1875
Initiation of accumulator injection system	About 2100	2180
Loop seal clearing only in loop without PZR	About 2200	2898
End of the transient	5547	5547

As shown in figure 10, primary and secondary pressure have good agreement with the experimental data until 2,100 seconds, when the initiation of the accumulator injection system causes some discrepancies on primary pressure and break mass flow (see figure 11). In the UPC-INTE model, accumulators refill cold legs increasing the mass flow across the break.

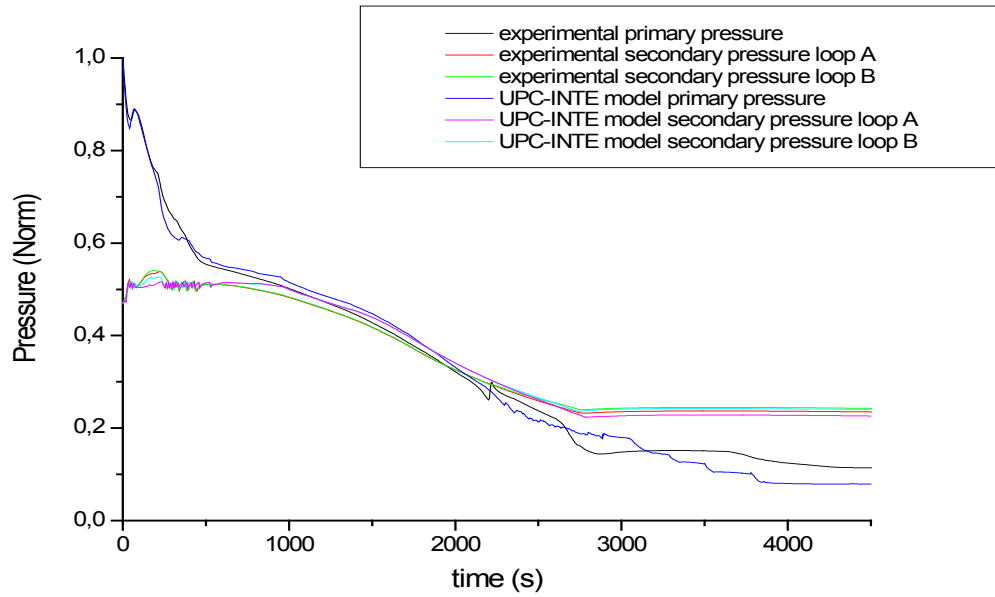

Figure 10 Primary and secondary pressure

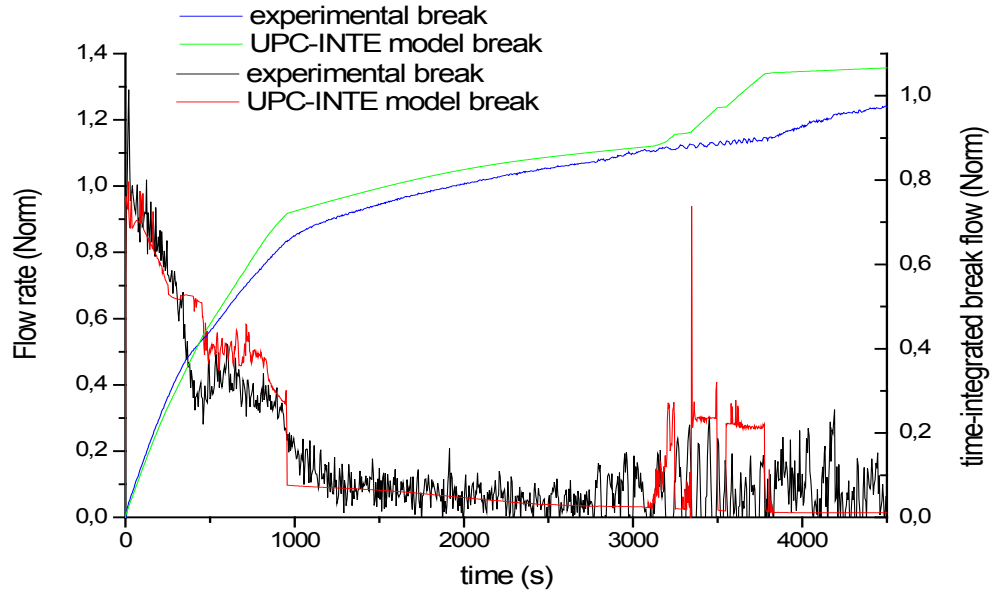

Figure 11 Break mass flow

Figures 12 and 13 show how the UPC-INTE model reproduces natural circulation and emptying of the core.

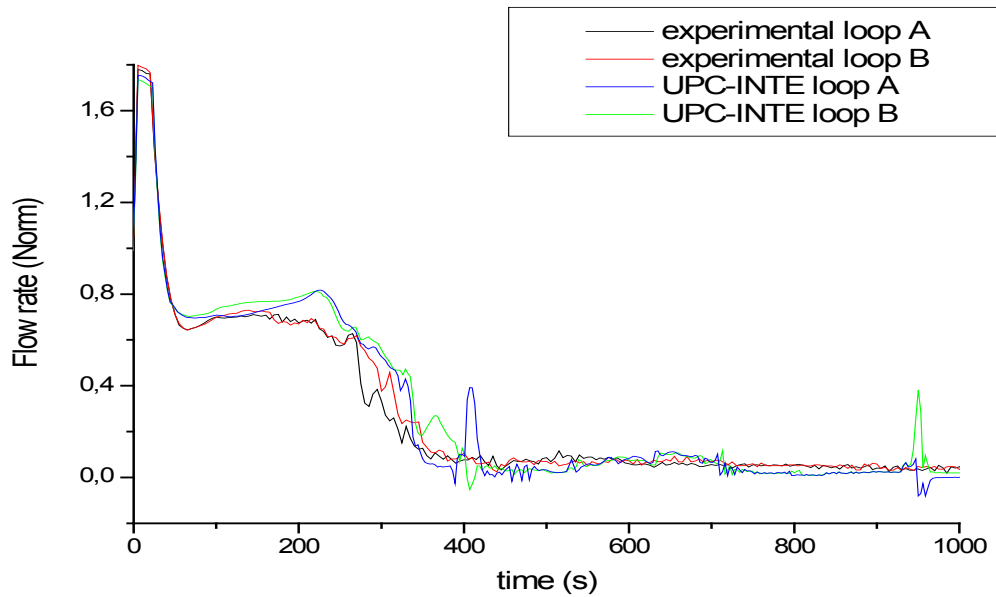

Figure 12 Cold leg flow rate

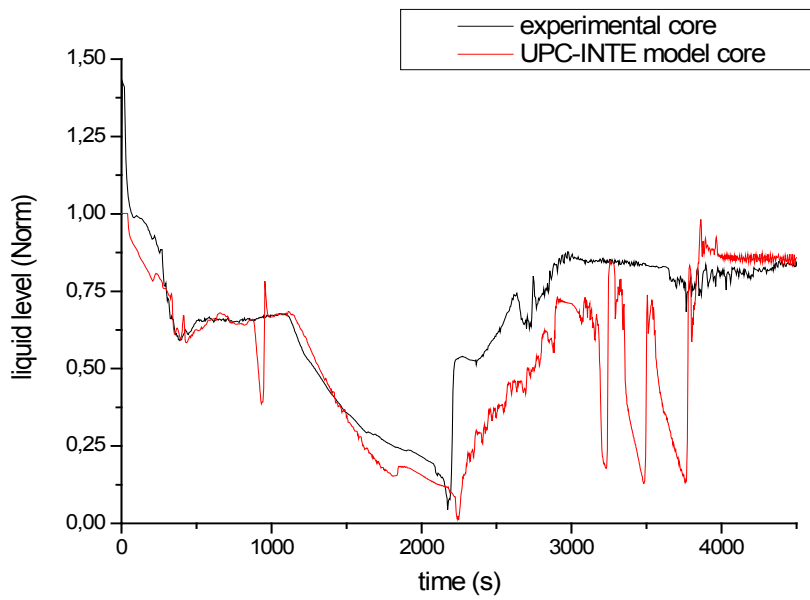

Figure 13 Core level

The UPC-INTE model performs a good secondary cooldown. It reproduces continuous opening of the relief valves during natural circulation (see secondary pressure in figure 10) and adjusts correctly the steam generators collapsed liquid level (see figure 14).

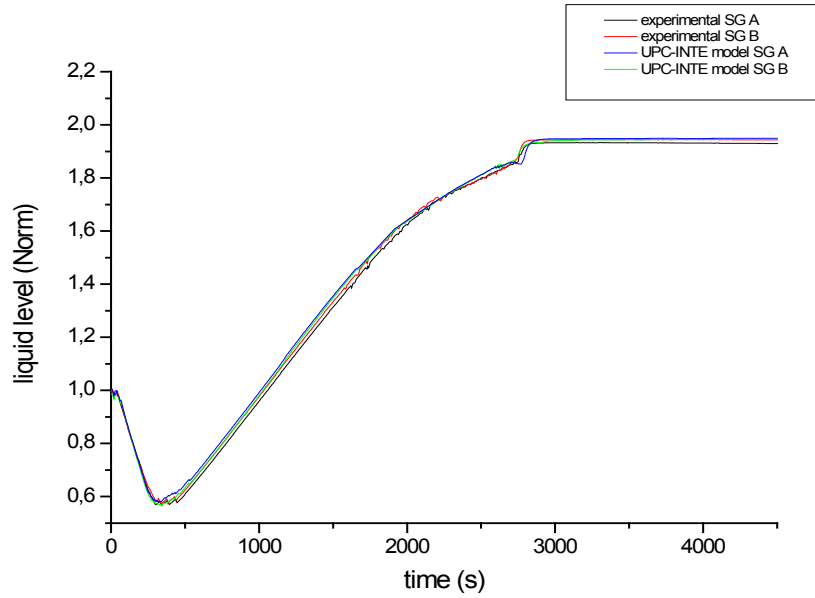

Figure 14 Steam generators level

Figure 15 shows rod surface temperature has a quite good agreement with experimental data until the initiation of accumulators because of a correct LSTF core protection system implementation (see figure 16).

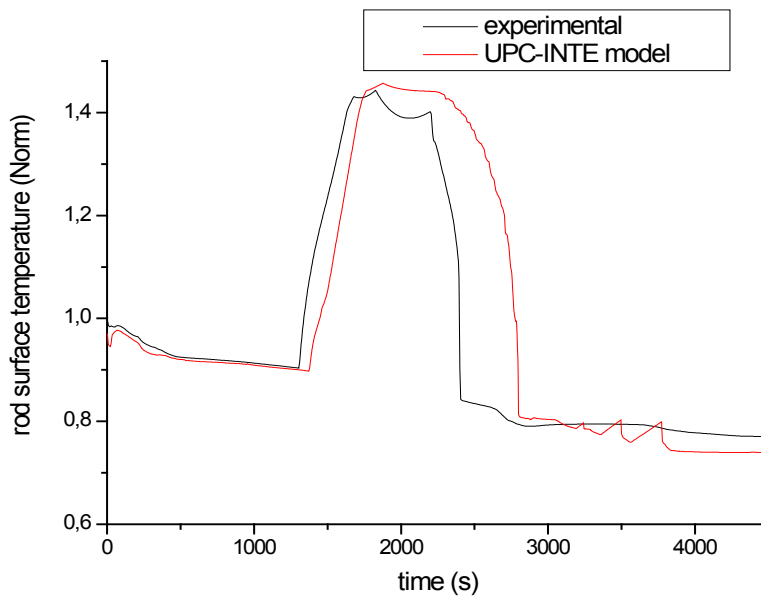

Figure 15 Maximum peak clad surface temperature

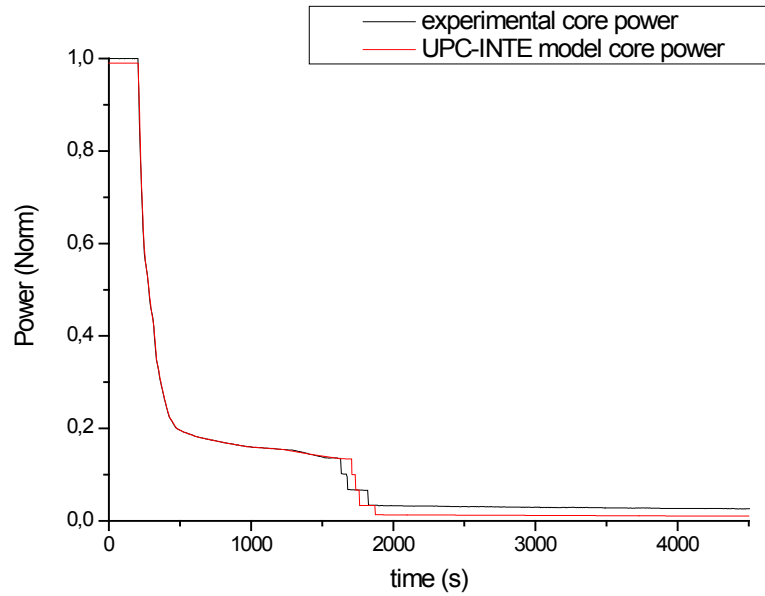

Figure 16 LSTF core power

Finally, it is observed that with a pre-determined core power curve (figure 16) RELAP code predicts the increase in core void fraction (figure 17) that induces the negative reactivity feedback which is the main factor of core power drop.

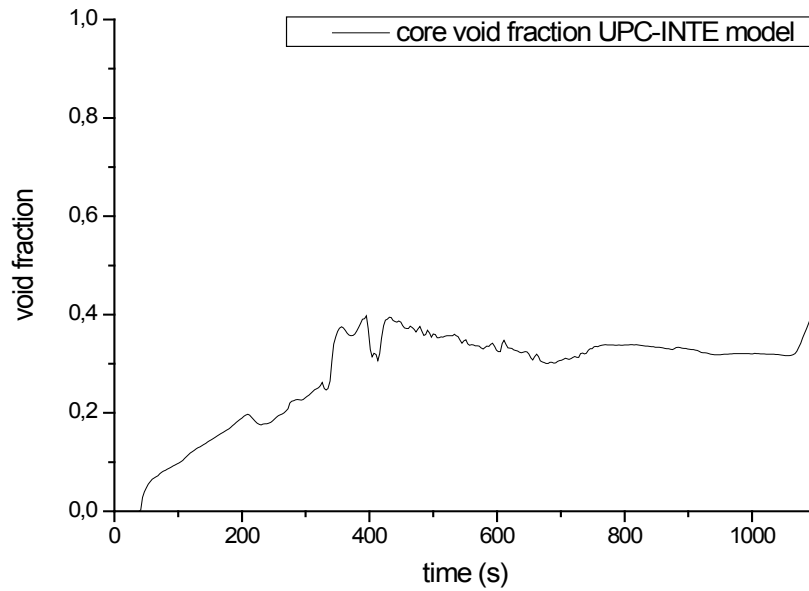

Figure 17 Core void fraction

4.2 Local Phenomena

4.2.1 Liquid Accumulation Due To CCFL:

Supercritical flow during two-phase flow Natural Circulation induces liquid accumulation in the U-tubes during reflux condensation because of counter current flow limitation in the inlet U-tube and in the bottom of the inlet plenum (see figure one). Partial core drop is observed as a result of this accumulation.

RELAP5mod3.3 reproduces supercritical flow (Froude number > 1) during the two-phase flow natural circulation (see figure 18) and simulates related phenomena like horizontal stratification in the hot leg (figure 19) and a partial drop of its level during supercritical flow (figure 20 shows an asymmetrical drop of the UPC-INTE model collapsed liquid level during a 100-200 seconds interval which seems to be related to the Froude number values of figure 18).

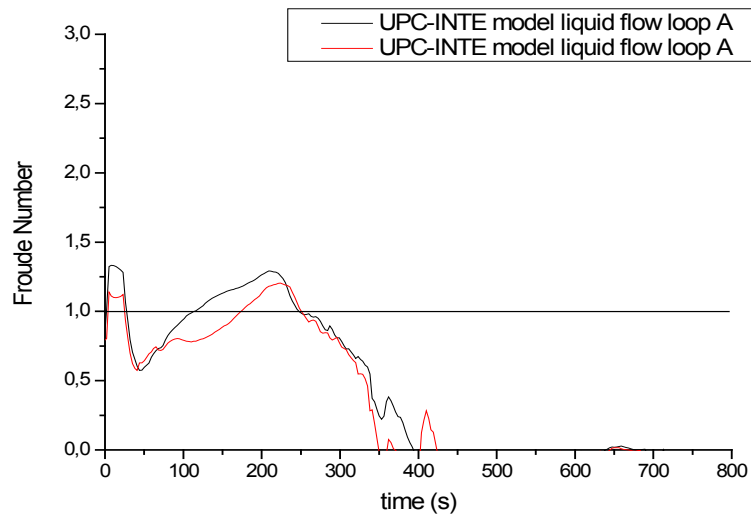

Figure 18 Froude Number

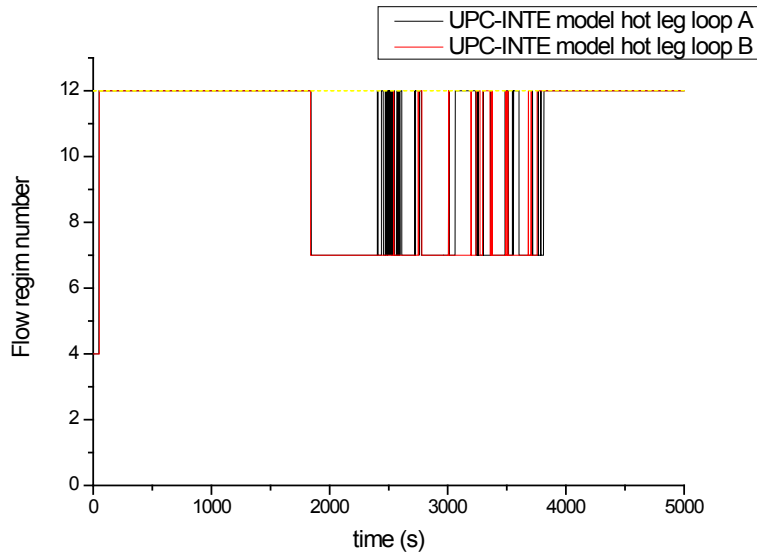

Figure 19 Flow regime number. Horizontal stratification associated to 12 value

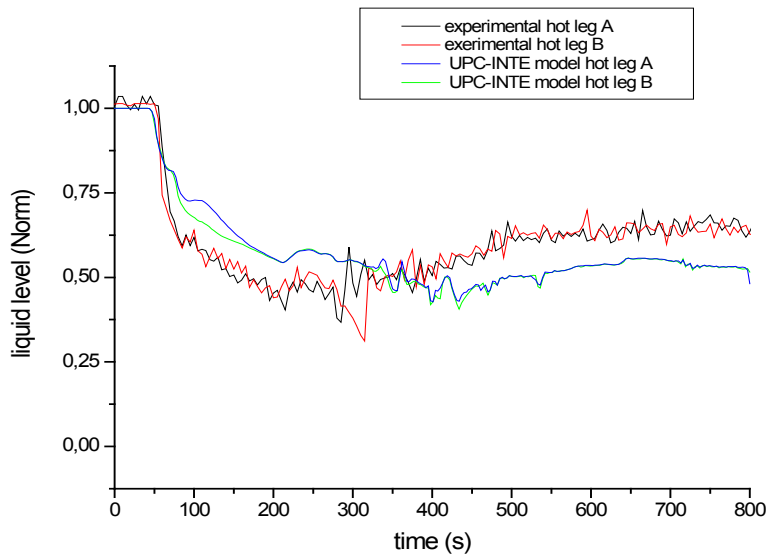

Figure 20 Hot leg collapsed liquid level

RELAP5/mod3.3 simulates a small negative liquid velocity (figure 21) and a positive gas velocity (figure 22) at the U-tube inlet during one-phase gas flow with high vapor velocity (from 400 seconds to 800 seconds approximately). These velocities justify counter current limitation at the U-tubes inlet and a possible liquid accumulation in them.

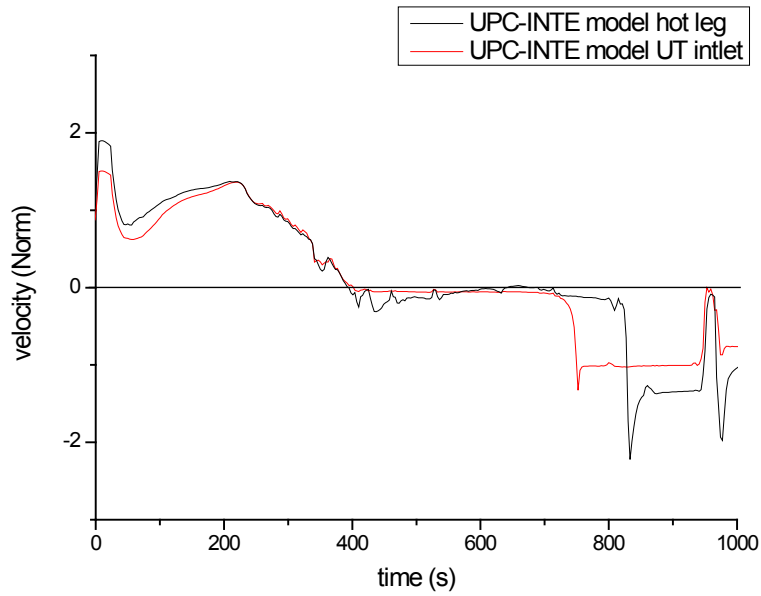

Figure 21 Loop B liquid velocity

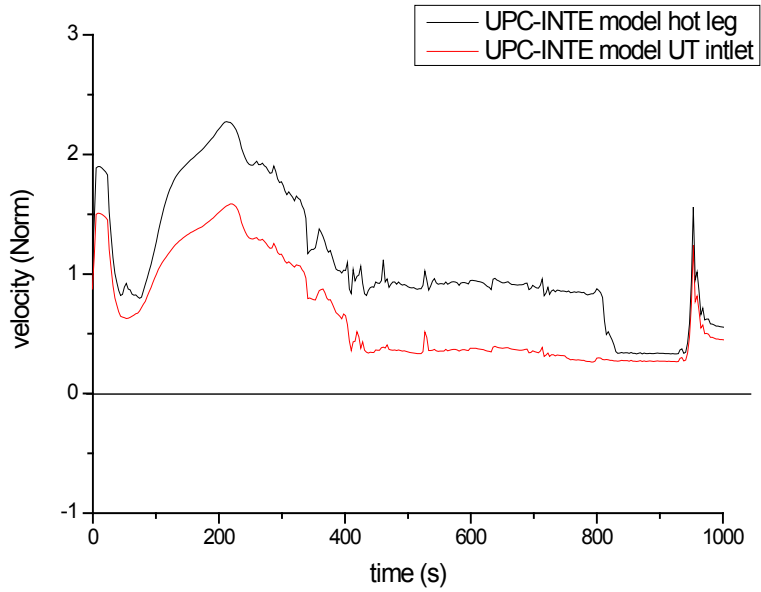

Figure 22 Loop B gas velocity

As shown in figures 23 and 24, although asymmetrical effect is not reproduced, the UPC-INTE model simulates the U-tube liquid accumulation phenomenon and its related partial core level drop (see figure 25).

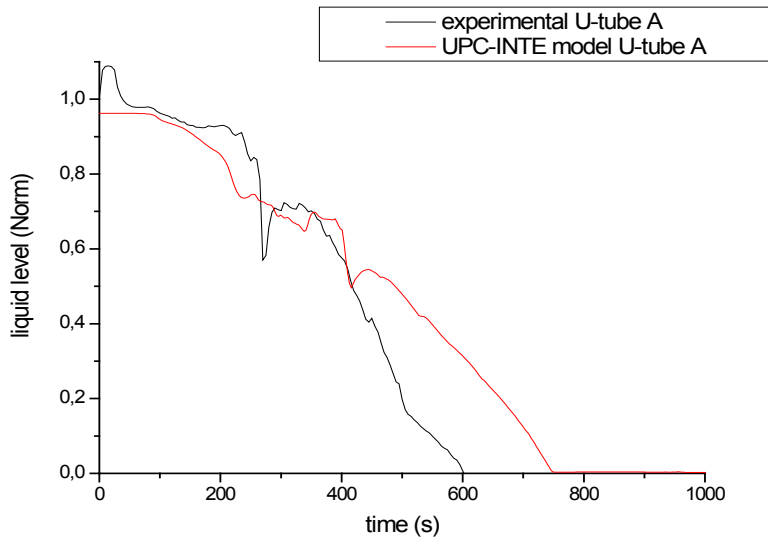

Figure 23 U-tube liquid level on broken loop

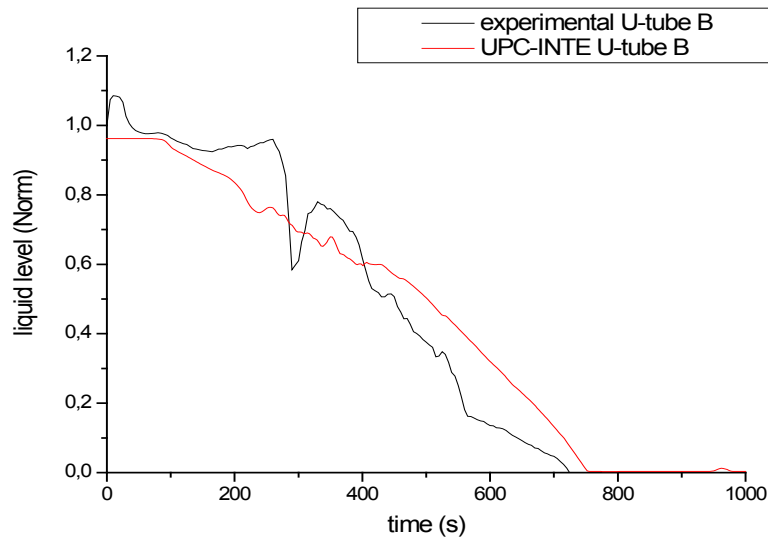

Figure 24 U-tube liquid level on intact loop

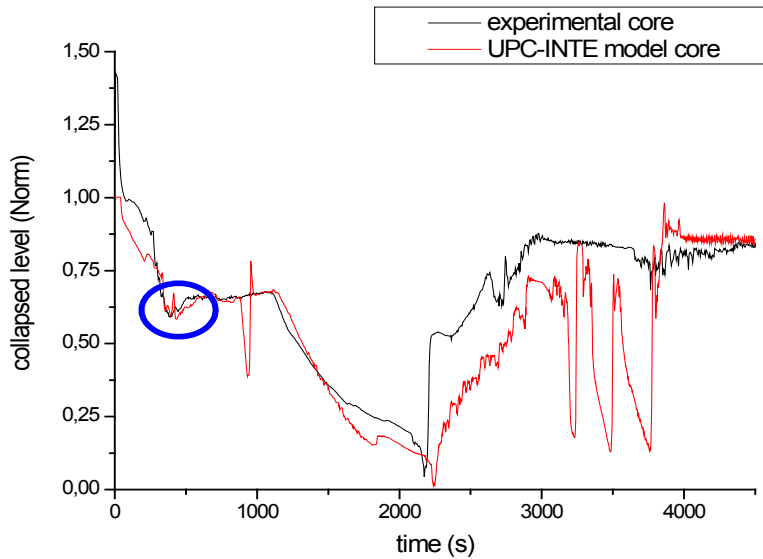

Figure 25 Core collapsed liquid level

4.2.2 Loop Seal Behavior

The UPC-INTE model shows discrepancies in primary pressure and break mass flow rate after the initiation of the accumulator injection system. In the simulation there is an important delay between the accumulators entrance (2180 seconds –see figure 26-) and the loop seal clearing in the broken loop (2898 seconds –see figure 27; black- green lines show the level between the SG outlet and the loop seal bottom, and red-blue lines show the level between the loop seal bottom and the pump inlet-).

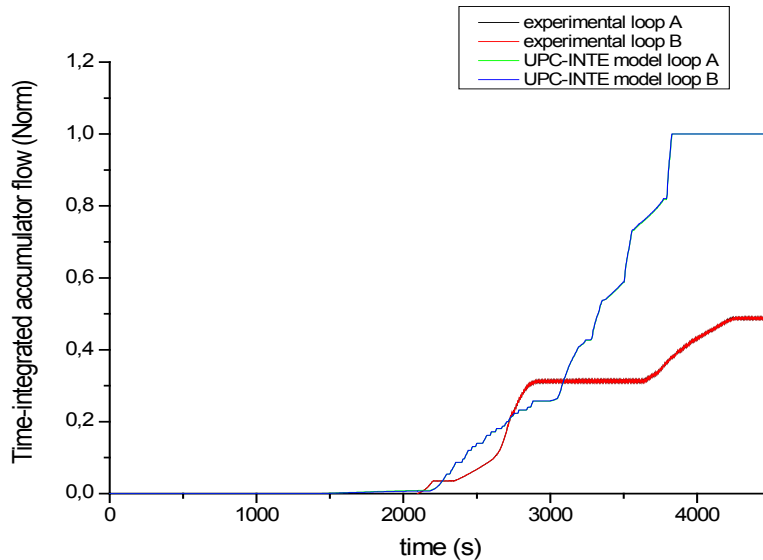

Figure 26 Time-integrated accumulator mass flow rate

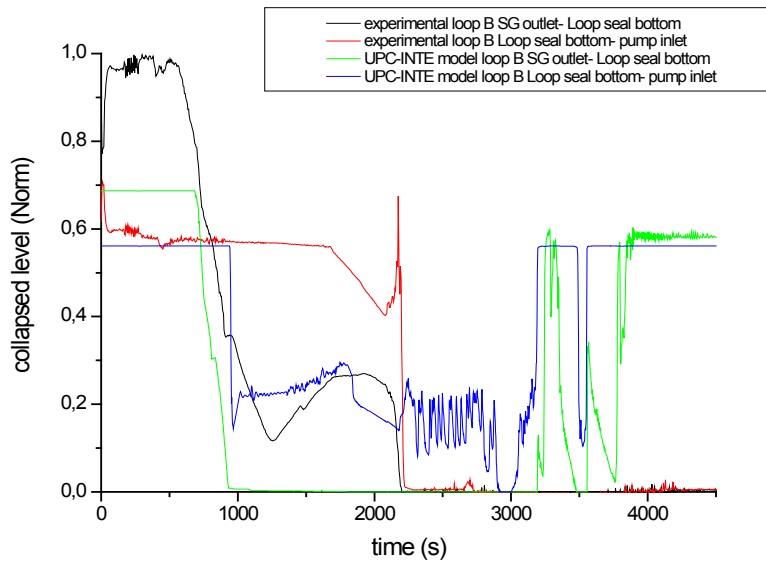

Figure 27 Loop seal collapsed liquid level on broken loop

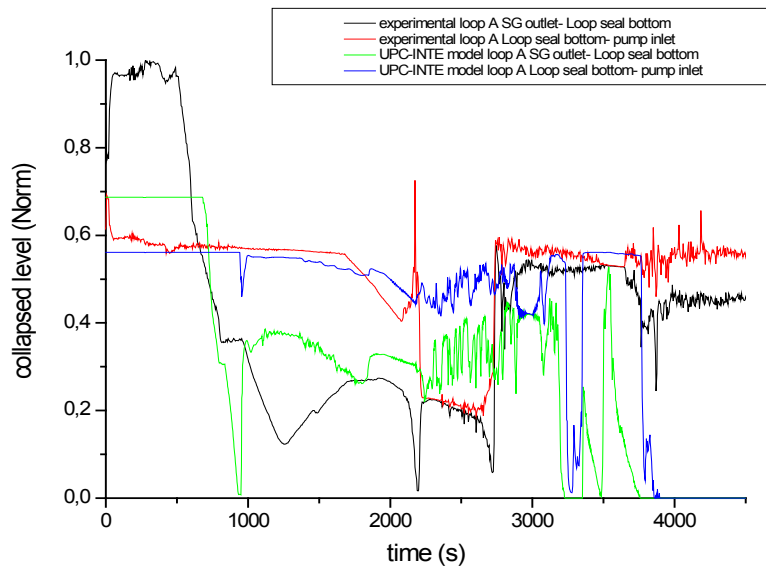

Figure 28 Loop seal collapsed liquid level on intact loop

As shown in figure 26, there are important discrepancies in the accumulator injection. This could be one of the factors why water distribution around the loops is different between the UPC-INTE model and the experimental data (see in figures 27 and 28 the opposite loop seal behavior after the initiation of accumulators system).

5. RUN STATISTICS

The calculations were performed on a Personal Computer with 3.4 GHz Pentium IV processor, 512 MB of RAM and Windows XP Service Pack 2 SO.

The 5379.02 seconds long transient consumed 4545.58 seconds CPU time. It means the CPU time / transient time ratio was 0.84506.

The mass error ratio (e_{mass} / t_{mass}) was reasonably low: $3.10425 \text{ kg} / 231,939 \text{ kg} = 1.338391\text{E-}05$.

6. CONCLUSIONS

A developed model of the LSTF Test Facility has been adjusted and has proved to be a suitable tool to simulate the behavior of this facility.

The post-test calculation for Test 3-1 has been performed. Model predictions were in quite good agreement with the available experimental data. Several conclusions have been obtained from the study of local phenomena (U-tube liquid accumulation due to CCFL and loop seal behavior) and preliminary calculations:

- RELAP5/mod3.3 reproduces supercritical flow and liquid accumulation in the U-tubes during High-Power Natural Circulation.
- A correct implementation of the vessel bypass is strongly related with a satisfactory simulation of the transient.
- There is an important delay in the loop seal clearing as a result of a different accumulator injection and an incorrect water distribution around the primary system after their actuation.
- Differences in the core refilling and fluctuations in the core level suggest vessel bypasses and upper head could be a source of uncertainty.

7. REFERENCES

1. *RELAP5/MOD3 Code manual. Volume IV: models and correlations.* June, 1999. SCIENTECH, Inc.
2. *ROSA-V Large Scale Test Facility (LSTF) system description for the Third and Fourth Simulated fuel assemblies.* The ROSA group JAERI. March, 2003.
3. *OECD/NEA. Quick-look Report of ROSA/LSTF Test 3-1 (High Power Natural Circulation Experiment SB-CL-38 in JAEA).* Report. OECD/NEA ROSA Project. March 20, 2007.

NUREG/IA-0409

BIBLIOGRAPHIC DATA SHEET

(See instructions on the reverse)

2. TITLE AND SUBTITLE

Post-Test Calculation of the ROSA/LSTF Test 3-1 using RELAP5/mod3.3

3. DATE REPORT PUBLISHED

MONTH

YEAR

March

2012

4. FIN OR GRANT NUMBER

5. AUTHOR(S)

V. Martínez, F. Reventós, C. Pretel

6. TYPE OF REPORT

Technical

7. PERIOD COVERED (Inclusive Dates)

8. PERFORMING ORGANIZATION - NAME AND ADDRESS (If NRC, provide Division, Office or Region, U.S. Nuclear Regulatory Commission, and mailing address; if contractor, provide name and mailing address.)

Institute of Energy Technologies
Technical University of Catalonia
ETSEIB, Av. Diagonal 647, Pav. C
08028 Barcelona, Spain

9. SPONSORING ORGANIZATION - NAME AND ADDRESS (If NRC, type "Same as above"; if contractor, provide NRC Division, Office or Region, U.S. Nuclear Regulatory Commission, and mailing address.)

Division of Systems Analysis
Office of Nuclear Regulatory Research
U.S. Nuclear Regulatory Commission
Washington, DC 20555-0001

10. SUPPLEMENTARY NOTES

A. Calvo, NRC Project Manager

11. ABSTRACT (200 words or less)

The Thermal hydraulic Studies Group of Technical University of Catalonia (UPC) holds a large background in nuclear safety studies in the field of Nuclear Power Plant (NPP) code simulators. RELAP5mod3.3 has been used in this study in order to analyze the LSTF Test 3-1, which simulates an anticipated transient without scram (ATWS) as a result of a small break LOCA without rods insertion (but with scram signal) and loss of off-site power. Two local phenomena have been object of study: U-tube liquid accumulation due to CCFL at the inlet of the SG U-tubes, and loop seal behavior during the transient.

12. KEY WORDS/DESCRIPTORS (List words or phrases that will assist researchers in locating the report.)

Consejo de Seguridad Nuclear (CSN)
Thermal-hydraulic
CAMP-Spain program
small break LOCA
LSTF Test 3-1
Technical University of Catalonia (UPC)
TRAC-P
TRAC-B
TRACE

13. AVAILABILITY STATEMENT

unlimited

14. SECURITY CLASSIFICATION

(This Page)

unclassified

(This Report)

unclassified

15. NUMBER OF PAGES

16. PRICE





Federal Recycling Program



**UNITED STATES
NUCLEAR REGULATORY COMMISSION**
WASHINGTON, DC 20555-0001

OFFICIAL BUSINESS

NUREG/IA-0409

**Post-Test Calculation of the ROSA/LTF Test 3-1
Using RELAP5/Mod 3.3**

March 2012