

ARMY **TM 38-400**
NAVY **NAVSUP PUB 572**
AIR FORCE **AFJMAN 23-210**
MARINE CORPS **MCO 4450-14**
DEFENSE LOGISTICS AGENCY **DLAM 4145.12**

**JOINT SERVICE MANUAL (JSM) FOR STORAGE AND
MATERIALS HANDLING**

Approved for public release; Distribution is unlimited.

**DEPARTMENTS OF THE ARMY, THE NAVY, THE AIR FORCE,
AND THE DEFENSE LOGISTICS AGENCY**

April 1994

ARMY
 No. 38-400
 NAVSUP PUB
 No. 572
 AIR FORCE
 No. 23-210
 MCO
 No. 4450-14
 DLA
 No. 4145.12

HEADQUARTERS
 DEPARTMENTS OF THE ARMY, THE NAVY,
 THE AIR FORCE, AND THE DEFENSE
 LOGISTICS AGENCY

Washington, DC, 12 April 1994

**JOINT SERVICE MANUAL (ISM) FOR STORAGE AND MATERIALS
 HANDLING**

REPORTING ERRORS AND RECOMMENDING IMPROVEMENTS

You can help improve this manual. If you find any mistakes or you know of a way to improve the procedures let us know. Mail your letter or DA Form 2028 (Recommended Changes to Publications and Blank Forms) directly to Director, U.S. Army Materiel Command, Packaging, Storage, and Containerization Center, ATTN: SDSTO-TM, Tobyhanna, PA 18466-5097. A reply will be furnished you.

	<i>Page</i>
CHAPTER 1. GENERAL	1-1
CHAPTER 2. STORAGE SPACE MANAGEMENT	2-1
Section I. Types of Storage Space	2-1
Section II. Space Requirement Factors	2-15
Section III. Determination of Storage Requirements (DOSSR) Method	2-25
Section IV. Planning the Storage Layout	2-25
Section V. Space Control and Reporting	2-44
CHAPTER 3. STORAGE PROCEDURES	3-1
Section I. Receiving	3-1
Section II. Shipping	3-14
Section III. Stock Location	3-16
Section IV. Pest Management	3-24
Section V. Inventory	3-27
Section VI. Care of Supplies in Storage (COSIS)	3-31
Section VII. Operations in CH Space	3-35
Section VIII. Security of Materials in Storage	3-40
Section IX. Carrier Loading	3-43
Section X. Unit Loads	3-85
CHAPTER 4. MHE AND PRINCIPLES	4-1
Section I. Basic Principles	4-1
Section II. Materials Handling Equipment	4-4
Section III. Storage Aids	4-42
Section IV. Selection of MHE	4-59
Section V. MHE Requirement Factor	4-63
Section VI. On-The-Job Training Course for Operators of MHE	4-76

	<i>Page</i>
CHAPTER 5. STORAGE OF SPECIAL COMMODITIES	5-1
Section I. Lumber	5-1
Section II. Ammunition and Explosives	5-18
Section III. Vehicles (Tracked and Wheeled) and Artillery	5-18
Section IV. Subsistence	5-39
Section V. Miscellaneous Commodities	5-66
Section VI. Packaged Petroleum Products	5-91
Section VII. Metal Products	5-96
Section VIII. Cable Storing and Handling	5-111
CHAPTER 6. SAFETY	6-1
CHAPTER 7. ON-THE-JOB TRAINING FOR STORAGE PERSONNEL	7-1
Section I. Training Plan	7-1
Section II. Training Program	7-4
Section III. Conference Leader	7-6
Section IV. Storage of Materials	7-16
Section V. Principles of Materials Handling	7-27
CHAPTER 8. STORAGE MANAGEMENT TECHNIQUES	8-1
APPENDIXES	
A. References	A-1
B. Forms	B-1
C. Metric/Temperature Conversion Charts	C-1
GLOSSARY	G-1

By Order the Secretaries of the Army, the Navy, the Air Force, and the Director, Defense Logistics Agency

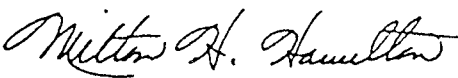
Official: 

MILTON H. HAMILTON
*Administrative Assistant to the
Secretary of the Army*

GORDON R. SULLIVAN
*General, United States Army
Chief of Staff*

Official:

EDWARD A. PARDINI,
*Colonel, USAF
Director of Information Management*

MERRILL A. McPEAK,
*General, USAF
Chief of Staff*

R.A. TIEBOUT
*Lieutenant General, U.S. Marine Corps
Deputy Chief of Staff for
Installations and Logistics*

R.A. ARCHER,
*Captain, SC, USN
Deputy Commander for
Fleet Logistics Operations*

GARY C. TUCKER
*Colonel, USA
Staff Director, Administration, DLA*

Distribution:

Army:

Navy:

Air Force: F

Marine Corps: MARCORPS PCN 10205650400

CHAPTER 1

GENERAL

1-1. Purpose and Applicability.

a. This manual establishes uniform storage and materials handling policies, procedures, and responsibilities for use by the Department of Defense (DOD) supply installations involved in the receipt, storage, issue and care of military supplies and equipment, except for preservation/packing and defense reutilization and marketing facilities, maintenance of bulk petroleum fuel handling facilities, and hazardous materials storage. It is based on an installation which has a wide product mix and stores heavy tonnage items such as subsistence, clothing/textiles, packaged petroleum, oils, and lubricants (POL), as well as small items such as electronics and repair parts. Regardless of what is stored, the basic storage principles apply.

(1) Preservation/packing of military supplies and equipment is contained in joint services publications DLAM 4145.2/TM 38-230-2/NAVSUP PUB 502/AFP 71-15/MCO P4030.31C (vol I), and DLAM 4145.2 (vol. II)/TM 38-230-2/NAVSUP PUB 503 (vol II)/AFP 71-16/MCO P4030.21C. Guidance applicable to bulk petroleum fuel handling facilities is set forth in MIL-HDBK-201, Petroleum Operations. Hazardous materials storage is provided in TM 38-410/DLAM 4145.11/NAVSUP PUB 573/AFR 69-XX/MCO 4450.XX, Storage and Handling of Hazardous Materials.

(2) Defense Reutilization and Marketing Services manual 4160.5, Storage Operations (Warehousing), at the Defense Reutilization and Marketing Offices provides guidance on storage of excess and surplus materials.

b. The provisions of this manual apply to the Department of the Army (DA), the Department of the Navy, the Department of the Air Force, the Marine Corps (MC), and the Defense Logistics Agency (referred to collectively as "DOD Components").

1-2. Policy.

a. Implementation of this manual also requires compliance with DOD directives 4165.60, Solid Waste Management-Collection, Disposal, Resource Recovery, and Recycling Program, and 6050.1, Environmental Effects in the United States of DOD Actions. Additionally, implementation outside the United States requires consideration of host nation environmental quality laws and regulations.

b. Storage and materials handling policies, procedures, and methods at DOD Component supply installations/activities will be uniform to the maximum practicable extent. Policies, procedures, and methods indicated herein by directive words such as "will," "shall," or "must," are mandatory. The use of such words as "may" or "should" indicates that the procedures and methods described are recommended, but not mandatory.

c. DOD ~~4145.19-R~~ Storage and Warehousing Facilities and Services, will be used in conjunction with this manual. *JN 78*

d. When necessary, DOD Components may authorize temporary deviations when compliance with mandatory provisions is temporarily impracticable or the deviation is required as an exigency measure. Temporary deviations, including any extensions thereto, will not exceed 90 days. DOD Components may authorize interim deviations from the mandatory provisions of the manual. Advice of any authorized deviation which may extend beyond 90 days will be forwarded to the Department of Army, ATTN: DALO-SMP, Washington, DC 20310, within 15 days of the date of authorization, for a coordinated determination as to whether it should be (*a*) incorporated into the regulation, (*b*) continued as an authorized deviation, (*c*) withdrawn, or (*d*) referred to the Assistant Secretary of Defense (Production and Logistics) (ASD (P&L)) for approval.

1-3. Organization and Use.

a. Organization. This manual is organized by major subjects (sections) and functions (parts). A table of contents reflects the scope of subjects included. The looseleaf format of the manual facilitates changes and additions to the text.

b. Table of contents and index. The organization of this publication makes it possible to locate desired information easily by referring to the table of contents in the front of the manual to determine general locations. Information that is too detailed for identification by this method may be located by reference to the topical index.

c. Illustrations. The purpose of the illustrations is to show by means of photographs, charts, or completed sample forms, the principles and procedures explained in the text. The illustrations do not necessarily show current names, dates, and

figures, but are included in order that the principles outlined in the written instructions may be clarified.

d. Publication of changes. The AMC, Packaging, Storage, and Containerization Center (PSCC), DOD Working Group, which is chaired by a PSCC representative, will coordinate all changes and revisions to the manual with the appropriate service/

DLA storage and warehousing focal points. Copies of proposed changes will be provided to the service/agency headquarters and an ASD (P&L) representative upon request.

1-4. Explanation of Terms.

Explanation of special terms used in this regulation are explained in the Glossary.

CHAPTER 2

STORAGE SPACE MANAGEMENT

Section I. Types of Storage Space

2-1. Introduction.

The contents of this section illustrate the general characteristics and functions of the most common types of storage space (covered and open) used by DOD Components.

2-2. Covered Storage Space.

a. Covered storage space is storage space within any roofed structure. It is used for the storage of a wide variety of material such as for the storage of general supplies and ammunition.

b. Covered storage space is generally comprised of two types of storage space, warehouse and nonwarehouse. Warehouse storage space includes general purpose, controlled humidity (CH), refrigerated, and flammable or hazardous materials facilities. All other roofed structures are of the nonwarehouse type. They include, but are not limited to, dry tanks, sheds, transitory shelters, nontraditional structures, and magazines.

(1) *Warehouse storage facilities.* These facilities have a roof, side and end walls, and many have ground-level and/or truck or railcar bed-level loading docks. Cantilever support canopies over docks may also be provided. They are generally single-story buildings, though multistory buildings qualify. These facilities can be modified to serve a variety of purposes such as converted to a controlled humidity facility.

(a) *General purpose warehouse.* This type of warehouse may be heated or unheated and is used for various storage functions and for the storage of a wide variety of items. The greatest portion of covered storage space at DOD installations is normally in this type of structure. The single-story structure with loading docks at truck and railcar bed level has become the standard warehouse. Figure 2-1 provides an example of a dock-level general purpose warehouse. An example of a ground-level general purpose warehouse is shown in figure 2-2.

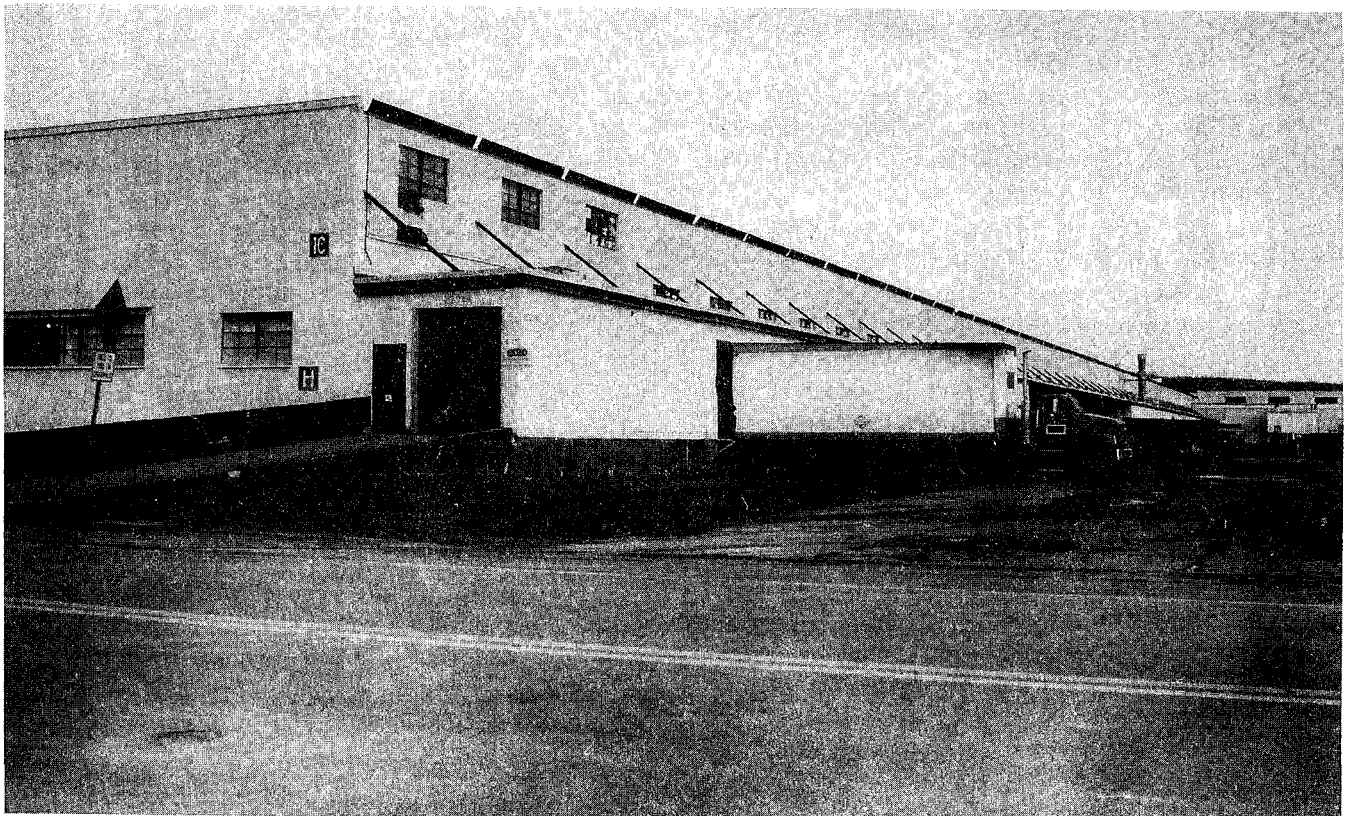

Figure 2-1. Dock-Level General Purpose Warehouse

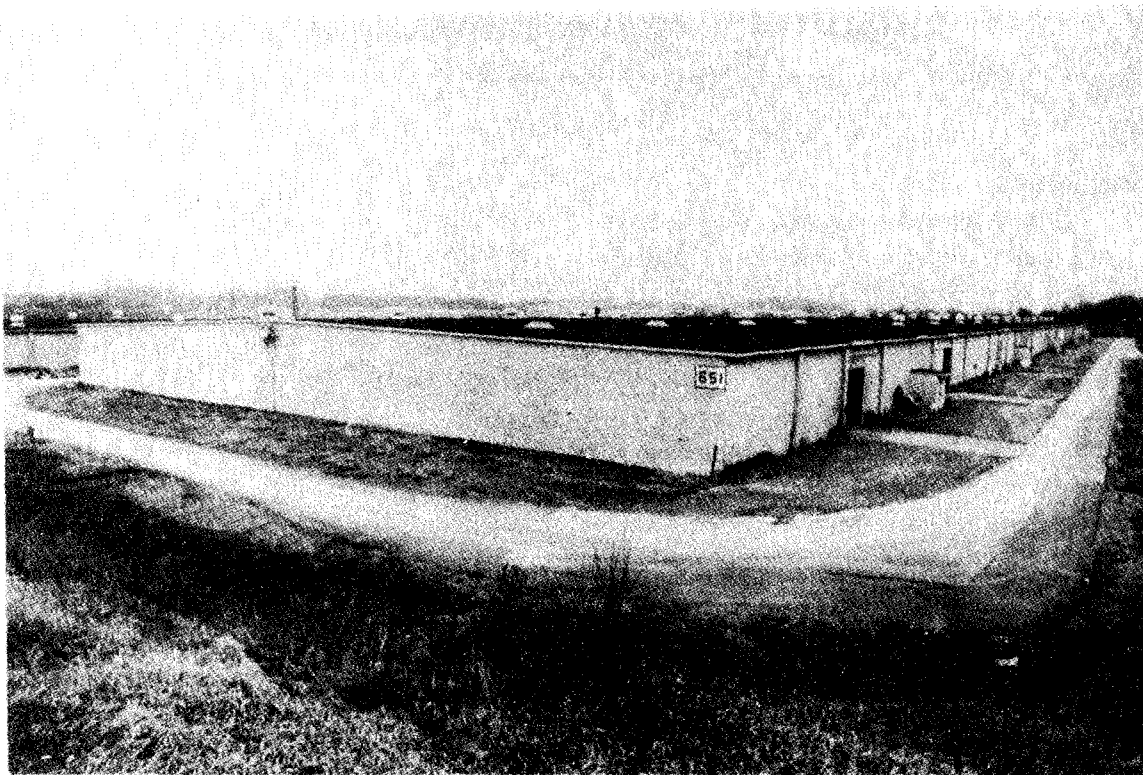

Figure 2-2 Ground-Level General Purpose Warehouse

1 As shown in figure 2-1, a truck dock of sufficient width on one side of the warehouse provides for loading/unloading of truck-hauled supplies. The matching dock and warehouse floor permit direct access of materials handling equipment (MHE) between warehouse interior and interior of carrier conveyance and vice versa.

2 Sometimes, on the side opposite the truck dock, a railcar dock runs the full length of the warehouse. This permits easy access to railcars from any warehouse door. Rail docks should be located on either side of the two right angle sides of new warehouses to allow for future expansion of the buildings. Current construction techniques do not favor full length docks due to cost; therefore, a dock(s) to service a lesser number of doors becomes more practical.

3 Office space may vary in size and location. In most instances, such space is located within the warehouse. In others, the space is attached to the outside of the warehouse. In either case, the office space is generally located on the same side of the warehouse as the truck docks.

4 Two main aisles normally run the length of the warehouse to allow MHE or supplies to move straight through the length of the building. These main aisles are typically connected by cross aisles.

5 Functions normally found in a general purpose warehouse include loose issue and/or bulk storage, receiving, shipping, preservation, packing, carton fabrication, and unit and set assembly. Special caged security areas may also be located in the warehouse for the storage of classified, pilferable, or sensitive items.

(b) *CH warehouse.* This type facility is used for the storage of items that require protection against damage and deterioration that can result from excessive humidity. It is particularly applicable for items that are to remain in storage for extended periods.

1 Almost any type of warehouse may be operated under CH conditions if properly sealed and equipped. The general purpose warehouse is, however, the type most frequently built for or converted into a CH environment (see fig 2-3).

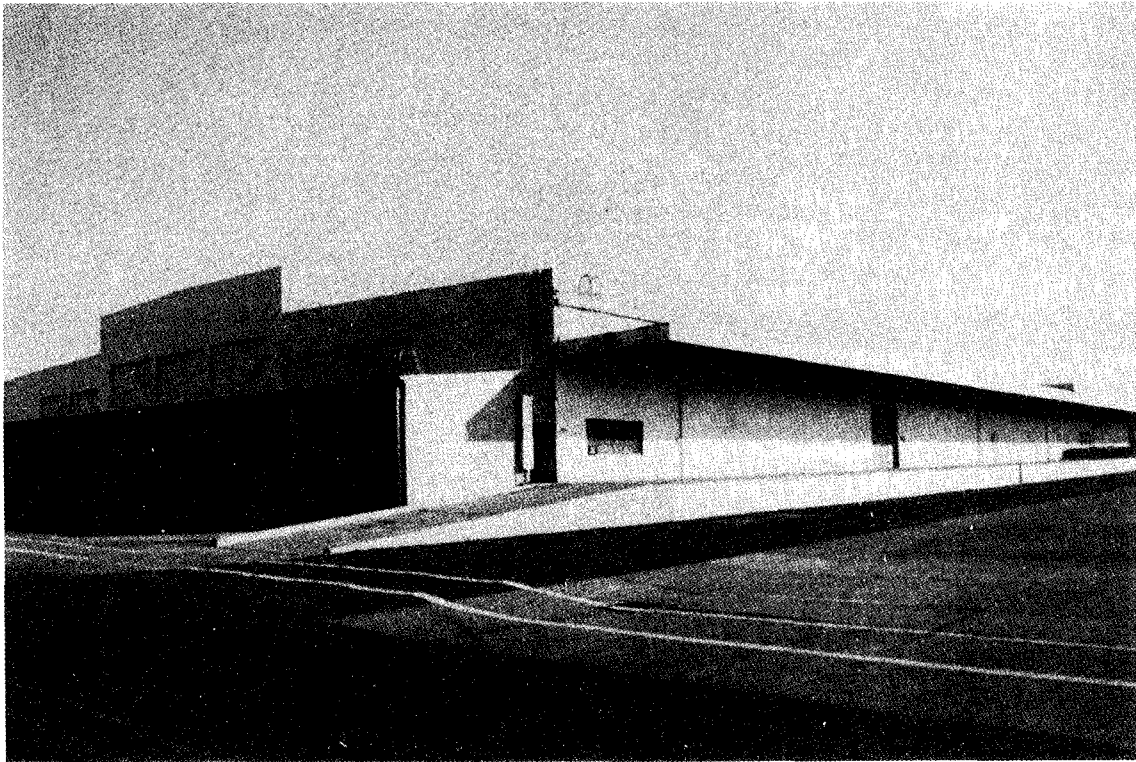

Figure 2-3. CH Warehouse

2 See section VII, chapter 3, for details on operations in CH space.

(c) *Refrigerated warehouse.* The refrigerated warehouse resembles a general purpose warehouse although it is usually smaller, as can be seen in figure 2-4. Truck and railcar docks may be on opposite sides of the warehouse or combined on one side.

1 The interior of the warehouse is normally divided into two parts. One part is des-

ignated as chill space in which the temperature can be controlled between 32 °F and 50 °F (0 °C and 10 °C). The other part is designated as freeze space in which the temperature can be controlled below 32 °F (0 °C).

2 When the warehouse is divided into chill and freeze space, there are no main aisles that run the length of the warehouse. Cross aisles provide the access to railcar and truck docks.

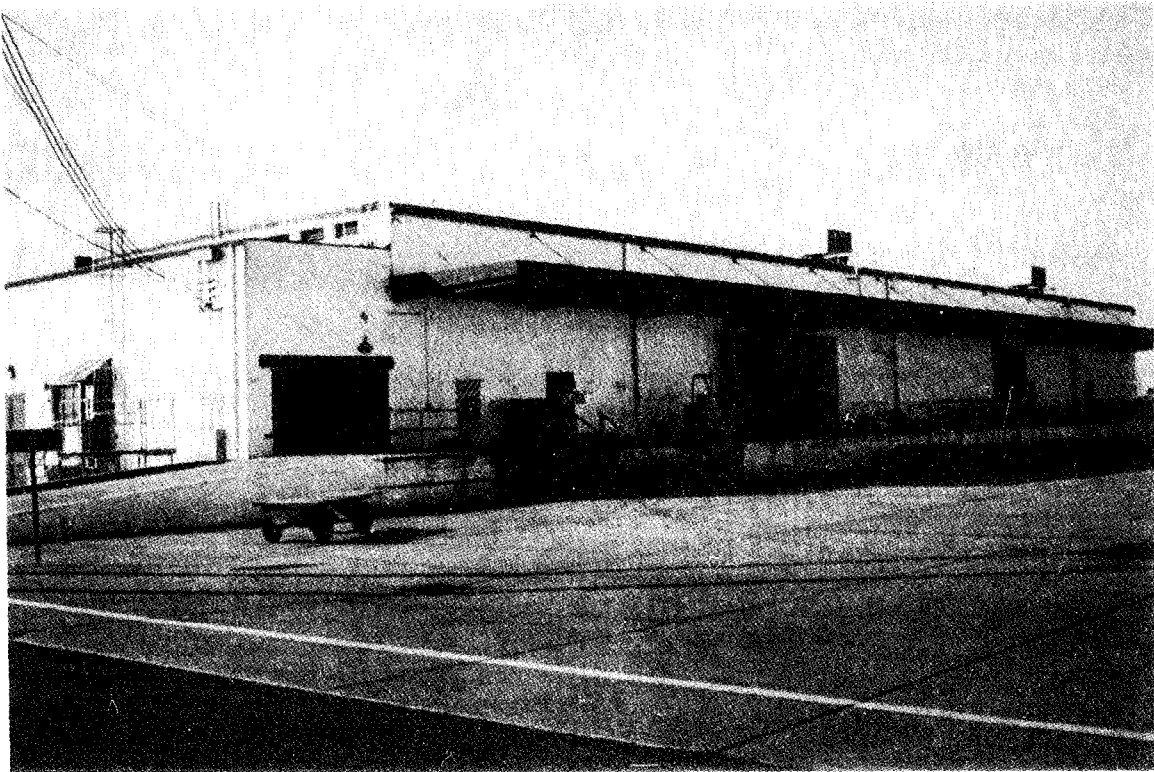

Figure 2-4 Refrigerated Warehouse

(d) *Flammable/hazardous materials warehouse.* This facility is built of noncombustible materials and is compartmentalized with fire walls that have a 4-hour fire resistant rating. The hazardous materials facility contains explosion proof lighting, spill containment with sloped floors, and trenches which allow spilled material to collect in a sump tank. Care must be taken to ensure that spills are contained and cannot enter into central sewerage or storm drain systems. Protection comes from an alarm reporting system and automatic deluge-type sprinklers connected to an adequate water supply. For further protection, the warehouse is usually located in an isolated area.

1 Inner fire walls without doors are preferred because of the greater fire protection af-

forded. However, fire walls without doors necessitate greater care in stock location since subsequent stock movements must be accomplished without benefit of free movement within the facility.

2 Figures 2-5 and 2-6 show an exterior view of a flammable warehouse and a hazardous materials facility, respectively. A floor plan of a typical flammable/hazardous materials facility is illustrated in figure 2-7. As indicated, storage areas are divided into acids, flammables, oxidizers, alkalis, and miscellaneous.

3 See TM 38-410 or individual service/agency publications, as applicable, for details on operations in flammable/hazardous materials areas.

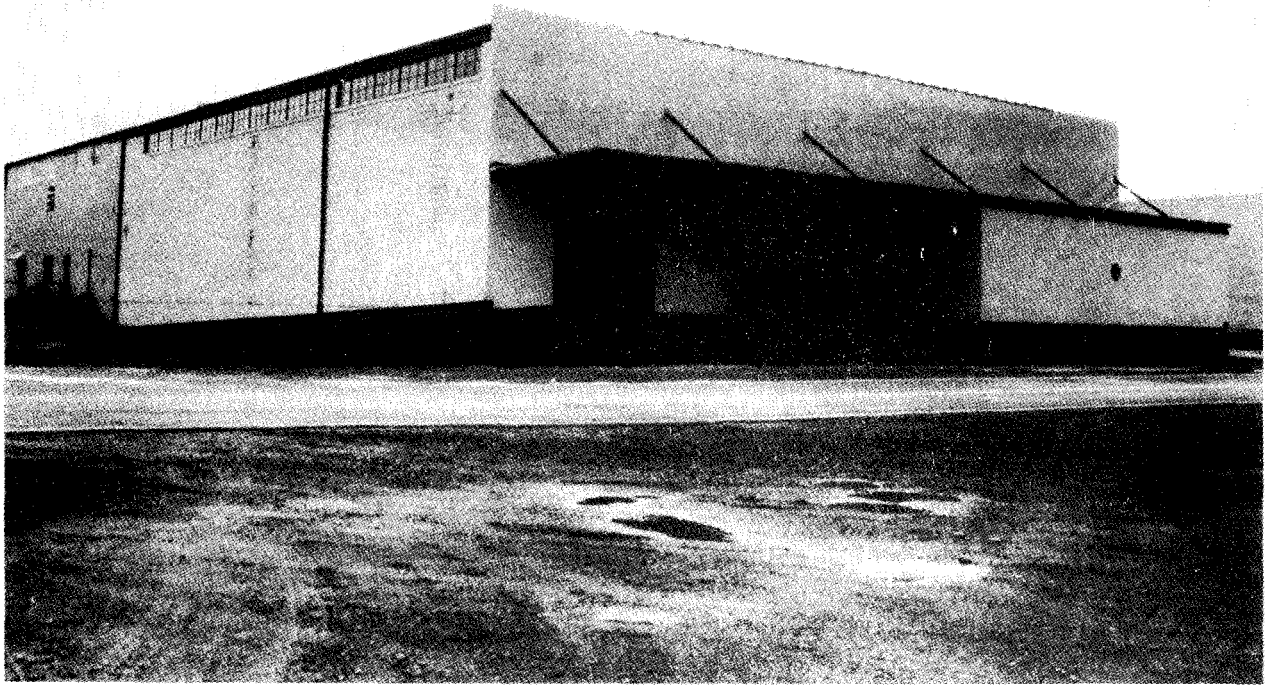

Figure 2-5 Flammable Warehouse

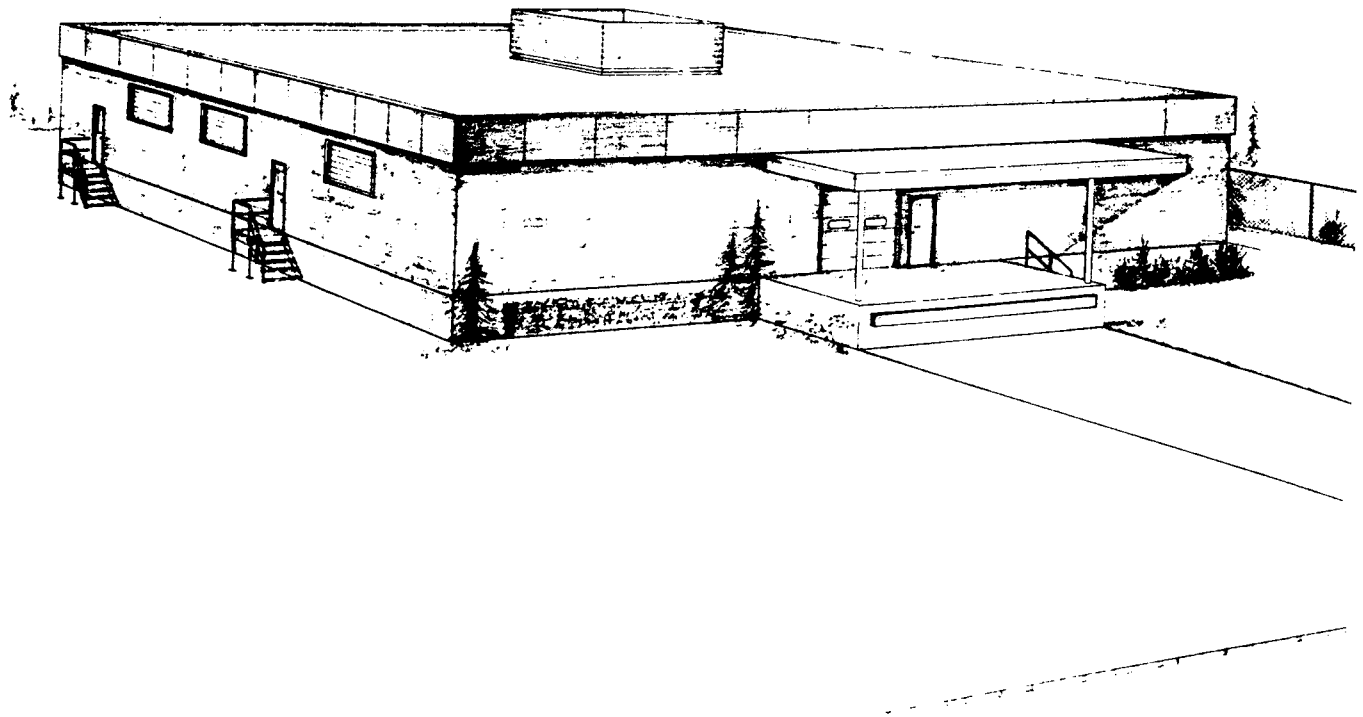

Figure 2-6 Hazardous Materials Facility

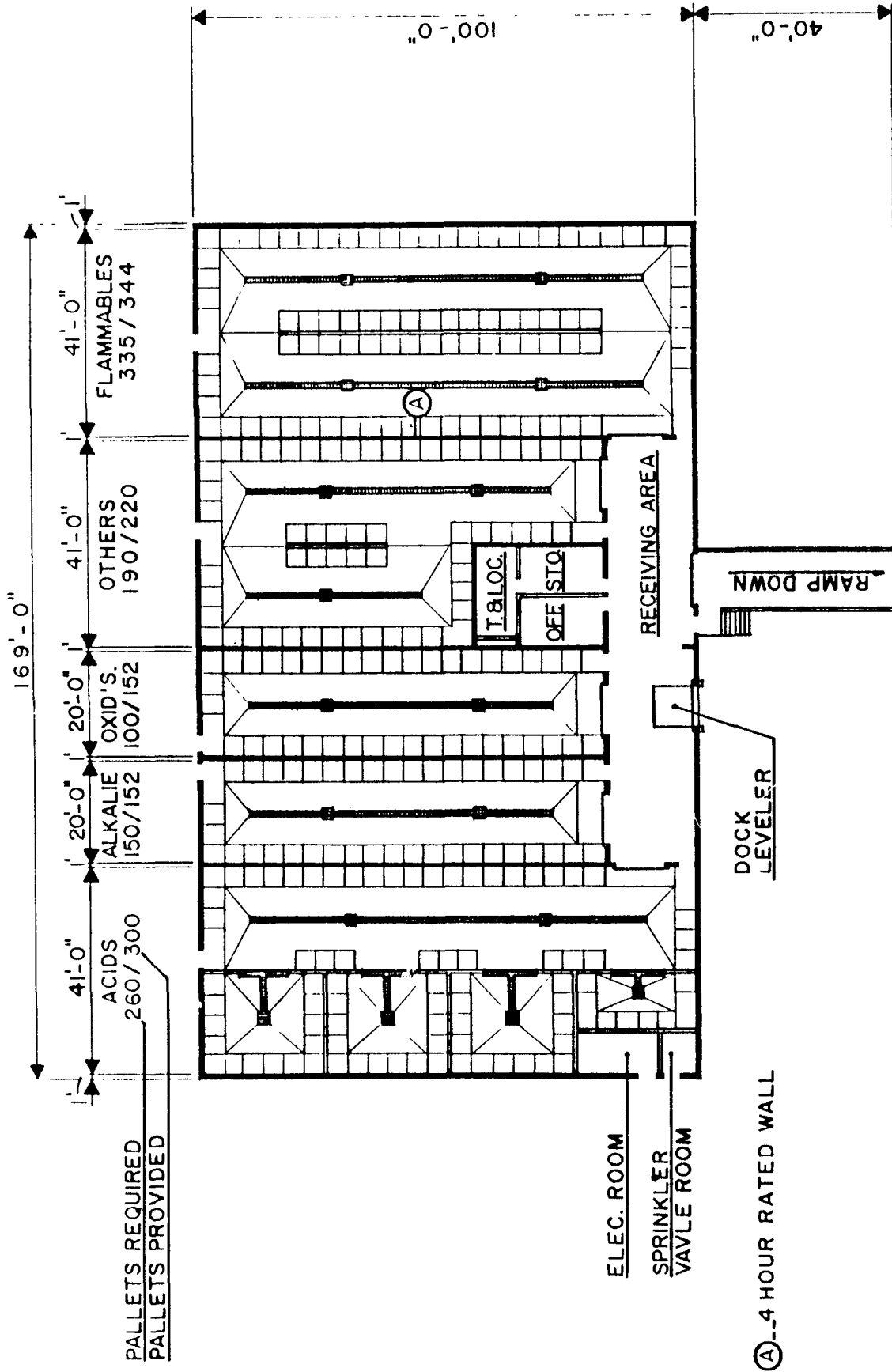

Figure 2-7 Floor Plan of a Flammable / Hazardous Materials Facility

(2) *Nonwarehouse storage facilities.* These facilities have a roof but vary as to the number of walls and type of construction. Examples include—

(a) *Shed.* A shed is a structure without complete side and end walls. It may be equipped

with utilities. A shed is used for the storage of materials that require maximum ventilation or materials that do not require complete protection from the weather. Figure 2-8 shows some typical examples of sheds.

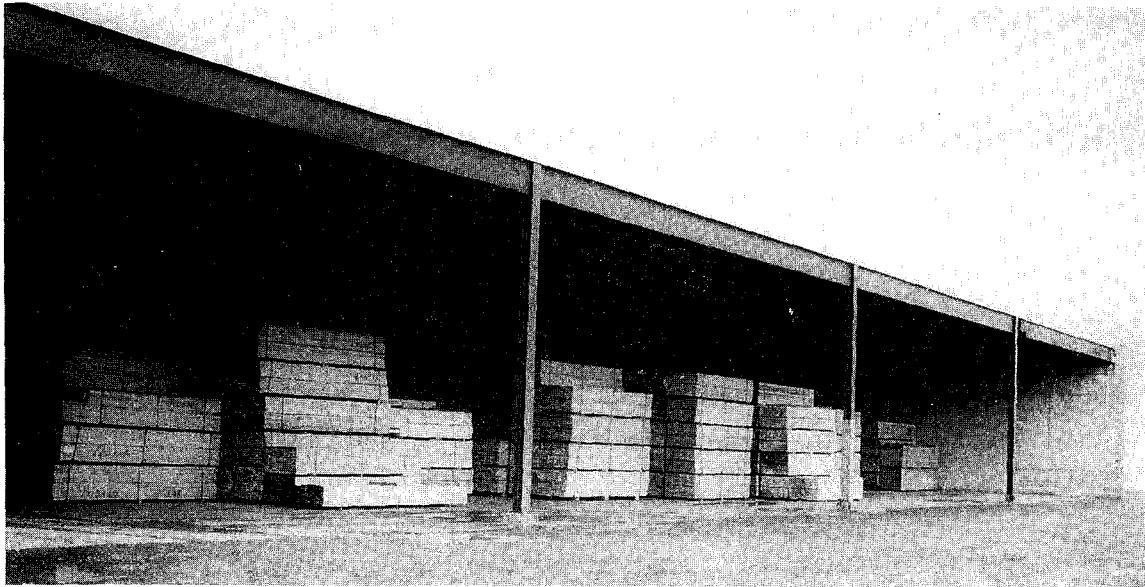

Figure 2-8. Typical Examples of Sheds

1 Most sheds are considered permanent structures since they are not readily dismantled for relocation. However, some sheds are transitory in that some are prefabricated structures which can be dismantled for movement and reassembly.

2 There are various means by which items that are stored in sheds and which require

added protection from the weather may be protected while other items requiring only minimum protection are left semiexposed. For example, tarpaulins maybe used as side walls or pallets maybe positioned to form a protective wall. The use of pallets in this fashion, where feasible, serves a dual purpose since valuable storage space inside the shed will not be occupied by empty pallets.



Figure 2-9 Above-Ground Magazine

(b) *Magazine.* This type of structure is designed for the storage of ammunition and explosives. These structures are widely separated in the storage area to minimize destructiveness should an explosion occur. There are two types, above ground and earth covered.

1 *Above-ground magazine.*

(a) This magazine is similar in appearance to the general purpose warehouse; however, it is built of fireproof materials and is well ventilated to lessen the danger of explosion (see fig 2-9). It normally has a dock that runs the entire length of the building to service both truck and railcars.

(b) Inside the typical magazine, main aisles do not run the length of the building as is common in a general purpose warehouse. Generally, cross aisles corresponding to the outside door locations run from the front to the rear of the building. However, in the instance of large-lot storage (e.g., a single item of ammunition, etc.), aisles in certain sections of the magazine may be eliminated.

(c) Although it may be necessary at times to use a general purpose warehouse to store small arms ammunition, the warehouse is not classified as a magazine because it does not have the special design construction required for proper storage of ammunition and explosives.

2 *Earth-covered magazine.*

(a) The structure, more commonly referred to as an igloo, is generally constructed of reinforced concrete with an arch-type roof covered with earth. The arched roof is an added safety feature since in the event of an explosion, the highest point of the arch which is also the weakest point would collapse first, thereby lessening the damage caused by the explosion. Figure 2-10 shows two common examples of igloos. Although igloos are not heated, the temperature inside ordinarily ranges between 40 °F and 45 °F in winter to between 60 °F and 70 °F in summer.

(b) The typical igloo has a single door on only one end which is smaller than a truck door; however, some have double doors. Truck doors are rare. Normally, a centrally located dock(s) is constructed in the ammunition area to service trucks and railcars.

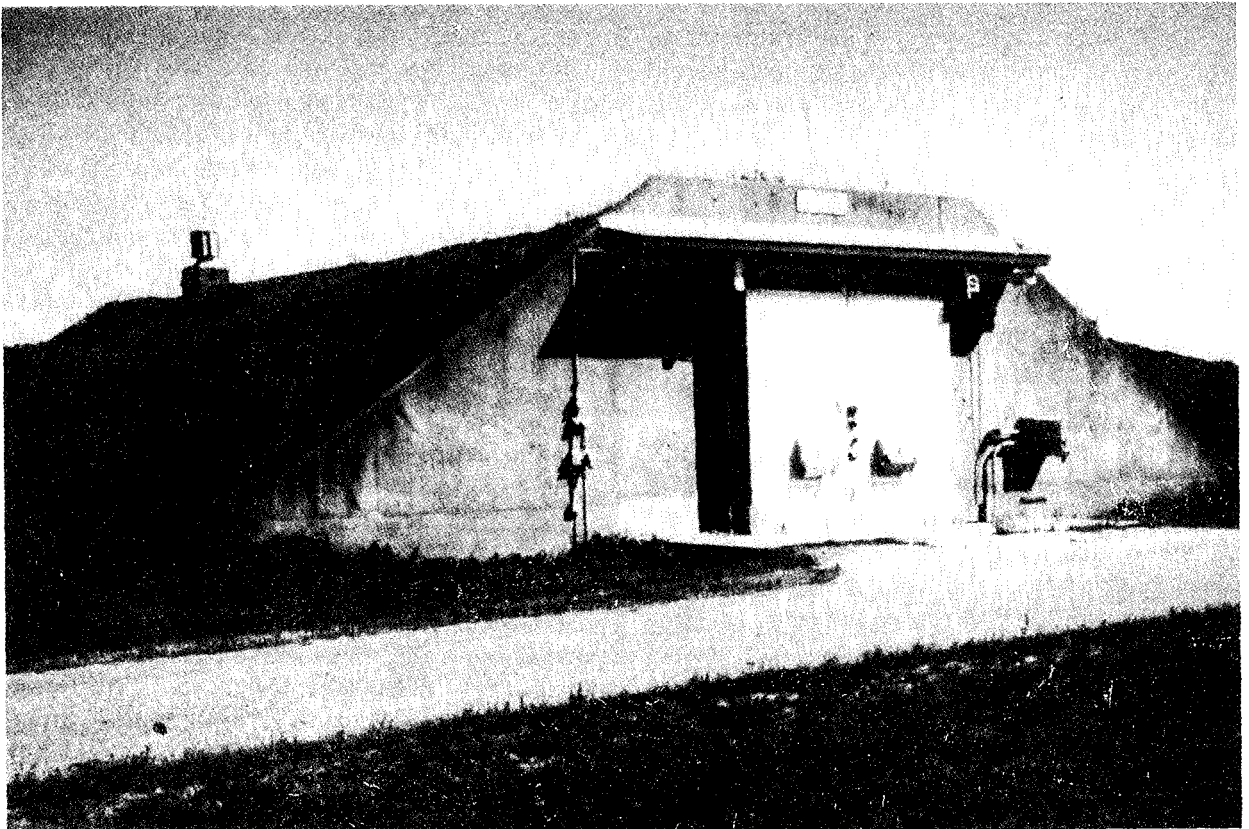
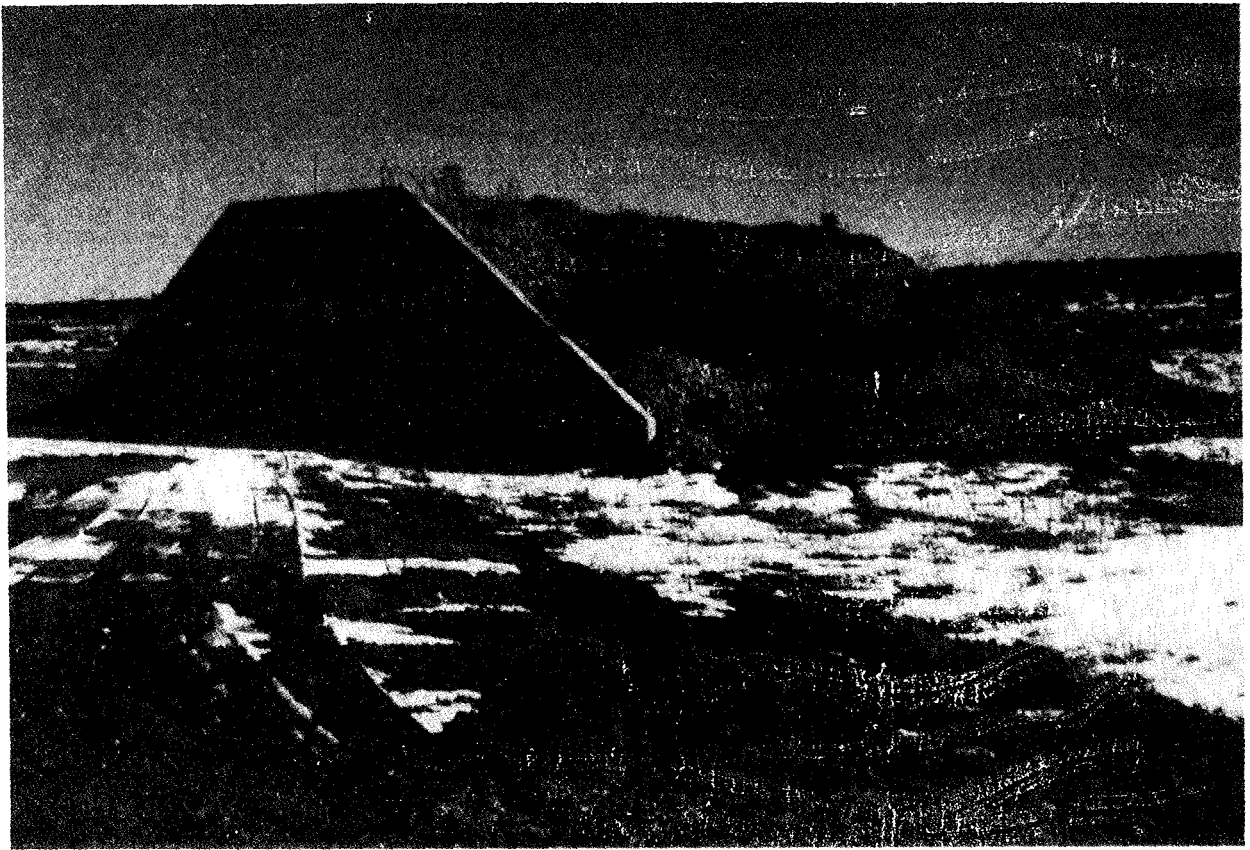

Figure 2-10 Typical Earth-Covered Magazines

(c) The isolated location and peculiar construction of the igloo limit the type of MHE that can be used. A clearance must be provided between stacks and walls. This clearance will be in accordance with commodity characteristics and regulations of the appropriate military service. In addition to quantity distance factors, uniform

stacking heights are limited due to the arched roof.

(c) *Other.* There are various other non-warehouse facilities that can be used for storage such as the hangar shown in figure 2-11 which is used for the storage of helicopters. In addition, the following are included:

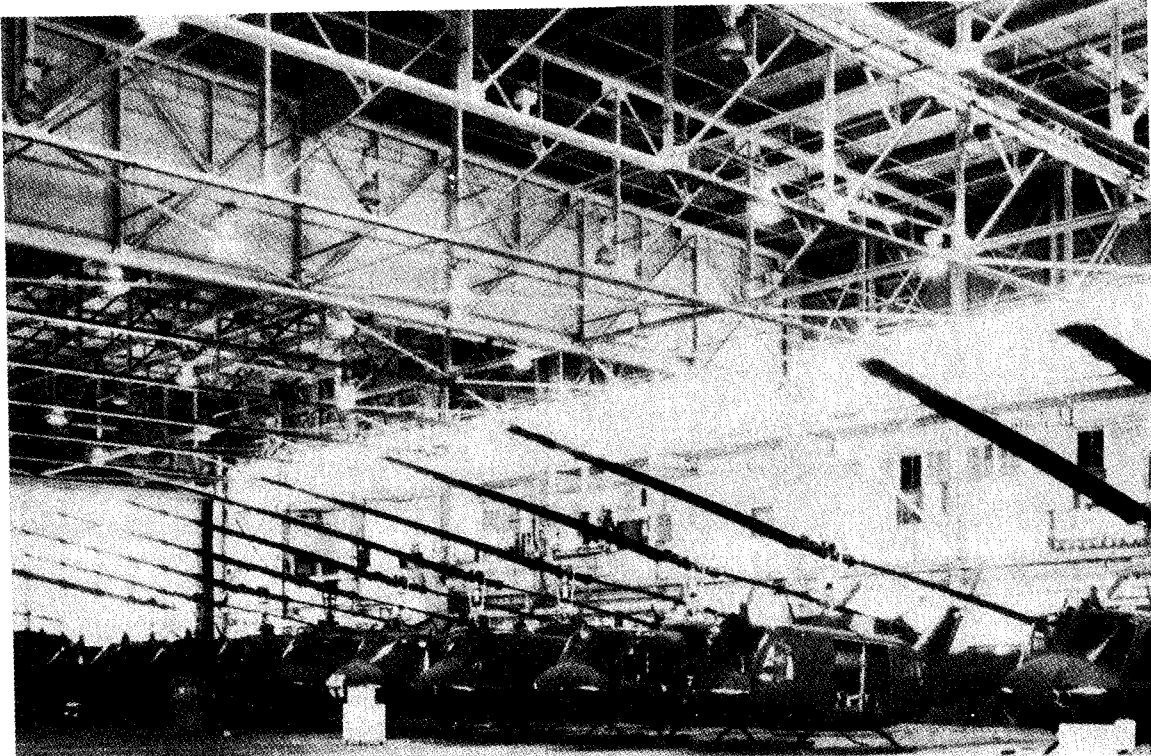

Figure 2-11 Helicopters Stored in a Hangar

1. *Dry tank.* Figure 2-12 shows a dry tank storage area. The tank is constructed of bolted metal except for a concrete floor. It may be temperature and/or humidity controlled. The tank may be completely sealed (sections must be un-

bolted for access) or fitted with a single door. Dry tanks are used for long-term storage. Access roads parallel the rows of tanks. Because of the size and shape of dry tanks, there are no operating aisles for MHE although MHE is used in the storing process.

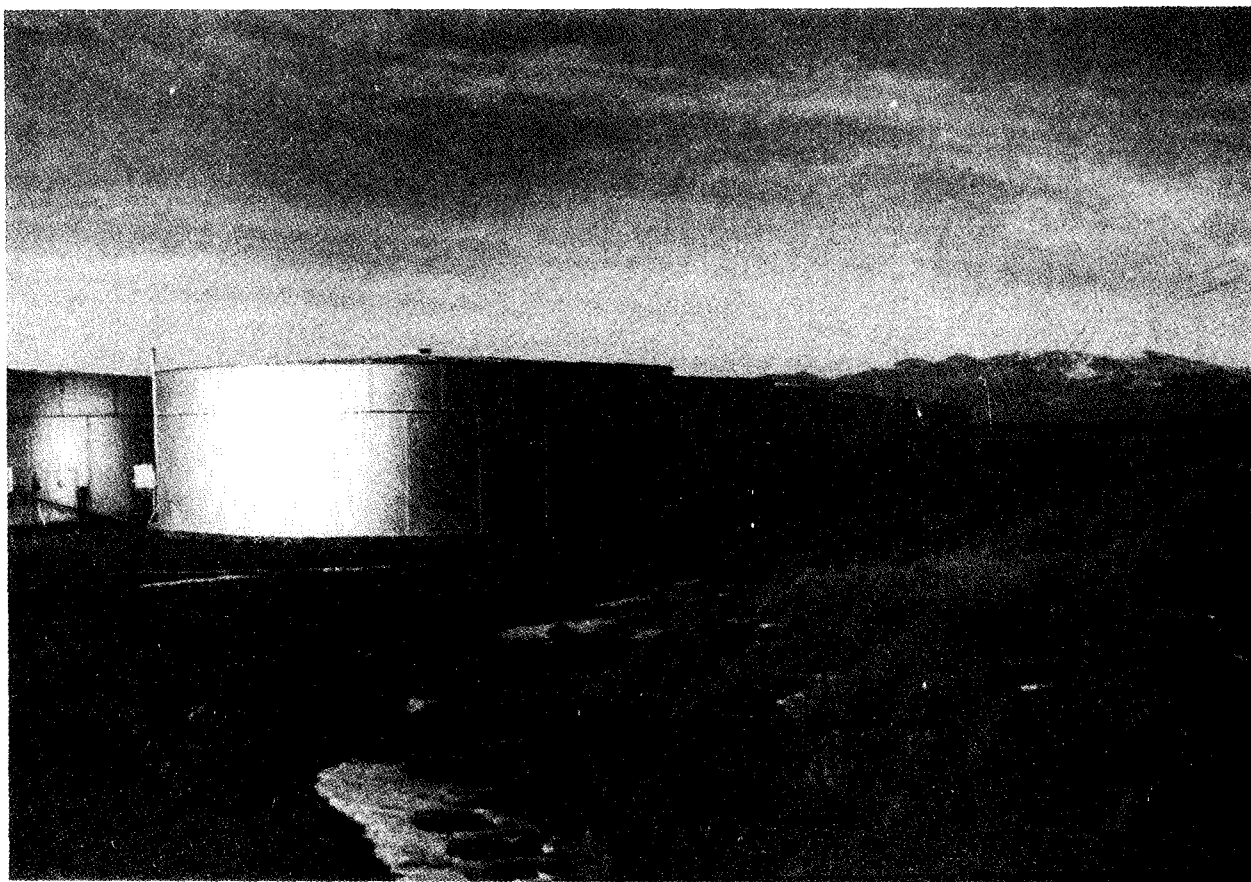

Figure 2-12 Dry Tank Storage Area

2. *Transitory shelter.* A transitory shelter is a prefabricated metal structure normally with complete sides and ends. Utilites are not normally included therein although they are some-

times provided. Such structures can be dismantled for movement and reassembly. A transitory shelter is classified as a storage aid rather than a real property facility. Figure 2-13 shows an example of a transitory shelter.

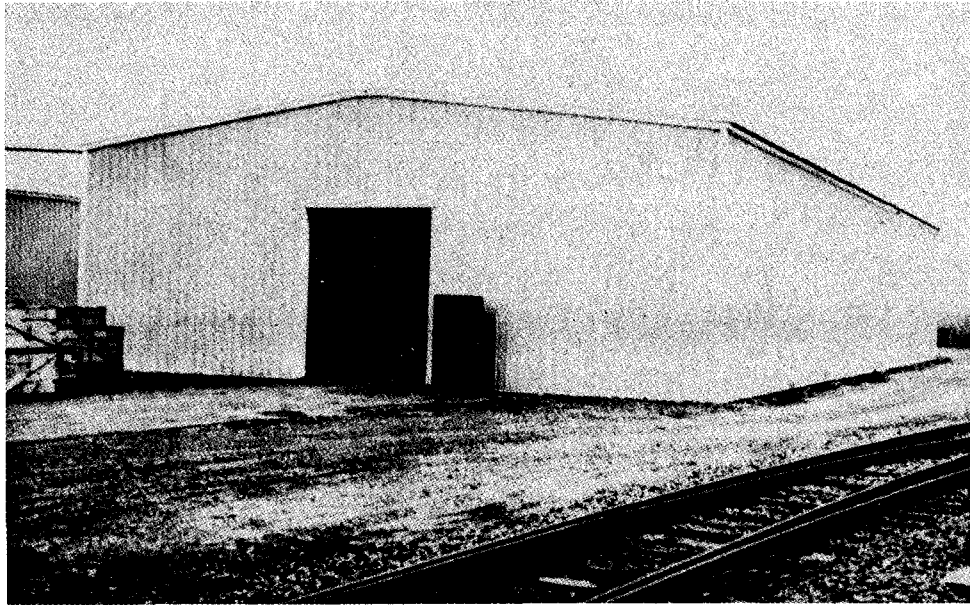

Figure 2-13. Type of Transitory Shelter

3. Nontraditional storage structures. These structures generally offer a less costly alternative to the conventional brick-and-mortar type storage facilities. Most offer the advantage of a clear span, on-site fabrication, and fast on-site assembly. Some offer the advantage of being totally

relocatable. They can be constructed of metal as can be seen in figure 2-14. This structure is referred to as a RELMS (rapidly erectable lightweight mobilization structure). Other structures are constructed of fabric stretched over a metal frame and are referred to as stress tension shelters (STS) (see fig 2-15).

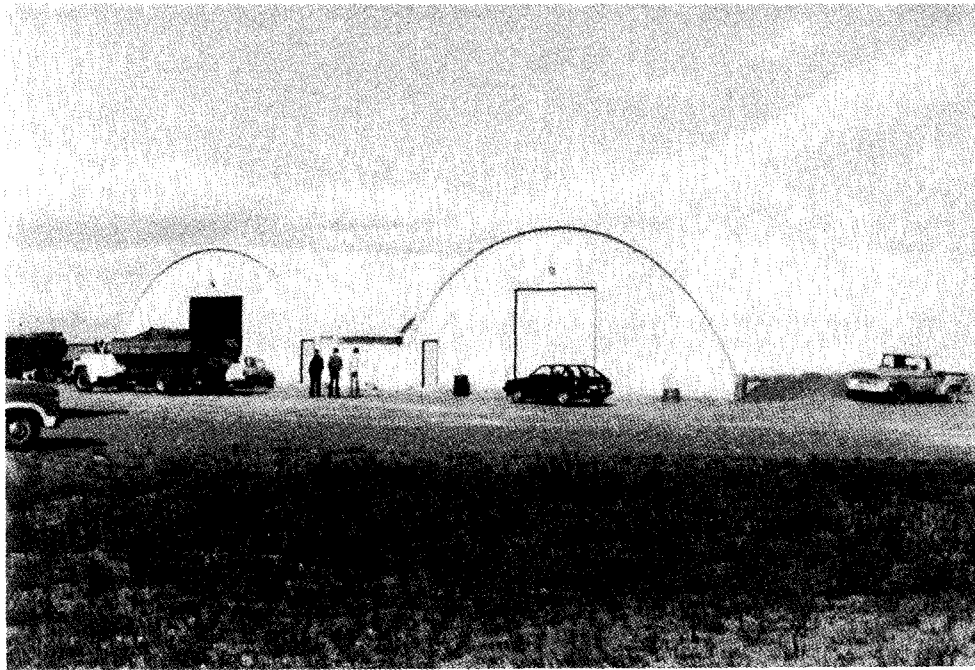

Figure 2-14. Example of RELMS



Figure 2-15 Example of an STS

2-3. Open Storage Space.

a. Open storage space is all uncovered space that is used for storage purposes. There are two types of open storage areas, improved and unimproved.

(1) *Open improved storage space.* This space includes areas that have a finished surface such as

space that has been graded and surfaced with concrete, tar, asphalt, crushed stone, gravel, or other suitable topping. The area is surfaced with a suitable topping which provides adequate drainage necessary to afford the item with protection from wet ground conditions. Figure 2-16 shows an example of a hard surface open improved storage area.



Figure 2-16 Hard Surfaced Open Improved Area

(a) An open improved storage area usually has a hard surface of a more conventional surfacing topping which provides an adequate running surface for the operation of MHE. A steel mat topping may be used in some instances due to immediate need or lack of other suitable topping; however, this method is not desirable.

(b) Storage layouts for open improved areas vary because of terrain features and types of commodity stored. In reality, aisles become roadways due to the size of the MHE required.

(2) *Open unimproved storage space.* This space consists of unsurfaced open areas designated for storage purposes.

(a) The limitation on the use of MHE is a significant disadvantage of open unimproved storage. This type storage should be used only with certain stock and only when a higher upgrade of open improved space is not available.

(b) A storage layout for an open unimproved area is affected by the same criteria as that for open improved storage areas. However, to take advantage of existing drainage, supplies may have to be positioned and aisles or roadways may have to be located, without regard to conventional storage practices.

b. Storage managers must be aware that material stored in open storage areas may be either approved or unapproved for storage in such areas. Material that is approved for open storage is so authorized because there is little or no concern of damage to the material which could result from the elements of an open environment. Sometimes material stored in open areas is unapproved for storage in that the material requires covered storage but is being stored in open areas. Unapproved open storage can result in causing severe damage to the material being stored because of overexposure to harsh environmental conditions.

Section II. Space Requirement Factors

2-4. General.

a. Storage space is a basic resource of any storage operation. Economy depends upon the optimum utilization of this space and the proper arrangement of operations incident to the receipt,

storage, and issue of materials. Space economy can be obtained only by thorough planning for the use of space.

b. Space requirements are not computed on an "after the fact" basis. That is, inventories are not

stored and then computations developed to indicate that X amount of storage space is required. To the contrary, space requirements are projected ahead of actual physical occupancy with sufficient accuracy to avoid overallocation.

2-5. Scope.

This procedure does not apply to wet storage areas; rolling stock yards; petroleum, oil, and lubricants (POL) tank farms; storage of complete aircraft; industrial tool storage in contractor plants; or to ammunition storage space computations which are developed under separate instructions of the military services.

2-6. Considerations in Space Requirement Computations.

There are many factors which must be considered in developing a procedure for computing storage space requirements. These factors must be recognized in a way that will enable ready adaptability by all echelons concerned with computing space requirements or occupancy factors. The following identify these key factors, some of which are illustrated in figures 2-17 through 2-19:

a. Quantity of inventory. Although many elements contribute to the computation of storage space requirements, quantity is the basic element or conversion factor. From this, space requirements can be computed through application of dollar value and/or cubic footage of supplies.

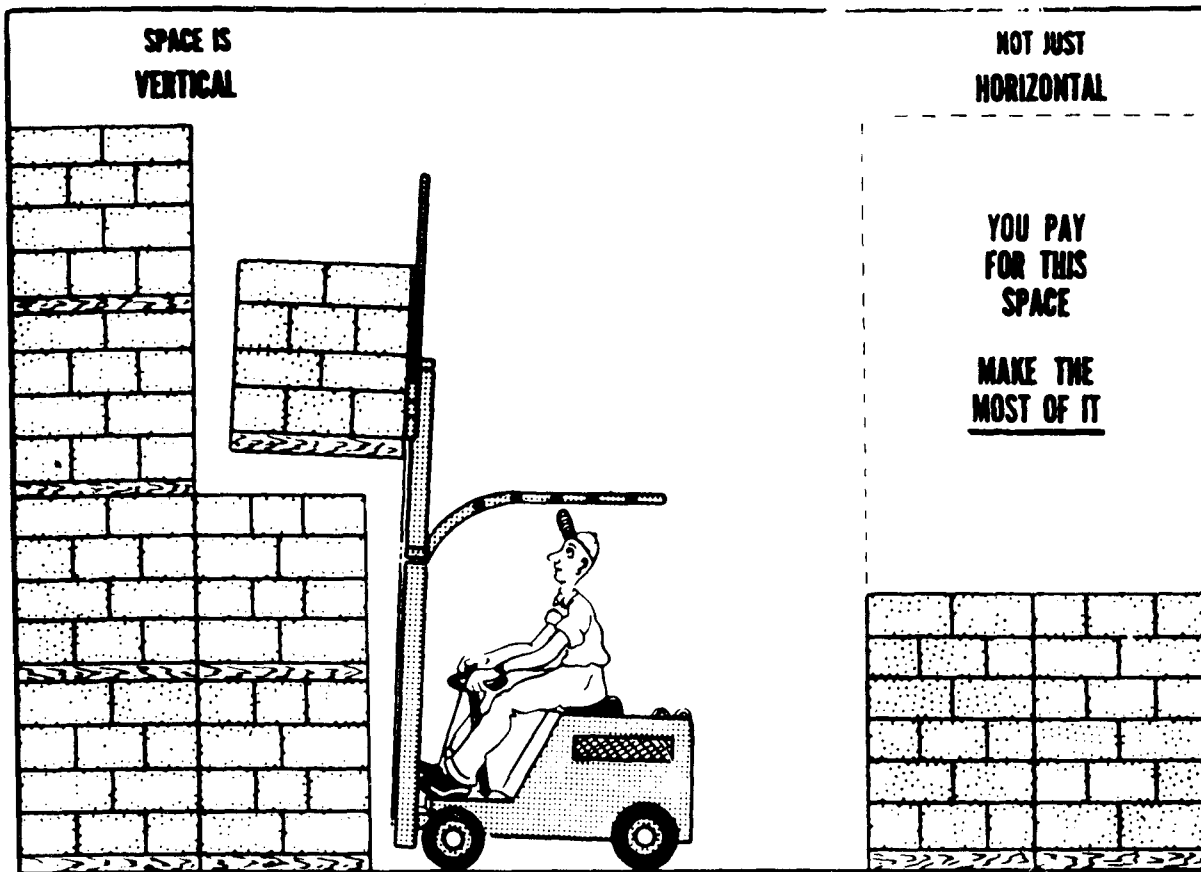
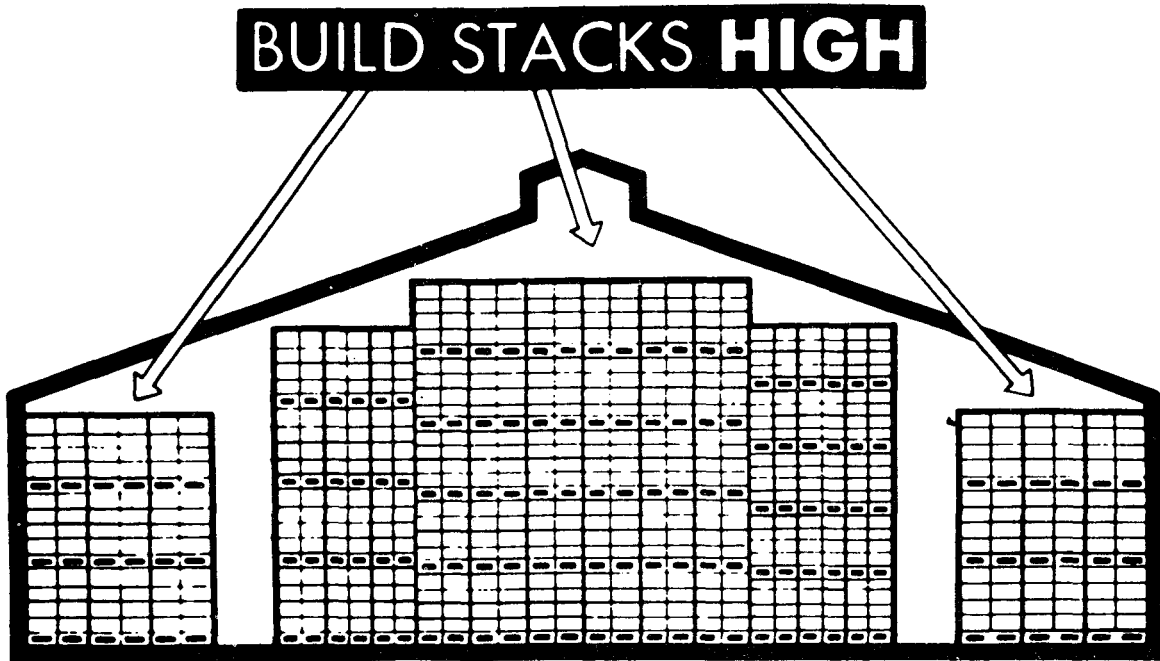

Figure 2-17. Space Is Three Dimensional



... utilize vertical space to the fullest extent ... save floor space for additional receipts.

Figure 2-18. Effective Use of Vertical Space

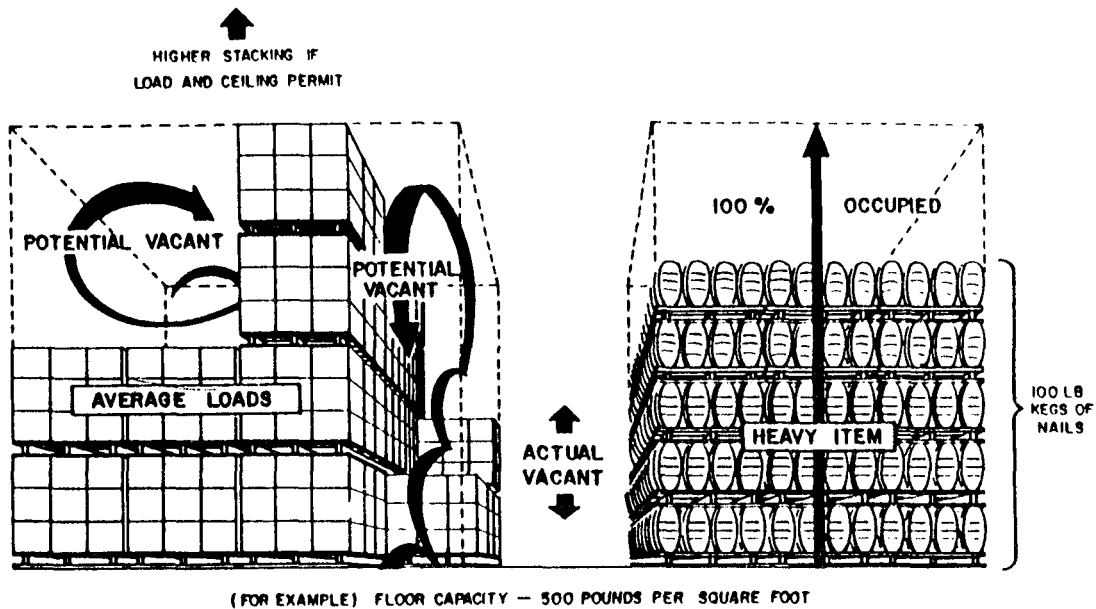

Figure 2-19. Floor Load Limitation

b. Characteristics of storage facility. Storage space is three dimensional; therefore, facility characteristics must be carefully analyzed. Limitations such as stacking height, floor capacity, structural clearance, and other obstacles must be recognized. For example, coils of steel banding are usually stacked in a column that is erected to only moderate storage height. Although the characteristics of this item with regard to stability would allow a substantially higher stacking level, the weight, considering floor load capacity, has reached the maximum. Therefore, floor load capacity may influence stacking heights.

c. Equipment capabilities. Use of potential warehouse storage height may be restricted by equipment capabilities to achieve the vertical utili-

zation. For example, even though a warehouse provides floor load capacity and clear vertical space, full utilization could not be realized if adequate stacking equipment were not available.

d. Commodity characteristics. The maximum stacking height potential is also influenced by the characteristics of the material or its packaging. These may not permit stacking to the height available. The type of commodity being stored must, therefore, be considered in determining whether the gross cube available can be filled. This consideration supports the idea of categorizing supplies into groups to promote a constant storing height potential. Some examples of the effects of commodity characteristics on storage heights (see fig 2-20) include—

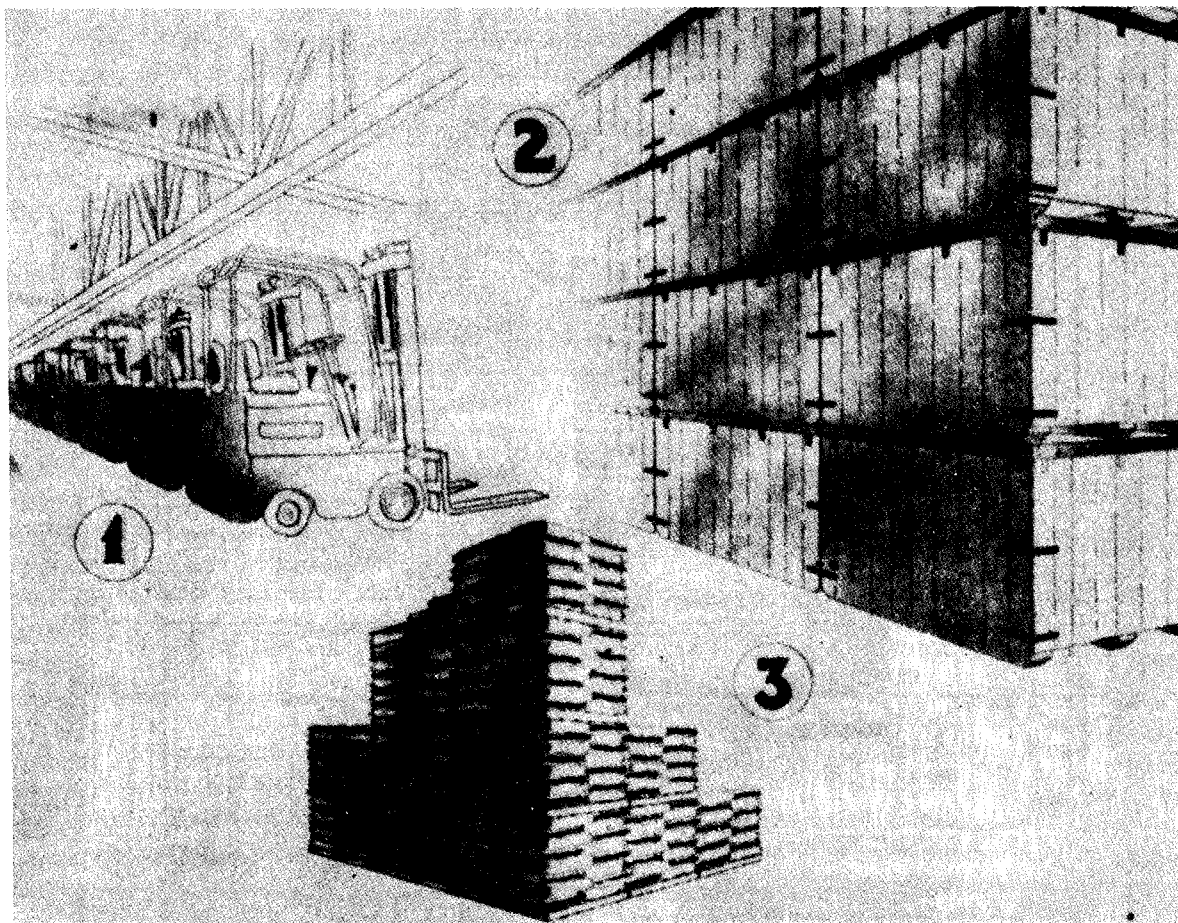

Figure 2-20. Examples of the Effects of Commodity Characteristics on Storage Heights

(1) Forklift trucks are representative of unstacked and unusually shaped items that preclude stacking. Items of this type, in the interest of efficient space utilization, are normally located in storage areas where the least storage height ex-

ists. Inventory such as this is categorized as being of limited stacking height potential.

(2) Items which are packed in containers of substantial strength or items which support the surface of the containers will ordinarily lend to

high stacking. Therefore, selection of storage location should provide for maximum stacking height potential.

(3) There are many items which lend only to moderate stacking heights for several reasons. Packs may be too weak to withstand the weight imposed as a result of relatively high stacking or the packs may be unstable. Bagged items are an example of items that can be stacked to a limited height.

e. Total warehouse storage space. The gross storage space within a warehouse includes—

(1) Storage support space. See paragraph 2-13e.

(2) Aisles. See paragraphs 2-9f and 2-13e.

(3) Structural loss. See paragraph 2-13e.

(4) Net storage space. See paragraph 2-13e.

f. Occupancy of net storage space. Considerations such as ceiling heights, commodity characteristics, and “elbow room” are factors which preclude the possibility of complete occupancy of net storage space. In any storage operations, it is desirable to have “elbow room” available for operations flexibility. This “elbow room” space must be limited to the absolute minimum for effective storage. Sufficient “elbow room” should be available to minimize the continuous necessity for relocation of stocks to “fit” additional receipts into the storage pattern. Fifteen percent of the net available space is considered an adequate allowance for “elbow room” for general supplies. Ammunition is governed by quantity-distance factors found in appropriate publications.

2-7. Development of Data for Use in Space Requirement Computations.

Computation of space requirements should use cubic feet and/or square feet as conversion factor(s) in relating material to space. In the planning for, and selection of material for storage in specific warehouses or warehouse sections, the selection should be based upon the volume of inventory, stackability, bin requirements, etc. In other words, material with low stackability should not be located in high ceiling warehouses when lower ceiling or lower floor load capacity warehouses are available. This also applies to bin areas, storage support areas, relatively small inventories of the same item, etc. The following will apply in developing data to support space computations:

a. Average stacking heights. The characteristics of storage facilities influence the heights to which material may be stacked. The composition of the inventory will normally vary from installation to installation with resultant effects on average

stacking heights. For example, a substantial inventory of an item that possesses very limited high storage potential, as opposed to a very limited inventory of the same item, would have a marked bearing on storage height average for that item. For this reason, each storage activity must compute independent data which will reflect average potential storage height of inventory.

(1) In order to relate to space, the stacking height must be established. Establishing stacking height should not be predicated on the basis of the height to which supplies are currently stored, but rather to the potential storage height, that is, the height to which supplies are capable of being stored in accordance with proper warehousing practices. Inventory is another influence which must be recognized. For example, the quantity on hand could result in some supplies being stacked to less than the potential height. This practice reduces the average potential height. The term “adjusted potential storage height” applies to this computation.

(2) It will be necessary to survey inventories in order to determine acceptable and attainable storage heights. To provide greater accuracy and lessen expenditure of manpower, computers should be used, when available. To attain satisfactory benefits from such a survey and to avoid establishing stacking heights for each item, supply inventory should be grouped into selected categories and the average heights determined for each category. For example, separate categories may possibly be established for type 1, easy load; type 2, average load; and type 3, difficult load, as defined in the glossary of terms, and for unpacked items such as vehicles.

(a) Supply groupings should be sufficiently categorized to reflect relatively constant and accurate average potential stacking heights as well as adjusted potential stacking heights which take into account the variables of supply inventory.

(b) Results of the survey will indicate an overall potential height and adjusted potential height for each category grouping. This should be frequently assessed to assure data correctly reflect the current storage situation.

b. Square foot computations.

(1) Stacking height data will be reconciled to the amount of floor area (square footage) that is currently utilized in storing inventory. In the event that potential or adjusted potential storage height is not fully occupied, provisions must be made to identify the current excessive occupancy of square feet of floor area in order to reflect the actual net square feet of storage space required to

store inventory. The height of stacking should be extended by attrition to bring the actual storage in balance with the adjusted potential, thereby equalizing the amount of net square feet actually occupied.

(a) Before the square feet required to store inventory can be obtained, the space occupancy effectiveness (see Fig 2-21) must be calculated, as follows:

$$\frac{A}{P} = \text{Potential vertical space utilization EFFECTIVENESS}$$

and

$$\frac{A}{AP} = \text{Adjusted vertical space utilization EFFECTIVENESS}$$

where:

- P = POTENTIAL Storage height,
- A = ACTUAL Storage height, and
- AP = ADJUSTED POTENTIAL storage height.

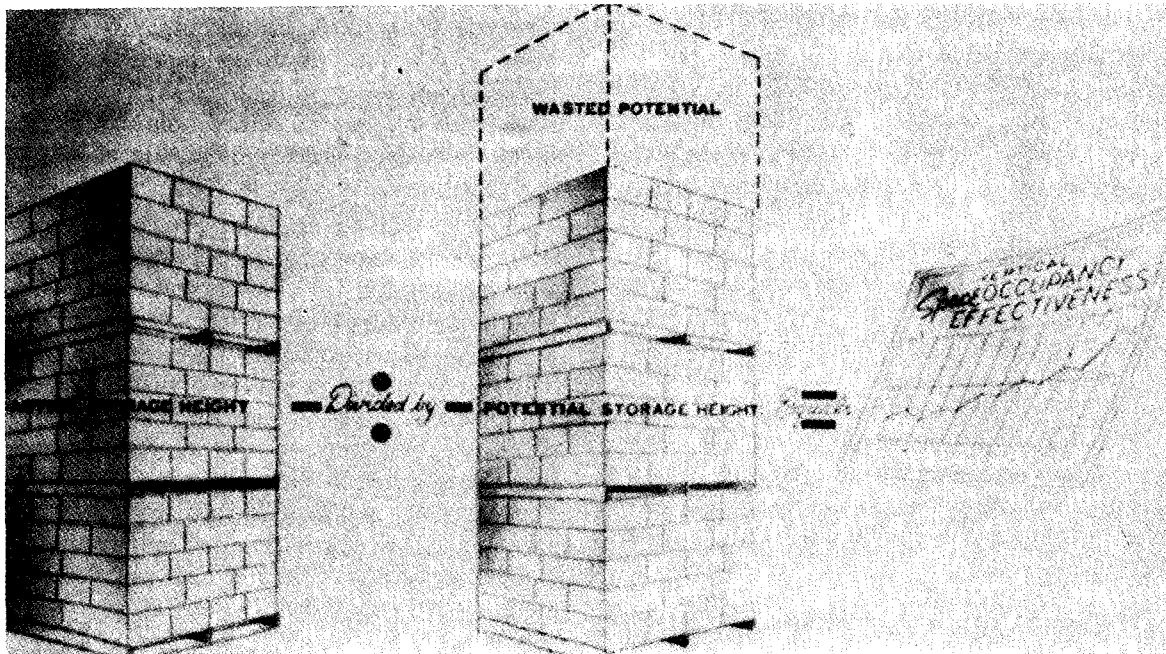

Figure 2-21 Space Occupancy Effectiveness

(b) The square feet required to store inventory (see Fig 2-22) is calculated as follows:

$$S \times E = R$$

where:

- S = SQUARE FEET occupied by inventory,
- E = Space occupancy EFFECTIVENESS, and
- R = Square feet REQUIRED to store inventory.

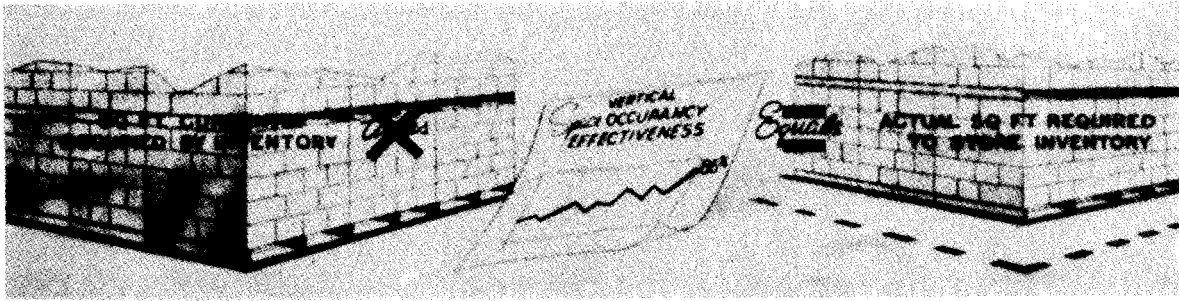

Figure 2-22 Actual Square Feet Required to Store Inventory

(2) As an example, a survey has indicated that supply category X is capable of being stacked to an average potential height of 14 feet and an average adjusted potential height of 13 feet. The survey also disclosed that material currently occupies 218,000 square feet of floor space. The average stacking height to which materials are actually stored averages only 12 feet. How many square feet are required to store the inventory?

(a) First, the space occupancy effectiveness is calculated as follows:

$$\frac{A}{P} = \frac{12}{14} = 86\% \text{ potential vertical space utilization effectiveness}$$

and

$$\frac{A}{AP} = \frac{12}{13} = 92\% \text{ adjusted potential vertical space utilization effectiveness.}$$

(b) Then, the square feet required to store the inventory can be calculated as follows:

$$S \times E = 218,000 \times .86 = 187,480 \text{ square feet required for optimum effectiveness}$$

and

$$S \times E = 218,000 \times .92 = 200,560 \text{ square feet required to store present inventory.}$$

c. *Cubic Foot computation.* Since both horizontal and vertical dimensions have been provided in paragraphs (a) and (b) above, the multiplication of the total square foot area of storage by the stacking height (feet) will equal the cubic feet of storage space available. The following is applicable:

$$H \times S = TCF \quad \text{and} \quad AH \times S = ACF$$

where:

- H = Vertical Storage HEIGHT,
- S = SQUARE FOOT area,
- TCF = TOTAL CUBIC FEET,
- AH = Attainable stacking HEIGHT, and
- ACF = ATTAINABLE CUBIC FEET.

d. *Dollar value of inventory (except ammunition).* In any space computation formula, quantity of inventory is the primary element. Knowledge of the total dollar value of the supply inventory is also a valuable asset for use in conversion of receipts and issues to space occupied or vacated. For example, computation of this data can be used in formula development to indicate that \$5,000 worth of supply receipts will require X amount of storage space or \$10,000,000 worth of supply inventory will occupy Y amount of space. (Inflation/deflation factors must be considered when determining space requirements by this method.) The value of this approach, as a convenient medium of space computation, should be apparent. These data may be applied as indicated in succeeding formulas—

(1) Determining dollar value of inventory per cubic foot (see fig 2-23). Compute as—

$$\frac{DV}{CF} = VC$$

where:

- DV = DOLLAR VALUE of supply inventory on hand,
- CF = CUBIC FEET required to store inventory (see para c above), and
- VC = Dollar VALUE of “on hand” inventory per CUBIC foot.

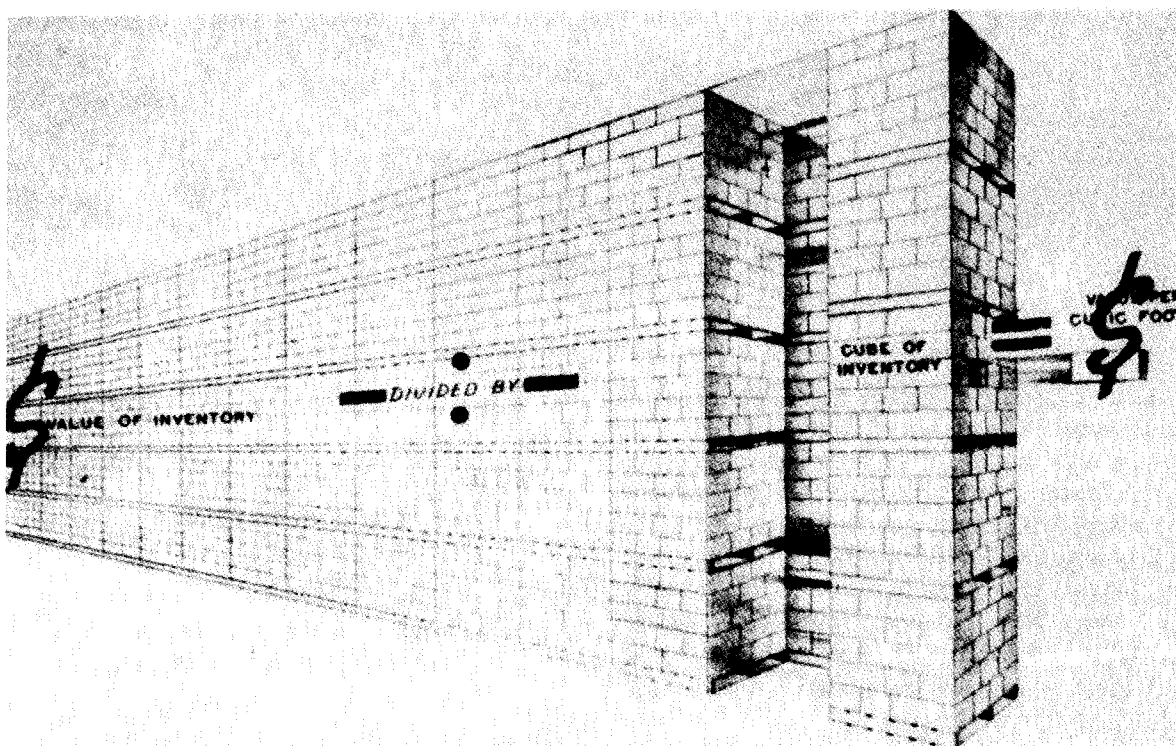

Figure 2-23 Dollar Value Per Cubic Foot

(2) Allowance for incoming receipts (estimated).
 Compute as follows to determine the additional cubic and square feet required to store additional inventory (see figs 2-24 and 2-25):

$$\frac{I}{VC} = CF$$

where:

- I = INBOUND receipts cost value,
- VC = DOLLAR VALUE of "on hand" inventory per CUBIC foot, and
- CF = CUBIC FEET required to store additional inventory.

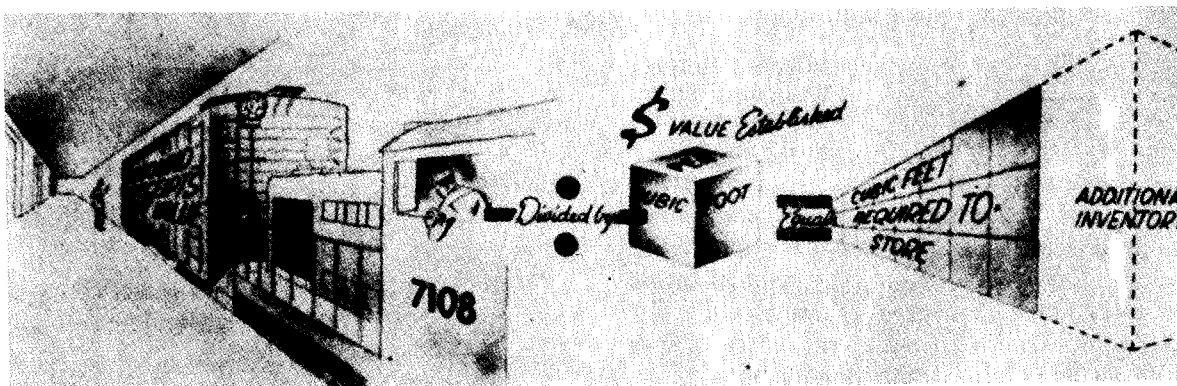

Figure 2-24. Cubic Feet Required to Store Additional Inventory

Also,

$$\frac{CF}{H} = S$$

where:

CF = CUBIC FEET required to store additional inventory,
 H = Vertical storage HEIGHT to which additional inventory may be stacked, and
 S = SQUARE FEET required to store additional inventory.

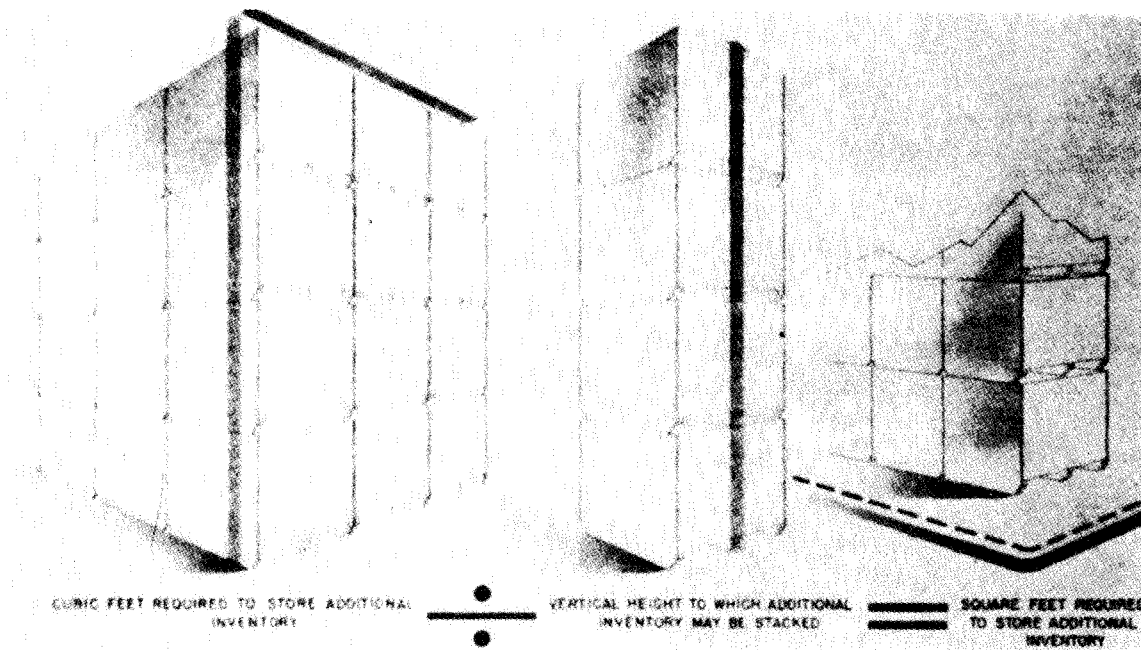

Figure 2-25 Square Feet Required to Store Additional Inventory

(3) Allowance for outgoing shipments (estimated). This is a reversal of the procedure for incoming receipts and is computed as follows:

$$\frac{O}{VC} = CR$$

where:

O = OUTBOUND shipment cost value,
 VC = DOLLAR VALUE of "on hand" inventory per CUBIC foot, and
 CR = CUBIC FEET of space RELEASED through shipment of inventory.

Also,

$$\frac{CR}{H} = SR$$

where:

H = Vertical storage HEIGHT to which inventory was stacked,
 CR = CUBIC FEET of space RELEASED through shipment of inventory, and
 SR = SQUARE FEET of space RELEASED through shipment of inventory.

e. Bin areas. The computation of space required for establishment of bin areas will be predicated on the following:

(1) The number of line items to be stored which will reflect the number of bin openings required.

(2) The size of bin openings (outside dimensions).

(3) The height to which bin columns will be erected.

f. Space utilization in storage support. Not all space in a storage area can be allocated to material storage. However, the allocation of space from actual storage to storage support functions should

be held to the minimum consistent with good operating practices. Considerations in computation of space requirements for storage support activities (see fig 2-26) are as follows:

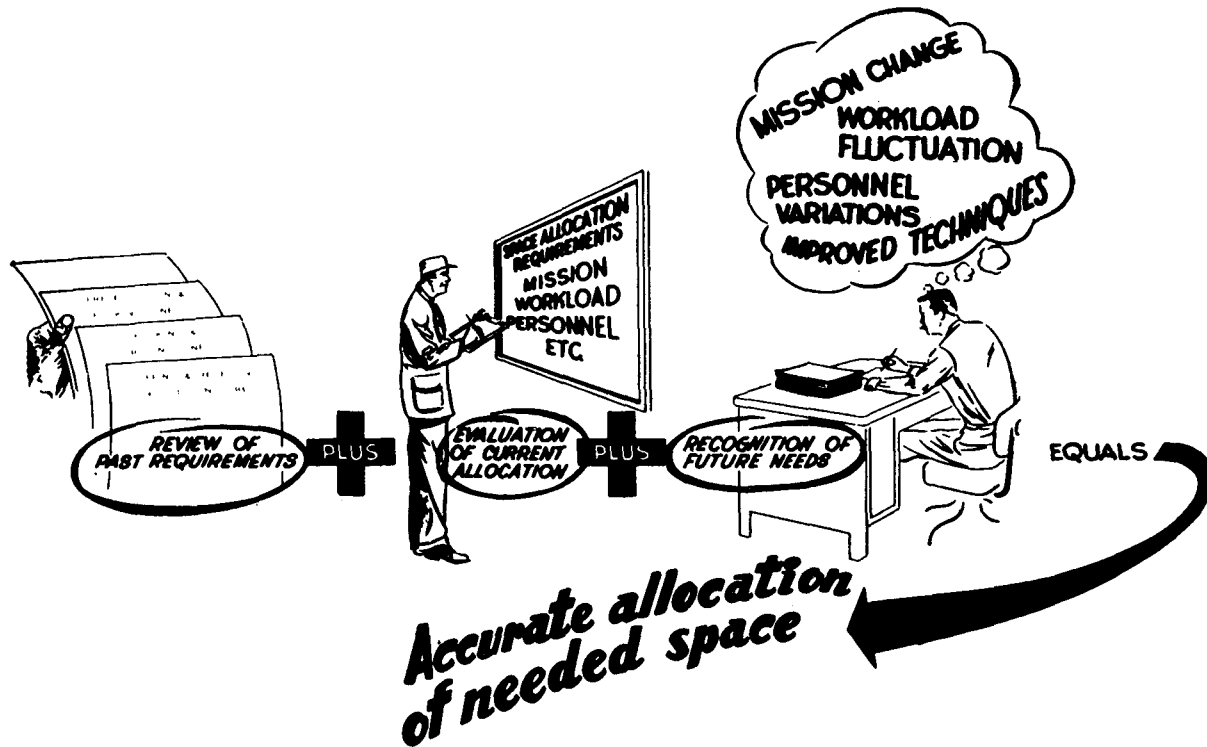

Figure 2-26 Factors of Consideration in Computing Storage Support Space Requirements

(1) The requirements for space for storage support functions are greatly influenced by the mission responsibilities of the particular activity. For example, tonnage handled or net storage space operated need not necessarily have an absolute bearing on the amount of space allocated to preservation and packing. Detailed evaluation of the particular operating circumstances would, therefore, be necessary before accurate computation could be accomplished.

(2) It would be impractical to establish firm ratios of space allotted for storage purposes on the basis of personnel employed or gross area operated. However, storage management personnel should frequently appraise actual support requirements to assure that valuable space is not allocated to these functions in excess of minimum requirements.

(3) Computation of space requirements for support functions should be developed, in great part, through review of both past and current requirement experience. When projecting future

needs, consideration should be given to possible mission changes which would alter requirements. Such acknowledgement will enhance the accuracy of projected allocations as compared to actual proved need.

g. Gross space requirements.

(1) The formula for computing gross space requirements is—

$$N + A + SS + S = G$$

where:

- N = NET SQUARE FEET of space allocated to storage,
- A = Space allocated to AISLES,
- SS = Space consigned to STORAGE SUPPORT functions,
- S = STRUCTURAL loss space, and
- G = GROSS storage area.

(2) This formula applies to determining gross storage space requirements in covered and open

storage areas. In applying the formula to open storage areas, consideration need not be given to such facility restrictions as may affect stacking heights.

Section III. Determination of Storage Space Requirements (DOSSR) Method

This section will be published at a later date.

Section IV. Planning the Storage Layout

2-8. Introduction.

a. A storage area floor plan layout is an excellent management tool for space control. It enables planning for the effective use of space. The layout is the framework in which the overall depot storage space is developed. It serves as the basis for developing the storage area planographs. The layout is also the basis for preparation of the storage space status report (see para 2-12f). Storage plans for installations and activities storing ammunition will be developed as prescribed by the responsible military service.

b. Using the principles of space requirements determinations outlined in section II, this chapter, and the DOSSR study method discussed in section III, this chapter, effective storage layouts can be developed.

c. A complete and current floor plan shows the actual manner in which the gross space within a storage area is used. The plan shows the division of space into storage, receiving, shipping areas, main and cross aisles, fire aisles, and offices. Each section or other subdivision of the floor plan will show the square footage of gross space, the nonstorage space, and the net space available for storage.

2-9. Factors Influencing Layout Plan.

a. Item similarity. Items with similar handling requirements should be stored together when prac-

ticable. This facilitates storage and issue and also contributes to effective care of supplies. There is normally no requirement that material will be segregated and stored by an inventory manager.

b. Item popularity. Activity or popularity is an important factor in planning the storage layout for material. The fastest moving bulk stocks should be planned for storage in areas that are quickly and easily accessible to reduce travel of MHE and stock selection personnel. Loose issue areas should be located adjacent to packing and processing areas. Fast moving bin stocks should be easily accessible to expedite stock selection and replenishment actions. To the extent feasible, items with the slowest turnover rate should be planned for placement in areas progressively farther from active stock or processing areas. The principle of location by popularity is shown in figure 2-27.

c. Item size and weight. The dimensions and weight of individual items affect not only the amount of storage space allotted, but also the location in which items are to be stored. For example, a 5-ton dynamo would be stored in a location that would provide a balance between accessibility to required MHE and the least amount of intradepot transport. Normally, except for those items requiring overhead cranes for handling, the greater the item density the less overhead clearance or ceiling height required.

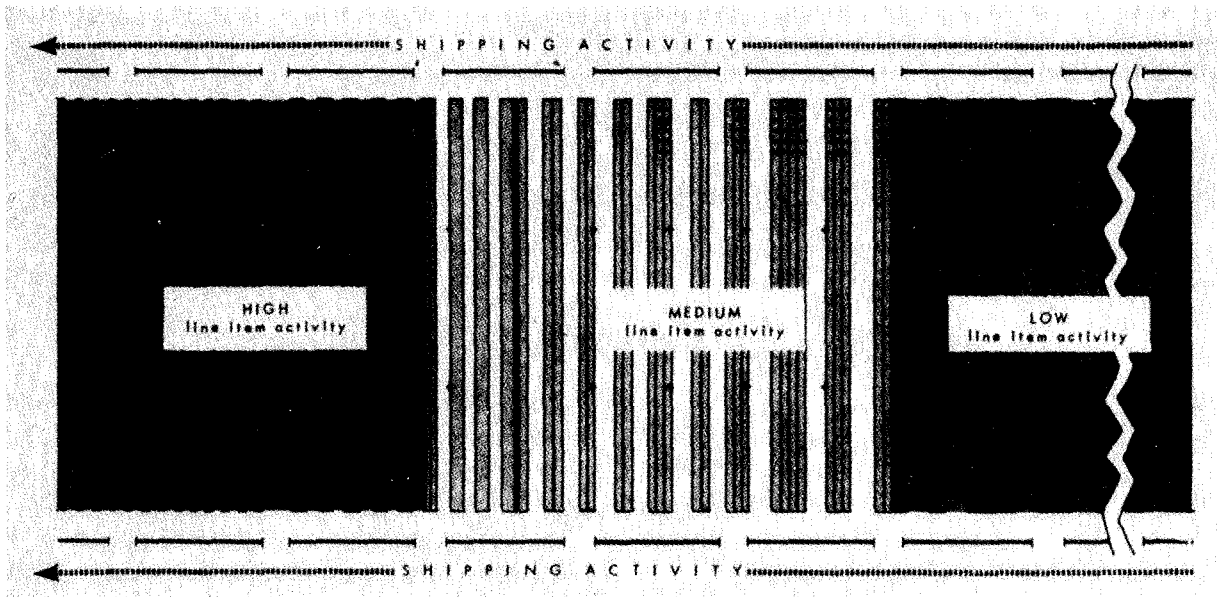

Figure 2-27. Storage of Stocks by Popularity

d. Item quantity. Quantity of material on hand affects the amount of space required on the layout. Frequently, it is desirable to increase the amount of space assigned to an item in a single location in order to eliminate the need for two locations. This may reduce effort and travel in replenishment actions for binnable items and reduce administrative effort required for maintenance of the location record system.

e. Item characteristics. The characteristics of most items of supply are such that special storage areas are not required. However, some items require special considerations. They include hazardous, sensitive, and perishable and deteriorative items.

(1) *Hazardous.* These materials have characteristics which require that they be specially stored or handled to prevent a hazard to personnel and facilities. This factor must be kept in mind when planning storage layouts (see TM 38-410) or service/agency publication, as applicable.

(2) *Sensitive.* Sensitive materials require a high degree of protection and control due to statutory requirements or regulations. Included in this category are items such as narcotics and drug abuse items; precious metals; high-value items; highly-technical items; items of a hazardous nature; and small arms, ammunition, explosives, and demolition material (see sec VIII, chap 3).

(3) *Perishable and deteriorative.* Some materials have a limited storage life and care must be taken to ensure that the oldest stock or that which may have an earlier expiration date is issued first.

Many foods, drugs, etc., must be kept in refrigerated areas or in temperature-controlled areas. For all items of a perishable or deteriorative nature, the most suitable storage environment must be made available (see sec IV, chap 5).

f. Aisles. Preplanning of aisle positioning on layouts must be done prior to placement of materials. Allowing the aisle layout to take shape as materials are placed in stock may result in placing materials in inaccessible locations and/or in loss of space.

(1) Aisle layout is determined by the structure of the warehouse; quantity, nature, and activity of materials to be stored; and by the types and capacity of available MHE.

(2) Aisles should only be wide enough to provide maneuvering room for MHE available for the stock storage and selection actions. For aisle widths required for forklift truck operation, see paragraph 1 below.

(3) Width of aisles in bin and shelving areas should permit easy movement of stock selector trucks through the storage area. Generally, this requires an aisle of 30 to 36 inches in width.

(4) Aisles should be planned to provide straight and clear passageways unobstructed by support columns, elevators, heaters, or other such construction features. A particularly important factor is the location of columns. Space loss due to columns will be reduced if columns are used as aisle and bay boundaries.

(5) There are three major types of aisles: working, personnel, and service.

(a) *Working Aisles.* Working aisles are passageways used to access storage locations during the receipt, inspection, and issue processes. Working aisles are of two types, transportation aisles which run the length of the building and cross aisles which run across the width of the building.

1 The working aisle widths specified herein are not to be construed as the absolute limitation for all operations. They represent the dimensions under which most operations may be conducted. Aisle widths must be established to ensure complete consonance between operational efficiency and space economy. The aisle widths specified below are based upon a load of 40 inches on electric vehicles.

Sit-down counterbalanced rider (4 wheel) truck	12 feet 0 inches
Stand up counterbalanced (3 wheel) truck	10 feet 0 inches
Reach truck	8 feet 0 inches
Deep reach truck	8 feet 6 inches
Swing reach truck	5 feet 6 inches to 6 feet 0 inches
Turret truck	5 feet 6 inches to 6 feet 0 inches

Aisles widths for different load lengths will be determined on the basis that a variation of 8 inches in the load length will have a corresponding variation of 6 inches in the aisle width. For example, a 48-inch load length will increase the aisle widths indicated above by 6 inches. Determination of aisle width is affected by turning radius of MHE to be used.

2 In most storage layouts, the volume of activity requires two transportation aisles of efficient layout. Such aisles run the length of the building and should be wide enough to permit two-way traffic of MHE being utilized in that particular area.

3 At least two cross aisles are needed in the standard warehouse section. Such cross aisles should be in accordance with the aisle requirements outlined in paragraph 1 above. The bulk of storage operations will be carried on in cross aisles.

(b) *Personnel aisles.* Personnel aisles are those used as pedestrian routes only and may be required for access to door or to special interior areas. Such aisles should be held to a minimum. If traffic volume does not create a safety hazard to personnel, working aisles can/should double as personnel aisles.

(c) *Service aisles.* Service aisles are those which provide access to stacks for inventory, inspection, or for protective processing. The requirements for service aisles are very limited. Efficient warehousing operations require that each storage row contain only one item with the same number of containers per pallet. This facilitates inventory as well as issue and normally makes special aisles unnecessary. However, such aisles may be necessary for special commodities (e.g., subsistence, etc.) which require frequent inspections.

(6) Every block of material should be adjacent to a working aisle and stored so that stock can be removed without the necessity of moving another item. The simplest means of providing accessibility is to create a large number of aisles and short rows, but this practice is inconsistent with the principle of minimizing the number of aisles. The best rule to follow is to be certain that materials are stored on both sides of and facing the working aisles. Pallet racks, placed parallel to the long dimension of the building, in side-to-back storage with a bulk stock, permit the use of transportation aisles to provide accessibility to small lot material.

(7) Since a mix of material may contain a wide variety of lot sizes, various bay depths must be provided. For example, if a single column of pallet loads is placed in a bay which has a capacity of five such columns, space for four columns is lost. The availability of a variety of bay sizes is affected by aisle layout and the direction of storage. When the best conceived plan for direction of storage fails to produce a sufficient number of small bays for the class of material handled, the number of working aisles must be increased.

g. *Working areas.* Working areas are nonstorage space (other than aisles) in which operations incident to storage or materials handling are performed. Working areas include receiving and shipping bays, packing floor space, strapping lines, battery charging stations, offices, and locker rooms. Such spaces reduce storage areas and, therefore, should be held to the minimum

(1) Working areas are normally located in those portions of a warehouse which have the lowest ceilings. Usually, areas which serve all personnel in a building (e.g., offices, locker rooms, etc.) are located in the center section of the building against a side wall. This precludes entering personnel from walking through the storage areas and interrupting work. Working areas are located so as to minimize to total time required for travel of personnel and equipment between storage locations and working areas.

(2) Although set rules cannot be established for allocation of space to working areas, it is essential to keep such space to a minimum. Working areas must be controlled to ensure that such areas do not expand beyond the defined boundaries.

(a) Temporary storage of materials within a working area, particularly in receiving and shipping bays, should be held to a minimum. Receipt and processing operations should be organized so that materials can be processed immediately and removed to their storage locations.

(b) Utilization of cube in working areas is just as important as in storage space. The use of pallet racks and shelving frequently will save space in working areas.

(c) When practical, working areas should be consolidated. For example, creating a centralized packing operations for several buildings will result in less space consumption than a separate operation in each of the buildings. Also, this facilitates the centralized use of special equipment and concentrates the supervision of specialized jobs.

2-10. Preparation of Layout Plan.

When making storage layouts, whether for covered or open storage, a floor plan for each storage area should be prepared. The plan must indicate all obstacles such as support columns, stairwells, elevator shafts, office locker rooms, and rest rooms (see fig 2-28).

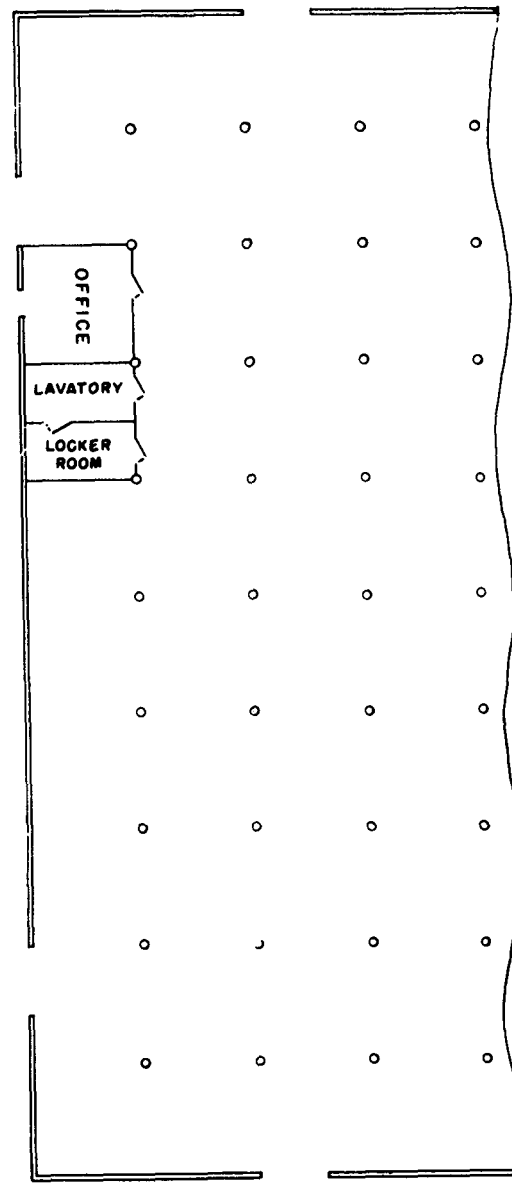

Figure 2-28. Storage Floor Prior to Stock Layout

a. *Basic bulk storage layout criteria.* Most of the principles involved in bulk storage are exemplified in the layout for a complete building as illustrated by figures 2-29 and 2-30. Various layouts for bulk storage are shown. There is practically no variation in bay depth as shown in figure 2-29; each bay is about 40 feet in depth, thus, a lot of less-than-carload quantity will not completely fill a bay and, therefore, results in loss of space. The main aisle runs lengthwise through the building. When comparing figure 2-29 with figure 2-30, note that the aisle layout is unchanged, but that in figure 2-30, all aisles are used as storage spaces and a variety of bay sizes are provided. Also, in figure 2-30, side-to-back bays of various

sizes located adjacent to each intersection. This minimizes the distance required to move a small lot from or to the door or another bay.

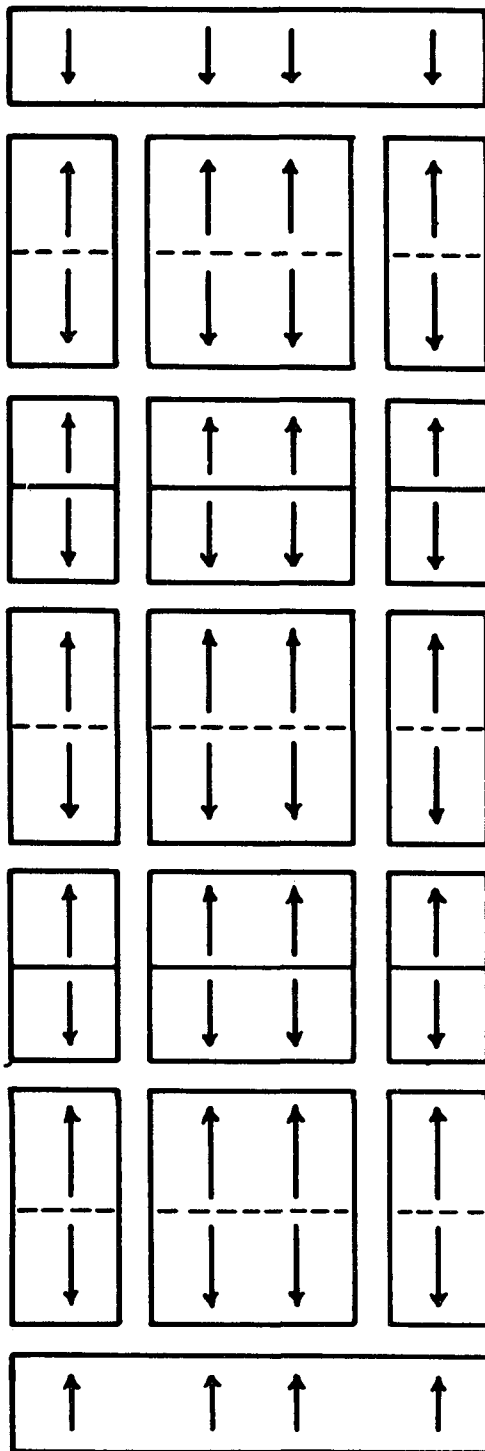

Figure 2-29 Space Layout for Large Lot

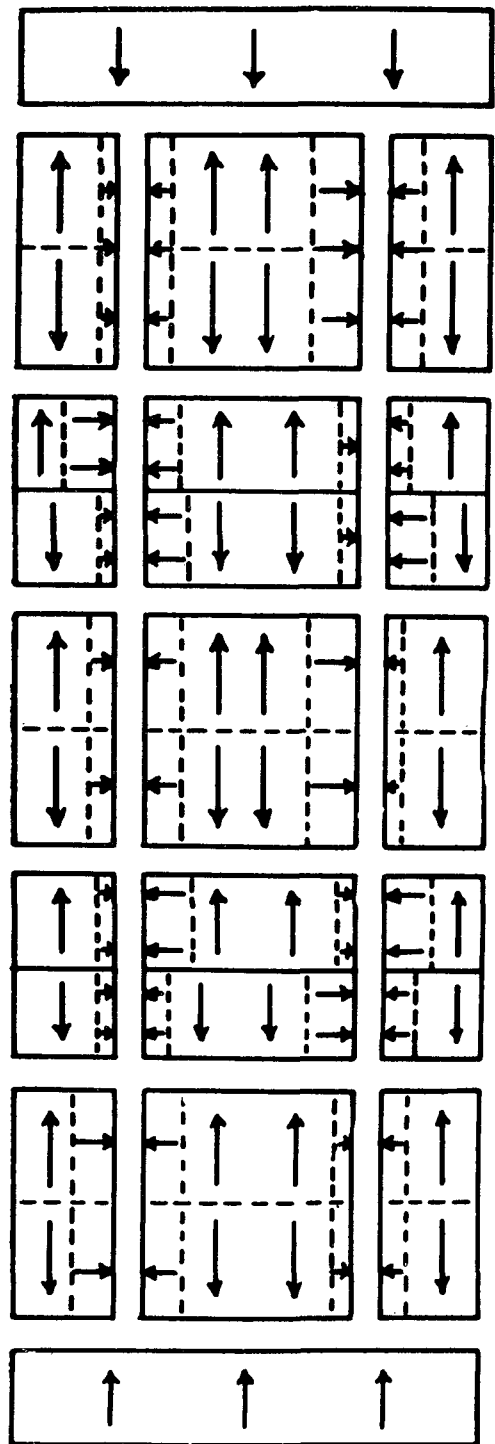

Figure 2-30. Space Layout for Large and Small Lots

(1) Easy access to material makes direction of storage a significant factor in space utilization. Selection of the proper direction of storage can be invaluable in providing a variety of bay sizes without increasing the number of working aisles. At the same time, such planning tends to spread to

volume of traffic equally over all working aisles thereby relieving congestion.

(2) Figure 2-31 shows a layout for large lot storage developed in respect to direction of storage. This was developed based on the direction of storage in a bay 80 feet square. Columns and other obstructions are not shown in this arrangement.

(3) The simplest but most inflexible disposition of storage space is storage of a single item aisle to aisle shown by figure 2-31, part A. With 4 pallet loads stacked in each space, there are faces for 17 different items, with each row containing 68 pallets. This is the equivalent of about two carloads of materials. This layout does not provide for storage of small lot items.

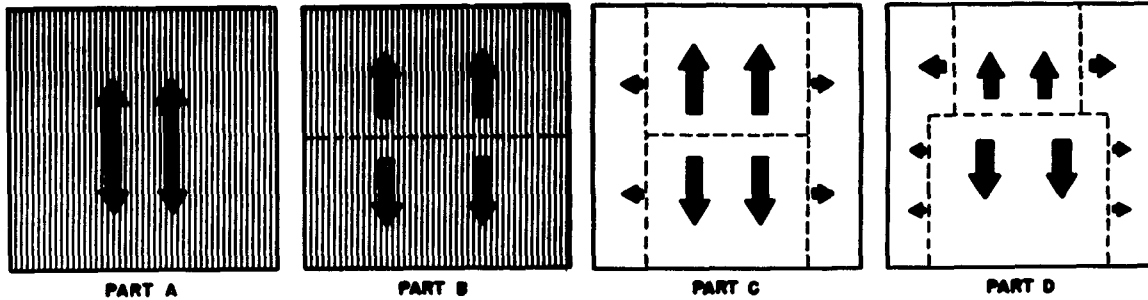

Figure 2-31. Example Direction of Storage Arrangements

(4) One method for increasing the number of rows and reducing the depth of each row is shown by figure 2-31, part B. The area has been bisected by an imaginary line perpendicular to the direction of storage, and in each row different items are placed in opposite directions from this line. This practice is known as "back-to-back" storage and is standard for all storage using the forklift truck and pallet system. This method allows faces for 34 items instead of 17 and each row is only 40 feet deep, the equivalent of 1 carload. This layout is an improvement over that shown in figure 2-31, part A; however, it still does not make provisions for less-than-carload quantities.

(5) Another method of storage which provides further flexibility is obtained by placing short rows of pallets along the sides of a large bay as shown in figure 2-31, part C. Stringers for these pallets are perpendicular to the predominant direction of storage; this is known as "side-to-back" storage. An imaginary line is drawn and small lots are placed from this line out to the aisles. Using all aisles as faces of stacks provides space for small lots without increasing the number of aisles and without sacrificing accessibility.

(6) The off-center division shows how further variety in row sizes can be provided (see fig 2-31, part D). The back-to-back line is set off-center which provides one very large bay and one of intermediate depth. Such a layout is desirable only when there is assurance that a substantial num-

ber of items will be held in quantities of two carloads or more. The depth of side-to-back bays varies from one to four pallets to provide a variety of short rows. Pallet racks placed side-to-back in bays permit fuller space utilization. Figure 2-31, parts A, B, C, and D, are not intended to present a standard layout for any class of materials, but only to point out what can be done with a fixed space and various aisle arrangements to provide maximum flexibility for storage operations.

b. Basin bin, shelf, and rack layout criteria. The amount of space assigned to a specific item within a bin section is governed by the factors shown in paragraph 2-9 above. However, the size or weight of an item is not necessarily related to its popularity. Fast moving binnable items, whether large or small, must be reassigned space adequate to minimize replenishment frequency, time, and effort. There are many factors favoring issues from bin locations and the repetitive issue of small quantities of binnable-type items from bulk storage can rarely be justified. Proper use of bins will minimize the inventory and security problems found where there are broken cases of binnable-type items in bulk storage locations. Fast moving items should be kept in the center levels to facilitate issue and the heavy items should be placed in the lower levels. Lightweight items should be placed on the upper levels. Bin shelving arrangements are developed on a sheet plan (see fig 2-32).

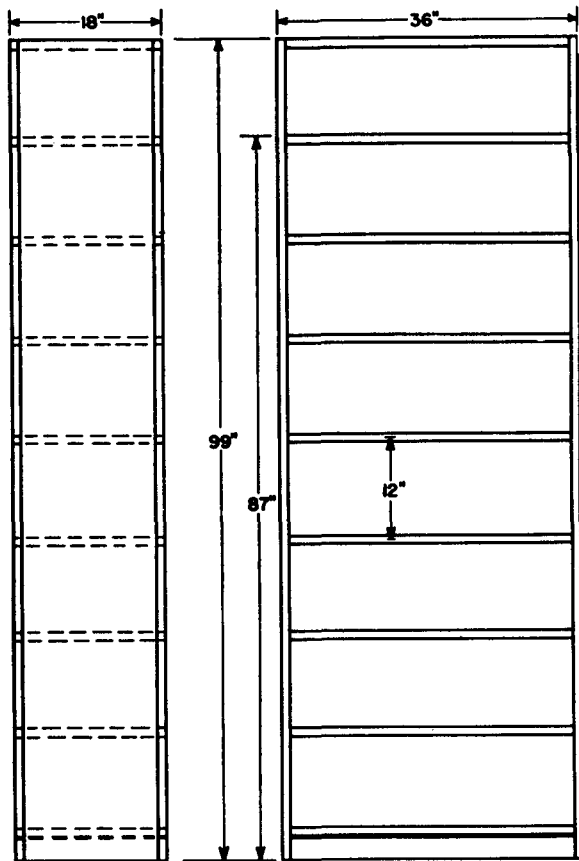

SIDE VIEW

FRONT VIEW

BILL OF MATERIAL			
ITEM	SIZE	QUANTITY ONE UNIT	QUANTITY UNITS
UPRIGHTS			
BACKS			
SIDES			
SHELVES			
LABEL HOLDERS			
BASE STRIPS			

Figure 2-32 Bin Shelving Plan Sheet

(1) The utilization of 75 percent of space within bin and shelf openings, determined on the stock level to be carried, will be considered adequate. Losses in cube beyond this figure indicate the need for readjusting the size of bin or shelf opening.

(2) Double decking of bins and shelving, if practicable, will result in better utilization of storage space. However, other factors involving econ-

omy of operation should be considered, and when increased operating costs offset the savings, bins and shelving should not be double decked. When mezzanine platforms are used, they should have open-type metal floors which will not obstruct the effective use of sprinkler systems.

(3) A determination of storage aid requirements should be made prior to actual development of stock layout planographs. Appropriate adjustment of these requirements should be accomplished at any time it is found that increased space utilization can be achieved. Typical storage aids are bins, shelving, shelf boxes, and various types of racks.

(a) Shelf boxes can provide a flexible arrangement for efficient use of shelf space. The shelf boxes provide retainer walls on four sides of the material being stored thereby eliminating stock sloping which wastes usable cube space. Shelf boxes can also be "double stacked" on a bin shelf to facilitate use of cubic space. When relocation of the item is required, it can be accomplished by moving the shelf box with contents. The result is reduced handling of loose stock. Basic types of shelf boxes are—

- 1 Small, one compartment.
- 2 Small, two compartments.
- 3 Large, metal, one compartment.
- 4 Large, corrugated.

A complete study of shelf boxes has been made to determine the sizes which provide the greatest flexibility. The standard small one and two compartment shelf boxes are 4½ inches high, 5½ inches wide, and 1 foot 5 inches deep as shown in figure 2-33. The standard large one compartment steel shelf box is 10¾ inches high, 11¼ inches wide, and 17½ inches deep as shown in figure 2-34. As shown in figure 2-35, the standard large corrugated shelf box is 8 inches high, 10 inches wide, and 16 inches deep. Figure 2-36 shows a typical bin shelf box arrangement. The shelf space sizes 1 through 6 indicate the number of standard boxes required to house the items; size 3X indicates one complete shelf without boxes; size 6X indicates two complete shelves without boxes. Smaller items are stored in small 1 or 2 compartment shelf boxes which fit 12 to the shelf. These small compartments can be further divided to accommodate small items (e.g., nuts, bolts, etc.).

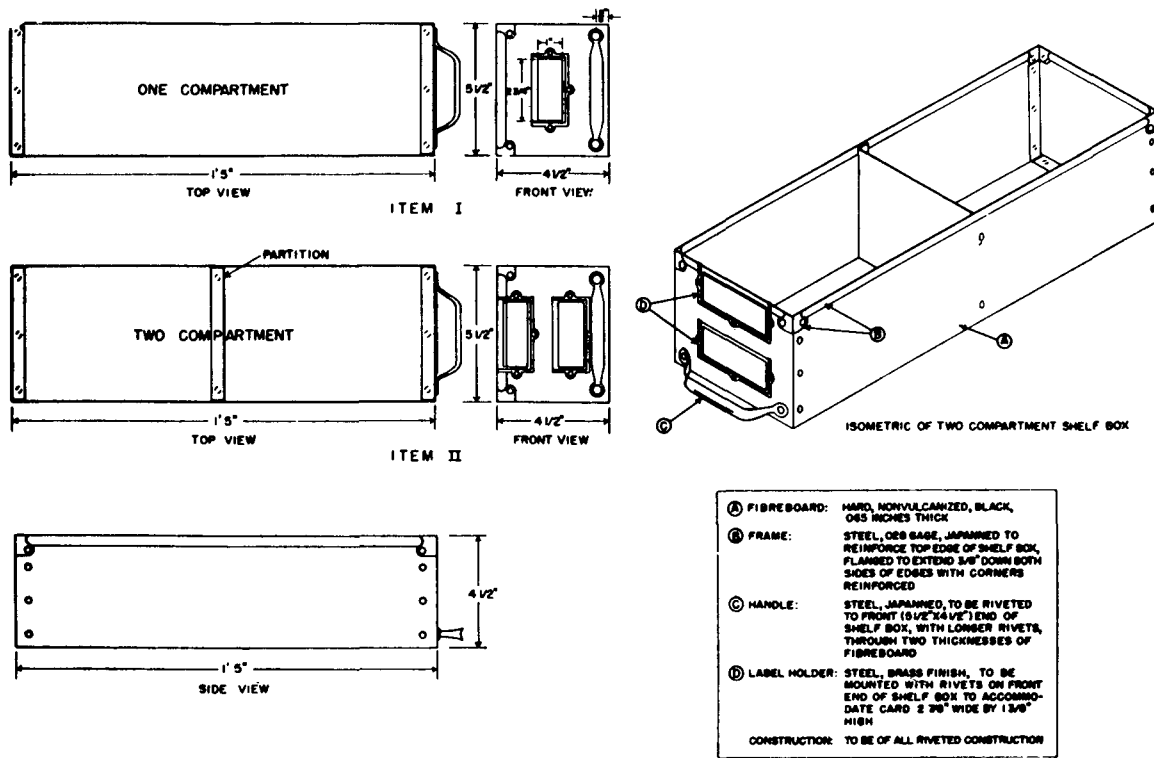
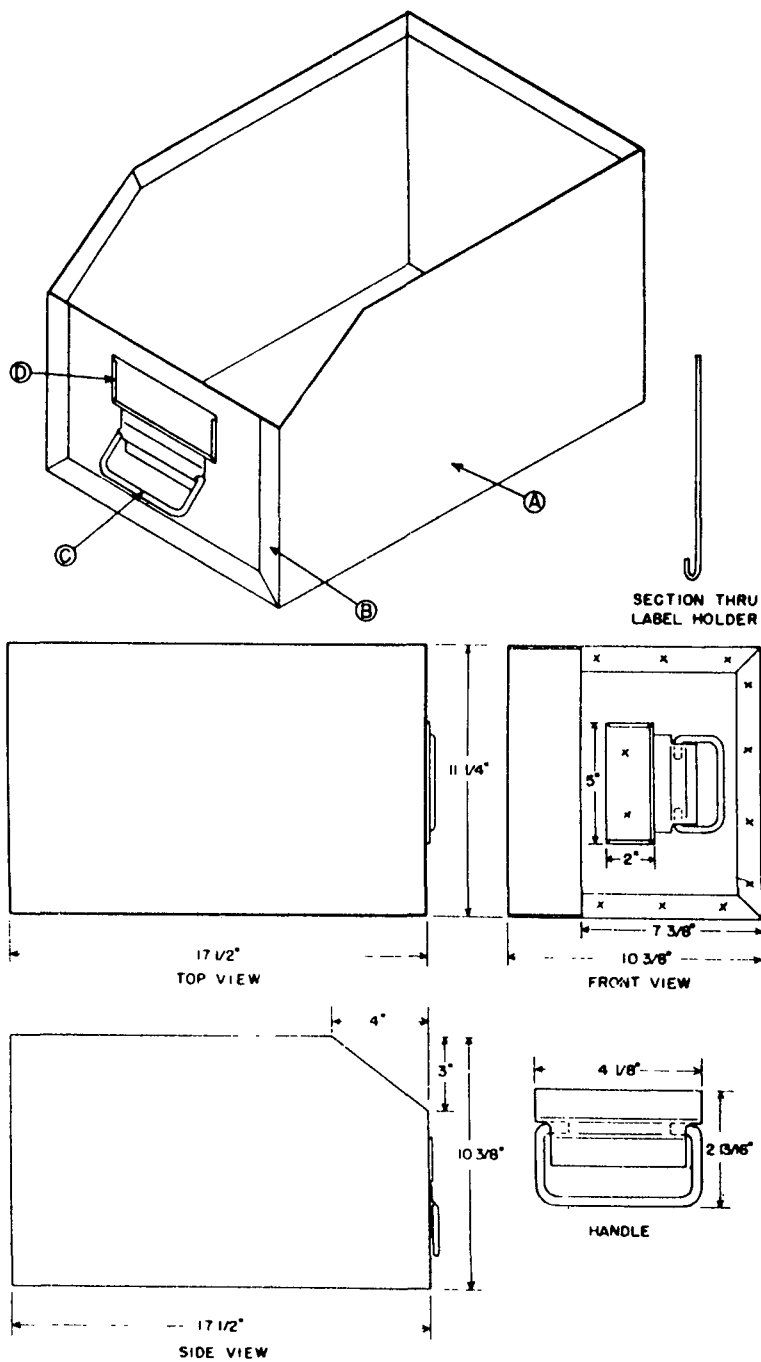
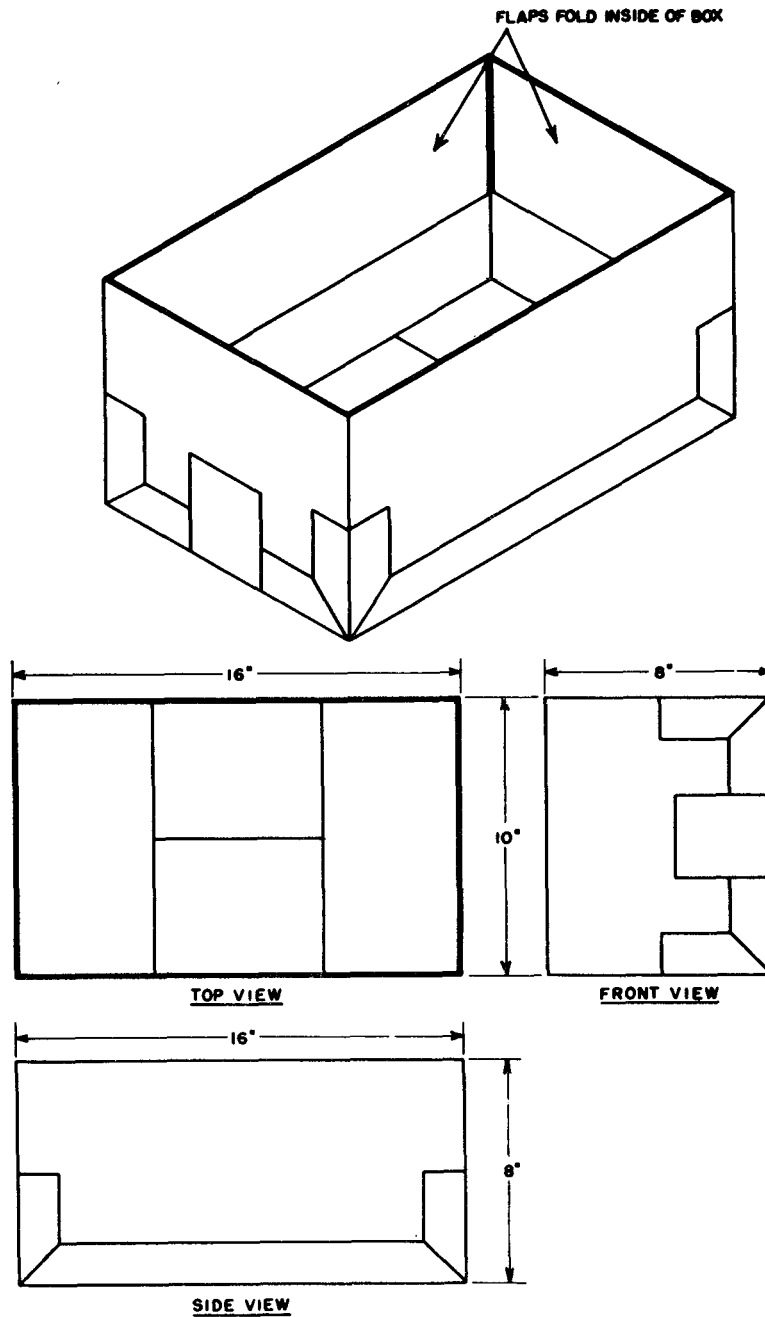

Figure 2-33. Shelf Box, Small, One and Two Compartment



- Ⓐ Steel..... # 18 ga.
- Ⓑ Construction.... Steel # 18 ga spot welded, all laps forming box shall be 1".
- Ⓒ Handle..... Steel No. 20 to be spot welded to front (11 1/4" x 7 3/8") end of shelf box.
- Ⓓ Label Holder.... Steel No. 20 to be spot welded on front end of box to accommodate card 4 1/2" wide by 1 3/4" high.

Figure 2-34 Large Metal Shelf Box



NOTES

SPECIFICATIONS: SHELF BOX, LARGE CORRUGATED IS MADE UP FROM A REGULAR SLOTTED FIBREBOARD BOX

APPLICATION: THIS TYPE SHELF BOX IS USED FOR LIGHT WEIGHT MATERIALS. WHERE POSSIBLE, BULK STOCKS SHOULD BE PACKED IN THIS BOX TO FACILITATE BULK TO BIN TRANSFERS. THE FLAPS SHOULD BE TURNED IN WHEN USED AS A SHELF BOX TO MAINTAIN SALVAGE VALUE.

Figure 2-35. Large Corrugated Shelf Box

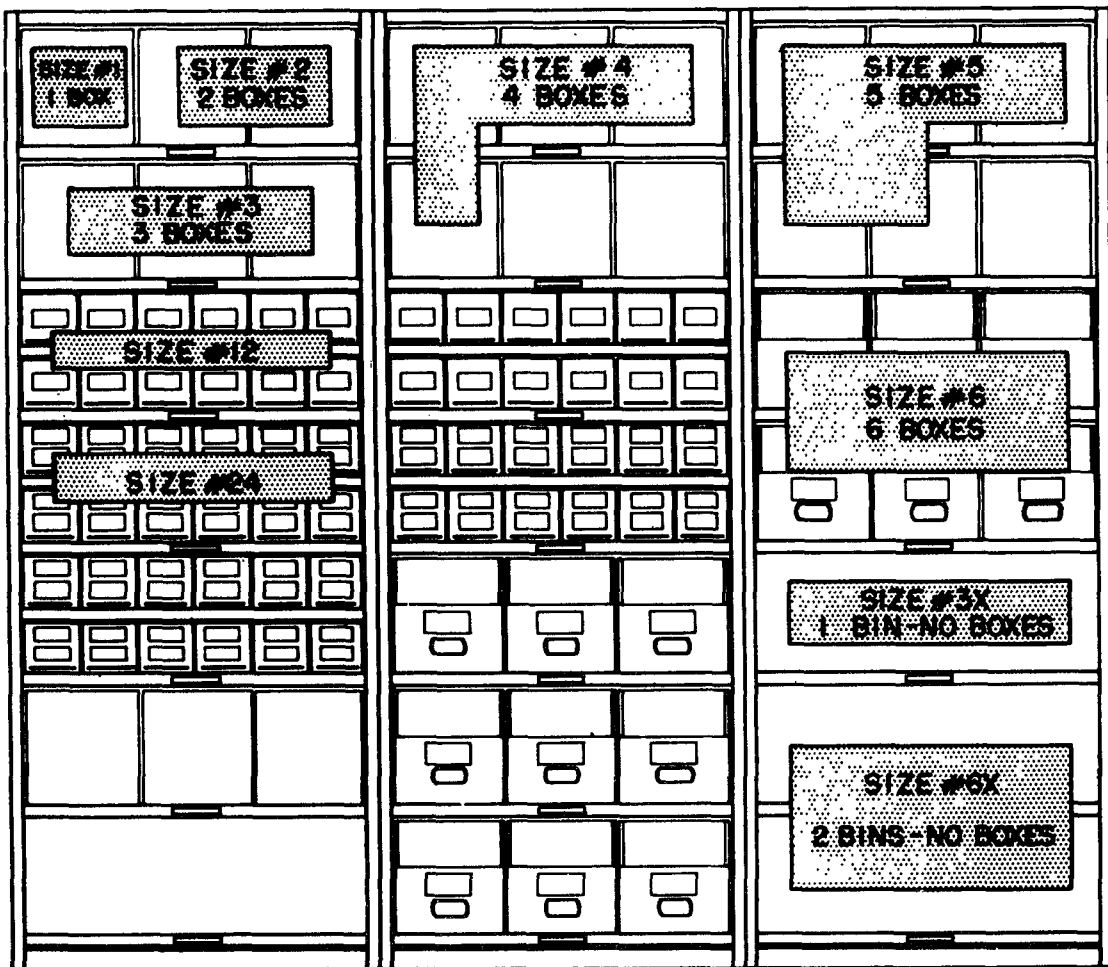

NOTE

THE SHELF BOX ARRANGEMENTS SHOWN ABOVE ARE EXAMPLES OF ONLY SOME OF THE LAYOUTS THAT CAN BE USED. THE NUMBER OF SMALL OR LARGE BOXES OR WHOLE SHELVES TO BE USED DEPENDS UPON THE PHYSICAL CHARACTERISTICS AND VOLUME OF BIN STOCKS TO BE STORED.

THE MAIN PRINCIPLES TO BE FOLLOWED ARE:

1. USE SHELF BOXES EXTENSIVELY FOR EASE OF INVENTORY AND STOCK RELOCATION.
2. SMALL LOTS IN THE CENTER SO THAT THE MAJORITY OF ITEMS ARE IN CHEST HIGH POSITION FOR EASY PICKING.
3. HEAVY, LARGE ITEMS TOWARD THE BOTTOM WITH MOST INACTIVE ON LOWEST SHELVES.
4. LIGHT, LARGE ITEMS TOWARD THE TOP WITH MOST INACTIVE ON HIGHEST SHELVES.

Figure 2-36 Typical Bin Shelf Box Arrangement

(b) All single pallet lots should be stored in metal pallet racks whenever practicable. In buildings with stacking overhead of 10 feet or less, a one-platform, two-level rack similar to the illustration in figure 2-37 should be used. In buildings with stacking overhead in excess of 10 feet, the

number of levels will be determined by the available stacking height, the reach capability of MHE, and the floor load capacity. Normally, 4 feet should be allowed for each level opening. A building with a 20-foot maximum stacking height could therefore accommodate five stacking levels or a four-platform pallet rack.

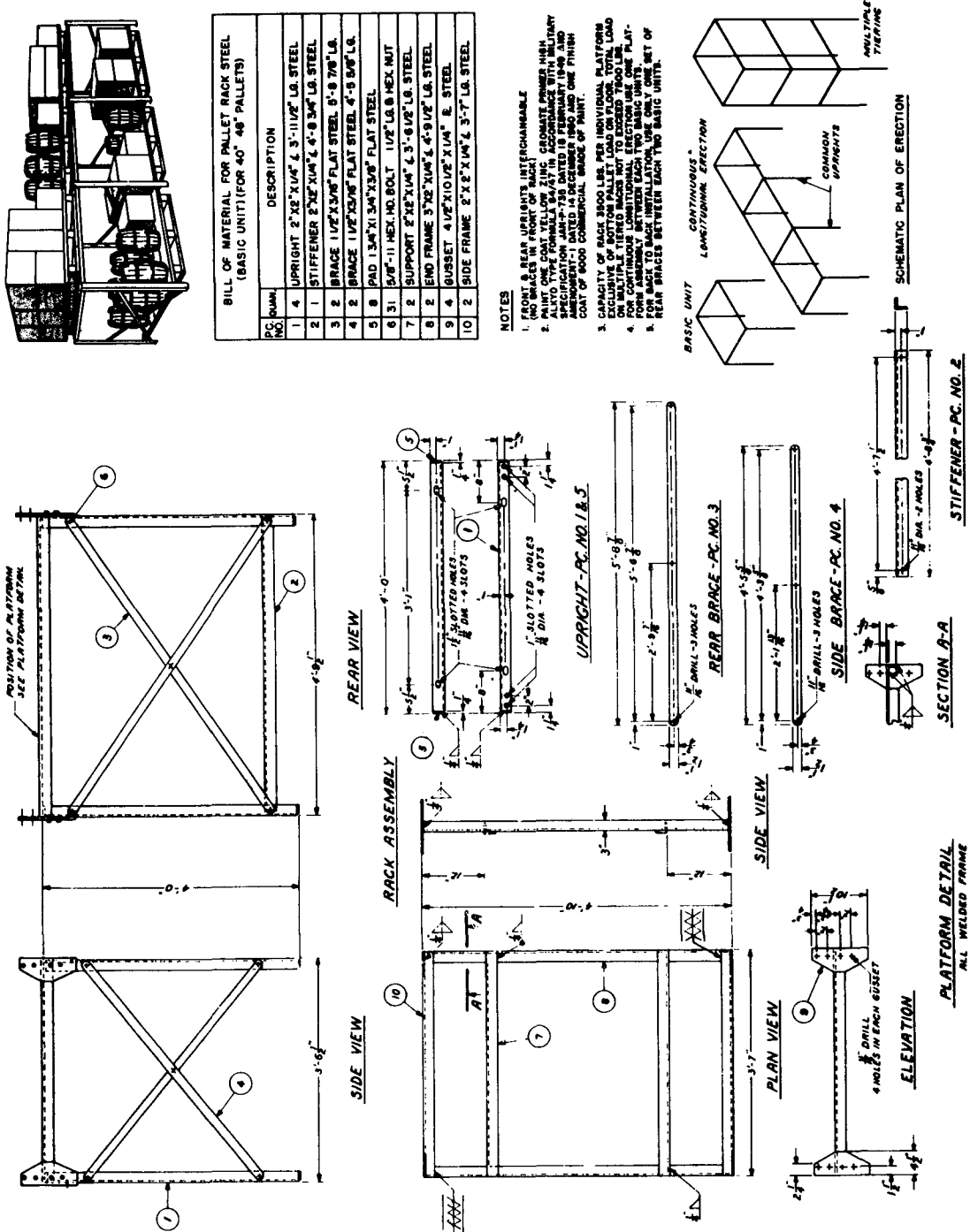

Figure 2-37 Metal Pallet Rack for Storage of Small Lot Items

1 Multiplatform pallet racks are illustrated in figure 2-38. The conversion to metal pal-

let racks at installations not so equipped is a highly desirable goal if maximum space utilization and most effective use of resources are to be achieved.

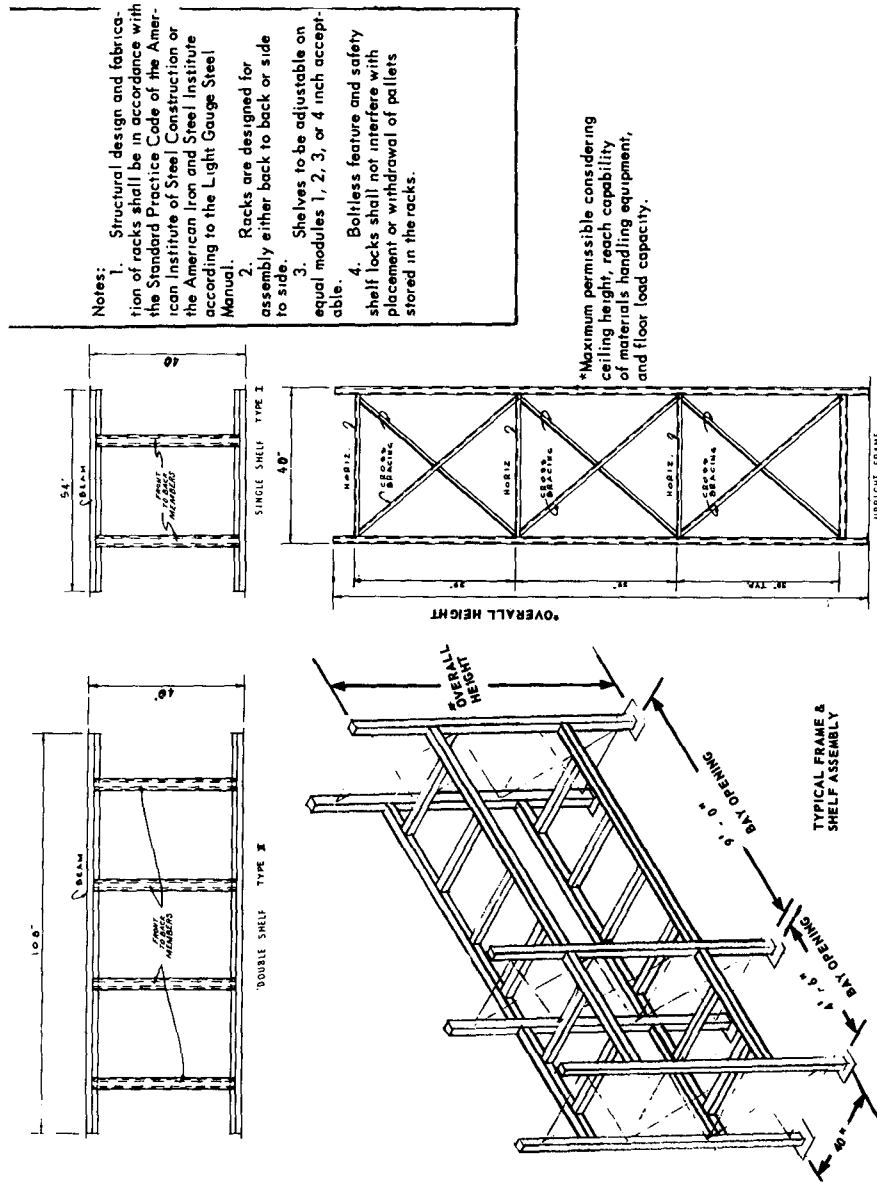

Figure 2-38. Metal Pallet Rack for Storage of Small Lot Items (Boltless Adjustable Type)

2 Racks for military use have been standardized for use with either one (single opening) or two (double opening) 40- by 48-inch pallet loads of material per level. Single opening racks have platforms approximately 54 inches wide and hold one 40- by 48-inch pallet per level. Cost per pallet opening is higher in a single opening rack and this should be used only when space limitations preclude use of the double opening. Double opening racks have platforms approximately 108 inches wide and hold two 40- by 48-inch pallets per level. Since the difference in cost between a

54- and a 108-inch platform is relatively small, and an upright column has been eliminated, the cost per pallet stored is smaller in a double opening rack than in a single opening rack.

3 Cantilever racks provide excellent storage aids for long, narrow items (see sec III, chap 4).

c. *Open storage layout criteria.* The efficient utilization of open storage space can be accomplished by proper planning and space layout. There are many types of open storage space and to utilize each in the most effective manner requires

judicious planning and a thorough knowledge of materials handling by storage personnel. Considerable thought must be given to the types of equipment to be used in each storage area to ensure

that adequate operational or working areas are provided in the layout of various types of space. Example layouts for open storage are shown in figures 2-39 and 2-40.

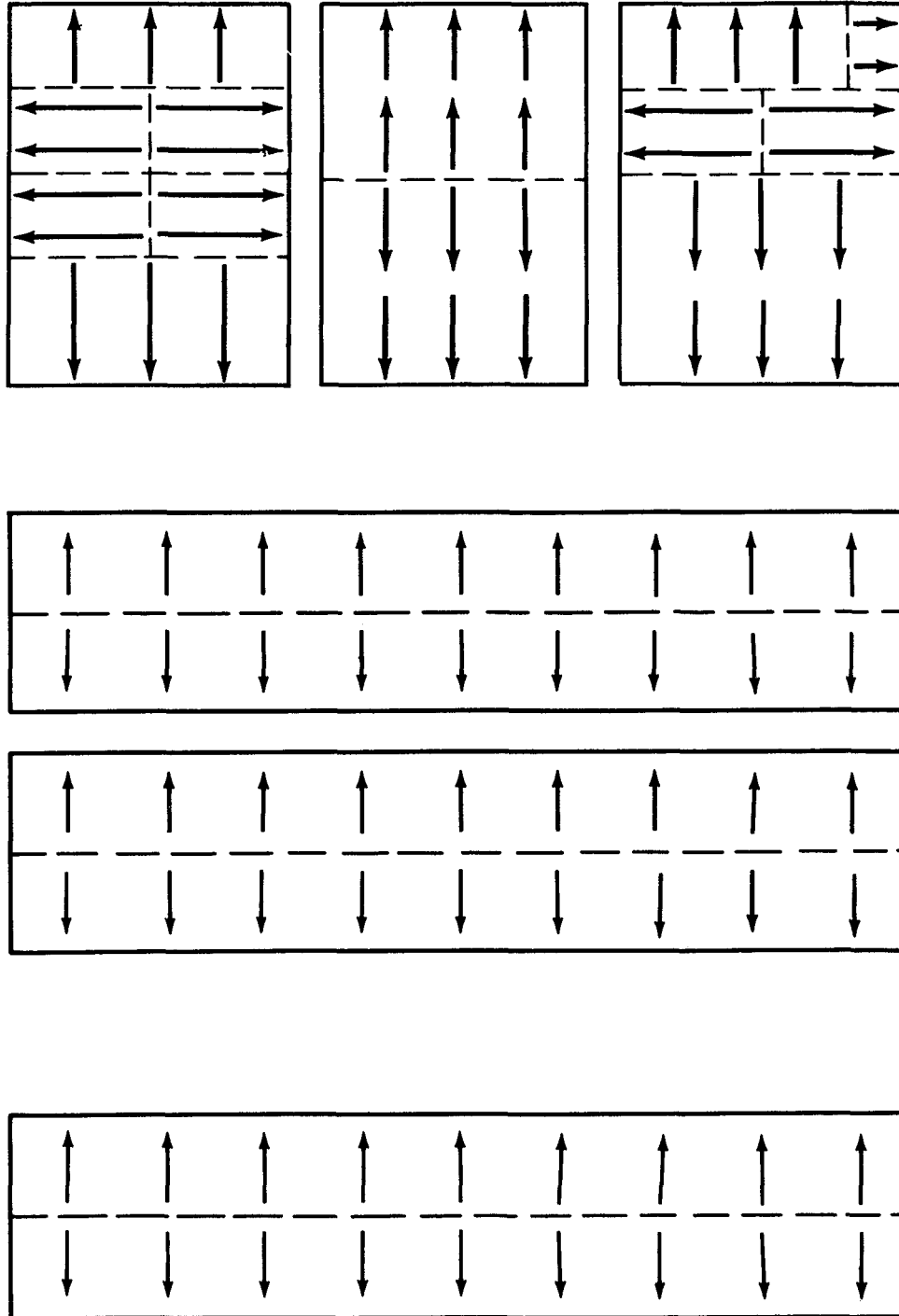

Figure 2-39 Example Layout for Open Storage Area

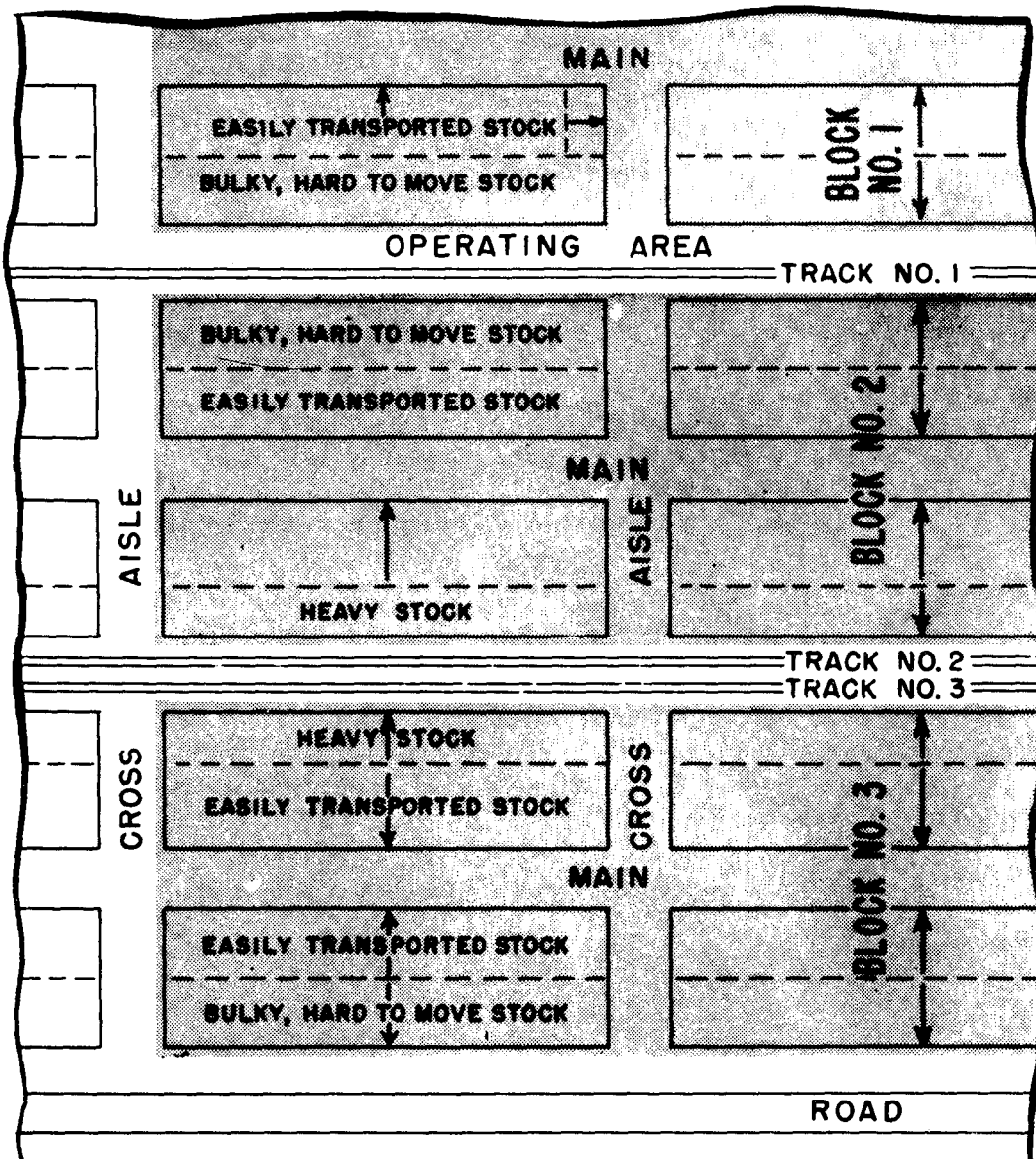

Figure 2-40. Example of Open Storage Area Layout

(1) the layout of open storage areas is determined, to a great extent, by the location and layout of the existing track and road facilities that serve the area.

(2) the objectives of open storage layouts are—

(a) Efficient utilization of each type of storage space.

(b) Straight line flow of stock from unloading point to storage.

(c) Maximum utilization of existing track and road facilities.

(d) Ready access to each storage area or stock item.

(3) Cube utilization in open storage may be increased by the utilization of storage aids. It is impossible to designate a maximum or minimum acceptable storage height for all open stored materials; however, cubic space should be utilized as efficiently in open storage areas as is practicable commensurate with good storage practices. The same general principles used in stacking supplies in covered storage apply to most items that can be stored in open storage. The efficient utilization of open storage cubic space is just as important as the utilization of covered storage space.

(4) Storage adjacent to double tracks should be reserved for storage of extremely heavy stock.

This is the ideal layout for heavylifts as it permits the car to be spotted on the more distant track and the crane to operate between the car and the storage point. In this arrangement, the distance from the crane to the material in the car or its intended storage point is cut to a minimum. This permits maximum utilization of crane lift capacity. Usually, double-track storage areas are at a premium; therefore, where possible, the area on both sides of a double track should be used for storage of heavy materials. However, to facilitate the use of the storage area behind this heavy material, it is necessary to provide 20-foot aisles at 100-foot intervals leading from the track to the inner storage areas.

(5) With a locomotive crane, a 2-foot clearance between stores and swing of the cab and counter balance is required. This will permit the crane to make the swing required to move material from the car to the stack without danger of the counter balance or cab of the crane colliding with the materials stored on either side of the tracks.

(6) Where crawler, truck-mounted, or warehouse cranes are used, it is necessary to maintain a 25-foot wide operational aisle along one side of the track, measured from the rail nearest to the storage area. This aisle provides the necessary clearance between the car and stock for efficient crane operations. Also, this aisle is necessary to permit the loading or unloading of cars by fork truck and the transportation of stock by crane, fork truck, or tractor-trailer train from car side to the storage areas not immediately adjacent to the track.

(7) Because of track, road layout, and/or terrain, each hard-surfaced open storage area presents varied problems in space layout. For this reason, layout plans must be flexible in order to utilize a higher percentage of the net usable space in each area.

2-11. Utilization of Floor Plan in Stock Layout.

a. Basic use. Using the floor plans, enter the location of aisles, shipping, receiving, bin, bulk, medium lot, pallet rack, and storage operational areas. After the location of the basic storage and

operational areas are determined, the direction of flow and storage must be established and entered on the floor plan. *Figures 2-41 and 2-42* are examples of layouts after preparation of initial floor plans.

b. Planning uses. The requirement for storage space by type, amount, and position must be calculated utilizing estimated or known item quantities, sizes, characteristics, and the demand frequency shown in current reports, historical data, and forecasts. Quantities of bin sections and the various types of racks required will then be determined. The amount and location of the space assigned for these storage aids will be in consonance of this section. A preliminary layout will be drawn on the floor plan and subjected to a comprehensive check to verify the validity of the data used and the calculations which were made from the data. It is essential that any revision of a layout be accomplished in the planning stage rather than after storage aids have been erected and material stored. The principles of efficient storage layout (see fig 2-41) require the minimum number and width of aisles, the maximum degree of straight flow movement patterns, the approximate positioning of bin and rack storage areas and storage support function areas, and the maintenance of flexibility in storage depth. The storage operation shown in figure 2-41 is small in size, but the principles shown apply to any storage operation regardless of square feet occupied, the range and depth of items stored, or the simplicity or sophistication of MHE used. Figure 2-42 illustrates placement of bins for a warehouse automated materials handling system. In such a system, popular items are placed in bins nearest the material flow lines (conveyors, etc.). Storage layouts must be planned to consolidate productive functions into a centralized location to the greatest feasible extent. Such planning will result in a layout which reduces travel time and distances. This, in turn, decreases the requirements for MHE, increases work unit production per man-hour, lessens personnel fatigue and error rate, provides for closer supervision and greater security, and permits flexibility in use of the work force.

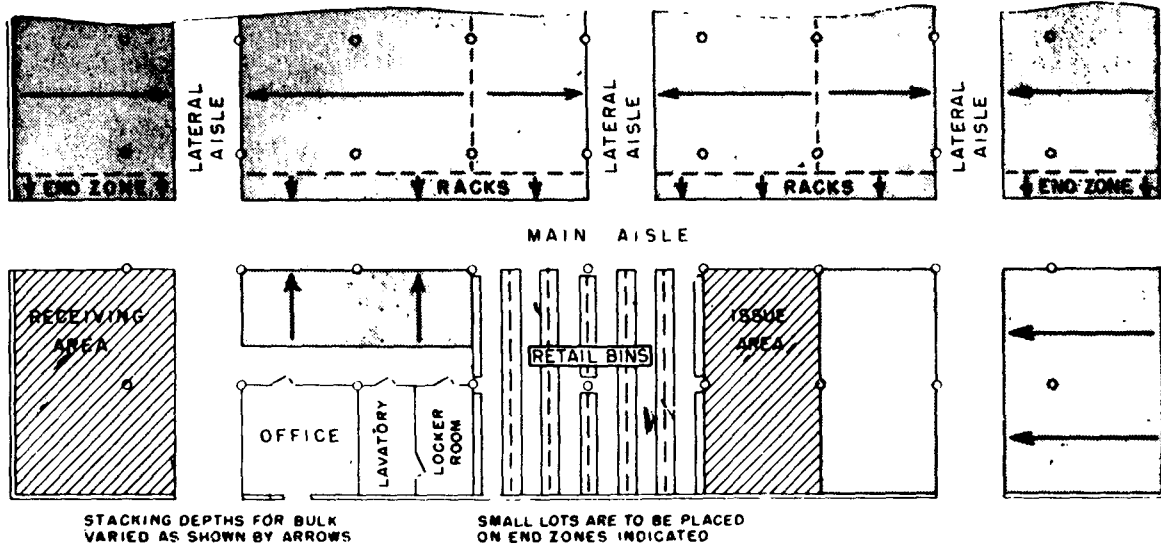

Figure 2-41. Example Stock Layout

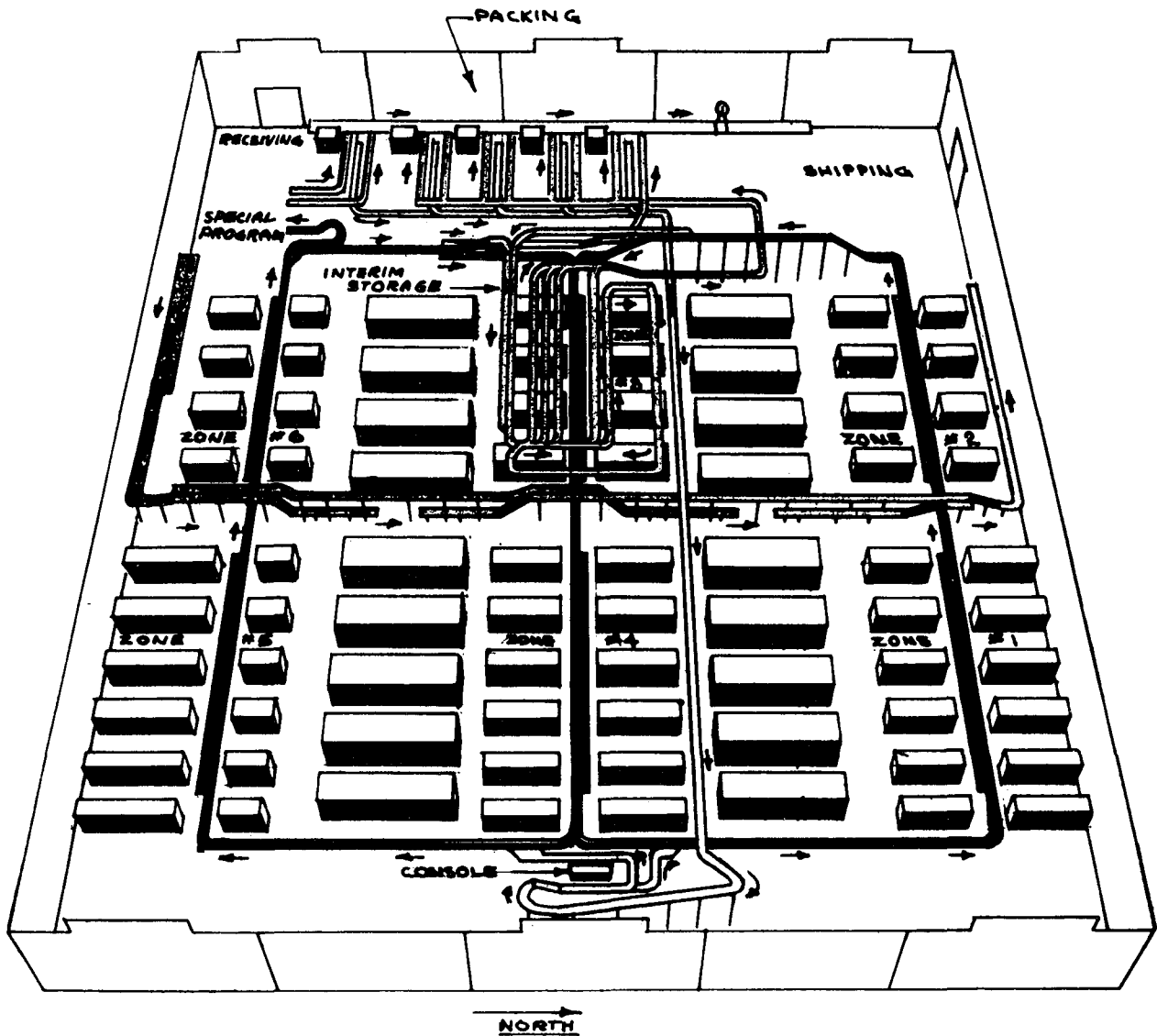

Figure 2-42 Layout Containing an Automated Materials Handling System

c. *Flexibility.* Changes in the types of the materials handled or the average quantities in stock will require periodic changes of layout. The storage officer must be aware of the need for changes and when such changes occur, alter a layout if a change will increase operational efficiency. Also, consolidation of the material in several partially depleted rows into one location or removal of residual quantities to small lot or loose issue areas can convert unusable space thereby reducing honeycombing.

d. *Effect of stock selection on layouts.* Stock selection from bulk storage areas can influence the effectiveness of layouts. Material must be withdrawn row by row starting from the aisle and

working back to the wall or imaginary line, and never across the whole front of the stacks. Withdrawals across the front of the stacks merely widen the aisle and do not create additional space for the storage of new commodities. This incorrect method of stock withdrawal is a common cause of "honeycombing" in storage areas (see fig 2-43). Honeycombing also includes void spaces within the arrangement of materials on pallets which results in space loss. Space loss between stacks may be due to excessive overhang resulting from poor palletization of the stock item.

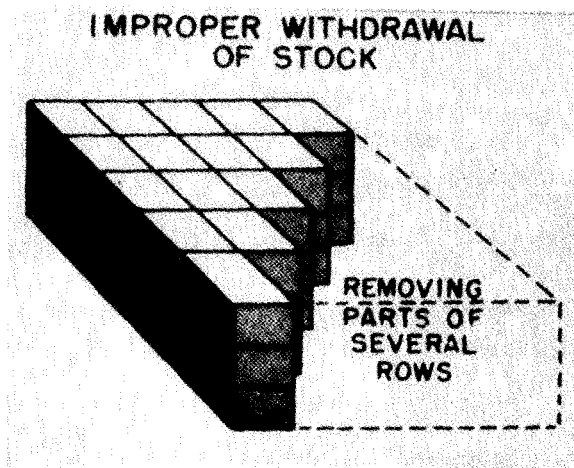

Figure 2-43 Honeycombing Due to Improper Withdrawal of Stock

Section V. Space Control and Reporting

2-12. Space Control Techniques.

a. Scope and purpose. Effective control of space begins with the operating supervisor and extends through the storage manager, the activity or installation commander, the major command headquarters, and to higher department or agency levels of command. This section provides certain uniform techniques to be used for proper space control. Storage plans for installations and activities storing ammunition will be developed as prescribed by the responsible military service.

b. Space allocation map. A map of the installation reflecting the current status of the total area allocated for storage operations and the location or other related activities will be maintained by the storage manager. This map will show the type of space and specific functional use (for example, receiving, shipping, bulk storage, loose issue storage, office space, etc.). When applicable, broad material groupings may be added to identify storage of repair parts, end items, ammunition, etc. Identification of these areas may be accomplished by the use of color coding. An overlay may be used to facilitate updating the map.

c. Floor plan or planograph. The base for designing local space control techniques for storage areas is the floor plan or planograph. Floor plans for general supply storage areas are discussed and illustrated in section IV of this chapter. Detailed planographs depicting specific storage layouts are generally developed from these floor plans. Detailed information on planographs for general supply storage areas are discussed and illustrated in section III, chapter 3.

d. Storage space survey worksheet. Utilizing information obtained from planographs, storage space survey worksheets should be developed for each general supply warehouse section, shed, open storage area, etc. These worksheets are scaled drawings of storage areas and provide feeder data input for storage space status reports. Figure 2-44 is a sample of a storage space survey worksheet which may be used; however, it is not applicable to ammunition. Ammunition storage space data will be maintained on planographs in the manner prescribed by the responsible service. For details on the use of the survey worksheet, see paragraph 2-13g below.

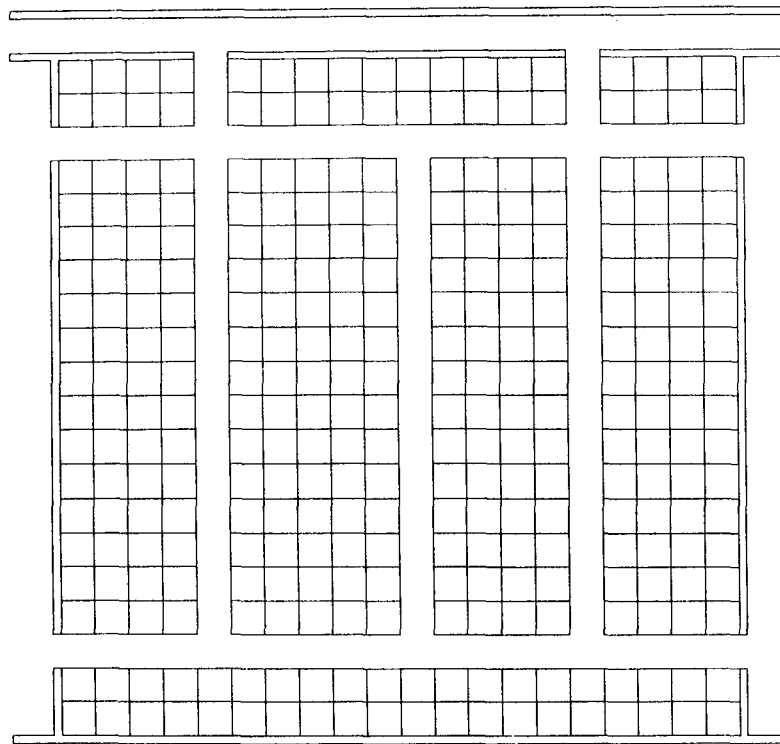

BUILDING OR AREA _____	SECTION _____
GROSS SQUARE FEET _____	UNOBSTRUCTED STACK HEIGHT _____
AISLES _____	BIN STORAGE AREA _____
STRUCTURAL LOSS _____	RACK STORAGE AREA _____
SUPPORT SPACE _____	BULK STORAGE AREA _____
NET SQUARE FEET (TOTAL) _____	ATTAINABLE STACK HEIGHT _____
BIN STORAGE AREA _____	BIN STORAGE AREA _____
RACK STORAGE AREA _____	RACK STORAGE AREA _____
BULK STORAGE AREA _____	BULK STORAGE AREA _____
OCCUPIED SQUARE FEET _____	AVERAGE STACK HEIGHT _____
VACANT SQUARE FEET _____	(BULK STORAGE) _____
OBLIGATED VACANT _____	OCCUPIED CUBIC FEET _____
COMMON/CROSS-SERVICED _____	BIN STORAGE AREA _____
DOD MATERIAL _____	RACK STORAGE AREA _____
NON-DOD MATERIAL _____	BULK STORAGE AREA _____
REPORTING COMPONENT _____	POTENTIAL VACANT SPACE _____
MATERIAL _____	TYPE A _____
SIGNATURE _____	TYPE B _____
ORGANIZATION _____	DATE _____
	PHONE _____

Figure 2-44. Storage Space Survey Worksheet

e. *Space recapitulation record.* Figure 2-45 represents a sample space recapitulation record which may be used to recap storage space data. Such a

record provides an effective means of consolidating storage space data by building, area, type of space,

etc., and can be used in conjunction with storage space status reports.

f. Storage space status report.

(1) A storage space status report will be prepared periodically. For control purposes, storage space status reports may be required monthly, quarterly, or as often as deemed necessary by the individual DOD Component. For reporting purposes, DOD Components must comply with the frequency requirements of the Storage Space Management Report (SSMR) (DD Form 805) (para 2-14c).

(2) Storage space status reports are basically current records of space utilization and occupancy. These reports are to be assembled by the storage administrative activity responsible for space control and reporting. The information contained therein will be recapitulated for space reporting to higher levels.

(3) Internal reports will also include specific data pertaining to potential space improvements. For general supplies, potential space improvement data are identified during storage space surveys as potential vacant type "A" (sq ft) and type "B" (cu ft). For local management purposes, potential vacant type "A" space warrants consideration when

it reaches 5 percent of net square feet occupied in a specific storage area. These affected areas will be reviewed by storage managers to direct efforts to reclaim such space by rewarehousing. Potential vacant space is discussed and illustrated in more detail in paragraph 2-13 below.

2-13. Space Reporting Guidance.

The following provides guidance in understandable terms for use by personnel involved in space reporting:

a. Classification of storage and nonstorage space. The entire area of a supply installation or activity is not classified as storage space (see fig 2-46). This means that not all of the buildings or all of the open areas are considered in computing actual storage space. For example, buildings such as the commissary, post engineering, and administrative offices and open areas such as a parking lot do not constitute storage space. Some offices, however, are part of storage space, but they include only those that are directly in support of storage operations. The only area of the installation reported as storage space is that which is either by nature or use a storage area. The dimensions of these areas, side by side and end to end, make up gross storage.

STORAGE VERSUS NON-STORAGE SPACE

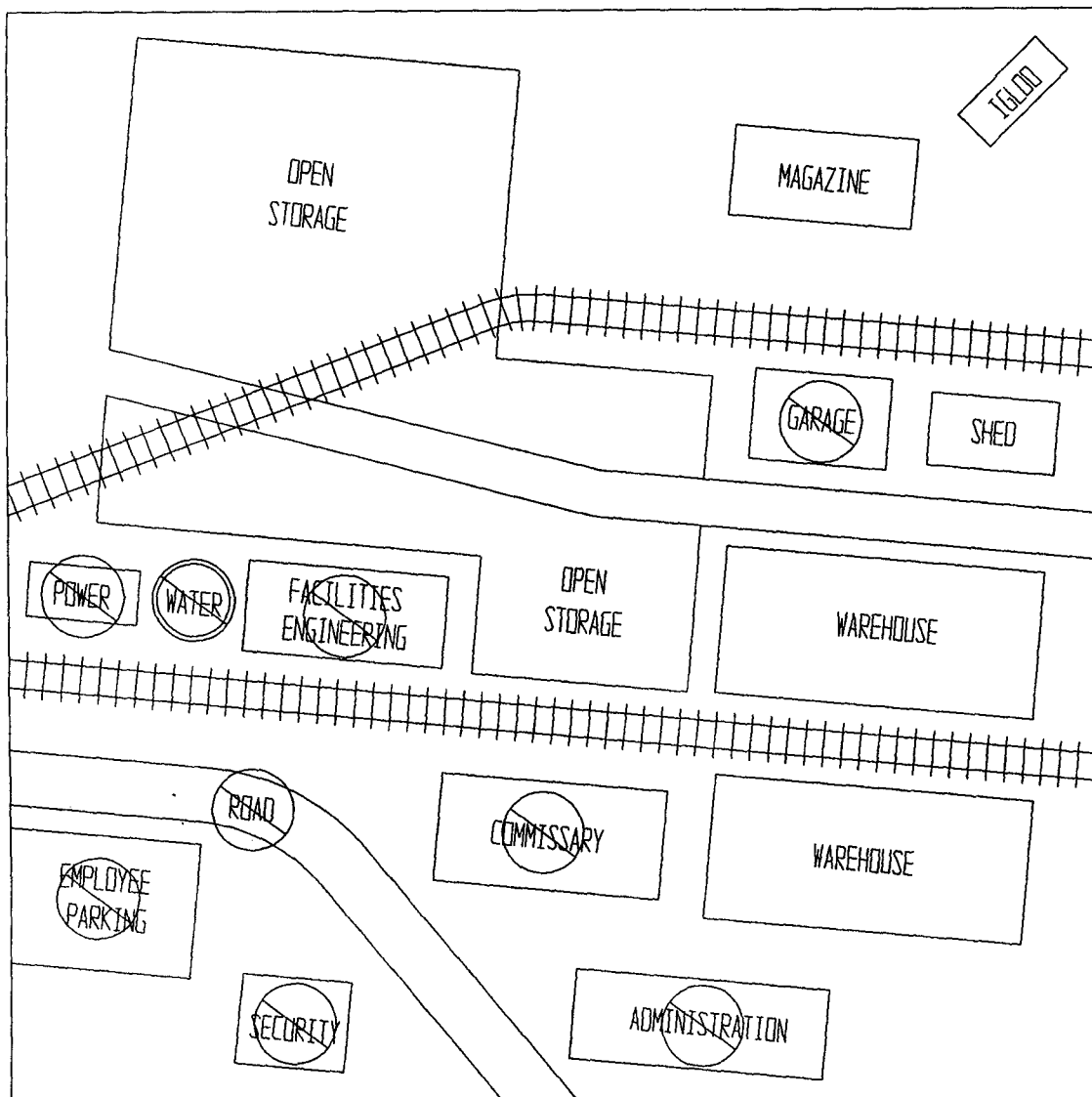

Figure 2-46. Classification of Storage and Nonstorage Space

b. *Measuring covered storage space.* All covered storage space is measured by using inside dimensions (see fig 2-47). The width in feet is multiplied by the length in feet which results in the square foot area or total gross storage area. This is less than the outside dimensions by the thickness of the walls and it ignores inside fire walls, passageways, ramps, stairwells, etc. However, if there is a cutback in walls of the building, the cutback is measured and excluded from total gross storage

area. If the building has a tower for offices or any portion not designed for storage but is part of the building, that portion is excluded from total gross storage area. However, if the tower or other portion had been designed for storage and later converted to storage offices, it would be included in total gross storage area. Even if it was not designed for storage but is being used for that purpose, it is reported during the period of use.

MEASURING WAREHOUSE SPACE (USE INSIDE DIMENSIONS)

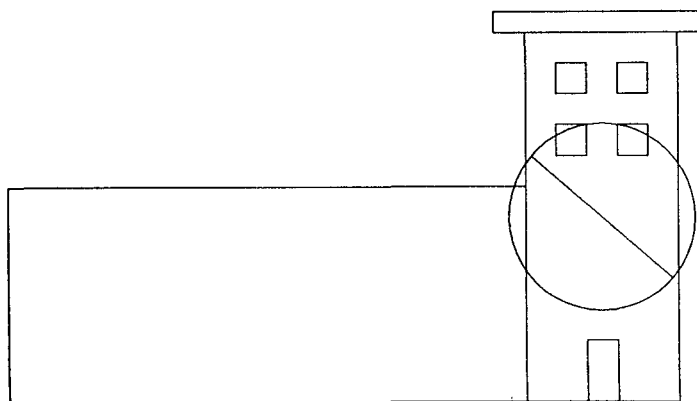
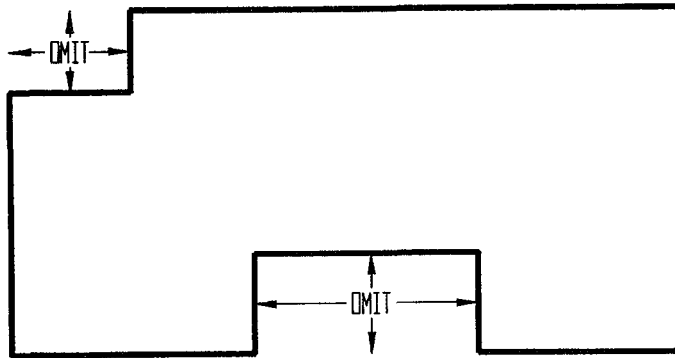
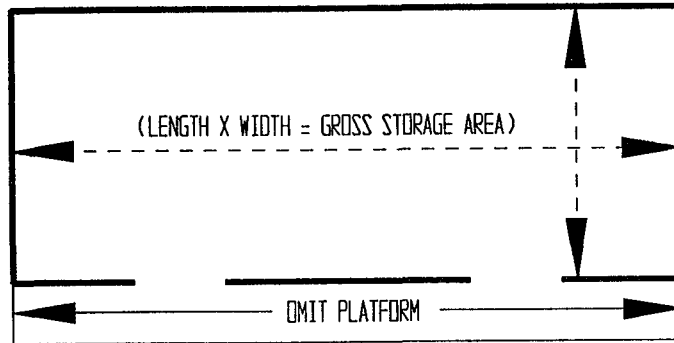

Figure 2-47 Measuring Covered Storage Space

c. *Measuring open storage areas.* Open storage may be either improved or unimproved. Improved

is included in total gross storage area; however, in the case of unimproved areas, only that space ac-

tually occupied by stored material or used in support of storage operations will be reported.

(1) Open space is measured in much the same way as covered storage, except outside dimensions of the area are used. The length in feet multiplied by the width in feet results in the gross area expressed in square feet. If the area is irregular, adjustments are calculated to arrive at a corrected

figure. The figure is not reduced for tracks or roadways running through the area.

(2) Open space does not include sand lots, parking areas, maneuvering space between warehouses, etc., even if these areas have prepared surfaces (see fig 2-48). However, if the space is actually occupied by material, it will be reported as storage space for the period actually occupied.

THIS IS OPEN STORAGE SPACE

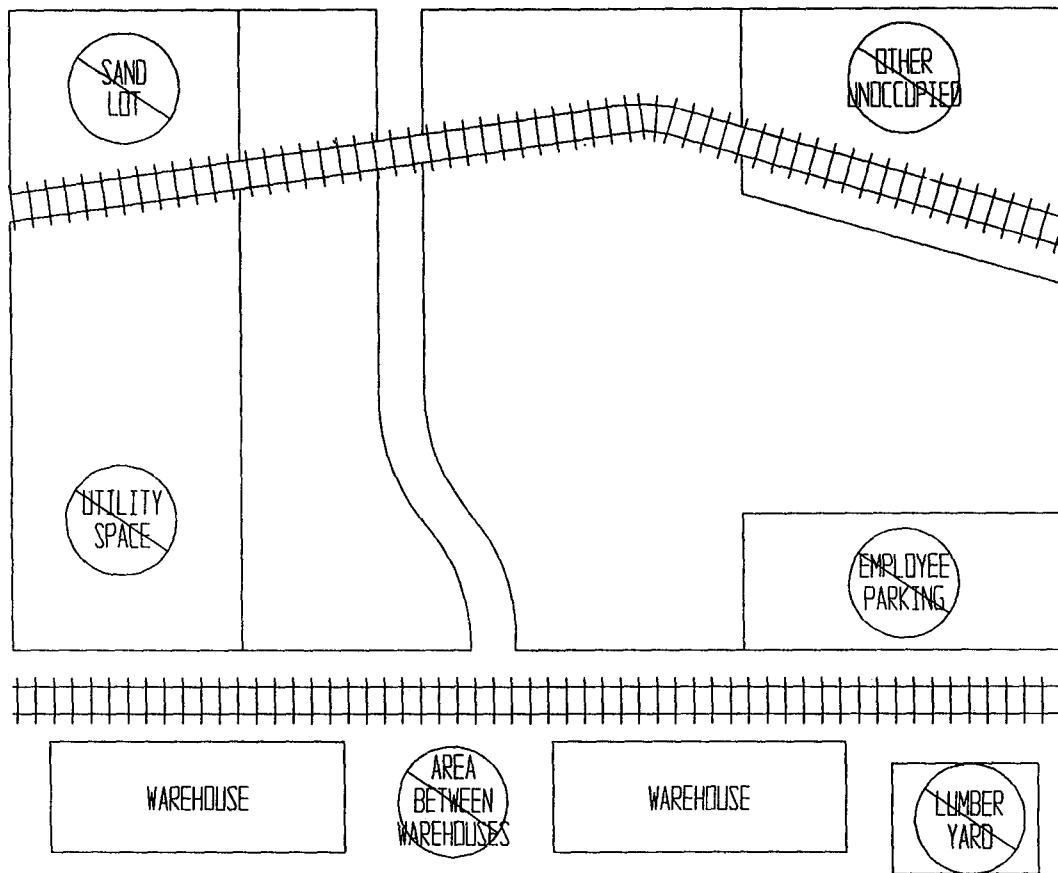

Figure 2-48. Classification of Open Storage Space

d. Calculating gross space for storage operations in square feet.

(1) This involves three steps—

(a) The first step involves calculating gross storage space. This is calculated by multiplying the length in feet by the width in feet of each building or area designated for storage (see fig 2-48).

(b) The second step involves subtracting all space not used for storage operations. That includes—

1 *Unusable space.* This is the amount of gross storage space so deteriorated that it fails to provide a sufficiently protective environment for the storage of material; space that is unsafe for storage operations or where its use would be in violation with established regulating criteria; and/or space that is restricted from use due to inadequate physical security protection.

2 *Standby space.* This is the amount of gross storage space contained in completely empty structures or in open improved areas which is not required to support the mission, which has

been secured, and which is not included in vacant storage space. Space in completely empty sections of covered structures which can be isolated and locked is also considered as standby.

3 *Outgranted space.* This is the amount of gross storage space which is not available for the reporting activity's operation because it is outleased, licensed, or permitted to private or non-

DOD Government agencies for their operation and/or licensed or permitted to other DOD Components for their operation.

(c) The third step involves adding ingrated space, that is, space which is leased, licensed, or permitted from one of the DOD Components.

(2) In other words,

$$\begin{array}{ccccccccc} \text{GROSS} & & \text{UNUS-} & & & & \text{OUT-} & & \text{GROSS} \\ \text{STORAGE} & - & \text{ABLE} & - & \text{STANDBY} & - & \text{GRANTED} & + & \text{SPACE} \\ \text{SPACE} & & \text{SPACE} & & \text{SPACE} & & \text{SPACE} & & \text{FOR STOR-} \\ & & & & & & & & \text{AGE OPER-} \\ & & & & & & & & \text{ATIONS} \end{array} =$$

e. *Reporting net storage space.* Net storage space is reported in square and cubic feet. First, the capacity of net storage space is determined in square feet and cubic feet measurements. Then occupied and vacant space is determined.

(1) *Determining net storage space in square feet.* This is calculated by subtracting the following from gross space for storage operations (see para d above):

(a) *Aisles.* An aisle is any passageway in storage areas including passageways in bin and rack areas. It includes fire, personnel, main, and cross aisles.

(b) *Structural loss.* This is the space that is not usable for storage because of obstructions caused by physical characteristics such as posts,

pillars, ramps, door clearances, fire walls, etc., and by installed equipment such as switch panels, dehumidification equipment, etc. In open or outside storage, it includes space lost due to railroad tracks and fire breaks as well as for clearances for utility lines, etc. Structural loss does not include aisles.

(c) *Support Space.* This is storage space that is used in support of storage operations. It includes space used for receiving, shipping, preservation and packaging, inspection and identification, packing, box shop, assembly, offices, MHE parking areas, battery charging stations, employee rest rooms, locker rooms, time clock areas, smoking areas, etc.; however, only storage space used for any of the above is included. For example, it does not include general administrative offices.

$$\begin{array}{ccccccccc} \text{GROSS SPACE} & & & & & & & & \\ \text{FOR STORAGE} & - & \text{AISLES} & - & \text{STRUCTURAL} & - & \text{SUPPORT} & = & \text{NET STORAGE} \\ \text{OPERATIONS} & & & & \text{LOSS} & & \text{SPACE} & & \text{SPACE} \end{array}$$

(2) *Determining net storage capacity in cubic feet.* There are two classifications of cubic capacity, total cubic feet and attainable cubic feet.

(a) *Determining cubic capacity in covered storage areas (see fig 2-49):*

1 Total cubic feet is the product of net storage space (sq ft) multiplied by the unobstructed stacking height(s) permitted by safety regulations/restrictions in a particular storage area, bay, or section of a covered facility. The un-

obstructed stacking height is the distance between the floor and the lowermost point of overhead obstructions (e.g., sprinkler heads, joists, rafters, beams, roof trusses, lighting fixtures, duct work, etc.) less safety clearances.

$$\begin{array}{ccccccc} \text{NET STOR-} & & & & \text{UNOB-} & & \text{TOTAL} \\ \text{AGE} & \times & & & \text{STRUCTURED} & = & \text{CUBIC} \\ \text{SPACE} & & & & \text{STORAGE} & & \text{FEET} \\ & & & & \text{HEIGHT(S)} & & \end{array}$$

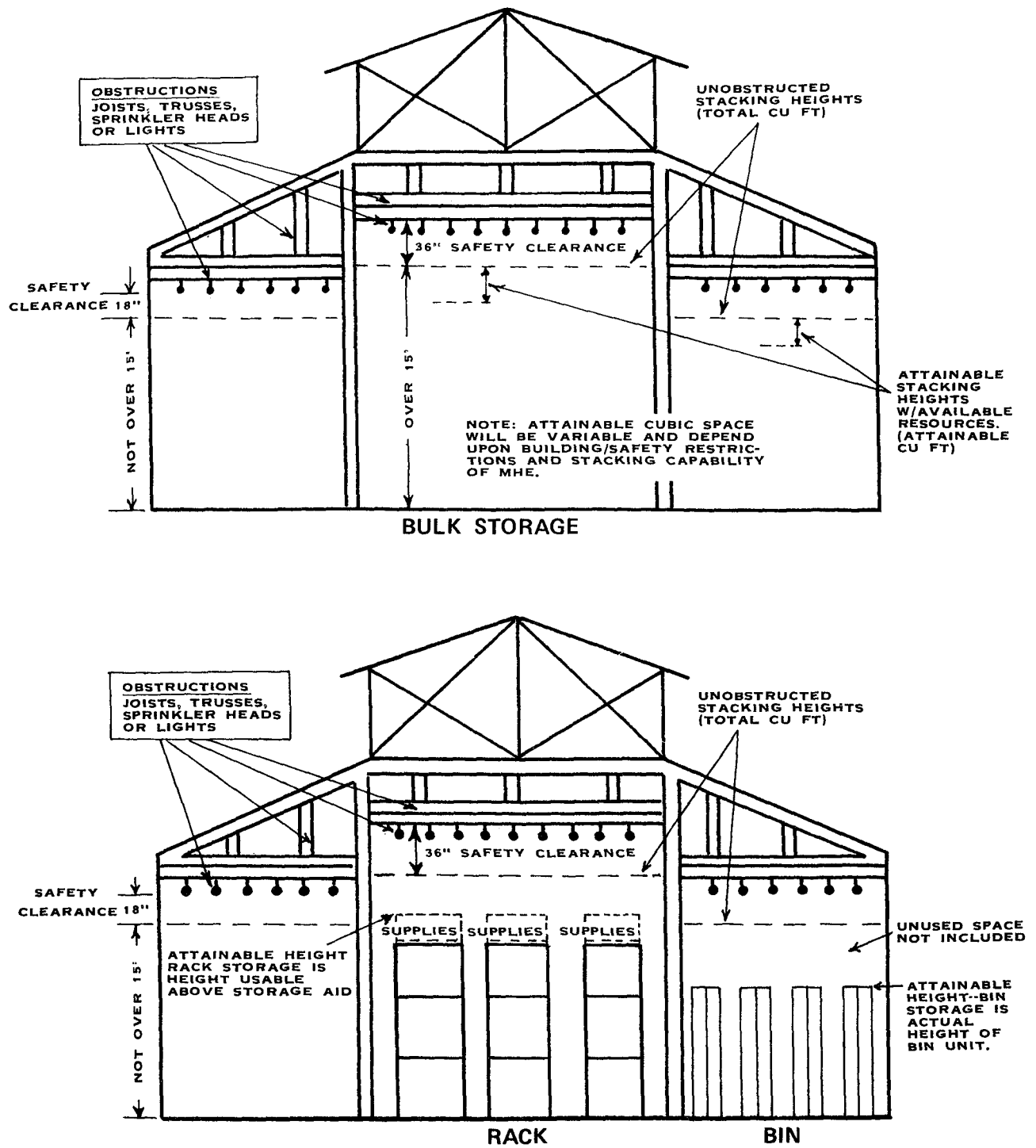

Figure 2-49 Determining Cubic Capacity in Covered Storage Areas

2 Attainable cubic feet is the product of net storage space (sq ft) multiplied by the stacking height(s) permitted by safety regulations/restrictions and floor load limitations with available

MHE. It represents the cubic space usable or available for storage with existing resources.

$$\begin{array}{r} \text{NET STOR-} \\ \text{AGE} \\ \text{SPACE} \end{array} \times \begin{array}{r} \text{ATTAIN-} \\ \text{ABLE STOR-} \\ \text{AGE} \\ \text{HEIGHT(S)} \end{array} = \begin{array}{r} \text{ATTAIN-} \\ \text{ABLE} \\ \text{CUBIC} \\ \text{FEET} \end{array}$$

(a) Bin cubic capacity is the product of outside dimensions—length, width, and height (L×W×H). Unused cubic space above the bins will not be included as attainable space.

(b) Rack cubic capacity is the product of the outside dimensions—length, width, and height (L×W×H). Cubic space above the racks will be included to the extent that use of such space is permitted by safety limitations.

(b) Determining cubic capacity in open storage areas:

1 Open improved storage areas.

(a) Total cubic capacity will be computed by multiplying net storage (sq ft) by an average stacking height of 10 feet. However, when local conditions and actual commodity characteristics dictate a specific stacking height, the latter will apply.

$$\begin{array}{r} \text{Net im-} \\ \text{proved open} \\ \text{storage} \\ \text{space} \end{array} \times \begin{array}{r} \text{Average} \\ \text{stacking} \\ \text{height (10} \\ \text{feet or} \\ \text{other)} \end{array} = \begin{array}{r} \text{Improved} \\ \text{open storage} \\ \text{cubic feet} \end{array}$$

(b) Attainable cubic capacity will be computed using the same criteria for total cubic capacity.

2 Open unimproved storage areas.

a In open unimproved storage areas, only cubic space actually occupied will be reported. The total cubic capacity is calculated by multiplying net storage space (sq ft) by a representative (sample) stacking height.

$$\begin{array}{r} \text{Unimproved} \\ \text{occupied} \\ \text{square feet} \end{array} \times \begin{array}{r} \text{Average} \\ \text{stacking} \\ \text{height} \end{array} = \begin{array}{r} \text{Unimproved} \\ \text{open storage} \\ \text{cubic feet} \end{array}$$

b Attainable cubic capacity will be computed using the same criteria for total cubic capacity.

(c) In determining cubic capacity in igloo and magazine areas, the basic instructions for covered storage also apply for reporting ammunition cubic capacity (i.e., cubic capacities in igloos and magazines). These guidelines, however, may be augmented by special DOD Component instructions establishing uniform unobstructed or attainable heights in the specific facilities (i.e., igloos and magazines). When such specific heights are

established and furnished, reporting activities will compute cubic capacities accordingly.

(3) *Determining occupied and vacant net storage space.* Space is either occupied or vacant. Also, occupied space can be utilized improperly and be classified as “potential vacant.” Determining the amount of net storage space that is occupied can be accomplished by measuring all the space actually occupied; however, since in most cases occupied space is greater than vacant space, it is simpler and more accurate to compute the total vacant space and subtract that figure from net storage space.

(a) *Determining occupied storage space.*

1 Occupied square feet is the amount of square feet occupied by bins, racks, and material in covered and open bulk storage areas. Bin and rack space is considered occupied whether or not material is stored therein. Occupied square feet is equal to length multiplied by width (L × W).

2 Occupied cubic feet is the product of net square feet occupied and actual storage height(s) or by heights determined through statistical sampling, when applicable.

a Bin and rack occupancy will be computed by determining what portion of total attainable space is vacant through statistical sampling or by records of available and occupied openings. Therefore, total attainable cubic feet minus vacant cubic feet equals occupied bin and rack space.

b Bulk occupancy in covered storage will be based upon periodic surveys of bulk locations to determine representative bulk stacking heights for each storage facility.

c Improved open occupancy will be based upon net square feet occupied multiplied by an average stacking height of 10 feet (or other specific height if determined).

d Unimproved open occupancy will be based upon occupied square feet times an average stacking height.

(b) *Determining vacant space.* There are two types of vacant space, actual and potential.

1 Actual vacant space is determined by measuring the floor space that is not occupied by supplies. It includes space occupied by empty pallets and dunnage. It does not include short spaces in front of stacks or broken spaces.

2 Potential vacant space is space that is usable but not used and can normally be recouped through rewarehousing. Since storage space is critical, it must be used wisely. Potential vacant space is “found” space and should not be overlooked. Actions should be taken to recover this space. There

are two types of potential vacant space, type A and type B.

a Type A, Honeycombing. Type A potential vacant includes all spaces in front of stacks which cannot be used for storage of supplies other than identical sizes, lots, etc. It is a type of space loss which can frequently be overcome by setting aside shallow spaces along aisles for small lots. This space is captured during space surveys and reported as space recoupable through rewarehousing (see fig 2-20). Figure 2-51 provides

an example of type A potential vacant space. Sometimes short spaces in front of stacks can be avoided. In some instances, the condition is unavoidable. However, in either case, the space that might be reclaimed is reported as potential vacant. Generally speaking, warehousing practice that leaves short spaces in the midst of stacks is not good warehousing. But good or bad, avoidable or unavoidable, such spaces are reported as potential vacant. Figure 2-52 provides an example of type A potential vacant space and the space that can be recouped through rewarehousing.

TYPE A
SHORT SPACES AND BROKEN
SPACES ("HONEYCOMBING")

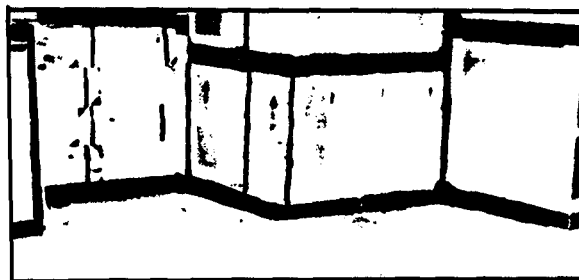

Figure 2-50. Honeycombing—Type A Potential Vacant Space

TYPE A

50%
POTENTIAL
VACANT

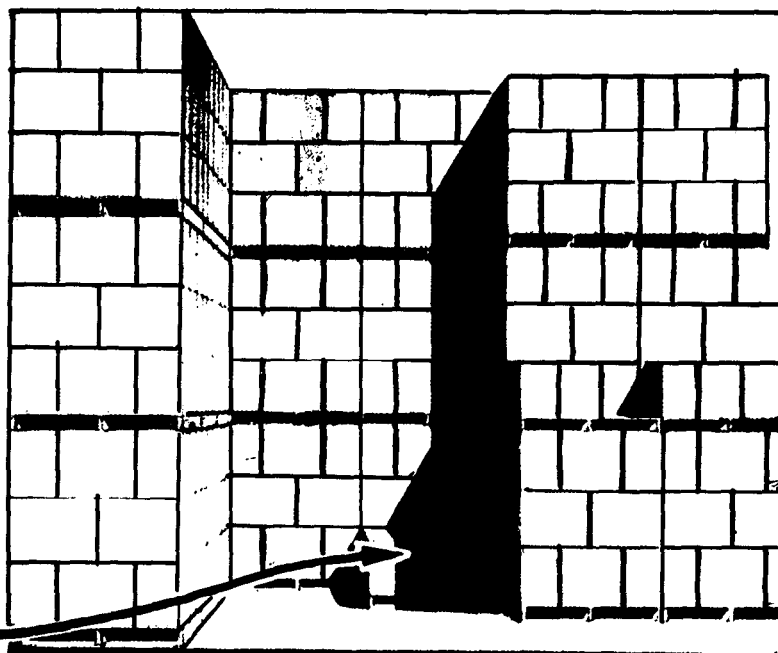

Figure 2-51 Type A Potential Vacant Space

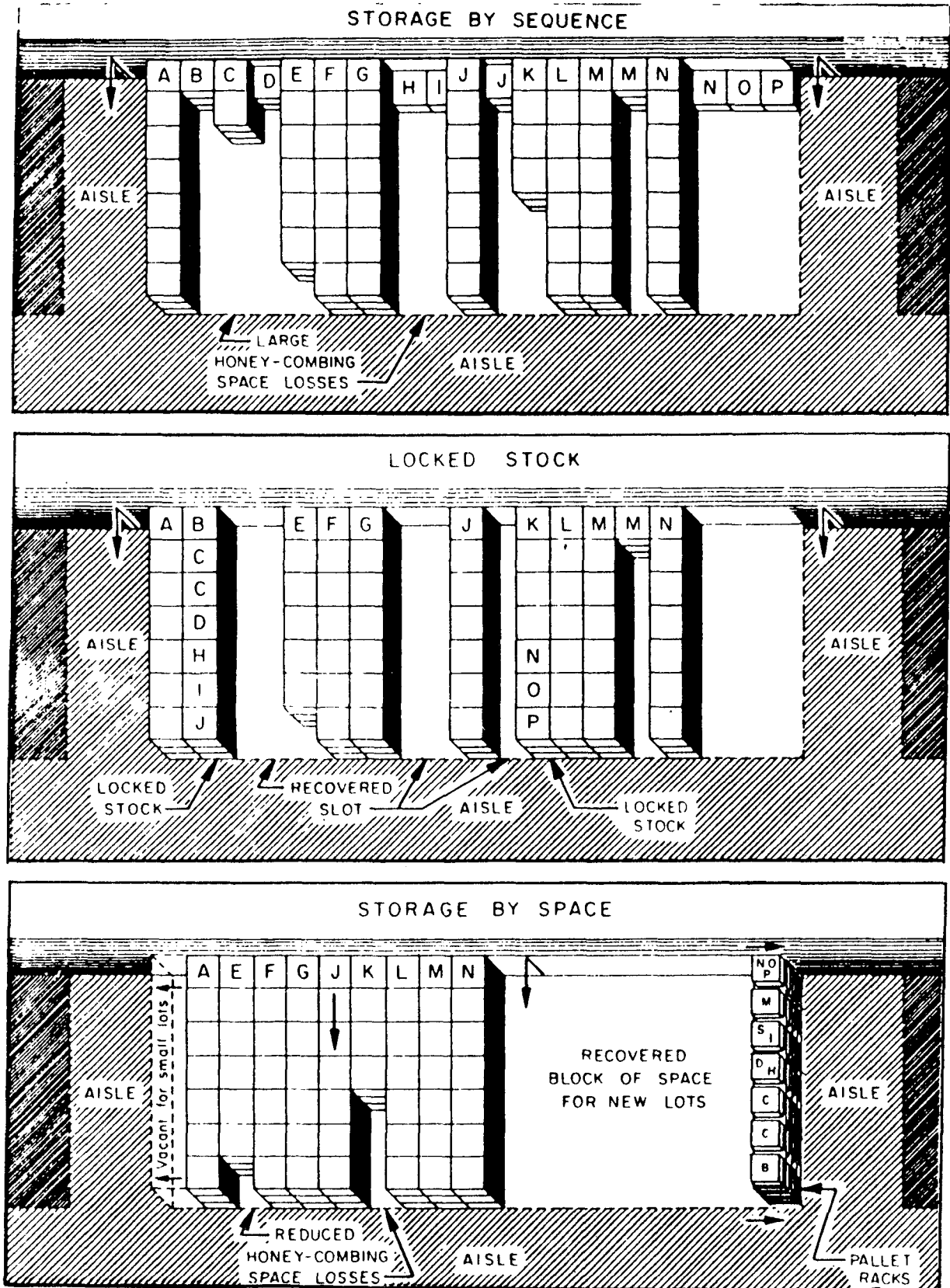

Figure 2-52 Type A Potential Vacant Space Recouped Through Rewarehousing

b Type B, Low stacking. Type B potential vacant space occurs as a result of low stacking, that is, failure to stack to full permissible heights considering the floor load, height of roof rafters and ceiling joists, commodity characteristics, and strength of package. Space is 100 percent occupied when the low stacking is caused by limitations of floor load, height of roof rafters and ceiling joists,

commodity characteristics, and/or strength of package (see fig 2-53). Figure 2-54 provides an example where there is 25 percent type B potential vacant space because if the pallets in the foreground were loaded in the same way as those in the rear, the foreground pallets could be stacked eight high instead of six. Figure 2-55 shows type B potential vacant space and the space that can be recovered through rewarehousing.

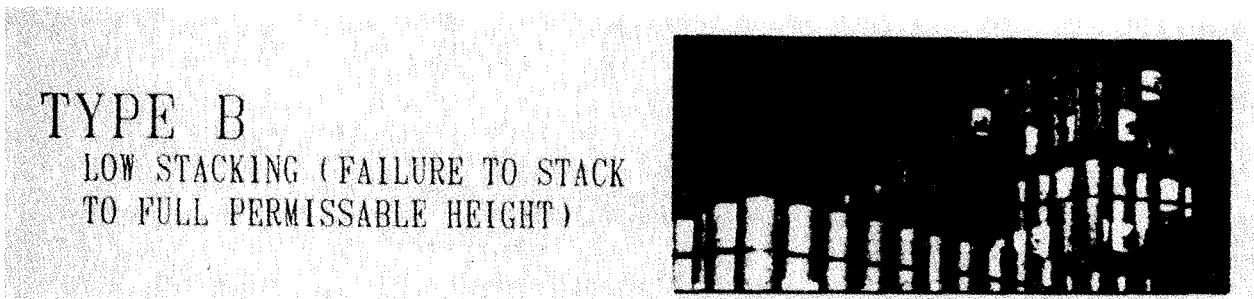

Figure 2-53 Low Stacking—Type B Potential Vacant Space

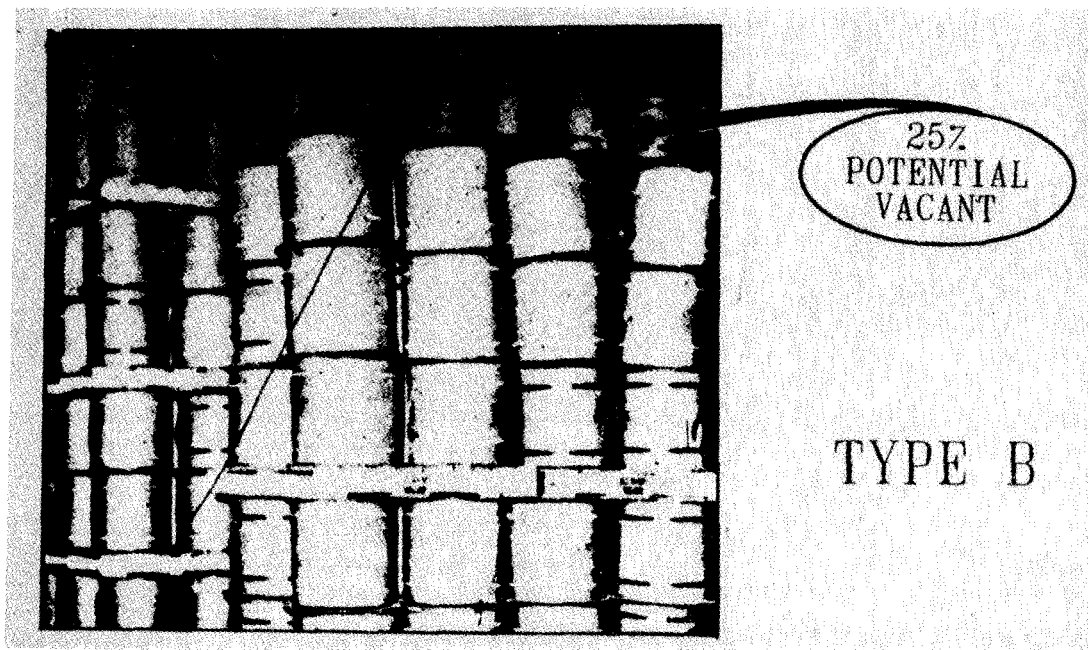
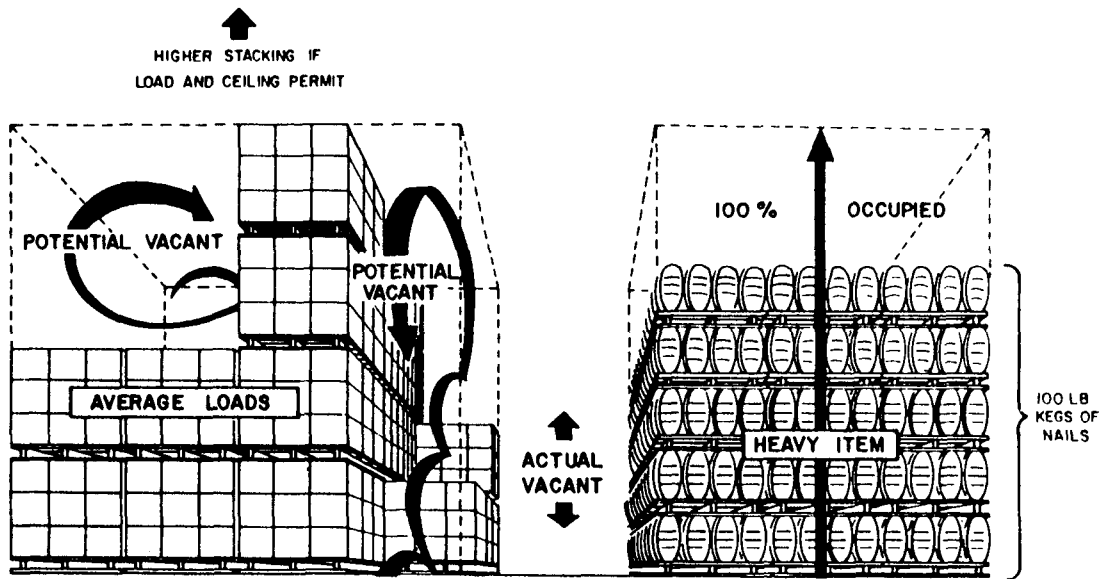
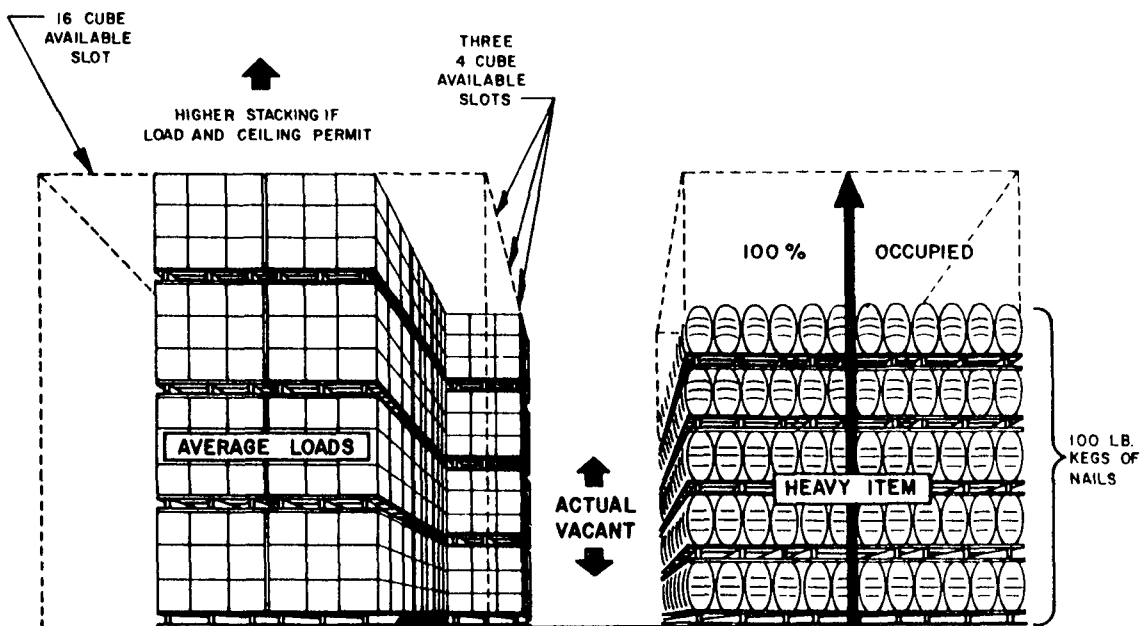

Figure 2-54. Type B Potential Vacant Space



(FOR EXAMPLE) FLOOR CAPACITY - 500 POUNDS PER SQUARE FOOT

UNUSED CUBE



(FOR EXAMPLE) FLOOR CAPACITY - 500 POUNDS PER SQUARE FOOT

RECOVERED SPACE

Figure 2-55. Type B Potential Vacant Space Recovered Through Rewarehousing

3 In some cases, there can be a combination of type A and type B potential vacant space in a particular storage location (see fig 2-56). This

can be seen when there are short spaces in front of the stacks as well as when some stock is not stacked to the permissible height.

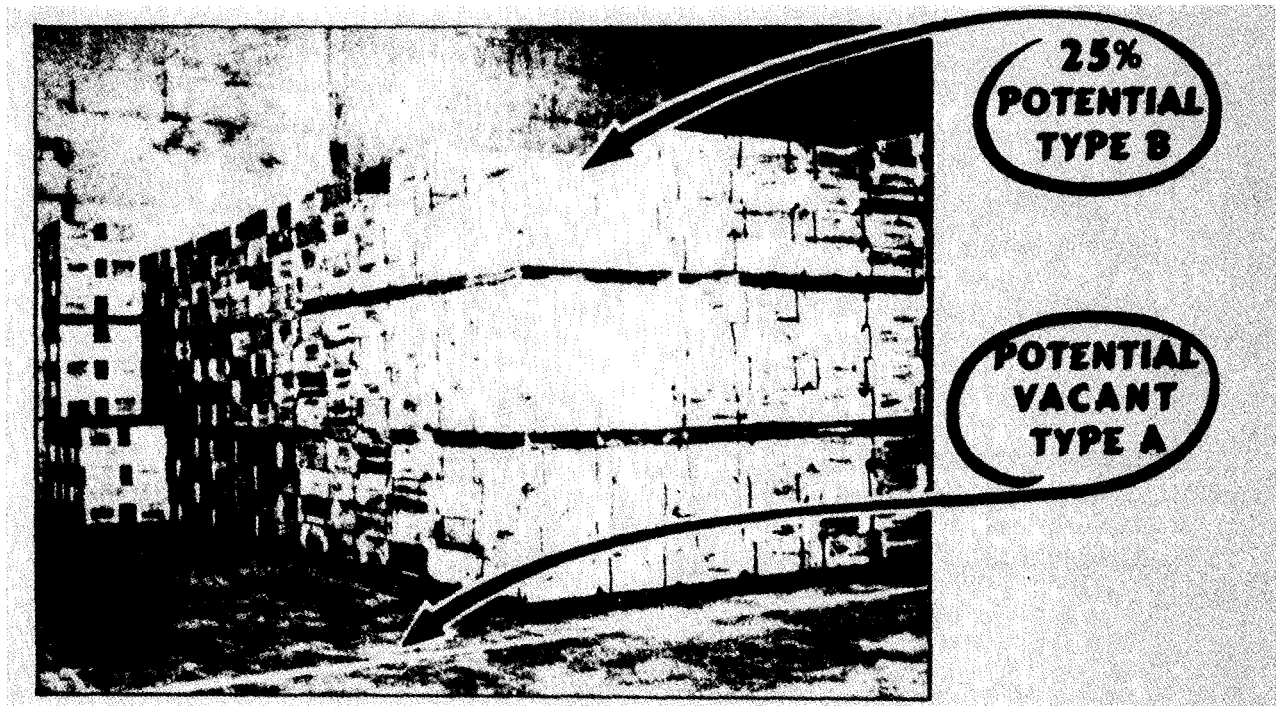

Figure 2-56. Combination of Types of A and B Potential Vacant Space

4 Determining vacant space can, at times, be misleading. There are special cases when at first glance, there appears to be potential vacant space but in reality the space is 100 percent occupied. For example, storing batteries on the second floor of a multistory building limits the

stacking height because of floor load limitations. More economical stacking of these batteries could be attained by placing them on the ground floor where the permissible floor load is greater. This, however, does not change the status of the stacks already in existence in which the space is 100 percent occupied (see fig 2-57).

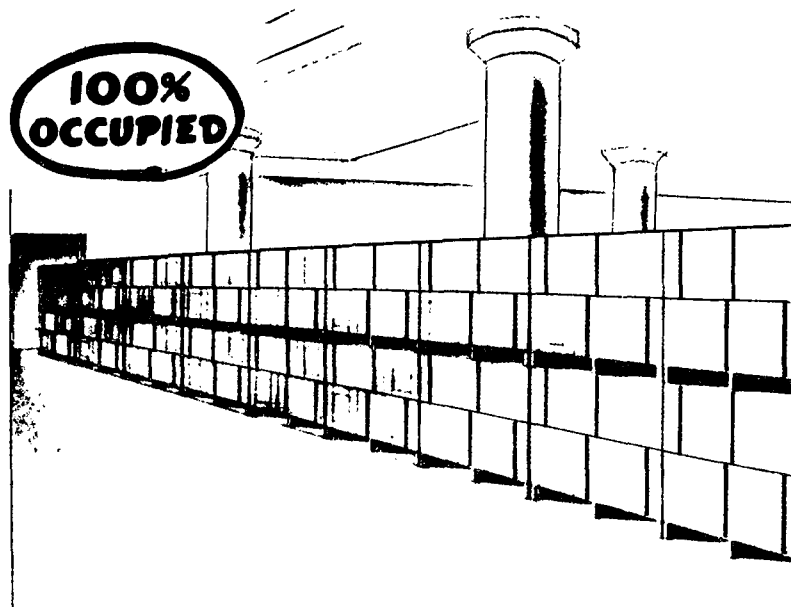

Figure 2-57 Battery Storage in a Multistory Building

f. Guide for computing occupied and vacant space.

(1) During storage space surveys, estimates and computations will be based upon pallet sizes and square feet grids occupied by each, including overhang and space between pallet tiers. The factors to use for various pallet sizes are—

- (a) 32 inches × 40 inches = 12 square feet.
- (b) 40 inches × 48 inches = 16 square feet.
- (c) 48 inches × 60 inches = 26 square feet.
- (d) 48 inches × 72 inches = 31 square feet.

(e) Other size pallets will be computed by multiplying the length plus 6 inches (2 in on each side for overhang plus 1 in on each for space between tiers) times the width plus 6 inches.

(2) To determine whether a partially loaded pallet is to be counted as full or empty, the standard will be a loaded pallet of a particular item and the following computation will be made:

(a) Pallet containing less than 50 percent of an item will be considered as empty.

(b) Pallet having more than 50 percent of an item will be counted as full.

(3) Difference between “actual vacant space” and “potential vacant space”—

(a) Actual vacant space is the floor area of net storage space which is not occupied by materials or storage bins. **DO NOT INCLUDE POTENTIAL VACANT AS VACANT SPACE.**

(b) Potential vacant space, type A, is that portion of occupied net usable space which is tem-

porarily not used for storage because of space voids in front of stacks of material (honeycombing) or space voids at the height of stacks which can be made available by rewarehousing or utilization of maximum heights in stacking. In computing potential vacant space on the floor, the following criteria is applicable:

1 Distance less than 6 inches will be disregarded (e.g., 5 in = 0 ft; 1 ft 4 in = 1 ft).

2 Distances in excess of 6 inches will be figured as 12 inches or 1 foot (e.g., 9 in = 1 ft; 1 ft 7 in = 2 ft).

(c) To compute type B potential vacant space, count the voids when maximum stacking heights are not achieved and can be recouped by rewarehousing. Multiply the number of void spaces by the cubic feet of each stack. The cubic feet of each stack is computed by multiplying the square feet factors for each pallet (see para f(1) above) by the height of the pallet. Figure 2-58 provides an example of computing type B potential vacant space. In this example, each stack of type B potential vacant space is equal to 64 cubic feet (16 sq ft per 40- by 48-in pallet multiplied by 4 ft high per pallet). In row B, there are two void spaces which equal 128 cubic feet (64 cu ft per stack multiplied by two stacks). This method can also be used for the depth of stacks. For example, if row B were two deep, there would be 256 cubic feet of type B potential vacant space (64 cu ft per stack multiplied by two stacks high multiplied by two stacks deep).

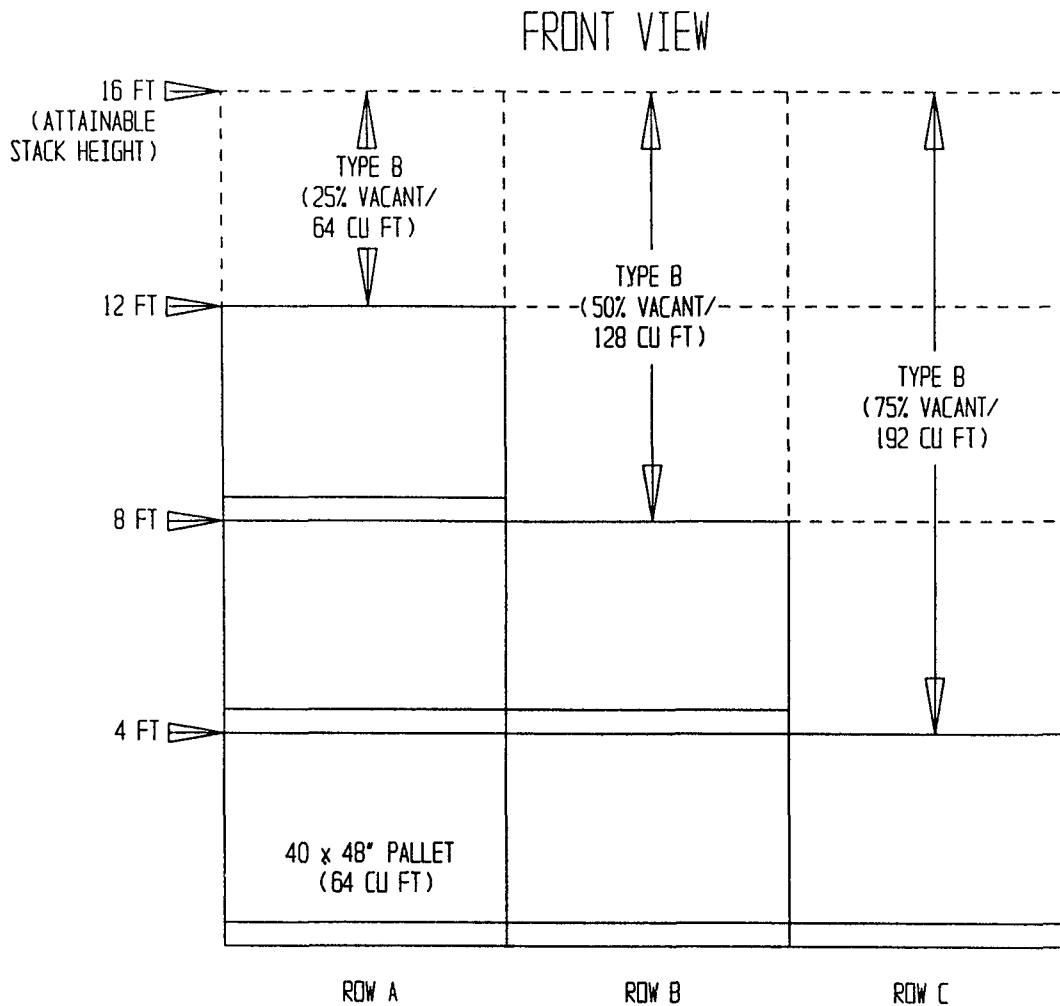

Figure 2-58. Computing Type B Potential Vacant Space

g. Using the storage space survey worksheet. An example of using the storage space survey worksheet is shown in figure 2-59. It is completed as follows:

(1) Shade in area which represent vacant space. This includes only space that is actually vacant and does not include potential vacant space.

(2) Leave unshaded all areas not considered occupied. This includes vacant floor space caused by short or broken spaces in front of stacks.

(3) Label potential vacant space with either an "A" for type A potential vacant floor space (where short spaces exist in front of stacks or when honeycombing is evident) and with a "B" for type B potential vacant cubic space. This space is marked only if occupied and recoupable by rewarehousing with existing resources (e.g., storage aids, MHE, etc.).

(4) Summarize the information.

(a) Vacant square feet is equal to the sum of all shaded grids.

(b) Occupied square feet is equal to the difference between net square feet and vacant square feet.

(c) Type A potential vacant space is equal to the sum of all grids annotated "A."

(d) Type B potential vacant space is the total cubic feet applied to the worksheet as calculated by survey personnel.

(5) Convert potential vacant space to cubic feet.

(a) Type A potential vacant cubic space is the product of the sum of all grids labeled "A" and the average stack height.

(b) Type B potential vacant cubic space is taken directly from the worksheet.

(6) Calculate the cubic feet recoupable through rewarehousing. This is equal to the sum of type A cubic feet and type B cubic feet.

SAMPLE STORAGE SPACE SURVEY WORKSHEET

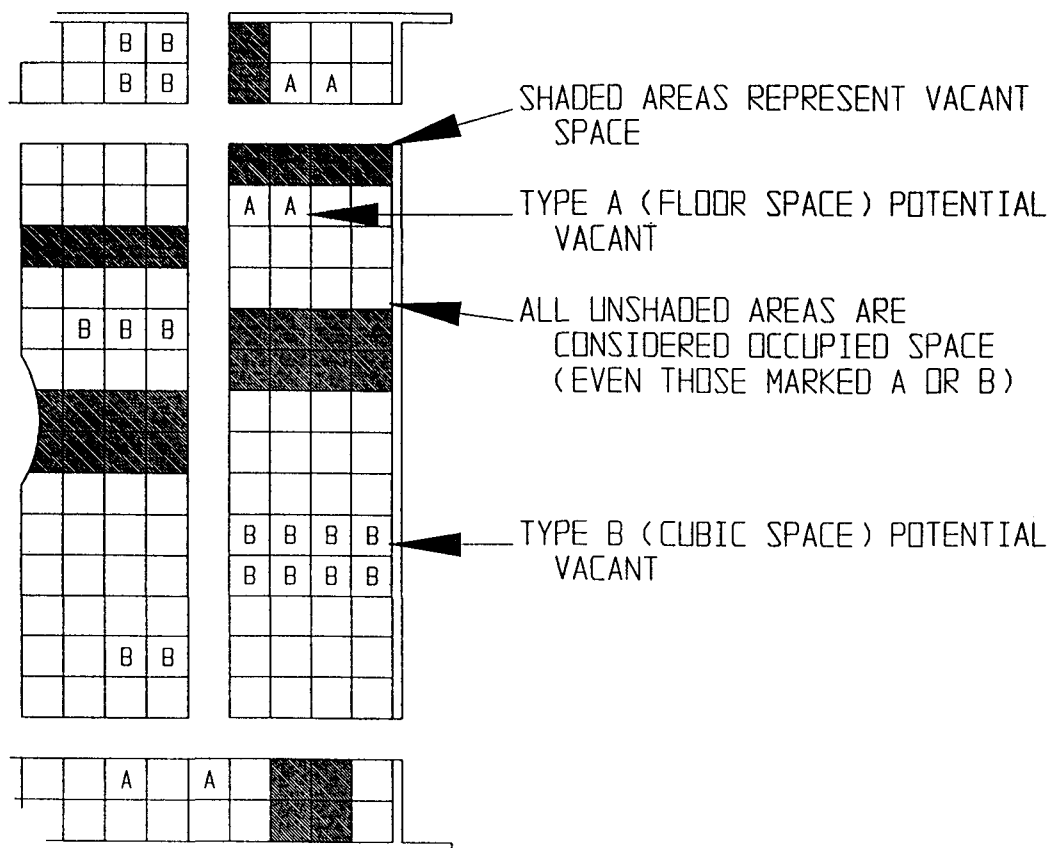

Figure 2-59 Using the Storage Space Survey Worksheet

h. Collection of cubic data.

(1) Determination of total cubic feet.

(a) The clear unobstructed stacking height, as permitted by safety restrictions (see para 2-14d(2)(c)2e below), will be determined for each section of each warehouse. The product of the clear stacking height times net square feet will be the total cubic feet of each section. The sum of the products (cu ft) of all sections will be the total cubic feet.

(b) The type structure or building configuration may dictate that several clear stacking height readings must be taken before determining total cubic feet. Monitor style warehouses have varied clear stacking heights depending upon that segment of the warehouse section in which material is to be stored. For example, the side segments

may afford a clear stacking height of 20 feet. In this case, the net square feet of each section segment will be determined and multiplied by the clear stacking height of each respective segment. The sum of the products will produce the total cubic feet of each section.

(c) Total cubic feet in open storage areas will be determined as per paragraph e(2)(b) above.

(2) Determination of attainable cubic feet.

(a) The attainable cubic space available for the storage of material in covered storage areas will be the product of net square feet of space available in bin, rack, and bulk areas and the stacking heights attainable under present storage arrangements with available MHE (see fig 2-49). Amounts will be computed as follows:

1 Bin and rack cubic capacity will be determined as per paragraph *e(2)(a)* above.

2 Bulk cubic capacity will be the product of the net square feet used for bulk storage multiplied by the stacking height permitted by safety restrictions and floor load limitations attainable with available MHE and storage aids, as appropriate. Cubic space beyond the reach of available MHE lift height and floor load limitations will not be reported even though safety limitations or permissible stacking heights have not been attained.

(b) The attainable cubic space available for storage of material in open storage areas will be determined as per paragraph *e(2)(b)* above.

(3) *Preparation of survey to determine cubic occupancy.*

(a) *Planograph worksheets will be designed for each warehouse section.* The worksheets will depict the storage pattern including structural loss and assigned support space as well as the location of rack, bin, and bulk storage areas. Bulk storage grids will be numbered sequentially by section (see fig 2-60). Partially obstructed grids or grids on which pallet rack storage aids, etc., are positioned will not be numerically designated. Planograph worksheets for warehouse sections having the same dimensions, clear stacking heights, and containing the same items, may be numbered (individual storage grids) continuously from section to section or warehouse to warehouse. This will reduce the efforts involved in accomplishing the statistical survey discussed in paragraph (4) below.

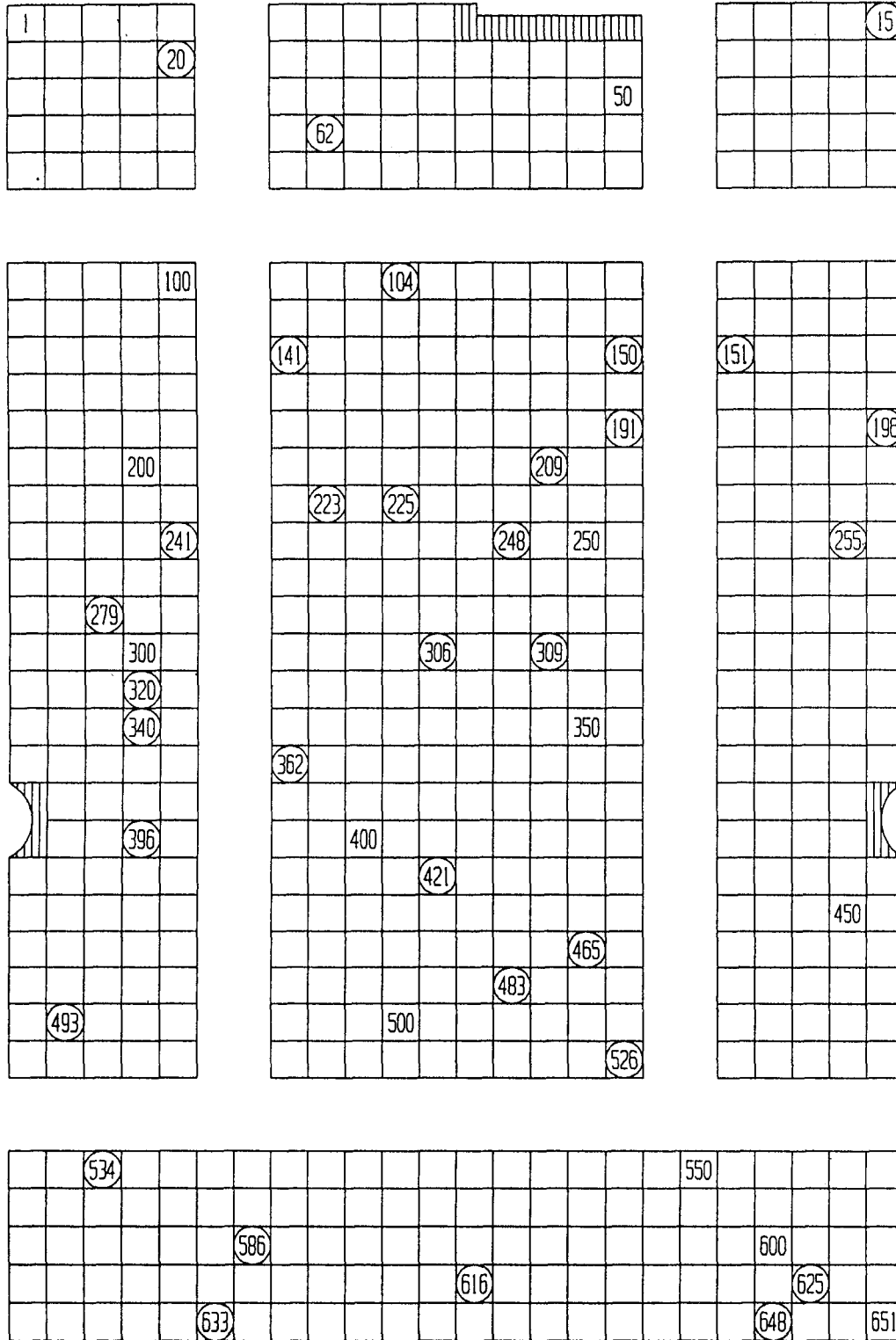

Figure 2-60 Example of Bulk Planograph Worksheet

(b) *Sample size.* Sample size will be determined through the use of table 2-1.

(c) *Random sampling.* A sample will consist of one or more bulk storage grids drawn from one or more warehouse sections. In order to assure that samples drawn for survey are representative of all storage grids in the section(s), the grids must be chosen at random. Computers may be utilized to generate a list of numbers for each warehouse section or group of sections requiring survey. The numbers generated will be limited by the total

quantity of grids involved in each section. The quantity of random numbers generated will generally be twice the number of grids to be surveyed. The quantity of random numbers generated is intentionally inflated to assure that the required number of occupied grids are included. In the event computer time or availability makes this course difficult or impractical, a table of random numbers (table 2-2) is provided.

Table 2-1. Determination of Sample Size

Table 2-1. Determination of Sample Size	
A Grids per Storage Facility/Section	B Sample Size
41 - 65	7
66 - 110	10
111 - 180	15
181 - 300	20
301 - 500	25
501 - 800	30
801 - 1,300	35
1,301 - 3,200	40
3,201 - 8,000	50
8,001 - 22,000	75

TABLE 2-2. TABLE OF RANDOM NUMBERS

	1	2	3	4	5	6	7	8	9	10	11	12	13	14
1	12480	12011	1536	2011	81647	91646	61179	12134	62290	36207	29969	99570	91281	90700
2	22348	15573	22595	85783	22955	80198	22382	22302	93565	32995	22666	19174	28815	95955
3	52130	18350	22527	97255	68809	68809	12121	28189	68809	12121	28189	68809	12121	28189
4	82167	93093	8243	61880	7856	16376	39440	53537	71341	57004	849	74517	97758	16379
5	37570	99975	81837	16556	6121	91782	60468	81305	49684	60672	14110	6927	1263	54613
6	71921	6807	11008	42751	27756	53498	18022	70659	80655	15053	21816	81225	44086	40880
7	95962	72905	56420	68994	58872	31016	71194	18738	44103	48840	63213	21069	10634	12952
8	96301	91977	5463	7972	18876	20922	94555	56889	69014	60045	18425	84803	42508	32307
9	89579	14942	63661	10281	17963	18103	57740	80378	25311	12566	58678	44947	5585	55841
10	85475	36857	53142	53988	57060	59575	38027	62900	8158	17983	16439	11458	18593	6052
11	28918	69578	88231	33276	70987	79936	56865	5859	90106	31595	1547	85590	91610	78188
12	63553	40861	88235	3427	49626	69445	18663	72695	52180	20847	12234	90511	33703	90322
13	9429	93869	92636	92737	88974	33948	36320	17617	30015	8272	84135	27156	36613	74952
14	10165	11028	87528	85580	52267	67683	93994	1511	62768	85104	20285	68975	68975	68975
15	7115	97336	71048	8178	72213	13916	47564	81056	57735	85977	28372	74461	28551	90707
16	51085	12765	51821	51259	77452	16308	60756	92144	84442	53900	70980	63990	75601	40719
17	2388	21382	92404	60268	89368	19485	55322	44819	1188	65255	64855	44818	5944	55157
18	1011	54032	33562	94004	31275	4146	18594	29852	71505	89200	51332	1515	92747	64851
19	52162	53916	46368	58566	23216	14513	83148	88736	23495	64350	94738	17752	35156	35740
20	7056	97628	33787	9988	42698	6681	76988	13502	51851	46104	88916	15509	25625	58104
21	48665	91245	85828	14346	9172	30188	90229	4754	59193	23178	30421	61686	99044	32812
22	21654	58482	24421	74023	47023	25106	74688	28184	26184	6546	21524	51237	36909	44589
23	32629	32363	5597	24200	13363	38005	94342	28728	35806	6912	17012	64161	18296	22851
24	28934	27001	87637	87308	58731	256	45834	15388	46557	41135	10367	7884	36188	18510
25	2488	33062	28834	7351	15711	92420	60952	61280	50001	67658	32386	86678	50720	94933
26	81564	72285	48598	64245	48598	82651	65566	14778	76197	14768	13760	80774	31666	65748
27	29676	20591	68086	26432	48081	20849	89768	81536	66645	12659	92259	57102	80428	25200
28	742	57392	39064	66432	84673	40027	32832	61362	88947	66667	64760	64584	56906	98253
29	5386	4213	25869	28422	44407	44048	37937	63304	45766	66134	75470	66520	34693	90480
30	91921	28418	64117	81905	25067	25940	30972	22909	71500	71500	71500	71500	71500	71500
31	582	4711	87117	77144	42206	74087	99547	81817	42607	43808	76655	66208	76650	76650
32	725	68808	62787	56370	88342	88072	76222	36086	84637	91161	76038	65855	77919	88006
33	68011	68795	95876	56295	18888	27358	26575	8625	40001	59320	28441	80150	12777	48051
34	25976	57948	29888	88604	67817	48708	18812	82771	65474	69774	31611	7844	68168	44589
35	9763	83473	75577	12908	30485	18517	28250	35787	5998	41688	34952	37888	38917	88050
36	91567	42595	27588	30134	4024	86385	28880	99730	55536	84855	28080	9250	78566	73211
37	17855	56349	90939	49127	20044	59931	6115	20542	18059	2008	73708	83517	36103	42791
38	45053	18584	18495	48181	2104	51038	2104	51038	2104	51038	2104	51038	2104	51038
39	52157	89634	94824	78171	84610	82834	9922	25417	44137	48413	25555	21246	35508	20468
40	14577	62765	35605	81263	39667	47358	56873	56307	61607	49518	88556	20103	77480	18062
41	98427	7523	33362	64270	1638	92477	66969	98420	4880	45385	46565	4102	46880	45709
42	349170	63976	88700	62765	39476	17032	87580	40836	32427	70022	37063	80663	77735	65748
43	70060	28277	39475	46473	23219	53916	94870	26832	69975	94884	19661	72828	102	66794
44	53976	54914	6990	67245	68350	82948	11398	42878	50287	38267	47363	46634	6541	97809
45	76072	29515	40980	7391	58745	25774	22887	90559	39911	90189	41151	14222	66697	59883
46	81725	52218	81974	28952	41024	38857	58974	57765	55657	57765	55657	57765	55657	57765
47	64364	67412	33339	31626	14885	24413	59744	92351	97475	89286	35931	4110	23726	19100
48	8962	3802	25388	61642	34072	81249	35648	56881	69352	48373	45578	78547	81788	81788
49	95012	68379	93526	70765	10592	4542	76465	94328	2348	17247	28865	14777	62730	92277
50	15664	10483	20492	38391	91132	21999	95516	28923	46751	82223	46751	82223	46751	82223
51	16408	81889	4153	53381	79401	21438	83035	52350	36693	31238	51649	91754	72772	2338
52	18629	81953	5520	91662	4739	13092	97662	28822	94730	6496	35090	4822	86774	98289
53	73115	35101	47498	87637	89016	71060	88824	71013	18735	20286	23153	72924	35165	43040
54	17495	16703	21867	49213	45024	31132	18594	41053	80700	43353	44812	12515	18931	91292
55	30405	83946	25792	14422	15058	45799	22716	14792	5985	74353	68868	30429	70735	25459
56	16631	35006	85900	98275	33308	52390	16815	69288	82732	39880	73817	32523	41681	44437
57	96073	20206	92559	78895	57009	22184	24369	94224	35083	18689	11052	91491	60783	19746
58	18056	64202	14348	66523	44133	687	35552	36970	61133	63318	28086	61133	28086	61133
59	31624	76584	17403	53363	44167	64886	64758	75366	76554	31001	12614	33072	60332	92325
60	78919	19474	23632	27889	47914	2584	37680	20801	72152	39339	34806	8930	85001	87620
61	3931	33309	57047	74211	63445	17361	62825	39908	5607	91284	68893	25570	38818	46920
62	14426	35278	43972	10139	80917	35665	50812	37863	73344	88062	80870	74492	51005	99378
63	9066	903	20795	95452	92448	44544	9552	88815	16553	51125	78755	97596	16296	66002
64	42238	12426	87025	14267	20979	4508	64555	31355	86064	29472	47889	5974	52468	18834
65	16153	8002	26504	41744	81859	65842	74240	56102	33	67107	77510	76625	28725	91511
66	21457	40742	29820	96783	29400	21940	15955	35417	33110	6116	95240	15957	16522	6004
67	21581	57802	2050	89728	17937	37621	47075	42080	97403	48626	68995	43805	33586	21547
68	55612	78095	83197	33732	5810	24813	88902	60397	16480	3284	88525	42786	5289	92532
69	44657	66999	99328	51281	84653	60563	79312	93654	68876	23471	39911	25650	12682	73572
70	91340	84978	49175	81944	91975	43987	15263	80144	37863	88013	71795	63553	50693	91292
71	91227	21199	31855	27022	80667	5462	35216	14486	29891	68607	41867	14951	91696	85065
72	50001	38140	66321	18924	72163	9538	12151	6878	81403	18749	88405	56087	82790	78925
73	63590	5224	72958	28809	81066	39147	25549	48542	42523	52702	94617	21772	78836	78836
74	27694	98131	83944	81575	10573	17611	64882	79025	5184	94142	25499	81387	29425	29425
75	37169	94851	39117	88632	558	16487	65536	49071	39782	17095	2330	73401	275	48280
76	11508	70225	51111	38351	19444	66499	71945	5422	13442	78675	84081	66938	93654	59894
77	37449	30362	6684	51690	4052	53115	62757	95348	78862	11163	81651	50245	34971	52924
78	45515	70331	93922	93929	59195	92765	97161	17869	45148	69796	66945	81073	81073	79880
79	30986	81523	42416	85553	21532	30502	32305	68482	1574	7901	44529	58861	74818	96812
80	63798	64995	46583	9785	44160	78128	83991	42865	92520	83531	80377	35909	81250	54238
81	82486	28046	99254	76752	43210	50076	21361	84816						

pansion of sample size is to determine the percent square feet vacant in the section. The sample size may then be expanded by this percent. For example, if 10 percent of the net square feet is vacant, multiply that percentage by the original sample size (i.e., $.10 \times 30 = 3$) and inflate the sample by this amount (i.e., $30 + 3 = 33$). This, in itself, may not always be sufficient to assure that the sample size will include the required occupied grid openings. Additional grid numbers, therefore, may be furnished as part of the planograph worksheet. The warehouse worker may then be instructed to locate these on the planograph worksheet and complete the required sample.

(e) Select the required random numbers in the sequence provided by the computer or from table 2-2 as appropriate and circle these numbers on the planograph worksheet. If table 2-2 is used, select a series of numbers from the table to correspond with the quantity of grids until the desired 33 grid numbers (per example) are obtained. The numbers are read as a book from left to right. The numbers underscored on table 2-2 indicate the selection process. It should be noted that numbers exceeding 651 are excluded from the process since there are only 651 grid openings in the sampled section.

(f) The selection of a starting point (i.e., column or row) should be accomplished in an unbiased manner.

(g) The planograph worksheet will serve as a guide and audit for the survey. Each encircled grid will be observed and the height of the stack measured and recorded in the circle provided on the planograph worksheet. Height will be recorded to the nearest one half foot (e.g., 14 feet 5 inches should be recorded as 14½ feet, 15 feet 1 inch should be recorded as 15 feet, etc.).

(5) *Determination of occupied cubic feet.*

(a) *Covered storage.*

1 From the survey of occupied bulk storage (i.e., each section), determine the simple average of the actual stacking height of the material. Determine the square feet occupied by material in the section and multiply this value by the appropriate average stacking height. The sum of these products (cu ft) will provide the total bulk cubic feet occupied.

2 Determine the quantity of rack openings occupied by type storage and the cubic dimension of the rack opening itself. The product of these two values (number of openings occupied times cu ft of opening) will provide the total cubic occupancy of rack storage.

3 Bin storage occupancy may be determined in the same manner. Determine either manually, mechanically, or statistically the quantity of occupied bin openings by size. Compute the cubic feet occupied by multiplying the cubic size (cu ft) of the occupied openings by the quantity of occupied openings. The result is total cubic feet occupied by bin storage.

(b) *Open storage.* The actual cubic feet of material stored in open storage is preferred. However, if the quantity of different items involved and the volume of this material is such as to create an undue manpower resource allocation, a statistical approach similar to that described in paragraph (4) above may be accomplished.

2-14. DOD Storage Space Reporting.

a. *Policy.* It is the policy of DOD to maintain a uniform, accurate storage space inventory and utilization reporting system to—

(1) Identify gross, net, occupied, and vacant storage space by type of storage.

(2) Exchange compatible storage space data among DOD Components to foster optimum use of DOD-owned space.

(3) Conduct DOD-wide and Federal Government-wide storage space management and distribution studies.

(4) Evaluate major storage space military construction or modernization projects.

(5) Identify future peacetime and contingency storage requirements.

(6) Evaluate the extent to which storage space policies are being implemented.

b. *Responsibilities.*

(1) The Assistant Secretary of Defense for Logistics (ASD (L)) designated the Defense Logistics Agency (DLA) as the DOD Storage Space Reporting Administrator (SSRA). The responsibilities as DOD SSRA will be accomplished by the DLA Depot Operations Division, Storage and Maintenance Branch (DLA-OWS), Cameron Station, Alexandria, VA 22304-6100. DLA-OWS as DOD SSRA will—

(a) Receive and consolidate DOD Component SSMR, DD Form 805 submissions.

(b) Develop and maintain the automated data processing program specification supporting the system.

(c) Perform routine analysis of the storage space inventory database and ensure automated integrity and accuracy of information.

(d) Publish and distribute DOD Components recurring storage space management and in-

ventory information and respond to ad hoc requests concerning storage space availability or storage space management information.

(e) Review all requests and responses on the availability of storage space with a view toward achieving optimum use of existing DOD storage assets.

(f) Recommend system improvements to ASD (L).

(2) The DOD Components shall submit DD Forms 805 in accordance with the provisions of this manual.

c. Reporting requirements.

(1) Each installation having 1,000,000 gross square feet (GSF) or more of warehouse space owned or ingranted for their use or any tenant of an installation having 1,000,000 GSF or more ingranted to them must report semiannually as of 30 June and 31 December. Reports may be submitted for installations having less than 1,000,000 GSF of covered storage space if the DOD Component considers the installation to be of significant logistic importance by reason of mission assignment, location, or activity. It is the responsibility of each DOD Component to maintain storage space visibility for installations having less than 1,000,000 GSF of covered storage space.

(2) DOD standard data elements and codes shall be used in complying with this reporting requirement when applicable. DOD Components shall identify installations in the Installation Code Block on DD Form 805 in accordance with JCS Pub 1-03.19, Joint Reporting Structure, General Use of Miscellaneous Subscription Form: Proponent ID. Other data elements used herein are subject to change after being disciplined under the criteria outlined in DOD 5000.12-M, DOD Manual for Standard Data Elements.

(3) Reports shall be submitted not later than 60 calendar days after June 30 and December 31 of each year. Only one report (a single copy of DD

Form 805) will be submitted for each installation site or activity. These reports will include the total amount of storage space of the installation, regardless of the identity of the occupants, except space used for—

- (a) Bulk petroleum storage.
- (b) Base exchange storage.
- (c) Installation civil/post engineer storage.
- (d) Clothing and small stores storage.
- (e) Commissary storage.
- (f) Bench and backup shop storage.
- (g) Transit sheds and open areas at terminals used exclusively for cargo throughput operations.

(4) DOD Components shall provide the Chief, Depot Operations Support Office (DOSO), Defense General Supply Center, ATTN: DOSO-DOI, Richmond, VA 23297-5000, reports prepared on DD Form 805 for installations meeting the criteria of paragraph (1) above. (Installations will report to higher authority in accordance with the format and guidance directed by their respective Component Headquarters.) The data will be transmitted via AUTODIN. DD Form 1392, Data Message Form, will be completed and submitted with DD Form 805 data in 80-column format (see para e below) to your local communications center for transmission to DOSO. The routing indicator code for this activity is RUQADGA, with a content indicator code of IAAA. This information is annotated in the addressee block.

(5) This reporting requirement has been assigned RCS DD-MRA&L (SA&A) 1337.

d. Preparation of the DD Form 805.

(1) The following general guidance is applicable to DD Form 805:

(a) DD Form 805 (fig 2-61) will be locally reproduced on 8½- by 11-inch paper. Army users can obtain this form through their normal publications supply channels.

STORAGE SPACE MANAGEMENT REPORT		DATE CY-HQ-DAY	FREQUENCY	INSTALL. CODE	DD COMPONENT	NAME OF INSTALLATION						CITY NAME			STATE/COUNTRY CODE	
						COVERED GENERAL PURPOSE STORAGE						AMMO STORAGE			OPEN SPACE	
ITEM	(LIMIT OF MEASURE IN THOUSANDS)	(A)	(B)	(C)	(D)	(E)	(F)	(G)	(H)	(I)	(J)	(K)	(L)	(M)	(N)	
SECTION A - GROSS SPACE AVAILABLE (SF=SQUARE FEET)																
1.	TOTAL SF PRIOR REPORT															
2.	TOTAL SF THIS PERIOD															
3.	UNUSABLE SF															
4.	SF IN STANDBY															
5.	OUTGRANTED SF (NON-DD)															
6.	OUTGRANTED SF (DD)															
7.	TOTAL SF OUTGRANTED (5+6)															
8.	INGRANTED SF															
9.	TOTAL AVAILABLE (2+8 LESS 3, 4 & 7)															
10.	ALISES STRUCTURAL LOSS & SUPPORT SPACE (SF)															
SECTION B - NET SPACE AVAILABLE (NSF=NET SQUARE FEET, TCF=TOTAL CUBIC FEET, ACF=ATTAINABLE CUBIC FEET)																
11.	NSF IN BIN AREA															
12.	NSF IN RACK AREA															
13.	NSF IN BULK AREA															
14.	TOTAL NSF (11+12+13)															
15.	TCF IN BIN AREA															
16.	TCF IN RACK AREA															
17.	TCF IN BULK AREA															
18.	TOTAL TCF (15+16+17)															
19.	ACF IN BIN AREA															
20.	ACF IN RACK AREA															
21.	ACF IN BULK AREA															
22.	TOTAL ACF (19+20+21)															
SECTION C - OCCUPIED STORAGE SPACE (SF=SQUARE FEET, CF=CUBIC FEET)																
23.	TOTAL SF OCCUPIED															
24.	OCCUPIED CF IN BIN AREA															
25.	OCCUPIED CF IN RACK AREA															
26.	OCCUPIED CF IN BULK AREA															
27.	TOTAL CF (24+25+26)															
28.	OBLIGATED VACANT SF															
29.	OBLIGATED VACANT CF															
SECTION D - REMARKS (USE REVERSE SIDE IF NEEDED)																

PREVIOUS EDITIONS ARE OBSOLETE

Figure 2-61. SSMR (DD Form 805)

DD FORM 28 FEB 60 805

(b) DD Form 805 will—

1 Cover the total amount of each type of storage space at the installation or activity concerned, even though this space is temporarily used for other purposes.

2 Include all space that has been outgranted, ingranted, or otherwise used.

3 Include the total amount of storage space at the installation, regardless of the occupants, except space excluded per paragraph c(3).

(c) Only one DD Form 805 will be prepared for each installation. Real property and improvements, located on adjoining land that is controlled by the DOD Component, will be considered as one installation regardless of missions, functions, installation classification, or activities that may be located there. A public highway or railroad right-of-way passing through an installation will not be considered as breaking the continuity of the land. In those cases in which installations are physically separated, they will be treated and reported as separate installations regardless of command structure.

(d) When an installation has an annex or subinstallation (geographically separated), the annex or subinstallation will be reported on a separate DD Form 805 at the same frequency as the parent installation. The parent installation will be

identified under "Remarks" on all subinstallation reports. Data pertaining to the subinstallation or annex (separated) will not be included in the parent installation report. Annexes or subinstallations not presently reporting will submit reports only if the 1,000,000 GSF standard is met. A separate installation identity code will be assigned in this instance.

(e) All entries (lines or remarks) on DD Form 805 pertaining to square feet (SF) or cubic feet (CF) will be expressed in thousands rounded to the nearest thousand (e.g., 23,499 will be reported as 23; 24,500 will be reported as 25, etc.)

(f) All entries in GSF will be computed by—

1 Using inside measurements between exterior walls of covered storage areas without deductions for firewalls or other structural losses. Employee parking areas in covered storage space is also included and will be reported as vacant.

2 Using overall measurements of open storage areas with no deductions for trackage and permanent roads within the area. For unimproved open areas, only that space occupied by stored materiel or used in support of storage operations will be reported.

(g) All reports must be in balance before submitting. A sample of a completed form is shown in figure 2-62.

STORAGE SPACE MANAGEMENT REPORT		DATE CY-MO-DAY	FREQUENCY	INSTALL. CODE	DDP COMPONENT	NAME OF INSTALLATION		CITY NAME		STATE/COUNTRY CODE			
ITEM (UNIT OF MEASURE IN THOUSANDS) (A)		9106	L	ABCD	A	WARREN ARMY DEPOT		WARREN		DHID/USA			
		COVERED GENERAL PURPOSE STORAGE										OPEN SPACE	
SECTION A - GROSS SPACE AVAILABLE (SF=SQUARE FEET)		HEATED (C)	UNHEATED (D)	CONTROLLED HUMIDITY (E)	FLAMMABLE HAZARDOUS (F)	CHILL (G)	FREEZE (H)	SHED (I)	OTHER (J)	MAGAZINE (K)	INERT (L)	IMPROVED (M)	UNIMPROVED (N)
1. TOTAL SF PRIOR REPORT		2500	1200	669	400			586	79			5726	12
2. TOTAL SF THIS PERIOD		1	3										
3. UNUSABLE SF													
4. SF IN STANDBY		6	4										
5. OUTGRANTED SF (NON-DDD)		4										3630	
6. OUTGRANTED SF (DDD)													
7. TOTAL SF OUTGRANTED (5+6)													
8. INGRANTED SF													
9. TOTAL AVAILABLE (2+8 LESS 3, 4 & 7)		1305	640	361	205			247	45			1025	
10. AISLES STRUCTURAL LOSS & SUPPORT SPACE (SF)													
SECTION B - NET SPACE AVAILABLE (NSF=NET SQUARE FEET, TCF=TOTAL CUBIC FEET, ACF=ATTAINABLE CUBIC FEET)		42											
11. NSF IN BIN AREA		300	22	10	10								
12. NSF IN RACK AREA		842	531	298	185			339	34			1071	12
13. NSF IN BULK AREA													
14. TOTAL NSF (11+12+13)		541											
15. TCF IN BIN AREA		3870	285	128	128								
16. TCF IN RACK AREA		11004	6915	3882	2412			4119	422			10710	121
17. TCF IN BULK AREA													
18. TOTAL TCF (15+16+17)		496											
19. ACF IN BIN AREA		3586	285	102	102								
20. ACF IN RACK AREA		9921	6282	3528	2188			4069	400			10710	121
21. ACF IN BULK AREA													
22. TOTAL ACF (19+20+21)													
SECTION C - OCCUPIED STORAGE SPACE (SF=SQUARE FEET, CF=CUBIC FEET)		961	448	250	156			312	19			250	12
23. TOTAL SF OCCUPIED		410											
24. OCCUPIED CF IN BIN AREA		2958	214	86	85								
25. OCCUPIED CF IN RACK AREA		8191	5186	2911	1805			3360	330			2500	121
26. OCCUPIED CF IN BULK AREA													
27. TOTAL CF (24+25+26)		223	98	58	35			22	15			821	
28. OBLIGATED VACANT SF		2444	1085	633	341			643	70			8210	
29. OBLIGATED VACANT CF													
SECTION D - REMARKS (USE REVERSE SIDE IF NEEDED)													

PREVIOUS EDITIONS ARE OBSOLETE

DD FORM 805
28 FEB 90

Figure 2-62. Example of a Completed DD Form 805

(h) An example of the output generated from the DD Form 805 submission is shown in figure 2-63.

(2) Detailed guidance for preparation of DD Form 805 is as follows (see para *e* below for guidance on the 80-column format for data submission):

(a) *Header section.*

1 *Report Date.* Enter the last two digits (00-99) of standard data element "year," and the two digits (01-12) of standard data element "month" to represent the as-of date.

2 *Installation Code.* Enter a four-character alpha identity code as prescribed in JCS Pub 1-03.19.

3 *DOD Component.* Enter "A" for Army, "N" for Navy/Marine Corps, "F" for Air Force, or "D" for DLA.

4 *Name of Installation.* Enter the name of the installation as listed in JCS Pub 1-03.19.

5 *City Name.* Enter the name of the city in which the installation is located as listed in JCS Pub 1-03.19.

6 *State/Country Code.* Enter the state/country code in which the installation is located as listed in JCS Pub 1-03.19.

7 *Frequency.* Enter "A" for annual or "L" for semiannual.

(b) *Column data definition (types of storage).* Refer to section A, this chapter, for detailed explanations on types of storage facilities.

1 *Column B, Total Covered.* No entry is required since the program will compute total covered and will enter this total in column B. Total covered is equal to the sum of columns C through L.

STORAGE SPACE MANAGEMENT BOS REPORT	DATE 9106	INST CODE ABCD	INST CODE A	ODD A	NAME OF INSTALLATION WARREN ARMY DEPOT	COVERED GENERAL PURPOSE STORAGE						CITY NAME WARREN	AMMO STORAGE			STATE/COUNTRY OHIO/USA
						TOTAL COVERED (B)	HEATED (C)	UNHEATED (D)	CONTROLLED HUMIDITY (E)	FLAMMABLE HAZARDOUS (F)	CHILL (G)		FREEZE (H)	SHED (I)	OTHER (J)	
SECTION A GROSS SPACE AVAILABLE (SF = SQUARE FEET)																
1 TOTAL SF PRIOR REPORT	5434	2500	1200	669	400	586	79							5725	12	
2 TOTAL SF THIS PERIOD	5434	2500	1200	669	400	586	79							5725	12	
3 UNUSABLE SF	4	1	3													
4 SF IN STANDBY																
5 OUTGRANTED SF (NON-ODD)	10	6	4													
6 OUTGRANTED SF (ODD)	4	4												3630		
7 TOTAL SF OUTGRANTED (5 + 6)	14	10	4											3630		
8 INGRANTED SF																
9 TOTAL AVAILABLE (2 + 8 LESS 3, 4, AND 7)	5416	2489	1193	669	400	586	79							2096	12	
10 AISLES STRUCTURAL LOSS AND SUPPORT SPACE (SF)	2803	1305	640	361	205	247	45							1025		
SECTION B NET SPACE AVAILABLE (NSF = NET SQUARE FEET, TCF = TOTAL CUBIC FEET, ACF = ATTAINABLE CUBIC FEET)																
11 NSF IN BIN AREA	42	42														
12 NSF IN RACK AREA	342	300	22	10	10											
13 NSF IN BULK AREA	2229	842	531	298	185	339	34							1071	12	
14 TOTAL NSF (11 + 12 + 13)	2813	1184	553	308	195	339	34							1071	12	
15 TCF IN BIN AREA	541	541														
16 TCF IN RACK AREA	4411	3870	285	128	128											
17 TCF IN BULK AREA	28754	11004	6915	3882	2412	4119	422							10710	121	
18 TOTAL TCF (15 + 16 + 17)	33706	15415	7200	4010	2540	4119	422							10710	121	
19 ACF IN BIN AREA	496	496														
20 ACF IN RACK AREA	4075	3586	285	102	102											
21 ACF IN BULK AREA	26388	9921	6282	3528	2188	4069	400							10710	121	
22 TOTAL ACF (19 + 20 + 21)	30959	14003	6567	3630	2290	4069	400							10710	121	
SECTION C OCCUPIED STORAGE SPACE (SF = SQUARE FEET, CF = CUBIC FEET)																
23 TOTAL SF OCCUPIED	2146	961	448	250	156	312	19							250	12	
24 TOTAL CF OCCUPIED	25536	11559	5400	2997	1890	3360	330							2500	121	
25 TOTAL VACANT SF	467	223	105	58	39	27	15							821		
26 VACANT CF IN BIN AREA	86	86														
27 VACANT CF IN RACK AREA	732	628	71	16	17											
28 VACANT CF IN BULK AREA	4605	1730	1096	617	363	709	70							8210		
29 TOTAL VAC CF (26 + 27 + 28)	5423	2444	1167	633	400	709	70							8210		
30 UNOBLIGATED VACANT SF	16	7			4	5										
31 UNOBLIGATED VACANT CF	180	55			59	66										
SECTION D REMARKS																

Figure 2-63. Example of a SSMR Output Product

2 Column C, General Purpose Heated.

This is warehouse space in buildings designed for storage purposes in which the temperatures can be controlled within specified limits by application of heat. It does not include space equipped with humidity control devices or areas specially designed for storage of highly flammable materials or hazardous commodities.

3 Column D, General Purpose Unheated.

General purpose unheated refers to warehouse space, other than controlled humidity and flammable/hazardous, in buildings designed for storage purposes that are not equipped with heating capability.

4 Column E, Controlled Humidity. This is warehouse space equipped with humidity control equipment.

5 Column F, Flammable/Hazardous.

Warehouse space which has been specially designed for the storage of hazardous and/or flammable materials excluding explosives, ammunition, and ammunition components is called flammable/hazardous space.

6 Column G, Chill. Chill refers to space in a refrigerated warehouse in which the temperature can be controlled between 32 °F and 50 °F (0 °C and 10 °C).

7 Freeze. This is refrigerated warehouse space in which the temperature can be controlled below a level of 32 °F (0 °C).

8 Column I, Shed. All space in non-warehouse buildings without complete side and end walls is shed space. It excludes transitory-type shelters.

9 Column J, Other. This is any space assigned for storage operations within a structure designed for other than storage purposes. It includes, but is not limited to, barracks, dry tanks, hangars, transitory shelters, and quonset buildings. A transitory shelter is a prefabricated sectional, metal structure, normally with complete sides and ends but without utilities. A transitory shelter is classified as a storage aid rather than a real property facility.

10 Column K, Magazine. Magazine refers to space in a warehouse (above ground) or igloo (earth covered) type structure used for the storage of explosives, ammunition, or loaded ammunition components.

11 Column L, Inert. Space in a warehouse-type structure which is dedicated for the storage of nonexplosive ammunition or ammunition components is classified as inert space.

12 Column M, Open Improved. This is open storage space which has been graded and

hard surfaced or prepared with topping of some suitable materials so as to permit effective materials handling operations.

13 Column N, Open Unimproved. Open unimproved storage space refers to an open area which has not been surfaced but which is actually in use (i.e., occupied) for storage purposes. Vacant open unimproved is not included.

(c) Line data definitions and descriptions.

1 Section A—Gross Space Available. All data reported in section A are in thousands of SF.

a Line 1, Total SF Prior Report. No entry is required since the program will automatically enter under columns B through N the total SF reported in the prior report.

b Line 2, Total SF This Period. Enter under columns C through N all of the gross storage space at the installation or activity, regardless of its location or the purpose for which the space being used was designed or is designated, which is assigned or used for any operation concerning storage or the support of storage functions at the installation or activity.

c Line 3, Unusable SF. Enter under columns C through M the amount of GSF included in the categories defined below:

(1) Space so deteriorated that it fails to provide a sufficiently protective environment for the storage of material.

(2) Space that is unsafe for storage operations or where its use would be in violation with established regulating criteria.

(3) Space that is restricted from use due to inadequate physical security protection.

d Line 4, SF in Standby. Enter under column C through M the amount of gross storage space in standby status which is contained in completely empty covered structures, or open improved areas which are not required to support the installation's mission and which have been secured. This entry will not include vacant Y-sites (i.e., sites with earthen barricade on four sides). Igloos currently used as fallout shelters will be included and identified under "Remarks." Space in completely empty sections of covered structures that can be isolated and locked is authorized to be placed into standby.

e Line 5, Outgranted SF (non-DOD). Enter under columns C through N the amount of gross storage space which is outleased, licensed, or permitted to private industry or non-DOD Government (Federal, state, county, local, or foreign) agencies for their operation (e.g., storage space identified under support agreement(s) and not

available for the reporting activity's operation). This includes all space which is allocated, assigned, or used for the storage of material other than that owned by DOD Components. For purposes of this report, material or supplies belonging to all other defense agencies will be treated as non-DOD material. Include space outleased to private industry on a landlord-tenant basis for which rent is paid by the leasee. Also include space classified as storage space at the time it was outleased, licensed, or permitted even though it is not currently being used for storage purposes. When a change occurs since the last reporting period, show under "Remarks" the complete agency name(s); the company or companies concerned; and the amount of gross space (covered and open, separately) used by, assigned to, or allocated to each.

f Line 6, Outgranted SF (DOD). Enter under columns C through N the amount of gross storage space which is licensed or permitted to another DOD Component for its operation (e.g., storage space identified under support agreement(s) and not available for the reporting activity's operation). Include space classified as storage space at the time it was licensed or permitted even though it is not currently being used for storage purposes. When a change occurs since the last reporting period, show under "Remarks" the Component name and the amount of gross space (covered and open, separately) licensed or permitted to each.

g Line 7, Total SF Outgranted (lines 5 plus 6). No entry is required since the program will compute the total SF outgranted and will enter this total under columns B through N. Total SF outgranted is equal to the sum of outgranted (non-DOD) (line 5) and outgranted (DOD) (line 6).

h Line 8, Ingranted SF. Enter under columns C through N the amount of gross storage space operated which is ingrated by lease, license, or permit from one of the DOD Components. Those activities having only ingrated DOD space of 1,000,000 or more GSF of covered space will begin their reports on this line. Lines 1 through 6 are not applicable.

i Line 9, Total Available (line 2 plus 8 less lines 3, 4, and 7). No entry is required since the program will compute total available SF and will enter this total under columns B through N. Total available is equal to the sum of total SF this period (line 2) and ingrated DOD space (line 8) less the sum of unusable SF (line 3), SF in standby (line 4), and total SF outgranted (line 7).

j Line 10, Aisles, Structural Loss, and Support Space (SF). Enter under columns C

through M the sum of SF used for aisles, lost to structural features, and used for support space.

(1) Aisles are defined as the amount of SF used in storage areas for movement of material to and from storage locations. Material conveyor systems are excluded.

(2) Structural loss is defined as the amount of SF not usable for storage because of construction features or physical characteristics. Within covered storage areas, such items as rest rooms, columns, firewalls, elevator shafts, ramps, stairwells, steam pits, switch panels, loading wells, and door clearances will be considered as structural loss. Within improved open storage areas, such additional items as firebreaks, stream beds, railroad tracks, and clearances maintained for utility lines will be considered as structural loss.

(3) Support space is defined as the amount of SF used in support of storage operations. Support space includes all space used for preservation and packaging, assembly, packing and crating, container manufacturing, receiving, inspection and identification, shipping, material conveyor systems, supervisory/administrative storage offices located in warehouses or other facilities used for storage operations (does not include general administrative offices), employees' rest areas, locker rooms, tool rooms, time clock areas, mechanical equipment rooms in refrigerated and controlled humidity warehouses, battery charging stations located in warehouses, and similar support functions. Support space also includes civil engineering (public works) functions that are in support of storage operations and are located in warehouses or other facilities used for storage operations. Work aisles that are contiguous to these support areas are classified as parts of such support areas.

2 Section B—Net Space Available. All data reported in section B are in thousands of SF or thousands of CF as appropriate for the specific line.

a Line 11, NSF in Bin Area. Enter under columns C through J the net SF (NSF) of space occupied by erected bins. The NSF is determined based on the outside dimensions, length times width, of the bin storage aids.

b Line 12, NSF in Rack Area. Enter under columns C through J the NSF of space occupied by erected racks. The NSF is determined based on the outside dimensions, length times width, of the rack storage aids.

c Line 13, NSF in Bulk Area. Enter under columns C through N the NSF of storage space designated for bulk storage.

d Line 14, Total NSF (lines 11 plus 12 plus 13). No entry is required since the program will compute the total NSF and will enter this total under columns B through N. Total NSF is equal to the sum of NSF in bin area (line 11), rack area (line 12), and bulk area (line 13).

e Line 15, TCF in Bin Area. Enter under columns C through J the total CF (TCF) in storage areas occupied by erected bin storage aids. The TCF in the bin area is computed by multiplying the bin area NSF (line 11) by the unobstructed stacking height. The unobstructed stacking height is defined as the distance between the floor and the lowermost point of overhead obstructions (e.g., sprinkler heads, joists, rafters, beams, roof trusses, lighting fixtures, duct work, etc.) less the following safety clearances:

(1) When vertical distance between floor and lowest obstruction does not exceed 15 feet, a safety clearance of 1½ feet is required.

(2) When vertical distance between floor and lowest obstruction is greater than 15 feet, a 3-foot safety clearance is required.

(3) When hazardous materials are involved or when storing in areas not equipped with sprinklers, a safety clearance of 3 feet is required.

(4) There is one exception. A clearance of only 14 inches is required for reclaimed drum storage, regardless of stacking height, provided that the building is of all-metal construction and contains no electric wiring.

NOTE

The unobstructed stacking height as defined above is an indicator of only the theoretical capacity of a facility. It does not allow for limitations which may be imposed by existing storage aids, MHE, or floor load capacity; therefore, the TCF also is an indicator of theoretical capacity.

f Line 16, TCF in Rack Area. Enter under columns C through J the TCF of storage areas occupied by erected rack storage aids. The TCF in the rack area is computed by multiplying the rack area NSF (line 12) by the unobstructed stacking height as defined above.

g Line 17, TCF in Bulk Area. Enter under columns C through N the TCF of storage areas designated for bulk storage. The TCF in the bulk area is computed by multiplying the bulk area NSF (line 13) by the unobstructed stacking height as defined above. The TCF of improved open storage will generally be computed using an

average stacking height of 10 feet; however, where local conditions and actual commodity characteristics dictate a specific stacking height, the latter will apply. In unimproved open storage, report only cubic space actually occupied by multiplying NSF occupied by a representative (sample) stacking height.

h Line 18, Total TCF (lines 15 plus 16 plus 17). No entry is required since the program will compute total TCF and will enter this total under columns B through N. Total TCF is equal to the sum of TCF in bin area (line 15), rack area (line 16), and bulk area (line 17).

i Line 19, ACF in Bin Area. Enter under columns C through J the attainable CF (ACF) in storage areas occupied by erected bin storage aids. The bin area ACF is computed by multiplying the bin area NSF (line 11) by the height in feet from the floor to the top of the bin storage aid or to the height which can be reached by existing MHE, whichever is less.

j Line 20, ACF in Rack Area. Enter under columns C through J the ACF of storage areas occupied by erected rack storage aids. The rack area ACF is computed by multiplying the rack area NSF (line 12) by height in feet from the floor to the top shelf (level) of the rack plus the additional height to which material can safely be stacked on the top shelf of the rack. For example, if the height from the floor to the top shelf is 12 feet and material can be stacked on the top shelf to a height of 4 feet, the attainable stacking height is 16 feet for that rack set. Cubic space above the racks will only be included to the extent that use of such space is permitted by safety limitations and the capacity of available MHE.

k Line 21, ACF in Bulk Area. Enter under columns C through N the ACF in storage areas designated for bulk storage. The bulk area ACF is computed by multiplying the bulk area NSF (line 13) by the stacking height that is attainable with available MHE and is permitted by safety restrictions and floor load limitations. Cubic space beyond the reach of available MHE lift height and floor load limitations will not be reported even though safety limitations or permissible stacking heights have not been attained. (The cubic capacities reported on line 21 are limited to those attainable under present storage arrangements and achievable with available equipment.) The cubic capacity of improved open storage space will generally be computed by using an average stacking height of 10 feet. Where local conditions and actual commodity characteristics dictate a specific stacking height, the latter shall apply. In un-

improved open storage, report only cubic space actually occupied, by multiplying occupied SF by a representative (sample) stacking height.

l Line 22, Total ACF (lines 19 plus 20 plus 21). No entry is required since the program will compute total ACF and will enter this total under columns B through N. Total ACF is equal to the sum of ACF in bin area (line 19), rack area (line 20), and bulk area (line 21).

3 Section C—Occupied Storage Space. All data reported in section C will be in thousands of SF or thousands of CF as appropriate for the specific line.

a Line 23, Total SF Occupied. Enter under columns C through N the total amount of NSF which is actually occupied by material in the designated areas for bin storage (line 11), rack storage (line 12), and bulk storage (line 13). The NSF in bin and rack storage areas is considered occupied whether or not material is stored therein.

b Line 24, Occupied CF in Bin Area. Enter under columns C through J the CF in bin areas which is occupied by material or assigned to an item as an active location. Surveys of occupied CF in bin areas can be accomplished through visual count of openings multiplied by the average CF of the openings. Manual or automated locator files or statistical sampling can be used. See paragraph 2-13*h* above for additional information on statistical sampling.

c Line 25, Occupied CF in Rack Area. Enter under columns C through J the CF of rack areas which are occupied by material or assigned to a specific item as an active location. Surveys of occupied CF in rack areas can be accomplished in the manner described for bin areas above. See paragraph 2-13*h* above for additional information on statistical sampling.

d Line 26, Occupied CF in Bulk Area. Enter under columns C through N the CF of bulk areas which are occupied by material. The bulk area occupied CF is computed by multiplying the bulk area occupied SF by the average height to which material is actually stacked. The average bulk stacking height will be determined by random sampling of bulk stacks. For additional information on statistical sampling, see paragraph 2-13*h* above.

e Line 27, TCF Occupied (lines 24 plus 25 plus 26). No entry is required since the program will compute the TCF occupied and will enter this total under columns B through N. TCF occupied is equal to the sum of CF occupied in bin area (line 24), rack area (line 25), and bulk area (line 26).

f Line 28, Obligated Vacant SF. Enter under columns C through M that portion of the vacant SF which is obligated to known future requirements within the next 12 months. Vacant SF is the difference between total NSF (line 14) and total SF occupied (line 23). If the obligated vacant SF for a column is equal to or greater than 25 percent of the vacant SF for that column, list in "Remarks" the specific quantities and programs to which all space reported on this line is obligated.

g Line 29, Obligated Vacant CF. Enter under columns C through M that portion of the vacant CF which is obligated to known future requirements within the next 12 months. Vacant CF is the difference between total ACF (line 22) and total CF occupied (line 27). If the obligated vacant CF for any column is equal to or greater than 25 percent of the vacant CF for that column, list in "Remarks" the specific quantities and programs to which all space reported on this line is obligated.

4 Section D—Remarks. The following types of remarks will be submitted when appropriate:

a Initial Report. Installations reporting for the first time will cite the date of activation of the installation, its primary function, and a brief description of the types of material to be stored.

b Final Report. A remark will be provided which indicates that the current report submission is the last that will be made by that installation. The reason for report termination will be explained.

c Inactivation. An installation or activity scheduled for inactivation will cite the proposed date. When known, the actual effective date and authority will be shown. When an installation or activity is to be completely closed out, the last report submitted will be marked "Final Report." If an installation is completely closed out between reporting periods and the last report submitted was not marked "Final Report," a special report marked "Final Report" will be submitted prior to the next scheduled reporting date to reflect any changes.

d Parent Installation. An annex or subinstallation (geographically separated) will identify the parent installation.

e Significant Data Changes. An explanation must be provided when changes in total covered or improved open storage from one report period to the next exceed 40,000 SF.

f Total SF Less Than 1,000,000. Changes that cause total SF for this period (line 2) to fall below 1,000,000 will be reported.

g Total Standby SF. If the amount of SF in standby (line 4) exceeds 15 percent of total SF this period (line 2), a remark will be included.

h Change in Outgranted SF. A remark will be provided for any change in outgranted SF (non-DOD) (line 5) and outgranted SF (DOD) (line 6). For outgranted (non-DOD), the remark will include the complete agency name(s); the company or companies concerned; and the amount of gross space (covered and open, separately) used by, assigned to, or allocated to each. For outgranted (DOD), the remark will include the Component name and the amount of gross space (covered and open, separately) licensed or permitted to each.

i Ingranted Space. The source and amount of gross space (covered and open, separately) ingrafted from each of the other DOD Components and ingrafted/leased from non-DOD sources will be identified.

j Significant ACF Changes. Installations with firm knowledge of changes in ACF which are expected upward or downward of 500,000 CF or more for any column (type of storage space) or any decreases which will inhibit mission performance must be reported. The remark will include the amount of the change, the reason, and the expected effective date.

k Obligated Vacant SF or CF. If the obligated vacant SF or CF for any column is equal to or greater than 25 percent of the total vacant for that column, each specific obligation must be identified. The remark will include the quantity obligated, the reason for the obligation, and the expected date when the obligated vacant space will be occupied.

l Unapproved Open Storage. The total SF of open storage space occupied by assets not approved for open storage (assets in open storage which require covered storage) will be included in remarks.

m Significant Required Space Changes. When known future changes in requirements are expected within the next 12 months, a remark will be included. Changes in required TCF, either upward or downward of 500,000 CF or more for any column (type of storage space), will be reported. The remark will include the amount of the requirement, the reason for the change, and the expected effective date.

n Contingency or Wartime Storage Requirements. From contingency or wartime scenario planning documents, estimate the total covered storage requirements in thousands of CF if significantly different from requirements previously reported. Installations without firm knowl-

edge of such plans may defer to the Component headquarters for input.

o Special Situations. Explanations of data submitted or conditions of which management should be cognizant will be included in the remarks. For example, if storage space of a particular type such as humidity controlled is currently occupied by material which can be safely stored outside or in storage affording less protection, the amount of such space should be identified.

e Submission of the SSMR. The following guidance is provided for the AUTODIN transmission of DD Form 805 entires in 80-column format:

(1) There are three formats for transmission of data: format 1, header; format 2, detail; and format 3, remarks.

(a) Format 1, header. Input will consist of one header line in the format shown in table 2-3.

Table 2-3. Format 1, Header

Table 2-3. Format 1, Header	
Field Columns	Explanation
1-3	Document identifier code (DIC) - Enter "805" to identify reporting form number.
4	Card type - Enter "H" to identify header.
5-8	Installation code - Enter a four-character alpha identity code as listed in JCS Pub 1-03.19.
9	DOD Component - Enter "A" for Army, "N" for Navy/Marine Corps, "F" for Air Force, or "D" for DLA.
10-13	Date - Enter the last two digits (00-99) of standard data element "year" (col 10-11) and the two digits (01-12) of standard data element "month" (col 12-13) to represent the as-of date.
14-53	Installation name - Enter the name of the installation as listed in JCS Pub 1-03.19.
54-68	City - Enter the name of the city in which the installation is located.
69-78	State/country - Enter the state/country in which the installation is located.
79	Frequency - Enter "A" for annual or "L" for semiannual.
80	Leave blank.

(b) Format 2, detail. Input will consist of 22 detail cards in the format as shown in table 2-4. A separate line image will be submitted for lines 2 through 6, 8, 10 through 13, 15 through 17, 19 through 21, 23 through 26, and 28 through 29

from DD Form 805. Shaded lines shown on DD Form 805 (i.e., lines 1, 7, 9, 14, 18, 22, and 27) will be computer generated; therefore, input is not required on these lines.

Table 2-4 Format 2, Detail

Table 2-4. Format 2, Detail	
Field Columns	Explanation
1-3	DIC - Enter "805" to identify reporting form number.
4	Card type - Enter "D" to identify detail.
5-8	Installation code - Enter a four-character alpha identity code as listed in JCS Pub 1-03.19.
9	DDO Component - Enter "A" for Army, "N" for Navy/Marine Corps, "F" for Air Force, or "D" for DLA.
10-11	Sequence number - Enter line sequence number from DD Form 805. Lines 2 through 6 and 8 will be preceded by a zero.
12-17	General purpose heated - Enter the amount of general purpose heated storage space.
18-22	General purpose unheated - Enter the amount of general purpose unheated storage space.
23-27	Controlled humidity - Enter the amount of warehouse space equipped with humidity control equipment.
28-32	Flammable/hazardous - Enter the amount of flammable/hazardous materials storage space.
33-37	Chill - Enter the amount of chill storage space.
38-42	Freeze - Enter the amount of freeze storage space.
43-47	Shed - Enter the amount of shed storage space.
48-52	Other - Enter the amount of storage space in other type storage facilities.
53-57	Magazine - Enter the amount of magazine storage space.
58-62	Inert - Enter the amount of space dedicated to inert storage.
63-69	Open improved - Enter the amount of open improved storage space.
70-76	Open unimproved - Enter the amount of open unimproved storage space.
77-80	Leave blank.

(c) Format 3, remarks. The format shown in table 2-5 will be utilized for submission of remarks. The remark segment (cols 14-77) of the remarks format is limited to 64 characters per line; however, an additional line(s) may be submitted to accommodate characters beyond the 64 of the first line. Continuation lines for an individual remark are identified by a "2," "3," etc. in column 13.

Table 2-5 Format 3, Remarks

Table 2-5. Format 3, Remarks	
Field Columns	Explanation
1-3	DIC - Enter "805" to identify reporting form number.
4	Card type - Enter "R" to identify remarks.
5-8	Installation code - Enter a four-character alpha identity code as listed in JCS Pub 1-03.19.
9	DDO Component - Enter "A" for Army, "N" for Navy/Marine Corps, "F" for Air Force, or "D" for DLA.
10-11	Sequence number - Enter line sequence number from DD Form 805 as the line relates to remark. Lines 2 through 6 and 8 are preceded by a zero.
12	Column letter - Enter the letter of the column (C thru N) from DD Form 805 as remark pertains to type storage addressed (e.g., C = Heated, etc.).
13	Remark line number - Enter "1" for the first line of a remark, "2" for the first continuation line, "3" for the second continuation line, etc., as required.
14-77	Remark - Enter required remarks.
78-80	Leave blank.

(2) A minimum of 23 line images (i.e., 1 header and 22 detail line images) in 80-column format will be transmitted to DOSO. Additional lines will be transmitted or remarks as required per paragraph (1)(c) above.

CHAPTER 3

STORAGE PROCEDURES

Section I. Receiving

3-1. General.

a. Prompt and accurate processing of receipts is a prime requisite of an effective supply system. The details of receiving operations are influenced by the types of supplies to be handled, distance to the storage location, type of MHE available, and the physical characteristics of the storage installation.

b. Although the basic principles of receiving are universally applicable wherever supplies are received for storage and subsequent distribution, receipts of classified, pilferable, and sensitive items (including small arms) require special handling and controls over and above the basic receiving principles. Section VIII of this chapter delineates the controls necessary to process these types of materials. Procedures for receiving hazardous materials may be found in TM 38-410/DLAM 4145.11/NAVSUP PUB 573/AFR 69-9/MCO 4450.12, Storage and Handling of Hazardous Materials.

3-2. Planning and Coordinating the Operation.

a. The planning of receiving operations requires complete coordination among the storage activities responsible for the different phases of the operation. This is particularly true for items with a security classification. The proper evaluation of advance information prior to actual material receipt is of utmost importance to ensure that appropriate preliminary steps are taken to receive the supplies as efficiently and economically as possible. Any correspondence concerning due-in receipts should be considered in planning. Prepositioned material receipt documents, purchase orders, contract schedules, advance bills of lading, or other shipping documents are types of data used to determine approximate arrival dates and type and quantity of supplies. Pertinent information on significant due-in receipts must be given to personnel concerned with warehousing, transportation, preservation, packing, and inspection.

b. Planning and coordinating promote effective storage space utilization, efficient assignment of labor and equipment, and recognition of receipts requiring special handling or processing. Normally, it is not recommended practice to reserve specific storage space for expected due-ins. However,

through advance planning, general determinations can be made on where receipts will be stored.

3-3. Spotting and Control of Carriers.

a. Although current directives require that the consignee be notified prior to the shipment arrival, railcars and trucks may arrive with little or no advance notice. Carrier scheduling can provide better workload leveling.

b. Upon notification of or arrival of a shipment, the carrier must be directed to the desired unloading site. This action is called spotting. Proper spotting results in the following:

(1) Straight line flow so that minimum travel distances and handling actions will be necessary from the carrier to the receiving area or storage location.

(2) Continuous flow and proper balance between labor and equipment. Lost motion and waiting time for labor and equipment must be held to a minimum.

(3) Localizing the unloading operation makes supervision easier. Also, the use of shorter hauls may reduce requirements for MHE.

c. Truckloads or carloads of a single item or other large quantities of an item should be spotted for unloading at the warehouse where the material will be stored. This should also be done for heavy or large cube items not suitable for handling in a central receiving area. Some carrier tariff provisions provide for multiple deliveries at the receiving installation. Such a provision should be used when practical to position material near the final storage location.

d. Truckloads or carloads of mixed material, containers with more than one line item, parcel post items, and returns from local shop facilities, and other organizations can normally be spotted and processed more efficiently through a central receiving activity.

e. Unloading operations to release the carrier must be closely monitored as there are specific periods for carrier holding without a penalty charge. These periods are called free time. If the carrier is retained beyond the authorized free time, time in excess is subject to demurrage or detention charges.

(1) Railcar demurrage charges are assessed for the detention of freight cars on the basis of a specified amount per car-day. Shippers or consignees who detain cars for loading, unloading, or furnishing orders to the carriers beyond the free time allowed by carrier tariffs are required to pay the lawfully published charge. Specific questions related to railcar demurrage should be referred to the installation transportation officer to ensure that current charges and rules are considered.

(2) Truck detention rules and penalty charges vary with individual trucking concerns and locations. Specific questions must be referred to the carrier freight traffic office.

3-4. Unloading Operations.

a. Each unloading operation requires planning and on-the-spot supervision. The unloading of supplies should be compatible with the procedures involved in tally-in and inspection of the receipt. In general, the mechanics of unloading supplies will vary according to the type of carrier, type and weight of supplies, type of unloading facility, and MHE available.

b. The general unloading sequence described below is applicable to supplies received by railcar or motor truck.

(1) Before a sealed railcar or truck is opened, the seal must be checked for condition and serial number. If the seal is broken or missing or if, in the case of exclusive use of van shipments and railcar shipments, the serial numbers do not agree, an annotation should be made on the documentation and in the case of sensitive cargo, the transportation office and security office should be notified prior to unloading.

(2) Railcar doors are opened by a device similar to that illustrated in chapter 4, section II. Federal safety regulations specifically prohibit the use of forklift trucks to open railcar doors even when the doors are equipped with "pockets" to provide for this type of operation. Truck doors are opened manually by the truckdriver. Doors must always be opened so that personnel are protected against falling containers or items.

(3) A preliminary inspection should be made when the carrier's equipment is opened. If there is obvious evidence of shortage or damage, the unloading operation should be suspended, if practical, pending inspection by the carrier's representative.

(4) The method of entry into the carrier for unloading depends upon the type of carrier, type of material received, and the physical characteristics of the receiving area. If unloading is to be accom-

plished at a dock level warehouse platform, a bridge plate or some type of mechanical or hydraulic dock leveler may be used to permit entry of unloading equipment into the carrier. Extensive conveyors may also be used at dock level warehouse platforms. If the warehouse platform is at ground level, a portable platform may be used to aid in unloading by forklift truck. Also, a portable ramp may be used to allow entry of a forklift truck into the carrier.

(5) Supplies which will move to the storage location either directly from the carrier or from the receiving area, should be palletized while in the carrier or as the receipt is offloaded from the carrier.

(a) In placing containers on pallets within the carrier, the aim must be toward maximum palletization (or unitization) so that the unloading operation can be accomplished as rapidly and efficiently as possible. During the stage of the operations, the supervisor should make certain that the appropriate pallet pattern is used. (See pallet pattern selection table (table 3-1) and pattern outline table (table 3-2). For further information on palletization, see MIL-STD-147, Palletized Unit Loads.)

(b) The pattern should be reversed on successive layers so that containers will interlock and be tied together. Protection of personnel, consideration of container strength, the size of the door opening, and capacity of equipment affect the size of the pallet load.

(c) Palletized containers should be positioned so that the identification markings are visible at the outer rows of the pallet load. Proper palletization upon receipt permits warehousing with a minimum of delay.

(6) A forklift truck must have a limited collapsed mast height to enter a conveyance to remove the supplies. Generally, a forklift truck with a capacity of 2,000 or 4,000 pounds and a collapsed mast height of 83 inches or less can be used for unloading railcars, trucks, or intermodal containers. However, the floor strength of carrier equipment must be checked to assure that the floor can support the equipment and load. Forklift trucks should not be used in semivans unless the tractor is in place or suitable jacks are in place to prevent the van from upending. Because of size limitations, a 4,000-pound forklift truck with a collapsed mast height of 91 inches is the largest that can normally be used for direct railcar unloading, and a 4,000-pound forklift truck with a collapsed mast height of 83 inches is the largest that can be used for direct motortruck unloading.

(7) Intermodal containers on chassis, railcars, or on the ground can be offloaded with the same MHE used to unload material from trucks. In general, containers are removed from railcars before contents are removed.

(8) Figures 3-1, 3-2, and 3-3 depict various workable methods of unloading and movement of supplies.

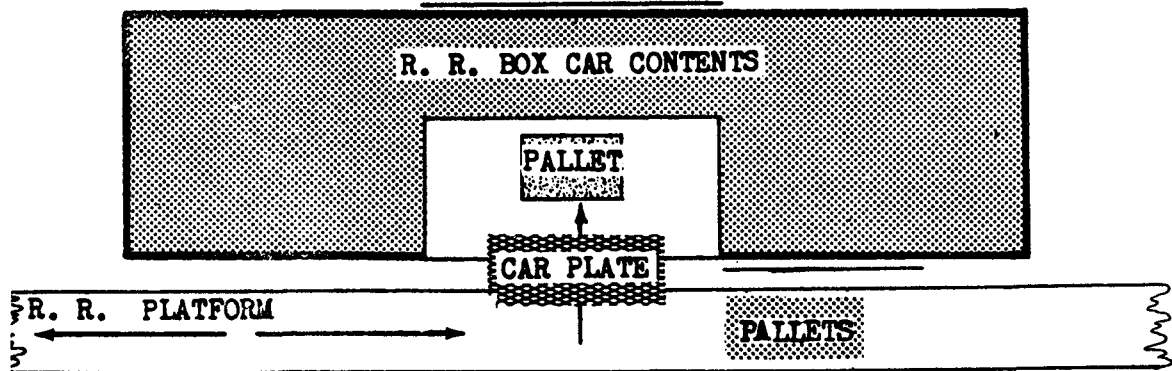

A. AFTER DOORWAY HAS BEEN BROKEN, PALLET SHOULD BE PLACED IN A STRAIGHT FORWARD POSITION.

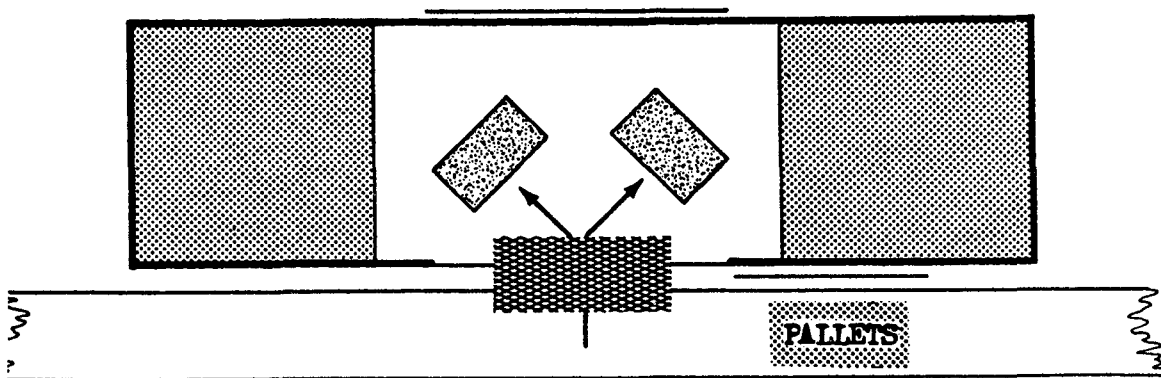

B. AFTER SUFFICIENT SPACE IN CENTER OF CAR HAS BEEN CLEARED, PLACE PALLET AT 45° ANGLE.

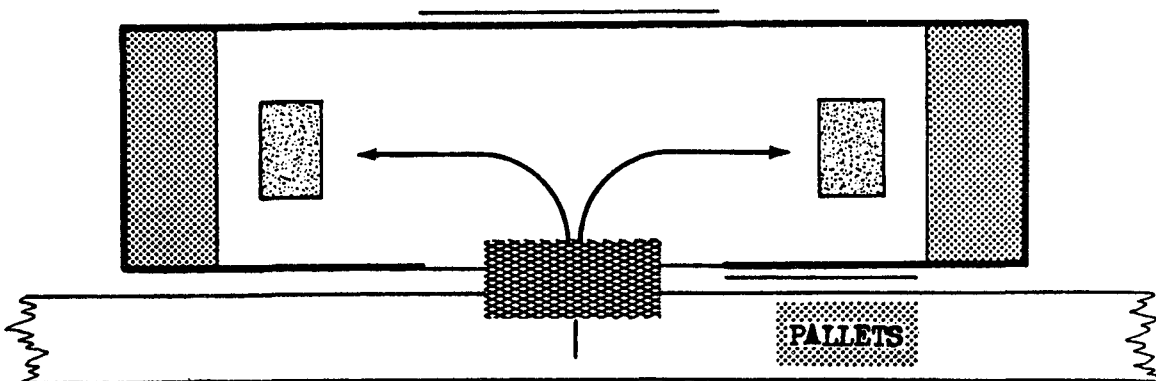

C. AFTER CENTER THIRD OF CAR CONTENTS HAS BEEN UNLOADED, PLACE SUBSEQUENT PALLET AT 90° ANGLES.

Figure 3-1. Unloading and movement to storage using forklift truck

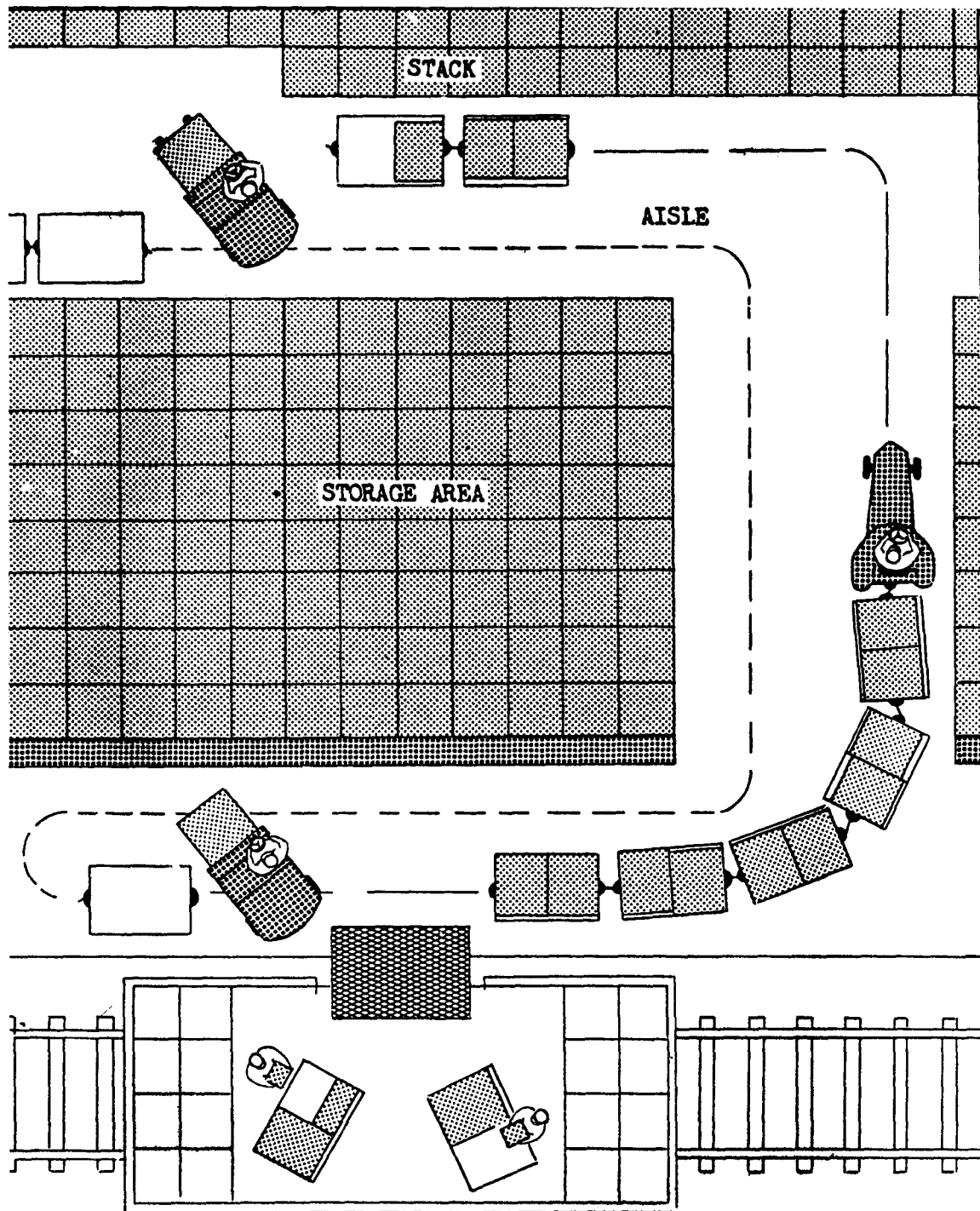
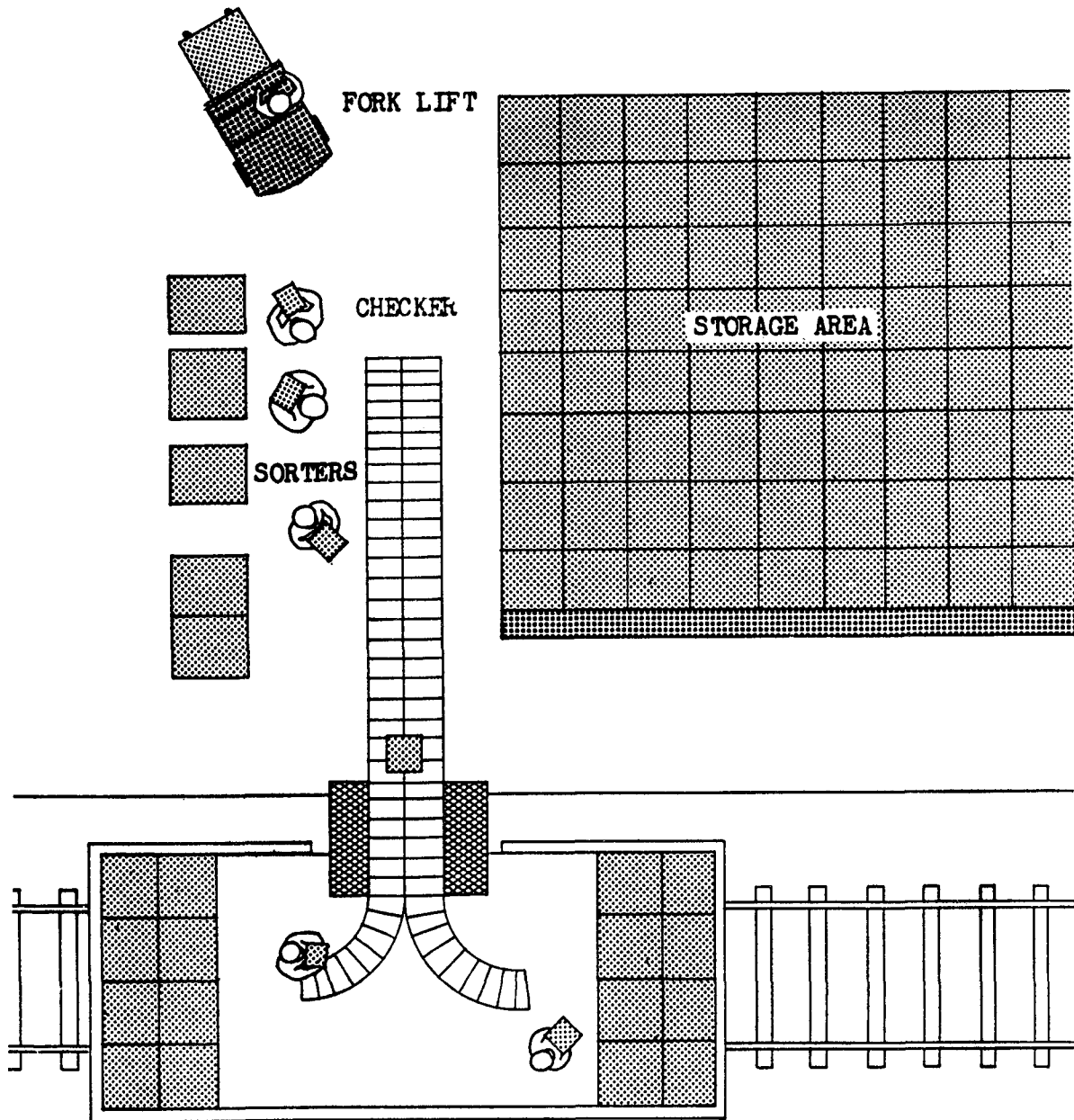

Figure 3-2 Unloading and movement to storage using tractor-trailer train



1. Checking, sorting, and palletizing is performed as contents of car are unloaded.
2. Containers should be placed on conveyor so contents and sizes are readable by checkers and sorters.
3. Conveyor line may be set up on platform provided there is sufficient working space.

Figure 3-3 Unloading and movement to storage—mixed car lots

3-5. Checking Incoming Material.

a. Tallying incoming material. Accurate checking for the number of containers and apparent damage to material is a basic receiving action. Material should be tallied concurrently with the unloading operation. The inbound receipt document is generally used as the tally record. Bar code equipment used at this point can enhance accuracy (see sec V, para 3-36). When such equipment is not available, a blank copy of the receipt document may be used to record and tally. When a blank copy is used for record and tally purposes, all available information pertaining to the receipt will be inserted in the appropriate portions of the form. The tally count may be made by lining through the numbers around the border of the inbound document and circling the number of missing packages; or it may be accomplished by the stroke tally method or by the recording of container quantities using the reverse side of the document as a worksheet. The quantity of supplies actually unloaded and accounted for must be reported as received. In many instances, full truck and freight car shipments of items packed in uniform quantities may be checked by the pallet load as they are removed from the conveyance. This method of checking is particularly advantageous for all unloading operations where the unit load method has been used by the shipping activity.

b. Inspecting supplies.

(1) Once unloading has begun, damaged containers should be set aside for examination by technically qualified personnel. In addition to these inspections, an SF 364 (Report of Discrep-

ancy) should be made for the reporting of items and packaging discrepancies, as defined in AR 735-11-2/DLAR 4140.55/NAVMATINST 4355.73/AFR 400-54/MCO 4430.3. A SF 361 (Transportation Discrepancy Report) will be prepared to report over, short, astray, damaged freight, or other types of transportation discrepancies, as defined in AR 55-38/NAVSUPINST 4610.33/AFR 75-18/MCO P4610.19/DLAR4500.15. Photographs are extremely valuable and should be used when details of the discrepancy cannot be adequately explained or can be more fully supported by such documentation. Additional inspection will be performed at the discretion of the service/agency concerned.

(2) The inspection-at-destination directives of the military services dictate whether a complete or a sample inspection is required.

(3) If the point of acceptance is at source, exterior containers (except for classified items and small arms) need not be opened unless there is evidence of tampering, damage during transit, or other indications that warrant such action. Classified items and small arms will require a 100 percent verification of quantity received by opening containers and physically viewing container contents (see sec VIII of this chap). Similarly, sealed inner containers need not be opened unless there is a justifiable reason.

(4) Repackaging and marking of receipts may be necessary if they are received in damaged containers or in containers unsuitable for proper storage. Opening and repacking may also be required if there is any question concerning the contents of the container.

Table 3-2. Pallet Pattern Outline Table (40- by 48-Inch Pallet)

				
1	8	15	22	29
				
2	9	16	23	30
				
3	10	17	24	31
				
4	11	18	25	32
				
5	12	19	26	33
				
6	13	20	27	34
				
7	14	21	28	35

Table 3-2. Pallet Pattern Outline Table (40- by 48-Inch Pallet) (Continued)

				
36	43	50	57	64
				
37	44	51	58	65
				
38	45	52	59	66
				
39	46	53	60	67
				
40	47	54	61	68
				
41	48	55	62	69
				
42	49	56	63	70

Table 3-2 Pallet Pattern Outline Table (40- by 48-Inch Pallet) (Continued)



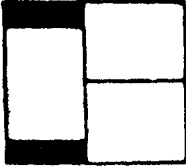
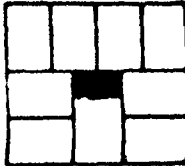
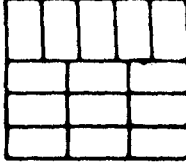
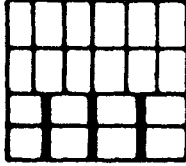
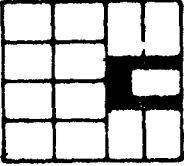
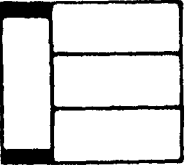
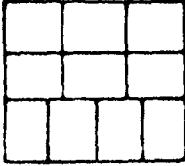
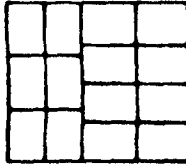
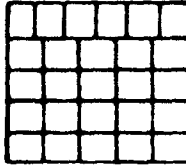
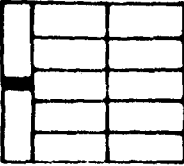
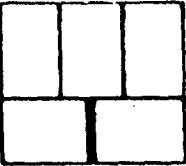
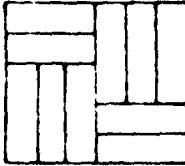
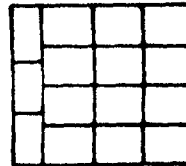
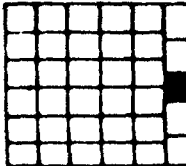
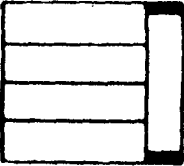
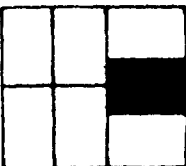
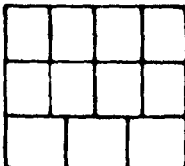
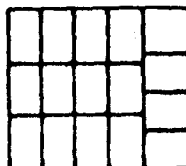
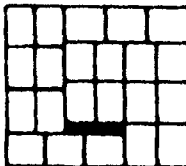
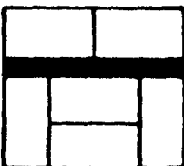
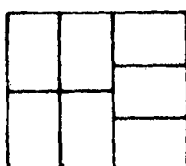
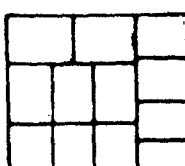
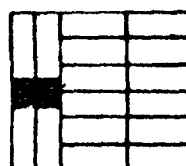
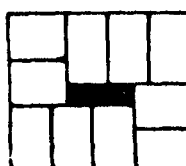
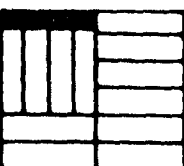
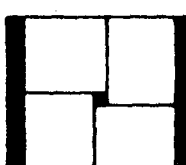
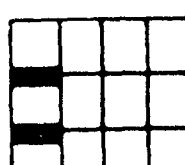
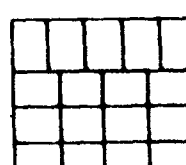
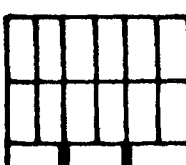
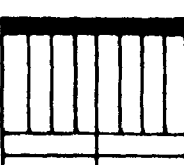
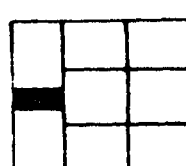
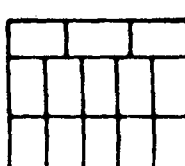
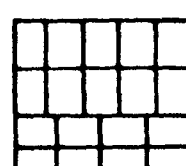
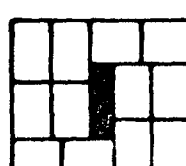
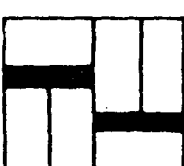

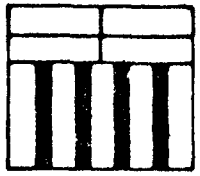
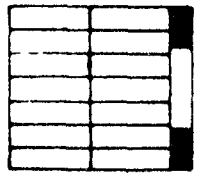
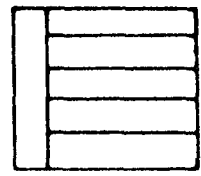
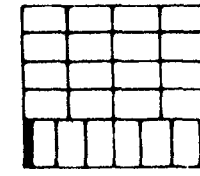
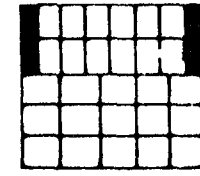
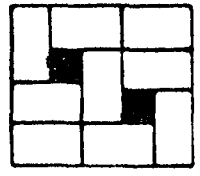
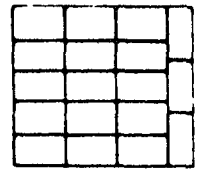
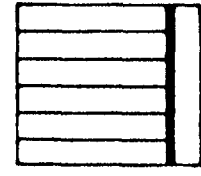
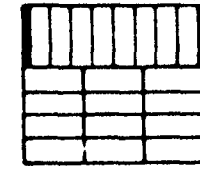
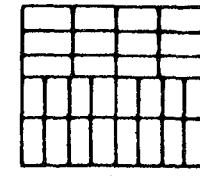
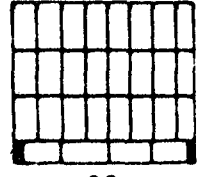
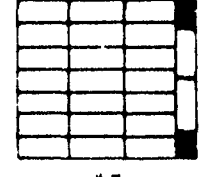
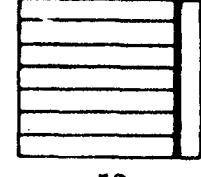
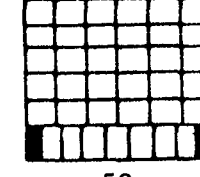
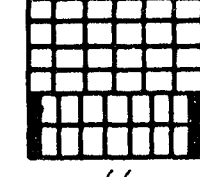
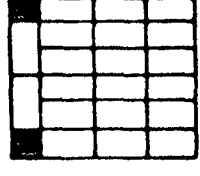
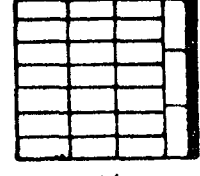
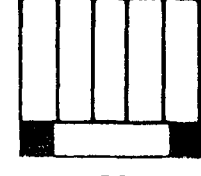
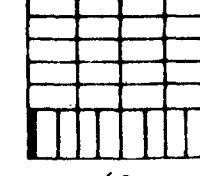
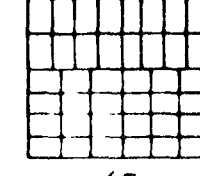
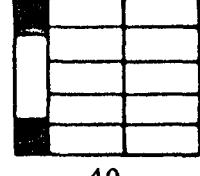
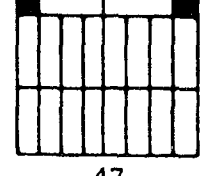
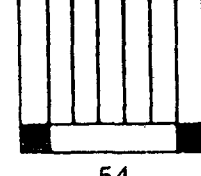
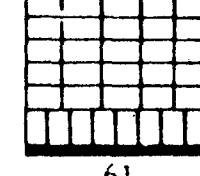
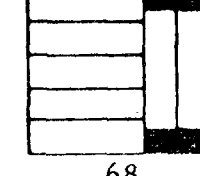
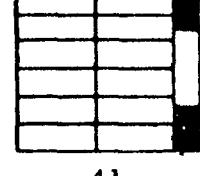
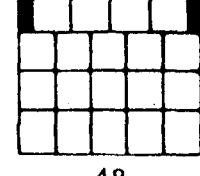
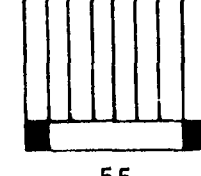
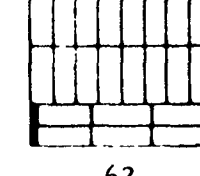
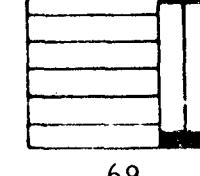
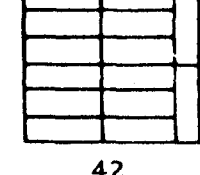
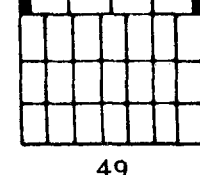
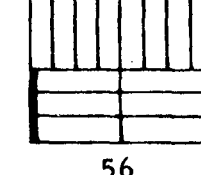
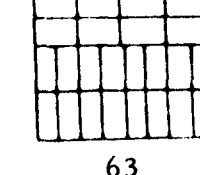
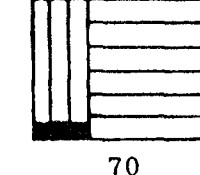

				
71	78	85	92	99
				
72	79	86	93	100
				
73	80	87	94	101
				
74	81	88	95	102
				
75	82	89	96	103
				
76	83	90	97	104
				
77	84	91	98	105

Table 3-2. Pallet Pattern Outline Table (40- by 48-Inch Pallet) (Continued)

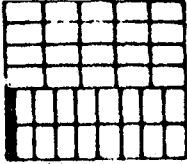
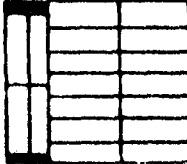
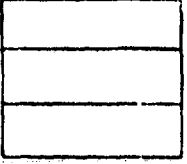
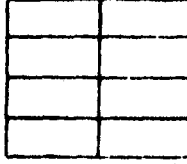
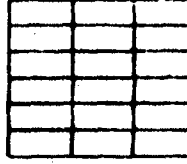
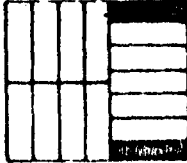
				
106	110	114	118	122
				
107	111	115	119	123
				
108	112	116	120	124
				
109	113	117	121	

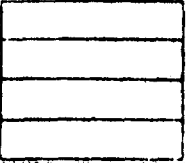
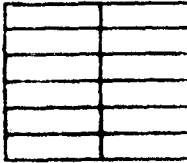
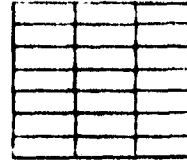
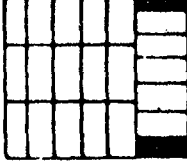
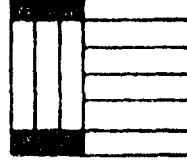
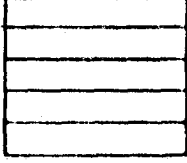
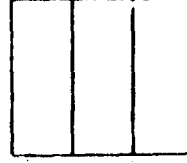
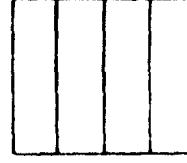
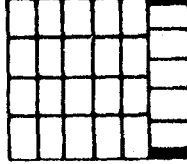
3-6. Receipt Documents.

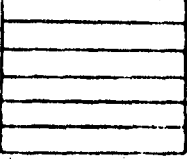
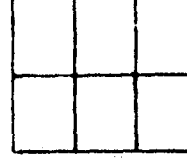
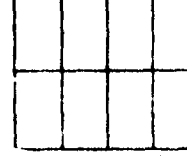
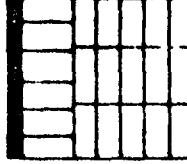
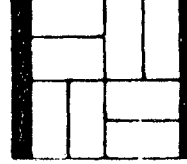
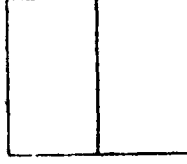
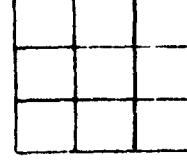
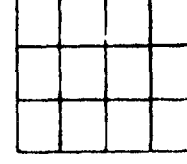
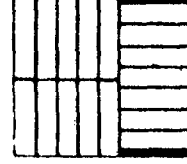
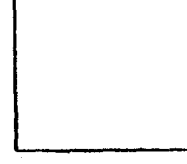
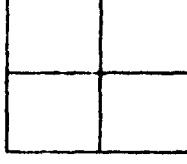
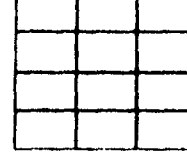
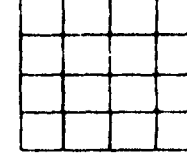
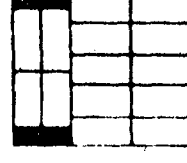
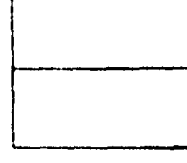
a. Control. The control of receipt documents is basic to effective receiving operations. It is essential that controls provide appropriate measures to avoid confusion in document handling and also provide timely status information. Such controls can be established through the use of document registers, a file of document suspense copies, or by use of microfilming techniques. Manual or computer methods may be used to develop and maintain the control system. A daily review of file makeup will be made to assess delays in the processing of receipts. The control system may be expanded to serve as a proof of storage tool or as a base for quality control samples on receipt actions. The specific type and extent of control will be determined by the appropriate service or agency.

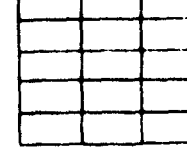
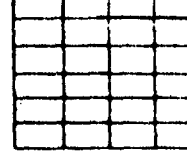
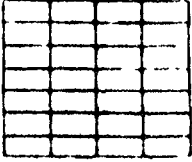
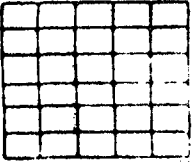
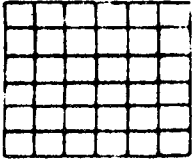
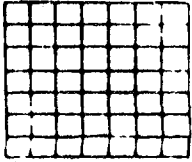
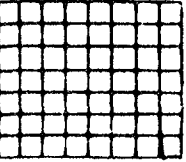
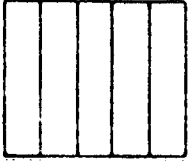
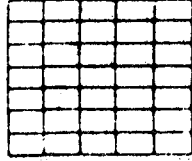
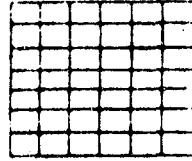
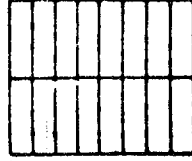
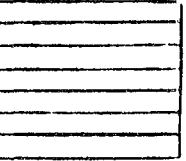
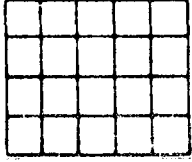
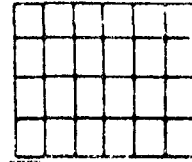
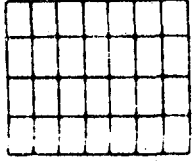
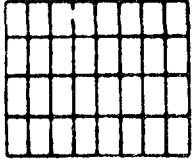
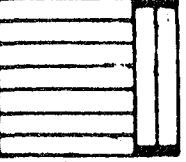
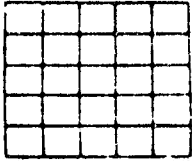
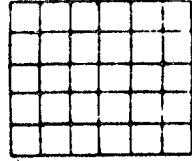
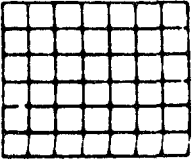
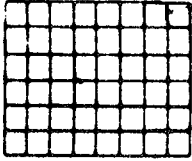
b. Processing. The flow of documents in the receipt processing cycle will vary, depending on the type of receipt and the location of activities involved in the receipt actions.

Copies of the document or information extracted from the documents are used for inquiries to the locator file and for updating the various accounting records associated with material receipts.

3-7. Marking of Material for Storage.

a. Material properly marked prior to movement to storage will result in more accurate stock accounting, more accurate issues, and easier inventory actions. The procurement of bar coded material can also aid inventory accuracy.

b. All material or its container (excluding small items of retail stock) must be marked in accordance with MIL-STD-129, Marking for Shipment and Storage. Material which deteriorates in stor-

age (e.g., subsistence, batteries, film, etc.) requires date marking(s) as specified in MIL-STD-129 to aid in FIFO issue. Any markings on containers not applicable to the present material will be obliterated.

c. Small items of retail stock may be identified by marking the bin or shelf where the item is stored. However, one item in each bin or shelf may be marked as a sample to assure positive identification of stock therein. The sample unit should not be issued except when quantity of items has been depleted to a point where issue is required.

3-8. Moving Supplies to Storage.

a. Movement of supplies to storage is a continuation of the unloading and receipt processing actions. The material movement should be made by the most expeditious and economical means available. Matters for consideration include the selection of equipment to be used, the type of supplies to be moved, and the distance of the storage area from the carrier or receiving area. Where conveyor or in-floor tow systems are not available, a forklift truck is generally used for short distance movements (less than 400 ft each way); a tractor-trailer train (possibly electronically guided) or straddle trucks for larger distances (over 400 ft); or automotive equipment for certain conditions such as difficult terrain or excessive weight of material. The latter equipment may be radio controlled intra-installation transport vehicle. See section C of this chapter for location control of material movement.

b. Repacking operations should be integrated with overall movement actions to reduce handling. In other words, the material should be routed through the appropriate processing actions prior to final storage.

Section II. Shipping**3-9. General.**

a. This section provides guidelines in shipping operations as they pertain to storage functions. Primarily, the guidelines deal with selection and movement of material through the supply operations and subsequent delivery to the transportation officer for outloading. Specific shipping instructions are found in DOD 4500.32-R (Military Standard Transportation and Movement Procedures (MILSTAMP)). In addition to the provisions of this section, the procedures and controls, prescribed in Section VIII of this chapter, will be applied to shipments of classified, pilferable, and sensitive items, including small arms.

b. The term "shipping" in its broad application covers many functions and tasks. When "shipping" is related to wholesale storage operation, it encompasses the actions necessary to delivery material to the carrier for movement to a consignee. Its effectiveness depends upon accurate recording of receipts, proper storage, and correct marking of material.

c. The application of the principles of efficient shipping practices can alleviate unnecessary strain on transport facilities and provide more efficient and economical handling and movement of DOD cargo.

d. The shipping operation involves different organizational elements. This section does not imply that functions mentioned will be performed by a particular element within the installation.

e. The provisions of this section do not apply to shipments of ammunition and other dangerous articles. Directions for the preparation and shipment of such items are contained in directives issued by the military services. TM 38-410/DLAM 4145.11/NAVSUP PUB 573/AFR 69-19/MCO 4450.12, Storage and Handling of Hazardous Materials, may be referred to for the procedures in the preparation and shipment of hazardous materials.

3-10. Shipment Planning.

a. Planning for shipping operations actually begins long before receipt of a document authorizing issue. The receipt, location, and storage of supplies should be planned in a manner to expedite and simplify subsequent stock selection and preparation for shipment.

b. Planning for a specific supply movement begins upon receipt of information regarding items to be shipped to a particular destination. Proper consideration of the factors will determine when and where to spot carrier equipment, when and where to use special equipment, and the most efficient way to assemble the material for shipment.

(1) Quantity, weight, and cube of material to be shipped.

(2) Requirements for security, packing, shipment marking, intra-installation material movement, personnel, and MHE.

(3) Mode(s) of transport to consignee.

(4) Date required for release to transportation.

3-11. Freight Planning.

a. Freight planning is the process of determining the number of transportation units (truckload, carload, and container) needed to move a given shipment. This is accomplished by determining the weight and, if possible, the cube of the line items shown on the shipping documents and ascertaining the mode of transportation. Transportation equipment of adequate capacities should then be obtained. Supplies and material should be assembled and shipped in intermodal containers or carload or truckload lots whenever practicable, in order to reduce the transit costs and conserve transportation equipment.

b. All shipments, regardless of weight, should be referred to the transportation officer at the originating installation. While route orders may be required and obtained on all shipments, generally a

10,000-pound minimum (subject to specific exemption by the individual services) is observed. A route order will specify the mode of transportation and routing. If a domestic shipment is involved, the route order will be valid for timeframe as designated in the Defense Traffic Management Regulation (AR 55-355, NAVSUPINST 4600.70; AFM 75-2, MCO P4600.14A, DSAR 4500.3); if an overseas shipment is involved, the order will specify a date for arrival at port.

c. It is the responsibility of the storage office to furnish the transportation office with all necessary information for obtaining routings

3-12. Documentation.

a. Efficient handling of supplies being readied for shipment requires the preparation of documentation in time to accompany the shipment. The system for control of outbound shipments varies with the services and, therefore, is not covered in detail here.

b. An overriding factor, regardless of shipping service, is the fact that all shipments must be properly documented to eliminate delay, damage, or loss. Unless properly documented, there can be delays in loading; turnaround time of equipment; time to reach destination; or material loss due to misdirected shipments.

3-13. Shipment Preparation.

a. Whenever a shipment is to be made, the supplies should immediately be properly packed, documented, marked, inspected, and assembled in a convenient area so that no time will be lost in carrier loading. Carrier equipment must be ordered by the transportation officer of the activity.

b. Generally, supplies are moved to an assembly area or shipped direct from the storage area. The latter method permits expeditious loading with elimination of the in-between step of consolidation at a preassigned area.

c. Supplies requiring preservation, packing, marking, or other processing should be moved to and from these functional areas via mechanized transport facilities when possible. Mechanized transport includes use of powered conveyors, intra-installation transport facilities designed especially for this task, and electronically controlled tractor-trailer tucks. The key is minimal or zero manual handling, crosshauling, and double handling. Intra-installation transport conveyances should be radio-controlled and operate on appropriate schedules to prevent backlog and bottlenecks at material transfer points.

d. After the load has been prepared for shipment (or before, if possible), the transportation of-

vice should be requested to order equipment from the carrier. The request should include precise information for spotting of equipment and any special requirements such as the need for double door freight cars, refrigerated trucks, etc.

e. When supplies must come from different warehouses or storage locations, the carrier equipment may be spotted accordingly, rather than

being held at a single loading point. Effective spotting will ensure loading within the prescribed free time limits and maintain a balanced operation by effective use of MHE and personnel.

3-14. Loading.

Section IX of this chapter provides procedures and techniques for loading carriers.

Section III. Stock Location

3-15. General.

Stock location systems must pinpoint an exact storage location in a simple, easily understood manner. This is necessary to minimize training requirements, to assist in timely and accurate storage or selection of stock, and to provide a base for optimum utilization of storage space. This section prescribes the basic requirements of a location system.

3-16. Policy.

a. Each military service/agency will establish a uniform stock location system to be used by subordinate supply and storage activities. These systems will provide a centralized stock locator file to the maximum extent practicable. Stock location systems will make optimum use of mechanized processing equipment, communications systems, and automatic data processing (ADP) equipment. Ammunition stock locations systems, including planographs, storage site data records, identifications, locator inventory records, and procedures will be established as prescribed by the responsible military services commands.

b. Planning for storage locations for classified, sensitive, and/or pilferable items will include coordination with the Security Officer/Provost Marshal to ensure that the security guidance provided in section VIII of this chapter is implemented.

3-17. Design of a Stock Location System.

a. *Planograph.* A planograph is a drawing of the actual layout of a storage structure or outside storage area. The planograph portrays the manner in which the gross space within the storage structure or outside storage area is subdivided. These subdivisions can be for such functions or uses as storage areas, shipping and receiving areas, main aisles, working aisles, locker or restrooms, and offices. The chief of the storage activity is responsible for the preparation and use of planographs. Planograph layouts are subject to approval of the individual designated by the pertinent commodity and capacity factors established in chapter 2, Stor-

age Space Management. Planographs for ammunition igloos will be developed as prescribed by the responsible military service. The warehouse planograph will be located in a prominent or focal point of activity in each warehouse, shed, or other storage area of comparable size. It should be mounted on a wood back and covered with a clear, acetate overlay. Space vacancy information may be incorporated on this overlay by use of a grease pencil which will enable easy revision, as required. Maintenance of planographs is at the discretion of each DOD Component.

b. *Perimeter lines.* The lines drawn around the outer side of any space subdivision on a planograph are called perimeter lines. The term describes the outer boundary of any storage area.

(1) The area shown on general purpose warehouse planographs for bulk storage will be divided into equal 52-inch segments in width and length directions. These segments will be subsequently referred to as "grids." This concept is based on use of the general purpose pallet, 40 inches long and 48 inches wide plus 4 inches for material overhang and handling space. These grids are used to denote locations and the position of pallets along working aisles. The depth of pallet storage can be shown on the planograph by broken lines (figs 3-4 and 3-5). If the perimeter line along any side of the storage area is not equally divisible by 52 inches, the marginal difference should be prorated to increase each grid proportionately.

(2) The details of drawing perimeter and intersecting lines on the planograph for large and medium lot bulk storage are the same (figs 3-4 and 3-5). Large and medium lot terms are explained in the Glossary.

(3) The use of perimeter and intersecting lines in establishing grid patterns for small lot bulk storage is shown in figure 3-6. The term "small lot" is explained in the Glossary.

(4) For storage areas with bin, shelving, and pallet rack storage aids, the dimensions of the storage aids will govern the planograph grid lay-

out. In these areas, the 52-inch grid pattern will be disregarded. Section 1 of figure 3-6 is an example of bin or shelving layout. Figure 3-7 is an example of pallet rack-type storage layout.

(5) Perimeter and intersecting lines for shed, transitory shelter, standard magazine, and open storage areas are shown on the planograph in the same manner as prescribed for general purpose warehouses.

c. Identification of grids.

(1) Identification of individual grids will begin at the bottom left side of the planograph and continue in sequence to the top. This procedure will be repeated for each row of grids moving in sequence from the left to the right side of the planograph (figs 3-4 and 3-5). Sequence of left to right identity may begin anew for each section, bay, etc., if desired. The sequence of planograph identity for these length and width grids will be consistent for all installation storage areas regardless of the number of area subdivisions. These grid identities then become part of the location description pattern (*d* below) used for locating material. Generally, a specific grid will be situated in the same relative position within similar structures or within open storage areas. This minimizes the need for personnel to reorient themselves when moving from one storage area to another. Once the grid identities have been determined, it is unnecessary to show on the planograph those grids not being used for material storage except aisles in bulk storage areas ((2) below). The planograph should show the grid identities required to locate stocks. Unused grids will remain available for floor plan changes as necessary.

(2) In order to provide flexibility for stock increases which require layout changes, grid identities will be provided for aisle space surface areas on bulk storage area planographs. Thus, grids required for locations in the new layout will be readily available in proper sequence without disturbing the marking of grids previously established (figs 3-4 and 3-5).

d. Location description pattern. Each material location in storage must have a description pattern which will permit immediate recognition of the

specific site. This description consists of numeric or alpha numeric characters and is preferably separated into groups for easier reading. The significance of individual characters or group of characters in the location description will be established by each military service or agency. The location description pattern established should assure that the number of characters used are kept to a minimum and yet clearly identify material locations.

e. Installations with building, warehouse, area, or block designations. Areas with permanently assigned engineer drawing numbers or letters may be assigned other code designators to such facilities for location description pattern purposes only. However, reports related to utilization, building schedules, etc., will refer only to the permanently assigned number or letters.

3-18. Location Site Identification.

a. Marking. When planographs have been drawn and the location description pattern has been established, location identifications at the actual sites are necessary.

(1) In open storage areas, appropriate location identification at strategic points will be shown on permanent, weatherproof placards or signs.

(2) In warehouses, where floor surfaces permit, location description markings should be displayed on the floor. Marking can be applied with decals, by stencil brush, or by spray paint equipment. When applied to a clean floor and protected by a coat of clear lacquer or other suitable compound, sprayed or stenciled markings should last for several years in normal warehouse operations. Markings should be placed within the aisle boundaries in order to be visible at all times and at the edges of the aisle to reduce wear from personnel and vehicle traffic. Where the floor-marking method is not practical due to type of floor surface, markings may be displayed on posts facing operating aisles or other suitable easily visible structural members, or as otherwise directed by the responsible military service/agency.

(3) For sheds and transitory shelters, location markings will be displayed in the same manner as warehouse markings.

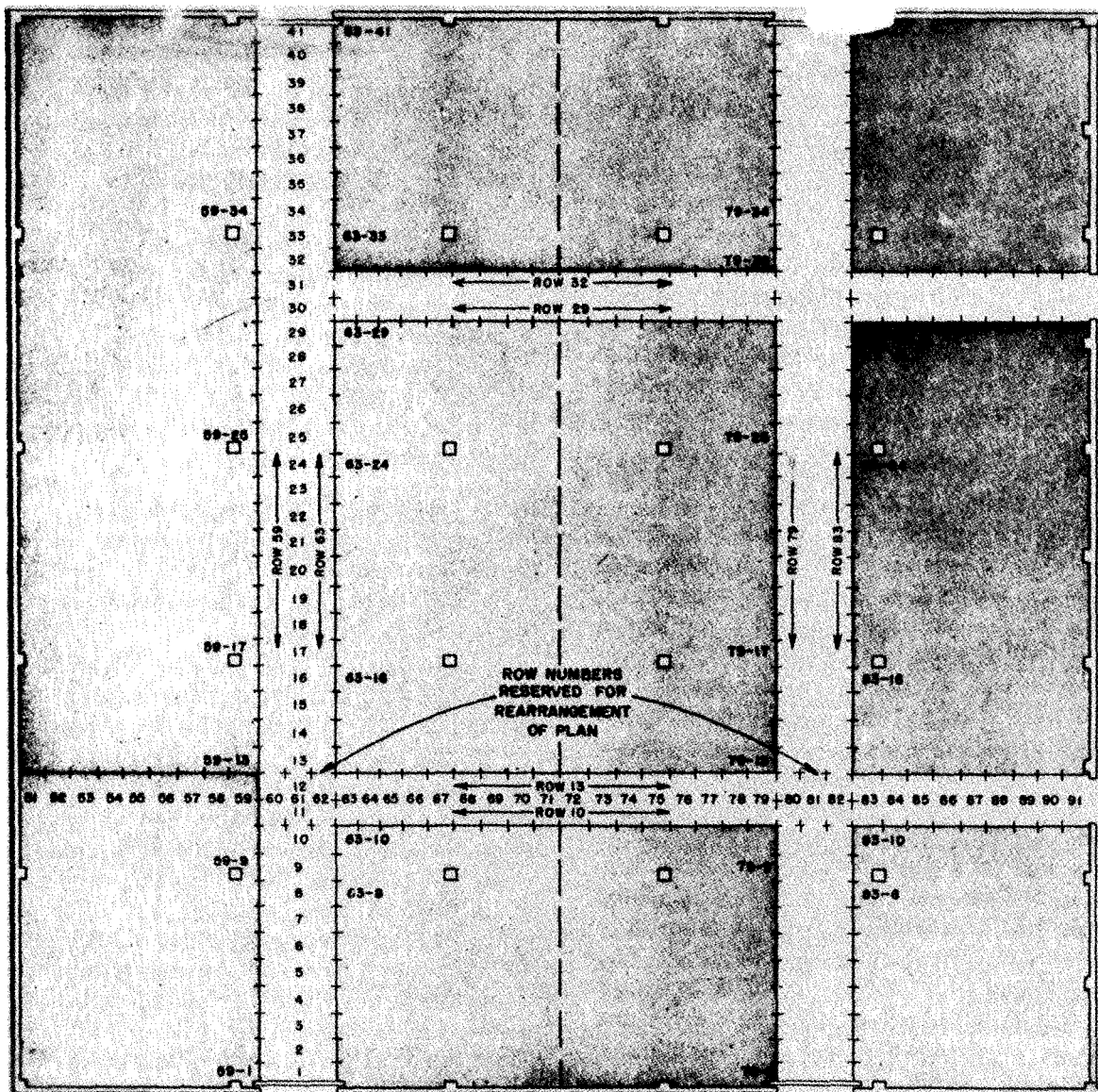

Figure 3-4 Example of stock location layout for large lot bulk storage

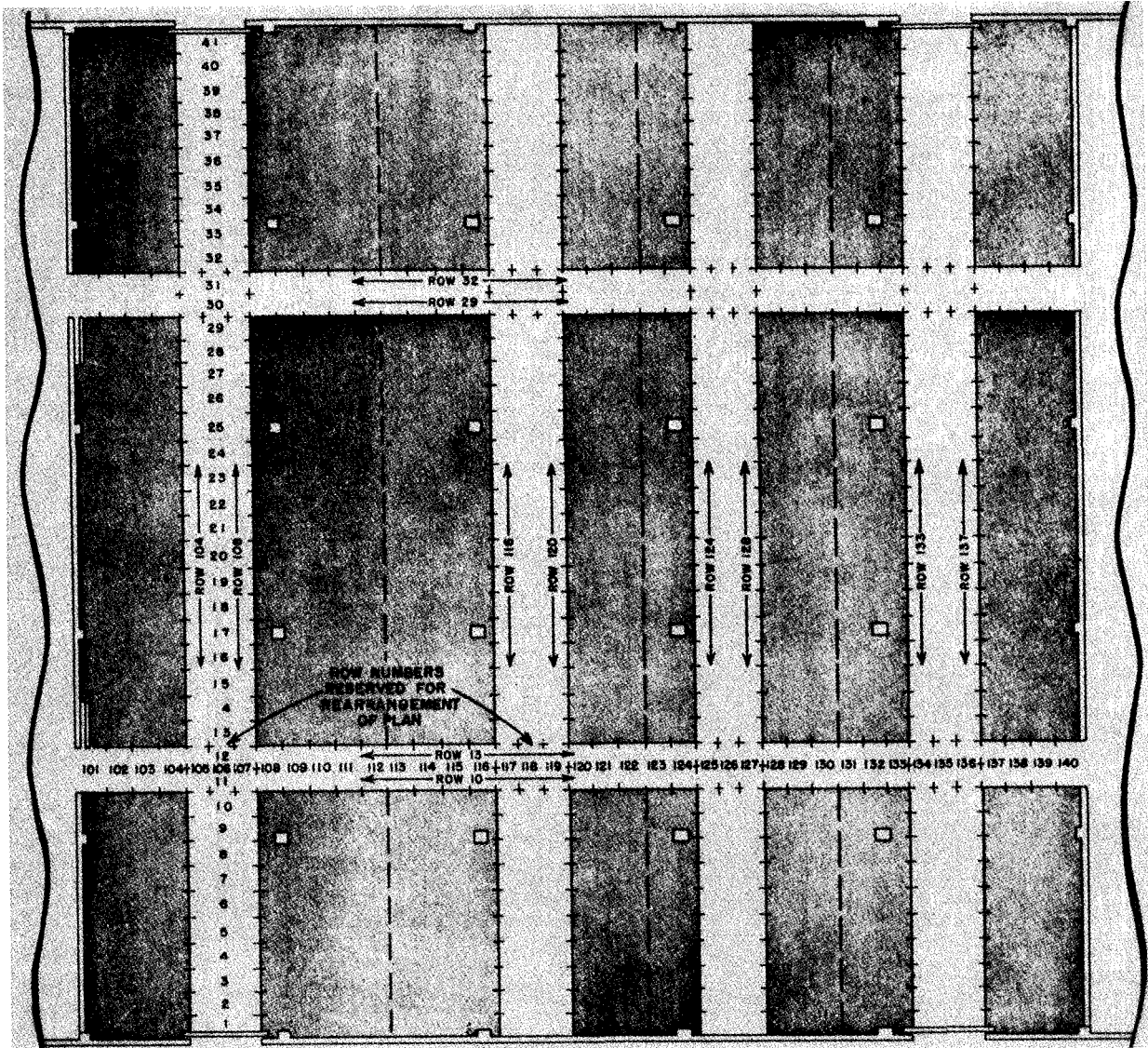

Figure 3-5 Example of stock location layout for medium lot bulk storage

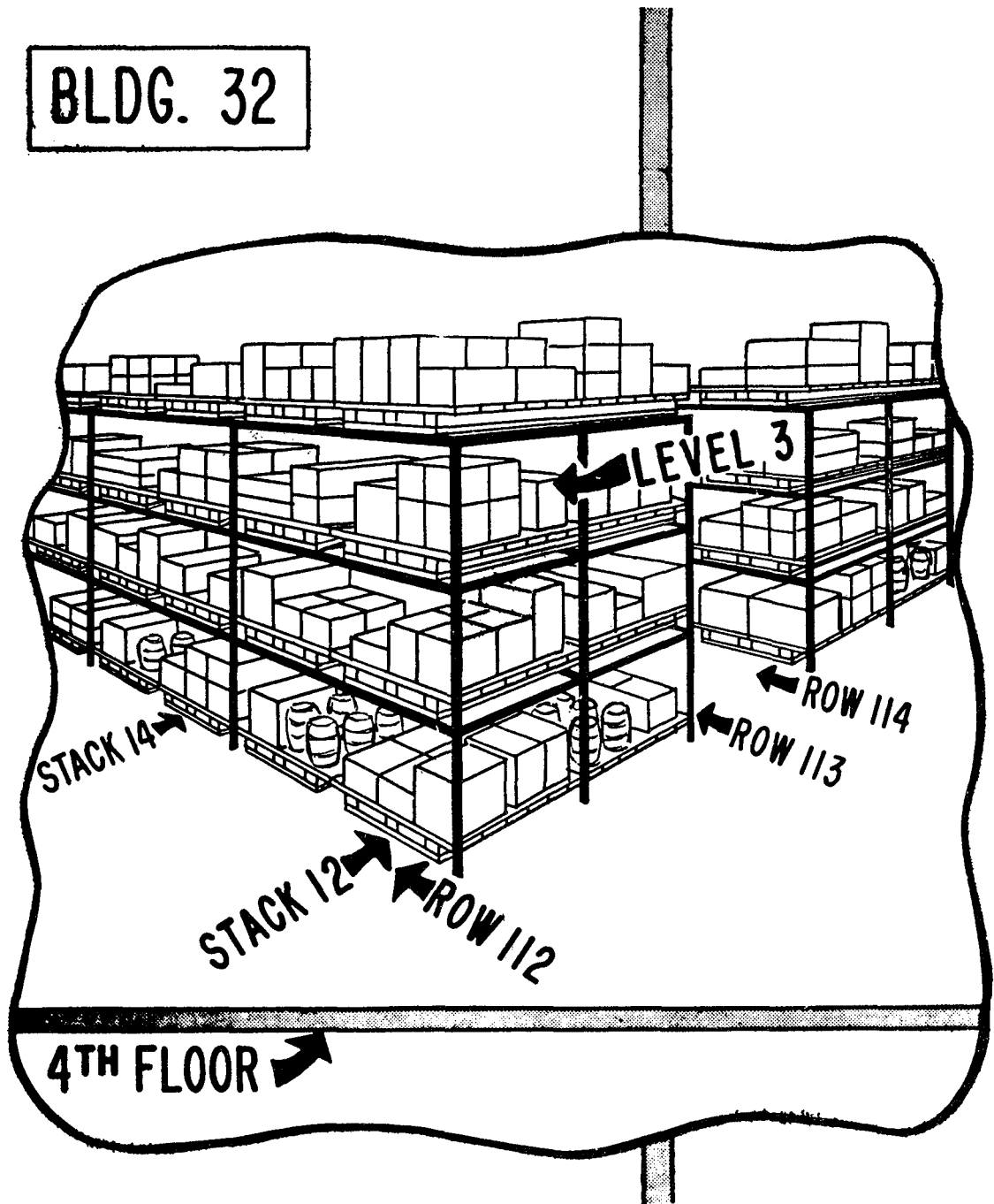

Figure 3-7. Example of view of a pallet rack-type stock location layout

(4) The quantity of location markings in storage areas will be as directed by the responsible military service/agency. As a minimum, each aisle intersection should be marked and every fifth grid should be marked along working aisles.

(5) Due to variables in aisle and storage aid dimensions in bin, shelf, and pallet rack storage

areas, the standard method of marking prescribed for bulk storage areas cannot always be applied. However, suitable location identification will be displayed. Applicable markings will be posted on storage aid ends facing working or traffic aisles. Additional markings may be painted on the floor (fig 3-8).

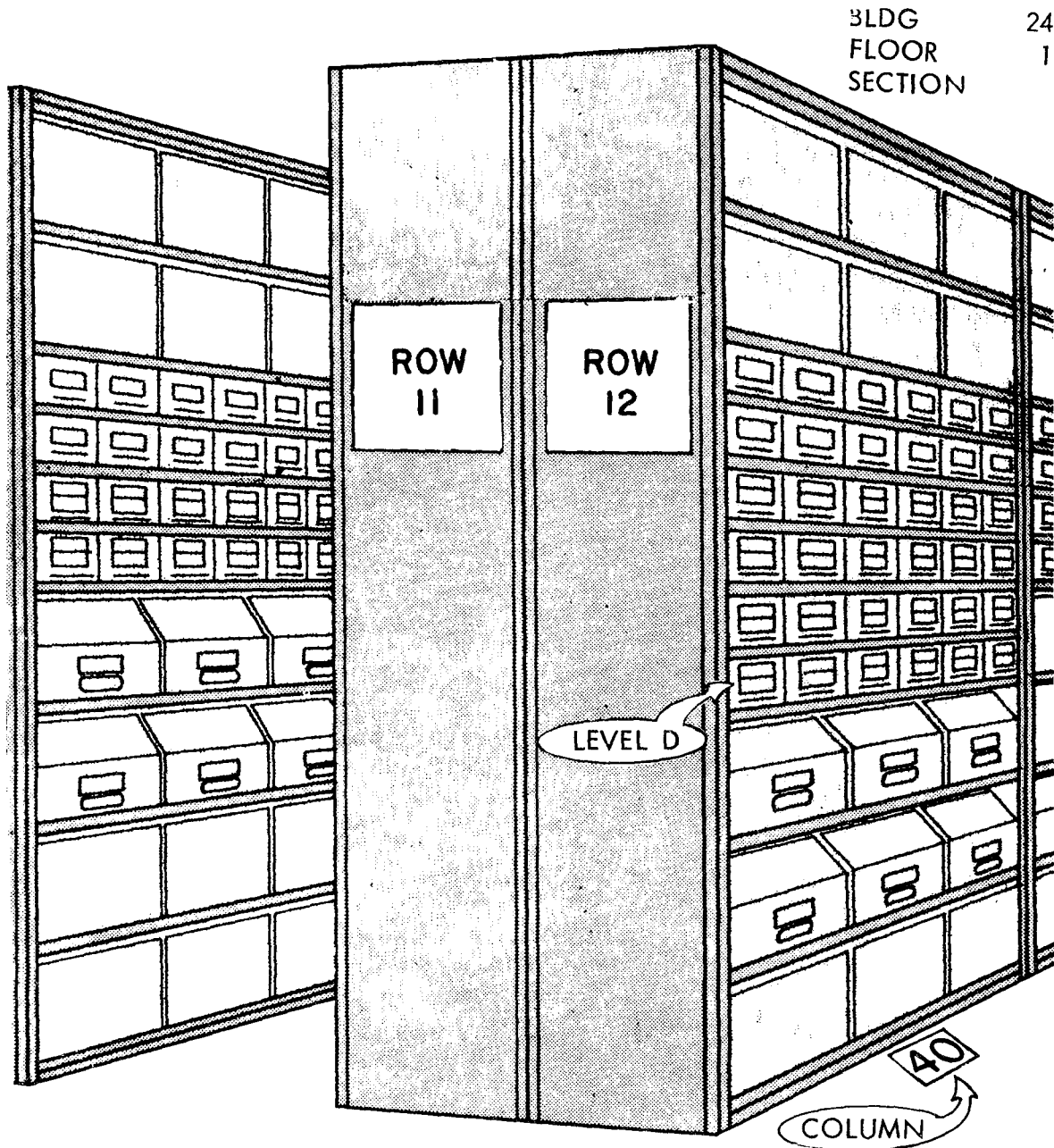

Figure 3-8 Example bin location descriptive pattern, including use of vertical location identifier

(6) In addition to the site marking described in the preceding paragraphs, marking is also required for vertical location identification in certain cases. For example, this type of marking is required on bin, shelf, and pallet rack openings to designate a particular vertical location. Numeric or alpha characters may be used (figs 3-7 and 3-8). In the case of bulk storage areas where vertical identification is not required, a standard alpha or

numeric character should be used within the location description pattern to maintain uniformity.

3-19. Maintaining the Location System.

Maintaining the stock location system is a responsibility of the storage management activity. Warehousing personnel will not normally keep records of receipts and issues or maintain balance records; however, military services may authorize an exception for ammunition.

a. Stock locator file. A stock locator file is the "heart" of a stock location system. It is an address directory for all stored material.

(1) Existing records may be used to initially develop the locator file. However, to assure optimum accuracy, file establishment should include a complete wall-to-wall survey of material onhand. Appropriate location information is then entered into the locator file. The file must contain a locator record for each item stored. A record should reflect, as a minimum, the stock number, condition code, unit of issue, and location(s). Additional data may be entered as deemed essential to operations (e.g., noun nomenclature, physical security/pilferage codes, shelf-life codes, expiration dates, or lot numbers).

(2) Procedures must be established to ensure positive control of all additions deletions, and changes to the locator file. Effort must also be directed to limiting the number of stock locator records. This can be done, in part, by selecting storage locations which can hold the total quantity onhand. Intelligent selection of locations for stock issues and receipts plus consolidation of multilocation material into fewer or into a single location will also aid in reduction of locations per item.

(3) The site of the locator file will depend on the installation layout and the type of stock locator system used (i.e., maintained by manual means or by use of Electronic Accounting Machine (EAM) or ADP equipment). The file could be located in an appropriate storage operation, in a central machine processing office, or as part of central computer records. There will, however, be only one locator file maintained except when a supplementary file is necessary for control of security items.

(4) Activities without an EAM or ADP capability or activities which store only a small number of items may use a locator file system which is maintained entirely on a manual basis. Location data maintained on ADP equipment can be available almost instantaneously by use of certain ADP remote inquiry equipment. The EAM and ADP methods can mechanically or automatically provide, in varying degrees, related supply documentation such as labels, stock selection forms, material movement forms, and inventory count cards. Use of EAM and ADP equipment will minimize actions and provide speed and accuracy in processing location actions and in the maintenance of the locator file.

b. Receipt of material. Upon receipt of material, the locator file will be screened for the stock

number received. When a location already exists, the material will normally be routed to that location upon completion of identification and classification actions. If the quantity received obviously would not fit into the existing location, the material will be routed to an appropriate warehouse area for final location selection by the warehouseman.

(1) For receipts without an existing location, if a file of empty locations by size and type is maintained, this file will be used to prelocate applicable items. If such a file is not maintained, the material will be routed to the appropriate warehouse for selection of a final location by the warehouseman.

(2) Placing material into an existing location, establishing a new location, or deleting a location requires feedback to the locator file control activity. For this purpose, receipts moving to the storage location will be accomplished by either an approved service/agency form, or a copy of the receiving document. The document accompanying the material to storage must be annotated by the warehouseman with the final location data and returned to or through the locator file control activity for proper recording.

c. Issue of material. EAM- or ADP computer-generated issue documents may have material locations printed on stock selection documents. Activities without this capability must screen the locator file and manually annotate locations. For general supply items, when the quantity selected reduces the location balance to zero, the warehouseman will prepare a location delete action on the appropriate service/agency form and forward it to the locator file control activity. Because of item configuration or replenishment frequency, certain locations may be designated as permanent and not require deletion when temporarily empty. Criteria and procedure for control of this will be established by each service/agency.

d. Location changes. Warehousing actions frequently involve movement of stored material into a new location or consolidation with similar material in existing location(s). The location additions or deletions caused by these actions will be immediately annotated by the warehouseman on the appropriate service/agency form and forwarded to the locator file control activity.

e. Changes to data elements in locator file. Changes to standard elements of management data in the locator record such as stock number, physical security/pilferage code, shelf-life code, etc., may be accomplished automatically based on centralized service/agency data broadcasts when

ADP capability exists. Activities without this ADP capability will require manual actions to alter locator file records. Service/agencies will establish procedures and documents to assure that the required data changes are addressed at the material location.

3-20. Special Requirements.

Stock location systems require a periodic validation of locator record data to ensure accuracy. This validation is accomplished in two phases. The first

phase, a location survey, is done by comparing certain data in actual warehouse locations with that in locator records. The second phase, a location audit reconciliation, involves a reconciliation between the validated storage activity locator records and the accountable activity stock record. DOD 4140.35, Physical Inventory Control for DOD Supply System Material, is the basic document which requires these validations and establishes accuracy levels for the survey and audits.

Section IV. Pest Management

3-21. Purpose and Scope.

This section provides guidelines to maintain an effective stored product pest management program. Pest management is an essential element in the overall care of supplies in land- and sea-based storage.

3-22. General.

Many types of supplies are susceptible to infestation and damage by insects, rodents, birds, and other pests. Methods and equipment normally are not available to the consuming organization to permit reclaiming infested stock or provide adequate control measures. Therefore, supply economy and troop health and morale require that supplies not be contaminated or damaged by pests upon receipt.

3-23. Objective.

The primary objective of stored product pest management is to prevent or minimize loss of supplies. This objective is achieved through the segregation and arrangement of infestible products, good housekeeping practices, regularly scheduled inspections by trained personnel, and use of appropriate pesticides, pesticide dispersal equipment, and other control measures. Pest management begins with the commodity production and continues throughout its life. Monitoring pest-induced supply losses is important in evaluating and maintaining the effectiveness of the stored product pest management program. An effective program uses nonchemical and chemical control methods. A pest management program must actively involve concerned personnel at all levels: storage, transportation, inspection, pesticide application, and command.

3-24. Policy.

DOD policy is to establish and maintain an effective stored product pest management program at DOD activities. This manual is consistent with

DOD Directive 4150.7, DOD Pest Management Program, which directs installations to have written installation pest management plans. Pest management consultants (PMCs) or certified pesticide applicators implement these installation programs.

3-25. Responsibilities.

a. Supply and subsistence managers:

- (1) Comply with recognized standards for storage configuration and housekeeping.
- (2) Implement recommendations from consulting and inspecting authorities.
- (3) Notify the pesticide applicator when pest infestations are detected and immediately isolate the infested product by removing or covering it.
- (4) Ensure final disposition of infested subsistence based on determination made by medical inspecting authority in accordance with MIL-STD-904 series, "Guidelines for Detection, Evaluation, and Prevention of Pest Infestation of Subsistence."
- (5) Ensure final disposition of infested nonsubsistence in accordance with applicable quality assurance guidelines.

b. Inspecting/reporting authorities (Army veterinary food inspector, Air Force environmental health officer, Navy entomologist, shipboard medical department representative, or preventive medicine technician):

- (1) Conduct routine inspections of stored subsistence in accordance with MIL-STD-904 series.
- (2) Maintain records of pest-induced subsistence losses and submit reports through appropriate channels in accordance with MIL-STD-904 series.

c. PMCs located at DOD Component headquarters, major commands, facility engineering field divisions, or area support activities:

- (1) Provide technical and management guidance for installation pest management programs.

(2) Train and certify pest management personnel in accordance with DOD requirements.

(3) Review and approve technical specifications of stored product pest management contracts prior to solicitation.

(4) Provide technical review of storage-related military construction, maintenance, and repair projects because of their impact on effective pest management.

(5) Review pest management records and pest-induced losses to evaluate program effectiveness.

(6) Identify stored product pests in accordance with the MIL-STD-904 series.

d. Pesticide applicators (any individual who is certified to apply pesticides or supervise their use):

(1) Manage or implement the installation pest management plan.

(2) Apply pesticides or supervise use of pesticides by others in an environmentally safe and effective manner.

(3) Notify activity safety, security, fire, and medical authorities prior to a fumigation operation.

(4) Maintain records of pesticide application on DD Form 1532 (Pest Management Report) or equivalent system in accordance with DOD Directive 4150.7.

(5) Shipboard pesticide application is performed by a medical department representative.

3-26. Inspection.

Inspection is the basis for an effective stored product pest management program.

a. Virtually all items of subsistence are susceptible to infestation or contamination by insects, rodents, and other pests.

(1) The term "infestible subsistence" in this document refers to the products listed below:

Dry pet food (includes bird seed and lab animal food)	Dried fruits Nuts
Flour	Cocoa and cocoa beverage powder
Pasta products	Dry milk
Grains and grain products (cornmeal, grits, rice, barley, rolled oats, wheat base, popcorn, farina, corn starch, etc)	Candy
Spices	Dehydrated soups, vegetables, and gravy mixes
Dry beans and peas	Tobacco products
Prepared breakfast cereals	Yeast food
	Grated cheese
	Powdered dairy drinks

Bakery and fry mixes	Coffee
Cookies and crackers	Prepared coconut
Confectioneries	Tea

(2) Items packaged in glass or cans are not susceptible to infestation except at the time of packaging. Additionally, operational ration packaging (Meal, Ready-to-Eat (MRE) rations) has been shown to greatly reduce the risk of infestation.

b. Clothing and textile items are also susceptible to rodent damage. Wool, wool blend fabrics, feathers, fur felt, and other materials of animal origin and untreated wood are infestible by insects. Infestible commodities, including MRE rations, should be stored in a single section or isolated to allow for proper inspection and localized pest control.

c. Inspection access aisle. Subsistence and other infestible materials should be stored off the floor and stacked at least 24 inches away from walls. Inspection/control aisles of at least 24 inches for infestible subsistence will be maintained between every three stacks/rows. Ships will comply with the concepts of isolation and clearances, as their special requirements permit.

d. Inspection of returned material. Materials returned to storage from using activities (especially international movement) may be infested. When returned subsistence is accepted, it should be inspected prior to placement in the warehouse. Returned material found or suspected to be contaminated by pest infestations will be placed in an isolated area and treated as prescribed herein, before being sent through the processing area.

e. Inspection procedure for clothing/textiles. Treated woolen clothing, blankets, and similar items in compressed bales are seldom affected by insects because naphthalene or paradichlorobenzene vapors are trapped within the bale for long periods of time. The odor is usually detectable. Treated materials packed in wooden boxes and fiberboard containers do not retain vapors for extended periods. Sample lots of items should be selected at random, removed from the containers, and examined for evidence of pests or pest damage. Folds and seams should be very carefully inspected. Clothing made from textiles that have been treated with a mothproofing agent within the last 2 years is not normally susceptible to insect infestation. The presence of pests or pest damage found by warehouse personnel should be immediately reported to the supervisor.

f. Inspection procedure for wood.

(1) All types of hardwood items without protective treatments are subject to attack by insects

(e.g., furniture, craft items, tool handles, wooden equipment parts, and pallets). Shipments received from tropical areas are especially prone to insect infestation. Wood dust (sawdust) and small holes indicate damage by insects.

(2) Termites are the most destructive insect pests at military installations. They eat wood and other cellulose products such as paper and fiberboard. They can destroy structural timbers, pallets, crates, boxes, tool handles, furniture, books, and other wood and cotton products. By attacking packaging or crating in storage areas, they will seriously damage stored items such as nylon parachutes and woolen clothing.

(3) The storage officer should request technical assistance from facilities engineering in the inspection of lumber and other forest products for insects and wood-destroying fungi. Infested timbers will be treated with approved pesticides. Depot stocks of wood products will be treated to prevent infestation and damage.

3-27. Information Report Requirements.

a. In accordance with service specific directives and MIL-STD-904, all DOD activities that store infestible supplies will report pest-induced losses.

b. The pest infestation loss record keeping and reporting requirements prescribed in this publication are assigned Report Control Symbol DD-A&L (AR) 1701. Existing data elements from DOD 5000.12-M, DOD Manual for Standard Data Elements, should be used in the reporting requirements to the greatest extent possible.

3-28. Reclamation or Disposal of Infested Stocks.

After infested stock has been fumigated, it should be examined for fitness for human consumption or serviceability. Subsistence unfit for human consumption may be salvaged for animal food or destroyed. Cloth or other nonsubsistence items, which are not heavily damaged, should be evaluated for return to stock. In each instance, technical advice prior to disposition of the affected stock should be obtained from the quality assurance inspector, military food inspector, or other appropriate personnel.

3-29. Housekeeping.

Proper housekeeping practices are essential for the protection of supplies in storage. Floors, containers, MHE, storage areas, pallets, and other storage aids must be clean and free of any substances that will attract; provide food and water for; or harbor insects, birds, rodents, and other pests. Tears and ruptures in food containers must be closed with a

patch or the product should be repackaged or removed. Rodent-proof garbage and trash receptacles will be provided in sufficient numbers and locations, and their use should be enforced. Eating and drinking must be restricted to designated areas because open food containers attract rodents. Dead rodents, birds, and other pests must be removed promptly from the storage area by warehouse personnel. Removal of all garbage and trash should be accomplished at least weekly.

3-30. Summary of Pest Management Procedures.

Effective pest management operations will provide the necessary measures to ensure the safe and efficient control of insects, rodents, weeds, and other pests. Pest management will be conducted in accordance with each installation's pest management plan and should include inspections to determine the need for and effectiveness of pest control measures; determination of construction needs and maintenance criteria to protect against pest damage; and pest control operations to include pesticide application and fumigation.

a. Insect Management.

(1) Installation pest management plans will provide for the application of preventive as well as remedial control measures. An effective stored product pest management program integrates the combination of biological, mechanical, physical, cultural, and chemical controls. Biological controls or measures include the use of pheromone traps for survey and insect growth regulators. An example of physical control is temperature regulation (i.e., cold storage).

(2) Mechanical controls include draining, eliminating harborage, and rodent proofing. Cultural controls involve increasing awareness, stock rotation, training personnel, and practicing good housekeeping. Chemical controls include selective use of pesticides in spraying, dusting, fumigating, baiting, and wood protection. Trained personnel are required for pesticide application. Regardless of the pesticide used, label instructions must be followed in accordance with Federal law. Technical assistance should be requested from the appropriate PMC since different stored products pests may require different control measures.

b. Rodent Management.

(1) Rodents are serious stored products pests. Rodent control is a continuous program with a sustained effort to eliminate the cause of infestation rather than one of periodic intensive campaigns. Effective rodent control is dependent on the elimination of food and shelter. The control program will include removal of food and water supply,

elimination of shelter, rodent proofing structures, and eradication by trapping, poisoning, and burrow fumigation.

(2) Observation of rodent signs is essential in determining whether rodents currently infest buildings and other structures, the degree of infestation, and in planning effective control. These signs include droppings, runaways, rub marks, tracks, burrows, nests, damage, rodent odors, rodent hairs, live or dead rodents, gnaw marks, and damage to stored products. Talc can be used as a tracking powder to identify active infestations.

(3) The cleanliness of an establishment is a most important factor affecting the number of rodents which may be present. A rodent infestation can usually be traced to unsanitary conditions, including infrequent refuse collection and inadequate disposal practices. General housekeeping which includes a planned and continuous program of collection and disposal of opened food containers, debris, rubbish, and garbage is crucial to rodent management. Proper stacking of food supplies reduces available harborage for rodents.

(4) Rodentproofing of buildings is essential. Sheet metal of 26 gauge or heavier, ¼-inch mesh hardware cloth, and concrete are suitable materials for use in rodentproofing. Openings greater than a quarter of an inch should be sealed. Openings such as cracks around doorways, gratings, and windows less than 5 feet above the ground should be covered. Openings around boxed-in piping and wire conduits should be closed. Access to

spaces between walls should be eliminated. Doors should be self-closing and tight fitting. Wood sills and doors at ground level may be sheathed in sheet metal to withstand gnawing.

c. Bird Management.

(1) *Contracting.* The facility engineer should be contacted on any bird problem. Each instance where pest birds are a problem is unique.

(2) Preventive measures.

(a) The ground around the storage area should be kept clean by removing trash and food and by using covered receptacles.

(b) Stored supplies in warehouses can be protected from bird droppings by covering the top layer of the supplies.

(c) Birds can be excluded from buildings or roosts with wire mesh or similar product. Screen all windows, ventilation openings, etc., with wire mesh no larger than three-quarters of an inch. Doorways that remain open should be fitted with self-closing screen doors. Large warehouse doors that remain open pose a special problem.

(d) Roosting should be eliminated by installing aluminum or galvanized sheetmetal at a 45 degree or greater slope on the exterior ledges of buildings. There are many temporary measures to discourage roosting, but these may require frequent servicing.

(3) *Reduction measures.* Bird populations may be reduced by destroying nests and eggs, trapping, and poisoning. Public sympathy may be very high in any type of bird control program.

Section V. Inventory

3-31. General.

a. To assist in achieving optimum economy in the management and use of DOD supplies, it is essential that accurate records of quantity, condition, and ownership of the individual items be maintained. Periodic verification of these records is accomplished through physical inventory. In its most basic form, physical inventory is an actual count of an item at its storage site. In the broad sense, inventory of military property involves a number of actions other than a physical count of the material on hand. Some of these actions are the verification of stock record balances; the investigation, disclosure, and analysis of cause of inventory discrepancies; and the adjustment of stock records and financial records. This part is concerned primarily with the actions related to the physical count of material.

b. Certain items have characteristics which require that they be identified, accounted for, secured, segregated, or handled in a special manner to ensure their safety or integrity. Because of these special considerations, inventory of such items is called a controlled item inventory. Controlled items are—

(1) *Classified items.* Material which requires protection in the interests of national security.

(2) *Sensitive items.* Material which requires a high degree of protection and control due to statutory requirements or regulations such as narcotics; precious metals; items which are of high value, highly technical, or of a hazardous nature; and small arms, ammunition, explosives, and demolition material.

(3) *Pilferable items.* Material having a ready resale value, civilian utility, or application as to

personal possession and are, therefore, especially subject to pilferage.

c. DODI 4140.35, Physical Inventory Control for DOD Supply System Material, is the basic document DOD Components use to implement DOD inventory policies.

d. DODI 4140.35 sets forth a minimum acceptable accuracy level for sample inventories below which a 100 percent inventory must be taken. The DOD Components may establish a more stringent accuracy level if deemed necessary. Only major discrepancies (see glossary of terms) are used to compute accuracy. DOD 4140.22-M, Military Standard Transaction Reporting and Accounting Procedures (MILSTRAP), provides direction for the statistical conduct and reporting of results.

e. DOD Component activities submit a quarterly *Report of Inventory Control Effectiveness* (RCS DD-I&L (Q) 935) to the next higher headquarters. This report is used to assess inventory performance.

3-32. Principles of Inventory Control.

Physical inventory procedures must provide positive control of "infloat" material and documentation. This control will include material release orders, receipts, adjustments, and catalog data changes. Mutually agreeable cutoff dates must be established between storage and accountable activities for inventory actions that must be identifiable to ensure proper consideration in balance reconciliations. Effective inventory control must also include the following:

a. Establishment of a physical inventory control organization to encompass all related inventory functions.

b. Establishment of training programs to develop optimum capability for the conduct of inventory.

c. Establishment and maintenance of accurate stock location records (see sec III of this chap).

d. Accomplishment of all directed physical inventories.

e. Adequate control over any movement of material undergoing inventory.

f. Accomplishment of required research prior to processing adjustment actions.

g. Isolation of causes of potential and actual discrepancies. Initiation of corrective action to prevent recurrence.

3-33. Inventory Planning.

Each physical inventory must be planned, taking into consideration the following:

- a. Number of items involved.
- b. Number of locations involved.
- c. Manpower requirements.
- d. Anticipated productivity.
- e. Scheduling to obtain maximum efficiency and accuracy.
- f. Preparation of material in storage to facilitate inventory counting.

3-34. Inventory Training.

With the planning factors established, actual steps to accomplish the inventory should be outlined. Each individual participating in the inventory should be given a specific assignment. Prior to starting inventory actions, necessary training for all personnel involved, both military and civilian, should be completed. Required training should be conducted through coordination of all organizational elements concerned. Suggested points for emphasis in the conduct of this training are—

- a. Purpose of inventory.
- b. Familiarization with the inventory organization and each participant's part therein.
- c. Importance of attaining the highest degree of accuracy.
- d. A thorough orientation in—
 - (1) Recognition and recording of correct stock number, nomenclature, and unit of measure.
 - (2) Item identification.
 - (3) Condition classification such as serviceable, unserviceable, or other appropriate category.
 - (4) Counting techniques.
 - (5) Recognition of improper or unsafe material storage practices.

3-35. Preparation of Material for Inventory.

Every effort should be made to arrange and maintain stored material in the best possible manner through application of proper storage practices. Prior to taking an inventory, stocks should be—

- a. Properly identified and clearly marked.
- b. Identified as a "Do Not Inventory" item, when these items are not to be included in the inventory count.
- c. Stored in the minimum number of separate locations commensurate with proper storage practices.
- d. Stored uniformly with respect to quantity per container and containers per pallet.
- e. Clearly highlighted to show where conditions other than those in *d* above exist.

3-36. Bar Code Utilization.

The use of bar code technology in physical inventory and location survey operations provides the following benefits:

a. Source data electronically downloaded from the host computer to a hand-held bar code reading device eliminates the requirement to produce cards and listings. The portable bar code reading device serves as both a prompt to the operator and a storage device for data taken from the location site. Bar coded labels on locations and key entry on the portable scanner provide the means of capturing survey data.

b. Bar coding technology can be economically integrated into existing physical inventory and location survey procedures. Bar coded information on locations can be scanned with a contact or noncontact scanner (laser-type).

c. The cost per transaction and processing time decrease, while accuracy increases.

3-37. Physical Inventory Guidelines.

The following key elements emphasize proper inventory actions.

a. Adequate training is a prerequisite of efficient inventory control operations.

(1) DOD educational centers offer many specialized courses of instruction in inventory control, statistical sampling, and quality control. Such courses of instruction will provide personnel with a high degree of skill.

(2) In addition to formalized off-post training, each individual assigned to inventory activities should be given adequate on-the-job training to include the following:

Preparation of documentation.

Identification of items.

Difficulties involved in counting at each type of location.

Safety requirements.

Security considerations.

(3) These training suggestions, if effectively organized, should result in each individual being fully qualified for this particular assignment.

b. Each error that creeps into the record keeping system has a potential adverse effect on inventory actions. The ideal attack on this problem would be to eliminate the introduction of errors. But with thousands of transaction entries made each day, it is impossible to prevent error introduction in total. So we do the next best thing—we try to minimize error introduction and contain error growth. Quality control actions are designed to do this as are the location survey procedures.

c. Classified, principal, sensitive, and controlled items of supply will be considered separate lots. A complete inventory of these lots will be accomplished once each year or more frequently if desired by the installation commander or accountable property officer. Reasons for this are as follows:

(1) Classified items require special protection because of their security designation and, therefore, should be given special treatment to ensure that each of these items is accounted for and our national interest is protected.

(2) Principal items are of strategic importance, high monetary value, unusual complexity of issue, and often involve procurement difficulties; therefore, these items should also be given special attention.

(3) Sensitive items have a ready sale in illicit markets and are especially likely to be pilfered. A periodic inventory of each of these items is essential for their protection and to discourage pilferage attempts.

(4) Controlled items of supply are closely supervised because of their basic cost, operational essentiality, complexity, or stock position and should also be given special attention.

d. An important point to keep in mind when performing inventories and reconciliations that inventories are normally conducted on an open "business as usual" concept.

(1) We can have documentation and material "in-float." Both these situations must be considered when counts and recorded balances do not agree.

(2) We must understand that, through normal receipt and issue transactions, counts may vary from balances and require recounting. Actions such as these are considered as "in-float" documents and should be reviewed carefully prior to submitting final inventory results.

e. A survey conducted prior to an inventory, to determine and correct deficiencies, is an important phase of inventory preparation. During this period, every effort should be made to ensure that conditions detrimental to the count are detected and eliminated. We know that normal warehouse activities tend to disrupt the orderly placement of stocks, identification placards, and containers on pallets, in pallet racks, or in bins. If left uncorrected, these and other warehousing irregularities could seriously deter satisfactory completion of the inventory. A preliminary survey which includes all facets of storage and warehousing methods that may interfere with inventory is a recommended pre-inventory action. Let us not compromise the

quality of the inventory through failure to make adequate preparations. The following are some of the storage situations that may be observed in a pre-inventory survey.

(1) During a preliminary survey, you may discover conditions such as a pallet rack containing material stored in such a manner that many handling actions would be necessary to determine quantities. When material is originally palletized, every effort should be made to place containers in such a manner that nomenclature and quantities can be easily seen.

(2) No markings on some of the containers and loose pieces in a rack location mean opening, counting, and repackaging most of the stock, thereby, increasing the chance for error. This is a condition which should be eliminated during the preliminary survey.

(3) When material is cartonized and placed to facilitate convenient recording of quantities without removal of stocks from the rack, time will be saved. Original containers such as these, or sealed and properly marked packages, need not be opened for inventory counting.

(4) Loose bin stocks placed in unit packs accelerates the process of counting and helps to eliminate counter errors.

(5) Identification and quantities should be exposed in such a manner that counting will be a simple matter.

(6) Another situation which can cause counting errors is a multi-item stack. A careless counter could inventory the whole stack as one item. Open boxes that are not labeled as open boxes in the stack, and markings not visible on the box, will also cause problems. Storing more than one stock number in a bulk storage stack should be avoided.

(7) Another example of warehousing which, if not recognized, could cause an inventory error is when multiple rows are the same item, but one row has a different size box. An inventory counter, if not alert for such a condition, might believe these boxes are another item and omit the quantity from the total stock in location.

f. Now that we have approached the starting point, let's take a final look at our pre-inventory checklist to assure that we take off in the right direction. When all points check affirmative, we can proceed with physical count and get the inventory off the ground.

g. When starting your physical count, all actions should be aimed at one target—ACCURACY. To hit this bull's-eye means a successful inventory with a minimum of effort and costs.

h. In striving for accuracy, nothing can be left to chance. When conducting the physical count, be sure you know what you are counting—do not guess. You cannot count what you cannot see, so examine bulk and bin locations carefully.

i. During the first count phase, the quantities indicated on containers and pallet and/or stack cards may be accepted provided an examination of the containers reveals no obvious errors. All irregularities (warehousing deficiencies) will be reported to the appropriate activity for correction.

j. Remember, it does not pay to take too much for granted. Although original containers or packages that have been packed and sealed locally, need not be opened for inventory, counters should be continuously alert for questionable containers. If there is a reason to believe that the quantity is inaccurate or the identification doubtful, the container should be opened, verified, and count recorded accordingly.

k. Incorrect counting is the prime example of how erroneous adjustments and secondary counts are generated. Counts should be recorded in terms of quantity times unit pack times pallet (if applicable). Modern scales are accurate to the weight of a paper clip and should be considered when available. After you have recorded your count, give it a second look to assure that what you are going to report is correct.

l. An important part of every inventory is the research and investigation conducted on discrepant items prior to and after the stock records are adjusted.

(1) Research and investigation is the responsibility of the inventory and stock accounting activities. Inadequate research actions will result in unwarranted adjustments and increase the number of complete inventories. A review, prior to updating stock records, could eliminate an inventory adjustment.

(2) Retain documents considered during the inventory phase to determine if material was in-float or if change had occurred which affected the quantity identified or condition of the item. After adjustments have been processed to the stock records, a complete and thorough investigation will be made on items designated by the accountable officer. Research lists prepared from the adjustment routine must be screened and transaction activity histories prepared on each major discrepancy. Review histories for receipt, issue, and adjustment documents prepared during inventory, which may have been in-float at the time count was conducted. Determine whether there are posting errors or adjustments of offsetting quantities

since the last inventory that would explain the discrepancy and preclude report of survey actions.

m. When an approving authority is examining inventory adjustment reports prior to approval, they may decide through personal judgement and experience that an item shortage may be due to loss through pilferage, theft, or other unauthorized

means. When this happens, and the storage cannot be explained by offsetting adjustments, erroneous posting, or improper shipments, they will direct preparation of DD Form 200 (Report of Survey). This form will be prepared by the responsible officer and processed in accordance with applicable service agency regulations. DD Form 200 is not used by Army users.

Section VI. Care of Supplies in Storage (COSIS)

3-38. General.

Caring for supplies to assure a ready-for-issue condition is an important task. The DOD Components prepare and publish detailed instructions to provide for the care of items for which they have management responsibility. Such publications will agree with the policies of this manual. The use of quality control techniques and storage serviceability standards will enable a COSIS program to be accomplished at minimum cost with optimum efficiency. Quality control and deterioration data will be generated to be used for improving standards of serviceability, specifications, and procurement quality standards.

3-39. Policy.

a. A program for COSIS must include a quality control system for inspection and/or test, a system for reporting and recording quality control data, provisions for the entry of true condition code of material into item balance records, exercising applicable material, and a system to assure corrective actions are accomplished on material deficiencies uncovered by inspections. DOD Components will determine the degree of activity required in each phase of the program and establish procedures. Major factors affecting the degree of activity are the type of item, type of storage provided, and anticipated length of storage.

b. For material not covered by storage serviceability standards or other adequate inspection procedures, frequency of material inspection (excluding shelf-life items) will be based on the type of storage provided for the material (table 3-3). Frequency of inspection for shelf-life items will be based on expiration dates.

c. Adequate protection from the elements and environmental conditions will be provided by means of proper storage facilities, preservation, packing, or a combination of these measures.

d. The results of quality data generated from analysis of inspection of items during shipping, set assembly, special inspections directed by the item manager, customer complaints, and other quality

feedback information will be used to supplement the regular cyclic inspection to evaluate the adequacy of the COSIS program.

Table 3-3. Inspection Frequencies for Material not Covered by Storage Serviceability Standards

Type of Storage	Frequency (Months)
CH (or equivalent rating when such rating has been approved by higher authority)	60
Controlled temperature warehouse	30
Noncontrolled temperature warehouse	24
Shed/transitory shelter	12
Open	6

3-40. Objectives.

The objectives of a COSTS program are to—

a. Maintain material readiness posture in CONUS and overseas commands at an optimum level.

b. Assure that the true condition of material is known and recorded through cyclic inspections and tests.

c. Provide a basis for realistic workload forecasts to determine and substantiate budget and manpower requirements.

d. Assure that only material representing current or anticipated supply system requirements is scheduled for preservation/represervation and packing to preclude expenditure of resources on excess or obsolete material.

e. Permit adjustments in storage inspection frequencies and quality control efforts to provide greater efficiency and economy through analysis of data concerning variation in deterioration rates.

3-41. Responsibilities.

a. The care of supplies is an integral part of the storage and quality control responsibilities. To discharge these responsibilities properly and with a minimum of cost, a carefully developed program is necessary at all echelons.

b. Where the stocks of one DOD Component are stored in a facility of another DOD Component, the Component operating the facility is responsible for accomplishing the care of supplies in the manner established by the owning Service or agency or in accordance with existing cross-service agreements.

3-42. Basic COSIS Program Actions.

a. Performance of scheduled inspection actions on material in storage.

b. Performance of required exercising actions.

c. Proper identification of items.

d. Determination of adequacy of storage environment, preservation, packing, and marking.

e. Accurate determination of item condition and posting of this condition to record.

f. Prevention of all forms of deterioration that will adversely affect the end use of required items.

g. Restoration of required items to a serviceable condition for issue.

h. Detection of fungi, mildew, spoilage, insect infestation, and/or rodent, or other pest damage to stocks; prescription or administration of treatment; and determination that adequate preventive and corrective measures are taken (see sec D, this chap).

i. Inspection of shelf-life items and assignment of condition codes in accordance with DODI 4140.27, Identification, Control, and Utilization of Shelf-Life Items.

Note The term shelf-life does not apply to class V items

j. Assuring that all applicable elements are informed of any unsatisfactory conditions found to exist in stocks; the reasons therefore; corrective actions required and taken; any pertinent data which can be used to improve the item and its care; and the packaging and/or storage environment considered to be best suited for its continued storage.

k. Recommending to the applicable DOD Component, basic changes in serviceability standards or adaptations to local conditions such as storage environment or availability of specialized testing capacity not normally found in storage installations. For example, quality analysis may indicate the need for adjusting the frequency of inspection, changing the preservation procedures, or for revision of Acceptable Quality Levels or defect classifications.

3-43. Guidelines for Systematic Inspection of Material in Storage.

a. *Cyclic inspection.* Inspection of material in storage is an extremely important step in the evaluation of material quality. Its purpose and objectives are directly related to a COSIS program. In many instances, long periods of time elapse from the time of receipt of material by the storage activity until ultimate issue/shipment to the user. During this interim period, stored material must be systematically inspected to detect condition, degradation, corrosion, damage, and other deficiencies caused by improper storage methods, extended periods of storage, or by the inherent deterioration characteristics of the material. Minor deficiencies must be detected before they become of major significance, thus providing for corrective actions before the material becomes unserviceable or unusable. In this regard, a program of cyclic inspection identifies those stocks which require corrective preservation and packing to assure that material is maintained in a serviceable condition and identifies those assets which require condition reclassification to a lesser degree of serviceability.

b. *Effective and efficient execution of the cyclic inspection system requirements.* This will assure that—

(1) Stored material is inspected at intervals indicated by the assigned shelf-life code, inspection frequency code, or type of storage afforded the material.

(2) Quantitative data generated by the cyclic inspection system are thoroughly analyzed, summarized, and furnished periodically to management to assist in the elimination of causes for deficiencies.

c. *DD Form 1225 (Storage Quality Control Report).* This Form will be used for recording visual and dimensional inspection results, unless a specialized report is required or the military services have prescribed a detailed form for this purpose. When testing is required, DD Form 1222 (Request for and Results of Tests) will be used by the requesting and testing facility, as appropriate, for initiation of the form and recording test results. DD Form 1225 will be used to report inspection results unless a summary report, satisfactory for the purpose, has been established. For certain supplies such as subsistence, the requirement for reporting voluminous quality data makes it essential that a summary report be used. When a summary report is used, DD Form 1225 will be used only for reporting quality deficiencies. When DD Forms 1222

and 1225 are used for an inspection lot, a copy of DD Form 1222 will be attached to each copy of DD Form 1225.

3-44. Special Considerations in Care of Stored Material.

a. Material in open storage. Ideally, all material should be stored in covered storage space. However, since covered space is usually at a premium, there are occasions when material must be placed in open storage areas. These items must be preserved properly to withstand the exposure to elements. Additional protection can be gained by use of plastics, tarpaulins, or portable shelters over material.

(1) Care must be exercised in the covering of materials placed in open storage. The relatively quick temperature changes, to which such materials are subjected, cause moisture to condense on the material, and, unless this moisture is evaporated and carried away by adequate ventilation, it will cause the stores to mold or decay. In the case of most metal products, moisture condensation will cause excessive rust, resulting in a high rate of deterioration for the stored item.

(2) When covering materials with tarpaulins or other such materials, a clearance of 12 to 18 inches should be maintained between the bottom of the covering and the ground, where possible. In the covering of machinery or other materials which are not boxed, the tarpaulin should extend to, but never below, the top of the dunnage on which the material is being stored. To further induce air circulation in and around the stored material, an opening should be provided in the upper area of the stack covering; however, it should be arranged so that rain or snow cannot enter the stack.

(3) All material stored outdoors should be elevated above the ground by use of dunnage or specially built platforms or foundations (see chap 5, sec III, para 5-16b(6) for wheeled and tracked vehicles exception). The type of storage area will determine to a great extent the type of dunnage required to provide adequate ventilation beneath the stack. On well-drained paved or blacktop areas, the dunnage used should provide a minimum clearance of 3½ inches between the stores and the ground. On well-drained gravel or similarly surfaced areas, the dunnage should be increased to provide a minimum clearance of 8 inches. Where it is necessary to utilize ungraded or poorly drained areas for storage, the dunnage used should provide a minimum clearance of 10 inches above the highest possible water level. Such clearances do not pertain to the storage of lumber in open areas.

(For detailed information on lumber storage, see chap 5, sec I.)

(*a*) It is impossible to specify the dunnage bearing surface required for all storage conditions. On good concrete surfaces, 4- by 4-inch dunnage spaced on 2-foot centers would be sufficient to support a stack of comparatively heavy equipment. However, if this same stack of equipment were to be stored on an ungraded or comparatively soft storage area, the bearing surface of the dunnage on the ground would have to be increased in proportion to the decrease in the supporting quality of the storage area. Therefore, the storekeeper must consider both the weight of the proposed stack and the supporting quality of the surface of the storage area in determining the type and quantity of dunnage required for each stack.

(*b*) Under certain conditions, concrete blocks may be substituted for, or used in conjunction with, wood dunnage. Warranting circumstances could include—moist or humid areas where damp rot or termite infestation may occur; dry or torrid areas where dry rot or wood beetle infestation may occur; planned long-term storage programs; or the lack of salvage dunnage, necessitating the use of new materials, in which case the cost factor would be considered.

(4) Materials stored in the open require closer attention than those stored in warehouses or sheds. Such material must be inspected for indications of preservation failure such as paint blisters due to rust beneath the paint, flaking or peeling of paint, or deterioration of other applied preservative. Usually, this is indicated by small areas of rust or corrosion on the preserved item. Additionally, after hard rains, heavy snows, windstorms, and abrupt changes in the weather, stocks must be inspected for torn or displaced coverings, accumulations of water or snow, or other conditions that may adversely affect the material, and for damage to corrosion preventives which have been applied. More frequent inspection is required when the atmosphere contains industrial waste, dust, salt, or acids; when the relative humidity (RH) is high; or when the material is subjected to wide variance in temperature.

b. Shelf-life items. Items which possess deteriorative or unstable characteristics to the degree that a storage time period must be assigned to assure that they will perform satisfactorily when issued. There are two types of these shelf-life items. Type I shelf-life items have a definite (non-extendable) storage time period terminated by an expiration date which was established by empirical and technical test data. Type II shelf-life items have an

assigned storage time period which may be extended after the completion of prescribed inspection and/or restorative action.

(1) Storage personnel are responsible for executing the control program as directed by the inventory manager. Effective shelf-life control at the warehouse level requires vigilance on the part of all personnel, careful supervision, and understanding of the intent of the controlling procedures. Shelf-life items will be identified on storage records by the assigned shelf-life codes. Warehousing practices should permit ready access to oldest stocks and controls will be established to ascertain that the releasing authority's directives, as to which stock to issue, are followed. Stocks and records will also reflect appropriate condition codes. Normally, shelf-life items will be issued on a FIFO basis although exceptions to this policy may be necessary when circumstances require.

(2) Stocks other than shelf-life items should also be rotated by use of FIFO principle wherever practicable.

c. Exercising. Storage serviceability standards may require exercising of certain equipment (e.g., weapon recoil mechanisms, certain vehicles, certain aircraft components, etc.). These exercising actions must be done when required.

d. Special material condition marking. Material condition tags/labels, DD Form 1574 series, DD Form 1757 series, DD Form 1576 series and DD Form 1577 series, (MIL-STD-129) will be used to identify material when material may possibly become mixed during maintenance, storage, or shipment within (or between) installations or when physical evidence of inspection is necessary for material control to prevent duplicate inspections. These forms/labels are not for indiscriminate use on material that presents no problem in storage or transfer. The five material condition tags and five material condition labels to be used in identifying material are itemized and their use explained on table 3-4. To preclude inadvertent shipment of unserviceable or condemned material, such material should be stored separately from serviceable material.

(1) The tags/labels conspicuously marked "SERVICEABLE," "UNSERVICEABLE (REPARABLE)," "UNSERVICEABLE (CONDEMNED)," "SUSPENDED," or "TEST/MODIFICATION," as applicable, will contain adequate information regarding the identity and condition of the item.

(2) Any additional information or data required to assist in depot material control may be added to the tags/labels provided that such data

are compatible with the prescribed usage of each tag/label.

(3) It is extremely important that material condition tags/labels be protected from being removed, defaced, mutilated, or altered to avoid duplication of work in redetermining the condition and identification of the material.

(4) These tags and labels may be obtained through normal supply channels.

Table 3-4 Listing of Material Condition Tags, Labels, and Instructions

Material Condition Tags and Labels	Use
DD Form 1574 (Serviceable Tag—Material)	To identify serviceable materiel in condition codes A, B, and C
DD Form 1574-1 (Serviceable Label—Material)	
DD Form 1577-2 (Unserviceable (Reparable) Tag—Material)	
DD Form 1577-3 (Unserviceable (Reparable) Label—Material)	To identify unserviceable materiel that is potentially restorable to a usable condition This includes material in condition codes E, F, and G
DD Form 1577 (Unserviceable (Condemned) Tag—Material)	
DD Form 1577-1 (Unserviceable (Condemned) Label—Material)	To identify unserviceable materiel that is condemned as unsuitable for restoration to a usable condition (condition codes H and P)
DD Form 1575 (Suspended Tag—Material)	
DD Form 1575-1 (Suspended Label—Material)	
DD Form 1576 (Test/Modification Tag—Material)	To identify material that is suspended (stocks awaiting classification, returned material awaiting classification, or stock held pending negotiation or litigation (condition codes J, K, L, and Q))
DD Form 1576-1 (Test/Modification Label—Material)	
DD Form 1576 (Test/Modification Tag—Material)	To identify serviceable materiel that requires test, alteration, modification, conversion, or disassembly prior to issue (condition code D)
DD Form 1576-1 (Test/Modification Label—Material)	

(5) Responsibility for authentication of material condition tags/labels will be restricted to quality assurance/quality control/inspection certified personnel.

3-45. Preservation and Packing Methods for Material Protection.

COSIS inspection may generate a need for preservation/packing.

a. *Basic regulation.* The Joint Regulation AR 700-15NAVSUPINST 4030.28A/AFR 71-6/MCO 4030.33A/DSAR 4145.7 (Packaging of Material) provides uniform criteria for use by all DOD Components in the selection and prescription of packaging.

b. *Detailed criteria.* Specific instructions governing basic techniques and details of cleaning, selecting and applying of preservatives, packaging, and packing to protect material against deterioration and damage are prescribed in appropriate Government specifications, standards, and in service/agency directives.

3-46. Stock Discrepancies.

Discrepant material found during COSIS, inventory, or issue actions may be identified and controlled by use of DD Form 857 (Stock Discrepancy (Notice)) (see fig 3-9). Procedures for use of this three-part form will be established by each service/agency using the form.

STOCK DISCREPANCY		222800
(NOTICE)		
BIN LOCATION		
STOCK NO.		
NUMBER OF SAMPLES	DATE	
STOREKEEPER		
CHECK REASON FOR DISCREPANCY		
MIXED MATERIALS	UNIT OF ISSUE IN QUESTION	
DAMAGED	DESCRIPTION IN QUESTION	
PARKING SPACE		
DD Form 857, 1 JUN 71		EDITION OF 1 AUG 55 IS OBSOLETE.

Figure 3-9. DD Form 857 (Stock Discrepancy (Notice))

Section VII. Operations in CH Space

3-47. General.

a. In a high humidity environment, conventional storage facilities do not afford adequate protection (to certain types of supplies) against damage and deterioration that can result from excessive humidity. This is particularly applicable where supplies are to remain in storage for extended periods. Items selected for CH protection will normally be those items afforded a minimum degree of military protection, commercially packed, or bare. To ensure that the capability of material to perform its intended function will not be impaired or that supplies will not become unfit for consumption as a result of exposure to excessive humidity, methods have been developed to provide control of humidity within storage warehouses.

b. The control of humidity within storage structures is a method of protection—not a method of rejuvenation. CH storage will not remove rust that is already present, nor will it otherwise restore material that has deteriorated prior to storage. Material placed in this type of storage in a condition other than clean may continue to deteriorate, particularly when contamination is of a corrosive nature.

c. The recommended RH levels for broad categories of material are as follows:

Material	Percent RH
Metals	40-50
Plastics	Below 70
Paper	40-55
Wood	40-55
Textiles	40-50
Rubber	45-60
Leather	Below 70
Optics	Below 60

3-48. Policy.

CH space will be considered premium space and will be occupied at all times to the maximum practicable extent on a priority basis with those items to which CH affords the greatest degree of protection and benefit. Procedures governing the control and usage of exterior doors in CH buildings will be developed locally to ensure that the operation of dehumidification machines is kept to a minimum.

3-49. Responsibilities.

a. The following responsibilities will be assigned to a proper organizational element:

- (1) Operate, calibrate, and maintain humidity reduction equipment and all meters, recording devices, and other similar equipment related thereto.
- (2) Accumulate, summarize, and distribute developed "control" data to the extent required to ef-

fect efficient operation of equipment and maintenance of humidity levels.

(3) Correct, or bring to the attention of the proper persons, any conditions exposed which indicate undesirable trends in inside moisture levels, unreasonable continuous operation of dehumidifying equipment, excessive "open door time," or any other factor which suggests excessive moisture ingress.

(4) Assure that the full objectives of the CH storage program are realized (i.e., maximum practical utilization of this asset by reduction and retention of inside RH at prescribed level through prudent control of "open door" time as well as other applicable moisture-influencing considerations set forth herein). Ensure the existence and maintain surveillance over safe operating conditions with regard to the potentiality of carbon monoxide gas.

b. A centrally located exterior RH recording instrument will be used as a means to advise CH space users when outside relative conditions are at such level as to allow access doors to remain open if desirable, and also to close doors when outside conditions rise above 50 percent RH.

c. Conditions in CH buildings which require repair will be reported as soon as detected.

3-50. Criteria for Facility Selection.

a. CH storage space should be provided for areas where the outdoor RH is above 50 percent for more than 50 percent of the total time.

b. Equipment for the control of humidity in storage space will be operated to provide an environment not to exceed 50 percent RH.

c. The modern, permanent warehouses (WW II and later) are preferred for the storage of current distribution stocks. These warehouses should be converted to CH space (by section or complete warehouse), as required and permitted by available funds.

d. The older type permanent warehouses with inconvenient loading docks or ramps, or other features which prevent maximum efficiency in storage operations will, when economically practicable, be converted to CH space for the long-term storage of selected items, including mobilization reserve stocks and industrial equipment reserves, which normally are not stored with regular distribution stocks for rotation.

e. Sections of warehouses used exclusively for shipping receiving, and box shop operations normally will not be converted to CH space.

f. Considering cost of installation and continuing cost of operation, CH space can be installed

most economically in permanent and standard portable frame warehouses such as—

(1) Permanent-type warehouses constructed with a build-up roof, concrete roof decking with steel framing or laminated wood roof framing, block or brick sidewalls, and dock level floors.

(2) Permanent-type warehouses, gabled roof with steel framing, block or tile walls, windows, and louvers.

(3) Permanent-type warehouses constructed with a monitor in center third of roof, block or brick sidewalls, and dock level floor.

(4) Standard portable frame warehouses of a type properly constructed for CH installation.

g. The mobilization-type warehouses (e.g., built-up roof with timber framing, monitor on roof with continuous window openings, wood or asbestos siding, etc.) should not be considered for conversion to CH space, except as a low priority, due to the expense of such conversion.

3-51. Selection of Supplies.

a. Supplies to be stored in CH areas will be selected in accordance with the criteria and provisions prescribed by the military service or agency.

b. In the storage of ammunition, safety factors inherent to this commodity will be followed.

c. Humidity affects materials as follows:

(1) Ferrous metals corrode in varying degrees above 50 percent RH.

(2) Aluminum alloy and nonferrous metals deteriorate to a limited extent at 90 percent RH.

(3) Minerals such as mica, asbestos, and fibrous glass show no deterioration by moisture.

(4) Fibers of manila and sisal rope may become very brittle at humidities under 30 percent RH; however, upon exposure to normal humidities, they absorb normal water content and resume normal physical properties.

(5) items such as voltmeters, resistors, telescopes, pressure gauges, and items comprised of both electrical parts and ferrous metals such as electric motors, controllers, telephone handsets, amplifiers, circuit breakers, and mechanical fire control computers show deterioration by moisture on various components and in various degrees above 50 percent RH.

(6) If the RH falls below 30 percent, there is a tendency for rubber cable coverings and other insulating materials or electronic equipment to dry out and crack.

d. Equipment items, mobile and immobile which, because of their physical characteristics, are not adaptable to stacking, should, when com-

mitted to CH storage, be first considered for storage in low roof areas, if such are available. Consideration of the storage method used will be given to serially numbered items.

e. Unserviceable, economically repairable material awaiting repair, classification (return material), or repackaging will be temporarily afforded CH storage in accordance with the priority established for the serviceable item on a space available basis.

f. Items for normal distribution and for mobilization reserve which are usually stored together for rotation of stock will continue to be so stored when committed to CH storage.

g. Depots having dry storage tanks must recognize one basic difference between CH warehouse space and CH tanks. Supplies stored in dry tanks must of necessity be confined to inactive, reserve-type stocks, since ready and frequent access to the interior of these tanks is not normally economical or practical.

3-52. Material Protection Factors.

a. Items to be placed in CH storage may be afforded the minimum practicable preservation and packing, in accordance with requirements of the military service or agency.

b. Items currently in storage or received from procurement will not be repackaged to attain a lower level of protection for CH storage, unless such is accomplished as a byproduct of normal care and preservation and maintenance operations.

c. Preservation and packing levels can be safely reduced to the minimum for material consigned to CH storage. However, the degree of additional hazard imposed on supplies from the time they are shipped from the safe confines of CH storage until they are consumed must be taken into account. Supplies in general must continue, as always, to be protected at a time of shipment to a degree commensurate with the maximum anticipated hazard to which they will be subjected in movement from storage to consumer.

d. In certain cases, supplies and equipment destined for storage in CH facilities are purchased at a reduced level of preservation and packing. Supplies received from vendors, so packed, will be placed in CH storage as soon as possible after re-

ceipt. In the event CH space cannot be made available after receipt, the level of protection will, if required, be raised consistent with the type of storage and the anticipated length of storage.

e. Items received from sources such as procurements, returns, and transfers, identified for CH storage, will be placed in available CH space according to priority. However, as a matter of judgment on the part of storage or inspection personnel, an item of higher priority, with levels of preservation and packing able to withstand normal storage, may be passed over in favor of items of lower priority with lesser levels of preservation or packing.

f. Any action which reduces the level of packaging of material, on the assumption that it will be stored in CH space, will require adequate controls to assure storage in CH space.

g. Movement of supplies and/or pallets which are wet or damp into CH areas should be avoided.

h. Interwarehouse transfers should be conducted under preferred climatic conditions.

i. Schedules for cyclic inspection will normally be extended for items under CH storage.

3-53. Utilization Factors.

a. Only through maximum use of CH space will the full extent of inherent economic and physical benefits be realized. Maximum use, however, does not mean simply filling the warehouse, but maximum occupation by supplies that require the protection.

b. Storage operations in CH warehouses will utilize the same basic principles of good warehousing that are practiced in conventional warehouses. Specific attention will be given to modernization plans which are geared to the improvement of practices. Storage arrangement should provide for maximum utilization of available cube, direct accessibility of supplies and equipment for proper stock rotation, accurate and legible identification, mobility of each item, and application of safe storage practices.

3-54. Equipment and Operations Factors.

a. CH equipment should be located within the warehouse so as not to obstruct traffic aisles (fig 3-10).

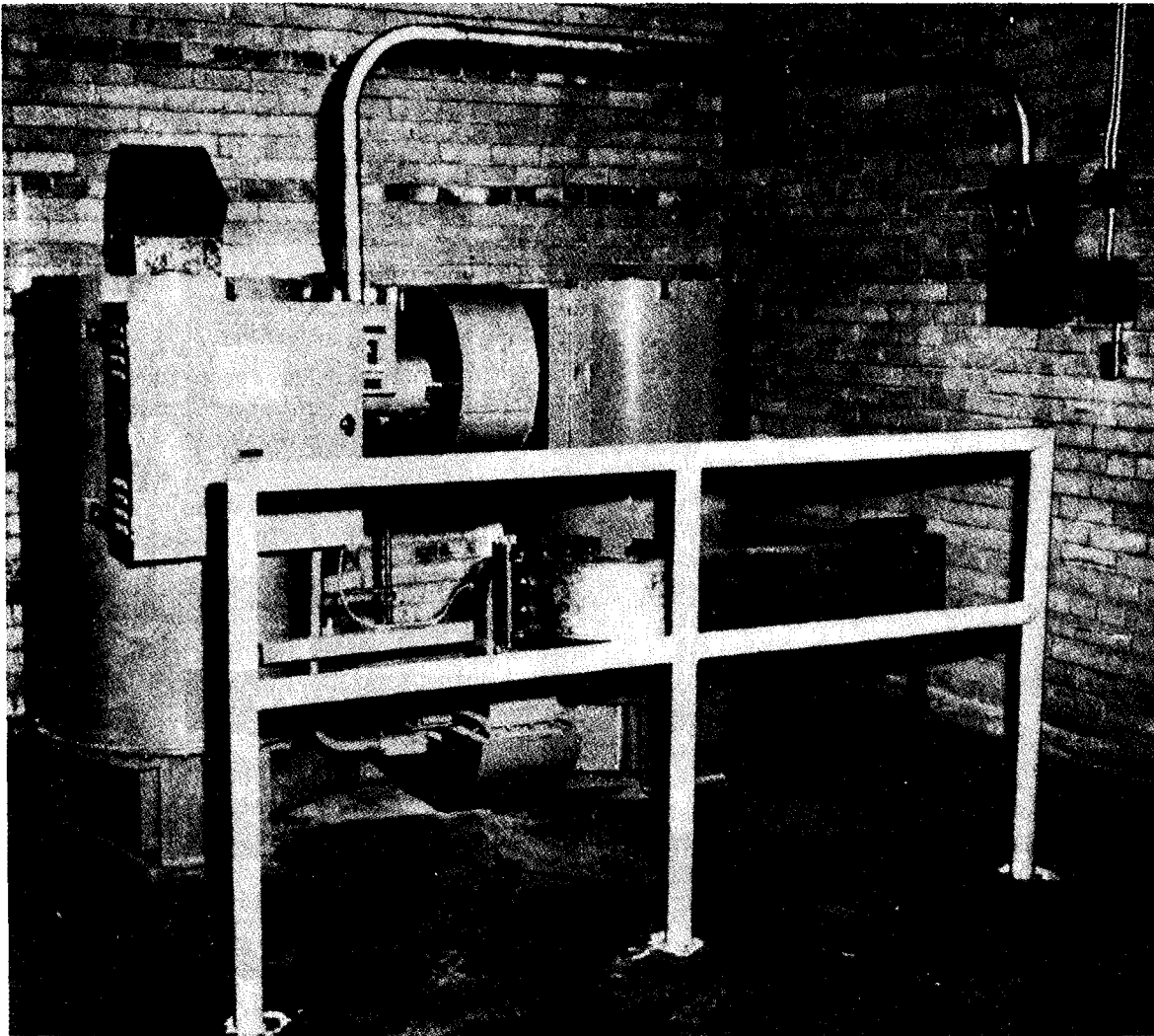

Figure 3-10 A desiccant-type dehumidifier

These machines are installed at prescribed intervals within the warehouse to draw in the moist air, extract the moisture, and blow the dry air into the area. To eliminate obstructing operating areas, these machines can be located on elevated platforms.

b. It is essential that the entrance of humid air into CH warehouses be kept to the minimum in order to maintain the RH at desired level. Door control is most important, since the greatest source of moisture penetration is through open doors. An alarm system may be provided to signal open doors.

c. Movement of supplies into and out of CH space will be planned to the greatest extent practicable, so that only one exterior cargo door in a section is open at a time. When two doors are open

at the same time, particularly on opposite sides of the warehouse, drafts are generated which greatly increase the infiltration of outside air.

d. To offset any operational disadvantage occurring as a result of the "closed door" policy, a convenient means can be provided that will cause cargo doors to immediately open and subsequently close when entrance or exit is made. It is time-consuming for operators to dismount from their vehicles, open the doors, remount the vehicles, and drive through the doors and then dismount once again to close the doors behind them.

e. Use of power-actuated auxiliary doors is one recommended means for counteracting this problem in active CH areas. Large curtain-type rubber metal doors actuated by contact with MHE (e.g., tractors, forklift trucks, etc.) can be installed in

appropriate openings when desirable. These auxiliary doors are not intended to replace current security doors; therefore, they will be so positioned as not to interfere with the opening and closing of the permanent doors (fig 3-11).

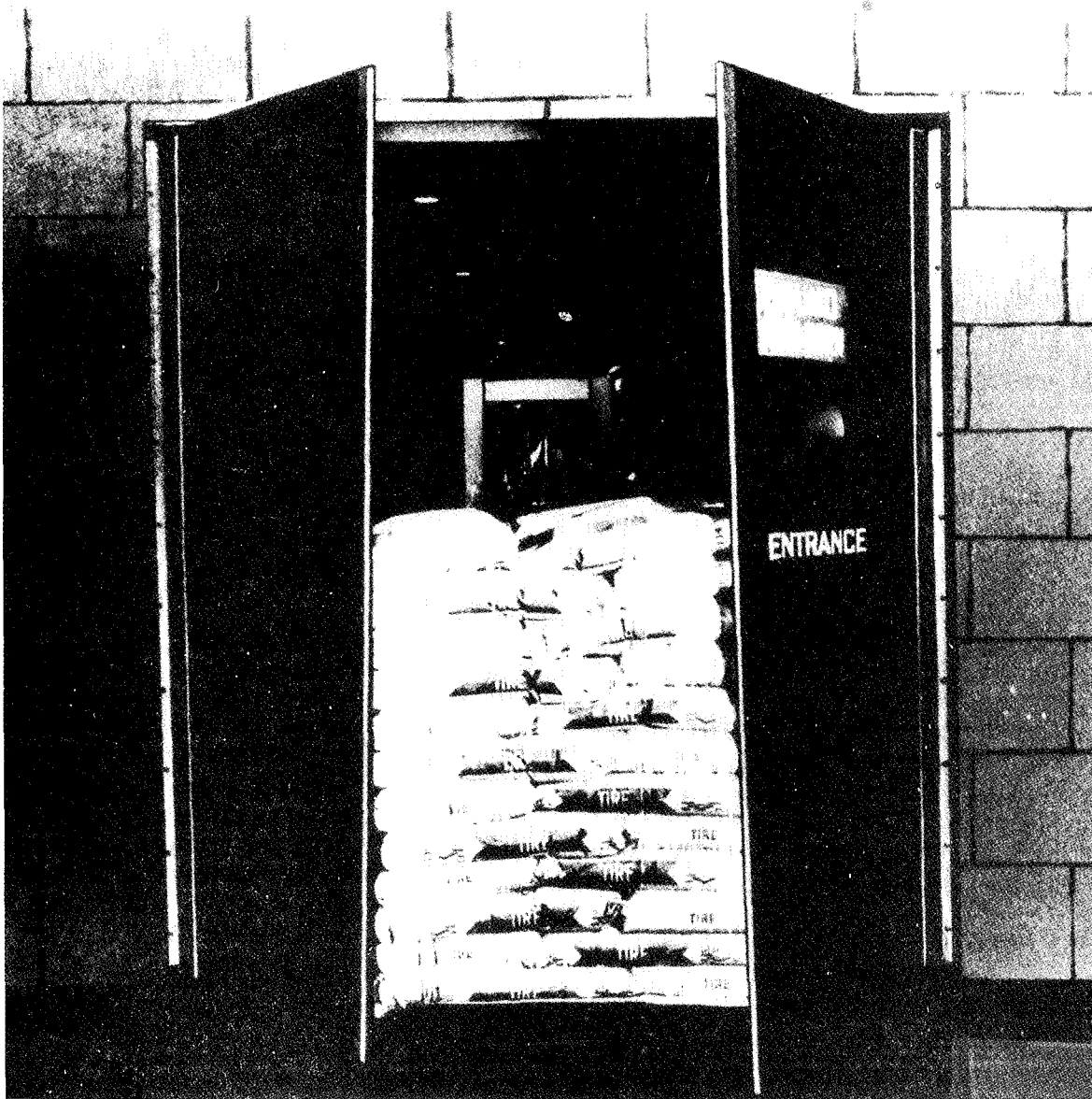

Figure 3-11 Auxiliary door actuated by contact with MHE

(1) In the normal warehouse operation, inside doors connecting the separate warehouse sections are left open during operational periods. For CH warehouses, during any extensive movement of materials into or out of a single CH section to an outside area, these inner connecting doors to adja-

cent sections should be closed to minimize spread of moisture.

(2) Normally, personnel traffic using regular personnel type doors will have little effect on CH operations. Personnel should be cautioned to use these doors in lieu of fire doors and also that the doors should not remain open.

(3) It is advocated practice to seal as many access doors as practicable in conversion to CH space. The sealing of cargo doors should be so designed that doors can be opened for use as peak work situations of major significance and duration warrant. It is also advisable to design sealing techniques in a manner that will allow doors to remain in "hung" position. Closure should not involve bricking up of doorways or removal of doors.

f. In certain geographic areas, there may be periods when the RH of outside air will fall below 50 percent. Under such conditions, cargo doors may be opened without securing the inside area from outside moisture penetration. This allowance of "free" air circulation must be predicated on day-to-day atmospheric conditions and not "time of year" considerations.

g. The use of battery-powered equipment in CH warehouses is preferred and is particularly recommended in very active areas.

(1) Availability can be an important factor in equipment selection for handling supplies in CH storage.

(2) Where battery-powered equipment cannot be or is impracticable to obtain or use in CH Storage, gasoline engine-powered equipment can be used with certain precautions. In use of such equipment, certain factors must be considered.

(a) Reduced ventilation multiplies the hazard of using gasoline engine-powered equipment, because of the increased concentration of exhaust contaminants.

(b) When utilizing gasoline engine-driven equipment in CH warehouses, any concentration of carbon monoxide gas which exceeds 50 parts of carbon monoxide per 1,000,000 parts of air must be prevented.

(c) An engine with a "rich" mixture produces far more carbon monoxide than one with a "lean" mixture and the output of carbon monoxide is much greater when the engine is cold.

(d) Gasoline engines in CH storage should be turned off when not in service, and should never be allowed to idle in standby service.

(3) Propane—or clean burning diesel-powered MHE are preferred, (when available), in order to maintain acceptable carbon monoxide levels within CH warehouses.

h. The installation safety officer, upon request, will perform or obtain qualified personnel to perform tests and make determination as to the extent of hazard caused by equipment engine exhaust and when deliberate ventilation must be introduced to prevent undesirable concentrations.

Section VIII. Security of Materials in Storage

3-55. Purpose.

This section establishes the minimum security requirements for the storage and handling of classified, pilferable, and sensitive material. It also addresses the requirements for serial number control and reporting of small arms under the DOD Small Arms Serialization Program (SASP).

3-56. Definitions.

a. Classified material. Material which requires protection in the interest of national security.

b. Pilferable material. Material having a ready resale value or civilian application as to personal possession and, therefore, is especially subject to theft (e.g., watches, certain tools, and clothing).

c. Sensitive items. Material which requires a high degree of protection and control due to statutory requirements or regulations such as narcotics and drug abuse items; precious metals; items which are of high value, highly technical, or of a hazardous nature; and small arms, ammunition, explosives, and demolition material.

d. Small arms. Handguns; shoulder-fired weapons; light automatic weapons up to and including .50 caliber machine guns; recoilless rifles up to and including 106mm; mortars up to and including 81mm; rocket launchers manportable; grenade launchers, rifle and shoulder fired; and individually operated weapons which are portable and/or can be fired without special mounts or firing devices and which have potential use in civil disturbances and are vulnerable to theft.

3-57. General.

a. Protection of property.

(1) The protection of property, including the prevention of internal pilferage or major thefts of Government supplies and equipment, is one of the functions in warehousing. This function must include the protection of supplies and equipment in storage areas and while they are in transit.

(2) Military installations throughout the world would lose millions of dollars worth of property each year if subjected to uncontrolled pilferage or theft. However, the risks incurred cannot be measured in terms of dollars alone. Loss of critical

supplies for tactical units could result in unnecessary loss of life and danger to national defense.

(3) In some areas, losses have assumed such proportions as to jeopardize the mission of the installation. All installations can anticipate loss. Actual losses will depend on such variable factors as type and amount of materials, equipment, and supplies which are produced, processed, and stored at the facility; number of persons employed; social and economic conditions in surrounding communities; command attitudes; and physical security measures employed. Because these factors will differ greatly in various types of installations and in different geographical locations, each must be considered separately.

b. Measures for control. Specific measures for prevention of pilferage will be based on careful analysis of the conditions at each installation. The most practical and effective method for controlling pilferage is the establishment of adequate physical security and psychological deterrents. This may be accomplished in a number of ways..

(1) An aggressive security education program is an effective means of convincing employees that they have much more to lose than they do to gain by engaging in acts of theft. It is important for all employees to realize that pilferage is morally wrong no matter how insignificant the value of the item taken.

(2) It is particularly important for supervisory personnel to set a proper example and maintain a desirable moral climate for all employees.

(3) All employees must be impressed with the fact that they have a legal responsibility to report any loss to proper authorities.

(4) Adequate inventory and control measures should be instituted to account for all material, supplies, and equipment. The awareness of poor accounting controls provides one of the greatest sources of temptation to a potential pilferer.

(5) An effective material control system will be established which includes inspection of delivery and vendor vehicles.

(6) All suspected losses will be investigated quickly and efficiently.

(7) An effective key and lock control system will be established and monitored regularly for security purposes.

(8) Keys controlling security areas will be limited to a minimum number of authorized individuals to maintain operations and will be strictly controlled by designated individuals.

(9) Bulk quantities of highly pilferable stock will be stored in enclosed security areas and dis-

tributed from there to using sections in limited amounts, except as noted in paragraph 5-59b(3).

(10) Accurate methods of taking physical inventories and of accounting for stock procurement, usage, and salvage will be established.

(11) Entrance to security areas will be limited to specific individuals properly authorized access to storage or processing areas. Sign-in and -out registers will be maintained in all security areas. All security areas will be posted as restricted.

3-58. Responsibilities.

a. Commanders will administer the necessary physical security measures for protection of classified, pilferable, and sensitive material, together with small arms control and operation of SASP in accordance with applicable military service/agency regulations.

b. Commanders will ensure that all persons involved in the receipt, storage, issue, repair, and inspection of classified material are versed in the instructions contained herein and in regulations governing the security of classified material.

c. The installation TOP SECRET Control Officer, or his alternate, will ensure the security control of TOP SECRET material during receipt, storage, and issue.

3-59. Storage Security.

a. Storage of classified items. These items should be kept separate from other material. The most satisfactory method is to store such items in a separate building with a higher degree of physical protection than other buildings. Where a separate building is not available or where its use is not warranted by the quantity of classified storage, a room, cage, or crib may be constructed within a warehouse building. All areas which contain classified material will be secured by means of approved locking systems. This will include any temporary storage space used for in-transit classified material. In addition to classified items being stored separately from other material, classified material will be segregated in storage from sensitive but unclassified items. This further segregation will prevent exposure to compromise of classified material incident to a break-in aimed at stealing unclassified but sensitive items. Standards for the physical protection of classified items are specifically established in DOD Directive 5200.1 as implemented by each military service and DLA.

b. Storage of pilferable and sensitive items.

(1) In addition to normal installation security procedures, commanders will assure that storage procedures and techniques afford adequate protection for pilferable/sensitive items. Structural

standards and control procedures should be as set forth in implementing military service/agency regulations. Depending on local conditions and experience, these protective measures should include vault types or caged and/or fenced and locked security areas, assignment of responsibility for control of pilferable/sensitive items to specific individuals, restricting access to pilferable/sensitive item storage areas, and procedures to control movement of these items within the storage installation.

(2) Pilferable/sensitive items will not ordinarily be stored in the same area with classified material. However, when instances require pilferable/sensitive and classified items be stored together, the entire storage area will be classified, and controls applied, equivalent to the highest security classification of any item therein.

(3) Pilferable items ordinarily will not be stored in warehouses where security protection is lacking. Circumstances, however, may result in pilferable items requiring general purpose storage environment (i.e., items in large banded containers for which secure storage space is temporarily not available). When this situation presents itself, general purpose storage environment is permitted; however, when such containers are open for partial issues, the residual quantities will be transferred to a specified secured area.

(4) Sensitive items classified as "controlled substances" in the Drug Act of 1970 must be stored in an approved vault or safe with a three-tumbler combination unless a U.S. Department of Justice, Drug Enforcement Administration (DEA) Regional Office has approved another type of secure facility. Retrograde-controlled substances must be approved for disposal by the DEA Regional Office before such disposal actions can be taken. Disposal actions must be observed and attested to by responsible personnel.

3-60. Storage of Small Arms.

a. Small arms will be stored apart from other pilferable and sensitive items for the purpose of maintaining strict physical security and limiting access to specifically authorized personnel.

b. When available facilities do not permit geographic separation of small arms into separate buildings, then, storage is permitted in buildings where other pilferable or sensitive items are stored. When this occurs, small arms will be separated from these items by a locked security cage, fencing, or other acceptable means.

c. Storage layouts for small arms should be designed to facilitate receipts, issues, inventory counts, and serial number verifications.

d. To meet these requirements, small arms storage areas must be planned to accommodate large, medium, and small lots of material with minimum rewarehousing.

e. Retrograde small arms awaiting decontamination, inspection, classification, or processing action prior to storage or disposition will be controlled, secured, and given surveillance to the same degree as provided issuable small arms.

f. Small arms will be stored in vault-type or highly secured storage areas in accordance with DOD and military service/agency directives addressed to this subject.

5-61. Receiving (classified material, pilferable/sensitive items, small arms, etc.).

a. Classified material.

(1) All duties involving handling or access to unpacked or unpackage classified material and the applicable classified documents or correspondence pertaining thereto, will be accomplished only by properly cleared individuals. All receipts will be subjected to a 100 percent verification of quantity.

(2) In cases where classified shipments are received with violations of security requirements, the installation security officer will be notified immediately. The shipment in question should not be left unattended until properly documented and securely stored.

b. Pilferable/sensitive items (to include controlled substances).

(1) Receipts of pilferable or sensitive items will be provided controls to assure proper handling, recording, and storing. Receipt inspection procedures for pilferable/sensitive items will include determination of any evidence of tampering and the material placed under control as expeditiously as possible. If pilferage or loss (shortage) in shipments is suspected, immediate coordination between the transportation and security office will be effected.

(2) Whenever possible, the unloading will be accomplished at the storage location site or, as deemed necessary, an authorized person from the receiving area will accompany the material to the storage area and obtain a warehouseman's signature upon release.

(3) Where pilferable or sensitive material moves to a storage area over a mechanical handling system such as a power and free conveyor or a towline conveyor system, special locked (padlocked) containers will be used. This also applies to material moving from the storage to shipping area.

c. Small arms. In addition to *b* above the following will be applied:

(1) All small arms receipts will be subjected to a 100 percent verification of weapons and serial numbers plus a quality check of the operations. The operational checks will be performed in accordance with the weapon's technical manual.

(2) Unloading of small arms will be accomplished on a priority basis and material placed under control as expeditiously as possible to reduce the opportunities for loss or pilferage. When unloading procedures cannot be completed during operational hours, a separate, secured area, vault, or cage, meeting the structural and security standards of the military service/agency regulations will be utilized as a temporary holding area.

(3) Whenever possible, the unloading will be accomplished at the storage location site, thereby eliminating additional movement.

(4) Stringent inspection procedures will prevail throughout operations to determine any evidence of tampering.

(5) Timely and close coordination between transportation and security office will be accomplished in cases of suspected pilferage or loss (shortage) in shipments of small arms.

3-62. Inspection.

a. All inspection, identification, repair, testing, packing, marking, checking, and associated physical operations required in connection with classified, sensitive, and pilferable material (including small arms) should be performed within the restricted storage area whenever possible. When quantity or complexity of processing precludes this, a temporary restricted area should be established, as required.

b. Discrepancies discovered during the receipt, issue, storage, inspection, and shipping operations will be processed in accordance with component regulations.

3-63. Inventory.

Inventory of classified, pilferable, and sensitive items will be in accordance with DODI 4140.35

and military service/agency directives addressed to this subject.

3-64. Shipping and Marking.

a. Shipments will be provided controls necessary to assure proper handling.

b. Preferably, classified, sensitive, and pilferable items selected for shipment should be packed by the consignor in the building where the material is stored.

c. Whenever the above cannot be accomplished, stringent visual and/or escort controls will be enforced during preshipment processing and material movement.

d. Shipments will be preserved, packed, and marked to minimize intransit exposure of material to scrutiny, container rupture, undetected entry, loss, damage, illegal acts, and security compromise.

e. Markings will not reveal the nature of the material except to the extent required for compliance with transportation regulations, or when the shipper service has determined that ready identification of items being shipped is necessary (ref MIL-STD-129).

f. Loading will be accomplished as soon as the cargo is brought to the carrier. Load preassembly outside of security areas should not be practiced.

3-65. DOD Small Arms Serialization Program (SASP).

a. Criteria. All DOD Components, activities, and installations will be part of a worldwide small arm serial number control system.

b. Concept and procedures.

(1) The concept for the serial number control of small arms is based on the use of the DOD Central Registry that provides investigative agencies, within 72 hours, the identification of the last accountable activity having a specific serial numbered small arm. Investigative agencies will process all inquiries to the DOD Central Registry.

(2) The procedures for serial number control and reporting are found in DOD 4140.22-M.

Section IX. Carrier Loading

3-66. Introduction.

a. Improper loading is one of the major causes of loss and damage during transportation and the resulting delay in use of material at destination. The purpose of this part is to provide guidance in proper loading and thereby help prevent discrepancies during transportation. TM 38-410/DLAM

4145.11/NAVSUP PUB 573/AFR 69-9/MCO 4450.12, Storage and Handling of Hazardous Materials, provides guidance in the proper loading of hazardous materials.

b. After determination has been made to move materials and supplies, the freight traffic office should be advised so that the proper mode of

transportation may be selected. This advice should include, among other things, information as to whether the shipment—

- (1) Is palletized or unpalletized.
- (2) Consists of high center of gravity items, requiring special tiedown or bracing methods.
- (3) Consists of items having heavy concentrated weights.
- (4) Consists of fragile, high value, one-of-a-kind, or critical items.
- (5) Consists of items subject to contamination such as flour, sugar, or other items.
- (6) Consists of explosives or other hazardous commodities and whether they have been properly marked and labeled.
- (7) Will be handled at origin or destination or both by MHE. In addition to the above information, selection of the proper mode of transportation requires consideration of conditions at origin and destination, probability of transshipment, degree of security needed in movement, military requirements, the cost of transportation, the type of service provided, etc.

c. Stowage of freight aboard vessels is not usually encountered by warehousing personnel and will not be discussed in this section; likewise, LCL and LTL shipments will not be included since they are generally loaded and unloaded by the carriers, except shipments of explosives and ammunition.

d. This section does not establish organizational alignments or functions. Although certain warehousing and traffic functions are described, it is not intended to imply that those functions will be performed by particular organizational elements within the services or shipping activities.

3-67. General.

a. *Types of commodities handled.* The shipment of military supplies is possibly the most complex traffic function in the world. This is due, in part, to the wide variety of commodities involved and their diverse physical characteristics. The commodities shipped range from small items easily handled by one person to those which are so bulky as to require the use of multiple or idler cars, or exceed the size or weight limitations of standard transportation equipment and facilities, and require the use of special routings or heavy duty equipment. Others may be hazardous (e.g., explosives, acids, poisonous gases, etc.), and require caution in preparation for transportation; perishable, and require protective service from heat or cold; delicate, and require special handling; or in critical supply. Another factor leading to this com-

plex situation is the multiplicity of types of shipping containers used.

b. *Selection of type of railcar.*

(1) In car loading, the selection of the proper car is of initial importance. This must be done with a view to its fitness for the particular commodity to be loaded, since properly loaded shipments are often damaged by unfit equipment. On the other hand, freight, which in itself is not highly susceptible to damage, may cause damage to equipment better suited for other classes of freight.

(2) Rail freight cars are generally classified as box, gondola, refrigerator, stock, hopper, tank, and flat. In this general range, many cars are constructed to transport specific commodities. Many freight cars are specially equipped with blocking and bracing appliances which form an integral part of the car. While it is the duty of the carrier to inspect cars thoroughly before they are placed for loading by shippers, it is to the shipper's interest to ensure that cars selected are in all respects suitable for the kind of freight to be shipped.

c. *Shipper's loading responsibilities.*

(1) Freight should be loaded to withstand the normal hazards of transportation. Shippers are required to load freight carried at carload rates, unless otherwise provided by tariff. They are also required to load heavy or bulky freight which is carried at LCL rates, but which cannot be handled by regular station employees or at stations where carrier's facilities are not sufficient for handling. In addition, shippers must observe carrier's rules for the safe loading of freight and protection of equipment, and movable parts (machinery) must be secured. When articles are loaded on open cars, small detachable parts must be removed and placed in packages or secured within the article. Shipments of explosives and ammunition will be loaded in accordance with service regulations and publications.

(2) In addition to selecting the proper type of car, the following precautions should be taken against the use of defective or unclean cars:

(a) Examine the interior of the car for any defects of roof, sides, or floor that might cause snagging, tearing, scarring, or rupture of container, or permit the entry of rain, dirt, or other matter likely to damage the freight.

(b) Remove protruding nails and other obstructions not part of the car.

(c) Reject cars that cannot be suitably conditioned without mechanical or other extensive repairs.

3-68. Loading Rules for Rail Carriers.

a. Conformance with loading rules. Personnel engaged in or responsible for loading, blocking, and bracing freight should have available for use and be familiar with the rules for the proper loading and securing of shipments, as outlined in the publications referred to in *b* below and in applicable service/agency publications. By complying with the applicable rules, procedures, and methods, the shipper has accomplished the first step in assuring safe and economical carloading.

(1) *Mandatory requirements.* Rule 27 of the Uniform Freight Classification requires shippers to observe carriers' rules regulating the safe loading of freight and the protection of equipment. Mandatory rules are contained in the Association of American Railroad's (AAR's) Circular Number 42-E, "General Rules Covering Loading of Carload Shipments of Commodities in Closed Cars," and all AAR pamphlets covering the loading and securing of shipments on open top cars.

(2) *Minimum standards.* The various methods and specifications contained in all AAR car loading pamphlets will be observed as minimum requirements for the proper loading, blocking, and bracing of shipments for movement by rail freight on or in open top and closed cars.

(3) *Loading methods not specified.* When freight is to be loaded on or in open top or closed cars and no loading and securing methods are provided, it will be blocked and braced according to the best method or procedure that can be devised from AAR pamphlets or other sources covering similar material (see also para 18, this sec).

b. Manual and Pamphlets (General Freight). The following manual and pamphlets are published by AAR. The "Open Top Carloading Manual" or supplements thereto may be obtained through appropriate departmental publication channels from the Association of American Railroads, Mechanical Division, 50 F Street NW, Washington, DC 20001. The pamphlets may also be obtained from this address.

OPEN TOP CARLOADING MANUAL

Section No.	Subject
1	General Rules Governing the Loading of Commodities on Open Top Cars.
2	Rules Governing the Loading of Steel Products, Including Pipe, on Open Top Cars
3	Rules Governing the Loading of Road Grading, Road Making, and Farm Equipment Machinery on Open Top Cars
4	Rules Governing the Loading of Miscellaneous Commodities, Including Machinery, on Open Top Cars.

OPEN TOP CARLOADING MANUAL (Continued)

Section No	Subject
5	Rules Governing the Loading of Forest Products on Open Top Cars.
6	Rules Governing the Loading of Department of Defense Material on Open Top Cars
7	Loading of Commodities on Open Top Trailers and Containers to Be Handled in Trailer-on-Flat-Car (TOFC) Service and Container-on-Flat-Car (COFC) Service
PAMPHLETS	
Subject	
1	Loading and Unloading of Motor Vehicles Shipped Carload in Auto Loader Cars and Protection of Equipment
2	Loading of Motor Vehicles Shipped L.C.L. or Carload in Closed Cars Other Than Auto Loader Cars and Protection of Equipment
3	Loading of Commodities in Bags in Closed Cars and Protection of Equipment.
4	Loading of Carload Shipments of Barrels, Drums, or Kegs in Closed Cars and Protection of Equipment.
5	Loading of Storage Batteries in Closed Cars and Protection of Equipment
6	Delete.
7	Delete.
8	Loading Methods for Plywood in Closed Car and Protection of Equipment
9	Rules Regulating the Safe Loading of Cable on Reels and Wire Commodities in Closed Cars and Protection of Equipment
10	Methods for Battening Car Doors as Protection Against Damage by Weather, Cinders, etc.
11	Delete
12	Methods for Loading, Bracing and Blocking Carload Shipments of Empty Cylinders with or without Caps in Closed Cars
13	Loading of Products in Cans and Glass
14	Rules Regulating the Safe Loading of Freight in Cars and Protection of Equipment
15	Rules Regulating the Safe Loading of Carload Shipments of Furniture in Closed Cars and Protection of Equipment.
16	Methods for Loading and Stowing of Less-Carload Shipments of Furniture in Closed Cars
17	Packaged Grain Mill Products and Foodstuffs.
18	Rules Regulating the Safe Loading of Commodities in Small Cylindrical Steel Containers in Closed Cars and Protection of Equipment, Including Mixed Loads of Commodities in Large Drums and Boxes
19	Delete
20	Methods for Loading, Bracing and Blocking Carload Shipments of Dressed Lumber and Mill Work in Closed Cars
21	Rules Regulating the Preparation and Safe Loading of Machinery in Closed Cars and Protection of Equipment
22	Methods for Loading, Bracing, and Blocking of Marble in Slabs "A" Frame Method in Closed Cars.
23	Metal Sheets or Plates, and Other Steel Products in Closed Cars

OPEN TOP CARLOADING MANUAL (Continued)

Section No	Subject
24.	Delete
25.	Rules Regulating the Safe Loading of Paper and Similar Commodities on Skids in Closed Cars and Protection of Equipment
26	Rules Regulating the Safe Loading of Gypsum Plaster-board, Wallboard, Sheathing, Lath, and Plaster in Closed Cars and Protection of Equipment
27.	Methods for Loading, Bracing and Blocking Carload Shipments of Empty Projectiles, Bombs, and Cartridge Cases in Closed Cars
28 .. .	Delete
29	Household Appliances in Closed Cars
30 . . .	Rules Regulating the Safe Loading of Prepared Roofing Materials in Closed Cars and Protection of Equipment
31 . . .	Delete.
32	Delete
33 . . .	Delete
34. . . .	Loading and Unloading Tank Cars Used for Transporting Non-Dangerous Liquids
35	Delete.
36	Delete.
37	Delete.
38. . . .	Carload Shipments of Unsaturated Roofing Felt and Pulp-board Paper in Closed Cars
39	Methods for Preparing and Loading of Newsprint.
40	Methods for Loading, Bracing, and Blocking Carload Shipments of Vitrified Clay Sewer Pipe in Closed Cars
41	Dictionary of Standard Terms for Use in Describing Loading and Bracing Methods for Shipments of Commodities in Closed Cars
42 . . .	Glass, Rolled and Plate
42-F	General Rules Covering Loading of Carload Shipments of Commodities in Closed Cars
43-A . . .	Rules Governing the Loading, Blocking, and Bracing of Freight in Closed Trailers and Containers for TOFC/COFC Service

c. Pamphlets and Tariffs (Explosives). The Bureau of Explosives publishes the following pamphlets and tariffs (or reissues thereof) which may be obtained from the Association of American Railroads, Bureau of Explosives, 50 F Street, NW, Washington, DC 20001:

Pamphlet No	Subject
6 ..	Illustrating Approved Methods for Loading and Bracing Carload and Less-Than-Carload Shipments of Explosives and Other Hazardous Materials
6-A	Illustrating Approved Methods for Loading and Bracing of Carload Shipments of Military Ammunition and Explosives
6-B	Delete

Pamphlet No	Subject
6-C	Illustrating Approved Methods for Loading and Bracing Trailer and Less-Than-Trailer Shipments of Explosives and Other Dangerous Articles Via Trailer-on-Flat Car (TOFC) or Container-on-Flat-Car (COFC) Service
Tariff No 19	Department of Transportation Regulations for Transportation of Explosives and Other Dangerous Articles by Land and Water in Rail Freight Service and by Motor Vehicles (Highway) and Water Including Specifications for Shipping Containers

d. Other Publications.

(1) Transportation of Hazardous Materials by Motor, Rail, and Water, American Trucking Associations, Incorporated, Agent Tariff No. 111C, or reissues thereof.

(2) Title 49, Code of Federal Regulations (CFR), parts 100 through 199.

(3) International Air Transport Association, Dangerous Goods Regulations.

3-69. Actions of Pressures on Cargo.

a. Types of pressure. The types of pressure action on loads shipped by rail are as follows:

(1) Lateral (or crosswise) pressure occurs when rounding curves.

(2) Vertical pressure occurs because of the action of the railcars hitting low joints and crossings.

(3) Lengthwise pressure occurs in coupling, starting, stopping, switching, and in slack action.

b. The closed care. Considering the pressures that materials are subjected to in over the road travel by rail and considering the boxcar as a big shipping container on wheels, the bracing and blocking mediums in the car should be essentially the same as the interior packaging of individual shipping containers.

c. Vertical pressure.

(1) *Absorption of vertical pressure.* The vertical pressures or vibrations, over and above the overhead weight of the load, are the most numerous but are small in magnitude and are accumulative. Generally, the damaging action from vertical pressure is absorbed by the interior cushioning or bracing within the individual package or containers.

(2) *Commodities affected by vertical pressures.* Certain commodities are sensitive to vertical pressures and must receive additional bracing or cushioning as well as a selected method of loading. For example, if rolls of lineolium are loaded flat, the vertical pressure of vibrations will tend to

flatten the rolls and bundles of light metal tubing or pipe will undergo a settling from vibrations and may become flattened or dented. However, if the linoleum is stood on end and separation gates are used to divide the load, and if the pipe or tubing is stowed with a filler between layers to absorb the pressures, there is little chance of damage to the shipment in transit unless the car should be subjected to abnormal shocks or impacts.

d. Lateral pressures.

(1) *Type of action.* Lateral pressures are stresses toward the sidewalls induced by a car rounding a curve which tends to move the containers out of alignment. Also, lateral pressures tend to crush the containers on the off side of the car when rounding a curve. Although these pressures are of small magnitude, if the containers are out of alignment, subsequent lengthwise forces can cause damage because of uneven distribution of pressure.

(2) *Distribution of weights.* To ensure against uneven distribution of weight in the car, the load should be braced to prevent cross car movement of the load. Uneven distribution to weight within the care may cause the side bearings to become fouled and the car derailed, as the trucks bind and do not roll around curved track. Of great importance is the side bracing of high center of gravity items; applicable bracing must be applied to prevent tipping (fig 3-12). For additional illustrations of bracing for high center of gravity or top heavy items, see AAR pamphlets 14 and 21.

rounding curves, and to facilitate opening of doors and assure protection to personnel opening doors (see figs 3-13 through 3-15).

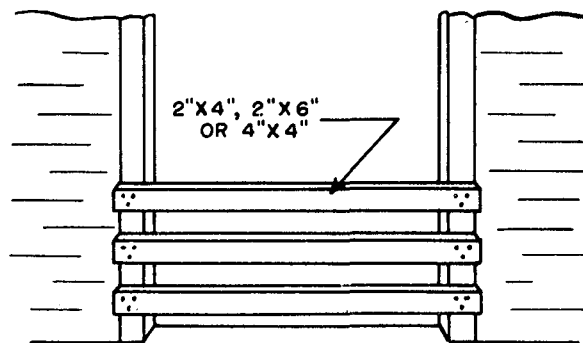

Figure 3-13 Doorway protection for rough freight only.

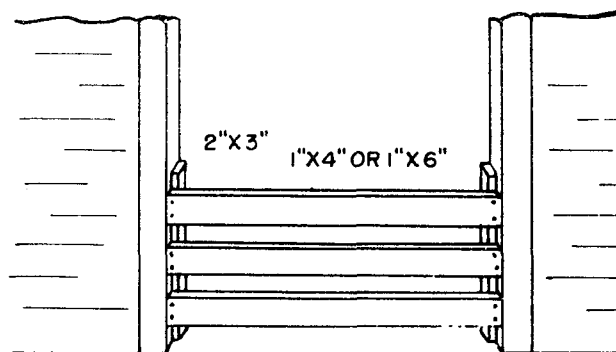

Figure 3-14. Flush doorway protection for cars with wooden doorposts

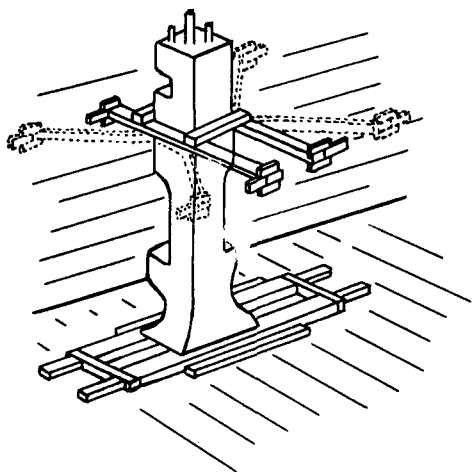

Figure 3-12 Side bracing of high center of gravity items

(3) *Doorway protection.* Provide proper doorway protection to assure that load does not cause doors of car to bulge or break open when

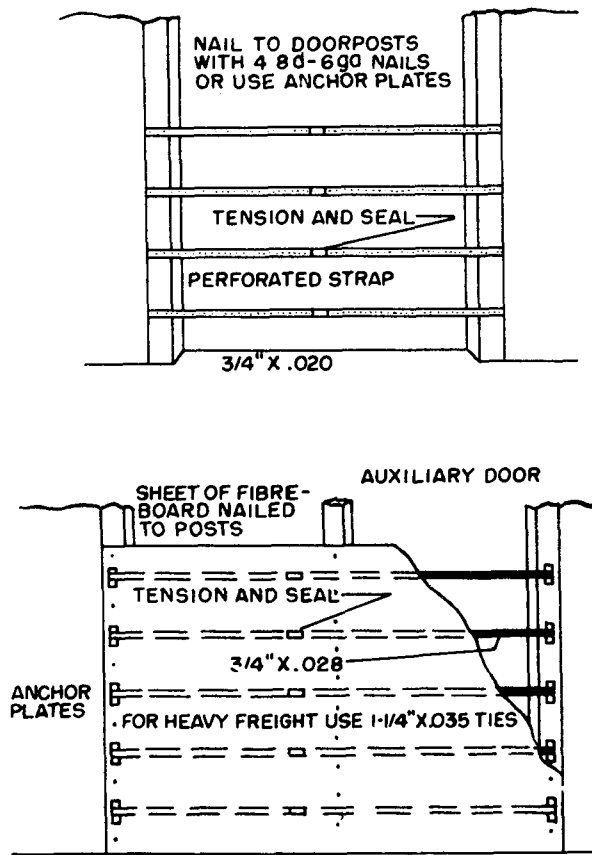

Figure 3-15 Use of steel straps for double door auto boxcar

(4) Prevention of lateral movement. To provide adequate protection against lateral movement at all times, the load must be tight crosswise. Proper blocking and bracing must be applied to prevent the load from shifting or moving out of alignment.

e. Lengthwise pressures. Most damage in rigid braced loads is prevented by loading containers tightly to prevent development of slack within the load. Once slack begins to develop within the load, repeated impacts may cause a void large enough to allow the containers on the top layer to fall between the load and the ends of the car. To protect against damage in rigid braced loads, containers will be loaded tightly with the strongest parts arranged to provide support lengthwise of the car. All loads (excluding floating loads) should be loaded or braced to minimize any possibility of movement.

3-70. Floating Loads. (Not permitted for shipments of explosives, ammunition, and other hazardous materials, nor permitted in any boxcar equipped with under-car or end-of-car shock mitigating cushion devices.)

a. Types of floating loads. There are two types of floating loads: the full floating load and the controlled floating load commonly called the "Snubbing Method." Many items present special loading and bracing problems because of the weight, size, shape, or fragility; such items of this type brought about the development of the floating load. For further information concerning loading to withstand the various types of pressure, see AAR pamphlets 14 and 21.

b. Controlled floating load.

(1) *Description.* When using the controlled floating load, blocking is not applied against the front or rear of the unit or the units to be shipped. Generally, the units that are to be shipped by this method are items that are skidded (i.e., engines, machine tools, generators, or large motors); snubbing or braking devices are applied against the side of the skids. Under lengthwise impact, the shift of the skidded item is controlled and the item is held in contact with the floor of the car. Thus, the greater part of the shock forces are dissipated through the friction and riding of the skid structures. The item is actually isolated from lengthwise shock forces. There are two commonly used snubbing devices—antiskid plates and lag screws. The antiskid plate and method of application are shown in A and B, figure 3-16. The lag screw and method of application is shown in C, figure 3-16.

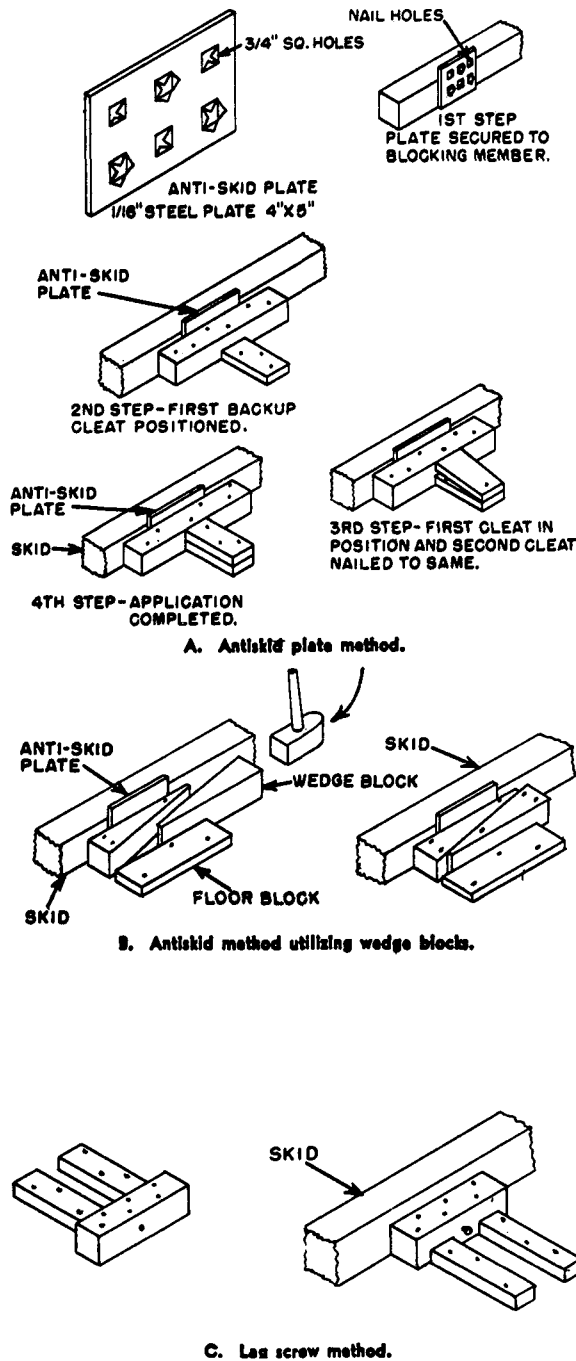
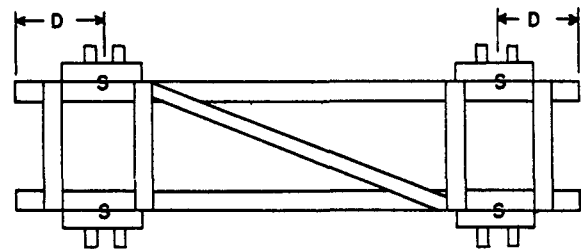

Figure 3-16. Snubbing machine

(2) *Application of snubbing devices.* In applying the lag screw snubber, the lag screw is turned in, in a predrilled hole in the snubbing block, until the screw tip is flush with the inside faces of the block. The snubbing block and the backup cleat are securely nailed and spiked to the floor. Measure the amount the lag screw head projects beyond the outside face of the snubbing block and with a wrench turn the lag screw into

the side of the skid until 1/2 inch penetration is obtained. The bite of the screw tip into the side of the skid will serve as a retarder to control lengthwise and upward movement. The antiskid method is basically the same except that a plate is inserted in lieu of a lag screw. The method of arrangement for placing either the antiskid plate or the lag screw snubbing device is shown by figure 3-17. The maximum distance for locating the end snubbing devices from ends of the skid should be approximately 24 inches to 30 inches (fig 3-17). The snubbing devices on each side of the skid should be equal in number and located directly opposite. The number of snubbing devices to be employed on each side of skid will vary with the weights of the desired amount of restriction of movement. Generally, the number varies from two to five devices on each side of the skid. After end devices are located, the additional devices are spaced in between.



NOTE: DISTANCE "D" NOT MORE THAN 30". "S" REPRESENTS SNUBBING DEVICES.

Figure 3-17 Location of snubbing devices.

(3) *Application and use.* The snubbing devices should be used on machinery (especially legged-type), boats, and those commodities that should be protected from sudden or severe shock.

(4) *Several items cleated together.* The use of the snubbed load is recommended wherever practicable.

c. *Floating load.* The floating load absorbs a great amount of shock pressure as containers slide over the floor of the car, thus ridding with the "punch." The materials may or may not be palletized. However, the pallet loads or containers are secured in a unit by binding with steel straps. Units may be placed in each end of the car or as a single unit extending through the doorway area. Space for floating may be at each end wall and doorway, all in the doorway, or with a single unit at the end walls. There are variations of this load which are termed "Restricted" floating loads. (For additional details, see AAR pamphlets 14 and 21

and section 2 of "Loading Rules for Open Top Cars.")

3-71. Mixed Loads.

a. Nature of problems. The variety of different shapes, sizes, and weights of articles and containers, so frequently required to be loaded together in one car, furnishes a greater problem than solid loads of one type container or commodity. It is paramount that the number of mixed cars be held to a minimum. Planning the shipments to obtain the maximum of solid loads will not only result in less damage, but will prove to be more economical in bracing material and loading time required. (See AAR pamphlets 4, 13, and 18 for additional information.)

b. Segregation of load.

(1) *Scheduling for segregation.* The same type containers or articles in a mixed load should be loaded together in the car; the loading and bracing practices should be followed as for solid loads of these individual items. More efficient working procedures are obtained when it is possible to schedule flow of supplies to the loading platform in order to be segregated.

(2) *Methods of segregation.* The following methods of segregation are suggested by—

- (a) Layer.
- (b) Units lengthwise of the car.
- (c) Units crosswise of the car.

(3) *Segregation by layer.* When segregating or separating articles by layers, the heavy articles should be in the lower layers; the lighter and fragile items in the upper layers. For example, drums, barrels, heavy crates, or boxes in the floor layers; bagged commodities, wirebound boxes, and fiberboard boxes should be loaded on top of the heavy containers. If the lighter containers or items cannot be loaded directly on top of heavier containers, separators or fillers will be placed between the layers. These separators may be of wood or fiberboard, depending on the amount of protection or support required. When loading commodities in bags or fiberboard containers or lightly constructed wood boxes on top of barrels or drums, wood filler boards will be used as separating medium; when separating bags loaded on fiberboard containers, heavy paper will suffice. Generally, separators are not required between layers of the same type of wood boxes, wirebound boxes, and fiberboard containers; however, small dimension containers will not be loaded directly on or against unsupported panels or cleated panel containers or open crates without adequate separating material.

(4) *Segregation by units.* When separating containers by units lengthwise of the car, the recommended loading pattern for the different containers as covered in the AAR pamphlets for solid loads of the containers should be followed (i.e., fiberboard boxes in bonded block patterns, cylindrical-type containers by nesting or offsetting, and bagged commodities by brick wall or binding methods).

c. Separation gates. Generally, separation gates are required when containers of different type and size are loaded side by side. Separation gates may be of the floating type (not secured to the car sidewalls) when used between units of containers having practically the same strength and rigidity. When separation gates are used between a unit of heavy strong containers on one side and a unit of lighter and weaker containers on the other side, the separation gate should be fastened in place to prevent the heavier containers crushing the lighter containers when subjected to load pressures. When the load pressure exerted in either direction may cause damage, the separation gate should be anchored in both directions by the reverse steel strap method. See AAR pamphlet 14 for detailed information concerning the construction of separation gates. In addition, AAR bulletin 527 of the General Information Series contains information on the construction of a reusable car brace for securing part car loads. This brace is adaptable for use when switching cars on the station during the loading of mixed shipments. Certain types of special box cars have built-in fixtures and equipment for quick application of multiple-deck flooring, adjustable gates, bulkheads, etc. These cars are particularly adaptable to the securing of delicate or fragile freight.

d. Blocking. Machinery and rough items such as castings, steel frames, pipes, and bars should be blocked lengthwise and crosswise in the car as recommended for these commodities in the applicable AAR pamphlets.

e. Separators. Separators will be used when one side of the car contains items or containers that may be crushed because of lateral pressures caused by side shift of heavier articles. The separators will be reinforced by blocking to car floors and sidewalls. Where the containers loaded adjacent to each other need protection only from tearing, snagging, or chafing, it will not be necessary to secure the separators in a fixed position. The separators will be placed lengthwise in the car between the two different type containers (i.e., when open crates are loaded adjacent to fiberboard containers). The fillers or separators serve the sin-

gle purpose of preventing physical contact between two types of containers.

f. Compliance with general rules. The weight distribution requirements of the general rules in AAR circular 42F will be complied with when loading mixed loads in cars, using the separation or segregation methods or procedures.

3-72. Bagged Commodities in Closed Cars.

a. Types of damage. The types of damages which can occur to bagged products are—

- (1) Contamination.
- (2) Snagging of bags on car walls, floors, and in doorway areas.
- (3) Chafing.

(4) Moisture damage.

b. Contamination and snagging. Contamination and snagging can be prevented by application of the principles mentioned in paragraph 3-67c(2).

c. Prevent chafing. Chafing against car wall can be controlled by loading the bagged commodities away from the car wall in a “pyramided layer” buildup (fig 3-18A). Tight loading and proper floor protection will prevent chafing in the lower layers. Jamming or wedging of bags in the doorway area can be prevented by installation of proper doorway protection or by setting back the load at least a half a bag length from each door post, continuing through the doorway area interlocking the bags in a pyramided layer pattern or by the retaining paper method (B and C, fig 3-18).

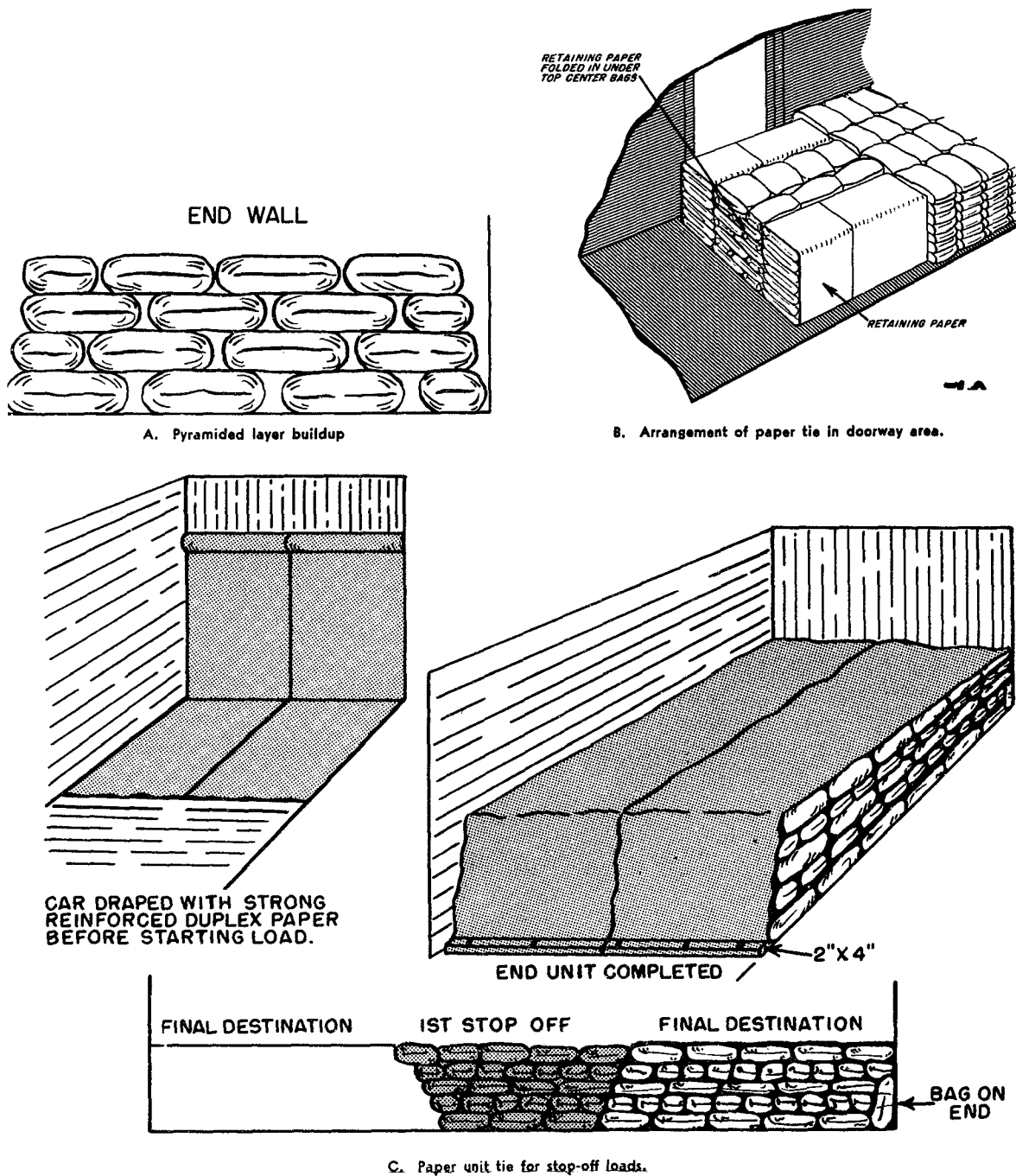

Figure 3-18. Methods to Reduce Chafing.

d. *Control of moisture damage.* Moisture damage to bags can be controlled by proper protection from the elements while loading the car. Bags should not be stacked on damp platforms or damp car floors.

3-73. Palletized Loads in Closed Cars.

a. *Economy of palletized cargo.*

(1) *Introduction.* Palletization is a system whereby a large number of small items are grouped and unitized on a pallet for handling by mechanical means such as a forklift truck. The efficiency gained by reducing the number of handlings is shown in the example of loading a freight car with 1,800 small boxes. For example, by grouping the boxes on 36 pallets, each contain-

ing 50 boxes, the ratio of transfers has been reduced from 1,800 individual box handlings to 36 mechanized pallet moves. Also, each time a package is handled, there is the possibility of damage; therefore, reduced handling results in less damage to cargo.

(2) *Stable pallet loads.* If the items are assembled carelessly on a pallet, the pallet will not protect the material during handling or transit operations. If a pallet unit becomes disarranged, it is not much better than individual loading and requires a large amount of manual handling to reassemble in an orderly arrangement. Therefore, it is important that the palletization of items be arranged carefully and the individual items be secured properly into a strong compact unit, capable of being handled and shipped safely.

NOTE

See section X, this chapter, for more detail on unit loads.

b. Boxcar information.

(1) *General.* For guidance in planning pallet units and loading, basic data on boxcars is necessary. While the dimensions listed in subparagraph (2) below are the most common for standard boxcars, dimensions of some older or special cars may vary.

(2) Inside floor dimensions of boxcars. Typical inside floor dimensions of boxcars are as follows:

(a) 9 feet 2 inches wide by 40 feet 6 inches long.

(b) 8 feet 6 inches wide by 40 feet 6 inches long.

(c) 9 feet 4 inches wide by 40 feet 6 inches long.

(d) 9 feet 6 inches wide by 50 feet 6 inches long.

(3) *Car door widths.*

(a) *Single door boxcars.* The doors in single door boxcars are from 6 feet to 10 feet wide. Some of the newer cars have doors with a 12-foot width.

(b) *Double door boxcars.* The doors in double door boxcars vary from approximately 10 feet 6 inches to 16 feet 6 inches. The average standard clear width opening is 15 feet.

(4) *Refrigerator car information.*

(a) *Inside floor dimensions.* The inside floor dimensions of a standard size refrigerator car are 8 feet 2¾ inches in width by 33 feet 2¾ inches in length. Some cars will vary from this standard.

(b) *Car door widths.* Car doors are 4 feet wide although newer cars are being built with 6-foot wide doors.

(5) *Boxcar floors.* When moving in and out of cars with a loaded forklift truck, this heavy concentrated load in motion causes a considerable strain on the car floors. In order to avoid accident or injury, the car floors must be protected. Circular 42F, rule 6(D), Operating-Transportation Division, AAR, General Rules Covering Loading of Carload Shipments of Commodities in Closed Cars, requires, when lift trucks are used for loading and unloading, suitable steel plates must be placed in the car to prevent damage to the floor (fig 3-19).

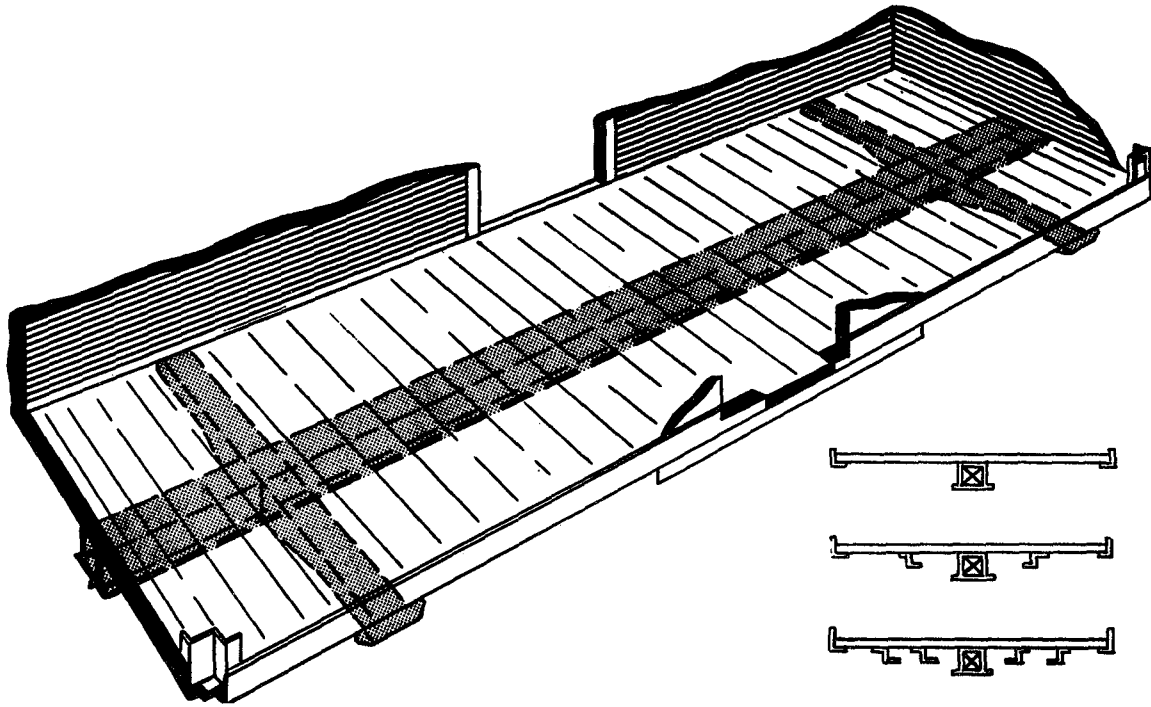

Figure 3-19. Protection Using Steel Plates.

c. Loading on Pallet.

(1) *Prevent pressure on load.* When the pallet units are loaded into a car, each unit must have a firm bearing contact against the adjacent unit. Pallet unit A (fig 3-20) provides bearing contact along the edges of the pallet only and not against the load. Generally, this is not recommended for small container assembled units as it is difficult to prevent the unit moving on the pallet.

(2) *Broad load bearing surface.* In the arrangements, as shown by pallet units B and C in figure 3-20, a broad-faced bearing contact is obtained between the vertical faces of the units, when placed in a carload. However, since this places the containers in the direct line of the load pressures occurring during transit, it is necessary that the containers and the assembled pallet unit must be sufficiently strong and carefully secured together on the pallet.

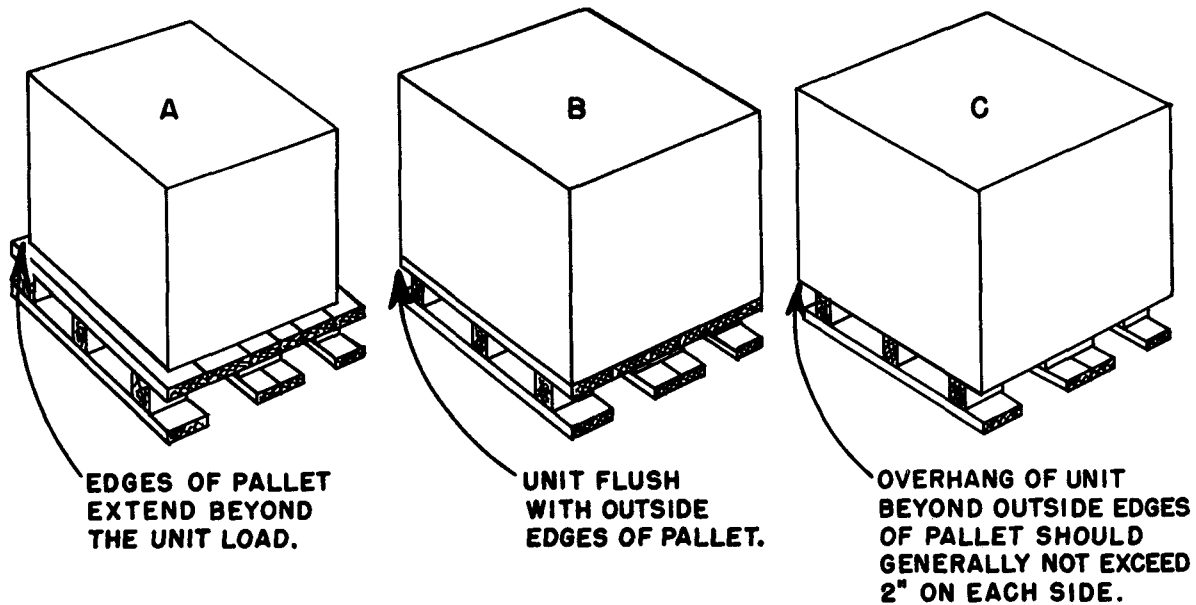

Figure 3-20 Prevention of chafing

d. Loading factors.

(1) *Tight loading.* Pallets should be placed tightly in both ends of the car. Generally, for practical purposes, it is necessary to have some side clearance space of approximately 1 to 2 inches between pallets in order to maneuver the pallets into place by the forklift truck. As shown in section A-A, figure 3-23, the total crosswise slack space between pallets and sidewalls in the car is relatively small (approx 6 in) and, ordinarily, would not require any additional crosswise bracing.

(2) *Side shifting.* In order to prevent side shifting of load and with a possible derailment of car in transit, circular 42F, Operating-Transportation Division AAR, rule 5(C) requires "In boxcars, lading must be secured to prevent tipping or moving towards car sides where the vacant space across car (figure 3-23, section B-B) exceeds the following:

(a) A total of 18 inches between lading and car sides.

(b) Vacant cross car space of less than 18 inches as may be specified in pamphlets covering methods for loading, bracing, and blocking carload shipments of individual commodities."

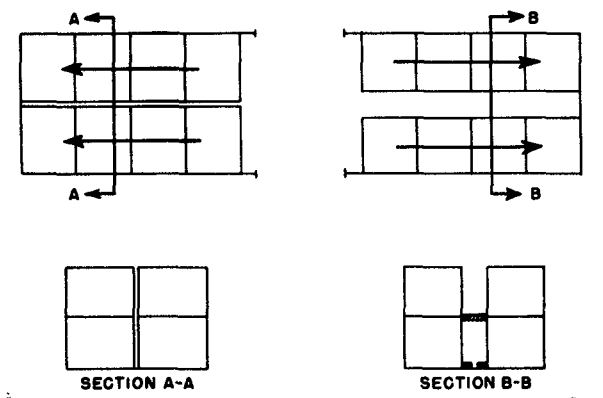

Figure 3-21. Floor supports.

(3) *Doorway space.* The loading at the doorway is finished off with proper bracing to secure and hold the load in place during transit. The doorway section of the load is a critical area in which to work, as space is needed to maneuver the forklift trucks or other mechanical equipment which might be used (parts A and B, fig 3-24). For example, the space C, indicated on part A, figure 3-24, at the doorway is braced securely by means of a wooden center gate D or steel strap anchored gate E indicated on part B, figure 3-24. By this method, the bracing can be removed at destination and with this work space in the doorway section, the car can be unloaded without difficulty.

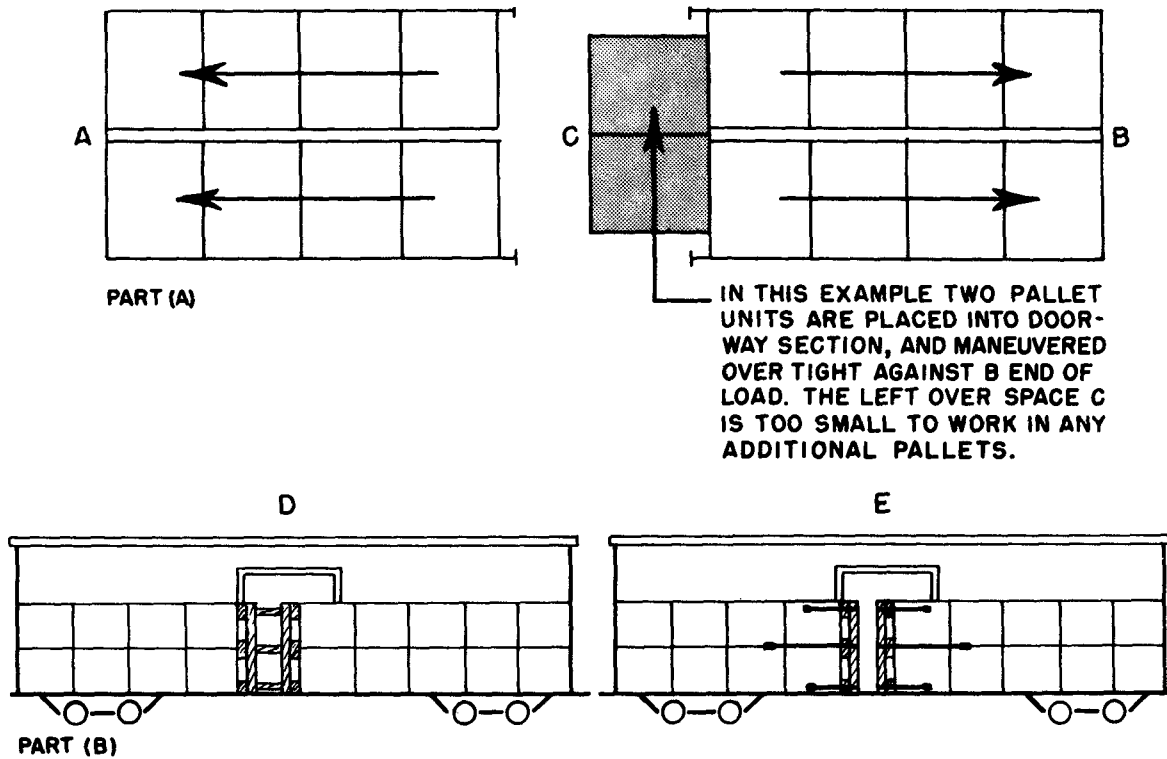

Figure 3-22 Palletized loads

(4) *Filling the doorway.* As shown in the example in (3) above, it is desired to completely fill the lengthwise space of the car with pallet units; however, some practical difficulties arise. When the last two pallets, shown by the shaded portion of figure 3-25, are moved into place, invariably, there is some slack space (possibly 4 to 12 inches) at one or both sides of these doorway pallets (fig 3-24). When this occurs, it is necessary to squeeze into this slack space some form of bracing dunnage that will secure the load tightly in place to prevent shifting and damage in transit. Also, it should be considered that in this type of solid load, the pallet units in the doorway will be squeezed tight during transit, and, consequently, will be difficult to pull out of the load at the destination. This difficulty

can cause damage to the merchandise on these first few doorway pallets when trying to "break into" such a load. Therefore, many shippers and receivers prefer to brace the loads as explained in (3) above leaving a space in the doorway section of the car to facilitate handling operations (part B, fig 3-24).



Figure 3-23. Crosswise slack.

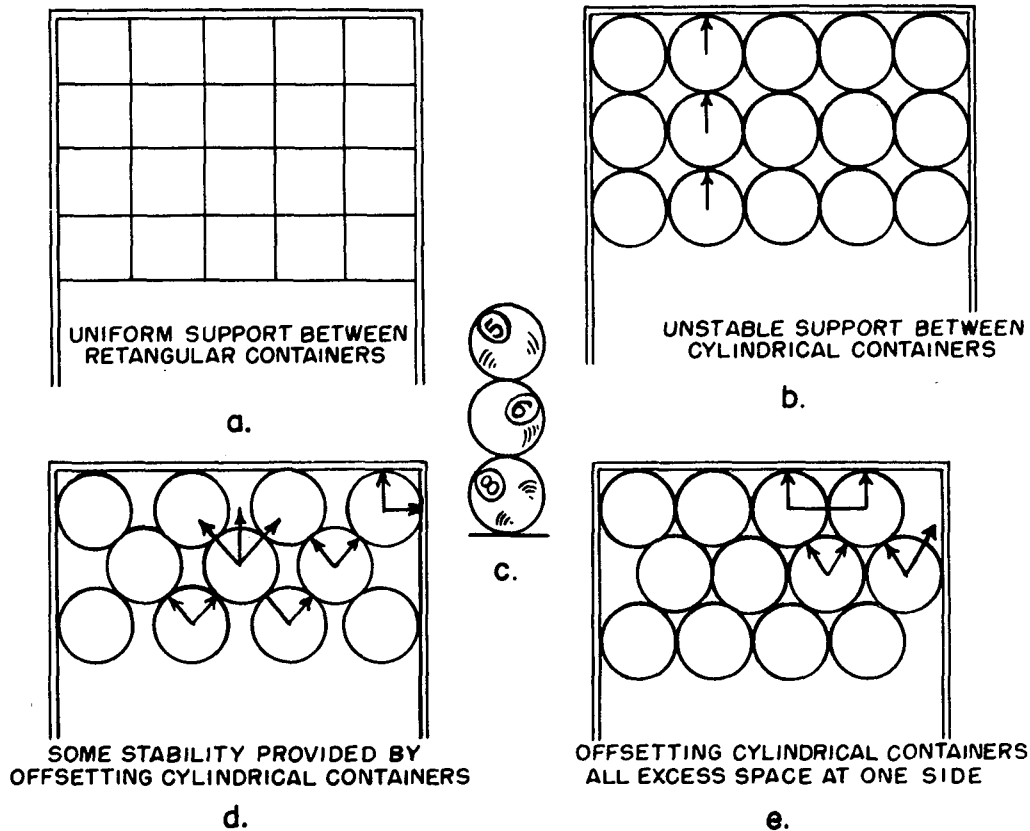

Figure 3-24 Doorway area

3-74. Cylindrical Containers in Closed Cars.

a. Special problems of loading.

(1) *Description.* Cylindrical containers include steel barrels, drums, slack, and tight coopered wooden barrels, kegs, pails, and fiberboard drums. See AAR pamphlet 4 for more detailed information on the loading of cylindrical containers.

(2) *Shape affects stability.* Cylindrical containers have a circular contour and when loaded in a car, do not have complete face or surface contact or support between adjacent containers, which creates an unstable condition. Many containers in use are constructed of lightweight materials that will flex, bend, or crush under concentrated pressure. Therefore, it is necessary to have at least a two-point contact between adjacent containers.

(3) *Contrasted stability of square and cylindrical shapes.* The alignment in bearing surfaces between containers having square or rectangular shapes is shown in part *a*, figure 3-26. With the units placed as illustrated, the construction resembles a multi-storied house. This arrangement provides complete stability for such containers. If cylindrical containers were placed in straight lines,

as shown in part *b*, figure 3-26, there would be no stability between the containers. This would be similar to trying to stack billiard balls one on top of another as shown in part *c*, figure 3-26.

(4) *Offset loading.* The method of loading containers shown in part *d*, figure 3-26, is the preferred method due to the stability obtained by offsetting the containers. This method provides a two-point contact between containers and any force or pressure brought to bear against a container is distributed to the adjacent containers. Other advantages are that this method retards rotation of containers and will accommodate crosswise loading where drums will not fill the voided space.

(5) *Diagram.* It is necessary at times to load a desired number of containers in a car as shown in part *e*, figure 3-26. However, there is a disadvantage to this method since the containers tend to be forced into the voided space at either side of the car. In the pattern shown in part *d*, figure 3-26, this open space is divided into three smaller spaces.

(6) *Importance of tight loading.* Emphasis will be placed on tight loading. The proper posi-

tioning of cylindrical containers placed tightly against others is a basic requirement. Tensioning of steel straps or the application of wooden braces will not produce a tight load if the containers are not loaded tightly during the process of loading.

b. Loading wooden barrels.

(1) *Bilge protection.* Bilge protection is necessary in the loading of wooden barrels and should be placed so that it will contact the barrel at the strongest point which is 6 inches from the top and bottom chimes. The bung stave is the weakest stave in the construction of the barrel. The barrel

should be positioned so that the bung stave does not contact adjacent barrels or the end walls or sidewalls of the car.

(2) *Double decked load.* When it is necessary to double deck the load, dunnage of not less than 1-inch thickness must be placed lengthwise on top of the bottom or floor layer.

c. Center bracing. When planning a load of cylindrical containers decide upon a pattern which will leave the least amount of open space in the doorway area; thus, the load in each end of the car will have the same number of containers against the bracing, preferably the lesser number.

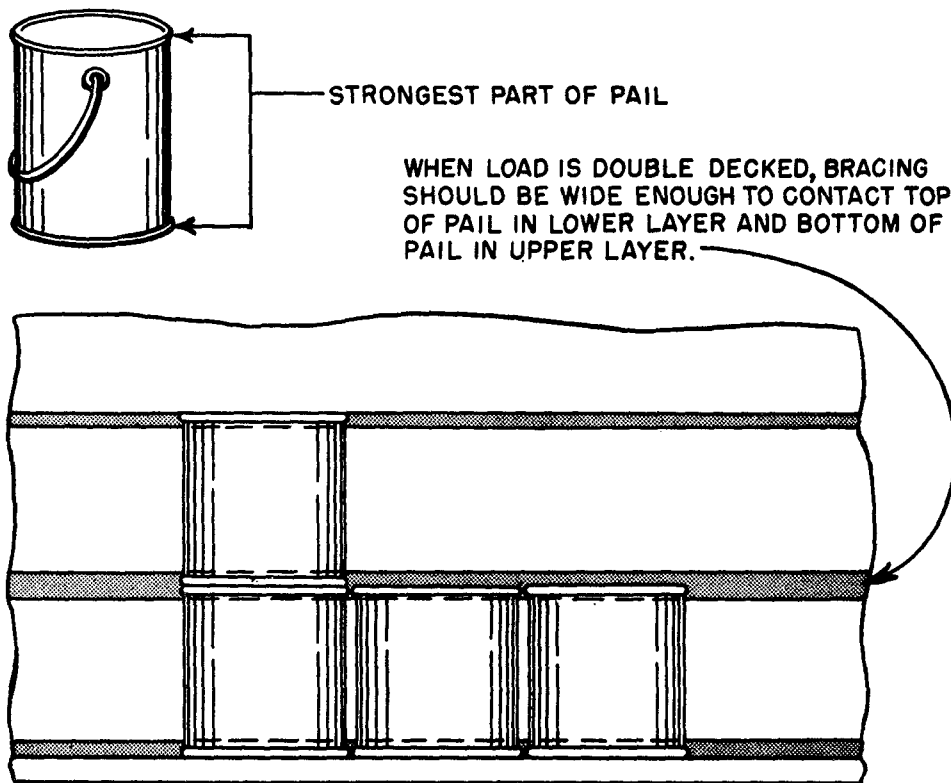

Figure 3-25 Placing of last two pallets

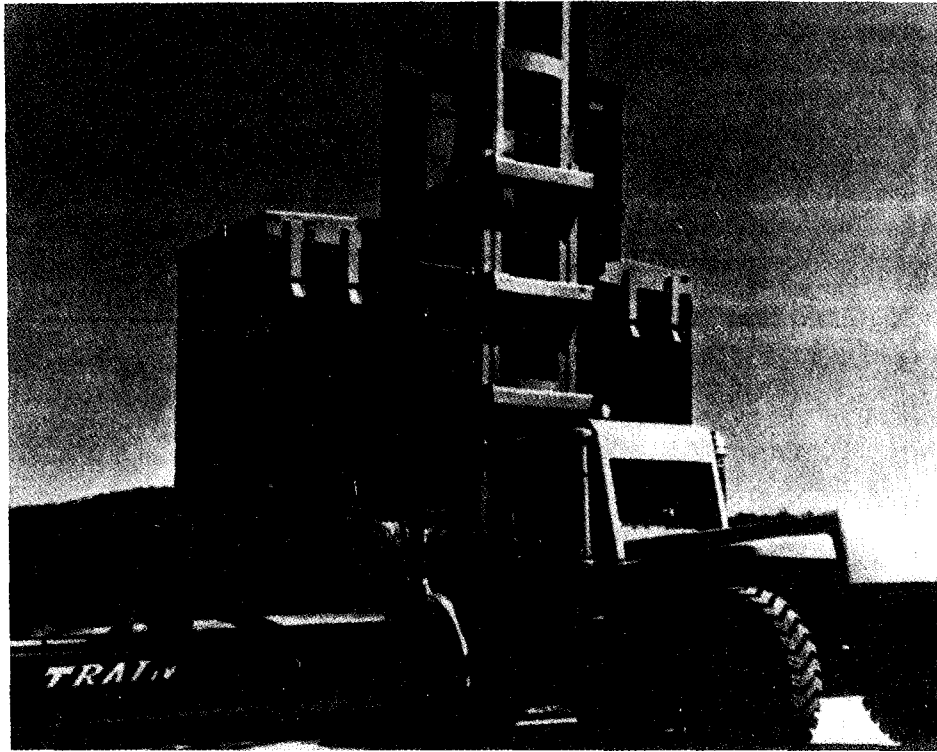

Figure 3-26. Loading diagrams cylindrical containers

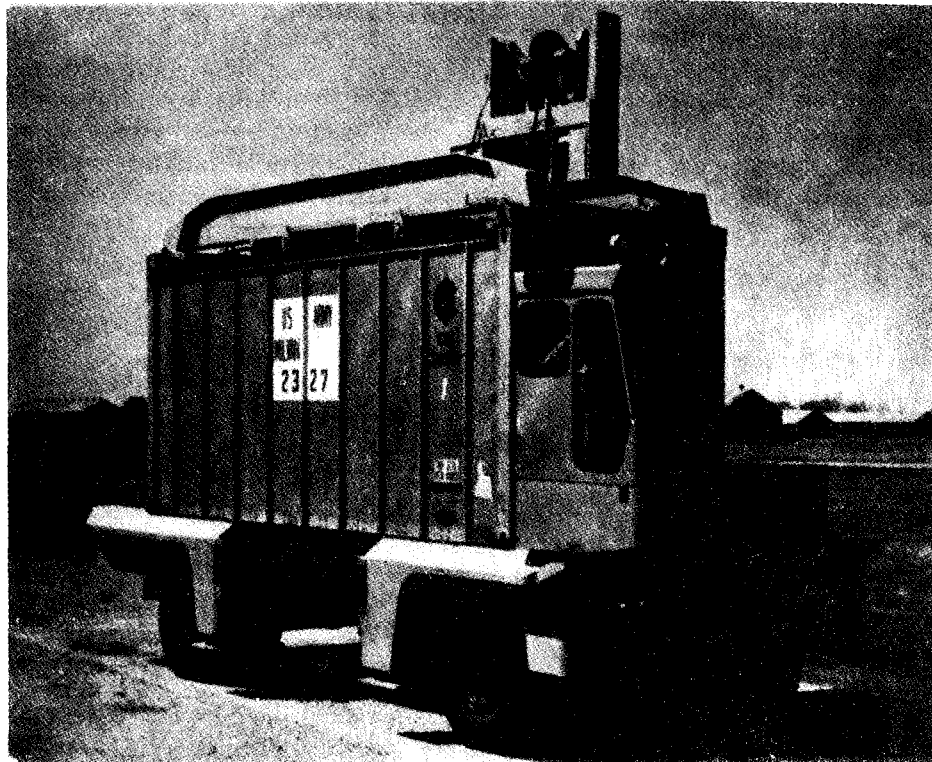

Figure 3-27 Bracing for flexible or light gauge cylindrical containers

d. Drums with rolling hoops. When loading drums with rolling hoops in a rigid, braced load, the load must be arranged so as to prevent the hoops from riding up on each other and thus creating slack lengthwise on the load. This method is also effective for preventing the latches from coming open, when loading drums with detachable tops.

e. Pails and 5-gallon containers. Because of the flexibility of light gauge pails and the method of fastening the tops (particularly of 5-gal containers of paint), it is mandatory that the load be sectionalized into a least four units. Divisional gates will be fastened securely to the sidewalls of the car (fig 3-27). The blocking and bracing will be placed against the strongest part of the container when blocking and bracing pails, 5-gallon containers, and fiber drums.

3-75. Machinery and Machine Tools.

a. Importance of proper loading.

(1) *Dollar damage.* Because of the high dollar value of this equipment, any damage can involve a large loss.

(2) *Delay to production.* When machinery destined to a manufacturing point is received damaged, there is a resultant delay in production until replacement parts can be produced.

(3) *Difficulty of replacement.* If possible, repairs can be effected or, if this is not feasible, it may be necessary to manufacture a unit or part as the damaged item may be the only one of its type.

b. Inspection before preparation for shipment. Prior to shipment (particularly if the machinery

has been in inactive storage) a careful inspection will be made of the item or items to be shipped. The items should be examined to determine if there are any damaged or missing parts that would make the machine inoperative or hazardous for shipment. Of special importance is the securing of interior bracing of movable parts such as tail stocks, counter-balancing weights, and swing turrets.

c. Blocking and bracing requirements. DOD machinery or like items moving on open top equipment will be blocked and braced in accordance with the mandatory minimum requirements of AAR section 6, of the Rules Governing the Loading of Commodities on Open Top Cars. When loaded in closed cars, general rules in circular 42-F will be followed. Recommended loading methods for blocking and bracing of machinery and allied or like items in closed cars are covered by AAR pamphlet 21.

3-76. Trailer-on-Flatcar (TOFC)/Container-on-Flatcar (COFC) Load.

a. TOFC shipments usually require a ramp to allow the chassis to be driven onto the flatcar. Two types of equipment are used for TOFC loads: Improved strength semitrailers (piggyback trailers), or ISO containers mounted on a chassis.

b. Containers (including ISO containers) not mounted on a chassis are often shipped on flatcars (COFC). Specialized equipment is available to lift these containers and position onto a flatcar. Several examples of handling equipment for such containers are shown in figures 3-28 through 3-30.

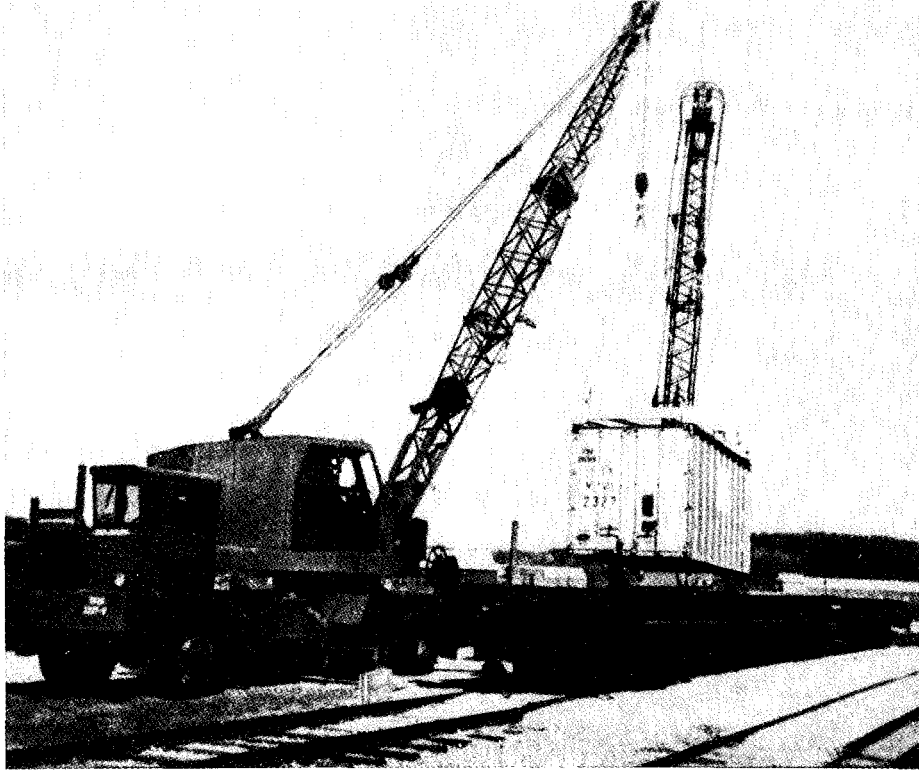
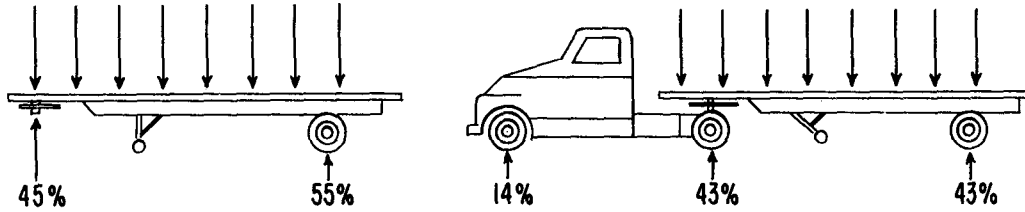
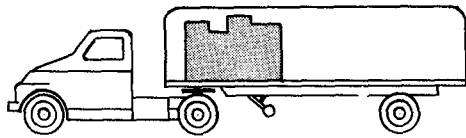

Figure 3-28 Frontloader forklift truck equipped with toplift attachment



Trailers are also designed for uniform load distribution, as shown by the above sketches. The fundamental difference between loading trailers and trucks is: in the case of trucks, the average design provides for about 90% of the payload on

the rear tires and 10% on the front tires. In the case of trailers, the payload should be distributed equally between the rear tires and the fifth wheel which transfers its load to the truck-tractor.



WRONG

With a part load or with a very heavy load having little bulk, it is common practice to put it at the front end of the trailer to get traction on truck-tractor rear tires. This overloads the truck tires and shortens their mileage life, to say nothing of bending the

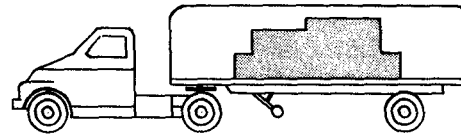

RIGHT

truck rear axle housing. Application of trailer brakes may lock wheels, cause tire flat spots, or skidding, or both.

The load should be distributed over the full length of the trailer floor or platform.

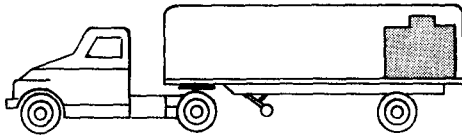

WRONG

These examples are obviously wrong. In the case of the first trailer, the heavy load at the rear is overloading the rear trailer tires. There is practically no load on the fifth wheel, and the truck-tractor rear tires would certainly slip and wear away rubber. Braking distribution would also be very uneven.

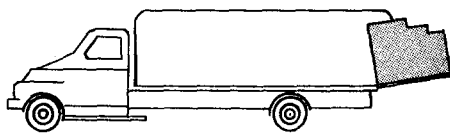

WRONG

Tail gate loading, of course, should never be practiced, even in the interest of speed, as it puts a severe strain on the equipment, and frequently results in serious accidents.

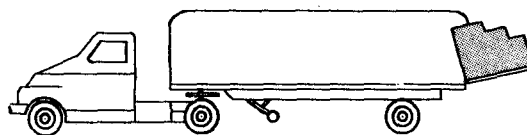

See above for the correct method of loading.

Figure 3-29 Sideloader truck equipped with toplift attachment

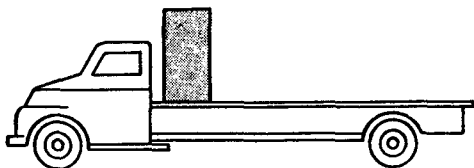

WRONG

A heavy load, like a big piece of machinery or a safe, should not be loaded against the cab. This loading will bend the frame, perhaps permanently. It will also overload the front tires, may even cause a blowout on a worn tire. Hard steering will also result, and the load may be top-heavy.

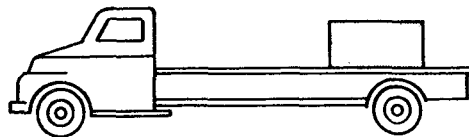

RIGHT

A heavy concentrated load should be placed near the rear and on its long side if at all possible. Most of the load should be over the rear axle to get proper tire loading and eliminate bending of the frame.

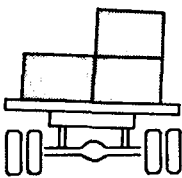

WRONG

A very heavy load should not be loaded at one side. This overloads one spring and the tires at that side. This loading could be bad enough to allow the brakes to lock on the wheels at the light side and cause flat spots on the tires, or a skid on a wet surface.

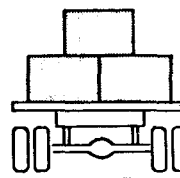

RIGHT

This loading has equal loads on rear tires and eliminates twisting of the frame, which might loosen rivets of cross members or frame brackets. Uniform loading crosswise prevents axle housing and wheel bearing overloading, too.

This above example applies to trucks and trailers alike.

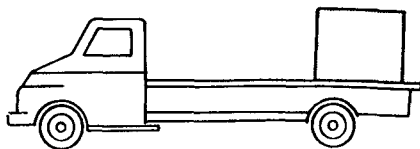

WRONG

This loading should never be permitted. The frame bends, the rear tires are very much overloaded, and enough weight is taken from the front tires to make steering almost impossible.

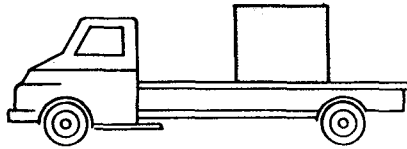

RIGHT

Again, the proper place for a concentrated load like this is just ahead of the rear axle, with the longest side on the floor.

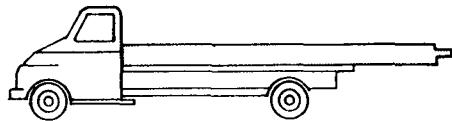

WRONG

This type of loading results from the use of the wrong vehicle for the job. Such loading can result, on rough roads, in an actual pivoting of the truck on its rear wheel, and taking the front wheels entirely off the road.

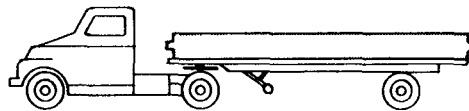

RIGHT

A tractor-trailer combination is the proper vehicle for use in service like this. By using the proper vehicle, damage to the truck and tires, and even serious accidents, may be avoided.

Figure 3-30. Mobile crane equipped with toplift attachment

3-77. Truck/Trailer Loading—Preparation for Loading.

Need for good equipment. Generally, a carrier has several types of vehicles, one of which may be suitable or more adaptable to the commodity to be shipped. It is the joint responsibility of the shipper and the carrier to make every effort to assure safety in transit as well as safe arrival at destination.

3-78. Loading.

a. Importance of proper loading. The delivery of truck and trailer shipments in good condition depends, to a large extent, on the manner in which the vehicle was loaded and on the care that was taken in preparing the vehicle for loading. Personnel responsible for loading, blocking, and bracing freight should have available for use and be familiar with the rules for the proper loading and servicing of shipments. Shipments of explosives and ammunition will be loaded in accordance with approved procedural publications/drawings issued by the military services.

b. Tight loading. The most important single factor contributing to the prevention of damage in truck and trailer loading is that of tight loading, which cannot be overemphasized. Rarely does the material to be shipped fit a closed truck, van, or trailer without side slack or end slack, particularly when the front end is rounded or curved. In most

instances, slack may be taken up with bulkheads or dunnage.

c. Difficulty of tie down. The construction of present day closed trucks, vans, and trailers does not facilitate tight loading, blocking, or bracing. Most commercial-closed trucks, vans, and trailer bodies are made of aluminum, plywood, or other thin metal shells designed to protect the materials from weather in transit. Ordinarily, provision is not made for the essential requirements of blocking, bracing, or tiedown. The safe bracing of high center of gravity items in closed trucks, vans, and trailers presents a problem calling for good judgment, ingenuity, and sound workmanship to assure safe arrival of these items at destinations.

d. Variation in vehicles. Physical dimensions, capacities, weight limitations, and load distribution of trucks and trailers vary greatly. These variations preclude the covering of all types of loads. Accordingly, the methods or procedures described must be considered typical and will be adapted to individual loads of various commodities, as required.

3-79. Balanced Load.

Equal distribution of load is just as important in truckloading as in carloading. The importance of weight distribution is shown in figures 3-31 and 3-32.

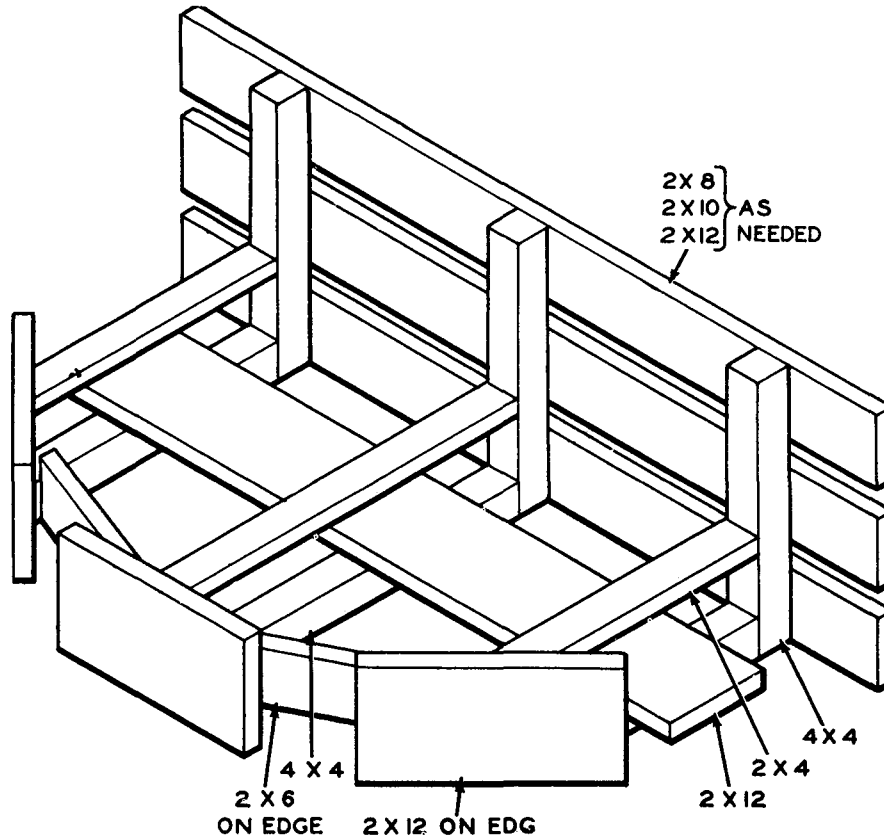

Figure 3-31 Approximate distribution of total weight-vehicle plus payload

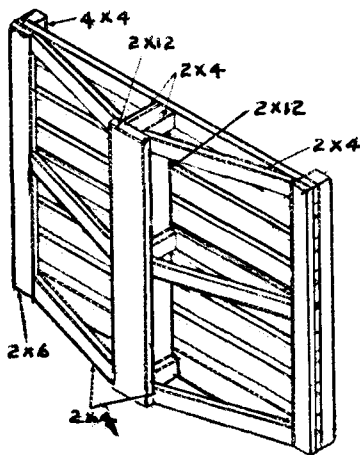

Figure 3-32 Examples of right and wrong truck loading.

3-80. Load Movements.

a. Causes of load movement.

(1) *Forward movement.* The forward movement of loads, if not braced properly, will be caused by—

- (a) Braking of vehicle on steep descents.
- (b) Sudden stops to avoid hitting pedestrians or vehicles.

(2) *Rearward movement.* The rearward movement of loads if not braced properly, will be caused by—

- (a) Ascension of steep hills.
- (b) Load rebounds after the sudden application of brakes.
- (c) Sudden increase of speed in order to avoid an accident.

(3) *Lateral movement.* The lateral movement of loads, if not braced properly, will be caused by—

- (a) Rounding corners on sharp curves.
- (b) Traveling on high crowned or banked roads.
- (c) Swerving to avoid accidents.

b. Prevention of load movement.

(1) *General.* All of the movements of loads may occur when vehicles are traveling on rough or unpaved road or when traveling over snow and ice. However, practically all load movement can be prevented or eliminated by proper blocking and

bracing. All loads will be balanced in the vehicle lengthwise and crosswise before the vehicle is released. Precautions will be taken to prevent vertical movement because of sudden stops or travel over rough terrain, as vertical movement can cause the breakdown of good blocking and bracing practices. If the load is not tight or is out of alignment, the unbalanced loading will cause unequal pressures. The use of bulkheads, separation gates, dividers (lengthwise and crosswise), layer separations, runners, blocks, cleats, and strapping properly fabricated and applied, will eliminate or prevent all load movement.

(2) *Forward movement.* Forward movement can be prevented by shoring firmly against the front or nose bulkhead. The front bulkhead serves to square the load and to distribute load pressures over the frontal area of the vehicle rather than just at points of contact. When a vehicle, furnished by the motor carriers, has a rounded or streamlined front end or an end other than square and the material to be loaded is a critical item, a delicate or fragile item, or an item that requires special protection and straight alignment to assure safe arrival at destinations, front bulkheads of a type and size compatible with the weight and type of commodity to be shipped may be used. A typical nose or front bulkhead is shown by figure 3-33. Front bulkhead detail and installation is shown by figures 3-34 and 3-35. The use of front bulkheads is not necessary in square nose trailers or vans unless the nose of the trailer or van has been bulged by forward load movement in previous shipments. If such a condition exists and the material to be shipped falls in the category previously outlined, the front bulkhead should be used.

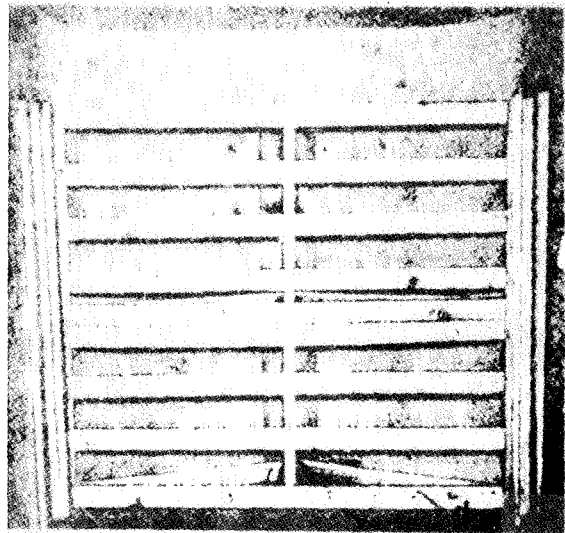

Figure 3-33 Front bulkhead

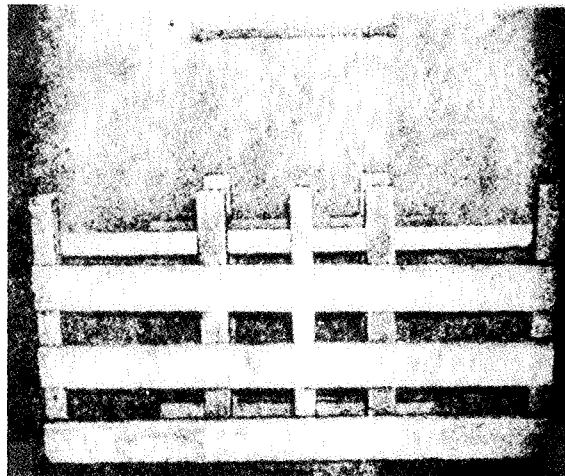

Figure 3-34 Front bulkhead—positioned in trailer, detail of bulkhead

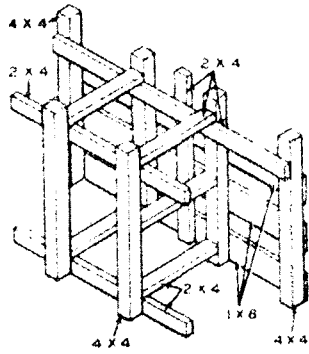

Figure 3-35 Front bulkhead—positioned in trailer, detail of bulkhead

(3) *Rearward movements.* Rearward movements can be prevented by use of a rear bulkhead or gate. The rear bulkhead or gate must be braced, either with diagonal supports back to the doorposts of the vehicle or by secured risers against the doorposts and the bulkhead or gate. Backup blocks must be driven into place and nailed to the risers and gate to eliminate slack (fig 3-36 (A and B) and figs 3-37 and 3-38).

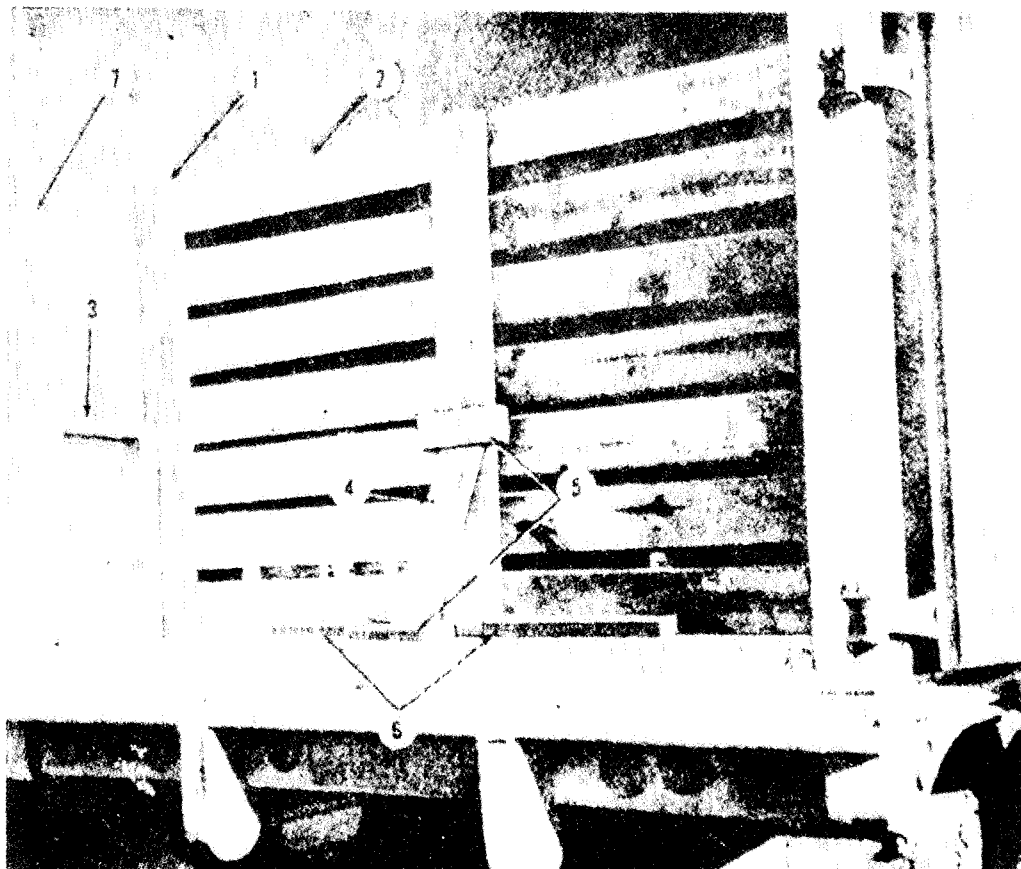
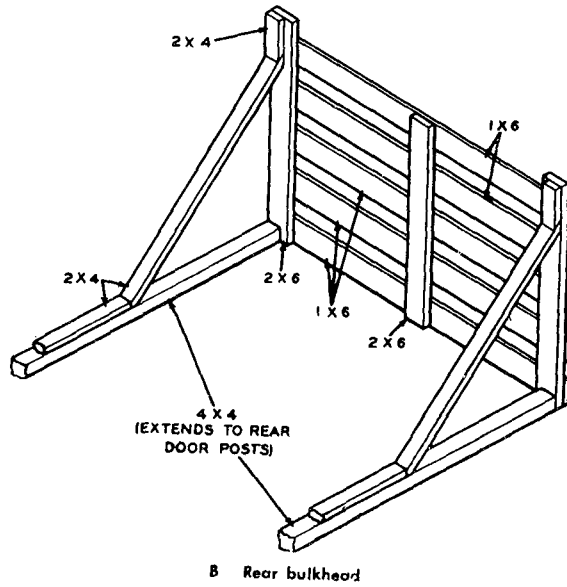

Figure 3-36 Rear gate.

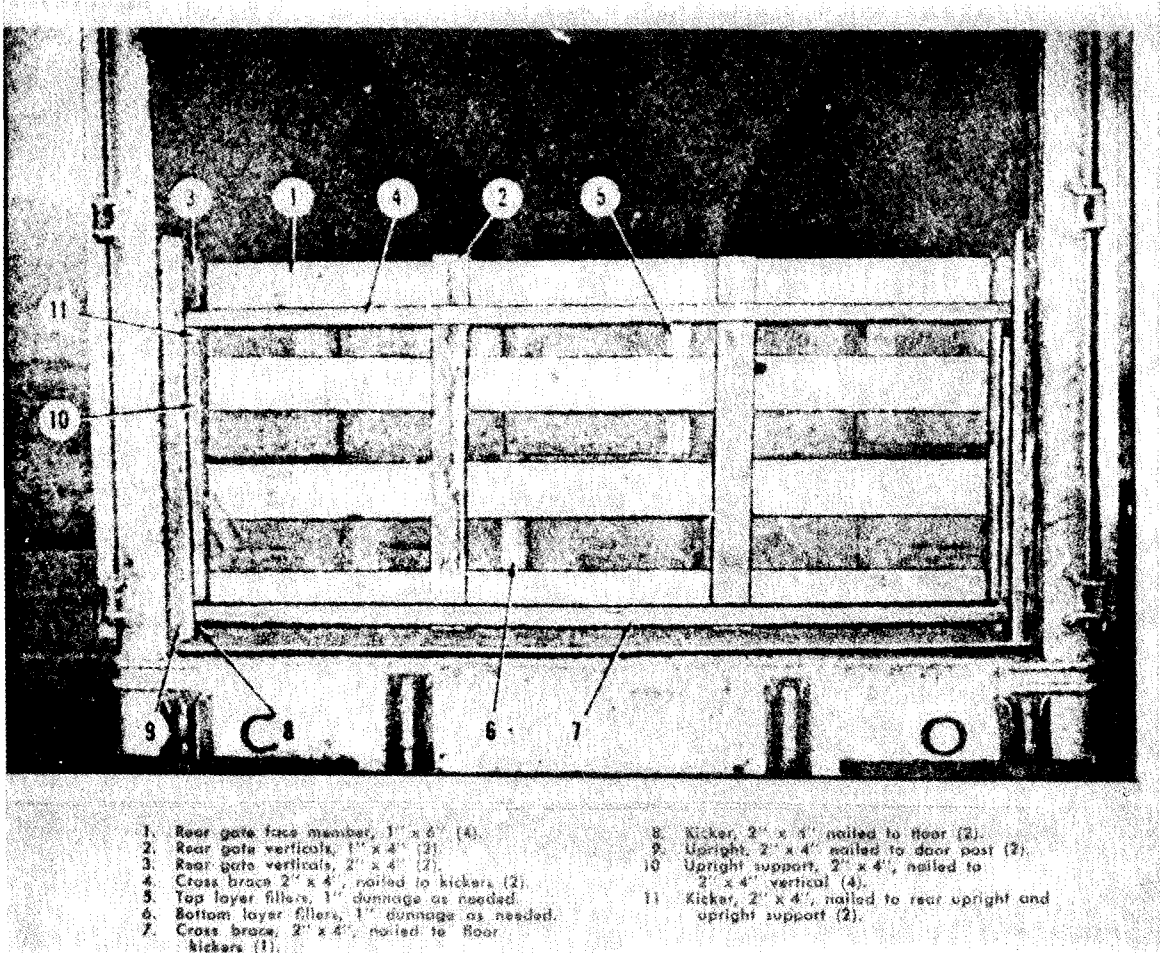
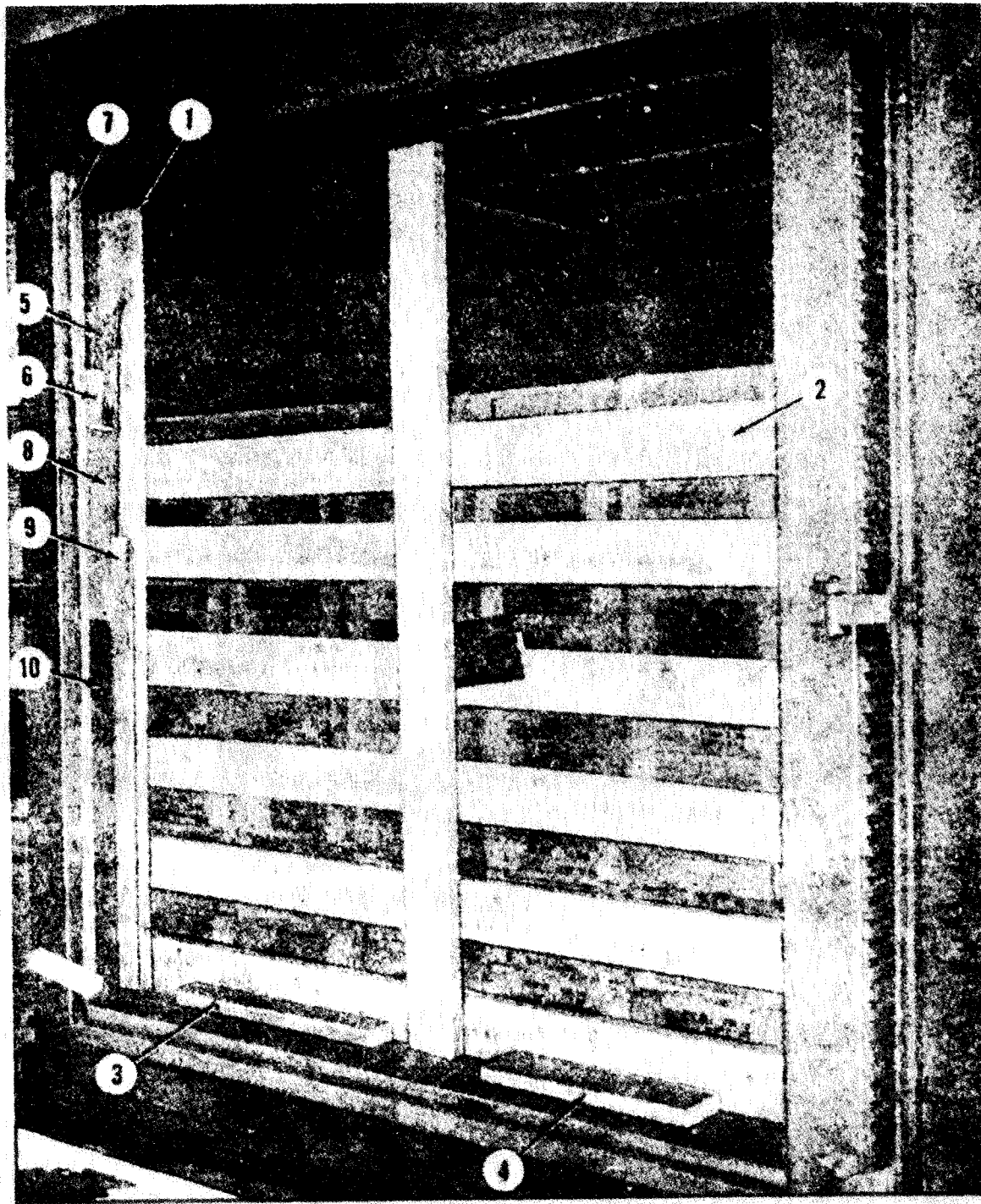

Figure 3-37 Rear gate positioned in truck



- | | | | |
|---|------------------------------------|----|--------------------------------------|
| 1 | Rear gate vertical, 2" x 6" (3) | 5 | Spacer, 2" dunnage as needed |
| 2 | Rear gate face member, 1" x 6" (6) | 6 | Upright, 2" x 4" nailed to door post |
| 3 | Backup cleat, 2" x 4" (2) | 8 | Filler strips, 1" dunnage as needed |
| 4 | Backup cleat, 2" x 6" (1) | 9 | Filler strip, 1" dunnage as needed |
| 5 | Upright, 2" x 4" as needed | 10 | Upright, 2" x 4" as needed |

Figure 3-38 Rear gate and dunnage

(4) *Lateral movement.* Lateral movement can be eliminated by the use of space fillers, longitu-

dinal separators, steel strapping, and by the use of rigid blocking and bracing devices.

3-81. Types of Loading.

a. Wheeled containers. Closed trucks and trailers should be considered as large containers on wheels; as such, the interior bracing or blocking of the vehicle should conform as nearly as possible to the packing of individual containers. Through the use of filler material, bracing, blocking, separation gates, and layer separators, it is possible to adapt the wide variety of items to the dimensions of the vehicle. Interior blocking and bracing provides cushioning and interior packaging to the material in this wheeled container and also protects the vehicle. Cargo containers of ISO/American National

Standards Institute standards loaded with general commodities will also use conventional blocking and bracing methods.

b. Adaptability of vehicles. The truck and trailer is adaptable to the many and various types of loads required to move the varied types of commodities such as heavy or light items, fragile, bulky, compact, dense and rough, and high center of gravity items. In order to accommodate this variety of items, the shipper must plan the load, properly prepare the truck, and block and brace accordingly. One method of preparing a truck for shipment of cylindrical items is shown by figure 3-39.

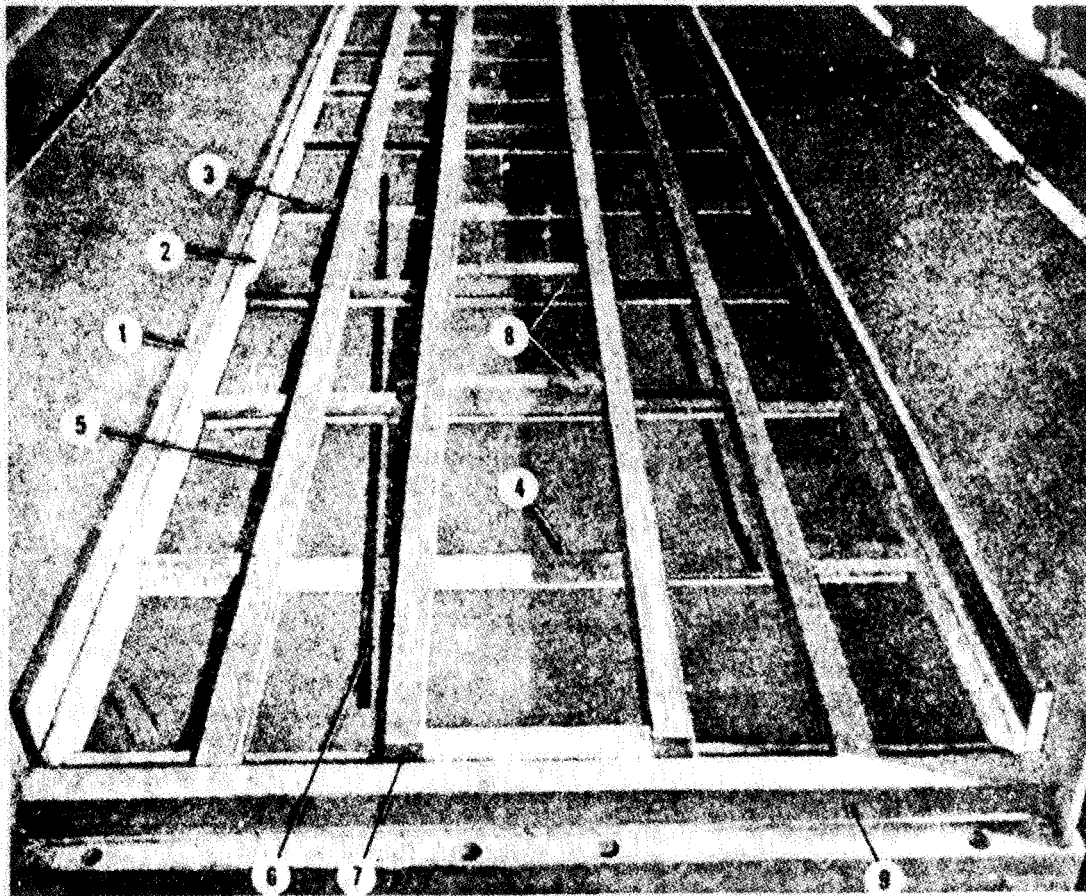

<p>1. Side-wall reinforcement, 2" x 12" on edge 2. Sockwa plate, 1" x 5" on edge 3. Spacers, 2" x 4", nailed to sleepers 4. Sleepers, 1" x 6", nailed to floor 5. Intermediate stiffers, 8" x 4"</p>	<p>6. Floor and aft strapping, 1 1/2" x 6,000' strength and positioned under sleepers 7. Center brace, 4" x 4" 8. Center brace, 6" x 4" 9. End cross plate, 4" x 4"</p>
------------------------------------------------------------------------------------------------------------------------------------------------------------------------------------------------------------------------------------------------------------------------------------------	----------------------------------------------------------------------------------------------------------------------------------------------------------------------------------------------------------------------------------------

Figure 3-39 Preparatory shoring for cylindrical items

c. Unit loads. There are many types of loads suitable for truck loading (i.e., the bonded block load for materials shipped in fiberboard containers); brick wall method; key sack method; paper

retaining method; and lengthwise crosswise methods for loading bagged materials. However, the key sack method of loading is restricted to cloth bags and is not recommended for multiwall paper sacks.

Paper retaining method of loading can be used for full truckload or stopoff load (see A, fig 3-40).

d. *Stepdown load.* In the stepdown-type load, the bulk of the weight is on the axles and is stepped down to the center of the vehicle. The stepping down of the load is achieved by use of a

riser; the height of the riser must be half the height of the unit or container being braced. The item or container may be utilized as a riser; however, in most instances, the riser should be fabricated from lumber or other suitable material (see B, fig 3-40).

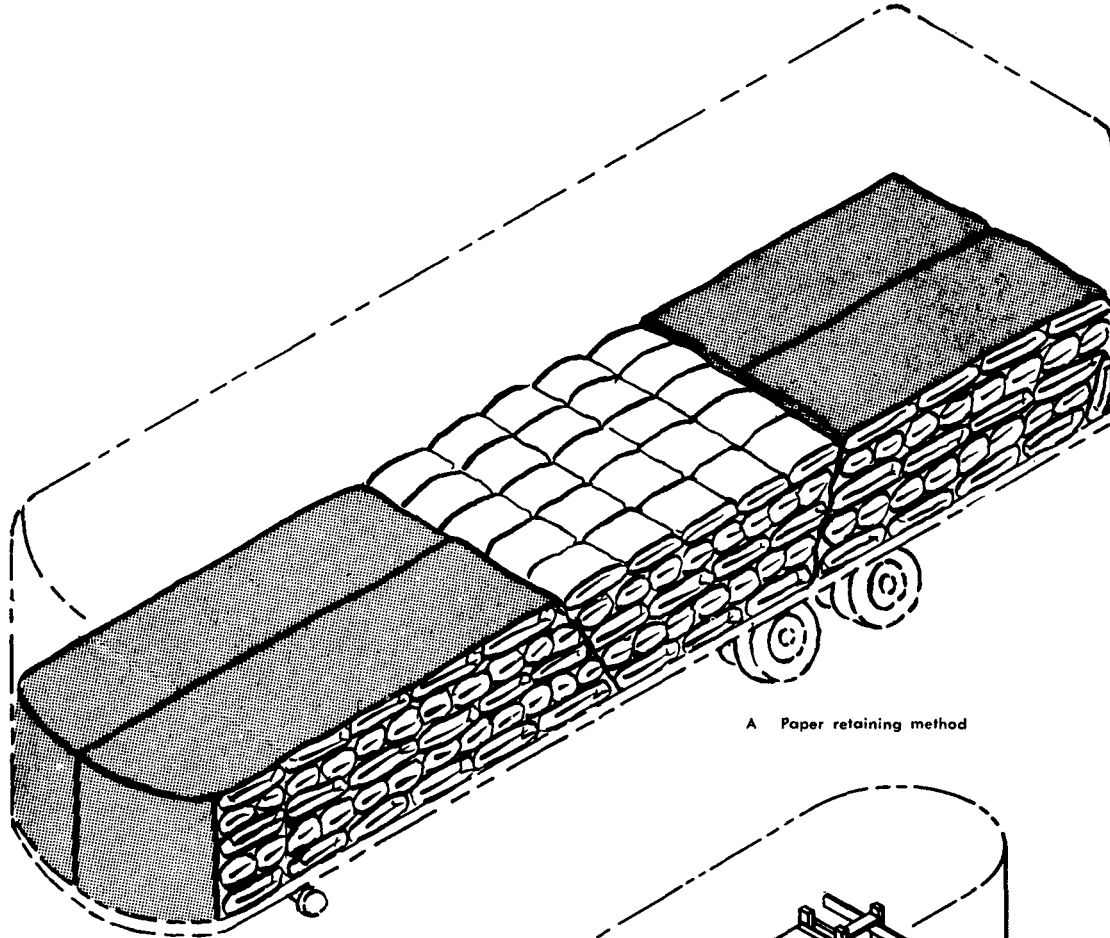

A Paper retaining method

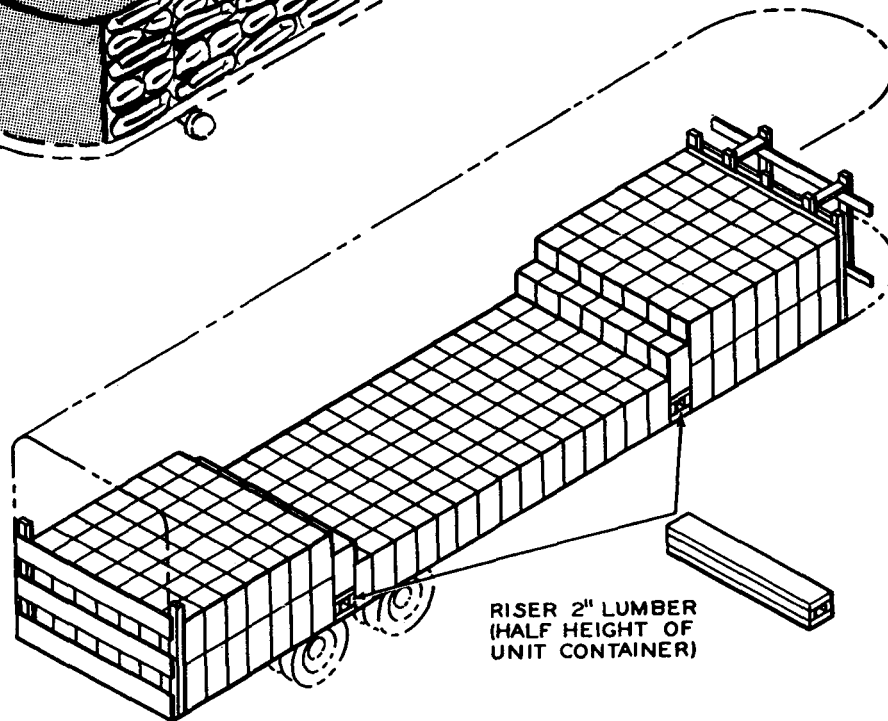

B. Stepped down

Figure 3-40 Loading

e. *Palletized loads.*

(1) *Advantages.* The advantage of a palletized load is that a quantity of small packs or units can be consolidated into a few large packs; thereby, reducing the number of handlings. For example, 300 containers of a given item can be consolidated into 10 pallet loads, thus, reducing the number of handlings by more than 96 percent. Consequently, the number of handlings involved in loading and unloading may be reduced from 300 to 10. Accordingly, palletization of materials for shipment would be beneficial to the shipper and the

carrier. Explosives and ammunition will be palletized in accordance with approved procedural publications/drawings issued by the military services.

(2) *Forming pallet loads.* Palletized load may form a full uniform load, a tiered load, a staggered load, or a strapped load. The load should be balanced, weight should be evenly distributed, and blocking and bracing should be kept to a minimum. A staggered load of palletized items is illustrated by figure 3-41. The pallets are staggered to obtain a compact balanced load.

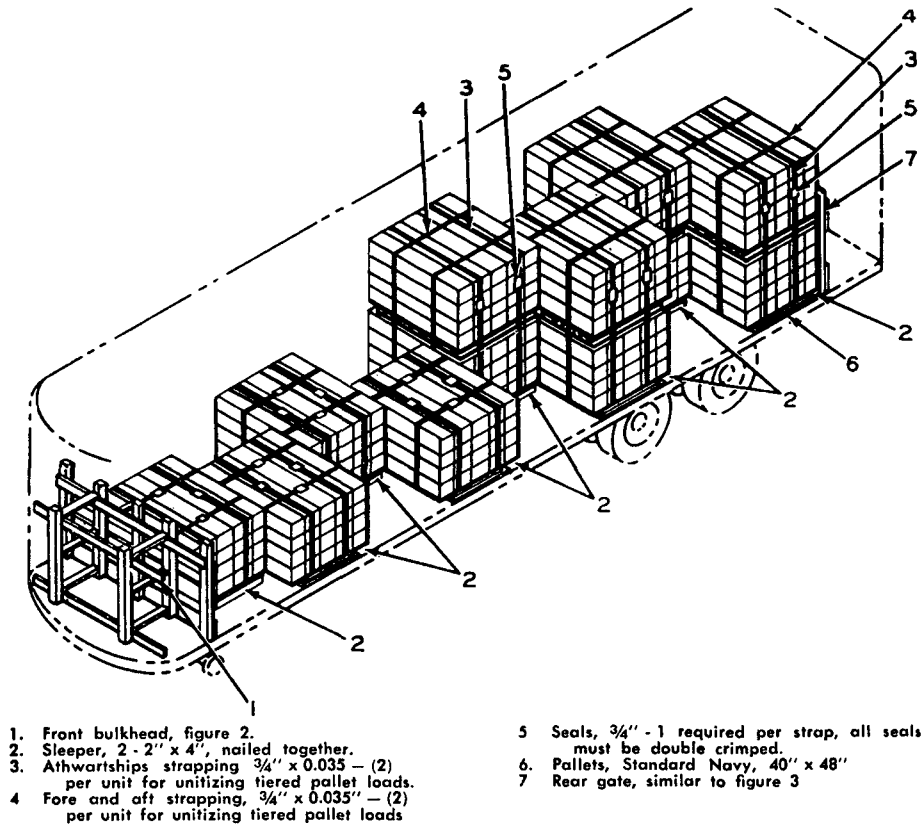

Figure 3-41 Staggered palletized loading.

(3) *Pallet size for maximum utilization.* Pallets must be suitable for handling by all media of transportation for maximum utilization. The general service pallet, 40 by 48 inches, meets these requirements.

f. *Strapped pallet loads.* Generally, pallet loads are strapped fore and aft and are secured on all sides. Blocking and bracing is kept to a minimum as the weight of the load combined with floor blocking of the bottom tier prevents the load from shifting in transit.

g. *Flatbed truck and trailer loading.* The basic principles of weight distribution, tight loading, and prevention of load movement all apply to the loading of open top vehicles. Materials loaded on an open top vehicle will be secured to the vehicle to prevent any possibility of the load shifting or falling off the vehicle, shifting and contacting other traffic, fouling underpasses, culverts, bridge abutments, and creating a hazard to pedestrians. When the trucks and trailer, either open or closed, are military equipment, it will be the responsibility of the driver to assure that the vehicle is prop-

erly loaded and the load secured before the vehicle moves.

3-82. Freight Loss and Damage.

a. Adherence to methods and techniques to prevent loss and damage. Adherence to prescribed loading and securing methods and techniques will help reduce loss and damage to shipments in transit to a minimum.

b. Visible loss or damage. Visible loss or damage existing at time of receipt of a shipment should be properly recorded by the receiving personnel in accordance with the procedures of the appropriate military department.

c. Concealed loss or damage. A complete report of circumstances, including the time damage to or loss of shipment was observed, should promptly be made to the appropriate local military freight traffic personnel responsible for initiating a Transportation Discrepancy Report (TDR), when—

(1) Damage to or shortage in a shipment was not observed at time of receipt from the commercial carrier (concealed loss or damage).

(2) Damage or shortage is discovered while being stored, processed, or reshipped from storage.

(3) It can be shown that the loss or damage did not occur after the material left the custody of the carrier.

(4) It is indicated that the loss or damage occurred during shipment.

3-83. Instructions for Securing Materials Transported by DOD-Owned-Motor Vehicles.

a. General Every truck, semitrailer, full trailer, and pole trailer used for transporting cargo over public streets and highways will be equipped with bulkhead, tiedowns, sideboards, and blocking as hereinafter specified. Combinations consisting of a truck trailer and a pole trailer shall have the option of providing a bulkhead mounted either on the front of the pole trailer or behind the driver's compartment of the tractor. When the bulkhead required is mounted on the tractor, the lading on the pole trailer will be securely fastened with tiedowns meeting the requirements listed herein.

b. Bulkhead requirements.

(1) *Height and width.* Bulkheads will be of such heights as to block the forward motion of any piece of lading on the vehicle, or alternately, as high as the driver's compartment of the vehicle or combination. Bulkheads will be of such width as to block the forward motion of any piece of lading of the vehicle or alternately, as wide as the widest portion of the vehicle.

(2) *Strength.* The bulkhead will be strong enough to withstand a horizontal forward force equal to one-half the static weight of the cargo carried. This would be when such force is distributed over that part of the bulkhead extending from the vehicle floor, upward to a height sufficient to stop the forward movement of any piece of lading carried on the vehicle. It could also be to the height of the driver's compartment or a combination, whichever is the lesser height.

(3) *Penetration resistance.* Bulkheads will be so designed, constructed, and maintained so as to resist penetration by any piece of lading carried on the vehicle when such vehicle is subjected to the maximum deceleration of its service brakes. Bulkheads will not have openings large enough to pass the smallest piece of lading carried on the vehicle.

c. Blocking and bracing requirements.

(1) *Cargoes subject to forward shifting.* On vehicles carrying cargoes which cannot be placed firmly against the forward bulkhead, suitable blocking and bracing or tiedowns will be provided in addition to the bulkhead specified in *b* above to prevent the forward shifting of such cargoes when the vehicle is subjected to the maximum deceleration of its service brakes.

(2) *Cargo subject to side shifting in transit.* Vehicles carrying cargoes of such nature as to be subject to side shifting in transit, even when equipped with sideboards or stakes, as required in *e* below, will have such cargo securely blocked or braced to the sides of the vehicle.

d. Tiedown requirements. Every cargo-carrying vehicle will be equipped with either sideboards or tiedown devices designed to prevent the falling, shifting forward, or backward motion of any lading being carried. Tiedown devices will be as follows:

(1) If the vehicle is without sideboards or sides, it shall be equipped with a minimum of two tiedown devices on load lengths of 21 feet or less. For loads over 21 feet, a minimum of three tiedown devices will be used and an additional tiedown device for each 10 feet of load length over 30 feet. If necessary, additional tiedown devices will be provided to secure each piece of lading being transported, either by direct contact with the tiedown devices or by use of dunnage contacting sufficient individual pieces of the lading and the dunnage then secured by the tiedown.

(2) Each tiedown device will be equipped with a load binder, Federal specification GGG-G-325, Binder, load. The binder chain will be attached to the tiedown bar or to such other tiedown devices provided by the truck manufacturer. When vehicles are not equipped with tiedown devices, the

binder chain will be of sufficient length to pass over the cargo and underneath the vehicle body or flat bed, stakes sides, or pole trailers. The chain will be 3/8-inch steel BBB Coil Chain in accordance with Federal specification RR-C-271, Chains and Attachments, Welded, Weldless and Roller Chain. Binding chains will be adjusted as tight as possible.

e. Stakes and sideboards. Vehicles carrying cargo not secured in compliance with (1) above will be equipped with sides, sideboards, or stakes; a rear end gate; and a header board. Stakes, sideboards, end gate, and header board will be of a height no less than the load carried, and without an opening large enough to pass the smallest article on the vehicle as loaded.

f. Long material. When cargo such as long lengths of pipe, piling, telephone poles, or similar material is carried on pole trailers and it is of such length that the cargo must be used for connecting the front and rear bolsters, uprights, the height of the cargo will be inserted in pockets on the right and left side of each bolster. Such uprights will be tied together above the load. Also, the cargo will be bound together by a binding chain at the center of the load length. A red flag will be tied to the end of the oversized material for safety purposes.

g. Vehicles exempt from tiedown requirements. Vehicles transporting articles which because of size, shape, or weight require special vehicles for their carriage or special methods for their fastening, are exempt from tiedown requirements stated herein. However, loads on such vehicles will be se-

curely and adequately fastened to prevent any forward, backward, or sideward motion of the load when the vehicle is subjected to the maximum deceleration of its service brakes.

h. Acceptable loads. DOD drivers will not be permitted to move a load if the load is not secured in compliance with these instructions when such loads are offered for transportation over public streets and highways.

3-84. Use and Maintenance of Pneumatic Dunnage.

a. Use. Pneumatic dunnage is an airtight bag with a valve or valves for inflating and, in the case of reusable types, for deflating. It is designed to occupy void spaces in loaded rail, highway, or marine conveyances, including intermodal containers, to secure shipments in transit. Pneumatic dunnage is not for use in aircraft. It may not be used to secure explosives or other hazardous articles without prior approval of the Bureau of Explosives. Also, it cannot be used to secure loads of military explosives and ammunition.

b. Types and sizes. Pneumatic dunnage is available in two types—reusable (fig 3-42) and disposable (3-43). The nomenclature is “Dunnage, Pneumatic, Cargo Shoring—Type I Disposable and Type II Reusable.” Both are covered by Federal Specification PPP-D-1427. Units are available through normal supply channels from the Defense General Supply Center, Richmond, VA. Sizes of pneumatic dunnage adopted by DOD as most suitable for general use are as follows:

	Inflated size	Deflated size	Weight (approx)
Type I	36 in by 48 in	36 in by 58 in	12 lbs
(Disposable)	48 in by 48 in	48 in by 58 in	18 lbs
	48 in by 71 in	48 in by 82 in	22 lbs
	48 in by 96 in	48 in by 106 in	26 lbs
Type II	48 in by 48 in	57½ in by 57½ in	18-22 lbs
(Reusable)	48 in by 72 in	57½ in by 81½ in	26-29 lbs

(1) *Reusable pneumatic dunnage can be utilized for an indefinite number of shipments.* It is fabricated from high tensile strength, finely woven, nylon fabric treated with a rubber or rubber-like compound and vulcanized as a single unit. (Units equipped with a removable bladder are also currently in the system. This design has been outdated by the specification listed above; however, these units should be used until no longer serviceable.) The unit has a high-flow valve assembly

which consists of a threaded valve body molded into the dunnage unit. On some models, the inflation valve has a metal washer and special nut to anchor the valve body to the dunnage unit. On these models, a valve stem screws into the valve body and is secured by a chain attached to the metal washer. Other manufacturers use an “O” ring-type inflation valve which incorporates a valve cap and a valve insert which houses a check disc.

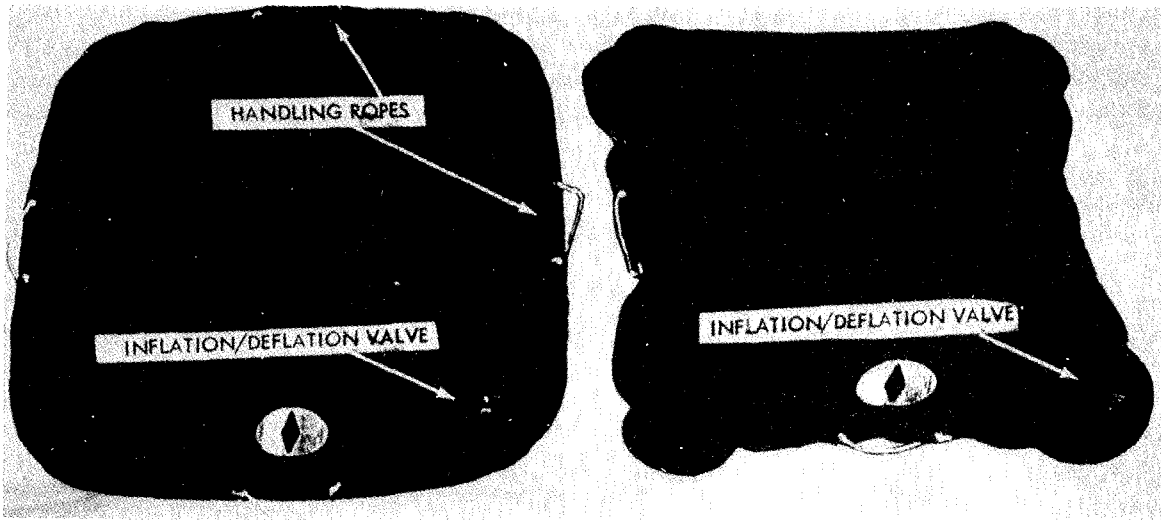

Figure 3-42 Reusable pneumatic dunnage unit complete

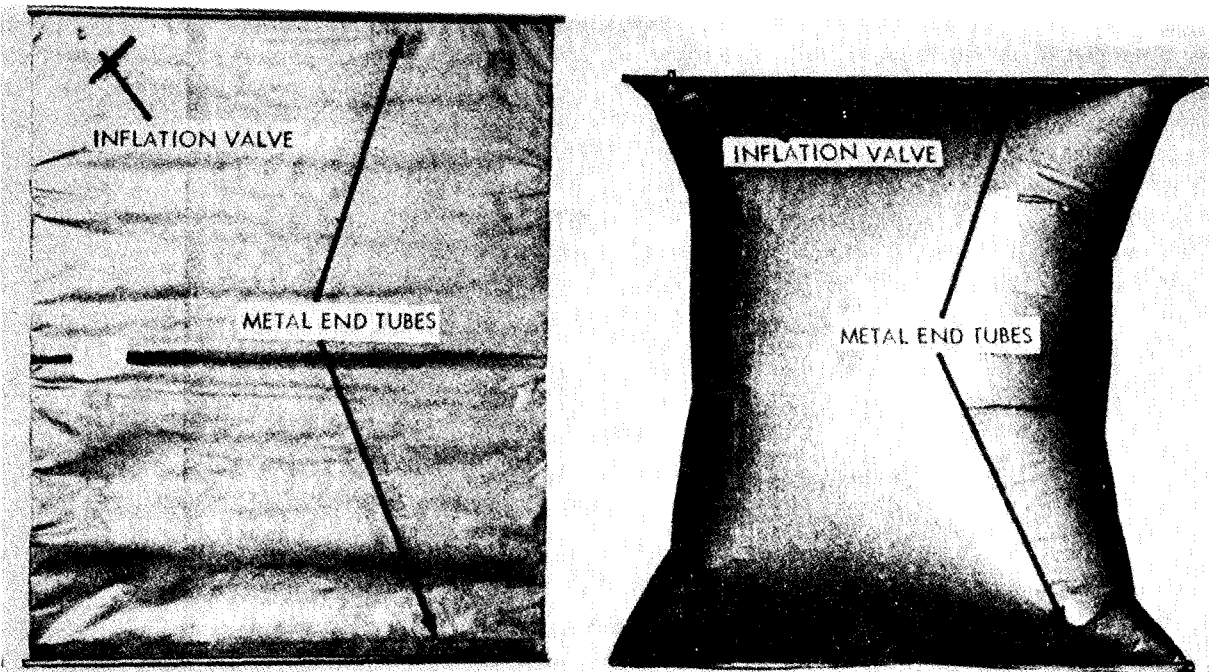

Figure 3-43 Disposable pneumatic dunnage unit complete

(2) *Reusable pneumatic dunnage units bear a serial number.* This affords opportunity for control purposes. Units can normally be returned to the shipper without significant expense or problem. When used for dunnaging rail shipments, most tariffs provide for the free rail return of the units by the reverse of the inbound routing. Where

free return is not provided, tariffs will indicate the charges involved. Where return cannot be reasonably achieved, disposable pneumatic dunnage units may offer a cost advantage.

(3) *Disposable pneumatic dunnage.* This type of dunnage, which is designed for a one-time use, consists of an inner bag made of high-density air-

tight polyethylene encased in layers of 100-pound test extensible kraft paper. The outer layer of kraft paper is coated with a weather-resistant polyethylene coating. The ends of the bag are sealed by a procedure in which the polyethylene inner bag and all layers of paper are wrapped around a $\frac{7}{16}$ inch wooden dowel. The inner bag and paper are held in position on the dowel by a $\frac{1}{8}$ inch thick tubular metal sleeve. An inflating valve is heat-sealed into the inner bag. This valve is not designed for rapid deflation of the unit. At destination, disposable pneumatic dunnage is deflated by cutting or otherwise puncturing the bag.

c. Dunnage. Performance and cost are two principal considerations in dunnaging of material in transportation conveyances. Regardless of costs, the selected methods must do the job; however, there is usually more than one method that will achieve the performance goal; hence, cost comes into clear focus. Over many years of experience, the application of fixed dunnage is well understood. This technique is explained elsewhere in this part. So that a method may be properly explored in determining the most preferable dunnage to install under a given situation, the advantages and considerations in the use of pneumatic dunnage are listed below:

(1) Allows more rapid installation and removal than conventional dunnage. Under many applications, this method is more economical in total than other dunnaging methods (see *d* below).

(2) Provides a highly resilient load restraining method.

(3) Provides relatively low pressure bracing (2 to 5 PSI) for loads. (Inflation pressure for pneumatic dunnage units in truck trailers/containers must not exceed three-quarters PSI maximum.)

(4) Is capable of tightening loads in which compactness was not sufficiently achieved during loading; however, efficiency of loading procedures should not be reduced because of this corrective action of pneumatic dunnage. (There is no substitute for proper loading, regardless of type of dunnage material used.)

(5) Is capable of repositioning cargo loads shifted by sudden impact and also will expand to take up slack developed through normal load jostling in transit. When a load does shift on sudden impact, the dunnage unit cushions the load, whereas fixed bracing does not. This cushioning action is advantageous for even slight impacts.

(6) Is capable of retaining adequate cushioning air pressure during long-distance shipments up to 30 days.

(7) Is not seriously affected by changes in temperatures and altitude encountered during surface transport (pneumatic dunnage is not for use in aircraft).

d. Comparative dunnaging costs.

(1) Use of pneumatic dunnage can result in substantial savings in certain applications when used in lieu of conventional-type dunnage. To effectively assess the possibilities of savings by use of this method as compared to fixed dunnage in a particular situation, it is necessary to consider the following:

(a) Man-hours required for the dunnage operations as well as hourly rates for workers (skilled car blockers are not required for pneumatic dunnage).

(b) Cost of conventional dunnage material as opposed to the cost of reusable pneumatic dunnage. In the case of reusable pneumatic dunnage, usage cost is obtained by dividing the original cost of the unit by the number of trips expected from the unit (this could range up to 100 or more trips).

(c) Miscellaneous costs to include any cost of the return or reusable pneumatic dunnage as well as administrative costs to control accountability. Maintenance of the reusable units is considered negligible.

(d) Salvage value of conventional dunnage.

(e) Dunnage removal costs.

(f) The choice between use of disposable or reusable pneumatic dunnage. Where the return of dunnage units can be reasonably assured, the reusable types are generally the more economical to use. The choice to be made is not solely a judgment as to whether pneumatic dunnage is more economical to use than the more conventional method. A further determination must establish which type and size of pneumatic dunnage offers the greater cost advantage.

(g) A loading pattern which results in the very minimum void space so as to eliminate the use of any dunnage is the most economical procedure. When applied to specific dunnaging problems employing various methods for staying a load, the savings to be realized through application of pneumatic dunnage are in direct relation to the type and extent of conventional dunnage which would otherwise be utilized.

e. Accessories. In addition to a source of compressed air, an inflation kit (fig 3-44) is required for the use of pneumatic dunnage (reusable or disposable). This kit consists of an air pressure gauge 0-15 pounds with 1 pound graduations and an inflator gun (air chuck) with a $\frac{1}{4}$ -inch inside pipe

thread. The gauge and gun are each fitted with a special rubber tip that seats into the valve. On occasions where inflation pressures must be more

finely controlled (such as use in truck trailers or when dunnage is securing fragile or critical items), an inflation gauge with 1/4-pound graduations should be used.

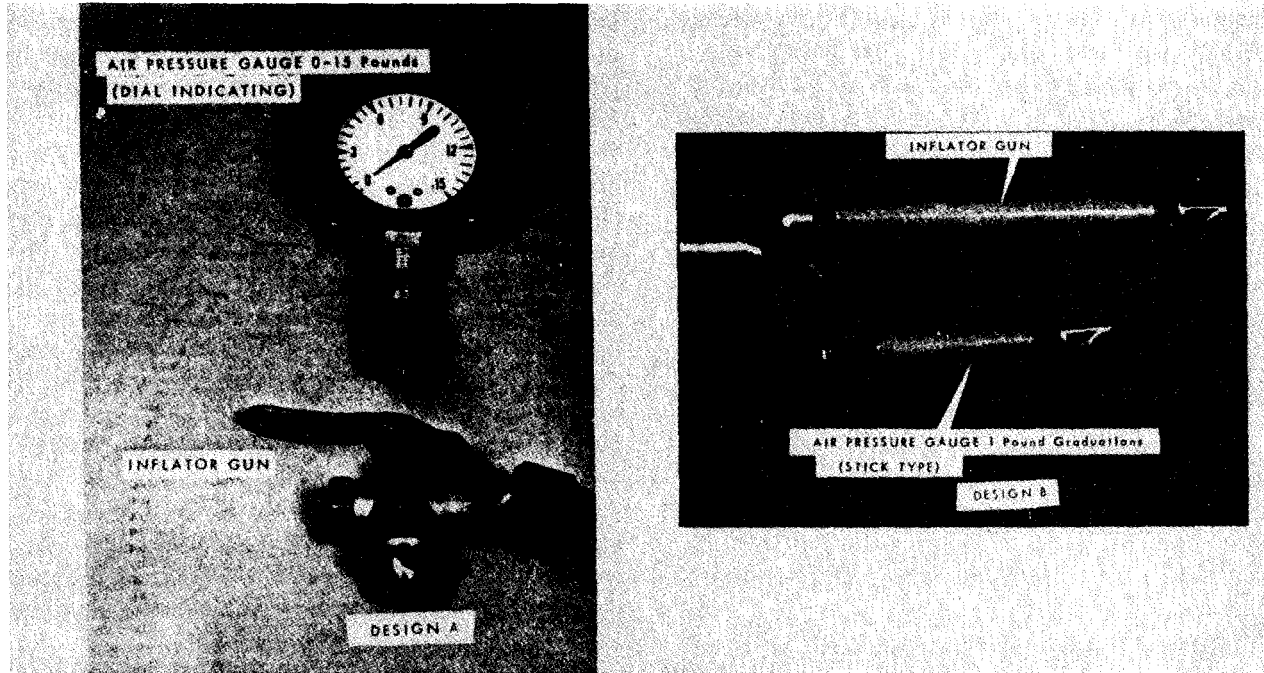

Figure 3-44 Pneumatic dunnage inflation kit

f. Placement.

(1) Consideration of the characteristics of pneumatic dunnage is required prior to use. Pneumatic dunnage units secure load contents by exerting pressure against the cargo surfaces facing the void; therefore, it is necessary that the profile and physical makeup of the surfaces be capable of accepting the pressures involved. Packaged or unpackaged items of a very irregular contour or with sharp or pointed edges may pose a problem in use or may cause damage to the pneumatic units. Rough surfaces can also cause abrasion and wear. Cargo must afford a rather solid, even surface for pneumatic dunnage contact. The use of buffer boards (plywood, fiberboard, or lumber) to spread pressures over a greater area may be desirable in some cases to ensure optimum results in use of pneumatic dunnage. Since cargo is loaded from the ends of a railcar to the center, void space results at the door area in the center of the car. Unless an extremely fragile load is involved, there is no need to shore cargo with dunnage units at ends of a car as adequate dunnage units in the center of the load will compress cargo against the

ends of the car. Use of dunnage units on top of a load is not necessary since the weight of cargo and lateral pressure of dunnage units will restrict vertical movement. Pressure exerted by the dunnage units will also generally restrain lateral movement of cargo. Additional units may be used for positive insurance against any excessive lateral movement of fragile or critical material.

(2) Pneumatic units are designed to fill a 12-inch void when inflated to 2 to 5 PSI air pressure. (Pneumatic dunnage used in truck trailers/containers should not exceed three-quarters PSI as sides or ends of trailer may be deformed by greater pressures.) Where cargo loading would result in a void significantly larger than 12 inches, the load should be planned, if practicable, to provide separate smaller voids. In the interest of load security (maximum cushioning) and wear upon the units, the dispersion of dunnage units to several points in the load is usually more desirable than placing two or more bags directly against each other to fill a large void. A point to emphasize is that the initial inflation of pneumatic dunnage within a void normally results in a 2- to 6-inch expansion of the

void depending on the cargo load characteristics, hence, what was a 12-inch void may finally measure 14 to 18 inches.

(3) For load configuration adaptable to pneumatic dunnage use, each conveyance with a void space of approximately 12 inches after cargo loading (across width of conveyance) can accommodate positioning of at least one unit of pneumatic dunnage or a row of the units to restrain the cargo. Figures 3-45 through 3-51 illustrate various sample patterns that may be used to adapt

pneumatic dunnage to the various load voids and configurations. Note that dunnage arrangement must be designed to secure the entire lading. Buffer boards (may be of various types depending on lading features) should be inserted when rough surfaces of load may puncture or abrade the pneumatic dunnage units, or when pressure of the inflated units may damage the cargo, or where the load faces offer a pattern that would be difficult to stay without buffers. These figures depict either disposable or reusable units.

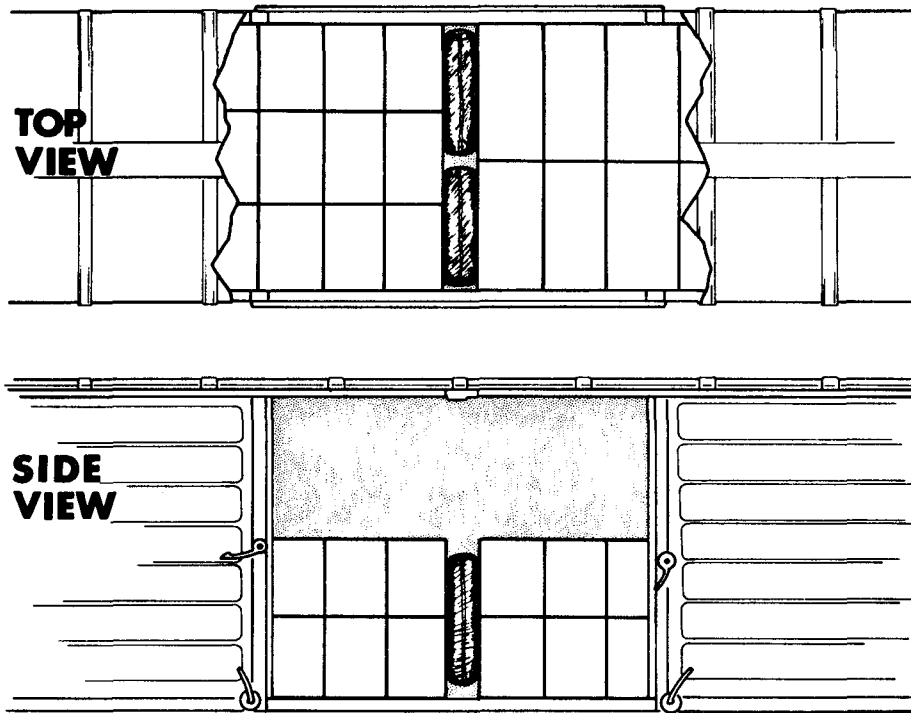

Figure 3-45. Single void pneumatic dunnage bracing pattern

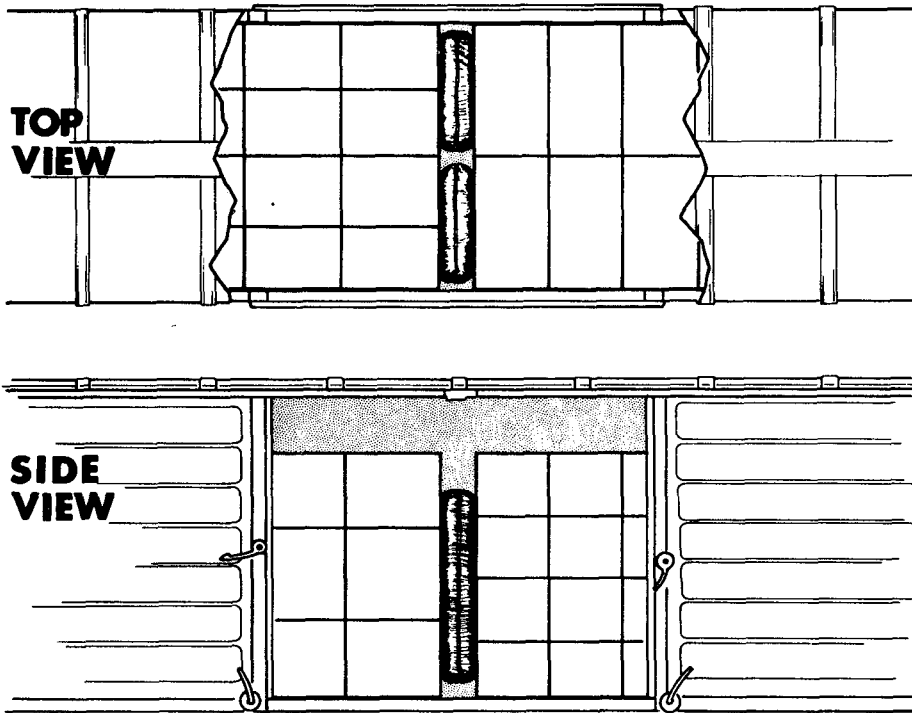

Figure 3-46. Larger dunnage units bracing higher loads

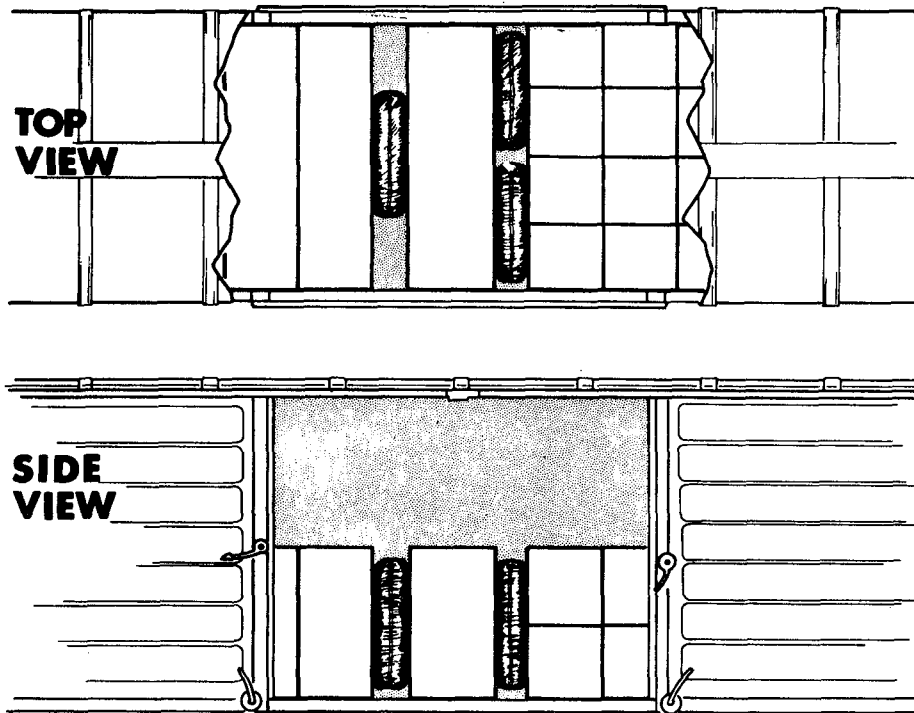

Figure 3-47. Multiple void bracing with pneumatic dunnage units

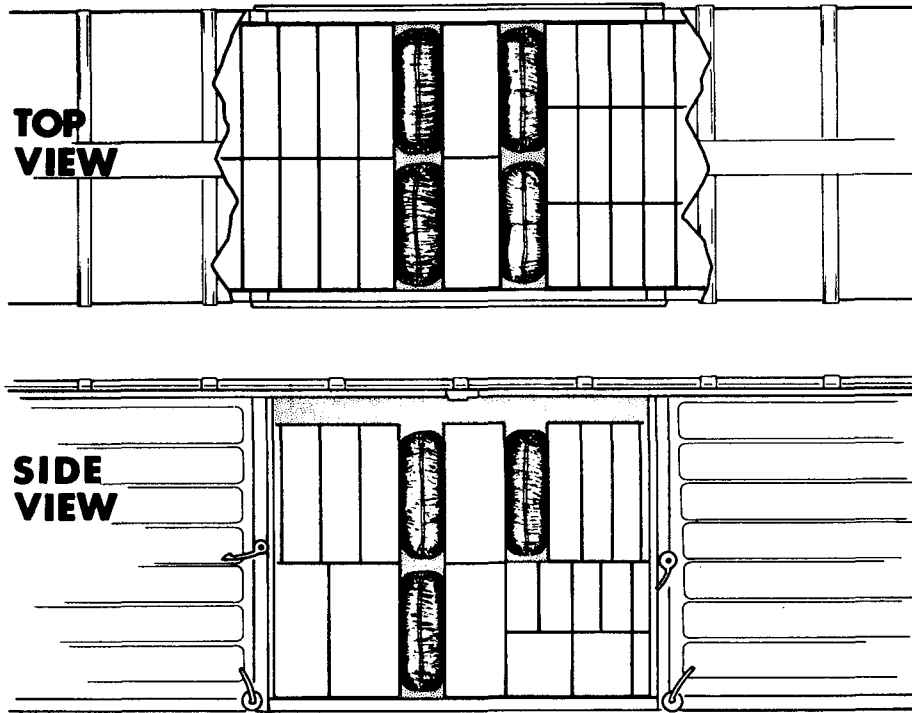

Figure 3-48 Pneumatic dunnage units in various void arrangements

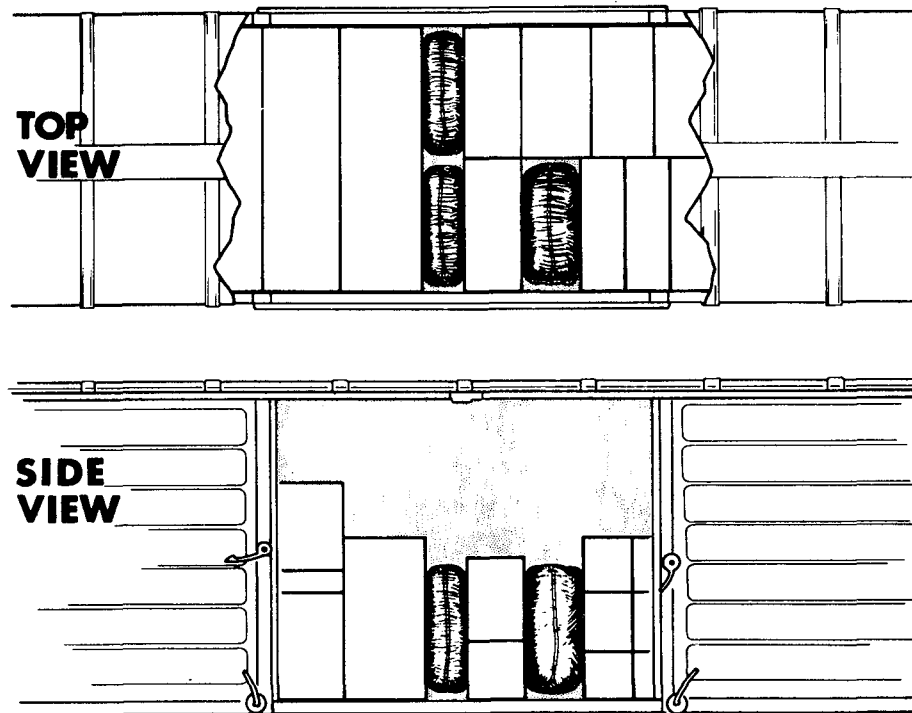

Figure 3-49. Pneumatic dunnage units staying load of various package sizes

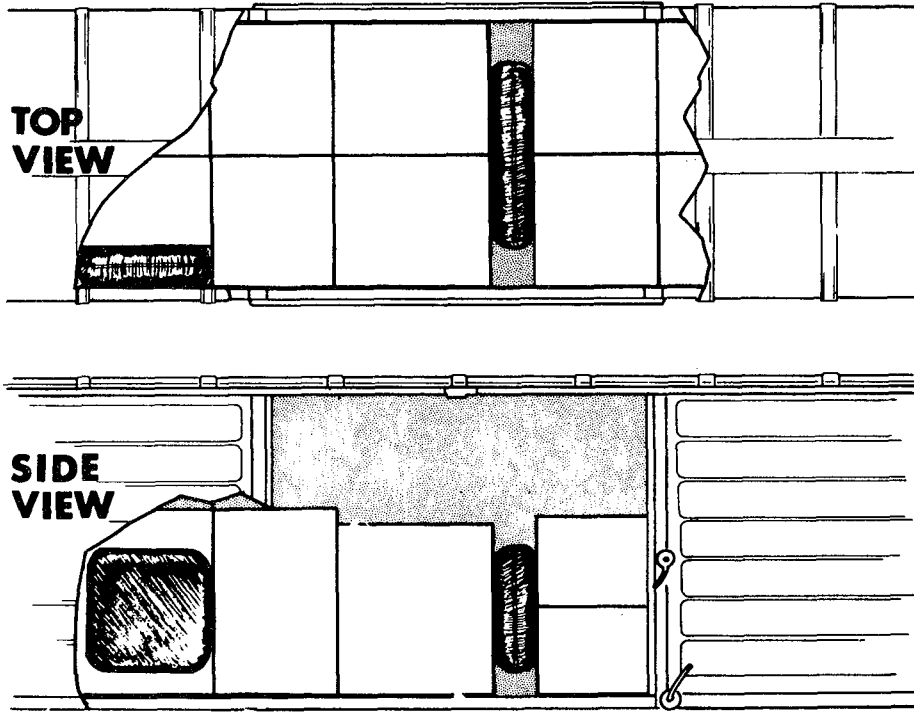

Figure 3-50 Pneumatic dunnage stays load laterally and longitudinally.

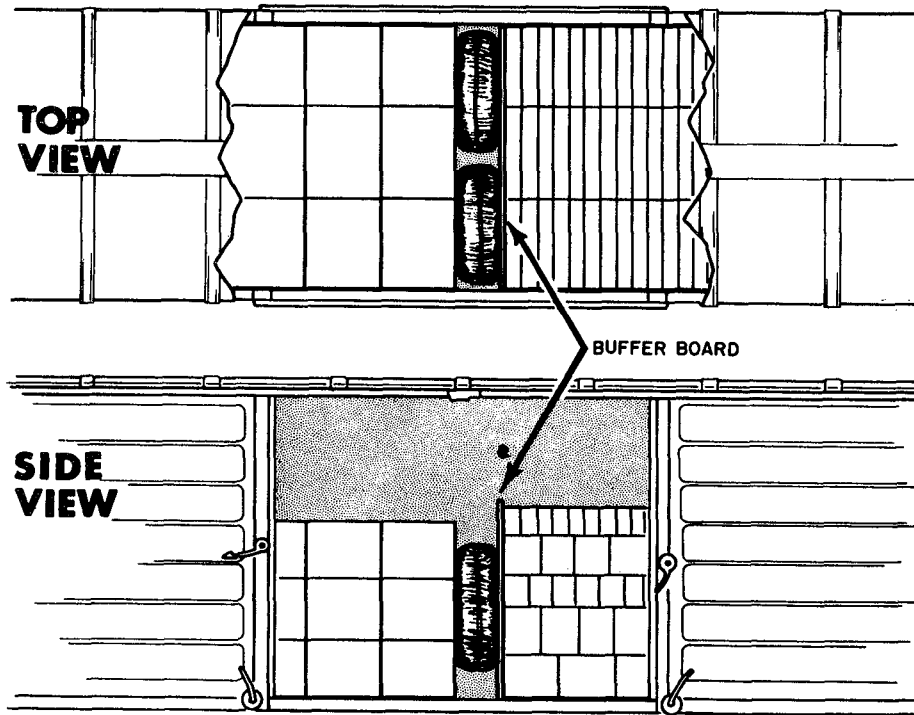

Figure 3-51 Buffer board insertions.

g. *Operational procedures.*

(1) *Installation.*

(a) Measure void space between cargo surfaces where dunnage units are to be inserted. Determine the number of units required based on horizontal and lateral void spaces, number of rows of cargo, number of tiers of cargo, and characteristics of cargo. Determine size of units required based on dimensions of surfaces facing the void. Determine the number of buffer boards required, if any.

NOTE

Loading practices which ensure tight cargo positioning will minimize void spaces between containers and reduce cargo movements upon dunnage inflation.

(b) Position dunnage units to ensure maximum effective contact with the part of the load they are to brace. Top tier units of a 2-tier installation which must be inflated several feet above the car floor may be suspended in position for inflation by hangers attached to dunnage handles (fig 3-52). This can be accomplished by spanning the void space with a bar across the top of the two load sections and then suspending the bags with two hangers hooked through the dunnage handles. Bags are then inflated just enough to secure the units in position. At this point, the suspending hangers and crossbar should be removed to prevent binding the hangers against the bags. Care should be taken to assure that valves are positioned for ease of inflation/deflation and pressure readings.

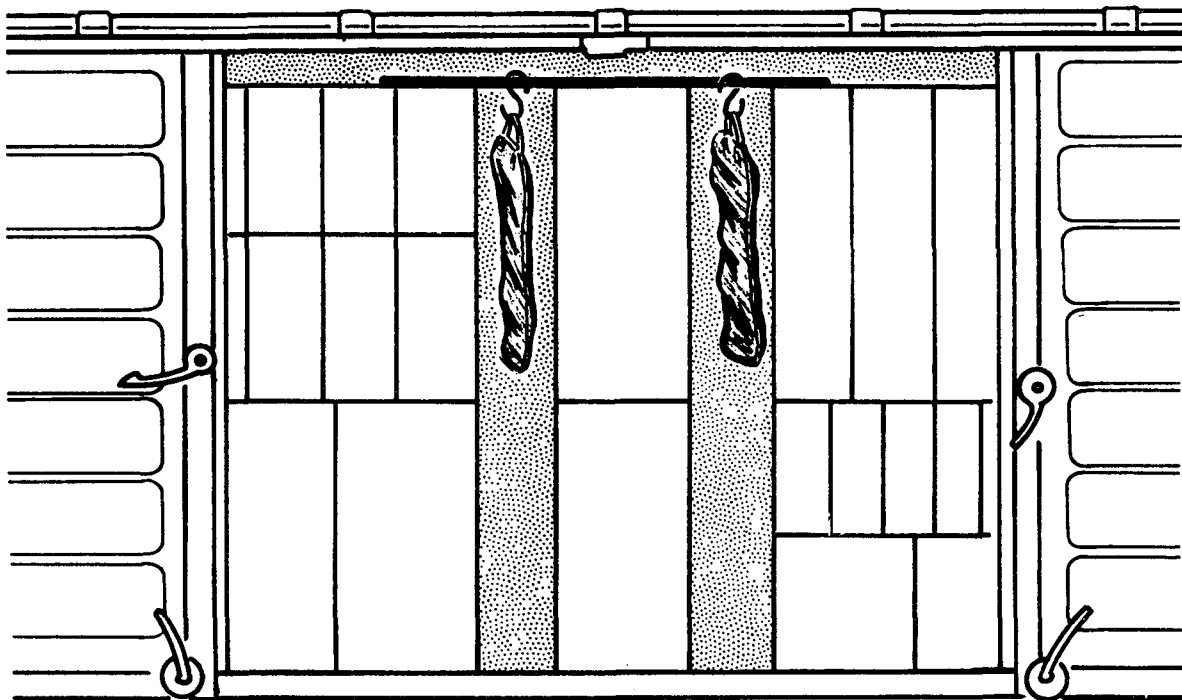

Figure 3-52 Technique for hanging dunnage units preparatory to inflation

(c) Inflate each unit to proper air pressure using air compressor/air supply and inflation kit. When more than one unit of pneumatic dunnage is placed in a conveyance, the inflation process should be alternated from one unit to another until all units reach desired pressures. This will assure that each unit will assume regularity in contour and size with subsequent firm positioning. Inflation requires only a few minutes per unit depending upon output volume of air compressor/air supply. A high volume air supply is most suitable.

Each unit is designed to normally cushion within a 2 to 5 PSI range as restricted by load characteristics. Pressure may be increased to a maximum of 8 PSI, depending on load characteristics, when initially compacting cargo. (Reminder: three-quarters PSI max in truck trailers/containers.) This over inflation must then be "bled off" to the proper shipping pressure. When inflation is completed, tighten each valve stem by hand (do not use a wrench or pliers to tighten valve). Properly inflated and positioned units will maintain correct contour in

void space, but an unrestrained, insufficiently restrained, or overly inflated unit will tend to assume a round shape and will transfer excessive pressure to a limited area of the cargo facing. When inflating disposable pneumatic dunnage, inflate the unit slowly until the bag has filled out; rapid inflation has a tendency to crystallize the polyethylene liner opposite the inflator valve.

(d) Measure the resultant void. If excessive void is present, deflate units. (This deflation process is more suitable for reusable units as disposal units do not provide rapid deflation using valve fixture.) Reposition cargo, if practicable, or insert additional dunnage units in the void. When dunnage units are correctly installed, they must be deflated to the normal shipping PSI, usually 2 to 5 pounds (three-quarters PSI max inflation in truck trailers/containers) depending on cargo characteristics. As mentioned above, deflation process is slow with disposable units so excessive pressures should not be built up.

(e) Figure 3-53 illustrates an application pattern in the use of disposable or reusable pneumatic dunnage units. Observe that figure 3-53, depicting a marine carrier application, shows multiple dunnage units positioned side-by-side for void filling. In this area of use (marine), this procedure has proven acceptable, notwithstanding the comments in *f(2)* above.

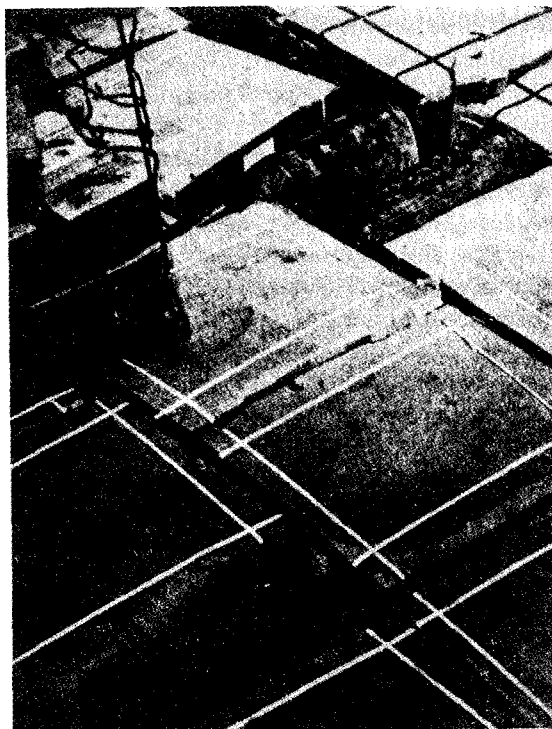

Figure 3-53 Variable sized voids occupied by dunnage units in storage

(2) Removal.

(a) Cut or otherwise puncture the disposable pneumatic dunnage units at any desirable location on the bag and remove from conveyance.

(b) Deflate the reusable pneumatic dunnage units by releasing the valve. Make sure that deflation of unit(s) will not permit any unsupported cargo to fall or shift to an unsafe position. Upon removing the unit from conveyance, roll up toward the valve end to force the exit of any remaining air. This should be done immediately upon removal and the valve components retightened to prevent valve damage or entry of foreign material. Units removed at destination should be marked for inspection and repair, as appropriate. Dunnage units should be placed in a protected storage area if not to be immediately returned to shipper. See *b(1)* above on return of units. Keep buffer boards for further use, if practicable, upon removal from carriers.

h. Care and handling of pneumatic dunnage units.

(1) Reusable pneumatic dunnage units should be stored in areas that are relatively cool and not exposed to excessive sunlight. A convenient means of storing the units is to lay them out on pallets equipped with superstructures so as to avoid excessive superimposed weight. Normally, not more

than 25 units should be contained within such a storage aid. The units, with male valves securely fixed in closed position, are to be laid flat. Folding of the units for storage will tend to cause deterioration of the unit at the fold area should they remain in such position for extended periods, especially with weight imposed on them. Disposal pneumatic dunnage units do not require any more protection in storage than given to other paper products. They can be stored in the receiving container. Disposal units have a recommended shelf-life of 12 months.

(2) A reusable pneumatic dunnage unit must be inspected and repaired, as necessary, when puncture, abrasion, valve failure, or other defects are evident.

(a) Inspectors should consider valve components and surface of casing; mark areas requiring patching. If punctures cannot be detected by visual inspection, inflate unit to 6 pounds pressure, and brush soap suds over the valve area and other areas of the bag to test for suspected leaks. Bubbles indicate leaks and these leaks should be clearly marked for repair. A sure way to determine the pressure retention capabilities of the units is to inflate them to 4 to 6 pounds PSI, then set aside for

24 to 48 hours. A final check would then be made before use to assure that they are holding adequate pressure.

(b) Repair of reusable pneumatic dunnage units can be accomplished as follows:

1 Install new valve parts if inspection indicates a leaking valve.

2 Patch punctures or tears. The damage area must not exceed 6 inches in length nor be within 3 inches of valve or bag seam. Repairs will be accomplished with repair kit (available from dunnage unit manufacturers). The instructions included with the kits should be carefully followed. Reusable dunnage units with major damage such as valve deformation, seam damage, or any damage within 3 inches of the seam or valve should be returned to the manufacturer for repair if the projected remaining life of the unit justifies such action.

NOTE

For bladder-type units remaining in system, the repair considerations above will also apply to the bladder.

3 Since disposable pneumatic dunnage is for one-time use, there is no inspection for repair nor any processing for return to shipper.

Section X. Unit Loads

3-85. Policy.

Maximum use will be made of unitized loads where such use will result in an overall economy to DOD. To conserve time, manpower, equipment, and reduce the possibility of pilferage, unit loads will be used in receiving, storage, and shipping operations wherever practicable. Items which can be palletized will be formed into unit loads as soon as received and handled as units throughout the entire storage and materials handling operation. Individual procedure publications/drawings will be issued by the military services to cover palletization of explosives and ammunition commodities. It is mandatory that these publications/drawings be used when palletizing explosives and ammunition.

3-86. Principles of Unit Loads.

a. The combining of numerous items into a unit load of appropriate size which can be handled with available equipment and within existing facilities is most economical. The larger the number of items handled as a unit, the smaller the handling cost per item. The savings by this method can offset the initial cost, operation, and maintenance of

the mechanical equipment required to lift and transport the heavier loads.

b. To minimize double handling of material, nonpalletized items which are received in quantities suited to palletization will be palletized at the earliest practicable point during the receipt process (fig 3-54).

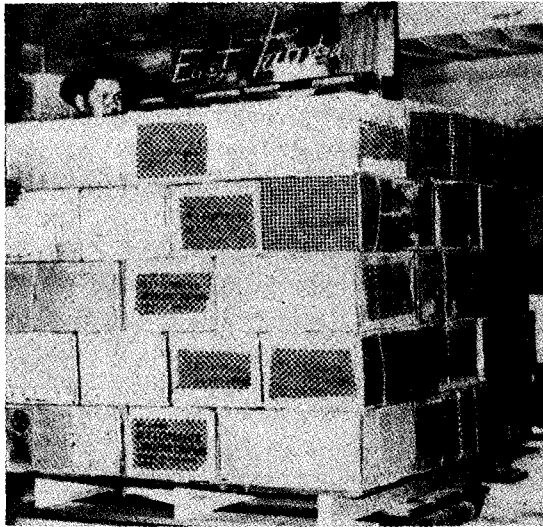

Figure 3-54 Cartons palletized close to stock for unit handling

c. Practical limits to the application of unit loads include the physical characteristics of the items, size of pallet, storage area, elevators (size and capacity), size of doors, capacities of available MHE, and aisle widths.

d. Generally, large rigid items such as lumber, pipe, and bar stock need not be palletized, but can be bound into unit loads for mechanical handling. As much tonnage as possible will be hauled in a single trip.

e. The unit load principle can also be applied to the design of the container for individual units or items. For example, a 50-pound unit can be handled in less time and at less cost per pound than two 25-pound units. However, the weight of any unit or container that must be eventually manhandled will be limited by the strength of the average man. For this reason, the gross weight of these containers or units should be limited to no more than 70 pounds where possible.

3-87. Types of Unit Loads.

a. *Unit load.* A unit load is normally composed of two or more pieces or containers handled as a single unit. Generally, the unit load will be supported on a pallet or on a base so designed that the load can be picked up from any direction by mechanized handling equipment. When a special base is not provided, the material will be arranged and tied in such a manner that handling as a unit load will be possible.

b. *Palletized and containerized unit loads.* Definitions, methods, materials, and techniques concerning palletized and containerized unit loads on

standard general purpose pallets, skids, runners, or pallet-type base will be in accordance with MIL-STD-147 (Palletized Unit Loads).

c. *Bonded unit load.* Frequently, because of the type of material or items to be transported, or because of shocks and movement which may occur while in transit, it will be necessary to bond the items comprising the unit load. The items will be formed into a bonded unit load (with or without a pallet) by means of adhesive, strapping, edge protectors, or other storage aids designed for this purpose (fig 3-55). The bonded load will be designed to remain as a unit from the place of assembly to the ultimate place of use throughout all phases of storage, handling, and shipment.

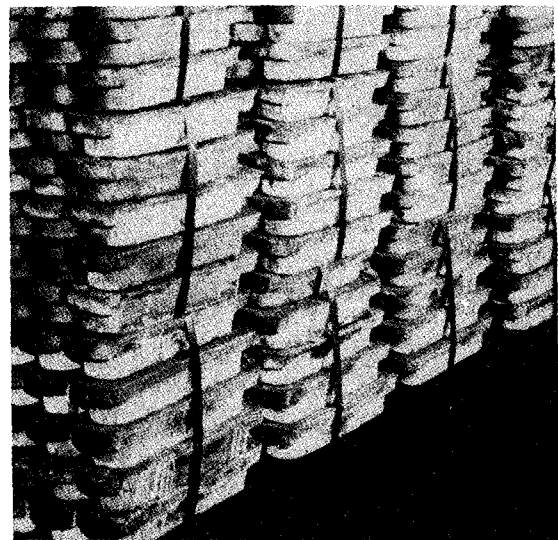

Figure 3-55. Bonded unit load

d. *Nonbonded unit load.* Nonbonded unit loads will be a type or shape that can be deposited, without bonding, or a load base and transported as a unit during normal handling and storage operations (fig 3-56).



Figure 3-56. Nonbonded loads

3-88. Advantages of Unit Loads.

a. Economy. Unit loads provide an economical means of handling, storing, and transporting by eliminating manual handling of individual items and minimizing the incidence of pilferage.

b. Speed in handling. With unit loads, more tonnage can be moved in less time than is possible with other handling methods.

c. Utilization of cubic space. Material in unit loads can be mechanically stacked to greater heights, thus, utilizing a greater percent of available cubic storage space. Covered space is expensive; therefore, increased utilization will decrease the overall cost of storage. During periods of increased receipts, the demand for storage space frequently exceeds the supply. Utilization of cubic space is even more important at this time.

d. Decreased damage to material. Incidence of damage to material handled under the unit load concept will be much less than for material handled as individual containers through all steps of storage and transportation.

e. Safety. Handling of material in unit loads is safer for personnel. Many of the accidents most common to storage operations occur where individual container handling is involved.

3-89. Unitizing Methods.

a. Nonpalletized unit loads. Usually, non-palletized unit loads (including lumber, steel, and bar stock) whether assembled for storage or shipment will be much larger in length than the normal palletized unit load. However, the dimensions of non-palletized unit loads should not exceed 48

inches in either width or height (figs 3-57 and 3-58). Notably, 48-inch high loads cannot be double stacked into 8-foot vans.

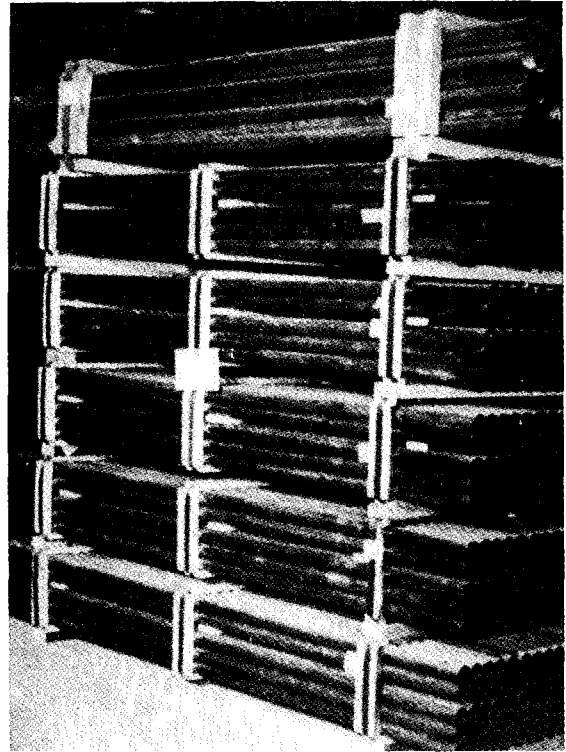

Figure 3-57 Nonpalletized unit load of boiler tubes.

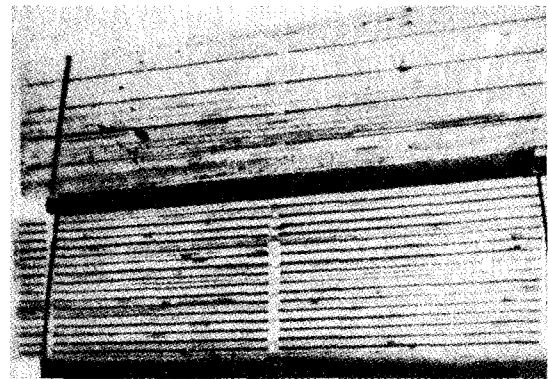

Figure 3-58 Nonpalletized unit load of lumber

b. Use of storage aids. Storage aids such as dunnage, collars, spacers, separators, strapping, and others should be utilized when necessary to secure, holster, or protect unit loads in storage as well as loads prepared for shipment. For details in the use of these aids for storage purposes, refer to chapter 5. For their use in shipping functions, refer to MIL-STD-147.

c. Cube dimension and weight requirements of unit loads.

(1) The detailed requirements concerning unit load cube dimensions and weight are contained in MIL-STD-147.

(2) Palletized unit loads made up for storage and not for shipment may exceed the height and weight limitations specified for unit loads designed specifically for shipment. Deviations will be limited to the following:

- (a) Capacity of MHE.
- (b) Stacking height of the unit.
- (c) Unusual shape or size of items.
- (d) Storage capacity of the building or storage area.

3-90. Unitizing Loads by Shrink Wrapping.

a. Definition. Shrink wrapping A technique of packaging in which the strains of a plastic film are released by raising the temperature of the film, thus, causing it to shrink over the package.

b. Types of shrink equipment. The major types currently available are—

(1) *Shrink chamber.* This is a heat chamber or oven (heat source can be gas or electricity) having a single door for entrance and exit and a conveyor or movable platform to transport the load. The operating temperature is automatically controlled and the time the load is subjected to the heat is either automatically or manually controlled. Length of load time in the chamber depends on film thickness and film type. Approximate capacity is 30 pallets per hour.

(2) A hand-held gas-fired gun is used for remote shrink-film operations (fig 3-59). This is designed to shrink wrap small cartons to full pallet loads. It uses natural or propane gas fuel; electricity is not required. All shrink films can be used with this item.



Figure 3-59 Hand-held, gas-fired gun for remote shrink-film operations

c. Types of shrink film available.

(1) A variety of shrink films is available and the user must assess his particular requirements to determine the density and type of film to be used. There are two general categories of film, sheets (figs 3-60 and 3-61) and preformed bags (figs 3-62 and 3-63).

(2) The preformed bags are more widely used, each type being available in a wide range of thick-

ness, construction, and sizes. Some of the shrink films available are listed below:

- (a) Polyethylene.
- (b) Polyvinylchloride.
- (c) Polystyrene.
- (d) Polypropylene.
- (e) Polyester.
- (f) Polyvinylidene chloride.

(g) Rubber hydrochloride.

d. *Shrink-film characteristics.*

(1) Because of its performance characteristics and low cost, polyethylene film is the most widely used. The ability to stabilize heavy loads becomes apparent when it is realized that the applied

shrink-film surface area is approximately 10 percent greater than the surface area of the palletized load. Shrink tension is thus applied after this 10 percent has been shrunk to fit the contour and allows the film to become a structural part of the package.

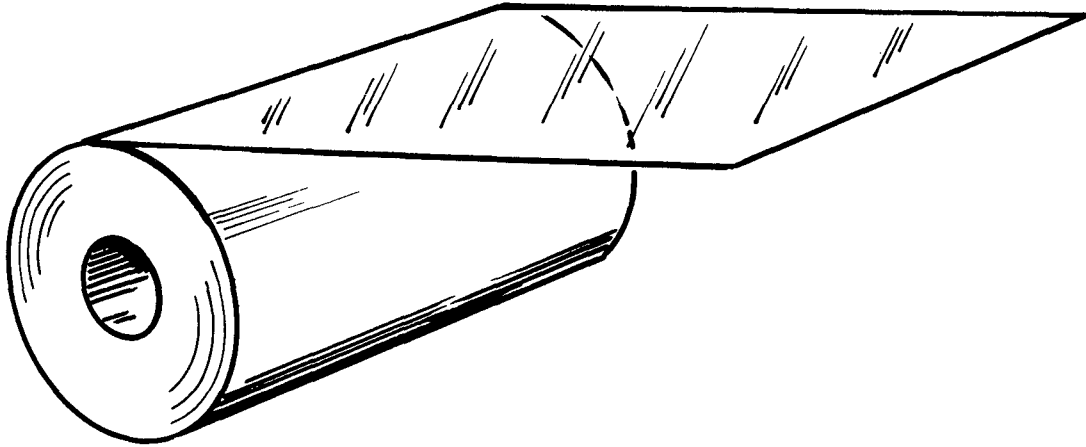

Figure 3-60 Flat sheeting

(2) In film production, controlled stretching builds stress characteristics into the film. Heating the film releases the built in stresses causing it to

shrink. The film shrinkage can be controlled in two directions, either in the circumferential direction or height of the load.

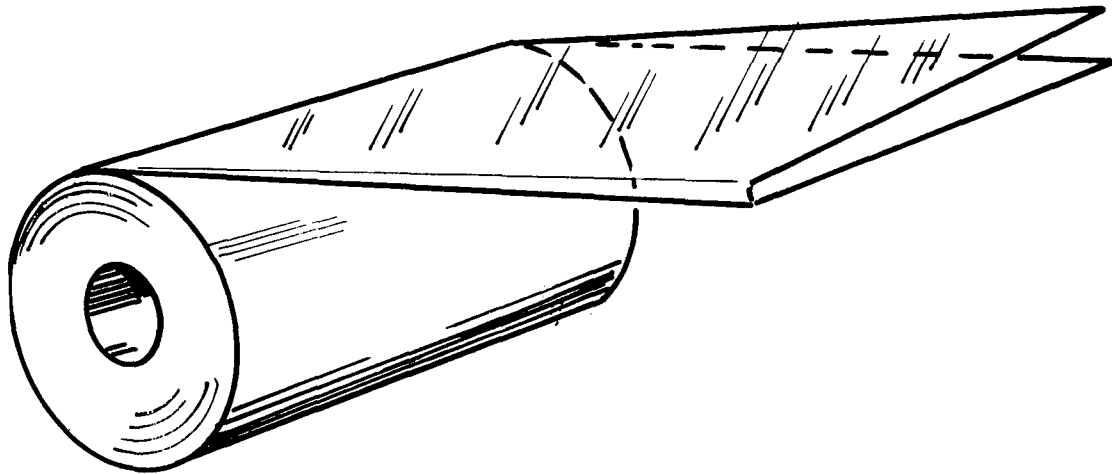

Figure 3-61 Centerfold sheeting.

(3) Thickness of polyethylene shrink film used varies, depending on the restraint requirements. Most industrial applications use film 2.5 to 8 mils thick. The ability of film to stabilize a heavy load is easy to visualize when one realizes that a restraining force of 2,000 PSI sometimes occurs over the entire area of the load surface. This factor, to-

gether with the inherent elasticity of film, makes it an outstanding containing medium.

(4) Shrink-film bags can be either centerfold or gusseted types (figs 3-62 and 3-63). The centerfold bags are rolled, sealed, and perforated from centerfold film and have their primary shrink around the circumference of the load. This type of

shrink direction gives a more consistent shrink and tends to keep film from pulling away from the bottom of the pallet. This factor is extremely important since the purpose of the application is lost if the film does not tightly grasp the pallet. The gusseted bags are rolled, sealed, and perforated

from gusseted tubing. The primary shrink here is in the vertical direction rather than the circumferential. This type of shrink direction tends to cause the film to pull away from the bottom of the pallet. This can be controlled by guiding the heated tunnel air primarily to the bottom of the pallet.

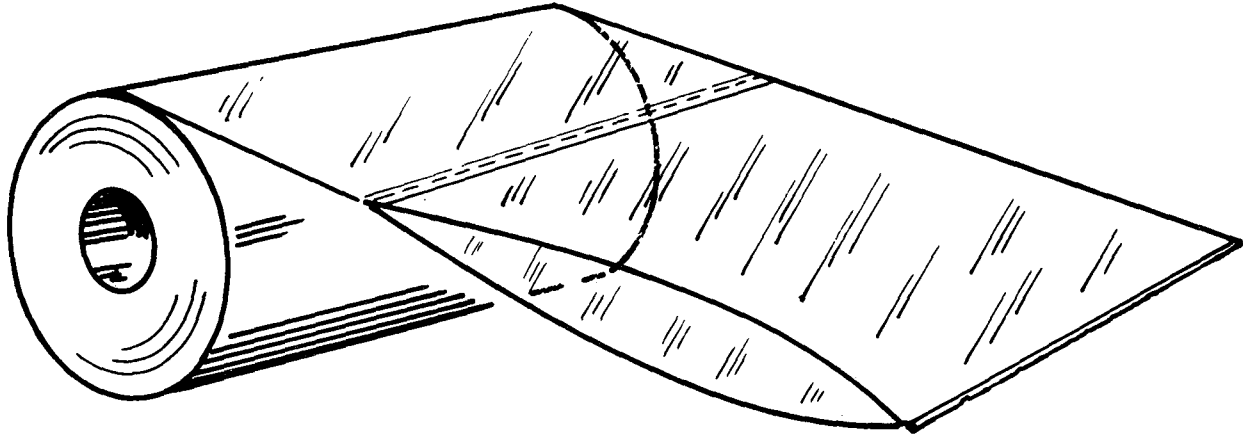

Figure 3-62 Centerfold bags.

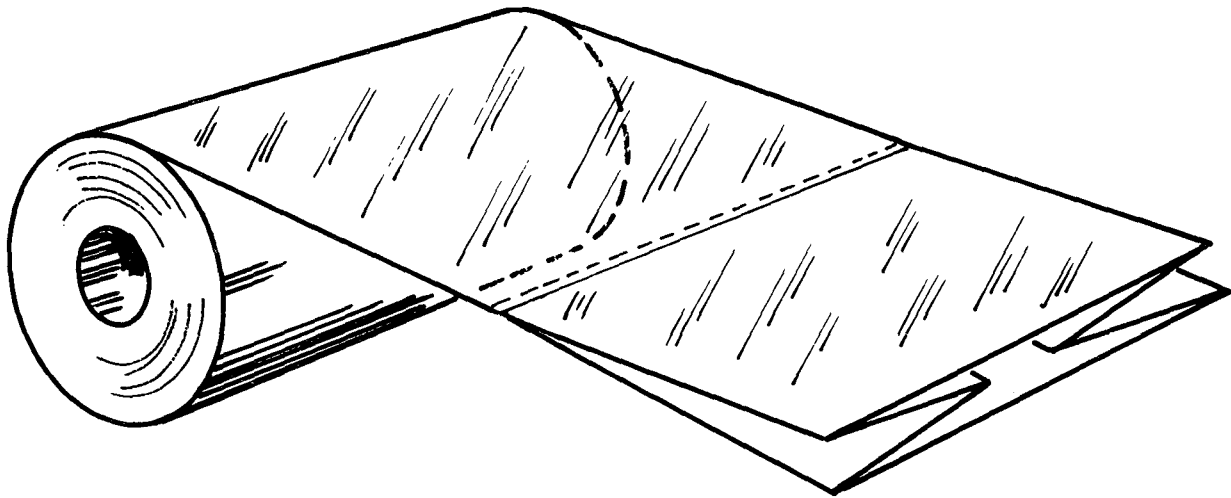

Figure 3-63 Gusseted bags.

e. Determining film bag size and thickness. Bags are specified by width, depth, length, and gauge.

(1) Bag size determination is based on the following:

(a) Width—approximately 4 inches more than load width.

(b) Depth—approximately 4 inches more than load width.

(c) Length—one half of depth of load plus height of load (including pallet) plus 4 inches.

(2) Thickness (gauge) of the film material needed is determined by the weight of the pallet load and type of film to be used (para 5.1.2.3., MIL-STD-147).

f. Advantages of shrink wrap. The advantages of shrink-wrap palletizing make it desirable for many load bonding applications.

(1) Shrink films conform to odd shapes and sizes thereby offering greater versatility in package size reduction than conventional strapping.

(2) Strapping impressions and product abrasion are eliminated.

(3) The overwrap of shrink film shields the load from outside moisture conditions and also prevents dust collection on the material. The load will frequently lend itself to temporary outside storage thereby easing warehouse problems.

(4) Shrink-film overwrap deters pilferage by making entry obvious when it has occurred. Opaque film is also available which prevents ready identification of specific contents of the pallet.

(5) Shrink film is more safely removed from the pallet load than conventional metal strapping.

(6) Shrink wrapping is more economical than the standard combination of corrugated triple-wall containers and steel strapping.

g. Disadvantages.

NOTE

Many of the disadvantages listed below also apply to conventional metal strapping methods.

(1) Shrink wrap does not add stacking strength. Stacking strength of noncartoned loads depends upon the strength of the commodity.

(2) Shrink wrap provides no protection from impact forces on sides or top of load.

(3) Interlocking pallet patterns are particularly important in order to take advantage of the frictional forces of the package surfaces to provide load integrity.

(4) For best results, outside dimensions of the load should be close to or slightly less than the size of the pallet to allow the film to cling to the pallet. (Film will perform adequately, in most cases, even with a material overhang.)

(5) Plastic film is elastic in varying degrees. Thickness and density of film must be carefully selected to provide sufficient tension to maintain load integrity.

(6) When pallet loads are stacked, nailheads, splinters, or a rough surface of the upper pallet can abrade or tear film. (Such abrasions or tears, however, will not spread further by themselves.)

(7) Most films are adversely affected by sunlight. (Ultraviolet inhibitor film can be used where this protection is desired.)

(8) Satisfactory application of film requires precise control of temperature and time during the shrinking process.

(9) Shrink ovens occupy more space than conventional strapping equipment.

(10) Some minor heat loss occurs in most convection-type shrink ovens. This must be considered if such units are to be used in refrigerated areas.

(11) Shrink equipment for high-speed operation is more expensive than conventional equipment. (This can be offset by labor savings and increased production.)

(12) Film envelope provides poor ventilation. Remember, film use is not a method of packaging protection, but a device to bond loads for movement from shipper to customer. Condensation build-up must be considered when selecting film, because certain commodities may be adversely affected.

(13) Some types of film may pose disposal problems. However, polyethylene is the most commonly used and can be easily recycled. If recycling is not feasible, incineration or disposal in sanitary landfills is preferred.

h. Safety. Shrink-film operations will be inspected at least every 3 months by installation fire prevention, safety, or health personnel. Matters such as ventilation, use of protective equipment and clothing, and potential fire conditions should be included in this inspection.

i. Items not suitable for shrink-film application. Few products need to be eliminated from consideration for shrink processes, even though they may be exposed to 500 °F. or higher, during the shrink process. Tests have shown that the temperature under the shrink film normally rises only a few degrees above the room or area temperature in which the packaging takes place. Products that are excluded from the shrink methods and procedures described because of their extreme heat sensitivity are ammunition, nuclear explosives, POL, and other flammable materials.

3-91. Unitizing Loads by Stretch Wrapping.

a. Definition of Stretch wrapping. A process of enclosing a load by using a roll stock plastic film bonding to secure contents without the application of heat to the film.

b. Methods of application.

(1) *Spiral.* This method uses a film of a width less than the height of the load. A predetermined number of film wraps are applied to the bottom of the load, the film is spirally wrapped to the top of the load, and a predetermined number of film wraps are then applied to the top of the load completing the wrapping operation. (See figure 3-64)

(2) *Convolute*. This method is identical to spiral, except that the film is spirally wrapped again to the bottom of the load following the application of a predetermined number of film wraps to the top of the load. At least two more wraps of film are applied than in the spiral method using the same machine settings.

c. Equipment.

(1) Stretch-film wrapping machines can be purchased with varying capabilities. Machines can be positioned to operate independently or they can be part of a conveyORIZED feed and take-away system. Sample, hand-held, stretch-film dispensers

are available and can be used to secure palletized loads in limited quantity.

(2) To provide proper control of a stretch-wrapping operation, equipment should have the following features:

(a) Variable speed controls for the turntable and film carriage.

(b) Soft starting (slow acceleration) of the turntable at the start of each stretch-wrap cycle.

(c) For stretch-wrapping operations involving random height palletized loads, automatic load height compensation can be provided by an electric eye mounted on the film carriage.

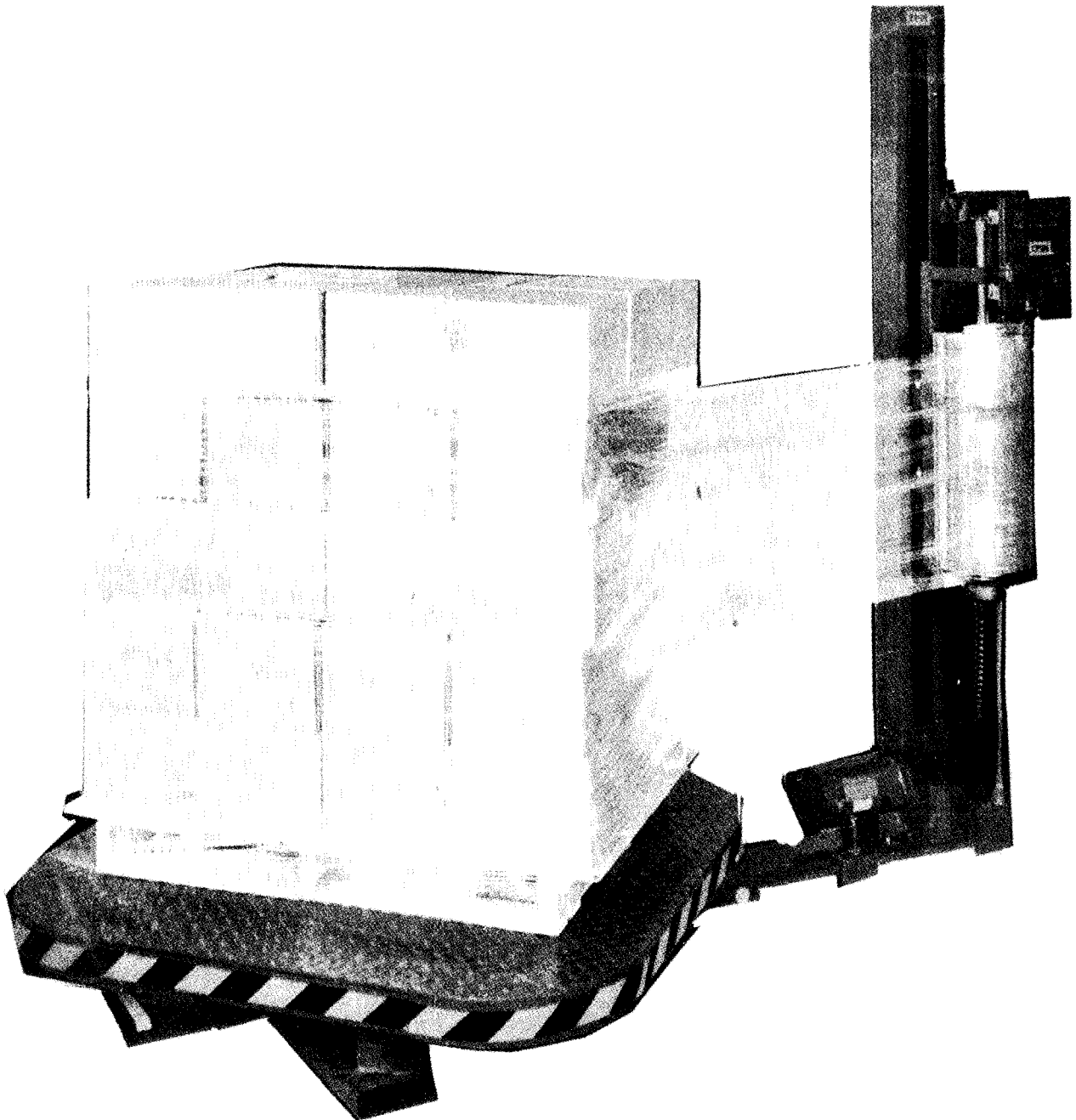

Figure 3-64 Spiral wrapper—narrow film.

d. Stretch-wrap films. Films currently available are polyethylene, polyethylene containing a portion of ethylene vinyl acetate, and polyvinylchloride (PVC) types. A film thickness of 1.5 mils is recommended. Since there is a charge of static electricity built up during a stretch-wrap operation, there is a potential hazard to static sensitive electronic components when this technique

is used. (See Figure 3-64 for one example of stretch-film equipment.)

e. Stretch-wrapping techniques.

(1) Adequate bonding of a load to a wing-type pallet requires overlapping of the pallet with a minimum of 6 inches of stretch film measured from the bottom of the load on the pallet. Also, the film must overlap the top of the load at least 4 inches.

(2) When stretch-wrapping tires, the stretch film must overlap both of the end tires at least 6 inches to assure maximum bonding.

(3) A caution must be observed when tensioning film in the wrapping process. Overtensioning of the stretch film (i.e., stretching the film to near the breaking point) causes the stretch film to lose its elasticity and resistance to rupture or splitting when subjected to shock. Optimum performance of the stretch film occurs when the film is tensioned to a point where a 1-inch neckdown is obtained at the top and bottom of the film as it is dispensed from the roll. This results in a reduction of film width of approximately 10 percent.

f. Advantages and disadvantages of stretch wrap.

(1) Most of the advantages and disadvantages stated in paragraphs 3-90*f* and *g* for shrink film also apply to stretch wrap when compared to other utilizing techniques. There are some additional considerations, however, when comparing stretch wrap with shrink film.

(a) Since the stretch-wrap process does not require heat, the equipment installation is less complicated (e.g., no ventilation needs).

(b) Absence of the need for a heat source allows a less costly operation.

(c) The stretch process can be used in more environments (e.g., cold rooms).

(d) Stretch-wrapping equipment is more portable and easier to reposition.

(e) The stretch-wrapped unit is not as waterproof as a shrink-film unit; however, a top cover can be placed on a load and down the sides before the stretch-wrapping process begins.

g. Items not suitable for stretch-wrap application. Few products need to be eliminated from consideration for stretch-wrapping. However, a charge of static electricity is developed during the stretch-wrap operation, especially during the stretch-wrapping of tires under low relative humidity conditions. The intensity of the static charge varies between the generic films with PVC films developing the highest intensities. Although this static charge is not harmful to tires, it does create a hazard to static-sensitive electronic components or highly flammable materials when either stretch-wrapped or stored in the vicinity of the stretch-wrap operation.

CHAPTER 4

MHE AND PRINCIPLES

Section I. Basic Principles

4-1. General.

a. Definition. Materials handling is the movement of materials to, through, and from productive processes in receiving, storage, packing, and shipping areas. While materials handling practices vary, the basic principles remain constant. Since these basic principles are sometimes overlooked, certain underlying guidelines must be recognized.

b. Least handling is the best handling. The greatest economy in moving materials is secured by not handling the material at all. Since this situation rarely exists, an attempt must be made to keep handling to a minimum.

c. Standardization of methods and equipment aids the materials handling activity. Standardization of equipment results in the reduction of costs of operation, in that, maintenance, repair, storage, and issue procedures can be simplified.

d. MHE must be selected for a multiple number of applications. Equipment selected should be chosen with the consideration that flexibility is the key note (i.e., that it can be used for multiple operations). Therefore, emphasis must be given to the flexibility with which equipment can be converted to handle other jobs.

e. Specialized equipment should be kept to a minimum. Materials handling operations requiring special equipment are costly. Normally, first cost, cost of operation, and maintenance costs are greater for special equipment than for standard equipment.

f. Volume dictates the method of handling materials. The number of pieces to be moved determines the method of handling. Regardless of the size, shape, or value of an item to be moved, the first question to be answered before the selection of method for moving is: How many pieces are to be moved?

g. Advanced planning. Planning on materials handling methods and equipment should be carried on simultaneously with other planning activities and undertakings with full recognition of present and future factors. The most essential phase of any program is planning. To be effective, planning activities in our organizations must be coordinated. As an example, some of the factors requiring advanced planning are—

(1) Protection required against weather or breakage.

(2) Legal and physical restrictions in reference to transportation (e.g., hazardous materials).

(3) The possibility of using unitized loads.

(4) The standardization of equipment and methods.

(5) The combination of materials handling methods.

(6) Consideration of the safety hazards involved.

h. The length and number of moves of materials should be kept to a minimum. Movement paths of material should be studied for the possibility of reducing “backtracking” and length of moves, resulting in better utilization of equipment and personnel.

i. Equipment capacities should never be exceeded. The rated capacities of equipment should never be exceeded. Over-loading causes excessive wear of equipment and creates additional accident potential.

j. Analysis. All materials handling operations should be analyzed for improvement possibilities by elimination, combination, or simplification. Combination of operations may result in the simplification and reduction of the number of times that material has to be handled.

k. Selection of MHE is based on the economies of operation. These economies are measured in the cost of moving the materials. Greater “pay loads” for each handling operation will result in less handling cost per piece.

l. The physical state of materials is a factor in determining MHE. The three physical states of material—solid, liquid, or gas—determine the method of containment (pack). Gases are contained in cylinders; liquids such as acids are contained in carboys; and solids such as sheet and bar stock metals may require wood skids. This, in turn, influences selection of MHE.

m. Straight line flow. The shortest distance between two given points is a straight line. The time required to travel a given distance is reduced by following a straight line.

n. All materials handling operations should follow a defined method. What causes variation in the length of time required for handling a given product? The method used in picking up, carrying to, setting down, and returning from is always the source of variation. The standardization of the method will provide a basis for determining handling requirements. It should be recognized that establishing this method, normally, will not require detailed refinement such as that used in micromotion analysis.

o. Short, irregular moves lend themselves to manual materials handling. Some materials handling operations do not occur with any degree of repetitiveness. The use of equipment for such an operation may be much more costly than manpower. When moves are short, irregular, and load capacity of men not exceeded, it may be more economical to use manpower.

p. Wherever practicable, materials should be prepositioned for the handling operations. Prepositioning places—

(1) Containers in a position to facilitate picking up.

(2) Containers on a conveyor which reduces accidents and lessens equipment damage.

(3) Materials so they won't obstruct other material movements, which may result in reduced materials and equipment damage and a reduction in the number of accidents.

q. Wherever practicable, materials should be moved in a horizontal plane or with the aid of gravity. During loading and unloading, personnel may have to reach either down or up. The excessive effort used might have been greatly reduced if the workplace layout had been planned. The ideal lifting position is at the waist. The nearer to the waist that a container or part can be picked up and disposed, the greater will be the efficiency.

4-2. Containers.

a. Definition. A container is defined as a means which provides the necessary enclosure, arranged so as to properly retain the product and restrain its movement to the degree necessary for protection in handling, storage, and transportation. The proper selection and design consideration given to each container reduces loss or damage to parts and assures protection to the container, especially the reusable types.

b. Within feasible cost limits, minimum materials with maximum strength should be used in container construction. When the possibility of tiering exists, containers should be so constructed

as to support the maximum number of filled containers which may be placed on its top.

c. Container Design and Use. Containers should be designed for shipping and storage as well as for use at point of use. It is often possible to design a container so that it acts as a hopper or supply bin for work in process. When this situation exists, storage area, cost of handling, and container costs may be reduced.

d. Unit load is basic, container incidental. Regardless of the type of container used, the important factor is the method of loading that container. Greater economy is obtained through the use of the unit load as more material can be moved at a single time. The more pieces or pounds moved, as a unit load in a single handling operation, the lower the cost per piece or per pound and the shorter the time required to move any given volume.

e. Collapsible containers. These items require less storage space when empty and can be returned at lower transportation costs. Because of the high transportation costs, it is important that a thorough study be made before selecting returnable containers. Some of the factors to be considered in the selection of returnable containers are—

(1) First cost, including initial shipping from container manufacturer.

(2) Cost of transportation to and from its destination.

(3) Total investment required.

(4) Records involved.

(5) Potential loss resulting from damage to product.

(6) Maintenance cost.

(7) Accumulating, segregating, and storage space involved at both user and supplier stations.

(8) Conservation of material resources.

(9) Number or reuses likely to be made.

f. Containers must be standardized wherever possible. Standardization of containers facilitates materials handling, in that, carriers, loading and unloading devices, conveyors, measuring methods, and methods of handling can be standardized. When containers are standardized, the amount of equipment necessary for handling can be reduced.

g. Unit loads should be increased to the economic maximum. Greater economy is obtained as the unit load is increased, provided container or equipment capacity is not exceeded. The more pieces carried in one load, the greater the efficiency.

4-3. Material Movement.

a. General. Any material movement requires adequate planning, MHE, manpower, and care. Flexibility of the operations is required where a majority of the material moved is widely varied. Operational standardization is generally more economical and feasible where the material remains a constant type, size and shape, or requires the same handling repeatedly.

b. Where economical, personnel should be replaced with mechanical devices. Where volume, size, and/or weight merit, mechanical handling devices can be used economically. Such devices as conveyors, industrial trucks, cranes, etc., aid the loading and unloading activity. Safety hazards can be reduced and protection increased when mechanical devices are used in place of personnel. The opportunity for loss and damage of packages is greatly reduced when manual handling is kept to a minimum.

c. Proper movement will prevent damage. In most instances, loose material is subjected to more damage than properly packed material. Adequate planning should precede any movement operation, recognizing such factors as center of gravity, adequate dunnage, heavy material on bottom, rated capacity of MHE, possibility of container and product damage while in transit.

d. Points of material pickup and delivery should be kept to a minimum. A larger number of pickup and delivery points will increase movement requirements, thus affecting manpower and costs. The possibility of combining several pickup points into one central point should be considered.

e. Where economical, material should be segregated by source or destination. In segregating material by source or destination, unnecessary shuffling and reshuffling of material is eliminated. Segregation of material for this purpose is advantageous in all cases where volume is great enough to warrant it.

f. High priority items should be placed in an accessible location. Proper loading of high priority material will expedite delivery at destination, so it can readily be unloaded.

g. Area, materials, tools, and equipment should be provided at proper locations. In the loading and unloading of box cards, areas for dunnage, strapping, strapping tools, lumber, tools, and other miscellaneous equipment and supplies should be provided at easily accessible points.

h. Ventilation. Proper ventilation and lighting facilities will aid in the reduction of errors and accidents. Portable lights and fans should be considered on docks where needed.

i. Dock heights. These should, as nearly as possible, be compatible with the bed height of carriers. This is primarily achieved with bridge plates or permanently installed adjustable ramps.

j. Expedited materials should be loaded and unloaded at a specific dock or location. Such items as parcel post, air freight, and express have the tendency to congest dock areas unless ample facilities are provided. Normally, the "detention time" for the agency, acting as carrier of expedited material, is short; but the loading and unloading delays which they may create are costly.

4-4. Industrial Trucking.

a. Definition. Industrial trucks are defined as mobile equipment and accessories designed for intradepot or on-base facilities materials handling. This covers a wide variety of mechanical equipment, each designed to perform some materials handling job efficiently. No one unit will perform all operations.

b. An economic balance exists between the amount of equipment used and the volume of materials handled. Too often the amount of equipment available is not sufficient. This results in the use of more costly means of moving materials or not being able to keep up with required schedules. The condition sometimes exists where too many units are available; consequently, there are idle units. Through proper performance records and planning, the most economical number of operating units can be determined.

c. The distance to be traveled is the principal factor in determining the proper equipment. "How far" will determine the equipment to be used. A tractor train is more economical to use for long hauls than the fork truck. In some instances, manual movement is more economical when the distances is just a few feet.

d. Industrial trucking operational costs should be analyzed. It is important that an operational cost record be kept of every unit of equipment. This will provide information which, among other things, may be used to improve preventive maintenance and the selection of new equipment.

4-5. Effective Utilization of Manpower.

Manpower is the most basic method for handling materials. Throughout the materials handling processing cycle, manual handling may occur. In view of this condition, each situation should be examined for possible improvement. Where a known manual handling operation exists, it should be accomplished in an efficient manner to preclude repetitive handling at another stage in the material processing cycle. An example would be proper

palletizing of material at the receiving dock to eliminate repalletizing at the warehouse where the material will be stored.

Section II. Materials Handling Equipment.

The illustrations in this part show some of the basic MHE and MHE accessories used by DOD Components. The inclusion of MHE and MHE accessories in this section does not preclude the continued use or adoption of devices with similar purposes.

4-6. Manual Equipment.

a. Handtrucks. Handtrucks are useful in all types of storage installations, particularly where mechanical equipment cannot be employed because of space limitations. They are often preferable to and more economical than a piece of mechanical equipment for the movement of a single item. The following types of handtrucks have been adopted as standard for the military services:

(1) *Handtruck, warehouse, double handle-type, two-wheel, solid-rubber tires.* The two-wheel handtruck consists of two handles, a platform on which the load rests, and a pair of wheels attached to the bottom of the framework. A blade extends at an angle from the bottom of the platform to retain the load, and two metal legs are located on the top corners of the platform to help bear the load when the truck is rested flat on the ground. The platform may consist of flat crossbars, which are used to handle boxes or crates, or curved crossbars, which are used for barrels or drums. The truck may be constructed of wood or metal. The hardwood combination, straight- and barrel-type, is not illustrated. A magnesium, general utility-type handtruck is also available (figs 4-1 and 4-2).

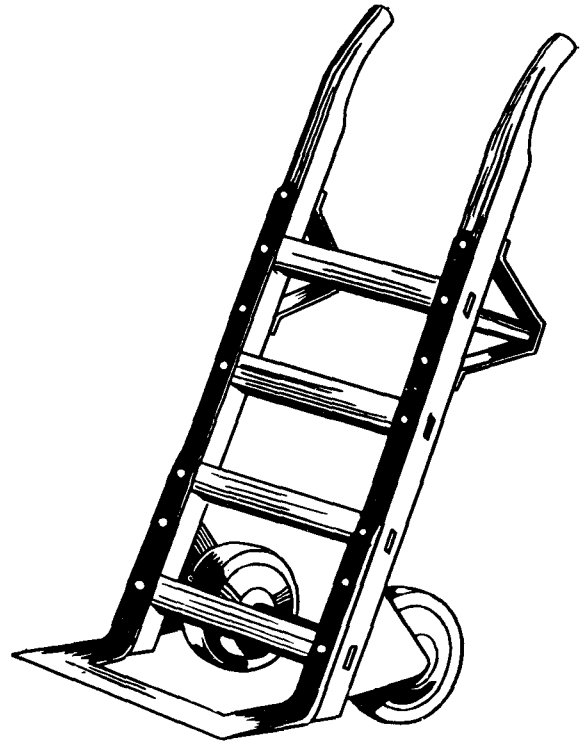

Figure 4-1. Handtruck, warehouse, double-handle type, 2-wheel, solid-rubber tires

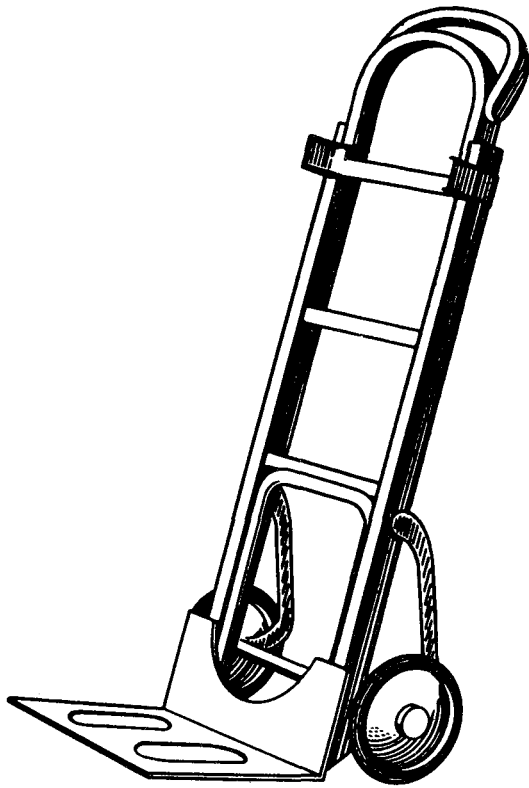

Figure 4-2. Handtruck, warehouse, utility

type is of the hardwood deck, caster steer design, and has a capacity of 2,500 pounds. The steel-wheel type is a steel deck, fifth-wheel design, and has a capacity of 6,000 pounds (figs 4-3 and 4-4).

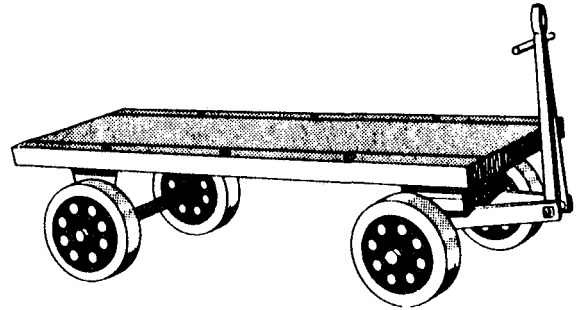

Figure 4-4 Handtruck, steel wheels.

(3) *Truck, stockpicker, multiple shelf, solid-rubber tires.* A stockpicker truck is a handtruck used for picking stock from retail shelves to fill orders. The storage employee pushes the truck into the aisles between the shelves and utilizes the truck shelves to carry the small retail issues in cardboard containers, paper envelopes, or tote boxes. Some models are equipped with a ladder to permit the stock picker to reach materials on high shelves safely (fig 4-5).

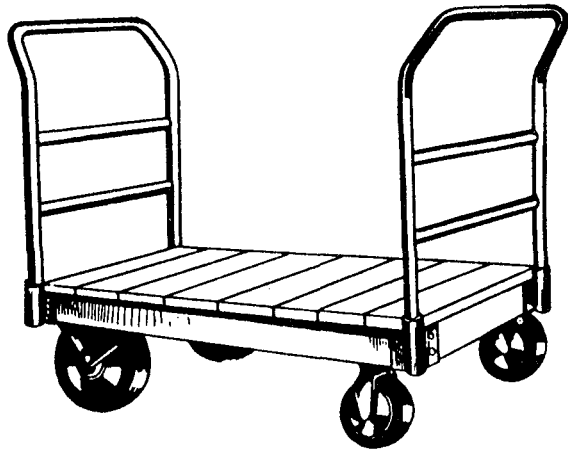

Figure 4-3. Handtruck, platform, four wheel.

(2) *Handtruck, platform, four-wheel.* The four-wheel hand truck may be used to advantage in breaking out retail issues for bins, carrying light loads, or for any operation involving short hauls with frequent stops. It may also be used in multi-story warehouses and for small-lot stock picking. The truck may be equipped with solid-rubber tires or steel wheels. The solid-rubber tire-

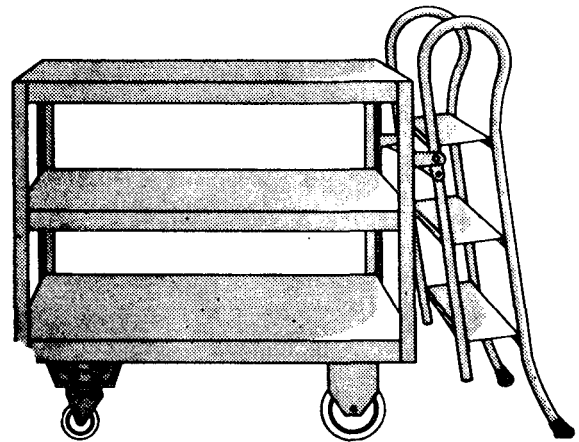

Figure 4-5 Truck, stockpicker

b. *Pallet-type handlift truck.* The pallet-type handlift truck is available in two distinct designs—the hand-operated, hand-propelled model and the electric-powered, hand-operated model. The truck is equipped with two load carrying forks that can be raised about 4 inches to carry palletized loads. It is used to move pallet loads that do not have to be tiered and where short hauls are required. It may be used for the movement of pallet loads in boxcars or into trucks as

well as for in-process movements during shipping and receiving operations. It works well in conjunction with forklift trucks and can be operated where the forklift cannot because of space limitations. The following types of handlift trucks have been adopted as standard for the military services:

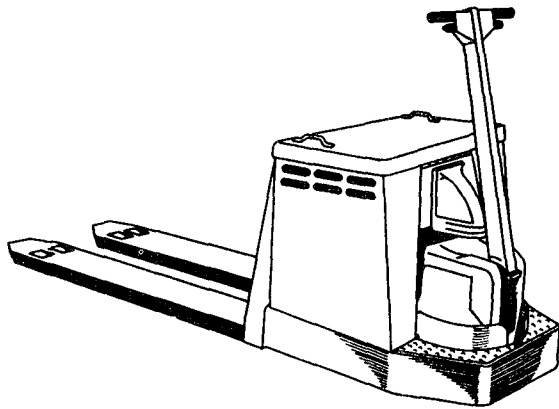

Figure 4-6 Truck, lift, hand, electric, pallet-type

(1) *Truck, lift, hand, electric, pallet-type.* This model is used whenever the distance the load is to be moved, the size of the load, the presence of grades or inclines along the route, or other considerations require the use of powered equipment (fig 4-6).

(2) *Truck, lift, hand, pallet-type.* This model is used whenever the operating conditions do not require a handtruck with the special characteristics of the powered model. It may be an advantage in the loading of boxcars, trucks, and aircraft (fig 4-7).

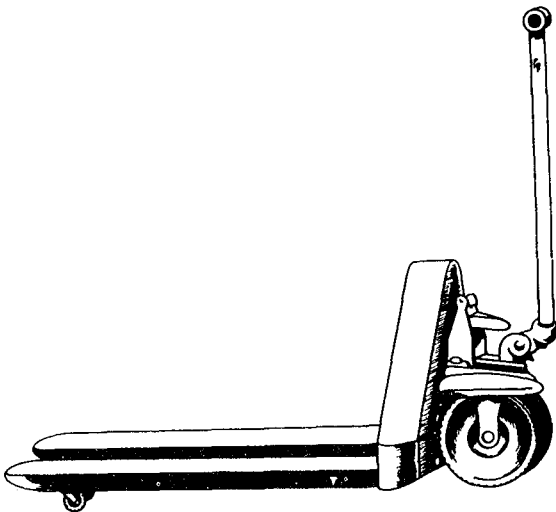

Figure 4-7. Truck, lift, hand, pallet-type

c. Dollies. Dollies are frames mounted on wheels or rollers used for shifting heavy loads over short distances. The following three standard types of dollies are available:

(1) The first is the general-purpose dolly with swivel wheels (fig 4-8). The second type of dolly, with a capacity of 4,000 pounds, is used primarily to move palletized loads in and out of boxcars, highway trucks, and trailers. Also, it is used within boxcars to move loads to doorway area for pick up by forklift trucks when the car is not alongside a loading platform (fig 4-9).



Figure 4-8 Dolly general-purpose.

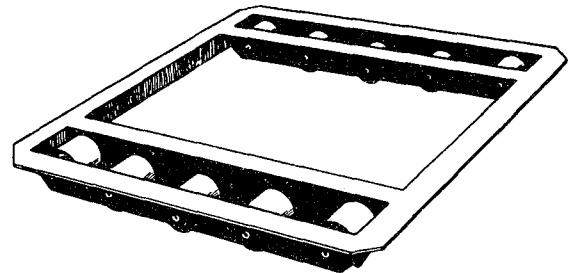

Figure 4-9 Dolly, pallet rollers

(2) The advantages of the third type of dolly are maneuverability, ease of operation, and suitability for use on truck and reefer floors. The wheels in the central portion are placed slightly lower than the wheels at the ends. The wheels at the ends are held in position by springs, which allow them to move on their axles as the load is guided to its destination. The difference in height of center and end wheels permits a certain amount of rocking motion which aids in movement and guidance. That is, the tilting effect allows the dolly to turn and the center wheels (on offset axles) prevent the lodging of wheels in slatted floors (fig 4-10).

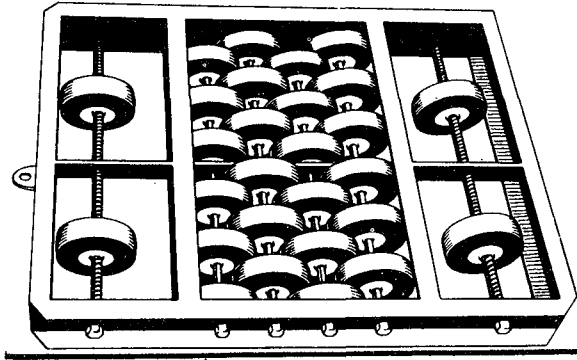

Figure 4-10 Dolly, reefer car

4-7. Lifting-Type Vehicles.

a. Stacker, walkie. The walkie stacker is electrically powered and operated with a hand throttle which controls the speed and direction of travel. This vehicle can be used in order picking operations for moving crates and skids and loading and unloading trucks. The walkie stacker is generally used when a low cost vehicle is required for low activity operations (fig 4-11).

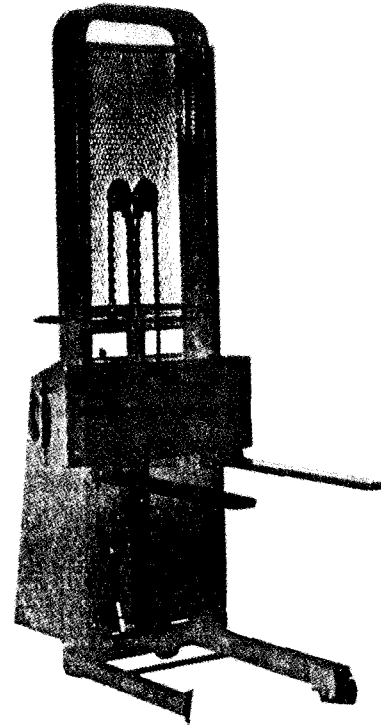

Figure 4-11 Truck, walkie stacker, solid rubber tires, 4,000-pound.

b. Stock selector, counterbalanced. The stock selector is an electrically powered truck with a preferred height of 186 inches and either 40- or 42-inch long forks. These vehicles can operate in aisles that are only several inches wider than the size of the vehicle and are available with either rail or wire guidance systems. This truck is used in narrow-aisle high rise, high density order picking operations. It has manual access to either side of the aisle and may be adapted to any guided aisle system (fig 4-12).

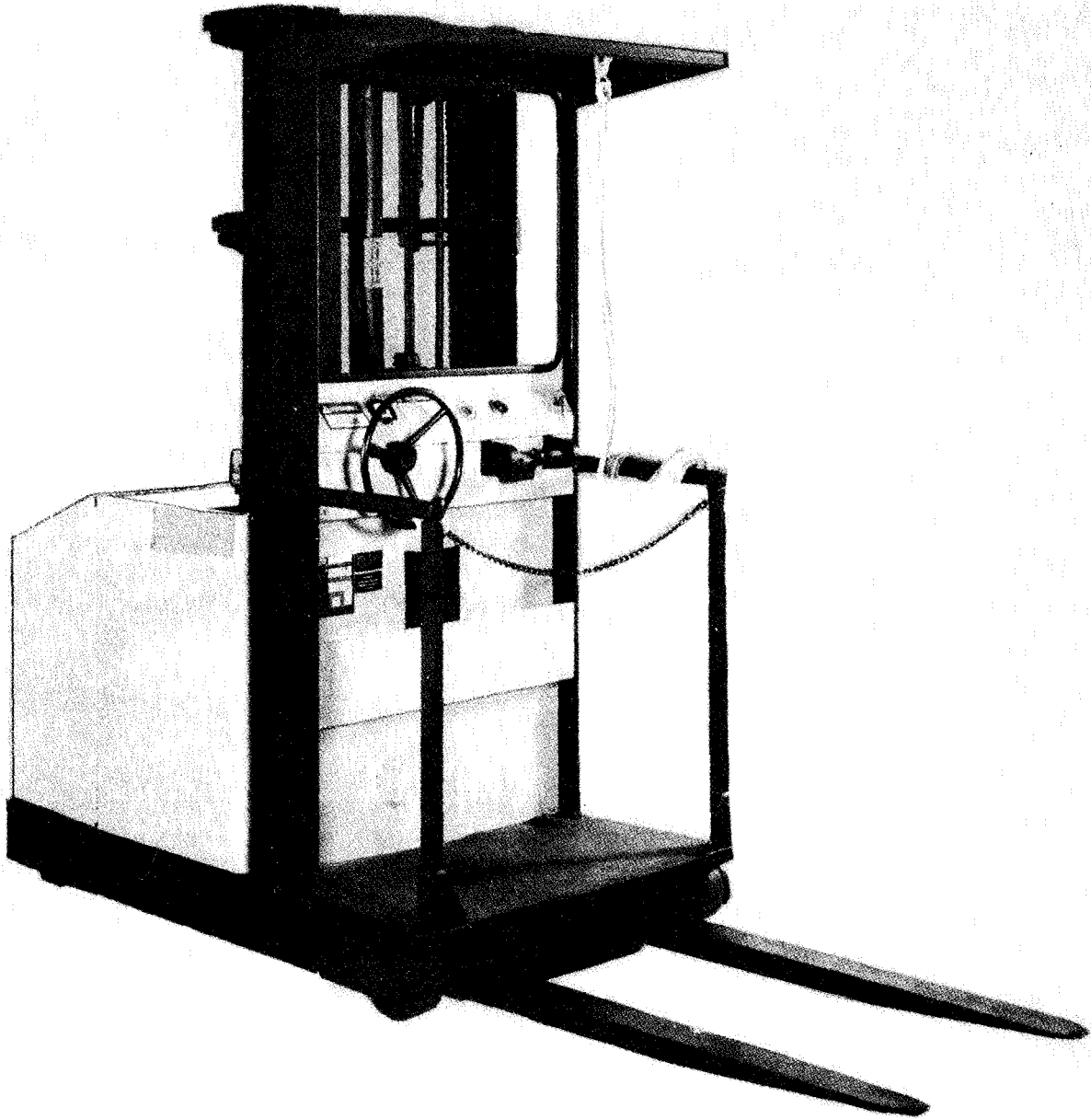

Figure 4-12 Stock selector-counterbalanced

c. *Tiering truck, electric, narrow-aisle.* The tiering truck is an electric-powered forklift truck of the straddle arm design. The forks on this truck are located between two outriggers, or straddle arms, that extend forward in a plane at floor level parallel to that of the forks to straddle the pallet load. Because the straddle arms have contact with the floor, they support the elevated load and no counterweight is required. The overall weight of the tiering truck is generally less than that of a conventional counter-balanced forklift truck of the same rated capacity. The tiering truck is more maneuverable than the standard forklift truck and

can generally operate in 6-foot aisles. The standard tiering truck for the military services is the electric-powered type that has a lifting height of 100 or 130 inches (fig 4-13).

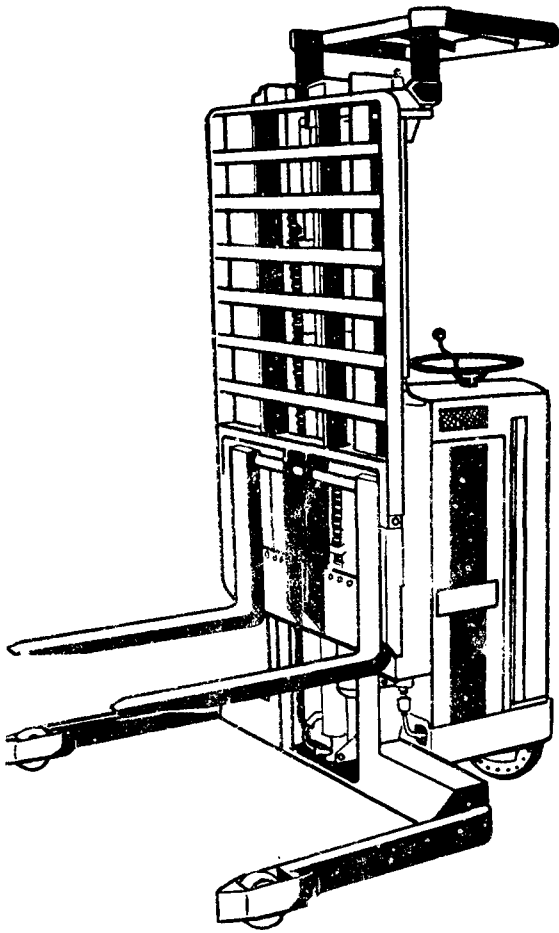

Figure 4-13 Truck, tiering, electric, 3,000-pound

d. Truck, reach, narrow-aisle. The reach narrow-aisle truck normally has a maximum height of 238 inches, a 40- or 42-inch long fork, urethane tires in the front, and rubber tires in the back. It has a 2,000- to 4,000-pound capacity range and a turning radius of 61 to 85 inches depending upon the model. This truck can operate in 68- to 72-inch aisles as opposed to a counterbalanced truck which operates in a 10-foot aisle. It can make turns in closer quarters because the pallet can be retracted to a position within the wheelbase. It is used in narrow-aisle rack storage operations in high density warehouses and distribution centers. This reach truck has a fork extension capability which allows positioning the pallets in racks or on the floor (fig 4-14).

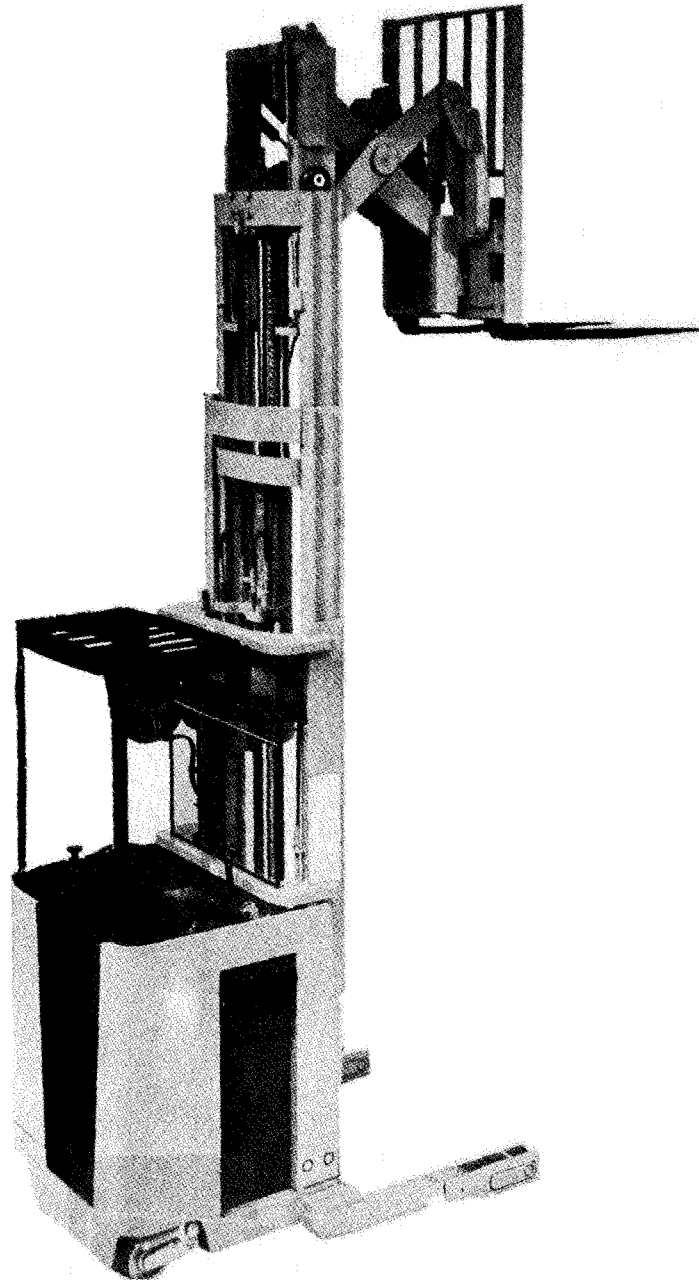

Figure 4-14 Truck, reach, narrow-aisle.

e. Truck, forklift, counterbalanced. A forklift truck is a vehicle designed to pick up, carry, and stack unit loads of supplies and equipment. Standard forklift trucks are available with lifting capacities from 2,000 to 20,000 pounds and lifting heights from 100 to 210 inches. The trucks are equipped with telescopic masts that permit loads to be lifted beyond the height of the collapsed mast, and most trucks have free lift, which is the height to which the forks can be raised before the inner slides move upward from the mast and in-

crease the overall height. Gasoline-, propane-, and clean-burning diesel-powered forklift trucks may be equipped with solid-rubber or semisolid tires for use in warehouses or pneumatic tires for use in outdoor storage areas. Electric-powered forklift trucks are equipped with solid-rubber or semisolid (cushion) tires for indoor operation only. Forklift trucks are not designed to be used as tow vehicles and should not be used for that purpose. Whenever a truck is equipped with vertical only or vertical and horizontal controls connected to the lifting

carriage or forks for lifting personnel, the following additional precautions will be taken for the protection of personnel being elevated: use of safety platform firmly secured to the lifting carriage and/or forks; means shall be provided whereby personnel on the platform can shut off power to the truck; and protection from falling objects, should the operating conditions require it, will be provided. The following types of forklift trucks have been adopted as standard for the military services.

(1) Truck, forklift, solid, semisolid rubber tires, 2,000-pound, 127- or 130-inch lift.

(a) *Type of power*—gasoline or electric.

(b) *Load center*—24 inches.

(c) *Standard operating aisle*—9 feet 6 inches to 11 feet with a 40-inch load length.

(d) *Application*—This is a special-purpose light duty forklift truck designed for use in areas where low overhead clearance requires the use of a truck with a low collapsed mast height. Also suitable for truck and railcar loading. This truck when equipped with pneumatic tires, may be used for limited outdoor storage operations with hard standings and on smooth surfaces with little tractive resistance (fig 4-15).

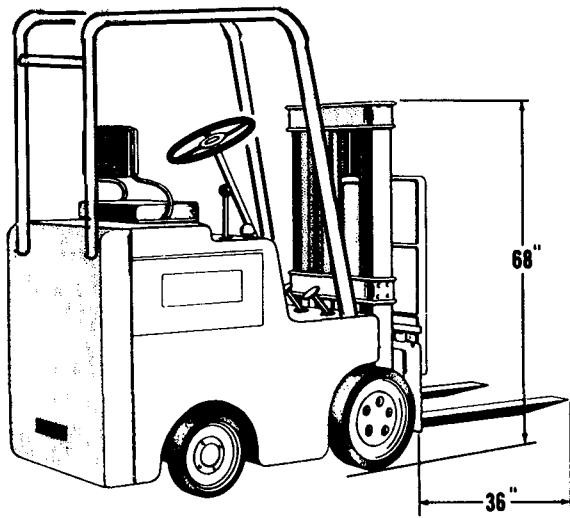

Figure 4-15 Truck, forklift, solid, semisolid rubber, or pneumatic tires, 2,000-pound, 130-inch lift

(2) Truck, forklift, solid, semisolid rubber, or pneumatic tires, 4,000-pound, 144- to 180-inch lift.

(a) *Type of power*—diesel, gasoline, or electric.

(b) *Load center*—24 inches.

(c) *Standard operating aisle*—12 to 14 feet with 40-inch load length.

(d) *Application*—Standard, medium duty forklift truck used in overall storage operations. Also available with a low mast for use in areas with limited overhead clearance (fig 4-16).

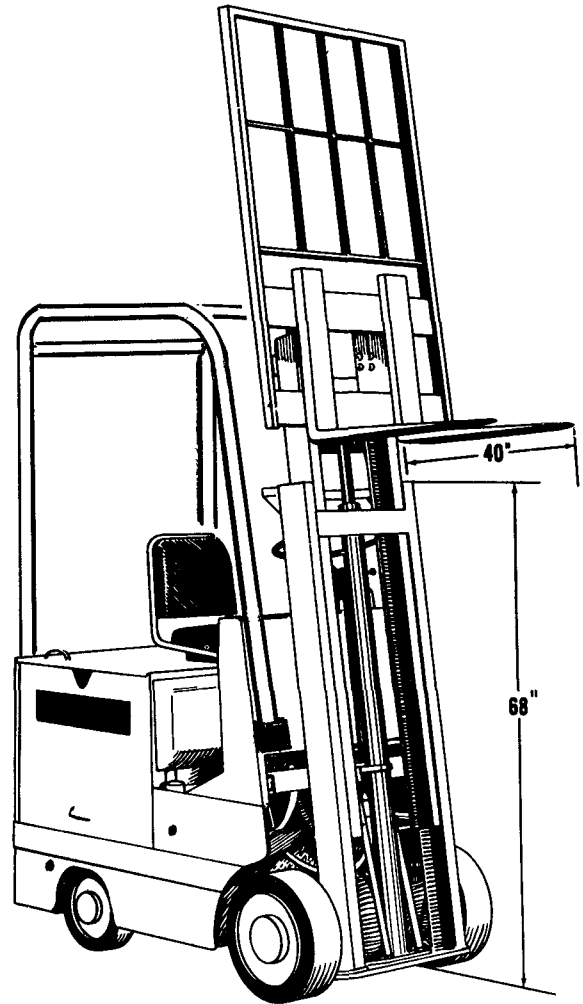

Figure 4-16. Truck, forklift, solid, semisolid rubber, or pneumatic tires, 4,000-pound, 100- or 127- to 180-inch lift

(3) Truck, forklift, pneumatic tires, 3,200-pound, 144-inch lift.

(a) *Type of power*—electric.

(b) *Load center*—24 inches.

(c) *Application*—General-purpose medium duty forklift truck for indoor or outdoor storage operations. It has maneuverability to operate in relatively confined storage areas, and can operate satisfactorily on many types of road surfaces and graded areas, including cinders or gravel (fig 4-17).



Figure 4-17. Truck, forklift (3-wheel) pneumatic tires, 3,200 pound, 144-inch lift

(4) Truck, forklift, solid or semisolid rubber tires, 6,000-pound, 144- to 180-inch lift.

(a) Type of power—diesel, gasoline, or electric.

(b) Load center—24 inches.

(c) Standard operating aisle—13 feet 4 inches with 40-inch load length.

(d) Application—Basic, heavy-duty truck for indoor or outdoor storage operations, principally shipping and receiving. The truck may also be used to handle and stack loads in low ceiling areas such as vaults at ports of embarkation (depending on mast height). Although mast height may permit entry into vans and railcars, the weight of the truck and lack of maneuverability must be taken into consideration before the truck is used for direct loading or unloading. The truck may be used to transfer heavy or bulky loads from railcars to a tractor-trailer train. Electric-powered forklift trucks are recommended for use indoors (fig 4-18).



Figure 4-18. Truck, forklift, solid or semisolid rubber tires, 6,000-pound, 127- to 180-inch lift.

(5) Truck, forklift, pneumatic tires, 6,000-pound, 168- or 180-inch lift.

(a) Type of power—gasoline or diesel.

(b) Load center—24 inches.

(c) *Standard aisle width*—16 feet 8 inches.

(d) *Application*.—A heavy-duty forklift truck for outdoor storage operations. It is used principally for loading and unloading flat-cars and trailers at yards, docks, and other outdoor shipping or receiving areas. The truck can be operated satisfactorily on all types of road surfaces. Use of chains makes it possible for the truck to operate in snow (fig 4-19).

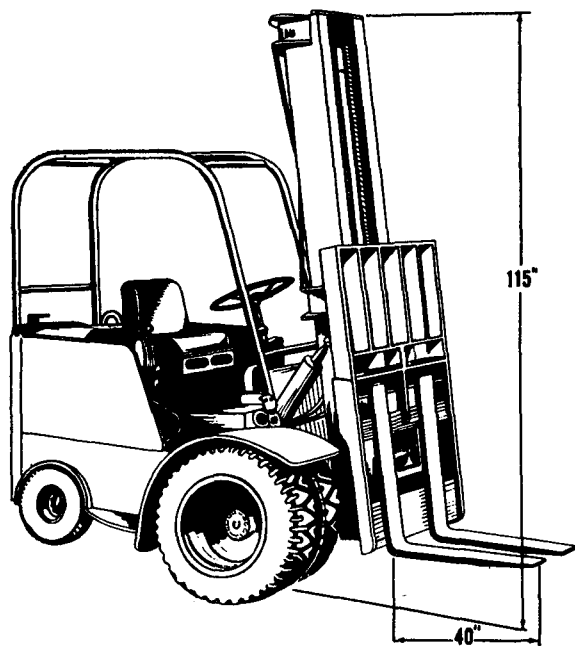

Figure 4-19. Truck, forklift, pneumatic tires, 6,000-pound, 168- to 180-inch lift

(6) Truck, forklift, pneumatic tires, 15,000- and 20,000-pound, 100- to 210-inch lift.

(a) *Type of power*—diesel.

(b) *Load center*—24 inches.

(c) *Application*—Maximum capacity truck for outdoor storage operations. It is used principally for loading and unloading oversize/heavy loads and for stacking and relocating large heavy materials in outdoor storage areas. It is very often needed to handle less-than-maximum-capacity loads that, because of size or shape, require a load center greater than 24 inches. This type of truck may, for example, lift 15,000 pounds at 24 inches and 7,500 pounds at 40 inches. The use of fork extensions or other attachments such as a bar and hoist for unloading will further reduce lifting capacity (fig 4-20).

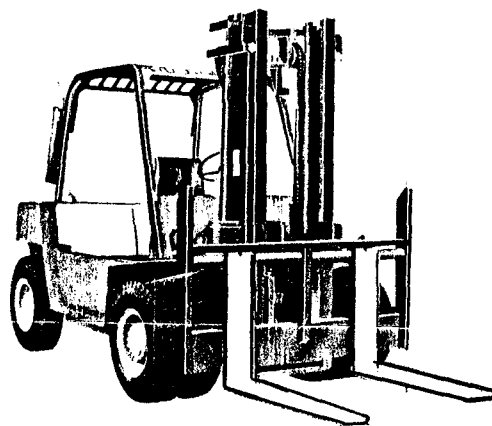

Figure 4-20 Truck, forklift pneumatic tires, 15,000- or 20,000-pound, 170- to 210-inch lift

(7) Truck, forklift, pneumatic tires, 10,000-pound, 114-inch lift, sideloading.

(a) *Type of power*—gasoline or diesel.

(b) *Application*—Standard sideloading truck used for receiving, transporting, and loading operations. It is used principally to load, directly into aircraft, supplies and equipment prepared for delivery by parachute. The truck can be used to handle pipe, lumber, or similar material up to lengths of 65 feet. It has a turning radius of approximately 25 feet and can travel on varying types of smooth surface roads up to 30 miles per hour (fig 4-21).

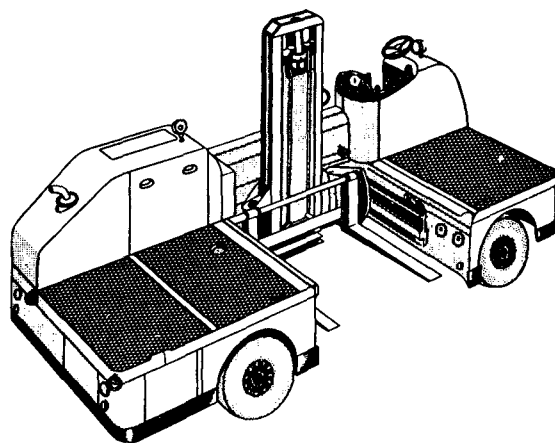

Figure 4-21 Truck, forklift, pneumatic tires, 10,000-pound, sideloading.

(8) Truck, forklift, pneumatic tires, rough terrain.

(a) *Type of power*—diesel.

(b) *Load center*—24 inches or 48 inches.

(c) *Application.* A standard rough terrain forklift truck, available in five load capacities—4,000, 6,000, 10,000, 12,000, and 16,000 pounds, is equipped with high-flotation pneumatic tires for operation on unprepared or unstabilized surfaces, over beaches, in deep sand, or in snow, ice, or mud. It is used primarily for loading and unloading flatbed trailers, landing craft, or other similar types of small cargo vessels. It may also be used for stacking large, heavy loads of equipment (fig 4-22).

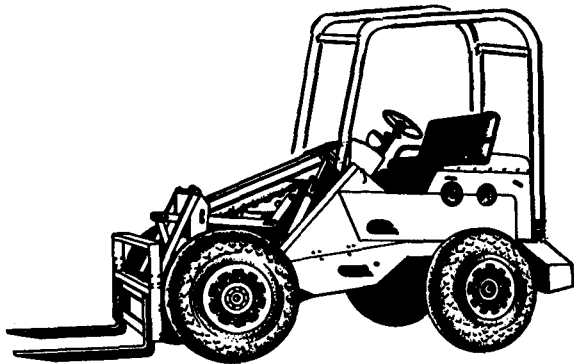
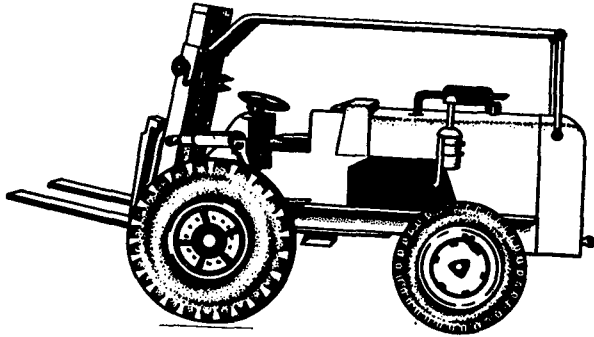

Figure 4-22. Truck, forklift, pneumatic tires, rough terrain

f. *Truck, front side-to-side loader.* The front side-to-side loader has the capability of rotating its forks 180 degrees which gives access to racks on

either side of the aisle. It is capable of transporting very long items in a relatively small aisle. These units are available in various capacities and lift heights. It operates in narrow aisles of 58 inches (guided) and 63 inches (unguided). It can be operated in high rise narrow-aisle rack storage areas or facilities. Trucks are also available in side loading or front to side loading models (fig 4-23).

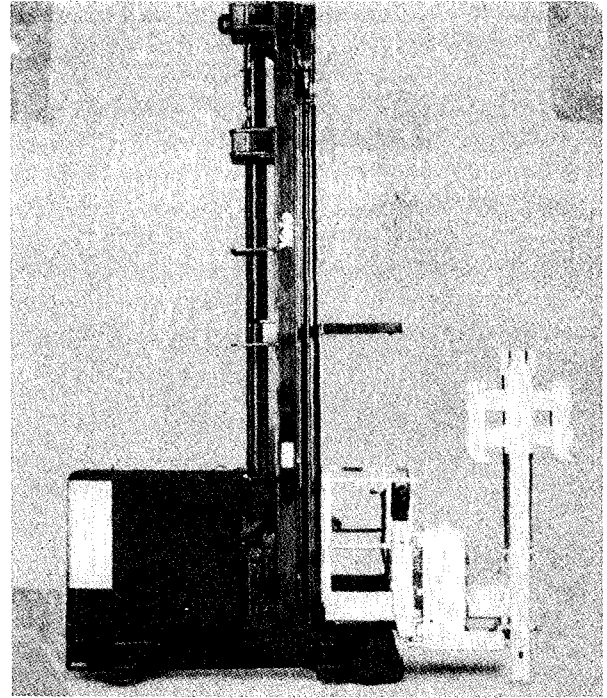

Figure 4-23. Side to-side narrow-aisle truck

g. *Cranes.* Cranes are lifting devices that are either stationary or mobile, and may be powered to increase lifting ability. Their use should be considered when an operation requires the lifting of materials above and beyond the capability of two workers. Additionally, they should be considered when one person with a crane can perform a task alone.

(1) *Jib Cranes.* Jib cranes consist of a hoist-type lifting device mounted on a horizontal boom (jib). Common configurations include:

(a) *Pillar supported*—The jib is attached to a self-supporting floor mounted or floor-to-ceiling mounted mast (fig 4-24).

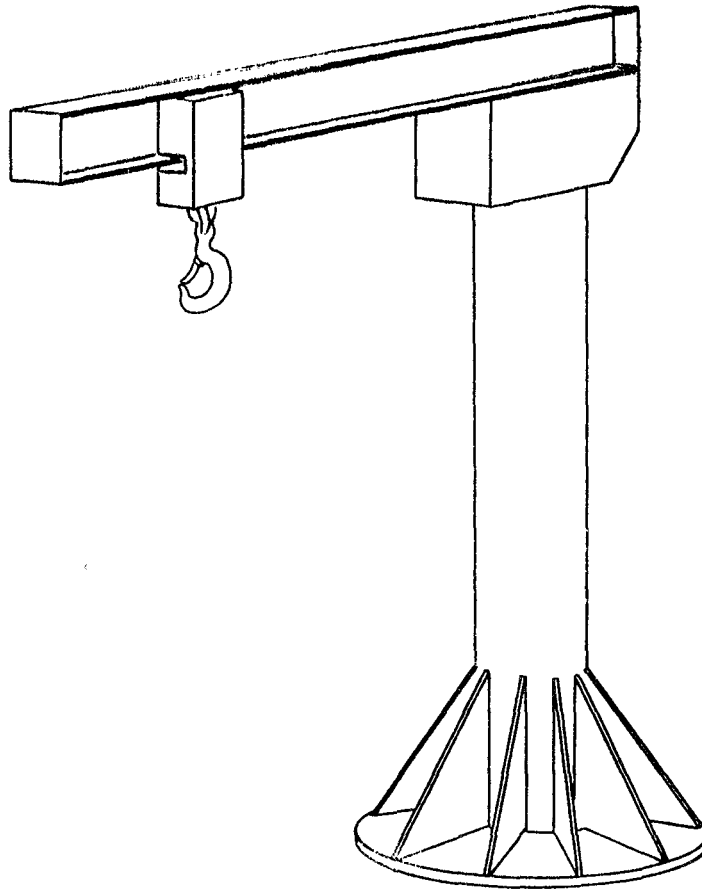

Figure 4-24 Jib crane.

(b) Mast supported—The jib is mounted on a mast which is supported on top and bottom supports and pivots.

(c) Bracket—The jib is attached to the wall or column by brackets.

(d) Walking—The jib is mounted on heavy undercarriages which may move back and forth on rails in the floor or floor and ceiling.

(e) Interlocking—A bracket crane designed to extend the travel of a monorail hoist by connecting the ends of adjacent jibs.

(2) *Gantry Crane.* A gantry crane consists of a hoisting device that rides on a horizontal beam connected to legs with wheels attached to the bottom. Usually the wheels ride on floor mounted tracks. Variations are possible when one of the legs is replaced by a runway attached to the building or other fixed object. Gantry cranes can be used either indoors or outdoors and can be pendant or radio controlled. Applications for the gantry crane are similar to the bridge crane; however, gantry cranes are more often used outdoors because of the support legs (fig 4-25).

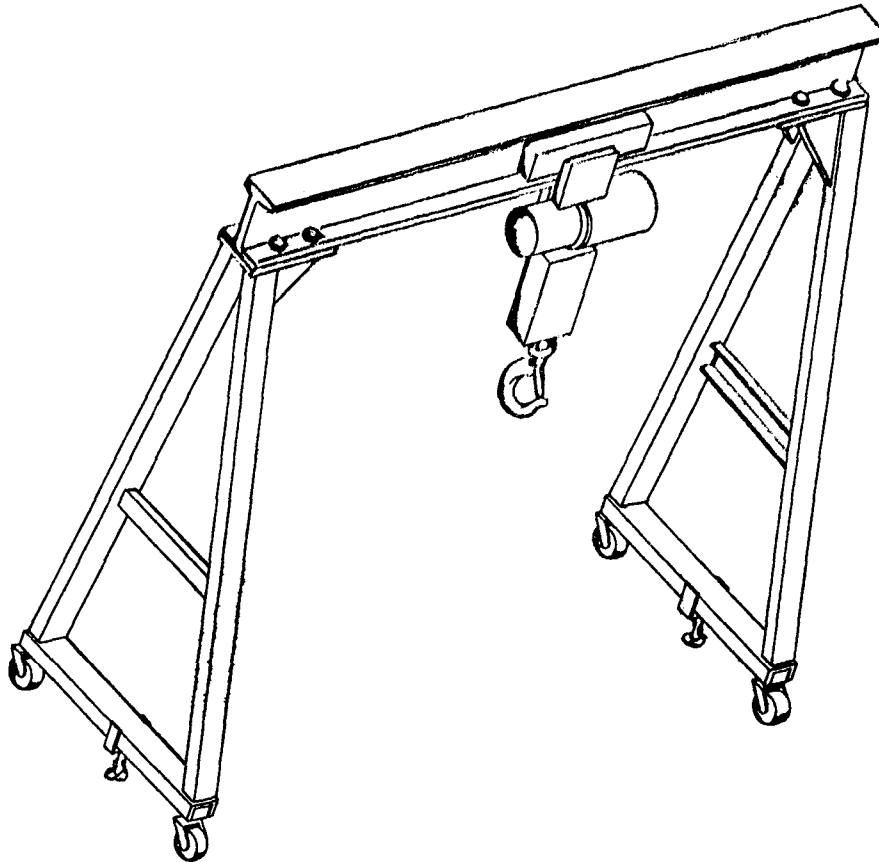

Figure 4-25. Gantry crane.

(3) *Bridge Cranes.* Bridge cranes are lifting devices mounted on a bridge consisting of one or two horizontal girders supported at each end by trucks riding on runways and installed at right angles on the bridge. The runways can be installed on building columns, overhead trusses, frames, or free standing columns. They provide three dimensional travel covering any spot within the rectangular area over which the bridge moves. The end riding trucks can be either top running, in which the trucks run on top of runway tracks, or bottom running, in which the trucks are suspended in a lower flange of the runway tracks. The three dimensional travel consists of horizontal movement along the length of the runway, horizontal move-

ment across the width of the bridge, and vertical movement provided by the hoist. Movement of the long bridge girders or runways can be either manual or powered. Powered models can be pendant or radio controlled from the floor, or, in larger models, operator ridden (fig 4-26). Bridge cranes are available with transfers to permit lifting devices to move into adjacent bays. The advantages of bridge cranes include no interference with the work on the floor, reduced aisle space requirements, easy access to most areas within the lifting bay, and extension to areas outside the building. Bridge cranes are best used in low to medium volume activities for lifting large, heavy, or awkward items.

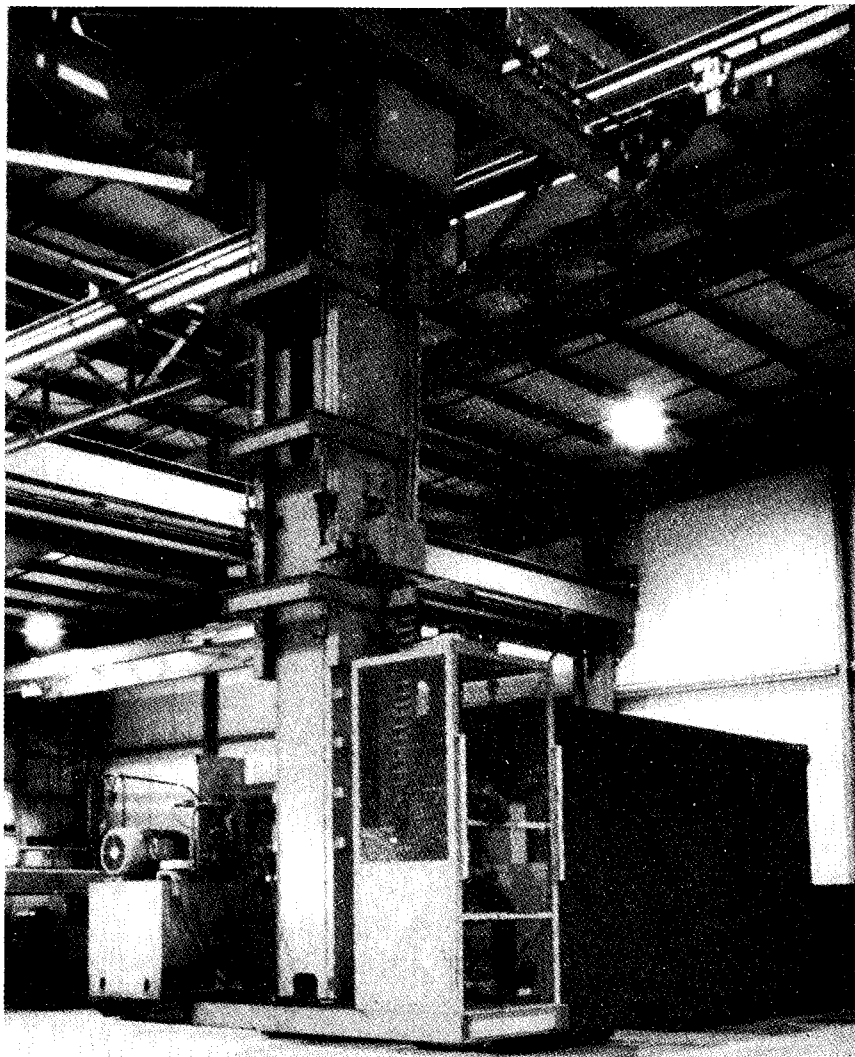

Figure 4-26. Bridge crane

(4) *Crane Truck.* A warehouse crane truck is a power-driven, self-propelled unit consisting of a boom mounted on a mobile wheel chassis. The boom can be operated independently so that sluing and topping can be accomplished without movement of the chassis. Power is supplied by a gasoline engine or by electric motors. Gasoline-powered crane trucks are equipped with pneumatic tires for outdoor operation and range in capacity from 6,000 to 20,000 pounds. Electric-powered crane trucks are equipped with solid-rubber tires for indoor operation and have a capacity of 6,000 or 10,000 pounds (fig 4-27). The warehouse crane truck is used to lift, swing, and lower loads that are too heavy or bulky or otherwise unsuitable for handling by other types of MHE. It may be used for loading and unloading flatcars, flatbed trailers, or gondolas. The warehouse crane truck is some-

times used to transport loads horizontally for short distances when sufficient overhead clearance is available.

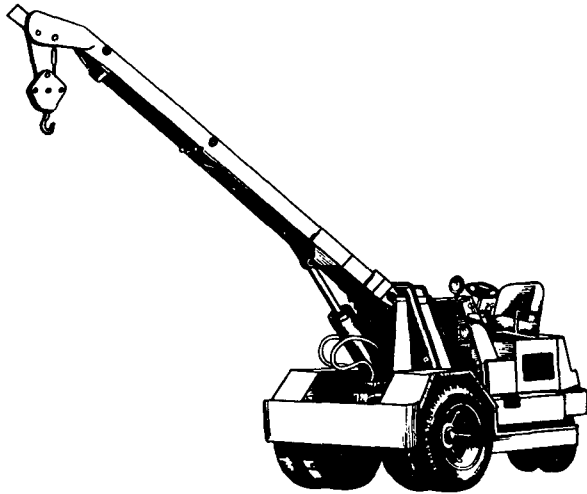

Figure 4-27. Crane truck, warehouse, gasoline

gasoline-powered vehicle used exclusively as a load carrier. It may be used to supplement a forklift truck in the same manner as the tractor-trailer train depending upon the size and weight of the load and the distance the load is to be moved. In addition to transporting supplies, the truck may be used as a portable servicing unit when equipped with spare parts and tools or with gasoline and oil dispensing facilities. The standard gasoline-powered model, equipped with pneumatic tires, has a load capacity of 4,000 or 6,000 pounds. The electric-powered, usually equipped with solid-rubber tires, has a load capacity of 2,000, 3,000, and 4,000 pounds.

4-8. Horizontal Transport Equipment.

a. *Truck, fixed platform, gasoline or electric.* The platform truck is a nonelevating electric- or

b. *Truck, burden carrier, electric, pneumatic tires.* The burden carrier is an electrical truck available in three- or four-wheel models. The burden carrier has a platform for cargo. It has a capacity range to 7,000 pounds and is used to transport loads over a long distance. For continuous use, optional rollout batteries can be used (fig 4-28).

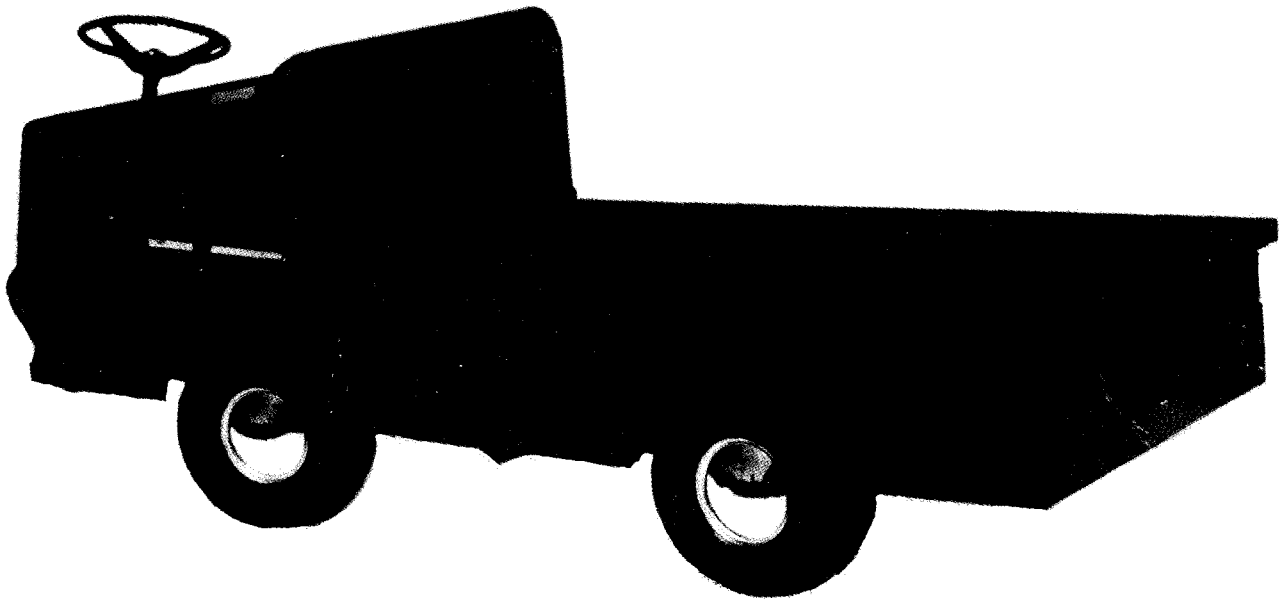

Figure 4-28 Truck, burden carrier, electric, pneumatic tires

c. *Warehouse Tractors.* A warehouse tractor is an electric- or gasoline- powered vehicle designed to pull a train of warehouse trailers. Gasoline-powered models, equipped with pneumatic tires, have a rated drawbar pull from 4,000 to 7,500 pounds. Electric-powered models with solid-rubber tires have a rated drawbar pull of 2,000 to 4,000

pounds. Drawbar pull, which is the motive force that the tractor can exert in pushing or pulling loads, is merely a means of indicating tractor capability, and the actual capacity of the tractor is normally far in excess of the drawbar pull rating. A tractor with a drawbar pull of 4,000 pounds may, for example, have an actual towing capacity of 90

tons; and a tractor with a drawbar pull of 7,500 pounds, may have a towing capacity of 200 tons. Its value to storage and warehousing, however, lies in the fact that the tractor-trailer train, when used in conjunction with forklift trucks, provides for the completely mechanized loading, transporting, stacking, and warehousing of supplies. The following types and sizes of warehouse tractors have been adopted as standard for the military services. These tractors are, in most cases, the low-profile industrial type. The 7,500-pound drawbar pull tractor may, however, be the agricultural type with high-flotation pneumatic tires for operation in rough or unpaved storage areas.

(1) *Tractor, warehouse, gasoline, pneumatic tires, 4,000-pound drawbar pull.* Standard medium-duty tractor for outdoor storage operations. It may be used in plant yards, for hauling trailers or towing airplanes from hangars to airfields. It may also be used for general purpose towing or pulling at freight sheds, piers, warehouses, or other areas. It has sufficient weight, horsepower, and traction to operate on virtually all types of running surfaces (fig 4-29).

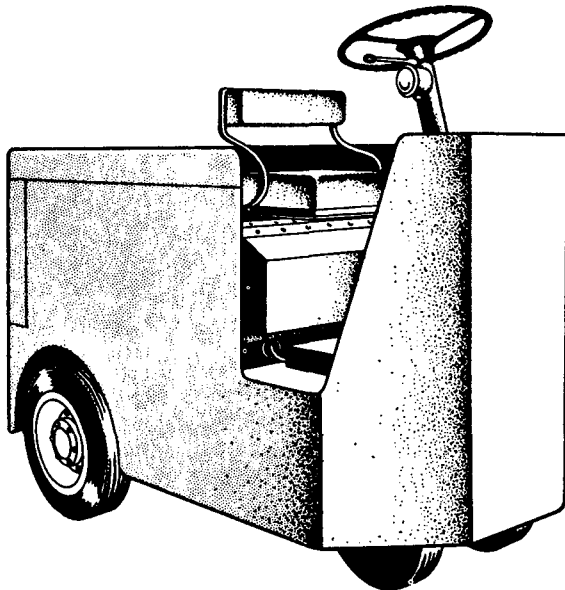

Figure 4-29 *Tractor, warehouse, gasoline, pneumatic tires, 4,000-pound drawbar pull*

(2) *Tractor, warehouse, gasoline, pneumatic tires, 7,500-pound drawbar pull.* Standard heavy-duty, gasoline-powered tractor for outdoor storage operations. This capacity tractor is available in two styles. The first is the low-profile, industrial type with conventional pneumatic tires on both drive and steering wheels. The second type is

the high-flotation model with oversize pneumatic tires on the drive wheels. This tractor may be used in storage areas with rough or muddy terrain. It has a greater underclearance than the low-profile type, but lacks its spread and maneuverability. It is possible, however, to use both types for towing heavy equipment or larger special-purpose vehicles such as refrigerator trailers. This may be accomplished by the use of a fifth-wheel attachment or truck carriers (fig 4-30).

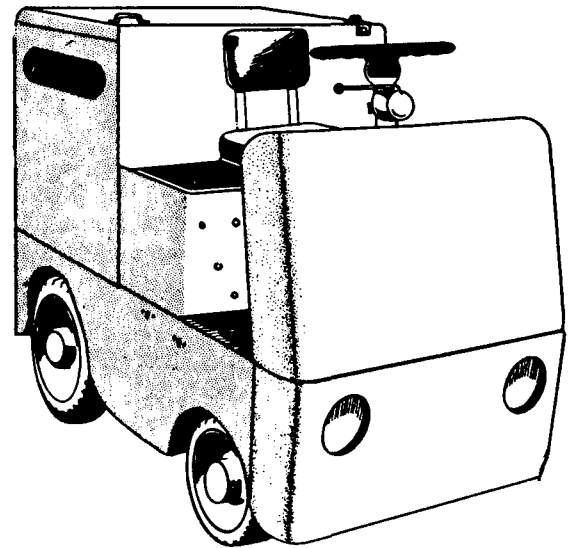

Figure 4-30. *Tractor, warehouse, gasoline, pneumatic tires, 7,500-pound drawbar pull*

(3) *Warehouse Trailers.* A warehouse trailer is a load-carrying platform mounted on casters or wheels. Standard trailers are available in a wide variety of sizes and capacities and may be equipped with solid-rubber or pneumatic tires. The caster-steering type has fixed rear wheels that carry about two-thirds of the load and caster wheels at the front through which steering is accomplished. The caster steering-type trailer is produced in 4,000- and 6,000-pound capacities, similar to that illustrated by figure 4-31. The fifth wheel steering type has rear wheels mounted on a rigid axle and front wheels mounted on a center-pivoted steering axle with drawbar attachment. This type of trailer is available in capacities of 6,000 to 20,000 pounds (fig 4-32). The selection of the size required for a specific operation may be based on load capacity, and the nature of the surface over which the load is to be towed. The fifth wheel steering-type trailer is more suitable for heavy loads or for operation over rough surfaces. The caster steering-type trailer is better suited to indoor operations.

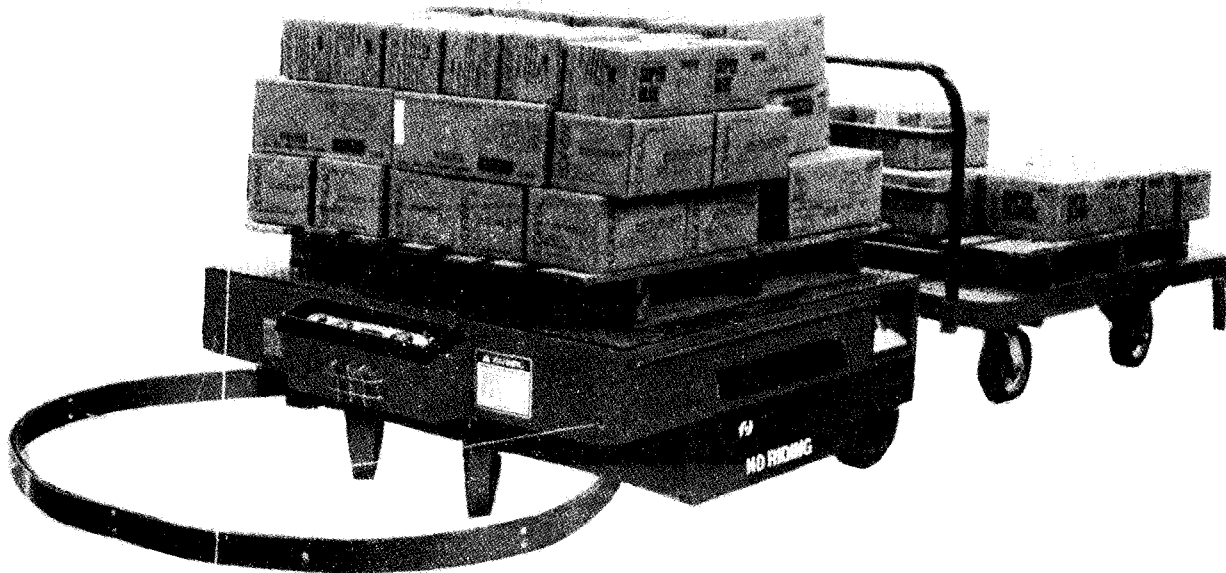

Figure 4-31 Trailer, platform, warehouse, 4,000- or 6,000-pound, towed by driverless tractor system:

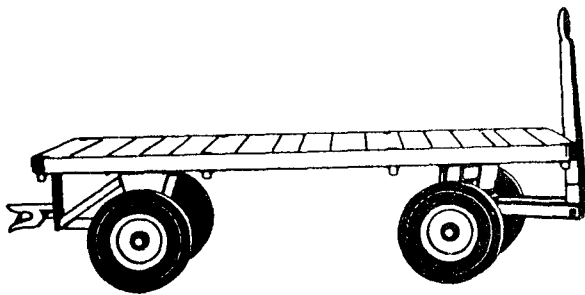

Figure 4-32 Trailer, platform, warehouse, 6,000-pound, pneumatic tires

d. *Hoist, straddle, mobile.* The mobile straddle hoist is a diesel-powered, four-wheel vehicle designed to straddle, pickup, and transport loads of long and heavy supplies such as pipe, lumber, and steel. It may also be used for handling pulpwood, bridge members, and containers of bulk materials such as coal, rocks, and similar commodities. The standard straddle hoist for the military departments has a capacity of 30,000 pounds (fig 4-33). The hoist may also be optionally equipped with pallet lifting and transporting devices.

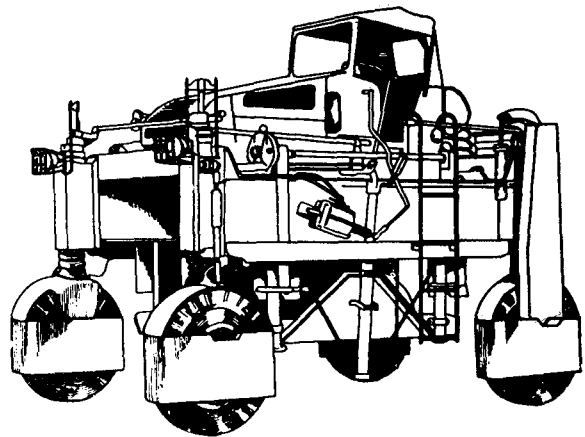

Figure 4-33 Hoist, straddle, mobile.

e. *Cargo transporter trucks.* Cargo transporter trucks are used for intrafacility hauling of palletized material. These trucks are equipped with power conveyors with up/down maneuverability for loading and unloading. The maximum load capacity is 15,000 pounds, maximum load length is 21 feet, and maximum load width is 90 inches. This is a special-purpose truck designed for efficient intrafacility movement of palletized material. The dispatch-controlled cargo transporter is equipped with transceivers in each truck for quick coordination in movement of material.

f. Conveyors. A conveyor, excluding mobile units, is defined as a device to move materials along a defined path. The storage and shipment of units in large quantities and materials handling depend upon each other. Since conveyors are one of the major devices for the handling of materials, the task of getting the highest efficiency and economy out of the use of conveyors involves selecting the right conveyor or system of conveyors for the job. Today, the conveyor is recognized as one of the more important tools in the materials handling field. It is a cost-saving, energy-saving, and profit-making modern mechanism. Before selecting a conveyor as a purely transporting medium, the economics involved should be studied. The cost of placing the item on, or removing it from the conveyor may exceed the value gained through the use of the conveyor. Gravity conveyor should be used where practicable.

When the analysis of the product indicates that for loading and unloading highway and railway equipment, some type of conveyance is required to facilitate the operation, roller-feed gravity conveyors should be considered. Gravity conveyors are used to advantage when loading or unloading small containers as they reduce handling and the need for industrial trucks, thus reducing detention time. Maintenance cost for gravity conveyors is considerably lower than for other means of conveyance. Conveyor speed controls rate of material delivery. The rate at which materials arrive at the work station can be controlled by the conveyor speed to maximize work station output. Whenever practicable, conveyors should be standardized. Conveyors should be purchased utilizing standardized specifications to reduce the cost of repair, the stockage of repair parts, and the cost of maintenance training. Cost and repair data should be maintained and used in the improvement of specifications. Wherever practical, conveyor loading and unloading should be accomplished by mechanical means. A basic principle of any materials handling

operation is: "Do not handle the item except for performance of essential operations."

Material should be moved mechanically whenever possible with emphasis on movement through the entire operation with minimized manual actions. Mechanical loading and unloading of material should be emphasized (i.e., items can be moved from belt conveyors to power and free conveyors by automatic pickup stations). The use of mechanical handling aids will maximize the productive time of available manpower. Synchronization of conveyors eliminates waits at transfer points and destination. Another advantage of the variable speed conveyor is that it can be set so as to tie in with other lines of operations. Conveyor installations must provide adequate clearances for industrial trucks. This applies not only to the vertical plane, but also to the horizontal plane.

In conveyor installations, ample clearance should be provided for industrial trucks and loads to be carried. The types of conveyors listed and illustrated in this section should be regarded as standard for the military services. Not every type in use has been listed; however, this listing should not preclude procurement of other items when required in the interest of efficient and economical materials handling.

(1) *Conveyor, skatewheel gravity.* Skatewheel gravity conveyor is a free-flowing, nonpowered conveyor used for light-duty applications. It is available in 12, 15, 18, and 24 inch widths. Wheel options include aluminum, steel, and polyethylene. It can be used in a gravity flow system or can be combined with motor driven conveyors to become part of an integrated materials handling system. The skatewheel conveyor's primary application is for handling lightweight loads when portability is required. Almost any object having a solid, reasonably firm conveying surface can be transported on a skatewheel conveyor (fog 4-34). Standard length is 10-foot sections, but is also available in curved sections of 45 degrees.

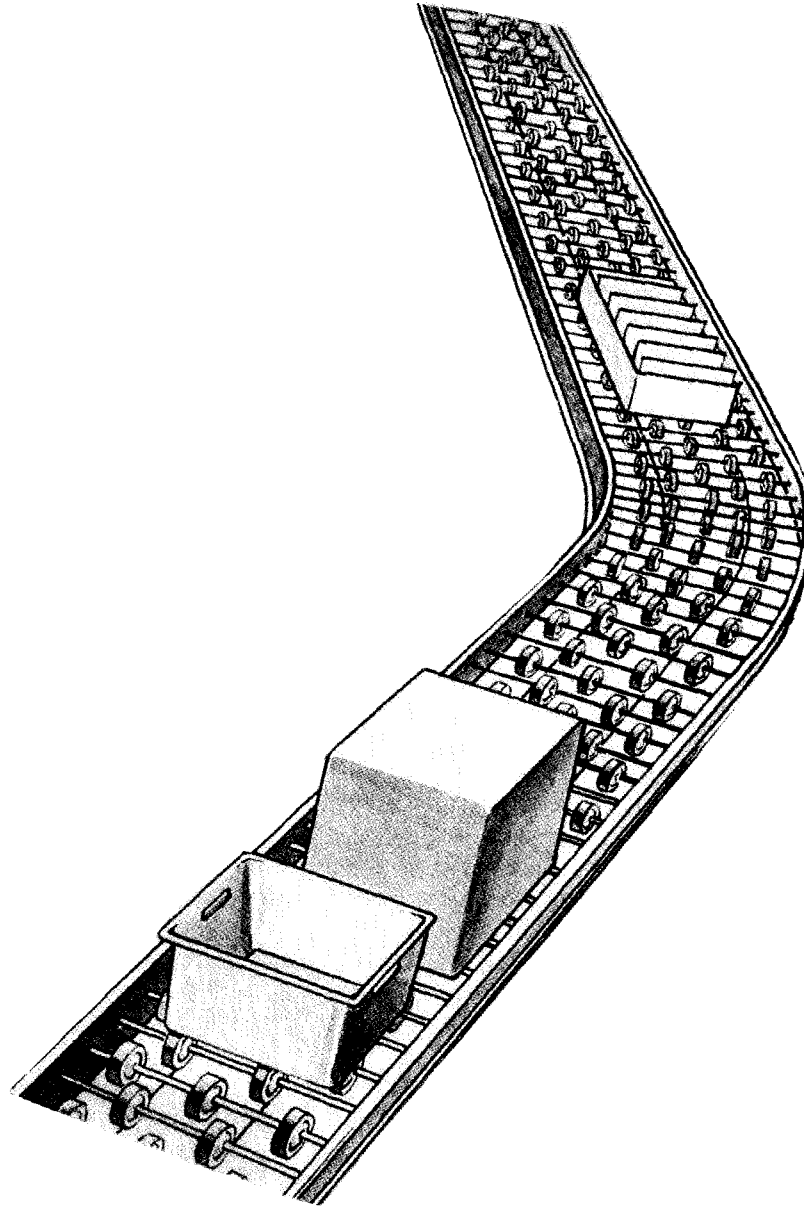

Figure 4-34 Conveyor, skatewheel

(2) *Conveyor, roller gravity.* Like the skatewheel gravity conveyor, the roller gravity is a free-flowing, nonpowered conveyor. The gravity conveyor, however, is a heavier duty design. This

conveyor has a heavier load capacity and is available in much larger sizes for movement of heavy items such as cases, crates, and pallets (fig 4-35). Available in standard 10-foot sections as well as in curved sections of 45 and 90 degrees.

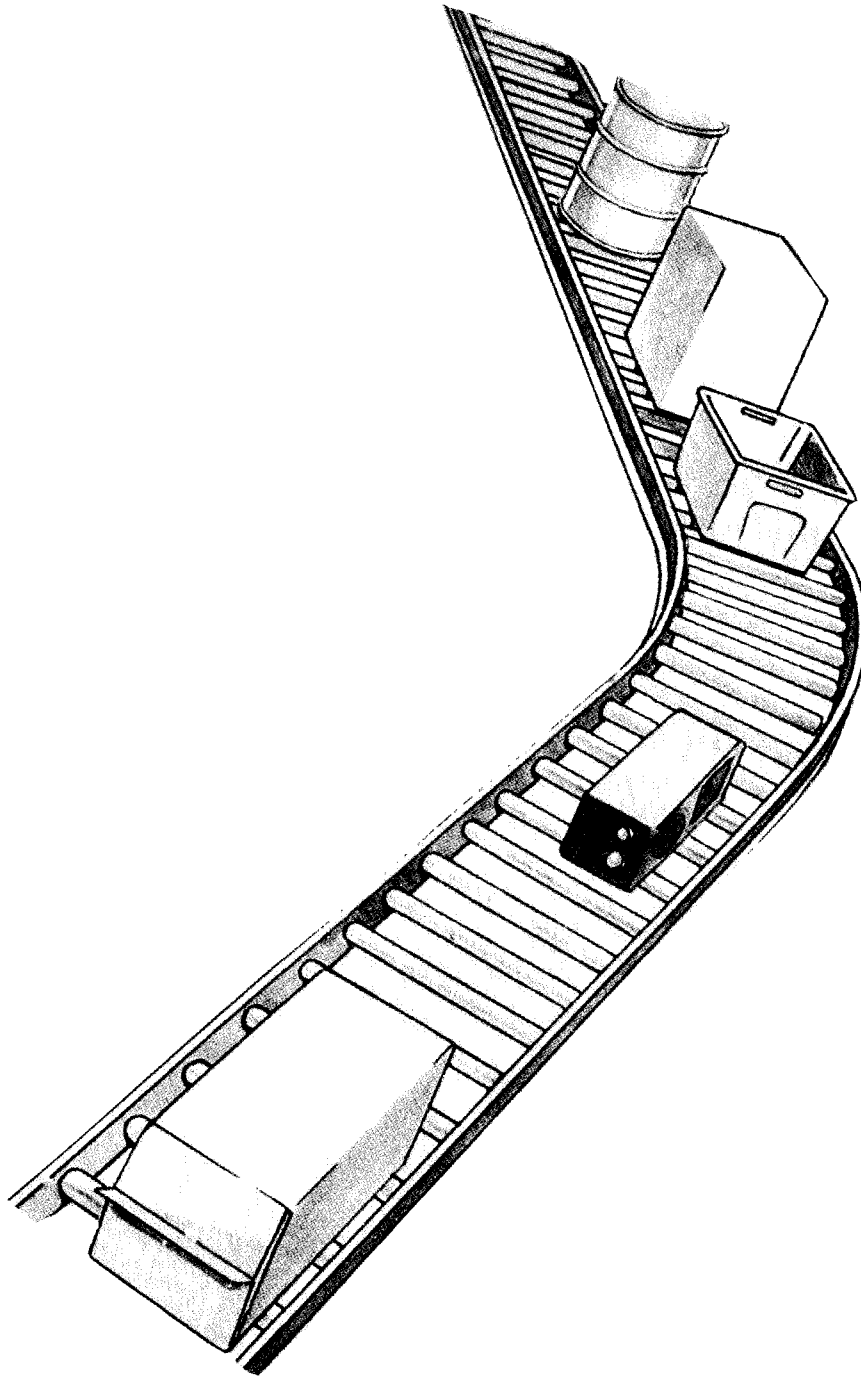

Figure 4-35 Conveyor, roller gravity

(3) *Conveyor, horizontal-slider bed, belt.* This box channel slider or roller bed-type conveyor ranges from 12¼ to 54¼ inches in width and the belt width ranges from 12 to 48 inches. The belt-type conveyor has the broadest application of any type of powered conveyor and is often used in automatic sorting systems. Because of nonslippery

conveying surfaces, the belt conveyors are most often used as spacing devices for metering loads onto the main sorting conveyor. Short belt sections can be mounted singly or grouped between other powered conveyors or at the discharge end of an accumulation line. Spacing between packages is provided by running the belt conveyor at a higher

speed than the infeed conveyor. The belt conveyor is especially useful for conveying loads such as bagged items which do not convey effectively on a roller conveyor. Inclined belt conveyors are used when a change in elevation is required (4-36).

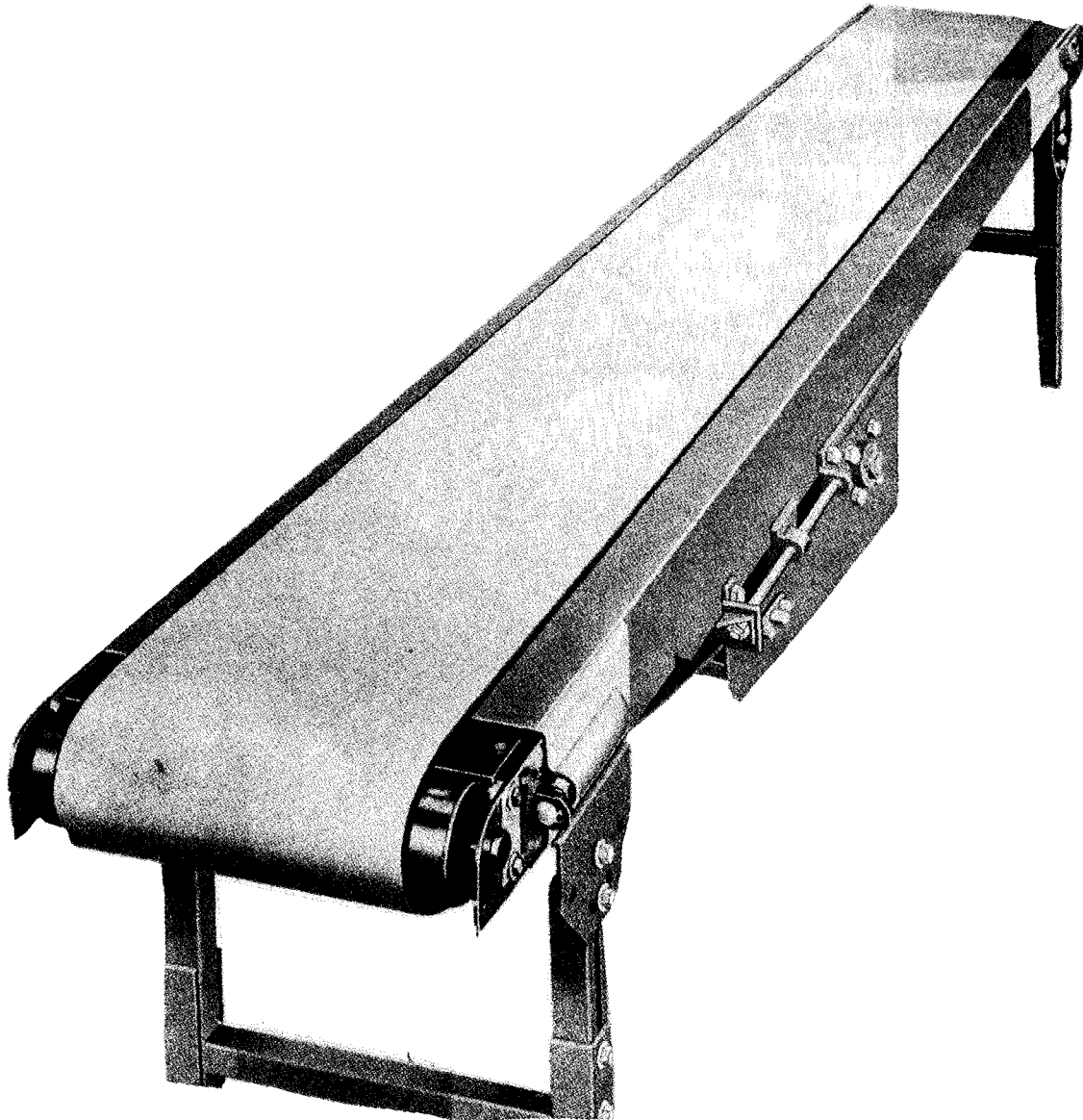

Figure 4-36. Conveyor, horizontal-slider bed, belt.

(4) Conveyor, gravity-extendable. The gravity-extendable conveyor has transfer rollers which connect each section of the skatewheel conveyor. Casters allow the movement of this conveyor into

or out of trailers. This conveyor comes in standard lengths of 10, 20, 30, and 40 feet. The gravity-extendable conveyor is used on loading docks, shipping areas, or whenever space is limited (fig 4-37).

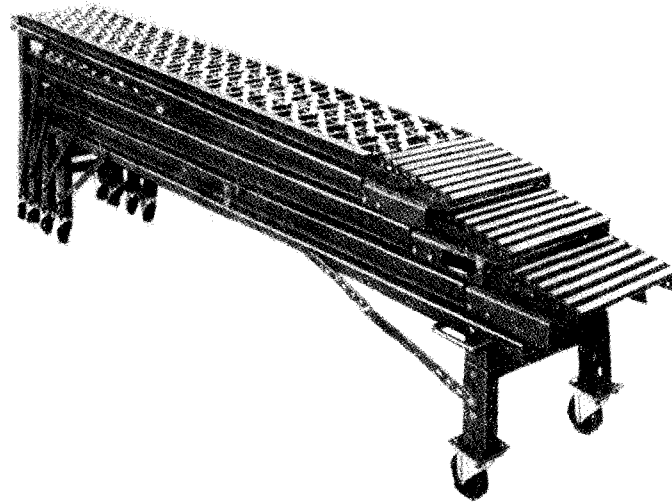

Figure 4-37 Conveyor, gravity-extendable

(5) *Conveyor, live-storage.* The live-storage conveyor consists of a sloping gravity conveyor system in a rack. Material is fed from the high end of the conveyor and is removed from the other end. The size of the rack is determined by the need of

each installation. This conveyor is used for automated operations or with stacker cranes, order pickers, and other automated equipment. Using the live storage conveyor offers the advantage of an FIFO stock rotation (fig 4-38).



Figure 4-38 Conveyor, live-storage

(6) *Conveyor, accumulation, dual-actuator.* This type of conveyor is used when item accumulation is desired. It handles a wide range of sizes

and weights without making adjustments. The accumulation conveyor offers an economical method

in handling items for work-in process, receiving, order assembly, and shipping operations (fig 4-39).

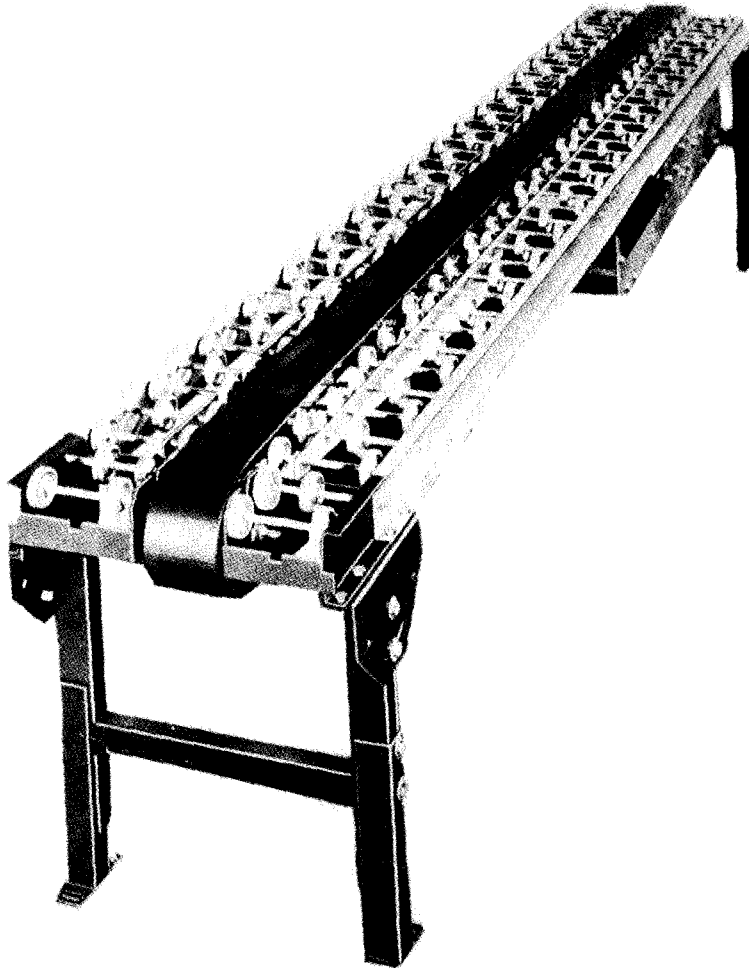

Figure 4-39. Conveyor, accumulation, dual-actuator.

(7) *Conveyor, power-driven belt, portable.* This conveyor is powered by a gasoline engine or electric motor. Electric models are available in 20-, 35-, and 50-foot sections. The gasoline-powered models are available in sections of 60 feet. A telescopic power-driven model is also available.

(8) *Conveyor, vertical.* The vertical conveyor is used to connect different levels in a handling system or can receive or discharge materials without an attendant, thereby, providing a continuous flow within a conveyor system (fig 4-40).

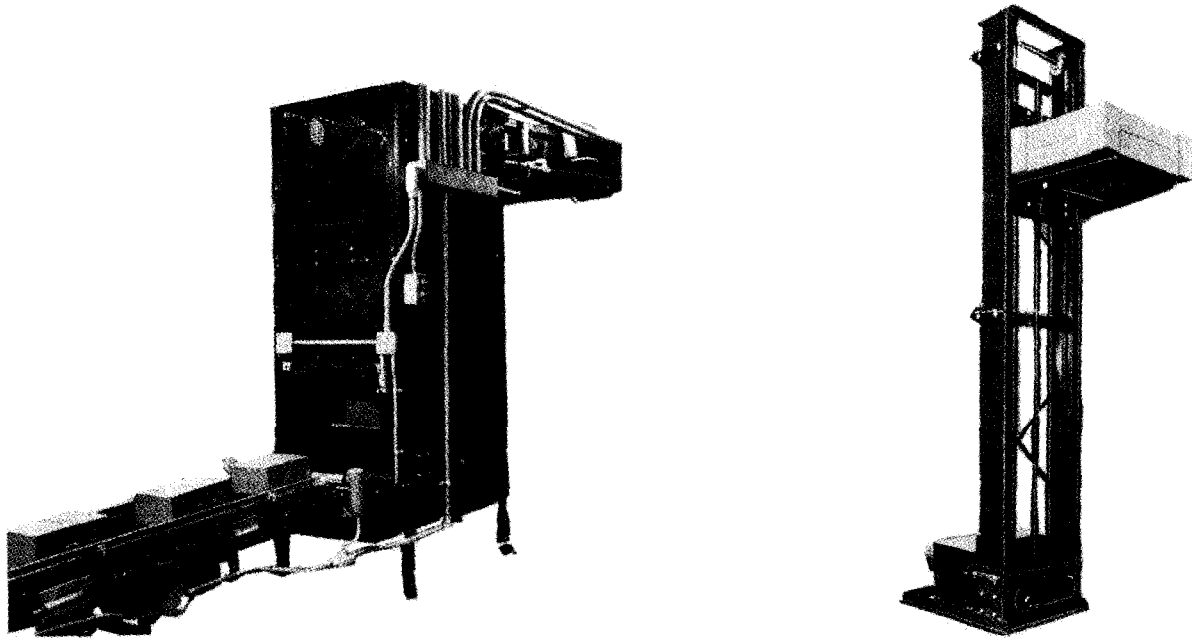

Figure 4-40 Conveyor, vertical

g. Conveyor, towline. In-floor towline conveyors are specially designed to move large quantities of materials. The in-floor towline can be installed in new and existing single and multi-floor structures. The cart consists of a load platform with two fixed rear wheels and two front swivel casters. A front rack is usually included to hold routing documents

and restrain the load. The carts are equipped with routing controls to automatically activate the spur diverters. Safety bumpers stop the cart when it contacts another object. This towline conveyor provides continuous flow of materials to work or storage areas. Another advantage of the towline is that it is a fixed path of equipment, but it does not obstruct traffic (fig 4-41).



Figure 4-41 Conveyor, towline, in-floor.

h. Automatic guided vehicles (AGVs). AGVs are wire guided, electrically operated, and can be programmed to stop at various stations on their path. This vehicle can be loaded from either side or from the rear. Transportation of material can go from medium to long distances. Systems can be de-

signed to meet requirements of users and can vary from closed loop to multiple path (fig 4-42). AGVs are also available with fork tines in lieu of platforms. These vehicles can lift pallet loads from floor level or from elevated heights such as conveyors or pallet racks.

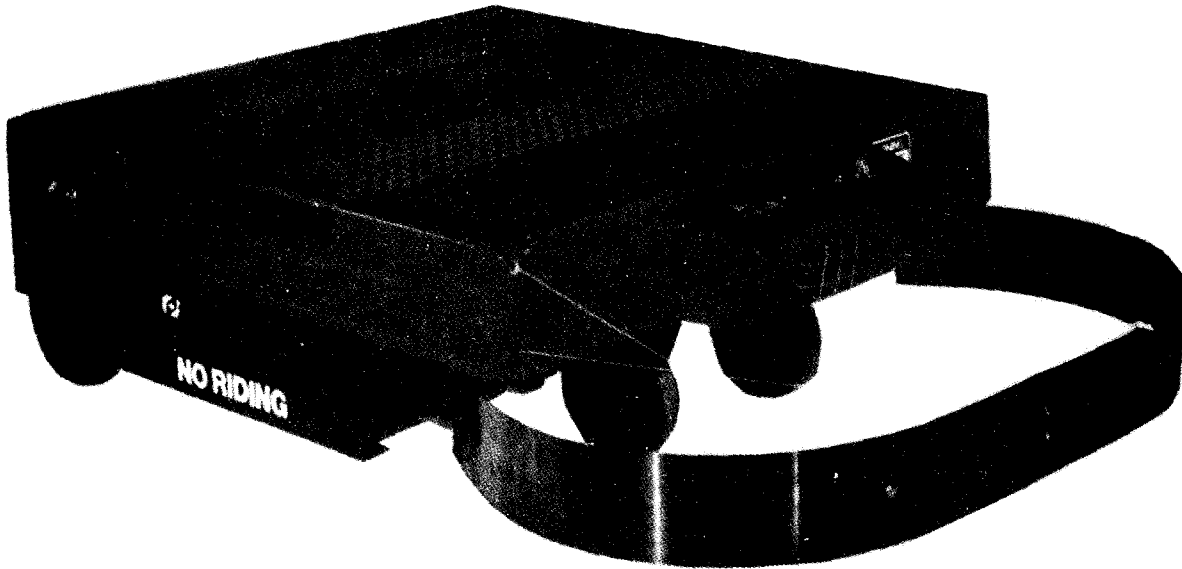

Figure 4-42. Automatic guided vehicles.

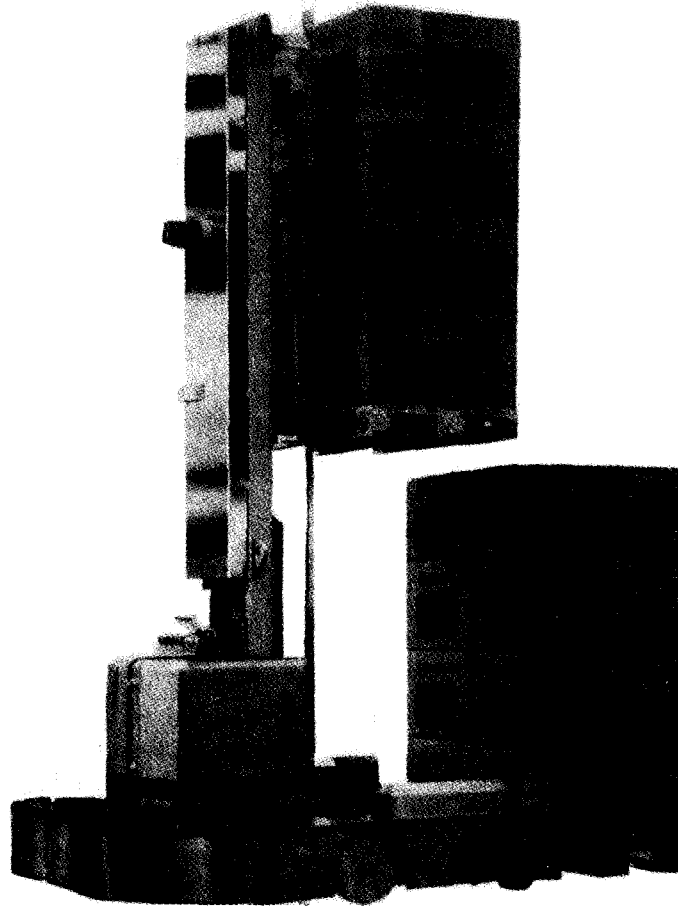

Figure 4-43. Automatic guided vehicles—forklift truck.

4-9. Sortation Systems.

Sortation systems perform two important functions, directing the material to a station or accumulation line and providing horizontal (and occasionally, vertical) movement. The sortation could

be performed manually; however, as the volume of material being processed increases—the profitability of automating the sortation increases. One example of an automatic sortation system is the tilt tray-type system (fig 4-44).

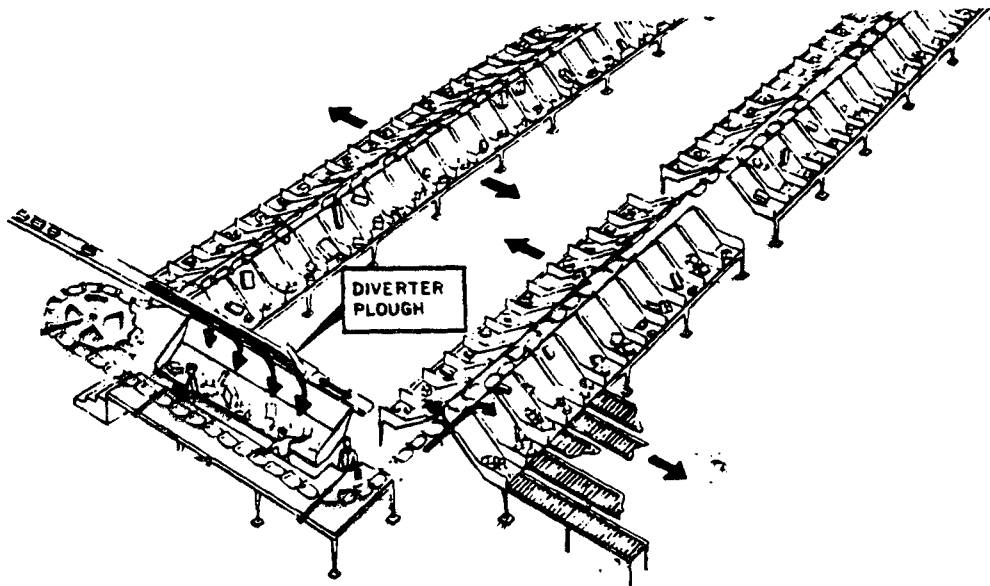

Figure 4-44. Tilt Tray Sorting System

4-10. MHE Accessories.

Numerous attachments are made for MHE in order to extend their capabilities. The representative sample of accessories shown herein must only be used as originally designed and never over the load capacity of the basic MHE.

a. Fork extensions. Fork extensions are used to extend the forks of a forklift truck. The extensions, consisting of welded steel arms, can be slipped into place over the regular forks. The use of fork extensions will permit the handling of items whose center of gravity is near to or beyond the end of the forks of the available forklift truck. Since the use of extensions moves the center of gravity of the load, it restricts the weight that can be lifted. This factor must be taken into account when the extensions are used to handle excessively large or bulky loads (fig 4-45).

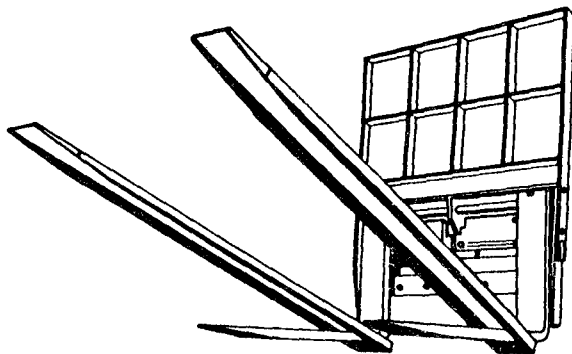

Figure 4-45. Fork extensions

b. Drum-handling sling.

The drum-handling sling is a device for picking up drums or barrels. It was originally designed for shipboard loading, but can be used with a crane truck for any drum- or barrel-handling operation. The sling may be of the chain type, which is a series of chain loops and sliding hooks; or it may be of the frame type, which is a steel bar from which a series of sling hooks are suspended (fig 4-46).

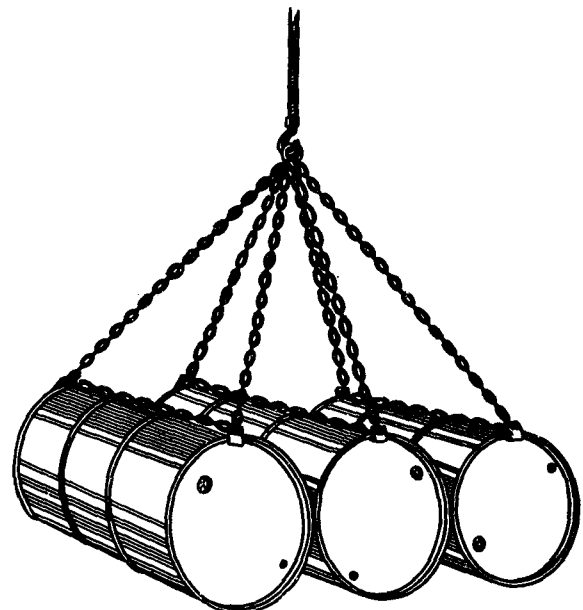

Figure 4-46 Drum-handling sling

c. Drum-handling attachment. The drum-handling attachment is a device capable of handling filled 55-gallon drums by means of a forklift truck. Three types of attachments are available. The first consists of a series of specially shaped and spaced forks that cradle the drums to be handled (fig 4-47). This type of attachment handles three filled drums at one time. The second type of attachment, which is mounted on the regular truck forks, consists of side rails from which specially designed hooks are suspended at front and rear. The attachment is lowered over the drums until the hooks drop into position over the drum rims (fig 4-48). This type of attachment handles two filled drums at one time. The third type of device is hydraulically operated, attaches easily to the hydraulic system of a gas- or propane-operated forklift truck and can be easily removed in minutes. The various applications include tilting, dumping, stacking, transporting, and lifting of 55-gallon drums using a forklift truck (fig 4-49).

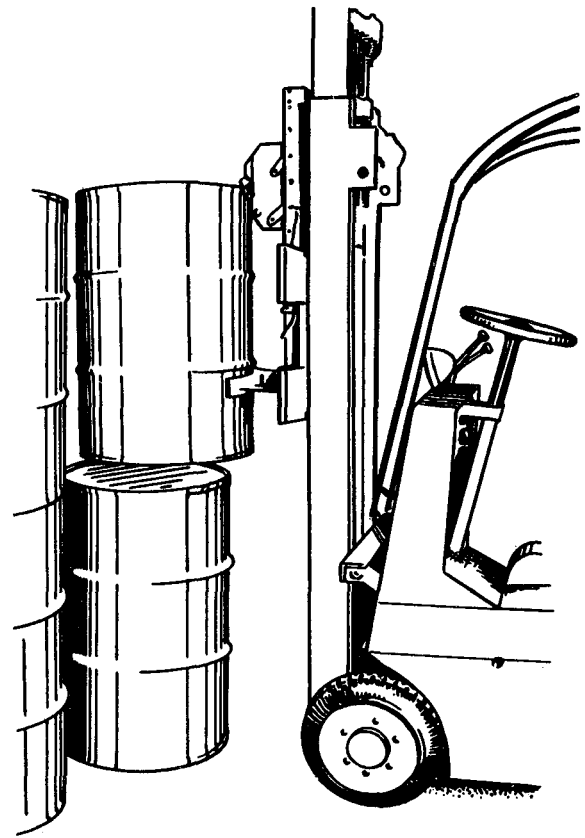

Figure 4-48 Drum-handling attachment single-drum type, vertical carry.

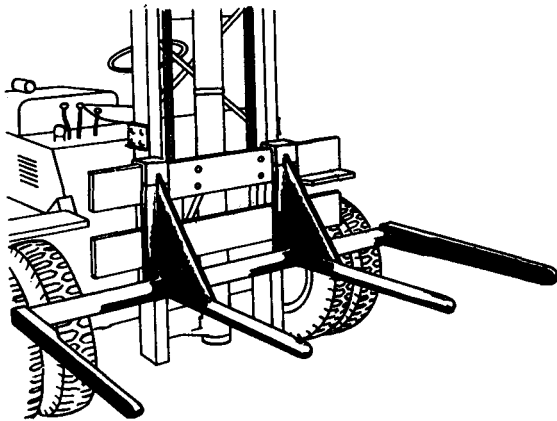

Figure 4-47. Drum-handling attachment

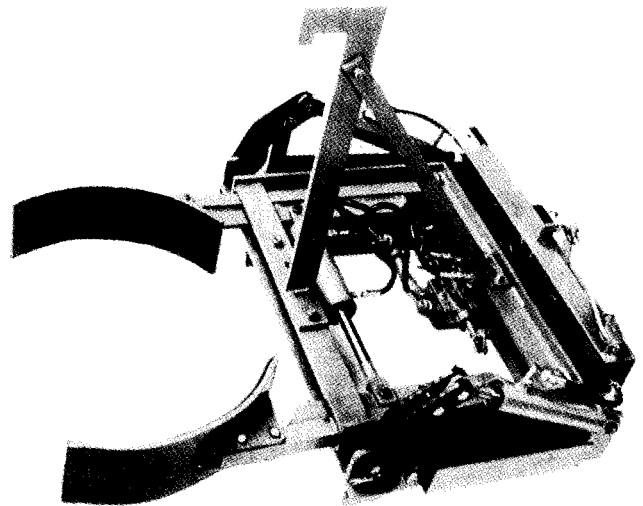

Figure 4-49 Drum-handling adaptor

d. Bottom-dumping hopper. The bottom- or self-dumping hopper is a forklift truck attachment that is used to load and unload bulk materials, small parts, or scrap (fig 4-50).

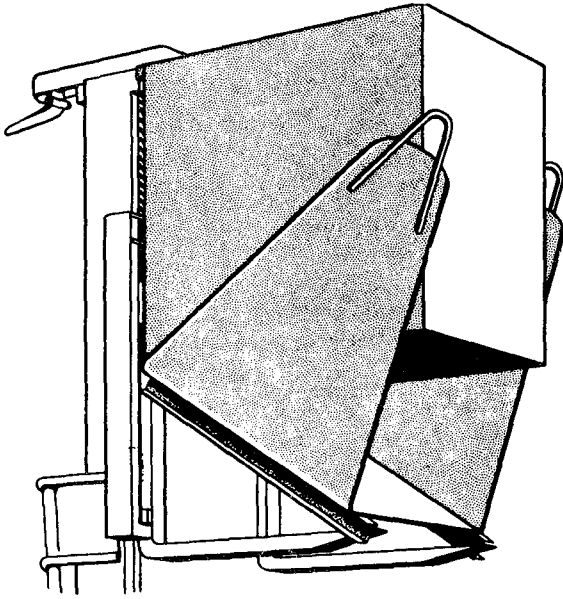

Figure 4-50 Bottom-dumping hopper

e. *Ram.* The ram is a solid, pole-like device attached to a forklift truck and used to handle coils of wire or cable, rolls of paper, or other cylindrical or open-center items (fig 4-51).

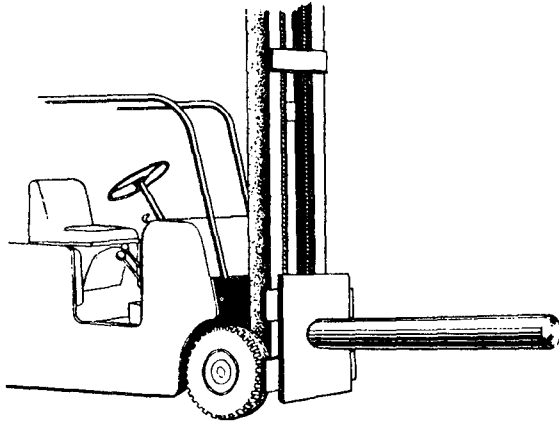

Figure 4-51 Ram

f. *Lifting arm bar.* The lifting arm bar is a crane attachment used for handling wire coils (fig 4-52).

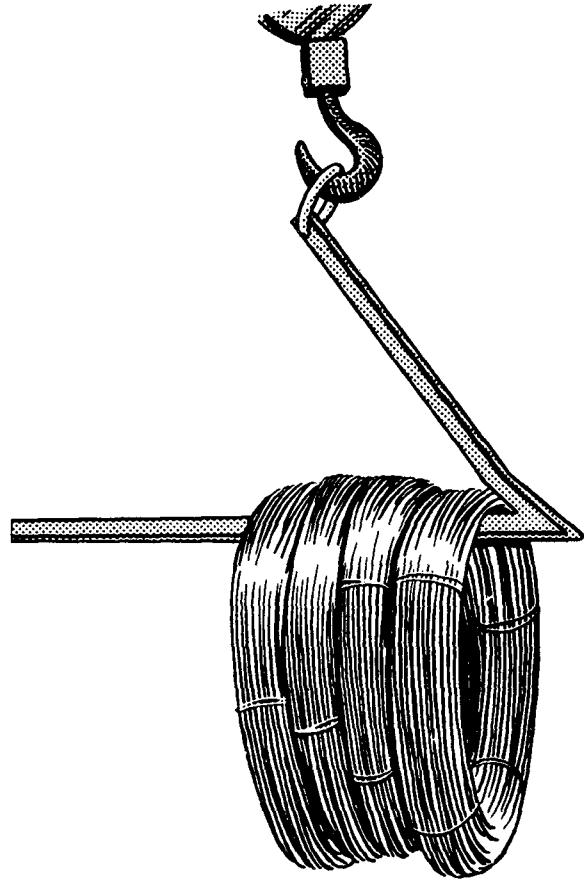

Figure 4-52. Lifting arm bar

g. *Crane boom attachment.* Converts forklift truck to mobile jib crane capable of handling bulky, irregular-shaped objects, and is a valuable aid in maintenance work. The crane boom is raised or lowered with the standard lift mechanism (figs 4-53 and 4-54).

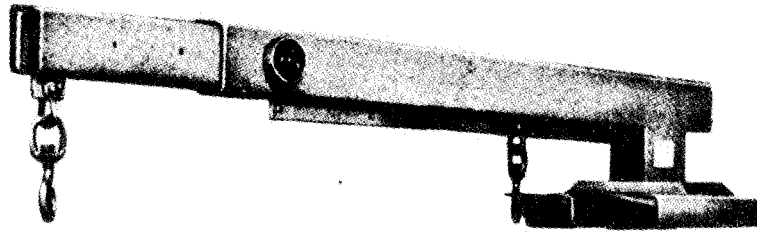

Figure 4-53. Crane boom attachment

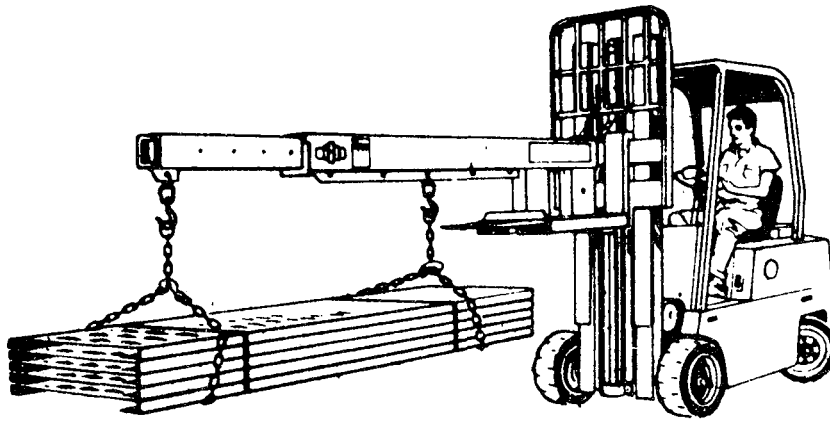

Figure 4-54 Crane boom attached to forklift truck

h. Clamp. The use of hydraulically operated clamp arms enables the fork truck to handle objects that cannot be palletized satisfactorily. The clamp arms grip the load by squeezing it between the clamp faces. There are numerous variations of clamp arms made to handle different types of bags, barrels, cartons, bales, and other commodities. The clamping pressure required depends on the load and usually is regulated by the operator (fig 4-55).

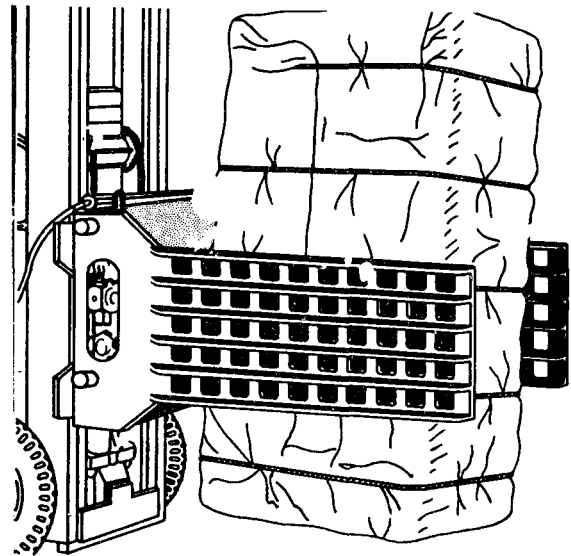

Figure 4-55 Clamp

i. Revolving carriage. The revolving carriage is generally made to rotate in a circle of 360°. It is normally used in handling granular or liquid materials that are to be dumped from one container

into another. The carriage is designed to accommodate forks and other attachments (fig 4-56).

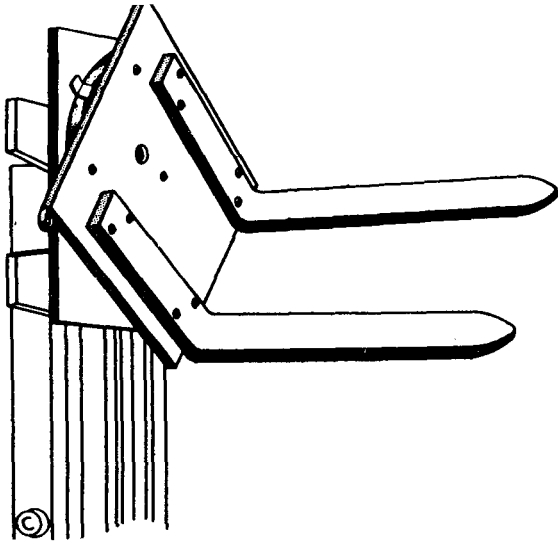

Figure 4-56 Revolving carriage.

j. *Retriever trailers.* Retriever trailers are used to haul forklift trucks to and from maintenance shops at widely dispersed activities. The single truck-type retriever can be towed by a 4,000- or 7,500-pound gasoline tractor (fig 4-57).

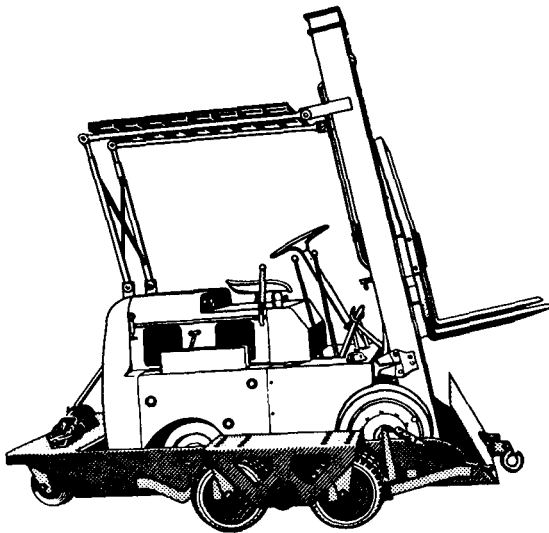

Figure 4-57 Retriever trailer, single truck-type.

k. *Safety pallet* (OSHA 1910.178). The safety pallet (fig 4-58) is used both for maintenance work and for placing materials into or removing materials from storage. The safety pallet is handled the same as an ordinary pallet except it is secured to the fork-lift truck. Primarily, the safety pallet is

used to elevate personnel and tools, and to permit warehouse personnel to safely store material in high racks when items cannot be stored by a fork-lift truck approaching at right angles due to narrow aisles. The entire pallet is painted yellow and is equipped with the following safety features (fig 4-59).

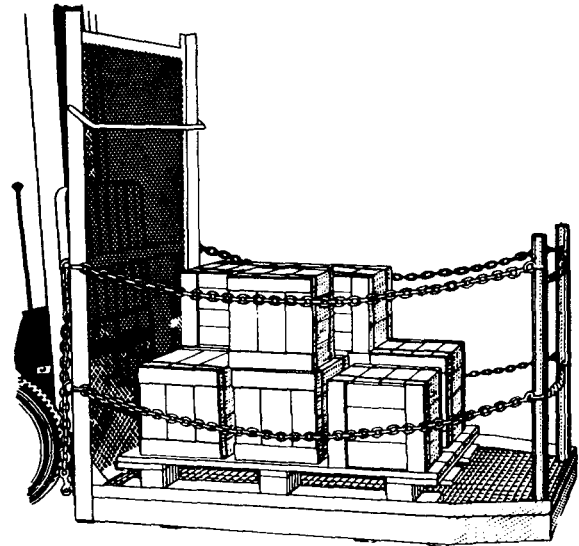

Figure 4-58 Safety pallet.

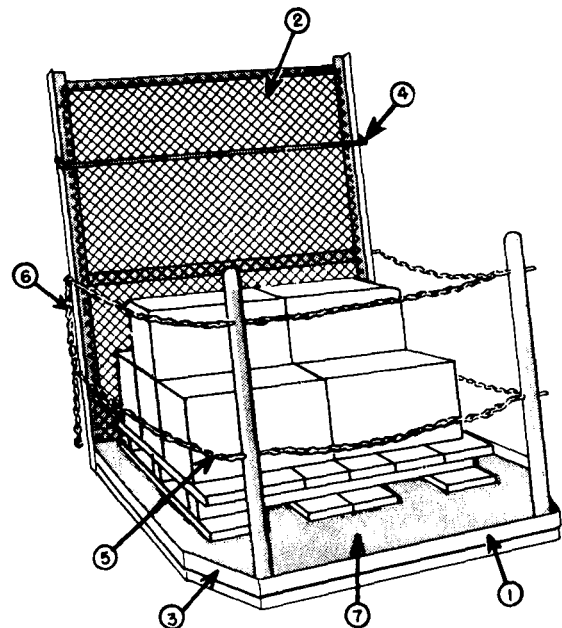

Figure 4-59 Features of the safety pallet

(1) A high edging to prevent tools or small items from falling off.

(2) An expanded metal backguard to protect personnel from moving parts of a fork truck.

- (3) Mitered corners.
- (4) A handrail on background.
- (5) Safety chains to enclose pallet area.
- (6) Chains for securing pallet to fork truck.
- (7) Checkerplate flooring to prevent slippage on pallet.

There are two types of safety pallets, type "A" and type "B." The type A safety pallet (fig. 4-58) is large enough to accommodate the average pallet and provide ample space from which a person can move materials safely into or out of storage. Fork extensions should be used with type "A" safety pallet (fig. 4-60) and, notice to this effect should be displayed prominently on the side of the pallet. The load carrying capacity of a fork truck rated at 24-inch load center is reduced by approximately 20 percent when handling loads of 60 inches long. This lower capacity must be considered when using the type "A" safety pallet. The type "B" safety pallet is similar to type "A," but smaller and more maneuverable in narrow aisles, a feature which is of value in maintenance work and in the movement of small lots of materials into and out of restricted storage areas. The specifications for construction of the type "A" and type "B" safety pallet are outlined in figure 4-62. In addition, protection from falling objects, should the operating

conditions require it will be provided to protect personnel who are being elevated.

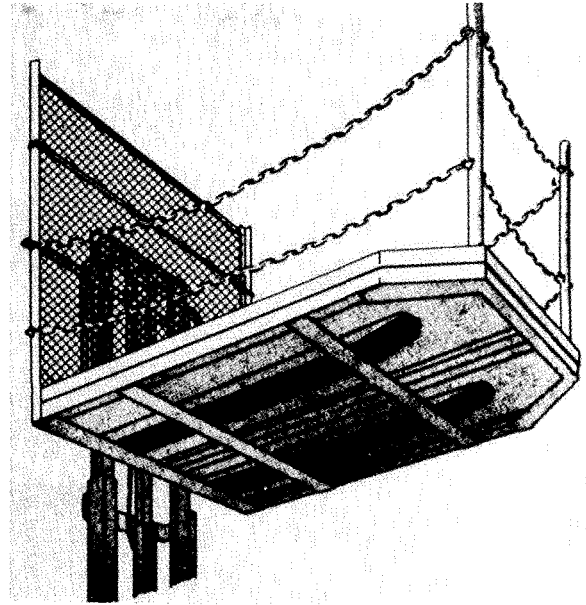

Figure 4-60 Extension forms used with the type "A" safety pallet

1. *Pallet sling.* Figure 4-61 shows a pallet sling which is used to handle a pallet for overhead lifting by a crane.

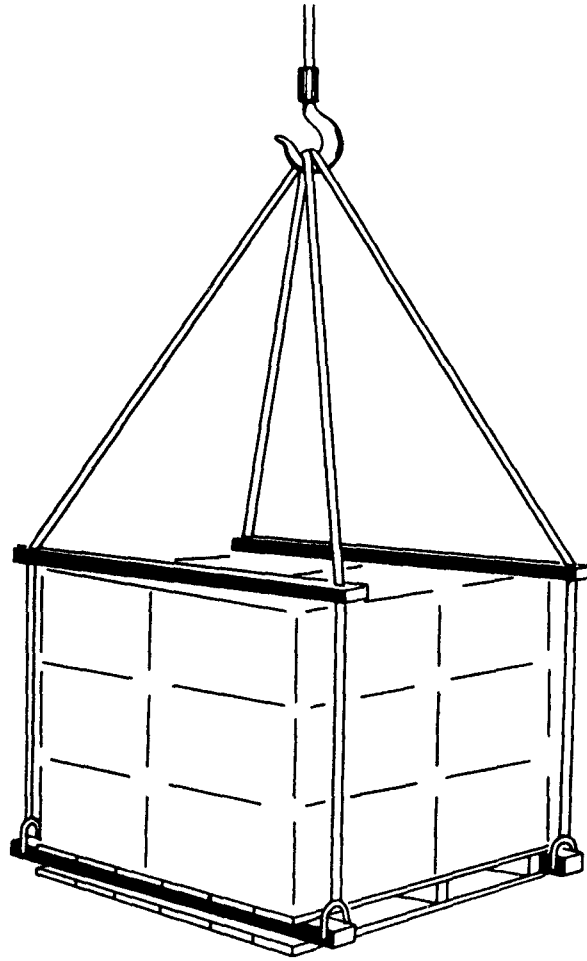

Figure 4-61 Pallet sling.

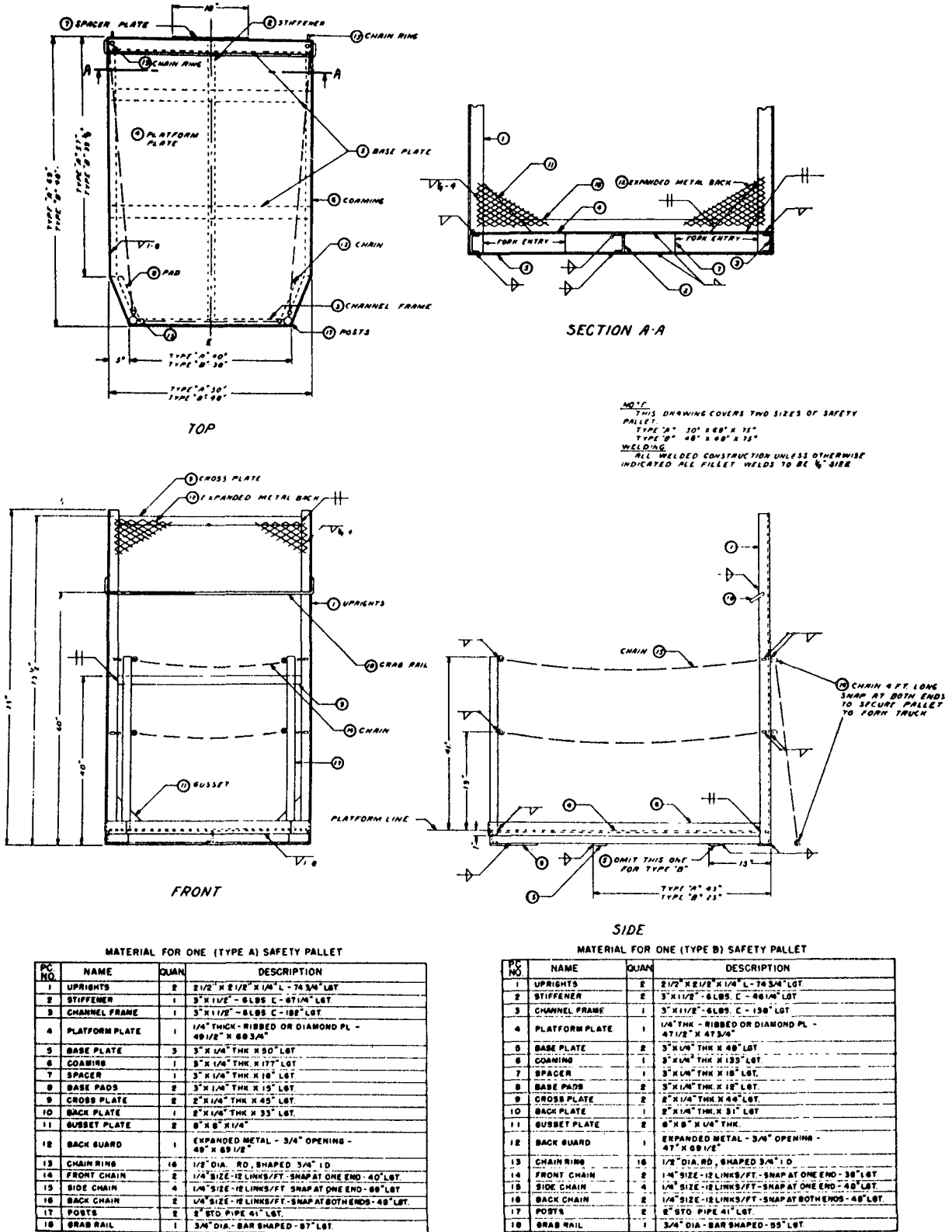

Figure 4-62 Safety pallet specifications

4-11. Dock Related Equipment.

a. Bridge plate. The bridge plate is a metal plate used to span the gap and compensate for the difference in height between the truck and truck dock and the railcar and rail dock. The bridge plate permits movement of MHE in and out of trucks and railcars. These plates are usually equipped with chains or recessed lifting hooks for pickup positioning by a forklift truck (figs. 4-63 and 4-64).



Figure 4-63 Bridge plate, chain-type

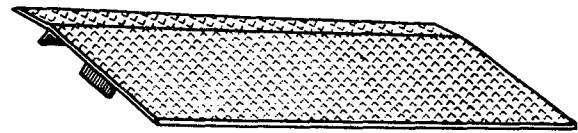

Figure 4-64 Bridge plate, lifting hook-type.

b. Mechanically operated ramp. The mechanically operated adjustable ramp is used at the truck dock. The ramp is vertically adjustable to the height of truck floors so that movement of MHE in and out of trucks is permitted. These ramps are either permanently installed in the dock or located in front of the dock (figs 4-65 and 4-66).

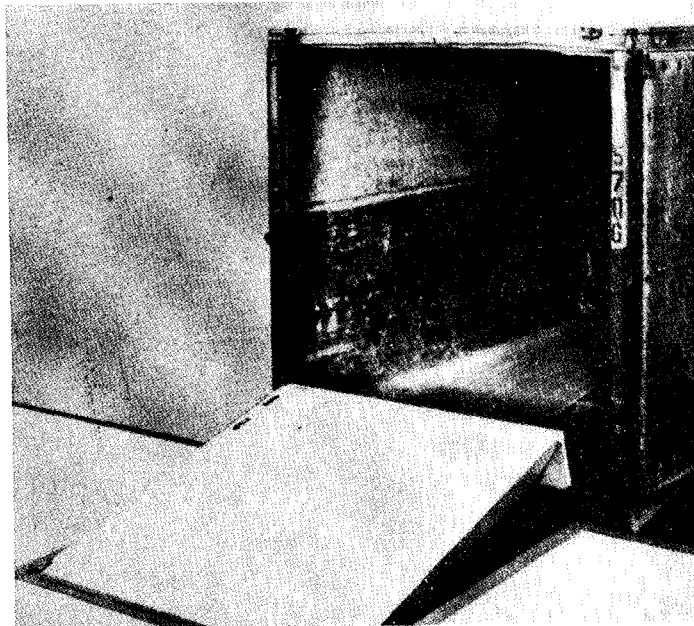

Figure 4-65. Mechanical ramp recessed in the loading dock.

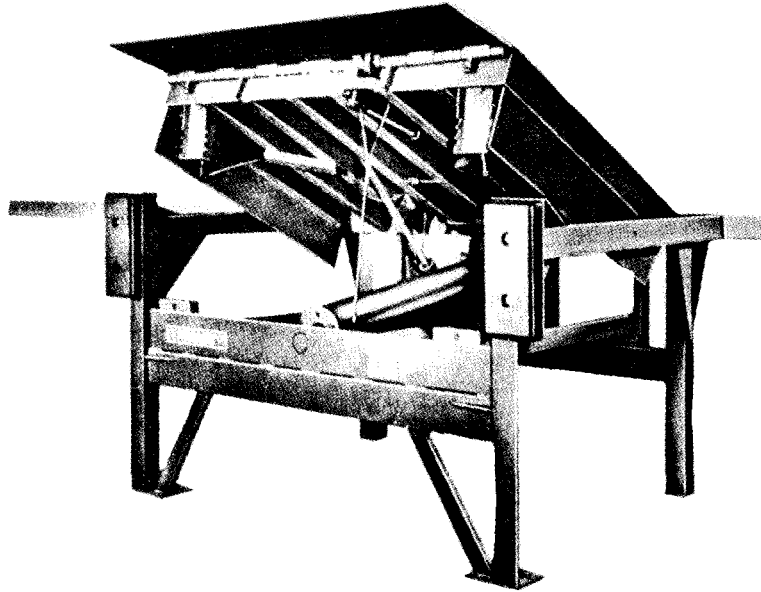

Figure 4-66 Mechanical ramp mounted in front of dock.

c. Flip ramp dock board. Used for truck loading and unloading. This manually operated dockboard is mounted to the front of the dock (figs 4-67 and 4-68).

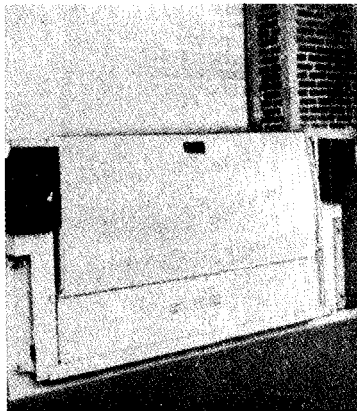

Figure 4-67 Dockboard in stored position

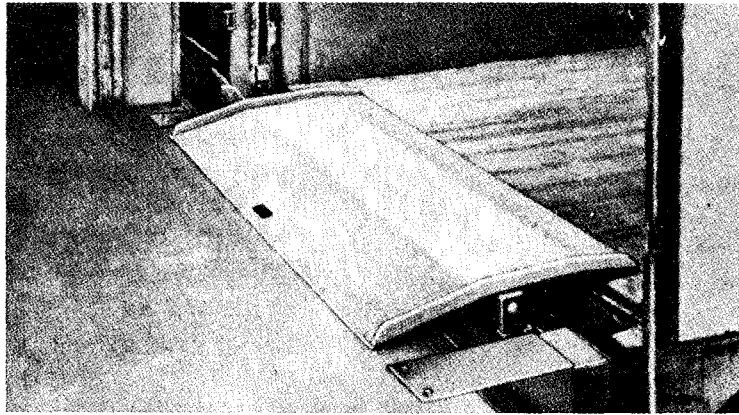

Figure 4-68. Dockboard in operating position

d. *Mobile vehicle loading ramp.* Portable ramp used for loading and unloading with forklift trucks from ground level. A detachable tow bar is provided for towing (fig 4-69).

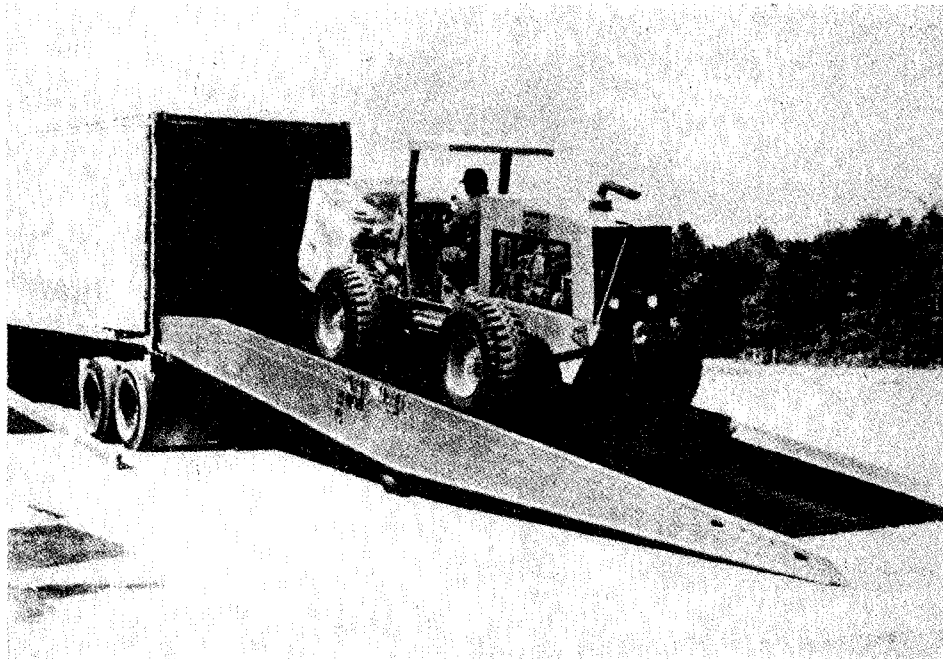

Figure 4-69 Mobile vehicle loading ramp

e. *Dock seal head pad.* Dock pads are designed to provide a seal between shipping/receiving doors and carrier trucks. These pads are available in

various sizes to accommodate all standard size doors. Operator positioning is not required. These sealers conserve energy and generally improve working conditions (fig 4-70).

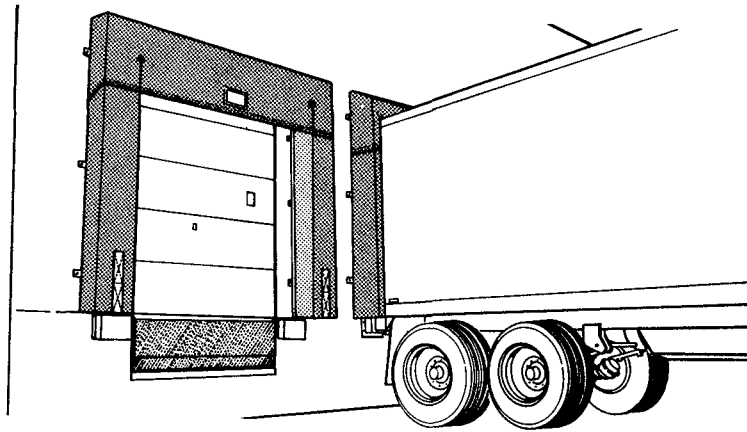

Figure 4-70. Dock seal head pad.

f. Portable platform. A portable platform is used to load and unload supplies at open sheds, open storage, or wherever cars are being worked from ground level. It can be moved by a forklift truck and has slings for handling by crane. One type of platform is equipped with legs only. Another type is equipped with retractable legs, wheels, and pneumatic tires (fig 4-71).

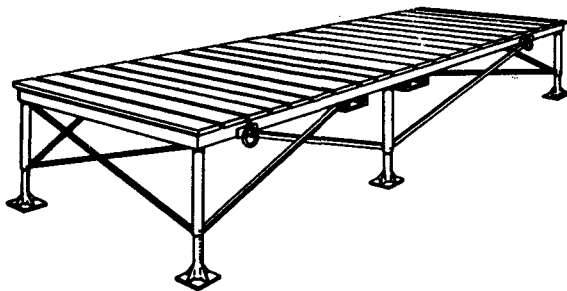

Figure 4-71. Portable platform.

g. Bridge plate rack. The bridge plate rack is used to store bridge plates. Several types made of wood or metal are in use (fig 4-72).

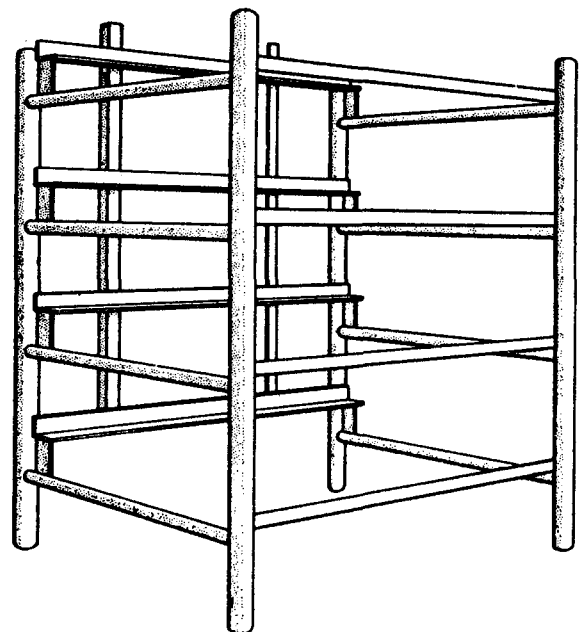

Figure 4-72. Bridge plate rack.

h. Car door opener. The car door opener is used to open the doors of rail-cars. This allows one man to open the car door and consists of a block, pawl, ratchet, and chain (fig 4-73).

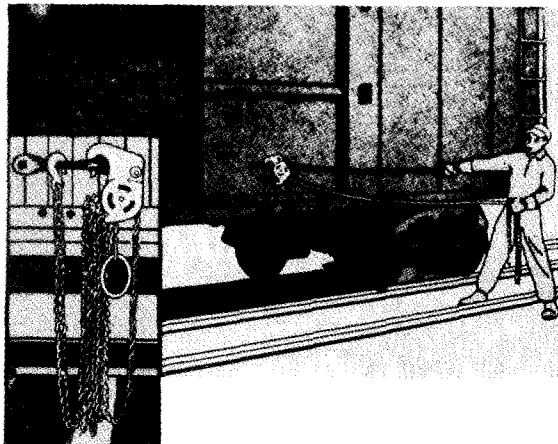

Figure 4-73 Car door opener, manual type.

Section III. Storage Aids.

4-12. Dunnage.

a. Application. Dunnage is used to permit mechanical handling of stock and to protect it from possible damage from waterflows or dampness normally generated from the floor or ground area. In either covered or open storage, stock should be stored on pallets or dunnage. Skids on boxes or crates should be considered as attached dunnage for storage purposes. Usually, dunnage consumes less storage cube than a pallet. Dunnage may be cut from salvaged dimension lumber at little cost and, therefore, may be used in lieu of a pallet when the material will not be handled multiple times. Multiple handlings increase the payback of palletization. Dunnage should be used at floor or ground level and between units in the stack when one dimension of a stable container exceeds the width of a fork truck. Large boxed or crated units, crated or boxed engines, and other such commodities may be stored efficiently on dunnage (figs 4-74 and 4-75). A supply of dunnage, cut into appropriate lengths, should be available in all storage areas in which portions of the material are to be stored on dunnage.

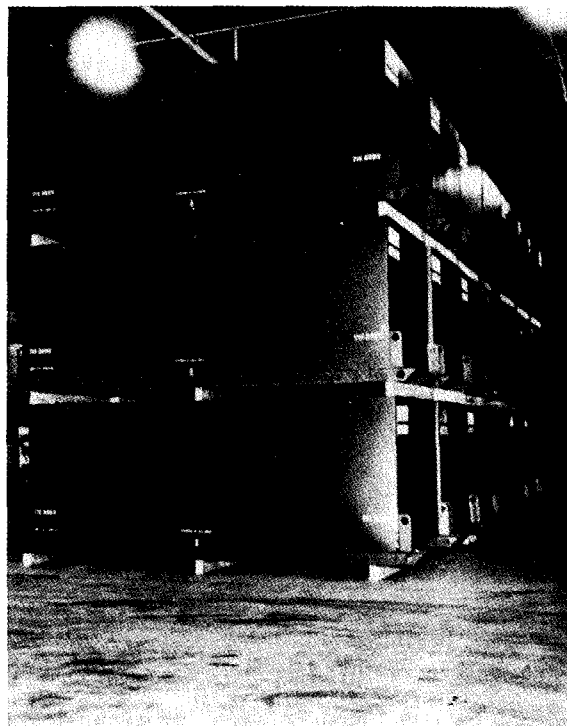

Figure 4-74. Dunnage used in the stacking of asphalt melters.

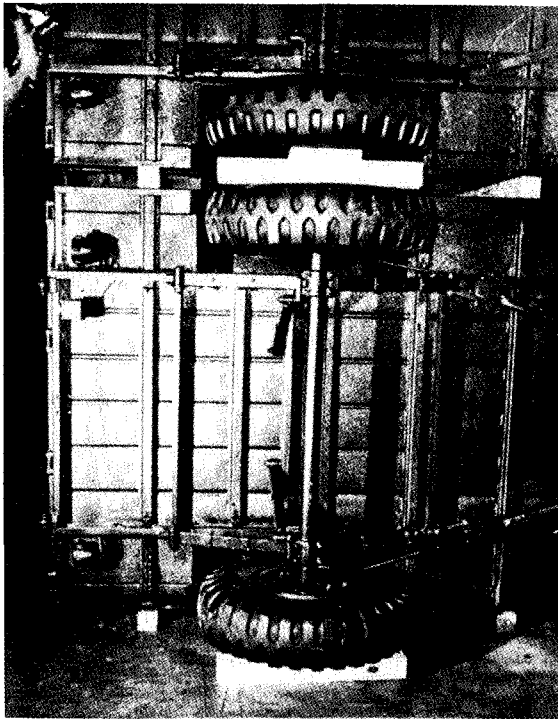

Figure 4-75 Dunnage used in the storage of trailers

b. Vertical dunnage. Vertical dunnage is lumber cut slightly shorter than the overall height of the load. When placed the same distance around the edge of the load or between containers in a vertical position, vertical dunnage stabilizes the load and prevents crushing of the containers by absorbing that part of the load which is in excess of the strength of the container. Also, pieces may be joined at right angles, placed at the four corners of the load, and held in position by strapping. The proper length of vertical dunnage is determined by the height of the pallet load. The friction of the loads upon each pallet bottom and the proper lengths of vertical dunnage that will support the load provide the required stability for the stack.

c. Horizontal dunnage. Some form of horizontal dunnage must be used to build stable unit loads of noninterlocking items which will withstand handling, as a unit load, by mechanical equipment. Pallets often have been used for this purpose, by placing one or two courses of a hard-to-stack item on a pallet and placing the small unit loads into storage. In such storage, a stack 18 feet high may contain as many as seven to eight pallets. This is an inefficient use of pallets and greatly reduces the quantity of stock which may be stored in a given storage cube. By the use of horizontal dunnage, stable noninterlocking items can

be made into full unit loads, without any measurable increase in the size of the unit load due to dunnage. Double-faced corrugated fiberboard, thin plywood, plain fiberboard, heavy wrapping paper, or similar materials may be used as horizontal dunnage. The type of horizontal dunnage to be used will depend upon the weight, shape, and cutting qualities of the item to be palletized.

d. Horizontal binder block dunnage. Another type of horizontal dunnage used for lateral binding of palletized loads is binder block dunnage. This dunnage consists of short lengths of dunnage lumber, cut to any desired length, with short pieces of blocking secured to each end. This dunnage is particularly adapted to the storage of such items as soil pipe, lengths of large pipe, or similar items which require blocking to prevent rolling (fig 4-76). Use of this type binder facilitates the removal of one or more layers of pipe from the pallet or stack at any time by use of the fork truck. Also, it results in safe unit loads and permits high stacking of this type of item.

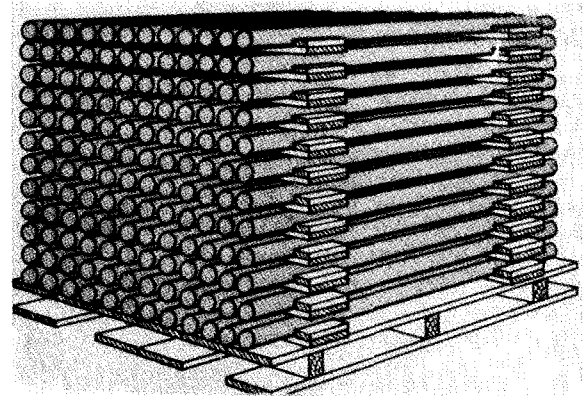

Figure 4-76. Binder block dunnage used in the storage of pipe

e. Collars and notched spacers.

(1) *Carboy collars.* To stack glass carboys and similarly packaged items, the superimposed weight of the upper pallets must be supported in such a manner that the weight will be carried by the protective crating around the carboy; this can be accomplished by the use of the wood collar (fig 4-77). By the use of this collar, carboys can be stacked to permit maximum utilization of storage cube. Since all carboys are not identical in size or packaging, the dimensions of the collar will have to be determined by local requirements. However, care should be taken to assure that the outer edges of the collar rest directly above the sides of the carboy crate. The center member of the collar should be midway between the carboys and securely fastened, as this member supports the cen-

ter stringer of the upper pallet. In ordering collars, the storekeeper should remember that a collar is not required on the top pallet.

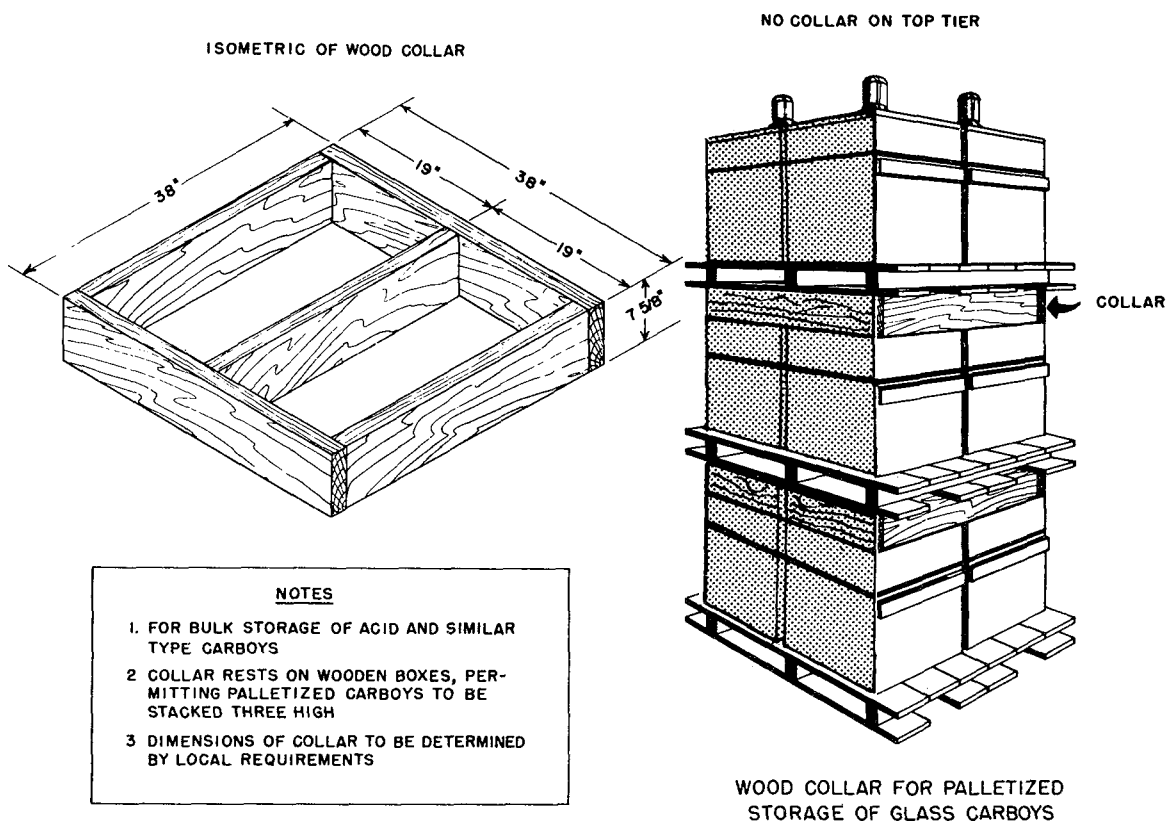

Figure 4-77 Collars used in the storage of glass carboys

(2) *Collars for compressed gas cylinders.* The valves on acetylene and similar type cylinders must be protected from the superimposed weight of the upper pallets; this is accomplished by the use of wooden collars (fig 4-78). However, since this collar depends upon the cylinder (the neck of

which has a slight slope) for support, it is necessary that this unit be reinforced. All cylinders palletized in an upright position must be bound with steel strapping to stabilize the load and to prevent accidental tipping of a cylinder during transporting or stacking operations.

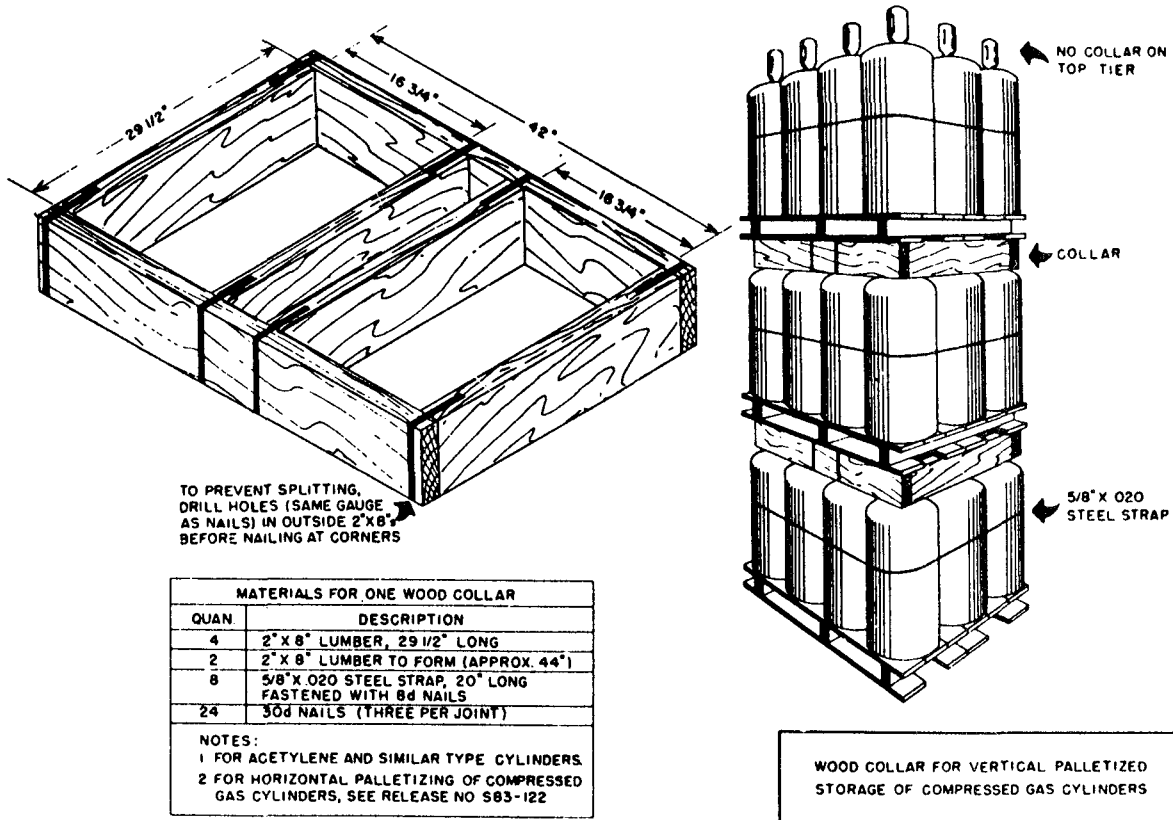

Figure 4-78. Wood collars for vertical palletized storage of acetylene cylinders

(3) *Notched spacers.* Notched spacers are used for the horizontal palletizing of compressed gas cylinders. Also, this spacer may be used to palletize short sections of large diameter pipe or similar items. The notches are on both the top and bottom of the dunnage (fig 4-79), which does not reduce the strength of hardwood dunnage below acceptable safety factor requirements. Notched spacers are recommended for smaller diameter cylinders. This method of palletization permits the issue of single units without disturbing the balance of the unit. When transporting items palletized in this manner, the units must be bound to the pallet with wire or steel strapping.

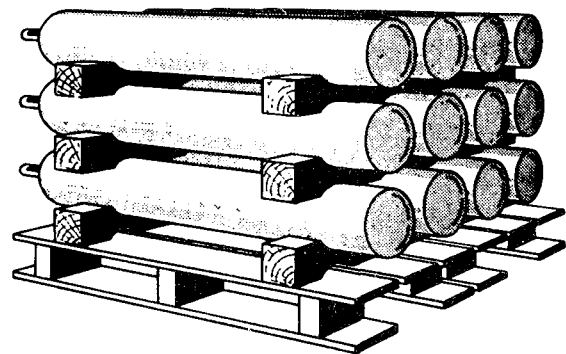

Figure 4-79 Notched spacers

4-13. Containers.

a. Tote Pans.

(1) General. Tote pans are temporary containers for odd-shaped, small, or fragile items built from fiberboard, wood, metal, or plastic on which supplies are loaded, transported, or stored. They are temporary in nature based on the fact that they will not be sent outside of the storage activity and do not provide permanent containerization for

the items. They can be stackable, nestable, and modular to accommodate various applications (fig 4-80).

(2) *Application.* Tote pans are primarily used to move the supplies from a loose issue operation to packing, shipping, or maintenance operations. The pan's design enables the stock selector to place the bare or packaged item into the pan with the stock selection document. The pan will enable an odd-shaped item to glide over the rollers of a conveyor, and is especially helpful when the conveyor is of the skatewheel variety.

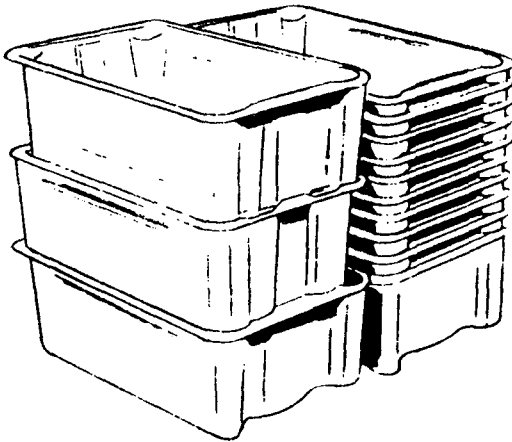

Figure 4-80. Tote pans

b. Pallets.

(1) *General.* A pallet is a low, portable platform constructed of wood, metal, or fiberboard, built to specified dimensions, on which supplies are loaded, transported, or stored in units. Flat pallets are either single faced or double faced. Single-faced pallets have one platform with stringers underneath on which the weight of the load rests. Double-faced pallets have two platforms separated

by stringers. Pallets may afford two- or four-way entry. The two-way entry pallet is so constructed that the forks of a forklift truck may be inserted from either the front or rear of the pallets. The four-way pallet is so constructed that the forks of a forklift truck may be inserted from any of the four sides. Flat pallets are constructed of either softwood or hardwood. Expendable pallets are four-way entry and are composed of either fiberboard, polystyrene, or a combination of these. A box pallet is constructed with a framework and crossmembers extended up from the pallet platform, the front side normally being left open for loading or unloading.

(2) *Application.* Figures 4-81 through 4-83 are hardwood pallets which permit transporting, storing, or issuing of quantities of material with a minimum of manual handling. Material is placed manually on the pallet at time of receipt and remains on the pallet for mechanical handling throughout the complete cycle of storage and issue operations. The efficiency of the operation is greatly increased, since the pallet system of storage provides for the transportation of packaged items in unit loads and increases the volume and tonnage of materials which may be handled per man-hour. MIL-P-15011 pallets are used for NATO shipments (fig 4-83). Softwood pallets, type I, two-way, flush, and type II, two-way, wing are intended for use in storage operations. Type IV, four-way (partial) wing (fig 4-84) is intended for use in storage, except where palletized material is contained by means of pallet support sets and for shipment world-wide regardless of the mode of transportation. The expendable buckboard pallet (fig 4-85) is used for air, CONUS, and Direct Support System shipments. The buckboard pallet stand (fig 4-86) facilitates the movement of the pallet to the shrink tunnel.

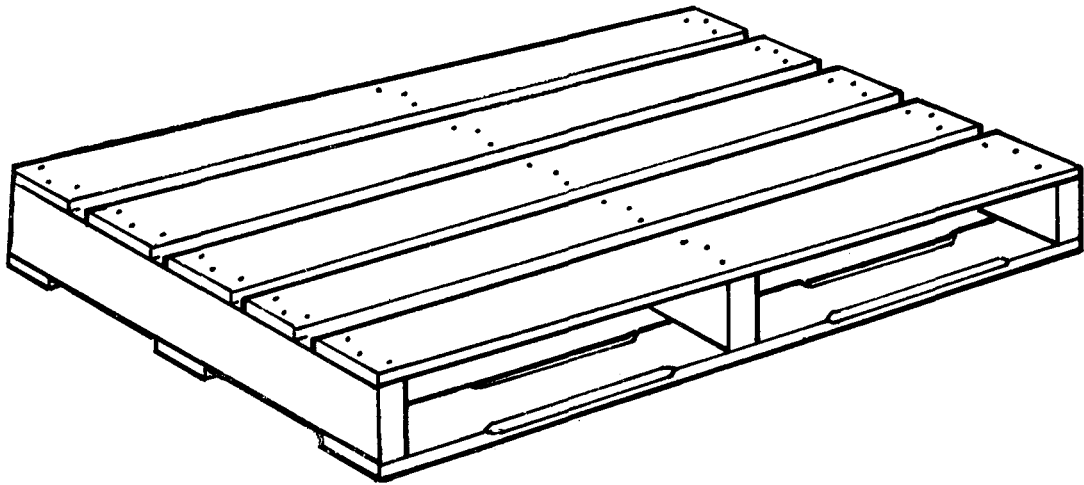

Figure 4-81 Pallet, 40 by 48 inches, flush-end, three-stringer, two-way entry, hardwood

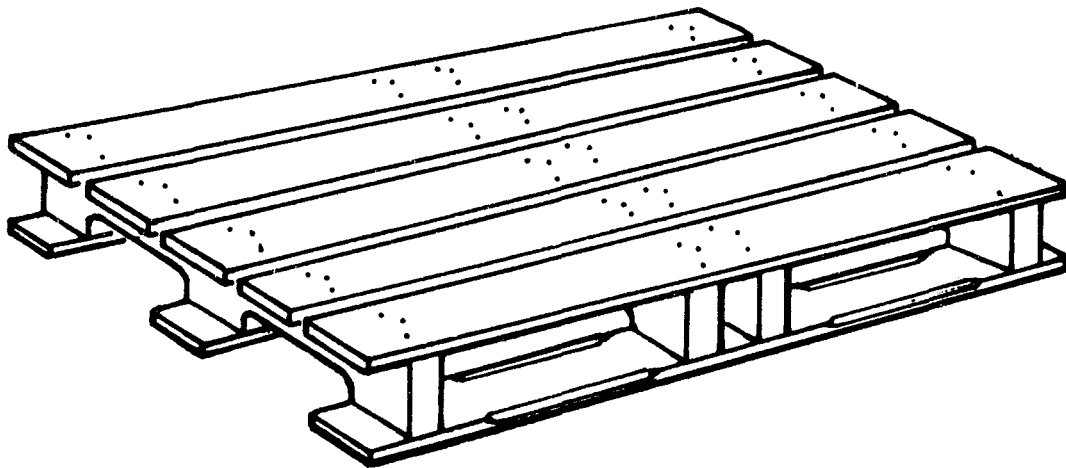

Figure 4-82. Pallet, 40 by 48 inches, wing-end, four-stringer, four-way (partial) entry, hardwood

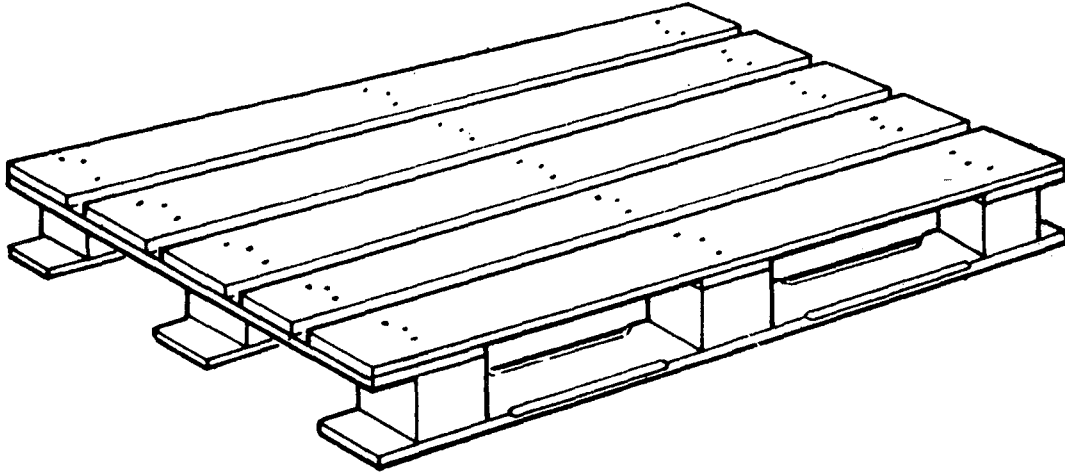

Figure 4-83 MIL-P-15011, pallet, 40 by 48 inches, wing-end, nine-post, four-way entry, hardwood (used for NATO shipments)

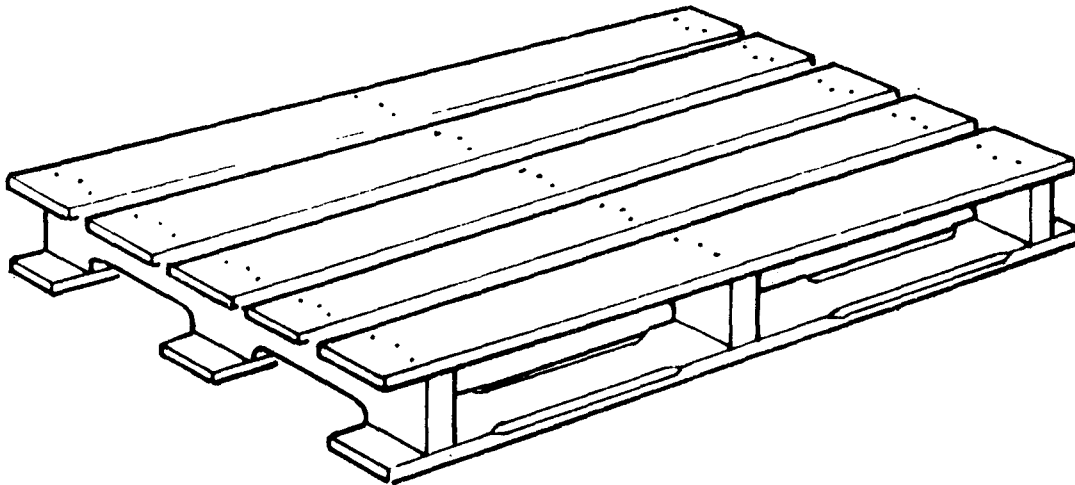

Figure 4-84. Pallet, 40 by 48 inches, four-way (partial) wing, softwood.

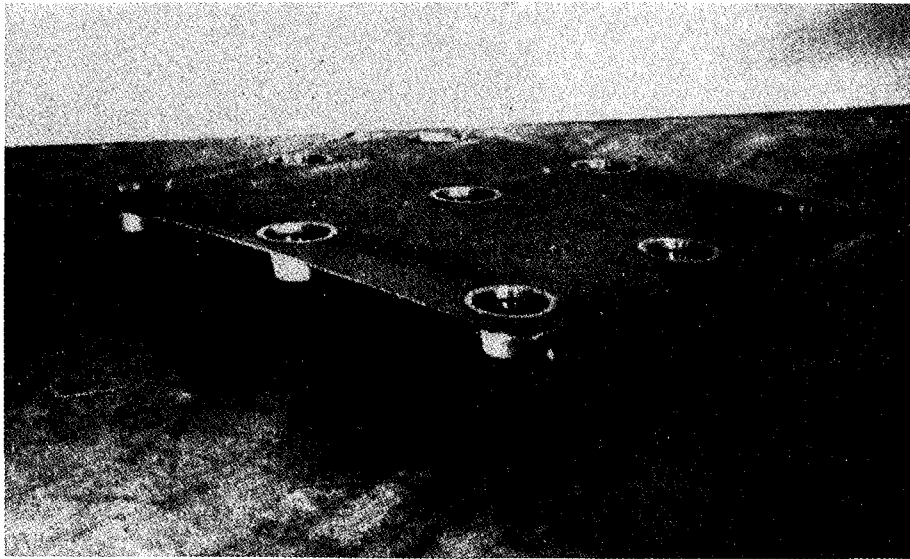
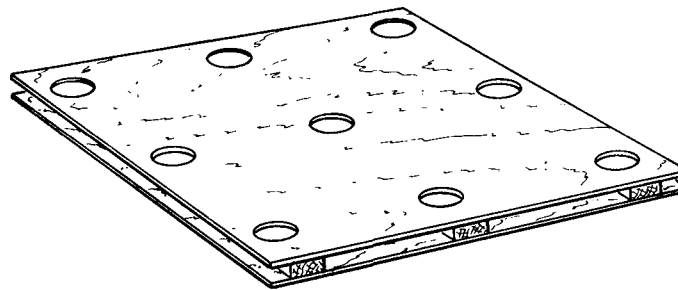

Figure 4-85. Pallet, buckboard, 40 by 48 inches, four-way entry, composed of polystyrene and fiberboard.



BUCKBOARD PALLET STAND

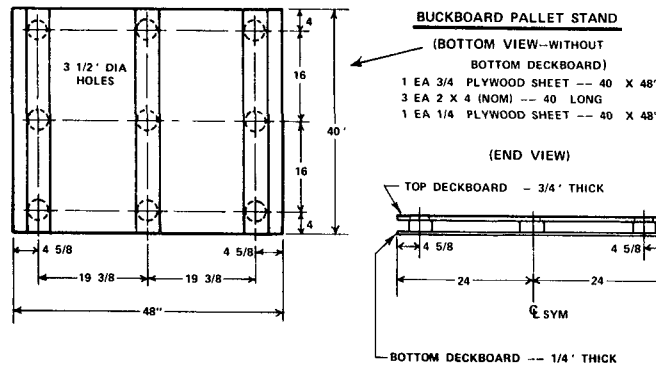

Figure 4-86. Buckboard pallet stand

c. *Wire basket.* The wire basket is a storage aid used for the storage of irregularly shaped, loose items. It is also used to transport material and can

handle up to 6,000 pounds, depending on the type of basket used. It can easily be moved by forklift truck. The basket legs interlock when stacked (fig 4-87).

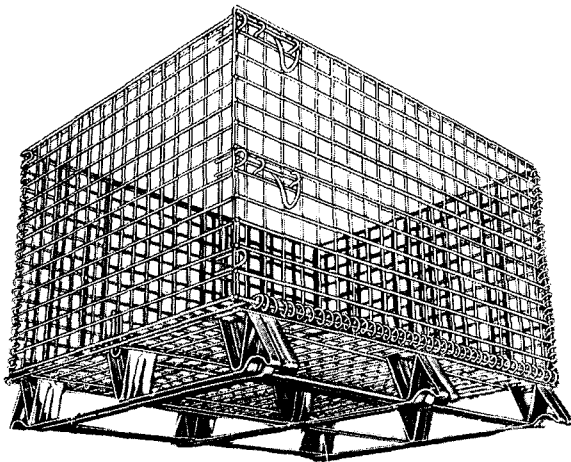
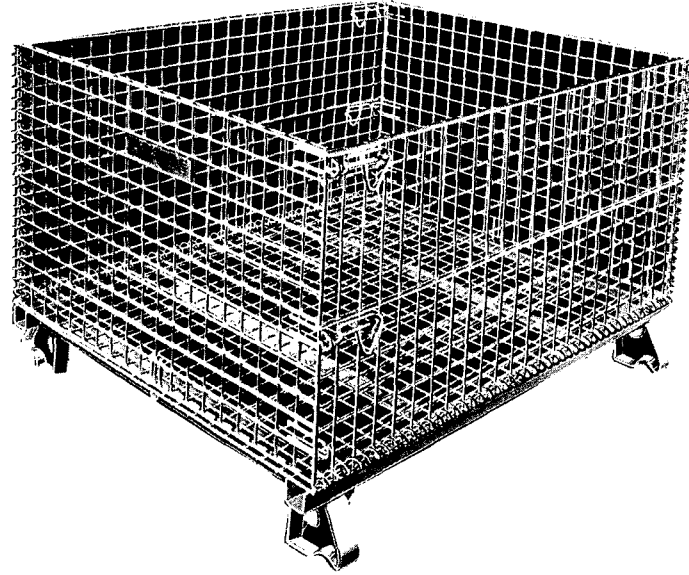

Figure 4-87. Wire basket.

4-14. Bins.

Bins are used in small parts or loose issue storage areas. Bins are available in various widths and depths to accommodate different size materials. The standard unit is 7 feet high. Cube utilization can be improved by double decking these units and using order picker vehicles to access material (fig 4-88).

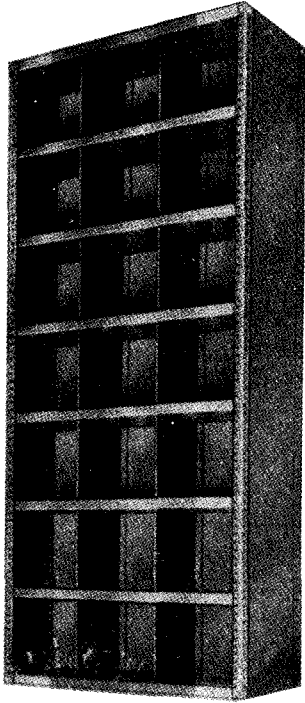

Figure 4-88 Bins

a. Static shelving. Figure 4-88 shows static shelving. The shelves can be either fixed or adjustable. Of course, adjustable shelves provide the most flexibility.

b. Drawers. Individual drawers can provide security for very small items. The drawers may even be fitted with special inserts to segregate items to ease inventory.

c. Cabinets. Cabinets can also be useful in small parts storage. The use of special cabinets can provide the same security and segregation as a drawer for slightly larger items.

4-15. Racks.

a. Pallet rack. Figure 4-89 shows the pallet rack which provides a support for pallets that is independent of lower loads. It is used where the material to be stored is: not strong enough to support a superimposed load; irregular in shape; too small for bulk storage and too large for bin storage; or desirable to be removed from a lower tier without disturbing upper tiers.

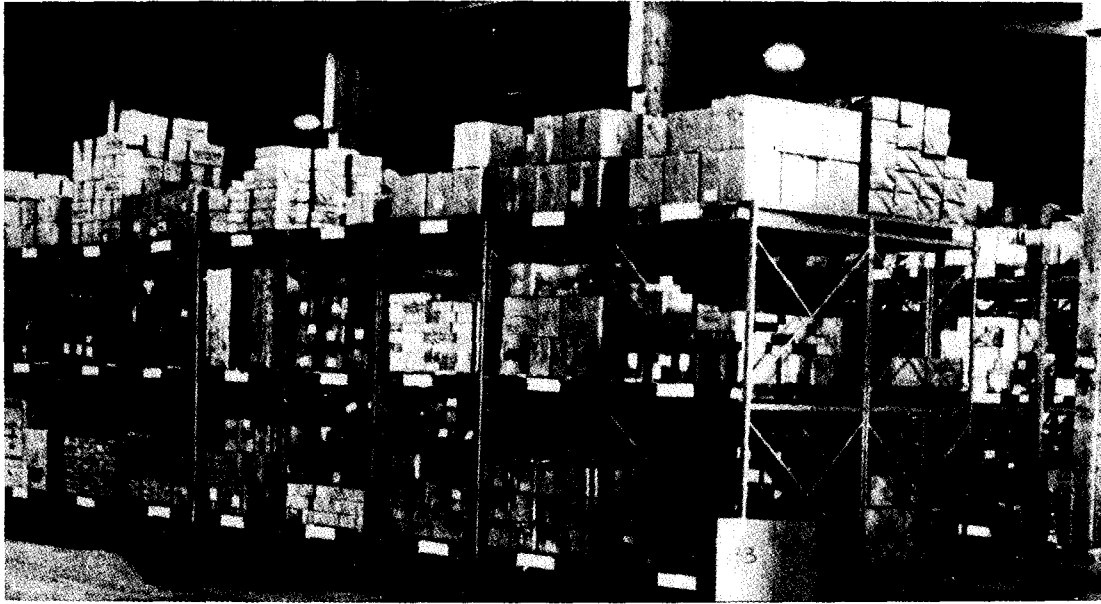

Figure 4-89 Pallet rack

b. Pallet storage racks (adjustable.) Pallet racks can be modified to suit a wide variety of shapes and sizes of items. The new type storage rack as shown in figure 4-90 has boltless connectors for the crossbeam. This type of rack is economical to erect or disassemble since no tools are

used. The distance between the crossbeams can be adjusted to accommodate varying heights of material, thereby, maximizing cube utilization. Racks are also available for two-deep pallet storage reach-type fork-lifts that are used to access material in this type of rack.

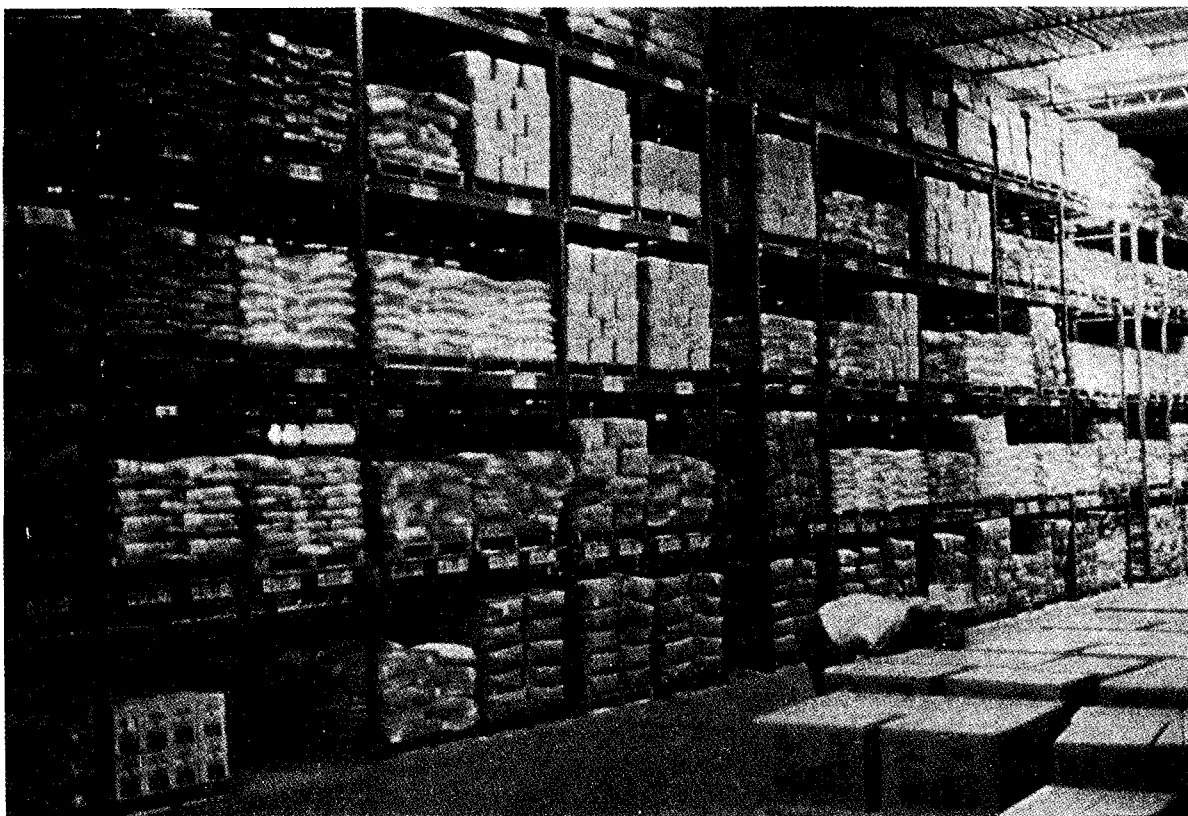

Figure 4-90. Adjustable pallet storage rack.

c. Rack, drive-in, drive-through. In a drive-in rack, lift trucks operate within the rack itself rather than from the aisles. Loads on pallets or skids are driven into the rack and placed on support rails. Subsequent loads are driven in until the rack is full. A drive-through rack has the advan-

tage of permitting loading and unloading from either end. Use of the drive-through rack is important in situations where FIFO inventory is required. These racks are designed specifically for high density storage of palletized items. Drive-in racks increase cube utilization by eliminating the requirement for working aisles (fig 4-91).

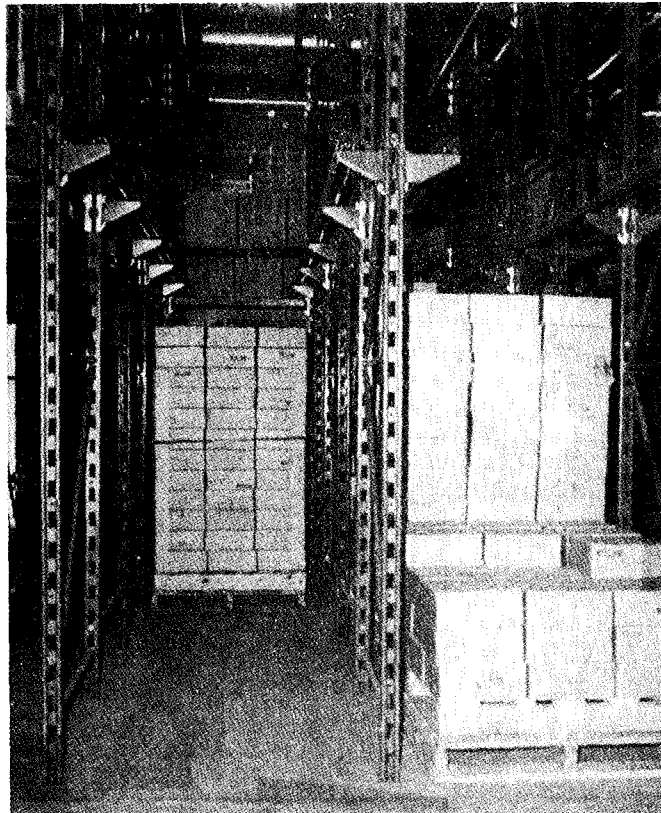

Figure 4-91 Rack, drive-in, drive-through.

d. Rack, flow-through. Flow-through gravity rack is most widely used for order picking operations. Flow-through racks offer the advantages of FIFO material flow and automatic gravity feed. As each pallet or carton is removed from the flow rack, remaining pallets or cartons advance at a controlled rate to fill the empty space. Increased storage density is possible because the requirement for aisles is reduced (fig 4-92).



Figure 4-92 Rack, flow-through.

e. Cantilever racks. Cantilever racks are made of steel and are generally used for storage of metal sheet, rod, or bar stock. These racks are also useful for storage of plywood and other bulky items not favorable for palletization. The height of a cantilever rack is normally limited only by the reach capability of MHE or the height of the warehouse

Rack specifications can be tailored with capabilities to meet individual storage requirements. Supporting rack columns are normally spaced from 4 to 6 feet apart. Arms vary from 2 to 4 feet in length and can be adjusted vertically on the columns to accommodate various types of material. Columns can have arms on only one side (single face) or on both sides (double face) (fig 4-93).



Figure 4-93. Cantilever rack (double face)

f. Box pallets. The box pallet (fig 4-94) is used for storage of odd-sized items or weak containers, which will not support a superimposed load.

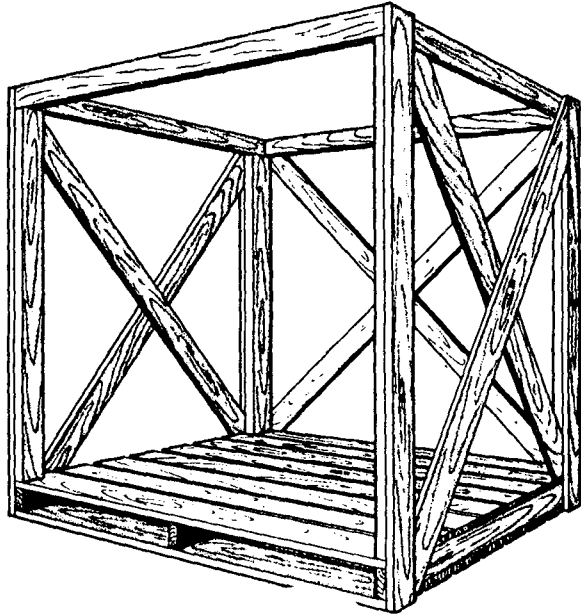

Figure 4-94. Pallet, box (may be constructed using flush or wing end-type pallet)

g. Pallet support sets. The pallet support set is recommended for use in lieu of the box pallet based on its flexibility and stability. Figure 4-95 shows a support set which is used to form a box pallet when assembled onto flat wood pallets, to allow for stacking of pallets containing irregular-shaped commodities that are susceptible to crushing. Support sets are used on standard two-way entry flush type or four-way entry flush type or four-way entry wing-type pallets. Figure 4-96 shows the use of support sets for tire storage. Support sets will not be used with pallets constructed of softwood.

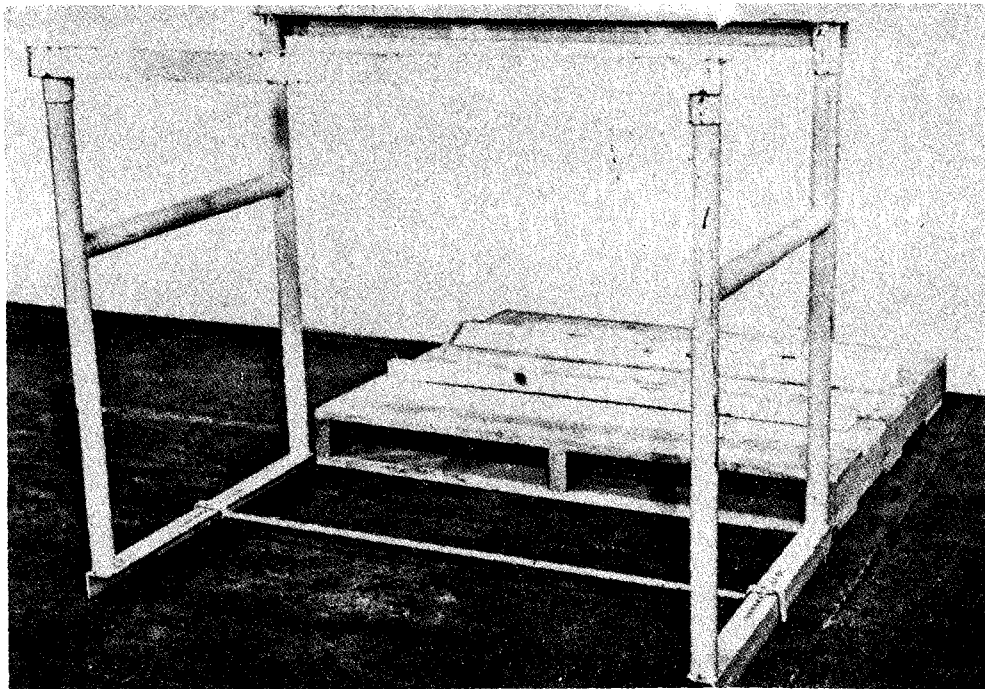

Figure 4-95. Support set, stacking, materials handling pallet.

236A



Figure 4-96 Support sets used for tire storage.

4-16. Storage and Retrieval Systems (SRSs).

a. General. SRSs are the composite methods, techniques, equipment, and equipment shelters required for handling materials in proven, systematic, mechanized, and automated ways with dedicated functions. These systems are varied in their complexity and automation. There is a direct relationship between the amount of expertise required to operate and repair these systems.

b. Application. SRSs are best suited for continually repetitive storage operations. Some of these systems can be married with a rack supported facility and can be designed for pallet rack and bin operations.

(1) *Pallet SRSs.* Receives, stores, and retrieves pallet loads of material.

(2) *Bin SRSs.* Receives, stores, and retrieves bin-type material.

(3) *Carousels.* Different than the bin SRSs in that the bin moves either horizontally or vertically to the operator who selects the material (fig 4-97).

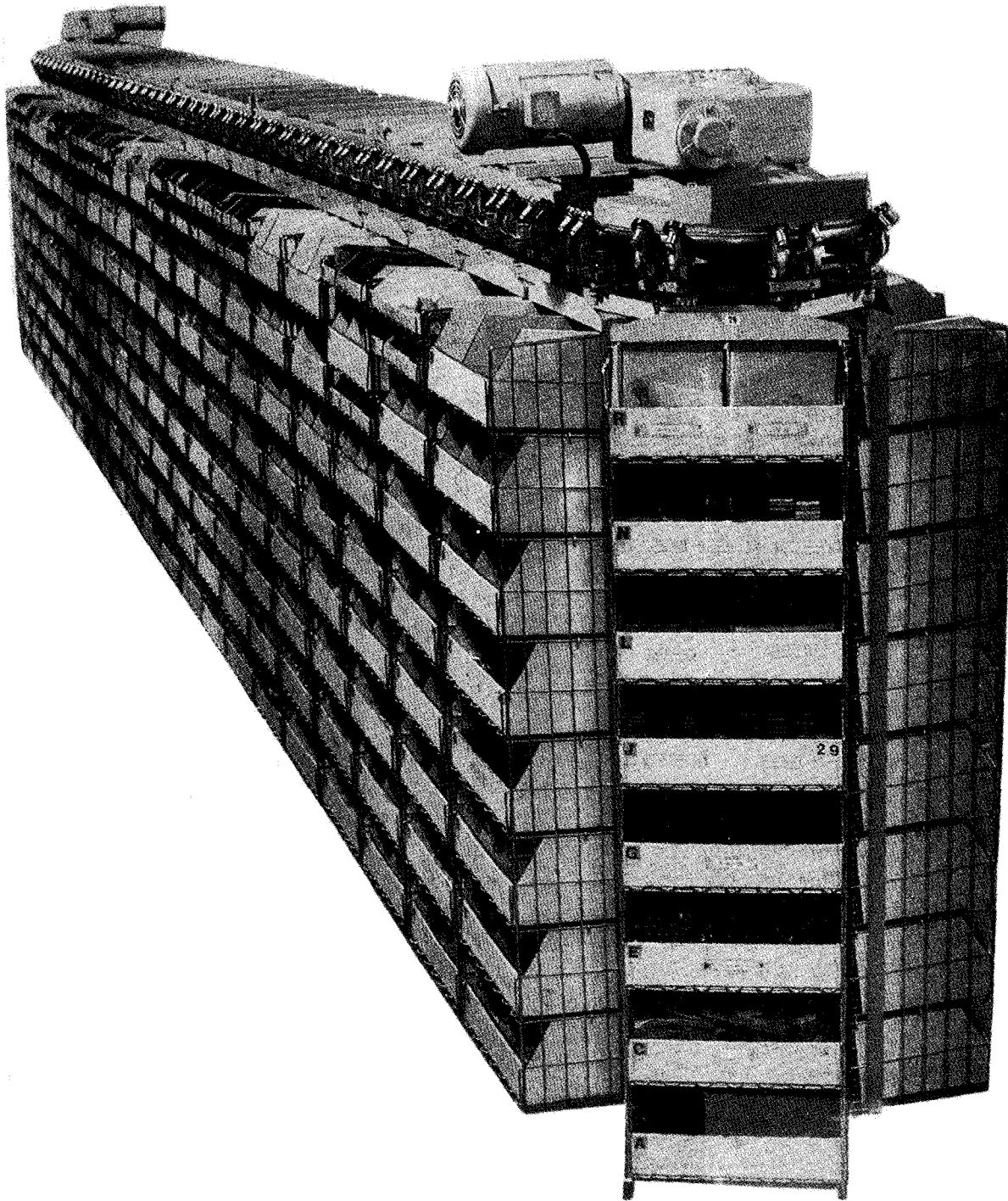

Figure 4-97 Rotary conveyor bins (carousel)

c. Types of SRSs.

(1) *Material-to-man.* These systems bring the material to the operator.

(a) *End-of-aisle order picking.* Loads are brought to the aisle end for order picking and the partially picked load sent back into storage (includes carousels).

(b) *Remote order picking.* Loads are brought to the aisle end by the storage and retrieval machine, routed to remote order picking stations via conveyor or other transport means, following which the partially picked loads are routed back to storage.

(2) *Man-to-material.* In-aisle order picking or pallet selection accomplished by a storage and re-

trieval machine or computer-controlled vehicle transporting a person to the opening where order picking is performed.

Section IV. Selection of MHE

4-17. General Selection Factors.

a. The potential savings in terms of time, funds, and personnel resulting from the selection of the right type of MHE for an operation cannot be over emphasized. The selection of costly MHE should not be made without considering all operational factors including the cost and suitability of alternate types of equipment available.

b. When selecting equipment, the size, shape, weight, and container strength of the commodities to be handled should be considered. Examples of the application of MHE are as follows:

(1) Palletized supplies are handled by forklift trucks, sometimes in conjunction with tractor-trailer or dragline conveyors and warehouse trucks.

(2) Small, uniform-sized commodities or containers are readily adaptable to palletization and handling as a unit by forklift trucks.

(3) Containers such as large bales, crates, or boxes may be efficiently handled and stacked by a forklift truck and use of short dunnage or special fork attachment.

(4) Large items (i.e., appliances or equipment packed in boxes or crates) with cleats or runners nailed to the underside of the container are generally adaptable to handling by forklift trucks.

(5) Cylindrical supplies with a hole through the center such as coils of wire can be handled by a forklift truck with a ram attachment.

(6) Heavy, bulky, and large irregularly shaped supplies are normally handled by cranes, crane attachments rigged on forklift trucks, heavy duty forklift trucks, or side loading forklift trucks.

(7) Small, flat-surfaced packages may be transferred in a continuous flow over gravity or powered conveyor systems. Chutes and slides quickly deliver smooth-surfaced nonfragile packages, sacks, and bales to lower levels.

(8) Lumber, rails, etc., are handled speedily in large unit loads by heavy duty pneumatic-tired forklift trucks, truck straddle carry, or side loading forklift trucks.

NOTE

Detailed information on applications for portable MHE is found in section II of this chapter.

4-18. Building Construction.

a. The construction of the building used for warehousing purposes should be reviewed to determine the type of handling equipment which can be used. The construction may limit the amount, weight, and type of materials which may be stored. These limitations are imposed by the size and strength of the structure and by certain safety and security measures. See chapter 6 for more information on limitations.

b. Equipment suitable for one-level operations may not be suitable for multilevel operations. Multistory operations generally are less economical than single-story operations; therefore, most warehouses built in recent years have been single-story structures. Two examples of multistory operational restrictions are explained below.

(1) *Elevators.* Generally, elevators in operation were not designed for the use of mechanized handling equipment. In many instances, the dimensions and the capacity of the elevator available will be inadequate to take the weight of the unit loads commonly used plus the weight of the equipment. For example, an electric fork truck capable of transporting a load of 3,000 pounds weighs nearly 4 tons; when loading an elevator with this equipment, this entire weight will be concentrated on the front edge of the elevator. Unless designed for this type of stress, even heavy capacity elevators will be strained.

(2) *Ramps.* The width and grade of ramps will be factors limiting the type and size of MHE which can be operated in the structures. Even a slight grade will require increased power to transport loads. Frequently, equipment capable of pulling or carrying heavy loads up inclines will be too large for ordinary use in other storage operations.

4-19. Types of MHE Power.

Gasoline, diesel, liquid petroleum gas, or electric power is used to propel forklift trucks and warehouse tractors. The following factors help to determine the selection of the proper power drive:

a. *Ventilation of operating area.* Closely confined or poorly ventilated spaces such as upper floors of multistory buildings require the use of electric trucks to avoid the hazard of accumulated carbon monoxide.

b. Flammable material. Electric-powered fork trucks, spark-enclosed type, will be utilized for the handling of flammable material such as paint, oil, gasoline, and flammable gas.

c. Fume absorbing materials. Certain commodities, particularly fresh fruits and vegetables, will absorb and become tainted by the fumes from gasoline or diesel engines. Electric power is required to handle these commodities.

d. Gasoline-and diesel-powered MHE. These are best suited for outside applications and, in most cases, can provide greater lifting, pulling, or pushing power than electric-powered MHE.

4-20. Forklift Truckload Ratings.

a. The fork truck pivots on the center of the drive axle; therefore, the weight of the load ahead of the front wheels must be counterbalanced by the weight of the truck. In accordance with the principles of leverage, the ability of the fork truck to lift a load depends upon the length of the load (the distance of its center of gravity from the center of the front axle of the truck) and the weight of the load. The capacity of the fork truck is stated in inch-pounds, which is the rated pounds capacity of the truck multiplied by the distance from the center of the front axle to the center of the rated load selected by the manufacturer. In general, trucks are rated by pounds and the distance from the heel of the forks to the center of gravity of the rated load (for instance, 4,000 lbs at 24-in load center). To determine inch-pounds capacity, add to load center the distance from the center of the front axle to the heel of the forks, which can be obtained from the manufacturer's specifications or by measurement, and multiply the sum by the rated load weight.

b. An example of the forklift truckload ratings is as follows: Assume a rating of 4,000 pounds at 24 inches, with a measurement of 15 inches from the heel of the forks to the center of the front axle; result: $4,000 \times (24+15) = 156,000$ inch-pounds. To determine the maximum weight which may be placed on a pallet of given size, assuming uniform weight distribution on the pallet, add half the dimension of the pallet parallel to the forks to the distance from the center of the front axle to the heel of the forks and divide the sum into the inch-pound capacity of the truck. To complete the example, the maximum weight on a 40-by 48-inch pallet is 156,000 divided by (15+20), which equals 4,457.

However, the load weight may not be in excess of the weight of the rated load stated by the manufacturer. If the dimensions of the pallet used, parallel to the forks, is less than twice the rated load center, the rated pounds capacity is the capacity of

the truck; therefore, the maximum load would still be 4,000 pounds. Bending of the mast channels as the load is raised, plus forward tilt action, will reduce the capacity of elevated loads by as much as 25 percent. Overloading of fork trucks is strictly prohibited. Among the effects of continued overload are damage to lift mechanism, excessive tire wear, and strain on the truck frame.

4-21. Warehouse Tractor Load Ratings.

a. Warehouse tractor capacity is stated in pounds drawbar pull, which is the motive force exerted at the coupling. The drawbar pull and pushing power of the tractor is figured on the basis of the engine torque, drive ratio, weight, and the traction of the tires. Although this pull is not the maximum load weight the tractor will draw, since under ideal conditions a tractor can pull a load equal to 20 times its drawbar pull, the maximum normal load weight should not exceed 10 times the drawbar pull which will allow for all technical and safety factors.

(1) *Tractive effort and resistance.* Tractive effort is the motive force (measured in lbs) exerted at the drive wheels of a tractor to overcome the resistance to motion. Tractor resistance is the result of rolling friction between the wheels and the surface, expressed in pounds per ton of gross weight of tractor. The type of surface over which the tractor is to travel has an important bearing on tractive resistance. The following table of road resistance shows the comparative road resistance of some of the more common types of road surfaces:

Table of Road Resistances

Type of Road Surface	Resistance in pound per ton
Asphalt (hard)	28
Brick (glazed)	47
Brick (poor)	57
Brick (smooth)	40
Clay	200
Concrete (poured)	53
Concrete road	36
Granite blocks	56
Gravel road	75
Ice and snow	40
Macadam	47
Macadam (poor)	75
Sand (loose, 3 in deep)	330
Sand road	275
Snow (hard)	50
Snow (soft)	66
Tarvia	47
Wood blocks	44
Wood planking	43
Wood planking (sticky surface)	57

(2) *Grade resistance.* Grade resistance is the resistance for movement on a grade, to be added

to or subtracted from that required for level movement. Grade resistance amounts to 20 pounds per ton of gross weight of the tractor-trailer train and the combined load for each 1 percent of grade encountered. On upgrades, the percent is added to the resistance; on down-grades, the percent is subtracted. Percent of grade is determined by the feet of vertical rise per 100 horizontal feet.

b. Estimating required drawbar pull. The estimated drawbar pull in pounds and application of tractors used by the military are as follows:

Drawbar pull	Application
2,600 pounds	Inside warehouse
4,000 pounds	Inside and outside
7,500 pounds	Outside work, heavy

At times, it may be necessary to make a rapid, reasonably accurate estimate of the drawbar pull required of the motive power unit of a tractor for the handling of loads on a level surface and also on grades. The following example will illustrate a fairly accurate method for this estimate:

Step 1 What is the drawbar pull required for a tractor-trailer for the following composition and conditions:

Weight of tractor	6,690 pounds
Weight of driver	170 pounds
Weight of 5 trailers at 500 tare each	2,500 pounds
Weight of net pay load	16,000 pounds
TOTAL GROSS LOAD	25,360 pounds
Equals	12.68 tons

Step 2 If the surface is level poured concrete, the value from the table to calculate drawbar pull is 53 pounds resistance per ton moved. The calculation then would be as follows:

12.68	×	53	=	672 pounds
Total load tons	×	Road resistance pounds per ton	=	drawbar pull required

Step 3 If the train is required to travel up a 5 percent grade, then the road resistance of 53 pounds per ton would be increased by 20 pounds for each percent of grade. The calculation for this drawbar would be:

12.68	×	(53	+	(*20	×	*5)	
Total load	×	Level	+	Grade re-	×	Percent	
tons		road		sist-		grade	
		resist-		ance			
		ance		pounds			
		pounds		per ton			
		per ton		per			
				percent			
				grade			
				OR			
12.68	×	153	=	1,940 pounds			
Total load tons	×	total	=	drawbar pull			
		resistance		required			
		pounds per					
		ton					

*These factors show the total grade resistance or rollback force in pounds per ton for a 5 percent grade.

For this application, a tractor with a 2,600-pound drawbar pull would be satisfactory.

4-22. Special Equipment Considerations.

a. Truck, tiering, electric (straddle-type). This truck eliminates the counterweight and the attendant increase in length by using outriggers which extend forward in a plane at floor level parallel to the plane of the forks. The truck can operate in 6-foot aisles; the forklift truck requires 10-foot aisles. However, the outriggers must straddle the bottom tier when the truck is positioning a pallet which necessitates the use of single-wing pallets (if double-opening racks are used, the bottom beam must allow outrigger clearance when using standard pallets on the rack beams). Since it is not practicable to use single-wing pallets for the bottom tier only and double-wing pallets for the upper tiers, this truck is used in pallet rack areas where single-wing pallets only can be used. The tiering truck is lighter in weight than the conventional forklift truck which permits its use on light construction and in elevators of limited capacity. The military services use a 3,000-pound capacity truck which is available in both riding and walkie type. A variation of these trucks provides for the forks to extend by mechanical means, thus eliminating the requirement to straddle the pallet.

b. Warehouse crane.

(1) Usually, the lifting and carrying capacity of the warehouse crane is stated as the maximum weights which may be lifted at various boom angles. (If the boom is telescopic, maximum capacity is obtained with the boom at the shortest length.) As the boom is lowered toward the horizontal position or as its length is extended, capacity decreases.

(2) A load chart showing the capacity of the crane under all circumstances should be visible on the crane. These charts furnished by the manufacturer will indicate clearly the safe load in pounds for maximum and minimum position of the boom and for at least two intermediate stations.

(3) If the crane has a sluing boom and if the load is to be moved only within the circumference of the slue, it is not necessary to move the crane. The boom is slued to the proper position and the load is ready for placing.

(4) If the crane has a rigid boom or if the load is to be carried farther than the sluing boom can reach, it is necessary to move the crane. The crane should not be moved until both the load and the

boom are in proper position for traveling, in order to reduce the swing of the load.

c. Fixed conveyor equipment. In choosing a conveyor system, the initial cost, the length of time it will take to pay for itself, the cost of maintenance and operation, volume of items processed, and the type of material handled by the activity contemplating the use of conveyor equipment must be considered. Through the use of conveyors, savings are achieved through the elimination of trailer train operation, elimination of double handling, and in various other ways. An increase in production can be realized due to maintaining work rhythm; that is, work-loads do not build up at any point but move to the next station in an even flow, reducing peaks and valleys to the minimum.

(1) *Power belt conveyor.* The powered belt conveyor consists of an endless belt mounted on a frame and driven by a head pulley connected to a drive motor. The belt travels over a series of rollers of a sliding bed. A takeup to adjust belt tension is provided. A belt conveyor can operate on inclines, declines, or horizontal paths. The maximum angle of incline on most materials is limited to approximately 25°. Small, semi-bulky, bulky, or individual items with flat, smooth surfaces that do not lend themselves to palletizing, or tote boxes and part baskets are transported on this type of conveyor. Inasmuch as it is powered, this type of conveyor may be used in conjunction with the dead roller conveyor to transport material from floor level to working level, or moving material to the next processing point by the use of timing devices, deflectors, and controls, over a distance where gravity would not suffice. It can be used in single or double combinations to form a portable conveyor system. In addition, a telescopic system may be used when a definite location for loading or unloading facilities cannot be set up due to shapes and sizes of vehicles transporting cargo (i.e., the conveyor could be extended or retracted (e.g., different types of aircraft at air freight terminals or various types of commercial trucks at receiving and shipping docks)). The performance of a belt conveyor depends on the width of the belt, the type of material used for the belt, the supports, and horsepower of the drive.

(2) *Overhead towing conveyor.* This conveyor consists of an overhead rail and chain mounted on rollers that run on the channeled rail. Loops are spaced as desired along the towing chain for the purpose of attaching material carriers. When the carriers are ready for movement, the carrier is positioned onto a loop of the moving chain and the carrier moves to its predetermined destination.

This conveyor is used to deliver material in point to point processing and to and from production lines (e.g., from receiving to various stockrooms for storage and from storage to packing and shipping points). This type of conveyor conserves floor space as it does not require as much space as tractor-trailer operations. The selection of this system for any operation should be primarily based on volume of items, tons handled, or combination of the two, which must be great enough to justify its installation.

(3) *Subfloor conveyor.* The subfloor-type conveyor consists of a moving link chain with chain track imbedded in the floor. Retractable pins or pods are mounted vertically on the front of platform trucks. When the truck is ready to be transported, it is placed over the chain and the pin is dropped. The truck is towed forward as the pin falls in the slot of the chain. The subfloor conveyor permits free travel of other MHE as there are no overhead obstructions to prevent use of high mast for trucks required for high stacking purposes. This conveyor is used for the same purpose as the overhead towing conveyor (i.e., to deliver material in point to point processing and to and from production lines).

4-23. Mechanical Alterations.

MHE is engineered and guaranteed by the manufacturers to perform specified functions. Mechanical alterations to power plants, hydraulic systems, operating levers, and controls, lifting and structural members and counterweights may seriously affect operation of equipment or endanger personnel. Alterations to MHE will not be effected prior to approval of the appropriate military service. Requests or recommendations to effect alterations will be addressed through normal channels and will include the following:

- a. Complete details of the proposed alterations, including such photographs, blueprints, and engineering data as may be necessary.
- b. Reasons for the alteration.
- c. Anticipated improvements.

4-24. Safety Considerations for MHE.

Chapter VI provides overall safety guidance for storage operations. The following Code of Federal Regulations (CFR), Title 29, OSHA, references are provided for specific equipment:

- a. 1910.178—Powered Industrial Trucks.
- b. 1910.179—Overhead and Gantry Cranes.
- c. 1910.180—Crawler, Locomotive, and Truck Cranes.

Section V. MHE Requirement Factors

4-25. General.

A balanced operation provides for the optimum number of people and MHE to accomplish a specified workload. Too many laborers and not enough equipment will cause bottlenecks. On the other hand, too much equipment and not enough laborers will also cause bottlenecks. In both cases, either people or equipment will be idle part of the time. In a balanced operation, a smooth flow of work is accomplished and neither people nor equipment are idle. This section provides basic guidance in determining MHE requirements.

4-26. Factors Affecting Equipment Requirements.

a. If all supplies moving into storage were palletized loads, squared off for stacking, there would be little need for anything other than a forklift truck and driver. However, this is not always the case. Trucks and railcars are sometimes hand loaded and consequently must be manually unloaded. Figure 4-98 represents some other conditions affecting equipment requirements.

VARIOUS CONDITIONS AFFECTING EQUIPMENT REQUIREMENTS

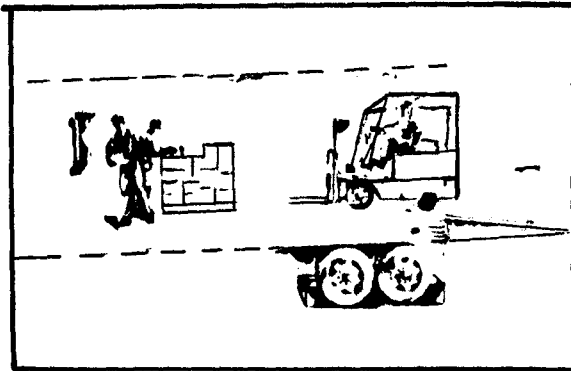

SHORT MASTED FORKLIFT TRUCK
SERVICING LOW DOOR HIGHWAY
VAN



REEFER CAR OPERATION

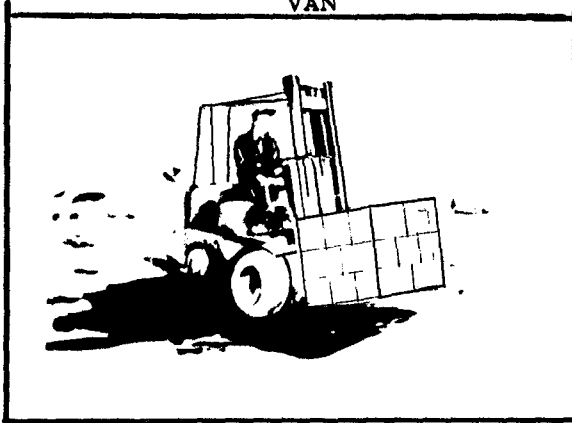

TERRAIN AND CLIMATIC
CONDITIONS

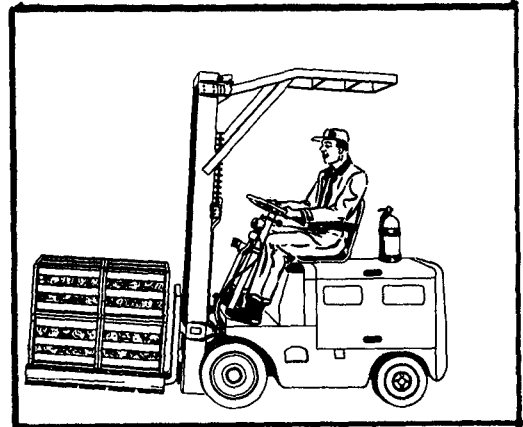

ELECTRIC TRUCKS ARE NECESSARY
FOR CERTAIN OPERATIONS

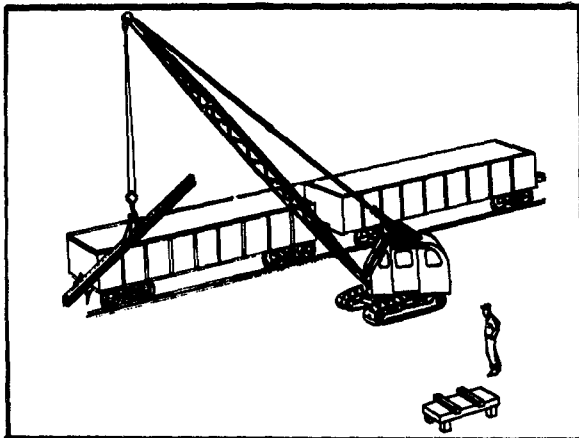

CRANE OPERATION UNLOADING
GONDOLA CAR

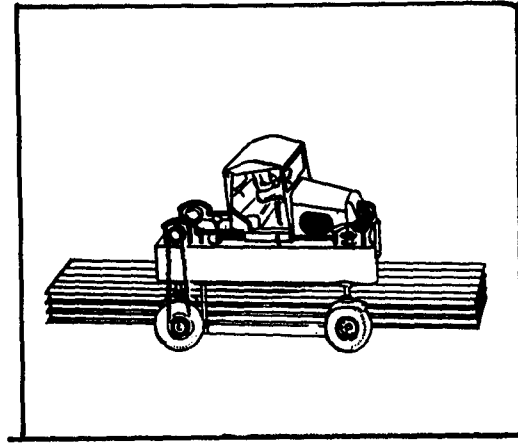

STRADDLE TRUCK CARRYING A
LOAD OF UNUSUAL SHAPE

Figure 4-98. Types of equipment that effectively serve supply operations under varying conditions

b. Terrain features, location arrangement and design characteristics of buildings, extent of open storage area, and road and rail facilities are all

elements under the general heading of physical layout which influence equipment requirements.

c. Equipment requirements are also influenced by mission responsibilities which determine the types of commodities handled and influence the types of handling equipment.

d. The number of forklift trucks, conveyors, etc., are influenced by the workload. An increased workload may require increased usage and greater payload or an increase in the equipment fleet. A decreased workload will have the reverse effect.

4-27. Planning the Operation.

a. Effective planning should include factors of types of material to be moved; quantity, types and

characteristics of equipment required; scheduling of use; economical travel ranges; and timing of the operations. See figures 4-99 through 4-104.

b. Figures 4-99 and 4-100 represent two examples of developing balanced operations. Figure 4-99 depicts a medium distance “in-between” haul wherein two tractors and four trailer trains keep pace with two lift trucks. Figure 4-100 depicts a shorter haul wherein only one tractor with three supporting trailer trains services two lift trucks. Determination of requirements will have been made by computing timing studies of each of the three separate parts of the operations.

OPERATIONS BALANCE

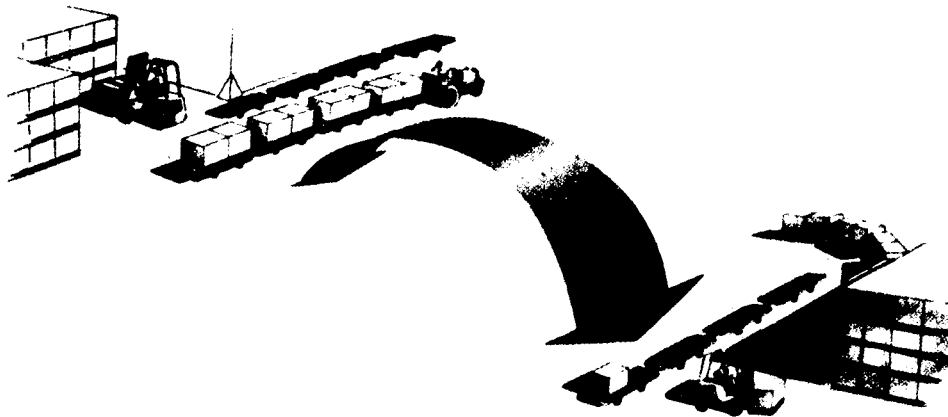

Figure 4-99 Tractor-trailer rewarehousing operation

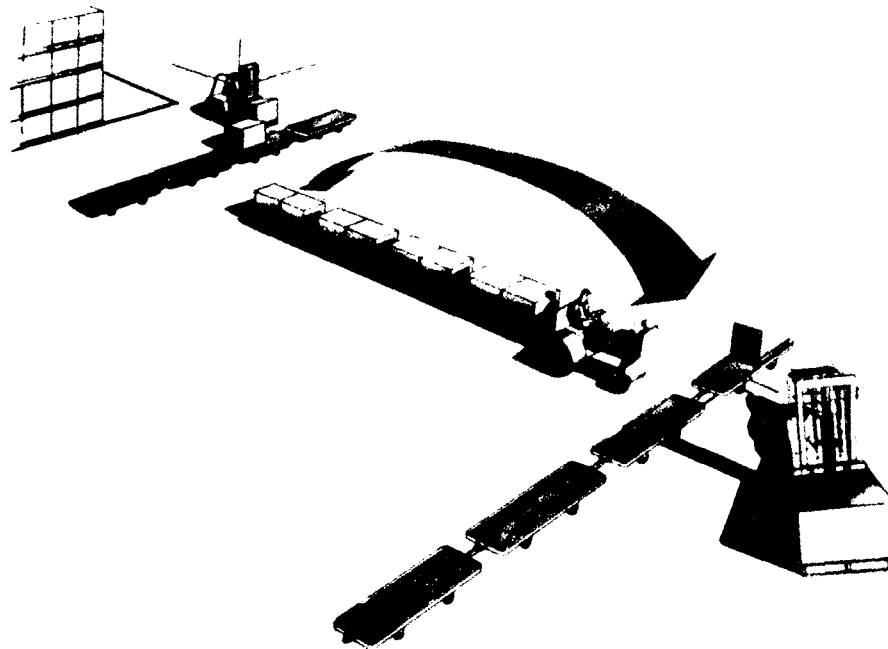

Figure 4-100 Tractor-trailer shipping operation

In a heavy volume movement, the assignment of additional lift trucks to each end of the operations would encourage the possibility of trailers remaining attached to tractors to effect more convenient placement of trailers for lift truck services. Ratio of trailers to tractors would then be equal, one train to one tractor. Ratio of trains to lift trucks would depend on the time consumed in the trains traveling between the two points as compared to the rate of loading or discharge by the lift trucks. In any case, the equipment ratio adopted will be aimed to develop maximum production of separate pieces.

c. Regardless of the apparent acceptability of materials handling method, the possibility of fur-

ther improvement should always be considered. As a technique is improved, the opportunities for reducing labor and equipment requirements are proportionately enhanced. Operations should be continually appraised for possible improvement. Acknowledging experience to be a factor of considerable magnitude to a storage operator, adoption of an attitude such as "let's do it this way because we always have" can only penalize the ability to improve. Therefore, an open-minded attitude regarding operational change is a must. Apparent benefits in progression of figure 4-101 are obvious. As each stage is implemented, the complications of operations balancing have been simplified and the production potential and operational costs have been considerably affected.

IMPROVING TECHNIQUES

Figure 102. Relative distance traveled for specific time elements as associated with miles per hour rates

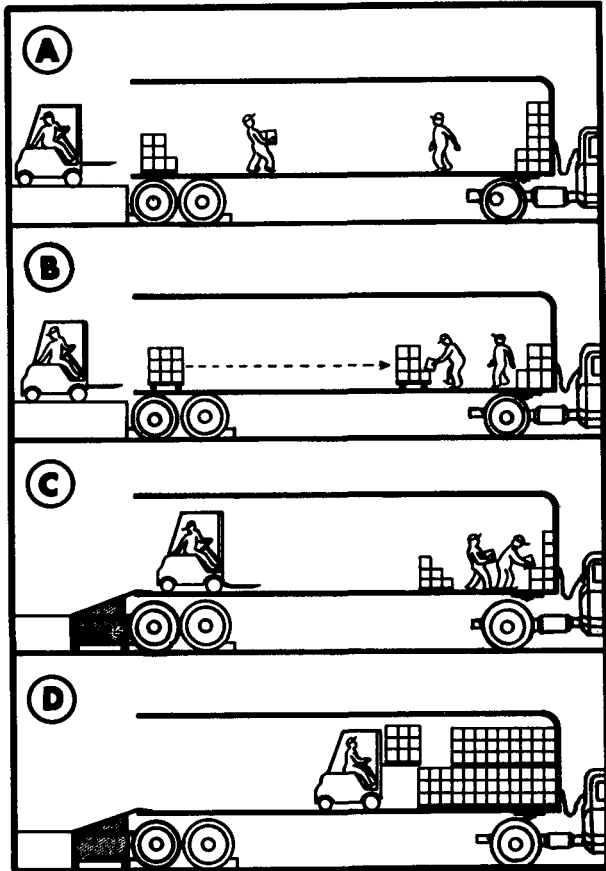

Figure 4-101 Graduated sequence of experienced operations improvement.

Miles per Hour	Feet per Second	Travel Time Expended (Seconds)				
		50'	100'	150'	200'	250'
2	2.9	17.3	34.5	51.7	69.0	86.2
3	4.4	11.4	22.7	34.1	45.6	57.0
4	5.9	8.5	16.9	25.4	33.9	42.4
5	7.3	6.8	13.7	20.5	27.4	34.2
6	8.8	5.7	11.4	17.0	22.7	28.2
7	10.3	4.9	9.7	14.6	19.4	24.4
8	11.8	4.2	8.5	12.7	17.0	21.2
9	13.2	3.8	7.6	11.4	15.1	18.9
10	14.6	3.4	6.8	10.3	13.7	17.0
11	16.1	3.1	6.2	9.3	12.4	15.5
12	17.6	2.8	5.7	8.5	11.4	14.2
13	19.1	2.6	5.2	7.9	10.5	13.1
14	20.6	2.4	4.8	7.3	9.7	12.1
15	22.0	2.3	4.5	6.8	9.1	11.4

Note. Speeds at which equipment may operate should not exceed those allowed under other chapters of this manual

d. Timing equipment using the relationship of distance traveled to time consumed at known travel speeds, as shown in figure 4-102, will allow for the preplanning of a balance between the facility layout and MHE. Figure 4-103 depicts an operation where: (1) represents that time expended in approaching stack from aisle, picking up or depositing load, and backing out to aisle; (2) indicates the time required to travel from stack area to dock; (3) identifies that time consumed in entering car and either depositing or picking up load and backing onto the dock; and (4) indicates the time expended in travel from dock back to stack area. The labor timing is divided into two parts: (1) removing or placing supplies on pallets, and (2) either carrying pallets to or from car, depending on type of operation.

OPERATIONS TIMING

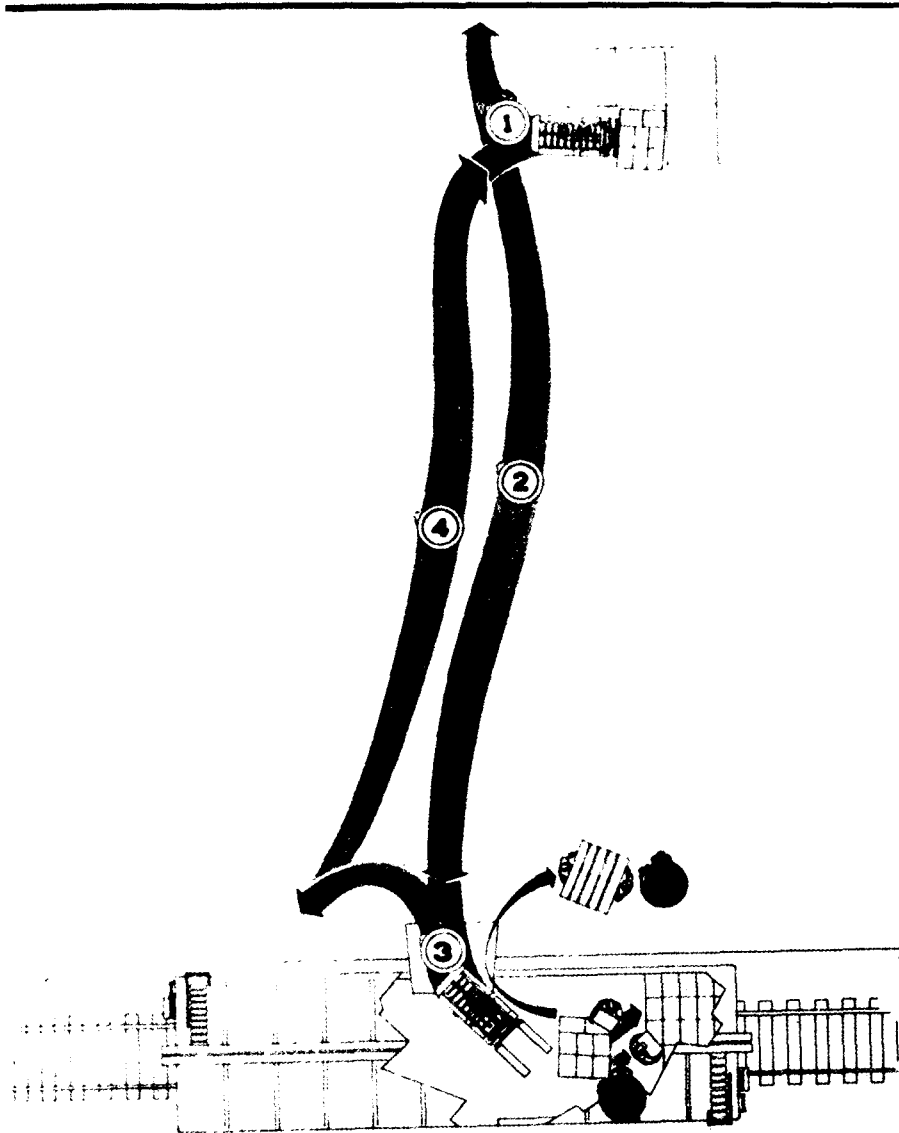

Figure 4-103. Example timing of a bulk shipping or receiving operation.

e. In a balanced operation, all men and equipment units are synchronized to an acceptable producing pace. Figure 4-104 depicts three separate equipment operations. Each must move in balance with productive capabilities of other units in this hypothetical operation. To attain this, two cranes are necessary to keep pace with one straddle truck and one lift truck. Separate timings of each segment have established pattern of equipment requirements. Considerations in timing are: (1) the time expenditure for a crane to discharge a unit

load quantity from the gondola car, (2) the time expended by a straddle truck in moving the unit load from the off loading point to the stacking point, and (3) the time required for a forklift truck to stack supplies as deposited by a straddle truck. Related time elements for each of these operations will form the basis for equipment assignment. The illustration is intended to depict one method of handling a particular commodity. It is recognized that other equipment and/or methods may also apply.

DOES YOUR EQUIPMENT BALANCE ?

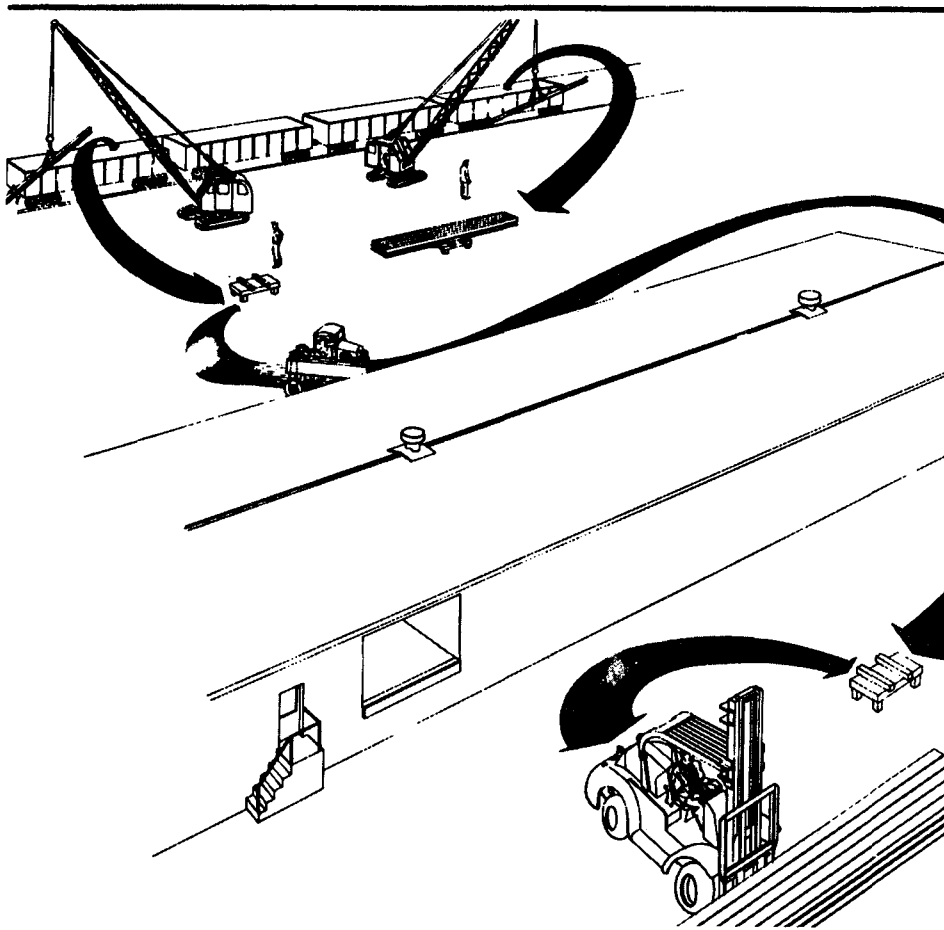

Figure 4-104 Open storage operation depicting receipt of odd-shaped items in gondola cars

4-28. Computing MHE Requirements.

a. Several factors must be considered in determining the number of pieces of equipment to do a particular job. The first is the volume (e.g., pallet loads, trailer trains, carloads, etc). The second is the number of units of the volume carried each

trip (e.g., pieces, pounds, pallets, etc.). The third is the average time used to accomplish a round trip for the equipment. The fourth factor is the time allotted to do the job. Figure 4-105 shows a formula which can be used to make a MHE requirements computation.

DETERMINING MOBILE MATERIALS HANDLING EQUIPMENT REQUIREMENTS

$$\text{FORMULA} - \frac{V \times T}{C} \div AT = R$$

EXPLANATION:

- V** - Volume or size of the operation to be performed.
- C** - Units of volume carried per trip (pieces, pounds, etc.) by equipment.
- T** - Average expended time to accomplish a complete equipment trip cycle.
- AT** - Allotted time to do the job.
- R** - Equipment requirement.

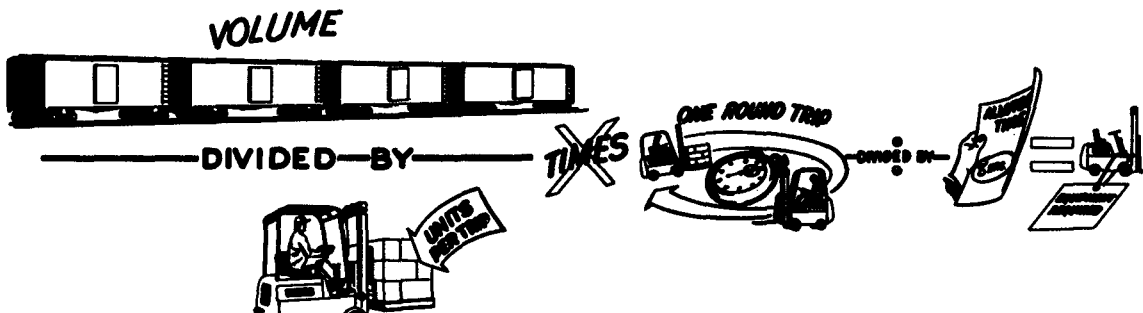

Figure 4-105. Formula to be applied in computing MHE requirements.

b. Example use of the formula in figure 4-105 is shown in the following situations:

(1) Storage operations require 48 pallet loads of supplies to be relocated a distance of 250 feet. One round trip takes 5 minutes, and 2 hours is the time allotted. Two pallets are carried each trip.

$$R = 48 \times \frac{5-120}{2} = 1 \text{ fork truck}$$

(2) In the same operation, a requirement exists to move 192 pallets the same distance in the same timeframe.

$$R = 192 \times \frac{5-120}{2} = 4 \text{ fork trucks}$$

(3) A requirement exists to relocate 4,064 pallet loads a distance of 1,500 feet. Time allotted is 3 days. Since the distance is greater than 400 feet (max travel distance of fork truck), tractor trains are required. One tractor and 4 trailers carry 8 pallets in a 20-minute round trip cycle. It takes 5 minutes for 1 forklift truck to load a train and 8 minutes to unload and stack.

Step 1

Computer pieces of equipment required.
 $R = 4,064 \text{ pallets} \times 0.33 \text{ hrs (20 min)} - 24 \text{ hrs}$
 8 pallets/train
 = 7 tractors

Step 2

7 trailer trains \times 5 min - 20 min
 1 trailer train
 = 2 forklift trucks for loading

Step 3

7 trailer trains \times 8 - 20
 1 trailer train
 = 3 forklift trucks for unloading/stacking

The entire operation will take 7 tractors, 28 trailers (4 trailers per tractor), and 5 forklift trucks with 12 operators to complete the job in 3 days.

$$R = (100,000 \times \frac{.70 \times .85}{16}) \times 4 = 14,875 \text{ pallets.}$$

4-29. Computing Pallet Requirements.

a. The investment in pallets. This can be substantial and should be based upon definite requirements. The standard pallet is 40 by 48 inches. Allowing for overhang (roughly 25 pct), the square feet occupied by each pallet is approximately 16 feet (4 by 4 ft). If height permits stacking 4 pallets high, 4 pallets are required for each 16 square feet of net usable floor space.

b. Not all space is usable. Roof supports, aisles, mechanical equipment required for the building, and other structural losses reduce the gross space to net usable space which should be the basis for computing pallets.

c. Percent of occupancy is another consideration. Assuming a goal of 85 percent occupancy of net space is a target, the following is an example of use of the formula shown in figure 4-106:

Compute the pallet requirements for 100,000 gross square feet of storage space, 70 percent net usable and 85 percent occupancy with stacking 4 pallets high.

DETERMINING PALLET REQUIREMENTS

$$\text{FORMULA} - \frac{S \times H}{D} = R$$

EXPLANATION:

- S - Net covered storage area, in square feet used for bulk storage.
- H - Average stacking height in such storage areas expressed in pallet courses (pallet loads).
- D - Square feet of floor area occupied by a pallet as determined by pallet size with 25% added to compensate for load overhang and clearance.
- R - Quantity of pallets required.

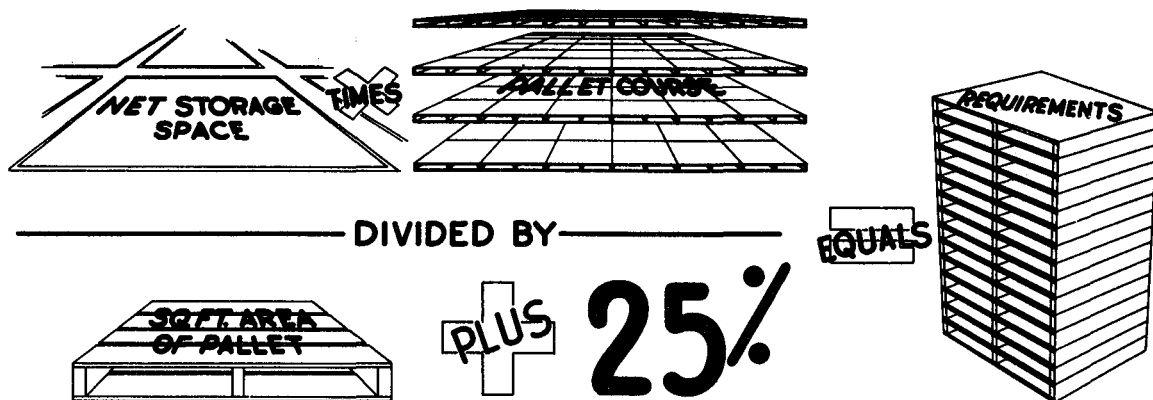

Figure 4-106. Formula for computing pallet requirements.

4-30. Considerations in Requirements for Fixed Equipment.

a. Under certain operating conditions, fixed equipment constitutes the most economical means of material movement and should be utilized to

the maximum extent practicable. In order to be able to compute requirements for fixed-type equipment, one must be thoroughly familiar with existing types and models and the conditions under

which they provide the most efficient materials handling.

b. There is no set formula for computing requirements for fixed-type equipment. It is the responsibility of the storage managers to determine when and where the installation of fixed equipment will offer greater advantage than mobile types, and the particular type and characteristics which will best perform the desired handling at the desired speed.

c. While there are no common mathematical factors applicable to computing fixed equipment requirements, there are certain other factors which help determine the practicability of fixed equipment installation:

(1) A repetitive and somewhat continuous flow of material to, from, or through a common point or fixed path (i.e., processing, packaging and packing lines, baling operations, segregation lines, etc.).

(2) Restricted operating space or other conditions which do not permit the maneuvering of mobile equipment.

(3) The operation being performed requires separate handling of individual units or packages.

(4) Multifloor storage areas.

d. An area where fixed equipment is serving well is shown in figure 4-107. The absence of such equipment would require support from mobile equipment which would serve less satisfactorily. Fixed equipment offers constant service at unvarying capacity. In use of mobile equipment, the operation is dependent on the equipment arriving at a balanced time cycle. When either the mobile equipment cycle is interrupted or the operation flow fluctuates, production complications can result.

DON'T OVERLOOK ADVANTAGES OF FIXED EQUIPMENT

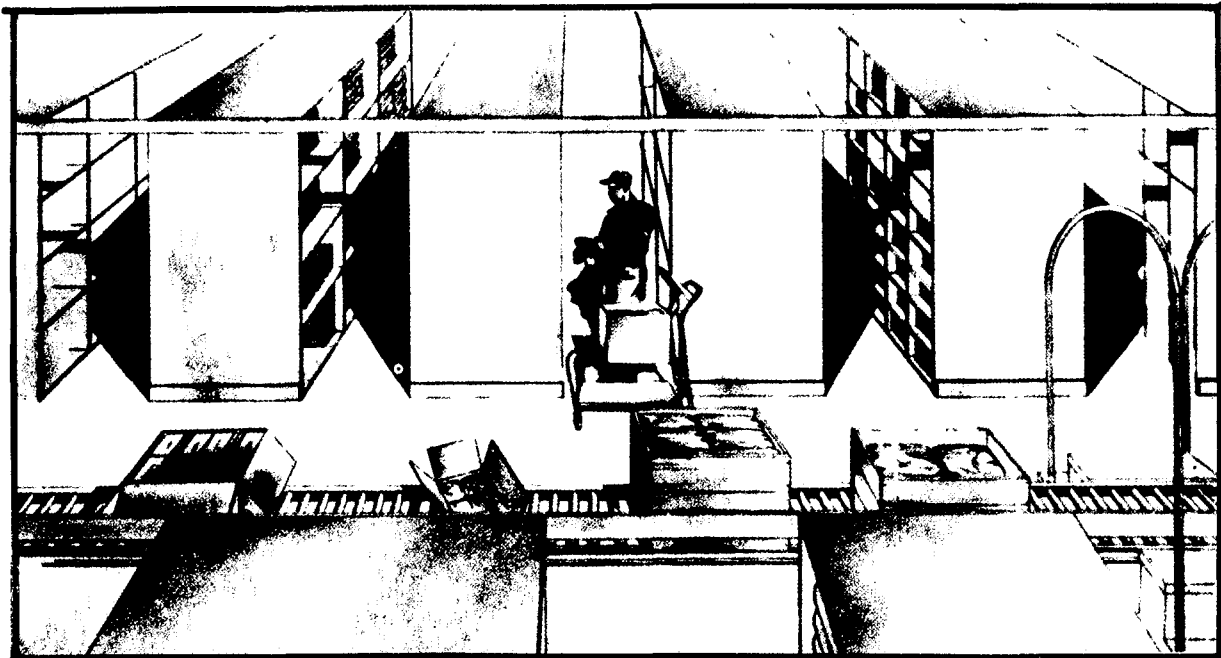

Figure 4-107 Fixed active roller conveyor line serves to good advantage in package transfer.

4-31. Fleet Management.

a. *Definition.* Fleet management as distinguished from operational use of MHE encompasses overall determination of quantitative requirements

at installation level. It analyzes fleet utilization to determine effectiveness of the materials handling program, remedial action, as required, proper maintenance for all MHE, and efficient distribu-

tion of MHE to job sites from a central control point.

b. Post analysis. A post analysis of requirements and utilization by using activities and at installation fleet management levels will verify the adequacy or inadequacy of total fleet, pinpoint activities that constitute problem areas in materials handling utilization, and indicate the type of remedial action required. In each case, proper analysis will result in an improved materials handling program, a close alignment of quantitative ceiling with workload volume, and a fleet complement containing the proper ratio of equipment by type

and capacity necessary to accomplish supply movement.

c. Maintenance. Scheduled preventive maintenance, fleet population sufficient for replacement of equipment undergoing maintenance, and an effective program of first echelon maintenance by operators will result in a compact working fleet without the necessity of maintaining extra equipment which is in reality "excess" equipment. Maintenance should be performed in such manner and with such dispatch as to preclude the growth of a theory that "I need one piece of equipment but must order two due to the possibility of breakdown." Figure 4-108 emphasizes where the value of equipment is gained.

EQUIPMENT — WHERE IS IT?

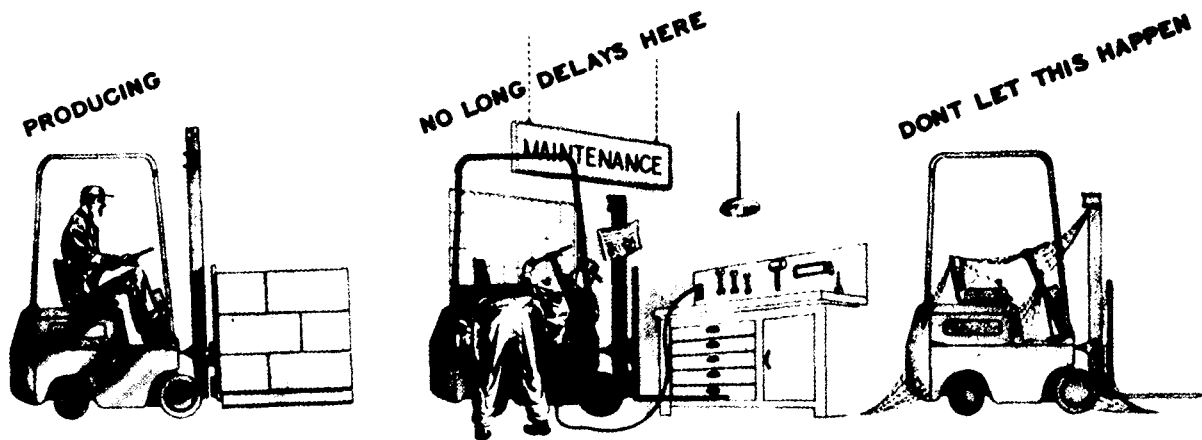

Figure 4-108 Equipment that is not producing is not "paying its way." Minimize "out of use" time

d. Distribution.

(1) In many operational areas, the period of requirement for MHE service constitutes only a small part of the day. Under such circumstances, rather than the assignment of an equipment item for the full day, it is better practice to have the equipment reported as being available for use to a central control office in order that further profitable dispatch can be accomplished. The office exercising control of equipment should maintain a means to visibly illustrate the location of equip-

ment currently in use as well as unassigned equipment available for immediate dispatch. Such an aid for the control of equipment by location and use activity is illustrated in figure 4-109. Removable cards or magnetic stickers identify, by number, each piece of equipment and the characteristics of the piece. Using units may represent any operational breakdown most suitable to exercise effective fleet control.

MHE CONTROL BOARD															
USING UNIT # 1	430	437	443	446	432	438									
USING UNIT # 2	400	400	404	404	404	404	404	404	404	404	404	404	404	404	404
USING UNIT # 3	400	401	402	403	404	405	406	407	408	409	410	411	412	413	414
USING UNIT # 4	400	400	400	400	400	400	400	400	400	400	400	400	400	400	400
USING UNIT # 5	400	400	400	400	400	400	400	400	400	400	400	400	400	400	400
USING UNIT # 6	400	400	400	400	400	400	400	400	400	400	400	400	400	400	400
USING UNIT # 7	400	400	400	400	400	400	400	400	400	400	400	400	400	400	400
USING UNIT # 8	400	400	400	400	400	400	400	400	400	400	400	400	400	400	400
USING UNIT # 9	400	400	400												
USING UNIT # 10	400	400	400	400	400	400	400	400	400	400	400	400	400	400	400
USING UNIT # 11	400	400													
MAINTENANCE	400	400	400												
UNASSIGNED	400	400	400	400	400	400	400	400	400	400	400	400	400	400	400

Figure 4-109. Typical MHE control board

(2) Efficient control will generally result in strategic placement or dispersal of equipment. Equipment should be moved, as required, to satisfy operational demand as determined by workload conditions. Normal dispatch of equipment to a user is for the accomplishment of a specific job; therefore, when the operation is completed, the equipment should become available for other use. However, this does not preclude the assignment of equipment, as required, to operations which need equipment periodically throughout the entire day. In each instance, administrative control of equipment should remain vested in a central office responsible for MHE.

e. Reports and reports procedure.

(1) With due consideration to the fact that MHE is a service to the operations being performed and the full potential from each piece of equipment cannot be expected, a generally acceptable method for analyzing equipment utilization and fleet quantity is the conversion of overall fleet activity to hours of operation expressed as a percentage of the utilization potential during an 8-

hour work period. Each service has published instructions which represent minimum utilization expectations from the basic type of mobile powered MHE.

(2) The procedure outlined below provides a suggested means for the compilation and reporting of data pertaining to the utilization of powered MHE.

(3) The agency charged with the administration of the installation concerned is responsible for the allocation of powered MHE in accordance with the needs of each installation, for providing technical supervision and guidance in equipment utilization, and initiating remedial action where appropriate. There should also be a central office of control, designated above installation level, who can—

- (a) Monitor the program for the reporting of MHE utilization.
- (b) Consolidate and analyze the data obtained from the reports.
- (c) Prepare a consolidated summary report of MHE utilization, as required.

(4) Each supply installation, in the discharge of assigned mission, is responsible for obtaining maximum efficiency in the operation of MHE. To accomplish this, compiled operating data must be detailed enough to furnish installations with utilization records by using units and still allow for recapitulation of a broader scale to furnish data to higher echelons. By so doing, the information compiled can be used at any management level and

the analysis and the application of the information so gained will result in an effective materials handling program and establishment of materials handling fleet quantities at a level required for normal operations. Figure 4-110 illustrates areas of benefit. Data should be compiled within each installation in the office responsible for the assignment of equipment from vehicle and equipment operational records, and maintenance shop records.

WHAT A MHE UTILIZATION REPORTING SYSTEM MEANS

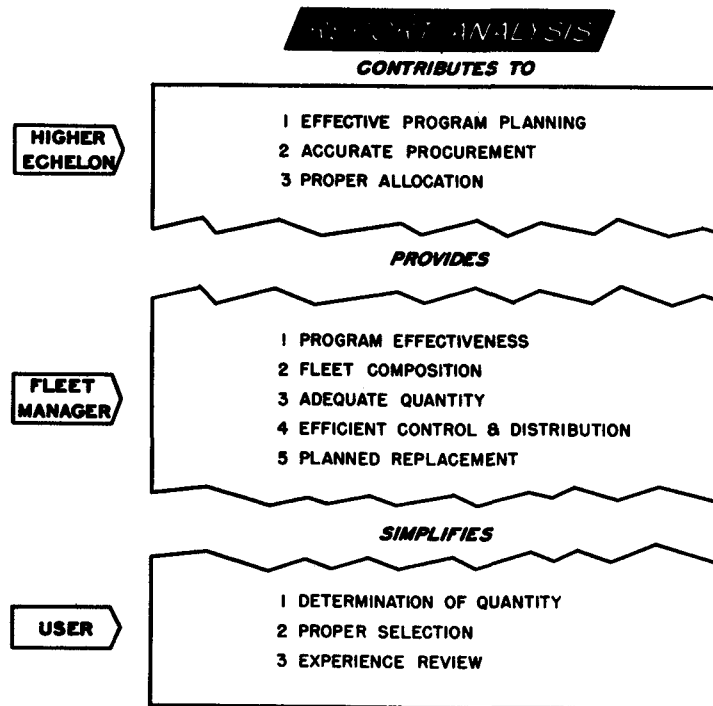

Figure 4-110. Value of an effective reporting system for MHE.

Section VI. On-The-Job Training (OJT) Course for Operators of MHE

4-32. Purpose.

The purpose of this section is to provide guidance to train personnel in the proper operation of MHE.

The guidance provides a system of training, testing, and licensing of personnel.

4-33. Vision, Hearing, and Reaction Tests.

a. These tests (properly administered) will ensure that operators of MHE possess at least minimum requirements for a safe operation.

b. Equipment for these tests is available in the Federal supply system as driver testing and train-

ing device, portable (NSN 6930-00-526-3639). If the testing equipment cannot be obtained through supply channels, equivalent materials may be constructed locally, provided they are made to accurately measure the physical characteristics as prescribed (fig 4-111).

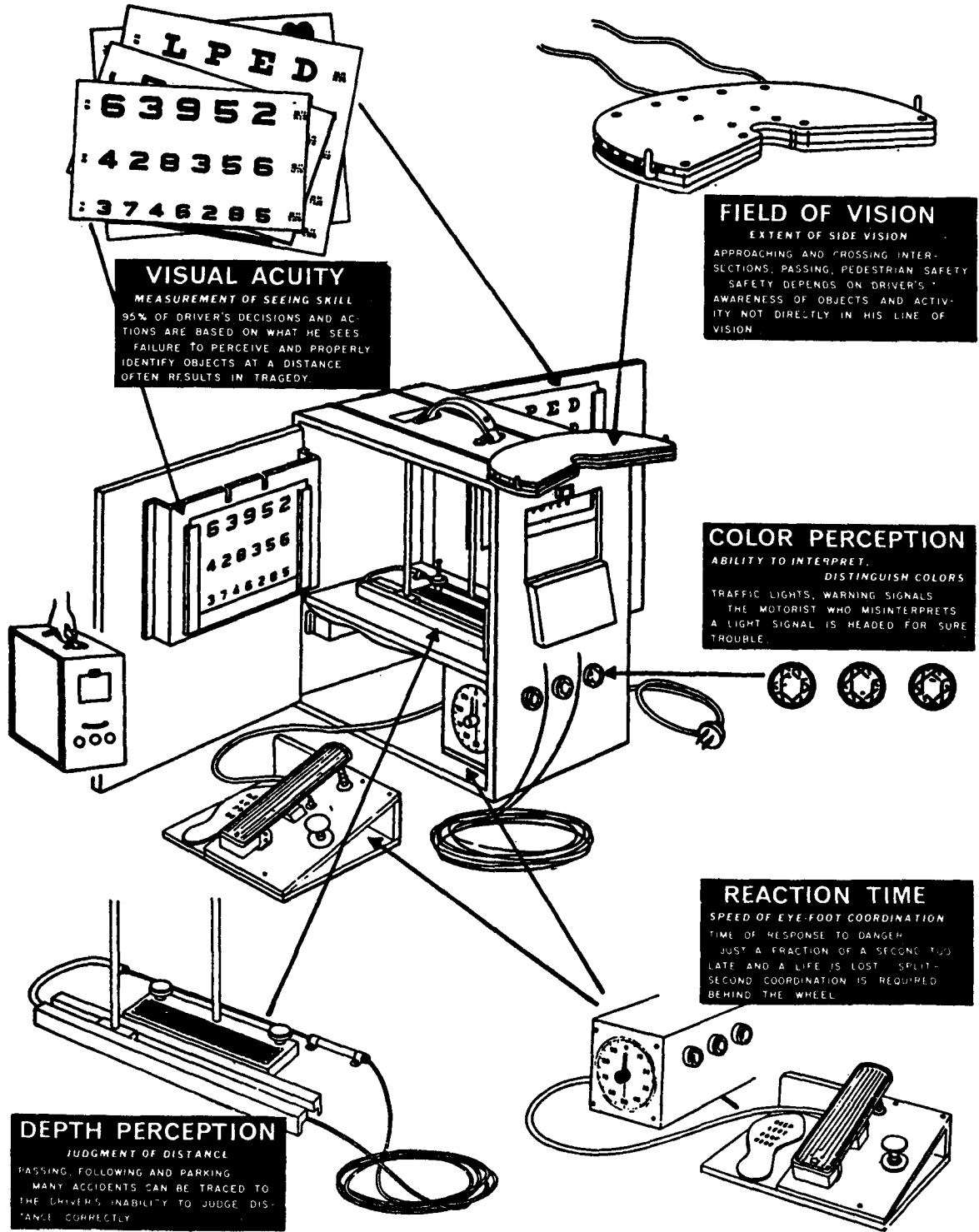

Figure 4-111. Driver testing and training device.

c. The following instructions apply to measuring physical abilities and supplement the specific instructions accompanying the test equipment:

(1) Before giving any test, the administrator of the test must know the purpose of the test

equipment to be used and the prescribed procedure. They should conduct a number of trial tests to become familiar with the test equipment.

(2) Prior to each test, they should explain the purpose and what the examinee is expected to do.

Upon completion of testing, any physical limitations of the examinee should be explained and the compensating measures the examinee may take should be emphasized.

d. A visual acuity test determines whether the examinee can see well enough to operate MHE safely. The minimum standard is visual acuity correctable to 20/30 in each eye. An individual whose visual acuity is 20/40, or poorer, will be referred to the installation medical examiner for decision on whether or not the individual's vision is sufficient for operation of MHE. Persons with sight in only one eye can operate industrial tractors in open areas, but not in warehouses. Sight in both eyes is required for handling ammunition and explosives.

e. A depth perception test, which is optional, determines how well the examinee can judge distances. The results of this test, if given, are used in counseling and training of the operator, although there is no minimum standard.

f. A field of vision test is given to determine whether the examinee can see to each side while looking straight ahead. A lateral range of 75° on each side of the focus line is the minimum standard acceptable. If the standard is not met, the examinee will be referred to the installation medical examiner for determination as to whether the individual's lateral vision is sufficient for safe operation of MHE. In the event an instrument is not available to test field of vision, a pencil can be used in this manner: have the person being tested look at an object straight ahead while the examiner, standing beside the person being tested and holding a pencil at eye level over the right or left shoulder, moves the pencil forward until the person can see it out of the corner of his eye. The angle at which the examinee first sights the pencil is noted. (Straight ahead is 0°.) Repeat for each eye.

g. A color perception test determines whether or not the examinee is colorblind. The examinee will not necessarily be disqualified as an operator of MHE because of colorblindness. However, if there is any indication of colorblindness, the examinee will be given information on traffic lights, observation of other traffic, etc., which will enable the individual to operate MHE safely. For those activities lacking a colored light signal device, this test may be conducted by either the colored yarn test or color cards.

h. A reaction time test (eye to foot) measures how quickly an examinee's foot can be moved in response to driving conditions. Reaction time up to an including .60 second is acceptable.

i. A hearing test determines whether a potential equipment operator can hear well enough to operate MHE safely.

(1) Where accurate measuring equipment is available, the MHE operator candidate must demonstrate a hearing acuity in the better ear of 15/20 with or without a hearing aid.

(2) If measuring equipment is not available, the potential operator may be tested by determining if he or she can hear conversation spoken clearly and in moderate tone from a distance of 20 feet.

j. Appendix A of the Federal Personnel Manual, chapter 930, instruction 261, contains additional information on physical standards for vehicle operators.

4-34. Physical Examination.

a. The physical condition of all trainees must be such that, in the opinion of the installation medical examiner, they are capable of performing their duties.

b. Amputees in good physical condition are acceptable as operators, when in the opinion of the installation medical examiner, they can perform in accordance with the physical requirements as established by the installation. The examination report will include a justification statement as to why the missing limb will not present a safety hazard.

4-35. Instructions on Types of Equipment.

a. Preparation. A classroom should be provided. Illustrations for applicable types and makes of equipment should be obtained. The illustrations can be of a size to be displayed to the entire class or may be smaller in size and be distributed to each trainee. These illustrations should show not only exterior views, but also cutaway views showing interior mechanisms to be described by the instructor. Other visual aids such as models, motion picture films, sound film strips, and safety posters are extremely helpful.

b. Discussion topics. Classroom instruction should cover the following:

(1) Discussion of the fork truck and its relationship to the palletization of material, including the placement of material in storage and the principles, handling methods, and procedures involved.

(2) Discussion of the fork truck and its uses as compared to those of other types of MHE (e.g., industrial tractors, tractor-trailer trains, cranes, industrial trailers, gravity conveyors, power-driven belt conveyors, handtrucks, pallet trucks, railroad cars, and other commercial vehicles).

(3) Discussion of the operating performance, operating parts, and the maintenance program of fork trucks, both gasoline and electric. All differences between the types of machines occasioned by a different power source should be emphasized, noting such things as:

(a) Mechanical construction, weight, weight distribution and ability to carry a load, turning radius and principle, pivot or turning point, fork types, mast construction, and operating principles. Figure 4-112 illustrates and explains the terms applicable to the forklift truck mast assembly.

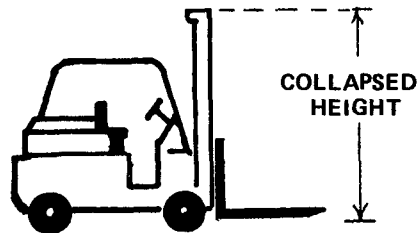
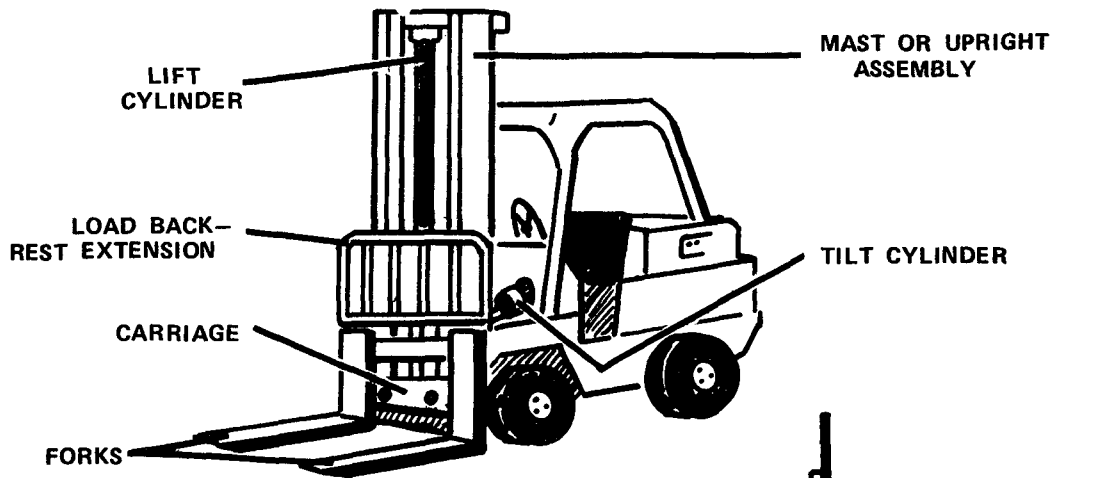

A. THE COLLAPSED HEIGHT IS THE DISTANCE FROM THE FLOOR TO THE TOP OF THE MAST WHEN THE FORKS ARE IN THEIR LOWEST POSITION.

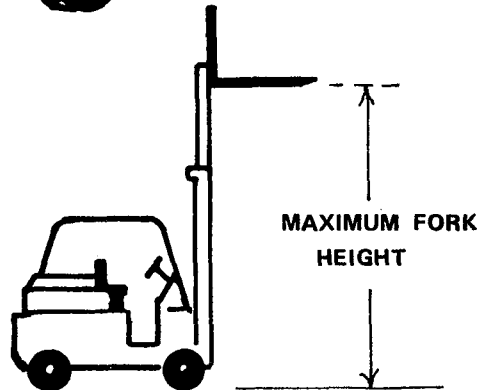

B. THE MAXIMUM FORK HEIGHT IS THE DISTANCE FROM THE FLOOR TO THE TOP OF THE FORKS WHEN THE MAST IS FULLY RAISED.

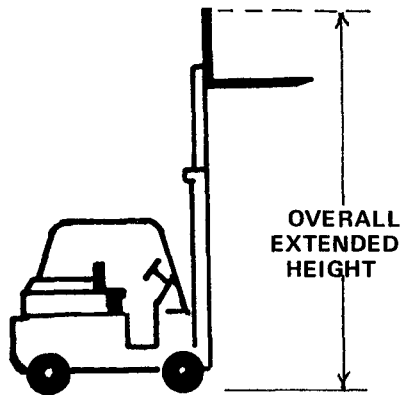

C. THE OVERALL EXTENDED HEIGHT IS THE DISTANCE FROM THE FLOOR TO THE TOP OF THE LOAD BACKREST EXTENSION WHEN THE MAST IS FULLY RAISED.

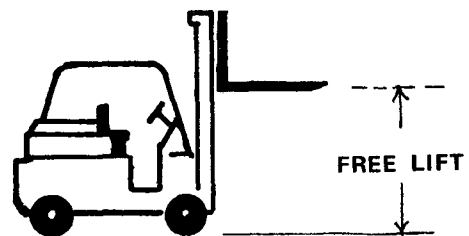

D. FREE LIFT IS THE DISTANCE THE FORKS MAY BE RAISED BEFORE THE COLLAPSED MAST HEIGHT IS INCREASED.

Figure 4-112. The mast or upright is the elevating assembly of a fork lift truck.

(b) Operating parts such as gauges for oil and gasoline, ammeter, ignition, brake, clutch,

starter, speed control, directional travel control, steering, boom lift, and tilt controls.

(c) Maintenance program, which includes regular and periodic servicing (or battery charging), washing, lubrication, cleaning, the checking of tire condition and hydraulic system (if any), and painting.

(4) An explanation of the results of misusing fork trucks. This could include an exhibition of worn and broken parts to illustrate the additional cost incurred as a result of improper operation of the equipment. The instructor should point out the equipment. The instructor should also point out the additional dangers involved in operating equipment which has been damaged by misuse.

(5) Review of savings effected by the use of mechanical equipment. The review should emphasize the saving of time in delivering needed supplies, earlier release of railroad equipment, saving of space by increased stacking height, and more compact storing of material.

(6) Discussion of safe loading practices, as outlined below:

(a) *Safe load.* Overloading of fork trucks is strictly prohibited. The truck will safely lift and carry no more than its rated capacity. Among the dangers of overloading are the possibility of injury to the operator, damage to the cargo, damage to the pump and lift mechanism, and excessive wear on the tires, engine, or electric motor.

(b) *Determination of safe loading.* A fork truck will tip forward if the load on the forks exceeds the lift capacity of the truck. The manufacturer has established the truckload rating (expressed in pounds of load on the fork) and the allowable distance in inches from the heel of the forks to the center of gravity of the load. This distance is known as the load center.

(c) *Pounds capacity/length of load.* Some manufacturers specify a number of pounds capacity with a particular length of load. Others specify a number of pounds capacity at a given number of inches from the heel of the fork. Some give an inch-pound rating based on the distance of the load center from the heel of the fork, while others base their inch-pound rating on the distance from the center of the load to the center of the front axle.

(d) *Uniformly distributed load.* When a load is uniformly distributed throughout the length (i.e., parallel to the prongs of the fork), the center of gravity will be located at half such length. When a load is not uniformly distributed throughout the length, care must be taken to determine the distance from the heel of the forks to the accurate center of gravity.

(7) The instructor's explanation of the details of warehousing procedures should include a discussion of warehouse aisle widths, selecting and storing stock, methods of palletizing and stacking, fire aisles, alarm boxes, and sprinkler systems.

(8) Explanation of the appropriate OSHA requirements applicable to safe operations.

4-36. Fundamental Operational Instructions for Fork Truck.

a. *Preparation.* One fork truck should be provided for every two students. All fork trucks will be equipped with over-head guards. The area selected for training should be level, with paved surface, and should be free of other traffic.

b. *Review of previous instructions.* Instructions should include a review of previous classroom discussions on the various controls, preventive maintenance, warehousing procedures, stacking methods, and safety rules pertaining to the operation of fork trucks.

c. *Operational condition of vehicle.*

(1) Before taking their place on the truck, the trainees will be instructed to check the following:

- (a) Gasoline.
- (b) Water.
- (c) Oil.
- (d) Tires.
- (e) Fire extinguisher (when truck is so equipped).
- (f) Security of forks.

(2) After mounting the truck, the trainee will check the following:

- (a) Horn.
- (b) Parking brake and foot brake.
- (c) Position of gear shift lever (should be in neutral).

d. *Instructor's demonstration.* The instructor should demonstrate to the entire class how to operate the machine forward and backward. At this point, the trainees should be cautioned against traveling with the foot resting on the clutch pedal ("riding the clutch") as this results in the loss of tension in the clutch springs, allowing the clutch to slip and causing excessive wear. The instructor should take particular care to explain that forks should always be raised just high enough for safe clearance, yet low enough to permit a clear view ahead when traveling either with or without a load. If the load's size obstructs the operator's forward view; drive the fork truck in reverse.

e. *Trainee's practice.*

(1) *Basic operation.* The trainee should now drive the machine in a straight line forward and

backward. The next operating practice should be circles or figure eights, performed at reduced speed. The instructor should closely observe the trainees as they perform these maneuvers.

(2) *Obstacle course.* After the trainees have performed the basic maneuvers, the instructor should have them set up an obstacle course constructed of empty pallets. The pallets should be placed on edge in a straight line and so spaced as to allow a fork truck to pass freely between them (fig 4-113). In traveling over this course, the fork truck weaves in and out between the pallets. Each trainee should traverse this course until they have become proficient in moving between the pallets in free, easy curves. As each trainee performs, the instructor should emphasize the danger of sudden stops and starts or turns with the fork truck. Sudden starts and stops may cause the pallet loads to upset, thus endangering the safety of personnel and probably resulting in damage to the material. All turns should be made as gradually as possible. Long, slow turns allow the operator to gauge distances and accurately place loads without loss of time. Spotting loads in the warehouse is a maneuver which requires extreme accuracy. Adequate time should be allowed for the trainee to practice these maneuvers before proceeding with further instructions.

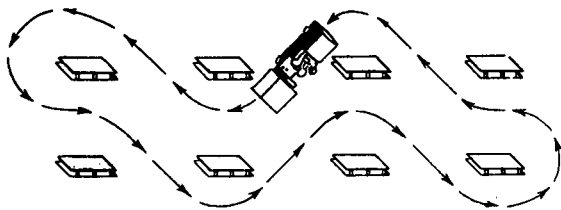

Figure 4-113. Obstacle course for operator training

(3) *Operation in aisles.* The next step in the training course should be the operation of the truck in aisles. First, empty pallets are arranged to form aisles of a width normally used at the installation for the size of the equipment used for training purposes with corners and intersecting aisles as shown in figure 4-114. The trainee should operate the fork truck up and down the aisles, both forward and backward. If two fork trucks are available, two trainees should perform this operation at the same time, thus learning to pass in aisles (fig 4-115). Each trainee should then practice all that has been learned to this point. After an adequate practice period, the instructor should make a careful evaluation of the performance to date to determine which trainees are to be eliminated, retained, or given advanced training.

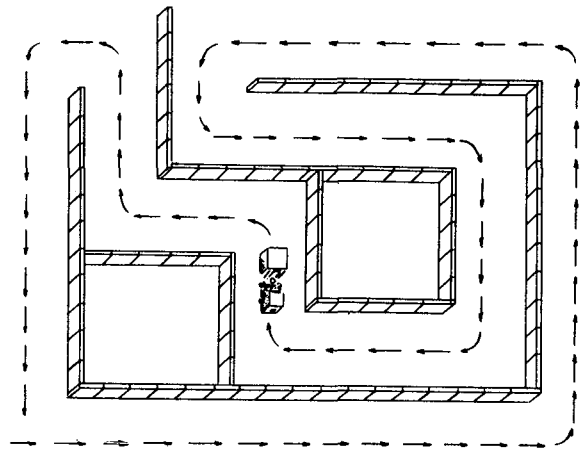

Figure 4-114. Practice aisles set up with empty pallets.

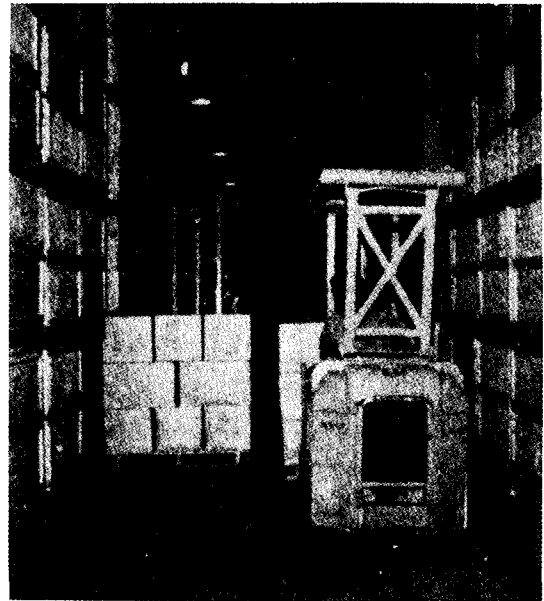

Figure 4-115. Experienced operators passing in an aisle.

4-37. Advanced Training in Fork Truck Operation.

a. Load handling demonstration. The next period of instruction (before the trainee operates the machine with pallets) covers the following load handling operations in the sequence given below:

(1) *Approaching a pallet* (fig 4-116). Aim the forks of the truck to enter between the top and bottom boards of the pallet, at an equal distance from the center stringers.



Figure 4-116. Approaching a pallet. Forks must enter at an equal distance from the center stringers.

(2) *Inserting forks.* The forks of the truck should be inserted into the pallet as far as they will go. It is important that the operator have the load as close to the heel of the fork as possible.

(3) *Lifting and moving the pallet.* The trainee should be instructed how to apply the lift control to lift the pallet from the floor, apply the tilt control to tilt the mast back, and then apply the travel controls to move the machine forward or backward.

(4) *Lowering the pallet.* The trainee should be shown how to lower the pallet to the floor and then tilt the mast to a vertical position so that the forks can be removed easily.

(5) *Using the mast tilt.* Demonstrate how the tilt is used to achieve the following:

(a) Lean the load against the back rest for stability during movement.

(b) Position loaded pallets during stacking.

b. *Load handling maneuvers for trainees.*

(1) *Lesson one.*

(a) The trainee lifts a pallet load with the fork truck and, after making a turn around the training area, spots the load on a right angle drawn on the floor (fig 4-117).

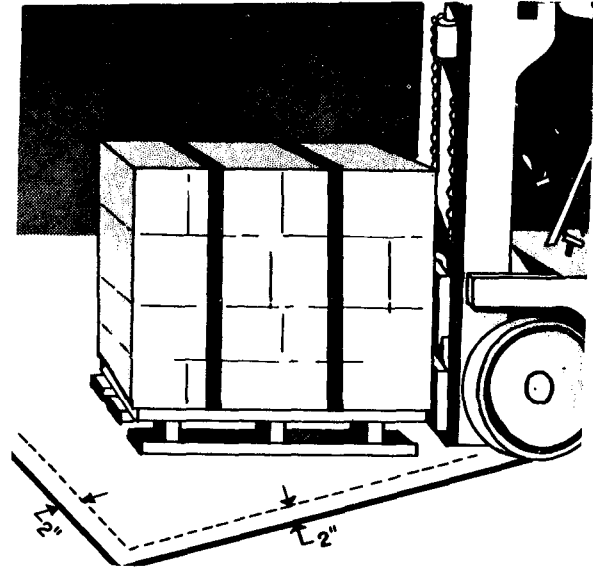

Figure 4-117. In one maneuver, the trainee spots a pallet load on a right angle drawn on the floor. This must be done with no more than 2 inches of lost space.

One swing is all the maneuvering that is permitted to place the load. The instructor should demonstrate each operation before turning the fork truck over to the trainee. Upon completion of a maneuver by the trainee, the instructor should point out those actions that were performed correctly and make appropriate comments on those that were not. In the problem of spotting a pallet load at a right angle in one maneuver, the instructor will point out that extra backing and shifting causes the greatest loss of time in a fork truck operation. If operators are trained to spot a load on the first approach, this time loser will be eliminated. The one-swing maneuver is accomplished by having the eye follow the path of the drive wheel on the inside of the turn. As the center of pivot of the machine lies on the line formed by the drive axle, it is obvious that the drive wheels are the key to the actual spotting of the load. After several attempts, each trainee should be able to spot a load on the right angle with no more than 2 inches of lost space.

(b) The next step is to spot a pallet load adjacent to another. This also must be performed in one swing of the machine. The fork truck approaches the stack (pallet load on the floor) by crossing in front of the stack rather than by approaching from the opposite side toward that stack (fig 4-118). If the stack is approached from the opposite side, the pallet load will move away from the stack when the fork truck is turned to set the

load down, leaving as much as 6 inches lost space. By crossing in front of the stack—the correct way—the load will travel toward the stack with no loss of space. It should be observed that in this position the fork truck is turning to straighten out

the load. When the fork truck turns, the back of the truck moves to the right and the load to the left and the load can be spotted directly in line with the stack, with no loss of space. The test refers to truck B coming from left (fig 4-118).

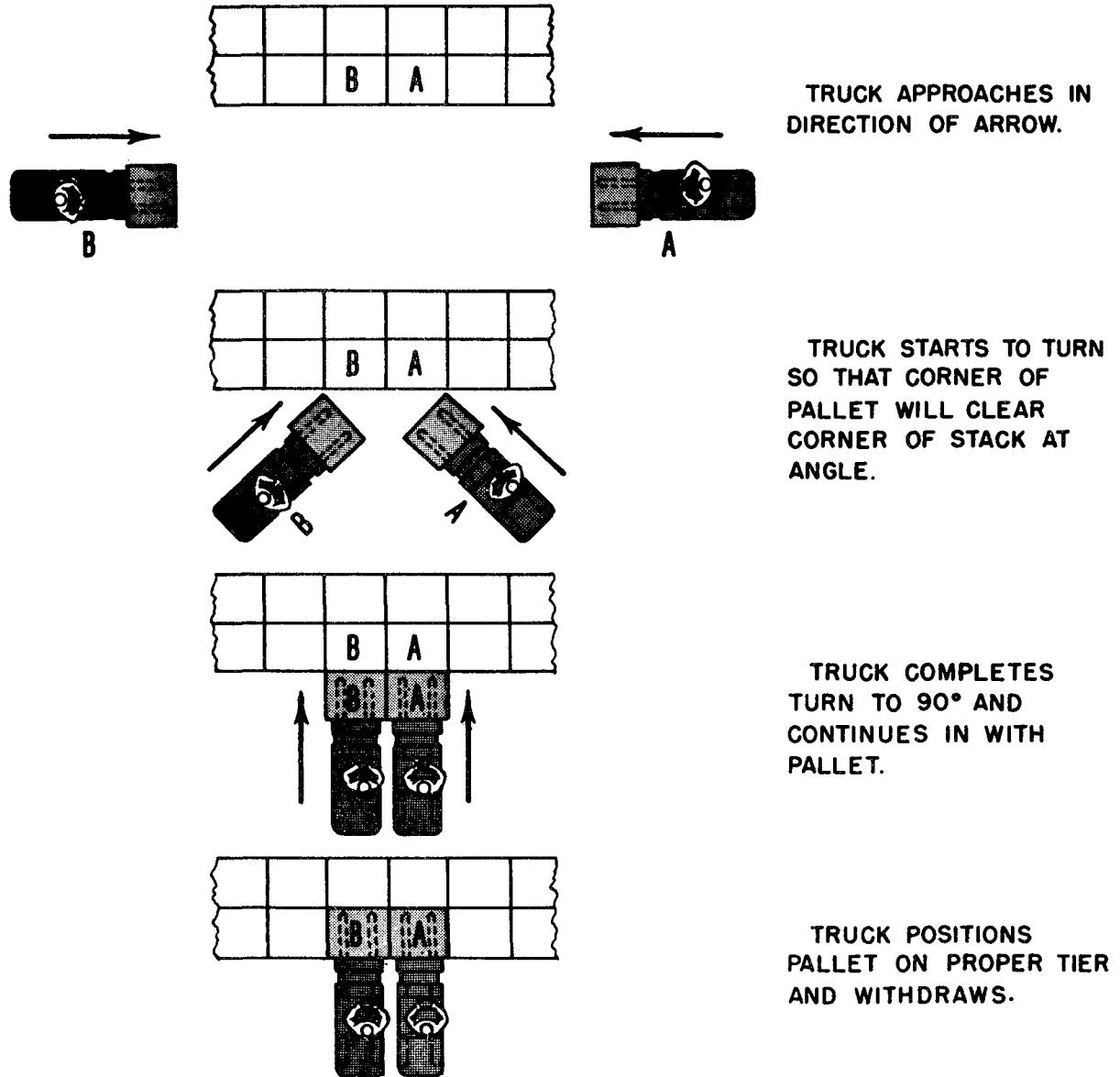

Figure 4-118. After crossing in front of the stack, the operator spots a pallet load adjacent to another

(2) Lesson two.

(a) This lesson is designed to acquaint the trainee with the fundamentals of tiering. The trainee is shown how to tier first one pallet load upon another and then place a double pallet load on top of the first two with an error of no more than 2 inches in any direction (fig 4-119). Raising a load into position for stacking while the fork truck is in motion is forbidden. Such a practice is

dangerous because it obscures the operator's view while traveling in a forward motion. The performance of two simultaneous operations (steering and lifting) endangers safety and limits operating efficiency. Operators should bring the machine to a stop close to the stack before raising the load to tiering position (fig 4-119).

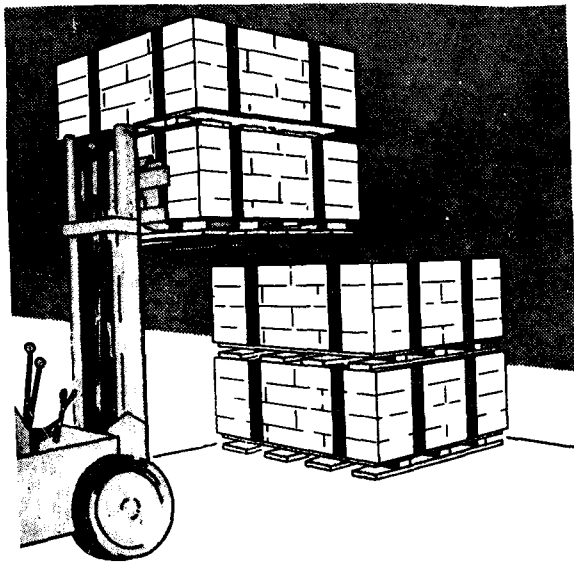

Figure 4-119. A double pallet load must be tiered with an overhang of no more than 2 inches in any direction

(b) The next step pertains to the tiering of a double pallet load adjacent to the stacks. This should also be accomplished with one swing of the truck and with an error of not more than 2 inches on any side. In carrying double pallet loads, the truck is operated in reverse so that the operator will have an unobstructed view. A fork truck has the same speed in reverse motion as it does in forward motion. At this point, the trainee can be instructed in the proper method of operating loaded fork trucks up and down ramps. A loaded truck, moving in a forward direction, can negotiate a slight downward grade (not to exceed 5°) safely when the mast is tilted back. However, a loaded fork truck will be driven up in forward motion and down in reverse motion on all ramps.

(3) *Lesson three.*

This lesson is a continuation of the trainee's practice in tiering pallet loads. In the previous lessons, there were no turning radius restrictions for the beginner. To get the feel of the truck and to accustom their eye to its travel, the operator was allowed unlimited space for maneuvering. Now, however, warehouse aisles should be simulated by the placement of pallet loads in two straight lines. The two stacks should be placed to form an aisle 14 feet wide. The trainee should not be instructed to do the same tiering done in the previous lessons in this limited aisle space. As the trainee progresses, the aisle width can be reduced to the width normally used at the installation.

(4) *Lesson four.*

This lesson is designed to teach placement and handling of loads in limited spaces. The trainee should now be ready to place a pallet load between two other pallet loads with only ½-inch clearance on either side of the load (fig 4-120). This is to be accomplished without stopping the fork truck. For the first few attempts, additional clearance may be provided. In the next operation, the trainee makes a similar maneuver, except that they turn off a 14-foot warehouse aisle and into another aisle which is not more than 4 inches wider than the pallet load. Since the space is only an inch or two wider than the pallet load, the truck's line of approach must be at a right angle to the line of stack. Making this turn from a 14-foot aisle requires considerable practice; the trainee should completely master this maneuver before going on to the next lesson.

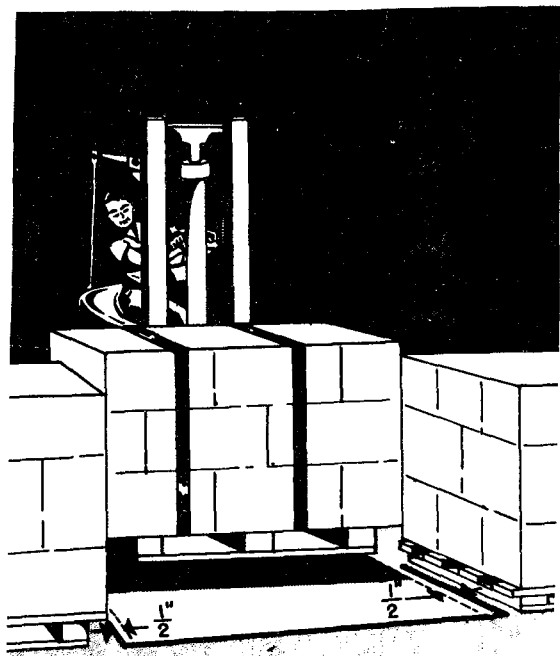

Figure 4-120. The trainee must be able to take a pallet load between two other pallet loads with only ½-inch clearance on either side

(5) *Lesson five.*

This lesson is a continuation of lesson four. The trainee is required to back through the space between two pallet loads with only 1-inch clearance on either side of the load. It is a difficult maneuver and must be performed often in warehousing operations. The trainee must learn that, as the fork truck is traveling backward, they must give equal attention to both the rear of the machine and to the pallet load, which are in opposite directions

from the operator. In backing into the space, the operator should look to the rear to make certain that the fork truck will be properly centered. They then look forward to assure proper pallet clearance. In this exercise of driving between pallet loads, the operator of a fork truck that has the seat on the left side should never be concerned with the right side of the load once it is certain there is sufficient clearance. Conversely, on trucks which the operator drives from the right side of the machine, attention will be given to the right

side of the pallet load. On seated center control trucks, they can give attention to either side.

(6) *Lesson six.*

This lesson is designed for final examination of the trainee. Standard warehouse conditions are simulated as nearly as possible in the training area and the trainee will tier and untier a set of pallet loads according to the rules learned in the previous lessons. Tiering eight pallet loads on a run of about 100 feet should be done in approximately 12 minutes before the trainee is qualified for an operator's permit (fig 4-121).

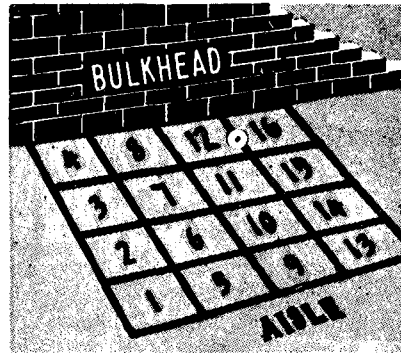
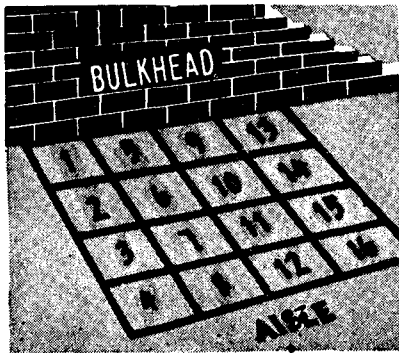

Figure 4-121. Typical floor pattern. Proper stacking procedure is shown at left. The numbers indicate the sequence in which columns are stacked. Sequence for the removal of pallet loads is shown at right.

(7) *Lesson seven.*

(a) A course in railroad carloading will be given to those trainees selected for these lessons. A preliminary to the course should be a short talk on the subject. The trainees then should be taken

to a loading or unloading operation so they may observe the procedure (fig 4-122). The function and use of bridge plates should be pointed out and the method of securing and moving them should be explained.

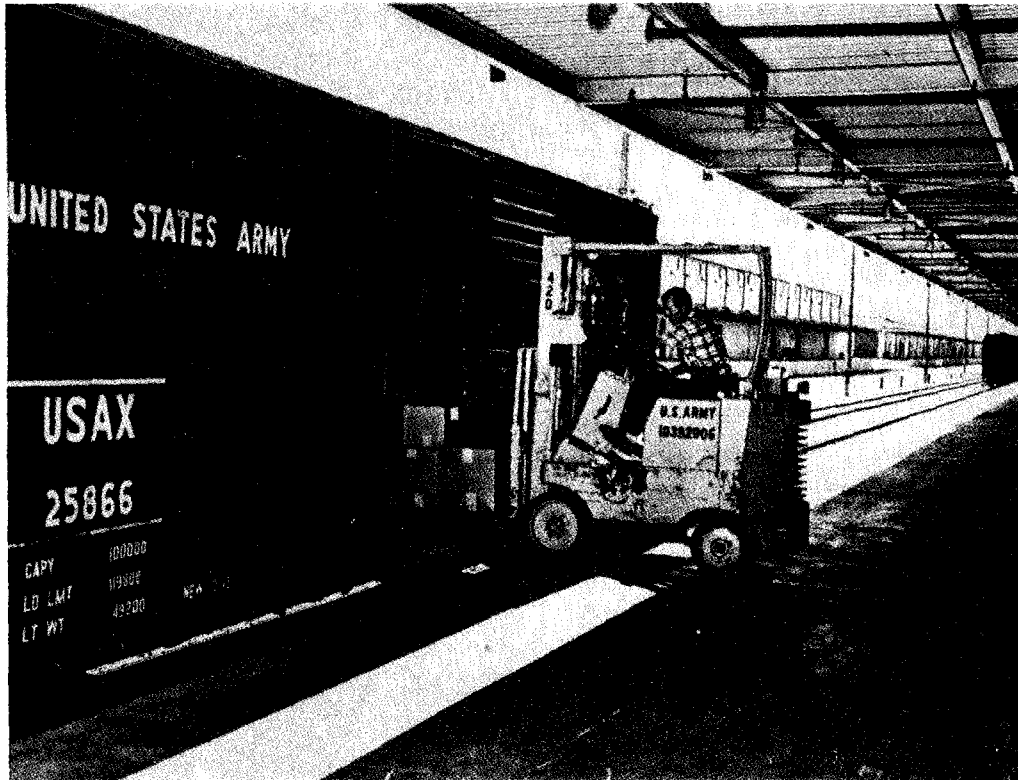

Figure 4-122 Loading a freight car.

(b) For practice in operation, a boxcar doorway, bridge plate, and boxcar wall should be marked out in the practice area by means of pallets (fig 4-123). The trainee should demonstrate the ability to drive in and out of a boxcar in the

practice area before proceeding to an actual boxcar. After proving capable, the trainee should be taken to a location where they can drive in and out of an empty boxcar with no load on the forks except an empty pallet.

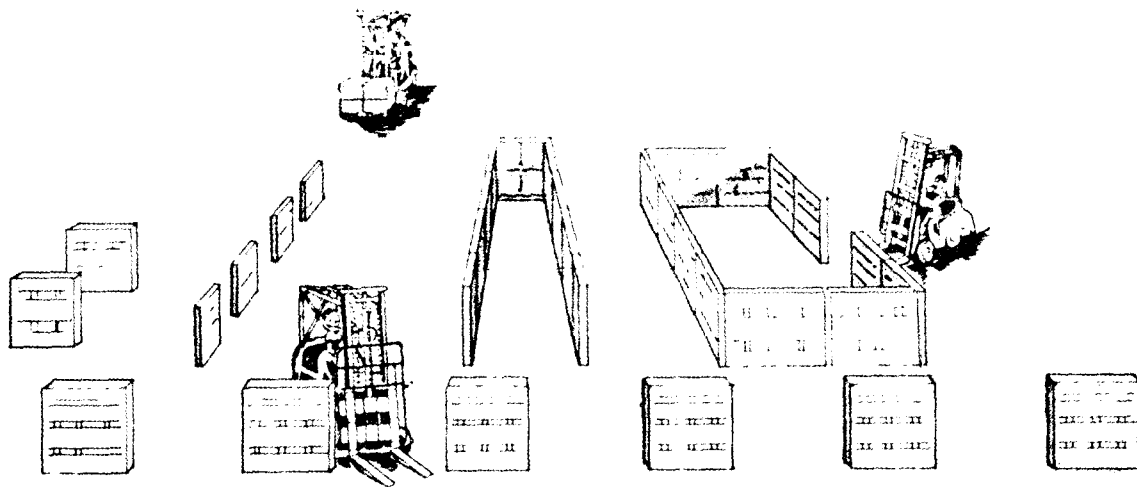

Figure 4-123 Practice area for carloading operations.

(c) Following this practice, the trainee should be taught to place 40- by 48-inch pallets for unit load shipment in a standard boxcar floor layout marked on the practice area floor. Actual pallet loads of unbreakable goods should be used if possible and a half car should be worked two tiers high in the practice area. After the trainee has demonstrated the ability to unload a boxcar on the practice floor, they should unload merchandise from an actual car in a fairly quiet location under the supervision of a competent operator.

(d) Instruction in actual car loading should include the following:

1. *Bridge plate placement.* Make certain the bridge plate between the boxcar and the loading platform cannot slip or slide. It should be securely fastened to prevent accidents. Inspect car floors to be sure the floor is strong enough to carry the combined weight of the truck and its load.

2. *Necessity for caution.* When entering or leaving the boxcar, the fork truck operator should drive over the bridge plate slowly and carefully—especially when loading. Fast operation at this point can cause accidents and damage. A fork truck with two or more speeds should always be operated in low speed when entering or leaving the boxcar with a load. By keeping the truck in low speed, the operator will be less likely to slip the clutch, thus preventing undue wear on clutch lining and facings. Boxcars are not always level with the loading platform. Sometimes they are higher, sometimes lower. This irregularity effects the method of loading and unloading with the fork truck. The following are considered good practices:

(a) If the boxcar is level or higher than the platform, the operator should drive forward into the boxcar with the load and drive out backwards.

(b) If the freight car is lower than the unloading platform, the operator should back in with the load and drive out forward.

3. *Handling loose containers.* When unloading loose containers, the operator should place the pallet as near to the boxcar door as possible, with fork entries placed in the proper position for easy pickup by the fork truck. Commodities are removed from the doorway first and palletized outside of the boxcar. After a sufficient number of containers have been removed, the remainder can be palletized on the boxcar floor. Again, care should be exercised to see that the fork entries are in the proper position. When containers in the center section of the boxcar have been removed, the unloading should continue towards the ends of the car. Pallets can be loaded at each end of the box-

car simultaneously. In such an operation, the fork truck operator should take the pallets first from one end and then the other, alternately.

4. *Handling palletized loads.* If the loads in the boxcar have been shipped palletized, the fork truck operator can work directly into the car and bring out one load at a time. In this type of operation, it is sometimes possible to have two trucks unloading the same boxcar without interfering with each other.

5. *Handling large items.* The following is a suggested procedure for the loading of large cases that have been stored on short dunnage:

a Drive the loaded truck into the boxcar.

b Place the case in the desired position.

c Set the case down on a two-by-four to permit the forks to be withdrawn.

d Withdraw the forks of the truck to within about 2 inches of the edge of the case.

e Lift slightly to withdraw the two-by-four.

f Set the load on the floor of the boxcar and back the truck away.

This procedure is reversed for the unloading of large cases from boxcars.

4-38. Fundamental Operational Instructions for Industrial Tractors.

a. *Preparation.* In beginning the course on the operation of industrial tractors and tractor-trailer trains, the instructor should show the same film as shown for fork trucks and make the following preparations:

(1) Provide one piece of equipment for every two students. The same training area, maze, and obstacle course, as used for training fork truck operators can be utilized (fig 4-112).

(2) Provide, if possible, one or more tractors representing each model used at the activity for the appropriate periods of instruction. If two or more types are equipped with identical controls, only one example of these types will be necessary. As mechanical operation of the tractor is all that is to be explained during the preliminary period, it is not necessary to have the trailers available.

(3) Point out to the trainees that operating a tractor is similar to driving an automobile. Functions of controls and preventive maintenance checks should be explained in the same manner as for fork trucks.

(4) Before mounting the truck, the trainee will be instructed to check the following:

- (a) Gasoline.
- (b) Water.
- (c) Oil.
- (d) Tires.
- (e) Fire extinguisher (when truck is so equipped).
- (f) Coupling.

(5) After mounting the truck, the trainee will check the following:

- (a) Horn.
- (b) Parking brake and foot brake.
- (c) Position of gear shift lever (should be in neutral).

(6) Explain in detail the differences between the operation of electric-driven tractors and gasoline-driven tractors.

b. Elementary driving.

(1) *Instructor's demonstration.* Elementary driving instructions should be given on a four-wheel tractor. Sitting beside the instructor on an auxiliary seat provided for the purpose, the trainee watches as the instructor performs and explains each phase of the operation. The initial drive should include several starts and stops. After several maneuvers, the instructor will ask the trainee to tell how to operate the controls.

(2) *Trainee operation.* After the instructor is confident the trainees can handle the tractor safely, the instructor permits them to operate it. The instructor should closely observe the trainee make solo maneuvers around the training area. When the trainee has stopped, the instructor should point out any errors that were made during the operation.

c. Obstacle course driving.

(1) *Instructor's demonstration.* After each trainee has satisfactorily completed the solo ride, the instructor drives over the obstacle course to demonstrate the proper method of maneuvering the tractor over this course.

(2) *Trainee operation.* The trainee then takes control of the tractor and drives over the obstacle course, stopping to set up any pallets knocked over. The instructor watches closely as the trainee drives and discusses the good and bad points of each trainee's operation. The trainee should drive over the obstacle course as many times as the instructor thinks necessary.

4-39. Course in Operation of Industrial Tractor-Trailer Trains.

a. Preparation. Since the principal use of the tractor is to haul trailers, the instructor's next step is to demonstrate the operation of a tractor-

trailer train. A sufficient number of trailers for this demonstration should be added to the equipment being used in the training area.

b. Elementary driving.

(1) *Instructor's demonstration.* The instructor should couple together a tractor-trailer train of the maximum length permitted by local activity rules. The instructor first drives it straight forward and then in long sweeping curves to demonstrate how each trailer turns in a smaller radius than the one preceding it. The instructor further demonstrate by operating a train of appropriate length over the obstacle course. Also, the instructor should operate a train in aisles established by pallets set on edge in the training area to show how, in making a sharp turn, it is necessary to veer to the right before turning to the left and vice versa (fig 4-124).

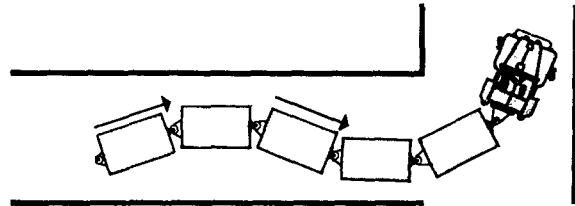

Figure 4-124 Right way to turn corners with a tractor-trailer train.

(2) *Trainee operation.* After the instructor's demonstration, each trainee should haul first one empty trailer, then two, and so on—adding one at a time until the maximum number permitted is reached. Each trainee should practice maneuvering a train of the maximum length permitted, repeating the maneuver practiced with the tractor itself. That is, the trainee should first practice starting, stopping, and turning in a clear space first with one trailer, and then with several. Then, they should operate the train through the maze and the obstacle course.

c. Driving loaded trains. Before starting, the trainees should inspect each trailer to see that it is properly loaded. A smooth, slow start is essential when the tractor is pulling a loaded trailer train. The trainee should be instructed to:

- (1) Drive on the right side of aisle to permit other tractors or trucks to pass.
- (2) Slow down when approaching a corner and, in turning, swing wide to allow for the clearance of the last trailer.
- (3) Stop and shift into the lowest gear before going up or down a ramp; do not shift into a higher gear until the entire train has cleared the ramp.

(4) Learn to properly position and park the trailer train perfectly on the first try, since the trailer cannot be backed into position.

(5) Always park the train at the side of an aisle, leaving as much aisle space as possible for other traffic.

(6) Execute a smooth, slow stop so that the trailer loads are not jarred.

d. Uncoupling tractor-trailer trains. After the tractor-trailer train reaches its destination, the tractor should not stand idle while the trailers are being unloaded. Instead, the operator should uncouple the tractor from the trailers, pick up the previously unloaded trailer train, and return again to pick up a loaded train.

4-40. Operational Instructions for Truck Straddle Carry (or Gantry Trucks).

a. Preliminary instructions. At the beginning of the course, the instructor should display and discuss appropriate illustrations of the straddle truck. Before starting the equipment, the instructor should point out to the trainee the necessity and method of checking gasoline, water oil, tires, battery, parking brake and foot brake, drive chains, positions of hoist shoes, lights, horn, position of gear shift lever (should be in neutral), and position of hoist lever (should be in neutral).

b. Instructor's demonstration. The instructor should now demonstrate to the trainee how to drive forward and backward.

c. Turning. The truck straddle carry is equipped with fourwheel steering. Although steering the truck when it is carrying a long and awkward load can be very difficult, the instructor should, in the preliminary instruction, merely make certain that the trainee knows the operation of the steering mechanism.

d. Using the hoist. Because power to operate the hoist comes from the truck engine, the engine must be running while the shoes are raised or lowered. The hoist is controlled by switch buttons or by a lever, which is moved to the "raise" or "lower" position. An automatic cutout is provided to release the power and apply the brakes when the load is bound in the truck or when the shoes reach the extreme upper and lower positions. A booster level is provided to furnish additional power for the hoist when needed. If the truck is equipped with swinging shoes, the swinging action may be controlled by a separate lever or it may be automatic with the raising and lowering of the shoes.

e. Training area and equipment. A large outdoor area should be used as a training area for

truck straddle carry operations. Because the truck is designed principally as a lumber carrier, a lumber storage yard would be ideal as a training area. The only other equipment needed will be several unit loads of lumber, placed on bolsters in such a way that they may be handled by the truck (fig 4-125). In the handling of the load, the shoes of the truck engage the ends of these bolsters. One short and one long load should be available for use in training. The trainee practices first with the short load and later with the long one in order to gain experience in maneuvering the truck under difficult conditions.

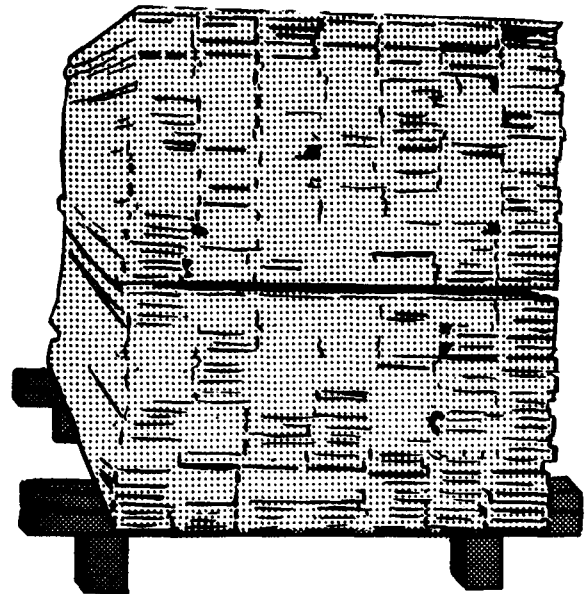

Figure 4-125. Material handled by truck straddle carry is usually stacked on bolsters.

f. Elementary operation. Under the instructor's supervision, the trainee should start the trucks properly and drive it slowly around the training area. Following the instructor's direction, the trainee should start and stop the truck, drive forward and backward, turn left and right, and maneuver it into various positions.

g. Training with hoist. After the trainees perform the elementary operations satisfactorily, they should practice use of the hoist. The trainees should then practice this operation until thoroughly familiar with the use of all the controls. They should be cautioned to abide by all safety rules governing the operation of truck straddle carry.

h. Picking up the load. Before the truck can pick up a load, the load must be properly stacked on bolsters. This stack must not be too high or too wide for the truck to handle and its weight must not exceed the maximum capacity of the truck. Be-

fore the truck is driven over a load, the hoist shoes must be swung outward. The truck must be driven carefully over the load and stopped so that the hoist shoes are midway along the sides of the load. Then with the gear shift lever in neutral, the hoist shoes are swung into contact with the bolsters on which the load is tacked and the hoist is engaged. (If the swing of the shoes is automatic with the hoist, or if the truck has rigid shoes, the engagement of the hoist will raise the load.) If necessary, the booster lever is used to assist in raising the load.

i. Moving the load. When the load is securely in position, the truck may be moved either forward or backward, as desired. When the load is to be carried a considerable distance, the truck should be driven forward. The truck must be driven only over solid ground. Hitting an obstruction may spill the load or seriously damage the truck. A truck carrying a load which extends ahead or behind the truck may be difficult for the trainee to maneuver. For this reason, the trainee should first practice moving relatively short loads. Also, the new operator must be cautioned not to stop the truck abruptly. A sudden stop can cause the load to slide out from the carriage and result in serious accidents.

j. Placing the load. The trainee should next practice placing the load in various positions designated by the instructor. The truck must be at full stop before the load is spotted. Loads must never be dropped to the ground, but must be lowered gradually under power. If the truck is equipped with swinging shoes which do not swing out automatically as the hoist is lowered, the shoes must be swung outward before driving away from the load. The trainee must avoid placing the load in such a position that they cannot drive the truck away from it. As an illustration, a careless operator may maneuver the truck into a limited space, lower the load, and then find that they cannot back the truck far enough to turn it and drive away.

k. Special handling jobs. The training should be completed with practice in handling the truck for special jobs and under unusual circumstances that might be encountered. If extremely long pieces of lumber are occasionally carried by the truck, or if it must, at times, operate in unusually restricted areas, trainees should practice operation under these difficulties and understand the problems and dangers involved.

4-41. Operating Rules.

During training sessions, operating rules applicable to individual types of equipment should be

stressed. The operating rules listed in this paragraph are examples of typical rules.

a. All equipment. The following operating rules are applicable to all MHE:

(1) No truck or tractor can be safer than the person who is operating it. For this reason, only authorized, properly trained and licensed persons will be permitted to operate industrial trucks and tractors.

(2) As soon as the operators go on duty, they should check the condition of the equipment. Operators will be required to inspect the brakes, steering apparatus, horn, oil, gas, and water. Defects noted should be reported immediately to the supervisor. The operator will have authority to refuse to move an improperly loaded truck or tractor or one which is not in safe mechanical condition.

(3) Insofar as practicable, each operator should be assigned to a specific truck or tractor and should be held responsible for it. No equipment will be operated by anyone other than the person to whom it is assigned.

(4) Operators will not permit their equipment to be operated by unauthorized, unlicensed personnel.

(5) No engine will be left running while the operator is off the truck or tractor or when the vehicle is parked within a building. The engine should always be stopped and the hand brake set.

(6) Equipment will always be taken out of the building to obtain gasoline. Under no circumstances is it permissible to refuel gasoline-driven vehicles inside warehouses. During the refueling operation, smoking is prohibited in the area.

(7) Gasoline tanks will not be filled while the engine is running.

(8) Before restarting an engine, all spilled gasoline will be cleaned up.

(9) A fire extinguisher must be on hand when operators are filling gasoline tanks. All operators should know how to use a fire extinguisher.

(10) At the outset, all loads to be moved will be inspected. The operator should not overload; should not move a questionable load; should avoid carrying loose material; and should refuse to move unsafe loads.

(11) Each operator must know the load capacity of his machine.

(12) Each operator must ensure that the load is well balanced before moving.

(13) Speeding, stunt driving, and "horseplay" will not be permitted.

(14) Operators must keep three truck or tractor lengths behind other vehicles.

(15) Speed in warehouses will not exceed 5 miles per hour.

(16) Feet must be kept inside the running line of a truck or tractor.

(17) Operators must drive to the right whenever possible.

(18) They must slow down at cross aisles and intersections and sound the horn or gong before proceeding. When vision is obstructed by doors, corners, and elevators, the horn or gong must be sounded.

(19) Operators must come to a stop and sound horn at exits.

(20) Operators should sound horn when approaching pedestrians, but should not use the horn unnecessarily. The horn should be sounded only as a signal.

(21) Operators should not start, stop, or turn trucks suddenly.

(22) They should approach elevators at a right angle; stop 5 or more feet from the elevator gate and wait for a signal from the elevator operator before entering. Hands and feet must be kept away from the controls when on the elevator.

(23) Operators should face in the direction in which they are traveling and should never back up without first facing in that direction.

(24) They should slow down on wet or slippery floors; and

(25) Avoid bumping into objects, especially in backing;

(26) They should never park on railroad tracks or in no parking areas.

(27) Operators must not use the reverse control for brake or run the battery beyond its rated capacity.

(28) They should not spin the wheels or race the engine;

(29) Ride or slip the clutch.

(30) Operators should always keep the machine clean.

(31) They should not drive with wet or greasy hands.

(32) Pushing one piece of machinery with another in order to get it started is strictly prohibited, except under the direction and in the presence of the supervisor.

(33) Operators should never attempt to enter a building through a partially opened door. The door will be fully opened before proceeding.

(34) Railcars will not be pushed or pulled with MHE except railcar-mounted cranes or other equipment designated for this purpose.

(35) Push poles will not be used to move or place materials or objects of any kind. Approved devices adopted by the activity for use in materials handling by industrial tractors are exempt from this rule.

b. Fork trucks. The following operating rules are applicable to fork trucks:

(1) Operators will not fix or adjust any mechanical parts. This rule may be modified at installations where no repairman is employed and where a specific operator is known to have competence to make minor adjustments. If a fork truck is not running properly, the supervisor should be called immediately.

(2) Check the security of overhead safety guard and back rest.

(3) Never use the fork truck to carry loads for which it is not intended; use the right truck for the job.

(4) No passengers will be allowed on fork trucks.

(5) It is not permissible for anyone to "ride" the load being handled by a fork truck. This includes "riding" a load being raised or lowered. If a person must be lifted to reach stock or material, they will stand on a safety pallet (equipped with guard rails) placed on the forks; the supervisor must give the order and assume responsibility.

(6) Rest forks on the ground or floor when the machine is not in use.

(7) When going down a grade or ramp with a load, back down; go forward up a grade or ramp.

(8) When traveling empty or loaded, be sure that the forks are raised just high enough to avoid any obstructions on the floor, yet low enough to permit a clear view ahead. Mast should be tilted backward.

(9) No counterweighting of the fork truck to increase lifting capacity will be permitted.

(10) Forks should always be the same distance from the center of the supporting crossbar.

(11) Check the load before moving or lifting to make sure that no material will fall.

(12) Balance the load and tilt the mast backward to prevent tipping.

(13) Never permit anyone to stand under suspended loads.

(14) Watch out for others; make sure that all is clear before setting down a load.

c. Industrial tractors. The following operating rules are applicable to industrial tractors:

(1) Weaving the train is dangerous and will not be permitted.

(2) Operators must not attempt to haul excessive loads that cause wheel slippage and loss of traction. Also, operators will ensure that loads are secure.

(3) When negotiating a turn into a road or aisle, allow sufficient time to get into position to make the turn and allow for proper clearance of the last trailer.

(4) Operators and supervisors should limit the height of the load on the first trailer behind the tractor. The height will not obstruct the rear view of the operator nor create a hazard to the operator in the event material accidentally shifts or falls.

(5) When a permanent passenger seat is provided, one passenger may be carried. No person will be allowed to occupy a temporary seat or ride on any part of the machine.

(6) No person will be permitted to ride on the trailer train to hold the load in place.

d. Trucks straddle carry. The following operating rules are applicable to trucks, straddle carry:

(1) Carry the hoist shoes up to avoid striking any obstruction when the truck is not loaded.

(2) Drive only on solid ground.

(3) Drive cautiously at all times because of limited visibility directly in front of and to the right of the truck.

(4) Avoid sudden stops, especially when the truck is loaded.

4-42. Examinations for Fork Trucks.

a. The following tests should be included in the operational examination for fork truck trainees:

Test 1. A circle with a 16-foot, 3-inch radius is made by placing pallets spaced 4 feet, 6 inches apart (fig 4-126). The trainee travels the circle twice with forks lowered and empty, weaving between pallets, first going forward, then backward. One point should be deducted for each pallet displaced. For a perfect operation, the trainee is credited 10 points.

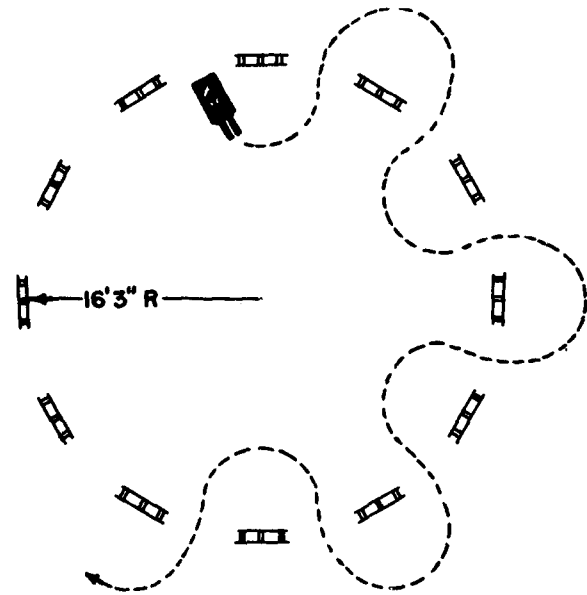

Figure 4-126. In this operational test, the trainee weaves in and out between pallets in a circle having 16-foot, 3-inch radius.

Test 2. In this part of the examination, the trainee picks up pallet loads one at a time from the supply area and places them in a row along a line drawn on the floor. On completion of this operation, they return the loads to the supply area. A possible score of 16 points is based on the trainee's ability to maneuver the fork truck properly and place pallet loads in a neat manner.

Test 3. The trainee is required to maneuver through a congested area similar to that shown in figure 4-127. They operate forward and backward through this maze of pallets. One point is deducted for each pallet displaced. Total possible score is 14 points.

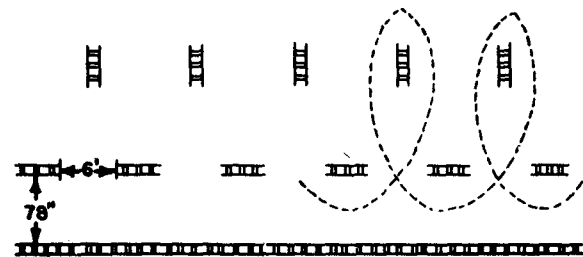

Figure 4-127. Prospective operators maneuver through a maze of pallets.

Test 4. An aisle 52 inches wide and 40 feet long, constructed of empty pallets set on end, is set up in the training area (fig 4-128). The trainee is instructed to travel the entire length of the aisle with a loaded pallet, then set the load down, back

the truck up about 30 feet, move forward, pick up the load, and back out the entire length of the aisle. Two points are deducted for each pallet displaced. Total possible score is 10 points.

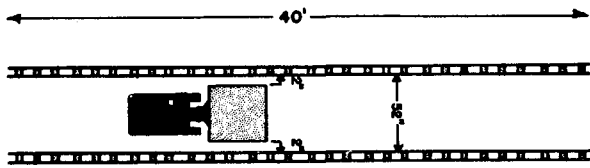

Figure 4-128 An aisle constructed of empty pallets set up in the training area.

Test 5 This test consists of placing two pallets with cylinders in a simulated boxcar made of empty pallets. The pallets to be used will have a plywood top, on the center of which is painted a circle 10 inches in diameter (fig 4-129). The trainee is instructed to place both pallets side-by-side in the car without disturbing the simulated boxcar or overturning the cylinders. If pallets walls are misplaced or cylinders toppled, the operator must first right them and then proceed with the test. Two points are deducted for each pallet displaced or cylinder toppled. Total possible score is 10 points.

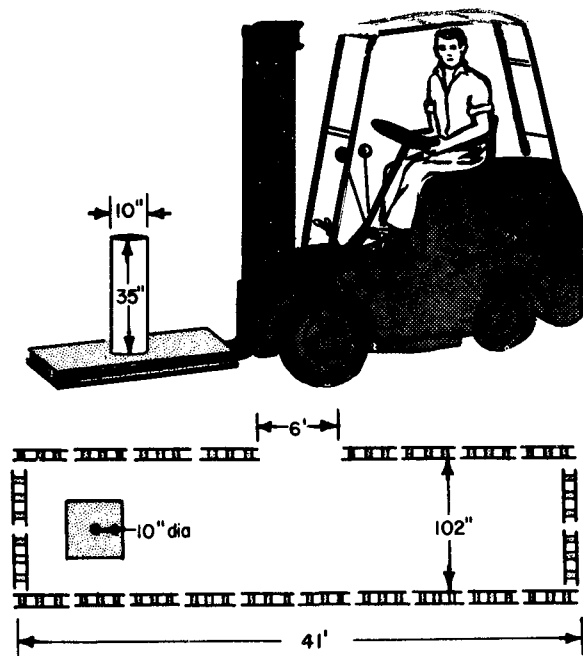

Figure 4-129. Another test consists of placing two pallets with cylinders in a simulated boxcar

Test 6 In this operation, the trainee will store loaded pallets in two tiers, three pallet loads high. The trainee is required to drive in at either end of the storage area and place pallets on right angle lines. No instructions other than the re-

minder to tier according to previous training should be given. Two points should be deducted for each pallet placed more than 2 inches out of line. Total possible points is 20 points.

Test 7 This test, to be devised by the instructor, should be designed to summarize the operator's ability, care, safe operation, and efficiency in maneuvering the fork truck about the training area. The time element should be considered an important factor in the test. If the trainee consumes an excessive amount of time in maneuvering properly, they should be graded accordingly. Total possible score is 20 points.

b. Written tests adaptable to particular types of operation may be developed as deemed appropriate by the service/agency concerned. The following score sheet can be set up for grading the trainee on the operational examination:

TEST 1—10%			
Pallets displaced:			
Forward	()	0.5	___
Reverse	()	0.5	___
TEST 2—16%			
Pallets out of line	()	2.0	___
Improper approach to place pallet	()	0.5	___
Improper direction to remove pallet	()	0.5	___
Excess backing, etc.	()	2.0	___
TEST 3—14%			
Pallets displaced ..	()	1.0	___
Encounters difficulty ..	()	4.0	___
TEST 4—10%			
Pallets displaced			
Forward ..	()	2.0	___
Reverse ..	()	2.0	___
TEST 5—10%			
Pallets displaced	()	2.0	___
Cylinder toppled	()	2.0	___
TEST 6—20%			
Improper approach ..	()	0.5	___
Improper leaving ..	()	0.5	___
Quality of storage	()	10.00	___
Cost lost	()	2.0	___
Forward=high load ..	()	2.0	___
TEST 7—20%			
Poor starting technique	()	1.0	___
Poor driving position ..	()	1.0	___
Rides clutch ..	()	2.0	___
Stalls engine	()	1.0	___
Clashes gears ..	()	2.0	___
Races motor	()	1.0	___
Too (slow-fast) operations	()	4.0	___
Careless operation ..	()	4.0	___
Inefficient operation ..	()	4.0	___
Total deduction			___
Grade			___

4-43. Examinations for Other Equipment.

An operational examination similar to the one given for fork trucks can be used. The operational test diagram and the fork truck test score sheet also can be used with slight modifications. This

test score sheet should be prepared in a manner to provide for a perfect score of 100.

4-44. Grading Examinations.

A grade of 70 should be established as a passing score for the examination. When the trainee has obtained a passing score, they should be issued a temporary operator's permit (para 14, this sec). Those items on which the trainee failed should be included as part of the student's additional OJT (para 15, this sec). At this point, training films should be shown for the second time selecting the films appropriate for the permits granted.

4-45. Temporary Permits.

Upon satisfactory completion of the training course, a temporary operator's permit should be issued to cover a 30-day probationary period. The temporary permit will contain a 30-day expiration date following the date of issuance. The temporary permit will be clearly stamped or otherwise marked with the word "Temporary" to distinguish it from a permanent permit. Operators holding temporary permits may be issued a large badge of a distinguishing color so that supervisors and qualified operators can recognize the trainee as a new operator and assist them with suggestions and advice. The permit will show equipment and capacities authorized and may be stamped or overprinted "MHE."

4-46. Additional OJT.

a. General. During the 30-day probationary period, the new operator should continue training. Such trainees can be assigned to an occasional class period with an instructor, or the instructor can carry out the training during routine inspection on all new operators at their work. This OJT has two objectives: to increase the operator's proficiency and to qualify them for use on additional MHE.

b. Increasing proficiency. To increase the new operator's proficiency, the instructor requires the trainee to perform various difficult maneuvers with the truck or tractor-trailer train and shows them the safe and simple manner of operating under all circumstances. The instructor should stress constantly the importance of safety and preventive maintenance. Also, OJT with the fork truck should consist of practice with various attachments to the fork truck, designed for specific jobs. Only skilled operators should be trained in the use of attachments.

c. Qualifying operators for additional equipment. If the operator's training has been exclusively in the fork truck during the 30-day proba-

tionary period, they should receive training in the operation of the tractor-trailer train so that in an emergency they will be available as a tractor operator. Tractor operators who show a high degree of skill and efficiency should be considered for training as operators of fork trucks. Even though no additional operators of fork trucks may be needed at the moment, the activity should maintain a pool of trained or partially trained operators who can carry on in an emergency. In the event the activity is in need of operators for trucks, straddle carry, cranes, or similar equipment, the new operators of MHE can be tested on this equipment during their 30-day probationary period. Those who show a high degree of aptitude for assignment to these more difficult types of equipment can be given additional training until they are qualified operators. Training films should be shown as appropriate.

4-47. Permanent Operator's Permit.

If, at the end of the 30 days, the operator has proved satisfactory, a U.S. Civil Service Commission Standard Form 46 properly completed and signed by the issuing official will be issued to the operator. The permit will show any restriction such as glasses required, hearing aid required, or other. The permit will also indicate qualification in explosive handling in accordance with the requirements and safety regulations of each military service. The operator will be instructed to carry the permit when operating equipment. Each operator may be issued, in addition to the permit, a badge of distinguishing color indicating that they are an authorized operator or industrial trucks and tractors. The permit will show equipment and capacities authorized and may be stamped or overprinted "MHE."

4-48. Renewal.

Every operator holding a permanent permit will be required to have it renewed within 30 days prior to the expiration date specified on the permit. Upon application for such renewal, the operator will be required to satisfactorily complete a physical examination. Operators holding nonstandard permits with a specified expiration date will be issued a standard permit within 30 days prior to the expiration date. Operators holding nonstandard permits that do not bear an expiration date will have their permits replaced with standard forms with the least practicable delay.

4-49. Preparation of Additional Courses.

The training data and test factors in this manual cover the training of operators for the major types of MHE utilized within the military supply system. It is realized, however, that a training pro-

gram is required for each of the various types of MHE in use. Therefore, it is suggested that as requirements occur for the training of operators for MHE not specifically covered in this manual, that

the activity utilize the data contained in this manual and data compiled by the activity to prepare a training program and test procedure applicable to the equipment for which training is required.

CHAPTER 5

STORAGE OF SPECIAL COMMODITIES

Section I. Lumber

5-1. General.

The information and instructions in this section are designed to aid personnel performing lumber storage and handling operations.

NOTE

Further technical data with respect to lumber storage can be found in MIL-HDBK-7, Lumber and Allied Products. That portion of section 6 of the handbook, dealing with handling and storage of lumber, is superseded by this manual.

a. Storage and materials handling. The advances made in the mechanized handling of lumber have changed storage and handling methods. The development of handling equipment such as forklift trucks and straddle carry trucks that can be used to stack, unstack, and transport lumber, has brought about revolutionary changes; the most notable being the handling of lumber in packages. Regardless of whether lumber is handled by mechanized equipment or by manual labor, the objectives of storage and handling are unchanged.

b. Objective of storage and materials handling. The objective of lumber storage is to maintain the lumber at, or bring it to, a moisture content suitable for its end use with a minimum of deterioration. The objective of lumber handling is to load, transport, unload, stack, and unstack lumber economically and without damage. Both of these objectives are obtained easily if good handling and storage practices are followed. Adequate protection of lumber in storage will help prevent attack by fungi or insects, as well as changes in moisture content, which encourage checking, warping, twisting, and straining in lumber and make it unsuitable for the intended use.

c. Condition of lumber placed in storage. The condition of lumber placed in storage, with respect to moisture content and possible fungus infestation, has an important bearing on the subsequent qualities of the lumber over long periods. Fungi (wood rot) and subterranean termites infecting wood are retarded in their growth when the moisture content of the wood is lower than 20 percent; however, dry wood termites, powder post beetles, and other wood borers can develop successfully in

well dried wood. Lumber may be treated with a preservative in accordance with section 5 of MIL-HDBK-7 to prevent infestation for longer storage periods. If infestation occurs during drying, the fungus will continue to live in a dormant state for months or years after the wood dries and will resume activity if moisture content again becomes high enough. A key to preventing deterioration during long-term storage is to eliminate infestation during drying and to keep the wood dry in storage. All lumber must be checked thoroughly at the time of receipt for moisture content and fungus infestation before storage. The preparation for storage and the type of storage will be based upon the results of these checks. It is important, especially when lumber is received in drafts, to choose drafts from different parts of each shipment and disassemble the drafts for examination; unless this procedure is followed, the condition of the lumber inside the draft cannot be ascertained. Lumber presents unique problems in storage. Special piling methods are necessary to provide proper ventilation that will prevent deterioration of the lumber. The method of stacking each shipment of lumber must be determined by competent personnel.

d. Ordering lumber.

As emphasized in the paragraphs above, the length of storage time and moisture content of lumber greatly affects the lumber's condition. Only the quantity of lumber that will be used during a reasonable period of time should be ordered. If the storage activity knows that the lumber will be stored for an extended period of time or a history of wood decay problems exists, then the lumber should be ordered requiring either stickering prior to shipment or dry (less than 19 percent moisture content) lumber with no substitution.

e. Protective equipment.

(1) *Lumber apron.* The lumber apron for use in lumber handling should be constructed in accordance with the specifications outlined in figure 5-1. The apron should consist of a soft leather backing faced with heavy leather three-sixteenths of an inch or more in thickness. The two pieces of leather should be riveted together and supported by a belt 1½ inches in width or wider to ensure adequate distribution of the weight of the apron and lumber being handled to prevent cutting or

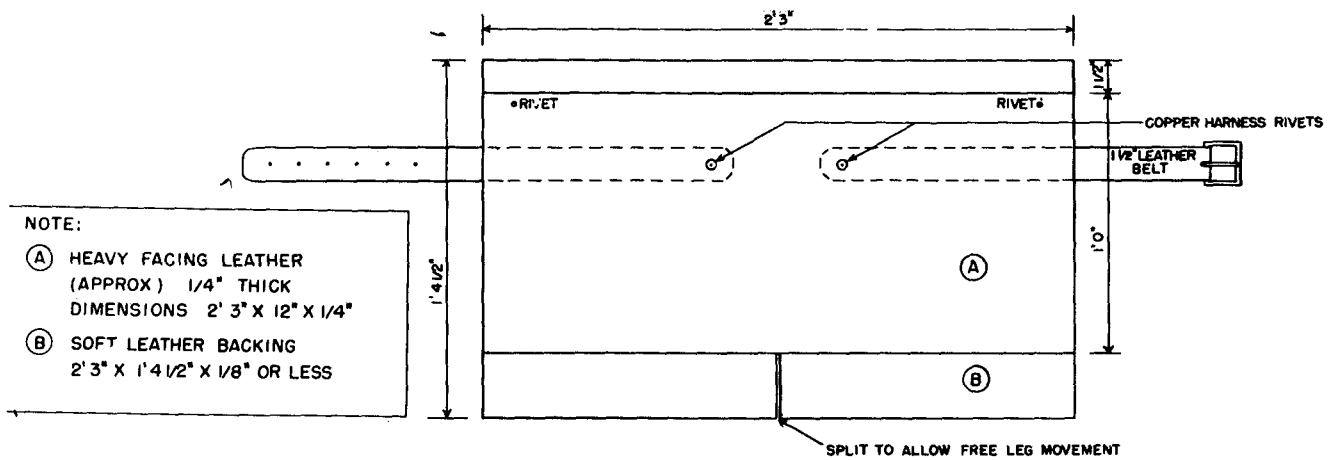

Figure 5-1 Diagram of leather apron for use in the handling of lumber

(2) *Protective gloves.* Gloves that provide adequate protection from splinters or splinters must be worn by lumber handlers.

5-2. Handling Methods.

a. *Receiving.* Lumber is normally received as strapped units on gondolas, flatcars, or trucks. The use of automatic and hand applied strapping and improved handling equipment has nearly eliminated handling boards one at a time. When lumber is unitized and loaded, as specified in MIL-L-14362, Unitizing and Loading of Lumber, the lumber may be moved by crane, forklift, straddle carry truck, or sideloader, eliminating manual handling (chap 4, sec II depicts MHE). Lumber received in this manner should be placed on bolsters for transport. When drafts do not meet requirements for storage because of moisture content, improper stickering, or other causes, the units should be reunitized (in accordance with para 176) to correct the deficiencies prior to being placed in storage.

b. Bolsters.

(1) Bolsters should be constructed in accordance with specifications shown in figure 5-2, except that the width of the straddle carry truck, if used, will determine bolster length. In selecting timber for bolsters, care should be exercised to select solid straight grained wood, as bolsters will be subject to excessive strain in the lifting and transporting of materials. Hardwoods are preferable for construction of bolsters; however, when hardwood is not available, straight grain Douglas fir or larch may be used.

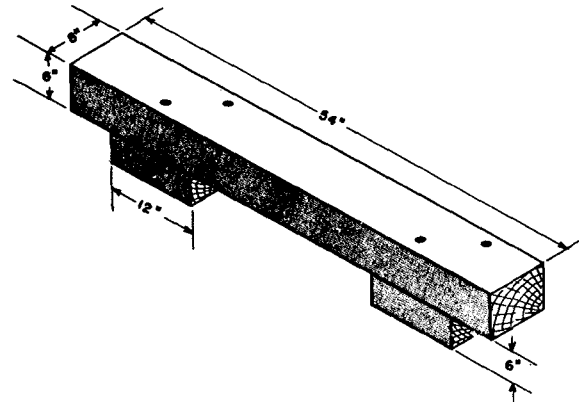

Figure 5-2. Diagram of bolster for use with a 57-inch straddle carry truck.

(2) As the lumber is placed in storage, the empty bolsters are removed and stacked for return to loading/unloading sites. These stacks are prepared by placing two or more bolsters in position for pickup and solid piling other bolsters across them. Each successive layer of bolsters is cross piled to bind the stack securely for stability while being transported.

5-3. Formation of Lumber Drafts.

a. *General.* The handling and transporting of lumber in drafts and stacking lumber in drafts have become accepted practice throughout the lumber-producing and wood-using industries. These practices have brought about changes in yard layout and in stacking methods. Although the

principles of good air-seasoning have not changed, a certain amount of adjustment is needed to conform to the more modern handling and stacking methods.

(1) When lumber is stacked for air drying in the form of drafts, the type of stickering will be determined by the seasoning required. Drafts for yard drying vary between 3½ and 4 feet, with 4 feet the most common width, and 3 to 4 feet the average height. The width of the draft will be determined by the width of the lumber and the fork capacity of the lift equipment. The forks normally available will handle drafts approximately 4 feet in width. Stacks of unitized lumber generally are

considerably narrower than handstacked piles. This tends to increase the drying rate of lumber stacked in drafts over lumber stacked by hand.

(2) Uniform size of boards in a draft is desired so that each draft of the same material will contain exactly the same number of board feet (fig 5-3). This will eliminate many of the problems encountered in the issue and inventory of lumber products. This applies to every size of lumber handled. When it is absolutely necessary to make up a draft of random lengths, the lumber should be sorted by length and unitized with the longest lumber placed on the bottom of the draft, and the balance of the lengths grouped by length in the draft in length sequence.

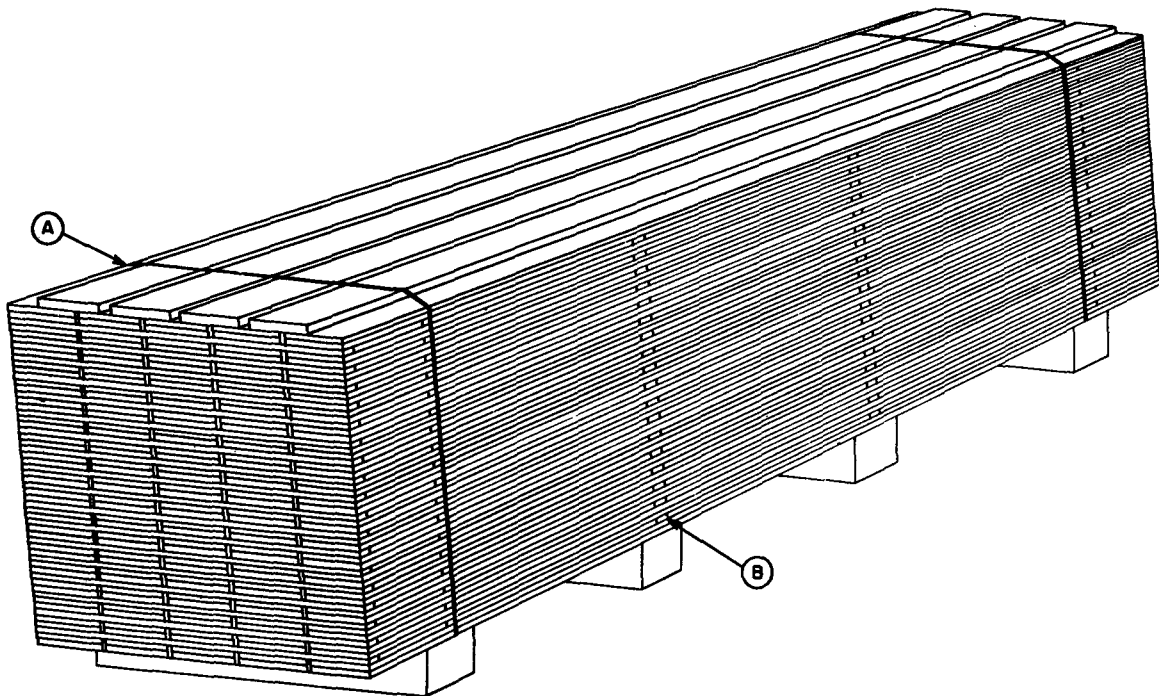

DRAFT DATA

STRAPPINGS A
 ITEM ① ROUND, STEEL, GALV. 10 GA.
 ITEM ② FLAT STEEL 1/4" WG. Q35 GA.
 (ITEM ① FIRST CHOICE)

STICKERING B
 ITEM ③ LATH SIZE 1/2" X 1/2" X 48"
 ITEM ④ STOCK SIZE 2" OR 3" X 3/4" X 48"

NOTE

LUMBER WHICH HAS A MOISTURE CONTENT OF 24% OR ABOVE IS TO BE STICKERED BETWEEN EACH LAYER. STOCK STICKERS ONLY (ITEM ④) ACCEPTABLE FOR LUMBER IN THIS CATEGORY

LUMBER WHICH HAS A MOISTURE CONTENT BETWEEN 19% & 24% IS TO BE STICKERED BETWEEN EACH TWO LAYERS OF MATERIAL 1/2" THICK OR LESS AND EACH LAYER 1 5/8" THICK & ABOVE

NOTE:
 1 5/8" PITCH FOR EACH FOOT OF HEIGHT

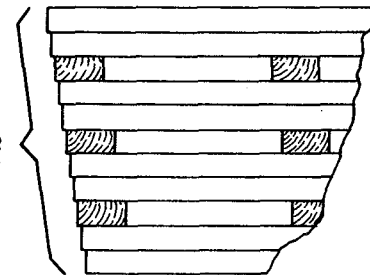

STANDARDS FOR LUMBER		
	MINIMUM	MAXIMUM
DRAFT WIDTH	40"	48"
DRAFT HEIGHT	36"	48"

Figure 5-3. Diagram outlining draft requirements for outdoor storage

b. Assembling a lumber draft.

(1) *Construction of butt boards.* The butt boards should be constructed according to specifications in figure 5-4. The 4-by-4-inch piece used

for the flat base should be oak. The base should be nailed together with 16d spirally grooved, screw-type nails. Metal corners or angle irons will help reinforce the base and are essential if Douglas fir

or other soft wood is substituted for oak. The angle on the butt boards is designed to give a forward pitch to each draft of $1\frac{5}{8}$ inches to each 12 inches in height. Since the slope of the stack foundations from front to rear is 1 inch for each 12 inches of length, this provides five-eighths of an inch pitch per foot in height in the completed stack. Should the slope of the lumber beds vary from 1 inch of slope in 12 inches of length, an adjustment to correct the pitch can be made easily by starting with a line perpendicular to the ground, then giving a forward pitch of five-eighths of an inch to each 12

inches of height plus the slope of the lumber bed. For example, suppose the slope of the foundation on which the lumber will be placed is $1\frac{1}{2}$ inches in each 12 inches of length. The slope forward on the butt board will then be $1\frac{1}{2}$ inches plus five-eighths of an inch in each 12 inches of height of the butt board. This equals $2\frac{1}{8}$ inches forward slope or pitch of the butt board in each 12 inches of height. For each 10 feet of height from the bottom of the first draft, the stack will project forward $6\frac{1}{4}$ inches at the top beyond the end of the bottom board.

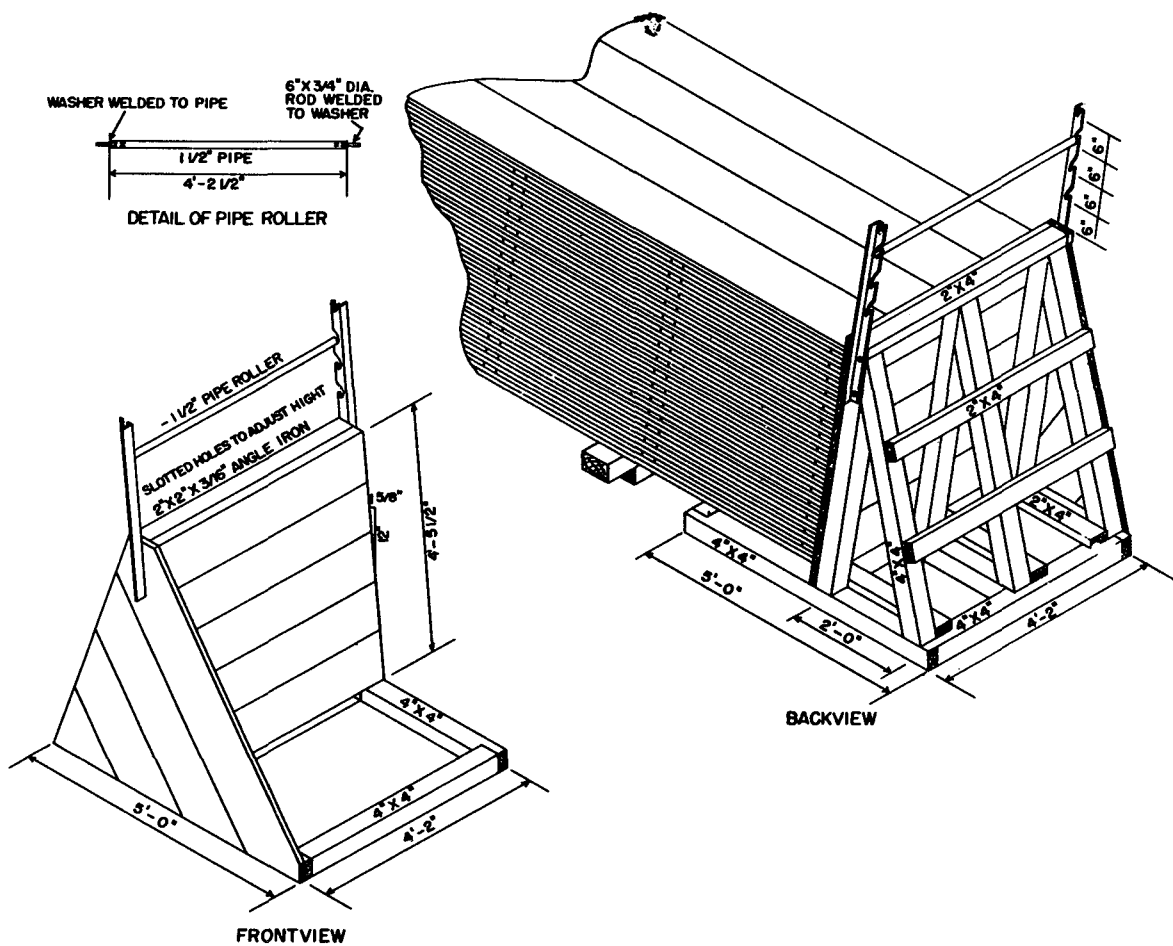

Figure 5-4 Diagram of butt boards used to control pitch on draft face.

(2) *Anchoring of butt boards.* Once the position of each butt board is established, it should be anchored firmly. This can be done by driving iron rods into the ground at points where pressure will be exerted or by nailing pieces of 2-inch stock to the butt board, extending these pieces to the platform, and nailing the pieces securely to the platform. To assist in stabilizing the butt board, a 2-

by-4 is sometimes placed across the base flush against and parallel to the face of the butt board. In this way, the front end of the draft should just clear the forward straddle carry truck bolster so that a portion of the weight of the front end of the draft rests on the 2-by-4. It is essential that each butt board remain in exactly the same position

once a draft of lumber is started to obtain the correct pitch and uniform face on each risk of lumber.

(3) *Placement/alignment of stickers.* The proper alignment of stickers in each draft of lumber is necessary to prevent warping and bowing. Proper alignment is also necessary to assure vertical columns of stickers from top to bottom of the storage stack when the stack consists of several drafts (fig 5-5). When placing stickers, the first stickers should be against the butt board. This will give an inverted stair step appearance to the face

of the completed draft and will cause water to drip from the front of the pile instead of seeping in. The sticker will retard end drying and tend to prevent end checking of the lumber. The second sticker should be placed 12 inches from the front of the pile and the balance of the stickers positioned at 5-foot 4-inch intervals directly over pile foundations, as shown in figure 5-5. The only variation in the sticker spacing will be in the stacking of hardwoods or other lumber prone to warp. Sticker spacing for these lumbers will be on 2-foot 8-inch centers.

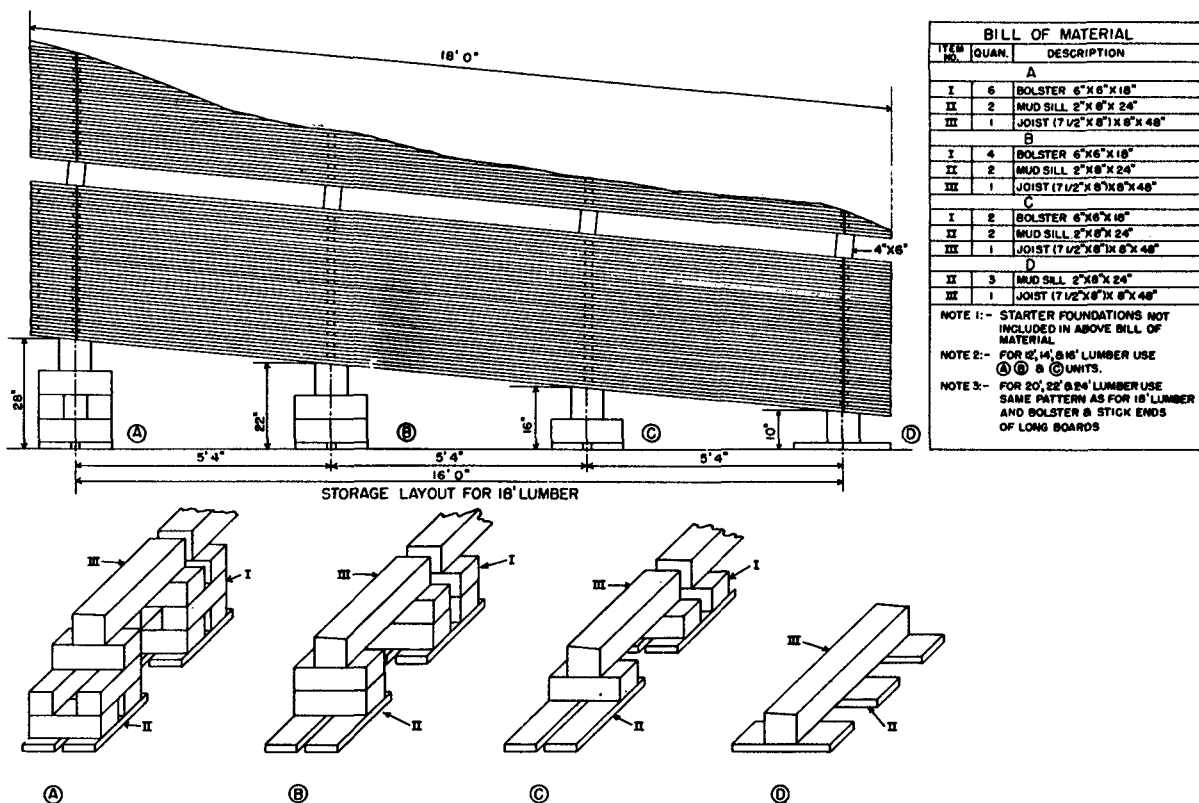

Figure 5-5 Diagram of properly stickered and formed drafts of lumber stored on wooden block foundation.

(4) *Sticker guide.* The sticker guide (fig 5-6) is essential in the formation of drafts of lumber. Its basic function is to guide the placing of stickers so that the stickers will provide vertical columns of support for the lumber over each foundation support timber. Sticker guides must be constructed to function in conjunction with the butt board to give the column of stickers the same degree of pitch as is maintained on the face of the pile. Otherwise, the proper stacking of drafts of lumber is impos-

sible as sticker alignment between drafts could not be maintained. Sticker guides should be constructed to provide the longitudinal sticker spacing shown in figure 5-5, except that, at activities where the standard storage plan has not been implemented, foundation spacing will determine sticker spacing. However, under no circumstances will sticker spacing exceed 6 feet.

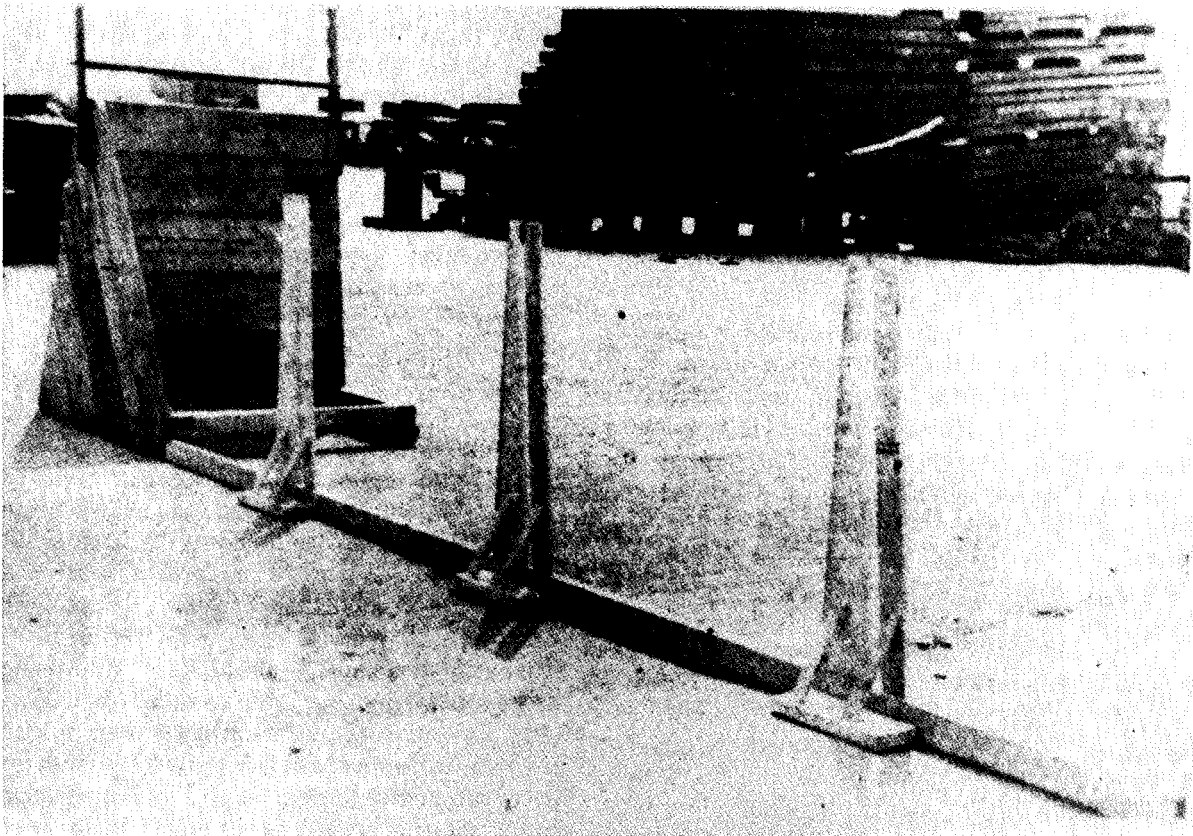

Figure 5-6. Sticker guide and butt board ready for use

(5) *Sticker construction and care.* Stickers may be made from any species, but preferably from heartwood. Sapwood is undesirable, as it may harbor stain organisms. All stickers must be sound, dry, free from stain and decay, of uniform thickness, and of sufficient width to support the weight of the pile without crushing the stickers or causing compression marks in the face of the lumber. Stickers, when not in use, should be protected from the weather to be kept dry and ready for future use.

(6) *Sticker requirements.*

(a) *General.* Lumber, when received, may be partially green, partially air dried, or thoroughly seasoned. To establish sticker requirements, the moisture content of the lumber must be determined.

(b) *Sticker requirements when moisture content exceeds 24 percent.* Partially green lumber or lumber with a moisture content of 24 percent or more, requires a greater amount of air circulation within the draft to remove this excess moisture as rapidly as possible to avoid possible stain and rot. Lumber with a moisture content of 24 percent and

above will be stickered between each layer with stickers 2 or 3 inches wide by three-fourths of an inch thick and of sufficient length to fully support each course of boards. Hardwoods 1¼ inches and over in thickness with a moisture content of 24 percent and above which are to be stacked in open storage for air drying will be stickered with 1-inch or thicker stickers. Hardwood is a slow-drying wood and should be well ventilated to speed drying and prevent stain and rot in these premium type woods.

(c) *Sticker requirements for lumber having 20 to 23 percent moisture content.* Lumber with a moisture content between 20 and 23 percent does not require as much drying as green lumber and consequently requires less air circulation within the draft. This lumber will be stickered with lath (1½ by ½ by 48 in) between each two layers of material 1½ inches thick or less and between each layer 1⅝ inches thick and above. However, hardwoods having a moisture content between 20 and 23 percent, which are being placed in open storage for continued air seasoning, will be stickered with 1-inch or 1½- by ¾-inch stickers of sufficient

length to adequately support each board and prevent warp.

(d) *Stickers of seasoned lumber.* Drafts of seasoned lumber having a moisture content of 19 percent or less may be placed directly into storage and stickered at sufficient intervals to stabilize the draft.

(7) *Air drying of lumber.* The air drying of lumber is dependent upon the temperature, the RH of the outdoor air, and the extent air is caused to enter and circulate within the stack so that it reaches each individual board.

(a) *Air flow.* Air, at any condition below 100 percent RH or moisture saturation, possesses the ability to take up moisture from green lumber. Air that enters a stack becomes cooled as it takes up moisture from the lumber and, as its temperature decreases and RH increases, it loses its ability to dry the lumber. As a consequence, if drying is to continue, the air within the stack must be replenished by ejecting the saturated air and admitting fresh drier air. This is accomplished by natural horizontal and vertical air movements. Horizontal movement within the stack is brought about by differences in pressure between the two sides of the stack caused by prevailing winds, while vertical movement is brought about by the increase in density of the air within the stack as the air is cooled. Since it has been established that the horizontal movement of air within a lumber stack is the principal means of accomplishing drying, it is highly important that channels for this movement be provided. Vertical movement in itself accomplishes little drying except in the case of squares or when stock is stacked on edge, but vertical movement through interior spaces induces horizontal air movement across the faces of the boards from which most of the evaporation of moisture occurs. Horizontal movement of air within the stack takes place through the spaces formed by the stickers. Spaces for the downward movement of air are obtained to a minor degree in the draft from the natural openings between the board edges; however, the major provision for the downward movement of air is the between-stack-spacing. The wider these spaces, with respect to the total width of the stack, and the smoother the vertical sides of the spaces, the greater will be the passage of air through them. Edge-to-edge stacked boards, in drafts 3½ to 4 feet wide, with good stack spacing in the rows are comparable to boards in a wide hand-stacked pile with chimneys at several foot intervals. In this manner, the spacing between the stacks acts as a chimney to carry the damp or saturated air down, thus stimulating horizontal movement of air within the draft.

(b) *Effect of stack height on air drying.* The effect of stack height on drying rate is similar to that of stack width. Increasing the stack height tends to retard drying, particularly in the lower parts of the stack. The air traveling downward in a stack becomes cooled and approaches saturation at a point higher up in a tall stack than in a short one, unless the air is replenished by horizontal movement as it moves downward. Tall stacks also tend to restrict general wind movement at the ground level of the yard. Lumber stacked in the form of drafts may range from about 4 to 20 feet in height. Movement of air through the 6-inch between-draft-spacings will increase to some extent air circulation at the lower levels of the stacks.

5-4. Binding of Lumber Drafts.

a. *Binding requirements.* Each draft of lumber, which is assembled for storage or shipment, should be bound with an appropriate binding. Binding of the draft is necessary to prevent movement of lumber during handling operations. Shifting of the lumber could alter the pitch on the draft face or cause the dislocation of stickers and the subsequent distortion of the lumber in the draft. Bindings must be placed directly over the stickers in order to secure a tight binding and to prevent distortion of the lumber. Also, binders placed other than over the sticker ends will tend to force the lumber in the draft together, thus closing any edge spacing between board edges which will restrict the vertical flow of air through the draft and retard drying. Bindings should be over the second and last sticker in each draft, as shown in figure 5-3. Lumber, which is to be transferred immediately from unloading point to point of use, will not require binding or stickering except as desirable to stabilize the draft for transportation purposes.

b. *Binding Materials.* Binding should be either 10-gauge round steel galvanized wire of ¾ by 0.023-inch, type I or IV flat steel strapping in accordance with QQ-S-781. Corner protectors are not required in the binding of lumber, as the bite of the binding will tend to hold the binding in place over the stickers.

5-5. Marking of Lumber Drafts.

Each draft of lumber should be properly marked prior to final storage. Marking should include stock number, board feet, and the date and year received. For example, lumber received on 11 July 1977 would be dated 192/77 (192d day of 1977). Marking lumber will facilitate issue and inventory and will make it possible to issue the oldest lumber first. Lumber received from other activities is

issued according to the original receipt date noted on the marker tag which should be placed on the front or pitched end of each draft. Thus, lumber received from another activity would be issued prior to lumber in stock if the marker tag indicated it was the older lumber. Adoption of this standard method of marking and dating lumber will aid in preventing the retention of old lumber in storage. Tags for the marking of lumber must be weather-resistant and capable of withstanding long periods of outdoor storage without becoming unreadable. Typed or handwritten paper tags, sprayed with a clear liquid plastic coating, may be used. Suitable dip-type plastic coatings are also available. Tags made of embossed aluminum or other weather-resistant materials may also be used.

5-6. Open Storage.

a. Yard location and surface. Preferably, the storage yard is located in an area where the lumber is received, shipped, or used. The best location is on high ground (i.e., level, well drained, and re-

mote from water bodies or wind obstructing objects such as tall trees or buildings). A low site is likely to be sheltered from the full sweep of the winds and can cause dampness which may retard drying and promote stain and decay. The ground surface should be kept free from debris and vegetation. Debris harbors stain and decay organisms and obstructs the movement of air over the ground surface and beneath the lumber piles. Vegetation can be controlled by applying crude oil, salt, or weed killers. Covering the ground with cinders, gravel, shells, or crushed stone will retard the growth of vegetation. Yard surfaces should be firm and smooth for the operation of lumber handling equipment. Rough terrain causes additional wear and tear on the machines and may cause injury to operating personnel. Also, such conditions may cause displacement of stickers and boards in the draft being transported and may impede the accurate placement of the draft being transported and may impede the accurate placement of the draft during stacking operations.

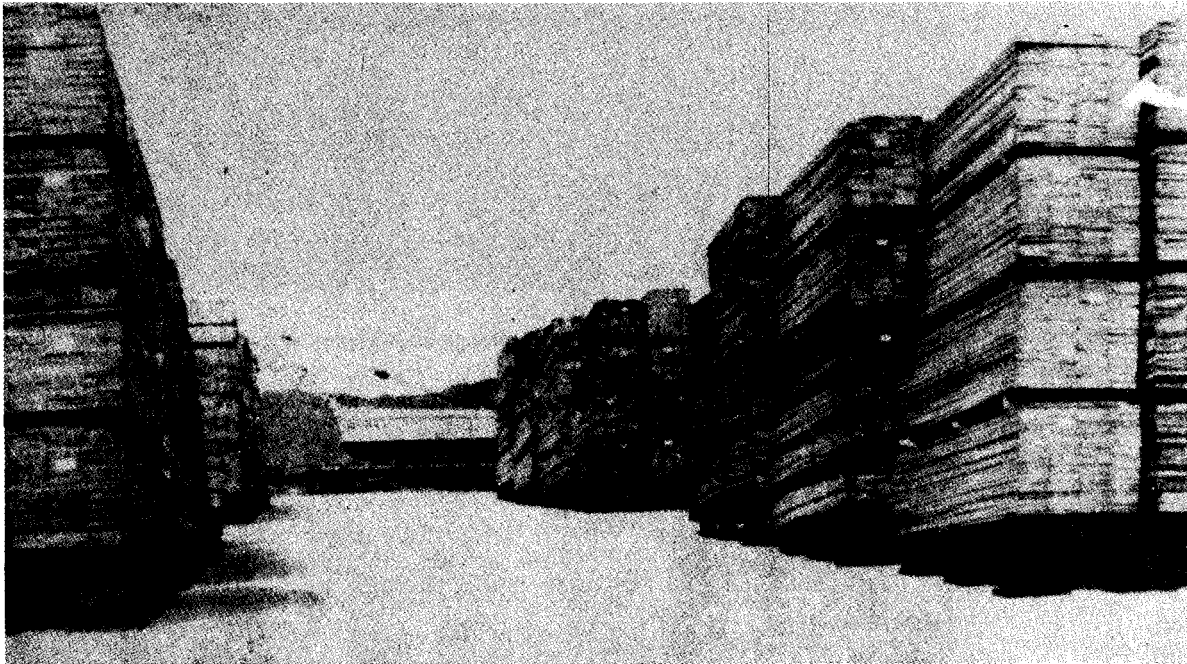

Figure 5-7. Yard layout

b. Yard layout. A yard for storage of lumber is laid out in blocks separated by aisles (fig 5-7). A well-designed yard facilitates the movement of lumber and the taking of inventories. The yard layout is affected by the size and shape of the available area and by the equipment used for

transporting and stacking. Aisles in yards where the lumber is machine-stacked are usually 24 to 30 feet wide, the optimum being 24 feet. The aisles provide routes for transporting lumber, permit the movement of air through the yard, and serve as a protection against the spread of fire. The rows of

lumber in machine-stacked yards run at right angles to the aisles with the boards parallel to the aisle. Storage blocks should not exceed 10 stacks in depth, preferably stored in combinations of 5-5, 7-3, or 6-4 stacks in back-to-back storage. The direction of the main aisles, those from which the stacks are built or taken down, generally is established by the nature of the yard site. Whether main aisles run parallel with or at right angles to the direction of the prevailing winds probably will not affect ventilation and air movement through the yard due to cross aisles which run at right angles to the main aisles. To permit rapid drying of aisles after a rainstorm or the melting of snow, it is advantageous to run the main aisles north and south. To increase air circulation within the stacks, an aisle 2 to 3 feet in width should be maintained between the rows of stacked lumber (fig 5-8). This between-rows aisle will be of valuable assistance in issue and inventory functions. The stack and aisle layout plan (fig 5-9) for shed and open storage has been prepared to assist stor-

age personnel in planning yard layout. The storage area is laid out to utilize the truck and railroad areas as main or longitudinal aisles with 24-foot cross aisles intersecting the storage area at approximately 50-foot intervals. This is sufficient storage depth to permit stacking five stacks deep in back-to-back storage. See chapter 3, section III, for stock numbering techniques.

c. Foundations, general. Flat piling is satisfactory for inside storage, but it is recommended that all out-of-doors stacks be given a reasonable amount of slope. Slope facilitates runoff when water leaks through or blows in at the sides of the stacks. This aids in keeping the lumber dry, thus preventing development of conditions favorable to the growth of stain, decay, and attack by insects. When lumber is stacked in drafts by a forklift truck, changes in stack foundations over those used for hand stacking are necessary. Also, efficient utilization of the fork truck in stacking operations requires that the drafts be stacked parallel to the aisles rather than at right angles. The top



Figure 5-8. Two-foot aisles maintained between rows of stacked lumber to facilitate flow of air through the lumber yard.

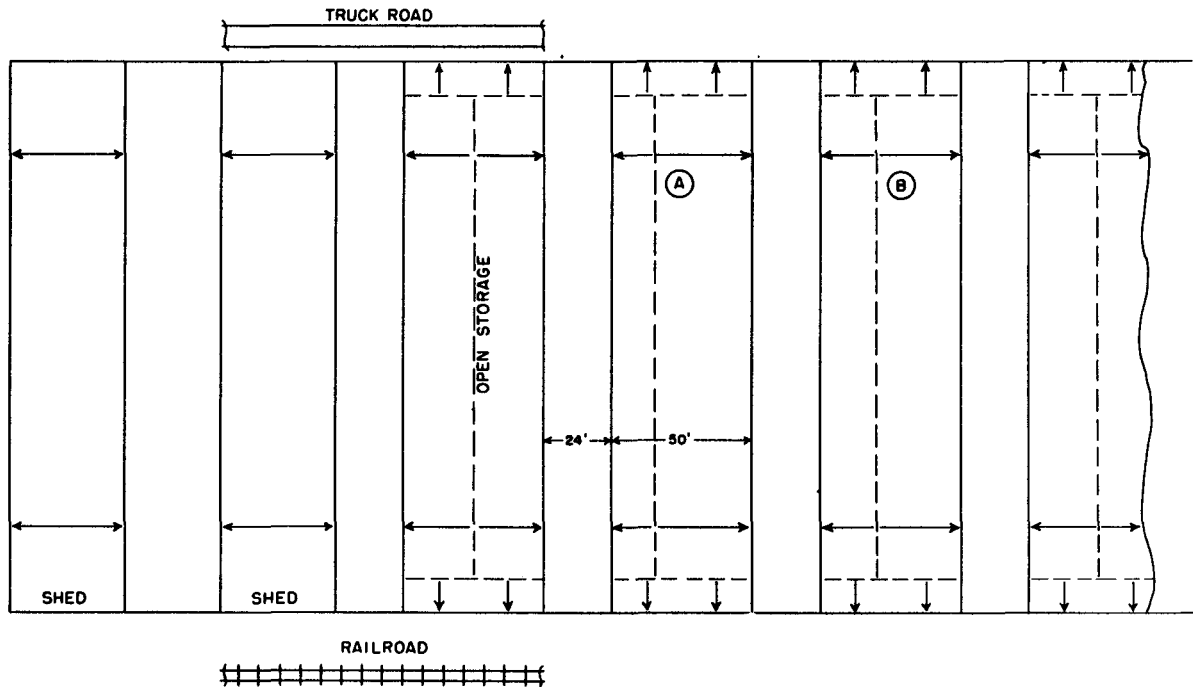

THIS RELEASE IS INTENDED TO ILLUSTRATE SEVERAL DESIRABLE FEATURES WHICH SHOULD BE CONSIDERED IN PLANNING LUMBER YARD LAYOUT

IT SHOULD BE NOTED THAT THE TRUCK AND RAIL ROAD AREAS ARE UTILIZED AS LONGITUDINAL AISLES ALSO THE STORAGE AREAS ADJACENT TO THESE AISLES ARE USED FOR SMALL LOT STORAGE THE STORAGE AREAS BETWEEN CROSS AISLES ARE 50' WIDE, WHICH IS SUFFICIENT TO STORE TWO LOTS, FIVE STACKS DEEP, IN BACK TO BACK STORAGE. THESE AREAS MAY ALSO BE UTILIZED TO ACCOMMODATE VARIED QUANTITIES OF LUMBER BY STORING LOTS IN COMBINATIONS OF 6-4 OR 7-3 PILES PER LOT, AS ILLUSTRATED IN AREAS A AND B

SUFFICIENT AREA ADJACENT TO THE RAILROAD SHOULD BE UTILIZED FOR UNLOADING OPERATIONS TO PERMIT LUMBER TO BE SORTED AND PLACED IN DRAFTS, AT CAR SIDE, AS IT IS UNLOADED. TRUCK UNLOADING AND SORTING AREAS SHOULD BE ASSIGNED ACCORDING TO ACTIVITY REQUIREMENTS.

Figure 5-9. Diagram of yard and shed layout.

of the foundation must afford at least 1 inch of slope for each lineal foot of length. At most activities, the sloping of stacks of unitized lumber is common practice. The foundations of all stacks, except the last stack of a row, must be spaced or arranged to permit the entrance of the fork truck. For this reason, long stringers cannot be used successfully as foundations for draft stacked lumber, especially for the center foundation.

d. Portable lumber foundations. The application of the portable lumber foundation for lumber storage is illustrated in figure 5-10. The stability of these foundations is obvious and they afford sufficient ventilation beneath the stack for drying purposes. The foundation is composed of creosote-treated timber to prevent deterioration. The portable lumber foundation is spaced on 5-foot 4-inch centers (fig 5-11). This spacing of the foundation, constructed as shown, produces the desired slope and is sufficient for the storage of most species of lumber. However, hardwoods and some other types of lumber require additional foundation support to prevent bow and warp during the drying process. This portable foundation can be increased easily from a 4- to a 7-point foundation to accommodate hardwood drafts stickered in accordance with paragraph 176. This increased support is achieved by placing an additional foundation unit midway between units A, B, C, and D shown in figure 5-5. The unit between is erected the same as the

lower of the units which it separates and the required increase in height is obtained by placing a 3-inch thick spacer between the joist and the bolster.

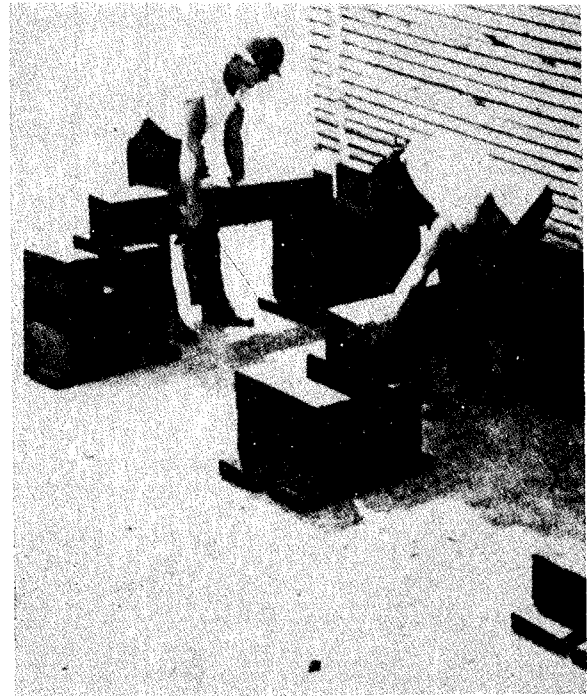

Figure 5-10. Application of the portable lumber foundation.

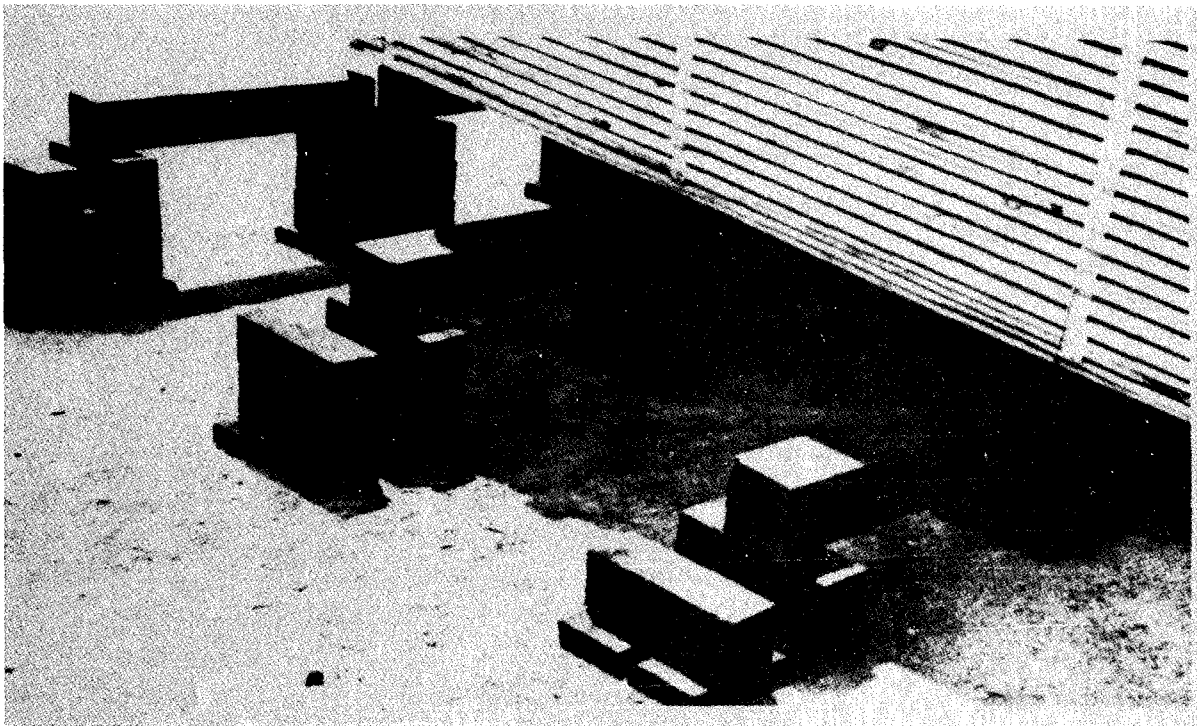

Figure 5-11 Portable lumber foundation spaced on 5-foot 4-inch centers

e. *Component parts of the portable foundation.*
 The portable foundation consists of three component parts—6-by 6-by 18-inch blocking (7½ by 8 in) by 8- by 48-inch joists, and 2-by 8-by 24-inch mud sills (fig 5-12). Utilization of these mud sills produces a bearing surface of approximately 11 square feet for each unit stack, which is sufficient to support maximum unit load stacks on yard surfaces that will withstand the normal operations of heavily loaded fork trucks. These foundations are

removed easily and unitized as lumber storage decreases, thus permitting easy readjustment or layout of the lumber storage area. To facilitate storage operations, foundation components should be unitized in the quantity required to store an average car load of lumber and placed at strategic locations throughout the lumber storage area. Foundations not required for immediate use, except those strategically located about the yard, should be stored in one central location by component type.

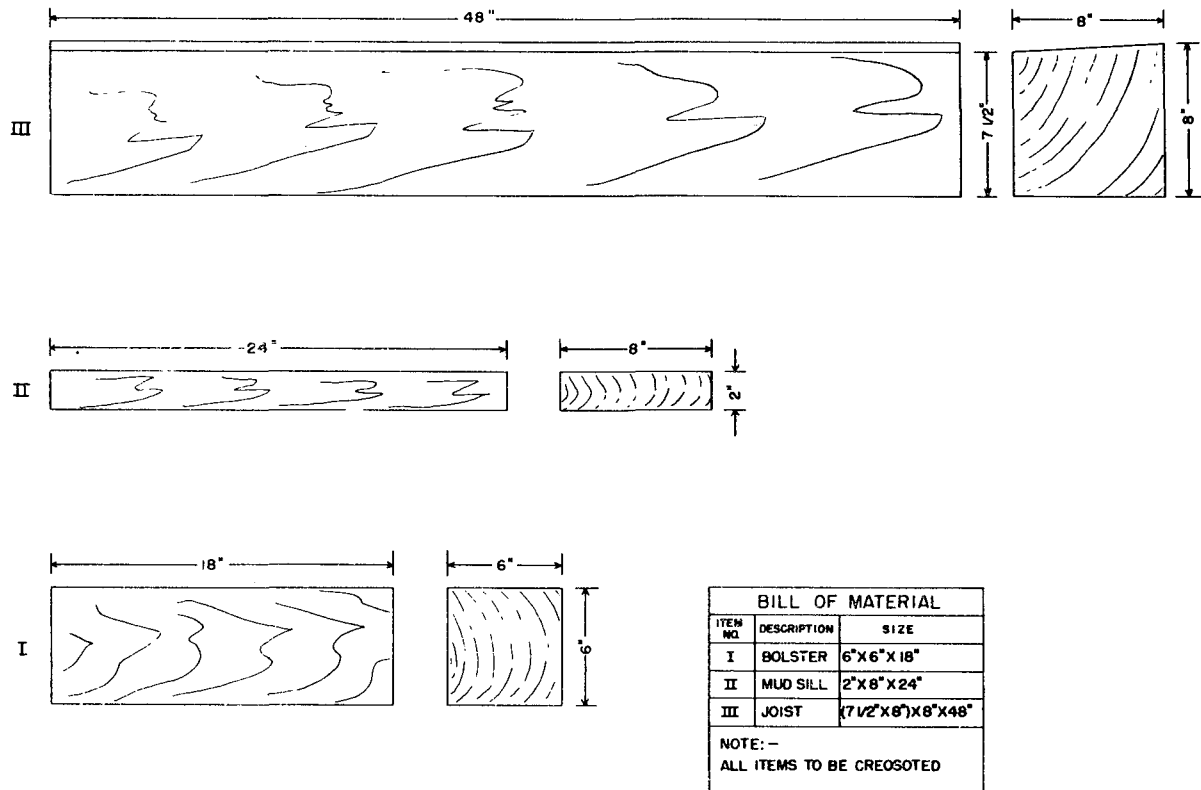

Figure 5-12 Diagram of lumber foundation components.

5-7. Stack Spacing and Roofing Protection.

a. *Horizontal spacing.*

(1) *General.* Although stack spacing will vary with different situations, stacks of stickered or solid piled drafts of lumber should not be placed too close together. Circulation around the stack is necessary if drying is to take place in lumber, which is above an air-dry condition, and to prevent dry lumber from picking up moisture from stagnant, humid air pockets.

(2) *Spacing between stacks of unitized lumber.* Lateral spacing between stacks should be 6 to 12 inches. Vertical passages or flues are somewhat more difficult to build into drafts of lumber than in the relatively wider hand-stacked piles. The

need, however, for building flues into drafts 4 feet or less in width has not been demonstrated. The sum of the width of flues in hand-stacked piles equals about 20 percent of the width of the stack. Flues within the drafts should not be required if 6 to 12 inches are allowed between the sides of the stacks of unitized lumber in the yard. With this arrangement, movement of air in the spaces adjacent to the stacks will induce horizontal movement of air through the draft and accomplish drying. When drafts are stacked in this manner, the spacing between the stacks takes the place of flues built into hand-stacked piles; therefore, this space should equal approximately 20 percent of the unit stack width.

(3) *Spacing of storage rows.* Generally, at machine-stacked lumber yards there are no rear aisles, and spaces between the ends of the stacks are provided by spacing the rows. Spaces between rows of unitized lumber stacks vary from 2 to 3 feet in air-drying yards. Here also, it is not feasible to recommend an optimum spacing, but a spacing of 2 to 3 feet should be sufficient at stack ends to induce sufficient air currents between, through, and under the stacks to carry off moisture saturated air.

b. Vertical spacing.

(1) *Space required for use of forklift trucks.* Spacers (dunnage) used in connection with the stacking of lumber in drafts may be considered to be a part of the stack foundation. When a draft of lumber is picked up or set down, space for the insertion or removal of the forks must be provided. Usually, this space is about 6 inches wide in slope stacked lumber, but may be narrower when the new model of forklift truck is used. These newer trucks have an arrangement for tilting the forks through an angle of 5 degrees for picking drafts from sloped stacks of lumber; however, tilting mechanism is not required if 6-inch spacing is maintained between drafts.

(2) *Placing of spacers.* When building a stack of prepared drafts of lumber, the spacers are placed (directly over the stickers) on top of each draft or on top of the upper one when handling two at a time, before stacking. Of course, this need not be done with the lower draft of the stack where the top is reached readily from the ground. When the stack is completed, the channels caused by the placement of these spacers provide additional area for air passage through the stack. Thus, these passages conceivably may counteract the disadvantages of the relatively high stacks usually found in mechanized lumber yards.

c. Roofing protection for stacks. Lumber, which cannot be stored undercover, should be protected

from the weather by adequate roofing. Roofing should be placed on the top draft and lashed down prior to placing the draft on the stack. A good roof always has been considered an essential feature of good air-drying practice. A roof shields the stack from direct sunshine and precipitation, particularly the upper lumber courses, and to a lesser extent, the lower part of the stack. Without a roof, the upper courses of lumber become warped and checked, and rain is permitted to penetrate the stack from the top or to drive in from the ends and sides. A leaky roof will afford protection against direct sunshine but will permit water to wet the upper lumber courses and to penetrate the stack. To afford maximum protection, a roof should project 12 to 18 inches at the ends of the stack and approximately 6 inches over the sides.

(1) *Staggered board protection method.* A good low-cost roof, adequate for lower grades of lumber, dimension stock, or lumber which will not remain in storage for a long period of time, can be built into each draft as it is formed. To form this roof, one piece of lumber is left out of the top layer and the remaining lumber is staggered or placed so that each board covers an opening between the tiers of lumber (fig 5-13). Thus, moisture is prevented from entering the draft and the two layers of each unit load becomes the roof. Since drafts are built with a 1⁵/₈-inch pitch per foot of height and stored on foundations which provide 1 inch of slope per lineal foot, this roof will afford good protection for normal storage requirements. This roof does not afford quite as much protection from the weather as roofs with extended ends and sides. This is compensated for in several ways (e.g., lumber is always roofed and cannot be accidentally left uncovered; permanent roofs are not maintained or stored when not in use; man-hours are not expended in subsequent roofing operations; and, as unit loads are bound, additional lashings are not required to keep roofs in place).

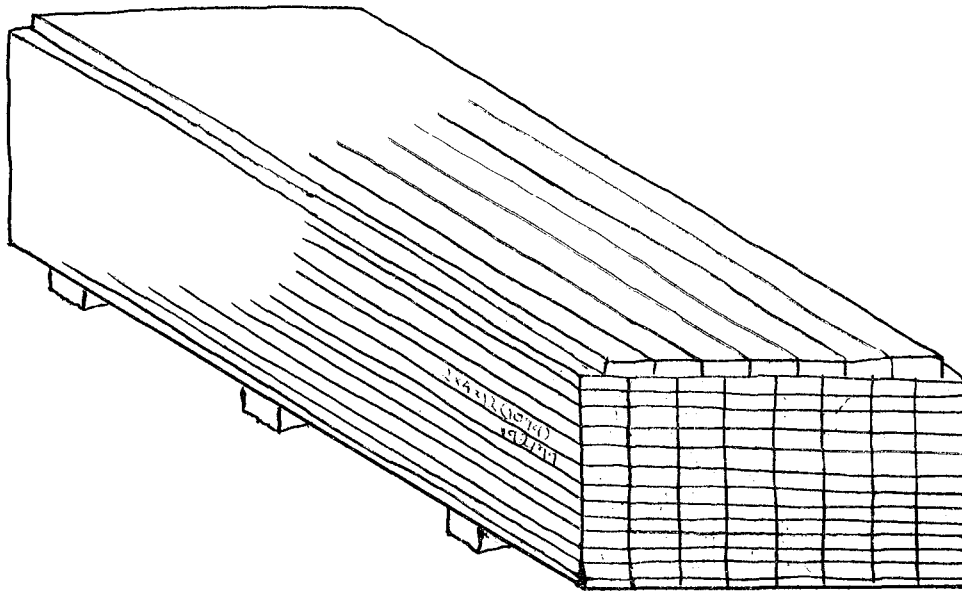

Figure 5-13 Method of building a roof into a draft of lumber

(2) *Paper or roll roofing protection method.*

Building paper or roll roofing may be combined with boards to form a roof. The paper or roofing provides watertightness, while the boards support the paper or roofing in a flat sheet and permit the roof to be anchored to the stack. The boards in this type of roof should be laid in a single layer and, roughly, edge to edge. The boards forming the front and rear portions need not be overlapped but can be butted over a central crosspiece. Since this type of roof is tight, the pitch can be flatter than one composed of a double layer of overlapping boards. The use of a combination of building paper or roll roofing and boards probably is more applicable to stacks of unitized lumber than to handstacked piles. The paper or roll roofing can be laid in strips, running either crosswise or lengthwise of the stack. When laid crosswise, the strips should be lapped like shingles and held down by three or more tie pieces running lengthwise of the stack. When the strips are laid lengthwise, a tie board should be placed over each lap. This type of roof consists of a double layer of boards with paper or roofing between. The boards of each layer are laid with several inches between the edges. With a roof of this type, there would not be a need for the boards to overlap. There is a wide variety of papers and roofing on the market, and the choice of a suitable material should be based on the life of the material with reference to the length of time the stack is to stand in the yard. It is probable that the most economical way would be to discard the paper or roofing when the stack is taken down.

(3) *Other protection methods.*

Boards, roofing, plywood, panels, corrugated aluminum, metal sheeting, and other roofing materials also may be combined to form roof panels. The panels may be used singly or doubly in the length of the stack. In all cases, the roof should be raised several inches above the top course of lumber to permit movement of air between the roof and the top of the stack. Special roofing should be used only when lumber such as oak and other high grade lumber is to be stored for long periods of time for air drying or when, because of unusual conditions, thoroughly seasoned lumber must be placed in open storage.

5-8. Covered Storage.

a. Sheds—open. An open shed may be likened to a storage yard with a roof. In covered storage, however, lumber may be stored on level foundations, 12 inches in height, as these stacks will not be exposed to rain or snow and will not require slope to accelerate moisture runoff. The open shed is advantageous for the storage of surfaced lumber or the better grades of lumber which are to be held in storage for a long period of time. Lumber having a moisture content in excess of 20 percent, which eventually will require covered storage, may be sticker piled and placed in open shed storage for air drying, as open shed storage has approximately the same drying qualities as an open lumber yard. Lumber is placed into and removed from open sheds from the open sides; therefore, the areas adjacent to the shed are utilized as working

aisles. Stocks may be stacked from the center of the shed out, in back-to-back storage, or completely through the shed depending on quantity and similarity of stocks stored. Surfacing requirements for open sheds are similar or equal to those required for open lumber storage areas

b. Sheds—closed.

(1) *Uses for closed sheds.* Closed sheds are used primarily for the storage of well-seasoned or kiln-dried lumber, plywood, molding, frame stock, and other show-type lumber intended for special use where end-use moisture content requirements will be 12 percent and less. The objective during storage is to prevent the lumber from absorbing atmospheric moisture. For this reason, it is advantageous to stack lumber and other items solidly with only sufficient stickers to stabilize the stack or to designate quantities, grades, or items of stock.

(2) *Floor surfacing.* Closed sheds should be provided with floors, preferably concrete, asphalt, wood block, or planking. Loose surfacing is not too satisfactory and, earthen floors, particularly if the shed is located on a low damp site, may increase the moisture within the shed. For this reason, closed sheds should be located on dry well-drained sites. Ventilation of the shed should be provided by adequate and adjustable openings in the walls. Stack foundations in closed sheds should be high enough to permit air to circulate beneath the stacks. Stagnant air underneath the stacks probably would accumulate excessive dampness and thus, increase the moisture content of the lumber in the lower part of the stack. If the floor is earth or surfaced with some loose-surfacing materials, the stack foundations should be about 12 inches in height. When the shed floor is surfaced with concrete or other hard surfacing, a clearance of 4 inches beneath the stack is sufficient.

(3) *Heating of closed sheds.* The efficiency of a closed shed in maintaining a low moisture content in lumber and other items for high-grade end uses is increased greatly if heat is available when weather conditions require it. When a source of heat is available, a low relative humidity within the shed and consequently, a low equilibrium moisture content for the lumber can be maintained by increasing the shed temperature 10° F. to 20° F. above the outdoor temperature. The heating system should be arranged so that the temperature throughout the shed is uniform.

5-9. Storage of Special Items.

a. Storage of shooks. Shooks should be stored undercover, preferably near the main packaging areas. Many activities find it beneficial to procure

shooks instead of box lumber for the majority of standard box requirements. Shooks can be procured in open-end contracts and delivered in the quantities required for normal operations. Thus, storage space is required for only a 30- to 60-day supply of each type shook. This reduces lumber storage yard requirements and, proportionately, the need for stack foundations, stickers, bolsters, pile spacers, butt boards, box manufacturing machinery, and the intradepot hauling of lumber.

b. Storage of lignum vitae. Lignum vitae is a greenish brown, hard, and heavy wood. Usually, it is stocked as blocks or logs. There is only one correct method of storage for lignum vitae, which is to store submerged in fresh water. There are various satisfactory methods of underwater storage. One method is to drive the U- or I-bolt into the end of the logs or blocks, attach the bolt to a cable, and place in any pond or other body of fresh water. In the absence of natural water storage facilities, ponds or tanks must be prepared for the submerged storage of this wood. When lignum vitae is stored in tanks or ponds, it is not necessary that the water be changed as stagnant water will protect this wood as well as water that is constantly being changed. Lignum vitae quickly becomes unsuitable for use if stored exposed to the air; therefore, another method will not be substituted for the submerged storage of this material.

c. Storage of plywood. Plywood will normally be in a dry condition when received and should be stored in a closed shed, particularly when the plywood has interior gluelines. For pro-longed storage, a heated storage building is recommended. Plywood is commonly solid piled. Under humid conditions, there is some tendency for edges to swell because of exposed end grain; this swelling causes dishing, especially in the upper panels of high piles. Dishing can be minimized by placing stickers in the pile at intervals. Enough stickers should be used so that plywood will not bend between them. Dry 1-inch strips are suitable for sticking plywood.

d. Storage of timbers. Moisture content itself is not of major concern for timbers. The objectives in timber storage are to prevent serious deterioration and at the same time accomplish slight drying. Timbers held in open air storage are subject to checking, splitting, and warping. They are also subject to decay. Checking, splitting, and warping are associated with shrinkage, stresses generated by the drying of the outer portions. Decay can result where infection takes place in those portions of timbers that are exposed to moisture and air. In large timbers, end checks may occur that are likely to develop into splits that may extend a consid-

erable distance along the length of the timber. Surface checks are generally of minor importance except where they develop into the relatively large cracks that are likely to occur in boxed-heart timbers. Timbers may decay in storage because of fungi that were in the living tree, or infection may start during the storage period. Decay may start on the surfaces of timber in solid piles because surface drying is retarded or in surface checks or splits into which rain or snow water penetrates.

(1) *Outdoor storage of timber.* Timbers stored in piles outdoors are usually exposed to sunshine and wetting because it is impractical to provide roofs. Timbers stored outdoors should be end-coated for protection from end-checking. If the coating is applied before end-checking has started, it will greatly retard the drying of the end-grain that causes checking and splitting. The various types of antisplitting irons that are used commonly on railroad ties may be used on timbers to prevent the opening up of splits that may develop from end checks. Timbers stored outdoors should be piled so that the air has access to all faces. The timbers in each layer, of course, should be placed several inches apart and the courses should be separated by 2-by-4s. The stickers should be spaced 6 to 10 feet apart. Pile foundations should slope and the pile of timbers should be built with a forward pitch much like hand-stacked piles of boards or dimension lumber.

(2) *Open shed storage of timbers.* Timber stored in an open shed are subjected to practically the same atmospheric conditions as timbers stored outdoors, but they are protected from sunshine and wetting by the roof of the shed. Piles are level, rather than sloped and pitched.

5-10. Measuring Moisture Content.

a. General. Ordinarily, the amount of moisture in wood is expressed as a percentage of the weight of the wood when oven dry. The three distinct methods of determining moisture content are the oven-drying method, the distillation method, and the electrical moisture meter method. The latter of the three methods is the most rapid and does not require cutting the material. The only accurate and rapid test is by using a lumber moisture meter in accordance with MIL-STD-1363, Measurement of Wood Moisture Content.

b. Use of the electrical-resistance method. When the rapid indication of the moisture content of wood is desired for inspection purposes, the electrical-resistance method is the most suitable. This method is based upon the well-known fact that the electrical resistance of wood changes with moisture content. Several types of portable electric moisture

meters are now on the market. The features common to the meters are two pairs of sharp metallic terminals that can be embedded quickly in the wood, batteries for supplying an electric current through the wood intervening between the two terminals, and a means for reading the resistance in the electric circuit directly in terms of the moisture content of the wood holding the terminals. Different species of wood vary in their electrical resistance for a given moisture content, and this fact must be taken into consideration in making moisture determinations. Usually, manufacturers supply proper correction factors. The range of the present meters is about 7 to 24 percent moisture content. Moisture meters are now available with needles that are insulated with a nonconductive coating except for the extreme tip. The insulated needles are preferred since they can measure the moisture content at various depths within a piece of lumber.

The electrical-resistance method has an advantage over the oven-drying and distillation methods, principally, because of its speed and convenience as only a few seconds are required to determine the amount of moisture in any piece of wood. Therefore, it is adaptable for sorting lumber on the basis of its moisture content. The moisture content is determined by inserting the prongs of the meter in the back of the piece somewhere near the center. This avoids marring the face of the board when the metallic terminal points are inserted. The electrical methods are the only practical means thus far developed by which the moisture content of finished woodwork in place can be determined without serious injury to the wood.

c. Methods of determining moisture content in timbers. Since wood acts as a resistance element in the electrical circuit of a moisture meter, the current flowing between electrode needles will follow the path of least resistance which is the path with the greatest amount of moisture. Thus, a meter with uninsulated electrodes will show the moisture content of the wettest wood contacted by the electrode needles. Therefore, electrical meters should not be used on lumber that has been recently wet by rainfall since the meter may indicate too high a moisture content. Meters equipped with insulated needles are preferred. The insulated needles respond only to the moisture content of the wood in contact with the uninsulated tips, hence, it is possible to take readings at different depths to obtain a more complete indication of the moisture distribution. If moisture meters with uninsulated needles are not available, the moisture content at a depth of one-fifth of the thickness

of a board will be nearly equal to the average for the entire cross section.

5-11 Kiln Drying.

a. Semidry lumber. Semidry lumber showing some visible evidence of decay either should be kiln dried to prevent further ravages of decay and then stored in the same way as uninfested dry lumber or, preferably, it should be used up as soon as possible after receipt at the installation. The

choice on bundling this type of lumber will depend on the extent of visible decay.

b. Wet lumber. Lumber that is wet and showing visible evidence of decay should be immediately kiln dried to prevent further deterioration. If a kiln is not available, the lumber should be used as quickly as possible. If the lumber can be kiln dried, then its subsequent handling will be similar to the handling of semidry infested lumber.

Section II. Ammunition and Explosives

Basic requirements for the receipt, storage, issue, and care of ammunition and explosives are in TM

38-410/DLAM 4145.11/NAVSUP PUB 573/AFR 69-XX/MCO 4450.XX, Storage and Handling of Hazardous Materials.

Section III. Vehicles (Tracked and Wheeled) and Artillery

5-12. Scope.

This section prescribes policy for the storage of wheeled and tracked vehicles and artillery at DOD installations. Detailed operational procedures will be prescribed, as deemed necessary, by the individual component.

5-13. Storage Areas.

a. General.

(1) Storage areas for vehicles and artillery may be located either undercover (as in a warehouse) or in the open. The type of storage area in which any specific type of vehicle or artillery piece should be stored will be determined by such factors as the degree and length of environmental exposure the item will satisfactorily withstand, the size and weight of the item, the ease with which the item may be handled, the availability and type of vacant storage space, and the requirements imposed by the owning military service/agency.

(2) Vehicles and artillery, being relatively heavy and bulky, are difficult to handle. Therefore, storage areas selected for such items should be in proximity to rail sidings and truck loading facilities; this reduces the handling time and travel distance incident to the receipt, storage, and shipment of these items.

(3) Sufficient space should be provided either within or adjacent to the storage area to serve as a preparation area for shipments of multiple item quantities which may require such actions as the marshalling of items for marking, addition of on-vehicle equipment items, inclusion of log books, and preshipment inspection.

(4) Once items have been placed in storage, control should be maintained through use of a locator system employing a grid layout as defined in chapter 3, section III.

b. Covered storage areas.

(1) There are three general types of covered storage space which may be used for the storage of vehicles and artillery: CH warehouses; general purpose warehouses, and other covered space such as sheds and transitory shelters. Though large items such as vehicles and artillery are expensive in terms of the space they occupy, there remain significant advantages in using covered space for the storage of such items. Some of the advantages to be gained, to varying degrees dependent upon the type of covered storage space used, are as follows:

(a) Ability to store material in assembled condition, requiring only minimal effort to ready it for issue.

(b) Reduced requirement for item preservation.

(c) Extended storage with reduced requirement for inspection and subsequent reprereservation.

(2) When planning for the storage of vehicles and artillery in covered storage areas, factors to be considered include the floor load rating of the applicable storage area and the size, quantity, and location of the doors in the structure(s) involved.

(3) CH storage space provides a high degree of protection to prevent item deterioration which decreases COSIS inspection processing requirements. To the extent this space is available and considering its necessary use for other critical material,

this type of storage is also suggested for artillery, wheeled trucks and truck-tractors, and tracked combat, assault, and tactical vehicles. It is recommended that items equipped with fire control (critical optics) components and other costly to preserve components be furnished CH storage. When determining what type of storage space to use for a specific application, it must be remembered that CH space is one of the most costly type of storage space to construct and maintain.

(4) General purpose storage space, though obviously less advantageous than CH, still offers substantial protection from the elements.

(5) Transitory shelters may be used for the storage of vehicles and artillery.

(6) Of all the types of covered storage space, sheds offer the least amount of protection from the elements since one side is normally open. When constructing sheds, care should be taken to assure that a closed side of the shed faces the direction of the prevailing wind to minimize the effects of rain and snow.

c. Open storage areas. Use of open storage areas results in the exposure of material to the elements; hence, the material may deteriorate from exposure to sun, rain, snow, dust, and sand. Exposure to dust or sand (especially if windblown) may result in difficulties such as clogged fuel lines and filters, stripping of paint or other protective materials from exposed surfaces, pitted glass, and malfunction of mechanical parts. For these reasons, plus the advantages noted earlier for covered

storage areas, the use of open storage areas is not recommended for wheeled and tracked vehicles. However, since this material must oftentimes be stored in the open for a variety of reasons, the following actions should be taken to assure achievement of the best possible results:

(1) Increase the degree of protection over what is required for items placed in covered storage areas.

(2) Increase the frequency of inspection over what is required for items placed in covered storage areas. Also, consider increasing the thoroughness of the inspection.

(3) For some parts of certain vehicles (e.g., cargo trailer beds, dump truck bodies, etc.), take precautionary action to reduce the accumulation of snow or rainwater. Such accumulation may result in the corrosion of both painted and unprotected surfaces on these parts of this type of vehicle. The probability of this occurring may be reduced by elevating one end of the vehicle or applicable vehicular component. Cargo trailers with tailgate assemblies which allow moisture to run off should be elevated at one end (fig 5-14). Dump truck bodies should be maintained in a slightly elevated position by inserting a 4- by 4-inch block between the dump body and the vehicle's frame the tailgate may also require blocking to open slightly. Exposed unpainted and machined surfaces of the hydraulic ram should be preserved, then wrapped in accordance with the requirements of the applicable military service/agency.

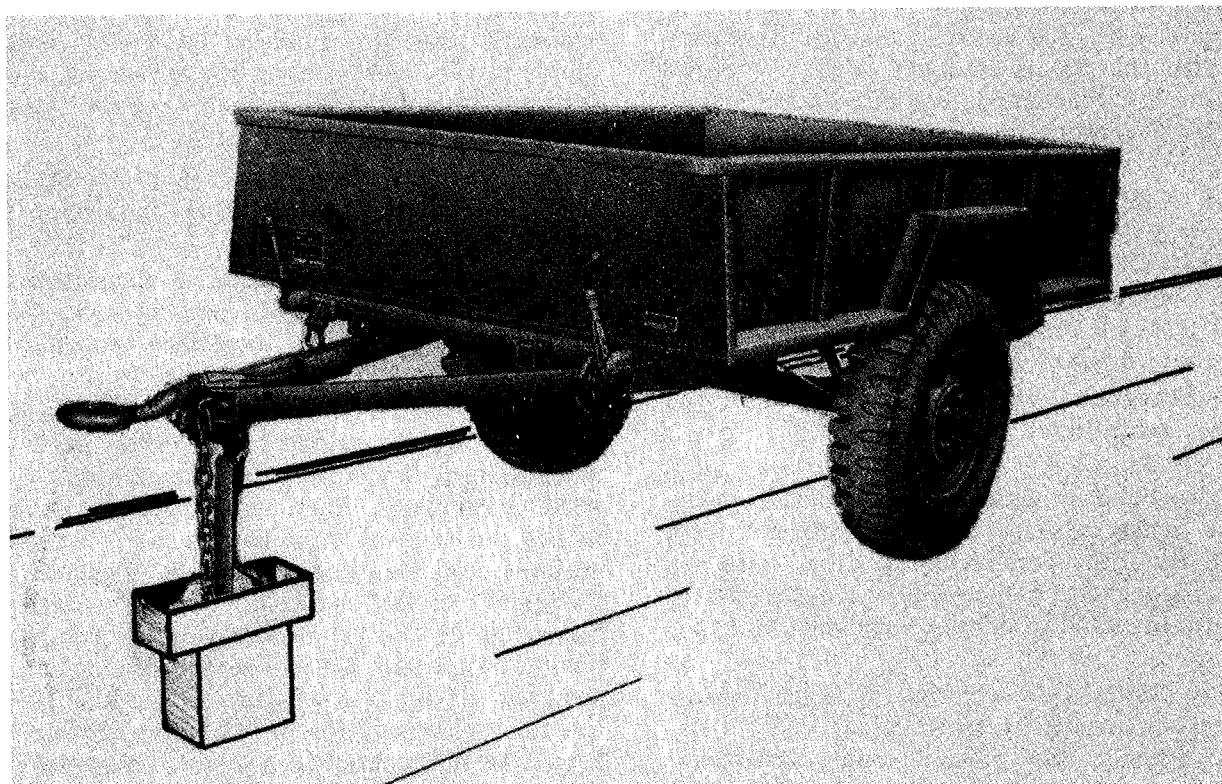

Figure 5-14 End of trailer elevated to promote drainage.

(4) Wheeled and tracked vehicles in open (or covered) storage need not be blocked off the ground. However, vehicles which must be stored in open areas should be placed on the most favorable terrain available to prevent this equipment from resting in mud or water. Where changing terrain or draining patterns cause this condition to exist, the equipment should be moved to a more desirable area, or some type of fill (e.g., gravel, stone, etc.), spread, or landing mat positioned to provide a more suitable ground condition.

5-14. Storage Patterns.

a. General. Whenever material is placed within a storage area, the manner in which items are located in relation to one another forms a pattern. This is referred to as a "storage pattern." The back-to-back and the block storage patterns are two efficient patterns for use in the storage of vehicles and artillery.

(1) The back-to-back storage pattern consists of two rows of material placed in proximity to one another as shown in figures 5-15 and 5-37. Note that an aisle separates each double row so that any item is accessible without the need to move any other item.

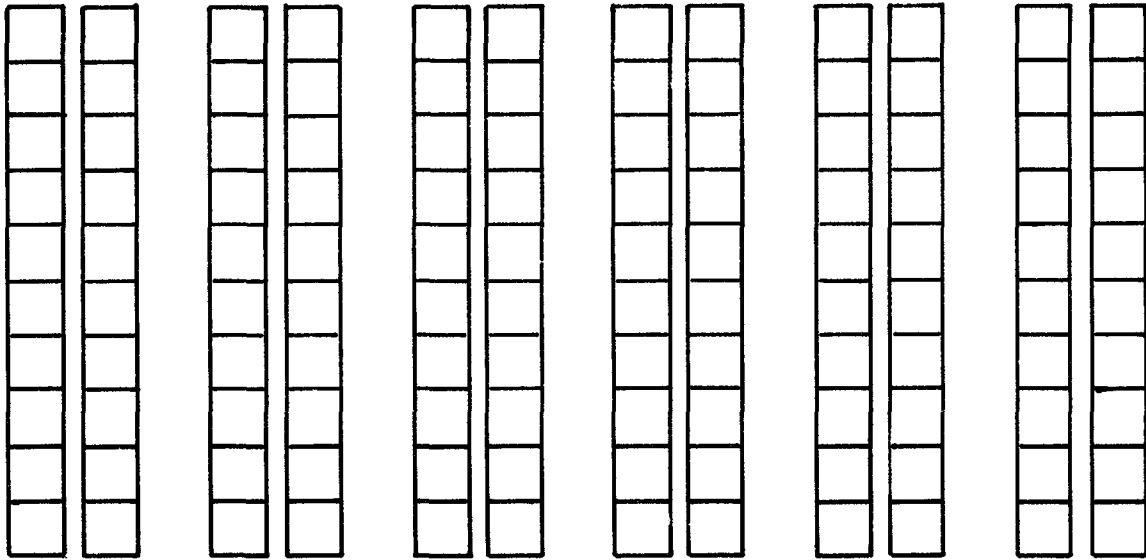
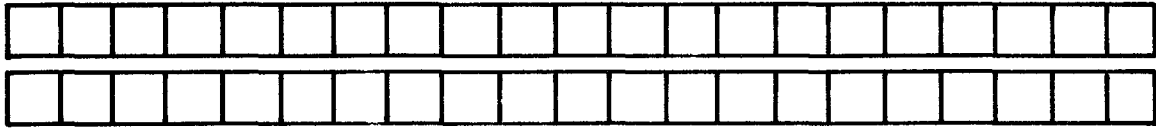

Figure 5-15 The back-to-back storage pattern

(2) The block storage pattern is made up of more than two rows of material placed in proximity to one another as shown in figure 5-16. With

the block pattern, depending upon the depth of the block, access to a specific item may require that other items must be moved.

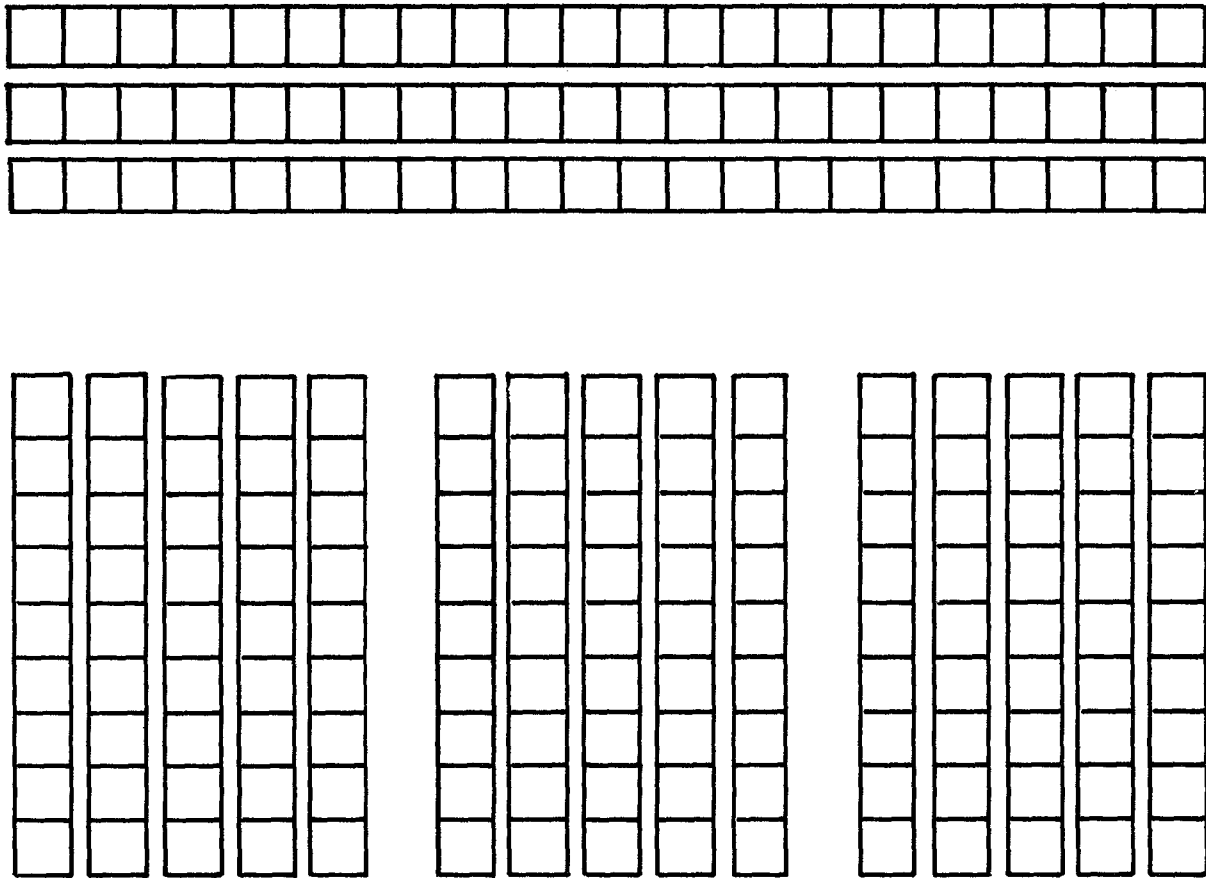

Figure 5-16. The block storage pattern.

b. *Selection of the proper pattern.* Many factors must be considered when determining the best storage pattern to use in a specific situation. Factors which must always be considered include, but are not limited to, the following:

(1) *Efficient space utilization.* A block storage pattern will make more efficient use of space than will a back-to-back pattern since the block pattern requires a minimal quantity of aisles. Although block patterns do result in more efficient use of space, consideration of other factors discussed below may dictate the use of a back-to-back pattern. However, a specific single type of pattern need not be used throughout an entire storage area; it is permissible to use a combination of both.

(2) *Type of storage area.* Normally, there is nothing which will physically inhibit the use of either type storage pattern in an open storage area. However, since open space is at less premium, the back-to-back pattern is usually used so as to minimize materials handling. In a covered storage area, the need for specific aisle placement and the

location of firewalls and building supports may not allow the use of a block pattern.

(3) *Item mix.* When a large quantity of a single item is to be stored, the use of a block pattern is usually the logical choice, if facility design will permit. Where small quantities of different items are involved, a back-to-back pattern generally proves to be more efficient.

(4) *Item issue requirements.* If the issue of each piece (vehicle or artillery piece) is controlled by serial number or a similar control factor, the use of a block storage pattern is not the logical choice unless the precise sequence in which pieces will be issued can be accurately predetermined. The requirement for a single piece in the center of a block pattern could necessitate the movement of many pieces so that the desired piece may be obtained.

(5) *Care of supplies in storage.* The care of supplies in storage program (chap 3, sec VI) for vehicles and artillery specifies that, under certain conditions, vehicle drive trains or artillery recoil mechanisms be exercised periodically. In some instances, this can be accomplished through use of a

mechanical device and, when such a device is used, sufficient space must be made available between items to allow the device to approach the item to be serviced. This may also be true when inspection defines the need to represerve material.

c. Planograph. Planographs should be used when planning and controlling space utilization in the storage of vehicles and artillery (see chap 3, sec III).

5-15. Fire Protection.

Fire protection policy is not prescribed in this section and will be that stipulated by the individual services and chapter 6 of this manual.

5-16. Methods for Storage, Receipt, and Issue.

a. Storage.

(1) *Stacking.* Since vehicles and artillery are relatively bulky items, they occupy considerable floor space within covered storage facilities. Economical and efficient use of such facilities may be appreciably enhanced if these items are stacked to

utilize available cubic space. Stacking methods vary with the weight, dimensions, and type of item to be stacked.

(a) Except for a few items which may be stacked without need for racks or a substantial quantity of supporting dunnage, vehicles should only be stacked in covered storage areas possessing a level, surfaced floor. The use of bare earth, which is normally uneven and highly compressible, can result in an unbalanced stack. When stacking vehicles or trailers for storage or when storing vehicles or trailers loaded with other material, it may be necessary to place blocks between the axle and frame to relieve tension on the springs.

(b) Some items such as certain types of trailers may be stacked by inverting one item and placing it over another as shown in figure 5-17. Normally, under these conditions, a relatively stable stack is produced which will allow storage on slightly uneven surfaces such as dirt floors or open storage areas. When this method of stacking is used in open storage areas, the under-carriage of the uppermost item is exposed to the elements and the degree of preservation should be increased accordingly.

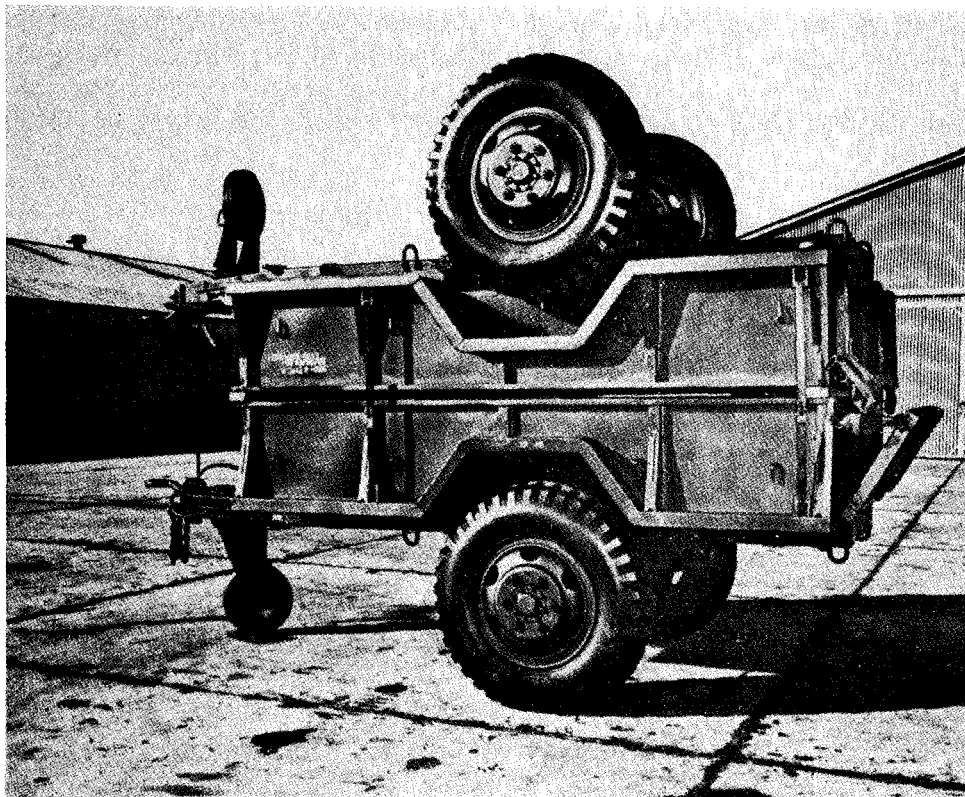

Figure 5-17 Inverted trailers ready for storage

(c) Vehicles and artillery should not be stacked in open storage areas, except as noted in (b) above. The costs for materials handling, racks, and dunnage far outweigh any potential benefit since open storage space is the least costly of all storage space.

(d) When stacking vehicles and artillery in covered storage areas, the floor load rating of the area must be known. The combined weight of all items in the stack, plus the nominal additional weight of stacking aids (racks, stands, or dunnage), must not exceed this rating; otherwise, damaged floors, structural damage, and damage to the stored material may result.

(e) A variety of MHE types may be used to stack vehicles and artillery. The type required must be determined prior to making the decision to stack. Some of the heavier MHE with sizeable lifting capacities may be too large to move through warehouse doors or may result in a need for over-size aisles. This would reduce the savings to be derived through stacking. The various types of MHE which may be used for stacking are covered elsewhere in this section.

(f) To facilitate the actual stacking of vehicles and artillery, racks, stands, or dunnage may be used. The cost of these aids rises in direct relation to their weight capacity. Racks and metal stands may be obtained from commercial sources while wood stands and pre-cut dunnage may be fabricated locally. Items which experience a relatively rapid rate of turnover should not be consid-

ered as prime candidates for stacking since the increased handling costs for such items will tend to negate the short-term space saving.

(g) Racks may initially be the most costly of the three types of stacking aids, but their cost may also be more rapidly offset by their minimal incidence of repair and the limited requirement to handle and rehandle them during stacking operations. Most racks are designed to accommodate one general type or size vehicle. They are constructed in one of three basic configurations: roll-through, cantilever, and suspension. Roll-through racks are well suited to the stacking of lightweight vehicles (fig 5-18); these are basically commercial pallet racks modified by adding channels upon which equipment may roll forward when inserted in the input end of the rack. Since roll-through racks may make up long rows and are both loaded and unloaded from the ends, they may be placed close together in a block pattern with minimal aisle requirements. This configuration will enhance the ease with which the FIFO principle may be practiced. The second type of rack is of cantilever design (fig 5-19). This type of rack consists of a pair of stanchions fitted with cantilever-type "arms" which support the stored item from underneath. The cantilever type of rack may be used to stack items considerably heavier than those which may be stacked on roll-through racks. The suspension-type rack (fig 5-20) consists of a pair of stanchions fitted with brackets from which lightweight or mediumweight vehicles may be suspended by their bumpers, lifting eyes, or pintles.



Figure 5-18 Roll-through racks for stacking vehicles in storage

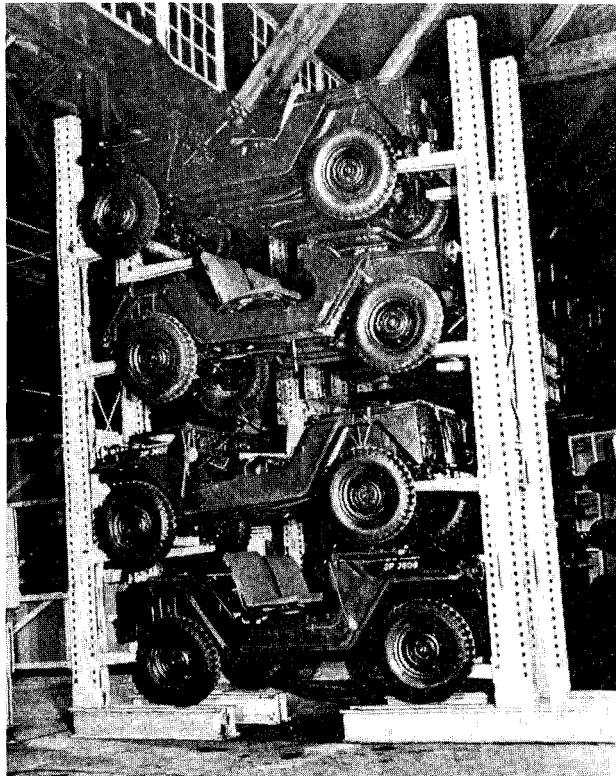

Figure 5-19. Cantilever racks for stacking vehicles in storage.

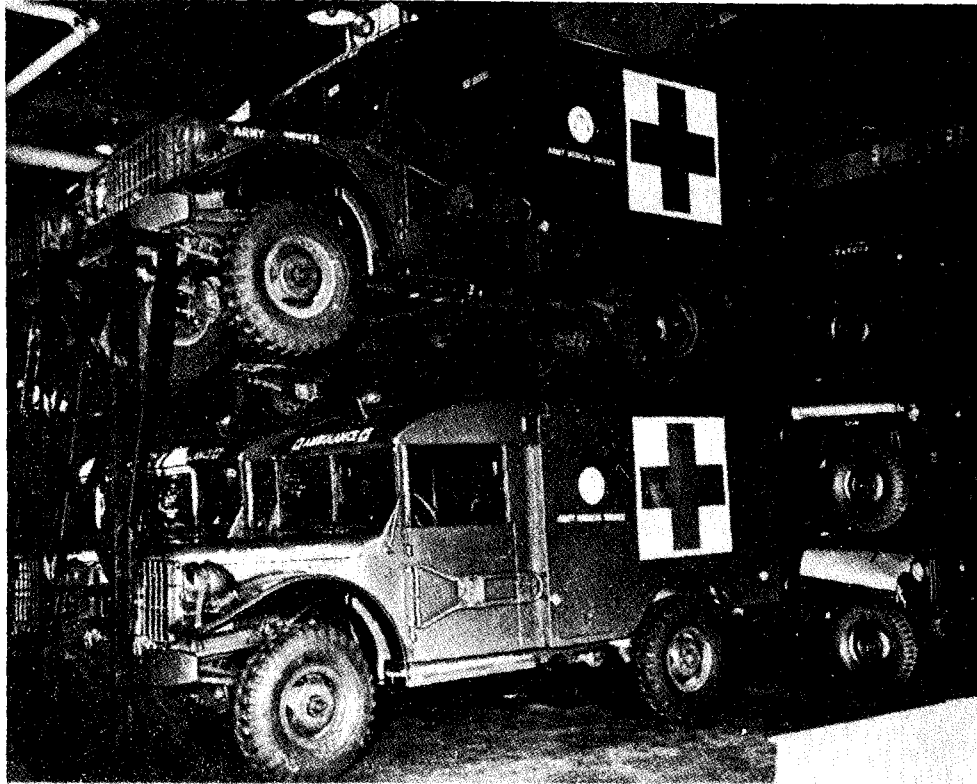

Figure 5-20 Suspension-type racks for stacking vehicles in storage

(h) Stands may be constructed from wood or metal. Many are built in a “sawhorse” configuration and, depending upon their design and the materials from which they are constructed, they can support items of nearly any weight (figs. 5-21 and 5-22). Unlike racks which support each item independently (no requirement for the lowermost item to support the superimposed weight of any items

stored above it), stands support the weight of all items above them. The stacking procedure involves placement of the stands directly upon the lowermost item in the stack, then placing the next item on top of those stands. Whenever stacking vehicles or artillery pieces on stands, the stands used must be sufficiently strong and placed to avoid instability of the stack and damage to the suspension of each stacked item.

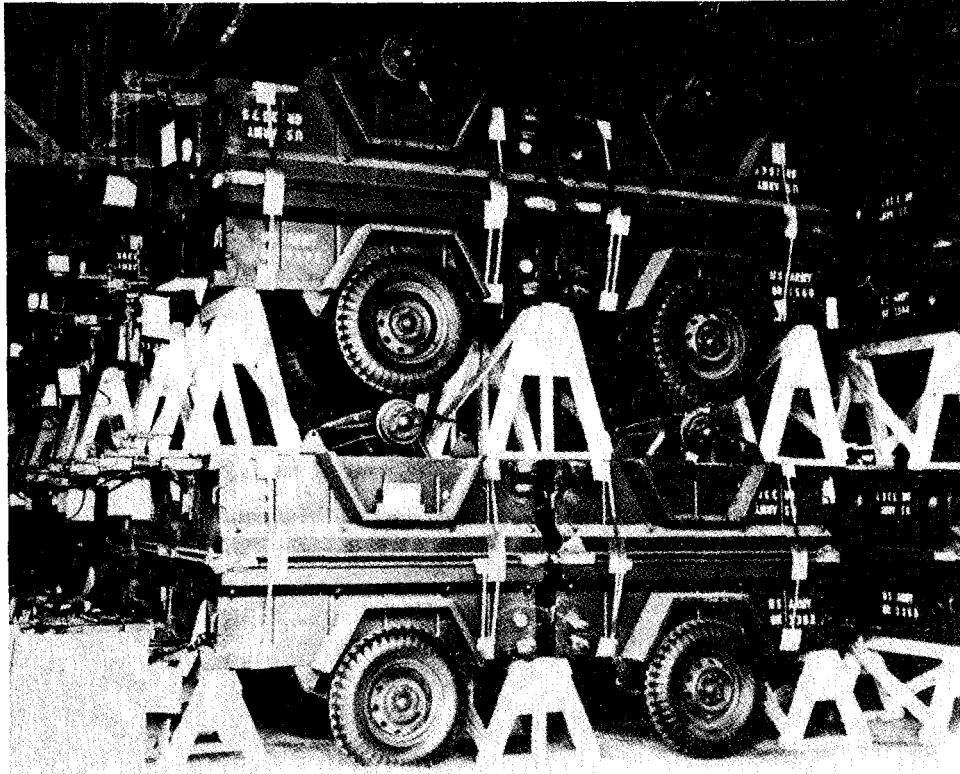

Figure 5-21 Wood stands for stacking vehicles in storage

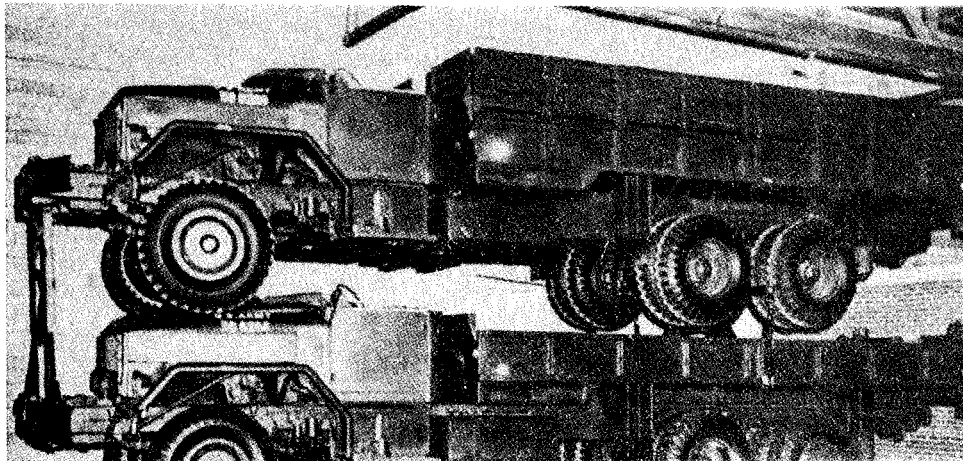

Figure 5-22 Metal stands for stacking vehicles in storage.

(i) In some instances, dunnage may be used for the same purpose of racks and stands. When properly used, dunnage permits the stacking of extremely heavy items (fig 5-23). Dunnage material must be carefully chosen to assure that it possesses sufficient strength to support the superimposed weight. Improperly chosen dunnage may

be too soft, resulting in compression and the inability to remove the stacked items, or it may be brittle and break, resulting in an unstable stack. Properly chosen dunnage can be an easily fabricated, safe, and economical stacking aid.

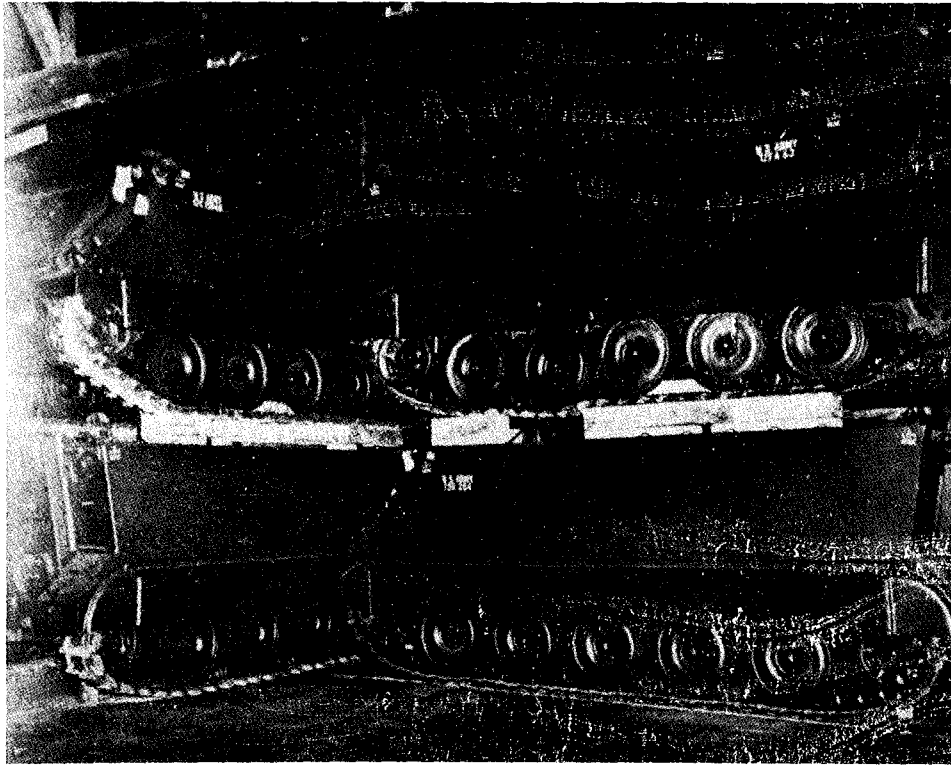

Figure 5-23 Wood dunnage for stacking vehicles in storage

(2) *Fork extensions and adapters.* By adding fork extensions to the common forklift truck (chap 4, sec II), it becomes possible for the truck to handle larger and bulkier items which it might otherwise not be capable of handling. Considering the extended load centers involved, care must be taken to assure that the forklift truck is not overloaded. Fork adapters may also be used for handling some vehicles and artillery pieces. Fork adapters are similar to fork extensions except that they are designed to accommodate specific types or styles of undercarriage configuration. As with extensions, when using adapters and extended load centers are involved, caution must be exercised to assure that the forklift truck is not overloaded.

(3) *Towing in storage.* Towing offers a distinct advantage over handling by MHE since, in many instances, towing may be accomplished by means of nonspecialized equipment already on hand. However, towing is a preferred method of movement only when item preservation will not be adversely affected by moving the item on its own wheels or tracks. Care must be exercised in the selection of a towing vehicle with adequate capacity (drawbar pull). A towing vehicle may be capable of

moving an item on level ground while being incapable of moving the same item up even a slight grade. Such conditions will cause damage to the towing vehicle. The same logic applies when towing items over rough, uneven terrain. Considerably more effort must be exerted when towing an item over rough terrain than when towing the same item on a smooth, level surface since the towed item's drag (inertia) is more on rough terrain (see chap 4, sec IV).

(4) *Towing equipment.*

(a) *Prime movers.* There are two basic types of prime movers, either of which, when properly outfitted, may be used to tow or push even the heaviest vehicles and artillery. One is a pneumatic-tired, diesel-powered industrial tractor with four-wheel drive which can operate on rough terrain as well as on improved surfaces (fig 5-24). The other common type of prime mover is the tracked tractor (fig 5-25) which can also operate on rough terrain as well as on improved surfaces. However, tracked tractors can damage improved surfaces unless their tracks are filled with rubber track blocks (fig 5-26).

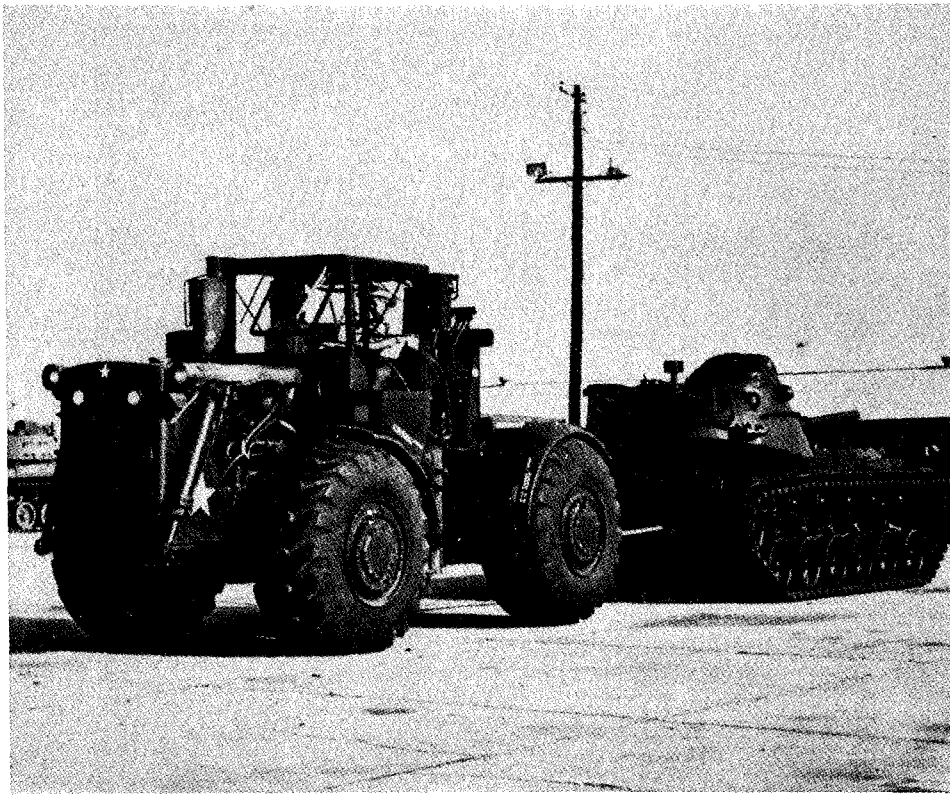

Figure 5-24 Example of a wheeled prime mover

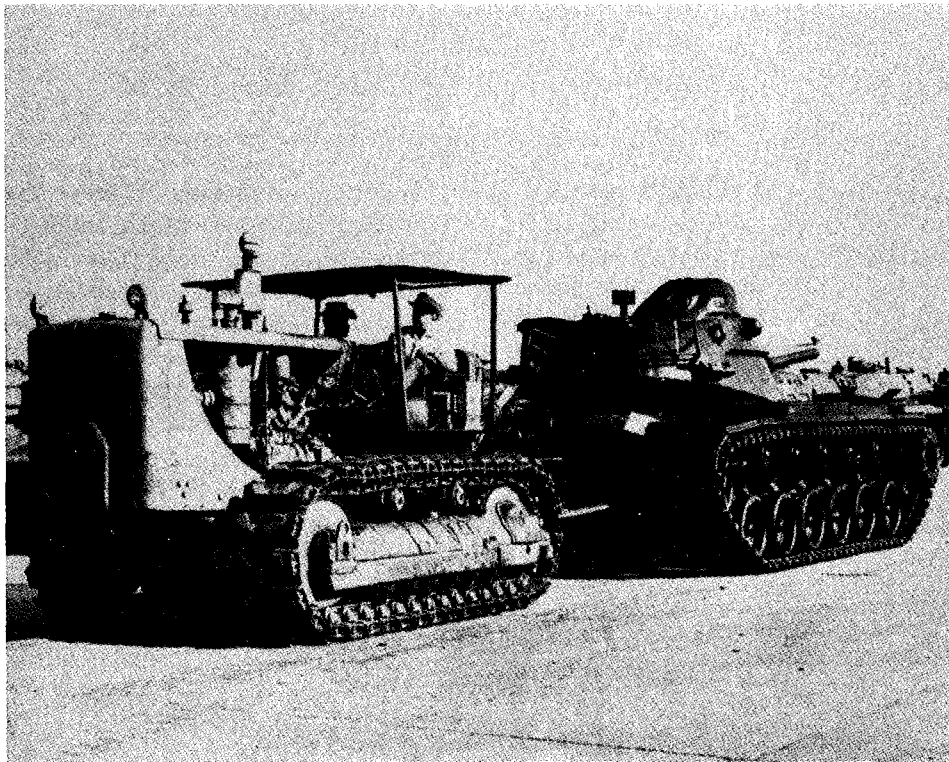

Figure 5-25 Example of a tracked prime mover

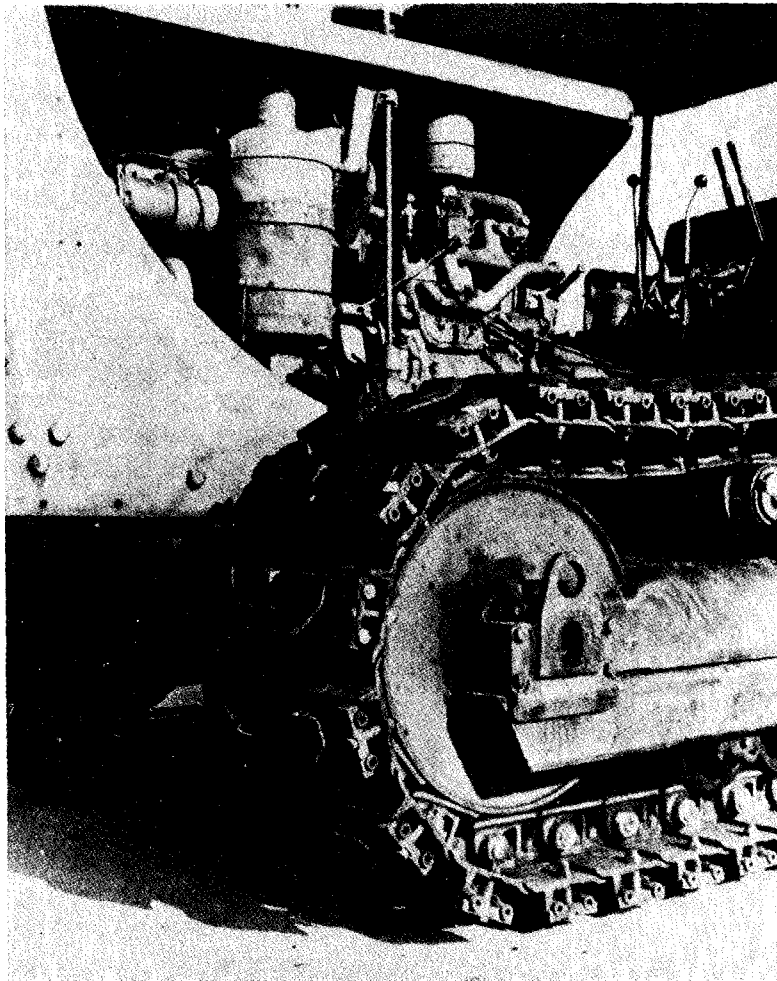

Figure 5-26 Rubber track blocks used to protect improved surfaces

(b) *Towing medium and lightweight materiel.* Medium and lightweight vehicles and artillery may easily be towed over improved surfaces with a variety of equipment such as warehouse tractors (chap 4, sec II), ¼-ton trucks, 5-ton trucks, etc. Care must be taken to assure that the drawbar pull of the equipment used is not exceeded (3) above). As the weight of the item to be towed increases and the quality of the terrain over which the item must be towed diminishes, consideration should be given to the use of a prime mover.

(c) *Towing aids.* Cables and chains of various lengths and strengths may be equipped with fittings which will allow them to be used in towing vehicles and artillery. However, since both chains and cables are flexible, an extra person is required to steer or apply the brakes of the towed item. This need may be circumvented by use of a tow bar (fig 5-27). Tow bars which are strong enough to allow both towing and pushing permit positive control of the towed item by the operator of the towing vehicle.

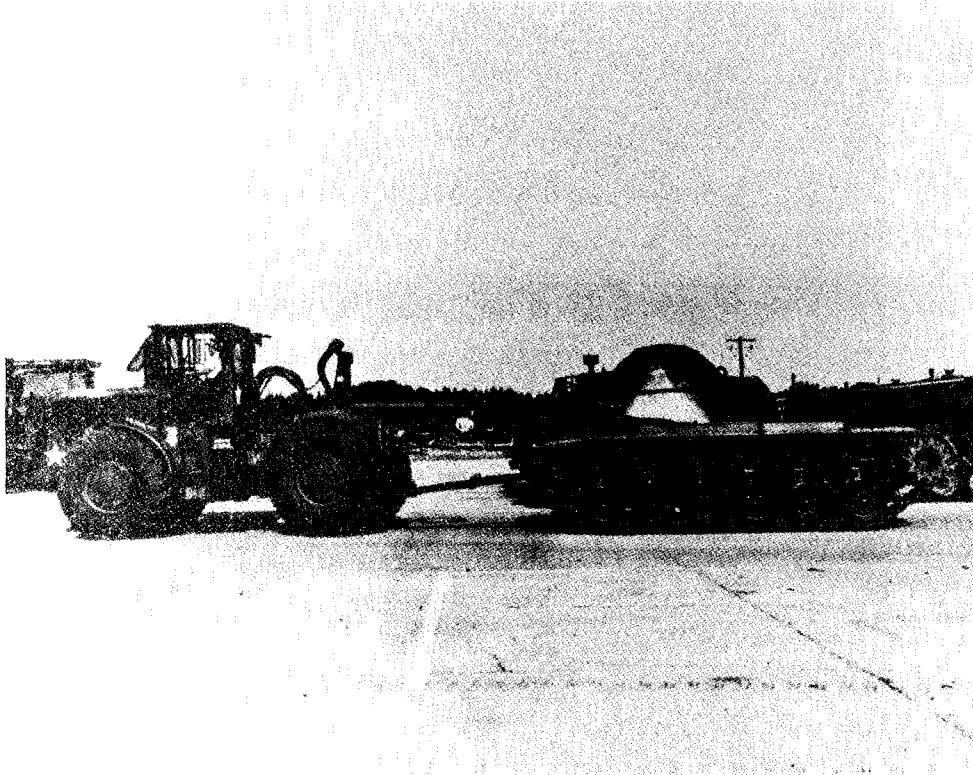

Figure 5-27 A tow bar for use when pulling a vehicle

(5) *Item disassembly.* Unless specifically approved and designated by the owning agency, the disassembly of vehicles and artillery for the express purpose of gaining storage space is prohibited, except as noted in *b(3)* below. If disassembly to some extent is deemed necessary, full justification will be furnished to the owning agency as a prerequisite to gaining approval for such action. As a minimum, the justification for desired disassembly action will include all pertinent costs, the time required for item reassembly, and the method(s) of maintaining item integrity.

(6) *Exercising.* The drive trains of some vehicles and the recoil mechanisms of some artillery

pieces must be exercised on a periodic basis (stipulated by the owning agency) to prevent deterioration in storage. In the case of vehicles, exercising may be accomplished by either running the vehicle or by the application of an exercising device consisting of a set of batteries mounted on a trailer (fig 5-28). The batteries are attached to the vehicle's starter motor which can then move the drive train without need of starting the vehicle's engine. Running the vehicle destroys preservation; the use of an exercising machine does not. Consequently, exercising machines are recommended for this action. Artillery recoil mechanisms should also be exercised with an exercising machine (fig 5-29) since manual exercising is often ineffective.

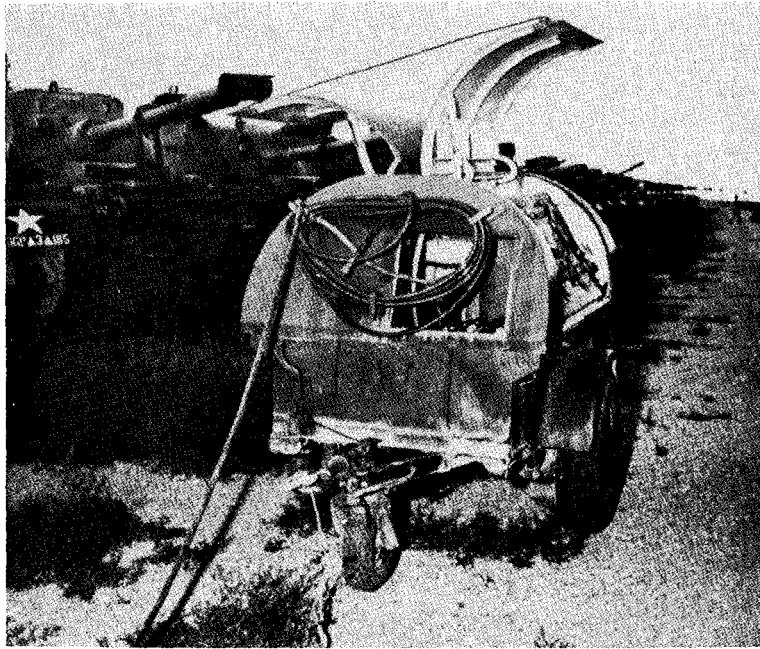

Figure 5-28 An exerciser for use on recoil mechanisms.

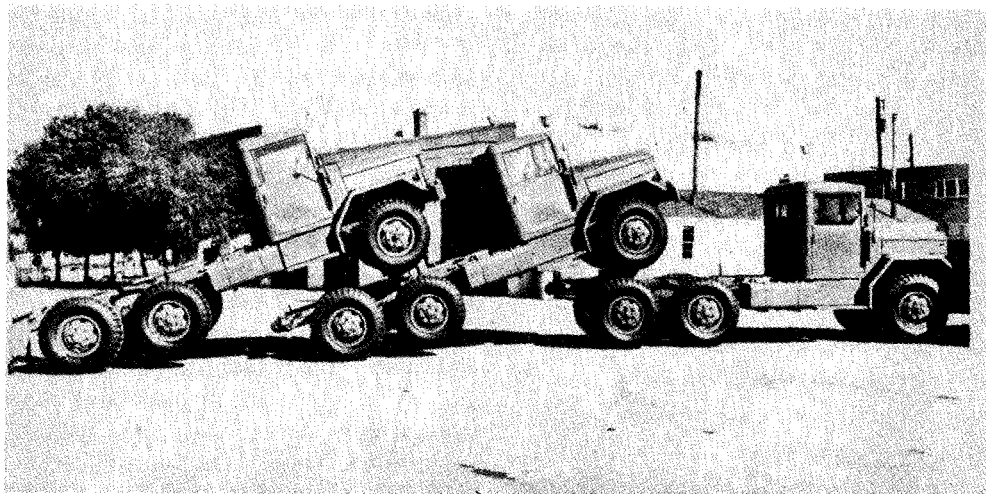

Figure 5-29 Truck tractors piggyback for driveway shipment.

(7) *Inflation of tires.* When vehicles and artillery are placed in storage, all tires (mounted and unmounted alike) will be inflated and kept at their normal operating pressure. Tire preservation should be as specified in section V, paragraph 5-35.

b. Receipt and issue.

(1) In some cases, special equipment such as heavy duty cranes may be required to facilitate the loading/unloading process. However, all receiving activities may not be equipped with such special handling devices. Consequently, the shipping activity (point of shipment origin) must determine and allow for any undue handling difficulties that may be created at the destination. Such difficulties may sometimes be avoided by merely changing the placement of items on the conveyance or by changing the type of conveyance to be used.

(2) Vehicles and artillery may be shipped on any commonly used conveyance (e.g., railcar, tractor-trailer, etc.) in accordance with loading drawings, AAR rules, or other applicable carrier requirements. One additional method of shipping vehicles is via the driveaway method where the vehicles are actually driven to their destination. Driving a vehicle to its destination will negate the application of preservation by the shipper or will destroy any preservation previously applied to its engine and drive train. This can mean that a port of embarkation or other consignee may be required to represerve the item before it is transshipped or stored. For shipments of some types of powered vehicles, these disadvantages may be overcome to some extent by using the piggyback method of shipment depicted in figure 5-30.

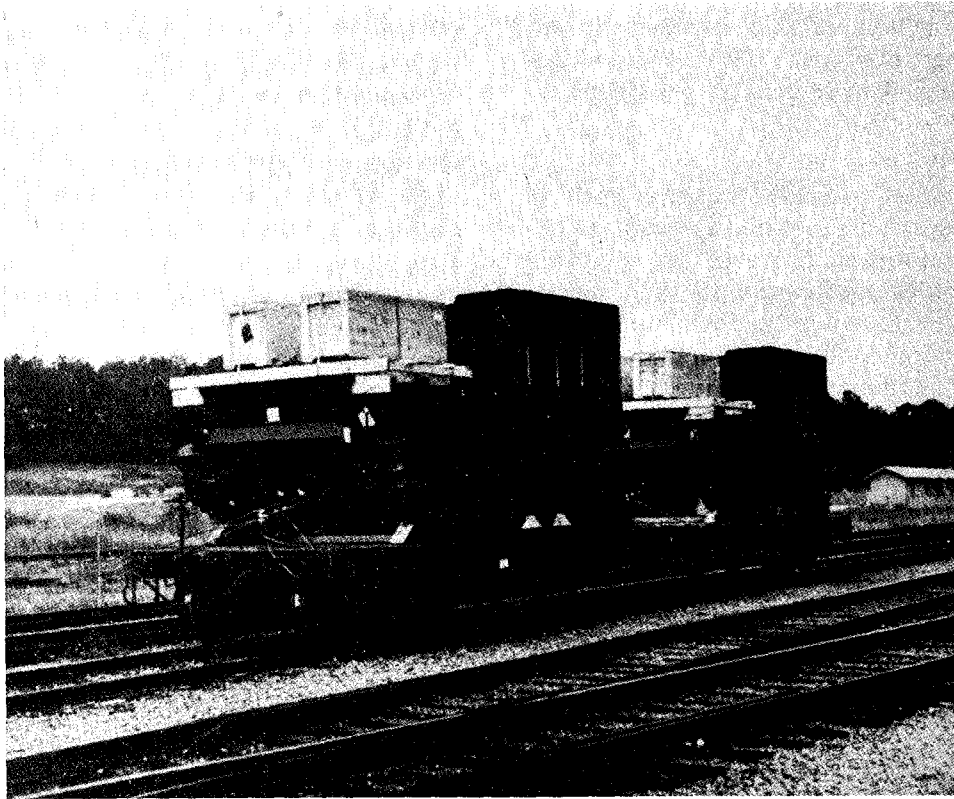

Figure 5-30 Parts boxed and attached to end item for shipment

(3) Many vehicles and artillery pieces possess parts that are prone to damage or pilferage (e.g., exterior mirrors, easily removed controls, soft-top cabs, on-vehicle equipment items, etc.). Such parts must be protected during shipment and storage. Small parts may be removed and placed in a protected area such as a vehicle map compartment. Larger parts may be removed, preserved, packed, then securely affixed to the end item by any appropriate means (e.g., strapped with steel banding). Removed bolts, nuts, washers, etc., must be placed in one of their mating parts and secured to prevent their loss. Figure 5-30 shows boxed parts affixed to the exterior of an item awaiting issue. Note that the box has been marked so that it may be readily identified by the ultimate user.

(4) The freight planning operation will take into consideration such factors as proper segregation or consolidation of the items being shipped to assure assessment of the lowest possible freight charges and the effective utilization of available cube on the conveyance. The load pattern in or on the conveyance should be established by taking into account the possibility of partial unloading of material at stopoff points enroute; improper item placement in or on the conveyance may result in

a need for much unnecessary handling at such stopoff points.

The Official Railway Equipment Register contains information regarding the dimensions and cubic capacity of the railcars owned and operated by individual railroads; this document will prove useful when determining the best load configuration to use when shipping on American railcars. Additionally, some military technical publications provide information as to the quantity of items which may be loaded in or on a specific type of conveyance. Such information, though useful for guidance, will not abridge the requirement for the most practical load configuration within the rated capacity of the conveyance.

(5) When making overseas shipments of vehicles and artillery, the transportation charges are in large part determined by the amount of cubic space occupied by the items being shipped. Therefore, item cube will be reduced to the maximum practicable extent for all overseas shipments. A word of caution: Item cube must not be lowered to the point where it becomes overly difficult for the receiving activity to ready the item for storage or use. The reduction of item cube may be accomplished by, among other things, lowering gun

tubes or artillery pieces to a horizontal position, removing soft-top cabs from vehicles, lowering and boxing the windshield to protect it from damage (fig 5-31), and, in general, removing or lowering all cube consuming parts on the item being shipped. Another method of reducing cube is to in-

vert one lightweight item, place it over another, and strap the two together with steel banding (fig 5-17). All parts removed or exposed by such action will be preserved and packed to the extent necessary to protect them from the hazards inherent to shipping and from exposure to the elements.

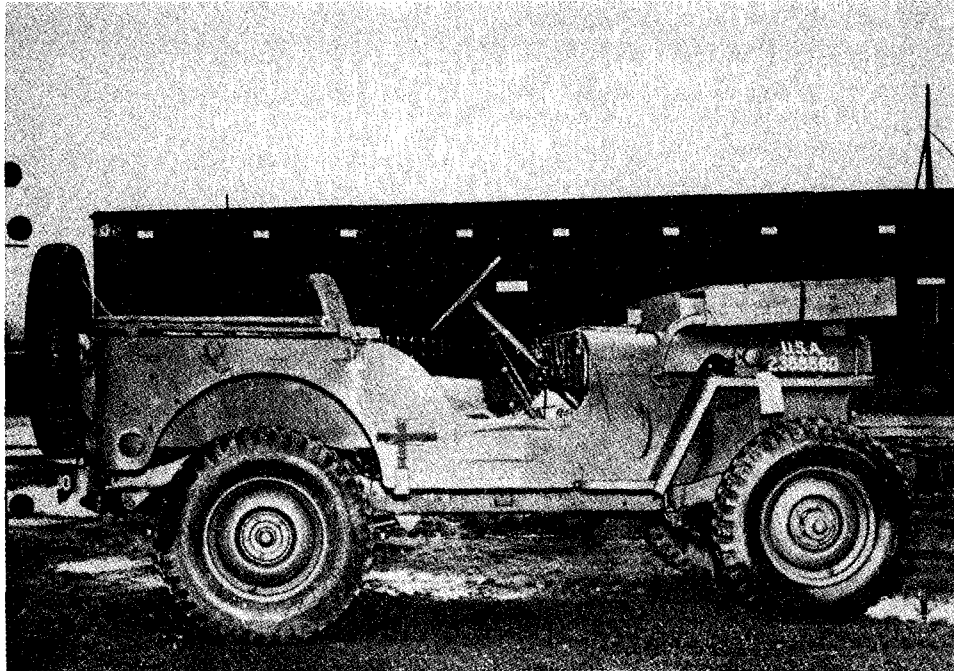

Figure 5-31 Windshield boxed for protection during shipment

(6) Cranes are not generally well suited to handling operations within confined spaces in a warehouse except where the warehouse has been specially designed. Cranes are particularly useful in handling vehicles and artillery in loading and unloading operations. While a large variety of crane types are available, this does not imply that a large variety are required at any installation.

Normally, one of two types in quantities commensurate with workload will suffice, especially if these are made more versatile with a carefully chosen selection of slings and spreader bars (fig 5-32). The use of slings and spreader bars will also protect the surfaces of the lifted item from marring or crushing. All of the general types of cranes discussed briefly below are available in a wide range of lifting capacities.

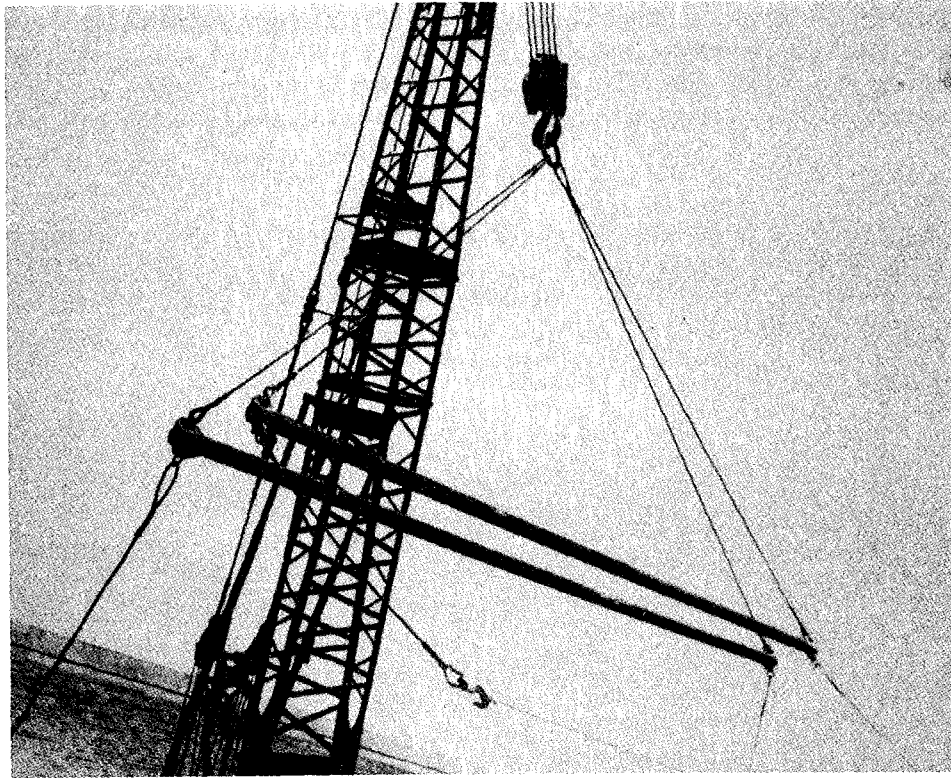

Figure 5-32. Slings and spreader bars for use with cranes.

(a) *Truck-mounted crane.* This type of crane (fig 5-33) consists of a self-powered crane unit which is equipped with a boom and mounted on a powered truck or truck chassis suitable for highway travel. The truck-mounted crane is highly

mobile, best suited to operation on a relatively smooth and level surface, and has a lifting capacity which is generally somewhat less than that of the other types of cranes discussed below.

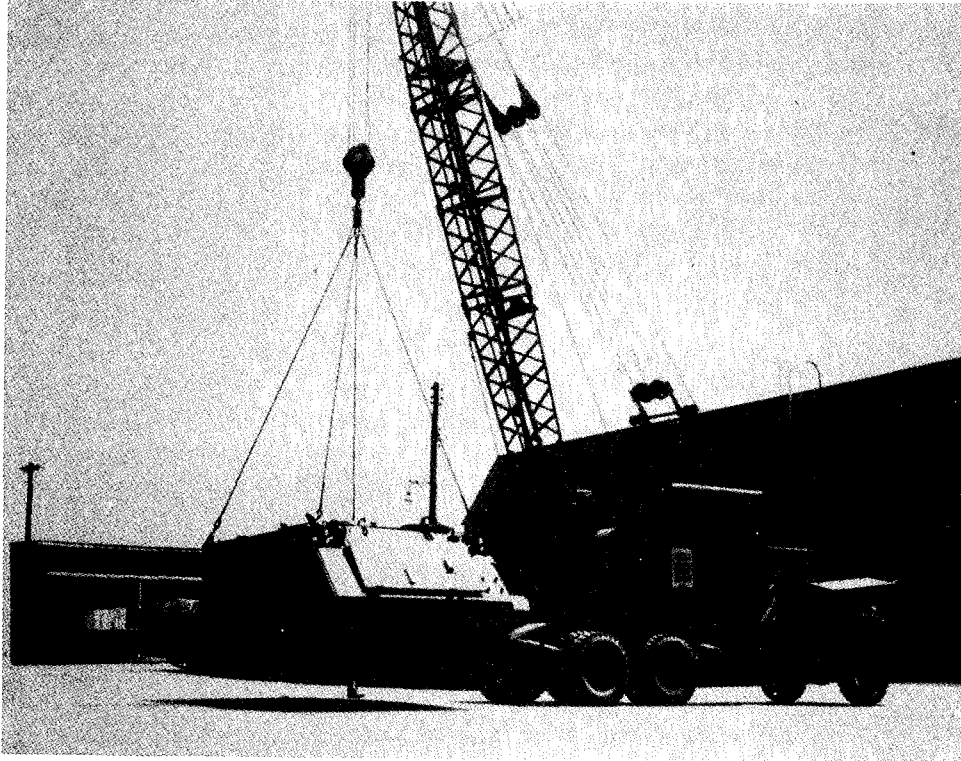

Figure 5-33 Truck-mounted crane

(b) *Wheel-mounted crane.* This type of crane (fig 5-34) is self-powered and equipped with a boom. The chassis on which it is mounted may or may not be self-propelled; if it is not self-pro-

ped, then the entire crane must be towed from one work site to another. A wheel-mounted crane that is self-propelled is nearly as mobile as the truck-mounted crane, yet its lifting capacity is normally greater.

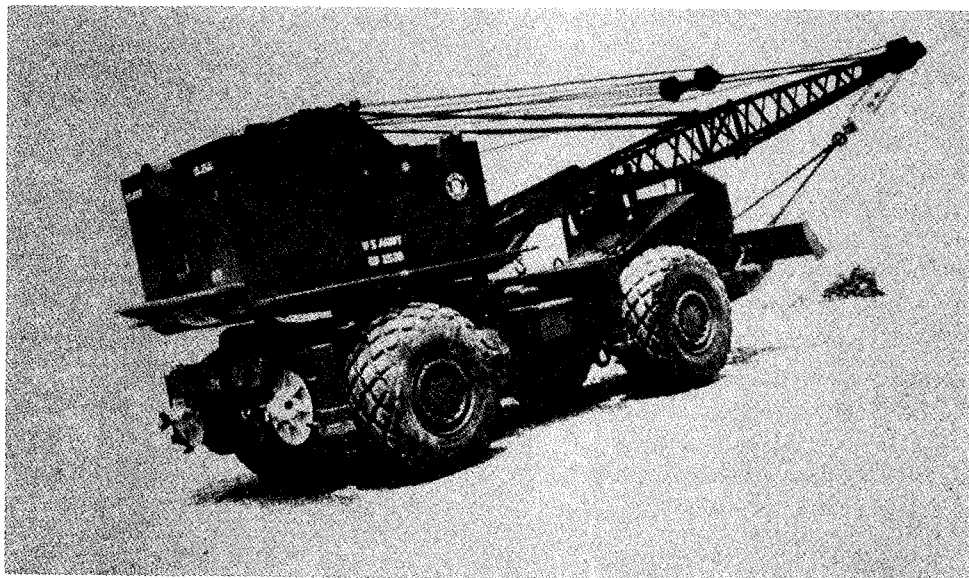

Figure 5-34 Wheel-mounted crane

(c) *Crawler-mounted crane.* This type of crane (fig 5-35), equipped with boom, is mounted on a self-propelled, track laying (crawler) chassis. Its lifting capacity approximates that of the wheel-

mounted crane and it is well suited to operation in unimproved open storage areas. The crawler-mounted crane is less mobile than either the truck or wheel-mounted type.

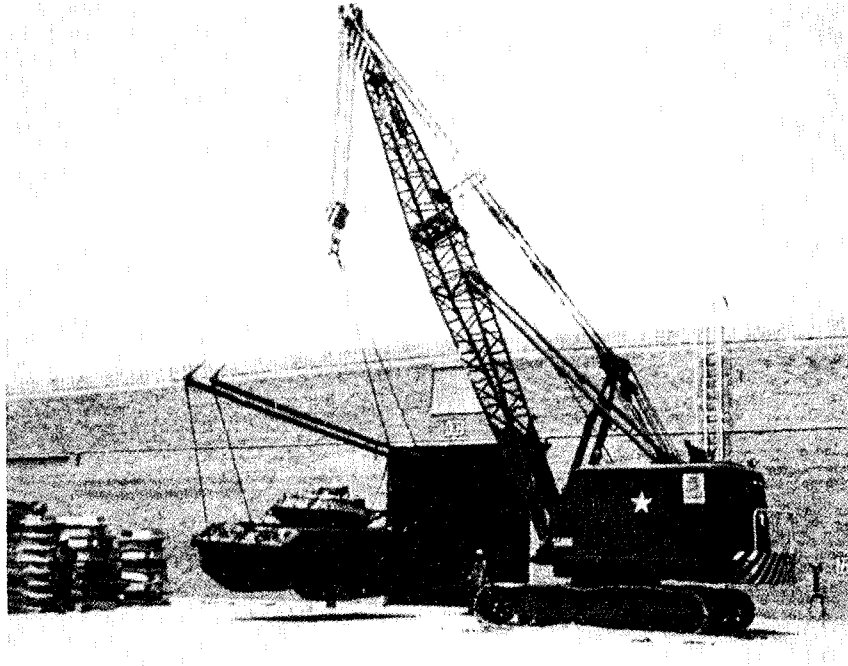

Figure 5-35 Crawler-mounted crane

(d) *Gantry crane.* The gantry crane is not equipped with a boom but consists of a hosting apparatus suspended above the ground by a gantry-type framework. It is a powerful crane of great lifting capacity (some with more than 100,000-pound

capacity). The gantry crane may be immobile, but more commonly it is mounted on rails (fig 5-36). It is very well suited to loading and unloading operations involving volume handling of very heavy, bulky items.

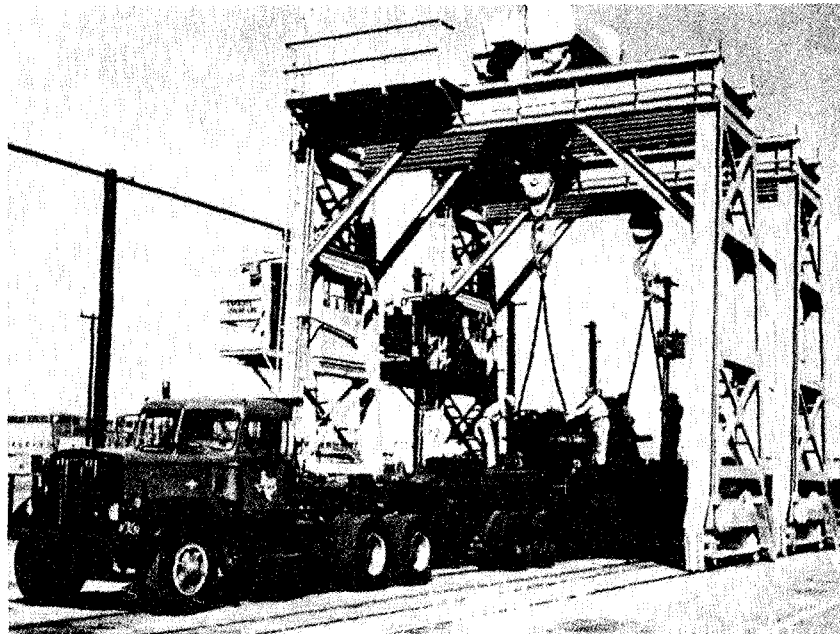

Figure 5-36 Rail-mounted gantry crane

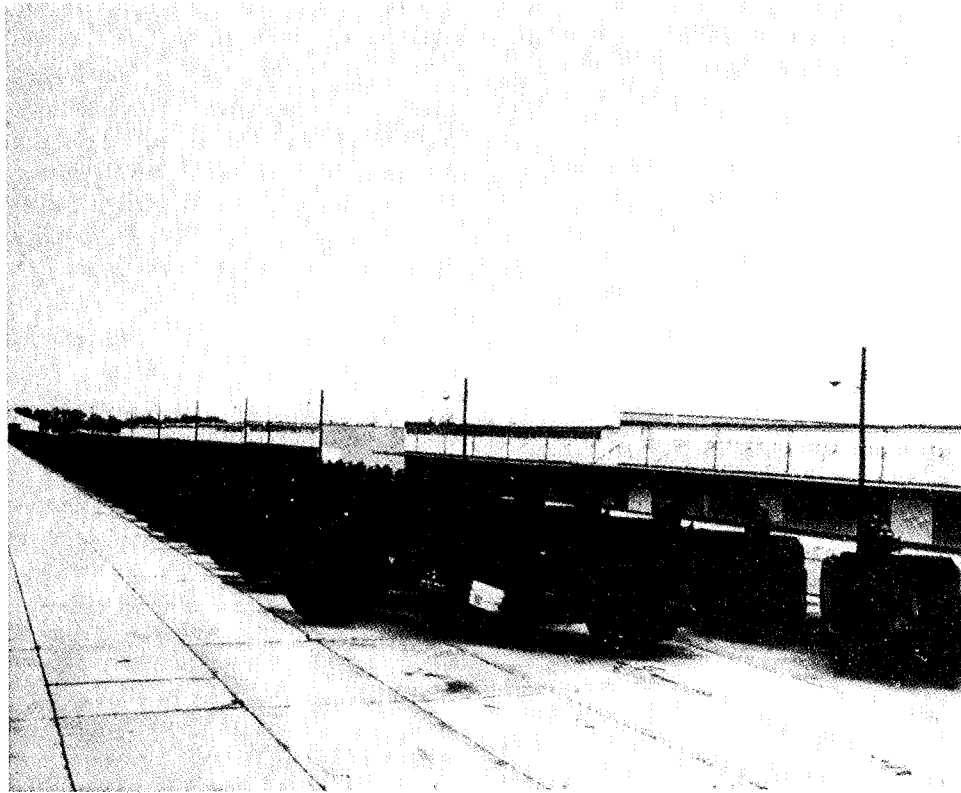

Figure 5-37 Modified back-to-back (herringbone) storage pattern

NOTE

This pattern allows items to be driven or maneuvered directly into their locations with minimal handling.

Section IV. Subsistence

5-17. Perishable Subsistence, Chill and Frozen Storage.

a. Prevention of deterioration.

(1) *General.* All chilled and frozen subsistence is highly perishable and subject to rapid deterioration when improperly stored. Storage at temperatures which are too high or too low, under unfavorable conditions of humidity, and in the absence of proper air circulation in unsanitary storerooms will result in rapid spoilage and eventual loss of the product. Most spoilage of chilled and frozen subsistence is caused by micro-organisms, particularly certain species of bacteria, yeast, and mold; the contamination spreads rapidly from the decayed items to the surrounding sound subsistence. Therefore, frequent inspection while in storage, followed by sorting and removal of the de-

cayed items or portions thereof, is of basic importance in maintaining the products in top condition and in keeping losses and surveys to a minimum.

All shipments should be segregated and marked in such a manner as will assure that the oldest lots are issued first, except when it may become necessary to issue a lot quickly to avoid loss by spoilage or when another lot of the same commodity is in a better condition for continued storage. Old lots of chilled or frozen subsistence should not be allowed to accumulate in storage rooms, but should be issued promptly or surveyed if unfit for use. Frozen products will not be accepted in a partially thawed condition, nor will such products be refrozen after having been defrosted.

(2) *Air circulation.*

(a) *General.* Along with proper temperature and humidity, air circulation in a storage room is an important factor in the proper storage of chilled and frozen stored subsistence. This is facilitated by stacking the products on pallets in such a manner that will provide a 4-inch wall clearance, 2-foot ceiling clearance, and sufficient working aisleway.

(b) *Fruits and vegetables.* Containers should be raised off the floor by the use of pallets and individual lots should be stacked so as to permit free circulation of air. In some cases, the use of a fan or duct system may be desirable to maintain proper circulation in all parts of the room. The introduction of outside air into cold storage rooms housing fruits and vegetables is not necessary. However, when fresh fruits and vegetables are stored in tight compartments at temperatures of 40 °F. or higher, the concentration of carbon dioxide produced by respiration may reach such a danger point that a match or candle will be extinguished. While this condition is not considered harmful to most products, personnel should not work in such rooms until a supply of fresh air has been introduced.

(c) *Quick-frozen fruits and vegetables.* Quick-frozen fruits and vegetables are highly perishable unless properly stored. Correct handling and proper storage of such foods are imperative in utilizing frozen foods to the best advantage. Upon delivery, quick-frozen fruits and vegetables should be transferred promptly to a low temperature storage space. Temperature of the load should be checked upon arrival by taking temperature readings of cartons selected from top layers inside shipping cases. If the temperature of the product is higher than the freezer room temperature, shipping cases should be scattered loosely about the room on hand-trucks or upon pallets on the floor with adequate space between individual cases to permit rapid lowering of the product temperature to freezer room temperature. The use of a portable fan to create an air current over the product will hasten temperature equalization. When the temperature of the product has been lowered sufficiently, cases should be stacked compactly. If the product temperature upon delivery is the same as or below temperature of freezer room, the cases should be stacked compactly immediately.

(d) *Meat, meat products, and poultry.* A prime factor in keeping the temperature in all parts of meat storage spaces at the recommended level is proper circulation of the refrigerated air. Meat items will not be stored on the bare floor; pallets should be placed on the floor to allow free circulation of air under all items stored in the

space. Generally, when the recommended temperature in all parts of the refrigerated space is uniform and is maintained within the stacks in the freezer space, the circulation of air may be considered to be adequate.

(e) *Dairy products and eggs.* To keep the air in a cold storage room fresh, the room must be kept clean and the air must circulate slowly. Ordinarily, adequate air circulation can be provided by the use of pallets on the floor and by proper stacking of the various lots. Egg cases should not be stacked more than five high to avoid pressure damage.

(3) *Transport and Storage Compatibility of Fresh Fruits and Vegetables.*

(a) *General.* Although it may be necessary to transport and store various fresh fruits and vegetables together, there are some products which should be separated whenever possible. Apples, pears, bananas, peaches, plums, cantaloupes, ripe honeydew melons, avocados, tomatoes, and other ethylene producing fruits or vegetables should not be stored with lettuce (causes russetting), carrots (become bitter), cucumbers, green peppers, acorn or Hubbard squash (loss of green color). Odors from apples and citrus fruits are readily absorbed by meat, eggs, and dairy products. Pears and apples acquire an unpleasant earthy taste and odor when stored with potatoes. Other combinations which should be avoided in storage rooms are apples or pears with celery, cabbage, or onions; celery with onions or carrots; green peppers with pineapples; and citrus fruits with any of the strongly scented vegetables. Green peppers can taint pineapples if the two are stored or shipped together. Onions, nuts, citrus fruits, and potatoes should each be stored separately whenever possible.

(b) *Perishable Subsistence Compatibility Groups.* For transport and storage, fresh fruits and vegetables have been divided into the following compatibility groups:

GROUP 1

Temperature: 32 °F. to 34 °F. (0 °C. to 1 °C.)

RH: 90 to 95 percent.

Atmosphere: Normally used in berries and cherries only—10 to 20 percent carbon dioxide (CO₂).

Ice: Never in contact with commodity.

Note. Most members of this group are not compatible with group 6a or 6b because ethylene production by group 1 can be high, and thus harmful to members of group 6a or 6b.

Apples (except those varieties listed in group 3)
 Apricots
 Berries (except cranberries)
 Cherries
 Figs (Not with apples, danger of odor transfer to figs; also see group 6a.)
 Grapes (Not fumigated with sulfur dioxide (SO₂) in vehicle and no chemicals that release SO₂ should be included in packages.)
 Peaches
 Pears
 Persimmons
 Plums and prunes
 Pomegranates
 Quinces

GROUP 2

Temperature: 55 °F. to 65 °F. (13 °C. to 18 °C.).
 RH: 85 to 95 percent.
 Ice: Never in contact with commodity.
 Avocados
 Bananas
 Eggplant (also see group 5)
 Grapefruit¹
 Guava
 Limes
 Mangos
 Muskmelons, other than cantaloupes
 Casaba
 Crenshaw
 Honey Dew
 Persian
 Olive, fresh
 Papayas
 Pineapples (not with avocados, danger of avocados' odor absorption)
 Tomatoes, green
 Tomatoes, pink (also see group 4)
 Watermelons (also see groups 4 and 5)

GROUP 3

Temperature: 36 °F. to 41 °F. (2 °C. to 5 °C.)
 RH: 90 to 95 percent; cantaloupes about 95 percent.
 Ice: In contact only with cantaloupes.
¹Citrus fruits—Biphenyl fungicide may impart off odors to other commodities.
 Apples (Grimes Golden and Jonathan (both, certain areas), Yellow Newton (California), and McIntosh.)
 Cantaloupes

Cranberries
 Lemons¹ (use 50 °F. to 55 °F. (10 °C. to 13 °C.) for more than a month)
 Lychees (also see group 4)
 Oranges¹ (Florida or Texas)
 Tangerines

GROUP 4

Temperature: 40 °F. to 45 °F. (4 °C. to 7 °C.); beans 38 °F. to 42 °F. (3 °C. to 6 °C.).
 RH: About 95 percent.
 Ice: Never in contact with commodity.
 Beans, snap
 Lychees (also see group 3)
 Okra
 Oranges¹ (California or Arizona)
 Peppers, green (not with beans)
 Peppers, red (if with green peppers, temperature adjusted toward top of range)
 Squash, summer
 Tomatoes, pink (also see group 2)
 Watermelons (also see groups 2 and 5)

GROUP 5

Temperature: 50 °F. to 55 °F. (10 °C. to 13 °C.); ginger not below 55 °F.
 RH: 85 to 90 percent.
 Ice: Never in contact with commodity.
 Cucumbers
 Eggplant (also see group 2)
 Ginger (not with eggplant, also see group 7)
 Potatoes (late crop)
 Pumpkin and Squashes, winter
 Watermelons (temperature adjusted for other members of group; also see groups 2 and 4).

GROUP 6a

This group, except for figs, grapes, and mushrooms, is compatible with group 6b.
¹Citrus fruits—Biphenyl fungicide may impart off odors to other commodities.
 Temperature: 32 °F. to 34 °F. (0 °C. to 1 °C.).
 RH: 95 to 100 percent.
 Ice: Never in contact with asparagus, figs, grapes, and mushrooms.
 Artichokes
 Asparagus
 Beets, red
 Carrots
 Endive and escarole
 Figs (also see group 1)

Grapes (Not fumigated with SO₂ in vehicle and no chemicals that release SO₂ should be included in packages.)

Greens

Leek (not with figs or grapes)

Lettuce

Mushrooms

Parsley

Parsnips

Peas

Rhubarb

Salsify

Spinach

Sweet Corn

Watercress

GROUP 6b

This group is compatible with group 6a, except for figs, grapes, and mushrooms.

Temperature: 32 °F. to 34 °F. (0 °C. to 1 °C.)

RH: 95 to 100 percent.

Ice: Contact acceptable for all.

Broccoli

Brussels sprouts

Cabbage

Cauliflower

Celeriac

Celery

Horseradish

Kohlrabi

Onions, green (not with rhubarb, figs, or grapes; probably not with mushrooms or sweet corn).

Radishes

Rutabagas

Turnips

GROUP 7

Temperature: 55 °F. to 65 °F. (13 °C. to 18 °C.)

RH: 85 to 90 percent.

Ice: Never in contact with commodity.

Ginger (also see group 5)

Potatoes, early crop (temperatures adjusted for others)

Sweetpotatoes

GROUP 8

Temperature: 32 °F. to 34 °F. (0 °C. to 1 °C.)

RH: 65 to 70 percent.

Ice: Never in contact with commodity.

Garlic

Onions, dry

The above information was extracted from Lipton, W.J. and J.M. Harvey, Compatibility of Fruits and Vegetables During Transport in Mixed Loads, U.S. Department of Agriculture, Agricultural Research Service, ARs 51-48 (September, 1972).

(c) *Chill injuries to certain products.* Although the shelf lives of many fruits and vegetables are significantly extended by storage at 32 °F., there are some fruits and vegetables which are subject to chill injury when stored at low but nonfreezing temperatures.

Commodity	Approximate lowest safe temperature F°	Character of injury when stored between 32 °F and safe temperature
Apples: Grimes Golden (certain areas) Jonathan (certain areas), Yellow Newton (certain areas), McIntosh	36-38	Internal browning, brown core, soggy breakdown, soft scald
Asparagus	36	Chill damage
Avocados	40-55	Grayish-brown discoloration of flesh
Bananas, green or ripe	53-56	Dull color when ripened
Beans (snap)	45	Pitting and russetting
Cranberries	36	Rubbery texture, red flesh
Cucumbers	45	Pitting, water-soaked spots, decay
Eggplants	45	Surface scald, alternaria rot
Grapefruit	50	Scald, pitting, watery breakdown
Lemons	52	Pitting, membranous staining, red blotch
Limes	45-48	Pitting
Mangos	50-55	Grayish scaldlike discoloration of skin, uneven ripening.
Melons		
Cantaloupes	36	Pitting, surface decay
Honey Dew	45-50	Pitting, surface decay, failure to ripen
Casaba	45-50	Pitting, surface decay, failure to ripen
Crenshaw and Persian	45-50	Pitting, surface decay, failure to ripen
Watermelons	40	Pitting, objectionable flavor
Okra	45	Discoloration, water-soaked areas, pitting, decay
Olives, fresh	45	Internal browning
Oranges, California and Arizona	38	Pitting, brown stain
Papayas	45	Pitting, failure to ripen, off flavor, decay
Peppers, sweet	45	Sheet pitting, alternaria rot on pods and calyxes

Commodity	Approximate lowest safe temperature F°	Character of injury when stored between 32 °F and safe temperature
Pineapples	45-50	Dull-green when ripened
Potatoes	38	Mahogany browning (Chippewa and Segao), sweetening
Pumpkins and hardshell squashes.	50	Decay, especially alternaria rot
Sweetpotatoes	55	Decay, pitting, internal discoloration
Tomatoes, ripe	45-50	Watersoaking and softening, decay
Mature-green	55	Poor color when ripe, alternaria rot

(4) Recommended average storage period for frozen perishable subsistence.

(a) *Temperature.* Storage temperature for all frozen subsistence items shall not exceed 0 °F. During shipment, the temperature shall not be higher than 10 °F. For ice cream, the recommended temperature is -10 °F. and in no case should the temperature exceed 0 °F.

(b) *Condition.* The recommended average storage periods listed for frozen items are based on the assumption that products delivered to the Government were processed and procured in accordance with current specifications and were in good condition at time of delivery. Condition should be the deciding factor when determining if an item is suitable for shipment to an overseas area. Exception to this rule is listed in (f) below. In no case should a product received in a thawed state be re-frozen for storage. Thawing will reduce the average storage life of most frozen subsistence items below the desired economical storage period.

(c) *Packaging.* The nature and condition of the packages are important factors which influence storage life expectancy. Example: packaging materials permeable to water vapor or which are defective will permit dehydration by sublimation (freezer burn) or other defects and materially detract from the quality and appearance of the stored product. A program should be established to re-seal

or repackage all damaged frozen cargo before it is stored or transshipped.

(d) *Detection of deterioration.* Deterioration due to time in storage and/or variations in temperatures can be detected by organoleptic inspection for such defects as dehydration (freezer burn), undue softness or mealy texture, discoloration, off odor, evidence of weeping and evidence of rancidity, and/or mold.

(e) *Initial quality or grade.* The initial quality of a product at time of receipt by the Government is an important factor which influences storage life expectancy. Initial quality of the product is determined by method of processing and handling as well as the grade of the ingredients.

(f) *Limitations.* Frozen subsistence items with a recommended average storage life of 3 months or less should not be stored for shipment to overseas areas. Such items will have exceeded the recommended storage life prior to issue in overseas areas. Prior to shipping frozen subsistence items with a recommended average life of less than 6 months, a careful inspection by veterinary personnel should be made with a view toward assuring that there is sufficient storage life remaining to enable routine issue within the overseas command.

(g) *Approximate storage life.* Storage life is the total elapsed time from date of pack to date of issue for immediate consumption. The approximate storage life given in tables below is the best estimate of expected life, based upon experience gained through subsistence procured and stored in accordance with the applicable specifications and regulations. Specific lots of subsistence may be expected to show signs of quality loss within +20 percent of the time listed. Therefore, procedures shall be established to provide surveillance from time of receipt until the subsistence is issued and consumed. The frequency of inspection should be established through actual experience with various products and as prescribed in pertinent military publications.

Table 5-1 Storage Life of Frozen Subsistence (0 °F. or Below)

See footnotes at the end of the table.

	Approximate storage life (months)
Apples	18
Apple juice, concentrated	30
Asparagus	12
Bacon ^{2,3}	
slab, vacuum packed	12
sliced, nonvacuum pack	2
sliced, vacuum pack	6

Table 5-1 Storage Life of Frozen Subsistence (Continued)
(0 °F or Below)

See footnotes at the end of the table

	Approximate stor- age life (months)
Canadian	9
Beans	
green	12
lima	14
wax	12
Beef ²	
boneless, fabricated	12
carcass, wholesale cuts	12
corned	12
diced	12
dried, sliced	9
ground, bulk	12
ground, patties	9
liver, whole or portion cut	6
tongue	6
Blackberries	18
Blueberries	18
Bologna ^{2,3}	6
Boysenberries, dewberries, loganberries, youngberries	8
Bread dough ²	6
Bread yeast raised (and rolls fresh)	6
Broccoli	14
Brussels sprouts	12
Burritos	9
Butter prints and patties ²	48
Cakes, coffee, layer, loaf, cheese	12
Carrots	12
Cauliflower	14
Cervelat ^{2,3}	
dry	12
soft (thuringer)	6
Cherries, RTP and dark, sweet, pitted	24
Cheese, pizza blend, shredded	12
Chicken	12
Chitterlings	
raw	3
precooked	12
Clams, shucked ²	9
Corn	24
Corn on the cob	9
Crabs	9
Cranberry juice cocktail	24
Dates	12
Duck ²	12
Egg roll	6
Eggs	
whole (including table grade) ²	12
whites ²	12
yolks, sugar or salt added	12
Enchiladas	9
Fish	
fish fillets, steaks ²	
fatty (mackerel, salmon)	3
moderately fatty (halibut, perch, rockfish)	6
lean (cod, haddock, flounder)	9
fish sticks and portions	12
Frankfurters ^{2,3}	
carton	3
flexible package	9
Giblets, chicken/turkey, hearts and gizzards	12
Grape juice, concentrated	24

Table 5-1. Storage Life of Frozen Subsistence (Continued)
(0 °F. or Below)
See footnotes at the end of the table.

	Approximate stor- age life (months)
Grapefruit juice, concentrated	24
Grapefruit-orange juice, concentrated	24
Grapefruit sections	12
Greens, leafy	14
Hams ²	12
Ice cream, sherbets or ices	6
Ice cream, novelties	9
Lamb ²	
carcass, wholesale cuts	12
cutlets, boneless (restructured)	10
slices, chops	10
telescoped	12
Lard	12
Lemon juice, concentrated	24
Lemonade, concentrated	24
Lime juice, concentrated	24
Lime juice, single strength	24
Lobster tail ²	9
Lobster, whole ²	9
Luncheon load ^{2,3}	6
Manicotti	6
Margarine, prints and patties ^{2,3}	48
Meal, precooked (TV dinners, pot pies, etc) ^{1,6}	6
Milk fat anhydrous ²	12
Milk, pasteurized, homogenized ²	3
Milk, whole, concentrated ^{2,4}	3
Okra	18
Onion rings, french fried and raw	14
Orange juice, concentrated	24
Oysters ²	12
Pastrami	12
Peaches	18
Peas	
black eye	12
dehydrofrozen	14
green	14
Peas and carrots	14
Pepperoni	12
Peppers	14
Pies, fruit, baked and unbaked ²	
cream filled	6
fruit filled	12
Pineapple	12
Pineapple juice, concentrated	24
Pizza	6
Pizza shells ²	6
Pork ²	
bulk	6
links, patties	3
barbecued	12
cutlets, boneless (restructured)	9
diced and sliced (restructured)	9
hocks, fresh	12
hocks, smoked	12
loin, boneless, fabricated	12
slices, chops	12
wholesale cuts	12
Potatoes	
white, french fried, precooked rounds	12
white, hash brown	12
Rabbit ²	

Table 5-1 Storage Life of Frozen Subsistence (Continued)
(0 °F. or Below)

See footnotes at the end of the table.

	Approximate stor- age life (months)
ready-to-cook	12
ready-to-cook, cut up	12
Raspberries	18
Rhubarb	18
Ravioli	6
Salami ^{2,3}	
cooked	6
dry	6
Sausage ^{2,3}	9
liver	9
New England style	6
pork, bulk style	6
pork patties	3
pork, precooked, Polish, Italian	9
pork and beef, precooked	9
Scallops ²	9
Scrapple	6
Shrimp ^{2,7}	
raw, peeled/unpeeled	9
raw, breaded, molded	9
Soups ⁵	12
Spinach	12
Spinach, chopped	12
Squash, summer and fall, cooked	12
Strawberries	18
Succotash	12
Sweet goods, yeast raised ²	6
Tamales	9
Topping, dessert	24
Tortillas, corn or wheat	12
Turkey ²	
boneless, cooked	6
boneless, raw	6
whole, ready-to-cook	9
Veal	12
Vegetables, mixed	12
Waffles	12

¹ Any evidence that meal has been thawed is reason for discarding.

² Many of the products listed herein are also storable under chill conditions (above 32 °F.). See 5-17a(4).

³ These products suffer deteriorative changes as a result of freezing. If frozen storage is necessary, storage times indicated will tend to minimize rancidity development.

⁴ Storage life above 0 °F. is 4 months.

⁵ Cream-style soups which have broken down during freezing will be satisfactory when heated.

⁶ These meals may be used for their intended purpose up to 9 months after date of pack provided surveillance inspections, performed at least every 30 days subsequent to the 6-month period, result in the product being accepted for consumption.

⁷ The quality of frozen shrimp will deteriorate within 30 days if held between 14 °F. and 18 °F.

(5) *Chill storage of perishable subsistence freezing point, storage temperature, RH, and storage life.* The following table (table 5-2) is for the guidance of personnel in computing the storage life of subsistence held in chilled storage. Many of the considerations mentioned in paragraph a(1), section D, above are applicable to chilled storage. The storage periods given are applicable only to products processed and procured in accordance with specifications.

(a) *Temperature.* Chill storage is generally within a temperature range of 32 °F. to 35 °F. For

some items, better quality is maintained at temperatures higher or lower than these are shown as accepted storage temperature. Some items are damaged by slow freezing; for these, the average freezing points are given.

(b) *Humidity.* Preferred RHs shown in the table are those which best inhibit the gain or loss of moisture in the item. Storage at higher RHs may allow water to condense on or be absorbed in the item, while at lower RHs, the item may dry and shrink.

Table 5-2. Storage Life of Perishable Substances
See footnotes at the end of the table

Item	Freezing point °F	Optimum RH (%)	Approximate storage life (days)			Remarks
			32-35 °F	35-45 °F	45-55 °F	
Artichokes						
Globe	30	90-95	14-30			
Jerusalem	28	90-95	150			
Apples						
Red Delicious, Washington (other varieties, see footnote 1).	30	90	120-150			Stalks continue growing above 36 °F
Apricots	30	90-95	7-21			Best storage at 40-45 °F.
Asparagus ^{2,3}	31	95+	14-21			Chill injury below 50 °F.
Avocados ²						
Lula, Both varieties ⁴	31	85-90		14-30		
West Indian varieties	31	85-90				
Bacon ⁵						
Slabs		90	60			
Sliced		90	60			
Bananas						
Green	30	90-95				7-10 days at 56-58 °F.
Ripe	30	85				3-4 days at 56-58 °F. (temp below causes chill injury)
Beans						Alternate Storage temp 56-70 °F.
Green or Waxed	31	95+				
Limas, Shelled	31	95		10		7
Beef						
Carcass, whole sale cuts		85-90	6			
Corned		85-90	45			
Cryovaced		85-90	21			
Dried, Sliced		85-90	45			
Ground		85-90	1-4			
Tongue, Fresh		85-90	7-10			
Tongue, Smoked		85-90	35-42			
Beets						
Bunched	31	95-100	10-14			
Topped	30	95-100	120-180			
Berries						
Strawberries	31	90-95	5-7			
Blueberries	30	90-95	7-15			
Elderberries	30	90-95	7-14			
Huckleberries	29	90-95	7-15			
Gooseberries	30	85-90	14-28			
All others	31	90-95	2-3			
Bologna ⁵						
Lebanon		85-90	60			
50% Beef		85-90	30			
Broccoli ²	31	95+	14-21			
Brussels Sprouts	30	90-95	21-35			

Table 5-2. Storage Life of Perishable Subsistence (Continued)
See footnotes at the end of the table

Item	Freezing point °F	Optimum RH (%)	Approximate storage life (days)				Remarks
			32-35 °F	35-45 °F	45-55 °F	-10 °F and below=365 days	
Butter	80-85	60	60	
Cabbage, early	30	90-95	21-42	
Cabbage, late	30	90-95	90-120	
Cantalopue	
Hard ripe ⁷	30	90-95	7-14	
Full Slip	30	90-95	5-14	
Carrots ^{6,8}	
Mature, topped	30	98-100	120-150	
Immature, topped	30	98-100	28-42	
Bunched	30	95-98	10-14	
Casaba melon	30	90-95	28-42	
Catsup ⁹	
Boat, Envelopes	80-90	180	135	
Cup, Foil Pouch	365	270	
Cauliflower ⁶	31	95+	14-28	
Celeriac	30	95+	90-120	
Celery	31	95	60-90	
Cervelat ⁵	
Dry ¹⁰	75-80	60	
Soft (Thuringer)	85-90	15	
Cherries	
Sweet ^{2,11}	29	90-95	14-21	
Chicory	30	85-98	10	14	
Chives, Potted	30	90-98	14	
Cheese	
Blue-Nat	70	90-180	
Cheddar-Nat	25	70	365	
Cheddar-Shredded	25	65-70	180	
Cottage	30	70	10-15	
Cream (hot pack)	70	60	
Cream Cheese	70-75	120	
Mozzarella, Nat	70	30	
Process American: Swiss Loaf	25	70	180-300	
Sliced	70	180	
Parmesan, Nat	70	300-720	
Pizza Blend	70	180	
Provolone, Nat	70	90-360	
Romano, Nat	70	300-720	
Swiss, Nat	25	70	240-360	
Chocolate Drink	29	12	7	
Clams, Shucked	4	
Cookie Dough	60-90	14-21	
Corn-on-the-Cob ²	31	95	4-8	
Cranberries	

Table 5-2. Storage Life of Perishable Substance (Continued)
See footnotes at the end of the table

Item	Freezing point °F	Optimum RH (%)	Approximate storage life (days)			Remarks
			32-35 °F	35-45 °F	45-55 °F	
Fresh	30	95+	60-120	180	
Sauce, Cup ⁹	
Creams						
Half and Half	31	10	
Sour, Cultured	31	20	
Table, including filled	31	10	
Whipping	31	10	
Whipping, UP ¹²	31	28	
Crenshaw Melon	30	90-95	14	
Cucumbers	31	90-95	10-14	
Currants	30	90-95	7-14	
Casheens (Taro Root)	30	98-100	60-120	
Dates, Pitted, Cured	1-5	70	
Eggnog	28	180	
Eggnog (UP)	28	14-21	
Eggs, Shelled						
Fresh	27	80-85	30	Best Storage 29-31 °F
Oil Processed	27	70-80	60	Best Storage 29-31 °F
Egg Plant ^{2,7}	31	90-95	7-14	
Fennel	30	90-98	60-120	
Figs, Fresh	27	85-90	7-10	
Frankfurters						
Carton	85-90	15	
Flex Pkg	85-90	30	
French Dressing	31	50-60	90	
Fruitcake, Fresh	50-60	300	
Fruits, Dry	22-26	50-60	360	
Garlic, Dry	31	65-70	360	270	180	
Grapefruit ¹³	30	85-90	180-210	28-42	
Grapes						
American ¹⁴	30	80-85	15	
European	28	90-95	90-180	
Greens						
Endive, Escarole ⁶	32	95+	14-21	
Collard, Kale, Beet, others	31	95	10-14	
Ham ⁵						
Cured, Canned	60-65	270	
Bnls, Ckd	85-90	30	
Smoked ¹⁰	85-90	30	
Honeydew/Honeyball Melon	31	90-95	14-21	
Horseradish, Prepared	30	
Horseradish, Root	29	95-100	90	
Jams, Jellies, Preserves:						
Boat, cup ⁹	80-90	300-365	180	
Foil pouch ⁹	365	

Table 5-2. Storage Life of Perishable Subsistence (Continued)

See footnotes at the end of the table

Item	Freezing point °F	Optimum RH (%)	Approximate storage life (days)			Remarks
			32-35 °F	35-45 °F	45-55 °F	
Kohlrabi ²	30	95+	14-28			
Kumquats	29	85-90	60-120			
Lamb Carcass ⁵		85	7-10			
Lard, Service Style		90-95	120-240			
Leeks	31	95+	30-90			
Lettuce, Iceberg						
Wrapped	31.7	95-100	21-42			
Naked	31.7	95-100	14-21			
Table-ready	31.7	95-100	5-7			
Lettuce, Romaine	31.3	95-100	5-8			
Lobster, Live						32-50 °F —Check daily. (30-120 days at 55-58 °F.)
Lemons ¹⁵	28	85-95			14-21	
Lemon Juice	30				125	
Limes	29	85-90			42-56	
Luncheon Loaf		85-90	14			
Mangos	30	85-90				
Margarine ¹⁶		40-60	90		60	14-21 days at 50-55 F Chill injury below 50 °F
Milk:						
Buttermilk	31		14			
Choc. Flavored			10			
Choc. Flavored UP ¹²	29		28-35			
Concentrated	29		10			
Fluid, Past.	30		7-10			
Fluid, Homo (UP) ¹²	31		28			
Ice or Shake Mix, Fresh	31		10			
Mushrooms	30	90-95	3-5			
Mustard ⁹						
Boat, Envelope	30	80-90			90	
Cup, Foil Pouch	30				270	
Nectarines	30	90	14-30			
Okra	31	85-95				
Olives	29	85-90	28		14	
Onions						
Bermuda	30	65-70	30-60			
Glove	30	65-70	180-240			
Green, Iced Top	30	95	10-28			
Spanish	30	65-70	90-180			
Peeled or Green	31	65-70	5-7			
Oranges						
CA, AZ ¹⁷	30	85-90		21-56		
FL, TX	30	85-90				
Temple, Tangelos	30	90-95		14-28		
Sections Pasteurized				540		
Orange Juice	30		21			
Oysters on Ice			4			

Table 5-2. Storage Life of Perishable Substance (Continued)
See footnotes at the end of the table

Item	Freezing point °F	Optimum RH (%)	Approximate storage life (days)			Remarks
			32-35 °F	35-45 °F	45-55 °F	
Papaya	30	85-90	7-12	
Parsley	30	95	30-60	
Parsnips	30	98-100	60-180	
Peaches ²	30	90-95	14-30	
Peanut Butter:						
Boat, Envelope		50	180	120	90	
Cup, Foil Pouch		50	365	270	180	
Pears ^{2,18,4}	29	90-95	60-240	
Peas, Unshelled	31	95	7-14	
Peppers, Sweet	31	92-95	14-21	
Peppers, Dry, Chili		60-70	180	180	180	
Pepperoni, Dry ⁵		75-80	45	
Persian Melons	31	90-95	14	
Persimmons	28	90	90-120	
Pies						
Fruit, Fresh		80-85	3	
Fried, Fresh		80-90	5	
Pineapple						
Mature, Green ⁷	30	85-90	14-28	
Ripe ²	30	85-90	14	
Plums	30	90-95	21-35	
Pomegranates	27	90	60-120	
Pork						
Whsle, Cut ⁵		85-90	5	
Cryovac		85-90	14	
Poultry	27	95-100	12-18	6-12	2-4	Chill injury below 50 °F. 90-120 days at 50-60 °F.
Potatoes						
Sweet ^{2,7}	30	85-90	
Potatoes, White ¹⁹						
Early, Uncured	31	95	60-90	
Early, Cured	31	95	120-150	
Late Crop	31	95	150-240	
Peeled, Table Ready	31	95	5-9	
Prunes, Ital.	30	90-95	14-28	
Pumpkins	31	60-70	30-180	
Quinces	28	90	60-90	
Radishes						
Spring, Topped, Poly-bag	31	95+	21-30	
Spring, Table Ready	31	95+	10-12	
Winter, Topped	28	95+	90-120	
Rhubarb	30	95	14-30	
Rolls, Brown and Serve		80-85	21	
Rutabagas	30	95+	120-180	
Salad Dressing, All ⁹		80-90	180	120	90	
Salmon Stks		85-90	12	

Table 5-2. Storage Life of Perishable Substance (Continued)
See footnotes at the end of the table

Item	Freezing point °F	Optimum RH (%)	Approximate storage life (days)			Remarks
			32-35 °F	35-45 °F	45-55 °F	
Salami ^{5, 10}						
Dry		75-80	45			
Cooked		85-90	15			
Salsify	29	95-98	60-120			
Sausage ⁵						
Liver		85-90	14			
New England Style		85-90	10			
Scallops		85-90	4			
Shallots	32	95	10-28			Freeze injury below 32 °F
Shortening Compound		55	1,800	1,800		
Shrimp, Unpeeled, Iced			10-12			
Syrup, Imitation Maple, etc. ⁹				365		
Spinach ²	31	80-90	7-14			
Squash		95				
Fall, Winter, Hubbard	30	70-75				
Acorn	31	70-75				180
Butternut	30	50				35-56
Summer	31	90-95	4-5	4-5		60-90
Swiss Chard ²	31	95	10-14			10-14
Tangerines	30	85-90	14-28			
Tomatoes						
Mature Green ^{2, 7}	31	85-90				
Pink	31	85-90				7-10
Firm, Ripe	31	85-90				4-7
Full Color	31	85-90	21			
Turnips	30	95	120-150			
Veal and Calf ⁵		85	6			
Watercress	31	90-95	7			
Watermelon ²	31	85-90	14-21			
Yeast, Bakers						
Active, Dry		60-70	365	548		
Compressed Cake		80-90	30-40			
Yogurt, Plain or Fruit Flavored	30		30			

Table 5-2. Storage Life of Perishable Subsistence

Variety	Storage period (months)	
	Normal	Maximum
Baldwin	4 to 6	7
Cortland	3 to 4	5
Delicious	4 to 5	8*
Golden Delicious	4 to 6	8*
Gravenstein	0 to 2	3
Grimes Golden (some areas 34-36 °F)	2 to 3	4
Johnathan (some areas 35-36 °F.)	2 to 3	4
McIntosh (some areas 38 °F.)	2 to 4	5
Northern Spy	4 to 5	8
Rhode Island		
Greening	3 to 4	6
Rome Beauty	4 to 5	7
Stayman Winesap	4 to 5	6
Wealthy	0 to 2	3
Winesap	5 to 7	8
Yellow Newton (CA 38 48 °F.)	5 to 6	8
York Imperial	4 to 5	6

*Stored in polyethylene bag liners (unsealed)

Storage of pear varieties at 30 °F to 31 °F	Length of storage period (months)
Stored immediately after harvest at 30 °F to 31 °F	
Anjou	4 to 6*+
Bartlett, Comice, Hardy, and Kieffer	2 to 3
Bosc and Seckel	3 to 4*+
Packam	5 to 6
Winter Nelis	6 to 7

*Stored in polyethylene bag liners (unsealed).

+ The storage life of Anjou, Bartlett, Bosc, and Comice pears may be extended for an additional 1-2 months by packaging in polyethylene liners

¹ The length of time apples can be held successfully in cold storage at 32 °F, unless otherwise specified, will vary with the variety and with the district where grown as well as with their condition when harvested. Controlled atmosphere can extend storage life an additional 2 to 4 months.

² Commodities not recommended for export, but which are suitable for immediate use by shore activities and by ships in port or shortly after sailing

³ Asparagus held too long at 32 °F. is subject to chill injury The butts of asparagus should be placed in absorbent material during storage

⁴ Pears—Length of safe storage for certain varieties of pears

⁵ Carcasses and cuts: Quarters, carcasses, and cuts of beef, lamb, and veal should be hung or placed on racks when in chill space. If such items are in a solid frozen condition when received, stow as compactly as possible in the freezer space Frozen boneless beef should be stacked compactly Veal carcasses or cuts, particularly of the lighter weights and lower grades, are subject to rapid deterioration Holding time of such items in the chill space should be a minimum. Fresh chilled pork cuts should be treated as highly perishable

Variety meats and sausage: Such items are highly perishable Hold storage time to a minimum.

Cured and smoked meat: The keeping qualities of cured and smoked meats depend upon the type of cure, the length of the smoking period, and the method of packaging. The storage life of such items is further influenced by the condition of the storeroom with regard to humidity, temperature, and sanitation.

Growth of mold and development of rancidity in hams and bacon can be retarded by stowing such items in the chill space for current consumption and in freezer space for seasonal stocks Since the growth of mold on cured and smoked meats is favored by the presence of condensed water, excessive humidity should be avoided. If the RH is higher than recommended, it is essential that good circulation of air be maintained.

Hams and bacon which have been individually wrapped in one or more layers of paper have a tendency to retain, upon the surface of the meat, any moisture which may have come from the product after wrapping. This moisture, in a measure, stimulates mold and bacterial growth. If hams so wrapped are held in temperatures of 45 °F. or above for a considerable length of time, mold and slime will form on the surface of the meat Surface slime and mold make the ham unattractive and unpleasant to handle, but do not necessarily indicate spoilage. Accordingly, such products should be carefully inspected to determine how far the mold has penetrated. In most cases, where only the surface is affected, the mold can be removed from the meat by brushing with a stiff-bristled brush, wiping with a clean cloth moistened with a vinegar or salt-water solution, and allowing to air dry When the mold growth is heavy, it may be trimmed away. If the ham does not have deep cracks or abrasions, the meat underneath the surface usually is found to be perfectly sound and wholesome When mold growth or spoilage is evidenced deeply between the muscles and around the bone, a survey is usually necessary

⁶ This item keeps better unwashed.

⁷ Damage will result if item is stored at lower temperature than indicated.

⁸ Carrots may become bitter if stored with fruits which give off ethylene such as apples and pears. If carrots are bitter, they should be stored in a room temperature for several days before use.

⁹ Keeping time in uncontrolled storage (dry space) is less than 3 months because of desiccation and because of swelling due to microbial activity.

¹⁰ Very susceptible to mold growth on surface. Inspect and wipe often.

¹¹ Sweet cherries packed in sealed polyethylene bag liners can be stored for up to 21 days.

¹² Imperfect seals will reduce shelf life.

¹³ The refrigerated storage of Florida grapefruit is not recommended for more than a limited period and, then, only if the fruit is inspected at intervals. Grapefruit is very susceptible to rind pitting and aging at comparatively low temperatures, especially around 38 °F. At higher temperature such as 50 °F., the rapid development of decay is troublesome.

¹⁴ Not recommended for export since the European type of grape from California with better keeping quality is available during the same period.

¹⁵ Foothill grown lemons store better than coastal grown lemons, especially late picked; at Receiving Markets, only "Strong" lots of lemons should be stored and frequently inspected.

¹⁶ Soybean oil margarine is considered by some authorities to be less stable than cottonseed oil margarine.

¹⁷ California and Arizona varieties are more susceptible to low temperature rind disorders

¹⁸ For best ripening, pears should be held at about 65 °F. for 2 to 3 days prior to serving

¹⁹ Early and intermediate crop potatoes may possess better or poorer keeping qualities than potatoes show on the table. Many lots of early potatoes are too immature for export, and some intermediate crop potatoes are not suitable for export because of poor quality and condition. Extreme care must be exercised in the selection of potatoes for export from the middle of May to the middle of August. The quality and condition of available supplies must govern the final choice between old and new crop stock for export during the first part of this period, and such factors also must govern the choice of stocks of new crop potatoes for export later in this period.

(c) *Approximate storage life.* Storage life is the total elapsed time from date of pack to date of issue for immediate consumption. The approximate storage life given in table 5-2 is the best estimate of expected life based upon experience for subsistence procured and stored in accordance with applicable specifications and regulations. Specific lots of subsistence may be expected to show signs of major quality loss within +20 percent of the time listed. Therefore, procedures shall be established to provide surveillance from time of receipt until the subsistence is issued and consumed. The frequency of inspection should be established through actual experience with various products and as prescribed in pertinent military publications. Storage life will be somewhat lessened depending on the extent of deviation from the ideal storage temperature and RH conditions cited in (a) Lutz, J.M., and Hardenburg, R.E., U.S. DA Agriculture Handbook, No. 66 (1977), the Commercial Storage of Fruits, Vegetables, and Florist and Nursery Stocks and (b) the Refrigeration Research Foundation, Commodity Storage Manual, 1982.

5-18. Semiperishable Subsistence in Dry Storage.

a. *The product.* The term semiperishable subsistence refers to food items that are canned, dried, dehydrated, or otherwise processed to the extent that such items may, under normal conditions, be stored in nonrefrigerated spaces. Semiperishable subsistence too often is regarded as nonperishable commodities which do not require care or protection in storage. While semiperishable subsistence is not nearly as susceptible to spoilage as perishable subsistence, spoilage can and will occur if the products are mishandled, improperly stored, or stored for excessive periods of time. It is important to remember that the

length of storage should be based on the date of packing and not on the date of receipt.

b. *Storage.* Careful, correct storage methods prevent damage to items in storage and assure speed and efficiency in the receipt, handling, and issue of such items. Shipments should be segregated and clearly marked so that the oldest lots, as packed and not as received, are issued first, unless the newer lots show evidence of deterioration or spoilage. The particular method used for storing each item depends on the nature of the container, the nature of the commodity, and the breaking strength of the bottom layers. For example, items packed in glass containers with cork stoppers should be inverted to prevent the drying out of the cork.

(1) *Storage precautions.* Care should be taken that items are not stacked so high as to cause a bursting or crushing of the bottom layers; nor should items be stacked so high that the top layer is subject to the higher temperature more prevalent near the ceiling or overhead. Stacking in close proximity to steam or other heated pipes shall be avoided. Use pallets to raise subsistence off the floor and pile individual lots to permit the circulation of air around the lots. Bagged items and those requiring fumigation and insect control should not be stored in large masses in corners of the storeroom or directly against the walls; such storage leaves insufficient room for cleaning and inspecting. Palletized storage is used as this facilitates handling of the stores and reduces losses by breakage in handling. All items should be properly cross stacked to keep the stack solid and prevent it from toppling.

(2) *Storage periods (keeping time).* The safe storage period for dry subsistence items varies greatly, depending on such elements as tempera-

ture, humidity, care in handling, protection from weather, quality of the food when received, and the packing. Safe storage periods become very uncertain at extremes of temperature and under combat conditions. The fact that subsistence has been on hand up to the limit of the "safe" storage period does not mean that the subsistence should be surveyed but should be consumed as soon as practicable. Subsistence which has been on hand beyond the safe storage period should be inspected carefully for spillage, leakage, or other damage and, if still good, issued as soon as possible; such items will be given priority of issue over newer stocks.

c. Causes of spoilage.

(1) *Age.* All foodstuffs are subject to varying degrees of natural deterioration; this deterioration is inherent in the food itself. It should not, however, be confused with the action of micro-organisms, chemical agents, or other outside agents. Such facts compel an observance of the basic principle of storage that the oldest lots of the item always should be used first, except under conditions indicated in *a*(1) above.

(2) *Insects (roaches, flies, weevils, and moths).* Insects can cause great damage to stored food, attacking both natural and manufactured food. Food stored at temperatures between 60° F. and 90° F. is especially attractive to insects. Infested supplies must be segregated and if not too heavily infested, may be "reconditioned" for use. Cornmeal, especially, is susceptible to insect infestation and rancidity. Insect repellents should be used carefully so as not to contaminate the foods or cause damage by the absorption, by the food, of the fumigant or insecticide flavor. Roaches and flies not only contaminate the foods, but may spread disease. (See chap 3, sec IV for information on pest management.)

(3) *Rodents (rats and mice).* Rodents not only physically destroy food by feeding, chewing, and cutting the bags for nests or nesting material, but also contaminate food with their excreta and hairs. Rodents are carriers of filth and disease; the importance of controlling these pests is evident. The most effective method of control is to prevent entry of these animals.

(4) *Physical environmental factors.*

(a) *Freezing.* Dry products such as grains, flour, sugar, starch, cereals, and dehydrated foods, ordinarily are not injured by freezing. If foods containing relatively large amounts of water such as canned products are frozen, the usefulness and palatability of such products have not been harmed. However, the physical appearance may

suffer due to change in consistency and texture (softening). Emulsions such as canned cheese and butter, prepared mustard, and mayonnaise may be broken (separated) by freezing although the food is not spoiled.

(b) *Heat (high temperatures).* A high temperature over long periods of time is very detrimental to the keeping of almost all food products. High storage temperature encourages bacterial growth, mold growth, and insect infestation and is particularly dangerous when accompanied by high humidity. Chemical action is accelerated, causing rancidity in many items; action of the food acids naturally present within the cans is accelerated, resulting in pinholing, blackening of the interior, and hydrogen swells. High temperature is the chief cause of accelerated spoilage in canned foods and should be controlled when possible by providing adequate ventilation.

Flour and associated products (barley, cereals, cornmeal, cornstarch, cracker and biscuit, hominy, noodles, oats, rice, spaghetti and macaroni, tapioca, and uncooked wheat) are subject to insect infestation, particularly at high temperatures. Flour and cereals will absorb odors and should be kept away from subsistence or materials giving off distinctive odors. Cocoa will keep years under cool, dry storage conditions. The formation of white "bloom" (described as a "whitening" or "graying" due to storage under fluctuating temperatures) has little or no effect on the flavor of cocoa. Long periods of storage at higher temperatures may cause mustiness or rancidity. Cocoa does absorb moisture and odors; therefore, cans should be kept tightly closed. Roasted, ground coffee rapidly develops a weak and stale flavor. If coffee is not hermetically sealed, it will absorb odors affecting the flavor.

(c) *Moisture (humidity).* High humidity is detrimental to stored subsistence in many respects (i.e., accelerating the growth of bacteria and molds promoting insect infestation and causing mustiness in flour, rice, and similar foods). High humidity causes products which readily absorb moisture such as sugar and salt to cake and become hard. Tea will absorb odors and high humidity causes it to become musty and sour. It should be emphasized that dehydrated products are perishable and should not be handled or stored carelessly. Such products are subject to moisture absorption, insect infestation, and mold. A loss of flavor and discoloration (darkening) will occur with age; this action is progressive and is accelerated at high temperatures. Dried vegetables and fruits are subject to insect infestation and molding (particularly fruits) and should be inspected at frequent intervals.

(d) *Ventilation.* Where sharply fluctuating temperatures and high humidity prevail, the lack of proper ventilation may cause excessively high temperatures. Proper ventilation is one of the most important factors in protecting foods, particularly in tropical areas. In extreme cases, it may be necessary to open doors and use fans to induce circulation.

(e) *Light.* Damage from light is restricted to products that are packed in glass or transparent containers. Exposure causes color changes and may affect the flavor of foods containing or composed of edible oils and fats.

d. *Physical factors for canned products.*

(1) *Subject to spoilage.* Canned products such as meats, fish, poultry, vegetables, fruits, and juices are subject to several physical environmental factors causing spoilage.

(2) *Spoilage factors.*

(a) *Rust.* Rust, unless it actually penetrates the can causing leakage, will not injure the contents or render them inedible.

(b) *Dents.* Dents, unless so severe as to cause leakage, do not indicate that the contents are in an unsatisfactory condition.

(c) *High temperature.* High temperatures are detrimental to all canned provisions and reduce the storage life to a considerable degree.

(d) *Freezing.* Freezing causes loss in palatability and may cause breakdown of the texture. Alternate freezing and thawing may cause delamination of the protective enamel.

(3) *Major defects.*

(a) *Quality change.* Fading of color, loss of flavor, or softening of contents is due to chemical action and the natural aging process.

(b) *Discoloration.* Discoloration of contents on the inside of a can because of chemical action is found usually in products containing sulphur compounds (i.e., corn, peas, and meat products).

(c) *Swells.* Swells, springers, and flippers are caused either by chemical or bacterial action or by overfilling. Regardless of the primary cause, cans exhibiting such defects should be discarded or referred to a medical or veterinary officer for recommendation as to disposition.

(d) *Pinholing.* Pinholing is due to the chemical action of the food acids on the tin. Pinholing is more often found in enamel-lined cans, brine- or vinegar-packed items, and in waterpacked fruits.

(e) *Flat sours.* Flat sours are caused by bacterial action, causing changes in odor, color, or

turbidity of the product, but not accompanied by gas production which would cause swelling of the can.

e. *Exterior can coating.*

(1) *Purpose.* Exterior can coatings are applied to protect the tin plate from external conditions promoting rusting and, depending on the coating specified, to camouflage the bright can surface.

(2) *Types of coating.* Three types of exterior coatings are used. Specification TT-C-495, Coatings, Exterior, for Tinned Food Cans, lists these as follows:

(a) *Type I.* Precoated camouflage (O.D. colored coating applied to tin plate before can fabrication). Precoated cans do not have the side seam area coated as manufactured. Depending on contract requirements, the side seam may or may not be striped with O.D. lacquer following filling and sealing.

(b) *Type II.* Post-coated camouflage (O.D. colored coating applied to the cans sometime following filling and sealing).

(c) *Type III.* Precoated unpigmented (clear lacquer applied before can fabrication—commonly called “gold coat”).

(3) *Labeling of coated cans.* Precoated cans will normally have completed label information lithographed on the body or one end of the cans. Post-coated cans will usually show only the name of the product or an abbreviation thereof since these cans have to be labeled after coating, and equipment for complete labeling is impractical for the packer to maintain. While it is intended that most post-coated cans will have as near as possible the full name stamped on the side or one end, there is the possibility that some cans will be embossed or impressed on the end only with an abbreviated legend (see MIL-L-1497).

f. *Storage periods.*

(1) *General.* Table 5-3 “Dry Storage of Semiperishable Subsistence” should be used only as a guide. This table is based on the optimum rather than the maximum storage life.

(2) *Overaged stock.* Activities receiving a pack older than that indicated on the storage life table should not on this basis alone consider the product as unfit or undesirable. Subsistence stored for periods in excess of the storage life shown in the table, but at temperature lower than those listed therein, should not be automatically considered as overaged stock.

(3) *Containers.* Since the container is one of the factors in the overall keeping period of an item, the container should be considered if it markedly differs (i.e., flour in bags vs. cans, coffee in bags vs. coffee in vacuum-packed tins). Thus, supply officers should be guided by the appearance, odor, color, and condition of the item.

(4) *Subsistence, table of safe keeping time for dry storage* (see note) of semiperishable subsistence.

NOTE

These products are not always subject to the same spoilage as are other foods. Their desirable properties of flavor, odor, and taste often depend upon very unstable or volatile components, and deterioration may result from a breakdown or loss of these constituents. However, excessive heat and moisture, contamination by insects, rodents, and micro-organisms, dirt and dust, and inadequate packaging and packing can be major factors contributing to deterioration.

g. Sanitation. All storage areas containing infestible material shall be maintained in such a manner as to assure that a high degree of sanitation is achieved. Spilled food, waste package/packing material, lumber, or other debris will be cleaned up and disposed of prior to the end of each workday. In no case, shall such spills or trash be allowed to exist within a storage area in excess of 24 hours.

h. Stock Location. All infestible material will be stored in the following manner:

(1) In a single section or isolated to the maximum extent possible to allow for the concentration of pest management procedures.

(2) Stacked away from all walls a minimum of 24 inches with inspection/control aisles of not less than 24 inches maintained between each three stacks/rows of infestible stock items. No three stack grouping will combine items produced under different contracts. These spaces are essential for the proper inspection of the materials for infestation and in-place fumigations.

Table 5-3. Storage Life of Semiperishable Subsistence
See footnotes at end of table

Item	Packaging	Approximate storage life (months)		
		40 °F	70 °F	90 °F
Almond paste	Can	36	9	3
Apples				
Regular pack	Can	48	24	12
Pie style, dehydrated	Can	48	36	18
Butter	Can/jar	36	18	9
Sauce	Can	48	24	12
Baby food, strained	Jar	36	18	9
Dehydrated (instant)	Can	48	24	12
Dietetic pack	Can	48	24	12
Junior food	Jar	36	18	9
Juice				
Dehydrated ⁸	Can	72	36	18
Single strength	Can	36	18	9
Spiced, rings	Can	36	18	9
Apricots				
Regular pack	Can	48	24	12
Baby food, strained	Jar	36	18	9
Dietary pack	Can	36	18	9
Dried	Carton	24	3	1
Apricot nectar				
Regular pack	Can	48	24	12
Freeze dehydrated	Can	48	36	18
Asparagus	Can	36	18	9
Baby formula preparation	Can	24	12	6
Bacon				
Sliced	Can	48	18	9
Sliced, prefried	Can/flex pkg	48	36	12
Bakery mixes, extended shelf life (except biscuit, cheese cake, cookie, corn bread or pie crust mix, see specific item)	Can	72	36	9
Bakery mixes, commercial	Bag/carton	12	6	3
Bakery mixes, commercial angel food	Bag/carton	24	12	6

Table 5-3. Storage Life of Semiperishable Subsistence (Continued)
See footnotes at end of table

Item	Packaging	Approximate storage life (months)		
		40 °F	70 °F	90 °F
Baking powder	Can	24	12	6
Baking soda	Carton	Indef.	Indef.	Indef.
Barley, pearl	Bag/carton	60	48	24
Banana, baby food, strained	Jar	24	12	6
Beans				
Dry ¹²	Bag/carton	24	12	9
Green, baby food, strained	Jar	36	18	9
Green, regular	Can (plain body)	36	18	9
Green, junior food	Jar	36	18	9
Green, dehydrated	Can	120	60	24
Green, dehydrated, compressed	Can	120	60	24
Kidney	Can	72	36	18
Lima	Can	72	36	18
Pinto	Can	72	36	18
Lima, dehydrated	Can	72	36	18
Salad, 3-bean	Jar	48	24	12
Sprouts	Can	48	24	12
Wax	Can (plain body)	36	18	9
	Can (enameled)	48	24	12
White, dehydrated	Can	48	24	6
White, with pork in sweet sauce	Can	72	36	18
White, with pork in tomato sauce	Can	48	24	12
Beans refried	Can	72	36	18
Beef, liver, pork, or veal				
Baby food, strained	Jar	36	18	9
Junior food	Jar	36	18	9
Beef				
Broth, baby food, strained	Jar	36	18	9
Chunks with natural juices	Can	60	36	18
Corned	Can	60	36	18
Diced, raw, dehydrated	Can	72	48	24
Flakes and shaped, raw, dehydrated	Can	72	48	24
With gravy	Can	72	36	18
Patties, dehydrated	Can	72	48	24
w/spiced sauce	Can	60	24	12
Beef steak, raw, dehydrated	Can	72	48	24
Beets				
Baby food, strained	Jar	24	12	6
Junior food	Jar	24	12	6
Regular pack, Gulf states	Can	36	18	9
except Gulf states	Can	48	24	12
Berries, black, etc.	Can	36	18	9
Beverage base				
Cocoa, powder	Can	72	36	12
Imitation, liquid	Bottle	24	12	6
Powder	Envelope	72	36	18
Beverage, base, liquid for post mix				
Cola pepper	Can	2	1	½
Fruit punch, lemon-lime, orange, root beer, ginger ale, grape.	Can	18	8	3
Biscuit, mix	Can	56	28	8
Blueberries	Can	60	36	18
Bouillon cubes, beef or chicken	Can	48	24	12
Bread crumbs	Bag	8	4	2
Brownie mix	Can	56	28	8
Cabbage				
Red, sweet, sour	Can	72	36	18
Raw, diced, dehydrated and dehydrated compressed	Can	72	36	18
Cake, fresh				
Layer, coffee			(2 days)	
Loaf			(4 days)	

Table 5-3. Storage Life of Semiperishable Subsistence (Continued)

See footnotes at end of table

Item	Packaging	Approximate storage life (months)		
		40 °F	70 °F	90 °F
Candy				
Caramel	Box	12	9	4
Coated (bridge mix)	Box	24	12	4
	Can	72	36	18
Hard	Can	72	36	18
Starch jelly	Box	24	12	6
Bars	Flex pkg	24	NR	NR
Carrots				
Baby food, strained	Jar	48	24	12
Junior food	Jar	48	24	12
Puree	Can	60	30	15
Regular pack	Can	60	30	15
Dehydrated, compressed N ₂ pack	Can	48	36	12
Catsup				
Regular pack	Bottle	24	12	6
	Can	36	18	9
Dehydrated	Envelope/can	72	36	12
Cereal				
Baby food, strained, barley	Container	24	12	6
Quick cooking	Carton	24	12	6
	Can	48	24	12
Ready-to-eat, rolled oats	Pkg	24	12	6
Sugar, coated	Pkg	24	12	6
Chalupa shells, corn	Container	12	6	3
Cheese				
Cheddar, processed	Can	48	24	12
Cheddar, shredded	Pkg	3 to 4		
Cottage, dehydrated	Can	48	36	12
Grated	Container	18	6	3
Processed, American, dehydrated	Can	48	24	12
Cheese cake mix	Bag	12	6	3
Cherries				
Dehydrated	Can	60	36	18
Dietetic pack	Can	36	18	9
Maraschino	Jar	36	18	9
RTP (Red tart pitted)	Can	36	18	9
Sweet, dark	Can	36	18	9
Sweet, light	Can	36	18	9
Whole, red, glaze	Plastic Tub	24	12	6
Chewing gum	Carton	9	4	2
Chicken				
Dehydrated, reg. pack	Can	72	48	24
Baby food, strained	Jar	36	18	9
Chili con carne				
Without beans	Can	60	36	18
Dehydrated, with beans	Can	72	36	24
Chili sauce	Bottle	48	24	12
Chives, dehydrated	Can	24	12	6
Chocolate, cooking				
Semisweet chips ¹⁶	Pkg	36	18	6
Unsweetened ¹⁶	Carton	48	24	12
Chocolate syrup, beverage	Can	72	36	18
Chutney sauce	Jar	48	24	12
Clams	Can	72	36	18
Cocoa, natural	Carton	36	18	9
	Can	72	36	18
Coconut, prepared				
Sweetened	Can	36	18	6
	Container	24	6	1
Unsweetened	Bag	24	6	1

Table 5-3 Storage Life of Semiperishable Subsistence (Continued)
See footnotes at end of table

Item	Packaging	Approximate storage life (months)		
		40 °F	70 °F	90 °F
Coffee				
Instant	Envelope	36	18	9
	Jar	72	36	18
Roasted and ground	Pouch	9	2	1
	Can	18	12	5
Cookie mix, chocolate and sugar	Can	36	18	9
Cookies	Carton	6	4	2
Corn bread mix	Can	56	28	8
Corn, cream, and whole grain styles	Can	72	36	18
Corn, dehydrated, uncooked, comp	Can	72	36	24
Corn, chips	Pkg	1	½	¼
Corn flake crumbs	Carton	24	12	6
Corn meal	Pkg	24	12	6
	Can	48	24	12
Crabapples, spiced	Can	24	12	6
Crab	Can	72	36	18
Crackers				
Graham	Carton	4	2	1
Other than graham	Carton	12	6	3
Crumbs	Bag	12	6	3
Cranberry sauce	Can	36	18	9
Cranberry juice cocktail	Can	30	12	3
Cream				
Coffee type, aseptically processed and packaged ¹⁹	Bottle	60	12	3
Whipping, aseptically processed and packaged ^{7 19}	Can	12	6	1
Substitute	Can/envelope	48	24	12
Whipping, dry	Can	8	6	4
Cream of tartar	Container	Indef	Indef	Indef
Cup, ice cream, edible	Box	24	12	6
Currants, dried	Carton	24	12	6
Custard pudding, baby food strained	Jar	24	12	6
Dessert powder				
Gelatin, base, all flavors ¹⁴	Can	72	36	18
	Container/pkg	36	18	9
Starch base, all flavors ¹⁴	Container/pkg	36	18	9
Instant, all flavors ¹⁴	Can	48	24	12
	Carton	36	18	9
Doughnuts				
Cake	Pkg		(5 days)	
Yeast	Pkg		(3 days)	
Eggnog (APP) ¹⁹	Can	12	6	1
Egg mix, dehydrated	Can	72	36	18
Eggs, whole, dry	Can	72	36	18
Emulsifier, bread & rolls	Bag/can	24	12	6
Enchiladas	Can	48	24	12
Figs	Can	48	24	12
Fish, dehydrated, squares	Can	60	36	18
Flavoring				
Imitation maple or vanilla	Bottle	Indef	Indef	Indef
Other flavors	Bottle	24	18	6
Rye	Fiber drum	12	6	3
Tablet, imitation maple or vanilla	Bottle	Indef	Indef	Indef
Flour				
Rye ¹⁸	Bag	24	12	6
Wheat, bread or general purpose	Can	54	27	12
	Bag	24	12	6
Food coloring, liquid	Bottle	Indef	Indef	Indef
Food coloring, paste	Jar	48	24	12
Frankfurters	Can	72	36	18
Fruitcake	Can	64	32	16
	Box	12	6	1
Fruit, candied	Jar	12	6	3

Table 5-3 Storage Life of Semiperishable Subsistence (Continued)
See footnotes at end of table

Item	Packaging	Approximate storage life (months)		
		40 °F	70 °F	90 °F
Fruit cocktail ..	Can ..	48	24	12
Fruit mix, freeze dehydrated ..	Can ..	36	18	9
Fruit puree ..	Can ..	48	24	12
Fry mix, breading ..	Bag ..	36	18	9
Garlic				
Dehydrated ..	Can ..	48	24	12
Dry ..	Box ..	5	4	3
Gelatin, plain, edible ..	Container ..	72	36	18
Grape juice				
Dehydrated ¹¹ ..	Can ..	72	36	18
Single strength ..	Can ..	24	12	6
Grapefruit				
Regular pack ..	Can ..	48	24	12
Juice, dehydrated (instant) ¹¹ ..	Can ..	72	36	18
Juice, single-strength ..	Can ..	48	24	12
Grapefruit-orange juice blend				
Single-strength ..	Can ..	48	24	12
Grapefruit-pineapple juice blend				
Single strength ..	Can ..	48	24	12
Ham chunks ..	Can ..	72	36	18
Hamburgers, without gravy ..	Can ..	72	36	18
Hash, corned beef or roast beef ..	Can ..	72	36	18
Hominy				
Grits ..	Container ..	24	12	6
Whole ..	Can ..	72	36	18
Honey, extracted ..	Jar ..	48	24	12
Horseradish, dehydrated ..	Bottle ..	48	24	12
Ice cream mix and ice milk mix				
Powder ..	Can ..	36	18	6
Icing mix ..	Can ..	72	36	18
Inhibitor, mold, bread, and rolls ¹⁴ ..	Bag ..	18	9	5
Jam, fruit ..	Can/jar ..	36	18	9
	Pkg ..	24	12	6
Jelly, fruit ..	Can/jar ..	36	18	9
	Pkg ..	24	12	6
Lard, service style ..	Carton ..	12	6	3
Lemon juice, dehydrated ¹¹ ..	Can ..	72	36	18
Lime juice, single strength ..	Can ..	24	12	6
Luncheon meat ..	Can ..	72	36	18
Macaroni ¹⁴ ..	Carton ..	72	36	18
Malted cereal syrup ..	Can ..	48	24	12
Margarine ..	Can ..	36	18	9
Marmalade ..	Jar ..	36	18	9
Marshmallow ..	Container ..	12	9	1
Mayonnaise ..	Can/jar ..	12	6	3
Meal, Combat, Individual ..	Case ..	See table 5-4		
Meal, Ready-to-Eat ..	Case ..	See table 5-4		
Meat, spread ..	Can ..	36	18	9
Meringue powder ..	Can ..	48	24	1
Milk				
Chocolate (cocoa flavored), dry ..	Envelope (vacuum) ..	40	20	10
	Envelope (no vacuum) ..	24	12	6
Chocolate, aseptically processed and packaged ..	Can/box ..	12	6	3
Dry, nonfat ..	Can ..	32	16	8
	Drum/bag/carton ..	24	12	3
Evaporated ⁸ ..	Can ..	24	12	6
Filled dry, including chocolate ..	Can ..	24	12	6
Ice and milk shake mix, dehydrated ..	Can ..	24	12	6
Malted, dry ..	Can ..	48	24	9
Whole, dry ..	Can (zero oxygen pouch) ..	6	3	1
Whole, aseptically processed and packaged ¹⁹ ..	Can ..	12	6	1

Table 5-3. Storage Life of Semiperishable Subsistence (Continued)
See footnotes at end of table

Item	Packaging	Approximate storage life (months)		
		40 °F	70 °F	90 °F
Mincemeat	Can	48	24	12
Molasses	Can	48	24	12
Monosodium glutamate	Container	Indef.	Indef.	Indef.
Mustard, prepared	Can/jar	36	18	9
Mushrooms	Can	48	24	12
Noodles				
Chow mein	Can	8	4	2
Egg ¹⁴	Carton	72	36	18
Nuts				
Shelled, roasted	Can	60	24	12
Unshelled	Bag	24	12	6
Okra	Can	48	24	12
Olives				
Green	Jar	48	24	12
Ripe	Can	48	24	12
Olive oil	Can	18	6	4
Onion ring mix	Can	24	12	6
Onions, dehydrated and dehydrated compressed	Can	60	24	12
Onions, whole, acidified	Can	36	18	9
Orange juice				
Dehydrated (instant) ¹¹	Can	72	36	18
Single strength	Can	48	24	12
Parsley, dehydrated	Can	48	24	12
Peaches				
Baby food, strained	Jar	36	18	9
Dietetic pack	Can	48	24	12
Regular pack	Can	48	24	12
Slices (freeze dehydrated)	Can	36	18	9
Peanut butter	Can/jar	36	18	9
Pears				
Baby food, strained	Jar	40	20	10
Dietetic pack	Can	36	18	9
Freeze dehydrated	Can	36	18	9
Regular pack	Can	36	18	9
Peas				
Baby food, strained	Jar	40	20	10
Blackeye	Can	72	36	18
Dehydrated compressed	Can	120	60	24
Dried ¹²	Bag/carton	24	12	9
Green	Can	72	36	18
Peas and carrots	Can	60	30	15
Peppers, green dehydrated	Can	72	36	18
Peppers, pickled, cherry	Jar	36	18	9
Peppers, jalapeno	Can	24	12	6
Peppers, red sweet	Can	48	24	12
Pickles				
Cucumber, cured	Jar	48	24	12
Can		24	12	6
Cucumber, fresh pack	Jar	36	18	9
Can		18	9	4
Mixed	Jar	48	24	12
Can		24	12	6
Relish	Jar	48	24	12
Can		24	12	6
Pie crust mix	Can	36	18	6
Pie filling, prepared fruit apple, blueberry, cherry, peach, lemon ¹⁵	Can	60	36	18
Pie shell, graham cracker	Container	8	4	2
Pimentos	Can	48	24	12
Pineapple				
Slices, glace natural	Plastic tub	24	12	6
Dietetic pack	Can	48	24	12

Table 5-3. Storage Life of Semiperishable Subsistence (Continued)
See footnotes at end of table

Item	Packaging	Approximate storage life (months)		
		40 °F	70 °F	90 °F
Freeze dehydrated	Can	36	18	9
Juice, dehydrated ¹¹	Can	72	36	18
Juice, single strength	Can	48	24	12
Regular pack	Can	48	24	12
Sliced, glazed	Plastic tub	24	12	6
Plums				
Dietetic pack, red	Can	36	18	9
Dietetic pack, green	Can	48	24	12
Regular pack, red	Can	36	18	9
Regular pack, green	Can	48	24	12
Popcorn, unpopped	Can	72	36	18
	Cello bag	24	3	1
Pork chops, raw, dehydrated	Can	72	48	24
Potato				
Chips	Pkg	1	½	¼
	Can, air	4	2	1
	Can, nitrogen	24	12	6
	Can vacuum	12	6	3
Sticks	Can	48	24	12
Sweet	Can	48	24	12
Sweet, instant, dehydrated	Can	60	36	18
White	Can	60	30	15
White, dehydrated, granules	Can	60	36	18
White, dehydrated, granules—8% H ₂ O	Can	24	12	6
White, dehydrated, slices	Can	60	36	18
White, dehydrated, slices—8% H ₂ O	Poly bag	24	18	6
White, dehydrated, slices—8% H ₂ O	Kraft bag	12	6	3
Mix, dehydrated for french fries	Can	18	9	5
	Bag	12	6	3
Prunes				
Baby food, strained	Jar	18	9	5
Dehydrated/pitted (low moisture)	Can	36	18	9
Dried	Can	36	18	9
Dried	Carton	18	9	5
Dried, soaked	Can	36	18	9
Pumpkin	Can	48	24	12
Raisins, dried	Can	36	18	9
	Carton	18	9	5
Ration, supplement aid station	Case	72	36	18
Ravioli w/meat sauce	Can	48	24	12
Rice				
Instant ¹⁴	Carton	36	18	9
Milled ¹⁴	Bag	48	24	12
Parboiled ¹⁴	Container/bag	30	20	10
Rolls, fresh				
Bagel	Pkg	(1 day)		
Sweet or finger	Pkg	(2 days)		
English muffin	Pkg	(7 days)		
Salad dressing, spoonable ⁴	Can/jar	8	5	2
Salad dressing, pourable ⁴	Bottle	7	5	2
Salad oil ⁹	Can	24	12	6
Salmon	Can	72	36	18
Salt				
Celery, garlic, onion	Container	72	36	18
Substitute	Envelope	Indef	Indef	Indef
Table ⁵	Bag/envelope	Indef	Indef	Indef
Sauces, Hot, Kitchen, Meat, Soy, or Worcestershire	Bottle	60	30	15
Sauerkraut	Can	36	18	9
Sardines	Can	72	36	18
Sardines in tomato sauce	Can	30	15	8
Sauce mix, brown gravy, spaghetti, taco seasoning	Can	36	18	9
Sausage, pork, link	Can	60	36	18

Table 5-3. Storage Life of Semiperishable Subsistence (Continued)
See footnotes at end of table

Item	Packaging	Approximate storage life (months)		
		40 °F	70 °F	90 °F
Shortening compound ¹⁰				
Bakery type ⁹	Can/cube	48	24	12
Deep fry, cooking type, fluid	Can	48	24	12
Deep fry, cooking type, plastic	Can	48	24	12
General purpose, regular	Can/cube	48	24	12
General purposes, high stability	Can/cube	60	30	15
Shrimp	Can	72	36	18
Shrimp, dehydrated	Can	72	36	18
Syrup				
Blended	Can	72	36	18
Maple syrup, imitation	Bottle/can	72	36	18
Soup				
Baby food, chicken, strained	Jar	36	18	9
Beef, instant, hydrated	Pkg	24	12	6
Beef, noodle, dehydrated	Pkg	48	36	12
Beef, vegetable, noodle, dehydrated	Can	48	36	12
Chicken, chunk, dehydrated	Pkg	48	36	12
Chicken or chicken flavored instant, dehydrated	Pkg	48	36	12
Chicken noodle, dehydrated	Can	60	30	15
Condensed ¹³	Pkg	24	12	6
Can	Can	72	36	18
Cream of onion, instant, dehydrated	Pkg	36	18	9
Cream of potato, instant, dehydrated	Pkg	36	18	9
Green pea, simmer type, dehydrated	Can	60	24	12
Pkg	Pkg	24	12	6
Onion, dehydrated	Can	60	30	12
Pkg	Pkg	36	18	9
Onion, instant, dehydrated	Pkg	36	18	9
Ready-to-serve	Can	48	24	12
Tomato-vegetable w/noodle, dehydrated	Can	48	24	9
Vegetable, dehydrated	Pkg	24	12	6
Soup and gravy base				
Beef flavored	Can/jar	60	30	15
envelope	envelope	24	12	6
Chicken flavored	Can/jar	60	30	15
envelope	envelope	24	12	6
Ham flavored	Can/jar	60	30	15
envelope	envelope	24	12	6
Can	Can	24	12	4
Sour cream sauce mix	Can	24	12	4
Spaghetti ¹⁴	Carton	72	36	18
Spices, seasoning, herbs ⁶	Can	48	24	12
Container	Container	36	18	3
Bottle	Bottle	36	18	9
Spinach				
Baby food, strained	Jar	36	18	9
Dehydrated, compressed	Can	60	36	12
Junior food	Jar	36	18	9
Regular pack	Can	48	24	12
Puree	Can	48	24	12
Starch				
Corn, edible	Carton	96	48	24
Pregelatinized, edible ¹⁴	Can/bag	96	48	24
Sugar				
Brown ¹⁷	Carton/bag	36	18	4
Confectioners ¹⁷	Carton/bag	36	18	6
Refined, granulated ¹⁷	Can/bag/envelope	Indef	Indef	Indef
Sugar, substitute	Envelope	Indef	Indef	Indef
Tamales	Can	48	24	12
Tapioca ¹⁴	Carton	96	48	24
Taco shells, corn	Container	12	6	3

Table 5-3 Storage Life of Semiperishable Subsistence (Continued)
See footnotes at end of table

Item	Packaging	Approximate storage life (months)		
		40 °F	70 °F	90 °F
Tea				
Black, bags or loose	Can/carton	36	18	9
Instant	Envelope	36	18	9
Tomato				
Juice, concentrated 3+1	Can	36	18	9
Juice, single strength	Can (plain body)	36	18	9
	Can (enameled)	48	24	12
Paste, instant, dehydrated	Can	72	36	18
Paste, regular pack	Can	36	18	9
Puree	Can	48	24	12
Regular pack	Can	48	24	12
Tomatoes and okra	Can	48	24	12
Topping, dessert				
Prepared, ice cream, non-acid syrup	Can	72	36	18
Prepared, ice cream, fruit, acid syrup	Can	36	18	9
Dehydrated	Can	36	24	6
Tortillas, corn	Can	36	18	9
Tuna				
Oil pack	Can	72	36	18
Turkey				
Regular pack	Can	72	36	18
Loaf	Can	72	36	18
Vegetable				
Baby food, mixed, strained	Jar	36	18	9
Juice, single strength	Can	36	18	9
Mixed, dehydrated, compressed	Can	48	36	12
Vinegar				
Liquid	Bottle	60	30	15
Synthetic, dry	Flexible bag	72	36	18
Wheat base ^{2,14}	Bag	48	36	12
Yeast, bakers, active dry	Can	6	1	¼
Yeast food	Bag	48	24	12

¹ In general, RH 50-55 percent. Metal cans are susceptible to rust and most boxed or bagged food to mustiness or molding above RH 60 percent.

² Flour should be stored under cool, dry conditions. The major problem is protection against dampness, insects, and rodents. Low temperatures, 32 °F.-40 °F., protect against insects; RH greater than 70 percent leads to mustiness. Best storage conditions are at temperatures below 50 °F and approximately 60 percent RH.

³ Footnote not used.

⁴ Separates at high temperatures or after freezing.

⁵ Humidity above 90 percent will cause caking. "Caked" salt is usable.

⁶ Above 100 °F. there is complete loss of flavor in less than 6 months. "Whole" spices keep longer than "ground" spices.

⁷ Guaranteed to whip only if stored below 50 °F.

⁸ Cases should be turned every 30 to 60 days to prevent separation of butterfat. Separated or grainy milk can be used for cooking.

⁹ When held below 32 °F, may show solid material which will disappear on warming.

¹⁰ If held above 90 °F, changes may occur in texture unfavorable to normal creaming properties.

¹¹ Store at cool temperatures below 75 °F. during the first 3 months.

¹² High temperatures harden; high humidity causes molding.

¹³ Cream style soups break down on freezing, but are not spoiled.

¹⁴ Highly susceptible to damage by moisture.

¹⁵ Freezing alters appearance of starch thickening. Baking restores desirable appearance.

¹⁶ Do not store near other material capable of imparting odor to chocolate.

¹⁷ Keeping time based on RH not more than 60 percent. For storage longer than 1 month, sugar should be covered with tarpaulins and not stored on damp or concrete floors or near cold walls.

¹⁸ Rye flour loses its most delicate flavor after 2 months at 40 °F., 1 month at 70 °F., or 1 week at 90 °F. After this time, further flavor change is very slow. It is said that only experts can detect this first, subtle flavor change.

¹⁹ These items should be stored at temperatures below 72 °F. For long holding, chill storage is recommended. Do not freeze.

Table 5-4 Operational Rations
a Ration and Packets Other than MRE; Meal, Combat, Individual (MCI); and Meal, Flight Feeding (MFF)

Item	Estimated Optimum Storage Life (Months)		
	40 °F	70 °F.	90 °F.
Food Packet:			
Assault (FPA)	84	48	24
In-Flight	48	24	12
Long-Range Patrol (LRP)	120+	120	36
Survival, Abandon Ship, Aircraft, Life-raft	84	84	72
Survival, General Purpose	60	48	24
MCI	60	24	12
MFF	(See table 5-4B)
MRE	(See table 5-4B)
Ration, Cold Weather	84	48	24
Ration, Supplement Aid Station.	72	36	18
Tray Pack, Canned	60	36	18
Water, Canned	120	60	30

b. *Estimated Serviceable (Maximum) Storage Life for MRE and MFF.* Persons using this table as an aid in planning storage facility utilization must be aware that using average environmental temperatures to enter the table will often result in inaccurate and misleading guidance. The use of maximum temperatures encountered will generally provide more useful guidance. Few nonrefrigerated storage facilities offer nonfluctuating and moderate temperatures; therefore, controlled tempera-

ture storage of MRE and MFF stock is generally recommended. In order to optimize quality of stocks shipped to using agencies, wholesale stocks should be stored at not more than 40 °F.

Sustained Storage Temperature (°F)	Estimated Serviceable Life (Months)
120	1
110	5
100	18
90	30
80	48
70	66
60	84
<50	96

When using this table, it must be remembered that effects of time and temperature are cumulative. For example, if rations are received 9 months after their DOP, and you determine that they have been held in a hot environment, say 100 °F., you can estimate that one-half of their serviceable life is gone (1/2=0.5). If they are to be stored at 70 °F. in your facility, you could expect a remaining serviceable shelf life of 33 months, not 66 months (66 × 0.5=33). See table 5-4.C for estimating remaining shelf life after initial refrigerated storage.

Fluctuating temperatures around the freezing point of foods (approximately 25 °F. to 30 °F.) should be avoided due to the potential for reduced product quality from repeated freezing and thawing. Frozen storage below 0 °F. is not recommended as rough handling of frozen MREs and MFFs will result in packaging failures.

Table 5-5 Estimated Serviceable (Maximum) Storage Life for MRE and MFF After Refrigerated Storage Storage (Years)¹ Estimated Remaining Storage Life (Months) (0 °F.)

	<50	60	70	80	90	100	110	120
0	96	84	66	48	30	18	5	1
1	84	74	58	42	26	16	4.5	1
2	72	63	50	36	22	14	3.8	0.8
3	60	52	41	30	19	11	3	0.5
4	48	42	33	24	15	9	2.5	0.5
5	36	32	25	18	11	7	2	0
6	24	21	16	12	8	4	1	0
7	12	10	8	6	4	2	0.5	0
8	0	0	0	0	0	0	0	0

¹ Held after acquisition from production under controlled refrigerated storage at 30 °F +1 °F and 50+5 percent RH.

Section V. Miscellaneous Commodities

5-19. General.

This section includes some of the more common miscellaneous commodities stored in military installations but is not intended as a complete list. Also, it prescribes the approved methods and practices for storing and handling the listed materials.

Storage and handling methods that are to be observed with respect to other commodities will be in accordance with the principles and practices included in the other sections and parts of this manual or as may be prescribed by the appropriate military service.

5-20. Batteries.

This paragraph deals with primary batteries (mercury, silver-oxide, alkaline manganese-dioxide, carbon-zinc (flashlight), lithium, and other dry or reserve batteries) and secondary batteries (lead-acid, nickel-iron alkaline, nickel-cadmium, and silver-zinc). Primary batteries cannot be recharged efficiently (a flashlight battery) and are of two types, dry and reserve. A dry battery is commonly referred to as a dry cell battery and a reserve battery is one that must be activated by the addition of a fluid, usually water. A secondary battery is one that can be recharged repeatedly (e.g., an automobile battery) and activated by the addition of electrolyte. Buildings with metal roofs must not be used for storage of batteries, since these types absorb and conduct heat to a high degree. Likewise, batteries will not be stored in direct sunlight. Batteries can be stored on pallets, in bins or racks, depending on the quantity and type to be stored. "This Side Up" batteries will remain in their original containers until ready for issue or use.

Batteries removed from original containers must never come in contact with steel, steel shelving, or other metal objects which can cause short circuits or discharging. Lithium primary batteries should be stored in individual containers or short circuiting may occur due to terminal contact. Small cell batteries must be stored in a cool, well-ventilated area. It is the responsibility of the storage supervisor to ensure that batteries are segregated by type, properly tagged, and stored in such a manner that the oldest stock is issued first. The expiration date will be annotated on the document when the issue is made. At the time the exterior container is opened, each intermediate or unit pack will be appropriately marked with the expiration date.

a. Primary batteries. The deterioration of all primary batteries during storage, standby, or when in service is caused by chemical action within the cells or from the loss of moisture through the sealing material. Proper storage conditions reduce this chemical activity to a minimum, resulting in extended battery life. It is recommended that batteries of the reserve type be shipped and stored in a completely dry state, as they do not deteriorate if kept completely dry.

(1) *Storage temperatures.* Primary batteries are perishable commodities and, when possible, will be stored in refrigerated space or in warehouses having constant or controlled temperature, as temperature is the most important factor to be considered in the storage of primary batteries. The chemical activity which causes battery deteriora-

tion is lessened considerably as the storage temperature is lowered. Primary batteries will be stored in the coolest practicable dry, ventilated storage space. Storage space temperature within the range -30°F. to 35°F. is recommended. This temperature range is preferable, provided such cold storage facilities are available without appreciable cost; however, the usual refrigerated storage space available in the supply system at this time provides temperature between 35°F. and 50°F. This is satisfactory for normally moving stocks. For long-term storage, however, dry batteries will be stored in areas having temperatures as close as possible to -30°F. but not lower than this and, if possible, will never be stored where temperatures exceed 50°F.

Nonrefrigerated storage areas for dry batteries must have as constant a temperature as possible, since wide temperature variations are as damaging as high temperatures. To prevent short-circuiting in the voltage socket terminals as a result of "seating," dry batteries, when removed from refrigerated storage, will not be removed from the polyethylene bags in which they are packaged until they have warmed up to an ambient temperature. Exceptions to refrigerated storage requirements will be as directed by the individual DOD Component.

(2) *Ventilation.* Some dry batteries generate small quantities of gas, particularly during the first few months after manufacture. To avoid the possibility of an accumulation of gas, adequate ventilation in the storage area will be provided.

(3) *Testing.* Maintenance during storage consists largely of testing stored dry batteries at periodic intervals in order to maintain depot stocks at a high level of reliability. Periodic tests are not made on reserve batteries because they are stored in a dry, inert condition, with a desiccant, in airtight cans or metallic bags. The test of a battery consists of taking a voltage reading across a specific load resistance for each battery.

(4) *Lithium Batteries.* Lithium batteries refer to the entire family of batteries or cells that consist of lithium metal and some other chemical (i.e., sulfur dioxide, methyl cyanide, lithium bromide, etc.) that are used as a source of energy. The proper storage of lithium batteries depend primarily on the size of the battery and not just the fact that it is a lithium battery. The size affects two aspects of storage. The first is whether the area should be sprinkler protected. The second is how many batteries should be stored in one stack.

(a) *Sprinkler protection.* There is a violent reaction when burning lithium metal comes into

contact with water. For most batteries, sprinklers are preferred. The batteries are containerized; therefore, water from the sprinkler system has the potential of suppressing the fire and preventing ignition of the lithium metal should a fire actually occur in the facility. However, for very large batteries such as the 10,000 amp hour batteries used in some missile systems, sprinklers are not a good idea. This is because if a cell of a large battery ruptures, the quantity of lithium in each cell is so great that the addition of water can cause a worse problem.

(b) *Firefighting.* Personnel will not use water in an attempt to extinguish lithium fires. A dry powder (class D) portable fire extinguisher will be strategically maintained in the battery storage area to assist in firefighting efforts. Halon fire extinguishers must not be used on burning lithium. Halon and lithium react violently and release highly toxic compounds. Some chemical solutions in the lithium batteries (e.g., thionyl chloride) are extremely toxic. Installation-level medical services should be contacted to recommend the proper type of emergency respiratory protection required with the extinguisher. Installation fire protection officials and the emergency response team shall be notified of facilities in which lithium batteries are stored.

(c) *Storage facilities.* The storage facilities shall be cool (where temperatures will not exceed 130 °F., well ventilated, and equipped with a sprinkler system in accordance with para (a) above. Signs should be conspicuously posted where lithium batteries are stored. The following storage facility options are in descending order of preference:

1 The preferred location for lithium battery storage is in flammable or hazardous material storage facilities. The area used for the battery storage shall be separated from the rest of the facility by a 3-hour fire-rated wall (preferably masonry), with the exception that quantities of two pallet loads or less may have only 2-hour fire-rated separations. Flammable or combustible locations should be selected that minimize personnel exposure and locations should be approved by the base fire chief.

CAUTION

The following options should only be considered as a temporary fix until optimum storage can be achieved.

2 Separate fire area in a storage shed or ventilated locker. The lithium battery storage area shall be separated from the remainder of the facility by 3-hour fire-rated construction (preferably

masonry), with the exception that quantities of two pallet loads or less may have only 2-hour fire-rated separations. No flammable or combustible liquids will be permitted within the battery storage area. Storage locations should be selected that minimize personnel exposure, and locations should be approved by the base fire chief.

3 Separate fire area within a general storage facility. The lithium battery storage area shall be separated from the remainder of the facility by 3-hour fire-rated construction (preferably masonry). With the exception that quantities of two pallet loads or less may have only 2-hour fire-rated separations. No flammable or combustible liquids will be permitted within the battery storage area. Storage locations should be selected that minimize personnel exposure, and locations should be approved by the base fire chief.

4 If the value at risk (building and contents at replacement cost) are considered and mission-essential materials are not present, a single pallet or less of lithium batteries may be stored in a general-purpose storage area without the special fire-rated cutoffs discussed above.

(d) *New or unused batteries.*

1 Lithium batteries shall be stored in individual/original manufacturer or shipping containers, one item per package, to ensure that there is no direct contact between any two batteries or cells. Personnel engaged in storing, handling, or moving lithium batteries will exercise caution to avoid crushing or puncturing any package.

2 Due to the potential hazards involved in the storage and handling of lithium batteries, the stock levels for these items shall be kept at the absolute minimum necessary to support mission requirements.

(e) *Used, damaged, or condemned batteries.*

1 Batteries in any of these categories will be stored temporarily (less than 90 days) and separately from serviceable assets. Storage in excess of 90 days must be in an RCRA permitted hazardous waste storage facility (interim or final). Batteries will be packaged and processed for turn in to the DRMO prior to temporary storage, according to DOD 4160.21-M, Defense Utilization and Disposal Manual. Normal fire protection and safety requirements apply to materiel stored in any of these categories.

2 Used, damaged, or condemned batteries must be managed under the hazardous waste regulation pertaining to accumulation time and facility holding requirements. The environmental coordinator should be notified whenever a battery is

damaged and no longer capable of performing its intended purpose.

3 Used batteries shall not be pierced, crushed, burned, dropped, cannibalized, dismantled, or carelessly handled, nor shall they be short-circuited, charged, or reused. (Reuse does not pertain to removal and reinstallation in paragraph 3e.) Some lithium sulfur dioxide batteries are unbalanced and have been determined to be potential hazards whenever they undergo excessive current drain (as in short circuits) or are unparalleled without dioxide protection. These batteries must be equipped or packaged in such a manner as to prevent accidental short circuit. Battery container shall be marked with hazardous waste labels according to Federal and state requirements.

(f) *Handling precautions.*

1 Lithium batteries contain pressurized cells similar to aerosol cans. Any attempt to disassemble, open, or mutilate them could result in injury or fatality.

2 Heating or incinerating lithium batteries may produce internal pressure at a rate in excess of venting capacity which will cause the item to explode.

3 Lithium batteries will never be recharged. Such action may lead to venting, rupturing, or possibly a fire.

4 Keep batteries in original protective packing until ready to use or installation in equipment.

5 When not in use, remove batteries from equipment. Equipment will not be turned-in or stored with batteries installed.

6 Nonsupply activity users (who are responsible for removal) should be advised of handling and storage procedures for new and used batteries.

7 Extreme care and proper protective equipment such as splash shield, mask, rubber gloves, and apron must be used when handling leaking or damaged batteries.

8 Additional special precautions identified in the literature or instructions provided by the manufacturer must be complied with by all handlers.

9 Any person who detects a noxious gas, such as sulphur dioxide, in an area where batteries are stored should leave the area immediately and call the installation spill response team.

10 Smoking is prohibited in battery storage areas.

11 Under no circumstances shall lithium cells or batteries be handled, placed, or transported with flammable liquids or gases, or a significant concentration of flammable fumes.

b. *Secondary batteries.* Secondary batteries will never be piled on top of one another, rather, they will be stored on storage racks. These racks will be made of loose, flat board; nails not being required. The uprights will be about 10 inches high and 12 inches wide. Shelf boards can be of any convenient size. The rack is assembled with batteries sitting on the shelves and on either side of the uprights. The batteries must be close enough together to hold the upright rigid.

(1) *Lead-acid batteries.*

(a) *Charged and wet.* When received charged and wet, the cells are completely assembled, contain electrolyte, are fully charged, and ready for use. The batteries will be stored in a fully charged condition and care must be exercised in handling. When stored in this manner, batteries must be kept fully charged either by continuous application of a trickle charge or by a periodic recharge once each month in temperatures below 80 °F. When charging batteries, the vent caps will be kept in place to avoid electrolyte spray. Care will be taken to assure that vent caps are functioning.

It should always be assumed that an explosive mixture of gases exists in and around charging batteries, unless positive steps have been taken to eliminate them. For this reason, anything that could ignite these gases such as an open flame, a spark, or smoking should be prohibited. Water will be added and specific gravity checked every week. Because equalizing charges are given, generally, at 30-day intervals, the batteries will be stored in a readily accessible place. As the temperatures of the storage area or zone and the age of the battery have a direct bearing on the frequency at which equalizing charges must be given, the individual activity storing batteries will determine the schedule of equalizing charges.

Batteries may be stored several months in this manner and are available for use at any time. New batteries that have electrolyte in them and that have been given their first charge on batteries that have been in service and are not worn out must be stored in as cool a location as possible, namely, between 60 °F. and 80 °F. Wet charged batteries should not be stored directly on a concrete floor. Lead-acid batteries, depending on the quantity and size, will be stored in racks or bins in an upright position to prevent spillage or leakage of electrolyte.

(b) *Charged and dry.* Batteries may be stored dry indefinitely. The plates are fully charged, dried, and stored either in their containers or separately. Rubber insulators may be stored dry, but wood separators must be stored in water or in a very weak electrolyte solution in a sealed container. This method is not generally used except for new batteries which are shipped dry by the manufacturers. Batteries received charged and dry will be kept closed tightly to prevent breathing. The batteries can be palletized or stored in bins or racks depending on the quantity and size of the batteries.

(c) *Charged and moist.* For moist storage, batteries are fully charged and the electrolyte then removed and stored separately. The batteries will be sealed with paraffin wax or battery sealing compound. When batteries are stored in this manner, the seals must not be disturbed until the batteries are ready to be used. This method is least desirable since plates and separators are subject to damage. These batteries have a short shelf life, and precautions should be taken to ensure FIFO procedures are followed.

(2) *Nickel-iron alkaline batteries.* Wet discharged nickel-iron alkaline batteries may be stored for temporary periods in any state of charge without deterioration. When prolonged storage is anticipated, the battery will be discharged to zero voltage and short circuited in trays of five or six cells each. Store in a clean, dry area with the solution at the prescribed level. Make certain the filler caps are in a closed position. Nickel-iron alkaline batteries are shipped dry only for overseas shipment. Electrolyte accompanies the battery in a separate container, along with specific instructions for filling and charging the battery.

(3) *Nickel-cadmium batteries.*

(a) Wet (vented cells)—electrolyte free flowing or flooded will not be stored with intertray connectors attached. In addition, cell tops will be coated with petroleum jelly to protect the metals. These batteries should not be exposed to temperatures exceeding -65°F . to $+120^{\circ}\text{F}$.

(b) Dry (sealed cell)—electrolyte is not free flowing or flooded. These batteries should not be exposed to temperatures exceeding -58°F . to $+122^{\circ}\text{F}$. This is the preferred type nickel-cadmium battery.

(4) *Silver-zinc batteries.* Silver-zinc batteries, uncharged-dry, may be stored indefinitely.

(a) Dry batteries which are shipped in a dry condition and which will not be placed in service for 30 days or more will be stored in the dry condition at a temperature not to exceed 150°F .

(b) Wet batteries stored for 30 days or longer must be discharged. Tape all cell vent valves with cellophane tape.

(c) Wet batteries may be safely stored at temperatures from 0°F . to 110°F . However, the lower temperatures within this range are more satisfactory for storage.

(5) *Safety measures.*

(a) Face shields, aprons, and rubber gloves will be provided for personnel handling corrosive materials.

(b) A facility for quick drenching of the eyes and body will be provided within 25 feet of the work area for emergency use.

(c) Facilities will be provided for flushing and neutralizing spilled electrolyte, for fire protection, and for adequate ventilation of battery charging areas to prevent a build-up of explosive gas-air mixture.

(d) Batteries should be separated and identified by type in the storage area.

(e) Lead-acid and base-type batteries should not be charged at the same time, in the same area. An explosion can result if this rule is not followed.

(f) Medical assistance should be sought immediately in case of injury as a result of battery-related accidents.

5-21. Electronic Materiel.

Many electronic devices are highly susceptible to damage and deterioration from electrostatic discharge (ESD) even at levels which can be neither seen or felt. If either label shown in figure 5-38 are on unit or intermediate packs, then these items must not be stored within 3 feet of any electrostatic, electromagnetic, magnetic, or radioactive generating equipment or material.

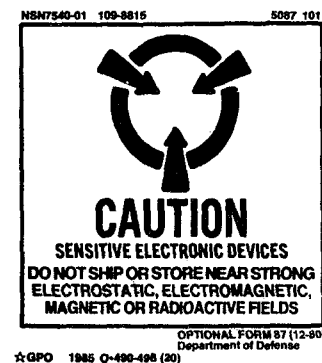

Figure 5-38. ESD Label

a. *Radioactive materiel.* See paragraph 24, this section and chapter.

b. Photo tubes. Strong light levels and high temperatures contribute to the deterioration of photo tubes. Photo tubes must be stored out of the direct light and away from high temperature areas such as heaters, etc.

c. Crystals. Crystals, when in storage, will not be stored adjacent to electrical wiring. Protection can be afforded, if necessary, by storing each crystal in a metal container or wrapping each crystal in metal foil.

d. Magnetrons, klystrons, traveling-wave tubes, backward-wave oscillators (carcinatron). These items must be stored away from magnetic fields which may be generated by adjacent equipment or wires. Interaction of magnets must also be avoided; therefore, these items must never be stored bare or without an inner and outer container.

e. Tubes. Tubes will be stored in racks or bins with sufficient shelving to prevent crushing. Tubes will be stored in original cartons if possible. Special storage instructions on the outside of the tube shipping containers will be complied with as appropriate. When moving tubes, sufficient protective shock absorbing materiel will be used to prevent damage.

(1) Large glass tubes will be stored with extreme care to ensure maximum safety of personnel as well as for maximum tube protection.

(2) When storing tubes with fins, care must be exercised to prevent fin damage. If fins are crooked or bent, attempts to realign them may affect tube properties.

(3) Shipping guards or dust covers are commonly used to protect critical or fragile elements from damage. These protective items must remain in place during storage.

f. Other electronic materiel.

(1) *Storage.* Electronic equipment and bulk boxes of maintenance repair parts and components will be palletized wherever practicable. Components can be stored on frame pallets, depending on the quantity, size, and shape of components to be stored. Long, heavy boxes of items such as wave guides and antennas should be kept in racks, preferably on rollers.

(2) *Temperature control.* Because the precision components of electronic equipment are susceptible to corrosion, mold, and fungus growth, temperature control is desirable in all warehouses where this materiel is stored. A dry warehouse is essential. At certain activities, temperature variance is so slight that mechanical controls need not be installed. A good temperature for the storage of electronic materiel is 70 °F.

(3) *Humidity control.* Because it is impractical to apply preservatives to all types and parts of electronic equipment, control of RH in storage areas is desirable for long-term storage. Fluctuating humidity and temperature causes condensation within the equipment, which results in rust. By the use of dehumidified storage space, the life expectancy of the equipment is increased considerably and additional preservation is reduced to a minimum. CH storage space is particularly desirable in areas having high humidity and where long-term storage is intended. Electronic materiel stored in dehumidified warehouses ordinarily will not require additional preservation. In dehumidified storage, open-framework packing cases can be used to provide complete ventilation.

(4) *Assembly of complete units.* To facilitate stock control, issue, and inventory, complete equipment will be stored as a unit. This is recommended also for the storage of complete sets of spare parts. In some instances, wave guides, antennas, and hoist mechanisms are too bulky to be stored with other components, but will be conveniently located so that such items will not be overlooked when the equipment is assembled for issue.

(5) *Stock issue.* Electronic materiel should be stored in issuable condition and in such a manner to allow issue of older material first, to the extent practicable. An effective method is to position new receipts and stocks being rewarehoused in a fashion to permit ready access to older materiel by stock selection personnel. Storage managers should periodically monitor stock issue procedures to ensure compliance at the warehouse level.

5-22. Photosensitized Materiels (Film and Paper) and Flash Bulbs.

a. Sensitized materiels. Unexposed photosensitized materiels are perishable and deteriorate with age. Improper storage results in loss of emulsion sensitivity, increased fog, inferior tone reproduction, and other defects that may render the materiel useless. The presence in the storage area of heat, moisture, X-rays, radioactive material, atomic fission radiation, and certain gases accelerate deterioration. Careless handling damages the package and ruins the contents. Assets and consumption reporting on a quarterly basis, rapid turnover, and careful handling will maximize the usage of this commodity.

b. RH control. The required RH for sensitized materiels ranges from 30 to 60 percent with 50 percent considered as ideal. A constant RH will be maintained.

c. Temperature control. Photosensitized materiels will be stored at temperatures of 50 °F. or

lower. A constant temperature will be maintained. Regardless of how photosensitized materials are packaged, temperatures should be controlled in the storage areas.

d. Refrigeration. Refrigerated space always should be utilized for proper storage of photosensitized materials. The required condition within the refrigerated space will be a maximum temperature of 50 °F. and constant RH within the range of 30 to 60 percent. Leakage of moist air from the outside should be reduced by using an air lock at the door. If the RH cannot be held as required, the sensitized material should be placed in vaportight containers inside the refrigerators.

e. Hazards.

(1) *Harmful gases.* Sensitized materials will be protected against harmful gases. High concentration of formaldehyde, hydrogen sulphide, ammonia, illuminating gas, mercury vapor, industrial gases, exhaust from engines, vapors of solvents, cleaners, and turpentine can damage photographic emulsions.

(2) *X-rays, radioactive, and atomic fission radiation.* When storage of packaged photosensitized materials near X-ray machines, radar, radioactive, or atomic fission radiation cannot be avoided, the material will be placed in facilities shielded with an adequate thickness of lead or other suitable barriers.

f. Operations.

(1) *Storage.* Immediately upon receipt, photosensitized material will be stored under specified optimum conditions. These optimum conditions will be utilized at storage or holding points within the limits of resources available. Deviation from the optimum storage conditions for storage of photosensitized materials is authorized whenever prescribed storage facilities (refrigerated) are unavailable and the expenditure of resources to modify existing or construct new facilities for such purpose cannot be economically justified. Photosensitized material will be placed on shelves, dunnage, or pallets allowing sufficient space between packages for adequate circulation of air. Refrigerators utilized for photosensitized material will not be used for the storage of food or water in any form. Likewise, these materials regardless of level of preservation and packaging will not be stored in damp basements, on damp ground, near escaping steam, steam pipes, boiler rooms, windows, on top floors of uninsulated buildings, or near other sources of heat. Each lot of materials will be stored according to the expiration date placed on the package by the manufacturer.

(2) *Handling.* Photosensitized materials should be moved to refrigerated storage immediately upon receipt at all points of destination. These materials will never be permitted to stand on docks, loading platforms, loading ramps, etc. The material should be moved by refrigerated carriers and unloaded directly into refrigerated storage. In other words, all photosensitized materials should be maintained under optimum temperature and RH condition from time of shipment from the manufacturer's plant until placed in use by the using activity to assure preservation in the best condition for the longest period of time.

(3) *Turnover.* The objective should be to have as rapid a turnover as is economically possible and to use photosensitized materials before the expiration date. All packages of the photosensitized materials are stamped by the manufacturer with an expiration date (month and year). This date gives the life expectancy of the sensitized materials under normal nonrefrigerated storage conditions. Improper storage conditions can render these materials useless long before the expiration date is reached. Photosensitized material will be issued according to the "Expiration Date" shown on the package. That is to say, the package with earliest expiration date will be issued first. Sensitized material stored under the optimum conditions specified herein will be issued for the following period after the stamped expiration date:

Materials	Domestic	Overseas
Black and white	12 months	6 months
Graded paper	12 months	6 months
Variable contrast paper	12 months	6 months
Color, camouflage detection, and infrared film	6 months	0 months
Polaroid-type material	No extension	

Photosensitized materials will be tested in accordance with the procedures and schedule as set forth in service/agency Quality Control Standards. Materials which have not been used within this time period or are suspected of damage in storage or handling will not be discarded without being tested. Often only partial impairment of speed and contrast will have taken place and the material will still serve adequately for training or non-critical use.

g. Storage of photographic chemicals.

(1) The optimum storage conditions for all photographic chemicals are at temperatures between 70 °F. and 75 °F. and at an RH between 20 and 40 percent.

(2) The recommended storage conditions for specific types of photographic chemicals are as follows:

(a) Dry chemicals in hermetically sealed containers at temperatures up to 90 °F. and RH.

NOTE

Sealed metal containers do not require special protection except where conditions could cause container corrosion or deterioration.

(b) Dry chemicals in containers with moisture barriers at temperatures up to 90 °F. and at RH up to 50 percent.

(c) Liquid chemicals in hermetically sealed containers at a temperature between 70 °F. and 80 °F. and any RH.

(d) High humidities will be avoided where possible to prevent deterioration of fiberboard packing cartons.

(e) These instructions are applicable to those photographic chemicals discussed. Where the manufacturer specifies special considerations, the manufacturer's instructions will be followed.

h. Flash bulbs. Personnel who store, handle, and ship flash bulbs should be cautioned about the fire hazard which exists from unpackaged or improperly packaged bulbs being fired or exploded by radar beams. Normally, flash bulbs should be shipped in full case lots. If not possible to ship in full case lots, broken case lots will be packed in accordance with Federal specification W-L-122. Bulbs will not be stored near sources of radiated energy unless suitably protected by containers which are impervious to such radiation.

5-23. Self-Sealing Fuel Cells.

a. Deterioration. All self-sealing fuel cells deteriorate with exposure to light, heat, and improper handling.

b. Precautions to be taken. When handling and storing self-sealing fuel cells, the following precautions should be observed:

(1) Store cells in clean, dry, dark, and cool warehouses.

(2) Store in a shipping container, if available, and do not remove the cell from the shipping container until needed. Save empty containers for storing used cells.

(3) Use frames or vertical dunnage to prevent crushing or distorting when more than four containers of cells are stacked.

(4) Uncrated cells should never be stacked but should be stored in contoured racks resting on the widest side where there are no fittings.

(5) For the support of uncrated cells, the use of paper tubes inserted within the cell is recommended.

(6) The cell should never be allowed to rest on protruding fittings. When crated, the proper position will be indicated on the container by arrows.

(7) When in storage, all openings will be covered to prevent the entrance of foreign materials.

(8) Internal support will be installed in all semi-flexible cells to prevent distortion.

(9) Cells with external supports will not be stored without these supports.

(10) Never roll or drag a cell.

5-24. Internal Combustion Engines.

a. Other than aircraft. When storing internal combustion engines, the following precautions should be observed:

(1) Engines should be stored in a clean, dry area which is not subject to extreme variations in temperature.

(2) Engines should be stored on dunnage, pallets, skids, or in racks depending on the size, type of engine, method of pack, and quantity to be stored.

(3) Engines are not to be turned over or cranked while in storage because of the danger of damaging the coating of preservative compound on the cylinder walls and on all moving parts.

(4) Engines in storage, other than dehumidified storage, should be treated periodically with preservative compounds.

(5) In nondehumidified storage, periodic spot checks on 5 percent of the engines on hand should be made at intervals of approximately 6 months. If deterioration is apparent, a complete check of all engines should be made and engines showing deterioration should be represerved.

(6) In dehumidified storage, normally, engines do not require as much attention; an annual check of 1 percent of the engines in stock should be sufficient to ensure the engines being operable when required.

(7) A different group of engines should be selected for each spot check.

b. Aircraft. Storage of aircraft engines will conform to specific instructions of the appropriate military service.

5-25. Lubricating Oils and Greases.

When storing oils and greases, the following precautions should be observed:

a. Store in fire resistant, sprinklered buildings or warehouses.

b. If a general warehouse is used, storage should be in end zones with immediate access to exterior doors.

c. Oils and greases should be separated from blocks of other materials by aisles not less than 3 feet wide.

d. Oils and greases should be segregated from highly combustible supplies.

e. Exteriors of containers should be free of oil and grease.

f. Containers should be inspected before being placed in storage and periodically thereafter. Containers which show signs of leakage, excessive corrosion, or are otherwise unfit, should be removed from storage. Contents should be removed from unfit containers and transferred to satisfactory containers.

g. Oils and greases in bulk storage should be palletized.

h. The height of stacks and the size of blocks should comply with regulations governing floor load capacities and ceiling heights.

5-26. Paints.

Paint, varnish, lacquer, thinner, and shellac should be stored as follows:

a. Where facilities are available, paint and paint materials will be stored in hazardous materials facilities (see TM 38-410/DLAM 4145.11/NAVSUP PUB 573/AFR 69-XX/MCO 4450.XX, Storage and Handling of Hazardous Materials).

b. If such space is limited, supplies bearing Interstate Commerce Commission red labels (flammable types) will be given preference.

c. If a general storage warehouse is used, storage will be in the end zone with immediate access to exterior doors.

d. Containers of paints will be segregated from highly combustible supplies.

e. Before placing in storage, containers will be inspected for leaks.

f. Good ventilation will be provided.

g. Containers of paint should be palletized before storing.

h. Containers of paint should be located so as to facilitate issue on FIFO basis.

i. Paints, in general, should be stored in a cool, dry place with exception of bituminous camouflage,

water emulsion, and latex-type paints. In colder climates, these types should be stored in heated buildings to prevent freezing.

j. Store in nonfireresistive, unsprinklered warehouses as a last resort only.

5-27. Life Floats.

Life floats should be stored in a clean, dry, and covered area; should not be exposed to the direct rays of the sun or extreme heat; and should be stored with caution against moisture accumulation in webbing and ropes. Floats should be reversed or turned periodically. When handling life floats, care should be taken to prevent damage to cork floats and webbing.

5-28. Linoleum.

When storing and handling linoleum, the following precautions should be observed:

a. Linoleum should be stored in a vertical position and in the original shipping container.

b. Heated or unheated storage of linoleum is satisfactory; temperature from 0 °F to 120 °F. will not harm it.

c. At low degrees, linoleum should be handled carefully as it will crack if dropped.

d. When removing linoleum from trucks and boxcars, do not drop crates over stringers.

5-29. Fiber Rope.

When storing fiber rope, the following precautions should be observed:

a. Fiber rope will always be stored in a cool, dry, and covered space as heat and moisture cause deterioration.

b. When manufactured, fiber rope is impregnated with oil which adds 10 percent to the weight. The rope deteriorates as the oil leaves the rope.

c. Rope will be protected from the direct rays of the sun.

d. Adequate ventilation will be maintained in rope storage areas at all times.

e. When properly stored, rope loses its strength because of age at about 2 percent per year; life of rope will be shortened by presence of mold, acid, or water.

f. Rope will not be stored near acid, batteries, chemicals, or alkalies and will be removed from all danger of fumes from such materials.

g. Rope up to 2 inches in circumference will be wrapped in burlap or waterproof paper.

h. Rope will never be put into storage while wet or covered in a manner that will cause it to retain moisture.

i. Coverings will be left on the outside of rope coils; lashings will be cut from the inside of the eye leaving the covering intact.

j. Rope will be inspected to locate the inside end which is in the eye (opening in center of coil) when opening a coil; all stock should be taken from this end.

k. Before cutting rope, whipping of yarn should be applied on both sides of the proposed cut to prevent the strands from becoming unlayed.

l. Rope will be stored on reels, in bins or racks, or on pallets according to the quantity and size to be stored.

5-30. Wire Rope.

a. *Storage.* Wire rope should be stored in a cool, dry place away from fumes, chemicals, heat, or dampness and should be kept on the reel or spool until used. If it is to be stored for a long period of time, the full length of the rope should be coated with a preservative (MIL-C-16173, grade 1). In the manufacture of wire rope, a lubricant is applied to the hemp center which acts as a stor-

age medium for the oil. Wire rope should be kept away from all chemicals such as acids which attack the metal and alkali which will destroy the internal lubrication. Damage by chemicals is not always noticeable and the concealed weakness makes the cable dangerous to use.

b. *Corrosion.* Corrosion or rust weakens a rope but it is almost impossible to ascertain the loss in strength. Exterior loops of the rope should be examined frequently for signs of rust or corrosion.

c. *Unwinding.* When removing wire rope from a reel, the reel must be rotated on a spindle resting on a cradle (fig 5-39), or a turntable, or by rolling the reels along the floor. A surplus race from a gun mount may be used as a turntable (fig 5-40). Wire rope should never be taken from one side of the reel as each wrap on the reel produces a kink in the rope which makes it unsafe for use. A short, angular bend, known as a "dog leg," resulting from a partial kink will chafe on the flanges of the sheave and wear the rope prematurely at that spot.

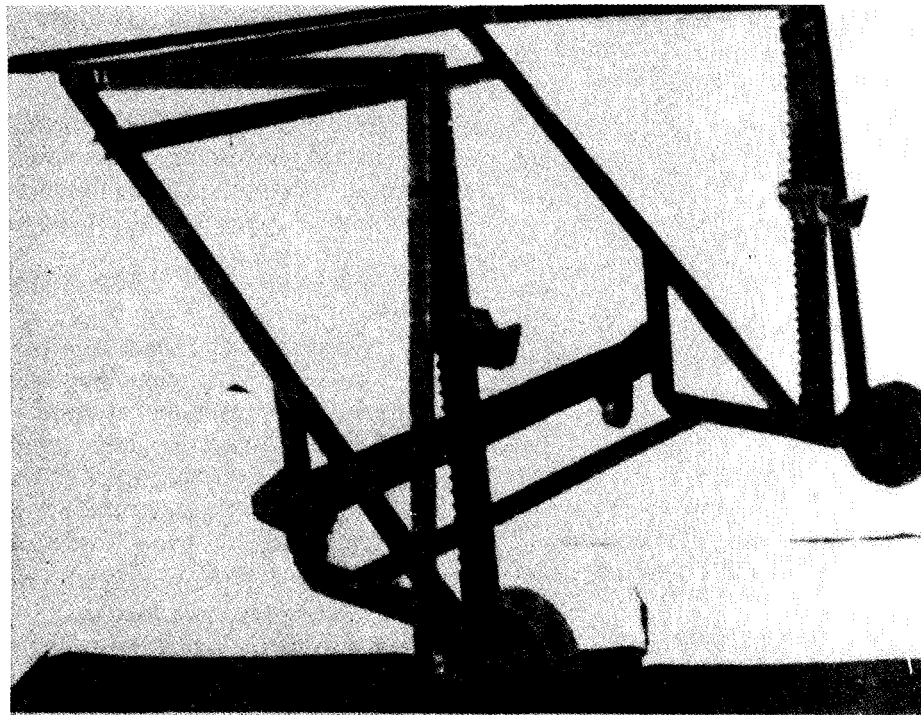

Figure 5-39 Cradle for handling reels



Figure 5-40. Wire rope dispensing turntable.

d. Cutting. Before cutting any wire rope (including preformed rope), apply three seizings on each side of the proposed cut. If cutting is done by an acetylene torch, the seizing can be omitted as the wires and strands will be welded together.

5-31. Clay Targets.

Clay targets are fragile items and the handler always will comply with the marking "this end up." Clay targets should be palletized and stored in storage racks or pallets and pallet support sets.

5-32. Cement.

a. Cause of deterioration. Causes of deterioration of cement are as follows:

- (1) Moisture.
- (2) Movement or circulation of air.
- (3) Failure to observe FIFO issue procedure.
- (4) Warehouse pack (packing of lower sacks of cement when stacked too high for a long period of time).

b. Method of storage. Cement will be stored in dry covered storage areas. The circulation of air should be held to a minimum as air carries moisture. Cement will be stacked away from walls to avoid condensation or moisture.

c. Pallet storage. Cement will be palletized not to exceed four courses high per pallet. Pallet loads will not be stacked more than two high unless aids are used to support the weight of superimposed pallet loads. Cement put into storage will not be

disturbed until it is issued. Restacking or shifting (to avoid warehouse pack) exposes the cement to air circulation which increases the absorption of moisture.

5-33. Navigation Timepieces.

a. Security. Timepieces should be stored in a room which has adequate security facilities. This room should be located away from the shock and vibration of machinery, air conditioned, and free of dust.

b. Temperature. The controlled temperature should be maintained near 70 °F. (+5 °F.), with an RH of not more than 50 percent.

c. Unpacking. When received from the observatory, the timepieces should be unpacked, wound, uncorked or unlocked, started, and set to Greenwich Central Time and given a 10-day run with daily winding and rating prior to storage. After the 10-day run, the timepieces should be allowed to run 48 hours more, then stopped and corked or locked, and stored.

d. Storage. When not running, all navigational timepieces should be inverted every 30 days to redistribute the oil on lubricated surfaces. When the timepieces has been in storage 6 months, and not more than 8 months, wind, start, and allow to run for 5 days with daily winding; after the timepieces have operated for a period of 2 days, they should be rated for 3 days. At the conclusion of this 5-day trial period, the timepieces should be stopped and returned to storage. Suitable shelving or cabinets should be provided for all timepieces.

5-34. Machine Tools and Production Equipment.

a. Reference. Detailed information concerning the preparation of machine tools and similar equipment for extended storage will be found in MIL-STD-107 and in joint publication TM 38-260, NAVSUP Pub 523, AFR 71-18, MCO 4870.62, DLAM 4145.9, Preparation of Industrial Plant Equipment for Storage or Shipment.

b. General. Most machine tools are large, bulky, and heavy; this fact should be considered in laying out space. Large, unwieldy pieces of equipment and unusually heavy items should be stored as close to removal aisles as possible. Machine tools vary considerably in weight, shape, and size, but this does not mean that the tools can be placed haphazardly in the storage warehouse. Machine tools should be lined up by type and arranged so that adequate aisle space is provided, not only to facilitate inspection, but also to provide easy removal without disturbing other units. This equip-

ment can be block stacked, providing it is composed of similar units.

c. Crating. Most crating of machine tools is unnecessary and costly. Crating should be used only when the individual tool is adaptable for tiering. Tiering of machine tools should be limited to such tools with solid bases, rectangular columns, and

circular pedestals. Only such tools weighing less than 10,000 pounds should be tiered. The use of bolts in place of nails for such crating is permissible. Consideration also should be given to floor load capacity and accessibility. Block stacking should be determined by qualified personnel at each activity (fig 5-41).

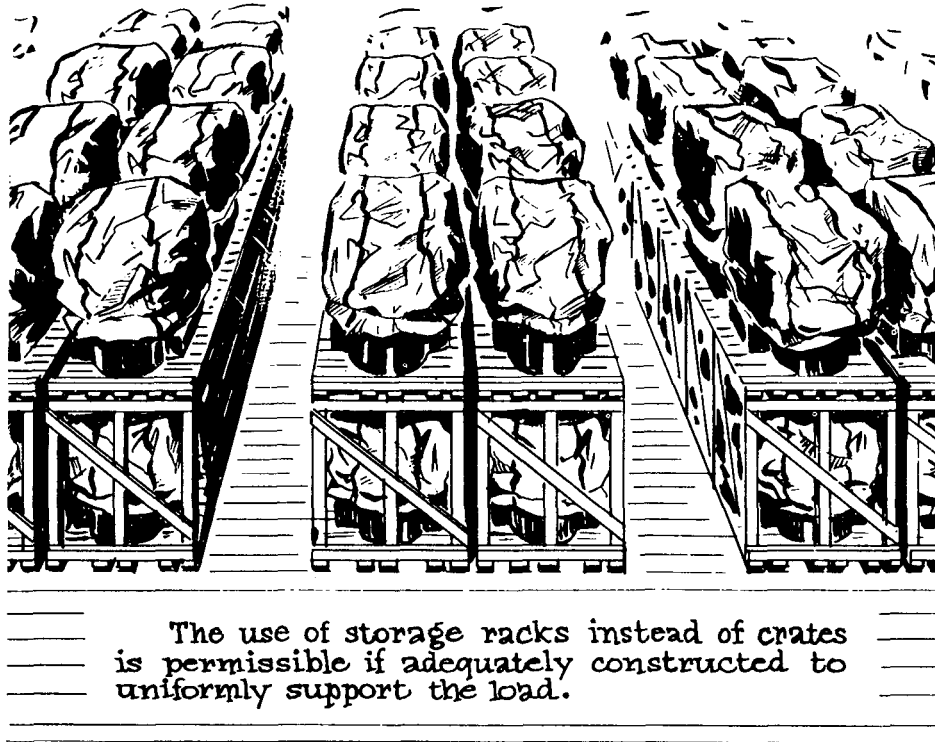
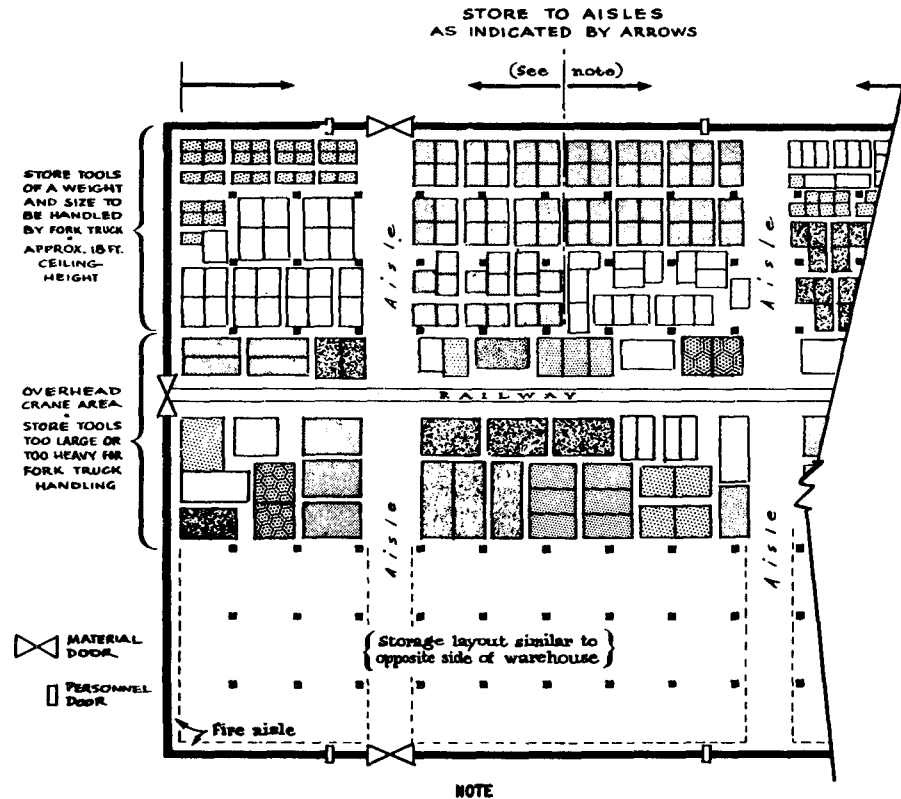

Figure 5-41 Tiering of machine tools

d. Storage. The areas directly under craneways are to be utilized, so far as practicable, for the heaviest units. This is the most expensive storage space and will require a limited number of removal or access aisles, since the direction of storage is upward. In order to facilitate inspection and

removal, units should be placed so that inspection and removal space is provided. The size of removal aisles will be governed by the size of the units, but should not exceed the width necessary to furnish convenient passage for handling equipment. Where practicable, the aisles should be continuous and provide straight movement (fig 5-42).



NOTE
 Where storage area is between aisles, establish an imaginary line approximately centered and store from this line in opposite directions toward the aisles.
 When issuing from a large area of like machine tools, as shown in diagram, remove to this center line from one aisle at a time, thereby making available space for additional storage.
 (This rule does not apply in section of warehouse where overhead crane is used.)

Figure 5-42. Typical storage layout of machine tools

For space conservation, it may not always be practicable to store units immediately adjacent to removal aisles; in this event, inspection aisles should be widened to provide enough space to move individual units through to the removal aisles. Steel rollers, overhead cranes, forklift trucks, dollies, lift jacks, or other suitable handling equipment can be used to move any unit from storage, provided care is taken to determine the center of balance and position of pedestal and bases. In order not to disturb the protective coating and preservatives, the material should be moved only for inspections, in emergencies, or when ordered for issue. Platforms and racks should be used when within the limits of floor load capacities and available air rights. When a unit is moved, the nuts of all holddown bolts should be tightened securely.

e. Use of skids. All units should be skidded when stored to protect the machinery during handling. It is recommended that the skids remain attached to the machine while in storage. Guidance

is provided in MIL-HDBK-701. However, at activities where leveling jacks are available and personnel are familiar with the storage of machine tools and production equipment, skids can be removed. When skids remain on the units, units should be leveled properly before storing. If the floor is too irregular to use shims, the skidded unit should be placed on wooden strips, 1 to 2 inches in thickness. To ensure proper distribution of weight and to maintain the unit level at all times, the strips should be placed at right angles directly under the bolt heads. The strips not only prevent the unit from warping and distorting, but also will protect the skids and facilitate movement of the units. In storage, the nuts will be backed off 1½ to 2 inches from the top of the skid. The bolts and nuts should be protected with a preservative. All machine tools in storage should be tagged with the following information (red tags preferably): "CAUTION: TIGHTEN ALL HOLDDOWN BOLTS BEFORE REMOVING THIS MACHINE FROM STORAGE."

f. Accessories. Accessories should be boxed or crated and placed on the skid or platform of the unit from which removed. Precautions should be taken so that the wood of the boxes or crates does not come in contact with the preserved machine surfaces. When it is not possible to place accessories on the skid, such accessories should be stored adjacent to, or in the vicinity of, the machine tool; proper identification should indicate clearly the unit to which the crated accessories belong.

g. Tiering. Where it is necessary to use tiering methods to conserve storage space, care should be taken in selecting machines to be tiered. Machines of long bed design, with leg-type, end frame, or multiple column bases, or weighing more than 10,000 pounds should rest on a solid base and not be placed on top of other machines.

h. machines weighing more than 10,000 pounds. Tiering of machines tools such as lathes with long beds or other units with extended legs, long tables, or double columns may distort or warp the tools beyond reasonable repair. Small machines that have rectangular columns or circular pedestal bases can be tiered, provided suitable crating or dunnage is inserted between the machines to bear the load. To avoid permanent distortion of frame members by undue stresses or strains, all machines should be leveled and supported. Machine tools may be tiered two tiers high, but there are some types of industrial equipment that can be tiered higher when crated such as welders, furnaces, heat treatment equipment, and washing machines.

5-35. Tires, Tubes, and Rubber Products.

a. Selection of Warehouse. Warehouses in which tires are stored must provide the maximum safety and protection to the tires housed. Buildings used for tires storage should—

- (1) Provide maximum protection against fire and reduce fire hazards to a minimum.
- (2) Provide protection from light.
- (3) Provide a uniformly cool temperature.
- (4) Be free of operating electrical equipment which generates ozone.
- (5) Provide protection against drafts or air movement since air currents increase rubber deteriorating oxygen in the air and aid combustion in case of fire.

b. Aircraft tires and tubes.

- (1) The age limits for aircraft tires and aircraft inner tubes are based on the date of manufacture. Retreaded tire age limits are also from the date of tire manufacture, not the date of retread-

ing. Aircraft tire manufacturing dates are included in the serial number of tires. The serial number consists of a maximum of ten positions, alpha and/or numeric. The first four positions are the date of manufacture in the form of a julian date (last digit of the year followed by the day of the year (i.e., 23 May 1968 is written 81440). Manufacturing dates shown previous to this method are identified by month and year such as 10-68/October 1968. Inner tubes have the date applied to the tube by decal or stamped on the surface. The outside of the tube cartons are also date stamped. Proper control and rotation of stock procedures will be implemented to assure that the oldest aged dated items are issued first. Color tape is used on aircraft tires manufactured in 1962 and subsequent years to aid in age identification of the tires while in storage at depots, storage sites, air bases, etc. Tires manufactured in 1962 and subsequent years are color coded with one circumferential band of 1-inch wide tape, completely around and approximately centered on the tread. This paragraph is intended as information only and is not used as authority to require tape markings of tires currently in storage. New tires will be color coded by the manufacturer before delivery.

***Tape Color Identification Data**

Tape color	Year
White	1962
Silver or gray	1963/1970/1977/1984/1991/1998
Green	1964/1971/1978/1985/1992/1999
Blue	1965/1972/1979/1986/1993/2000
Orange	1966/1973/1980/1987/1994/2001
Yellow	1967/1974/1981/1988/1995/2002
Magenta or purple	1968/1975/1982/1989/1996/2003
Red	1969/1976/1983/1990/1997/2004

*Tires manufactured after 1971 have the year printed on the colored tape

- (2) Serviceable aircraft tires will be placed into suitable tire racks so that tires will be held in a vertical position and with each tire holding its own weight only. The rack will provide a flat or covered surface for the tire rather than a round surface such as pipe or tubing. If this procedure is not followed, particularly in the case of tubeless tires, it maybe impossible to mount the tire without the aid of additional equipment. The flat spots on the tread, which may develop from storing tires vertically, are not harmful. Such Flat spots will disappear when the tire is mounted and inflated.

- (3) Repairable aircraft tires may be stored in a vertical or horizontal position. Flat spots caused by storage in either position are corrected during the retreading process. Tires stored in a horizontal po-

sition will not exceed the stacking limits specified below.

(4) Repairable aircraft tires with a normal cross section width of 10 inches and above will not be stacked more than 5 tires high.

(5) Repairable aircraft tires with a normal cross section width of less than 10 inches will not be stacked more than 8 tires high.

(6) Aircraft inner tubes will be stored to avoid creasing. Inner tubes will not be completely deflated and will be dusted with tire talc to prevent the tubes from sticking together. Whenever possible, inner tubes will be packed in fiberboard boxes. If fiberboard boxes are not available, tubes will be wrapped in heavy paper and stored in a dark room. Packages will be plainly marked to indicate contents and will state size, type of tube, date of manufacture, and stock number.

(7) Tires and tubes should not be stored in the vicinity of electrical discharges from the operation of electric motors, generators, welders, or other electrical devices.

c. Over-the-road and industrial vehicular tires and tubes.

(1) The preferred method of storing pneumatic rubber tires, mounted and unmounted, tube and tubeless, new, used, and reconditioned, is in a vertical position. Horizontal storage is not as satisfactory because of the necessity for reversing at 6-month intervals. However, where small quantities of tires are involved, horizontal stacking is economical. When horizontal pallet storage is used, the quantity of tires to be stacked on each pallet should not exceed the following limits:

Maximum Number of Tires To Be Stacked

Tire size	One upon another
600x16	15 each
650x20	14 each
750x16	12 each
700x20	12 each

Maximum Number of Tires To Be Stacked (Continued)

Tire size	One upon another
900x16	8 each
1,000x20	6 each
1,200x24	6 each
1,300x20	6 each
1,400x20	5 each

If the indicated limit is exceeded, the bottom tire is in danger of permanent damage. This limit also applies to placing one pallet on top of another when intervening supports are not provided between the pallets. If tires stored horizontally remain in storage for over 6 months, each stack should be reversed so that the bottom tire is put on top.

(2) Vertical storage of tires eliminates the necessity for periodic rewarehousing which is required when tires are stored horizontally.

(a) Tires stored in a vertical position may be grouped by size on standard 40- by 48-inch pallets combined with appropriate size standard pallet support sets to form a tire storage unit (fig 5-43). As an alternate method, pallet racks may be used if they are more readily available. Suitable wood racks, steel racks, or slotted-angle receptacles, and nonstandard pallet support sets, now in use, are acceptable pending normal replacement action.

(b) Tires up to 48 inches outside diameter may be stored in bundles in pyramidal fashion. This method permits the attainment of adequate storage heights with a minimum requirement for storage aids. The tires may be unitized in bundles by securing (fig 5-44) with either the stretch-film or the shrink-film method. Figure 5-45 is an example of tires unitized by use of stretch film. Chapter III, section X, provides information on use of stretch and shrink film. Also, MIL-T-004 contains instructions for tire unitization to include use of strapping.



Figure 5-43 Typical storage in pallet support sets

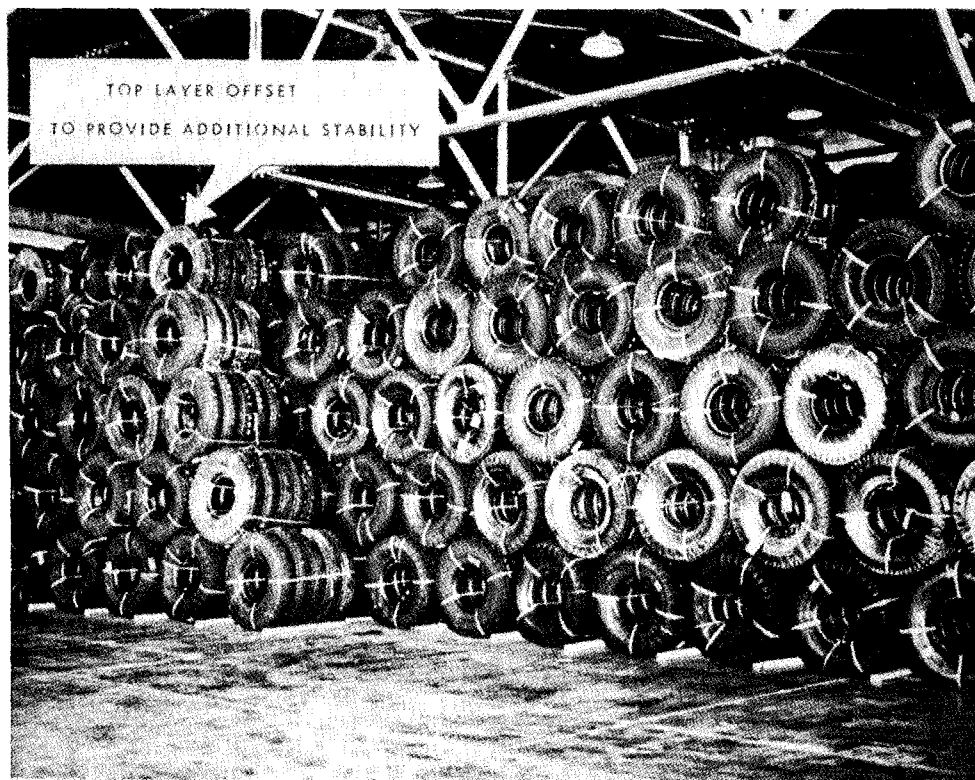

Figure 5-44 Block stack of 11.00X15 tires

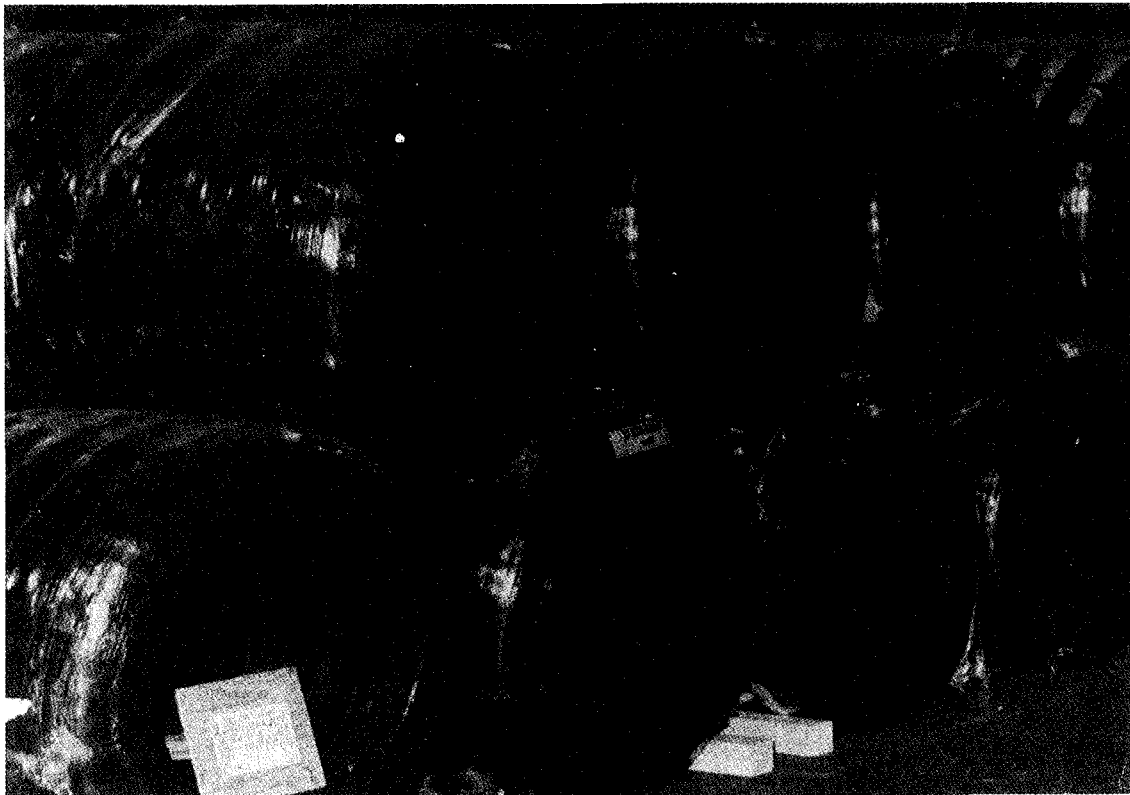

Figure 5-45. Tires unitized by stretch-wrap method

1 As long as the tire bundles on the bottom layer are chocked with a 4 by 4, larger tires can be safely stacked four bundles high.

2 Tires sized 11 by 15 inches and smaller can be pyramidally stacked 5 bundles high (fig 5-44). The fifth layer should be offset from front to rear to tie the stack of tires together to provide more stability to the block stack.

3 Only one tire size should be stored in each pyramid pile. Also, the same number of tires should be contained in each strapped-, stretch-, or shrink film unit for a particular size to aid the inventory process.

(c) Tires in storage can deteriorate in time to an unusable state. To ensure maximum protection against loss from deterioration, a strict policy of issuing oldest stock first will be practiced. When tires or tubes are received for storage, the month and year of manufacture or retread will be indicated on the pallet placard. This will aid in selecting the oldest stock first.

(3) Care must be used at all times in the handling of tires, tubes, and rubber products. They must not come in contact with gasoline, oil, or other petroleum products. (If such contact occurs, wash as soon as possible with soap and water.)

Cutting, scuffing, or scraping of tires during handling must be avoided.

(4) Unmounted tires must not be stored in the open. If closed warehouses are not available for storage of unmounted tires, or if it is necessary to store vehicles with mounted tires in open storage for periods exceeding 90 days, tires must be preserved with rubber preservative conforming to MIL-P-11520.

NOTE

Date of manufacture and "OZ" marking are normally imprinted on the tire sidewall. Date of reprocessing is normally imprinted on a reconditioned tire sidewall.

(5) Used serviceable tires will not be placed in storage until they have been cleaned, had all foreign material removed, preserved with MIL-P-11520, and inspected. Serviceable used tires, including those reconditioned, will be stored and handled the same as new tires.

(6) Tubes must be handled with care equal to that given to tires.

(a) New tubes should be stored in the original package and protected as outlined for tires.

(b) Used serviceable tubes should be completely deflated by removing the valve core. They can be folded and stored.

(c) Tubes will be placed in storage grouped according to size and type. Removal from storage will be on the basis of oldest stock first.

(d) Self-sealing tubes must be inflated enough to retain full molded size. Storage aids (e.g., pallet support sets) will be used to assure retention of shape and size.

d. *Solid rubber tires and track components.* Solid rubber tires, rubber components of combat vehicle track, track support rollers, and track idler wheels will be protected as outlined in c above.

e. *Rubber cements.* Rubber cements must be kept within 32 °F. to 90 °F. and all containers must be kept tightly closed at all times. Rubber cements, dependent upon flash point, are either flammable liquids or combustible liquids and must be considered for storage in light of their flammability properties.

5-36. Abrasive or Grinding Wheels.

a. *General.* All grinding wheels are fragile and should be handled and stored carefully to prevent breakage and chipping.

b. *Location.* Wheels should be stored in covered, dry areas, and should not be exposed to extreme temperature changes. Escaping steam and rain will seriously affect grinding wheels; consequently, such wheels should be away from radiators and open windows.

c. *Storage.* Generally, grinding wheels are stored in bins and racks. Smaller sizes are often carried in bin drawers. The bins, racks, or drawers

should be built to accommodate wheels of various sizes. Separate sections of storage racks should be constructed within standard shelving to prevent the wheels from rolling off (fig 5-46). Wheels of the same size, type, and specification should be stored together and should be arranged, so far as possible, to facilitate issue on the basis of FIFO (fig 5-47).

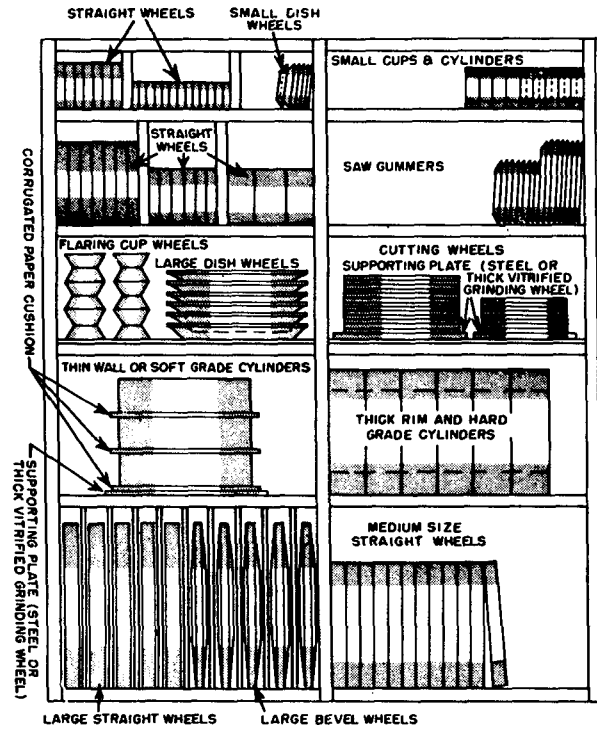

Figure 5-46 Bin storage of grinding wheels

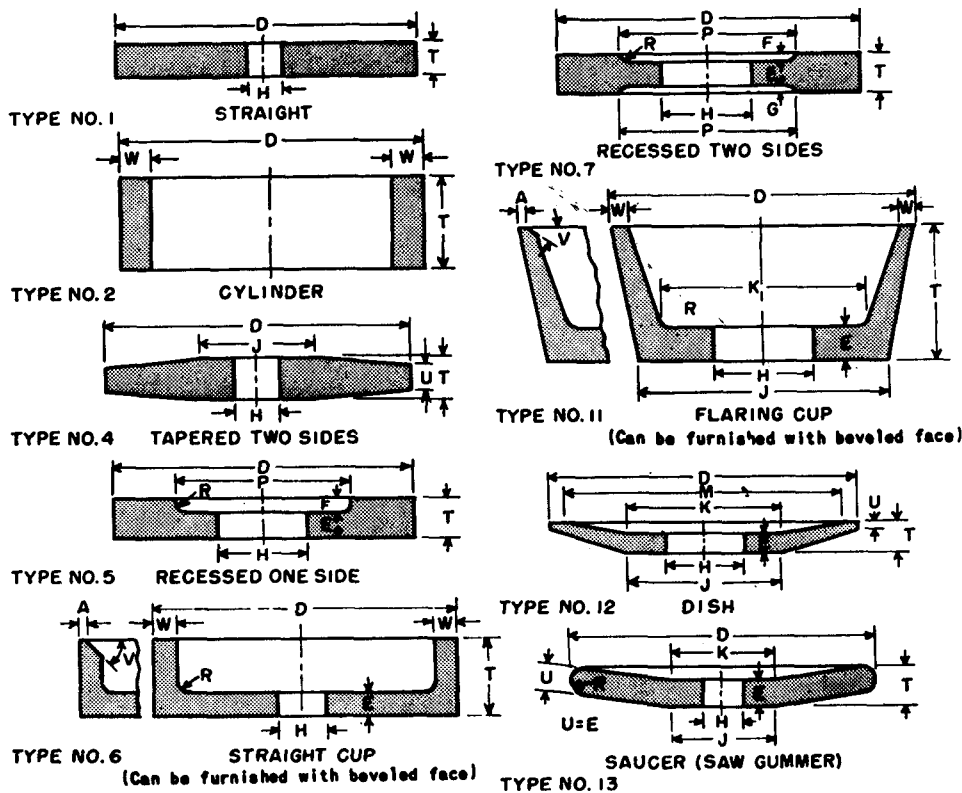

Figure 5-47 Typical types of grinding wheels

d. *Straight and tapered wheels.* Most straight and tapered wheels should be stored on edge in racks. The racks should provide two point cradle support for the wheels to prevent rolling. A sufficient number of partitions to prevent wheels from tipping over should be provided. An individual section is recommended for each wheel of unusual shape.

e. *Thin organic bonded wheels.* Thin organic bonded wheels should be stored on a flat surface away from excessive heat. A heavy steel plate or thick vitrified wheel makes a good foundation for stacking, and similar plate or wheel placed on the top of the stack will help prevent warpage.

f. *Cylinder, cup, and saucer wheels.* Cylinder wheels and large straight cup wheels can be stacked on the flat side with corrugated paper or other cushioning material between the wheels, or can be stored in racks similar to the racks used for storing straight wheels. Large flaring cup wheels should be placed flat on a horizontal shelf, alternating the position so wheels are stacked base against base and face against face. Small saucer, cup, and dish wheels, without thin, easily damaged edges or rims, can be stored on edge.

g. *Cloth-backed thin discs.* Cloth-backed thin discs should be supported and weighted the same as bonded wheels and should be stacked cloth to cloth and grain to grain to avoid damage to the cloth backing. Also, this method of stacking will help to prevent warpage.

h. *Small-shaped wheels.* Small-shaped wheels such as plugs and cones should be stored in boxes, bins, or drawers.

5-37. Glass.

a. *Storage.* The RH in glass storage areas should not exceed 65 to 70 percent, because moisture and dampness have a tendency to etch glass when it is stored for long periods of time. Glass should be stored in original containers until ready for issue. If glass is removed from original containers, the three types of storage racks generally used for storage are the "A" type, pocket type, and slotted type. Because of its fragility, glass should be handled with extreme care. Persons handling large sheets of glass should use rubber grips or pads.

b. *Small size glass.* Window glass and other small size glass should be stored in pocket-type storage racks if removed from original containers. If possible, the racks should be constructed from

redwood because this lumber is free from knots and gives added protection to the edges of the glass. Glass stored in pocket racks should have an absorbent type of paper between each sheet of glass. Bulk storage of small size will be palletized if the quantity is large enough.

c. Plate glass. Medium size plate glass, if removed from original containers, should be stored in slotted-type storage racks. The slotted rack should be constructed from stock lumber with the slots made of maple, if available. The maple should be three-eighths of an inch milled and three-eighths of an inch routed to form the slots, and the separators at the top of the racks should be constructed of various thickness of masonite. Plate glass in original containers should be stored on edge.

d. Extra large sizes. Glass of extra large or special sizes should be stored on "A" type racks.

e. Handling block. A wedge-shaped handling block is used for handling plate and large size sheets of glass. This wedge-shaped block is constructed from stock lumber and is covered with carpet. The carpet protects the edge of the glass and permits easy removal from the racks.

5-38. Musical Instruments.

a. Woodwinds and brass. The following instructions pertain to the storage of woodwinds and brass instruments:

- (1) Instruments should be kept in cases when in storage.
- (2) Each case should contain a 1-ounce block of camphor to reduce humidity, prevent tarnish, and act as a moth repellent for the plush lining of the case.
- (3) Instruments should be inspected, cleaned, and repaired, if necessary, before being placed in storage.
- (4) Woodwinds and brass should never be stored in damp areas or in extreme heat as heat and dampness cause corrosion and tarnish.
- (5) Woodwinds should be oiled twice yearly while in storage; bore oil is preferred.
- (6) A desirable temperature for woodwinds and brass is between 65 °F. and 75 °F.
- (7) Small instruments should be packed in containers and palletized.
- (8) Large instruments should be packed in containers and crated with a skeleton frame strong enough to sustain the weight of stacking.

b. String instruments. The following instructions pertain to the storage of string instruments:

(1) String instruments should be kept in carrying cases, with a 1-ounce block of camphor to reduce humidity.

(2) String tension should be released before the instruments are placed in storage. Sound posts must not be allowed to become loose.

(3) Before being placed in storage, instruments should be cleaned, inspected, and repaired, if necessary.

(4) A desirable temperature for the storage of string instruments is between 65 °F. and 70 °F. Temperature should be kept as constant as possible.

(5) Open containers of water should be kept near large string instruments such as the violin, cello, and brass.

(6) Bass violins and violin cellos should be suspended in an upright position while in storage, with the bottoms of the instruments fastened to prevent swinging and bumping each other.

(7) Small string instruments should be packed in containers and palletized or placed in bins or racks, depending on the quantity to be stored.

c. Drums. When storing drums, the following precautions should be observed:

- (1) Drums should be kept in cases while in storage.
- (2) Tension on drum heads should be released before drums are placed in storage.
- (3) A desirable temperature for the storage of drums is between 65 °F. and 70 °F.
- (4) Drums should be packed in containers and palletized.

d. Pianos. Excessive heat and dampness can damage a piano in a very short time. A temperature variance of 18 °F. is the maximum permitted in areas where pianos are stored. Pianos can be stored in nonheated warehouses, but should not be placed near an open window or in extremely dry spaces because of the large amount of glue used in the case and action. If a piano is not stored at a constant temperature of 68 °F., a small package of unslaked lime should be put inside the case to prevent rusting of the strings. The heat from a lighted 15-watt light bulb attached to the base of a keyboard instrument will act as a dehumidifier. Because of the large amount of felt in a piano, it is recommended that a suitable moth repellent be kept in the case at all times. For long-term storage, grand pianos will be stored flat.

e. Instrument accessories. Generally, accessories are bin storage items. Reeds should not be stored in dry, overheated places that will cause the reeds to split, crack, or lose the vibrating qualities.

Also, reeds have a tendency to mold or mildew when exposed to air. Gut should be stored in a refrigerated unit with a quart of water containing 2 teaspoonfuls of formaldehyde placed nearby.

5-39. Brushes: Feather, Wool, Bristle, and Hair.

a. General. The two hazards encountered in the storage of brushes manufactured from keratinous materials such as feathers, wool, bristle, and hair, are infestation of the brush by various beetles, mold, or mildew and rot due to humid atmospheric conditions.

(1) *Beetle infestation.* Four types of beetles which cause damage to the keratinous part of the brush are commonly known as the black carpet beetle, the furniture beetle, the varied carpet beetle, and the buffalo or moth beetle (see figs 3-11 and 3-12). There is also the lyctus powder post beetle which attacks all types of hardwoods generally used for handles.

(2) *Climatic hazards.* During long-term storage in humid climates, the keratinous part of the brush may develop mildew, mold, or rot.

b. Precautions prior to storage. Usually, Federal specifications require manufacturers to enclose insect repellent with brushes. Receipts that have not been afforded the necessary protection will be inspected for infestation and, subsequently, properly packaged for storage. Particular attention should be given to roll back, salvage, or surplus stock.

c. Precautions in storage. Brushes made of keratinous materials will always be protected from infestation by including naphthalene flake or balls or paradichlorobenzene flake or powder in each pack. Since these repellents tend to evaporate, care should be taken to replenish, as required.

(1) *Bulk lot storage.* Bulk lots will be stored in original containers; if material is repackaged locally, a small amount of repellent should be added to each container which should be kept sealed.

(2) *Bin storage.* Brushes stored in bin boxes or openings should be kept in the unit pack. When the size of the smallest unit pack precludes shelf or bin storage, bin stocks may be placed in a protective wrap with a small amount of repellent.

(3) *CH or temperature.* To prevent mildew, mold, or rot, especially in high humidity areas, material should be stored in CH or temperature storehouses.

(4) *Inspection of material in storage.* Sample quantities of stock should be regularly inspected for signs of insect infestation, mildew, mold, and rot. The frequency and scope of these inspections

should be established by the military service/agency concerned and should be predicated on local conditions.

(5) *Housekeeping.* Good housekeeping is the best additional preventive measure to be taken against infestation.

(6) *Safety.* Contact with insect repellent such as naphthalene and paradichlorobenzene can cause skin irritations. The fumes in heavy concentrations are toxic. Personnel concerned will take the necessary precautions such as the use of goggles, rubber gloves, and half-mask respirators. Conditions permitting, storage areas should be well-ventilated.

(7) *Damage stock.* Material found to be damaged by infestation, mildew, mold, or rot should be disposed of in accordance with procedures set forth by the service/agency concerned.

5-40. Clothing and textiles.

a. General. The purpose of this paragraph is to provide general/minimum guidelines for the receipt inspection of direct vendor deliveries and wholesale procurement receipts of clothing and textile products. These paragraphs also provide general/minimum guidelines for storage surveillance inspections of clothing and textile products. These inspection requirements are intended to provide an indication of the items' condition and are not intended to be (or to replace) technical inspections. Those DOD Components having established COSIS programs that provide alternate/equivalent methods/criteria for determining clothing and textile product condition are exempt from the storage surveillance inspection requirements established in this paragraph.

Specific guidelines for standard clothing and textile products are contained in appendix T, DLAM 4155.5/TB 740-10, Quality Control Depot Serviceability Standards, Clothing and Textiles. Guidelines for special purpose clothing and textile products requiring special care, handling, and storage are published in the specific items' technical and/or supply publications. All types of clothing, textiles, and related materials are subject to deterioration. The occurrence of deterioration in storage depends principally upon storage conditions, the nature of the materials, and the types of preservation and packaging. As a minimum, clothing and textile storage requirements should not be downgraded below the general purpose unheated warehouse level. For most clothing, textiles, and related materials, good storage conditions will either prevent deterioration entirely or make it very unlikely. However, periodic inspections are required

and must be performed in accordance with the referenced publications.

b. Receipt inspection and storage surveillance. The following guidelines are provided as the minimum requirements for clothing and textiles receipt inspection and storage surveillance:

(1) *Receipt inspection.* At least one container/package/roll per NSN, contract line item, and shipment will be selected as the representative sample size. At least one bare item per container/package and/or at least the first 5 yards of product per package/roll selected should be inspected.

(2) *Storage surveillance.* At least one container/package/roll per location and NSN requiring inspection will be selected as the representative sample size. At least one bare item per container/package and/or at least the first 5 yards of product per package/roll selected should be inspected.

(3) *Kinds of deterioration/damage.* The following descriptions of typical deterioration and/or damage which may be encountered during the inspection of clothing textiles and related materials are provided as general guidance and information:

(a) *Containers, packages, and/or rolls.* All shipment units shall be visually inspected for the proper markings and evidence of damage during the receipt process. All shipment units should be palletized at the time of receipt. Containers should be modular to standard 40- by 48-inch pallet without overhang and should not contain mixed NSNs. The receipt process to include discrepancy reporting is described in chapter III of this manual. Sample inspection of the containers/packages/rolls must be accomplished, as described in the preceding paragraph (22b(2)). In addition to normal receipt inspections, containers, packages, and/or rolls must be visually examined for openings which may expose the contents to attack by contaminants or infestation by insects or rodents. The presence of water stains or other discolored or sticky areas caused by exposure to excessive light, heat, water, weather, or by contact with foreign matter signifies the possibility of contents' damage or deterioration. Storage surveillance procedures should also include these visual examinations on a continual basis to alert facility managers to any potential facility maintenance requirements and product damage or deterioration.

(b) *Abnormal odors.* Odors which are unrelated to the normal characteristics of the specific materials should arouse suspicion that some form of deterioration is occurring (i.e., musty odors, sharp pungent odors, and/or unusual odors).

(c) *Mildew and bacterial attack.* Microbiological action on clothing, textiles, leather, rubber,

and plastic may result in recognizable musty or foul odors and may produce discoloration, spotting, or staining which can normally be readily identified by visual examination.

(d) *Deterioration due to chemical change.* Finishes and particularly coatings on textiles fabrics may become hard and stiff or soften and become sticky. Improper storage conditions, particularly exposure to extreme heat, light, moisture, etc., can cause chemical change. However, normal aging should also be considered as a potential cause for chemical changes.

(e) *Tarnishing.* A discoloration or dulling found on highly lustrous metallic surfaces of items such as buttons, insignia, or braid. Tarnishing can usually be corrected by cleaning or polishing, therefore, it is not considered as serious damage.

(f) *Corrosion.* The condition of rusting, pitting, oxidation, or flaking on the surface of metal components. It is considered serious if the conditions are severe enough to detract from the appearance and expected function of the item.

(g) *Insect and rodent infestation.* The presence of insect infestation usually is revealed by visual evidence of the insect, insect web, case skins, and pellets of excrement. The presence of rodents may be disclosed by evidence of gnawing at the corners and edges of cartons, packaging cases, and bales as well as area spoilage and pellets of excrement. Damage caused by insects or rodents is usually evidenced in textiles materials by the presence of holes or thin areas, as revealed by light transmission through the affected places. Common insects which contribute to the deterioration of clothing and textiles in storage are carpet beetles, clothes moths, silverfish, crickets, and cockroaches. Detailed "pest management requirements/procedures" are contained in chapter 3, section IV, of this manual.

(4) *Shelf-life items.* For all items with an indicated shelf life, inspections should be performed at the frequency designated. Visual examination is performed for the condition indicated on the specified sample quantity to determine that no product deterioration developed. If testing is required, the proper sample should be submitted, as specified in the referenced publications (see para 5-40a).

c. Special procedures.

(1) *Life supportive items.* Clothing and textile items such as parachute materials must be laboratory tested to verify serviceability, as specified in the referenced publications (see para 5-40a). This would include all types of materials used in the production of life supportive items.

(2) Organizational clothing and equipment (OCE).

(a) OCE, which is issued at least annually, does not require storage surveillance provided that adequate storage facilities/environment are used. OCE that is not issued on an annual basis such as contingency/special purpose clothing and equipment and/or OCE stored in inadequate storage facilities/environment will be included in a storage surveillance program, as specified in this paragraph.

(b) All OCE issued will be inspected by the storage/receiving activity upon return by the user. The OCE will be cleaned and reconditioned in accordance with the applicable procedures/specifications, as necessary, prior to return to storage. (Subpara c(2) above is not applicable to wholesale depot receipts of IM/ICP directed customer returns of C&T items (i.e., field returns).)

(3) *Storage of textile yard goods.* Rolls or flat-folded fabric should never be stored on end and they must be stored off the floor. When supported pallets are used, stacking height is dependent only on safe height determination and MHE capabilities. When unsupported pallets are used, the maximum height should be two tiers, if packaged in fiberboard boxes. If packaged in wood cleated boxes, stack height is dependent on the vertical stacking strength of the box walls. All nonrigid pack rolls must be stored on side supported pallets or equivalent with the long axis of each roll in the same direction, front to back. Successive layers should be staggered so that each roll above the bottom roll is centered between and resting on two rolls of the lower layer. Alternating layers at right angles is unacceptable as is the use of wedges or cleats on unsupported pallets. Storage aids, equipment, and tools with rough surfaces, sharp edges, and/or protrusions that may come in contact with the fabrics should not be used.

5-41. PVC Plastic Pipe.

Although PVC plastic pipe will withstand some abusive handling conditions, there are limits. Establishing the limits is a subjective process since the physical properties of PVC compounds cover a rather broad range. In addition, some of the properties are affected by temperature. The following are basic precautions and care guidances for handling and storing this commodity.

a. Loading PVC Pipe.

(1) Care should be used when loading and unloading PVC pipe with mechanical equipment such as forklifts. Dragging or jamming by said equipment can and will damage the pipe.

(2) Bundles of pipe should be loaded in such a manner as to prevent unnecessary loads on the lower bundles.

(3) When nesting PVC pipe, chicken wire, plywood, etc., suitable material should be used to keep the pipe within the pipe from sliding out during shipping. It is recommended that heavy wall pipe not be nested in thin wall pipe. Pipe should be free of dirt or caked mud since this can cause excessive scratching and abrading as the pipe is nested or denested.

(4) Straps or ropes should be used to tie loads down. Chains and binders that could gouge the pipe should be avoided. If chains and binder cable are used, adequate protection should be used where possible damage may occur (e.g., on edges, etc.).

(5) Large diameter pipe should be loaded on top. This will allow tighter cinching of pipe, keep the pipe from crushing, and prevent bundles from shifting. When the lengths vary, the shorter lengths should be on top.

(6) To prevent shifting that may occur during shipping, interbanding of the bundles in the load is recommended. This requires banding the top half of the load and the bottom half of the load into two modules, then banding the top and bottom modules together. Alternately, separate bundles may be laid side by side and then secured to the bed by straps.

(7) Pipe lengths should not overhang the truck bed more than 2 feet.

(8) Extra care should be used in handling PVC pipe as the temperature drops below freezing since flexibility and impact resistance decrease with lower temperatures. Also, moisture that accumulates on the pipe freezes, creating a slippery surface and enhancing the chances of the pipe sliding off forklifts or shifting on the truck. (Refer to para 23a(6), above).

(9) Pipe may be distorted if stacked too high or heavily loaded when temperatures exceed 100 °F.

(10) Adequate protection should be provided so that PVC pipe will not be exposed to engine exhaust.

b. Receiving and Handling PVC Pipe.

(1) *Inspection.* Each pipe shipment should be carefully inspected on its arrival. Pipe should be examined for cuts, scratches, gouges, holes, and other imperfections before use. Any imperfections in the pipe that will adversely affect serviceability should be cause for rejection

(2) *Unloading Precautions.*

(a) The same precautions observed when loading pipe should also be observed while unloading.

(b) PVC pipe may be unloaded from trucks by sliding over other plastic pipes, but care should be taken not to slide pipe over rough or abrasive surfaces.

(c) PVC pipe should not be dropped or thrown off a truck nor should the ends of the pipe be allowed to dig into the ground after sliding off a truck.

c. Storage.

(1) Pipe stored outside for long periods of time should be covered to protect it from prolonged exposure to direct or reflected sunlight. The cover may be canvas or an opaque material as long as adequate air circulation is provided under the cover to avoid overheating.

(2) Pipe stored on uneven surfaces may, in time, assume the contour of this uneven surface. This is accelerated by the weight of the stack and/or by temperature above 100 °F.

(3) PVC pipe at the bottom of a stack may become out-of-round due to the weight of the material above. At moderate temperatures, this corrects itself soon after the load is removed; at low temperatures, several hours may be required for recovery.

CAUTION

Long times or heavy loads may cause permanent out-of-roundness.

(4) Bundles of PVC pipe should have the belled ends or couplings alternated at each end of the bundle and extended beyond the other pipe ends. Alternately, bundles may be constructed in any manner that does not stress the bells and couplings.

(5) Store single lengths of PVC pipe on a flat surface so as to support the barrel evenly. If the pipe is to be placed in racks, support the pipe at least every 3 feet. Contact areas should be padded to prevent abrasive damage.

(6) Keep PVC pipe away from hot objects, pipelines, heaters, etc.

d. Loading Transfer Trucks.

(1) Use trucks with long bodies making certain the truck bed is smooth, without cross-strips,

bolt heads, or other protrusions that could cause damage.

(2) The first layer should allow couplings and belled ends to overhang the bed with each successive layer overhanging the layer below. Alternately, bundles may be constructed in any manner that does not stress the bells and couplings.

(3) Short body trucks may be used if fitted with racks that properly support the pipe in a horizontal position.

5-42. Radioactive Material.

Many commodities employed by the Federal services incorporate a radioisotope (ionizing radiation) as a functional component. Since ionizing radiation presents a significant potential hazard, rigid controls are imposed on handling and storage of radioactive material by Title 10, Code of Federal Regulations. These controls are stated in a general way in DLAM 4145.8/AR 700-64/ NAVSUPINST 4000.34/AFM 67-8/MCO P4400.105, Radioactive Commodities in the DOD Supply System and in OSHA 1910.96. For further information, see TM 38-410/DLAM 4145.11/ NAVSUP PUB 573/AFR 69-XX/MCO 4450.XX, Storage and Handling of Hazardous Materials.

5-43. Magnetic Tapes, Disks, Diskettes, and Cassettes.

Extreme or repeated temperature fluctuations in the storage environment may cause a deterioration in the oxide uniformity of magnetic mass memory media materials. This is especially critical in magnetic tapes and disks designed for use with automated data processing equipment (ADPE); however, other sound or video tapes and cassettes are similarly sensitive to changes in the storage temperature. These items must be afforded long-term storage in a facility with a controlled temperature between 50 to 125 degrees Fahrenheit (F) (10 to 50 degrees centigrade (C)). Magnetic tapes, disks, and cassettes shall be moved to a controlled temperature storage environment immediately upon receipt. Materials will not be permitted to sit for extended periods on docks, loading platforms, or ramps exposed to the elements. This action will maximize the shelf-life of the material and prevent the premature chemical deterioration of the items.

Section VI. Packaged Petroleum Products

5-44. General.

(a) The storage of packaged petroleum fuels and lubricants (not including special fuel combinations of guided missile propellants unless specifically classified in this category) in standard containers involves nearly all the fire hazards encountered in the final use. In recognition of these inherent hazards, minimum safeguards must be established to avoid serious fires.

(b) The procedures and instructions for the storage of packaged petroleum products are contained in MIL-HDBK-201, Petroleum Operations.

(c) Special markings of packaged petroleum products are contained in MIL-STD-290, Packaging, Packing, and Marking of Petroleum and Related Products.

(d) Application of the appropriate storage principles set forth herein is a responsibility of the installation commander. It is recognized that under certain local conditions, strict adherence to the prescribed storage practices will not be practicable. The following factors will be evaluated by the installation commander in consultation with petroleum, safety, and fire prevention specialists before deviation from the prescribed practices is authorized:

- (1) Type of product stored.
- (2) Cost.
- (3) Type and condition of drums.
- (4) Availability of storage space and handling equipment.
- (5) Terrain features.
- (6) Climate.
- (7) Proximity and type of structures, source of ignition.
- (8) Other pertinent information.

5-45. Use of Drums.

(a) As a general policy, storage of filled drums should be held to the absolute minimum needed to meet ordinary requirements. When bulk facilities are available, it is safer and more economical to store empty drums (see para 5-50), provide adequate drum-filling equipment, and store only enough filled drums to meet immediate requirements while the filling plant is in process of reaching full capacity, than to store large quantities of filled drums. Quality surveillance of product is more easily maintained in bulk quantities.

(b) The practices covered below apply to large amounts of drummed products stored outside buildings, not to the storage of station supplies

presently accommodated in standard flammable storage warehouses with the proper installed fire protection equipment.

5-46. Location.

A level site should be selected that is not in or adjacent to a congested area, with the contour of terrain being such that an immediate runoff of surface water is possible through a system of open ditches. Drainage into any sewer system is prohibited. An area with a cinder base, marsh, or wasteland overlaid with peat and usually more or less wet will not be used when other terrain is available. Consideration will also be given to direction of flow with the main outlets so located that flow is away from a congested area and toward a harmless area where fire extinguishing agents can be applied en route or at destination. An adequate supply of water for fire fighting purposes should be taken into consideration in the selection of this site. The drum storage area should be located or arranged so that escaping flammable vapors normally flow away from operational areas and sources of ignition. Depressed areas should be avoided because hazardous vapors tend to remain in them. Gasoline vapors are heavier-than air and tend to lie in a stratum less than 4 feet above grade and flow toward lower ground much as liquid flows to a lower level.

5-47. Standards for Storage of 55-Gallon Drummed Petroleum Products.

(a) *General.* The fire hazard involved in the storage of petroleum products is dependent, to a great degree, upon the flashpoint (see para 5-49, and chap 2 of MIL-MHBK-201) of the product and to the gross amount stored.

(b) *Covered Storage.* Covered storage is the preferred type of permanent storage.

(c) *Outdoor Storage.* Filled and empty 55-gallon drums may be stored outside. Drums may be stacked vertically (on pallets) or horizontally (on sides).

(1) *Stacking.*

(a) When stored in the vertical position, service—or agency—approved drum top covers must be used to prevent the collection of water on drum tops and subsequent corrosion/contamination and oxidation. Tops of the drums must be dry before applying protective cover. For multiple tiers of drums stored in the vertical position on pallets, a single strap or band will be placed around the drums on each pallet to ensure stability. A sampling inspection will be made periodically to en-

sure tops of drums are dry (size of sample and frequency of inspection to be determined by cognizant service/agency).

(b) When stored horizontally (on sides), the drums will be placed in double rows, butt to butt, with closures (bungs and vents) facing outward. Drum closures should be placed at the 3 and 9 o'clock positions. The closures are turned outward to facilitate the detection of leaks and prevent a leaky drum from being shipped.

(c) Spacing of rows is necessary to permit efficient operation of drum handling attachments or inspection of drums such as butts and chimes. Spacing will also conform to the requirements of TM 38-410/DLAM 4145.11/NAVSUP PUB 573/AFR 67-XX/MCO 4450.XX, Storage and Handling of Hazardous Materials. Areas of high humidity and salty atmosphere accelerate corrosion and drums stored in such areas will require more frequent inspection than in low humidity areas.

(d) For low flashpoint products, the rows of drums will not be more than 35 drums long. The drums of each superimposed tier of drums will be nested between drums of the supporting tier. The second tier will contain 34 drums and the third tier 33 drums; thus, the double row, or unit, will contain a total of 204 drums.

(e) For high flashpoint products, the quantity of drums in a major storage division can be doubled either by increasing the number of sections or the height of the stack to six.

(f) To ensure drums against damage from rolling, cross blocking every fifth drum will be required and, in addition, the ends of the bottom tiers will be braced.

(g) The bottom tier of drums will be placed on not less than 2 by 6 inches of lumber or other comparable dunnage running parallel to the length of the rows.

(2) *Storage identification.* MIL-STD-290, Packaging of Petroleum and Related Products, covers markings required on top and side of drums. For identification and quality surveillance, product will be stored to maintained product/grade and batch/lot integrity. A placard will be prepared and displayed on the outward (aisle side) of each location. The placard will contain the following information: stock number, nomenclature, date of manufacture, batch/lot number, and contract number.

(3) *Palletized stacking.* Occasionally, drums may be placed on special drum pallets, which allow four 55-gallon drums to be placed on their sides on each pallet. Pallets will be constructed to prevent drums from rolling. Stack pallets one over

the other with drum closures toward aisles. No end braces are necessary for palletized stacks.

(4) *Aisles.* Aisles should be provided so that no container is more than 12 feet from an aisle. Main aisles shall be at least 8 feet wide and side aisles at least 4 feet wide (OSHA 1910.106).

(5) *Physical layout.* The physical layout of the storage area within the limitation specified in this part will be as prescribed by chapter 3, section III, this manual.

(6) *Dikes (berms).*

(a) A recommended procedure for a major storage area containing petroleum products is to surround such an area by a dike at least 18 inches high, assuming the terrain to be practically level. This will prevent burning liquids from flowing to adjacent divisions, buildings, storage areas, or waterways. In any case, the dikes should be sufficient to retain all of the liquid contents of drums stored in the division and provide for a free board of not less than 6 inches.

(b) Access roads will be provided with ramps or graded to allow entrance of MHE into the diked area.

(c) Drainage will be accomplished by use of clay or metal pipe of sufficient size placed through the dike at the lowest point to ensure an immediate runoff of surface water. The aperture will remain closed except when it is necessary to remove surface water.

5-48. Standards for Storage of 5-Gallon Military Gasoline Containers (Blitz or Jerry).

a. General. Observe the following precautions when storing filled containers:

(1) Inspect all containers for leakage. If a container shows evidence of leaking, transfer contents to another suitable container, taking all precautions to prevent contamination during transfer.

(2) Make sure all containers are properly marked before stacking. Check date of filling and store products so that the oldest product can be issued first.

(3) Visually inspect closure for leakage. Tighten, if necessary.

b. Stacking.

(1) *Pyramidal stacking.* To conserve space and to provide stability of stacks, filled 5-gallon gasoline cans should be stacked in pyramids, unless cans are palletized. (See (2) below for method of stacking palletized cans.) To stack cans in pyramids, proceed as follows:

(a) Lay out a 50-foot square section.

(b) Build a partial flooring for the first tier of cans by laying out rows of 2- by 6-inch lumber or other comparable dunnage and tying in with wooden strips or boards. No dunnage is necessary between tiers.

(c) Beginning at one corner of the square, place six cans side by side along one side of the square. Place cans 6 inches from edge of dunnage and allow ¼-inch expansion space between the cans.

(d) Place a row of six cans side by side with backs facing aisle, along adjacent side of square to form an L.

(e) Place three rows of cans within the L.

(f) Place a second tier of cans on top of the first. Indent the second tier on both sides approximately 3½ inches so that each can in the tier rests on three or four cans.

(g) Place a third and fourth tier on the stack, indent each tier as described in (f) above. Do not stack cans more than four tiers high.

(h) Continue building the pyramid outward until the entire 50-foot square is completed. Turn cans at the end of each row so that backs of all outside cans in a pyramid face the aisle. The first tier should contain 3,528 cans, the second tier 3,403 cans, the third tier 3,280 cans, and the fourth tier 3,159 cans, totaling 13,370 cans in the section.

(2) *Vertical stacking.* Filled 5-gallon cans may be stacked vertically when cans are palletized and forklift trucks or cranes are used. To stack palletized cans vertically, proceed as follows:

(a) Lay out 50-foot square sections, if necessary, adjust the size of a section to accommodate a definite number of pallets. It is not necessary to construct a floor for the containers;

(b) Place cans upright on pallet and group them close together allowing an even border around pallet. Terrain and equipment limitations must govern the number of tiers of cans on pallets. Size of the pallet will determine the number of cans to be included in the tiers.

(c) Start at one corner of the section and place several pallets of containers along adjacent side of the section. Pallets should be as close together as possible.

(d) Place additional pallets of containers directly over the first tier until the desired number of tiers is reached. Palletized cans may be stacked higher than single cans, but available handling equipment and stability of stacks must determine the number of tiers.

(e) Continue building stacks until the section is completed. Each stack must be completed to the desired height before the next stack is begun to avoid obstructing the range of the truck or crane.

5-49. Standards for Storage of Packaged Fuels, Lubricants, and Greases.

a. Covered storage.

(1) *General.* All packaged lubricants and greases should be under covered storage, wherever possible. See TM 38-420/DLAM 4145.XX/NAVSUP PUB 574/AFR 69-XX/MCO 4450.XX, Storage Space Management, regarding types of facilities. Packaged fuels, paint thinner, and other low-flash products may be stored in buildings provided adequate dispersion and ventilation are obtained and the buildings which are used meet the requirements of the current edition of Flammable Liquids Code No. 30 published by National Fire Protection Association, 470 Atlantic Avenue, Boston, MA 02110.

(2) *Stacking containers.* Layout of sections and stacking height depend upon warehouse design, available storage space, load capacity of floor, and available MHE. The primary objective in the arrangement of containers is to store the maximum quantity of products in a limited space while maintaining fire control and providing ease and safety in handling the containers.

(3) Safety precautions.

(a) Uncased containers' exteriors will be free of grease and oil before being placed in storage.

(b) Follow inspection procedures described in c(1) below.

(c) Additional safety information is to be found in chapter IV.

b. Outdoor storage.

(1) *General.* Although packaged lubricating oils and greases are normally stored under cover, they may be stored outdoors when storage buildings are unavailable and containers are protected from water and heat of sun by fire-retardant tarpaulins. The stacking areas should be laid out to provide for segregation of products into sections. The lubricants may be stacked on pallets or adequate dunnage.

(2) *Precautions.* Observe precautions described in paragraph 5-46.

(3) *Methods of stacking.* Place necessary dunnage between ground and first tier and stack containers as follows:

(a) Stack uncovered cylindrical 5-gallon oil cans in an inverted position, with closures on the

bottom. Cans may be stacked vertically or in pyramids (para 5-48).

(b) Stack 55-gallon drums as described in this section, paragraph 4.

(c) Stack all containers other than 55-gallon drums upright.

(d) When containers are packed in cases, stack cases on pallets or adequate dunnage.

c. Inspection.

(1) Inspect stacks periodically for evidence of leakage, abnormal swelling or corrosion of containers, and for stability of stacks. If leakage is apparent, locate leaking containers and remove from the stack immediately. See that all containers requiring shelter are properly covered with fire-retardant tarpaulins or other suitable materials and adequate ventilation provided.

(2) Examine markings frequently to see that they are legible. If illegible and it is economically feasible to identify the contents of the container, obliterated markings should be restored.

5-50. Storage of Empty Containers.

a. General. Empty containers may be stored in open storage. These containers will be protected from mechanical damage and from contamination of interiors by dirt, water, and other extraneous matter. Tightly closed containers will retard interior corrosion to a great degree. New or reconditioned containers received for storage will have no product markings thereon. These containers require inspection periodically to ensure their usability at all times. Containers evidencing interior or exterior corrosion should be removed for reclamation. Empty containers previously containing products should be treated as explosion hazards and handled accordingly prior to reconditioning. Closures should be tightly closed as an open bung or vent emits hazardous vapors for some time after removal of product. Uneconomically repairable containers will be salvaged.

b. Stacking empty 55-gallon drums. Normally, empty drums will be stacked in the same manner as filled drums or by the method prescribed by each military service.

c. Stacking empty 5-gallon cans. Empty 5-gallon gasoline cans may be stacked by either method described in paragraph 5, this section, without regard to height. Occasionally, empty 5-gallon gasoline cans are strapped side by side in groups of five. Those groups may be placed on pallets with cans resting on their bases or their sides. Cans strapped into groups may be stacked vertically without the use of pallets; but dunnage must always be used between the bottom tier and the

ground, and containers should not be stacked so high as containers stacked by other methods, unless shoring is placed at ends of each row to prevent stacks from slipping. Filler plugs must be tightened before cans are stacked.

5-51. Handling Procedure.

a. General. Personnel charged with the responsibility of loading, unloading, and storage of filled containers will instruct workmen as to the proper method of handling. Tearing down a pile by pushing, pulling, manually, or by the use of powered ground equipment or dropping a container from either a pile or load will not be permitted. When skids are used to ease or expedite unloading, the container will be slid down with the plain end first. Care should be exercised to see that a container is not allowed to strike against another because of possible damage and the creation of a percussion spark which might result in an immediate fire.

b. Handling equipment. When storing petroleum products, the types and quantities of handling equipment is determined by the quantity of product stored, location and arrangement of storage areas, and the height to which drums may be stacked. Typical equipment used in storing petroleum drums include the following:

- (1) Forklift trucks (see OSHA CFR 29 1910.178(b)).
- (2) Skids.
- (3) Cranes.
- (4) A-frames.
- (5) Conveyors.
- (6) Empty drum track.
- (7) Drum pallets.

c. Drum handling attachments, forklift truck.

(1) *Standard types of attachments.* The standard types of attachments used with forklift trucks for the handling and storing of commodities in 55-gallon drums are shown in chapter 4.

(2) *Construction of attachments.* The drum handling attachments for use with forklift trucks will be constructed in accordance with current military specification MIL-D-11303. The attachments, when constructed to this specification, will incorporate the basic operating and safety features necessary for efficient handling of drummed liquids or semiliquids in 55-gallon drums by supply facilities.

(3) *Utilization.* The drum handling attachment is used for placing 55-gallon drums into or removing from storage. The drums will be picked up from the horizontal position (drums placed on

sides). The drums are transported to and from shipping or hauling vehicles by the forklift truck in combination with the attachments when the distances are approximately 400 feet, or are placed on large warehouse trailers for transporting between carriers and storage location when distances are greater than 400 feet.

c. Drum pallets. Drum pallets constructed to MIL-P-21875 requirements may be efficiently used for some storage applications.

5-52. Quality Surveillance.

a. Quality surveillance as used herein is the aggregate of measures to be applied to maintain the usability quality of petroleum products in order that these products may be in a condition suitable for immediate use. The petroleum industry and the military procurement activities make every effort to provide clean and on-specification products. A vigilant quality surveillance program is necessary to ensure the supply of clean and on-specification products to the using fields units. Good house-keeping practices will ensure order and cleanliness as well as promote safety.

b. Many things can happen to petroleum products to affect their quality and performance value after delivery and during their handling, storage, and dispensing in the depot. For example, careless handling, contamination, exposure to abnormal temperatures, confusion of markings, or inefficient control of stock can cause leakage and spoilage, resulting in damage to, and excessive maintenance of equipment.

c. Water is a common source of contamination which can render petroleum products useless for service. Many petroleum products contain various types of additives and the seepage of water into the containers may remove these additives or cause emulsions. The use of such products may result in damage to equipment. Water contamination may result from rough handling or from improper application of plugs and gaskets, which permits breathing and subsequent condensation of water vapor. Storage of drums on their sides with proper blocking and shoring will avoid the trapping of water on the heads within the chimes.

d. Opened packaged products should be sealed and marked as having been previously opened and for immediate consumption.

e. Inefficient supply control of products in a depot can result in spoilage and loss. The practice of "FIFO" will reduce spoilage caused by long storage. Check date of filling and store products so that the oldest is issued first.

5-53. Inspection.

All filled drums will be carefully inspected for condition and proper marking before being put in the storage area. After storage has been completed, periodic inspection should be adequate under normal conditions. If a drum leaks at the closure, it should be tightened and the gasket replaced if necessary. Drums which show signs of leakage or excessive corrosion or appear otherwise unfit for storage will be removed immediately from the area and the contents transferred to satisfactory containers. If the integrity of the product is suspect, usability must be determined prior to issue.

5-54. Safety Measures.

a. General. Instructions relative to safety measures and fire protection are covered in chapter 6.

b. Cause of petroleum fires. Fires in packaged petroleum storage areas may be caused by the following:

(1) Sparks and open flames can produce explosions and subsequent fires in flammable vapors.

(2) Static electricity can be generated by the passage of fluid through a hose, by agitation of a fluid in a container, by the movement of a truck over the highway, and by other means. In the presence of readily flammable vapors, such an electrical charge constitutes a definite hazard.

(3) Lightning discharge can cause petroleum fires.

(4) Leaks not only waste product, but also constitute fire hazards.

(5) Smoking is a common hazard and will not be tolerated in petroleum storage areas.

c. Fire plan.

(1) *Petroleum.* Every petroleum storage area will have a definite fire plan, with regulations on fire prevention and instructions on fire fighting.

(2) *Fire dangers.* All personnel handling petroleum will be made conscious of the constant danger from fires and of the precautions required.

(3) *Equipment.* Proper equipment for fighting fires must be provided in accordance with section II, chapter 7, MIL-HDBK-201.

(4) *Clearance.* The distance from filled drum storage to structures, drum filling plants, operational buildings, and sources of ignition must not be less than 500 feet for low-flash products and 200 feet for high-flash products. Storage areas for drummed petroleum products must be far enough away from overhead electric lines so that no part of a broken wire can fall upon the drums.

(5) *Arrestors.* Flame and spark arrestors must be provided for all equipment within and adjacent to drum storage areas containing filled drums.

(6) *Electrical equipment.* All electrical equipment and installations in drum storage areas containing petroleum products and within 10 feet of grade must be in accordance with requirements outlined in the current edition of the National Fire Protection Association Codes, volume 5, class 1, division 2, National Electric Code.

(7) *Vegetation.* Vegetation must be eliminated in outside drum storage areas and must be kept short on dikes (berms) by frequent cutting. All cuttings or dry vegetation must be removed immediately. A 50-foot wide strip around the outside of the storage area must be free of vegetation and combustible material.

(8) *Drainage.* The drainage system for removing surface water from the storage area must be provided with a means of retaining and removing any petroleum product that may leak into the area.

(9) *Access roads.* All-weather access roads should be provided either outside or on the dike, to include the drummed storage groups. Access roads will be provided with ramps and graded to allow entrance of MHE into the diked areas.

(10) *Portable explosion proof extension lights.* The portable explosion proof extension light, constructed in accordance with military specification MIL-L-83762 (USAF), will be utilized in the inspection of interiors of empty or partially filled drums or any drums, cans, fuel cells, and other containers having contained or containing liquids or semiliquids which could result in the presence of explosive vapors therein.

Section VII. Metal Products

5-55. General.

The importance of metal to DOD requires that storage and materials handling methods used will result in metal products being maintained in a ready-for-issue condition at all times. This section establishes standard methods for the storage and handling of metal products such as pipes, bars, steel beams, strip and sheet metal, and armor plates. In establishing these methods, it is realized that in some instances, circumstances will determine the method used. The methods and practices outlined herein provide effective means of storing large quantities of metal in a safe accessible manner, permit maximum utilization of storage space with a minimum expenditure of manpower, but do not preclude variances and/or substitutions peculiar to a specific problem area or condition.

5-56. Item identification.

Identification of metal products in accordance with current directives of the military services concerned must be maintained to facilitate receipts, issues, and inventory. Proper identification is necessary to minimize losses or the expense incurred when physical and chemical analysis is necessary for reidentification when identity of the metal has been lost. It is also essential for the effective utilization of metal products.

5-57. Storage Space.

a. Warehouse space. Installations having warehouses equipped with overhead bridge cranes should utilize such facilities for the loading, un-

loading, and handling of heavy or large quantities of metal products. In the absence of such warehouses, conventional warehouses and standard forklift equipment should be used for the storage of metal products. Appropriate metal storage racks should be utilized to the maximum extent practicable in order to make full use of cubic storage space.

b. Shed space. Shed storage of metal products will provide protection against rain, snow, and sun. However, this type of metal storage is generally limited to the storage of lightweight products such as pipe, tubing, and angles that can be normally handled by hand. Use of pigeonhole-type racks and/or horizontal dunnage in these sheds permits maximum utilization of cubic storage while maintaining accessibility.

c. Open space. Open area surfaces utilized for the storage of metal products will have sufficient bearing strength to support the materials to be stored at the height desired. Advance planning is a prime requisite for effective utilization of open storage space for metal products.

5-58. Storage Aids.

a. Dunnage. Dunnage is particularly important for the storage of metal products. Dunnage provides clearance for forks of the fork truck and allows crane hooks or slings to be placed underneath a load. Additionally, dunnage is used to stabilize stacks and keep the metal off the floor or ground or separated from other contaminating materials or objects. The storage of heavy metal products on

inadequate dunnage could result in stacks collapsing when ground softens due to thawing or erosion. Also stacks may collapse on surfaces such as asphalt when the surface softens due to hot weather. Wooden, masonry, or concrete dunnage, as appropriate, should be used as beaming surfaces or for pile stabilization.

b. Pallets. Pallets are utilized for the storage of small metal products such as welding rods, tin, and lead solder.

c. Storage racks for metal products.

(1) The following types of racks are utilized for the storage of bar, pipe, tubing, angles, and other elongated types of metal products:

(a) Fixed pigeonhole-type (fig 5-48).

(b) Nesting type with automatic grab hook attachment (fig 5-49).

(c) Tree frame racks (fig 5-50).

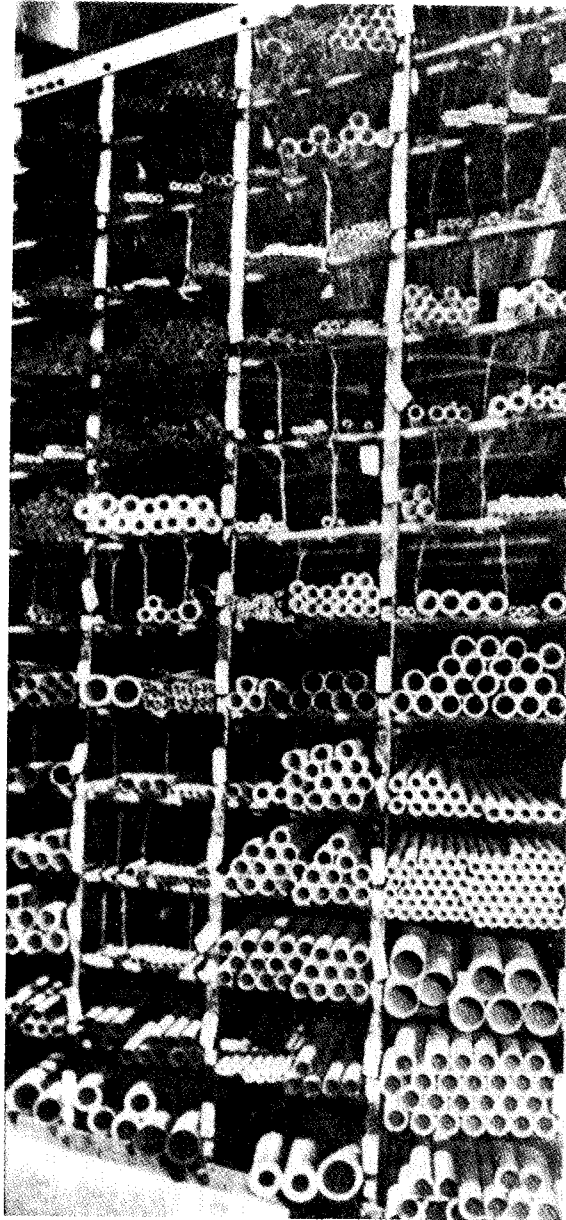

Figure 5-48 Pigeonhole-type metal storage rack

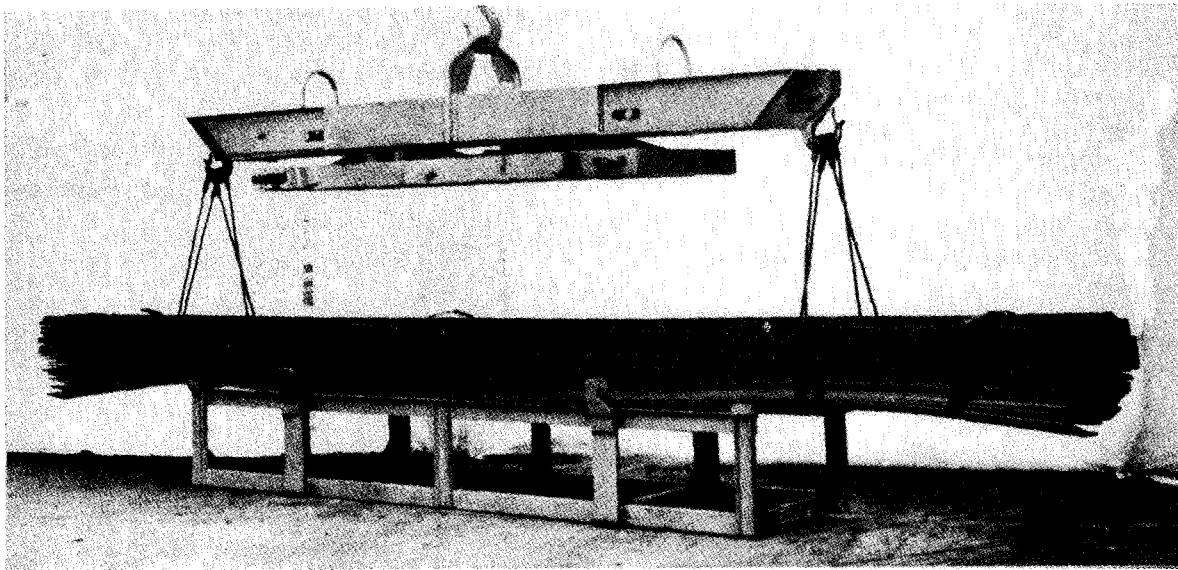

Figure 5-49 Nesting-type rack with automatic grab hook attachment

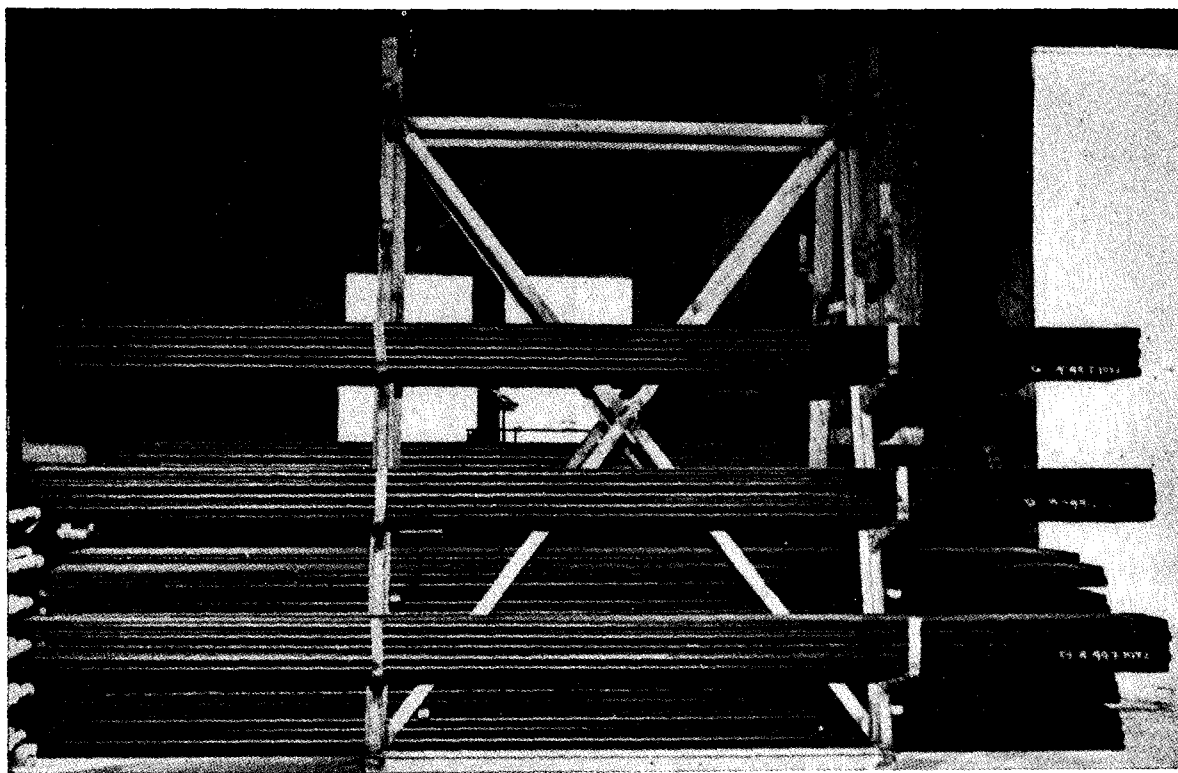

Figure 5-50 Tree frame rack.

(d) Lightweight sheet or strip racks (fig 5-51).

(e) Concrete forms, timber foundations with special fittings, and uprights inbedded in concrete (fig 5-52).

(2) Selection of the appropriate rack depends upon the quantity, weight, and issue requirements of the items to be stored.



Figure 5-51 Lightweight sheet or strip racks

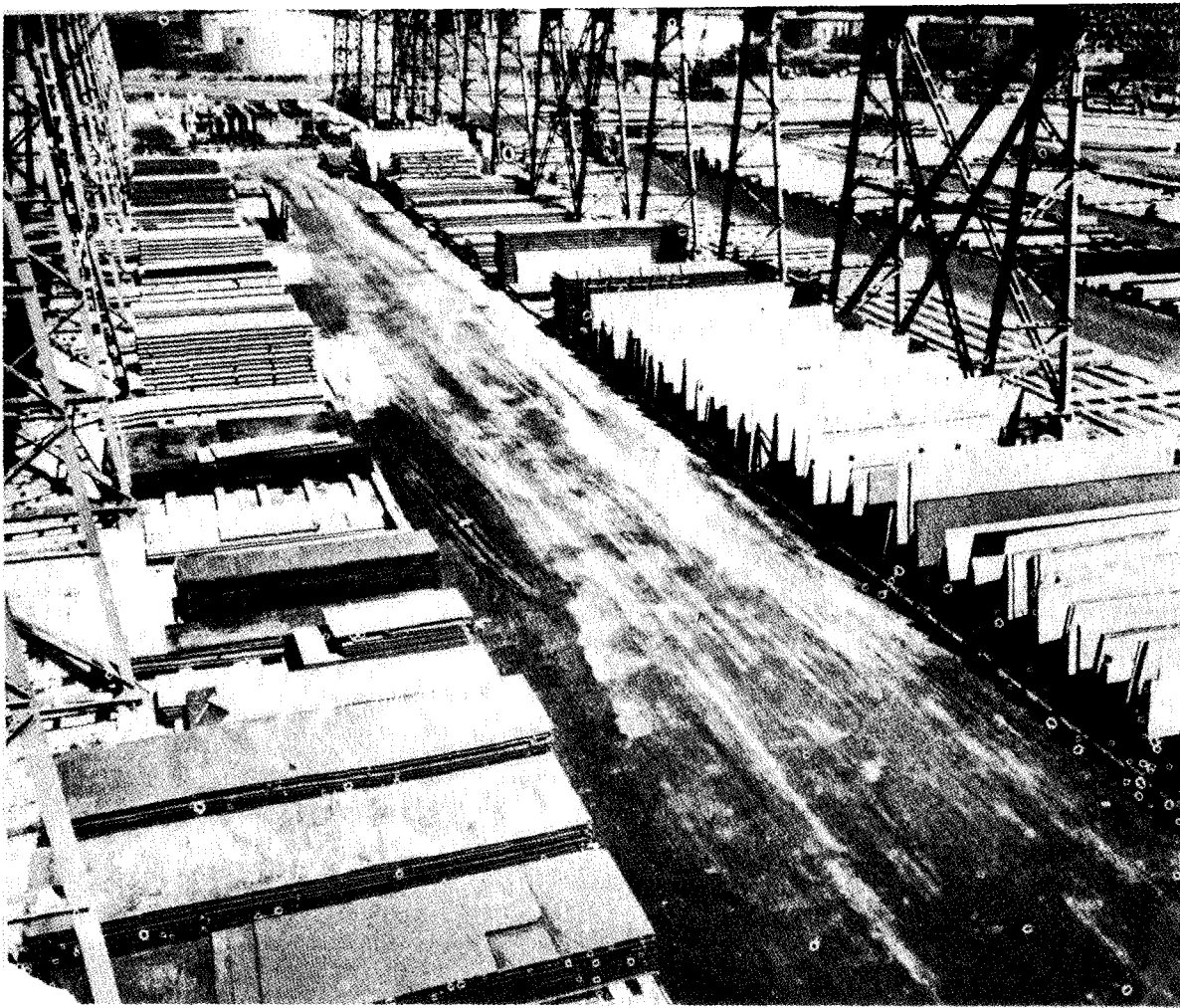

Figure 5-52 Storage of heavy plate and structural shapes

5-59. Handling Equipment.

a. Selection of the proper equipment depends upon the size, quantity, and weight of the material, and the type of storage and distance material must be transported.

b. Examples of handling devices, gears, and equipment used for the effective handling of metal products are as follows:

- (1) Swivel bolsters mounted on warehouse trailers and trailers hooked in tandem.
- (2) Tree frame racks mounted on warehouse trailers (fig 5-53).
- (3) Dollies equipped with cradles or frames (fig 5-54).
- (4) Automatic grab hooks and spreader beams (fig 5-55).

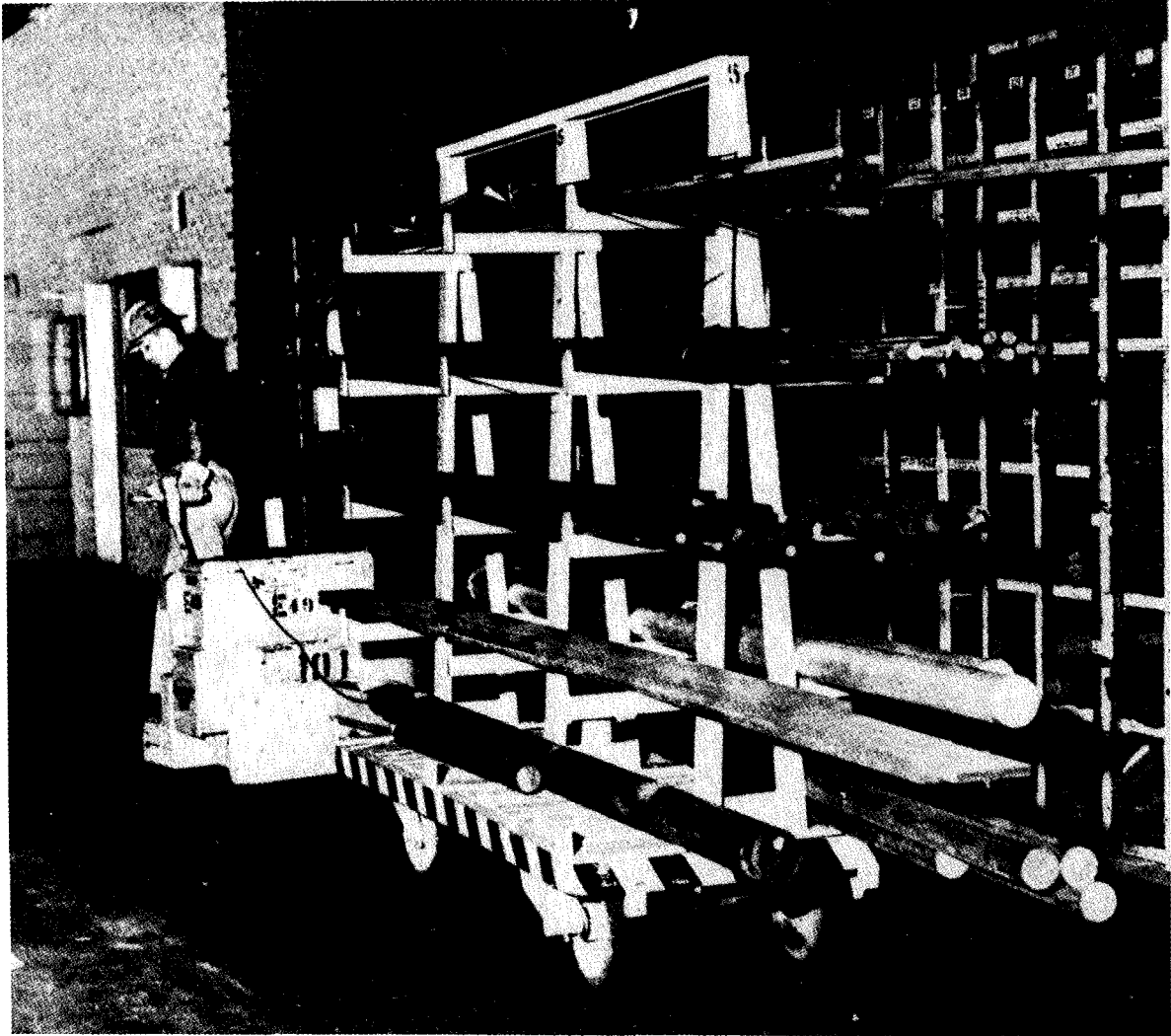

Figure 5-53. Tree frame racks mounted on warehouse trailer

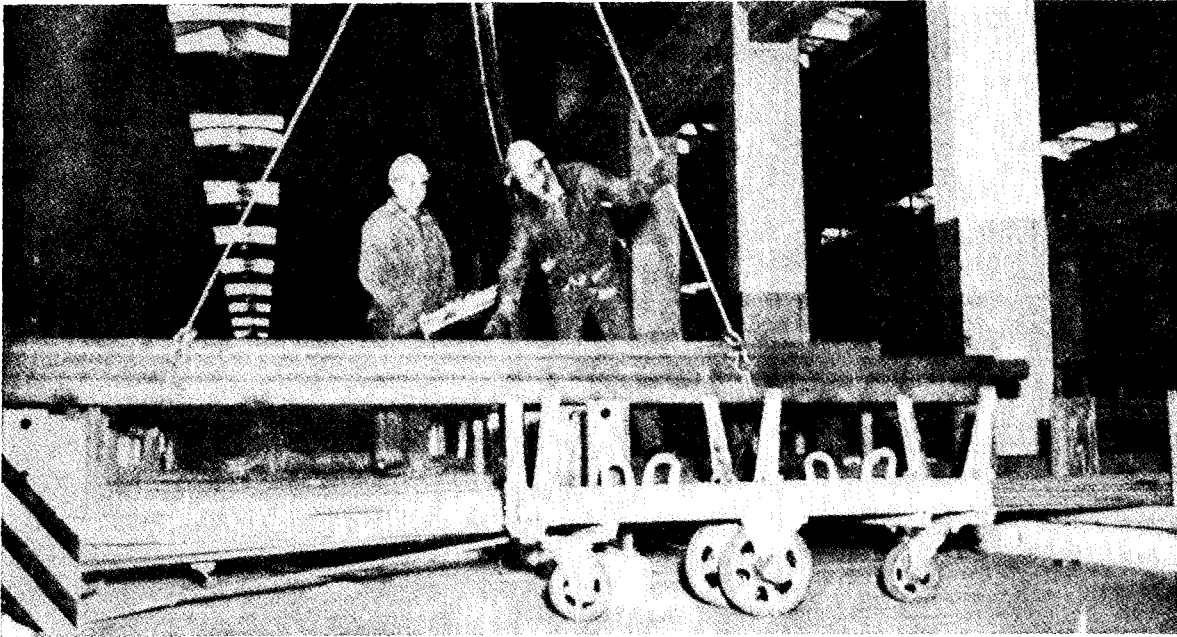

Figure 5-54 Dolly equipped with cradle

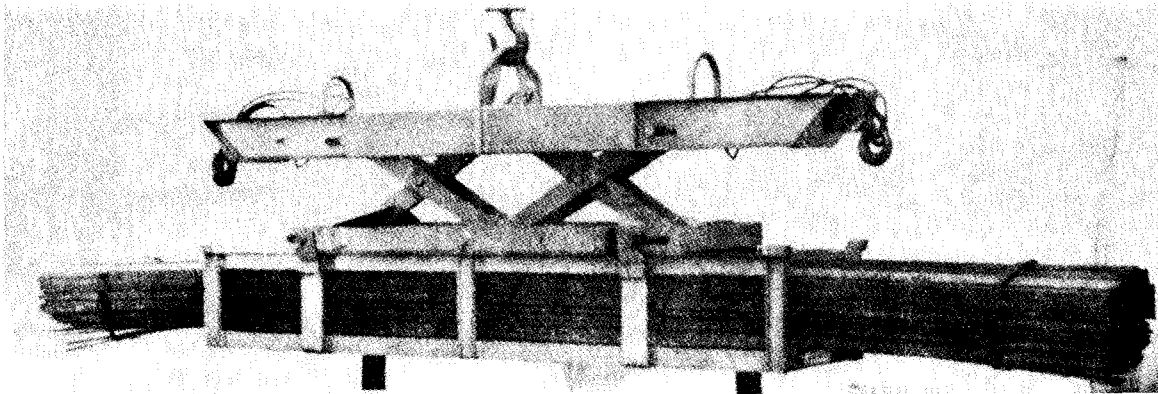

Figure 5-55 Automatic grab hook and spreader beam

(5) Overhead bridge cranes, warehouse cranes, and forklift trucks (used in covered storage areas).

(6) Locomotive, mobile, gantry, and warehouse cranes or forklift trucks (used in open storage areas).

(7) Truck, straddle carry used in conjunction with platforms or racks (fig 5-56).

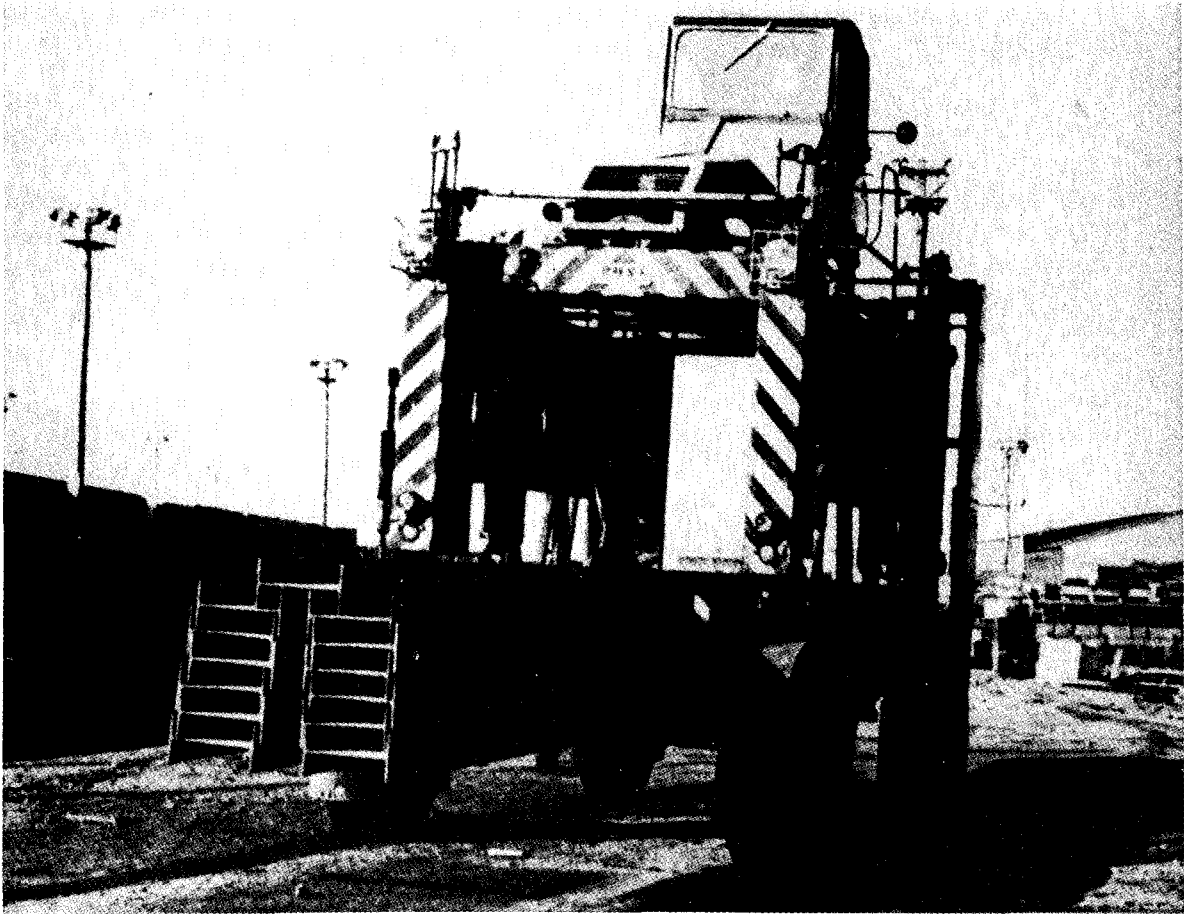

Figure 5-56 Truck, straddle carry

(8) Tractor trailer trains, railcars, trucks, and trailers.

(9) Hooks, shackles, slings, clamps, plate grabs, and tongs.

(10) Swing mast or turret forklift trucks, and high-rise man aboard stock selectors.

5-60. Handling Methods.

The methods outlined and illustrated herein are representative of several types currently approved for use by the military services. However, this does not preclude the continuous use or adoption of new storage and handling methods that will produce equal or better results in a more economical or feasible manner.

a. Bar stock, angles, pipe, tubing, and other similar types of elongated metal products.

(1) Replenishments and issues in and out of pigeonhole-type racks are usually hand operations; however, dollies equipped with cradles or frames may be used as a handling aid in servicing this type of rack. Also, cranes may be used for the movement of heavy items on top of the racks.

When sufficient room is not available on top of the racks or when the use of cranes is not practical, the heavier items should be stored in the extreme lower openings of the racks to facilitate handling (fig 5-57). Generally, movement of this type of material, other than in and out of racks, is accomplished by crane, side carrying fork truck, truck, straddle carrying, swivel bolsters mounted on warehouse trailers and trailers hooked in tandem, tree frame racks mounted on warehouse trailers, dollies with cradles or frames, or any other combination of such equipment as appropriate.



Figure 5-57 Storage of materials in pigeonhole-type racks

(2) The use of nesting-type metal storage racks equipped for use with the automatic grab

hook and spreader bar is limited to areas where equipment such as overhead or mobile cranes can be utilized (figs 5-58, 5-59, and 5-60). Materials may be loaded or unloaded directly from the racks, open railcars, or trucks. Each rack is a separate unit that will nest securely and safely on top of the rack beneath. Care should be exercised when loading the nesting-type racks to ensure that the material is "weight centered" lengthwise in the racks. This will improve the safety factor and reduce the swaying of the load when hoisted.

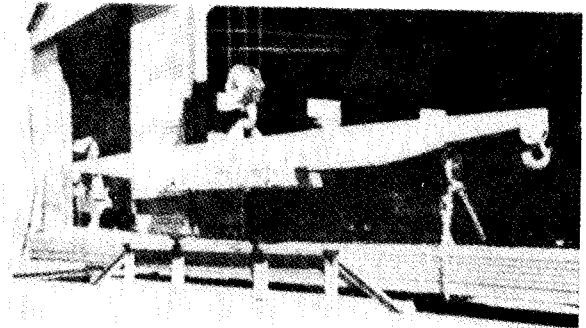

Figure 5-58. Combination crane, automatic grab hook, spreader bar, and nesting rack

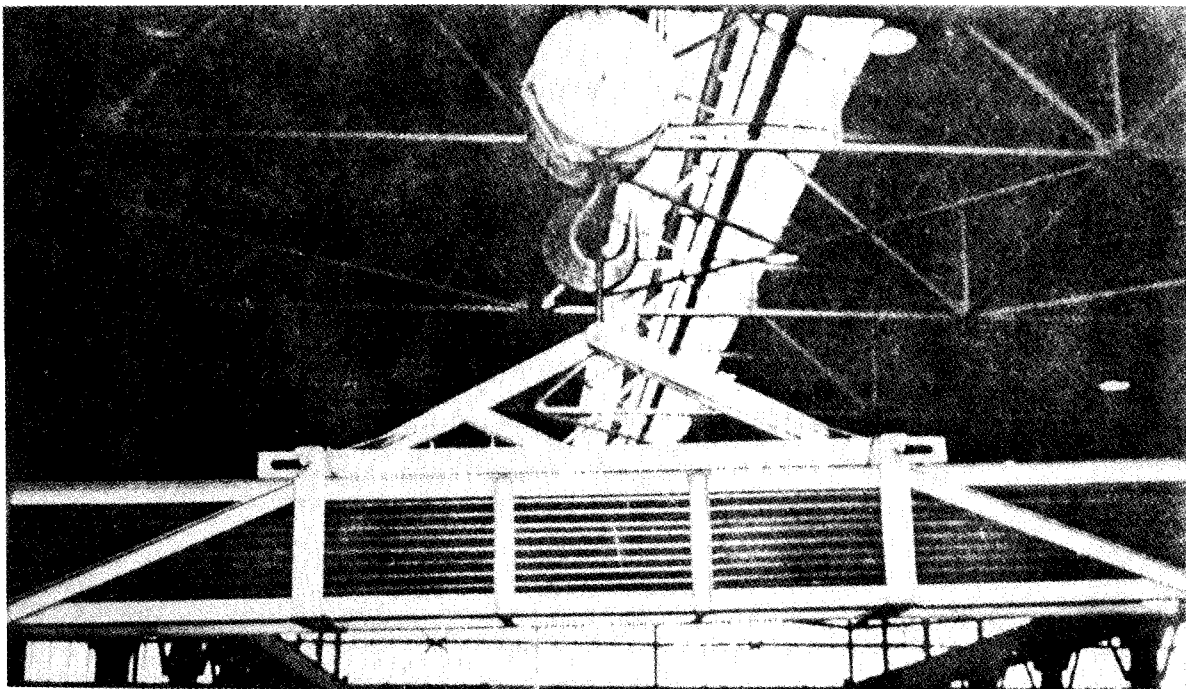

Figure 5-59 Crane handling loaded rack

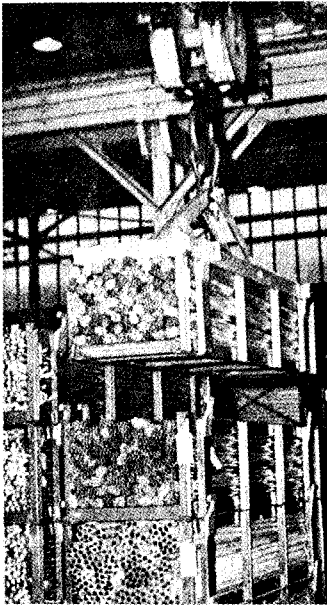

Figure 5-60. Crane positioning rack into storage

(3) Heavy items and large quantities of bar, pipe, and tubing stock may be stored in warehouses, sheds, or open areas. Materials received in bundles, crates, or other type unit loads will be stored in the unit as received, whenever practical. Dunnage should be placed between each layer of material when stacked and, where necessary, binding cleats or stops will be secured at each end of the dunnage to prevent shifting or rolling materials (figs 5-61, 5-62, and 5-63). Stacking height will be governed by safety factors, floor load limits, and types of handling equipment utilized. Handling materials in this type of storage may be accomplished by fork trucks or cranes with appropriate accessory devices such as bridles, straps, clamps, or hooks.

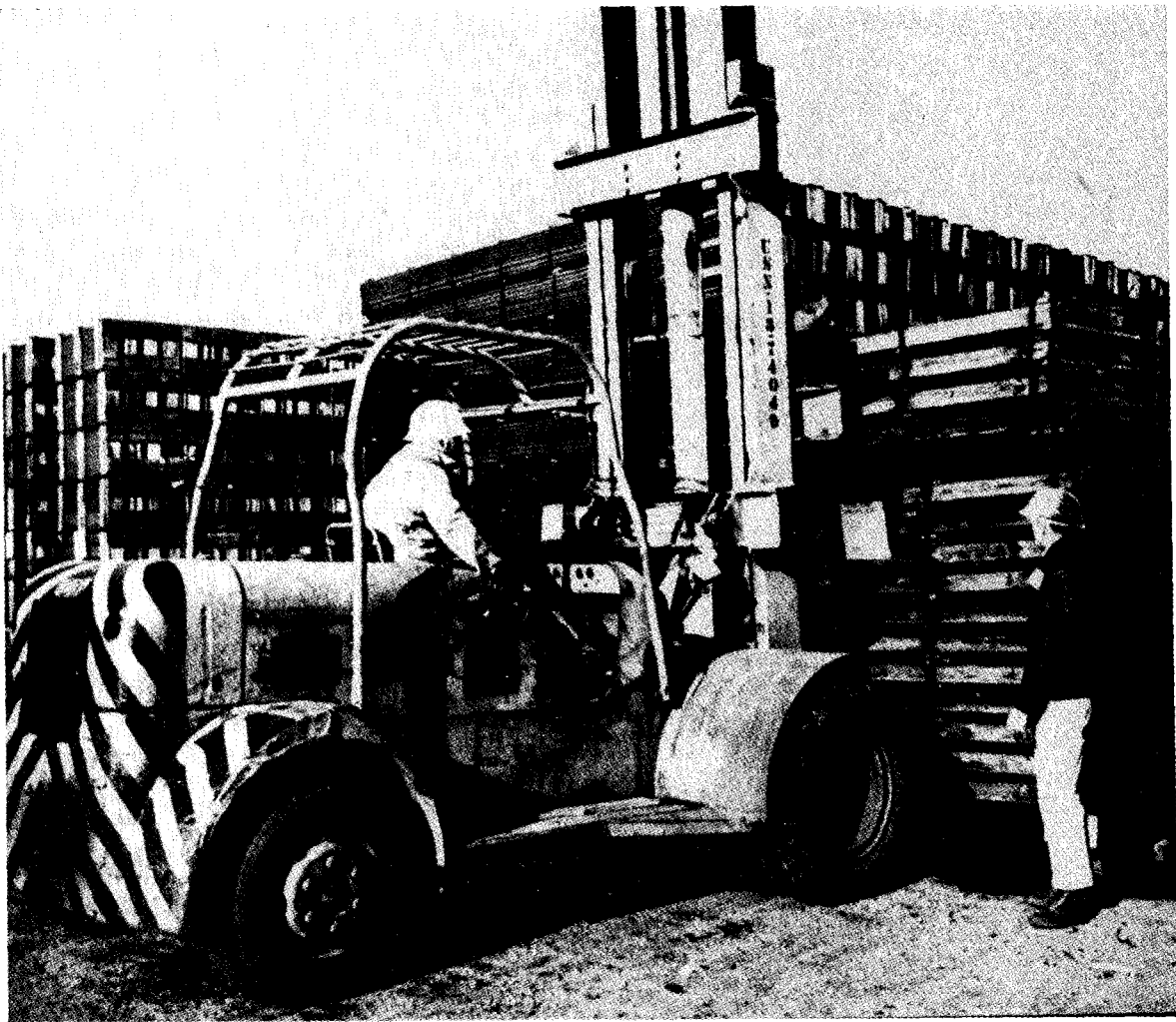

Figure 5-61. Fork truck operation in open storage



Figure 5-62 Open storage area

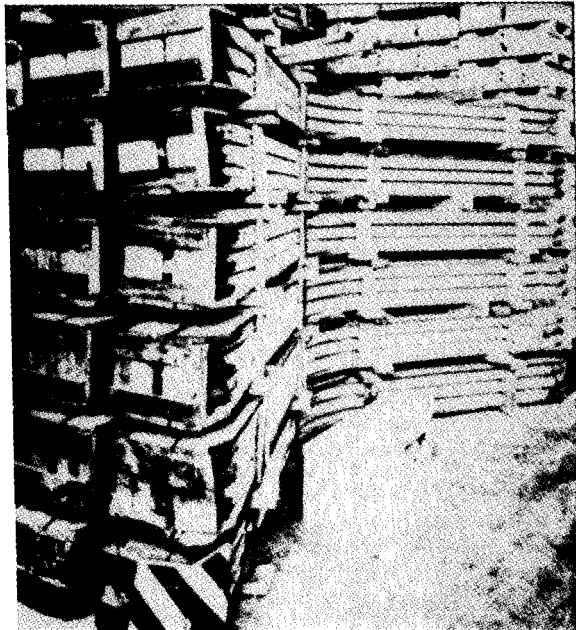

Figure 5-63. Storage of odd shapes

b. Quantities of small metal products which are issued often such as drill rod, welding rod, and shim metal should be stored in pallet racks or bins (fig 5-64).

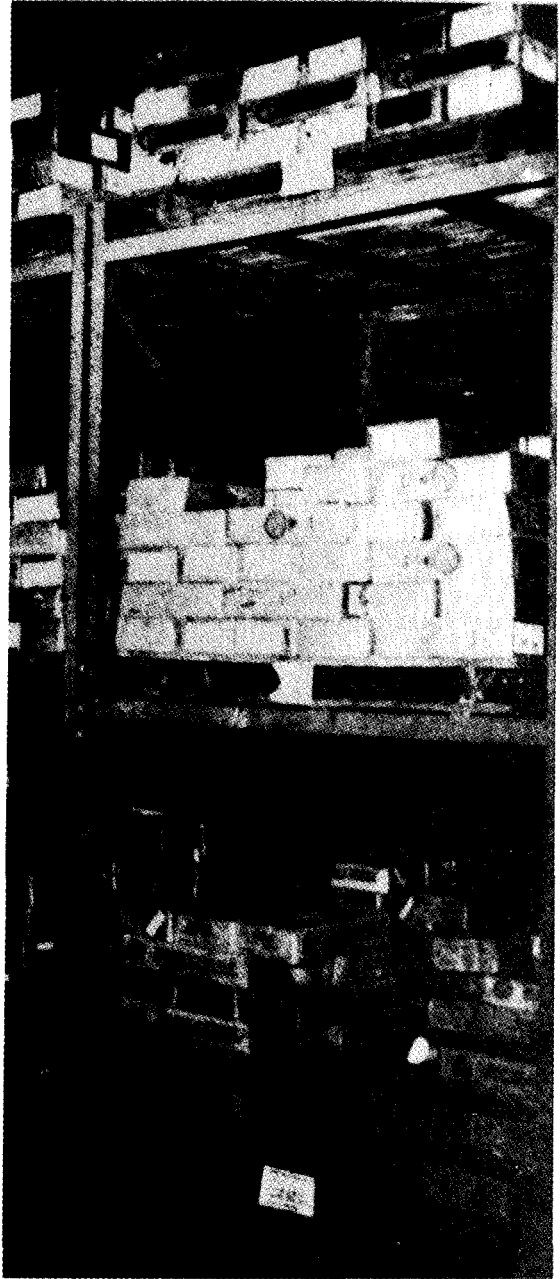

Figure 5-64. Storage in pallet racks

c. Strip and sheet metal products should be provided covered storage space when possible. Retail issue quantities are stored in special types of storage racks designed to meet local requirements (fig 5-65). Handling of these in and out of the racks is normally a hand operation. Appropriate materials handling/transporting equipment is used for other movement. Unit loads (strapped bundles or crates) are block stored on appropriate dunnage to facilitate handling. When covered storage is not avail-

able, open storage may be utilized if adequate protection for deterioration is provided (fig 5-66).

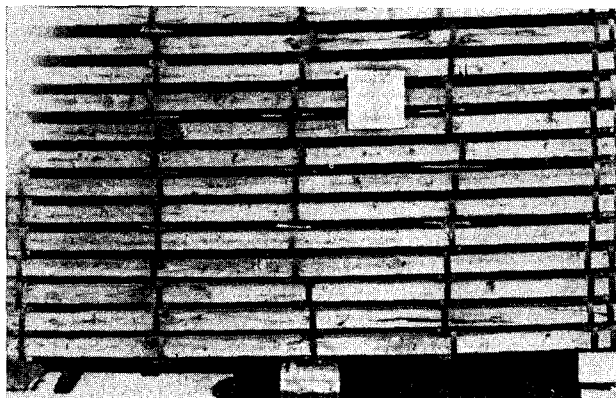

Figure 5-65. Strapped bundles of steel in open storage

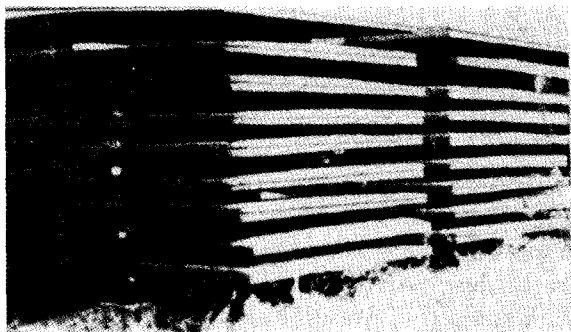

Figure 5-66 Use of horizontal dunnage in flat storage of armor.

d. Heavy plate and other heavy metal sheets may be stored in covered or open storage depending on space availability and handling facilities. Usually, these items are stored between uprights

imbedded in concrete stringer-type footings (figs. 5-67). When storage of heavy plate or sheets is utilized, horizontal dunnage will be placed between each layer of material to facilitate handling and to assure a level stack (fig 5-68). Handling is accomplished by crane with appropriate handling gear such as clamps, slings, and straps.

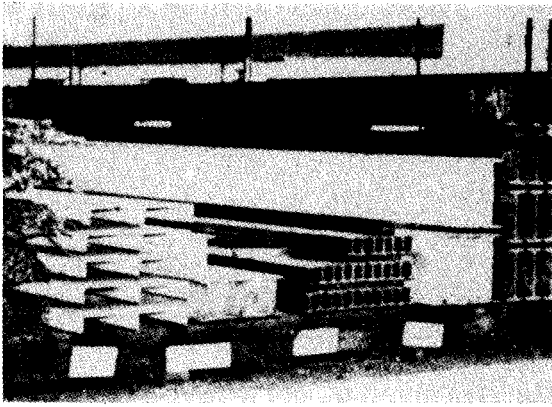

Figure 5-67 Open storage of metal shapes.

e. Special metal shapes and structural steel such as angles, beams, and channels may be stored in the same manner as metal bars, pipe, or tubing. Heavy items or large quantities are normally stored in open space on dunnage and will be adjacent to rail or truck loading/unloading facilities (fig 5-69). Handling equipment and procedures employed will be substantially the same as for other similar types of elongated metal products.

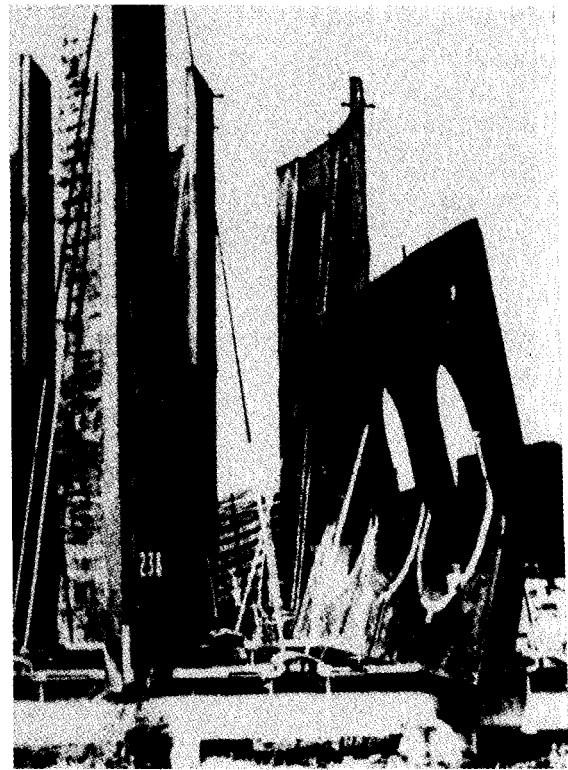

Figure 5-68 Storage of large and heavy items

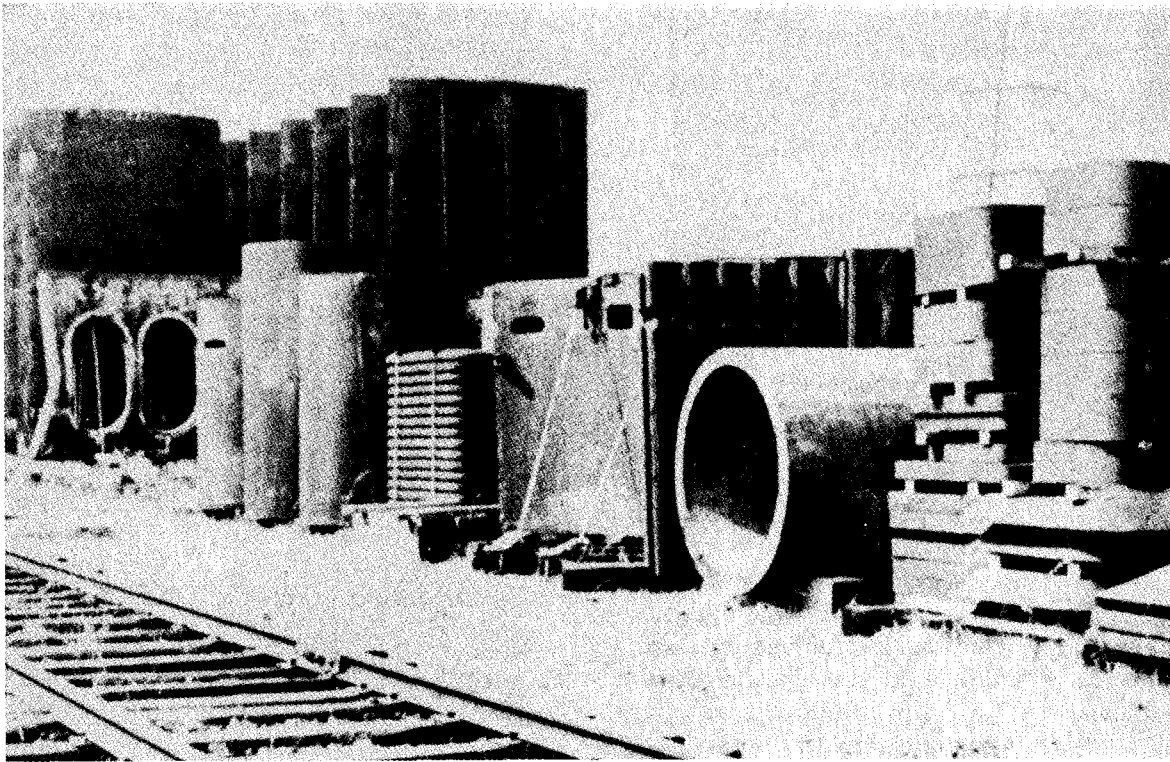

Figure 5-69 Open storage adjacent to rails

5-61. Safety.

Due to the weight, size, shape, handling, and transportation requirements peculiar to metal products, safety must be given prime consideration. Appropriate safety precautions of chapter 6, this manual, and of the military service concerned will be carried out with emphasis on the following:

- a. Authorized safety toe footwear will be worn by personnel.
- b. Metal studded leather palm gloves should be worn when handling metal as a protection against cuts from sharp edges.
- c. Standard hand signals will be used when directing lifting, lowering, or movement of materials. Such signals will be given by only one person in an area regardless of the number of personnel engaged in the operation.
- d. Supervisors should assure that all personnel engaged in physical lifting have been instructed in the proper techniques.
- e. Precautions should be taken to prevent overloading of handling equipment.
- f. Special MHE attachments will not be used without prior approval of the military service concerned.

g. Railcars, trailers, and trucks will be properly braked and blocked to prevent movement during loading and unloading operations.

h. Floor load limitations must not be exceeded.

5-62. Preservation.

Preservation of metal products will be conducted in accordance with current directions of the respective military service. In the absence of specific instructions, MIL-STD-163C establishes the basic requirement for the preservation of steel products. MIL-HDBK-729, Corrosion and Corrosion Prevention of Metals, contains basic guidance on corrosion and corrosion prevention. Contents include: factors influencing corrosion, forms of corrosive attack, corrosive characteristics of metals and alloys, and general methods of protection from corrosion. The prime causes of corrosion are the nature of the materials and unfavorable storage environments. Metal products are more susceptible to corrosion in areas having higher RH than in dry, arid areas. Metal with a polished surface should always be handled with gloved hands to protect the metal from acid stains caused by perspiration. When preservatives are to be applied to metal products, the surface to be coated will be dry, clean, and free from mill scale, dirt, and corrosion. It is essential

that materials, which have been treated with a preservative are not unduly handled, especially during the setting of the coating. Scheduled surveillance inspections are required to evaluate the

continuous effectiveness of the preservative. Metal products stored in open areas for long periods of time may require repeated application of preservative.

Section VIII. Cable Storage and Handling

5-63. General.

Cable and wire products are wound on spools and reels to facilitate storage and handling. Spools containing wire range in diameter up to 12 inches and the weight usually does not exceed 25 pounds. Reels will range in diameter from 12 inches up to 108 inches and in weight from about 50 pounds up to approximately 5 tons. This wide range of weight and cube necessitates the use of careful storage and handling practices.

5-64. Storage.

a. Cable should be stored indoors in a cool dry location. When indoor storage is not possible, lead covered, jute-protected, and tape armored cables may be stored in an open shed or in the open, provided the cable and cable reel are protected against moisture absorption from the ground. This can be accomplished by placing the reels on a raised platform or on planks which will provide air circulation under the reels. Cable will not be

stored in close proximity to oils, acids, or chemicals.

b. Because most heavy or large diameter cable is wound on the reel with few layers (normally five to eight), but with the number of turns three to four times the number of layers, it is best to store a loaded reel in the vertical position so the inner layer on the top of the barrel will have the weight of only four to seven layers on top of it. If the same reel was stored on the side (horizontal) position, the cable turn next to the bottom flange would be subjected to the weight of all turns above it and be more susceptible to damage.

c. Quantities of cable with the same stock number may be pyramided as shown in figure 5-70. The storage area should have crane service available to facilitate the storage and issue of reels. Storage with low ceilings should be utilized to the greatest extent possible for vertical storage of single lot items to reduce the loss of cube space.

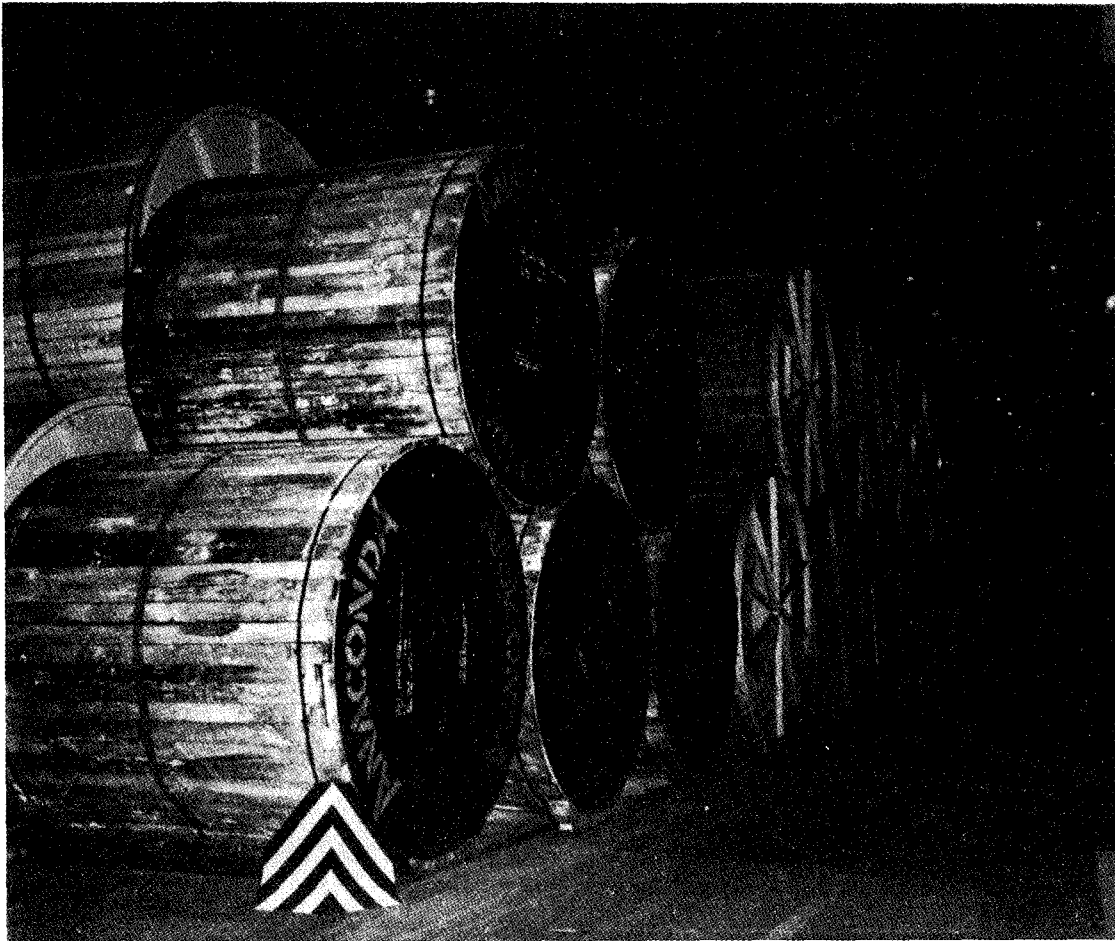

Figure 5-70 Pyramid stacking of cable reels

d. Small reels, less than 36 inches in diameter, of electrical or wire cable on reels without wood lagging may be stored horizontally but they should be handled carefully, especially when being tiered.

(1) Dunnage required for horizontal storage is usually 3 by 3 inches and of sufficient length to adequately support the reel of cable being stored (fig 5-71). However, dunnage thickness requirements will be determined to a great extent by the weight of the reels being stored and the distance

the hub assembly protrudes from the reel flange surface. Sufficient space must be maintained between reels to permit the entrance of the forks of MHE. Two parallel pieces of dunnage should extend completely across each reel in the stack and between the base reel and the floor. The dunnage should be placed vertically in line in order to distribute the weight of superimposed reels over as much of the surface of the lower reels as possible, thereby providing maximum stack stability.



Figure 5-71 Small cable reels properly dunnaged for safe efficient stacking

(2) Many small reels of cable and wire products, due to their size, should be stored in bin or pallet racks. This is especially true of small spools of wire or small lot quantities of cable or wire which are received in cartons or coil quantities. Generally, these items will be located in the bin issue area and the back-up stock stored in pallet racks.

5-65. Handling of Cable.

a. Cable reels are usually well constructed and capable of withstanding considerable abuse. However, serious damage can be incurred through improper handling. Therefore, it is necessary that

care be exercised in the movement and handling to avoid damage to the reel or its contents.

b. When handling cable reels by crane, a spreader bar should be used to prevent the sling from crushing the reel (fig 5-72). Unless reels are handled with a spreader bar, the inward thrust of the sling may severely damage the reel flange and cable. Therefore, activities storing and handling cable on reels should provide spreader bars for use in crane handling operations. Slings should be attached to a bar running through the hub of the cable reel and not by placing the sling over the lagging around the circumference of the reel. Placing the sling around the circumference of the reel

may result in damage to lagging and cable and require extensive repairs.

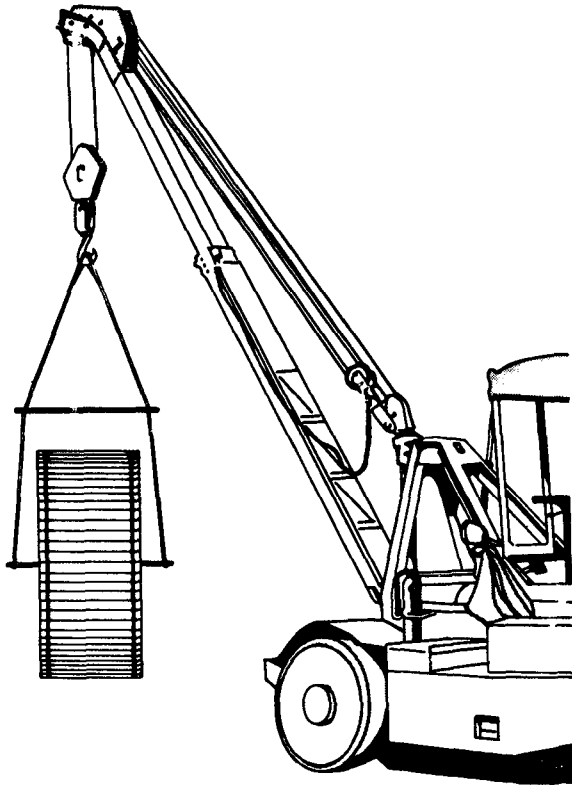

Figure 5-72. Handling cable reels by crane with spreader bar

c. The fork truck is commonly utilized in the storage and handling of cable, especially where the reels are stored on their side. When handling reels with a fork truck, a crane should be used to place reels in a horizontal position. Reels should not be tipped and allowed to fall to a horizontal position,

as the impact may damage the reel or cable. To further facilitate storage operations, it is good practice to place on each reel, prior to being stored, necessary dunnage to support the reel of cable to be superimposed on the stack.

5-66. Cable Rereeling.

At most military activities, cable reeling is not required to the extent that special reeling equipment is necessary. Most storage activities issue only full reel quantities of cable. There is, however, a demand for less than full reel quantities at some activities where cable is issued for use. Reeling of all types of cable is required to fill retail quantity requirements. Activities which are required to issue electric cable in retail lots should provide personnel with cable reeling equipment, which will permit economical and safe operation.

a. Basic factors to determine need of cable rereeling equipment includes the following:

- (1) Cost of equipment.
- (2) Availability of empty reels.
- (3) Cost of additional man-hours required.
- (4) Savings of man-hours when making issues.
- (5) Number of less than full reel issues.

b. Methods and equipment.

(1) *Reeling equipment required.* The reeling equipment required should be determined by the quantity of cable issued in less than full reel quantities. At activities where small quantity issues are infrequent, hand reeling equipment as shown in figure 5-73 should be utilized. However, if large quantities of less than full reel quantity issues are made, powered reeling equipment will be more economical.

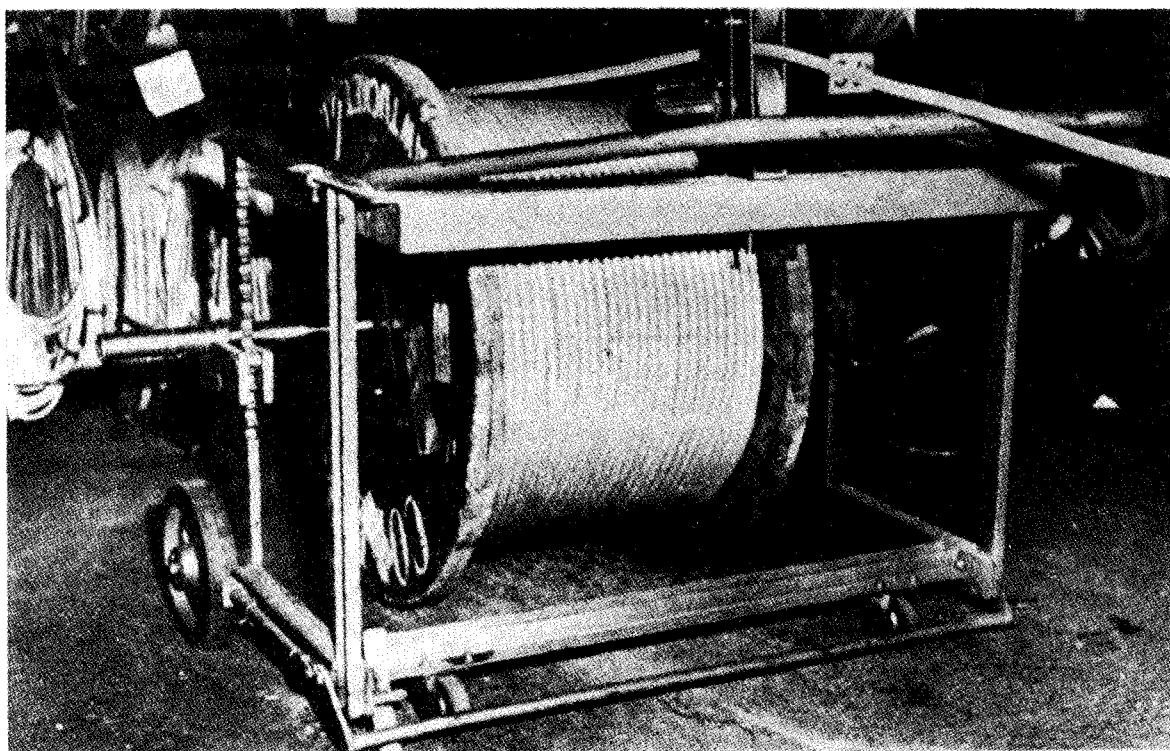

Figure 5-73 Hand operated cable reeling unit and measuring device.

(2) *Cable reeling dispenser.* Two methods of supporting the full cable reel during the reeling operations which have proven very satisfactory are:

(a) To support the reel on a horizontal roller bearing support turntable (fig 5-74).

(b) To insert a shaft through the axis of the reel and support the shaft with cable reel jacks (fig 5-75).



Figure 5-74 Cable dispensing turntable



Figure 5-75 Cable dispensing bar and jacks

c. A measuring device should be utilized in all rereeling operations. This device should be located between the reeling equipment and reel dispenser and so positioned that the footage indicator for cable transferred between reels can be easily seen by the operator (fig 5-73).

d. Cable cutting devices should be utilized for cutting cable. Multicircuit cable should be cut with circular cutters only. Straight shearing action cutters distort the ends of the circuit wires within the sheathing and make splicing or use of the cable difficult.

5-67. Protection of Cable Ends.

When cut, certain types of cable will absorb moisture from the atmosphere or other sources rendering the cable useless for the purpose intended. It is therefore mandatory that immediately following cutting cable, cord, and wire, each of the severed ends be sealed by one of the methods listed below. Hermetically sealed lead-sheathed cable; semi-rigid cable with solid extruded polytetraflouroethylene (PTFE) dielectric core conforming to MIL-C-17, paragraph 3.5.2.1(J); varnished and bare wire; nonwicking-type wire; and cable, cord, or wire preserved method IC per MIL-P-116 are not affected and are excluded from the requirement for end seals.

a. The end shall be wrapped with waterproof tape applied over the end and extending back from the end approximately four inches.

b. The ends shall be sealed by dipping to a minimum 2-inch depth in compound conforming to MIL-P-149.

c. The ends shall be sealed with neoprene caps fastened with hose clamps or wire. Caps shall be approximately 4 inches in length.

d. The ends shall be sealed with heat shrinkable plastic end caps secured to the ends of cable in a manner that will retain the caps firmly in place during shipment (See MIL-C-12000 for specifics.).

CHAPTER 6

SAFETY

Section I. Policy

6-1. Applicability.

Provisions of this chapter apply to general industrial and operational safety for storage and handling of military supplies.

a. Occupational safety and health requirements set forth in this manual are based in part on the DOD occupational safety and health standards established by DOD instruction 6055.1.

b. Selected Department of Labor (Occupational Safety and Health Act (OSHA)) standards are cited in this manual as a ready reference.

c. Specific safety requirements for storage and handling of ammunition and explosives are established by DOD standards and military service directives.

d. In the event of a conflict between the requirements set forth in this manual and a specific

OSHA standard, the issue will be referred to component headquarters for resolution.

6-2. Program establishment.

A safety program will be established for storage operations at major supply installations and separate storage activities in the continental United States and overseas. Safety will be included in and made an integral part of storage operations. It is the responsibility of each official in charge of storage at these installations to institute a suitable program, utilizing the technical services of the installation safety director or safety engineer in all matters dealing with accident prevention. Installation and separate storage activity commanders will take steps to assure that the accident prevention program in storage operations is effectively enforced at all levels of supervision under their jurisdiction.

Section II. Accident Costs

6-3. Man-hours.

Accidents involving personnel can have an adverse effect on productive man-hours and planned production schedules. Productive man-hours lost through accidents cannot normally be recouped immediately since replacement personnel or required

skills are not readily available. When material is damaged or destroyed by accident, costs are incurred to accomplish necessary repairs and/or replacement of material. Other consequences include production delays and a possible shortage of critical material.

Section III. Training Personnel to Avoid Accidents

6-4. Safety knowledge and training.

Operating personnel must be given proper instruction and training concerning potential dangers associated with their daily tasks. An awareness of apparent or potential dangers and training to avoid such hazards will assist in reducing accidents while performing normal tasks.

6-5. Knowledge of hazardous material.

Certain items such as explosives, flammable material, chemicals, acids, etc., obviously require more care and attention than other items. The characteristics of the material being stored or handled dictate the care and attention necessary to avoid risks and potential hazards. Personnel handling hazardous material must possess a knowledge of

all potential hazards concerning the commodities under their control (see TM 38-410/DLAM 4145.11/NAVSUP PUB 573/AFR 69-XX/MCO 4450.XX, Storage and Handling of Hazardous Materials for details).

6-6. Knowledge of equipment.

a. Design. Equipment is generally designed to perform a specific function. For example, MHE will safely handle a specified maximum load, travel at a maximum speed, ascend or descend a maximum grade, and operate safely under specified conditions. A potential hazard can be created when equipment is selected for use in operations beyond the rated capacity or for other than the purpose designated.

b. Use. Equipment must be used only for the purpose for which it is designed. For example, use of electric-powered spark enclosed equipment is required when handling flammable gases. All equipment must be checked to determine suitability for the task and if any doubt exists as to suitability, qualified personnel must be consulted.

c. Special attachments. In areas where flammable materials are stored and handled, the use of spark enclosed equipment and special attachments thereto will reduce operating hazards. When front end attachments are used which are not factory installed, the user shall request that the truck be marked to identify the attachment and show the approximate weight of the truck and attachment combination at maximum load elevation with load laterally centered.

d. Maintenance. Equipment which is not in proper operating condition constitutes a hazard. Operator will not operate equipment that appears to be mechanically unsafe. They will not attempt to repair such equipment but will report unsafe equipment to their supervisor for appropriate corrective action or replacement.

6-7. Methods.

Personnel will be trained in the proper methods of operating equipment. Training information or programs may be found in chapter IV, section E, of this manual or in the National Safety Council Drivers Training Course.

6-8. Layout.

Familiarity of the storage layout or area is an important factor for the prevention of accidents. The following conditions must be considered:

a. Distance. The greater the distance traveled, the greater the potential for accidents.

b. Terrain. The rougher the terrain, the greater potential for accidents.

c. Elevation changes. Changes in elevation can constitute a hazard. Elevation changes can involve extra handling and increase the potential for accidents.

d. Aisles. Narrow aisles, turns and jogs in aisles, bumps or protruding objects constitute hazards.

Section IV. Accident Prevention Program

6-9. Analysis of operation.

Each physical operation will be analyzed by supervisory or safety personnel to predetermine inherent and manmade hazards. Operating procedures will then be developed which either remove or control the hazards identified. Method of control include substitution with safer equipment or procedures, isolation of hazardous operations, mechanical guarding, redesign of facility and/or equipment layout, and others. Installation safety specialists can be of great assistance in developing hazard controls to satisfy specific safety requirements.

6-10. Training of personnel.

At each facility, safety training programs will be developed for supervisors and employees. Formal safety training, fire prevention training, or other required instruction will be performed by supervisors with assistance from installation safety, fire prevention, and health activities.

6-11. Reports.

All accidents will be investigated and reported in accordance with existing procedures of the appropriate military department.

Section V. Safety Equipment and Clothing

6-12. Use.

When a hazard still exists after all practical control methods have been taken, workers must be given further protection through protective equipment or clothing. The type of equipment and/or clothing required will depend upon the nature of the hazards involved. This equipment will not be used as a substitute for the elimination or control of unsafe acts and conditions, but rather as a supplemental safety measure.

a. Gloves. When performing general labor work and when sharp or rough material is being

handled, general purpose workmen's gloves will be worn for protection of hands from cuts and abrasions. The glove palm, thumb, and index finger are covered with leather. When glass is handled, gloves with suction cups or leather palms will be worn. When gloves with leather parts are used, care must be taken that the leather parts do not become greasy. Special purpose workmen's gloves available and situations requiring their use are contained in TM 38-410/DLAM 4145.11/NAVSUP PUB 573/AFR 69-XX/MCO 4450.XX, Storage and Handling of Hazardous Materials.

b. Hoods, aprons, sleeves, and suits. Hoods, aprons, sleeves, or suits made from natural or synthetic rubber or acid-resisting rubberized cloth will be worn for protection when filling open vessels with acid or when handling individual containers of acid to protect personnel from possible leakage or breakage of containers.

c. Rubber-framed goggles (29 CFR 1910.133). Rubber-framed goggles will be worn for protection of the eyes against smoke, gas, fine dust, mists, and sprays or splashes of liquid or other substances, including acids and alkali solutions.

d. Spectacle goggles (29 CFR 1910.133). Spectacle goggles with side shields will be worn for eye protection against flying particles of dust, chips, and machine cuttings. Spectacle goggles without side shields will be worn for other operations requiring eye protection.

e. Protective hat (helmet) (29 CFR 1910.135) (ANSI Z89.1).

(1) A protective hat will be worn for head protection against falling or flying objects or from bumping the head when working in cramped places. A protective hat will always be worn when in yards or areas when material is being lifted or hoisted. A protective hat will be worn when stowing or handling material above head level, if using MHE equipped with inadequate overhead guard, or in high rise warehouses when local authority determines that falling material may present a hazard.

(2) Bump caps are of a thin shelled lightweight plastic construction and do not meet the specifications of ANSI Z89.1 for impact flying particle and electric shock protection. Bump caps are not to be substituted for protective hard hats and their use should be limited to exposures where bumping of the head is the only consideration.

f. Protective headgear (cap or beret type). Protective headgear will be worn to confine long hair and prevent entanglement with moving or rotating machinery, open flames, or dust accumulation.

g. Welders gloves, goggles, mitts, helmets, and jackets (29 CFR 1910.252(e)). Welders gloves, goggles, mitts, helmets, and jackets will be worn for protection of hands, face, eyes, and body against sparks, chips, and flame resulting from welding or cutting processes.

h. Safety toe shoes. Authorized safety toe footwear will be worn while working in areas or while performing operations designated by the appropriate authority as hazardous to feet or toes of the workers. Safety toe shoes will meet standards as set forth in 29 CFR 1910.136 and ANSI Z41.1 for occupational footwear. The activity will provide ad-

vice and instructions on procurement of safety toe footwear.

i. Sparkproof safety shoes. The friction and shock of shoes on explosive materials and sparks from metal parts in shoes are potential hazards with all explosive materials. Conductive sparkproof shoes shall be worn in the vicinity of exposed explosives which are susceptible to static spark of the energy that can be discharged from a person. The construction of nonspark-producing or explosives operation shoes should be in accordance with the latest U.S. Safety Standard. Shoes with soles and heels of leather, rubber, or synthetic compositions (neolite, Neoprene, and similar compositions) may be used provided the soles and heels contain no exposed nails or holes. The shoes shall have a fully enclosed safety toe cap. Periodic inspections shall be made to detect and eliminate any shoes with exposed metal. The soles and heels of shoes must be cleaned free from sand and dirt before entering a building containing explosives. Conductive shoes meeting the requirements for explosives operations (nonspark-producing shoes) may be substituted for them if desired.

j. Respiratory protection (29 CFR 1910.134). An effective respiratory protection program should include the following:

- (1) Written standard operating procedures.
- (2) Instruction and training in the proper selection and use of respirators.
- (3) Assignment of respirators to individual users who have been medically approved by a physician and are periodically, (for instance, annually) reviewed for medical status.
- (4) Cleaning and disinfection procedures for respirators.
- (5) Proper techniques for storage of respirators.
- (6) Criteria for inspection of respirators.
- (7) Surveillance of work conditions to determine respirator needs.
- (8) Determination of proper size respirator to fit workers.
- (9) Periodic program evaluation.
- (10) A requirement that personnel who wear respirators are prohibited from having beards and mustaches if they prevent a snug or proper fit.

k. Combustible gas and oxygen indicator. The purpose of this dual purpose instrument is to monitor areas for buildup of potentially hazardous combustible gases and/or oxygen deficiency. Typically such areas include vaults, tunnels, sewers, ship holds, and areas where combustible fluids are used or stored.

l. Portable combustible gas indicating detectors. Portable combustible gas indicating detectors are available for use as follows:

(1) For detection of miscellaneous flammable gases (including hydrogen) and vapors.

(2) For indication of the concentration of hydrogen in mixtures with air or oxygen.

(3) For detecting combustible gases or vapors associated with fuel oils, gasoline, and paints.

(4) For detecting concentrations of one or more specific combustible gases in mixture with air or oxygen.

m. Safety hand tools.

(1) Safety hand tools are constructed of wood or other nonsparking or spark resistant materials such as bronze, lead, beryllium alloys, and "K" Monel metal which, under normal conditions of use, will not produce sparks. Properly maintained, nonferrous hand tools shall be used for work in locations which contain exposed explosives or hazardous concentrations of flammable dusts, gases, or vapors. Hand tools or other implements used in the vicinity of hazardous materials must be handled carefully and kept clean. All tools should be checked out before beginning work and checked in at its completion.

(2) If the use of ferrous metal hand tools is required because of strength characteristics, the immediate area should be free from exposed explosives and other highly combustible materials except in specific operations approved by the service/agency concerned. Prior to use, all ferrous metal hand tools to be used must be examined by the local safety office and approved for use.

n. Safety treads. Safety treads should be installed on ladders, stairs, and floor surfaces to prevent slipping. Several types of safety treads are available.

o. Knee pads. Knee pads will provide for protection of knees of carpenters, riggers, or mechanics who must kneel while working.

p. Carboy tilter. Carboy tilters will be used for safe removal of dangerous liquids such as acids from carboys.

q. Special bung fittings and automatic faucets. Special bung fittings and automatic faucets will be used on drums for dispensing and storing of dangerous liquids (ref NFPA Code 30).

r. Special gas fill caps and metal sediment bowls. Special gas fill caps and metal sediment bowls will be used on powered MHE for safety in replenishment of fuel.

Section VI. Fire Protection (29 CFR 1910.156)

6-13. Classification of fires.

a. Class A fires are fires in ordinary combustible materials such as wood, cloth, paper, and rubber.

b. Class B fires are fires in flammable liquids, gases, and greases.

c. Class C fires are fires which involve energized electrical equipment where the electrical nonconductivity of the extinguishing media is of importance. (When electrical equipment is de-energized, extinguishers for class A or B fires may be used safely.)

d. Class D fires are fires in combustible metals such as magnesium, titanium, zirconium, sodium, and potassium.

b. The classification and rating system described in this section is that used by Underwriters' Laboratories, Inc. and Underwriters' Laboratories of Canada and is based on extinguishing preplanned fires of determined size and description as follows:

(1) Class A rating—wood and excelsior fires excluding deep-seated conditions.

(2) Class B rating—2-inch depth gasoline fires in square pans.

(3) Class C rating—no fire test. Agent must be a nonconductor of electricity.

(4) Class D rating—special tests on specific combustible metal fires.

6-14. Classification of portable extinguishers.

a. Portable fire extinguishers are classified for use on certain classes of fires and rated for relative extinguishing effectiveness at a temperature of plus 70 °F. by nationally recognized testing laboratories. This is based upon the preceding classification of fires and the fire extinguishment potentials as determined by fire tests.

6-15. Classification of hazards.

a. A light hazard is a situation where the amount of combustibles or flammable liquids present is such that fires of small size may be expected. These may include offices, schoolrooms, churches, assembly halls, telephone exchanges, etc.

b. An ordinary hazard is a situation where the amount of combustibles or flammable liquids present is such that fires of moderate size may be

expected. These may include mercantile storage and display, auto showrooms, parking garages, light manufacturing, warehouses not classified as extra hazard, school shop areas, etc.

c. An extra hazard is a situation where the amount of combustibles or flammable liquids present is such that fires of severe magnitude may be expected. These may include woodworking, auto repair, aircraft servicing, warehouses with high-piled (14 ft or higher) combustibles, and processes such as flammable liquid handling, painting, dipping, etc.

6-16. Sprinkler system.

A sprinkler system, for fire protection purposes, is an integrated system of underground and overhead piping designed in accordance with fire protection engineering standards. The system includes a suitable water supply such as a gravity tank, fire pump, reservoir, or pressure tank and/or connection by underground piping to a city main. The portion of the sprinkler system aboveground is a network of specially sized or hydraulically designed piping installed in a building, structure, or area, generally overhead, and to which sprinklers are connected in a systematic pattern. The system includes a controlling valve and a device for actuating an alarm when the system is in operation. The system is usually activated by heat from a fire and discharges water over the fire area.

NOTE

The design and installation of water supply facilities such as gravity tanks, fire pumps, reservoirs, or pressure tanks, and underground piping are covered by NFPA standards No. 22-1970, Water Tanks For Private Fire Protection; No. 20-1970, Installation of Centrifugal Fire Pumps; and No. 24-1970, Outside Protection.

6-17. Sprinkler alarms.

A sprinkler alarm unit is an assembly of apparatus approved for the service and so constructed and installed that any flow of water from a sprinkler system equal to or greater than that from a single automatic sprinkler will result in an audible alarm signal on the premises.

6-18. Class of service—standpipe systems.

a. Standpipe systems are grouped into the three following general classes of service for the intended uses in the extinguishment of fire:

(1) Class I—For use by fire departments and those trained in handling heavy fire streams (2½ inch hose). The system is capable of furnishing the

effective fire streams required during the more advanced stages of fire on the inside of buildings or for exposure fire.

(2) Class II—For use primarily by the building occupants until the arrival of the fire department (small hose). The system affords a ready means for the control of incipient fires by the occupants of buildings during working hours and by watchmen and those present during the night time and holidays.

(3) Class III—For use by either fire departments and those trained in handling heavy hose streams or by the building occupants. The system is capable of furnishing the effective fire streams required during the more advanced stages of fire on the inside of buildings as well as providing a ready means for the control of fires by the occupants of the building.

b. Standpipe systems are usually of the following types:

(1) A wet standpipe system having a supply valve open and water pressure maintained at all times.

(2) A standpipe system so arranged through the use of approved devices as to admit water to the system automatically by opening a hose valve.

(3) A standpipe system arranged to admit water to the system through manual operation of approved remote control devices located at each hose station.

(4) Dry standpipe having no permanent water supply.

NOTE

See 29 CFR 1910.158 for specific design and requirements for standpipe and hose systems.

6-19. Types of storage (in relation to fire protection).

a. *Type I storage.* Type I storage is that in which combustible commodities or noncombustible commodities involving combustible packaging or storage aids are stored over 15 feet, but not more than 21 feet high, in solid piles or over 12 feet, but not more than 21 feet high, in piles that contain horizontal channels. Minor quantities of commodities of hazard greater than ordinary combustibles may be included without affecting this general classification.

b. *Type II storage.* Type II storage is that in which combustible commodities or noncombustible commodities involving combustible packaging or storage aids are stored not over 15 feet high in solid piles or not over 12 feet high in piles that

contain horizontal channels. Minor quantities of commodities of hazard greater than ordinary combustibles may be included without affecting this general classification.

c. Type III storage. Type III storage is that in which the stored commodities, packaging, and storage aids are noncombustible or contain only a small concentration of combustibles which are in-

capable of producing a fire that would cause appreciable damage to the commodities stored or to noncombustible wall, floor, or roof construction. Ordinary combustible commodities in completely sealed noncombustible containers may qualify in this classification. General commodity storage that is subject to frequent changing and storage of combustible packaging and storage aids is excluded from this category.

Section VII. Fire Suppression Equipment (Portable Fire Extinguishers, 29 CFR 1910.157)

6-20. Operable condition.

Portable extinguishers will be maintained in a fully charged and operable condition and kept in their designated places at all times when they are not being used.

6-21. Location.

Extinguishers will be conspicuously located where they will be readily accessible and immediately available in the event of fire. They will be located along normal paths of travel.

6-22. Marking of location.

Extinguishers will not be obstructed or obscured from view. In large rooms, and in certain locations where visual obstruction cannot be completely avoided, means will be provided to indicate the location and intended use of extinguishers conspicuously.

6-23. Marking of extinguishers.

If extinguishers intended for different classes of fire are grouped, their intended use will be marked conspicuously to ensure choice of the proper extinguisher at the time of a fire.

6-24. Mounting of extinguishers.

Extinguishers will be installed on the hangers or in the brackets supplied, mounted in cabinets, or set on shelves unless the extinguishers are of the wheel type.

6-25. Height of mounting.

Extinguishers having a gross weight not exceeding 40 pounds will be installed so that the top of the extinguisher is not more than 5 feet above the floor. Extinguishers having a gross weight greater than 40 pounds (except wheeled types) will be so installed that the top of the extinguisher is not more than 3½ feet above the floor.

6-26. Cabinet mounting.

Extinguishers mounted in cabinets or well recesses or set on shelves will be placed so the extinguisher operating instructions face outward. The location of such extinguishers will be marked conspicuously.

6-27. Vibrating locations.

Extinguishers installed under conditions where they are subject to severe vibration will be installed in brackets specifically designed to cope with this vibration.

6-28. Temperature range.

Extinguishers will be suitable for use within a temperature range of at least plus 40° F. to 120° F.

6-29. Extreme temperature exposure.

When extinguishers are installed in locations subjected to temperatures outside the range prescribed in this subparagraph, they will be of a type approved or listed for the temperature to which they will be exposed or placed in an enclosure capable of maintaining the temperature within the range prescribed in this subparagraph.

6-30. Selection of extinguishers.

The selection of extinguishers for a given situation will depend upon the character of the fires anticipated, the construction and occupancy of the individual property, the vehicle or hazard to be protected, ambient temperature conditions, and other factors. The number of extinguishers required will be determined by reference to paragraph *m* below. Approved fire extinguishers will be used to meet the requirements of this section.

NOTE

Approved means listed or approved by (1) at least one of the following nationally recognized testing laboratories: Factory Mutual Engineering Corporation; Under-

writers' Laboratories, Incorporated, or (2) Federal agencies such as Bureau of Mines, Department of the Interior; Department of Transportation, or U.S. Coast Guard, which issue approvals for such equipment.

6-31. Selection by hazard.

Extinguishers will be selected for the specific class or classes of hazards to be protected in accordance with the following:

a. Extinguishers for protecting class A hazards will be selected from the following: foam, loaded stream, multipurpose dry chemical, and water types. Certain smaller extinguishers which are charged with multipurpose dry chemical are rated on class B and class C fires, but have insufficient effectiveness to earn the minimum 1-A rating even though they have value in extinguishing smaller class A fires. Such smaller extinguishers will not be used to meet the requirements of paragraph *m* below.

b. Extinguishers for protection of class B hazards will be selected from the following: bromotrifluoromethane, carbon dioxide, dry chemical, foam, loaded stream, and multipurpose dry chemical. Extinguishers with ratings less than 1-B shall not be considered in determining suitability.

c. Extinguishers for protection of class C hazards will be selected from the following: bromotrifluoromethane, carbon dioxide, dry chemical, and multipurpose dry chemical.

NOTE

Carbon dioxide extinguishers equipped with metal horns are not considered safe for use on fires in energized electrical equipment and, therefore, are not classified for use on class C hazards.

d. Extinguishers and extinguishing agents for the protection of class D hazards will be approved for use on the specific combustible metal hazard.

6-32. Distribution of portable fire extinguishers.

a. The number of fire extinguishers needed to protect a property will be determined as prescribed herein, considering the area and arrangement of the building or occupancy, the severity of the hazard, the anticipated classes of fires, and the distances to be traveled to reach extinguishers.

b. Fire extinguishers will be provided for the protection of the building structure, if combustible, and the occupancy hazards contained therein.

c. Required building protection will be provided by fire extinguishers suitable for class A fires.

d. Occupancy hazard protection will be provided by fire extinguishers suitable for such class A, B, C, or D fire potentials as may be present.

e. Extinguishers provided for building protection may be considered also for the protection of occupancies having a class A fires potential.

Table 6-1. Areas To Be Protected per Extinguisher.

Basic minimum extinguisher rating for area specified	Maximum travel distances to extinguishers (ft)	Light hazard occupancy (sq ft)	Ordinary hazard occupancy (sq ft)	Extra hazard occupancy (sq ft)
1A	75	3,000	See Note	See Note
2A	75	6,000	3,000	See Note
3A	75	9,000	4,500	3,000
4A	75	11,250	6,000	4,000
6A	75	11,250	9,000	6,000

Note Not permitted except as specified in 14b

f. Combustible buildings having an occupancy hazard subject to class B and/or class C fires will have a standard complement of class A fire extinguishers, as required by table 1 for building protection, plus additional class B and/or class C extinguishers. Where fire extinguishers have more than one letter classification such as 2-A, 2-B, or C, they may be considered to satisfy the requirements of each letter class.

g. Rooms or areas will be graded generally as light hazard, ordinary hazard, or extra hazard. Limited areas of greater or lesser hazard will be protected, as required.

6-33. Fire extinguisher size and placement for class A hazards.

a. Minimal sizes of fire extinguishers for the listed grades of hazard will be provided on the basis of table 6-1. Extinguishers will be located so that the maximum travel distances will not exceed those specified in table 6-1.

b. The protection requirements specified in table 6-1 may be fulfilled by several extinguishers of lower ratings for ordinary or extra hazard occupancies.

c. Where the floor area of a building is less than that specified in table 6-1, at least one extinguisher of the minimum size recommended will be provided.

d. The protection requirements may be fulfilled with extinguishers of higher rating provided the travel distance to such larger extinguishers will not exceed 75 feet.

Table 6-2.

Type of hazard	Basic minimum extinguisher rating	Maximum travel distance to extinguishers (feet)
Light	4B	50
Ordinary	8B	50
Extra	12B	50

NOTE

Where this section calls for minimum extinguisher ratings of 4B, 8B, or 12B, the requirements may be met by existing extinguishers or multiple foam extinguishers as allowed by *c*(2) below. However, if a single extinguisher must be purchased to fulfill such requirements, the next higher rating will be used.

6-34. Fire extinguisher size and placement for class B fires other than for fires in flammable liquids of appreciable depth.

a. Minimal sizes of fire extinguishers for the listed grades of hazard will be provided on the basis of table 6-2. Extinguishers will be located so that the maximum travel distances will not exceed those specified in table 6-2.

b. Two or more extinguishers of lower rating, except for foam extinguishers, will not be used to fulfill the protection requirements of table 6-2. The maximum of three foam extinguishers may be used to fulfill these requirements.

c. The protection requirements may be fulfilled with extinguishers of higher ratings provided the travel distance to such larger extinguishers shall not exceed 50 feet.

6-35. Fire extinguisher size and placement for class B fires in flammable liquids of appreciable depth.

a. For flammable liquid hazards of appreciable depth (class B) such as in dip or quench tanks, class B fire extinguishers will be provided on the basis of one numerical unit of class B extinguishing potential per square foot of flammable liquid surface of the largest tank hazard within the area.

NOTE

Appreciable depth is defined as a depth of a liquid greater than one-quarter of an inch.

b. Two or more extinguishers of lower ratings, except for foam extinguishers, will not be used in lieu of the extinguisher required for the largest tank. The maximum of three foam extinguishers may be used to fulfill these requirements.

c. Scattered or widely separated hazards will be individually protected if the specified travel distances in 15a and 15c above are exceeded. Likewise, extinguishers in the proximity of a hazard will be carefully located so as to be accessible in the presence of a fire without undue danger to the operator.

6-36. Fire extinguisher size and placement for class C hazards.

Extinguishers with class C ratings will be required where energized electrical equipment may be encountered which would require a nonconducting extinguishing media. This will include fire either directly involving or surrounding electrical equipment. Since the fire itself is a class A or class B hazard, the extinguishers are sized and located on the basis of the anticipated class A or class B hazard.

6-37. Inspection, maintenance, and hydrostatic tests.

a. *General.* For details of conducting needed inspections, proper maintenance operations, and required tests, see NFPA No. 10A, Maintenance and Use of Portable Fire Extinguishers.

b. *Inspection.*

(1) Extinguishers will be inspected monthly, or at more frequent intervals when circumstances require, to ensure they are in their designated places, to ensure they have not been actuated or tampered with, and to detect any obvious physical damage, corrosion, or other impairments.

(2) Any extinguishers showing defects will be given a complete maintenance check.

c. *Maintenance.*

(1) At regular intervals, not more than 1 year apart, or when specifically indicated by an inspection, extinguishers will be thoroughly examined to ensure operability and safety. Defective extinguishers will be recharged, repaired, or replaced, as needed.

(2) Extinguishers removed from the premises to be recharged will be replaced by spare extinguishers during the period they are gone.

(3) Pails or drums of powder-extinguishing agents for scoop or shovel application to metal fires will be kept full at all times.

(4) Each extinguisher will have a durable tag securely attached to show the maintenance or re-charge date and the initials or signature of the person who performs this service.

d. Hydrostatic tests.

(1) If, at any time, an extinguisher shows evidence of corrosion or mechanical injury, it will be subjected to a hydrostatic pressure test or replaced.

(2) For evaluating the condition of extinguisher cylinders made to DOT specifications (49 CFR, chap 1), see the Standard for Visual Inspection of Compressed Gas Cylinders (CGA C-6), published by the Compressed Gas Association, 500 Fifth Avenue, New York, NY 10036.

(3) At intervals not exceeding those specified in table 6-3 and (4) of this subparagraph, extinguishers will be hydrostatically tested. The first hydrostatic retest may be conducted between the fifth and sixth years for those with a designated test interval of 5 years.

(4) Nitrogen cylinders (or other cylinders used for insert-gas storage) such as found on wheeled extinguishers will be tested at a 5-year interval.

(5) On those extinguishers, which are equipped with a shutoff nozzle at the outlet end of the hose, a hydrostatic test will be performed on the hose with its couplings (but without the discharge nozzle) at the test interval specified for the unit on which the hose is installed.

(6) The test pressure for dry chemical and dry powder hose assemblies requiring a hydrostatic test will be at a test pressure of 300 psi for a 1-minute period. Carbon dioxide hose assemblies requiring a hydrostatic test will be at test pressure of 1,250 psi for a 1-minute period.

(7) Hydrostatic tests are not required on fire pails, pump-type water or antifreeze extinguishers, and factory-sealed disposable (nonrefillable) containers. If such an extinguisher or water pail shows evidence of corrosion or mechanical injury, it may be unsafe or unsuitable for further use and will be replaced with a new unit.

Table 6-3. Hydrostatic Test Interval for Extinguishers.

Extinguisher type	Test interval year
Cartridge-operated water or antifreeze	5
Stored-pressure water or antifreeze	5

Table 6-3 Hydrostatic Test Interval for Extinguishers (Continued)

Extinguisher type	Test interval year
Wetting agent	5
Foam	5
Loaded stream	5
Dry chemical extinguishers with stainless steel shells or soldered-brass shells	5
Carbon dioxide extinguishers	5
Dry chemical extinguishers with brazed brass shells, mild steel shell, or aluminum shells	12
Bromotrifluoromethane	12
Dry powder extinguishers for metal fires ..	12

NOTE

Cylinders under jurisdiction of DOT may require hydrostatic testing at more frequent periods.

(8) The hydrostatic test date will be recorded on a record tag of metal or equally durable material, or a suitable metallized decal which will be affixed (by a heatless process) to the shell of an extinguisher which favorably passes the hydrostatic test. The record tag will contain the following information: date of test, test pressure, and name or initials of person or agency making the test.

(9) For extinguishers subjected to an original factory test pressure of 350 psi or greater, the test pressure will be 75 percent of the factory test pressure (as noted on the extinguisher nameplate), but in no case less than 300 psi (see table 6-4). For extinguishers subjected to an original factory test pressure of less than 350 psi, the test pressure will be 75 percent of the factory test pressure (see table 6-4). Pressure will be applied at a rate of rise to reach the test pressure in approximately 1 minute, and the pressure will held for 1 minute, after which it will be released.

(10) Carbon dioxide extinguishers, nitrogen cylinders, and other cylinders or cartridges used for the storage of inert, compressed gases will be hydrostatically tested in accordance with the requirements of DOT (see 49 CFR, parts 171-190).

(11) Extinguisher shells, cartridges, or cylinders which show leakage or permanent distortion in excess of specified limits, or which rupture, will be removed from service.

e. Characteristics of fire extinguishers. The characteristics of fire extinguishers are summarized in table 6-5. The table is designed to familiarize the reader with the various types of extinguishers in use. The table may also be used as an aid in selecting fire extinguishers.

Table 6-4. Hydrostatic Test Pressure Requirements for Shells Not Specified in DOT Regulations.

Extinguisher type	Original factory test pressure	Requires hydrostatic test pressure
All dry chemical and dry powder.	400 psi or greater	75% of factory test pressure
	350-399 psi below 350 psi	300 psi 75% of factory test pressure
Foam—500 psi factory test	500	375
Foam—350 psi factory test	350	300

Table 6-4. Hydrostatic Test Pressure Requirements for Shells Not Specified in DOT Regulations. (Continued)

Extinguisher type	Original factory test pressure	Requires hydrostatic test pressure
Stored-pressure or cartridge-operated water-typed (including antifreeze and loaded stream)	400 psi or greater	75% of factory test pressure
	350-399 psi below 350	300 psi 75% of factory test pressure

Section VIII. Housekeeping as Related to General Storage (29 CFR 1910.14)

6-38. General.

Good housekeeping practices are as essential to safety as they are to efficient storage operations. Many potential accidents and fires are prevented

when warehouses, storerooms, and outside storage areas are maintained in a clean and orderly condition.

Table 6-5. Characteristics of Extinguishers.

Extinguishing agent	Method of operations	Capacity	Horizontal range of stream	Approximate time of discharge	Hydrostatic test interval	Protection required below 40° F.	UL or ULC classifications*
Water	Stored pressure ..	2½ gal	30-40 ft	1 min	5 yr	Yes	2-A
Water	Pump	1½ gal	30-40 ft	45 sec	—	Yes	1-A
	Pump	2½ gal	30-40 ft	1 min	—	Yes	2-A
	Pump	4 gal	30-40 ft	2 min	—	Yes	3-A
	Pump	5 gal	30-40 ft	2-3 min	—	Yes	4-A
	Cartridge & stored pressure.	1¼ 1½ gal ...	30-40 ft	30 sec	5 yr	No	1-A
Water (Antifreeze Calcium Chloride).	Cartridge & stored pressure.	2½ gal	30-40 ft	1 min	5 yr	No	2-A
	Cartridge & stored pressure. (wheeled).	33 gal	50 ft	3 min	5 yr	No	20-A
	Cartridge & stored pressure. (wheeled).	25 gal	35 ft	1½ min	5 yr	Yes	10-A
Water (Wetting Agent).	Cartridge & stored pressure. (wheeled).	45 gal	35 ft	2 min	5 yr	Yes	20-A
	Chemically generated expellent.	1¼, 1½ gal ..	30-40 ft	30 sec	5 yr	Yes	1-A
Water (Soda Acid)	Chemically generated expellent.	2½ gal	30-40 ft	1 min	5 yr	Yes	2-A
	Chemically generated expellent. (wheeled).	17 gal	50 ft	3 min	5 yr	Yes	10-A
	Chemically generated expellent.	33 gal	50 ft	3 min	5 yr	Yes	20-A
	Cartridge & stored pressure. (wheeled).	2½ gal	30-40 ft	1 min	5 yr	No	2 to 3-A and 1-B
Loaded Stream ..	Cartridge & stored pressure.	33 gal	50 ft	3 min	5 yr	No	20-A

Table 6-5 Characteristics of Extinguishers (Continued)

Extinguishing agent	Method of operations	Capacity	Horizontal range of stream	Approximate time of discharge	Hydrostatic test interval	Protection required below 40° F	UL or ULC classifications*
Dry Chemical (Foam Compatible)**	Cartridge & stored pressure.	4¾ to 9 lbs ..	5-20 ft	8 to 10 sec	5 or 12 yrs	No	10 to 20-B:C
	Cartridge & stored pressure	9 to 27 lbs ...	5-20 ft	10 to 25 sec	5 or 12 yrs	No	20 to 30-B:C
	Cartridge & stored pressure.	18 to 30 lbs ..	5-20 ft	10 to 25 sec	5 or 12 yrs	No	40 to 60-B:C
	Nitrogen cylinder & stored pressure.	150 to 350 lbs (wheeled).	15-45 ft	20 to 150 sec	5 or 12 yrs	No	80 to 240-B:C
Dry Chemical (Foam Compatible) (Potassium Chloride)	Cartridge & stored pressure.	2½ to 5 lbs .	5-12 ft	8 to 10 sec	5 or 12 yrs	No	10 to 20-B:C
	Cartridge & stored pressure	9½ to 20 lbs	5-20 ft	8 to 25 sec	5 or 12 yrs	No	40 to 60-B:C
	Cartridge & stored pressure.	19½ to 30 lbs.	5-20 ft	10 to 25 sec	5 or 12 yrs	No	60 to 80-B:C
	Nitrogen cylinder & stored pressure (wheeled)	50 lbs	15-45 ft	30 sec	5 or 12 yrs	No	120-B:C
Dry Chemical (Foam Compatible) (Potassium Bicarbonate Urea based)	Stored pressure	5 to 11 lbs	11-22 ft	13 to 18 secs	12 yrs	No	40 to 80-B:C
	Stored pressure .	17 to 19 lbs .. 175 lbs (wheeled).	15-30 ft 70 ft	26 to 30 secs 62 secs	12 yrs 12 yrs	No No	120-B:C 480-B:C
Bromotrifluoromethane	Self expellent	2½ lbs	4-6 ft	8 to 10 secs	12 yrs	No	2-B:C
Bromochlorodifluoromethane	Stored pressure ..	4½ lbs	6-10 ft	8 to 10 secs	12 yrs	No	5-B:C
	Stored pressure	2 to 4 lbs	8-12 ft	8 to 12 secs	12 yrs	No	2 to 5-B:C
Foam	Pressurized . . .	5½ to 9 lbs . 21 oz	9-15 ft 4-6 ft	8 to 15 secs 24 secs	12 yrs —	No Yes	10-B:C 1-B
	Chemically generated expellent.	1¼, 1½ gal	30-40 ft	40 secs	5 yr	Yes	1-A; 2-B
	Chemically generated expellent	2½ gal ...	30-40 ft	1½ min	5 yr	Yes	2-A:4-B to 2-A:6-B
	Chemically generated expellent	5 gal	30-40 ft	2 min	5 yr	Yes	4-A:6-B
	Chemically generated expellent	17 gal (wheeled).	50 ft	3 min	5 yr	Yes	10-A:10-B to 10-A:12-B
	Chemically generated expellent	33 gal (wheeled)	50 ft	3 min	5 yr	Yes	20-A:20-B to 20-A:40-B
	Carbon Dioxide***	Self expellent	2½ to 5 lb ...	3-8 ft	8 to 30 sec	5 yr	No
10 to 15 lb			3-8 ft	8 to 30 sec	5 yr	No	2 to 10-B:C
20 lb			3-8 ft	10 to 30 sec	5 yr	No	10-B:C
50 to 100 lb (wheeled).			3-10 ft	10 to 30 sec	5 yr	No	10 to 40-B:C
Dry Chemical (Sodium Bicarbonate)	Stored pressure	1 lb	5-8 ft	8 to 10 sec	5 or 12 yrs	No	1-B:C

Table 6-5. Characteristics of Extinguishers (Continued)

Extinguishing agent	Method of operations	Capacity	Horizontal range of stream	Approximate time of discharge	Hydrostatic test interval	Protection required below 40° F	UL or ULC classifications*
Dry Chemical (Potassium Bicarbonate)	Stored pressure	1½ to 2½ lb	5-8 ft	8 to 12 sec	5 or 12 yrs	No	2 to 5-B:C
	Cartridge & stored pressure	2¾ to 5½ lb	5-20 ft	8 to 20 sec	5 or 12 yrs	No	5 to 10-B:C
	Cartridge & stored pressure	7½ to 30 lb	5-20 ft	10 to 25 sec	5 or 12 yrs	No	10 to 60-B:C
	Nitrogen cylinder or stored pressure	75 to 350 lb (wheeled)	15-45 ft	20 to 105 sec	5 or 12 yrs	No	40 to 240-B:C
	Stored pressure	1 to 2 lb	5-8 ft	8 to 10 sec	5 yrs	No	1 to 5-B:C
Dry Chemical (Potassium Chloride)	Stored pressure	2¼ to 5 lb ...	5-12A	8 to 10 sec	5 or 12 yrs	No	5 to 20-B:C
	Cartridge or stored pressure	5½ to 10 lbs	5-20 ft	8 to 20 sec	5 or 12 yrs	No	10 to 60-B:C
	Cartridge or stored pressure	16 to 30 lbs	10-20 ft	8 to 25 sec	5 or 12 yrs	No	40 to 80-B:C
	Nitrogen cylinder or stored pressure	125 to 300 lbs (wheeled)	15-45 ft	30 to 60 sec	5 or 12 yrs	No	80 to 320-B:C
	Stored pressure	2 to 2½ lbs ..	5-8 ft	8 to 10 sec	5 or 12 yrs	No	5 to 10-B:C
Dry Chemical (Ammonium Phosphate)**	Cartridge or stored pressure	5 to 10 lbs ...	5-20 ft	8 to 25 sec	5 or 12 yrs	No	20 to 40-B:C
	Cartridge or stored pressure.	19½ to 30 lbs.	15-45 ft	8 to 25 sec	5 or 12 yrs	No	60 to 80-B:C
	Nitrogen cylinder or stored pressure	50 to 160 lbs (wheeled)	15-45 ft	30 to 60 sec	5 or 12 yrs	No	120 to 160-B:C
Dry Chemical (Ammonium phosphate)**	Stored pressure or cartridge	1 to 5 lbs	5-12 ft	8 to 10 sec	5 or 12 yrs	No	2 to 10-B:C
Dry Chemical (Ammonium phosphate)**	Stored pressure or cartridge	2½ to 8½ lbs	5-12 ft	8 to 12 sec	5 or 12 yrs	No	1 to 3-A and 10 to 40-B:C
	Stored pressure or cartridge	9 to 17 lbs	5-20 ft	10 to 25 sec	5 or 12 yrs		2 to 4-A and 10 to 60-B:C
	Nitrogen cylinder or stored pressure		15-45 ft	30 to 60 sec	5 or 12 yrs		

*UL and ULC rating ratings as of 27 December 1974

** Certain pressurized types have special requirements for hydrotesting to comply with regulations of DOT

***Carbon dioxide extinguishers with metallic horns do not carry a "C" classification

****Some small extinguishers containing ammonium phosphate dry chemical do not carry an "A" classification.

6-39. For all areas of storage.

All areas of storage space will have the following housekeeping rules enforced:

- a. Provide adequate lighting.
- b. Keep machines, equipment, and working surfaces clean and orderly.
- c. Provide adequate tool storage and maintain that storage in neat order.
- d. Provide approved waste containers in sufficient number.

e. Remove and dispose of scrap and waste systematically.

f. Clean up work areas as soon as work is completed. Remove hazardous objects from floor or ground areas during work.

g. Remove broken straps, exposed nails, or wire from containers or unit loads.

h. Allow eating only in authorized places.

i. Keep offices and rest rooms in orderly condition.

j. Clean up immediately any spilled flammable liquids, greases, or other dangerous or slippery substances from working floors or paved areas.

k. Use containers, pallets, and units of sound construction only.

l. Maintain proper and safe storage of hazardous packing materials such as excelsior, sawdust, wood cellulose, preservative liquids, and chemicals.

m. Provide ample space in aisles and work areas and avoid congestion.

n. Eliminate tripping hazards such as telephone, light, and power cables.

o. Place flammable waste such as oily rags, steel wool, and sweepings of excelsior in special covered metal containers and dispose of regularly. Ashes will be placed in noncombustible containers.

p. Store dunnage material in an orderly manner.

q. Provide regular inspections by supervisory personnel for unsafe conditions, unsafe acts, and cleanliness.

r. Maintain adequate emergency fire fighting equipment and access thereto.

s. Remove ice, snow, or sleet from outside walkways, ramps, docks, and stairways, or spread sand, fine gravel, or fine cinders to prevent slipping. Usually ice is treated first with calcium chloride or sodium chloride to prevent the sand from blowing off.

6-40. For inside storage areas (additional precautions).

The following precautions will be enforced for inside storage areas:

a. All doors and windows in warehouses should be kept closed and locked when work is not being done near them or when not required to be open for ventilation.

b. Except when authorized in offices or rest rooms, do not allow smoking within warehouses. Assure that "No Smoking" signs are posted in locations where smoking is not permitted.

c. Maintain, as required, proper clearances at fire doors, near overhead sprinklers, and bulkheads.

d. Floors should be kept dry.

e. Keep hose, cable, and wire off floors and remove from walkways and work areas.

f. Park powered MHE in warehouses in accordance with the provisions of paragraph L2i(2).

g. Store gasoline or other highly flammable liquids, in small quantities for station use only, in flammable-type warehouses or in special nonflammable small structures, only when safe

containers are used, and in locations approved by the fire chief or safety officer.

h. Prohibit smoking near warehouse doors and entrances to prevent a discarded lighted cigarette or cigar being blown in through open doorways or under closed doors.

i. Use soap and hot water to clean decks and floors. Gasoline, naphtha, thinners, or other highly flammable materials will not be used.

j. Assure that floor elevation differences and other fixed stumbling and tripping hazards are clearly indicated.

k. Park two-wheel hand trucks with handles in upright position and in a location where fellow workers will not stumble over them.

l. Do not block or otherwise make established fire doors inoperative.

6-41. Wash and locker rooms.

The following good housekeeping conditions should be enforced for wash and locker rooms:

a. Clean rooms regularly.

b. When a disinfectant is used, add directly to the wash water. A germicidal-type disinfectant may be used in addition to, but not in place of, soap and water.

c. Clean floors and fixtures daily using soap and hot water. After cleaning, remove all soapy water from the floors.

d. Where salt water is used in closets and urinals or where the water supply is likely to contain grit, a strainer should be connected to the supply line to prevent grit or dirt from reaching the valves. Clean the strainers regularly.

NOTE

TM 5-506, NAVFACMO-125, AFM 91-2 give further guidance in wash and locker room care.

6-42. Lockers.

The following restrictions will be enforced for lockers:

a. Two lockers will be provided for each employee working with open containers of lead compounds or other poisonous or toxic materials, one for street clothes and the other for work clothes.

b. Old clothes and miscellaneous articles will not be stored on top of lockers.

c. Oil soaked or badly soiled cloths will be stored in lockers.

6-43. For outside storage areas (additional precautions).

a. Smoking prohibited. Smoking will not be allowed in immediate outside storage areas; within areas where lumber, gasoline, and other petroleum products are stored; and within specified distances of boundaries of such areas. Assure that "No Smoking" signs are posted in locations where smoking is not permitted.

b. Frequent inspections will be conducted in all open storage areas. Particular attention will be focused on stability of stacks of steel and lumber, potential causes of fire in lumber storage, leaking

solvent, paint or petroleum product containers, bulging drums due to expansion of liquids under high temperatures, and other similar unsafe conditions. The storage area will be inspected for encroaching vegetation. Vegetation, including dry weeds, will be cleared away from outside storage areas.

c. Life preservers at docks and piers. At docks and piers where depth of water is a possible hazard, should personnel fall overboard, life preservers will be maintained at 200-foot intervals at all times. Life preservers and belts will be provided at work areas where personnel work over water.

Section IX. Rules for Safe Storage**6-44. General.**

a. All materials. All materials (palletized or unpalletized) will be placed and secured in a safe manner.

b. Pallet loads. All pallet loads will be squared to achieve a four-point level top. Superimposed loads will be set squarely and firmly to preclude rocking or tipping. When loads have voids, the perimeter units will be placed at or near pallet edges. (A four-point load is one which provides four points of contact, level with each other on top, at or near the four sides of pallet.) Pallet support sets may be used for storing unstable loads.

c. Partially loaded pallets. Partially loaded pallets will be stored in pallet racks or on top of stacks. A full load will not be superimposed on a partial load and a large load will not be superimposed on a small load. Heavy loads will not be stored on top of a light load or on material which could be broken or damaged.

d. Nonsecured top loads. Nonsecured top loads of tall cylindrical units stacked on the end or any type of unit which has a tendency to lean or settle outwards will be tied with cord or tape; in multiple course top loads, a piece of fiberboard or wrapping paper should be laid horizontally between the two upper courses of units. When stacked vertically, loads with cylinders of compressed gas will be strapped and collared.

e. Unusable pallets. Broken or damaged pallets will be replaced with pallets in safe condition.

f. Use of dunnage. Where it is necessary to stack heavy materials in open storage on muddy or soft ground or on asphalt-type paved surfaces that soften in hot weather, sufficient base dunnage of broad dimensions will be provided to preclude later tipping or settling of such material.

g. Tying load. In regions where strong winds prevail, noncapped or nonstrapped stacks of lumber or empty drums in open storage will be tied to prevent top units from being blown off.

h. Stacking clearance. Pallet loads will be stacked with 2 inches of clearance on all sides to prevent dislocation of adjacent units.

i. Storing of crushable containers. Crushable containers will have vertical supports placed in such a manner that weight of material stored above will not be supported entirely by the containers. Unstable or odd-shaped units such as brooms; swabs, bales of rags, cloth, and oakum; coils of rope; or any item which may settle slowly in prolonged storage will have the top loads in proximity to each other in parallel rows. Each load will contact parts of four vertical columns or stacks of loads so that the containers may be tied at the top to prevent outward leaning of the stacks. Pallet support sets may also be used to support crushable loads.

j. Moving or lifting unstable units. To move and lift tall or unstable units on pallets, especially when heavy units could cause outward bowing of the pallet, the forks of the forklift truck will be spread as wide as possible and when necessary, the units will be tied to prevent perimeter units from falling off the pallet.

k. Securing loads placed on trailers. Loads of material placed on warehouse trailers for movement within the warehouse, between warehouses, to docks, piers, and loading platforms will be secured and tied, if necessary, to prevent material from falling off when turns are being made, when moving up or down ramps, or when turns are being made, when moving up or down ramps, or when crossing railroad tracks or unlevel surfaces.

l. Storing of cylindrical units. Cylindrical units stored in horizontal position will be blocked, nested, or separated by notched horizontal spacers, as applicable.

m. Corner markers. In bulk storage, the use of corner markers at main and cross aisle intersections will be based upon necessity through local determination. The need for corner markers at main and cross aisle intersections should be limited to those intersections where operating MHE may damage containers or material in storage. Corner markers are not required at the main and cross aisle intersections where storage racks or bins are erected. Suggested corner marker construction is as follows and may be locally constructed:

(1) Plywood of $\frac{1}{2}$ to $\frac{3}{4}$ inch thickness is a good material for corner markers. If markers are for outside storage areas, exterior-type plywood should be used. Other products such as sheetmetal, hardboard, or particle board can be considered if cost effective under local conditions. The use of hinges to join the two wings of the corner markers will make it easier to move and store the markers when necessary.

(2) Corner markers may be triangular, square, or rectangular. Triangular shapes are the most easily identified shapes to denote corner markers and are the most economical to construct. However, square or rectangular shapes offer more surface area for visual attention and physical protection against MHE and should be considered for use in bulk storage areas.

(3) Markers should not be less than 30 inches high or 24 inches wide (along one wing). No maximum size is established, but a square marker that measured 48 inches along each side would be considered a large size.

NOTE

To reduce splintering, 2 or 3 inches could be removed from each sharp point.

(4) Alternating yellow and black diagonal stripes 3-5 inches wide will be painted on each wing of the corner marker. The yellow should be color No. 13538 or 13655 and should be the predominant color on the marker (i.e., if there is room for seven stripes, four stripes will be yellow and three stripes will be black). If corner markers are also used as row markers, it is permissible to have a suitable area on the markers reserved for a numbering system.

n. Loose straps and protruding nails. Remove all loose straps or wire from units and loads in storage to prevent future injury of personnel when handling. All nails protruding from units,

dunnage, or boards will be pounded level or removed.

o. Storing of flammable packing materials. Provide closed bins for storing flammable packing materials pending use by the packing section.

p. Clear aisles and exits. Keep aisles and exits clear at all times.

6-45. Floor load limits.

Floor load limits will be observed whether a warehouse is of single or multistory construction. It is the activity Civil Engineering Officer's duty to see that floor capacities are determined and signs are posted in conspicuous places stating the capacity of all floors in that area. For safety standards concerning floor loads, refer to 29 CFR 1910.22, (d)(1).

6-46. Spontaneous combustion.

Under special conditions, certain materials generate enough heat to ignite spontaneously. Oils, lubricants, and fats when absorbed by fibrous materials such as rags, waste, and paper are particularly dangerous. Other such items are coal, brooms, oakum, jute, hemp, green fiber, sisal, skins, rubber, metal dross and turnings, leather scrap, and items containing a nitrocellulose base. The chief cause of fire is poor housekeeping. Paper, scrap, excelsior, and other combustible packing materials must be placed in approved containers or structures. To combat combustion, proper ventilation must be provided at all times. Spontaneously combustible materials will be segregated from each other and from other flammable materials in accordance with TM 38-410/DLAM 4145.11/NAVSUP PUB573/AFR69-XX/MCO 4450.XX.

6-47. Adequate illumination in storage areas.

Adequate lighting in storage areas decreases safety hazards and enhances workers' health and morale. Adequate lighting minimizes sight weaknesses, conserves manpower, and will be maintained at all times in working areas and traversed spaces. Such lighting will be free from glare caused by exposed bulbs or reflection from highly polished surfaces. Provision will be made for an adequate number of globes or tubes and reflectors to prevent glare. Lamps of proper voltage, wattage, and type for the area will be provided. Burned out globes or tubes will be replaced promptly. Globes, reflectors, and walls effecting the lighting should be kept clean at all times. Walls should be painted a light shade and lighting should be at recommended levels (see reference to documents of appropriate military department). Some types of fluorescent lamps are now approved for class 1,

group D locations of NFPA. Fluorescent lighting will never be used in flammable storage areas unless approved by Underwriters Laboratories for class 1, group D locations. Translucent roof panels may be used in single-story buildings to aid in lighting and reduce lighting costs.

6-48. Safe handling and disposal of fluorescent lamps.

The principal consideration in handling discarded fluorescent lamps is the need to minimize breakage. Lamps must be handled with care and when-

ever possible, used lamps should be stored in lamp cartons. Employees should not intentionally shatter lamps. This policy will prevent employee exposure to glass fragments and will preclude unnecessary contamination from the mercury contained in the lamps. In regard to the environment aspects of the disposal of fluorescent lamps, small quantities can routinely be disposed of in sanitary landfills. If disposal quantities exceed 200 lamps per week, specific disposal instruction should be requested from the appropriate military department.

Section X. Size of Storage Blocks, Clearances, Heights, and Limitations

6-49. Floor area.

The floor area or individual storage blocks for combustible materials is indicated in TM 38-410/DLAM 4145.11/NAVSUP PUB 573/AFR 69-XX/MCO 4450.XX, *Storage and Handling of Hazardous Materials*.

6-50. Height of stacks.

a. General. Height of stacks should not be limited except as may be required for operations stability and to maintain clearances and floor load limits. Stack height limitations listed below may be exceeded and clearances reduced with the approval of the installation fire authority.

b. Below automatic sprinkler deflectors. The height of the stack below automatic sprinkler deflectors will be limited as follows:

- (1) When stack heights do not exceed 15 feet, an 18-inch clearance will be maintained (fig 6-1A).
- (2) When stack heights exceed 15 feet, a 36-inch clearance will be maintained (fig 6-1B).

c. Below joists, rafters, beams, and roof trusses. The height of the stack below joists, rafters, beams, and roof trusses will be limited as follows (fig 6-2):

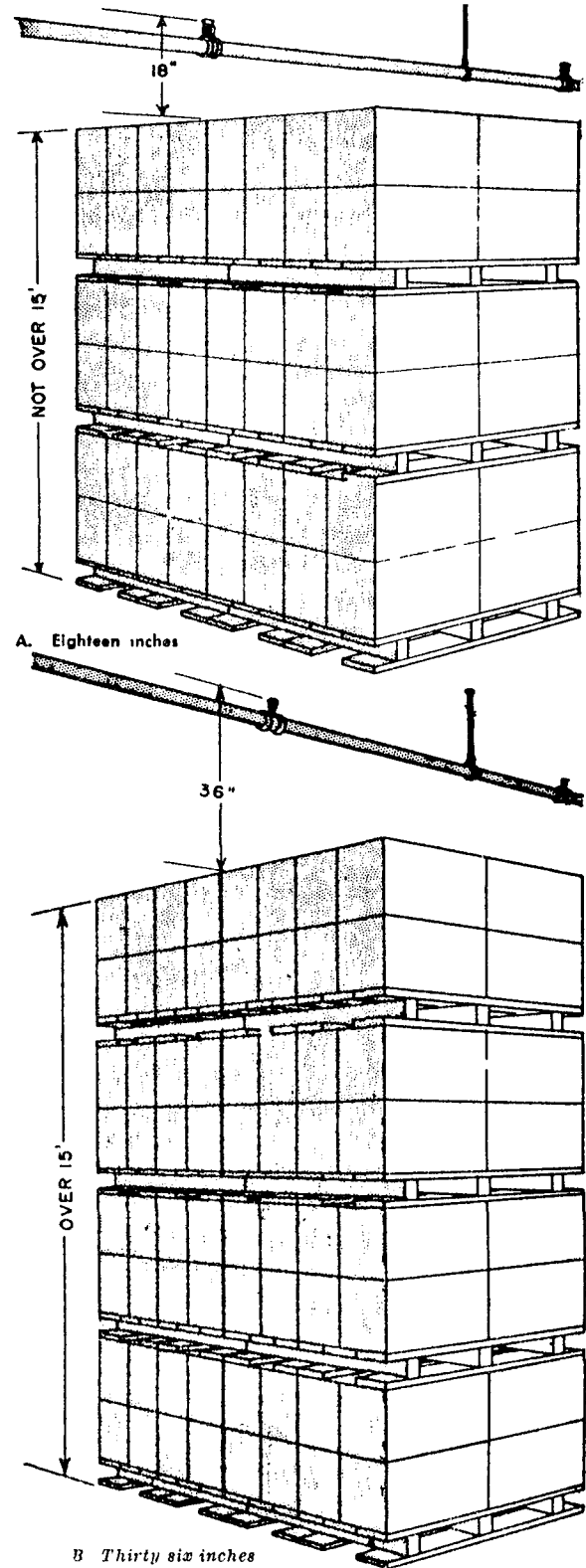

Figure 6-1 Overhead stack clearance at sprinkler head

(1) When stack heights do not exceed 15 feet, an 18-inch clearance will be maintained.

(2) When stack heights exceed 15 feet, a 36-inch clearance will be maintained.

(3) Regardless of their height, stacks in nonsprinkled buildings will have a 36-inch clearance, except that reclaimed metal drums may be stacked within 14 to 20 inches from metal joists, rafters, beams, and roof trusses in nonsprinkled buildings of all metal construction and without electrical wiring.

d. Light or heating fixtures. Around light or heating fixtures, an 18-inch clearance will be maintained.

e. Above level of roof truss. When supplies are stacked above the horizontal level of lower roof truss members or beams, the horizontal clearance between supplies and structural members or other installed devices will be 18 inches (fig 6-2).

6-51. Clearances.

a. General. Clearances between stored materials and walls will not be maintained except as follows:

(1) Substandard firewalls (less than 4-hour rating) clearance of 24 inches will be maintained (fig 6-3).

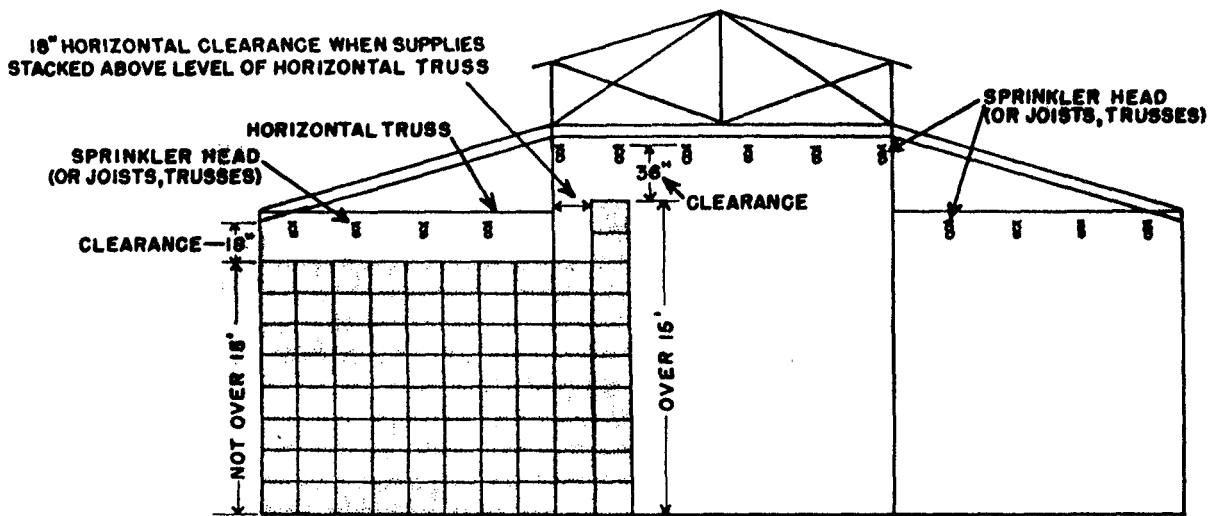

Figure 6-2 Clearance of material from sprinkler heads and trusses.

(2) When infestible subsistence items are stored in general purpose storage buildings, an 18-inch clearance will be maintained.

(3) No clearance is required when nonhazardous materials are stored in general purpose storage buildings, except a 24-inch clearance around personnel doors or fire aisles (fig 6-5).

(4) When materials stored are subject to excessive swelling, clearance usually not exceeding 12-inches (fig 6-6).

b. Clearance to maintain nonhazardous materials storage block limitations. When clearances are found necessary to maintain storage block limitations, such clearance between stacks will not be more than 4 feet in width for 2,000-square foot blocks or 6 feet for 8,000-square foot blocks.

c. Clearance around fire doors. A 24-inch clearance will be maintained between stock and the fire

door except for the portion of the fire door near the aisle. For this portion of the fire door, a 36-inch clearance will be maintained between stock and the fire door (fig 6-6). Where a protective barricade is provided for the fire door, no clearance between stock and barricade is required.

6-52. Aisles.

Aisles will not be maintained for access to electrical equipment, fire fighting equipment, or sprinkler valves, except where such equipment or valves cannot conveniently be moved to a more accessible location.

6-53. Exceptions.

Exceptions to the requirements may be authorized where such exceptions will result in increasing space utilization without materially increasing the fire risk. Requests for such exceptions, with ade-

quate justification, will be submitted to the appropriate military department for review and approval. These requirements do not apply to materials stored in public warehouses under service contracts.

Section XI. Signs and Color Code Markings in Relation to Safety in Storage.

6-54. Posting of "No Smoking" signs.

"No Smoking" signs of sufficient size to be seen from the far end of a normal size storage room or for a considerable distance in outside storage areas will be posted. Signs will comply to 29 CFR 1910.144 or 1910.145, as applicable. The signs will

be of adequate quantity and posted in storage areas at the following locations:

- a. Over doorways, on each side of firewalls.
- b. In center of each cross aisle in each store-room, hanging double-sided signs.

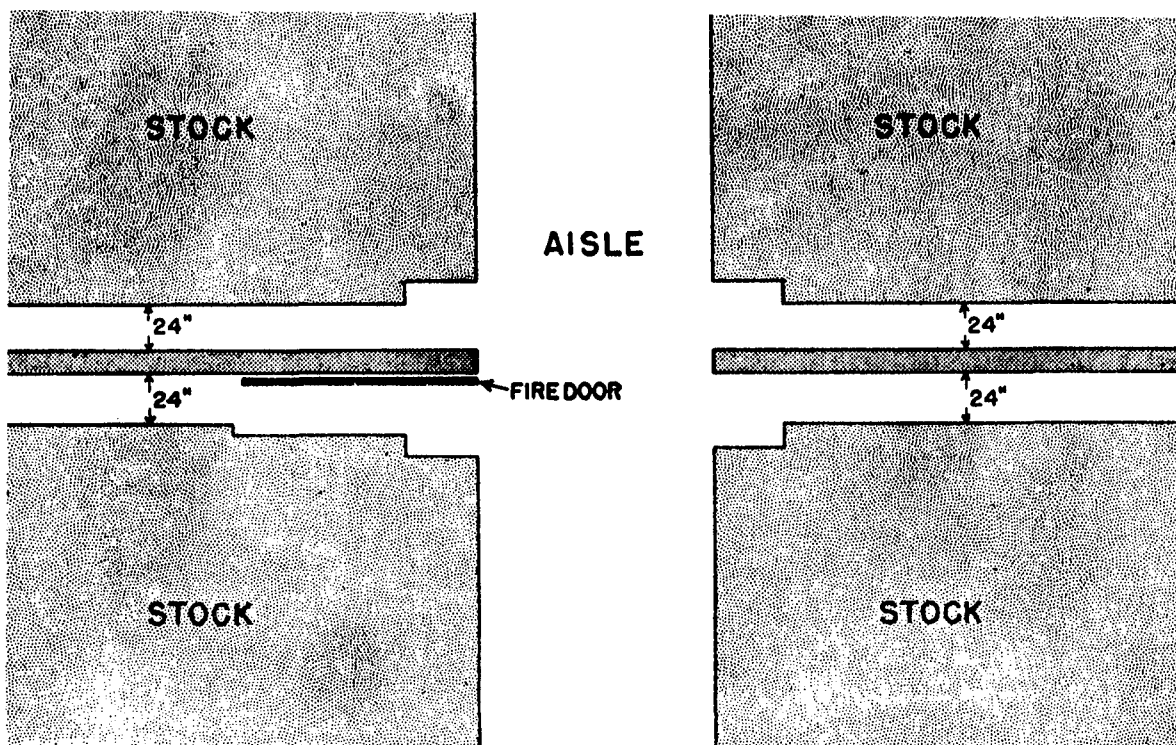

Figure 6-3. Stack clearance of substandard firewalls

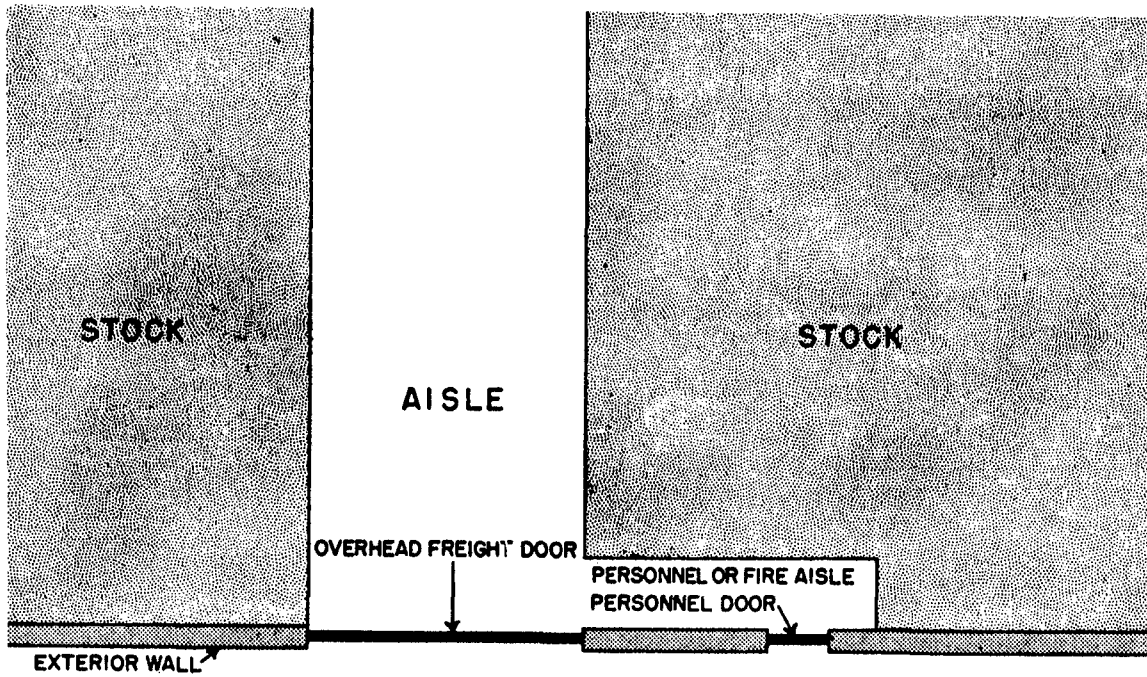

Figure 6-4 Stack clearance at exterior walls (nonhazardous materials)

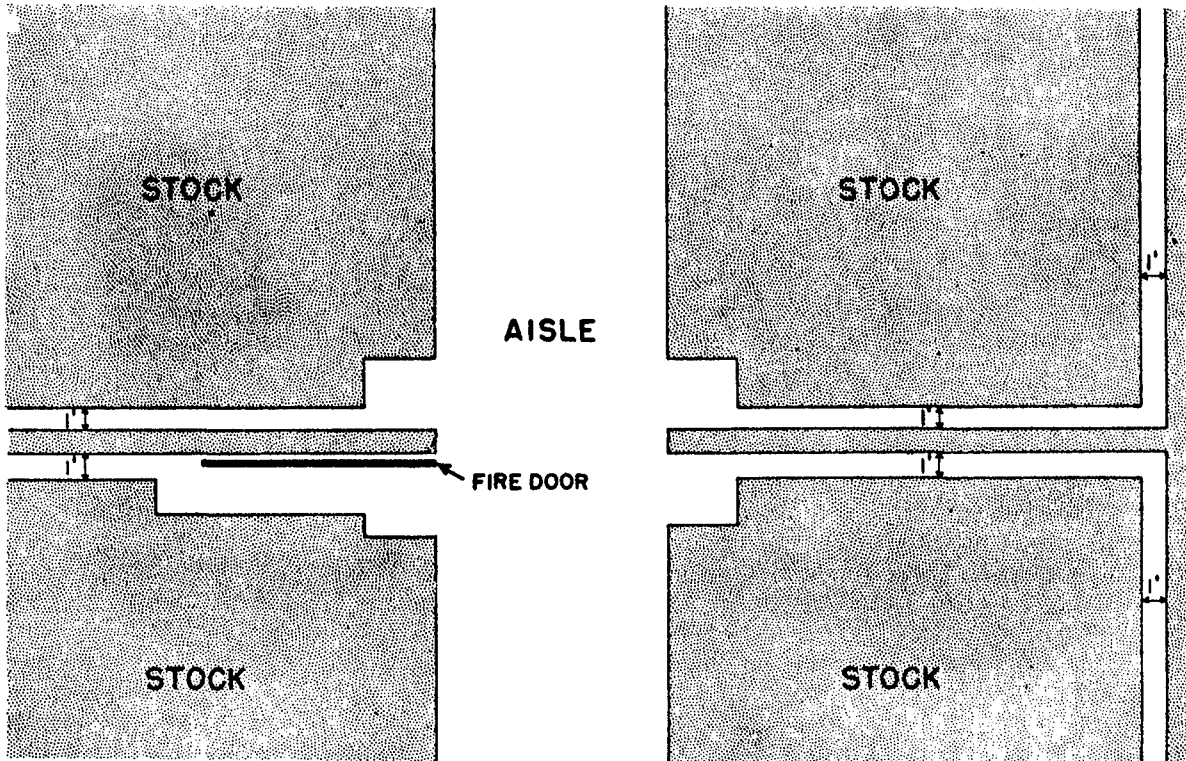

Figure 6-5. Stack clearance at walls for material subject to excessive swelling

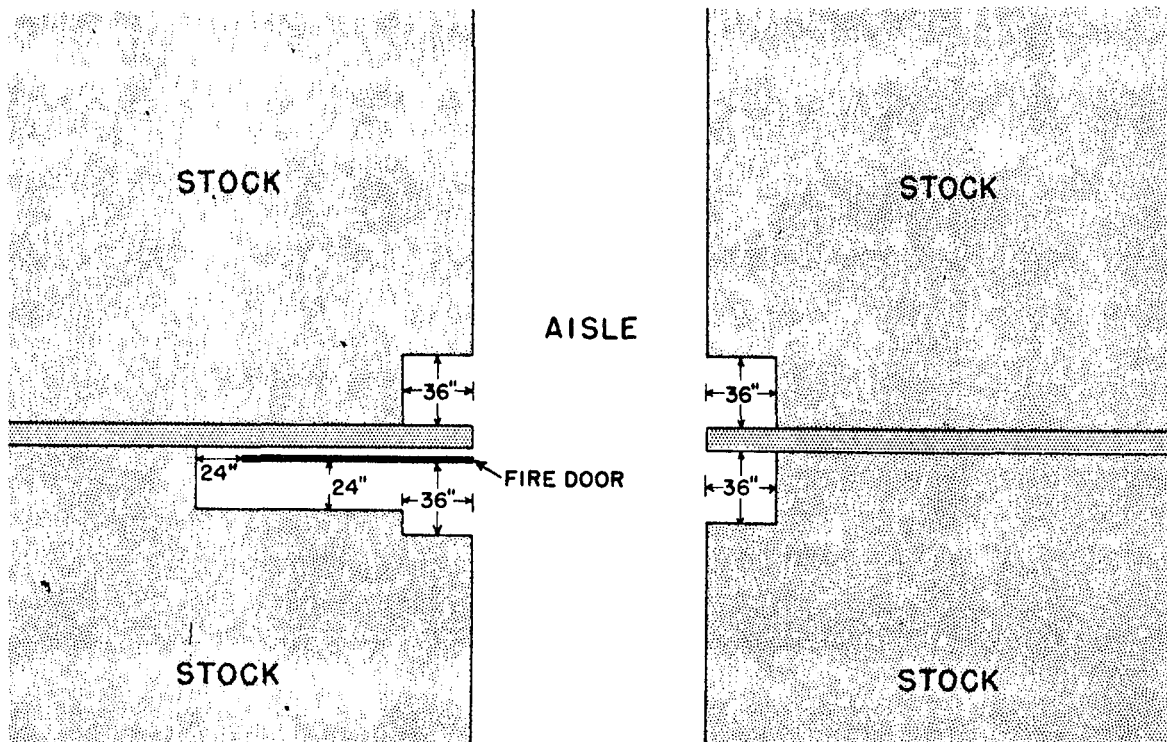

Figure 6-6. Stack clearance at standard firewalls and at fire doors (nonhazardous materials)

c. In aisleway or lobby, hanging to face each passenger and each freight elevator entrance to warehouse.

d. In addition, in "flammable storage" warehouses, on the outside of the building at each entrance, one at each end of the building, and on each side of the building where there are no entrances. (also see TM 38-410/DLAM 4145.11/NAVSUP PUB 573/AFR 69-XX/MCO 4450.XX, Storage and Handling of Hazardous Materials).

e. Unusually long or wide "flammable storage" buildings will have signs posted at the ends of side and the ends of building.

f. In aisleways of lumber yards, affixed to standards, posts, or corners of stacks; in such quantity and manner as to be discernible from any direction of approach.

g. Outside areas for highly flammable materials, affixed to standards, posts, or corners in aisleways so as to be discernible from any approach (areas where stores of gasoline, oils, compressed gases, acids, or materials which could prove dangerous if fire causes breakage or damage with subsequent exposure to other types of hazards such as to danger of contact with acids and corrosives).

h. In all outside locations, in adequate quantity where any materials not especially of fire hazard is stored.

NOTE

Specifications for "No Smoking" signs, other warning signs, and directional arrows are found in 29 CFR 1910.144 and 1910.145.

6-55. Directional arrows (OSHA 1910.145).

Directional arrows will be placed in storehouses, in aisleways, and where fire extinguishers or other firefighting emergency equipment is not easily discernible from a reasonable distance in the aisleway. Directional arrows, indicating placement of firefighting equipment, will be of adequate size to be seen from the far ends of the aisles. Also, if required, such signs will be used in outside storage areas. Directional arrows indicating the location of fire exits which are not easily discernible will be similarly posted. In this instance, the lower portion of the sign will read "FIRE EXIT."

6-56. Color code markings.

The following color codes will be used except at overseas installations when such colors are not deemed feasible.

a. White markings. All floor markings which do not involve caution or hazardous areas will, when required, be painted white.

b. Yellow markings.

(1) All floor markings which involve caution areas or physical hazards will be painted yellow of color chip No. 13538 or 13655, FED-STD-595.

(2) MHE used in storage and operational areas will be of a paint color which provides ready visibility. Exceptions are combat operational equipment which will be painted the color prescribed by the applicable military service.

(3) Guard railings top and bottom stair risers will be painted with a 3-inch yellow stripe of color chip No. 13538 or 13655 under the nosing of each tread.

c. Yellow and black striping. Yellow color chip No. 13538 or 13655 used with black paint to form stripes will be used to highlight particularly hazardous environments by providing contrasting background as in the following examples:

(1) Large machinery and moving parts thereof.

(2) Pit and platform edges.

(3) Obstructions, dead ends, barricades, and curbing.

(4) Corner markers for stacks of stored materials stripped in such a way as to form an inverted V (para 9a(13)).

d. Yellow and black checkerboard symbol. Eye hazardous areas will be marked by permanent screens, door jambs, and floor markings or by port-

able signs and screens. All of these will display a black and yellow checkerboard symbol and the phrase "Eye Hazard." Portable signs should be used to warn personnel of eye hazardous operations such as welding, acid handling, and other operations which generate flying particles.

e. Red. The locations of a fire extinguisher and other emergency fire-fighting equipment and accessories will be identified by painting walls behind and floor below such equipment with paint color chip No. 11105, red, of FED-STD-595. Emergency chip No. 13538 or 13655. Stop devices, or hazardous machinery or tools will be painted red for easy and immediate recognition.

f. Red with yellow lettering. Small containers for flammable liquids will be painted red with the contents indicated in yellow lettering.

g. Yellow with black lettering. The contents of fixed tanks will be identified with black lettering on background of yellow color chip No. 13538 or 13655. These liquids include gasoline, naphtha, kerosene, alcohol, and solvents.

h. Exit identification. Types and locations of exit identification media, when required, will be prescribed by 29 CFR 1910.35, 36, 37.

i. Special purple and yellow. Areas used for storage of items containing radioactive materials will be conspicuously marked with special purple (magenta) and yellow as indicated in MIL-STD-1458. Placards bearing the standard radiation symbol will be placed at each entrance to a radioactive storage area and around the perimeter so that at least one placard is clearly visible from any direction of approach, as shown in "Radioactive Commodities in the DOD Supply Systems" (DLAM 4145.8/AR 700-64/NAVSUPINST 4000.34/AFR 69-8/MCO P4400.105).

Section XII. Safety Practices for Powered MHE (29 CFR 1910.176; 1910.178; 1910.179; 1910.180; 1910.181)

6-57. General.

Safety practices for powered MHE will be followed and the operators will be trained in the use of equipment. The following regulations will be established:

a. Operators will be trained under the prescribed training program established for the operation of such equipment and will pass all physical, aptitude, and licensing examinations required.

b. The proper type of equipment will be used for the specific job involved.

c. Equipment will be of the correct rated load capacity for the weight of material to be handled.

d. Equipment will be properly serviced and maintained at all times to assure maximum safety and efficiency in its operation.

6-58. Operating safety rules.

a. Spark enclosed electric equipment (29 CFR 1910.178). Battery-powered, EE-type (spark enclosed) equipment will be used for handling and storing flammable liquids with a flash point of 100 °F. or lower in sealed containers. This type of equipment should also be used for handling other

flammable liquids with flash points higher than 100 °F. as determined by the safety and fire prevention authorities. The need for an EX type of explosion-proof truck will be determined by the safety and fire prevention authorities of the individual military services.

b. Equipment to be kept free of grease. Steering columns and electrical wiring on diesel-, gasoline-, or electric-powered equipment must be kept free of excessive grease accumulation at all times.

c. Special protective equipment. Special protective equipment as cleared by the appropriate military department will be used when work involves explosives and ammunition.

d. Fire prevention devices.

(1) *Sediment bowls and gas caps.* Gasoline and gas electric-powered MHE will be equipped with metal sediment bowls and gas filler caps with special safety features.

(2) *Spark flame arrestor.* Internal combustion engine powered MHE with built-in devices to provide adequate safeguards against spark or flame will be used, when available, to handle or to operate in storage areas containing readily ignitable materials such as cotton, jute, sisal, coca fiber, or excelsior. When such MHE with built-in devices is not available, a spark or flame arrestor device, conforming to the requirements of military specification MIL-A-27302, may be attached to the muffler tail pipe. These devices require periodic inspection for accumulation of carbon deposits and, when necessary, will be removed for cleaning. Intervals between servicing of arrestors will vary with the condition of the engine and the type of operations performed. Other types of spark arrestors/devices may be used when authorized by the military service concerned.

(3) *Fire extinguishers.* The installation of fire extinguishers on powered MHE will be as prescribed by the military service concerned. Requirement considerations should include criteria described in section G of this chapter.

e. All warehouse and open area aisles must be kept clean and free of refuse. MHE can be jarred going over obstructions which will cause the load to shift or swing.

f. Overhead guards (29 CFR 1910.178). Forklift trucks of all types will be equipped with an overhead safety guard fabricated from steel. Exceptions are permitted only for forklift trucks where height of the overhead guard would deny entry of truck into work locations such as entry into vehicles being loaded or unloaded in receiving or shipping operations. In such cases, the forklift truck will be fitted with blocking devices that will not

permit the forks to elevate the load higher than the operator's head. Guards and means of attachment will not interfere with the operation of the forklift truck and will not impede the operator in mounting and dismounting the truck.

g. Area to be free of oil and fuel spills. All spills will be cleaned up before starting an engine. Gasoline will not be flushed down a drain unless a special drain designated for this purpose is provided. Gasoline spills will be cleaned up in accordance with local spill control requirements. Only approved absorbent material will be used to clean up the gasoline. Sawdust, wood shavings, or rags will not be used to clean up the spilled gasoline. Metal shovel, metal grid, or other spark producing tools will not be used in the immediate area. When cleaning up spilled gasoline in excess of 1 pint, one person will stand by with a fire extinguisher while another person does the cleaning.

h. Safety precautions by the operator. The following safety precautions are applicable for the operator of MHE:

(1) Operators, as soon as they go on duty, will inspect brakes, steering apparatus, horn, oil, gas, and water. Any defects noted will be reported immediately to the supervisor.

(2) The operator will refuse to drive an improperly loaded truck or any MHE which is not in safe mechanical condition.

(3) The operator will stop the engine and set the brake before getting off the machine, except when picking stock, in which case the brake will be set and the engine permitted to idle in neutral provided the operator remains in the immediate area of the vehicle.

(4) Only licensed operators will be permitted to operate equipment.

(5) The operator will inspect all loads to be moved, will not overload, will not move an unstable load, will avoid moving loose material, and will refuse to move an unsafe load, or unload from a truck or trailer that is not chocked or does not have a stabilizer placed under the fifth-wheel area on the trailer, if disconnected from the tractor.

(6) Operators will be trained in the use of all types of fire extinguishers and will ascertain their location in the areas in which they are working.

(7) Operators will keep three truck or tractor lengths behind other vehicles.

(8) Operators will face in the direction they are traveling and will not back without facing in that direction.

(9) Operators will slow down and sound the horn or gong before proceeding at cross aisle intersections or when vision is obstructed.

(10) Operators will not attempt to repair or adjust any mechanical part of any MHE but will immediately report defects to the supervisors.

(i) *All equipment.* The following safety operating rules are applicable to all MHE.

(1) Fuel tanks on gasoline- or diesel-powered equipment will not be refueled within warehouses or while the engine is running. Refueling of this equipment will be accomplished in a designated outside area at least 20 feet from the warehouse. The individual in charge of fueling operations will be responsible for ensuring that spilled fuel is thoroughly cleaned from the equipment before it is driven into the warehouse. Any spilled fuel will be disposed of in accordance with *g*, above.

(2) Powered MHE not in excess of those assigned to the warehouse for normal operations, may be parked on covered truck or rail platforms or in warehouses under conditions as set forth below. The selection of either place, or some combination of the two, will be the responsibility of the installation commander.

(a) In general purpose (nonflammable storage) warehouses, powered MHE may be parked in designated locations such as vacant space in receiving or shipping areas or any large vacant area that will provide the following suitable clearances:

1 Minimum clearance of 10 feet will be maintained between the parked equipment and easily ignitable material such as loose combustible fibers in bales or crates.

2 A minimum 5-foot clearance will be maintained between parked equipment and boxed items or other combustible material.

(b) Aisles will not be used for parking MHE during nonworking hours. This equipment will not be parked where main, cross, or fire aisles, fire-fighting equipment, fire alarm boxes, stairways, elevators, or fire exits will be blocked or where fire-fighting operations would be hampered.

(c) Warehouse areas used for parking MHE must be approved by local fire and safety personnel.

(d) An oil-absorbent compound, Federal specification P-S-863 or equal, will be used under each piece of equipment parked, to absorb oil and grease drippings from leaks or other sources. A metal pan may be used in conjunction with the compound. Corrective action will be taken on equipment showing signs of leakage.

(e) MHE may be parked in multistory buildings; however, gasoline- or diesel-powered equipment must be parked on the first floor and the provisions of (a) through (d) above apply.

(f) Only spark-enclosed or explosion-proof equipment may be parked in flammable storage buildings and the provisions of (a) through (d) above apply.

(g) Gasoline- or diesel-powered equipment should not be "warmed up" inside the building. After starting the engine, such equipment should be driven outside the building for the "warm up" period to minimize fumes and carbon monoxide.

(h) Scheduled inspections must be made to ensure that powered MHE is parked in proper location; that the equipment is free from accumulations of excess grease and lint; and that gasoline lines, tanks, oil seals, etc., are not leaking.

(3) A gasoline- or diesel-driven machine will not be used in a building, unless the building is properly ventilated, either naturally or artificially (see para 7 below).

(4) Forklift trucks or other MHE will not be equipped with a steering knob or extension to the gear shift lever.

j. All powered MHE will be painted as prescribed in Section XI 3b(2).

6-59. Forklift truck safety rules (29 CFR 1910.178).

The following safety rules are applicable to forklift truck operation:

a. Forklift truck operators will slow down at all cross aisles and other passageways; when entering or leaving buildings or warehouses, the operator will come to a complete stop at the entrance, sound horn, and proceed only when the way is clear.

b. Under all travel conditions the truck shall be operated at a speed that will permit it to be brought to a stop in a safe manner (29 CFR 1910.178(N)(8)).

c. Forklift trucks will not travel with the forks elevated more than 4 inches above the floor or ground, but when parked, the forks will be lowered and rested on the floor.

d. Stacks will not be bumped or pushed with the forklift trucks to straighten or move the stack.

e. The load capacity plus the gross weight of each truck will be placed on the machine at a place that is visible at all times. The capacity will not be exceeded and counter-weighting of the trucks to increase lifting capacity is prohibited. Modifications which affect truck capacity or safe

operations will not be performed without the approval of appropriate installation officials.

f. Personnel will not stand under the loads being hoisted or lowered.

g. Forklift trucks will be driven forward when transporting cargo up ramps or other grades and will be driven in reverse on downgrades.

h. The mast will be tipped back when loads are transported.

i. Forklift trucks will not be lifted by the overhead guard; lifting pads will be installed when required.

j. For operations involving more than one fork truck, vehicles will be 20 feet apart, unless two vehicles are transporting the same load.

k. Forklift trucks will not be used to elevate personnel, unless authorized by the supervisor. When lifting is authorized, a safety pallet will be used, the truck will not be moved, and the person being lifted will face away from the mast and remain clear of the hoisting mechanism.

l. Personnel will not be allowed to ride forks, machine, or load when the forklift truck is moving.

m. Forklift trucks will be driven slowly over railroad or rough surfaces.

n. Standard load back rests (vertical package guard) will not be removed during operations except when facility characteristics such as curved roofs prevent use of the load back rest. Stacking of loads on the forklift truck tines will be controlled so that no more than one-third of the height of the top tier protrudes.

o. Overhead doorways and crossbeams will be cleared by the forklift truck.

p. When the operator parks a forklift truck, he/she must check the brake to be sure the truck will not move.

q. Operators of forklift trucks must not cut corners. This practice may result in upset loads, damaged goods, and serious injury to personnel.

r. Bridge plates will be secured in position, either by being anchored or equipped with devices which will prevent their slipping and have sufficient strength to support fork trucks (see para 6-64 below).

s. Freight cars will not be towed or pushed with forklift trucks.

t. Operators will not jam on the brakes or stop suddenly.

u. Operators will not attempt to repair fork trucks. They will notify supervisors and request a qualified repairman to make repairs.

v. Operators will not allow personnel to counter-balance a load on a forklift truck by riding rear of machine, but will use a truck of greater capacity.

w. Operators will not extend hand or arm through the mast while in operation.

x. Forklift trucks will be equipped with overhead guards.

6-60. Straddle carry trucks safety rules.

The following safety rules are applicable to straddle carry truck operations:

a. Before starting daily operations, each straddle carry truck operator will check the vehicle thoroughly (see chap 4, sec E).

b. All loads placed on straddle carry trucks will be blocked to prevent any part of the cargo coming in contact with the surface over which the cargo is being transported.

c. In the vicinity of personnel, operators will sound the horn or other noise making device.

d. All approved guards and safety devices will be kept in proper repair at all times.

e. Straddle carry trucks operated on public streets or highways will be equipped with all safety devices required by state laws.

6-61. Tractor-trailer train safety rules.

The following safety rules are applicable to tractor-trailer train operations:

a. Tractor operators will obey all traffic regulations at all times.

b. Trailers will be firmly coupled to each other and to the tractor before starting operations. The couplers will be inspected at each time of coupling. Safety chains will be attached when directed by the service/agency concerned.

c. The individual activity will establish the maximum number of trailers permitted in each train.

d. Loads being transported by tractor-trailer trains will be lashed, if necessary, to prevent materials from falling. The operator will inspect all loads before moving the tractor-trailer train.

e. The trailer immediately behind the tractor will not have a load of such height as to obstruct the operator's view when he/she looks back to observe if the loads are riding safely.

f. The speed limit of tractor-trailer trains within warehouses is 5 miles per hour and in outside areas in accordance with installation directives.

g. When leaving or entering buildings, operators will come to a complete stop, sound horn, and proceed only when the way is clear.

h. Railroad tracks and unlevel roadways will be traversed at reduced speed, to reduce jarring of material, and at an angle.

i. Tractors will not be used to push or pull railcars.

6-62. Warehouse crane safety rules.

The following safety rules are applicable to warehouse crane operations (29 CFR 1910.180):

a. When entering or leaving a warehouse, the crane boom must be lowered to clear doorways and other overhead obstructions.

b. The weight of crane and load must not exceed floor load limits.

c. Prior to actual turning of the crane, the operator must use extreme caution to swing the crane boom sufficiently to avoid posts and stacked materials.

d. Suspended loads will be carried as high as possible on the crane line, without fouling topping gear, in order to reduce swinging of load. The boom will be as near perpendicular as possible.

e. Before moving or lifting the load, the operator will ascertain the approximate weight of load to be moved in relation to crane capacity.

f. Before moving the load, the operator will determine what is to be done, where the load is to go, and the route to be traversed.

g. When the operator leaves the crane, a crane load will never be left suspended.

h. Sling lines will be securely attached, spread, and centered in relation to the load and, if necessary, properly padded at edge crossings to assure safety and protection to material.

i. Ditches, railroad tracks, and other recessed or raised crossings will be crossed at right angles to prevent undue swing of load.

6-63. Carbon monoxide.

a. Characteristics. Carbon monoxide, a colorless, odorless, toxic gas, is contained in varying amounts in the exhausts of almost all internal combustion engines. An engine with a rich mixture produces far more carbon monoxide than an engine with a lean mixture. When a cold engine is fired, the development of carbon monoxide is much greater than when firing an engine that is warm. Carbon monoxide replaces the oxygen in the blood stream, in proportion to the amount being breathed; until the concentration has built up to a considerable amount, ill effects are not experienced. Most persons may breathe each working day, without harm, air in which the concentration increases to 50 parts of carbon monoxide per mil-

lion parts of air (time weighted average). Above that level, headaches start, and at higher concentrations, dizziness, fatigue, and general weakness are experienced. Extreme concentrations of carbon monoxide are fatal.

b. Ventilation. When gasoline-driven equipment is used in confined areas where adequate natural ventilation is not available, artificial ventilation must be supplied to prevent the average concentration in any space exceeding 50 parts of carbon monoxide per million parts of air (time weighted average). Such ventilation may be obtained from ventilating systems, by portable blowers, or both.

c. Rate of development. The amount of carbon monoxide developed by gasoline-driven trucks is dependent on the size of the engine, the adjustment of the carburetor, the condition of the spark plugs, and timing of the distributor. An average engine in normal operation will give off 1 cubic foot of carbon monoxide per hour per horsepower.

d. Atmosphere tests. Since the value of 1 cubic foot of carbon monoxide generated per hour per horsepower is only approximate, decisions on the amount of ventilation required for various operations should be determined by tests in working areas with appropriate carbon monoxide detectors. Such tests should be made regularly, since conditions of engines may change, and it is difficult to determine the actual amount of ventilation being furnished, particularly where natural ventilation is used.

e. Safety precautions. Gasoline engines in trucks should be turned off when not in use. Gasoline engines should not be permitted to idle in standby service for longer than 30 seconds. Gasoline engines should be checked at frequent intervals with a motor analyzer and readjusted for maximum performance and minimum carbon monoxide generation. Personnel will not be permitted to work in buildings where concentration of carbon monoxide is greater than 50 parts per million parts of air (time weighted average).

6-64. Auxiliary equipment.

a. Exhaust gas purification devices. Exhaust gas purification devices of various types, designs, and effectiveness are available from commercial sources as a component of an exhaust pipe or as a muffler for attachment to petroleum-fueled powered MHE and vehicles. These devices are designed, when properly attached and maintained, to prevent accumulation of lethal, toxic, and irritating exhaust gases in excess of the permissible limits established by the American Standards Association Code for Allowable Concentration of Car-

bon Monoxide. Normal control measures to protect health of personnel against such gases will not be relaxed when MHE, with exhaust gas purification devices attached, are operated within enclosed and unventilated areas. Carbon monoxide detector tubes or direct reading instrumentation should be obtained and used by trained personnel to measure carbon monoxide levels. Use of petroleum-fueled MHE with exhaust gas purification devices is warranted in high density confined operations only when carbon monoxide poisoning is a hazard and when battery-powered type is not available. When high density operations are performed, in closed warehouses using petroleum fueled MHE, carbon monoxide constant measuring instruments or indicators, fixed to area walls or mounted on mobile equipment, will be used in addition to the detector kit and indicator tube. Exhaust gas purification device(s) will be procured and used only when authorized by the appropriate authority of the military service having jurisdiction.

b. Bridge plates. Information on bridge plates (dock-boards) is contained in 29 CFR 1910.30 and 1910.178. A bridge plate must be strong enough to support the equipment and load which traverses it and long enough to bridge the gap it spans with

adequate support area at both ends. The length, especially, is important when the floor of the platform is lower or higher than the floor of the car or vice versa. Drive slowly when mounting or driving over the bridge plates in rainy weather, or when icy conditions prevail. Bridge plates will be—

(1) Equipped with stops at both ends near the edges of the platform or the car or truck to prevent plate from sliding.

(2) Equipped with adjustable stops of different lengths permanently located in channels or slots. The use of steel pins as stops is not authorized.

(3) Of sufficient length to provide support of approximately 8 inches at all times.

(4) So constructed to provide handholds for manually lifting or other means for lifting by fork truck.

(5) Constructed with a rough or checkered surface to reduce skidding or slipping.

(6) Equipped with safety curbs to prevent fork truck runoff.

(7) Marked to indicate the load capacity.

(8) Checked frequently during lengthy loading/unloading operations.

Section XIII. Safety Practices for Nonpowered MHE

6-65. Hand trucks.

a. Two-wheel hand truck. The two-wheeled hand truck will not be used to transport units of material heavy enough to cause undue strain or risk to personnel.

b. Barrel hand truck. Barrel-type hand trucks should be provided for personnel to move drums, large kegs of material, or other cylindrical units to prevent rolling or slipping of the material causing possible damage to material or injury to personnel.

c. Hand trucks with sparkproof wheels or rims. Hand trucks with sparkproof wheels or rims will be used only for work requiring such equipment, in areas or rooms where materials of highly flammable, combustible, or explosive nature are stored or handled.

d. Nonpowered hand pallet truck. Nonpowered hand pallet trucks will not be used to move loads in excess of rated capacity.

6-66. Use of crowbar.

In areas or rooms where highly flammable, combustible, or explosive materials are stored, a crowbar or pinch bar will not be used to pry or move material as sparks may cause fire or explosion.

6-67. Standard safety pallet (29 CFR 1910.178).

Standard safety pallet (described in para 4-10*k*) and not the ordinary pallet will be used with fork-lift trucks in the following operations:

a. To elevate personnel to a sufficient height above the floor of the warehouse for the purpose of storing material on an elevated pallet or when removing individual items from elevated pallets.

b. To elevate personnel performing maintenance work on the inside or outside of warehouses. Personnel will not be elevated on the forks of the fork-lift truck without the use of the safety pallet.

c. Whenever a truck is equipped with vertical only, or vertical and horizontal controls elevatable with the lifting carriage or forks for lifting personnel, the following additional precautions shall be taken for the protection of personnel being elevated:

(1) A safety platform firmly secured to the lifting carriage or forks will be provided.

(2) Means shall be provided whereby personnel on the platform can shut off power to the truck.

(3) Such protection from falling objects as are necessary in operating conditions shall be provided.

6-68. Fork extension.

The fork extension added to forklift trucks may reduce the load carrying capacity of a truck rated at 25-inches load center approximately 20 percent when handling 60-inch long loads (chap 4). The fork extension should be used only in handling loads of relatively light weight.

6-69. Ladders (29 CFR 1910.25; 1910.26; 1910.27; 1920.29).

a. Construction. The regular rung-type ladder will have the bottoms of side rails sheathed or covered with safety nonskid pads of corrugated or skidproof rubber, duck, or other skidproof material. Nails or screws securing such pads will be countersunk. The pads should be inspected often and replaced when considered unsafe. The regular rung-type ladder must be constructed so that the rung ends set into notches in the rails. Only stepladders with safety hand and guardrails should be used when such ladders are necessary. Three sides of the top step of platform-type stepladders will be protected with guardrails. Stepladders should have only two wheels to preclude unsafe movement of such a ladder when in use. Wheels should be attached to back legs.

b. Use.

(1) *Position.* For safe use, the ladder must set on a firm, solid, and level base with the top

end resting squarely against the wall or other support. The distance of the foot of the ladder from the base of the wall support should be approximately one-fourth of the length of the ladder.

(2) *Defective ladders.* Ladders with cracked rungs or defective or cracked rails will not be used.

(3) *In front of doors.* A ladder will not be placed in front of a door unless the door is locked or otherwise blocked, barricaded, or guarded.

(4) *Stock picking or storing.* Ladders should not be used when stock picking or storing in bin racks; the stock pickers cart described in chapter 4 will be used.

(5) *Safety rules.* Safety rules will be observed and personnel—

(a) Will not reach sidewise more than length of the arm.

(b) Will climb down and reposition the ladder.

(c) Will position feet firmly on the rungs.

(d) Will wear appropriate shoes for protection against slipping.

(e) Will clean all grease or oil from shoe soles.

(f) Will not carry heavy units up or down a ladder. Forklift trucks or stock selectors will be used to elevate material.

(g) Will assure that the bottom brackets of the upper section of extension ladders are properly secured by pins or rungs.

Section XIV. Manual Handling

6-70. Proper lifting method.

Persons who manually handle materials of any type will be instructed in the proper method of lifting heavy objects. The proper way to lift heavy objects from the floor is for the lifter to stand close to the load, with feet slightly apart and solidly placed. With knees bent, the object will be grasped firmly and lifted by straightening the legs, keeping the back as nearly vertical as possible. When lifting from an elevated surface, the object will be brought as close to the body as possible to avoid an unbalanced position. With a straight back, the lifter will keep the load close to the body and will avoid carrying a heavy load a long distance without resting. The load will be carried in such a manner that full view is permitted. When lifting with another person, both persons should start and finish the lift simultaneously to prevent undue strain on either person. Persons with existing her-

nias, or those who have a history of previous back strains, will be assigned to duties that do not require heavy lifting. Lifting or lowering operations performed by several persons will be done on signal from one individual and only after everyone's feet, hands, and other portions of the body are clear. Generally, mechanical means will be used for handling heavy objects.

6-71. Precautions for manual handling.

Safety precautions which apply to manual handling of materials include the following:

a. Protective clothing or accessories, including gloves, face shields, goggles, and safety shoes will be worn as prescribed in paragraph *e*.

b. Finger rings will not be worn.

c. Material will be examined for sharp edges, protruding points, weakened places of ropes, or other factors which may cause injury to personnel.

These defects should be corrected before proceeding.

d. All stacked cargo and materials will be arranged in an orderly manner for convenient and safe handling.

e. Defective or broken strapping on cargo will be removed, repaired, or replaced. Face shield or goggles and proper gloves will be worn when cutting steel strapping, and personnel will stand out of the way of a snapping line of cut strapping.

f. Drums will be rolled by pushing with the hands, not the feet.

g. Material will not be thrown from elevated places to the floor or ground. Use suitable lowering equipment.

h. Wheelbarrows, hand trucks, and other similar devices will not be overloaded. These devices will be pushed, not pulled, except when going up inclines.

i. Defective carrying, towing, lifelines, or scaffold line ropes will be replaced.

j. Chisels, hammer faces, and pliers which have burred, chipped, or badly worn working surfaces or edges will be replaced to prevent serious injury to eyes, hands, or face.

k. Appropriate tools will be used for each job. For example, nail pullers will be used for opening boxes, strap or wire cutters for cutting metal strapping or wire, and hammers for driving nails.

l. Plugs will be disconnected when electrical power tools are not in use.

m. Sharp edge tools will not be carried unshielded in pockets.

n. Hand operated trucks, dollies, and similar equipment will not be parked in traffic lanes or roadways.

o. Cylindrical objects will be blocked to prevent rolling.

p. When working at high elevations, a lifeline and safety belt will be worn if other safeguards are impractical.

q. Personnel will not reach around, over, or under the moving part of any machine.

Section XV. Safety in Loading and Unloading Railroad Cars/Trucks and Trailers

6-72. Railroad cars (ref 29 CFR 1910.178).

a. Protection. Blue flags or signals must be placed at both ends of a car or cut of cars when personnel are working in, on or under the cars. Tank cars shall be so protected when connected for loading or unloading. When thus protected, the car or cars shall not be coupled to or moved. The supervisor or foreman in charge of the personnel loading or unloading the car(s) shall be responsible for placing the blue flags or signals and their removal. Train crews shall be informed of all installation regulations relative to the use of blue flags or signals.

b. Opening doors. Boxcar doors should be opened with a car door opener to prevent backstrains and injuries to personnel. Also, this will prevent material loosened in transit from falling and striking personnel.

c. Checking contents. Contents of railroad cars will be checked for unsafe loads before starting to unload. Empty railroad cars should be checked for weak or broken floor boards and such boards repaired. Steel plates should be placed in doorway areas while loading with MHE. When unloading cars, steel plates will be used over weak or broken floors.

d. Gondola cars. When loading or unloading gondola cars with cranes, all persons must be removed from the immediate area before the lift is made. Unless required for rigging purposes, personnel should not be permitted to stand on top of the car while the load is being raised, lowered, or swung into position.

e. Hopper bottom cars. Personnel will not be permitted to work inside hopper bottom cars while material is being unloaded. Personnel will use a hopper car safety wrench to open and close hopper car doors to prevent backstrains and injuries from falling materials.

f. Bridge plates. Bridge plates between platforms and boxcars will be secured in position, either by being anchored or equipped with devices which will prevent slipping.

g. Moving railcars. Railcars will not be pushed or pulled with fork trucks or warehouse tractors. Wheel stops or other recognized positive protection shall be provided to prevent railroad cars from moving during loading or unloading operations. Positive protection shall be provided to prevent railroad cars from being moved while dockboards or bridge plates are in position.

6-73. Trucks/trailers (ref 29 CFR 1910.178).

a. Flooring. Operators should check flooring for breaks and weakness before a fork truck is driven over them.

b. Wheel chocks. Operators should ensure that wheel chocks are positioned at the rear wheels of

the truck or trailer to prevent them from rolling while being boarded with fork truck.

c. Bridge plates. See paragraph 4-11a for information on the use of bridge plates.

d. Trailer safety jacks. Safety jacks may be necessary to support a semitrailer to prevent unspending during the loading or unloading when the trailer is not coupled to a tractor.

Section XVI. Building and Physical Equipment

6-74. Safety related to stairways (29 CFR 1910.23).

Safety precautions which apply to stairways include the following:

a. Unless steps in stairways are made of wood, the steps will have antislip treads.

b. Stairways over 88 inches wide will have an auxiliary handrail in center and one on each side; those over 44 inches wide, but less than 88 inches, will have a handrail on each side; those 22 inches to 44 inches wide will have at least one handrail.

c. Stairway openings will be guarded with railings which measure 42 inches from floor to top of railing.

d. Stairway handrails will be not less than 30 inches nor more than 34 inches from the top of railing to surface of the tread at the face of the riser. Intermediate railings or suitable screening will be provided from top of handrails and quardrails to floor or treads.

e. Stairways will be well lighted and maintained clean, dry, and free of slippery substances, refuse, or stored material.

f. Personnel will walk, not run, up or down stairways and will use handrail.

6-75. Safety concerning doors in warehouses.

Safety precautions which apply to doors include the following:

a. Doors will be opened slowly. When opened suddenly, a door can cause serious injury to personnel near to or approaching from the opposite side.

b. Clear vision panels of average eye-level height are desirable in solid doors, especially doors which are used considerably.

c. Loose doorstops will be kept in a safe place when not in use.

d. Door spring or patented door closers will be properly tensioned or adjusted to prevent the door from closing too rapidly.

e. Only one person will enter a section of a revolving door.

f. Door hardware must be kept in good repair. Also, any device or alarm installed to restrict the improper use of an exit shall be so designed and installed that it cannot, even in case of a failure, impede or prevent emergency use of the exit.

g. Safe and vault doors must be closed carefully. Do not lock a vault door nor spin the combination lock until assured that no one is inside.

6-76. Safety concerning elevators.

a. Passenger. Safety precautions which apply to passenger elevators include the following:

(1) Qualified inspectors will inspect passenger elevators quarterly.

(2) Any elevator found defective will be plainly tagged and not used until repaired.

(3) All elevators will have signs posted indicating the carrying capacity. The safe capacity for passenger elevators will be expressed in terms of maximum number of passengers to be carried.

(4) Rated capacity of elevators will not be exceeded.

(5) Non-automatic elevators will be operated only by trained operators.

(6) Caution will be exercised by anyone entering or leaving elevators, by watching their step, and by not boarding or debarking while the elevator is in motion.

(7) Passengers will not be permitted in an elevator unless it is specifically authorized as a passenger-carrying elevator.

(8) A self-service elevator must be in proper position to board or debark. Do not enter or leave until doors are opened fully.

(9) Smoking will not be permitted in any elevator. Signs to that effect will be posted.

b. Elevator operators. Safety precautions which apply to elevator operators include the following:

(1) The operator will not converse with passengers except for business reasons.

(2) The operator will not eat or read while operating the elevator.

(3) The operator will keep clear of shaft way.

(4) The operator will assure that shaft way doors or gates are closed and locked before car starts and that car gates are closed while running.

(5) The operator will keep passengers away from the open edge of a platform if car gates are not provided.

(6) The operator will assure that car has completely stopped at the landing level before doors and gates are opened.

(7) When an elevator is taken off duty or service is suspended during normal working hours, a sign stating "Car not working" will be displayed.

(8) If a car will not start, it may be overloaded, in which instance the operator will remove the load. If elevator still will not move, the person in charge will be notified.

(9) If car will not stop, the operator will not attempt to jump off.

(10) If car stops suddenly between floors, the operator will call for the person in charge and operate car only at his/her direction.

c. Freight elevators. Freight elevators which are not authorized to carry passengers will be marked to that effect. Freight elevators will be inspected semiannually by qualified inspectors. The safe capacity of freight elevators will be expressed in pounds. The operator will assure that the locking device and hoisting attachments are in place before any heavy, concentrated load such as a safe is moved on or off the platform. The operator will not raise the car more than a few inches at a time until the locking device has been withdrawn. Safes or other heavy objects, near the capacity of the elevator in weight, will be loaded in the center of the car and extreme caution will be exercised. Only the operator will be allowed to ride in the car during such a procedure.

d. Adjustable platform ramps. Where adjustable ramps (either mechanically or power-operated) are installed in loading and unloading platforms, such ramps will be equipped with a safety device which can securely lock the ramp in a fixed position. The safety device so used will be of such design that the load capacity of the ramp when in the locked position will be sufficient to support the specified capacity of the ramp or platform. Such ramps or platforms will be periodically inspected by competent personnel.

Section XVII. National Defense Stockpile.

a. General. Certain commodities are categorized as national stockpile material from time to time as dictated by availability conditions in relation to potential national emergencies. Some materials so segregated require special consideration for safety while in storage. So far as is consistent with the provisions of this manual, such material will be handled and stored in accordance with the *National Defense Stockpile Manual* published by General Services Administration and available through the individual departments. Safety precautions as directed in this manual will be followed. Proposed deviations in methods to be employed in the storage of national stockpile material

or required clarification concerning safe storage will be referred to the appropriate military department.

b. Fire protection. Generally, the normal fire prevention and protection measures established at military activities, and as herein covered, are considered adequate for national stockpile material. However, additional fire prevention and protection measures will be established when special precautions are outlined in storage specifications furnished with combustible or flammable material. When such measures result in additional costs, prior approval of the appropriate military department must be obtained.

CHAPTER 7

ON-THE-JOB TRAINING FOR STORAGE PERSONNEL

Section I. Training Plan

7-1. Introduction.

In an ideal situation, every person in any organization is thoroughly trained in their duties. In addition, they have been made aware of the value of their individual job to the entire operation and just exactly how and where their position fits into the complete organization. Attainment of this goal in today's complicated and complex storage and materials handling operations is very difficult, yet it is one which must be constantly striven for if we are to have efficient, economical, quickly expandable, and flexible storage and materials handling. If left to their own devices, each person learns something each day and develops a little more the abilities required to do the job; however, this learning by "chance" or development by trial and error is costly both in time and in mistakes made. Systematic training organizes the learning process and reduces teaching errors. It reduces learning time, accidents, and wasted material.

7-2. Purpose of Training.

Training must have as its primary goals: trained and competent personnel, adequate and properly maintained equipment, intelligent job planning, alert supervision, and satisfactory organization morale.

7-3. Responsibility for Training.

Every storage and materials handling activity must assume direct responsibility for initiating, directing, supervising, and conducting all training pertaining to its operation. Training is more effective when it is made a part of operations and is not considered as being disconnected from the job. Personnel responsible for operations must have a

thorough knowledge of their work and have the confidence of their associates and subordinates. Training must be considered by operating supervisors as an integral part of the daily workload.

7-4. Support by Storage Managers.

Since training is part of the daily workload, storage managers must strongly support and participate in the program. Such support and participation should ensure the necessary balance between operations and training, with the training program receiving proper emphasis. It is important that this training should be a continuous program and not an isolated, temporary interest.

7-5. Survey of Need for Training.

The first step in installing a training program is instituting an overall survey to determine areas in which training is needed. In-service training cannot be justified unless a definite need exists. Conversely, it is not justifiable to stop training until the need has been met. A typical preliminary "check sheet" developed as a means of determining possible areas in which training may be needed and groups of personnel which might need the various types of training is shown in figure 7-1. Since it is possible that training may be needed in many or all of the indicated areas, priorities must be assigned so as to meet needs on the basis of urgency. An important point to remember is that too much training attempted at one time will interfere with operations and decrease training benefits. Thus, a well thought-out and balanced plan, increasing or decreasing in intensity and scope as the conditions require, is essential to the success of a training program.

	Military Personnel	Storage Officer or Chief Assistant Chief	Staff	Unit Supervisors	Warehousemen	Labor Foremen	Laborers	Checkers	Forklift Operators	Packer Foreman	Packers	Clerks	Inspectors-Classifiers	Processors
LAYOUT OF STORAGE SPACE: Policies and Methods.....	(X)	(X)	(X)	(X)	(X)	X								
STORAGE OF MATERIALS: Policies and Methods.....	(X)	(X)	(X)	(X)	(X)	X			(X)				(X)	
ORGANIZATION: Duties and Responsibilities.....	(X)	(X)	(X)	(X)	X	(X)				(X)		X	(X)	
LABOR AND EQUIPMENT POOLS: Organization and Operation.....	(X)	(X)	X	(X)	X	(X)				X				
RECEIVING AND SHIPPING PROCEDURES.....	(X)	(X)	(X)	(X)	(X)	X		(X)	X			(X)	X	
SPACE AND OPERATING REPORTS: Compilation and Interpretation.....	(X)	(X)	(X)	X	X	X				X		(X)		
INVENTORY: Procedures and Methods.....	X	(X)	X	(X)	(X)			X				X	X	
CHECKING: Procedures and Methods.....	X	(X)	X	(X)	(X)			(X)	X			X	X	
CARE OF HAZARDOUS COMMODITIES.....	X	(X)	X	(X)	(X)	X								
BLOCKING, BRACING, DUNNAGING OF RAILROAD CARS.....	X	(X)	X	X	X	X	X							
PACKING AND CRATING: Methods and Specifications.....	X	(X)	X	(X)	(X)					(X)	(X)			(X)
FORK TRUCK OPERATION.....	X	(X)	X	(X)	X	(X)			(X)					
TRACTOR OPERATION.....	X	(X)	X	X	X	(X)			(X)					

X To be trained.
 (X) Have been trained.

Figure 7-1. Check sheet for storage and materials handling training program.

7-6. The Three Phases of Instruction.

a. *Study of principles.* The first phase of the program should center around the principles and fundamental facts basic to operations of which supervisors and key personnel should have an understanding.

(1) *Text.* The material in the Conference Leader's Guide, section 3, Storage and Materials Handling Training Program for Supervisors, will be used as the basic guide for the first phase of the

program. The three parts, covering Detailed Training Outline, Storage of Materials, and Principles of Materials Handling can be adapted to the needs of the installation or activity.

(2) *Classes.* All key personnel, military and civilian, should be included in this phase. Experience has indicated that a minimum of 8 to 10 hours will be required to complete this portion of the training program. Ordinarily classes should be

arranged and scheduled so that no less than 10 or more than 14 persons will be in attendance.

(3) *Leader.* The leader of these sessions will be a qualified representative of top storage management who has authority to act upon or obtain action upon suggestions and problems which arise as a result of discussions held during the training period.

b. Study of organization and procedures. The second phase of the overall program should concentrate on a specific organization, operating procedures, and standard practices of which the supervisors and key personnel should have a complete working knowledge.

(1) *Source material.* The material to be used in this phase of the program must be adapted from the actual organization charts, duties and responsibilities sheets, written operating procedures, and standard storage and materials handling practices already developed.

(2) *Coverage.* In addition to organization and functions, general operational procedures and standard practices of prime importance to the activity will be covered. Examples of such procedures and standard practices are:

- Receiving
- Shipping
- Inventorying
- Warehousing
- Care of Supplies in Storage
- Materials Handling Operations
- Assembly/Disassembly Operations
- Packing and Crating Operations

(3) *Kind of training.* All key personnel should receive general training in all procedures and standard practices. In addition, they must receive detailed instructions in those with which they are specifically concerned. The amount of time devoted to training on each function as well as operational procedures should be determined according to the complexity of the job and the detail required for the training.

(4) *Method of training.* A modified conference method, in which group participation and discussion, within the bounds of the training objective and under the guidance and control of the session leader, should be used in presenting material in the first two phases. The leader of each session should be the top supervisor or manager of the operation concerned.

c. Job instruction. The third phase of the training program will concentrate on actual job instruction for non-supervisors. Included in this phase (but not confined to) will be on-the-job in-

struction and step-by-step demonstrations through the use of working models, films, charts, diagrams, and by the training leader or an assistant actually performing the job. Jobs covered in this phase will consist of those involved in such activities as equipment operation, checking, packing, palletizing, recording stock locations, and other duties, as necessary. Training in safety practices should be an inherent factor in this type of training. Followup also must be an integral part of this program.

(1) *Responsibility of supervisors.* For purposes of expediency, an adequate number of supervisors/trainers will be delegated the responsibility of carrying on this training under the person responsible for directing and/or coordinating training activities. Ultimately, each supervisor should be prepared for and responsible for training workers in on-the-job instruction.

(2) *Benefit to new and old employees.* The training in this third phase is necessary if new employees are to be raised to the highest point of productivity in the shortest possible time. Old employees should be kept abreast of any and all changes in the job processes in which they are engaged through whatever medium of training is applicable; however, a survey made to determine the amount of benefit old employees could obtain from the type of organized training defined in this third phase will be beneficial and should be made.

7-7. Understudies.

In addition to the training given for the performance of their assigned jobs, selected personnel will be trained as understudies for all employees in key positions.

7-8. Qualifications of Trainers.

The following qualifications should be considered in selecting personnel to act as trainers:

- a. Experience in storage and materials handling operations.
- b. Aptitude for imparting instruction to others in an effective manner.
- c. Probability of being able to remain on the trainer assignment until the program is completed.
- d. Interest in doing a training job.
- e. Patience and consideration for the feelings of others.

7-9. Training Administrator (Specialist).

A specialist in training, responsible for planning and initiating the training program, should be a member of the top storage manager's staff or available from installation management as determined

by the military service. Responsibilities of this position will relate primarily to:

- a. Determining needs as well as points of weakness in operations and training.
- b. Advising the staff as to whether training can assist in solving specific operating problems as they arise.
- c. Obtaining information concerning current changes which might affect training already in progress.

7-10. Coordination With Other Installation Activities.

Coordination should be maintained between the storage and materials handling training administrator and other affected elements of the installation (e.g., the installation personnel office and management offices). In this manner, the overall policies and objectives of the installation can be injected in the specific training programs of the separate activities or operations being trained. Where

a training coordinator or staff is employed as a part of the overall civilian personnel placement and utilization program, the services and/or knowledge of this element should be utilized by the training administrator of the storage and materials handling activity to:

- a. Instruct trainees in the techniques of presenting material to others.
- b. Develop methods and devices for measuring and testing; and instruct trainees in their use.
- c. Utilize existing training materials and adapt them to the needs of the storage and materials handling program.
- d. Train supervisors in the techniques for analyzing their jobs and the jobs of their subordinate employees.
- e. Assist in setting up necessary training records and schedules.
- f. Assist in setting up and/or providing necessary physical facilities for training purposes.

Section II. Training Program

7-11. What Is Storage and Materials Handling Training?

a. The main reason for having the military storage installations is to receive, store, and move military supplies. The actual operations within the installation directly related to these activities may be called warehousing and materials handling. Training in this field must cover many specific jobs which require the use of a great deal of knowledge of warehousing principles, procedures, storage methods, and warehousing and materials handling management problems.

b. Training in warehouse and materials handling should be carried on by two methods:

(1) A series of planned conferences in which warehouse supervisors, military and civilian, have an opportunity to think through, step by step, and in a logical and organized way, the many points that go into making or breaking an efficient operation.

(2) On-the-job training in which specific operations are taught individually to men and women whose main duty is centered on one or two segments of the whole operation.

c. Too often all training in warehousing and materials handling has been called "on-the-job" training. This may mean anything, from no training at all, training given by many different people (who may or may not be in agreement on what they are

teaching), or planned, organized, practical and valid on-the-job training. We need not choose between group or individual on-the-job training; both are essential. The purpose of this training program is to give warehouse supervisors and understanding of the basic fundamentals and management policies of storage operations and materials handling.

7-12. What Is Included in Storage or Warehouse Operations and Materials Handling Training?

a. This manual will be considered the textbook for training in these fields. Instructors should ensure that all students have a working knowledge of the manual and a detailed knowledge of the portion that affects their specific jobs.

b. *The Conference Leader's Guide* places emphasis on:

(1) Proper methods of laying out and allocating space.

(2) Accepted ways of storing and stacking the many different items handled, so that space can be utilized to the best advantage.

(3) Efficient and speedy methods of handling materials in order to save manpower, equipment, and time. This is known as "materials handling."

(4) The need for training the best qualified employees in the installation to carry on this program under the direction of the storage manager.

(5) Improvement of training already being done to make sure that each employee is receiving the fullest benefits from the training being given and, in turn, to assure that training "pays its way" through increased employee productivity.

7-13. The Requirements for a Successful Storage and Materials Handling Training Program.

Although the following points do not necessarily guarantee the success of this training program, they are fundamental and important:

a. Management support. The backing and interest of installation officials, the commander, staff, and all key personnel of the storage and materials handling function are essential.

b. Working relationships. Close working relationship between the storage operation and other elements of the installation includes an appreciation of each other's responsibility and contribution and a willingness to pull together to finish the job.

c. Competent leadership. A prime requisite for competent leadership is the qualification of personnel to conduct training effectively and is the key to the success of the storage and materials handling program. Such leaders may be chosen from either of the following two sources:

(1) From any point within the installation—an individual with teaching background and experience who either has or can be prepared for the assignment by: reading about the fundamental principles and practices of storage and materials handling, learning storage policies, observing operations and storage procedures, studying first hand and "living with" the actual work going on in the various storage operations, and knowing personally the supervisors of these operations.

(2) From the storage activity—an individual with warehousing background and experience should have the benefit of any supervisory courses given at the installation and should work closely with the person responsible for training to prepare himself in teaching and conference leadership techniques.

d. Adequate conference rooms. No compromise should be made in securing a comfortable, well-lighted and aired, quiet, and easily accessible space for conferences.

e. Continuous training. The turnover of warehouse personnel, changes in procedure, improvements in methods, and changes in commodities all point to the absolute necessity of a continuous training program.

7-14. How To Use The Conference Leader's Guide.

a. To aid in the presentation of a training program in warehousing and materials handling sectionalized guide material has been prepared. As many sections as logical, or as many as time permits, may be covered in one session. There is no necessity that this outline be followed word for word; however, its intent and scope should be followed very closely, particularly as to the order of presentation of topics and key points within the topics.

(1) This presentation has been built along organized lines, in logical sequence, that can be used effectively to give those concerned a thorough knowledge of the "ABCs" of warehousing and materials handling in the shortest possible time. The conference leader by prior knowledge of local problems and groups of trainees must fit this guide to installation requirements.

(2) The established outline should be followed—but not read. There is nothing more deadly to a group than continuous reading. The guide has been designed so that it can be followed with an occasional glance. The discussion should be kept running smoothly. In this outline are included: key ideas and questions, suggestions for group discussion, suggestions for illustration, and group answers to key questions.

b. Key points or questions are preceded by a hyphen and are included in quotation marks. Important words therein are capitalized. These key points or questions are the basis for conference discussion—they need not be quoted as written, but should be expressed in a manner which puts the points across. For example:

—"Keep your STOCK LOCATOR SYSTEM as SIMPLE as POSSIBLE."

—"What do we MEAN by ORDERLY STACKING?"

c. Suggestions for group discussion are indicated by instructions with such introductory words as: DISCUSS or ASK; these introductory words are in capital letters. For example: DISCUSS with the group BULK STORAGE as it occurs in their warehouses.

d. Suggestions for illustrations are always enclosed in parentheses. In cases where blackboard illustration is suggested, the material to be put on the board is enclosed in a rectangle. (WRITE the following points on blackboards, charts, or other visual aids:)

CONSERVE SPACE
 ASSURE SPEED OF MOVEMENT
 ASSURE STABILITY
 HAVE ORDER IN FORMING STACKS

AISLES WIDE ENOUGH
 LOCATION OF FAST MOVING ITEMS
 TYPE OF STACKING, AND MECHANICAL EQUIPMENT

e. Group answers to key questions are shown in the guide in capital letters and are enclosed in brackets and should be used as a check list. Answers should not be given by the leader unless they have been overlooked by the group. If the answers are given by the leader, they should be brought out in some indirect manner, such as: "Do you think _____ is important?" Leaders should never give the impression that they know all the answers. Answers should be drawn from the group.

—"HOW can we ASSURE RAPID AVAILABILITY?"

f. The outline and discussion comments have been developed in a manner to give the attending groups the "ABCs" of storage and materials handling. Many questions and points of discussion will arise regarding methods and practices for handling specific problems and conditions peculiar to the installation or to a specific commodity. The conference leader, therefore, should be thoroughly familiar with the contents of this manual, as well as with the various storage and handling conditions within the installation, in order that they may be measured against the criteria defined in the manual. The manual should be used both in and out of the classroom as a basic text and reference book by those attending as well as the instructor.

Section III. Conference Leader

7-15. Foreword for the Conference Leader.

a. Things you should do BEFORE you meet the group:

- (1) Plan your work carefully.
- (2) Plan an enthusiastic beginning to the conference.
- (3) Collect enough examples from your own depot experience.
- (4) Plan to arrive at the conference room 15 minutes before the scheduled starting time.
- (5) Check the conference room equipment: Is the room in order? Are there enough chairs, sufficient tables and writing space, chalk, eraser, notebooks for the group, pencils, and ash tray (where smoking is permitted)?
- (6) Arrange the room so that each person can see everyone in the group, the blackboard, charts, or other visual aids.
- (7) Have sufficient copies of handouts (figs 7-2, 7-3, and 7-4 can be reproduced and used as handouts).
- (8) Begin on time—end on time!

b. *Purpose of session.*

EXPLAIN PURPOSE AND PROCEDURES OF SESSIONS

—"To give the LESS EXPERIENCED people an OPPORTUNITY to THINK THROUGH the BASIC PROBLEMS of WAREHOUSING and MATERIALS HANDLING."

—"To give you MORE EXPERIENCED people an OPPORTUNITY to REFRESH YOUR KNOWLEDGE of the BASIC PROBLEMS and DISCUSS SPECIFIC PROBLEMS."

—"To EXCHANGE IDEAS so that: we are AWARE of EACH OTHER'S PROBLEMS; we can AID in the a SOLUTION of THESE PROBLEMS; we can INCREASE the EFFICIENCY and PRODUCTION."

c. *Why members of group were selected.*

—"YOU ARE RESPONSIBLE FOR ACTUAL OPERATIONS."

—"YOU KNOW the PROBLEMS."

—"YOU CAN INCREASE the EFFICIENCY and REDUCE the COST of OPERATIONS."

—"YOU MUST TEACH OTHERS to DO THEIR JOBS—YOU MUST KNOW the WHOLE PICTURE."

d. *Discussion procedure.*

—"This is a special kind of school."

—"All of us should ENTER into the DISCUSSION—ONE AT A TIME."

—"Address your ideas and questions to the GROUP—NOT TO ME."

—"You will benefit by taking notes—they make things STICK."

—"Keep your notes and the mimeographed material that will be given to you—in this way you can compile a reference book which you can USE ON THE JOB."

e. Content of program.

(WRITE the TOPICS on the blackboard and GIVE a BRIEF DESCRIPTION of what each section of the program will consist of.)

WAREHOUSE LAYOUT
 STORAGE OF MATERIALS
 Storage Principles
 Storage Standard Practices
 PRINCIPLES OF MATERIALS HANDLING

Warehousing—the SCIENTIFIC and ECONOMICAL
 RECEIPT
 STORAGE
 ISSUE
 of materials for their BEST SAFEKEEPING
 and RAPID AVAILABILITY.

7-16. Key Ideas and Questions.

a. Warehouse layout and allocation of space. This will include a discussion of the problems and knowledge needed in planning a storage area for the receipt, storage, and shipment of materials, and also, efficient methods of meeting these problems as well as systems of space and location control. Planographs or other visual aids should be utilized.

b. Storage principles. This will include a discussion on the basic principles of stacking and storing and the accepted practical methods for doing this job. The members of the group will be asked to present some of their specific problems.

c. Storage standard practices. This will include a discussion of DOD-developed standard practices for storing materials. The adaptation and application of these practices will be covered as well as the development of standard methods.

d. Principles of materials handling. This will include a discussion of the advantages to be gained by the proper use of MHE; existing physical conditions which determine and limit the type of operation; and basic principles of materials handling, stressing the importance of a balanced operation.

7-17. Layout and Allocation of Space.

a. Definition of warehousing.

DEFINE "WAREHOUSING"

—"Before discussing the problems in warehousing, we should all UNDERSTAND what we mean by 'warehousing' and just that we are trying to prove."

(WRITE the DEFINITION across the top of the blackboard.)

—"UNLESS this job of warehousing is done in a SCIENTIFIC manner, it is NOT ECONOMICAL."

—"To be ECONOMICAL—WHAT THINGS or in WHAT WAYS can we save in our warehouse operations?"

SPACE—————in terms of CUBIC FEET
 LABOR—————in terms of MAN-HOURS
 EQUIPMENT—————in terms of EQUIPMENT HOURS and EQUIPMENT TYPES

DAMAGES

ACCIDENTS

ELIMINATION OF WASTE————in every form"

—"The definition mentions BEST SAFEKEEPING—by that is meant: we must PROTECT THE MATERIALS.

PROTECT AGAINST WHAT?"

THEFT
 FIRE
 DETERIORATION—damage by: weather,
 careless handling, poor stacking conditions.

—"The final statement in the definition of warehousing RAPID AVAILABILITY—is ALWAYS IMPORTANT."

—"To do an efficient job of warehousing we must lay out our warehouses so that the MATERIALS are EASILY ACCESSIBLE."

—"In these discussions—and more important, in doing your jobs in the warehouses—we must NEVER OVERLOOK or FORGET these POINTS:

—"We must constantly check to make sure that we are effecting SAVINGS in SPACE, LABOR, and EQUIPMENT; REDUCING DAMAGES and ACCIDENTS; PROTECTING the materials AGAINST THEFT, FIRE, and DETERIORATION; and storing our MATERIAL SO WE CAN GET TO IT IN A HURRY."

—“How we are going to do all this and WHAT WE HAVE TO KNOW to accomplish it are the things we want to discuss.”

—“And we want to discuss them in a logical order—FIRST THINGS FIRST.”

b. Discussion guide for definition of warehousing.

(1) *General.* The main purpose in developing the definition of warehousing is to start the group thinking about the objectives of their jobs, to make them critical of whether or not they are accomplishing their work along the lines set forth in the definition. Each of the main points in the definition should be carefully developed.

(2) *Ways in which we can save in a warehouse.*

(a) *Space.* Space is the basic resources in the warehousing operation. The entire storage operation hinges upon the efficient utilization of space. Space is emphasized in terms of CUBIC FEET. Too often operators think in terms of “square feet.” Except where floor load capacities limit full use of cubage, material must be stacked as high as features of pack, facilities, and handling equipment permit in order to take full advantage of cubage and thereby save in square feet.

(b) *Labor.* Labor must be conserved in every job. The amount and use of labor should be thought of in terms of MAN-HOURS rather than just in terms of number of men. We must get the most efficient use out of each hour paid to labor. In so doing, we can increase production and reduce cost.

(c) *Equipment.* The proper use of mechanical equipment helps to conserve labor. Every effort must be made to conserve the amount of equipment used and, as in the case of labor, its efficient use should be considered in terms of equipment hours. Care must also be given to its mechanical maintenance.

(d) *Accidents and damages.* By reducing accidents and damages in the warehouses, it is evident that cost is reduced, materials saved, and man-hours reduced.

7-18. Facility Characteristics.

a. Detailed planning.

STRESS NEED FOR PLANNING

—“Before we can actually STORE materials, we must PLAN.”

—“In order to PLAN, there are certain FACTS we must know.”

b. Facts about the warehouse.

DEVELOP FACTS ABOUT THE WAREHOUSE

—“What must we know ABOUT the WAREHOUSES?”

(Try to obtain the following points from the group and list them on the blackboard as they are given:)

TYPE OF BUILDING
 SIZE. HOW MANY?
 SHIPPING AND RECEIVING PLAT-
 FORMS
 DOORWAYS AND ENTRANCES
 PILLARS, POSTS, OR COLUMNS
 WINDOWS
 FLOOR LOADS
 ELEVATORS—in multistory buildings

(1) Two prime factors influence the storage manager layout of available space; the characteristics of the storage area—THE CAPACITY FACTOR; and the characteristics of the supplies to be stored—THE COMMODITY FACTOR which will be discussed later.

(2) These factors cannot be separated; the one influences the other all through the storage operation. It must be realized that before we can actually store materials, there must be planning—WHERE and HOW we are going to store it? Unfortunately, many of our buildings were not designed primarily for the type of warehousing we must do. We must, therefore, in some cases, make the best of physical difficulties.

(3) In the planning of warehouse operations, we are mainly interested in the actual physical layout and size of the platforms, door, columns, and windows. In multistory buildings particularly, we are concerned with floor load capacities and elevators. Without a thorough knowledge of all of these factors, we cannot efficiently start to do the job.

c. Type of building.

DISCUSS each in detail and in the order followed below:

—“There are two main types—SINGLE-STORY and MULTISTORY.”

—“The SINGLE-STORY BUILDING has MANY ADVANTAGES:

NO ELEVATORS

FEWER POSTS AND COLUMNS

DIRECT CONTACT WITH SHIPPING AND RECEIVING DOCKS

**GREATER FLOOR LOAD LIMITS
BETTER TRANSPORTATION FACILITIES"**

—"The MULTISTORY BUILDING has TWO ADVANTAGES:

COVERS LESS GROUND AREA

CAN BE LOCATED IN A METROPOLITAN AREA."

(1) In a majority of our storage installations, particularly in the newer ones, we find single-story buildings constructed along similar lines.

(2) Storage installations vary in size from one or two to any number of these single-story buildings. Each building is usually divided into several sections. There is no typical multistory warehouse.

d. Size of building.

—"What primary facts must we know in order to determine our storage space in each warehouse?

LENGTH WIDTH HEIGHT

—"Remember, in all buildings we must think in TERMS OF CUBAGE."

(1) To know how much storage space is available, we must know the size of our warehouse and the size of each section; and in the multistory buildings, the size of each floor.

(2) We must consider size in terms of length, width, and height—in other words—in terms of CUBIC FEET. We can use our square feet to fullest capacity and at the same time waste a great part of our full storage capacity by not stacking high enough. WE MUST CONSERVE OUR VALUABLE STORAGE SPACE.

e. Shipping and receiving platforms.

—"There are THREE THINGS we must consider about our PLATFORMS or DOCKS:

LOCATION

SIZE

HEIGHT (in relation to cars and trucks)."

—"To intelligently plan location of materials, we should also have some general appreciation of what percentage of our material is SHIPPED BY RAIL and what percentage BY MOTOR TRUCK."

—"ASK the group if they know percentages as applied to their own warehouse or section. If they are guessing, ask them to check on the information."

(1) The normal, general-purpose, single-story warehouses have one long platform stretching the entire length of the warehouse, used for shipping and receiving by rail. On the opposite side, materials are received or shipped by motor truck on small docks at each section, or on one or more large docks spaced at intervals along the warehouse. The width of these platforms is a very important factor because it determines the type of materials handling operation that can be applied. For example: if the platform is too narrow, the use of the tractor-trailer train system is difficult or the platform may become dangerously congested during receiving and shipping operations in the same vicinity. The entire width of platforms should be covered to protect the material from the weather.

(2) In multistory buildings, the platforms are located in as many different locations as there are buildings. In some of the buildings, however, it is possible to use separate platforms for receiving and shipping in respect to both rail and truck facilities. Such a condition helps to ease the bottlenecks caused by elevators and permits a more continuous flow of material in the materials handling operation. Care should be taken to keep the platforms, which occupy a large portion of the ground floor, clear of stored material.

(3) The height of the platforms, whether in single-story or in multistory buildings, is an important factor. Platforms either too high or too low will cause serious handicaps in our materials handling operations as well as create a serious accident hazard. A difference of 6 inches between the height of the platform and the floors of cars or trucks is maximum if an efficient operation is to be accomplished. Conditions where excessive difference in height exists should be corrected by either lowering or raising the track bed, the road surface, or through the use of a compensating bridge plate. The cost of such a change should pay for itself in speedier and more economical operations.

f. Doorways and entrances.

—"It is evident that we must know the LOCATION, NUMBER, and SIZE of our DOORWAYS or ENTRANCES."

—"Care must be taken that we make efficient use of these openings."

(1) There should be a sufficient number of doorways leading to platforms and between sections of a warehouse to handle the movement of materials. This is particularly true of single-story buildings.

(2) In most of our typical single-story warehouses, there are at least two, and sometimes

more, doorways per section leading to the rail platforms; and two doors giving access to sections. THESE DOORS SHOULD BE OF SUFFICIENT SIZE TO ENABLE MECHANICAL EQUIPMENT TO PASS EACH OTHER. TOO MANY DOORWAYS CAN BE A HINDRANCE BECAUSE THEY REDUCE THE WALL SPACE WHICH IS SO VALUABLE FOR STORAGE AREAS.

g. Pillars, posts, and columns.

—“The location, number, and size of the pillars, posts, and columns in a warehouse are IMPORTANT FACTORS CONTROLLING OUR LAYOUT.”

—“They consume valuable storage space.”

—“They are usually more of a problem in multi-story buildings.” ASK the group to figure approximately how much square footage and cubage are taken up by the columns on their warehouse floors; also, how much wasted storage space there is around the columns.

(1) The general plan of our floor layout is controlled, to a great extent, by pillars, posts, and columns which are necessary as floor and roof supports and cannot be removed, yet which do reduce the amount of storage space and must be considered carefully in our planning.

(2) Pillars, posts, and columns are a problem in our single-story buildings, but not so critical as in some multistory warehouses, where each column may use up as much as four square feet and many more cubic feet of storage space. In addition to this loss of space, we will lose even more in stacking pallets around columns, unless extreme care is given to the method of storing.

(3) Where possible, columns or posts should be used as aisle guides and also to define the size and location of bays. Certain pieces of fire equipment can be placed on these columns, but care should be taken to place this equipment so that it uses the least amount of storage space. It should be hung on the post adjacent to an aisle, BUT NOT EXTENDING INTO THE AISLE BECAUSE IT CUTS DOWN THE AISLE WIDTH AND MAY BE DAMAGED BY PASSING MECHANICAL EQUIPMENT.

(4) Fire equipment should be placed on the front or sides of the post facing the aisle. If not, storage space is greatly reduced and valuable seconds can be lost looking for equipment in case of need.

h. Windows.

—“Can you name any ADVANTAGES or DISADVANTAGES in having WINDOWS in a warehouse?”

Advantages	Disadvantages
LIGHT	LOSS OF WALL SPACE
AIR	DAMAGE TO MATERIALS (by elements)
ENTRANCE FOR FIREMEN	WASTE OF FLOOR SPACE

Windows are more numerous in multistory than in single-story buildings. Although the light and air admitted by windows do improve working conditions, from a purely operations standpoint they are a handicap.

i. Floor load limits.

—“We should all have the SAME IDEA of HOW to FIGURE the AMOUNT of MATERIALS we can STORE on a FLOOR and STAY WITHIN FLOOR LOAD LIMITS.”

—ASK one of the group to explain how he determines this on his own floor. Continue to ask various members until an agreed method is reached.

—“We should note the following CAUTIONS: WEIGHT should be FIGURED from EACH SQUARE FOOT COVERED.

—In the use of pallets, weight is determined by square feet covered by the pallet.

—Include the weight of the pallets.

—Do not depend too much on safety factor.”

NOTE

Floor load limits apply to all storage buildings. Point out some of the problems that are caused and some typical floor load limits.

(1) Floor load limits can cause a great waste in cubic feet of storage space; however, if these limits are not considered, a tremendous safety hazard is caused. Limits in this type of multistory building usually range from 100 pounds per square foot to 350 pounds per square foot. The problem in single-story buildings is smaller because in the majority of them the limit is so high that it poses little restriction. In multistory buildings, it is important that a standard method of determining permissible floor loads be decided upon in line with conditions existing in each building. Such a method should be clearly defined, agreed upon, and enforced by those responsible for storage operations.

(2) Normally, safe warehouse floor load limits are determined by reference to the building plans on which the floor capacities in pounds per square foot are customarily designated. Generally, plans for unconverted private buildings may be secured from the former owner or tenant. A competent engineer should be brought in to establish floor load

capacity in all cases where building plans are not available, where the plans do not indicate safe floor loads, or where the accuracy of the stated floor load is doubtful.

j. Elevators.

NOTE

As in the case of floor loads, the subject of elevators should be touched only briefly in single-story operations, but in detail in multistory buildings.

—“ELEVATORS in multistory buildings are often the cause of **SERIOUS BOTTLENECKS.**”

—“What must we consider about elevators?”

LOCATION
SIZE
CAPACITY
SPEED

—“They are a **SERIOUS SAFETY HAZARD.**”

(1) Freight elevators are the “arteries” of the multistory warehouse. The number and location of these elevators are important factors in determining the general plan of floor layout. Care must be taken to keep sufficient space clear in front of the elevators on each floor. The size and load capacity of these elevators determine the type of materials handling operation which can be performed. Care must be taken not to overload the elevator; **THIS IS A SAFETY MUST.** This means, of course, that we must figure not only the weight of the materials, but also the weight of the mechanical equipment such as trailers or fork trucks, if such equipment is used. **PROPER MAINTENANCE OF THE ELEVATORS AND TRAINING OF THE OPERATORS IS ALSO A SAFETY “MUST.”**

(2) Because these elevators are often small in size and slow in movement, they create a bottleneck in the operation which is difficult to eliminate. In most cases, we cannot enlarge or speed up the elevators; therefore, careful planning and thought can profitably be given to “timing” of the operation to the existing conditions.

7-19. Commodity Characteristics.

a. Facts about commodities.

DEVELOP FACTS ABOUT COMMODITIES

—“After we have viewed the warehouse from all physical angles, we must then consider the **COMMODITIES WE WILL STORE.**”

—“We cannot separate these two factors in our planning and thinking—**TOGETHER THEY IN-**

FLUENCE OUR METHOD OF LAYOUT AND ALLOCATION OF SPACE.”

—“In this portion, we are interested in **WHERE** we will store the materials—**NOT HOW.**”

—“**WHAT DO WE HAVE TO KNOW ABOUT THE COMMODITIES?**”

(Try to obtain the following points from the group and list them on the blackboard as they are given:)

NATURE (KIND OR TYPE)
AMOUNT
SIZE
WEIGHT
SHAPE
TURNOVER (ACTIVITY)
PERISHABILITY
ODOR

b. Amounts of each commodity.

—“The **AMOUNT** of each commodity handled **VARIES** in **EACH STORAGE INSTALLATION** and from time to time **WITHIN AN INSTALLATION.**”

—“To keep our planning up to date, **WE MUST, AT ALL TIMES KNOW** what we will be expected to **STORE.**”

—“As **STORAGE MANAGERS AND WAREHOUSE SUPERVISORS,**

What **INFORMATION** is **AVAILABLE TO US?**

What information **DO YOU GET?**

What information **WOULD YOU LIKE TO HAVE** to help you plan efficiently?”

STOCK LEVELS
DUES-IN NOTICES
AVERAGE ACTIVITY OF MOVEMENT
ADVANCE NOTICE OF SHIPMENT

(1) The supplies handled by the average military storage installation consist of thousands of items of different weight, size, shape, perishability, and crushability. These supplies are packaged in various ways within different types of containers such as boxes, crates, cartons, bags, bales, or drums. The items vary from a small package of bearings to a complete field hospital, and are shipped to the storage installation from thousands of manufacturers and producers.

(2) The fact that commodities or items vary to such a degree complicates the problem not only of handling in transportation, but also of storing in our warehouses or other storage areas. We must study our problem as it relates to the different commodities and do everything within our power to handle the materials efficiently.

(3) Before we can allocate space and layout warehouses or storage areas, we must know something about the type of material and how much will be stored. To aid in this, the controlling agency responsible for a particular storage installation furnishes such data as stock levels, tonnage, item forecasts, and information on manpower strength within a given area of distribution. All of these aids are a valuable asset in planning storage.

(4) By whatever means secured, a knowledge of the stock level or quantities to be stored will enable storage personnel to get an overall picture of supply and also helps in laying out space in order to eliminate storage bottlenecks and unnecessary rewarehousing. On the other hand, experience gained through issue and receipt will be of invaluable help to storage personnel in determining the best layout for their commodities. Remember that a stock level is only a guide and should not be used as the absolute figure for determining space for an item. You must keep your storage layout simple and above all flexible.

(5) Usually, the first notification of incoming stock is a distribution directive, schedule of delivery, letter of award, or specific directive from the supply agency. From this information, the "dues in" can be compiled. Storage personnel should study these "dues in" and have their area planned for storage of material when supplies are received; this will help to eliminate unnecessary rewarehousing.

c. Popularity, size, weight, shape, perishability.

—"After we know HOW MUCH we have to STORE, and HAVE DECIDED in general WHERE it will be STORED, we must CONSIDER the ITEMS as to their POPULARITY, SIZE, WEIGHT, and SHAPE."

—"WHERE do you STORE your LARGE, BULKY material?"

—"Can you move your FAST MOVING goods EASILY and QUICKLY?"

—"Are you having TROUBLE with DAMAGES to your PERISHABLE materials? If so, it is because of WHERE THEY ARE STORED?"

(1) After we have determined the amount of material we have to store, allocated the proper amount of space, and formulated a GENERAL PLAN; we THEN MUST determine the actual lo-

cation of the material. Such location is controlled partly by certain characteristics of the items. Large and bulky items should be placed as near the shipping and receiving points as possible to reduce the amount of handling.

(2) In locating materials that have a rapid turnover, every effort should be made to place the materials as near the shipping points as possible and, in multistory buildings as near the elevators as possible and on the floors near the shipping and receiving docks. Slow-moving commodities, of course, can be placed in less accessible locations.

(3) Perishable items should not be stacked near windows or doors because of possible damage from sunlight, rain, or snow. Care should also be taken to store perishable items, bagged materials in particular, where they cannot be damaged by floor dampness caused by sweating. Generally, bagged items should be kept in storage areas having the least amount of temperature change. Commodities which need periodic turning, such as certain items of compounded or chemical nature, or items such as kegs of vinegar or pickles should be placed in an accessible location. Commodities which absorb odors should be kept away from odorous items.

7-20. Aisles.

a. Layout.

EXPLAIN HOW TO PLAN LAYOUT

—"Once we know ALL the facts ABOUT the BUILDINGS and the COMMODITIES, we can then LAY OUT the FLOOR PLAN."

—"First, we must decide on AISLES regarding:

TYPE

NUMBER

SIZE (Length and width)

LOCATION

DIRECTION"

—"We all realize that AISLES ARE NECESSARY TO:

PROVIDE ACCESS to DOORS on LOADING PLATFORMS,

PROVIDE ACCESS to ELEVATORS in multistory buildings,

PROVIDE SUFFICIENT SPACE for operating EQUIPMENT,

PROVIDE ACCESS to different kinds of SUPPLIES,

PROVIDE SHORTER HAULING DISTANCE."

—“AISLES should be kept to a minimum in number and size because they WASTE STORAGE SPACE.”

NOTE

Illustrate the above point by an example and then ask members of the group if they know exactly what percentage of their available storage space is used for aisles. If they do not know, work out one problem with the group.

(1) The number, type, size, and location of aisles are directly dependent upon the CAPACITY FACTOR and the COMMODITY FACTOR. A warehouseman should not be content to lay out aisles according to a pattern determined either by “someone else” or by precedent. They should know WHY the aisle plan is used and BE SURE THAT IT FITS INTO THE PARTICULAR OPERATION after studying the question from all angles. They should constantly TRY TO REDUCE the amount of space used by aisles WITHOUT HAMPERING THE OPERATION.

(2) To illustrate the percentage of storage space that can be used by aisles, the following examples can be used: Consider a warehouse section 120 by 180 feet or a total of 21,600 square feet. Two 10-foot main aisles, the length of section, equal 2,400 square feet which uses about 11 percent of gross storage space and leaves 89 percent for storage. This PLUS two 10-foot cross aisles running the width of section equals 3,600 square feet. TOTAL aisle space equals 6,000 square feet which uses about 27 percent of gross storage space and leaves about 73 percent for storage (actually, 100 sq ft should be subtracted for each point of crossing of aisles; however, for ease of illustration, this has not been considered). If we reduce the width of each of the four aisles ONE FOOT and make them 9 feet instead of 10 feet, we will have 600 square feet. This saving would make space for about 200 additional pallet loads where pallets are stacked three high. This reduction of ONE FOOT would raise the available storage space to 76 percent.

(3) How much area should be used for storage? Naturally, the thought in relation to this question is “every available square foot.” That is certainly very true, but just how much should be the minimum available area for storage? This will certainly vary from installation to installation depending upon many factors such as building characteristics and type of commodity to be stored or mission. As a good rule of thumb, we may say that a minimum of 65 percent of the available gross space should be available for storage of supplies.

This leaves approximately 35 percent of the gross space (inside measurement) that can be used for offices, restrooms, posts, aisles, and other necessary space. To make the group think about the problem of aisle layout from a practical “know-the-reasons” viewpoint rather than from a “how-we-do-it-here” viewpoint, a chart or plan of a different type of building should be used in the discussion. For example: Use a physical floor plan which is different from the one used to your installation. As each type of aisle is discussed, it should be on a chart as suggested by the group. A blackboard, about 3 by 4 feet, can be used with sample warehouse plans painted on the board. Aisles and commodity locations can then be chalked on it as suggested by the group.

(4) Before laying out aisles, the storage person must ask:

(a) Where and how far away are platforms and door openings?

(b) Approximately how much space will be needed for each item and the sizes of the lots the warehouse is at present expected to store?

(c) It it likely that there will be changes in the quantities and types of material in the near future and can such changes be anticipated, so as to avoid extensive rearrangement of aisles?

(d) Where are firewalls and fire line valves?

(e) How many posts or columns support the roof and floors? Where are they, how big are they, and how far apart?

(f) Will materials be block-stocked or binned? Where binned, aisle space must be reserved in front of each bin.

(g) Which supplies will be stored mechanically and which by hand? Forklift trucks cannot work in tight spots behind columns, nor pass packages around a corner.

(h) What is the size of the forklift trucks to be used? If 6,000 pounds, a larger aisle should be provided; if 2,000 pounds, smaller aisles naturally result.

b. Types of aisles.

—“There are three TYPES of AISLES COMMONLY used in our warehouses: MAIN AISLES, CROSS TRAFFIC AISLES, AND FIRE AISLES.”

—“DISCUSS in DETAIL each of these types, as to number, size, location, and direction.

c. Main or transportation aisles.

—“MAIN AISLES are sometimes referred to as TRAFFIC or TRANSPORTATION AISLES.”

—“As in the case of elevators in multistory buildings, MAIN AISLES are the LIFELINES or ARTERIES of a warehouse.”

—“The location, number, length, and width of these aisles depend upon certain conditions.”

—“WHAT ARE THE DETERMINING FACTORS?”

OBTAIN the following points from the group and then have them designate where they would place main aisles on the sample layout under varying conditions:

TYPE OF STORAGE (mechanically
or by hand)
SIZE OF EQUIPMENT
LOCATION OF DOORS
SIZE OF LOTS

—Have the group explain WHERE and WHY main aisles are located in their own respective areas of operation.

(1) These serve as the lifeline or arteries of a warehouse. There should be no “breaks” or “bottle-necks” and they should be kept clear at all times. THEY SHOULD BE LOCATED so that they give direct access to shipping and receiving platforms, doorways between sections, and, in multistory buildings, give access to elevators and conveyors. Although 10 feet is the normally accepted width in warehouses utilizing 4,000-pound forklift trucks, the WIDTH may vary. Size is determined by the type of mechanical equipment used. Aisles should be wide enough to permit equipment to pass and to permit easy working of the forklift truck. Experience has taught us that a forklift truck of 2,000-pound capacity requires a 7-foot aisle, and a truck of 6,000 pounds requires an 11-foot by 6-inch aisle in which to work efficiently.

(2) The NUMBER of transportation aisles in a section or on a floor of a multistory building depends on the number of communicating doors and elevators that must be used to move material in and out of the area. The number is also determined somewhat by the size of the lots and the number of different commodities. In a section where ONE ITEM will fill the entire area, the section could be stacked to its capacity. It would be necessary to leave only enough space to “get at” the items and to permit access for fire prevention or fire fighting purpose.

d. Fire aisles.

—“FIRE AISLES are NECESSARY IN SOME LOCATIONS under FIRE REGULATIONS.”

—“What are the REGULATIONS governing our own installation?”

—DISCUSS the fire aisle regulations with the group and be sure each member has a clear understanding of them.

—CAUTION—BE SURE YOU, AS LEADER, UNDERSTAND THEM.

—“What factors usually determine the location and number of fire aisles?”

FIRE DOORS
SUBSTANDARD WALLS
WINDOWS
LOCATION OF FIRE FIGHTING
EQUIPMENT
MATERIAL SUBJECT TO SPONTANEOUS
COMBUSTION

—“What is the MAXIMUM WIDTH of FIRE AISLES?”

—Have the group designate where they would place fire aisles on a sample plan.

(1) Fire fighting aisles were once widely used in warehouses. Experience has proved that they are often of little help in controlling fire and may actually constitute a fire hazard. The present thinking is that fire aisles should be eliminated except along substandard interior walls and where they lead to fire fighting equipment. Ordinarily, fire is on the surface of the material; the greater the surface, the greater the fire hazard. The exception to this is material subject to spontaneous ignition; which must be watched constantly for overheating; however, fire aisles will not prevent ignition.

(2) In every depot or storage activity a certain number of fire aisles are necessary. The policy in each should be the guide in establishing these aisles. ALTHOUGH THEY ARE NECESSARY, THEY SHOULD BE REDUCED TO A MINIMUM IN NUMBER AND WIDTH. THEY WASTE VALUABLE STORAGE SPACE. It is seldom necessary to have fire aisles wider than 24 inches. In many cases, fire aisles can be eliminated by a simple change in the location of the fire fighting apparatus. Previously, it has been mentioned that extinguishers and hose fixtures should never be hung BEHIND posts or columns opposite the aisle. Fire aisles must be used adjacent to windows THAT WILL BE USED AS ENTRANCES by firemen. Fire aisles are not necessary next to exterior walls or standard walls which serve as dividers of sections or units of a warehouse.

(3) Standard firewalls separating buildings or dividing warehouses and sheds into fire areas are

those constructed in such a manner that the resulting wall will have a minimum fire resistance rating of 4 hours. The types of firewall construction which will provide fire resistance for a period of 4 hours under revised ratings and are established as the minimum standard are:

- Clay or Shale Brick, 8 inches thick
- Mass Concrete, 7½ inches thick
- Reinforced Concrete, 6½ inches thick
- Structural Tile, 12½ inches thick
- Concrete Block, 10 inches thick

A concrete block wall, 8 inches in thickness, compounded of expanded slag pumice in which 62 percent of the wall unit is solids will also meet the standard requirement.

(4) A 24-inch aisle is maintained along SUBSTANDARD firewalls. Commodities are stored up to a STANDARD firewall (but not in such a manner as to use the wall to support the stack) EXCEPT that a 36-inch clearance must be maintained at the sides of the portals between the warehouse section.

7-21. Stock Locator.

a. Locator system.

—“Keep your LOCATOR SYSTEM as SIMPLE as POSSIBLE.”

—“There are TWO THINGS we want to know:

Where is it located?

Which is the oldest?

—“First, we must decide on a METHOD OF NUMBERING OR LETTERING the warehouses, sections, and bays.” Explain the method employed at your depot.

—“Then a method of RECORDING information is needed.” Explain operation of your locator system.

—“Remember THREE THINGS about STOCK LOCATOR RECORDS:

They should be as SIMPLE as POSSIBLE,

They are USEFUL ONLY IF they are FOLLOWED UP and KEPT UP TO DATE,

They should be USED FOR PROPER STOCK ROTATION.”

(1) We must be able to locate any item upon call and we must not “take a chance” or carry this information only around in our heads. We must

devise a system for controlling the placement and locating of material. This system must be understandable not only to the storekeeper, but to ANY-ONE who may be called upon to find materials for ANY REASON.

(2) The locator system should contain the information necessary to identify and locate stored supplies. Complicating the system by including “extras” such as inventory figures, stock levels, and records of shipments and receipts breaks down its primary function, which is the quick and accurate locating of requested supplies.

(3) A good locator system must start with a plan of the storage areas. The system for numbering warehouses, sections, bays, and rows must be devised and made as simple as possible. It must be readily understandable to ALL personnel working in the storage areas. This includes warehousemen, stockpickers, checkers, laborers, and other personnel. There also must be a file maintained, either mechanically, manually, or a combination of both, on which the data necessary to identify the item are maintained and which will reflect all established locations of the item.

(4) The importance of keeping such a locator system up-to-date cannot be stressed too strongly. Any system that is not accurate is of no value; therefore, it will be necessary that the system be audited periodically. Every location of every item in storage areas will be surveyed and the locations reflected by the locator, as presently established, will be reconciled with those locations surveyed.

b. Bar coding. The use and maintenance of bar coded labels is important to the accuracy and ease of maintaining the location file.

7-22. Summary and Check List. (Summary of session.)

SUMMARIZE IMPORTANT POINTS OF SESSION

—“The fact that it has taken THIS LENGTH OF TIME to BREAK DOWN and DISCUSS some of the FACTORS in only a SMALL PART of our JOB as WAREHOUSEMEN SHOULD MAKE US REALIZE that we have a COMPLICATED and IMPORTANT job to do.”

—“As we warned you earlier, MANY OF THESE FACTORS SEEM TRIVIAL—BUT THEY ARE IMPORTANT.”

—“FAILURE to CONSIDER ALL of THESE FACTORS can and has caused WASTE of SPACE, MANPOWER, and VALUABLE TIME.”

—“The following are a few things on which you can CHECK YOURSELVES.” (HAND OUT checklist, see fig 8-2.)

—“If YOU can sit back and answer these questions to your own satisfaction, you can consider yourself a SUPER WAREHOUSEMAN.”

—“If you CAN’T—LET’S DO SOMETHING ABOUT IT.”

—“That’s all for this session. We will meet again on

(Day)

(Time)

(Place)

HANDOUT

CHECK YOURSELF CAREFULLY AND SERIOUSLY ON THE FOLLOWING QUESTIONS

- | | Yes/
No |
|----------------------------------------------------------------------------------------------------------|------------|
| 1. Is there enough light (daylight or electric) in aisles to permit safe and efficient operations? | |
| 2. In multistory buildings, are the floors overloaded? .. | |
| 3. Does layout permit efficient use of all available storage space? | |
| 4. Are “rapid turnover” items easily accessible? | |
| 5. Does aisle layout permit speedy movement? | |
| 6. Are aisles as narrow as practicable? | |
| 7. Are there any inventory aisles? | |
| 8. Are there unnecessary lateral or fire aisles? | |
| 9. Can everyone find material? | |
| 10. Is excessive rewarehousing necessary? | |
| 11. Is the section or floor satisfactory? | |
| 12. Are plans being made to improve layout? | |

Note. Unless you can answer “Yes” to Nos. 1, 3, 4, 5, 6, 9, 11, and 12, and “No” to the others, LET’S DO SOMETHING TO CORRECT THE FAULTS.

Figure 7-2

Section IV. Storage of Materials

7-23. Review.

Review of previous session(s).

REVIEW PREVIOUS SESSION

—“In our previous session(s) we discussed HOW we would LAY OUT our storage area and WHERE we would STORE MATERIALS under certain conditions.”

—“The SUCCESS of our PLANNING depends upon HOW WELL we are ACQUAINTED with the TOOLS with which we have to work.”

—“How much we KNOW about the WAREHOUSES regarding:

- TYPE
- SIZE
- PLATFORMS
- DOORS
- COLUMNS
- WINDOWS
- FLOOR LOADS
- ELEVATORS.”

“How much we KNOW about the MATERIALS regarding:

- TYPE
- AMOUNT
- SIZE
- WEIGHT
- SHAPE

**TURNOVER
PERISHABILITY
CRUSHABILITY.”**

—“From this information we determine the NUMBER, WIDTH, and LOCATION of the TRANSPORTATION and FIRE AISLES.”

—“These AISLES DIVIDE our FLOORS into a number of AREAS where we STORE the MATERIAL.”

7-24. Objectives.

a. Objectives to be achieved.

STATE OBJECTIVES

—“Today, we will discuss HOW we can STACK MATERIAL, the DIFFERENT METHODS used, and WHEN they are used.”

—“BEFORE we actually ‘put away’ our supplies we must know the OBJECTIVES—WHAT we are trying to achieve.”

—“There are FOUR MAIN OBJECTIVES in storing.”

(WRITE the following points on a blackboard:)

CONSERVE SPACE
ASSURE SPEED OF MOVEMENT
ASSURE STABILITY
ORDERLINESS

(1) There is more to "warehousing" and "storing" than handling materials. Certain objectives must be kept in mind at all times and constantly checked by those concerned. There are **FOUR MAIN OBJECTIVES** that must be accomplished if the job is to be done efficiently.

(2) Storage methods should **CONSERVE SPACE, ASSURE SPEED OF MOVEMENT, ASSURE STABILITY OF THE STACKS, AND PERMIT THE EASY LOCATION AND INVENTORY OF MATERIAL BY HAVING GOOD ORDER IN FORMING STACKS.**

b. Conservation of space.

—"We all agree and realize that we **MUST CONSERVE SPACE.**"

—"To **CONSERVE SPACE** we must **STACK** as **HIGH** as practicable and as **COMPACTLY** as possible."

—"What are some of the **FACTORS** that **LIMIT HEIGHT?**"

TRUSSES
 FIRE EXTINGUISHER LINES
 HEATING EQUIPMENT
 LIGHTS
 FLOOR LOAD LIMIT
 METHOD OF STACKING—
 BY HAND
 BY MECHANICAL EQUIPMENT
 CRUSHABILITY OF MATERIALS

—"What are some of the **FACTORS** that make it **DIFFICULT** to **STACK COMPACTLY?**"

DISCUSS the following points as to how they can **CAUSE DIFFICULTY:**

NUMEROUS POSTS AND COLUMNS
 POORLY TRAINED LABOR AND EQUIPMENT OPERATORS
 TYPE OF STACKING
 ODD SIZE CONTAINERS OF THE SAME ITEM

(1) The necessity to **CONSERVE STORAGE SPACE** is generally accepted, particularly covered space—not only because of the possible shortage of such space, but also because of the cost. It would seem ridiculous if the Empire State Building engineers had planned to have office space on the first floor only, and left those millions of cubic feet over-

head vacant. It is just as ridiculous to have ceilings 25 feet high in a warehouse and then stack material only 5 feet high. There are two things that **SHOULD BE DONE** if space is to be conserved. Material must be stacked as **HIGH** as practicable and as **COMPACTLY** as possible. Naturally, there are certain physical conditions that limit the height and compactness of stacking material in a warehouse.

(2) In many of our older buildings trusses handicap the height to which material can be stacked. In any case, the height of stacks **BELOW** the level of roof trusses or beams will provide that an 18-inch clearance will be maintained when stack heights do not exceed 15 feet or a 36-inch clearance when stacks exceed 15 feet in height. In those instances where supplies are stored **ABOVE** the level of the lower truss members, a **HORIZONTAL** clearance of 18 inches will be maintained.

(3) The height of the stack **BELOW** automatic sprinkler **DEFLECTORS** will allow for an 18-inch clearance when stack heights do not exceed 15 feet and a 36-inch clearance for stacks which exceed 15 feet.

(4) Handicapping floor load limits occur most frequently in multistory buildings, however, they may also be present in single-story structures. Because of the limitations on floor loads, full advantage of height can be taken by locating heavier materials on floors or portions of floors having higher load limits.

(5) Whether we do stacking by hand or whether we use mechanical equipment, there are height limits in stacking.

(6) Ways must be devised to avoid damage to crushable materials. Use of racks, bins, or box pallets help. Even with the use of such aids, it is sometimes difficult to stack to any great height and maintain stability.

(7) Compactness in stacks is just as important in storing as in packing a trunk. The more compactly we pack, the more we can get into a trunk. Likewise, the more compactly we stack, the more we can get into warehouses or other storage areas.

(8) Much space is lost by failure to stack compactly around the posts and columns in buildings. In the planning of layout and stacking methods, we must consider how we can best eliminate waste space around posts and columns. Although the space lost around **EACH COLUMN** may be a question of only a few feet, the total loss, when we consider **ALL THE POSTS AND COLUMNS** in a building, may amount to as much as several hun-

dred square feet. In stacking PALLETS around COLUMNS, the pallets, in some instances, can be turned to make them fit closely. Care must be taken not to block the movement of other pallets.

(9) The method used to stack the material directly affects the compactness of stacks. In block stacking by hand, there should be no wasted space. If block stacking by fork trucks with pallets or dunnage is not properly done, much space can be wasted. Operators should be well trained in the correct methods of stacking. These methods will be discussed in the portion devoted to materials handling.

(10) In stacking various sizes of containers of the same item, much space can be wasted and compactness decreased UNLESS an effort is made to match and stack the containers by size. Although such care may take a little more time, it usually pays dividends in the conservation of space and convenience in inventory.

c. Assure speed of movement.

—“There are certain PRECAUTIONS we can take in our PLANNING and in our STACKING to ASSURE SPEED of MOVEMENT—to ASSURE RAPID AVAILABILITY as mentioned in our definition.”

—“HOW can we ASSURE RAPID AVAILABILITY?”

OBTAIN the following points from the group:

AISLES WIDE ENOUGH
 LOCATION OF FAST MOVING ITEMS
 TYPE OF STACKING, AND MECHANICAL EQUIPMENT

—“Are we going to SACRIFICE STORAGE SPACE for SPEED?”

(1) In the objectives of storing, RAPID AVAILABILITY of the material is stressed. We must be “movement minded as well as storage minded.” Movement of supplies is an all-important objective. Our present storage program must be built around the movement of material. Storage must be considered in terms of MORE material stored in the SAME amount of space—perhaps in less amount of space. The speed of the movement of material can be increased if certain precautions are taken in the warehouse to assure RAPID AVAILABILITY.

(2) Aisles must be wide enough to enable the mechanical equipment to operate easily and speedily. Material that is fast moving and has a high rate of turnover must be stored in locations where

it can be quickly reached, thereby reducing the amount of handling. The type and method of stacking used must be considered first and in the light of the turnover of the material.

d. Assure stability.

We must be sure that our STACKS ARE STABLE.

—“This can be assured by CAREFUL PLANNING and by CAREFUL STORING OR STACKING.”

—“We must know HOW to STACK commodities packed loose, in cartons, drums, bags, glass, boxes, and crates.”

—“We must know HOW to USE the various STORAGE AIDS such as DUNNAGE, and PALLETS which we will discuss in detail later in this session.”

—“Once we PUT the STACKS UP, we want them to STAY PUT.”

—“Both LABOR and MATERIAL must be PROTECTED from ACCIDENTS, DAMAGE, and INJURY.”

(1) Unfortunately, many items handled do not lend themselves easily to good stable stacking. Many items, subsistence for instance, because of their shape, size, and pack can be stacked uniform and stable without too much difficulty. Other items lend themselves to efficient stacking only by the use of proper storage aids.

(2) Every effort should be made to standardize the methods of stacking these commodities; this can be done only by a constant fashion. We would not tolerate a dangerous unsightly three-legged chair in the room; we would not stack a table on top of a sofa; or we would not buy a beautiful picture and spend valuable time in the hanging procedure then turn the picture facing the wall.

(3) Examples which can be easily applied to warehousing military supplies in an orderly manner are:

(a) STABLE STACKS in reasonably regular and neat arrangement.

(b) QUANTITY in each row UNIFORM for ease in inventory.

(c) Boxes arranged so that CONTENTS are READILY DETERMINED.

(d) No “MIXED STACKS” to waste valuable time during inventory or “LOST” MATERIAL that causes WAREHOUSE REFUSALS.

7-25. Types of Stacks and Their Use.

a. Stacking.

—“Name and describe the storage circumstances wherein we build stacks for”—

LARGE LOT BULK BAY STORAGE
 MEDIUM LOT STORAGE

SMALL LOT STORAGE

—“**BULK BAY STORAGE** consists of **LARGE BLOCK STACKS** for storing large quantities of the same item.”

—“**MEDIUM LOT STORAGE** is defined as a stack of material requiring one to three pallet stacks, stored to maximum storage height.”

—“**SMALL LOT STORAGE** is a stack consisting of a quantity of supplies ranging from one container to a lot consisting of two or more pallets but less than the quantity required to complete a full pallet stack. Stress following **KEY THOUGHT**:

—“Where possible, all stacks should **START AT THE WALL** and be **WORKED FORWARD TO AN AISLE**.”

—“Stacks built in the large center sections should be started at an imaginary back line and built forward to an aisle.”

Discuss with the group large bulk lot stacking as it is used in their warehouses.

—“**WHERE** in your warehouse do you use this type of stacking?”

—“**WHAT** items are usually stacked in large bulk lots?”

Discuss the items and conditions of stacking supplies in medium lot storage.

—“Explain ‘side to back’ stacking.”

—“Where is it used?”

—“What commodities do we stack in this manner in our warehouses?”

Discuss small lot storage.

—“Why is it necessary to have small lot stacks?”

—“What do you stack in small lot storage?”

b. Discussion guide for types of stacks.

(1) When discussing stacking we should take care to differentiate between type of stack and method of stacking. In this outline, method refers to a **WAY** of building a stack such as by the use of forklift trucks and pallets or through the use of stacking equipment in outside storage. Excluding retail bin areas, study and search for improvement. These items must be stacked as high as possible with as little loss of space as possible. Constant check should be made of all stacks; those that are unstable, shifting, or leaning should be corrected and studied in the light of **WHY** they are not stable and what causes them to shift. By so doing, many accidents and much lost time rebuilding or repairing stacks can be prevented.

c. Orderliness.

—“Bring out through questions and comments from various class members their idea of **ORDERLINESS** in stacking.”

—“Means **STRAIGHT, STABLE, EASILY ACCESSIBLE** stacks.”

—“Does **NOT** mean **PRECISION** warehousing which is **NOT DESIRED**.”

—“Means like items placed together so that **CONTENTS** of stack and containers may be **QUICKLY** and **EASILY IDENTIFIED**.”

—“There is **NO** excuse for **SLOPPY STACKING**.”

—“There are three self-evident reasons for **ORDERLINESS** in stacking”

**STOCK PICKING
INVENTORY
INHERENT NECESSITY IN STORAGE OPERATIONS TO MAINTAIN GOOD HOUSEKEEPING**

(1) There is no more excuse for confusion and disorder in arranging stacks in a storage location than there is in placing the furniture in your home around the room in “helter skelter” fashion. We might consider that our storage area is made up of two types of stacks—**BLOCK STACKS** and **SHORT LOT STACKS**.

(a) A **BLOCK STACK** may be defined as a “self-supporting regular stack two or more wide, two or more deep, and two or more high.” From this we can see that the supplies we place in **LARGE LOT BULK STORAGE** as well as those we stack in **MEDIUM LOT STORAGE** are both block stacks. However, we have come to a general understanding that a **BLOCK STACK** consists of supplies stored in carload or truckload lots filling an area of perhaps 20 by 20 feet and stacked to a height of from 10 to 14 feet, or in other words **LARGE** lot storage. This type of stack is the most efficient method of conserving space, and we should try to follow this type of stacking as often as possible. It should be done with mechanical equipment.

(b) Block stacks are limited only by:

MHE.

Quantity of the item.

Size and height of the building.

Floor load limits.

Necessary aisle space.

Size, shape, and crushability of supplies.

Items subject to spontaneous combustion.

(c) Block stacks start back at the wall and end at an aisle, or in the case of large center sections of storage space, the block stack starts at an imaginary line drawn through the longitudinal

axis of the space, and extends in either direction to the nearest aisle. Often two blocks of different kinds of supplies are stacked back to back in one of these large center spaces. In cases of extremely large quantities of one commodity such as mattresses, it is possible to fill an entire floor area of a section and leave only the necessary aisles for fire protection and to get to and move the material. FOR SAFETY REASONS, CARE SHOULD BE TAKEN IN BUILDING BLOCK STACKS TO MAKE THEM STABLE AND SELF-SUPPORTING.

(2) When stacking for medium lot storage, one very efficient manner of stacking items in medium lots storage is "side to back" storage adjacent to aisles. By so doing, we can eliminate in many instances, the need for additional aisles or reduce the rewarehousing necessary to recapture bulk storage space.

(3) One of the greatest problems in stacking small lots is the necessity for obtaining accessibility without using bulk storage areas or increasing aisle requirements. To eliminate this, small lots should be stacked in shallow storage space adjacent to warehouse walls bordering transportation aisles or side to back with large storage blocks running parallel with aisles. Box pallets, pallet racks, or bin racks are the most convenient means of stacking this type of supplies in order to take full advantage of storage heights and to maintain quick accessibility to the various odd sizes, lots, or quantities of supplies stored in this manner.

7-26. Honeycombing.

Cause and effect of honeycombing.

EXPLAIN CAUSE AND EFFECT OF "HONEYCOMING"

—"One of the BIGGEST SPACE WASTERS IS HONEYCOMBING." (EXPLAIN what is meant by HONEYCOMBING. ILLUSTRATE by picture or drawing on the blackboard.)

—"By HONEYCOMBING, we mean the LOSS of SPACE caused by storage or PARTIAL SHIPMENT of lots in a manner that leaves HOLES which CANNOT be FILLED except with an identical item until the BALANCE of the particular LOT is SHIPPED."

—"HONEYCOMBING can occur in ANY TYPE of STACKING."

—"Do you have difficulty with this problem?"

—"What ITEMS or what CONDITIONS cause the biggest 'headache'?"

LESS THAN CARLOAD LOTS
MOTOR TRUCK SHIPMENTS
ITEMS WHICH MUST BE SHIPPED IN
ORDER OF AGE
SIZE ITEMS
SMALL LOTS

—"What have YOU DONE or what CAN BE DONE to ELIMINATE or REDUCE HONEYCOMBING?"

—"What CORRECTIVE MEASURES can we take to REDUCE HONEYCOMBING?"

PROPER PLANNING
USE OF SHORT ROWS IN BLOCK AND
SIZE STACKING
USE OF SHORT ROWS ALONG EDGES OF
BLOCK STACKS
USE OF RACKS, BINS, BOX PALLETS
USE OF SHORT WALL SPACE
MINOR REWAREHOUSING—"Floor CLEAN-
UP"

a. To honeycomb is to store or remove supplies in such a way that unusable areas of storage space are created within the stack. Bad storage and delivery methods conceivably could leave a warehouse only partially occupied, yet with no space available for new storage. Preventing honeycombing is one of the most difficult problems faced by a warehouseman; it can occur, almost before he/she realizes it, in any commodity or in any method of stacking. Although honeycombing can occur even in large blocks of stacked commodities that are shipped in carload lots, its most usual occurrence is in the storing of LESS THAN CARLOAD LOTS, MATERIAL RECEIVED BY MOTOR TRUCKS, ITEMS WHICH MUST BE SHIPPED IN ORDER OF AGE, SIZED ITEMS IN ROW STACKS, AND SMALL LOTS. There are certain things that can be done to REDUCE the amount of honeycombing in a warehouse.

b. The problem of honeycombing emphasizes the necessity for CAREFUL PLANNING of operations and emphasizes the importance of knowing WHAT we are going to store, HOW MUCH and WHERE we will store, as well as HOW we are going to store. We must also know whether the material will be received or shipped in carload lots or whether they must be shipped in order of age. AFTER we know all of these facts, there are cer-

tain precautions to take in stacking and storing to reduce the amount of honeycombing in the warehouse. Minor rewarehousing or "floor cleanup" of short lots, which have caused honeycombing due to shipping out of large blocks, should be considered. These items should be moved to short lot areas if receiving of similar items is not expected in the immediate future.

c. In the discussion of LAYOUT, we mentioned that by experience we determined that, as a general rule, we should limit the depth of our rows to between 25 and 40 feet. This means that under ordinary circumstances, a shipment will cause the removal of one, two, or three rows, and leave space for a similar amount of new material to be stored in the same location. In cases where we know that exceptionally small shipments of a certain commodity are made, it is sometimes advantageous to shorten the rows further.

d. Another method that can be used in the case of short lots is to store such items along the edges of a large block stack, facing at right angles to the block stack, and also facing a transportation aisle. The depth of these rows depends, of course, upon the amount of the commodity and may vary from one to three containers or loads.

e. In stacking material along the edges of block stacks, the use of storage aids further reduces the chance for honeycombing and also conserves space, in that it is possible to stack higher and thereby reduce the square footage. In other words, it eliminates having to spread material all over the floor and takes advantage of cubage.

f. In many warehouses, there are numerous short wall spaces which can be used for the storing of odd lots. This, of course, prevents wasting valuable square footage and cubage in the large center bays.

7-27. Storage Aids.

a. Types and uses of storage aids.

DISCUSS TYPES AND USES OF STORAGE AIDS

—"There are NUMEROUS WAYS of STABILIZING STACKS—they might be called 'tricks of the trade'."

—"They are such things as:

CROSS-STACKING

DUNNAGE

BINDERS

PALLETS/PALLET SUPPORT SETS/BOX PALLETS."

—"We should understand HOW, WHEN and WHERE to use them."

—DISCUSS each of these STORAGE AIDS in order and ILLUSTRATE.

—ASK the group to give EXAMPLES of where they are used in their own warehouse and get suggestions for improvements, if possible.

(1) Regardless of the quantity of supplies to be stored, there are certain "tricks of the trade" which we must know and use if we are to stabilize our stacks properly and facilitate handling.

(2) Such things as "cross-stacking," dunnage binders, bulkheads, and the most used storage aid—pallets—must be understood from the standpoint of both meaning and purpose.

b. Cross-stacking.

—"What is meant by "CROSS-STACKING?"

—"What ADVANTAGE is to be gained by CROSS-STACKING material on a pallet?"

STABILITY

—"What OTHER MEANS can be used to obtain STABILITY in addition to, or instead of, CROSS-STACKING?"

DUNNAGE
BINDERS

(1) By cross-stacking, we mean alternating the direction of placing cartons or containers in a stack in order to "tie" them together. The method of cross stacking varies with the size, shape, and crushability of the various items. Care must be taken to cross-stack in a uniform manner so that inventory can be easily taken. Also, care must be taken in cross-stacking to effect as little loss of space as possible; this calls once more for careful PLANNING—it must NOT be done haphazardly. Thousands of valuable cubic feet can be lost in a warehouse by poor cross-stacking; this is particularly true in cross-stacking loads on pallets.

(2) Although the primary purpose of cross-stacking is stability, poor cross-stacking can cause serious INSTABILITY. In stacking pallet loads, the effort to assure stability often causes excessive waste of space. Both factors must be carefully weighed before a standard practice is set up. Sometimes it pays to use other ways to get the desired stability.

c. Dunnage (general).

—“The term “DUNNAGE” as applied to warehousing covers a NUMBER of TYPES—DIFFERENT as to MATERIAL and USE.”

—“Let’s WRITE them on the blackboard and DISCUSS IT and WHERE YOU USE them in the warehouse.”

HORIZONTAL DUNNAGE
FLOOR DUNNAGE
LONG DUNNAGE
SHORT DUNNAGE
VERTICAL DUNNAGE

(1) Dunnage as applied to warehousing covers a number of different uses. Dunnage is used primarily for spacers and in some cases to protect the material from deterioration. Specifically, the types of dunnage used throughout our military warehouses may be identified as horizontal dunnage consisting of floor dunnage, long dunnage, short dunnage, and vertical dunnage. Each of these has a definite place in our stacking methods and should be used only for the purpose intended and when actually needed.

(2) We should not use dunnage “just for the sake of using dunnage.” Many times careful PLANNING and a thorough study of the problem will effect with satisfactory results some way to stack WITHOUT the use of dunnage.

d. Floor dunnage.

—“What do we mean when we speak of ‘FLOOR DUNNAGE?’”

—“WHERE do you USE FLOOR DUNNAGE?”

—“IS IT NECESSARY? REMEMBER—LUMBER IS EXPENSIVE.”

—“What are the ADVANTAGES to be gained?”

SAFEGUARDS PERISHABLE ITEMS such as
BAGGED COMMODITIES
CLOTHING
From: FLOOR SWEATING
RAIN LEAKS

—“Are there any DISADVANTAGES?”

USES MANY BOARD FEET OF LUMBER
HANDICAPS MATERIALS HANDLING
SAFETY HAZARD

(1) Floor dunnage consists of boards of various thicknesses and widths, laid in some systematic way on the floor to raise the material and protect it from moisture and dampness. This type of dunnage should be used only where materials are handstacked and is required only in a few instances and under certain unusual conditions. Perishable items, which can be damaged by moisture, should be either palletized or placed on floor dunnage.

(2) If the lengths of dunnage are 10 feet or more, floor dunnage may be a hindrance to materials handling operation. Such misuse tends to slow up the movement of equipment and is also hazardous to people working in the area. A good rule to follow is: Eliminate the use of floor dunnage as much as possible.

e. Long dunnage.

—“ALTHOUGH LONG DUNNAGE can be used as FLOOR DUNNAGE, we USUALLY THINK of LONG DUNNAGE as being used to STABILIZE STACKS of IRREGULARLY SHAPED and CRUSHABLE ITEMS.”

—“Can you think of any DISADVANTAGES in the use of LONG DUNNAGE?”

DIFFICULT TO HANDLE
SAFETY HAZARD
WASTES LUMBER (usually must be cut)

—“BEFORE you use LONG DUNNAGE, BE SURE there is NO OTHER WAY. IF YOU MUST USE IT, KEEP the lengths within 10 FEET.”

—“Is LONG DUNNAGE being used?” (If “YES”)

—“WHERE is it used? Can we use SHORT DUNNAGE instead?”

(1) The use of dunnage is being discontinued as much as possible; it has been found by experience that many of the items formerly thought to require long dunnage can be more effectively and economically stabilized by either cross-stacking or the use of short dunnage or pallets. As in the case of floor dunnage, long dunnage hampers the materials handling operation. In “tearing down” a stack, the long dunnage must be sawed off as the work progresses; this results in a waste of lumber as well as a cumbersome operation. If the lumber

is not cut, then the stack must be broken down layer by layer rather than by column.

(2) In some instances in outside storage, long dunnage is used—merely because “that’s the way we have always done it”—rather than as a result of a careful study of the problem. For example, in stacking drums, the use of long dunnage on top of each layer is sometimes used to get a more stable and more even stack—and supposedly to facilitate handling. Actually, if the surface of the storage area is leveled off by use of long dunnage (floor dunnage) and the drums are pyramided with blocks placed under the front and rear of the stack, the job will be much easier, more compact, and much more stable. This method of forming block stacks is known as PYRAMIDAL stacking. Six inches of long dunnage should be placed on the ground, but no dunnage is needed between the tiers. Wedge-shaped blocks or butt boards can be used at the end of tiers for stability.

f. Short dunnage.

—“We usually refer to SHORT DUNNAGE as meaning pieces of LUMBER 2 by 4 inches or 4 by 4 inches, cut in 2- to 4-lengths.”

—“What is the MOST COMMON USE of SHORT DUNNAGE?”

SPACERS BETWEEN BOXES PERMITTING USE OF FORKS FOR LIFTING

—“WHERE are you using SHORT DUNNAGE, and in handling WHAT COMMODITIES?”

—“How do you DETERMINE WHETHER to use PALLETS or SHORT DUNNAGE?”

—“When using SHORT DUNNAGE be sure that it is cut to the CORRECT SIZE and RIGHT AMOUNT—READY BEFORE you START the job.”

(1) Usually, this type of dunnage is cut from pieces of 2- by 4-inch lumber and is used primarily in handling heavy boxes that do not lend themselves to palletizing such as refrigerators, machinery, and similar items. Short dunnage serves to separate the containers so that the forks of the truck can be inserted for transporting and stacking the commodity. Care should be taken in cutting this type of dunnage so that there is sufficient dunnage to do the job and that it is cut in correct lengths. Dunnage to be used in handling a container 30 inches deep should to cut between 28 and 30 inches. UNDER NO CONDITIONS SHOULD IT BE CUT SO THAT IT EXTENDS BEYOND THE LIMITS OF THE CONTAINER.

(2) One problem that often confronts storage personnel is whether to use pallets or short dunnage. This should be easily solved by remembering one of the principal objectives in materials handling: “to transport and stack as much as is humanly or mechanically possible in one load, under existing conditions, with an eye to cost, speed, and safety—in other words, to do the job efficiently.” Therefore, IF AN EQUAL AMOUNT OF MATERIAL CAN BE HANDLED EFFICIENTLY ON EITHER PALLET OR SHORT DUNNAGE, SHORT DUNNAGE IS MORE ECONOMICAL.

g. Vertical dunnage.

—“Pieces of DUNNAGE can ALSO be used in a VERTICAL position to STABILIZE CRUSHABLE ITEMS and to SPREAD WEIGHT OF PALLET LOADS.”

—“WHERE in your warehouses have you used VERTICAL DUNNAGE?” Pieces of dunnage can be used in a vertical position to stabilize crushable items and to spread the weight of pallet loads.

h. Binders.

—“Strips of PAPER, FIBERBOARD, or BURLAP, and sometimes thin strips of WOOD, can be used to ‘TIE’ columns of MATERIALS TOGETHER.”

—“In some depots, they speak of these types of binders as DUNNAGE.”

—“We should refer to them simply as BINDERS.”

—“When and WHERE do you think that such a method can be used to advantage?”

BETWEEN LAYERS OF SLIPPERY CONTAINERS
BETWEEN THE TWO TOP LAYERS OF A PALLET WHICH NEEDS STABILITY BECAUSE IT HAS NOT BEEN CROSS-STACKED

—“WHAT OTHER MEANS, besides CROSS-STACKING and BINDING, can we USE for STABILIZING and TYING TOGETHER ODD SHAPED and SLIPPERY ITEMS on PALLETS or in BLOCK STACKS?”

CORD or STRING STRAPPING

(1) Strips of paper, fiberboard, or burlap, and sometimes thin strips of wood can be used to “tie” columns together. Although such storage aids are sometimes referred to as “dunnage,” they are actu-

ally "binders" and should be referred to as such. The binder in this case should be inserted between the two top layers, depending upon the commodity. Such binders can be used also to "tie" cartons on a pallet if, due to their shape, they cannot be cross-tied, or if they have been stacked to conserve space on the pallet. In the latter case, the binder should be inserted between the two top layers of the pallet load.

(2) In addition to the use of the above-mentioned aids, pieces of cord, string, or strapping can be used to bind pallet loads together. These can be used to bind loads of paper rolls or cartons which have not been cross tied. It is necessary to tie such loads around the top layer only or, in the case of paper rolls, around the tops of the rolls. The use of strapping is recommended only in exceptional cases.

i. Pallets (general).

—"PALLETs are really 'GLORIFIED DUNNAGE'. They are an IMPROVEMENT on the SKID."

—"There are THREE GENERAL TYPES of PALLETs used in our warehouses. Can you NAME them?"

SINGLE-FACED (SKID)
DOUBLE FACED
BOX (Permanent and Collapsible)

—DESCRIBE AND DISCUSS TYPES in the following order:

(1) A pallet is a small wooden platform upon which containers are loaded in unit blocks. There are three common types: SINGLE-FACED PALLET, DOUBLE-FACED PALLET, and BOX PALLET.

(2) Actually, pallets might be called "glorified" dunnage and are an improvement in storage operations over the "skid" or "sling board" used in marine operations.

j. Single- and double-faced pallets.

—"What do we mean by SINGLE-FACED PALLETs?"

—"Do you USE SINGLE-FACED PALLETs in your operation?" (If "YES"):

—"WHERE and HOW?" (If "NO"):

—"COULD we USE them to ADVANTAGE?"

—"The MOST COMMONLY USED PALLET in our warehouses is the DOUBLE-FACED PALLET."

—"FORK TRUCK and PALLETs have become as closely connected as 'HAM and EGGS'."

—"They have become so CLOSELY related that quite often we forget that FORK TRUCKS can DO many EFFICIENT JOBS WITHOUT the AID of PALLETs. BUT PALLETs ARE USELESS WITHOUT FORK TRUCKS."

—"Will someone explain the basic CONSTRUCTION of the DOUBLE-FACED PALLET and give the REASONS for its CONSTRUCTION THIS WAY?"

Check to make sure that he/she explains the following points with the "whys."

TYPE OF WOOD (hard or soft)
SIZE OF BOARDS AND SPACING—TOP PLATFORM
SIZE OF BOARDS AND SPACING—BOTTOM PLATFORM
SIZE AND NUMBER OF STRINGERS
CHAMFER ON BOTTOM OF FRONT FACE
NAILS OR BOLTS FOR FASTENING (Drive screw nails)
PLATFORM OVERHAND STRINGERS
4-WAY OR 2-WAY ENTRY
WEIGHT

—"WHAT SIZE PALLETs are used here? WHAT DETERMINES the SIZE?"

—"WHAT are the DIFFERENT SIZES USED for?"

—"COULD THE NUMBER OF DIFFERENT SIZES BE REDUCED?"

—"DISCUSS THE 4-way 40- by 48-inch pallet

CONSTRUCTION
PURPOSE
FEATURES
ADAPTABILITY

(1) A single-faced pallet is a single platform with stringers underneath to provide clearance for the tines of a forklift truck and may be set down upon such items as wooden boxes, barrels, and drums which will not be damaged by the concentrated pressure of the stringers. Single-faced pallets could be used to advantage in some multi-story buildings on floors which have such a low floor load capacity that pallet loads cannot be stacked and mechanical equipment cannot be used. Single-faced pallets are used quite often in

conjunction with hydraulic handlifts and straddle-type fork trucks.

(2) A double-faced pallet is the one most commonly used; hundreds of thousands of them are in use at this time. A double-faced pallet is constructed as a double platform separated by stringers. The tines of the fork truck enter between the two platforms. The boards of the lower platform are separated to make room for the drop wheels of hand fork trucks. The smooth bottom surface distributes pressure equally on the pallet load stored beneath. Fork trucks and pallets have become as closely connected as "ham and eggs," and we sometimes forget that fork trucks can do many efficient jobs without the aid of pallets. Pallets, however, are of little value without fork trucks.

(3) It would not be efficient to have as many different sized pallets as we have items. To make pallet loads fit perfectly would require hundreds of different sizes; although it might save space, it would cause confusion and waste of time in the operation. The basic factors which determine pallet design and size are: size of package or pieces of material to be stored; distance between warehouse and columns; distance between loading or unloading points and points of storage; width of aisles required for types of forklift trucks to be used; layout of storage space and location of aisles; whether pallets are to be used in hoisting operations; whether pallets are to be used for shipping purposes; maximum weight to be stored on a pallet; floor load-weight limit; whether pallets are to be used for storage in the open; and whether pallets must pass through doors of railroad cars or trucks and loaded therein.

(4) Much experience and research have developed the 40- by 48-inch pallet as the size that will accommodate most packages and also store well in most military warehouses and commercial carriers, both car and truck; it has, therefore, been adopted as the standard size for use in the military supply system. There are other sizes which have special, though somewhat limited, application.

k. Box pallets/pallet support sets.

—"BOX PALLETS/PALLET SUPPORT SETS are being used MORE AND MORE in our storage operations."

—"What is meant by BOX PALLET/PALLET SUPPORT SET?"

—"WHEN and WHERE can we use BOX PALLETS/PALLET SUPPORT SETS EFFICIENTLY?"

STACKING SMALL LOTS
 STACKING CRUSHABLE ITEMS
 STACKING SLIPPERY BAGGED ITEMS
 STACKING AGAINST SHORT WALL SPACE
 STACKING ALONG ENDS OF LARGE
 BLOCK STACKS

(1) Box pallets/pallet support sets are being used more and more in warehouses; as in the case of anything that solves problems for us, we tend to overuse it. These aids have a definite place in our operations and should be used only in their place. Pallet support sets adapt to pallets and form a metal super structure (box effect) for stacking pallets and material. Box pallets are merely an adaption of the standard double-faced pallet. A simple superstructure is built on the pallet to give the general appearance of a crate.

(2) CRUSHABLE ITEMS which will not bear up under the weight of stacked regular pallet loads can be stored in these aids; this method gains more height and assures stability. In handling such crushable items, box pallets/pallet support sets are speedier than portable racks. SLIPPERY BAGGED ITEMS in many cases can be handled more efficiently on box pallets/pallet support sets than by hand stacking. SMALL AND ODD LOTS can be stacked to advantage in box pallets; this eliminates much honeycombing and permits higher stacking. Box pallets/pallet support sets instead of regular pallets or permanent racks, can be used to advantage against SHORT WALL SPACE and along the EDGES OF LARGE BLOCK STACKS.

1. Stacking material on pallets.

—"What are the main PURPOSES and the ADVANTAGES of using PALLETS in warehousing?"

MOVE GREATER NUMBER OF PIECES AT
 ONE TIME
 INCREASE SPEED OF HANDLING
 PERMIT HIGH STACKING FASTER AND
 WITH LESS DANGER

—"Are there any DISADVANTAGES in the use of PALLETS?"

USE LARGE AMOUNT OF LUMBER
 COSTLY
 WASTE OF CUBAGE IN STORAGE SPACE

—“HOW can we determine WHAT ITEMS should be PALLETIZED?” CAUTION GROUP IN FOLLOWING KEY THOUGHT:

—“NO MATERIAL SHOULD BE PALLETIZED ON FLAT PALLETS UNLESS WE ARE SURE THE STACKS WILL BE STABLE.”

—“What determines the NUMBER OF CONTAINERS that can be STACKED on a PALLET?”

SIZE OF PALLET
 SIZE AND SHAPE OF ITEM
 WEIGHT OF ITEM
 FLOOR LOAD LIMIT (in multistory buildings)
 LIFTING CAPACITY OF FORK TRUCK
 LIFTING HEIGHT LIMIT OF FORK TRUCK
 EFFICIENT STACKING HEIGHT OF MANPOWER

DISCUSS each of the above points with reference to how it affects the number of containers to be placed on a pallet. Give examples.

(1) The use of pallets helps in attaining this objective because it enables us to move a greater number of pieces at one time, increases speed of handling, and reduces higher stacking with more speed and less danger. Care must be taken to make sure that pallets are used to advantage. We must remember that palletizing loads does consume more storage space than hand stacking. All of these points are mentioned to emphasize the need for PLANNING and knowing WHEN and WHERE to use pallets; they should not be used indiscriminately. We must weigh carefully the advantages with the disadvantages.

(2) The number of containers that can be placed on a pallet depends upon a number of factors:

- (a) SIZE OF THE PALLET.
- (b) SIZE AND SHAPE OF THE CONTAINER.
- (c) WEIGHT OF THE COMMODITY.

(3) If we are using a truck with 108-inch lift and we want to stack three pallets high and maintain uniformity in the pallet loads, care must be taken to load the lower two pallet loads so that

their combined overall height will not exceed 102 inches or an average of 51 inches overall for each pallet load; or, in another vein, the lifting capacity of the forklift truck AT SPECIFIED DISTANCES FROM THE HEEL OF FORK should not be exceeded in forming pallet loads. Most 2,000-pound forklift trucks will lift 2,000 pounds IF THE LOAD DOES NOT EXTEND BEYOND 24 inches FROM HEEL OF FORK; however, for EVERY INCH the load protrudes beyond this point, a sharp reduction in lifting capacity occurs.

(4) Careful PLANNING is again emphasized in order that the number of different sizes of pallets be reduced to a minimum, and that those sizes agreed upon fit the requirements of the operation. We must keep in mind also the overall picture of all installations and the trend to shipping and receiving unit pallet loads. Although such handling has not been completely perfected, it is an important objective which must be kept in mind.

7-28. Summary for Storage Aids.

Summary.

SUMMARIZE SESSION

—“As a review, let’s make a list on the blackboard of the various STORAGE TYPES, METHODS, and AIDS or DEVICES we have discussed.”

1. BINDING AIDS; PAPER FIBERBOARD
2. BINS AND RACKS
3. BLOCK STACK
4. BOX PALLET/PALLET SUPPORT SETS
5. CROSS-STACKING
6. DOUBLE-FACED PALLETS
7. 4-WAY PALLETS
8. FLOOR DUNNAGE
9. LONG DUNNAGE
10. PYRAMIDAL STACKING
11. SHORT DUNNAGE
12. SINGLE-FACED PALLETS
13. SIZE OR ROW STACK
14. VERTICAL DUNNAGE

—“Referring to this list, WHAT STORAGE METHOD OR STORAGE DEVICE or AID WOULD YOU USE in EACH of THESE WAREHOUSE SITUATIONS?”

PRESENT each of the following warehouse problems one at a time, with some such introductory remark as: “Suppose we had to _____.”

What type of stack and storage space would you use?"

1. Store small amounts of 10 different items that are packed in corrugated cartons.
2. Give a single row of supplies support to avoid spilling into the aisle.
3. Warehouse a large shipment of 36-inch rolls of paper.
4. Warehouse two boxcars of one item.
5. Warehouse three bays of an item such as mattresses.
6. Store crated refrigerators.
7. Prevent damage from moisture to a block hand-stacked item.
8. Store ten thousand 55-gallon empty drums in outside storage.

—"That's all for this session. We meet again on

(Day)

(Time)

(Place)"

a. The purpose of this portion of the course was to discuss the various methods and storage devices or aids commonly used in storing material in military supply warehouses. At the close of a discussion, it is wise to try to pull together the general idea, conclusions, or points discussed. It is likely to make every member of the group more conscious of what they have learned. It is probable that additional discussion will result. Any doubts should be cleared up.

b. Some of the warehouse situations indicated may have been discussed in the session. The leader should be prepared to add or substitute others from observation or experience at the depot. If a member of the group answers in a very general way such as: "it depends on the size," or "it depends on the commodity," or "it depends on the warehouse," they should be asked to pick a specific situation and present their method to the group. There may be different answers. Each person should give reasons or enough details to make the answer clear. If time does not permit the use of this summary, it may be used at the beginning of the third session as a review.

Section V. Principles of Materials Handling

7-29. Review.

Review of previous session(s).

REVIEW PREVIOUS SESSION—STATE TODAY'S TOPIC

"In our previous sessions we have discussed STORAGE OF MATERIALS, with regard to BASIC FACTS WE MUST KNOW as well as the NECESSITY FOR DEVELOPING STANDARD PRACTICES."

—"We determined that, in order to accomplish the FOUR OBJECTIVES OF STORAGE:

- CONSERVE SPACE
- ASSURE SPEED OF MOVEMENT
- ASSURE STABILITY
- ORDERLINESS

we must determine the BEST METHOD and then ALWAYS USE IT."

—"We emphasized the fact that once these methods are standardized, THEY SHOULD BE PUT DOWN IN WRITING."

a. To "warm up" the group mentally, a short time at the beginning of the class should be spent in reviewing some of the main points in the previous session(s). This helps, not only to impress these points upon the participants' minds, but also

to continue the line of thought into the following meetings.

b. Future session(s) will deal with the most expensive, most troublesome, and most important part of any storage operation: the handling and movement of supplies. The purpose of the next series of conferences is to point out many of the problems involved in materials handling to make the group THINK about them and to emphasize the necessity for ANALYZING each operation from the bottom up. The success or failure of the entire program can depend upon how well YOU put over this session.

Since certain material in this session is likely to be a "new approach"—in the eyes of the group—it requires skillful presentation and leadership. The group probably has never considered "Principles of Materials Handling" and, unless these principles are carefully related to their specific jobs, they may be considered as "theories" or "schoolish." In preparing for this session, the leader should have up-to-date information on many of the materials handling operations taking place in the depot. This information may be used to illustrate principles or methods of analyzing. At the conclusion of these sessions, the group must have a clear understanding of the five main principles of materials han-

dling and their application to actual jobs. The group also must have a realization of the necessity for analyzing EACH JOB and their responsibility for maintaining efficient operations.

7-30. Materials Handling Efficiency.

a. Definition of materials handling.

—“To be sure that we all have the SAME UNDERSTANDING of what we mean by MATERIALS HANDLING in warehouses, let’s put the DEFINITION on the blackboard.” “MOVEMENT OF MATERIAL, other than by common carrier.”

In further explanation of the definition of materials handling:

MATERIALS HANDLING

Is the LIFTING and SHIFTING of commodities UP, DOWN, or SIDEWAYS (i.e., VERTICALLY or HORIZONTALLY). This can be done MANUALLY, MECHANICALLY, or by a COMBINATION of BOTH.

(REFER to definition on blackboard)

—“In EACH of these TYPES of MOVEMENT we are faced with PROBLEMS—WHETHER we do them by HAND, by MACHINE, OR by a COMBINATION of BOTH.”

—“These points alone, without considering others, make us understand that MATERIALS HANDLING IS NOT A SIMPLE JOB.”

—“There’s more to it than ‘picking-it-up and laying-it-down!’”

—“There are TWO WAYS to ‘pick-it-up and lay-it-down’—the WRONG or HARD way and the RIGHT or EASY way.”

—“At the conclusion of these meetings, we hope you will be able to DISTINGUISH more easily between the WRONG and the RIGHT way—and be sure of it.”

(1) One of the purposes for defining materials handling is to give the group an understanding of what is meant generally by the term. In many cases, the interpretation of materials handling is LIMITED TO THE JOBS DONE BY FORK TRUCKS. Many times we hear the person in charge of the equipment pool or the shop referred to as the “materials handling chief.” Materials handling, in the broader aspect, refers to ANY MOVEMENT of materials, whether by hand or by use of a locomotive crane. Materials handling is the physical handling of supplies into and out of

storage; its most elementary method is a person carrying a package from a freight car to a storage pile. An advanced method is the operator of a fork-lift truck driving the machine into a freight car, picking up supplies loaded on a pallet, carrying the loaded pallet to its storage location and lifting it, still unaided, onto the top of a stack. Materials handling is the actual storage process in operation; the aims are conservation of labor, time, and space to the maximum degree consistent with safety of men and materials.

(2) A second purpose for developing the definition of materials handling is to establish a means through which the importance of analyzing and breaking down a materials handling operation can be emphasized. By breaking down this definition with the group, we can immediately make them aware of the fact that there are problems in the warehouses which can be broken down and analyzed. We can drive home the point that materials handling is not a simple job, that there is more to it than merely picking up and laying down materials, and that THERE IS A RIGHT WAY and A WRONG WAY TO DO IT. The leader must be careful not to read the definition—make it PROVE AND MEAN SOMETHING to the group.

b. Where materials handling occurs.

WHERE MATERIALS HANDLING OCCURS

—“To start, let’s LIST on the blackboard WHERE and WHAT MATERIALS HANDLING TAKES PLACE in our WAREHOUSES or STORAGE AREAS.”

—“Will someone name the THREE MAIN OPERATIONS in a storage operation and point out the MATERIALS HANDLING INVOLVED?”

WRITE ON BLACKBOARD

Operation and Materials Handling Involved

RECEIVING—Unloading cars and trucks, horizontal movement to storage, elevating to upper floors multistory buildings).

STORING—Stacking.

SHIPPING—Removing stock from stacks; lowering from upper floors in multistory buildings; horizontal movement to processing, packaging, and crating areas and to platforms; loading cars and trucks.

—“Are there any ADDITIONAL OPERATIONS in which MATERIALS HANDLING is INVOLVED?”

(Add to list on blackboard)

ADDITIONAL—Checking, assembly, inspecting, rewarehousing, selecting.

(1) Before we can identify specific materials handling operations, it is necessary to know WHERE and WHAT materials handling takes place in our depots. This can be done by determining what handling takes place in each of the three main operations: RECEIVING, STORING, and SHIPPING.

(2) In the three basic operations of receiving, storing, and shipping, about 85 percent of all of the work in a warehouse is done. Unloading cars and trucks, moving from receiving platforms to storage points, stacking at the storage point, pulling down those stacks, moving back to the shipping point, and then loading the cars and trucks—these activities include most of the interior transportation mentioned previously. In addition, there is some materials handling that takes place in miscellaneous operations such as assembly, inspection, packing, processing, and rewarehousing.

(3) After we have isolated the problems involved in each of these operations, we should then study them—one at a time. In this way, we can reduce, slowly but surely, the cost of our materials handling operations, and thereby help to reduce the cost of the entire operation.

c. General way to raise efficiency.

DEVELOP WAYS OF RAISING EFFICIENCY (REFER to blackboard)

—“The TIME AND LABOR involved in these operations amount to about 85 percent of all WORK done in our storage and materials handling operations.”

—“Therefore, if we can REDUCE the COST of HANDLING, we can greatly REDUCE the COST of the WHOLE OPERATION.”

—“In What GENERAL WAYS can we REDUCE the COST and INCREASE the EFFICIENCY of operations?”

TRY TO OBTAIN the following points from the group, and discuss generally what each means and how it can be applied.

BETTER PLANNING
 BETTER UTILIZATION OF MANPOWER AND EQUIPMENT
 BETTER METHODS
 BETTER SUPERVISION

—TO ANALYZE THOROUGHLY and THINK THROUGH our operations to ATTAIN our OBJECTIVE, we MUST HAVE a WORKING KNOWLEDGE of the following:

—Types of equipment available and the advantages to be gained by their use.

—Existing physical conditions which determine and limit types of operation.

—BASIC PRINCIPLES OF MATERIALS HANDLING.”

(1) There are four things that can be done to increase the efficiency of any job: take time for better planning, use better methods, get better utilization of manpower and equipment, and provide better supervision. These four points are more easily said than done. They are essentially the basis for a good operation, but each in its own right presents a problem to those responsible for the operation.

(2) The necessity for taking time to plan was mentioned previously but cannot be stressed too strongly. As a matter of fact, much of the “planning” should be “ADVANCE PLANNING.” For example, to plan a receiving operation, we must know what commodities are coming in, how they will be received, by car or truck; how many are to be received; and where and how they will be stored. Such information should be available as far ahead of time as possible. Unfortunately, the supervisor concerned often does not have ALL OF THE INFORMATION to do a good PLANNING JOB.

(3) THE USE OF BETTER METHODS must always be uppermost in the minds of supervisors. They must not be content to do things because “they-have-always-been-done-that-way.” There are very few jobs in which improvement cannot be made. The efficient improvement depends upon the supervisor’s ability to analyze jobs properly, step by step.

(4) The assurance of better utilization of labor and equipment depends upon the results of a good analysis. The supervisor, in the role of the watchdog, must ever be on the lookout for waste.

(5) Better supervision is perhaps the hardest to get. There is an acute shortage of GOOD SUPERVISORS. We must develop our supervisors. They should know: type of equipment available, physical limitations of equipment, and basic materials handling principles.

7-31. Various Types of and Advantages in Using Mechanical Equipment.

a. Types of equipment.

DISCUSS TYPES AND USES OF EQUIPMENT

—“Will someone name the various types of equipment that are being used in materials handling operations at our own installations?”

(LIST types on blackboard)

- | |
|------------------------|
| TRACTORS |
| TRAILERS |
| FORK TRUCKS |
| CONVEYORS |
| TWO-WHEEL HAND TRUCKS |
| FOUR-WHEEL HAND TRUCKS |
| STOCK PICKING TRUCKS |
| HANDLIFT TRUCKS |
| CRANES |
| DOLLIES |

DISCUSS in general terms how each type is being used. Suggest additions to the list if any have been omitted.

(1) *General.* To help speed the movement of supplies and to make the materials handling job easier for laborers, there are certain types of handling equipment that are used in military storage establishments. Any person in a supervisory job—whether the warehousing supervisor or a squad leader—should know what these types are, how they should be used, and in what operations they serve to the best advantage. Many man-hours and equipment hours can be wasted by failing to use proper equipment in an operation or by failing to know how to use it. For example, in stacking unit loads by fork truck, it is not necessary to have a helper for the fork truck operator if the operator has been properly trained. In most operations of this type, a helper represents man-hours wasted. The most commonly used equipment AND their primary uses are listed and further identified in chapter 4, section II, of this manual.

(2) *Forklift truck.* These machines have become the most used mechanical aid of all. The primary use of forklift trucks is to transport and stack palletized loads or large boxes and crates with skids. They are most economically used when the distance of travel is limited to distance under 400 feet. Selection of the size of the forklift truck is determined by the weight of loads, size of pallets, width of aisles, width of doorways, and whether it must be used to enter freight cars. Generally, the 2,000- and 4,000-pound capacity trucks are the most popular for inside storage operations.

Trucks having a greater lift capacity are used chiefly in outside storage areas.

(3) *Tractors.* Their low gearing and weight give them increased drawbar-pull capacity. They come equipped with pneumatic tires and are most often used for outside hauls, in outside storage, or hauls between warehouses; the most common use is in connection with trailers to make up tractor-trailer trains.

(4) *Trailers.* The trailers used in our storage operations are an adaptation of the four-wheel platform truck, with attachments for hooking them together so that two or more can form a “train.” Light duty trailers have capacities up to 6,000 pounds; heavy duty up to 10,000 pounds. Platforms are usually 6 to 9 feet long and 3 to 4 feet wide. Platform height from the floor ranges from 14 to 18 inches. The most commonly used trailer has a capacity of 4,000 pounds, platform 6 feet by 3 feet at a height of 14 inches from the floor. Automatic coupling devices have replaced the old hook and eye coupler; this has reduced injuries. The primary use of the tractor-trailer train is for hauling unit loads, palletized or not, for distances over 400 feet. Tractor-trailer trains also can be used to advantage in collecting and delivering LCL shipments to the collecting point. Trains should never be “frozen” by storing on them materials that will not be moved for a long period of time.

(5) *Straddle trucks.* When equipped with pallet loading devices, these vehicles are self-loading/offloading and do not require forklift support. Based on these benefits, some installations will not use trailer-trains.

(6) *Conveyors.*

(a) There are many types of conveyors that can be used in our depots. The permanent belt conveyor, portable belt conveyor, gravity roller conveyor, and skate roller conveyor can be used to advantage, if they are used for the purpose for which they were designed. In many operations, the conveyor can be used in conjunction with the fork truck. The conveyor cannot efficiently replace the fork truck in certain operations any more than the fork truck can replace the conveyor in other operations. The skate wheel conveyor which is light in weight, speedy, easily set up, and readily transported is the type most commonly used. This conveyor can be used efficiently for loading and unloading trucks or freight cars where no platform is available and where the surface does not permit the use of a fork truck.

(b) Conveyors can be used to advantage also in packing operations, serving both as a work table and a means of moving the material from one op-

eration to the next without lifting. Care must be taken regarding the weight of the material handled by conveyors. Heavy roller gravity conveyors can be used in handling heavier material.

(c) In permanent operations roller gravity conveyors can be set up with a certain number of power-driven "live rollers." In such operations as assembly of various kits or sets where the material is not too heavy and the operation is permanent, power belt conveyors can be installed and used efficiently. The big advantage of a conveyor, particularly the power-driven type, is that it **ACTS AS A PACE SETTER FOR THE OPERATION**. In setting up any conveyor, care should also be taken that it be the correct speed and easiest working height from the floor or ground.

(7) *Handlift truck.* The handlift truck, sometimes known as the hydraulic pallet jack, can be used to move pallet loads short distances as on and off elevators or for moving material in packing or inspection rooms. In no case should it be used to replace the forklift truck, but merely to supplement it.

(8) Two- and four-wheel platform trucks. Although both of these types of hand trucks are used, they are fast becoming outmoded. Two-wheel hand trucks can be used in handling large cartons, cases, bags, or barrels for very short hauls. The four-wheel platform truck can be used in stock rooms and in packing rooms for miscellaneous movement of material where it would not be economical to use mechanical equipment.

b. There are advantages in using mechanical equipment.

DISCUSS ADVANTAGES OF PROPER USE OF EQUIPMENT

—"What are some of the **ADVANTAGES** that **YOU WANT to GAIN** by the **PROPER USE** of this **MECHANICAL EQUIPMENT**?"

- | |
|-----------------------------------------------------------------------------------------------------------------------------------------------------------------------------------------------------------------------------------------------------|
| <p>SAVE TIME (man-hours)
 SAVE LABOR
 SPEED MOVEMENT OF CARS AND TRUCKS
 GET MAXIMUM USE OF OVERHEAD SPACE
 REDUCE INJURIES
 REDUCE DAMAGES</p> |
|-----------------------------------------------------------------------------------------------------------------------------------------------------------------------------------------------------------------------------------------------------|

—"Will some of you give specific examples where any or all of these advantages have been gained in

your own operations by the proper use of mechanical equipment?"

(1) To use mechanical equipment just for the sake of using it, is **NOT REASON ENOUGH**. There are certain advantages which are quite evident:

(a) *Time.* If time is not saved when we are using mechanical equipment, it is not properly used. Time **SHOULD BE** saved when equipment is added to an operation, if the equipment is in good condition and is properly used.

(b) *Labor.* Saving of labor can be accomplished if mechanical equipment is properly used; this saving can come in the better utilization of labor. For example, in an extreme situation, if eight laborers are used to unload a freight car, the addition of one or two fork trucks to the job permits the unloading of **TOW CARS** at the **SAME TIME** in **LESS OVERALL TIME**.

(2) We should be able to speed up the movement of cars and trucks if we use mechanical equipment properly. If, by the addition of mechanical equipment and the reduction of manual handling in a job, we reduce the amount of labor involved, we automatically **REDUCE THE POSSIBILITY OF INJURY**. Reduction in labor and consequent reduction in injury can be effected only if mechanical equipment is maintained and used properly.

7-32. Movement Factors.

a. *Factors to be considered in horizontal movement.*

POINT OUT OPERATING PROBLEMS IN HORIZONTAL MOVEMENT

—"Our definition of materials handling points out that there are **TWO TYPES** of **MOVEMENT**—**HORIZONTAL** and **VERTICAL**."

—"In **EACH TYPE** of **MOVEMENT** there are **CERTAIN FACTORS** which **AFFECT** our **MATERIALS HANDLING OPERATIONS**."

—"We must **UNDERSTAND** these **CONDITIONS** **PECULIAR** to **OUR OWN OPERATIONS** **BEFORE** we can **PLAN** an **EFFICIENT OPERATION** and **DETERMINE** the **TYPE** of **EQUIPMENT** to be used."

—"For example, we have to know whether the **HAULING DISTANCE** is **LONG** or **SHORT**."

"We have to consider the **PLATFORM SPACE**, the **CONDITION** of **ROADWAYS** and **FLOORS**, and the **WIDTH** of **DOORS** and **AISLES**." (**LIST FACTORS** on blackboard)

SHORT HAULS
 LONG HAULS
 PLATFORM SPACE
 ROADWAYS AND FLOORS
 DOORS AND AISLES

—“What do we mean by LONG and SHORT HAULS?”

LONG HAUL, OVER 400 FEET

SHORT HAUL, UNDER 400 FEET

—“How can the AMOUNT of PLATFORM SPACE affect your operation?”

—“What trouble can you run into, if your ROADWAYS and FLOORS are not smoothly surfaced?”

—“How does the WIDTH of the DOORS and AISLES affect the job?”

(1) *Two types of movement.* Our definition of materials handling states that there are two general types of movement: HORIZONTAL and VERTICAL. In both of these types there are certain existing conditions which affect our materials handling operations. We must understand them as they apply, not only generally, but to a particular job. Failure to understand will handicap the efficiency of the job and the type of equipment used.

(2) *Distance of haul.* In horizontal movement, THE DISTANCE OF THE HAUL will have a bearing on the type of equipment to be used. Is it a long or a short haul? What is meant by a short haul? From experience, we have come to apply the term “short haul” to any distance under 400 feet. Distances over 400 feet, hauling between warehouses or the length of one warehouse, have been accepted as “long hauls,” usually, these distances are handled by tractor-trailers, trailer-trains, or straddle trucks. There is a difference, in application of this rule, between long and short hauls in single-story and in multistory buildings, where the elevator must be taken into consideration.

(3) *Platform space.* The amount of platform space available for loading and unloading cars and trucks is a determining factor in the method used. For example: Platforms may be too narrow for tractor-trailer or conveyors; or they may be too narrow to permit the use of tractor-trailer trains in conjunction with a gravity conveyor for unloading, sorting, and checking sized items.

(4) *Roadways and floors.* If we plan to carry commodities any distance by means of mechanical equipment, THE CONDITION OF THE ROADWAYS OR FLOORS will determine the method used. In cases where the roadways and floors are

rough and uneven, it may be necessary to stack the material differently. In some cases tying or strapping is necessary to keep the material from shifting.

(5) *Width of aisles.* Width of aisles, as mentioned in our study on LAYOUT, is important, since it influences the type of equipment that can be used in the handling of material. The aisles and doors must be wide enough to permit mechanical equipment to be used; otherwise material will have to be handled by hand. For example: It would not be efficient to try to use a 6,000-pound fork truck in 9-foot aisles. Trailers and tractors cannot be used in 30-inch or even 36-inch aisles, which are sometimes found in loose issue rooms.

b. *Factors to be considered in vertical movement.*

POINT OUT LIMITING FACTORS IN VERTICAL MOVEMENT

—“There are CERTAIN CONDITIONS which LIMIT or AFFECT the OPERATION in VERTICAL MOVEMENT.”

(LIST CONDITIONS on blackboard)

CEILING HEIGHTS
 OVERHEAD OBSTACLES
 TYPE OF MATERIAL
 SAFETY PRECAUTIONS

—“How do ceiling heights limit the operation?”

—“What overhead obstacles are likely to be found? What regulations are related to them?”

—“How does the type of material affect the operation?”

—“What safety precautions must be observed?”

(1) Ceiling heights determine the height to which we can stack and also constitutes a factor in the size and type of equipment that can be used in an installation. In a building that has a 15-foot ceiling, it would certainly be uneconomical to sacrifice the advantage of “full air rights” by using only forklift trucks with 9-foot materials lifting height.

(2) Overhead obstacles such as trusses, sprinklers, lighting fixtures, and skylights are all factors that affect vertical movement.

(3) Type of commodities (the shape, size, weight, and crushability) directly controls our method of handling as well as the height to which we can stack.

(4) Size and capacity of elevators in multistory buildings are controlling factors in the equip-

ment used such as trailers, pallets, handlift trucks, or fork trucks as well as how and in what order such equipment can be used. Care must be taken to prevent damage and injury in handling materials in vertical movement. There are certain SAFETY PRECAUTIONS AND REGULATIONS as to stability, height, and weight of a stack that must be considered. Such elementary regulations are prohibiting men from riding or being elevated on the forks are primary. The use of a "backrest" and a overhead guard on a fork truck to protect the operator from being injured by a falling load are important. Training laborers in the proper way of lifting to avoid strains is another safety need.

7-33. Principles of Materials Handling.

a. Definition of principles of materials handling.

DEFINE "PRINCIPLE." DEVELOP IN DETAIL MAIN PRINCIPLES OF MATERIALS HANDLING

—"The third—and perhaps the most important—KNOWLEDGE a good warehouseman or store-keeper must have, is knowledge of the PRINCIPLES OF MATERIALS HANDLING."

—"Before discussing these, let's determine first what is meant by 'PRINCIPLE'."

—"One definition which covers it pretty well is: a PRINCIPLE is the DEVELOPMENT of a THEORY which has been USED MANY TIMES SUCCESSFULLY and has become accepted as a STANDARD RULE or PRACTICE."

"These PRINCIPLES are NOT THEORIES—THEY WORK!"

"The most significant PRINCIPLES which should be applied are as follows:"

(LIST PRINCIPLES on blackboard)

STRAIGHT-LINE FLOW
CONTINUOUS FLOW
CONCENTRATION OF OPERATION
EFFICIENT HANDLING
PRINCIPLE OF WORK

DISCUSS in detail each of these principles and use them as a guide to analyze some operation which is being done in your organization.

(1) The third requisite of a good storage person is that they know the basic principles of materials handling. They must not only know what they are, but also understand how to APPLY them in THE OPERATION. They should be able to ascertain quickly when principles do not apply and

correct the condition immediately. Too often the word "principle" is used as a "blanket" term to cover up real understanding. Because of this, the word often has been associated—incorrectly—with things divorced from practical, down-to-earth facts that are so important to the average warehouseman. As pointed out in the definition of principle—"a principle is the DEVELOPMENT of a theory which has been used many times successfully and has become accepted as a STANDARD RULE or PRACTICE."

(2) Principles are not theories. They are sound GROUND RULES which, if applied, will work. There are many principles applied to materials handling; however, there are FIVE SIGNIFICANT PRINCIPLES. Their meaning should be discussed at length and subsequently applied to the various operations with which the members are familiar. These principles are: principle of straight-line flow; principle of continuous flow; principle of concentration of operation; principle of efficient handling, applied to both manual and mechanical handling; principle of work, which includes what may be considered by some as another principle—that of a balanced operation.

b. Principle of straight-line flow.

—"By PRINCIPLE of STRAIGHT-LINE FLOW we mean the MOVEMENT OF MATERIAL BETWEEN ANY TWO POINTS SHOULD TRAVEL BY WAY OF THE SHORTEST DISTANCE."

—"This is based on the old principle—'a straight line is the shortest distance between two points'."

—"We cannot always travel in a STRAIGHT LINE, but we should always travel the SHORTEST DISTANCE."

—"In our SHIPPING AND RECEIVING OPERATIONS, what is the FIRST THING TO BE CONSIDERED if this principle is to be applied?"

CAR SPOTTING

—"In those cases where warehouses are constructed with multiple truck docks or with truck docks extending the length of the warehouse, then TRUCK SPOTTING must be considered also."

—"What is the METHOD we use here in SPOTTING CARS?" DISCUSS the car spotting system and have the group evaluate its efficiency.

(1) THIS PRINCIPLE MEANS THAT THE MOVEMENT OF MATERIALS BETWEEN ANY TWO POINTS SHOULD TRAVEL BY WAY OF THE SHORTEST DISTANCE. In application to our problems, it cannot always be thought of as

the shortest distance. How well we adhere to this principle determines, in some cases, the type of equipment used in the operation. For example, in receiving and stacking commodities in a warehouse, the distance from the car to the stack determines whether we use a fork truck and pallet method alone, or with the addition of tractor and trailers. We have discussed previously that it is not economical, in an average operation, to have a fork truck travel farther than 400 feet in hauling and stacking. To save man-hours and equipment; therefore, we should make every effort to keep the distances from car to stack under 400 feet. We cannot move our warehouse, but we can move the car to a location nearer the stack. This, of course, calls for PLANNING and the correct SPOTTING OF CARS.

(2) Car spotting means placing the freight car at a SPECIFIC location or SPOT for loading or unloading. By spotting cars as near the storage points as possible, the hauling distance of supplies is reduced and man-hours and equipment are saved.

c. Principle of continuous flow.

—"The second principle is the PRINCIPLE of CONTINUOUS FLOW."

—"By that is meant—MATERIALS SHOULD MOVE CONTINUOUSLY ALONG ANY PRODUCTION LINE."

—"WHICH materials handling JOBS do you know about that lend themselves most naturally to the application of this PRINCIPLE?"

LOOSE ISSUE FROM PACKING
KIT ASSEMBLY
UNLOADING CARS
SORTING SIZED ITEMS

—"What is one of the best ways to ASSURE CONTINUOUS FLOW?"

USE OF CONVEYORS

—"CONTINUOUS FLOW should be applied to ALL of our SHIPPING and RECEIVING operations."

NOTE

DISCUSS shipping and receiving operations generally, to determine if the principle does apply. If it does not apply, discuss the reasons and get the group to think along the lines of eliminating these causes.

(1) This principle stresses the point that materials should move continuously along any production line. Material should always move as smoothly as possible; choppy or broken flow causes confusion and delay. In shipping or receiving materials, every effort must be made to move the materials DIRECTLY to the car or stack; this, of course, requires PLANNING. There are certain operations that lend themselves more easily than others to the application of this principle. Loose issue room packing, kit or set assembly, and sorting sized items on a conveyor are all operations in which we SEE the continuous flow, or easily recognize the lack of it.

(2) Whenever it can be used, one of the best methods to assure continuous flow is the use of a conveyor system of some type. Such a conveyor will act as a PACE SETTER and interruptions are easily observed. We can, however, have continuous flow, even in the following: operations involving hand labor, use of platform trucks, tractor-trailer trains, forklift trucks, and pallets. We must take care in such operations, particularly in shipping and receiving, that the flow is not interrupted by inefficient checking or inspection methods, unnecessary marking, miscellaneous bottlenecks caused by poor planning, or lack of necessary labor and equipment. A very simple ground rule to follow is: "Plan where you want the material to go—and then take them there!" Question very critically the necessity and reason for any stops en route.

d. Principle of concentration of operation.

—"The next principle listed is the PRINCIPLE of CONCENTRATION OF OPERATION which implies that—in the MOVEMENT and HANDLING of material, the OPERATION SHOULD BE LIMITED IN DISTANCE AND AREA COVERED."

—"We all realize that an OPERATION SPREAD OVER TOO MUCH AREA causes PROBLEMS in HANDLING and SUPERVISION."

—"Don't however, limit the operation to the point of CONGESTION."

—"In which operations could we most likely make improvements along the lines implied in this PRINCIPLE?"

PACKING
 LOOSE ISSUE ROOMS
 INSPECTIONS
 ASSEMBLING
 SIZE CHECKING

DISCUSS setup of these operations. Have the group apply the principle to determine whether it is applied efficiently in the depot.

ASK the following questions to stress application of principle in terms of manpower. Have members give reasons for their answers.

—“How many people can be used efficiently in strapping a carton?”

—“How many people can be used efficiently in ‘breaking’ a freight car door and getting working space inside the car?”

—“How many people can be used efficiently to load or unload INSIDE the freight car?”

—“How many people can be used efficiently in loading a pallet?”

(1) In movement and handling of materials the operation should be limited in distance and area covered. This principle stresses the idea that operations spread over too much area cause problems in handling and supervision which do not occur in more compact operations. It is unwise, however, to limit a production line or area to a point of congestion. We can see clearly the importance of applying this principle in operations such as packing, inspection, assembly, and certain checking operations. In setting up such operations, it is necessary first to study just what and how much work must be done; then apply the first two principles, straightline and continuous flow, which should eliminate much of the confusion that can occur; then limit the operation to an area in which people can work without interference, and without taking unnecessary steps, or making unnecessary motions in doing their part of the job.

(2) Often by combining different operations into one, we can save not only in working space required, but also in number of laborers required and amount of supervision needed. For example, in preparing shipments, we are faced with many different operations: removing from the stack, strapping, “blotting out” old markings, stenciling new markings, weighing, checking, transportation to car, and loading car. Instead of moving each container to five or six different locations in the warehouse to get the whole job done, it is certainly

more economical to move the operations to one spot and, in the smallest workable area, perform the job with the least amount of handling of the containers.

(3) In connection with this principle, we must take care not to over-man an operation to the extent that workers are getting in each other’s way. Many times an operation is CONGESTED merely because there are too many people involved. We must determine by careful study how many people can efficiently perform a certain operation at one time in one location. For example, it would be very inefficient to permit three or four persons to strap an average-sized container; at most, two persons can do the job efficiently and then only if one doesn’t have to wait on the other. Generally, it is inefficient for four or five persons to “break” a freight car. Usually, two persons can do the job faster and easier. Once inside the car, two persons can work more efficiently unloading one end of a car; three or four persons get in each other’s way. When you see three or four persons trying to load a standard sized pallet with average sized containers, it is probable that there is “congestion.” The work area is too small for an efficient operation by more than two people, unless the operation is so planned and balanced that two “crews” can work in opposite ends of the car.

(4) Studying the various operations, considering the amount of space used, and the number of people working in the area will pay dividends. BE SURE THAT THERE IS CONCENTRATION OF OPERATION, BUT NOT CONGESTION.

e. Principle of efficient handling.

—“The FOURTH PRINCIPLE—the PRINCIPLE OF EFFICIENT HANDLING is one which too often is overlooked.”

—“It is perhaps the MOST IMPORTANT.”

—“It means simply that—In the MOVEMENT OF MATERIALS, THERE SHOULD BE THE LEAST POSSIBLE HANDLING.”

—“It should be applied to both MANUAL and MECHANICAL OPERATIONS.”

—“Despite the use of mechanical equipment, the MAJORITY of our MATERIALS HANDLING is still done by HAND.”

This principle means that in the movement of materials, there should be as little handling as possible. Constant picking up and putting down is wasteful of time and energy, ties up the use of equipment, and causes damage. The principle of efficient handling should be applied to both manual and mechanical operations.

f. Applied to manual handling.

(ILLUSTRATE this point on the blackboard. Example included with this outline can be used.)

—“You will note that in this unloading operation 75 percent of the total WORK-HOURS consists of MANHANDLING.”

—“We can improve the efficiency of an operation immediately by REDUCING excessive MANHANDLING.”

—“What things in an operation cause a laborer to tire rapidly?”

ITEMS TOO HEAVY
EXTREME BENDING
HIGH LIFTING
LONG CARRYING

“Those are things that WE CAN CORRECT.”

—“Can you think of any of your operations in which a laborer handles the same items two or three times?”

NOTE

If not, point out an operation you have observed personally. (Take care not to embarrass any member of the group.)

—“We should constantly check our operations and reduce MANUAL REHANDLING to a minimum.”

—“It is part of our jobs as supervisors to show our people the EASY WAY to do a job.”

—“These few POINTERS on LIFTING may be a guide in showing the workers the SAFE and EASY way.”

(HAND OUT mimeographed material on “WHAT EVERYONE SHOULD KNOW ABOUT LIFTING.”)

DISCUSS each point with the group or have one member demonstrate the correct procedure.

DISCUSS carefully and in detail the following EASIER METHODS.

Point out advantages and determine extent of use of each method.

—SWING instead of STRAIGHT lift.

—Unloading cars and trucks by TIERING method.

—REPALLETIZING by use of “THREE PALLET” method.

(1) Regardless of the type of mechanical equipment we use, there will be SOME MANUAL HANDLING somewhere along the line. Manual handling should be reduced to a minimum and done properly.

(2) Manual handling of material can be illustrated if we break down the job of unloading a freight car in which we use two laborers and one fork truck and operator. For purposes of illustration, the job takes 2 hours to complete.

2 laborers × 2 hours=4 man-hours

1 truck operator × 2 hours=2 man-hours

1 truck × 2 hours=2 truck-hours

Total 8 work-hours

It can easily be seen that in the 8 WORK-HOURS consumed, only 2 hours were used by mechanical equipment and 6 hours consumed by man-hours. In other words, about 75 percent of the work in this job was done by MANUAL LABOR.

(3) The job might have taken many more hours to complete without the use of mechanical equipment and may have involved many more laborers. Do not make the mistake of thinking that mechanical equipment REPLACES manual handling; it does not, it merely supplements it and makes it easier. By eliminating all excess manual handling, particularly that involving lifting, it is possible to increase immediately the efficiency not only of the laborer, but of the job itself. Whether picking up pieces from floor level or loading a truck from ground level, the element of fatigue rapidly cuts efficiency and production. The human body is a most flexible and adaptable machine, but this machine is also subject to two weaknesses: FATIGUE AND HABIT.

(4) People can move a light object in the same plane from one position to another continuously for a long time and at a high production rate without excessive fatigue, if they do not have to take steps, bend extremely low, or reach extremely high. A good rule, which can be applied to the work done by manpower alone, might be found in the answers to these questions: Does the weight exceed 50 pounds? Does picking up require extreme handling? Does carrying require more than one step? Must lifting be higher than eye level? If the answer to any of these questions is “yes,” then it is very doubtful whether manpower alone is the answer to that particular handling problem. Persons should be given the help of the proper type of mechanical equipment; this will help to reduce the element of fatigue. The elimination of rehandling will further reduce the element of fatigue—LET’S PLACE THE MATERIAL IN ITS FINAL RESTING PLACE AND LEAVE IT THERE.

(5) Part of a supervisor’s job is to teach workers the EASY WAY to do a job. It was mentioned that the human body had two weaknesses: FATIGUE AND HABIT. It is important that we do

everything possible to reduce the fatigue element and, even more important, that we guide our workers into correct habits of doing the job. Once formed, incorrect habits are difficult to break.

(6) The HANDOUT on "Lifting" should be mimeographed and distributed to the group for use in teaching workers. In addition to these correct methods for lifting, there are certain "knacks" or "tricks" that can be used to reduce the element of fatigue. For example, in handling containers of average size and weight, it is easier to move and lift them by using a certain "swing" motion than by a stiff or rigid lifting motion. In using this "swing" motion, the laborer can take advantage of pendulum motion, obtain a kind of rhythm, and reduce the physical effort required.

(7) In unloading average-size containers from a freight car or truck onto trailers or pallets, a systematic method should be used to break down the load. The method might be called "UNLOADING BY THE TIERING METHOD." The load should be broken down in such a way that the number of times it is necessary to lift the bottom cartons in the load to the top of the pallet is reduced to a minimum. Where repalletizing must be done, the "three pallet method" can be used as follows: Repalletize half of loaded pallet No. 1 onto empty pallet No. 2; temporarily withdraw pallet No. 2 from the operation; place empty pallet No. 3 into position and repalletize the rest of pallet No. 1 onto empty pallet No. 3; half of loaded pallet No. 4 is repalletized on half-loaded pallet No. 3. Such a method reduces the amount of bending and lifting as a SHIFTING rather than a lifting process is employed.

g. Applied to mechanical handling.

—"To use our mechanical equipment to fullest advantage we must constantly try to:

- ELIMINATE EXCESSIVE HANDLING
- ELIMINATE REHANDLING
- AVOID INCORRECT HANDLING."

—"There are certain PRECAUTIONS we must take to assure greater efficiency in use of equipment:

- PROPER TRAINING OF OPERATORS
- APPLICATION OF BOTH PRINCIPLES—
- STRAIGHT-LINE AND CONTINUOUS FLOW
- COMBINE CARRYING AND LIFTING OPERATIONS."

—"In the majority of SHIPPING and RECEIVING OPERATIONS there should be NO STOPPING

PLACE between the STORAGE POINT and the CARRIER'S VEHICLE."

DISCUSS with the group the shipping and receiving operation and have them determine whether there is rehandling—setting down and picking up—which could be eliminated.

(1) To use mechanical equipment to its fullest advantage, we must eliminate excessive handling, rehandling, and incorrect handling. Equipment improperly used can cause more waste and hamper operations to a greater extent than failure to use it at all. There are certain precautions that must be taken to assure efficiency in the use of equipment.

(2) Operators of mechanical equipment must be properly trained; this should include operators of equipment such as fork trucks, tractors, conveyors, and strapping machines. We should not take it for granted that because a person has been operating a machine over a period of time, they are operating it correctly or in the most efficient manner; we must be sure. We can be sure only by carefully spot checking at frequent intervals and then providing time and means for improving their work by training.

(3) In addition, we must be sure that the application of the first two principles—STRAIGHT-LINE AND CONTINUOUS FLOW—be made in the use of equipment. We should determine the shortest possible moves and then take advantage of them. The "flow" of the equipment must be continuous, with no time wasted. Maximum loads should be determined and carried to reduce the number of trips and pieces of equipment to a minimum. One large handling unit requires less total handling than many small units. Concentrating small packages into large units, as the palletized load plan, reduces handling time.

h. Principle of work.

"The PRINCIPLE OF WORK stresses the fact that the GREATEST AMOUNT of WORK MUST BE DONE in the LEAST AMOUNT OF TIME (MAN-HOURS."

—"The successful application of this principle is largely dependent upon the FIRST FOUR PRINCIPLES."

—"To REDUCE COST and INCREASE SPEED, we must constantly CHECK in TWO WAYS; TIME IT TAKES TO DO THE JOB MAN-HOURS USED IN DOING IT."

(1) The fifth important materials handling principle may be referred to as the PRINCIPLE OF WORK. It cannot be supplied unless the other four principles have been adhered to and is actu-

ally the culmination of a **BALANCED OPERATION** through proper application of the other four principles. The principles of work means simply, doing the greatest amount of work in the least amount of time (man-hours). Speed of movement does not necessarily mean a good operations.

A balanced operation, with each step performed in its proper sequence without lost motions and at speed consistent with the slowest step or capabilities of the personnel or mechanical equipment involved, is a good operation. The question "How long does it take to do a job?" can be answered in two ways: Length of time it takes to accomplish the job, and the **TOTAL MAN-HOURS** it takes to accomplish the job; both are important in relation to results that are to be attained. The fact that a carload of materials has been unloaded in 1½ hours is a clue **ONLY TO THE SPEED** with which it was unloaded. The added fact that it took six persons 1½ hours to do the job is indicative of the **MAN-HOURS** required and also the efficiency of the job in relation to cost in manpower.

(2) We must remember that we want to accomplish **TWO THINGS: REDUCE COST**—directly in **MANPOWER**, in **MONEY**—and **INCREASE THE EFFICIENCY** with which the job is done. Figures indicating this decrease in manpower and increase in efficiency are difficult to compute, but it is most nearly accomplished by use of the **TONS PER MAN-HOUR** figure. How well this **PRINCIPLE OF WORK** is applied can also be measured by the **TONS PER MAN-HOUR** figure. Some examples of variations in operation and results in tons per man-hour follow:

i. Balance in an operation.

—"To do any **MATERIALS HANDLING JOB EFFICIENTLY** and apply the **PRINCIPLE OF WORK**, we must have **BALANCE IN THE OPERATION.**"

—"By 'BALANCE' we mean—**WORK** has been **PLANNED** so that all **MAN-POWER** and **EQUIPMENT** used on the job are **WORKING CONTINUOUSLY WITHOUT LOST MOTION OR TIME.**"

—"To get **BALANCE** in an operation: The **TIME** it takes to perform **EACH PART** of the job must be determined and the **DIFFERENCE EQUALIZED** by the **NUMBER** of persons used and the **PIECES** of **EQUIPMENT** used."

ILLUSTRATE what is meant by using the example given or one which you have prepared from an actual operation that you observed and studied.

—"After you have determined **WHERE** the operation is **OUT** of **BALANCE**, then **CHECK EACH PART** of the **JOB** to make sure it is being done **PROPERLY.**"

NOTE

To illustrate how this can be done, use the suggested check list if the tractor-trailer train example has been used. If you have used an example of your own, develop a similar check list by breaking down the job into all of its parts. (Have the group discuss each of the points and decide what is the "PROPER WAY.")

—"If each part of this job cannot be improved—and we are convinced of that fact—**THEN ADD** or **REDUCE MANPOWER** or **EQUIPMENT.**"

—"We can also aid in the attaining of **BALANCE** if we take care to **AVOID** the following **TIMEWASTERS:**

EQUIPMENT WAITING FOR LABORERS
LABORERS WAITING FOR EQUIPMENT
EQUIPMENT ARRIVING EMPTY WHEN PALLETS OR OTHER NECESSITIES SHOULD BE CARRIED
WAITING FOR CHECKERS."

(1) Even after the seemingly best method has been chosen, it will not produce the desired results unless there is balance in the operation. Need for synchronized and balanced operations is a most pressing problem in warehouses today. "**BALANCE**" **IN AN OPERATION** MEANS THAT THE **WORK HAS BEEN PROPERLY PLANNED** SO THAT ALL **MANPOWER** AND **EQUIPMENT** USED ON THE **JOB** ARE **WORKING CONTINUOUSLY—WITHOUT LOSS OF MOTION OR LOSS OF TIME.**

(2) In order to gain balance in any materials handling operation, the time it takes to perform each part of the job must be determined and the differences in production of the separate parts equalized by adding or reducing the number of persons and pieces of equipment used. For example, in unloading a boxcar, using a tractor-trailer train, we should determine: time it takes two persons to load pallet; time it takes tractor to travel to stack with loaded train, uncouple at stack, pick up empty train, and return to car; and time it takes for truck to stack loaded pallets.

(3) In this operation, the tractor-trailer is the balance wheel and by increasing or reducing the number of trailers hauled, the entire operation should be kept continuous. After it has been determined where the operation is **OUT OF BALANCE**, we must then check each part of the job to make sure that it is being done properly—that the workers know how to do it. Applying this idea to the illustration, we would jot down the various parts of the job and then check them: Laborers handling

material properly, the easy way; pallets properly placed on trailer; trailers placed in car correctly; trailers coupled and ready for the tractor; trailers in proper location at the stack; fork truck stacking properly, the easy and safe way; empty trailers in the proper location near the car; and in the case of multistory buildings the elevator operation must be checked. If all of these operations are being done correctly—the easy and the safe way—then we should consider adding or reducing manpower and equipment.

(4) Quite often an operation gets out of BALANCE because of poor timing at the start. Part of the supervisor's job is to PLAN properly so that everybody and everything is READY and ON THE SCENE at the time the job is scheduled to start. Care should be taken to avoid such time wasters as: equipment on the job waiting for the laborers to arrive; OR, laborers on the job waiting for the equipment; OR, both laborers and equipment on the job waiting for a checker; OR, equipment arriving "empty handed," when it should have brought pallets or other miscellaneous equipment needed. DO NOT OVERLOOK THE LITTLE DETAILS THAT GO INTO MAKING AN OPERATION. LOOK FOR TIMEWASTERS IN ALL OPERATIONS!

7-34. Summary.

BRIEFLY SUMMARIZE MAIN POINTS

—"To SUMMARIZE briefly, we can list THREE MAIN QUESTIONS which must be asked in analyzing a materials handling operation." (LIST points on blackboard)

ARE THE PRINCIPLES APPLICABLE?
IS THE OPERATION BALANCED?
IS EACH PART OF THE JOB DONE PROPERLY?

—"There are NO SHORT CUTS—NO TRICKY OFFICE METHODS for analyzing a MATERIALS HANDLING operation."

—"It requires CAREFUL STUDY ON THE JOB—some clearly ORGANIZED THINKING."

—"After we arrive at what WE THINK is the BEST METHOD, we should PUT IT DOWN IN WRITING—not carry it around in our heads."

—"Have the CORRECT METHOD AVAILABLE for YOUR FUTURE REFERENCE."

—"Give the next fellow a break."

a. Throughout this discussion many points have been addressed concerning THINKING ABOUT and DOING an efficient operation. The number of things to think about emphasizes that it is no simple job; that it has many complexities. The summary stresses the necessity for ANALYZING, in an organized way, EVERY JOB for which supervisors are responsible. The basis for such an analysis can be summed up in three questions:

Are the principles applicable?

Is the operation balanced?

Is each part of the job done properly?

b. After answering these questions, we should be better equipped to spot the weak points and take the necessary action to correct them. REMEMBER, SUPERVISORS CAN DO A BETTER JOB BY USING THEIR HEADS AND SAVING THEIR BACKS.

CHAPTER 8

STORAGE MANAGEMENT TECHNIQUES

8-1. General.

a. Management. In storage and materials handling operations, management encompasses four principal areas of responsibility: people, workload, space, and equipment. This chapter treats those essential management techniques which are particularly appropriate to storage and materials handling operations and which experience has proven to be the most effective.

b. Importance of management. Managers/directors at major military supply installations are business executives with broad responsibilities. Organization is the structure by which these responsibilities are affected. Management is the planning, organizing, directing, coordinating, and controlling mechanism by which the organization is made to function. Thus, there is a continuing cycle in which good managerial techniques are made effective through proper organizational structure as the structure itself produces good managers.

(1) There are certain basic principles that apply to effective organization and leadership. As a manager, basic leadership principles enumerated below, judiciously applied, will result in a beneficial return.

(a) Encourage employees to do a better job by example and by inspiring them to innovate and suggest improvements.

(b) Maintain the "open door" policy so subordinates will feel free to approach you. One good idea from them may revolutionize your operation.

(c) Make no commitments that cannot be kept. Build confidence by becoming known as one who keeps a promise.

(d) Nourish the morale of your organization. Believe in your fellow employee.

(e) Instill confidence that your instructions will be complied with, that your suggestions will be heeded, and that your orders will be carried out.

(f) Cultivate the art of delegating responsibility. Promote teamwork by developing leadership qualities.

(g) Make such things as promotions, citations for meritorious service, retirements, and bonus awards a special event.

(h) Recognize that years pass quickly and assure that there is someone capable and trained to carry the major part of the load when the need arises.

(i) Encourage all personnel in supervisory positions to have and maintain an updated manager's handbook.

(2) These principles, coupled with the application of such management techniques, will contribute immeasurably to achieving maximum efficiency and economy in storage operations.

c. The storage and materials handling manager.

(1) A good manager establishes objectives within the framework of the mission of the organization and operates according to the capabilities of the work force and the facilities placed at their disposal. The manager knows the "how" and "why" of what they are asking and is able to evaluate results. Above all, the work force is led to understand directions in order to obtain the desired objectives.

(2) Complete and common understanding between the storage and materials handling manager and operators requires the preparation of standard operating procedures, the training of personnel in those procedures, and the maintenance of a continuing program to restudy procedures and retrain personnel. The manager encourages recommendations for improvement in operations and, where indicated, effects revision and refinement of operating procedures.

(3) The successful manager operates with a high degree of flexibility. Through the organizational structure they meet sudden and large impacts on one activity by shifting personnel and equipment from tasks of lesser priority, including delegation of authority where practicable. Tasks of lesser priority are maintained as standby projects to be accomplished during periods of nonpeak workload. This balancing of workload, people, and materials begins with the smallest operation and ends with the total production from the entire activity.

(4) No matter how powerful a combination of resources the storage and materials handling manager may have, they cannot succeed without a team of willing, thinking, and articulate people to guide that combination. The manager has a job to create, develop, and maintain voluntary cooperation and initiative among the people supervised.

d. Planning. Planning is the deliberate consideration of a problem or an operation with a view to determining, in advance, the most effective means of accomplishing a desired result with the least expenditure of manpower, time, and material.

(1) Planning involves the determination and visualization of what should be done, where, when, how, why, and by whom it should be done, and how long it should take (how many man-hours are required (i.e., work standard)).

(2) Once a recurring problem or operation has been defined, a procedure or system should be established for handling the situation. Establishment of a system reduces everyday work to routine and the recurring problems or operations can be handled by less experienced personnel. Additionally, personnel at the top echelon are relieved for the more important work of planning for any new or broader problems and for directing, controlling, and coordinating the organization's total effort.

e. Directing. Once a plan has been developed, it then becomes necessary to issue appropriate instructions for implementation.

(1) Instructions should be in sufficient detail to assure that the recipient has a clear understanding of what, when, and how the job should be done. On the other hand, except for uniform recurring procedures and methods, which should be reduced to written documents, the instructions should not be in such defined detail that the recipient has nothing left to his judgment. Too much detail can destroy the initiative of the recipient and waste the time of top echelon officials in its preparation.

(2) The potential of the most effective planning or the most productive system in existence can never be reached without motivation of the people involved. To be successful, management must operate with recognition of abilities and unique desires of people. For example, when a person is involved through contribution of ideas and energies to a group goal, the enthusiasm to give their best runs deep. To be still more specific, whenever changing to new procedures or techniques, employees meet goals better when those aims take on a personal meaning gained through understanding of the goals and recognition of their ideas.

f. Coordination. Two of the more noticeable features of a major military supply installation are specialization and large-scale operations. Specialization provides experts attention to related but limited subjects. Specialization also intensifies the need for coordinating the various specialized ac-

tivities into a composite, well-balanced operation. One of the chief functions of the storage manager is to coordinate activities within their area of responsibilities, whether that area be the installation as a whole or an organizational element of the installation.

g. Control. A plan having been developed, its execution directed and coordinated, a last and very important step is to determine the status of the resulting operation during its various stages of accomplishment.

(1) Proper controls permit timely corrective action if the operation is not being effectively executed or proves to be defective. Control founded on comprehensive and accurate information takes the guesswork out of management and forms a sound basis for decisions and planning. However, reports and charts do not in themselves provide solutions to management problems. They merely serve to highlight areas of deficiency which must then be subjected to further planning, direction, and coordination.

(2) The use of ADP equipment and techniques to their maximum potential usefulness must be exploited. The astute manager will be constantly aware of the possible improvements to the organization as a result of the modern management techniques made possible by computers.

(a) Daily progress or status registers are easily maintained by computer program. Voluminous printouts, however, are to be avoided. The manager must be ever mindful of the cost of preparation and distribution of ADP reports, hence, reports should be keyed to the exceptional items or out of tolerance conditions which warrant immediate attention. Ideas for new or improved reporting techniques as well as elimination of those reports which are no longer useful, contribute to a higher overall effectiveness and therefore are actively solicited.

(b) Toward this end, consideration should be given to the installation of peripheral input/output devices in the executive office(s). Several of the newer high speed terminals such as the cathode ray tubes or thermal printers are fast and totally silent, thereby lending themselves to the office environment. In this way, required information is available in the form of graphics or text for display on a realtime basis, at a touch of the finger.

(3) Those installations which do not have extensive central computer facilities should consider the availability of time-shared terminals. Many commercial terminals are available on a rental basis with installation as simple as replacing an office typewriter. The only additional requirement

is the availability of a standard telephone to accomplish the computer to terminal link.

(4) While most of the storage applications program will require special purpose software, there exists an extensive variety of "canned" programs available in the industry at minimal or no cost to the Government. Frequently, these simulation-type models can be employed in the decision-making processes where before only best guesses were possible.

(5) One area in the field of ADP storage where substantial savings are possible, and therefore of obvious concern to the storage manager, is the generation of source data. Older methods of handscribing with subsequent keypunch card generation are giving way to original preparation of information in a machine-readable form. At the present time bar codes and optical character readers are playing an ever increasing role in source data automation.

(6) The use of standard terms, symbols, documents, etc., will provide a level of uniformity and compatibility and permit operation of systems designed at one activity to function at multiple locations. All information requirements, internal and external, should be derived from common use data to the maximum extent feasible.

8-2. Manpower and Equipment.

a. Manpower. Manpower is one of the primary resources of a supply installation. It is also the greatest item of expense. As such, it must be properly utilized, assigned, and directed. Economical and proper personnel/labor assignment depends on thorough planning during consideration of scheduled assignments. General personnel labor problems should be openly discussed among staff members and heads of component units of the activity. By this means, every individual performing management duties will be fully informed of the overall labor situation and made aware of his own responsibilities toward the efficient employment of the forces assigned to them.

b. Labor and equipment pools.

(1) *This section is not applicable to ammunition operations.*

(2) *Labor.* Operational requirements in warehouses or other component elements of depots and other major supply installations can and do vary extensively from day to day. In view of this, the assignment of laborers and equipment to subdivisions of such activities on a permanent basis can become an uneconomical practice. Consistent with mission and organization of the activity, it is more economical to permanently assign to a unit that

amount of laborers and equipment needed to perform no more than 75 percent of the average work load. All other labor and equipment can be assigned to a Central Labor and Equipment Pool from which they may be dispatched, as required, to those components of the storage activity confronted with peak or heavy work requirements exceeding the capabilities of permanently assigned minimum work force.

(a) The pooling and assignment of manpower and equipment, according to priority workload, proves successful only when such assignment is conducted on an absolutely impartial basis. Personnel and equipment pools must be operated for the benefit of all elements concerned, based purely on needs generated by work load or the purpose of the Labor and Equipment Pool will be defeated. For this reason, organizational placement of the Labor and Equipment Pool should be given careful consideration. This can best be accomplished when such assignments are directed by a Production Planning and Control Activity. This will assure maximum utilization of facilities and manpower by the application of work measurement standards (where feasible) in the planning, scheduling, and controlling of workload and manpower distribution.

(b) Notwithstanding the overall management and distribution of men and equipment based on work standards, instances often arise in actual floor situations where the workload increases in several areas of an activity simultaneously and the combined labor requirement exceeds the capabilities of the forces available. When this occurs, a decision as to equitable use of available pooled resources should be made by the chief of each activity involved, with prime consideration given to the higher priority workloads. When this management effort is not sufficient to cope with the volume of priority workload in a given operation or function, the decision on realignment of priorities should move up the echelons of management/command to the necessary level.

(c) Separately trained elements may be developed in the pool so long as flexibility is not impaired. Personnel and squads should be assigned to like jobs whenever possible (i.e., warehousing, shipping, receiving, etc.). Over-specialization should be avoided since it defeats the purpose of a labor pool.

(d) Effective management of pooled resources requires constant consideration of the time factor involved in any movement of labor and equipment from one assignment to another. Assignments/reassignments should be closely studied

before being placed into effect otherwise and excessive amount of the working day can be lost in traveling from one work site to another.

(e) The ideal situation exists when the workload is sufficiently large to permit the assignment of a squad or crew to a given job or area for an entire working day. In instances where this is not possible, and transfer from one area or warehouse to another throughout the day becomes necessary, good management and planning will assure labor assignments to jobs which are located in proximity to each other.

(3) *Equipment.*

(a) Equipment dispatched from the Labor and Equipment Pool should be in balance with the assignment of labor. MHE on-hand should be categorized (i.e., powered, nonpowered, age, size, capabilities, and capacity). Managing the use of equipment to achieve maximum economy in its utilization should be a prime management objective.

(b) Where it is practicable, operators of motorized equipment operating from pools should be assigned permanently to a given vehicle.

8-3. Production.

a. Criteria. Productivity of an operation is contingent upon the establishment of a standard performance. Achievement of maximum productivity comes about through informed workers, practical production standards, use of standard methods, and by reducing as many operations as practicable to routine tasks.

b. Production records. Records of production are beneficial as management tools in that they provide a means of planning and distributing resources. Depending upon the echelon of management, the production unit(s) selected should be broad units (e.g., mixed trucks received) which most typifies the work to be accomplished. A production record should consist of substantially the following types of information:

(1) The number of production units on-hand at the beginning of the report period (day, week, etc.).

(2) The number of production units received during the period.

(3) The number of production units processed and the average processing time per unit. Average processing time may be determined from a frequency analysis of the occurrence of the various elements of the operation and their time standards.

(4) The number of man-hours required to accomplish this work.

c. Analysis. To determine the efficiency of current operations, production records should be analyzed periodically. The frequency and depth of such analysis will depend upon the degree of management impact at the various echelons of review. Analysis should answer such questions as—

(1) Where do backlogs or bottlenecks exist?

(2) Where is the workload light or heavy in terms of assigned personnel?

(3) What organizational element(s) are failing to meet production standards?

(4) When did the element(s) start to fall behind schedule? Were required management actions taken to correct the situation?

d. Cause of deficiencies. Disclosure of the existence of deficiencies enables the manager/supervisor to find the cause. These may be traceable to—

(1) Poor or inadequate supervision.

(2) Low morale.

(3) New and inexperienced labor, or poorly trained labor.

(4) Breakdown of tools or equipment, or inadequate or poorly utilized tools and equipment.

(5) Careless or poorly organized work methods.

(6) Excessive absenteeism.

(7) Personnel not assigned to units in proportion to work load.

8-4. Use of Charts.

a. Charts to record daily cumulative performance data are excellent management tools for improving operations. Such charts reflect trends and establish a factual basis for needed in depth evaluation of operating efficiency and productivity. They also provide an opportunity to identify and correct weaknesses before they assume dangerous or serious proportions.

b. Suggested examples for development and maintenance of charts reflecting such performance data as receiving and shipping records are shown in figure 8-1 (A and B).

c. Examples for charts reflecting tons of material handled and units inspected are shown in figure 8-2 (A and B).

d. A continuing chart record of receiving and shipping performance would show as a minimum:

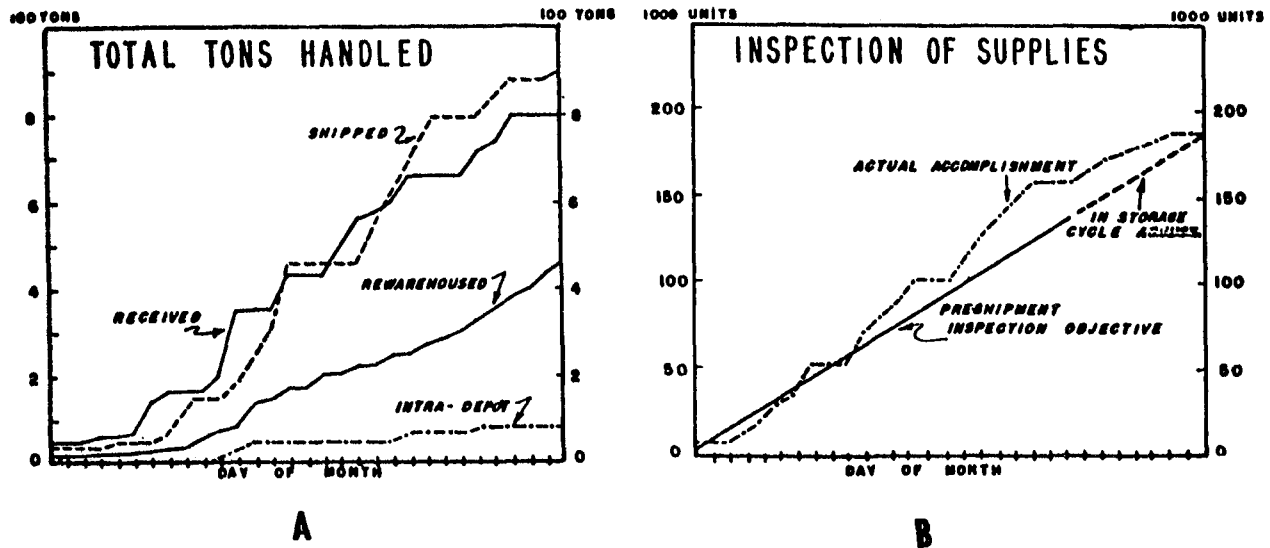

Figure 8-1. This type of chart shows where you have been, where you are, and where you are heading.

(1) Productivity to date as better or worse and its plus or minus relationship to the record of the previous day or week.

(2) Current productivity comparison with that of the previous month or year.

e. Charts may be kept on a daily, weekly, or monthly basis according to type data presented.

f. In preparing charts, the first step is identification and insertion of the acceptable performance standard.

g. Next, apply horizontal lines above and below the identified standard. As shown in figure 8-1 (A and B), one line is drawn at 20 percent above the standard and another drawn 20 percent below standard.

h. An activity is rarely able to judge its progress overall by how many units are processed on a given day but rather by how many units were processed through a given date in a period of time. An acceptable means of accomplishing this is if, beginning with the first day of the month, the performance units per production man-hour are inserted for that day. On the second day, the first and second day's performance is added. Average the two and insert the figure, and so on.

i. Charts should be large enough to be easily read and placed in a conspicuous location to command attention to personnel employed in the activity.

j. Payload tonnage (fig 8-2A) handled by an activity is normally the sum of tons received and tons shipped. A rise in handling intra-installation

tonnage or a continual and significant increase in intra-installation tonnage bears investigation because a number of deficiencies may be entering the operation. Some of these may be crosshauling that could be reduced or eliminated, the use of inefficient or improper vehicular equipment, or lack of proper planning or supervision. Generally speaking, the less the intra-installation material movement and handling and the more the tonnage handled in and out, the healthier the situation.

k. Figure 8-2B shows the material inspection (quality control) objective(s) for a given period. In the example, the number of units anticipated for preshipment inspection is shown together with an estimate of in-storage or in-process inspections planned or scheduled which, in the main, would have negated the need for preshipment inspection. The dotted line shows how close to attainment of the objective was the accomplishment.

8-5. Analysis of Methods.

a. *Analysis to precede equipment selection.* MHE and tools should not be selected or requisitioned for an operation until after a thorough analysis has been made of the materials to be handled, the conditions and environment in which the work will be performed, and the method to be employed.

b. *Operation lists.* In any handling problem, there will be several specific operations which must be performed. Listing these operations, in the sequence performed, may be sufficient to indi-

cate the method to be employed and, in any case, should serve as a valuable guide and check to more detailed analyses which may be made at a later date.

c. *Work simplification.* The purpose of work simplification is to eliminate unnecessary work

elements and develop or find simpler methods of accomplishing necessary work. This can be accomplished by questioning each step in the process (what and where, when and how, what and who), changing the sequence of operations as necessary, combining some operations, or eliminating some job elements.

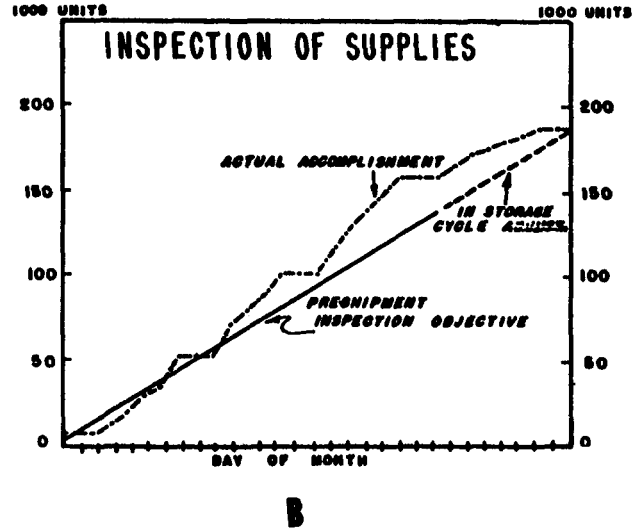
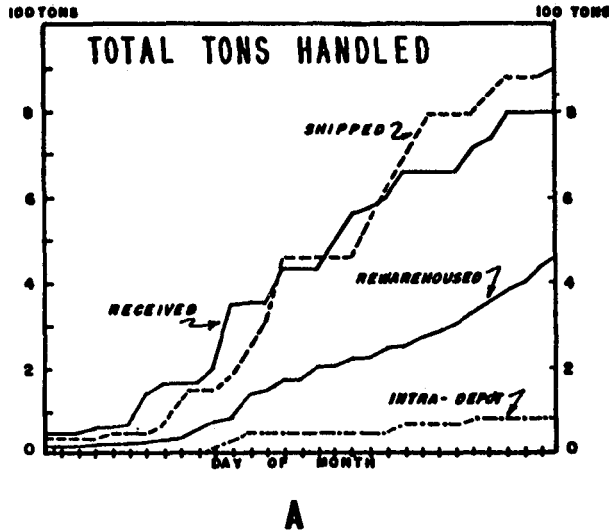

Figure 8-2. Charts can take different forms.

d. *Motion study.* Motion study refers to the study of the motions made by the workers in performing assigned tasks. This study may be merely the visual observation of the worker. Important things to observe include the distance the operator reaches for his tools and supplies, the number of steps he takes, the repetition of tasks, and the smoothness of the motion pattern. Often, merely by listing the specific tasks carried out by a worker in connection with the performance of an operation, unnecessary steps and excessive movements can be eliminated.

e. *Flow chart diagram.* The flow chart and the flow diagram are used for the study of material flow from one work area to another. A completed chart or diagram graphically depicts an operation. Included in the chart are distances, physical conditions affecting the operation, and the number of times procedures and tasks are repeated.

f. *Methods study/work standards.* This is a systematic analysis of an operation utilizing industrial engineering techniques to determine the optimum method or procedure to accomplish an operation and the time it should take. The operation must be segmented by the analyst into elements appropriate for timing. This is not to be construed

as physical revision to the production process unless this is an obvious and necessary recourse. The actual timing of each performance is relatively simple. Assuring that the time reflects normal operations under normal conditions is more difficult and requires an estimate of the pace of a worker by a skilled analyst or technician. Time standards are valid as long as changes are not made in the operation, system, method, condition or type of operating equipment, or the number of personnel assigned to perform the work. Time standards include a time allowance for personnel needs, normal worker fatigue, and avoidable delays of short duration. Changes made to work under time standards should be the result of methods analysis, change in product, equipment work content, or economic factors. Time standards provide a valuable tool for planning and controlling work, as a means for measuring the efficiency of operations and for determining the amount of manpower resources required.

8-6. Use of Incentive Awards Program.

a. The awarding of case and/or commendations for new and acceptable suggestions has become one of management's most important tools. The

use of an Incentive Awards Program has two basic advantages, one of which is that it encourages new ideas. Experience has shown that top level management has no monopoly on originality. New ideas can flow up as well as down and very often do. The individual actually performing a warehouse operation is perhaps in the best position to recognize the need or desirability for a change in procedure and to develop scientific methods for its improvement.

b. The other advantage of this program is that it stimulates interest and encourages employee participation in management. It serves as a means of according due recognition to those who make suggestions. By inviting the attention of supervisors to those employees who are striving to improve the efficiency of their organization, it is a morale builder of major importance.

8-7. On-site Reviews and Checks.

a. General. Periodic on-site reviews are another indispensable tool of management.

(1) By this means managers can determine the extent to which instructions, regulations, and operational procedures are being carried out.

(2) The manager should make a daily review of at least one phase or segment of the operation. These reviews should be planned on a cycle basis so that at the end of a specific period they will have covered all phases of the operations. In turn, key and line supervisors should also make frequent checks of their particular activity.

(3) Reviews made by management personnel should include all administrative and operational functions bearing directly or indirectly on operations. More specifically, they should include the following:

(*a*) Application of established operational policies, procedures, and instructions.

(*b*) Application of the most economical administrative and technical methods for the utilization of personnel, equipment, and storage space.

(*c*) Suitability of space, MHE, and operational methods, as applied to a specific facility and the type of material stored or handled therein.

(*d*) Training of personnel.

(*e*) Information with respect to methods and procedures which do not conform to agency regulations.

(*f*) Labor difficulties being experienced either within the operation or from outside sources.

(*g*) Excessive operational costs pertaining to personnel, space, equipment, and storage.

(*h*) Inaccurate, superfluous, or insufficient documentation for required recording and accomplishment of operations.

b. Supervisory checks. Checks made by supervisors should normally be more frequent and more detailed than those made by the manager. To ensure that any deficiencies on reviews are speedily corrected, appropriate followup action must always be taken.

APPENDIX A

REFERENCES

A-1. Joint Service/Agency Publications

DLAM 4145.2/TM 38-230/NAVSUP PUB 502/AFP 71-15/MCO 4030.31, VOL I. Packaging of Materiel: Preservation (Vol I)

DLAM 4145.2, VOL II/TM 38-230-2/NAVSUP PUB 503, VOL II/AFP 71-6/MCO 4030.21, VOL II. Packaging of Materiel: Preservation (Vol II)

AR 700-15/NAVSUPINST 4030.28/AFP 71-6/MCO 4030.33/DLAR 4145.7. Packaging of Materiel

DLAM 4145.8/AR 700-64/NAVSUPINST 4000.34/AFP 67-8/MCO P4400.105. Radioactive Commodities in the Department of Defense Supply Systems

DLAR 4145.25/AR 700-68/NAVSUP INST 4440.128/MCO 10330.2/AFP 67-12. Storage and Handling of Compressed Gases and Gas

AR 55-355/NAVSUPINST 4600.70/AFM 75-2/MCO P4600.14/DLAR 4500.3. Military Traffic Management Regulation

AR 735-11-2/DLAR 4140.55/NAVMATINST 4355.73/AFP 400-54/MCO 4430.3. Reporting of Item and Packaging Discrepancies

AR 55-38/RCS MTMC-54 (RI)/NAVSUPINST 4610-33/AFP 75-18/MCO P4610-19/DLAR 4500.15. Reporting of Transportation Discrepancies in Shipment

TM 38-260/NAVSUP PUB 523/AFP 71-18/MCO 4870.62. Preparation of Industrial Plant Equipment for Storage or Shipment

TM 38-410/DLAM 4145.11/NAVSUP PUB 573/AFP 69-9 XX/MCO 4450.12. Storage and Handling of Hazardous Materials

TM 5-632/AFM 91-16/NAVDOCKS MO 310. Military Entomology Operational Handbook

TB MED 144/NAVMED P-5052-26/AFM 161-3. Rodent Control

AR 40-14/DLAR 1000.28. Control and Recording Procedures for Exposure to Ionizing Radiation, and Radioactive Materials

A-2. DOD Publications

DODI 4145.19 Storage and Warehousing Facilities and Services

DOD 4500-32-R, Vol I. Military Standard Transportation and Movement Procedures

DOD 4500-32-R, Vol II. Military Standard Transportation and Movement Procedures

DOD 5200.1-R DOD Information Security Program Regulation (DODI-SPR)

DODI 4140.27 Identification, Control and Utilization of Shelf Life Items

DODI 4140.35 Physical Inventory Control for DOD Supply System Material

DPDO 4150.7 Department of Defense Pest Management Program (MRA&L)

DODI 4500.35	Processing and Shipping DOD Sponsored Retrograde Materiel Destined for Shipment to the United States, its Territories, Trusts, and Possessions (I&L)	MIL-C-16173	Corrosion Preventative Compound, Solvent Cutback, Cold Application
DODI 4140.22	Military Standard Transaction Reporting and Accounting Procedures	MIL-D-11303	Drum Handling Attachment, Forklift Truck (for Horizontal Handling)
A-3. Army Publications		MIL-L-1497	Labeling of Metal Cans for Subsistence Items
SB 11-30	FSC Class 6135; Dry Battery Management Data	MIL-L-14362	Lumber, Unitizing and Loading of
A-4. Air Force Publications		MIL-T-46755	Tires, Pneumatic, and Tires Semipneumatic, Installed on Vehicles, Preparation for Storage of
T.O.-00-25-213	Dry Cell Battery Procedure	MIL-C-495	Coating, Exterior, for Tinned Food Cans
A-5. Specifications and Standards		MIL-L-83762	Light, Extension, Fluorescent, Explosion Proof
<i>Federal Specifications</i>			
QQ-S-781	Strapping, Steel, Flat and Seals	MIL-W-19928	Wrenches, Box and Open-End, Fixed, Non-Sparking, and Non-Magnetic
RR-C-271	Chains and Attachments, Welded, Weldless and Roller Chain	<i>Military Standards</i>	
GGG-B-325	Binder, Load	MIL-STD-101	Color Code for Pipelines and for Compressed Gas Cylinders
PPP-D-1427	Dunnage, Pneumatic, Cargo Shoring	MIL-STD-107	Preparation and Handling of Industrial Plant Equipment for Shipment and Storage
<i>Federal Standards</i>			
FED-STD-595	Color (Requirements for Individual Color Chips (3 X 5 Supplements) Should be Submitted to the Naval Publications and Forms Center, Philadelphia, citing FED-STD-595 Together with Appropriate Chip Number as Shown Therein)	MIL-STD-129	Marking for Shipment and Storage
<i>Military Specifications</i>			
MIL-T-004	Tire, Pneumatic, and Inner Tube, Pneumatic Tire: Tire and Flap, Packaging of	MIL-STD-137	Materials Handling Equipment
MIL-C-12000	Cable, Cord, and Wire Electric Packaging of	MIL-STD-147	Palletized and Unit Loads
		MIL-STD-163	Steel Mill Products, Preparations for Shipment and Storage

MIL-STD-290	Packaging, Packing and Marking of Petroleum and Related Products
MIL-STD-904	Guidelines for Insect Infestation of Subsistence
MIL-STD-1189	DOD Standard Bar Code Symbology
MIL-STD-1363	Measurement of Wood Moisture Content
MIL-STD-1458	Radioactive materials, Marking and Labeling of Items Packages and Shipping Containers for Identification in Use, Storage, and Transportation
MIL-STD-1486	In-Transit Fumigation of Freight Cars
<i>Military Handbooks</i>	
MIL-HDBK-7	Lumber and Allied Products
MIL-HDBK-201	Petroleum Operations

MIL-HDBK-701

Blocking, Bracing, and Skidding of Industrial Plant Equipment for Shipment and Storage

MIL-HDBK-721

Corrosion and Corrosion Protection of Metals

A-6. Miscellaneous Publications

SECTION 5 Codes volume 5, class 1, division 2—National Electric Code

National Fire Codes, 10 volumes, Published by National Fire Protection Association (May be obtained from 470 Atlantic Avenue, Boston, MA 02210)

Strategic and Critical Material Storage Manual, published by General Services Administration (GSA)

Cleaning Petroleum Storage Tanks, Accident Prevention Manual No. 1 (Available from American Petroleum Institute, 1801 K Street, N.W., Washington, DC 20006)

Federal Personnel Manual, chapter 930, appendix A, instruction 261—Physical Standards for Motor Vehicle Operators and Incidental Operators

APPENDIX B

FORMS

DD Form 200	Report of Survey
DD Form 626	Motor Vehicle Inspection
DD Form 805	Storage Space Management Report
DD Form 857	Stock Discrepancy (Notice)
DD Form 858	Material Transfer Record
DD Form 1222	Requests for and Results of Tests
DD Form 1225	Storage Quality Control Report
DD Form 1348-1	Issue Release/Receipt Document
DD Form 1387-2	Special Handling Data Certification
DD Form 1532	Pest Management Report
DD Form 1574	Serviceable Tag—Materiel
DD Form 1574-1	Serviceable Label—Materiel
DD Form 1575	Suspended Tag—Materiel
DD Form 1575-1	Suspended Label—Materiel
DD Form 1576	Test/Modification Tag—Materiel
DD Form 1576-1	Test/Modification Label—Materiel
DD Form 1577	Unserviceable (Condemned) Tag—Materiel
DD Form 1577-1	Unserviceable (Condemned) Label—Materiel
DD Form 1577-2	Unserviceable (Reparable) Tag—Materiel
DD Form 1577-3	Unserviceable (Reparable) Label—Materiel
SF 361	Transportation Discrepancy Report
SF 364	Report of Discrepancy (ROD)

APPENDIX C

METRIC/TEMPERATURE CONVERSION CHARTS

CHEMICAL INDEX

TEMPERATURE CONVERSION CHART—Part One

SAUVEUR TEMPERATURE CONVERSION CHART

This very convenient set of tables was compiled by Dr. Albert Sauveur. When converting temperatures from either Centigrade or Fahrenheit, refer to the center column in italics. If converting from Centigrade to Fahrenheit, the equivalent temperature is indicated in the column to the right. If converting from Fahrenheit to Centigrade, the equivalent temperature is indicated in the column to the left.

Other temperatures may be converted based upon the formulae:

Degrees Centigrade equals $5/9$ (degrees F. minus 32).

Degrees Fahrenheit equals $9/5$ degrees C. plus 32.

C.	F.	C.	F.	C.	F.			
-73.0	-100	-148.0	-12.8	9	48.2	17.8	64	147.2
-68.0	-90	-130.0	-12.2	10	50.0	18.3	65	149.0
-62.0	-80	-112.0	-11.7	11	51.8	18.9	66	150.8
-57.0	-70	-94.0	-11.1	12	53.6	19.4	67	152.6
-51.0	-60	-76.0	-10.6	13	55.4	20.0	68	154.4
-46.0	-50	-58.0	-10.0	14	57.2	20.6	69	156.2
-40.0	-40	-40.0	-9.4	15	59.0	21.1	70	158.0
-39.4	-39	-38.2	-8.9	16	60.8	21.7	71	159.8
-38.9	-38	-36.4	-8.3	17	62.6	22.2	72	161.6
-38.3	-37	-34.6	-7.8	18	64.4	22.8	73	163.4
-37.8	-36	-32.8	-7.2	19	66.2	23.3	74	165.2
-37.2	-35	-31.0	-6.7	20	68.0	23.9	75	167.0
-36.7	-34	-29.2	-6.1	21	69.8	24.4	76	168.8
-36.1	-33	-27.4	-5.6	22	71.6	25.0	77	170.6
-35.6	-32	-25.6	-5.0	23	73.4	25.6	78	172.4
-35.0	-31	-23.8	-4.4	24	75.2	26.1	79	174.2
-34.4	-30	-22.0	-3.9	25	77.0	26.7	80	176.0
-33.0	-29	-20.2	-3.3	26	78.8	27.2	81	177.8
-33.3	-28	-18.4	-2.8	27	80.6	27.8	82	179.6
-32.8	-27	-16.6	-2.2	28	82.4	28.3	83	181.4
-32.2	-26	-14.8	-1.7	29	84.2	28.9	84	183.2
-31.7	-25	-13.0	-1.1	30	86.0	29.4	85	185.0
-31.1	-24	-11.2	-0.6	31	87.8	30.0	86	186.8
-30.6	-23	-9.4	+0.0	32	89.6	30.6	87	188.6
-30.0	-22	-7.6	0.6	33	91.4	31.1	88	190.4
-29.4	-21	-5.8	1.1	34	93.2	31.7	89	192.2
-28.9	-20	-4.0	1.7	35	95.0	32.2	90	194.0
-28.3	-19	-2.2	2.2	36	96.8	32.8	91	195.8
-27.8	-18	-0.4	2.8	37	98.6	33.3	92	197.6
-27.2	-17	+1.4	3.3	38	100.4	33.9	93	199.4
-26.7	-16	3.2	3.9	39	102.2	34.4	94	201.2
-26.1	-15	5.0	4.4	40	104.0	35.0	95	203.0
-25.6	-14	6.8	5.0	41	105.8	35.6	96	204.8
-25.0	-13	8.6	5.6	42	107.6	36.1	97	206.6
-24.4	-12	10.4	6.1	43	109.4	36.7	98	208.4
-23.9	-11	12.2	6.7	44	111.2	37.2	99	210.2
-23.3	-10	14.0	7.2	45	113.0	37.8	100	212.0
-22.8	-9	15.8	7.8	46	114.8	40.6	105	221.0
-22.2	-8	17.6	8.3	47	116.6	43.3	110	230.0
-21.7	-7	19.4	8.9	48	118.4	46.1	115	239.0
-21.1	-6	21.2	9.4	49	120.2	48.9	120	248.0
-20.6	-5	23.0	10.0	50	122.0	51.7	125	257.0
-20.0	-4	24.8	10.6	51	123.8	54.4	130	266.0
-19.4	-3	26.6	11.1	52	125.6	57.2	135	275.0
-18.9	-2	28.4	11.7	53	127.4	60.0	140	284.0
-18.3	-1	30.2	12.2	54	129.2	62.8	145	293.0
-17.8	0	32.0	12.8	55	131.0	65.6	150	302.0
-17.2	1	33.8	13.3	56	132.8	68.3	155	311.0
-16.7	2	35.6	13.9	57	134.6	71.1	160	320.0
-16.1	3	37.4	14.4	58	136.4	73.9	165	329.0
-15.6	4	39.2	15.0	59	138.2	76.7	170	338.0
-15.0	5	41.0	15.6	60	140.0	79.4	175	347.0
-14.4	6	42.8	16.1	61	141.8	82.2	180	356.0
-13.9	7	44.6	16.7	62	143.6	85.0	185	365.0
-13.3	8	46.4	17.2	63	145.4	87.8	190	374.0

APPENDIX C (Continued)

CHEMICAL INDEX

TEMPERATURE CONVERSION CHART—Part Two

C.	F.	C.	F.	C.	F.			
90.6	195	383.0	237.8	460	860.0	510.0	950	1742 0
93.3	200	392.0	240.6	465	869.0	515.0	960	1760 0
96.1	205	401.0	243.3	470	878.0	520.0	970	1778 0
98.9	210	410.0	246.1	475	887.0	526.0	980	1796 0
101.7	215	419.0	248.9	480	896.0	532.0	990	1814 0
104.4	220	428.0	251.7	485	905.0	538.0	1000	1832 0
107.2	225	437.0	254.4	490	914.0	549.0	1020	1868 0
110.0	230	446.0	257.2	495	923.0	560.0	1040	1904 0
112.8	235	455.0	260.0	500	932.0	571.0	1060	1940 0
115.6	240	464.0	265.0	510	950.0	582.0	1080	1976 0
118.3	245	473.0	271.0	520	968.0	593.0	1100	2012 0
121.1	250	482.0	276.0	530	986.0	604.0	1120	2048 0
123.9	255	491.0	282.0	540	1004.0	615.0	1140	2084 0
126.7	260	500.0	288.0	550	1022.0	627.0	1160	2120 0
129.4	265	509.0	293.0	560	1040.0	638.0	1180	2156 0
132.2	270	518.0	299.0	570	1058.0	649.0	1200	2192 0
135.0	275	527.0	304.0	580	1076.0	660.0	1220	2228 0
137.8	280	536.0	310.0	590	1094.0	671.0	1240	2264 0
140.6	285	545.0	315.0	600	1112.0	682.0	1260	2300 0
143.3	290	554.0	321.0	610	1130.0	693.0	1280	2336 0
146.1	295	563.0	326.0	620	1148.0	704.0	1300	2372 0
148.9	300	572.0	332.0	630	1166.0	716.0	1320	2408 0
151.7	305	581.0	338.0	640	1184.0	727.0	1340	2444 0
154.4	310	590.0	343.0	650	1202.0	738.0	1360	2480 0
157.2	315	599.0	349.0	660	1220.0	749.0	1380	2516 0
160.0	320	608.0	354.0	670	1238.0	760.0	1400	2552 0
162.8	325	617.0	360.0	680	1256.0	771.0	1420	2588 0
165.6	330	626.0	365.0	690	1274.0	782.0	1440	2624 0
168.3	335	635.0	371.0	700	1292.0	793.0	1460	2660 0
171.1	340	644.0	376.0	710	1310.0	804.0	1480	2696 0
173.9	345	653.0	382.0	720	1328.0	816.0	1500	2732 0
176.7	350	662.0	387.0	730	1346.0	843.0	1550	2822 0
179.4	355	671.0	393.0	740	1364.0	871.0	1600	2912 0
182.2	360	680.0	399.0	750	1382.0	899.0	1650	3002 0
185.0	365	689.0	404.0	760	1400.0	927.0	1700	3092 0
188.2	370	698.0	410.0	770	1418.0	954.0	1750	3182 0
190.6	375	707.0	415.0	780	1436.0	982.0	1800	3272 0
193.3	380	716.0	421.0	790	1454.0	1010.0	1850	3362 0
196.1	385	725.0	426.0	800	1472.0	1037.0	1900	3452 0
198.9	390	734.0	432.0	810	1490.0	1065.0	1950	3542 0
201.7	395	743.0	438.0	820	1508.0	1093.0	2000	3632 0
204.4	400	752.0	443.0	830	1526.0	1121.0	2050	3722 0
207.2	405	761.0	449.0	840	1544.0	1149.0	2100	3812 0
210.0	410	770.0	454.0	850	1562.0	1177.0	2150	3902 0
212.8	415	779.0	460.0	860	1580.0	1204.0	2200	3992 0
215.6	420	788.0	465.0	870	1598.0	1232.0	2250	4082 0
218.3	425	797.0	471.0	880	1616.0	1260.0	2300	4172 0
221.1	430	806.0	476.0	890	1634.0	1288.0	2350	4262 0
223.9	435	815.0	482.0	900	1652.0	1316.0	2400	4352 0
226.7	440	824.0	487.0	910	1670.0	1343.0	2450	4442 0
229.4	445	833.0	493.0	920	1688.0	1371.0	2500	4532 0
232.2	450	842.0	498.0	930	1706.0	1398.0	2550	4622 0
235.0	455	851.0	504.0	940	1724.0			

PARTIAL IMMERSION CORRECTION

For correcting the reading of a total-immersion thermometer when used partially immersed, the following formula will be found fairly accurate:

Correction degrees equals 0.00016° C. (or 0.000089° F.) multiplied by the degrees of mercury column emergent, the product of which is multiplied by the remainder after subtracting the temperature reading of the thermometer minus the average temperature of the emergent stem.

Otherwise stated, Correction ° equals 0.00016° C. (or 0.000089° F.) N (T—t).

N equals degrees of mercury column emergent. T equals temperature reading of thermometer t equals average temperature of emergent stem.

GLOSSARY

Uniform terminology is basic to uniform operating procedures.

Following is a glossary of words and terms making up the language of storage and materials handling for operating personnel:

Advanced decay—The stage of decay in which the disintegration is readily recognized because the wood has become punky, soft and spongy, stringy, pitted, or crumbly.

Air-dried or *air-seasoned*—Dried by exposure to the air, usually in a yard, without artificial heat.

Airshipment—Transportation by air either CONUS or OCONUS.

Aisle—Any passageway within a storage area.

Allocated space—A definite number of net square feet of a specified type of storage space formally apportioned for use.

Assembly—Area used for collecting and combining material components.

Assignment of space—Designation of specific space within the installation for storage purposes.

Attainable cubic feet—The product of net storage space (sq ft) multiplied by the stacking height(s) permitted by safety regulations/restrictions and floor load limitations with available materials handling equipment (MHE) and storage aids.

Attainable storage height—The height permitted by safety regulations/restriction and floor load limitations with available MHE and storage aids.

Backlog—An accumulation of incompleted work.

Bale—Articles or materials compressed in a shaped unit and usually bound with cord or metal ties under tension. May be wrapped in paper, thin veneer wood, textile material, or combinations thereof.

Bar code—An array of rectangular marks and spaces in a predetermined pattern depicting machine language information which can be numeric, alpha, or combinations.

Bare item—An item that has had all packaging materials removed to allow for functional inspections.

Battery charger—An electrical device used for recharging batteries that operate equipment.

Bay—Designated area within a section of a warehouse or depot shop, usually outlined or bounded by posts, pillars, columns, or painted lines.

Bill of lading—A document used to procure freight and cargo transportation, and related services, from commercial carriers for the movement of material.

Bin area—An area for the storage of supply items which are binnable.

Binder—Any material such as burlap, heavy paperboard, or thin lumber placed between layers of stock to stabilize stacks.

Bin storage space—Area in which bins have been erected, including the aisles and working space between bins.

Blitz can—The standard U.S. Government issue 5-gallon container used especially to transport water or gasoline. (Sometimes referred to as a "jerry can.")

Block—Self-supporting regular stack of supplies, two or more units wide, two or more deep, and two or more high. A block may be rectangular or pyramidal.

Block storing—Storage of similar containers or material in a block.

Blue stain—A bluish or grayish discoloration of the sapwood caused by the growth of certain moldlike fungi on the surface and in the interior; made possible by the same conditions that favor the growth of other fungi.

Bolster—Block of hardwood supporting drafts of lumber and used when transporting the drafts by means of truck straddle carriers.

Box—A rigid container having closed faces, usually constructed of wood, metal, paperboard, fiberboard, plywood, plastic, or a combination of such materials. Strength and stability is dependent upon the material of the faces and the fastening of faces in assembling the box.

- Box car*—A fully enclosed freight car having doors on both sides and/or sometimes on the ends. Used for general freight services.
- Box pallet*—A pallet with framework on the back and sides. This storage aid is designed so that several may be stacked and the weight is supported by the framework rather than the supplies.
- Box shop*—Area used for fabricating, manufacturing, assembling, or repairing containers and storage aids.
- Bridge plate*—Plate, usually of metal, used to span the space between freight cars or trucks and the loading platform.
- Brown stain*—A rich brown to deep chocolate-brown discoloration of the sapwood in some pines caused by a fungus that acts similarly to the blue-stain fungus.
- Bulk liquid storage space*—Space inside tanks designed for the storage of liquid bulk.
- Bulk storage*—Storage in warehouses of any large quantity of supplies usually in original containers or storage of liquids or solids such as coal, lumber, rubber bales, petroleum products, or ores in tanks or piles.
- Bursting strength*—The pressure required to rupture a container when it is tested in a specified instrument under specified conditions.
- Butt boards*—Boards arranged at an angle on a sorting platform to facilitate the formation of lumber drafts with uniform faces.
- Caged storage*—Storage space segregated within a building and specially screened or barricaded to prevent pilferage or to isolate hazardous materials.
- Care of supplies in storage (COSIS)*—A program whereby supplies and equipment in storage are preserved in a serviceable condition through inspection and action taken to correct any forms of deterioration and to restore the supplies to ready-for-use condition.
- Carrier*—A commercial transportation media providing railroad cars, motor trucks, ships, airplanes, or other conveyances for transporting supplies.
- Check*—A lengthwise separation of wood, the greater part of which occurs across the rings of annual growth.
- Chemical brown stain*—A discoloration of wood that sometimes occurs during the air or kiln drying, apparently caused by the oxidation of extractives.
- Chill space*—Refrigerated warehouse area in which the temperature can be controlled between 32°F. and 50°F. (0°C. and 10°C).
- Chute*—Usually an inclined trough (sometimes a tube) used to convey supplies from an upper to a lower level.
- Classified material*—Any product, substance, or media on, or in which classified information as defined in DOD 5200.1-R, information security program regulation, is embodied or from which such information can be obtained.
- Cleated-plywood box*—A rigid container constructed by joining six panel faces which are made of plywood, reinforced with wood edges or intermediate cleats.
- Commodity*—A specified grouping of items of supply.
- Common carriers*—See carrier.
- Condensation*—Moisture resulting from condensing such as the moisture gathered on a cold surface in a warm room.
- Consolidation station*—Place to which less than carload lots of freight are relayed so that they can be grouped with other freight to make full carloads for the same delivery point.
- Container*—A receptacle such as a bag, barrel, drum, box, crate or package used to hold and to protect contents. (See also the definition of container, intermodal, International Organization for Standardization (ISO).)
- Container, intermodal, ISO*—A reusable cargo conveyance which confines and protects the cargo from loss or damage, can be handled in transit as a unit, can be mounted and secured in or on marine, rail, or highway equipment and which meets the standards of ISO. Common types of containers are: weatherproof, dry enclosed, refrigerated, van, tank, non-weatherproof, open tops, car carrier, and flat rack.
- Contamination*—Any matter foreign to the finished element, compound, or part, which has an adverse effect on the material.

- Controlled humidity (CH) warehouse space*—Space which has been especially prepared for and equipped with equipment for control of humidity.
- Cooper*—To cover holes and cracks from the inside (e.g., freight cars, bags, containers, etc.) to prevent leakage of bulk grain.
- Corner marker*—A conspicuous marker placed at aisle intersections as a caution to personnel to prevent bumping stacks or other fixed objects.
- Corrosion*—Deterioration of material by chemical action, usually as a result of galvanic acid, alkaline action, or oxidation of metals.
- Corrosion preventive*—Any agent such as oil, plastic, paint, wrap, or other surface treatment of metals whose primary function is to prevent, inhibit, or deter corrosion.
- Corrosion preventive compound*—A compound applied to metal surfaces to prevent, inhibit, or deter rust or corrosion. The term is usually applied to compounds which can be removed by water or solvent cleaners in order to distinguish compound from paint films.
- Covered space*—Area within any roofed structure.
- Crate*—A rigid shipping container constructed of structural members fastened together to hold and protect the contents. It may be sheathed or unsheathed.
- Critical item*—Essential item which is in short supply or expected to be in short supply for an extended period. (Not to be confused with “critical application item” which is defined as an item essential to preservation of life in emergencies.)
- Cross aisle*—A passageway at right angles to main aisles used for the movement of supplies, equipment, and personnel.
- Cross stacking*—The placing of one layer of containers at right angles to those just below to increase the stability of the stack.
- Cross tie*—Cross layers of supplies as in cross stacking, except that only an occasional layer is crossed and not every other one.
- Cube*—The product of length by width by depth.
- Decay*—Disintegration of wood substance through the action of wood-destroying fungi.
- Deck boards*—Top or bottom surface of a pallet.
- Defect*—Any nonconformance with specified requirements.
- Degreasing*—Solvent cleaning by dipping, using hot vapor.
- Demurrage*—An assessment against the shipper or consignee for the detention of common carrier equipment beyond the period of free time allowed for loading or unloading.
- Direction of storage*—A method used to gain maximum storage space and various aisle arrangements to provide flexibility for storage operations.
- Desiccant*—A material which will absorb moisture by physical or chemical means.
- Deterioration*—Any impairment of item quality, value, or usefulness. Includes damage caused by erosion, oxidation, corrosion, or contamination.
- Down load*—The transmission of data and commands from the host computer to the portable bar code reader.
- Draft of lumber*—Lumber arranged and stacked in a bundle so as to facilitate shipment, storage, and handling.
- Drawbar pull*—The pulling power exerted at the drawbar (as by a locomotive or tractor).
- Drum*—Metal container for liquids, usually preceded by the quantity (e.g., 5-gal drum, 55-gal drum).
- Dry tank space*—Area in tanks designed for the storage of supplies other than bulk liquids or gases.
- Dry rot*—A term loosely applied in many types of decay but especially to that which, when in an advanced stage, permits the wood to be easily crushed to a dry powder. The term is actually a misnomer for any decay, since all fungi require considerable moisture for growth.
- Dunnage*—Any material (e.g., boards, planks, blocks, pneumatic pillows, etc.) used to support or secure supplies in storage or while in transit.
- End item*—A final combination of a product, component part, and/or material which is ready for its intended use.

Fire aisle—A passageway established to aid in fighting or preventing the spread of fire or for access to fire fighting equipment.

Fiberboard box—A three-dimensional shipping container made either of solid or corrugated fiberboard. Distinguished from a carton which is not designed as an outer shipping container.

Floor load—Weight that can safely be supported by a floor, expressed in pounds per square foot of floor space.

Floor plan—A scale drawing of the floor area of a building showing columns, stair wells, elevator shafts, offices, washrooms, doors, and other structural features.

Fogging—Application of chemical compound, in the form of vapor, to interior surfaces or relatively inaccessible surfaces.

Fragile—Delicate, weak, and easily damaged.

Freeze space—Refrigerated warehouse area where temperatures can be controlled below a level of 32 °F. (0 °C.).

Freight—All material, products, or commodities, express and mail, shipped by rail, water, highway, or air.

Fungus—A germ-like parasite which flourishes on organic material in a humid atmosphere at moderate and high temperatures.

Gondola—An open-top freight car with sides and ends.

Grain thief—Device consisting chiefly of a long tube used for taking grain samples from various depths in a load of grain.

Gross space for storage operations—That amount of gross storage space plus ingrated space minus unusable space, standby space, and outgranted space.

Gross space used in support of storage operations—That area used for preserving and packaging, assembling, packing and crating, container manufacturing, receiving, shipping, inspecting and identifying, administrative storage offices, rest areas, tool rooms, battery charging stations, and other similar support areas.

Gross storage space—Gross area, regardless of its location or the purpose for which the space was designed or designated, which is assigned or used for any operation concerning storage or the support of storage functions.

Gross weight—The weight of the container plus its contents.

Hazardous commodities—A commodity consisting of a material which, because of its quantity, concentration, or physical, chemical, or infectious characteristics, may either cause, or significantly contribute to, an increase in mortality or an increase in serious, irreversible, or incapacitating reversible illness; or pose a substantial present or potential hazard to human health or the environment when improperly treated, stored, transported, disposed of, or otherwise managed.

Hazardous materials/flammable warehouse—A compartmentalized facility for the storage of hazardous and/or flammable materials, excluding explosives, ammunition, and ammunition components.

Heartwood—The hard wood at the core of a tree trunk.

Honeycombing—The storing or withdrawing of supplies in a manner which results in vacant space that is not usable for storage of other items.

Humidity—Moisture in the air.

Humping—The switch of railroad car(s) in classification yards where the car(s) are pushed over a mound (hump) and the slope of the hump used to supply the motivation power for switching the car(s) onto the desired track(s). The "hump" track may or may not be equipped with car retarders.

Igloo space—Area in an earth-covered structure of concrete and/or steel designed for the storage of ammunition, explosives, and/or loaded ammunition components.

Incipient decay—The early stage of decay in which the disintegration has not proceeded far enough to soften or otherwise perceptibly impair the hardness of the wood.

Inert space—Space in a warehouse-type structure dedicated for the storage of nonexplosive ammunition or ammunition components.

Ingranted space—That amount of gross storage space operated which is leased, licensed, or permitted from one of the DOD Components.

Inspection—Examination and testing of supplies and services (including, where appropriate, raw materials, components, and intermediate

assemblies) to determine whether the supplies and services conform to contract requirements.

Intermediate pack—A wrap, box, or bundle which contains two or more unit packs of identical items.

Inventory—A physical count performed to determine the onhand quantity of an item or group of items.

Ionizing radiation—Any electromagnetic or particulate radiation capable of producing ions, directly or indirectly, in its passage through matter. (See radioactive material.)

Kiln dried—Dried in a kiln with the use of artificial heat.

Labor pool—A centrally controlled group of workers who are assigned to particular jobs or areas when needed.

Large-lot storage—A quantity of supplies, four or more stacks, stored to maximum height, usually accepted as stock stored in carload or greater quantities.

Laser gun—A laser-based bar code reading system operated by moving a focused spot or light beam across the pattern of bars and spaces that form the bar code, deciphering it instantly.

Layout—A floor plan showing assignment of gross space for storage operations and supporting functions.

Less-than-carload (LCL)—A quantity of freight less than that required for the application of a carload rate.

Leaker—A container which, through mechanical maladjustment or damage, is not hermetically sealed, permitting air to enter and product to exude.

Levels of packaging—A term used to refer to the degree of protection required during shipment, handling, and storage of supplies.

Line item—A separate item of supply on a transaction document.

Loading platform—A flat surface to facilitate loading or unloading, usually erected alongside a warehouse at the approximate level of a rail-car or truck floor.

Location audit reconciliation—Match between valid location records and the accountable

records, in order to identify and correct situations where items are in physical storage but not on record, on record but not in storage, or where common elements of data (other than quantity) do not match. Research of mismatches, including special inventories when required, results in corrective action.

Location survey—A physical verification, other than actual count, between actual assets and recorded location data to ensure that all assets are properly recorded as to location, identity, condition, and unit of issue.

Long ton—2,240 pounds or 1,016 kilograms.

Less-than-truckload (LTL)—A quantity of freight less than that required for the application of truckload rate.

Low combustibility—Materials which, in themselves, will not normally ignite, but which, in combination with their packaging, will contribute fuel to fire.

Magazine—Area in a warehouse-type structure above or below ground designed for storage of ammunition, explosives, and/or loaded ammunition components.

Main aisle—A passageway wide enough to permit the easy flow of equipment, supplies, and personnel (generally runs the length of the building). (Sometimes referred to as a transportation aisle.)

Major discrepancy—When the total dollar value of the overage or shortage for the stock number exceeds the dollar limits established by DODI 4140.35, Physical Inventory Control for DOD Supply System Material. Major discrepancies are used to compute and report error rates on a line item basis as a percentage of items inventoried.

Marking—Numbers, nomenclature, or symbols stamped, painted, or otherwise affixed to items or containers.

Materials handling—The movement of materials (raw, scrap, semi-finished, and finished) to, through, and from productive processes; in warehouses and storage; and in receiving and shipping areas.

Materials handling equipment (MHE)—As discussed in this manual, is defined as any stationary or mobile equipment, powered, mechanical, or hand operated, that is used for

the physical handling, storage, and movement of supplies.

Medium lot storage—A quantity of supplies, one to three stacks, stored to a maximum height.

Metric system—A decimal system of weights and measures based on the meter as a unit length and the kilogram as a unit mass. Derived units include the “liter” for liquid volume, “stere” for solid volume, and “are” for area.

Metric ton—2,205 pounds or 1,000 kilograms.

Mezzanine—Area provided by the construction of an intermediate or fractional story between any floor and ceiling of any building used for storage operations.

Moderate combustibility—Materials and their packaging, both of which will contribute fuel to fire.

Moisture content of wood—Weight of the water contained in the wood, usually expressed in percentage of the weight of the oven-dry wood.

Nailed wood box—A box constructed of wood/faceboards assembled by fastening the top, sides, and bottom to the ends with nails or screws or sides to ends with interlocking mortise and tenon corners.

Net storage space—That amount of gross space for storage operations minus space used for aisles, structural loss, and support space.

Net weight—The weight of the contents, not including the container.

Nomenclature—A noun and any necessary modifying adjectives required to describe and identify an item of supply.

Noncombustibility—Materials and their packaging which will neither ignite nor support combustion.

Nonperishable items—Items which do not require refrigeration during transportation and storage.

Nonstorage space—Area within gross space which is not used for storage because of structural loss or designation for other than storage purposes.

Obligated—Portion of net usable storage area earmarked by depot authority for the storage of supplies due in.

Occupied net storage space (cu ft)—The product of occupied net square feet multiplied by actual storage heights or representative storage heights determined by statistical sampling when applicable.

Occupied net storage space (sq ft)—Floor area which is actually occupied by material plus the entire bin and rack areas minus aisles.

Office space—Space utilized by storage personnel in the performance of routine office-type duties. Excludes office space located in warehouses or other buildings not used in support of storage operations.

Open space—Improved or unimproved area designated for use in storing material.

Open improved space—Area which has been graded and hard surfaced or prepared with topping of some suitable material so as to permit effective materials handling operations.

Open unimproved space—Area which has not been surfaced but which is actually in use (occupied) for storage purposes.

Open unimproved wet space—Water area specifically allotted to and usable for the storage of floating equipment.

Organizational clothing and equipment—Common use clothing and equipment centrally accounted for and temporarily issued to activities, units, and/or individuals on a recurring or temporary basis. Normally managed for, or by, military organizations for operations and exercises.

Original pack—The first pack applied to a specified quantity of items.

Osnaburg—A rough, coarse, durable cotton fabric in plain weave used for bagging and industrial purposes.

Other space—Any area assigned for storage operations within a structure designed for other than storage purposes, such as dry tank space, barracks, hangers, transitory shelters, and quonset buildings.

Outgranted space (DOD)—The amount of gross storage space which is not available for the reporting activity's operation because it is licensed or permitted to other DOD Components for their operation.

Outgranted space (non-DOD)—The amount of gross storage space which is not available for the reporting activity's operation because it is outleased, licensed, or permitted to private or non-DOD Government agencies for their operations.

Overseas shipment—Supplies consigned to a destination OCONUS.

Packaging—The process and procedures used to protect material from deterioration and/or damage. Includes cleaning, drying, preserving, packing, marking, and unitizing. (See preservation and packing.)

Packing—Assembly of items into a unit, intermediate or exterior pack with necessary blocking, bracing, cushioning, weather-proofing, reinforcement, and marking.

Packing and crating area—Area used for the application of exterior shipping containers.

Pallet—A low, portable platform of wood, metal, or fiberboard to facilitate the act of moving, storing, and transporting of supplies as a unit.

Pallet support sets—Intended to form box-type pallets when assembled onto flat wood pallets to allow for stacking of pallets containing irregularly shaped commodities that are susceptible to crushing.

Palletized unit load—Quantity of any item, packaged or unpackaged, arranged on a pallet and securely fastened thereto, so that the whole is handled as a unit.

Palletizing—The placement and securing, when necessary, of units or containers on pallets.

Perishable items—Items which require refrigeration during transportation and storage.

Pest control management—A program to prevent or minimize losses or building damage caused by vermin.

Pile—A quantity of material that can be stacked or stored in a specified area.

Planograph—A scale drawing of a storage area showing the approved layout.

Pocket rot—Advanced decay which appears in the form of a hole, pocket, or area of soft rot usually surrounded by apparently sound wood.

Portable bar code reader—A device used for machine reading of a bar code. Readers may em-

ploy hand-held wands or laser guns with fixed or moving optical beams.

Portable tank—A closed container having a liquid capacity over 60 U.S. gallons and not intended for fixed installation (see 29 CFR 1910.106).

Potential storage height—The height to which supplies are capable of being stored in accordance with proper warehousing practices.

Potential vacant—Space that is usable but not used and can normally be recouped through rewarehousing.

Potential vacant space—That portion of occupied net usable space which is temporarily not used for storage because of space voids in front of stacks of material (honeycombing) or space voids at the height of stacks which can be made available by rewarehousing or utilization of maximum heights in stacking.

Preservation—Application of protective measures including cleaning, drying, preservative materials, barrier materials, cushioning, and containers when necessary.

Preservation area—Area used for preserving, unit/intermediate packing, and marking of materials.

Preservative—Materials or substances that are applied to, or come in contact with, items to protect them from deterioration resulting from exposure to environmental conditions during shipment or storage.

Prompt—A command generated by the host computer and transmitted to the portable bar code reader to direct inventory personnel while performing inventories.

Rack space—Floor area occupied by racks, box pallets, or pallets with metal superstructures installed when such are used as permanent storage aids, identified as a specific location, and as distinguished from bulk storage.

Radioactive material—Any material or combination of materials which spontaneously emits ionizing radiation, includes natural elements such as radium and accelerator-produced radionuclides.

Rail storage space—Trackage allotted for the purpose of storing rolling stock.

Ramp—An inclined plane serving as a way between different levels.

Receiving—The receipt of inbound supplies, includes planning, handling, and document processing incident thereto.

Receiving area—Area used for checking, inspecting, and preparing incoming material (both new procurements and returns) prior to its delivery to storage areas.

Rejection—Nonacceptance of material.

Relative Humidity (RH)—The amount of water vapor in the air, expressed as a percentage of the maximum amount that the air could hold at the given temperature.

Requisition—Authoritative demand or request for supplies or services on form(s) authorized for such requests.

Retrograde—Any material being returned to a storage activity from the user. This includes, but is not limited to, material in unserviceable condition.

Rewarehousing—Relocation of supplies within the same storage activity.

Scan—Moving a reading device (wand with a fixed or moving optical beam) across a pattern of bars and spaces that form a bar code.

Security—Protection of supplies against theft, sabotage, or other malicious acts.

Seasoning—Removing moisture from green wood in order to improve its serviceability.

Shed—A nonwarehouse building without complete side and end walls.

Shipping—Actions necessary to deliver material to a carrier for movement to a consignee.

Shipping area—Area used to assemble material pending its loading for shipment.

Shipping container—Any suitable exterior container used for shipment of supplies.

Shipping document—Form used to authorize the shipment of Government property.

Shooks—A bundle or set of tops, bottoms, sides, and ends of boxes ready to be put together; a veneer of wood out of which boxes (as wire-bound boxes) are made.

Small lot storage—A quantity of supplies comprising less than one stack.

Spacers—Wooden strips inserted between drafts of lumber to induce sufficient air currents between, through, and under the stacks to carry off moisture saturated air.

Spot—The placing of a truck or freight car in a desired location preparatory to loading or unloading.

Springer—A filled can with ends bulged as a result of overfilling, insufficient exhausting, or evolution of hydrogen or carbon dioxide gas through bacterial actions or action of acid contents on metal cans. (Sometimes referred to as a “sweller.”)

Stack—A quantity of supplies stored vertically, occupying approximately one pallet space on floor, utilizing necessary storage aid to assure stability.

Standby space—The amount of gross storage space contained in completely empty structures or in open improved areas which is not required to support the mission, which has been secured, and which is not included in vacant storage space.

Sticker—A wooden stick or strip placed between boards or plywood sheets stacked in piles to hasten drying and reduce warping—also called “crosser.”

Stock condition code—An alphabetic code to identify stock in terms of readiness for issue or to delineate status of material in storage not ready for issue.

Stock number—National stock number (NSN)—A 13-position designator assigned to a specific item of supply, that is purchased, stocked, or distributed within the Federal Government.

Storage—The keeping or placing of property in a warehouse, shed, or open area, or the state of being stored.

Storing—The orderly arranging of supplies in storage.

Strapping—Metal or nonmetallic materials used, or their application, for the reinforcing or securing of crates, boxes, bales, or bundles.

Structural loss—The amount of space not usable for storage because of construction features or physical characteristics.

Supplies—All items necessary for the equipment, maintenance, and operation of a military command.

Support set—A knockdown metal framework consisting of upright side sections, top supporting crossbars, and one or more bottom tie rods to be affixed to a pallet. (See pallet support set.)

Tally-in—Itemized list of supplies received or process of recording the number of containers or quantity of material received.

Tally-out—Itemized list of supplies included in an issue or shipment or process of recording the number of containers or quantity of material issued or shipped.

Tank storage—See dry tank.

Tarpaulin—Canvas or other materials usually treated to resist moisture and chemicals; used as a protective covering.

Temperature controlled space—Space in which the temperature can be controlled within specific limits.

Tier—A horizontal layer of a column, row, or stack.

Tonne—Metric ton (British).

Total cubic feet—The product of net storage space (sq ft) multiplied by the unobstructed stacking height permitted by safety regulations/restrictions in a particular storage area.

Transitory shelter—A prefabricated sectional, metal structure (normally with complete sides and ends but without utilities) classified as a storage aid rather than a real property facility. When used for storage, it is reported as "other nonwarehouse space."

Transportation—Media for the movement of personnel and material.

Type of loads—Type of loads as relating to stackability of material.

Type I—Easy load—The load is single item or single interior container which provides complete and uniform support to all faces of the shipping container. The contents are of moderate density and relatively sturdy. Some examples are wood or metal chests, tool kits, and canned/boxed items packed in a fiberboard box which completely fills the shipping container.

Type II—Average load—The load is composed of more than one item or interior container which gives some support to all faces of the shipping container. The contents are of moderate density and are relatively sturdy. Some examples are goods in metal cans which are not packed in the interior containers, bottles individually cushioned, hardware in cartons, etc.

Type III—Difficult load—The load gives little or no support to the shipping container. The contents can be extremely heavy, very fragile, very irregular in shape, bulk materials which are free to shift and flow, or a combination of several of these factors. Some examples are rivets, bolts and nuts, delicate instruments, machined parts, assemblies, etc.

Unheated space—Area not equipped with heating facilities.

Unit of issue—Designation of the item unit (e.g., as each, number, dozen, gallon, pair, pound, ream, set, yard).

Unit pack—The first tie, wrap, or container applied to a single item or quantity unit thereof, or to a group of items of a single stock number, preserved or unpreserved, which constitutes a complete or identifiable package.

Unobstructed stacking height—The distance between the floor and the lowermost point of overhead obstructions (e.g., sprinkler heads, joists, rafters, beams, roof trusses, lighting fixtures, duct work, etc.) less safety clearances.

Unusable space—The amount of gross storage space so deteriorated that it fails to provide a sufficiently protective environment for the storage of material, space that is unsafe for storage operations or its use would be in violation with established regulating criteria, and/or space that is restricted from use due to inadequate physical security protection.

Up load—The transmission of data from the portable bar code reader to the host computer.

Utilities—Facilities constructed for the service of the depot such as boiler rooms, power plants, etc.

V-board—Weather-resistant fiberboards of various grades and types.

Vacant net space—Usable space which is not occupied by material, storage bins, or racks.

Vacuum packed—Package from which air has been withdrawn, prior to hermetic sealing.

Vacuum packaging—A packaging method in which a commodity is sealed under vacuum.

Vault—A specially constructed, nonportable, burglarproof, fire-resistant structure for storage of material requiring maximum protection against pilferage or destruction.

W-board—Weather-resistant fiberboard of lower grades, thicknesses, and bursting strengths than V-board.

Wand—A reader that is hand held, applicable to bar coding, which when moved across the surface of a bar code, instantly deciphers the code.

Warehouse—A building designed for storage purposes and constructed with a roof and complete sides and end walls.

Warehouse chart—(See planograph.)

Warehouse denial—Advice that a specific item required on a shipping directive is not available due to stock exhaustion or other reasons.

Warehousing—The performance of physical functions incident to receipt, storage, and issue of supplies. (See definition of storage.)

Wet storage—Storage of ships or other floating equipment, afloat.

Wet tank—A tank designated for the storage of liquids.

Whipping of yarn—Material with which a rope end is bound.

Wirebound box—A shipping container whose sides, top, and bottom are of rotary cut lumber, sliced lumber, resawn lumber, fiberboard or combinations thereof, usually three eighths of an inch or less in thickness, fastened to cleats and to each other by means of binding wire and staples.