

**GUIDE FOR DESIGNING AND STAKING
CULVERT IN THE FIELD**

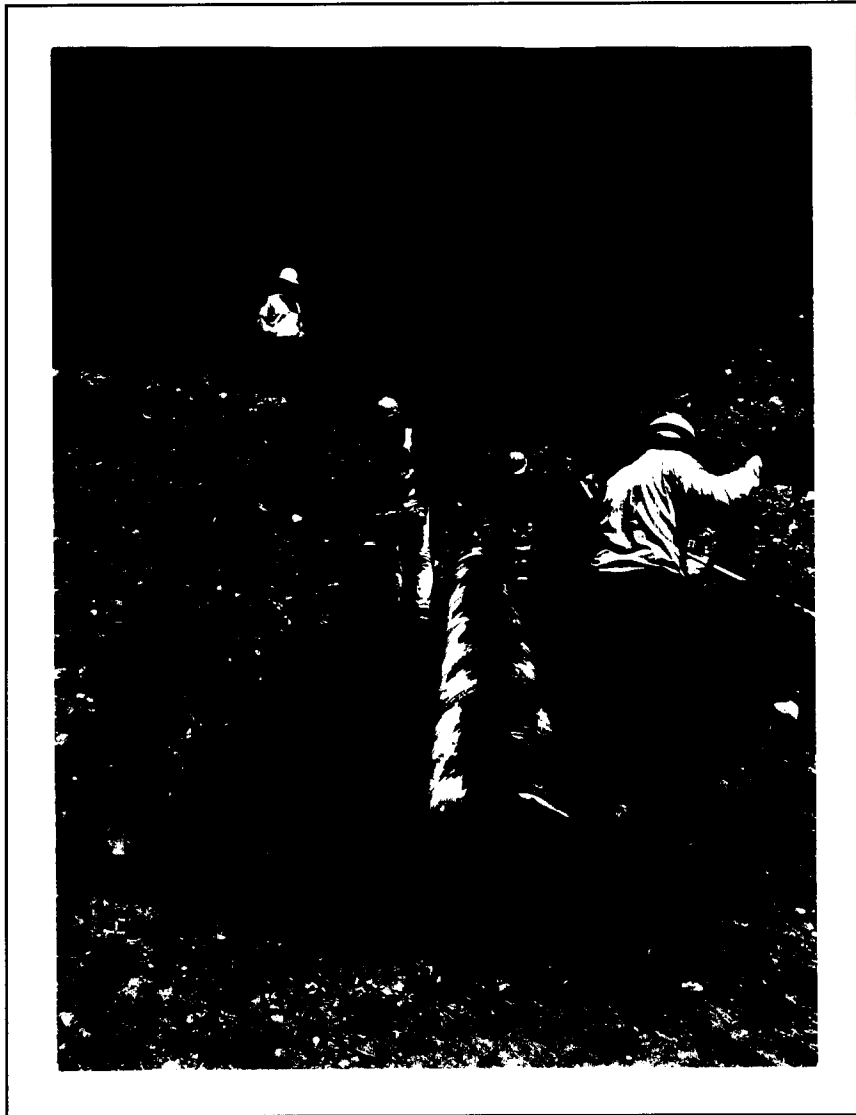

Central Federal Lands Highway Division

January 9, 1996

TABLE OF CONTENTS

I. Purpose	1
II. Introduction	2
III. Culvert Location	3
A. General Location Considerations	3
B. Location Considerations Based on Culvert Function	4
1. Natural Water Course Culvert	4
2. Ditch Relief Culvert	6
3. Approach Road Culvert	7
IV. Specific Elements	8
A. Catch Basins	8
B. Culvert Cover	9
C. Clear Zone Requirements	10
D. Fill and Cut Slope Intersection with Culvert	11
E. End Treatments	12
F. Camber	12
G. Elbows	13
H. Ditch Blocks	14
I. Gaskets	14
J. Broken Back Culvert and Over-the-side Drains	15
K. Pipe Anchors	16
L. End Sections with Toe Plate Extensions	17
V. Culvert Design and Plotting	17
A. Survey and Calculations	17
B. Plotting	19
VI. Referencing Culvert	21
VII. Glossary	22
Appendix A -- Standard Drawings	
Appendix B -- Guidelines for Clear Zones	
Appendix C -- Staking and Plotting Examples	

I. PURPOSE

When developing a project, As-Planned culvert locations are typically determined based on survey data generated on 20-meter (50-foot) interval cross sections. Due to variations in terrain between cross sections, the As-Planned culvert location will most likely require adjustment to properly fit the site conditions.

As set forth in the contract documents, the contractor is responsible for determining the final location of the culvert and designing and staking the culvert pipe. Each of the aforementioned tasks are subject to acceptance by the CFLHD contracting officer.

The process is somewhat subjective by nature and is further complicated by variations in contractor and contracting officer representative expertise. The purpose of this Guide is to address the typical situations which are encountered when designing and staking culvert.

The Guide will identify general design considerations for locating and positioning culvert to best fit field conditions. It will also identify design, plotting, and staking requirements. At times the guidance may appear contradictory because of the particulars of a site. In these cases, engineering judgement must determine the relative degree of importance of each design consideration for the particular site in question. This approach will allow one to arrive at the overall best "fit" for the culvert.

II. INTRODUCTION

Culvert should be staked early in the construction process. This allows slope stake changes associated with culvert installations to be incorporated into the production phase of earthwork operations.

This Guide is laid out in a chronological fashion. The following section (Section III) provides items to be considered for location of culvert. Section III is divided into general location considerations and considerations based on pipe function. Section IV discusses specific elements typically associated with culvert installations (e.g., end sections and elbows). The remaining portion of the text provides step-by-step instructions on surveying, plotting and referencing culvert. Section VII contains a glossary of terms pertinent to this manual. Standard drawings, guide lines for clear zones, and staking and plotting examples are appended.

Measurements and distances are listed in metric units with the corresponding English units in parentheses. The Standard Specifications for Construction of Roads and Bridges on Federal Highway Projects (FP) uses United States Standard measure (English) in versions up to and including the FP-92. The FP-96 uses the International System of Units (metric). For information regarding conversion to the metric system, see the *Metric Guide For Federal Construction* which is published by the National Institute of Building Sciences (call 202-289-7800 for ordering information).

III. CULVERT LOCATION

A. GENERAL LOCATION CONSIDERATIONS

Each As-Planned culvert location will need to be reviewed in the field. As mentioned above, the location and staking process should be performed early in the construction process. Adjustments will often be necessary. Site specific field conditions such as roadway template, roadway grade, cover requirements, and inlet/outlet conditions must be considered when determining the final location and subsequent design of culvert. Each of these elements will be discussed in detail where applicable.

In cut sections, culvert is typically positioned to intercept flow from roadway ditches. When locating and designing culvert in cut areas, avoid placing inlets and/or catch basins within the clear zone because of the resulting traffic safety hazard. Outlets and inlets located in fill sections are commonly placed at the toe of the fill. In sag vertical curves, care must be taken to accurately determine the low point of the terrain and locate the culvert inlet accordingly.

It is imperative for water to be directed away from the toe of the embankment at outlets. Do not outlet the culvert so as to direct water into tree trunks, structures, or other major obstructions unless approved by the contracting officer. When the culvert outlets into a river or stream, do not outlet the pipe below the annual mean high-water elevation.

The desirable range of culvert grade is from 2 to 15 percent. Grades less than 2 percent can result in sedimentation and, ultimately, blockage. Grades in excess of 15 percent can be difficult to construct and can produce damaging, high velocity discharges. Unfortunately, grades in excess of 15 percent are often unavoidable in mountainous terrain, particularly where fills of significant depth exist.

B. LOCATION CONSIDERATIONS BASED ON CULVERT FUNCTION

Culvert is generally designed to fulfill one of two functions: (1) to carry natural water course flow through an embankment, or (2) to provide roadway ditch relief. It is necessary to determine the primary purpose of the culvert and perform location operations and subsequent design based on this purpose.

The following is a discussion of three basic culvert functions and associated location considerations:

1. NATURAL WATER COURSE CULVERT

If a natural water course is in the vicinity of the proposed culvert location, locate the culvert to intercept the water course. Culvert may need to be moved slightly and/or skewed to match the features of the natural water course.

a. Inlet Placement

When natural water courses are coincidental with proposed cut slopes, swales are commonly constructed to

convey the flow down the face of the cut. If the natural water course is likely to convey high volume flows, a riprap waterway may be specified in the plans (see page A-10). Locating the logical flow path on the cut slope can be done by assessing the site conditions. Once the flow path has been established, place the inlet at or slightly downstream of the flow path/ditch line intersection. Inlets for natural waterways with continuous flows or other major natural water courses should always be placed in the natural water course.

b. Outlet Placement

When possible, place the outlet in the natural water course at the toe of the fill. If field conditions do not permit this, provide riprap or culvert rundowns or other means that will prevent erosion. Culvert for major water courses should always outlet into the original channel to prevent erosion. If the water course is not identifiable, outlet the culvert on natural ground at the low point along the toe of the fill slope. Assure that natural obstructions will not cause the culvert discharge to be diverted back towards or along the toe of the fill.

c. Grade

For continuous flows or other major natural water courses, the desirable grade of the culvert is the same as the natural water course grade. Matching the natural water course grade will minimize siltation and/or erosion. For minor intermittent natural water

courses the desirable grade is that of the natural water course or 2 percent, whichever is greater. Natural water courses can be particularly sensitive to culvert grades, which can cause erosion or siltation and subsequent realignment of the natural water course. Consider the potential impacts carefully if the natural water course has a very flat grade.

2. DITCH RELIEF CULVERT

Ditch relief culvert removes flow from a cut section ditch so that maximum ditch water levels are not exceeded. Culvert of this type is spaced at intervals based on hydraulic studies of the project. Do not move ditch relief culvert substantial distances (i.e., more than 20 meters [50 feet]) from the As-Planned location without approval of the contracting officer. Ditch relief culvert is typically positioned perpendicular to the roadway centerline to minimize the length of pipe required. The aforementioned positioning should be used whenever conditions permit.

a. Inlet Placement

When in a sag vertical curve, place culvert at the low point of ditch line. For further information please refer to the first four subsections in Section IV.

b. Outlet Placement

Placement of ditch relief outlets should generally conform with the outlet placement recommendations as

identified in Section III, B, 1, b., above.

c. Grade

The minimum desirable grade of the culvert is the grade of the incoming ditch line, but not less than 2 percent. Several options are available if the roadway template does not permit installation at the minimum desirable grade. The culvert may be skewed to take advantage of the local terrain and increase the grade. Alternatively, the grade of the culvert may be increased to the minimum desirable grade and an outlet ditch can be constructed. If achievement of the minimum desirable grade results in undesirable conditions such as excessive culvert length, a very long outlet ditch, or a culvert outlet well below the natural ground, it will be necessary to flatten the grade of the pipe. Do not design pipe at a grade of less than 2 percent without the approval of the contracting officer. For particularly difficult locations, request the assistance of the contracting officer.

3. APPROACH ROAD CULVERT

Approach road culvert needs to be designed to ensure that the required roadway clear zone (see Section IV, C, below) is achieved. It is generally necessary to shift the flow line of the mainline roadway ditch away from the roadway centerline in order to accommodate the 1 (vertical) : 6 (horizontal) foreslope at the radius of the approach road. Approach road culvert, otherwise, fall

into one of the categories above and should comply with the guidance included elsewhere in this document. Standard Drawing 204-3 on page A-11 provides a typical approach road pipe location.

IV. SPECIFIC ELEMENTS

A. CATCH BASINS

Catch basins are typically required for culvert inlets in cut sections so that clear zone and cover requirements can be met. Additionally, they assist in directing the water into the culvert. Catch basins should include a flat bottom ditch and ditch block in accordance with Standard Drawing M602-6 (see page A-6).

The slope stake notes may or may not account for catch basins. If catch basins are not indicated by the notes, set slope stakes for the basin and affected slopes and construct the basin during roadway grading operations. Conversely, if catch basins are included in the notes and a ditch relief culvert has been moved, assure that slope stakes of abandoned catch basins are changed appropriately. Tables that show slope ratio as a function of depth-of-cut or height-of-fill are commonly provided in the plans. Said tables should generally be used for re-staking abandoned catch basins.

When staking catch basins, the objective is to achieve a smooth transition in to and out of the basin based on the adjacent cut slope ratios. Further, catch basin slopes must be sufficiently laid back to assure that slope failures do not occur.

B. CULVERT COVER

Cover is defined as the depth of material as measured from the top of the culvert to the top of the subgrade for flexible (asphalt) pavements, and to the top of the pavement for rigid (concrete) pavements. Minimum cover is a function of pipe diameter, thickness, and material. Standard Drawings M602-1, M602-5, and M602-7 on pages A-1, A-5, and A-7, respectively, specify the minimum cover requirements for the different types of culvert used.

When minimum cover requirements cannot be met, there are several options that can be used alone or in combination with one another. These options include, but are not limited to, the following:

1. The inlet or outlet invert can be lowered below the natural ground elevation. This can be done by utilizing an inlet ditch or an outlet ditch. When this is done, there must be sufficient grade for the culvert and outlet ditch to allow water to drain away from the toe of the fill.
2. When only a small amount of lowering is required, an elbow may be used to raise the inlet end section to natural ground elevation.
3. The culvert may be skewed to increase cover while still maintaining sufficient grade.
4. A drop inlet may be used if the invert inlet elevation will be too deep for an end section or when using an

end section would otherwise result in a traffic hazard. It should be noted that drop inlets are typically used with paved ditches and in urban areas.

Maximum cover requirements are also set forth in the Standard Specifications. This information is provided in Standard Drawings M602-1, M602-5, and M602-7 on pages A-1, A-5, and A-7, respectively.

C. CLEAR ZONE REQUIREMENTS

Clear zone is defined as the roadside border area that is available for safe use by errant vehicles. The inner limit of the clear zone is the outer edge of the traveled way. Limits of the traveled way are commonly defined on the roadway typical section in the plans. Clear zone width is influenced by the type of traffic, traffic speed, horizontal alignment, and side slope ratios. Slopes steeper than 1 (vertical) : 4 (horizontal) are not considered traversable and recoverable by vehicles and are not to be included in the clear zone determination.

Determine the required clear zone from the contract documents or, if not indicated therein, from Appendix B. There may be cases where the clear zone cannot be maintained. In these cases, the potential severity of the problem must be evaluated and a determination made whether to install a drop inlet in lieu of an end section. More information on clear zones can be obtained from the AASHTO Green Book, the AASHTO Roadside Design Guide, and FHWA Project Development and Design Manual.

D. FILL AND CUT SLOPE INTERSECTION WITH CULVERT

1. FILL SECTIONS

A small portion of the culvert pipe should be extended beyond the fill slope to prevent material that sloughs down the fill slope from plugging the end section. At a minimum, the fill slope should intersect the end of the culvert at least 150 mm (6 inches) below the top of the pipe. When the culvert is in a deep fill and/or has a steep gradient, it is desirable to have the bottom of the slope intersect near the bottom of the culvert. For specific intersections based on pipe diameter and slope ratio see page C-1. During construction, the slope should be warped sufficiently to obscure the end of the culvert from view, while minimizing the amount of soil that could potentially slough into the end section. Warp or transition the slope in a smooth manner such that the final slope is aesthetically pleasing.

On fill slopes that are 1 (vertical) : 4 (horizontal) or flatter and in shallow installations the end of the culvert must be outside of the clear zone. This may necessitate additional flattening of the foreslope to allow for the required clear zone.

2. CUT SECTIONS

As a rule of thumb, in cut sections the elevation at the top of the culvert should be no higher than the normal hinge point elevation. This normally provides allowances for cover and clear zones (see Standard Drawing M602-6 on

page A-6 and diagrams on pages C-2 and C-3).

E. END TREATMENTS

Common end treatments include end sections, drop inlets, slope paving, and headwalls. A notable comment regarding headwalls: If the headwall is significantly skewed in relation to the centerline of the culvert, provisions should be made when ordering culvert to allow for the additional length needed to accommodate the skew. Typical end section dimensions for metal and concrete pipe may be found in Standard Drawings M602-4 and M602-8 on pages A-4 and A-8, respectively.

If there is a need to change to a type of end treatment other than that shown in the plans, discuss the situation with the contracting officer prior to going forward with the changes. Further, if a change to a drop inlet is proposed, ensure that the agency responsible for the maintenance of the roadway is agreeable to the drop inlet (note: this is not generally necessary if there are other drop inlets on the project, but if it is the only drop inlet, it could cause a problem with maintenance).

F. CAMBER

Camber is placed in culvert to allow settlement without creating a ponding or silting situation. The settlement occurs as the material beneath the culvert further consolidates during construction and over time.

The type of soil under and around the culvert most often

determines the need for camber. Peaty, loamy, or otherwise "fluffy" soils that consolidate with loading (such as those loads created by the construction of deep fill) most often require camber. There is less need for camber in shallow fills than in deep fills. This is primarily due to the relatively limited influence of the prism load on consolidation. Even in poor soils, however, camber is not typically necessary when the grade of the culvert is greater than 5 percent because the culvert will continue to function as intended even if some settlement occurs. Note 1 of Standard Drawing M602-3 on page A-3 addresses the particulars of camber.

Culvert with marginal grades and located in deep fills present the greatest dilemma. If the culvert settles, it may cause siltation, ponding, and eventual plugging or corrosion of the culvert. However, by placing camber in the culvert with a marginal grade, the grade becomes even more marginal. Discuss these difficult situations with the contracting officer. The best option may be to subexcavate below the culvert and install a material with good structural integrity to minimize settlement of the pipe.

G. ELBOWS

Elbows are commonly used at the inlet for the following reasons:

1. To better transition the water flow into the culvert;
2. To raise the end section closer to ditch line grade; and

3. To provide adequate cover over the culvert at the shoulder (typically used in cut sections).

Elbows are commonly used at locations other than the inlet in the following situations:

1. At the outlet of steeply graded culvert, broken back culvert, or over-the-side drains to turn the water to match the natural water course grade; and
2. To turn water at grade breaks in broken back culvert or over-the-side drains.

H. DITCH BLOCKS

Ditch blocks are primarily used in conjunction with ditch relief culvert and catch basins to force water into an end section. Ditch blocks should conform to the contract when specified and be out of the clear zone when possible. When they are within the clear zone, they must be constructed with drivable foreslopes and backslopes. In no case should the top of the ditch block be higher than the adjacent subgrade elevation.

I. GASKETS

Gaskets are often specified to prohibit the infiltration and exfiltration of fines in certain non-clayey soils and to make culverts water tight in clayey (A-6 and A-7) soils. The use of gaskets is required only when specified in the contract.

J. BROKEN BACK CULVERT AND OVER-THE-SIDE DRAINS

Culverts of this nature are generally discouraged as they increase outlet flow velocity and can trap debris at the elbows. Additionally, they are difficult to maintain.

Do not design a broken back culvert or an over-the-side drain unless indicated in the contract documents or approved by the contracting officer. Broken back culvert are sometimes used in situations where there is a cut or shallow fill on the inlet end and a deep sliver fill on the outlet end. An elbow is typically used to steepen the grade of the pipe thereby reducing the amount of excavation necessary for culvert installation. The elbow is placed near the transition from cut to fill and can result in the flume portion being at a considerable depth under the fill slope. A diagram of a typical broken back culvert may be found on page C-6.

Conditions that may warrant a broken back culvert or over-the-side drain are:

1. When the outlet needs to be at the bottom of a deep sliver fill or a steep existing slope; and
2. When the straight installation would require trenching through existing material to an excessive depth (e.g., 4 meters deep for more than 7 meters length to install a 600mm culvert).

Over-the-side drains are placed in similar situations, but are installed with the drain pipe on or near the surface of the fill slope. Over-the-side drains also require an elbow

in the middle of the installation to turn the water. A diagram of an over-the-side culvert may be found on page C-7. In some areas over-the-side drains are undesirable due to aesthetic problems with the permanently exposed pipe.

When a broken back culvert or over-the-side drain is used, the portion of the culvert that is installed on the fill slope should be perpendicular to the centerline of the roadway. The portion of the culvert crossing the road may be skewed to match the natural drainage or to meet grade requirements.

Pipe anchors will most likely be necessary for the flume portion of broken back culvert and over-the-side drain situations.

K. PIPE ANCHORS

Reasons for installing pipe anchors are as follows:

1. CULVERT GRADE

Use of pipe anchors is generally required on culvert with steep grades (i.e., 20 percent or steeper), at elbows of broken back culvert and over-the-side drains, and other locations as indicated in the contract documents. These anchors need to be installed accurately by the contractor. Two types of pipe anchor details are shown in Standard Drawing M606-1 on page A-9.

2. BACKFILL OPERATIONS

Some type of anchor is needed to hold culvert in position when backfilling operations include the placement of lean concrete or when plastic culvert is used. These anchorage systems are generally designed by the contractor. Wood or reactive material should not be used in the anchoring system, and the system should not otherwise compromise the integrity of the work.

L. END SECTIONS WITH TOE PLATE EXTENSIONS

Toe plate extensions may be required in order to eliminate scour under end sections in highly erodible soil. They may also act as a cutoff to prevent piping (i.e., flow along the outside of the pipe). Toe plate extensions are only required when included in the contract (e.g., Standard Drawing 602-4, page A-4, which calls for the toe plate extension).

V. CULVERT DESIGN AND PLOTTING

A. SURVEY AND CALCULATIONS

1. After determining the function of the culvert based on the information previously included in this guide, roughly establish the end of pipe for both the inlet and outlet. This may be done by utilizing the location information provided above and the slope stake notes. Care must be taken to assure that the pertinent slope stake limits are being accurately located when working in areas with irregular terrain and/or horizontal alignments with a high

degree of curvature. Look at the slope stake notes to determine if a catch basin is already included in the notes. If so, the slope stake notes may need to be revised to fit the final culvert location. If the catch basin is not included in the notes, revise the notes as appropriate for the culvert site.

2. Assess the proposed alignment of the culvert with regard to inlet and outlet characteristics/impacts, cover requirements, and grade considerations. Adjust alignment if necessary and reassess.
3. Set reference stakes on the proposed alignment of the culvert with hubs for elevations and offsets. These stakes should be set outside of the construction limits to allow room for the installation of the culvert.
4. After establishing the final location, profile the existing ground along the centerline of the proposed culvert alignment. **Extend the profile a minimum of 8 meters beyond the anticipated inlet and outlet end treatment of the culvert in fill sections.** In cut sections, extend the profile to a point outside the area of possible disturbances, (e.g., beyond the slope stake limits). Record extra elevations near the proposed inlet and outlet to facilitate plotting.
5. If the culvert is on a skew, determine the centerline station of the inlet, subgrade shoulders, and outlet of the proposed culvert alignment. Also determine the station where the culvert intersects the roadway centerline. The plot on page C-5 shows how to establish

the skew angle.

6. Compute the subgrade, centerline and shoulder elevations along the culvert alignment. Determine the culvert flow line elevations at these points and verify minimum cover requirements, as shown in Standard Drawings 602-1, 602-5, and 602-7 on pages A-1, A-5, and A-7, respectively. In some cases (such as broken back culvert or unusual crossroad situations), there may be other template points that are critical and need to be evaluated for adequate cover or grade considerations. These points should be evident from plotted cross sections. Even when adequate cover is apparent compute the amount of cover at the shoulders.

B. PLOTTING

Plots should comply with the contract documents and be neat and orderly in appearance. Plot at a scale of 1:100 (1" = 10') unless otherwise specified by the contract.

1. Plot original ground and roadway template elevations along the culvert alignment.
2. Using the original ground elevations and associated roadway template, plot the theoretical top of pipe elevations which will maintain the minimum cover requirements.
3. Plot flow line of the culvert using pertinent elevations (surveyed and/or calculated). Plot a parallel line for top of culvert and verify that cover requirements are met.

4. Establish the end points of the culvert.
5. Determine the length of the culvert by measuring the slope measurement (distance along the culvert grade). Adjust the length and location of the pipe to optimize the positioning. Further, attempt to achieve a final pipe length that is a multiple of 2 feet (note: at the time this document was compiled, major pipe suppliers had not converted metric pipe lengths). Once the final end points have been established compute the grade, reference cut(s) and/or fill(s), and offsets.
6. When a separate pay item is provided in the contract compute quantity of culvert excavation and/or structural backfill.
7. In addition to the plot itself (i.e., original terrain and final design section), the drawing must include project identification; culvert centerline stationing, diameter, length, grade, invert elevations, reference cut(s) and/or fill(s), offsets, end treatments, and, if applicable, skew, and camber. Additionally, indicate on the plot whether or not a ditch block is to be constructed. Example plots are provided on pages C-5, C-6, and C-7.
8. Submit plot, information form, and staking notes adjustments or other slope transitions or warping to contracting officer for acceptance prior to final staking and installation of culvert in the field. An example of an acceptable information form that includes the required data is provided on page C-4.

VI . REFERENCING CULVERT

After the culvert plot is accepted by the contracting officer, stake the culvert in the field. Stake culvert to the tolerances shown in the contract (FP-96, Table 152-1: +/- 50 millimeters horizontal, +/- 20 millimeters vertical). Indicate the reference cut(s) and/or fill(s) and offset distances on the reference stakes. Typically, the offset distance references end of pipe. Also indicate culvert centerline stationing, diameter, length, grade, reference cut or fill, end treatments, and, if applicable, the skew and camber on the stake. Note any riprap aprons or waterways as well as inlet and outlet ditches. Sample culvert stakes may be found on page C-8.

In cut sections adjust slope stakes to allow for inlet catch basin or flatten cut slope into a drainage swale so that the flow is directed toward the culvert inlet. Standard Drawing M602-6 on page A-6 shows the required dimensions of the inlet catch basin.

When the project or the vicinity of the culvert installation does of not include earthwork operations consult the contract documents to determine the work to be performed and take appropriate action.

VII. GLOSSARY

Annual mean high water elevation - The maximum water elevation that occurs, on average, on a yearly basis; typically distinguishable by the visible upper boundary of significant erosion along an open channel.

As-Planned - A location of a culvert as shown in the contract plans.

Backslope - The surface area of the earthen slope between the ditch line and the upper limit of the cut slope.

Camber - An upward deviation from a chord through the inlet and outlet inverts an ordinate amount equal to 1 percent of the pipe length. Camber is to be developed on a parabolic curve.

Clear zone - The roadside border areas (starting at the edge of the traveled way) that is available for safe use by errant vehicles.

Culvert - Any structure, not classified as a bridge, that provides an opening under the roadway. For the purpose of this document, the term culvert does not include box culvert.

Degree of curvature - A measure of the curvature of a roadway, equal to the angle subtended by a 30 meter (100 foot) arc measured along centerline.

Design Section - A dimensioned drawing that is coincidental to the culvert centerline and shows the features of a culvert

installation.

Exfiltration - Flow that exits the culvert at a location other than the intended outlet.

Flow line - The floor or bottom of a culvert, the path a trickle of water would make (synonymous with invert).

Flume - The steep portion of the culvert downstream of a vertically oriented elbow.

Foreslope - The surface area of the earthen slope between the subgrade shoulder and ditch line.

Infiltration - Flow that enters the culvert at a location other than the intended inlet.

Invert - The floor or bottom of the culvert (synonymous with flow line).

Natural water course - Any natural open channel that conveys water intermittently or continuously.

Offset - A distance measured horizontally from a reference hub on the culvert alignment to a point on the culvert alignment for the purpose of locating the end of the culvert.

Roadway prism - The volume defined by the area between the original terrain cross-section and the final design cross-section multiplies by the horizontal distance along the centerline of the roadway.



Reference fill - The difference in elevation from the flow line at the end of the culvert to the reference hub (when said difference is a positive number).

Reference cut - The difference in elevation from the flow line at the end of the culvert to the reference hub (when said difference is a negative number).

Shoulder - The portion of the roadway contiguous to the traveled way for accommodation of stopped vehicles, for emergency use, and for lateral support of the pavement structure.

Skew - The angle between the centerline of a culvert and a line drawn perpendicular to the roadway centerline through the centerline station of the culvert (see diagram on page C-5).

Swale - An open channel constructed in the terrain to convey water.

Roadway template - A dimensioned drawing that is perpendicular to the roadway centerline showing the general construction features of the roadway.

Traveled way - The portion of the roadway designated for the movement of vehicles, exclusive of shoulders.

APPENDIX A

STANDARD DRAWINGS

METAL ROUND PIPE CULVERT
 FILL HEIGHT AND METAL THICKNESS TABLE FOR HELICAL LOCKSEAM AND WELDED SEAM PIPE CULVERT

PIPE SIZE DIAMETER	STEEL									
	68 x 13 CORRUGATIONS		75 x 25 CORRUGATIONS			125 x 25 CORRUGATIONS			150 x 25 CORRUGATIONS	
	MINIMUM COVER	METAL THICKNESS	MINIMUM COVER	METAL THICKNESS	MINIMUM COVER	METAL THICKNESS	MINIMUM COVER	METAL THICKNESS	MINIMUM COVER	METAL THICKNESS
300	30.0	1.63	30.0	2.01	30.0	2.77	30.0	3.51	30.0	4.27
375	30.0	1.63	30.0	2.01	30.0	2.77	30.0	3.51	30.0	4.27
450	30.0	1.63	30.0	2.01	30.0	2.77	30.0	3.51	30.0	4.27
525	30.0	1.63	30.0	2.01	30.0	2.77	30.0	3.51	30.0	4.27
600	30.0	1.63	30.0	2.01	30.0	2.77	30.0	3.51	30.0	4.27
750	30.0	1.63	30.0	2.01	30.0	2.77	30.0	3.51	30.0	4.27
900	30.0	1.63	30.0	2.01	30.0	2.77	30.0	3.51	30.0	4.27
1050	30.0	1.63	30.0	2.01	30.0	2.77	30.0	3.51	30.0	4.27
1200	30.0	1.63	30.0	2.01	30.0	2.77	30.0	3.51	30.0	4.27
1350	30.0	1.63	30.0	2.01	30.0	2.77	30.0	3.51	30.0	4.27
1500	30.0	1.63	30.0	2.01	30.0	2.77	30.0	3.51	30.0	4.27
1650	30.0	1.63	30.0	2.01	30.0	2.77	30.0	3.51	30.0	4.27
1800	30.0	1.63	30.0	2.01	30.0	2.77	30.0	3.51	30.0	4.27
1950	30.0	1.63	30.0	2.01	30.0	2.77	30.0	3.51	30.0	4.27
2100	30.0	1.63	30.0	2.01	30.0	2.77	30.0	3.51	30.0	4.27
2250	30.0	1.63	30.0	2.01	30.0	2.77	30.0	3.51	30.0	4.27
2400	30.0	1.63	30.0	2.01	30.0	2.77	30.0	3.51	30.0	4.27
2550	30.0	1.63	30.0	2.01	30.0	2.77	30.0	3.51	30.0	4.27
2700	30.0	1.63	30.0	2.01	30.0	2.77	30.0	3.51	30.0	4.27
2850	30.0	1.63	30.0	2.01	30.0	2.77	30.0	3.51	30.0	4.27
3000	30.0	1.63	30.0	2.01	30.0	2.77	30.0	3.51	30.0	4.27
3150	30.0	1.63	30.0	2.01	30.0	2.77	30.0	3.51	30.0	4.27
3300	30.0	1.63	30.0	2.01	30.0	2.77	30.0	3.51	30.0	4.27
3450	30.0	1.63	30.0	2.01	30.0	2.77	30.0	3.51	30.0	4.27
3600	30.0	1.63	30.0	2.01	30.0	2.77	30.0	3.51	30.0	4.27

METAL PIPE ARCH CULVERT
 FILL HEIGHT AND METAL THICKNESS TABLE FOR HELICAL LOCKSEAM AND WELDED SEAM PIPE CULVERT

PIPE ARCH SIZE SPAN x RISE	STEEL									
	68 x 13 CORRUGATIONS		75 x 25 CORRUGATIONS			125 x 25 CORRUGATIONS			150 x 25 CORRUGATIONS	
	EQUIVALENT DIAMETER	MINIMUM COVER	MINIMUM CORNER RADIUS	METAL THICKNESS	MINIMUM COVER	METAL THICKNESS	MINIMUM COVER	METAL THICKNESS	MINIMUM COVER	METAL THICKNESS
430 x 330	375	300	75	1.63	30.0	2.01	30.0	2.77	30.0	3.51
530 x 380	450	300	75	1.63	30.0	2.01	30.0	2.77	30.0	3.51
630 x 460	525	300	75	1.63	30.0	2.01	30.0	2.77	30.0	3.51
710 x 510	600	300	75	1.63	30.0	2.01	30.0	2.77	30.0	3.51
885 x 610	750	300	75	1.63	30.0	2.01	30.0	2.77	30.0	3.51
1060 x 740	900	300	90	1.63	30.0	2.01	30.0	2.77	30.0	3.51
1240 x 840	1050	300	100	1.63	30.0	2.01	30.0	2.77	30.0	3.51
1440 x 970	1200	300	130	1.63	30.0	2.01	30.0	2.77	30.0	3.51
1620 x 1100	1350	205	155	1.63	30.0	2.01	30.0	2.77	30.0	3.51
1670 x 1300	1500	230	180	1.63	30.0	2.01	30.0	2.77	30.0	3.51
1800 x 1200	1500	180	180	1.63	30.0	2.01	30.0	2.77	30.0	3.51
1850 x 1400	1650	305	305	1.63	30.0	2.01	30.0	2.77	30.0	3.51
1950 x 1320	1650	305	305	1.63	30.0	2.01	30.0	2.77	30.0	3.51
2050 x 1500	1800	305	305	1.63	30.0	2.01	30.0	2.77	30.0	3.51
2100 x 1450	1800	230	300	1.63	30.0	2.01	30.0	2.77	30.0	3.51
2200 x 1620	1950	365	300	1.63	30.0	2.01	30.0	2.77	30.0	3.51
2400 x 1720	2100	410	400	1.63	30.0	2.01	30.0	2.77	30.0	3.51
2600 x 1820	2250	410	450	1.63	30.0	2.01	30.0	2.77	30.0	3.51
2840 x 1920	2400	460	450	1.63	30.0	2.01	30.0	2.77	30.0	3.51
2970 x 2020	2550	460	450	1.63	30.0	2.01	30.0	2.77	30.0	3.51
3240 x 2120	2700	460	600	1.63	30.0	2.01	30.0	2.77	30.0	3.51
3470 x 2220	2850	460	600	1.63	30.0	2.01	30.0	2.77	30.0	3.51
3600 x 2320	3000	460	600	1.63	30.0	2.01	30.0	2.77	30.0	3.51

NOTE:

- Dimensions not labeled are in millimeters.
- When directed, camber pipe culverts upward from a chord through the inlet and outlet inverts an outside amount equal to 1/2 of the pipe length. Develop camber on a parabolic curve. If the midpoint elevation on the parabolic curve as designed exceeds the elevation of the inlet invert, reduce the amount of camber or increase the pipe culvert gradient.
- Fill heights exceeding 30 meters require special analysis by the CO.
- The fill heights in the table are for helical lockseam and welded seam pipe only. Fill heights for culvert pipe with annular corrugations are more restrictive than those of helical lockseam and welded seam pipe. Obtain approval before furnishing annular corrugation pipe.
- Measure minimum cover from the top of the pipe culvert to the subgrade for flexible pavements, and to the top of the pavement for rigid pavements. Measure maximum fill height from the top of the pipe to the top of the pavement for both flexible and rigid pavement.

REG	STATE	PROJECT	SHEET TOTAL NO. SHEETS

NOTE:

1. Dimensions not labeled are in millimeters.
2. Watertight pipe joints are not required unless specified in the Special Contract Requirements.
3. Other types of coupling bands or fastening devices that comply with the joint performance criteria of AASHTO Standard specifications for Highway Bridges, Division II Section 26 may be used.

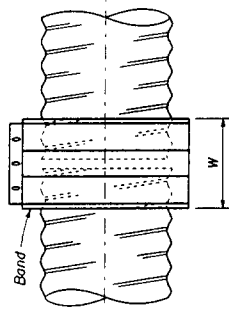

FLAT BAND

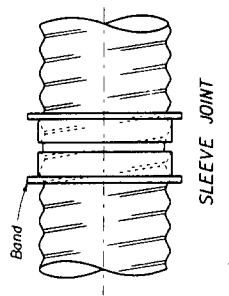

SLEEVE JOINT
Smoother sleeve with center stop.
Stab type joint.

SMOOTH SLEEVE BAND

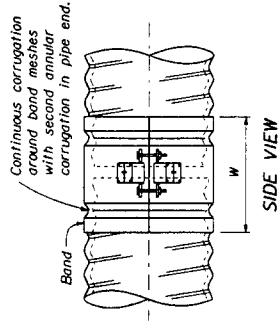

SIDE VIEW

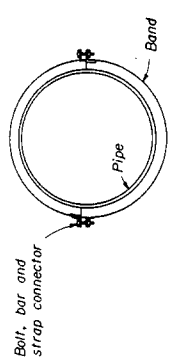

END VIEW

SEMI-CORRUGATED BAND

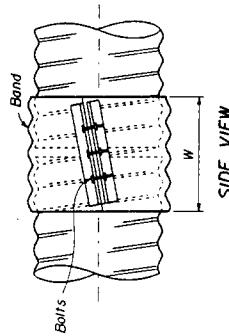

SIDE VIEW

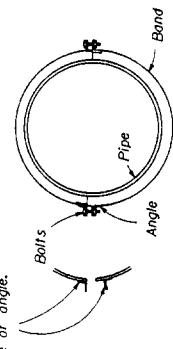

END VIEW

HELICAL BAND
Second angle connection optional to 1050 mm diameter, required above 1050 mm diameter.

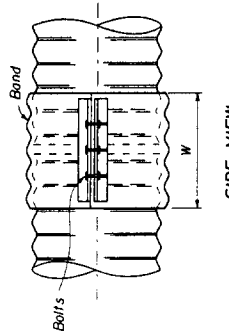

SIDE VIEW

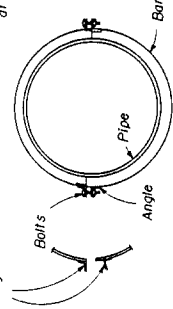

END VIEW

ANNULAR BAND
Second angle connection optional to 1050 mm diameter, required above 1065 mm diameter.

CORRUGATION SIZE ψ	ROUND PIPE DIAMETER ϕ	PIPE-ARCH SPAN X RISE	MINIMUM BAND WIDTH	
			ANNULAR CORRUGATED BANDS	HEMICALLY CORRUGATED BANDS
38 x 6.5	under 600	-	265	SEM-5 BANDS 265
	300 to 900	430 x 330 to 1060 x 740	180	300
68 x 13	1050 to 1800	1240 x 840 to 2100 x 1450	265	300
	1950 to 2100	-	265	300
75 x 25	900 to 1800	1520 x 1170 to 2050 x 1500	300	350
	1950 to 3600	2200 x 1620 to 3600 x 2320	300	350
125 x 25	900 to 1800	1520 x 1170 to 2050 x 1500	500	560
	1950 to 3600	2200 x 1620 to 3600 x 2320	500	560

U) Fabricate annular, helical and semi-corrugated type coupling bands from the same metal as the connecting pipe. Provide coupling bands not more than 3 nominal sheet thicknesses thinner than the thickness of the pipe to be connected, and no thinner than 1.32 mm for steel or 1.2 mm for aluminum. Fasten coupling bands with the following diameter of bolt:
M10 for 450 mm round culvert (530x380 mm pipe arch) or less
M12 for 525 mm round culvert (610x460 mm pipe arch) or more

2) For helically corrugated pipe with rolled ends, the nominal corrugations size refers to the dimension of the end corrugation in the pipe.

3) Use annular corrugated bands with pipes having annular corrugations or with helical pipe having rolled end to form annular corrugations. A 265 mm band is acceptable on pipe ends related with 68x13 mm corrugations. A 300 mm band is acceptable on pipe ends related with 75x25 mm pipe corrugations.

4) Use helical corrugated bands with pipes having helically corrugated ends.

5) The minimum band widths shown for 75x25 mm and 125x25 mm corrugated sizes apply to 68x13 mm corrugations on rolled pipe ends.

6) Smooth sleeve-type couplers and flat bands may be used for pipe diameters of 300 mm or less. Use a matching metal having a nominal thickness of not less than 1.02 mm for steel, or 0.51 mm for aluminum, or a plastic with an equivalent strength to metal.

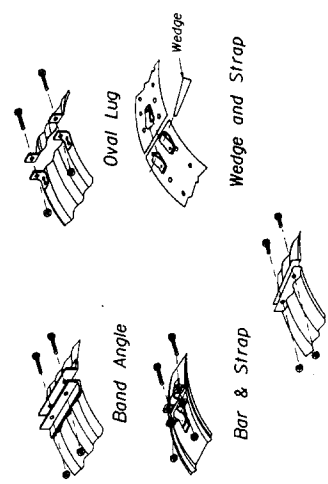

STANDARD BAND CONNECTIONS

NO SCALE

U.S. DEPARTMENT OF TRANSPORTATION
FEDERAL BUREAU OF SURVEY
FEDERAL LANDS HIGHWAY OFFICE

METRIC STANDARD

**METAL PIPE CULVERT
COUPLING BAND**

REVISION

STANDARD
M602-2

REG.	STATE	PROJECT	SHEET TOTAL
MW	ND	PRA-THRO 1103 SOUTH LOOP RD	SHEETS

NOTE:

- When directed, camber pipe culverts upward from a chord through the inlet and outlet inverts on ordinate amount equal to 1% of the pipe length. Develop camber on a parabolic curve. If the midpoint elevation on the parabolic curve as designed exceeds the elevation of the inlet invert, reduce the amount of camber or increase the pipe culvert gradient.
- H equals the diameter of all round pipe culverts or the rise dimension of all pipe arch culverts.
- Bed pipe culverts 48 inches and larger in diameter and pipe arch culverts 36 inches and greater in rise in Class B Bedding. Bed smaller pipe culverts in Class B or C Bedding.

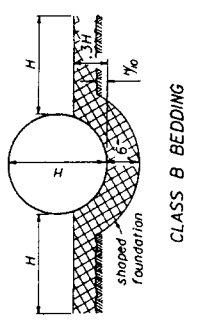

CLASS B BEDDING

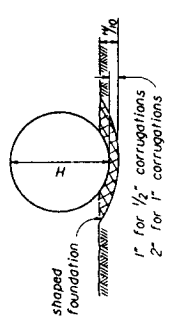

CLASS C BEDDING

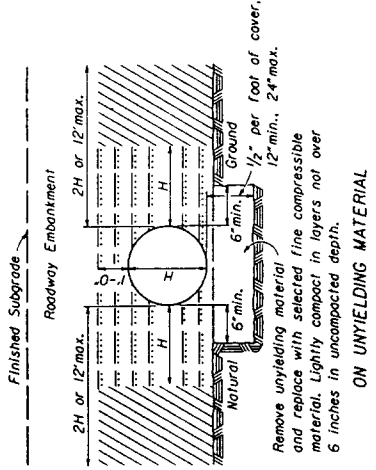

ON UNYIELDING MATERIAL

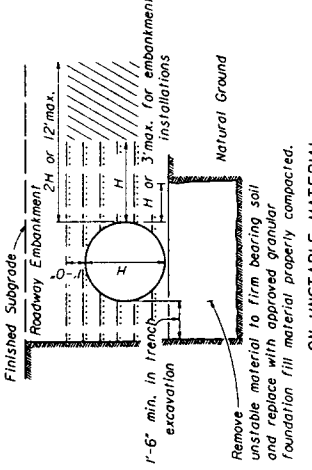

ON UNSTABLE MATERIAL

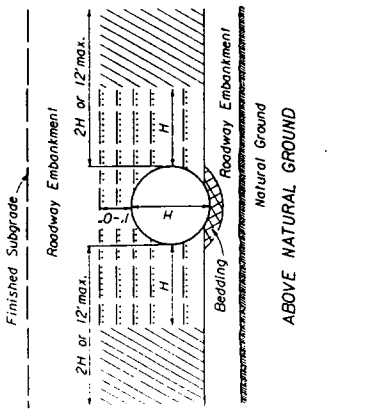

ABOVE NATURAL GROUND

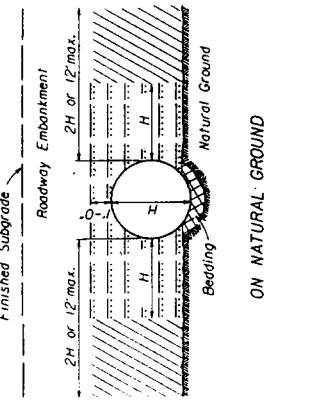

ON NATURAL GROUND

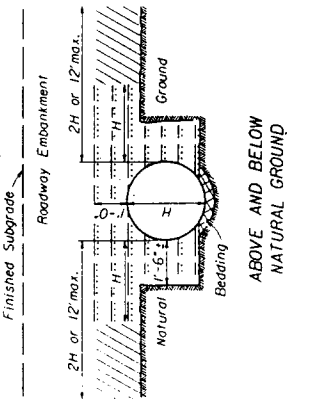

ABOVE AND BELOW NATURAL GROUND

- Bedding Material
- Embankment material placed in layers not exceeding 6" compacted depth.
- Approved granular material or fine compactable soil placed in layers not exceeding 6" compacted depth.

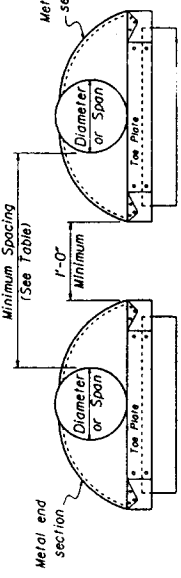

MINIMUM SPACING	
DIAMETER or SPAN INCHES	SPACING INCHES
UP to 48	24
48 and UP	1/2 Diameter or Span or 36 whichever is less

MULTIPLE PIPE INSTALLATION

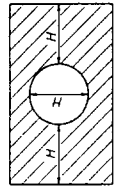

SECTION A-A

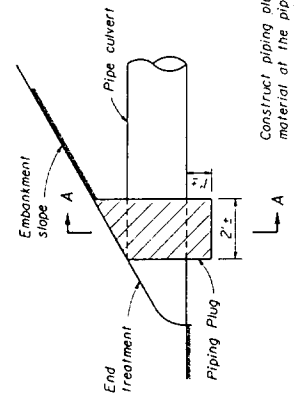

PIPING PLUG

TRENCH EXCAVATION IN EMBANKMENT

Construct piping plug of impermeable backfill material at the pipe culvert inlet where granular material is used for backfill.

U.S. DEPARTMENT OF TRANSPORTATION
FEDERAL HIGHWAY ADMINISTRATION
TECHNICAL SERVICES DIVISION

STANDARD
METAL AND PLASTIC PIPE CULVERT BEDDING

PIPE SIZE		MINIMUM METAL THICKNESS		DIMENSIONS										SLOPE	
		STEEL INCH GAGE	ALUM. INCH GAGE	A	B	H	F	L	W	Approx.	W	Approx.			
17 x 13	.064	.064	.064	2	6	24	24	24	52	2 1/2	2 1/2				
21 x 15	.064	.064	.064	2	6	34	24	24	58	2 1/2	2 1/2				
24 x 18	.064	.064	.064	7	12	40	28	28	63	2 1/2	2 1/2				
28 x 20	.064	.064	.064	7	16	46	32	28	70	2 1/2	2 1/2				
35 x 24	.075	.075	.075	9	16	58	39	40	85	2 1/2	2 1/2				
42 x 29	.075	.075	.075	14	18	73	46	40	104	2 1/2	2 1/2				
49 x 33	.09	.09	.09	12	21	82	53	41	114	2 1/2	2 1/2				
57 x 38	.09	.09	.09	16	26	102	62	42	132	2 1/2	2 1/2				
64 x 43	.09	.09	.09	17	26	102	62	42	130	2 1/2	2 1/2				
71 x 47	.09	.09	.09	17	30	120	69	44	144	2 1/2	2 1/2				
77 x 51	.09	.09	.09	17	36	120	70	44	142	2 1/2	2 1/2				
84 x 55	.09	.09	.09	17	36	120	70	44	136	2 1/2	2 1/2				
91 x 59	.09	.09	.09	17	44	136	77	46	156	2 1/2	2 1/2				
98 x 63	.09	.09	.09	17	44	136	77	46	152	2 1/2	2 1/2				
105 x 67	.09	.09	.09	17	44	136	77	46	148	2 1/2	2 1/2				
112 x 71	.09	.09	.09	17	44	136	77	46	142	2 1/2	2 1/2				
119 x 75	.09	.09	.09	17	44	136	77	46	138	2 1/2	2 1/2				

PIPE SIZE		MINIMUM METAL THICKNESS		DIMENSIONS										SLOPE	
		STEEL INCH GAGE	ALUM. INCH GAGE	A	B	H	F	L	W	Approx.	W	Approx.			
17	.064	.064	.064	5	7	6	22	21	44	2 1/2	2 1/2				
18	.064	.064	.064	6	6	28	26	52	24	2 1/2	2 1/2				
21	.064	.064	.064	7	10	34	31	58	24	2 1/2	2 1/2				
24	.064	.064	.064	8	12	40	36	66	24	2 1/2	2 1/2				
30	.075	.075	.075	11	16	46	41	72	24	2 1/2	2 1/2				
36	.075	.075	.075	13	19	50	46	78	24	2 1/2	2 1/2				
42	.09	.09	.09	15	25	60	51	88	24	2 1/2	2 1/2				
48	.09	.09	.09	17	29	68	57	96	24	2 1/2	2 1/2				
54	.09	.09	.09	17	33	74	62	102	24	2 1/2	2 1/2				
60	.09	.09	.09	17	36	80	67	108	24	2 1/2	2 1/2				
66	.09	.09	.09	17	39	86	72	114	24	2 1/2	2 1/2				
72	.09	.09	.09	17	44	94	79	122	24	2 1/2	2 1/2				
78	.09	.09	.09	17	48	102	87	130	24	2 1/2	2 1/2				
84	.09	.09	.09	17	52	110	95	138	24	2 1/2	2 1/2				
90	.09	.09	.09	17	56	118	103	146	24	2 1/2	2 1/2				
96	.09	.09	.09	17	58	122	108	150	24	2 1/2	2 1/2				

NOTE:
 1. Variations in design and dimensions are permitted to allow for manufacturer's standards.
 2. Fabricate the diameter of the end section of Design B to match the inside diameter of the concrete pipe culvert.
 3. Design C may be used in lieu of Design A for all metal pipe culvert sizes. Coupling bands may be any acceptable type for the pipe culvert specified.
 4. Fabricate multiple piece bodies with lap seams tightly joined by 3/8" rivets or bolts. Fabricate end section center panels for 60" and larger diameter pipe and 71" x 47" and larger pipe arch from 0.138" (10 gage) steel or 0.135" (10 gage) aluminum.
 5. On end section center panels for 77" x 55", 73" x 55" and larger pipe arch, provide 2 1/2" x 2 1/2" x 1/4" angle reinforcement bolted or riveted under the center panel seam.
 6. Supplement the reinforced edges of end sections for 60" and larger diameter pipe and 77" x 52", 73" x 55" and larger pipe arch with 2" x 2" x 1/4" stiffener angles attached with bolts or rivets.
 7. Fabricate connector section, corner plate and toe plate extensions from the same metal thickness as the panel body. Use toe plate extension where shown on the plans.
 8. Warp embankment slopes to match the slope of the flared end sections.

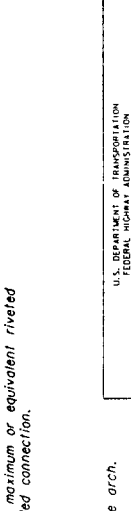
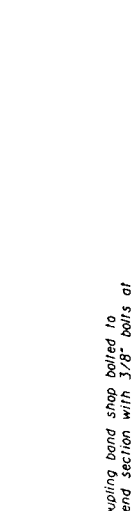
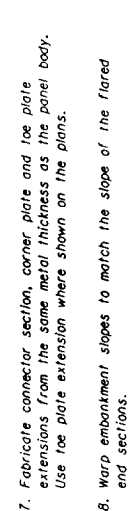
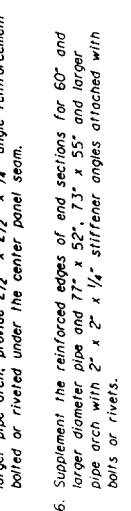
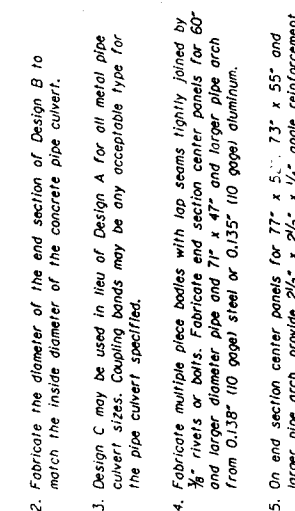

For all sizes of round pipe and pipe arch.
 For 12" thru 24" round pipe and 17" x 13" thru 28" x 20" pipe arch
 For 30" thru 60" round pipe and 35" x 24" thru 66" x 51" pipe arch

DESIGN B
 CONNECTION TO CONCRETE PIPE INLET END

DESIGN C
 CONNECTION TO METAL PIPE OR OUTLET END OF CONCRETE PIPE

DESIGN A
 CONNECTION TO ANNULAR CORRUGATED METAL PIPE

Metric version not available as of January 9, 1996

REC	STATE	PROJECT	SHEET NO.	TOTAL SHEETS

POLYETHYLENE (PE) PLASTIC ROUND PIPE CULVERT										
FILL HEIGHT TABLE AND MINIMUM CELL CLASSIFICATION NUMBER PER ASTM D 3350										
SMOOTH WALL (SOLID WALL)					CORRUGATED					
PIPE SIZE	MINIMUM COVER	CELL CLASSIFICATION NUMBER 335434C	MINIMUM WALL THICKNESS		PIPE SIZE	MINIMUM COVER	CELL CLASS. NO. 315412C	CELL CLASS. NO. 324420C	PIPE SIZE	MINIMUM COVER
			15.4	21.7						
DIAMETER			MAXIMUM FILL HEIGHT IN METERS		DIAMETER				DIAMETER	
300	300		17.5		300	300	3.5	3.0	300	300
450	300			16	375	300	3.5	3.0	300	300
600	300			11.5	450	300	3.5	3.0	300	300
750	300				600	300	3.5	3.0	300	300
900	300			11.5	750	300	3.5	3.0	300	300
1050	300				900	300	3.5	3.0	300	300
1200	300			8.0						

NOTE:

- Dimensions not labeled are in millimeters.
- When directed, camber pipe culverts upward from a chord through the inlet and outlet inverts an ordinate amount equal to 1% of the pipe length. Develop camber on a parabolic curve. If the midpoint elevation on the parabolic curve as designed exceeds the elevation of the inlet invert, reduce the amount of camber or increase the pipe culvert gradient.
- Measure minimum cover from the top of the pipe invert to the subgrade for flexible pavements, and to the top of the pavement for rigid pavements. Measure maximum fill height from the top of the pipe to the top of the pavement for both flexible and rigid pavement.

POLYVINYL CHLORIDE (PVC) PLASTIC ROUND PIPE CULVERT										
FILL HEIGHT TABLE AND MINIMUM CELL CLASSIFICATION NUMBER PER ASTM D 1784										
SMOOTH WALL (SOLID WALL)					RIBBED					
PIPE SIZE	MINIMUM COVER	CELL CLASS. NO. 12454C	MINIMUM WALL THICKNESS		PIPE SIZE	MINIMUM COVER	CELL CLASS. NO. 12454C	CELL CLASS. NO. 12364C	PIPE SIZE	MINIMUM COVER
			S1	S2						
DIAMETER			MAXIMUM FILL HEIGHT IN METERS		DIAMETER				DIAMETER	
300	300		20	19	300	300	11.0	8.0	300	300
375	300				375	300	9.5	6.5	375	300
					450	300	10.0	7.0	450	300
					600	300	9.0	6.5	600	300
					750	300	8.5	6.0	750	300
					900	300	8.0	5.5	900	300
					1050	300	8.0	5.5	1050	300
					1200	300	7.5	5.5	1200	300

PIPE SIZE	DIMENSIONS			
	A	B	C	D
300	1065	370	840	150
375	1170	620	1155	150
450	1370	735	1395	150
600	1625	940	1650	150
750	2235	915	1615	150
900	2235	1090	1690	150

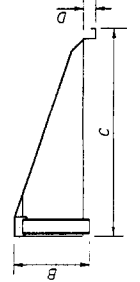
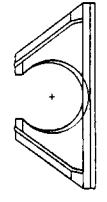
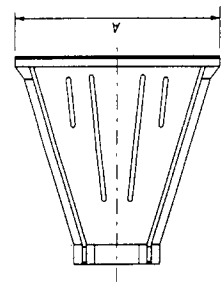

480 58009 15A

U.S. DEPARTMENT OF TRANSPORTATION
 FEDERAL BUREAU OF SURVEYING
 FEDERAL LANDS HIGHWAY OFFICE

METRIC STANDARD

PLASTIC PIPE CULVERT

STANDARD M602-5

REVISION

REG	STATE	PROJECT	SHEET	TOTAL
			NO.	SHEETS
MW	ND	FR. THRO. ILL. SOUTH LOOP RD.		

NOTE:
1. D equals the diameter of all round pipe or the rise dimension of all pipe arch culverts.

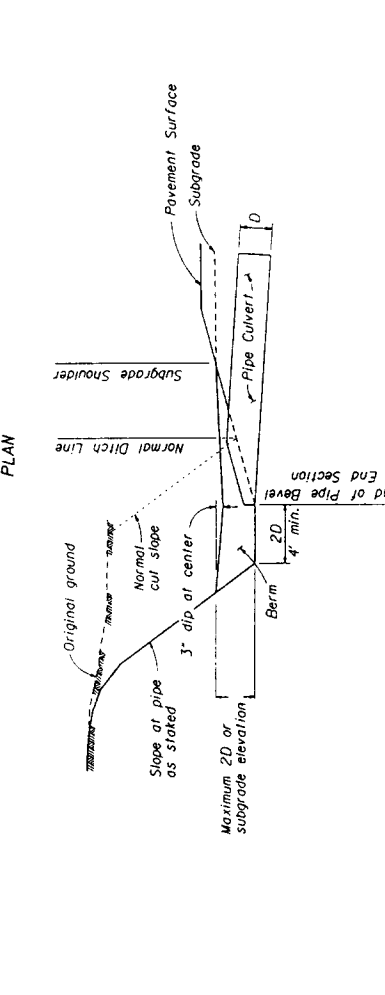
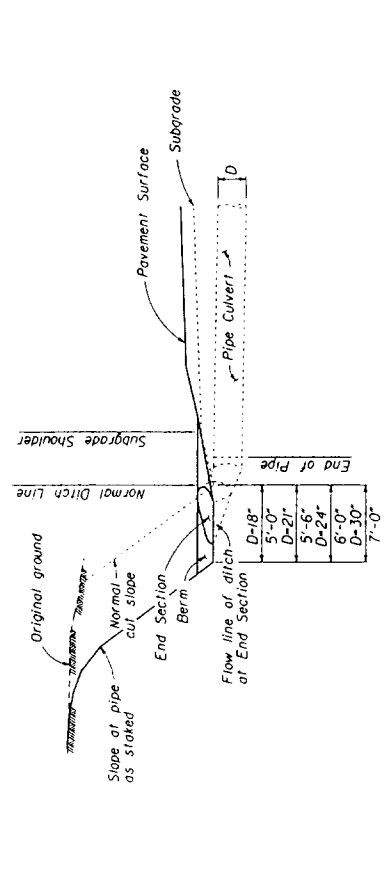
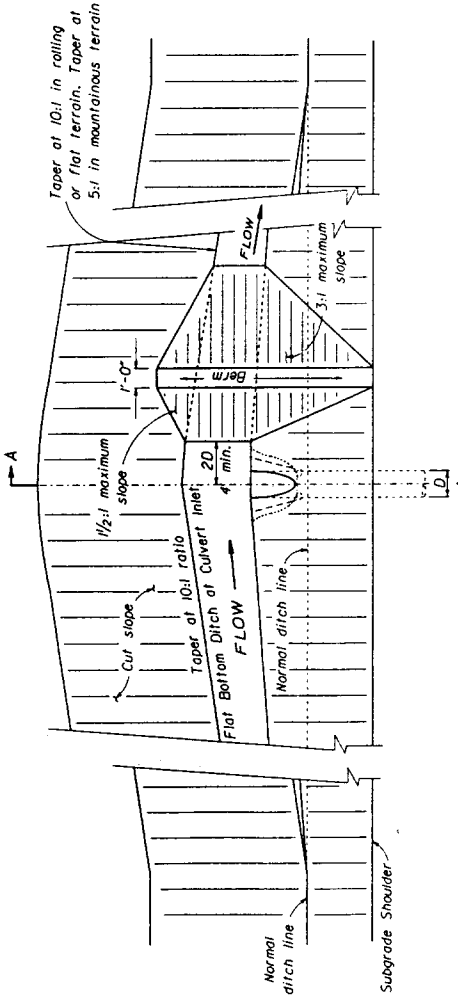
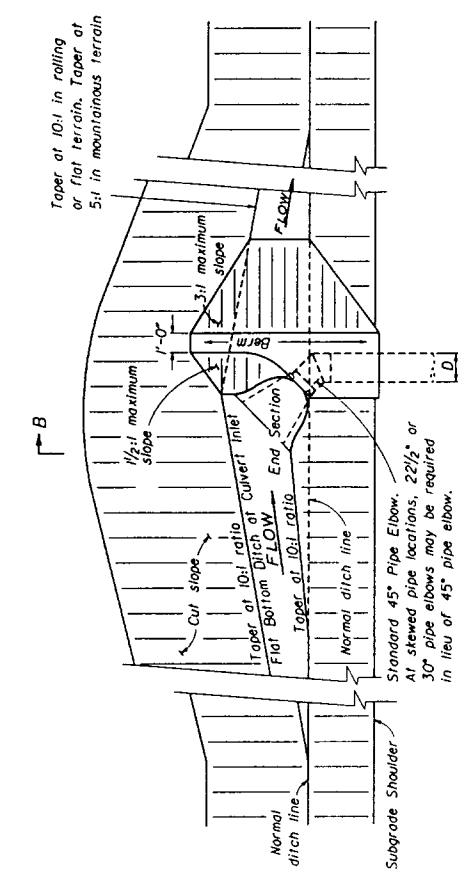

U.S. DEPARTMENT OF TRANSPORTATION
FEDERAL HIGHWAY ADMINISTRATION
FEDERAL LANDS HIGHWAY OFFICE

STANDARD
PIPE CULVERT INLET
TREATMENT IN CUT SLOPES

TYPE II
SECTION B-B

D=18"
5'-0"
D=27"
5'-6"
D=24"
6'-0"
D=30"
7'-0"

NO SCALE

TYPE I
SECTION A-A





Metric version not available as of January 9, 1996

REC	STATE	PROJECT	SHEET NO.	TOTAL SHEETS

**CONCRETE ROUND PIPE CULVERT
FILL HEIGHT AND PIPE CLASS TABLE**

PIPE SIZE	EM BANKMENT					TRENCH				
	CLASS II	CLASS III	CLASS IV	CLASS V	MAXIMUM FILL HEIGHT ABOVE TOP OF PIPE IN METERS	CLASS II	CLASS III	CLASS IV	CLASS V	CLASS VI
300	3	3.0	4.5	7.0	5.5	5.5	8.0	4.0	4.0	4.0
450	3	3.0	7.5	12.0	4.0	4.0	9.0	13.5	4.0	4.0
600	3	3.0	4.5	9.0	4.5	4.5	6.5	12.0	4.5	4.5
750	600	2.5	4.0	4.5	10.5	4.0	5.0	14.0	4.0	4.0
900	600	2.5	2.5	6.0	12.5	3.0	4.0	17.0	4.0	4.0
1200	600	3.5	4.0	8.0	13.5	4.5	5.0	9.0	9.0	15.0
1500	600	4.5	5.0	8.5	13.5	4.5	6.0	9.5	15.0	15.0
1800	600	4.0	5.0	9.0	12.5	4.5	6.0	10.5	15.0	15.0
2100	600	4.0	5.5	9.0	4.5	7.0	11.0	15.0	15.0	15.0
2400	600	4.0	6.0	4.5	7.0	4.5	8.0	15.0	15.0	15.0
2700	600	4.5	6.0	5.5	8.0	5.5	8.0	15.0	15.0	15.0

LEGEND:

-  Bedding material
-  Embankment material placed in layers not exceeding 150 mm compacted depth.
-  Approved granular material or fine compactable soil placed in layers not exceeding 150 mm compacted depth.
-  Embankment material placed in layers not exceeding 150 mm compacted depth.

NOTE:

1. Dimensions not labeled are in millimeters.
2. When directed, camber pipe culverts upward from a chord through the inlet and outlet inverts an ordinate amount equal to 1/2 of the pipe length. Develop camber on a parabolic curve. If the midpoint elevation on the parabolic curve as designed exceeds the elevation of the inlet invert, reduce the amount of camber or increase the pipe culvert gradient.
3. Measure minimum cover from the top of the pipe culvert to the subgrade for flexible pavements, and to the top of the pavement for rigid pavements. Measure maximum fill height from the top of the pipe to the top of the pavement for both flexible and rigid pavements.
4. Pipe compaction limits shown are for pipe installation in an embankment. For pipe installation in a trench, the compaction limits shall be the walls of the trench.
5. Where unyielding or unstable material is encountered, install the pipe culvert according to the limits of pipe compaction shown on Standard M602-3.
6. When grades exceed 10% install supplemental concrete pipe ties on pipe culvert or install bell and spigot pipe.
7. Maximum fill heights for pipe culvert installations may be increased on approval of site-specific structural pipe designs meeting the criteria of AASHTO Standard Specifications for Highway Bridges.

EM BANKMENT INSTALLATION

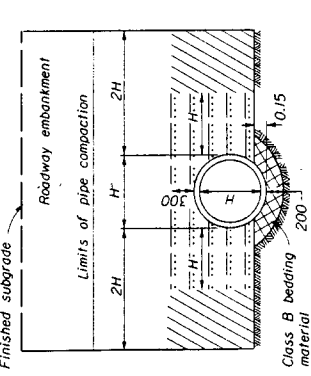

TRENCH INSTALLATION

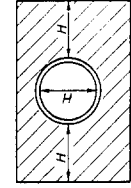
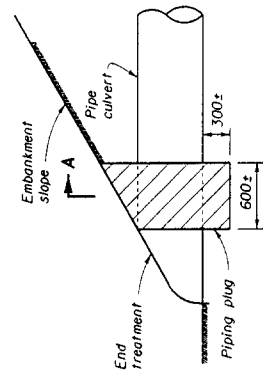
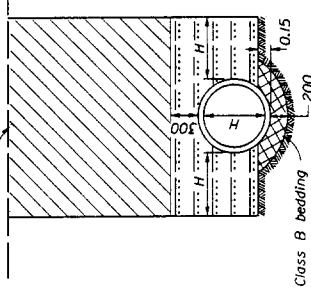

Construct a piping plug of impermeable backfill material in the pipe inlet where granular material is used for backfill.

PIPING PLUG

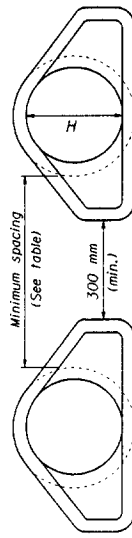

DIAMETER	EM BANKMENT	TRENCH
300-900	380	2H
900-2400	0.5H	1B30
OVER 2400	1220	1B50

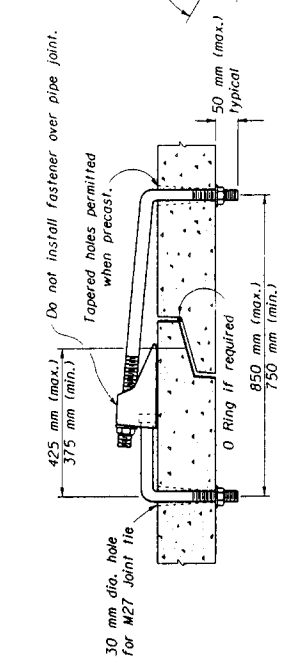

MULTIPLE ROUND PIPE INSTALLATION

SUPPLEMENTAL CONCRETE PIPE TIE

NO SCALE

U.S. DEPARTMENT OF TRANSPORTATION
FEDERAL HIGHWAY ADMINISTRATION
FEDERAL LANDS HIGHWAY OFFICE

METRIC STANDARD

**CONCRETE PIPE
CULVERT INSTALLATION**

STANDARD M602-7

REG	STATE	PROJECT	SHEET TOTAL NO. SHEETS

NOTE:

1. Dimensions not labeled are in millimeters.
2. Variations in design and dimensions are permitted to allow for manufacturer's standards.
3. Fabricate the outlet end section with a groove end and the inlet end section with a tongue end.
4. Warp embankment slopes to match the slope of the tapered end section.

END SECTIONS FOR ROUND PIPE CULVERT

PIPE SIZE DIAMETER	DIMENSIONS										
	T	A	B	C	L	W	F	R1	R2	R3	
300	50	100	600	1222	1822	600	325	253	225	100	
375	57	150	675	1150	1825	750	400	312	275	150	
450	63	225	675	1150	1825	900	475	388	300	188	
525	69	225	900	925	1825	1050	550	412	325	125	
600	75	238	1088	750	1838	1200	625	420	350	200	
675	82	263	1200	638	1838	1350	700	---	362	225	
750	88	300	1350	494	1844	1500	775	462	375	200	
825	94	345	1485	938	2400	1650	865	594	438	225	
900	100	375	1585	825	2400	1800	925	580	500	275	
1050	113	525	1585	825	2400	1950	1095	---	550	275	
1200	125	600	1800	600	2400	2100	1225	---	550	300	

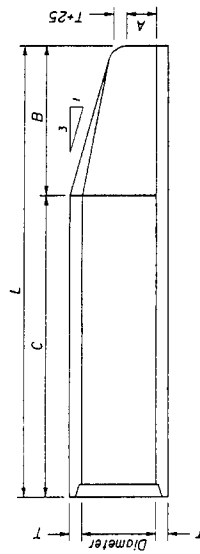
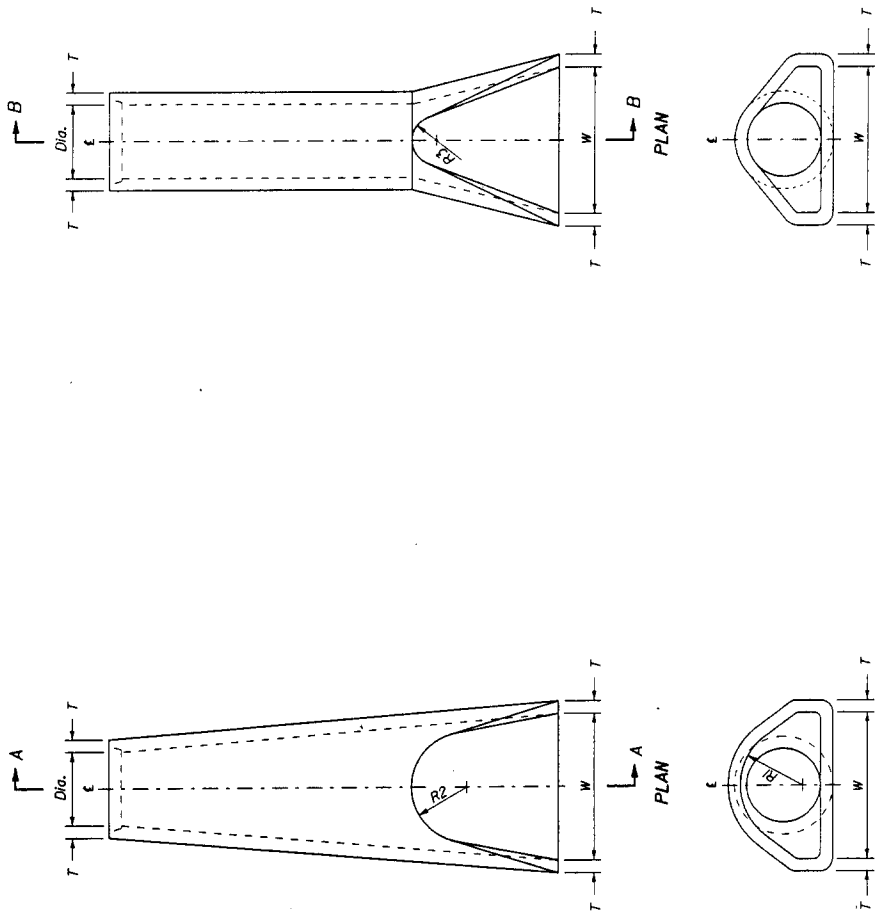

SECTION B-B

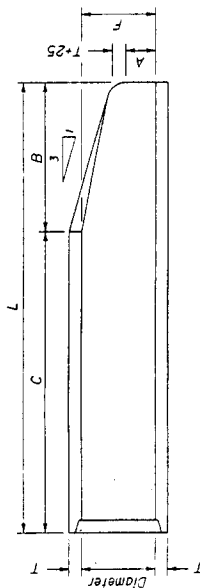

SECTION A-A

U.S. DEPARTMENT OF TRANSPORTATION
 FEDERAL BUREAU OF HIGHWAY
 FEDERAL LANDS HIGHWAY OFFICE
 METRIC STANDARD

**CONCRETE END SECTION
FOR ROUND PIPE**

NO. SCALE

STANDARD
M602-B

REC	STATE	PROJECT	SHEET TOTAL
			REL SHEETS

NOTE:

- Dimensions not labeled are millimeters.
- Fabricate slotted drain pipe, down drain pipe culvert, elbows, end section, and coupling bands from sheets 1.62 mm thickness.
- Grate slot assembly and plate end plug conform to AASHTO M 183.
- Galvanize grate slot assembly, plate end plug, and all hardware according to AASHTO M 111.
- Approved alternate pipe anchor assemblies may be used.
- Place Class 2 riprap conforming to Section 251 for protective apron.
- Place pipe anchor assemblies approximately 6 meter intervals along down drain pipe culvert.
- For installations at sag vertical curves, use a tee connection instead of an elbow and a minimum of two 6 meter slotted drain pipe sections.
- Make all band connections watertight by placing gaskets or O-rings under the bands before tightening.
- Use either the grate slot or the angle slot slotted drain assembly.
- Provide hardware in the metric sizes shown. Equivalent imperial sizes may be used when metric sizes are not available.

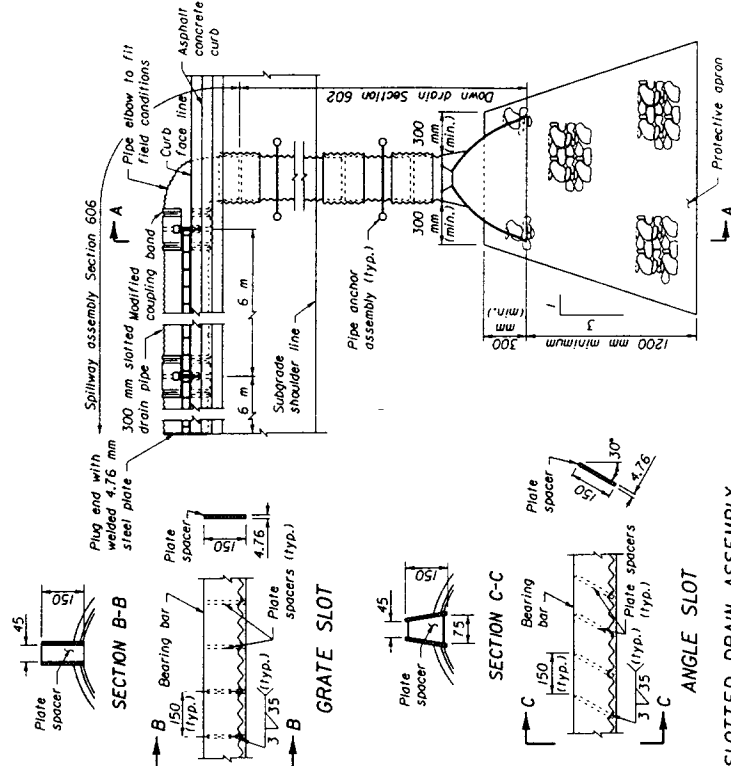

SLOTTED DRAIN ASSEMBLY

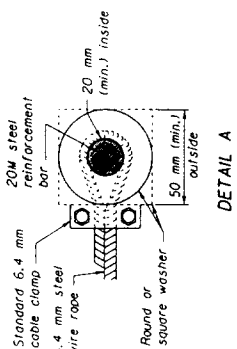

DETAIL A

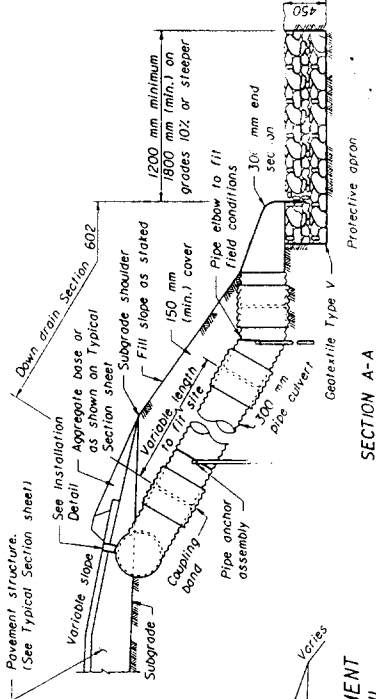

SECTION A-A

NO SCALE

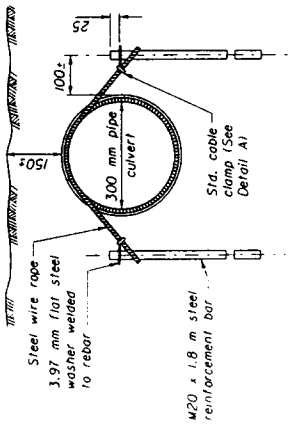

ALTERNATE 1

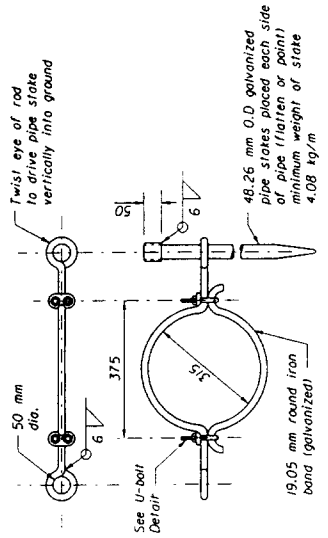

ALTERNATE 2

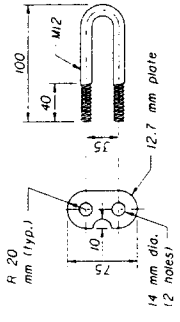

U-BOLT DETAIL

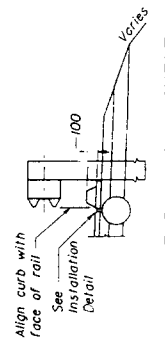

TYPICAL PLACEMENT AT GUARDRAIL

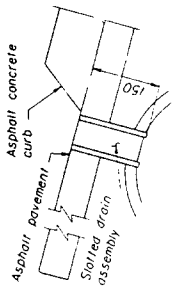

INSTALLATION DETAIL

U.S. DEPARTMENT OF TRANSPORTATION
 FEDERAL HIGHWAY ADMINISTRATION
 METRIC STANDARD
**SLOTTED DRAIN
 SPILLWAY ASSEMBLY**
 STANDARD
 M606-1

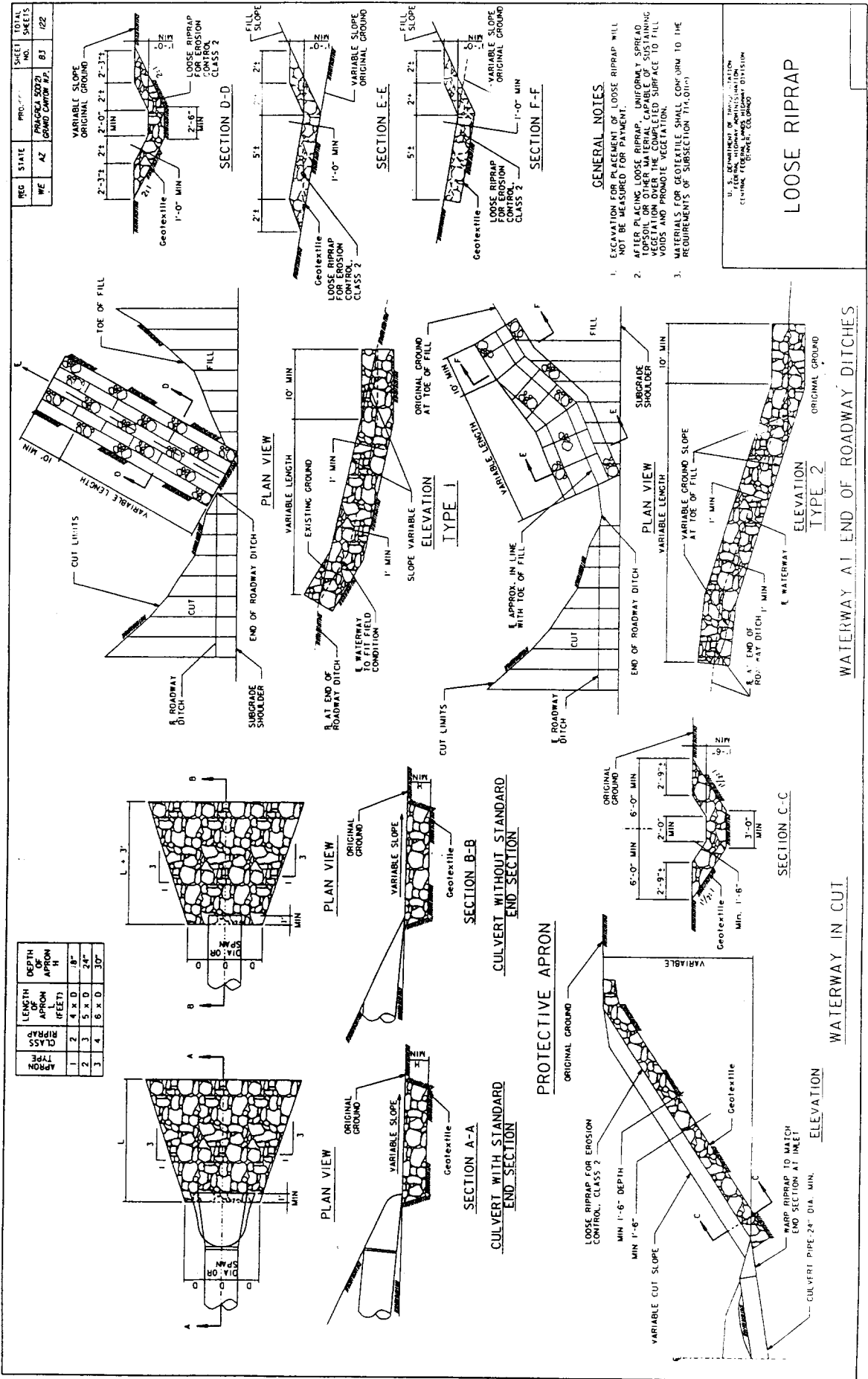

REG STATE	PROJ. NO.	SHEET NO.	TOTAL SHEETS
NE AZ	PRAGUE 50021	83	122
	GRAND CANYON P.P.		

RRD TYPE	CLASS	LENGTH OF APRON (FEET)	DEPTH OF APRON "H"
1	2	4 x D	8"
2	3	5 x D	24"
3	4	6 x D	30"

- GENERAL NOTES**
1. EXCAVATION FOR PLACEMENT OF LOOSE RIPRAP WILL NOT BE MEASURED FOR PAYMENT.
 2. AFTER PLACING LOOSE RIPRAP, UNIFORMLY SPREAD TOPSOIL OR OTHER MATERIAL CAPABLE OF SUSTAINING VEGETATION OVER THE COMPLETED SURFACE TO FILL VOIDS AND PROMOTE VEGETATION.
 3. MATERIALS FOR GEOTEXTILE SHALL CONFORM TO THE REQUIREMENTS OF SUBSECTION 714.0110.

U. S. DEPARTMENT OF TRANSPORTATION
 FEDERAL HIGHWAY ADMINISTRATION
 OFFICE OF TECHNICAL SERVICES

LOOSE RIPRAP

WATERWAY AT END OF ROADWAY DITCHES

WATERWAY IN CUT

Metric Version not available as of January 9, 1996

APPENDIX B

GUIDELINES FOR CLEAR ZONES

8.4 Safety Analysis and Design. (continued)

The following information is reproduced from:

FEDERAL LANDS HIGHWAY
PROJECT DEVELOPMENT AND
DESIGN MANUAL

Volume 1, Chapter 8
Safety Analysis and Design
Published by :

U.S. Department of Transportation
Federal Highway Administration
Publication No: FHWA-DF-88-003
Last Revised 6/94

D. Clear Zone. A clear zone (L_c) is defined as the roadside border areas (starting at the edge of the traveled way) that is available for safe use by errant vehicles. The width of the clear zone is influenced by the type of traffic, speed, horizontal alignment, and side slopes. Slopes steeper than 3:1 are not considered traversable by vehicles and the need for traffic barriers as discussed in Section 8.4.E should be evaluated. The AASHTO *Barrier Guide* also discusses clear zone widths.

Determine clear zone widths for all roadway tangent sections (except tangent sections on rural collectors and local roads and streets) by using Figure 8-1.

On rural collectors and local roads and streets with a design speed of less than 40 mph or an ADT less than 250, the clear zone width will be determined and documented on a project-by-project basis. Where feasible and environmentally acceptable, the clear zone width should be a minimum of 10 feet. Consult the AASHTO *Barrier Guide* and Green Book (pages 500, 501, 516, and 517) for additional guidance.

The clear zone on a curved alignment is determined by increasing the value obtained for a tangent section of highway. The tangent section clear zone is increased by a curve correction factor based on the degree of curvature, the design speed, and the roadside width.

Clear zone widths for horizontal curves can be determined using the following formula:

$$CZ_c = (L_c)(K_{cz})$$

$$K_{cz} = \frac{L_o + W_r}{W_r}$$

$$L_o = \sqrt{\left(\frac{5729.6}{D}\right)^2 + \left(\frac{(0.9V + 15)^2}{13}\right)^2} - \frac{5729.6}{D}$$

Where V = Design speed, mph

W_r = Roadside width, ft. (from table below)

L_o = Increase in roadside width, ft.

K_{cz} = Curve correction factor

CZ_c = Clear zone for curve, ft.

L_c = Clear zone for tangent, ft. (from Figure 8-1)

D = Degree of curvature (in degrees)

Finite Limit of Roadside*	
Design Speed, V (mph)	Roadside Width, W_r (feet)
40	91
45	100
50	108
55	117
60	125
65	134
70	142

*Based on theoretical encroachment model.

Clear zone widths for tangents (Figure 8-1) and clear zone widths for horizontal curves (formula) have been computed for a variety of design speeds, curvatures, and sideslope conditions. The results of these computations are tabulated in Exhibit 8.8. Designers are encouraged to use these tables as a simplified method of determining clear zone widths.

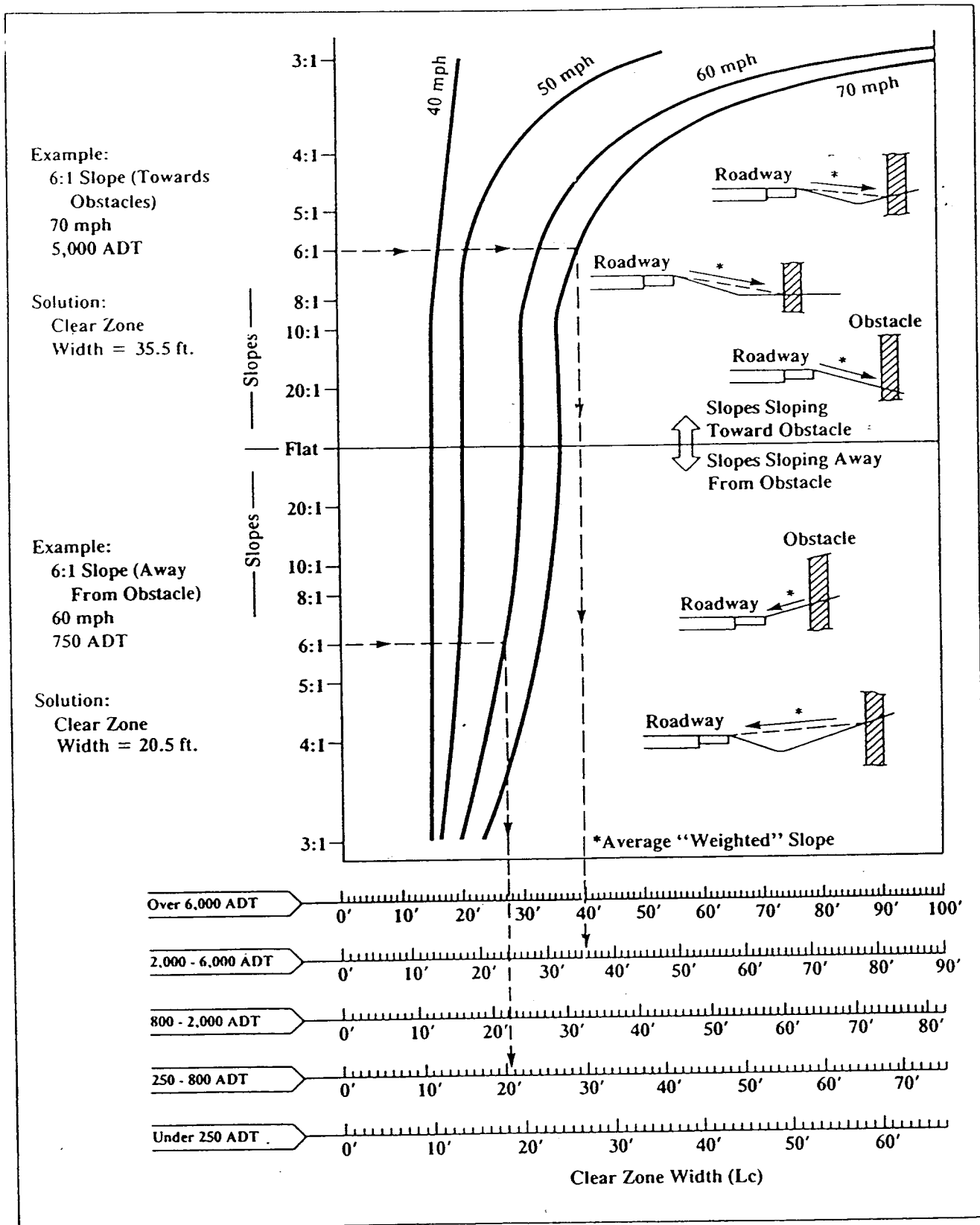

Figure 8-1
 Clear Zone Width Criteria on Tangent Roadway Sections

Clear Zone Width (feet) – 40 mph Design Speed																
ADT < 250									ADT 250 to 799							
Degree of Curve	Slope Ratios (cuts)				Slope Ratios (Embankments)				Slope Ratios (cuts)				Slope Ratios (Embankments)			
	3:1	4:1	6:1	10:1	10:1	6:1	4:1	3:1	3:1	4:1	6:1	10:1	10:1	6:1	4:1	3:1
Tangent	10	10	10	10	10	11	13	13	11	11	11	11	11	13	14	15
1	10	10	10	10	10	11	13	13	11	11	11	11	11	13	15	16
2	11	11	11	11	11	12	14	14	12	12	12	12	12	14	15	16
3	11	11	11	11	11	12	14	14	12	12	12	12	12	14	16	17
4	12	12	12	12	12	13	15	15	13	13	13	13	13	15	16	17
5	12	12	12	12	12	13	15	15	13	13	13	13	13	15	17	18
6	12	12	12	12	12	14	16	16	14	14	14	14	14	16	17	18
7	13	13	13	13	13	14	16	16	14	14	14	14	14	16	18	19
8	13	13	13	13	13	14	17	17	14	14	14	14	14	17	18	20
9	13	13	13	13	13	15	17	17	15	15	15	15	15	17	19	20
10	14	14	14	14	14	15	18	18	15	15	15	15	15	18	19	21
11	14	14	14	14	14	15	18	18	15	15	15	15	15	18	20	21
12	14	14	14	14	14	16	19	19	16	16	16	16	16	19	20	22
13	15	15	15	15	15	16	19	19	16	16	16	16	16	19	21	22
14	15	15	15	15	15	17	20	20	17	17	17	17	17	20	21	23

--	--	--	--	--	--	--	--	--	--	--	--	--	--	--	--	--

Clear Zone Width (feet) – 40 mph Design Speed																
ADT = 800 to 1999									ADT = 2000 to 6000							
Degree of Curve	Slope Ratios (cuts)				Slope Ratios (Embankments)				Slope Ratios (cuts)				Slope Ratios (Embankments)			
	3:1	4:1	6:1	10:1	10:1	6:1	4:1	3:1	3:1	4:1	6:1	10:1	10:1	6:1	4:1	3:1
Tangent	13	13	13	13	13	14	16	17	14	14	14	14	14	16	17	18
1	13	13	13	13	13	15	17	18	15	15	15	15	15	17	18	19
2	14	14	14	14	14	15	17	18	15	15	15	15	15	17	18	19
3	14	14	14	14	14	16	18	19	16	16	16	16	16	18	19	20
4	15	15	15	15	15	16	18	20	16	16	16	16	16	18	20	21
5	15	15	15	15	15	17	19	20	17	17	17	17	17	19	20	21
6	16	16	16	16	16	17	20	21	17	17	17	17	17	20	21	22
7	16	16	16	16	16	18	20	22	18	18	18	18	18	20	22	23
8	17	17	17	17	17	18	21	22	18	18	18	18	18	21	22	23
9	17	17	17	17	17	19	21	23	19	19	19	19	19	21	23	24
10	18	18	18	18	18	19	22	23	19	19	19	19	19	22	23	25
11	18	18	18	18	18	20	23	24	20	20	20	20	20	23	24	25
12	19	19	19	19	19	20	23	25	20	20	20	20	20	23	25	26
13	19	19	19	19	19	21	24	25	21	21	21	21	21	24	25	27
14	20	20	20	20	20	21	24	26	21	21	21	21	21	24	26	27

EXHIBIT 8.8
Clear Zone Widths for Tangents and Horizontal Curves
 (page 1 of 4)

Clear Zone Width (feet) – 50 mph Design Speed																
ADT < 250									ADT 250 to 799							
Degree of Curve	Slope Ratios (cuts)				Slope Ratios (Embankments)				Slope Ratios (cuts)				Slope Ratios (Embankments)			
	3:1	4:1	6:1	10:1	10:1	6:1	4:1	3:1	3:1	4:1	6:1	10:1	10:1	6:1	4:1	3:1
Tangent	11	12	13	13	13	14	19	36	12	14	15	15	15	17	22	41
1	12	13	14	14	14	15	20	38	13	15	16	16	16	18	23	44
2	12	13	15	15	15	16	21	40	13	16	17	17	17	19	25	46
3	13	14	15	15	15	17	23	43	14	17	18	18	18	20	26	49
4	14	15	16	16	16	17	24	45	15	17	19	19	19	21	27	51
5	14	16	17	17	17	18	25	47	16	18	20	20	20	22	29	54
6	15	16	18	18	18	19	26	49	16	19	20	20	20	23	30	56
7	16	17	18	18	18	20	27	51	17	20	21	21	21	24	31	58
8	16	18	19	19	19	21	28	53	18	21	22	22	22	25	33	61
9	17	18	20	20	20	21	29	55	18	21	23	23	23	26	34	63

Clear Zone Width (feet) – 50 mph Design Speed																
ADT = 800 to 1999									ADT = 2000 to 6000							
Degree of Curve	Slope Ratios (cuts)				Slope Ratios (Embankments)				Slope Ratios (cuts)				Slope Ratios (Embankments)			
	3:1	4:1	6:1	10:1	10:1	6:1	4:1	3:1	3:1	4:1	6:1	10:1	10:1	6:1	4:1	3:1
Tangent	13	15	16	16	16	18	24	45	15	16	18	18	18	20	26	50
1	14	16	17	17	17	19	25	48	16	17	19	19	19	21	28	53
2	15	17	18	18	18	20	27	51	17	18	20	20	20	22	29	56
3	15	18	19	19	19	21	28	53	18	19	21	21	21	24	31	59
4	16	19	20	20	20	22	30	56	19	20	22	22	22	25	32	62
5	17	20	21	21	21	23	31	59	20	21	23	23	23	26	34	65
6	18	20	22	22	22	25	33	61	20	22	25	25	25	27	35	68
7	18	21	23	23	23	26	34	64	21	23	26	26	26	28	37	71
8	19	22	24	24	24	27	35	67	22	24	27	27	27	30	38	74
9	20	23	25	25	25	28	37	69	23	25	28	28	28	31	40	77

Clear Zone Width (feet) – 60 mph Design Speed																
ADT < 250									ADT 250 to 799							
Degree of Curve	Slope Ratios (cuts)				Slope Ratios (Embankments)				Slope Ratios (cuts)				Slope Ratios (Embankments)			
	3:1	4:1	6:1	10:1	10:1	6:1	4:1	3:1	3:1	4:1	6:1	10:1	10:1	6:1	4:1	3:1
Tangent	14	16	18	20	20	22	30	68	15	18	20	22	23	25	33	75
1	15	17	20	22	22	24	33	74	16	20	22	24	25	27	36	82
2	17	19	21	24	24	26	36	81	18	21	24	26	27	30	39	89
3	18	20	23	26	26	28	38	87	19	23	26	28	29	32	42	96
4	19	22	25	27	27	30	41	93	21	25	27	30	31	34	45	103
5	20	23	26	29	29	32	44	99	22	26	29	32	34	36	48	109
6	22	25	28	31	31	34	46	105	23	28	31	34	35	39	51	116

EXHIBIT 8.8
Clear Zone Widths for Tangents and Horizontal Curves
 (page 2 of 4)

Clear Zone Width (feet) – 60 mph Design Speed																
ADT = 800 to 1999									ADT = 2000 to 6000							
Degree of Curve	Slope Ratios (cuts)				Slope Ratios (Embankments)				Slope Ratios (cuts)				Slope Ratios (Embankments)			
	3:1	4:1	6:1	10:1	10:1	6:1	4:1	3:1	3:1	4:1	6:1	10:1	10:1	6:1	4:1	3:1
Tangent	17	20	22	24	25	27	36	83	18	22	24	26	27	30	40	90
1	19	22	24	26	27	30	39	91	20	24	26	28	30	33	44	98
2	20	24	26	28	30	32	43	98	21	26	28	31	32	36	47	107
3	22	26	28	31	32	35	46	106	23	28	31	33	35	38	51	115
4	23	27	30	33	34	37	49	114	25	30	33	36	37	41	55	123
5	25	29	32	35	36	39	52	121	26	32	35	38	39	44	58	131
6	26	31	34	37	39	42	56	128	28	34	37	40	42	46	62	139

Clear Zone Width (feet) – 70 mph Design Speed																
ADT < 250									ADT 250 to 799							
Degree of Curve	Slope Ratios (cuts)				Slope Ratios (Embankments)				Slope Ratios (cuts)				Slope Ratios (Embankments)			
	3:1	4:1	6:1	10:1	10:1	6:1	4:1	3:1	3:1	4:1	6:1	10:1	10:1	6:1	4:1	3:1
Tangent	16	19	21	23	25	28	39	83	17	21	23	25	27	30	42	90
1	18	22	24	26	28	32	44	94	19	24	26	28	31	34	48	102
2	20	24	27	29	32	35	49	105	22	27	29	32	34	38	53	114
3	22	27	29	32	35	39	55	116	24	29	32	35	38	42	59	126
4	24	29	32	35	38	43	59	127	26	32	35	38	41	46	64	137

Clear Zone Width (feet) – 70 mph Design Speed																
ADT = 800 to 1999									ADT = 2000 to 6000							
Degree of Curve	Slope Ratios (cuts)				Slope Ratios (Embankments)				Slope Ratios (cuts)				Slope Ratios (Embankments)			
	3:1	4:1	6:1	10:1	10:1	6:1	4:1	3:1	3:1	4:1	6:1	10:1	10:1	6:1	4:1	3:1
Tangent	19	23	26	28	30	33	47	100	21	26	28	30	33	37	51	110
1	22	26	29	32	34	37	53	113	24	29	32	34	37	42	58	125
2	24	29	33	35	38	42	60	127	27	33	35	38	42	47	65	139
3	27	32	36	39	42	46	66	140	29	36	39	42	46	52	71	154
4	29	35	40	43	46	50	72	152	32	40	43	46	50	56	78	168

EXHIBIT 8.8
Clear Zone Widths for Tangents and Horizontal Curves
 (page 3 of 4)

Clear Zone Width (feet) – 40 mph Design Speed									Clear Zone Width (feet) – 50 mph Design Speed							
ADT > 6000									ADT > 6000							
Degree of Curve	Slope Ratios (cuts)				Slope Ratios (Embankments)				Slope Ratios (cuts)				Slope Ratios (Embankments)			
	3:1	4:1	6:1	10:1	10:1	6:1	4:1	3:1	3:1	4:1	6:1	10:1	10:1	6:1	4:1	3:1
Tangent	15	15	15	15	15	17	19	20	16	18	20	20	20	22	29	55
1	16	16	16	16	16	18	20	21	17	19	21	21	21	23	31	58
2	16	16	16	16	16	18	20	22	18	20	22	22	22	25	33	62
3	17	17	17	17	17	19	21	22	19	21	24	24	24	26	34	65
4	17	17	17	17	17	20	22	23	20	22	25	25	25	27	36	69
5	18	18	18	18	18	20	23	24	21	23	26	26	26	29	38	72
6	18	18	18	18	18	21	23	25	22	25	27	27	27	30	40	75
7	19	19	19	19	19	22	24	25	23	26	28	28	28	31	41	78
8	20	20	20	20	20	22	25	26	24	27	30	30	30	33	43	81
9	20	20	20	20	20	23	25	27	25	28	31	31	31	34	44	84
10	21	21	21	21	21	23	26	27								
11	21	21	21	21	21	24	27	28								
12	22	22	22	22	22	25	27	29								
13	22	22	22	22	22	25	28	30								
14	23	23	23	23	23	26	29	30								

Clear Zone Width (feet) – 60 mph Design Speed									Clear Zone Width (feet) – 70 mph Design Speed							
ADT > 6000									ADT > 6000							
Degree of Curve	Slope Ratios (cuts)				Slope Ratios (Embankments)				Slope Ratios (cuts)				Slope Ratios (Embankments)			
	3:1	4:1	6:1	10:1	10:1	6:1	4:1	3:1	3:1	4:1	6:1	10:1	10:1	6:1	4:1	3:1
Tangent	20	24	27	29	30	33	44	100	23	28	31	33	36	40	56	120
1	22	26	30	32	33	36	48	109	26	32	35	37	41	45	64	136
2	24	28	32	34	36	39	52	119	29	35	39	42	46	51	71	152
3	26	31	35	37	38	42	56	128	32	39	43	46	50	56	78	168
4	27	33	37	40	41	45	60	137	35	43	47	50	55	61	85	183
5	29	35	39	42	44	48	64	146								
6	31	37	42	45	46	51	68	154								

EXHIBIT 8.8
Clear Zone Widths for Tangents and Horizontal Curves
 (page 4 of 4)

APPENDIX C

STAKING AND PLOTTING EXAMPLES

CULVERTS WITH END SECTIONS

150 mm (0.5 ft)

ALL CULVERTS IN FILL
SLOPES OF 1v:3h
AND FLATTER

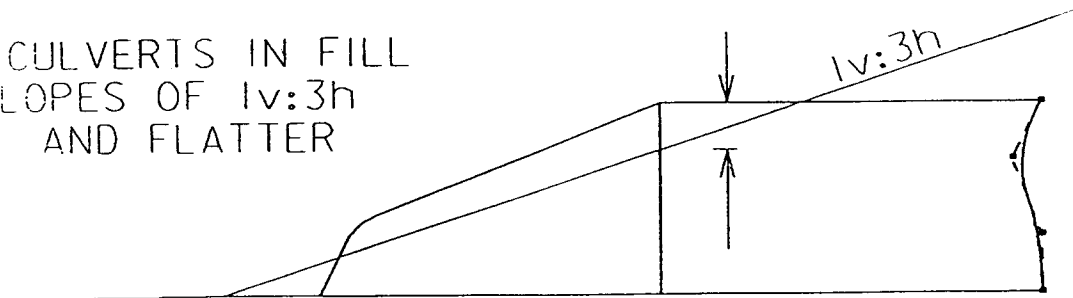

ALL CULVERTS IN FILL
SLOPES 1v:2h

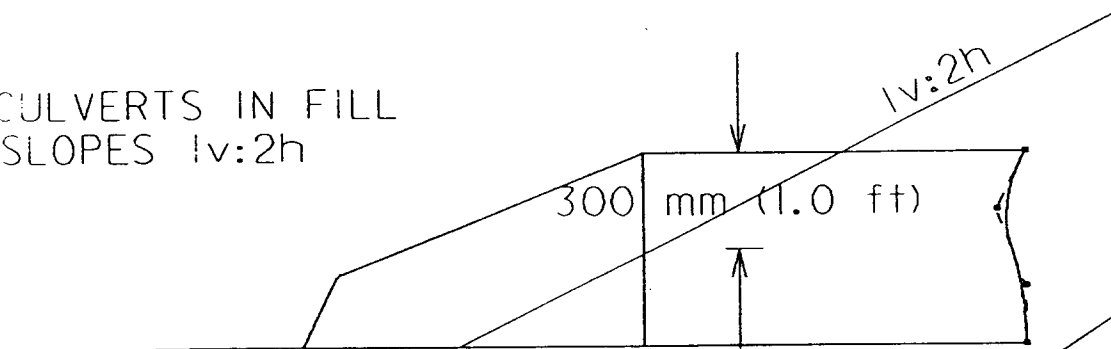

600 mm (24 IN.)
CULVERTS IN FILL
SLOPES OF 2v:3h
AND STEEPER

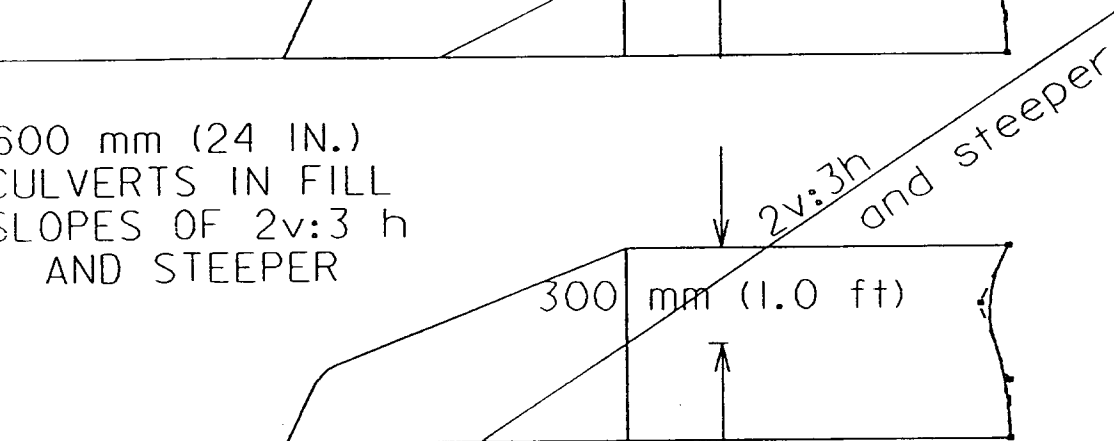

750 mm (30 INCH) AND
LARGER CULVERTS IN FILL
SLOPES OF 2v:3h
AND STEEPER

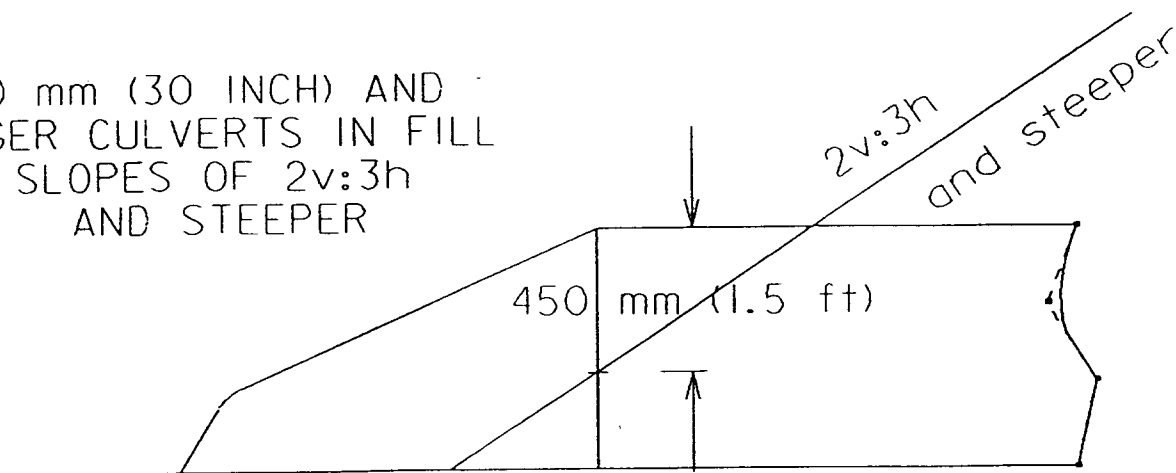

CULVERTS IN CUT SECTIONS

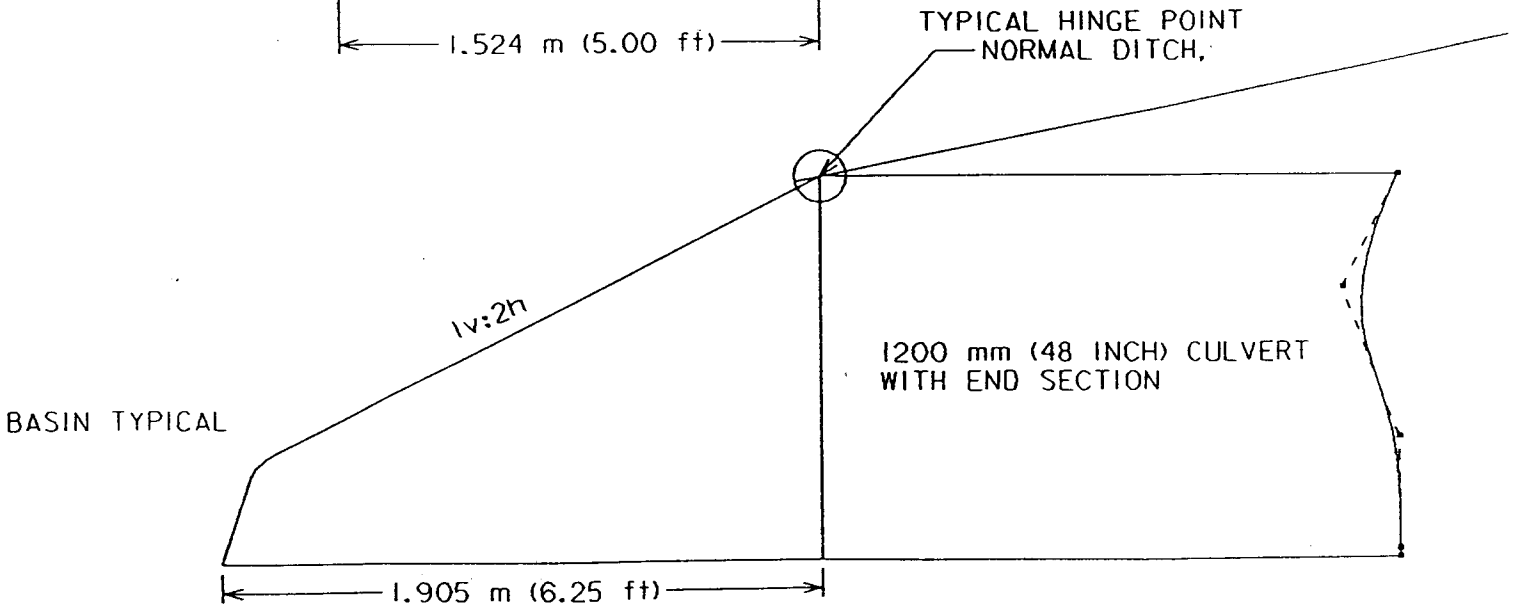
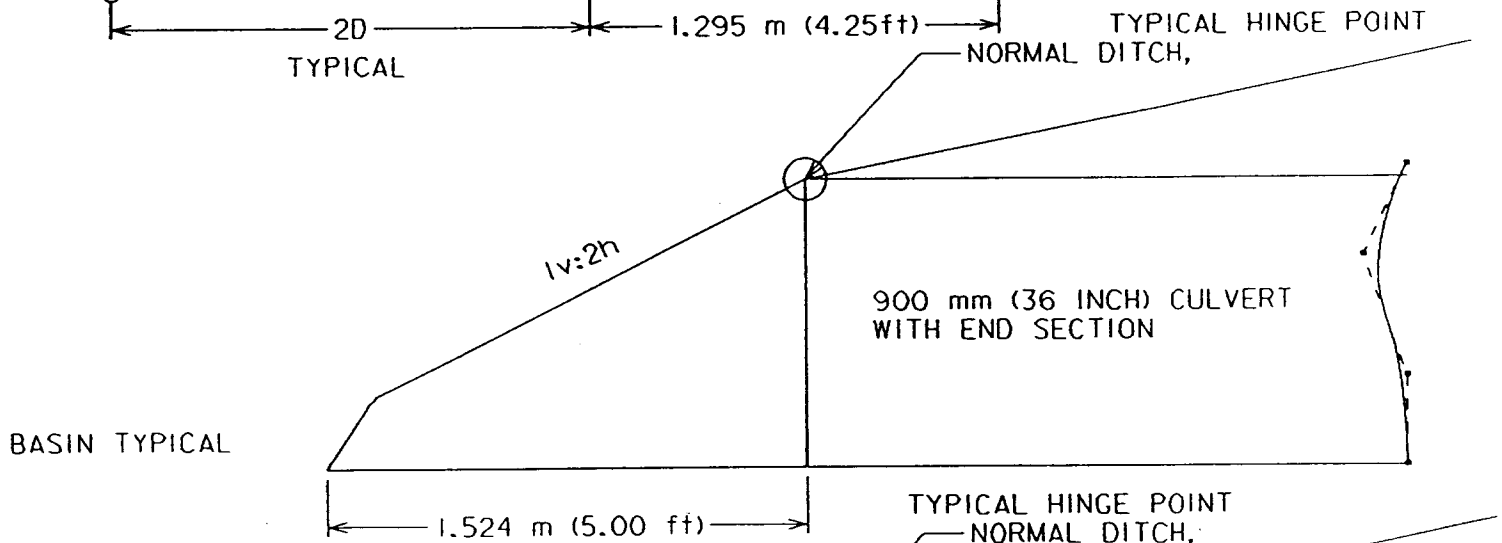
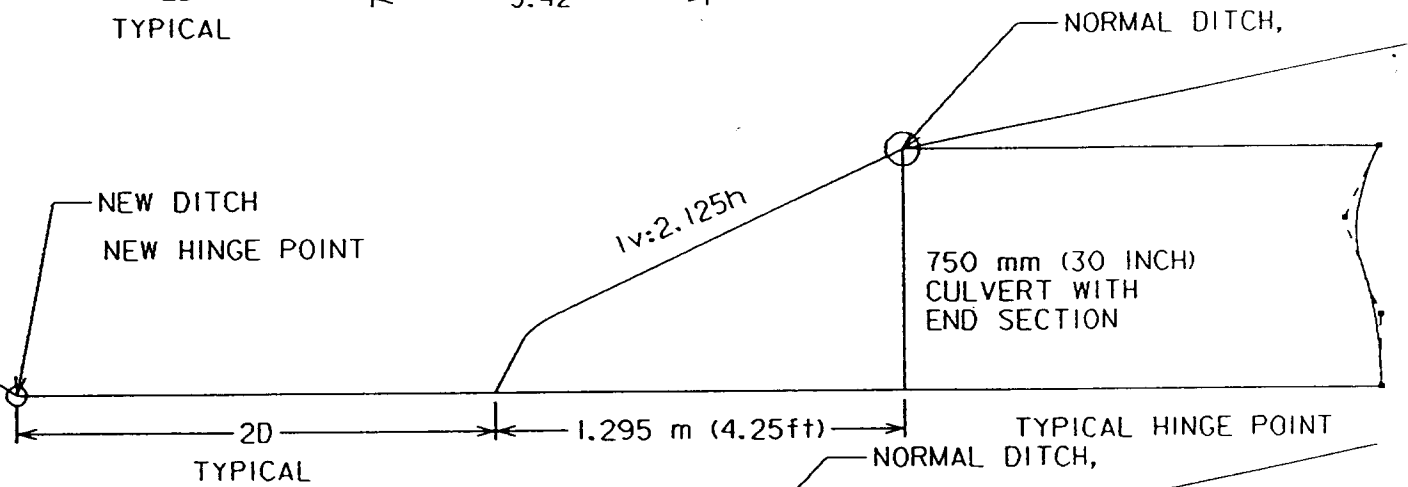
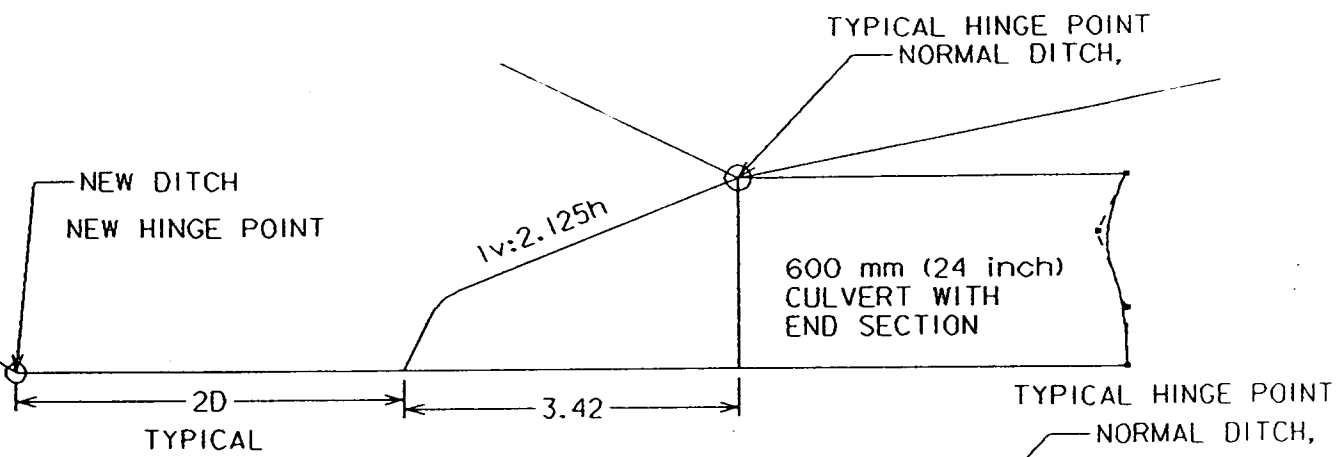

CULVERT PIPE WITH ELBOW AND END SECTION

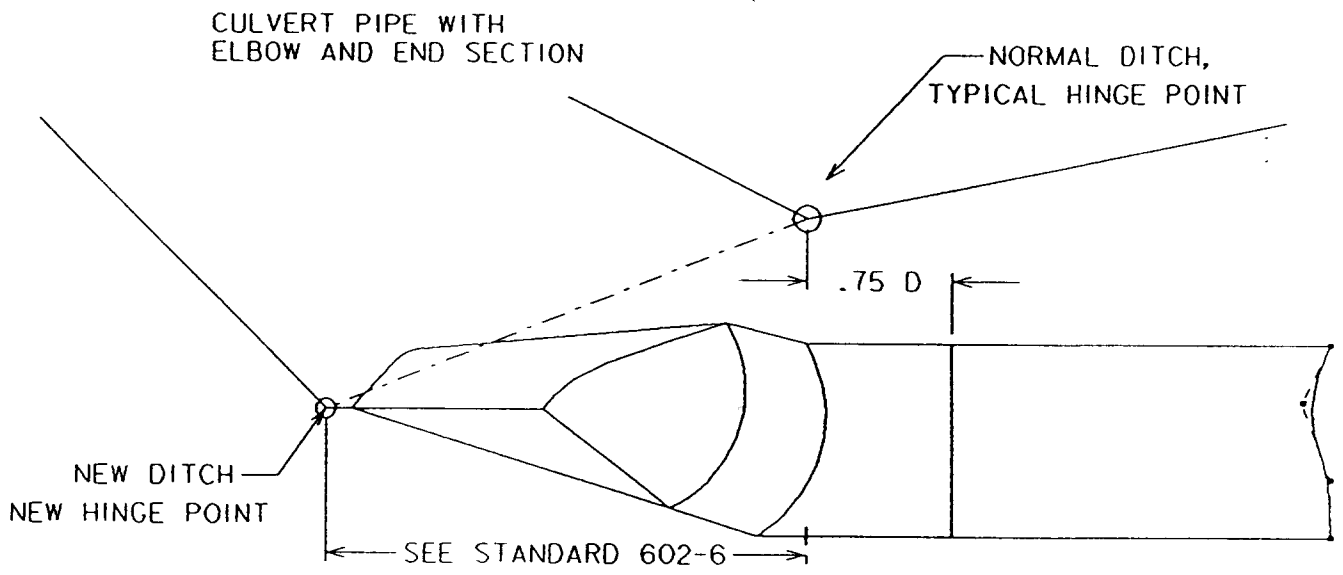

**CULVERT STAKING DATA
TO BE SUBMITTED WITH PIPE PLOT FOR APPROVAL**

DESCRIPTION	PLANNED	ACTUAL	
CENTERLINE STATION			
DIAMETER			
LENGTH			
GAUGE			
SKEW ANGLE			
ELBOWS			
END SECTIONS			
DROP INLETS			
OTHER END TREATMENT			
ANCHOR ASSEMBLIES			
RIPRAP AT INLET TYPE/QUANTITY			
RIPRAP AT OUTLET TYPE/QUANTITY			
INLET		OUTLET	
F.L. ELEV STAKED @EOP		F.L. ELEV STAKED @EOP	
C/F STAKED AT F.L.		C/F STAKED AT F.L.	
REF. HUB ELEV.		REF. HUB ELEV.	
REF HUB C/F TO F.L.		REF HUB C/F TO F.L.	
DIST TO F.L. FROM RH		DIST TO F.L. FROM RH	
F.L. ELEV AT S.G. SH.		F.L. ELEV AT S.G. SH.	
COVER AT SUBGRADE SH.		COVER AT SUBGRADE SH.	
DROP		PERCENT GRADE	
PIPE CULVERTS ON A SKEW -	DISTANCE	PERPINDICULAR TO C.L. OF	ROAD
CENTERLINE STATION INLET		CENTERLINE STATION OUTLET	
DIST TO INLET OF PIPE		DIST. TO OUTLET OF PIPE	
CENTERLINE STA. REF. HUB		CENTERLINE STA. REF. HUB	
DIST. TO INLET REF. HUB		DIST. TO OUTLET REF. HUB	
	SIGNATURES	DATE	
STAKED BY:			
SUBMITTED BY:			
APPROVED BY:			
INSPECTED BY:			

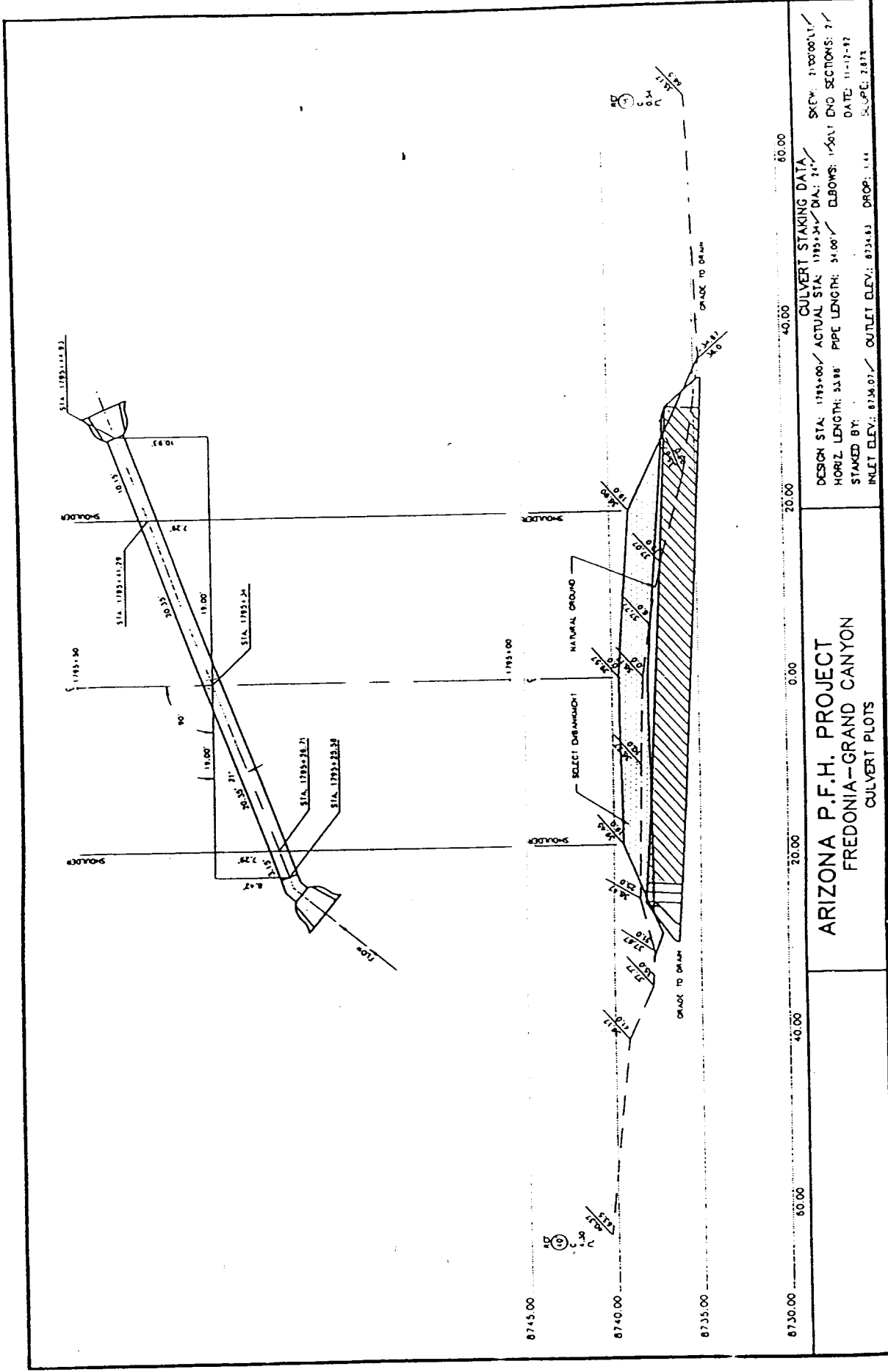

CULVERT STAKING DATA
 DESIGN STA: 17831.00 / ACTUAL STA: 17831.34 / DIA: 35.88' / SKETCH: 11/00/00/LV
 HORIZ LENGTH: 35.88' / PIPE LENGTH: 34.00' / ELBOWS: 11/30/1' END SECTIONS: 2' /
 STAKED BY: / INLET ELEV: 8734.07' / OUTLET ELEV: 8734.63' / DROP: 1.44' / DATE: 11-12-97
 SCALE: 2.072

ARIZONA P.F.H. PROJECT
FREDONIA--GRAND CANYON
 CULVERT PLOTS

EXAMPLE OF BROKEN BACK CULVERT PIPE

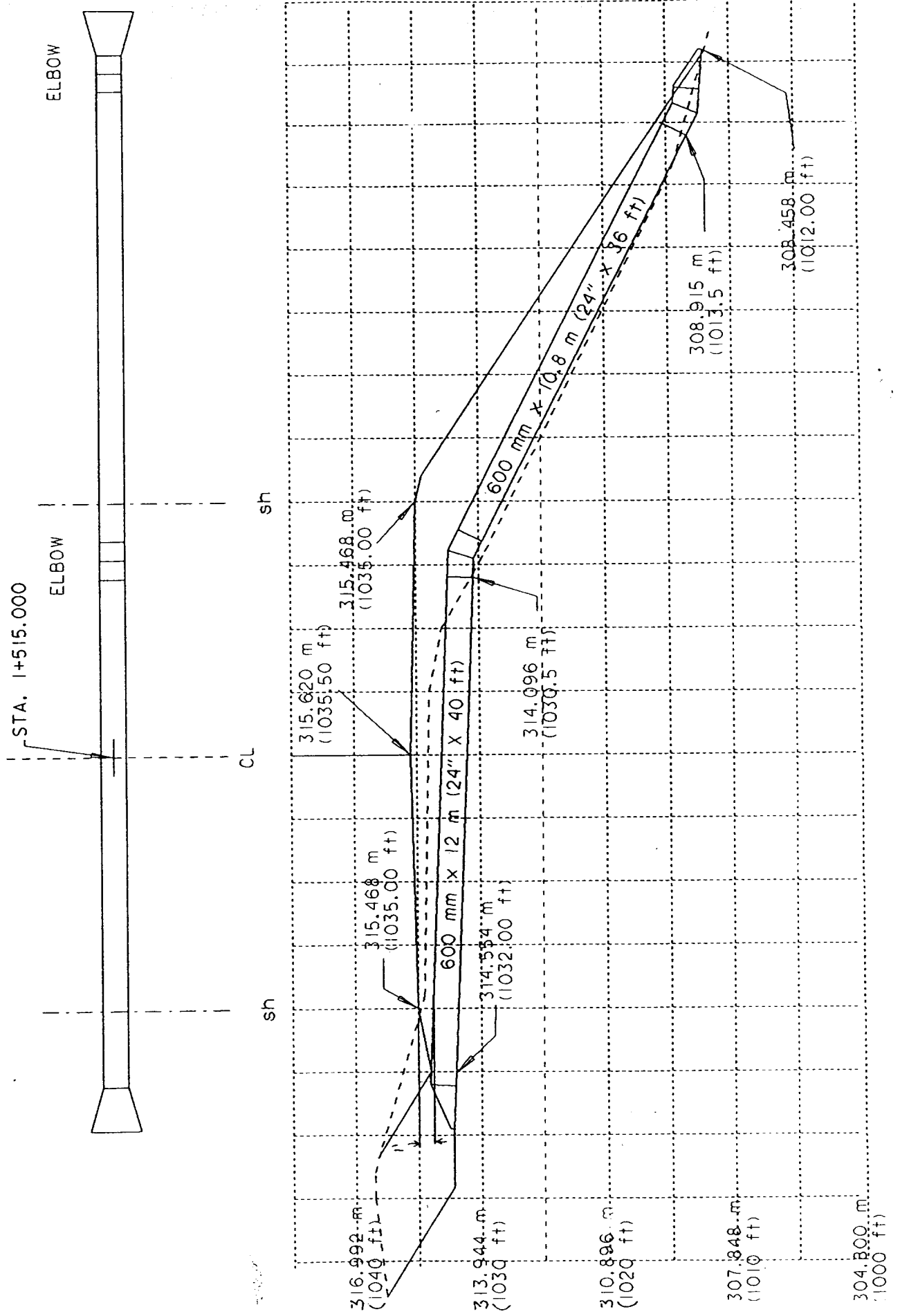

EXAMPLE OF
OVER THE SIDE DRAIN

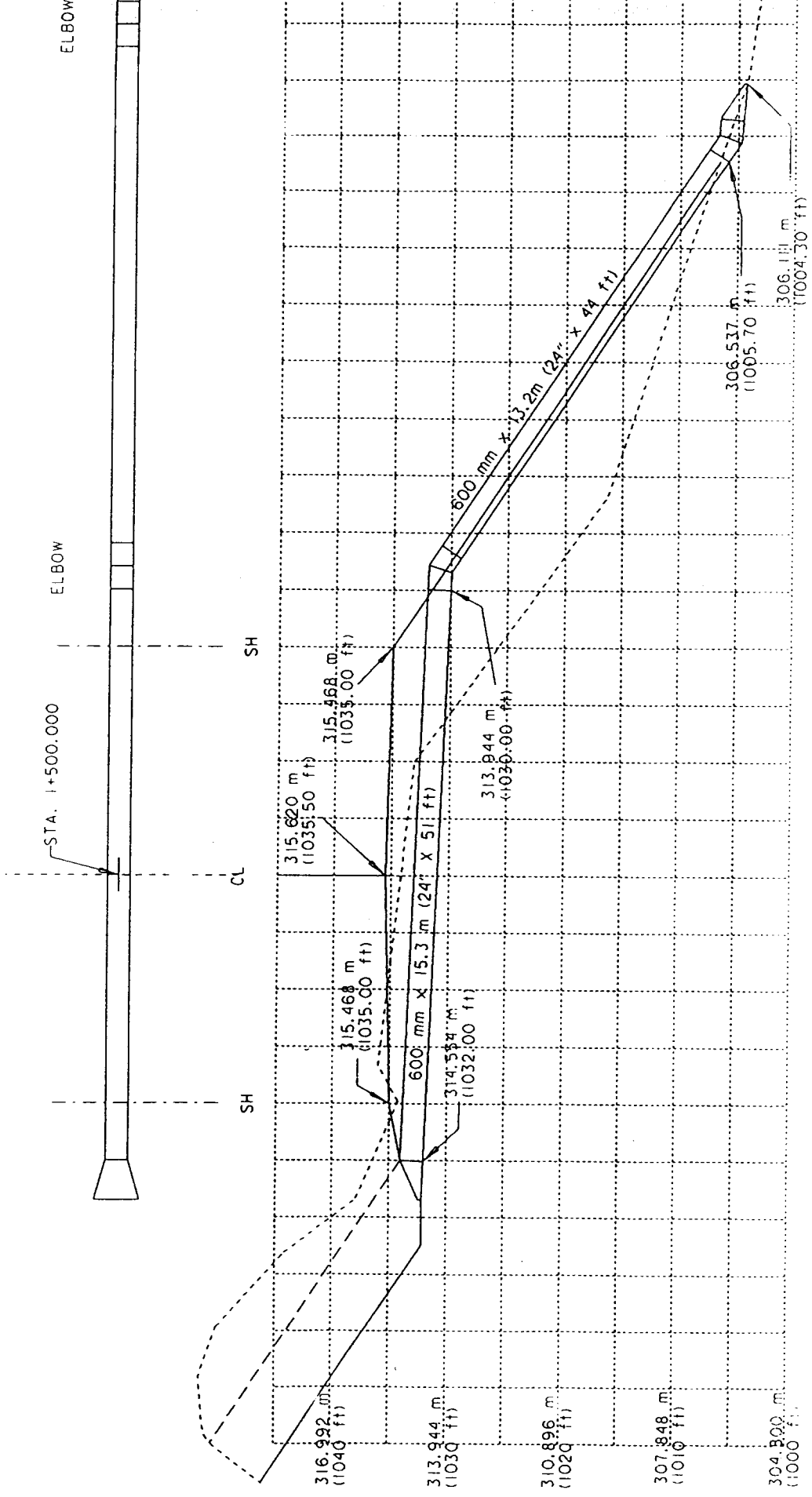

SAMPLE CULVERT STAKES

FRONT OF
REFERENCE
STAKE

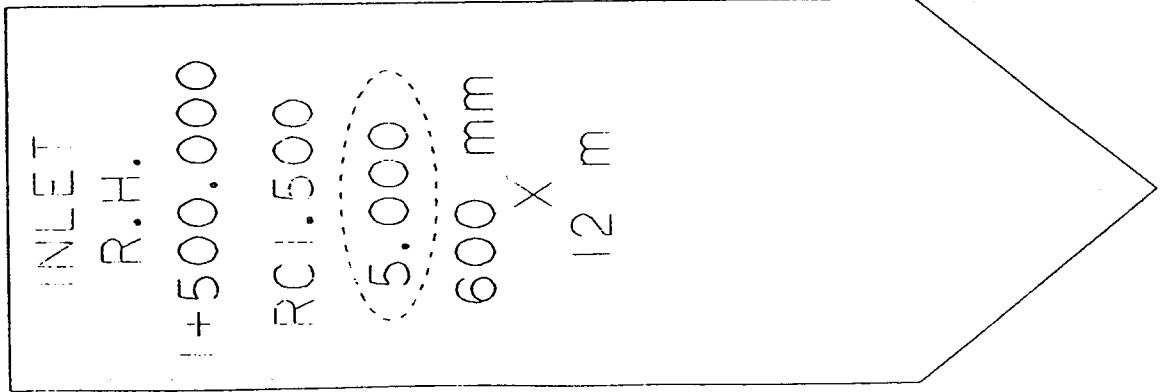

CULVERT STAKES AT END
OF PIPE AND ON BACK OF
REFERENCE STAKES

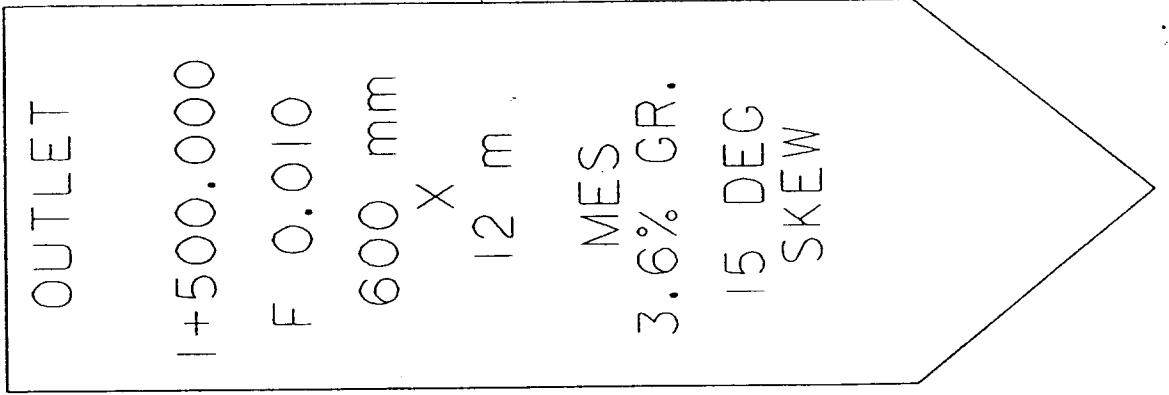
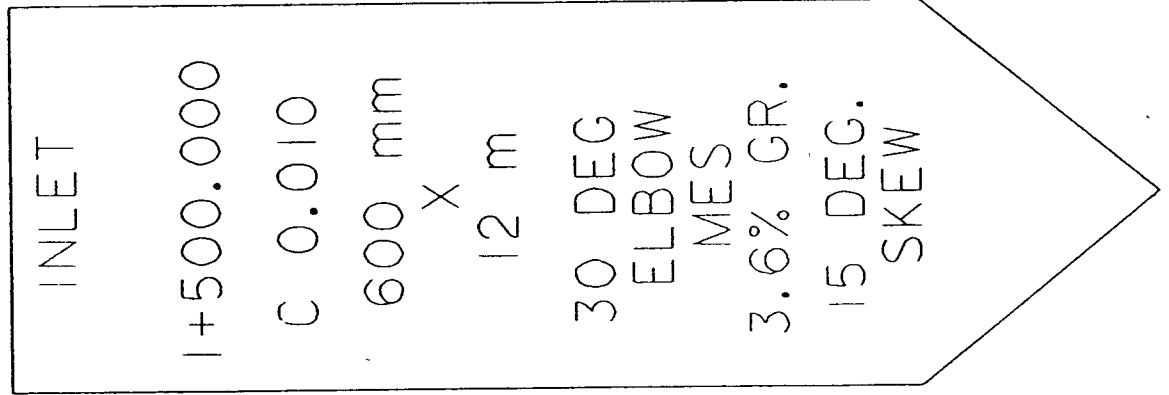

FRONT OF
REFERENC
STAKE

